

FOIL YOUR LOCAL BURGLAR AND PROTECT YOUR HOME

Elementary
Electronics

02342

SEPTEMBER-OCTOBER

1975

\$1.00

elementary Electronics

FOR
BEGINNERS

THE ROAD MAP OF ELECTRONICS

OUR BASIC COURSE

Charging Saves Cash!

Bank
your watts
in a NiCad energy account

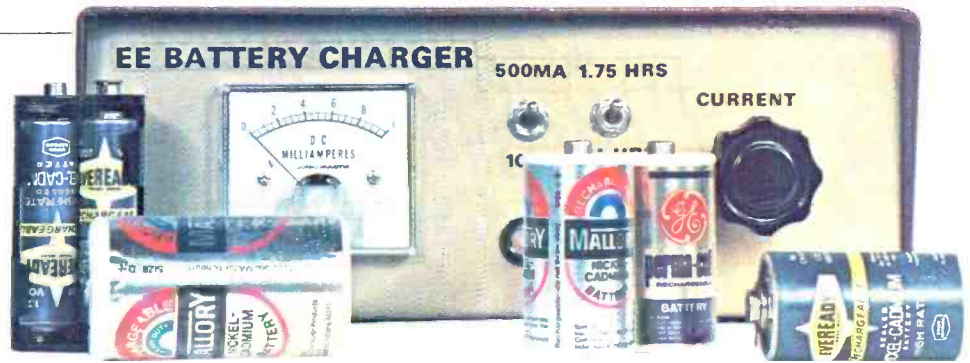

Clear Up a Cloudy Day!

Build a no-fault
windshield
wiper
interval
delay



Intergrated Circuit Fans!

To power
up all this
jive, turn
on to TTL 5



PLUS

Don Jensen decodes DX mysteries for shortwave listeners
Kathi "phones" into CB with Lafayette's Com-Phone 23
Jim Fred's "Antique Radio Corner" reflects radio's golden days

Have you ever asked yourself, "Can I make it in Electronics?"



CIE may be the answer if you have a technical aptitude and a serious desire to get ahead.

Right now, you're reading a technical magazine with articles that require a certain amount of electronics know-how. And that says a couple of things about you.

First, you're involved in Electronics . . . on the job, or as a hobby.

Second, you obviously realize the importance of staying up-to-date on the latest technical applications and developments. Reading a technical magazine *helps*, but it takes more than that to get you where *you* want to be . . . if you're serious about Electronics.

How can you afford

. . . *not* to continue with your electronics training?

You know the answer to that as well as we do.

To achieve continuing success, you have to keep building more knowledge into the Electronics background and experience you already have. You have to sharpen the tech skills you've already got and add new ones.

And one of the most logical ways for you to get what you need is to seriously consider an in-depth electronics training program that could help you achieve your ambitions in Electronics.

How can you afford

. . . the time and trouble of going back to school?

An excellent and *convenient* way for you to develop and expand your electronics knowledge is to "let the *school* come to *you*."

CIE's independent education plan does just that. Because we can effectively train you with an "education by mail" electronics training program that makes sense. And it makes sense for these reasons:

You can master *career* Electronics without missing one day of work. Without sacrificing one paycheck! Because you study in your free time . . . setting the study pace that best fits your schedule. *You* decide when and where *you* want to study. So you can go right on enjoying your leisure time because there are no *rigid* classroom schedules to be met. *You're* in control!

How can you afford

. . . the expense of the additional education you need?

A lot depends on which CIE course best fits your educational goals and background. We have a variety of electronics courses at beginner, intermediate, and advanced college-level. And there's a convenient payment plan available for every course. But, one way to evaluate your investment in CIE is this . . . you can *graduate* from CIE for about the cost of one year's tuition at some colleges or universities.

How can you afford

. . . to learn Career Electronics from anyone other than an electronics *specialist*?

If you are *serious* about your career in Electronics, you owe it to yourself to investigate *the* home study school that devotes its entire curriculum and instructional efforts to Electronics. That's CIE — Cleveland Institute of Electronics.

We have *specialized exclusively* in Electronics education-by-mail for more than 40 years. Just Electronics. Nothing else. And, the courses we offer today are the result of these years of teaching experience and proven methods of training . . . all based on the expert guidance of our



specialized Electronics Instruction Staff. Our lessons reflect this specialized experience. No frills. No unnecessary fancy stuff. Instruction is thorough . . . designed to meet the demands of electronics employers.

Each CIE course is built on the principle that the best way for you to *learn* and *retain* what you've learned is to *explain*; then to *check* your understanding; then to *reinforce* your comprehension with practical applications. In some courses, you will perform experiments and tests with your CIE Experimental Electronics Laboratory using authentic electronic components and gear. And, if you select a course that includes Color TV technology, you will not only build and keep a big screen Color TV which features digital circuitry . . . you'll also learn how to troubleshoot your TV.

The course you select will be a complete educational program, designed by *experts* to give you the best in Electronics independent home-study education. It will not be a "snap" course. No easy exams. It will make you work . . . and think. So that when you've earned your CIE Diploma, you'll *really* know your stuff.

In education just like in the "real world" of Electronics, your success depends on you and the effort you make. That's a real plus in CIE independent home-study . . . you build a strong foundation of self-discipline. And *that* pays off!

How can you afford . . . to stop now?

There is a lot more to CIE than this advertisement can tell you. And because you're looking for the *best*, we think it's well worth your while to find out what CIE is

all about. Detailed Courses of Study outlines. In-depth training programs in Electronics Technology, Broadcasting, Industrial, Color TV, Engineering, and 1st Class FCC License preparation. Special CIE Student Services.

All this information is available to you, **FREE**, when you mail the card or coupon to us. For your convenience, we'll try to have a school representative contact you to review the benefits of CIE training and assist in course selection. And as soon as we hear from you, we'll mail a complete package of information, including our school catalog, G. I. Bill details, special FCC License information. All the facts you need to start your Electronics career program with CIE.

Send TODAY for CIE'S FREE information.

CIE Cleveland Institute of Electronics, Inc.
 1776 East 17th Street, Cleveland, Ohio 44114
Accredited Member National Home Study Council

Yes, I want your **FREE** school catalog and career information package today. EL-59

I am especially interested in:

<input type="checkbox"/> Electronics Technology	<input type="checkbox"/> Industrial Electronics
<input type="checkbox"/> FCC License Preparation	<input type="checkbox"/> Electronics Engineering
<input type="checkbox"/> Color TV Maintenance	<input type="checkbox"/> Other _____
<input type="checkbox"/> Mobile Communications	_____

Print Name _____

Address _____ Apt. _____

City _____

State _____ Zip _____ Age _____

Check box for G.I. Bill information. Veteran On Active Duty

CIRCLE 21 ON READER SERVICE COUPON

Elementary Electronics

Dedicated to
America's
Electronics
Hobbyists

Including Electronics Digest®

PUT DOWN A PROBLEM

- 51 Foil Your Local Burglar—home owner and small business protection with inexpensive Radio Shack materials ★
- 59 Which Shortwave Receiver Should I Buy?—our most often asked SWL/DXer question

IDEAS INTO REALITY

- 64 Ion-Conditioner for Better Living—air-conditioning another way
- 68 Wire Up, Get Set, Go!—monitoring by radio
- 90 The Most Often Invented Invention—he really did it!

GETTING DOWN TO BASICS

- 45 Warming Up to Thermistors—all about a simple, but little-known device
- 65 An Electronics Career—if it's for you, here's one way to go
- 79 Op Amp Insights—you've requested this advanced theory
- 82 10 Steps to Safe Battery Boosting—easy to follow—good to know
- 85 Basic Course—pick up facts about electronic diagrams ★

PICK A PROJECT AND BUILD

- 41 Wiper-Trol II—no-fault automobile sight insurance ★
- 55 Supercharger—with built-in digital timer for sure NiCad battery refills ★
- 77 Power Supply for TTL—a regulated 5-volts for TTL-type ICs ★

THREE FACES OF RADIO

- 24 DX Central Reporting—shortwave listeners' forum, authored by Don Jensen ★
- 70 CB to Come—looking ahead with some hard predictions
- 71 Antique Radio Corner—the latest in ancient radio, from Jim Fred ★
- 83 Kathi's CB Carousel—a second "handset" CB checked by Kathi Martin ★

ELECTRONICS AND HISTORY SPECIAL

- 62 Piano Wire to Super-Fi—unusual milestones in the development of magnetic tape recorders

CHECK THESE OUT

- 6 Hey, Look Me Over
- 16 Ask Hank, He Knows!
- 30 Bookmark
- 34 Newscan
- 36 Scientifically Speaking—our cartoon page

MAILBAG REGULARS

- 17 Reader Service Page—look, circle, clip, mail, and receive!
- 91 Literature Library—four bits brings some interesting information
- 94 Classified Marketplace—where everybody looks for a bargain

★ Cover Features

• **Editor-in-Chief**—Julian S. Martin, WA2CQL • **Technical Editor**—Peter L. Dennis, WA3LOQ
 • **Audio Editor**—Stephen B. Gray • **Associate Editor**—Jeffrey Apter • **News Editor**—Rosina F. Sokolnicki • **Citizens Band Editor**—Kathi Martin, KGK3916 • **Workbench Editor**—Hank Scott • **Art and Production Managing Director**—Gertrud Borchardt • **Graphic Design Director**—Ralph Rubino • **Cover Art Director**—Irving Bernstein • **Art Assistants**—John Harper, Kenneth Kummer, Joseph Orlando, David Pindar • **Advertising Director**—David J. Miller • **Assistant Production Editor**—Philip Clark • **Newsstand Circulation Director**—Don Gabree • **Subscription Circulation & Marketing Director**—Robert V. Enlow • **Instruments Division Manager**—Wilfred M. Brown • **Director of Market Development**—James C. Weakley • **Electronics Group Coordinator**—Julian S. Martin

• **President, Chairman of the Board (1957-1972)**—B. G. Davis • **President and Publisher**—Joel Davis • **Vice President and General Manager**—Leonard F. Pinto • **Vice President and Treasurer**—Victor C. Stabile, KBP0681

September-October 1975
Volume 15, No. 5

FOIL YOUR LOCAL BURGLAR AND PROTECT YOUR HOME



Charging Saves Cash!
Bank your watts in a NiCad energy account

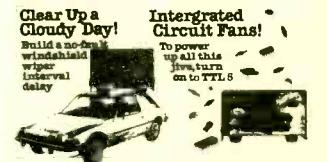

PLUS Don Jensen decodes DE in problem for shortwave listeners
Kathi "upgrades" her CB with a 100-watt 4-Corn Power DE
Jim Fred's "Antique Radio Corner" replaces radio in garden 4/17

Cover design by Irving Bernstein



AUTHORS IN THIS ISSUE

James A. Fred, Herb Friedman, Joe Gronk, Myrtle Gronk, Jorma Hyypia, Don Jensen, C. R. Lewart, Adolph Mangieri, Kathi Martin, Felix Peterson, Bob Sandorf, Jack Schmidt, Hank Scott, Thomas R. Sear and the ELEMENTARY ELECTRONICS editorial staff.

ELEMENTARY ELECTRONICS is published bi-monthly by Davis Publications, Inc. Editorial and Executive offices: 229 Park Ave. So., New York, NY 10003; all subscription orders and mail regarding subscriptions should be sent to P.O. Box 2600, Greenwich, CT 06830. One-year subscription (six issues)—\$6.50; two-year subscription (12 issues)—\$13.00; three-year subscription (18 issues)—\$19.00; and four-year subscription (24 issues)—\$25.00. Add \$1.00 per year for postage outside the U.S.A., its possessions and Canada. For change of address, please advise 4 to 6 weeks before moving. Send us your current mailing label with new address. Advertising offices: New York, 229 Park Avenue South, 212-673-1300; Chicago, 520 N. Michigan Ave., 312-527-0330; Los Angeles; J. E. Publishers' Rep. Co., 8732 Sunset Blvd., 312-527-0330; Los Angeles, J. E. Pub- paid at New York, NY and at additional mailing office.

Copyright 1975 by
Davis Publications, Inc

BUILD 20 RADIO

and Electronics Circuits

PROGRESSIVE HOME RADIO-T.V. COURSE

Reg. U. S. Pat. Off.



Training Electronics Technicians Since 1946

Now Includes

- ★ 12 RECEIVERS
- ★ 3 TRANSMITTERS
- ★ SQ. WAVE GENERATOR
- ★ SIGNAL TRACER
- ★ AMPLIFIER
- ★ SIGNAL INJECTOR
- ★ CODE OSCILLATOR

- ★ No Knowledge of Radio Necessary
- ★ No Additional Parts or Tools Needed
- ★ EXCELLENT BACKGROUND FOR TV
- ★ SCHOOL INQUIRIES INVITED
- ★ Sold In 79 Countries

YOU DON'T HAVE TO SPEND HUNDREDS OF DOLLARS FOR A RADIO COURSE

The "Edu-Kit" offers you an outstanding PRACTICAL HOME RADIO COURSE at a rock-bottom price. Our Kit is designed to train Radio & Electronics Technicians, making use of the most modern methods of home training. You will learn radio theory, construction practice and servicing. THIS IS A COMPLETE RADIO COURSE IN EVERY DETAIL.

You will learn how to build radios, using regular schematics; how to wire and solder in a professional manner; how to service radios. You will work with the standard type of punched metal chassis as well as the latest development of Printed Circuit chassis.

You will learn the basic principles of radio. You will construct, study and work with RF and AF amplifiers and oscillators, detectors, rectifiers, test equipment. You will learn and practice code, using the Progressive Code Oscillator. You will learn and practice trouble-shooting, using the Progressive Signal Tracer, Progressive Signal Injector, Progressive Dynamic Radio & Electronics Tester, Square Wave Generator and the accompanying instructional material.

You will receive training for the Novice, Technician and General Classes of F.C.C. Radio Amateur Licenses. You will build Receiver, Transmitter, Square Wave Generator, Code Oscillator, Signal Tracer and Signal Injector circuits, and learn how to operate them. You will receive an excellent background for television, Hi-Fi and Electronics.

Absolutely no previous knowledge of radio or science is required. The "Edu-Kit" is the product of many years of teaching and engineering experience. The "Edu-Kit" will provide you with a basic education in Electronics and Radio, worth many times the low price you pay. The Signal Tracer alone is worth more than the price of the kit.

THE KIT FOR EVERYONE

You do not need the slightest background in radio or science. Whether you are interested in Radio & Electronics because you want an interesting hobby, a well paying business or a job with a future, you will find the "Edu-Kit" a worth-while investment.

Many thousands of individuals of all

ages and backgrounds have successfully used the "Edu-Kit" in more than 79 countries of the world. The "Edu-Kit" has been carefully designed, step by step, so that you cannot make a mistake. The "Edu-Kit" allows you to teach yourself at your own rate. No instructor is necessary.

PROGRESSIVE TEACHING METHOD

The Progressive Radio "Edu-Kit" is the foremost educational radio kit in the world, and is universally accepted as the standard in the field of electronics training. The "Edu-Kit" uses the modern educational principle of "Learn by Doing." Therefore you construct, learn schematics, study theory, practice trouble shooting—all in a closely integrated program designed to provide an easily-learned, thorough and interesting background in radio.

You begin by examining the various radio parts of the "Edu-Kit." You then learn the function, theory and wiring of these parts. Then you build a simple radio. With this first set you will enjoy listening to regular broadcast stations, learn theory, practice testing and trouble-shooting. Then you build a more advanced radio, learn more advanced theory and techniques. Gradually, in a progressive manner, and at your own rate, you will find yourself constructing more advanced multi-tube radio circuits, and doing work like a Professional Radio Technician.

Included in the "Edu-Kit" course are Receiver, Transmitter, Code Oscillator, Signal Tracer, Square Wave Generator and Signal Injector Circuits. These are not unprofessional "breadboard" experiments, but genuine radio circuits, constructed by means of professional wiring and soldering on metal chassis, plus the new method of radio construction known as "Printed Circuitry." These circuits operate on your regular AC or DC house current.

THE "EDU-KIT" IS COMPLETE

You will receive all parts and instructions necessary to build twenty different radio and electronics circuits, each guaranteed to operate. Our Kits contain tubes, tube sockets, variable, electrolytic, mica, ceramic and paper dielectric condensers, resistors, tie strips, hardware, tubing, punched metal chassis, Instruction Manuals, hook-up wire, solder, selenium rectifiers, coils, volume controls and switches, etc.

In addition, you receive Printed Circuit materials, including Printed Circuit chassis, special tube sockets, hardware and instructions. You also receive a useful set of tools, a professional electric soldering iron, and a self-powered Dynamic Radio and Electronics Tester. The "Edu-Kit" also includes Code Instructions and the Progressive Code Oscillator, in addition to F.C.C. Radio Amateur License training. You will also receive lessons for servicing with the Progressive Signal Tracer and the Progressive Signal Injector, a High Fidelity Guide and a Quiz Book. You receive Membership in Radio-TV Club, Free Consultation Service, Certificate of Merit and Discount Privileges. You receive all parts, tools, instructions, etc. Everything is yours to keep.

PRINTED CIRCUITRY

At no increase in price, the "Edu-Kit" now includes Printed Circuitry. You build a Printed Circuit Signal Injector, a unique servicing instrument that can detect many Radio and TV troubles. This revolutionary new technique of radio construction is now becoming popular in commercial radio and TV sets.

A Printed Circuit is a special insulated chassis on which has been deposited a conducting material which takes the place of wiring. The various parts are merely plugged in and soldered to terminals.

Printed Circuitry is the basis of modern Automation Electronics. A knowledge of this subject is a necessity today for anyone interested in Electronics.

FREE EXTRAS

• SET OF TOOLS

- SOLDERING IRON
- ELECTRONICS TESTER
- PLIERS-CUTTERS
- VALUABLE DISCOUNT CARD
- CERTIFICATE OF MERIT
- TESTER INSTRUCTION MANUAL
- HIGH FIDELITY GUIDE & QUIZZES
- TELEVISION BOOK & RADIO
- TROUBLE-SHOOTING BOOK
- MEMBERSHIP IN RADIO-TV CLUB: CONSULTATION SERVICE • FCC AMATEUR LICENSE TRAINING
- PRINTED CIRCUITRY

SERVICING LESSONS

You will learn trouble-shooting and servicing in a progressive manner. You will practice repairs on the sets that you construct. You will learn symptoms and causes of trouble in home, portable and car radios. You will learn how to use the professional Signal Tracer, the unique Signal Injector and the dynamic Radio & Electronics Tester. While you are learning in this practical way, you will be able to do many a repair job for your friends and neighbors, and charge fees which will far exceed the price of the "Edu-Kit." Our Consultation Service will help you with any technical problems you may have.

FROM OUR MAIL BAG

J. Stataitis, of 25 Poplar Pl., Waterbury, Conn., writes: "I have repaired several sets for my friends, and made money. The "Edu-Kit" paid for itself. I was ready to spend \$240 for a course, but I found your ad and sent for your Kit."

Ben Valerio, P. O. Box 21, Magna, Utah: "The Edu-Kits are wonderful. Here I am sending you the questions and also the answers for them. I have been in Radio for the last seven years, but like to work with Radio Kits, and like to build Radio Testing Equipment. I enjoyed every minute I worked with the different kits; the Signal Tracer works fine. Also like to let you know that I feel proud of becoming a member of your Radio-TV Club."

Robert L. Shuff, 1544 Monroe Ave., Huntington, W. Va.: "Thought I would drop you a few lines to say that I received my Edu-Kit, and was really amazed that such a bargain can be had at such a low price. I have already started repairing radios and phonographs. My friends were really surprised to see me get into the swing of it so quickly. The Trouble-shooting Tester that comes with the Kit is really swell, and finds the trouble, if there is any to be found."

Progressive "Edu-Kits" Inc., 1189 Broadway, Dept. 574DJ Hewlett, N.Y. 11557

Please rush me free literature describing the Progressive Radio-TV Course with Edu-Kits. No Salesman will call.

NAME

ADDRESS

CITY & STATE ZIP

PROGRESSIVE "EDU-KITS" INC.

1189 Broadway, Dept. 574DJ

Hewlett, N.Y. 11557

CIRCLE 11 ON READER SERVICE COUPON

Hey, look me over

Showcase of New Products

New Bearcat

Scanning up to eight fixed frequencies in any one or two public service bands, the BEARCAT III is built for the future with its interchangeable RF module system. New bands (low, high, UHF) can be added to the existing circuitry via plug-in modules to enable the user to change bands or to add authorized future bands. One set can do it all! Ideal for home, office or mobile use anywhere, the BEARCAT III may be purchased as a single-band unit, or a dual-band unit—buy only what is required for the locale. Its patented "track tuning" searches, locks in, and then moves on to other active channels for on-the-scene action. Weather, fire, police, business, marine, and civil defense transmissions are monitored at 25 times per second with incoming signals processed through sophisticated components, such as quartz crystal filters. The BEARCAT III comes equipped with mobile mounting bracket,



CIRCLE 73 ON READER SERVICE COUPON

12-VDC/117-VAC power supplies and telescoping antenna. Crystals are not included. Suggested retail price: Dual-Band, \$159.95; Single-Band, \$139.95. The BEARCAT III is manufactured by the Electra Company, Cumberland, IN 46229 and they'd be happy to hear from you.

Kirlian Photography Set

Now you can explore the fascinating world of "aura" photography with a new, self-contained Kirlian Electrophotography Research Unit. This superior, compact unit has everything, except a photo changing bag, to meet the needs of most Kirlian researchers and experimenters. It is ideal for color or black & white 35 mm, sheet, or even Polaroid film for photos up to 5 x 7-in. — without a camera or lens. Kirlian photographs may show a correlation between illness, fatigue, emo-



CIRCLE 72 ON READER SERVICE COUPON

tions and the "aura." With Kirlian photography you can make a direct physical measurement of emotional changes. You can record corona discharge photography of both organic and inorganic objects. Dramatic changes can also be recorded after one receives good or bad news, since anger, laughter, pleasure or pain will also change the "aura." No set-up time is needed. There's no separate electrode, power supply or glass plate to be concerned with. You can use it to experiment with photos of fingers, coins, leaves, elbows, portions of feet, and more. Output voltage is continually variable from under 12 volts to over 32 kilovolts, giving excellent picture density under all conditions. The Kirlian Electrophotography Research Unit is available by mail from Edmund Scientific Co., 380 Edscorp Bldg., Barrington, NJ 08007. Stock No. 72,104. It is \$139.95 post-paid. As with everything Edmund sells, it carries a 30-day money-back guarantee.

Why you need a Hustler CB base station antenna.

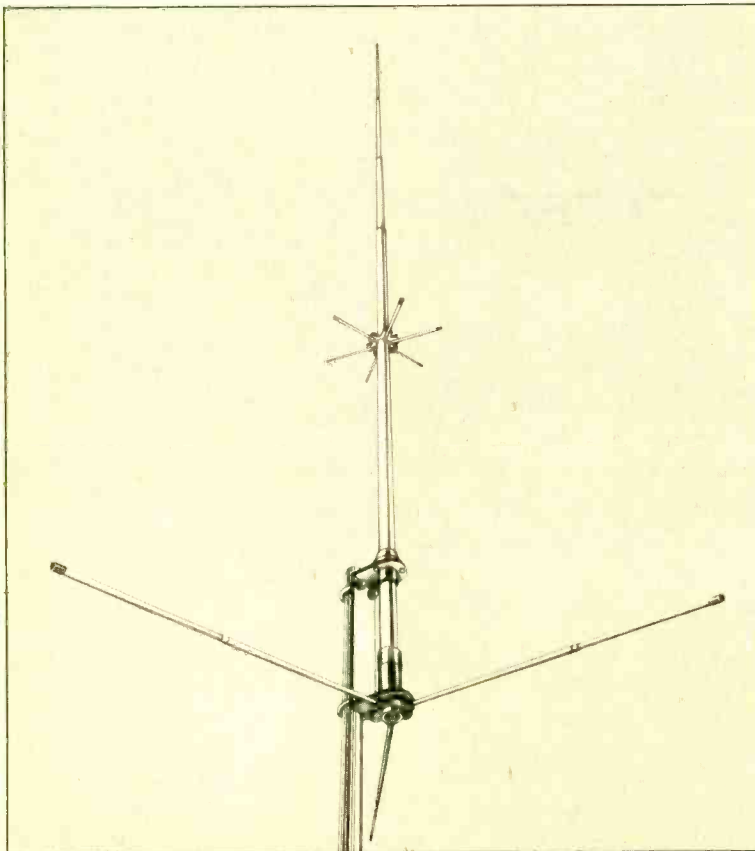

Your antenna is your link with other CB'ers. The more effective that link, the better you hear, and the better you're heard. Hustler CB base station antennas are electrically longer for greater range — up to 20% — to extend your signal over the miles. And they're easy to install, stay tuned for peak performance no matter what Mother Nature does. Each Hustler is manufactured to the highest standards of the industry with the very best materials. Get outstanding all directional coverage with a Hustler "Trumpet" — Model 27T or "Jam Ram" Model 27JR.

AVAILABLE FROM ALL DISTRIBUTORS WHO RECOGNIZE THE BEST!

HUSTLER

new-tronics
corporation

15800 Commerce Park Drive
Brookpark, Ohio 44142
(216) 267-3150

"the home of originals"

CIRCLE 18 ON READER SERVICE COUPON

LIVE IN THE WORLD OF TOMORROW... TODAY!

And our FREE 164 PAGE CATALOG is packed with exciting and unusual values in electronic, hobby and science items — plus 4,500 finds for fun, study or profit... for every member of the family.

A BETTER LIFE STARTS HERE

SOLAR ENERGY CUBE!

Unique demonstrator dramatically shows how sunlight converts to kinetic energy. Clear plastic Solar Energy Cube placed in the sun with its 3 highly efficient silicon solar cells powers the motor to whirl the propeller! Unit actually produces 1.5v DC, 825ma. Same cells found in our mighty panels. Speed directly related to sunlight available. Nothing to wear out! Great for executives, hobbyists, teachers.



No. 42.287EK (4 X 4 X 4") \$19.95 Ppd.

3-CHANNEL COLOR ORGAN KIT

Easy to build low-cost kit needs no technical knowledge. Completed unit has 3 bands of audio frequencies to modulate 3 independent strings of colored lamps (i.e. "lows"-reds, "middles"-greens, "highs"-blues. Just connect hi-fi, radio, power amp etc. & plug ea. lamp string into own channel (max. 300w ea.). Kit features 3 neon indicators, color intensity controls, controlled individ SCR circuits; isolation transformer; custom plastic housing; instr.



Stock No. 41.831EK \$18.95 Ppd.

BUILD A SOLAR HOME AND SAVE!

Beat the energy crisis—build a modern 10 room solar heated & air conditioned home designed by famous ecological architect Malcolm B. Wells! Its 10-yr.-proven Thomason "Solaris System" can cut conventional heating costs as much as 2/3! Your builder can modify or use as is the complete blueprints included with "Solar House Plans III" (by Edmund, Homan, Thomason & Wells). Estimated \$40,000 building cost. 48-pg book shows all pro's and cons. Illustrated.

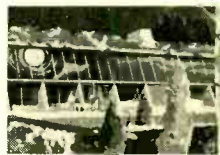

No. 9469EK (8 1/2 X 11" PPRK) \$24.95 Ppd.

ELECTRONIC DIGITAL STOPWATCH: \$69.95

A price breakthrough! New pocket size 4 oz. timer acc. to $\pm 2\%$ of last digit (1/100 sec. increments). Compares with others twice the price! Instant error-free readouts to 9999.99 sec. (over 2 1/2 hr). Starts, stops, re-starts (accumulates). Mechanical pushbutton & electrical remote on/off w/ any 3.5-150v AC/DC source. Plug-in jack. Incls. 9v batt. Solid state.



No. 1943EK (2 1/4 X 4 1/2 X 7/8") \$69.95 Ppd.
DELUXE 2 EVENT STOPWATCH ($\pm 0.01\%$ OF LAST DIGIT) \$149.95 Ppd.
No. 1653EK

WHEN YOU COME TO PHILADELPHIA BE SURE TO SEE
FREE BICENTENNIAL LIGHT SHOW
IN BARRINGTON, N.J. ONLY 10 MINUTES AWAY AT
EDMUND FACTORY STORE

SUPER POWER FOR ANY AM RADIO



New antenna assist turns a tiny transistor into a tiger, has pulled in stations 1000 miles away! Just set it beside your radio (no wires, clips, grounding) and fine-tune Select-A-Tenna's dial to same frequency—"Gangbusters"! Terrific for sportsmen, vacationers. Great for clearing weak signals in radio depressed areas, off-coast islands, stations in crowded frequencies. Solid state—uses no electricity, batts., tubes. Works almost forever.

Stock No. 72.095EK \$15.95 Ppd.

AM RADIO FITS IN/ON YOUR EAR!



Wear it inconspicuously everywhere, listen as you work (lawn, yard, office), watch (game, beach) or wait. Instant music, news, sports. No gimmick—6/10 oz. technological wonder w/ integrated circuit, 11 transistors, patented ferrite antenna/tuner/volume dial. Works best outdoors. Uses hearing aid batt. (incl.)—up to 100 hrs. playing. New batt. to slip in avail. at drug stores (about 50¢). No lengthy wires, bulky cases, or power-packed!

Stock No. 42.275EK \$14.95 Ppd.

The MOST POWERFUL SOLAR CELL!



World's biggest (3" dia.), strongest silicon cell delivers over 1 amp. @ .5v D.C. or 1/2W. 5 times more efficient per cost than ever before! Only 1 mil thick. Tab leads for any circuit, 100's of applications. Hook in series for more voltage; parallel—more current. Real breakthrough!

No. 42.270EK \$19.95 Ppd.
2" DIA. 500 mA. @.5v No. 145EK \$ 9.95 Ppd.
PIE-SHAPED 1/4 2" DIA. 100 mA. @ .5v No. 42.146EK \$ 5.50 Ppd.

PRO ELECTRONIC SOUND CATCHER



Parabolic mike w/ 18 3/4" reflecting shield & 2 I.C.'s in amplifier magnifies signals 100X that of omnidirectional mikes. Catch a songbird 1/2 mile off; QB's huddle strategy; sounds never before heard. Super directivity gives highest signal to noise ratio poss. Safe: auto. cuts off ear damaging noises. Earphones, tape recorder output, tripod socket. Req. two 9v trans. batt. (not incl.)

No. 1649EK (5 1/2 LB.) \$299.00 Ppd.
BIG EAR "TOY" MODEL #80.176EK \$ 32.25 Ppd.

KNOW YOUR ALPHA FROM THETA!



For greater relaxation, concentration, listen to your Alpha-Theta brainwaves. Ultra-sensitive electrode head-band slips on/off in seconds—eliminates need for messy creams, etc. Atch'd to amplifier, filters brainwaves, signals beep for ea. Alpha or Theta wave passed. Monitoring button simulates Alpha sound; audio & visual (L.E.D.) feedback. Reliable, easy-to-use unit comparable to costlier models. Completely safe. Comprehensive instruction booklet.

No. 1635EK (8x3x4"; 24 oz.) \$144.50 Ppd.
LOW COST "Starter" UNIT, No. 71.809EK \$ 55.00 Ppd.
No. 1652EK DELUXE "ON" TIME MONITOR—Measures & Records % \$375.00 Ppd.



MAIL COUPON FOR GIANT FREE CATALOG!

164 PAGES • MORE THAN **4500 UNUSUAL BARGAINS**

Completely new Catalog. Packed with huge selection of telescopes, microscopes, binoculars, magnets, magnifiers, prisms, photo components, ecology and Unique Lighting items, parts, kits, accessories — many hard-to-get surplus bargains. 100's of charts, illustrations. For hobbyists, experimenters, schools, industry.

EDMUND SCIENTIFIC CO.
300 Edscorp Building, Barrington, N. J. 08007
Please rush Free Giant Catalog "EK"

Name _____
Address _____
City _____ State _____ Zip _____



COMPLETE AND MAIL WITH CHECK, M. O. OR CHARGE NO.
EDMUND SCIENTIFIC CO. 300 Edscorp Building, Barrington, N.J. 08007

How Many	Stock No.	Description	Price Each	Total
<input type="checkbox"/>		PLEASE SEND GIANT FREE CATALOG "EK"		
<input type="checkbox"/>		Charge my BankAmericard*		
<input type="checkbox"/>		Charge my Master Charge*		
Add Handling Chg.: \$1.00, Orders Under \$5.00, 50¢, Orders Over \$5.00				
Interbank No. <input type="text"/>				
My Card No. Is <input type="text"/>				
Signature <input type="text"/>				
Card Expiration Date <input type="text"/>				
30-DAY MONEY-BACK GUARANTEE. Name <input type="text"/>				
You must be satisfied or return any purchase in 30 days for full refund. *\$15.00 minimum Address <input type="text"/>				
City <input type="text"/> State <input type="text"/> Zip <input type="text"/>				

CIRCLE 17 ON READER SERVICE COUPON

The great new
Super Scanner

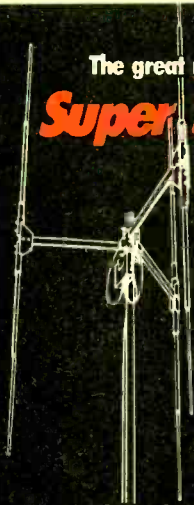

The only "two-antennas" antenna. It scans 360° in milliseconds with 5.75 dB gain. Or beams an 8.75 dB gain signal where and when you want it—instantaneously. (And you'll wish you had a radio as handsome as the control box!)

- New contemporary control console with blackout panel, simulated leather end panels.
- Compact size—radius just 3 feet. Wind rated in excess of 100 mph.
- Ideal for emergency teams—zero in on trouble spots instantly.

MODEL MS 119 Super Scanner electronic beam antenna with control console.



the antenna specialists co.

Division of ORION INDUSTRIES, INC.
12435 Euclid Ave., Cleveland, Ohio 44106
Export: 2200 Shames Dr.,
Westbury, L.I., New York 11590
Canada: A. C. Simmonds & Sons, Ltd.

CIRCLE 5 ON READER SERVICE COUPON

STAR-TRONICS

**INDUSTRIAL AND GOVERNMENT
ELECTRONIC SURPLUS**

PARTS & PIECES FOR SCHOOLS, SHOPS, HAMS & HOBBYISTS
SEND FOR OUR LATEST ALL DIFFERENT
MONTHLY PICTURE CATALOG. NOW!

Box 17127, Portland, Ore. 97217

HEY, LOOK ME OVER

Also available from Edmund is a Vinyl Photo Changing Bag. (No. 42,240) for \$6.50 postpaid.

Top Dog Mixer

Bozak, Inc., has announced the Model 919 Audio Signal Processing Center which will give the home music-lover "all the essential facilities of a small-scale studio console." The Model 919 permits the user to blend three different two-channel stereophonic input signals with separate level and bass, mid-range and treble controls on each input. The standard input channels include a phono input, a microphone input and a switch-selected choice of tape, tuner or auxiliary input. A "panning" circuit permits the operator to locate the apparent position



CIRCLE 71 ON READER SERVICE COUPON

of a microphone input anywhere he chooses between left and right channel outputs, even give the illusion of an announcer walking across the front of a recorded symphony. Stereo blend control permits the selection of the width of the output, all the way from mono to extra-wide, in which case an orchestra has a wider frontal area. A "cue selector" makes it possible to monitor each of the inputs separately. Wide dynamic range and frequency response, Bozak claims, contribute to minimal distortion for the unit—less than 0.1% over a frequency band of 20 to 20,000 Hz with full 10-volt output into a 200-ohm load. The unit, which sells for \$797, is 7 in. high, 17 3/4 in. wide and 10 3/4 in. deep without the cabinet. Weight is 21 lbs. Also available is an optional true-walnut enclosure for shelf mounting. Complete technical specifications are available from Bozak, Inc., Box 1166, Darien, CT.

Curve Tracer

Hickok's new model 440 Curve Tracer dynamically tests all types of semiconductors under actual conditions, in or out of circuit. Used with any scope having external horizontal input, it generates calibrated "characteristic curves" that can be accurately scaled right from the screen. It safely tests J-FETs, MOS-FETs, diodes, zeners, transistors, UJTs and SCRs—silicon or germanium, power or signal. Insta-Beta takes the guesswork out of transistor beta and FET parameter calculations. In the transistor mode, Insta-Beta displays a single, full range I/c I/B curve from which AC and DC beta

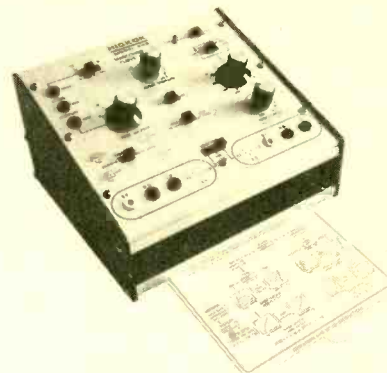

CIRCLE 70 ON READER SERVICE COUPON

can be instantly determined without interpolation. This curve also shows beta linearity at a glance. In the FET mode, Insta-Beta displays the entire transfer curve including pinch-off voltage, full-on current, and the active portion for easy calibration of Gm. In normal semiconductor testing, a variable step control provides characteristic curve displays with up to ten steps per family (steps of base current for transistors and steps of gate voltage for FETs). A Horiz V/Div control changes horizontal sensitivity without requiring scope recalibration. Maximum sensitivity of 1V/div is especially useful for measurements in the semiconductor threshold or turn-on region. Controls are logically arranged on the front panel and use color-coding and fast set-up marks where applicable. A handy pull-out card provides ready reference information for calibration, set-up and operation of the instrument. Sells for \$165.00. For more information on the model 440 Curve Tracer contact Instrumentation & Controls Div., Hickok Electrical Instrument Co., 10514 Dupont Avenue, Cleveland, Ohio 44108.

Sidetailk Twins

PACE Communications, Div. of Pathcom, Inc. has introduced a totally new pair of SSB and AM citizen band 2-way radios, the Sidetailk Twins. The Sidetailk 1000M (mobile) and 1000B (base) are all solid-state units with the maximum legal output power of 12 watts PEP, plus full control of upper side bands, lower side bands or the 23 conventional AM channels. This combination of sideband (which allows a greater range of operation) and AM gives the user the best of both worlds. Both units offer noise-blanker control for suppressing impulse

Sidetailk 1000B base

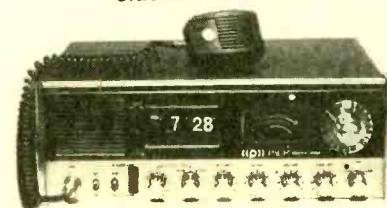

(Continued on page 14)

PARTS! CORNELL TUBES!

Send For FREE CORNELL'S New Color Catalog 48 Pgs. New Items

33¢ per tube

36¢ per tube

ORDER FREE IF NOT SHIPPED IN 24 HOURS!

4219 E UNIVERSITY AVE. SAN DIEGO, CALIF. 92105



Now! Full 23-channel operation from only 2 crystals!

Other Model 1-612 features:

- **LARGE (1 $\frac{3}{8}$ " x $\frac{3}{8}$ ") S-RF METER.** Offers visual signal input and power output indication.
- **TWIN LED LIGHT** indicate transmit (red) and receive (green).
- **VARIABLE TONE CONTROL.** You adjust audio response level to compensate for high noise levels.
- **LOCAL-DISTANT RF GAIN SWITCH** prevents overload and distortion from nearby transmitters.
- **AUTOMATIC NOISE ELIMINATOR SWITCH**—with On-Off feature.
- **PLUS THESE OTHER GREAT FEATURES AND CONVENIENCES:** CB-PA switch converts unit into powerful, 5-watt P.A./Hailer system... full-size, plug-in mike... illuminated channel dial... AMC circuit to prevent overmodulation... Tuned RF stage... Positive and negative ground operation... Full 4 watts power to antenna... Dual conversion super-heterodyne receiver... External speaker jack.

Send for full-line color brochure today!

Royce Model 1-612 Gyro-Lock Citizens Band Transceiver

That's Gyro-Lock! An amazing new innovation in CB engineering design. Imagine—full, 23-channel operation from only 2 crystals. Advanced, integrated circuits (10 of them) replace other crystals formerly needed. So, unlike old synthesizers which can be affected by temperature changes—with Royce Gyro-Lock you are always on channel, on every channel.

Reason enough to choose the Royce Model 1-612. But, your Royce Dealer has many other features to show you. Stop by and see them all—soon!

Royce  **electronics**
corporation

1142 Clay St., North Kansas City, Mo. 64116
CALL: (816) 842-0252. TELEX: 426-145

CIRCLE 12 ON READER SERVICE COUPON

Compare what you get training and you'll

Compare costs

Only NRI offers five complete TV/Audio Servicing Courses from \$370 to \$1,095 . . . with convenient, inexpensive time payment plans. In the Master Course in color TV servicing, with a 25" diagonal solid-state color TV, you save as much as \$600 under the next leading home study school.

NRI saves you tuition because our costs are lower. We pay no salesmen, and we engineer our own kits and training equipment. We don't buy "hobby kits" from others. Nor do we penalize you with big interest charges for time payments. We pass the savings on to you.

Compare training

NRI is one of the few home study schools that maintains its own full-time staff of technical writers, editors, illustrators, development engineers and publications experts. The people who design the kits also design the lessons . . . so that theory and practice go hand in hand. The lessons aren't "retro-fitted" to an outside-source "hobby kit." At each stage of building, you experiment with the *power on*; you don't wait till the set's completed to learn troubleshooting. The NRI set is designed exclusively for training. It is also a superb 100% solid-state receiver for your personal use.

Compare choices

Most schools offer one course in color TV servicing, period. Only NRI offers you five different courses to match your needs and budget. The comprehensive 65-lesson course, complete with 7 kits, costs as little as \$370. Or you can choose the \$465 course that includes a 12" diagonal black & white portable TV for hands-on experience. Then there's the 19" diagonal solid-state color TV course for \$795; the advanced color TV course for trained technicians with an 18" diagonal color TV for \$645; and finally, the magnificent 25" diagonal solid-state color TV course, complete with console cabinet, oscilloscope, TV pattern generator, and a 3½ digit digital multimeter, for \$1,095. Other schools charge you hundreds of dollars more for an equivalent course.

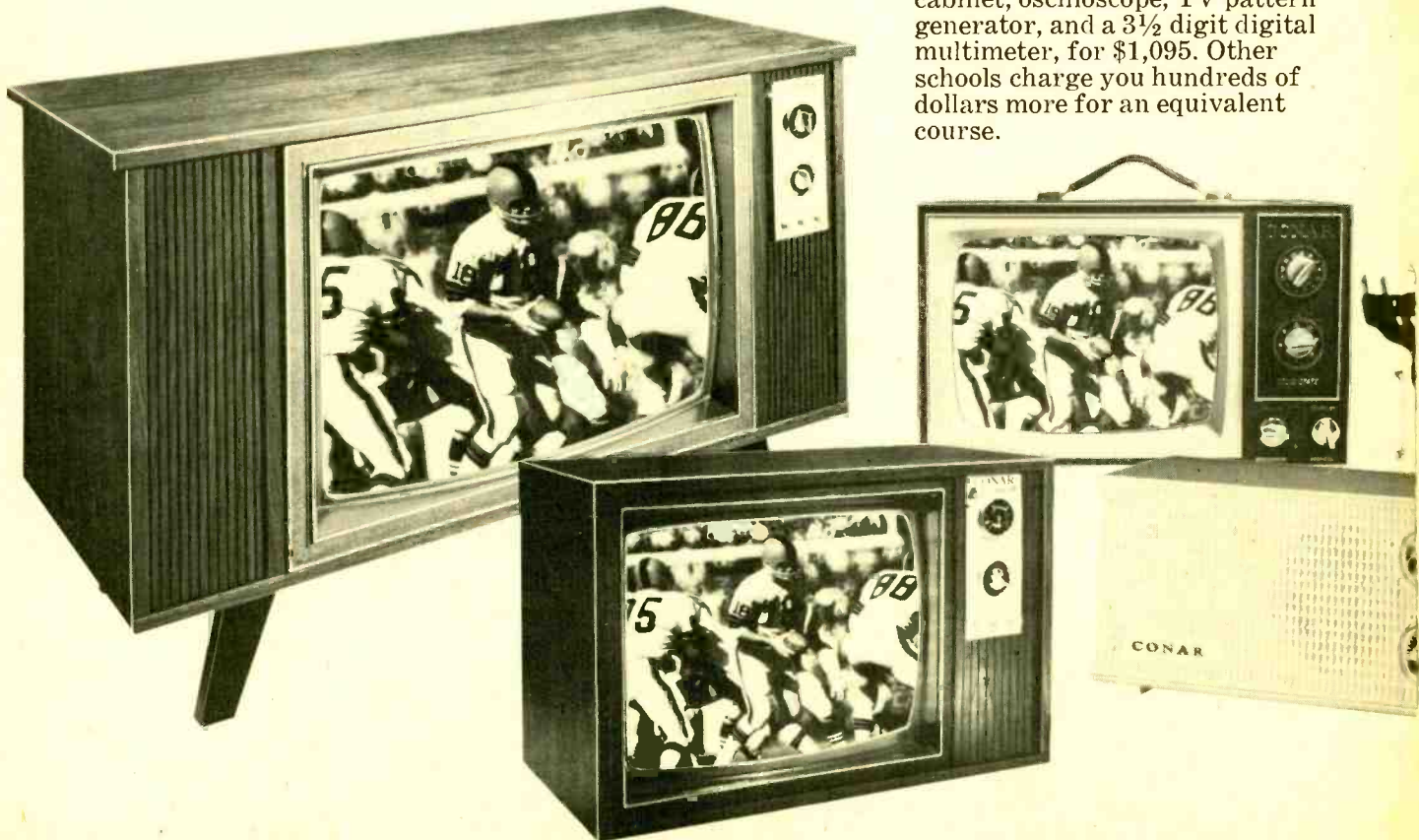

in TV/Audio home choose NRI.

Compare equipment

NRI has engineered the widest variety of professional electronic lab equipment ever designed entirely for training at home. When you enroll in the Master Course in TV/Audio Servicing, for instance, you receive kits to build a wide band, solid-state, triggered sweep, service type 5" Oscilloscope; color pattern generator; solid-state radio; and a digital multimeter.

Before you settle on any home training course, compare the over-all program. See if you are getting kits engineered for experimentation and training . . . or merely "hobby kits". Count the experiments . . . compare the components. Don't just count kits. (Some schools even call a slide rule a kit.)

Compare schools

Home study isn't a sideline with NRI. We've been its innovating leader for 60 years. Ask any of the hundreds of thousands of NRI graduates. They'll tell you . . . you can pay more but you can't buy better training.

Along with each course, NRI provides bite-size, fully-illustrated lessons; personally graded tests; and the kind of person-to-person teaching that makes learning easier and faster.

Send for the free NRI full-color electronics catalog and discover why so many choose NRI. You'll find courses offered in TV/Audio Servicing, FCC License, Complete Communications Electronics, Digital Computer Electronics, Marine and Aircraft Electronics, Mobile Communications, etc.

**MAIL CARD
FOR YOUR
FREE NRI
CATALOG**

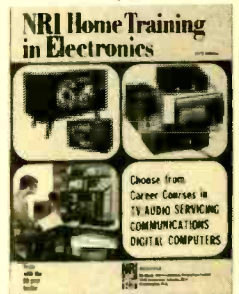

NO SALESMAN WILL CALL.

**AVAILABLE FOR CAREER
STUDY UNDER GI BILL**

Check box on card for information.



NRI SCHOOLS
McGraw-Hill Continuing Education Center
3939 Wisconsin Avenue,
Washington, D.C. 20016



HEY, LOOK ME OVER

(Continued from page 8)

noise interference, public address circuit, full range RF gain control for receiver sensitivity adjustment, clarifier for compensating drift errors in the received SSB signal frequencies, indicator lights for easy recognition of AM, LSB or USB mode status, receive and transmit status indicator lights, and positive or negative ground applications. Technical features of the Sidetalk Twins include a crystal-lattice filter that provides band-pass with

Sidetalk 1000M mobile

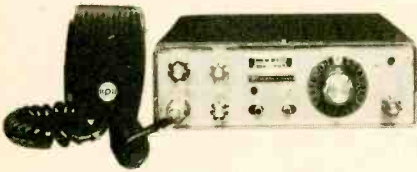

CIRCLE 69 ON READER SERVICE COUPON

over 60 dB suppression of unwanted sidebands. Sidetalk 1000M also features a full size S/Rf meter for monitoring incoming signal strength and relative transmitter output power strength, operating on 12 VDC. Sidetalk 1000B is also equipped with a full scale digital alarm clock for timing transmissions. A full-size, multiple-functioning meter is provided for monitoring incoming signal strength, relative transmitter power output, and SWR (standing wave ration of antenna) condition and performance. Engineered for 110-VAC and 12-VDC applications, it includes an external speaker jack/headphone jack. Units are FCC type accepted. Suggested retail price: 1000M, \$349.95; 1000B, \$449.95. Get all the facts direct from Pace Communications (Pathcom, Inc.) 24049 So. Frampton Avenue, Harbor City, CA 90710.

Discriminating Detector

White's Electronics now offers a new discrimination feature on all of its "Series II" TR metal detectors. Representing a big advance in detector efficiency, the discriminator reduces time wasted digging up tin foil, bottle caps, gum wrappers and other types of junk items. Two of the most popular Series II detectors are the Goldmaster 66 TR-4B and The Alaskan TR-4B, which have suggested retail prices of \$309.50 and \$309.50, respectively, with discriminator.



CIRCLE 68 ON READER SERVICE COUPON

New circuitry added to the Series II circuit accomplishes the discrimination. Instead of Low-High-Auto, the discriminator TR units have Normal-Auto-Discriminate modes, plus a separate control for adjusting the degree of discrimination desired. Discriminator-equipped detectors can be easily adjusted to reject beverage-can pull-tabs and still detect most coins, making prospecting on beaches and other areas where there is

public access much more productive than with standard units. From White's Electronics Inc., 1012 Pleasant Valley Road, Sweet Home, OR 97386.

MATV Crimper

Channel Master has developed a new crimping tool whose unique jaw configuration eliminates the danger of crushing 75-ohm fittings, a common cause of signal loss in MATV installations and other antenna installations using 75-ohm cable. The new Crimp-O-Matic, model 7188C, is made so that its jaws "bottom



out" (close down) on each other instead of on the fitting. When a fitting has too large an outside diameter, the tool will deflect at the handle end, again preventing undue pressure on the fitting, no matter how hard the technician squeezes the tool. Specially designed jaws further protect the fitting. List price for model 7188C is \$16.30. For further information, contact MATV Department, Channel Master, Ellenville, NY 12428.

Heat-Shielded Irons

Featherweight soldering irons with heat resistant or shielded pencil-like handles and extra long cords will make home wiring repairs, fixture installations and creative crafts easier and without hand discomfort. Finely balanced Weller irons weigh as little as 1 1/4 oz. and no more than 1 lb. even in the heavy duty models.



CIRCLE 67 ON READER SERVICE COUPON

They are rated from 25 to 175 watts, and their long-life, pre-tinned tips of plated copper are replaceable. Prices range from \$5.50 to \$14.00 at hardware stores and home centers. Weller, a member of The Cooper Group, Apex, NC 27502.

avanti's Astroplane gives CBers Performance to brag about.

The unique construction features are exceptional.

4.46 db gain over isotropic is, and provides, a stronger transmit and a stronger receive.

To make use of the better signal, the Astroplane radiates the signal from higher up than other CB antennas and at a better angle. According to Dr. Alva Todd of the Midwest College of Engineering, "it possesses an unusually low angle of maximum radiation." This low angle of radiation means that your power is radiated at the horizon and not up into the clouds.

You'll also get long lasting, trouble-free performance because it is compact in design

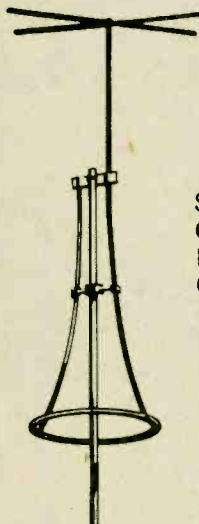

—without long drooping radials, without coils to burn or short out, and with direct ground construction for positive lightning protection and static dissipation.

\$36.95 Sugg. Retail

Gain 4.46 over isotropic

Lightning protection D.C.

Ground

V.S.W.R. 1.2:1

Length 12 Ft.

Diameter 30 In.

Free 16 page color catalog

Write: Avanti R & D, Inc.

340 Stewart Avenue

Addison, Illinois 60101

In Canada:

Cardon Import Co. LTD, Montreal

avanti
RESEARCH AND DEVELOPMENT, INC.

creators of
the famous

MOONRAKER

five new breadboard testers from CSC

Continental Specialties Corp. offers a total line of breadboard test devices . . . everything from inexpensive kits to high-power professional units and logic monitors too. Each high quality, compact unit comes with a guarantee of complete satisfaction or your money back within 10 days. Here are but five of the "hottest" items we make. . .



Power for the Professional!

New Proto Boards PB-203 and PB-203A with built-in regulated short-proof power supplies!

Ready-to-use. Just plug in and start building! 2 extra floating 5-way binding posts for external signals (PB-203 only). Completely self-contained with power switch, indicator lamp and power fuse. 24 14-pin DIP capacity. All metal construction . . . no chipping or cracking as with plastic cases. Two-tone quality case makes both PB-203 and PB-203A aesthetically, as well as technically attractive.

PB-203

- 3 QT-59S Sockets
- 4 QT-59B Bus Strips
- 1 QT-47B Bus Strip
- Fuse • Power Switch
- Power-On Light
- 9.75" L x 6.6" W x 3.25" H
- Weight: 5 lbs.
- 5V, 1 AMP regulated power supply

75.

Add \$2.50 shipping/handling

OUTPUT SPECIFICATIONS

Load Regulation Better than 1%
Output Voltage 5V ± ¼V
 @ ½ AMP
Ripple & Noise 10 millivolts

PB-203A

- 3 QT-59S Sockets
- 4 QT-59B Bus Strips
- 1 QT-47B Bus Strip
- Fuse • Power Switch
- Power-On Light
- 9.75" L x 6.6" W x 3.25" H
- Weight: 5 lbs.
- 5V, 1 AMP regulated power supply (same as PB-203)
- +15V, ½ AMP regulated power supply
- -15V, ½ AMP regulated power supply

120.

Add \$2.50 shipping/handling

OUTPUT SPECIFICATIONS

Load Regulation Better than 1%
Output Voltage 15V, internally adjustable
 @ ¼ AMP,
Ripple & Noise 10 millivolts

PROTO BOARD 100

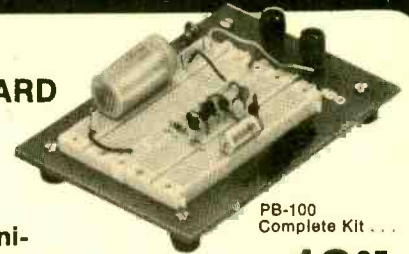

A complete mini-breadboard budget kit with full IC capacity

PB-100 Complete Kit . . .

19⁹⁵

Add \$1.50 shipping/handling

The PB-100 is a low cost, big 10 IC capacity breadboard kit, complete down to the last nut, bolt and screw. Includes 2 QT-35S Sockets; 1 QT-35B Bus Strip; 2 5-way binding posts; 4 rubber feet; screws and easy assembly instructions. 4.50" (114.3mm) wide x 6.00" (152.4mm) long x 1.35" (34.3mm) high. Order your PB-100 kit! Start building and testing now!

CSC PROTO-CLIP offers power-on . . . hands-off signal tracing . . . under \$5!

Trace signals or troubleshoot fast. Inject signals or wire unused circuits into existing boards. Flexible plastic web* construction eliminates springs and pivots. Plus, the narrow throat is perfect for high density pc boards. Order now!

PC-14 14-pin Proto-Clip: \$4.50 ea.
 PC-16 16-pin Proto-Clip: \$4.75 ea.

Add \$1.00 shipping and handling

Scope probes, test leads lock onto unique toothed grips



©COPYRIGHT CONTINENTAL SPECIALTIES CORPORATION 1975

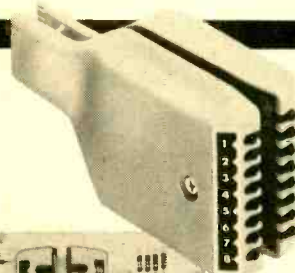

Continental Specialties Corp. LOGIC MONITOR brings ICs to life faster than a scope . . . safer than a voltmeter

LM-1 **84⁹⁵ each**

Add \$2.50 shipping/handling

Self-contained, pocket size. No adjustments or calibrations needed. Puts life into digital designs. Just clip to any DIP IC up to 16 pins. **NO POWER SUPPLY NEEDED!**

Simultaneously displays static and dynamic logic states of DTL, TTL,

HTL or CMOS on 16 large high Intensity LEDs. Watch signals work through counters, shift registers, timers, adders, flip flops, decoders, entire systems. Concentrate on signal flow and input/output truth tables. Forget probe grounds, pin counting or sync polarity. Precision plastic guides and flexible plastic web* insure positive connections. Versatile. Fast. Accurate. Indispensable. Order yours today!

All Continental Specialties breadboard test devices are made in the USA, and are available off-the-shelf from your local distributor or CSC. Direct purchases may be charged on BankAmericard, Master Charge or American Express. You get a FREE English/Metric conversion slide rule with each order. Foreign orders please add 10% for shipping/handling. Prices are subject to change. Write or phone for complete illustrated catalog, plus the name and address of the CSC dealer nearest you.

*Patents Pending

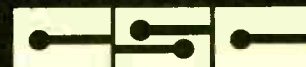

CONTINENTAL SPECIALTIES CORP.
 44 Kendall St., Box 1942, New Haven, CT 06509 • 203/624-3103

West Coast Office: Box 7809, San Francisco, CA 94119 • 415/383-4207
 CANADA: Available thru Len Finkler Ltd., Ontario

CIRCLE 16 ON READER SERVICE COUPON

TAKE YOUR CHOICE



Mini-Scan™
is the pocket scanner that works a week on just 4 penlight cells.

A breakthrough we call "mini-miser circuitry" makes it possible ... and it's

actually 2½ to 5 times more efficient than any other pocket scanner we tested!* Just 4 alkaline penlight cells power it for a full week, 8 hours a day, on a tough 50-50 duty cycle (50% full volume, 50% squelched). And its performance is bred from our experience in public safety two-way radio ... so it also gives you the crispest, clearest messages possible. Just \$119.95 with built-in ferrite antenna (batteries, crystals and optional flexible antenna extra.)

*Test results gladly supplied on request.



Johnson
MINI-SCAN™

... the professional pocket scanner

E. F. JOHNSON CO., WASECA, MINNESOTA 56093
IN CANADA: A. C. SIMMONDS & SONS, LTD.

CIRCLE 33 ON READER SERVICE COUPON



**ASK HANK,
HE KNOWS!**

Got a question or a problem with a project—ask Hank! Please remember that Hank's column is limited to answering specific electronic project questions that you send to him. Personal replies cannot be made. Sorry, he isn't offering a circuit design service. Write to:

**Hank Scott, Workshop Editor
ELEMENTARY ELECTRONICS
229 Park Avenue South
New York, NY 10003**

Read the Rules

How long has Channel 9 (27.065 MHz) been the CB call channel?

—L. S., Buffalo, NY

Never! Channel nine has been officially designated as an emergency call channel by the FCC. Call your friends on another channel. That's 10 through 15 or 23. Know your rules!

Grounded Out

I must voice strong objection to your statements concerning the ground (green) terminal of electrical outlets in the Jan./Feb. 1975 issue of ELEMENTARY ELECTRONICS. The National Electrical Code requires without exception that the ground terminal be connected to the power line ground via a conductor at least as large as the "hot" wire to the outlet, in all new installations. Many deaths are the direct result of operating certain equipment (especially power tools and appliances) without the proper ground. Electrical noise reduction, which you gave as the reason for grounding an outlet, is strictly a fringe benefit. Your ignorance on the subject was further indicated when you said that the ground terminal should be connected to the outlet box via the outlet mounting lugs. I strongly suggest that you clarify your statements.

—C. B., Monroe, LA

You are correct. It appears that I erred but I would like to call your attention to your phrase "all new installations." I was talking about an old installation, which is not covered by this code. I would like to point out that if the ground terminal is automatically connected to the box, why the green ground screw? The answer is simple—do not rely on the mounting screws, which may rust. Also, plastic boxes are making the scene—they're good insulators. One thing I believe we both agree on is the reading of the National Electrical Code. It's good reading and may save your life.

What's a BFO

I have an 8-band radio and on it there is a BFO switch. Can you tell me what it's for?

—R. P., Edinburg, PA

Sure can. When the BFO is on, it will cause a whistle to be heard whenever a station's carrier is present. You may have to jiggle the fine tuner knob to get the tone you like to hear. Now this whistle, or tone, is annoying when listening to an AM station, and that's why you can turn it off. However, when a station is broad-

casting an unmodulated or Morse code signal, the BFO provides the tone necessary to hear the signal. That way you can copy it down.

Good Trio

I'm looking for a shortwave receiver, one with good sensitivity. I picked out three receivers, one a Heathkit GR-78 which is a six-band covering 190 kHz to 30 MHz. I also saw a Lafayette HA-600, a 5-band amateur and shortwave receiver, covering 150 kHz to 30 MHz. The third one was a Realistic DX-160, 5-band covering 150 kHz to 30 MHz. Which one shall I get? I need some professional help.

—J. G., Greenfield Park, Que.

All these products have published specifications which are believable—they are made by reliable outfits. As for which receiver to buy, it is your decision because only you can know exactly what you want. Check the specs carefully. Then check the features and compare the lot against the prices. Lots of luck!

Ham Parts

In your March/April issue of ELEMENTARY ELECTRONICS there was an article on shortwave antennas by Joe Rolf, and it included a schematic and picture of an antenna tuner. At what company (their address too, if possible) can I get the coil. The ones mentioned were B&W 3008 and Air Dux 532T.

—W. M., Waterloo, IA

The parts in question are typical ham radio parts available from most parts supplies stores who service hams.

Wind Power

I set up a fan-generator combination on a small tower and now I get about 30 amps AC at 15 volts. I'm using a car's alternator as the generator. What can I do with this power after seeing it is not reliable because the wind varies in speed?

—E. E., Ellenville, NY

You're talking about 450 watts of power. Pass it through a resistor and use the heat to assist your regular heating system. Maybe the resistive load can be placed on your garage floor which will keep the car warm for fast starts on very cold mornings. The wind is fickle and you can't rely on a fixed frequency output or constant voltage output. But, a resistor doesn't care provided it can take the maximum power or current available. For maximum power transfer, the lead-in line must be #10 copper wire or better.

(Continued on page 19)

ELECTRONICS INFORMATION CENTER

FREE

TO ALL READERS OF ELEMENTARY ELECTRONICS

At no cost to you the Editor will have information and literature about products and services advertised in this issue sent to you at no cost!

FILL OUT AND MAIL TODAY!

YOU SIMPLY

- Tear out the coupon.
- Circle the number under the ad that interests you.
- Circle the number identifying products mentioned in columns and articles.
- If you wish, answer the simple questionnaire on the coupon.
- Print or type your name and address on the coupon.
- Mail to ELEMENTARY ELECTRONICS before the expiration date.
- Please allow 4-6 weeks for delivery.

FILL OUT AND MAIL TODAY!

AND IF YOU WISH

to subscribe to

ELEMENTARY ELECTRONICS

please check subscription box 83 on the coupon: \$4.97 brings you 9 issues.

FILL OUT AND MAIL TODAY!

ELEMENTARY ELECTRONICS

Box 886, Ansonia Station, New York, NY 10023

September/October 1975

Void after February 19, 1976

1	2	3	4	5	6	7	8	9	10	11	12	13	14	15
16	17	18	19	20	21	22	23	24	25	26	27	28	29	30
31	32	33	34	35	36	37	38	39	40	41	42	43	44	45
46	47	48	49	50	51	52	53	54	55	56	57	58	59	60
61	62	63	64	65	66	67	68	69	70	71	72	73	74	75

We would like to know about you. Please help us by placing an "X" in the appropriate boxes. • Do you own a CB transceiver? 76 Yes 77 No • If your answer is Yes, please check appropriate boxes below if you have one or more of the types indicated. 78 Base Station 79 Mobile Unit 80 Portable • Do you use CB in your work? 81 Yes 82 No • 83 Please enter my subscription for 9 issues at \$4.97 and bill me. 84 \$4.97 subscription payment enclosed

Name (print clearly)

Address

City

State

Zip Code

ELEMENTARY ELECTRONICS

Box 886, Ansonia Station, New York, NY 10023

September/October 1975

Void after February 19, 1976

1	2	3	4	5	6	7	8	9	10	11	12	13	14	15
16	17	18	19	20	21	22	23	24	25	26	27	28	29	30
31	32	33	34	35	36	37	38	39	40	41	42	43	44	45
46	47	48	49	50	51	52	53	54	55	56	57	58	59	60
61	62	63	64	65	66	67	68	69	70	71	72	73	74	75

We would like to know about you. Please help us by placing an "X" in the appropriate boxes. • Do you own a CB transceiver? 76 Yes 77 No • If your answer is Yes, please check appropriate boxes below if you have one or more of the types indicated. 78 Base Station 79 Mobile Unit 80 Portable • Do you use CB in your work? 81 Yes 82 No • 83 Please enter my subscription for 9 issues at \$4.97 and bill me. 84 \$4.97 subscription payment enclosed

Name (print clearly)

Address

City

State

Zip Code

ELEMENTARY ELECTRONICS

Box 886, Ansonia Station, New York, NY 10023

September/October 1975

Void after February 19, 1976

1	2	3	4	5	6	7	8	9	10	11	12	13	14	15
16	17	18	19	20	21	22	23	24	25	26	27	28	29	30
31	32	33	34	35	36	37	38	39	40	41	42	43	44	45
46	47	48	49	50	51	52	53	54	55	56	57	58	59	60
61	62	63	64	65	66	67	68	69	70	71	72	73	74	75

We would like to know about you. Please help us by placing an "X" in the appropriate boxes. • Do you own a CB transceiver? 76 Yes 77 No • If your answer is Yes, please check appropriate boxes below if you have one or more of the types indicated. 78 Base Station 79 Mobile Unit 80 Portable • Do you use CB in your work? 81 Yes 82 No • 83 Please enter my subscription for 9 issues at \$4.97 and bill me. 84 \$4.97 subscription payment enclosed

Name (print clearly)

Address

City

State

Zip Code

This is the actual size of a

Brownie



. . . don't let its
small size fool you
— it's **BIG** in performance!

Imagine a mobile less than 2" high x 5½" wide and only 6½" deep—then add features such as a series-gate automatic noise limiter (ANL) and high level class B modulation! Like all Browning mobiles, the Brownie is undeterred by rugged terrain or extreme weather conditions—it will, in fact, operate faithfully at winter temperatures to -25°F. or desert conditions of 125°F. While the Brownie's features mean big performance, *this remarkably engineered little package has been designed with a price tag to match its elf-like size . . . only \$139.95!*

All Browning products are FCC Type Accepted

Visit your local dealer or write direct for your copy of our 1975 catalog containing full color photos and complete specifications of the Brownie—plus our Golden Eagle base station and other mobile models.

browning[®] laboratories inc.

1269 UNION AVENUE
LACONIA, NEW HAMPSHIRE 03246
TELEPHONE (603) 524 5454

CIRCLE 3 ON READER SERVICE COUPON

ASK HANK, HE KNOWS

(Continued from page 16)

Inside CB

Can you advise me where I can get information on basic CB operation, rules and regulations. I am also interested in a copy of 1975 CB YEARBOOK. Where can I get one?

—R. H., Davenport, IA

You're out of luck—the 1975 Edition of the CB YEARBOOK is sold out! But don't despair. ELEMENTARY ELECTRONICS has Kathi Martin giving inside info each issue along with timely and interesting features and technical reports throughout the year. And more! The 1976 issue of CB YEARBOOK is due on the newsstands on November 18, 1975. Look for it!

Tube Switch

I had my color TV picture tube replaced in my home. The repair man "broke the vacuum" and told me to get rid of the dud. In doing so, I noticed that he replaced a 18VBTP22 with a H-18VBKP22. Is he screwing me up?

—B. M., Jeffers, MN

Heck no! The replacement is the new type to be used with your set. I'll bet it's an RCA make and uses the latest "matrix" which means better color than before. Also, the new tube contains improved X-radiation attenuating glass—a safety plus at no extra cost. You know, you have a good man servicing your TV set.

Get the Point?

I have a very large collection of 78 rpm records dating back to 1910 and play them from time to time using "Kacti" needles. Alas, my supply has dwindled to zero and I can't seem to buy any. What should I do?

—Edwin Strauch
327 No. Penn St.
Allentown, PA 18102

Some of our readers, Edwin, are sure to have a few spares they can let you have or let you know of a suitable substitute. May I suggest you record your discs on cassettes? Playback would be easier and record wear-and-tear reduced considerably.

Insulation Is Gone

Working on a 1930 Westinghouse Radio (WR-7), I found the three IF transformers' primary and secondary windings were arcing between breaks in insulation on the surface wires. I was wondering if there was anything that I could use to reinsulate the winding wires from each other?

—R. W., Seattle, WA

Wait for a warm, low-humidity day and spread a coat of clear lacquer over the coils. A second coat one hour later wouldn't hurt either. If any of the coils are shorted together, you are in store for a coil rewinding job. A little patience in hand rewinding will result in a serviceable radio in "like-original" condition.

Getting Out of Town

Please burn this letter after you answer it. Last night I jumped a pair of leads to a burglar alarm system in a supermarket and all hell broke loose. What gives?

—A. P., Chicago, IL

The better systems sense changes as well as circuit breaks. When you put your clip lead across the circuit to deactivate a portion of the system, you changed the resistance of the loop. This was sensed by the alarm system and it automatically called the cops besides waking up the neighborhood and your getaway driver. Listen, if you are electrically inclined, why not investigate one of the home correspondence schools that advertise in this magazine. Earn some scratch from an honest job like TV servicing and become a good customer of your local supermarket. In the meantime, get out of town. This is one letter I will not burn.

Sheet Metal

The classroom in which I work is located in a preengineered metal building. Because of the metal shell, I am not able to receive any AM radio waves. How can I get a strong enough signal to enter the classroom so that the repairing of AM radios can be practiced?

—S. G., Attica, MI

Erect a long-wire antenna on the roof with suitable lightning protection. This is a common problem in many new metal and air conditioned structures with few, if any, windows.

Can You Help Out?

● Allen Madsen of 4608 38th Avenue N.E., Salem, OR 97303 is working on a double leader. He needs schematics and instruction books for Solar Capacitor Analyzer, Model C.E. and for the DC to DC converter for an Osborn CB Radio, Model 300. The converter Model No. is 840. Input is 12-VDC at 300 mA and output is 27-VDC at 135 mA.

● If you can xerox or give up your manual on the Hammarlund HQ-129X receiver, send it to John Zemanick, Rd. 2, Averill Park, NY 12018.

● Denny Swain wants a Heathkit BW-42 transceiver manual and crystals. Denny's at Lot No. 189, New Trailer Court, K.I. Sawyer AFB, MI 49843.

● Larry Reid of 301 Elm Street, Saskatoon, Sask., Canada needs schematic diagrams for two Canadian 821 and Universal Radio, Model Z1T85.

● Basketball fans—Donald Abare of 32 Walnut Street, Wenchendon, MA 01475 would like diagram and details so he may hook up a basket ball score board. ■

All New PROBE IV

CAT. NO.
5104



CHECK FOUR FUNCTIONS
WITH ONE INSTRUMENT!

- Continuity
- Polarity
- Voltage
- Digital Logic

LIGHTWEIGHT — POCKET SIZE
PROTECTIVE VINYL CARRYING
POUCH. SEE YOUR FAVORITE
ELECTRONICS DISTRIBUTOR.

LIFT-IT!



The All-New,
Quick And Easy
Way To Reproduce
Printed Circuits.
Get Your Kit From
Your Favorite

CAT. NO.
J4-828

 CALECTRO Electronics
Distributor Today!



GC ELECTRONICS
DIVISION OF HYDROMETALS, INC.
ROCKFORD, ILLINOIS 61101 U.S.A.



WRITE
NOW FOR **McGEE'S**

BIG SPEAKER CATALOG

1001 BARGAINS IN

SPEAKERS — PARTS — TUBES — HIGH FIDELITY
COMPONENTS — RECORD CHANGERS
Tape Recorders — Kits — Everything in Electronics
1901 McGee Street, Kansas City, Missouri 64108

The better the training the better you'll

Send for
FREE
illustrated
career
guide

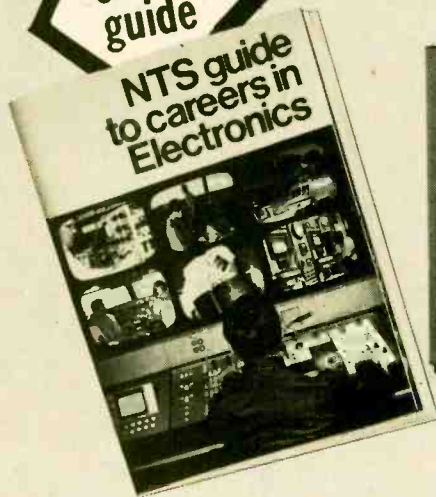

IN-CIRCUIT TRANSISTOR TESTER
COMPU-TRAINER
TROUBLESHOOTER
VOM

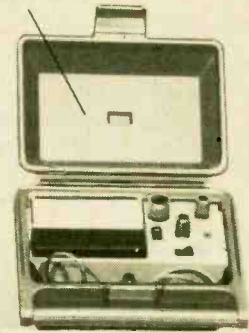
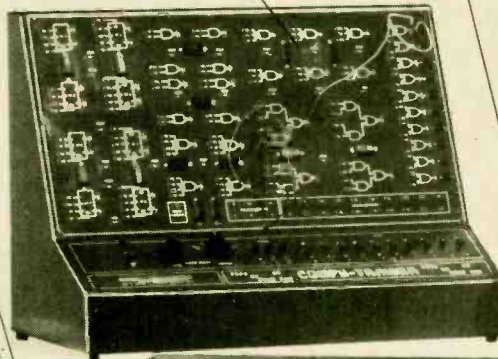

SOLID-STATE
OSCILLOSCOPE

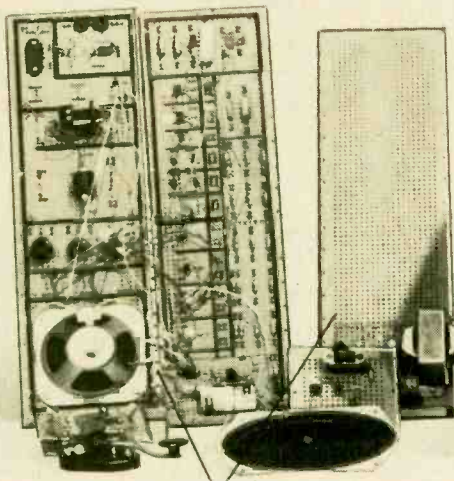

ELECTRO-LAB



(Simulated TV Reception)

As an NTS student you'll acquire the know-how that comes with first-hand training on NTS professional equipment. **Equipment you'll build and keep.** Our courses include equipment like the **NTS/Heath Digital GR-2000 Solid State color TV** with first-ever features like silent varactor diode tuning; digital channel selection, (with optional digital clock), and big 315 sq. in. ultra-rectangular screen.

Also pictured above are other units — 5" solid state oscilloscope, vector monitor scope, solid-state stereo AM-FM receiver with twin speakers, digital multimeter, and more. It's the kind of better equipment that gets you better equipped for the electronics industry.

This electronic gear is not only designed for training; it's field-type — like you'll meet on the job, or when you're making service calls. And with NTS easy-to-read, profusely illustrated lessons you learn the theory behind these tools of the trade.

Choose from 12 NTS courses covering a wide range of fields in electronics, each complete with equipment, lessons, and manuals to make your training more practical and interesting.

Compare our training; compare our lower tuition. We employ no salesmen, pay no commissions. You receive all home-study information by mail only. All Kits, lessons, and experiments are described in full color. Most liberal refund policy and cancella-

and the equipment be equipped.

**COMPARE OUR
KITS AND LESSONS.
COMPARE OUR
TUITION.**

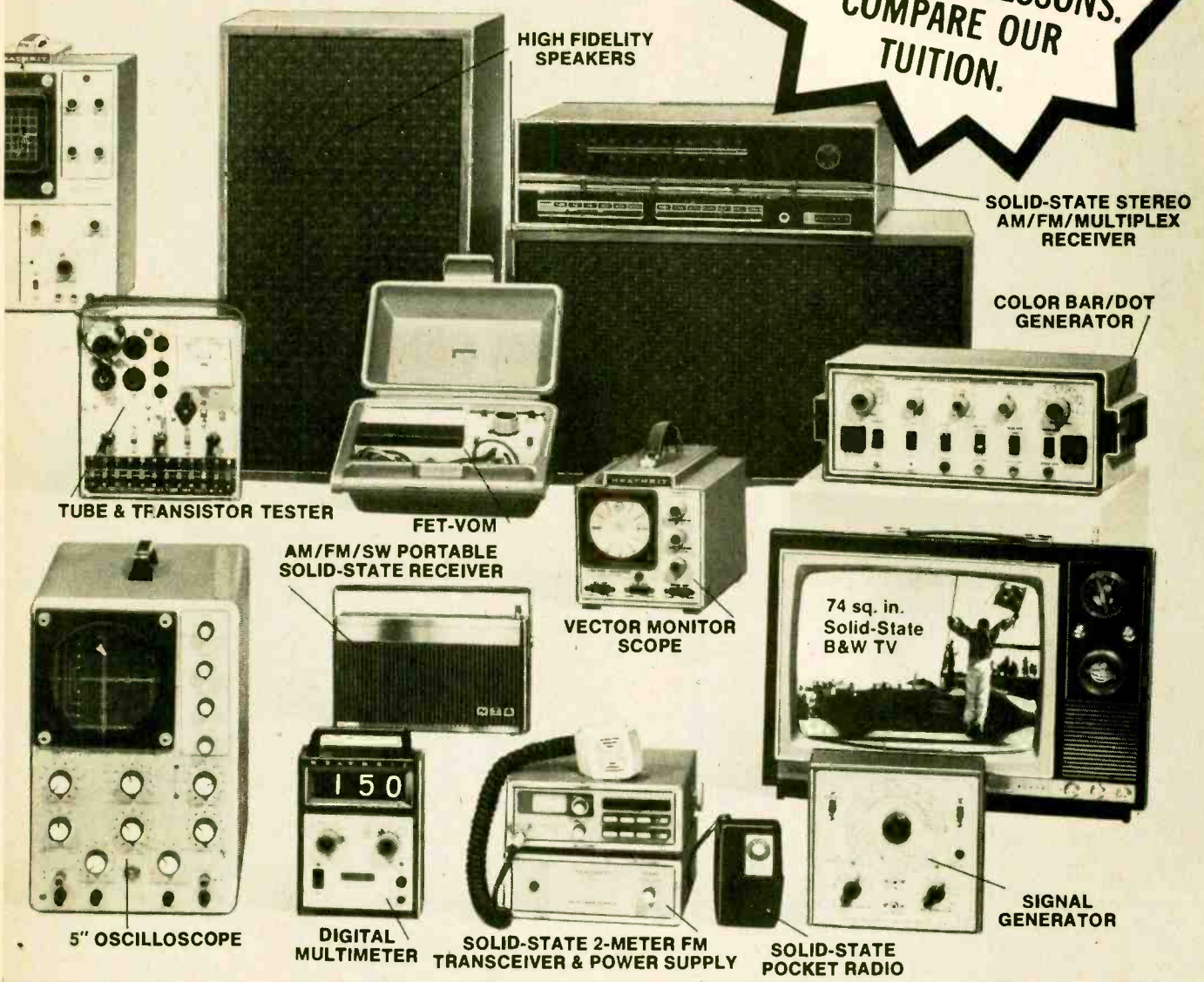

tion privileges spelled out. Make your own comparisons, your own decision. Mail card today, or clip coupon if card is missing.

NO OBLIGATION. NO SALESMAN WILL CALL

APPROVED FOR VETERAN TRAINING

Get facts on new 2-year extension

NATIONAL TECHNICAL SCHOOLS

TECHNICAL-TRADE TRAINING SINCE 1905
Resident and Home-Study Schools
4000 So. Figueroa St., Los Angeles, Calif. 90037

NATIONAL TECHNICAL SCHOOLS
4000 South Figueroa St., Los Angeles, Calif. 90037 Dept. 222-095
Please send FREE Color Catalog and Sample Lesson.
NO OBLIGATION. NO SALESMAN WILL CALL.

- | | |
|---|--|
| <input type="checkbox"/> Color TV Servicing | <input type="checkbox"/> Electronics Technology |
| <input type="checkbox"/> B & W TV and Radio Servicing | <input type="checkbox"/> Computer Electronics |
| <input type="checkbox"/> Electronic Communications | <input type="checkbox"/> Basic Electronics |
| <input type="checkbox"/> FCC License Course | <input type="checkbox"/> Audio Electronics Servicing |

NAME _____ AGE _____

ADDRESS _____ APT # _____

CITY _____ STATE _____

Please fill in Zip Code for fast service _____

- Check if interested in G.I. Bill information.
 Check if interested ONLY in classroom training in Los Angeles.

DX central reporting

A world of SWL info!

BY DON JENSEN

☐ Sunspots have been known to man for at least several thousand years. Galileo saw them in his first primitive telescope—and wrote about them—in the early 1600s. Systematic records of sunspots have been kept since the middle of the 18th Century. Still, scientists don't have all the answers.

Sunspots, those eruptions on the sun's surface that send waves of energy hurtling through space toward us, have been of great interest to DXers for a number of decades. SWLs know that there is a very definite link between the number of sunspots and shortwave reception. The solar activity has a direct bearing on the ionosphere surrounding Earth, and the state of the ionosphere controls distant radio reception.

The number of sunspots runs in cycles. The length of an individual cycle varies but it approximates 11 years. Broadly speaking, during a period of maximum sunspots, reception on the higher short-

wave bands is greatly improved. During the minimum sunspot years, reception on the top bands is poorer and DXers concentrate on the lower frequency shortwaves.

Currently we are approaching the end of the 20th cycle since man began keeping records in the 1700s. The last sunspot minimum occurred in 1964. Cycle 20 reached its peak about four years later and began its decline. If the 11-year cycle was exact, we could expect the minimum point to be reached this year. But indications are that the bottom won't be reached until late 1976 or early 1977.

In general, DXers can expect, then, no real recovery of the high SW bands for several years. And lower frequency SWLing should continue to be favorable.

Sharpening the focus, let's look at the dozen SWBC bands and the sort of reception conditions to expect for the remainder of 1975.

• 11 Meter Band (25,600-26,100 kHz)—At the peak of the present sunspot cycle, back in 1968, in any given month, DXers were reporting quite a number of strong SW signals on this band. But a quick check of the bulletins of one major SWL club shows you have to go back to January 1974 to find even one report of an overseas shortwave station on 11 meters. Few international broadcasters bother with the band these days because of the limited reception possibilities at this stage of the sunspot cycle. Other than the WWV time-ticker on 25,000 kHz, and perhaps the

VOA station at Greenville, N.C., there isn't much to be heard.

• 13 Meter Band (21,450-21,750 kHz)—Also adversely affected by the low sunspot count, there are far fewer broadcasters using "13" than there were a few years ago. But still there are enough stations to make for some interesting listening, including some European outlets and Africans such as Radio Cairo and the Ghana Broadcasting Corporation. Expect the band to pick up a little on longer haul reception as we move into fall and winter. Band openings may last for several hours during daylight.

• 16 Meter Band (17,700-17,900 kHz)—You'll find quite a range of stations in this SWBC band, particularly during the afternoon, in the coming months. A number of broadcasters who have down-shifted their frequencies from 11 and 13 meters can be found. Likely targets include Mexico, Pakistan, France, Sweden, Saudi Arabia, Brazil and South Africa, to name a few.

• 19 Meter Band (15,100-15,450 kHz)—This will be one of the better bands for SWLs hunting the major international broadcasting stations around the world. This should produce solid signals from dawn until early evening, with the best times being a brief period in the morning and a longer time span in the late afternoon. There are any number of target stations including China, Japan, Malaysia and the Philippines, the more powerful European stations, Africans such as ETLF,

(Continued on page 26)

312 FASCINATING PAGES!

A FLICK OF THE SWITCH new 1930-1950 book



- Re-live the great days of radio broadcast and the beginnings of TV-electronics.
- Browse through 1,000 pictures and interesting old ads.
- Discover the rewards of radio collecting and restoration.
- Own a First Edition of this valuable reference book.

This new book includes broadcasting, home radio-TV, Amateur radio, World War II radio-electronics, the radioman, collecting and "how it works." \$9.95 hard-cover, \$6.95 handbook.

Other valuable books are Vintage Radio (1887-1929) \$7.95 hard-cover, \$5.95 handbook; Radio Collector's Guide (1921-1932) \$4.95; 1927 Radio Encyclopedia \$12.95 hard-cover, \$9.95 soft-cover; 1926-1938 Radio Diagrams, \$7.00. Also, we'll furnish any pre-1951 diagram for \$3.50. 10-day return privileges.

Send today to Vintage Radio, Dep't E, Box 2045, Palos Verdes Peninsula, CA., 90274. Postage paid. Cal. residents add 6% tax.

_____\$
_____\$
_____\$
TOTAL _____



Name _____
Address _____
City _____ St. _____ Zip _____

FREE Radio Age Guide with each order FREE

NEW VINTAGE RADIO BOOK

INTRODUCING THE EXCLUSIVE CB RING

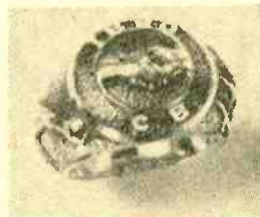

IN ANTIQUED 14 kt. YELLOW
GOLD FINISH FOR MEN & WOMEN

(Cat. No. RCB 303)
Only \$9.95

C B CLUBS: SEND FOR PERSONALIZED CLUB RING OFFER
REPRESENTATIVES WANTED: SEND FOR REP KIT OFFER
DEALERS WANTED: INQUIRE ON LETTER-HEAD

THE UNIQUE CHRISTMAS GIFT

ORDER FORM DEPT. CB76

REGAL LAPIDARIES, INC.
420 MADISON AVE.
NEW YORK, N.Y. 10017

Yes, enclosed is a \$5.00 deposit for each ring. Send me the following rings, C.O.D.

RCB 303

(Quantity) (Sizes)

At \$9.95 each plus postage and C.O.D. charges. (Postage and insurance Free if full payment accompanies order)

- Gift Boxed — add \$1.00 for each ring ordered.
 Send special club ring information
 Send representatives information.

Name _____
Address _____
City _____ State _____ Zip _____

CIRCLE 25 ON READER SERVICE COUPON

Why settle for a piece of the CB action...



when Siltronix SSB/AM gives you all of it?

Citizens Band radio has a lot more to offer than 23 channels and a weak signal.

Siltronix single sideband CB sets can double or triple your range by giving you more efficient use of your communications power. And they give you twice as many modes to get through on.

And Siltronix CB sets wrap up those 46 modes of single sideband talk power together with full AM capability to give you everything CB radio has to offer in one compact rig.

Sure Siltronix SSB/AM costs more. About a third more than a good AM rig. For that you get over 12 watts of input power punch and twice the number of modes plus AM to boot.

Like three for the price of one.

Believe us, SSB works better. A whole lot better. But you don't have to take our word for it. Check the amateur bands and you'll find that the hams are all talking on SSB—almost to a man.

Why buy just a piece of CB? Go single sideband with the leader and get in on all the action the band has to offer. See your Siltronix dealer today.



A Cubic Corporation Company

269 Airport Road • Oceanside, CA 92054
Telephone: (714) 757-8860

Join the SILTRONIX SIDEBANDERS—See your SILTRONIX dealer.

CIRCLE 22 ON READER SERVICE COUPON

DX CENTRAL

(Continued from page 24)

Ethiopia and the VOA relay at Monrovia, Liberia, and Brazil, Argentina and Uruguay.

• 25 Meter Band (11,700-11,975 kHz)—Look for crowded band conditions on "25" as we move into the DX season. There will be strong reception of the nearer stations, those in our hemisphere such as Mexico and Cuba, during daylight hours. Longer range reception is likely during the early part of the morning and again in the late afternoon. The band may hold up into the early evening hours as well. European,

Asian and African signals should be heard without difficulty, plus some South American, notably Brazil.

• 31 Meter Band (9,500-9,775 kHz)—During the fall and early winter evening hours, expect to find conditions crowded here too. It will be alive with the major European stations which will be beaming programs, often in English, to North America during our prime listening hours. Another time to try is for an hour or so after the sun rises. Shorter distances will be possible even later in the morning when you may find some Mexicans and, perhaps, a rarer Nicaraguan. Don't expect too much in the way of DX during the very late

night and post-midnight period.

• 41 Meter Band (7,100-7,300 kHz)—You can expect some interference from the amateur radio operators who share part of this band in our hemisphere. Begin tuning several hours before the sun goes down and into the night. Lately this has been a favorite hangout of a number of Radio Moscow's English-language North American Service outlets. Often it is a good spot to find Czechoslovakia and several other European stations. For a period after dawn, look westward for DX. Pakistan and Indonesia are two good possibilities.

• 49 Meter Band (5,950-6,200 kHz)—During daylight, you won't hear much more than a Canadian station or two. As we move into fall and winter, the band will come alive after dark and should be active until the sun rises. In addition to a good selection of Latin Americans audible, some international broadcasters will also be heard. It will be a crowded band and, as a result, you'll find considerable interference among stations.

• 60, 75, 90 and 120 Meter Bands (The Tropical Bands)—These are the frequencies combed by experienced DXers in search of really interesting and sometimes very tough SW catches. The frequencies are 4,770-5,060 kHz (60), 3,800-4,000 kHz (75), 3,200-3,400 kHz (90), and 2,300-2,500 (120). On really good days, 60 can open up several hours before sunset and remain excellent until a short time after dawn. Check the "Tropicals" on a late fall afternoon. Watch the first Africans begin to fade in on the 60 meters, then, a short time later, the Latin Americans. Move down the dial and watch the same fade-in pattern begin to develop on 90 meters a bit later. About dawn, the Asians will be observed to fade in, then rapidly drop out as daylight arrives. On 75 and 120 meters there are fewer active stations, but among them are some top notch DX items. Hardcore DX fans will give special attention to the Indonesian and Papua New Guinea regional outlets in the early fall morning hours. In the heart of winter watch for the subcontinental stations, the regional and local outlets in India and Pakistan.

So there you have a picture of what to look for in the way of band conditions on the shortwave frequencies during the coming months.

Bits and Pieces. It is possible to combine two interesting hobbies, SWling and stamp collecting. And for those of you who do, you may be interested in a new illustrated checklist of postage stamps depicting radio station or electronic topics. The list, called "DX-Filatel", lists some 100 different stamps from 48 countries. Using the list you can purchase from your favorite stamp dealer those which you want for your collection. The list will be airmailed to you for two International Reply Coupons (IRCs, costing 26 cents each and available at your post office) by Christer Brunstrom, Fjallgatan 23, S-91200 Vilhelmina, Sweden.

(Continued on page 28)

Checklist of Books for the Libraries of Technicians, Hobbyists & Students

BRAND-NEW BOOKS...JUST PUBLISHED

- Practical CB Radio Troubleshooting & Repair 210 p. \$5.95
- I/II Digital & Linear IC Projects. 210 p. \$7.95
- Computer Programming Handbook 518 p. \$8.95
- Step-By-Step Guide: Carburetor Tuneup & Overhaul. \$4.95
- Handbook of Practical Boat Repairs. 224 p. \$4.95
- Small-Screen TV Servicing Manual. 240 p. \$6.95
- Hang Gliding Handbook/Fly Like a Bird. 208 p. \$5.95
- 2nd Class FCC Encyclopedia. 602 p. \$7.95
- International Transistor Selector. 140 p. \$4.95
- Radio Astronomy for the Amateur. 252 p. \$8.95
- Radio Control for Models. 350 p. \$6.95
- Electronic Experimenter's Gdbk. 182 p. \$7.95
- Gde. to Outboard Motor Service/Repair. 96 p. \$6.95
- Integrated Circuits Guidebook. 196 p. \$4.95
- Complete Hdbk. of Lawnmower Repair. 434 p. \$7.95
- Color TV Case Histories Illus. 238 p. \$7.95
- Advanced Applications/Pocket Calculators. 308 p. \$5.95
- Jack Darr's Service Clinic No. 3. 252 p. \$4.95
- Complete Hdbk. of Home Painting. 210 p. \$6.95
- Crafts for Kids. 182 p. \$3.95
- Transistor Theory for Tech/Engineers. 224 p. \$5.95
- How to Train a Watch Dog. 224 p. \$5.95
- 4-Channel Stereo/Source to Sound-2nd Ed. 254 p. \$4.95
- Auto Electronics Simplified. 256 p. \$5.95
- The Complete Auto Electric Handbook. 210 p. \$3.95
- The Home Appliance Clinic. 196 p. \$6.95
- Amat. Filmmaker's Hdbk. of Sound Sync. Scoring. \$6.95
- Complete FM 2-Way Radio Handbook. 204 p. \$11.95
- Directional Broadcast Antennas. 210 p. \$5.95
- Practical MATV/CCTV Sys. Design & Serv. 252 p. \$5.95
- Basic Digital Electronics. 210 p. \$7.95

AUDIO, HI-FI & TAPE RECORDERS

- Electronic Music Production. 156 p. \$4.95
- Servicing Cassette & Cartridge Tape Players. 294 p. \$6.95
- Cassette Tape Recorders—Work/Care/Repair 204 p. \$4.95
- Questions & Answers on Hi-Fi. 204 p. \$5.95
- FM Stereo/Quad Receiver Servicing Manual. 192 p. \$4.95
- Stereo/Quad Hi-Fi Principles & Projects. 192 p. \$4.95
- Acoustic Techniques for Home & Studio. 224 p. \$4.95
- Selecting & Improving Your Hi-Fi System. 224 p. \$4.95
- Basic Audio Systems. 240 p. \$3.95
- Pictorial Guide to Tape Recorder Repairs. 256 p. \$4.95
- How to Repair Musical Instrument Amplifiers. 288 p. \$5.95
- How to Build Solid-State Audio Circuits. 320 p. \$5.95
- Hi-Fi for the Enthusiast. 176 p. \$3.95
- Electronic Musical Instruments. 92 p. \$2.95
- Servicing Modern Hi-Fi Systems. 248 p. \$4.95
- Handbook of Magnetic Recording. 224 p. over 90 ill. \$4.95
- Installing & Servicing Home Audio Systems. \$5.95
- Tape Recording for Fun & Profit. 224 p. over 200 ill. \$5.95
- Audio Systems Handbook. 192 p. \$4.95
- Servicing Electronic Organs. 196 p. 8 1/2 x 11" \$7.95
- Japanese Radio Receiver Control Serv. Manual. \$5.95

AUTO ENGINE & APPLIANCE REPAIR

- Complete Hdbk. Auto Engines/Systems. 252 p. \$3.95
- Small Appliance Repair Guide—Vol. 2. 210 p. \$11.95
- Rapid Auto Tuneup & Troubleshooting. 192 p. \$7.95
- The Complete Snowmobile Repair Handbook. 350 p. \$6.95
- Auto Stereo Service & Installation. 252 p. \$5.95
- Auto Tuneup & Repair Control Systems. 210 p. \$5.95
- The Complete Mini-Bike Handbook. 309 p. \$4.95
- Everyman's Guide to Auto Maintenance. 192 p. \$8.95
- How to Repair Small Gasoline Engines. 288 p. \$5.95
- Using Electronic Testers for Auto Tune-Up. \$4.95
- Major Appliance Repair Guide. 288 p. \$5.95
- How to Repair Home/Air Conditioners. 208 p. \$4.95
- Small Appliance Repair Guide. 224 p. over 100 ill. \$4.95
- Refrigeration. 131 p. \$3.95

RADIO & TV SERVICING

- Pinpoint Transistor Troubles in 12 Minutes. 492 p. \$6.95
- Popular Tube & Transistor Substitution Guide. 256 p. \$2.95
- C.E.T. License Handbook. 276 p. \$8.95
- TV Tuner Schematic/Servicing Manual. 8 1/2 x 11" \$6.95
- How to Troubleshoot/Repair TV Equipment. \$5.95
- TV Troubleshooter's Handbook—3rd Ed. 488 p. \$4.95
- Effective Troubleshooting with EVM & Scope. 238 p. \$5.95
- Logical Color TV Troubleshooting. 240 p. \$5.95
- Color TV Trouble Fact Book—2nd Ed. 348 p. \$4.95
- 10-Minute Test Techniques For PC Servicing. 216 p. \$4.95
- TV Branch Handbook. 228 p. \$7.95
- T/shooting Solid-State Wave Gen. & Shaping Cir. \$4.95
- Pict. Guide to Color TV Circuit Troubles. 256 p. \$4.95
- Installing TV & FM Antennas. 168 p. \$5.95
- Simplified TV Trouble Diagnosis. 320 p. \$2.95
- How to Interact TV Waveforms. 259 p. \$7.95
- Kwik-Fix TV Service Manual. 384 p. \$5.95
- Basic Color Television Course. 420 p. over 300 ill. \$7.95
- All-in-One TV Alignment Handbook. 304 p. \$4.95
- 199 Color TV Troubles & Solutions. 224 p. \$4.95
- Modern Radio Repair Techniques. 260 p. \$5.95
- TV Trouble Diagnosis Made Easy. 256 p. \$3.95
- Home-Call TV Repair Guide. 144 p. \$4.95
- 101 TV Troubles—From Symptom to Repair. 224 p. \$4.95
- Pinpoint TV Troubles in 10 Minutes. 372 p. \$9.95

COMPUTER TECHNOLOGY

- Getting the Most Out of Your Electronic Calculator. \$4.95
- Simplified Computer Programming—The RPG Way. \$5.95
- Beginner's Guide to Computer Programming. 480 p. \$6.95
- Computer Technician's Handbook. 480 p. over 400 ill. \$8.95

- Beginner's Guide to Computer Logic. 192 p. \$4.95
- Computer Circuits & How They Work. 192 p. \$4.95
- CATV Circuit Engineering. 294 p. \$14.95
- Commercial FCC License Handbook. 444 p. \$5.95
- Amateur FM Conversion/Construction Proj. 256 p. \$5.95
- Pictorial Guide to CB Radio Installation & Repair. \$5.95
- Modern Communications Switching Systems. 276 p. \$17.95

COMMUNICATIONS, CB & HAM RADIO

- Blicl Announcer 3rd Class FCC Study Gde. 168 p. \$3.95
- How To Be A Ham—Incl. Latest FCC Rules. 192 p. \$6.95
- Complete Shortwave Listener's Handbook. 288 p. \$6.95
- Mobile Radio Handbook. 192 p. \$7.95
- Modern Radar/Theory/Operation/Maintenance. 480 p. \$7.95
- CB Radio Operator's Guide. 224 p. scores of ill. \$5.95
- Marine Electronics Handbook. 192 p. \$6.95
- 2-Meter FM Repeater Circuits Handbook. 312 p. \$6.95
- RTTY Handbook. 320 p. \$3.95
- Citizens Band Radio Service Manual. 228 p. \$5.95

—AMATEUR RADIO STUDY GUIDES—

- Novice \$5.95 General \$7.95 Advanced \$5.95
- Extra \$4.95 Incentive \$3.95

LEARN YOURSELF TO SERVICING BOOKS

- Dictionary of Electronics. 420 p. \$7.95
- Working With The Oscilloscope 104 p. \$4.95
- 99 Ways to Use Your Oscilloscope. 192 p. \$4.95
- Working With Semiconductor. 224 p. \$4.95
- How to Become a Radio Disc Jockey. 256 p. \$9.95
- Pictorial to Medical Electronics. 272 p. \$6.95
- Understanding & Using the VOM & EVM. 192 p. \$4.95
- How to Read Electronic Circuit Diagrams. 124 p. \$4.95
- Elect. Unraveled/A New Commonsense Approach. \$4.95
- Electrical Wiring/Lighting For Home/Office. \$4.95
- Basic Electricity & Beginning Electronics. 252 p. \$5.95
- Basic Electronic Test Procedures. 16 p. \$7.95
- Basic Electronics Course. 384 p. \$7.95
- Beginner's Guide to TV Repair. 176 p. \$4.95
- Electronics Self-Taught With Experiments/Projects. \$5.95
- Basic Electronics Problems Solved. 192 p. \$4.95
- How to Test Almost Everything Electronic. 160 p. \$2.95
- Basic TV Course. 224 p. \$2.95
- Basic Transistor Course. 224 p. packed with ill. \$4.95
- Basic Radio Course. 224 illustrated pages. \$4.95
- Basic Math Course for Electronics. 168 p. \$4.95
- Electronic Motor Test & Repair. 160 p. \$6.95

HOBBY PROJECTS & PLANS

- Electronics For Shutterbugs. 204 p. \$5.95
- Handbook of Semiconductor Circuits. 444 p. \$5.95
- Digital Electronics: Principles & Practice. 288 p. \$5.95
- Practical Circuit Design for the Experimenter. 196 p. \$4.95
- Practical Triac/SCR Projects For The Experimenter. \$4.95
- Model Sail & Power Boating—by Remote Control. \$4.95
- Practical Test Instruments You Can Build. 204 p. \$4.95
- Miniature Projects For Electronic Hobbyists. 168 p. \$3.95
- Experimenting With Electronic Music. 180 p. \$4.95
- Landailing/From RC Models to the Big Ones. 192 p. \$4.95
- Handbook of IC Circuit Projects. 224 p. \$3.95
- New IC FET Principles & Projects. 154 p. over 60 ill. \$3.95
- VHF Projects for Amateur & Experimenter. 224 p. \$4.95
- Model Car Racing—by Radio Control. 224 p. \$3.95
- Solid-State Projects for the Experimenter. 224 p. \$4.95
- Practical Solid-State Principles & Projects. 176 p. \$3.95
- Radio-Electronics Hobby Projects. 192 p. \$4.95
- IC Projects for Amateur & Experimenter. 192 p. \$4.95
- Transistor Projects for Hobbyists & Students. 192 p. \$4.95
- 125 One-Transistor Projects. 192 p. \$2.95
- 104 Easy Proj. for Electronics Gadgets. 160 p. \$3.95
- 64 Hobby Projects for Home & Car. 192 p. \$4.95
- 104 Simple One-Tube Projects. 192 p. \$4.95
- Electronic Hobbyist's IC Project Handbook. 154 p. \$4.95
- 104 Easy Transistor Projects You Can Build. 224 p. \$4.95
- Radio Control Manual—2nd Ed. 192 p. \$5.95

ALL-IN-ONE COLOR TV/PC/TV SCHEMATIC/SERVICING MANUALS

- Each vol. has complete service data, parts lists, full-size schematics, and all other info needed. Each 8 1/2 x 11" 196-212 pgs. Each only \$4.95 unless marked \$5.95. COLOR TV: Adm. Vol. 1 \$5.95 Vol. 2 G-E Vol. 1 \$5.95 Vol. 2 Jap. Vol. 1 Vol. 2 Vol. 3 Vol. 4 \$5.95 Vol. 5 \$5.95 Magnavox Vol. 1 Vol. 2 Vol. 3 \$5.95 Airline \$5.95 Motorola Vol. 1 Vol. 2 \$5.95 Philco \$5.95 RCA Vol. 1 \$5.95 Vol. 2 \$5.95 Vol. 3 \$5.95 Vol. 4 \$5.95 Sears \$5.95 Serv. Manual Recv. Vol. 1 Vol. 2 Svl. Vol. 1 \$5.95 Vol. 2 Toshiba \$5.95 Zenith Vol. 1 \$5.95 Vol. 2 Vol. 3 B&W TV: Adm. G-E Jap. Mag. Mot. Philco RCA Svl. Zenith

NO-RISK COUPON—MAIL ENTIRE AD

TAB BOOKS, Blue Ridge Summit, Pa. 17214
Please send me books checked above.

I enclose \$_____; send postpaid
 Please invoice on 10-day FREE trial.
 Send FREE 44 page catalog.

Name _____ Phone _____
City _____ State _____ Zip _____
Company _____
Address _____

SAVE POSTAGE by remitting with order.
Foreign add 10%; Pa. residents add 6%. EE-95

FREE!

The all-new 1976 Lafayette Radio Electronics CATALOG



The most comprehensive consumer electronics catalog available. Fully illustrated, the Lafayette catalog features: high fidelity components and accessories of every description; tape equipment, police/public service radios; car stereo; CB and communications equipment; TV/FM and communication antennas; public address; telephones accessories; test equipment; tools; musical instruments and amplifiers; electronic calculators and watches; books; security systems; and an exciting new line of parts, tubes; solid-state devices and hardware *plus* exclusive Lafayette and Criterion brand products backed by our 55 years of experience. Our modern, complete facilities assure you of continual satisfactory service.

Also see the finest in brand name products which offer outstanding features, performance and reliability at Lafayette's competitive prices.



We've got an exciting selection of stereo, quad components and compacts.



We've got everything in car stereo, plus auto test equipment and driving aids.



We're communication specialists, with a wide selection of CB and Ham gear, police and fire receivers, weather radios.



We've got the parts, tubes, hardware you need for hobby and experimenter projects of every type.

- Stores Coast to Coast
- Personalized Service and Demonstrations
- Check Your White Pages or Shop by Mail
- Use Your BankAmericard or Master Charge on Mail Orders, Too!

Lafayette

the electronics shopping center

Mail Coupon Today! 

FREE!

Lafayette

Radio Electronics, 111 Jericho Turnpike, Syosset, L.I., N.Y. 11791

Send me your FREE 1976 Catalog.

Name Apt.

Street

City State

Zip | | | | |

Send a 1976 Catalog to my friend.

Name Apt.

Street

City State

Zip | | | | |

Dept. 25095

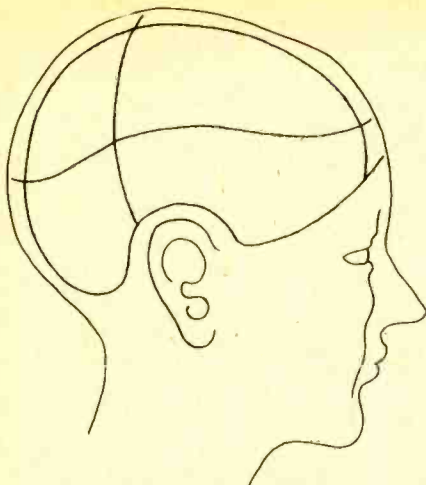

'GET INTO YOURSELF'

Discover your Alpha Brainwaves with this professional Biofeedback System.

Lowest Cost Brainwave Monitor

EICO introduces a price breakthrough in the fantastic new field of brainwave biofeedback... a completely safe, battery operated, biofeedback system that offers features and sensitivity comparable to professional models costing much more.

You Will Be Amazed At What You Hear

The BW-300 will detect your alpha brainwaves (which occur when you are totally relaxed) and produce a tone varying in frequency according to your mental state.

100% Solid State Circuitry

Reliable All Solid State IC Circuit Design features an active filter that isolates alpha brainwaves and a high-gain low-noise amplifier providing 5-microvolt sensitivity for easy alpha recognition. The BW-300 is supplied with stethoscopic earphones, electrodes headband, contact cream and instructions.

KIT 34⁹⁵
WIRED 59.95

FREE EICO CATALOG

For latest EICO Catalog on Test Instruments, Automotive and Hobby Electronics, Eicocraft Project kits, Burglar-Fire Alarm Systems and name of nearest EICO Distributor, check reader service card or send 50¢ for fast first class mail service.

EICO—283 Malta Street, Brooklyn, N.Y. 11207

Leadership in
creative electronics



CIRCLE 2 ON READER SERVICE COUPON

DX CENTRAL

(Continued from page 26)

One of North America's major SW DXing clubs, the North American Shortwave Association (NASWA) has changed its headquarters location. Inquiries about membership may be sent to NASWA, P.O. Box 13, Liberty, Indiana 47353.

If you are interested in information about the other DXing clubs which are affiliated with the Association of North American Radio Clubs (ANARC), it may be obtained for a stamped, self-addressed envelope to Executive Secretary, ANARC, 557 North Madison Avenue, Pasadena, California 91101.

Bandsweep. (Frequencies in kHz, times, GMT).

2360 Reception is tough on 120 meters, but Radio Maya de Barillas in Guatemala may be your best bet. Tune in about 1130. **3,250** If you've already heard South Africa's overseas voice, Radio RSA, tune, about 0200-0300 for the South African Broadcasting Corporation's domestic services, pop music, disc jockeys, commercials, weather forecasts and all. **4,930** Radiodifusora Casa de la Cultura is an Ecuadorian station much in evidence lately. Perhaps the best time to hear this Spanish-speaking outlet is between 0400 and approximately 0415, when it signs off. A four-chime interval signal is an identification tip-off. **6025** According to press information, the Arabian Gulf nation of Kuwait is the wealthiest in the world in terms of per capita income. A nice bit of DX is Radio Kuwait, broadcasting in Arabic, around 0500. **6,095** A number of DXers have logged Radio Sahara at El Aaiun in Spanish Sahara, on Africa's northwest coast. This one has a new 100 kilowatt transmitter and has been reported around 2200 to 2300 or later. **7,300** During the evening hours, several East European stations are audible in the 41-meter band, broadcasting in English. Radio Tirana, Albania can be heard around 0445, and on **7,345** listen for Radio Prague, Czechoslovakia around 0130. **0,370** For those looking for Asian signals in the morning, try North Korea's Radio Pyongyang with an English commentary at 1230. **9,590** A good bet for beginning SWLs is the Swiss Broadcasting Corporation's outlet at Berne. Listen around 2100 or 2200 for English programming. **11,800** Your map may show it as Ceylon but it is really Sri Lanka now. The SLBC broadcasts in English to Europe—but it can be heard in the U.S. and Canada as well—around 1930 to 2000. **15,150** ORTF, the former French broadcasting organization, is no more. It has been replaced by Radio France International. And the best time to log this one is during its English language "Paris Calling Africa" transmission at 1700 to 1800. (Credits: Ernest Behr, Ontario; Carol Patterson, GA; Robert Zilmer, WI; John Tuchscherer, WI; Bryan Dorbert, MD; Jim Meehan, CA; Keith Martin, PA; William Sparks, CA; Hadley Cress, VA; North

American SW Association, P.O. Box 13, Liberty, IN 47353).

Backtalk. A few months back, a Canadian listener wrote to good buddy Hank Scott, whose column appears elsewhere in e/e, asking about a shortwave station called "Radio Today." Since then, other readers have written also asking about the station. One of our readers, Elliot Royce, Norwalk, CT, for instance, notes that he's heard it in the 25 meter band around 0200 GMT.

Independently, two other listeners have come up with the answer, Andy Campbell, Niantic, CT, reports that "Radio Today" is not a station, but rather a transcribed program aired by Trans-World Radio on the West Indian island of Bonaire.

Similar info comes from Ronald Howard, Harrodsburg, KY, who gives the time period for "Radio Today" as 0100 to 0130 GMT. Ron adds that it is a religiously oriented program transcribed in Chicago and is presented as part of TWR's shortwave schedule. As of this writing, TWR can be heard on 11,815 kHz. Reception reports may be sent to Trans World Radio, Bonaire, Netherlands Antilles.

"I'm interested in DXing the BCB and I was wondering if these stations send out QSL cards. Please help me," writes Bruce Allen of Brooklyn Park, MN.

For those of you who aren't sure what BCB means, it's "broadcast band," in other words, your normal, everyday AM stations operating between 540 and 1600 kHz. Yes, many—but by no means all—domestic medium wave stations will verify correct reports which include sufficient program details to establish that you did hear the station. You should also send return postage.

Correct reports? You bet! It is very easy to confuse call letters, so make certain you have the right one. Sufficient program details? Absolutely! The best proof is the name of a local advertiser whose commercial you heard and the exact time you heard it. A reception report saying only, "I heard your station with music. Please QSL," proves nothing and is a real bummer!

Some widely heard stations, especially the 50 kW biggies, have printed QSL cards. A letter confirmation is more common, however.

There was a time when the Belgians were big in international broadcasting. Extensive broadcasting facilities were developed in its African colony, the Belgian Congo (now the independent country of Zaire), during World War II, when Belgium was occupied by the Nazis. After the war and until the mid-'50s, the International Goodwill Station, OTC, in Leopoldville (now Kinshasa) was one of the most popular in the world among SWLs. Later there was a brief upsurge of SWBC activity from ORU, the Belgian station in Brussels. This shortwave activity was cut back in later years. ■

Science Fair P-BOX[®] Kits have helped launch 1000's of careers in electronics!

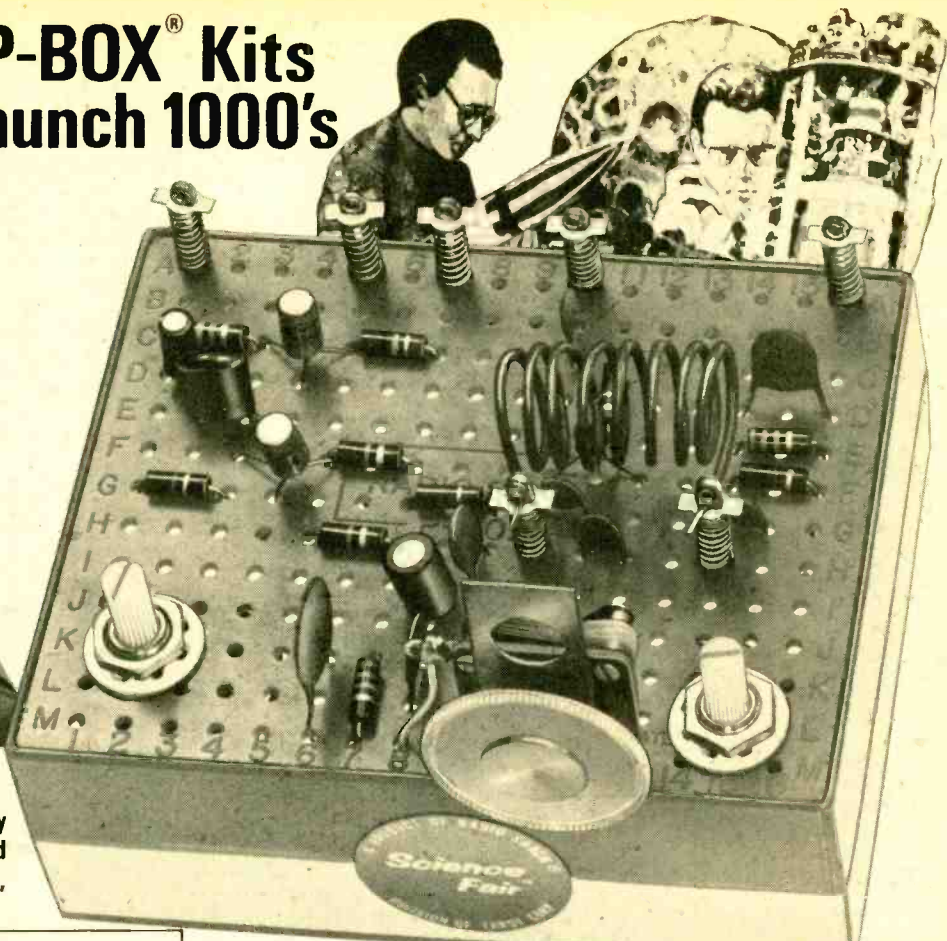

Great for youngsters . . .
Build and learn like an engineer by
"breadboarding" on a unique molded
and coded Perfboard chassis. Fun,
safe, educational!

FREE New 1976 Radio Shack Catalog

OVER 2000 PRODUCTS
EXCLUSIVES ON EVERY PAGE
BEAUTIFUL FULL COLOR

**Stereo • Quadraphonic • Phonographs
TV Antennas • Radios • Citizens Band
Kits • Recorders • Tape • Tools
Auto Tune-Up • Electronic Parts
Test Instruments • More!**



164 pages of the finest in home and hobby electronics. Respected brand names like Realistic, Micronta, Archer, Science Fair — and they're available only at Radio Shack stores and dealers nationwide! See what's really new in electronics by getting this catalog now.

**SEND FOR YOURS TODAY!
FILL OUT COUPON BELOW**

1976 Mail to Radio Shack, P. O. Box 1052, 546
Catalog Ft. Worth, Texas 76101. (Please print.)

Name _____ Apt. No. _____

Street _____

City _____

State _____ ZIP _____

Shortwave Radio Kit— a world of excitement

**ONLY
795**

Build your own worldwide radio! Tune in foreign stations, Voice of America, WWV, Amateurs, CB'ers and more on the 4.5-50 MHz band. Regenerative high-gain detector and two audio amplifier stages make it sensitive enough to pick up Moscow, London, Tokyo — almost any spot on the globe! And you can listen privately with the earphone that's included. Like every P-BOX kit, it has all parts, wire and step-by-step instructions for easy assembly. Requires one 9-volt battery. #28-110. There's only one place you can find it . . . Radio Shack!

There's a P-BOX for every interest!

Electronic Organ
Electronic Metronome
Telephone Amplifier
IC AM Radio
Voice Controlled Relay
Electronic Thermometer
Metal Locator
"Rise-Fall" Siren
Photo Night Light
Wireless AM Mike

Shortwave Radio
Transistor AM Radio
One-Tube AM Radio
2-Transistor FM Radio
Solar-Powered AM Radio
3-Way Code Oscillator
OTL Audio Amplifier
"Goofy-Lite" Flasher
Light Operated Alarm
3" Extension Speaker

Radio Shack[®]

A TANDY CORPORATION COMPANY

OVER 3800 STORES • 50 STATES • 7 COUNTRIES

Retail prices may vary at individual stores. Prices and products may vary in Canada.

CIRCLE 32 ON READER SERVICE COUPON



BOOKMARK

BY BOOKWORM

It Adds Up. After you've balanced your checkbook, totalled up your expense account, added up the groceries at the supermarket, what do you do with that pocket calculator you own? Play with it! says James T. Rogers, who, in his new book, *The Calculating Book: Fun and Games with Your Pocket Calculator*, shows you how. Want to make your calculator talk? Enter the numbers 107734 and turn the calculator upside down—hello! Your calculator knows some dates in American History even if you don't! The calculation

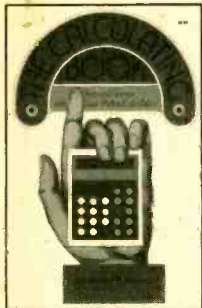

Soft Cover
80 pages \$2.95

32159 x 464 will give you these two important dates: 1492 and 1776. And 33928.75 x 12 will give you the name of a famous Civil War battle if you read it upside down—Shiloh. And there's more in *The Calculating Book*—more puns, puzzles, tricks, games and maneuvers. All have been worked out on a standard, medium-priced calculator that does not have fancy keys but does have a floating decimal fea-

ture and a chain-constant switch. However, for most of the games in this book, the lack of either of these will not matter. Published by Random House, Inc., 201 East 50th Street, New York, NY 10022.

Go Ham. Radio Shack's new publication, *From 5 Watts to 1,000 Watts* is a programmed study course designed to help the citizens band radio operator, electronics hobbyist or complete beginner learn the theory and law necessary to earn an Amateur Radio License. For those not specifically interested in amateur radio, the course can also serve as an easy way to learn basic electronics. The programmed course takes the student step-by-step through the basics of learning Morse code



Soft Cover
154 pages \$2.25

to the electronics theory and regulations needed for the novice, technician and general class ham licenses. Each step is presented in small, digestible bits followed by a checkpoint which asks for a use or practical application of the information. The student can then check his response, continuing if correct or reviewing the information if necessary. *From 5 Watts to 1,000 Watts* edited by Radio Shack's staff of ham radio operators is available exclusively from Radio Shack stores and Authorized Sales Centers nationwide.

Dial 911. "3:30 a.m. A light flashes on the TV-like screen of one of the many computer-controlled electronic displays which line the large operations room of the New York City Police Communications

Division. Someone has just dialed 911—the emergency telephone number. . . ." *Dial 911: Modern Emergency Communications Networks* by George Leon and Leo G. Sands is a concise book on the many electronic communications systems and techniques that are so vital to the efficient operation of the police forces of our cities and metropolitan areas. Though technically accurate, *Dial 911* has purposely been written in a simple, easy-to-read style, and it should make vital, intriguing reading for

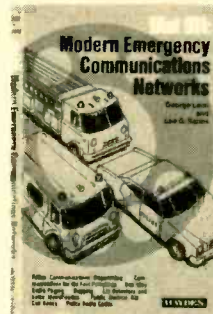

Soft Cover
128 pages \$3.95

lawman and layman alike. Included in its wide-ranging coverage are police dispatching techniques, with detailed information on the specific systems now in operation in New York City, Philadelphia, Los Angeles, and other cities; radio system technicalities (with a convenient appendix listing the various police service frequencies); foot patrolman's communications; helicopter, TV and other types of surveillance; electronic "bugging"; lie detectors and voice identification; airport detection devices; call boxes; and more. Published by Hayden Book Company, Inc., 50 Essex Street, Rochelle Park, NJ 07662.

TV Troubleshooting. This book is a teaching tool that provides both state-of-the-art television servicing information in a functional format and a source of high level motivation for students. *Television Troubleshooting* by Clyde N. Herrick assumes that the student has completed a course in radio theory and basic servicing procedures; however, no prior knowledge of television circuit action is necessary. The author has made every step clear as he leads the reader from trouble symptoms to component defects. The emphasis is on logical reasoning. General principles of

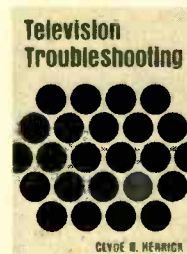

Hard Cover
230 pages \$14.95

circuit function (and malfunction) are stressed throughout. Specifics of circuit actions, exemplified by commercial design, illustrate the detailing with which practical troubleshooting procedures are concerned. Test and measurement techniques are explained and illustrated for each basic subdivision of troubleshooting methodology. Questions are presented at the end of each chapter to further understanding of the material. Published by

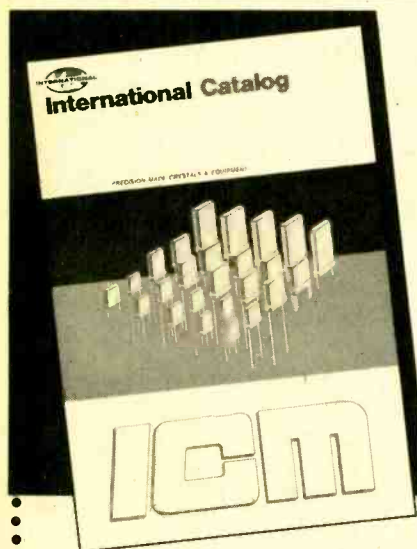

FREE INTERNATIONAL CATALOG

Your electronics buying guide for precision made radio crystals and electronic equipment.

ICM

International Crystal mfg. co., inc.
10 N. Lee, Oklahoma City, Okla. 73102

NAME _____

ADDRESS _____

CITY _____ STATE _____ ZIP _____

CIRCLE 23 ON READER SERVICE COUPON

NEW FREEDOM OF SPEECH on your phone with Radio Shack's DUOFONE electronic telephone amplifier

*Amplifies calls to
room filling volume!*



only
29⁹⁵
per set



Executives — everyone can join in conference calls

Mom — calls are no longer an interruption

Dad — talk while you enjoy your hobby

FREE New 1976 Radio Shack Catalog

OVER 2000 PRODUCTS
EXCLUSIVES ON EVERY PAGE
BEAUTIFUL FULL COLOR

Stereo • Quadraphonic • Phonographs
TV Antennas • Radios • Citizens Band
Kits • Amateur Radio • Tools
Auto Tune-Up • Batteries • Wire
Test Instruments • More!



164 pages of the finest in home and hobby electronics. Respected names like Realistic, Micronta, Archer, Science Fair — and they're available only at Radio Shack stores and dealers nationwide! See what's really new in electronics.

SEND FOR YOURS TODAY!
FILL OUT COUPON BELOW

1976 Catalog 547
Mail to Radio Shack, P. O. Box 1052,
Ft. Worth, Texas 76101. (Please print.)

Name _____ Apt. No. _____
Street _____
City _____
State _____ ZIP _____

Hands-free use — talk and listen as if the other party were in the room with you

DUOFONE® is the first low-cost amplifier system that lets you write, work, even walk around as you talk on your phone. Its ultra-sensitive microphone picks up your normal conversational voice from anywhere in the room. And its solid-state amplifier lets you hear callers as clearly as listening to a radio. Volume control, reliable battery operation, stylish molded enclosures. Our Jack-In-A-Plug makes installation instant with most phones. #43-270. There's only one place you can find it . . . Radio Shack!

Freedom of travel, too! DUOFONE automatic telephone answerer

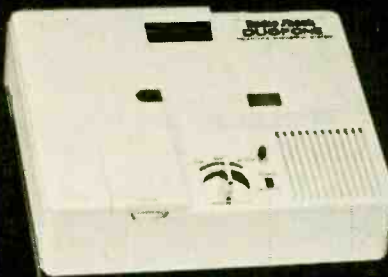

Never miss another call while you're away. DUOFONE answers up to 20 calls with a 15-second message recorded in your own voice. And it records each caller's reply. Change your message anytime using the built-in recorder. With batteries, adapter for hookup to most standard private line phones with-outwiring. #43-250. **79⁹⁵**

Customer-owned equipment directly connected to telephone company equipment is subject to extra charges.



Master Charge or
BankAmericard at
participating stores

Radio Shack®

A TANDY CORPORATION COMPANY

3800 STORES • 50 STATES • 7 COUNTRIES

Retail prices may vary at individual stores.

Products and Prices May Vary in Canada.

CIRCLE 32 ON READER SERVICE COUPON



THE SHOPPING CENTER FOR ELECTRONICS

(our catalog index of Mfrs.) extends from ADC to XCELITE

• HOBBYISTS . . . EXPERIMENTERS . . . SERVICE TECHNICIANS . . . ENGINEERS

Your Satisfaction is Our Target!

Top Name Brands

Low Prices



AMPLE STOCKS—Including those hard-to-find Parts whether you want a 15c capacitor, a \$50. FET-VOM, or a \$450. stereo system—you can get it at EDI.



Transistors, ICs, Modules, Speakers, Stereo, HI-FI, Photo Cells and thousands of other Electronic Parts . . .

Send for your FREE Catalog Today! (updated 5 times a year)

RUSH FREE CATALOG

ELECTRONIC DISTRIBUTORS INC.
Dept. TA-2, 4900 Elston
Chicago, IL 60630

name

street

city

state

zip

CIRCLE 8 ON READER SERVICE COUPON

FIND BURIED TREASURE

Powerful electronic detector finds buried gold, silver coins, etc. Write or call for free catalog. Dealer inquiries invited.



Financing Available

Phone day - night (713) 682-2728

RELCO, Dept. DD-28

BOX 10839, HOUSTON, TEX. 77018

"LISTEN IN" TO POLICE FIRE RADIO CALLS IN YOUR CAR

Works with Any Car—Portable or Home Radio! Just Plug in. No wiring. 3 minute hookup. Switches instantly from regular radio to All Police - Fire - Emergency - Taxi - State - Gov't 2 way radio calls! Works Everywhere - Anytime! Dual Band 36-49 & 150-175 MHz.

SEND ONLY \$2.00 (cash, Ck. M.O.) and pay postman \$12.99 COD postage or send \$14.99 for PPD Del in USA. Complete with Special Antenna and Plug in for use with Any Home or Portable Radio! Full instructions! 1 year Service Warranty. 10 Day Money Back Trial - Sold Only Direct from Factory. WESTERN RADIO, Dept. BE-9 KEARNEY, NEB. 68847



Reston Publishing Co., Inc., P.O. Box 547, Reston, VA 22090.

REACT's New Era. REACT national headquarters has been reorganized into a new independent non-profit public service organization known as REACT International, Inc. An informative brochure describes the new structure of REACT. It points out that as a totally independent



beginning an exciting new era of Growth and Service with... REACT International, Inc.

an independent non profit public service organization.

REACT is the representative of electronic amateur service technicians. These technicians are the backbone of the hobby. They are the ones who build and maintain the equipment that makes the hobby possible. They are the ones who provide the technical support and advice that is so essential to the hobby.

REACT is a national organization of electronic amateur service technicians. It is a non-profit organization that is dedicated to the promotion and support of the hobby. It is a organization that is committed to the service of its members and the hobby as a whole.

REACT is a national organization of electronic amateur service technicians. It is a non-profit organization that is dedicated to the promotion and support of the hobby. It is a organization that is committed to the service of its members and the hobby as a whole.

REACT is a national organization of electronic amateur service technicians. It is a non-profit organization that is dedicated to the promotion and support of the hobby. It is a organization that is committed to the service of its members and the hobby as a whole.

REACT is a national organization of electronic amateur service technicians. It is a non-profit organization that is dedicated to the promotion and support of the hobby. It is a organization that is committed to the service of its members and the hobby as a whole.

REACT is a national organization of electronic amateur service technicians. It is a non-profit organization that is dedicated to the promotion and support of the hobby. It is a organization that is committed to the service of its members and the hobby as a whole.

REACT is a national organization of electronic amateur service technicians. It is a non-profit organization that is dedicated to the promotion and support of the hobby. It is a organization that is committed to the service of its members and the hobby as a whole.

REACT is a national organization of electronic amateur service technicians. It is a non-profit organization that is dedicated to the promotion and support of the hobby. It is a organization that is committed to the service of its members and the hobby as a whole.

REACT is a national organization of electronic amateur service technicians. It is a non-profit organization that is dedicated to the promotion and support of the hobby. It is a organization that is committed to the service of its members and the hobby as a whole.

REACT is a national organization of electronic amateur service technicians. It is a non-profit organization that is dedicated to the promotion and support of the hobby. It is a organization that is committed to the service of its members and the hobby as a whole.

REACT is a national organization of electronic amateur service technicians. It is a non-profit organization that is dedicated to the promotion and support of the hobby. It is a organization that is committed to the service of its members and the hobby as a whole.

REACT is a national organization of electronic amateur service technicians. It is a non-profit organization that is dedicated to the promotion and support of the hobby. It is a organization that is committed to the service of its members and the hobby as a whole.

REACT is a national organization of electronic amateur service technicians. It is a non-profit organization that is dedicated to the promotion and support of the hobby. It is a organization that is committed to the service of its members and the hobby as a whole.

REACT is a national organization of electronic amateur service technicians. It is a non-profit organization that is dedicated to the promotion and support of the hobby. It is a organization that is committed to the service of its members and the hobby as a whole.

REACT is a national organization of electronic amateur service technicians. It is a non-profit organization that is dedicated to the promotion and support of the hobby. It is a organization that is committed to the service of its members and the hobby as a whole.

REACT is a national organization of electronic amateur service technicians. It is a non-profit organization that is dedicated to the promotion and support of the hobby. It is a organization that is committed to the service of its members and the hobby as a whole.

REACT is a national organization of electronic amateur service technicians. It is a non-profit organization that is dedicated to the promotion and support of the hobby. It is a organization that is committed to the service of its members and the hobby as a whole.

REACT is a national organization of electronic amateur service technicians. It is a non-profit organization that is dedicated to the promotion and support of the hobby. It is a organization that is committed to the service of its members and the hobby as a whole.

REACT is a national organization of electronic amateur service technicians. It is a non-profit organization that is dedicated to the promotion and support of the hobby. It is a organization that is committed to the service of its members and the hobby as a whole.

REACT is a national organization of electronic amateur service technicians. It is a non-profit organization that is dedicated to the promotion and support of the hobby. It is a organization that is committed to the service of its members and the hobby as a whole.

REACT is a national organization of electronic amateur service technicians. It is a non-profit organization that is dedicated to the promotion and support of the hobby. It is a organization that is committed to the service of its members and the hobby as a whole.

REACT is a national organization of electronic amateur service technicians. It is a non-profit organization that is dedicated to the promotion and support of the hobby. It is a organization that is committed to the service of its members and the hobby as a whole.

REACT is a national organization of electronic amateur service technicians. It is a non-profit organization that is dedicated to the promotion and support of the hobby. It is a organization that is committed to the service of its members and the hobby as a whole.

REACT is a national organization of electronic amateur service technicians. It is a non-profit organization that is dedicated to the promotion and support of the hobby. It is a organization that is committed to the service of its members and the hobby as a whole.

REACT is a national organization of electronic amateur service technicians. It is a non-profit organization that is dedicated to the promotion and support of the hobby. It is a organization that is committed to the service of its members and the hobby as a whole.

REACT is a national organization of electronic amateur service technicians. It is a non-profit organization that is dedicated to the promotion and support of the hobby. It is a organization that is committed to the service of its members and the hobby as a whole.

REACT is a national organization of electronic amateur service technicians. It is a non-profit organization that is dedicated to the promotion and support of the hobby. It is a organization that is committed to the service of its members and the hobby as a whole.

REACT is a national organization of electronic amateur service technicians. It is a non-profit organization that is dedicated to the promotion and support of the hobby. It is a organization that is committed to the service of its members and the hobby as a whole.

REACT is a national organization of electronic amateur service technicians. It is a non-profit organization that is dedicated to the promotion and support of the hobby. It is a organization that is committed to the service of its members and the hobby as a whole.

REACT is a national organization of electronic amateur service technicians. It is a non-profit organization that is dedicated to the promotion and support of the hobby. It is a organization that is committed to the service of its members and the hobby as a whole.

REACT is a national organization of electronic amateur service technicians. It is a non-profit organization that is dedicated to the promotion and support of the hobby. It is a organization that is committed to the service of its members and the hobby as a whole.

REACT is a national organization of electronic amateur service technicians. It is a non-profit organization that is dedicated to the promotion and support of the hobby. It is a organization that is committed to the service of its members and the hobby as a whole.

REACT is a national organization of electronic amateur service technicians. It is a non-profit organization that is dedicated to the promotion and support of the hobby. It is a organization that is committed to the service of its members and the hobby as a whole.

REACT is a national organization of electronic amateur service technicians. It is a non-profit organization that is dedicated to the promotion and support of the hobby. It is a organization that is committed to the service of its members and the hobby as a whole.

REACT is a national organization of electronic amateur service technicians. It is a non-profit organization that is dedicated to the promotion and support of the hobby. It is a organization that is committed to the service of its members and the hobby as a whole.

REACT is a national organization of electronic amateur service technicians. It is a non-profit organization that is dedicated to the promotion and support of the hobby. It is a organization that is committed to the service of its members and the hobby as a whole.

non-profit organization, REACT is receiving recognition and support from many new sources as well as a new grant from General Motors, the most recent commercial sponsor of the organization. You can get your copy by writing directly to Mr. Henry B. Kreer, National Director, REACT International, Inc., 111 East Wacker Drive, Chicago, IL 60601.

For the Builder. A new updated edition of the *RCA Solid State Hobby Circuits* manual, HM-92, presents 68 practical and useful solid-state circuits plus substantial operation and construction information for experimenters, hobbyists, radio amateurs, educators, students, and others interested in solid-state devices and circuits. This book features separate chapter devoted to

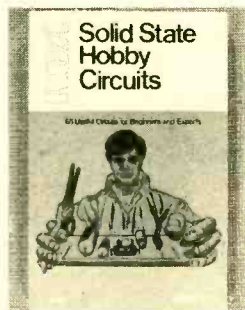

Soft Cover
399 pages \$2.95

each of the hobbyist's major areas of interest. The operation of each circuit is described in detail, with photographs, schematic diagrams, parts lists, and construction layouts given. For most of the circuits, full-size drilling or printed-circuit templates are provided to simplify construction of the circuit boards. The manual includes a chapter on construction practices which describes how to fabricate printed circuit boards, how to wire, how to solder, how to heat sink, how to ground properly, and many other considerations vital to the proper construction of circuits in the home to assure their successful operation. A chapter on trouble-shooting is also included for those who skipped the chapter on construction. Circuits in the

Hobby Circuits Manual include power supplies (fixed, variable, series, shunt), a shift register, counting circuits, a large-scale lamp display, a twenty-four-hour clock, stop clock, audio and code-practice oscillator, 30-watt audio amplifier, four-channel stereo preamplifier, 100-kHz crystal oscillator, and many more. Copies of HM-92 may be purchased from RCA parts distributors or by sending checks or money orders to RCA Solid State Division, Box 3200, Somerville, NJ 08876.

Ticket to SWL DX. For those persons searching for an extremely exciting and interesting hobby, *The Complete Shortwave Listener's Handbook* by Hank Bennett will introduce them to the ranks of the short-wave listeners. It is very easy to read and understand—even for those who know nothing about electronics or the art of tuning in DX (distant stations). Shortwave listening (SWL) is probably the world's most popular hobby—a hobby in which the action is here and now, and a hobby where something is happening every minute of every day. This book is designed to acquaint the reader with the basics of the SWL hobby. It covers receivers, antennas, frequencies, radio-wave propagation, harmonics, Q codes, where to tune for various type stations, how to keep a logbook, and how to prepare and send reception reports. It contains a thorough guide to stations of the world by general continental area and frequency. Even the practicing SWL will discover elusive new signals

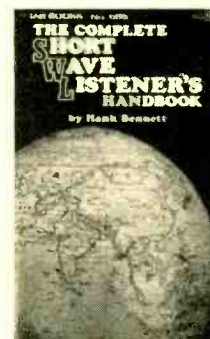

Soft Cover
288 pages \$6.95

to pursue, signals transmitted from virtually every country in the world. Individual chapters are also devoted to other SWL pastimes: amateur radio, citizens band radio FM DXing, TV DXing, utility station (maritime, aeronautical, etc.), and time and standard frequency stations around the world. The reader will learn about the fraternal aspects of the hobby—the clubs and associations in existence and how to participate in such activity—and he or she will learn how to acquire an SWL "call-sign" and earn DX awards. The appendices offer much information quite valuable to the SWL: a list of FAA stations offering continuous weather broadcasts on the longwave band, a worldwide time chart, commonly used amateur and SWL abbreviations, language abbreviations, signal reports, Morse code, Q signals, the official NNRC-WDX country list, and call sign allocations of the world. Published by Tab, Blue Ridge Summit, PA 17214. ■

Improve your gas mileage...

"After an hour or so of driving . . . we noted that the engine was acting the way it did two years and 20,000 miles ago . . . a definite improvement in performance. Acceleration, specifically was much improved." Popular Electronics, May '73

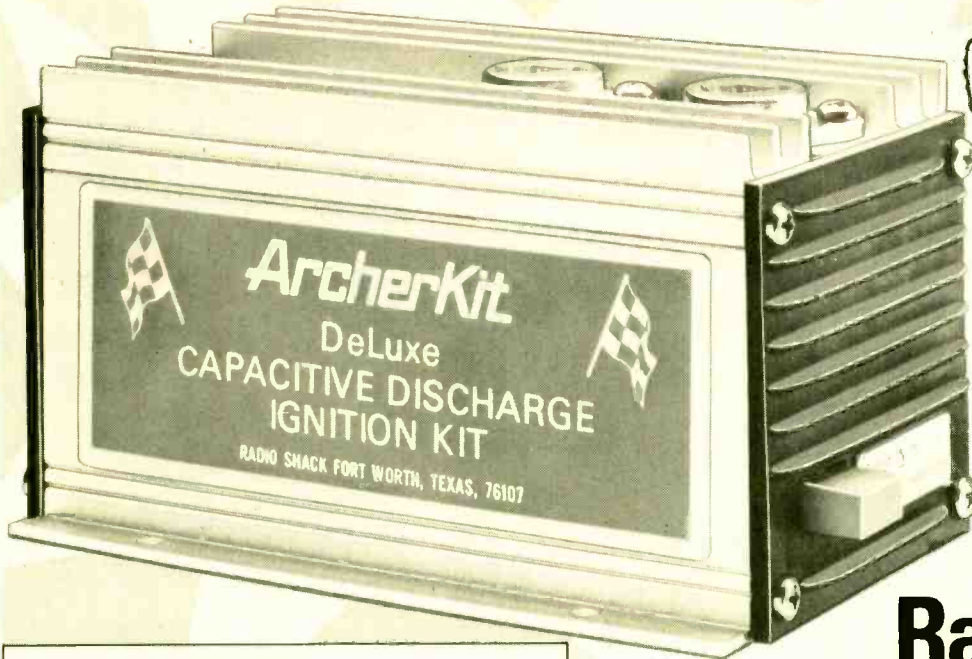
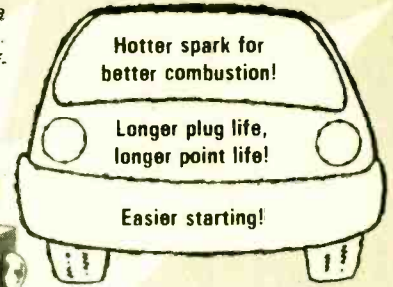

with this ArcherKit from Radio Shack!

FREE New 1976 Radio Shack Catalog

OVER 2000 PRODUCTS
EXCLUSIVES ON EVERY PAGE
BEAUTIFUL FULL COLOR

Stereo • Quadraphonic • Phonographs
TV Antennas • Radios • Citizens Band
Kits • Recorders • Tape • Tools
Auto Tune-Up • Electronic Parts
Test Instruments • More!



164 pages of the finest in home and hobby electronics. Respected brand names like Realistic, Micronta, Archer, Science Fair — and they're available only at Radio Shack stores and dealers nationwide! See what's really new in electronics by getting this catalog now.

SEND FOR YOURS TODAY!
FILL OUT COUPON BELOW

1976 Mail to Radio Shack, P. O. Box 1052, 545
Catalog Ft. Worth, Texas 76101. (Please print.)

Name _____ Apt. No. _____

Street _____

City _____

State _____ ZIP

39⁹⁵ KIT

SOLID-STATE IGNITION SYSTEM KIT

Radio Shack's electronic ignition kit does just about everything the new factory installed systems do. It's the easy and inexpensive way to add 1975 performance and reliability to your car, pickup or RV. The solid-state capacitive discharge design delivers up to 50% more voltage to your spark plugs. This means you get improved combustion. In turn, this gives you easier starting, especially in cold and damp weather, plug and point life that's up to 3 times longer, and cleaner exhaust for cleaner air. And tuneups will be required less often and be less expensive. A special "in-out" switch lets you make performance comparisons with your regular ignition system, which remains intact. Easy step-by-step instructions make the ArcherKit easy to assemble even for a first-time kit builder. Easy installation, too—there's no rewiring to do in your car. Improves any vehicle with 12 VDC negative ground, 28-3203.

There's only one place you can find it . . . Radio Shack!



Master Charge or
Bank Americard at
participating stores



ArcherKit[®] at Radio Shack[®]

A TANDY CORPORATION COMPANY
OVER 3800 STORES • 50 STATES • 7 COUNTRIES

Retail prices may vary at individual stores. Prices and products may vary in Canada.

CIRCLE 32 ON READER SERVICE COUPON

Inside Loudspeakers

Although the quality of loudspeakers has been considerably improved in recent decades, their design has been hitherto more a question of intuition

and practical experience than of quantitative understanding of the behavior of loudspeaker cones, especially at the higher audio frequencies. In the Philips Research Laboratories in Eindhoven, The Netherlands, a computer "model" has been developed so that it is now possible, when designing loudspeakers, to choose the geometry and material of the cone to obtain the required frequency response.

The theoretical analysis of loudspeaker behavior has been carried out by a Philips scientist, F. J. M. Frankfort. He set up twelve simultaneous differen-

tial equations to describe this behavior, and, with the aid of a computer, solved them numerically for a large number of frequencies and for various types of loudspeaker cones. In this way it proved possible, for example, to calculate the frequency characteristics and the radiated sound power as a function of the geometry and properties of the cone material.

All the power the law allows.

Because, like all Midland CB mobiles, this new 23-channel transceiver is F.C.C. type accepted at a full 4.0 watts legal maximum transmitter output power. And high level modulation puts this power to best use, so you won't feel like you have to shout to get through.

On the receiver side, there's delta tuning to help match your receiver to the other guy's "off-center" signal. While a switchable automatic noise limiter cuts interference.

We've added an antenna warning light that flashes if there's a mismatch, or short, or failure to help you protect your rig. Of course there's a lighted signal strength/power meter and channel selector... and a separate P.A. switch to direct amplifier power to your P.A. horn.

Like most Midland mobiles, operation can be with positive or negative ground for use in car, truck or boat.

Interested? Ask your Midland dealer about Model 13-882. Or write for Midland's free brochure: P.O. Box 19032, Kansas City, Missouri 64141.

MIDLAND
INTERNATIONAL®
Communications Division

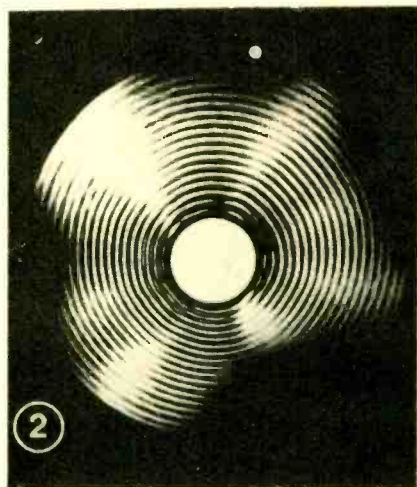
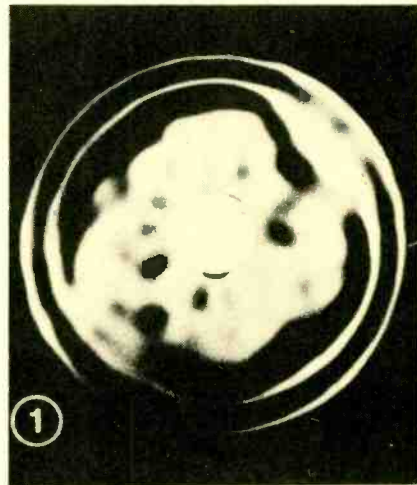

At low frequencies the cone vibrates as a rigid entity. Above a certain frequency, standing waves appear on the cone surface. These can clearly be seen in photos 1 and 2. Photo 1 is an interferogram obtained holographically of a cone driven at a frequency of 2000 Hz; at this frequency, nodes and antinodes begin to appear along the periphery of the cone. In photo 2 the drive frequency was 9000 Hz; the whole surface of the cone is now covered with patterns of nodes and antinodes, and the cone radiates little sound.

To verify the theoretical results experimentally, the mechanical vibrations of the cone were visualized holographically. In addition, the velocity of the coil, the sound pressure and the sound power levels of the loudspeaker were recorded as a function of frequency.

(Continued on page 37)

SPECIAL INTRODUCTORY OFFER!

Now get **ELEMENTARY ELECTRONICS** sent to your home for 1½ yrs. for **ONLY \$4.97!** Order Now and Save!

* * * For beginner or expert EE is valuable * * *

Written by experts—you get a practical understanding of IC circuits . . . semi-conductors . . . power supplies . . . networks . . . transistors . . . pulse circuitry, much more! Get general rules

of electronics, develop trouble-shooting techniques, know how to calculate changing effects. **TRY THIS NO-RISK SUBSCRIPTION OFFER TODAY!**

**PROJECTS
IN
EVERY
ISSUE**

•
**CB
RADIO**

•
**SHORT-
WAVE**

•
**NEW
PRODUCTS**

•
**BASIC
ELECTRONICS
COURSE**

•
**PRODUCT
LAB
TESTS**

PUBLISHER'S DISCOUNT SAVINGS CERTIFICATE



Good for up to **\$4⁷⁵** off the subscription price of **ELEMENTARY ELECTRONICS**



Enter my trial subscription for 9 issues of Elementary Electronics, for only \$4.97 (regularly by subscription \$9.72).

New Subscription

Renewal Subscription

Name _____
(please print or type clearly)

Address _____

City _____ State _____ Zip _____

SEND NO MONEY, WE'LL BILL YOU LATER

You must seal (staple, scotch tape or glue) before mailing. Dept. H5F146

FOLD HERE



BUSINESS REPLY MAIL
First Class Permit No. 790 (Sec. 34.9 P. L. & R.) New York, N.Y.

ELEMENTARY ELECTRONICS

P.O. Box 2600

Greenwich, Connecticut 06830

Dept. H5F146



Scientifically Speaking

by Jack Schmidt

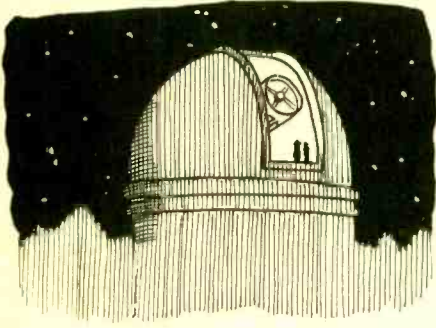

"Melvin, I'd like to use it for about a half hour to check out my horoscope."

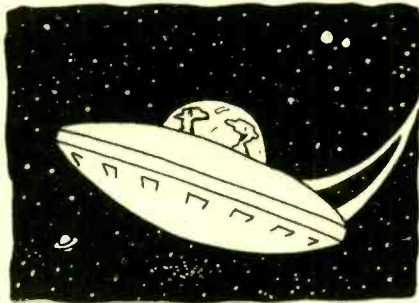

"Let's run by earth, Cosmo. . . . They haven't seen us in quite awhile!"

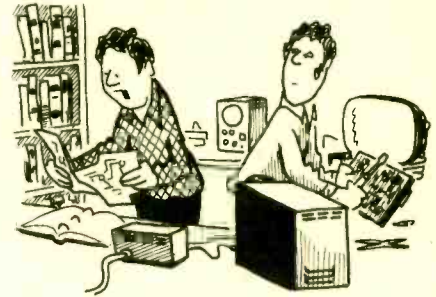

"According to the schematic, that circuit should be putting out 4 watts. . . . Give 'er a rap with the hammer!"

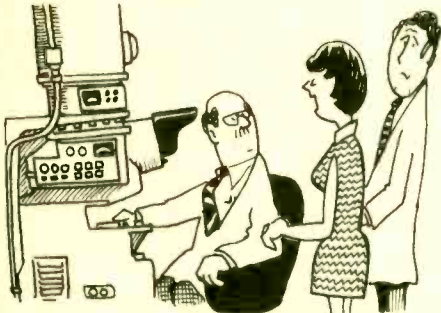

"Uncle Felix, Fred and I just got engaged! I'd like to use the electron microscope to see if I can find my diamond."

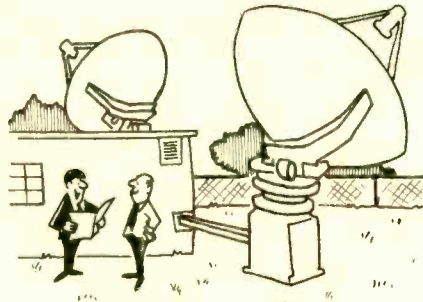

"The 'Farmer's Almanac' says that Jupiter will be at its closest point tonight!"

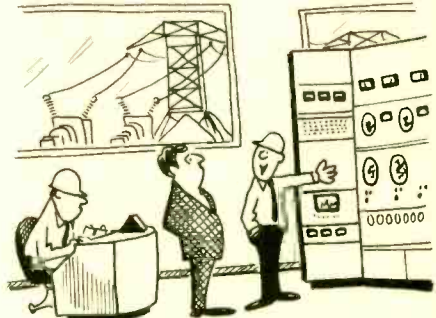

"... and these automated panels control our power output—give or take a couple o' million watts."

PACE CB 100ASA

This 6 channel CB radio is extremely versatile: • fits in glove compartment • transportable with battery pack power supply. Gives you talkability from any location. Supplied with gutter clip antenna. Portable base antenna, battery field pack and carrying case are optional. Suggested retail price \$109.95.

See your distributor today.



PACE COMMUNICATIONS, DIV. OF PATHCOM INC., 24049 S. Frampton Ave., Harbor City, CA. 90710

Available in Canada from Superior Electronics Ind. Export: 2200 Shames Dr., Westbury, N.Y. 11590 61

CIRCLE 24 ON READER SERVICE COUPON

NEWSCAN

(Continued from page 34)

The experimental data agreed well with the theoretical values. Philips' scientists concluded that the new approach will lead to further improvements both in the method of design and in the quality of loudspeakers. The results described refer to laboratory experiments; they do not necessarily imply a follow-up in production or marketing. Theoretical approach to loudspeaker design still requires the final listening test when human ears sense and rate the loudspeaker.

Blood Counts

A new experimental computer programming system may one day aid doctors in diagnosing blood disorders. Based on statistics developed in the eighteenth century, this system is currently undergoing limited field tests at two American medical schools. Known as "Heme"—an abbreviation for "hematology," the medical study of blood—the system uses data from a standard hospital examination to predict the likelihood of a patient having any one of about 40 blood disorders. It also suggests tests to confirm or rule out any given diagnosis. The system was developed by Betty J. Flehinger of IBM and Ralph L. Eagle, Jr., a physician and professor of

medicine and public health at Cornell University Medical College in collaboration with a group of other physicians.

Conceptually, HEME is envisioned as a computerized consulting service, a tool which would parallel the physician's own traditional methods of evaluating data and reaching conclusions. Physicians would be able to compare their own thinking with the computer's statistical evaluation at each stage of the diagnostic process. Moreover, HEME would indicate which of the blood diseases is the most probable and it would also provide some tests to check for it, thus serving as a prod to the doctor's memory.

In practice, HEME would be used if the routine patient "work-up" performed in a hospital seemed to indicate some blood disorder. The physician would check off those findings exhibited by the patient, such as symptoms and laboratory results, on a master list of more than 500 body signs. Utilizing this data, the system would print out a preliminary differential diagnosis, which ranks diseases in descending order of their probability, and accompanying lists of patient findings from the medical examination which would tend to both prove and disprove each diagnosis. Still an-

(Continued on page 38)



Richard B. Friedman (center), Assistant Professor of Medicine at the University of Wisconsin, analyzes a HEME "diagnosis" with several of his students.

Half-wave co-phased Thundertwins

Each 76" antenna acts like it's 18' tall!

Knights of The Road really go for the tall talk power of this bumper-mounted co-phased whip combo in gleaming fiberglass.

Shakespeare has teamed up twin center-loaded two-section whips with our exclusive Diplexer co-phasing harness to make each half-wave beauty deliver 18 foot performance. Adjustable tips let you "lock in" lowest SWR.

Move up to Shakespeare Thundertwins for the big gain. Packaged complete with dual mounts, Diplexer harness, and membership application in the Knights of The Road at no extra charge. Shakespeare Industrial Fiberglass Division, P. O. Drawer 246, Columbia, South Carolina 29202.



Style 4038

Single version
Style 4038-1

Shakespeare

THE ROYAL LINE OF FIBERGLASS ANTENNA

In Canada Len Finkler, Ltd., 25 Toro Road, Downsview, Ontario
CIRCLE 13 ON READER SERVICE COUPON

Our objective is to serve as best we can the ever broadening interest in the electronics and communications field. *Elementary Electronics* is made available nationally on all leading newsstands and in Radio Shack stores. Should, for some reason, copies of E/E not be available, or are sold out at your favorite location, we shall appreciate your letting us know by dropping a card in the mail to the Publisher, *Elementary Electronics*, 229 Park Avenue S., NY, NY 10003.

Are you,
of all people,
still opening
your garage

the
hard
way?



Anybody who's into electronics

certainly should be getting the everyday convenience and family security of automatic garage door operation... especially now, with Perma Power's great Electro Lift opener...

made to fit in the trunk of your car, designed for easy handling and simple do-it-yourself installation.

Available now at a surprisingly low price from your distributor.



P.S. Show off your opener to your friends and neighbors. You'll probably be able to pay for yours with what you make installing openers for them.

Perma Power

Chamberlain Manufacturing Corporation
Perma Power Division

5740 North Tripp Avenue, Chicago, Illinois 60646
Telephone (312) 539-7171

CIRCLE 36 ON READER SERVICE COUPON

NEWSCAN

(Continued from page 37)

other feature of HEME would permit it to suggest further tests to help confirm or rule out each diagnosis.

The doctor would then use past experience to assess the computer analysis and order additional tests. This new test data would next be fed into HEME for evaluation, and a revised list of diseases would be printed out, ranking the diseases in order of their probability, with suggested tests for confirmation. After several such cycles, a "single-most-likely" disease would emerge and the physician would finalize the diagnosis and then initiate treatment.

For all its potential, such a system would not replace the physician in diagnosing illness. No computer program in existence is capable of mimicking the human ability to recognize patterns, which is vital for making any diagnosis. Instead, it's viewed as a tool that permits the doctor to tap the huge reservoir of medical knowledge in the computer. It offers a "consulting service," the computer being the equivalent of a statistician-consultant with total recall, performing instantaneous calculations and digesting volumes of new clinical findings.

To date, HEME's track record is still inconclusive. In a recent test of the program using 31 cases of hematologic diseases selected from the medical record library of the New York Hospital, its "diagnosis" of 14 cases was rated excellent by the work group responsible for HEME. In addition, 7 cases were rated good, 1 fair, 3 poor and 6 not evaluable because the correct diagnoses were not in the system.

To improve the system a new experimental HEME program is being written which affects its "diagnosis" by sifting patient data through a three-part analysis. At the first level, the patient is categorized as falling into one group—representing a broad range of hematological diseases—based on preliminary findings. In the next stage, HEME refines its predictions, assigning to the patient specific diseases within this large group. Bayes' Theorem is employed at each of these levels to calculate the various probabilities. Finally, the system prints out selected medical data pertinent to these diseases in order that the physician may utilize them to make a final diagnosis. This new experimental program should be ready for preliminary testing in about one year.

Radar Controls Traffic

At the Mullard Research Labora-

tories, Salfords, England, a simple radar has been designed which can detect whether moving objects are advancing or receding. One of these has been applied to the control of portable traffic lights.



Taking power from a nearby street lamp or power main, the radar-controlled traffic light controls two-way traffic in one lane.

The radar is fitted to a pair of traffic lights (see photograph) and are interfaced with a control unit. They respond to traffic movement but not to irrelevant objects such as moving branches of trees. The advantage of this system over conventional timed lights is that traffic is not held at "stop" when no traffic is approaching from the other direction. At times when traffic is approaching from each direction the control unit shares the cycle time, thus ensuring a steady flow of traffic at all times.

The system is now at the pre-production stage, with actual production planned to start this year. ■

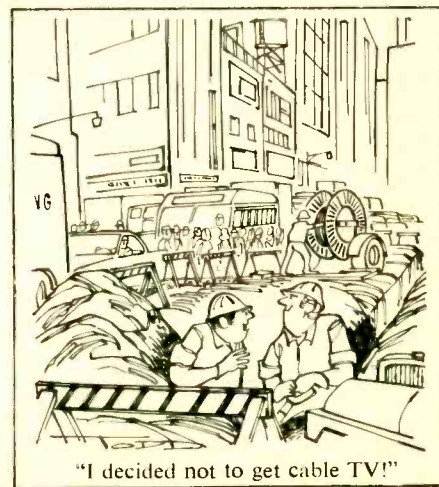

HOW TO SOLVE YOUR STORAGE PROBLEMS WITH A TOUCH OF STYLE

- #J-TA—Tape Album (holds 6)
- #J-R7—45's (holds 20)
- #J-R10—10" Records (holds 20)
- #J-R12—12" Records (holds 20)

RECORD AND TAPE CASES



Decorative, sturdy, in rich leatherette. Exclusive design on back is gold tooled on Black, Brown, or Green—sides black. Center divider separates records up to 20 in original jackets. Tape Cases hold 6 tapes in their original boxes.



DELUXE CASSETTE STORAGE CASES*
(Includes presensitive labels for titling)

#JC-60 holds 60 Cassettes. 13½" high, 12¾" deep, 5½" wide. Storage slots are tilted to keep cartridges from falling out. Outer case embossed in gold on black, brown or green.

#JC-30 holds 30 Cassettes. 5½" high, 6½" deep, 5½" wide. Same color choices.

JESSE JONES BOX CORP., Dept TH-JF75 P.O. Box 5120, Phila., Pa.19141
(POSTAGE PREPAID IN USA ONLY)

- quantity _____
- _____ #JC-30 \$11.95 ea., 3 for \$33. Black Brown Green
- _____ #JC-60 \$16.95 ea., 3 for \$48. Black Brown Green
- Check colors for the items below Black Brown Green
- _____ #J-TA—Tape Album \$5.95 each, 3 for \$17
- _____ #J-R7—45's \$5.95 each, 3 for \$17
- _____ #J-R10—10" Records \$6.50 each, 3 for \$18.50
- _____ #J-R12—12" Records \$6.50 each, 3 for \$18.50

EE S/075

I enclose check or money order in amount of \$_____

Name _____

Address _____

City _____ State _____ Zip _____



BE FOREMOST with the **HUSTLER** "DOUBLE-TALK" antenna system

Join the thousands of CB'ers who communicate longer, louder, while traveling over the miles with the Hustler "Double-Talk" mobile antenna system. Guaranteed superior performance over a single antenna installation — more uniform signal pattern because of uniquely detailed phasing design, more consistent communications with virtually no fading or blind spots when changing direction in travel.

CHOOSE FROM FOUR POPULAR VERSIONS
All are supplied ready for easy installation and operation

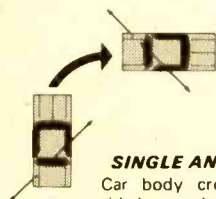

SINGLE ANTENNA
Car body creates lop-sided ground plane with directional signal pattern

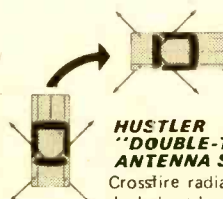

HUSTLER "DOUBLE-TALK" ANTENNA SYSTEM
Crosstire radiation with dual phased antennas results in greater coverage, reinforced signal pattern

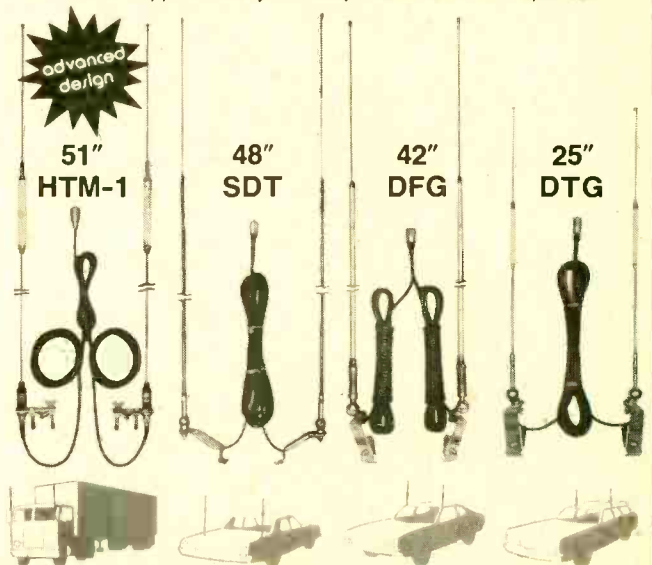

new tronics corporation

15800 commerce park drive,
brook park, ohio 44142

HUSTLER

Available from all distributors who recognize the best!

CIRCLE 9 ON READER SERVICE COUPON

Cobra 19, the mini 23 that talks like Big Brother

If you've ever heard a Cobra 21, you know it's hard to believe all that talkpower is legal. Cobra found the way to make their radios really talk—and still obey the rules.

Now you can talk just as loud and far with a smaller package.

Cobra 19 is thin and narrow enough to mount conveniently in any car—even the latest subcompacts—Cobra 19 has other features you'd expect like plug-in mike and external speaker jack.

And has it got ears! Cobra 19 has the same receiver sensitivity, selectivity, and interference rejection as its big brother, Cobra 21. It has an efficient automatic noise limiter too; you'll hear clearly in the heart of heavy traffic.

Like every Cobra radio, it's backed by warranty service stations in all fifty states even though Cobra quality assures you of minimum need for service. See Cobra 19 at your dealer. It's small on the counter and pocketbook and big on the air.



 **Cobra 19**

PRODUCT OF DYNASCAN CORPORATION • 1801 W. Belle Plaine • Chicago, Ill. 60613

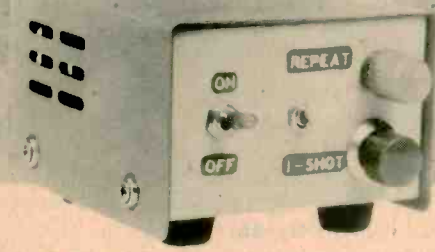

WIPER-TROL II

Mating "single sweep" windshield wiper gadgets to vehicles often turns into an installer's nightmare—no more!

by Felix Peterson

WHAT'S IN COMMON with all these vehicles (besides Middle East oil)? Wrong! It's not that they're out of gas, it's simply that until now, the very popular wiper delay function which helps keep windshields clean in a drizzle or winter slush has given many auto buffs, hobbyists and commuters a rough time.

So many different windshield wiper systems are used on so many different cars and trucks that no one wiper delay system has been right for everyone. A control system that worked in a '68 "Belchfire 8" might send its SCR or transistor up in a puff of smoke when connected to a new "Mini 4-Banger."

Yet the popularity of these add-on gadgets grows and prospers. Big names and small list wiper delay units in their catalogs and ads. There's no doubt that drivers want to build a project that gives the convenience of a single-flick automatic windshield wiper. That's why we're here, and e/e likes a challenge, so we put an author's head together with ours and came up with the ideal wiper delay project.

Why It's Best. If this system is not for your car, or if your car and you refuse to get together with a workable installation, you will know it *before* you sink valuable bucks and construction time into the project. We show you how to check your car, truck, motorhome, Henry J, or anything that has electrically operated wipers to be sure Wiper-trol II will work—*before* you build it.

Interested? Read on.

Basic Operation. In virtually all cars, turning on the wiper switch momentarily will cause the wipers to sweep once, then return to their park position. The operation of the wiper

unit described here is simply equivalent to turning the wiper switch on then off. A 555-type timer controls the opening and closing of relay contacts which are connected in such a way as to simulate turning the dashboard switch on and off. The time interval between wipes can be varied, and the unit does not interfere with normal operation of the wipers.

There are other wiper control units available, but one has to buy them before he can find out if they work on his car. Another problem with existing units is that some do not park the wipers after each sweep. Eventually the wipers can stop in the middle of the windshield. This happens when the rain lets up and there is more drag on the wipers, or when the car is stopped at a traffic light and the wiper motor slows down due to drain on the battery. In contrast, the wiper control presented here causes the blades to return to exactly their park position after each sweep.

There are two other useful features of this wiper unit. It has a button for one-shot operation of the wipers, and during installation it can be adjusted to give two sweeps for each kick of the motor instead of one.

Before You Build. The object here is to determine whether Wiper-Trol II will work on your car before you build it. Some *dpdt* switches (such as Radio Shack 275-1537) are used because they are more convenient than *spdt*. While car wiper circuits vary a great deal, most run four wires to the motor; therefore, the test described here will assume four wires. If your wiper motor has more wires, just use more switches. This will correspond to another relay in the control box. If your wiper motor and washer pump are housed together, use only the wires to the wiper motor.

e/e WIPER-TROL II

There are two ways to determine how to connect the *dpdt* test switches into your car wiper circuit. One is to have a schematic for your car which shows the inside workings of the wiper dashboard switch. The other is to determine the inside workings of the dashboard switch through a tracing procedure described later.

Let us first suppose you have a schematic. The figure shows a typical wiring arrangement (in this case, a Chrysler wiper). For low speed operation, the dash switch connects the red and brown wires to the car battery + terminal. Equally important, however, is the fact that the blue is connected to nothing for low speed, and the green is grounded. Your test switches would be connected as shown in the next figure. With the dash switch off, and the test switches at position A, the wipers should sweep. More important, however, with the test switches returned to B, the wipers should go to their park position because the dash switch is turned off. If the test works, the test switches can be replaced with the relay contacts of the control unit with confidence that the unit will work on your car.

Finding Data. Wiring diagrams that show the operation of the dash switch can sometimes be found in the car's manual. Some manuals come with the car, others can be obtained from car dealers or the library. Several books of value are listed at the end of this article. These can be found in most public libraries. The Chilton's Manual has a specific section on wiper circuits. There is detailed information in it for American Motors, Chrysler, Ford, and Gen-

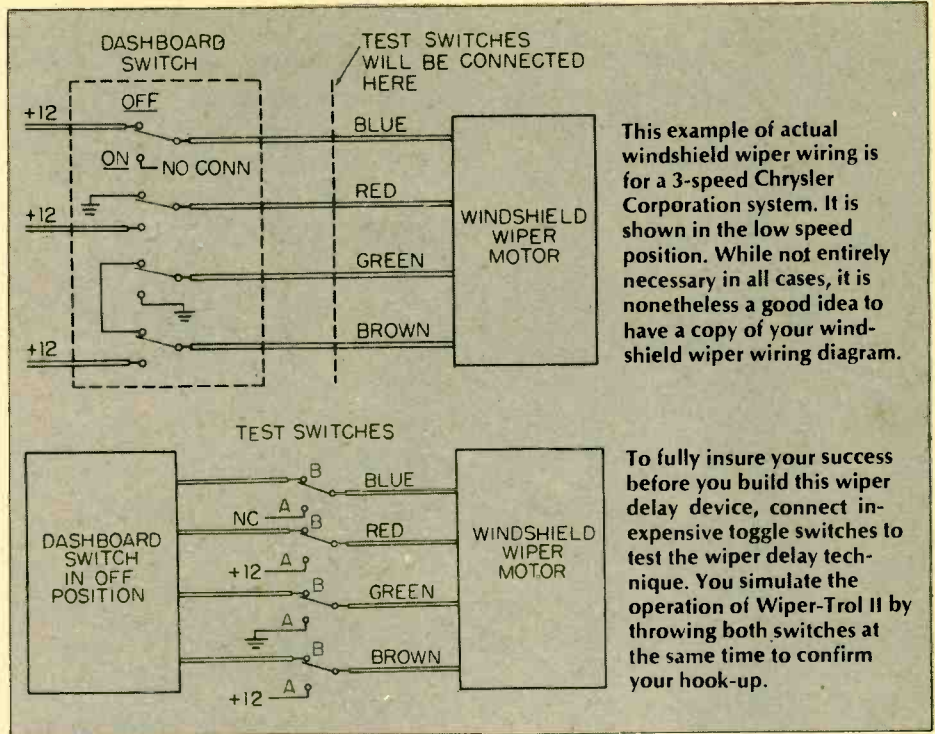

This example of actual windshield wiper wiring is for a 3-speed Chrysler Corporation system. It is shown in the low speed position. While not entirely necessary in all cases, it is nonetheless a good idea to have a copy of your windshield wiper wiring diagram.

To fully insure your success before you build this wiper delay device, connect inexpensive toggle switches to test the wiper delay technique. You simulate the operation of Wiper-Trol II by throwing both switches at the same time to confirm your hook-up.

eral Motors wiper circuits and switches. The Volvo manual also shows switch details. The National books do not contain switch details, but have numerous wiring diagrams which can be quite useful.

If a diagram for your dash switch can not be found, a tracing scheme shown in the figure may be used to find out how to connect the test switches. The + battery lead is disconnected (for positive ground cars, disconnect the negative lead) and the ignition switch and wiper dash switch are both turned on. The wires to the motor are disconnected at the motor. Generally, there is a connector at the motor that can just be unplugged. Now sketch a table like that shown, with the first column

containing the color of each of the wires, and the second column blank. The object now is to find what each wire coming from the switch side (denoted "S") is connected to, and write the data in the second column of the table. One ohmmeter lead is connected to an "S" wire, the other is connected to the + battery lead, then to the chassis, then to each of the other "S" wires. In this way, for example, one finds that the brown "S" wire is connected to the + battery lead, and the green "S" wire is connected to nothing. To conduct this test, one should have an ohmmeter that can distinguish between a direct connection, and a connection through a resistance of about five ohms. Some dash switches have resistors between

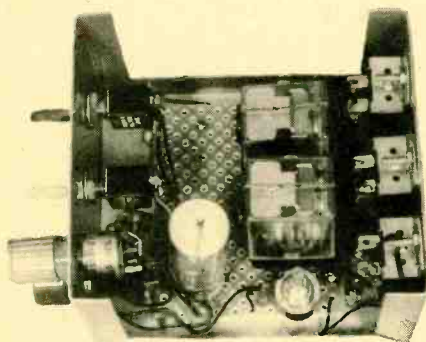

Relay coils are wired in parallel to operate in unison since more contact pairs are required than are conveniently available in an easy-to-find relay. One coil draws 50 mA.

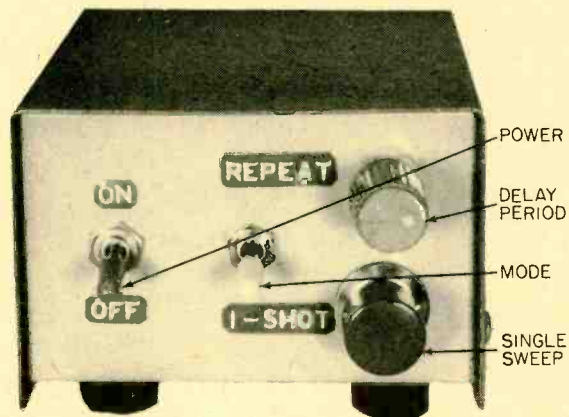

Perhaps the most interesting and clever feature of the Wiper-Trol II is the single sweep (1-shot) mode. Should you accidentally fail to turn the power off, the wiper will single-sweep 10 minutes after the last push of the button to improve your mind.

their terminals, and can make it appear at first glance that one "S" wire is connected to two different points, when there may actually be a resistor between the "S" wire and one of the points.

After the table is filled-in, the test switches can be tried, also as illustrated in the figure. Once the switches have been connected, the car battery is re-connected and the ignition switch is placed in the on position, but the car engine should not be running. If placing the switches in the A position sweeps the wipers, and placing them in the B position causes the wipers to park, the control unit will work when the test switches are replaced with the relay contacts.

Other Hints. For those cars with relays built into the wiper circuitry, as on some GM cars, the wiper control unit can still work well, but the test procedure described above is best performed with a car wiring diagram in hand so that you are sure to trace connections *through the dash switch* and not through the car relay. Again, a GM or Chilton Manual can be very useful here. Also, remember that an improper trace may cause some sparks to fly when the test switches are closed—so be prepared to open them quickly. A 3 amp fuse in the power lead to the relay contacts should prevent damage. The test switches should be operated simultaneously, and all leads to them should be double-checked before the experiment is tried. If the test switches do not operate the wipers, check the switches themselves, check your wiring and tracing, and, finally, try getting a description of the dashboard switch from the library, a bookstore, or car service center. This may be the challenging do-it-yourself part.

As can be seen from the schematic, it requires only one IC and a handful of other components. The final assembly fits on a 3 x 3-in. perf board, and inside a small (3 x 2 x 4-in.) cabinet. Power to the IC should come through the ignition switch and S1, which is on the front of the control box. Switch S2 allows the unit to operate in a repeat mode, or a one-shot only mode. In the one-shot mode, the wipers can be kicked at will with a touch of pushbutton S3. With S2 in the one-shot position, R1 causes the wipers to sweep once every ten minutes as a reminder that power is on. In the repeat mode, the wipers are kicked by relays K1 and K2 at intervals determined by R3 which is mounted on the front panel of the control box. The repeat mode allows one-shot operation as well.

Set-Up. Resistor R5 is important be-

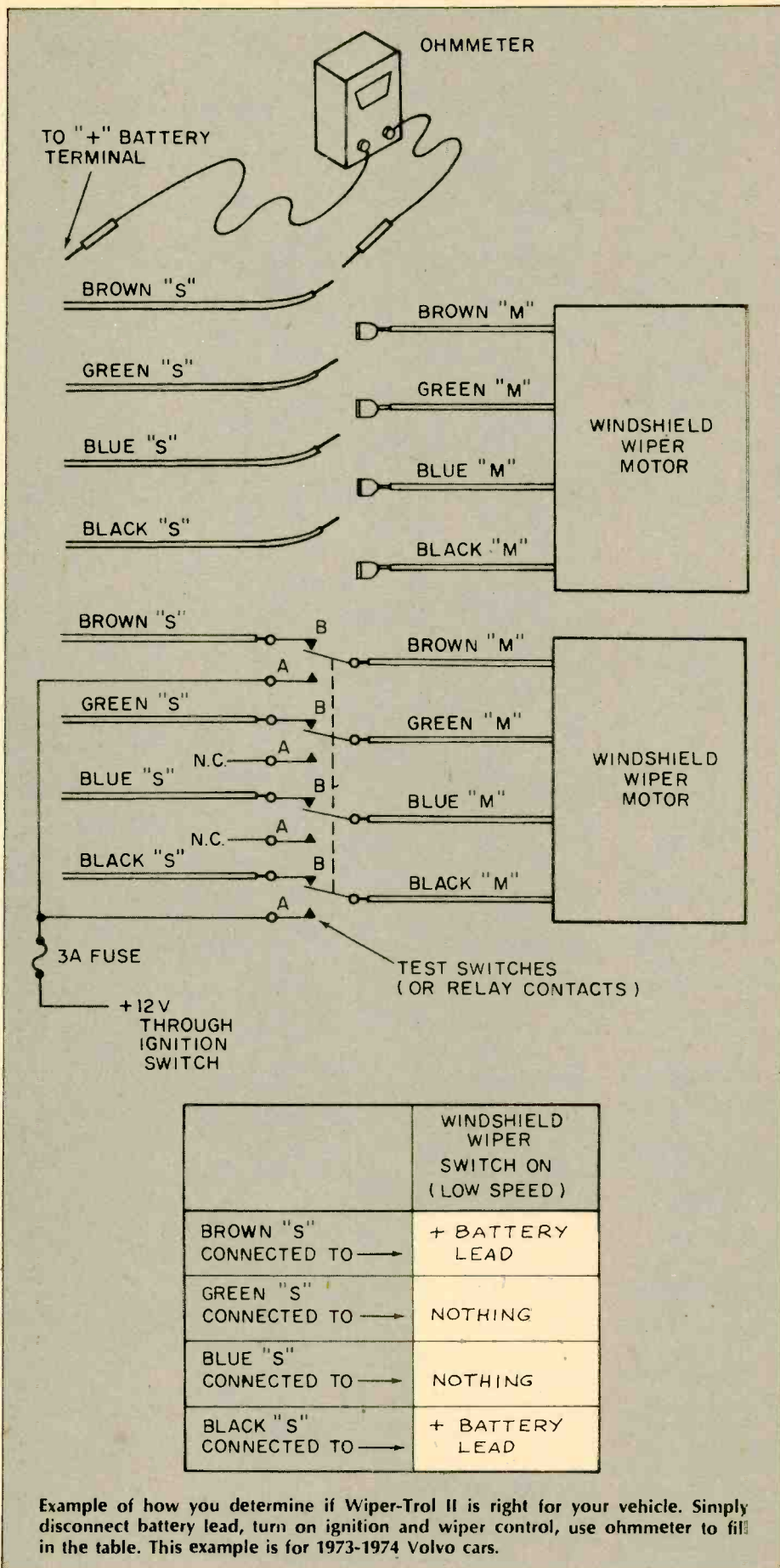

e/e WIPER-TROL II

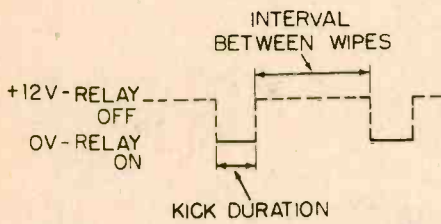

For the math-minded, relay-on "kick duration" time equals $0.7(R_4 + R_5)C_1$ and is 1.3 to 4.8 seconds in duration. Interval between "kicks" is equal to $0.7(R_2 + R_3 + R_4 + R_5)C_1$ and varies with R_3 from three seconds to fifty seconds. Waveform is output of 555-timer Pin 3.

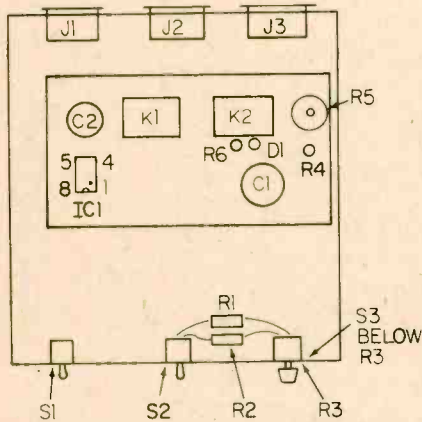

Typical layout of parts on perf board.

cause it allows you to adjust the duration of kick that is best suited to your car, but it is located inside the control box because the adjustment need be made only once. The figure shows that the kick duration is adjustable from 1.3 to 4.8 seconds, and the interval between "sweeps" is adjustable from 3 seconds to 50 seconds. Adjusting the kick duration to be a bit long (around 4-5 seconds) will cause the wiper to sweep twice before parking, thereby drying the windshield just a little bit better.

Relays K1 and K2 have *dpdt* contacts, but a *4pdt* relay may be used instead. The contacts must be of the break-before-make type, and should be rated for at least 3 amps, as should the wires connecting them to the wiper motor. Chassis connectors (female) are convenient for handling wires from the

References

- Chilton's Auto Repair Manual, 1974, Chilton Book Co., Radnor, PA
- Volvo Service and Repair Handbook, Clymer Publications, Los Angeles, CA
- National Service Data, 1974, Mitchell Manuals, Inc., San Diego, CA

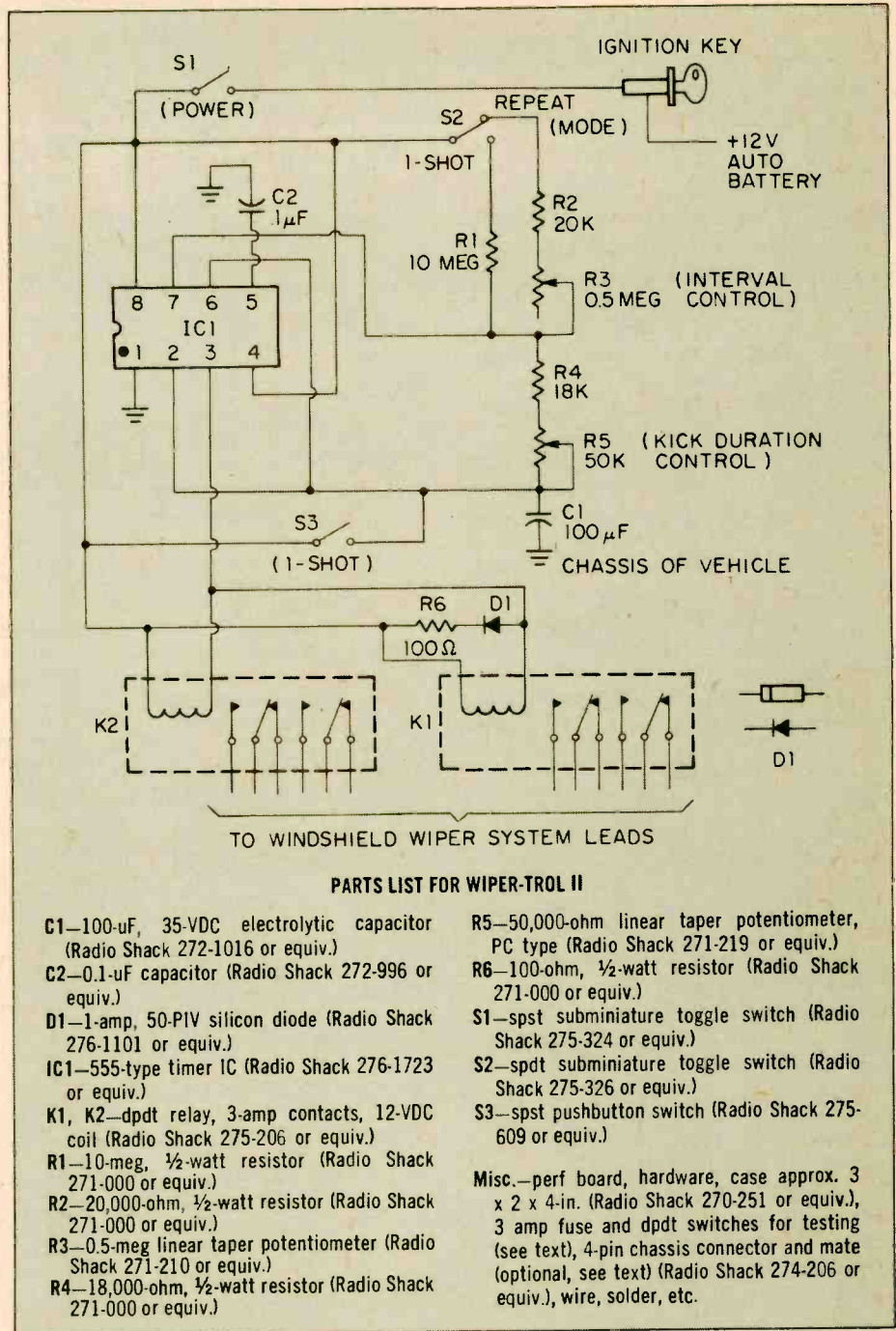

PARTS LIST FOR WIPER-TROL II

- C1—100- μ F, 35-VDC electrolytic capacitor (Radio Shack 272-1016 or equiv.)
- C2—0.1- μ F capacitor (Radio Shack 272-996 or equiv.)
- D1—1-amp, 50-PIV silicon diode (Radio Shack 276-1101 or equiv.)
- IC1—555-type timer IC (Radio Shack 276-1723 or equiv.)
- K1, K2—*dpdt* relay, 3-amp contacts, 12-VDC coil (Radio Shack 275-206 or equiv.)
- R1—10-meg, $\frac{1}{2}$ -watt resistor (Radio Shack 271-000 or equiv.)
- R2—20,000-ohm, $\frac{1}{2}$ -watt resistor (Radio Shack 271-000 or equiv.)
- R3—0.5-meg linear taper potentiometer (Radio Shack 271-210 or equiv.)
- R4—18,000-ohm, $\frac{1}{2}$ -watt resistor (Radio Shack 271-000 or equiv.)
- R5—50,000-ohm linear taper potentiometer, PC type (Radio Shack 271-219 or equiv.)
- R6—100-ohm, $\frac{1}{2}$ -watt resistor (Radio Shack 271-000 or equiv.)
- S1—*spst* subminiature toggle switch (Radio Shack 275-324 or equiv.)
- S2—*spdt* subminiature toggle switch (Radio Shack 275-326 or equiv.)
- S3—*spst* pushbutton switch (Radio Shack 275-609 or equiv.)
- Misc.—perf board, hardware, case approx. 3 x 2 x 4-in. (Radio Shack 270-251 or equiv.), 3 amp fuse and *dpdt* switches for testing (see text), 4-pin chassis connector and mate (optional, see text) (Radio Shack 274-206 or equiv.), wire, solder, etc.

relay contacts. One arrangement is to run all normally closed contacts to connector 1, the center poles to connector 2, and the normally open contacts to connector 3. This places all wiper motor wires on one incoming male connector, and all switch wires on another, thereby making installation straight-forward. This method was used in the author's model.

Another relay may be added in parallel with K1 and K2 if more contacts are needed; up to 150 mA may be drawn by the coils without harming the 555. Power connected to the contacts can come from the ignition switch to

be sure wiper motor power is off when the car is unattended (when the ignition switch is off).

Trouble Shooting. If the unit fails to properly operate the wiper motor even though testing with the *dpdt* switches was successful, there can be only a few simple reasons for the cause. Check to see that the 555 operates the relay coils, that the wiring to the wiper motor is correct, and that the relay contacts all open and close properly.

There it is—a do-it-yourself wiper control that lets you drive with both hands on the wheel while it does the clean windshield bit!



Warming Up To Thermistors

Get the inside facts about a hot electronics item!
by Bob Sandorf

A THERMISTOR is simply a thermal resistor or, more descriptively, a temperature sensitive resistor. Its composition is basically ceramic, made by sintering metallic oxides such as manganese, nickel, cobalt, copper and the like.

Now it is fairly common knowledge that resistors are temperature sensitive (the resistance changes with temperature), however, thermistors are many times more sensitive to temperature than are resistors. It is not uncommon to see a change in resistance of fifty times from 32 to 122° F (0 to 50° C) in a thermistor. The proportion of resistance change from 0° C to 50° C is called the *ratio* of the thermistor. For example, a thermistor having a resistance of 150,000 ohms at 0° C and a ratio of 15 would have a resistance of 10,000 ohms at 50° C. Thermistors are classified as having *negative temperature coefficients* since, as the temperature increases, the resistance decreases.

Thermistors are available in many configurations. Typical among these are beads, probes, rods, discs, glass coated beads and washers. Each of these configurations except the washer is usually formed with two leads that are used for electrical connection. The washer requires metal plates, pads or the like to butt against the opposite, electrically conductive, flat surfaces for electrical connection. Depending upon the manufacturer, most of these types can be used up to 300° C (572° F). However, some discs, washers and beads are limited to 150° C (302° F). In the higher temperature applications, the insulation should be of teflon or glass braid and the method of joining the circuit wires

to the thermistor leads should be done by crimping with a suitable terminal.

To understand and apply thermistors, we must first look at the effect on the resistance of the thermistor as it is subjected to heat. The curve of Fig. 1 shows the nominal resistance versus temperature for a thermistor made by Fenwall, the QB42L1 (rod-type). Note the sharp decrease in resistance as the temperature increases from 0° C to 200° C.

So What? Up to this point we've talked a lot of theory but just how practical is this device? I'm glad I asked that question—let's look at some applications.

Suppose that we wanted to build a "thermometer" using a thermistor that corresponds to the nominal temperature-resistance curve of the QB42L1. Let's say that we wanted to cover the range of 32° F to 104° F and we plan to use the basic circuit of Fig. 2 where R1 is a potentiometer, R2 is the thermistor (QB42L1) and M1 is a milliammeter. We will adjust R1 for 10,000 ohms (and explain later why). The resistance of the circuit will be at its minimum at 104° F. From the table we see that, at 104° F, R2 = 11,484 ohms; therefore, the total circuit resistance is 21,484 ohms. If V is nine volts, $I = 9/21,484 = .42$ mA. This means we can use a .5 mA meter. At 32° F, R2 is 56,500 ohms; total circuit resistance is 66,500 ohms, $I = 9/66,500 = .13$ mA.

From additional calculations the meter plate can be copied and re-labeled with the appropriate temperatures. The thermistor can be mounted quite a distance from the meter. One limitation is that the wire resistance must be very

Table 1. This data was used to generate the graph of Fig. 1. It describes the resistance of a Fenwall QB42L1 thermistor at various temperatures. In practice, this data can be generated at home by the experimenter.

temperature °F	°C	resistance Ohms
32	0	56,500
50	10	36,600
68	20	24,320
77	25	20,000
86	30	16,534
104	40	11,484
122	50	8,134
140	60	5,874
158	70	4,320
176	80	3,230
194	90	2,458
212	100	1,892
230	110	1,480
248	120	1,170
257	125	1,050
266	130	942
284	140	764
302	150	628
320	160	518
356	180	360
392	200	260

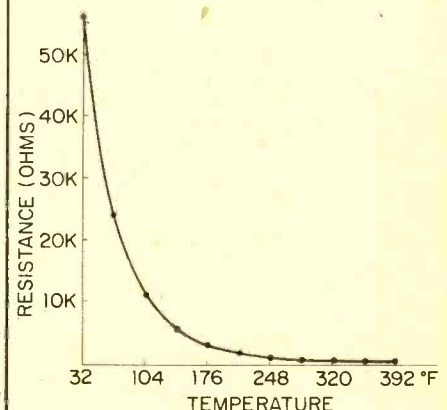

Fig. 1. Temperature-resistance graph.

The whole neighborhood wondered what Frank Mallon was up to in his workshop.

Word had it he was up to something mighty peculiar. And when he didn't show up for bowling practice one Wednesday night, the Wabash Cannonballs (that was the name of his neighborhood team) began to wonder, too.

So it was that a bunch of the boys decided to pay their "star" a visit, and talk him out of his workshop and back into action.

It didn't happen that way, though.

Matter of fact, it was Frank Mallon who talked the Wabash Cannonballs out of their bowling night and down into his workshop. What was it... what could be exciting enough to keep a bunch of ten-pin tigers from their favorite pastime? One of the most fascinating learn-at-home programs in the world, that's what!

Actually build and experiment with the new generation color TV in Bell & Howell Schools' fascinating learn-at-home program. It will help you develop new occupational skills as an electronics troubleshooter.

You'll set up your own electronics laboratory to learn first-hand, the technology behind such innovations as digital-display wrist-watches and tiny pocket calculators.

In fact, as part of the program, you'll actually build and experiment with a 25" diagonal color TV incorporating digital features.

But most important of all will be the new skills you'll develop all along the way... the kind of skills that could lead you in exciting new directions. While we cannot offer assurance of income opportunities, once you've completed the program you can use your training:

1. To seek out a job in the electronics industry.
2. To upgrade your current job.
3. As a foundation for advanced programs in electronics.

Go exploring at home, in your spare time. No traveling to class. No lectures. No one looking over your shoulder.

Bell & Howell Schools wants to introduce you to the modern way to learn. It means you'll be able to develop new skills in your own home—on whatever days and hours you choose. So you don't have to give up your present job or paycheck just because you want to learn new occupational skills.

What's more, we believe that when you're exploring a field as fascinating as electronics, reading about it is just not enough.

That's why you'll get lots of "hands on" experience with some of the most impressive electronic training tools you've ever seen.

No electronics background necessary.

That's one of the advantages of this program. We start you off with the basics and help you work your way up, one step at a time. In fact, with your first lesson you receive a Lab Starter Kit to give you immediate working experience on equipment.

You build and perform exciting experiments with Bell & Howell's Electro-Lab®. An exclusive electronics training system.

First comes the design console. After you assemble it, you'll be able to set up and examine circuits without soldering.

Next, you'll put together a digital multimeter. This instrument measures voltage, current and resistance, and displays its findings in big, clear numbers like on a digital clock.

Then comes the solid-state "triggered sweep" oscilloscope. An instrument similar in principle to the kind used in hospital operating rooms to monitor heartbeats. You'll use it to analyze the "heartbeats" of tiny integrated circuits. The "triggered sweep" feature locks in signals for easier observation.

You'll build and work with Bell & Howell's new generation color TV... investigating digital features you've probably never seen before!

This 25" diagonal color TV has digital features that are likely to appear on all TV's of the future.

As you build it, you'll probe into the technology behind all-electronic tuning. And into the digital circuitry of channel numbers that appear right on the screen! You'll also build in a remarkable on-the-screen digital clock that will flash the time in hours, minutes and seconds.

And you'll program a special automatic channel selector to skip over "dead" channels and go directly to the channels of your choice.

You'll also gain a better understanding of the exceptional clarity of the Black Matrix picture tube, as well as a working knowledge of "state-of-the-art" integrated circuitry and the 100% solid-state chassis.

After building and experimenting with this TV, you'll be equipped with the kinds of skills that could put you ahead of the field in electronics know-how.

We try to give more personal attention than other learn-at-home programs.

1. Toll-free phone-in assistance. Should you ever run into a rough spot, we'll be there to help. While many schools make you mail in your questions, we have a toll-free line for questions that can't wait.

2. In-person "help sessions". These are held in 50 major cities at various times throughout the year, where you can talk shop with your instructors and fellow students.

So take a tip from Frank Mallon. Find out more about the first learn-at-home program that could stir up your neighborhood!

Mail this postage-paid card today for more details!

Taken for vocational purposes, this program is approved for Veterans' Benefits.

If card has been removed, write:

An Electronics Home Study School
DEVRY INSTITUTE OF TECHNOLOGY



ONE OF THE
BELL & HOWELL SCHOOLS

4141 Belmont, Chicago, Illinois 60641

"Electro-Lab®" is a registered trademark of the Bell & Howell Company.

695R3



On-screen digital clock



Channel numbers that flash on the screen

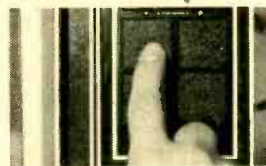

Automatic pre-set channel selector



low with respect to the value of the minimum circuit resistance (less than 1/100) and it is good practice to twist long leads in a spiral fashion to avoid electrical pick-up in the leads.

That Series Resistor. In the thermometer circuit we used a 10,000-ohm series resistor. This resistor is used to limit the power applied to the thermistor and it concerns the self-heating effect or, as the specification sheets call it, the *dissipation constant* of the thermistor. As we said earlier, the thermistor resistance is sensitive to heat. Now visualize putting a large voltage, E , across the thermistor. The power dissipated by the thermistor is E^2/R where R is the thermistor resistance. So what happens? As current flows, heat is generated in the thermistor to the extent that the resistance of the thermistor begins to decrease. More power is dissipated in the thermistor because E^2/R is larger because R has become smaller. This continues until either the thermistor is damaged or the conduction of heat away from the thermistor is large enough to balance the heat generated by the current flow. In either case, the thermistor resistance cannot give a true indication of ambient temperature.

To minimize this effect we must consider the *dissipation constant* (d.c.) of the thermistor. The dissipation constant is the amount of power, in milliwatts (10^{-3} watts), that will raise the temperature of the thermistor 1°C above the ambient temperature. For example, if a thermistor whose d.c. is 0.1 milliwatt is placed in a 25°C ambient and then caused to dissipate 0.1 milliwatt by applying a voltage to the thermistor leads, the temperature of the thermistor would rise to 26°C . Typical dissipation constants (in milliwatts) are as follows; bead 0.1, glass coated bead 1.7, disc 2.0, rod 4.0, washer 5.0.

Self-heating cannot be eliminated but it can be minimized to the extent that it is negligible. Without going into the detailed mathematics, the following pro-

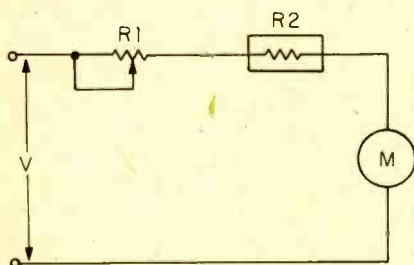

Fig. 2. Basic electronic thermometer.

Table 2. This formula is used to determine the series resistor which limits the self heating effect. See text for more info.

Power (mW)	Resistance
1/2	$V^2 \times 1000/2$
1	$V^2 \times 1000/4$
2	$V^2 \times 1000/8$
3	$V^2 \times 1000/12$

cedure will allow you to limit the self-heating to an acceptable level. Use a resistor (or resistors) in series with the thermistor as shown in Fig. 2. The resistor value can be determined as follows: first determine the amount of error in degrees that is acceptable to the circuit; multiply the error by the dissipation constant to determine the maximum power dissipated by the thermistor. From Table 2, select the proper formula for R that appears in the same column as the maximum power that you calculated. (Note that you must select, or at least assume a value of voltage, V , for your circuit).

Suppose you have a thermistor whose d.c. is 2 and you want to limit the error to 1°C . Let's say that the circuit voltage is 10 volts. Multiplying the maximum error (1°C) by the dissipation constant (2 milliwatts/ $^\circ\text{C}$) gives a maximum allowable power of 2 milliwatts. To limit the dissipation to 2 milliwatts we use the formula from Table 2 where, in the 2 milliwatt column, $R = V^2 \times 1000/8$ or $(10)^2 \times 1000/8 = 12,500$ ohms. Any R larger than 12,500 ohms will mean a smaller maximum dissipation and hence a smaller maximum error. Using a resistor of 12,500 ohms and a voltage of 10 volts will allow a maximum error of 1°C . This error will occur when the thermistor resistance is 12,500 ohms. As the thermistor resistance changes from 12,500 ohms (either increases or decreases), the self-heating and also the error becomes less.

The self-heating effect of the thermistors can be used to an advantage. A typical application is shown in Fig. 3 where V is the applied voltage, $S1$

is a switch, $R1$ is the thermistor and $K1$ is a relay. The thermistor is placed in series with the relay coil to provide a "delay on make." When $S1$ is first closed, the relay remains de-energized until the thermistor heats to the point where its resistance is low enough to allow the current to reach the level of the pull-in current of the relay (note that the self-heating effect can be used with AC as well as DC).

A more complex application of the self-heating effect is shown in Fig. 4 where it is required to regulate the voltage across lamp $L1$. The source voltage, V , varies 28 ± 4 volts and it is necessary to maintain a voltage of 2 to 3 volts across the lamp. Let me say at this point that using a thermistor in a self-heating mode is largely a trial and error situation. This is primarily because it is difficult to predict the amount of heat conducted away from

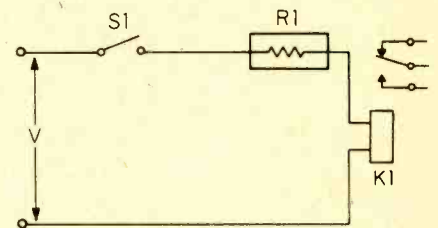

Fig. 4. Application of thermal delay.

the thermistor. Since this is not known, the thermistor temperature (and hence its resistance) cannot be determined exactly. The more you learn about thermistors, the easier it becomes. Nevertheless, self-heating applications require a certain amount of "Kentucky Windage." After several attempts, using a Fenwall GB32J2 (Allied Electronics stock no. 791-0427) as $R2$, $R1 = 345$ ohms and $R3 = 17.6$ ohms, the voltage across the lamp is maintained at $2.65 \pm .07$ volts!

Other Applications. Thermistors have found extensive use in temperature con-

(Continued on page 93)

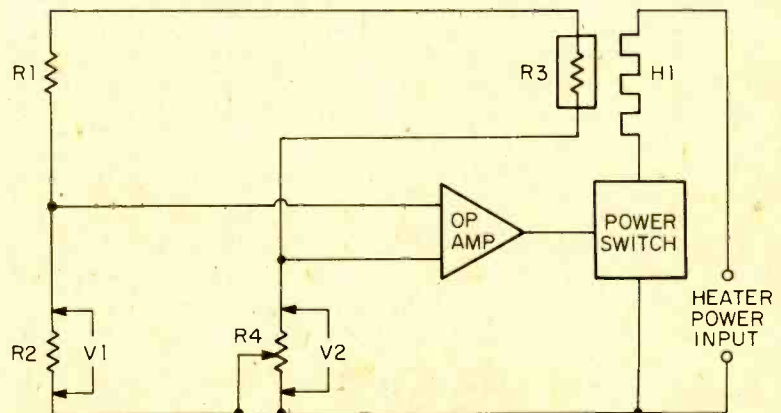

Fig. 5. Automatic temperature controller using thermistor and op amp.



Foil Your Local Burglar...

with a three point program
for home or small business
protection covering doors,
windows and glass!

by Jorma Hyypia

EVERY TIME another neighbor of yours installs a burglar alarm system the chance of your home being burglarized increases, because any crook who has even a little more sense than honesty knows it's stupid to try to rip off a protected home when there's a defenseless one next door. If you have procrastinated about installing your own electronic line of defense because you think the wiring job is too complicated for a novice, this is the time to dispel those defeatist notions. Wiring your own intruder alarm circuit takes a little time, but it's not difficult.

Basically, all you need to do is screw magnetic switches to your doors and windows, and perhaps add some sensor foil to windows that an intruder might break to gain entry. Then wire all sensors in series to form a loop that begins and ends at the control unit you buy ready-made. For the sake of simplicity, the diagram shows only one switch and one foil loop, but you can insert as many of these sensors into the circuit as are needed to protect every vulnerable door and window in your home.

In the first part of this article we'll consider only ways to attach magnetic switches to windows and doors. Then we will deal with the technique of installing window foil. Specific directions for connecting the sensor loop to your control unit, and wiring of a suitable

horn, will come with the particular alarm unit you buy.

Each magnetic sensor consists of a switch and a magnet encased in a matching plastic shell. The switch is mounted on the framework of the door or window, and the magnet is mounted on the door or window sash (the moving part) as close as possible to the switch. When the door or window is shut the magnet keeps the switch closed so that a weak sensing current can constantly flow through the alarm circuit. When the window or door is opened the magnet moves away and allows the switch to open in order to trigger the alarm.

Numbers Count. If you have many windows and doors to protect, you might find the total dollar outlay for switches quite substantial. However, there are ways to cut down on the number of switches used and still obtain full protection. Incidentally, do not rush out and buy several hundred feet of two-conductor cable as some wiring guides recommend. As the circuit diagram clearly shows, you need *single*-conductor wire to form the loop circuit. This wire can be the lightest insulated wire you can find at your local electronics shop because the sensing circuit operates at low voltage and current. However, two-conductor cable of the kind used to install intercom systems may be handy to connect an outside horn

to the control box or to tap into the sensor loop a particular switch that is physically far removed from all other sensors—the switch on a basement door, for example. In some instances it may be physically easier to run a two-conductor lead from each sensor to a central location near the control unit, but note that even then a loop circuit must be formed. The single-conductor loop is usually preferable because the sensing current flows through a much shorter, lower resistance circuit.

On doors, the magnetic switches are usually best located along the top edge, or near the top on the knob side of the door. If you place the switch near the hinged side of the door, the door will have to open much wider before the alarm is triggered because the magnet portion of the switch moves through a smaller radius arc. If you don't like the appearance of the exposed switches, you can sink the magnet into one edge of the door and set the switch section into a pocket chiseled into the door frame. The installation of such concealed switches of course involves much more work.

Other Entrances. On a garage door, try mounting the magnet to the top edge of the door, and the switch onto the frame. Check carefully to make certain that the two switch parts are as close as possible without jamming when the door is moved up and down. Small

FOIL BURGLARS

wood blocks may be needed to support the components in just the right positions. Jiggle the *closed* door vigorously when you test the sensor to make certain that back-and-forth door movements caused by gusts of wind won't trigger false alarms.

Mount switches on sliding glass doors by drilling small holes to take self-tapping metal screws, or fasten the switches in place using epoxy-type cement. Be sure that wires leading to the switches do not short-circuit through the metal framework. By adding a bypass switch to shift the monitoring current from the door switch to a second switch mounted on a sliding screen door, you'll have protection against intruders even if the sliding glass door is left open for ventilation.

To protect a double-hung window, locate the magnetic switch near the top of the lower window section. A second magnet placed about three inches lower than the first allows you to keep the window partly open and still have the alarm system operative.

More Protection. Note that a switch on the lower section of the window would not trigger an alarm if a cagey intruder were to slide the upper section down to gain entry. For full protection, you should add a second switch to the upper part of the window. If the upper half of the window is rarely opened it's less expensive to drop a thin-wire loop from the alarm circuit to a small nail or hook set into the upper part of the window sash. Then, if the upper window is moved down, the wire breaks to trigger the alarm.

You can use break wires to protect other doors or windows that are rarely opened—some basement windows or the second door in a set of sliding glass doors for example.

On an awning-type window place the magnetic switch near the *bottom* of the window so that the alarm is triggered before the window can be opened wide enough for insertion of an arm or tool. If the switch is near the top of the window the intruder will be able to reach in and deactivate the switch with a small magnet of his own before the alarm goes off. If the awning window has inside screens, be sure that the switch does not protrude into the screen-mounting track in the frame.

As you plan your alarm switch circuit, try to think like a burglar who has already managed to get a look at your system from inside the house. Is it pos-

TIPS ON APPLYING FOIL

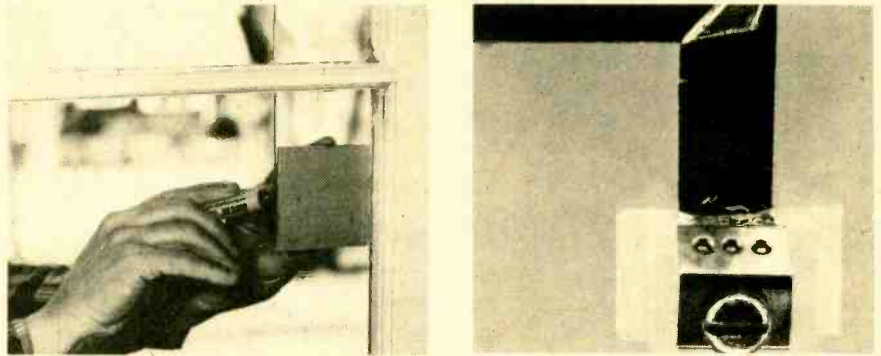

Before applying foil, clean the window glass thoroughly using an ammonia type cleaner. Use wax pencil to draw guide lines on the outside of the window (the foil goes on the inside). The foil is usually placed three inches from the sides of the window. Plastic block connector has metal cap with three prongs that grip the foil to provide good electrical contact. Note triangular tab created when foil is turned at right angles; glue this down with varnish.

sible to knock a small pane of glass from a door side-light, or from glass on the door itself, and to reach in to deactivate the door switch? If so, try to move the switch to where it cannot be easily reached.

Another Possibility. Up to now we have talked about ways of mounting magnetic switches to doors and win-

dows. Such switches provide only partial protection if a burglar can break glass in order to crawl in without actually moving a door or window, or if he can break glass and reach in to deactivate a door or window switch sensor. To provide complete protection, add window foil sensors to especially vulnerable glass areas.

TIPS AROUND WINDOWS

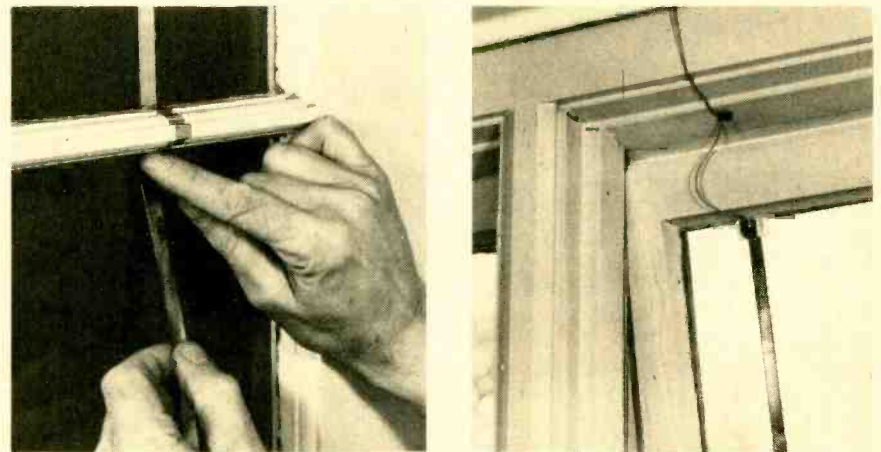

For a professional quality job, apply a coat of varnish to the foil. Use flexible wire to make a connection to the block connector or awning or casement type windows. Note how upholstery tack is used to hold down the wire. Window frame sections can also be bridged with insulated wire by soldering to foil.

THREE SPECIAL SITUATIONS

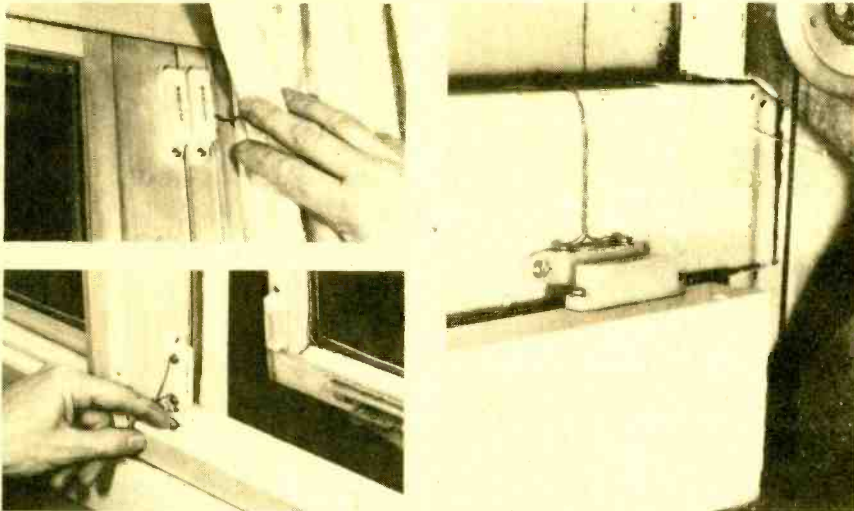

Protect a garage door by mounting the magnet on the top edge of the door, and the switch on the door frame. Mount switch to sliding glass door with epoxy cement, or drill small holes to take self-tapping metal screws, or place switch at bottom of awning window, and keep it away from screen-mounting track.

You've undoubtedly seen metallic foil bands on store windows and doors. If the glass is broken the foil also breaks and sets off the alarm. Actually, the foil is a strong deterrent against unlawful entry because it provides clear notification that your property is fully protected. Neatly installed foil is not at all unsightly and in some cases actually adds to the appearance of a glass area.

The only materials you need are a roll of metal foil and some foil block connectors that make connecting wire to the foil a cinch. The only tools required are a screwdriver, a straightedge, and a wax pencil for drawing guide lines on the glass. If you want a truly professional-quality job, get a small can of varnish and a $\frac{3}{8}$ -inch wide stiff bristle paint brush.

Most of the photographs in this article show foil being installed on a three-section window next to a front door. This is an excellent example of the kind of window area that really needs foil sensor protection. By knocking out one pane of unprotected glass a burglar could crawl inside without disturbing the door switch sensor. No half-way intelligent burglar will try it once foil has been installed.

Stick It On. Start by cleaning the window area thoroughly using an ammonia-type window cleaning material. This is very important because the self-adhesive foil will not stick properly to a dirty or greasy window.

Using a piece of stiff cardboard three inches wide as a marking gauge, draw guide lines on the *outside* of the glass area using the wax marking pencil; if necessary, use a straightedge to get per-

fectly straight lines. The line should form a loop around the entire glass area and be open only where the foil goes to the two foil block connectors. These take-off points can be anywhere that it's easy to connect the foil circuit to the main alarm system wiring.

Install a foil block connector to the *inside* surface of the glass at those points where the loop terminates, making sure that the beveled sides of the connectors face the foil. To mount, just peel off the protective paper and press firmly into place.

Handling the roll of foil may be easier if you suspend it on a nail tacked above the window. Use bits of masking or other tape on the sides of the roll to keep it from unraveling. Peel the protective paper off the tape gradually as you align the foil with the guide lines, beginning at one of the connectors. Leave some extra foil at the start for later connecting to the block. Lay the foil down carefully and smooth into good contact with finger pressure.

Bend and Fold. To make a right angle turn, first bend the foil in exactly the *opposite* direction from where you actually want it to go, and then press the bend section firmly to the glass. Now reverse direction with the foil so that it doubles back over itself at the corner. If you do it right you should have a square corner with a small triangular flap of foil that you can raise with a fingernail. Do *not* trim this flap off because you would break the electrical circuit around the foil loop; instead, glue the flap down with a bit of varnish. It's a good idea to practice making the right angle bends with a short length of

foil, placed on scrap glass, before you tackle the actual installation job.

To connect a foil end to a block connector, remove the terminal screw on the block and lift off the metal cover that runs down the beveled side. Carefully press the foil in contact with the block bevel and trim off any excess foil. Note that three little prongs on the metal cover dig into the foil to make good electrical contact. The screw that holds down this clamp is also used to tie down wires leading to the main alarm circuit. You of course connect these two foil terminals in *series* with other foil and switch sensors in the alarm circuit.

If the foil must pass over a section of window framing to get from one glass area to another, just mold the foil carefully over the frame *if* the frame is of wood. If you have a metal frame, the foil must be insulated from the metal to prevent a short circuit; ordinary surgical adhesive tape under the foil may serve the purpose. Another way is to bridge the frame with a piece of insulated wire and solder the wire ends to foil on each side of the frame. You will find that solder takes to the foil very easily. Use a low wattage iron, and practice first on scrap foil. It's a good idea to glue the wire bridge to the window frame to prevent it from being

OPEN TO TRIP CIRCUIT

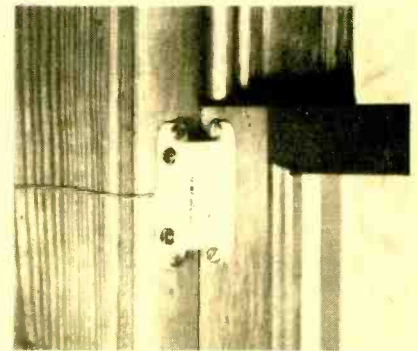

This inexpensive little device is the magnetic switch that serves as a silent monitor against unauthorized opening of a door or window to which it is attached. When magnet moves, below, alarm sounds.

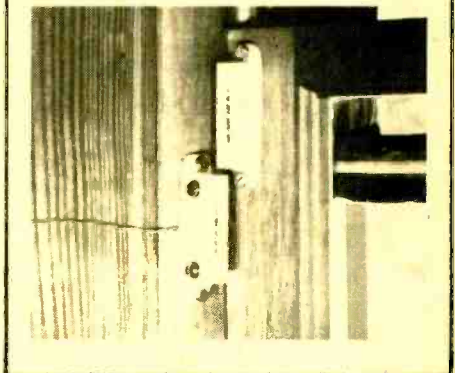

e/e FOIL BURGLARS

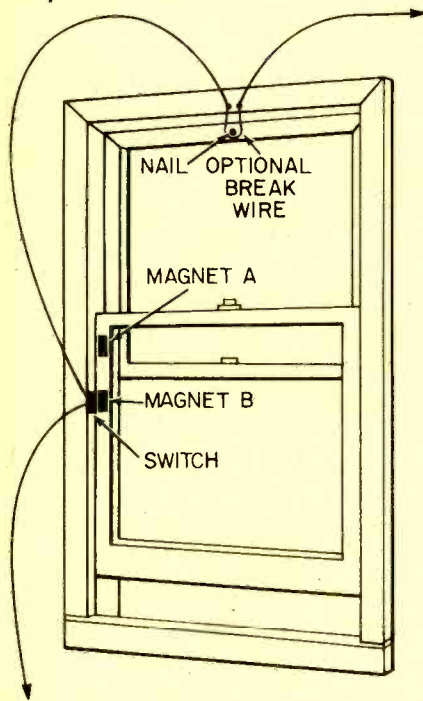

Second magnet on sash keeps alarm system operative when the window is cracked for ventilation. Note break-wire loop used to protect top half of the window.

pushed around during window-cleaning operations because such movement could pull up or tear the foil to which the wire is connected. If you should accidentally tear the foil during installation, you can solder a bit of foil across the tear to restore electrical contact.

The Finishing Touch. Although the foil loop is now ready for use, it's a good idea to complete the job in a pro-

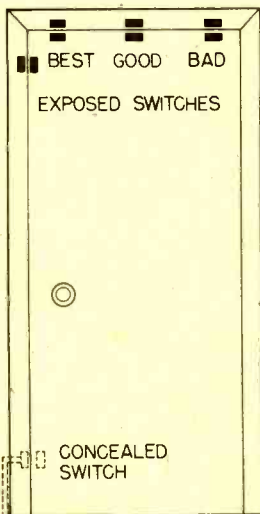

Best location for a door switch is near the top corner farthest from the hinged side of the door. Concealed switch may be located anywhere along the knob side.

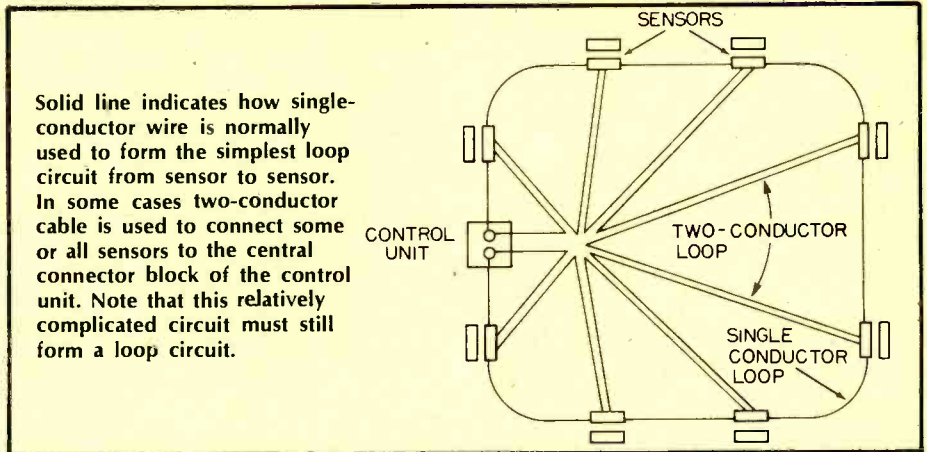

feSSIONAL manner by adding a coat of varnish to the foil. Use a stiff bristle brush that is the same width as the foil and try to avoid smearing the varnish onto the adjacent glass.

Installing foil on fixed windows is easy because there are no special problems in making wire connections to the main alarm circuit. If you have awning-type windows, locate the block connectors somewhere along the top edge of the window (preferably near one corner where they are hidden by curtains). Use a length of flexible (stranded) wire as lead-off from each block; allow enough extra length to reach the tie-down point even when the window is fully open. Use a flexible wire lead-off on a casement window after placing the block connectors on the hinged window side.

Gliding windows, sliding glass doors, and double-hung windows need somewhat more elaborate take-off devices that disengage when the door or window is opened. The drawing shows how to fashion a simple contact for a double-hung window using a strip of spring metal and a brass screw. Similar contacts can be devised for gliding windows and for sliding glass doors. Just

remember that if the door or window sashes and frames are of metal you will have to insulate the spring and button contacts from the door or window to prevent electrical grounding. If you prefer something a bit more professional, and are willing to pay the tax, check your local professional alarm equipment supplier for special contacts designed for this purpose. Note that where you have this type of foil contact on a sliding-type door or window, you don't really need a separate magnetic switch to trigger the alarm if the door or window is opened in normal fashion. ■

Do-it-yourself contact made from strip of spring metal is fastened to lower sash member of double-hung window. One end of metal strip attaches to block connector; the other end is bent to make connection with head of brass screw on window sill.

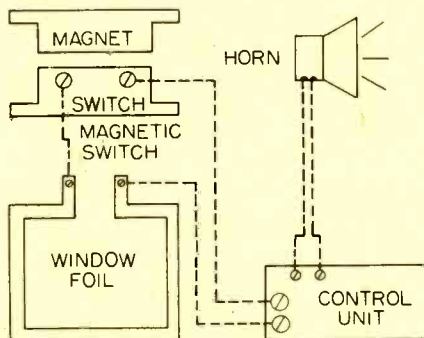

Basic alarm circuit consists of a loop connecting the control unit in series with magnetic switches and possibly window foil sensors. The horn is on a separate circuit from the control box. Many foil and switch sensors can be put into the same circuit.

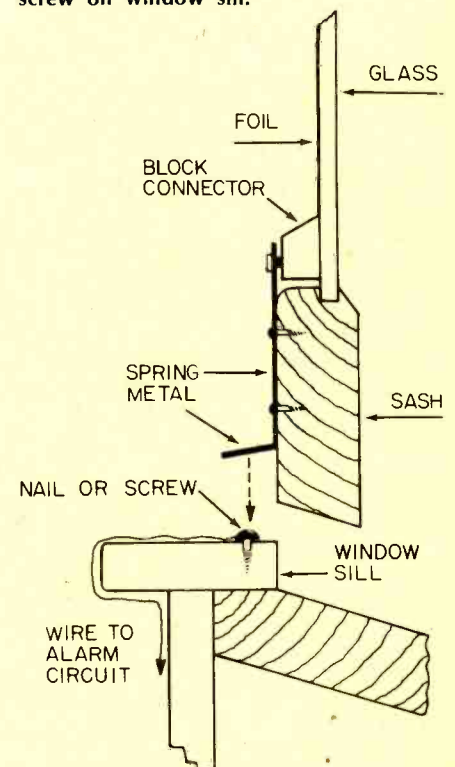

SUPERCHARGER

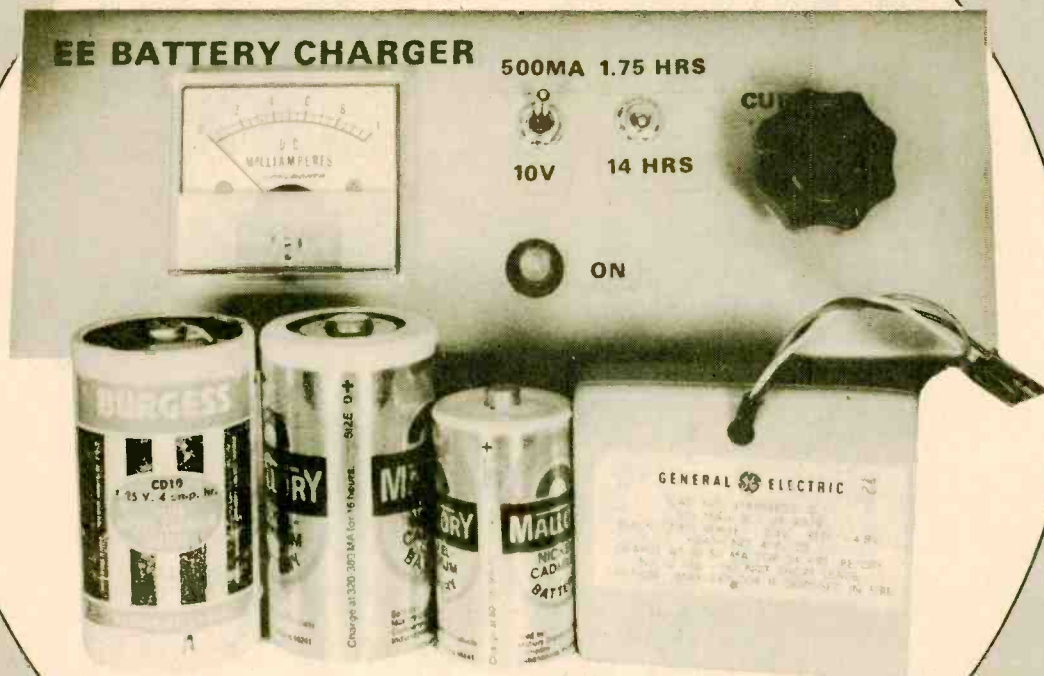

Build this wide range NiCad battery charger with built-in automatic cut-off timer!

by C. R. Lewart

PROLIFERATION of portable electronic gadgets such as calculators, tape recorders, walkie-talkies, radios, etc., gave a big boost to sales of rechargeable batteries. This article should bring your knowledge on the rechargeable battery up-to-date and tell you about a truly universal charging circuit with an electronic timer which you can build.

Rechargeable sealed batteries, besides many other advantages, make the operation of portable equipment quite inexpensive. Do you still remember the high cost of B and filament batteries for portable tube radios? But even with transistorized equipment, the cost of "cheap" throw-away batteries may be quite high. For example, a portable calculator or a radio using four AA throw-away cells needs battery replacement about once a week if it is used for 2 to 3 hours each day. This comes to about \$50 per year. A set of four rechargeable AA-size Nickel-Cadmium (NiCad) batteries costs around \$8 and with proper care should last 3 to 5 years or more. The cost of electricity used for recharging comes to only about 10 cents per year. Quite a difference in cost!

What Proper Care? We mentioned that a rechargeable NiCad battery will last for many years if proper care is exercised. Our charger described in this article will give your rechargeable batteries such proper care. There are three rules to observe when handling rechargeable batteries. They are all expressed in terms of battery capacity in milliampere hours

(mAh). This value is usually given by the manufacturer on the battery label. If no battery capacity is given, some common values are shown in this table.

However, watch for the figures given by the manufacturer. For example, you may find a sub C cell in a D cell package.

Battery Size	Capacity (mAh)	10-Hour Rate (mA)	5-Hour Rate (mA)
AA	450	45	90
sub C	1000	100	200
C	1500	150	300
D	3500	350	700

Rule 1. Do not discharge continuously at more than the hourly rate (450 mA for AA cells). Whether this rule is satisfied depends on the kind of equipment you are using. This rule will seldom be violated. Just don't try to run your electric power mower on a bunch of AA cells!

Rule 2. Do not continue discharging when the battery voltage is 0 volt (cell reversal). If you have several batteries in series, one will always have slightly smaller capacity than the others. When that battery is completely discharged, the other batteries will still pump current through it. The only way to avoid this condition is to turn off your appliance immediately when the total series battery voltage drops significantly (by more than 1 volt). You will notice it when, for example, your radio starts distorting. Turn it off immediately.

Rule 3. Do not charge at more than the 10-hour rate

e/e SUPERCHARGER

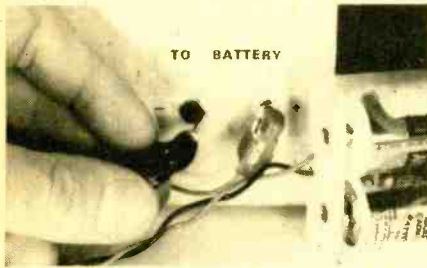

Phone tip jacks shown here can be replaced with five way binding posts or, if you're handy enough, eliminated altogether and replaced with battery holders built right into the supercharger case. Remember, too, that you must remove the AC power cord from the AC outlet to "reset" this timer.

(45 mA for AA cells) and do not continue charging at that rate beyond full capacity for more than a few hours. Slightly higher charging rates of up to the 5-hour rate are permissible as long as the battery is still discharged. To satisfy this rule, you need to control the charging current and the charging time as is provided by this charger. Some so-called universal battery chargers put either a too-high or a too-low current into your batteries. As a result either the battery will be damaged and its life shortened or it will not get fully charged in a reasonable amount of time.

These are general and safe rules. Specially-constructed batteries (for example, the so-called quick-charge batteries) may let you break one or more of these without causing permanent damage. However, unless the battery manufacturer assures you to the contrary you better stick with our three rules; otherwise permanent damage may result. Either the battery will fail (go dead) immediately or its life-span and capacity will be shortened.

Battery Charger. This charger is capable of charging one to six cells from AA to D size. It lets you control the charging current and the charging time. You turn the charger on, set the current to the 10-hour rate for a full charge or 5-hour rate for a quick boost, and forget it. After 14 hours (or 13 1/4 hours for a quick boost) the charger will turn itself off. In other words, we pump in 140 percent of battery capacity to charge it fully (40 percent is the typical loss in the charging process). For a quick boost of 13 1/4 hours when the battery is completely or partially discharged, we can go up to the 5-hour rate to obtain about one-quarter full battery capacity. For special quick-charge batteries follow manufacturer's recommendations.

The charger makes use of a newly-developed integrated circuit which combines a built-in oscillator (similar to the 555-type) and a frequency divider of up to 65,536 (2^{16}). This way we can choose a basic oscillator frequency of 0.77 Hz which can be obtained with reasonable resistance and capacitance values and divide it by 2^{16} to obtain timing values of up to 14 hours. The basic frequency, f , is determined by C2, R3, and R4. The frequency

$$f = \frac{1}{2 \times R3 \times C2}$$

where $R4 = 2 \times R3$. The IC is connected in such a way that the timer resets itself when the circuit is first turned on. When its timing interval is up, it will turn the SCR off permanently until the circuit is first removed from, then connected to the power line again. The rest of the circuit is straightforward. The output of the IC (pin 8) controls the gate of the SCR and lights up the LED. The charging current is controlled by the variable resistor R9. The current range with the values shown is between approximately 40 and 500 mA for up to 6 cells. Switch S1

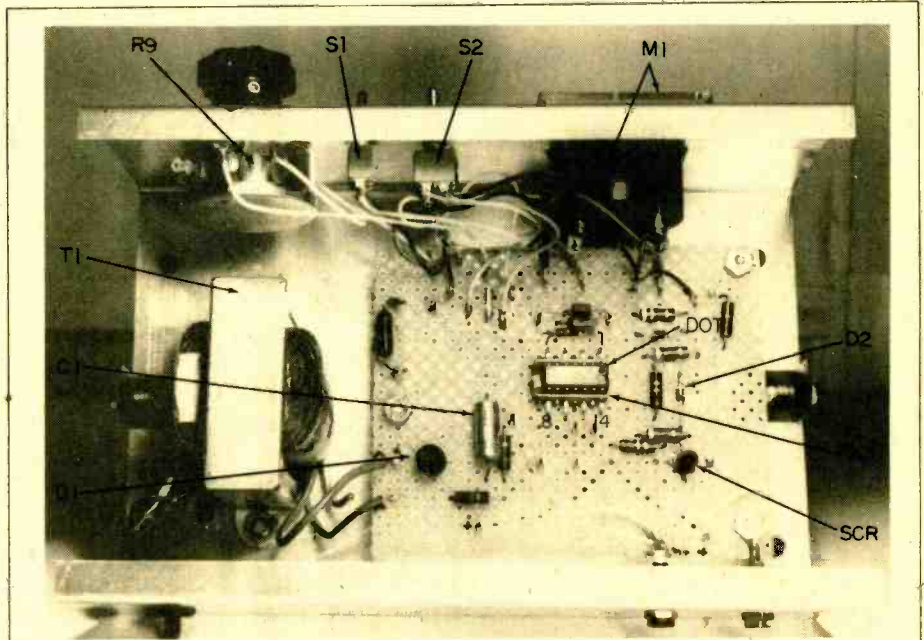

With our photographer and artist both on the job, you should have little difficulty locating parts on your supercharger perf board. While it is possible to build this unit in a much smaller area if you wish, beginners will find the extra room a benefit.

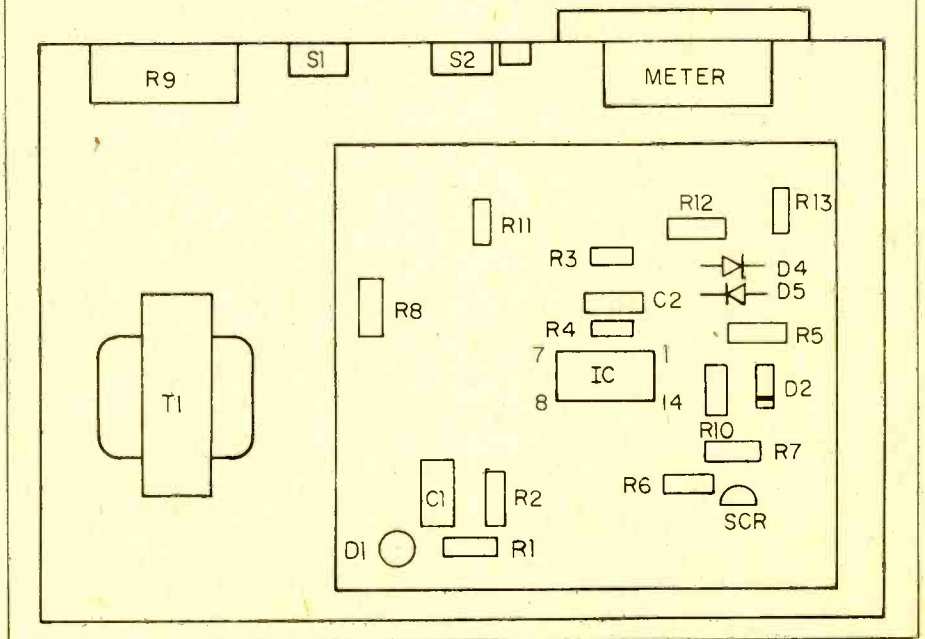

selects the IC divider output of either 2^{16} or 2^{13} .

The lowest divider ratio the IC is capable of, 256, is particularly useful during the charger calibration. To select this counting/dividing mode, disconnect pins 12 and 13 from S1 and temporarily connect pin 12 to pin 14 and pin 13 to pin 5. When you have finished the test, reconnect pins 12 and 13 to S1 after removing your temporary connection. In this mode the timer should turn itself off after 3 minutes 17 seconds plus or minus 10 seconds. The meter M1 is used as a volt meter (0 to 10 volts) across the batteries or as a charging current milliamp meter of 0 to 500 mA. Its function is selectable with S2. The diodes D1 and D2 protect the meter from overload.

Put It Together. You can mount all components on a perfboard as shown in the photographs. The wiring is not critical. The MOS integrated circuit is internally protected against static charges, however we still recommend

using a 14 pin socket. Do not insert the IC until you are (1) finished with the wiring, (2) have checked all connections, (3) and made sure the power is off.

If you plan to charge the batteries outside your equipment, then you must provide battery holders for various size batteries which you want to connect to the charger. Under certain conditions, you may be able to connect the charger directly to your appliance without removing the batteries, usually via the "adapter" jack. You may have to look at the schematic of your radio or walkie-talkie to find out if the "adapter" jack is connected to batteries when a plug is inserted. If so, you can charge the NiCads in the unit.

Once construction is complete, apply power and check to see whether or not the LED pilot lamp is on. If so, it should remain on for either one and three quarters of an hour or fourteen hours, whichever time you have selected with the *time select* switch. To check

the correct operation of the timing circuit in less time, you can make the following temporary connections to enable the divide by 256 function. Connect pin 12 and 13 of the IC temporarily to pins 14 and 5 respectively to select the 256 divider ratio. Try different values of capacitor C2 till you get a timing interval of approximately 3 minutes and 17 seconds. Of course, this is not a critical parameter, but it should be accurate to at least 3 minutes and 17 seconds plus and minus 30 seconds.

More Savings. Besides rechargeable batteries, regular throw-away zinc-carbon batteries can also be recharged under certain conditions. Those conditions follow.

- Battery should not be completely discharged (battery voltage should stay above 1 volt).
- Battery should not be leaking.
- Battery should be used soon after being recharged.

Other popular "throw-away" batteries are alkaline and mercury batteries. Mer-

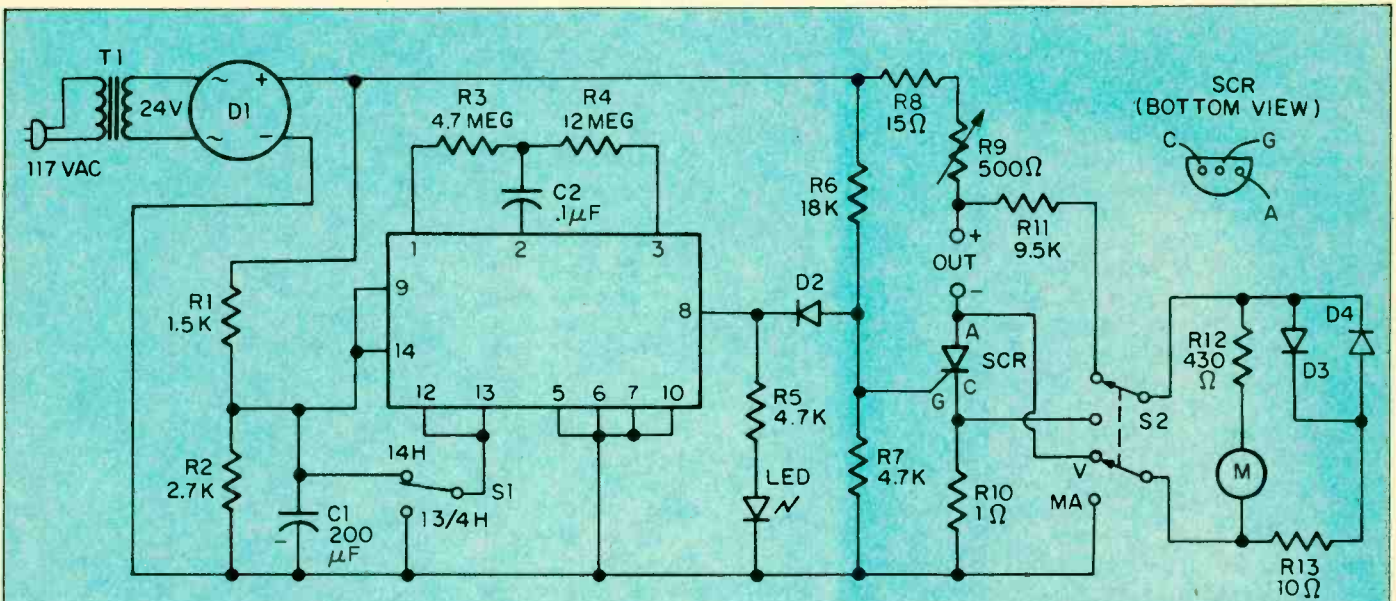

PARTS LIST FOR SUPERCHARGER

C1—200 μ F electrolytic capacitor, 20 VDC or better (Radio Shack 272-1017 or equiv.)
 C2—0.1 μ F capacitor, 12 VDC or better (Radio Shack 272-1069 or equiv.)
 D1—1 amp, 50 VDC bridge rectifier (Radio Shack 276-1151 or equiv.)
 D2—general purpose germanium diode such as 1N34A
 D3, D4—general purpose silicon diode such as 1N914
 IC1—oscillator-timer integrated circuit, Motorola MC14541CP
 Note—The oscillator-timer IC, a Motorola MC14541CP, is available for \$3.50 postpaid from Circuit Specialists, Box 3047, Scottsdale, AZ 85257.
 LED—light emitting diode, red, 20 mA (Radio Shack 276-041 or equiv.)
 M1—0 to 1 mA panel meter (Radio Shack

22-052 or equiv.)
 R1—1500-ohm, 1/2-watt resistor (Radio Shack 271-000 or equiv.)
 R2—2700-ohm, 1/2-watt resistor (Radio Shack 271-000 or equiv.)
 R3—4.7 megohm, 1/2-watt resistor (Radio Shack 271-000 or equiv.)
 R4—12 megohm, 1/2-watt resistor (Radio Shack 271-000 or equiv.)
 R5, R7—4700-ohm, 1/2-watt resistor (Radio Shack 271-000 or equiv.)
 R6—18,000-ohm, 1/2-watt resistor (Radio Shack 271-000 or equiv.)
 R8—15-ohm, 3-watt or better resistor
 Note—You can use two 7 1/2 ohm resistors in series such as Radio Shack 271-147.
 R9—500-ohm wire-wound potentiometer (Allied Electronics 875-4041 or equiv.)
 R10—1-ohm, 1/2-watt resistor

R11—9500-ohm, 1/2-watt resistor, 5%
 R12—430-ohm, 1/2-watt resistor, 5%
 R13—10-ohm, 1/2-watt resistor (Radio Shack 271-000 or equiv.)
 S1—spdt switch (Radio Shack 275-326 or equiv.)
 S2—dpdt switch (Radio Shack 275-1546 or equiv.)
 SCR—0.8 to 1 amp, 100 volt silicon controlled rectifier, G.E. C103 (Radio Shack 276-1059 or equiv.)
 T1—power transformer, 117 V primary to 24 V secondary @ 1 amp (Radio Shack 273-1480 or equiv.)
 Misc.—perf board, hardware, push-in clips, case approx. 6 x 4 x 3-in. (Radio Shack 270-252 or equiv.), 14-pin IC socket, output terminals such as Radio Shack 274-724 phone tip jacks, wire, solder, etc.

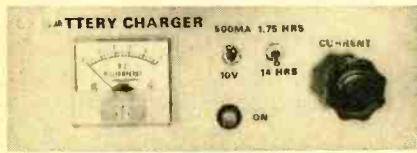

Notice there's no on-off switch. That is a function handled by the power cord. Plug it in for on—pull it out for off! Why? It's cheaper to build, for one. For another, all counter reset signals are automatically generated each time the AC power is applied. This no power switch arrangement makes it easier to operate without accidentally resetting the counter timer integrated circuit.

Mercury batteries are used where high energy concentration in low volume is required. A camera or a hearing aid is a prime example of such an application. The mercury cell has three to five times the capacity of a carbon-zinc cell of the same size but it costs five to ten times as much.

Non-rechargeable alkaline batteries have about twice the capacity of a comparable carbon-zinc cell at approximately three times the price. Mercury and alkaline cells have similar nearly constant discharge voltage and low internal resistance characteristics as the NiCad cells. However, they are not leakproof and should be removed from equipment if not in use. We strongly discourage you from trying to recharge mercury or non-rechargeable alkaline batteries. Gases generated by the recharging process in the sealed cell may cause an explosion and spread the caustic electrolyte.

You may also run across rechargeable alkaline batteries. They are not as popular as NiCad batteries, but are slightly cheaper and have similar characteristics to NiCad batteries. They are not, however, as long-lived. Many other excellent types of batteries are used in military and commercial applications. They did not yet find their way to the consumer market because of high cost.

From this short description, you may deduce that the NiCad battery is the most cost-effective battery in many applications where the appliance is in frequent use.

On the Inside. A NiCad battery consists of layers of sintered cadmium and sintered nickel separated by fiber soaked in potassium hydroxide electrolyte.

Sintering consists of baking a powdered metal to the consistency of a solid. A sintered material is highly porous. Its active area is several hundred times larger than that of a solid plate of the



All commercially available nickel-cadmium batteries for consumer use will (or, certainly should) have some indication of what its charge rate and/or ampere hour rating is. The Burgess CD10 cell (far left) does not specifically mention charging rate, but its ampere hour rating is shown on the label. You can, therefore, use the rule of thumb which says charge for 14 to 16 hours at one tenth the battery rating or, in this case, 400 mA. This compares favorably with a 4 Ah Mallory cell.

same dimension. The basic chemical reaction in a NiCad battery is as follows:

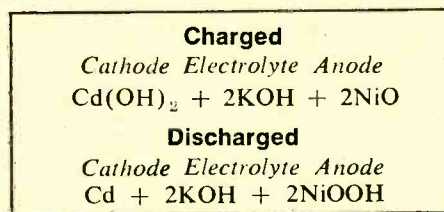

This reaction does not generate any gases. However, during the latter part of the charging cycle, during overcharging and during high discharge, hydrogen, oxygen and electrolyte fumes are being generated. These gases will normally reach an equilibrium condition reacting with each other and with the porous electrodes. Sealed cells also have a safety venting mechanism (activated above 100 PSI) assuring that the cell will not rupture under extreme conditions. Repeated venting however, causes loss of the electrolyte and subsequent battery deterioration. For this reason controlled charging is beneficial to NiCad batteries.

Other Advantages. A major advantage of NiCad cells, in particular when used for portable radios and walkie-talkies, is a nearly constant voltage during the discharging cycle. Regular zinc-carbon batteries lose their voltage at a fairly constant rate and thus affect the performance of the equipment they are powering; however, rechargeable batteries keep their voltage nearly constant until they nearly completely discharge. For example, the voltage of a carbon zinc battery drops by approximately 0.3 volts per cell when it is 50 percent dis-

charged. The voltage of a NiCad battery drops by only 0.1 volt during the same period. Another important feature of NiCad batteries is the low internal resistance on the order of about 30 milliohm (AA cells)—about ten times less than for a comparable zinc carbon battery. This feature is particularly important for class B type audio circuits which require more power during peaks of speech or music. Batteries with a low internal resistance can supply the sudden surges of power required for good, low distortion sound. Another important feature of NiCad batteries, as compared to zinc carbon, is that they can be stored in a charged or discharged state and are virtually leakproof.

For additional information about batteries in general and/or NiCad batteries in particular, refer to the following material. "More Staying Power for Small Batteries", *Machine Design* magazine, December 13, 1973; *Nickel-Cadmium Battery Application Engineering Handbook*, General Electric publication number GET-3148; *Nickel-Cadmium Battery Application Engineering Handbook Supplement*, General Electric publication number GET-3148-S1; *RCA Battery Manual*, RCA publication BDG-111B; *Eveready Application and Engineering Data Book*.

From flashlight to photoflood, from toys to 2-way, NiCads are in widespread use. Everyone is ready to save a buck these days; from a money-saving standpoint, NiCad batteries have some definite advantages. Maybe, if you are a heavy battery user, NiCad rechargeable batteries can help you. Why not check it out? ■



Readers Ask...

WHICH SHORTWAVE RECEIVER SHOULD I BUY?

A beginning listener may not have to invest a nickel to get started in DXing. The BCBer (broadcast band listener) can start with almost any "regular" AM radio that covers this medium wave band. For shortwave listening, it might be a multi-band portable you already own, or that old all-wave console in the attic.

Frequently, we get letters from readers who ask which shortwave receiver they should buy. Frankly, this is an area we shy away from. Why? When you plan to invest some hard-earned cash in a SW rig you don't want to make a mistake. There are many factors to take into consideration, and we can't put ourselves in your shoes.

There is no *one* best receiver. Even experienced DXers can't agree. One swears by one manufacturer, another wouldn't touch that band with a ten foot pole. One thing they do agree on, though, is not to get in over your head. Don't "overbuy." Nothing will sour a novice DXer faster than spending *mucho dinero* with the expectation that he will, overnight, be able to hear anything and everything.

A receiver is probably the single most important piece of equipment a DXer can buy. But, in our not so humble opinion, experience and knowhow—which come only after one serves a learning apprenticeship in the hobby—count for at least half the game. A receiver is no better than the guy twisting the dial.

So, whatever receiver you use for

Shortwave Editor Don Jensen provides points to ponder.

your DXing, learn to use it, tax it to its maximum DX potential, then trade up to a better set. In this day and age it is more than likely that you'll be able to sell or trade the old jobbie and move up without too great an additional investment. And by the time you get that set you've been dreaming about you'll have built up your DX skills to the point where you can use the new rig to best advantage.

Money Matters. Price is one factor that for many of us is the critical one. A new communications receiver doesn't sell for pennies. Yet I don't think DXing can fairly be called an expensive hobby.

Yes, the initial outlay—whether it's \$100, or \$4000, or somewhere in between—is not peanuts. But with proper attention and care, periodic replacement of tubes or perhaps a realignment when that's called for, there is no reason why it shouldn't continue to perform well for a decade or two.

The state of the electronics art is always advancing, to be sure. But much of today's electronic design work is very specialized. Receivers of the future probably will have fancy digital electronic readouts. Top-of-the-line models have that feature today. Sets may become even more compact.

There are some mighty good com-

munications receivers on the market today; not as wide a selection as there was a few years back perhaps, but those sold today are fine DX machines. Yet it is also true that some very experienced SWLs, who very likely could afford a new multi-kilobuck beauty, choose to operate with a good 15- to 20-year-old receiver. This suggests two things: there's a lot of life in a DX receiver and, in radios, one man's meat is another man's dog food.

Basically there are three or four things to look for in a communications receiver. One, and probably not the most important these days, is stability. This means the ability of the radio to stay tuned to the desired frequency without drifting.

The two major causes of instability are heat and mechanical shock, both of which can alter the actions of delicate circuitry. As there is no appreciable heat generated in a solid state transistorized design, thermal stability is not an important factor.

Vacuum tubes do generate heat and every tube set will drift somewhat. However, a good unit will stabilize on frequency and not drift after about a half hour warm-up. Thermal stability usually is only worth worrying about in the case of an inexpensive tube set.

Manufacturers can lick the mechanical shock problem by using solid construction techniques, a sturdy chassis, and heavy-duty components. Again, it is only in the less expensive sets, where corners are cut to meet a price, that this

e/e WHICH SHORTWAVE?

is worth considering.

Something More. Sensitivity is more important. This is the ability of the communications receiver to bring in a weak radio signal; and this is what DX-ing is all about, after all. One way to obtain sensitivity is to design a set with a tuned radio frequency (RF) amplifier stage. Again, except for the budget units, most communications rigs have an RF stage.

A sensitive receiver is one thing, but it's not enough. The electronics of a receiver creates at least some internal noise. But proper design can minimize this. Too much internal receiver-generated noise will mask an incoming signal, no matter how sensitive it might be.

You want a good signal to signal-plus-noise ratio (S/S+N) to make the most effective use of your receiver's available sensitivity. Here's a quick and easy test you can make, even in a dealer's showroom if he has some sort of suitable antenna available.

With the antenna connected, tune across all the bands. Don't be concerned about the stations you can hear; listen instead for the background noise between stations. Next, disconnect the antenna and make the same check. A set without the antenna connected should produce significantly less background noise. The noises you hear with the antenna disconnected are produced by the receiver circuitry.

It is possible to boost the sensitivity of an inexpensive receiver. Adding an outboard auxiliary preselector can be a big help by increasing signal gain and rejecting images: unwanted false signals that crop up where they don't belong.

The Most. There are two more factors to look for in choosing a communications receiver, perhaps the two most important. They are selectivity and frequency readout.

Selectivity means being able to bring in the wanted station but rejecting all or most other signals on adjoining frequencies (rejecting interference).

Today's shortwave frequencies are crowded, and it takes a good receiver to sort out the desired signal from the unwanted ones. Without adequate selectivity, station will seem to pile up upon station, creating a bedlam of noise and unintelligibility. And, in most cases, much of what you are paying for in an expensive set is circuitry to provide selectivity.

This can be done in a number of ways or a combination of ways. A superheterodyne receiver makes use of



Four well established DXers are, upper left, Bob Hill, Berkeley, CA., into DXing for 14 years and an editor of the North American SW Association bulletin. Dan Hagfors, upper right, uses a Hallicrafters S-125 at his home near Chicago. "Down Under" DXer Graeme Dixon, lower left, has been DXing at his home in New Zealand for five years. And finally, Charlie Davidson of Iowa started DXing at sixty-five.

an intermediate frequency amplifier, the so-called IF stage, to produce basic selectivity. A double or triple conversion model, with multiple IF stages, will provide better selectivity and will, of course, cost more.

Some receivers use the notch filter technique. The device, built into the set, suppresses a narrow range of frequencies. This "dead" notch is tunable a few kilohertz on each side of the frequency to which you are tuned. Tune the "dead spot" right on top of an adjacent undesired signal and you go a long way toward attenuating that interference.

There are several types of filters employed in receivers today. A crystal filter is a bit of quartz ground to resonate at the IF amplifier frequency. It "narrows the gate" to shave off most of the interference on either side of the tuned frequency. Other receivers use ceramic or mechanical filters to perform the same function. Mechanical filters, which employ a series of resonant discs instead of quartz or ceramic devices, are considered superior if well made. But mechanical filtering, done properly, really kicks up the price of a receiver.

Two More. But all the selectivity and sensitivity in the world won't help you bring in wanted DX signals unless you are able to tune your receiver to exactly the frequency where your station transmits. So frequency readout becomes very important.

In the '70s, the problem of poor frequency readout has been licked, but to get it you have to pay! Top-of-the-liners usually feature an electronic digital readout. Want to tune to 15,220 kHz? You just tune the receiver until its little illuminated numeral readout indicates you're tuned right on the button. You can have tuning accuracy to a fraction of a kHz.

Some less costly sets—but still costing a couple of hundred dollars—will give you a highly accurate mechanical type readout of "course" frequency, at least to the nearest kilohertz, and, with interpolation, to fractional kilohertz. In terms of practical DX operation, the mechanical type of direct frequency readout is no less satisfactory than the electronic type.

But with the inexpensive sets you normally get a slide rule type system,



Ever had the itch to travel to exotic spots around the globe? These painted thatched huts in Senegal are part of the real world you may never visit in person, but you can "travel" by radio when you listen to the earth's many shortwave broadcast signals.

in which a bar marker moves across a marked dial plate. Often these are poorly marked and, with a fairly small dial plate, it is hard to tell, for instance, if you're tuned to 9,600, 9,650 or 9,700 kHz. Unless you can tell a frequency far more accurately than that, your DXing will be rather hit or miss.

Some sets have a built-in frequency determining aid called a crystal calibrator. This device spots audio tones, usually every 100 kHz (though external crystal calibrators producing tones every 50, 25, 10, etc. kHz can be added to your listening setup).

Using the frequencies of certain regular, known stations, plus the marker tones, it is possible to make homemade graphs of each DX band to help you find the frequencies you want to tune. This will give a fair degree of accuracy.

Previously Owned. Since communications receivers have a long life, but because many listeners choose from time to time to trade up to a classier rig, there are used receivers on the market.

Like an auto that's been "pre-driven," a used communications set can be a real buy . . . or a lemon. Many dealers take in old but perfectly good radios in trade. Many will recondition the set before reselling it. Others will simply sell "as is." If it needs work but is basically okay you can recondition it yourself (with some electronics know-how) or pay to have it done.

There may be a bit of a gamble in buying a used set. But you can minimize the risks by dealing with a reputable dealer, buying from someone you know and trust, getting a guarantee from the seller that it is in the condition he purports it to be, or by taking along a knowledgeable friend—perhaps a local ham radio operator—when you go shopping.

Most American manufacturers will realign and recondition an older set

they once manufactured, and the result will be more than satisfactory. This service will cost a modest amount, but if you buy at the right price you can afford it. Depending on the condition, and the demand for a particular used set, you can probably save a quarter or a half of the original price.

One of our faithful readers, Norman Sims, found a well-used Hallicrafters SX-28 Super Skyrider at a flea market not long ago. True, it is a very old

model, at least 30 years old, but it worked. The price? Two dollars! We also know of an early '50s receiver, once Hallicrafters top line, an SX-62 in very good shape, that recently sold for about one-tenth of its new price. Finding aging but adequate beginner sets for under \$20 at amateur radio hamfests is not uncommon.

So, new or used, cheap or expensive, go get yourself a receiver and get in on the DXing fun. ■



"I'm a beginner in shortwave listening," writes Russell Pryor, Cambridge, OH. "One of my main interests is learning more about people in other countries." Russell's austere listening post is an excellent example of how to get started on a shoestring. His receiver is a General Electric model 2960. "Reception of foreign broadcasts is surprising, considering I use only a 15 foot outside antenna."

SHORTWAVE RECEIVER MAUFACTURERS/DISTRIBUTORS

- Channel Master, Division of Avnet, Inc., Ellenville, NY 12428
- Collins Radio Company, Cedar Rapids, IA 52406
- R. L. Drake Company, 540 Richard Street, Miamisburg, OH 45342
- Galaxy Electronics, RR #3, Lincoln, NE 68505
- Hammarlund, 20 Bridge Ave., Red Bank, NJ 07701
- Heath Company, Benton Harbor, MI 49022
- Lafayette Radio Electronics, 111 Jericho Turnpike, Syosset, NY 11791
- Radio Shack, 2617 W. Seventh Street, Ft. Worth, TX 76107
- Zenith Radio Corporation, 1900 N. Austin, Chicago, IL 60639
- Panasonic, 1 Panasonic Way, Secaucus, NJ 07094
- Gilfer Associates Inc., P.O. Box 239, Park Ridge, NJ 05676
- National Radio Company, Inc., 111 Washington Street, Melrose, MA 02176

WITH THE CAPTURE of recording equipment from the Germans at the end of World War II, tape recording was "discovered" and imported to the United States. But the invention of the magnetic recorder, forerunner of the modern tape machine, goes way back to the last decade of the nineteenth century. The credit for this goes to Valdemar Poulsen, a Danish telephone engineer who patented the telegraphone in 1898. This machine, which stored sounds on steel cylinders or spools of piano wire by means of magnetization, was used by Poulsen primarily to record telephone conversations and then transmit them over telephone lines at much higher speeds. In the days before multiplexing this served to speed up telephone service.

Poulsen obtained an American patent for his invention in 1900, and was employed for five or six years by the American Telegraphone Company, which attempted to develop his patents. As far as we know, Poulsen never attempted to apply his invention to recording music. He returned to Denmark in 1908, where he remained in relative obscurity until World War II, when he surfaced briefly in some mysterious connection with the Danish underground.

Replaces Piano Wire. Significant improvements were made to Poulsen's invention during the 1920s and 1930s, both in Germany and in the United States. In 1927 two U.S. Navy scientists—W. L. Carlson and G. W. Carpenter—came up with the idea of using AC bias to cut down background noise and insure the permanence of recordings. At about the same time, a German engineer, Fritz Pfeumer, succeeded in coating strips of paper, and later plastic, with powdered iron oxide. This was a great improvement over the steel tape and piano wire which Poulsen had used—and which this development eventually replaced.

Music Recording Milestone. In 1932, a unit of the German dye trust Badische Anilin Soda-Fabrik (BASF) succeeded in producing the first practical coated tape. BASF then joined forces with AEG, the German electrical combine, to produce the Magnetophone, which was exhibited for the first time at the Berlin Radio Fair in 1935.

This was the first magnetic recorder which bears any resemblance to the equipment used today. It was also the first unit on which a live concert was recorded. This happened on November 19, 1936, when Sir Thomas Beecham, touring Germany with the London Philharmonic, recorded portions of Mozart's Symphony No. 39. The event took place in the employee's hall at the

In design and performance today's tape recorder barely recalls its humble beginnings.



BASF factory in Ludwigshafen, and is properly considered a milestone in the history of recorded music.

Allied Soldiers Discover. It was the same Magnetophone, somewhat improved over the 1935 prototype, which Allied soldiers "discovered" when they captured Radio Luxembourg in the fall of 1944. This discovery solved one of the most puzzling aspects of the war. Despite the pounding the Germans were taking in 1944, broadcasts from Nazi leaders continued to be heard

with startling clarity from all over the Reich. Since Hitler's well-known regard for his personal safety made it unlikely that he was traipsing all over the Third Reich to deliver his rambling pep talks, the puzzled British and American communications experts suspected that the Germans had developed a superior recording medium for these broadcasts. The captured Magnetophones confirmed their suspicions.

Among the U.S. Army officers who

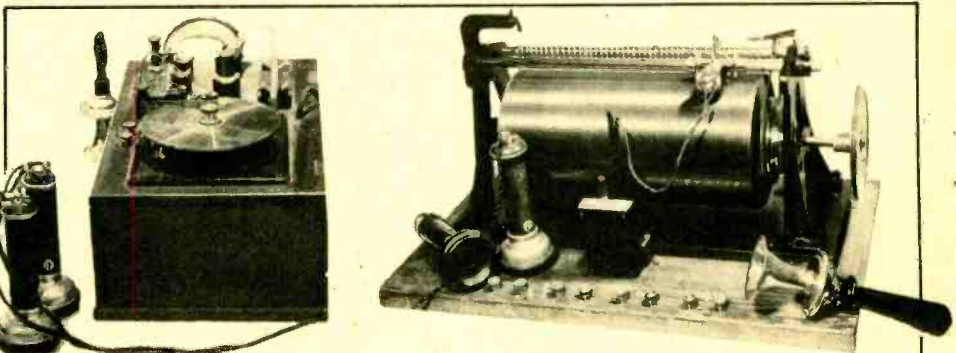

On the left is the first magnetic recorder, or telegraphone, invented by Valdemar Poulsen in 1898. A gradual development in concept is seen with the disc telegraphone (right) built by Poulsen in 1905. Note the steel cylinder used to store sounds.

helped "liberate" the Magnetophone recorders were three engineers—Colonel Richard H. Ranger, Major John Herbert Orr and Captain John Mullin. These Signal Corps officers quickly recognized the possibilities of this new recording medium and managed to get a number of the machines back to the United States. These captured units really launched the tape recording industry in this country.

German Imports. It was the late Colonel Richard H. Ranger who discovered the AEG factory in Berlin where the Magnetophone units had been assembled. Ranger managed to wrest six units away from the French authorities, five of which were pressed into Army broadcasting, where they provided excellent service. The sixth was brought back to Fort Monmouth, for study and analysis by the Signal Corps.

Colonel Ranger was a fantastic individual, who served as an Army officer in both World Wars and had a string of engineering achievements as long as your arm. His most notable feat was the development of the first trans-oceanic wireless picture transmitter in 1926. In addition, he held patents for a pipeless electronic organ, an airborne radio relay system, assorted radar developments, and a synchronized tape

and motion picture recording machine for which he won an Oscar in 1956.

However, from the point of view of the average audiophile, Ranger's most important discovery was the captured German tape recorders. Shortly before World War II, he had set up Rangertone, Inc., and after leaving the service his company developed and produced one of the first and finest tape recording machines.

Colonel Ranger demonstrated one of the captured tape units to several industrialists whom he was trying to interest in investing in his company. Unfortunately, not all of them were impressed by its possibilities. One leading disc equipment manufacturer, with great prophetic insight, told Ranger bluntly, "Forget about tape recording. It's only a toy, a gimmick. It will never get off the ground."

Tape Takes Off. Despite this sage advice, Colonel Ranger continued to produce tape recorders at Rangertone, though Ampex and other manufacturers soon outdistanced him in the marketplace. Ranger continued on as president of Rangertone, specializing in radio and acoustic developments, until his death in 1962 at the age of 72.

Another Signal Corps officer, John T. Mullin, had "liberated" two Magnetophones in Frankfurt, which he dis-



In addition to developing the telephone at 29, Poulsen also invented the radiotelegraphic method of undamped waves (1903). This led to the construction of the first station at Lyngby, Denmark, assembled and shipped back to the United States. When he was discharged, he reassembled the machines, and in May 1946 he demonstrated them before an IRE (now IEEE) group of about 250 engineers. He must have made a good impression, because the next day Mullin was visited by Alexander M. Pontiatoff, the head of Ampex Electric Co.

Ampex had been turning out electric motors during the war, but the company was interested in the high-fidelity field, which was just emerging from the hobby stage to a profitable business. Mullin's company built its first production tape recorder in 1947, and the rest is history.

The Irish Are First. The third army officer who pioneered the development of tape recording, was John Herbert Orr. Major Orr, like the other two officers, had also taken apart and shipped home a Magnetophone, which he reassembled and experimented with at his ORR radio plant in Opelika, Alabama.

However, Orr was more interested in magnetic tape than in the tape recording mechanism. At the end of the war he was stationed at the Wald-Michelbach plant supervising the coating of Luvitherm, the magnetic tape developed by the Germans, and became familiar with both plastic and paper-base tapes. So, in 1947, Orr produced Irish Tape, the first American-made plastic tape with an oxide coating. The Irish Tape company was subsequently acquired by Ampex in 1957. Major Orr, however, is still active in the electronics field as one of the principals of Orrox, an Alabama firm producing industrial film and tape.

Turn page



Sir Thomas Beecham conducted the London Philharmonic in the world's first public recording of music at BASF in Germany with a magnetophone similar to the one on the left. Hitler is also known to have recorded speeches for maximum security and exposure. The magnetophone he used would have resembled the one shown here, which was presented at the 1935 Broadcasting Exhibition in Berlin.

e/e MAG TAPE OLDIES

Crosby's First. With the development of an effective magnetic tape and suitable devices for putting a sound track on it, only one ingredient was still required for making tape the prime recording medium—user demand. The tape pioneer who first provided it was Bing Crosby, the popular singer and showman. The year was 1947 and the event which produced it was the first tape-recorded broadcast Crosby produced for his popular ABC network show.

Crosby had started transcription broadcasting in 1946, using conventional 16-inch discs. But putting together a finished program by transcribing from disc to disc was a tedious business, and successive generations of re-recording degraded the quality of the final job. So Bing decided to test out all three recording media—disc, film, and tape—against each other.

Tape vs. Disc and Film. The tests were conducted in the summer of 1947. The program was recorded at station WJZ (now WABC) in New York on disc and film, and piped over a telephone line for tape recording by Muzak. It took NBC three weeks to put the recorded disc program together, and equally long for RCA to produce a film version. Jack Mullin, however, was able to provide a taped program in a matter of hours by splicing and editing the original tape.

Then came the blind test of the three versions in the board room of the old Blue Network in the RCA Building. All three recordings were started simultaneously, identified only as A, B, or C, and it was possible to switch

from one to the other. At the end of the playback session the twelve experts on the listening panel were asked to select the best one. Six panelists selected the tape version, five opted for the disc recording, and only one chose film. Significantly, all the sound engineers in the group had voted for the disc recording—because, as the chairman later pointed out, they were so used to hearing disc recording that they regarded it as the only true sound.

Now we have cartridges and cassettes, which have made tape recording and playback a lot more convenient, if not necessarily superior to the old reel-to-reel recording. But, somehow, these latter-day developments seem to pale by comparison and certainly lack the glamour of those old swashbuckling days when three ex-army officers started a whole new industry with a few captured German tape recorders. ■

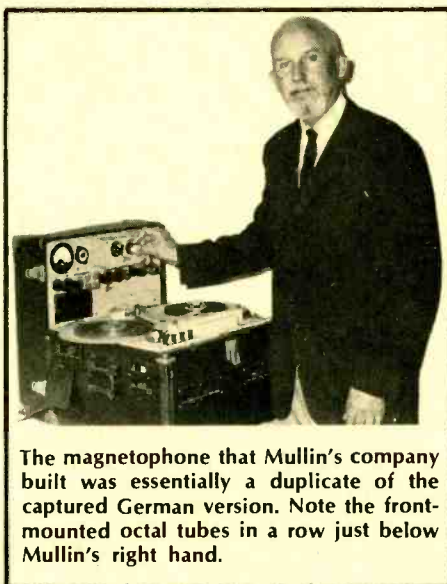

The magnetophone that Mullin's company built was essentially a duplicate of the captured German version. Note the front-mounted octal tubes in a row just below Mullin's right hand.



At the end of World War Two, Colonel Ranger (center) located the AEG factory in Berlin where the magnetophones had been assembled during the war. Flanking him are two other pioneers of the tape industry, C. J. LeBel (left) and A. W. Schneider.

ION-CONDITIONER FOR BETTER LIVING



By Myrtle Gronk

What You Don't Know Can Make You Moody!

□ Man has evolved and now lives in an atmosphere he seldom sees. This is the electrostatic field that exists between the ionosphere and the earth. A smaller example of this field is exhibited by lightning—when dark clouds come close to the earth. In this space between the ionosphere and the earth, charged particles called "ions" scoot about this electrostatic field interacting with the earth's magnetic field. This results in natural occurring frequencies of between 0 and 40 Hz, day in and day out.

We don't know exactly how or why, but man reacts favorably to these natural frequencies. His behavior becomes erratic and unusual when these frequencies are disturbed or removed.

In the past, man slept in caves, removing himself from this stimulating atmosphere at night. During the day, man ventured out to hunt or farm, thus exposing himself to this beneficial environment. Today, man still shields himself from this charged field at night, but also during the day in metal-constructed buildings. This latter situation upsets the natural rhythm of activity, where tasks requiring high activity should be performed in an electrically stimulating environment.

To offset this daytime deficiency, two young German brothers, Klaus and Edmund Zöbisch, have developed a biotropic environmental instrument which produces an electrostatic field with superimposed 10 Hz square waves. This field has its physiological effect in an improved constitution which affects the entire metabolism. This artificial field improves bodily well-being, partly by increasing oxygen and energy consumption, and also by increasing thought-reaction time. Never, according to observations, does this field hyperactivate the individual. It makes you feel good, and as a result you work better. 10 hertz can't hurt! ■

WHAT'S THE MOST important decision to make if you are thinking seriously about seeking a new career in electronics through correspondence school training? How to finance the course? How to choose the "best" school and the right training program for your purposes? How to finance the training? As important as these considerations are, they must be put second to one other evaluation you must make first: whether you have the personal initiative and drive to complete a study course that will require months, and in some cases years, of concentrated study effort.

Don't join the army of disillusioned dropouts who end up losing money and self-confidence instead of realizing that dream about "making big money" as an electronics expert just by taking an "easy" home study course "in your spare time." No correspondence course can be a road to *guaranteed* riches or an exciting career. A good course *can* lead to better vocational opportunities, but only if you can honestly answer "yes" to the following basic question: Can I work steadily, sometimes for many hours each week, for months or even years, to attain the kind of education I will need to make it in electronics?

If you are the type who needs constant prodding by parent, teacher, or boss to keep you going, forget the whole thing! There will be nobody to prod

train at home for... AN ELECTRONICS CAREER

by Jorma Hyypia

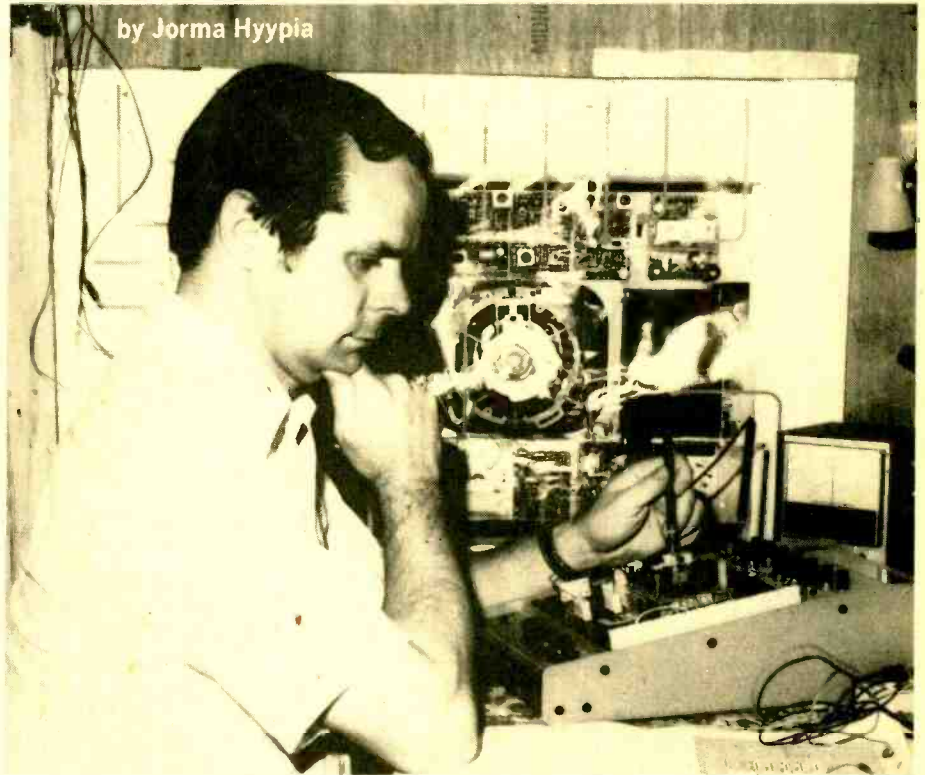

Here's a list of course material from major correspondence schools specializing in electronics career training.

Course and Description	Completion Time—Months	Cost
CLEVELAND INSTITUTE OF ELECTRONICS (CIE)		
Intro. to Electronics with Lab I —21 lessons for beginners including 40 "learn by doing" experiments using simple hardware. No G.I. Bill approval.	6	\$295
Intro. to Electronics with Lab I & II —43 lessons that include more than 200 experiments and projects. No G.I. Bill approval.	12	395
Electronics Technology —76 lessons including 1st class FCC license preparation.	24	695
Electronics Technology with Lab —93 lessons including 1st class FCC license preparation. Perform more than 200 experiments.	27	895
Broadcast Engineering —76 lessons including 1st class FCC license preparation. How to maintain radio, TV and other transmitting equipment.	24	695
FCC License —Necessary theory to get 1st class license for jobs in broadcasting, mobile radio, microwave, marine, air, radar. 64 lessons.	20	595
Electronic Communications —For those interested in 2nd class FCC license. 67 lessons.	20	595
Industrial Electronics —Troubleshooting industrial electronic equipment. 78 lessons.	24	695
Electronics Engineering —College-level program for qualified technicians having high school diploma or equivalent with one or more years math. Covers matrix theory, pulse/digital circuitry, calculus, etc. 100 lessons.	30	895

Course and Description	Completion Time—Months	Cost
Electronics Technology & Engineering with Lab —For beginning students wanting to become electronics engineers. Goes up to solid-state physics, pulse techniques, computer logic, math through calculus. 1st class FCC license preparation. 207 lessons.	48	1,595
Electronics Technology & Color TV Maintenance with Lab —Emphasizes home entertainment electronics, 1st class FCC license preparation. 111 lessons, 25-in. color TV, dot generator, other hardware.	40	1,795
1st Class FCC License & Color TV Maintenance —For students with previous experience. Repair TV and other receiving equipment. 82 lessons, 25-in. color TV.	24	1,495
Electronics & Color TV Technology —Service electronics equipment used in business and industry, color TV maintenance, 1st class FCC license. 94 lessons, 25-in. color TV.	27	1,595
DeVRY INSTITUTE OF TECHNOLOGY (BELL & HOWELL SCHOOLS)		
Digital Industrial Electronics —Covers electronic instrumentation and control systems. 163 lessons including 5 digital trainer lessons, Electro-lab equipment, home lab manuals.	22	1,095
Home Entertainment Electronics Systems —Understanding of color TV circuits and digital integrated circuits. 173 lessons including 5 color TV lab sessions and kits. Assemble 25-in. (diag.) solid state color TV.	22	1,595

you, and the project is doomed to failure unless and until you find some personal stimulus that will give you the necessary drive. It's possible you don't, at this point, really know whether you could sustain interest in an electronics study course, especially if you have had no prior experience in electronics. In that case, try this test. Turn to the Basic Course, "The Roadmap of Electronics" on page 85, or get the most clearly written elementary textbook about radio or some other area of electronics from your local library or electronics supply store and study it for a while. Start at the beginning, and try to understand what you read. If you fall asleep before you finish the first chapter, there is reason to doubt the wisdom of your taking a correspondence course; if you can't put the book down until hours after your regular bedtime, it's a good indication that electronics is indeed a subject that can turn you on.

This type of self-evaluation is not necessary, of course, if you already are into electronics and plan to take a correspondence course to *improve* your expertise in a familiar field, or to branch

off into relatively unfamiliar fields. The electronics hobbyist who already has spent some pleasant hours experimenting with electronics equipment of one kind or another also knows whether he would enjoy puzzling over electronics circuits on a continuing day-to-day basis. Incidentally, some people are attracted to electronics correspondence courses although they have no intention of ever making a living at electronics. They take the courses simply to further their hobby activities. If that sounds odd, consider how much you might spend on a ready-made color TV set, on audio hi-fi equipment, and perhaps on some test equipment such as a tube and transistor tester, a voltmeter, and maybe even an oscilloscope in the hope that you might "pick up" enough knowledge to do some of your own troubleshooting. Add it all up and you are a long way to paying for a correspondence course that brings with the package a top-notch color TV set, and often much test equipment, plus all the know-how you would ever need to keep your equipment in top operating shape.

Compare Offerings. No matter how appealing the advertising put out by a particular correspondence school might be, don't sign up until you have acquired descriptive information about

other schools and their offerings for comparison. In this article we summarize the courses offered by leading electronics schools by indicating the number of lessons in each course, some of the equipment that is supplied, what the courses are intended to prepare you to do, either the average or total allowed completion time, and the cost. You should not make any final decisions on the basis of this necessarily limited information; write to the companies for complete descriptive literature.

You can obtain some measure of the relative lengths and degrees of difficulty of different courses offered by the same school by comparing the number of lessons in different courses, and also by comparing the average completion times of the various courses. However, comparing one school against another in this manner could be misleading because you have no way of knowing whether the lesson lengths, on the average, are comparable. It could be that you might actually receive more instruction through 90 lessons offered by one school than through 100 offered by another. Note also that the average completion time for any given course not only probably measures the volume of information provided, but also possibly the clarity with which it is pre-

Course and Description	Completion Time—	
	Months	Cost
Electronic Communications —Vocational preparation to enter two-way communications field. 169 lessons, design console, oscilloscope, voltmeter and loan of two-way radio communications lab.	22	\$1,395
Audio Technology —Emphasizes stereo and quad sound systems, tape recorders and other audio systems. 161 lessons, design console, oscilloscope, digital multimeter, 4-channel sound lab consisting of FM stereo tuner and 4-channel audio amplifier.	22	1,795
GRANTHAM SCHOOL OF ENGINEERING		
Communications Electronics —For beginners with high school or equivalent education. 160 lessons including lab experiments. Preparation for 2nd class FCC license.	36	1,180
Electronics Engineering —Prerequisites: high school or equivalent education plus experience in electronics. 480 lessons covering electronics theory and practice, math through calculus, engineering sciences including fluid mechanics, thermodynamics, engineering economy. Degrees awarded.	96	1,740
NRI SCHOOLS (NATIONAL RADIO INSTITUTE)		
TV/Audio Servicing (I) —65 lessons, 14 reference books, 7 kits, TVOM.	18	312
TV/Audio Servicing (II) —Everything in TV/Audio (I) plus portable B&W TV kit.	19	425
Color TV Servicing —53 lessons, 8 books, 6 audio kits, 19-in. (Diag.) color TV kit.	16	695
Color TV Servicing (Master Course) —Everything in TV/Audio (I) plus 25-in. color TV kit, triggered-sweep oscilloscope, TV pattern generator, digital multimeter.	24	1,095

Course and Description	Completion Time—	
	Months	Cost
Color TV Servicing (Advanced) —Five color training kits plus 18 lessons limited to color TV servicing. For qualified technicians only, not beginners.	8	535
Digital Computer Electronics —58 lessons, math texts, slide rule, 10 kits, TVOM, programmable digital computer with memory, digital multimeter. Technician level course.	24	749
Electronics Technology (Master Course) —70 lessons, 10 kits with manuals. To develop technicians in broad industrial electronics field.	24	425
Communications Electronics with FCC —72 lessons, 12 reference books, 8 kits incl. CB transceiver and 14 FCC exam data publications. Also digital multimeter.	24	695
FCC License —41 electronics lessons, 8 reference books, FCC exam supplements. For those who need license fast; previous basic experience advisable.	8	202
Marine Electronics with FCC —47 lessons, 8 reference books, FCC exam supplements. Emphasis on boat-type gear (two-way radio, radar, sonar, depth finders, etc.).	10	224
Aircraft Electronics with FCC —49 lessons, 8 reference books, FCC exam supplements. Aeronautical radio service, maintenance, OMNI, aircraft guidance and landing systems.	10	224
Mobile Communications with FCC —47 lessons, 8 reference books, FCC exam supplements. For license to service and adjust transmitters and communications receivers.	10	224
Applied Math in Electronics —10 lessons, slide rule, grading and consultation service. For brush-up on electronics math.	5	60

sented. It could be that a course offered by school "A" can be completed faster than basically the same course offered by school "B" because lessons provided by the first are more readily understood; on the other hand, it might just be that the second school's course is in fact more comprehensive and as easily understood. Unfortunately, you cannot make such comparative value judgments in advance.

To be certain that you do not get stuck with a course that provides less than you could reasonably expect, be sure that the fine print in the contract specifies some sort of acceptable trial period, and that you can drop out at any time without paying unreasonable monetary penalties.

In this article we indicate the cash prices quoted at the time of this writing. The prices in some cases may be different by the time this gets into print. All schools also offer deferred payment plans so that you can pay as you go; it will cost more in the long run because of added interest payments, but if you don't like the idea of paying cash it's the way to go. Make certain you know how much interest you will be paying in actual dollars and in terms of true annual percent interest.

The school of your choice should be

accredited by some recognized accreditation authority which itself is recognized reliable, for example the Accrediting Commission of the National Home Study Council, or an agency of the state in which you live or in which the school is headquartered. Another plus for a school is its approval for educational benefits under the G.I. Bill; however, realize that in some cases certain courses given by a particular school may not be approved under the G.I. Bill even if most others are.

Choose Courses Carefully. Several electronics correspondence schools each offer a dozen or more different courses because no single general course could provide the training needed for many specialized electronics fields, or to satisfy the personal needs of students ranging from already experienced technicians to novices who wouldn't know a transistor from a jelly bean, or a resistor from a firecracker.

There are basic courses specifically designed for rank amateurs, and others you are not allowed to take unless you already know certain kinds of mathematics and have some working familiarity with basic electronics. Some courses emphasize color TV servicing, others dig deep into digital computer electronics, communications, business and in-

dustrial electronics, or home entertainment equipment servicing. If your goal is to earn an FCC license, be certain that the course you choose will prepare you to obtain the kind of FCC license you need for the type of commercial electronics work you envision. For example, a first class radiotelephone license is most important because with it you can legally operate, maintain, and repair most commercial transmitters, regardless of size and power. With a second class license you can operate most transmitters, except in AM, FM, and TV broadcast stations. A third class license is for people who, like airline pilots or operators of small ships, will operate transmitting equipment which they themselves would not adjust. There are also first and second class telegraph licenses. If you hold either type of first or second class license, you still need special endorsement to mess around with radar or to engage in broadcasting. The point being made is this: know in advance what *kind* of FCC license you would be prepared to acquire after completing a given training course.

Check The Equipment. Understandably, correspondence schools like to put their best foot forward by displaying, in their advertising, students working

(Continued on page 93)

Course and Description	Completion	
	Time— Months	Cost
Basic Electronics—30 lessons for those needing general understanding of fundamental theory—mfg. reps., writers, managers, etc.	6	112
NATIONAL TECHNICAL SCHOOLS (NTS)		
Color TV Servicing (Master Course)—Over 125 lessons, reference books and 30 kits to build including: 25-in. (diag.) color TV, pocket radio, VOM, tube/transistor tester, oscilloscope, color bar/dot pattern generator, vector monitor scope.	17	1,059
Color TV Servicing (Qualified Technicians)—Over 78 lessons, reference books, 12 kits to build including: 25-in. color TV, VOM. Prerequisite: radio theory background.	9	958
TV/Radio Servicing (Master Course)—Over 120 lessons, manuals, and 27 kits including: B&W TV (74 sq. in. picture), AM/FM/SW receiver, FET VOM, tube/transistor tester, signal generator.	15	345
TV/Radio Servicing (Practical Course)—Qualifies to service B&W TV sets, AM and FM radios. Over 95 lessons, and 15 kits including: AM/FM/SW receiver, pocket radio, FET VOM, tube/transistor tester.	12	230
Audio Electronics Servicing—Install and repair home and commercial sound equipment. Over 105 lessons plus 17 kits including: transistor tester, radio, FET VOM, AM/FM stereo receiver, twin speaker system.	15	555
Audio Technology (Qualified Technicians)—For advanced skills in home and commercial audio systems installation and maintenance. Over 40 lessons and 13 kits including: AM/FM stereo receiver, twin speaker system, digital multimeter.	8	618

Course and Description	Completion	
	Time— Months*	Cost
Electronic Communications with FCC (Master Course)—Over 130 lessons plus 14 kits including 2-meter transceiver, FET VOM, regulated power supply, code practice oscillator.	16	415
FCC License—Qualifies to earn 3rd, 2nd and 1st class FCC license. Over 85 lessons plus 17 kits including, 2-meter FM transmitter/receiver, regulated power supply, code practice oscillator.	10	355
Electronics Technology (Master Course)—Learn complex automation switching, memory banks of computers, etc. Over 170 lessons and 25 kits including: Electro-Lab, Compu-Trainer, FET VOM, oscilloscope, slide rule.	21	450
Industrial/Automation Electronics—Install and maintain automation systems. Over 130 lessons and 15 kits including: Electro-Lab, oscilloscope, slide rule.	13	380
Computer Electronics—Assist in the construction, installation and servicing of computers. Over 98 lessons and 10 kits including: Compu-Trainer, FET VOM, slide rule.	12	300
Basic Electronics—Fundamentals that apply to TV, radio, automation, communications. Qualify for entry jobs. Over 60 lessons and 5 kits including: pocket radio, transistor/diode tester, two industrial control units.	4	167

*All are average completion times except the CIE and Grantham listings which are maximum allowed completion time. In addition, the maximum allowed completion time for each NRI course is three years with the following exceptions. Advanced color TV, FCC license, marine electronics, aircraft electronics, mobile communications—each two years; applied math, one year; basic electronics, one year or longer. Also, NTS describes its maximum completion time for each course as "up to four years."

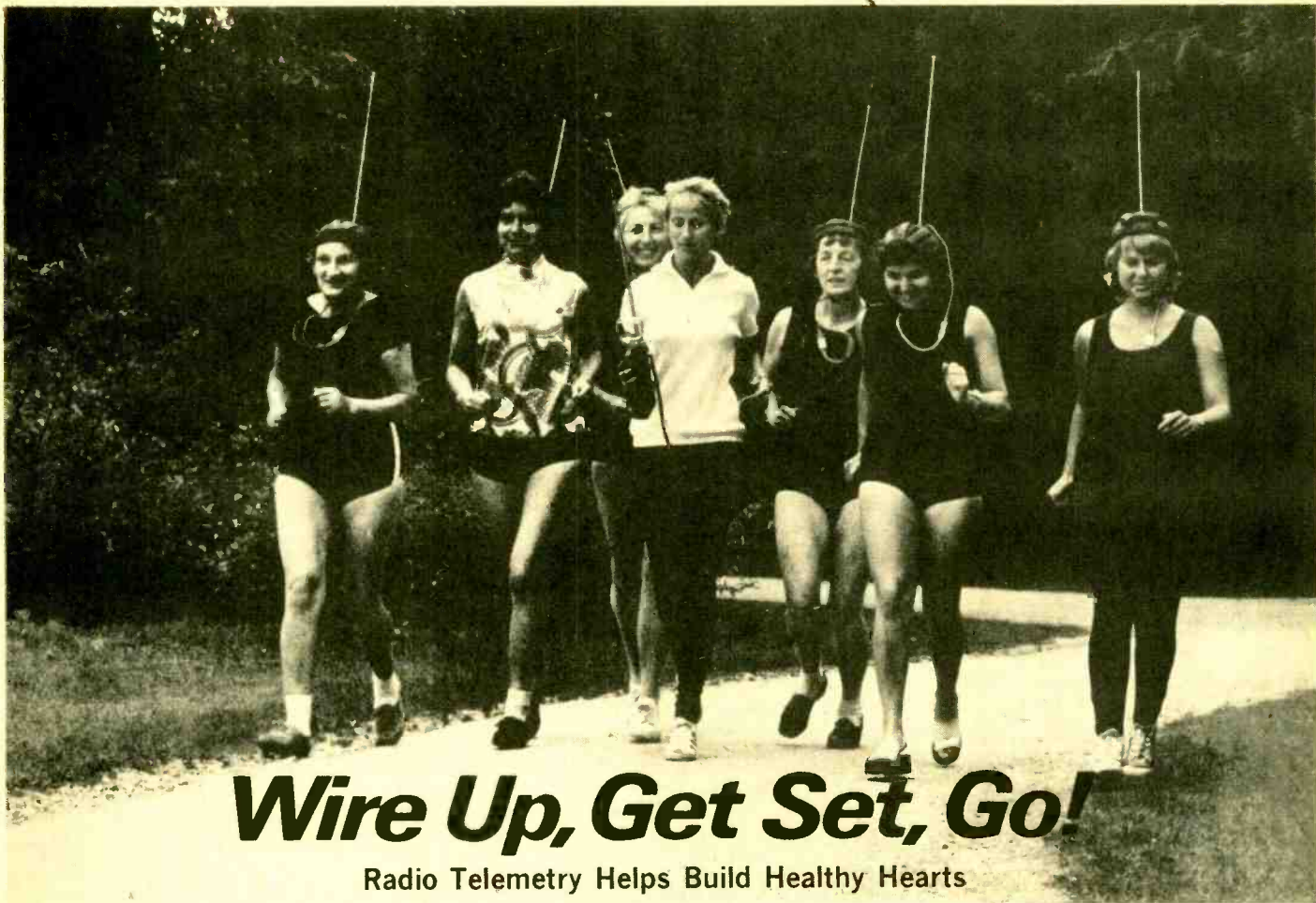

Wire Up, Get Set, Go!

Radio Telemetry Helps Build Healthy Hearts

by Myrtle Gronk.



The increasing importance of electronics in the treatment of patients is evident as Dr. Baum checks the electronic "watchdog" transmitters before the vigorous training exercises begin.

□ Being a muscle, the heart, like all muscles, must be exercised if it is to remain strong. After heart trouble it is even more important to exercise the heart.

Doctor Karl Baum of the Physiotherapeutical Rehabilitation Center of Bad Salzungen, Germany believes that, "If we can successfully train people, especially after heart trouble, then indeed we are giving them 'new hearts.'" The heart must be "built up" to the right proportion to the size and weight of the patient. A step-by-step method of recovery and strengthening is necessary for the heart to regain, and maintain, health.

Until recently, however, it wasn't possible to monitor heart patients during the course of their rehabilitation exercises. Therapy either had to be interrupted for a quick check on blood pressure, heartbeat, etc., or this check had to be made after the end of the exercise period. Needless to say, this required a one-on-one patient-technician relationship that made costs soar for such treatment.

To solve the problem of monitoring many patients, Bad Salzungen has now introduced a new, novel method of keeping exercising patients under constant observation by means of a telemetry installation. Based on medical practices used in space travel, telemetry measures, at a distance, quantities such as blood pressure, speed, temperature, and heartbeat. An electrical apparatus is attached to the patient, whose vital signs are transmitted via radio to a distant monitoring station where the signals are recorded.

Patients at Salzungen get a portable transmitter attached



Group exercise in the park is part of the regular regimen for these heart patients. Here they are seen doing knee bends, and being monitored!

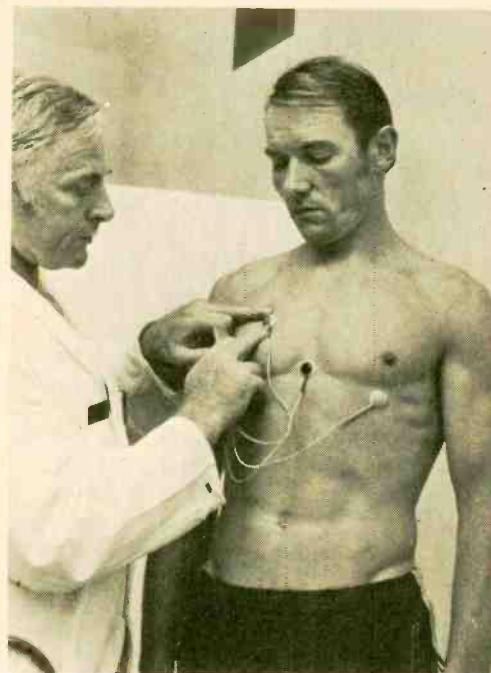

Signals from electrodes being attached are transmitted for cardiac monitoring.



Dr. Baum adjusts the transmitter positioned behind the patient's head.

to their heads. This transmitter measures, no larger than $3\frac{1}{2} \times 2\frac{1}{4} \times 1$ inch, weighs only 6.3 ounces, and works on a tiny battery. Electrodes are also attached to the body. The reach of transmissions is approximately 5 miles, depending on the surrounding terrain.

The strange headgear that the patients wear looks very much like the racing helmets that bicycle racers wear, but with the addition of an antenna. This antenna gives the wearer an "otherworldly" appearance.

A physician mans the receiver at the hospital, where he can tune in to different patients and record electrocardiograms or just monitor them on an oscilloscope screen. By pressing different controls, he can also keep a constant check on blood pressure and other body signs.

If the doctor notices anything unusual on his receiver back at the clinic, he immediately radios the therapist who always accompanies the exercising group. The therapist then receives instructions as to what he should or not do for the patient. In this way the risk involved in exercising the heart back to health is much reduced.

Consequently, one doctor can monitor several patients while they are actually exercising, releasing other doctors for work elsewhere. Saving on medical expenses is important, but even more important is the saving on doctors' time, which cannot be bought with dollars.

Through telemetry, electronics has made it possible for convalescing heart patients to wire up, get set, *GO!* on their way to stronger hearts and healthier living. ■



Back at the receiving station, Dr. Baum can monitor vital life signs of exercising patients as far away as five miles!

follow-up
report

CB TO COME

by the Elementary Electronics Editorial Staff

IT'S BEEN a cartwheel response! According to Charlie the office mailman, dime-size holes in his shoes have burnished open to dollar diameter hauling irate mail to e/e editors for their views on the proposed new "ham" communicator license.

From our point of view here at e/e, everyone missed a basic principle in our May-June '75 issue; namely, the FCC wanted to clean house and make up for a lot of previous errors of judgment, and in general, to get hobby communications out of the 1930s and into the '70s. On top of this, the EIA (Electronics Industries Association) who so desperately wanted 220 MHz CB with its estimated \$2 billion equipment market, saw class D—its real money-maker—going out of business with the proposal to make it an all single-sideband service since SSB accounts for maybe only one out of ten class D sets sold. There just isn't enough interest in class D SSB to support a single all-SSB company, let alone an entire CB industry. It would be very nice to have class E in addition to class D—not as a substitute. That one-not-the-other is just what the EIA faced.

As for the communicator license, it's probably a great idea, but on the wrong frequency. As now implied it would be a quick entry to the amateur ranks for many CBers, which we feel is the FCC's intent. But can we expect a hobbying CBer to buy new equipment to do something he's already doing? Probably not. Besides, there's just not enough room on 2 meters for the thundering herd. Most likely, a communicator test

would fall somewhere between "10 easy choices" and the present technician exam (minus the code), and a few serious CBers who can't or won't learn code will become amateurs via the communicator license. From the business point of view, the new communicators would probably buy more of what already exists, with no *great* effect on individual manufacturers. Perhaps, as we will mention later, the communicator license would best serve the public at 220 MHz.

About All-SSB. If all of class D were expanded to only SSB, as is proposed, the cost per station would be so high as to preclude its use by hobbyists; but there would still be several million older AM rigs around, many in the hands of those who just don't give a damn. They would still use their old AM equipment—legal, or not—continuing a policing problem for the FCC. The latest talk (not official) is to dedicate new CB channels to sideband only, leaving the old class D channels as is. Small business users could use the new channels with new, more expensive SSB gear. The hobbyist would continue to chit-chat, legally or not, on the older class D frequencies until his equipment died of old age, and a simple law ending the manufacture of AM equipment, that could be operated under the old class D rules, would insure its eventual demise.

But hold on, the latest thinking has the planned obsolescence part of class D CB rules proposals under reconsideration. It seems unlikely that public response to the demise of AM class D would be mild. There are hundreds of millions of dollars worth of AM gear out there, and that's a block of influence that can't go away.

There is yet a second proposal docket that can be expected to affect CBers and readers of e/e. In amateur radio, the novice license was supposed to simplify entry into amateur radio. But it hasn't really worked out the way we think it was intended. Up to the time novices got the privilege to use VFOs, the amateurs entering the general ranks were not keeping pace with the drop-outs. In fact, amateur radio is still shrinking in membership; but not as fast, for a whole new breed of hobbyist has discovered it—the "Morse code" former-CBer. It's someone not necessarily interested in becoming an electronic expert or technician—he just wants to "work the world" legally.

At any given moment, there appear to be more "brass pounders" using the tiny novice allocations of 80 and 40 meters than on all the other high frequency bands.

So, in the new FCC docket, a novice license would be renewable and higher

(Continued on page 97)



This Clegg 2-meter FM ham transceiver is a good example of today's already existing advanced technology. Dial any one of 1000 channels from 143.5 to 148.5 MHz. And, the power output is switchable from 1 to 35 W.



This is a repeater, the unattended, automated transmitter/receiver package that can extend the range of 2-way radio signals. This model from VHF Engineering is for use on the ham VHF band.



ANTIQUUE RADIO CORNER

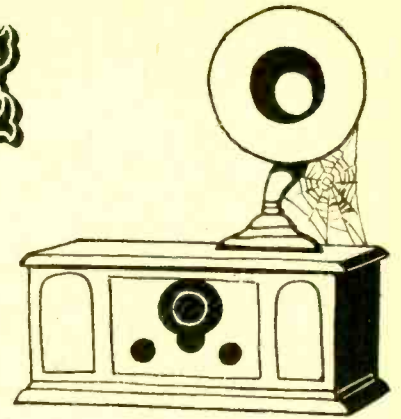

by James A. Fred

□ Hello out there in Radioland. Here it is fall again and schools will soon be in session. It is time to plan to restore those radios you found during the summer. The AWA annual conference will be held in Canandaigua, New York on October 3 and 4. This is a must for all of you who can make it. This is the best chance you will ever have to see so many old radios in one place. The AWA museum is about ten miles away at East Bloomfield, NY.

How many of you readers remember Charles Leutz Sr. and the radios he designed? He was active in the Experimenters Information Service Inc., Norden-Hauck, and the Golden-Leutz Corp. from 1923 to 1930. His work on the early superheterodyne radio was outstanding. He wrote three books: *Superheterodyne Receivers*, in 1923, *Modern Radio Reception* in 1925, and *Short Waves* in 1930. His son, Charles Leutz Jr. has recently written me a letter asking my help in finding some copies of these books. He only has a revised copy of *Modern Radio Reception* published in 1928. If any reader has a copy of these books he can spare, please write

to me in care of this magazine and I will forward the information on to Leutz. In the next "Antique Radio Corner" we will present some of the highlights of Charles Leutz Sr.'s career.

Signal Sponge. Many radio collectors need to put up a long-wire outdoor antenna, but lack the space to do it. For over four years I planned to put up a 100 foot long antenna as high above ground as I could, but somehow or another I just never got it done.

While restoring an Atwater Kent model 46 I realized I had to have an outdoor antenna to run a listening test. I had a 100 foot roll of stranded antenna wire and two of those old-fashioned window lead-in strips. I took some "nail-it" electric fence insulators and ran the antenna wire from the window to the eaves, I went 28 feet north turned a corner, and went 36 feet west and anchored the wire end. Next I drove a rod into the ground and ran another piece of wire from the ground clamp to a lightning arrester and on to the lead-in strip. After connecting the antenna and ground wires to the radio I was amazed at how well the radio

played. Those old radios performed very well on the lower half of the broadcast band. It was just as I had remembered it from the 1930's. The stations on 770, 720, 700, and 670 "kc" that I had listened to as a boy were still there on the same frequencies. Of course the programming has changed, but I was surprised to hear Bob Elson still broadcasting Chicago Cubs baseball games.

Busted! After two years I am still receiving letters without a return address being printed on the letter. I would like to suggest that every letter writer put his name and address on the letter. I am having trouble reading some of the letters, too. More attention to penmanship would be appreciated!

Many letters asking for specific information are coming without a stamped, self-addressed envelope. When you realize that my out-of-pocket expense for postage runs to \$12 per week, you can understand why I am asking for a stamped, self-addressed envelope. There aren't many writers of magazine columns that will answer letters individu-

(Continued on page 76)

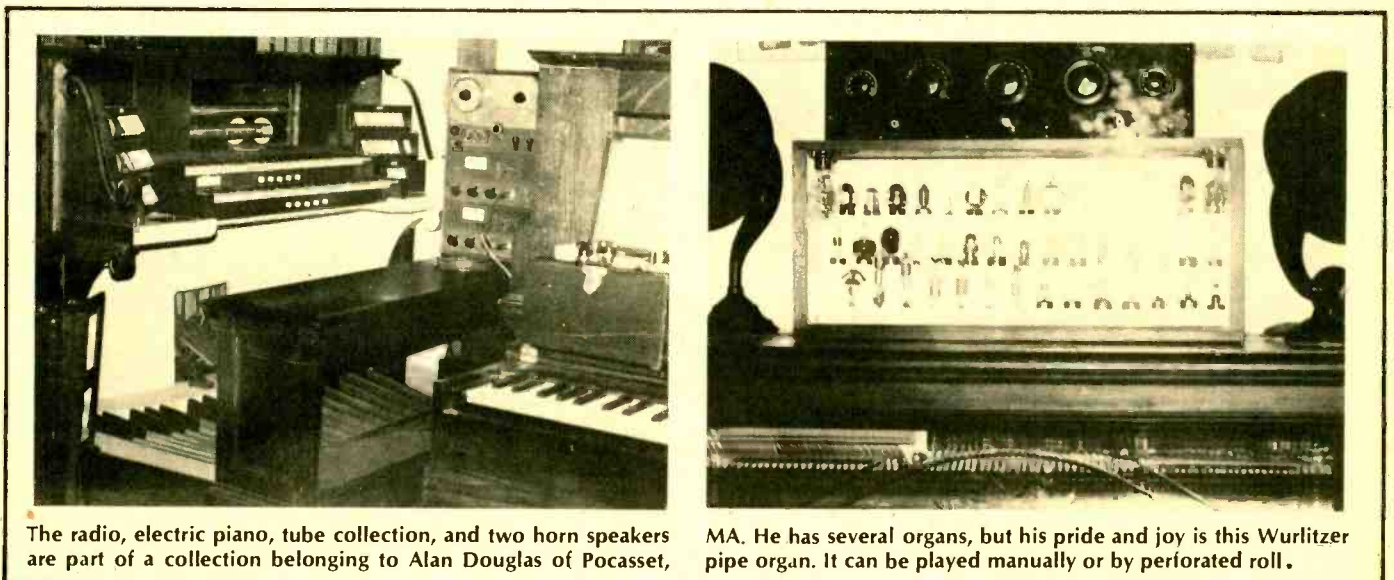

The radio, electric piano, tube collection, and two horn speakers are part of a collection belonging to Alan Douglas of Pocasset,

MA. He has several organs, but his pride and joy is this Wurlitzer pipe organ. It can be played manually or by perforated roll.

Your NEW Heathkit Catalog is ready



Now over 400 do-it-yourself electronic kits for home, hobby, and industry. All designed to give you more for your money... more value, more performance, more satisfaction. All designed so even beginners can build them. Send for your free catalog today.

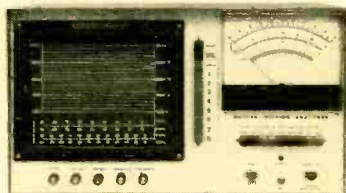

New Professional 12" Ignition Scope — Kit or Wired

Does more than others for \$1000 less. Spots tough ignition problems on all types of systems in 3, 4, 6, 8 cyl. or 2-rotor Wankel engines; sets itself automatically for no. of cylinders. Big 12" screen has 2 calibrated primary and secondary voltage grids plus dwell angle indications. Special circuit maintains trace length regardless of RPM. Displays "superimposed" patterns, single cyl. pattern, primary or secondary "parade" patterns. "Power balance" feature even helps spot bad valves or rings. 8" meter with tach & DCV ranges. Optional low cost timing light, alternator adaptor & cart. Kit CO-2500 \$379.95; Assembled WO-2500 \$695.



New Automobile Intrusion Alarm Kit

Total Protection. Alarm mounts anywhere; connects to switches on doors, hood, & trunk. Underdash switch arms or disables unit. Adjustable delay time allows you to quickly enter or leave car without triggering alarm, but opening trunk or hood triggers alarm instantly. Alarm sounds car horn in repeated 2-minute cycles. Kit GD-1157 Alarm \$24.95; Kit GDA-1157-1 Siren (gives yelping sound louder than car horn) \$19.95.

waiting to serve you with more values, more new kits, than ever before



New Programmable Digital Stop Watch Kit

Another "first" from Heath. 2 IC counters, 8 digits & 7 functions with typical accuracy to $\pm 0.003\%$ and resolution to 1/100th of a second. Function 1 (Start/Stop Elapsed) times individual events while also counting total. Function 2 (Sequential) times each part of event & displays each separately while timing overall event. Function 3 (Total Activity) accumulates total elapsed time of a series, excluding time between events. Function 4 (Split) displays cumulative time to each "split" point while continuing overall event time. Function 5 (Start/Stop Activity) shows separate time for each event & totals all individual times. Function 6 (Programmed Upcount) counts up to "learned" time. Function 7 (Programmed Downcount) counts down from "learned" time. Stop watch can "learn" time from other functions or be programmed up to 9 hours, 59 minutes, 59 seconds. Has jacks for external triggering devices and alarms. Includes nickel-cadmium batteries & charger. Kit GB-1201, \$99.95.



New Digital Wind Speed & Direction Indicator Kit

Unique. Two big, bright digits show wind speed to 99 mph. As you build, choose 2 readout modes: miles, knots, or kilometers per hour; front panel light shows mode in use. 8 incandescent lights show wind direction at principal compass points; adjacent lighted bulbs give 16 point resolution. Remote transmitter boom clamps to TV mast. Styled in black plastic to match Heathkit GC-1005 Digital Clock and ID-1390A Digital Thermometer. Kit ID-1590, \$69.95 less cable.

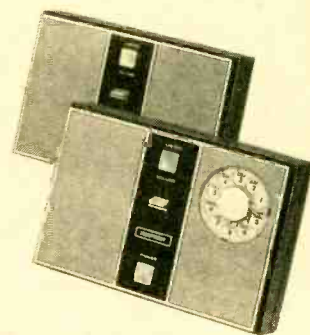

New — Two-Way Telephone Amplifier Kits

Now, hands-free telephone use with amplified "talk" and amplified "listen" — with or without dialer. Talk & listen from 10' away. Voice-actuated circuitry switches from talk to listen without feedback or clipped words. Listen button lets you monitor line without built-in microphone activated. Dialer model may be used with or without regular telephone. Includes 4-prong jack & phone coupler connector. Battery powered. Kit GD-1112 (no dial) \$49.95; Kit GD-1162 (w. dial) \$69.95.

New Public Address Sound System Kits

Outperforms those costing twice as much. **TA-1620 Control/Amp.** takes 6 low impedance mikes, each with level, bass & treble controls & reverb sw. Has VU meter, 4 switched response "shaper" circuits, exclusive bass filter, 100 rms watts drives 2 speaker columns. **TA-1625 Booster Amp.** 100 rms watts to drive 2 extra speaker columns. **TS-1630 Speaker Column.** Six 8" full-range drivers response tailored for voice; 60 watt rms rating; 12 ohm impedance. Kit TA-1620 \$449.95; Kit TA-1625 \$179.95; Kit TS-1630 \$199.95.





New DC-5 MHz Triggered Scope — Kit or Wired

Best scope value today. Wide bandwidth, 20 mV sensitivity, & stable triggering — ideal for TV, audio and RF servicing. Easy-to-use controls. Trigger circuit (not recurrent type) has normal & automatic modes, switched AC & DC coupling, & front panel external inputs (special TV position allows low freqs. to pass while rejecting high freqs. for easy triggering on complex TV signal. 7 calibrated time bases from 200 ms to 0.2 μ s/cm. 20 mV/cm vertical sensitivity with 9 calibrated attenuator positions up to 10 v/cm, plus variable control. 5" round flat-face CRT (8 x 10 cm graticle). Lightweight, durable blue plastic cabinet with white panel. Kit IO-4540 \$179.95; Assembled SO-4540 \$275.



New — Lowest cost Triggered 5 MHz Scope Kit

The scope everyone can afford, and it has the performance you need. DC-5 MHz band width, 100 mV vertical sensitivity with X1, X10 & X100 attenuation, AC or DC. Automatic, positive locking horizontal sweep continuously adjustable from 20 ms to 200 ns/cm. Stable displays due to zener regulated amplifiers and sweep. 5" round flat-face CRT with 8 x 10 cm graticle. Simplified controls and switches make it easy to use. Lightweight, durable blue plastic cabinet; white panel. It's the best instrument buy in years. Kit IO-4560 \$119.95

New catalogs and kits also available at

HEATHKIT ELECTRONIC CENTERS —
Units of Schlumberger Products Corporation
Retail prices slightly higher.

ARIZ.: Phoenix; CALIF.: Anaheim, El Cerrito, Los Angeles, Pomona, Redwood City, San Diego (La Mesa), Woodland Hills; COLO.: Denver; CONN.: Hartford (Avon); FLA.: Miami (Hialeah), Tampa; GA.: Atlanta; ILL.: Chicago, Downers Grove; IND.: Indianapolis; KANSAS: Kansas City (Mission); KY.: Louisville; LA.: New Orleans (Kenner); MD.: Baltimore, Rockville; MASS.: Boston (Wellesley); MICH: Detroit; MINN.: Minneapolis (Hopkins); MO.: St. Louis (Bridgeton); NEB.: Omaha; N.J.: Fair Lawn; N.Y.: Buffalo (Amherst), New York City, Jericho (L.I.), Rochester, White Plains; OHIO: Cincinnati (Woodlawn), Cleveland, Columbus, Toledo; PA.: Philadelphia, Pittsburgh; R.I.: Providence (Warwick); TEXAS: Dallas, Houston; VA.: Norfolk (Va. Beach); WASH.: Seattle; WIS.: Milwaukee.



New Variable Isolated AC Supply

What every tech & hobbyist needs. The IP-5220 isolates equipment under test from the AC power line and provides an AC output which is variable from zero to 140 volts. Great for locating circuit faults caused by high or low voltage or testing equipment with unknown power requirements. Power rating is 360 volt-amperes, continuous. Variable output current rating: 3A. max. Direct output current rating: 10A. Two meters: voltmeter 0-150 VAC; ammeter: 0-1 & 0-3A. Ammeter and variable output socket are fused. Kit IP-5220, \$109.95

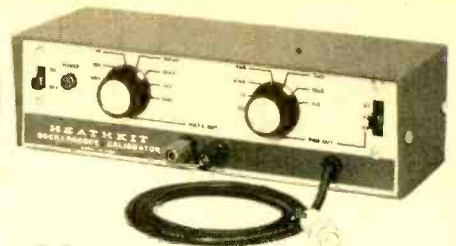

New Oscilloscope Calibrator Kit

For time calibration, it generates a 0.5 second to 1 μ sec square wave in 1-2-5 sequence accurate to 0.01% with 200 mV peak (\leq 3% overshoot) and \leq 4 ns rise time. Voltage calibration ranges are 1 mV to 100 v. in decade sequence, accuracy within 2%, DC plus variable 2 Hz to 10 kHz in 1-2-5 sequence (internal std. accuracy within 1%). Use it to calibrate scopes up to 35 MHz and voltmeters; it's also a fast rise time squarewave generator and good bench freq. standard. Kit IG-4505 \$44.95

New 21" (diag.) Digital Design Color TV Kit

All the advanced technology of digital circuitry in a smaller screen size. **Electronic touch-to-tune** varactor front end (nothing mechanical to wear out) with computer-like programming board for up to 16 channels. **On-screen channel numbers**, adjustable in brightness, position, and duration. **On-screen digital clock**; a low-cost option; programmable in 12 or 24 hour format, displays 4 or 6 digits. **Fixed-filter IF**, a Heath exclusive that assures better pictures longer, never needs instrument alignment. **100% solid state** — more ICs than any other — sophisticated circuitry that results in less interference, better color tints, improved sensitivity, greater noise immunity, improved picture definition. **Black negative matrix 21V picture tube** for brighter, sharper pictures. **Total touch-tune remote control** — low cost option that operates all functions, including recall of time & channel.



Easier to build & service — thanks to extensive modular design and built-in servicing tools including digital-design dot generator, front access slide-out Service Drawer, new picture centering and pin-cushioning correction circuits, and Test Meter. **Enjoy the best in TV design** — now in smaller size at lower cost. Kit GR-2050 \$599.95. Kit GRA-2000-6, remote control, \$89.95. Kit GRA-2000-1, digital clock accessory, \$29.95. Contemporary or Mediterranean cabinets from \$119.95.

Use coupon below to order your favorite new kit or to get your FREE new Heathkit Catalog.

HEATH Schlumberger	Heath Company Dept. 139-09 Benton Harbor, MI 49022
<input type="checkbox"/> Please send my free 1975 Heathkit Catalog. <input type="checkbox"/> Enclosed is \$ _____ plus shipping. Please send model(s) _____	
NAME _____	
ADDRESS _____	
CITY _____ STATE _____ ZIP _____	
<small>PRICES ARE FACTORY MAIL ORDER, FOB PRICES & SPECIFICATIONS SUBJECT TO CHANGE WITHOUT NOTICE.</small>	
CL-571	

CIRCLE 1 ON READER SERVICE COUPON

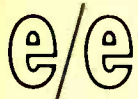

ANTIQUE RADIO

(Continued from page 71)

ally. I try to answer each and every one, but unless the sender encloses a stamped, self-addressed, envelope I too will have to stop answering. One more thing along these lines; when you send a SASE for your free Fact Sheet and write me a letter too, the magazine will use the envelope for the Fact Sheet. If you also write me a letter, send two envelopes, and they will forward the extra one to me with your letter.

TV Too. Something akin to the battery radios of the 30's is the scanning disc television receiver. There is a small group of collectors of these old TV receivers. The scanning disc and scanning drum receivers seldom produced a picture larger than an inch square, it flickered, and was usually orange in color, because the picture was produced by a "crater" neon lamp. Many viewers used a magnifier to enlarge the picture to 4 or 5 inches.

There are also collectors who are now collecting the 3- and 5-in. TV receivers of the late 1940's. The 3 inch Pilot TV set is becoming very scarce and collectors are searching everywhere for them. The 5 inch Hallicrafters receiver in the gray hammertone steel cabinet is also in demand. If you travel around the country visiting flea markets and auction sales, be sure to watch for early TV sets. If you don't have the urge to collect them yourself, you can always trade them for something you need. We would like to have some photographs of the scanning disc receivers to print in this column. If a reader has glossy photos of one of the scanning disc TV receivers, we will be happy to have it for the column.

I understand one of the editors is building a color TV collection, and it now includes the first color set sold, the RCA CT100 (with the CTC-2 chassis). If there are readers interested in this phase of antique collecting, we would also like to hear from you.

An institution in most smaller towns is the cigar store. Now the cigar stores have become a club room, tavern, tobacco store, and home away from home for retired workers. If you have ever tried to look through the window of many of these business places, you probably didn't see much. Some have displays featuring girlie magazines and a *Police Gazette*, but one cigar store owner recognized his responsibility as a merchant to keep his store window attractive to passersby. He features attractive store window displays of local hobbyists' collections. At present his

window has two pre-1928 battery radios and three speakers on display from a local collector. The sets on display will be changed monthly so there will be something new to see. Neatly lettered cards tell when each radio and speaker was made and who its manufacturer was. Another sign will give the collector's name and telephone number.

New Thought. Now here is an idea for each of you collectors. What a wonderful way to find new items for your collection, and at the same time, show the younger generation what old-time radio equipment looks like. There are several businesses that have front windows, but don't have merchandise to display. There are barber shops, cigar stores, laundramats, dry cleaners, and beauty shops. Surely each collector knows one or more places where he could display several radios and speakers. Another idea is to sponsor an antique radio contest. A sign could be placed in the window announcing that a prize would be given for the oldest radio registered. A committee of local collectors could judge those registered, and a prize could be awarded. Local newspaper publicity could be easily arranged, and a picture of the winning radio and its owner could appear in the paper. Now this would produce a fine list of many old radios plus their owners. Probably many of the radios would end up in the collections of local collectors. You would be surprised at the number of antique radios still in the homes of the original owners or their relatives. As soon as they find a person who appreciates the radio, they will give it to him.

I have received a copy of Morgan McMahon's new book, *A Flick of the Switch*. It contains pictures of hundreds of the better known AC operated radios



Last issue we showed a Readrite model 1000 set analyzer. A much better example is the Readrite model 712A. The left hand meter was made by Triplett, and it increased the sensitivity of the voltmeter to 1000-ohms/V.

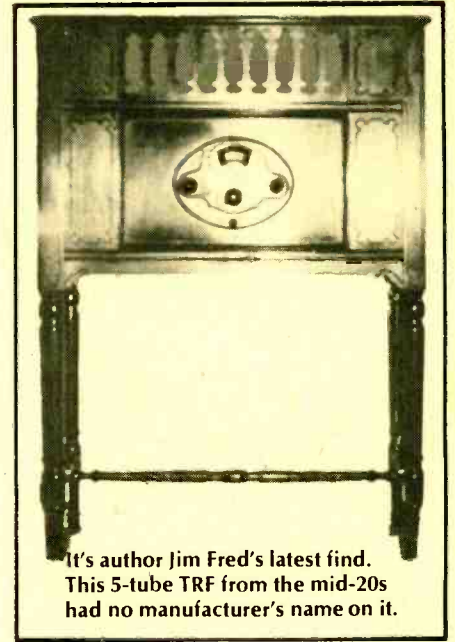

It's author Jim Fred's latest find. This 5-tube TRF from the mid-20s had no manufacturer's name on it.

manufactured between 1930 and 1950. There are sections for communications receivers and some armed forces radios used during World War II. It contains a wealth of information and will make an invaluable addition to the library of any collector. It will be especially useful to the beginning and younger collector who has never seen most of the radios pictured in this book. The hard back library edition sells for \$9.95 and the soft back edition sells for \$6.95. You may buy them postpaid from the Antique Radio Press, P.O. Box 42, Rossville, Indiana 46065. Also, *A Pocket Guide to Antique Radio Collecting* will soon be available from Antique Radio Press and will sell for \$1.00. The guide is designed to fit into a shirt pocket and is written for the beginner in radio collecting. He can carry it to auction sales, antique shows, junk shops, etc. whenever he is looking for radios, tubes, speakers, and other radio collectibles. A brief review of its contents will appear in this column in the next issue.

And Finally. One of the best reprints of an old radio catalog is the 1922 Radio, Wireless Telephone, and Wireless Telegraph Equipment catalog of Montgomery Ward & Company. It is produced by Klipsch and Associates, Inc. of Hope, Arkansas.

There are ten pages of radio receivers, two pages of speakers and headphones, seven pages of parts, and many more pages of tubes, books, and transmitters. It is a goldmine of information for any collector.

Next time we will answer some of our readers' questions, show the old-time resistor and capacitor color codes, and give you a lot more information. ■

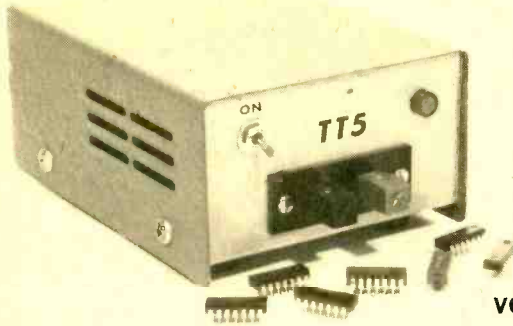

Hobbyist Power Supply For TTL

TTL-type digital integrated circuits require a steady 5 volts for superior operation. Get ready for TTL projects with this ultra-simple, high performance regulator.

by Herb Friedman

ELECTRONICS is going digital! Not only are space TV photos relayed by digital techniques, but inter-country TV sound across the big pond (Europe) uses bits to represent audio. Right here in the U.S. we find TV receivers and FM tuners are "going digital." Even hobby projects such as you'll find here in e/e are using digital ICs.

The 7400 series of digital ICs is presently the most popular digital device "family," primarily because of its rock-bottom cost and easy handling; and it is more than likely that many hobby or experimenter projects you're going to run across in the next year or so will use the 7400 series of TTL (Transistor Transistor Logic).

The only problem is that TTL almost always requires a tightly regulated 5-volt power supply, and take careful note of those words *tightly regulated*. Often, the 7400-series device will instantly "blow" if 6 volts or a line transient is applied. The margin for error when working with TTL is essentially zero. While a zener diode can be used to provide, say, 5.1 volts, they are not easy for the average experimenter to find, nor do they necessarily provide protection against line voltage transients or short circuit protection.

What's needed is a full voltage regulator having both current and short circuit protection. Should the supply run

The completed supply ready for installation in a cabinet or project. Pilot lamp I1, which also serves to discharge the output capacitor, is not part of the PC board assembly.

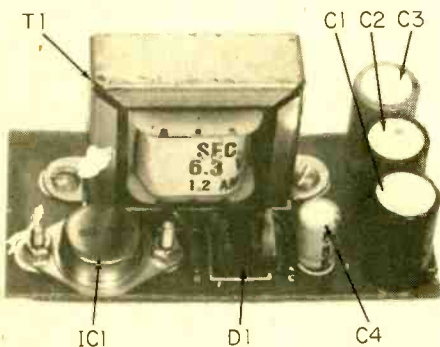

hot due to excess current drain, or should a wiring error or breakdown in the external circuit short-out the power supply, the supply will automatically turn off, thus protecting both the power supply components and the connected circuit.

While you can always use a handful of components to build a 5-volt regulated supply for TTL—assuming you could possibly find the necessary components in your area—it's much easier to use a LM-309K, a single IC that contains *all* the components of a power supply regulator in a standard TO-3 case. Best of all, the LM-309K can be purchased locally for about \$2.50; and that's probably less than the cost of discrete components if you decided to build from scratch.

Inside Look. The LM-309K 5-Volt Regulator is available from many surplus dealers and Radio Shack. Mounted on a PC (printed circuit) or perfboard, it can safely deliver up to 1 ampere. Mounted on a heat sink you can squeeze out 3 amperes. The LM-309K gives the average experimenter everything he's looking for in a TTL power supply: tight regulation, transient protection, thermal shutdown, and short circuit turn-off.

A typical TTL 5-volt supply using the LM-309K that's suitable for the experimenter is shown. It's a rather easy circuit to build and provides 5 volts at up to 1 ampere with the IC mounted on a PC board. If you want to

avoid the fuss and bother of making your own PC board, you can use a pre-drilled factory-made board which we'll describe later.

Transformer T1 is an ordinary 6.3-volt filament transformer rated at least 1 ampere. Capacitors C1, C2, and C3 can be replaced with a single 3000- μ F unit rated at least 15 volts, but you'll find it much easier to locate three 1000- μ F capacitors. Diode bridge D1 should be rated 5 to 6 amperes to handle the peak current load of the heavy filtering (C1, C2, C3). Do not try to get by with a 1-ampere bridge rectifier.

Capacitor C4 provides a low power supply impedance to the connected circuit; do not eliminate C4. Also, pilot lamp I1 should not be eliminated or its position in the circuit changed because it is used to discharge C4 when the power supply is turned off. Without I1 C4 might retain a charge for several minutes after the 117 VAC input power has been removed and can cause headaches and grief. When? Suppose you connect up your project thinking there's no voltage from a supply that's turned off!

To insure long life, and since the

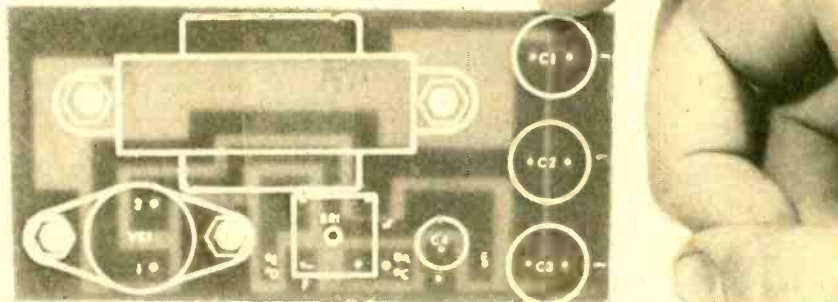

Easiest way to build the power supply is to use this Radio Shack PC board. All holes are pre-drilled and the component positions are "screened" on the top side. Backlighting shows the heavy copper foil showing through; it means customization without fear of damage to the foil strips.

e/e POWER SUPPLY FOR TTL

pilot lamp doesn't have to be bright enough to read by, I1 is a 12 volt/25 mA lamp—one of those miniature pilot assemblies that comes with attached leads. Connected to 5 volts, it's bright enough to see even in sunlight.

The supply shown in the photographs is assembled on a factory pre-drilled PC board available from Radio Shack for \$1.49. The top side has the component locations screened in white paint. While the transformer mounting holes are spaced for the Radio Shack 273-050 6.3-volt filament transformer, you can, however, use any rated transformer although you may have to drill new holes. A rear-lighted photograph shows the extra-wide copper foil that permits easy customizing of the PC board.

More Data. The instructions supplied with the Radio Shack PC board indicate a different pilot lamp connection than shown in our schematic. For this supply do not follow the Radio Shack connections; install the pilot lamp exactly as indicated in our schematic.

The entire supply—except for power switch S1, pilot lamp I1, and fuse F1—is on the PC board which you can install in any type of cabinet. The complete supply shown uses a 4 x 2 $\frac{3}{8}$ x 6-in. metal cabinet, with the PC board end mounted by L brackets fashioned from scrap aluminum. The fuse holder is mounted on the base of the cabinet. Output is from two spring-loaded push-button terminals, but you can substitute 5-way binding posts or any other output connections you prefer.

Fuse F1 can be anything from $\frac{1}{8}$ to $\frac{1}{4}$ ampere. Use a standard fuse such as 3AG—not a slow-blow type.

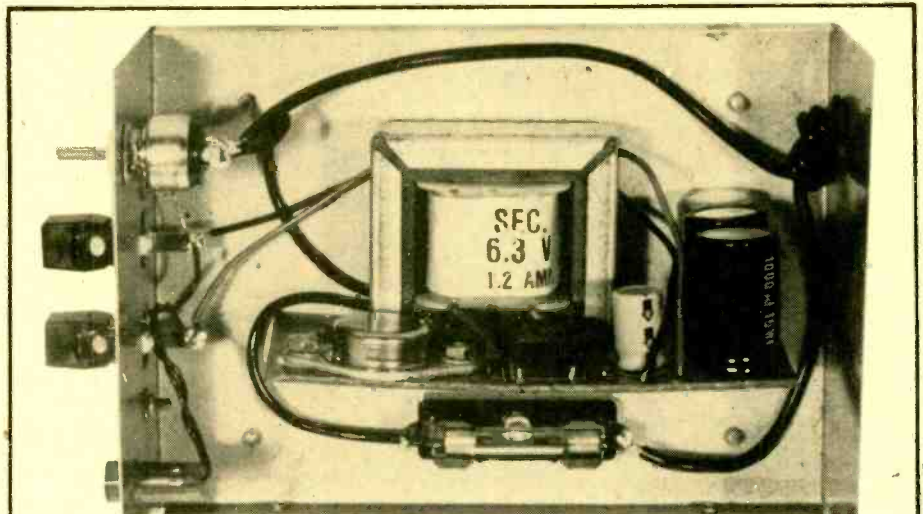

Just one example of a suitable cabinet installation, though any layout will work. The fuseholder is mounted on the cabinet base, while pilot lamp I1 is connected directly across the output binding posts. An old plastic cap was used to give the base lamp a professional appearance.

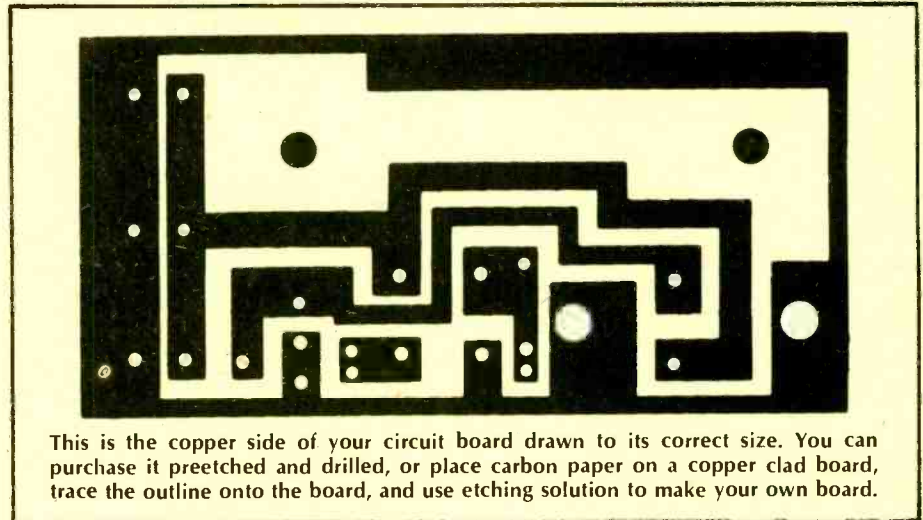

This is the copper side of your circuit board drawn to its correct size. You can purchase it preetched and drilled, or place carbon paper on a copper clad board, trace the outline onto the board, and use etching solution to make your own board.

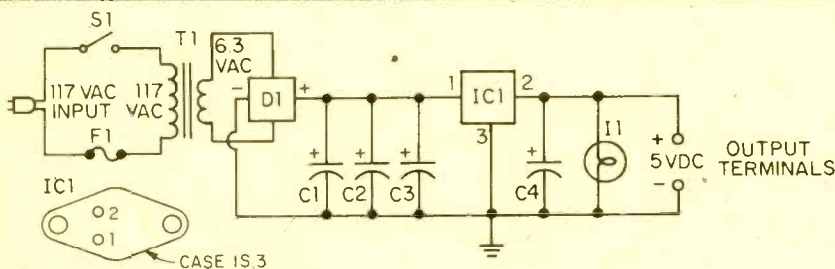

PARTS LIST FOR TTL POWER SUPPLY

- C1, C2, C3—1000- μ F, 15 VDC or higher electrolytic capacitor. see text (Radio Shack 272-958 or equiv.)
- C4—100- μ F, 15 VDC or higher electrolytic capacitor (Radio Shack 272-955 or equiv.)
- D1—50-volt, 6-amp diode bridge rectifier (Radio Shack 276-1146 or equiv.)
- F1— $\frac{1}{4}$ -amp fuse, fast-acting (Radio Shack 270-1270 or equiv.)
- I1—12-volt, 25-mA pilot lamp, see text (Radio Shack 272-1141 or equiv.)

- IC1—LM-309K IC voltage regulator (National Semiconductor Corp.), (Radio Shack 276-1830 or equiv.)
- S1—spst switch (Radio Shack 275-602 or equiv.)
- T1—6.3-VAC, 1-amp or better transformer (Radio Shack 273-050 or equiv.)
- Misc.—cabinet (Radio Shack 270-252 or equiv.), fuse holder (Radio Shack 270-739 or equiv.), pushbutton or other type terminals (Radio Shack 274-315 or equiv.), Radio Shack 277-102 circuit board (optional), wire, solder, hardware, etc.

Too Hot. If the last things you solder are the IC terminals, let everything cool down before you check out the supply. If IC1 is excessively hot—from soldering heat—the automatic thermal protection shuts down the output and you won't get any output voltage. A meter connected across the output terminals will indicate zero. After you are certain IC is cool, measure the output; it should be 5 volts. Next, connect your voltmeter across either C1, C2, or C3, then short circuit the output terminals. If you have assembled everything correctly the meter will indicate approximately 10 volts even though the output is shorted. After the short is removed you should read 5 volts at the output terminals.

The only thing to keep in mind when using this TTL 5-volt supply is that the output current is automatically limited to 1 ampere.

OP AMP INSIGHTS

by Adolph A. Mangieri

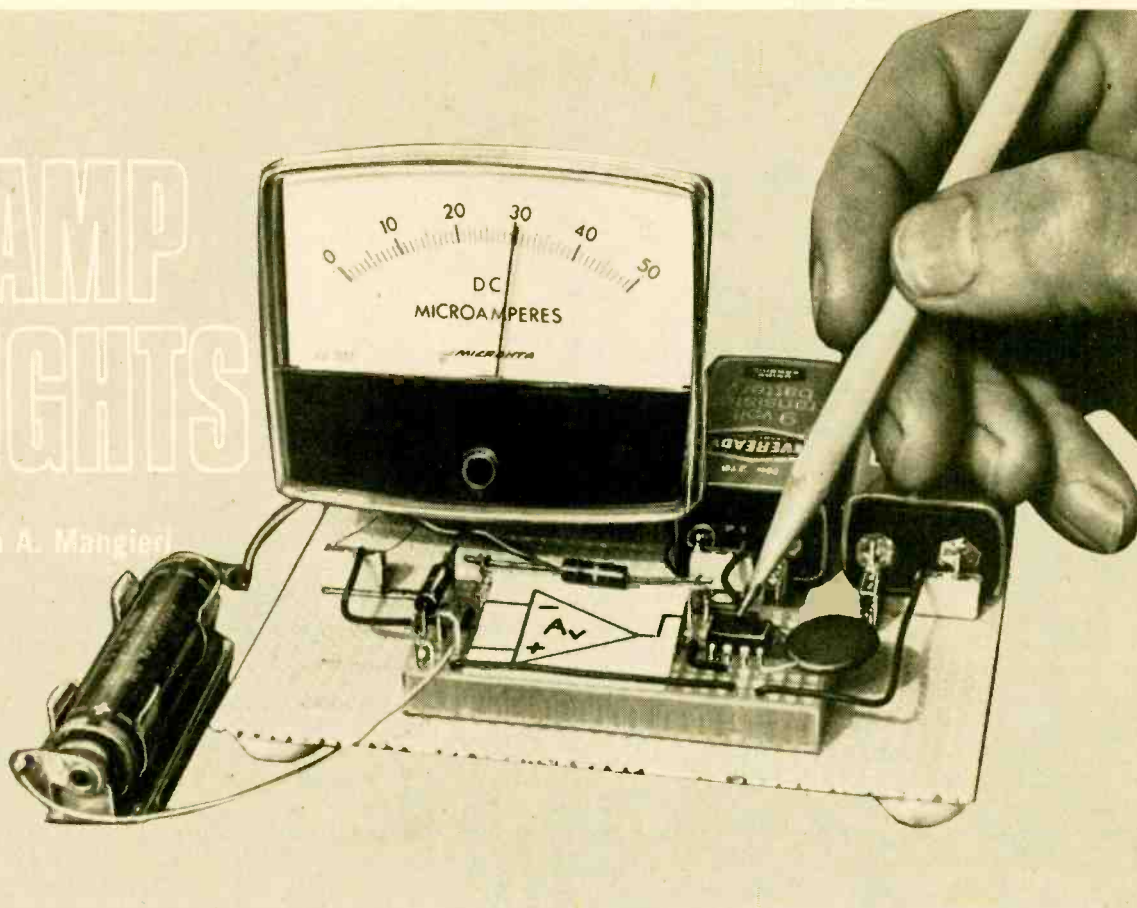

**Design your own op amp circuits... understand op amp specs
...you can be sure with this hobbyist's advanced course!**

FEW LINEAR (non-digital) ICs have achieved the wide popularity of the op amp in hobbyists projects of every description. Combined with few other circuit components, the op amp circuit vastly outperforms the multiple transistor circuit of yesteryear. Because you will encounter the op amp time and time again in many circuit applications and may desire to work up your own op amp circuits, it is essential to become familiar with the device.

This will introduce you to the basics of op amp circuits and applications. Four simple rules of operation are logically applied to trace and deduce the operation of the basic linear op amp circuits. Test circuits are included for "hands on" familiarity. Only a few

Think of op amp as a high gain amplifier capable of boosting a minute signal many thousand times. With a little trick called inverse, or negative, feedback, you hook a resistor between the input and output which, in effect partially shorts out the gain to reduce it to your requirements.

mathematical relationships are listed to effect a comparison of the several circuits.

Some Basics. As shown in Fig. 1a, the op amp has two input terminals and one output terminal. A plus sign at one input identifies the *non-inverting* or "follower" input. When this input goes positive (with respect to the other) the output voltage V_{OUT} also goes positive, thus "following" the polarity of the input. The minus sign at the other input identifies the *inverting* input. When this input goes positive (with respect to the other), V_{OUT} goes negative, thus "in-

verting" the polarity of the input. In technical terms, the input stage of the op amp is a balanced "differential input" amplifier and is one which responds to the *difference* between the voltages at the inputs.

Output voltage V_{OUT} equals V_{IN} times A_{VOL} (A_{VOL} equals the open-loop voltage gain as listed on spec sheets). Input impedance (AC resistance) Z_i and output impedance Z_{oi} are shown in Fig. 1b. These are the primary characteristics of the op amp. If a perfect op amp could be constructed, A_{VOL} and Z_i would be infinitely large and Z_{oi} would

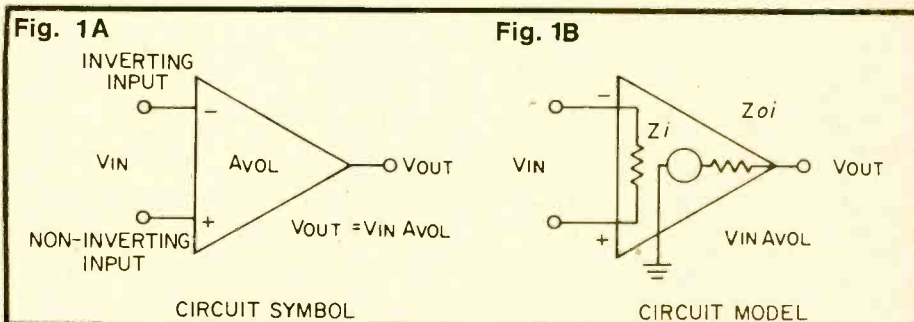

be zero. Actually, for a general purpose 741 op amp, $AVOL$ equals 200,000 Zi equals 2 megohms, and Zoi equals 75 ohms.

Important Concept. In linear applications such as an AC or DC amplifier, the op amp is operated closed-loop with negative feedback. To do this, the loop is "closed" by connecting a feedback circuit from the output terminal to the inverting input; this results in negative feedback. That portion of the output voltage fed back to the input tends to negate, or oppose, the applied input signal voltage. As will be shown later, the resulting closed-loop gain, $AVCL$, is very much smaller than the open-loop gain. Also, the closed-loop gain now depends on the particular feedback circuit itself and not on the actual value of the open-loop gain. This makes it possible to build amplifiers with precise closed-loop gains. Among other beneficial effects, negative feedback imparts high linearity and stability to the amplifier.

Rules Of Operation. A few basic facts of op amp operation will be stated as rules and applied to the operation of several circuits. The implications and meanings of these rules will become clear as you apply them to the circuits. These rules assume an ideal op amp, or nearly so, operating within its linear range.

1. The difference in voltage between the + and - input terminals is always small and can be assumed to be zero. (This fact is a direct result of very high $AVOL$.)

2. The current entering the + and - input terminals is small and can be assumed to be zero. (This rule is a direct result of a very high Zi .)

3. If the + input terminal is at ground voltage or zero, the - input terminal can be assumed to be virtually at ground voltage or zero. (This rule is also a direct result of high $AVOL$.)

4. When an op amp is connected in a negative feedback configuration, a voltage change at the + input must result in an equal voltage change at the - input terminal. (This is a description of rule 1 in operation.)

Setting Up. Breadboard the op amp circuit shown in Fig. 2. You can use perforated board and flea clips to assemble the circuit. Better still, use a breadboarding kit such as the Vector 38X solderless breadboard kit or similar. Use only the 741 or the HEP 6052P op amp for IC1. These are short-circuit proof and are internally frequency com-

Fig. 2

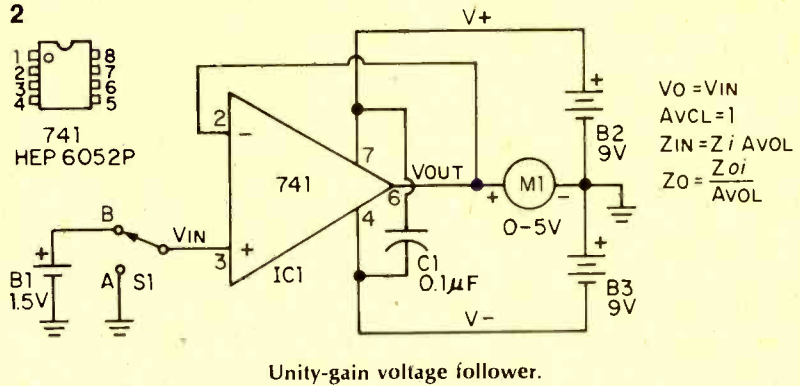

Unity-gain voltage follower.

$$V_O = V_{IN}$$

$$A_{VCL} = 1$$

$$Z_{IN} = Z_i A_{VOL}$$

$$Z_O = \frac{Z_{oi}}{A_{VOL}}$$

Fig. 3

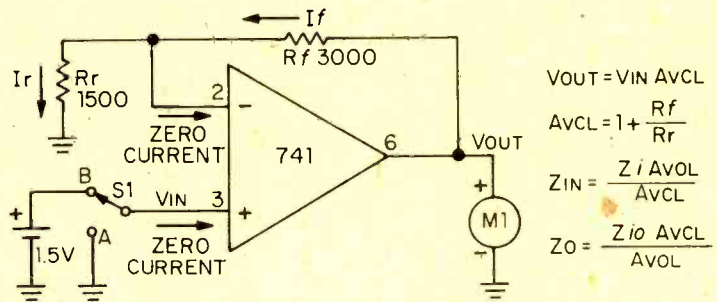

Non-inverting voltage amplifier.

$$V_{OUT} = V_{IN} A_{VCL}$$

$$A_{VCL} = 1 + \frac{R_f}{R_r}$$

$$Z_{IN} = \frac{Z_i A_{VOL}}{A_{VCL}}$$

$$Z_O = \frac{Z_{oi} A_{VCL}}{A_{VOL}}$$

pensated to prevent oscillations. Switch S1 may be simulated by a clip lead.

Install disc capacitor C1 as close as possible to the IC. Use either a common tie point for all ground connections or a heavy ground bus. Keep the input lead wires well separated from the output lead wires. The prototype breadboard uses a 50 μ A DC meter (Radio Shack 22-051) connected in series with a 100,000-ohm, 1% resistor for meter M1. Alternately, you can use your VOM (100 ohms/volt or better) to measure output voltage. Use two fresh nine-volt transistor batteries for B2 and B3 and 1½ volts (an AA cell) for B1.

• **Unity Gain Follower.** Simplest of the op amp circuits, the unity-gain follower shown in Fig. 2 has a direct connection from output to the inverting input. This provides one-hundred percent negative feedback. With switch S1 at position A, the + input is grounded and meter M1 indicates zero. By rule 3, the - input is at virtual ground. Therefore, V_{OUT} is also at virtual ground. With S1 set to position B, the meter now indicates the voltage of battery B1, near 1.5 volts. By rule 4, the 1.5 volt increase at the + input must be accompanied by a 1.5 volt increase at the - input. Hence, V_{OUT} must rise to 1.5 volts.

The resulting closed-loop gain, or $AVCL$, is unity (one unit out for one unit in). However, the high $AVOL$ inside the IC itself is still present, enforcing close compliance with the several rules. As noted on Fig. 2, actual input and

output resistances ZIN and ZO are much improved due to feedback. The resultant input resistance now equals Zi times $AVOL$ or 400,000 megohms for the 741 op amp! The resultant output resistance now equals Zoi divided by $AVOL$, or .0035 ohms! Consequently, the unity gain follower can duplicate the input voltage at its output without loading down the input voltage source due to the high input resistance and with high accuracy due to the low output resistance. Actually, input and output resistances are degraded somewhat by secondary factors. Nevertheless, this unity gain follower offers the highest input resistance and lowest output resistance of the several basic circuits.

• **Non-Inverting Voltage Amplifier.** Stable op amp voltage amplification is obtained by feeding back only a portion of the output voltage. Alter your breadboard circuit to include feedback voltage divider resistors Rf and Rr as shown in Fig. 3. With Rf equal to $2Rr$, only one-third of the output voltage is fed back to the inverting input.

With S1 at position A, the + input is at ground voltage and the meter indicates zero. By rule 3, the - input is at virtual ground or zero. With zero voltage across Rr , current Ir is zero. In view of rule 2, I_f always equals Ir and is zero in this case. With zero current in Rf , the - input and the output voltage must be equal and zero in this instance.

With S1 at position B, the + input is raised to 1.5 volts and the meter indicates 4.5 volts. By rule 4, the - input

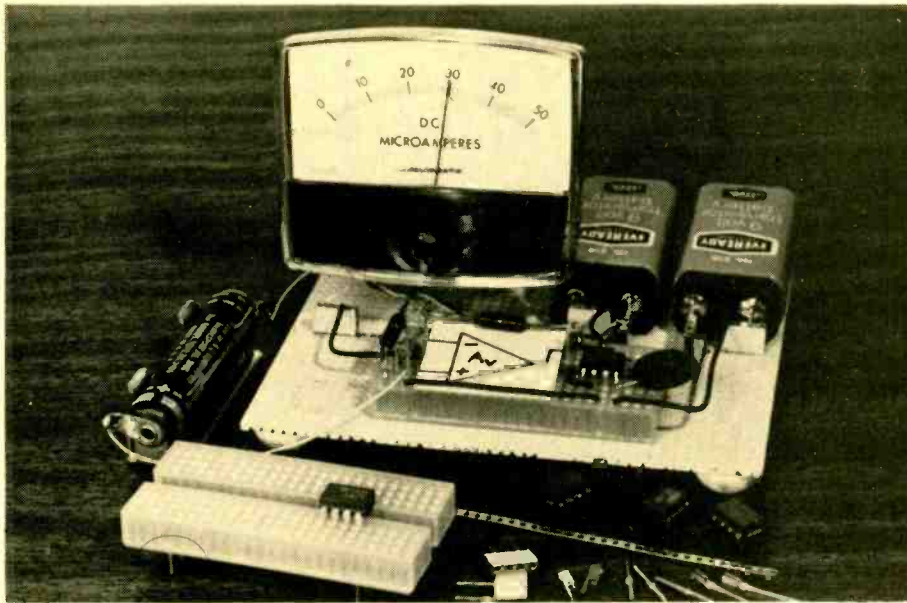

Circuit test and four simple rules of operation enhance understanding of op amps. You can construct an experimental test circuit on Vector's 38X Klip-Block board.

Fig. 4

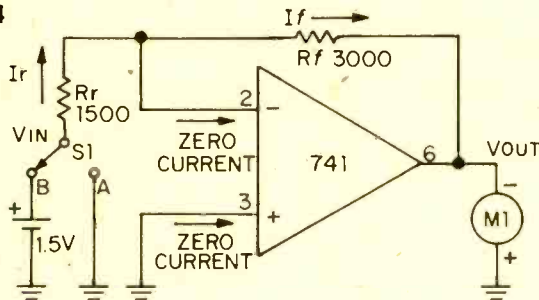

Inverting voltage amplifier.

$$V_{OUT} = V_{IN} A_{VCL}$$

$$A_{VCL} = \frac{R_f}{R_r}$$

$$Z_{IN} = R_r$$

$$Z_o = \frac{Z_{oi}}{A_{VOL}} (1 + A_{VCL})$$

Fig. 5

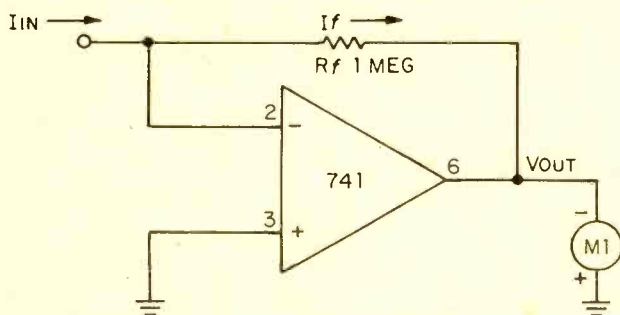

Current to voltage converter.

$$V_{OUT} = I_{IN} R_f$$

$$Z_{IN} = 0$$

at position B, the meter indicates 3 volts (actually, minus 3 volts since the meter is now reversed).

In this case, the - input does not rise to 1.5 volts. By rule 3, with + input grounded, the - input must remain at virtual ground. Therefore, and quite importantly, the voltage across R_r equals the input voltage, or 1.5 volts. Current I_r equals 1.5 volts divided by 1500 ohms, or 1 mA, flowing in the direction shown. Since I_f equals I_r , the voltage across R_f equals 1 mA times 3000 ohms, or 3 volts. With the - input at virtual ground, the output voltage must be minus 3 volts as indicated on the reversed meter.

The closed loop voltage gain, A_{VCL} , is simply R_f/R_r , or 2 in this case. Quite unlike the previous cases, actual input resistance Z_{IN} equals R_r , the input resistor. Compared with the unity gain non-inverting amplifier, actual output resistance Z_o is greater by a factor of $(1 + A_{VCL})$ or three times as much, still acceptably small at this (and even much higher) gain.

By connecting additional input resistors to the - input and upon applying several input voltages, the amplifier will sum the several input voltages at the output. For this reason, the amplifier is often termed a summing amplifier and the - input is termed the summing node or input.

● **Current to Voltage Converter.** A variation of the inverting amplifier, the current to voltage converter shown in Fig. 5, omits input resistor R_r . Because the - input must remain at virtual ground for linear operation, this circuit cannot accept an input voltage. Instead, it accepts an input current and is used to measure very small currents. If I_{IN} were 1 μA , the output voltage would be 1 μA times 1 megohm, or 1 volt. By making R_f very large, the circuit can measure extremely small currents. The input resistance of this circuit is zero. The output voltage, V_{OUT} , equals I_{IN} times R_f .

If you breadboard this circuit, you may observe a small output voltage at zero input current. This output "offset" voltage is caused by the flow of a small bias current from output to input through the large feedback resistor, R_f . Unless special op amps having very low bias currents are used, it is necessary to include a nulling circuit to reset the meter to zero.

● **Input Bias and Offset.** Although rule 2 assumed zero input currents, an op amp does require a small input current I_b to bias the input stage into linear operation. For the 741, I_b may range up to .5 μA . The difference between

(Continued on page 93)

must rise to 1.5 volts matching that at the + input. The op amp does this by forcing a current into the feedback voltage divider as shown. With 1.5 volts across R_r , current I_r equals 1.5 volts divided by 1500 ohms, or 1 mA. Also, the voltage across R_f equals 1 mA times 3000 ohms or 3 volts. Thus, V_{OUT} equals 1.5 plus 3 or 4.5 volts.

Closed-loop voltage gain A_{VCL} equals $1 + (R_f/R_r)$ or 3 in this case. Compared with the unity gain circuit, actual output resistance Z_o is three times

greater and input resistance Z_{IN} is one-third that of the unity gain circuit. This reflects the effect of feeding back 1/3 of the output voltage. To obtain a closed-loop gain of ten, resistor R_f must equal $9R_r$, and so forth.

● **Inverting Voltage Amplifier.** Alter the breadboard circuit to that of Fig. 4 including reversal of the meter. With S1 at position A, the meter indicates zero. The proof of this result is identical to that of the non-inverting voltage amplifier with switch at position A. With S1

IT IS A LITTLE KNOWN FACT, but the simple act of using jumper cables to start (boost) a car with a dead battery can lead to severe personal injury. It's true!

A good Samaritan in California was helping his neighbor start his car by jumping the battery. The battery exploded and our hero got a face full of sulfuric acid for his trouble. A man in Pennsylvania noticed another charging his battery incorrectly. When he attempted to rearrange the cables from the charger there was some sparking, and the battery exploded.

The reason for both of these accidents, and many others, is the fact that a battery being charged produces hydrogen gas, a very combustible and explosive element. The longer a battery is charged the greater the accumulation of hydrogen, and the greater the danger of a serious explosion. All that is required is a single spark as one connects either of the jumper cables to a battery post.

How does one avoid such an occurrence? Simple. Just follow the step-by-step procedure given below whenever you need to jump one battery to another.

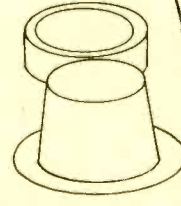
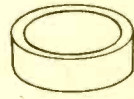
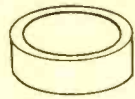
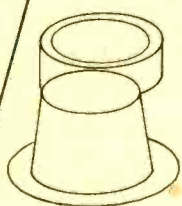

10 steps to safe battery boosting

By Thomas R. Sear

1. Ensure that the ignition switches and all electric accessories, including the lights, are turned off in both cars.

2. Verify that both batteries are rated for the same voltage. Most automotive-type batteries are 12-volt models these days; but many older cars, as well as some of the smaller models, may have a 6-volt battery.

3. Remove the dustcaps from each cell of both batteries, and make certain that the electrolyte reaches the FULL-mark. If not, ordinary tap water can be used to top-off each cell if distilled water is not available. If the dead battery is to be recharged, the dustcaps should be left off to prevent any buildup of pressure due to the rapid release of hydrogen gas from the battery fluid.

4. Cover the battery openings to prevent any splashing acid from reaching your skin or clothing. Your handkerchief will suffice.

5. Attach *only* one jumper cable at a time. Connect one end of the *red* jumper cable to the positive terminal of the good battery first. This is the terminal marked with a +, a P, or POS. Then connect the other end to the positive terminal of the dead battery.

6. Connect one end of the *black* jumper cable to the negative terminal of the good battery. This is the terminal marked with a -, an N, or NEG.

Then connect the other end to a point on the frame of the car with the dead battery at least 18 inches from the battery.

7. Start the engine of the car with the good battery. Allow the car to warm up for a few minutes, holding engine speed to a fast idle.

8. Start the engine of the car with the dead battery. If the engine starts, proceed to Step 9. If it doesn't, turn off the ignition and wait several minutes. Don't flood the engine with too much gasoline. If the battery is completely dead, wait about half an hour so the battery may be charged by the running car. Try to start the dead car again. Now, if successful, proceed to Step 9. If the car cannot be started, see a mechanic.

9. Disconnect the jumper cables by reversing the order in which they were connected. Keep the car with the bad battery running at a fast idle until it is warmed up. The chance of stalling is thus greatly reduced.

10. Replace the dustcaps on the dead battery. Some final notes: It's always best to determine why the car didn't start in the first place and have the car adjusted or repaired. Repeated battery boosts are unwise and unsafe. Also, because of the hydrogen gas present when batteries are involved, *never* smoke a cigarette near a battery that is being charged. ■



by Kathi Martin, KGK3916

Kathi's CB Carousel

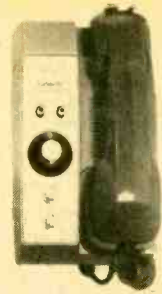

AT ONE TIME just about anything that wasn't packaged in a black box just wasn't considered "pro." Add a touch of color, some fancy trim, maybe a little modern styling and the average CBer wouldn't touch it with a nine foot whip. Some might, just might, accept a battleship grey paint job, and some heavy chrome trim, but if it didn't shape up as a boat anchor in the weight department, it just wasn't pro.

But now that the commercial radio outfits such as Motorola, RCA and G.E. have decided that color and styling are a rest for sore eyes, not to forget the "Princess" phone Ma Bell makes available for rear deck mounting in autos (so the world can see your status symbol), CB manufacturers are finally going mod.

The latest entry in the modern styling and features sweepstakes is the Lafayette Radio Com-Phone 23, another lie-flat/telephone-type CB transceiver.

The Com-Phone 23 is a mobile rig for 12 VDC with positive or negative ground. Frequency synthesis provides full 23 channel coverage. As shown in the photographs the rig is designed to either lie flat or be vertically mounted.

A supplied swivel-type mobile bracket can secure the transceiver to the car drive-tunnel hump, the floor, or a table. The mount can also be used for installing the rig vertically on a wall (or dashboard), or it can be directly vertically mounted on a wall with two supplied picture-frame type brackets. (If the rig is used in your home you will need an AC to 12 VDC power supply.) Since the Com-Phone 23 is slightly larger than a standard wall telephone (and neutral grey in color), it can be placed just about anywhere and not disturb the decor.

On the left side of the unit is a transmit indicator lamp, a PA/CB switch, a speaker/handset switch, the channel selector, the volume control, and the squelch control. On the right side is a locking cradle for the handset; the PTT

(push to talk) switch is in the handset.

The top edge of the rig has the power cord socket, the antenna jack, and the remote speaker/PA jack. For monitoring with a remote speaker the PA/CB switch must be placed in the PA position. If the PTT switch is pressed while the switch is set for PA, the remote speaker also serves as the PA speaker.

In normal operation the PA/CB switch is set for *CB* while the speaker/handset switch is set for *speaker*. With the handset in the cradle, received signals are heard in the speaker located under the handset. If the handset is lifted, the signals are heard both in the speaker and handset (so a passenger can also hear the signal). For privacy the speaker/handset switch is set to *handset*. While the handset is in the



The PTT switch is mounted in the handset handle. When the handset is lifted from the cradle it releases a small switch that disconnects the speaker located in the center of the cradle. If desired, the speaker can be left on even when the handset is in use.



Clean and trim look of the Com-Phone 23 more closely resembles a modern wall phone than a CB rig. You can mount it on the wall just like a telephone or let it lie flat on a table like a "Princess" phone or a business desk-set.



An input/output panel at the top has the antenna jack, remote speaker/PA speaker jack, the power input connector, and a user-adjustable TVI filter.

cradle it presses on a small switch that holds the speaker on. If the handset is lifted, the speaker is cut off and the signal is heard only in the handset. To transmit using either the speaker or handset receiver, you simply press the PTT switch in the handset and speak, just as you would into a standard telephone.

Replacing the handset in the cradle at the end of a private contact automatically restores the speaker connection so you can monitor for calls.

Though the Com-Phone 23 has an all-class exterior, inside are the tried-and-true circuits and performance we've come to expect. The transmit and receive frequency control is via a crystal controlled synthesizer. The transmitter is more or less conventional; the major difference is a user-adjustable TVI filter (on the jack strip), which is becoming more and more rare as new CB models are introduced.

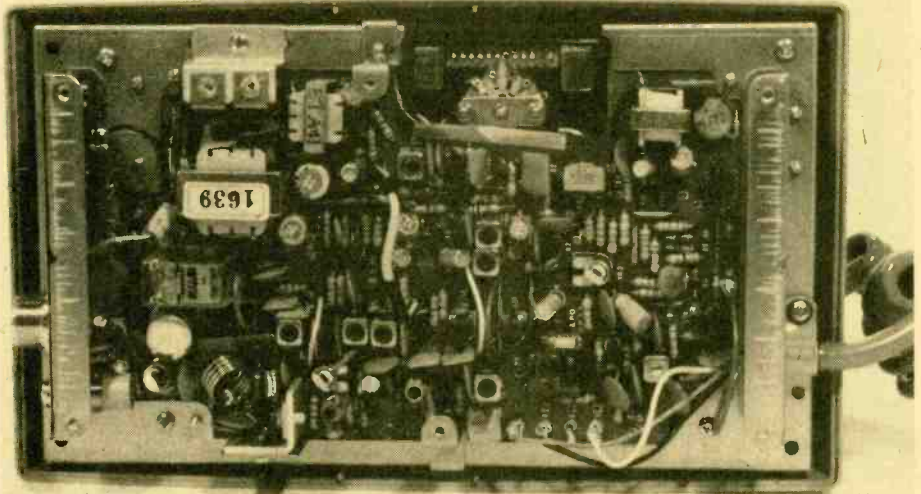

Underneath the Com-Phone 23 with its base removed. The Com-Phone 23 is rugged. Even the handset cord is firmly clamped to the frame. The excellent modulation is due in part to the heavy modulation transformer and an excellent range-boost circuit.

The modulator has a compressor, called a Range Boost by Lafayette, and I'll have more to say on this feature later.

The receiver is double-conversion with a ceramic filter in the second IF amplifier. The filter is followed by two stages of IF amplification, the detector, and a noise limiter.

Working Out. Except for the range boost, overall performance is just about what I'd expect from this type of hardware. The receiver had a measured sensitivity of 1 μ V for a 10 dB signal plus noise to noise ratio (S+N/N). Image rejection was a shade over 55 dB and selectivity in terms of adjacent channel rejection measured 43 dB. (Everything more or less typical for the price.) The AGC action was notably excellent, measuring only 2 dB for an input signal range of 1 to 10,000 μ V. In practical terms, this means that if you have the volume control wound up to hear a weak station, a strong station coming in on the channel won't blow out your car's windows or your eardrums. This is a particularly important feature when we consider that the sound is literally poured into the ear by the handset. Just imagine what would happen if the sound from a strong station rolled in when the handset was against your ear. Just about all signals—weak and strong—are heard from the Com-Phone 23 at about the same volume level.

The transmitter put out 3.2 watts RF into a 50 ohm load. A -21 dB microphone input signal (average value cor-

responding to an "average" voice level) produced better than 85 percent modulation.

Modulation was limited to 100 percent by the range boost circuit, which also had the unusual property of low distortion even when the voice level was very high. Several CBers reported quite favorably on the modulation, so I swapped rigs with the base station to hear it for myself. It was really good: a crisp clean sound with lots of talk power. A check with a modulation scope showed that even at very high sine wave input levels the modulation more closely resembled the original input rather than a distorted sine wave or a squared sine wave. The excellent range boost performance might be due to the fact that, unlike an audio-only compressor, the range boost in the Com-Phone 23 also controls the RF amplifiers in the transmitter, much like RF-ALC found in commercial communications gear; but however it's done, it does work well.

Summing Up. The Com-Phone 23, priced at \$189.95, comes supplied with all crystals, the handset, a mobile mount, wall brackets, and a DC power cable. Virtually any AC to 12 VDC power-pack intended for CB use (meaning good power supply filtering) can be used for base station operation. If you dig the modern pro look, want a handset, and are looking for a solid all-talk-power signal, the Com-Phone 23 is the way to go. For more information circle No. 75 on the reader service coupon on page 17. ■

e/e BASIC COURSE IN ELECTRICITY & ELECTRONICS

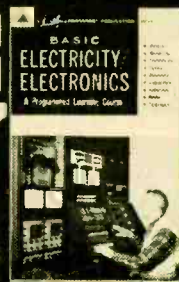

This series is based on BASIC ELECTRICITY/ELECTRONICS, Vol. 1, published by HOWARD W. SAMS & CO., INC.

THE ROADMAP OF ELECTRONICS

What You Will Learn. Before proceeding to more complex circuits, you should learn how to read and draw diagrams used in electricity and electronics. There are many varieties of diagrams, but they have all grown from two basic types—wiring and schematic. The fundamentals will be explained.

THE REASON FOR DIAGRAMS

A textbook can be written without illustrations, but very few are. Words alone cannot always fully describe the idea or thought the author wants the reader to understand. A writer uses drawings or illustrations with his words to make sure his descriptions are more completely understood.

Most of the illustrations used thus far in this series have been in three-dimensional form. A dry cell was drawn as it actually looks—in the shape of a cylinder and with its terminals in the correct positions. A lamp appeared similar to those in your home. Wires were drawn to look as natural as possible. The artwork was time-consuming but necessary.

However, can you imagine the task required to draw all of the circuits, parts, wires, and terminals of a television set in three-dimensional form?

The illustrations would not only be difficult to draw, but also awkward to use. Technical drawings are needed by engineers who design equipment, workers who construct it, and technicians who service it. They are also required by persons who study electricity and electronics.

TWO-DIMENSIONAL DIAGRAMS

Two-dimensional (flat instead of shaped) diagrams are now used almost exclusively because they are easier to "read." Reading a diagram means obtaining information from it, such as following the path of current flow through a circuit. Reading a two-dimensional diagram is simplified by eliminating unnecessary and confusing details. But reading this type of diagram is easy only if you understand the language.

THE LANGUAGE OF SYMBOLS

Electrical and electronic diagrams have symbols that either resemble or represent the real item. There are symbols (most of them rather simple) for every electri-

cal or electronic part. When new parts are invented—such as the light emitting diode—a corresponding, identifiable symbol is also developed.

Using symbols instead of cumbersome pictures is not new. Shortly after man emerged from the Stone Age, he found it difficult to work with his counting and numbering system. Making marks on the ground or stacking pebbles in a pile became fairly tedious when he wished to indicate "how many" of anything. Numerical symbols were invented to show how many. This permitted the ancient Arab who owned nine sheep and four horses to show on his inventory record the symbols "9" and "4" instead of a number of marks.

Learning electrical and electronic symbols requires the same process you used to learn the meaning of numerals. Learn what the symbols stand for and how to use them.

WIRING DIAGRAMS

Wiring diagrams are used as a guide when constructing a circuit or equipment. They are also useful for locating wires or connections when servicing or troubleshooting.

Lamp Circuits Diagrams

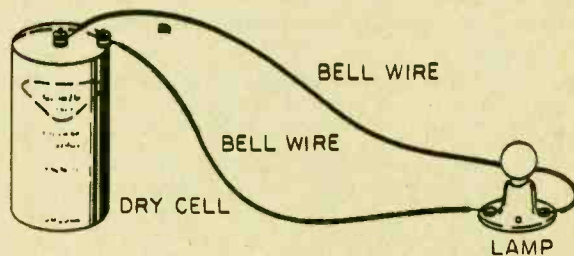

THREE-DIMENSIONAL (PICTORIAL) DIAGRAM

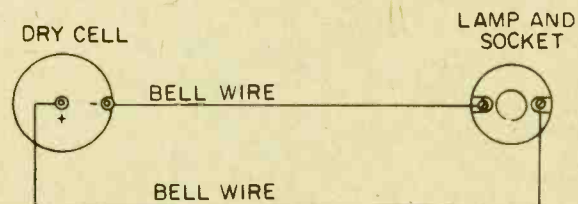

TWO-DIMENSIONAL (SCHEMATIC) DIAGRAM

BASIC WIRING DIAGRAMS

The fundamental wiring diagram shows a symbol for each part. Emphasis is placed on displaying the terminals of each part and the wire connections between them. A circuit can be easily put together by following a wiring diagram. As an example, compare the two diagrams.

Note how easy it would be to follow the two-dimensional diagram if you were to construct the circuit. The symbols are easily identifiable. The dry cell is a flat circle (top view) with terminals in the correct positions and polarity markings shown. The lamp symbol is two circles, a bulb in a base, plus two terminals. Wires are straight lines, and the parts are labeled.

QUESTIONS

1. The three basic types of electrical/electronic diagrams are _____, _____ and _____.
2. Why are two-dimensional diagrams used in electricity and electronics? Give two reasons.
3. Reading a technical diagram requires an understanding of _____.
4. Name two purposes of a wiring diagram.

ANSWERS

1. The three basic types of electrical/electronic diagram are **pictorial**, **wiring** and **schematic**.
2. Two-dimensional diagrams are used because they are easier to draw and easier to read than a three-dimensional diagram.
3. Reading a technical diagram requires an understanding of **symbols**.
4. Two purposes for a wiring diagram are: A guide for constructing a circuit or equipment. A means of locating wires or connections in equipment.

No two manufacturers will necessarily use identical symbols for the same part. Each symbol however, will be a close representation of the real thing. The switch symbol thus should show the terminals and make clear the difference between the open and hinged ends.

Lamp Circuit Wiring Diagram With Terminal Strip

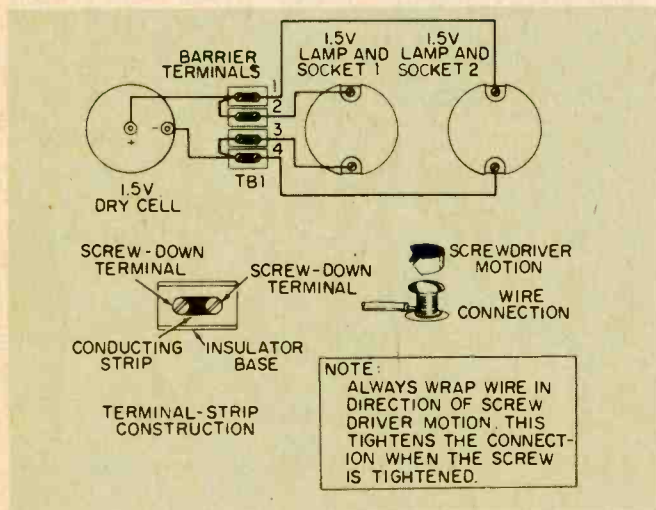

The illustration shows a wiring diagram for two 1.5-volt lamps connected to a 1.5-volt dry cell. You may construct it if you wish. The circuit is intended to demonstrate a principle of electricity.

You will note that the lamp symbol has been changed. A single circle is often used for this purpose.

A new part has been added—a terminal board (TB1). As shown in its construction detail, a terminal board has a metal strip with two screws on either end, mounted on an insulating material. These boards serve as connecting points for wires. The barrier strip mentioned previously is also a screw-down junction point for wires with a plastic “barrier” between terminals to help prevent stray wires from one terminal from shorting to the adjacent terminal.

The electrical principle demonstrated in the diagram is that two lamps can be connected to a single voltage source. Since both lamps are connected across the voltage source (the top terminal of each lamp is wired to the positive pole and the bottom terminal to the negative pole), the lamps are said to be in parallel. This means the same voltage (1.5 volts) is being applied to each lamp.

QUESTIONS

5. What is the purpose of a terminal strip?
6. Two devices connected across a voltage source are in _____.
7. Remove lamp 1 from the circuit by disconnecting the wire at terminal 3. Will lamp 2 go out?

ANSWERS

5. A terminal strip provides a means of securely joining two or more wires.
6. Two devices connected across a voltage source are in **parallel**.
7. Lamp 2 will remain lit. (Even though lamp 1 is removed from the circuit, lamp 2 is still across the source. If you guessed wrong, trace the path of current through the circuit.)

MULTIWIRE DIAGRAMS

The wiring diagram shows three lamps in parallel.

Conventional Wiring Diagram

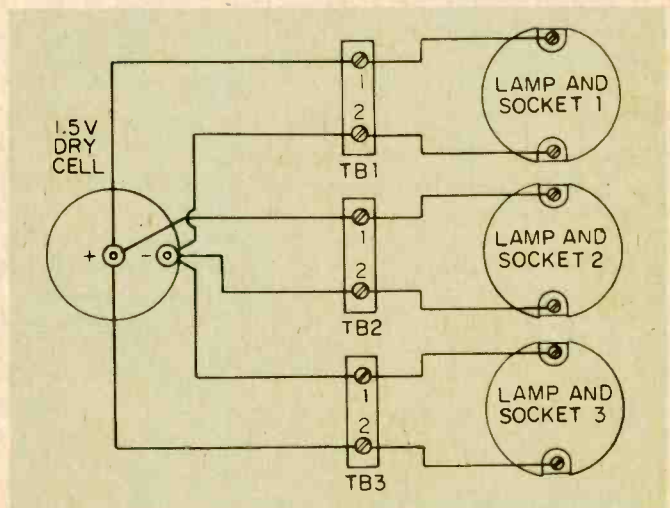

HIGHWAY WIRING DIAGRAM

Even with three lamps, the diagram is cluttered, and the lines are difficult to follow. A highway wiring diagram (it looks like a highway with secondary roads leading from it) removes the clutter. The same three lamps are redrawn. Each wire entering the "highway" has its destination marked.

Highway Wiring Diagram

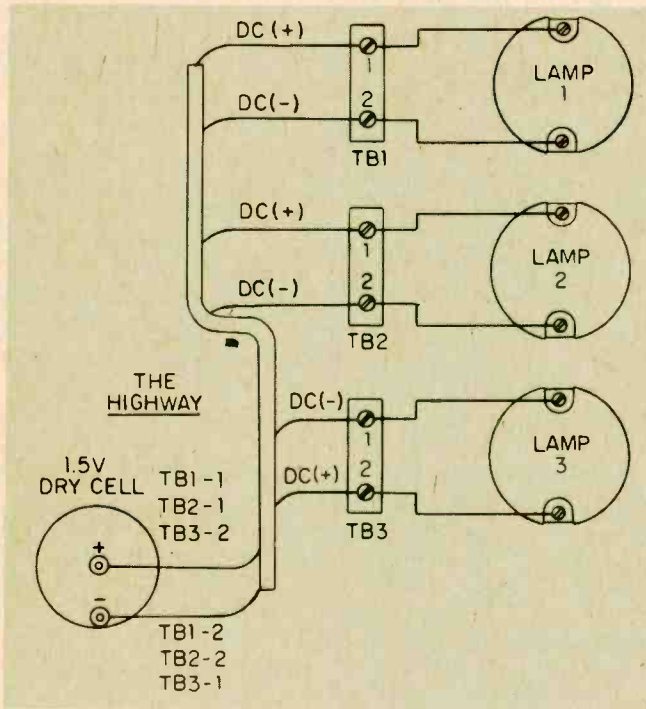

TB1 is the abbreviation for terminal board 1. TB2-1 (terminal 1 of terminal board 2) is positive and therefore connected to the positive pole of the cell. Although only two wires are shown connected to the cell, there are actually three at each pole as indicated by the TB listings.

QUESTIONS

8. To which pole of the dry cell is the wire from TB3-2 connected?
9. Which dry-cell terminal is connected to TB2-2?
10. What would the abbreviation TB4-3 mean?
11. Draw a wiring diagram showing only lamp 4 connected to TB4 with TB4-1 positive.

ANSWERS

8. TB3-2 is connected to the positive pole.
9. The negative terminal of the dry cell is connected to TB2-2.
10. TB4-3 would mean the third terminal of terminal board 4.
11. Your wiring diagram should look like this.

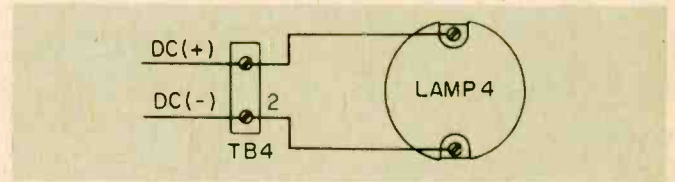

AIRLINE WIRING DIAGRAM

The airline wiring diagram shows wire destinations without a connection between terminals. This type of diagram is used in the same manner as the highway diagram.

Airline Wiring Diagram

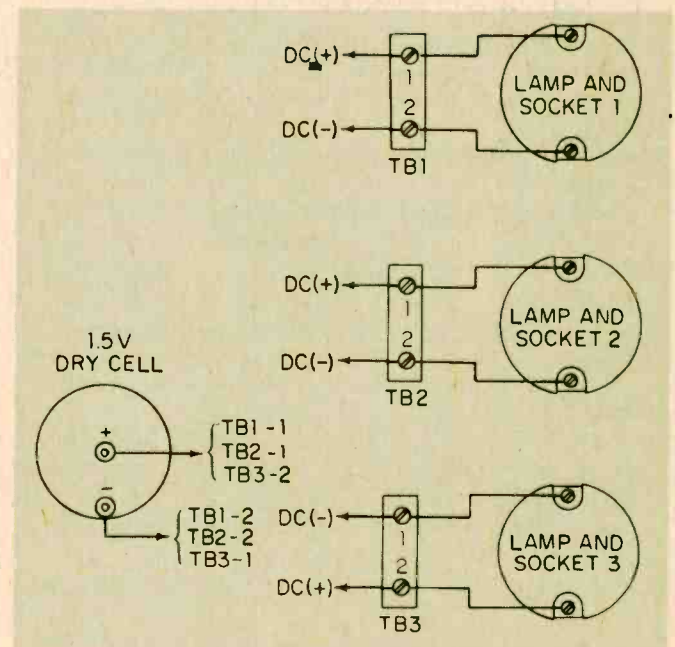

SCHEMATIC DIAGRAMS

Schematic diagrams are used more than other technical diagram in electronics. Engineers use schematics (the term "diagram" is usually dropped) when designing equipment and testing its performance after construction. Technicians and repairmen constantly refer to a schematic while servicing or troubleshooting equipment.

Information including a schematic is available for nearly every television set, radio, and other electronic equipment ever manufactured. These can be purchased at electronic supply stores and from mail order companies—the same source from which you purchase electronic components to repair or construct equipment.

The schematic is used in nearly all electricity/electronics textbooks. The reason for using this kind of diagram, of course, is the need for all future technicians and engineers to become familiar with the type of diagrams they will be using most often. Another reason is the clarity with which the schematic provides information. The many parts of a circuit, or group of circuits,

can be drawn in a limited amount of space. The symbols used are fairly standard and do not vary as the representations do in wiring diagrams.

SYMBOLS

The schematic symbol for a lamp is shown.

Symbols For A Lamp

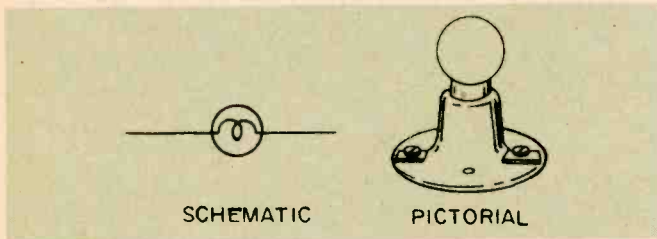

QUESTIONS

12. What is the difference between highway and airline diagrams?
13. Technicians use schematic diagrams to and equipment.
14. Engineers use schematics to and equipment.
15. What does the curved line inside the symbol for a lamp represent?

ANSWERS

12. A highway wiring diagram has a broad line (highway) drawn to each of the wires in the circuit. An airline diagram does not.
13. Technicians use schematic diagrams to **service** and **troubleshoot** equipment.
14. Engineers use schematics to **design** and **test** equipment.
15. The curved line inside the symbol for a lamp represents its filament.

CELLS AND BATTERIES

The symbol for a cell is two parallel lines, one shorter than the other, each with a perpendicular line attached. The lines represent the negative and positive

Symbols For Cells And Batteries

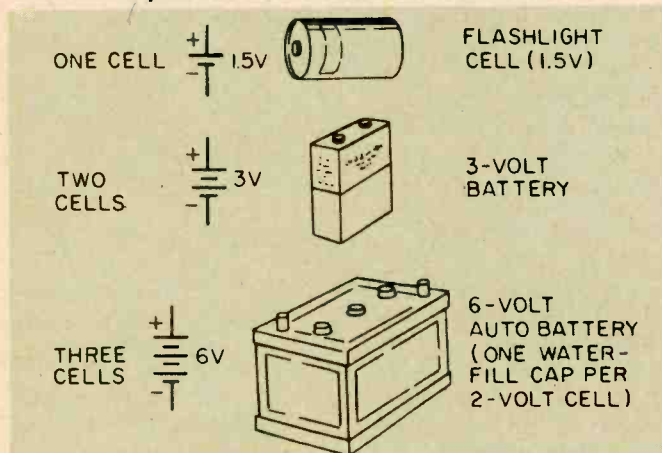

materials in a cell (the longer is positive). Since a battery contains two or more cells, its symbol is two or more pairs of plates—the standard symbol usually used is either two or three pairs. Since a battery may have any number of volts, the symbol is usually labeled with the voltage. It is also good practice to mark the polarity of the battery on at least one end of the symbol, (–) for negative and/or (+) for positive.

A CIRCUIT SCHEMATIC

Now that you are familiar with the symbols for a voltage source and an operating device, you should be able to draw the schematic of a simple circuit. It should look like the one shown here.

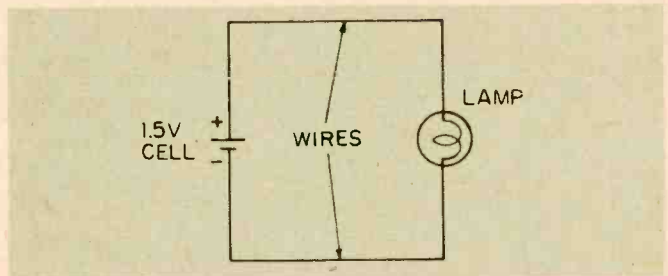

The lamp and cell symbols are connected by lines representing wires. Note that the lines run in only two directions—horizontal and vertical. Slanted or curved lines lessen the clarity of a diagram. Also note that a voltage value and polarity markings appear on the cell.

SWITCHES

The symbol for a simple switch is very simple to picture.

Symbols For A Switch

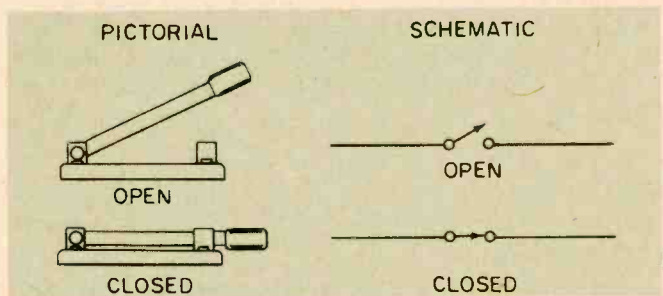

The arrowhead has no real significance other than helping to identify the symbol as a switch when it is shown in a closed position. Without the arrowhead, the symbol would look like a wire between two terminals.

METERS

Meters are quite often inserted into circuits to monitor voltage and current. The wattmeter (a functional combination of a voltmeter and an ammeter) in your home is an example. It is often necessary to show on a schematic where a meter reading is being taken. The

Some Meter Symbols

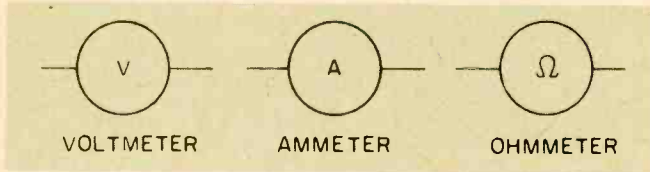

symbols for three types of meters are shown.

You should recognize these meters as the three functions built into a multimeter. They are also available as separate meters.

VOLTAGE SOURCES

The battery symbol obviously represents a source of DC voltage. There are also other types of DC sources. The symbol for one of these, in addition to symbols for AC sources, is shown.

Symbols For AC and DC Voltage Sources

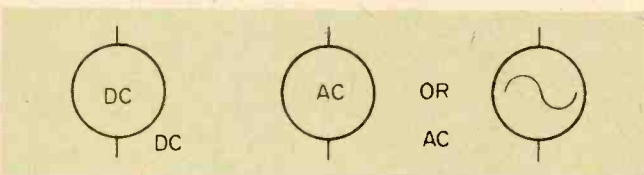

DC and AC voltages can be supplied by generators or developed by other methods. An example is the AC voltage developed by the vibrating diaphragm of a telephone. The basic symbol is the circle, with the letters DC or AC (to designate the type of voltage) placed inside. The second AC symbol includes a sine wave instead of letters. The sine wave in the circle represents the rise and fall of alternating voltage.

COILS

A coil symbol actually looks like the several turns of wire it represents. The symbol on the left is the most common version.

Schematic Symbols For A Coil



WIRE CONNECTIONS AND CROSSINGS

Quite often one wire is connected to another. In a wiring diagram the terminal where the connection is

Symbols For Connections And Crossing Wires

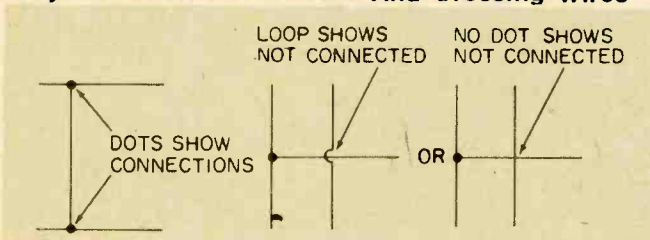

made is shown. In a schematic, however, terminals are usually not indicated. In addition, it is sometimes necessary to show lines crossing each other. The following illustration shows how connections and crossings are indicated.

SERIES AND PARALLEL CONNECTIONS

In the discussion on wiring diagrams, two lamps were connected in parallel. Both were connected across the battery terminals. Devices can also be connected in series, like knots in a string. If two lamps are connected in series with a battery, the same current flows through both lamps.

There are dozens of other symbols which will be shown at the time new parts or devices are introduced. The purpose here is to teach you the basic principles of how to read and draw simple diagrams. More complicated diagrams which include many different components will be used later as you gain more experience and become familiar with simple schematics.

As a summary of the fundamentals of schematics, how would you draw this 4-part circuit?

1. The voltage source is two 6-volt batteries (series-connected) in parallel with a 12-volt battery. The polarity of all three batteries is in the same direction.
2. The load (another term for operating devices) is two 6-volt lamps (connected in series) in parallel with a 12-volt lamp. The load is to be connected across the voltage source.
3. Switches are placed in the circuit so that each parallel leg (a separate current path) of the load can be switched on and off individually.
4. An ammeter and a voltmeter are placed in the circuit between the load and source.

The easiest and most accurate way to draw the schematic from the above description is in sections. Section 1, the voltage source. Section 2, the load with its switches. Section 3, the meters between the load and source.

Drawing A Schematic By Sections

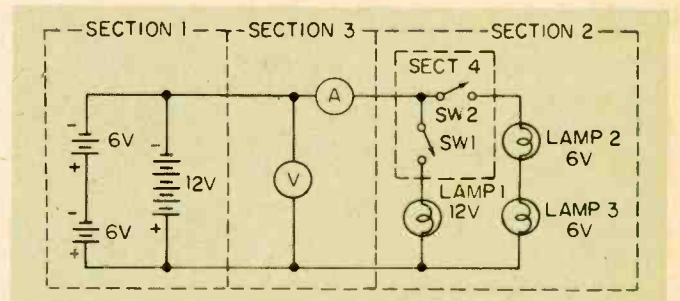

As you recall, an ammeter is always connected in the circuit path. Therefore, the ammeter in the illustration is placed in *series* with the source and the load. A voltmeter is always placed across (in *parallel* with) the load or source.

QUESTIONS

18. Draw a schematic for the following.



1. Load—A coil in series with two coils in parallel. Letter "L" is the symbol for a coil. Label the coils L₁, L₂, and L₃ in the order of their distance from the source.
 2. Source—Two 100-volt AC generators in series.
19. Draw a schematic for two 50-volt DC generators (in parallel) supplying voltage for three 50-volt lamps, also in parallel. Show a voltmeter to measure the source voltage and an ammeter to measure the current through lamp 2.

ANSWERS

18. Your schematic should be similar to this.

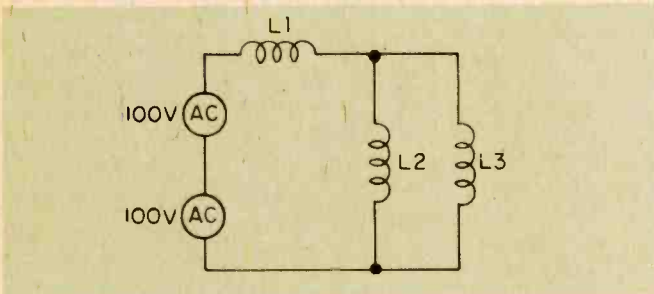

19. Your schematic should be similar to this.

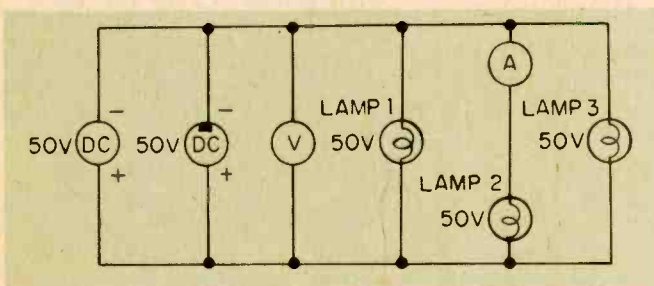

WHAT YOU HAVE LEARNED

1. Technical diagrams are drawn with symbols to clearly present a great deal of information in a limited amount of space.
2. There are three basic types of diagrams generally used in electrical and electronic work. These types are pictorial, wiring and schematic diagrams.
3. Wiring diagrams are useful as a guide when detail is required for construction purposes.
4. Pictorial diagrams are simple drawings of the parts used in a circuit, and are shown interconnected according to the circuit schematic.
5. Schematic diagrams with their simple symbols are widely used by engineers for designing and testing equipment, and by technicians for servicing and troubleshooting.
6. A fundamental or conventional wiring diagram shows each wire and a representative symbol for each part, and clearly defines each terminal.
7. When several parts must be included, an airline or highway wiring diagram is drawn. A highway diagram uses a broad line representing the many wires going between blocks of terminals. All terminals are marked. An airline diagram contains the same details without the broad line.
8. Wiring diagrams usually contain too much detail for general use, other than construction.
9. Symbols for circuit parts have been fairly well standardized.

This series is based on material appearing in Vol. 1 of the 5-volume set, BASIC ELECTRICITY/ELECTRONICS, published by Howard W. Sams & Co., Inc. @ \$22.50. For information on the complete set, write the publisher at 4300 West 62nd St., Indianapolis, Ind. 46268.

THE MOST OFTEN INVENTED INVENTION!

There's an Englishman who actually had the nerve to build one, two, three...

by Joe Gronk

□ If a dirty outside rear-view mirror is one of your pet peeves in foul weather, consider this innovation as a future addition to your well-dressed car. Working models of self-cleaning wing mirrors have been developed in which a tiny wiper blade the size of the mirror's radius is fitted rigid to the base of the mirror housing. A switch on the dashboard of the car activates the small electric motor in the mirror housing. The mirror then makes one complete revolution, and, voilà, a clear view of the traffic to the rear. This special mirror projected cost is about twice as much as an ordinary one. H. P. Smallbone, inventor, hopes to market his recent most invented invention soon. ■



Shown here is a completely assembled and mounted model of the self-wiping mirror. Mr. Smallbone poses in his office in Birmingham, England where he does his experimenting. On his desk are prototypes of his invention in various stages of assembly.

LITERATURE LIBRARY

153. *MFJ* offers a free catalog of amateur radio equipment—CW and SSB audio filters, electronic components, etc. Other lit. is free.

101. Kit builder? Like weird products? *EICO's* 1975 catalog takes care of both breeds of buyers at prices you will like.

102. *International Crystal* has a free catalog for experimenters (crystals, PC boards, transistor RF mixers & amps, and other comm. products).

103. See brochures on *Regency's* 1975 line-up of CB transceivers & scanner receivers (for police, fire, weather, & other public service emergency broadcasts).

104. *Dynascan's* new B & K catalog features test equipment for industrial labs, schools, and TV servicing.

105. Before you build from scratch, check the *Fair Radio Sales* latest catalog for surplus gear.

106. Get *Antenna Specialists'* cat. of latest CB and VHF/UHF innovations: base & mobile antennas, test equipment (wattmeters, etc.), accessories.

107. Want a deluxe CB base station? Then get the specs on *Tram's* super CB rigs.

108. Compact is the word for *Xcelite's* 9 different sets of midjet screwdrivers and nut-drivers with "piggyback" handle to increase length and torque. A handy show case serves as a bench stand also.

115. *Trigger Electronics* has a complete catalog of equipment for those in electronics. Included are kits, parts, ham gear, CB, hi fi and recording equipment.

111. *Midland's* line of base & mobile CB equipment, marine transceivers & accessories, and scanner receivers are illustrated in a new full-color 16-page brochure.

112. The *EDI (Electronic Distributors, Inc.)* catalog is updated 5 times a year. It has an index of manufacturers literally from A to X (ADC to Xcelite). Whether you want to spend 29 cents for a pilot-light socket or \$699.95 for a stereo AM/FM receiver, you'll find it here.

113. Get all the facts on *Progressive Edu-Kits* Home Radio Course. Build 20 radios and electronic circuits; parts, tools, and instructions included.

116. Get the *HUSTLER* brochure illustrating their complete line of CB and monitor radio antennas.

117. *Teaberry's* new 6-page folder presents their 6 models of CB transceivers (base and mobile): 1 transceiver for marine-use, and 2 scanner models (the innovative "Crime Fighter" receiver and a pocket-size scanner).

118. CBers, *GC Electronic's* 8-page catalog offers the latest in CB accessories. There are base and mobile mikes; phone plugs; adaptors and connectors; antenna switchers and matchers; TV1 filters; automotive noise suppressor kits; SWR Power and FS meters, etc.

152. Send for the new, free descriptive bulletin from *Finney Co.* It features the Finco line of VOM multi-testers (and accessories) for electronics hobbyists and service technicians.

128. A new free catalog is available from *McGee Radio*. It contains electronic product bargains.

119. *Browning's* mobiles and its famous Golden Eagle base station, are illustrated in detail in the new 1975 catalog. It has full-color photos and specification data on Golden Eagle, LTD and SST models, and on "Brownie," a dramatic new mini-mobile.

120. *Edmund Scientific's* new catalog contains over 4500 products that embrace many sciences and fields.

121. *Cornell Electronics'* "Imperial Thrift Tag Sale" Catalog features TV and radio tubes. You can also find almost anything in electronics.

122. *Radio Shack's* 1975 catalog colorfully illustrates their complete range of kit and wired products for electronics enthusiasts—CB, ham, SWL, hi-fi, experimenter kits, batteries, tools, tubes, wire, cable, etc.

123. Get *Lafayette Radio's* "new look" 1975 catalog with 260 pages of complete electronics equipment. It has larger pictures and easy-to-read type. Over 18,000 items cover hi-fi, CB, ham rigs, accessories, test equipment and tools.

154. A government FCC License can help you qualify for a career in electronics. Send for information from *Cleveland Institute of Electronics*.

125. *RCA Experimenter's Kits* for hobbyists, hams, technicians and students are the answer for successful and enjoyable projects.

127. There are *Avanti* antennas (mobile & base) for CB and scanner receivers, fully described and illustrated in a new 16-page full-color catalog.

129. *Semiconductor Supermart* is a new 1975 catalog listing project builders' parts, popular CB gear, and test equipment. It features semiconductors—all from *Circuit Specialists*.

130. There are over 350 kits described in *Heath's* new catalog. Virtually every do-it-yourself interest is included—TV, radios, stereo & 4-channel, hi-fi, etc.

131. *E. F. Johnson's* new full-color catalog for CB transceivers and accessories is now available. Send for a free copy. They also have a free brochure on their line of scanner receivers.

150. Send for the free *NRI/McGraw Hill* 100-page color catalog detailing over 15 electronics courses. Courses cover TV-audio servicing, industrial and digital computer electronics, CB communications servicing, among others. G.I. Bill approved, courses are sold by mail.

132. If you want courses in assembling your own TV kits, *National Schools* has 10 from which to choose. There is a plan for GIs.

133. Get the new free catalog from *Howard W. Sams*. It describes 100's of books for hobbyists and technicians—books on projects, basic electronics and related subjects.

134. *Sprague Products* has L.E.D. readouts for those who want to build electronic clocks, calculators, etc. Parts lists and helpful schematics are included.

135. The latest edition of *Tab Books'* catalog has an extensive listing of TV, radio and general servicing manuals.

137. *Pace* communications equipment covers 2-way radios for business, industrial and CB operations. Marine radiotelephones and scanning receivers are also in this 18-p. book.

138. *Shakespeare's* new pocket-size catalog lists and describes their full line of fiberglass CB antennas, mounts and accessories offered in 1975.

144. For a packetful of material, send for *SBE's* material on UHF and VHF scanners, CB mobile transceivers, walkie-talkies, slow-scan TV systems, marine-radios, two-way radios, and accessories.

145. For CBers from *Hy-Gain Electronics Corp.* there is a 50-page, 4-color catalog (base, mobile and marine transceivers, antennas, and accessories). Colorful literature illustrating two models of monitor-scanners is also available.

147. *Telex's* 4-page, 2-color folder illustrates their new line of boom microphone head-sets for CBers and hams, as well as their line of communications headphones.

142. *Royce Electronics'* new full-color catalog updates information on their CB transceivers (base, mobile, handheld). It also describes new product lines—CB antennas and a VHF marine radiotelephone.

Elementary Electronics, Box 886
Ansonia Station, New York, N.Y. 10023

Please arrange to have this literature whose numbers I have circled at right sent to me as soon as possible. I am enclosing 50¢ to cover handling. (No stamps, please.) Allow 4 to 6 weeks for delivery.

Indicate total number of booklets requested. _____ Not Valid After
S/O75 Sorry, only 10 circled items maximum. February 19, 1976

Are you a subscriber to this magazine? Yes No

101	102	103	104	105	106	107	108	111	112	113	115
116	117	118	119	120	121	122	123	124	125	127	128
129	130	131	132	133	134	135	137	138	142	144	145
147	150	152	153	154							

NAME (print clearly)

ADDRESS

CITY

STATE

ZIP

HOW THE RICH MAKE MONEY IN 30 DIFFERENT WAYS

Gold & Silver... Real Estate... Art... Oil... Stocks... Business Opportunities

Receive up to \$178 worth of Money-making publications for only \$9. Here's how you can receive the same confidential newsletters whose advice the rich seek in 30 different money-making areas: art, commodities, gold, silver, stocks, business opportunities, etc. Through this bargain-packed offer, SELECT INFORMATION EXCHANGE, America's leading financial publications subscription agency, makes available to you 1-5 issue current trials to 30 of these money-making publications. Their regular annual price ranges as high as \$325 apiece. Your price for the entire package under this amazing, one-time-only offer is \$9, or 40¢ apiece. To order the entire package of 30 sample subscriptions, send your name and address together with this ad and your \$9 remittance to:

DAVIS PUBLICATIONS INC. EE910
229 Park Avenue South
New York, N.Y. 10003 Package #24

HOW TO OBTAIN OVER 400 MONEY-MAKING PUBLICATIONS

for less than a Quarter Apiece... Stocks... Real Estate... Oil... Commodities... Business Techniques

Receive 1-5 issue current trials to well over 400 different, high-priced, money-making publications — newspapers, newsletters and magazines — covering virtually every conceivable money-making area from SELECT INFORMATION EXCHANGE, America's leading financial publications subscription agency covering almost 800 different financial publications. Their regular annual prices range as high as \$325 apiece. Your price for the entire package under this one-time-only, bargain-packed offer is \$95, or less than 25¢ apiece. Check here if you wish to receive them spread over a 6 months period, rather than all at once over a two-month period. Send your name and address together with this ad and your \$95 remittance to receive all 400 publications.

DAVIS PUBLICATIONS INC. EE910
229 Park Avenue South
New York, N.Y. 10003 Package # A

An Unusual Newsletter Bargain

WHICH ARE THE 30 MOST POPULAR INVESTMENT ADVISORY SERVICES?

Receive short 1-5 issue current trials to the 30 most popular investment advisory services based upon the confidential sales records of SELECT INFORMATION EXCHANGE, America's leading financial publications subscription agency covering almost 800 different investment publications. Send your name and address together with this ad and your \$21 remittance to receive all 30 publications.

DAVIS PUBLICATIONS INC EE910
229 Park Avenue South
New York, N.Y. 10003 Package # 1

HOW TO MANAGE YOUR BUSINESS BETTER... AND FOR LESS

Comprehensive Coverage for the Professional Business Manager

Receive short 1-5 issue current trials to 20 different publications designed to show you how to improve your management effectiveness and which rounds up and reports on the best techniques used by the best managed corporations and small companies for its readers from SELECT INFORMATION EXCHANGE, America's leading financial and business publications subscription agency covering almost 800 different business and investment publications. Send your name and address together with this ad and your \$18 remittance to receive all 20 publications.

DAVIS PUBLICATIONS INC. EE910
229 Park Avenue South
New York, N.Y. 10003 Package #13

FOREIGN INVESTMENTS Comprehensive Coverage for the Sophisticated Investor

Low-priced natural resource and oil & gas stocks in Canada; real estate and orange groves in Israel; 15% and higher interest-paying, government-secured financieras in Mexico; low-priced securities in Japan; gold and gold securities in South Africa; business opportunities in Taiwan; real estate in the Bahamas; etc. Receive short 1-5 issue current trials to over 30 different foreign investment services from SELECT INFORMATION EXCHANGE, America's leading financial publications subscription agency covering almost 800 different investment publications. Send your name and address together with this ad and your \$21 remittance to receive all 30 publications.

DAVIS PUBLICATIONS INC. EE910
229 Park Avenue South
New York, N.Y. 10003 Package # 5

SAVE THOUSANDS OF DOLLARS

with the Super-sensitive S & M A-4, The One Photo-Meter That Does It All!!

TRY ONE—FREE FOR 10 DAYS.

Use your A-4 Meter with dial lights as darkroom PROS now do. It's easy to use at the enlarger with the 5/8 in. high EASEL probe to determine accurate exposures for B & W and COLOR photos, correct paper for prints, and even ft. candle measurements.



A-4 In Darkroom Action

Use your versatile battery-operated A-4 with double sensitivity to do the work of several instruments costing Thousands of Dollars.

Use your A-4 to eliminate waste of films and prints, chemicals and time, and to increase production and earnings.



Make this densitometer with the A-4 meter and easy-to-build Light Source.

Use your A-4 with the 5/8 in. dia. STANDARD probe as a LIGHT METER. Features? Four sensitivity ranges: EV-EVS-LV settings; ASA settings from 3 to 25,000;

f/stops from 0.7 to 90; exposure times from 1/15,000 sec. to 8 hours.

Special Graphic Arts Applications? Ground-glass, contact printing, color separation, screening, copying, standardizing exposures from camera to camera, evenness of lighting, film density readings, etc.



A-4 In Ground-glass action

3 ft. Standard Probe

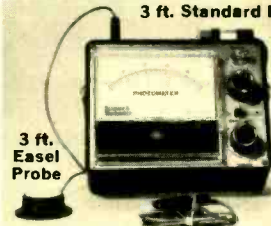

3 ft. Easel Probe

Exposure Calculator

Uses Plug-In Probes 3 ft. Mini Probe

Attn: Wilfred M. Brown
SCIENCE & MECHANICS INSTRUMENTS DIVISION,
229 Park Ave. South, N.Y., N.Y. 10003 EE 9/10

Send the meter and probe(s) with cable length (3-12 ft.) as indicated below. I understand that if I am not satisfied, I may return the meter within 10 days for a complete refund.

S & M A-4 Graphic Arts Photo Meter.
 \$109.95 with _____ ft. long Standard probe, exposure calculator and carrying case and manual.

EXTRA PROBES

- \$9.95 5/8 inch high Easel probe with _____ ft. long cable
- \$9.95 3/8 inch diameter Mini-probe with _____ ft. long cable
- Check or money order enclosed, ship ppd.
- Company Purchase Order attached.

NAME _____

ADDRESS _____

CITY _____

STATE _____ ZIP _____

24 HOUR PROTECTION—ANYWHERE!

Protect yourself, your family and your home with this 7-shot automatic .22 caliber non-lethal tear gas pistol. Instantly stop attackers, molesters, rapists and muggers with this high quality precision machined automatic. Fires 7 rounds as quickly as you can squeeze the trigger. Solid metal construction — dependable operation. Convenient trigger safety lock. No Federal Firearms License required. Don't be confused by cheap metal and plastic imitations that might misfire or jam in an emergency.



FITS EASILY IN PURSE OR POCKET

ONLY \$24.99 ADD \$5.00 FOR 25 ROUNDS AND PREPAID, INSURED DELIVERY. NO C.O.D.'S PLEASE.

DEFENDER DEPT. A258 • NEW CASTLE, DEL. 19720

Warming Up

(Continued from page 50)

trollers. A typical circuit is shown in Fig. 5 where R1, R2, thermistor R3 and R4 form a bridge network. R3 is located in close proximity to the heater, R4 is used to select the desired temperature; A1 is an op amp that senses the difference in voltage between V1 and V2. When V2 is smaller (R3 is large), the op amp turns on the power switch and the voltage is applied to the heater, H1. When $V1 = V2$ (R3 reaches temperature), the op amp stops energizing the power switch. The power switch can be a relay or a triac or a silicon controlled rectifier.

Be Practical. If you have a thermistor but do not have the resistance-temperature curve, the curve can be determined fairly easily. You will need a thermometer that covers the range of temperature over which you want to measure the thermistor, a method to heat the thermometer and thermistor simultaneously, a means of viewing the thermometer while, at the same time, you measure the resistance of the thermistor. You must arrange the thermometer to be very close to the thermistor and adjust the heat, in steps, so that at each step the temperature of the

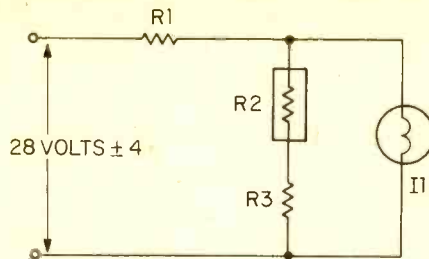
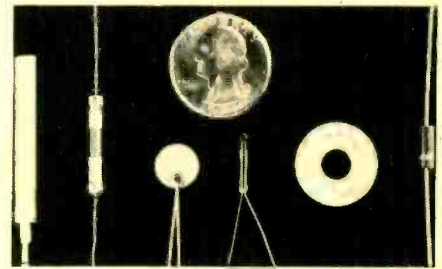

Fig. 3. Voltage stabilization using thermistor.

thermometer has stabilized after which the resistance of the thermistor is read and then the temperature and resistance readings are recorded. This step is repeated until the desired temperature range is completed. Usually only about four to seven readings are required to allow an accurate curve to be drawn.

If the thermistor is sealed (glass or epoxy covered), a simple method of heating is to immerse both the thermistor and the thermometer into a pan of water on top of a range; another method is to heat them inside a closed or semi-closed container such as an oven. In either case be sure not to let any part of the thermometer, or the thermistor, or the bare leads, touch the metal since this will probably draw off heat and cause an erroneous reading. Also, when reading the resistance, disconnect the meter immediately after the reading to avoid self-heating.



The more common types of thermistor configurations are, from left to right, the probe, rod, disc, glass coated bead and washer. A quarter, above and a 1/2 watt resistor are shown for a relative comparison of size.

By using the ratio for a general evaluation, the resistance-temperature curves and the formulas for self-heating, the thermistor offers many applications in the areas of temperature measurement, temperature control, timing and control circuits.

This article is meant to be a first introduction to thermistors. For experimentation, one of the cheapest sources of thermistors is from junked pocket transistor radios. Most use thermistors to stabilize the class B push-pull audio output stage. Some even spell it out for you on the manufacturer's ident plate when they list the number of transistors, diodes, and thermistors. Good hunting and good luck!

Op Amp Insights

(Continued from page 81)

the input bias currents at the two inputs is the input offset bias current I_{io} . This current is usually much smaller than I_b . Both I_b and I_{io} cause an objectionable output offset voltage when R_f is very large. To restore the output voltage to zero, add the nulling circuit potentiometer R1 and resistor R2 as shown in Fig. 5. With S1 open, adjust the control until the meter indicates zero.

If R_f is small, and upon closing S1, you may observe that the meter again loses its zero. This is caused by the input offset voltage V_{io} resulting from slight mismatches of the input transistors. Input offset voltage V_{io} is defined as that input voltage required to restore V_{out} to zero. It is measured under open-loop conditions with very low value resistors at the input. For the 741, V_{io} may range up to 6 millivolts. Con-

veniently, the 741 includes terminals allowing compensation for input offset voltage. Add potentiometer R3 and adjust the control with S1 closed, until the meter indicates zero. If both circuits are included, adjust the controls several times in succession.

Conclusion. Having become acquainted with the basic operation of the op amp, and with some knowledge of the six primary op amp specifications,

you will now be able to experiment with op amp circuits with some degree of confidence rather than apprehension. With some appreciation of how and why the circuit functions as it does, how the performance of the several circuits compare with each other, and how negative feedback plays its part, you will find that op amp literature and circuits are more easily understood.

Fig. 6 Op amp nulling circuits.

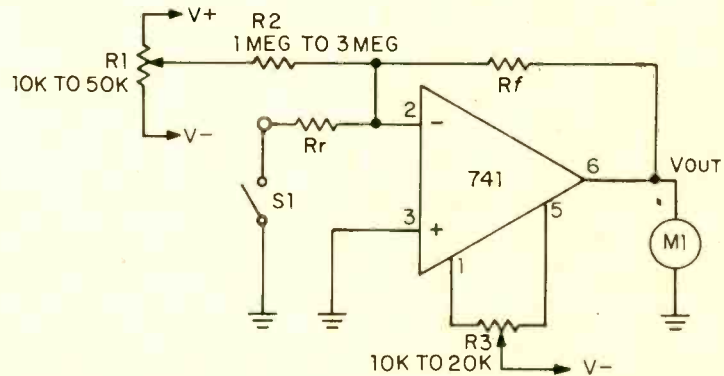

An Electronics Career

(Continued from page 67)

on high quality color TV sets that are

provided in kit form with some course material. And you will also see illustrations of mouth-watering pieces of equipment ranging from VOMs to oscilloscopes and from TV pattern generators

to small programmable digital computers.

You can be inspired by all these displayed goodies provided you don't get
(Continued on page 96)

ELEMENTARY ELECTRONICS—is published Bi-monthly. The rate per word for CLASSIFIED ADVERTISEMENTS is \$1.15 payable in advance—minimum ad \$15.00. Capitalized words 40¢ per word additional.

ADDITIONAL INCOME

AEROSOL FIRE EXTINGUISHERS \$2.88 and \$3.98. Distributors quantity price 87½¢ and 99½¢. Sample of each \$4.50. Trial Case of each \$34.50 Postpaid. **AUTOMOBILE SIXTY SECOND TIRE FIXER**. No Tools, No Jack—Dealers Invited. Sample and Details, \$4.98. Trial Case \$35.00 Postpaid. Warren, 6922 Congress, Detroit 48207.

WRITE TECHNICAL ARTICLES: Step-by-step instructions. Send \$5.00: **TECHMAT-1**, P.O. Box 518, Moses Lake, WA 98837.

\$10 DAILY writing short articles at home. Begin immediately! Copyrighted Report reveals: How and Where. Send \$1.50. House of Ellis, 7326 So. Crescent Avenue, Dept. 1, Cincinnati, OH 45229.

ADVERTISING SERVICES

HOMEWORKERS EARN IN ADVANCE! Details, three stamps. **REYES**, 145 So. Lincoln, Ft. Bragg, CA 95437

AGENTS WANTED

SELL: Personalized, Colored, Social Security Plates. Big Profits! Free Sample! **DRS Specialties**, 73 E. Hunter Place, Pompton Lakes, New Jersey 07442.

AUTHOR'S SERVICE

PUBLISH your own book! Join our successful authors: publicity advertising promotion, beautiful books. All subjects invited. Send for free manuscript report and detailed booklet. **Carlton Press**, SMU, 84 Fifth Avenue, NY 10011.

BIG MAIL

RECEIVE mail galore! National listing \$1.00. **Sullins**, Box 1313-EE, Brunswick, GA 31520.

BLUEPRINTS, PATTERNS & PLANS

NEW CRAFT PRINT CATALOG—Choose from over 100 great easy-to-build plans. Send \$1.25 (completely refunded with your first order). **BOAT BUILDER**, (CP Div.)—229 Park Avenue South, New York, NY 10003.

BOOKS & PERIODICALS

AMAZING Opportunities in Import-Export. New booklet reveals how to get started. Mail \$1.50 today to: Southland Sales, Louisville, TN 37777.

ORGAN, amp plans. Technical information. Send stamp. 51, Clay, NY 13041.

BUSINESS OPPORTUNITIES

I MADE \$40,000.00 Year by Mailorder! Helped others make money! Free Proof! **Torrey**, Box 318-TT, Ypsilanti, MI 48197.

MAKE Magnetic Signs. Big Profits. Details. **Universal**, Lenora, KS 67645.

1000% PROFIT Bronzing Baby Shoes. Free Literature. **NBC-DG**, Gover, MO 64454.

HOW To Make Money Addressing, Mailing Envelopes. Offer Details 15¢. **Lindbloom Services**, 3636 Peterson, Chicago 60659.

FREE Secret Book "2042 Unique, Proven Enterprises." Fabulous "Little Knowns" Work Home! **HAYLINGS-E14**, Carlsbad, CA 92008.

ADDRESSERS, Mailers, Homeworkers needed! 50 Firms listed. Information: Rush 25¢ stamped addressed envelope. **LBBS**, P.O. Box 39087, Wanamaker, IN 46239.

MAKE YOUR CLASSIFIED AD PAY. Get "How to Write A Classified Ad That Pulls." Includes certificate worth \$2.00 towards a classified ad in this publication. Send \$1.25 (includes postage) to **R. S. Wayner, Davis Publications, Inc.**, Dept. CL, 229 Park Avenue South, New York, NY 10003.

SELL Carded Merchandise: Combs, Novelties. **Carleton House (I.O.)**, La Marque, TX 77568.

BECOME our Mail Order Distributor with \$150 investment. Free brochure. **Audit Controls**, 35 Brookside Av., Fair Lawn, NJ 07410.

MAILORDER Millionaire helps beginners make \$500 weekly. Free Report reveals secret plan! Executive 1G9, 333 North Michigan, Chicago 60601.

BUSINESS OPPORTUNITIES—Cont'd

OWN Your Own Business! Correspondence Club Magazine, Information. Details 25¢. **Destiny**, Box 5637-BC Reno, Nevada 98503.

FREE MAILORDER OPPORTUNITY PARTICULARS—CUTLER, Rockland, DE 19732.

LAZY? Produce oil portraits in seconds! Details 25¢. **JiffyPortrait**, 2830BT-Gaffey, San Pedro, CA 90731.

ESTABLISH successful mailorder business. Immediate, continuous income! **Mears**, G5363 Essex, Alexandria, VA 22311.

HOW MUCH does being your own boss or making \$25,000.00 per year interest you? The Warner Break-through in the engraving field could be your future. Write: **Warner**, Room EC-107-EK, 1512 Jarvis, Chicago, IL 60626.

WE NEED GINSENG GROWERS! \$3,000-\$30,000 annually! We Buy Your Crop. Send \$2. For seed sample and information: **Glass's Ginseng Exchange**, Box 336, Rochdale Station, Jamaica, NY 11434.

BUSINESS OPPORTUNITIES—Cont'd

MAKE 2 to 3 TIMES your COST on HUNDREDS of PRODUCTS, GIFT ITEMS, NOVELTIES, TOYS, CARDED MERCHANDISE, 1001 OTHERS. \$1.00 brings Giant Catalog, refundable on first order. **Morehart's Gift World**, 9 A North Progress Avenue, Harrisburg, PA 17109.

\$250/THOUSAND Stuffing Envelopes. Free Supplies, send stamped addressed envelope. **Phillips**, Box 332, Idaho Falls, ID 83401.

GET RICH with Secret Law that smashes debts and brings you \$500 to \$2 million cash. Free report! **Credit 4G9**, 333 North Michigan, Chicago 60601.

NEW BOOK, FREE DETAILS. Dog TV Repair by: **B & K Pro**, Box 21366, Fort Lauderdale, FL 33316.

INCREASE income through knowledge! Mail order entrepreneurs: "Library of Wealth-Building Information," \$1.00 postage/handling. **T. R. Enterprises**, Dept. 5601, 4115 Kirkham, San Francisco, CA 94122.

EASIEST Home Business To Operate. 50¢ (Refundable) Brings Details. **Jon-Jon**, 7160C Northwoods Station, Jacksonville, NC 28540.

BUY IT WHOLESALE

SAVE MONEY! Bargain hunters, jobbers, wholesalers, Opportunity seekers. Lists, Catalogs, unusual items, \$2.00 refundable first order. **Winchester Enterprises**, 2807SS Hargrave Street, Philadelphia, PA 19136.

WHY PAY RETAIL? Save \$300.00-\$500.00 yearly on over 1,000 household and personal items. Wholesale-to-you! Free details!! **Marketing**, 1338 Bennett, Lept. 491-D, North Madison, OH 44057.

CB MARINE AMATEUR

FANTASTIC Savings on name brand Communications Equipment. Catalog 25¢. **UNI-COM**, P.O. Box 4683, Walnut Creek, CA 94523.

COINS, CURRENCY & TOKENS

HOW To Collect Coins for Investment and Profit! This booklet is worth its weight in gold—coins, of course! Act Now! \$1.00 brings details. **Gaither Enterprises**, 4704 Sheryl, Bossier City, LA, Dept. 1010.

DETECTIVES

CRIMEFIGHTERS! Investigators-Detectives-Police, Catalog \$1.00 Refundable. **Don-Q**, Box 548, Seattle, Washington 98111.

DO IT YOURSELF

FOR the Garden enthusiast. Having problems? Here's a guide to help you select the right plants or vegetables and how to care for them. Send \$1.25 for 101 Great Garden Ideas. To: **Davis Publications, Inc.**, 229 Park Avenue So., New York, NY 10003.

EDUCATION & INSTRUCTION

ACUPUNCTURE TRAINING Correspondence Course. Supplies! **Tsang**, Box 219W, Toronto, Canada M6M 4Z2.

USED Courses! Books! List 10¢. **Smith's 124 Marlborough**, Salem, MA 01970.

COLLEGE Degrees By Mail, Free Details Box 3199D, Pasadena, CA 91103.

FREE Details about highly effective and thorough course in Digital Electronics. Cost of course—\$10.00. Your success guaranteed or \$1.00 refunded! **Dynasign**, POB 60EE, Wayland, MA 01778.

UNIVERSITY DEGREES BY MAIL! Bachelors, Masters, Ph.D.s. Free revealing details. **Counseling**, Box 1425-EE-9, Tustin, CA 92680.

EARN WHILE YOU LEARN at home in your spare time. Home study "Hands On" training in gun repair, outdoor equipment, fishing tackle, small engines. **Coleman, Briggs & Stratton**, Winchester, Remington, Colt, Euger, Shakespeare, Fluager, all major products. We also offer a full (wholesale) line of silver & turquoise authentic Indian Jewelry to sell in home or store. 20,000 students since 1946. **Modern Schools, Inc.**, 4225 N. Brown Avenue, Dept. DC, Scottsdale, AZ 85251.

NOW Available Lincoln and Kennedy 18 coincidences. Send \$1.00. Honor, 400 Herkimer St., Bklyn, NY 11213.

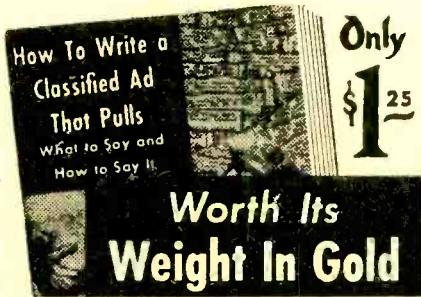

MAKE YOUR CLASSIFIED AD PAY. Get "How to Write A Classified Ad That Pulls." Includes Certificate worth \$2.00 towards a classified ad in this publication. Send \$1.25 (includes postage) to **R. S. Wayner, Davis Publications, Inc.**, Dept. CL, 229 Park Avenue South, New York, NY 10003.

ASK For Money (never repay) International, 2148 Lawrence Drive, Benton Harbor, MI 49022.

BORROW ANY AMOUNT. Enjoy A-1 credit. Keep money in bank, get 80% more. Send Stamp. **Vernon**, Box 75010-HH, Oklahoma City 73107.

\$30.00 HUNDERD Stuffing Our Circulars Into Stamped Addressed Envelopes. Immediate Earnings. **Beginners Kit \$2.00 COLOSSI**, 1433-61 Street, DC-8, Brooklyn, NY 11219.

BE YOUR OWN BOSS! Enjoy freedom & prestige... prosperity. Easy proven methods show how. Free details!! **Marketing**, 1338 Bennett, Dept. 491-C, North Madison, OH 44057.

\$150 WEEKLY stuffing our sales letter into stamped addressed envelopes. Immediate income! Details 25¢. **Lily**, Box 4967-F57, NYC 10017.

STUFF ENVELOPES \$250/Thousand. Free details. Send stamped addressed Envelope. **Mantor House**, Dept. 8, SM10, Minna, NY 13116.

JOIN Wealth Builders Club! Details. **Plan**, Box 267, Elkin, NC 28621.

\$300 WEEKLY—Guaranteed Easy, Immediate Spare-time earnings at home—Free Proof. **Research**, Box 9013310, Atlanta, GA 30344.

YOUR name sent to 250 firms seeking homeworkers. Be flooded with moneymaking offers. Save \$25 postage. Rush \$2.00 (refundable). **Snyders**, Box 2113Z, Greenville, NC 27834.

\$2.00 CAN GET YOU EXTRAORDINARY PROFITS. Product catalog. **Starlite Studios**, 920 South Cypress A., Ontario, CA 91761.

THERE IS NO CHARGE FOR THE ZIP CODE—PLEASE USE IT IN YOUR CLASSIFIED AD

PLACE

To be included in the next issue, please send order and remittance to R. S. Wayner, ELEMENTARY ELECTRONICS, 229 Park Avenue South, New York, N.Y. 10003

EDUCATION & INSTRUCTION—Cont'd

GREAT OPPORTUNITIES in electronics! Chicago school teaches burglar alarm installation and FCC licenses. Veterans approved. Free booklet. Call (312) 649-0927. OMEGA STATE INSTITUTE, 333 East Ontario, Chicago, IL 60611.

UNDERSTAND digital electronics—calculators, microprocessors, clocks. New programmed learning courses. Design of Digital Systems, 6 volumes only \$14.90. Digital Computer Logic, 4 volumes, \$9.90. CAMBRIDGE LEARNING, 300 East 56 St., New York, N.Y. 10022.

ELECTRONIC EQUIPMENT & SUPPLIES

FREE 36-page catalog, updated 5 times a year. Everything for the electronics hobbyist—from TV antenna wire to the latest stereo music equipment. ELECTRONIC DISTRIBUTORS, INC., 4900 N. Elston Ave., Chicago, IL 60630 EE-5.

SHORT WAVE from your AM transistor radio. Send only \$3.00 to: Box 482, Dover, OH 44622.

PC BOARDS (one sided only) 24¢ square inch from 1:1 artwork or foil pattern. You send art work and check, we'll send board(s). Holes 4¢ each. If desired Malleable Elements, Inc., Route 6, Mahopac, NY 10541.

EMPLOYMENT INFORMATION

"GUIDE To Better Employment During Recession," \$1.25. IRS, 8002 Downing Circle, Tampa, FL 33610.

FARMS, ACREAGE & REAL ESTATE

GOVERNMENT LANDS DIGEST. A Monthly review of government Real Estate offerings throughout the U.S.A. Free subscription information! DIGEST, Box 25561-DP, Seattle, WA 98125.

FOR INVENTORS

HOW to apply for a patent. \$1.00 brings complete facts. Hutchinson, Dept. IES, 10818 Brentway, Houston, TX 77070.

FOR SALE—MISCELLANEOUS

ELECTRONIC TV MIRACLE! ELIMINATES ANTENNAS, \$2.95. Stevenson, 805 W. 69th Street, Los Angeles, CA 90044.

FOR THE HOME

FOR anyone who wants the satisfaction and economy of repairing, furnishing and maintaining the furniture in his home. Send \$1.25 to FURNITURE, 229 Park Avenue South, New York, NY 10003.

FORMULAS & TRADE SECRETS

"HOW to Win Contests!" Get the facts. Informative booklet 25¢. Floyd's, Box 98-C2, Venice, IL 62090.

GIFTS THAT PLEASE

SAMPLES: GREETING CARDS, STATIONERY. 15¢ FOR ONE, \$4.00 FOR 30. CARRIE RUST, (D-7) 1432 OAK CT., Lafayette, IN 47905.

HI-FI EQUIPMENT

CANADIANS—Free HI-FI discount catalog. Name brands, immediate delivery from our huge stock. Etc. Dept. AA, Box 741, Montreal "A".

HOBBIES & COLLECTIONS

FREE CATALOG: Electronic supplies—kits for the hobbyist. Low prices. Anklam Electronics, 4709 nth, 6th St., Wausau, WI 54401.

HOBBIES & COLLECTIONS—Cont'd

COLLECTORS! Original WWII German Helmets. \$21.95. Other Military collectibles. FREE CATALOG. Unique Imports, Dept. EE, 610 Franklin St., Alexandria, VA 22314.

HOME WORKSHOP SUPPLIES

NUTS, Bolts, Screws, Assortment, Washers. Catalog 60¢. Nutty Co., 1576SMS, Fairfield, CT 06430.

25 WEEKEND BUILD-IT PROJECTS—Practical designs for home/shop buffs who enjoy working with wood, tools, materials and techniques. Send \$1.25 for your copy (includes postage) to Davis Publications, Inc., 229 Park Avenue South, New York, NY 10003.

HYPNOTISM

AMAZING self-hypnosis record releases fantastic mental power. Instant results! Free trial! Write: Forum (AF9), 333 No. Michigan, Chicago 60601.

FREE Fascinating Hypnosis Information! Startling! DLHM, Box 487, Anaheim, California 92805.

IMPORT-EXPORT

IMPORT-EXPORT Booklet tells how. Directory of Foreign Suppliers. \$1.50. Cornell Gifts, 9906 E. Flower #1, Bellflower, CA 90706.

LOGIC

QUESTIONS about computers answered by a professional. Let me get you started! Send typed letter and \$17.00 to: Mr. Hindman, Box 15411, Austin, TX 78761. This is my hobby, not my business. Ordinary contracting also available, \$1150 per week; direct inquiry to same address.

MAGNETS

FREE flexible magnetic strip with, 20 disc, or 10 bar, or 2 stick, or 8 assorted magnets, \$1.00. Any 5 sets \$4.50. Magnets, Box 192-FE, Randallstown, MD 21133.

1,000 MAGNETS, Fantastic Bargain. Only \$3.95. Humphrey Moynihan, 107 North Brighton, Atlantic City, NJ 08401.

MISCELLANEOUS

FREE UNIQUE COLLECTION TECHNIQUE for Business with pastdue accounts. Write: Raymond Fry, 1702 S. Palm, Ontario, CA 91761.

MONEYMAKING OPPORTUNITIES

STUFF MAIL ENVELOPES!! \$250.00 profit per thousand possible. Offer details: Stamped self-addressed envelope. Kings, B-21487K-95, Ft. Lauderdale, FL 33316.

STUFF ENVELOPES \$250/Thousand. Send stamped addressed Envelope. Mantor House, Dept. 8, SM, Minoa, NY 13116.

MAKE YOUR CLASSIFIED AD PAY. Get "How to Write A Classified Ad That Pulls." Includes certificate worth \$2.00 towards a classified ad. Send \$1.25 (includes postage) to R. S. Wayner, Davis Publications, Inc., 229 Park Avenue South, New York, NY 10003.

HOW to Make Money Writing Short Paragraphs. Information Free. Barrett, Dept. C-21-D, 6216 N. Clark, Chicago 60660.

\$100 WEEKLY Clipping Newspaper Articles! Details 25¢ and Stamped Envelope. Sunny, Box 579A, Plais-tow, NH 03855.

\$1,000 MONTHLY!! Stuffing Envelopes And Clipping Newspaper: Send Stamped Addressed Envelope. JOY, Box 936-A, Hyattsville, MD 20783.

LOW-Cost mailorder know-how books: Huge listing! Leemarr-I.O., Peterstown, West Virginia 24863.

MONEYMAKING OPPORTUNITIES—Cont'd

NEW Spare Time Fantastic Import-Export without investing, \$1.00. MA Distinctive Gifts, 1101 East 4 Avenue, Box 1561, Hialeah, FL 33011.

\$300 DAILY in Your Mailbox—Free Report reveals wealth-building secrets. Saffar, Box 9013310, Atlanta, GA 30344.

37 WAYS to make money when you are out of work. Details Free. R&R Investment Co., 729 Treat Blvd., Tallmadge, OH 44778.

I HAVE DYNAMIC INFORMATION FOR EASY FORTUNE. SEND \$2.00 for DETAILS. ET-CETERA ENTERPRISES, P.O. Box 3206, Keltys Station, Lufkin, TX 75901.

STUFF Envelopes. \$25.00 Hundred. Start immediately! Rush Stamped Envelope. United, 3638½ Van Dyke, San Diego, CA 92105.

MAKE EXTRA MONEY. New booklet shows you how to make money in your spare time—without working. \$1.00. Shields Co., 18635 Groverdale, Dept. 975, Covina, CA 91722.

DISTRIBUTE Circulars: Paying \$50.00 per hundred. Free instructions. Dettler Associates, Box 473D, Elmira, NY 14902.

MONEY made with small ads. No work! And you can operate on credit! Ads placed in your name. Reply ad costs advanced monthly, while ad works. Information, application, \$1.00 (refundable). Norman Drake, 320 East 43rd St., New York, NY 10017.

MAILORDER! \$2,000 MONTHLY POSSIBLE WORK HOME... EVENINGS ONLY! Free proof. Associates, Route 3-D8, New Sharon, IA 50207.

\$\$\$\$\$ EXTRA! List of Self Improvement books, send 50¢ (refundable) to: J. P. Hall, 7305 Bay Street, Dept. A, St. Petersburg Beach, FL 33706.

EXTRA Money! Booklet reveals unusual hobby which could bring a trip around the world. Only \$1.50. Brandon House Ltd., 3678 Hidden 2401, San Antonio, TX 78217.

FANTASTIC MONEY-MAKING OPPORTUNITY! At home stuffing envelopes. FREE information. Send Stamped Self-Addressed Envelope NOW. Shields Gifts, 18635 Groverdale, Covina, CA 91722.

200% TO 300% Profit! Hundreds of Gifts. Novelties. Giant catalog \$1.00, refundable. ISCO, 10235 Brian, Boise, ID 83706.

MUSIC & MUSICAL INSTRUMENTS

FREE RECORD COLLECTION—Reviewers wanted. Each month we ship you new record releases to rate. Anyone can qualify. All you pay is postage. You pay nothing for the records. Applicants accepted on first come basis. Write: Music Research, 6162 Washington Circle, Milwaukee, WI 53213.

GUITARISTS—Strings, accessories Cheap! Free catalog Guitar Clinic, EE-1, 189 Morris, Albany, NY 12208.

EXCEPTIONAL PROFITS installing professional grade, silent, police-calling holdup & burglary alarms. We show you how—fast. Write: Garrison Protective, B-350, 42-55 Couden, Flushing, NY 11351.

OF INTEREST TO WOMEN

STUFF N' SERVE SAUSAGE KIT. Homemade sausage in your kitchen. Includes seasoning, spices, casings, stuffing horn. Makes 10 lbs. Only \$5.95. Refills available. C. and L. Watson Sales, 2A Hwy. W, Box 166b, Foristell, MO 63348.

PERSONAL

JAPANESE introductions! Girls' photographs, descriptions, brochure, details, \$1.00. INTER-PACIFIC Box 304-SC, Birmingham, MI 48012.

MORE

For Greater Classified Savings... Results... and Profits...

Place your ad in one of our SPECIAL COMBINATIONS: Business Group, Science & Mechanics, or Davis Combination. Each Combination is designed to give your ad the largest audience available. For further information write to R. S. Wayner, Classified Advertising Manager, Davis Publications, Inc., 229 Park Avenue South, New York, N.Y. 10003.

Classified Continued

PERSONAL - Cont'd

SINGLE? Widowed? Divorced? Nationwide Introductions! Identity, Box 315 DC, Royal Oak, MI 48068.

JAPANESE Girls Make Wonderful Wives. We have large number of listings. Many interested in marriage. Only \$1.00 brings application, photos, names, descriptions, questionnaire, Etc. Japan International, Box 1181-AA, Newport Beach, CA 92663.

"DATE WITH DIGNITY" Professional Matchings. Drawer 6765, Fort Worth, 76115 (817) 921-0281 Anytime.

BEAUTIFUL MEXICAN GIRLS Wanting American Boy-Friends. Details. Photos "Free." World, Box 3876-DC, San Diego, CA 92103.

ADVICE ON JOB HUNTING. I Have Some Startling Information. Not Commonly Known. Price \$1.00. (Ohio Residents Add 5 Cents Sales Tax). W. J. Wagner, Dept. 517, 5715 Chevrolet Blvd., Parma, OH 44130.

A serious, informative, entertaining magazine covering just about every topic of interest to hikers. Includes a "Buyers' Guide to Equipment" and a "Beginners Section" for those who want to learn about hiking and backpacking. Send \$1.60 (includes 25¢ for postage/handling) to: Backpacking Journal, 229 Park Avenue South, New York, NY 10003.

CONTRACEPTIVES FOR MEN-by mail! Samples and Catalogue-\$1.00. **POPLAN**, Box 2556-Dept. CDG-2, Chapel Hill, NC 27514.

ACUPUNCTURE without needles. Complete course \$10. Synergy, Box 26113, Ft. Worth 76116.

1001 LONELY LADIES PHOTOS in world's largest marriage partner catalog-\$5. Intercontact, Box 737, Lauderdale 33302 or Box 12, Toronto M4A 2M8.

FEEL BETTER! Easy common sense diet program. \$1.00. Jon Dee Associates, 7610 Penn Avenue South #218H, Richfield, MN 55423.

PERSONAL - Cont'd

CORDLESS VIBRATOR-MASSAGER. Unique tubular shape with smooth contours for facial toning, penetrating and relaxing spot massage. Operates on flashlight battery. 7"x1 1/2". \$3.00. Deluxe model, complete assortment of attachments. 7 1/2"x1 1/2", battery \$8.95. **ADAM & EVE**, Box 2556, Dept. CDG-3, Chapel Hill, NC 27514.

CUBAN Cigars. Formerly made in Havana, now Hand-Rolled by Tampa's Master Craftsmen from finest imported tobaccos. Satisfaction Guaranteed. Brochure free. Boutique, 8501-B Woodburn Court, Tampa, FL 33615.

X FILMS-Lovelace, Others. Sample \$1.00 (Refundable). Action, 217DP, Port Richey, FL 33568.

DATES GALORE! Meet exciting singles-anywhere. Free application: DATELINE, Alpha, OH 45301.

PHOTOGRAPHY-PHOTO FINISHING & SUPPLIES

SAVE HUNDREDS OF DOLLARS!!! Make your own S & M Densitometer. Send \$3.00 for detailed drawings and instructions. A must for successful photography in your darkroom. Order direct: S & M Instruments, Dept. EE9, 229 Park Avenue South, N.Y., NY 10003.

RADIO & TELEVISION

TV TUBES 36¢ each. Send for Free 48 page color catalog. Cornell, 4217-W University, San Diego, California 92105.

"CRYSTAL Experimenter's Handbook"-50¢. "20 Crystal Set Plans" Handbook-50¢. Catalog-25¢, refundable. Laboratories, 1477-G, Garden Grove, CA 92642.

A NEW CANADIAN MAGAZINE. "Electronics Workshop" \$5.00 yearly, sample \$1.00. ETWCO, Box 741 "A" Montreal, Canada.

FREE Electronics Catalog! Plans, Kits, Tubes, Security Equipment, etc. McCord Electronics, Box 276-F, Sylvania, Ohio 43560.

TELEVISION servicing manuals. \$4.00. Sample typical volume, \$1.00. Supreme Publications, 1760 Balsam, Highland Park, IL 60035.

REMAILING SERVICE

DISCREET Personalized Remail Service. 25¢. P.O. Box 21366, Fort Lauderdale, FL 33316.

SALESMEN-DISTRIBUTORS

AUTOMATIC Fishhooks, Profitable samples, \$2.00 (refundable), Arons, 61 Mastic Beach, New York 11951.

SCIENCE & CHEMISTRY

FIREWORKS. Spectacular novelties. Simplified manufacturers textbook. \$5.00. Guaranteed. Tropic, Box 95M4, Palm Bay, FL 32905.

KITS. Electronic games. Digital circuitry. From \$7.75. Information 10 cents. NBL-A, Box 1115, Richardson, TX 75080.

SONGWRITERS

EXCITING offer! Send poems, songs. Crown Music, 49-RX West 32, New York 10001.

SONGPOEMS! SONGS! URGENTLY NEEDED. 50-50 Agreement. Betty's Music Makers, Dept. E, 10355 Paradise Blvd., Treasure Island, FL 33706.

STAMP COLLECTING

10 QATAR Stamps free no approval applications. Dept. DP, W-B Stamps, Wilkes-Barre, PA 18703.

SURPLUS EQUIPMENT

GIANT Bargain Packed Canadian Surplus Catalogs \$1.00. Eico Electronics-DG, Box 741, Montreal "A".

TIPS FOR THE HOME, ETC.

PRACTICAL tips for home, garden and workshop are in "1001 How-To Ideas." Send \$1.00 for your copy includes postage to 1001 How-To Ideas, 229 Park Avenue South, New York, NY 10003.

WATCHES, WATCHMAKING & REPAIRING

WATCH and clock repairing books, tools, materials. Free catalog. North American, Box 77, IO-9, Fox River Grove, IL 60021.

YOU'LL MAKE MONEY

SAVE MONEY TOO - BY READING and ANSWERING THESE CLASSIFIED ADS

(Continued from page 93)

the notion that you get all that fancy gear with every course that is offered or that you get to keep as your own every piece of equipment shown or described. Take the trouble to study carefully the equipment lists provided in the promotional literature you can get from the various schools. Some courses provide *no* equipment of any kind because it's just plain book-larnin' all the way. Another course that is designated as a "lab" course may provide, along with the printed lessons, such simple experimental supplies as transistors, diodes, neon lamps, relays, a compass, magnets, switches, and the like—but no oscilloscope or TV set. The equipment is kept simple because only simple equipment is needed to supplement the written course material. On the other hand, when you get into the area of color TV servicing, for example, you obviously must have a TV set on which to work because textbooks can't provide the tools-in-hand experience you need.

Read school literature very thoroughly and carefully with respect to the more elaborate equipment you see il-

lustrated on page after page of the promotional material. Some of it will become yours to keep when you pay for certain courses. The school may offer to sell you other equipment at additional cost, but you should have the option to obtain comparable equipment elsewhere (maybe borrow it from a friend). Finally, you may be allowed to use certain equipment at specified training centers operated by the school; or, if that is inconvenient, you may obtain the gear on two-week loan by advancing a bond (probably \$100) and agreeing to pay shipping and insurance charges.

If a course emphasizing the construction, maintenance, and repair of color TV receivers is what appeals to you, compare not only the printed course material offered by competing schools, but also the TV set kits that are provided. Some sets are top-quality 25-inch (diagonal measurement) jobs, other color sets are smaller or you can select just black-and-white sets. Know what you will get. Also check to see if the basic course price also brings a good cabinet (you might have to pay extra for this) and a premium quality new picture tube (instead of a rebuilt job).

If the cabinet is provided "without extra charge," interpret that to mean that it is not offered to you as an extra charge *option*; you pay for it in the basic course price, never fear!

One more point about equipment needs mentioning for the benefit of some folks who, unlike you and me, are not too savvy about advertising techniques. Scattered about in some school promotional literature are photos showing electronics technicians surrounded by all kinds of fancy equipment. These are *mood* photos designed to encourage you to imagine yourself in a similar professional situation *after* completing one of the training courses. It would be a mistake to assume that students receive the equipment shown in such photos.

Your Opportunities. The best electronics training program around won't get you that big-money job if you live in an area where the kinds of jobs you've trained for do not exist. You might try to play it safe by choosing a course dealing with color TV repair because you find TV sets just about everywhere. But suppose there are already too many fully qualified and competent radio/TV technicians in your

area. How are you going to fight that kind of entrenched competition? Wouldn't it perhaps be wise to redirect your plans toward another area where there is less competition and perhaps even a severe shortage of qualified people? For example, there may be businesses or industries within your reach that are seeking people having special knowhow relating to electronic equipment used for commercial or industrial purposes.

Thus our final bit of advice is this. While you survey the offerings of leading electronics schools, take time to make a study of electronics job opportunities in your area, or in the area to which you might plan to move, so that you will choose the kind of training that seems to offer the best long-range opportunities. ■

CB To Come

(Continued from page 70)

power of a "work the world" rating would be permitted. Welcome to the 1970s.

A Solution? Since SSB CB equipment would be priced beyond the average user's budget, and since SSB has not had record breaking success in CB, the best way to meet the original intent of the citizens radio service, namely, a short range, low cost system, would be to use the FM on the VHF frequencies above 2 meters. But it is the amateurs who are assigned the 144 and 220 MHz bands—for which, incidentally, much high quality, low cost equipment exists. If the personal communicator, legit hobbyist, and business CB user could be pushed into this frequency range, a tremendous market would be created overnight for equipment that already exists. Since CB applications now number about 100,000 per month, imagine what a class E CB band (VHF) could mean to our economy. But how does one get a new class E band in the already overcrowded VHF spectrum? Simple. Just ask for part of the 220 MHz amateur band, cause a real uproar, and then settle ("compromise") on some frequency close enough to the amateur band to permit available ham equipment to be used—perhaps with just a change in cabinet design.

By selecting the reasonable proposals for the amateur and CB services, we can actually come up with a balance in terms of both user and business benefits.

• **Novice Ham**—Unless insanity suddenly rears its head, the renewable novice license looks like a shoo-in, but look for some trouble from hams themselves

over the higher-power section of the proposal. Right now there's just a handful of inexpensive novice-type equipment available—people don't usually spend good money for gear they might not be able to use after one year. But a more-or-less permanent novice license with high power privilege allows room for upgrading to better receivers and transmitters.

• **Communicator Hams.** The place for communicators is really 220 MHz and 450 MHz. There's plenty of room for repeaters by the dozen and a need for a healthy market to force equipment prices down. A simple test of the "10 easy questions" variety would serve to open these bands wide, increase the amateur ranks, and maybe develop some interested technically-oriented hams. If an FM class E citizens band were placed directly below 220 MHz so the same equipment could be used for both class E and the communicators license, the business potential—with its concomitant benefit to the user—is enormous.

• **Class E.** Similarly, if class E does go through, it will be just below the current 220 to 225 MHz ham band, but we doubt whether commercial repeaters for business and personal (not hobby) use will be initially allowed; however, it may well be the wave of the future. Again, commercial repeaters would offer enormous user and business benefits.



With VHF FM mobile transceivers like this Midland ham unit already in production, a new class E band or communicator ham band would have up to date technology ready and waiting for only a simple frequency shift.

• **Class D.** Finally, we come to the proposed restructuring of class D CB. We believe that new channels will be added, that they will be SSB only, and that they will serve far fewer people than what class D CB now does. The old original 23 AM channels will remain nearly as crowded and unregulated as ever (with the possible exception of linear amps; the FCC is cracking down on their manufacture in no uncertain terms). Plus, the handful of users who invest in SSB will neither justify the severe change in spectrum management nor deliver an effective business stimulation. ■

ELEMENTARY ELECTRONICS INDEX TO ADVERTISERS

READER SERVICE NO.	ADVERTISER	PAGE NUMBER
5	Antenna Specialists	8
6	Avanti Research	14
	Bell & Howell Schools	46-49
3	Browning	18
21	Cleveland Institute of Electronics	Cover 2, p. 3
7	Cobra, Div., Dynascan Corp.	40
16	Continental Specialties Corp.	15
	Cornell Electronics	8
	Defender Co.	92
8	Electronic Dist. Corp.	32
17	Edmund Scientific	7
	Eico Electronics	28
	G. C. Electronics	19
1	Heath Co.	72-75
	International Correspondence Schools	p. 98, Cover 3
23	International Crystal Mfg.	30
33	E. F. Johnson Co.	16
20	Lafayette	27
19	Midland Electronics	34
	McGee Radio	19
	National Radio Institute	10-13
	National Technical Schools	20-23
9,18	Newtronics Corp.	6, 39
24	Pace	36
36	Perma-Power	38
11	Progressive Edu-Kits	5
4,32	Radio Shack	4th Cover, 33, 31, 29
	Relco	32
12	Royce Electronics	9
25	Regal Lapidaries	24
13	Shakespeare Antennas	37
22	Siltronix	25
	Star-Tronics	8
14	Tab Books	26
15	Teletronics of America	97
	Vintage Radio	24
	Western Radio	32

now available for the telephone experimenter

COMPLETE CONSTRUCTION PLANS

TELEPHONE PLANS: \$1.00 each.
Answering Device, Automatic Dialer, "Black Box", Call Diverter, Call Limiter, Conference Bridge, Central Dial Exchange, Melodic Ringing Generator, Recorder - Activator, Remote Control, Schematics, Speakers, etc. Teletalk Burglar Alarm, Voice Scrambler, Dial/Tone Converter, Tone/Dial Converter.

MISC. PLANS: \$6.00 each.
Bustleback Conditioner, Multifrequency Encoder, Network, Horticulture Simulator, Dodecahedron Speaker Enclosure, Photographic Pinhole Camera.

ALL OF THE CONSTRUCTION PLANS ABOVE: \$24.95 AIRMAILED.

PUBLISHED MONTHLY LEARN THE SECRETS OF YOUR TELEPHONE **PUBLISHED MONTHLY**

Telephone Electronics Line

Have you ever wondered what lies behind that telephone dial? Now you can learn the tricks of the telephone trade, test the inside story of telephone systems—their quirks and flaws, and remain up to date on vital occurrences within the telephone industry. TELEPHONE ELECTRONICS LINE is a publication designed for the telephone enthusiast, Phone Phreak, and experimenter, containing interesting articles which offer a wealth of hard to find information. Technical theory is also discussed, among the following items:

Current News Items • Code Numbers Illustrations • Games • Facts • Plans Projects • History • Comics • Stories Facts previously Tel. Co. confidential is now published in TEL!

One year subscription rate: United States \$6.00, Canadian & foreign \$8.00.

ALL OF THE CONSTRUCTION PLANS ABOVE PLUS A ONE YEAR SUBSCRIPTION TO TELEPHONE ELECTRONICS LINE: \$24.95 AIRMAILED.

THE LEGAL ASPECTS OF INTERCONNECTION

\$24.95 AIRMAILED

The complete reference book to your LEGAL RIGHTS as a telephone subscriber. Study toll evasion, tariffs, wiretapping, customer provided equipment, and many more!

ALL OF THE CONSTRUCTION PLANS ABOVE AND A ONE YEAR SUBSCRIPTION TO TEL PLUS "THE LEGAL ASPECTS OF INTERCONNECTION": \$49.00 AIRMAILED.

TELETRONICS COMPANY OF AMERICA
22035 BURBANK BLVD., WOODLAND HILLS CA 91364 USA

