

FOR BEGINNERS ONLY  
**BASIC  
COURSE**

# elementary Electronics

Understanding  
Cathode-Ray  
Tubes

Inside the Great 4-Channel Revolution

Including Electronics Digest

## CD-4 DISC

The only truly discrete  
quadraphonic LP playback  
system you can own today!  
See page 45

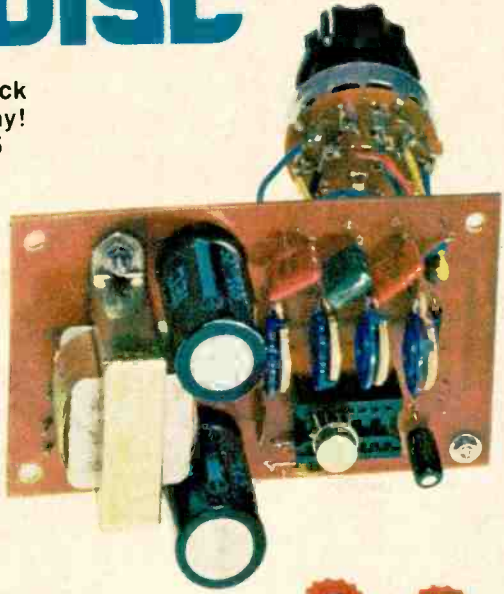

Build our...

## DIRECT READING CAPACITY METER

Goof proof IC project checks out  
capacitors ranging from .000002  
to .1  $\mu$ F—costs less than \$20  
See page 67



Plus Other Great Features...

- Recording on Tape like the Pros Do
- DXing with a Hidden Antenna
- Clock Radio Repair Tricks and Tips
- Aligning 8-Track Cartridge Decks
- Assembling an Alarm Generator

12 86 7140 CREZ29CNL-6 ITG04  
MR LLOYD CRETAL  
3729 CONNOR ST  
SAINT LOUIS MO 63121

From Cleveland Institute of Electronics

# learn by doing!

Perform more than 200 exciting experiments  
with CIE's fascinating **ELECTRONICS**  
**LABORATORY PROGRAM!**

Put theory... into practice



# You get your own 161-piece electronics laboratory... with authentic electronic components used by industry!

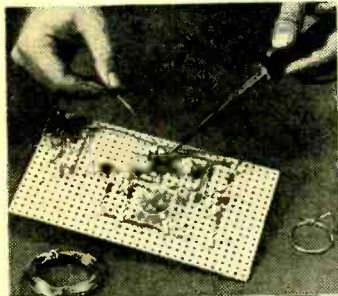

You learn how to construct circuits and connect them with a soldering iron, which is part of your CIE laboratory equipment. This "hands on" experience is extremely valuable in applying what you learn.

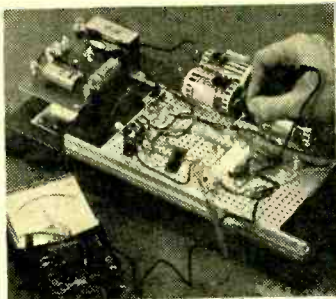

Testing and troubleshooting are an important part of your learning experience. Included in your laboratory is a precision "multimeter" to diagnose electrical and electronic troubles quickly and accurately.



Modern space-age components like this IC (integrated circuit) are professional quality and can be used again and again in many of your projects. Lesson by lesson, piece by piece your knowledge grows!

## Prepare now for a high income career in Electronics...the Science of the Seventies.

Electronic miracles are changing today's world with breathtaking speed.

And with this growth in electronics technology has come a brand new need... a demand for thousands of electronics technicians, trained in theory and practice to build the products, operate them and service them during the Seventies.

Don't just wait for something to "happen" in your present job. Get ready now for a career you'll really enjoy with a good income and plenty of opportunity for advancement.

### Experience with experiments is your best teacher

"Hands on" experience helps to reinforce basic theory. When you learn by doing, you discover the "how" as well as the "why." You'll find out for yourself the right way as well as the wrong way to use electronic components. How to construct your own circuits, to discover trouble spots and learn how to fix them. And with CIE's special Auto-Programmed® Lessons, you learn faster and easier than you'd believe possible.

CIE's fascinating course, Electronics Technology with Laboratory, teaches you Electronics by making it work before your eyes. And you do it yourself, with your own hands.

### Importance of FCC License and our Money-Back Warranty

Many important jobs require an FCC License and you must pass a Government licensing exam to get one.

But, a recent survey of 787 CIE graduates reveals that better than 9 out of 10 CIE grads passed the FCC License exam.

That's why we can offer this famous Money-Back Warranty: when

you complete our Laboratory Course, which provides FCC License preparation, you'll be able to pass your FCC exam or be entitled to a full refund of all tuition paid. This warranty is valid during the completion time allowed for your course.

You get your FCC License - or your money back!

### You'll have high paying job opportunities

Electronics is still young and growing. In nearly every one of the new exciting fields of the Seventies you find electronics skills and knowledge are in demand. Computers and data processing. Air traffic control. Medical technology. Pollution control. Broadcasting and communications. With a CIE Diploma and an FCC License you can choose the career field you want... work for a big corporation, a small company or even go into business for yourself.

Here's how two outstanding CIE students carved out new careers: After his CIE training, Edward J. Dulaney, President of D & A Manu-

facturing, Inc., Scottsbluff, Nebraska, moved from TV repairman to lab technician to radio station chief engineer to manufacturer of electronic equipment with annual sales of more than \$500,000. Ed Dulaney says, "While studying with CIE, I learned the electronics theories that made my present business possible." Marvin Hutchens, Woodbridge, Virginia, says: "I was surprised at the relevancy of the CIE course to actual working conditions. I'm now servicing two-way radio systems in the Greater Washington area. My earnings have increased \$3,000. I bought a new home for my family and I feel more financially secure than ever before."

### Send now for 2 FREE BOOKS

Mail the reply card or coupon for our school catalog *plus* a special book on how to get your FCC License. For your convenience, we will try to have a representative call. If coupon is missing, write: Cleveland Institute of Electronics, Inc., 1776 E. 17th St., Cleveland, Ohio 44114. Do it now!



Approved under  
G. I. Bill

All CIE career courses are approved for educational benefits under the G.I. Bill. If you are a Veteran or in service now, check box for G.I. Bill information.

**CIE** Cleveland Institute of Electronics, Inc.  
1776 East 17th Street, Cleveland, Ohio 44114  
Accredited Member National Home Study Council

Please send me your two FREE books:

1. Your illustrated school catalog, "Succeed in Electronics."
2. Your book, "How to Get a Commercial FCC License."

I am especially interested in:  Electronics Technology with Laboratory  
 Electronics Technology  Industrial Electronics  
 Electronic Communications  First Class FCC License  
 Broadcast Engineering  Electronics Engineering

Name \_\_\_\_\_ Age \_\_\_\_\_  
(PLEASE PRINT)

Address \_\_\_\_\_

City \_\_\_\_\_ State \_\_\_\_\_ Zip \_\_\_\_\_

Veterans and Servicemen: Check here for G.I. Bill information.

EL-42

CIRCLE NO. 18 ON PAGE 17 OR 101



# elementary Electronics

Dedicated to America's Electronics Hobbyists

## FIVE BIG CONSTRUCTION SPECIALS

- 31 Big Nine—spectacular audio fireworks from a 9-speaker console you build
- 51 Flag Down that DX—with a double-duty flagpole antenna
- 58 Put that Clock Radio Back on the Job—moneysaver tip rejuvenates the old clock radio
- 67 Cap Rapper—a simple tester tells capacitor values
- 77 Electronic Alarm Generator—lame duck sound scares babies—but startles burglars!

## WHAT WILL THEY DO NEXT?

- 44 World's Largest Digital Clock—the Big Apple has it!
- 60 Hands Down Identifier—shake hands with a super checkout system
- 65 Over Hell's Inferno Flies LARP—radio control airplane flies serious mission
- 80 Computer-Diagnosed EKG—heartthrob electronics checkout

## IMPROVE YOUR ELECTRONIC KNOWHOW

- 41 Getting Eight-Track Players on the Level—auto 8-track tune-up tips
- 63 Make Better Recordings—copy records or FM radio? Don't dub your flubs!
- 82 Signal Shifter—this tip puts UHF action on your low band monitor
- 83 Basic Course—understanding the cathode-ray tube

## DON, KATHI, HERB, HANK 'N BIG JULIE

- 16 DX Central Reporting—Don Jensen keeps readers in touch with short-wave listening
- 23 Ask Hank, He Knows!—Hank Scott, the answer to a reader's question
- 40 CB Coffee Break—an editor's look into CB, 1974 style
- 76 Hey Herb—for an expert's answer to your audio problems
- 79 Kathi's CB Carousel—your CB miss discovers a sleek Cobra

## 4-CHANNEL INFORMATION FOR ALL

- 45 Get the Facts About CD-4—to help you make a wise choice
- 50 Four Ways to 4-Channel
- 61 JVC 8-Track Player/Recorder—lab check reveals excellent stereo record/play performance

## PLUS THESE READABLE REGULARS

- 8 Hey Look Me Over—new products to check out
- 17 Reader Service Page—get more info free, also on 101
- 26 Newsman—electronic happenings you should know about
- 29 Literature Library—look over the list
- 81 Bookmark—late releases selected for e/e readers
- 101 Reader Service Page—get more info free, also on 17
- 104 Classified Ads

☆  
Cover  
Highlights

Cover  
photograph  
by  
Leonard  
Heicklen

## AUTHORS IN THIS ISSUE

F. J. Bauer W6FPO, Elmer C. Carlson, Homer L. Davidson, Emma Fluffin, Emmett Fluffin, Herb Friedman, Morrie Goldman, Julian S. Martin, Kathi Martin, Gary McClellan, Hank Scott, Shinri Sensei, David B. Weems.



# BUILD 20 RADIO

## and Electronics Circuits

### PROGRESSIVE HOME RADIO-T.V. COURSE



Reg. U. S. Pat. Off.

**Now Includes**

- ★ 12 RECEIVERS
- ★ 3 TRANSMITTERS
- ★ 50. WAVE GENERATOR
- ★ SIGNAL TRACER
- ★ AMPLIFIER
- ★ SIGNAL INJECTOR
- ★ CODE OSCILLATOR

- ★ No Knowledge of Radio Necessary
- ★ No Additional Parts or Tools Needed
- ★ EXCELLENT BACKGROUND FOR TV
- ★ SCHOOL INQUIRIES INVITED
- ★ Sold In 79 Countries

### YOU DON'T HAVE TO SPEND HUNDREDS OF DOLLARS FOR A RADIO COURSE

The "Edu-Kit" offers you an outstanding PRACTICAL HOME RADIO COURSE at a rock-bottom price. Our Kit is designed to train Radio & Electronics Technicians, making use of the most modern methods of home training. You will learn radio theory, construction practice and servicing. THE COMPLETE RADIO COURSE IN EVERY DETAIL. You will learn how to build radios, using regular schematics; how to wire and solder in a professional manner; how to service radios. You will work with the standard type of punched metal chassis as well as the latest development of Printed Circuit chassis. You will learn the basic principles of radio. You will construct, study and work with RF and AF amplifiers and oscillators, detectors, rectifiers, test equipment. You will learn and practice code, using the Progressive Code Oscillator. You will learn and practice trouble-shooting, using the Progressive Signal Tracer, Progressive Signal Injector, Progressive Dynamic Radio & Electronics Tester, Square Wave Generator and the accompanying instructional material.

You will receive training for the Novice, Technician and General Classes of F.C.C. Radio Amateur Licenses. You will build Receiver, Transmitter, Square Wave Generator, Code Oscillator, Signal Tracer and Signal Injector circuits, and learn how to operate them. You will receive an excellent background for television, Hi-Fi and Electronics.

Absolutely no previous knowledge of radio or science is required. The "Edu-Kit" is the product of many years of teaching and engineering experience. The "Edu-Kit" will provide you with a worthwhile education in Electronics and Radio, worth many times the low price you pay. The Signal Tracer alone is worth more than the price of the kit.

### THE KIT FOR EVERYONE

You do not need the slightest background in radio or science. Whether you are interested in Radio & Electronics because you want an interesting hobby, a well paying business or a job with a future, you will find the "Edu-Kit" a worthwhile investment. Many thousands of individuals of all

ages and backgrounds have successfully used the "Edu-Kit" in more than 79 countries of the world. The "Edu-Kit" has been carefully designed, step by step, so that you cannot make a mistake. The "Edu-Kit" allows you to teach yourself at your own rate. No instructor is necessary.

### PROGRESSIVE TEACHING METHOD

The Progressive Radio "Edu-Kit" is the foremost educational radio kit in the world, and is universally accepted as the standard in the field of electronics training. The "Edu-Kit" uses the modern educational principle of "Learn by Doing." Therefore you construct, learn schematics, study theory, practice trouble shooting—all in a closely integrated program designed to provide an easily-learned, thorough and interesting background in radio. You begin by examining the various radio parts of the "Edu-Kit." You then learn the function, theory and wiring of these parts. Then you build a simple radio. With this first set you will enjoy listening to regular broadcast stations. Learn theory, practice testing and trouble-shooting. Then you build a more advanced radio. Learn more advanced theory and techniques. Gradually, in a progressive manner, and at your own rate, you will find yourself constructing more advanced multi-tube radio circuits, and doing work like a professional Radio Technician.

The "Edu-Kit" course are Receiver, Transmitter, Code Oscillator, Signal Tracer, Square Wave Generator and Signal Injector Circuits. These are not unprofessional "breadboard" experiments, but genuine radio circuits, constructed by means of professional wiring and soldering on metal chassis, plus the new method of radio construction known as "Printed Circuitry." These circuits operate on your regular AC or DC house current.

### THE "EDU-KIT" IS COMPLETE

You will receive all parts and instructions necessary to build twenty different radio and electronics circuits, each guaranteed to operate. Our Kits contain tubes, tube sockets, variable, electrolytic, mica, ceramic and paper dielectric condensers, resistors, tie strips, hardware, tubing, punched metal chassis, instruction Manuals, hook-up wire, solder, selenium rectifiers, etc.

In addition, you receive Printed Circuit materials, including Printed Circuit chassis, special tube sockets, hardware and instructions. You also receive a useful set of tools, a professional electric soldering iron, and a self-powered Dynamic Radio and Electronics Tester. The "Edu-Kit" also includes Code Instructions and the Progressive Code Oscillator, in addition to F.C.C. Radio Amateur License training. You will also receive lessons for servicing with the Progressive Signal Tracer and the Progressive Signal Injector, a High Fidelity Guide and Quiz Book. You receive Membership in Radio-TV Club, Free Consultation Service, Certificate of Merit and Discount Privileges. You receive all parts, tools, instructions, etc. Everything is yours to keep.

### PRINTED CIRCUITRY

At no increase in price, the "Edu-Kit" now includes Printed Circuitry. You build a Printed Circuit Signal Injector, a unique servicing instrument that can detect many Radio and TV troubles. This revolutionary new technique of radio construction is now becoming popular in commercial radio and TV sets.

A Printed Circuit is a special insulated chassis on which has been deposited a conducting material which takes the place of wiring. The various Parts are merely plugged in and soldered to terminals.

Printed Circuitry is the basis of modern Automation Electronics. A knowledge of this subject is a necessity today for anyone interested in Electronics.

Training Electronics Technicians Since 1946

### FREE EXTRAS

#### • SET OF TOOLS

- SOLDERING IRON
- ELECTRONICS TESTER
- PLIERS-CUTTERS
- VALUABLE DISCOUNT CARD
- CERTIFICATE OF MERIT
- TESTER INSTRUCTION MANUAL
- HIGH FIDELITY GUIDE + QUIZZES
- TELEVISION BOOK + RADIO TROUBLE-SHOOTING BOOK
- MEMBERSHIP IN RADIO-TV CLUB:
- CONSULTATION SERVICE + FCC AMATEUR LICENSE TRAINING
- PRINTED CIRCUITRY

### SERVICING LESSONS

You will learn trouble-shooting and servicing in a progressive manner. You will practice repairs on the sets that you construct. You will learn symptoms and causes of trouble in home, portable and car radios. You will learn how to use the professional Signal Tracer, the unique Signal Injector and the dynamic Radio & Electronics Tester. While you are learning in this practical way, you will be able to do many a repair job for your friends and neighbors, and charge fees which will far exceed the price of the "Edu-Kit." Our Consultation Service will help you with any technical problems you may have.

### FROM OUR MAIL BAG

J. Stataitis, of 25 Poplar Pl., Waterbury, Conn., writes: "I have repaired several sets for my friends, and made money. The "Edu-Kit" paid for itself. I was ready to spend \$240 for a Course, but I found your ad and sent for your Kit."

Ben Valerio, P. O. Box 21, Malina, Utah: "The Edu-Kits are wonderful. Here I am sending you the questions and also the answers for them. I have been in Radio for the last seven years, but like to build Radio Testing Equipment. I enjoyed every minute I worked with the different Kits: the Signal Tracer works fine. Also like to let you know that I feel proud of becoming a member of your Radio-TV Club."

Robert L. Shuff, 1534 Monroe Ave., Huntington, W. Va.: "Thought I would drop you a few lines to say that I received my Edu-Kit, and was really amazed that such a bargain can be had at such a low price. I have already started repairing radios and phonographs. My friends were really surprised to see me get into the swing of it so quickly. The Trouble-shooting Tester that comes with the kit is really swell. It finds the trouble. If there is any to be found."

Progressive "Edu-Kits" Inc., 1189 Broadway, Dept. 562DJ, Hewlett, N.Y. 11557

### UNCONDITIONAL MONEY-BACK GUARANTEE

Please rush my expanded "Edu-Kit" to me, as indicated below: Check one box to indicate choice of model

- Deluxe Model \$31.95
- New Expanded Model \$34.95 (Same as Deluxe Model Plus Television Servicing Course and valuable Radio & TV Tube Checker).

Check one box to indicate manner of payment

- I enclose full payment. Ship "Edu-Kit" post paid.
- I enclose \$5 deposit. Ship "Edu-Kit" C.O.D. for balance plus postage.
- Send me FREE additional information describing "Edu-Kit."

Name .....  
Address .....  
City & State ..... Zip .....

### PROGRESSIVE "EDU-KITS" INC.

1189 Broadway, Dept. 562DJ, Hewlett, N.Y. 11557

CIRCLE NO. 28 ON PAGE 17 OR 101



- THE SHOPPING CENTER FOR ELECTRONICS  
(our catalog index of Mfrs extends from ADC to XCELITE)
- HOBBYISTS . . . EXPERIMENTERS . . . SERVICE  
TECHNICIANS . . . ENGINEERS •



Your Satisfaction is Our Target  
Top Name Brands . . .  
Low Prices

AMPLE STOCKS—including  
those hard-to-find Parts  
whether you want a 15¢ capacitor,  
a \$50 FET-VOM, or a \$450 stereo  
system—you can get it at EDI!



Send for your FREE catalog Today.

**RUSH FREE CATALOG**

Name \_\_\_\_\_

Address \_\_\_\_\_

City \_\_\_\_\_ State \_\_\_\_\_ Zip Code \_\_\_\_\_

**ELECTRONIC DISTRIBUTORS INC.**  
Dept. TA-2, 4900 Elston Chicago, Ill. 60630

CIRCLE NO. 24 ON PAGE 17 OR 101

**NEW 5-ELEMENT**

**GB  
MINI-  
BEAM**  
Model GA-5D

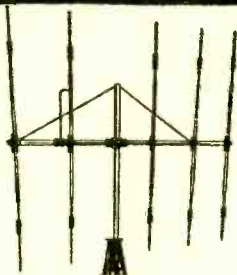

**9.5db Gain .... 500 Watt Power Rating**

The secret of success in this five-element miniature beam is in its coils. Ten High "Q" coils molded on each element-extension limit the mechanical size of the GA-5D without limiting its electrical capability. These coils are built to take a powerful beating----in fact, the same coils are used in the construction of 10-meter amateur antennas. The GA-5D is lightweight. Erect on TV antenna mount and turn with an inexpensive TV rotor. Get all the facts: see your Dealer or write factory direct, Dept. 211-RTV

**Mosley Electronics Inc.**

4610 N. LINDBERGH BLVD., BRIDGETON MO. 63044

CIRCLE NO. 12 ON PAGE 17 OR 101

**elementary  
Electronics**

July/August 1973

Vol. 13/No. 4

Dedicated to America's Electronics Hobbyists

- Editor-in-Chief*  
**JULIAN S. MARTIN, WA2CQL**
- Technical Editor*  
**PETER L. DEXNIS, WA3LOQ**
- Audio Editor*  
**STEPHEN B. GRAY**
- News Editor*  
**JEFFREY APTER**
- Circulation Board Editor*  
**KATHI MARTIN, KA1Ø614**
- Workbench Editor*  
**HANK SCOTT**
- Art Director*  
**JIM MEDLER**
- Cover Art Director*  
**IRVING BERNSTEIN**
- Associate Art Director*  
**ANDY STEIGMEIER**
- Art Associate*  
**RALPH RUBINO**
- Advertising Director*  
**DAVID J. MILLER**
- Production Director*  
**CARL BARTEE**
- Production Manager*  
**GERTRUD BORCHARDT**
- Assistant Production Manager*  
**MARILYN BONILLA**
- Newsstand Circulation Director*  
**DON GABREE**
- Subscription Circulation—Marketing Director*  
**ROBERT V. ENLOW**
- Instruments Division Manager*  
**WILFRED M. BROWN**

*President, Chairman of the Board (1957-1972)*

**B. G. DAVIS**

*President and Publisher*

**JOEL DAVIS**

*Vice-President and General Manager*

**LEONARD F. PINTO**

*Vice President and Treasurer*

**VICTOR C. STABLE, KBPØ681**

ELEMENTARY ELECTRONICS is published bi-monthly by Davis Publications, Inc. Editorial, Business and Subscription offices: 229 Park Avenue South, New York NY 10003. One-year subscription (six issues)—\$3.95; two-year subscription (12 issues)—\$7.95; three-year subscription (18 issues)—\$11.95; and four-year subscription (24 issues)—\$15.95. Add \$1.00 per year for postage outside the U.S.A., its possessions and Canada. For change of address, please advise 4 to 6 weeks before moving. Send us your current mailing label with new address. Advertising offices: New York, 229 Park Avenue South, 212-673-1300; Chicago, 520 N. Michigan Ave., 312-527-0330; Los Angeles; J. E. Publishers' Rep. Co., 8560 Sunset Blvd. 213-659-3810; Long Island: Len Osten, 9 Garden Street, Great Neck NY 516-487-3305; Southwestern advertising representative: Jim Wright, 818 Olive St., St. Louis, 314-CH-1-1965. Second-class postage paid at New York NY and at additional mailing office. Copyright 1973 by Davis Publications, Inc.

CIRCLE NO. 22 ON PAGE 17 OR 101

ELEMENTARY ELECTRONICS

# Now there's a CB radio with too much talk power.

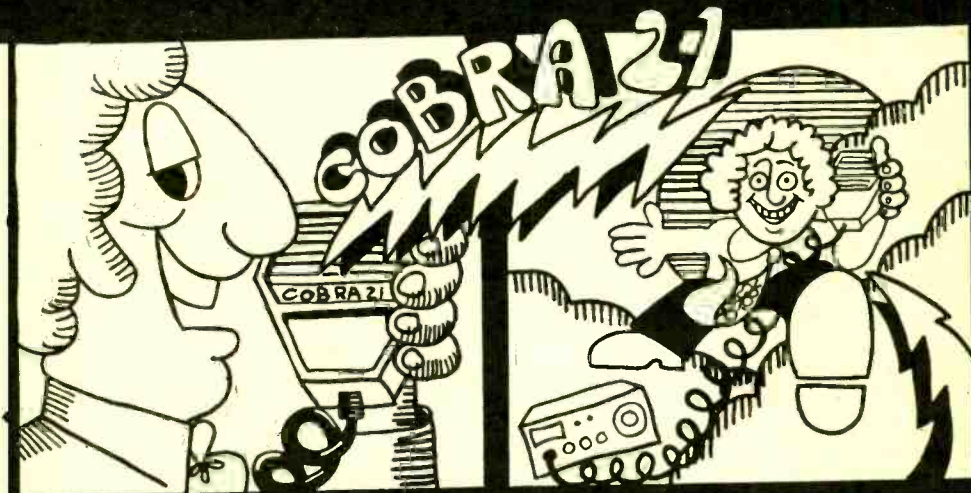

Put punch in your voice, from a block away to the fringes of your range. New Dync-Mike gain control puts out absolute modulation. So much talk power you'll have to turn it down.

An important feature, but only one that makes this fantastically low-priced CB radio the best CB value on today's market.

The Cobra 21 with crystal filter, dual conversion receiver; transmits and receives on all 23 AM channels.

Features 60 dB adjacent channel rejection that completely eliminates bleedover.

Extra large Power S Meter let's you monitor your set's performance easily even when it's tucked under the dashboard.

And you get switchable automatic noise limiter, P.A./external speaker jack, large built-in speaker and detachable mike.

It's all wrapped up in a beautiful, compact cabinet only 6" wide x 2½" wide x 7½" deep. Meets FCC requirements.

Ask your CB Dealer for the Cobra 21. The radio with too much talk power for not much money.



**\$119.95**  
with mike

**COBRA 21**  
WITH EXCLUSIVE DYNA-MIKE

Product of DYNASCAN CORPORATION • 1801 W. Belle Plaine • Chicago, Illinois 60613

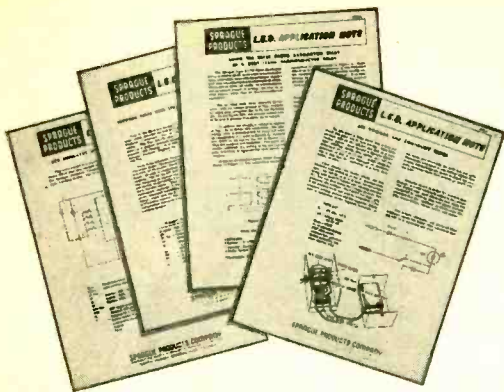

# FREE

## L.E.D. Application Notes to help you do new things with new circuits!

Now . . . get four **free** Application Notes hot-off-the-press that describe various uses and circuits for Sprague LED devices. Notes cover a BCD simulator, seconds timer, voltage and continuity tester, and an all-solid-state semiconductor relay. They've been prepared specifically to help open up a new world of electronic experimentation for **YOU**.

Ask your distributor for copies, or write our Guy Ezelle at Sprague Products Co. Better yet, fill out and mail coupon today!

**Sprague Products Company**  
641 Marshall St., North Adams, Mass. 01247  
Attention: Mr. Guy Ezelle

YES . . . send me free L.E.D. application notes on:

- BCD Simulator     Voltage & Continuity Tester  
 Seconds Timer     Semiconductor Relay

Name.....

Address.....

City.....

State.....

Zip.....



65-2112

CIRCLE NO. 29 ON PAGE 17 OR 101

# Hey, look me over

## Showcase of New Products

### 3-in-1 Radio

A new three-band portable radio that includes UHF has been introduced by Radio Shack priced at \$49.95—well below other radios with UHF capability presently on the market. The Realistic Patrolman-3 tunes AM, 450-470 MHz UHF and 144-174 MHz VHF for



police, fire, public utilities, business radio, weather broadcasts, 2-meter amateur radio and other two-way radio services. Separate tuning controls are provided for AM and for UHF/VHF, and each band has a "window-type" rotary dial for accurate frequency selection. An adjustable squelch control reduces background noise while monitoring VHF and UHF. An optional AC adapter is available for \$4.95. Realistic products are available at more than 1600 Radio Shack and Allied Radio stores in all 50 states and Canada. For catalog, circle No. 63 on Reader Service Page.

### Automatic Secretary for AWOLs

Don't miss what was being said by you, by your employees, or by your answering service. Record the number and nature of all telephone calls even while you are out of your office or home. Tele-Secretary is a telephone accessory which can be used with any telephone and any standard portable tape recorder. Tele-Secretary will start and stop your



# Kiss that "nothing" job good-bye forever!

We'll show you how to be a "somebody" in the high-paid world of **ELECTRONICS**

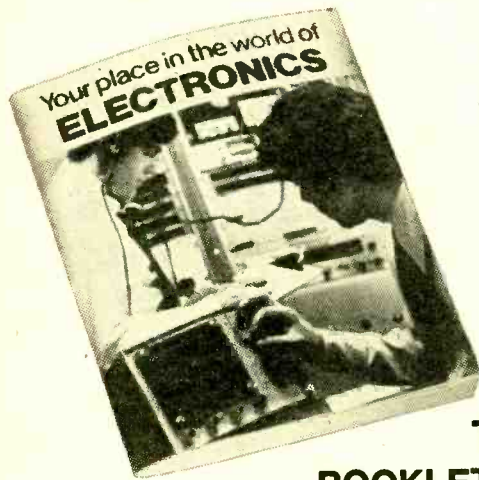

This **FREE BOOKLET** tells you how to get started right away. No obligation!

Why stay in a job without a future when there are so many opportunities in the big, exciting world of electronics? That's where the action is today. And you can get into it, too!

Thousands of technicians are needed NOW in TV and radio broadcasting. And in the fascinating new areas of Electronic Crime Detection . . . Electronic Factory Automation . . . Electronic Traffic Control. And many other "world of tomorrow" fields.

LaSalle will train you at home, in your spare time, to start a fascinating, high-pay career in electronics. No previous experience or college

is necessary. Experienced LaSalle instructors teach you basic principles, then lead you step-by-step to practical applications. You even build your own electronics equipment. *Emphasis is on the most modern techniques.* And, if you choose the communication field, LaSalle will prepare you to pass the exam for the FCC license.

Get with it today! Send for free sample lesson and valuable career booklets now. No obligation. LaSalle, 417 S. Dearborn Street, Chicago, Illinois 60605.



## ALL 3 FREE!

FREE sample lesson. FREE illustrated booklet, "Your Place in the World of Electronics", and FREE guide on "How to Obtain Your Commercial FCC License."

© 1973 LaSalle Extension University.

## MAIL FOR FREE BOOKLETS

### LA SALLE EXTENSION UNIVERSITY

*A Correspondence Institution*

417 S. Dearborn Street, Dept. 91-071, Chicago, Illinois 60605

YES, I want, free of cost or obligation, your sample lesson and also your two illustrated booklets, "Your Place in the World of Electronics" and "How to Obtain Your Commercial FCC License." I am especially interested in: (check one)

- |  |  |
|--|--|
| <input type="checkbox"/> Communication Electronics   | <input type="checkbox"/> Automation Electronics  |
| <input type="checkbox"/> Instrumentation Electronics | <input type="checkbox"/> First Class FCC License |

Mr. \_\_\_\_\_ Age \_\_\_\_\_  
Mrs. \_\_\_\_\_  
Miss \_\_\_\_\_ (Circle title and please print)

Address \_\_\_\_\_ Apt. No. \_\_\_\_\_

City \_\_\_\_\_ State \_\_\_\_\_ Zip \_\_\_\_\_

04B

CIRCLE NO. 15 ON PAGE 17 OR 101

**The Hustler Fiberglass  
CB Mobile Antenna...**

**48" of  
SUPERIOR  
PERFORMANCE**

Hustler's exclusive copper armoring design gives maximum performance of any fiberglass antenna. Get the advantages of the larger conductive diameter for greater signal radiation, lowest SWR, superior mechanical performance—and at reasonable cost.

Choose a gleaming white Hustler to fit your present mobile mount or a complete system including antenna, mount and cable for easy installation on any vehicle location, any body style, domestic or foreign.

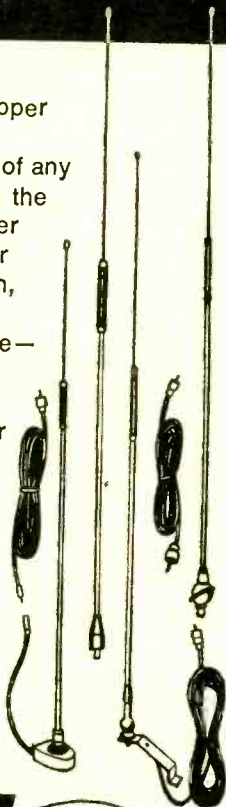

**HUSTLER**

**Available from the more than  
3000 distributors and dealers  
who recognize the best.**

**NEW-TRONICS CORP.**

15800 COMMERCE PARK DRIVE  
BROOK PARK, OHIO 44142

CIRCLE NO. 27 ON PAGE 17 OR 101

**HEY, LOOK ME OVER**

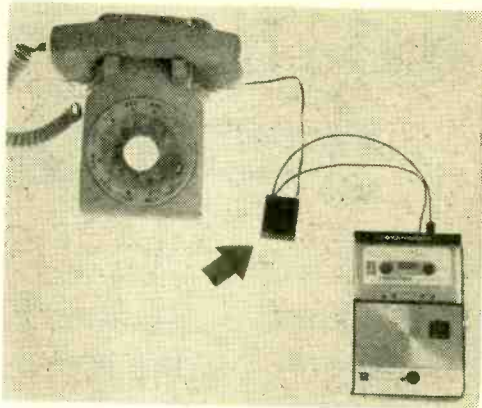

tape recorder everytime your telephone is being used. You now have a permanent record of all telephone conversations. Tele-Secretary is completely self-contained, needs no batteries, and connects to any point on your telephone line and will not interfere with normal telephone operation. Priced at only \$29.95. For more information, circle No. 58 on Reader Service Page.

#### **A Sensitive VOM**

Dynascan has added the Model 120P VOM to its B&K line of test equipment for labs, hobbyists, and schools. A sensitivity of 20,000 ohms per volt and 2% accuracy on DC,



the new 120P also offers a .25 volt DC range and a 50 microampere DC current range. In addition, it features a resettable electronic overload protection circuit that prevents accidental destruction of instrument, shunts, multipliers, meter, pointer and sensitive rectifier. Ranges covered by the 120P are as follows: DCV: 0-1000 V in 8 ranges; DC Current: 0-10 amperes in 6 ranges; ACV: 0-1000 V

ELEMENTARY ELECTRONICS

# SPECIAL INTRODUCTORY OFFER!

Now get **ELEMENTARY ELECTRONICS** sent to your home all year long for **ONLY \$2.47!** Order Now and Save!

\* \* \* For beginner or expert EE is valuable \* \* \*

Written by experts—you get a practical understanding of IC circuits . . . semi-conductors . . . power supplies . . . networks . . . transistors . . . pulse circuitry, much more! Get general rules

of electronics, develop trouble-shooting techniques, know how to calculate changing effects. **TRY THIS NO-RISK SUBSCRIPTION OFFER TODAY!**

**PROJECTS  
IN  
EVERY  
ISSUE**

•  
**CB  
RADIO**

•  
**SHORT-  
WAVE**

•  
**NEW  
PRODUCTS**

•  
**BASIC  
ELECTRONICS  
COURSE**

•  
**PRODUCT  
LAB  
TESTS**

## PUBLISHER'S DISCOUNT SAVINGS CERTIFICATE



Good **\$2.03** off the newsstand price of  
for **ELEMENTARY ELECTRONICS**



- Enter my trial subscription for 1 year (6 issues) of Elementary Electronics, for only \$2.47. (I save \$2.03 off the newsstand price.)
- I prefer 1½ years (9 issues) for \$3.67 (on the newsstand \$6.75).
- New Subscription       Renewal Subscription

Name \_\_\_\_\_  
(please print or type clearly)

Address \_\_\_\_\_

City \_\_\_\_\_ State \_\_\_\_\_ Zip \_\_\_\_\_

**SEND NO MONEY, WE'LL BILL YOU LATER**

You must seal (staple, scotch tape or glue) before mailing. Dept. B688

**FOLD HERE**



## BUSINESS REPLY MAIL

First Class Permit No. 1050 (Sec. 34.9 P. L. & R.) New York, N.Y.

**ELEMENTARY ELECTRONICS**

**P.O. Box 2600**

**Greenwich, Connecticut 06830**

**Dept. B688**

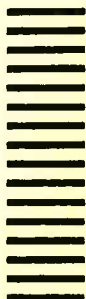

**CUT OUT  
AND MAIL  
TODAY!**

# Pocketful of news!

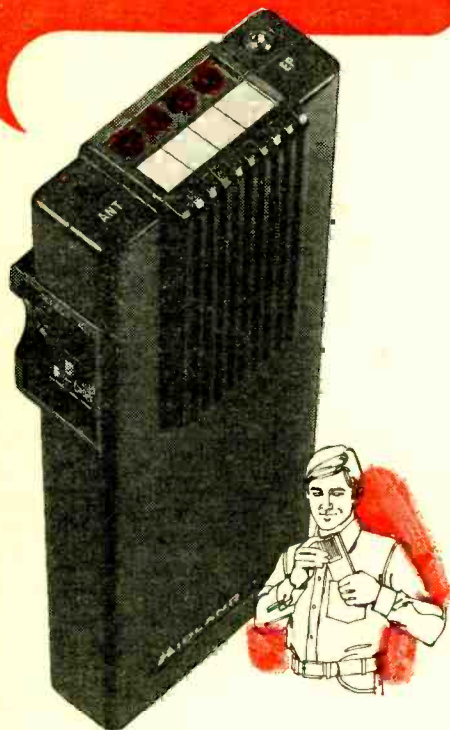

## Midland's New Pocket-Size 4-Channel VHF Scanner — Always First with What's Happening

Fits in a shirt pocket—scans any four channels in the 152-159 MHz range automatically or manually. (Can be set to cover any 7-MHz part of 150-170 band.) Dual conversion superhet receiver... automatic squelch... L.E.D. scan lights. Ask for Model 13-906.

**MIDLAND**  
ELECTRONICS COMPANY

Write for FREE Midland Scanner/CB Brochure:  
P.O. Box 19032, Kansas City, Missouri 64141

CIRCLE NO. 17 ON PAGE 17 OR 101

## HEY, LOOK ME OVER

RMS, with 3% accuracy and frequency response of  $\pm 1$  dB to 100 KHz through 50 VAC, to 20 KHz on 250 VAC range; AC Output Volts: 0-250 VAC in 4 ranges; Ohms: Rx1, Rx100, Rx10,000; it also reads decibels. Test leads, batteries and instruction manual are supplied at the price of \$69.95. Get all the facts, and more, by circling No. 64 on Reader Service Page.

### Roof Topper

Big Momma III, a tough and resilient new rooftop version of Antenna Specialists Company's popular Big Momma CB antennas, is now in production. Like her name-sake, the new M-412 is unconditionally guaranteed not to burn out regardless of operating conditions, and features a heavy-duty, oversized loading coil with virtually unlimited reserve power handling capability. A new professional style shock spring and heavier gauge whip contribute to Big Momma III's rugged new appearance and performance. The whip is copper and nickle plated for exceptionally cool operation. The antenna is easily removable for avoiding obstructions and car washes. Priced at \$30.99. Complete specifications may be obtained by circling No. 60 on Reader Service Page.



### Police Decoder

Introducing PD, the handy little add-on accessory that perfectly mates any police receiver to decode single inversion scrambled speech. It's made by Krystal Kits. The operation of the PD is quite simple; connect the speaker output of any police receiver to the input of the PD. When the transmission goes scramble, switch to Decode and tune the Clarity control for best speech quality and listen to a new world of communication. Sells for only \$44.95. For more information, circle No. 56 on Reader Service Page.

### Install-It-Yourself Car Alarm

A new self-contained automobile burglar alarm by Omnico is as easy to install as a license plate. Called Car-Guard, the new alarm simply bolts to the license plate holder on the front or back of any car. The Car-Guard includes a motion sensing circuit, triggered by two silicon activated mercury switches. Once the alarm is activated, any movement of the car sets off a piercing 115 dB alarm. Car-Guard is completely self-contained. It works from two Mallory Duracells which must be changed about once a year. There are two separate, complete circuits, each of which includes an alarm horn, a mercury switch and

a power supply. This increases the reliability of the alarm. Car-Guard carries a minimum

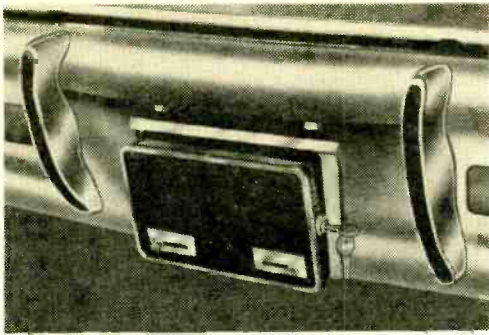

resale price of \$39.95. It is available for immediate delivery. For more information, circle No. 66 Reader Service Page.

### Hex Head Swivel Driver

Xcelite has come up with a line of Allen hex-type screwdrivers and interchangeable blades with an unusual "ballpoint" tip design that achieves a speed and ease in engaging and

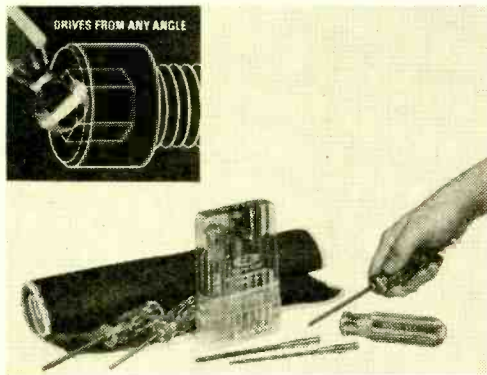

turning that is unattainable with conventional drivers. The tools work at any angle, thus being able to handle hex socket screws which cannot be reached straight-on. Because they slip into sockets more easily and faster than regular hex socket drivers, they simplify adjustments and they speed up work. Nine sizes, from .050-in. through  $\frac{3}{16}$ -in., are available; fixed handle types singly or a complete set in a handy roll kit with extra pockets for associated tools, and several other combinations. Complete information, specifications, and prices are available by circling No. 68 on Reader Service Page.

### Quadphones

The new Lafayette F-4400 4-channel stereo headphones features a unique patented "baffle plate" which increases acoustic front-to-rear separation. The F-4400 consists of four separate  $2\frac{1}{4}$ -in. speakers each in its own

JULY-AUGUST, 1973

# CALECTRO panel meters



A SIZE AND SHAPE  
FOR EVERY NEED

### LEVEL METER AND BATTERY CHECKER

Precision construction. Features D'Arsonval movement, jeweled bearings, and hand calibration.



### MINIATURE EDGEWISE PANEL METERS



NEW  
One Hole  
Mount

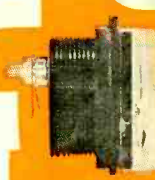

### MINIATURE PANEL METERS

Full range of panel mini-meters featuring single hole mounting. Simply bore hole for movement and that's it. Thread nut onto back of meter. Meter in line—every time.

### PRECISION PANEL METERS

Rugged construction — 2% accuracy. Hand calibrated and linear dial scales. D'Arsonval movement with jeweled bearings. Crystal clear plastic cover plate.

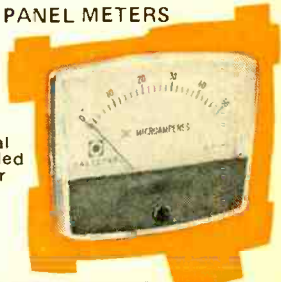

## GC ELECTRONICS

DIVISION OF HYDROMETALS, INC.  
ROCKFORD, ILLINOIS 61101 U.S.A.



CIRCLE NO. 16 ON PAGE 17 OR 101

**SCIENCE · OPTICS · ELECTRONICS**  
**UNUSUAL & HARD TO FIND BARGAINS**  
 NEW PRODUCTS · NEW MATERIALS · NEW METHODS

**KNOW YOUR ALPHA FROM THETA!**  
 See Feature Article May/June Issue



Learn to control your Alpha Theta brainwaves for relaxation, improved memory, concentration. Head electrodes, hooked to amplifier filter brainwaves signaling audible beep for each Alpha-Theta wave passed. Wrist & finger contact amplify heart beat, skin resistance. Reliable, easy-to-use trainer has features comparable to many higher priced modes. Completely safe. Most people learn Alpha control in 10-12 hrs. Full instructions.

Stock No. 71.606EK ... \$120.00 Ppd.

**FEATHERWEIGHT TREASURE FINDER**



Best, easiest to use solid state metal detector at its price. U.S. made! Only 3 lbs! 6" search head detects penny at depth of 6", silver dollar at 8", bag of coins at 18". Easily works thru dirt, sand, wood, water (30" deep) and rock with no power loss. Detects your "find" sharply with "sound off" loudspeaker. Comes ready to go. One tuner control; all transistor; adjus. stem; perfect balance. Incl. 9v. batt. **FREE TREASURE GUIDE TO 101 Treasure Sites.**

Stock No. 80.175EK ... \$39.95 Ppd.

**BUILD A "PRO" WEATHER STATION**



Meteorology kit can give you the know-how to check your predictions against official forecasts! Has remote reading anemometer w/windvane. Indoor indicator board flashes neon. Shows wind speed, direction. Safety power cord holds current to less than 1 ma. Also; sensitive air-tank barometer w/2-ft. indicator column; sling psychrometer to measure rel. humidity; rain gauge that measures to 1/100th inch; 100 ft. lead-in wire; cloud chart; forecasting manual.

Stock No. 71.022EK ... \$15.95 Ppd.

**BIG BOOM & FLASH CANNON**



Perfectly safe giant noisemaker for sports, games, the 4th and just plain fun produces brilliant flash and loud bang. Completely harmless—no gun powder, matches or recoil. Easily operated. Beautiful reproduction of regular Army 60 MM cannon in hefty cast iron. "Ammo" is pulverized Bangsite combined with water in cannon producing harmless gas. Cannot be ignited by hottest flame or heaviest concussion. Incl. ammo for 200 shots. Instr. Wt. 2 1/4 lbs.

Stock No. 70.898EK ... \$6.95 Ppd.  
 25" "Big Bertha" Cannon (5 1/2 lbs.)  
 Stock No. 71.654EK ... \$16.50 Ppd.

**STROBE SCREWS IN ANYWHERE**



Self-contained Flashing Strobe unit w/ Edison base easily screws into any std socket! Great for party fun, and dramatizing store displays. Or as safety signal to warn of industrial "hot" spots and construction areas. Adj. slow flash rate from 0.1 flash per sec. (Does not stop action). Not as sophisticated as our other strobes, but very handy & economical. Avg life: 5 million flashes. 120v. 60 Hz. Approx 5x3" dia.

Stock No. 41.918EK ... \$27.50 Ppd.  
 REPLACEMENT BULBS  
 No. 41.918EK ... \$4.75 Ppd.



**MAIL COUPON FOR GIANT FREE CATALOG!**

**164 PAGES • MORE THAN 4,000 UNUSUAL BARGAINS!**

Completely new edition. Dozens of electrical and electromagnetic parts, accessories. Enormous selection of astronomical Telescopes, Microscopes, Binoculars, Magnifiers, Magnets, Lasers, Lenses, Prisms, ecological and unique lighting items. Many war surplus items for hobbyists, experimenters workshop, factory.

EDMUND SCIENTIFIC CO. Barrington, N.J. 08007  
 PLEASE SEND FREE CATALOG "EK"

NAME \_\_\_\_\_

ADDRESS \_\_\_\_\_

CITY \_\_\_\_\_

STATE \_\_\_\_\_

ZIP \_\_\_\_\_

**EDMUND SCIENTIFIC CO.** 300 EDSCORP BLDG. BARRINGTON, NEW JERSEY 08007  
 ORDER BY STOCK NUMBER • SEND CHECK OR MONEY ORDER • MONEY-BACK GUARANTEE  
 CIRCLE NO. 2 ON PAGE 17 OR 101

**HEY, LOOK ME OVER**



acoustically isolated "air tight" sealed chamber. Special circuitry is "built-in" and switchable for deriving rich 4-dimensional stereo program sources as well as delivering magnificent full 4-channel sound from 4-channel amplifiers and receivers. Each ear cushion is foam filled as is the adjustable headband, and both are covered in vinyl leatherette. With 10 ft. cable and two phone plugs. Frequency response 20-20,000 Hz. Impedance 4-16 ohms. Priced at only \$39.95. Available at all Lafayette Radio stores. For more info, circle No. 61 on Reader Service Page.

**Q-C Removal Aids**

A quick and easy method of removing transistors or capacitors is offered with Quick Picks from GC Electronics. A set of seven tools in a convenient plastic carrying case,



Quick Picks fit more than 25 different outlines of transistors or can capacitors. These non-magnetic tools leave hands free to desolder leads and are color coded for fast, easy size selection. They also make excellent heat sinks. The set of Quick Picks, catalog number 9216, is suggested to retail for \$9.95, however, each size is available individually. For more information on Quick Picks, circle No. 69 on Reader Service Page. ■

# Radio Shack Is Electronic Parts Paradise!

We're "The Parts Place" for Magazine Projects & Do-It-Yourself Experiments!



**Auto Siren Alarm Kit.** For 24-hour protection against would-be car thieves or vandals. Shrill alarm sounds if hood, trunk or doors are tampered with. 6 switches, 2 keys, lock, wire/hardware included. For 12-volt DC neg. ground. **21<sup>95</sup>**



**12-Volt Power Converter.** Converts 120 VAC to 12 VDC. Use to charge 12-volt batteries or as a battery eliminator when servicing 12 VDC equipment. Output: 12V at 1.75 amps continuous, 5 amps surge. Blow-out protected. **18<sup>95</sup>**

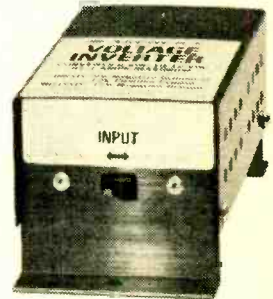

**6 to 12 VDC Inverter.** Converts 6-VDC input to 12-VDC output. Dual inputs — 6V neg. & 12V pos. grd. Output: 12V neg. grd. at 3 amps. Solid state, fuse protected. Ideal for use in VW's, dune buggies, etc. **18<sup>95</sup>**

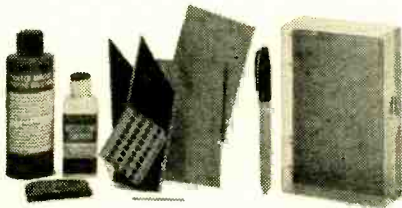

**Printed Circuit Kit.** All you need to custom-design your own circuits. Two 4½x3" copperclad boards, resist-ink solvent with pen, 6-oz. bottle of etchant, layout strips & circles, scouring pad, 1/16" drill bit, 4½x6¼x2¼" plastic etching tank. Safe to use. **6<sup>95</sup>**



**Etchant Solution.** Takes copper off perfboard without damage to the board. Safe, easy to use. A "must" for hobbyists, builders & experimenters. 16 fluid oz. **16<sup>95</sup>**

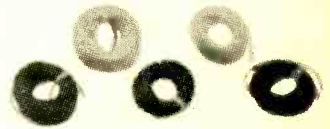

**Hook-Up Wire.** Five 100' coils in assorted colors. Sizes #18 thru #22. Solid & Stranded types. **36<sup>95</sup>**



**Transistor Substitution Guide.** Indispensable for technicians. Lists up to 15,000 types, foreign & domestic. Also has biasing diagrams, polarities, etc. **100**



**SPST Magnet Contact Switches.** Rated 0.5 A at 125 VAC. **19<sup>95</sup>**



**"Mini" Size Filament Transformers.** From 6.3V to 24V. 300 mA DC rated. Low as **19<sup>95</sup>**



**Aluminum "Mini" Boxes.** Lightweight, sturdy. Many sizes available. Low as **19<sup>95</sup>**

**FREE CATALOG! AT YOUR NEARBY STORE OR SEND IN THIS COUPON** 209

*CB, Stereo Hi-Fi, Ham, Kits, Radios, Recorders, Tools, More!*

Name \_\_\_\_\_ Apt. # \_\_\_\_\_

Street \_\_\_\_\_

City \_\_\_\_\_ State \_\_\_\_\_ Zip \_\_\_\_\_

CIRCLE NO. 32 ON PAGE 17 OR 101

**Radio Shack®**

and ALLIED RADIO STORES

A TANDY CORPORATION COMPANY

P. O. Box 1052, Fort Worth, Texas 76107

The great new  
**Super Scanner**

It scans 360° in milliseconds with 5.75 dB gain. Or beams an 8.75 dB gain signal where and when you want it—instantaneously. (Otherwise, it's just another beautiful base antenna.)

MODEL MS-119 Super Scanner electronic beam, incl. control console—sugg. price, \$99.95



**the antenna specialists co.**

Division of ORION INDUSTRIES, INC.  
12435 Euclid Ave., Cleveland, Ohio 44106  
Export: 2200 Shames Dr.,  
Westbury, L.I., New York 11590  
Canada: A. C. Simmonds & Sons, Ltd.

CIRCLE NO. 21 ON PAGE 17 OR 101

HIGHLY PROFITABLE **ONE-MAN ELECTRONIC FACTORY**

Investment unnecessary, knowledge not required, sales handled by professionals. Ideal home business. Write for facts today! Postcard will do. Barta-DEEB, Box 248, Walnut Creek, CA 94597.

CIRCLE NO. 7 ON PAGE 17 OR 101

**SEMICONDUCTOR SUPERMART**

FREE CATALOG  
NAME BRAND—  
PRIME QUALITY  
SEMICONDUCTORS

- MOTOROLA
- FAIRCHILD
- NATIONAL
- RCA
- HEP
- SIGNETICS

Other Parts For Elementary Electronics Projects  
**CIRCUIT SPECIALISTS CO.**  
Box 3047 Scottsdale AZ 85257

CIRCLE NO. 20 ON PAGE 17 OR 101

MONITOR YOUR BRAINWAVE SIGNALS WITH A VISTA ALPHA MONITOR. USE BIONIC FEEDBACK AND TRAIN YOURSELF TO RELAX. BUILD YOUR OWN MONITOR. STARTER PARTS KIT, \$49.95 COMPLETE

PHOTOLUM CORPORATION  
118 EAST 28 STREET, NEW YORK, N.Y. 10016  
SEND FOR FREE "VAM" LEAFLET

CIRCLE NO. 13 ON PAGE 17 OR 101

# DX central reporting

A world of SWL info!

☐ Most SWL's are familiar with the numeral "73". In the lingo of amateur radio, "seventy-three" means best regards, or as it is more generally used, simply, goodbye.

And, incidentally, properly it is used in the singular, 73, not as is often seen, 73's, which, of course, would literally be "best regards's".

The exact history of how the number acquired its special meaning is a bit obscure. There are several theories that have been proposed by communications historians. But there's no doubt that back in the early experimental days of ham radio, the term was borrowed from commercial wire telegraphy.

It is obvious that telegraphers would create short-cut symbols to stand for longer words and phrases commonly used. Pounding out the messages on the hand telegraph key took time and effort. The use of abbreviations and symbols made their work just that much easier.

Back when radio—wireless as it was called then—was in its infancy, there were no voice communications. Radio operators, like the telegraphers, used the old Morse Code to send signals with their spark-gap transmitters. So they, too, needed the telegraphy short-cut symbols. And, 73 became a part of the radio amateur language which remained even after voice AM and, later, single sideband, largely replaced CW and the real need for code symbols.

As the years passed, shortwave listeners picked it up from the hams. The SWL, of course, has no need to use telegraphic shorthand, but it has become something of a tradition and, today, DXers often use 73 to end their correspondence to stations and other shortwave listeners.

This year, 73 has taken on a new significance. Two years ago, it seems, a Greek DXer, Nikos Dendrinis from Athens, had an idea and wrote a letter to the European DX Council, an organization affiliating the major DX clubs on that continent.

"The number 73," Nikos wrote, "has become a symbol of friendship and mutual goodwill. I think the year 1973 could be proclaimed as *The World Year of DXing*, with all relevant manifestations; the purpose being to make DXing known to the wide public in every coun-

(Continued on page 22)



## READER SERVICE PAGE

• The Editor of ELEMENTARY ELECTRONICS offers readers an easy way to get additional information about products and services advertised in this issue. Also, if you would like more information about any new product mentioned in our column "Hey, Look Me Over," it's yours for the asking. Just follow the instructions below and the material you requested will be sent to you promptly and at no cost.

• The coupon below is designed for your convenience. Just circle the numbers that appear next to the advertisement or editorial mention that interests you. Then, carefully print your name and address on the coupon. Cut out the coupon and mail to ELEMENTARY ELECTRONICS, Box 886, Ansonia Station, New York, N.Y. 10023. Do it today!

JULY/AUGUST 1973

Void after November 30, 1973

**ELEMENTARY ELECTRONICS**  
 Box 886, Ansonia Station, New York, N.Y. 10023

Please arrange to have literature whose numbers I have circled at right sent to me as soon as possible. I understand that this is a free service offered by the magazine. Please limit circled items to 12 maximum.

	1	2	3	4	5	6	7	8	9	10
11	12	13	14	15	16	17	18	19	20	
21	22	23	24	25	26	27	28	29	30	
31	32	33	34	35	36	37	38	39	40	
41	42	43	44	45	46	47	48	49	50	
51	52	53	54	55	56	57	58	59	60	
61	62	63	64	65	66	67	68	69	70	

Are you a Subscriber to this magazine? YES  NO

Name (Print Clearly) \_\_\_\_\_  
 Address \_\_\_\_\_  
 City \_\_\_\_\_ State \_\_\_\_\_ Zip Code \_\_\_\_\_

# PREPARE FOR A NEW CAREER IN HOME ENTERTAINMENT ELECTRONICS...AS YOU BUILD YOURSELF A BELL & HOWELL SOLID STATE COLOR TV!

Work on this exciting "hands on" project—while you build the know-how in electronics you'll need to get ready for a rewarding new career. Get all the facts about this complete Bell &

Howell Schools learn-at-home program in home entertainment electronics!

## Your color TV project is part of your complete electronics education!

For the guy who likes to work with his hands, here's a way to pick up a pretty solid knowledge of electronics. You not only learn sophisticated electronics theory—you get to use it in this "learn-by-doing" electronics project. You build yourself a Bell & Howell solid state 25-inch diagonal color TV! It gives you valuable "hands on" experience in solid state circuitry—the kind of *practical* experience you'll need to build a successful career in electronics.

As color TV moves more and more in the direction of *total* solid state circuitry, you'll be familiar with the most advanced troubleshooting techniques for these sophisticated circuits.

## Beyond color TV, there's a whole new world...

...of home entertainment electronic equipment—from stereo systems to the new home videotape players. Next year the world will buy about \$17 billion worth of consumer electronic equipment. And by 1985 the figure will climb to \$35 billion!

Somebody's going to make a lot of money fixing it when it breaks. That's where *you* come in!

## Fix stereo systems... FM-AM radios... phonographs... tape recorders!

The thorough knowledge of electronics you gain from completing this course and building your own color TV will give you the know-how you need to service almost any type of home entertainment electronic device—even some that aren't on the market yet!

## One thing's certain, you're going to need...

... something to sell if you want to build yourself a future. That's what this Bell & Howell Schools program is designed to give you—up-to-date technical skills that employers are looking to buy.

## Start a business of your own — or earn extra part-time income!

The technical skills you build through



this unique learn-at-home program will help you build the foundation you'll need

to start a business of your own—or earn extra money in your spare time—servicing home entertainment electronics equipment. With the right kind of skills, being your own boss needn't be just a dream. Many of our graduates are doing it right now!

## This is the Bell & Howell solid state color TV you build yourself!

- Ultra-rectangular tube • 25-inch picture measured diagonally • Full 315 square inch viewing area • Solid state modular circuitry • 4 advanced IC's • 100 transistors • 72 diodes • Individual plug-in circuit boards • Special UHF/VHF tuning features • Built-in self-service components

## New... with your first lesson you get...

... the brand-new Laboratory Starter Kit! A volt-ohm-meter (VOM) with design panels, modular connectors, experimental parts, battery power source.

"Electro-Lab" is a registered trademark of the Bell & Howell Company.

## You also build the improved Bell & Howell Schools Electro-Lab® electronics training system...

... gives you troubleshooting experience with precision instruments you assemble and use in your new career. *Design Console*... "breadboard" circuits without soldering for both solid state and vacuum tube experiments. *Oscilloscope*... professional technician's diagnostic instrument. *Transistorized Voltmeter*... measures current, voltage, resistance.

## Get the facts.

Mail the postage-free card today!

## If card has been removed, write:

An Electronics Home Study School  
DEVRY INSTITUTE OF TECHNOLOGY  
ONE OF THE

**BELL & HOWELL SCHOOLS**  
4141 Belmont, Chicago, Illinois 60641

ELEMENTARY ELECTRONICS

# USE IT ALL AS YOU GET READY FOR A NEW CAREER ...\$1,500.00 WORTH OF TWO-WAY RADIO ELECTRONICS COMMUNICATIONS EQUIPMENT!



Find out about the Bell & Howell Schools learn-at-home program that can help you get ready for a new career—or maybe even a business of your own—in two-way radio. You'll get a thorough knowledge of electronics—plus “hands on” experience with \$1,500.00 worth of commercial-grade two-way radio equipment!

If you like to work with your hands, solid training in two-way radio could help you get ready for the career opportunities that are waiting for you now. Two-way radio is one of the biggest growth areas in electronics today.

**Mail the card for all the facts about...**  
...how you could take advantage of the opportunities coming up next year in two-way radio. Almost two million commercial two-way radio systems are vital communications links for trucks, planes, boats and taxis. And the FCC requires each system to have its equipment serviced regularly by a licensed technician.

It's almost like having a ready-made market for your skills. Will you be ready to take advantage of it?

**FCC regulations could be your key to a profitable new career...**  
...if you've got the technical know-how. Those two million two-way radio systems

spell “opportunity” for you. As a Bell & Howell Schools graduate, you'll be ready to take advantage of it.

With your FCC license, you could build your own servicing business—or work for a top corporation. FCC regulations could mean security and regular income for you!

**But first you'll need...**  
...1) Career-oriented training; 2) “Hands on” experience with commercial-grade equipment; 3) FCC License. By the time you've finished your Bell & Howell Schools learn-at-home program, you'll have the training and the “hands-on” experience—and we'll do everything we can to make sure you get your license!

**As part of your program, you work with the real McCoy...**  
...\$1,500.00 worth of commercial-grade equipment! *Commercial-Band Transceiver*...the kind of two-way radio you'll be servicing in your new career. *Deviation Meter*...checks modulation of transmitted signal. *Frequency meter*...used to check signal frequency. *Alignment Generator*...generates test signals for transceiver alignment.

Work with the equipment by attending one of our “help sessions” or by dropping by one of the Bell & Howell resident schools. Or you can have the equipment shipped to your home for a \$100 deposit

which is refundable when you return it.

**NEW...with your first lesson you get...**  
...the brand-new Laboratory Starter Kit. A volt-ohm-meter (VOM) with design panels, modular connectors, experimental parts, battery power source.

**You also build the exclusive Bell & Howell Schools Electro-Lab® electronics training system...**  
...three precision instruments you assemble and use in your new career. *Design Console*...“breadboard” circuits for solid state, vacuum tube experiments. *Oscilloscope*...professional technician's diagnostic instrument. *Transistorized Voltmeter*...measures current, voltage, resistance.

**We help you pass the FCC License Exam!**  
Getting your FCC license is your first step toward a new career in two-way radio electronic communications. When you've completed your Bell & Howell Schools program in two-way radio, you should have the know-how you'll need to pass the First Class License Exam. If you don't, we'll arrange special tutoring at no additional cost. If you still can't get your license after retaking the exam, your full tuition will be refunded.

**Mail the postage-free card today!**

**If card has been removed, write:**  
An Electronics Home Study School  
DEVRY INSTITUTE OF TECHNOLOGY  
ONE OF THE  
**BELL & HOWELL SCHOOLS**  
4141 Belmont, Chicago, Illinois 60641

517

# take your pick

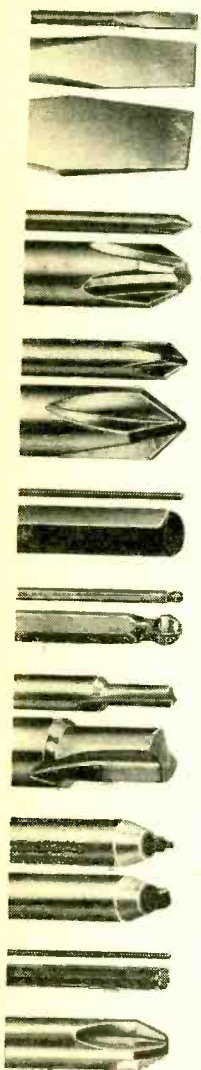

## LARGEST RANGE, GREATEST VARIETY

What are you driving? Slotted, Phillips, Frearson, Reed & Prince, Allen hex, clutch head, Scrulox®, Bristol Spline, or Pozidriv® screws? Xcelite makes screwdrivers for every type and size. Metrics, too.

- ⊕ from 2 1/8" miniatures to huge 2 footers.
- .040" to 7/16" tip widths.
- round or square blades.
- tough, forged alloy steel or non-magnetic beryllium-copper.
- nickel chrome, black oxide finish, or insulation coated.
- fixed-handle or interchangeable and reversible blades.
- straight and tee handles — regular and ratcheting types.
- available individually or in handy kits and sets.

Made in U.S.A. to highest standards.

REQUEST FREE TOOL CATALOG 171 nationwide availability through local distributors



# XCELITE

## professional screwdrivers

XCELITE, INC., 80 Bank St., Orchard Park, N. Y. 14127

Send complete tool catalog, which includes information on all Xcelite screwdrivers.

name \_\_\_\_\_

address \_\_\_\_\_

city \_\_\_\_\_ state & zip \_\_\_\_\_

In Canada contact Charles W. Pointon, Ltd.

CIRCLE NO. 9 ON PAGE 17 OR 101

## DX CENTRAL REPORTING

(Continued from page 16)

try, and to promote the idea of world communication and understanding."

The EDXC representatives liked Nikos' idea and took the necessary steps to proclaim and promote '73 as World DX Friendship Year. A number of SWL clubs in Europe and the rest of the world, including North America have backed the concept.

Now, Radio Nederland, one of the DX world's most popular shortwave broadcasters, has joined in. To promote the World DX Friendship Year '73, the station has issued gummed seals proclaiming the message of fellowship and understanding through shortwave radio listening.

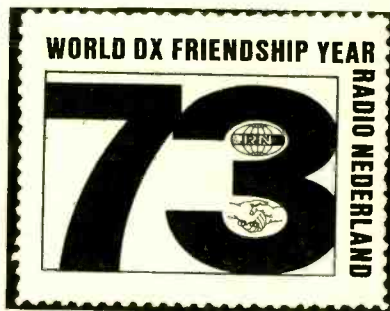

Radio Nederland is making these seals available to SWLs free of charge. A sheet of 20 stamps, printed in red, white and blue, suitable for use on your correspondence, is available by writing DX Juke Box, c/o Radio Nederland, P.O. Box 222, Hilversum, Holland.

**Bandsweep.** (Frequencies in kHz, times in GMT): **1265**—*Radio Paradise*, on the Caribbean island of St. Kitts, is a fairly new radio target for medium wave listeners. Early evening seems the best time to tune this religious station. It has been widely heard on the east coast and even has been heard in California. . . . **4,912**—Another West Indian to try, this one on shortwave, is the reactivated *Radio HIN* at Santo Domingo, Dominican Republic. One listener reported an English identification at 0000, but the rest of the programming is in Spanish. . . . **6,147**—On the other side of the island of Hispaniola lies Haiti. Not an easy catch, with few SW stations operating, but you may log Haiti by tuning for *Radio Citadelle*, at Cap Haitien, around 0230 to 0300. . . . **6,240**—Get in on the ground floor with a new African clandestine station recently noted on this frequency. It seems to be operated by Portuguese-speaking West African exiles, apparently identifies as *Radio Libertacao*—or something similar but its location presently is unknown. . . . **7,170**—The *Voice of America's* new relay transmitters at Kavala, Greece, are now in operation. (Continued on page 98)



**ASK HANK,  
HE KNOWS!**

### Needs Help

Does anyone have a copy of the *Globe Scout Model 65A* manual? If you send it to me, I will make a Xerox copy and return the original to you.

Jon Apfeld WB4POT  
1679 Virginia Drive  
Eau Gallie FL 32935

Lend a hand, friends, and old Hank thanks you in advance.

### 4-Channel

What's the difference between SQ and QS?

—F.B., New York NY

To the listener, practically nothing. You can't tell one system from the other except by the patent numbers. In fact, they are reasonably compatible, so much so, that SQ and QS encoded recordings can be played on both systems and only the musical director will be able to tell the difference. As for me, I like CD-4, but that's another question.

### More on 4-Channel

What is CD-4 Quadraphonic Sound?

—B.K., Syosset NY

CD-4 means Compatible-Discrete, 4-channel sound. This LP encoded technique to produce truly 4-channel discrete sound is the finest system for quadrasonic listening on the marketplace today! It is totally compatible with your present stereo records so that you can listen to full stereo on CD-4 and lose nothing. CD-4 encoded discs (at no increase in price) bring full four-channel sound to your listening area if you have the CD-4 demodulator. Also, if you only have a stereo system, buy CD-4 records. They cost no more and give perfect stereo performance playback. (Turn page)

Hank Scott, our Workshop Editor, wants to share his project tips with you. Got a question or a problem with a project you're building—ask Hank! Please remember that Hank's column is limited to answering specific electronic project questions that you send to him. Sorry, he isn't offering a circuit design service. Write to:

**Hank Scott, Workshop Editor  
ELEMENTARY ELECTRONICS  
229 Park Avenue South  
New York NY 10003**

## EXAMINE ANY TAB BOOK ON 10-DAY FREE TRIAL!

### BRAND-NEW BOOKS...JUST PUBLISHED

- The Complete Minibike Handbook—320 pgs., 135 ill.—\$5.95
- Landsailing—From RC Models to the Big Ones—\$4.95
- Introduction to Medical Electronics: for Electronics & Medical Personnel—272 pgs., 131 illus.—\$6.95
- Jap Radio, Record & Tape Player Serv. Man'l.—\$4.95
- Basic Electricity & Beginning Electronics—256 pgs.—\$4.95
- Marine Electronics Handbook—192 pgs., 121 illus.—\$4.95
- 4-Channel Stereo—From Source to Sound—176 pgs.—\$3.95
- Servicing the New Modular Color TV Receivers—Vol. 1 (RCA, Motorola, Philco)—178 pgs., 8 1/2" x 11"—\$4.95
- Servicing the New Modular Color TV Receivers—Vol. 2 (Zenith, Magnavox, GE, Packard-Bell)—178 pgs.—\$4.95
- Stereo/Quad Hi-Fi Principles & Projects—192 pgs.—\$4.95
- Modern Radio Programming—192 pgs., hardbound—\$9.95
- Passive Equalizer Design Data—496 pgs., hardbound—\$19.95

### BEST SELLERS...INVALUABLE TO ALL IN ELECTRONICS

- DICTIONARY OF ELECTRONICS—420 pgs.—\$3.95
- Installing/Servicing Electronic Protect. Syst.—256 pgs.—\$4.95
- Popular Tube-Transistor Substitution Guide—256 pgs.—\$2.95
- How to Read Electronic Circuit Diagrams—192 pgs.—\$3.95
- Beginner's Guide to TV Repair—176 pgs., 100 illus.—\$3.95
- Fire & Theft Security Systems—176 pgs., 100 illus.—\$4.95
- Handbook of Electronic Tables—2nd Ed.—224 pgs.—\$4.95
- How to Become a Radio Disc Jockey—256 pgs., illus.—\$7.95
- Designing/Maintain. CATV & Small TV Studio—\$12.95
- Electronic Musical Instruments—192 pgs., 121 illus.—\$4.95
- Model Car Racing... by Radio Control—224 pgs.—\$3.95
- Tape Recording for Fun & Profit—224 pgs.—\$4.95
- Radio Control Manual—2nd Edit.—192 pgs., 158 illus.—\$3.95
- Basic Math Course for Electronics—160 pgs., 90 illus.—\$3.95
- Getting Started With Transistors—152 pgs.—\$4.95
- Elements of Tape Recorder Circuits—224 pgs., illus.—\$4.95
- Basic Transistor Course—224 pgs., packed with illus.—\$4.95
- Electronics Data Handbook—2nd Edit.—256 pgs., illus.—\$4.95

### A UNIQUE CONCEPT IN KITS—TAB ELECTRONIC BOOK KITS

For the price of a kit alone, you get a book by an expert who opens the world of electronics to you—PLUS a complete kit to help you start building and learning. Guaranteed to work!

- Audio Mixer, \$7.95  5-Watt Hi-Fi Amplifier, \$9.95  Electronic Fortune Teller, \$4.95  AM Wireless Mike, \$6.95  Electronic Touch Switch, \$6.95  Garage Light Control, \$9.95  Audio Signal Generator/Injector, \$5.95  Low-Voltage DC Power Supply, \$4.95  Diode Tester, \$5.95  High Power Lamp Dimmer, \$4.95  20W Four-Channel "Quad" Amplifier, \$19.95  Electronic Siren, \$4.95  Intrusion Alarm, \$7.95  Tunable Electronic Organ, \$9.95

### BOOKS TO BROADEN YOUR SERVICING CAPABILITIES

- How to Repair Home & Auto Air Conditioners—\$4.95
- Pictorial Guide to Tape Recorder Repairs—256 pgs.—\$4.95
- How to Repair Home & Auto Air Conditioners—208 pgs.—\$4.95
- All-in-One TV Alignment Handbook—304 pgs., 137 ill.—\$5.95
- Using Electronic Testers for Auto Tune Up—256 pgs.—\$4.95
- How to Repair Musical Instr. Amplifiers—256 pgs.—\$5.95
- How to Solve Solid-State Circuit Troubles—304 pgs.—\$5.95
- Servicing Electronic Organs—196 pgs., 8 1/2" x 11"—\$7.95
- Simplified TV Trouble Diagnosis—320 pgs., 229 ill.—\$5.95
- Major Appliance Repair Guide—228 pgs., illus.—\$5.95
- Citizens Band Radio Service Manual—228 pgs.—\$4.95
- Kwik-Fix TV Service Manual—384 pgs.—\$5.95
- Industrial Electronics: Principles & Practice—416 pgs.—\$5.95
- Modern Radio Repairs—256 pgs.—\$4.95
- Troubleshooting Solid-State Amplifiers—256 pgs.—\$4.95
- Computer Technician's Handbook—480 pgs., 400 illus., \$7.95
- How to Interpret TV Waveforms—256 pgs., 250 photos—\$4.95
- Small Appliance Repair Guide—224 pgs., over 100 ill.—\$4.95
- Servicing Modern Hi-Fi Stereo Systems—248 pgs.—\$4.95
- How to Test Almost Everything Electronic—160 pgs.—\$2.95
- T/shooting Solid-State Electr. Power Supplies—192 pgs.—\$4.95
- Refrigeration—160 pgs., 53 illus.—\$2.95
- Home-Call TV Repair Guide—144 pgs.—\$2.95
- Electric Motor Test & Repair—160 pgs., leatherette—\$6.95
- Modern Radar—Theory, Oper. and Maint.—480 pgs.—\$7.95
- CATV System Maintenance—192 pgs., illustrated—\$12.95
- Inst. & Servicing Home Audio Systems—256 pgs.—\$4.95
- How to Repair Solid-State AM Imports—184 pgs., 8 1/2" x 11"—\$4.95
- Pinpoint TV Troubles in 10 Minutes—372 pgs., 394 ill.—\$5.95
- Rapid TV Repair—224 pgs., 107 illus.—\$4.95
- How to Use Your VOM-VTVM & Scope—192 pgs.—\$3.95
- Color TV Repair—160 pgs.—\$2.95
- Rapid Radio Repair—224 pgs., filled with diagrams—\$3.95
- Pinpoint Transistor Troubles in 12 Minutes—495 pgs.—\$5.95
- Servicing Record Changers—224 pgs., 173 illus.—\$5.95

### ALL-IN-ONE COLOR & B&W TV, CHEMATIC/SERVICING MANUALS

Each volume contains complete service data, incl. full-size schematic diagrams and all other info needed. Each 8 1/2" x 11", 212 pgs., each \$4.95: COLOR TV: Admiral Vol I  Vol 2  G-E Vol I  Japanese Vol I  Vol 2  Magnavox Vol I  Vol 2  Motorola Vol I  Vol 2  Philco  RCA Vol I  Vol 2  Sylvania Vol I  Vol 2  Zenith Vol I  Vol 2  B&W TV: Admiral  G-E  Japanese  Magnavox  Motorola  Philco  RCA  Sylvania  Zenith

SEE THESE HELPFUL BOOKS AT YOUR PARTS DISTRIBUTORS, OR CLIP THIS AD AND order on FREE 10-DAY Trial, or attach payment and save postage. Fully guaranteed or money back! Pa. add 6% tax, Foreign 10%. (EE-73)



**TAB BOOKS**  
BLUE RIDGE SUMMIT, PA. 17214

CIRCLE NO. 30 ON PAGE 17 OR 101

## ASK HANK, HE KNOWS!

### In a Rush

*I plan to fix TV sets for a living. I'd like to start collecting tubes now before I finish the course. In fact, the first lesson came today.*

—S.D., Brownsville TX

Hold on, how sure are you of completing the course. Take it easy. Put all your time and money into the learning process. In fact, why not apprentice yourself out to a TV repair shop. They have everything you need to fix a set plus the knowhow. Between books and practice, you'll soon be telling me what tubes to put into a caddy. And when you do, you'll be driving a Caddy.

### Wise Guy

*Hank, if you are so smart, what is "isochronism"?*

—L.M., Walla Walla WA

Two periodic phenomena are said to be *isochronous* when their frequencies, or periods, are equal. They need not, however, be in phase, or identical in shape. See, I'm not so dumb.

### Keep Asking

*I have a four-track tape cartridge player and I wondered if there is any way to convert it to an eight-track cartridge player. If not, is there any way I can use eight-track tapes on my tape*

*player? If that is not possible, would you know where some good four-track tapes could be bought? Thank you very much.*

—W.T., Randolph WI

Give up the ghost on four-track and swing to eight-track by buying both the unit and tapes. No, I doubt you can make the conversion. I'm sure, because most hobbyists who write to me do not have an iron model shop at home to do the job.

### Lend a Hand, Boys

*About five years ago I bought a Scott kit AM-FM receiver. I need the complete schematic and I have written to the Scott Company several times requesting same. I received no answer. Can anyone send me a copy of the Scott-Kit Stereomaster LR-88?*

Duane H. Gumz  
R. Rt. #3 Box 170A  
Newland NC 28657

I'm sure one of our readers can help you out, Duane, and maybe the Scott Company will begin answering their mail.

### Look-a-Like Pair

*How can you tell what wire to connect to the red dot terminal on a loudspeaker when zip cord (rubberized lamp wire) is used and you can't trace the individual lead from the amplifier?*  
(Continued on page 96)

## avanti's Astroplane gives CBers Performance to brag about.

*The unique construction features are exceptional.*

4.46 db gain over isotropic is, and provides, a stronger transmit and a stronger receive.

To make use of the better signal, the Astroplane radiates the signal from higher up than other CB antennas and at a better angle. According to Dr. Alva Todd of the Midwest College of Engineering, "it possesses an unusually low angle of maximum radiation." This low angle of radiation means that your power is radiated at the horizon and not up into the clouds.

You'll also get long lasting, trouble-free performance because it is compact in design —without long drooping radiators, without coils to burn or

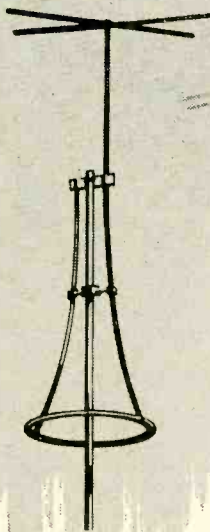

short out, and with direct ground construction for positive lightning protection and static dissipation.

\$29.95 Sugg. Retail

Gain 4.46 over isotropic  
Power Capacity 2KW  
Lightning protection D.C.  
Ground  
V.S.W.R. 1.2:1  
Length 12 Ft.  
Diameter 30 In.

Free 16 page color catalog

Write: Avanti R & D, Inc.  
35 W. Fullerton  
Addison, Illinois 60101

**avanti**

RESEARCH AND DEVELOPMENT, INC.

creators of the  
famous

**MOONRAKER**

CIRCLE NO. 6 ON PAGE 17 OR 101

# They both sound great!



+3

M+3

\$75 list

\$55 list

**TURNER**  
MICROPHONES

Regardless of speech characteristics and mouth-to-mike distances, they both sound great. That's because the +3 and M+3 amplified microphones both have Modu-Gard® compression. The +3 for base stations lets you boom out 100 percent modulation without worry about over-modulation... whether you speak a foot away or move up to within a couple of inches. The M+3, with rugged ceramic cartridge, has a slide-action volume adjustment on the back of its stylish case to give controlled base station type gain in an amplified mobile microphone.

Add a +3 to your base station and an M+3 to your mobile. They'll both sound great.

For more details, see a Turner dealer, or write 909 17th St. N.E., Cedar Rapids, Ia. 52402.

**CONRAC**  
CORPORATION



CIRCLE NO. 31 ON PAGE 17 OR 101

# FREE

## LAFAYETTE 1973 CATALOG 730



Ready  
Now!

### The World's Largest Consumer Electronics Catalog

#### Everything In Electronics for Home, Business, Industry

• Stereo/Hi-Fi Components • Musical Instruments and Amplifiers • CB & Ham Equipment • Tools and Test Equipment • Police and Fire Monitor Receivers • Public Address Systems • Photography Equipment • Semiconductors, Books, Parts • Plus Much More!

### Your Complete Electronics Buying Guide

Send  
Today!

Lafayette Radio Electronics  
P.O. Box 10, Dept. 25073  
Syosset, L.I., N.Y. 11791

Send FREE 1973 Catalog 25073

NAME \_\_\_\_\_

ADDRESS \_\_\_\_\_

CITY \_\_\_\_\_

STATE \_\_\_\_\_ ZIP \_\_\_\_\_

CIRCLE NO. 3 ON PAGE 17 OR 101

# newscan

## Electronics in the News!

### ELECTRONIC DRAFTSMAN

A computer run by a paper "keyboard" can convert free-hand sketches into fully proportioned drawings. Placed at random on a special electronic tablet, a sketch and the paper keyboard are simply touched with an electronic pen to enter graphic or alphanumeric data and to initiate computer program functions.

The experimental system is designed to speed the creation, filing and updating of large volumes of graphic material such as maps and engineering drawings. It is the result of contributions by IBM's Research Division and Advanced Systems Development Division. A rough drawing, no matter how out of scale, can be automatically turned into a finished product moments after the assignment of proper dimensions. And the paper keyboard, through which the automated functions are controlled—can easily be shifted from one place on the tablet to another to suit the user's convenience as he works.

A user wishing to create a drawing can place a rough sketch and the paper keyboard anywhere on the tablet to suit his work methods. He can enter the sketch into the computer by quickly outlining it with the pen, and can point to the keyboard to specify such details as broken or dotted lines, arrows or circles. To cre-

*(Continued on page 94)*



A paper "keyboard is touched with an electronic pen to run an experimental graphics system that can convert rough sketches into fully proportioned finished drawings.



# Radio Shack Presents "The Sight of Music"



Five easy-to-build kits that add spectacular "space age" lighting effects to your favorite musical selections. Whether your bag is Bach or Rock, you can fill it with an entire new dimension in sight and sound experience! See them at any of our over 1800 stores in all 50 states.



Strobe Lite Kit

Strobe Lite Kit makes any party a "now" scene! Stops motion—pulses of blue-white light give a throbbing "far-out" effect. Adjustable to tempo of music from 60 to 600 beats per minute. Has super-bright xenon strobe bulb, woodgrain vinyl case. It's the "with-it" way to add good vibes to any situation! \$29.95

3-Channel "3D" Color Organ Kit connects to any hi-fi set and makes reds, greens and blues dance to your musical beat! Each color responds to a different frequency, and color brilliance controls let you adjust 'em the way you want! \$29.95

3-Channel Light Control/Color Organ Kit. Here's a two-way fun-maker that guarantees a good time! Use the built-in color organ, or plug in three separate light sources (room lamps, Christmas tree bulbs, etc.) to create a pulsating scene. Handles 900 watts. \$29.95

Psychostrobe Kit. Super-compact—take it along to create an exciting "stop-motion" effect on any party scene. Has 100's of hobby and mechanical uses too! Xenon bulb, intensity switch, and three "freeze-speed" ranges with fine adjustment control. \$19.95

Psycholite Kit attaches to the speaker terminals of your music system, lets you hook up room lights so they pulsate with your music. Also doubles as light dimmer. Handles 600 watts. \$14.95



3-Channel "3-D" Color Organ Kit



3-Channel Light Control/Color Organ Kit



Psychostrobe Kit



Dazzling "Psycholite" Kit

**FREE CATALOG! AT YOUR NEARBY STORE OR SEND IN THIS COUPON**

CB, Stereo Hi-Fi, Ham, Kits, Radios, Recorders, Tools, More! 210

Name \_\_\_\_\_ Apt. # \_\_\_\_\_

Street \_\_\_\_\_

City \_\_\_\_\_ State \_\_\_\_\_ Zip

CIRCLE NO. 32 ON PAGE 17 OR 101

**Radio Shack**  
and ALLIED RADIO STORES

A TANDY CORPORATION COMPANY  
P. O. Box 1052, Fort Worth, Texas 76107

# These miniature Realistic® models pack a full-size CB punch!

Small is beautiful when it comes to our mighty miniature CB units! We've got the size to fit any car, ANY budget—and with the features of units twice as big! All have 5-watt input, mounting brackets, mikes with coiled cords, power cables. FCC Type Accepted.

## TRC-9 Transceiver

Be prepared in case of accident or car breakdown! 3-channel unit includes Emergency Channel 9 (Highway Emergency Locating Plan). Small enough to fit in glove box or under seat! Offers excellent sensitivity, separate speaker and mike; adjustable squelch control, push-pull audio, automatic noise limiter. Pilot lamp doubles as transmit modulation indicator. Includes Channel-9 crystals.



Only 1-1/2x5-1/4x7-7/8"



## "Mini-23" Mobile Unit

Our smallest 23-channel transceiver is small enough to fit in most glove boxes, Ceramic filter and dual-conversion for high selectivity and sensitivity. ANL, transmit/modulation light, lighted channel selector and 100% solid-state circuitry make this one hard to beat!

## TRC-24A Transceiver

Improved version of a best seller! Now with a delta-tune switch to bring in off-frequency stations, plus a special noise blander to reduce or eliminate unwanted noise! Has illuminated 23-channel selector, S-RF meter, ANL. Dual-conversion and rugged silicon transistors for stable reception and clear, dependable transmissions!

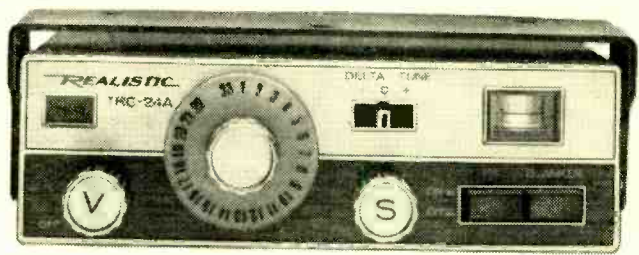

Only 1-3/4x6x7"

**FREE CATALOG! AT YOUR NEARBY STORE OR SEND IN THIS COUPON** 211

*CB, Stereo Hi-Fi, Ham, Kits, Radios, Recorders, Tools, More!*

Name \_\_\_\_\_ Apt. # \_\_\_\_\_

Street \_\_\_\_\_

City \_\_\_\_\_ State \_\_\_\_\_ Zip \_\_\_\_\_

**REALISTIC®**  
**by Radio Shack®**  
 and ALLIED RADIO STORES  
 A TANDY CORPORATION COMPANY  
 P. O. Box 1052, Fort Worth, Texas 76107

CIRCLE NO. 32 ON PAGE 17 OR 101



# LITERATURE LIBRARY

101. Kit builder? Like weird products? EICO's 1973 catalog takes care of both breeds of buyers at prices you will like.

102. International Crystal has a free catalog for experimenters (crystals, PC boards, transistor RF mixers & amps, and other comm. products).

103. See brochures on Regency's 1973 lineup of CB transceivers & VHF/UHF receivers (public service/business bands—police, fire, etc.).

104. A pamphlet from Electra details the 6 models of the Bearcat III, a scanning monitor receiver.

105. Dynascan's new B&K catalog features test equipment for industrial labs, schools, and TV servicing.

106. Before you build from scratch, check the *Fair Radio Sales* latest catalog for surplus gear.

107. Get Antenna Specialists' cat. of latest CB and VHF/UHF innovations: base & mobile antennas, test equipment (wattmeters, etc.), accessories.

108. Want a deluxe CB base station? Then get the specs on *Tram's* super CB rigs.

109. Xcelite has the largest selection of screwdrivers anywhere. There's just about any size and type for every popular screwhead. They have fixed or removable handles with interchangeable blades, and come individually, in sets, or kits.

110. Bomar claims to have C/B crystal for every transceiver... for every channel. The catalog gives list of crystal to set interchangeability.

111. A *Turner* amplified mike helps get the most from a CB rig. This free brochure describes line of base & mobile station models.

112. Midland has recently published a 4-color brochure that folds out to 17" x 21", printed on both sides. Over 40 CB and scanner products are featured.

113. EDI (*Electronic Distributors*) has a catalog with an index of manufacturers' items literally from A to Z (ADC to Xcelite). Whether you want to spend 29 cents for a pilot-light socket or \$699.95 for a stereo AM/FM receiver, you'll find it here.

114. Get all the facts on *Progressive Edu-Kits* Home Radio Course. Build 20 radios and electronic circuits; parts, tools, and instructions included.

115. *Olson Electronics'* 188-p. fully-illustrated 1973 catalog has leading national brands, all in the electronic product categories.

116. *Trigger Electronics* has a complete catalog of equipment for those in electronics. Included are kits, parts, ham gear, CB, hi fi and recording equipment.

117. Get the free, new twenty-four page *HUSTLER* CB and Monitor antenna catalog featuring improved antennas and accessories for base station and mobile operation.

118. *Teaberry Electronics* has information on CB radios—Twin "T," Big "T," Mini "T" II, and Five by Five; also information on Scan "T" Monitor radio receiver.

119. *Burstein-Applebee's* new 1973 catalog has over 280 pages of Radio-TV/Electronics bargains. Selling for \$2, it is offered free to our readers.

120. For a colorful leaflet on the Golden Eagle Mark III SSB receiver and the Mark III SSB transmitter, write to *Browning Laboratories*.

121. *Edmund Scientific's* new catalog contains over 4000 products that embrace many sciences and fields.

122. For 1973's value-packed sale catalog, featuring TV & radio tubes, send for *Cornell's*. There is a special offer of 25¢ per tube on orders over \$10.

123. *Radio Shack's* 50 Anniv. cat. has 180 pages, colorfully illustrated, of complete range of hi fi, CB, SWL, ham equip. and parts (kits or wired) for electronics enthusiasts.

124. It's just off the press—*Lafayette's* all-new 1973 illustrated catalog packed with CB gear, hi-fi components, test equipment, tools, ham rigs, and more.

125. *Mosley Electronics, Inc.* is introducing 78 CB Mobile Antenna Systems. They are described and illustrated in a 9-page, 2-color brochure.

126. *RCA Experimenter's Kits* for hobbyists, hams, technicians and students are the answer for successful and enjoyable projects.

127. For "dynamic breadboards", elite 1 and 2; and for "basic breadboard," elite 3, send for *EI Instruments'* literature. Included is a catalog, "The Digital Design Line."

128. *Avanti* antennas (mobile and base for CB and VHF/UHF) are fully described and illustrated in new catalog.

129. A new free catalog is available from *McGee Radio*. It contains electronic product bargains.

130. *Semiconductor Supermart* is a new 1973 catalog listing project builders' parts, popular CB gear, and test equipment. It features semiconductor.—all from *Circuit Specialists*.

131. *Heath's* new 1973 full-color catalog is a shopper's dream—chockful of gadgets and goodies everyone would want to own.

132. *E. F. Johnson's* 1973 line of CB transceivers and CB accessory equipment is featured in a new all-line brochure. Send for your free copy today.

133. If you want courses in assembling your own TV kits, *National Schools* has 10 from which to choose. There is a plan for GIs.

134. Free 1973 Catalog describes 100s of *Howard W. Sams* books for the hobbyist and technician. It includes books on projects, basic electronics and many related subjects.

135. *Sprague Products* has L.E.D. readouts for those who want to build electronic clocks, calculators, etc. Parts lists and helpful schematics are included.

136. The 1972-73 edition of *Tab Books'* catalog has an extensive listing of TV, radio and general servicing manuals. Also listed are books on audio and hi-fi, basic technology, and test equipment.

## ELEMENTARY ELECTRONICS

Box 886

Ansonia Station

New York, N.Y. 10023

Please arrange to have this literature whose numbers I have circled at right sent to me as soon as possible. I am enclosing 25¢ to cover handling. (No stamps, please).

J/A-73



101	102	103	104	105	106	107	108	109	110
111	112	113	114	115	116	117	118	119	120
121	122	123	124	125	126	127	128	129	130
131	132	133	134	135	136				

Indicate total number of booklets requested  
Sorry, only 15 circled items maximum.

NAME \_\_\_\_\_

ADDRESS \_\_\_\_\_

CITY \_\_\_\_\_

STATE \_\_\_\_\_ ZIP \_\_\_\_\_

Not Valid After November 30, 1973

# Free

## HEATHKIT 1973

Over 350 kitbuilding ideas

# '73 Heathkit® Catalog

Shown below are only a few of the more than 350 kits fully described in the 1973 Heathkit catalog. Kits for every interest, every budget...including color TV; stereo systems; electronic organs; marine equipment; a kitchen waste compactor; home intercoms and protection systems, garage door openers; table radios; portable radios and phonographs; guitar amplifiers and accessories; educational electronic workshops for youngsters and adults; tool sets; electronic test instruments; amateur and shortwave radio gear; radio-control equipment; metal locators.

Can you build a Heathkit? For 25 years people just like you have been doing it - armed with no more than a soldering iron and a few conventional hand tools.

No matter how complex the kit, the manual reduces assembly to a simple step-by-step operation. Add to that the availability of the technical correspondence department here in Benton Harbor, and service people in 36 retail stores across the country, and you see why we say "we won't let you fail." And finally, building a Heathkit is fun, pure and simple. The coupon below gets you started.

**Here are just a few of the new kits in this new '73 edition**

				
Heathkit 50-watt Stereo Receiver. \$169.95*	Heathkit Deluxe Metal Locator has submersible sensing head. \$89.95*	Heathkit VHF/FM Band-Scanning 8 channel Receiver. \$119.95*	Heathkit Cassette Deck, Dolby Circuit. \$249.95*	Heathkit 6-Digit Electronic Clock-Alarm. \$54.95*
				
NEW Heathkit Ultrasonic Alarm. \$49.95*	NEW Heathkit 8-transistor AM Radio for first-time kit-builders. \$14.95*	Heathkit 2 1/2 Digit VOM. \$79.95*	NEW Heathkit 8-digit pocket Calculator. \$92.50*	NEW Heathkit 8-digit desktop Calculator. \$79.95*
				
NEW Heathkit Small-engine Tune-up Meter for 2- and 4-cycles, all ignitions. \$39.95*	NEW Heathkit 2-Meter Amateur Transceiver. \$179.95*			

**Send Today for Your Free '73 Heathkit Catalog**

**HEATHKIT ELECTRONIC CENTERS**

ARIZ.: Phoenix, 2727 W. Indian School Rd.; CALIF.: Anaheim, 330 E. Ball Rd.; El Cerrito, 6000 Potrero Ave.; Los Angeles, 2309 S. Flower St.; Pomona, 1555 Orange Grove Ave. N.; Redwood City, 2001 Middlefield Rd.; San Diego (La Mesa), 8363 Center Dr.; Woodland Hills, 22504 Ventura Blvd.; COLO.: Denver, 5940 W. 38th Ave.; CONN.: Hartford (Avon), 395 W. Main St. (Rte. 44); FLA.: Miami (Hialeah), 4705 W. 16th Ave.; GA.: Atlanta, 5285 Roswell Rd.; ILL.: Chicago, 3462-66 W. Devon Ave.; Downers Grove, 224 Ogden Ave.; IND.: Indianapolis, 2112 E. 62nd Ave.; KANSAS: Kansas City (Mission), 5960 Lamar Ave.; MD.: Baltimore, 1713 E. Joppa Rd.; Rockville, 5542 Nicholson Lane; MASS.: Boston (Wellesley), 165 Worcester St.; MICH.: Detroit, 18645 W. Eight Mile Rd. & 18149 E. Eight Mile Rd.; MINN.: Minneapolis (Hopkins), 101 Shady Oak Rd.; MO.: St. Louis, 9296 Gravois Ave.; N.J.: Fair Lawn, 35-07 Broadway (Rte. 4); N.Y.: Buffalo (Amherst), 3476 Sheridan Dr.; New York City, 35 W. 45th St.; Jericho, L.I., 15 Jericho Turnpike; Rochester, Long Ridge Plaza; OHIO: Cincinnati (Woodlawn), 10133 Springfield Pike; Cleveland, 5444 Pearl Rd.; PA.: Philadelphia, 6318 Roosevelt Blvd.; Pittsburgh, 3482 Wm. Penn Hwy.; TEXAS: Dallas, 2715 Ross Ave.; Houston, 3705 Westheimer; WASH.: Seattle, 221 Third Ave.; WIS.: Milwaukee, 5215 Fond du Lac.

HEATH <b>Schlumberger</b>
HEATH COMPANY, Dept. 139-7 Benton Harbor, Michigan 49022
<input type="checkbox"/> Please send FREE Heathkit Catalog.
Name _____
Address _____
City _____ State _____ Zip _____
*Mail order prices; F.O.B. factory. CL-470R

CIRCLE NO. 1 ON PAGE 17 OR 101



build...

# BIG NINE

by David B. Weems

**A**ny good speaker should sound big, even if it's small. Big in the sense that it is expansive, which too often means expensive. Another way a speaker can sound big, to our conditioned ears, is with rich bass. A speaker that combines full bass with spacious highs will sound big at both ends of the audio range.

The big nine, described here, does just that. It offers big sound at a bargain price because you build your own wide-sound speaker system. Even with a high compliance 15-inch woofer for the bass and multi-directional high compliance mid-range speakers and dome tweeters for the highs, your speaker cost is only about \$65.00 per enclosure. And you can make two big nine enclosures from

# e/e BIG NINE

only 1½ sheets of ¾-inch unfinished plywood. A few tools are all you need, particularly if you have your local lumber yard cut out the parts for you.

After getting the parts home, mark and cut out the speaker holes at the proper locations (see Fig. 1). The outside edges of the

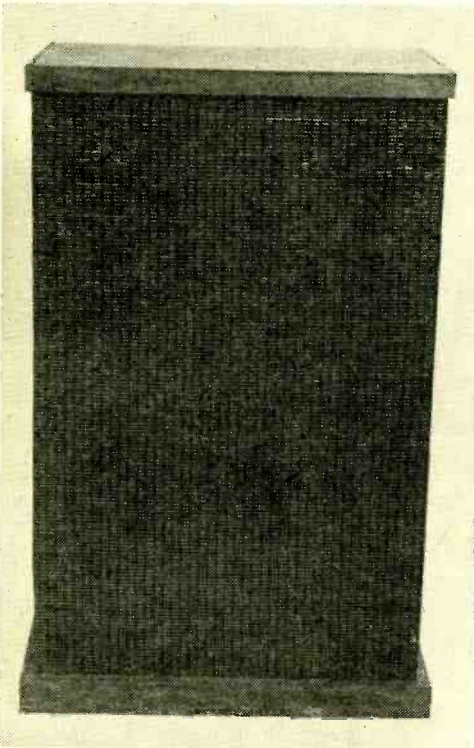

An assembled Big Nine stands a full three feet tall, nearly two feet wide. Trim both top and bottom after stapling grill cloth.

holes for the mid-range speakers and the tweeters should be beveled off with sandpaper, a file, or a sabre saw set at 45°. If left intact, the sharp edge at the outside of the speaker panels can cause diffraction and interference effects which will affect the mid-range and high-frequency response.

**Speaker Cutouts.** Select a sample speaker of each size and center it at each speaker hole. Mark the location of pilot holes for speaker mounting screws. Drill 3/32-inch pilot holes for the mid-range speakers and tweeters. For the woofers drill ¼-inch holes at each mark and install "T-nuts" from the

front of the board to receive 3/16-inch stove bolts. If you can't find 3/16-inch T-nuts, you can substitute slightly longer 3/16-inch flathead stove bolts installed from the front.

Next set up the parts on your work bench to form a partial enclosure. Mark a line

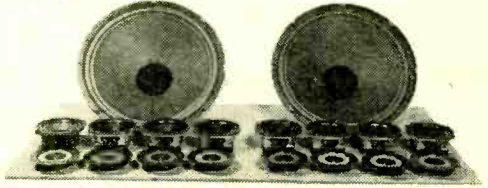

A total of eighteen speakers fill your room with a powerful sound. Fifteen inch woofer has a polyfoam suspension and low resonance.

where the edge of a panel butts against another panel. For example, you will mark lines on the bottom and sides to outline the edge of the front panel when the front is flush with the front edges of the other panels. You will also mark lines on the bottom to show the inner edges of the sides, and so on until you have outlined the position of each panel. Next measure and cut glue blocks to fit each corner location. The approximate length of the glue blocks is given in the bill of materials, but you may find that minor differences in panel dimensions will require these lengths to be trimmed or increased slightly.

Now attach glue blocks to panels, using glue and screws. It is much easier to install all the glue blocks at once, with the panels flat on your work bench, than later after the panel is fastened to another panel. Drill shank holes of about 13/64-inch through

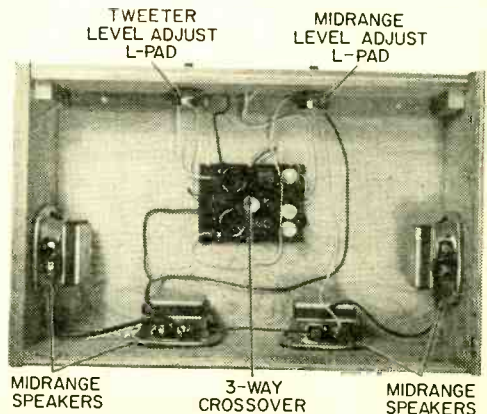

TWEETER LEVEL ADJUST L-PAD MIDRANGE LEVEL ADJUST L-PAD  
MIDRANGE SPEAKERS 3-WAY CROSSOVER MIDRANGE SPEAKERS

Remove top cover to see L-pads, crossover network, and the four mid-range speakers. Parts substitutions are possible. See text.

the blocks at 4-inch to 6-inch intervals. Nail the blocks lightly in position and drill pilot holes in the panel with a 3/32-inch drill. Next apply glue to the block and the panel; then attach the block to the panel and screw it down. Note that the blocks should be indented 3/4-inch from the front and back edges of the sides, 3/4-inch from each edge of the bottom, and 3/4-inch from the back edge of the partition. The other 3 blocks on the partition are flush with the edges because this panel sets inside the sides and front.

**Continue.** Drill shank holes in panels for assembly screws. These should be located at about 4-inch to 6-inch intervals on lines to match the center line of each opposing glue block. For example, there will be a line of screw holes around the perimeter of the front panel and back panels indented about 3/8-inch from the edge. Also a line of holes at the bottom and the top

of the sides. Don't forget a line of holes about 6 3/8-inches below the top edge of the front and sides to bind the front and sides to the glue blocks on the lower side of the partition.

Attach sides to bottom with glue and screws. Next glue and screw the front panel to the sides and bottom. Use glue and nails to join the sides to the front above the partitions where there are no glue blocks. Paint the front panel and sides with flat black paint. This completes the assembly of the basic box, minus the top and back panels.

**Install The Speakers.** When the glue has set and the paint has dried, the speakers can be installed. Start with the tweeters. Smear a very thin layer of caulking compound on the speaker board to seal each tweeter to the board. Silicone rubber caulk is ideal for this job. Set the tweeter on the ring of caulking material, and screw it down.

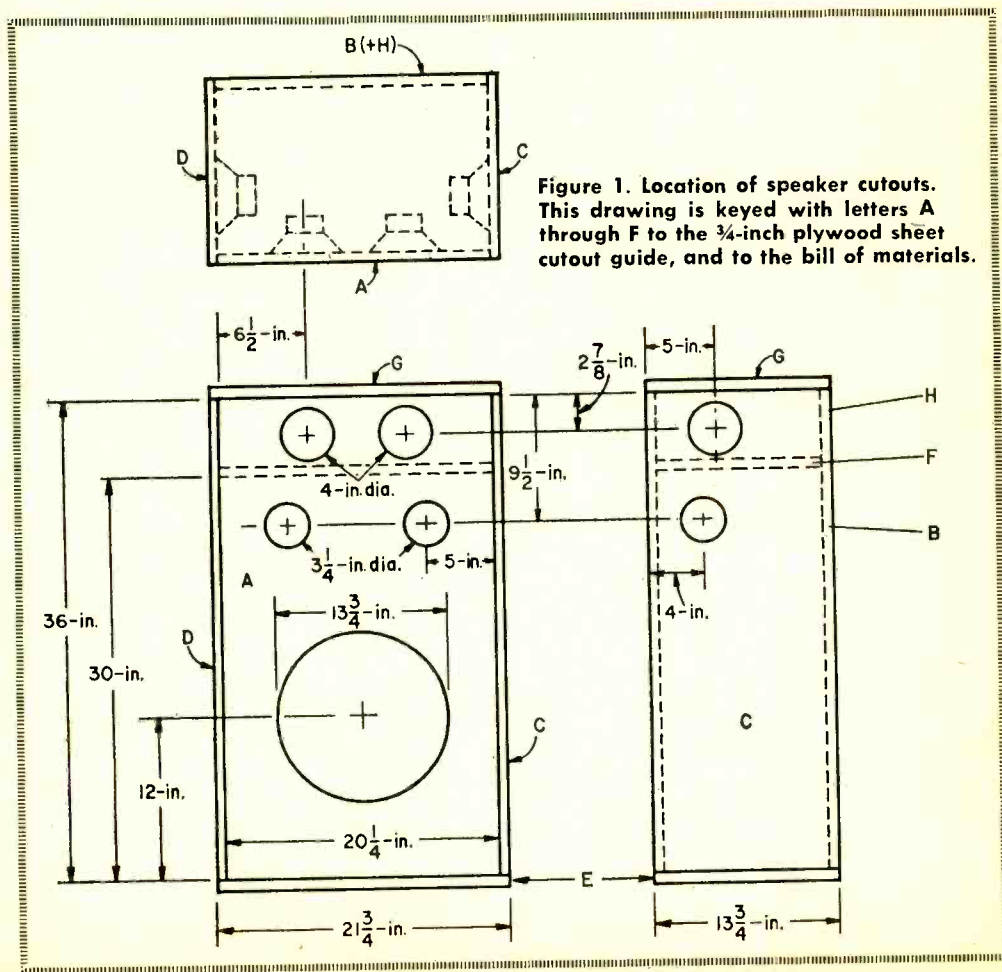

**Figure 1. Location of speaker cutouts. This drawing is keyed with letters A through F to the 3/4-inch plywood sheet cutout guide, and to the bill of materials.**

# e/e BIG NINE

Now install the mid-range speakers with screws and the woofer with bolts. Both mid-range units and the woofer have adequate gaskets, no caulking compound needed. The mid-range speakers should be mounted upside down so that their terminals are pointed up for easy wiring.

Install the crossover network with four non-magnetic screws, aluminum or brass, and with "spacers" between the crossover network board and the partition. Pieces of plastic tubing or rubber grommets about 3/8-inch long will serve as spacers or stand offs. After the screws are installed, tap the network board lightly and check for rattles. If loose, the board will tend to "sing," but not very musically.

Drill two 1/4-inch holes through the mid-range back (H), for the speaker leads.

Ream the holes on the outside of the back so that a two-terminal strip, screw type, will fit flush against the back. Split a 12-inch piece of lamp cord far enough to feed the two leads through the holes from the inside of the back, and solder them to the terminal strip. Install the strip with glue and small screws.

**Install The Controls.** Drill 3/8-inch holes for the control shafts; then enlarge the holes on the outside surface with a 3/4-inch drill to recess the retaining nuts. Tighten the nuts on the shafts, then stick the control plates on the back with contact cement. Install the mid-range back panel with screws—no glue.

Wire the speakers using lamp cord for conductors. The logical first step in speaker wiring is to connect the paralleled pairs of mid-range and tweeters. Wire the left pair of each in parallel, and the right pair of each in parallel. Use care to see that the same conductor on a piece of lamp

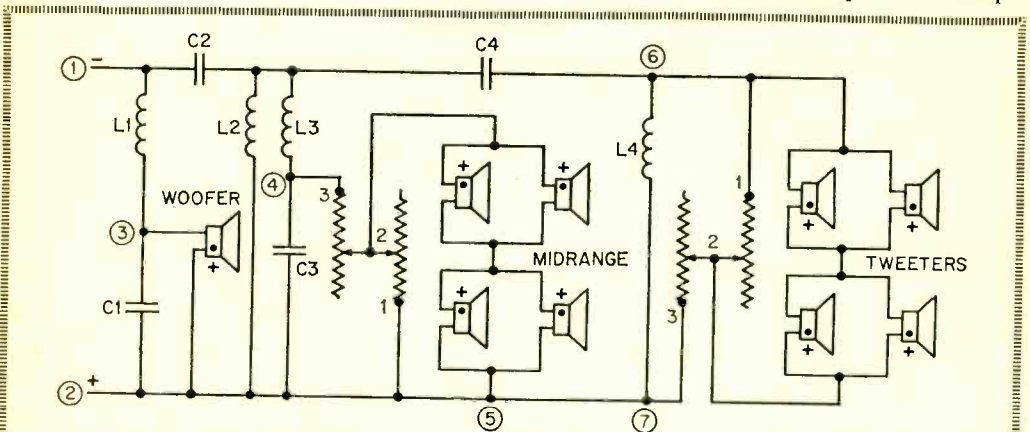
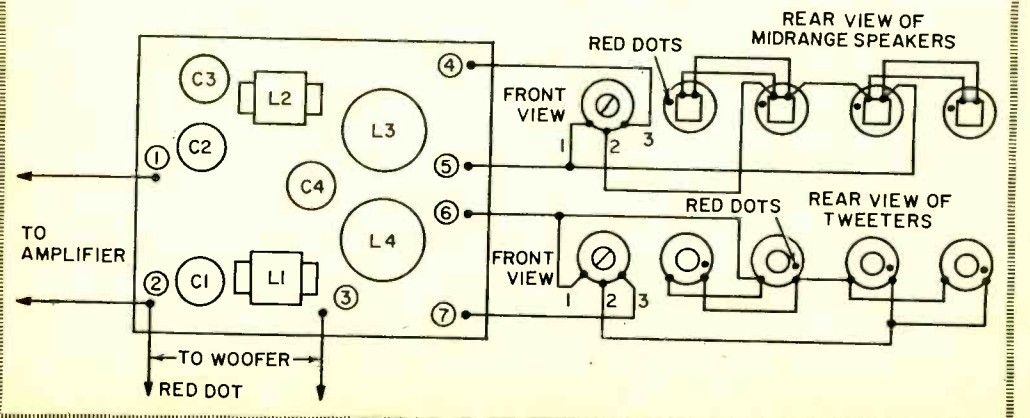

Figure 2, above, shows the Big Nine wiring diagram for bill of material parts. Figure 3, below, is a pictorial wiring of the speakers, L-pads, and crossover.





cord goes to the red dot on each speaker in the pair. After the pairs are wired, connect the pairs together by a single conductor from the red dot terminal on one pair to the unmarked terminal on another pair. This puts the two parallel pairs in series when the four speakers are wired by connecting the proper tap on the crossover network through the control to the red dot on one pair and the unmarked terminal on the other pair. (See Figures #2 and #3.)

In order to keep the wiring straight, it's a good idea to split several pieces of brown lamp cord and equal lengths of white lamp cord. Use the individual leads to connect the speaker to the network and controls, a brown lead for negative and a white lead

for positive, or vice versa. The leads to the woofer and tweeters can be carried through the partition through two 1/4-inch holes. After wiring, fill the space at each end of the holes with caulking compound.

**Check For Phase.** Before soldering the speaker wires, hook up the system to an amplifier or other source and test to see if the speakers and controls are working right. Keep the volume low when the back is off. You should hear bass from the woofer, mid-range from the squawkers, and highs from the tweeters. Now listen to each mid-range speaker in turn, without changing any controls on the amplifier or the speakers. Each of the four speakers should

*(Continued on page 99)*

### Bill of Materials for Big Nine

Quantity	Speakers, Network and Controls	
1	15 in. high compliance woofer (CTS-FR-15-20-8)	about \$19.95 each
4	5 in. high compliance speakers (XS-510)	about 3.99 each
4	3 in. tweeters (CTS-2TA3)	about 3.95 each
1	3-way crossover network, Norelco (4304-07X)	about 7.95 each
2	8-ohm L-pads (Radio Shack 40-980 or equiv.)	about 1.99 each

See Hints-On-Parts for more information.

#### 3/4-in. Plywood

1	20 1/4 x 36-in. front panel (A)
1	20 1/4 x 29 7/8-in. back (B)
2	13 3/4 x 36-in. sides (C, D)
2	13 3/4 x 21 3/4-in. top and bottom (E, G)
1	13 x 20 1/4-in. partition (F)
1	5 1/4 x 20 1/4-in. M-R back (H)

#### 3/4 x 3/4-in. Pine Blocks

4	28 1/4-in. Vertical side blocks
6	20 1/4-in. Bottom and partition front and back, top rear
4	10 3/4-in. Bottom and partition sides

#### Trim

2	13 3/4 x 1 3/8 x 1/4-in. Top
1	22 1/4 x 1 3/8 x 1/4-in. Top
2	13 3/4 x 2 x 3/4-in. Base (sides)
1	23 1/4 x 2 x 3/4-in. Base (front)

#### Miscellaneous

	Grille cloth, approx. 52 x 36-in.
150	#8 x 1 1/4-in. flathead wood screws
32	#8 x 3/4-in. panhead sheet metal screws (mid-range speaker mounting)
32	#8 x 1/2-in. panhead sheet metal screws (tweeters)
8	3/16-in. T-nuts
8	3/16 x 1 1/4-in. round head stove bolts with washers (woofer mounting)
	Flat black paint, terminal strip, lamp cord, glue, etc.

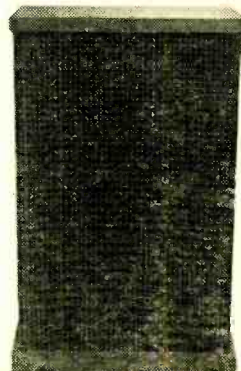

**NRI “hands-on” training in  
Television, Communications,  
Electronics and Computers  
can give you as much  
as 2 years of on-the-job  
experience.**

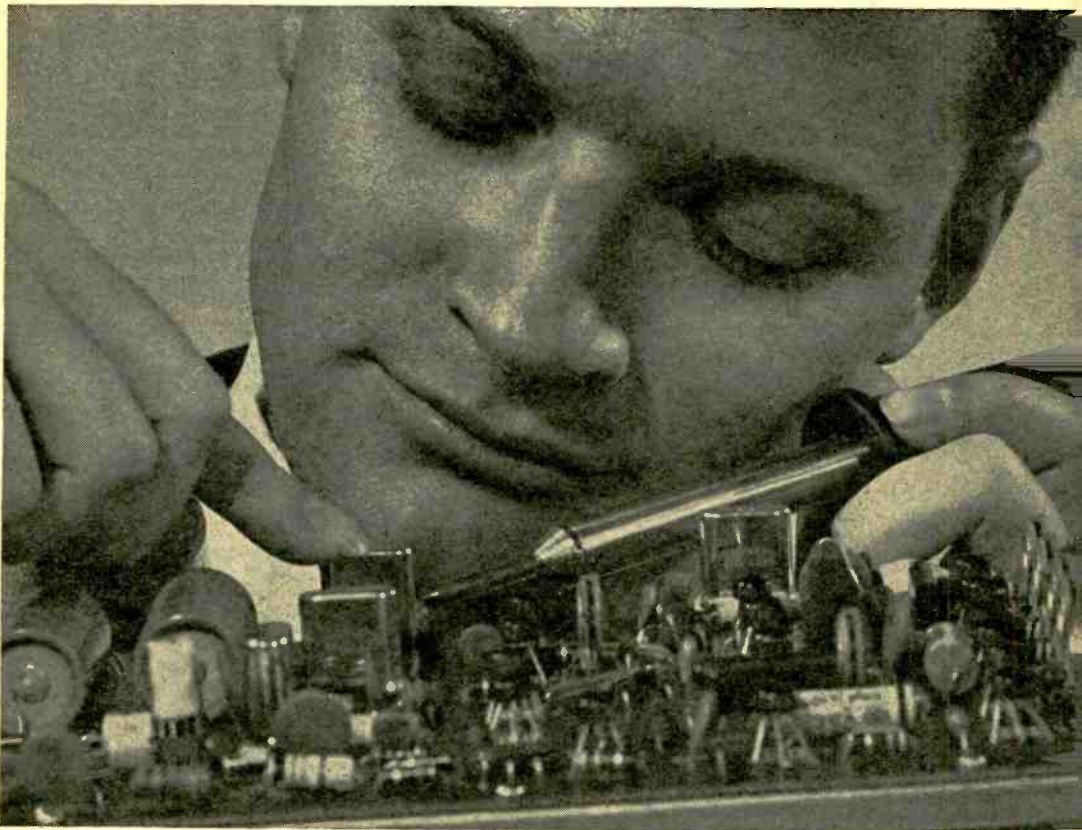

**EARN YOUR FCC LICENSE – OR YOUR MONEY BACK**

NRI Communications training programs will qualify you for a First Class Commercial Radiotelephone License issued by the FCC. If you fail to pass the FCC examinations for this license after successfully completing an NRI Communications course we will, on request, refund in full the tuition you have paid. This agreement is valid for the period of your active student membership and for six months after completion of your training. No school offers a more liberal FCC License agreement.

# Experience is still your best teacher

*... here's how you get it with  
unique NRI training at home*



**NRI Achievement Kit** is educator-acclaimed and the original "starter" kit in home study training. Imitated but never duplicated, this kit is designed and personalized for you and your training objective. It has one purpose — to get you started quickly and easily.

Ask any teacher, job counselor, engineer, technician or prospective employer about the need for practical application of theory in Electronics. He'll tell you Electronics is as much a "hands-on" profession as dentistry or chemistry. That's how you learn at home with NRI. You prove the theory you read in "bite-size" texts, by actual experimentation with the type of solid-state, transistor and tube circuits you'll find on the job today — *not* hardware or hobby kits. You introduce circuit defects, analyze results, discover quickly the kind of trouble-shooting and design techniques that will make you employable in Electronics.



**"Bite-Size" Texts** average an easily-digested 40 pages of well-illustrated, scientifically prepared subject matter in the course of your choice. Questions in each book are carefully hand-graded and returned to you with helpful instructional notes. You get unlimited personal help from the day you enroll.

## ***Train with the leader — NRI***

NRI lab equipment is designed from chassis up for effective, fascinating training — not for entertainment. The fact that end results are usable, quality products is a bonus. In Communications, for example, you build and analyze, stage by stage, your own 25-watt phone/cw transmitter. It's suitable for use on the 80-meter amateur band, if you have an interest in ham radio. In TV-Radio Servicing your practical training gives you your choice of monochrome or color TV sets. All training equipment is included in the low tuition — you pay nothing extra. Discover for yourself the ease, excitement and *value* of NRI training. Mail postage-free card today for new NRI Catalog . . . or use the coupon below. No obligation. No salesman will call on you. NATIONAL RADIO INSTITUTE, Washington, D.C. 20016.



## ***Designed-For-Learning Equipment***

Like this phone-cw transmitter (Kit #7 in the Communications course) is engineered from chassis up to demonstrate principles you must know. NRI does not use modified hobby kits for training, but the finest parts money can buy, professionally and educationally applied.

### **APPROVED UNDER NEW GI BILL**

If you have served since January 31, 1955, or are in service now, check GI line on postage-free card or in coupon.

MAIL THIS COUPON IF CARD IS GONE



### **NATIONAL RADIO INSTITUTE**

Washington, D.C. 20016

Please send me your new NRI Catalog. I understand no salesman will call and there is no obligation.

Name \_\_\_\_\_ Age \_\_\_\_\_

Address \_\_\_\_\_

City \_\_\_\_\_ State \_\_\_\_\_ Zip \_\_\_\_\_

Check for facts on new GI Bill

**ACCREDITED MEMBER NATIONAL HOME STUDY COUNCIL**

# CB coffee break

THIS ISSUE'S COLUMNIST—JULIAN S. MARTIN, KMD4313

**What's Ahead In '74?** With most of us wrapping up winter clothes and tools while looking ahead to an easy sort of loafing-around summer, there is one section of our industry where the busy bees are starting to worry about their ulcers. I, of course, refer to the catalog department of the major mail order distributors, for this is the time they start preparing the 1974 catalog of electronic goodies. In the few months ahead those thousands of sheets of paper strewn across desks and floors must be assembled into a book with several hundred pages so attractive they'll make us want to draw our wallets faster than a six-gun.

Although no one is talking either on or off the record—for fear a competitor will put two and two together, advance rumors say the 1974 CB equipment will be upgraded, but with no new advances to the state of the art. When you start to think about it, what state of the art advances could we expect? What new state of the art isn't already used in CB gear? We already have some AM transceivers small enough to fit into a glove compartment, and the new SSB transceivers deliver the ultimate in CB effectiveness. As for antennas, anything you can think up in performance levels and convenience-of-installation is already being manufactured. So what is really ahead for '74?

Since no one is talking—yet, we have to add rumor to rumor, throw out the ridiculous and make an educated guesstimate.

First off, there's the question of Class E CB frequencies. Even with all the high pressure salesmanship in many hobby publications, Class E hasn't moved off dead center, so don't look for new "and better" Class E equipment in '74. CB gear will still be AM and SSB on the same old 23 channels.

As far as AM transceivers are concerned, there's virtually no room for improvement, for how can supersensitivity, superselectivity and crystal synthesis be improved beyond what is already great performance? What you're more likely to find is a greater emphasis on miniaturization: full 5 watt transceivers small enough to fit into a coat pocket; even smaller walkie-talkies, some no larger than a pocket transistor radio (and I mean quality equipment, not a four transistor toy for the children); and most of all, dual channel monitoring.

Fact is, advance word is that dual channel monitoring is really big. Just about every major

CB outfit is putting at least one dual receiver model in their line. Some are sticking to just a channel 9 monitor, with some sort of indicator to show channel 9 is in use. Others are building in *over-ride*, with the channel 9 signal breaking into the speaker at a higher volume. Still others are adding two independent channel selectors so you can monitor any channel. And still others are thinking of expanding the present idea of two switch-selected monitor channels (one usually reserved for channel 9) by adding three or more switch-selected monitor channels in addition to channel 9. And there's a rumor going around that someone will even provide a scanner on the monitor channels so several channels can be monitored while you're working your regular frequencies.

Another big feature for '74 is extensive metering. More transceivers than ever before will have, at the least, built-in SWR metering (saving you the cost of an accessory meter); some will have output power meters with the normal operating output power range color-coded.

Base station equipment has often been provided with full metering and most of the "extra" features of high-performance mobile equipment, so there's not much room left for upgrading. But you can expect to find more built-in digital clocks, automatic receiver start-up and shut-down, tape recorder outputs and even automatic recorder start so you can receive messages when you're not home.

SSB equipment has always been high-performance so just about any conceivable operating feature has been incorporated into the models presently available. Big changes will be found in styling; since more and more CB'ers are putting the gear out in the living room and dens, the SSB gear is getting away from the "black box" communications appearance and starting to look more like decorator styling. (See Kathi's Carousel in this issue for a report on the new, stylish Cobra 135.) SSB is also starting to shrink. With greater use of integrated circuits you can expect to start seeing micro-mini SSB transceivers in '74 (I expect the day will come when CB transceivers will be blister-packed on a pegboard rack).

Though the picture can change at any time, we've heard of no new surprises in antenna equipment. Right now there is the most complete selection possible, everything from minia-

*(Continued on page 103)*

# Getting Eight-Track Players

## on the Level

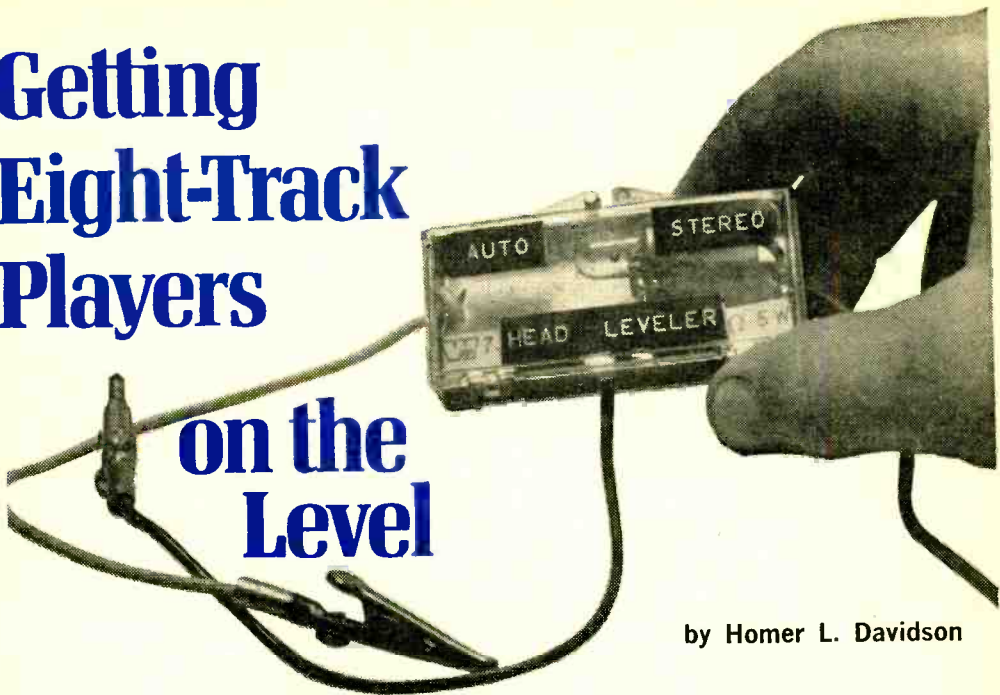

by Homer L. Davidson

□ Does music bust in where it is not wanted on your auto eight-track stereo tape unit? In other words—two music channels are being heard at the same time. Man, that's crosstalk! With a simple Auto Stereo Head Leveler, which we tell you how to build, you can quickly touch up those critical playback adjustments and eliminate crosstalk or co-channel distortion. Not only will the Leveler stamp out crosstalk, but it can serve as a balance meter, and it can give some indication of frequency response. It's cheap at half the price—actually less than a buck, or you may now have the parts in your junk box at no cost at all. Just clip the leads of the Leveler to the stereo output speaker leads and you're in business. But, read on 'cause we're going too fast.

**How It Works.** Most car-stereo, 8-track, tape decks have a speaker and power output plug at the rear of the unit. The Stereo Head Leveler can be attached on these connec-

tions or at the speakers themselves. Clip the Leveler to each speaker and common ground lead. Leave the speakers connected with the Leveler in the circuit and hear the music, or tone, as you make the head adjustments.

When rotating the volume control on the tape deck, the pilot light will illuminate proportionally to the music, or sound level, taken from the tape. The light is brightest with the balance control at its center position, indicating correct balance. Height and azimuth adjustments can be made on a regular music tape, but accurate adjustments are made with a cartridge test tape. Since the channels of music are very close together, only a slight adjustment of the height screw on the head assembly is needed to correct crosstalk conditions. Generally, the height screw may be off a smiggen—so go very easy.

**Construction.** A 47 pilot light, two 7.5-



A whole host of tests and checks can come from a handfull of junk box parts. Pep up any 8-track auto tape player with hints and techniques revealed in this article. Turn the page for an inside view of this simple but handy tester.

## ON THE LEVEL

ohm, 5-watt wirewound resistors and three alligator clips are the only parts used. The light and two resistors are mounted inside a small plastic box. Drill and prepare the mounting holes before placing the parts inside the plastic box. Heat the tip of an ice pick or sharp metal point with a soldering iron to make holes in the plastic. Holes are made in each end and top of box for flexible test leads.

Twist one end of each wirewound resistor together and bend the remaining ends so the resistors will fit snugly inside the plastic box. Form a loop in the remaining end in front of each hole so flexible test leads can be soldered and will not pull out through the hole. Bolt the pilot light socket in place and solder a wire to the metal socket shell. Connect one end of both resistors to this point. Insert a flexible lead through the top hole, tie a knot and solder to the remaining pilot light socket. Recheck the wiring and the Leveler is ready for use!

**Hookup Procedure.** Clip the Stereo Balance Leveler to the speaker leads of the stereo 8-track tape deck speaker leads. Now locate the height and azimuth adjustments near the tape head. Generally, the height adjustment screw is located right behind the tape head assembly and the azimuth screw is off to the side of the tape head. These two adjustments can be made on most tape units by removing a plate located on top of the outer case and adjusting inside with a screwdriver. Some units have manual and screwdriver adjustments at the bottom side of tape player. In most cases, the tape player will have to be dropped down from the dashboard to get at the top adjustments. It may be wise to remove the unit and take it to the test bench. The height screw selects the correct channels and eliminates crosstalk conditions. Adjustment of the azimuth screw levels the tape head on the playing tape for good frequency response. Both of these adjustments are made for maximum brightness of the pilot light.

Before making adjustments set the volume control so the pilot light with Leveler just begins to glow. Turn the bass, treble and balance control to the center position. When the balance control is at center balance position, the pilot light will be brightest. Manually trigger each channel through several

times to see if the channel program selector is functioning properly. If not, a good clean-up of gear, pivot arm and solenoid will produce clean program change over. Use a swab of cotton dipped in alcohol. Also, it's possible to have foreign material such as gum wrappers and excessive oxide dust preventing automatic or manual switch function. Now, before attempting any adjustments, determine if crosstalk is noted on all channels. If crosstalk is noted on just one channel, a slight touch-up of that channel may cure the problem. Recheck each and every channel for crosstalk conditions.

**Adjustments.** Start adjustment at top or bottom channels of the stereo tape player. If adjustments are to be made with a regular stereo cartridge, select one with constant or continuous music. A good stereo cartridge test tape is inexpensive and can save you money in the long run. Recheck the balance control and position where the pilot light is brightest. It is possible one of the channels may be weak, throwing the balance control off to the side. In case the balance control is way off, repair the defective stage before attempting to make head adjustments. Sometimes when using a regular stereo cartridge one of the speaker channels may be recorded a little lower resulting in the balance control off to one side. An audio, 8-track, test cartridge will produce accurate speaker balance and separation.

When making these adjustments always keep the tape player in upright position. If laid on its side or upside down, the tape head assembly may not be in the correct position resulting in improper and repeated adjustments. Remember, the height adjustment may be off  $\frac{1}{16}$  inch of a turn and requires just a touch-up. Make the height adjustment with the tape playing back about 1000 Hz. Any band of frequencies from 750 to 5000 Hz can be used. Some audio test tapes have a 7500 Hz azimuth or tilt test signal for azimuth adjustments. This test is for proper angular positioning of the playback head with relationship to the tape. Make both adjustments for greatest brightness of pilot light in the Leveler.

After making azimuth and height adjustments check for crosstalk on each tape track. Turn the balance control to the far left and listen for crosstalk. Check the right channel in the same manner. Test each track with a recorded cartridge and listen for crosstalk at the end of each recording.

**Other Tests.** Besides tape head alignment you can check the tape player for frequency response, equalization, sweep frequency, intermodulation distortion, channel identification and separation on an audio test cartridge.

A series of tones from 70 to 8000 Hz are used for checking the overall frequency response of the tape player system on frequency response and equalization test. Adjust the volume until the bulb barely glows and leave it. In perfect equalization the brightness of the light should be approximately the same on all frequencies.

A continuous frequency sweep from 8000 down to 70 Hz is used in sweep frequency test. It will clearly indicate any serious peaks or dips your tape players may have. Don't be surprised if the tone varies up and down in the speakers. This sweep frequency test will also indicate any serious resonant peaks in the speaker or mounting location.

Intermodulation distortion tests will show up any "buzz" or indicate trouble in poor

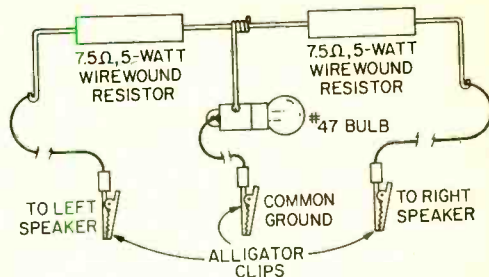

**Use a number 51 lamp for high power installations. Its shape is shown above. The number 47 lamp bulb, shown on the first page, is for average power players.** circuitry, dirty heads, bad speakers, etc. Now is the time to clean up that dirty tape head.

The channel identification and separation test will identify each channel and check placement of speakers. You can check the gain of each channel by turning the balance control fully to each channel under test. Notice the gain of each channel. All speakers should be connected in making these tests. ■

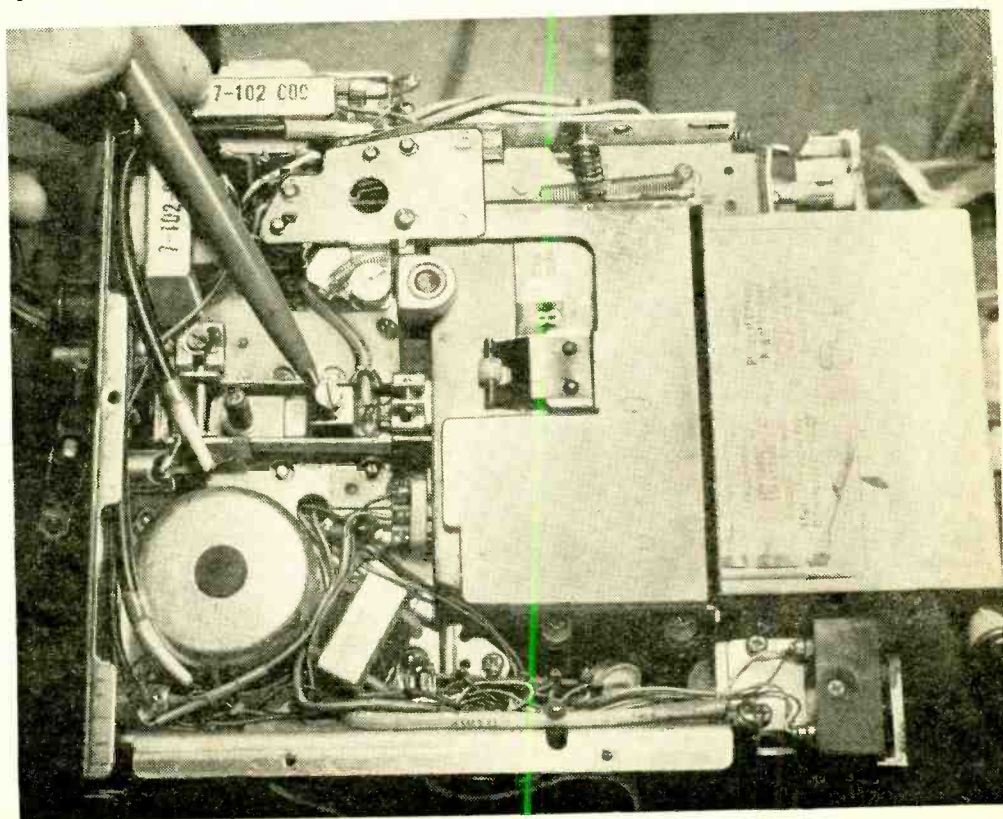

Simply connect the auto-stereo head leveler to the left and right speaker connections. Clip the common wire to common speaker ground. Be sure to locate the height screw shown.

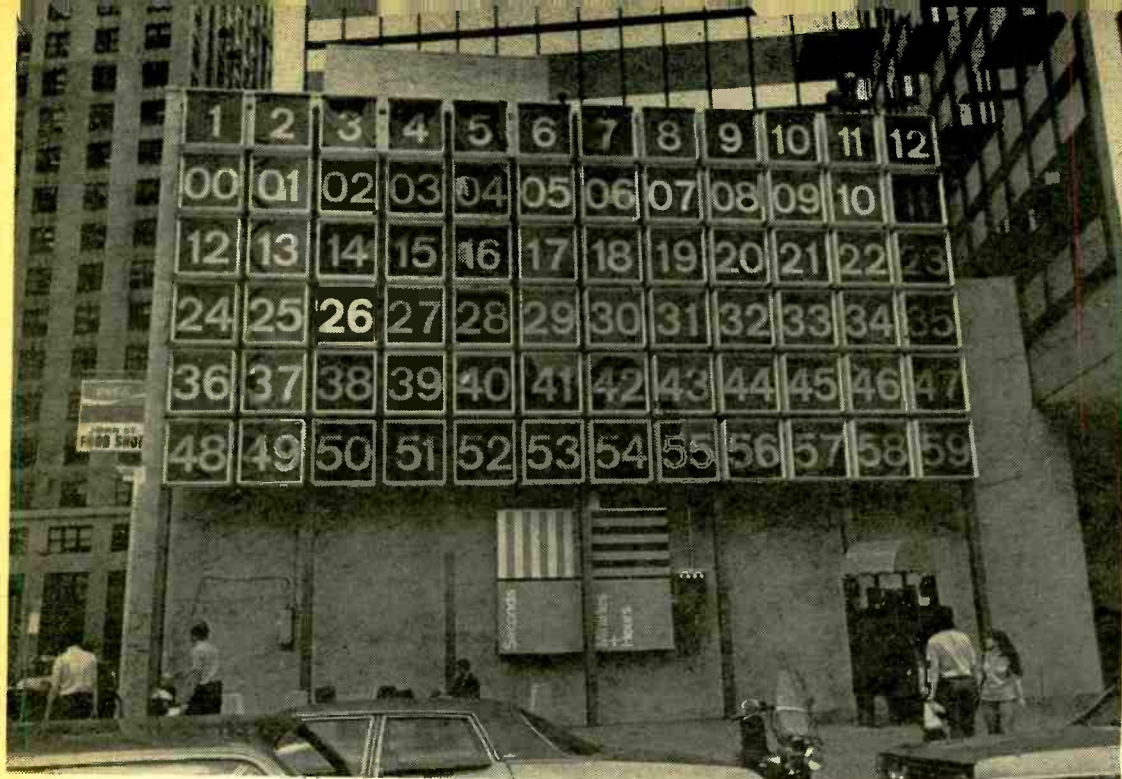

# THE WORLD'S LARGEST DIGITAL CLOCK

BY EMMA FLUFFIN

□ No one could ever get lost in New York if they were to keep a rendezvous under the John Street clock—the world's largest digital clock. The clock is so big that a person with average eyesight can tell the time from several blocks away without squinting.

The clock face is 50-feet long and 45-feet high. The face area is divided into 72 squares, each with a number in it. The top row reads 1 to 12, the second row reads 00—01—02 . . . to 11 and the remaining four rows bring the numbers from 12 to 59.

To tell the time one merely has to remember that the top row numbers stand for hours and are colored yellow. The remaining 5 rows and 60 numbers are seconds and minutes. The minutes light up red and the seconds tick by in blue.

Watching time pass at this point in New York can be fun and the eye can see that blue light flash through 60 times a minute and travel through 250 feet. Now, New York not only has the place, it has the time! ■

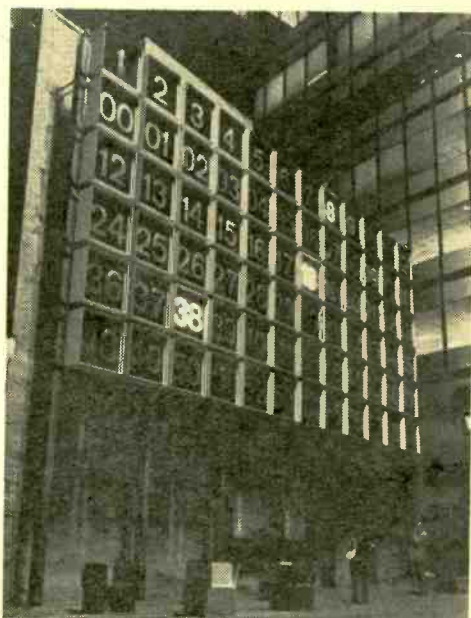

Even people with color blind sight can tell the time. Seconds fly by whereas minutes creep along—hours stand still!

ELEMENTARY ELECTRONICS



# 4-CHANNEL MATRIX

# RECORDS MEAN OR DISCRETE...



## GET THE FACTS ABOUT CD-4

by Shinri Sensei

**T**he time has come to stop talking of cabbages and kings, Matrix and decoders, SQ and QS, ambience and psychoacoustics. Discrete 4-channel sound is here, both in equipment and records, and it's totally compatible with your present stereo system.

The discrete 4-channel system finding its way into our homes is tabbed CD-4—Compatible, Discrete 4-channel. Now, you can play and thrill to the most realistic sounds on records. You can feel that delusive "sound field" that brings the fuller dimension to music as experienced in live performances. CD-4 captures and reproduces the natural reverberation, presence, movement and resolution heard by the conductor, musicians and audiences that have never been fully realized on disc recordings before! CD-4 is the culmination of musical excitement.

Unfortunately, for the reading public, too much has been said about CD-4 before it was fully understood. Many editors, reporters and authors promulgated myths mixed with facts until the CD-4 picture clouded in confusion. So, let's set the record straight now! Forget whatever you learned about CD-4. Let's pick up the threads of facts and weave a new picture—honest, reliable, and—by all means—*correct*.

The CD-4 technique of discrete 4-channel sound maintains four separate channels of sound from the recording studio all the way through the audio reproduction system to the four loudspeakers. Unlike matrix systems, the four discrete channels

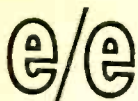

## FACTS ABOUT CD-4

are never blended, encoded or scrambled into two channels and then decoded. Consequently, there is no blending or overlapping of sound from channel to channel. Instruments intended to be heard through only one speaker in the CD-4 system are *only* heard through that speaker, and *not* the others. There is no psychoacoustical crutch to lean on, no complex logic circuits

bonus feature when playing back ordinary stereo discs.

● **A CD-4 disc demodulator.** The only units currently available at this writing are JVC's 4DD-5 and Panasonic's SE-405H. Unconfirmed rumors have it that Pioneer will market a CD-4 line of components soon. Also, JVC offers a combination automatic changer and CD-4 demodulator, the 4VC-5244. By late Fall 1973 several other manufacturers will enter the market.

● **A 4-channel amplifier.** If you are adding on to a stereo system, you'll be in the market



Circle No. 47  
Panasonic SE-405H CD-4 Demodulator



Circle No. 44  
JVC 4VN-770 4-Ch Integrated Amp



Superscope QA-420 Amp  
Circle No. 48



Audio-Technica AT14S  
Circle No. 49

to ride gain, no tricks, no fast talk to confuse you.

CD-4 requires some special equipment. If you want to go discrete 4-channel today by adding on to your present stereo system, here is what you need:

● **A high performance record player.** But, you have one in your stereo system. If it's of the quality of the Benjamin/Lenco L75, Elac/Miracord 650, Dual 1229, Empire 598 Mark II, Garrard Zero-100, JVC VL-8, PE 3012, Pioneer PL-61, or Thorens TD-125AB Mk II, among others, you are all set. If not, this stereo system component needed upgrading before you started this article!

● **An extended range phono pickup with Shibata stylus.** The ordinary elliptical stylus in the best stereo pickup is not quite suitable for playing CD-4 records. So far, only Audio Technica has a line of CD-4 phono pickups with Shibata styli, and JVC offers their 4MD-20X model. One important technical feature of these phono pickups is extended frequency range—required for CD-4, a

for a piggyback amplifier—a component that provides two additional power amplifying stages for the rear channels. A reasonably low-cost unit is the Lafayette LA-524. JVC's VN-5101 should be considered, too. At best, the piggyback is a stop-gap idea that can be avoided by planning to switch to a 4-channel amplifier unit. Your best bet will be to invest in a new 4-channel amplifier such as the JCV 4VN-770, Heath AA-2010, Lafayette LA-64, Pioneer QL-600A, Realistic QA-680, or Superscope QA-120.

● **A 4-channel receiver.** Stereo receivers require a piggyback amplifier for 4-channel discrete operation exactly the same as for stereo amplifiers. However, this is the one component area where considerable consideration should be given to replacing the stereo receiver with a *quality* 4-channel unit. Some excellent 4-channel receivers are the Fisher 801, Hitachi SR-800, JVC 4VR-5445, Kenwood KR-6200, Lafayette LR-4000, Panasonic SA-6400X, Pioneer QX-

## How CD-4 Gives You Discrete Sound

□ The biggest design problem facing CD-4 was how to put four discrete channels of sound into a V-shaped record groove. This seemingly insurmountable technical problem was solved by modulating two additional audio channels into the groove in much the same way as is done in FM stereo broadcasting. See Fig. 1.

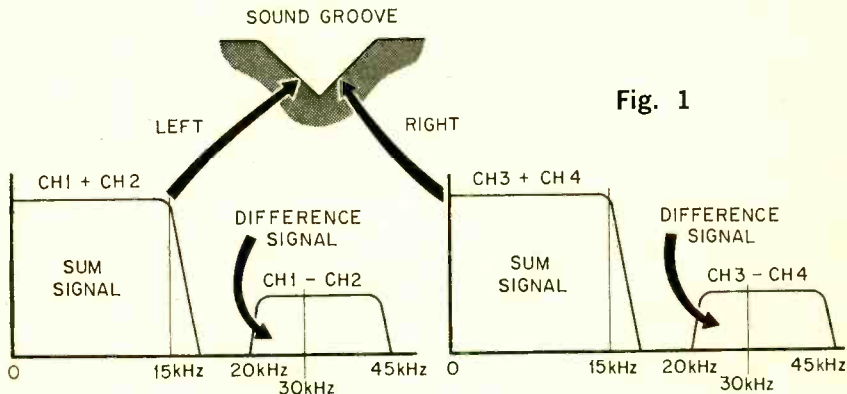

Fig. 1

In CD-4 records, each side of the groove is at a 45-degree angle to the surface of the record as it is in stereo discs. See Fig. 2. While the conventional 2-channel stereo record contains one channel of sound on each side of the groove, the CD-4 disc has two channels of sound on each side of the groove. The sum of the left-front and left-rear channels (#1 and #2) is recorded by the conventional method on the left-channel side of the record groove, and the sum of the right-front and right-rear channels (#3 and #4) is recorded on the right channel side. (See Fig. 3 for speaker placement.) Thus, CD-4 is totally compatible with the present stereo system when played back by a stereo cartridge. No loss of frequency response or undesired mixing of front channels occurs. When using CD-4 for 4-channel discrete playback, the high frequency difference signal on each groove side is used to demodulate the front from rear signal, restoring them to their original status as discrete signals, unblended and in full fidelity. All this was made possible on a CD-4 recording by employing new techniques in the recording process. By low speed cutting, new cutting stylus, and an automatic noise reduction system, to name a few, CD-4 playback from a disc is possible in your home today!

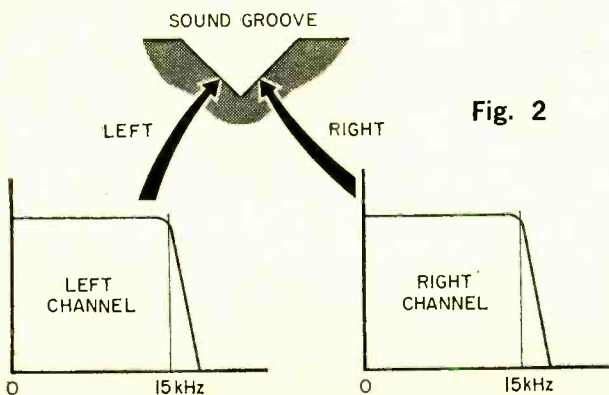

Fig. 2

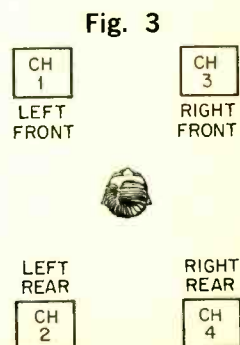
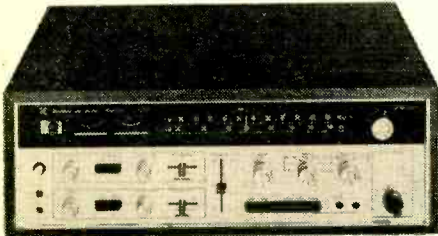

Fig. 3

## FACTS ABOUT CD-4

8000A, and Sansui QRX-6500. You guessed it—there are many good 4-channel receivers.

● **Two more speakers.** The most reasonable selection of rear speakers would be identical units to match the front pair. Forget about the cheaper, or poorer performance speakers for use as rear speakers in a 4-channel system. This practice was practical for ambience and early matrix decoders, but not so for CD-4. Each channel must be matched to the other three for CD-4 is high-fidelity throughout!



**Sansui QR-6500 4-Channel Receiver**  
Circle No. 41 on the Reader Service Page.

If you have a matrix or discrete 4-channel system that plays SQ records or 4-channel, 8-track tape, you can swing to the CD-4 system immediately with JVC's 4DD-5 demodulator and a Shibata stylus pickup.

Once you have a CD-4 system, you'll need CD-4 discs to hear discrete programming. RCA is already producing discrete 4-channel records called QUADRADISCS and the selection of records, currently at 50 albums, is being rapidly expanded to include all kinds of music, with 20 new releases each month. Other companies, such as Warner, have been licensed to make CD-4 records, and their discrete CD-4 discs may be in the record shops by the time you read this.

**Disc Price Is Compatible.** Unlike many matrix records sold at premium prices of one dollar or more, CD-4 records sell for the same suggested retail prices as ordinary 2-channel stereo records. Since CD-4 records are compatible, record stores don't have to carry a double inventory and pass a price increase on to the consumer. And the myth about CD-4 discs playing only half the time of a standard stereo LP (because they carry twice as much information) isn't so. CD-4 records now have essentially the same playing time as 2-channel discs.

While you shouldn't use your present stereo phono pickup with a CD-4 demodulator (a CD-4 cartridge with Shibata stylus must be used in higher-quality light-tracking tone arms), you can use the CD-4 cartridge on your old stereo records. There is a Panasonic demodulator, the SE-405C, that includes a cartridge with a conical stylus which, in less sophisticated playback equipment, can track CD-4 records at up to 3.5 grams. The results are *good to great!* The CD-4 phono pickups often enhance stereo playback because of their excellent, extended, flat frequency response. Also, the Shibata stylus—shaped differently than the standard elliptical stylus—rides on a different portion of the groove wall. Hence, it will often deliver excellent sound from standard stereo records with grooves worn from numerous plays by a standard stereo stylus.

Now, here are some facts learned from actually playing, experimenting and enjoying CD-4 recordings.

Extended repeated play of CD-4 discs by



**Empire 598II Turntable**  
Circle No. 42 on the Reader Service Page.

the Shibata stylus does not seriously degrade the high frequency subcarrier information contained in the grooves. Earlier forecasts of 5, 10, or a maximum of 20 plays on a CD-4 disc have been proven false. Four-channel playback quality lasts nominally as long as stereo playback quality does; thus, CD-4 playback is good for the life of an average stereo disc.

**Keep It Clean.** CD-4 records are very susceptible to the effects of dust and dirt in the grooves. If the sound gets "hairy" wash the record in room-temperature water. If a mild detergent is used, rinse thoroughly

under tap water. Do not wipe dry, but allow the records to drip dry. Then play the record through once and the stylus will remove the dust from the grooves. Be sure to clean the stylus tip with a stylus brush. (The stylus tip always must be kept scrupulously clean.) A "dustbug" or similar record cleaner tracking ahead of the stylus is a must-have accessory for CD-4 records.

One important point should be mentioned. Many audio reporters and authors claimed that the bottom-end frequency limit of the CD-4 record was near 100 cycles. This is definitely not so; as any listening test will indicate CD-4 discs are capable of going down to the deep bass. The myth began when the press was told that CD-4 disc masters were cut at approximately one-third the normal playback speed. Since the typical stereo recording goes down to near 40 Hertz, the press wrongly concluded that the CD-4 recording must be limited about 100 Hz minimum. This is not so. (Normal stereo cutting techniques can go as low as 10 cycles but no one can hear it, most phono pickups cannot pick it up, and many record manufacturers cut off almost everything below 50 Hertz anyway.) Current recording practice brings the frequency range down to 40 Hertz and below when needed. CD-4 recordings match stereo recording playback frequency range.

Though the best Shibata-equipped phono-pickups track at forces about 1 to 1½ grams above that of the best stereo pickups, the Shibata stylus contacts a larger

area of the groove. Thus, the actual pressure of the stylus on a unit area of the groove wall is not higher than an elliptical.

**To Keep The Subcarrier . . .** CD-4 pickups must be used with low-capacity cables supplied with the demodulator. The turntable's standard shielded output cables cannot be used because they attenuate the high-frequency subcarrier output from the CD-4 phono pickup. Most better turntables have standard phone jacks concealed under the turntable. Simply unplug the standard shielded cables and substitute the low capacity cables. Empire turntables have a special connecting jack with attached cables for which an adapter plug for low capacity cables is available from CD-4 equipment manufacturers. Try not to use cable extensions. If you must, be sure to use only low capacity cables.

#### **What Does The Future Hold For CD-4?**

More and more equipment manufacturers will switch to CD-4 as they have done in the Orient and Europe. A holding down of record costs will spirit buying by the consumer, producing a bonus crop of new CD-4 recordings as the market volume blossoms. Even CD-4 FM broadcasts are in the works. Extensive successful field tests and actual broadcasts in San Francisco and Toronto have proven CD-4 broadcasts to be technically feasible. The FCC is currently studying proposals for Quadrasonic FM broadcasting. The future is bright for CD-4, the *compatible, discrete 4-channel* audio system. ■

**Lafayette LA-524 Decoder/Amplifier**  
Circle No. 43



**Fisher 801 4-Ch Receiver**  
Circle No. 45



**JVC 4VC-5244 Changer w/CD-4 Demodulator**  
Circle No. 44



**Pioneer QA-800A 4-Ch Integrated Amplifier**  
Circle No. 46

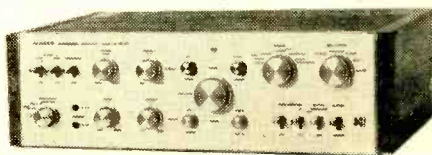

# Four Ways To 4-Channel



◀ From Marantz, the 4415 Quadradial will synthesize 4-channel sound from any stereo source, and decode any matrix-encoded disc or FM broadcast. With Marantz's Gyro-Touch tuning, you rotate the actual tuning flywheel for more accurate tuning. The 4415, rated at 60 watts rms total, is \$399.95. The RC-4 remote control is \$39.95. Circle No. 50 on the Reader Service Page.



◀ The Concord CD-8-4 is a 2/4-channel 8-track cartridge deck with a computer-type readout of channel and program selection. The illuminated Program Selector pushbutton allows manual selection of programs, and also indicates the program playing. The CD-8-4 has adjustable output-level controls, and is priced at \$99.85. Circle No. 51 on the Reader Service Page.



◀ The JVC 4VN-990 four-channel integrated amplifier is rated at 280 watts total dynamic power (IHF), and features four independent VU meters and level controls. The tone-control system permits altering the level of sound at or around five center frequencies: 30, 250, 1,000, 5,000 and 15,000 Hz. The 4VN-990 is priced at \$469.95. Circle No. 52 on the Reader Service Page.



◀ Electrographic's 447C combines an AM/FM quadrasonic/stereo receiver, a tape playback mechanism for 8-track or discrete 4-channel cartridges, and four full-range air-suspension speaker systems with horn diffusers. The amplifier is rated at 200 watts (IPP), and the receiver has individual slide volume controls for the four speakers. The 447C is \$329.95. Circle No. 53 on the Reader Service Page.

## DOUBLE-DUTY SKYHOOK HELPS...



# FLAG DOWN THAT DX

by Elmer C. Carlson

**I**F the neighborhood vigilantes come to lynch you every time they get a little squiggle in their TV picture, it's time to run up the flag and take down your attention-getting antenna. Don't quit! Just go underground with this flagpole antenna. If you carefully hide your antenna lead, the neighbors will never suspect a thing and go looking for someone else to blame for their TVI.

**Easy To Build.** With our flagpole antenna you put together your own flagpole. Sometimes it's almost impossible to find a ready-made flag pole, but you can put together a flagpole using the simplest of hand tools, a little effort, and low-cost materials available from any well-stocked hardware or building supply store.

For SWLing and BCB DXing the antenna length can be as long as practical. But remember, the flagpole also has to hold the flag on those 8 or 10 flag raisin' holidays in each year. If you don't run up that flag, the neighborhood vigilantees might just get suspicious and come knocking at your door once again!

The length of the flagpole antenna isn't really critical because the "flagpole" can be tuned either electrically or mechanically. For easier construction, break down the project

into four separate tasks: assemble the flagpole, bend the TV-mast brackets, attach the brackets to the house, and the final assembly, erecting the flagpole. Actually, more than half of the work can be done indoors with just the final assembly being done outdoors.

**Flagpole Assembly.** First, the lengths of aluminum pipe or thick-wall tubing must be joined. If the "flagpole" is to be no more than 14½ feet in length, only two sections will have to be joined. For a "flagpole" between 14½ and 21 feet, three lengths must be joined. To reinforce the joint, drive a tight-fitting dowel into the smaller diameter section of the two lengths to be joined. The length of the dowel used should be somewhat longer than the amount of overlap in the two lengths of aluminum pipe. For example, if there is an 18 inch overlap—18 inches of the smaller diameter tube telescoped inside the larger—you should use about 24 inches of dowel.

Next, mark the aluminum pipe to show how much of the smaller diameter pipe should be telescoped into the larger diameter pipe. Put marks on the larger diameter pipe at 4 and 14 inches. Now telescope one pipe into the other and drill a 7/64-inch hole (or

## E/E FLAG DOWN THAT DX

use a #35) at least  $\frac{1}{2}$  inch deep into the pipe at the 4-inch mark. Drive a #8 gimlet-point pan-head sheetmetal screw into the hole. Now drill the second hole, at the 14-inch mark.

It is important to drive that first screw into its pilot hole *before* drilling the second hole as this will make sure that both sets of holes through the sides of the pipes are properly aligned when you drive the screw into that second hole. At this time you can remove that first sheetmetal screw and separate the pipes if it's more convenient for you to store the flagpole temporarily or to carry it out of the workshop.

If three lengths of pipe are to be used, just repeat the procedure for the second joint.

Before you go running outside with the "flagpole" be sure to attach the top ornament or cap (from the flag set) to the end of the top section of the flagpole. And don't forget to attach the small awning pulley to the cap. Once attached, the cap and pulley do not have to be removed.

**Bracket Bending.** If you can mount the TV antenna wall brackets on the side or end of the house, you won't have any bracket bending to worry about. Unfortunately, such installations are rare because they are not usually practical or architecturally suitable for an honest-to-goodness flagpole.

But it's easy to bend the low-priced wall brackets so they will hold the "flagpole" at an angle when one bracket is mounted on the house proper and the other is attached to the eaves of the roof. Even if you don't have a bench vise, it's still not difficult to bend the brackets. Instead of a vise you can use a large adjustable open-end wrench.

After both legs of the bracket are bent, place the bracket on a flat surface to see if the bracket has enough angle to it. (You can put the other half of the dowel into the clamp of the wall bracket to get a better idea of what the angle of the "flagpole" will be.) When you are satisfied with the angle the bent bracket will give the "flagpole," just bend the second bracket to match the angle of the first bracket.

**Attaching The Brackets.** First attach the upper bracket to the eaves of the roof. You can use #14 round-head wood screws, but

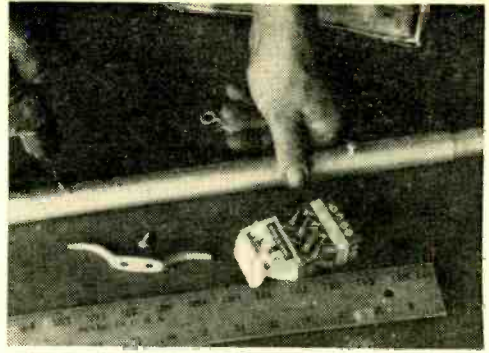

Items used are found in most hardware and building supply stores. Holes through pipe and dowel are shown drawn on the next page.

### Bill of Materials

Flag set (one with a 3 x 5-foot flag)  
8-foot length  $\frac{3}{4}$ -in. o.d. ( $\frac{1}{2}$ -in. i.d.) aluminum pipe  
8-foot length 1-in. o.d. ( $\frac{3}{4}$ -in. i.d.) aluminum pipe  
3 or 4-foot length  $\frac{1}{2}$ -in. o.d. hardwood dowel  
4-inch TV mast bracket (Radio Shack 15-883 or equiv.)  
25-foot length of venetian-blind cord  
Small awning pulley (one required)  
Small awning cleat (one required)  
Small lanyard clips (two required)  
Miscellaneous,  $\frac{1}{2}$ -in. number 8 gimlet-point pan-head sheetmetal screws, lag screws, flat washers, masonry anchors or toggle bolts



A small lead weight sewn into the bottom corner of the flag will prevent it from becoming wrapped during a windy day.



lag screws are a lot easier to work with on a ladder. The square head on the lag screw makes it easy to tighten with a wrench, while the wood screws need considerable effort and pressure to keep a screwdriver in the slot. Applying enough pressure to a screwdriver while at the top of a ladder isn't easy—or very safe either.

Once the upper bracket is attached to the house, insert the bottom section of the mast into the clamp. Tighten the clamp with your fingers just tight enough to help hold the bottom section of the "flagpole" while you adjust it to match the angle of the bent wall brackets.

Attach the lower bracket to the bottom section of the "flagpole" about 3 inches up from the end. If you don't think your eye is good enough to set the "flagpole" straight

insulate the antenna since roof flashings (those metal edgings) and rain gutters would seem to be useful as conductors for added signal pick up. Sure, they can give you more signal, but sometimes they can give you less. Those additional conductors can add directional effects to your almost vertical flagpole antenna, instead of more signal you'll get less signal from some directions. Be safe. Insulate! Afterwards you can test the effects on the SWL and BCB signals by using short jumpers or clip leads to connect to those handy flashings and gutters. Remember, these additional conductors may improve signal strength on some frequency bands or from some directions while making the reception of signals worse for other frequency bands or directions.

The insulating material you use is not too important. It should not be too soft and it should not readily absorb water. Wide plastic tape or strips of plastic (cut from milk or liquid detergent containers) can be wrapped around the "flagpole" and field in place with tape or cord. The thicker the insulation the better, just don't make it so thick that it won't fit in the clamps of the wall brackets.

**Erecting The Flagpole.** This last step includes the final assembly. Join the lengths of aluminum pipe and then thread the venetian-blind

**Large diameter tube fits into a smaller tube with hardwood dowel for support and added strength.**

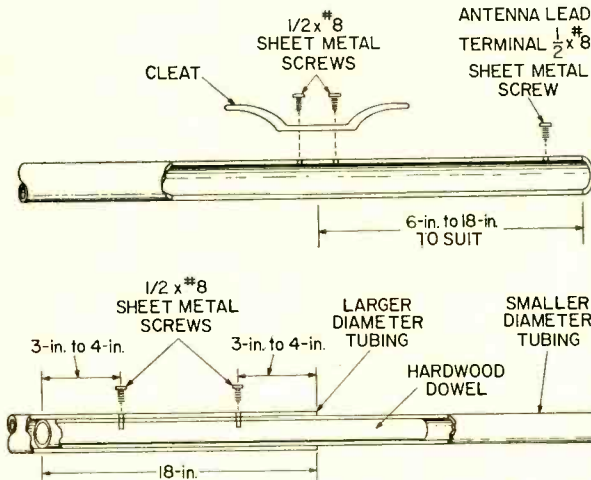

out from the side of the house you'd better use a level. While holding the level against the side of the pipe, mark the location of the holes of the bracket on the wall. Also mark the position of the upper bracket on the mast, and the top and bottom edges of both clamps before you take the mast down. These marks will show where the antenna insulators must go if they are needed. If your wall is a non-conductor, like wooden lap siding or asbestos siding, you may not need insulators if the climate is dry. Attach the lower bracket to the wall of the house. If the wall is brick or concrete you'll need expansion anchors. For a cinder block wall you may need toggle bolts if you drill into one of those open areas of the block. For wooden or asbestos siding you can use lag screws.

**Antenna Insulators.** For SWLing and BCB DXing it may not seem necessary to

cord through the awning pulley. Be sure to unroll the complete length of cord and tie the two ends together to prevent their slipping out of the pulley. Now all you have to do is slip the flagpole into the loosened clamp of the lower bracket and replace the clamp of the upper bracket.

**Finishing Up.** All the hard work is finished—just a few final touches left and then you'll be all through. Drill two more holes to attach the lead-in wire and the cleat (to hold the rope) to the "flagpole" antenna. If you tie down the lead-in wire with nylon fish-line or lacing cord, the lead-in will be almost invisible except for close inspection. Tie a pair of lanyard snaps to the ends of the venetian blind cord to make it easy to attach and remove the flag. Wrap the loose end of the rope around the cleat, connect the other end of the lead-in to your receiver. Tune across the band and see who QSLs. ■

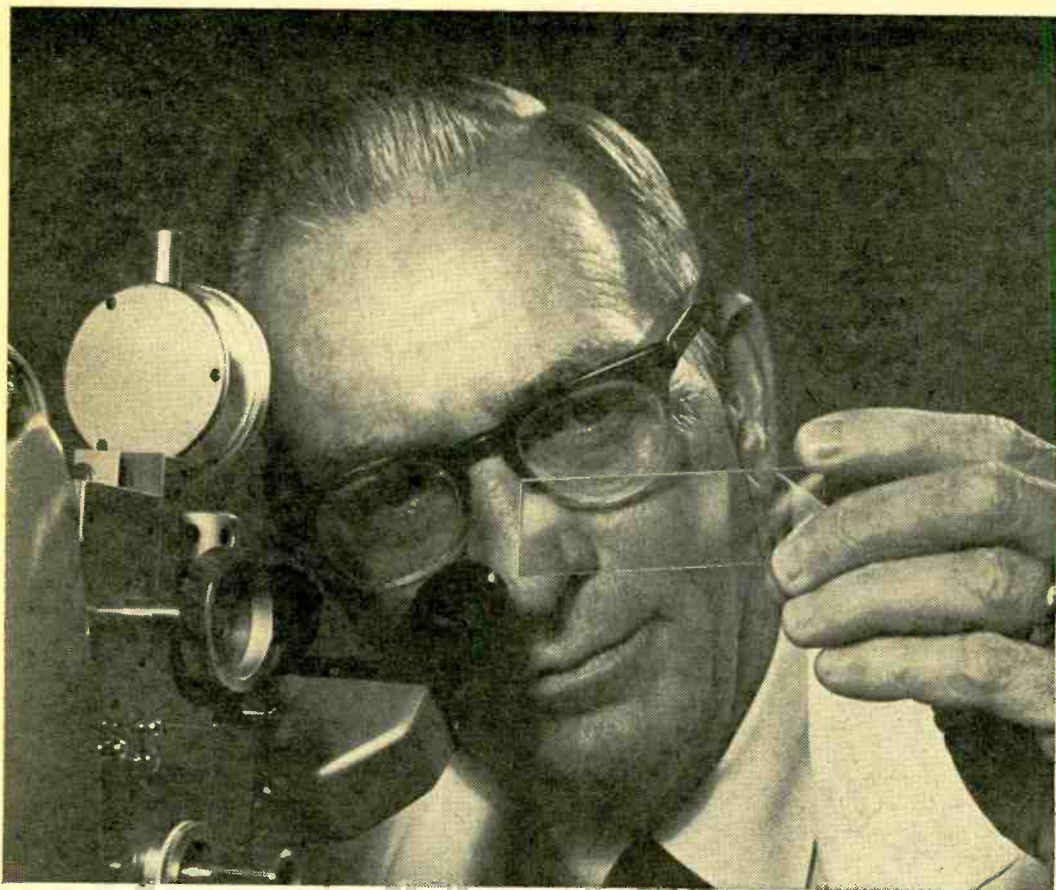

# NTS Home-Training in Electronics was the start of something big for James Gupton

## **An NTS Graduate**

James A. Gupton Jr. graduated from National Technical Schools with a diploma in TV & Radio Servicing. Today, he's a mighty important man in the world of Electronics!

Research associate with a major electronics corporation; author of numerous articles in electronics magazines; an inventor with five patent applications to his credit. In the field of electro-optics, he has perfected a revolutionary phosphor deposition technique for cathode ray tubes.

Quite a list of accomplish-

ments for a man who began his career with an NTS diploma and a job in TV & Radio servicing.

## **Any student can succeed**

James Gupton is certainly an exceptional NTS graduate.

He proves there's nothing to keep a determined man from becoming a success in Electronics.

As he himself says, "Any student, properly motivated, can succeed in Electronics through home-training."

Every NTS Electronics Course is specially designed to keep you motivated from the time you

start building your first test instrument until you're ready to plug-in your solid-state Color TV or other advanced electronics equipment.

## **Exciting "Project Method" Training**

NTS Project Method Training is the best way to learn electronics.

You build advanced equipment while you learn Electronics principles and applications.

Each week brings new excitement when you actually see the progress you've made.

# NTS builds self-confidence.

For a man to become successful, like James Gupton, he must have confidence in himself.

As an NTS graduate you have this confidence. Your training is practical and thorough. You know Electronics from the bottom up. You enter a world of Electronics you're familiar with.

And if you have the drive and determination of a man like James Gupton, there are no limits on your success!

(James Gupton's address available upon request).

## NTS COLOR TV SERVICING



Solid-state  
315 sq. in.  
Heath Color TV

Build and keep the largest, most advanced color TV made! Over-all solid-state design, ultra-rectangular screen, matrix picture tube, built-in self-servicing features, "Instant On," A.F.T., solid-state, 24-channel detent UHF/VHF power tuning, and much more! Also build and keep AM-SW Radio, solid-state Radio, FET Volt-Ohmmeter, and Electronic Tube Tester. Learn trouble-shooting, hi-fi, stereo, multiplex systems, radio, color and B&W TV servicing.

## NTS B&W TV SERVICING

Learn sophisticated solid-state circuitry as you build this B&W TV Receiver, Lo-Silho "Superhet" Radio, FET Volt-Ohmmeter, solid-state Radio, Electronic Tube



Solid-state  
B&W TV,  
74 sq. in.  
picture  
(cabinet  
included)

Checker, and Signal Generator. TV and all other equipment are yours to keep.

## NTS ELECTRONIC & COMPUTER TECHNOLOGY

Solid-state  
Compu-Trainer  
14 integrated  
circuits  
replace 198  
Transistors!

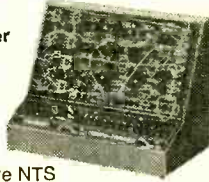

Build and keep this exclusive NTS Compu-Trainer. It teaches you the same principles used in million-dollar systems. Contains 14 integrated circuits! All solid-state! You perform all wiring and patchcording. No shortcuts. No pre-wired circuit boards. Your training is complete! Also receive a FET Volt-Ohmmeter and a 5" wide-band solid-state Oscilloscope.

## NTS ELECTRONIC COMMUNICATIONS

Gain the prestige and earning power of owning and F.C.C. First Class Radio-Telephone license. Two comprehensive NTS Courses cover the big opportunity field of transmitting and receiving.



5-watt AM  
Transmitter/  
Receiver

You build and keep 14 kits, including this amateur phone 6-meter VHF Transceiver, NTS's exclusive 6-transistor solid-state Radio, and a fully transistorized Volt-Ohmmeter. Also, learn 2-way radio, Citizens Band Microwaves, and radar.

## NTS INDUSTRIAL & AUTOMATION ELECTRONICS

Automation is the future of industry, and you can play an important part! Learn industrial controls by training on the NTS Electro-Lab (a complete workshop). You also build and operate this 5" solid-state

oscilloscope. And you perform experiments that involve regulating motor speeds, temperature, pressure, liquid level, and much more. All equipment is yours to keep.

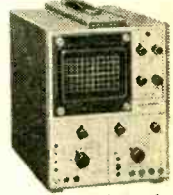

All solid-state!

## NTS AUDIO ELECTRONICS SERVICING

Learn sound theory — how it works in home radio, car tape decks, stereo multiplex component systems, and more! Set up a spectacular music system. Learn about sound distortion, amplification and control, loud-speaker baffles, problems of system installation, etc.

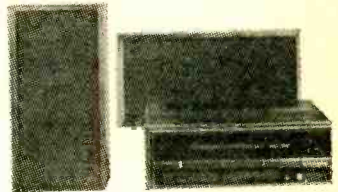

Build and keep this famous Heath  
Stereo Receiver and Speakers

Included is Volt-Ohmmeter, In-Circuit Transistor Tester and solid-state Radio. Prepare yourself for great opportunities in the Home Entertainment Industry!

## CLASSROOM TRAINING AT LOS ANGELES

You can take classroom training at Los Angeles in sunny Southern California. NTS occupies a city block with over a million dollars in technical facilities. Check box in coupon below

## APPROVED FOR VETERAN TRAINING

Accredited Member: National Association of Trade and Technical Schools; National Home Study Council.

## NATIONAL TECHNICAL SCHOOLS

World-Wide Training Since 1905  
Resident & Home Study Schools  
4000 S. Figueroa St., Los Angeles, Ca. 90037

Dept. 222-073

Big, Colorful NTS Guide to new opportunities in Electronics. Yours FREE!



**NATIONAL TECHNICAL SCHOOLS**  
4000 S. Figueroa Street  
Los Angeles, California 90037

Please rush me FREE Color NTS Electronics Guide & FREE lesson, plus information on course checked at right. No obligation. No salesman will call.

- MASTER COURSE IN COLOR TV SERVICING
- COLOR TV SERVICING (FOR ADVANCED TECHNICIANS)
- MASTER COURSE IN B&W TV & RADIO SERVICING
- MASTER COURSE IN ELECTRONIC COMMUNICATIONS
- PRACTICAL RADIO SERVICING
- FCC LICENSE COURSE
- MASTER COURSE IN ELECTRONICS TECHNOLOGY
- AUTOMATION & INDUSTRIAL ELECTRONICS
- COMPUTER ELECTRONICS
- BASIC ELECTRONICS
- AUDIO ELECTRONICS SERVICING

NAME \_\_\_\_\_ AGE \_\_\_\_\_

ADDRESS \_\_\_\_\_

CITY \_\_\_\_\_

STATE \_\_\_\_\_ ZIP \_\_\_\_\_

- Check if interested in Veterans Training under new G.I. Bill.
- Check if interested ONLY in Classroom Training at Los Angeles

CIRCLE NO. 26 ON PAGE 17 OR 101

# Put that Clock



By F. J. Bauer W6FPO

When the clock radio blows, it is hardly worth your while trying to find out why the radio chassis quit. Unless the trouble is something obvious like a bad electrolytic capacitor or output transistor, why not replace the AM radio chassis with a new one? If you have a portable transistor radio with a broken case or a bad speaker, you can use it as a replacement chassis by making a simple change in the clock radio power supply. If you have no spare transistor radio, you could install a code practice

oscillator in place of the radio. It will not awaken you to music, but it will wake you up with the tone of your choice.

**Radio-Fix-It.** If you decide to replace the AM radio chassis with working unit, it is a good idea to retain the tuning capacitor and audio gain control of the original clock radio. The original knobs may then be used without the bother of having to mate them to replacement control shafts. The only catch is that the tuning capacitor of both receivers should be electrically identical for proper tuning.

Simply remove the mounting plate with the controls on it from the defunct chassis and wire the assembly to the replacement chassis after removing the old tuning capacitor and gain control. The additional lead lengths make no difference in the performance of the replacement set. Also, the modification will not affect tuning dial settings noticeably, since these receivers have only an approximate tuning scale. However, play it smart, keep the leads reasonably short. This completes the mechanical job of adapting the replacement AM chassis to the cabinet.

Many clock radio chassis run on a 15-VDC supply instead of the usual 9 VDC for portables. If your replacement chassis is designed for 9 VDC, you may still use the

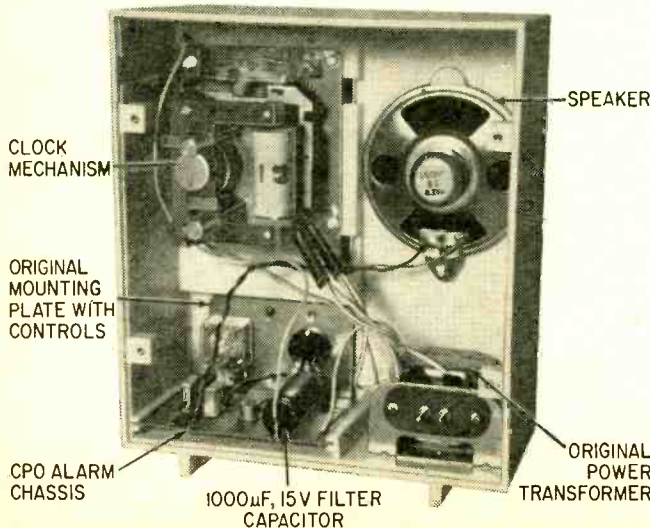

Here's a great way to salvage a good clock that caught radio failure! The Rx includes either a new transistor radio chassis or your own home-built one-transistor tone generator. Either way, your sack-time terminator doesn't sound quite as harsh when you revamp it yourself. Or does it?

# Radio Back on the Job...

original power transformer in the clock radio, but it will be necessary to add a dropping resistor in the DC filter circuit of the power supply. See the *Power Supply* schematic diagram. Experiment with the value of the series dropping resistor, R1, until the voltage to the chassis is about 9 VDC. Start with, say, 1000 ohms and *gradually decrease* the resistance value until the proper voltage is obtained with the AM radio volume set at minimum. A convenient way to do this is to use a potentiometer. There is no danger of damaging the potentiometer since the power dissipated is only a fraction of a watt. Remove the potentiometer from the circuit and replace it with a one-watt fixed resistor that closely approximates the potentiometer setting. Insert the fixed resistor into the circuit and recheck the voltage.

Now check the performance of the receiver at normal volume. The power supply voltage will drop on volume peaks, but not enough to cause serious distortion.

**Add A Tone.** If you have no suitable AM chassis available as a replacement, why not install a code practice oscillator instead? Its

dulcet tone will awaken you just as readily as any local radio station would. A suggested circuit for the CPO, using a minimum of parts, is shown in the *CPO* schematic diagram. The oscillator requires 3 volts, or so, for proper operation and a series dropping resistor, R1, in the filter circuit should be selected as described previously to give this output voltage.

The 5000-ohm potentiometer, R2, should be adjusted for a pleasing tone and, if you prefer, replaced with a fixed, 1/2-watt resistor of the nearest standard value. In some cases, it may be necessary to add a capacitor, C2, across the primary of T2 to get the tone you want, since the frequency of oscillation of the oscillator depends to a degree upon the characteristics of the transformer used. Do not use a capacitor larger than .25  $\mu$ F. It may result in unstable oscillation and low output. After the capacitor is permanently installed readjust R2 for a pleasing tone and check the oscillator for prompt starting.

That's all there is to giving the old clock radio a new lease on life. Pleasant dreams! ■

## A BUILD IT FAST PROJECT

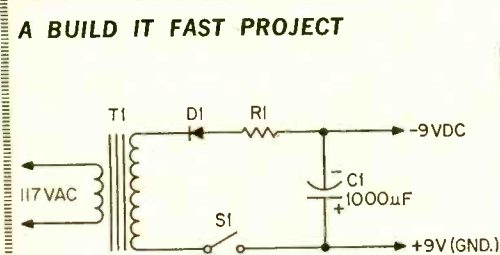

### PARTS LIST FOR POWER SUPPLY

- C1—1000- $\mu$ F 15-VDC electrolytic capacitor. (Use capacitor in clock radio or replace with Radio Shack 272-1008, or equiv.)
- D1—Diode rectifier, 200 PIV, 1A (Use unit in clock radio or replace with Radio Shack 276-1102, or equiv.)
- R1—1/2-watt resistor (See text for selecting value)
- S1—SPST switch (Alarm switch in clock movement)
- T1—Power transformer (Use unit in clock radio or replace with 115-VAC primary; 12-VAC, 1.2-A secondary; or Radio Shack 273-1505)

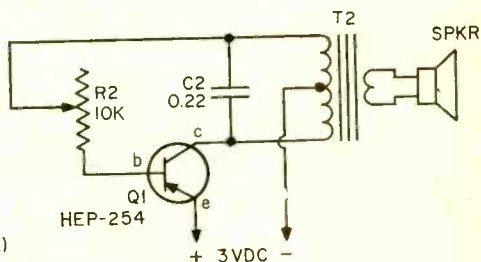

### PARTS LIST FOR CPO

- C2—0.22- $\mu$ F, 100-VDC disc or tubular capacitor. (Radio Shack 272-1070, or equiv.)
- Q1—Audio transistor, PNP, 2N427, 2N396, SK3004, HEP-2, HEP-254, etc. (Radio Shack 272-2005, or equiv.)
- R2—5000 or 10,000-ohm potentiometer, taper not critical (Radio Shack 271-218 or equiv.)
- SPKR—Use original unit in clock radio or replace with speaker with same physical dimensions.
- T2—Audio output transformer (Salvage from old transistor radio or Radio Shack 273-1381, or equiv.)



# Hands Down Identifier

Your hand is your face to this strange box with finger grooves. The box, we'll call it Geomind, measures the human hand geometry and uses it like a fingerprint to determine to whom the hand belongs. In actual use at some banks and at SAC's headquarters, you approach a guard station and insert an ID card into Geomind. Your right hand is placed on a platform with slots and

posts that fit in between the fingers. If the geometry of your hand matches that encoded on the card, the machine tells the guard it's okay for you to pass.

A common feature of the hand is duplicated about one per thousand and as Geomind works on some 35 different geometrical measurements, the likelihood of Geomind making a mistake is very small.

So small, in fact, that the hand can be used as a key to have Geomind unlock hospital drug supplies, police arms rooms, bank vaults, etc. One thing Geomind can't do—it can't read your palm. ■

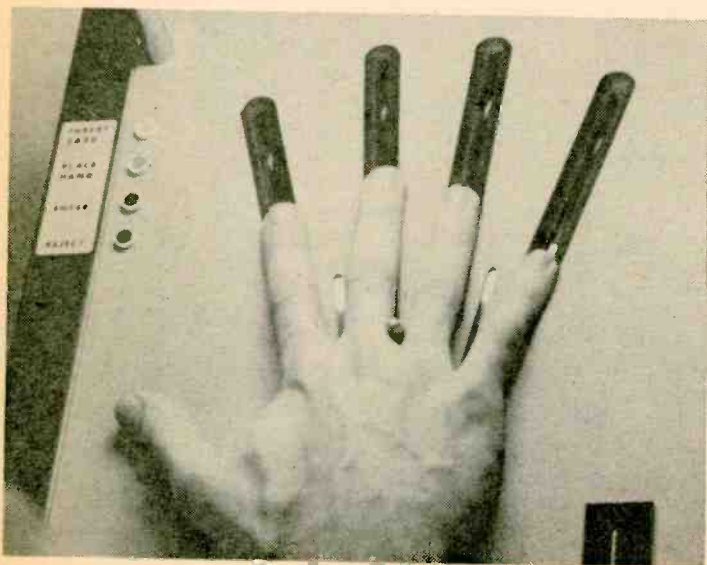

With the ID card in the slot at lower right, and the hand in place, Geomind is making an automatic identification.

by Emmett Fluffin

e/e  
checks  
out a...

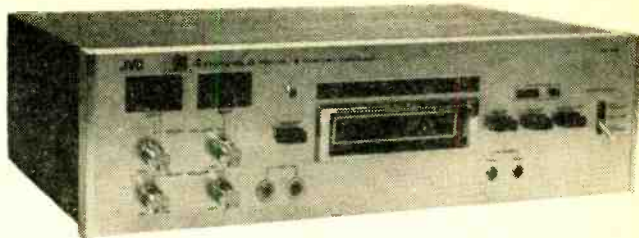

## JVC 8-Track Player/Recorder

Model 4ED-1205 has outstanding record performance, handy elapsed-time meter

**T**HOUGH the 8-track stereo cartridge player sells by the thousands, if not millions (eventually), it is nevertheless true that it hasn't made a dent in true high fidelity installations. The same stereophile who uses a cartridge player in his car will most likely use a cassette for in-home recordings.

The chief reason the cartridge player or recorder hasn't made it in hi-fi is simple to understand: the typical cartridge equipment lacks a counter, if not a fast forward. There is virtually no way to skip ahead to a desired program, nor is there any easy way to know how much recording time is left (assuming you record your own cart's.)

But the new JVC 4ED-1205 cartridge deck now changes the picture, and the cartridge deck is ready for real hi-fi use—and all it took was the addition of an *elapsed time counter* and a *monitored fast forward*. As you'll see, it's a wonder no one thought of these inexpensive ideas before.

The JVC cartridge deck is a 4-channel/2-channel player or a 2-channel recorder. The playback mode is automatically determined by a coding notch moulded into the case of prerecorded cartridges. Four channel cart's have this notch, and when the player senses the notch it automatically switches to 4-CH play. Stereo (and older mono) cart's do not have this notch, so the player automatically switches to stereo (2-CH) operation.

**The Extra Touches.** Unlike many other cart players which have one master output level control, or no control at all, the 4ED-1205 has individual output controls for each channel, so you can precisely balance the cart player output without disturbing the balance controls of your main quadrasound amplifier—or your stereo amplifier if you haven't yet switched to 4-channel. Two controls used for the left and right front output also serve as the stereo record level

controls, and two independent, calibrated VU meters for left and right front are provided. The signal input can be either microphones or line. The line inputs are disconnected when the microphone plugs are inserted.

Moving on, the JVC cartridge deck features a resettable elapsed time counter. This counter is driven directly by the tape transport, so it's accurate for both the play and fast forward. The counter has three digits, two calibrated in minutes and one calibrated from 0 to 60 seconds in 5 second increments. The counter shows how much time you have recorded, so you therefore know how much time is left. For example, assume you are using an 80 minute cartridge. Since you get four stereo programs per cart, each program is 20 minutes. At the end of the program the cartridge player automatically will stop, or will switch to the next program, as you prefer. Now assume you are transcribing (dubbing) 45 rpm records to the cart, and the elapsed time counter shows you have used 18 minutes of tape; it's obvious you don't have enough tape left to record another record on the 20 minute

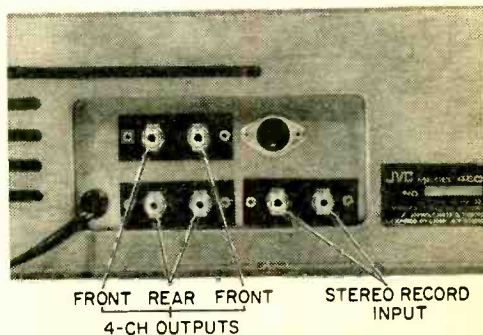

Very simple input/output panel has standard audio jacks that carry a very high quality sound. More info by circling No. 54 on 101.

# e/e JVC CARTRIDGE DECK

program, unless you set the deck for automatic switching to the next program.

**Another Example.** Assume you don't want to hear a complete program, you just want the second selection on the tape. Checking your records you find the second program starts at, say, 2 minutes and 40 seconds. You simply insert the cart, reset the counter to zero, and hold the fast forward button until the counter shows 02.40. Release the fast forward and the cart picks up at the second selection.

The fast forward is really fast, almost 3X, and unlike the typical fast forward it is *monitored*—you hear the program running through at a reduced level. So if you want to cue up within a selection for which you don't have a timing, you won't skip past trying to guess when to release the fast forward. To assist you in both monitoring recordings and cueing without blasting through the speakers, the JVC deck is equipped with both front and rear headphone outputs.

The tape transport has a cartridge-controlled power switch. Inserting the cart applies power and starts the tape drive. Removing the cart disconnects the power. Transport controls include a record interlock, a program selector, a pause control and the fast forward. A blackout indicator strip shows which program is playing or ready to play (if the unit is stopped), the 4-CH or 2-CH mode, and *READY*. The *READY* light comes on when the tape has been cued to the beginning of a program, or if the entire tape has been stopped and it is ready for record or play.

An auto-stop selector determines three modes of tape drive. In the record mode the selector switch will stop the tape after each program or after all programs. In the play mode the selector can stop the tape after each program, after all programs, or will repeat-play the entire tape until manually stopped. The automatic stop modes stop the tape in both normal and fast forward operation.

**It Sounds Good.** As far as sound quality is concerned, the JVC 4ED-1205 is also a winner. The playback frequency response from a standard test tape measured  $\pm 3$  dB from 30 to 10 kHz—the test tape frequency limits.

The overall record play frequency re-

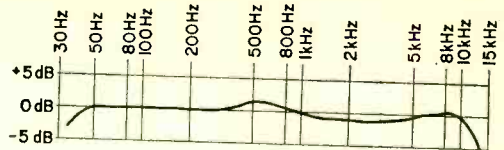

**This would be a particularly smooth record play response from any cartridge deck. But recorded on budget tape, it is outstanding.**

sponse using budget priced Audiotape cartridges measured  $+1.5/-3$  dB from 35 to 12 kHz, with a nice smooth response rolling off at the extreme end frequencies. The machine has a lot more frequency response capacity, and with higher priced cartridge tape the response pushes out beyond 14 kHz.

At the meter-indicated 0 VU record level and 0 VU playback level, the output is 500 mV. With the volume controls cranked wide open, so the VU meters pin, the output level is 1 volt. Separation is 40 dB. With the VU meter indicating 0 VU record level, the distortion measured 2.5% THD with a 46 dB signal to noise ratio. The wow and flutter was 0.16%, an outstanding value for cartridge recorders, as it is a typical value for many high priced reel-to-reel recorders.

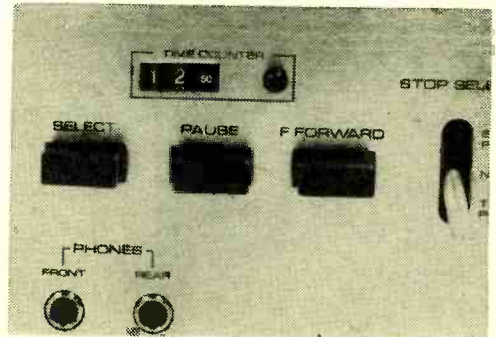

**Here you see a fast forward pushbutton. It doesn't come with many 8-track decks! Also the phone jacks are doubled for 4-Ch sound**

In short, the JVC's high fidelity capacity and performance is so good, certainly equal to the better cassettes, that the addition of a noise reduction system (such as a Dolby) as you would use for a cassette makes it completely suitable for hi-fi installations. And you get the extra of being one notch up on quadrasound.

**Summing Up.** From any viewpoint, the JVC 4ED-1205 is an outstanding cartridge deck. It will serve as the standard of reference for other new models. For further information circle No. 54 on the Reader Service Page.



# Tape or Disc, even Off-The-Air!

## MAKE BETTER RECORDINGS

An Editing Guide For Tape Audiophiles

**M**AKE A PERFECT TAPE RECORDING the first time around with our edit as you record technique. Here's a method that will permit you to make clean, professional sounding recordings with no *bloops*, *plops* or *burps* in evidence. The procedure applies equally to mono or stereo recording; the only difference is that, for stereo recording, proper channel adjustment and balance must be achieved *before* recording. Of course it goes without saying that all recording equipment must be in top shape both mechanically and electronically if good results are desired.

**Disc To Tape.** The simplest recording problem you are likely to have is transcribing disc recordings onto magnetic tape. The procedure is self evident, but certain precautions must still be observed if the results are not to be amateurish. For instance, as

the record changer drops a record and the pickup arm engages the disc, a plop will be heard as well as a scratching noise as the pickup stylus engages the recording groove. This can be annoying and also advertise the fact that the tape was made from disc recordings.

The proper way to make such a recording is to play part of the first selection and note the proper recording level. Now return the recorder gain to zero, start the changer, wait for the pickup arm to engage the record groove, and then quickly set the recording level at the previously determined setting. Once the recording has started, do not make any recording level adjustments, ie ride the gain. This has already been done for you by the record manufacturer.

Similarly, at the end of the first recording, fade down rapidly after the music stops and keep the recorder gain down to zero until the pickup arm engages the next record. Then quickly set the recorder to the predetermined level before the next selection.

Everybody knows how economical it is to copy favorite music from FM radio as this amateur recordist is doing. But not everyone realizes how not to sound like an amateur! Get an important hint or two from this article by . . .

F. J. Bauer W6FPO



# e/e MAKE BETTER RECORDINGS

This procedure takes a little practice in coordination, but in no time at all you will get the knack and produce a perfectly quiet pause between recordings every time. If you should goof, merely rewind to the end of the last selection, play the end, leave a short blank space, and continue your recording as before. There procedures are summarized in Fig. 1, below.

Cut out and tape to your recorder

## Tape Dubbers Guide For Better Recordings

1. Determine proper recorder gain setting with a trial run.
2. Start disc or tape player.
3. Start recorder *then* set recorder gain to predetermined level before selection starts.
4. Return recorder gain to zero if noise is anticipated between selections, *then* return gain setting to predetermined level before next selection begins.

**Air To Tape.** Now that you have mastered the technique of making technically clean recordings, you may like to see what you can do with off-the-air material. This is a more complicated problem than dubbing from disc or tape because the recordist does not control any of the program factors such as announcements, programs material, or commercials.

### Typical FM Station Format

10:00 AM	Sta. Bk.-Time Com. Music (3) (9.5 min.) Com.-Time-Com. Music (1) (3 min.)
10:15 AM	Sta. Bk. Music (1) (3 min.) Com. Music (3) (9.5 min.)
10:30 AM	Com.-Sta. Bk.-Time-Com. Music (3) (7 min.) Com.-Sta. Bk.-Com.
10:45 AM	Music (3) (9.5 min.) Com.-Time-Com.
11:00 AM	Music (2½) (2 min. 45 sec.) Com.-Time-Sta. Bk.-Com. Music (3) (9 min.) Com.-Time-Com.
11:15 AM	Music (1) (3 min.) Sta. Bk.

Fig. 2. Station programming follows a pattern

Your first step making good off-the-air recordings is to study the program format of the station. Make a list similar to the one shown in Fig. 2. It lists the sequence of events such as frequency of commercials, number of musical selections played without a break, and announcements. Such information will help you anticipate unwanted material so that it may be left out of the recording.

For a first try, you should make a few background music tapes. Start recording your first number and keep on recording until you run into an announcement or a selection you do not want. Stop the recorder, put it in the PLAY mode, and cue in the tail-end of the last selection. Put the recorder in the RECORD mode and, with the gain control completely off, run a two or three second silent strip on the tape. A little practice will make you perfect! You are now ready to pick up the next number.

Once you familiarize yourself with this procedure, you will be surprised how quickly you can recover and cue-in the next selection. It is actually quicker and easier to do than describe. As a matter of fact, you should be able to reset in less than sixty seconds the average time for a single commercial.

This technique, of course, presupposes that you can monitor the program while you are going through these gyrations. Most recording setups permit hearing program material as background when the recorder is in the play mode, so it is relatively easy to cue-in your recorder for the next selection and, at the same time, monitor the program.

**More Pro Pointers.** The same general operating techniques also apply when recording programs other than background music such as symphonies, operas, musical shows, etc. This material, nevertheless, has its own special problems. Unlike background music, a selection spoiled cannot be eliminated since it is part of the complete performance. To further complicate the problem, the unwanted announcement may be very short, thus not allowing sufficient time for resetting the recorder and cueing-in.

When this occurs, the first rule is don't panic! Fade the program out immediately and stop the recorder. This will give you a glitch on the recording followed by a two second or so silent period. When the program resumes, just continue recording as

(Continued on page 95)

# Over Hell's Inferno

## Flies



## LARP

**An expensive toy to some, a budget angel to others,  
this radio controlled drone fights fires its way!**

by Emmett Fluffin

**T**he flying or drone model aircraft is a fascinating pastime for thousands of hobbyists, but to the United States Forest Service it's a serious business. The service has recently developed the "LARP" (Low Altitude Retriever Probe) to help in their never ending effort to cut forest and brush fire losses and save the lives of firefighters who are endangered by erratic weather conditions.

Flying high above the windswept Californian canyons, the drone (which has a wing span of 70 inches and can fly at up to 10,000 feet) carries a compact 3 lb. payload of instruments which measure and record pressure, humidity and temperature of the air.

These climatic factors give a "3D" picture of the weather over fire areas and are analyzed with information from other sources to determine the behavior pattern of the winds. "Increased knowledge of wind behavior and weather conditions allow firefighters to anticipate problems of control during fires and indicate what sort of action should be taken," says Mark Schrodder, chief of the fire laboratory's Fire Meteorology Project. He adds: "The knowledge of weather above a fire area helps us base our decisions on educated guesses. This results not only in a decrease in the acreage ravaged by the flames, but also reduces deaths and injuries among firefighters."

The LARP is actually a radio-controlled drone which is remote controlled from the ground by the means of a small transmitter and control panel. The plane is small, light and completely portable. It can be trans-

## e/e FLIES LARP



The LARP's chart recorder (left) weighs only three pounds and can record air pressure, humidity and temperature. The entire system (right) is ready for flight.

ported in a box or a trunk to remote areas and there quickly assembled and launched. In a matter of minutes, after the LARP crew has arrived on the scene, the little plane can be flying into inaccessible areas.

The findings of the sensing instruments in the little plane are recorded by an electronic stylus on a paper-covered rotating drum. When the flight is completed and the "LARP" returns to the ground, recorded data on pressure, temperature and humidity are recovered. The data is then radioed to the nearest weather station where it is, along

with information gathered from other sources, used to complete a picture of the weather conditions in the fire area.

The cost of the development of the Fire Meteorology Project's two original model planes ran into several thousand dollars but the LARP can now be replaced for about \$3,500. In the short time that the drone has been on duty, it has already proven itself an extremely valuable tool. Work has started on more sophisticated machines along the same principle for an even more thorough analyzing of weather conditions. ■



Imagine, grown Forest Rangers getting paid to test fly LARP! Here, two Rangers start LARP's engine (left), preflight tests between transmitter and the LARP's airborne servos (center), and, finally, (right) launch from a homo bipodus.

# Build e/e's... CAP RAPPER

by Herb Friedman

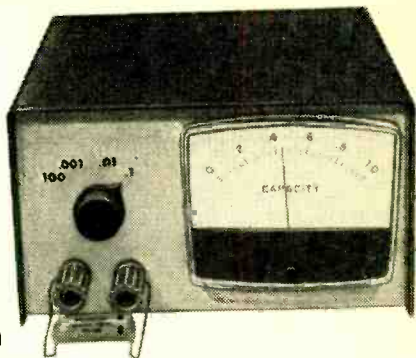

**W**ITHOUT DOUBT a direct reading capacity meter is the fastest and probably the most reliable way to check and sort small capacitor values. Simply place the unknown value capacitor across the instrument's test terminals and a meter directly indicates the correct value with no potentiometers to balance or false *magic eye* indications to confuse things.

Direct-reading capacity meters were once strictly a laboratory item. Now, using modern solid state devices, you can build a high-accuracy model for your own shop for less than \$20—money you'll get back many times over by sorting out those 50 capacitors for a \$1 in a matter of minutes, rather than hours.

Also, because the direct reading capacity meter is so easy to use, you'll no longer get hung up on capacitors which are nowhere near their indicated values. For example, small disc capacitors can easily be 20, 50 and sometimes 100 percent off their indicated value. Now imagine the next oscillator you build that calls for a 20 pF capacitor; after hours of troubleshooting you find it doesn't work because the capacitor is really 50 pF! With a direct reading capacity meter you can, in seconds check each and every capacitor value before it's installed in your project.

The Direct Reading Capacity Meter shown in the photographs checks capacity from 4 pF to 0.1  $\mu$ F in four switch selected ranges. The test voltage applied to the "unknown" capacitor is a square waveform 15 V peak-to-peak maximum, so it's safe for just about all capacitors generally used, and it presents no shock hazard to the user. The overall accuracy is just about 5 percent, allowing for the tolerance of the meter movement itself and the capacitors you use for alignment. In actual practice the overall accuracy can work out to about 3 percent.

**How It Works.** Integrated Circuit 1 is a

multivibrator producing square waves which are applied to the unknown capacitor connected across binding posts BP1 and BP2. The current that is allowed to pass through the capacitor is measured by meter M1, whose scale is linear (no tricky calibration needed). Since the capacitor's reactance determines the current flow, the meter indication is in direct proportion to the total capacity.

Meter calibration is obtained by varying the multivibrator output frequency from approximately 20 to 20 kHz. (The DC voltage applied to the unknown capacitor is essentially 100 mV worse-case, so you don't have to worry about DC voltage ratings.)

Though meter movement M1 is 50  $\mu$ A, a simple-to-make 0 to 1 scale simplifies measurements. Three ranges are indicated as .001, .01 and .1, representing full-scale values. If range switch S1 is set to .01 and the meter indicates .6 the "unknown" capacitor value is .01 x .6 or .006  $\mu$ F. If the range switch is set to .001 and the meter

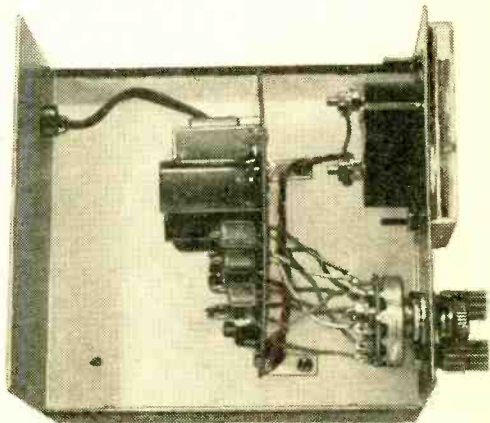

This technical teething ring tells you instantly the value of an unmarked capacitor. All but front panel parts are on a PC board.

# e/e CAP RAPPER

indicates .2, the unknown capacitor is .001 x .2 or .0002  $\mu$ F.

The fourth range switch position is marked 100, meaning 100 pF full scale. This has been done to avoid answers with four or more decimal places and because small-value capacitors are generally marked directly in pF, such as 10 pF, or 68 pF. To obtain the correct value for small capacitors multiply the meter reading by 100 pF. For example, if the meter reads .4 the capacitor value is .4 x 100 pF or 40 pF. In actual practice you won't have to bother

**Use the exact size template found later in article to make your PC board. This somewhat oversized view shows component (top) side of board and X-ray view of copper area.**

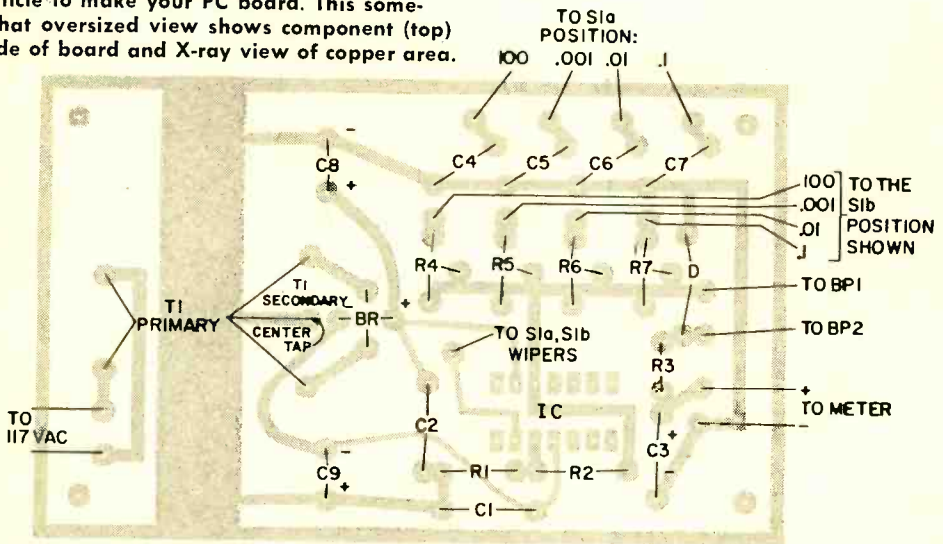

with the calculations as the meter reading will suffice—you'll know that a .4 reading on the 100-scale is 40 pF. The same applies to the other ranges. This procedure is a lot simpler than cluttering up the meter scale with four sets of numbers.

**Putting It All Together.** This is one project in which neatness will work against you, so assemble the capacity meter exactly as described; do not try for square-corner wiring, that's fine for military equipment but not the capacity meter. Where short, direct wires are specified, make them short and direct even if it all starts to resemble a rat's nest. With the assembly procedure specified and shown in the photographs, the meter can read capacitor values below 10 pF; if you get too neat with the wiring between the PC board and range switch, the inherent

instrument capacity can rise well above 10 pF.

The most critical part of the meter is the square-wave generator, so use a PC board as specified; do not substitute point-to-point wiring. There are no stability or accuracy problems if you use the PC layout template.

Note that even though IC1 is the round TO-55 type, we have used a socket. While the socket is not critical, the entire assembly is a lot easier if the socket is used, and it also avoids soldering-heat damage to the IC. IC1's socket is a 14 pin type with only eight terminals used for IC1. Before starting any assembly, fan-out IC1's leads so they match the socket. Using only finger pressure—no tools—fan out IC1 number 1

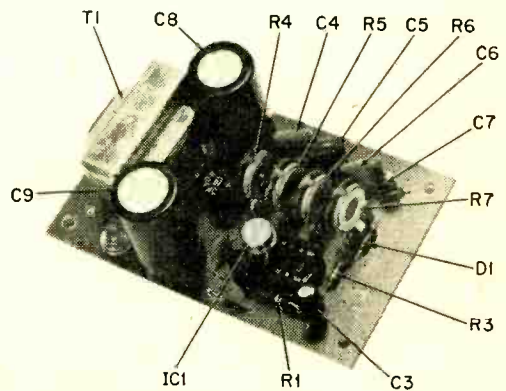

**Most parts are called out in this photo. Also, check the front cover for another (in color) look at the printed circuit board.**

through number 4 leads so they are in-line to one side. Similarly, fan-out the number 5 through number 8 leads so they are in-line on the opposite side. Take careful note that the lead opposite the tab on IC1's case is the number 8 lead—check with the small diagram next to the schematic. Using diagonal cutters, cut *each* group of leads approximately  $\frac{3}{4}$ -in. below IC1's case. You should end up with two sets of leads cut straight across. Using finger pressure, line up each set of leads so they exactly match the socket connections, then insert IC1 into the socket to *open* the socket connections. Remove IC1 and set it

as desired. All other assembly is completed. We suggest you use a Radio Shack IC socket as it is imprinted with a white color dot on one end; you can use this dot to correspond with IC1's tab. When you install the socket on the PC board, the white color dot should face power transformer T1.

**Make The Board.** To make the PC board, first cut a piece of any type of copper-clad board to  $2\frac{3}{8}$ -in. x  $3\frac{7}{8}$ -in. and scrub the board clean with steel wool or a strong household cleanser such as Ajax or Comet; rinse thoroughly and dry. Place a piece of carbon paper on the foil (carbon side against the foil)—and tape the PC board

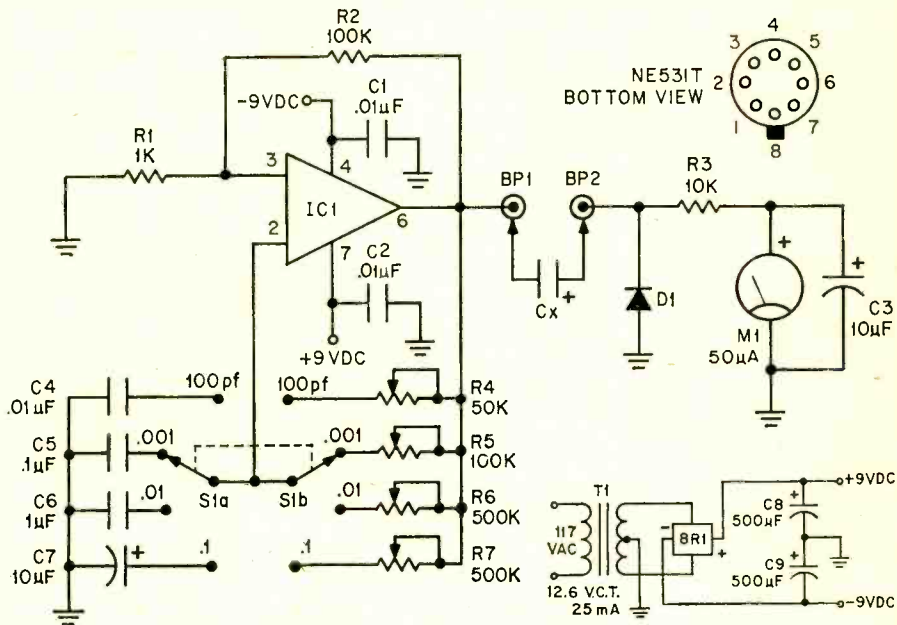

### PARTS LIST FOR THE CAP RAPPER

- BP1, BP2**—Insulated binding post (any style)  
**BR1**—Bridge rectifier, 25 PIV, 100 mA or better (Radio Shack 276-1146 or equiv.)  
**C1, C2, C4**—0.01  $\mu$ F capacitor, 25 VDC or better (Radio Shack 272-1065 or equiv.)  
**C3**—10  $\mu$ F electrolytic capacitor, 6 VDC or better (Radio Shack 272-1002 or equiv.)  
**C5**—0.1  $\mu$ F capacitor, 25 VDC or better (Radio Shack 272-1069 or equiv.)  
**C6**—1.0  $\mu$ F capacitor, 25 VDC or better (Radio Shack 272-1055 or equiv.)  
**C7**—10  $\mu$ F electrolytic or mylar capacitor (see text)  
**C8, C9**—470 or 500  $\mu$ F electrolytic capacitor, 35 VDC or better (Radio Shack 272-1030 or equiv.)  
**D1**—Diode, silicon, 1N456A  
**IC1**—Integrated Circuit, Signetics NE531T (Available from Circuit Specialists Co.)  
**M1**—Meter, 50  $\mu$ A (Radio Shack 22-017 or equiv.)  
**R1**—1000-ohm,  $\frac{1}{4}$ -watt resistor (Radio Shack 271-1800 or equiv.)  
**R2**—100,000-ohm,  $\frac{1}{4}$ -watt resistor (Radio Shack 271-1800 or equiv.)  
**R3**—10,000-ohm,  $\frac{1}{4}$ -watt resistor (Radio Shack 271-1800 or equiv.)  
**R4**—50,000-ohm trimmer potentiometer (Radio Shack 271-219 or equiv.)  
**R5**—100,000-ohm trimmer potentiometer (Radio Shack 271-220 or equiv.)  
**R6, R7**—500,000-ohm trimmer potentiometer (Radio Shack 271-221 or equiv.)  
**S1**—Rotary switch, 2-section, 4-circuit (DP4T, see text)  
**T1**—Low voltage transformer, 12.6 V.C.T., 120 mA (Radio Shack 273-1505 or equiv.)  
**Misc.**—Wire, solder, cabinet  $\frac{5}{8}$ -in. x 3-in. x  $\frac{5}{8}$ -in. (Radio Shack 270-253 or equiv.), etching solution, PC board material, etc.

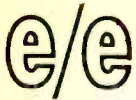

## CAP RAPPER

under the full-scale template provided. Indent the copper foil at each component mounting hole by pressing a sharp pointed tool, such as a scribe or an ice pick, through the template at each hole. Then, using a ball point pen, trace the foil outlines. Remove the copper-clad board from the carbon paper and, using a resist-ink pen, fill in all the foil areas to be protected.

Fill a container with approximately  $\frac{1}{4}$ -in. of etchant and float the PC board on top with the foil side down (foil against the etchant). Every few minutes agitate the etchant container to insure a continuous flow of fresh etchant under the foil. After all the excess copper has been etched away—in about 20 minutes—rinse the board under running water and strip off the resist with steel wool or resist solvent (all PC supplies are available from Radio Shack).

Using the indents in the foil as guides, drill all holes with a number 58, 59 or 60 bit. Then enlarge the T1 mounting holes and the corner mounting holes to clear a number 4 or 6 screw. The two holes near T1 used for the line cord should be enlarged with a number 50 bit.

**Install The Parts.** Install all PC board components starting with the IC socket. Take particular care when soldering the socket leads that you don't get a solder bridge across two leads. Transformer T1 is a miniature 12.6 V center-tapped unit at 120 mA. You can use a transformer rated as low as 25 mA. A transformer larger than 120 mA will not fit on the board.

Take care when mounting bridge rectifier BR1. Note the diamond lead pattern shown in the diagram. If the bridge rectifier you obtain has a different lead configuration, you will have to modify the PC board's foil layout accordingly. Leave approximately  $\frac{1}{4}$ -in. space between the bridge rectifier and the PC board. Make certain filter capacitors C8 and C9 are installed with the polarity correct. The arrow indicating the negative terminal should face the same way on both capacitors. If you use Radio Shack capacitors, the arrows will face the edge of the board where capacitors C4 through C7 are mounted.

After the IC socket, T1, BR1, C8 and C9 are installed, mount trimmer controls R4, R5, R6 and R7 on the board. Control R4,

which is 50,000 ohms, is positioned closest to T1; then comes R5 which is 100,000 ohms and R6 and R7 which are each 500,000 ohms. The ends of the trimmer leads have a small bend at the tip; installation on the board will be much easier if you squash the tips flat with long nose pliers.

Next, install all the resistors, C1 and C2, C3, and diode D1. Bend the D1 leads so the diode body does not touch the R7 wiper terminal. Finally, install capacitors C4 through C7. The mounting holes for C4 through C7 match miniature components; that is, the printed circuit type with both leads out the same end. Any voltage rating from 25 VDC and up can be used. Though capacitor C7 is specified as a tantalum type, the circuit will usually work with an ordinary electrolytic. The tantalum simply insures long-term stability and is not much more expensive than an ordinary electrolytic. Take note that tantalum capacitors generally have the *positive* (not negative) lead marked with a color dot.

**Panel Components.** Meter M1 is 50  $\mu$ A Calectro, chosen to fit the cabinet. Any 50  $\mu$ A meter can be substituted. Using the edge of a knife with care, snap off the plastic cover (the front of the meter) and remove two screws holding the scale in place. Carefully, so as not to bend the pointer, slide the scale out from under the pointer. Using the same dimensions from the 0 to 50 marks, prepare an 0 to 1 scale and cement it to the original scale. Slide your new scale under the pointer, re-install the two screws and snap the plastic cover back in place.

Install M1, two insulated binding posts (BP1 and BP2) and range switch S1 on the panel. S1 can be anything that has two circuits and 4-positions—whatever you can get at low cost. For example, the unit shown uses a surplus three-circuit 4-position switch, the extra terminals aren't used. No power switch is used because the unit is plugged in when it's needed. If you want a power switch place it on the rear apron next to the line cord.

**Final Assembly.** Install the PC assembly as shown; it is positioned about  $1\frac{1}{2}$ -in. behind the back of the meter case. The connections to C4 through C7 should be at the top, and the PC board foil should face S1. Note that a metal chassis mount is secured under one of the T1 mounting screws, providing a ground connection to the cabinet. If you use a different mounting for the PC



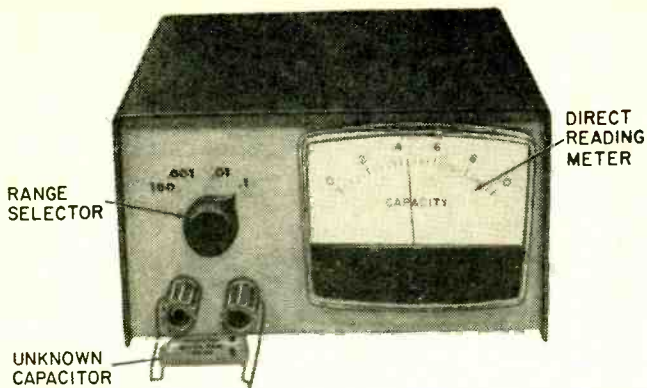

Be sure you understand the operating principles of this direct reading capacity meter. Any capacitor whose value is greater than the range to which you have the unit switched will peg the meter offscale. Simply lower the range switch until the pointer moves back down.

board, make certain you have a connection between the cabinet and the PC board ground foil.

Install the PC-board-to-panel wiring in the following order using the *shortest, most direct connection*. Leave just a smidgen of slack to avoid strain on the wires. Plastic insulated, solid number 20 or 22 wire is suggested. Note that the wires from S1 enter the foil side of the board. Make certain they don't short any components when they pass through to the top of the board. Of course, solder to the foil side of the board.

Since you are measuring capacitance (C) with this circuit, it's a good idea to duplicate this template exactly to hold down stray C.

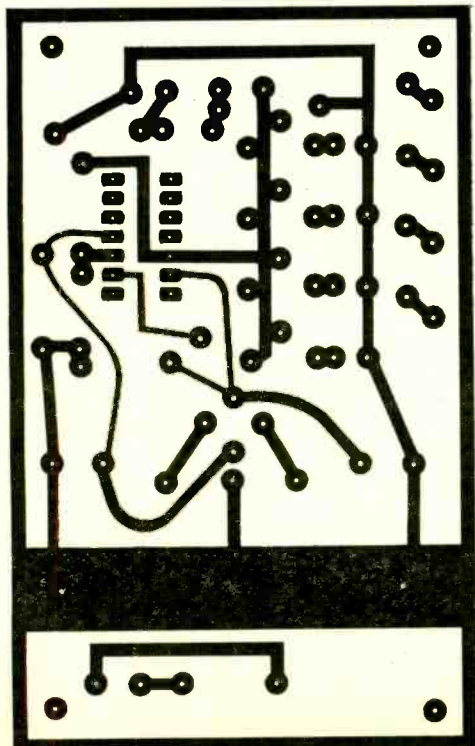

Install a wire from the R4 "hole" to S1; then R5, R6 and R7. Install a wire from C4 to S1, then C5, C6 and C7. The wires from the capacitor connections will probably cross, so just separate them about 1/8-in. Install wires from BP1 and BP2, keeping them at least 1/4-in. apart. These wires should not touch any other wire or component.

Twist together about 8 inches of red and black wire (positive and negative). Connect the black wire to the negative output PC board terminal—the one closest to the bottom of the cabinet. Connect the red wire to the positive output (directly above the black wire). Route the wires along the bottom of the cabinet, spaced about 1/2-in. from the PC board, to the meter. Connect the red wire to the positive (+) meter terminal, and the black wire to the remaining terminal. Then install the linecord.

Finally, install IC1 in its socket. The tab should point towards or be directly above the white color dot on the socket. Rotate each trimmer control towards the IC.

**On The Mark.** Maximum accuracy is assured if the calibration capacitors represent, as close as possible, half-scale; for example, if calibrating the 100 pF range, use a 50 pF capacitor. The voltage across the binding posts is negligible and you can change capacitors with the power on.

The calibration capacitors can be 5% or 1% silver mica, or anything else with a 5% worst-case tolerance. Don't use ordinary capacitors as they can be 50% off value and still be within their tolerance. Each range calibration is independent of the others, what you do to one range does not affect any other adjustment.

Note that when the calibration capacitors are first installed, meter M1 will "pin", this is normal. If the meter indicates a very low

(Continued on page 97)

# YOU'RE INVITED TO ACCEPT

in the most remarkable camping/travel club ever developed!

Act Now! Enjoy savings and privileges you never before dreamed were possible. Your special group discounts will pay for your membership many times over. Here are all 21 benefits!

★**\$10,000 Travel Accident Insurance.** Membership covers you 24 hours a day (not just portal to portal) with Accidental Death and Dismemberment Insurance whether you are on a vacation trip, going to work or just crossing the street. You are covered as a passenger in a taxi, bus, train, airplane, ship, etc. to carry passengers for hire. You also get \$1,000 protection while driving or riding as a passenger in any private passenger car or recreational vehicle. ★**RV and Auto Trip Planning Tour Kit.** Tell us where you are going. We'll send you your custom-prepared tour kit complete with full-color maps, mileage charts, check lists and other information. ★**FULL YEAR OF CAMPING JOURNAL Magazine.** Your \$12 dues—\$5.95 of which is allocated for a subscription to CAMPING JOURNAL—cover all membership privileges for one year including a year of CAMPING JOURNAL Magazine. ★**\$500 RV or Auto and Home Burglary Reward.** Decals warn would-be thieves that your car or rig and your residence are protected by a \$500 reward to anyone giving information leading to the arrest and conviction of a person who has stolen your property. ★**20% Discount on Car Rentals.** Membership entitles you to a 20% cash discount on Hertz Rent A Cars, and 10% on Hertz trucks. ★**Mail Forwarding Service.** We'll forward first-class mail to any address you specify. ★**25% Discount on Books.** On any book you come across, on camping or whatever subject—simply send us the title, publisher, author, and remit the price of the book less 25% plus 50¢ per book for postage and handling. Over 100,000 titles (fiction and non-fiction) to choose from. As many as you want! ★**Membership I.D. Card, Luggage Tags and Club Decals.** Your I.D. card is imprinted with your name and membership number and has space for important medical and emergency data. Luggage tags hasten the return of lost bags. A distinct car-window emblem attests to your membership. ★**SAVE Hundreds of \$s on U.S. Make New Cars (including Station Wagons) and Vans and Pickups.** Learn how to buy a brand new car or light truck at only \$125 over dealer's cost! ★**Weather Forecasts.** Plan your trips with our professionally prepared monthly weather forecasts. ★**Group Discounts on Merchandise.** Save on camping equipment, radios, TV, luggage, sports equipment, appliances. Hundreds of items available. More becoming available as expanded arrangements are made for merchandise ranging from food for campers to motorhomes. Buy direct and save! ★**Overseas Travel Aids.** Useful, free directories. One directs you to English-speaking doctors and gives you their prescribed rates. You receive information on passports, immunizations, foreign currency, customs duties, tipping hints and more. ★**20% Member Discount on Home Movies.** Professionally produced film tours of the world's most interesting cities

and countries. Save 20% on the retail price of 8mm and 16mm . . . color, black and white, sound or silent. ★**10% Hotel/Motel Discount.** A 10% cash discount on rooms at more than 4,000 hotels and motels in 50 states, Canada and Mexico. ★**20-50% Discounts on Vitamins & Prescriptions.** Order drug and vitamin needs by mail, save 20-50% compared to regular drug store prices! Big savings for diabetics and on life-sustaining medication! Each member of your family gets a \$3 cash discount on his first prescription order! ★**Travel Club Newsletter.** Updates you on new money-saving opportunities and ideas. ★**10% Restaurant Discounts.** Your Directory to over 500 outstanding restaurants, and a 10% discount off the check. ★**Optional Special Insurance Plans.** Without obligation, your membership makes you and your family eligible for specially priced association protection NOT AVAILABLE ON AN INDIVIDUAL BASIS! For example: **Disability Income Plan.** Guarantees regular monthly income as long as you cannot work because of covered sickness or injury! Select the amount you need according to your income. **Hospital-Surgical Insurance.** Helps pay for hospital room and board, surgical and maternity benefits. Features specified miscellaneous benefits as outlined in the policy to help pay for many hospital "extras." Many other health insurance plans are available—plus life insurance. Because rates are Association rates, they are specially priced. Regardless of how many claims you have, your rate will not increase. Exception would be when all policy holders of the same form in the same state are given an increase on a class basis. You are never obligated to take out any policy with your membership. Protection underwritten by Bankers Life & Casualty Company of Chicago, Illinois and Bankers Multiple Line Insurance Company of Des Moines, Iowa. ★**Photo Finishing Savings.** A custom-quality service to members at low prices for color, black and white, and including slides and movies! ★**Camping Information Service.** Tell us where you plan to stop and we'll send you a rundown on campsites along your route with accommodations and nearby places of interest. ★**Recreational Vehicle Insurance Plan.** Through CJTCA you can purchase RV insurance, at special low group rates and especially designed for the needs of campers and travelers. If you need an immediate binder, you can arrange it by placing a TOLL-FREE call. The same TOLL-FREE privilege available for reporting any claim. Applies to all RV's: Motorhome, Snowmobile, Travel Trailer, Tent/Camper Trailer, All Terrain Vehicle, Houseboat, Sailboat, Yacht, Runabout, Motorcycle, Mini-Bike, Motor Bike, Air Cushion Vehicle, or Trail Bike. On certain policies offered, you can also get emergency expense allowance, personal effects coverage, towing coverage, supplemental vacation liability—all with nationwide claim service.

**GET CHARTER MEMBERSHIP AT SPECIAL SAVINGS! MAIL APPLICATION TODAY!**

# A CHARTER MEMBERSHIP

in the Camping Journal  
Travel Club of America

You'd expect CAMPING JOURNAL, with over 1½ million camping-enthusiast readers, to bring you a camping/travel club that gives you MORE OF EVERYTHING USEFUL AND ENJOYABLE FOR YOU AND YOUR FAMILY. And it does that—and more!—with its fabulous brand-new CAMPING JOURNAL TRAVEL CLUB OF AMERICA! Here is your open road past city skylines, beyond the fences and time-tables . . . your chance to enjoy the pleasure and fun of outdoor recreation and camping vacations all year 'round! As a member of CJTCA, you'll discover new opportunities for you and your family to DO MORE . . . SEE MORE . . . ENJOY MORE camping/travel in the U.S. and elsewhere. All at savings that would not be available to you any other way!



Membership in Camping Journal's Travel Club is regularly \$20 a year—but your participation as a Charter Member now entitles you to a special 40% SAVINGS off the regular price. Only \$12 for a full year of fabulous Club privileges for you and your family whenever you're camping or traveling.

Whether on a weekend trip or an extended camping vacation . . . you may be a tent camper, backpacker, or owner of a fully equipped recreational vehicle—YOU'RE ENTITLED TO ALL THESE 21 CJTCA MEMBER BENEFITS

**SPECIAL BONUS**  
Get CAMPING JOURNAL  
magazine for as many years  
as you like at the  
**LOWEST**  
**POSSIBLE PRICES!**

**Yours! 21 outstanding benefits  
for ONLY \$12—regularly \$20!**

## Charter Membership APPLICATION

CAMPING JOURNAL TRAVEL CLUB OF AMERICA  
a division of NACT Dept. EEJ/A73  
1000 Sunset Ridge Road, Northbrook, Ill. 60062

**40% SAVINGS**  
if you act now!

Please enroll me as a Charter Member of the Camping Journal Travel Club of America, entitling me to all membership privileges.

I understand my travel/accident insurance becomes effective on the first of the month following your approval of my Club membership. NO MEDICAL EXAMINATION IS NEEDED FOR A CLUB MEMBER TO OBTAIN THIS INSURANCE COVERAGE.

**To make this Charter Membership Application valid, please sign here, complete the information, and mail your dues.**

Your signature \_\_\_\_\_ Date \_\_\_\_\_  
(PLEASE PRINT) Month/Day/Year  
Mr./Mrs./Miss \_\_\_\_\_  
Last Name First Name Initial

Address \_\_\_\_\_

City \_\_\_\_\_ State \_\_\_\_\_ Zip \_\_\_\_\_

Name of Beneficiary for  
Travel/Accident Insurance \_\_\_\_\_

If different from yours, please  
give address of beneficiary here \_\_\_\_\_

City \_\_\_\_\_ State \_\_\_\_\_ Zip \_\_\_\_\_

Your Birthdate \_\_\_\_\_ (Month) \_\_\_\_\_ (Day) \_\_\_\_\_ (Year) \_\_\_\_\_

My Charter Membership dues of \$12, which includes \$5.95 for a subscription to Camping Journal magazine, is enclosed. Please send approved insurance certificate, Club Membership identification and camping/travel benefits card, plus other money-saving materials to which I am entitled.

Yes, I'll take the SPECIAL BONUS! Send me CAMPING JOURNAL for the number of years shown below AT THE LOWEST POSSIBLE PRICE.

Bill me for \_\_\_\_\_ year(s) x \$3.67 . . . \$ \_\_\_\_\_ (Total)

B-543

# HEY HERB

## THE AUDIO ANSWER MAN

by Herb Friedman



**HEY HERB:** Where can I obtain extra pickup carriers for my Dual automatic turntable? My audio dealer claims the Shibata pickup I use tracks at 2 grams and will destroy stereo records. I'd like to be able to switch back to my stereo pickup for stereo records, but my dealer can't get me an extra carrier.

*Find a new audio dealer.* If he sells Dual turntables, he can order extra carriers. Also, he's 100% wrong. Though a Shibata equipped pickup tracks at 2 grams, the force is distributed over a larger area and the area-pressure is equal to or less than a 1 gram stereo (elliptical) pickup. You're also going to be disappointed because the Shibata pickups—at least the top-of-the-line—delivers outstanding reproduction from ordinary stereo records. You'll discover that the stereo *highs* you at first think are missing are not. It's really distortion that's missing.

**HEY HERB:** Since matrix 4-channel depends on phase and amplitude relationships isn't it true that matrix records cannot be copied on tape because the recorder's heads alter the phase relationships between the stereo channels?

*Depends on the recorder.* Cassette recorders, or any other recorder with a combination record/play head maintain the phase relationships. I have yet to find a typical hi-fi cassette recorder that didn't reproduce an exact duplicate sound field as delivered by the matrix record. But three-head recorders are a different story. My Revox A77 has phase-aligned heads so I don't have any problems with matrix dubs. But I have used some reel-to-reel recorders, in the \$400 to \$1000 price range, whose heads were not phase aligned, and there was a decided shift in the reproduced sound field. It wasn't a bad sound . . . just different.

**HEY HERB:** I need to mix four microphones into my Pioneer cassette deck. I've tried some of these four channel mixers, the type powered by a transistor radio battery, and I get a lot of distortion and noise. Are there any decent low cost mixers? I can spend about \$20 to \$40 from school G.O. funds.

*You get what you pay for.* Those cute, but cheap mike mixers are for experimenters with tin ears. Put the screws on your G.O. teacher-in-

charge for a few more dollars and head for your local Shure distributor. Shure puts out a line of professional quality audio accessories (mixers, compressors, etc.) at very modest prices. If you're thinking of recording a school play, give particular attention to Shure's compressor; it does a fine job at leveling stage voices and conferences.

**HEY HERB:** I have an Altec 710 receiver to which I have connected an oscilloscope for multipath and audio observations. Whenever I switch on the scope's *chopper* for a dual display I get a growl in the receiver. What causes this growl or squeal?

*Now that's what I call a real status symbol—a dual trace "stereo scope".* The scope's switching oscillator is radiating (or leaking through the connecting cables) into the receiver where it probably beats against harmonics from the stereo 19 kHz pilot to 38 kHz oscillator. Get rid of the scope, or settle for one trace at a time.

**HEY HERB:** I've splurged for the complete 4-channel system: a full logic SQ receiver and a JVC CD-4 demodulator with Shibata stylus pickup. I'm using a Garrard Zero 100 record player with the tracking angle always set for *manual*. My problem is the discrete sound appears to drift in and out; sometimes I hear 4-channel and at other times it sounds like stereo. Friends suggest the CD-4 records haven't been perfected. Can you suggest any *test* records that really deliver discrete sound?

*Your problems are your friends, not the records.* You also indicate in the three page letter that they've had you experimenting with the stylus overhang, and that's your problem. The high frequency CD-4 subcarrier in the grooves

*(Continued on page 99)*

Herb would like to answer all the questions our readers send. However, he can only sample the questions received and answer as many as possible through this column. Sorry, it's impossible to answer questions by return mail. Questions of a personal listening nature cannot be answered. Send your questions to Hey Herb, ELEMENTARY ELECTRONICS, 229 Park Avenue So., New York NY 10003.

# SOUND OFF WITH THIS NOISEMAKER

## ELECTRONIC ALARM GENERATOR

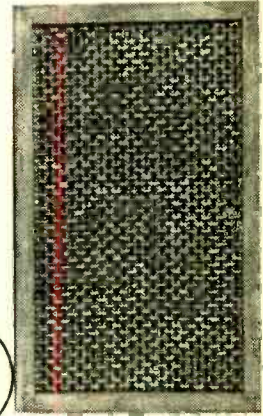
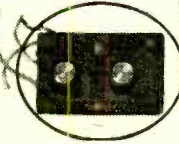
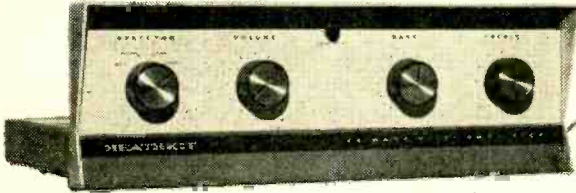

by Gary McClellan

There are times to make noise in these days of noise abatement concern. Of course, an ambulance must have a wailing siren to help clear traffic. A volunteer fire department depends on a raucous blast from a horn for its efficient operation. And certainly no one would deny a new-year's eve merry-maker his hour to howl. So whatever your interest—burglar alarm to wake-up alarm—here's an electronic alarm generator with an extra low-frequency modulation oscillator that produces a "yelp-yelp-yelp" that's sure to attract plenty of attention.

Both the pitch and repetition rate of this generator are variable over a wide range, so you can create other unusual sounds. If you want to experiment with the circuit, you will probably discover other hookups that give even more strange sounds.

**What Is It?** It's an electronic alarm generator that's inexpensive and easy to build. The parts are all common and inexpensive. There are no oddball integrated circuits to buy, and you will probably have most of the parts in your junkbox. If not, you shouldn't have to spend more than \$4 for new parts. Construction? It's very easy! The parts layout is noncritical and you can build it in any way, shape, or form you wish. Our generator uses two unijunction transistor oscillators which are DC coupled to produce the strange sounds.

Electronically, the first oscillator (which consists of C1, Q1, R1, R2 and R3) gener-

ates a series of low frequency pulses. The output of this oscillator appears across R3 as a corresponding series of voltage fluctuations. R3 also biases the second oscillator (consisting of C3, C4, Q2, R4, R5 and R6) to a point just below oscillation. This resistor must be adjusted to suit the characteristics of the unijunction used for Q2. As the voltage across R3 drops, it will reach a level where the second oscillator fires and its output frequency starts to rise with the voltage. As the voltage across R3 increases, the output frequency drops. Potentiometer R1 controls the repetition rate of the output, while pot R5 controls the frequency.

**Putting It Together.** I built my version on

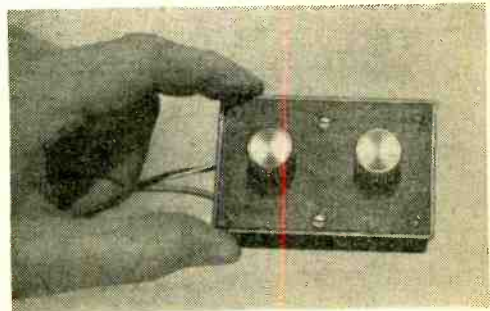

Great for attention-getting emergency type alarms. So easy to build, it's recommended for beginners. Inside the case just a dozen parts put a warbling squawk of a sound into your hi-fi, PA amp—even drives earphones!

# e/e ALARM GENERATOR

a 1 7/8-in. x 2 1/4-in. scrap of perfboard and enclosed it in a Radio Shack Mini Case. This arrangement worked very well and you might want to duplicate it.

Start construction by laying out the capacitors on the perfboard. Note that C1 and C4 are positioned near the ends of the board. Next, insert all of the resistors but R3. The value of R3 will probably have to be optimized by experiment, so just ignore it for now. On our version potentiometers R1 and R5 were left off the board to save space. These pots are mounted on the front panel of the box and connected to the circuit via short leads. You should now be able to wire up most of the circuit, and you might want to add push-in terminals for the pots, output, and power leads. These terminals will make external connections to the board much easier.

When you have finished the wiring, insert the unijunctions. Be careful to check out the leads on your particular unijunctions before you solder them in. The location of the E, B1, and B2 leads may vary with the type of unijunction you use.

Finish the construction by "working" the

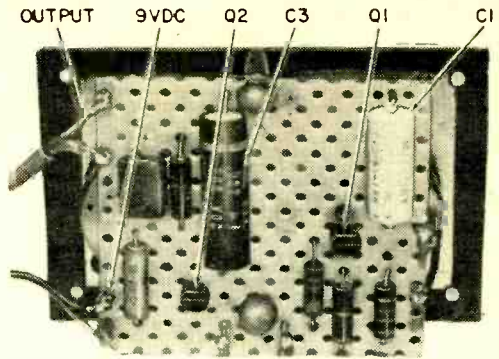

Locate parts on this photograph as you put parts together. Also, see page 103 for the complete wire layout under the perf-board. Drill two 1/4-in. holes in one side of the box for the power and output leads. Next, the front panel: drill two holes for the pots and two holes to mount the board. Clean up the panel and apply decals if you wish. Install the two pots and temporarily wire them to the rest of the circuit with long leads. Also connect the power and output leads to the module. This completes your mechanical construction of the generator.

**Putting It To Work.** By now you should be all set to fire it up. In place of R3 connect a series combination of 330-ohm (Continued on page 103)

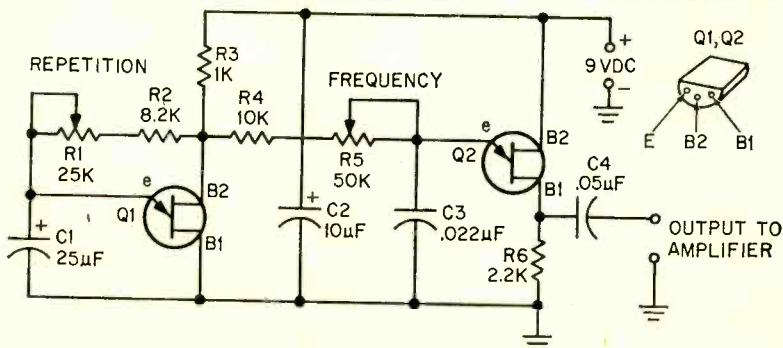

## PARTS LIST FOR ELECTRONIC ALARM GENERATOR

- C1—25  $\mu$ F electrolytic capacitor, 12 VDC or better (Allied Radio 926-1547 or equiv.)
  - C2—10  $\mu$ F electrolytic capacitor, 12 VDC or better (Radio Shack 272-1002 or equiv.)
  - C3—0.022  $\mu$ F tabular capacitor, 50 VDC or better (Radio Shack 272-1056 or equiv.)
  - C4—0.05  $\mu$ F capacitor, 12 VDC or better (Radio Shack 272-1068 or equiv.)
  - Q1, Q2—Unijunction transistors, exact type not critical (Radio Shack 276-111)
  - R1—25,000-ohm potentiometer, linear taper (Radio Shack 271-094 or equiv.)
  - R2—8,200-ohm, 1/2-watt resistor (Radio Shack 271-000 or equiv.)
  - R3—1000-ohm, 1/2-watt resistor, see text (Radio Shack 271-000 or equiv.)
  - R4—10,000-ohm, 1/2-watt resistor (Radio Shack 271-000 or equiv.)
  - R5—50,000-ohm potentiometer, linear taper (Radio Shack 271-1716 or equiv.)
  - R6—2,200-ohm, 1/2-watt resistor (Radio Shack 271-000 or equiv.)
- Misc.—Perfboard, knobs, spacers, wire, solder, case (Radio Shack 270-230), 9-volt battery or power supply, etc.



# KATHI'S CB CAROUSEL

by Kathi Martin KA10614

I AM ABSOLUTELY CERTAIN that somewhere out there is a group of old men—who were old men at 21—in charge of styling for CB equipment. For some reason they believe the heyday of modern styling was the early 1930s, when everything electronic came in a black wrinkle finish.

Now I'm might proud of the decorating job I did on my one room efficiency last year. But since then there has always been a black box CB rig looking like a miniature coffin among my day-glow colors. So it was with some surprise and much pleasure when I opened the box containing my new Cobra 135 SSB rig and found the styling wild. Sure, it was the same old black color (I'll spray it day-glow yet), but it was on an ultra-mod walnut cabinet—a real *heavy* in styling. To tell the truth, it looks like something we'd stick on Boss Julie's desk just to impress visitors.

Now I know that any manufacturer with enough guts to pay for a real industrial stylist isn't going to skimp on performance, and as you'll see, I was right. But before I get ahead of myself let me tell you more about the rig, 'cause styling alone doesn't get the signal out.

The Cobra 135 is a deluxe AM SSB

transceiver for both auto and home use. The AC power supply is built-in and both AC and DC power cords are supplied, as is a plug-in microphone. The rig features full 23 channel coverage, a noise blanker, crystal IF filters, P.A. operation, a built-in digital clock that can turn on the rig at a preset time, a combination S/RF/SWR meter and push-button selected operation for AM, SSB lower sideband, and SSB upper sideband.

The clock, a large multi-purpose meter, AM, LSB and USB selector switches, and the channel selector, are mounted on a plastic blackout strip that looks like high gloss enamel. Under the strip, angled outward like a computer control panel, is a sub panel with the power switch, clock auto-control selector switch, PA/CB switch, SWR FWD/REV switch, noise blanker switch, SWR forward power calibrate control (when this control is switched off, the meter shows relative RF output power), squelch control, RF gain, volume control and voice lock control. The voice lock is really a receive fine tune to clarify broadcasts from stations operating slightly off the center channel frequency.

**Under The Pretty Face.** On the rear apron you'll find the power socket, antenna



Looking more like a computer console than a CB transceiver, the Cobra 135 is a welcomed change from the usual black box type of styling. A built-in digital clock (on the left) is capable of turning-on the radio at a preset time of your choice. Circle Reader Service Number 57

connector, PA speaker jack and a remote speaker jack. One feature I've left out, because there's nothing to indicate it's there, is one of the finest speech compressors the lab has ever used—both in CB and commercial gear, and I'll tell you more about it later.

The receiving performance is typical of

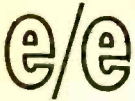

## KATHI'S CB CAROUSEL

high performance equipment. The AM sensitivity measured  $0.5 \mu\text{V}$  for a 10 dB signal plus noise to noise (S + N/N) ratio. SSB sensitivity exceeded the capability of our signal generator, which goes down to  $0.25 \mu\text{V}$ ! The selectivity was steep-sided, providing 52 dB adjacent channel rejection on AM and better than 60 dB on SSB. The image rejection from the double conversion IF also exceeded 60 dB. The AGC action was 12 dB, meaning an input signal range of 2 to 10,000  $\mu\text{V}$  produced an audio output variation of 12 dB. This isn't the greatest in the world; a loud station will blast in if you have the volume cranked open to hear a weak signal, but it compares with the better high performance tube receivers. The S-meter takes a 100  $\mu\text{V}$  input signal to read S9, and the S-unit calibrations are relative, there is no definite dB value to the S-unit calibration.

Two even more outstanding receiver features are the rock-steady stability and super-clean audio. This is one SSB rig where you don't have to keep your hand on the fine tuning. Once you've tuned-in an SSB station, the receiver *stays* tuned to the signal. If it drifts into Donald Duck chatter, you can bet it's the other station. And when the signal is tuned-in it is clean, sounding almost like a high priced radio.

**Envelope Power.** The transmitter put out 3.8 watts of AM into a 50 ohm load, with modulation limited to 100 percent. Of note, the microphone sensitivity measured  $-38$

dB, meaning a little more than a whisper produces full AM and SSB modulation. But speaking louder did not produce noticeable distortion, for the compressor does a fantastic job at increasing the talk power without boosting the distortion. At the receiving end the Cobra 135 comes in like a tidal wave of sound.

**Summing Up.** To say I was enthusiastic about the Cobra 135 would be putting it mildly. This rig gives outstanding performance in every direction; particularly so in transmitting, for I still can't get over the

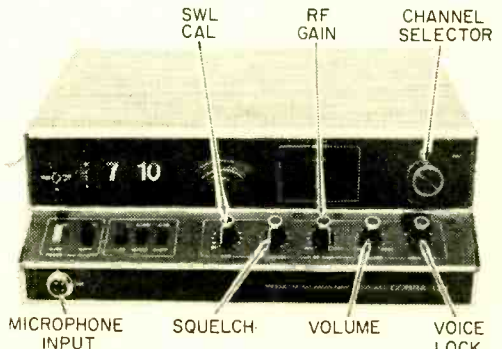

On the rear panel phono jacks provide the PA and remote speaker outputs, while a single power socket takes 117 VAC or 12 VDC.

speech compression. I was able to sock in 100 percent readable modulation with the Cobra 135 when the signal level at the receiving end was so low my other transmitters couldn't get through clearly. I guess the best way to sum up the Cobra 135 is call it a real winner!

For additional information, circle No. 57 on the Reader Service Page. ■

## COMPUTER-DIAGNOSED EKG

□ Hospitals and clinics now have electrocardiograms completely diagnosed by computer in as little as two minutes through a new emergency service being offered by Cro-Med Bionics, a subsidiary of Chromalloy American Corporation.

Cro-Med's system, known as Compu-Gram, is the only one in which a computer provides  
(Continued on page 103)

With the electrocardiogram recorded on magnetic tape, the nurse dials the Cro-Med Bionics Computer Center and the signals are transmitted directly to the computer for diagnosis. In as little as two minutes, the computer can print out a precise interpretation of the patient's heart condition.





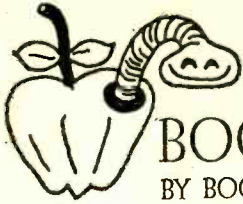

## BOOKMARK BY BOOKWORM

**Always Better.** Want to know if Jamaica has a shortwave broadcasting station? Or, the frequency of the station on Timor? Or, the mailing address of HIRZ? Or, the number of radio receivers in Ethiopia? It's easy to find such information—but, only in the latest edition of the *World Radio and TV Handbook 1973*. More pages—and more comprehensive—is one way

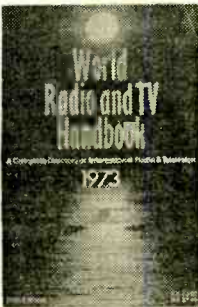

Soft cover  
400 pages  
\$6.95

of describing the 27th annual edition of this encyclopedia handbook. No other publication provides the wealth of detailed information on all types of broadcasting stations (AM, short-wave, FM and TV), times on the air, languages and frequencies in use, power, specific addresses, etc. Extra pages in the 1973 edition reflect the expanding broadcasting activities in Africa and South America. Distributed by Gilfer Associates, Inc., P.O. Box 239, Park Ridge NJ 07656. Circle No. 70 on Reader Service Page for more information.

**Auto Guide.** If you are a car owner who services his own vehicle, then you need a completely new and up-to-date book that will save you time and money! It's the *Automotive Test Equipment You Can Build* by A Edward Evenson. It's an easy-to-read guide that shows



Soft cover  
160 pages  
\$4.95

you how to build your own "professional level" automotive test equipment. The dwellmeter, tachometer, points and condenser tester, ignition tester, dynamic compression tester, the volt-amp tester, and alternator tester are covered. Not only are construction and theory of operation discussed, but also applications and testing procedures. Published by Howard W. Sams & Co., Inc. For more information, circle No. 55 on Reader Service Page.

**For Beginners.** For student, hobbyist, or technician, *Basic Electronic Circuits Simplified* by Nelson W. Hibbs an easily digested text

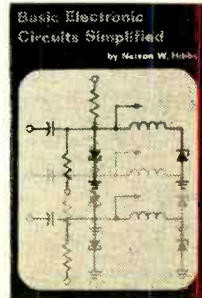

Soft cover  
352 pages  
170 illustrations  
\$5.95

with a conversational approach to electronic theory. Nelson Hibbs' skillful handling of facts and figures in this new book will hold reader interest (and retention of knowledge) at the highest possible level. Pertinent facts are interwoven into technical discussions so that theoretical expressions can be followed with only a rudimentary knowledge and limited math background. Each presentation of fact becomes a building block that is used to form the foundation of basic electronics. Published by Tab Books. For more information, circle No. 65 on Reader Service Page.

**It's Free.** A new 22-page, pocket-size handbook illustrating more than 500 symbols commonly used in electronics has been introduced



Soft cover  
22 pages  
Free

by Cleveland Institute of Electronics, Inc. Entitled *Electronics Symbols Handbook*, the handy 3½" by 5½" reference guide is shirt pocket size. Symbols are grouped in 19 general classifications. An added feature of the Handbook is a two-page Electronics Data Guide—conversion factors and constants, Ohm's Law formulas, (Continued on page 102)

# UHF ACTION BAND... SIGNAL SHIFTER

by Morrie Goldman  
WA9RAQ



**Clever  
nothing-to-build  
technique puts  
UHF action band signals  
on any 30-50 MHz  
low band FM monitor**



**I**F YOU already own a low band 30-50 MHz Action Band (public service) monitor and would like to tune the UHF public service band as well, here's a simple solution: Just connect the output of a standard UHF TV converter to the antenna input of your low band monitor. Since a UHF television converter must cover a broad frequency range (470-890 MHz) and since its IF output is also broad, it is possible to tune-in UHF Action Band (450-470 MHz) signals on a low band monitor.

**A Little More Detail?** Most TV converters are designed with an IF output on channel 5 or 6; a few use 2 or 3. Whenever the converter is fed into a lower frequency IF, the tuning range of the converter is effectively shifted lower (the dial calibration moves up). While tuning a UHF TV converter connected to a TV set, you may have already noticed the effect. If your converter's IF output is adjusted for channel 6 and you switch to channel 3 or 4, the cali-

bration moves up. There is a limit to this of course, but it is far enough below 450 MHz to make a hook-up like this work the way we want it to.

The connections are simple. We just substitute the low band monitor receiver for the normal TV set connections. With a converter output of channel 5 or 6, tune your monitor to about 49 MHz. If your converter's output is channel 2 or 3, try around 40 MHz. Now tune your UHF converter slowly around channel 17. If there is UHF activity in your area, you should be hearing it.

**Final Hook-Up.** A regular UHF TV antenna should prove suitable in most areas. Of course, an outdoor antenna is preferred. At my home in Chicago, many UHF stations (including police, taxi, radiotelephone, etc.) are "solid copy" using just a low-cost UHF converter, regular UHF TV antenna, and either of my two low band monitors, one of which is an \$18 portable! ■

# e/e's

## ALL NEW BASIC COURSE in ELECTRICITY & ELECTRONICS



This series is based on  
**BASIC ELECTRICITY/ELECTRONICS,**  
Vol. 4, published by  
**HOWARD W. SAMS & CO., INC.**

## UNDERSTANDING CATHODE-RAY TUBES

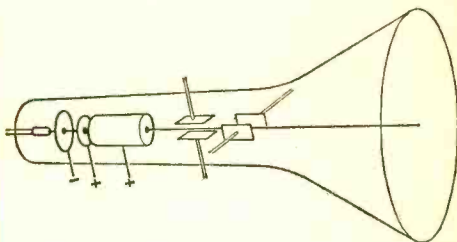

**W**hat You Will Learn. A cathode-ray tube is a vacuum tube capable of visually displaying an electrical signal. You will learn about electrostatic principles applicable to cathode-ray tube operation and how those principles are put to use. You will learn how a cathode-ray tube electron beam is electrostatically accelerated and focused. And there is a brief explanation of the use of the cathode-ray tube in television.



## COMPLEX WAVEFORM

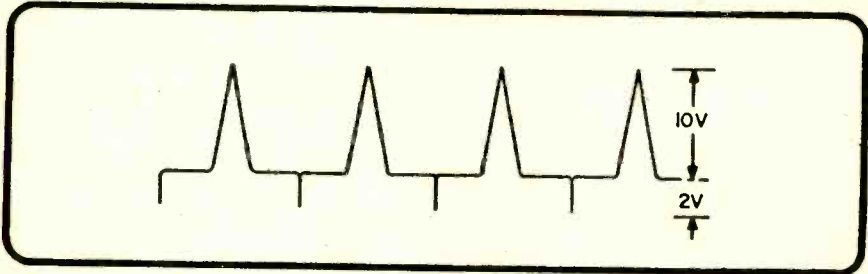

## LIMITATIONS OF METERS

You have become acquainted with multimeters and probably vacuum-tube voltmeters. If asked to describe them in a brief statement, you might say they are instruments capable of measuring the magnitude (size) of certain electrical characteristics. This would be a good description if you added that the characteristics are basically limited to voltage, current, and resistance.

How much information would a multimeter, FETVOM, or VTVM tell you about a voltage that varies as shown above?

Your answer might be merely voltage. This would be a good answer, since you did not specify the amount of voltage. A multimeter or a VTVM is designed and has its scales calibrated to measure sinusoidal (sine-wave) AC voltages. It cannot accurately measure a nonsinusoidal voltage. Since the meter pointer is not able to follow the rapid rise and fall of such a voltage, the meter reading, if any, will be only a slight indication.

## AMPLITUDE VS. TIME

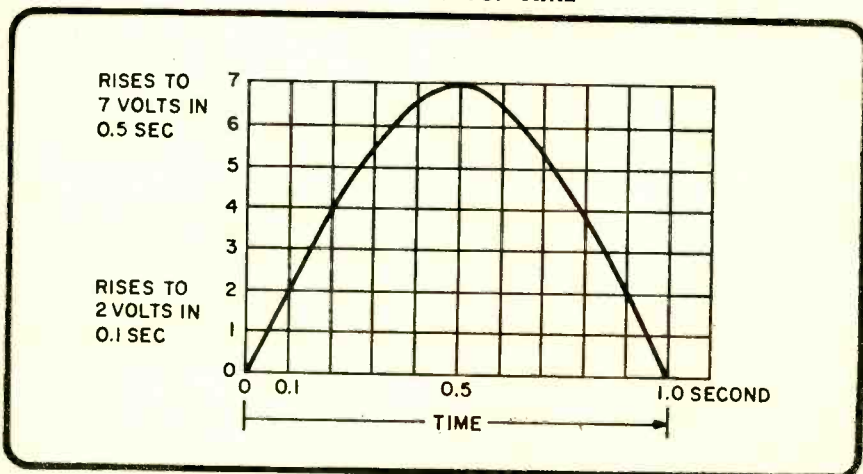

## IMPORTANCE OF WAVEFORMS

Since a voltage or current can be described in terms of amplitude and time, you can identify and analyze any signal in these terms. A graph or picture of how the amplitude of a signal varies with time is called a waveform.

To maintain, troubleshoot, and repair electronic equipment, a technician needs to look at the waveform of a signal passing from one circuit to another. For this, an instrument is needed that will provide a reliable representation of the signal. If the representation

matches the desired size and shape of a signal that should occur at the test point, the technician can assume the circuit from which it came is operating as it should. If the representation does not match the signal, the type and amount of difference will help in identifying the cause of the trouble.

### THE OSCILLOSCOPE

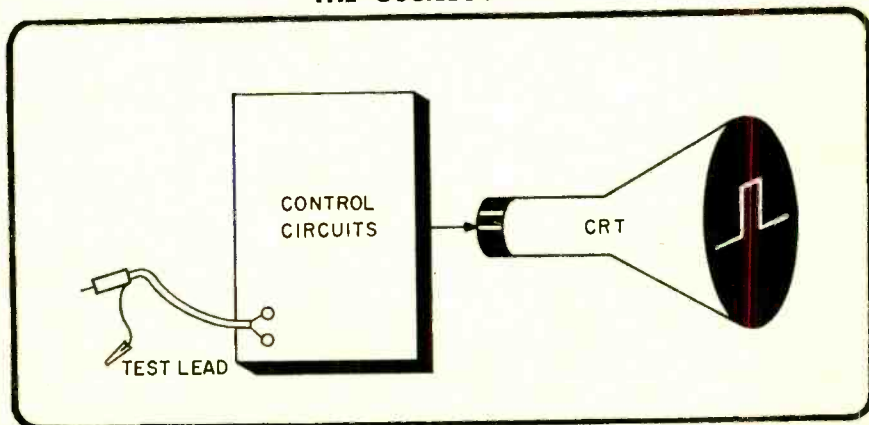

### THE CRT FOR OSCILLOSCOPES

An oscilloscope is an indicator. It indicates the shape of a signal appearing at a test point. Some oscilloscopes are better at showing a reliable reproduction of waveforms than others. The difference is merely one of design. All oscilloscopes function in accordance with the same set of fundamentals, and all oscilloscopes contain a *cathode-ray tube* (CRT) and a group of control circuits. The CRT displays the waveform. The control circuits present the signal to the CRT. A set of test leads brings the waveform to the control circuits.

#### QUESTIONS

- Q1. A waveform can be described in terms of its vertical and horizontal dimensions. What are these dimensions?
- Q2. A cathode-ray tube can display a picture on its face, or screen. What causes the picture to appear?
- Q3. An oscilloscope is made up of a cathode-ray tube and a group of control circuits. What is the function of the control circuits?

#### ANSWERS

- A1. The vertical and horizontal dimensions of a waveform are amplitude and time.
- A2. The picture on a CRT is developed by a moving electron beam that strikes and illuminates a chemical coating on the inside face of the tube.
- A3. The function of the oscilloscope control circuits is to present a signal to the CRT.

### THE CRT FOR TELEVISION

The cathode-ray tube is a vital part of a television set. The CRT operates by moving a controllable beam of electrons across the inside face of the tube. The number of electrons in the beam is determined by the blacks, grays, and whites of the scene the TV camera is viewing. White is produced by a large number of electrons striking a chemical coating on the inside of the tube. The electrons cause the coating to give off light. Black is achieved by stopping the electron flow, and shades of gray are obtained by varying the amount of electrons between the amounts required for black and white.

The picture is "painted" on the screen by the narrow electron beam moving back and forth across the tube many times a second. This movement is due to a varying magnetic field produced by a set of coils around the neck of the CRT.



The principle of putting a picture of a waveform on the screen of an oscilloscope is similar. The movement of an electron beam is controlled *electrostatically* so that the beam traces out the pattern of the waveform being measured. As in the TV tube, electrons illuminate a coating on the inside of the tube.

## Electrostatics

To understand how a CRT operates requires a review of what you learned about electrostatic fields. As you may recall, an electrostatic field is a region in which electric forces are acting.

An electrostatic field can be developed between two charged plates. If one plate is negative with respect to the other, the direction of the electric force can be determined.

## Forces in an Electrostatic Field

In the figure, lines of electric force take a direction from negative to positive. This means a negatively charged body entering the field would be moved downward (from negative to positive). A positively charged body, however, would be moved upward

### ELECTROSTATIC FIELD

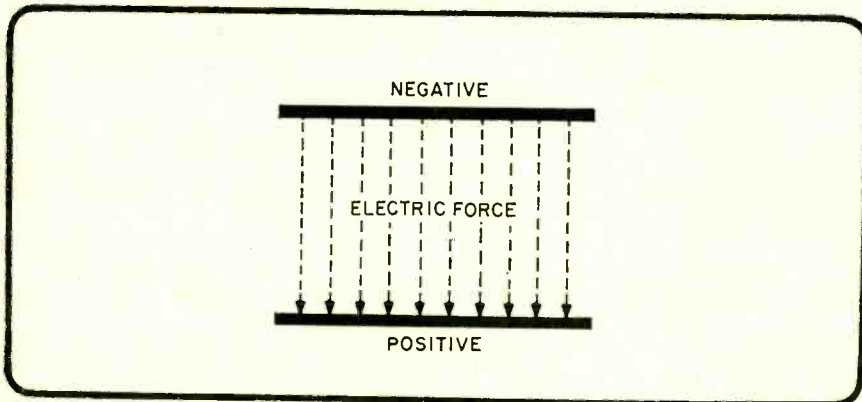

(positive to negative). Like charges repel, and unlike charges attract. Do you recall how an electrostatic field is formed?

An electrostatic field is formed with a voltage source and a pair of metallic plates to hold the charges.

If a 6-volt battery is connected to the plates in the manner shown, the battery will draw electrons from the bottom plate and deposit them on the top plate until the difference in potential between the plates equals the battery voltage. The potential of the plate having an excess of electrons will be negative. The other plate, being deficient in electrons, will be positive.

### QUESTION

- Q4. What is an electrostatic field?
- Q5. What causes an electrostatic field to exist between two metallic plates?

### ANSWER

- A4. An electrostatic field is a region in which electric forces are acting.
- A5. An electrostatic field is formed when one plate has an excess of and the other a deficiency of electrons.

## Electrostatic Forces Between Circular and Tubular Plates

In the diagram, an electrostatic field between two plates having center holes is shown. Observe the curvature of the force lines under the holes.

## PRODUCING AN ELECTROSTATIC FIELD

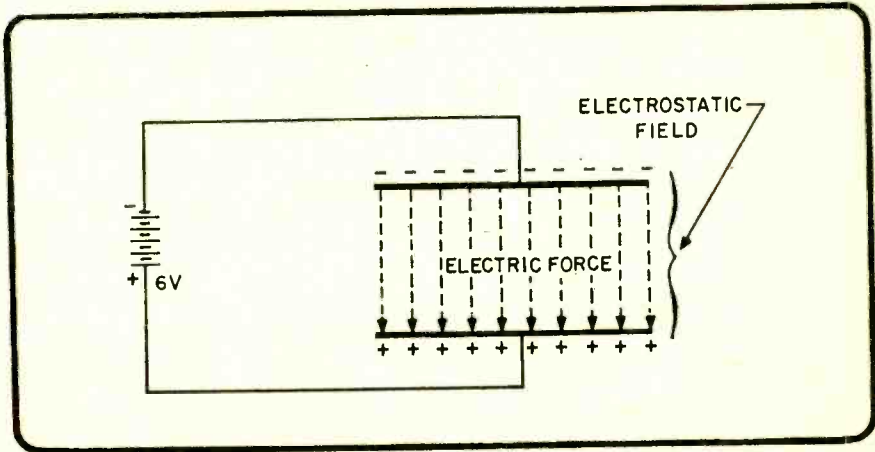

Since its path is parallel to the force lines, electron B will pass straight through the axis (center line) of the holes. Electron A starts in the same direction as electron B. When electron A enters the field, it turns in the direction of the force lines. Just before it leaves the field, it is turned even further and in the direction of the curvature of the force lines.

Suppose a small and a large cylinder, both charged with a positive potential, are placed so the electrons must pass through them. Also suppose the larger cylinder has a more positive charge. The distribution of the lines of force would look like the next illustration.

An electron in the space at the left of the small cylinder will be attracted toward the cylinder by the positive charge. If the electron is traveling along the axis of the cylinder, it will pass through without crossing a line of force. As it approaches the larger, more positively charged cylinder, the velocity of the electron will increase.

An electron entering the small cylinder at an angle will cut the lines of force and be turned in their direction as shown by the top and bottom electron paths in the figure.

## ELECTROSTATIC LENS

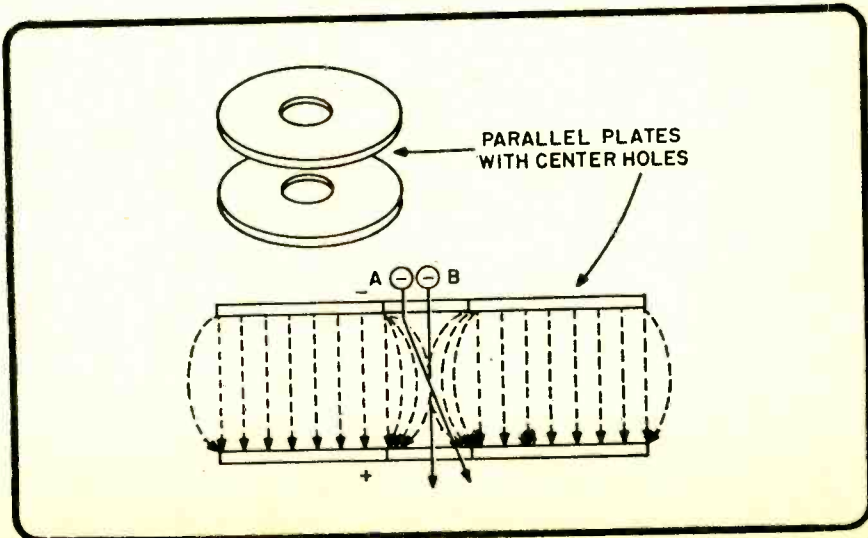



## ELECTROSTATIC FOCUS

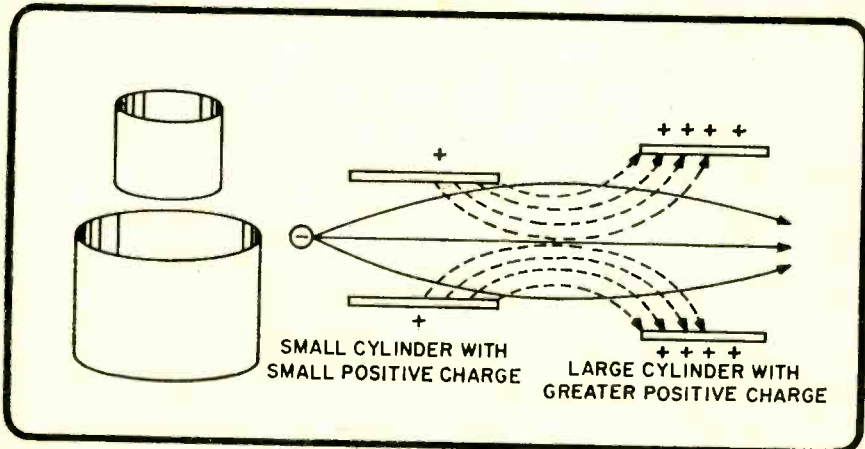

As it approaches the larger cylinder, the electron will be accelerated by the higher positive potential. Because of the higher electron velocity, the force lines in the larger cylinder will have a smaller turning effect on the electron. If the difference of potential between the cylinders is adjusted properly, the electrons will unite at a given distance after passing through the second cylinder. This action of the electrons as they pass through the influence of the two cylinders provides a convenient method of focusing the electron beam.

### QUESTIONS

- Q6. As an electron approaches the larger cylinder, the velocity of the electron will - - - - - .
- Q7. Why is the above statement true?

### ANSWERS

- A6. As an electron approaches the larger cylinder, the velocity of the electron will increase.
- A7. The above statement is true because the larger cylinder is more positively charged. It will attract the electron with a greater force, thereby increasing the velocity of the electron.

## ELECTRON GUN

Cathode-ray tubes used in oscilloscopes consist of an *electron gun*, a *deflection system*, and a *fluorescent screen*. All elements are enclosed in an evacuated container, usually glass. The electron gun generates electrons and focuses them into a narrow beam. The deflection system moves the beam across the screen in the manner desired. The screen is coated with a material that glows when struck by the electrons.

An electron gun has a cathode to generate electrons, a grid to control electron flow, and a positive element to accelerate electron movement. The control grid is cylindrical in shape and has a small opening in a baffle at one end. The positive element consists of two cylinders, called anodes. They also contain baffles (or plates) having small holes in their centers. The main purpose of the first anode is to focus the electrons into a narrow beam on the screen. The second anode speeds up the electrons as they pass.

### Cathode and Grid

The cathode is indirectly heated and emits a cloud of electrons. The control grid is a hollow metal tube placed over the cathode. A small opening is located in the center of a



## ELECTRON GUN

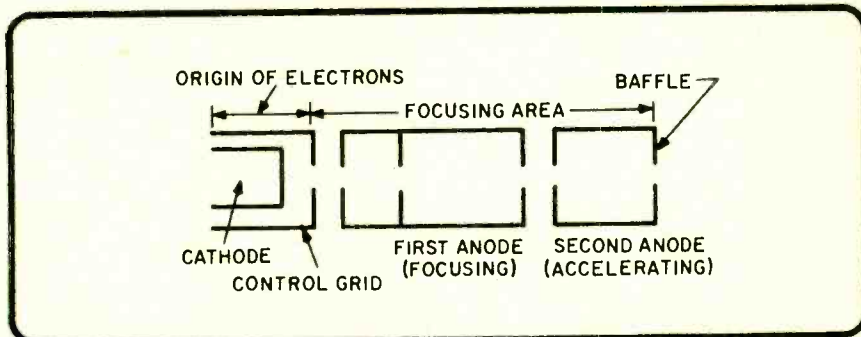

baffle at the end opposite the cathode. The grid is maintained at a negative potential with respect to the cathode.

A high positive potential on the anodes pulls electrons through the hole in the grid. Since the grid is near the cathode, it can control the number of electrons that are emitted. As in an ordinary vacuum tube, the negative voltage of the grid can be changed to vary electron flow or stop it completely. The brightness of the image on the fluorescent screen is determined by the number of electrons striking the screen. Intensity (brightness) can, therefore, be controlled by the voltage on the control grid.

## ELECTROSTATIC FIELDS

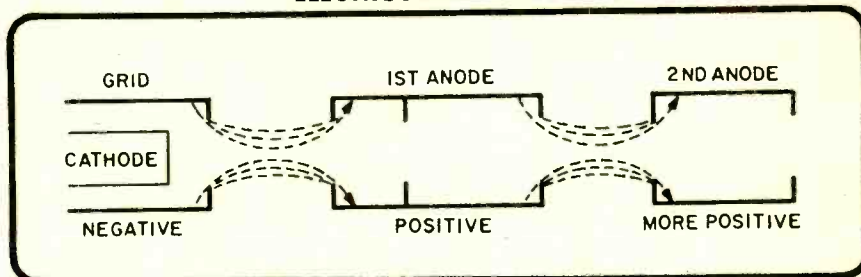

### Focus Control

Focusing is accomplished by controlling the electrostatic fields that exist between the grid and first anode and between the first and second anodes. Study the diagram. See if you can determine the paths of electrons through the gun.

### QUESTIONS

- Q8. Which element controls the number of electrons striking the screen in the drawing titled *electrostatic fields*?
- Q9. Which element controls the focus of the beam?

### ANSWERS

- A8. The control grid controls the number of electrons striking the screen.
- A9. The first anode controls the focus of the beam.

### Electrostatic Lenses

The next diagram shows electrons moving through the gun. The electrostatic field areas are often referred to as *lenses*. The first electrostatic lens causes the electrons to cross at a focal point within the field. The second lens bends the spreading streams and returns them to a new focal point.

The diagram also shows the voltage relationships on the electron-gun elements. The cathode is at a fixed positive voltage with respect to ground. The grid is at a variable



## ELECTRON BEAM FORMATION

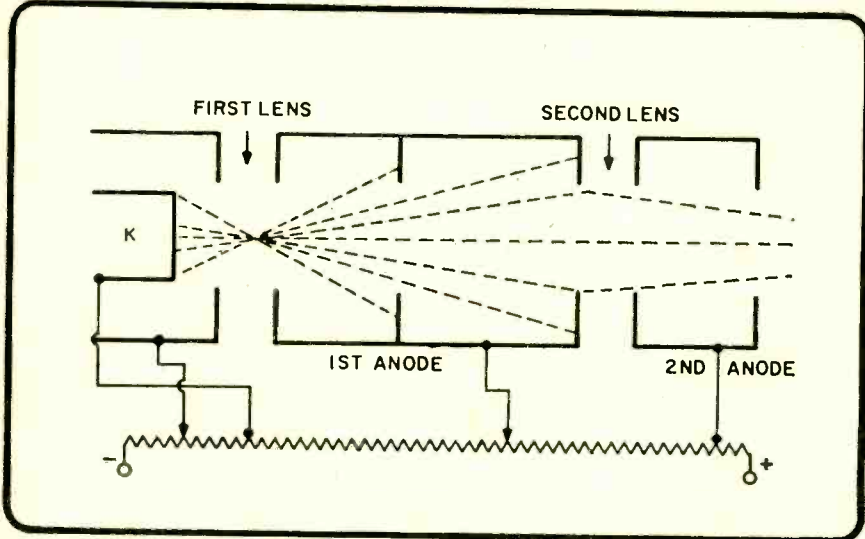

negative voltage with respect to the cathode. A fixed positive voltage of several thousand volts is connected to the second (accelerating) anode. The potential of the first (focusing) anode is less positive than the potential of the second anode. It can be varied to place the focal point of the electron beam on the screen of the tube. Control-grid potential is established at the proper level to allow the correct number of electrons through the gun for the desired screen intensity.

## ELECTRON-BEAM DEFLECTION SYSTEM

The electron beam is developed, focused, and accelerated by the electron gun. It appears on the screen of the CRT as a small, bright dot. If the beam is left in one position, the electrons will soon burn away the illuminating coating in that one area. To be of any use, the beam must move. As you have learned, an electrostatic field can bend the path of a moving electron.

Assume the beam of electrons passes through an electrostatic field between two plates. Since electrons are negatively charged, they will be deflected in the direction of the electric force (from negative to positive). The electrons will follow a curved path through the field. When the electrons leave the field, they will take a straight path to the screen

## CRT WITHOUT DEFLECTION

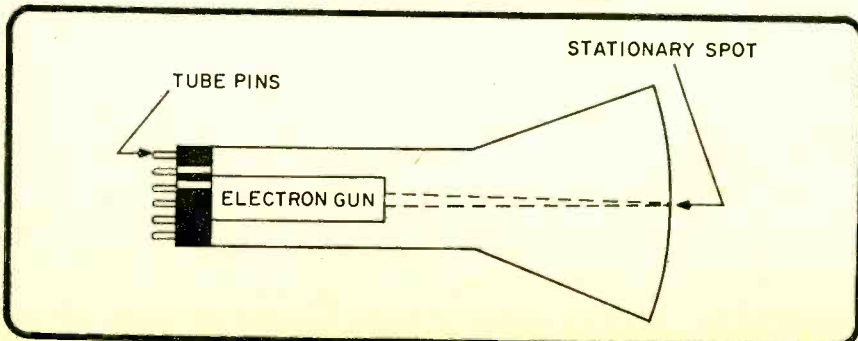

at the angle at which they left the field. Although the beam is still wide (the focal point is at the screen), all the electrons will be traveling toward the same spot. This is assuming, of course, that the proper voltages are existing on the anodes which produce the electrostatic field. Changing the voltages changes the focal point of the beam.

**QUESTION**

**Q10.** Why are the electrostatic fields between electron-gun elements called lenses?

**ANSWER**

**A10.** They are called lenses because the fields bend electron streams in the same manner that optical lenses bend light rays.

**Vertical and Horizontal Plates**

If two sets of deflection plates are placed at right angles to each other inside a CRT, the electron beam can be controlled in any direction.

**DEFLECTION-PLATE ARRANGEMENT**

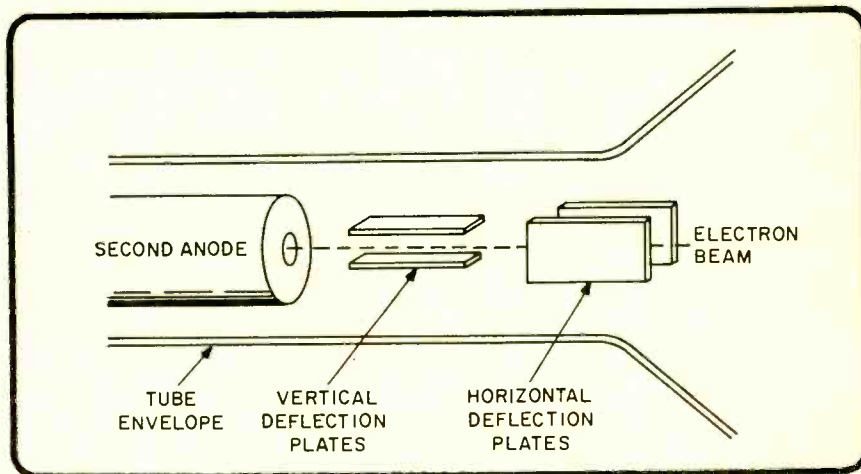

By varying the potential of the vertical-deflection plates, the spot on the face of the tube can be made to move up and down. The distance will be proportional to the change in potential between the plates. Changing the potential difference between the horizontal-deflection plates will cause the beam to move a given distance from one side to the other. There are directions other than up-down and left-right. The beam must be deflected in all directions.

Note the double diagram. You should be able to see that the beam can be moved to any position on the screen simply by moving it both vertically and horizontally.

In the top diagram, position A of the beam is in the center. Movement of the beam to position B by going up two units and then right two units. Movement of the beam is the result of the simultaneous action of both sets of deflection plates. The electrostatic field between the vertical plates moves the electrons up an amount proportional to two units at the screen. As the beam passes between the horizontal plates, it is moved to the right an amount proportional to two units at the screen.

**QUESTION**

**Q11.** In the right figure, how many units and in which direction will each set of deflection plates move the beam from A' to B'?

**ANSWER**

**A11.** The vertical plates will move the beam down three units. The horizontal plates will move the spot one unit to the left.



## DEFLECTION OF CRT BEAM

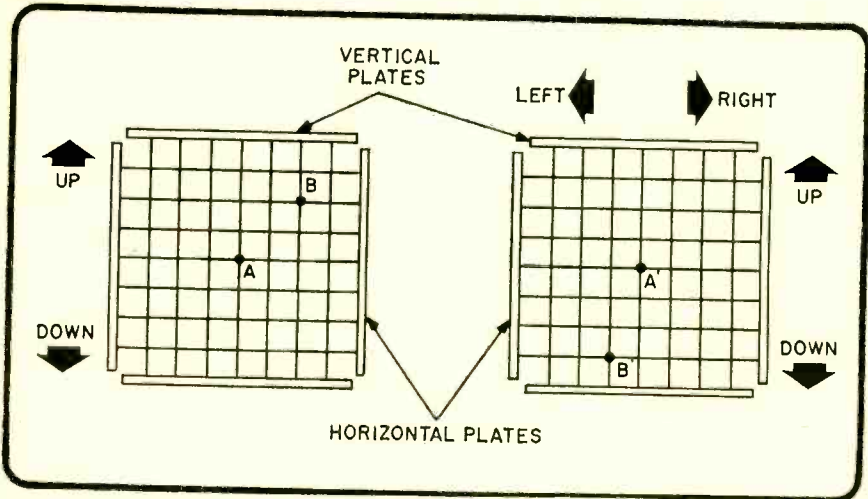

### Voltage Control of Horizontal Plates

Assume that the resistance of the potentiometer in the figure is spread evenly along its length. When the arm of the potentiometer is at the middle position, there is the same potential on each plate. Since here is zero potential difference between the plates, an electrostatic field is not produced. The beam will be at zero on the screen. If the arm is moved downward at a uniform rate, the right plate will become more positive than the left. The electron beam will move from 0 through 1, 2, 3, and 4 in equal time intervals. If the potentiometer arm is moved at the same rate in the opposite direction, the right plate will decrease in positive potential. The beam returns to the zero position when the potential difference between the plates again become zero. Moving the arm toward the other end of the resistance will cause the left plate to become more positive

### HORIZONTAL PLATES—TOP VIEW

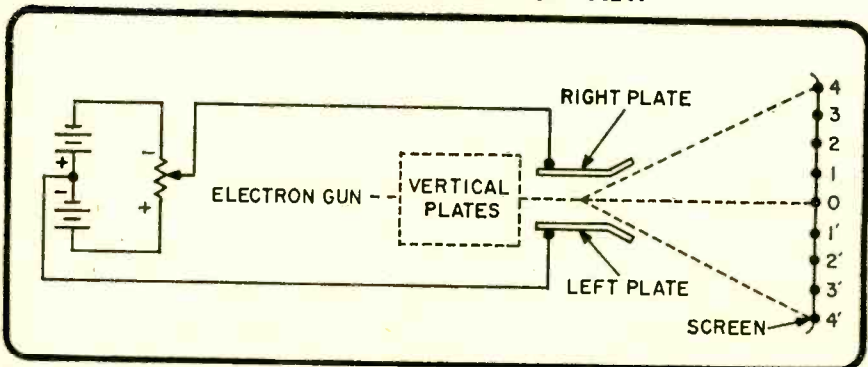

than the right. The direction of the electric force reverses, and the beam moves from 0 through 4'. If the movement of the potentiometer arm is at a linear (uniform) rate, the beam will move at a steady rate.

### AMPLITUDE VERSUS TIME

Do you recall the statement made earlier that waveforms could be described in terms

of amplitude and time? You have just seen how the movement of the CRT beam depends on both potential (amplitude) and time.

From zero time to 1 second the waveform in the diagram is at zero volts. In the CRT the vertical plates remain at the same potential difference while the potential difference between the horizontal plates increases 1 unit in the direction necessary to move the beam toward the right. When time is equal to 1 second the waveform rises to +2 volts. The potential difference between the vertical plates increases enough to move the electron beam 2 units in the positive direction. From 1 to 4 seconds, the waveform remains at +2 volts and then decreases to -2 volts. As the horizontal-plate potential difference increases by 3 units, the vertical potential remains the same. (+2 units) and then drops sharply 4 units. For the next 3 seconds the waveform remains at -2 volts. In the CRT, the potential difference between the vertical plates remains unchanged as the horizontal potential increases uniformly by 3 units.

The vertical-plate potential difference follows the *voltage* of the waveform. The horizontal-plate potential follows the passage of *time*. Together they determine the *trace* (image produced on the screen by the moving beam).

**QUESTIONS**

- Q12. Waveforms can be described in terms of ..... and .....
- Q13. The horizontal-deflection plates are used to reproduce the .....
- Q14. The vertical-deflection plates are used to reproduce the .....

**ANSWERS**

- A12. Waveforms can be described in terms of **amplitude** and **time**.
- A13. The horizontal-deflection plates are used to reproduce the **time component**.
- A14. The vertical-deflection plates are used to reproduce the **amplitude component**.

**AMPLITUDE-TIME GRAPH**

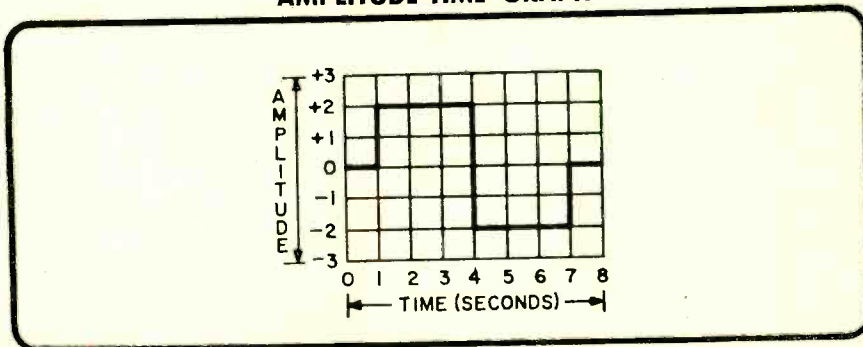

**WHAT YOU HAVE LEARNED**

An electron gun contains a cathode (to emit electrons), a control grid (to control the intensity of the trace on the screen), a first anode (to develop the electric lenses that focus the beam on the screen), and a second anode (to accelerate the electrons toward the screen). Deflection plates in vertical and horizontal pairs are used to position the beam on the screen. If a waveform is applied to the scope, the plates deflect the beam according to the amplitude and time characteristics of the waveform.

This series is based on material appearing in Vol. 4 of the 5-volume set, BASIC ELECTRICITY/ELECTRONICS, published by Howard W. Sams & Co., Inc. @ \$22.50. For information on the complete set, write the publisher at 4300 West 62nd St., Indianapolis, Ind. 46268.

**Dreaming about  
a pair of \$300  
condenser  
microphones?**

**Think seriously  
about these:  
\$39.75\* each!**

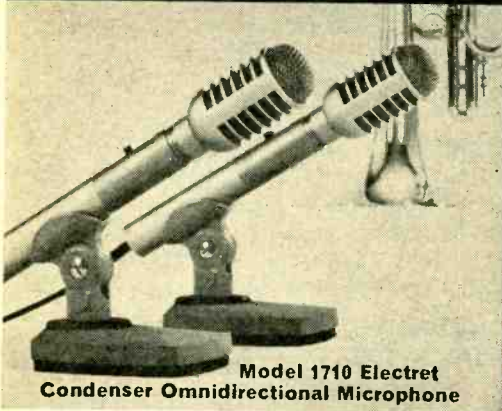

**Model 1710 Electret  
Condenser Omnidirectional Microphone**

All of the great condenser advantages are here without compromise. Flat, extended range, excellent transient response, high output, low noise, and ultra-clean sound. But the new E-V electret condenser microphones need no high voltage power supply. Just an AA penlite battery to operate the built-in FET impedance converter. The result is studio performance without complications and at a dramatically lower price.

There are 4 new E-V electret microphones, including cardioid models, from \$39.75 to just \$75.00, audiophile net. Second-generation designs with unusually high resistance to heat and humidity. Hear them today at your nearby Electro-Voice sound-room. Or write for details.

**More U. S. recording studios use Electro-Voice**

\*Suggested net price. Microphones shown on Model 421 Desk Stand. \$12.60 each.

**ElectroVoice®** a **Gulton**  
COMPANY

ELECTRO-VOICE, INC., Dept. 832EY  
678 Cecil Street, Buchanan, Michigan 49107  
In Europe: Electro-Voice, S. A., Römerstrasse 49,  
2560 Nidau, Switzerland

**CIRCLE NO. 10 ON PAGE 17 OR 101**

## NewsScan

(Continued from page 26)

ate a circle, for example, he would merely point to the keyboard's circle-drawing function and then, on the sketch, indicate the center of the circle and any single point on its circumference.

The user can also add dimensions and labels by selecting the appropriate characters from the keyboard and pointing out where they should be placed on the sketch.

To check his work, the user can at any time have the sketch displayed on the television screen merely by pointing to the "display" function on the keyboard. Similarly, he can cause the sketch to be produced in hard-copy form by the plotter or stored by the computer for later work.

To convert the sketch into a finished drawing proportioned according to the entered dimensions, the user merely touches the "finished drawing" function box on the paper keyboard. He is alerted automatically if dimensions conflict or are incomplete.

Finished drawings and maps can be altered with these same techniques, which are estimated to help a draftsman complete a job in as little as one-fifth of the time required by manual methods.

## MODERN, MOBILE, AND MODULAR

The next time you spot a large white trailer with Bell System markings on the highway, take a second look; it may be your town's new telephone office. Conventional telephone switching offices, which often take months to install and test, are gradually giving way to newer, pre-packaged and pre-tested gear. With the new modularized equipment, certain kinds of telephone switching offices can now be completely

(Continued on page 96)

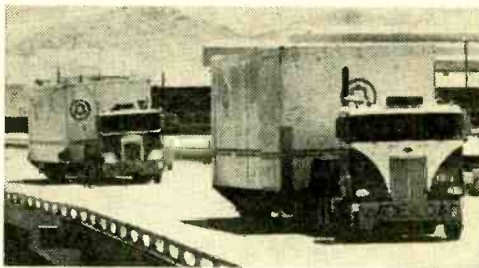

A telephone central office is on the move, bound for the Reno, Nev., suburb of Sun Valley. The "wide loads" each contain 2A electronic switching equipment. When the pre-tested modular equipment reaches its destination, it will be set down on a concrete foundation and pre-cast walls will be built around it to form a telephone central office capable of serving up to 15,000 lines.

## Make Better Recordings

Continued from page 64

before. Any other glitches that may occur to the recording should be handled in the same manner and erased later as follows. Cue in the glitch and time it either by stopwatch, by counting to yourself, or by watching the supply reel on the recorder. Then, rewind, cue in the glitch once more, set recorder on RECORD, run the recorder for the proper time interval with the gain down, and stop.

You will be surprised how effective and accurate this method is for removing extraneous material and errors from tape recordings that would otherwise be spoiled. The trick, of course, is to allow enough lead time for the next number so that there is little danger of erasing the beginning of the following number. You will learn, in time, not to leave too long a lead time for the next number; it would appear as an awkward pause.

**Another Twist.** The procedure described so far assumes that all voice announcements and commentary are to be deleted from the recorded program, but this isn't necessarily so. Some program formats simply do not lend themselves to this procedure. A typical case is a California based program *Hawaii Calls*, where the commentary is an integral part of the program. The blending of commentary and music is such that it is undesirable as well as impossible to separate the two. In such a case it is best to go along with the program format (except for the commercials!).

Admittedly, making good off-the-air recordings isn't easy. It is more of an art than a science and will demand your best operating skills even with the best of recording equipment. This brings us to the final question as to what operating features are most desirable for making good recordings using this technique.

**Finally.** Tape recorder features and operating controls vary considerably from make to make and model to model but fortunately only two basic features are really needed for making good off-the-air recordings. These are a pause control and a digital counter. Although not absolutely necessary, a digital counter is very handy for approximately locating spots on the tape that need later correction or erasure. ■

# The Bore-Proof Science-Fair® Way to Learn About Electronics!

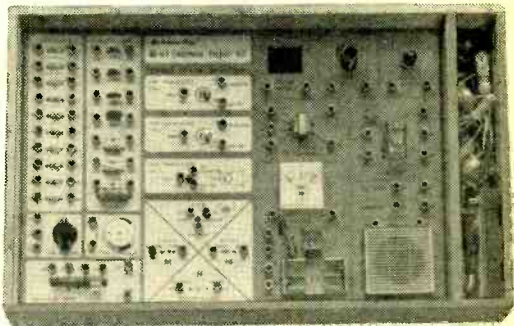

## Our Big, Exciting 65-in-1 Project Kit — As Seen On TV

### Easy to Use — Learn by Doing

The fun way to learn theory and practice of modern solid-state electronics. No experience needed — just imagination! Has all the parts needed for up to 65 electronic adventures: meter, transformer, solar cell, SCR and Zener diodes, code key, earphone, speaker. Everything is conveniently arranged in a fitted hardwood case. Build solar or battery-powered transistor radios, code practice oscillator, electronic thermometer, time delay relay, test equipment and computer circuits, more. Solderless spring-clip connectors make wiring a snap! 100% safe battery operation. Requires one 9-volt and two "AA" cells. "Professional" lab-type manual explains every component and why it is used along with illustrated step-by-step instructions for each project. Sure to captivate any junior Marconi or Edison!

**UNDER  
\$20**

## Science Fair® by Radio Shack

and ALLIED RADIO STORES  
A TANDY CORPORATION COMPANY

212

Dept. LB, 2617 W. 7th St., Fort Worth, Texas 76107

Please PRINT CLEARLY:  Send FREE Catalog.

Name \_\_\_\_\_ Apt. No. \_\_\_\_\_

Street \_\_\_\_\_

City \_\_\_\_\_

State \_\_\_\_\_ Zip

CIRCLE NO. 32 ON PAGE 17 OR 101

**Straight to your tape recorder, or through your integrated amp or a hi-fi preamp, either way gets you a top sound.**

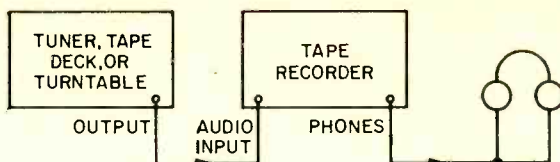

Also, a pause control permits stopping the tape deck mechanism without disturbing the recording function. It permits you, among other things, to fade down, run a silent strip for two or three seconds, and be ready for immediate recording. *The pause control also permits you to cue your recorder very accurately by hand while listening to the output on a set of headphones or the tape monitor facilities of your amplifier.*

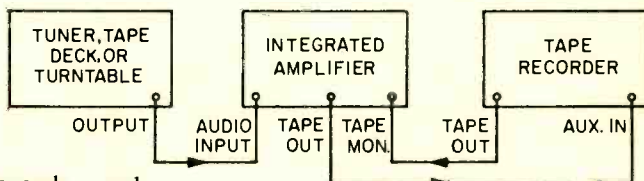

Cassette tape recorders may be used, of course, if the recorder has a pause control.

However, resetting and cueing cannot be done as easily or as smoothly with push-button controls. With reel-to-reel recorders, the reels may also be moved by hand.

And be sure to watch e/e for upcoming articles on capturing important events in sound, and how to put professional sound in your line recordings. ■

## Ask Hank

*Continued from page 24*

*fier? Can you do it without using a battery and buzzer?*

—K.M., Pittsburgh PA

Easy, take a close look at the zip cord and you'll see on one lead the insulation has a ribbon or ridge on it running the length of the lead while its mate is perfectly smooth. Use the marked wire to connect *red dot* or + terminals. Other apparently identical twin wire leads are often marked. Some times one wire is silver and the other is copper in color. Also, a fine thread (often red) or cord is packaged in the insula-

tion of one lead and not the other. Always look carefully at 2-lead cables—you will see a difference between the leads. Well, almost always.

## Skin Antenna

*I heard the term "Skin Antenna" used on the air at about 122 megahertz. What does it mean?*

—M.H., Miami FL

A skin antenna is an insulated section of the skin, or surface, of an aircraft. Antennas of this type offer practically no additional air resistance and usually operate in the VHF and UHF bands. This antenna's radiation pattern varies with frequency, size and shape of the radiating section, and position of the radiator on the aircraft. ■

## Newsan

*Continued from page 94*

assembled and pre-tested at a Western Electric plant location, trucked into a community, and set up in a fraction of the time previously needed. The new offices—an electronic switching system called *2A ESS*, and an electro-mechanical system known as *5A Crossbar*—are important to telephone companies and their customers because of the speed with which they can give a community new or expanded telephone service.

The two systems, similar in their portability, differ in their applications. The *5A Crossbar* is designed for small rural communities. The in-

stallation procedure, to a spectator, is simple enough: first the building to house the unit is constructed, minus a wall or a section of roof; then the *5A* is trucked to the site and either lifted by crane or rolled into the building. The remaining construction is completed, and the *5A* is ready for service. With a 1,000-line capacity that can be doubled without prolonged service interruptions, *5A Crossbar* is ideally suited for smaller established communities. And should the community outgrow its system, the *5A* can be packed up and shipped to another location.

The *2A ESS* is a bigger all-around unit, with a maximum line capacity of up to 15,000 versus the *5A's* 2,000. The *2A ESS* is well suited to provide telephone service for those communities and housing developments that seem to spring up almost overnight, and which expand rapidly. The *2A ESS* is set down by crane on a



concrete foundation, and the precast walls of the office then go up around it.

Both 2A ESS and 5A Crossbar are signs of what the future will bring to customers of Western Electric and the Bell System—reliable, modular, reusable telephone equipment that provides fast, efficient service with built-in allowances for population growth. ■

## Cap Rapper

Continued from page 71

reading you have pre-set the trimmers in the wrong direction. Set S1 to 100 (pF), install a calibration capacitor across the terminals, and adjust R4 until the meter indicates the correct capacitor value. In a similar manner, calibrate the .001, .01 and .1 ranges. Recommended calibration capacitor values are approximately 50 pF, .0005  $\mu$ F (500 pF), .005  $\mu$ F and .05  $\mu$ F.

If you cannot adjust the trimmers so the meter indicates a low enough reading (if the meter reads higher than the indicated capacitor value) you had the trimmer pre-set to the wrong side. Simply rotate the trimmer to the opposite side; the meter reading will rise, pin the pointer and then decrease to the correct reading as the trimmer(s) are adjusted. ■

## ● QUICKY REVIEW

199 *Electronic Test & Alignment Techniques* by Art Margolis, Tab Books publisher; quick reference guide for solving tough electronic troubles at home; soft cover, 224 pages, 131 illustrations, \$4.95.

For more information circle No. 40 on the Reader Service Page.

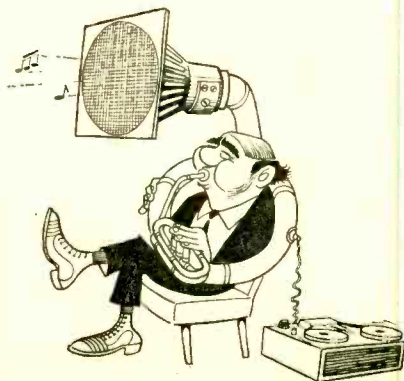

FOR THOSE WHO NEED WEATHER INFORMATION

# REALISTIC "Talking Barometer" INSTANT WEATHERADIO®

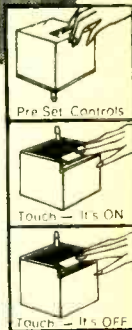

Get continuous reports and *emergency info* from the U.S. Weather Service VHF station in your area.\* Pre-set controls & unique "Play-Bar" for instant listening at the touch of a finger. Telescoping antenna. Battery powered. Palm sized simulated rosewood cube—ideal for desk, den or deck. Made only by Realistic, sold only at Radio Shack stores nationwide.

\*Now Broadcasting Akron, Anchorage, Astoria Or, Atlanta, Atlantic City, Baltimore, Baton Rouge, Boston, Brownsville, Buffalo, Charleston SC, Chicago, Cleveland, Corpus Christi, Dallas, Denver, Des Moines, Detroit, Eden Md, Erie, Eugene Or, Eureka Ca, Fort Worth, Galveston, Hilo, Honolulu, Hyannis, Indianapolis, Jacksonville, Kansas City, Lake Charles, Los Angeles, Maui, Miami, Milwaukee, Minneapolis, Mobile, Monterey Bay, New Bern NC, New London, New Orleans, New York, Norfolk, Pensacola, Pharr Tx, Phoenix, Portland Me, Portland Or, Rockland Me, Sacramento, Salt Lake City, San Diego, Sandusky, San Francisco, Savannah, Seattle, Seward, St. Joseph, St. Louis, St. Petersburg, Tampa, Washington, W. Palm Beach, Wichita, Wilmington NC.

REALISTIC®

by Radio Shack

and ALLIED RADIO STORES  
A TANDY CORPORATION COMPANY

213

Dept. LB, 2617 W. 7th St., Fort Worth, Texas 76107

Please PRINT CLEARLY:  Send FREE Catalog.

Name \_\_\_\_\_ Apt. No. \_\_\_\_\_

Street \_\_\_\_\_

City \_\_\_\_\_ State \_\_\_\_\_ Zip \_\_\_\_\_

CIRCLE NO. 32 ON PAGE 17 OR 101

# Free! 1973 Eico catalog

OVER 200 INSTRUMENTS • KIT & WIRED!

NEW! TR-410 Solid State Triggered Sweep Scope  
 NEW! 300C "Clamp-On" Current Tester  
 NEW! TD-88 Track Stereo Tape Deck  
 NEW! SS-200 "Time Delay" Burglar Alarm System  
 NEW! ASA-300 Electronic Siren Auto Alarm

Build all-professional Eico Kits and save up to 50%. The more you know about electronics, the more you'll appreciate Eico. Over 2500 local Eico dealers offer you all the top brands, personal technical counsel, fast off-the-shelf service. Free catalog includes Test Equipment, Stereo, Eico-craft Projects, Burglar/Fire Alarm Systems and name of nearest Eico distributor, check reader service card or send 25¢ for first class mail service.

EICO, 283 Malta St., Brooklyn, N.Y. 11207  
 Leadership in creative electronics since 1945



CIRCLE NO. 23 ON PAGE 17 OR 101

**Opening doors  
 for the  
 handicapped  
 involves more  
 than just  
 being polite.**

**Hire the handicapped.**



PUBLIC ADVERTISING SYSTEM  
 A DIVISION OF THE SCHOOL OF VISUAL ARTS



## 24 IN 1 BURGLAR ALARM PROJECT KIT

BUILD 24 DIFFERENT SOLID-STATE ALARM CIRCUITS.  
 UNIQUE PLUG-IN COMPONENT STRIPS, ETCHED CIRCUIT BOARDS, SEMICONDUCTORS, INSTRUCTIONS AND SCHEMATICS INCLUDED. \$10.50 POST PAID

**PHOTOLUM CORPORATION**

118 EAST 28TH STREET, NEW YORK, N.Y. 10016

CIRCLE NO. 14 ON PAGE 17 OR 101

## DX Central Reporting

Continued on page 22

eration. Recently it has been reported operating on this frequency with the VOA Jazz Hour program around 2330. . . . 10010—A long-time clandestine operation is the Viet Cong's *Liberation Radio*, which continued broadcasting on shortwave after the signing of the Vietnam peace agreement. You may find its English language program from 2030 to 2045. But the frequency does vary a bit, so tune on either side of this channel if you don't find them on 10,010 kHz.

(Credits: Gregg Calkin, Ontario; Gerry Dexter, Wisconsin; H. Robert Bundy, Truk, Caroline Is., Pacific Ocean; A.R. Niblack, Indiana; Alan Roth, New York; Larry Magne, Pennsylvania; Gladys Martin, Brooklyn; Elliot Straus, New Jersey; Joe Torok, Pennsylvania; National Radio Club, Box 99, Cambridge, Mass. 02138; International Radio Club of America, 6059 Essex St., Riverside, California 92504; North American SW Association, Box 8452, South Charleston, W. Virginia 25303)

**Backtalk.** First, this month, our congratulations to Al Reynolds of Jackson, Tennessee, recently elected executive secretary of the Association of North American Radio Clubs. ANARC is the organization affiliating most of the major DX clubs in North America. And we'll be telling you more about ANARC activities in the coming months.

"I have one tip to report," writes Russ Mappin of Spokane. "*Radio Tahiti* (Ah ha, see what I told you about that one's popularity!) has an English news broadcast at 1745 GMT on 15,170 kHz. At this time they identify in English, the only time I've heard an English ID."

Thanks for the tip, Russ. And by the way, best wishes to you as you enter your 45th year as a DXer!

Russ began DXing in 1928. It was only four years later that RCA built a three-band shortwave receiver, model 9K3. That receiver is still bringing in the DX for teen-age Mark Carlsen of Minneapolis. Mark calls his rig a "working antique," but work it does. His listening has brought him 57 QSLs and six pennants.

"My biggest DX thrill," writes Mark, "was picking up Hanoi's *Voice of Vietnam* and receiving a QSL from them."

John Lisiiecki is a 16-year-old high school sophomore from Detroit who has been listening to shortwave for two years. John's interest in DXing began when some relatives in Poland dedicated a program to his family over Radio Warsaw.

John notes that he finds the SWL hobby "very interesting, educational and challenging."

And fun, too, John, right? ■

## Hey Herb

Continued from page 76

are very sensitive to improper overhang adjustment, much more so than for standard stereo—which is already somewhat critical. Garrard provides an overhang gauge, as do most other manufacturers of quality turntables. Use it exactly as specified and don't make improvements.

About 15 years ago, whenever an Editor was short on ideas he commissioned someone for a feature on "How to adjust the stylus' overhang." About 50% of the industry was suckered into actually believing it took endless experimentation to get the correct overhang; even some prestigious consumer labs got sucked in. There is a standard overhang and your turntable's gauge sets it up. I dread to think of the myths we're going to get about quadrasound.

**HEY HERB:** I have a Kenwood KM-8002 power amplifier driving two Bozak speakers. I have the speaker wiring phased but there's no bass. If I reverse the phasing to one speaker I get a good solid bass. Is it possible one speaker has reversed connections inside the cabinet?

*Possible, but not probable.* When you get to quality equipment, like Bozak, they don't usually make mistakes. I have never seen or heard of this wiring "error" in a Bozak. More likely, your room acoustics is flipping the phase of the radiated sound. This is common in the modern "L" shaped living-dining room when the speakers are mounted along a leg of the "L", with one speaker in the corner. Walk around the room, you'll probably hear the bass "boom in" in certain areas. Just use the speaker wiring phasing that gives the big bass at the listening location.

## Big Nine

Continued from page 35

be producing sound at equal loudness. Perform the same test with the tweeters. Operate the controls to see if they reduce the volume of the mid-range, or tweeters, when rotated to the left. Double check your wiring and, if satisfied, solder all lugs. Connect a 1½-volt flashlight battery to the terminal strip. Reverse the battery if necessary until the woofer cone moves forward at contact. Put a drop of red paint on the terminal connected to the positive pole of the battery.

The woofer compartment should be lined with a minimum of about 2 inches of fiber glass batting on the walls and back panel. House insulation grade of fiber glass is low in price and works very well, but

# EXPERIMENTER

International EX Crystal and EX Kits



**OX OSCILLATOR**  
**\$2.95**

**OX OSCILLATOR** Crystal controlled transistor type. Lo Kit 3,000 to 19,999 KHz Hi Kit 20,000 to 60,000 KHz (Specify) **\$2.95**

**MX-1 TRANSISTOR RF MIXER** A single tuned circuit intended for signal conversion in the 3 to 170 MHz range. Lo kit 3-20 MHz. Hi kit 20-170 MHz. **\$3.50**

**SAX-1 TRANSISTOR RF AMP.** Amplifier to drive MX-1 mixer. Lo kit 3-20 MHz. Hi kit 20-170 MHz. **\$3.50**

**PAX-1 TRANSISTOR RF POWER AMP.** A Single tuned output amplifier to follow the OX oscillator. 3,000 to 30,000 KHz **\$3.75**



**EX CRYSTAL**  
**\$3.95**

**EX CRYSTAL** Available from 3,000 KHz to 60,000 KHz. Supplied only in HC 6/U holder. Calif. IS ±.02% when operated in International OX circuit or its equivalent. (Specify frequency) **\$3.95**

**BAX-1 BROADBAND AMP.** May be used as a tuned or untuned amplifier in RF and audio applications 20 Hz to 150 MHz. **\$3.75**



**CRYSTAL MFG. CO., INC.**  
10 N. LEE • OKLA. CITY, OKLA. 73102  
Write for FREE Catalog

CIRCLE NO. 19 ON PAGE 17 OR 101

## "LISTEN IN" TO POLICE-FIRE RADIO CALLS IN YOUR CAR!

WORKS with ANY CAR—Portable or HOME RADIO! Just PLUG IN—No wiring—3 minute Hookup! Switch instantly from regular to ALL POLICE-FIRE-EMERGENCY-COMMERCIAL-TAXICAB-STATE-CITY-GOV'T 2 way Radio calls in YOUR AREA. DUAL-HI-LOW BANDS—46/50-150/175 MHX. OVER A MILLION Radio Cars/stations. USE Everywhere—Anytime—always works!

**SEND ONLY \$2.00** (cash, Ck, M.O.) and pay post-\$11.99 for ppd. Del. in USA. COMPLETE ready to use with instructions. One Year service Warranty—**10 DAY MONEY BACK TRIAL** (if retnd) **AMAZING OFFER** good only by mail—**WESTERN RADIO Dept. BE-7, KEARNEY, NEBR. 68847**

CIRCLE NO. 8 ON PAGE 17 OR 101

**PARTS! FREE CORNELL TUBES!**

FREE Send For FREE CORNELL'S New Color Catalog 48 Pgs. New Items

**33¢ per tube**

**36¢ per tube**

ORDER FREE IF NOT SHIPPED IN 24 HOURS!

4219 E UNIVERSITY AVE. SAN DIEGO, CALIF. 92105

CIRCLE NO. 11 ON PAGE 17 OR 101

**FIND BURIED TREASURE**

Powerful electronic detector finds buried gold, silver coins, etc. Write or call for free catalog. Dealer inquiries invited.

Financing Available 19.95 to 198.50

Phone day - night (713) 682-2728

**RELCO, Dept. D-58**

BOX 10839, HOUSTON, TEX. 77018

CIRCLE NO. 4 ON PAGE 17 OR 101

first it must be stripped from its paper backing. The fuzzy edge should be faced away from the walls, toward the cabinet interior. The chief purpose of the fiber glass is to kill reflections in the upper frequency of the woofer, but it will also help slightly to reduce any tendency toward booming. You can experiment with different amounts of fiber glass until the woofer sound is right.

Screw down the back, then prepare the top. The top will be installed with screws through the sides, back, and front into blocks under the top. The blocks should be cut to short lengths, except for a long block at the back, so that they can be positioned at intervals between speaker positions. Glue and screw the blocks to the under side of the top. Before installing the top, loosely fill the mid-range compartment with fiber glass pads. Arrange the pads flat so that their edges face the speakers.

**Finishing Touches.** It is somewhat easier to stain and finish the top and trim pieces before putting on the grille cloth. Sand lightly, stain, and finish to your own taste. Staple grille cloth to the back edge of one side and wrap it around tightly; then staple or tack at the back edge of the other side. Install the trim pieces with finishing nails. If glue is not used, you can easily remove the trim and grille cloth later for a change of cloth.

Now connect the speakers to your amplifier. Observe polarity by connecting the red dot terminal of each Big Nine speaker system to the positive sides of your amplifier output terminals. Begin listening with the mid-range and tweeter controls fully clockwise. If the sound is too bright, adjust the tweeters back by degrees. If the bass is less prominent than you like, rotate both mid-range and tweeter controls counter clockwise until the sound is balanced. Un-

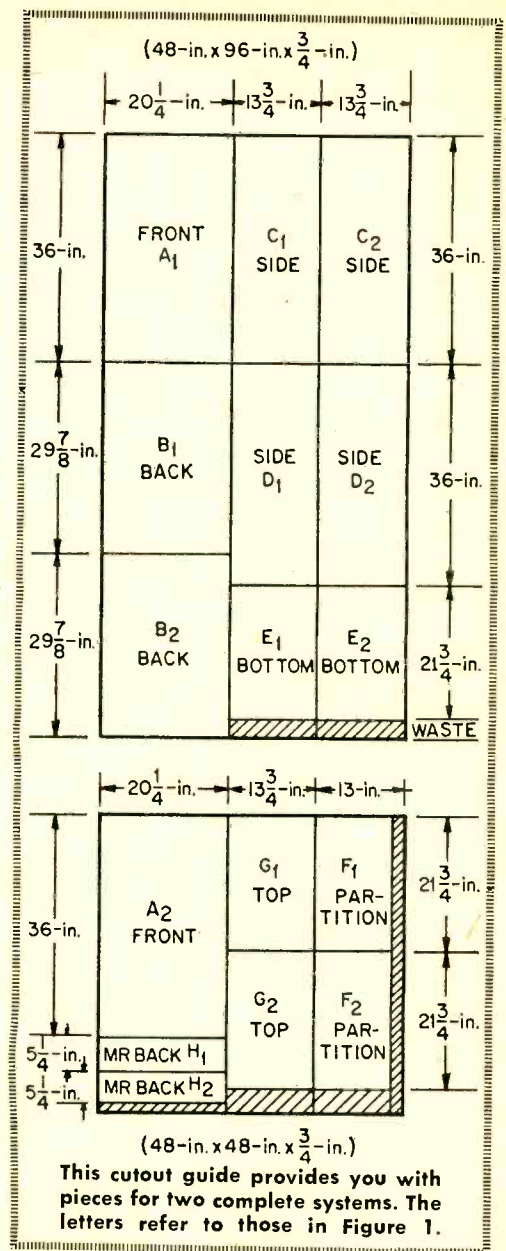
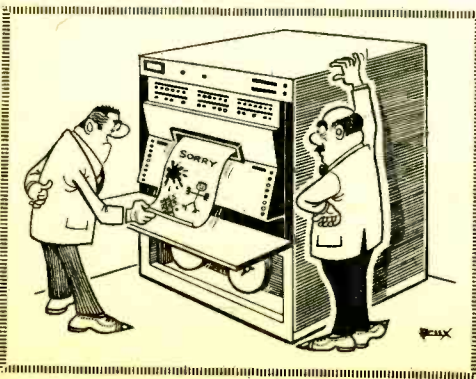

less your room is acoustically asymmetrical, such as heavy curtains near one speaker, you should try to keep the controls on both speakers at similar settings for good stereo performance.

**Hints-On-Parts.** Prices for parts shown in the bill of materials are for CTS speakers available from McGee Radio, 1901 McGee Street, Kansas City MO 64108. However, you can substitute similar-size speakers and

(Continued on page 102)

## READER SERVICE PAGE

- The Editor of ELEMENTARY ELECTRONICS offers readers an easy way to get additional information about products and services advertised in this issue. Also, if you would like more information about any new product mentioned in our column "Hey, Look Me Over," it's yours for the asking. Just follow the instructions below and the material you requested will be sent to you promptly and at no cost.

- The coupon below is designed for your convenience. Just circle the numbers that appear next to the advertisement or editorial mention that interests you. Then, carefully print your name and address on the coupon. Cut out the coupon and mail to ELEMENTARY ELECTRONICS, Box 886, Ansonia Station, New York, N.Y. 10023. Do it today!

JULY/AUGUST 1973

Void after November 30, 1973

**ELEMENTARY ELECTRONICS**  
**Box 886, Ansonia Station, New York, N.Y. 10023**

Please arrange to have literature whose numbers I have circled at right sent to me as soon as possible. I understand that this is a free service offered by the magazine. Please limit circled items to 12 maximum.	1	2	3	4	5	6	7	8	9	10
	11	12	13	14	15	16	17	18	19	20
	21	22	23	24	25	26	27	28	29	30
	31	32	33	34	35	36	37	38	39	40
	41	42	43	44	45	46	47	48	49	50
	51	52	53	54	55	56	57	58	59	60
	61	62	63	64	65	66	67	68	69	70

Are you a Subscriber to this magazine? YES  NO

Name (Print Clearly) \_\_\_\_\_  
 Address \_\_\_\_\_  
 City \_\_\_\_\_ State \_\_\_\_\_ Zip Code \_\_\_\_\_

parts from other sources such as the 40-1224 tweeter and 40-1339 crossover network from Radio Shack. The crossover includes the L-pads to make the job of interconnecting speakers an easier one. You can even use 3/4-inch flake board in place of the regular plywood to cut your wood costs. Grill cloth, hardware, terminal strips and other miscellaneous items can be purchased from local hardware and electronic stores as well as from your favorite mail order catalog. Smart shopping and use of junk parts can hold your parts costs to as little as \$65 per speaker, and even less.

**Summing Up.** If you are not used to a large woofer, you will note the difference right away. Amplifier controls may require different settings than for small speakers.

But the important difference is that there is a firmness to the bass that is missing with most small systems.

With the proper balance you will begin to appreciate the advantage of the side facing speakers. A change of listening position produces much less change in stereo quality than with conventional speakers. Also, the better dispersion produces the illusion of a wider sound source, a big one.

A further advantage is that mid and high frequency power is divided between four speakers. Each of the small speakers is working far below its power limit, with reduced distortion in the frequency ranges where the ear is most sensitive to distortion. The result is a smoother sound. Two Big Nines add up to impressive stereo. ■

## Bookmark

*Continued from page 81*

resonant frequency-impedance-decibel table, and color table. For a free copy of the Electronics Symbols Handbook, circle No. 59 on Reader Service Page.

**Color TV.** Why is a delay line used in color-TV receivers? How can electrical interference be eliminated? What can be done to prevent changes in color intensity that occur during a program? You can ask, but *Questions & Answers About Color TV* by Leo G. Sands gives



Soft cover  
96 pages  
\$3.95

you the answers, too! The first part of the book concerns theory and operation. Part two covers installation procedures and problems. The third part discusses color-television servicing. The concluding part tells how to make simple modifications of and additions to receivers to improve and extend their capabilities. Published by Howard W. Sams & Co., Inc. For more information, circle No. 62 on Reader Service Page.

### Quickie Reviews

● *The True Sound of Music* by Hans Fantel; published by E. P. Dutton, 201 Park Ave. So.,

NY 10003; here's a book that takes out the technical double talk, spelling out the precise meaning of technical audio concepts in plain language; hard cover, 237 pages, \$7.95.

● *All-in-One TV Alignment Handbook* by Jay Shane; TV alignment procedure explained by plain-language descriptions; published by Tab Books, Blue Ridge Summit PA 17214; soft cover, 304 pages, 145 illustrations, \$5.95.

● *Security & You*; a do-it-yourself guide to burglar and fire protection for your home, car and business using conventional parts from Audiotex; published by Hydrometals, Inc., Rockford IL 61101. For more information, circle No. 67 on Reader Service Page.

● *Control of Electric Machines* by Irving L. Kosow; detailed treatment of practical overload prevention devices, starters, speed controls, and automatic feedback control systems, published by Prentice-Hall, Inc., Englewood Cliffs NJ 07632; hard cover, 376 pages, \$15.95. ■

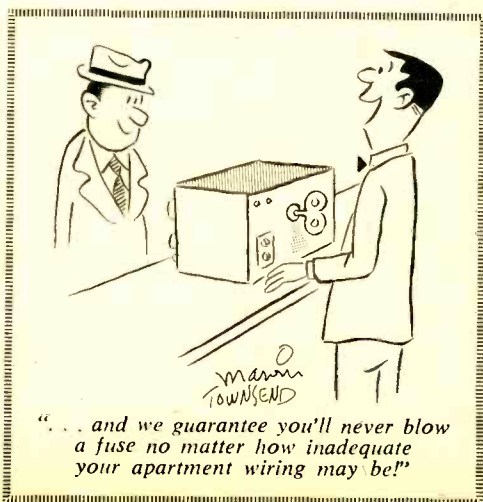

## Computer Diagnoses EKG's

Continued from page 80

a detailed EKG diagnosis which can be used clinically by any physician. The system speeds up hospital procedures, cuts administrative delays and improves patient care. The emergency service is of special value to hospitals that may not be able to avail themselves of a cardiologist or expert EKG reader on a 24-hour basis.

Compu-Gram does not send back raw data or a listing of possible alternatives. The hospital does not need a cardiologist to interpret the findings. The information produced by the computer is a complete diagnosis that can be used directly by the attending physician, whether he is a cardiologist or not.

## CB Coffee Break

Continued from page 40

ture mobile whips to multi-element base station beams. There's an antenna for every need and every type of installation. The most I can see for '74 is new packaging and appearance; as with transceivers, there's little that can be done to improve upon what is already superb performance.

One area where we can expect surprises is police-fire monitors. The new translators for low and high band VHF reception have really caught on. These low cost devices convert an

## Alarm Generator

Continued from page 78

resistor and a 5000-ohm pot. Connect a pair of 2000-ohm headphones (or the AUX input of an amplifier-speaker combination to the output and connect a 9 volt power supply to the power leads. Now adjust the pot until you get a good sound. If all's well you should be able to get an attention grabbing sound by adjusting the pots on the front panel. If not, try interchanging the unijunctions. When you are satisfied with the results, remove the pot/resistor combination, measure it with an ohmmeter, and replace it with a resistor of the closest value.

In operation, the ELECTRONIC ALARM GENERATOR works very well as an alarm device with just headphones as a repro-

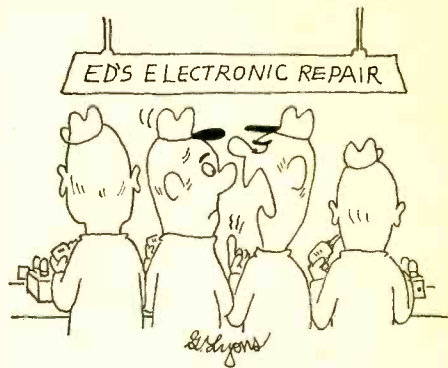

"Cut it out, Charlie, that was my finger you were soldering!"

ordinary CB transceiver into a VHF monitor receiver without interfering with normal CB operations. As usually happens with ideas too good to pass up, someone's bound to offer the same idea for other than the public service frequencies: maybe it will be an aircraft frequency monitor, or a TV audio monitor (TV????).

As usual, '74 will have a new crop of old ideas. CB phone patches in new styling, RF receiving preamplifiers, portable test equipment and test sets, etc. However we look at CB in '74, one common thread runs through all the equipment: *The changes will be mostly cosmetic.* The CB equipment on your dealer's shelves right now is probably as good as what you'll get in '74, and the prices are likely to be substantially lower now. ■

ducer. If your application calls for more volume, connect it to an amplifier. Just be careful with the special effects. You wouldn't want to attract a flight of passionate wild ducks winging it south this fall! ■

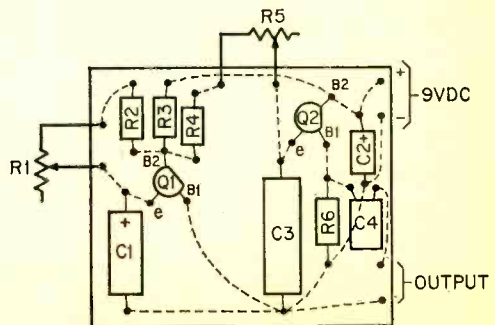

Top view of the Electronic Alarm Generator. Dashed lines represent wiring underneath a completed board. Unit will drive headphones

# CLASSIFIED Market Place

Classified Ads 65¢ per word, each insertion, minimum 15 words, payable in advance. For information on Classified ads—to be included in our next ELEMENTARY ELECTRONICS—write to R. S. Wayner, Classified Ad Manager, 229 Park Ave. South, N. Y. 10003.

## ADDITIONAL INCOME

WIN ONE MILLION DOLLARS in the New Jersey State Lottery. Rush \$3.00 for complete details and instructions. Satisfaction Guaranteed. Davidson's, Box 274-SM, Belleville, Illinois 62222.

## AUTHOR'S SERVICE

Publish your book! Join our successful authors' publicity advertising promotion, beautiful books. All subjects invited. Send for free manuscript report and detailed booklet. Carlton Press, SMH, 84 Fifth Avenue, New York 10011.

## BOOKS & PERIODICALS

WIRETAPPING Expose! Revolting National Scandal. Details \$1.00 Refundable. Don-Q, Box 548, Seattle, Washington 98108.

GREAT catalogs—Free! Diane D. Anderson, 260 Crittenden Blvd., Rochester, NY 14642.

DIGITAL INTEGRATED CIRCUITS MANUAL—1973 edition—1500 types—double listing by type and wiring diagram number. Many cross-referenced. \$3.95. Electronics, Box 278, Cranbury, N.J. 08512.

FREE SUBSCRIPTION—Projects, Construction, Theory Solid State Newsletter. Box 4188R, Mountain View, California 94040.

## BUSINESS OPPORTUNITIES

I made \$40,000.00 Year by Mailorder! Help others make money! Start with \$10.00—Free Proof! Torrey, Box 318-T, Ypsilanti, Michigan 48197.

MAKE Magnetic Signs. Big profits. Details. Universal, Lenora, Kansas 67645.

1000% PROFIT Bronzing Keepsakes. Free Literature. NBC, Box C-4-0, Coral Springs, Florida 33065.

HERBALISM! The home gold mine! Free lesson, Seeds. Herbalism Institute-D, 1339 Remuda, Glendora, Ca. 91740.

ADDRESSERS and Mailers needed. Details 10¢. Lindbloom Services, 3636 Peterson, Chicago 60659.

FREE—Wholesale Catalog and Sales Plan. JAM Enterprises, 3100U Liberty Avenue, Pittsburgh, Pa. 15201.

MAKE money typing at home! Details for self-addressed stamped envelope and \$1.00 to: SC Ventures, 4731 Clinton. Klamath Falls, Oregon 97601.

FREE BOOK "2042 Unique, Proven Enterprises." Beat inflation with fabulous, successful "Little Knowns." Work Home! Haylings-E9, Carlsbad, Calif. 92008.

## BUSINESS OPPORTUNITIES—Cont'd.

WE NEED GINSENG GROWERS! \$3,000-\$30,000 annually! We Buy Your Crop. Send \$2. For seed sample and information. Glass's Ginseng Exchange, Box 336, Rochdale Station, Jamaica, N.Y. 11434.

GROUND FLOOR opportunity in an Engraving business of your own—Spare time or Full time. One piece of raw material costing \$4.50 will produce products worth \$180.00! Free particulars! Write: Warner, Room EC-107-CF, 1512 Jarvis, Chicago, Il. 60626.

TRUTH ABOUT MAILORDER! REPORT \$2.00 GERALD STIDLEY 831 CRANE 402F-7, DEKALB, ILLINOIS 60115.

MAKE BIG Money Selling Car Electricity Adapter. Powers Electric Appliances. Free Details: HMS, Post Office Box 606, Glendora, California 91740.

\$35/HUNDRED stuffing envelopes. Details, send \$1.00! Bolon Enterprises, 6110 Renwick # 165A, Houston, Texas 77036.

## DO-IT-YOURSELF

BUILD 32-FUNCTION DIGITAL COMPUTER. 24-Pin integrated circuit, 12 transistors, complete instructions, \$15.25. Electronics, Box 278, Cranbury, N.J. 08512.

NEW CRAFT PRINT CATALOG—Choose from over 100 great easy-to-build plans. Send \$1.00 (completely refunded with your first order). BOAT BUILDER, (CP Div.)—229 Park Avenue South, New York, N.Y. 10003.

## EDUCATION & INSTRUCTION

HIGH SCHOOL DIPLOMA for adults. Earn State Diploma. Accepted by Civil Service, business, colleges. Low Cost. No tedious study. Money-back guarantee. Details: H-S Program, Suite 25 24, 1221 Avenue Of Americas, New York, N.Y. 10020.

LIFETIME Ordination Church Charters. Details 25¢. Life Science, 2207 Cardinal, Rolling Meadows, Illinois 60008.

"LOGIC newsletter, design and construction, sample copy. \$1.00. Logic Newsletter, POB 252, Waldwick, N.J. 07463."

## FARMS, ACREAGE & REAL ESTATE

GOVERNMENT LANDS—Low as \$125 Acre! Buy, lease or homestead. Free Details! Lands Digest, Box 25561-JC, Seattle, Wa. 98125.

BUY LAND cheap your community or any state on signal. Information \$2.00. DDPI, Land Signals, Box 325, Scottsville, Texas 75688.

## FOR SALE—MISCELLANEOUS

FREE Catalog of Amplifiers, Power Supplies, Alarms, Etc. Write: CPA Radio, 2115 Norris Canyon Road, San Ramon, Ca. 94583.

## FOR THE HOME

FOR anyone who wants the satisfaction and economy of repairing, furnishing and maintaining the furniture in his home. Send \$1.25 to FURNITURE-229 Park Avenue South, New York, N.Y. 10003.

## HEARING AIDS

HUGE SAVINGS! BUY DIRECT! Eliminate dealer markups 20 days FREE Trial Terms arranged. No salesman will call. LLOYD'S-79, Rockford, Illinois 61108.

## INVENTIONS WANTED

WE either sell your invention or pay cash bonus. Write for details. Universal Inventions, 298-3, Marion, Ohio 43302.

## LOGIC

LOGIC NEWSLETTER. Design, Theory, Construction. Sample copy \$1.00. Logic Newsletter, POB 252, Waldwick, N. J. 07463.

## MAGIC TRICKS, JOKER NOVELTIES & PUZZLES

CATALOG 10¢. 1,500,399 Tricks, Novelties, Jokes, Elbee, 7408-S, San Antonio, Texas 78207.

## MAIL-ORDER OPPORTUNITIES

100% PROFIT. SELL SECURITY products by mail. Details, samples free. CSA, Dept. 1E, Box 12127, Dallas, Texas 75225.

BIG MONEY IN OLD SOCKS! Send \$1.00. Kittell, 8115 W. Chester Pike, Upper Darby, Pa. 19082.

## MISCELLANEOUS

NEW Indoor Electronic TV Antenna. Fantastic reception. Uses no Electricity. Plugs into wall outlet. \$2.49. A. R. Products, Dept. 386, 1461 Rising Glen Road, Los Angeles, California 90069.

## MONEYMAKING OPPORTUNITIES

MAKE BIG MONEY raising Chinchillas, Cavies, Rabbits for us. Catalog 25¢ Keeney Brothers, New Freedom, Penna. 17349.

Guaranteed Home Income raising chinchillas. 25¢. Chinchilla, 11DC2, Port Richey, Fla. 33568.

SELL YOUR PHOTOS. REPORT tells HOW WHERE COLOR SLIDE MARKETS. Only \$1.00. Wilson Gift Enterprise, 4158 Barnes Ave., Bronx, N.Y. 10466.

## FOR GREATER CLASSIFIED PROFITS, RESULTS AND SAVINGS

Place your ad in one of our SPECIAL COMBINATIONS: Business, Science & Mechanics, or Davis Combination. Each Combination is designed to give you the largest audience available. For further information write to R. S. Wayner, Manager, Classified Advertising, Science & Mechanics, 229 Park Avenue South New York, N.Y. 10003.



# CLASSIFIED MARKET PLACE—Cont.

## MONEYMAKING OPPORTUNITIES— Cont'd.

**\$35-HUNDRED.** Put our brochures into preaddressed-stamped envelopes. Details \$1.00. F&P 720M East South Blvd., Troy, Michigan 48064.

Make Your Classified Ad Pay. Get "How To Write a Classified Ad That Pulls." Includes certificate worth \$2.00 toward classified ad in S & M. Send \$1.25 (includes postage) to R. S. Wayner, Science & Mechanics, 229 Park Ave., South, New York 10003.

## OF INTEREST TO WOMEN

**\$25.00 DAILY** Possible addressing-stuffing envelopes Typewriter-longhand, also Clipping News items at home. Information. Send stamped addressed envelope. Ame-7, Box 310, Le Mars, Iowa 51031.

## OPTICAL GOODS—TELESCOPE

**EYEGLASSES Wholesale—Free Catalog** A-1 Optical Company, Box 175, Dept. 28 C, Bay Station, Brooklyn, N. Y. 11235.

## PERSONAL

**ORIENTAL introductions!** Photographs, descriptions, questionnaire, brochure, etc. \$1.00. **INTER-PACIFIC**, Box 30 SC, Birmingham, Michigan 48012.

**CONTRACEPTIVES FOR MEN—By Mail.** Samples and Catalogue—\$1.00. **POPLAN**, Box 2556-DCG-4, Chapel Hill, N.C. 27514.

**EAT ANYTHING—LOSES WEIGHT—FORMULA \$2.00.** EDISON, 125, MIAMI, FLORIDA 33151.

## PHOTOGRAPHY—PHOTO FINISHING

**SAVE HUNDREDS OF DOLLARS!!!** Make your own S & M densitometer. Send \$3.00 for detailed drawings and instructions. A must for successful photography in your darkroom. Order direct from: S & M Instruments, Dept EET, 229 Park Avenue South, New York, New York 10003.

## RADIO & TELEVISION

**TV TUBES 36¢ each.** Send for Free 48 page color catalog. Cornell, 4217-W University, San Diego, California 92105.

"**DISTANCE One Tube**" Handbook—50¢. 15 Distance one tube plans—25¢. Catalog 25¢. refundable. Laboratories, 1477-G, Garden Grove, California 92642.

**TELEVISION PROJECTOR KIT.** Bele Electronics Corp. 138 Hialeah Drive, Hialeah, Florida 33010.

**OLD RADIO PROGRAMS** on Tapes, Cassettes, Cartridges. Free Catalogue. Pro-Log Productions, Box 6, Dobbs Ferry, N.Y. 10522.

**FREE BARGAIN CATALOG—Electronic parts, Kits.** Pacific, Box 4192W, Mountain View, California 94040.

**DISCOVER** how to avoid calling the serviceman. Save by servicing home equipment yourself. Send \$1.25 for magazine. **RADIO-TV REPAIR—229 Park Avenue South, New York, New York 10003.**

## REMAILING SERVICE

**RECEIVING - Forwarding - Remailing,** monthly rates. Nortex, Drawer 430, Weatherford, Texas 76088.

## SCIENCE & CHEMISTRY

**ANTIGRAVITY DEVICE.** Brochure 35¢. AGD, Box 3062-EE, Bartlesville, Oklahoma 74003.

## STAMP COLLECTING

**200 DIFFERENT** worldwide stamps 10¢. Approvals included. White, 6808-B Chrysanthemum, Indianapolis, Indiana 46224.

**ABSOLUTELY FREE! COMPLETE SET.** JUST SEND 25¢ HANDLING FOR ADULT APPROVALS. Hoffman, Route 3, Lucan NOM 2JO, Canada.

## SURPLUS EQUIPMENT

**GIANT 120 Page Canadian Surplus Catalog \$1.** Etc., Dept. DG, Box 741, Montreal.

## TAPES, RECORDERS, SOUND EQUIPMENT, RECORDS

**OLD-TIME RADIO PROGRAMS** on Cassettes or Reel-To-Reel Tapes. Send \$1.00 For Catalog. W. D. HAGEWOOD, 1154 TIMBERLANE DRIVE, INDIANAPOLIS, IND. 46260.

## TIPS FOR THE HOME, ETC.

**PRACTICAL tips** for home, garden and workshop are in "1001 How-To Ideas." Send \$1.25 for your copy includes Postage. to 1001 How-To Ideas, 229 Park Avenue South, New York, New York 10003.

## TREASURE FINDERS—PROSPECTING EQUIPMENT

**DISCOVER AMERICA'S FASTEST GROWING HOBBY.** White's Electronics, Inc. would like to send you absolutely FREE, their 42 page, fact-filled catalog on Mineral and Metal Locating Equipment. Amateurs or Professionals select from world's largest line of metal detectors, priced as low as \$79.50 up. Detect Gold, Silver, Copper-Nuggets, Coins, Jewelry, etc. Budget terms available. For your convenience we have three major factory locations in the U.S. and Canada, as well as over 1,000 authorized dealers to serve you. See your local Yellow Pages, under "Metal Locating Equipment" or write: White's Electronics, Inc. Room No. 399, 1011 Pleasant Valley Road, Sweet Home, Oregon 97386-Elk-Air Industrial Park, Dexter Drive, East, Elkhart, Indiana 46514 or White's Electronics Ltd. 33784 Hazel Street, Abbotsford British Columbia, Canada.

## WANTED TO BUY

**RADIO WANTED:** National 57 M. in good condition. Send Price and Model Year to: James Walls, 721 Menlo Avenue, Menlo Park, Cal. 94025.

## INDEX TO ADVERTISERS

READER SERVICE NO.	ADVERTISER	PAGE NUMBER
21	Antenna Specialists	16
6	Avanti Research, Inc.	24
7	Barta Bell & Howell Schools	16 18-21
20	Circuit Specialists	16
18	Cleveland Institute of Electronics	2nd Cover & Page 3
11	Cornell Electronics, Co.	99
22	Cobra Communications Div., Dynascan Corp.	7
2	Edmund Scientific	14
23	Eico Electronics	98
24	Electronic Distributors, Inc.	6
10	Electro-Voice	94
16	GC Electronics	13
1	Heath Company	30
5	I.C.S.	106 & 3rd Cover
19	International Crystal Mfg. Co.	99
33	E. F. Johnson	4th Cover
3	Lafayette Radio	26
15	Lasalle Extension University	9
25	Lee Electronic Labs	11
17	Midland Electronics Co	12
12	Mosley Electronics	6
	National Radio Institute	36-39
26	National Technical Schools	54-57
27	New-Tronics Corp.	10
13 & 14	Photolum Corp.	16/98
28	Progressive Edu-Kits, Inc.	5
32	Radio Shack	15/27/28/95/97
4	Relco Electronics	99
29	Sprague Products	8
9	Tab Books	23
31	Tuner Div., Conrac Corp.	25
8	Western Radio	99
9	Xcelite Company	22

## Receive a FREE COPY of the "CRAFT PRINT DO-IT-YOURSELF CATALOG"!

This unusual catalog is yours FREE (regularly \$1) if you complete and staple this coupon to your CJTCA membership application. (See advertisement for CAMPING JOURNAL TRAVEL CLUB OF AMERICA in this issue.)

AND as a member of CJTCA you receive a 25% discount on any blueprints you order!

Otherwise send \$1 for the Craft Print Catalog. Blueprints for all kinds of BOATS, BOAT TRAILERS, CAMPER TRAILERS, RACING KART, MARINE ENGINE, TRACTOR, PONTOONS, SNOWMOBILE, SCUBA-SCOOTER, ARC WELDER, LEEBOARD SCOW!

**CRAFT PRINT Dept. SM7**  
Davis Publications Inc.  
229 Park Ave. S. NY NY 10003

As a member of CJTCA I receive the \$1 catalog FREE and a 25% DISCOUNT on all blueprints. (Attach this coupon to CJTCA application).

I do not wish to join CJTCA and enclose \$1 for the catalog.

Name (please print)

Address

City State Zip

If you've ever said...

# "There must be a better

Send for a free Career Guidance Booklet that could start you on the road to success in a rewarding new career.

It happens to all of us, sooner or later. No matter what kind of job we have.

One day, it suddenly strikes home that we're going to have to work for a living, the rest of our lives. And most of us are horrified at the thought of forever being locked into the jobs we now hold.

"Surely," we tell ourselves, "there must be a way to earn enough extra dollars each month to balance the family budget. Surely, there must be

a way to get the kind of position where you don't have to worry about job security."

"Surely," in other words, "there must be a better way to earn a living!"

If you, too, have been thinking these same thoughts, you'll find one of our free Career Guidance Booklets very helpful at this time. We invite you to send for one.

Your free booklet will describe the opportunities for higher income and greater job security you might ex-



# way to earn a living..”

ect in one of the career fields listed in the coupon below. It will also explain why ICS can prepare you for his new career field...right in your own home...in your spare time...*regardless of your education or past experience.*

In addition, you will receive a free "Demonstration Lesson" that lets you see for yourself why preparing for a more rewarding career—the ICS way—may be a lot easier than you think.

Please bear in mind, as you check off your career choice on the coupon below, that ICS has a long and distinguished record of success. In fact, more than 8,500,000 men and women have turned to ICS for career training, since 1891.

## Major corporations use ICS Career Training

ICS has provided training programs for various divisions and branches of companies like Ford; U.S. Steel; Chrysler; Mobil; DuPont; etc.

ICS Career Training is approved for Veterans and Servicemen under the new G.I. Bill, and is Accredited by the Accrediting Commission of the National Home Study Council.

Now it's your turn to discover how ICS training can start *you* in a rewarding new profession. Just fill in the postpaid card or coupon and mail for your free Career Guidance Booklet and free "Demonstration Lesson."

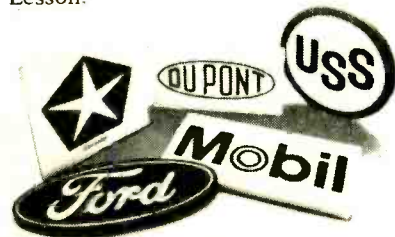

## Mail attached card or coupon for Free Career Guidance Booklets and Free "Demonstration Lesson."\*

These free Career Guidance Materials are yours without obligation. They will help you find out what you should know about the career field of your choice. They will also let you see for yourself why preparing for a more rewarding career—the ICS way—may be easier than you think.



Mail attached postage-free card today. If card is missing, use coupon:

**ICS** International Correspondence Schools XA626W  
Scranton, Pennsylvania 18515

Please send me a free Career Guidance Booklet, and a free "Demonstration Lesson" for the field I have checked below. I understand that I am under no obligation.

- |   |   |
|---|---|
| <p><b>Air Conditioning/<br/>Refrigeration &amp; Heating</b></p> <p><input type="checkbox"/> Air Conditioning/<br/>Refrigeration Technician</p> <p><input type="checkbox"/> Heating Specialist</p> <p><b>Engineering</b></p> <p><input type="checkbox"/> Mechanical <input type="checkbox"/> Civil</p> <p><input type="checkbox"/> Chemical <input type="checkbox"/> Industrial</p> <p><input type="checkbox"/> Electrical-Electronics</p> <p><input type="checkbox"/> Surveying &amp; Mapping</p> <p><b>TV Servicing</b></p> <p><input type="checkbox"/> Color TV Technician</p> <p><input type="checkbox"/> Stereo/Hi-Fi Specialist</p> <p><input type="checkbox"/> CATV/MATV Specialist</p> <p><b>Electronics</b></p> <p><input type="checkbox"/> Electronics Technician</p> <p><input type="checkbox"/> Specialized programs in<br/>Computer Servicing,<br/>Communications/<br/>Broadcasting, CATV</p> <p><input type="checkbox"/> FCC Licensing</p> <p><b>Automotive</b></p> <p><input type="checkbox"/> Master Mechanic</p> <p><input type="checkbox"/> Air Conditioning Specialist</p> <p><input type="checkbox"/> Body Rebuilding Specialist</p> <p><input type="checkbox"/> Diesel/Gas Mechanic</p> <p><b>Drafting</b></p> <p><input type="checkbox"/> General Drafting</p> <p><input type="checkbox"/> Specialized Drafting</p> <p><input type="checkbox"/> Check here for special information, if age 16 or under</p> | <p><input type="checkbox"/> <b>Architecture</b></p> <p><b>Electrician</b></p> <p><input type="checkbox"/> Master Electrician</p> <p><input type="checkbox"/> Practical Electrician</p> <p><input type="checkbox"/> <b>Interior Decorating<br/>&amp; Design</b></p> <p><input type="checkbox"/> <b>Airline-Travel Training</b></p> <p><b>Computer Programming</b></p> <p><input type="checkbox"/> Programming Concepts</p> <p><input type="checkbox"/> COBOL <input type="checkbox"/> System 360</p> <p><input type="checkbox"/> Fortran IV</p> <p><input type="checkbox"/> <b>Secretarial</b></p> <p><b>Accounting</b></p> <p><input type="checkbox"/> Business Accounting</p> <p><input type="checkbox"/> CPA Training</p> <p><input type="checkbox"/> Income Tax Specialist</p> <p><b>Motel/Hotel Management</b></p> <p><input type="checkbox"/> Motel Management</p> <p><input type="checkbox"/> Club, Restaurant<br/>Management</p> <p><input type="checkbox"/> Hotel Executive</p> <p><b>Business Management</b></p> <p><input type="checkbox"/> Executive Management</p> <p><input type="checkbox"/> Industrial/Production<br/>Management</p> <p><input type="checkbox"/> <b>High School</b><br/>For those who want to earn<br/>ICS High School Diploma</p> |
|---|---|

Miss \_\_\_\_\_ Age \_\_\_\_\_  
Mrs. \_\_\_\_\_  
Mr. \_\_\_\_\_  
Address \_\_\_\_\_ Apt. \_\_\_\_\_  
City \_\_\_\_\_ State \_\_\_\_\_ Zip \_\_\_\_\_

Approved for Veterans' Training. Eligible Institution under the Guaranteed Student Loan Program. Accredited Member National Home Study Council. Canadian residents use coupon address for service from ICS Canadian, Ltd. In Hawaii: 931 University Ave., Honolulu, Hawaii 96814

CIRCLE NO. 5 ON PAGE 17 OR 101

# He has to hear what you want to hear...

Over a third of the Duo-Scan® FM monitor receivers we make are purchased by police, fire departments, and other professionals... because they can't settle for less than Johnson performance! After all, since we engineer and build professional FM 2-way radios, we just naturally know how to build a better FM scanner: With integrated circuit symmetrical limiting to make it really quiet. Dual ceramic filters to reject interference. Ultra-sensitive "front end" circuitry to pull in the weakest signals. And a true noise-operated squelch that's crisp and clean... just like in a regular police radio. If you want to hear all the action, you want the scanner the professionals use!

Duo-Scan for low and high band VHF ..... \$169.95  
Duo-Scan for high band VHF and UHF ..... \$179.95  
Mono-Scan for high band VHF ..... \$139.95  
Mono-Scan for UHF ..... \$159.95



## The professional monitor: Duo-Scan®

EXCELLENCE



THROUGH HALF A CENTURY OF EXPERIENCE.

# JOHNSON

® Waseca, Minnesota 56093

CIRCLE NO. 33 ON PAGE 17 OR