

elementary Electronics

JULY-AUGUST
1972
75c

FOR BEGINNERS ONLY!
**BASIC
COURSE**
UNDERSTANDING
SIMPLE CIRCUITS

02342

NOISE CAN KILL

Our easy-to-build
Sound Pollution Tipster
lets you check three
critical sound levels
for killing noise.

PLUS

- Tour Canada with your CB Rig
- How to identify non-English DX
- How to select a Police/Fire monitor

WE TEST

- Fisher 801
4-Channel Receiver
- Realistic Mini-23
CB Transceiver
- Electra Bearcat III
Scanning Monitor



MILWAUKEE
2624 SE-SMAIN AVE
MRS J S FLEMING
12 45 5620 FLE6245AJ-4 17G05
OR 97222



FREE

Heathkit Catalog

Build and save on over 350 kits

Your free 1972 Heathkit catalog describes more kits than ever... over 350... all designed to give you fine performance and save you money when you buy and when you use. Choose solid state color TV, stereo, marine, automotive, test instruments, amateur radio, short-wave, home appliances, and more! Send for your free copy today.

NEW Solid-State Heathkit Color TV — the best TV kit ever offered

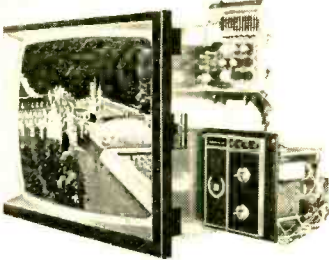

25" diagonal matrix tube, 24-position UHF/VHF detent power tuning, varactor UHF tuner, MOSFET VHF tuner, tint switch. New performance and convenience. Detent tuned UHF & VHF. Preselect any 12 favorite UHF stations, then power pushbutton (or remote) tune all 24 channels in either direction. New angular tint control switch selects normal or wide angle color to reduce tint changes between stations. Exclusive Heath MTX-5 ultra-rectangular black matrix tube has brighter pictures, better contrast. "Instant-On." Automatic fine tuning. Adjustable tone control. Automatic chroma control. Adjustable video peaking. More sensitive tuners. Transformer operated. Built-in dot generator and volt-ohm meter. Choice of cabinet styles from \$81.95*.

Kit GR-900, less cabinet \$599.95*
Kit GRA-900-6, remote control \$79.95*

NEW Heathkit Solid-State Ignition Analyzer

Analyzes standard, transistor, or capacitive discharge systems on 3, 4, 6, or 8 cyl. engines to find bad plugs, points, wiring or distributor parts, incorrect dwell time, coil, condenser, transistor or CD circuitry problems. Built-in tach, 0-1000 & 0-5000 rpm ranges for carb. adjustments. Constant width patterns, primary or secondary, parade or superimposed, plus expanded. Optional 12VDC supply for road checks, \$24.95*.

Kit CO-1015 \$129.95*



NEW Heathkit 8-Digit Calculator

Adds, subtracts, multiplies, divides, chain or mixed functions, and constant. Floating or selectable 7 position decimal. Plus, minus, and overflow indicators. Overflow protection of most significant 8 digits. Clear-display key to correct last entry. Standard keyboard. American LSI circuitry. Bright 1/2" red digits. 120 or 240 VAC operation. Desktop black & white cabinet, 3 1/2" h x 6" w x 10 1/4" d.

Kit IC-2008 \$129.95*



See them all at your Heathkit Electronic Center... or fill out the coupon below

HEATHKIT ELECTRONIC CENTERS — ARIZ: Phoenix, 2727 W. Indian School Rd.; CALIF: Anaheim, 330 E. Ball Rd.; El Cerrito, 6000 Potrero Ave.; Los Angeles, 2309 S. Flower St.; Pomona, 1555 Orange Grove Av. N.; Redwood City, 2001 Middlefield Rd.; San Diego (La Mesa), 8363 Center Dr.; Woodland Hills, 22504 Ventura Blvd.; COLO: Denver, 5940 W. 38th Ave.; FLA: Miami (Hialeah), 4705 W. 15th Ave.; GA: Atlanta, 5285 Roswell Rd.; ILL: Chicago, 3462-66 W. Devon Ave.; Downers Grove, 224 Ogden Ave.; KANSAS: Kansas City (Mission), 5960 Lamar Ave.; MO: Rockville, 5542 Nicholson Lane; MASS: Boston (Wellesley), 165 Worcester St.; MICH: Detroit, 18645 P. Eight Mile Rd. & 18149 E. Eight Mile Rd.; MINN: Minneapolis (Hopkins), 101 Shady Oak Rd.; MO: St. Louis, 9296 Gravois Ave.; N.J.: Fair Lawn, 35-07 Broadway (Rte. 4); N.Y.: Buffalo (Amherst), 3476 Sheridan Dr.; New York, 35 W. 45th St.; Jericho, L.I., 15 Jericho Turnpike; Rochester, Long Ridge Plaza; OHIO: Cincinnati (Woodlawn), 10133 Springfield Pike; Cleveland, 5444 Pearl Rd.; PA: Philadelphia, 6318 Roosevelt Blvd.; Pittsburgh, 3482 Wm. Penn Hwy.; TEXAS: Dallas, 2715 Ross Ave.; Houston, 3705 Westheimer; WASH.: Seattle, 2221 Third Ave.; WIS.: Milwaukee, 5215 Fond du Lac.



NEW Heathkit Digital FM Tuner

Another Heathkit "first" in consumer electronics. Pure digital computer design including digital frequency synthesizer tuning employing phase-lock-loop techniques, FET varactor FM RF front end, digital discriminator and readout result in performance specs and tuning convenience that already are the talk of the audio world: channel frequency accuracy better than 0.005%; less than 1.8 uV sensitivity; distortion levels of 0.1%; selectivity and IF rejection better than 95 dB; image & spurious rejection better than 90 dB; S/N ratio better than 65 dB; separation better than 40 dB. One of a kind, the AJ-1510 "computer tuner" is the only tuner offering you 3 distinct tuning modes: keyboard, computer-type punch cards (up to 3), plus automatic band scanning with variable speed and stereo-only capability. The 55 ICs, 50 transistors and 50 signal diodes mount on 10 modules with 7 plugging into a master board for optimum computer modularity & ease of assembly. Join the computer generation of audio equipment — order your AJ-1510 today.

Kit AJ-1510, tuner only \$539.95*
Cabinet \$24.95*



NEW Heathkit 4-Channel Amplifier

Brings you 200 versatile watts for discrete or matrixed 4-channel sound, and stereo or mono. Built-in matrix circuitry decodes matrixed 4-channel recordings or broadcasts, lets you use your existing stereo equipment as well as enhancing your present stereo records and tapes. As discrete 4-channel media grows the AA-2004 is ready... with four amplifiers producing 260 watts into 4 ohms (4x65), 200 watts into 8 ohms (4x50), 120 watts into 16 ohms (4x30), and controls for every source, mode and installation. Amplifier sections are controlled in pairs with one complete stereo system for left and right front speakers and another for left and right rear — so it can be used to power two complete 4-channel systems (up to 8 speakers) ... or, four separate-source mono systems if desired. Easy circuit board assembly.

Kit AA-2004, amplifier only \$349.95*
Cabinet \$24.95*

NEW Heathkit Solid-State FET VOM

Dual FET portable multimeter with lab grade accuracy, 10 megohm input and the ranges you really need. 9 DCV & ACV ranges, 0.1 to 1000 v, ± 2% accuracy. 6 DC & AC current ranges, 10 microamps. to 1 amp. 7 resistance ranges, X1 (10 ohm center) to X1Meg. 9 dB ranges, -40 to + 62. 1% precision metal-film dividers. 4 1/2", 100 uA, ruggedized tauband meter, diode & fuse protected. Battery check.

Kit IM-104, less batteries, \$79.95*.



| | |
|--|-----------------------|
| HEATHKIT Schlumberger | |
| HEATH COMPANY, Dept. 139-7 Benton Harbor, Michigan 49022 | |
| <input type="checkbox"/> Please send FREE Heathkit Catalog. | |
| <input type="checkbox"/> Enclosed is \$ _____, plus shipping. | |
| Please send model(s) _____ | |
| Name _____ | State _____ Zip _____ |
| Address _____ | |
| City _____ | |
| Prices & specifications subject to change without notice. *Mail order prices; F.O.B. factory. | |
| CL-434R | |

CIRCLE NO. 1 ON PAGE 17 OR 103

If You Do Not Wish To Cut Cover, See Coupon on Page 23

Your paycheck says a lot about you

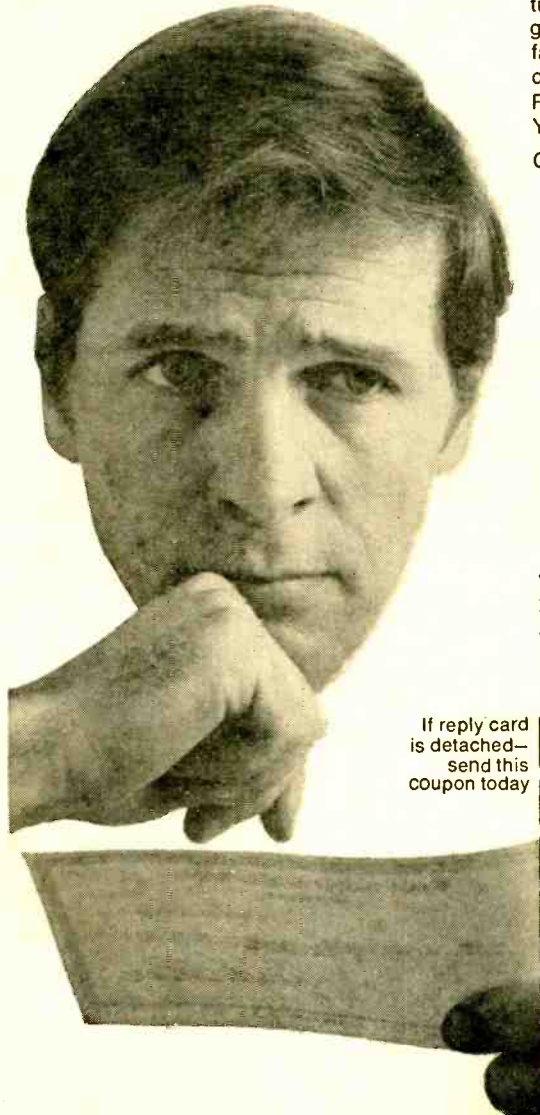

It tells you more than how much you make. It tells you how far you've come. And if your paycheck looks very much the same as it did last year, or the year before, it simply means that *you* look very much the same as *you* did last year and the year before.

But times change, and you should be changing with them. Old dull jobs are disappearing. New exciting ones are being created. There are challenging new fields that need electronics technicians...new careers such as computers, automation, television, space electronics where the work is interesting and the earnings are greater.

RCA Institutes has one of the nation's largest and most respected home study schools devoted to electronics. They can get you started even if you've had no previous training or experience. RCA Institutes has developed a faster, easier way for you to gain the skills and the knowledge you need for a fascinating, rewarding electronics career. And you don't have to quit work and go back to school. With RCA Institutes Home Study Plan you can do both. You set your *own* pace depending on *your* schedule.

Check over these RCA benefits:

- You get Hands-On Training—over 300 experiments and as many as 25 kits with some programs.
- You get RCA's unique "Autotext" method of learning—individual programmed instruction, the *easy, faster*, simplified way to learn!
- You get the widest choice of electronics courses and programs—everything from Electronics Fundamentals right up to Solid State Technology and Communications Electronics.
- You get a selection of low-cost tuition plans!

Sounds great, and it is! For complete information, without obligation, send in the attached postage card... or return the coupon below. That will say a lot about you.

Veterans: Train under new GI Bill. Accredited Member National Home Study Council. Licensed by N.Y. State—courses of study and instructional facilities approved by the State Education Department.

If reply card
is detached—
send this
coupon today

RCA Institutes

Home Study Dept. 246-207-0
320 West 31st Street, New York, N.Y. 10001

Please rush me FREE illustrated catalog.
I understand that I am under no obligation.

Name _____ Age _____
(please print)

Address _____

City _____ State _____ Zip _____

Veterans: Check here



elementary Electronics

Dedicated to America's Electronics Hobbyists

SPECIAL THIS ISSUE—ACTION BAND MONITORS

★ 29 Monitor Receivers—the ultra-high, low down on what's available

AUDIO/HI-FI NOOK

- ★ 41 e/e Listens to Surround Sound from the Fisher 801 4-Channel Receiver
- 57 Hey Herb—introducing our Audio Answer Man
- 76 e/e Looks at Hi-Fi Components
- 79 e/e Checks out a CTS Futura V Speaker System

THE SHORTWAVE LISTENERS' CORNER

- 24 DX Central Reporting—better DX Habits
- 35 e/e Looks at New Communications Gear
- ★ 43 Identify DX—the clues are birds, chimes, drums and umuduli
- 46 Shortwave Listeners Get the Pennant Fever—flag down this DX
- ★ 53 e/e Field Checks Electra's Bearcat III Scanning Monitor

CB RADIO CIRCUIT

- ★ 55 Touring Canada with your CB Rig—DX Canadians by visiting them
- 75 CB Coffee Break—some comments on creative CBing
- ★ 77 Kathi's CB Carousel—KA1O614 checks out Realistic's Mini-23 on her 2nd anniversary

WORKSHOP PROJECTS

- ★ 49 Sound Pollution Tipster—simple noise indicator spots the sound pollution in your home
- 59 Vibra-tone—a pocket organ with an 11-note keyboard and 3 voices

FEATURETTES FOR EVERYONE

- 52 Handle for Help—the new pull to get police, fire, ambulance and help on highways
- 66 Photographing the TV Scene—electronics and photography combine into a fascinating hobby
- 74 Rechargeable Money—the credit card that takes on a charge
- 80 Pointing Pays Off—map reading electronically

INSIGHT TO THE BASICS

- 27 Ask Hank, He Knows—our theory Q & A
- 62 Ten Steps to Cassette Player Repair—fixing is easy if you step along with us
- ★ 81 Basic Course—understanding simple circuits

DEPARTMENT NITCHES

- 8 Hey, Look Me Over—What's new in the marketplace
- 17 Reader Service Page—also on page 103
- 25 Literature Library—yours for the asking
- 26 Bookmark by Bookworm
- 28 Electronic Store—our funny page
- 40 e/e Etymology—wordtronics
- 103 Reader Service Page—also on page 17



★
Cover
Highlights

AUTHORS IN THIS ISSUE

Len Buckwalter, Herb Cohen, Homer L. Davidson, Herb Friedman, Webb Garrison, Joe Gronk, Myrtle Gronk, Don Jensen, Jackson Kaye, Julian S. Martin, Kathi Martin, Jack Schmidt, Hank Scott, Matt P. Spinello, Darrell Thorpe and the ELEMENTARY ELECTRONICS' editorial staff.



Cover Illustration
by
Len
Goldberg

Only RCA Institutes offers you all these advantages:

1 A broad range of courses to help you qualify for good-paying jobs in such rewarding fields as communications, color TV servicing, automation, nuclear instrumentation, space electronics, drafting, computer programming.

2 RCA's exclusive Autotext training method—the easy, faster, simplified way to learn electronics at home.

3 Personal supervision throughout your training.

4 Over 250 experiments and up to 22 kits in some programs

5 Easy monthly payment plan.

6 Over 60 years of leadership in technical training.

7 Recognition from leaders in the field as an RCA Institutes graduate.

Veterans can train under new GI Bill. Licensed by the State of New York. Accredited Member National Home Study Council.

Courses available in Canada too.

If you've ever thought about getting into electronics...

you owe it to yourself to see what RCA home training has to offer.

This entire fold-over coupon makes a no-postage-required business-reply envelope. Fill in your name and address ... then cut out along dotted lines... fold, seal and mail.

246-207-9

RCA INSTITUTES, Inc., Home Study School
320 West 31st St., New York, N. Y. 10001

Please send me free illustrated home study career catalog.

Name _____ Age _____

(please print)

Address _____

City _____ State _____ Zip _____

- Check here if interested in Classroom Training.
 Veterans check here

NO STAMP NEEDED

You must seal (Staple, tape or glue) before mailing.

↓ **FOLD HERE**

↓ **DO NOT CUT HERE**

FIRST CLASS

Permit No. 10662
New York, N. Y.

BUSINESS REPLY MAIL

No Postage Necessary if Mailed in United States

Postage will be paid by

RCA INSTITUTES

Home Study School
320 West 31st St.
New York, N. Y. 10001

246-207-9

SCIENCE · OPTICS · ELECTRONICS
MONOSUM & HARD BARGAINS
 NEW PRODUCTS · NEW MATERIALS · NEW METHODS

NEW! ELECTRONIC DIGITAL COMPUTER KIT!



Solve problems, play games, predict weather with this actual working model of giant electronic brains. Amazing new fun way to learn all about computer programming, logic, decimal binary systems. Laws of Sets—even do your own programming after completing simplified 116 page instructive booklet. Includes step-by-step assembly diagrams. Circuits easily changed. Readout from illuminated control panel. Req. 2 "D" batt. (not incl.). Best model we've seen for home, school, industry.

No. 71-434EK (11"X12 1/2"X4") \$31.50 Ppd.

EXTRA SENSORY PERCEPTION KIT



Amazing, Amusing. Tests for your power of ESP using scientific techniques, individually or with a group. Also tests for Telepathy (ability to send messages from one mind to another); Perception; Psychokinesis (ability to influence movement of things by mental power); Precognition (ability to see into future). Great for adult party games, Science Projects, etc. Has everything you need for hours of stimulating fun and games including scientific tests, booklets. Stock No. 41-454EK \$3.00 Ppd.

3" DIA. SURPLUS PARACHUTES!



THE REAL THING! . . . kids and model rocketeers love them! Tie toy soldiers to the shroud lines, toss 'em in the air and watch it gently float to earth. In model rocketry, it's an ideal deployment chute for recoverable nose cones. These 3-ft. diameter all-nylon parachutes with 8 shroud lines originally cost the govt. about \$5 each. We offer 4 of them, each packed in a small cloth bag, at a fraction of the cost. Great buy, great fun!

Stock No. P-41-680EK \$3.00 Ppd.

BUILD A "PRO" WEATHER STATION



Meteorology kit can give you the know-how to check your predictions against official forecasts! Has remote reading anemometer w/windvane, indoor indicator board flashes near shows wind speed, direction. Safety power cord holds current to less than 1 ma. Also: sensitive air-tank barometer w/2-ft. indicator column; sling psychrometer to measure rel. humidity; rain gauge that measures to 1/100th inch; 100 ft. lead-in wire; cloud chart; forecasting manual. Stock No. 71-022EK \$13.95 Ppd.

STARTS SEEDS IN 3 TO 5 DAYS!



New thermostatically controlled electric greenhouse provides constant 70° growing temperature, accelerates seed germination, helps produce healthy thriving plants, ready for outdoor planting. Big 3 sq. ft. planting area—29" X 15" X 4 1/2" hgt. holds 12 bushes of growing medium. Germinates tomato seeds in 3-5 days; asters, dahlias, petunias, wk. or less. Incl. 3 X 4 ft. clear plastic cover, supports 4 pkgs. of veg. & flower seeds. Uses p.g. home current.

Stock No. 80-153EK \$12.95 Ppd.

AMAZING NEW Wankel Engine KIT!



Thrill to the fun of building your own see-through motorized model of revolt. Rotary pistonless type engine . . . only engine experts think economically modifiable to meet new pollution standards. Replaces piston, cylinder, crank assemblies with rotating discs (sections removed for firing chambers). Smaller than conventional; fewer parts, greater reliability, same speed w/less horsepower. Feat. flashing plugs, rubber fan belt, stick-shift on-off switch. Req. 2-1.5V batt. (not incl.).

No. 71-424EK (4 1/2" 5" X 9") \$6.75 Ppd.

"Bright Ideas" in Unique Lighting. Big, new 100 page handbook packed with facts, loaded with illustrations, applications, equipment. 8 1/2" x 11" looseleaf paper to fit 3 rings. Stock No. 9100EK \$3.00 Ppd.

Order by Stock No.—Check or M.O.—Money-Back Guarantee
EDMUND SCIENTIFIC CO., 300 EDSCORP BLDG., BARRINGTON, N.J. 08007



WRITE FOR FREE GIANT CATALOG
148 PAGES!—1000'S OF BARGAINS

EDMUND SCIENTIFIC CO., 300 EDSCORP BLDG., BARRINGTON, N.J. 08007
 Completely new edition. Dozens of electrical and electronic parts, accessories. Enormous selection of astronomical Telescopes, Microscopes, Binoculars, Magnifiers, Magnets, Lasers, Lenses, Prisms, ecological and unique lighting items. Many war surplus items: for hobbyists, experimenters, workers.

EDMUND SCIENTIFIC CO. 300 EDSCORP BLDG. BARRINGTON, NEW JERSEY 08007
 ORDER BY STOCK NUMBER · SEND CHECK OR MONEY ORDER · MONEY-BACK GUARANTEE

CIRCLE NO. 11 ON PAGE 17 OR 103

elementary Electronics

July/August 1972 Vol. 12/No. 3
 Dedicated to America's Electronics Hobbyists

Editor-in-Chief
JULIAN S. MARTIN, WA2CQL

Technical Editor
STEPHEN B. GRAY

Communications Editor
PETER L. DEXNIS, WA3LOQ

News Editor
CAROL J. BRUCKNER

Critics' Band Editor
KATHI MARTIN, KA1Q614

Workbench Editor
HANK SCOTT

Art Director
JIM MEDLER

Cover Art Director
IRVING BERNSTEIN

Assistant Art Director
ANDY STEIGMEIER

Art Associate
ANGELO MARFISI

RALPH ROBINO

DAVID J. MILLER

Production Director
CARL BARTE

Production Manager
GERTRUD BORCHARDT

Assistant Production Manager
MARILYN VARGAS

Newsstand Circulation Director
DON GABREE

Subscription Circulation—Marketing Director
ROBERT V. ENLOW

Instruments Division Manager
WILFRED M. BROWN

Chairman of the Board
B. G. DAVIS

President and Publisher
JOEL DAVIS

Vice-President and General Manager
LEONARD F. PINTO

Vice President and Treasurer
VICTOR C. STABLE, KBP0681

ELEMENTARY ELECTRONICS is published bi-monthly by Davis Publications, Inc. Editorial, Business and Subscription offices: 229 Park Avenue South, New York, N.Y. 10003. One-year subscription (six issues)—\$3.95; two-year subscription (12 issues)—\$7.95; three-year subscription (18 issues)—\$11.95; and four year subscription (24 issues)—\$15.95. Add \$1.00 per year for postage outside the U.S.A. and Canada. For change of address, please advise 4 to 6 weeks before moving. Send us your current mailing label with new address. Advertising offices: New York, 229 Park Avenue South, 212-OR 3-1300; Chicago, 520 N. Michigan Ave., 312-527-0330; Los Angeles; J. E. Publishers' Rep. Co., 8560 Sunset Blvd. 213-659-3810; Long Island: Len Osten, 9 Garden Street, Great Neck, N.Y., 516-487-3305; Southwestern advertising representative: Jim Wright, 818 Olive St., St. Louis, 314-CH-1-1965 Second-class postage paid at New York, N.Y. and at additional mailing office. Copyright 1972 by Davis Publications, Inc.

FREE...demonstration lesson to prove that you can learn TV servicing at home.

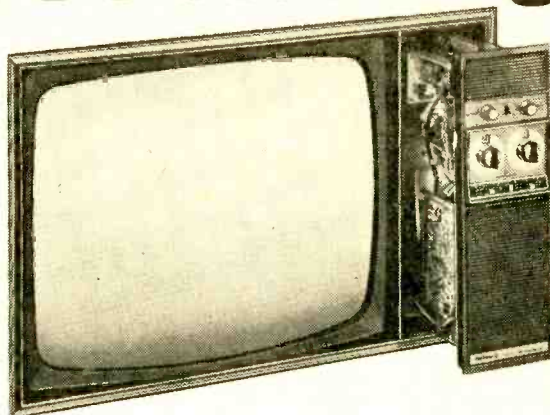

Practice on a new 25"
MOTOROLA QUASAR II® chassis.

TV Servicing is a satisfying career . . . and the pay is great. Qualified men are needed now to maintain the 93 million sets in U.S. homes. And prospects for the future are even brighter.

Now . . . here's an opportunity for you to prove to yourself that **you** can learn TV Servicing . . . at home, in your spare time. ICS, the world's most experienced home-study school, will send you a **FREE** Demonstration Lesson (complete with sample questions) if you will merely fill out the coupon below and mail it to us.

In addition to your free demonstration lesson, we'll send you . . . also **FREE** . . . a brochure that describes the 25" (diagonally measured screen) MOTOROLA QUASAR II® Color TV chassis that we include in our TV Service Training Program.

This chassis with automatic fine tuning control is ideal for training purposes because it combines solid state devices with vacuum tubes to give you both kinds of practical experience.

Credit towards a Certified Electronic Technician (C.E.T.) rating will be granted by the National Electronics Association to ICS students upon completion of the ICS Career Program in TV Service/Repair.

ICS

Since 1890
School of Electronics
Scranton, Pa. 18515

Approved for veterans under the new GI bill/approved for federally insured loans/Accredited by the Accrediting Commission of the National Home Study Council.

All parts carry Motorola's two year replacement guarantee!

The QUASAR II chassis comes to you in three basic sub-assemblies . . . **NOT AS A KIT** . . . because we want you to learn how to **repair** TV sets, not build them.

Our free literature also describes the fully assembled test equipment you receive such as the Deluxe 5" Solid State Oscilloscope, the tools and the learn-by-doing kits, all of the finest quality.

And we're going to tell you about eight other career opportunities in Electronics and the ICS Career Programs that can help prepare you for them. All you've got to do is mail the coupon. **SEND IT TODAY!**

**ICS School of Electronics Dept. AA201W
Scranton, Pa. 18515**

YES, I want you to mail to me without obligation, the **FREE DEMONSTRATION LESSON** and complete literature on the career program checked below. (Please check one.)

- | | |
|---|--|
| <input type="checkbox"/> Color TV Servicing | <input type="checkbox"/> FCC License |
| <input type="checkbox"/> Computer Maintenance | <input type="checkbox"/> Communications/Broadcasting |
| <input type="checkbox"/> CATV Installation | <input type="checkbox"/> Hi-Fi Sound Systems |
| <input type="checkbox"/> Telephony | <input type="checkbox"/> Industrial Electronics |

Name _____ Age _____

Address _____

City _____

State _____ Zip _____

CIRCLE NO. 13 ON PAGE 17 OR 103

Johnson put it all together.

□ low band and high band channels in any combination □ base and mobile operation with built-in power supply □ auto-scan with push-button "lock out" plus manual "lock in"

new
Duo-Scan™
\$169⁹⁵

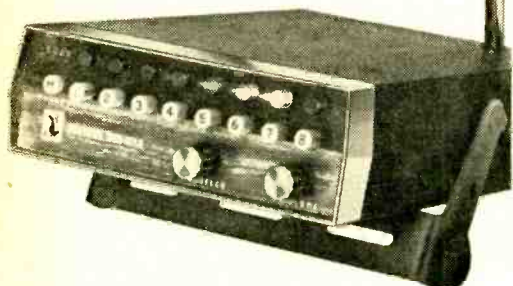

Eight VHF FM channels, in any combination of high and/or low band, keep you on top of all the action. Operates mobile or base with performance features previously found only in professional public safety radio equipment. Two ceramic filters give unsurpassed adjacent channel rejection. Integrated circuit symmetrical limiting makes it really quiet. 0.4 μ V sensitivity lets you hear what others miss. Powerful transistor audio produces clear, undistorted sound. The new Duo-Scan puts it all together, for just \$169.95 (less crystals).



E. F. JOHNSON COMPANY
WASECA, MINNESOTA 56093

1214

CIRCLE NO. 5 ON PAGE 17 OR 103

Hey, look me over

Showcase of New Products

Homework by Heathkit

For \$129.95 and approximately eight hours of your time you can own an eight-digit desk-top calculator with functions and features to equal or surpass units costing hundreds of dollars more. The new Heathkit IC-2008 Calcu-

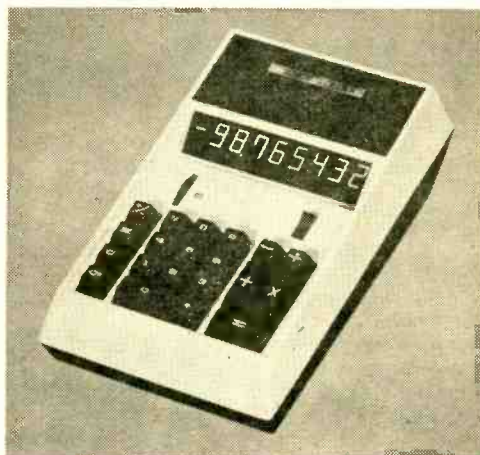

lator performs addition, subtraction, multiplication and division electronically, and shows up to eight-figure totals on extra-bright 1/2-in. seven-segment display tubes. Punch-up the problem the same way it would be written ($7 \times 8 =$) and you have the result. For additional information, circle No. 1 on Reader Service Coupon on page 17 or 103.

The Big Clean Up

The Bib Groov-Kleen sophisticated Automatic Record Cleaner, reduces record and stylus wear and improves reproduction without the application of a liquid. Finished in chrome, bright aluminum and gleaming black, it gives the appearance of a miniature high quality tone arm. A self-adhesive base permits it to be

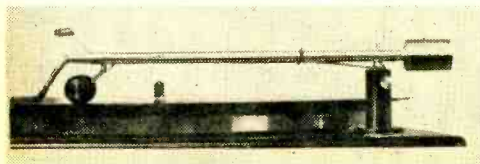

ELEMENTARY ELECTRONICS

*the tape that
turned the
cassette into
a high-fidelity
medium*



TDK SUPER DYNAMIC (SD) TAPE



TDK ELECTRONICS CORP.

LONG ISLAND CITY, NEW YORK 11103

CIRCLE NO. 19 ON PAGE 17 OR 103

TDK

Until TDK developed *gamma ferric oxide*, cassette recorders were fine for taping lectures, conferences, verbal memos and family fun—but not for serious high fidelity.

Today you can choose among high-quality stereo cassette decks.

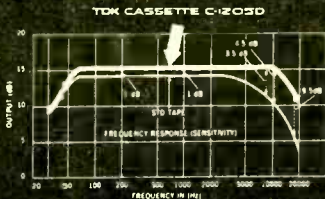

The new magnetic oxide used in TDK Super Dynamic tape distinctively differs from standard formulations in such important properties as coercive force, hysteresis-loop squareness, average particle length (only 0.4 micron!) and particle width/length ratio. These add up to meaningful performance differences: response capability from 30 to 20,000 Hz, drastically reduced background hiss, higher output level, decreased distortion and expanded dynamic range. In response alone, there's about 4 to 10 db more output in the region above 10,000 Hz—and this is immediately evident on any cassette recorder, including older types not designed for high performance. There's a difference in clarity and crispness you can hear.

Available in C30SD, C60SD, C90SD and C120SD length.

PARTS! CORNELL TUBES!

FREE Send For FREE
CORNELL'S
New Color
Catalog
48 Pgs. New Items

33¢ per tube
IN LOTS OF 100

36¢ per tube
ORDER FREE
IF NOT SHIPPED
IN 24 HOURS!

4219 E UNIVERSITY AVE. SAN DIEGO, CALIF. 92105

CIRCLE NO. 2 ON PAGE 17 OR 103

"LISTEN IN" TO POLICE-FIRE RADIO CALLS IN YOUR CAR!

WORKS with ANY CAR—Portable or HOME RADIO! Just PLUGS In—No wiring—3 minute hookup! Switch instantly from regular to ALL POLICE-FIRE-EMERGENCY-COMMERCIAL-TAXICAB-STATE-CITY-GOV'T 2 way Radio calls in YOUR AREA. DUAL-HI-LOW BANDS—36/50-150/175 MHz. OVER a MILLION Radio Cars/stations. USE Everywhere—Anytime—always works!

SEND ONLY \$2.00 cash, Ck. M.O. and pay post-man \$7.99 plus COD pkg. or send \$9.99 for ppd. Del in USA. COMPLETE, ready to use with instructions. One Year service Warranty—10 DAY MONEY BACK TRIAL (if ret'd) AMAZING OFFER good only by mail—WESTERN RADIO Dept. BE-7, KEARNEY, NEBR. 68847

CIRCLE NO. 17 ON PAGE 17 OR 103

**THOUSANDS OF BARGAINS
TOP VALUES IN ELECTRONIC PARTS**

Transistors, Modules, C. B., Speaker, Stereo, Hi-Fi, Photo Cells and Thousands of Other Electronic Parts.

Send for FREE Catalogue

ELECTRONIC DISTRIBUTORS INC.



EDI
Dept. TA-2, 4900 Elston
Chicago, Ill. 60630
 RUSH CATALOGUE

Name

Address

City

State Zip Code

CIRCLE NO. 15 ON PAGE 17 OR 103

Hear your police and firemen in action!

Listen on these channels, too...



- WEATHER
- TRAFFIC
- UTILITY
- BUSINESS
- MARINE
- CIVIL DEFENSE

WITH ALL-NEW **Bearcat III**

The Only Monitor Receiver You'll Ever Need

Meets present and future needs in any locality. Scans 1 to 8 FM emergency and business channels you select, in any 1 or 2 bands—low, high, UHF. Stops for any transmission, then resumes search. Plug-in interchangeable RF module for each band. Built-in front speaker. Complete band coverage. Comes with one or two RF modules, mobile mount and cords for AC and DC. American built by Electra, originator of the scanning receiver. At better dealers.

\$139.95 WITH RF MODULE FOR ANY 1 BAND
\$159.95 WITH RF MODULES FOR ANY 2 BANDS
Plus plug-in crystals at \$5 each. Additional modules \$20 each.

Electra COMPANY Div. of Masco Corp.
CUMBERLAND, INDIANA 46229

CIRCLE NO. 21 ON PAGE 17 OR 103

JULY-AUGUST, 1972

new 19-piece midget reversible ratchet offset screwdriver set



3-3/4" heavy duty, stainless steel reversible 20-tooth ratchet with short turning radius for close work.

Unique 6" spinner/extension has drive socket insert in handle for ratchet. Use also as regular screwdriver with bits.

1/4" hex to 1/4" square adapter bit permits use of ratchet or spinner/extension with Xcelite Series 1000 or other 1/4" sq. drive sockets.

16 precision made, alloy steel bits with knurled spinner tops . . . 12 Allen hex type, 2 slotted screw bits, 2 Phillips bits.

FREE STICK-ON

INITIALS personalize the sturdy plastic case and help prevent loss or mix-up.

No. XL-70 Set

Also 5-Piece Kit (No. XL-75)

Reversible ratchet with 3/16" and 1/4" slotted screw bits, #1 and #2 Phillips bits, all in a durable plastic, pocket size, snap fastener case.

nationwide availability through local distributors
REQUEST BULLETIN N770



XCELITE, INC. • 80 BANK ST., ORCHARD PARK, N.Y. 14127
Send Bulletin N770 on Reversible Ratchet Offset Screwdriver Set.

name _____
address _____
city _____ state & zone _____

CIRCLE NO. 10 ON PAGE 17 OR 103

HEY, LOOK ME OVER ★★★★★★★★★★

fitted easily and permanently to the record player. The aluminum arm has its own arm-rest. A sable brush silently removes dust from the record grooves, while a velvet roller collects any residual dust. A separate brush for cleaning the roller is provided. The adjustable counterweight ensures that the Groov-Kleen functions with no appreciable slow-down of record speed. Price: \$7.50. For more information, circle No. 45 on Reader Service Coupon on page 17 or 103.

Go Fly a Kite

At one time or another this summer you'll get the urge to fly a kite. Don't repress it, do it, but run up an antenna at the same time. Try



your hand at a long wire antenna that'll be the talk of your DX club. However, play it safe—try it on cloudless days and nights. And The Gallery would like you to run up your antenna using their Super Space-Bird kite. Completely covered with cloth, it needs no tail or running launch to get off the ground. Priced at \$7.95 plus 75¢ shipping for adults only. Super Space-Bird's 5 1/2-ft. wing-span may lift a small child in the air. Comes complete with 500 feet of heavy-duty line. Order direct from The Gallery, Amsterdam NY 12010.

Hey, Ma, I'm On Radio

Mogull, Inc. has announced the development and availability of the REMOTA, a compact, battery-powered electronic transmitter that enables any amplifier (for phonograph or tape recorder) to broadcast to any radio (portable



or otherwise) in the owner's house or grounds. The REMOTA is available in two models: The AM REMOTA for broadcast to AM radios, or the FM REMOTA for broadcast to FM radios. The suggested retail price of the REMOTA is \$24.95. For further information, circle No. 55 on Reader Service Coupon on page 71 or 103.

John's Radio

This radio is a combination of transistor radio and bathroom tissue fixture. Avoid missing parts of broadcast while absent from living

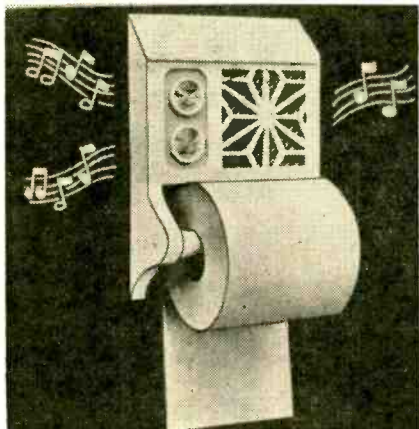

room. Enhances bathroom privacy and makes a delightful conversation piece. It'll make a great gag gift. Each of John's Radios are sold with a guarantee of complete satisfaction or full refund, only \$14.95 postpaid. Mason's Gifts, 1208 Cheyenne, El Paso TX 79925.

CB 5-Element Beam

The deluxe Mosley CB Mini-Beam antenna, Model GA-5D, is designed to deliver full-size beam performance in a smaller amount of space. The secret of success in this five-element miniature beam is in the coils. Ten deluxe

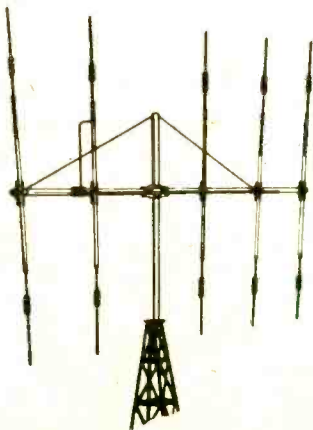

JULY-AUGUST, 1972

Dreaming about a pair of \$300 condenser microphones?

Think seriously about these: \$39.75* each!

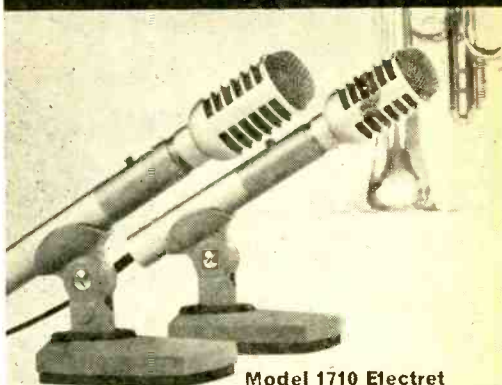

Model 1710 Electret Condenser Omnidirectional Microphone

All of the great condenser advantages are here without compromise. Flat, extended range, excellent transient response, high output, low noise, and ultra-clean sound. But the new E-V electret condenser microphones need no high voltage power supply. Just an AA penlite battery to operate the built-in FET impedance converter. The result is studio performance without complications and at a dramatically lower price.

There are 4 new E-V electret microphones, including cardioid models, from \$39.75 to just \$75.00, audiophile net. Second-generation designs with unusually high resistance to heat and humidity. Hear them today at your nearby Electro-Voice sound-room. Or write for details.

More U. S. recording studios use Electro-Voice microphones than any other brand.

*Suggested retail price. Microphones shown on Model 421 Desk Stand. \$12.00 each.

Electro-Voice® a Gulton COMPANY

ELECTRO-VOICE, INC., Dept. 722P
678 Cecil Street, Buchanan, Michigan 49107
In Europe: Electro-Voice, S. A., Römersstrasse 49,
2560 Nidau, Switzerland

CIRCLE NO. 14 ON PAGE 17 OR 103



avanti

EVERYTHING IS COMING UP ASTRO PLANES

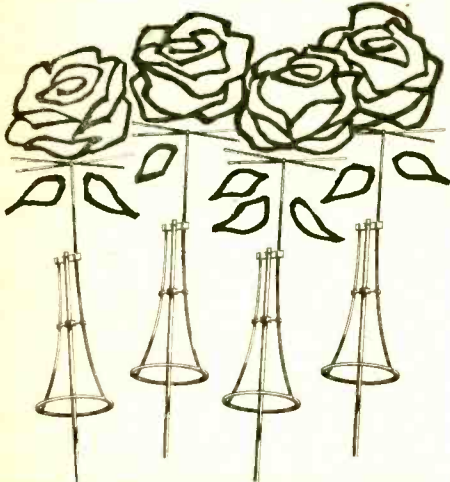

33-35 WEST FULLERTON AVENUE,
ADDISON, ILLINOIS 60101

AVANTI RESEARCH & DEVELOPMENT, INC.
MAKERS OF THE FAMOUS "MOONRAKER"

CIRCLE NO. 12 ON PAGE 17 OR 103

HEY, LOOK ME OVER ★★★★★★★★★★

high "Q" coils molded on each element extension limit the mechanical size of GA-5D without limiting its electrical capability. These coils are built to take a powerful beating—in fact, the same coils are used in the construction of 10-meter amateur antennas. A new swaging technique seals both ends of all ten element extensions (coil sections) to prevent moisture accumulation and assure reliable all-weather performance. The GA-5D was engineered to reduce the area exposed to wind so the antenna can be mounted, without a tower, on a TV antenna mount and turned with an inexpensive TV rotor. The new Mosley five-element Mini-Beam can be assembled and installed quickly and easily: solid-state gamma match, pre-assembled parts and color-coding combine with lightweight and compact size for ease in handling. Sells for only \$48.83. For complete specifications and performance data circle No. 7 on Reader Service Coupon on page 17 or 103.

For One or Two Ears

A new stereophone, Model KO-747, compatible with both stereo and monaural music sources has been introduced by Koss Corporation. For added convenience, the KO-747 has a volume control in each earcup, which allows the wearer to make fine adjustments in both



level and balance without returning to his receiver or amplifier control center. Also, the stereo-monaural feature gives the listener one set of stereophones for use with stereo hi-fi as well as with monaural sources such as conventional radio and television sets, electronic home entertainment units. Delivering a frequency response from 30 to 20,000 Hz, the new stereophone set is a dynamic model retailing at \$45. For more information, circle No. 50 on Reader Service Coupon on page 17 or 103.

Edmund Catalog

Air pollution testing equipment to zoom binoculars, and practically everything else from A to Z that's interesting and unusual, can

ELEMENTARY ELECTRONICS

Our 51st Year



FREE!

Your One Dependable
Source For
Everything In
Electronics

LAFAYETTE

1972 CATALOG 720

- 4-Channel Stereo Equipment
- Cartridge and Tape Players
- CB Gear
- PA Systems
- Tools
- Cameras
- Auto Accessories
- Books
- Musical Instruments and Amplifiers

Lafayette Radio Electronics Dept. 25072
P.O. Box 10, Syosset, L.I., N.Y. 11791

Please Send the FREE 1972 CATALOG 720 25072

Name

Address

City

State Zip

CIRCLE NO. 6 ON PAGE 17 OR 103

EXPERIMENTER

International EX Crystal and EX Kits



be found in the latest 1972 catalog (#722) of Edmund Scientific Co. This brand new, fully illustrated edition, available free by mail, describes over 4,000 items of interest to every member of the family. Its 148 pages are packed with many hard-to-find bargains for hobbyists, experimenters, science and crafts enthusiasts, students, gardeners and workshop buffs. To get your catalog, circle No. 11 on Reader Service Coupon on page 17 or 103.

For Mobile Rescue Units

CBer and Hams need the Universal Survival Kit in the trunk of their cars. Designed to sustain life for several days when lost or stranded, the Kit contains more than a dozen carefully selected survival essentials including an easy-



to-read instruction booklet written to inspire confidence in the user. Kit weighs only 1½ pounds, and all items are neatly packed in a 5-in. x 4-in. x 3-in. rain-proof pouch. Items included are food, aspirin, fishing hook and line, copper wire, adhesive tape, 30-ft. nylon cord, metal match, sterno, rescue blanket, cable saw, 14 oz. aluminum cup, two-bladed knife, flashlight with batteries, and signal mirror. Maybe you need two kits? Cost per kit is \$19.95, post-paid, with satisfaction guaranteed, from Downey Variety Products, 2019 East 21st South, Salt Lake City UT 84108. (turn page)



OX OSCILLATOR
\$2⁹⁵

OX OSCILLATOR Crystal controlled transistor type. Lo Kit 3,000 to 19,999 KHz Hi Kit 20,000 to 60,000 KHz (Specify) \$2.95

MX-1 TRANSISTOR RF MIXER A single tuned circuit intended for signal conversion in the 3 to 170 MHz range. Lo kit 3-20 MHz. Hi kit 20-170 MHz. \$3.50

SAX-1 TRANSISTOR RF AMP. Amplifier to drive MX-1 mixer. Lo kit 3-20 MHz. Hi Kit 20-170 MHz. \$3.50

PAX-1 TRANSISTOR RF POWER AMP. A Single tuned output amplifier to follow the OX oscillator. 3,000 to 30,000 KHz. \$3.75

CIRCLE NO. 3 ON PAGE 17 OR 103



EX CRYSTAL
\$3⁹⁵

EX CRYSTAL Available from 3,000 KHz to 60,000 KHz. Supplied only in HC 6/U holder. Calib. is ±.02% when operated in International OX circuit or its equivalent. (Specify frequency) \$3.95

BAX-1 BROADBAND AMP. May be used as a tuned or untuned amplifier in RF and audio applications 20 Hz to 150 MHz. \$3.75



INTERNATIONAL
CRYSTAL MFG. CO., INC.
10 NO. LEE • OKLA. CITY, OKLA. 73102

Write for FREE Catalog

ANOTHER SUPERB VALUE

from **Olson**

Electronics
ONLY

\$10⁹⁸

DELUXE BATTERY TESTER

Compact precision tester checks all types of batteries from radio to industrial. 12 position switch selects most popular ranges from 1.5 volts to 240 volts. 1.5v to 15v ranges are tested under load. Complete with test leads and instructions.

Olson Electronics, Dept. T8, 260 S. Forge St., Akron, Ohio 44308

- I enclose \$10.98 plus \$1 for postage and handling. Send me the TE-237 Battery Tester.
- Send me the next seven issues of the Olson Catalog, without cost or obligation. **FREE**

Name _____
Address _____
City _____
State _____ Zip _____

CIRCLE NO. 9 ON PAGE 17 OR 103

new deluxe

CB MINI-BEAM

Gamma 323 Miniature
3-Element CB Beam
with deluxe coils -
Mini-Size, Mini-Cost,
Maxi-Performance.
Sound too good to
be true? Get the
whole story . . .

From

Mosley

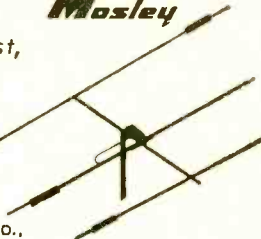

4610 N. LINDBERGH BLVD.,
BRIDGETON MD. 63042

Please send me FREE information about
the new Mosley Deluxe Mini-Beam.

Name _____

Address _____

City/State _____ Zip _____

#173A

Mosley Electronics Inc. 4610 N. Lindbergh Blvd.,
Bridgeton Missouri 63042

CIRCLE NO. 7 ON PAGE 17 OR 103

AT LAST! PROFESSIONAL HOME PROTECTION EVERYONE CAN INSTALL AND AFFORD.

Model FC-100
\$59.95
WIRED

- Start your custom Burglar/Hold-up/Fire Alarm System with the FC-100. Add on Sensors, Alarms and Accessories to suit your own needs.
- "Do-it-Yourself" Installers Handbook included. No technical knowledge needed - No soldering.
- 100% Professional in Design, Reliability, Performance.



'Fail Safe'-SYSTEM BY EICO

A New Concept in "Do-it-Yourself" Home Protection

FREE 32 PAGE EICO CATALOG

For latest catalog on EICO Test Instruments, Stereo, EICOCRAFT Projects, Environmental Lighting, Burglar/Fire Alarm Systems, and name of nearest EICO Distributor, check Reader Service Card or send 25c for First Class mail service.

EICO, 283 Malta Street, Brooklyn, N.Y. 11207



CIRCLE NO. 18 ON PAGE 17 OR 103

HEY, LOOK ME OVER *****

Gas Welding Torch

The "do-it-yourself" dad will find the Microflame Deluxe Gas Welding Torch Kit a welcome gift for his home workshop. Microflame is a completely self-contained miniature hand



torch producing 5000°F pinpoint accurate flame. No wires or connections needed. Unit operates on miniature oxygen and LP gas cylinders. Microflame is ideal for lightweight welding jobs . . . great for electronic/electrical work, jewelry repair, even soldering and brazing operations. For example, you can silver solder two pieces of copper 1 inch x 2 inches x 1/16 inch quickly and easily. Deluxe Kit contains 6 oxygen cylinders, 3 LP gas cylinders, spark igniter, 2 welding tips, 12 6-in. silver solder rods and flux, a two-way bench bracket for mounting on bench or pegboard plus booklet on "How To Weld" properly. Retail price is \$34.49. Complete information including details on Microflame accessories and supplies may be obtained by circling No. 47 on Reader Service Coupon on page 17 or 103.

Fail-Safe Alarm System

This tiny (4 3/4 x 2 3/8 x 1 1/4 in.) freon-powered horn can be used to frighten prowlers, mashers, vicious dogs . . . and has dozens of other uses. You just press with your thumb and it lets loose a blast of 118 decibels. Available



by mail from Edmund Scientific Co., it is useful for boating, beach and seashore (it floats). It can be used as a ship-to-shore signal, to summon help and—most importantly—to call children. An important item for mobile radio rescue units. This compact safety horn (No. 41,423 . . . \$3.25) weighs just 3 ounces, but contains up to 100 mile-piercing blasts. Two refill cartridges (No. P-41,424) are available at \$2.75. To order, just clip and mail this article with your name, address and check or money order to Edmund Scientific Co., 380 Edscorp Bldg., Barrington NJ 08007. If you would like to get the Edmund catalog of over 4000 unusual items, circle No. 11 on Reader Service Coupon on page 17 or 103.

Count on this One

Heath Company has introduced the IB-1101 Frequency Counter with a 1 Hz to over 100 MHz range and a list of features before now unheard of in "low-cost" counters. The IB-1101 has an exclusive input circuit that will accept input levels from less than 50 mV to more than 200 V, depending on frequency, without damage to the instrument. The full five-digit readout can be expanded to eight-digit capability by simply using the overrange circuitry. And to make accurate readout even easier, the deci-



mal point is automatically placed with range selection, while MHz, kHz, overrange and gating are indicated by front-panel lights. A one megohm input impedance and low input capacitance reduce the chance of circuit loading. Priced at just \$269.95, mail order, the IB-11-1 can be assembled in 10 easy hours. The 26 digital ICs and five cold-cathode readout tubes plug into individual sockets. For more information, circle No. 1 on Reader Service Coupon on page 17 or 103.

Mighty Big Peewee

Pearce-Simpson has introduced Cheetah SSB a new plateau in mobile SSB/AM CB radio. Cheetah SSB is the smallest mobile side-band unit on the market, yet features the maximum 15-watts peak envelope power allowed on single side-band. Cheetah SSB is, up to now, the

How to subscribe to:

**elementary
Electronics**

SPECIAL INTRODUCTORY OFFERS!

Just check below to start your money-saving subscription to EE at once.

- Get 1 Year (six issues) only \$3.33.
- Get 2 years (12 issues) only \$6.66
- Bill me.

PAY CASH—GET VALUABLE BOOK FREE!

This \$1.25 copy of **ELECTRONICS HOBBYIST**—yours FREE if you enclose payment for your introductory subscription now.

- Enclosed is \$_____ (Rates apply in all 50 States and Canada)

name _____
 address _____
 city _____ state _____ zip _____

Mail to: **ELEMENTARY ELECTRONICS** B650
 229 Park Avenue South • New York, N.Y. 10003

Act now and Save!

How to subscribe to:

**Science &
Mechanics**

SPECIAL INTRODUCTORY OFFER!

Just check below to start your money-saving subscription to S&M at once.

- 10 Months for only \$2.97
- Bill me.

**PAY CASH—
GET VALUABLE BOOK FREE!**

This latest copy of **DIRECTORY OF FREE GIFTS** (\$1.00 retail)—yours FREE if you enclose payment for your introductory subscription now.



- Enclosed is \$2.97 (Rates apply in all 50 States and Canada)

name _____
 address _____
 city _____ state _____ zip _____

Mail to: **SCIENCE & MECHANICS**
 229 Park Avenue South • New York, N.Y. 10003 B972

HEY, LOOK ME OVER *****

only mobile SSB/AM CB with an SWR bridge for checking antennas, yet retails for only

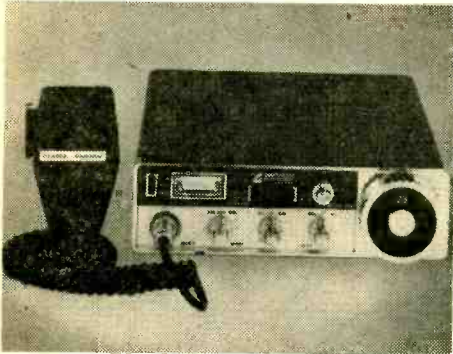

\$339.95. Some of the features include: variable RF gain that controls both AM and SSB, plug-in mike and power cord, S/RF meter that changes color from transmit to receive, push-button controls for the true RF noise blanker, and the built-in variable volume P.A. More information available by circling No. 49 on Reader Service Coupon on page 17 or 103.

Electric Char-B-Que

An outdoor grill called Electric Char-B-Que with a rustproof, die-cast aluminum housing, has a baked enamel finish and is treated with high-temperature resistant paints that won't



chip or peel. Made by Electric Char-B-Que, Inc., it is available in 1972 House & Garden coordinated colors: Bitter Sweet Orange, Sun Yellow, Avocado and Kettle Black. The suggested retail price is \$59.95. Get the straight dope from Electric Char-B-Que by circling No. 52 on Reader Service Coupon on page 17 or 103.

Microwave Oven

Sharp Electronics Corporation has intro-



duced a new improved microwave oven, the R-6500. It features double safety switches, door interlock latch and concealed cam interlock switch, which completely cut off the power when oven door is opened. The front bronzed-tinted plastic window offers see-through convenience, and a stable heating system operates despite power fluctuations. The R-6500 operates on 120 V, 60-Hz. It measures 22½-in. x 16-5/16-in. x 13¾-in., with an oven cavity of 13½-in. x 7⅝-in., and weighs 86 pounds. It sells for \$399.99. For further information, circle No. 53 on Reader Service Coupon on page 17 or 103.

Film Saver

Did the airport fuzz ever x-ray your traveling case when valuable and unexposed film were inside? Avoid this headache with a warn-



Caution!
do not
X-ray

This bag contains photographic film.
Do not X-ray, as this can damage film.
Owner will display contents on request.

Mfgd. by B. Ross, P.O. Box 223, Jamaica, N.Y. 11431

ing decal. Made available after an expensive personal loss, B. Ross offers his two-color decals for only \$1.00 for two, 12 for \$5.00. Stock up now. Order direct from B. Ross, P.O. Box 223EE, Jamaica NY 11431.

TVOM Kit

The Conar Model 212 believed to be the industry's lowest price TVOM Kit, uses printed circuit board construction for easier and faster assembly. Also, the complicated and time-consuming job of wiring switches has been elimi-

(Continued on page 96)

READER SERVICE PAGE

• The Editor of ELEMENTARY ELECTRONICS offers readers an easy way to get additional information about products and services advertised in this issue. Also, if you would like more information about any new product mentioned in our column "Hey, Look Me Over," it's yours for the asking. Just follow the instructions below and the material you requested will be sent to you promptly and at no cost.

• The coupon below is designed for your convenience. Just circle the numbers that appear next to the advertisement or editorial mention that interests you. Then, carefully print your name and address on the coupon. Cut out the coupon and mail to ELEMENTARY ELECTRONICS, Box 886, Ansonia Station, New York N Y 10023. Do it today!

JULY/AUGUST 1972 Void after December 31, 1972

ELEMENTARY ELECTRONICS

Box 886, Ansonia Station, New York, N.Y. 10023

| | | | | | | | | | | |
|---|----|----|----|----|----|----|----|----|----|----|
| Please arrange to have literature whose numbers I have circled at right sent to me as soon as possible. I understand that this is a free service offered by the magazine. | 1 | 2 | 3 | 4 | 5 | 6 | 7 | 8 | 9 | 10 |
| | 11 | 12 | 13 | 14 | 15 | 16 | 17 | 18 | 19 | 20 |
| | 21 | 22 | 23 | 24 | 25 | 26 | 27 | 28 | 29 | 30 |
| | 31 | 32 | 33 | 34 | 35 | 36 | 37 | 38 | 39 | 40 |
| | 41 | 42 | 43 | 44 | 45 | 46 | 47 | 48 | 49 | 50 |
| | 51 | 52 | 53 | 54 | 55 | 56 | 57 | 58 | 59 | 60 |

• Please limit circled items to 12 maximum.

Are you a subscriber to ELEMENTARY ELECTRONICS? Yes No

How many of the last 3 issues did you read? None 1 2 3

Name (Print Clearly) _____

Address _____

City _____ State _____ Zip Code _____

Let Bell & Howell Schools help you get ready for a rewarding Color TV Service Business of Your Own

Ultra-rectangular,
25" diagonal with
full 315 sq. inch
screen. Lets you
view more of the
transmitted image.
25,000 volts. 45
transistors, 55 diodes,
4 advanced IC's.
3-stage solid-state IF.
Solid-state VHF, UHF
tuners. Automatic fine
tuning and many other
quality features.

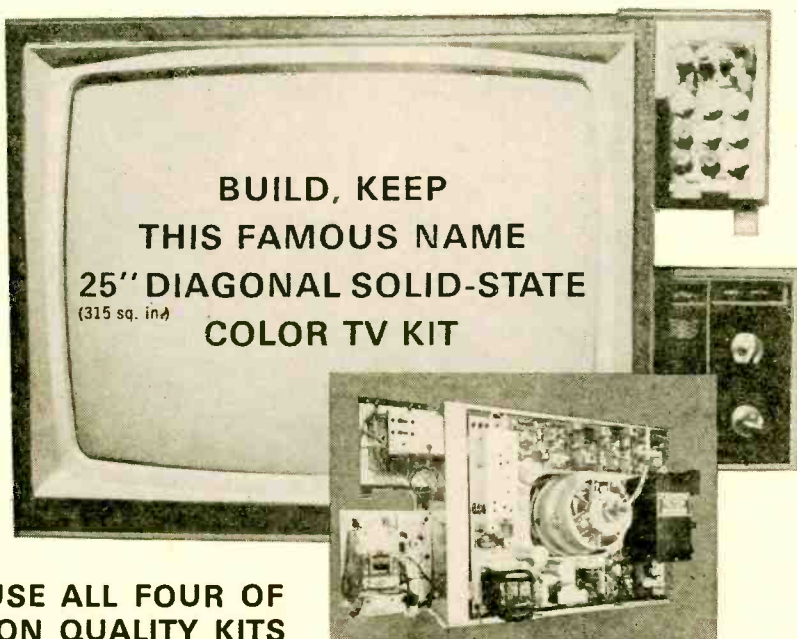

**BUILD, KEEP, USE ALL FOUR OF
THESE PRECISION QUALITY KITS**

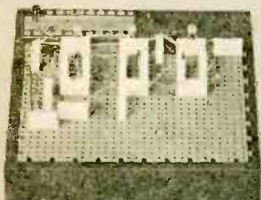

INCLUDES—
Design Console with built-in power supply, test light and speaker. Plus patented plug-in Modular Connectors.

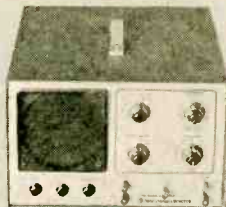

INCLUDES—
Portable 5-inch, wide-band oscilloscope calibrated for peak-to-peak voltage and time measurements.



INCLUDES—
Transistorized Meter . . . a multimeter for current, voltage and resistance measurements registered on a large, easily-read dial.

FREE! MAIL CARD TODAY FOR ALL THE FACTS
No Postage Needed



YOU'LL BE READY FOR COLOR TV . . . B&W AND MOST HOME ENTERTAINMENT ELECTRONICS DEVICES

This exciting new program offers you the *first* 315-sq. inch Solid-State Color TV available for at-home training.

As you follow the simple, step-by-step assembly procedures, you become thoroughly familiar with the most advanced solid-state TV circuitry. And as you build this kit you'll prepare yourself for a profitable Color TV service business of your own—either full or part time.

Why Color TV pays better.

Today, Color TV is the big seller. As Color Television goes completely solid-state, the man who has mastered this type of circuitry will be in demand. Obviously, this is where the money is going to be made.

This new Bell & Howell Schools program will also give you an in-depth knowledge of the basics as well as TV circuit theory and analysis. You'll get the theory and practical experience you need to handle radios, hi-fis, stereos, and tape recorders.

You will also receive three precision quality instrument kits which you assemble and keep. These are highly sensitive professional instruments which you'll use constantly.

**EXCLUSIVE ELECTRO-LAB®
IS YOURS TO KEEP, USE**

This unique at-home laboratory comes to you in 16 shipments and includes a remarkably instructive *design console*. You can rapidly "breadboard" a great variety of circuits without soldering. The *Oscilloscope* offers 3-way jacks to handle test leads, wires, plugs. Images on screen are bright, sharp. Your *Transistorized Meter* is fully portable, features a sensitive, 4-inch, jewel-bearing d'Arsonval meter movement. It's a multimeter for current, voltage and resistance measurements.

CONSIDER THESE ADVANTAGES:

Bell & Howell Schools' Electro-Lab-at-Home Plan gives you thorough, career-oriented training in solid-state Color TV. Everything

Note: TV picture is simulated.

comes to you by mail and you go at your own speed. You'll be prepared not only for a service business of your own but for many positions in the Electronics and Television industries. All without missing a paycheck!

When you have completed your program our *Lifetime National Placement Service* will help you locate in an area that interests you. This service is available at any time—now or in the future.

Veterans' Benefits

We are approved by the state approval agency for Veterans' Benefits. If you're a Vet, check the space in the card at left for full details.

Student Financial Aid

We are an eligible institution under the Federally Insured Student Loan Program. Just check the space on the card and we'll send you full information.

Special Help Sessions. These are scheduled regularly (Saturdays) at seven Bell & Howell Schools and in many other cities. Here you can get expert guidance by top instructors to help you over the rough spots.

Bell & Howell Schools offer you even more. Once you have finished your program at home, you may decide you want more advanced preparation. In this case, you may transfer to any one of our seven schools which are located all across the country.

Mail the postage-free card today for all the facts. There is no cost or obligation of any kind.

DEVRY INSTITUTE OF TECHNOLOGY

ONE OF THE



BELL & HOWELL SCHOOLS

4141 Belmont, Chicago, Illinois 60641

(TV kit is not available in Canada)

321

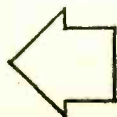

FREE! MAIL CARD TODAY FOR ALL THE FACTS
No Postage Needed

JULY-AUGUST, 1972

21

Automatic Tri-Speed SCAN ACTION

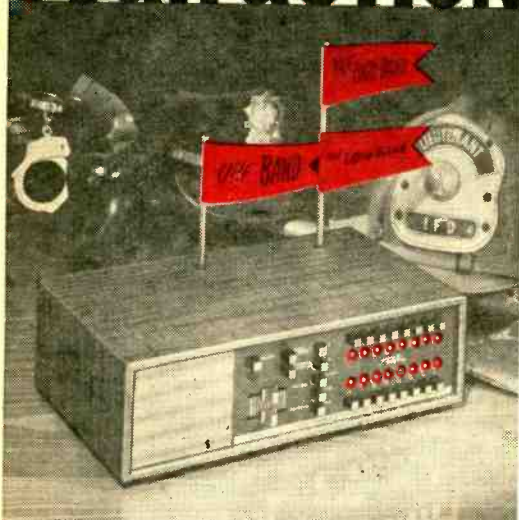

16 big channels in three bands with push button program control

Hear it now!

A UHF, High/Low VHF monitor in one handsome, easy-to-operate package.

Our new Monitorradio/Executive Scanner, Model TME-16 H/L/U, doesn't miss a trick on transmission.

It conducts an automatic, or manual, search for active signals on your choice of frequencies in three busy bands. It stops to hear the transmitted action, loud and clear . . . then automatically resumes the search.

Each of the 16 crystal controlled channels is push button equipped for programming any channel "in" or "out" of service. Push buttons, too, for programming either of the three bands.

Tri-speed scan action speeds the signal search to "super-scan" the channels you want most—eliminates signal sampling of channels you choose to temporarily "program-out".

Best of all, it does the complete monitor job that formerly required 3 receivers—only \$219.00. Crystals \$4.95 each.

Hear it now—at your favorite Regency retailer.

Ask for our complete color catalog of 25 monitor models

Regency

ELECTRONICS, INC.

7900 Pendleton Pike
Indianapolis, Indiana 46226

CIRCLE NO. 20 ON PAGE 17 OR 103

newscan

Electronics in the News!

IT'S A NEW TWIST

Twisting two wires together for use in miniaturized circuits can be difficult if the wires are only a few thousandths-of-an-inch thick and the tension on them must be identical to get a proper twist. An experimental twisting device that maintains this precision through repeated applications has been designed and tested by Paul Hug and his colleagues at the IBM Systems Development Division Laboratory

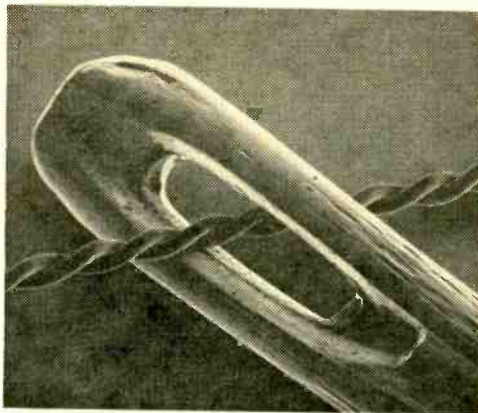

Size of circuit wire is apparent when compared with the head of an ordinary needle. Both are magnified 32 times.

in San Jose, Calif. Equal tension on the wires insures uniform twisting and predictable electrical behavior in the completed circuit boards.

The problem lies in the accumulation of tiny micron-sized dust and fiber particles that lodge in the wire guide slots and threading holes of conventional twisters. Contamination buildup in these areas can change the tension on the wires even when they have been carefully adjusted as they leave their spools.

In the experimental twister, the two strands are not threaded internally but rather are held in the guide slots by a clip of common piano wire. This clip has sufficient flexibility to let particles pass through, and at the same time accommodates variations in wire insulation thickness that could further affect the tension.

Contrary to problems encountered with the conventional approach, hair-thin (2 to 3 mil) wires twisted by the experimental device produced no operating failures in any of the cir-

(Continued on page 93)

ELEMENTARY ELECTRONICS

Learn more about electronics this easy way by mailing the coupon below

EVERY ISSUE of ELEMENTARY ELECTRONICS brings you easy-to-follow aids for better understanding of theory and applications of electricity and electronics...in word and picture with diagrams that are easy to follow...a source of up-to-the-minute information for everyone interested in electronics who wants to increase his knowledge...followed every issue by thousands of Cbers, Hams, SWLs, Experimenters.

Save
up to
\$4.00

MAIL THE COUPON below today and you can save up to \$4.00 over the cost of buying copies on the newsstand...and be sure you don't miss a single information-packed issue...because the mailman will bring your copy to your door just as soon as each issue is off the press.

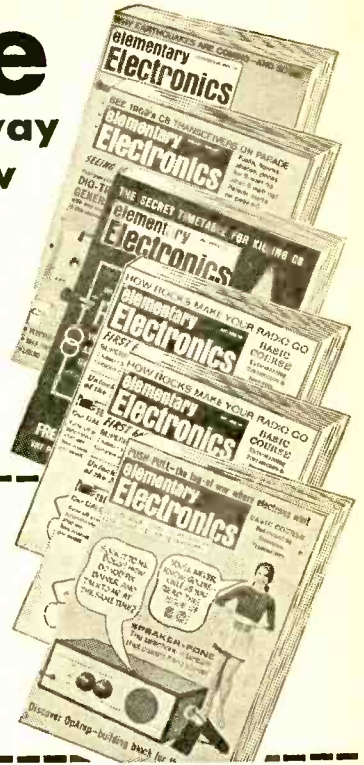

Elementary Electronics, 229 Park Ave. South, New York, N. Y. 10003

I don't want to miss a single issue. Enter my subscription for:

Dept. B652

6 issues (1 year) \$3.33
I save \$1.17

12 issues (2 years) \$6.66
I save \$2.34

PAY CASH—GET EXTRA BONUS
receive free copy of Electronics
Hobbyist, regular value \$1.25

Bill me

I enclose \$ _____

NAME _____

STREET ADDRESS _____

CITY _____

STATE _____

ZIP CODE _____

Outside U.S. and Canada: Add \$1.00 per year

SAVE HUNDREDS OF DOLLARS

Buy a S&M Model A-3 Supersensitive Darkroom Meter with Standard Probe & Make your own DENSITOMETER. The meter and the light source make up your DENSITOMETER. Materials for the light source under \$20. Mail coupon today!

S&M Densitometer plans are included with purchase price of meter.



SCIENCE & MECHANICS

Instruments Division, Dept. EE7-72
229 Park Avenue South, N.Y. 10003

Send the S & M Supersensitive Darkroom Meter including standard probe, computer and case. Complete instructions supplied to build your own densitometer. If not satisfied, I may return the meter within 10 days for a complete refund.

(Add 10% for Canadian and Foreign orders; N.Y.C. residents add 7% for sales tax.)

Darkroom Model A-3 @ \$75.00.

S&M Densitometer plans \$3.00.

Check or money order enclosed, ship ppd.

Corporate purchase order attached.

NAME _____

ADDRESS _____

CITY _____

STATE _____

ZIP _____

Don't sit back... REACT!

Join the REACT Team... Monitor Channel 9
Help provide emergency communications.

Write for Free pamphlet... How
you can join the REACT Team.



REACT® National Headquarters

111 East Wacker Drive, Chicago, Illinois 60601

SEE AD ON INSIDE FRONT COVER

HEATH COMPANY, Dept. 139-7

Benton Harbor, Michigan 49022

Please send FREE Heathkit Catalog.

Enclosed is \$ _____, Plus shipping.

Please send model(s) _____

Name _____

Address _____

City _____ State _____ Zip _____

Prices & specifications subject to change with-
out notice. *Mail order prices; F.O.B. factory.

CL-434R

DX central reporting

A world of SWL info!

By Don Jensen

How can I improve my DXing? In various forms, that question pops up in letter after letter received here at DX Central. Usually the writers are anxious to improve the performance of their receivers or antennas to bring in more of that elusive DX.

Specifically, it seems, you want to soup up your rigs, improve the ability to read the correct frequencies, knock out images, those unwanted false signals that crop up where they shouldn't on the dial, and lick certain antenna difficulties.

Case-by-case troubleshooting is tough to tackle but there are some relatively new products on the market which may help you beat your specific problem.

Of all the DX accessories sold today, DX Central gets more questions about the British-made Joystick antenna than about any other product.

The Joystick is an omni-directional, compact antenna designed for medium and short-wave reception. Its big plus is its size, only about eight feet long, making it a handy device for the apartment-dwelling DXer. The Joystick can be mounted outside on your roof, or, in many cases, simply leaned against the corner of your DXing den. It can be the answer for the fellow who just can't string up a wire antenna outdoors.

The Joystick requires a special antenna tuning unit, the Joymatch. The model SM Joymatch is for tube circuitry receivers; the TR model for transistorized radios.

An older version of the Joystick system was handled by several distributors in the U.S. Some months ago, however, it was replaced by what is billed as "a new lightweight model." Now the DXer must import the Joystick/Joymatch combination directly from the British manufacturer. With the introduction of the new model, the price took a drastic jump! Air delivered, the antenna-tuner system will cost something over \$60.

Complete information is available from Partridge Electronics, Ltd., Prospect Road, Broadstairs, Kent, England.

For SWL's plagued with electrically noisy

locations, the Australian Aegis AF-1 noise reduction antenna may help. No antenna will eliminate static pickup, but this antenna, covering 540 to 1600 kHz and 4 to 18 MHz, may make satisfactory reception possible.

The AF-1 needs outdoor supports about 45 feet apart and in the clear, away from possible electrical noise pickup from house wiring, power lines and the like. A shielded transformer, with Faraday screening, feeds a very low impedance transmission line. At the receiver end, a second transformer couples the antenna to the set. Because of its low impedance and critical balance to ground, the transmission line may pass through areas of electrical noise without adverse effects.

The Aegis AF-1 costs \$29, and is imported by Gilfer Associates, Inc., P.O. Box 239, Park Ridge NJ 07656.

The A-20 PreSelector, also sold by Gilfer Associates, may be the answer to two common receiver difficulties.

In less expensive communications receivers, images can be a problem. Images are pesky repeat signals from more powerful stations that can be heard at a number of points, other than the actual transmitted frequency, on the short-wave bands. If an image turns up on a frequency where you're trying to hear a weak DX signal, you're in trouble.

The PreSelector can substantially reduce the strength of these unwanted images.

Secondly, the unit could also be called a signal booster, in that it can amplify desired signals by at least three s-meter units, while improving the signal plus noise to noise ratio.

Gilfer's A-20 PreSelector sells for \$49.95.

A useful gadget in improving your ability to know the frequency your receiver is tuning is a frequency marker. Some receivers have them as built-in equipment, but many don't.

What a frequency marker does is to superimpose an audio tone, at certain regular frequencies on the shortwave bands. These tones act as road signs, giving you an idea of where you're tuning. Most frequency markers spot these tones every 100 kilohertz. Several newer models, however, produce markers at additional spots on the dial.

Data Engineering Inc., Box 1245, Springfield VA 22151, has developed the FMS-3 which spots these tones every 5, 10, 25, 50, 100, 200 or 400 kHz, depending on where you set its controls. It costs \$32.95; \$19.95 in kit form.

The K-OCS-G1, by K-Enterprises, 1401 North Tucker, Shawnee OK 74801, produces marker tones every 1,000, 100, 50 or 25 kHz. The tone pulses three times a second, making it less likely that you'll mistake them for heterodynes or any of those other odd squeals you frequently hear on shortwave. Wired and calibrated, it costs \$45.50. In kit form, the price is ten dollars less.

(Continued on page 99)



LITERATURE LIBRARY

61. Kit builder? Like weird projects? EICO's 1972 catalog takes care of both breeds of buyers at prices you will like.
62. Want some groovy PC boards plus parts for communication projects? Then get a hold of International Crystal's complete catalog.
63. Now available from EDI (Electronic Distributors, Inc.): a catalog containing hundreds of electronic bargains.
64. A pamphlet from Electra details the 6 models of the Bearcat III, a scanning monitor receiver.
65. Dynascan's new B&K catalog features test equipment for industrial labs, schools, and TV servicing.
66. Before you build from scratch, check the Fair Radio Sales latest catalog for surplus gear.
67. Hallicrafter's literature features new SR-400A, "Cyclone III", 550 watts P.E.P., SSB/CW, 5 band transceiver for OM or YL amateur.
68. Want a deluxe CB base station? Then get the specs on Tram's super CB rigs.
69. Learn how to do all kinds of jobs with Xcelite's 19-piece midget reversible ratchet offset screwdriver set and 5-piece pocket kit.
70. Prepare for tomorrow by studying at home with Technical Training International. Get the facts on how to step up in your job.
71. Pep-up your CB rig's performance with Tuner's New M+3 mobile microphone.
72. A fully illustrated brochure from Midland gives readers a look at their new, complete line of radio monitoring receivers and CB transceivers.
73. The MONITOR antennas—keys to superior reception—are available from Antenna Specialists in their catalog.
74. Get all the facts on Progressive Edu-Kits Home Radio Course. Build 20 radios and electronic circuits; parts, tools, and instructions included.
75. Olson's catalog is a multi-colored newspaper that's packed with more bargains than a phone book has names.
76. Trigger Electronics has a 1972 catalog of equipment for those in electronics. Included are kits, parts, ham gear, CB, hi fi and recording equipment.
77. Get the free, new twenty-four page HUSTLER CB and Monitor antenna catalog featuring improved antennas and accessories for base station and mobile operation.
78. Teaberry Electronics has information on CB radios—Twin "T," Big "T," Mini "T" II, and Five by Five; also information on Scan "T" Monitor radio receiver.
79. Keep up-to-date on latest electronics bargains with Burstein-Applebee's '72 catalog and supplements.
80. Two leaflets by R. L. Drake Co. are available. One is on their SPR-4 communications receiver; the other on the SW-4A international short wave broadcast receiver.
81. Edmund Scientific's new catalog contains over 4000 products that embrace many sciences and fields.
82. Pick Cornell Electronic's 10th anni. catalog and discover yesterday prices. Tubes go for 36¢ and 33¢. Plus many other goodies.
83. Allied Radio Shack's 1972 Electronic Equipment Catalog features all-new 4-channel quadraphonic stereo equipment. The 92-pages include exclusive audio equipment.
84. It's just off the press—Lafayette's all-new 1972 illustrated catalog packed with CB gear, hi-fi components, test equipment, tools, ham rigs, and more.
85. Mosley Electronics, Inc. is introducing 78 CB Mobile Antenna Systems. They are described and illustrated in a 9-page, 2-color brochure.
86. RCA Experimenter's Kits for hobbyists, hams, technicians and students are the answer for successful and enjoyable projects.
87. You can become an electrical engineer only if you take the first step. Let ICS send you their free illustrated catalog describing 17 special programs.
88. Avanti's catalog describes and illustrates their complete line—mobile base CB antennas, many others.
89. A new free catalog is available from McGee Radio. It contains electronic product bargains.
90. B&F Enterprises has an interesting catalog you'd enjoy scanning. Goodies like geiger counters, logic cards, kits, lenses, etc. pack it. Get a copy!
91. Heath's new 1972 full-color catalog is a shopper's dream—chockful of gadgets and goodies everyone would want to own.
92. E. F. Johnson's 1972 line of CB transceivers and CB accessory equipment is featured in a new all-line brochure. Send for your free copy today.
93. If you want courses in assembling your own TV kits, National Schools has 10 from which to choose. There is a plan for GIs.
94. Free 1972 Catalog describes 100s of Howard W. Sams books for the hobbyist and technician. Includes books on projects, basic electronics and many related subjects.

ELEMENTARY ELECTRONICS
Box 886
Ansonia Station
New York, N.Y. 10023

Please arrange to have this literature whose numbers I have circled at right sent to me as soon as possible. I am enclosing 25¢ to cover handling. (No stamps, please.)

J/A72



- | | | | | | | | | | |
|----|----|----|----|----|----|----|----|----|----|
| 61 | 62 | 63 | 64 | 65 | 66 | 67 | 68 | 69 | 70 |
| 71 | 72 | 73 | 74 | 75 | 76 | 77 | 78 | 79 | 80 |
| 81 | 82 | 83 | 84 | 85 | 86 | 87 | 88 | 89 | 90 |
| 91 | 92 | 93 | 94 | | | | | | |

Indicate total number of booklets requested
 Sorry, only 12 circled items maximum.

NAME _____

ADDRESS _____

CITY _____

STATE _____ ZIP _____

Not Valid After December 31, 1972



BOOKMARK

BY BOOKWORM

Shortwave Phonebook. The 26th Edition of the "telephone directory" of International Radio and Television has just arrived in North America. *The World Radio-TV Handbook* is the only annual publication detailing every facet of shortwave, medium wave and TV broadcasting—from nominal information such as call sign and frequency to the name and title of the

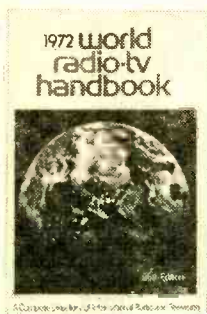

Soft cover
384 pages
\$6.95

station manager—from Afars & Issas to Zambia. Thousands of users of the *World Radio-TV Handbook* rely on this publication for schedules and programming. Others, refer to the *Handbook* for information on broadcasting organizations, station identifications, interval signals, QSL policies, etc. From the just starting short wave listener to the broadcasting industry executive, the *World Radio-TV Handbook* is the invaluable reference without which no one can afford to be. Available mail-order from Gilfer Associates, Inc., Box 239, Park Ridge, NJ 07656. For catalog of shortwave books and paraphernalia circle No. 57 on Reader Service Coupon on page 17 or 103.

Big on Business. *Industrial Electronics: Principles & Practice* by Alfred Haas is a comprehensive text on the electronic systems used in modern control and processing applications.



Soft cover
416 pages
380 illustrations
\$5.95

It includes information on all the up-to-date, sophisticated solid-state digital techniques. Here's the book that has been long needed to update existing knowledge of electronic devices and systems used in modern manufacturing plants. The content provides an indepth treatment of modern industrial control, processing and monitoring applications, including many of the latest innovations brought about by advances in solid-state electronics technology. Published by Tab Books, Blue Ridge Summit Pa. 17214. For more information, circle No. 59. on Reader Service Coupon on page 17 or 103.

Hob-Nob with Hobbyists. Here is an effective, project-oriented approach to learning about the latest semiconductor devices and circuits. *Practical Solid-State Principles & Projects* by Ken Sessions includes practical circuits anyone can understand and build, such projects as an electronic burglar alarm, a solid-state timer, a metronome, an automatic night light switch, even a doorbell with a different tone for each door! Not only does this book clearly explain how to build these and dozens of other

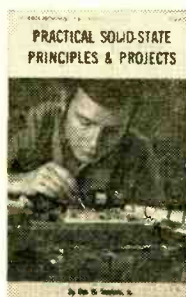

Soft cover
176 pages
127 illustrations
\$3.95

practical working devices, but also how to use all the new types of solid-state devices now available for everyday use by the electronic hobbyist/experimenter. Published by Tab Books, Blue Ridge Summit, Pa. 17214. Circle No. 56 on Reader Service Coupon on page 17 or 103.

Another RCA Book. A new technical manual on RF power transistors is now available from RCA Solid State Division. The *RCA RF Power Transistor Manual*, Technical Series RFM-430, provides detailed information on the use of RF
(Continued on page 100)



Soft cover
176 pages
\$2.50



Hank Scott, our Workshop Editor, wants to share his project tips with you. Got a question or a problem with a project you're building—ask Hank! Please remember that Hank's column is limited to answering specific electronic project questions that you send to him. Sorry, he isn't offering a circuit design service. Write to:

Hank Scott, Workshop Editor
101 ELECTRONIC PROJECTS
 229 Park Avenue South
 New York NY 10003

Cut and Try

I'm having trouble finding a single-channel trap for Channel 3. Where can I get one?

A.H., Clark SD

Any store that sells TV lead-in wire or coax cable can help you. All you need do is cut a 55-in. length of cable and connect to the antenna lead-in-line—make a "T" connection. The free end of the cable is shorted to itself. That is, if TV twin lead is used, connect both wires together. For coax connect the center lead to the shield. This will weaken the Channel 3 signal somewhat. However, a 55-in. long half-wave stub is too long. Cut off an inch and check TV set for results. Continue to do this, noting results on paper. Should you cut off too much, the signal will become stronger. No loss! Wire is cheap and you have now recorded the exact length required. You have now designed a half-wave Channel 3 shorting stub. Congratulations. If you find some loss of signal strength on Channels 2 or 4, connect a 28-in. quarter-wave stub somewhere else on the antenna lead-in line and proceed as before by cutting 1/2-in. of the end of the stub each try. You may see the signal improve.

Widgit Expert

My friend says pliers are for wires only. Is he right?

—A.C., Houston TX

Your friend is a lot of hot air! Tell him about gas pliers. Actually, what your friend is saying is that many tools are abused by incorrect usage. The other day a dime fell from my hand into a crack in my bench floor. I fished out the dime with needle-nose pliers. Ask your friend if I should have used a dime retrieving widgit instead?

Cheaper by the Dozen

I have a Regency 16 Band VHF-UHF Scanner Model TME-16 H/L/U. The instruction booklet indicates that a 3 to 4-ohm external speaker may be connected to terminals on the set. I

Sorry, I cannot answer your problems by return mail. The press of time and the large volume of mail makes this impossible. Also, I cannot offer design services. Hints, yes! Plans, no!
 —Hank

would like to set up four or five speakers, with an on/off volume control on each, to control that speaker only. The comments I have received so far range from "impossible due to impedance mismatch with different number of speakers operating at various times," to "you will blow the audio-output on the scanner if you hook up more than one speaker." Please advise!

—R.S., Windsor, Ont.

The Regency unit you own is like many others—the manufacturer provided enough audio oomph for two speakers without loading down the audio final stage. In fact, the unit will probably drive three loudspeakers with ease. However, you're asking too much from a small audio power amp. I suggest you add on a public-address-type amplifier unit to give you the audio boost required and then add on the speakers you need with T-pad volume attenuators in each speaker circuit. This'll do it!

How Long Is Long?

I purchased a phono to connect to my present stereo system. The audio cable is no longer than 2-ft., thus requiring very close placement to the speaker. I was going to extend it with another cable so I could separate speaker and turntable. I had second thoughts and not being any electronics engineer, didn't know whether this should be done or not. Should I or shouldn't I?

—B.S., Columbus IN

It's okay to add on an additional cable of about three feet and no longer. As length increases, the high frequencies are attenuated by the cable's capacitance.

De-gasser

I am experimenting with a 20-in. black-and-white picture tube and I would like to know how to discharge the vacuum without too much damage to the neck. Also, how can I cut a hole 4 or 5-in. round on the bell (flare) of the picture tube opposite the high voltage connection?

—J.G., Bronx NY

Breaking the seal on a picture tube is as easy as going blind! However, if you must, then wrap the entire tube except for the socket prongs in several heavy blankets. If the prongs are on a

(Continued on page 98)

ELECTRONIC STORE

by Jack Schmidt



"Where can you find that much power in a speaker this size?"

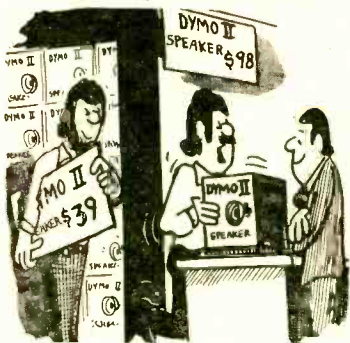

"You're lucky you got here when you did . . . this is the last one we can sell at this price!"

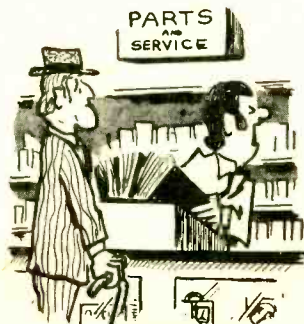

"hey, Eddie, what t'ell is a vacuum tube?"



"You see, he needs full volume to penetrate the hair."



"Think of the publicity, 'Radio-TV Store Robbed at Laser Point'!"



"Quad sound during dinner! Not on your life . . . it reminds me of work!"

the Ultra High, Low down on... **MONITOR RECEIVERS**

We show you how to set your sights on an exciting panorama of signals.

By Len Buckwalter

It's mind boggling! Ever stop to think about the sheer number of radio signals flashing under, over, around, and even through you? Signals that convey pictures, typewritten messages, medical data, computer-talk, and certainly plenty of small-talk.

As you know, some of the most interesting and worthwhile communications take place on what the FCC calls the public service bands. This encompasses those hundreds of thousands of two-way narrow-band FM radio systems in use throughout our continent by law enforcement, fire, emergency and safety services.

Such communications have been allotted a number of relatively small slices of the frequency spectrum. These are scattered throughout the RF spectrum from just above the broadcast band to the new land mobile communication band just below 1000 MHz.

Today communication equipment manufacturers have provided us with a wide variety of monitor receivers for those two-way communication channels above 30 MHz—the frequency at which most communication receivers stop. If you think you'd like to try your hand at bagging some of these services, or

(Turn leaf)

e/e MONITOR RECEIVERS

maybe have a working association with local fire or police activities, here's the scoop on a representative cross-section of available receiving equipment for the VHF low, VHF high, and UHF bands.

e/e's TABLE OF MONITOR BAND FREQUENCIES

| | |
|-------------------|----------------|
| VHF Low Band | 30 to 50 MHz |
| VHF High Band | 150 to 174 MHz |
| VHF Aircraft Band | 108 to 136 MHz |
| UHF Band | 450 to 470 MHz |

Background. My mother-in-law has a radio with a band marked Police but the last time it received the fuzz was around 1935. Because of remarkable growth in two-way radio, there are now at least three portions of the radio spectrum for police communications. So a major decision about any monitor receiver is selecting the right bands. Some models tune only single channels, others capture almost any signal on the air. Not only must you decide on your listening preference, but know which band it's using in your particular area.

Low Band. After World War II, public safety services (police, fire, government, etc.) moved from crowded low frequencies into the spectrum above 30 MHz. It created the first of the VHF regions known today as the low-band. It runs from 30-50 MHz with police, fire, highway maintenance trucks and others using the frequency. When you live in a rural area or a small town, chances are the police are on low-band. If you're not on speaking terms with the Sheriff, one way to determine the band is to drive past headquarters and look at the whip antennas on police cars. If they're about 6 to 8 feet tall, they're advertising the low-band.

Because of population increases in many cities, additional radio channels are often assigned in the high-band. This one runs from 150 to 174 MHz and you can spot the antenna because it's only about 18-in. high and is usually placed on the vehicle roof (low-band antennas are often on the rear deck). The high-band, incidentally, also in-

Directories of police, fire, and emergency call signs and frequencies are available from CRB Research, Inc. For their free catalog, send a stamped, self addressed No. 10 (4½ x 9½-in.) envelope to P.O. Box 56-EE, Commack NY 11725.



Lafayette P-100 VHF Mobile, Xtal-Tune.
\$79.95. Circle No. 40 on page 17 or 103.

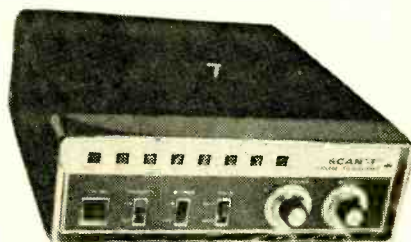

Teaberry Scan-T, VHF 8-channel scanner.
\$129.00. Circle No. 34 on page 17 or 103.



Johnson Duo-Scan, VHF/UHF scanner.
\$169.95. Circle No. 35 on page 17 or 103.

cludes two other notable services—the new VHF marine band (approx. 156 MHz), which will soon accommodate all pleasure boats, and the other is a continuous weather channel on 162.55 MHz or 162.40 MHz.

If airplanes are your thing, consider the aviation monitoring band from 108 to 136 MHz. There is little activity in the first 10 MHz portion (mostly navigational beeps), but plenty of activity above 118, like control towers, air traffic and ground communications. The aircraft distress frequency on 121.5 MHz is here.

The last major band for monitoring is away up in the UHF region from 450-470 MHz. It's been used for business communications for years and is now absorbing the overflow of public-safety stations from lower bands. You can tell if a mobile is operating UHF because of the trusty clue given

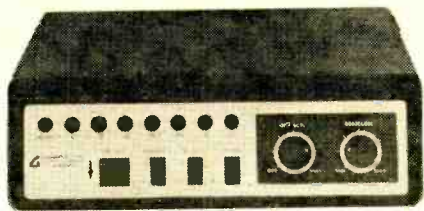

Gladding Hi-Scan, VHF 8-channel scanner.
\$114.95. Circle No. 36 on page 17 or 103.



Courier Auto-Scan, COP-75, 8-channels.
\$149.95. Circle No. 37 on page 17 or 103.



Midland 13-925 8-channel Lo-Hi scanner.
\$169.95. Circle No. 26 on page 17 or 103.

by the antenna—a metal toothpick about 4 inches high.

The Channel Rock. Once you've narrowed down your bands of interest, there's another important decision. Do you need continuous tuning, crystal control, or both? There are monitor receivers in every category, so evaluate the type of listening you'll do. Continuous tuning, like that of an ordinary radio, has the great advantage of giving complete frequency coverage over a whole band. The disadvantage is that tuning accuracy is only approximate. If you want to hear a specific channel, you'll have to guess at the correct dial setting. This is aggravated by the fact that stations transmit only in short bursts and you may have no signal to home in on.

Crystal control, on the other hand, locks the receiver to an exact frequency. The station doesn't have to be heard, but the

short-coming in this system is limited frequency coverage. And, crystals cost about \$6 per rock.

Which type of tuning do you need? If you wish you can buy a deluxe rig that has it both ways. A rig which tunes only by crystal control would appeal to listeners with some professional link to the service. An auxiliary policeman, a volunteer fireman or town official, for example, might want a crystal on his department's frequency for accurate, drift-free tuning. The casual listener, though, might be happier with the greater frequency range of a receiver with continuous coverage.

Why Not Ask? Whether a receiver has fixed (crystal) or continuous tuning, you'll have to know where to pick up local stations on the dial. The exact value of a crystal frequency must be known for ordering purposes. This information should be obtained locally, looked up in a directory or some other listing. Besides checking published information, I've used several methods to learn local police and fire frequencies. Try taking a tour of the local fire station and see the radio room. Keep your eyes open—or simply ask for the frequencies. Here's another tactic that works. Whenever I'm home and hear a siren, I dash to the monitor receiver and sweep the dial back and forth. In time, you can mark the dial with several police and fire channels. Yet another good source of information is a local store that sells monitor receivers.

A novel development in tuning is the scanner receiver. It's a combination of fixed and continuous tuning and has the advantages of both. You can order crystals for eight desired channels, and the receiver will automatically search them about twice every second. If there is no activity on a channel, you'll hear nothing. But for an active channel, the scanning halts and opens the speaker for you to hear message. At the end of the transmission the receiver resumes scanning until it hits the next busy channel. The advantage is very accurate and automatic reception on more than one local channel of interest. You can load one receiver with municipal and state police, local fire, wide-area frequencies (shared by many towns) and weather.

As you can see, pushbuttons on a scanner receiver allow you to manually lock the receiver to a given channel, or *program* it to scan only selected channels out of the group. These receivers started on the 150-174 MHz

e/e MONITOR RECEIVERS

band, but recent models are going even further. Some models intermix channels in both low and high-band in any combination you wish to punch on the buttons. Besides the ability to sweep across specific channels, any scanner receiver is a pleasure to behold as a row of twinkling lights flashes in step with channels being scanned.

Picking The Package. Once you've made the decision on bands and type of tuning, the next step is selecting a receiver that contains the coverage you want. Here we count some half-dozen different approaches in packaging. Since there are no real standards we'll use general headings to describe the major categories now in the marketplace.

Multiband SW Portable. This is an expansion of the popular solid-state shortwave portable. Although it started with AM-FM broadcast, plus one or more shortwave bands in the 2-30 MHz region, many current portables now add a VHF band. Thus the primary job of this receiver is broadcast reception, but it allows the listener an occasional exploration of the low, high or possibly the aviation band. Such a receiver with High Band coverage is attractive to the boat-owner because it brings in continuous weather reports. For serious monitoring, however, these sets may respond only to very strong, nearby signals. They rarely include crystal control or other circuit feature useful to monitoring.

VHF Portable. This is a very small receiver that's handy for listening while away from home. Its simple circuits usually have one VHF band. Since these models are often low cost and mainly for entertainment listening, sensitivity is usually sacrificed on the monitor band. Tuning is probably difficult, too.

Good performance in a hand-held model is possible with the better single-band VHF portables, and some models include AM as a secondary feature in what is primarily a portable VHF-FM receiver. They may be a continuously tunable type, or offer crystal control through a selector switch. The latter model would be attractive to a volunteer fireman since he can carry a monitor on the company frequency in his pocket.

Tabletop Monitors. By excluding all coverage except monitor bands, this group contains some of the best performers. There is

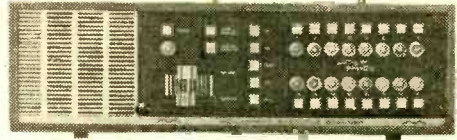

Regency 3-band 16-channel scanner.
\$219.00. Circle No. 31 on page 17 or 103.



Pace Scan 101. 8-channel VHF scanner.
\$129.50. Circle No. 32 on page 17 or 103.



Sonar FR-103-SA.
3 crystal channels plus BCB, portable.
\$49.95. Circle No. 33 on page 17 or 103.

little compromise since the electronics are not shared with broadcast, SW or other entertainment coverage. The photos show that such sets package the bands in almost any assortment—one-band, two-band, or a full house (low, high and UHF). Tuning may be fixed by crystals, be continuous, or be a combination of both. Such receivers are widely used by professionals with an occupational tie to two-way radio, or by the se-



Electra Bearcat III 2-band, 8-channel scanner.
\$159.95. Circle No. 43 on page 17 or 103.



Radio Shack PRO-3. Dual tuner, 3-bands.
\$198.50. Circle No. 30 on page 17 or 103.

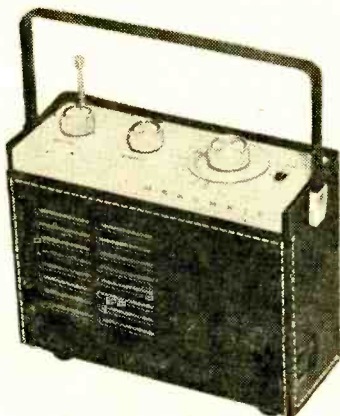

Heath GR-89. Aircraft band kit.
\$49.95. Circle No. 1 on page 17 or 103.

rious listener who wants superior performance and is willing to pay for it.

Mobiles. You may operate some of the sets just described in a vehicle, but the mobile monitors are handier for long-term listening in a car. These sets are physically small and lend themselves to mounting under a dash. They're powered by 12 VDC and come with a bracket for convenient installation. *One precaution:* There is no

restriction against tuning the bands while at home, but some local authorities have laws against monitoring while in a car.

Special Features. Performance and circuits usually vary among monitor receivers as a matter of price. A few minutes' operation reveals certain obvious differences between low-cost and high-grade gear. The dial calibration on a cheap, continuously tunable set is only approximate and it's almost impossible to locate a channel by dial reference alone. Better receivers have improved band spread, which stretches the numbers for easier tuning and station separation. The better set usually has a *squelch* control. It eliminates background hiss and other noises in the loudspeaker until a signal arrives. If you plan to monitor for long periods, a squelch is a virtual necessity to keep the peace. Another item for noise reduction, and one that's especially valuable in mobile work, is an Automatic Noise Limiter (ANL). Ignition noise tapers off at higher frequencies, but it seriously affects reception down on the Low (30-50) Band. The ANL can *clip* much of this interference.

The ability of a receiver to pluck signals out of the air is a measure of its *sensitivity*. This is specified as a certain number of microvolts required to quiet the receiver (lower the background hiss) a given number of decibels (dB). For example, if a receiver is rated at 2 microvolts for 20 dB quieting, decreasing the number of microvolts to 1.5 means an improvement. Better receivers have an RF amplifier stage for good sensitivity. If you spot a multiband monitor receiver with more than one dial, chances are it has a separate front end for each tuning system; this could mean high sensitivity. The double tuner allows circuits to concentrate on a narrower group of frequencies. It also permits you to connect two antennas simultaneously to the set. With each antenna cut specifically to its own band, you'll enjoy better reception.

Speaking of Sensitivity. Even the best monitor receiver can't be expected to pull in signals like a table AM radio. VHF and UHF transmitters operate on *far* less power than do AM, FM and TV broadcasters, so they're usually local in coverage. Any monitor receiver should be connected to an antenna rather than a random wire or bed-spring antenna. The built-in whip on a monitor receiver is mostly valuable for close-in listening.

Another variable quality in circuits is

e/e MONITOR RECEIVERS

selectivity. This is an ability to separate stations which are closely spaced on the dial. Any ham or SWL knows that high selectivity is a precious quality on lower frequencies where stations jam each other with interference. This is rarely the case in VHF or UHF monitoring; you'll often sweep across a whole band and hear only one or two signals. Unlike broadcasters and hams, public-safety services transmit for brief intervals. A receiver with good selectivity, however, is still desirable for other reasons. It minimizes *capture* of receiver tuning by a stronger station on another frequency. Also, high selectivity narrows the receiver's response to atmospheric and other noises. Better monitor receivers improve selectivity by several techniques—more IF stages, a crystal, ceramic, or mechanical filter, and dual conversion circuits. A selectivity specification is stated in dB over a given frequency span; for example, selectivity may be rated at 6 dB at ± 12 kHz. This rating would improve in a better receiver if the 6 were larger.

Other receiver items that might be of interest include a headphone jack for late-night listening without disturbing the rest

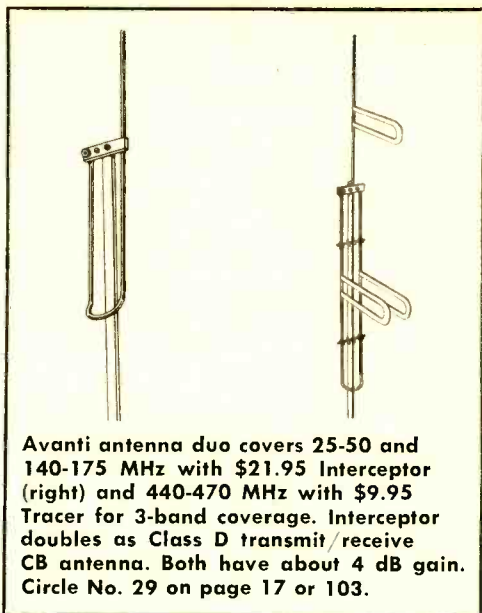

Avanti antenna duo covers 25-50 and 140-175 MHz with \$21.95 Interceptor (right) and 440-470 MHz with \$9.95 Tracer for 3-band coverage. Interceptor doubles as Class D transmit/receive CB antenna. Both have about 4 dB gain. Circle No. 29 on page 17 or 103.

of the family. Some models provide connections for an external speaker so you can listen in another room, or an output jack for tape recording a transmission of special interest. Finally, if building kits is your idea of fun, you'll find everything from tiny printed-circuit boards to complete receiver circuits that rival the performance of their factory-wired brothers. ■

MANUFACTURERS OF MONITOR RECEIVER CRYSTALS

Bomar, 201 Blackford Ave., Middlesex NJ 08864
 Crystek, 100 Crystal Drive, Fort Meyers FL 33901
 C. T. S. Knights, Inc., 101 E. Church Street, Sandwich IL 60548
 International Crystal Mfg. Co. Inc., 10 North Lee, Oklahoma City OK 73102
 Petersen Radio Co., Inc., Council Bluffs IA 51501
 Sentry Manufacturing Co., Crystal Park, Chickaska OK 73018
 Shepherd Industries, Inc., 8106 Santa Fe Drive, Overland Park KS 66204

MANUFACTURERS OF MONITOR RECEIVERS

Browning Laboratories, Inc., 1296 Union Ave., Laconia NH 03246
 E. F. Johnson Co., Waseca MN 56093
 Electra Corporation, Cumberland IN 46229
 Fanon/Courier Corporation, 175 East William St., Hopelawn, Perth Amboy NJ 08861
 Gladding Corporation, Pearce-Simpson Division, Biscayne Annex, Miami FL 33152
 Gonset Division of Aerotron, Inc., Box 6527, Raleigh NC 27608
 Lafayette Radio Electronics, 111 Jericho Turnpike, Syosset NY 11791
 Midland Communications Co., 1909 Vernon Street, North Kansas City MO 64116
 Pathcom, Inc., 24049 S. Frampton Ave., Harbor City CA 90710
 Radio Shack, 2617 W. 7th St., Fort Worth TX 76107
 Regency Electronics, Inc., 7900 Pendleton Pike, Indianapolis IN 46226
 Robyn International, 269 Northland Drive, Rockford MI 49341
 Sonar Radio Corporation, 73 Wortman Ave., Brooklyn NY 11207
 Teaberry Electronics, Corp., 3401 North Shadeland, Indianapolis IN 46226
 Unimetrics, 23 West Mall, Plainview NJ 11803

E/E looks at new...



Discrete 4-channel sound for cars—
Panasonic CX-601 car/home tape player.
 Two extra plus your regular stereo
 speakers put you right in the
 midst of the music. Features simple
 transfer from home to car. Converts
 automatically from 8-track stereo
 to the new 4-channel cartridges.
 Circle No. 46 on page 17 or 103.

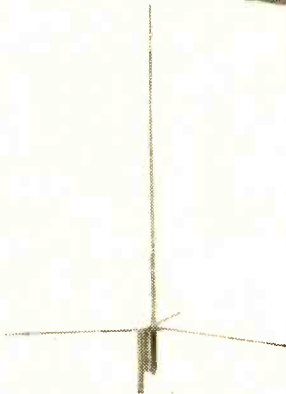

Stretch out that coverage—
Antenna Specialists Model M-417.
 Nicknamed the Polecat,
 this CB base station has a full
 17-foot radiator with Hi-Q phas-
 ing coil. Circle No. 54 on page
 17 or 103.

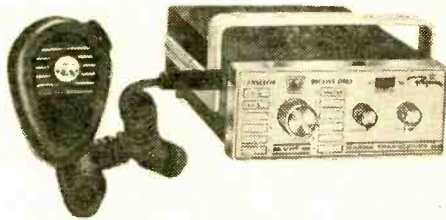

Boaters please take note—
Regency MT-15 VHF/FM transceiver.
 Rated at 15-25 watts, here's a
 low cost way to get on the Marine
 Radio Service channels. For 2-way
 communications on any six channels
 plus receive-only on six more.
 Circle No. 51 on page 17 or 103.

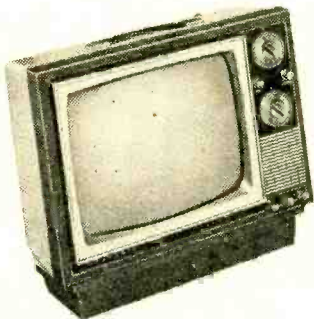

For your long haul TV DX—
Heathkit 12-in. portable TV.
 A real play anywhere set with an
 optional battery pack or 12 VDC
 car, camper, or boat battery cord.
 A kit anyone can assemble.
 Circle No. 1 on page 17 or 103.



Which way do we go, Mate?
Gladding Islander, RDF+
 Along with the 2-4 MHz AM marine
 band you get VHF marine, aircraft,
 standard AM plus FM and shortwave
 in this radio direction finder.
 Circle No. 60 on page 17 or 103.

Communications Gear

**NRI “hands-on” training in
Television, Communications,
Electronics and Computers
can give you as much
as 2 years of on-the-job
experience.**

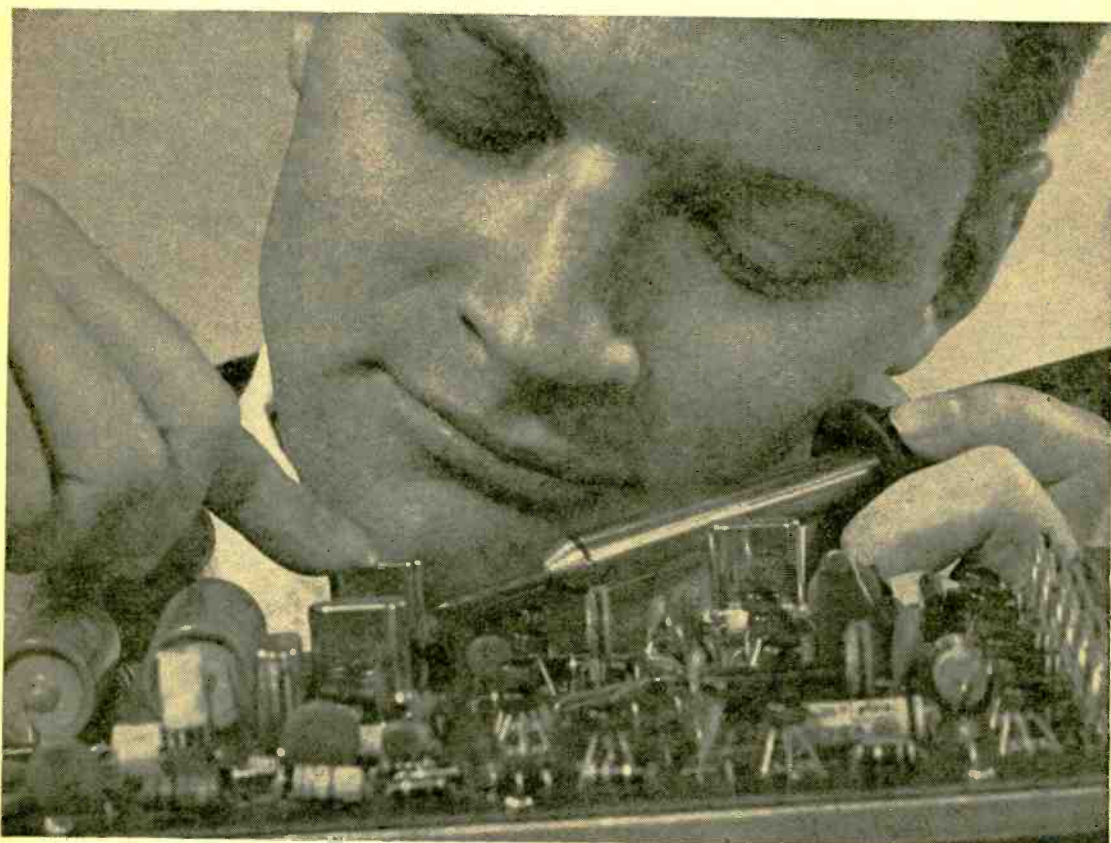

EARN YOUR FCC LICENSE – OR YOUR MONEY BACK

NRI Communications training programs will qualify you for a First Class Commercial Radiotelephone License issued by the FCC. If you fail to pass the FCC examinations for this license after successfully completing an NRI Communications course we will, on request, refund in full the tuition you have paid. This agreement is valid for the period of your active student membership and for six months after completion of your training. No school offers a more liberal FCC License agreement.

Experience is still your best teacher

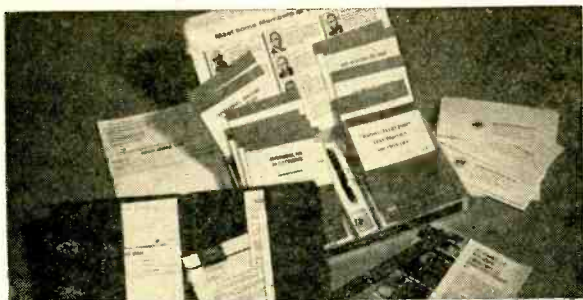

NRI Achievement Kit is educator-acclaimed and the original "starter" kit in home study training. Imitated but never duplicated, this kit is designed and personalized for you and your training objective. It has one purpose — to get you started quickly and easily.



"Bite-Size" Texts average an easily-digested 40 pages of well-illustrated, scientifically prepared subject matter in the course of your choice. Questions in each book are carefully hand-graded and returned to you with helpful instructional notes. You get unlimited personal help from the day you enroll.

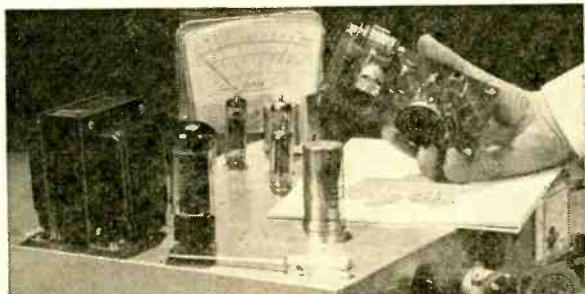

Designed-For-Learning Equipment

Like this phone-cw transmitter (Kit #7 in the Communications course) is engineered from chassis up to demonstrate principles you must know. NRI does not use modified hobby kits for training, but the finest parts money can buy, professionally and educationally applied.

...here's how you get it with unique NRI training at home

Ask any teacher, job counselor, engineer, technician or prospective employer about the need for practical application of theory in Electronics. He'll tell you Electronics is as much a "hands-on" profession as dentistry or chemistry. That's how you learn at home with NRI. You prove the theory you read in "bite-size" texts, by actual experimentation with the type of solid-state, transistor and tube circuits you'll find on the job today — *not* hardware or hobby kits. You introduce circuit defects, analyze results, discover quickly the kind of trouble-shooting and design techniques that will make you employable in Electronics.

Train with the leader — NRI

NRI lab equipment is designed from chassis up for effective, fascinating training — not for entertainment. The fact that end results are usable, quality products is a bonus. In Communications, for example, you build and analyze, stage by stage, your own 25-watt phone/cw transmitter. It's suitable for use on the 80-meter amateur band, if you have an interest in ham radio. In TV-Radio Servicing your practical training gives you your choice of monochrome or color TV sets. All training equipment is included in the low tuition — you pay nothing extra. Discover for yourself the ease, excitement and *value* of NRI training. Mail postage-free card today for new NRI Catalog . . . or use the coupon below. No obligation. No salesman will call on you. NATIONAL RADIO INSTITUTE, Washington, D.C. 20016.

APPROVED UNDER NEW GI BILL

If you have served since January 31, 1955, or are in service now, check GI line on postage-free card or in coupon.

MAIL THIS COUPON IF CARD IS GONE



NATIONAL RADIO INSTITUTE

Washington, D.C. 20016

Please send me your new NRI Catalog. I understand no salesman will call and there is no obligation.

Name _____ Age _____

Address _____

City _____ State _____ Zip _____

Check for facts on new GI Bill

ACCREDITED MEMBER NATIONAL HOME STUDY COUNCIL

e/e etymology

How about a word with us?

NEW BREED OF GIANTS

▲ Ancient Greeks used *gigas* in about the same way we use "giant" today. To qualify as *gigas* a building or an animal or a ship didn't have to be very large—at least, by present-day standards.

But in our age of new immensities, we've had to turn back to Greek in order to label some of the giants spawned by technology.

One of them, still a-borning, is the *gigabit computer*. That's right, it was named more than ten years ago, but hasn't yet been built. But it is on the way. When it arrives, this giant of electronics will be capable of processing one billion bits of information per second. Cooling, one of the last remaining big problems, may be licked by switching from air cooling to use of Freon.

Another member of the new breed of giants, the unit known as the *giga-electron-volt* is often abbreviated as GeV. Rise of the abbreviation shows how often the enormous label is now used. During the 1950's there were only a few proton accelerators in the world that operated in terms of GeV's. But even then, physicist E. O. Lawrence predicted that levels of 36 GeV's would be reached "within the century."

Lawrence was too cautious.

Today the goal has mounted to 500 *giga-electron-volts* (about 7 times higher than the energy now available from the USSR's proton synchrotron at Serpukhov).

So far, no one has ventured to coin a name for 1,000 GeV's—but when this energy level comes within sight someone will have to name it: probably but not positively from Greek!

GOOGOL

▲ Anyone stumbling across the term *googol* for the first time might easily take it as a made-up word from a children's book by Dr. Seuss. It's made up, all right, but by a mathematician rather than a story-teller.

American mathematician Edward Kasner (1878-1955) coined the word shortly before the

outbreak of World War I. Explosion of electronics and of information, Kasner insisted, required the formation of a label for the number 10 raised to the hundredth power (10^{100}). Refusing to borrow from Greek or from Latin or from German or from Russian or from English or any other tongue, Kasner framed the artificial word—and it stuck.

Before his death, mathematicians dealing with immense numbers decided they needed a symbol for 10 raised to the power googol (1 followed by 10^{100} zeros). It was logical to dub it *googolplex*. Especially in astronomy and in particle physics, these mathematical giants without ancestors see everyday use.

SPLINTERED SECONDS

▲ In the "good old days," our ancestors didn't need any term smaller or more exact than "split second." Why bother framing labels that could not be used? For practical purposes, the second was the smallest unit of time that could be measured until very recent periods.

Largely through impact of electronics, the second has now been so thoroughly and so accurately splintered that new units just had to be devised.

From Latin *nanus* (dwarf) one-billionth of a second came to be called a *nanosecond*. No wildly theoretical term, it is in everyday use. Radar technicians couldn't get along without it. Accuracy of an altimeter is limited by precision of the counter that measures time required for a signal to travel to the ground and back to the craft sending the signal. So in practice, one nanosecond means about six inches of range—crucial for pinpoint precision in photomapping as well as in some kinds of bombing.

Once the nanosecond came into general use, another and still more sophisticated step was inevitable: measurement of one-trillionth of a second. Here, Latin proved barren. There was no suitable root from which to frame the space-age term. So Spanish *pico*, a general label for "small," named the *picosecond*.

GOOD OLD STANDBYS

▲ In a world of picoseconds, gigabits and googols it is helpful to have a few faithful old timers around. Since practically everybody knows that *micro-* (from Greek *mikros*, meaning "small") indicates one millionth of a unit in the metric system, few persons have trouble with *microsecond*, *microvolt*, and their first cousins in speech.

At the other end of the scale, good old *mega-* (from Greek *me-gas*, meaning "great") is easily understood to be shorthand for one million. So the *megawatt*, *megahertz*, *megavolt* and all their tribe of relatives pose no problems to electronics buffs who somehow got through school without learning Greek. ■

e/e
listens to
surround
sound
from the...



Fisher 801 4-Channel Receiver

Our lab says, "Close to perfection!"

CALL IT state-of-the-art technology, or just loving care in assembly and alignment; put it in whatever terms you wish. In the Fisher 801 4-channel receiver you will find FM performance that many consider close to perfection. Though we detest using the term new dimension in sound, it is true that the 801 delivers FM reception several cuts above that of "the best" FM tuners and receivers.

The Fisher 801 is a 4-channel (quad-ri-sonic) AM/FM stereo receiver that features electronic FM tuning, FM autoscans, wireless or wired remote control options, four independent amplifiers and an ambient sound decoder that functions on all signal inputs. To make things easy to follow, we'll break down the individual sections of the Fisher 801.

dial and tuning knob are provided for manual tuning. Front and back stereo amplifiers (4-channels) are independent amplifiers with their own controls and inputs; both are identical except for the magnetic phono input which is connected only to the front amplifiers. Other inputs are aux 1, aux 2 and tape. Each of the four amplifiers has outputs for main and remote speakers, tapes and phones. Signals from the front and rear stereo amplifiers are blended into the front panel jack for monitoring by standard stereo phones. There is a derived ambient sound decoder connected to the front stereo amplifiers. When switched in, the decoder automatically connects the derived ambient sound from any signal source to the rear stereo amplifiers.

Front panel controls include manual

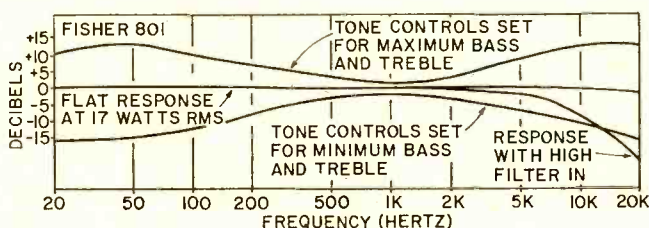

Power response of each channel at 17 watts rms output is within $\pm 0.75/-0.2$ dB and shows no more than 0.32 percent total harmonic distortion. Circle 44 on page 17 or 103.

General Features. The Fisher 801, priced at \$749.95, is supplied with a wood cabinet; the overall dimensions are 17 $\frac{1}{16}$ -in. x 6-in. x 16 $\frac{1}{2}$ -in. D, and total weight is 35 pounds. The FM receiver is equipped with a stereo beacon. A single meter serves as a signal strength tuning meter for AM and FM and as a frequency indicator for the autoscans; an 88-108 MHz frequency scale is printed across the top of the meter scale. A standard

tuning, tape monitor, input selector, mode, concentric F/R (front/rear) bass, concentric F/R treble, concentric F/R balance, and speaker selector. There are separate slider type volume controls for the front and rear amplifiers. Push switches provide for front and rear high filter, front and rear loudness compensation, FM muting, AFC, and auto-scan/manual tuning.

An internal line-cord antenna and exter-

e/e FISHER 801

nal 300-ohm connection are provided for FM. There is a rod antenna and external connection for AM. Also, two switched AC outlets are included for your use.

Remote Control. The Fisher 801 is supplied with an ultrasonic wireless remote control. The controller itself is a small hand-sized ultrasonic transducer powered by a

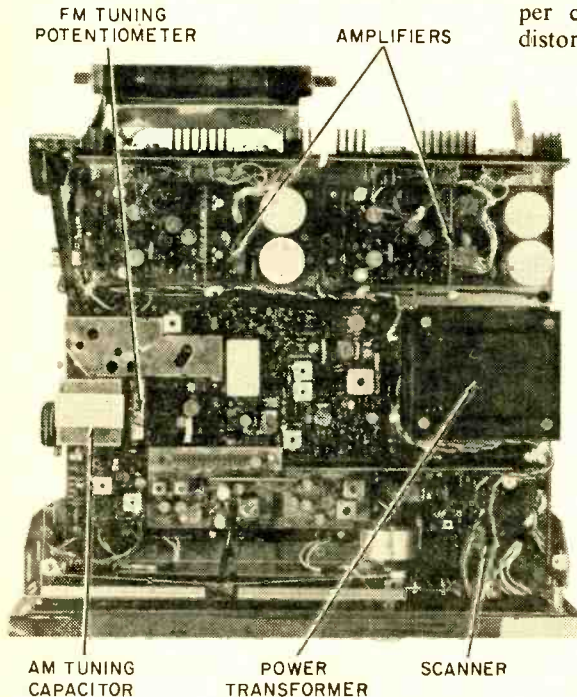

standard transistor-type 9-volt battery. Press a button on top of the controller and the automatic tuning system—autoscan—is activated. The ultra-sound receiver, built right into the Fisher 801, is concealed behind a decorative grill on the front panel.

The optional RK-40 wired remote control is supplied with 20 feet of cable and connects to a socket on the receiver rear apron. It costs just \$14.95.

FM Tuner. The FM tuner uses electronic tuning. A potentiometer connected to the dial drive adjusts voltage to the capacitor diodes which, in turn, tune the front end. An autoscan circuit can be used to automatically sweep from the bottom of the band. With the autoscan set to *continuous* the tuning will sweep until you release the control. With the autoscan set to *One station* the tuning will lock on the next higher

frequency station and remain there.

When manually tuned, the signal strength meter and the AFC insure center channel tuning.

AM Tuner. The AM tuner is straightforward. It is tuned by a standard tuning capacitor which is attached to the dial drive cord. Actually, the AM capacitor and the FM tuning potentiometer are connected together.

Amplifiers. The paired stereo amplifiers (front and back) are rated for 44 watts rms per channel into 4 ohms at 0.5 percent distortion. Both stereo amplifiers, except for the phono input found only on the front stereo amplifiers, are identical and can be individually used; for example, the phono can feed main speakers in the living room while the rear channels feed a tape to remote speakers on the patio. The derived ambient sound decoder is automatically connected to the rear stereo amplifiers when the front panel *mode* switch is set to "2+2."

Fisher 4-channel 801 comes from a company that began making HI-Fi receivers way back in the late 1930's.

The payoff for all this hardware is in the performance, particularly in the FM tuner. The FM tuner's sensitivity measured 1.8 μV , with 55 dB of quieting occurring at only 7 μV . This is great performance.

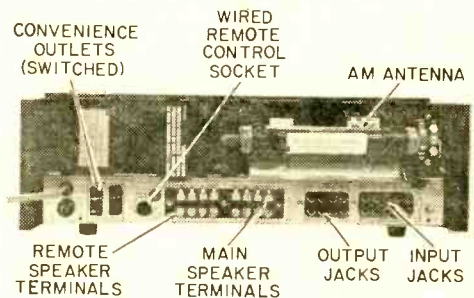

4-channel amps can feed 2-stereo programs to two different rooms.

It takes but 10 μV to trip the FM mute or lock the autoscan (autoscan will pass over stations weaker than 10 μV). At standard
(Continued on page 96)

It's for the birds, chimes, drums and umuduli when you . . .

IDENTIFY DX

Hey, DXer, do you automatically tune away from a shortwave station not broadcasting in English? Have you ever given up trying to identify a station because interference was so heavy you couldn't quite make out the announcement?

If so, you're missing a lot of top-notch DX needlessly. The trump card to play when things get rough is a knowledge of interval signals, those brief melodies, gongs, drums and other distinctive sounds that identify a station as surely as voice announcements.

The famous NBC chimes? An interval signal! The clock strikes of Big Ben? Another, identifying the British Broadcasting Corporation. How about a fragment of "Yankee Doodle"? That's the Voice of America, of course.

But there are hundreds more, folk tunes and gongs, bird calls and weird native instruments. Some are as familiar as your own name, others are more obscure. But all can help pinpoint the identity of the stations using them.

Most SWL's think of interval signals as useful means of tuning in stations before

they actually sign on with programming. But they also can be helpful in identifying a station when language problems and poor conditions make trouble for the DXer.

How It's Done! The trick, naturally, is learning which interval signals—*IS* is the abbreviation used by DXers—are used by

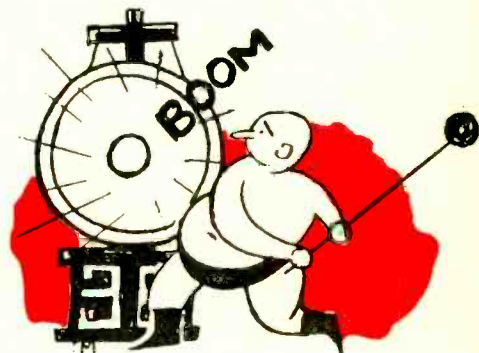

which stations. Which broadcaster can be identified by four notes whacked out on a gong; which toots the nose flute?

Let's take a look at some of the distinctive interval signals used by the world's stations.

On a July evening in 1967, the author tuned the 60-meter band. Summer static was heavy and band conditions were bad. On about 4,835 kHz there was a weak signal. While the station seemed to be broadcasting in Portuguese, identification was impossible—until, on the hour, a four-note *IS*, a quartet of bongs on a gong, was heard through the noise.

Checking through reference material, it was determined that Radio Clube de Mocambique, a southern African station, used that frequency at that time, broadcast in Portuguese, and used a four-gong signal.

A tentative report to the station brought a QSL card and the notation, "Yes, it was us!"

Long, Long Ago. During the war years, listeners to the European Service of the BBC





IDENTIFY DX

were cheered by the four-beat tympany IS—boom-boom-boom-BOOM! In Morse code, the signal, borrowed from Beethoven's Fifth Symphony, signified di-di-di-dah, "V" for Victory! Today, 30 years later, the BBC European Service still uses this drum interval signal.

There are drums all over the shortwave dial. Radio Tahiti's signal is a pulse-racing Polynesian drumming that, once heard, will never be mistaken for another. And if it doesn't conjure up visions of luscious, hip-swinging wahines in grass skirts, nothing ever will.

The many drum beats of Africa can be confusing, but in a class by itself is the interval signal of Radio Nigeria's National Service. These are the famous talking drums, specially tuned to sound almost like a voice chattering in a strange tongue and used, originally for tribal signalling.

Even more exotic is that of La Voix de la Revolution at Bujumbura, capital of the African republic of Burundi. The monotonous, rhythmical, two-toned droning is played on the *umuduli*.

So what's an *umuduli*? A native bow, stretched over the tendon of an ox, fitted to a calabash bowl, which acts as its resonance

Abbreviations for Beginners

| | |
|---------------|---|
| BBC | British Broadcasting Company |
| DX | long distance, distant (contact or country) |
| DXer | hobbyist who seeks DX contacts |
| DXing | to seek DX contact |
| IS | interval signal |
| kHz | kilohertz (kilocycles) |
| NBC | National Broadcasting Corp. |
| QSL | decorated postal card or letter from station acknowledging reception report |
| SW | shortwave |
| SWL | shortwave listener |
| SWLing | to listen to or for shortwave stations |
| WRTH | World Radio-TV Handbook |

box. You won't find one in your average rock band, but it's a big thing in Bujumbura.

Bird Lovers Only. If you hear the wild and eery screeching of birds, chances are you're tuned to Radio Zambia, which uses the cry of the fish eagle as its IS. The call of another bird native to Africa, the Bokmakierie, together with the mellow guitar chords of a folk song, combine in the tuning signal used by South Africa's Radio RSA.

The kookiest bird on the airwaves still is Radio Australia's kookaburra, the "laughing jackass," whose maniacal laughter starts off each transmission from Down Under.

Italy's RAI also goes the "boid choip" route, a gentle, twittering interval sound. And Radio Baghdad's IS is the voice of a mechanical nightingale, not a real bird at all.



RADIO JAPAN



EE's Guide to IS Identifiers

| Station | Location | Freq. (kHz) | Interval Signal |
|----------------------------|-------------------------|-------------|--|
| Austrian Radio | Vienna, Austria | 6,155 | "Blue Danube" theme |
| Greek Armed Forces Station | Athens, Greece | 6,045 | Trumpet fanfare |
| L. V. de la Revol. | Bujumbura, Burundi | 6,140 | Umuduli (see text) |
| R. Nigeria | Lagos, Nigeria | 4,990 | Talking drums |
| Windward Is. Bc. Svc. | St. Georges, Grenada | 3,300 | Caribbean steel drums |
| Radio Rumbos | Caracas, Venezuela | 4,970 | Gong |
| Vatican Radio | Vatican City | 5,995 | "Christus Vincit" on celeste |
| Radio Tahiti | Papeete, Tahiti | 6,135 | Tahitian drums and flute |
| R. New Zealand | Wellington, N.Z. | 11,780 | Call of the Bell Bird |
| Radio Havana Cuba | Havana, Cuba | 11,760 | Xylophone melody |
| L. V. de Guinea | Sta. Isabel Ec. Guinea | 6,250 | "Los Voluntarios" melody |
| Ecuatorial | | | |
| Deutsche Welle | Cologne, W. Germany | 6,145 | 10-notes, "Fidelio" motif on celeste |
| Radio RSA | Johannesburg, S. Africa | 9,525 | Call of Bokmakierie bird/guitar melody |

The List Gets Longer. Bits and scraps of national songs are common interval signals among the European shortwave outlets. Some are well known to SWLs, like Austrian Radio's "Blue Danube" theme. Others, such as the blaring trumpet fanfare of the Greek Armed Forces Station, are less well known.

Radio *Nederland*, one of the most popular SW stations around, uses a 12-note carillon melody, an old folk tune. Germany's *Deutsche Welle*, a ten-note motif from Beethoven's "Fidelio," played on a celeste.

And the Swiss feature—what else?—a music box IS tune.

Hopscotching the globe for interval signals, Radio Peking uses the first few bars of "The East is Red," a hit of the Cultural Revolution. Or, music to fight bulls by? A shortwave outlet in Ecuatorial Guinea, an island off Africa's west coast, uses a Spanish pasodoble, "*Los Voluntarios*," real matador-music, as its identifying sound. The first dramatic notes of its national anthem, "O

(Continued on page 102)



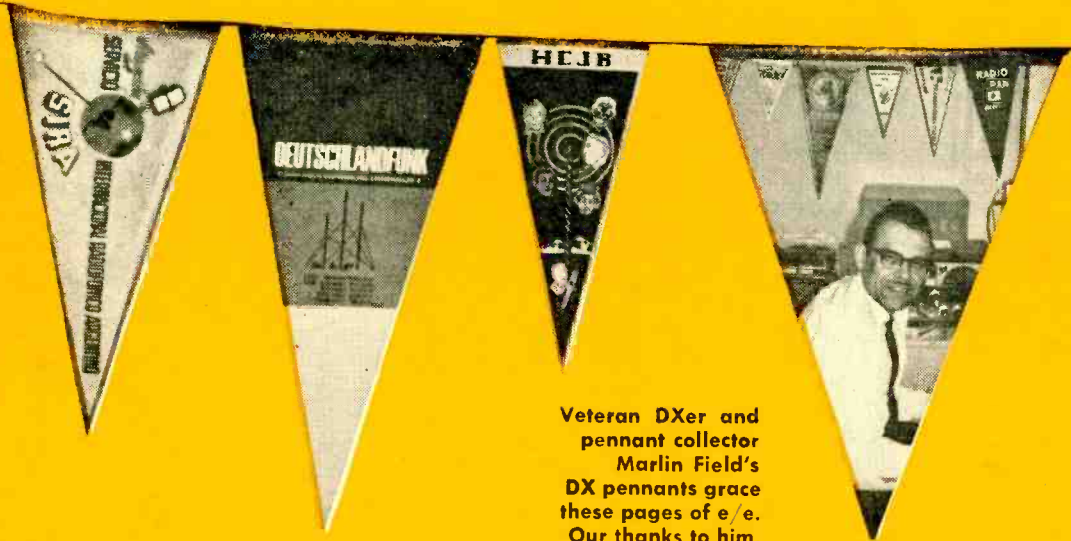

Veteran DXer and pennant collector Marlin Field's DX pennants grace these pages of e/e. Our thanks to him.

SHORT WAVE LISTENERS GET

A young man's fancy turns to DX pennants with help

Not enough kick in QSL collecting these days? Then, DXers, get in the pennant race! QSL's, you know, are those cards and letters short-wave listeners receive from distant stations they hear, confirming their reception reports were correct. Since DXing began decades ago, listeners have been collecting QSLs as proof of their skill in tuning far-off short-wave broadcasts and because they make attractive and exotic radio shack decor. But more recently, a new DX mania has swept the SWL world—shortwave pennant fever.

Hardly a juvenile bedroom wall has not, at some time or other, sported a series of felt triangles emblazoned "New York Mets," or "Souvenir of Tepid Falls, Arkansas." DX pennants, sent by many stations to SWLs, aren't really so very different, except they bear the names, call letters and slogans of broadcasters around the globe.

DX pennants, of course, are not substitutes for verifications proving you heard certain stations, but they can provide an added fillip to the SWL hobby.

In the Beginning. No one is sure when stations first began sending out souvenir pennants to listeners, but it's almost certain that the practice began somewhere in Latin America. For some unaccountable reason our southern neighbors have a thing about pennants, any kind of pennant. In Caracas and Cuzco, Lima and La Paz you'll find them everywhere. You'll find these cloth triangles in store windows and homes. Business firms pass them out to customers for advertising reasons. In incredibly



THE PENNANT FEVER

by Don Jensen

from Ecuador, Japan, Italy, Brazil, Spain and others!

decrepit taxis, pennants proudly proclaiming loyalty to the local “futebol” team hang from rear view mirrors.

So it’s only natural that radio stations follow suit. Originally, it seems, the broadcasters intended them for their local Latin listeners, but later many stations began sending them out as souvenirs to overseas DXers who reported reception.

When major international broadcasters learned that DXers dig pennants, they got into the act. Unlike the South American operations, these big boys intend their programs for foreign audiences and they leap at any promotional gambit that promises to attract listeners.

Who’s Doing It? So into the pennant race came the likes of South Africa’s Radio RSA and West Germany’s Deutsche Welle. SWLs began reporting receipt of pennants from Radio Bucharest, Radio Sofia, Radio Japan and Radio Canada International. Others like Italy’s RAI, France’s ORTF, Polish Radio and even Radio Kuwait joined in.

Two Soviet stations that go out of their way to curry favor among DXers, Radio Moscow and Radio Kiev also have pennants, but, curiously, seldom send them to SWLs.

Shortwave DX pennants come in all colors, sizes and shapes, fancy or plain, fringed and tasseled, silk, rayon or what have you.

The easily logged government station, Radio Mexico sends out an attractive banner type pennant, rather than the traditional triangular shape. The six-by-eight-inch bit of cloth carries the station’s name and

(Turn page)

e/e PENNANT FEVER

call, XERMX, plus an outline map of Mexico with concentric circles radiating from an antenna.

And, El Salvador's YSS has an information-packed pennant printed with call letters, slogan and a string of frequencies used. Transmisora Caldas, in Manizales, Colombia, sends a foot-long triangle in green and black.

One of the rarer Latin American stations, La Voz de Galapagos, on one of Ecuador's islands 600 miles out in the Pacific, has a pennant depicting the famed Galapagos tortoise.

While most pennants are silk screen printed on cloth, some, like that of religious broadcaster KGEI, San Francisco, are paper.

Get Started! How does one go about collecting DX pennants? One of the more successful collectors, veteran DXer Marlin Field has a few tips. His technique, by the way, has brought him more than 150 DX

Note to New DXers

Joining a DX club is a great way to keep current on all aspects of SWLing, whether you're a pennant collector or not. A list of SWL clubs and their addresses is available for a stamped, self-addressed envelope from the Association of North American Radio Clubs, Public Relations Committee, 2 Country Way, North Haven, Connecticut 06473.

Old hands at DXing know that station addresses can be found listed in the SWL's Bible, "World Radio TV Handbook," which can be ordered from several sources in the U.S., including Gilfer Associates, Inc., Box 239, Park Ridge, N.J. 07656, and SWL Guide, 414 Newcastle Rd., Syracuse, N.Y. 13219. Another source of station addresses is the "SWL Address Book" published by Gilfer Associates, Inc.

pennants.

- Join a good DX hobby club. From information in the club bulletins you can learn which stations currently are sending pennants to SWLs.

- Tune for those stations. If and when you do, send a correct and useful reception
(Continued on page 102)

PENNANT WINNERS

The following stations have sent DX pennants to SWL's reporting reception in recent months.

| Country | Station | Frequency (kHz) |
|--------------------|-------------------------------|-----------------|
| Bulgaria | Radio Sofia | 9,700 |
| France | Radio-Television Francaise | 17,720 |
| Italy | RAI | 11,800 |
| Rumania | Radio Bucharest | 9,570 |
| Spain | Radio Nacional de Espana | 9,520 |
| USSR | Radio Kiev | 11,900 |
| Germany | Deutsche Welle | 9,545 |
| South Africa | Radio RSA | 9,696 |
| Japan | Radio Japan | 15,445 |
| Korea | Voice of Free Korea | 15,430 |
| Taiwan | Voice of Free China | 9,685 |
| Kuwait | Radio Kuwait | 11,925 |
| Canada | Radio Canada International | 9,625 |
| USA | Radio Station KGEI | 11,880 |
| Costa Rica | Radio Casino | 5,952 |
| Dominican Republic | La Voz de las Fuerzas Armadas | 4,825 |
| Guatemala | Radio Chortis | 3,380 |
| Mexico | Radio Mexico | 11,770 |
| Bolivia | Radio La Cruz del Sur | 4,875 |
| Brazil | Radio Bandeirantes | 11,925 |
| Colombia | Transmisora Caldas | 5,020 |
| Ecuador | Radio Quito | 4,923 |
| Uruguay | Radio El Espectador | 11,835 |
| Venezuela | Ecos del Torbes | 4,980 |
| El Salvador | Radio Nacional | 5,980 |

SOUND POLLUTION TIPSTER

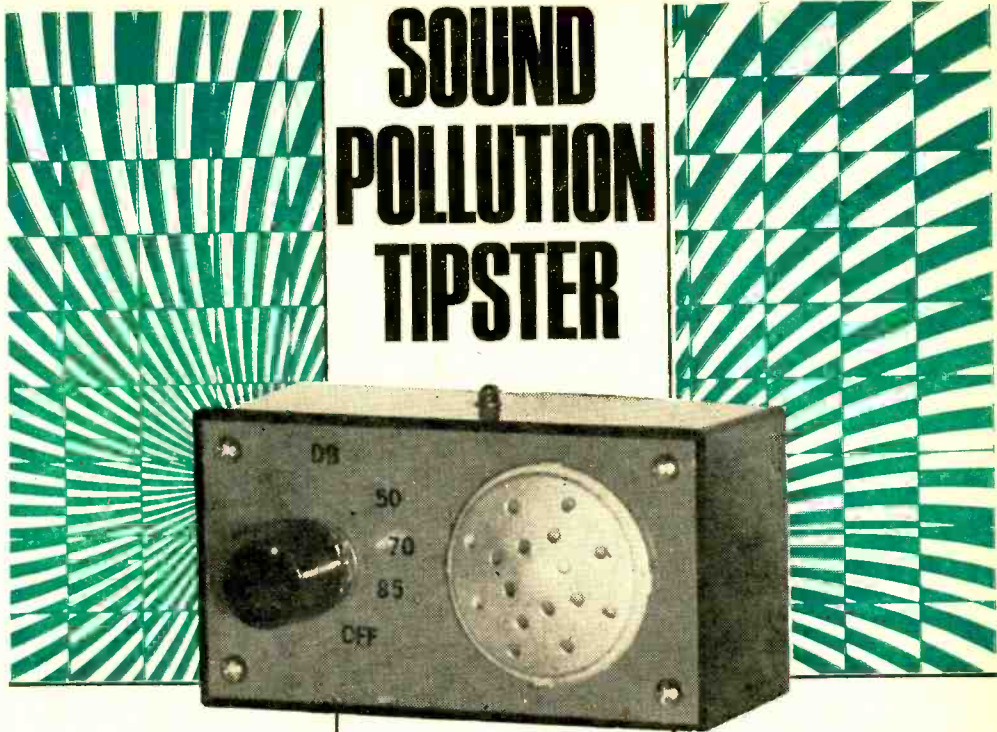

THERE'S BEEN a lot said lately about high-level sound and your ears. Much of the publicity and controversy centers around today's pop music with its electronic sound reinforcement and big-bass. But if loud sounds can be harmful, as experts say, just where does the danger cease? What about medium level sounds we come in contact with every day?

Quite recently the City of New York completed a study about noise. Some of the results are quite disquieting! Not only can noise levels in the city cause hearing loss, they can interrupt enough sleep to cause fatigue and possible personality changes. In addition, Massachusetts has

Blow the whistle on noise with this simple, portable detector; it measures local environmental noise levels with a flashing light emitting diode.

By Herb Cohen

just outlawed snowmobiles with a sound level of more than 82dB (decibels) and after July 1973, the ceiling is just 73dB.

What's a dB? In terms of sound, a dB describes the smallest increase or decrease that an ear can hear. Pile one dB on top of another and pretty soon you'll have a genuine ear splitting sound. At levels approaching 120dB you actually begin to *feel* the sound; at slightly higher levels, the threshold of pain occurs.

Would you like to know if you're living and working or playing in a danger zone? For about twenty dollars in parts and an evening of soldering fun you can build a noise pollution tipster to find out. It's a lightweight portable sound-level meter that uses the latest technology and comes straight from an electronic experimenters workbench. Based on data from the New York and other studies, we've built our tipster to flash when the sound intensity reaches certain minimum values. They are 50dB, 70dB, and 85dB.

For an idea of what some typical levels are, a whisper at 5 feet is about 35dB, a normal conversation is about

60dB, a full symphony orchestra at front row center can average 94dB. The New York City subway is about 100 dB.

How-it-Works. The mike voltage is sent to a three-position divider, this selects the different dB levels that are amplified by the I.C.

The I.C. is an operational amplifier, the 741C. Here it is used as a 40dB audio amp. The amplifier gain is set by R8 and R6. The I.C. output is coupled to Q1, another audio amplifier, which adds another 30dB of gain to give us a total of 70dB.

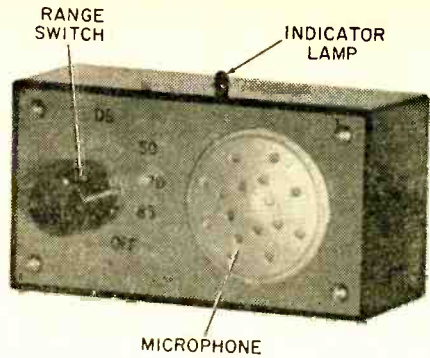

From here we go to a driver that fires the Light Emitting Diode on negative-going pulses. The LED draws about 25 milliamps on peaks, enough for viewing without placing an excessive drain on the battery.

Construction. In order to make the unit as compact as possible a 1 5/8-in. x 4-in. x 2 1/8 in. box is used. The circuitry is mounted on perf. board and secured to the box using double-backed adhesive tape. The battery is mounted the same way. Be sure to ground

Sound Pollution at Home

Source Average dB

| | |
|----------------------------|-----|
| Air conditioner | 55 |
| Alarm clock | 60 |
| Blender—electric | 93 |
| Can opener—electric | 78 |
| Clothes dryer—automatic | 64 |
| Dishwasher | 69 |
| Doorbell | 100 |
| Drill—1/4" portable | 70 |
| Fan—12" portable | 70 |
| Fan—vent | 63 |
| Fan—wall exhaust | 90 |
| Furnace blower | 100 |
| Garbage disposer | 78 |
| Hair dryer | 77 |
| Knife sharpener | 78 |
| Mixer—electric | 85 |
| Pots and pans | 73 |
| Radio | 78 |
| Sander—belt | 91 |
| Sander—disc | 93 |
| Sander—orbital | 70 |
| Saw—8" radial | 92 |
| Saw—sabre | 76 |
| Sewing machine | 64 |
| Shaver—electric | 85 |
| Shower | 78 |
| Sink drain | 86 |
| Telephone ring (6 1/2 ft.) | 78 |
| TV | 68 |
| Vacuum cleaner | 85 |
| Washing machine—automatic | 64 |
| Water faucet | 68 |
| Whisper (5 ft.) | 10 |

It should be noted that we are not talking about a linear scale when we discuss dB. We are talking about a measurement technique that uses logarithmic ratios. It means that each time a sound intensity doubles, the new sound measurement is just 3dB greater than before. For example, doubling the intensity of a 50dB sound level will increase the value to 53dB, not 100. This technique must be used because there is such a great difference between loud and soft sounds. By using a logarithmic system, the number describing the difference can be small. Why say an increase of 4,000,000 times when it's easier to convert to the logarithmic notation and say a 66dB increase?

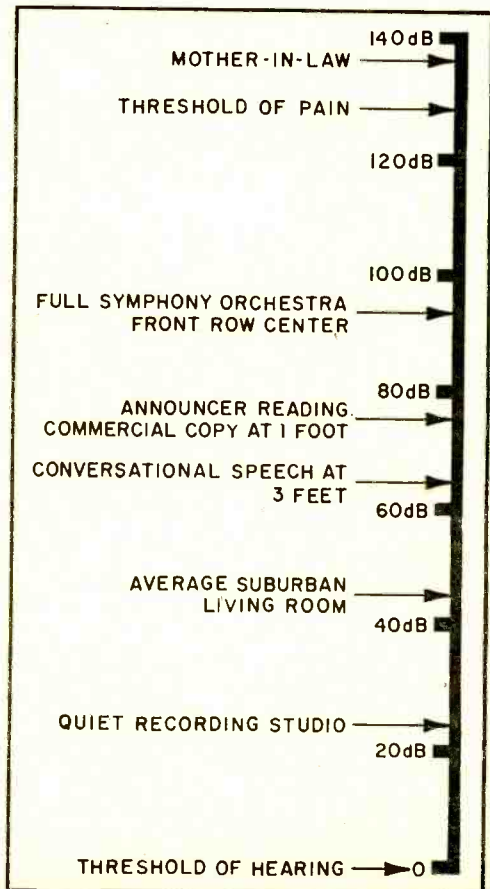

Our sound pollution tipster may not be as fancy as commercial units, but it doesn't cost 800 dollars either!

the aluminum panel and switch frame; also check which lead on the mike is common to the mike case and be sure it goes to ground. To mount the Light Emitting Diode, drill $\frac{1}{8}$ in. hole and ream it out until the LED fits snugly. Then apply a drop of Duco cement.

Scat! Cat. What do the three levels mean? Try the 85 dB level in the plant. If you listen to a sound level above 85dB for 8 hours a day over a period of time your hearing can be permanently damaged. You should be able to map out safety and danger areas. The

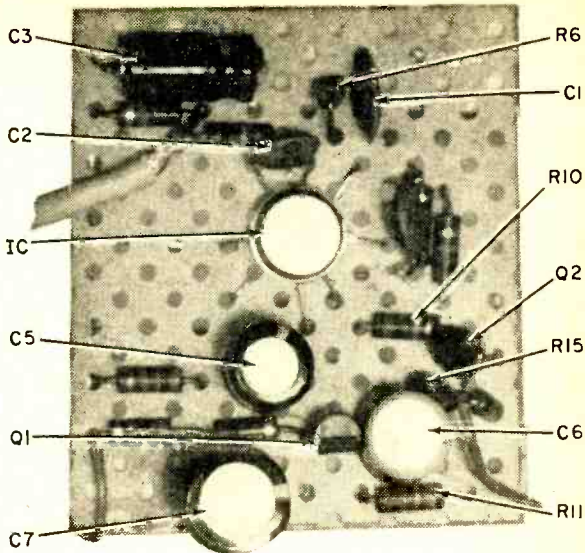

Most parts mount on this perf. board. Put R1, 2, 3 on switch S1, mount LED to case.

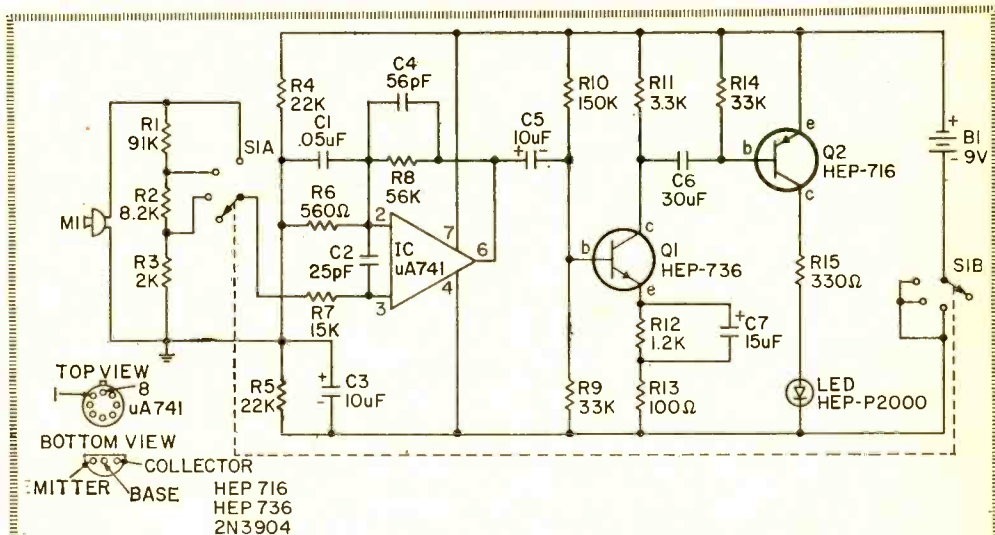

PARTS LIST FOR SOUND POLLUTION TIPSTER

- B1—9-volt battery, Eveready 216 or equiv.
- C1—0.05 μ F disc capacitor, 15 VDC or better
- C2—25 pF disc capacitor, 15 VDC or better
- C3—5—10 μ F, 15 VDC electrolytic capacitor
- C4—56 pF disc capacitor, 15 VDC or better
- C6—30 μ F, 10 VDC electrolytic capacitor
- C7—150 μ F, 15 VDC electrolytic capacitor
- IC1—Operational amplifier, type 741 (Radio Shack No. 276-010, Fairchild μ A 741, etc)
- LED—Light emitting diode, Motorola HEP-P2000
- M1—Microphone, crystal (Radio Shack No. 270-095)
- Q1—NPN transistor, 2N3904, HEP-736 or equal
- Q2—PNP transistor, HEP-716
- R1—91,000-ohm, $\frac{1}{2}$ -watt resistor, 5%
- R2—82,000-ohm, $\frac{1}{2}$ -watt resistor

- R3—2000-ohm, $\frac{1}{2}$ -watt resistor, 5%
- R4, 5—22,000-ohm, $\frac{1}{2}$ -watt resistor
- R6—560-ohm, $\frac{1}{2}$ -watt resistor
- R7—15,000-ohm, $\frac{1}{2}$ -watt resistor
- R8—56,000-ohm, $\frac{1}{2}$ -watt resistor
- R9, 14—33,000-ohm, $\frac{1}{2}$ -watt resistor
- R10—150,000-ohm, $\frac{1}{2}$ -watt resistor
- R11—3300-ohm, $\frac{1}{2}$ -watt resistor
- R12—1200-ohm, $\frac{1}{2}$ -watt resistor
- R13—100-ohm, $\frac{1}{2}$ -watt resistor
- R15—330-ohm, $\frac{1}{2}$ -watt resistor
- S1—Switch, 3-pole, 4-position (Mallory No. 3234J)

Misc.—Hardware, knobs, perforated board, push-in clips, wire, solder, etc.

e/e TIPSTER

50dB level is for testing your bedroom at night. Place the meter on your bed and switch to 50dB. If the LED stays on, or goes on periodically from vent noises, pipe gurgles, traffic noise, or a loud-mouth alley cat, your bedroom is too noisy for sleeping. The 70dB level is the point that will jolt a sleeper into wakefulness. Try this level on your desk at work. If the light goes on periodically, you probably have trouble concentrating.

Take Steps. To get an idea of what some typical dB levels for familiar sounds are, check the table. To help you reduce home noise pollution, here are some suggestions. Appliances make a lot of noise; refrigerators hum, washers rattle, and dryers whirl, so the kitchen and utility room are good places to start.

Try to use only one appliance at a time because the noise level is accumulative. When shopping for a new appliance, choose the one that makes the least noise, and let manufacturers know that this is an important factor in your purchase. Fiberglass padding for plumbing, and cork or rubber pads under major appliances can lower the noise levels. Consider installing thick, perforated sound-absorbing wall panels in noisy areas such as the laundry room.

In another part of the home, acoustical tiling, padded carpeting and lots of upholstered furniture will absorb noise. Weather

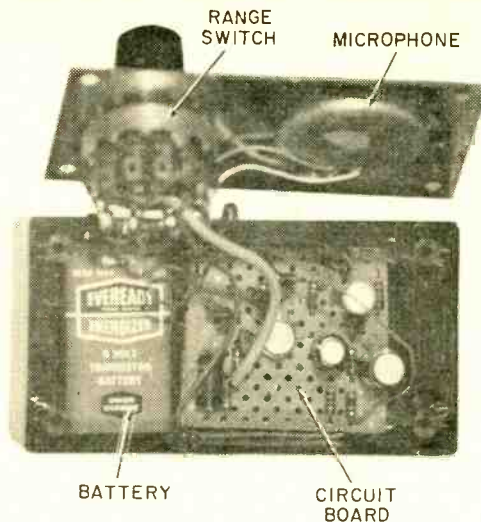

Solder leads to battery and save space. Microphone, LED mount to case with glue. Battery makes tight fit, watch for shorts.

strip an exterior door facing a noisy street. If you are building or remodeling, insist on solid inside doors and soft weather stripping at the tops and sides. Ask for fiberglass-lined heating and air ducts, which cost no more than metal ducts, to eliminate racket coming through them. Similar practices can line water pipes to cut down the noise. You can even use stereo headphones for listening to stereo, hi-fi and other home electronic entertainment units. Stereophones, which operate without the loudspeakers, bring the sound only to the listener's ears. ■



Handle for Help

□ Just press the button and help arrives! Sound too good? Well, the ADT roadside emergency call box is designed for such fast results and low maintenance. It has an inert power supply that is energized by the user, so there are no batteries or cables. All you do is pull down the door lever and press one of four buttons—*Fire, Police, Ambulance* or *Service*. Within a split second after releasing the button, the coded distress signal is received at a master console at a central station and aid is sent. The boxes have solid-state circuitry and get power from an electro-mechanical power module—so no added problems from power lines.

—Myrtle Gronk

ELEMENTARY ELECTRONICS

e/e
field
checks



Electra's Bearcat III Scanning Monitor

Zips through 8 channels and 2 bands 3 times a second

WHETHER you're just a fire *buff* who vicariously rides the trucks by radio, or an active photographer hot on the trail of a fast-breaking news story, or just a listener who likes to keep track of the action around the neighborhood, a high-performance FM monitor radio is a real must. One of the most sensitive and flexible monitor receivers we've come across is Electra's Bearcat III.

The Bearcat III is called a scanner because it will automatically scan 8 crystal controlled channels until one becomes active; it then locks onto the active channel. As soon as the channel activity ceases the Bearcat resumes scanning, looking for the next channel that becomes active. Naturally, manual channel selection is provided so the user can switch select (directly tune) a desired channel.

Features. The Bearcat III is both a mobile and fixed model. It is supplied with AC and DC power cables (12 VDC with negative ground), a mobile swivel mounting bracket and a screw-in telescopic antenna. There is also a Motorola type input jack that matches the standard plug used on auto antennas.

The overall size is 9 in. W x 3¾ in. H x 6¼ in. D. The front panel contains 8 channel selector switches with matching indicator lamps, a *squelch* control, a *volume* control and a *scan/manual* mode selector switch.

The really big feature of the Bearcat III is the plug-in tuning modules. The basic package actually serves as a *main frame* that accommodates up to two plug-in tuners. Tuners are available for the low band

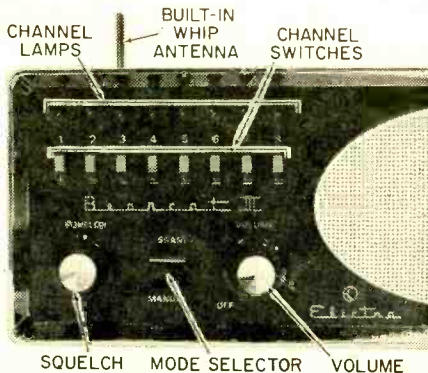

Controls and active channel indicator lamps are grouped to left of front panel.

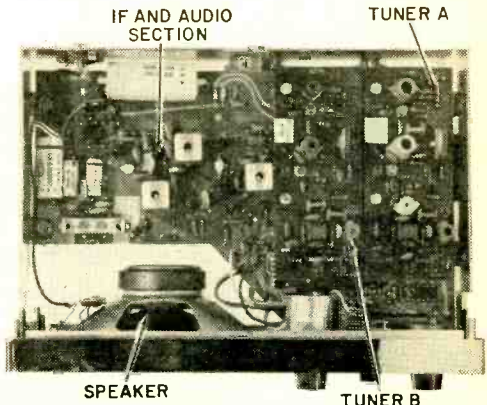

Bottom view with separate Lo and Hi tuners. Circle No. 43 on page 17 or 103 for info.

e/e BEARCAT III

(30-50 MHz), the VHF band (146-174 MHz) and the UHF band (450-470 MHz). You can order the Bearcat III with any one or two tuners. The advantage of the plug-in tuners is that should your local fire or police move to a different band you need only replace a relatively inexpensive plug-in module. Or, say the police remain on the low band and the fire-laddies move to the high band, you just plug a VHF module into the second mounting position. Of course, you can change frequencies within a band simply by plugging in a low-cost crystal.

In a Row. The scanning and manual tuning is from crystal-to-crystal rather than band-to-band. This means that should you have two tuners installed, the scan goes from channel 1 through 8 and repeats regardless of which band the crystal is for. The switching between tuners is automatic—there is no need for the user to manually switch from band to band, thereby eliminating the possibility of missed calls.

The crystal sockets are part of the main frame; the terminals are arranged in three rows—A, B and C. Terminals A and B connect to the tuner plugged into position #1, terminals B and C connect to the tuner plugged into position #2. As you can see you can intermix the crystals so that #1 is high band, #2 is low band, etc. The scan and manual tuning automatically selects the correct tuner.

Performance. The Bearcat III is as hot as a gunslinger's pistol after a duel at Black-rock! Our model was equipped with Low and VHF tuners, and both could be used

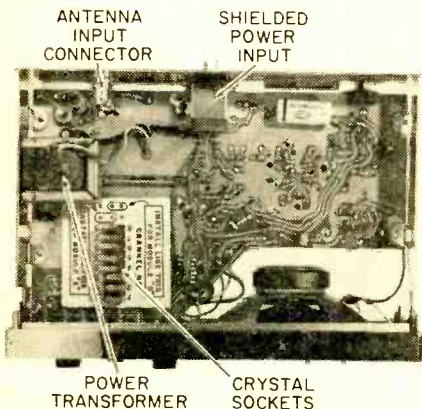

Once you select your area's frequencies, switching between bands is automatic.

with signals slightly under $0.5 \mu\text{V}$. To give you an idea of practical performance, using the supplied telescopic antenna we could pick up police and fire calls from as far as 40 miles out, and all were well over the noise level.

The selectivity proved very good, due to a built-in crystal filter IF amplifier. The only *spill* we received was when two strong stations in the local area were spaced less than 100 kHz apart (a rare occurrence).

The sound output is very good. A large front-facing speaker produces a low distortion, well-balanced sound, not at all tinny or growly. Microphonics, even on the VHF band, were non-existent, and you can pound the table, or even the Bearcat itself, and there won't be any ringing or howling.

Another outstanding Bearcat feature is its immunity to overload. All three tuners have dual-gate MOSFETs as the RF amplifier: even if a unit down the block keys a transmitter, the signal is received cleanly.

Quick Wink. Another excellent feature is an auto-scan almost too fast to follow with the eye. As close as we can determine, the auto-scan can sweep all 8 channels in better than a quarter-second. It can sweep two or three channels so fast you can barely see the channel lamps flicker. There is no seemingly endless waiting for the scanner to crawl its way from channel to channel. This is of particular benefit if you're monitoring a system with separate talking and listening frequencies. Just select the two channels and the Bearcat will switch back and forth without dropping a word!

In both the auto-scan and manual tuning modes the Bearcat tunes only those channels *punched up* by the selector switches. For example, you might have seven action channels with the weather broadcasts on the eighth channel. You would normally keep #8 off so the unit scanned only the action channels. To monitor the weather broadcasts you would manually switch in channel #8. Similarly, you can eliminate any of the remaining channels with the channel selector switches. Or, you can select just one channel, or go to manual tuning for full-time monitoring of a particular channel.

Built by Us. Everyone had the same reaction when we first opened the case to change crystals: "This is made in the U.S." The construction quality really stands out. There are no chintzy switches and controls:

(Continued on page 95)

Touring Canada With your CB Rig

By Matt P. Spinello KHC2060



How would you like to Q-signal your way through Quebec, monitor Manitoba, ten-four Toronto and call Calgary? That's right, you as a CBer can tour Canada and use your CB rig this summer provided you make the necessary provisions and obey the rules! But before we get along too quickly, let's back track to the beginning.

Canada's General Radio Service closely parallels the United States' Citizens Radio Service. The GRS, governed by the Department of

Transport (Canada's equivalent to the United States' FCC), activated the service four years after the U.S. launched the CB service for its citizens in 1958. Canada was the first of the two however, to recognize licenses out of its own boundaries when it established the Tourist Radio Service. In effect, it meant that U.S. CBers could operate their systems in Canada by requesting in advance a permit from the Department of Transport (DOT). Experienced operators who
(Turn leaf)

e/e CB TOURING

like to travel a great deal realized an immediate extension of their two-way radio systems. Trips into the wilds of Northern Canada; hunting and fishing in remote areas and just general travel throughout Canada, could all become more eventful, less hazardous, more complete with the feeling of confidence that, if needed, information, help and a comforting voice to an accident victim could now be as close as the microphone button.

Here's How. The Tourist Radio Service license has been used by thousands of CBers over the years and is available to any legally licensed American CBER by application to the Regional Superintendent, Telecommunications Regulation, at the address nearest to his port of entry into Canada. The applicant should apply at least 30 days in advance of his planned visit to Canada, although authorities advise that 45-60 days lead time might better insure arrival of the license in time for a planned trip.

Following the CBers written request for a TRS license, the DOT will forward a form which requires that the CBER supply his name, address, his CB call-sign and the length of time he expects to be in the country. The license is valid for a period of one year, renewable if the citizen will have additional need to operate his equipment over the border. And, there is *no fee* for the service!

XM, You All! The Department of Transport does not issue individual call signs for the TRS; American CBers simply add to their present call, the letter "XM". Thus the CB call, KHC2060 would become licensed in the Tourist Radio Service as KHC2060XM. Once received, the license should remain in the operator's possession at all times. It is *not* transferable. Acceptance of the license and the privilege to operate outside the boundaries of the U.S. includes acceptance of the General Radio Service rules and regulations as well. It is recommended that a copy of the GRS rules be perused in-depth prior to entry into Canada. The complete rules and regulations can be found in the 1972 CB YEARBOOK. GRS rules are also available in the same publication and through the DOT. You can get a copy of the 1972 CB YEARBOOK by sending \$1.25 to this magazine.

Rules are Rules. The American CBER will

memorize the rule that Canadian CBers are limited to operation on CB channels 4 through 23; 19 of the authorized 23 used in the United States. In fact, should he attempt to operate in Canada on U.S. CB channels 1, 2, or 3, his rear view mirror may soon reveal great hordes of amateur radio mobiles in close pursuit, with a DOT paddy wagon to back them up. In Canada, the first three channels still belong to the amateurs! Channel 23 is likewise shared for use with private paging and municipal services.

Canadian General Radio Service regulations are clear, having been established after the DOT took a long look at the Citizens Radio Service in its infancy (from 1958 to 1962) before initiating authority for citizens to operate similar systems in the same frequency band.

The current DOT rules and regulations make direct reference to the Tourist Radio Service in Section 73, (1a) which reads, in part: "... a licensed station may carry on two-way radio-telephone communication with a station licensed under the Tourist Radio Service where the personal or private activities of the licensees of the respective sta-

(Continued on page 100)

Where to Write for Canadian Tourist/CB application

| Port of Entry | Nearest Regional Supt. of Telecommunication Regulation |
|--|--|
| All ports of entry in British Columbia | 739 West Hastings Street Vancouver 1, B. C., Canada |
| All ports of entry in Alberta | Federal Building 9820—107th Street, Edmonton, Alberta, Canada |
| All ports of entry in Saskatchewan, Manitoba and Ontario from the Manitoba border east to and including Port Arthur | Revenue Building, Room 405 391 York Avenue Winnipeg 1, Manitoba, Canada |
| All ports of entry in Ontario except Port Arthur and ports of entry west of Port Arthur | 55 St Clair Avenue East, Toronto, Ontario, Canada |
| All ports of entry in Quebec | Regional Administration Bldg., Montreal International Airport Dorval, Quebec, Canada |
| All ports of entry in New Brunswick, Nova Scotia, Prince Edward Island and Newfoundland | Terminal Center Ltd. Building P. O. Box 42, 1234 Main Street Moncton, N. B., Canada |

HEY HERB

THE AUDIO ANSWER MAN

by Herb Friedman



Hey Herb: I note that most articles on the Dolby B noise reduction system talk in terms of 10 dB noise suppression, yet just about every test report on a Dolbyized cassette recorder shows at most a 3 or 4 dB noise reduction when the Dolby is switched in. What happened to the rest of the noise reduction? Or is somebody cheating?

The Dolby B system *really does* provide 10 dB of noise suppression, but only for the higher frequencies—the ones you hear as “hiss”. Test equipment used, on the other hand, usually has a wide-band frequency response, so the reduced high-frequency noise is measured as added to the *low frequency noise*. Dolby B does not reduce

weak stations, though both sound equally as good on the stronger signals. I have tried several units of each so the problem is not one particular model. Shouldn't the most sensitive tuner really be “most sensitive”?



The difficulty in using test reports to determine the sensitivity of FM tuners is caused by a test procedure that is about 15 years old and had no relevance then, let alone now! Unfortunately, we are all stuck with this test procedure whereby sensitivity is determined by the signal level needed for 30 dB suppression of noise and distortion. But 30 dB noise suppression is a grinding, ear jarring noise. A tuner or receiver's real usable sensitivity is really the signal level needed for at least 55 dB suppression of noise. Distortion does not enter the picture in modern hi-fi tuners. I believe a noise level of -55 dB is acceptable in tuners because we will accept this level in reel-to-reel tape recorders. Regardless of the so-called IHF sensitivity which generally falls around 1.4 to 2 μV in modern FM receivers, the signal level required for -55 dB noise can range anywhere from 5 to 200 μV , or worse. Now assume for a moment that tuner A has a 1.8 μV IHF sensitivity but requires 100 μV for -55 dB quieting. Tuner B, on the other hand, is a Dynaco FM-5 whose IHF sensitivity I have measured as 2.5 μV . But, and it's a big *but*, the Dynaco FM-5 provided -55 dB quieting at 8 μV ; it will walk rings around tuner A in weak signal reception.

In short, the IHF sensitivity test is *outdated* and *useless*. It's time the industry adopted a sensitivity test procedure more closely linked to quality FM reception.

Hey Herb: I have found that a cheap cassette available at my local camera shop sounds exactly the same as the more expensive cassettes such as TDK, Maxwell and BASF. I don't even notice any difference in oxide flake-off or jamming. Pre-

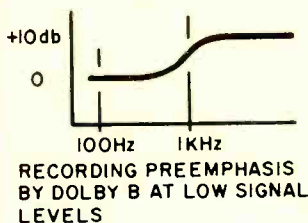

low frequency noise, rumble, wow and what not! The noise figures usually specified in test reports are Dolbyized *wide-band* noise, which is some 5 dB greater than the high-frequency noise. For example, a Wollensak 4760 Dolbyized cassette deck usually measures -46 dB noise level with the Dolby out and -51 dB with the Dolby in. But if a Hewlett-Packard 333A meter is used with the 1 kHz high-pass filter switched in to eliminate low-frequency noise and hum, the Wollensak measures a true -56 dB noise level. As a general rule, *wide-band* noise measurements should be so specified. So you see, no one is cheating—we're just talking different languages.

Hey Herb: I am trying two FM tuners rated as among the most sensitive (I have very weak FM signals in my area). Yet the one rated as “the most sensitive” is noisier on most of the very

e/e HEY HERB

cisely what justifies the more than \$1.50 price difference other than the brand name?

The difference is there, but your recorder has such a sharply limited, high-frequency response you probably won't hear the difference between the highest quality tape and the *three-for-a-buck*

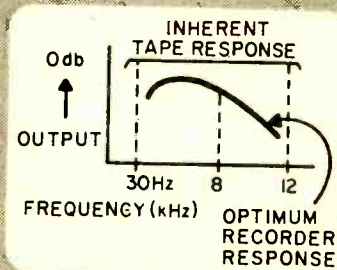

variety. If you were to use a quality cassette deck of true hi-fi capability such as the TEAC A-24, the high performance tapes such as TDK SD would deliver from 2 to 4 kHz *greater* high-frequency performance. While your budget tape would most likely poop-out at 8 kHz, the TDK SD would go to at least 12 kHz and beyond.

Hey Herb: I have recently read that Norelco is "against" a change in the playback equalization of cassette recorders. Aren't all characteristics of the cassette system standardized so a tape made on one recorder can be played with equal performance on any other machine?

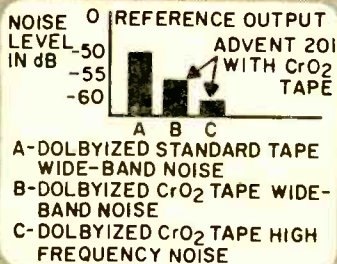

Yes, there is a standard, and Philips (Norelco) insists the standard be used. Unfortunately, the cassette system was never intended for the recording of music; it was designed for the recording of speech. Just about everything is wrong

with the system as far as music is concerned. In particular, the record-play equalization more or less establishes the optimum signal-to-noise ratio—using modern tape—at about 50 dB; a value in which a *hiss* is apparent to all listeners. But by using the high-frequency boost possible with a minor bias adjustment, and by changing the record equalization so that greater play de-emphasis can be employed, it is possible to push the signal-to-noise ratio towards a *dead quiet 60 dB*. A perfect example of this technique can be found in the Advent 201 Dolbyzied cassette recorder. Though standard equalization is used for "standard" tape, producing a -51 dB wide-band Dolbyzied noise level, Advent uses a modified equalization for the CrO₂ tape, producing a -55 dB wide-band Dolby noise level (which is the equal of a -61 dB high-frequency noise level)—you can't hear any hiss.

Hey Herb: Just about every FM tuner and receiver has its frequency response specified at 20-15,000 Hz. Why do some H. H. Scott tuners and receivers have a 50 to 15,000 Hz specification?

For many, many years, Scott has refused to play the "numbers game". The FCC requires a *proof of performance* only in the 50-15,000 Hz range, and the broadcast equipment that can go below 50 Hz is few and far between. Fact is, I'd

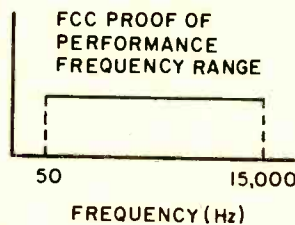

like to see the proof of performance of any station claiming to go below 50 Hz. In many FM transmitters, 100% modulation at 20 Hz would trip the off-frequency detector. So Scott has avoided the possibility of providing reception of room and motor rumble generated at the station. I don't know if honesty pays, but H. H. Scott's practices keeps this audiophile humble.

Herb would like to answer all the questions our readers send. However, he can only sample the questions received and answer as many as possible through this column. Sorry, it's impossible to answer questions by return mail. Questions of a personal listening nature cannot be answered. Send your questions to Hey Herb, ELEMENTARY ELECTRONICS, 229 Park Avenue So., New York NY 10003.

VIBRA-TONE

Dig it! This pocket vibra-tone has three voices, an eleven note keyboard, real vibrato and uses only three IC's in a real Hep circuit. It builds with new stick-on printed circuit material.

by Darrell Thorpe

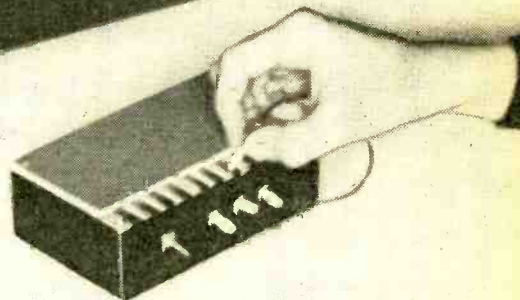

Maybe, to make a hit at a party, to spring a surprise on the boys in the combo, or give the kids a terrific toy, all you need is this pocket Vibra-Tone. Made from three low-cost integrated circuits and only a few other parts, the vibra-tone provides a really excellent little musical instrument—and it includes the sophisticated effects of voicing and vibrato that you would expect to find only in rather expensive musical instruments.

This project is simplified by the use of integrated circuits and instant printed circuits. A new technique has recently become available to the hobbyist. It's a new concept of instant printed circuits that permits you to rapidly build projects directly from a schematic diagram. This new approach consists of a complete family of circuit sub-elements and associated circuit materials. With instant printed circuits there is no messy etching and in most instances you don't need to drill any holes.

How-it-Works. Dual buffer IC1 is the tone oscillator. Capacitor C1 and a set of tuning resistors—R9 through R19—provide a tuned musical scale. A note will sound-off when-

ever a probe is touched to one of eleven pads on the vibra-tone's keyboard. Since C1 is fixed for all of the notes, the pitch or musical tone is proportional to the total resistance at each position.

A second oscillator, which is part of IC3. (pins 1 to 7) provides a fixed low frequency of about 6 Hz, with C3 and R1. This signal is filtered and attenuated in R2 and C4, and fed back to pin 12 of the tone oscillator, IC1. This provides a periodic frequency modulation to the tones, which is an excellent vibrato. The tone output from IC1, pins 5 and 10, passes through resistor R5 to switch SW2 that selects this particular tone when it is closed. This same output from IC1 also goes to pin 2 of IC2, a dual J-K flip-flop. This integrated circuit provides two flip-flops, and each of these, by the natural binary count action, can divide any input frequency exactly by 2. This division by 2 produces two new frequencies exactly $\frac{1}{2}$ and $\frac{1}{4}$ the input frequency, these are the same notes one and two octaves lower.

Changes Tone. The first flip-flop output, pin 13 of IC2, is the one octave lower output. This goes through R6 to switch SW3.

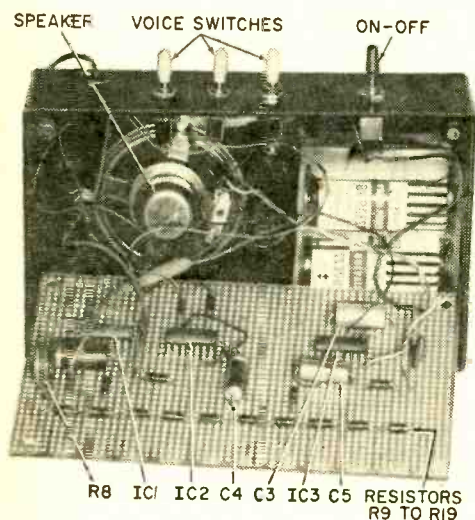

PHOTO BY MARTIN

Pin 13 also connects to pin 6 of IC2, the second flip-flop input. This provides a sec-

ond division by 2, providing a tone two octaves lower than the oscillator. The range switches, SW2 to SW4, are terminated on a common line which goes to pins 9 and 10 of IC3. Part of IC3 was used for the vibrato oscillator. However it also provides a simple two-stage audio amplifier. One of the gates (input 9, 10 and output pin 8) provides the first stage. Pin 8 drives pins 12 and 13 through C5. R4 provides bias. Pin 14 drives the 8-ohm speaker. C6 suppresses high frequency oscillations which might occur in this amplifier. The circuit operates on 3 volts, conveniently provided by two C cells in series, and draws approximately 120 mA standby current.

Quick Put Down. The instant printed circuit sub-elements consists of printed conductive patterns on a very thin epoxy glass board backed with pressure sensitive adhesive. Sub-elements are available for all types of integrated circuits, transistors, and other components, and, any combination of circuit element configuration can be mixed on one board. The circuit sub-elements are all pre-drilled with holes on a 0.100 inch grid. That is, they perfectly match the pattern of



Parts location suggestion when stick-on printed circuit construction is used. Wiring is applied to underside of board.

e/e VIBRA-TONE

0.100 inch vectorboard.

For this project, three 14-lead dual in-line printed circuit sub-elements are used. To use one of these sub-elements, strip off the protective backing and stick it in position, matching the holes in the printed circuit sub-element with holes in the vectorboard.

To use the conductive tape, hold one end and strip off its protective paper as the tape is laid down. A knife blade is then used to cut the tape. For best adhesion, roll the tape down with the side or heel of the knife. The adhesive on the copper tape is electrically conductive and, provided it is burnished for good adhesion, will make electrical contact. However, to eliminate any possibility of opens or intermittents, solder is (Continued on page 95)

PARTS LIST FOR VIBRATONE

- B1—Two C cells in series
- C1—0.1 μ F Mylar capacitor, 15 VDC or better
- C2—0.002 μ F disc capacitor, 15 VDC or better
- C3—10 μ F, 10 VDC electrolytic
- C4, C5—1 μ F, 10 VDC electrolytic
- IC1—Integrated circuit, HEP-571, MC799 or equal
- IC2—Integrated circuit, HEP-572, MC790 or equal
- IC3—Integrated circuit, HEP-750, MC724 or equal
- R1—6800-ohm, $\frac{1}{4}$ -watt resistor
- R2—120,000-ohm, $\frac{1}{4}$ -watt resistor
- R3—68,000-ohm, $\frac{1}{4}$ -watt resistor
- R4—3300-ohm, $\frac{1}{4}$ -watt resistor
- R5, 6, 7—22,000-ohm, $\frac{1}{4}$ -watt resistor

- R8—1000-ohm, trim pot
- R9—1500-ohm, $\frac{1}{4}$ -watt resistor, 5%
- R10—240-ohm, $\frac{1}{4}$ -watt resistor, 5%
- R11, 12, 13—300-ohm, $\frac{1}{4}$ -watt resistor, 5%
- R14—150-ohm, $\frac{1}{4}$ -watt resistor, 5%
- R15—360-ohm $\frac{1}{4}$ -watt resistor, 5%
- R16—430-ohm, $\frac{1}{4}$ -watt resistor, 5%
- R17—510-ohm, $\frac{1}{4}$ -watt resistor, 5%
- R18, 19—620-ohm, $\frac{1}{4}$ -watt resistor, 5%
- SW1, 2, 3, 4—SPST toggle or slide switch
- Misc.—8-ohm speaker, battery holder, printed circuit material and board, cabinet, wire, solder, probe (banana plug or equal), etc.

Vectorboard and instant printed circuit material for this project are available for \$4.50 from Circuit Specialists Co., Box 3047, Scottsdale, AZ 85251

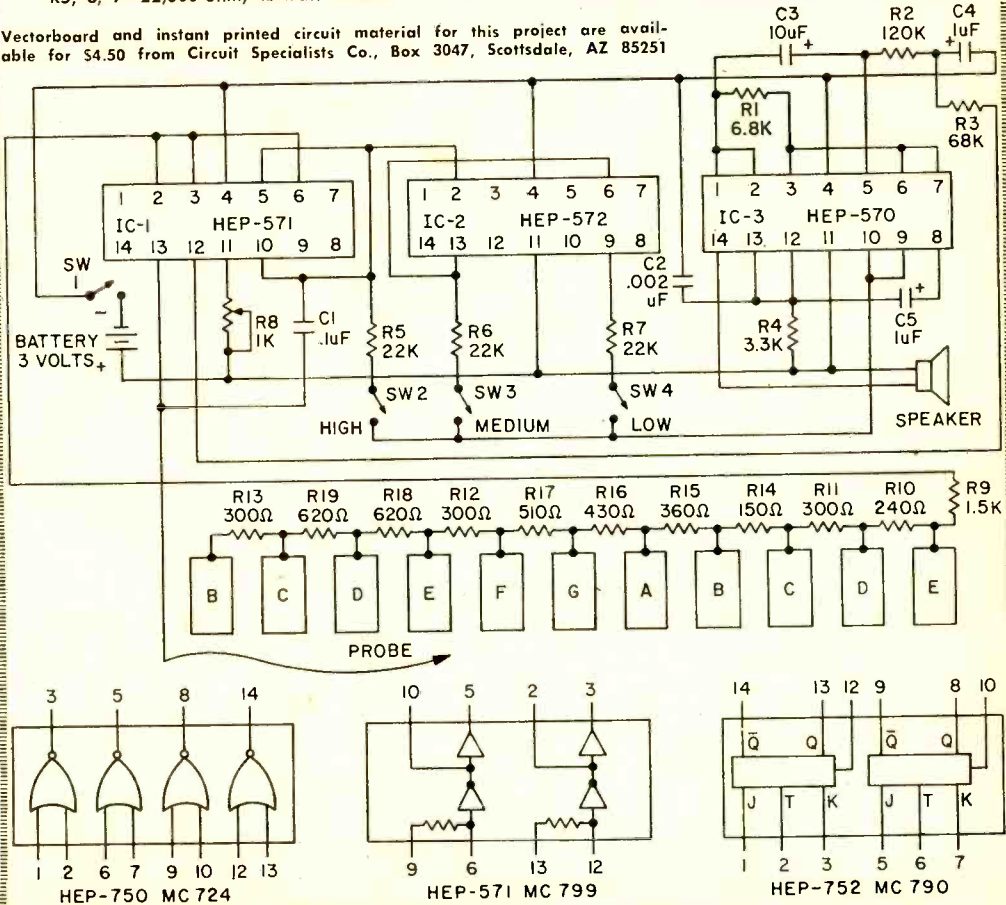

10 STEPS TO CASSETTE PLAYER REPAIR

by Homer L. Davidson

Cassette recorders come in every size and shape. They play on dry cells, AC line or operate right in the car. Generally, the portables are monophonic while table and console models are stereophonic. New cassette decks may feature "pop-up" cassette loading, level meter, remote control mike, push-button controls, tag-along speakers, and AC bias erasing system, to name only a few. After many hours of rough handling these cassette units will require servicing. Our 10-step approach to troubleshooting will give you an edge in the unknown world of cassette repair.

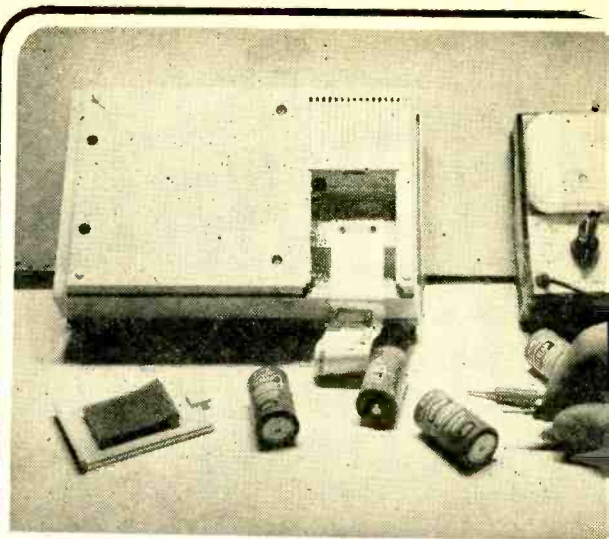
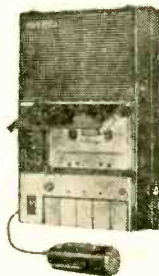

1 In case the recorder will not play, check the batteries. Check for corroded battery terminals or broken wires. Clean battery terminals with a knife or emery board. Disconnect one battery wire and insert VOM switched to low milliammeter scale. No current indicates a defective on/off switch, bad battery connections or dead batteries. Excessive current indicates a short in motor or amp circuit. If unit works on batteries and not on AC suspect trouble in the power supply. A step-down transformer and rectifier produces this DC. Check AC voltage at rectifier and DC voltage at motor.



2 Low volume and background noise caused by a dirty tape head. Excessive oxide dust will accumulate and pack upon the tape head. Tape heads should be cleaned every sixty days to keep them in tip-top condition. Clean head with tape-head cleaner or just plain rubbing alcohol. Use a cotton swab, dip in alcohol and remove the oxide dust. A special tape head cleansing cassette can also be inserted in place of the cassette. Don't forget to clean around and under the tape head assembly. Always try to keep magnetized screwdrivers away from the tape head.

If the tape plays slow, suspect a worn or stretched drive belt. In case the tape won't move, check for a broken belt. Oil on the drive belt or capstan pulley will result in slow tape movement. Clean the belt, idler, and motor pulleys with rubbing alcohol. If the speed is erratic (wow), check for oil upon belt and capstan drive pulley. A belt partially off the track or a misaligned capstan assembly can cause wow conditions. Defective cassette or motor can produce erratic speed or wow conditions. After a good clean-up with alcohol, check the capstan flywheel for dry bearings. A drop of light oil on motor bearings will clear up a noisy motor. Some small motors are self-contained and do not require oiling. Just a drop will do; do not over-lubricate any bearing. Wipe off excess oil to prevent dripping upon drive belt.

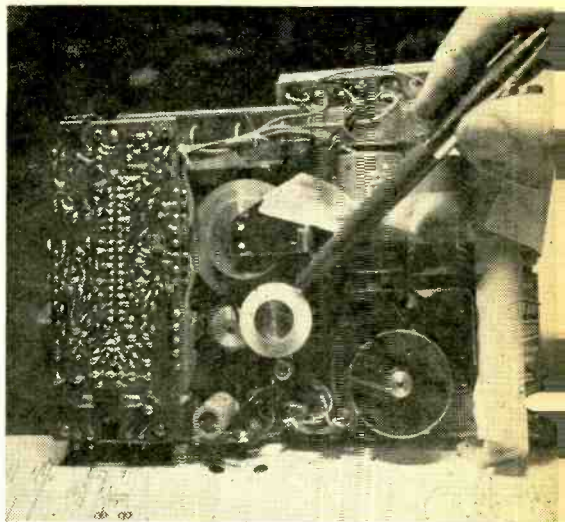

4 Suspect mechanical trouble when there is no tape motion and power is applied to the motor. Spin motor belt and see if the capstan drive wheel takes off. If not, remove the drive belt and see if the motor shaft is free. If not, clean out motor and bearings with alcohol, assemble and lubricate bearings. If starting is intermittent, remove drive belt and hold the motor pulley between fingers. Switch the power off and on. Sometimes under load, the motor armature will have a flat side and will not rotate. Replace defective motor. A frozen or binding capstan drive wheel will result in slow or no tape motion. Remove the capstan flywheel assembly, clean and lubricate. Wipe off excess oil. Especially, suspect dry bearings on plastic pulleys working on metal posts. Don't overlook a possible defective cassette.

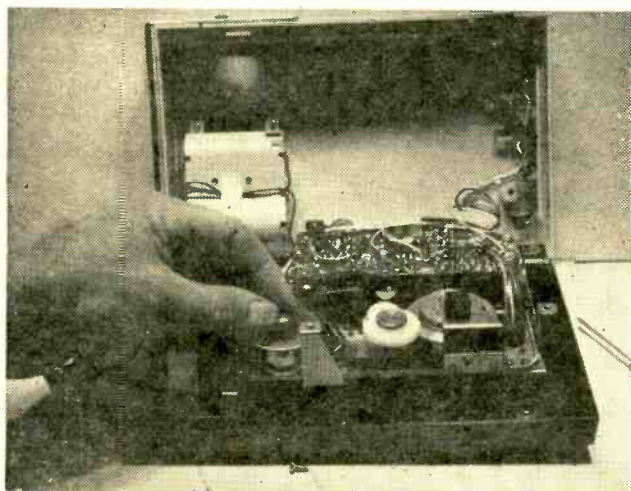

Most mechanical troubles are related to the drive or switch cassette mechanism. 5 Remove the outside case of the cassette player so you can see the mechanical action. Check the sequence of operation and try to isolate the cause of trouble. For instance, if the record button will not stay down suspect a bent lever or locking pin. In some of these small recorders the thin levers are quite fragile and bend rather easily. Remove the lever and bend back in shape. Be careful not to compound the trouble. Many of these metal parts are rather difficult to obtain and you may have to repair them. Check for broken or loose springs. You can spot these springs rolling around in the case and fall out in removing the outside covers. Spring replacement is rather difficult unless you have an exploded drawing of the mechanism.



CASSETTE PLAYER

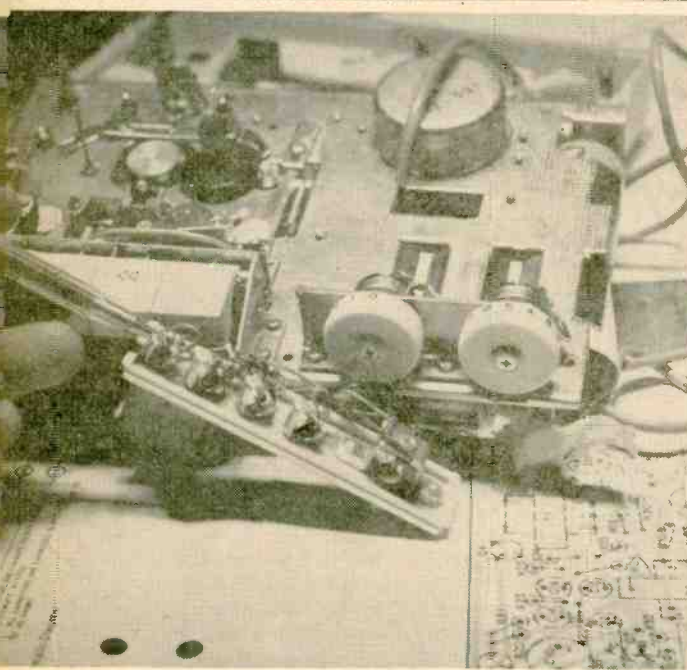

6 A broken remote mike cable will result in intermittent or no power supplied to the cassette player. When hum or intermittent recording is noted, suspect a defective cable. These breaks are found where the wire enters the mike or at the male plug. If the remote unit will not shut off the recorder, check for a bent female plug or defective switch. Check to see if the cassette recorder will operate without a remote unit plugged in. If not, check shorting contacts of female remote-control jack. Continuity of the remote power switch can be checked with an ohmmeter. Cut off the broken section of cable and resolder mike or plug. Be real careful in soldering the small shielded cable so that you do not solder the shield to the shielded wire. Recheck continuity with an ohmmeter.

If the unit will not record, **7** check the microphone and mike jack. If the unit will play back a cassette, the amplifier and speaker are functioning. The trouble must be in the microphone circuit, play/record switch or switch transfer linkage. Clean and spray the play/record switch contacts. Then, check for poor soldered switch connections on PC board. Make sure the switch can be fully engaged and make contact. In case the unit will not play or record, turn volume wide open and touch the ungrounded wire from the tap head to the amplifier. You should hear a loud hum if the amplifier is working. If not, inject a signal from an audio generator at the volume control. Signal trace the defective amplifier by going from base to collector terminal of each transistor. Make voltage and transistor tests where the signal is lost. If you hear hum and the recorder will not play or record suspect the tape head.

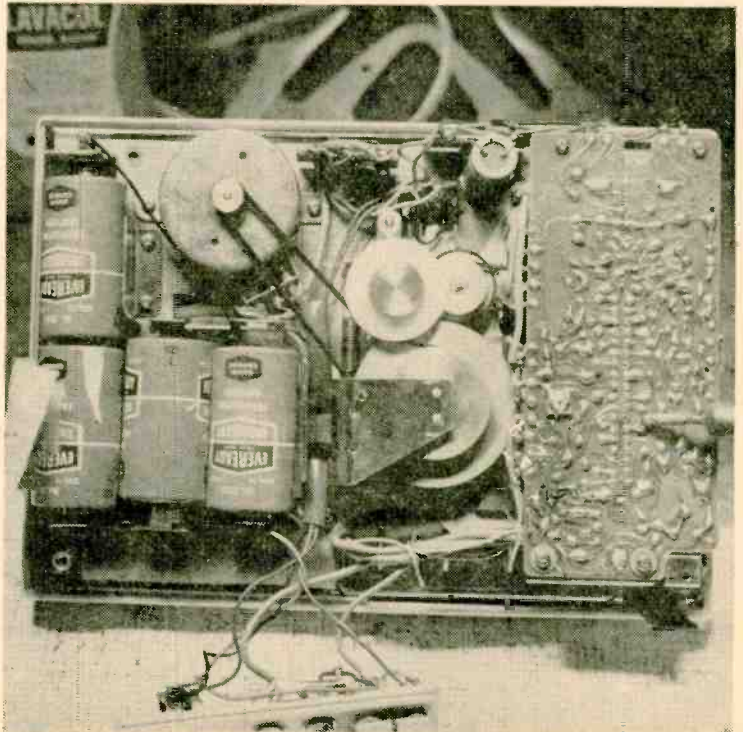

Suspect a scored or rough tape drive assembly when the unit repeatedly tears tape. **8**

Check for sticky substance on capstan (tape drive) shaft. Clean the tape drive with alcohol and check for roughness. Packed tape oxide or small pieces of tape may be wound around the drive shaft and will pull or tear tapes. Make sure the drive belt is properly installed. If a new drive belt has been installed, it may be around the wrong idler pulley. This will let the tape bunch up, pull and tear out the tape. Bunching and tearing of tape may be caused by a defective cassette. Some tapes will bind and cause wow conditions. Stop the recorder if the tape has bunched up in the small plastic window. Quickly, rewind the tape and start once again. In case the tape pulls or seems to form a loop, check the rubber drive belt and take-up pulley.

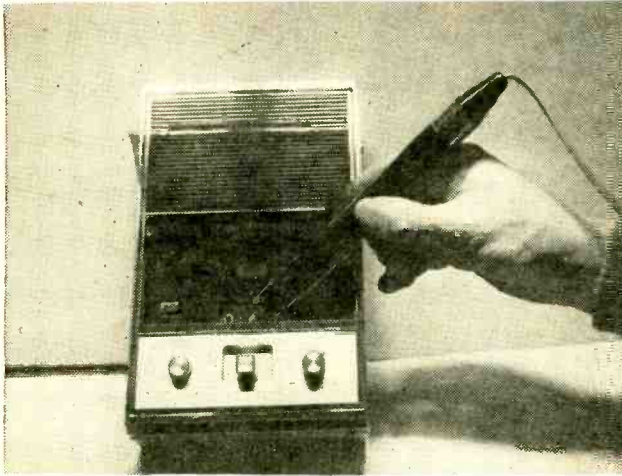
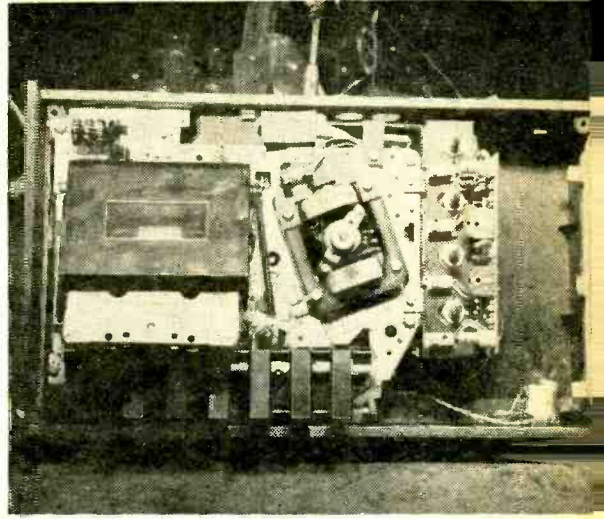

9 Is your cassette player unusually noisy?

Try to isolate the noisy condition in amplifier or tape head assembly. Make sure the tape head is clean and demagnetized. If the player is still noisy, see if the noise exists in a pre-recorded tape cassette. Try a few new pre-recorded cassettes. Now, turn the volume down and see if noise is still present. Generally, noise produced in the amplifier is caused by leaky AF or driver transistors. Also, check for a poor ground on the PC board. The noisy transistor can be isolated by substitution or removing the collector terminal from the circuit. When the noise disappears you have located the noisy transistor or stage. A popping noise can be caused by a defective output transistor or burned resistor.

Two recordings heard at the same time indicate crosstalk. Excessive crosstalk and poor frequency response are caused by either poor erase or improper tape head alignment. Adjust the height and azimuth screws, located at the rear and side of the tape head, to correct. Use a cassette audio test cartridge in making these adjustments. Before performing these tests clean up the tape head. Connect a 40, 47 or 49 bulb across the speaker leads. Adjust the volume control so the bulb rarely glows and then adjust the tape head height and azimuth. ■



PHOTOGRAPHING

How would you like to photograph President Nixon in the White House? Hank Aaron clouting one over the fence? A U.S. Olympic track star winning a Gold Medal? Or how about your favorite actress receiving an Academy Award? You can snap your camera's shutter at home while focused at your black-and-white or color television set.

Camera and Film. You can use almost any camera for taking black-and-white pictures of television images. However, you'll get better results with an automatic or adjustable camera. If you have a simple camera without exposure or distance settings, you must use a high-speed film, such as Kodak Tri-X Pan Film. For taking color pictures, you should use a camera with an $f/2.8$ or faster lens and a shutter that you can set at $1/8$ second or slower. If you want to take movies, you'll need a movie camera with an $f/1.9$ or faster lens. Check your cameras now!

To determine the correct exposure, you can use an automatic camera or a *reflected-light* exposure meter. If you don't have either of these, you can set your camera according to the Exposure Table.

TV images are quite dim compared to average subjects in daylight. Therefore, to avoid using large lens openings and very slow shutter speeds, you may want to use a high-speed film such as Kodak Tri-X Pan Film—ASA 400—for black-and-white prints, or *Kodak High Speed Ektachrome* Film (Daylight)—ASA 160—for color slides.

TV Set Set-Up. To obtain the best quality in your photographs, adjust your TV set so that the contrast of the television picture is slightly lower than normal. Adjust the brightness control so that both the high light and shadow areas of the TV image show detail. The shadows should not be light gray or completely black. Adjust the controls on a color set for a pleasing color picture on the screen.

Reflections on the face of the television tube can ruin your photographic attempt! To help eliminate reflections, turn off all of the room lights. Eliminating the light in



THE TV SCENE

Jackson Kaye

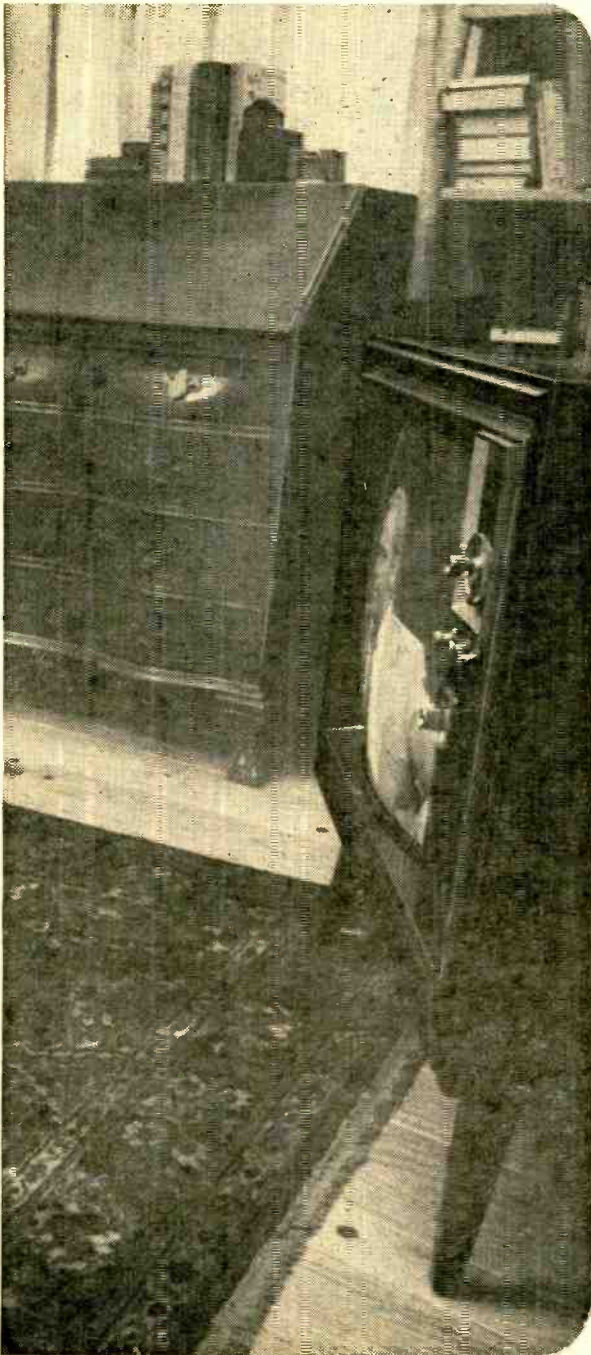

the room also helps make the area surrounding the TV image appear black in your photographs. A black area surrounding the TV image is usually more pleasing than a lighter area showing part of the room or the border around the picture tube.

Don't use flash or flood lighting to photograph television images. These light sources actually reduce the brightness of the TV image, and your pictures would show a blank television screen.

Shutter Snapping. Move in close to the television screen with your camera. If the minimum focusing distance for your camera will allow it, move in until the TV screen fills the picture area in your viewfinder.

If your camera is a single-lens reflex with through-the-lens viewing, when you look through the viewfinder you'll see exactly what you'll get in your close-up pictures. But if the viewfinder on your camera is separate from the lens, it may not show you exactly what will be included in the picture.

Shutter Speed. Television images are composed of 525 straight horizontal lines called "scanning lines." The image is formed in your TV set by a moving electron beam which scans the picture in two sections. All the odd-numbered lines are traced in $1/60$ second to produce an image. As soon as this cycle is completed, the picture is scanned again in $1/60$ second, this time tracing the even-numbered lines. Therefore, it takes $1/30$ second to make a complete picture on the screen. That's why you must use a shutter speed of $1/30$ second or slower to record at least one complete picture cycle. Otherwise you may get a dark band across your photograph. If your camera has a focal-plane shutter, you should use a shutter speed of $1/8$ second or slower to obtain uniform exposure. For sharp pictures, make the exposure when the subject on the screen is not moving. Put your camera on a tripod or other firm support, such as a table. Books and boxes can be used if the tables you have are too tall. Do not tilt camera up or down to capture picture. Rather, raise or lower

e/e PHOTOGRAPHING TV

camera until picture is framed properly.

Color Pictures. Use *daylight* color film for photographing TV images. Color pictures of color television will have a somewhat blue-green appearance because the film's sensitivity to the TV picture is different from the eye's sensitivity. You can improve color rendition in your pictures by using a Kodak color compensating filter, CC40R (gelatin), over your camera lens to help bring out the reds. When you use the CC40R filter, increase exposure by 1 stop. You can pick up this filter from your photo dealer.

Automatic Cameras. Fill the picture area in the viewfinder with the TV image so that the exposure meter in your camera "sees" only the TV screen. If your automatic camera (with built-in exposure meter) is too far away from the TV screen, the exposure meter "sees" too much of the dark area surrounding the TV image, resulting in overexposure on your film.

When you're taking pictures, the low-light indicator may appear in your camera viewfinder. Usually you can ignore this "warning" and take pictures anyway. You'll probably get satisfactory results, although your pictures may be on the dark side.

If your automatic camera has a separate peep hole for the light meter, you must cover this peep hole with the CC40R filter when the lens is so covered. If not, your photos will be overexposed.

Adjustable Cameras. If you have an adjustable camera with a built-in exposure meter, when you make the meter reading be sure the TV screen fills the picture area as recommended for automatic cameras. If your camera doesn't have a built-in meter, you can use a separate reflected-light exposure meter to determine the exposure. Hold the meter close to the TV screen so that it reads only the screen. Position your meter to read approximately equal parts of light and dark areas of the TV picture.

For Simple Cameras. The camera settings in the Exposure Table apply to most television sets. However, since individual adjustments of TV pictures can vary, and since improvements are continually being made in the picture tubes for color television, the suggested exposures are approximate. You may want to bracket your exposure to be sure of getting a properly exposed picture

of an especially important subject. Take one picture at the suggested exposure, one at $\frac{1}{2}$ the exposure and another at 2 times the suggested exposure. Remember do not use shutter speeds higher than $\frac{1}{30}$ second or $\frac{1}{8}$ second for a camera with a focal plane shutter.

Movie Cameras. To make good-quality movies of television images, you would need a special camera synchronized with the television set to record successive picture cycles on successive frames of movie film. Of course this isn't practical for the amateur-



Take movies too!
New high speed Super-8 makes color TV photography a snap. You can also use regular Kodachrome II, see how below.

movie maker. However, you can still obtain satisfactory results with an ordinary movie camera that has an $f/1.9$ or faster lens.

Operate your camera at the normal camera speed of 16 or 18 frames per second. Since your movie camera is not synchronized with the TV picture cycle, your projected movie will show a slightly uneven, or banding, effect.

With a camera that has an $f/1.9$ lens, you can make recognizable, though somewhat dark movies of black-and-white and color TV images when you use Kodachrome II Movie Film (Daylight); or Kodachrome II Movie Film (Type A) with a No. 85 filter. This filter is built into all super 8 cameras and some 8mm cameras. When using these films, turn up the brightness control on your TV set for maximum brightness without losing too much detail. If your camera has manually adjustable lens openings, set the lens at its largest opening.

You can obtain brighter movies of *black-and-white images* by using the Type A film without a No. 85 filter. The black-and-white

EXPOSURE TABLE

(Suggested Camera Settings for Pictures of Television Images)

| Film (Use) | Black-and-White Television Set | | Color Television Set | |
|--|-----------------------------------|------------------------|-------------------------|------------------------|
| | Leaf-Type Shutter | Focal-Plane Shutter | Leaf-Type Shutter | Focal-Plane Shutter |
| Verichrome Pan Plus-X Pan (Black-and-White) | 1/30 sec f/4 | 1/8 sec f/8 | 1/30 sec f/2.8 | 1/8 sec f/5.6 |
| Tri-X Pan (Black-and-White) | 1/30 sec f/5.6-8 | 1/8 sec f/11-16 | 1/30 sec f/4-5.6 | 1/8 sec f/8-11 |
| Kodacolor-X (1) (Color Prints) | 1/8 sec f/2.8 | 1/8 sec f/2.8 | 1/4 sec f/2.8 | 1/4 sec f/2.8 |
| Kodachrome-X (1) Ektachrome-X (1) (Color Slides) | or 1/15 sec f/2 | | or 1/8 sec f/2 | or 1/8 sec f/2 |
| High Speed Ektachrome (1) (Daylight)—with Normal Processing ASA 160 (Color Slides) | 1/15 sec f/2.8-4 | 1/8 sec f/4-5.6 | 1/8 sec f/2.8-4 | 1/8 sec f/2.8-4 |
| High Speed Ektachrome (1) (Daylight)—with ESP-1 Processing for a Speed of ASA 400 (Color Slides) | 1/30 sec f/4 | 1/8 sec f/8 | 1/30 sec f/2.8 | 1/8 sec f/5.6 |

NOTE: When two lens openings are given, such as f/4-5.8, lens setting is midway between these stops.

(1) Pictures of color television taken without a filter will look blue-green. With the color films in the table, you can use a Kodak color compensating filter, CC40R, over your camera lens to help bring out the reds in your pictures. Increase the exposure suggested in the table by 1 stop.



Expensive equipment is nice but not necessary. Ordinary fixed focus camera is fine for photographing live-from-the-moon TV at home from large-screen set.

images in your movies will be somewhat bluish, but will certainly be acceptable. Your camera manual will tell you how to move the No. 85 filter out of the light path in the camera.

If you have a super 8 camera, you can use a high-speed black-and-white movie film—Kodak Tri-X Reversal Film 7278—ASA 200. Your photo dealer may have to order

this film for you. Although some cameras are not designed to expose this film properly under normal lighting conditions, most cameras will give satisfactory exposure for movies of television programs. To make movies on this film, you can leave the TV brightness control at its normal setting. If you have a manually adjustable camera, try a lens opening halfway between f/2.8 and f/4 for both black-and-white and color television.

A New QSL Idea. Here's a good idea which will pay off rich rewards in the future. Collect autographed pictures of people who will soon become famous. Photograph first-year professional athletes while they are competing in a game. Send a print to the player addressed to care of the player's club. You'll receive an autographed photo with a personal note, in most cases. Imagine snapping Willie Mays twenty years ago. Don't shoot superstars—they have too much mail to answer. Results will be poor.

Get started today. The TV picture you shoot now will be a valuable memory tomorrow. ■

Great careers

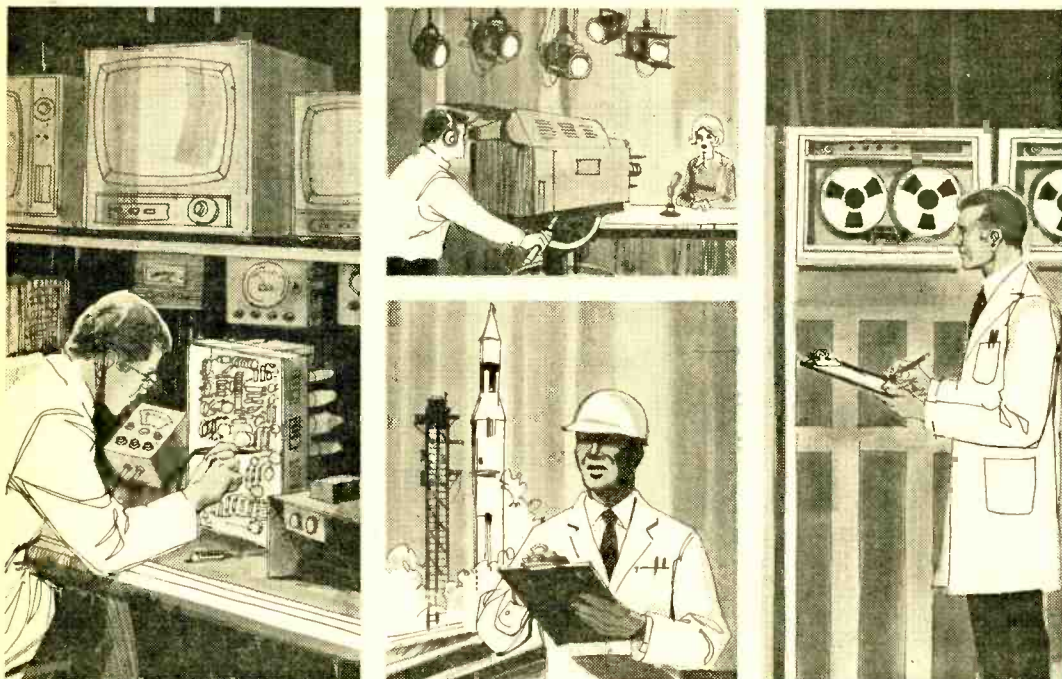

Join the high-paid electronics technicians who got their start through NTS Home Training.

Your home can become your own private classroom-workshop. NTS sends you everything you need to learn valuable technical skills in electronics. You get easy-to-grasp lessons, comprehensive kit manuals, large fold-out charts, and more. Plus the finest professional equipment available today. It's all included in your tuition, yours to keep.

Your equipment is sent to you in kit form, matched to lesson material. With the NTS Project Method, you start with simple projects, then move from basics to more complex concepts. You discover how electronic principles work by performing practical, fascinating experiments. Learn at your own pace.

You quickly become expert in the actual equipment and meth-

ods you'll use on the job. And soon you're ready to cash in on the tremendous opportunities in the expanding, exciting world of electronics!

If your field is television, you might decide to join a first-class TV repair center. Or start a shop of your own. Or specialize in industrial applications of television. Once you master an area of electronics, the direction you take is really up to you. And you'll be able to use the test instruments you built yourself!

It all begins at home, with NTS Project Method Training. Find out how fast and easy it is to learn skills that pay off. Check card or coupon today for your free full-color NTS Catalog and complete details. No obligation. No salesman will call.

NTS COLOR AND B&W TV SERVICING

Build the largest, most advanced color TV made! Over-all solid-state design, 315 sq. in. ultra-rectangular screen, matrix picture tube, built-in self-servicing features, "Instant On," A.F.T., solid-state VHF tuner, and much more! Also build and keep AM-SW Radio, Solid-State Radio, FET Volt-Ohmmeter, and Electronic Tube Tester. Learn trouble-shooting, hi-fi, stereo, multiplex systems, radio, color and B&W TV servicing.

Solid-state B&W TV 74 sq. in. picture (cabinet included)



Learn sophisticated solid-state circuitry as you build this B&W TV receiver. Course covers the full range of home entertainment electronics.

begin at home.



New solid-state
315 sq. in. color TV

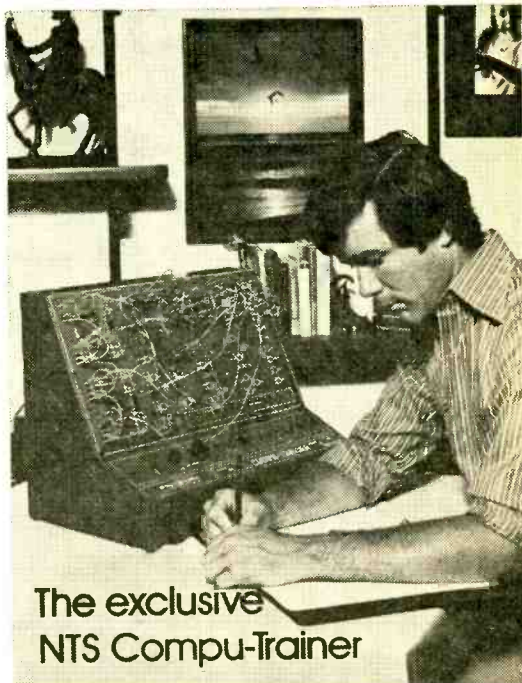

The exclusive
NTS Compu-Trainer

NTS COMPUTER ELECTRONICS

Build and operate the exclusive NTS Compu-Trainer! Loaded with integrated circuits, it teaches you the how, what, and why of computers faster, more thoroughly. You perform all wiring and patch-cording. No short-cuts. No pre-wired circuit boards. Also receive an FET Volt-Ohmmeter and a 5" wide-band Oscilloscope.

NTS ELECTRONIC COMMUNICATIONS

Gain the prestige and earning power of owning an FCC First Class Radio Telephone License! Two exciting courses in the fields of transmitting and receiving. Experiment with an amateur phone 6-meter VHF transmitter, NTS' exclusive 6-transistor solid-state radio, and a fully transistorized volt-ohmmeter.

5-watt AM transmitter/receiver.

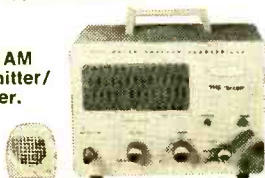

NTS AUTOMATION/ INDUSTRIAL ELECTRONICS

Systems automation is the future of industry — and you can play an important role! Enter the age of electronic controls by training on the NTS Electro-Lab — a complete workshop. Also receive a 5" wide-band professionally rated Oscilloscope. Build five industrial controls to regulate motor speed, temperatures, pressure, liquid level and much more.



5" Oscilloscope

CLASSROOM TRAINING AT LOS ANGELES

You can take classroom training at Los Angeles in sunny Southern California. NTS occupies a city block with over a million dollars in facilities devoted exclusively to technical training. Check box in coupon.

APPROVED FOR VETERANS

Accredited Member: National Association of Trade and Technical Schools; National Home Study Council.

NATIONAL TECHNICAL SCHOOLS

WORLD-WIDE TRAINING SINCE 1905
4000 S. Figueroa St., Los Angeles, CA 90037

Please rush Free Color Catalog and Sample Lesson, plus information on course checked below. No obligation. No salesman will call.



National Technical Schools

4000 S. Figueroa St., Los Angeles, CA 90037

- Master Course in Color TV Servicing Color TV Servicing (For Advanced Technicians)
- Master Course in B&W TV & Radio Servicing
- Master Course in Electronic Communications
- Practical Radio Servicing
- FCC License Course
- Master Course in Electronics Technology
- Automation & Industrial Electronics
- Computer Electronics
- Basic Electronics
- Stereo, Hi-Fi & Sound Systems
- High School at Home Dept. 222-072

Name _____ Age _____

Address _____

City _____ State _____ Zip _____

- Check if interested in Veteran Training under new G.I. bill.
- Check if interested ONLY in Classroom Training at Los Angeles.

CIRCLE NO. 8 ON PAGE 17 OR 103

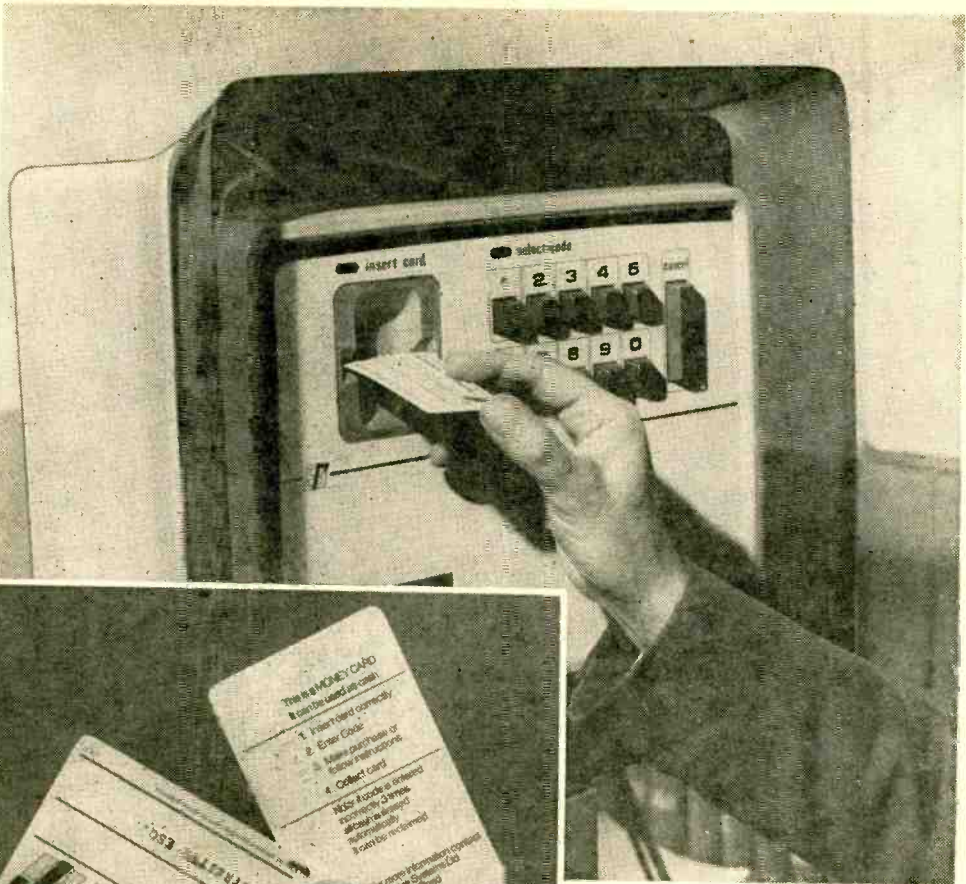

The credit card that takes on a charge

RECHARGEABLE MONEY

This is certainly the age of credit cards, but here's one with a difference—this one should usher in the age of the cashless society. That means no money, no checks, and no credit cards—just "electronic money."

The electronic money card looks like any other credit card but the similarity ends here. It too has an identifying code for the owner, but it also has a section dealing with money. The owner's spending power is determined by the number of magnetic pulses the card contains. (This is of course determined by the owner and his bank.) Once he has "x" amount of pulses, he's set to buy whatever he wants by simply slotting his

card into appropriate terminals, which then charge off the money spent.

This is all linked up to central computers which monitor both the buyer and the dealer. All the buyer does is to punch out his code on the register for his card to be accepted for the transaction—until he's run out of pulses. If he punches the wrong code or has no pulses left, the card is rejected. At this point, he goes to his bank to get recharged.

This system is due for a trial run in a chain of gas stations in Great Britain. The garages will accept these pulses as payment. This could be the start of electronic money. But, what'll a brownout do to inflation? ■

CB coffee break

THIS ISSUE'S COLUMNIST—JULIAN S. MARTIN

How shall I use thee? Shall I chit-chat with friends? Call in the fence riders? See if there's room in the mobile park? Boost the business with free home-delivery?

If you stop to think about it, the uses for CB are almost endless; yet all too often a perfectly useful idea for CB goes down the drain because the potential user is oriented to CB usage in his immediate locality. For example, the big-city CB'er who thinks in terms of keeping up with friends in the boat club does not realize that a rancher way out West sees CB only as a quick way to call in a line rider 20 miles out. And the vacationer tooling his Winnebago through the endless desert wastelands thinks of CB as a means to check if there's space for him at the next national park—'cause he'll be miles from nowhere if there's no room at the next water hole for his home-on-wheels.

In any given instance, CB can probably handle the job better than the way you're doing it; you've got to think of CB as an entirely new idea—as if it never existed before. For example, we recently had an electrical job done at the shop. The two electricians pulled up with their "flagpole" announcing to all that the truck was CB-equipped. Yet an hour later they were shouting to each other from the roof to the basement as they pulled new wires. How much easier it would have been if each had a walkie-talkie in their pocket. But they saw CB only as a way to get a message from their office to their truck; they didn't consider that CB could be a "wireless intercom."

Another time, a CB'er in Yosemite Park was extolling the virtues of CB to another camper: how he could always call ahead for reserved space. Yet, I saw this same CB'er drive back over 10 miles of the toughest mountain road when the store didn't have what his wife needed; then he turned around and went back out for a substitute—a 20-mile round trip for nothing. He could have saved racking the wheel for 20 miles by simply carrying a portable "full 5" rig with telescopic antenna. Everytime he camped he could set the rig in a corner of his lot, and call back to the XYZ when problems arose at the general store or launderette. But again, this CB'er saw CB only as a way to call ahead for camping space; he didn't see CB as his own personal "remote telephone system."

One CB'er I met while sharing a lift at a

turnpike garage really had a well-thought out plan of CB emergency service. After once having snapped a fan belt on the turnpike and waiting for what seemed like hours in the broiling sun, with a car full of noisy, complaining children, he decided a handkerchief tied to the door handle was not really the best way to get help. So when Channel 9 was declared the "National Emergency Channel" he put an inexpensive rig into the car and figured he'd come out on top of the next breakdown. Sure enough, a few months after he'd put in the rig his XYL had a tire blow-out on a limited access highway—one of those roads in New York City where the cops *do not* help anyone who pulls off the road. (The first rule a driver learns in NYC is to stay on the road and cause a massive traffic jam; else, no one stops to assist.) Anyway, the XYL yells for help on Channel 9 and five minutes later there's a CB'er lending a hand. A great idea? Sure! That rig is used for no other purpose than to give the guy and his wife peace of mind.

Creative CBing. So you see, different applications of CB other than the one(s) with which you're familiar can give a large boost to your personal comfort and enjoyment.

One way you can expand your CB activity into new fields and ideas is to treat every bit of CB hardware as a separate entity. Then prepare a list of all possible uses for each *individual* item. Try to peg your ideas to typical family situations or business activity. For example, are you one of those country-fair hounds who sample apple pies from Cayuga County to Great Salt Lake; well then, you know how easily kids get lost in crowds. Well, those pocket pagers touted for the active businessman are great for calling kids to the car. Pop carries a 5-watt walkie-talkie and the kids carry the receivers in their pockets.

A good place to start looking for new CB horizons is in the Lafayette catalog, where in something like six pages is virtually every gadget and doodad made for CB; everything from portable battery power supplies for "full five" solid-state transceivers to antennas you can clip to a motel window. Just keep in mind that the most obvious use is not the only one.

Visit Kathi's CB column this issue. She's enjoying her second anniversary with e/e. Discover how the staff took it! ■

E/E looks at new...

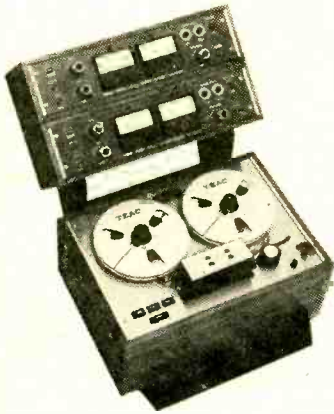

For overdubbing, try the TEAC TCA-43 Simul-Sync 4-channel tape deck, at \$729.00. Any one of the four tracks can be synchronized to any or all of the other three tracks. Circle No. 42 on Reader Service Page.

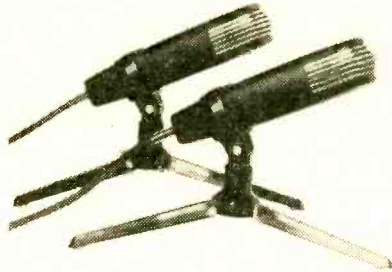

For making high-quality live recordings, Advent introduces its first microphone. The MDC-1 is a low-impedance cardioid dynamic mike, at \$90.00 for a matched pair. Circle No. 41 on Reader Service Page.



Heathkit's AA-2004 four-channel 200-watt amplifier operates in mono, stereo, discrete 4-channel, or matrixed 4-channel with a built-in decoder; \$349.95 mail-order. Circle No. 1 on Reader Service Page.



Compatible with both stereo and monaural sources, the Koss KO-747 headphones have a volume control in each earcup; \$45.00. Circle No. 38 on Reader Service Page.



Four-channel sound in your car? It's yours with SSI's Quadrasizer 8 playback decoder, which synthesizes quad-sound from any 2-channel source, for \$19.95. Circle No. 39 on Reader Service Page.

HI-FI COMPONENTS



by Kathi Martin KAIO614

KATHI'S CB CAROUSEL

It was a *complete* surprise. When I walked into the office right before the deadline for this issue's column, the entire gang—from my Editor-in-Chief to our Art Director, Jim Medler, to our Publisher, Mr. Davis—surprised me with a second anniversary birthday party. I was stunned! After all, I'm not a very big cog in the wheels around here (but until now, they never heard me admit it), so it made my second anniversary as your CB Editor a super-great day. It was just two years ago that my first column appeared in *e/e*. Throughout these two years we've tried to keep you up-to-date in CB with the able help of one of the best equipped test labs available. And, we've tried to give you straight talk about the technical aspects of CB transceivers, but with a personal touch—my reaction to the set and its operation.

So, I hope you'll continue to read my column. It's been a lot of fun to "poke around the CB marketplace and report on what's new and groovy," as I wrote in my very first column. Here's a great big thanks to all you readers. A gal just couldn't ask for better. I have picked a mini to report on today, partly because we checked one in our very first column in 1970.

The Mini Look. Realistic's Mini-23, an itty-bitty *full-five*, is just 5¼-in. x 1½-in. x 8-in. D. The plain fact is, the package is so small there was no room for a standard 23 channel selector switch; instead, the Mini-23 takes two switches to cover all 23 channels, but more on that later.

The Mini-23 is supplied with all crystals, a DC power cable, a mobile mounting bracket and a microphone that plugs into a socket on the rear apron. The apron also has a standard antenna connector and an external speaker jack that automatically disconnects the internal speaker. The front panel has volume and squelch controls, a channel selector switch and a crystal range switch for channels 1 through 12 and 13 through 23.

The range switch, a push-to-hold, push-to-release type, controls the illumination of the channel selector. Pushed *in* the selector switch illuminates channels 1 through 12. When the range switch is *out*, channels 13 through 23 are illuminated.

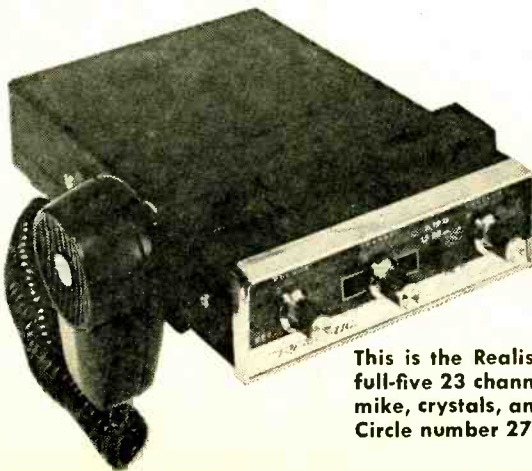

This is the Realistic Mini-23 transceiver, Radio Shack's full-five 23 channel mini. It comes complete with mike, crystals, and mobile mounting bracket for \$99.95. Circle number 27 on page 17 or 103 for more information.



KATHI'S CB

Even husky football player types have room to flip the Mini-23's channel selector. Note dual display for showing active channel.

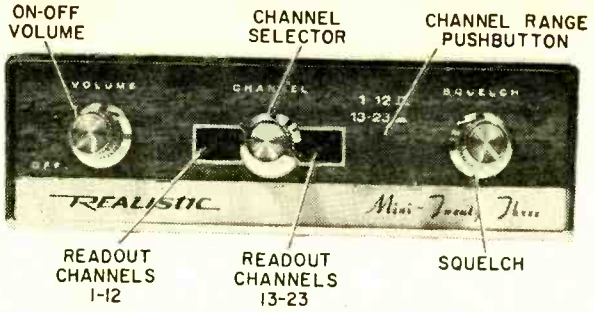

It's hard to imagine that anyone could pack a cabinet this size with as much circuitry as Radio Shack has managed to cram into the Mini-23. The RF input amplifier has diode protection against strong-signal damage. It drives a double conversion IF with mechanical filter in the second IF amplifier. The rest of the transceiver is more or less what we've come to expect in solid-state gear—100 percent modulation limiting, factory tuned (optimized) transmitter tuning with internal tuning adjustments, and very low idling current that allows the unit

to be powered by a pack made of premium type flashlight batteries. A reverse polarity protection diode is built into the transceiver. If you accidentally reverse the power supply wires, you won't blow out a string of expensive components.

ture size found in small solid-state rigs, the sound quality is very good—crisp and clean even at very high volume levels. The transmitter put out a healthy 3.9 watts of RF into a 50 ohm dummy load. The modulation sensitivity for 85 percent modulation was -25dB, almost exactly the average sensitivity of most transceivers. The modulation is limited to 100 percent, so even if you scream your signal won't splatter into a contact on nearby channels.

Lot's of Uses. After I finished putting the Mini-23 through its on-the-air paces, the very small size started to get through to me. The Mini-23's bulk is even less than that of a 5-watt walkie-talkie, and would take up next to no room in a suitcase if you wanted to take the rig on vacation (I've found that gutter-type mobile antennas make excellent portable antennas). You can tuck the Mini-23 in an out of the way spot in a camper, or even lose it in a glove compartment with plenty of room left over for maps, cups, and sandwiches. It will actually fit into a jacket or coat pocket (though a large pocket), and the battery pack also available from Radio Shack—their 21-127 @ \$24.95—makes it a really nice portable rig. The Mini-23 costs only \$99.95. For additional information circle No. 27 on Reader Service Coupon on page 17 or 103.

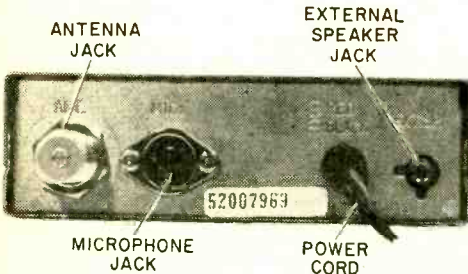

Standard size antenna jack looks large compared to overall size of this mini.

to be powered by a pack made of premium type flashlight batteries. A reverse polarity protection diode is built into the transceiver. If you accidentally reverse the power supply wires, you won't blow out a string of expensive components.

Our Lab Says. The receiver's sensitivity measured $1 \mu\text{V}$ for a 10 dB S + N/N ratio (signal plus noise to noise). The adjacent channel selectivity was 36 dB on the lower and 40 dB on the higher frequency channel. The image rejection measured 20 dB. Our labs measurement of AGC action for a signal range of 2 to 10,000 μV was almost 20 dB which, I'm afraid, isn't even average for a tube rig. If the volume is cranked open to hear a weak signal, a strong signal coming on the channel will cause the speaker volume to blast—but I guess that's one of the trade-offs for super-miniaturization.

Though the speaker is the usual minia-

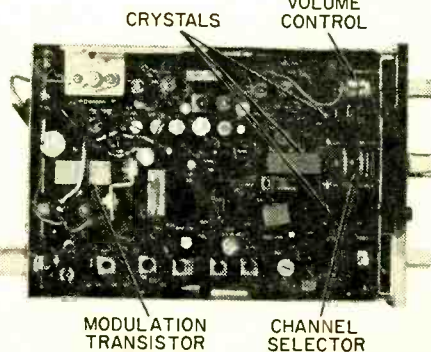

Modulation transformer, output transistor give 100 percent modulation capability.

e/e
checks
out
a...

CTS FUTURA V SPEAKER SYSTEM



It's a sure bet for console sound

Do you look at your pip-squeak sound system and vicariously substitute an ultimate supersound layout you've been planning for years? And whenever your buddy takes the plunge and comes up with a new stereo console, do you drool?

Keep cool, friend. With a reasonably good hi-fi stereo amplifier you can update your speaker system to sound as good as those speakers in his multi-\$ console. Here's how.

A manufacturer of literally millions of custom-design loudspeakers—who until now dealt with manufacturers only—offers seven speakers from its line for home construction through mail order. The company, CTS, has supplied its speakers to every major home equipment manufacturer in the U.S. Now CTS offers both the speakers and applicable crossover components for use in a do-it-yourself enclosure.

The Futura V system includes hardware needed for a complete high quality speaker

except for the cabinet. Priced at \$63.91 it includes a 12 in. woofer, 4½ in. honker (midrange) and 3 in. tweeter. Also included are three coils and three condensers for the crossover network, and two level controls—one for the honker and one for the tweeter.

Basically, the builder does what we all did back in the early days of hi-fi, he uses component hardware with an enclosure built and finished to his own specifications. If the wife wants a Mediterranean, or even Roman finishing, there's no hassle; you simply add the necessary cabinet trim and stain or paint lacquer. If you don't feel like paying for finishing material because the speaker will be used in the shop or playroom, simply leave the cabinet *au naturel*. Unlike complete factory assembled speaker systems you don't have to pay for finishing if you don't need it.

Woofed Sound Spreads. The photographs show a typical unfinished enclosure assembled with the Futura V components. As usual, the woofer is mounted near the bottom of the cabinet; it has no directional characteristics so its position is really unimportant. But if placed near the top, the center of gravity would be much too high for good cabinet stability—it would easily be tipped over.

The midrange honker is positioned above the woofer, and the tweeter is located near

(Continued on page 94)

Three way crossover has full control over high and midrange speakers. Mount crossover components on rear panel for strength. Circle No. 28 on page 17 or 103 for info.

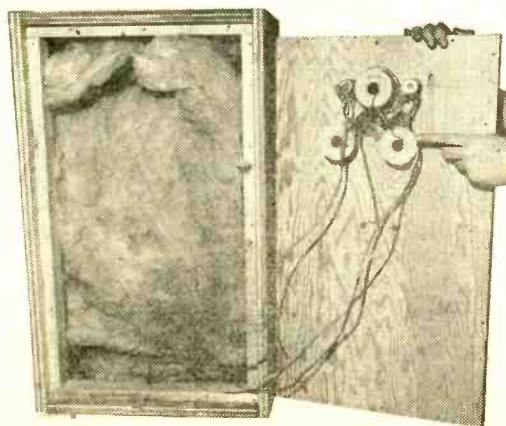

POINTING PAYS OFF

All it takes is the poking digit prodding with pressure on a map to point out your present position!

By Joe Gronk

Imagine an electronic system that enables a taxi or truck driver to report the location and status of his vehicle in less than one second by touching a pressure-sensitive map! Well, it was made possible by GTE Sylvania Incorporated who designed Digimap. This new system is designed for use with existing GTE Sylvania communications equipment that reduces radio channel congestion by sending messages in quick tone bursts rather than by voice.

The system consists of a terminal mounted in a vehicle and base station equipment which includes a computer, a map situation screen, and a keyboard video unit. Each vehicle terminal has a pressure-sensitive map mounted on a grid-coordinate board which the driver merely touches to indicate his position. The vehicle also has a keyboard and small video screen for sending and receiving messages. The base computer decodes and processes messages, the situation screen illustrates vehicle status and location, and the keyboard video terminal transmits and receives information.

With Digimap, a dispatcher, who must know

the status and location of his vehicles, need not cope with radio congestion. He can, thus, respond more effectively to an incident. An officer reports his status and location by touching a "status" key, and then pressing the point on the map that coincides with the location of his vehicle. A color-coded indicator appears immediately at that spot on the headquarters map. This frees the dispatcher from frequent radio checks and the manual updating of the status board.

The system also permits patrol cars to send pre-selected messages such as "send ambulance" simply by pressing a button. In addition, they can transmit numerical and descriptive text by typing on the keyboard. License plate checks can be made from patrol cars directly to computer files in seconds.

An important secondary benefit of the system is in supervising and planning. Each digital transmission can be stored on magnetic tape. Analysis of the tape helps determine what workloads should be and how patrol vehicles should be deployed. ■



Here's Digimap, an electronic system that enables a driver to report the location and status of his vehicle in less than one second by touching a pressure-sensitive map.

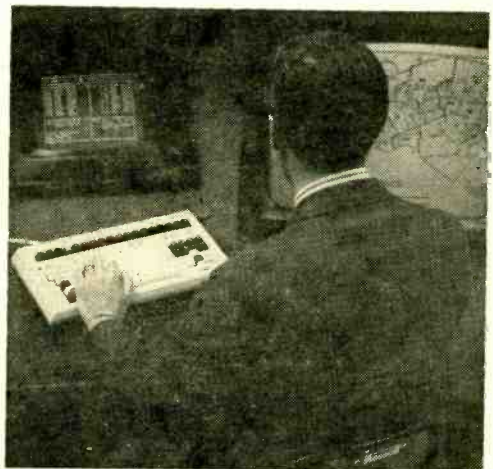

The Digimap base station equipment includes a computer, a map situation screen, and keyboard video unit for sending and receiving messages. Each vehicle contains a pressure-sensitive map which the driver merely touches to reveal his status and location. A color-coded indicator appears immediately at that spot on the headquarters map (right).



all *NEW* BASIC COURSE in ELECTRICITY & ELECTRONICS



UNDERSTANDING SIMPLE CIRCUITS

What you will learn. You are now going to learn what simple electrical circuits are and what they can consist of. You will become familiar with voltage and current and will learn the difference between direct current (DC) and alternating current (AC). You will become acquainted with electrical diagrams and construction of circuits.

This series is based on **Basic Electricity/Electronics, Vol. 1**, published by **Howard W. Sams & Co., Inc.**

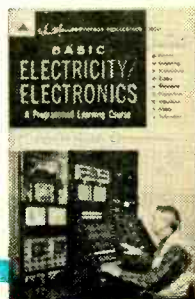

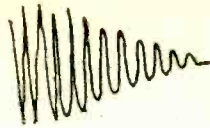
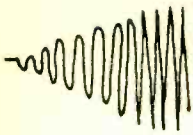

COMPLETE ELECTRICAL CIRCUITS

If you look in a dictionary, you will find that *circuit* means to make a complete trip. In electricity, current makes a complete trip through an *electrical circuit*. However, if the circuit is not complete, current does not flow. Current flows only if the path through the circuit is complete. A broken wire, a loose connector, or a switch in the *off* position will prevent current from flowing.

You must now learn two important facts regarding the flow of current. A voltage source *causes* current to flow, and a complete circuit *allows* current to flow.

Voltage is measured in terms of a unit called a volt. A measurement unit indicates quantity or amount, as in gallons of water or pounds of sugar. Volts, therefore, express a quantity. Though voltage is not visible like water and sugar, the number of volts expresses an amount of electrical pressure available from an electrical power source. It is this pressure that causes current to flow from the source. The greater the pressure (number of volts), the greater the current will be through a given circuit.

- Q1. In electricity, a circuit provides a path for to make a trip.
- Q2. Current flow is caused by a(an) and permitted by a(an)

Your Answers Should Be:

- A1. In electricity, a circuit provides a path for **current** to make a **complete** trip.
- A2. Current flow is caused by a voltage source and permitted by a **complete circuit**.

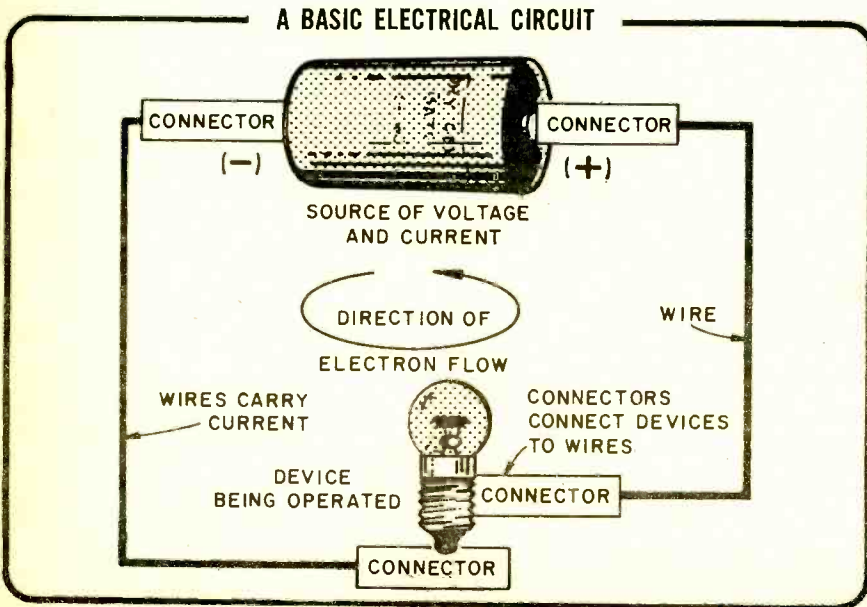

HOW ELECTRICAL CIRCUITS ARE MADE

All electrical circuits consist of the basic units shown in the illustration. The device being operated, a small lamp in this case, can be any electrical or electronic device. In fact, many electrical circuits contain more than one device to be operated.

Now that you are familiar with the basic units of an electrical circuit, you are ready to learn more about each part.

Voltage Source

A battery is an example of a voltage source. As you recall, a voltage source is also a source of current.

The electrical wall socket (or outlet) is another widely used source of voltage and current. The outlet is part of another circuit that has a generator as a voltage source. There may be many miles of wire between the generator and the outlet.

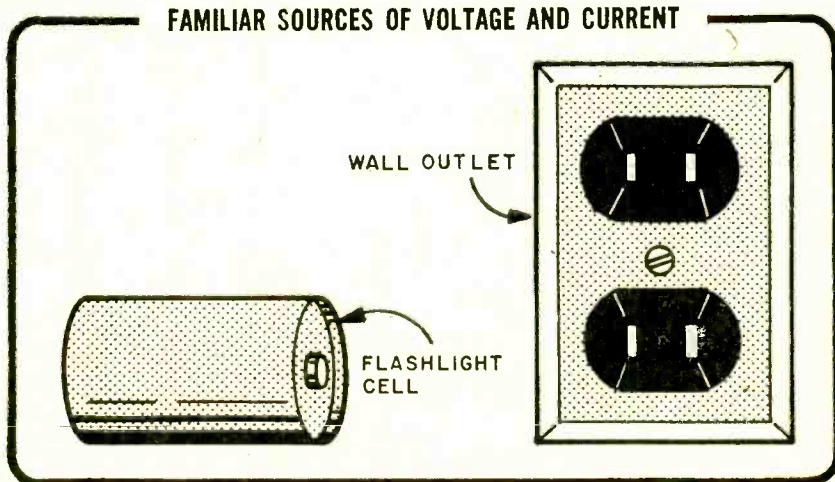

The battery shown in the illustration is more properly called a *cell*. A cell was originally considered to be a storage device. Cells, such as those used in a flashlight, develop approximately 1.5 volts each. A *battery*, such as the 6- to 12-volt source in an automobile, is constructed of two or more cells. In everyday English, a cell is often referred to as a battery.

- Q3. List the four basic units of an electrical circuit.**
Q4. A lamp will light only when it is part of a(an)
.....
Q5. A(an) joins wires to a voltage source or operating device to make a complete current path.
Q6. A(an), such as a battery, is also a source of current.
Q7. Voltage sources of the type used in a flashlight are more properly called
Q8. A single flashlight cell is a source of . . . volts.
Q9. If a 6-volt battery has four 1.5-volt cells, a 12-volt battery will have 1.5-volt cells.

Your Answers Should Be:

- A3. The four basic units of an electrical circuit are:**
1. Voltage source.
 2. Device being operated.
 3. Wires.
 4. Connectors (terminals).

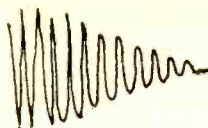
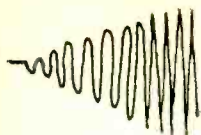

- A4. A lamp will light only when it is part of a **complete circuit**.
- A5. A **connector** joins wires to a voltage source or operating device to make a complete current path.
- A6. A **voltage source**, such as a battery, is also a source of current.
- A7. Voltage sources of the type used in a flashlight are more properly called **cells**.
- A8. A single flashlight cell is a source of **1.5 volts**.
- A9. If a 6-volt battery has four 1.5-volt cells, a 12-volt battery will have **eight 1.5-volt cells**. (If a 12-volt battery provides twice as much voltage as a 6-volt battery then it must have twice as many cells.)

Voltage Source Connections

All sources of voltage (and current) have at least two connections.

The source of voltage and current in an electrical circuit is similar to a pump in a water system. The *pump* provides both the *pressure* and the *water* to cause a flow through the *water system*. A *voltage source* provides *electrical pressure* (voltage) and *current* (electrical equivalent of water) to cause a flow through an *electrical circuit*.

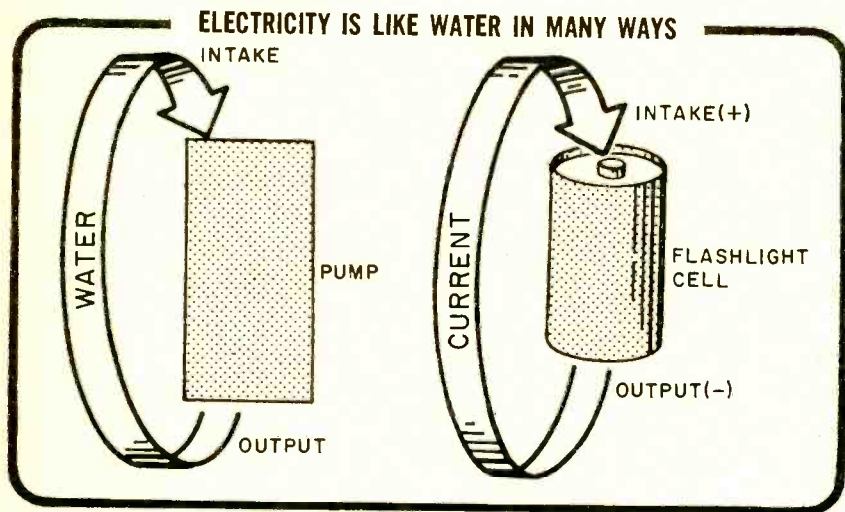

Like the water pump, the source of voltage and current requires an input connection and an output connection.

Safety note. Caution must always be observed when working near voltage sources or circuits. If you come in contact with both connections of the source, *your body becomes part of the circuit*, and current will flow through you. This can cause painful burns and even death. If you touch only one side of the source or a single wire leading to it, *be sure you do not touch a pipe or other metal surface in contact with the ground*. This precaution is necessary because many voltage sources have one connection wired to ground.

Conductors and Insulators

Wires provide a path for electric current just as pipes provide a path for water. Metals such as copper and aluminum are most commonly used in the manufacture of electrical wire. Their atomic structures make these metals good *conductors* of current. Silver is the best conductor but is much more

expensive than other metals. Other more economical metals, such as copper and aluminum, are good conductors and are quite easily formed into wire. When connected into a circuit, wire is most often referred to as a *conductor*.

Most nonmetals are very poor conductors of electric current. These materials are called *insulators*. Rubber and plastic are two commonly used materials for insulators because they are flexible, easily molded, and can be readily cut when necessary. Because of their better insulating qualities, glass and ceramic material are used where high-voltage insulators are required.

Q10. How many connections must be made to a voltage source?

**Q11. Materials which provide an easy path for current are called
..... Those which do not provide an easy path
are called**

Your Answers Should Be:

A10. At least two connections must be made to a voltage source.

A11. Materials which provide an easy path for current are called **conductors**. Those which do not provide an easy path are called **insulators**.

Working With Wire

Practically all wire used in electrical and electronic work consists of a conducting metal (usually circular in cross section) covered with insulation. The insulation prevents *undesired connections* to and between conductors.

Exceptions include wire used for heating purposes. In these cases, the heating element (wire) is wrapped or formed on an insulating material or supported in air (a nonconductor) between insulators.

If a bare wire comes in contact with another conductor or other metal in an electrical unit, a *short circuit* develops. Current will flow through the *short* instead of the complete circuit containing the operating device. For this reason, wire should be handled with sufficient care to ensure that its insulation is not damaged.

Wire Stripping. In order to join a wire to a connector, a length of insulation must be removed from the wire. A metal-to-metal connection is required to permit current flow.

The process of removing the insulation is called *wire stripping*. Both wire cutting and stripping are usually done with a type of pliers called *diagonal cutters*.

Precautions. When stripping wire, do not be discouraged if at first you cut the end of the wire while stripping it. Success will come with practice.

Do not squeeze the plier handles too tightly when attempting to remove the insulation from the wire. Just break the surface of the insulation with the cutting head. The cut need not go through to the wire. A steady pull should then part or tear the remaining insulation. Placing the index finger between the handles prevents the cutters from closing completely and nicking or cutting the wire.

Q12. Nearly all metals will conduct

**Q13. Copper or aluminum are used in electric wires because
they are good**

**Q14. Materials that are nonconductors of current are called
.....**

**Q15. Insulation is used on wires to (make, prevent) contact
with other conductors of current.**

**Q16. Undesired contact between two conductors is called a(an)
.....**

**Q17. is the process of removing insulation from
a wire. It can be accomplished by pliers known as
.....**

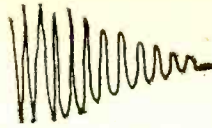
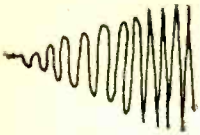

Your Answers Should Be:

- A12. Nearly all metals will conduct current.
- A13. Copper or aluminum are used in electric wires because they are good conductors.
- A14. Materials that are nonconductors of current are called insulators.
- A15. Insulation is used on wires to prevent contact with other conductors of current.
- A16. Undesired contact between two conductors is called a short circuit.
- A17. Wire stripping is the process of removing insulation from a wire. It can be accomplished by pliers known as diagonal cutters.

Devices

Current from a voltage source operates devices such as electric light bulbs, heaters, and motors. Radio and television receivers are also operated by current from voltage sources. These devices process voltages and current contained in received radio waves by changing the input energy into sound and pictures. The voltage sources make it possible for these devices to perform this process.

Connections. As stated earlier, all electrical devices must have two or more connections to a circuit. These connections are used to join conductors to the device, thus completing the circuit and permitting current to flow into and out of the device.

Operation. The voltage source operates the device by forcing current through the circuit. All connections must be made in the circuit, including those at the device and the source. Current will then be able to flow through the device and cause it to operate.

Connectors

The terms *connectors* and *terminals* are often used interchangeably. A

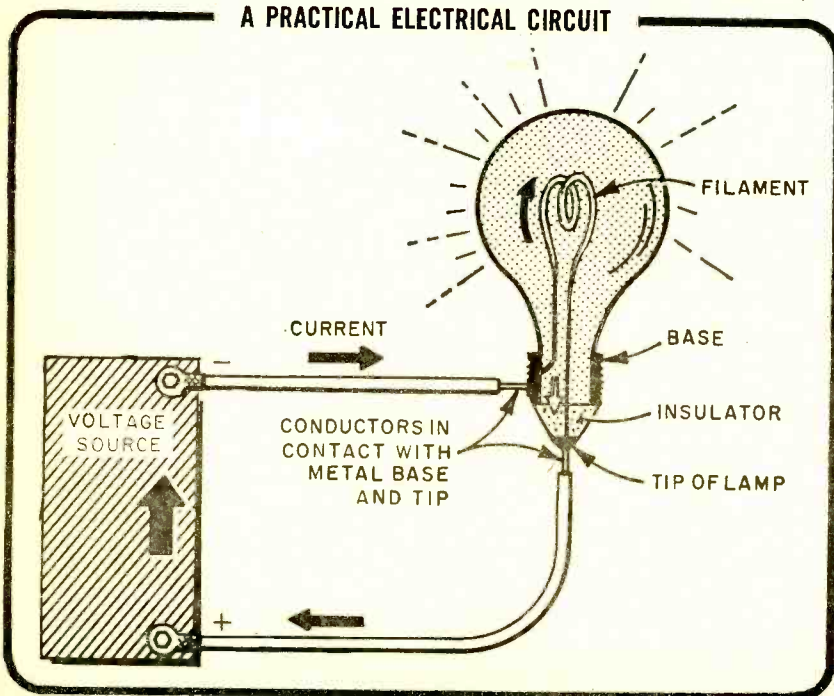

connector, however, is normally thought of as being a mechanical part, such as a battery clamp, used to connect a conductor to a device. A *terminal*, on the other hand, is a point on a device where a connection can be made—a screw or other contact point.

The illustration (opposite) shows how connections are made to a voltage source and an operating device. The lamp will light with the bare conductors merely touching the lamp terminals. In practice, however, the lamp is placed in a socket and the wires connected to the socket terminals.

Wires, connectors, and terminals allow current to flow in a circuit because they are made of conducting metals. Care must be taken, however, when joining these parts to each other. Metal at the contact points must be clean and free from the insulating properties of dirt, grease, etc. Sandpaper or a small file can be used to clean these junction points when necessary. After a wire has been stripped, it should be cleaned of any remaining insulation.

When connecting a wire to a terminal, make sure the screw or clamp makes a tight connection. For current to flow, all parts of the circuit must be connected.

Q18. To permit current to flow into and out of a device, the device must have at least - - - connections.

Q19. That part of a device where a connection can be made is called a - - - - - .

Your Answers Should Be:

A18. To permit current to flow into and out of a device the device must have at least two connections.

A19. That part of a device where a connection can be made is called a terminal.

A PRACTICAL CIRCUIT

The circuit shown below demonstrates the way in which all basic circuits are connected. It contains a voltage source, wires, connectors (or terminals), and an operating device. The voltage source pictured is a large 1.5-volt dry

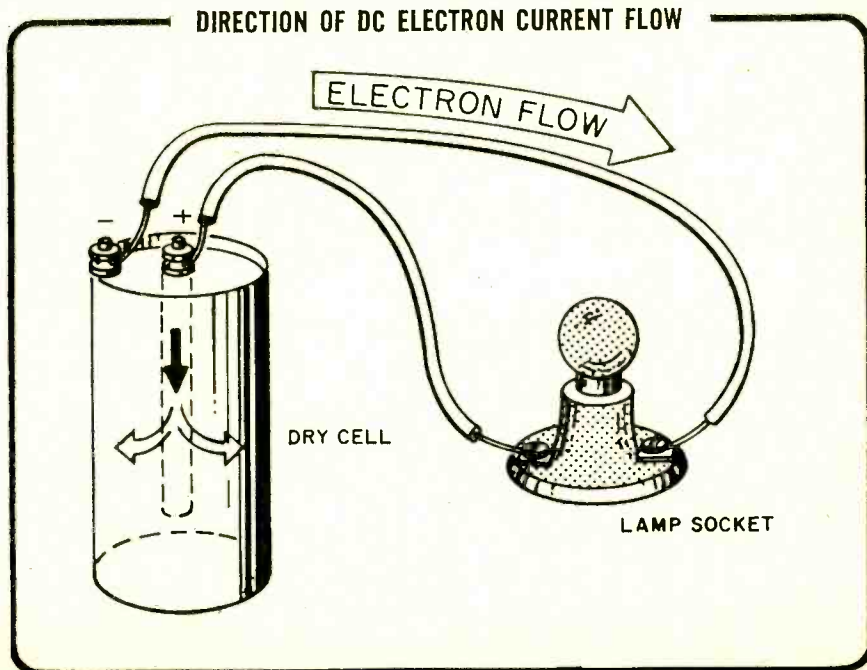

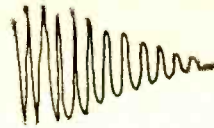
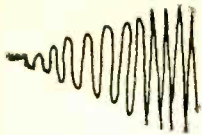

cell used in some doorbell systems. This is a practical circuit because it will actually work and is often used.

Open Circuits

If all the connections are made as shown in the illustration, the lamp will light. If any of the connections are not properly made, the lamp will not light—a condition known as an *open circuit*. An open circuit represents a condition that prevents the flow of current. In other words, the circuit is not complete.

Closed Circuits

A *closed circuit* has all of its connections made and forms a complete path through which current can flow.

SWITCHES

Since it is often desirable to open and close a circuit, nearly all circuits contain some form of *switch*.

Knife Switch

The simplest type of switch is called a *knife switch*. It was given this name because it has an element resembling the blade of a knife.

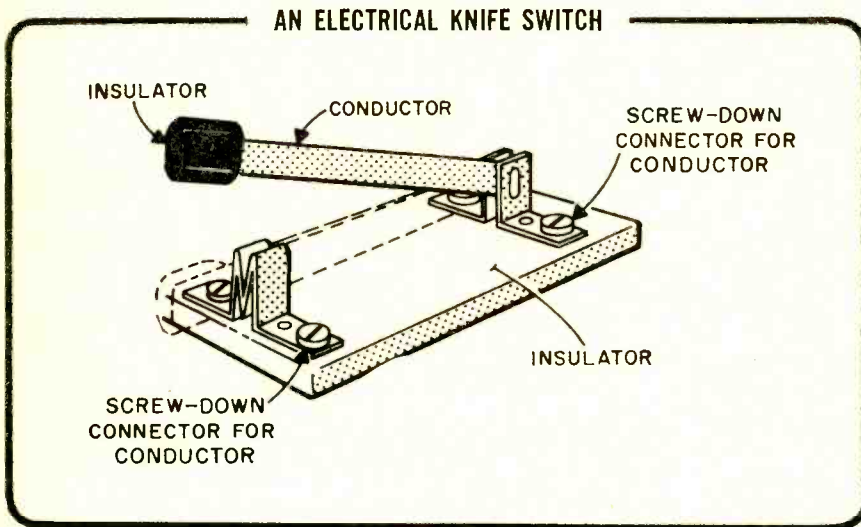

- Q20. The lamp in the illustration on the opposite page lights because is it a(an) (open, closed) circuit.
- Q21. Disconnecting one of the wires will develop a(an) (open, closed) circuit.
- Q22. To permit opening and closing a circuit, a(an) - - - - - can be connected into it.
- Q23. A(an) - - - - - is the basic type of switch.

Your Answers Should Be:

- A20. The lamp lights because it is in a closed circuit.
- A21. Disconnecting one of the wires will develop an open circuit.
- A22. To permit opening and closing a circuit, a switch can be connected into it.
- A23. A knife switch is the basic type of switch.

The basic circuit just explained can be reconnected to include a knife switch. The illustration shows how the connections are made. Be sure you understand what happens to the flow of current when the switch is open (position shown) and when it is closed.

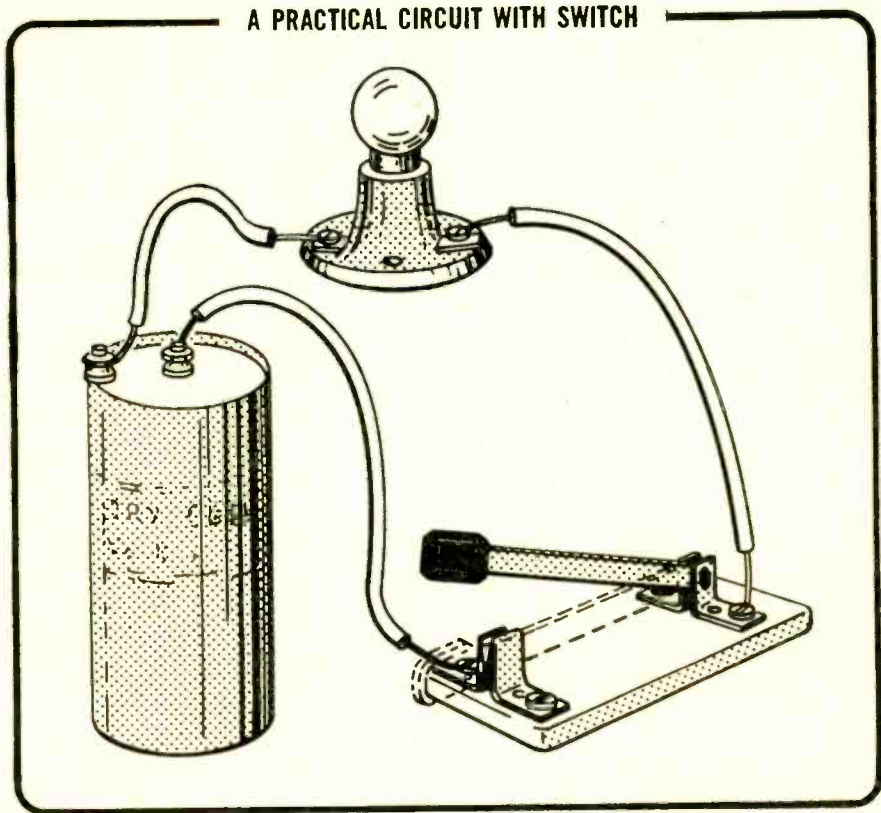

There are many other types of switches, some of which you have used. For example, there are switches on the walls of your home, on the front of your appliances, and on the dashboard of your car. Nearly all operate on the knife-switch principle. In the closed position, a metal blade makes an electrical contact between at least two conductors.

VOLTAGE AND CURRENT

In this section you will become acquainted with voltage and current measurement units. You will also become familiar with the commonly used values of these units.

Voltage

Voltage is measured in terms of a unit called a volt; the number of volts expresses the amount of electrical pressure available from the source. As you remember, it is this pressure that causes current to flow. The greater the pressure (number of volts), the greater the current will be.

Current

Current is measured in terms of a unit called an *ampere*. The number of amperes defines the amount of current that is flowing in a circuit. A typical flashlight lamp (bulb), for example, draws 0.25 *ampere* (abbreviated as A or

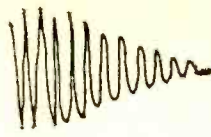
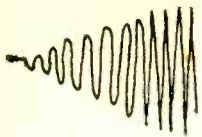

amp) from the voltage source.

A 100-watt lamp draws approximately 1 amp from the 117-volt home electrical system. Ten amps flow through some electric irons, toasters, and heaters. A car battery supplies 100 amps or more to a starter motor.

Large and Small Values

Values of voltage and current can be very large or very small. Since it is awkward to talk and write about 500,000 volts or 0.003 amp., units which are more easily handled have been developed. With this system the quantities mentioned become 500 kilovolts and 3 milliamps, respectively. A *kilovolt* represents 1000 volts and a *milliamp*, 0.001 amp.

The table will help you convert from one unit to another.

CONVERSION TABLE

| WHEN YOU SEE | DO THIS TO CONVERT | EXAMPLE |
|----------------|-----------------------------|-----------------------------------|
| Mega or M | Multiply by 1,000,000 | 2 Megavolts is 2,000,000 volts |
| Kilo or k | Multiply by 1,000 | 5 Kiloamps is 5,000 amps |
| Milli or m | Divide by 1,000 | 7 Millivolts is 0.007 volt |
| Micro or μ | Divide by 1,000,000 | 9 μ amps is 0.000009 amp |
| Nano or n | Divide by 1,000,000,000 | 5 nano volts is 0.000000005 volt |
| Pico or p | Divide by 1,000,000,000,000 | 4 pico-amps is 0.000000000004 amp |

- Q24. Voltage is measured by a unit called a(an) - - - .
- Q25. The number of volts indicates the quantity of - - - - - contained in a voltage source.
- Q26. An ampere is a unit that indicates the quantity of - - - - -.
- Q27. Assuming that the voltage source can provide the current, what determines the number of amps that will flow in a circuit?
- Q28. 3 kilovolts is (larger, smaller) than 100 millivolts.
- Q29. How much of an amp is 15 microamps?
- Q30. Convert 16 megavolts to volts.

Your Answers Should Be:

- A24. Voltage is measured by a unit called a **volt**.
- A25. The number of volts indicates the quantity of **electrical pressure** contained in a voltage source.
- A26. An ampere is a unit that indicates the quantity of **current**.
- A27. The operating device determines the number of amps that will flow in a circuit, assuming the voltage source can provide it.
- A28. 3 kilovolts is **larger** than 100 millivolts.
- A29. 15 microamps is 0.000015 amp.
- A30. 16 megavolts is equivalent to 16,000,000 volts.

DIRECT CURRENT

A current that always flows in the same direction is called *direct current*. Dry cells and batteries are sources of direct current. Some type of electric generators also supply direct current. Later you will learn about a power supply which provides direct current for use within radio and TV receivers.

Is There a Direct Voltage?

Yes. A voltage which provides direct current is considered to be a direct voltage. Since direct current is abbreviated DC, the abbreviation is used to identify direct voltage as DC voltage. Direct current is often shortened to DC current, or merely DC.

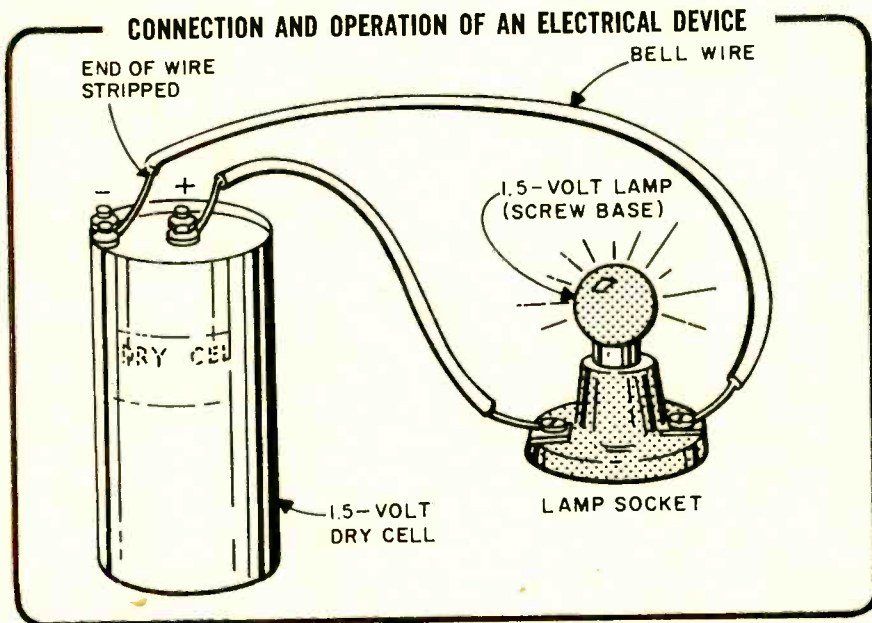

Direction of Current Flow

Marking the terminals of a voltage source with plus (+) and minus (-) signs indicates the direction in which current flows in a circuit. There are two systems describing the direction of current flow—*conventional* and *electron*.

The *conventional current* theory was the first to be developed. Benjamin Franklin is considered to be its originator, and it is still being used in many electrical engineering texts. *Conventional current* is said to flow *from the positive (+) voltage terminal*, through the circuit, and to return *to the negative (-) voltage terminal*.

The *electron current* theory, of more recent origin, permits a clearer explanation of how current flows through electronic circuits. For this reason, the electron current direction of flow will be used in this course. This theory states that current *leaves the negative (-) terminal*, flows through the circuit, and *returns to the positive (+) terminal* of the voltage source.

Current flow does all the work involved in the operation of any electrical or electronic device, whether it is a simple lamp or a complicated electronic system on the Moon. In any application a continuous path must be provided between the two terminals of a voltage source before current can flow.

Q31. The connecting posts on the cell in the illustration are marked (+) and (-). The (+) post is the terminal.

Q32. Inside the cell, electron current flows from the terminal to the

Your Answers Should Be:

A31. The (+) post is the **positive** terminal.

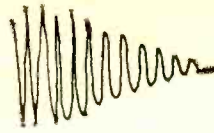
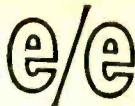
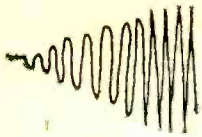

A32. Inside the cell, electron current flows from the positive terminal to the negative terminal. Though the text did not provide this information, the illustration reveals the proper direction. Current must flow in this direction inside the battery if it is to move from negative to positive through the circuit.

ALTERNATING CURRENT

A current that reverses its direction of flow at regular intervals is called *alternating current (AC)*. You might ask, "Why should we have a current that is constantly changing its direction?" The answer is fairly simple. AC has certain features that make it desirable. The two main reasons are:

Reason 1. Wall outlets in your home supply an AC voltage. This voltage is produced by generators located many miles away. During the earliest days of electricity, DC was supplied to homes. However, DC can be sent through lines for only short distances.

AC can be easily changed to a higher or lower value. This characteristic makes possible its economical transmission over long distances—hundreds of miles in some cases. As a result, AC generating plants can be located at remote sources of water power and still be able to supply customers miles away. A good example of this application is the generating equipment at Hoover Dam in Arizona supplying power to cities on the West Coast, hundreds of miles distant.

Reason 2. Energy in many forms, such as sound and radio waves, occurs in alternating cycles. Sound waves, for instance, are alternating areas of maximum and minimum air pressure. When converted into electricity, as in the telephone, the resulting current is also alternating, thus the sound is faithfully transmitted. Clearly, it simply isn't feasible to convey such information via DC.

WHAT YOU HAVE LEARNED

1. An electrical circuit provides a complete path for current flow.
2. Every electrical circuit consists of: (1) a source of voltage which causes current to flow; (2) conductors which provide a path for the current; (3) electrical devices which are operated by the current; (4) connectors (terminals) to join conductors to a source or a device.
3. Volt and ampere quantities are often expressed in very large and very small numbers. To ease the task of writing or speaking of very large or very small numbers, prefixes, such as mega-, kilo-, milli-, and micro-, have been added to the basic units of volts and amperes.
4. A current that always flows in the same direction is direct current. Its abbreviation is DC, which can be used to specify DC current or DC voltage.
5. Current flows from the negative terminal of a voltage source, through the circuit, and returns to the positive terminal. Inside the voltage source, current flows from the positive to the negative terminal.
6. A current that reverses its direction of flow at regular intervals is called alternating current (AC). AC voltage and current can be transmitted over long distances, but DC cannot. AC is also the only means of converting certain types of energy into useful electrical representations.

This series is based on material appearing in Vol. 1 of the 5-volume set, BASIC ELECTRICITY/ELECTRONICS, published by Howard W. Sams & Co., Inc. @ \$22.50. For information on the complete set, write the publisher at 4300 West 62nd St., Indianapolis, Ind. 46268.

NewsScan

Continued from page 22

cuits tested. This high reliability makes the device suitable for use in automatic wire routing systems where twisting is continuous as wires are bonded to the boards.

BETTER TRAVEL—ELECTRONICALLY

Six-foot squares of sensing wires buried in the roadbed . . . an electronic eye watching down from the sky . . . a voice by the side of the road . . . and a fleet of tow trucks racing to the rescue. These are some of the components of a new California Division of Highways' system to relieve freeway tieups caused by traffic accidents.

The motorist, who often feels that the State opens a fast freeway and then leaves him there all by himself to cope with traffic problems, will soon lose his feeling of abandonment under the new Los Angeles Area Freeway Surveillance and Control Project. The system is considered to be the first step toward a fully automated freeway system.

The general concept of the California Division of Highways' Freeway Operations Department is to develop and put to use electronic hardware that will provide safer and more efficient use of freeways.

One phase is to try to minimize the tieups that result when car accidents, truck turnovers, stalled vehicles, fires and other "random events" occur on a busy freeway. Such incidents account for about 50% of the congestion today, equalling that caused at predictable known sites that normally jam up during peak traffic hours.

To ease freeway congestion, a helicopter borne "eye in the sky" will begin this month to aid in guiding Los Angeles motorists through the world's most intricate traffic complex. The closed circuit television system is one element of a real-time surveillance, control and early warning system that will help keep moving the 700,000 vehicles that daily travel the Santa Monica-Harbor-San Diego Freeway triangle.

Some bottlenecks have been alleviated by restriping or building added lanes. Timing vehicle entry at critical on-ramps has also eased access by metering. The closing of a few ramps has also improved traffic flow. But the stubborn problem of "non-recurring" incidents brings many other factors into play.

To learn quickly exactly where such incidents occur in real-time sequence, the pilot project has just been completed on a 42-mile loop on the three major freeways: for 12.7 miles on the Harbor Freeway, for 16.6 miles on the San Diego, and for 12.7 miles on the Santa Monica.

The surveillance system includes squares of wire that are buried in the roadbed to provide instant data about how many cars are passing

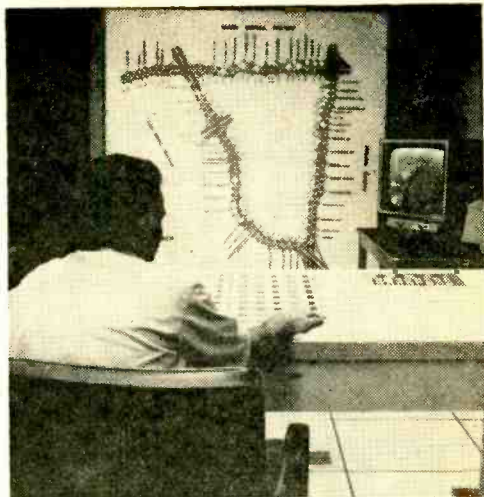

Control Center for Los Angeles freeway surveillance and control system developed by Raytheon Company receives information about traffic conditions on three heavily traveled freeways in Southern California. The control center can then direct appropriate corrective actions to help keep traffic flowing.

a given point, and how long they are staying over that point, which indicates the volume and density of traffic.

Telemetering equipment has been installed to relay that information to the Control Center on Vermont Street near downtown Los Angeles. The computer instantaneously analyzes this input and transfers the data to an information display map of the freeway loop.

Speeds and densities of traffic at stations ½ mile apart are indicated on the map by red, green and yellow lights. Trouble or unusual incidents are indicated by a flashing red light at the appropriate spot on the map.

The push of a button will provide the actual count and density at several stations in the area and tells if the incident is blocking lanes, how many are blocked and how congestion is stacking up behind the trouble spot.

The first phase will include an operational ramp control project which is instantly responsive to freeway traffic flow. If an unexpected tieup occurs, on-ramps beyond the site will be automatically metered to cut back entering vehicles until the troubled area is cleared.

The second phase to begin operations this month is the dispatching of a California Highway Patrol helicopter to the scene as advised by the computer and signal system. The helicopter will transmit pictures of the actual incident live over closed circuit television to the Control Center.

The television picture will aid in determining what kind of emergency equipment should be dispatched to help the situation. The California

Highway Patrol will direct the assignment of ambulances, fire trucks, sanding trucks and sweepers to clean the roadway, as well as the tow vehicles operated by the Division of Highways.

The entire system will also include the installation of alternative methods for warning the motorist of trouble ahead and providing information useful for fast, safe travel.

WHERE THERE'S NO SMOKE

Unlike conventional fire detectors, the new ionization detector doesn't depend on smoke or flame or heat to trigger an alarm. Instead it uses space-age technologies to spot the "invisible smoke" given off by any combustion, no matter how slight. A fire gives off more than



Firebelle displays Honeywell's new ionization detector that reacts to "invisible smoke," spots a fire long before there's any flame or wisp of smoke. The fact that fires give off twice as much "invisible smoke"—aerosols and other combustion by-products—as regular smoke, enables this detector to respond much earlier than conventional detectors.

twice as much invisible smoke—aerosoles and other by products—as the visible kind, and the new detector's ability to sense this invisible smoke enables it to react more swiftly than even the most sensitive thermal unit.

In use, the detector has a small electrical current trickling between two charged plates. Even a very small amount of combustion gives off enough of this invisible smoke to interrupt the current and trigger an alarm. To forestall false alarms the detector has a special checking chamber for reference, so that changes in temperature, humidity or barometric pressure won't

turn in a false signal. It ignores, for example, ordinary cigarette smoke.

The detector made by Honeywell, measures about five inches across, and can be flush- or surface-mounted. A telltale light glows if a detector has turned in an alarm. An integral sensitivity switch permits adjustments for special room situations, computer areas and the like.

CTS Futura V

Continued from page 79

the top to spread the highs which are more directional and, therefore, require top billing.

A crossover network is mounted on the rear panel. Note that the coils are large and are wound with heavy wire, so connections can be simply twisted and soldered; there's no need for terminal strips or fancy lead dress.

When everything is mounted and connected, you simply fill the enclosure with loose-packed fiberglass (the type used for house insulation will do), screw in the back, and the speaker is ready for use. If you intend to finish the cabinet we suggest you get everything assembled for a trial run. If all is okay, remove the components before the final finishing operations. No useful purpose is served by loading speaker cones with sawdust, varnish or stain!

Both the honker and tweeter level controls have a full off-to-on range, so just about any degree of midrange and high frequency performance can be user adjusted—unlike many commercial speaker systems with brilliance and brightness controls that have

(Continued on top of next page)



a limited adjustment range.

Listener's Report. Our listening panel judged the finished system—in the cabinet we built from scratch—to have a good “console” sound, comparing favorably or even better than the systems supplied in many high-cost complete equipment consoles. The low end goes down low enough for a full, rich sound, but not so low to produce an annoying rumble from low cost turntables or record changers.

The overall sound quality is well suited for modern sounds; the *hard* midrange sound being well suited to rock, soul and

folk music. The wide range of honker and tweeter level adjustments proved particularly good at adjusting the overall sound to match what each listener considered optimum for modern music.

The Futura V speaker system is rated at 8 ohms so it can be used with just about every solid-state and tube-type amplifier made. It can even be used to improve the performance from portable phonographs and compacts.

For additional information circle No. 28 on the Reader Service Coupon on page 17 or 103. ■

Vibra-Tone

Continued from page 61

highly recommended at all points of termination.

Double Up. Note that in some instances two pads are required at some termination points. Be sure that these overlap and that

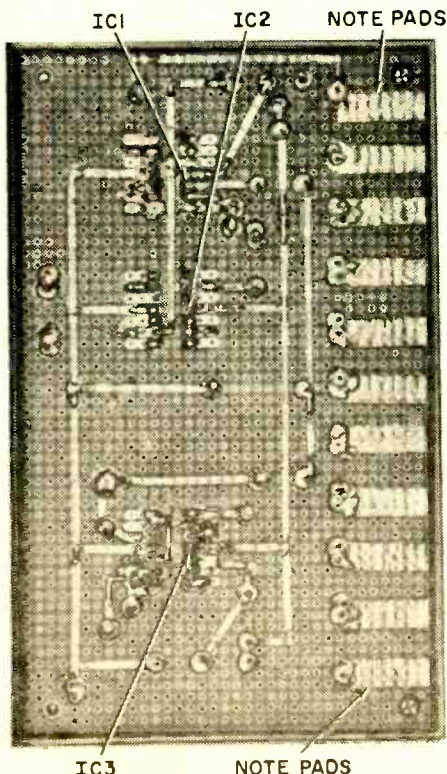

Lead photo shows cardboard cover over suggested wiring layout for Vibra-Tone.

solder flows between the pads for a good connection. The components terminated on the pads should be mechanically secure without support from the pad. That is, resistors and capacitors should be pushed through holes in the board so that the component rests firmly on the vectorboard.

Identify the IC's and insert them correctly in the board. Once the IC's are mounted, the other parts, resistors and capacitors can be mounted in any order. Electrolytic capacitors have a polarity marking. Be sure the positive (+) end is properly connected. Tuning resistors R9 to R19 must be the resistance values indicated, and be sure they are $\pm 5\%$ as specified, otherwise the tuning may be way out. The 5% resistors have a gold band. If the vibrato is too strong causing a break up on the lowest two or three notes, vary the size of resistor R3; an increase will decrease vibrato.

Tune Up. Trim pot R8 provides some adjustment of the tone over the entire scale. Adjust this control as required to tune the vibratone. If the resistance of R8 is set to low, the low notes may not play. Also, at least one of the switches must be closed for the unit to work. ■

Bearcat III

Continued from page 54

everything is quality all the way. For example, every switch, wire and terminal that handles 110 VAC is fully shielded, and should you unknowingly plunge in to change crystals while the power is *on*, you're not going to get across the high voltage. Another example is the connecting pins for the tuners; they look as though they can withstand a shot to the moon and back. Even

stand a shot to the moon and back. Even the socket for the screw-in telescopic antenna is well thought out—it is V-tapered so the antenna, lowered blind through the cabinet, automatically centers in the socket to avoid cross-threading.

Pick Two. You need buy only the tuners you need; the letters L, H and U after the model number BC3—indicate the equipment. For example, BC3-L is only the low band coverage; BC3-H/U is VHF and UHF coverage. Keep in mind that each tuner is factory aligned for a specific tuning range, ie, low band is 33-48 MHz. VHF is 150-174 MHz. If a channel you wish to monitor is outside these ranges be sure to specify a factory alignment to cover the desired channel (this is a common feature in scanners). The Bearcat III with one RF module costs \$139.95, and with your choice of any two modules, \$159.95. For additional information circle No. 43 on Reader Service coupon on page 17 or 103. ■

Fisher 801 Receiver

Continued from page 42

test level of 1000 μ V, the distortion measured 0.27 percent with a 75 dB signal to noise ratio—which is *dead quiet* from any viewpoint. The frequency response was a tight $+0.5/-0.2$ dB from 20 to 15,000 Hz. The selectivity was notably excellent and we were even able to separate *adjacent channel* stations. And if all this isn't enough, the worst-case stereo separation was 46 dB at 1000 Hz and 38 dB at 15,000 Hz—many tuners can't deliver 38 dB separation at 1000 Hz! Simply fantastic!

But measurements alone cannot really express the excellence of the FM reception. It is clean, amazingly clean. Many in our listening panel feel the 801's FM performance is "perfection."

The AM reception is AM reception. No one can turn a sow's ear (transmission) into a silk purse (reception).

The amplifier section sound is *first rate*. Power output per channel from each stereo amplifier with both channels driven at the clipping level measured 34 watts rms into 4 ohms, 24 watts into 8 ohms and 16 watts into 16 ohms. Frequency response at 17 watts rms output measured $+0.75/-0.2$ dB from 20 to 20,000 Hz at a distortion no higher than 0.32% THD at any frequency. The tone control performance is shown in

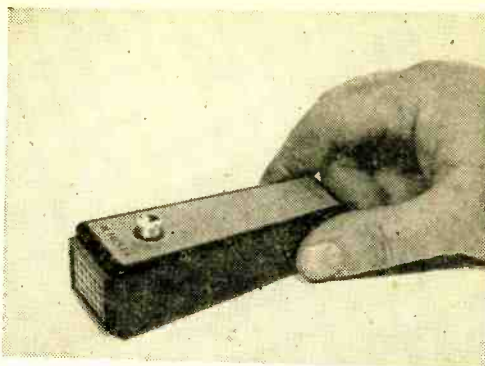

Remote control tuning with ultrasonic sound. Fisher 801 automatically pinpoints FM station with electronic vari-cap tuning.

the curves. Magnetic input hum and noise was 62 dB and notably hum-free—as though the amplifiers were powered by a battery.

Summing Up. The Fisher 801 is one helluva performer. It's what is meant by the term Gold Plated Special. For additional information circle No. 44 on the Reader Service Coupon on page 17 or 103. ■

Hey, Look Me Over

Continued from page 16

nated. The switches simply plug into the circuit board. Other features include: use of a single cable for all functions, AC, DC, Ohms, special measurements are provided for by two extra zero-center DC scales, full-view 6-in. meter gives accurate readings at a glance,

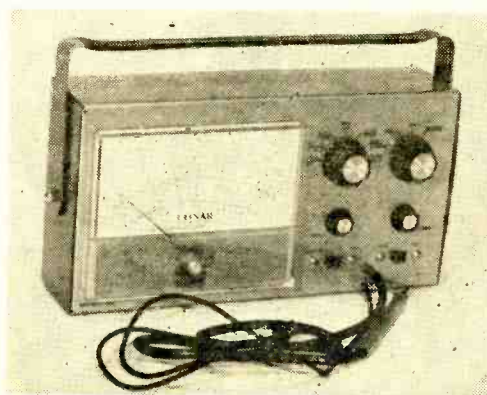

polarity reversing switch works on ohms scale and also makes testing semiconductors easier, and more. Retail price of the TVOM Kit is \$29.95 and the factory assembled model goes for only \$42.95. For further information, circle No. 48 on Readers Service Coupon on page 17 or 103. ■

Why over-pay as much as \$1000 for a new car?

Now \$1.50 gives you the bargaining muscle to get the car you want at the lowest price

160-plus fully-indexed pages by make and model of car • Thousands of listings • Prices for all domestic cars including American Motors, Chrysler, Ford, GM, GMC, International, Jeep • All models and accessories prices • Prices on light trucks

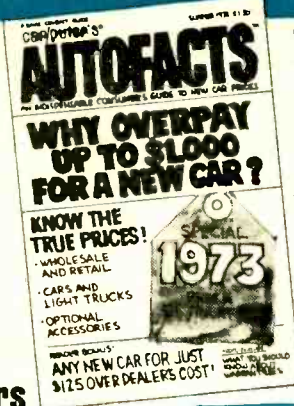

- WHAT DEALERS ACTUALLY PAY FOR CARS
- HOW MUCH DEALERS MARK UP THEIR COST ON THOSE "SPECIAL DEALS" YOU'RE OFFERED
- EXACT COST OF OPTIONS AND ACCESSORIES
- CHARGES THAT CAR DEALERS CAN ADD ... and lots more useful information.

Join thousands of smarter car buyers

More than a car-buying guide! More than a price-comparison listing. You get the easy-to-use, reliable, accurate dollars-and-cents figures that put you on even terms with professional auto-sales people who seek profits as avidly as you seek savings—on one of the biggest single dollar investments you make! Car/Puter's **AUTOFACTS** is an indispensable working tool for insurance companies settling claims, for banks in financing loans, for car dealers and salesmen in "cutting" from list prices. **AND FOR YOU, THE CONSUMER, WHO AT LAST HAS THE FIGURES TO SAVE HUNDREDS & HUNDREDS OF DOLLARS ON ANY NEW CAR PURCHASE!**

Dealers will take a small profit over their cost, rather than lose a sale—if it's offered to them! And this is where **AUTOFACTS** gives you real bargaining power!

With this truly valuable price-facts book, in seconds you flip to the new car you want... you check the dealer's cost... and you **MAKE YOUR OFFER RIGHT THERE ON THE SPOT!** Today, thousands have already saved unbelievable sums of money—this simple, no-begging way. **BEFORE YOU BUY ANY NEW CAR, get your copy of AUTOFACTS.**

Simply fill in and mail immediately the coupon with \$1.50 plus 25¢ for postage and handling (cash payment only) and the newest issue of **AUTOFACTS** will be sent to you immediately. Or if you prefer a subscription, send \$7.50 cash for all 5 editions shown in the coupon and save \$1.25 in postage.

estimated
1973
NEW CAR
PRICES

Fill in and mail this coupon today! do it now... limited copies!

SPECIAL BONUS FOR AUTOFACTS READERS!
***How to get a brand new car for only \$125 over dealer's cost!**
 New 48-hour computerized, service helps you make the best deal on your own—or you can arrange purchase through UAB for \$125 over cost! **HOW?** Through the United Auto Brokers' Car/Puter organization, participating with 400 dealers. Your purchase price includes freight, and pre-delivery service. No hidden charges! Take delivery from a local dealer without delay. A new car of your choice with every option you selected. **SAME NEW CAR WARRANTY AND SERVICE** as if you had paid full list... same financing and terms as if you had dealt with the dealer directly. **A BONUS COUPON** in your **AUTOFACTS** entitles you to a 20% discount off the Car/Puter computerized service. *Certain limited production or specialty models priced higher. Some foreign models not available.

If you're buying or selling a USED CAR, get the complete listing of all American make cars (and light trucks) for the past 7 years. There are two **AUTOFACTS** used car editions—Spring and Fall—complete with wholesale and retail prices. Only \$1.50 each.



Car/Puter's **AUTOFACTS** • Davis Publications, Inc. 229 Park Avenue South • New York, N.Y. 10003

Please enter my order for Car/Puter's **AUTOFACTS** as indicated below:

- Send Summer issue of estimated 1973 New Car Prices. Payment enclosed of \$1.50 plus 25¢ for postage and handling.
- Send Fall/Winter edition of Used Car Prices. Payment enclosed of \$1.50 plus 25¢ for postage and handling.
- I prefer a full year's subscription of five issues (this Summer's issue of estimated '73 New Car Prices; followed by actual '73 New Car Prices issue; '72 Fall/Winter Used Car Prices edition; next Spring a revised '73 New Car Prices issue; '73 Spring/Summer Used Car Prices edition.)
- Full year's subscription payment of \$7.50 is enclosed.

Write publisher for bulk rates. Add \$1.00 per issue for orders outside Continental USA & Canada.

name _____ (please print)
 address _____
 city _____ state _____ zip code _____

MAIL THIS COUPON TODAY! CC-AFX

Ask Hank, He Knows!

Continued from page 27

black plastic, drill a hole right through the center of the plastic locator key with a 1/8-in. drill bit. You'll break the seal and a hiss will follow indicating all's safe. If the base is all glass, then drill through the plastic locator key. Results will be the same—a hiss! As for that 4 or 5-in. hole in the bell of the tube—don't do it! Picture tube glass is prestressed and may shatter dramatically if damaged. Why don't you make lamps out of bottles as I do.

Watta Ground Plane

I have a Mosley SWV-7 vertical type antenna with 7 radial wires. I have this huge structure mounted on the roof. These radials are not to cross and touch. They all meet at the aluminum base (ground). The problem is under the roof's top layer. The insulation is partly aluminum. The screw-type tie downs used to fasten the radials penetrate the aluminum and thus short the radials just opposite the ground, at the ends only. Please tell me if this harms the performance of the antenna.

—M.M., Flushing NY

Real cool—you have a built-in ground plane. Try to make a good electrical connection to the aluminum at the base of the antenna and at various points along each radial.

Electronic Playboy

I am currently teaching my students about positively and negatively charged bodies by giving each a different sex. Our Superintendent of Schools thinks I should be brought up on charges. What do you say, Hank?

—D.C., Chicago IL

You know what happens when you bring the sexes together—sparks. Change your teaching style or you'll have trouble explaining uncharged or neuter bodies.

Clear Channel

I started tuning in the broadcast band because it was easy, but now new stations are getting tough to pull in. So I did some reading and came on a term "Clear Channel." What does it mean?

—G.A., Benton Harbor MI

There are exactly 107 channels on the broadcast band. They are 10 kHz apart starting at 540 kHz and ending at 1600 kHz. It is easy to spot the clear channels in White's listing for AM stations by frequency. Some 50 (approximately) channels have very few stations listed, and only one or two are 24-hour 50,000 watt jobs. Hence, you can bet your BFO they travel quite some distance without interference, especially at night. That, in a nut shell is what it's all about. Try to pull in the clear

channels one evening and you will notice how easy they are. However, the low power stations bunched up on one frequency (or channel) are tough to pull in because they interfere with one another. Usually you can hear only the nearest one on your BCB rig.

Cheaper by the Gross

Why are resistors so expensive?

—O.H., Boston MA

They're not! In fact, they are real cheap if you buy in quantity. But, buy one or two from your dealer's pegboard rack and you'll pay through the nose.

Don't Send Money!

Where can I get info on how to construct a loop antenna for the broadcast band? I have written several times to the National "Bleep" Club and even sent \$2.00 for a DX aid list, but they failed to respond.

—R.C., Baltimore MD

I'm glad you didn't send cash to me. Cash does not speed an answer back to you. You see, my policy is to answer letters in my column only! As for that National Bleep club, they are two bucks richer. As for your loop antenna, buy one or salvage one from an old AM set. I really don't know of plans for a loop antenna, so I can't help you. However, I do plan to experiment with some Litz wire and a ferrite rod—never can tell, I may be starting a whole new DX mania.

Phooey on PHET

I have built an FET millivoltmeter from a construction article that appeared in another electronics magazine. The unit has a flat response from 10 Hz to 1 MHz. After completing the unit as described, I find that I have trouble measuring voltages whose frequencies are higher than 50 kilocycles. For instance, when I am taking the measurement of low AC voltages which are less than 1 volt and the frequency is 100 kHz, I get extremely high readings on the meter when it is set to the 500 volt range and 150 volt range and the 50 volt range. I have double and triple checked my wiring and components and I cannot find anything wrong. It appears to me that the instrument is frequency sensitive.

—A.E.C., Brooklyn NY

Let's face it, you are correct. The unit is frequency sensitive. ELEMENTARY ELECTRONICS normally would not make such a claim because of varied construction practices of its readers. And the next time, why not write to "Bleep" Illustrated and let them know about your problem. It's their project. ■

Sorry, I cannot answer your problems by return mail. The press of time and the large volume of mail makes this impossible. Also, I cannot offer design services. Hints, yes! Plans, no!

—Hank

DX Central Reporting

Continued from page 24

If any of these products sound like they might help solve your DXing problem, drop a note to the manufacturer or distributor. They'll be happy to send you complete information.

Tip Toppe. Some of you have been telling DX Central that you'd like information on how to log a really exotic DX station. Well, how about Radio Greenland? Now that's really an exotic one, no? Visions of ice fields and fjords, polar bears and Eskimos should be whirling through your imagination.

If you're a guy who prefers to stick with those powerful international broadcasters and their English language transmissions, forget about this one. But if you've cut your teeth on the easier stuff and want to tackle some real DX, with a reasonably good chance of hearing it, try Radio Greenland!

Programming is all in Danish or Greenlandic, no English here, but some careful listening may allow you to identify it. If you've been DXing for a while, you may note the Scandinavian "sound" of the language and pick out a few key words.

The best chance to hear this one is on weekends—that's a break, isn't it?—between about 1930 and 2000 GMT. The frequency to try is 9,575 kHz. On certain other days of the week, Rome's shortwave signals blanket this spot, but on Saturdays and Sundays it is reasonably clear of other interference. Radio Greenland uses a 10 kilowatt transmitter on this wavelength.

Or, if you want something a bit harder, try the one kilowatt outlet on 3,999kHz, around 1030 GMT.

Radio Greenland will verify correct reports with an attractive folder QSL card, and you can write your reports in English. The address is Grønlands Radio, Godthab, Greenland.

Bandsweep. Times in GMT; frequencies in kHz. **650**—Honolulu's KORL has been heard quite well on the east coast early on some Monday mornings around 0800 when the Nashville Sounds of WSM are silent. . . . **3,300**—The old Windward Islands Broadcasting Service in the Caribbean is now called Radio Grenada. A noisy channel can make reception rough, but try this one during the early evening hours after 0000. . . . **6,155**—Remember the new one, Swazi Radio we mentioned a few months back? Well this commercial outlet in Swaziland is now on the air from 0400 s/on. It is hard to hear, though, with strong interference from Austrian Radio. . . . **7,140**—The regional station at Ambon may be the easiest of all the Indonesian stations to log. Frequently it comes through better, about dawn, than does the foreign service Voice of Indonesia. . . . **9,475**—Here's an easy one for those looking for Egypt. Try Cairo Radio's

English program at 0200. . . . **11,780**—An easy listening pop music show from Radio Clube de Mozambique in southern Africa has been heard by a Texas listener about 0515. The announcements are in English. (Credits: Page Taylor, New Jersey; Russ Edmonds, New Jersey; Ralph Perry, Illinois; Glenn Hauser, Texas; National Radio Club, Box 99, Cambridge MA; North American SW Association, Box 989, Altoona PA; SPEEDX, Box 321, Santa Ana CA) **Backtalk.** DX Central isn't a forum for information on the various illegal shortwave stations that crop up from time to time, but several readers have mentioned hearing one of these pirates mentioned in our last column, The voice of the Purple Pumpkin.

Al Niblack of Vincennes, Indiana, reports hearing a WXWL, using the slogan of the Purple Pumpkin on 9,752 kHz one afternoon recently. Virginian Kevin Strom caught the call letters WSWL, Purple Pumpkin Radio, on 7,345 kHz. And Alvin Sizer in Connecticut also reports hearing the illicit SW'er.

We had the opportunity to meet one of our readers. Bob Parks of Union Grove, Wisconsin, not long ago. Bob is a social studies teacher and tape records foreign broadcasts for classroom use.

"Hearing news right from the source raises students' interest," Bob notes.

The DX Central spotlight this month focuses on another organization for the hobby listener, SPEEDX.

SPEEDX, founded in the summer of 1971, by a veteran band of DXers, has come a long way in less than a year. It puts out a nifty printed, not mimeographed, publication each month. Its coverage includes shortwave broadcast news, a fine section for the "utility chaser," and a top-notch column on propagation condition predictions.

A yearly subscription, with bulletins sent via first class mail, costs \$10. A sample copy of SPEEDX will cost you a buck, to look before you leap.

If you're interested, use the form on this page. Remember to send it to SPEEDX, not to DX Central Reporting. ■

SPEEDX
P.O. Box 321
Santa Ana CA 92702

I read about SPEEDX in ELEMENTARY ELECTRONICS "DX Central Reporting." (Please check one:)

I want to join. I am enclosing \$10 for one year's membership.

Please send me more information. I am enclosing \$1 for a sample copy of SPEEDX.

Name: _____

Address: _____

City: _____ State: _____ ZIP: _____

CB Touring

Continued from page 56

tions are of mutual interest . . .”

In additionally defined terms the DOT, like the FCC, warns that a licensed station shall not use the system in any manner contrary to federal or provincial law or municipal by-laws, nor the transmission of music or other material for amusement or entertainment. System users may not engage in “transmission of a frivolous nature or transmission directed to any person or station beyond the ground wave coverage range of the station.”

Five plus Deuce. Under Canadian rule a station must clear the channel following five minutes of verbal exchange with another station, but may return to the same frequency following a two-minute silent period, providing the channel is not being used by others. Under U. S. Part 95 rules however, the “5+5” rule remains in effect: Five minutes of exchange is permissible, followed by a five-minute silent period by the same operator *on all channels*.

An important point: *Law is law*; there can be no sympathy at the border for poor Joe Smith who learned just this morning that he must make the trip to Canada, with no time for license application. The unfortunate rule provides that any vehicle approaching the border with an unlicensed CB transceiver on board, will be detained while the unit is *sealed off*, that is, “banded” so that the microphone or transmit feature is temporarily disabled until the vehicle is returned to the border for re-entry into the United States.

All points considered: A simple application procedure; no charge for the privilege of operating the system over the border for a period of a year, renewable for one year; and abiding by a set of rules that provide efficient and orderly operating procedures and use of the band by all who qualify, it appears well worth the little effort involved to have the added safety and convenience of two-way radio along, available when you need it during your trip in Canada. And when in Canada, send the Editor of this mag a picture postcard. Let him know that ELEMENTARY ELECTRONICS made your Canadian trip safer and more enjoyable. ■

INDEX TO ADVERTISERS

| READER SERVICE NO. | ADVERTISER | PAGE NUMBER |
|--------------------|------------------------------------|-----------------|
| 12 | Avantic Research Development | 12 |
| | Autofacts | 97 |
| | Bell & Howell Schools | 18-21 |
| 4 | Cleveland Institute of Electronics | 104 & 3rd Cover |
| 2 | Cornell Electronics | 9 |
| 15 | Edi Electronics | 9 |
| 18 | Eico Electronics | 14 |
| 21 | Electra Co., Div. of MASCO Corp. | 9 |
| 14 | Electro-Voice | 11 |
| 11 | Edmund Scientific | 6 |
| 1 | Heath Company | 2nd Cover |
| 13 | I.C.S. | 7 |
| 3 | International Crystal Mfg. Co. | 13 |
| 5 | E.F. Johnson | 8 |
| 6 | Lafayette Radio | 12 |
| 7 | Mosley Electronics | 14 |
| | National Radio Institute | 36-39 |
| 8 | National Technical School | 70-73 |
| 9 | Olson Electronics | 13 |
| 16 | Progressive Edu-Kits, Inc. | 4th Cover |
| | R.C.A. Institute | 1-3 & 9 |
| 20 | Regency Electronics, Inc. | 22 |
| 19 | TDK Electronics | 9 |
| 17 | Western Radio | 9 |
| 10 | Xcelite Company | 10 |

BOOKMARK

Continued from page 26

power transistors in a variety of power-circuit applications at frequencies that extend from the vhf range to well within the microwave region. This 176-page manual explains the basic design features, characteristics, and capabilities of commercially available RF power transistors and describes current design techniques and practices employed in the application of such devices in many widely different high-frequency power circuits. Copies of the *RCA RF Power Transistor Manual* can be obtained from RCA distributors, or by sending \$2.50 to RCA Solid State Division, Box 3200, Somerville, NJ 08876. For more information on this manual and other RCA books circle No. 58 on Reader Service Coupon on page 17 or 103.



CLASSIFIED Market Place

Classified Ads 65¢ per word, each insertion, minimum 10 words, payable in advance. To be included in the next available issue of **ELEMENTARY ELECTRONICS**, copy must be in our New York Office by June 1st. Address orders to R. S. Wayne, Manager, Classified Advertising, **ELEMENTARY ELECTRONICS**, 229 Park Avenue South, New York, N. Y. 10003.

ADDITIONAL INCOME

EARN at Home. Stuff envelopes. Rush self addressed stamped envelope. G. Birt's Crafts, 2292 Woodbridge Avenue, Edison, N. J. 08817.

BOOKS AND PERIODICALS

WILDERNESS Living! Survival, Guerilla Warfare, Hunting, Firearms, Self-Defense, Books—Vital, Fascinating, Extraordinary! Free Catalog Adobe Hacienda, Route 3, Glendale, Arizona 85301.

HOME SECURITY and SAFETY book, featuring installation and procedure descriptions of burglar alarms. Send \$1.00 to Bradley Electronics Inc., Dept. 110, 15 Gaval Road, Sayreville, New Jersey 08872.

BUSINESS OPPORTUNITIES

I made \$40,000.00 Year by Mailorder! Help others make money! Start with \$10.00—Free Proof! Torrey, Box 318-T, Ypsilanti, Michigan 48197.

MAKE Magnetic Signs. Big profits. Details. Universal, Lenora, Kansas 67645.

1000% PROFIT Bronzing Keepsakes. Free Literature. NBC, Box C-4-0, Coral Springs, Florida 33065.

1000% PROFIT!! Sell Books by Mail. Free Kit, Wallace, Box 288-D11, Gladstone, Oregon 97027.

MAILORDER: How to prepare your own catalog for pennies! Free catalog! Obie-BHG, Brooklyn, New York 12119.

WE NEED GINSENG GROWERS! \$3,000—\$30,000 annually! We Buy Your Crop. Send \$2. For seed sample and information. Glass's Ginseng Exchange, Box 336, Rochdale Station, Jamaica, N.Y. 11434.

\$100 DAILY! Mail Business! Free Information! Xcito Incomes, 5715 N. Mozart, Chicago, Illinois 60659.

MAILORDER Money-making Kit. Home Business. Valuable lists, concrete information, details, steps. Capital unnecessary. Free Details Pictures. Meadows, Box 327 DC7, Boston 02199.

FREE BOOK "999 Successful, Little-Known Businesses." Work Home! Plymouth B/G, Brooklyn, New York 11218.

FREE Report: Manufacture your products. Write Simpson (417) 10014 South Paxton, Chicago 60617.

START small, highly profitable electronic production in your basement. Investment, knowledge unnecessary. Postcard brings facts. Barta-EEA, Box 248, Walnut Creek, California 94597.

LEARN MAILORDER! Complete 24 lesson course. Only \$3.00. Wood, 254 East 204th Street, Bronx, N. Y. 10458.

DO-IT-YOURSELF

ELECTRONIC temperature and wind speed indicator, complete set of easy to follow plans plus how to obtain surplus parts for this low cost precision instrument. send \$2.00. Chucks Electronics, Box 112, Lake Havasu City, Arizona 86403.

EARTHWORMS

FISHWORMS At Your Fingertips. Easy Illustrated Instructions \$1.00. It's a, P.O. Box 135, Martinsville, Indiana 46151.

EDUCATION & INSTRUCTION

UNIVERSITY Degrees By Mail. Free Information. Norman, Dept. 63, Box 3199, Pasadena, California 91103.

EMPLOYMENT INFORMATION

AUSTRALIA NEEDS YOU! Fantastic Job Opportunities! Latest Australian employment directory lists employers, explains application procedures, housing and transportation. Guaranteed! Send \$3. Now! Unico, Box 200B, Howard Beach, New York 11414.

FORMULAS & TRADE SECRETS

FORMULA one way glass ideas unlimited. Send \$2.00. Roberts, 1550 Annabelle, Ferndale, Mich. 48220.

HOME MOVIES

HOW to develop home movies without darkroom. Get complete, easy, instructions. Save. Send \$2.26 Haddoncraft, 210 E. Maple, SM7, Merchantville, N. J. 08109. Guaranteed.

INVENTIONS WANTED

WE either sell your invention or pay cash bonus. Write for details. Universal inventions, 298-3, Marion, Ohio 43302.

MISCELLANEOUS

PROTECT YOUR CHEQUES! Print Amount with Pocket Cheque Writer. Order complete kit \$5.95 PPD—Guaranteed. Nita Internat. 1606 Denison, Cleveland, Ohio 44109.

WINEMAKER'S: Free Catalog, Fast Service. Arbolyn, Box 663X, West Columbia, S. C. 29169.

DON'T Die Without A Will! Protect Your Family. Two Forms \$2.00—Guaranteed! Order Today!! VanDyke, 1063 Grant Avenue, Dept. SM2, Bronx, N.Y. 10456.

MONEYMAKING OPPORTUNITIES

MAKE BIG MONEY raising Chinchillas, Cavies, Rabbits for us. Catalog 25¢ Keeney Brothers, New Freedom, Penna. 17349.

BIG PROFITS in becoming a supplier to major industry through electroplating small parts and metalizing non-metals. Write for free particulars: Mason, Room MC6-107-BF, 1512 Jarvis, Chicago, Illinois 60626.

HIGH Earnings!!! Become Public Relations Advisor. Free Proof. House, Box 288DR, Gladstone, Oregon 97207.

BLUEPRINT FOR SUCCESS, FORTUNE. Opportunities Report \$3.00. Details \$1.00. International FINDERS, 1925 Pine, Niagara Falls, New York 14301.

MONEYMAKING OPPORTUNITIES—Cont.

WANT to make money legally and honestly INSTANT CASH. NO INVESTMENT. Write: G. Dery, Box 8573, Durham, N. C. 27707.

DROPOUTS! Yes you can become a millionaire! Details Free. D7, Box 2892, Reno, Nevada 89505.

MAKE Your Classified Ad Pay. Get "How To Write a Classified Ad That Pays." Includes certificate worth \$2.00 toward classified ad in S & M. Send \$1.25 (includes postage) to R. S. Wayne, Science & Mechanics, 229 Park Ave., South, New York 10003.

OF INTEREST TO WOMEN

EXCELLENT MONEY addressing in your own home. \$46.00 daily possible. Typewriter-Longhand. Send stamped addressed envelope. AME-7, Box 310, La Mars, Iowa 51031.

PERSONAL

ELIMINATE Debts Without Borrowing! Particulars 25¢. Helper, Box 9308, No. Hollywood, California 91609.

PHOTOGRAPHY—PHOTO FINISHING

SAVE HUNDREDS OF DOLLARS!!! Make your own S & M Denominator. Send \$3.00 for detailed drawings and instructions. A must for successful photography in your darkroom. Order direct from: S & M Instruments, Dept. EE, 229 Park Avenue South, New York, N. Y. 10003.

PROFITABLE OCCUPATIONS

CHINCHILLA income guaranteed. Terms 25¢—Bulletin \$1.00. Rainbow, 11DC, Port Richey, Florida 33568.

RADIO & TELEVISION

TV TUBES 36¢ each. Send for Free 48 page color catalog. Cornell, 4217-W University, San Diego, California 92105.

"DISTANCE Crystal Set Construction" Handbook—50¢. "20 Crystal Plans"—50¢. Catalog, Laboratories, 745-G Cordone, Reno, Nevada 89502.

C B LOWEST Prices Catalog 15¢. Puget Sound R/C, 4230 Hoff Rd. Bellingham, Washington 98225.

REMAILING SERVICE

FOREIGN Country Remails \$1.00. Forwarding, Receiving, S. E. Johnson, Box 1119, APO, San Francisco 96370.

STAMP COLLECTING

FREE Stamps. Send Dime. UX Stamp, 320 Congress, Austin, Texas 78701.

SUPER NATURE TABLETS

NO man should be a sexual weakling or failure, for virile Powers can be made to Respond at Will. I have The Amazing Superior Tonic Tablets. Pep for all the things you want to do. 30 for \$3.00. Nina of Germany, 324 So. First Street, Alhambra, California 91802.

THERE IS NO CHARGE FOR THE ZIP CODE—PLEASE USE IT IN YOUR CLASSIFIED AD

Identify DX

(Continued from page 45)

Canada," are a sure tip off to Radio Canada International.

Oh yes, the nose flute mentioned earlier? That is used by the rarely heard medium wave outlet of the Tonga Broadcasting Commission. Playing this particular nasal passage on this wacky instrument is probably no tougher than pronouncing the name of Tonga's capital, Nuku'alofa!

Get the "Bible"! To use the interval signal technique you've got to know the territory. And that means getting a copy of the DXers' standard reference, "World Radio-TV Handbook," which describes most of them. The Danish publisher lists two sources in the U.S. for WRTH; Billboard Publications, Inc., 2160 Patterson St., Cincinnati, Ohio 45214, and Gilfer Associates, P.O. Box 239, Park Ridge, N.J. 07656.

If you own a tape recorder, why not record the interval signals you hear for future reference. Some sound quite similar and with your own reference tape it is a simple matter to play it back now and again to refresh your memory, or check out a familiar-sounding, but forgotten signal you stumble across while DXing.

Follow the Rules! When you use the IS identification technique, all the normal rules

of SWLing apply. Begin your Sherlock Holmes act. When you find a station and have trouble in determining just who it is, first determine the frequency as accurately as possible. Identify the language as best you can. Remember that with some effort and practice you can often manage to make out at least some of the words, even in a foreign language.

Interval signals are usually broadcast just before the start of a transmission, and sometimes, just after. Also, frequently they can be heard at station break time, on the hour and half hour. A short piece of music, a repeated identifying tone, generally means IS. When you've noted the signal, and narrowed down the possible stations to a handful, check *WRTH* listings of station IS's.

A word of caution, though. The interval signal identification technique is a supplement to your normal SWLing methods. Until you're really familiar with many interval signals, use the ploy only when you're quite sure of the station's identity, but would like that one last measure of proof. After all, it is all too easy to confuse one station's gong with another, one drum lick for that of another broadcaster.

However, when you get really proficient, you'll find that when the chips are down, interval signals can be your ace in the hole for identifying DX!

Pennant Fever

(Continued from page 48)

report of your logging to the station.

- When you write the broadcaster you heard, mention that you collect pennants and tell the station a bit about collection.

- Courteously ask the station to send you one of their pennants to add to your collection.

Unwritten Rules. It is said, correctly, that a shortwave station is under no obligation to send an SWL a QSL card. Most stations do, if your reception report is correct and useful, as an expression of thanks and as a public relations gesture. This is even more true when it comes to DX pennants. It is considered extremely bad form to write to a station asking for their pennant if you haven't bothered to listen to their programs!

If you expect the broadcaster to send a pennant by way of thanks, then give him something to be thankful for, the best quality reception report you can write! ■

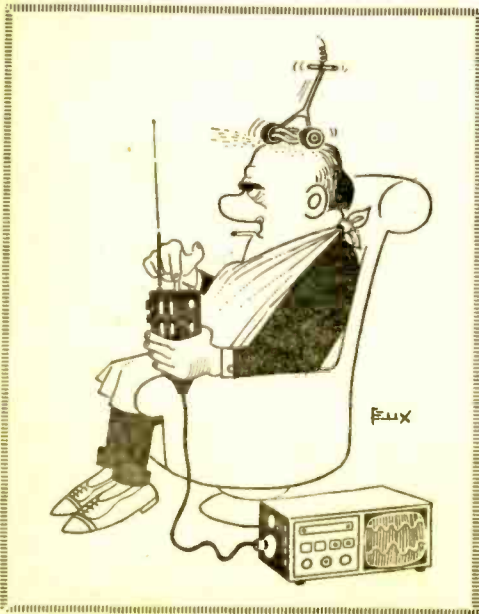

READER SERVICE PAGE

• The Editor of ELEMENTARY ELECTRONICS offers readers an easy way to get additional information about products and services advertised in this issue. Also, if you would like more information about any new product mentioned in our column "Hey, Look Me Over," it's yours for the asking. Just follow the instructions below and the material you requested will be sent to you promptly and at no cost.

• The coupon below is designed for your convenience. Just circle the numbers that appear next to the advertisement or editorial mention that interests you. Then, carefully print your name and address on the coupon. Cut out the coupon and mail to ELEMENTARY ELECTRONICS, Box 886, Ansonia Station, New York N Y 10023. Do it today!

JULY/AUGUST 1972

Void after December 31, 1972

ELEMENTARY ELECTRONICS

Box 886, Ansonia Station, New York, N.Y. 10023

| | | | | | | | | | | |
|---|----|----|----|----|----|----|----|----|----|----|
| Please arrange to have literature whose numbers I have circled at right sent to me as soon as possible. I understand that this is a free service offered by the magazine. | 1 | 2 | 3 | 4 | 5 | 6 | 7 | 8 | 9 | 10 |
| | 11 | 12 | 13 | 14 | 15 | 16 | 17 | 18 | 19 | 20 |
| | 21 | 22 | 23 | 24 | 25 | 26 | 27 | 28 | 29 | 30 |
| | 31 | 32 | 33 | 34 | 35 | 36 | 37 | 38 | 39 | 40 |
| | 41 | 42 | 43 | 44 | 45 | 46 | 47 | 48 | 49 | 50 |
| | 51 | 52 | 53 | 54 | 55 | 56 | 57 | 58 | 59 | 60 |

• Please limit circled items to 12 maximum.

Are you a subscriber to ELEMENTARY ELECTRONICS? Yes No

How many of the last 3 issues did you read? None 1 2 3

Name (Print Clearly) _____

Address _____

City _____ State _____ Zip Code _____

learn by doing!

Perform more than 200 exciting experiments
with CIE's fascinating **ELECTRONICS
LABORATORY PROGRAM!**

Put theory... into practice

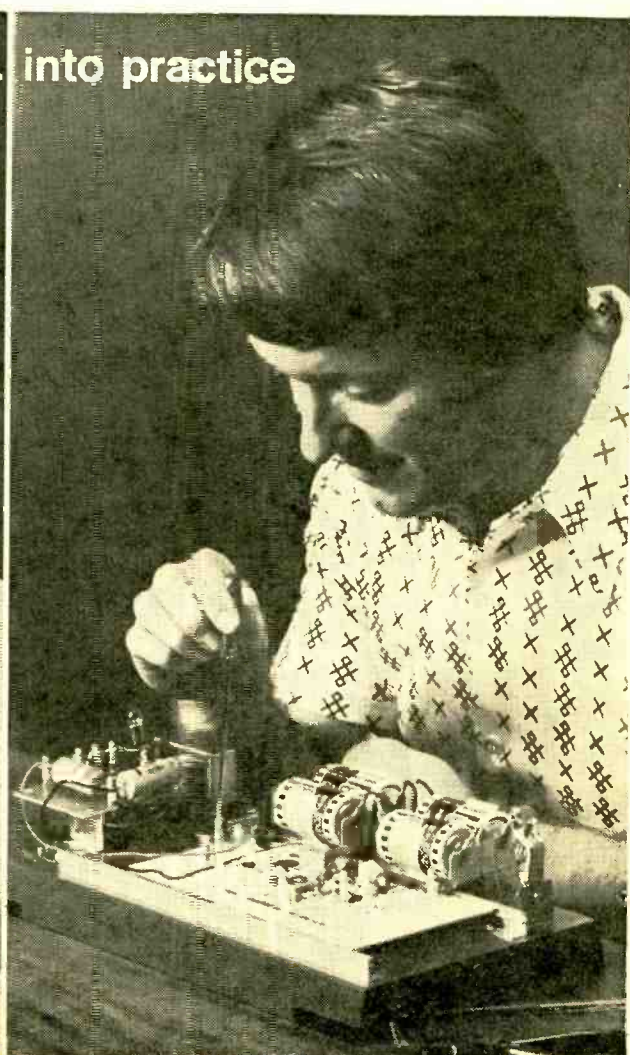

You get your own 161-piece electronics laboratory... with authentic electronic components used by industry!

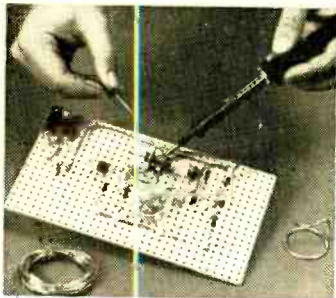

You learn how to construct circuits and connect them with a soldering iron, which is part of your CIE laboratory equipment. This "hands on" experience is extremely valuable in applying what you learn.

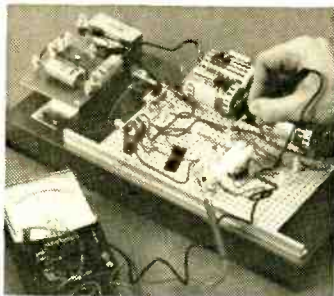

Testing and troubleshooting are an important part of your learning experience. Included in your laboratory is a precision "multimeter" to diagnose electrical and electronic troubles quickly and accurately.

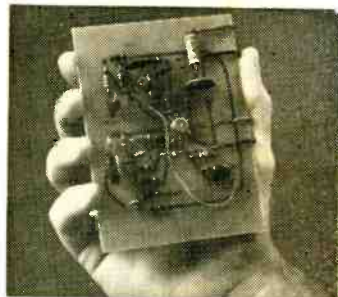

Modern space-age components like this IC (integrated circuit) are professional quality and can be used again and again in many of your projects. Lesson by lesson, piece by piece your knowledge grows!

Prepare now for a high income career in Electronics...the Science of the Seventies.

Electronic miracles are changing today's world with breathtaking speed.

And with this growth in electronics technology has come a brand new need... a demand for thousands of electronics technicians, trained in theory and practice to build the products, operate them and service them during the Seventies.

Don't just wait for something to "happen" in your present job. Get ready now for a career you'll really enjoy with a good income and plenty of opportunity for advancement.

Experience with experiments is your best teacher

"Hands on" experience helps to reinforce basic theory. When you learn by doing, you discover the "how" as well as the "why." You'll find out for yourself the right way as well as the wrong way to use electronic components. How to construct your own circuits, to discover trouble spots and learn how to fix them. And with CIE's exclusive Auto-Programmed® Lessons, you learn faster and easier than you'd believe possible.

CIE's fascinating course, Electronics Technology with Laboratory, teaches you Electronics by making it work before your eyes. And you do it yourself, with your own hands.

Importance of FCC License and our Money-Back Warranty

An FCC License is a legal requirement for many important jobs. And it is not easy to get!

But better than 9 out of every 10 CIE graduates who take the Government licensing exam pass it!

That's why we can offer this famous Money-Back Warranty: when

you complete our Laboratory Course, which provides FCC License preparation, you'll pass the FCC License exam or be entitled to a full refund of all tuition paid. This warranty is valid during the entire completion period established for the course.

You get your FCC License — or your money back!

You'll have high paying job opportunities

Electronics is still young and growing. In nearly every one of the new exciting fields of the Seventies you find electronics skills and knowledge are in demand. Computers and data processing. Air traffic control. Medical technology. Pollution control. Broadcasting and communications. With a CIE Diploma and an FCC License you can choose the career field you want... work for a big corporation, a small company or even go into business for yourself.

Here's how two outstanding CIE students carved out new careers: After his CIE training, Edward J. Dulaney, President of D & A Manu-

facturing, Inc., Scottsbluff, Nebraska, moved from TV repairman to lab technician to radio station chief engineer to manufacturer of electronic equipment with annual sales of more than \$500,000. Ed Dulaney says, "While studying with CIE, I learned the electronics theories that made my present business possible."

Marvin Hutchens, Woodbridge, Virginia, says: "I was surprised at the relevancy of the CIE course to actual working conditions. I'm now servicing two-way radio systems in the Greater Washington area. My earnings have increased \$3,000. I bought a new home for my family and I feel more financially secure than ever before."

Don't put it off...

Send now for 2 FREE BOOKS

Mail the postpaid reply card for our school catalog *plus* a special book on how to get your FCC License. If the card is missing, use the coupon below or write to: Cleveland Institute of Electronics, 1776 East 17th Street, Cleveland, Ohio 44114. But do it now!



Approved under new G. I. Bill

All CIE career courses are approved for full tuition refund under the new G. I. Bill. If you served on active duty since January 31, 1955 or are in service now with more than 180 days active duty, check box on reply card or coupon for latest G. I. Bill information.

CIE Cleveland Institute of Electronics

1776 East 17th Street, Cleveland, Ohio 44114

Please send me without cost or obligation:

1. Your illustrated school catalog, "Succeed in Electronics."
2. Your book, "How to Get a Commercial FCC License."

I am especially interested in: Electronics Technology with Laboratory
 Electronics Technology Industrial Electronics
 Electronic Communications First Class FCC License
 Broadcast Engineering Electronics Engineering

Name _____ Age _____

Address _____

City _____ State _____ Zip _____

Check here for G. I. Bill information.

Accredited Member National Home Study Council

EL-34

CIRCLE NO. 4 ON PAGE 17 OR 103

BUILD YOUR OWN RADIO

and Electronics Circuits

Reg. U. S.
Pat. Off.



Training Electronics Technicians Since 1946

PROGRESSIVE HOME RADIO-T.V. COURSE

Now Includes

- ★ 12 RECEIVERS
- ★ 3 TRANSMITTERS
- ★ SQ. WAVE GENERATOR
- ★ SIGNAL TRACER
- ★ AMPLIFIER
- ★ SIGNAL INJECTOR
- ★ CODE OSCILLATOR

- ★ No Knowledge of Radio Necessary
- ★ No Additional Parts or Tools Needed
- ★ EXCELLENT BACKGROUND FOR TV
- ★ SCHOOL INQUIRIES INVITED
- ★ Sold In 79 Countries

YOU DON'T HAVE TO SPEND HUNDREDS OF DOLLARS FOR A RADIO COURSE

The "Edu-Kit" offers you an outstanding PRACTICAL HOME RADIO COURSE at a rock-bottom price. Our best methods of home training. You will learn radio theory, construction practice and servicing. THIS IS A COMPLETE RADIO COURSE IN EVERY DETAIL.

You will learn how to build radios, using regular schematics; how to wire and solder in a professional manner; how to service radios. You will work with the standard type of punched metal chassis as well as the latest development of Printed Circuit chassis.

You will learn the basic principles of radio. You will construct, study and work with RF and AF amplifiers and oscillators, detectors, rectifiers, test equipment. You will learn and practice code, using the Progressive Code Oscillator. You will learn and practice trouble-shooting, using the Progressive Signal Tracer, Progressive Signal Injector, Progressive Dynamic Radio & Electronics Tester, Square Wave Generator and the accompanying instructional material.

You will receive training for the Novice, Technician and General Classes of F.C.C. Radio Amateur Licenses. You will build Receiver, Transmitter, Square Wave Generator, Code Oscillator, Signal Tracer and Signal Injector circuits, and learn how to operate them. You will receive excellent background for electronics and Radio, Hi-Fi and Electronics.

Absolutely no previous knowledge of radio or science is required. The "Edu-Kit" is the product of many years of teaching and engineering experience. The "Edu-Kit" will provide you with the best education in electronics and Radio, worth many times the low price you pay. The Signal Tracer alone is worth more than the price of the kit.

THE KIT FOR EVERYONE

You do not need the slightest background in Radio or science. Whether you are interested in an interesting hobby, a well paying business or a job with a future, you will find the "Edu-Kit" a worth-while investment. Many thousands of individuals of all

ages and backgrounds have successfully used the "Edu-Kit" in more than 79 countries of the world. The "Edu-Kit" has been carefully designed, step by step, so that you cannot make a mistake. The "Edu-Kit" allows you to teach yourself at your own rate. No instructor is necessary.

PROGRESSIVE TEACHING METHOD

The Progressive Radio "Edu-Kit" is the foremost educational radio kit in the world, and is universally accepted as the standard in the field of electronics training. The "Edu-Kit" uses the modern educational principle of "Learn by Doing." Therefore you construct program designed to provide an easily-learned, thorough and interesting background in radio.

You begin by examining the various radio parts of the "Edu-Kit." You then learn the set you will enjoy listening to regular broadcast stations, learn theory, practice testing and trouble-shooting. Then you build a more advanced radio, learn more advanced theory and techniques. Gradually, in a progressive manner, and at your own rate, you will find yourself constructing more advanced multi-tube radio circuits, and doing work like a Professional Radio Technician.

Included in the "Edu-Kit" course are Receiver, Transmitter, Code Oscillator, Signal Tracer, Square Wave Generator and Signal Injector Circuits. These are not unprofessional "breadboard" experiments, but genuine radio circuits, constructed by means of professional wiring and soldering on metal chassis, plus the new method of radio construction known as "Printed Circuitry." These circuits operate on your regular AC or DC house current.

THE "EDU-KIT" IS COMPLETE

You will receive all parts and instructions necessary to build twenty different radio and electronics circuits, each guaranteed to operate. Our kits contain tubes, tube sockets, variable, electrolytic, mica, ceramic and paper dielectric condensers, resistors, tie strips, hardware, tubing, punched metal chassis, Instruction Manuals, hook-up wire, solder, selenium rectifiers, coils, volume controls and switches, etc.

In addition, you receive Printed Circuit Materials, including Printed Circuit chassis, special tube sockets, hardware and instructions. You also receive a useful set of tools: a professional electric soldering iron, and a self-powered Dynamic Radio and Electronics Tester. The "Edu-Kit" also includes Code Instructions and Progressive Code Oscillator, in addition to F.C.C. Radio Amateur License training. You will also receive lessons for servicing with the Progressive Signal Tracer and the Progressive Signal Injector, High Fidelity Guide and Quiz Book, you receive Membership in Radio-TV Club, Free Consultation Service, Certificate of Merit and Discount Privileges. You receive all parts, tools, instructions, etc. Everything is yours to keep.

Progressive "Edu-Kits" Inc., 1189 Broadway, Dept. 556DJ, Hewlett, N.Y. 11557

UNCONDITIONAL MONEY-BACK GUARANTEE

Please rush my expanded "Edu-Kit" to me, as indicated below:

Check one box to indicate choice of model:

- Deluxe Model \$31.95
- New Expanded Model \$34.95 (Same as Deluxe Model Plus Television Servicing Course and valuable Radio & TV Tube Checker).

Check one box to indicate manner of payment:

- I enclose payment. Ship "Edu-Kit" post paid.
- I enclose \$5 deposit. Ship "Edu-Kit" C.O.D. for balance plus postage.
- Send me FREE additional information describing "Edu-Kit."

Name _____

Address _____

City & State _____

Zip _____

PROGRESSIVE "EDU-KITS" INC.

1189 Broadway, Dept. 556DJ, Hewlett, N.Y. 11557

FREE EXTRAS

► SET OF TOOLS

- SOLDERING IRON
- ELECTRONICS TESTER
- PLIERS CUTTERS
- VALUABLE DISCOUNT CARD
- CERTIFICATE OF MERIT
- TESTER INSTRUCTION MANUAL
- HIGH FIDELITY GUIDE + QUIZZES
- TELEVISION BOOK + RADIO
- TROUBLE SHOOTING BOOK
- MEMBERSHIP IN RADIO-TV CLUB:
- CONSULTATION SERVICE + FCC
- AMATEUR LICENSE TRAINING
- PRINTED CIRCUITRY

SERVICING LESSONS

You will learn trouble-shooting and servicing in a progressive manner. You will practice on the sets that you construct. You will learn symptoms and causes of trouble in home, portable and car radios. You will learn how to use the professional Signal Tracer, the unique Signal Injector and the dynamic Radio & Electronics Tester. While you are learning in this practical way, you will be able to do many a repair job for your friends and neighbors, and charge fees which will far exceed the price of the "Edu-Kit." Our Consultation Service will help you with any technical problems you may have.

FROM OUR MAIL BAG

J. Statatits, of 25 Poplar Pl., Waterbury, Conn., writes: "I have repaired several sets for my friends, and made money. The "Edu-Kit" paid for itself. I was ready to spend \$240 for a Course, but I found your ad and sent for your Kit."

Ben Valerio, P. O. Box 21, Magna, Utah: "The Edu-Kits are wonderful. Here I am sending you the questions and also the answers for them. I have been in Radio for the last seven years, but like to work with your kits, and like to build Radio Testing Equipment. I enjoyed every minute I worked with the different kits; the Signal Tracer works fine. Also like to let you know that I feel proud of becoming a member of your Radio-TV Club."

Robert L. Shuff, 1534 Monroe Ave., Huntington, W. Va.: "Thought I would drop you a few lines to say that I received my Edu-Kit, and was really amazed that such a bargain can be had at such a low price. I have already started repairing radios and phonographs. My friends were really surprised to see me get into the swing of it so quickly. The Trouble-shooting Tester that comes with the Kit is really sweet, and finds the trouble, if there is any to be found."

PRINTED CIRCUITRY

At no increase in price, the "Edu-Kit" now includes Printed Circuitry. You build a Printed Circuit Signal Injector, a unique servicing instrument that can detect many Radio and TV troubles. This revolutionary new technique of radio construction is now becoming popular in commercial radio and TV sets.

A Printed Circuit is a special insulated chassis on which has been deposited a conducting material which takes the place of wiring. The various parts are merely plugged in and soldered to terminals.

Printed Circuitry is the basis of modern Automation Electronics. A knowledge of this subject is a necessity today for anyone interested in Electronics.