

PROJECTS — Flash Slaver, Fish Finder, Signal Tracer

02342

NOVEMBER-DECEMBER

1971
75c

elementary Electronics

**BASIC
COURSE**

Understanding
Power
Supplies

tune in the **ACTION BANDS**

Our VHF converter
lets you pick up
Police, Fire, Ambulance,
Aero, Weather, Marine,
Business and more
on your table FM radio!

Easy to build —
fun to operate! 

Plus

What's new in ...

- Hi-Fi stereo
- Simple circuits
- Alpha waves
- Test gear
- Pollution fighting
- Electronic sleep
- Gadgets
and more!

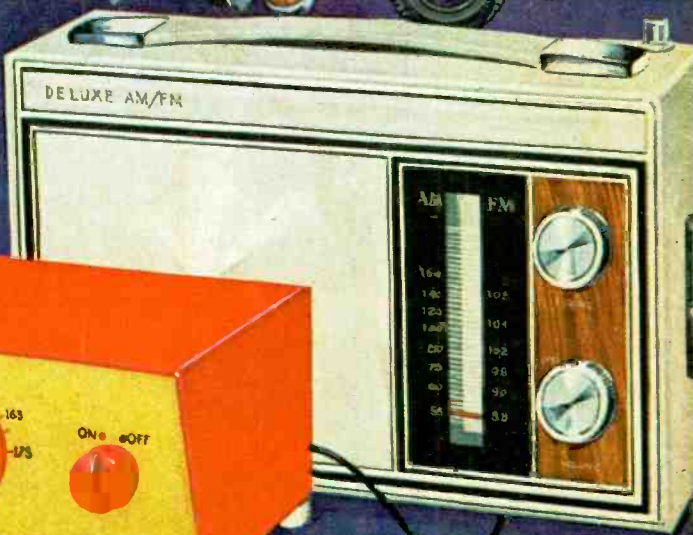
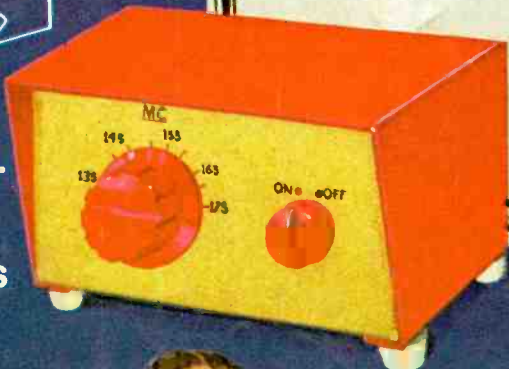

Take command of your future... now!

Choose the job you want from 266 ICS Courses

Dozens of new careers are open to you with ICS training. Oldest, largest correspondence institution. 8,000,000 students since 1890. Learn facts, theories, practical applications. Instructors guide

you, answer your questions. Texts, written by authorities, are yours to keep. Famed ICS diploma to graduates. Convenient payment plan. Send our coupon for three FREE booklets.

LEADERS IN THE ICS SUCCESS PARADE

Automobile Engine Tune-Up
Introduction to System/360 Computer
Business Administration Accounting
Civil Engineering
Practical Electrician
TV-Radio Servicing

Architectural Drafting High School Courses High School Equivalency
Domestic Commercial Refrigeration and Air Conditioning Serv.
Aircraft and Power Plant Mechanics

ACCOUNTING
Accounting (U.S.A.)
Accounting (Canadian)
Accounting for Business Programmers
Auditing
Business Law (U.S.A.)
Cost Accounting
CPA Review (U.S.A.)
General Accounting
Federal Tax (U.S.A.)
General Business Accounting
Junior Accounting
Office Accounting
Practical Accounting
Public Accounting
Small Business Accounting (U.S.A.)
Starting and Managing a Small Accounting Service (U.S.A.)

ARCHITECTURE AND BUILDING
Architectural Drawing and Designing
Architecture
Building Contractor
Building Estimator
Building Inspector
Building Maintenance
Carpenter/Builder
Carpentry and Millwork
House Planning and Interior Design
Mason
Painting Contractor
Reading Architects Blueprints

ART
Amateur Artist
Commercial Art
Cartooning
Illustrating
—Advertising Layout
Interior: Decorating and Design
Oil Painting
Show Card and Sign Painting and Designing

Show Card Writing
Sign Painting and Designing
Sketching and Painting

AUTOMOTIVE
Automatic Transmission Specialist
Automobile Air Conditioning Specialist
Automobile Body Re-Building & Refinishing
Automobile Engine Tune-Up
Automotive Mechanic
Automobile Master Mechanic
Automotive Diesel-Gas Mechanic

BUSINESS
Advertising Acct. Exec
Advertising Media
Advertising Copywriting
Advertising Production
Business Administration
Business Law
Canadian Business Course
Industrial Psychology
Basic Inventory Control
Managing a Small Store
Marketing Management
Marketing Research Management
Exec. Management
Office Management
Production Management
Purchasing Agent
Retail Bus. Management
Retail Buyer
Systems and Procedures Analysis

BUSINESS SALES
Real Estate Agent
Modern Salesman
Sales Manager

BUSINESS SUPERVISION
Advanced Management
Basic Management

Industrial Foremanship Management
Industrial Supervision
Sales Management
Personnel—Labor Relations—U.S.A.
General Supervision

CHEMICAL
Chemical Analyst
Chemical Engineering
Chemical Laboratory Technician
Chemical Process Operations
Elements of Nuclear Energy
General Chemistry
Instrumental Laboratory Analysis

CIVIL ENGINEERING
Civil Engineering
Construction Engineering Technician
Highway Engineering
Principles of Surveying
Reading Highway Blueprints
Reading Structural Blueprints
Sanitary Engineering Technology
Sewage—Plant Operator
Structural Engineering
Surveying and Mapping
Water-Works Operator

COMPUTERS
Fundamentals of Computer Programming
COBOL Programming
Fortran IV Programming
Introduction to Digital Computer Programming
Programming the IBM 1401 Computer
Introduction to System 360 Computer

DRAFTING
Aircraft Drafting
Architectural Drafting
Design Drafting
Drafting Technology
Electrical Drafting
Electronic Drafting
Introductory Mech. Drafting
Mechanical Drafting
Pressure Vessel and Tank Print Reading
Sheet Metal Layout
Structural Drafting

ELECTRICAL
Electrical Engineering—Electronics Option
—Power Option
Electrical Appliance Serv.
Electrical Contractor
Electrical Eng'g Tech
Electrical Home Maint.
Electrical Instrumentation Tech
Electric Motor Repairman
Industrial Elec. Tech
Industrial Electrician
Industrial Maintenance Electrician
Power Line Design and Construction
Power Plant Operator—Hydro Option
—Steam Option
Practical Electrician
Utility Lineman
Reading Elec. Blueprints

ENGLISH AND WRITING
Better Business Writing
English for Spanish U.S.A.
Free Lance Writing for Fun and Profit
Modern Letter Writing
Practical English
Reading Improvement
Short Story Writing

HIGH SCHOOL
High School Business
High School Canadian
High School General
High School Math
High School Secretarial
High School Vocational
High School College Preparatory—Arts
High School College Prep—Engineering and Science
Preparatory Course for High School Equivalency Exam.

MACHINE SHOP PRACTICE
Industrial Metallurgy
Mach. Shop Inspection
Mach. Shop Practice
Metallurgical Tech
Reading Shop Blueprints
Tool & Die Maker
Tool and Die Foreman
Welding Foreman

MATHEMATICS
Math and Mechanics for Engineers

Math and Physics for Engineers

MECHANICAL
Mechanical Engineering
Aircraft and Power Plant Mechanic
Principles of Hydraulic and Pneumatic Power
Industrial Engineering
Industrial Eng'g Tech
Instrumentation
Machine Design
Quality Control
Safety Eng'g Tech.
Tool Design
Vibration Analysis and Control

PETROLEUM
Natural Gas Production and Transmission
Oil Well Servicing
Petroleum Production Operator
Petroleum Production Field Tech
Petroleum Refinery Operator

PLASTICS
Plastics Technician

PLUMBING, HEATING AND AIR CONDITIONING
Air Conditioning Estimator
Air Conditioning Maint.
Domestic Heating with Gas and Oil
Heating & Air Conditioning with Drawing
Industrial Air Cond.
Pipe Fitting Plumbing
Plumbing and Heating
Plumbing and Heating Est.

Practical Plumbing
Domestic Commercial Refrigeration and Air Conditioning Serv.

PULP AND PAPER
Paper Machine Operator
Paper Making
Pulp Making
Pulp & Paper Tech.

SECRETARIAL
Clerk-Typist
Secretary, Private Sec'y. Legal Sec'y. Med. Secretary, Executive

Shorthand Stenographic Typewriting

STEAM AND DIESEL POWER
Boiler Inspector
Building Eng's
Power Plant Engineering
Stationary Diesel Eng's—operation and maintenance
Stationary Fireman
Stationary Steam Eng'g

TEXTILES
Carding and Spinning
Dyeing and Finishing
Loom Weaving
Textile Designing
Textile Mill Superintendent
Textile Mill Supervisor

TRAFFIC
Motor Traffic Man'g'm't
Traffic Management

TV-RADIO-ELECTRONICS
Cable TV Installer
Commercial Radio
Telephone License

1st Class
2nd Class
3rd Class
Electronics Service Technician

Principles of Electronic Computers
General Electronics
Hi-Fi Stereo and Sound System Servicing
Industrial Electronics
Numerical Control
Maintenance and Troubleshooting
TV and Radio Servicing
Solid State Electronics
Telephony

APPROVED FOR VETERANS FOR TUITION REFUND
G.I.'s qualify after 180 days active service.
Accredited member, National Home Study Council.
Easy pay-as-you-learn plan.
Special rates to members
U.S. Armed Forces

ICS
International Correspondence Schools
Division of Intext
ICS, Scranton, Pa. 18515
Canadian residents: Send coupon to Scranton. Our affiliate in Canada will reply. In Honolulu: Use P.O. Box 418, Honolulu.

TAKE YOUR FIRST STEP... MAIL THIS COUPON TODAY—ICS, SCRANTON, PA. 18515 **N1058K**

I'm interested in a program of independent study. Send me, without cost, your booklet on the principles of success, sample text demonstrating famous ICS method, and your catalog for _____

(Print name of course. See list.)

Miss _____ Age _____
Mrs. _____
Mr. _____

Address _____ Apt. _____
City _____ State _____ Zip Code _____

Occupation _____ Employed by _____ Working hours _____ A.M. to _____ P.M.

Your paycheck says a lot about you

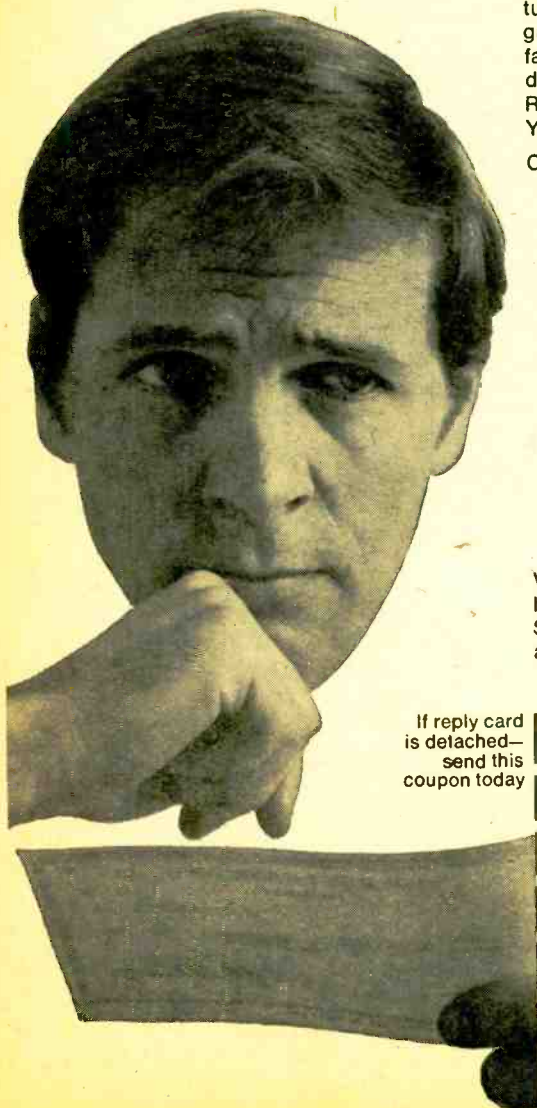

It tells you more than how much you make. It tells you how far you've come. And if your paycheck looks very much the same as it did last year, or the year before, it simply means that *you* look very much the same as *you* did last year and the year before.

But times change, and you should be changing with them. Old dull jobs are disappearing. New exciting ones are being created. There are challenging new fields that need electronics technicians...new careers such as computers, automation, television, space electronics where the work is interesting and the earnings are greater.

RCA Institutes has one of the nation's largest and most respected home study schools devoted to electronics. They can get you started even if you've had no previous training or experience. RCA Institutes has developed a faster, easier way for you to gain the skills and the knowledge you need for a fascinating, rewarding electronics career. And you don't have to quit work and go back to school. With RCA Institutes Home Study Plan you can do both. You set your *own* pace depending on *your* schedule.

Check over these RCA benefits:

- You get Hands-On Training—over 300 experiments and as many as 25 kits with some programs.
- You get RCA's unique "Autotext" method of learning—individual programmed instruction, the easy, faster, simplified way to learn!
- You get the widest choice of electronics courses and programs—everything from Electronics Fundamentals right up to Solid State Technology and Communications Electronics.
- You get a selection of low-cost tuition plans!

Sounds great, and it is! For complete information, without obligation, send in the attached postage card... or return the coupon below. That will say a lot about you.

Veterans: Train under new GI Bill. Accredited Member National Home Study Council. Licensed by N.Y. State—courses of study and instructional facilities approved by the State Education Department.

If reply card is detached—send this coupon today

RCA Institutes

Home Study Dept. 246-111-0
320 West 31st Street, New York, N.Y. 10001

Please rush me FREE illustrated catalog.
I understand that I am under no obligation.

Name _____ Age _____
(please print)

Address _____

City _____ State _____ Zip _____

Veterans: Check here

ELEMENTARY ELECTRONICS (Vol. 11, No. 5) is published bi-monthly by Science & Mechanics Publishing Co., at 229 Park Ave., S. New York, N.Y. 10003. One year subscription (six issues)—\$4.00. Second class postage paid at New York, N.Y. 10003 and at additional mailing offices.

CIRCLE NO. 1 ON PAGE 17

e/e

elementary Electronics

Dedicated to America's Electronics Hobbyists

☆

YOU CAN BUILD IT

- 43 Photog's Third Eye—*why be a slave to single-flash shadow when this slave can eliminate it?*
- 73 Mini-Trace Signal Sniffer—*makes troubleshooting easy*
- 77 Build a Better Fish Finder—*fish are temperature sensitive and so is the Thermocliner*

☆

SHORTWAVE LISTENING IS FOR EVERYBODY

- 12 DX Central Reporting—*bye-bye pirates*
- 29 Discover the World of Shortwave Listening—*we tell you how to get started, what to buy and you have all the fun*
- 69 VHF High-Band Converter—*lets you tune in the emergency/business band on your FM broadcast receiver*

☆

JUST PURE ELECTRONICS THEORY

- 59 The Case For and Against Oscillating Amps
- 81 Basic Course—*Understanding Power Supplies—Part I*

☆

THE HUMAN SIDE OF ELECTRONICS

- 22 Newscan—*electronics and science on a broad front*
- 40 Riding High on your Alpha Waves—*tune yourself in as the yogi do*
- 49 Pushbutton Sleep: Fact of Fancy?
- 65 This Teddy Has a Heart—*that runs on DC*
- 68 The Pollution Fighter's Electric Motorcycle

WE TEST THE BEST

- 45 Kathi's CB Carousel—*B&K Cobra 25 Passes the test*
- 47 e/e Checks out the Heathkit Electronic Oven

CIRCUIT SHORTIES

- 72 Regulated 9-Volt Power Supply
- 80 Clip Book Circuits

NEW PRODUCTS HIT PARADE

- 26 Hey, Look Me Over—*our regular department*
- 42 e/e Looks at New Hi-Fi Components
- 58 e/e Looks at New Test Gear
- 66 e/e Looks at New Tools and Gadgets

THE e/e REGULARS

- 16 Bookmark by Bookworm
- 17 Reader Service Page
- 18 Stamp Shack—*philatronic news*
- 21 e/e Etymology—*words about words*
- 24 Ask Hank, He Knows—*and he tells*
- 27 Literature Library
- 28 Ham in the Big City—*cartoon page*

☆

Cover
Highlights

AUTHORS IN THIS ISSUE

Charles E. Bryson, Norman Crawford, Steve Daniels—WB2GIF, Webb Garrison, Charles Green, Joe Gronk, Don Jensen, Jackson Kaye, Ernest A. Kehr, Kathi Martin—KAIQ614, Gary McClellan, Jack Schmidt, Hank Scott, and the ELEMENTARY ELECTRONICS' Editorial Staff

Cover Photo
by
Leonard
Heicklen



Only RCA Institutes offers you all these advantages:

1 A broad range of courses to help you qualify for good-paying jobs in such rewarding fields as communications, color TV servicing, automation, nuclear instrumentation, space electronics, drafting, computer programming.

2 RCA's exclusive Autotext training method—the easy, faster, simplified way to learn electronics at home.

3 Personal supervision throughout your training.

4 Over 250 experiments and up to 22 kits in some programs

5 Easy monthly payment plan.

6 Over 60 years of leadership in technical training.

7 Recognition from leaders in the field as an RCA Institutes graduate.

Veterans can train under new GI Bill. Licensed by the State of New York. Accredited Member National Home Study Council.

Courses available in Canada too.

If you've ever thought about getting into electronics... you owe it to yourself to see what RCA home training has to offer.

This entire fold-over coupon makes a no-postage-required business-reply envelope. Fill in your name and address ...then cut out along dotted lines...fold, seal and mail.

246-111-9

RCA INSTITUTES, Inc., Home Study School
320 West 31st St., New York, N. Y. 10001

Please send me free illustrated home study career catalog.

Name _____ Age _____
(please print)

Address _____

City _____ State _____ Zip _____

- Check here if interested in Classroom Training.
 Veterans check here

NO STAMP NEEDED

You must seal (Staple, tape or glue) before mailing.



FOLD HERE

DO NOT CUT HERE



FIRST CLASS

Permit No. 10662
New York, N. Y.

BUSINESS REPLY MAIL

No Postage Necessary if Mailed in United States

Postage will be paid by

RCA INSTITUTES

Home Study School
320 West 31st St.
New York, N. Y. 10001

246-111-9

CIRCLE NO. 2 ON PAGE 17

CALL ME!



I'll send you 2 FREE BOOKS describing the opportunities in Electronics. Call me TOLL-FREE **800-321-2155** (in Ohio, call 800-362-2105).

For details about the famous CIE home-study courses in Electronics, see our ad on page 106

Cleveland Institute of Electronics
1776 East-17th Street, Cleveland, Ohio 44114

Put it to Work!

NEW AND ONLY FROM EICO—THE INDUSTRY'S LOWEST-PRICED PROFESSIONAL FET-TVM.

Model 239
\$39.95
KIT



Use the battery powered Solid State EICO 239 on your bench or in the field. Check semiconductor and vacuum tube circuits. 11 Megohm DC input impedance. Read AC rms and DC voltages in seven steps from 1 to 1000 volts on large 4 1/2" meter. Measure and read peak-to-peak AC to 2800 volts. Check resistance from 0.2Ω to 1000MΩ on seven ranges. Provides a total of 28 useful ranges on 12 accurate scales. Automatic battery check. Includes exclusive DC/AC ohms Uniprobe™. Factory Assembled, \$59.95.

FREE 32 PAGE EICO CATALOG

For latest catalog on EICO Test Instruments, Stereo, EICOCRAFT Projects, Environmental Lighting, Burglar/Fire Alarm Systems, and name of nearest EICO Distributor, check Reader Service Card.

EICO, 283 Malta Street, Brooklyn, N.Y. 11207



CIRCLE NO. 3 ON PAGE 17

elementary Electronics

INCLUDING SCIENCE AND ELECTRONICS

Nov./Dec. 1971 Vol. 11/No. 5
Dedicated to America's Electronics Hobbyists

Editor-in-Chief

JULIAN M. SIENKIEWICZ, WA2CQL

Technical Editor

STEPHEN B. GRAY

News Editor

CAROL J. BRUCKNER

Citizens Band Editor

KATHI MARTIN, KA1Ø614

Workbench Editor

HANK SCOTT

Art Editor and Art Director

JIM MEDLER

Cover Art Director

IRVING BERNSTEIN

Assistant Art Director

ANDY STEIGMEIER

Art Associate

ANTONY BARONOWSKI

Advertising Director

DAVID J. MILLER

Production Director

CARL BARTEE

Production Manager

GERTRUD BORCHARDT

Assistant Production Manager

MARILYN VARGAS

Subscription and Marketing Manager

ROGER G. CAVANAGH

Newsstand Circulation Director

DON GABREE

Instruments Division Manager

WILFRED M. BROWN

Chairman of the Board

B. G. DAVIS

President and Publisher

JOEL DAVIS

Vice President and General Manager

LEONARD F. PINTO

Vice President and Treasurer

VICTOR C. STABILE, KBPØ681

ELEMENTARY ELECTRONICS is published bi-monthly by Science & Mechanics Publishing Co., a subsidiary of Davis Publications, Inc. Editorial, Business and Subscription offices: 229 Park Avenue South, New York, N.Y. 10003. One-year subscription (six issues)—\$3.95; two-year subscription (12 issues)—\$7.95; three-year subscription (18 issues)—\$11.95; and four year subscription (24 issues)—\$15.95. Add \$1.00 per year for postage outside the U.S.A. and Canada. Advertising offices: New York, 229 Park Avenue South, 212-OR 3-1300; Chicago, 520 N. Michigan Ave., 312-527-0330; Los Angeles, J. E. Publishers' Rep. Co., 8560 Sunset Blvd., 213-659-3810; Long Island: Len Osten, 9 Gordon Street, Great Neck, N.Y., 516-487-3305; Southwestern advertising representative: Jim Wright, 818 Olive St., St. Louis, 314-CH-1-1965. Second-class postage paid at New York, N.Y. and at additional mailing office. Copyright 1971 by Science and Mechanics Publishing Co.

SPECIAL INTRODUCTORY OFFER

TO
SCIENCE & MECHANICS
One Full Year of "S & M" for only \$2.57
A Regular \$4.00 Value — You Save over 35%

HOT HOW-TO PROJECTS

Yes! Each and every issue of Science & Mechanics brings you hard-hitting informative reading, from space technology to new products—Science & Mechanics has the flair and flavor of right now. Every issue is written for the man who wants to keep ahead of this fast changing world we live in.

Every issue of Science & Mechanics is packed with these typical firsts: an expose of the famous Russian space walk films as frauds... why scientists are concerned over the possibility of a major California earthquake... how various auto diagnostic centers perform on a comparative basis.

HUNDREDS OF GREAT NEW IDEAS

Right now is the time to get with Science & Mechanics, the magazine that has the newest, hottest, and best in How-To Projects... not just great projects on how to build furniture, bookshelves, and decorative items for the home, but great new home projects like how to get started in model rocketry... how to build your own street buggies... how to stereo-ize your home and many more great and timely how-to projects that are not only fun but that can be profitable for you too. So make sure you

have the next issue and following issues of Science & Mechanics for action and entertainment.

GUARANTEE

Your subscription to Science & Mechanics will be sent to you with an unconditional guarantee. To get yours, fill out and mail the coupon below. When your first issue arrives you'll see why millions of readers across the country have read and enjoyed S & M for over 40 years. And we are so sure that Science & Mechanics will be welcomed into your home each and every issue that we make this unconditional guarantee—that if for any reason you are dissatisfied, we will cancel your subscription and you will receive a full pro-rata refund on the unused portion of your subscription... no questions asked!

LIMITED OFFER

We urge you to order your subscription to Science & Mechanics today, so that your copies will start coming right away. Orders will be processed so that you will receive the very next available issue. We will enter your subscription to S&M for only \$2.57, 1 full year — 12 issues... saving you over 35% of the regular price. This offer may not be repeated again.

SCIENCE & MECHANICS, Dept. 936
229 Park Avenue South
New York, N.Y. 10003

Please enter my subscription to "S & M" — for only \$2.57.
I save over 35% on the regular subscription price.

- New Subscription Regular Subscription
 Enclosed is \$ _____
 Bill me later

Name _____ (please print or type clearly)
Address _____
City _____ State _____ Zip _____

NO STAMP NEEDED

You must seal (staple, scotch tape or glue) before mailing.

FOLD HERE

DO NOT CUT HERE



BUSINESS REPLY MAIL
First Class Permit No. 1050 (SEC. 34.9 P.L. & R.) New York, N.Y.



SCIENCE & MECHANICS
229 Park Avenue South
New York, N.Y. 10003

Dept. 936

Announcing 16 exciting new Heathkit projects for wintertime kitbuilding fun!

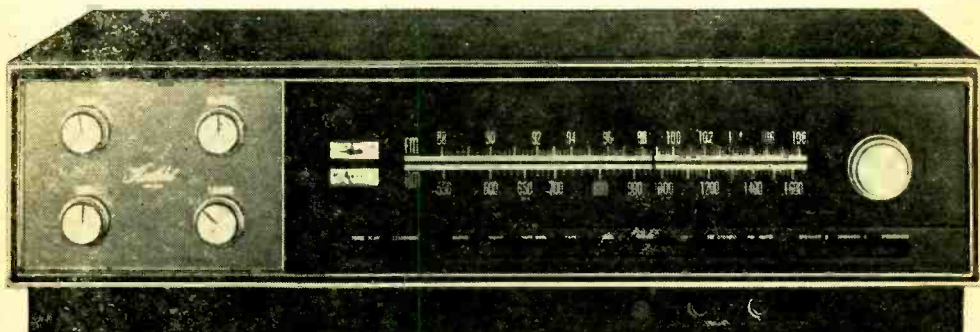

Meet the second generation AR-15 ...new Heathkit AR-1500!

From the AR-15, hailed at the time of its introduction in 1967 as the most advanced receiver of its kind, comes the AR-1500... with impressive improvements in every critical area! **180 Watts Dynamic Music Power**, 90 watts per channel (8 ohm load); 120 watts dynamic music power per channel under 4 ohm load, with less than 0.1% intermod distortion, less than .25% harmonic distortion. A 14-lb. power transformer and massive output transistor heat sink are mute testimony to the power at your command. Direct coupled output and drive transistors are protected by limiting circuitry that electronically monitors voltage and current. **FM selectivity greater than 90 dB**, better phase linearity, separation, and less distortion are the result of two computer-designed 5-pole LC Filters. An improved 4-gang 6-tuned circuit front end offers better stability, 1.8 uV sensitivity, 1.5 dB capture ratio, and 100 dB image and IF rejection. Four ICs are used, three in the IF and one in the Multiplex. Patented automatic FM squelch is both noise and deviation activated, fully

adjustable for sensitivity. *Vastly Superior AM*, an "also ran" with many receivers, has two dual-gate MOSFETS in the RF and Mixer stages, one J-FET in the oscillator, 12-pole LC Filter in the IF, and broad-band detector. Result: better overload characteristics, better AGC action, and no IF alignment. *Greatly simplified kit construction*. Ten plug-in circuit boards, two wiring harnesses and extensive use of pre-cut wiring with installed clip connections make the AR-1500 a kit builder's dream. Built-in test circuitry uses signal meter to make resistance and voltage checks before operation. *Other advanced features* include Black Magic panel lighting that hides dial markings when set is not in use; flywheel tuning; pushbutton function controls; outputs for two separate speaker systems, bi-amplification, oscilloscope monitoring of FM multipath; inputs for phono, tape, tape monitor and aux. sources — all with individual level controls. *Versatile installation* in optional new low-profile walnut cabinet, in a wall, or black-finish dust cover included. Join the "NOW" Generation in audio technology...order your Heathkit AR-1500 today!

Kit AR-1500, less cabinet, 42 lbs. 349.95*
ARA-1500-1, walnut cabinet, 6 lbs. 24.95*

New Heathkit Stereo Cassette Recorder



119.95*

Frequency response of ± 3 dB, 30-12 kHz, brings your stereo system into the cassette age. Features built-in bias adjustment to accommodate the new chromium dioxide tape; counter; automatic motor shutoff; preassembled and aligned transport mechanism. The AD-110 offers fidelity recording and playback of stereo or mono when used with your stereo system.

Kit AD-110, 10 lbs. 119.95*

New Heathkit Stereo-4 Decoder



29.95*

Compatible with your present stereo system and FM receiver, lets you hear all Stereo-4 material currently being broadcast by a number of stations across the country. Additionally, imparts a 4-channel effect to your existing stereo library. Requires second amplifier and 2 speaker systems for installation with conventional stereo system.

Kit AD-2002, 5 lbs. 29.95*

New Heathkit Stereo Phonograph with AM Radio

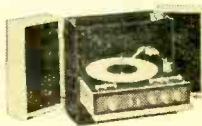

109.95*

Gets it together in a portable package with a purple plum snake skin that's as far out as today's sounds. Solid-state 18-watt amplifier, fold-down 4-speed automatic changer and swing-out high compliance speakers. Speakers can be separated up to 5'. A flip of the mode switch and you're into AM radio! 45 spindle adapter included.

Kit GD-111, 50 lbs. 109.95*

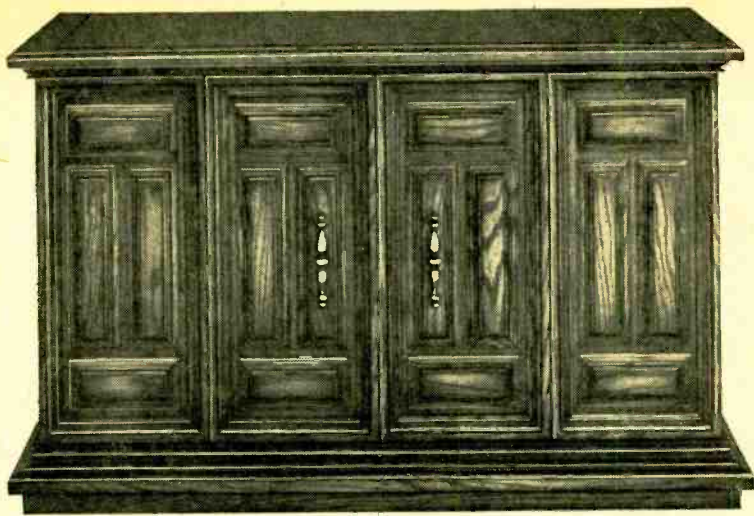

Now Heath's finest color TV package comes wrapped in a handsome new optional cabinet!

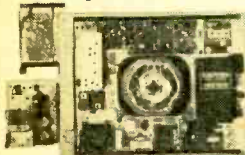

Here's the inside story:...the Heathkit 25" solid-state color TV with exclusive MTX-5 ultrarectangular tube to bring you the largest color picture in the industry! The etched, bonded tube face cuts glare, increases contrast for sharper picture, purer colors, more natural flesh tones. But the true story of color TV reliability starts in the solid-state modular circuitry... 45 transistors, 55 diodes, 2 silicon-controlled rectifiers, 4 ICs containing another 46 transistors, 21 diodes, and just two tubes (picture and high-voltage rectifier). Major circuit functions are contained on individual plug-in glass epoxy boards (see chassis inset above) to simplify assembly, service and adjustment. And, of course, only Heathkit color TV offers you the money-saving advantages of home-serviceability... with the built-in dot generator and tilt-out convergence panel to let you perform the periodic adjustments required of all color receivers.

Other advanced design features include solid-state VHF tuner with MOSFET for greater sensitivity, lower noise and cross modulation; solid-state UHF tuner with hot-carrier diode design for greater sensitivity; 3-stage solid-state IF for higher gain and superior picture quality; Automatic Chroma Control for constant color quality under different signal conditions; adjustable video peaking; adjustable noise limiting and gated AGC; "Instant-On"; VHF power tuning on 13 channels plus one preselected UHF channel; Automatic Fine Tuning; Tone-Control; and an output to your stereo/hi-fi system for the ultimate in sound reproduction.

And to wrap it all up... your Heathkit GR-371MX is available in a magnificent new Mediterranean cabinet with doors that transform your home television theater back into an attractive center of decor. This finest cabinet in the Heathkit line features deep-grained pecan veneers on hand rubbed furniture grade hardwood solids. Two beautifully scalloped double-hinged bi-fold doors hide the TV screen when it's not in use, fold neatly to the cabinet sides when opened. Ornate brass "Canterbury Antique" handles add the perfect finishing touch. Measures 29 $\frac{5}{8}$ " H x 56 $\frac{1}{4}$ " W x 22 $\frac{3}{8}$ " D.

- Kit GR-371MX, TV less cabinet, 125 lbs. 579.95*
- GRA-404-25, assembled cabinet, 87 lbs. 139.95*

New Heathkit Solid-State Wireless Intercom



29.95*

Plug two of them into standard 105-130 VAC outlets for 2-way communications. Three channels let you carry on 3 conversations in a 6-unit system, call one unit without disturbing the others in a 3-unit network. Intercoms have channel selectors, spring loaded "talk" button, slide-action volume control, and "dictate" for extended one-way communication.

Kit GD-113, 5 lbs. each 29.95*

New Heathkit Solid-State Shortwave Receiver



59.95*

Four overlapping bands provide continuous coverage from 550 kHz to 30 MHz, giving you local AM plus international, amateur, marine & weather and citizens band broadcasts. Features band-spread tuning for close station separation; BFO control for receiving code; signal meter; front-panel headphone jack; noise limiter; built-in AM antenna.

Kit SW-717, 10 lbs. 59.95*

New Heathkit Automatic Battery Charger...



Charges 12-volt batteries automatically. 10 amp max. charge rate. Impossible to hook up wrong. No charge setting to make... can be left hooked up indefinitely. Meter monitor charge. Kit GP-21, 13 lbs. 29.95*

New Heathkit Automotive Timing Light...



Completely self-contained. Bright flash lets you work in sunshine. Adapter for connecting to distributor. Hi-impact plastic case.

Kit CI-1020, 2 lbs. 19.95*

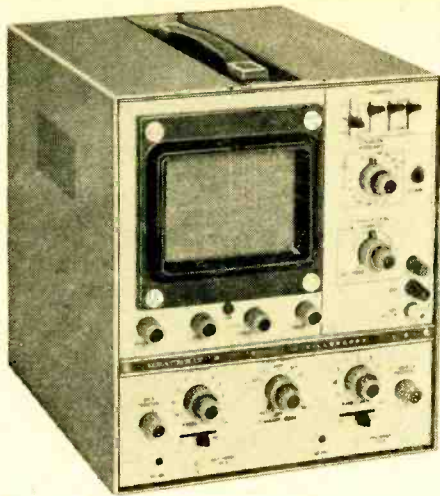

399^{95*}

New Heathkit DC-15 MHz Dual Trace Solid-State Oscilloscope...

The new Heathkit IO-105 is a high-performance scope designed to give you a wide range of measurements for use in instrumentation courses, engineering, R&D and electronics...at a fraction of the cost of comparable scopes! The IO-105 brings you complete dual trace and X-Y capability, allowing comparison of input/output for such parameters as loss, gain, phase shift and distortion. You can display two separate input signals in Channel 1 or Channel 2 modes of operation. Direct comparison of both signals is possible in alternate and chopped modes. In the alternate mode, both signals are alternately displayed on successive sweeps...at faster sweep speeds they are retained on the screen for time relationship comparison. In the chop mode, both signals are sampled at 100 kHz and appear as a function of the same time base. In X-Y, both channels are displayed as a function of each other...channel 1 controlling the vertical (Y) axis and channel 2 controlling the horizontal (X) axis. Both input channels are precision balanced for 5% or less phase shift to 50 kHz. Switch selected AC or DC coupling lets you trigger the time base at a given point on the signal or at a preselected

DC level. Flipping a switch gives you automatic triggering at the crossover (O) point. You can also switch select positive or negative slope triggering. Internal, External and Line trigger inputs are provided. The convenient 18-position time base switch in a 1, 2, 5 sequence provides sweep rates from 100 msec/cm to 0.2 usec/cm. The separate vernier control with a calibrated position gives you continuous control between settings, while a 5-times magnifier switch allows detailed trace viewing. The DC-15 MHz bandwidth capability and 24 nsec rise time make possible analysis of high frequency signals and transient waveforms. Full bandwidth is featured from 20 V/cm to 50 mV/cm in 1, 2, 5 sequence. For special applications, a rear panel Sweep Gate output delivers a 3.5V pulse in sync with the sweep. A TTL-compatible external blanking input is also provided. Other features include a CRT bezel incorporating standard camera mount dimensions...flush mounted handle for easy stacking...easily-removable side panels for quick accessibility...compact, 15" depth for bench installation instead of cart. If you want to expand your analysis capability while holding the budget line, order your new Heathkit IO-105 now! Or send for more information and complete specification sheet.

Kit IO-105, 35 lbs. 399.95*

New Heathkit Vector Monitor...

49^{95*}



Designed for use with the Heathkit IG-28 Pattern Generator or similar units which display either "rainbow" (offset carrier) or NTSC patterns, the IO-1128 vector display helps you perform fine tuning, static and dynamic convergence,

purity, 3.58 oscillator, reactance coil, phase detector transformer, demodulator angle check, and chroma bandpass adjustments. Represents exactly the color signals fed to CRT guns.

Kit IO-1128, 10 lbs. 49.95*

New Heathkit Electronic Switch... 39^{95*}

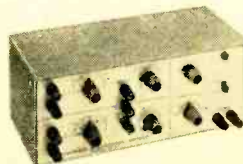

Provides simultaneous visual display of 2 input signals on a single trace oscilloscope. Has DC coupling and DC-5 MHz ± 3 dB frequency response. Conventional binding posts permit fast

hook-up. Can be left connected to scope. Ideally suited for digital circuit work; amplifier input and output for gain and distribution checks; simultaneous monitoring of 2 stereo channels.

Kit IO-101, 6 lbs. 39.95*

New Heathkit "Minimizer" kitchen waste compactor...

Today's most modern refuse handling method in easy-to-assemble kit form! Now you can own the most exciting kitchen appliance on the market for less than you'd pay for any other comparable compactor. The Heathkit Minimizer lets Mom throw out the unsightly waste baskets and garbage cans for the latest in clean, convenient, odor-free disposal. The Minimizer handles all normal household trash — food wastes, glass and plastic containers, tin cans, wrappings, boxes, floor sweepings, light bulbs, etc. The packing ram descends with 2,000-lb. force to reduce refuse to almost 1/4 of its original size, packaging the material in a strong disposable bag — one bag holds an entire week's trash for a family of four! When the bag's full, Mom simply folds over the top and removes a neat, dry package for normal rubbish pickup. And the Minimizer deodorizes the contents each time the drawer is opened and closed. The sanitation man will love Minimizer, too!

Simple, safe operation! To use, Mom merely inserts a Minimizer plastic-lined bag in the drawer and starts the compacting cycle. In less than a minute the ram forces down the trash, returns to its normal position, and the Minimizer shuts itself off. For maximum safety, the Minimizer uses a key lock switch and an interlock which automatically turns unit off if drawer is not fully closed or is accidentally opened during cycling. Your Heathkit Minimizer can be built-in under the kitchen counter or left free-standing. Its bright white enamel finish with marble-tone vinyl-clad top complements any decor. And you can build it yourself in 6 to 10 hours. Has long-life 1/2 hp motor, plugs into 110-120 VAC conventional household outlet. Kit includes 5 plastic-lined bags, one 9 oz. aerosol can of deodorant. Minimizer measures 34 3/8" H x 15" W x 25 1/2" D.

Kit GU-1800, 203 lbs. 199.95*
 GUA-1800-1, 25 plastic-lined bags,
 2 aerosol cans, 6 lbs. 10.95*

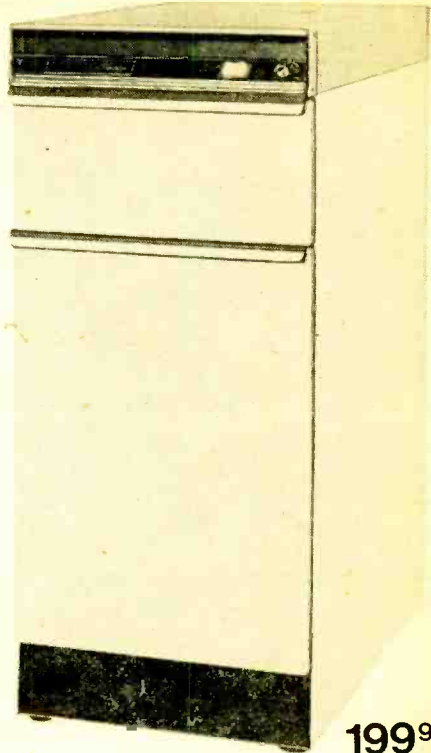

199.95*

New Heathkit Thermo Spotter



24.95*

Seeks out the temperature where your favorite fish live. Includes submersible sensing element, 100' of strong nylon cord, battery-powered solid-state meter circuitry... in high-impact plastic take-up reel case.

Kit MI-104, 3 lbs. 24.95*

New Heathkit Digital Depth Sounder



139.95*

Gives accurate, digital depth readings to 199'. Red warning light alerts you to shoals of 10' or less. Automatic noise rejection and range switching.

Kit MI-101-1 (w/thru-hull trans.)
 6 lbs. 139.95*
 Kit MI-101-2 (w/transom-mount trans.) 8 lbs. 139.95*

New Heathkit Economy Garage Door Opener

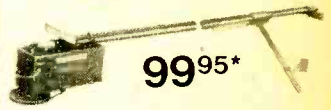

99.95*

Deluxe features include husky 1/4 hp motor, heavy-duty chain drive, automatic safety reversing, automatic light. Preassembled transmitter & solid-state receiver.

Kit GD-309A, 43 lbs. 99.95*
 Kit GD-309B (w/2 trans.)
 43 lbs. 114.95*

SEE THESE KITS AT YOUR LOCAL HEATHKIT ELECTRONIC CENTER... or send for FREE catalog!

CALIF.: Anaheim, 330 E. Ball Road; El Cerrito, 6000 Potrero Avenue; La Mesa, 8363 Center Drive; Los Angeles, 2309 S. Flower St.; Redwood City, 2001 Middlefield Rd.; Woodland Hills, 22504 Ventura Blvd.; COLO.: Denver, 5940 W. 38th Ave.; GA.: Atlanta, 5285 Roswell Road; ILL.: Chicago, 3462-66 W. Devon Ave.; DOWNERS GROVE, 224 Ogden Ave.; MD.: Rockville, 5542 Nicholson Lane; MASS.: Wellesley, 165 Worcester St.; MICH.: Detroit, 18645 W. Eight Mile Rd.; MINN.: Hopkins, 101 Shady Oak Rd.; MO.: St. Louis, 9296 Gravois Ave.; N.J.: Fair Lawn, 35-07 Broadway (Rte. 4); N.Y.: Jericho, L.I., 15 Jericho Turnpike; New York, 35 W. 45th Street; OHIO: Cleveland, 5444 Pearl Rd.; Woodlawn, 10133 Springfield Pike; PA.: Philadelphia, 6318 Roosevelt Blvd.; Pittsburgh, 3482 William Penn Hwy.; TEXAS: Dallas, 2715 Ross Avenue; Houston, 3705 Westheimer; WASH.: Seattle, 2221 Third Ave.; WIS.: Milwaukee, 5215 Fond du Lac.

Retain Heathkit Electronic Center prices slightly higher to cover shipping, local stock, consultation and demonstration facilities. Local service also available whether you purchase locally or by factory mail order.



HEATH COMPANY, Dept. 139-11
 Benton Harbor, Michigan 49022

Enclosed is \$_____ plus shipping.

Please send model(s) _____

Please send FREE Heathkit Catalog.

Name _____

Address _____

City _____ State _____ Zip _____

*Mail order prices; FOB factory.

Prices & specifications subject to change without notice. CL-415

CIRCLE NO. 5 ON PAGE 17

KEEP PACE WITH SPACE AGE! SEE SPACE FLIGHTS, LANDINGS CLOSE-UP!

AMAZING SCIENCE BUYS for FUN, STUDY or PROFIT

NEW LIGHT-EMITTING-DIODE KIT

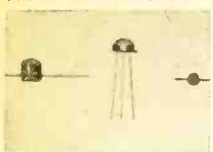

Bargain kit ideal for economical experimenting with amazing L.E.D.s, the tiny solid state monochromatic lamps that use low voltage DC, last up to 100,000 hrs. Used in card-tape readers, character recognition, hi-speed detectors, all kinds of electro-optical applications. Kit incl. 3 L.E.D.s: gallium arsenide (MLED 600, MV 50, MLED 930); 2 visible red emitting (3000 A°); 1 infrared emitting (9000 A°); 6 resistors; 1* 20mm plastic fibre optic light pipe; 10Wrs.

Stock No. 41,597EK \$5.95 Ppd.

LOW COST TREASURE FINDER

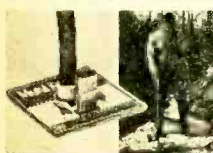

Discover the fun and profit of treasure hunting inexpensively. Light as a feather (10 oz.), solid-state metal detector finds hidden coins, jewelry, precious minerals. Distinguishes minerals from metal objects. Great for school, beach, campground or backyard. Requires 9V transistor batt.—works with any common AM transistor radio thus eliminating costly extra circuitry, weight, dangling wires. Adjustable multi-purpose plastic handle reduces immediate area metal—adds to efficiency. No tuning needed.

Stock No. 71,395EK \$14.95 Ppd.

Stock No. 71,436EK (w/ R dia)

BUILD A WORKING CRYSTAL RADIO

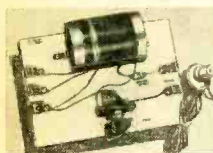

Bring the 20's back with the fun of a modernized earphone crystal set that receives 1 or more stations! So simple you can have it working in less than an hour. Connects to a permanently fixed germanium crystal. Kit incl: 43% x .63 x 3/8" thick plating base, high-Q tuning coil, germanium diode, variable condenser, all radio parts, earphone & holder plus diagram & simple instructions. A charming conversation piece, great fun at parties and ideal gift.

Stock No. 71,513EK \$5.95 Ppd.

NEW! ELECTRONIC DIGITAL COMPUTER KIT!



Solve problems, play games, predict weather with this actual working model of giant electronic brains. Amazing new fun way to learn all about computer programming . . . logic, decimal, binary systems. Laws of Sets—open door to your own programming after completing simplified 116 page instructive booklet. Includes step-by-step assembly diagrams. Circuits easily changed. Readout from illuminated control panel. Req. 2 "D" batt. (not incl.). Best model we've seen for home, school, industry.

Stock No. 71,434EK \$41.50 Ppd.

NEW 18" BLACK-LIGHT STROBE

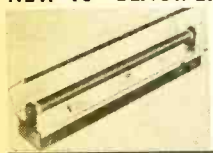

It's a versatile strobe . . . and it's black-light! Adjustable flash rate from as slow as 1 flash per several secs. to a continuous flow beyond visual flicker perception (1,500 flashes a minute)—may be used as reg. light source. Top quality, solid state unit has hi-polish reflector, long lamp life. Ideal for parties, black-light posters, combo's, decoration and experiments. Incl. 18" black-light tube, 4 1/2 ft. cord. Approx. 3 X 2 1/2 X 1 1/2".

Stock No. 71,480EK \$42.95 Ppd.

AMAZING NEW Wankel Engine KIT!



Thrill to the fun of building your own see-through motorized model of revolutionary pistonless type engine . . . only engine expert to this date. Easily modifiable to meet pollution standards. Replaces piston, cylinder, crank assemblies with rotating discs (sections removed for firing chambers). Smaller than conventional; fewer parts, greater reliability, same speed w/ less horsepower. Feat: flashing plugs, rubber fan belt, stick-shift on-off switch. Req. 1* 1.5V batt. (not incl.).

Stock No. 71,424EK \$6.75 Ppd.

VISIT OUR RETAIL STORE!

5 minutes from Jersey Turnpike Exit #3. 15 min. to Phila., either bridge. See 4,000 unusual bargains, plus exclusive Store Sale Items. FREE Light Show every afternoon. Store Hours: Mon.—Thurs. 8 to 6; Fri. & Sat. 8 a.m. to 9 p.m.; Sun. 11 to 6.

Order by Stock No.—Check or M.O.—Money-Back Guarantee
EDMUND SCIENTIFIC CO., 300 EDCORP BLDG., BARRINGTON, N.J. 08007

WRITE FOR FREE GIANT CATALOG

148 PAGES!—1000's OF BARGAINS

EDMUND SCIENTIFIC CO., 300 EDCORP BLDG., BARRINGTON, NEW JERSEY 08007. Completely new edition. New items, categories, illustrations. Dozens of electrical and electromagnetic parts, accessories. Enormous selection of unique lighting items, Astronomical Telescopes, Microscopes, Binoculars, Magnifiers, Magnets, Lasers, Lenses, Prisms. Many war surplus items: for hobbyists, experimenters, work shop, factory. WRITE FOR CATALOG "E.K."

DX central reporting

A world of SWL info!

By Don Jensen

The last major holdout to the Strasbourg Treaty reportedly is about to sign on the dotted line. By the time you read this, the Netherlands already may have added its name to the list of signatories.

So what's the Strasbourg Treaty? A new economic common market scheme? A nuclear non-aggression pact? Nope, it's an agreement hammered out several years ago by the main European powers to deep six the private broadcasting stations that operate shipboard from International Waters.

Plagued by a rush of illicit offshore stations operating during the '60's and egged on by their state radio monopolies, the European nations agreed to crack down on owners, suppliers, advertisers, and even in some cases, on listeners to these illegal broadcasters. And, for the most part, the lid stayed on.

The one real exception was Holland, which never ratified the treaty. And Holland became the haven for the two or three remaining pirate stations, the most important of which were Radio Veronica, a medium wave outlet, and Radio Nordsee International, which operated on medium and short waves and on FM.

But now the Netherlands will—or perhaps has already—decided to join the rest of Europe by signing the pact.

What brought about this seeming change of heart was a nasty bit of internecine warfare between Radios Veronica and Nordsee International that culminated in the firebombing of RNI's radioship in mid-May.

Among radio pirates, Radio Veronica was unique. While others came and went, Veronica enjoyed 11 years of illegal, but highly profitable broadcasting from a ship anchored outside Holland's three-mile limit. Though regularly supplied from a Dutch shore base, the authorities made no move to interfere with the popular station.

Then, a couple years ago, Radio Nordsee International moved in. After a few false starts, it began successfully luring away both listeners and advertisers. Allegedly, Veronica tried to buy off the competition. Negotiations between

(Continued on page 14)

NEW 1971 CRAFT PRINT CATALOG



The new 1971 Craft Print Catalog has over 100 great easy-to-build plans . . . Sail boats . . . recreational travel trailer . . . Biplane . . . and many home projects you can order. With the 71 Craft Print Catalog you can get top mailage from your own craft skills . . . outstanding design . . . utility value . . . and ease of construction. Each Craft Print is fully illustrated . . . step-by-step construction procedures . . . and complete material list.

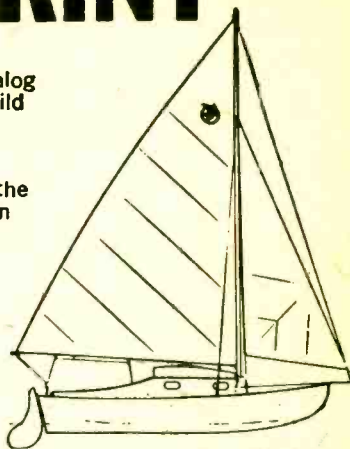

Here are just 3 of the many great Craft Prints Plans included in the catalog.



255. MINIMAX. For minimum cost and maximum performance you can't beat "Minimax." Actually, it was built in one day at a cost of less than \$30.00. It will carry two persons, take outboard motors ranging from 3 hp to 15 hp, and has a watertight air compartment that will support 900 lbs. even with the cockpit completely filled with water. As to performance, it will plane a 165 lb. man up to 15 mph with a 3 hp motor. With motors of 10 hp or more, "Minimax" just about rides on the engine's cavitation plate. Length, 8'; beam, 48"; weight, 68 lbs. Full size patterns No. 347 are available for "Minimax." \$12.00



334. EAA BIPLANE. Completely modern in design, but based on the traditional one-man flying machine of yesteryear, is the EAA Sport Biplane. It's a real plane, adaptable to home construction at a cost of less than \$2000 (with a used engine). She can carry a 230 lb. pilot at a rate of climb of 700' per minute to a ceiling of 11,500'. With an 85 hp engine, she can attain a speed of 130 mph. (Plans are \$15.)

106. PETREL. As a sailboat, "Petrel" fulfills the greatest possible variety of uses in one model. It can be built as an open cockpit racing craft, or as a cabin cruiser with accommodations for overnight trips and shelter on fishing excursions. Cockpit seats four. Either model is constructed from the same basic design, and possesses unusual seaworthiness, stability, trim attractive lines, speed, and ability to handle well. Construction is easy and inexpensive, utilizing marine or exterior grade plywood. An outboard of up to 6 hp can be used for auxiliary power. Due to the simplified construction, ordinary carpenter's tools and only average skill are required to build this boat. Length, 16'; beam, 6'; depth, 23" amidships; draft with fixed keel, 24"; draft with centerboard down, 30"; weight 650 lbs.

AMAZING OFFER

All Craft Prints are unconditionally guaranteed; if you are not completely satisfied you may return them and your money will be promptly refunded.

To order Craft Print or Catalog use the handy order form below.

MAIL TODAY

SCIENCE & MECHANICS/ Dept. CP-96
CRAFT PRINT DIV.,

229 Park Avenue South, New York, N.Y. 10017
Please send me _____ copy(s) of the 1971 Craft Print Catalog for only \$1.00 ea . . . COMPLETELY REFUNDED WITH FIRST ORDER.

Please send me the following Craft Print Plan(s).

Craft Print(s) #255 _____ @ \$3.00 each

Craft Print(s) #334 _____ @ \$15.00 each

Craft Print(s) #106 _____ @ \$3.00 each

Enclosed is \$ _____

A FREE Catalog is included with each Craft Print Order. Sorry No C.O.D. orders accepted. First class mail. 50¢ extra

NAME: _____

ADDRESS _____

CITY _____ STATE _____ ZIP _____

SAVE! SPECIAL OFFER: Order 2 or more sets of Plans and you can deduct 10%—from the total price.

meet the metrics

Xcelite's where the Metrics are!

A great variety of tools and sets to help you turn most any Metric fastener or adjusting screw you're likely to encounter . . . hex socket set screws and cap screws, hex nuts, hex head cap screws, and whatever.

All tools precision made for exact fit. Bright nickel chrome nutdriver shafts and protective black oxide finished hex socket screwdriver blades. Plastic (UL) handles shaped for perfect grip and balance.

FIXED HANDLE NUTDRIVERS



NUTDRIVER SHANKS & HEX SOCKET SCREWDRIVER BLADES for use interchangeably in Series 99 plain and ratchet type handles.

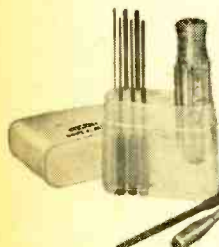

COMPACT SETS
No. 99-PS-41-MM
(7 Metric hex socket blades, extension and handle)



No. 99-PS-51-MM
(10 Metric nutdriver shanks, extension and handle)

nationwide availability through local distributors

XCELITE

XCELITE, INC.,
80 BANK ST., ORCHARD PARK, N. Y. 14127

Send Catalog with information on Xcelite Metric Tools.

name _____

address _____

city _____ state & zip _____

CIRCLE NO. 7 ON PAGE 17

DX Central Reporting

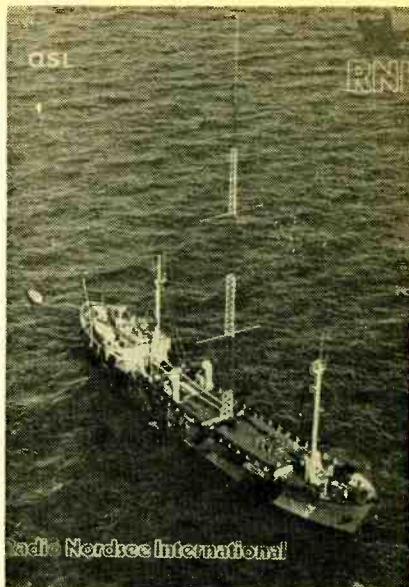

It's dull work for station personnel to address QSL cards to interested listeners except on the RNI ship where anything can happen!

the pirate broadcasters led to court action, in which the Veronica owners apparently felt they came out on the short end.

That brings us to the night of Saturday, May 15, when three men, dressed in black "wet suits," launched a rubber raft near the Dutch harbor of Scheveningen and paddled toward the psychedelic-hued hull of the radioship, MEBO II, seagoing home of RNI. Aboard, the crew and off-duty disc jockeys were watching a soccer game on TV and never saw the approaching raft.

Shortly before 9 p.m., the trio slipped aboard the MEBO II, entered the engine room unnoticed and taped an ounce of dynamite to the pipe leading from a 250 gallon diesel fuel tank to the station's generators. The unexpectedly powerful blast touched off a raging blaze and blew the three men, unharmed, into the water. They managed to make it back to shore, where they buried the raft and their rubber suits in the sand dunes.

Aboard MEBO II there was instant chaos. The radiomen and the ship's crew vainly tried to fight the fire. At 2158 GMT, the station broke its rock music programming and began calling, "Mayday! Mayday!"

Luckily, no one was killed or injured and a nearby supply tender moved in to take off the crew. Then, with only the captain and two assistants aboard, the station went silent.

A Dutch naval craft and the fireboat Volans from Scheveningen came alongside to fight

the blaze. By 1 A.M., the fire was under control. Though the flames had caused nearly \$50,000 worth of damage, the broadcasting facilities were untouched and Radio Nordsee International resumed broadcasting at its normal 0500 GMT sign-on time.

Later that day, Dutch police arrested three frogmen and their statements led to charges against 48-year-old Norbert Jurgens, an employe of the firm that owned Radio Veronica, who allegedly hired them.

The biggest surprise of all came on Tuesday, two days later, when Hendrik "Bull" Verwey, the tough, bearded director of Radio Veronica, admitted on Dutch TV that he had given his support and financial backing to the firebombing scheme. On Wednesday, Verwey, too, was arrested. All are now awaiting trial.

The bombing shook the Dutch parliament and newspapers began predicting that by fall it would act to shut off the pirates' last haven.

As of this writing, both pirate stations were still on the air, with RNI's shortwave signal on 6,205 kHz offering U.S. DXers their best—and perhaps last—opportunity to tune an honest-to-goodness shipboard pirate. Best time to try is around 0500 to 0600 GMT.

If legal action does end the offshore broadcasting, what then? One of RNI's co-owners has hinted he might move the refurbished MEBO II to the Mediterranean for one last

try. There also are rumors afoot that the Dutch government may legalize limited commercial broadcasting and give one or both of the pirate stations licenses to operate ashore, under proper supervision, of course, to guarantee that nothing like the incident in May occurs again.

Bandsweep. Frequencies in kHz, all times GMT: **3,300**—The English-speaking station you're hearing on this frequency around 0045 is the *Windward Islands Broadcasting Service* at St. George's, Grenada, not British Honduras. According to recent word from the Central American, it no longer broadcasts on shortwave. . . . **3,220**—Want a real toughie to shoot for? Try the brand new *Radio Morobe*, a two kilowatt located at Lae, Papua Territory, New Guinea around 1100 to 1200 sign off. . . . **4,923**—"*Radio para usted, Radio Quito*." Translated that means *radio for you*, and this station in Ecuador's capital is one of your best bets among the Latin American broadcasters. Listen for its Spanish language programming and easy-to-understand identification around 0400. . . . **6,130**—If you prefer your programs in English, try for CHNX, one of Canada's private shortwave broadcasters, in Halifax, Nova Scotia about 2300. It's an easy one for east coasters; tougher for those living farther west. . . . **8,630**—Libya is a hard country to log, even for DXers with a few

(Continued on page 97)

True 4 Channel Sound

[\$42.50 per 20 watt channel]

There are several components on the market today that will give you true 4-channel sound.

All are expensive. Except ours.

We call ours QAUDIO*. It's an amplifier and player with 4 discrete channels. And we designed it primarily to play the new 8-track 4-channel cartridges.

But it will also play ordinary 8-track stereo cartridges, and make them sound fuller and richer than they ever have before.

Of course it takes a specially recorded 4-channel cartridge to give you the real QAUDIO experience.

You can experience it today—at a price that's almost as unbelievable as the sound: \$169.95. (That's \$169.95 for a true 4-channel amplifier-player with 80 watts of total music power.) A unit for car/boat is just \$129.95.

We'll be happy to send you the names of dealers near you demonstrating QAUDIO, together with a brochure describing it in detail.

Write to Toyo Radio Company of America, Inc., 1842B W. 169th St., Gardena, Calif. 90247.



QAUDIO
BY TOYO

A SHOCKING EXPERIENCE IN SOUND

*PRONOUNCED "KWAH-DIO". THE NAME QAUDIO IS BASED ON THE GENERIC "QUADRIPHONIC".

CIRCLE NO. 8 ON PAGE 17

CALL ME!



I'll send you 2 FREE BOOKS describing the opportunities in Electronics. Call me TOLL-FREE **800-321-2155** (in Ohio, call 800-362-2105).

For details about the famous CIE home-study courses in Electronics, see our ad on page 106

Cleveland Institute of Electronics
1776 East 17th Street, Cleveland, Ohio 44114

new deluxe

CB MINI-BEAM

Gamma 323 Miniature
3-Element CB Beam
with deluxe coils -
Mini-Size, Mini-Cost,
Maxi-Performance.
Sound too good to
be true? Get the
whole story . . .

From
Mosley

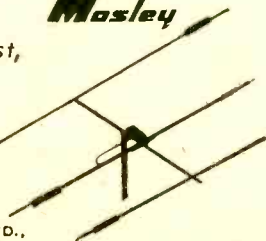

4610 N. LINDBERGH BLVD.,
BRIDGETON MO. 63042

Please send me FREE information about the new Mosley Deluxe Mini-Beam.

Name _____

Address _____

City/State _____ Zip _____

#173A

Mosley Electronics Inc. 4610 N. Lindbergh Blvd.,
Bridgeton Missouri 63042

CIRCLE NO. 9 ON PAGE 17



BOOKMARK

BY BOOKWORM

Going Commercial. Sooner or later you're going to say, "Why didn't I get a commercial radio operators license?" Well, don't let a job or opportunity escape you. Get started today on your "third-class ticket." It's easy! Leonard C. Lane authored *Simplified Radiotelephone License Course, Vol. 1*, which covers the latest requirements for successful completion of the FCC examination for the Radiotelephone

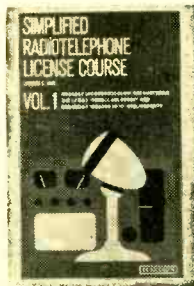

Soft cover
136 pages
\$3.95

Operator's third-class permit and additional broadcast endorsement. The book combines review theory and up-to-date exam questions grouped by subject area. If you want to go on for a second-class or first-class license, all you need do is obtain Volumes 2 and 3. Published by Hayden Book Co., Inc.

Circle No. 42 on Reader Service Page

Long Title. Here's a book whose title is the longest we've reported on in many years—*How to Use Vectorscopes, Oscilloscopes, Sweep-Marker Generators*. Written by Stan Prentiss, this volume has a combination of



Hard cover
256 pages
\$7.95

instructions not equalled anywhere. Guesswork and frequent substitution techniques are grossly outmoded and inefficient in today's electronic work. The technician must know
(Continued on page 98)

ELEMENTARY ELECTRONICS

READER SERVICE PAGE

• The Editor of ELEMENTARY ELECTRONICS offers readers an easy way to get additional information about products and services advertised in this issue. Also, if you would like more information about any new product mentioned in our column "Hey, Look Me Over," it's yours for the asking. Just follow the instructions below and the material you requested will be sent to you promptly and at no cost.

• The coupon below is designed for your convenience. Just circle the numbers that appear next to the advertisement or editorial mention that interests you. Then, carefully print your name and address on the coupon. Cut out the coupon and mail to ELEMENTARY ELECTRONICS, Box 886, Ansonia Station, New York N Y 10023. Do it today!

NOV./DEC. 1971

Void after May 31, 1972

ELEMENTARY ELECTRONICS

Box 886, Ansonia Station, New York N Y 10023

Please arrange to have literature whose numbers I have circled at right sent to me as soon as possible. I understand that this is a free service offered by the magazine.	1	2	3	4	5	6	7	8	9	10
	11	12	13	14	15	16	17	18	19	20
	21	22	23	24	25	26	27	28	29	30
	31	32	33	34	35	36	37	38	39	40
	41	42	43	44	45	46	47	48	49	50
	51	52	53	54	55	56	57	58	59	60

Name (Print Clearly) _____

Address _____

City _____ State _____ Zip Code _____

stamp shack

Philatronics Today!

BY ERNEST A. KEHR

●● On last May 22, when the International Stamp Exhibition opened in Capetown, the Republic of South Africa released a pair of special commemoratives. One of them, the five-cent denomination, features the J. G. Strijdom Tower and a portrait of the prime minister who served from 1954 to 1958, and after which this fantastic building was named.

● Such towers and stamps honoring them are not exactly new to collectors. It all began in April, 1961, when the United Arab Republic issued its 10-millieme, greenish-blue commemorative for the opening of the Cairo Tower on Gezireh Island—first of its kind in the world and precursor of all the others that now are sprouting from the earth's scattered nations.

● The Strijdom's main purpose—like those of Cairo and London—is to provide improved electronic communications facilities. It becomes



the heart of South Africa's ultra-modern and sophisticated microwave network which links all the major cities of the land.

● Careful investigation and study revealed that the microwave technique offers superior communications quality and also is cheaper than expanding existing underground trunk routes.

● The network comprises a number of high-frequency radio relay stations over which microwaves are transmitted in direct visual lines from one station to the next with saucer-shaped antennas. Because of their high frequency, microwaves have the same characteristics as light beams: they travel in straight lines, so it becomes essential that no obstacles lie within their paths. To maintain adequate transmission performance, stations are situated about 30 or 40

miles apart, in direct line of sight with each other.

● One such route can provide up to 32,000 channels for simultaneous telecommunications since the microwaves are electronically processed into individual telephone calls at the terminal stations through automatic switching equipment to subscribers.

● Including a 115-foot mast for Post Office VHF radiotelephone communications, the Strijdom Tower rises 870 feet above Johannesburg to make it the tallest structure man ever built in Africa. (Until it was finished last March, the Cairo Tower, at nearly 700 feet, held this record.)

● In silhouette, it looks a bit like some strange giant flower atop a slender stem. The topmost cluster of extensions house elevator motors, a VIP room, and battery storage chambers for radios and associated apparatus. These are recessed to accommodate the antennas not only to preserve the architectural beauty of the whole, but to make them more easily accessible for maintenance and repairs.

● Built at a cost of \$5 million, it has a mass of some 19,050 metric tons of concrete and reinforcing steel. Its walls which are sunk 140 feet below street level are more than two yards thick at the bottom and a yard thick at the top. It took 38 months in the building and installation, after the foundation was begun in January, 1968.

● Because it is so high above the streets of Jo'burg's Hillbrow, there never need be any worry that it ever will be surpassed by other structures that are continuing to rise in this great African metropolis.

● But its communications facilities are not the only Strijdom Tower attractions. Just below the technical installations is a seven story complex designed to make it a popular, utilitarian landmark. There is, for example, a swank revolving restaurant where 108 guests may be accommodated in its luxurious salon decorated with murals depicting exotic native birds. Just below is a grill room to handle another 113 diners. Its murals have stylized pictures that record the postal history of South Africa from the time when native couriers brought letters to pioneers in forked sticks.

● Still lower are bars and lounges offering refreshments and snacks for those who have less time and funds. Also, an observation level from whose 24 large windows one gets an unobstructed, clear view of the surrounding countryside to a distance of about 60 miles.

● Two high-speed elevators (they call them "lifts") carry visitors up through the interior of the tower at 20 feet per second. One is intended for tourists to the observation deck, the other, to the dining rooms and VIP room.

●● To commemorate the centenary of telegraph service in what today is Yugoslavia, this nation issued, on June 20, a half-dinar brown,

(Continued on page 99)

e/e etymology

How about a word with us?

BORON

▲ Names of many elements are rooted in ancient discoveries and hence can't be dated within several centuries. Many found in recent times can be precisely pinpointed.

That's the case with *boron*.

Sir Humphry Davy, English chemist whose curiosity was insatiable, was fascinated by the fact that electrolysis often breaks down compounds.

With no special purpose in mind, one day in October, 1807, he tried his hand at electrical decomposition of boracic acid. One product of the experiment was a dark brown powder. Davy immediately recognized it as a new element.

The discoverer took the first three letters of the *borax* with which he had started. Because his end product looked a bit like powdered carbon he borrowed the last two letters from the name of that familiar element.

Named in this helter-skelter fashion, boron attracted little interest until German chemist Alfred Stock found that it can form unusual compounds. Later it was discovered that though boron is a poor conductor of electricity at normal room temperatures, conductivity increases remarkably as temperature rises.

Development of nuclear technology led to a spurt of new research, for the stable isotope boron 10 proved to be an excellent absorber of thermal, or slow, neutrons.

Today the element found almost casually in an English laboratory is basic to manufacture of compounds used in semiconductors designed to operate at high temperatures, thermoelectric generators, and many other highly sophisticated pieces of Space Age hardware.

LITHIUM

▲ Swedish chemist Johann August Arfvedson isolated a most perplexing element precisely a decade after Davy found and named boron.

Though it was only half as heavy as water, the Swede was sure he had discovered a new metallic element. Because of its mineral origin he modified Greek *lithos* (Stone) and called the odd stuff *lithium*.

Since it frees hydrogen when placed in water, lithium was a vital commodity during World War II. Antenna balloons used with emergency radio sets were almost always filled with hydrogen that had been secured from water by means of lithium.

Pound for pound, it can be used to generate 240 times as much electricity as lead. Hence it is a prime candidate for a role in the battery-powered car of the future.

In spite of its strange properties and potential role in 21st-century transportation, millions had never even heard of the rare element until Apollo 13 ran into trouble. Carbon dioxide in the spacecraft could have taken the lives of John Swigert, Fred Haise and James Lovell had it not been for lithium. It was this versatile element that astronauts used to scrub the spacecraft's air and make it breathable.

TITANIUM

▲ English scientist William Gregor is so obscure that few reference works even include his name. The only thing of importance he ever did was to probe into the nature of the rare mineral menachinite. About 1789 he discovered that the substance is an oxide.

Gregor was sure it couldn't be anything but a metallic oxide, so used "menachin" to name the substance he never succeeded in isolating from the oxide.

Working without knowledge of Gregor's findings, Martin Klaproth of Germany delved into the properties of the mineral called rutile. It, too, proved to be an oxide. Klaproth failed in attempts to prepare a pure sample from the oxide. His experiments of 1793 convinced him that rutile was compounded of oxygen plus a highly unusual metallic element.

For so powerful an element no ordinary name would do.

Klaproth remembered that in Greek mythology the sun-god Titan was regarded as ancestor of all persons of colossal size and strength. It was fitting, he felt, to borrow the name of the sun-god and frame *titanium* as a label for the "colossal metal" whose tracks he found but which he never came close to isolating in pure form.

Even the oxide of titanium wasn't fully refined until 1821. Minute quantities of the pure metal were isolated at intervals during the 19th century, but there was no commercial production until a huge DuPont plant went into operation in 1948.

Though it is estimated to be the world's ninth most plentiful element, titanium clings too firmly to oxygen and other substances to be isolated by primitive methods.

Now available in quantity to those willing to pay the price, titanium remains strong at high temperatures. This quality makes it vital in manufacture of high-speed aircraft and of rockets. Lacking the strength of the element named for the sun-god, man never would have made it to the moon! ■

Automatic Tri-Speed SCAN ACTION

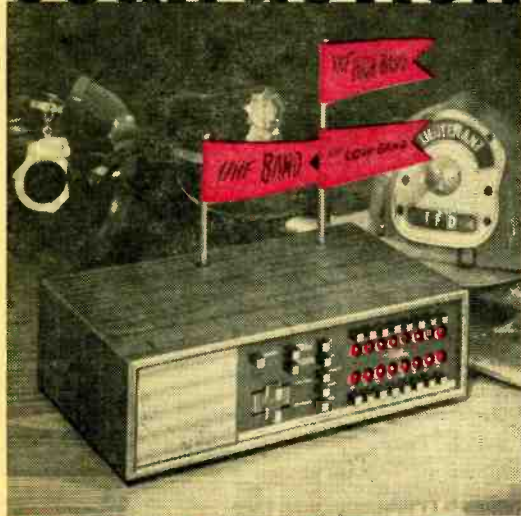

16 big channels in three bands with push button program control

Hear it now!

A UHF, High/Low VHF monitor in one handsome, easy-to-operate package.

Our new Monitorradio/Executive Scanner, Model TME-16 H/L/U, doesn't miss a trick on transmission.

It conducts an automatic, or manual, search for active signals on your choice of frequencies in three busy bands. It stops to hear the transmitted action, loud and clear . . . then automatically resumes the search.

Each of the 16 crystal controlled channels is push button equipped for programming any channel "in" or "out" of service. Push buttons, too, for programming either of the three bands.

Tri-speed scan action speeds the signal search to "super-scan" the channels you want most—eliminates signal sampling of channels you choose to temporarily "program-out".

Best of all, it does the complete monitor job that formerly required 3 receivers—only \$219.00. Crystals \$4.95 each.

Hear it now—at your favorite Regency retailer.

Ask for our complete color catalog of 25 monitor models

**Regency** **ELECTRONICS, INC.**
7900 Pendleton Pike
Indianapolis, Indiana 46226

CIRCLE NO. 30 ON PAGE 17

newscan

Electronics in the News!

LIFE SAVER

A "lifeguard" that protects premature babies has been developed by British engineers of International Telephone and Telegraph Corporation. The device protects the infants from an ailment known as apnoea, a condition in which the baby suddenly stops breathing for no ap-

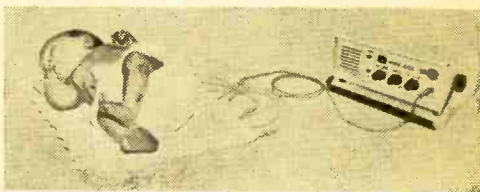

The mattress monitors the slight motions of the child's body as it breathes. It flashes a signal if the baby's breathing ceases due to the ailment called apnoea.

parent reason. Engineers developed a special mattress to detect this condition. The baby merely lies on this special mattress; this has the advantage that nothing is connected to the child.

The mattress has a number of tubular sections filled with air. When the baby breathes, the small motions of its body cause the air to circulate around a pinhead-sized electrical device (a "thermistor"), which is cooled by the moving air. Should the baby stop breathing, the air stops circulating, the device immediately warms up, and an alarm sounds. The concept is advantageous especially in these times of hospital help shortage.

IT'S DONE WITH LOOPS

A new radio direction finder that "rolls its eyes instead of turning its head" has been introduced by Raytheon Company. The new navigation aid for pleasure boats and small commercial craft electronically seeks out the strongest signal on any frequency, locks on it, and then continuously points out the direction of the distant radio beacon, commercial radio broadcasting station, or the transmitter aboard another vessel.

The new automatic radio direction finder, called the *Navimatic*, uses phase-shifting techniques to point out the bearing of the distant signal. Ordinary radio direction finders must rotate their antennas in order to find the bear-



Radio Direction Finder attracts Jan Cody of Raytheon Company, Lexington, Mass. The antenna loops of the new "Navimatic" automatic radio direction finder for mariners remain stationary. The Raytheon electronic navigation aid is priced at \$1200.

ship and ship-to-shore channels found between 1400 and 3500 kilohertz.

In operation, the boatman tunes to the frequency of the stations selected and then switches on the automatic feature. A bearing arrow on a dummy compass continuously points out the relative bearing of the signal. For even quicker operation, five crystal-tuned channels can be used to automatically tune-in stations frequently homed on or used for navigation.

ing on which the distant radio station lies. The new *Navimatic* ADF uses two 13-inch loops that remain fixed.

Three bands are covered by the automatic direction finder: the 190 to 420 kilohertz beacon band including marine and aviation beacons and consolan signals; the 500 to 1400 kilohertz standard broadcast band for U. S. and Canadian commercial broadcasting stations; and ship-to-

LESS THAN SKIN DEEP

A photoelectron spectrometer is like a near-sighted X-ray machine—it can't see very deeply. But what it does see, it sees exceedingly well. It's a new development in spectroscopy—the most significant advance in more than 20 years—that has scientists excited by its promise to quickly and nondestructively analyze the first few layers of the surface of any number of materials for any number of reasons. The photoelectron spectrometer permits nondestructive analysis of only the first two to ten atomic layers of a specimen, by bombarding the material

(Continued on page 102)

*the tape that
turned the
cassette into
a high-fidelity
medium*



TDK SUPER DYNAMIC (SD) TAPE



TDK

Until TDK developed *gamma ferric oxide*, cassette recorders were fine for taping lectures, conferences, verbal memos and family fun—but not for serious high fidelity.

Today you can choose among high-quality stereo cassette decks.

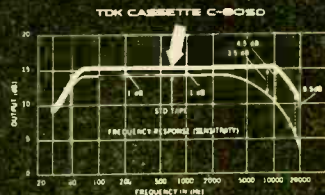

The new magnetic oxide used in TDK Super Dynamic tape distinctively differs from standard formulations in such important properties as coercive force, hysteresis-loop squareness, average particle length (only 0.4 micron!) and particle width/length ratio. These add up to meaningful performance differences: response capability from 30 to 20,000 Hz drastically reduced background hiss, higher output level, decreased distortion and expanded dynamic range. In response alone, there's about 4 to 10 db more output in the region above 10,000 Hz—and this is immediately evident on any cassette recorder, including older types not designed for high performance. There's a difference in clarity and crispness you can hear.

Available in C60SD and C90SD lengths,

TDK ELECTRONICS CORP.

LONG ISLAND CITY, NEW YORK 11103

CIRCLE NO. 11 ON PAGE 17

ANOTHER SUPERB VALUE
from **Olson**

Electronics

ONLY

\$28

**DELUXE
WIRELESS
INTERCOM**



Save steps, keep in touch with this compact two-station Intercom. Needs no cable. Just plug into any AC outlet in your home wiring system and talk between them. Can continuously monitor baby's room, sick-room or any desired location.

Olson Electronics, Dept. TW, 260 S. Forge St., Akron, Ohio 44308

- I enclose \$28, plus \$1 for postage and handling. Send me the AM-366 Wireless Intercom.
- Send me the next seven issues of the Olson Catalog, without cost or obligation. **FREE**

Name _____
Address _____
City _____
State _____ Zip _____

CIRCLE NO. 12 ON PAGE 17



**ASK HANK,
HE KNOWS!**

Crystal Filter

I would like to know if a Heathkit Q multiplier, Model GD-125, could be converted to an IF of 1681 kHz. If it can be done, tell me what modifications are necessary.

—D.T., Lykens, Pa.

Unfortunately, Q multipliers are more effective at lower frequencies and work well at 455 kHz.

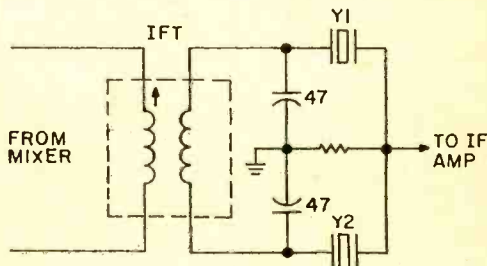

You might try modifying your receiver by adding a crystal filter, as shown in the diagram. Crystals Y1 and Y2 should be ground for approximately 1-1.5 kHz above and below 1681 kHz. You'll probably have to order them direct from a crystal manufacturer.

TVI Times Three

I live in an apartment complex. Three hams live in the same building as I do. The complex has a master antenna with a very poor filtering system. I know for a fact that all of these hams are legal but my TV reception is still very poor on almost all stations, high and low. Could you please give me information on either building or buying a filter for my TV set and FM radio?

—R.A.M., Norwalk, Conn.

If spurious emissions of the ham transmitters (Continued on page 99)

Hank Scott, our Workshop Editor, wants to share his project tips with you. Got a question or a problem with a project you're building—ask Hank! Please remember that Hank's column is limited to answering specific electronic project questions that you send to him. Sorry, he isn't offering a circuit design service. Write to:

**Hank Scott, Workshop Editor
ELEMENTARY ELECTRONICS
229 Park Avenue South
New York NY 10003**

FREE Catalog Of The **WORLD'S** FINEST GOV'T **SURPLUS ELECTRONIC BARGAINS**



Now BIGGER and BETTER Than Ever!

MAIL THIS COUPON NOW

NAME: _____
ADDRESS: _____
CITY: _____ STATE: _____ ZIP: _____

For your FREE copy, fill out coupon and mail. Dept. TV

FAIR RADIO SALES
1016 E. EUREKA • Box 1105 • LIMA, OHIO • 45802

CIRCLE NO. 13 ON PAGE 17

WRITE NOW FOR

**McGEE'S
BIG SPEAKER CATALOG**

1001 BARGAINS IN

SPEAKERS—PARTS—TUBES—HIGH FIDELITY COMPONENTS—RECORD CHANGERS—Tape Recorders—Kits—Everything in Electronics
1901 McGee Street, Kansas City, Missouri 64108

CIRCLE NO. 14 ON PAGE 17

**AMAZING
HALF-PRICE
OFFER!**

TO
INCOME OPPORTUNITIES
ONE FULL YEAR ONLY \$4.48

(regular subscription price \$8.95)

includes 12 reg. issues plus 2 directories
"I.O." brings you each month America's
best money-making ideas . . . in franchising—
specialty sales—mail order

YES! Now you can profit from America's best money-making ideas in **INCOME OPPORTUNITIES** not just every other month, but every single month of the year. And what's more, you get our famous **FRANCHISE** and **SALES AND SMALL BUSINESS** Directories all in the same package for the one low price.

Whether you're looking for extra spare-time money, or for that special big break, your chances of finding them in **INCOME OPPORTUNITIES** have just doubled. If you're a subscriber now, you can use this offer to extend your present subscription. Or if you're not a subscriber, now's the perfect time to start.

So hurry! Fill out subscription order card and drop it in the mail today. You need send no money now. We'll be glad to bill you later.

MAIL COUPON TODAY

INCOME OPPORTUNITIES Dept. 829
229 Park Avenue So.
New York, N.Y. 10003

Please enter my subscription to "I.O."—for only \$4.48. I save 50% off the regular subscription price—includes 12 regular issues plus 2 directories.

- New Subscription Renewal Subscription
 Enclosed is \$ _____
 Bill me later

Name _____
(please print or type clearly)

Address _____

City _____ State _____ Zip _____

"LISTEN IN" TO POLICE-FIRE RADIO CALLS IN YOUR CAR!

WORKS with ANY CAR—Portable or HOME RADIO! Just **PLUGS** in—No wiring—3 minute hookup! Switch instantly from regular to ALL **POLICE-FIRE-EMERGENCY-COMMERCIAL-TAXICAB-STATE-CITY-GOV'T** 2 way Radio calls in YOUR AREA. **DUAL-HI-LOW BANDS—38/50-150/175 MHX. OVER a MILLION** Radio Cars/stations. **USE** Everywhere—Anytime—always works! **SEND ONLY \$2.00** (cash, Ck, M.O.) and pay post-man \$7.99 plus COD pstg or send \$9.99 for ppd. Incl in USA. **COMPLETE**, ready to use with instructions. One Year service Warranty—**10 DAY MONEY BACK TRIAL** (if retr'd) **AMAZING OFFER** good only by mail—**WESTERN RADIO** Dept. BE-11, KEARNEY, NEBR. 68847



CIRCLE NO. 15 ON PAGE 17

FIND BURIED TREASURE

Powerful electronic detector finds buried gold, silver, coins, etc. 5 new models. Write for free catalog.



RELCO, Dept. D-58 **19⁹⁵**

BOX 10839, HOUSTON, TEX. 77018

CIRCLE NO. 16 ON PAGE 17

PARTS! CORNELL TUBES!

FREE Send For **FREE**
CORNELL'S
New Color
Catalog
48 Pgs. New Items

33¢ per tube

36¢ per tube

ORDER FREE
IF NOT SHIPPED
IN 24 HOURS!

4219 E UNIVERSITY AVE. SAN DIEGO, CALIF. 92105

CIRCLE NO. 17 ON PAGE 17

SUBSCRIBER SERVICE

Please include an address label to insure prompt service whenever you write us about your subscription.

mail to: Elementary Electronics Subscriber Service, 229 Park Avenue South, New York, New York 10003, Dept. 11-71

change of address: If you are going to move, please let us know 4 to 6 weeks in advance of your moving. Place your magazine label here, print your new address below. If you have a question about your subscription, place your magazine label here and attach this form to your correspondence.

to subscribe, mail this form with your payment and check:
 Renew my present subscription. New subscription.

subscription rates: 1 Year \$3.95
 2 Years \$7.95 3 Years \$11.95
Rates in all 50 States & Canada

Enclosed is \$ _____

name _____ (please print)

address _____

city _____ state _____ zip code _____

**ATTACH
LABEL
HERE**

Build this magnificent Schober Theatre Organ

for only

* \$1730!



*Includes finished walnut console. Amplifier, speaker system, optional accessories extra. Only \$1256 if you build your own console.

You couldn't touch an organ like this in a store for less than \$3500—and there hasn't been a musical instrument with this vast variety of genuine Theatre Organ voices since the days of the silent movies! If you've dreamed of the grandeur of authentic big-organ sound in your own home, you won't find a more satisfying instrument anywhere—kit or no kit.

You can learn to play it. And you can build it, from Schober Kits, world famous for ease of assembly without the slightest knowledge of electronics or music, for design and parts quality from the ground up, and—above all—for the highest praise from musicians everywhere.

Send right now for your copy of the full-color Schober catalog, containing specifications of the five Schober Organ models, beginning at \$499.50. No charge, no obligation — but lots of food for a healthy musical appetite!

The *Schober* Organ Corp., Dept. EE-6
43 West 61st Street, New York, N.Y. 10023

- Please send me Schober Organ Catalog and free 7-inch "sample" record.
- Enclosed please find \$1.00 for 12-inch L.P. record of Schober Organ music.

NAME _____

ADDRESS _____

CITY _____ STATE _____ ZIP _____

CIRCLE NO. 19 ON PAGE 17

THOUSANDS OF BARGAINS TOP VALUES IN ELECTRONIC PARTS

Transistors, Modules, C. B., Speaker, Stereo, Hi-Fi, Photo Cells and Thousands of Other Electronic Parts.

Send for FREE Catalogue

ELECTRONIC DISTRIBUTORS INC.



EDI

Dept. TA-2, 4900 Elston

Chicago, Ill. 60630

RUSH CATALOGUE

Name _____

Address _____

City _____

State _____ Zip Code _____

CIRCLE NO. 20 ON PAGE 17

Hey, look me over

Showcase of New Products

Mike Talk

A modern-style microphone, with a slide-action control plus a new compression amplifier circuit to prevent over-modulation, has been made for CB applications by Turner Division of Conrac Corporation. The Turner Model M+3 allows the user to set the volume for up to 20 db gain over



Turner Model M+3 Microphone

conventional microphones with a new slide-action control that is easier to see and use than previous knob designs. The added feature of a compression amplifier circuit then allows the user to talk close to, or far from the microphone without varying the output signal or transmitter modulation. Model M+3 is designed for relay switching, JM+3 for electronic switching. List price of each model is \$55.00.

Circle No. 35 on Reader Service Page

Laser Bargain

The model S101 self-contained laser made by the C. W. Radiation, Inc., has a series of inter-

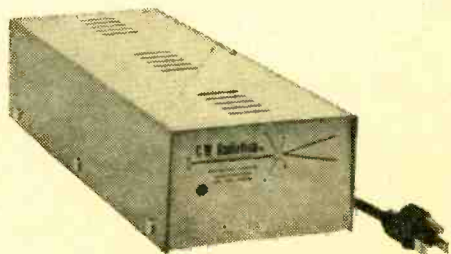

C. W. Radiation, Inc. Laser

changeable output tubes which can provide power levels of .5, 1.0, 1.5, and 2.0 milliwatts. Tubes can be changed in less than 5 minutes. Model

(Continued on page 100)



LITERATURE LIBRARY

61. Here's a free 20-page booklet that tells you how to improve your TV pic and a do-it-yourself approach to installing a Master Antenna TV (MATV) system. Mosley Electronics will wing it your way.
62. RCA Experimenter's Kits for hobbyists, hams, technicians and students are the answer for successful and enjoyable projects.
63. You can become an electrical engineer only if you take the first step. Let ICS send you their free illustrated catalog describing 17 special programs.
64. GC Electronics has the part you are looking for! Pick up their free catalog and build again without worry.
65. CBers, Hams, SWLs—get your copy of World's Radio Lab's 1971 catalog. Circle 65 now!
66. Hy-Gain's new CB antenna catalog is packed full of useful information. Get a copy.
67. B&F Enterprises has an interesting catalog you'd enjoy scanning. Goodies like geiger counters, logic cards, kits, lenses, etc. pack it. Get a copy!
68. Heath's new 1971 full-color catalog is a shopper's dream. Its 116 pages are chock full of gadgets and goodies everyone would want to own.
69. Get two free books—"How to Get a Commercial FCC License" and "How to Succeed in Electronics"—from Cleveland Institute of Electronics.
70. National Schools will help you learn all about color TV as you assemble their 25-in. color TV kit.
71. Free 1972 catalog describes 100s of Howard W. Sams books for the hobbyist and technician. Includes books on projects, basic electronics and many related subjects.
72. Kit builder? Like wired products? EICO's 1971 catalog takes care of both breeds of buyers at prices you will like.
73. Want some groovy PC boards plus parts for communication projects? Then get a hold of International Crystal's complete catalog.
74. Now available from EDI (Electronic Distributors, Inc.): a catalog containing hundreds of electronic items.
75. Bargains galore, that's what's in store! Poly-Paks Co. will send you their latest 8-page flyer.
76. Get it now! John Meshna, Jr.'s new 96-page catalog is jam packed with surplus buys.
77. Before you build from scratch, check the Fair Radio Sales latest catalog for surplus gear.
78. Get your copy of *Hallicrafters' "Shortwave Puts You Where It's At."* Get started today on shortwave radio for more fun tomorrow!
79. Want a deluxe CB base station? Then get the specs on Tram's super CB rigs.
80. Get the scoop on Versa-Tronics' Versa-Tenna with instant magnetic mounting.
81. Prepare for tomorrow by studying at home with *Technical Training International*. Get the facts on how to step up in your job.
82. Pep-up your CB rig's performance with Turner's M+2 mobile microphone.
83. CBers, Midland has come up with a neat colorful brochure on their line. Before you buy, check on Midland.
84. CB antenna catalog by Antenna Specialists makes the pickin' easy. Get your copy today!
85. Get all the facts on *Progressive Edu-Kits Home Radio Course*. Build 20 radios and electronic circuits; parts, tools, and instructions included.
86. Olson's catalog is a multi-colored newspaper that's packed with more bargains than a phone book has names.
87. *Custom Alarms* reveals how inexpensive professional alarms can really be. Install one yourself. Circle 87 for exclusive catalog.
88. "Meet the Metrics," Xcelite's broad line of metric hand tools and compact interchangeable blade sets for driving hex heads, hex sockets and nuts. All in catalog 166 Supplement.
89. Troubleshooting without test gear? Get with it—let *Accurate Instrument* clue you in on some great buys for your test bench.
90. *Burstein-Applebee* offers a new giant catalog containing 100s of big pages crammed with savings.
91. Your not receiving like a pro unless you step up with a hot receiver. R. L. Drake Co. model SPR-4 is one communications receiver you should consider—it's a winner.
92. *Edmund Scientific's* new catalog contains over 4000 products that embrace many sciences and fields.
93. Pick *Cornell's Electronic's* 10th anniversary catalog and discover yesterday prices. Tubes go for 36¢ and 33¢. Plus many other goodies!
94. *Allied Radio Shack* wants to introduce you to the colorful world of electronics. Discover great buys from wide selections. Get the details from *Allied* today!
95. It's just off the press—*Lafayette's* all-new 1971 illustrated catalog packed with CB gear, hi-fi components, test equipment, tools, ham rigs, and more—get your free copy!

ELEMENTARY ELECTRONICS
Box 886
Ansonia Station
New York, N.Y. 10023

Please arrange to have this literature whose numbers I have circled at right sent to me as soon as possible. I am enclosing 25¢ to cover handling. (No stamps, please.)

61	62	63	64	65	66	67	68	69	70
71	72	73	74	75	76	77	78	79	80
81	82	83	84	85	86	87	88	89	90
91	92	93	94	95					

Indicate total number of booklets requested
Sorry, only 20 circled items maximum.

NAME _____
ADDRESS _____
CITY _____
STATE _____ ZIP _____

Not Valid After May 31, 1972

1171



THE HAM IN THE BIG CITY

By Jack Schmidt

W424X... THIS IS
W2QZ7... HOW DO
YOU READ ME... OVER

REALLY STRONG...
YOU SOUND LIKE YOU'RE
NEXT DOOR.

W2QZ7... THIS IS
W424X... LOUD AND
CLEAR... HOW ME... OVER.

SOMETHING ODD HERE
W2QZ7. EVERY TIME
YOU TRANSMIT, MY
LIGHT GOES DIM...

WHO IS HE
TALKING TO NOW?

I CAN'T TELL...
IT'S SOME KIND
OF CODE.

YOU JUST GIVE
US THE WORD AND
WE'LL BASH THAT
SPY'S BRAINS OUT!

THIS IS IT
CHIEF... WE'VE
GOT 'EM COLD

SCHEIDT

Discover the World of Shortwave Listening

by Jackson Kaye

Becoming an SWL (Shortwave Listener) means more than tossing a coil of wire on the back of a kitchen-type AC-DC receiver and listening to the distant stations roll in. This is not to say that this describes the listening posts of many beginners, but after awhile every beginner wants really to get into this fascinating hobby more seriously. This article will give beginners and old-timers, alike, the combined experiences of several leading SWL's who have dragged some of radio's rarest stations from out of the static—and *without* necessarily spending fantastic sums of money in the process.

THE HOBBY ITSELF. Before delving into the trade secrets of SWLing, let's briefly scan the hobby itself to see what it has to offer. SWLing is actually a peculiar name for the hobby—a name which has ruffled more than one set of feathers in the ranks of listeners.

You don't have
to be an expert
to roam the dial
and tune in Chad,
Botswana, Sarawak,
Fiji, Upper Volta,
Yemen and Nepal.
Get started now!



SHORTWAVE LISTENING

Why limit listening to shortwave stations? That's a good question, and a sufficient number of listeners have asked themselves these words to form an entirely separate segment of the hobby. So, while the hobby has become to be generally known as "shortwave listening," it actually means listening for distant stations on *all* frequency bands—usually encompassing the long waves (starting as low as 15 kHz) and running all the way up through the VHF (very high frequency) portions of the radio spectrum where the hobby of watching for far-off TV stations has become popular in the past few years. The hobby is actually getting into the UHF (ultra high frequency) band.

Between these frequency extremes there are literally millions of stations to be chased down, and most SWLs eventually gravitate to a certain group of stations to concentrate upon—well, isn't this an age of specialization? Some of the most popular stations for the specialists are: Hams, SWBC (Short Wave International Broadcasting), Utility (police, aeronautical, maritime, military, point-to-point communications, etc.), Citizens Band, and all of the various broadcasting services, which includes AM, TV, and FM stations.

We will concentrate upon setting up a station which will receive international transmissions—so that naturally excludes TV and FM stations—also VHF transmissions on the ham and utility bands.

The Receiver. A popular misconception among beginners is that just about any piece of electronic equipment which can be scrounged up will be suitable for a receiver. This is *not* so.

Best results are always obtained from a "communications receiver," that is, a radio receiver specifically designed for reception of frequencies approximately between 535 kHz to at least 30 MHz. These sets have features which include noise limiting circuits, bandsread (fine tuning), a BFO (beat frequency oscillator) for the reception of code and SSB (single sideband) transmissions, an antenna trimmer to match the antenna for maximum performance at the frequency to which the receiver happens to be tuned, and optional features such as an RF gain control to cut down the sensitivity of the set when desirable, and a switch to elim-

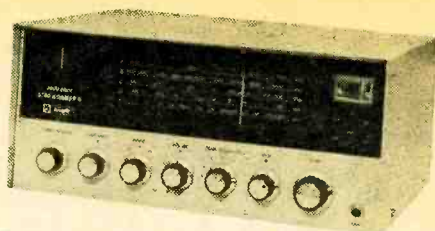

Knight Star Roamer II, \$69.95

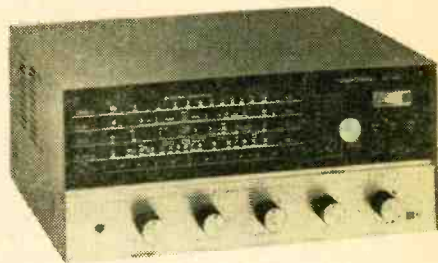

Realistic DX-120, \$69.95



Heathkit SW-717, \$59.95



Hallicrafters S-214, \$89.95

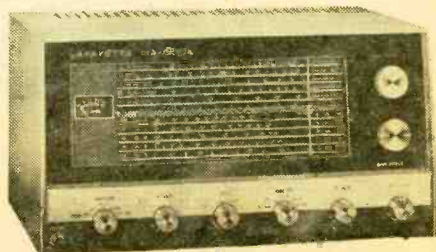

Lafayette HA-600A, \$99.95

inate the automatic volume control from the receiver circuit when necessary. This then is the communications receiver and no serious chaser of DX would dare be caught without one.

We do not suggest that you attempt to seriously DX on even the high priced imported radios which have all the foreign cities marked on their dial plates. It's one thing to mark "Tahiti, Minsk, Pago Pago, and Little America" on a receiver, but another to actually hear such exotic DX on the gear (all receiving equipment is affectionately known as "gear" to the SWL). While these sets are very tempting, what with their sleek lines and sophisticated prices, they are generally to be avoided for real listening.

Communications receivers can be purchased for as little as \$29.95 brand new in

kit form, or you can pick up a second hand receiver for a fraction of its original purchase price. Of course, you can run on up the price scale and start pushing into the high hundreds, but this is hardly necessary unless you have heard all the stations on this planet and want to start pulling them out of the universe. The low-cost receivers are relatively basic and do not contain some of the real aids to listening, but somewhere between \$29.95 and \$130.00 you should certainly be able to find yourself the set of your dreams. Manufacturers of the most popular receivers are Heath, Lafayette, Hallicrafters, Allied, Knight, EICO, and Realistic. See our table of currently available receivers listing features, price and other data. Be wary of off-band electronic equipment, regardless of price.

SHORTWAVE RECEIVERS FOR THE BEGINNER

Price	Model	FET Front End	Freq. (MHz)	Tuning Bands	Signal Strength Meter	Antenna Trim	Internal Speaker	Band Spread	Kit or Wired	Power (P)
\$ 39.95	Knight Star Roamer	A	.200-400 .550-30.0	4	yes	yes	yes	yes	K	AC
54.95	Lafayette Explor-Air Mark V	A	.550-1.60 5.9-6.25 9.45-9.8 11.45-12.0 15.05-15.5	5	no	no	yes	no	W	AC
59.95	Hallicrafters S-125 Star Quest II	*	.550-30.0	5	no	no	yes	yes (E)	W	AC/12VDC
59.95	Heathkit SW-717	yes	.550-30.0	4	yes	no	yes	yes	K	AC
69.95	EICO 718 Space Ranger	yes	.535-30.0	4	yes	no	yes	yes	W	AC/12VDC
69.95	Knight Star Roamer II	yes	.220-400 .550-30.0	5	yes	yes	yes	yes	K	AC/12VDC
69.95	Realistic DX-120	yes	.535-30.0	4	yes	no	yes	yes	W	AC/12VDC
75.95	Allied A-2509	yes	.550-1.60 5.9-6.25 9.45-9.85 11.45-12.0 15.05-15.55	5	yes	no	yes	no	W	AC/12VDC
89.95	Hallicrafters S-214		.550-160 5.90-6.25 9.45-9.9 11.65-12.00 15.05-15.6 88-108 FM	6	no	no	yes	no	W	AC
99.95	Allied A-2515	yes	.150-400 .550-30.0	5	yes	yes	no	yes	W	AC/12VDC
99.95	Hallicrafters S-240		.550-30.0 88-108 FM	5	yes	no	yes	no (T)	W	AC
99.95	Knight R-195	*	.200-400 .550-30.0	5	yes	yes	yes	yes	K	AC/12VDC
99.95	Lafayette HA-600A	yes	.150-400 .550-30.0	5	yes	yes	no	yes	W	AC/12VDC
119.95	Realistic DX-150A	yes	.535-30.0	4	yes	yes	no	yes	W	AC/12VDC
129.95	Heathkit GR-78	yes	.190-410 .550-30.0	6	yes	no	yes	yes	K	9.6VDC (B)

A—uses tubes, K—kit, W—factory wired, *—not announced, E—electronic bandspread, T—fine-tune vernier, P—12 VDC power supply usually external, B—built-in recharger

e/e SHORTWAVE LISTENING

The Sky Hook. Don't ask why, but everyone in SWL circles calls an antenna a "sky hook." Regardless of the comical name bestowed upon antennas, they are, nevertheless, an extremely important part of your receiving setup.

The most common antenna for all band receiving is simply 100 feet of wire strung on insulators out of your window to a point on a telephone pole or other building. See Fig. 1. Glass or porcelain insulators should be used at each end of the antenna and the wire should be kept in the clear of all objects (especially metal) along its length. You will find that this antenna will receive best in the direction broadside to the length of the wire.

A possible aid to this type of antenna would be to attach as short an insulated wire as possible from the chassis of the receiver to a cold water pipe. This often helps reception, but sometimes makes absolutely no difference. Most receivers have a terminal on the rear deck marked "G" for the ground connection.

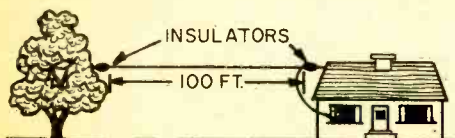

LONG WIRE SET CONNECTIONS

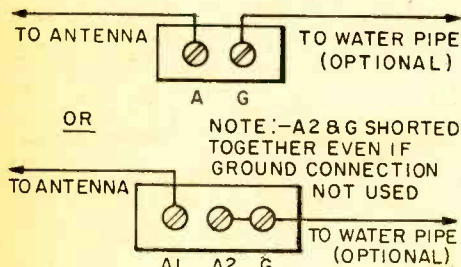
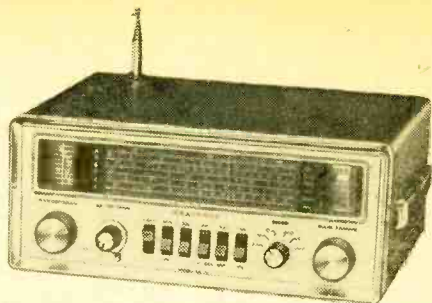

Fig. 1—This simple 100-foot antenna should be connected to the shortwave receiver as shown. The pipe-ground connection may not be needed.

ceiver to a cold water pipe. This often helps reception, but sometimes makes absolutely no difference. Most receivers have a terminal on the rear deck marked "G" for the ground connection.

Doublet. Another popular antenna for listening is the "doublet," which will also receive broadside signals, with best reception offered on specific bands to which the doublet is tuned. The doublet is tuned for only one specific band, and this is determined by the length of the antenna as given in the



Heathkit GR-78, \$129.95

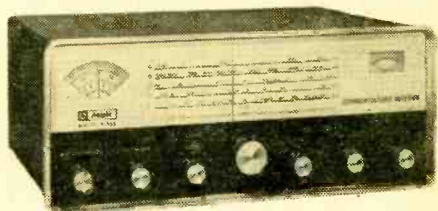

Knight R-195, \$99.95



Hallicrafters S-240, \$99.95

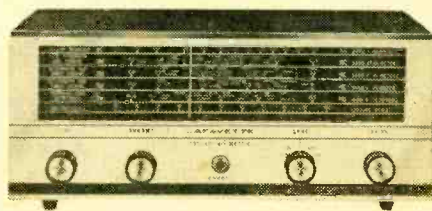

Lafayette Explor-Air Mark V, \$54.95



Realistic DX-150A, \$119.95

Doublet Measurements Table. The antenna is to be constructed with No. 12 or 14 wire, and fed with 75-ohm twin lead or RG-59U coaxial cable. See Fig. 2. At the receiver end of the antenna, one side of the twin lead is attached to the "A" or "A1" terminal on the rear deck of the receiver. The other wire on the twin lead connects to the "A2" or "G" terminal. If coaxial cable is used, the center conductor of the cable connects to the "A" or "A1" terminal, and the outer shield of braided copper connects to "A2" or "G."

Doublets cut for various bands are inexpensively available from Mosley and Hy-

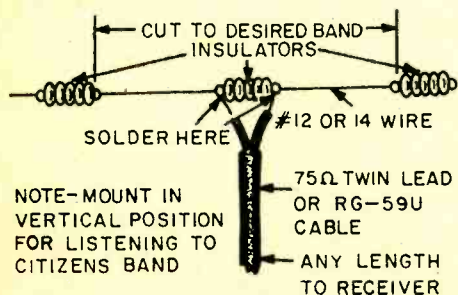

DOUBLET SET CONNECTIONS

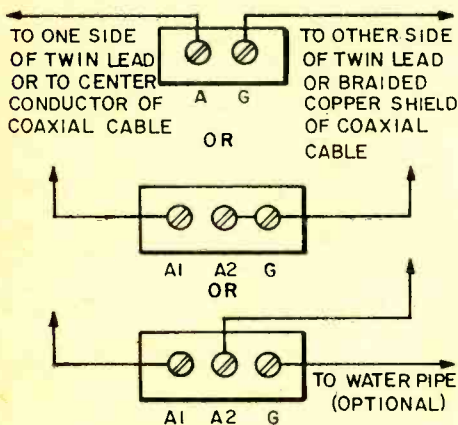

Fig. 2—How to construct a doublet antenna and connect it to your receiver, using measurements from the table below. Note the mounting position for CB listening.

Double Measurements

Band (Meters)	Overall Length (Feet)	Band (Meters)	Overall Length (Feet)
10/11	16	31	48
13	21	40/41	66
15/66	22	49	76
19/20	33	60	95
25	39	75/80	120

Gain. These are to be found at many dealers and are listed in mailorder electronics catalogs.

Accessories. Now that you've got the receiver warmed up and the sky hook all hooked, you will find that certain accessories will make your listening more convenient and efficient.

For instance, what about a headset (also known as earphones, headphones, or "cans") You will find that stations which might just be barely audible ("readable") in the noise ("QRM" or "QRN") will pop out into the clear when you are wearing cans. When purchasing a headset, make certain as to whether or not your receiver offers a high or low impedance. If your receiver does not offer provisions for your using a headset, one may be easily attached in parallel with the loudspeaker from the audio transformer. Low impedance phones of about 10 ohms would be used in this instance. It will be necessary for a switch to be inserted in this circuitry so that you can switch back and forth from speaker to cans as required by conditions. Hi-fi stereo headphones are great for the job.

Now that you're listening to that distant station it would be a shame if the fellow in the next apartment, or in the house down the road decided to use his electric razor, or some other devilish instrument of torture to the constitution of every ardent SWL. What do I mean? Well, if you've ever tried to nurse a station out of the great beyond only to have the identification obliterated by a burst of man-made static then you can't

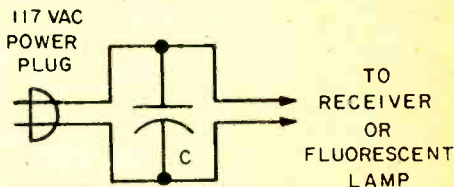

Fig. 3—One cure for man-made static is to put this .05-uF capacitor across the power line.

count yourself among the "in" crowd of SWLs. In most instances, this interference can be eliminated by the insertion of a line noise filter (see Fig. 3) consisting of only a single .05-uF 600-volt capacitor in the power line cable of your receiver. Be sure to solder all connections and it would be a good safety measure to enclose the whole thing, capacitor, connections and all, in one

e/e SHORTWAVE LISTENING

of those medicine capsule plastic containers which are given out by drug stores.

If you have the common problem of an annoying buzzing from a fluorescent desk lamp, the problem is easily conquered by the simple addition of a .01-uF 600-volt disc ceramic bypass capacitor across the power line. Best place for this connection is inside the base of the lamp where it will be unobtrusive. By the way, don't forget to unplug the lamp and receiver.

Squelch. A further refinement in your receiving station can be had by adding a squelch circuit, something not normally found in inexpensive communications receiver, but mighty handy if you intend monitoring a single utility frequency over an extended period of time. Eventually the back-hiss and static will have you on the way to the funny farm but our little squelch device will silence the receiver altogether—

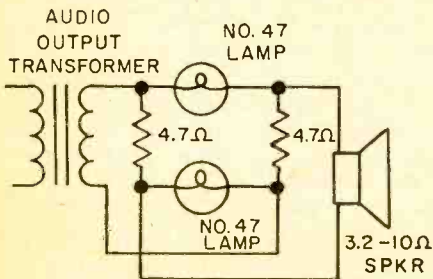
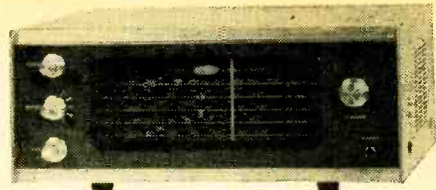

Fig. 4—A squelch circuit is handy for long-term monitoring of a single utility frequency.

that is until a signal pops onto the frequency. There is a slight loss in audio when you use this gadget, but this is easily compensated for by adjusting the volume control.

The squelch circuit (see Fig. 4) consists of two No. 47 lamps wired into the speaker leads together with two 4.7 ohm resistors, details are simple and are shown in the schematic diagram. This device is well worth the slight effort and few cents expense to silence the receiver during periods of no-signal.

SWL Antenna Tuner. Should you find yourself with a receiver not having an antenna trimmer for peaking the set and antenna on your monitoring frequency, you might try tinkering with a tuning device of your own. See Fig. 5. About as basic as you can get, it consists solely of a 150 uuF mini-



Allied A-2509, \$75.95

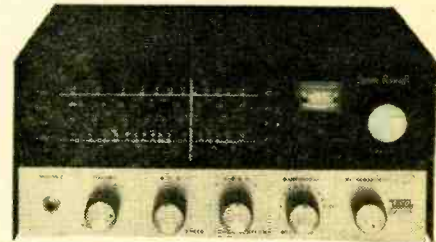

EICO 718 Space Ranger, \$69.95



Allied A-2515, \$99.95

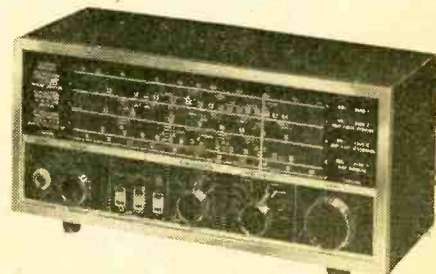

Hallicrafters S-125 Star-Quest II, \$59.95



Knight Star Roamer, \$39.95



Bob Zilmer of Milwaukee, Wisconsin, is a member of the American Short Wave Listeners Club. He does his tuning with Drake 2-C and SPRA4 receivers. The photo also shows a cassette recorder Bob uses to help remember details when he sends in reports to shortwave stations. The clock is a 24-hour type.



This dyed-in-the-wool SWL is John Zaharek. Though industrial arts is the vocation of this resident of Torrington, Conn., he enjoys tuning this Realistic DX150A rig. Note the neat array of framed DX certificates on his shack wall.



Martin Martelle of Sarnia, Ontario, Canada, calls himself "The Happy Listener." His listening gear includes a Hallicrafters S-38D receiver, a Heathkit Trio Jr.-200 receiver, a Lafayette VHF monitor, and various types of CB equipment. Considering the number of QSL cards displayed on Martin's wall, The Happy Listener must also be known as The Avid Listener.

ature variable capacitor and a sub-miniature antenna rod (Miller type 2002, or equivalent). When a station is heard, both the capacitor and the coil slug are tuned for maximum signal loudness or maximum reading on the receiver's S-meter.

Other Gadgets. Other electronic attachments to your station would come into the

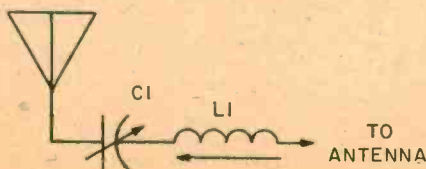

Fig. 5—If your set has no antenna trimmer, you can easily make up this tuning device.

"elite" class and might include such things as a tape recorder, remote speaker, digital clocks, etc. These are useful devices but are certainly not a necessity for basic listening. If you can build or buy a small 100 kHz crystal calibrator you will probably find it handy, but far from a necessity. Some of the more expensive receivers have these calibrators built in.

Non-electronic aids for the listening post include a good world atlas or map, a log book and an up to date listing of the stations you expect to monitor. Ham stations are listed in the Radio Amateur Callbook (published 4 times a year with separate U.S. and foreign listing editions, and sold through most ham radio stores or mail order houses)

(Continued on page 97)

**NRI "hands-on" training in
Television, Communications,
Electronics and Computers
can give you as much
as 2 years of on-the-job
experience.**

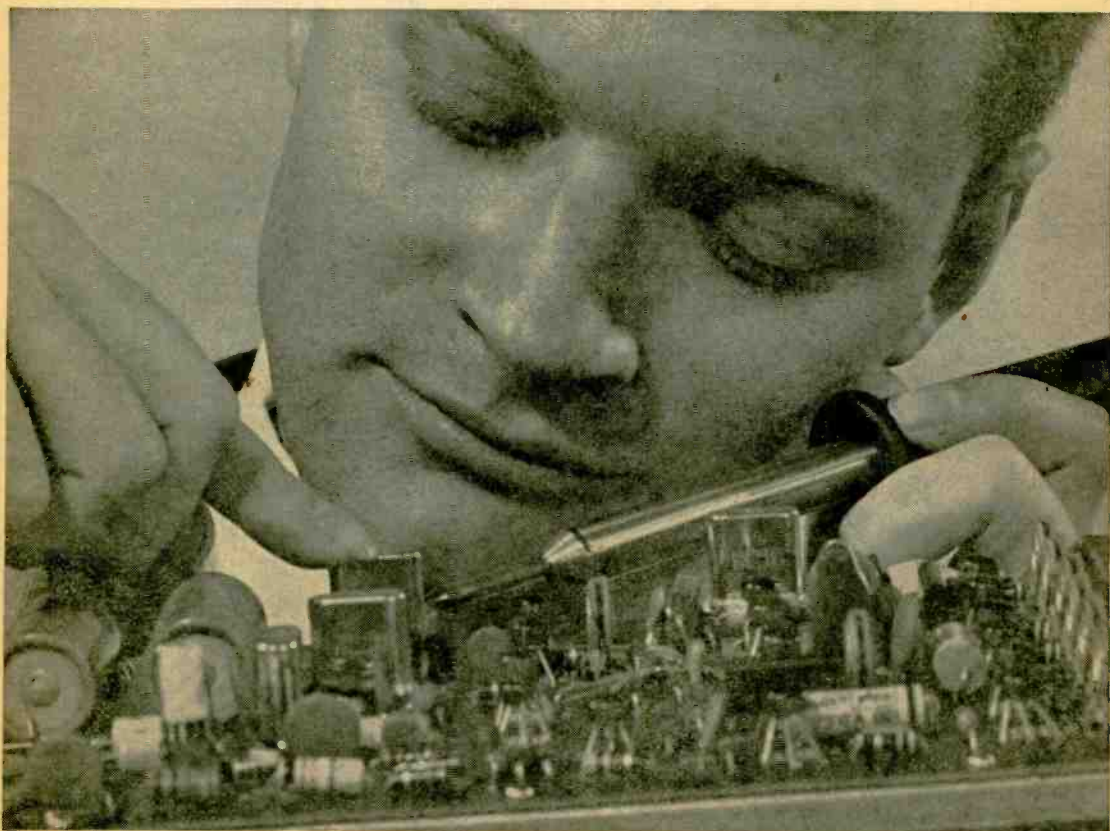

EARN YOUR FCC LICENSE – OR YOUR MONEY BACK

NRI Communications training programs will qualify you for a First Class Commercial Radiotelephone License issued by the FCC. If you fail to pass the FCC examinations for this license after successfully completing an NRI Communications course we will, on request, refund in full the tuition you have paid. This agreement is valid for the period of your active student membership and for six months after completion of your training. No school offers a more liberal FCC License agreement.

Experience is still your best teacher

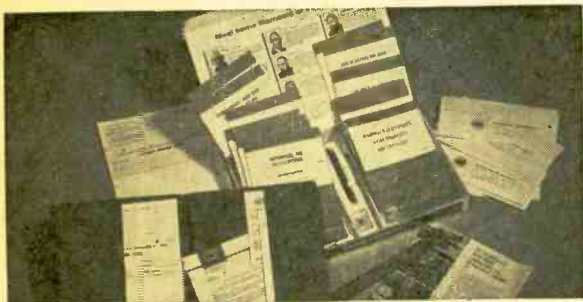

NRI Achievement Kit is educator-acclaimed and the original "starter" kit in home study training. Imitated but never duplicated, this kit is designed and personalized for you and your training objective. It has one purpose — to get you started quickly and easily.



"Bite-Size" Texts average an easily-digested 40 pages of well-illustrated, scientifically prepared subject matter in the course of your choice. Questions in each book are carefully hand-graded and returned to you with helpful instructional notes. You get unlimited personal help from the day you enroll.



Designed-For-Learning Equipment

Like this phone-cw transmitter (Kit #7 in the Communications course) is engineered from chassis up to demonstrate principles you must know. NRI does not use modified hobby kits for training, but the finest parts money can buy, professionally and educationally applied.

...here's how you get it with unique NRI training at home

Ask any teacher, job counselor, engineer, technician or prospective employer about the need for practical application of theory in Electronics. He'll tell you Electronics is as much a "hands-on" profession as dentistry or chemistry. That's how you learn at home with NRI. You prove the theory you read in "bite-size" texts, by actual experimentation with the type of solid-state, transistor and tube circuits you'll find on the job today — *not* hardware or hobby kits. You introduce circuit defects, analyze results, discover quickly the kind of trouble-shooting and design techniques that will make you employable in Electronics.

Train with the leader — NRI

NRI lab equipment is designed from chassis up for effective, fascinating training — not for entertainment. The fact that end results are usable, quality products is a bonus. In Communications, for example, you build and analyze, stage by stage, your own 25-watt phone/cw transmitter. It's suitable for use on the 80-meter amateur band, if you have an interest in ham radio. In TV-Radio Servicing your practical training gives you your choice of monochrome or color TV sets. All training equipment is included in the low tuition — you pay nothing extra. Discover for yourself the ease, excitement and *value* of NRI training. Mail postage-free card today for new NRI Catalog . . . or use the coupon below. No obligation. No salesman will call on you. NATIONAL RADIO INSTITUTE, Washington, D.C. 20016.

APPROVED UNDER NEW GI BILL

If you have served since January 31, 1955, or are in service now, check GI line on postage-free card or in coupon.

MAIL THIS COUPON IF CARD IS GONE



NATIONAL RADIO INSTITUTE

Washington, D.C. 20016

Please send me your new NRI Catalog. I understand no salesman will call and there is no obligation.

Name _____ Age _____

Address _____

City _____ State _____ Zip _____

Check for facts on new GI Bill

ACCREDITED MEMBER NATIONAL HOME STUDY COUNCIL

RIDING HIGH ON YOUR ALPHA WAVES

The worst you can do
on your next trip is blow a fuse!



Put down that pipe and pick up these Alpha-phones—just turn on to your own brainwaves and get high (legally, of course). All it takes is a little control and training and your head can fill you with tranquility and peace. Sound like a good trip? Well, it is and we all possess the ability to turn on this way. The secret lies in your own brainwaves, or should we say Alpha waves. This discovery is the result of research being done by both Japanese and American scientists on the electrical activity that constantly goes on within one's own head. The brain is continually producing small electrical currents on different wave lengths. During the research it was discovered that certain mental states were associated with the prominence of certain wave lengths (such as the state of consciousness of a Zen master). When large amounts of Alpha waves are produced, people appear extremely relaxed, yet

quite open and sensitive to outside stimuli.

Alpha waves are produced by everyone and they may be characterized by a high fluttery sound. However, the waves are generally random and almost totally dominated and even drowned out by Beta waves, also produced by the brain. Dr. Joe Kamiya, at the Langley-Porter Neuropsychiatric Institute in San Francisco, decided that there was no reason why the average person couldn't learn to turn on his Alpha waves at will, even though they had no training in the meditative arts. He attached electrodes to the skulls of volunteers, and connected them to an electroencephalogram (EEG) to record the changing voltages of brainwaves. When the test person was in the Alpha-state, a bell or bleep would go on, turning off when his Alpha wave was drowned in Beta. Soon the subject learned how to turn on his Alpha—no encouragement was necessary since most of those



Gene Etribou (left) adjusts a tape in his sound room. He uses both music and tapes of Alpha waves to create the total environment with the aid of a huge speaker.

With the aid of Alphaphones, these two women (right) are learning how to turn on their Alpha waves at will. After a little training, they will be able to achieve tranquility and peace of mind through proper thinking.



Battery-operated Alphaphones can even be worn while in water without any worry. Gene relaxes with some friends in his Japanese bath (above) as they turn on their Alpha.



tested found the experience rather pleasant and tended to describe the sensations in terms usually associated with drug highs.

As a result of his work with Dr. Kamiya, Ken Keefe, a psychologist, began working with Gene Etribou, a micro-biologist, to try training themselves to turn on large amounts of Alpha. They did this by wiring themselves up to laboratory EEGs. "We thought, wouldn't it be great if we could get more people, whole communities for that matter to turn on Alpha. It would have such a fantastic effect on their peace of mind and general level of sanity. But an EEG machine costs anywhere between \$6,000 and \$40,000. So we set about trying to compress that vast laboratory equipment into something relatively cheap and portable for people to use to turn on at home." Their research continued for over six months, and the result of their labors was the Aquarian Alphaphone, or just Alphaphone for short.

With the aid of the Alphaphone, a person is

able to listen to his own brainwaves—the headset amplifies the sounds of these waves. In this way, the individual can determine when he is in an Alpha-state. These headphones are merely designed to teach the person how to achieve an Alpha-state by practicing the calm thinking that produces the Alpha waves. Through the use of the Alphaphones, one eventually learns what types of thoughts and moods produce Alpha waves. The headphones operate on batteries, so you can even wear them in water without any worry.

During an Alpha "trip," a high fluttery sound fills the person's ears. A warm, glowing feeling flows through the limbs, and peace of mind is achieved. People have continually searched for such relaxed states but generally these sensations were only externally induced. Due to the work of these men, people can now turn to their own brainwaves as a means to reach peace with themselves. And, there is no worry of addiction or withdrawal!

—Joe Gronk

E/E looks at new...



For the music lover who wants a quality AM/FM stereo receiver, but doesn't need high-power output, Sansui has the 100-watt 1000X, at \$269.95. Circle No. 45 on Reader Service Page.

At the top of Kenwood's line of stereo amplifiers is the 196-watt (IHF) KA-7002, featuring direct coupling and a complementary-symmetry driver stage to deliver clear, pure, undistorted stereo sound, for \$299.95. Circle No. 46 on Reader Service Page.

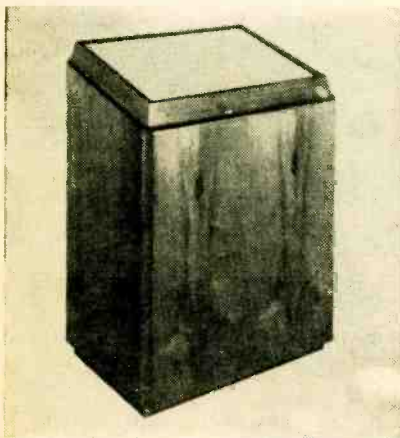
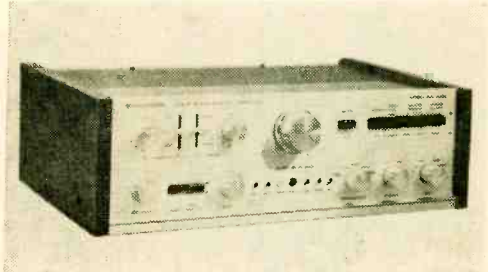

Harman-Kardon's new approach to omnidirectional sound is the Citation Thirteen speaker system, at \$295. The 14-degree tilt of the mounting board, to which all drivers are attached, produces a natural blend of direct and reflected sound. Circle No. 47 on the Reader Service Page.



A versatile high-impedance, cardioid, dynamic microphone (\$29.95), floor stand (\$17.95) and adjustable boom (\$11.95) from GC Electronics. Circle No. 48 on the Reader Service Page.

HI-FI COMPONENTS



Shadow-free snaps
shot with your strobe
can be yours with the . . .



by Steve Daniels, WB2GIF

At a recent party I attended, a photographer was taking shots of the guests. He had an assistant with him (it was a large party), who held a second strobe light over the scene. I noticed—before my glass of fortified grape juice took effect—that this second strobe light was not connected to the camera. Yet, it fired at the same time as the master strobe mounted to the camera. “Why two flash sources?” I thought. “I’ve always gotten along with one.” A few weeks later I saw the photog’s results. Still stuck to the ferrotyper were prints of the party—all shadowless pictures. Unlike snapshots I’ve taken lately, nobody looked as if they were wearing pasty masks to a masquerade ball. Was this the result of “filling in” with a strobe slave? Photog’s answer was: Yes!

My reflections resulted in a gizmo I’ve dubbed *Photog’s Third Eye*. It will convert any strobe flash into a fast-acting slave, actuated as far as 30 feet away from the master strobe light’s source. *Photog’s Third Eye* needs no external power source; the strobe it plugs into provides power. It has a sensitivity adjust pot to help you compensate for ambient lighting conditions, and mounts right on the accessory shoe of all low-cost strobe units typically available. Using *Photog’s Third Eye* with a Honeywell-type mount, for instance? Just adapt the mounting strap to your needs!

Strobe Theory Recycled. Before I describe *PTE’s* theory and design, let’s take a look at its reason for being: the typical electronic speed light, or strobe. Look at the simplified schematic of a unit. A power supply charges the storage capacitor to (about) 300 volts and the trigger capacitor to about half that value through voltage divider R1-R2. When the shutter contacts are closed, the trigger capacitor discharges through the trigger coil. A very large current flows for an instant through the trigger coil, producing a high voltage at the top-most end of the transformer due to auto-transformer action. The developed high voltage produces a discharge either inside or around the body of the flash tube. Either way, the gas inside ionizes, and the tube fires.

Note that in our *Photog’s Third Eye*, SCR1 is directly in series with the shutter contacts. When phototube V1 is energized by a flash of light from the main strobe, its gaseous atmosphere momentarily breaks down. Result is a positive pulse applied to the gate of SCR1. The SCR, in turn, fires,

e/e PHOTOG'S THIRD EYE

triggering off the slave strobe by serving as a pair of closed contacts.

The tube specified for V1 was in my spare parts box. No doubt, other phototubes will also work with proper values of R1-R2 plugged in. The silicon controlled rectifier used is rated at 200 volts. Measure the voltage at the shutter cord of your strobe and make sure it is within this limit with the unit fully charged. If the voltage present is over 200 volts, buy type C106C1 SCR; it has a 300-volt rating. In no case use an SCR of a different series unless it matches the gate sensitivity of these units.

Eyes toward Construction. Scrounge around your workshop and find the smallest minibox that will hold the photocell comfortable. I made a cutout measuring $\frac{3}{4} \times 1 \frac{7}{16}$ -in. for the phototube's sensitive surface with a nibbling tool. Cover both minibox face and cutout with black electrical tape; bring enough tape back inward so that the tube

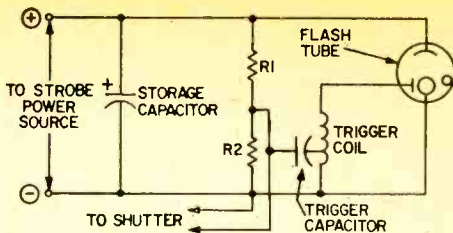

In this simplified strobe, the trigger capacitor is charged by the power supply and discharged by closing the trigger contacts.

will be insulated from the case.

You'll have to make your own contacts for V1. Find a pair of $\frac{3}{8}$ -in. snap-in button-hole plugs. Allied Radio Shack's hole plug assortment (64B3024) will do the job. Solder a wire to each button, and insulate the soldered button with a patch of electrical tape. Form the tube's holding bracket with a piece of sheet aluminum.

Drill holes for the terminal strip, potentiometer, and cable. Mount these components before bolting down the phototube

(Continued on page 96)

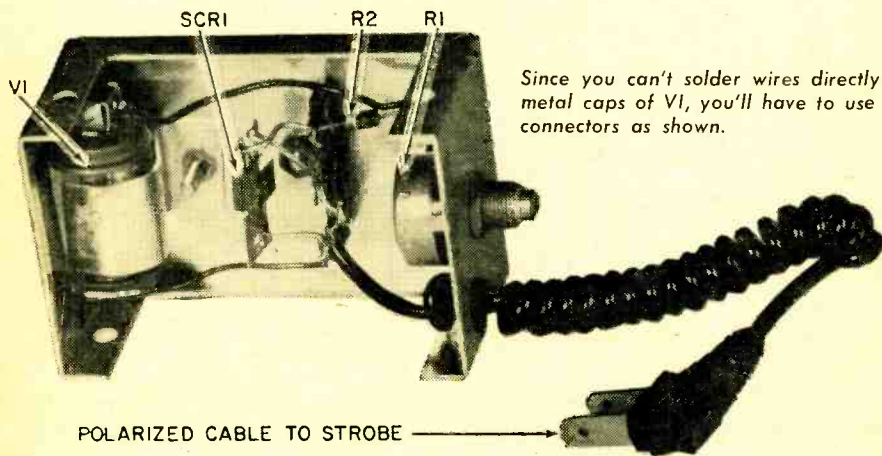

Since you can't solder wires directly to the metal caps of V1, you'll have to use plug-in connectors as shown.

PARTS LIST FOR PHOTOG'S THIRD EYE

R1—10,000,000-ohm, $\frac{1}{2}$ -watt linear taper potentiometer (Allied Radio Shack 961B1813 or equiv.)

R2—10,000,000-ohm, $\frac{1}{2}$ -watt carbon resistor

SCR1—Silicon controlled rectifier (GE C106B1 or equiv.)

V1—gas photodiode (RCA type 921)

1—aluminum minibox (see text)

1—polarized camera strobe cable

Misc.—electrical tape, snap-in button-hole plug (Allied Radio Shack (64B3024 or equiv.) terminal strip, paint, solder, etc.

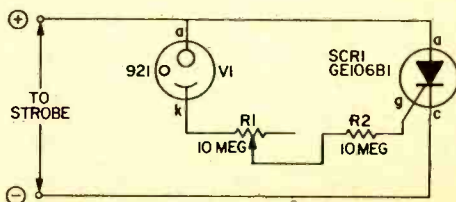

In the Photog's Third Eye, the SCR is in series with the shutter contacts, and is fired with the phototube V1 is energized.



KATHI'S **CB** CAROUSEL

By Kathi Martin, KAIQ614

I don't know about you, but the spirit of egg nog, holly berries, and a little pink-cheeked man squirming down the chimney is already upon this YL's shack. Although Thanksgiving is still a few weeks away, I've started my yuletide gift list. Seems to me that my local electronics mail order outlet is as busy with wide-eyed CBers carting home goodies as is the downtown department store trying to cope with the crush of women returning armloads of duplicate gifts the day after Christmas.

Gift swapping for CBers isn't much different than trying to satisfy any other group of electronics devotees. First, know your recipient's base station setup; that'll save you from the embarrassment of buying a piece of gear the CB enthusiast can't make use of. On the other hand, if you can't exactly afford to let your cup of goodies

runneth over, useful accessories like a log-book, or supply of new QSLs, would bring a smile to any CBER's face. And some Band buffs, lucky bunch for sure, are going to tear open a carton holding the Ultimate Gift: a new rig!

If you're thinking of giving the U.G. to the type of CBER that tailors his modulation for maximum "talk power," or if he's the kind of CBER who delights in tuning his antenna system as fine as a gnat's eyelash in hopes of mustering up every smidgen of soup out of the sky hook, *B&K's Cobra 25 Base Station Transceiver* might well be the answer to his dreams. Obviously intended for the professional and experimental CBER, the *Cobra 25* features a built-in double duty SWR/modulation meter, and a second combination power output/S-meter setup. It also sports a do-it-yourself mike connector, and a microphone gain control. All this built into a 23-channel base-station-only transceiver.

Snake Charmin' Straight Talk. Let's talk about the *Cobra's* first things, first. The *Cobra 25* is supplied with all crystals, but as I said before, comes less the microphone.



B&K's Cobra 25 Communications Transceiver features two meters that monitor several functions. The unit comes with all crystals, but without a microphone, allowing the CBER to choose his favorite type. The total transceiver consists of several sections mounted on a rigid chassis assembly. To make tests and service a little bit easier than usual, the power-supply components are completely independent of the main printed-circuit board. Both the power-supply output and the modulation limiting can be adjusted by the *Cobra 25's* owner.

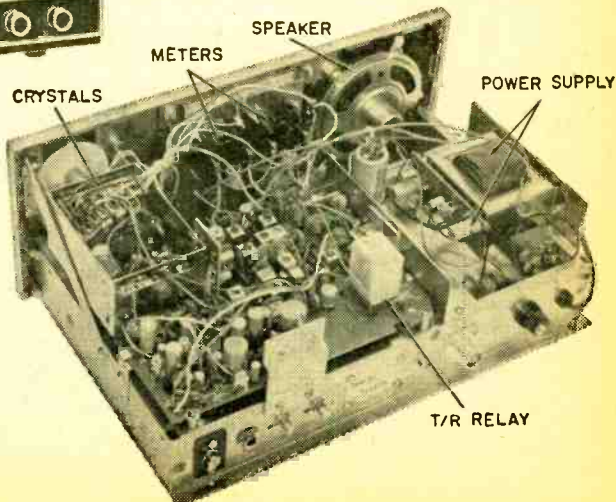



KATHI'S CB CAROUSEL

Reason for this seeming omission becomes clear once you think about it. The pro, or advanced CBer, would almost certainly want to provide his favorite type of microphone! There's no need to worry about what type of mike he tries to plug into the *Cobra 25*—standard dynamic type, built-in amplifier, mike-with-compressor—all work well because cranking up the mike gain control while watching the modulation meter draws optimum modulation from any mike. The only restriction is that the microphone (or mike with built-in compressor/amplifier) has a low-impedance output.

Two meters allow full-time monitoring of just about, well . . . everything! One meter triples as an S, RF output, and SWR forward power meter. The other meter doubles as a percent modulation/reflected power meter. With the front panel Mod/SWR switch set to SWR, the meters indicate the forward power and the reflected power (SWR). Set the switch to Mod, and one meter indicates the percent modulation, while the other meter indicates the forward power. In the receive mode, one meter is inoperative, while the other functions as an S-meter.

The SWR metering equipment, by the way, is actually a section of transmission line with both forward and reflected power pick-off loops and detector diodes. Everything's built into the transceiver—there are no external cables or connections.

Cuddled around the front panel are the microphone connector and what appears

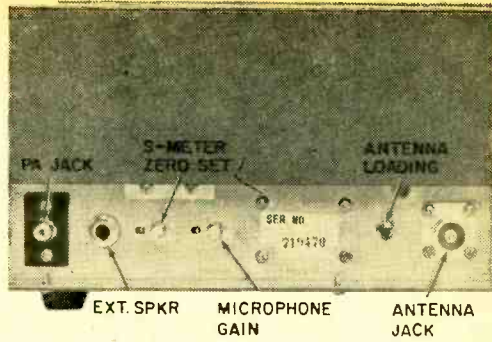

A mike gain control is provided on the rear apron of the *Cobra 25*. Just about any mike and voice level results in 100% modulation.

B&K Cobra 25 Box Score

Power supply—117 VAC
 Sensitivity—1.1 μ V
 Selectivity—60 dB
 Image rejection—86 dB
 AGC action—3 dB
 Input level for S9—20 μ V
 RF output—3.8 watts
 Modulation to 85%—Yes (adjustable)
 Relative microphone sensitivity for 85% mod.—Adjustable
 Modulation limited to 100%—Yes

to be a vast array of six controls: channel selection, SWR calibrate/power output trimmer, squelch, volume, PA/CB selector, and a three-position Delta tune. In addition to the Mod/SWR panel switch on the *Cobra 25*, there is a Noise Limiter on-off switch.

Turning the rig on its ear, the CBer finds that the *Cobra 25's* rear apron has the an-

(Continued on page 95)

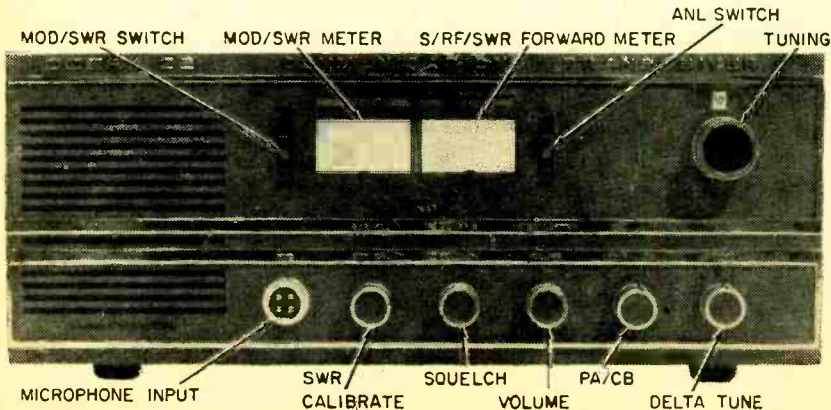

The front end of the B&K *Cobra 25* is all business, with dual meters providing full-time monitoring of SWR, power output, percent modulation and received signal strength.

e/e
checks
out
a...



Sophisticated Electronic Oven kit

Bake potatoes in 4 minutes, cook hamburgers in about the same time—with electronic cooking! The Heath microwave oven, with safety interlocks, takes only a couple of evenings to build.

In the time it takes for you to say Galloping Gourmet, you, or your wife, can start rummaging through the refrig for a snack and get a fully-cooked, piping hot meal on the table! Drool no longer. With electronic cooking, you can prepare a full-course gourmet meal in less time than it takes to think about *Heathkit's GD-29 Electronic Oven*.

Just a few examples illustrate the speed of electronic cooking. Baked potatoes usually take at least an hour in a conventional oven—not even allowing for the time needed to heat the oven. *Heath* electronic

cooking takes but 4 minutes.

A grilled cheese sandwich takes about 1 minute, while burgers or ground steak takes several minutes. It all depends on whether you like your meat rare or like shoe leather. Roast beef takes but 5 minutes per pound, while a turkey needs 10 minutes per pound. And, just in case you've pulled the dinner out of the freezer rock-hard, add 30 seconds per pound to allow for thawing.

Even cooking. An interesting—and never before attainable with any other cooking medium—feature of *Heath* electronic cooking is *uniformity*. If you want rare roast

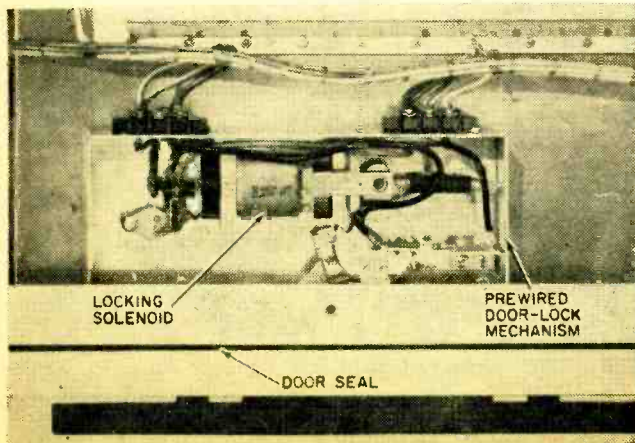

The *Heathkit GD-29 Electronic Oven* is designed so that anybody can operate it, and almost anybody can build it. The prewired door-lock mechanism turns off the Magnetron whenever the oven door is opened, and there's a backup interlock just in case that doesn't work. Other safety devices make the oven foolproof.

HEATHKIT ELECTRONIC OVEN

beef, it is rare from inside to outside, and from end to end. Want well-done steak-burger? It is uniformly well-done from core to shell. But bear in mind that electronic cooking means *roasting* or *heating*; you cannot prepare a char-broiled steak in an electronic oven because there is no *sear heat* as there is in a conventional oven.

The Molecules Move. Electronic cooking bears no relationship to normal high temperature cooking. Fact is, there is really no external heat in electronic cooking! The actual "cooking" is accomplished through molecular movement caused by microwave radiation.

The *Heath Electronic Oven* is basically a metal cabinet surrounding a Magnetron oscillator. It's essentially the same type of oscillator used in radar equipment. The 650-750 watt Magnetron oscillates at 2450 Mhz; a waveguide (just like in radar) spews RF output to the main oven compartment.

When food is placed in the oven compartment, it is subjected to "bombardment" by the microwave radiation, which causes the food molecules to vibrate. The vibration of the molecules generates heat, and it is this molecular-movement heat which cooks the food. Since the radiation more or less penetrates the food evenly, all the molecules vibrate with equal intensity. Result: the heat, and therefore cooking, is uniform throughout the food.

As you would expect, the greater the food density, the greater—and more close—the individual molecules. Dense food such as roast beef "cooks" faster than a low-density food such as fowl (turkey, chicken, etc.)

Water content is the key to molecular density. Ordinary paper plates and even glass can be used as cookware because they will not heat—there is no water density, hence, no heating through molecular movement. Fact is, paper plates don't even get warm! Metal cookware *cannot* be used because it reflects the microwaves. Food placed in a covered metal pot would come out "ice cold" because the metal reflects all the microwave energy away from the food.

Inside Heath's Electronic Oven. The *Heath Electronic Oven* consists of a decorative cabinet containing a shielded Magnetron compartment. Also, there's a waveguide that transmits the microwave radiation to an

interior cooking compartment (the oven), a *stirrer* that distributes the microwave energy equally throughout the oven, a timer—and a heck of a lot of safety interlocks.

The oven compartment contains a glass shelf that allows the microwave radiation to enter the food from the bottom as well as from top and sides. The oven door has both a capacitive plate shield and a vinyl door seal to prevent excessive exterior radiation. In addition, the door has an interlocked handle that turns off the Magnetron as soon as the lock is released. A



Because metal cookware reflects microwaves, this pie was baked in a glass pie-plate, and could have even been baked in a paper plate!

back-up interlock disables the Magnetron if the door is opened, the Magnetron is therefore disabled even if one or the other of the door interlocks fail.

The timer also receives its power from the door interlock so that it stops when the door is opened, allowing foods which require shorter cooking times to be added to the oven without affecting the cooking of items previously placed in the oven.

Other features include a *fluorescent oven light*, an *external circuit breaker*, a *power on lamp*, a *cook lamp* that indicates the Magnetron is on, a *door open lamp* that warns if the door is not closed and a *high temperature lamp* that indicates the Magnetron heat is excessive—that the filter needs a cleaning. (The Magnetron is air-cooled by forced air).

Mostly Metalwork. Unlike most other kits which you might have assembled, the *Heath GD-29 Electronic Oven* requires little electronic assembly. Most of your work goes into assembling the metal components comprising cabinet, oven, door, waveguide, etc. The electrical assembly consists primarily of connecting the door interlock to the Magnetron and the timer. (Continued on page 104)

PUSHBUTTON SLEEP:

FACT or FANCY?

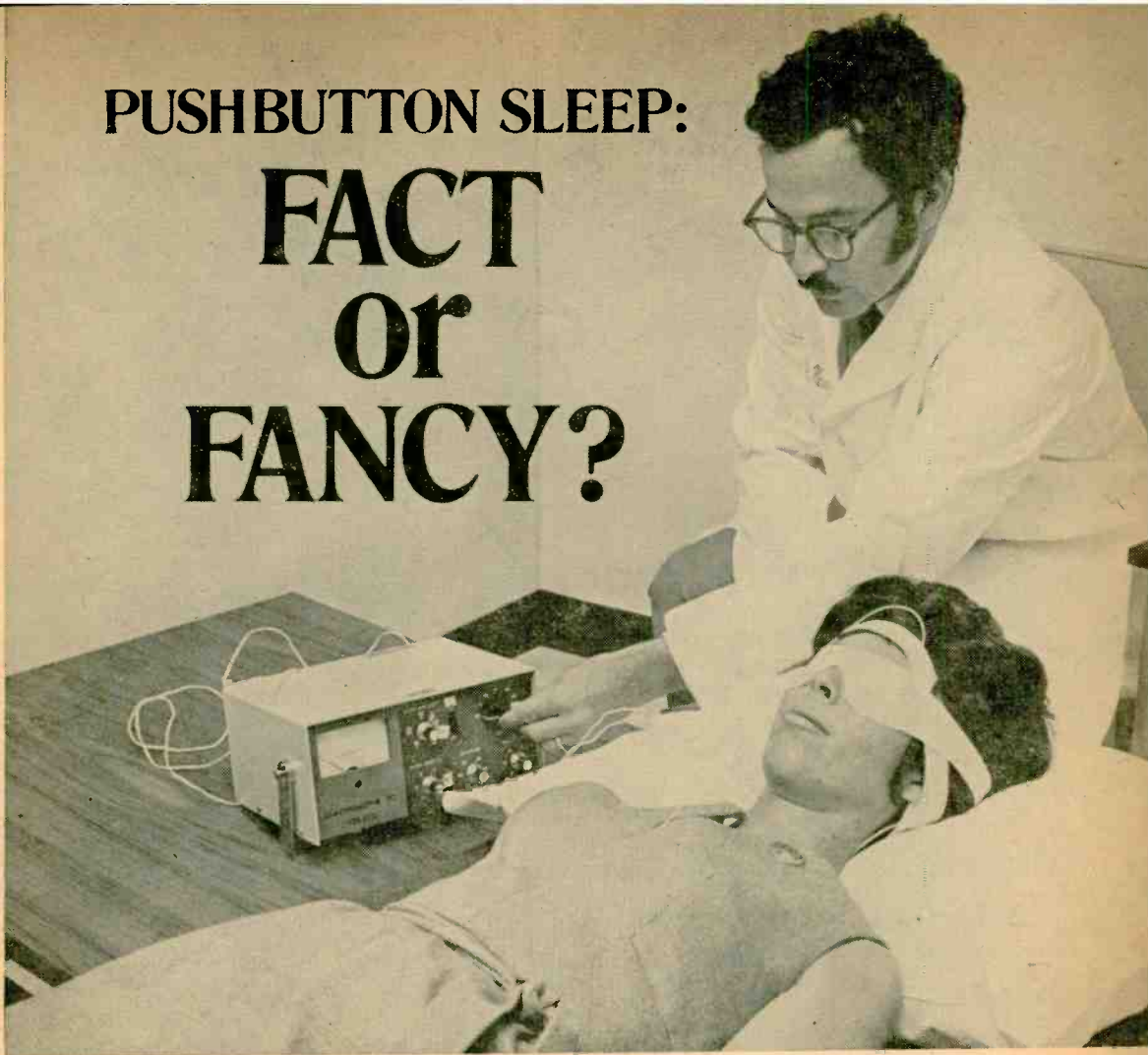

Does an electrosleep machine actually put you to sleep, or does it work simply because you believe it does?

/By Webb Garrison

Ten years ago no U. S. research worker who valued his reputation would have admitted interest in using electrical devices to induce sleep.

Today this special application of a still-mysterious force is one of the hottest areas of medical research. Ranks of Americans who were considered to be hopelessly addicted to bedtime pill-popping have already been thinned a little. Some of the nation's leading clinics are eagerly testing, or planning to test, solid-state electrosleep machines.

Sophisticated new variants of methods long linked with quackery are yielding positive results that can't be ignored. Debate

still flourishes, though, on the unresolved question of whether results stem from pulsating current entering the brains of patients—or from subjective reactions to techniques and gadgets.

A Willing Guinea Pig. Take the case of Harold Y. A successful junior executive whose performance during the next two or three years will determine whether or not he makes it to the top, Harold has always been rated as exceptionally competent.

He sometimes suffers from periods of depression, though. Since 1959 he has been plagued with insomnia that didn't respond to any conventional treatment. Harold's physician prescribed Elavil and later Librium.

ⓐ/ⓐ PUSHBUTTON SLEEP

Neither drug helped him. Valium, another standard pharmaceutical weapon against sleepless nights, was totally ineffective. So was chloral hydrate.

Though he showed some symptoms of anxiety, nothing in his personality profile indicated that intensive psychiatric treatment was needed. There was nothing left—or so it seemed.

As a desperate last resort, Harold's family doctor referred him to an electrosleep clinic where he registered as an outpatient. Neither he nor his physician had any real hope of positive results, but every other alternative had been tried.

He took a battery of tests. Finally the day came for his first treatment.

At the clinic, the specialist working with him had already explained that he would be treated with the Electrosone 50. This machine is based on the circuitry of the Electrosonom "sleep machine" widely used in Russia, but differs from the Iron Curtain device

in several important respects.

Electrosone. Manufactured and sold by Tri-Tronics Laboratory, Inc., near Dallas' Love Field in Euless, Texas, the Electrosonone 50 is the only electrosleep machine that has won F.D.A. approval. Currently, such approval isn't absolutely necessary. Unless electronic medical devices can be considered "drugs" under recent court interpretations, they don't have to prove either efficiency or safety.

This situation may change any time, however. Once such devices are promoted for sale to the public, the F.D.A. is likely to initiate regulatory action. Two major brand-name electrosleep machines, made in Russia and Germany, are readily available in Europe and other parts of the world. So are half a dozen competing products.

Even without specific laws governing manufacture and sale in the U. S., F.D.A. pressure is strong enough to limit distribution to "qualified scientific investigators" wishing to use electrosleep machines for research purposes. This meant that in subjecting himself to treatment by means of the Electrosone 50, Harold Y. was a willing

What's Inside a Sleep Machine?

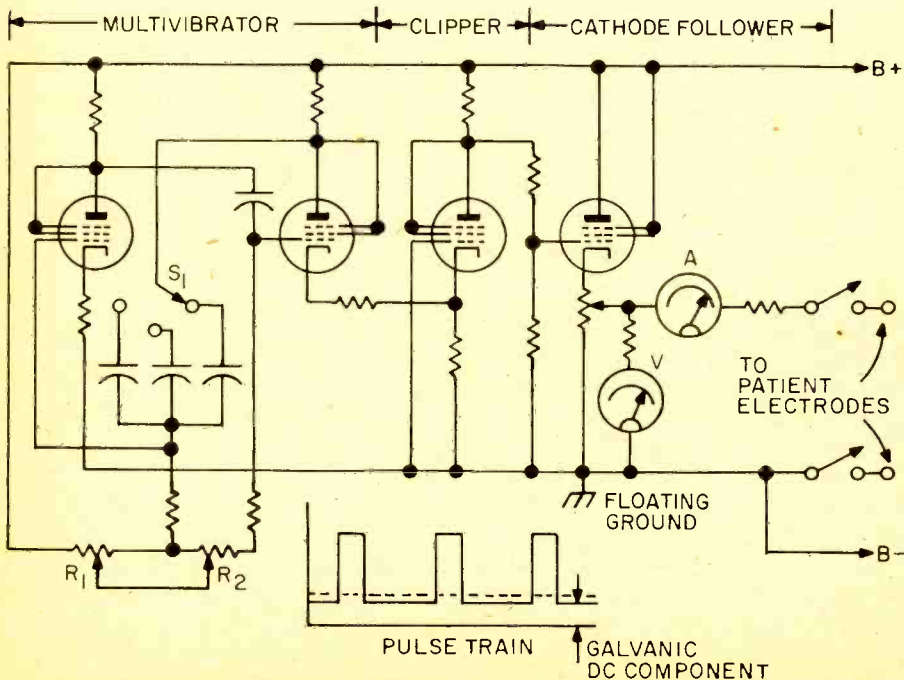

Schematic of Russian-developed sleep inducer (above). The machine's output resembles the brain's alpha rhythm. The sleep inducer on the opposite page will modulate dreams.

guinea pig. The result of his experience could affect the future of the electronic device as well as his own health and career.

From his doctor's instructions, Harold already knew that he didn't have to strip and don a hospital gown to receive his first treatment. So he walked into the clinic wearing an ordinary business suit. He elected to lie down—not because this is considered necessary, but because it is more comfortable than sitting.

Sleep Treatment. A sleep mask was placed over his eyes in such away that the built-in negative electrode was positioned over his eyelids and the positive over his mastoid areas. It took only seconds for connection of the positive wire to the mastoid electrode and the negative wire to the eyelid electrode.

Electrical contact, Harold already knew, would be made by means of throw-away plastic pads moistened in a saline solution to improve electrical conductivity. Manipulating dials of the Electrosone 50, his physician set the machine for a frequency of 100 positive pulses per second and a pulse duration of 1 millisecond. By turning a third

dial, the timer control was set for a thirty-minute treatment with automatic cutoff.

Harold felt a slight "prickling" or "flashing" sensation over the eyes. Then the same sensation was felt in the mastoid area. He was in no way uncomfortable—simply aware of the reaction he had been told most patients experience. He knew enough about electronics to realize that the squarewave pulse yielded by the Electrosone 50 closely approximates the brain's alpha wave.

Tense for a few minutes but never actually apprehensive, the patient soon relaxed. Though he didn't fall asleep, he found himself in that never-never land where there are no conscious thoughts or dreams. His pulse rate and breathing assumed such patterns that though fully conscious, he was, for clinical purposes, asleep.

At the outset, Harold had agreed to a course of ten half-hour treatments. Largely as a courtesy to his physician he completed the entire series. After the third treatment he found himself drifting off to sleep more easily and sleeping more restfully than in years. He voluntarily gave up all medication.

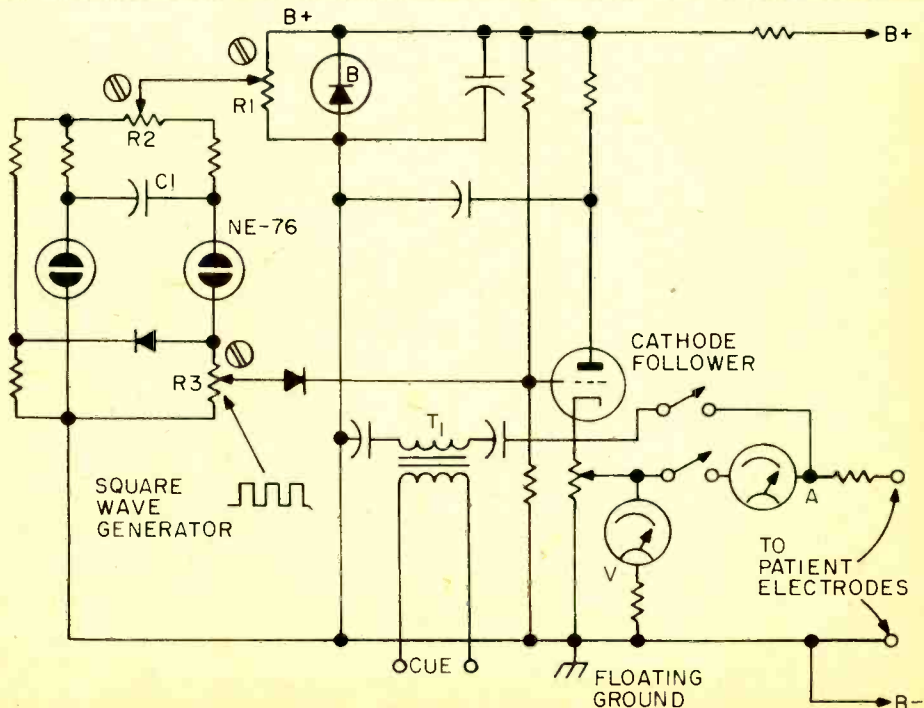

The output is lowered, and cued information is fed in at T1, in the form of music or speech. Frequency is determined by R1 and C1, pulse width by R2, and output amplitude by R3.

e/e PUSHBUTTON SLEEP

Still waiting to see whether or not he'll get the promotion that will determine the course of his career, Harold Y. threw away his bottles of pills after his seventh electro-sleep treatment. In the nearly eighteen months that have elapsed since he received treatment #10, he has had only a few sleepless nights.

Though the name is fictitious and details have been changed to prevent identification, the story of Harold Y. is no fairy tale. It represents one fruit of very recent American willingness to give European electro-sleep techniques a genuine clinical try.

Pioneer. One of the pioneers in this country is Saul H. Rosenthal, M.D. Associate professor in the department of psychiatry, University of Texas Medical School at San Antonio, Rosenthal himself was highly skeptical of electro-sleep. But he felt that low-intensity electrostimulation of the brain as a psychiatric treatment was too important to be ignored. Pioneer work began in Europe more than fifty years ago. The *Foreign Science Bulletin*, published by the Library of Congress, lists hundreds of technical papers reporting results of tests and treatments involving tens of thousands of persons.

European Activity. Practically all European nations have encouraged experimentation. In Russia, electro-sleep machines are in daily use in more than three hundred "sleep centers." Scientists from all over the world converged on Graz, Austria, in 1965 and again in 1969 for international conferences on electro-sleep and electroanesthesia. The international society whose headquarters are located there (Chirurgische Universitaetsklinik, 8036 Graz, Austria) has a big and growing library, and publishes extensive literature on current work.

During the past decade, Moscow has been host for four symposia on electro-sleep and electroanesthesia, involving participants from the Union of Soviet Socialist Republics.

Russia's "All Union" symposia have concentrated entirely upon electro-sleep and electroanesthesia. In the U. S., a much broader approach has been followed. Milwaukee was host to the nation's first "neuro-electric conference" in 1968; others followed in San Francisco the following year and in Las Vegas in 1970.

"One would think that with all this activity," Dr. Rosenthal said at the American Psychiatric Association annual meeting in May, 1970, "electro-sleep would be a flourishing area of investigation in the U. S. Amazingly, this is not so. There is a very small amount of clinical work published on electro-sleep in the U.S. and almost nothing at all in the psychiatric literature."

Rosenthal himself got into the field quite by accident and was at first skeptical about positive results reported by European research workers. He now confesses that he "had the university trained psychiatrist's traditional distrust of anything electrical in the treatment of patients as being at least vaguely disreputable."

Some Tests. With Normal L. Wulfsohn, M.D., associate professor in the department of anesthesiology in the medical school where he teaches, Rosenthal set out to make some tests of the way precisely-regulated electrical pulses affect the brain and behavior patterns. Results of their clinical studies were communicated to the American Psychiatric Association and summarized in the *Journal of the American Medical Association*.

Rosenthal's personal skepticism notwithstanding, nine of the twelve patients in his first series of tests gained "relatively total remission of symptoms" through electro-sleep. Partial improvement was noted in one, while two showed no improvement at all.



Controls for the battery-operated portable *Electrosone 50* were adjusted so that the patient felt no sensation except a slight tingling. Relaxed but not actually asleep, the patient will virtually "float" until electro-sleep is ended by a preset timer.

On a 7-point scale where 1 represents no symptoms, the average rating for sleep disturbances fell from 5.9 to 2.7. On a similar scale, the average anxiety rating dropped from 5.9 to 2.7, while the depression rating declined from 5.2 to 2.3. Still, the most remarkable effect was total disappearance of insomnia—usually by the third treatment.

Not yet convinced that extra attention and suggestion might not account for the remission of symptoms, Rosenthal made “blind” tests. He treated a group of patients with simulated current. None showed the dramatic “total remission of symptoms that were seen in the active treatment group.” It was a different story when four of these patients who had undergone simulated treatment got the real thing. This time, two had complete remissions and two showed partial improvement.

A later and more complicated “double-blind” study (in which neither patient nor physician knew who actually received electrical treatment and who had gear attached without current being turned on) gave “startling confirmation” of European findings about electrosleep.

Quackery. This doesn’t mean that the U. S. medical-scientific community is anywhere near being convinced—or even open-minded to experimentation. Nowhere in the world is the prevailing mood of medicine more conservative than in this country. This general conservatism is particularly prominent in relation to any form of “electrical

treatment”—because quackery ran rampant during the nineteenth century.

Electric belts made and sold by the Pulvermacher Galvanic Company as “a common-sense treatment for weak men” offered quick relief from “sexual debility, impotency, drains, losses,” and related conditions by means of current that was supposed to pass “through the Sexual centre and kidneys at the back to the Liver and Sexual organs in front.” The “Improved Graduated Magnetic Machine” was guaranteed to cure anything from arthritis to cancer. As late as 1899, the Electropoise Co. of New York marketed a machine designed to cure “Catarrh, Neuralgia, Asthma, Hay Fever, Insomnia, Inflammatory Rheumatism,” and a host of other ailments.

Present-day findings suggest that makers
(Continued on page 96)

A Common-Sense Treatment for Weak Men



[Part of insulating case is removed, showing position of batteries.]

The above shows how extremely rational my treatment is for men suffering from Sexual Debility, Impotency, Drains, Losses, Varicocele, Atrophy, etc., as the current fully envelops EVERY PART AFFECTED, in passing through the Sexual centre and Kidneys at the back to the Liver and Sexual organs in front. Any man who can move about and eat and sleep is in line for a cure by my system of electrical treatment, as I have demonstrated in thousands of cases, and any one who suffers as above is simply throwing health and happiness away who does not avail himself of it. The belt is also used same as above in Rheumatism, Kidney, Bladder, Liver and Stomach complaints, Nervousness, General Ill-Health, etc., either with or without the Spiral Suspensory. When the latter is detached all the negative current goes to the Liver or Stomach Disc.

30 DAYS' TRIAL

DR.
DYE'S

VOLTAIC
BELT.

(BEFORE — AND — AFTER)

Electric Appliances are sent on 30 Days' Trial.

TO MEN ONLY, YOUNG OR OLD,

WHO are suffering from NERVOUS DEBILITY,
LOST VITALITY, LACK OF NERVE FORCE AND
VIGOR, WASTING WEAKNESSES, and all those diseases
of a PERSONAL NATURE resulting from ARTERIES and
OTHER CAUSES. Speedy relief and complete resto-
ration of HEALTH, VIGOR and MANHOOD GUARANTEED.
The grandest discovery of the Nineteenth Century
Send at once for Illustrated Pamphlet free. Address

VOLTAIC BELT CO., MARSHALL, MICH.

Grandiose claims for electric and magnetic devices made physicians and scientists skeptical of all machines dispensing power. Electric belts widely sold after the Civil War era varied in their construction, but were alike in extravagant claims for curing a great variety of complaints.



**Train on this
315 sq. in.
picture
color TV
and get the
skills that
mean a
high-paying
career!**

Solid-State — the newest development

**Count on NTS training to always
feature the latest electronic equipment.**

Now included in two exciting NTS color TV courses, this set is the largest, most advanced color television made. Guided by the NTS "Lab-Project Method" of combining professional kits and easy-to-follow lessons, you build this color TV step by step — learning TV Servicing as you go! NTS has successfully trained thousands of men at home for rewarding careers as electronics technicians. Prepare for the great opportunity fields of TV-Radio Servicing, Computers, Communications, and Automation.

This solid-state color set contains: 45 transistors, 55 diodes, 2 silicon controlled rectifiers, and 4 advanced Integrated Circuits representing an addi-

tional 46 transistors and 21 diodes. The first solid-state color TV this large — yours to keep! It features Automatic Fine Tuning; "Instant On"; an Ultra-Rectangular Screen (25 in. diagonal measurement) that lets you see the complete transmitted image for the first time — a full 315 square inches; exclusive built-in Self Servicing features which eliminate the need to buy costly test equipment; exclusive design Solid-State VHF Tuner with an MOS Field Effect Transistor; 3-stage Solid-State IF; Automatic Chroma Control; Adjustable Noise Limiting and Gate Automatic Gain Control; High Resolution Circuitry; Matrix Picture Tube; and a specially formulated Etched Face Plate that eliminates unwanted glare, and heightens contrast. Colors are more vivid,

fresh tones more natural, and the picture is sharper than ever before. By training on this unique color TV, you'll gain the most up-to-date skills possible in TV Servicing!

Other valuable equipment you build and keep includes an AM SW Radio, Solid-State Radio, FET Volt-Ohmmeter, and Electronic-Tube Tester. All included in your tuition. You learn troubleshooting, hi-fi, multiplex systems, stereo, and color TV servicing. Step right into a technician's job at top pay or open a business of your own! For complete details on all NTS electronics courses, mail the coupon today for the full-color NTS Catalog. No obligation. No salesman will call.

Build this set
and learn
solid-state
circuitry—the
electronics
of today!

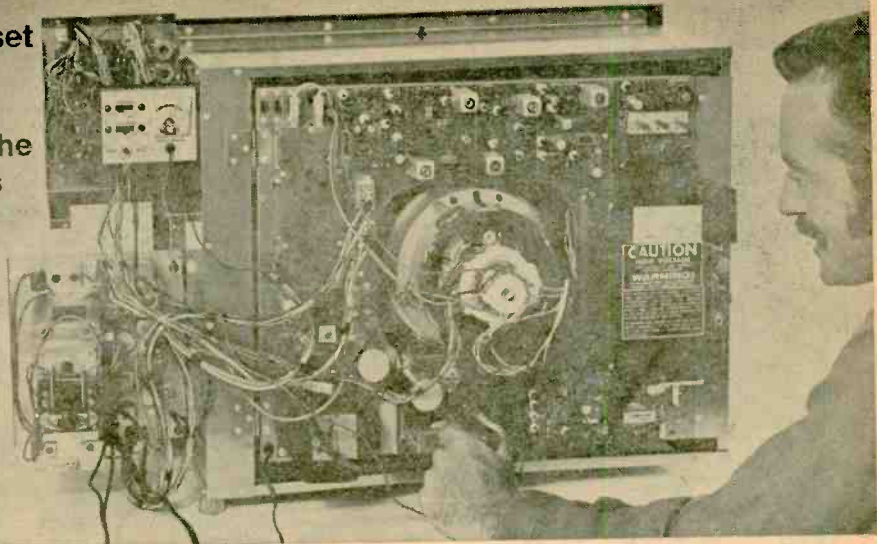

in color TV — comes to home training.

NTS ELECTRONICS & COMPUTER TECHNOLOGY

Build this exclusive NTS Computer Trainer! Loaded with integrated circuits, it shows you the how, what, and why of computers. Learn this exciting field faster, more thoroughly. You also assemble and learn to operate an FET Volt-Ohmmeter and 5" wide band Oscilloscope.

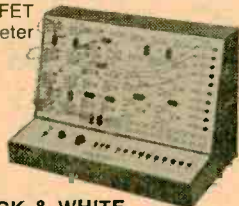

NTS BLACK & WHITE TV AND RADIO SERVICING

Learn all phases of television, radio, stereo, and hi-fi. You receive this 74 sq. in. picture Solid-State B&W TV, Lo-Silho "Superhet" Radio, FET Volt-Ohmmeter, Solid-State Radio, Electronic Tube Checker, and Signal Generator. Start earning extra money even before you complete the course!

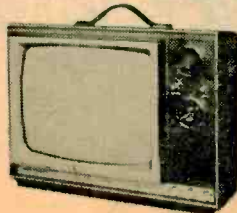

NTS ELECTRONICS COMMUNICATIONS & F.C.C.

Gain the security and prestige of owning an F.C.C. First Class Radio-Telephone License! Two comprehensive NTS courses cover the big opportunity field of transmitting and receiving. You build 14 kits, including a 5 watt AM Transceiver, 6 Transistor Pocket Radio, and FET Volt-Ohmmeter. Learn 2-way radio, Citizens Band, micro-waves and radar.



NTS INDUSTRIAL & AUTOMATION ELECTRONICS

Automation is the future of industry and you can play an important part! Learn industrial controls by training on the NTS Electro-Lab — a complete workshop. You also build and operate this 5" wide band Oscilloscope. And you perform experiments that involve regulating motor speeds, temperature, pressure, liquid level, and much more.



CIRCLE NO. 18 ON PAGE 17

Classroom Training

at Los Angeles. You can take classroom training at Los Angeles in sunny Southern California. NTS occupies a city block with over a million dollars in technical facilities. Check box in coupon.

APPROVED FOR VETERANS

Accredited Member: National Association of Trade & Technical Schools; National Home Study Council.

NATIONAL TECHNICAL SCHOOLS

WORLD-WIDE TRAINING SINCE 1905
4000 South Figueroa Street, Los Angeles, Calif. 90037

Please rush Free Color Catalog and Sample Lesson, plus Information on course checked below. No obligation. No salesman will call.



National Technical Schools
4000 S. Figueroa St.
Los Angeles, Calif. 90037

- Master Course in Color TV Servicing
- Color TV Servicing (For Advanced Technicians)
- Master Course in B&W TV & Radio Servicing
- Master Course in Electronic Communication
- Practical Radio Servicing
- FCC License Course
- Master Course in Electronics Technology
- Industrial and Automation Electronics
- Computer Electronics
- Basic Electronics
- High School at Home Dept. 222-111

Name _____ Age _____
Address _____
City _____ State _____ Zip _____

Check if interested in Veteran Training under new G.I. Bill.
 Check if interested only in Classroom Training in Los Angeles.

E/E looks at new...



If you service color TV, you know how useful a vectorscope can be. Heath combines this with a color generator in the \$129.95 IO-101 kit, which also produces test patterns such as dots and cross-hatch. Circle No. 50 on Reader Service Page.



The easy-to-read display is only one of the many advanced features of the Triplet 6028 DVOM, or digital VOM. It operates on line voltage or from an optional battery pack, costs \$275. Circle No. 51 on Reader Service Page.

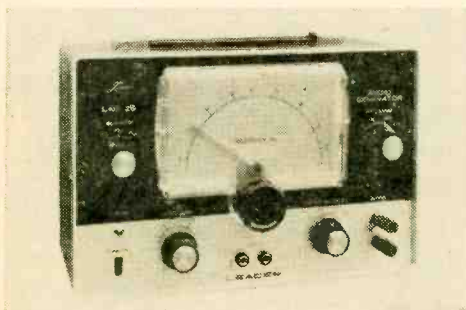

For testing the most sensitive audio equipment, the solid-state LAG-25, by Leader Instruments, generates a complex wave for IM distortion checks, plus sine and square waves. Featuring a range of 20 Hz to 200kHz, the LAG-25 is priced at \$99.50. Circle No. 52 on the Reader Service Page.

Built with digital integrated circuits, the 1246 color generator, by B&K-Dynascan, checks convergence, color, linearity, size and focus. The 1126 provides nine test patterns, costs \$149.95. Circle No. 53 on the Reader Service Page.



TEST GEAR

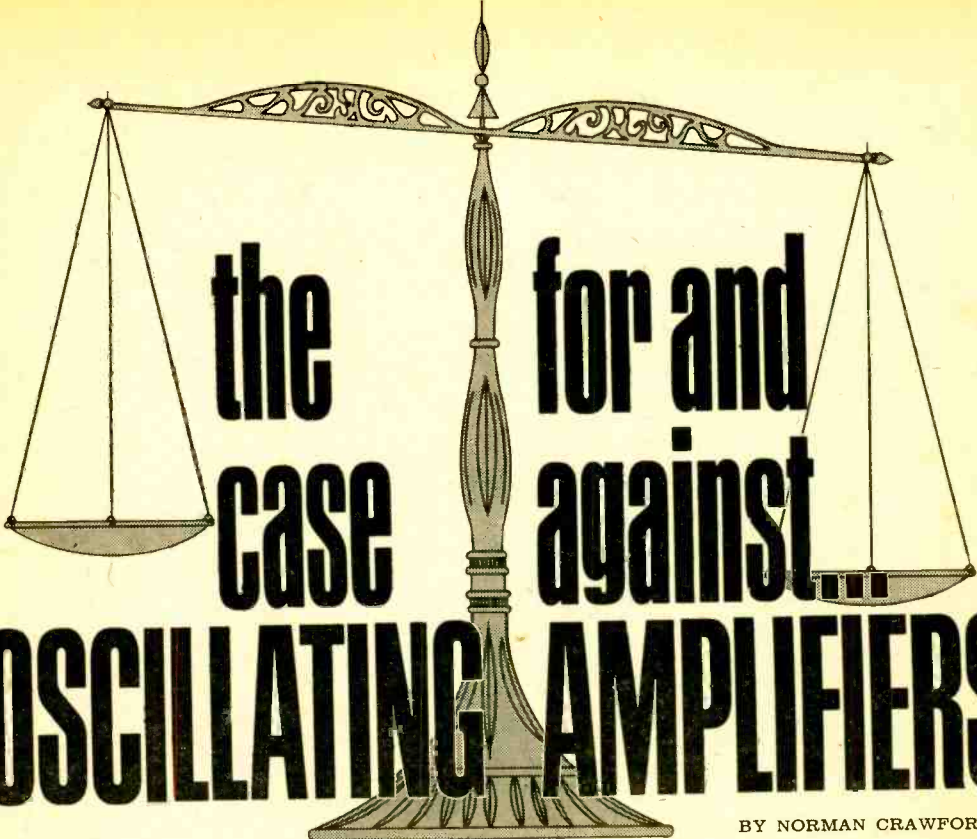

the case for and against OSCILLATING AMPLIFIERS

BY NORMAN CRAWFORD

AS ANY slightly cynical experimenter can tell you, if you want an oscillator, build an amplifier—it's sure to oscillate. Conversely, if you want an amplifier, (this same cynic will tell you), build an oscillator—it's sure to fail to oscillate, and you can then use it as an amplifier!¹

Our informed cynic must have had long and unhappy experience with negative-feedback amplifiers, which are known to have at least two outstanding characteristics:

1. They function beautifully if carefully designed and built.
2. Otherwise, they oscillate!

Why do they oscillate? Or, more basically, how does a feedback amplifier differ from an oscillator?

The fundamental block diagrams of an oscillator and an amplifier with feedback bear a strong resemblance to each other, as you can see from Fig. 1. From a block diagram viewpoint, both diagrams are very similar. Both contain some type of amplify-

ing device, and both have part of their output signal fed back to their input. There are only two major differences between them:

1. The amplifier with feedback contains an *inverting* amplifier; the oscillator contains a *non-inverting* amplifier.
2. The oscillator doesn't have an input.

The circuit action obtained from these two circuits is entirely different. In the amplifier with feedback, the output waveform is upside down with respect to the input, so when it is fed back to the amplifier input, it cancels a portion of the input waveform. The output is therefore less than it would be without feedback. See Fig. 2.

The feedback signals from inverting amplifiers are not "in phase" with the input signal and subtract (or reduce) the input signal level to the amplifier. When a feedback signal does this, it is called *negative feedback*.

So Why Negative Feedback? Of course, if you merely want the biggest possible gain for your money, negative feedback's not

¹ This is well known as a corollary to Murphy's famous Law, "If anything *can* go wrong—it *will*!"

e/e OSCILLATING AMPLIFIERS

your game. However, negative feedback offers other advantages, which can be summed up by saying that the amplifier's output, though smaller, is always nearly constant for the same input signal. For example, if the amplifier weakens with age, and the output tries to drop, there is less signal to be fed back; hence there is less cancellation, and the output is restored almost to its former level. Similarly, if you feed a high-frequency signal through the amplifier—so high in frequency that the amplifier can barely amplify it—the resultant drop in output reduces the feedback voltage, produces almost no canceling feedback signal, and keeps

the output nearly the same as it was at lower frequencies. Moreover, any clipping or other distortion of the waveform inside the amplifier produces an output waveform which does not match the input; hence the non-matching part is not cancelled, and the distortion is removed, or at least greatly reduced. Without this action, hi-fi amplifiers would not exist.

So the loss in output you obtain from negative feedback repays you by providing less distortion, better long-term stability, and better frequency response—that is, the best and most uniform output in response to all input frequencies.

On the Flip Side. The oscillator, on the other hand, is not supposed to give the best output from all input frequencies, but is instead made to give an output at a *single* frequency—with no input at all. It's not surprising that the opposite type of internal amplifier (non-inverting) is used to obtain this opposite result. See Fig. 3.

In the oscillator, any output at all (probably the result of some random noise in the internal amplifying device) is fed back, non-inverted, to the input, where it does not cancel but instead serves as the signal at the input. This feedback signal causes an even larger output, which results in an even larger signal fed back, further reinforcing the in-

AMPLIFIER WITH FEEDBACK

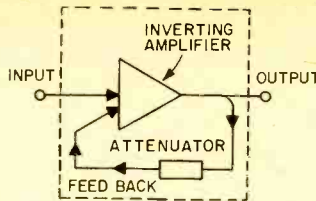

OSCILLATOR

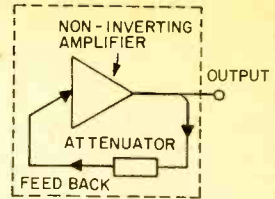

Fig. 1

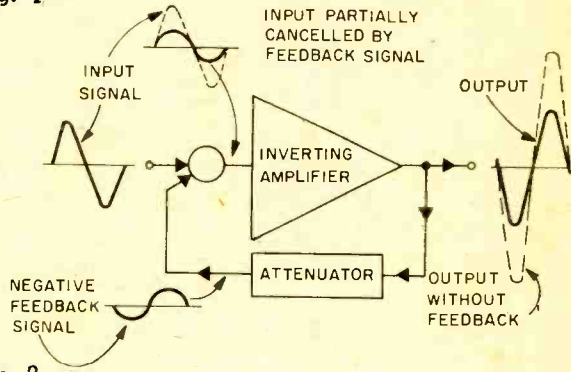

Fig. 2

put signal, and so on.

You guessed it—this type of feedback signal is commonly referred to as *positive feedback*. In theory, the output waveform should continue to get larger forever. In practice, the amplifier is limited in the maximum size of the signal it can deliver, so the output waveform stops growing at this amplitude. As it stops to grow, so does the positive feedback signal. Now the signal reduces rapidly and the positive feedback signal lends a hand until the signal can get no lower. This is the beginning of the first cycle of many to follow.

All well and good, you say, but if the major difference between feedback amplifiers and oscillators is the inverting or non-inverting nature of their internal amplifiers, why does an amplifier sometimes oscillate? What turns an inverting amplifier into a non-inverting one?

To answer this question, first observe that an inverting amplifier, in passing a sine-wave signal, *effectively* shifts the signal's phase by 180° as shown in Fig. 4. We say *effectively*, because it doesn't really shift the timing by delaying the signal (which is what a real phase-shifter does) but, by turning the signal upside down, the amplifier makes it look like a signal which has been delayed (phase-shifted) by 180° .

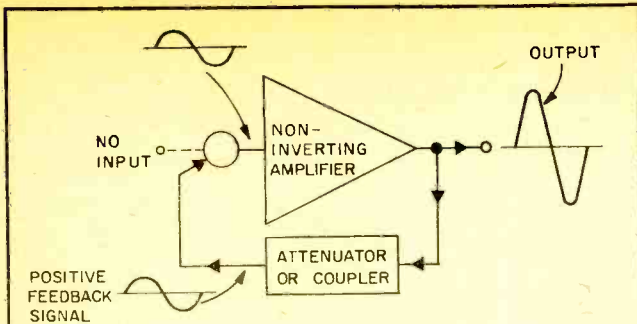

Fig. 3

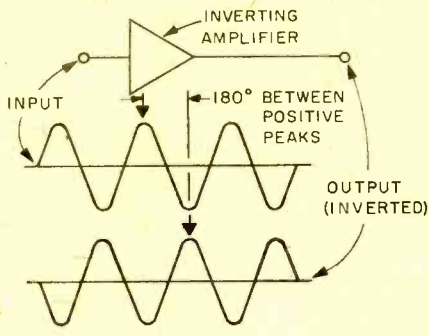

Fig. 4

A real phase-shifter, on the other hand, is normally nothing but a fistful of judiciously connected resistors and capacitors (and sometimes inductors) which can be designed to give a 180° phase shift at a single frequency, such as 1,000 Hz, for example.

What happens if we combine an inverting amplifier and a 180° phase-shifter? Take a look at Fig. 6.

This combination will shift the phase of a given frequency by a total of 360° (an entire cycle) so the output is identical to the input. In effect, this combination (at 1,000 Hz) will behave the same as a non-inverting amplifier. See Fig. 6.

Therefore, if we build a feedback amplifier which contains the normal inverting amplifier but also (inadvertently) contains a 180° phase-shift network, the resultant circuit will oscillate at the particular frequency, (1,000 Hz in the figure) for which the phase-shifter provides 180° phase shift. See Fig. 7.

How can one "inadvertently" make a phase-shifter? It's easier than you might think. The circuit shown in Fig. 8A will provide 60° phase shift at 1,000 Hz. Three such networks connected in a "ladder" (see Fig. 8B) will provide $3 \times 60^\circ = 180^\circ$ of phase shift.² This network, if dropped into a normal feedback amplifier circuit, will convert it to an oscillator. (turn page)

² But not at 1,000 Hz. Because of the way the networks load each other, the 180° shift occurs at 707 Hz. However, if an amplifier were located between each network, then the amplifier will oscillate at 1,000 Hz.

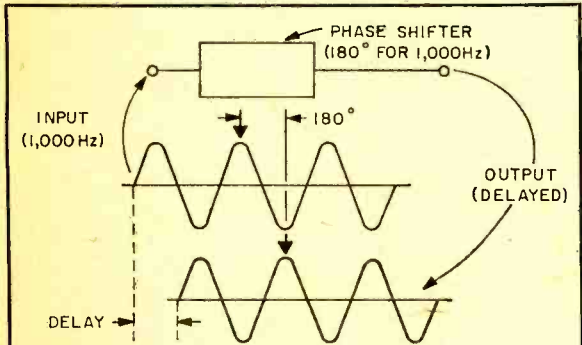

Fig. 5

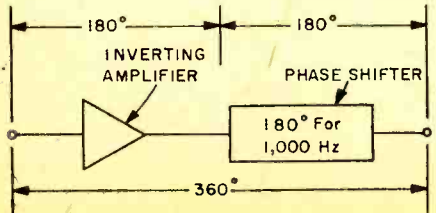

Fig. 6

e/e OSCILLATING AMPLIFIERS

This circuit (Fig. 9) is known as a *phase-shift oscillator* and is widely used in electronics.

Of course, when you set out to build a phase-shift oscillator, you *deliberately* insert a phase-shifter to make the circuit oscillate. How could one ever *inadvertently* place such a circuit in a feedback amplifier, thereby producing unwanted oscillations?

Phase-shift circuits can "hide" within an amplifier, posing as other circuits. For example, vacuum-tube amplifiers often have grid circuits arranged as shown in Fig. 10A. Does that resistor/capacitor circuit look familiar? In form, it's just like the phase-shift circuit above. And transistor amplifier circuits often take the form shown in Fig. 10B.

Again, the coupling/biasing network looks just like the basic phase-shifter network. At some frequency, this network will provide 60° of phase shift. If we use three such identical networks in a three-stage amplifier we have a 180° phase-shift network "buried" inside the amplifier, masquerading as three normal coupling networks. If this three-stage amplifier is used as part of a feedback amplifier arrangement, the amplifier will oscillate at some frequency, and be quite useless for the purpose for which it was intended.

This is not the only way an amplifier can get into trouble. There are other types of

phase-shifters than can creep into amplifiers, unrecognized, and drive the unwary experimenter up the nearest wall. This circuit (shown in Fig. 11A) can also produce a phase-shift of 60° at 1,000 Hz. Three of them, can produce the 180° phase-shift required for oscillation. See Fig. 11B. This particular network can invade amplifiers in an even more insidious fashion. The "masquerading" part of the circuit is shown heavily in Fig. 11C. The dotted capacitor doesn't appear physically in the circuit, because it is the so-called "stray" capacity associated with wires, sockets, terminals, etc. Three of these circuits hiding in an amplifier, can produce an unwanted oscillation. See Fig. 12. Since the stray capacities are so small, this "osc-plifier" will oscillate at a very high frequency; often so high that it is undetected as an oscillation. However, such oscillation can make an amplifier behave erratically; sometimes distorting, sometimes not; sometimes overheating, sometimes not. Fig. 7 and Fig. 12 have a lot in common.

Are feedback amplifiers the only culprits in this oscillating-amplifier business? Absolutely not! Often, so-called "straight" amplifiers—with no *intentional* feedback—will gaily oscillate away. But watch that word *intentional*. Close inspection of these misbehaving circuits usually uncovers an *unintentional* feedback path hiding within the amplifier. Consider the innocent-looking circuit in Fig. 13. This is an ordinary two-stage amplifier, obviously assigned the task of

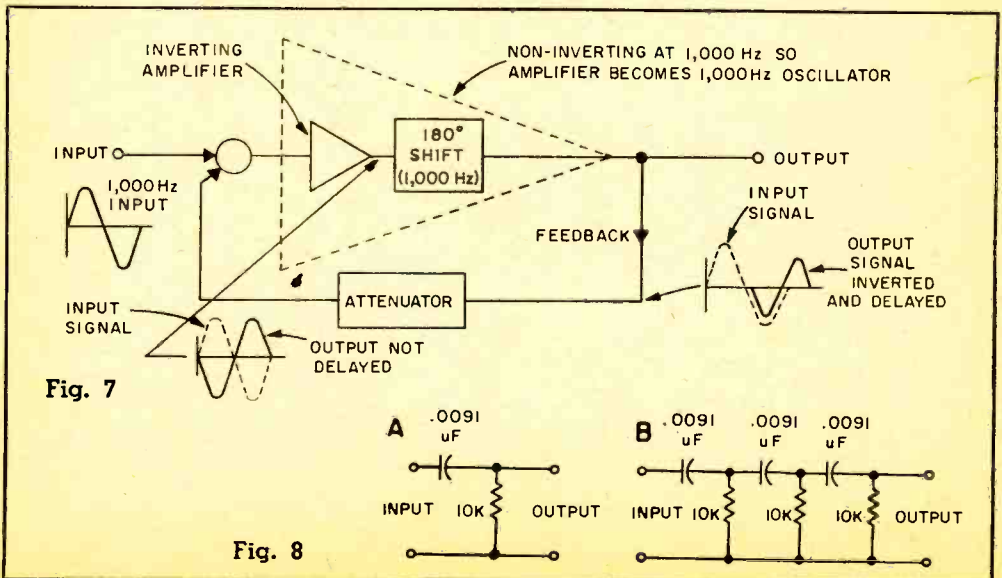

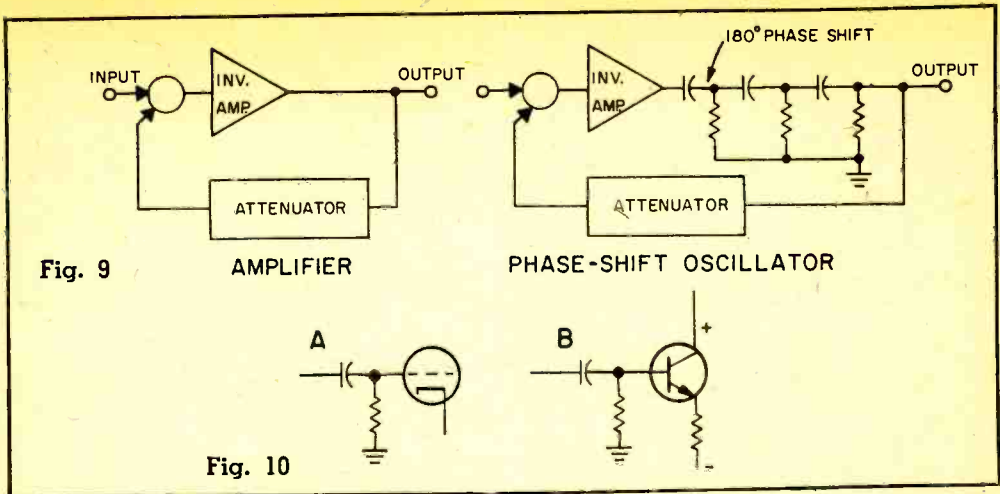

converting a small, positive-going signal into a large, positive-going signal. To help it along, the designer has even provided a decoupling network, R1 and C1. At high frequencies, C1 acts like a short circuit, effectively isolating (de-coupling) the amplifier's power bus, Ecc+, from the main power bus, Ecc++. But, at low frequencies, the capacitor acts like an open circuit—it just isn't there! A small part of the output voltage now appears across R1, and is coupled through the amplifier's power bus back to the input, arriving there with the same polar-

ity as the normal input. True, the signal unintentionally fed back isn't very large, because the unintentional feedback path provides substantial losses for this stray signal. For example, the signal may arrive back at the input 100 times smaller than it was at the output. However, if the amplifier has a gain of 101, it makes an even larger output signal out of the fed-back signal, which then is fed back as an even larger voltage, and we're off and running . . . and oscillating!

Careless construction can get you into

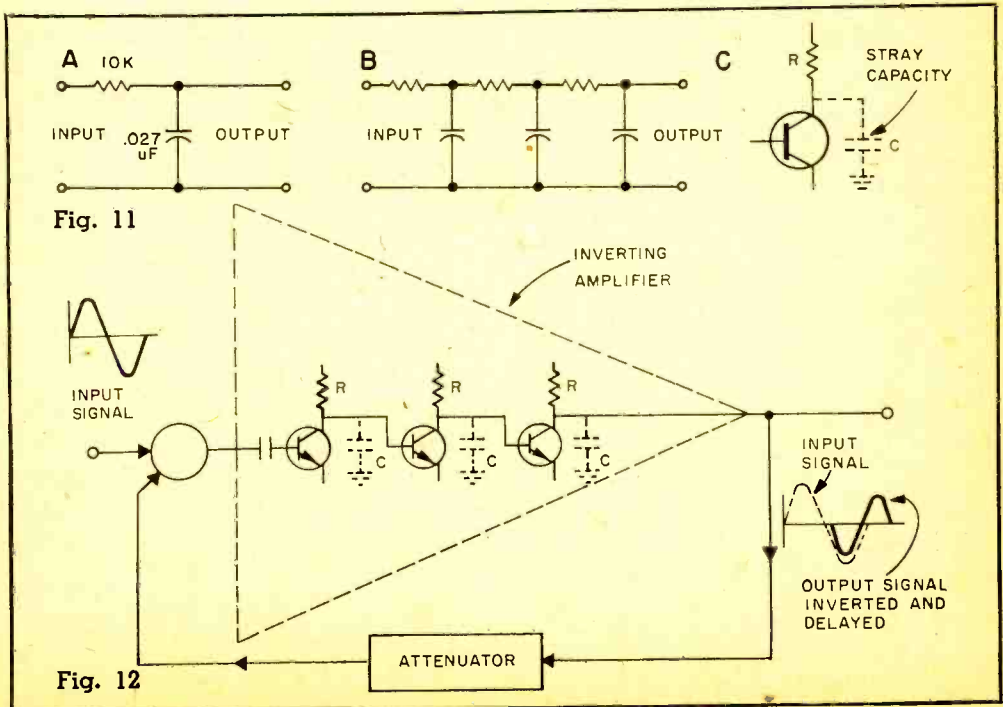

e/e OSCILLATING AMPLIFIERS

trouble, too. The amplifier show in Fig. 14 is trying to convert a 10-millivolt input into a 200-ma signal needed by the load, R2. The builder has tied all ground returns to a heavy ground bus, and returned this bus to ground at only one point. Unfortunately, that single ground wire has to carry both the tiny input signal and the large output current. And, since every wire has *some* resistance, the actual circuit includes an 0.06-ohm resistor that does not appear in the original construction schematic diagram, but must be considered and is shown in Fig. 14.

Again, an uninvited, unintended feedback path has appeared, coupling the output back to the input. In the sketch, the large output current, flowing through the tiny ground-lead resistance, produces a voltage which is even larger than the original input voltage. And, since this voltage is also connected to the input (through the bias resistor R3), the fed-back voltage appears uninverted (and uninvited!) at the input, and will cause the amplifier to oscillate.

All this presents a pretty bleak picture, with amplifiers oscillating at the drop of a hat. What is to be done to convert these oscillators back into well-behaved amplifiers?

The general rule is *divide and conquer*. In the example just above, we can conquer the oscillation by dividing the ground re-

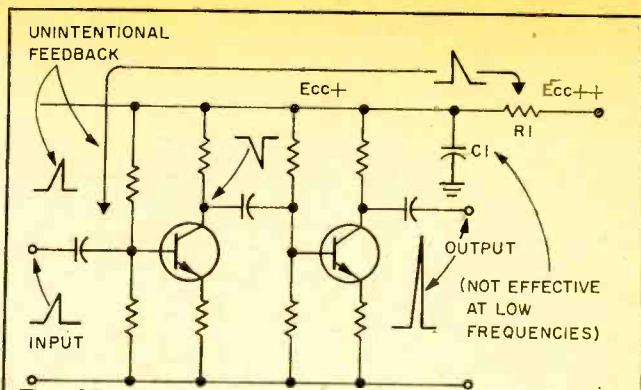

Fig. 13

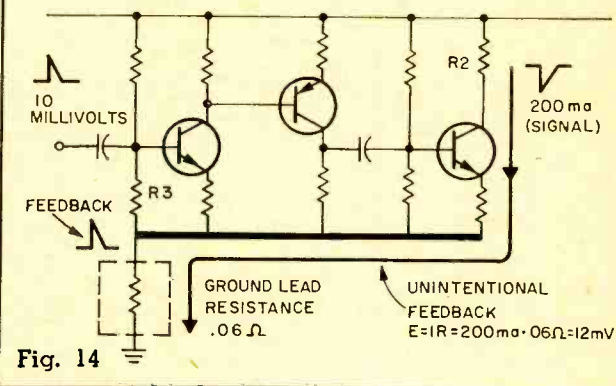

Fig. 14

turns, making sure that the high-current output circuits and the sensitive input circuits have their own private and individual paths to the power supply. See Fig. 15.

Short leads to the input connector are also helpful in squashing oscillations.

The misbehaving decoupling network, R1 and C2 in Fig. 13, can also be brought under control by dividing the network into *two* decoupling networks, as shown in Fig. 16.

The stray capacities causing the unwelcome phase shifter to hide in the amplifier are harder to exorcise. Your best divide-
(Continued on page 104)

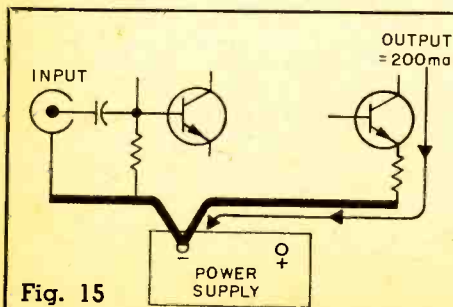

Fig. 15

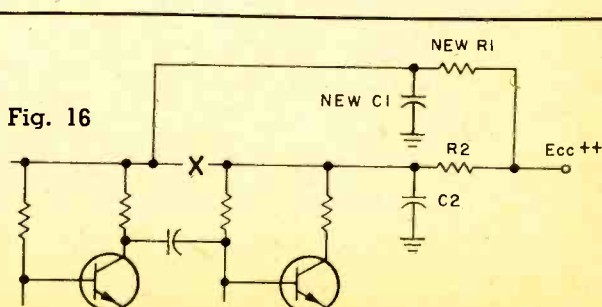

Fig. 16



THIS TEDDY HAS A HEART

This is no ordinary teddy bear—he has a heart, which is kept in a small tin containing capacitors, resistors and other assorted electronics. They all help make Teddy tick.



Everyone sleeps better with a teddy bear, especially one that ticks you to sleep! That's right, Mr. Bear will help your child gently fall off to sleep just as if she were rocking in her mother's arms.

This surrogate mother was developed because little Janine Masters had difficulty falling asleep. Her parents recognized the soporific effect of being rocked near the mother's heart, and decided to apply this principle in a practical way. First, they tried tape recordings of a heartbeat, but this lacked the comfort and security necessary. Then they tried "Teddy"—and it worked!

Although it may look like an average toy on the outside, Teddy houses a mechanism that creates a dull thud, perfectly imitative of the mother's heartbeat. Contained within a 2-oz. tobacco tin, the small battery-operated circuit releases a solenoid regularly to hit the side of the tin. The resultant tapping sound is dulled by the soft composition of the bear. To activate the circuit, simply press the head of the bear into its body. The beat is regulated by balancing the capacitor against the resistor.

Surgical repairs on Teddy's heart are no problem. Mr. Masters simply inserts new batteries through the seam in the back of the animal, and then resews it. Teddy's now good as new and ready to tick—he doesn't need much time to recuperate. ■

E/E looks

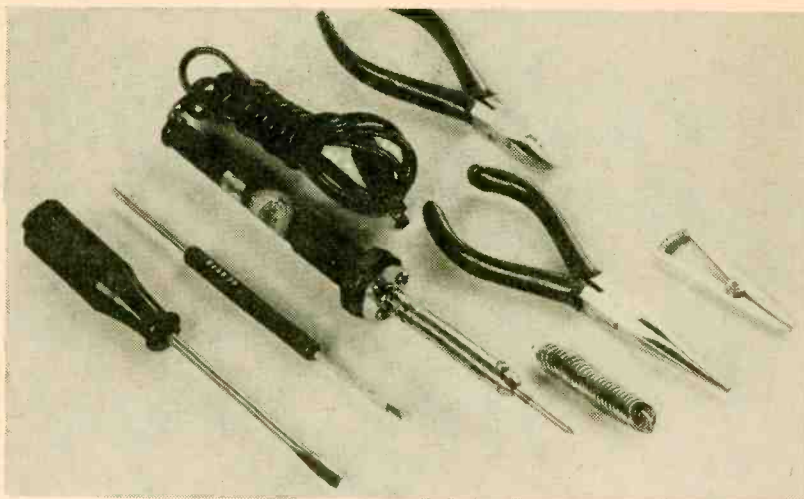

No need for the beginning hobbyist to buy tools one by one—now GC Electronics has a kit of just what you need to start. You get pliers, cutters, soldering iron, screwdriver, soldering aid, heat sink and solder—all for only \$7.95. Circle No. 54 on Reader Service Page.

Soldering parts together is easy, but how about removing the solder? A tough job, unless you use Ersas's new Soldapullit tool, at \$5.95. Just thumb the release and the solder is sucked up and away. Circle No. 55 on Reader Service Page.

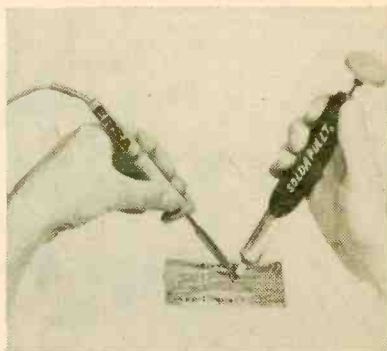

When you're on a service or repair call, how long does it take you to find a tool? If it's more than a few seconds, do what the pros do, and get Xcelite's tool case that looks just like one of those neat attache jobs. Straps and pockets hold up to 59 hand tools. Model TC-100 sells for \$50, and Xcelite also sells the tools. Circle No. 56 on the Reader Service Page.

Reader
Service Page
is on 17

TOOLS AND

ELEMENTARY ELECTRONICS

at new...

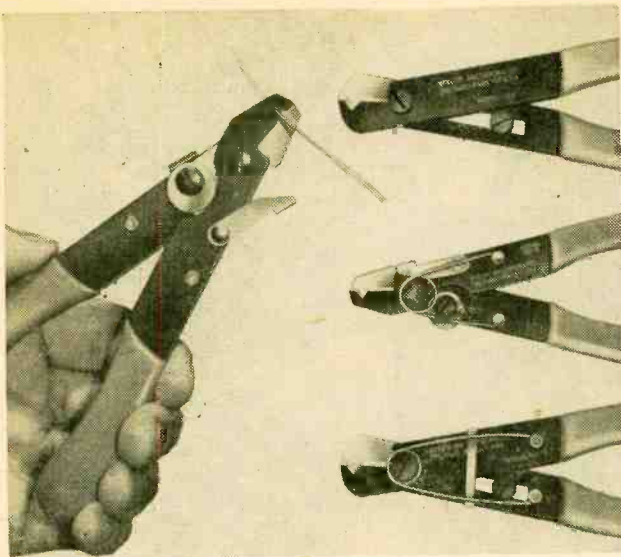

Three wire-strippers from Xcelite, with screw stop or cam for setting to wire size, spring for self-opening. Prices are, top to bottom, \$1.88, \$3.08, \$2.55. Circle No. 58 on Reader Service Page.

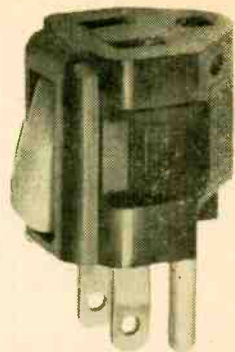

No more problems when you need to put a three-prong plug into a two-hole receptacle. Just press the button on the Delfex plug adapter, and the grounding blade swings aside. Only \$1.00. Circle No. 57 on the Reader Service Page.

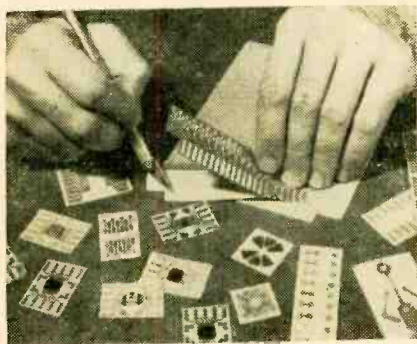

Assemble a PC board in minutes with these "Quik-Circuit" copper patterns from Circuit-Stik. No drilling, no terminals. Just press these conductive stick-ons on P-pattern Vector board—the .100-inch grid matches exactly. Dozens of patterns available, from TO-5 to 16-pin IC. Circle No. 59 on Reader Service Page.

Solderless terminals save time for the serviceman or active hobbyist. Vaco now has a convenient package containing the ten most popular insulated terminals including the ring-tongue, spade and flanged-spade types, plus a crimping tool. Circle No. 60 on the Reader Service Page.

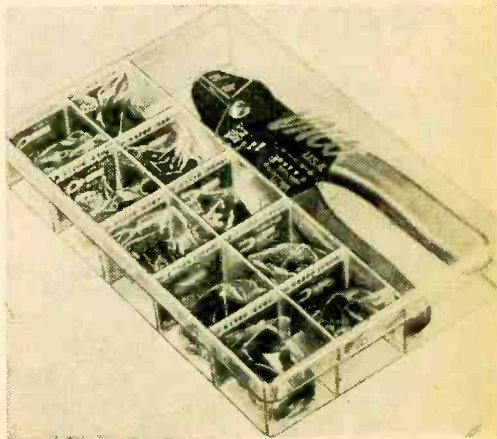

GADGETS

NOVEMBER-DECEMBER, 1971

The Pollution Fighters' Electric Motorcycle



If you think this cycle looks pregnant, well it is—electrically. All that bloat is really fiberglass fairing to reduce drag from wind resistance. This non-polluting model has a low center of gravity and aerodynamic shape. The result? She handles like a dream! But cleaner air may no longer be a dream with developments like this.

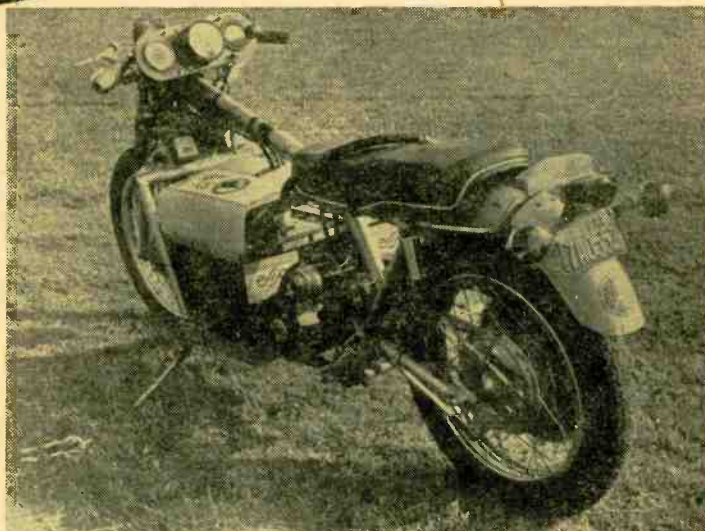

Pollution-minded? Well, you can still get the power and thrill of a motorcycle, without the polluting fumes! Scientists have finally developed an electric motorcycle. And this cycle can go over 65 MPH—it's the fastest electric motorcycle in the world. Eight feet long and weighing 650 lbs., this bike was constructed from a scrambler frame, specially modified to accommodate the batteries and motor. The vehicle is powered by four 12-volt lead-acid cobalt batteries, designed for electric vehicle use. A golf-cart motor was rewound to obtain better

efficiency and higher speeds. This type of winding made regenerative braking possible, which conserves energy in hilly regions. Velocity is regulated by varying the voltage to the series and shunt fields of the motor. Through the use of a twist-grip selector, any one of four voltage levels can be delivered to the series field. Current to the shunt field is controlled by a small variable resistor. A fiberglass fairing cuts down wind resistance. And it accelerates from 0-45 MPH in 9 seconds—not bad for a "modified golf cart"!

Connect this novel circuit to your FM receiver, and listen to police and fire calls, weather, marine, emergency services!



TUNE IN
THE ACTION
WITH

VHF HIGH-BAND CONVERTER

by Charles Green

Cliff-hanging emergencies, weather forecasts, ham QSO's, law enforcement patrols in action, mobile radio telephones—two-way broadcasts make listening to the VHF High Band an ever-changing adventure. Our VHF High Band Converter covers from 135 to 175 MHz, and it pulls in public safety, industrial, marine, land transportation and the 2-meter ham band signals.

You can listen to the VHF High Band with our compact converter, which connects to an FM-band home broadcast receiver. The converter uses a dual-gate FET and a UHF-type transistor in a simplified solid-state circuit. The components are housed in a 4 x 4½ x 2¾-in. aluminum cabinet, with perf-board construction for ease in building. You can build it—start today!

About the circuit. Signals from the antenna are connected via J1 to the L1-C1 tuned circuit, and fed to gate 1 (g1) of the dual-gate FET mixer Q1. Gate 2 (g2) of Q2 is coupled via C2 to the oscillator circuit of Q2.

C11 tunes L3 (and the Q2 oscillator circuit) 88 MHz above the incoming signal frequency. The oscillator RF output is coupled via C2 to the Q2 Gate 2 (g2) and mixed with the incoming signals. The resultant 88-MHz RF output (the difference

e/e VHF-HIGH-BAND CONVERTER

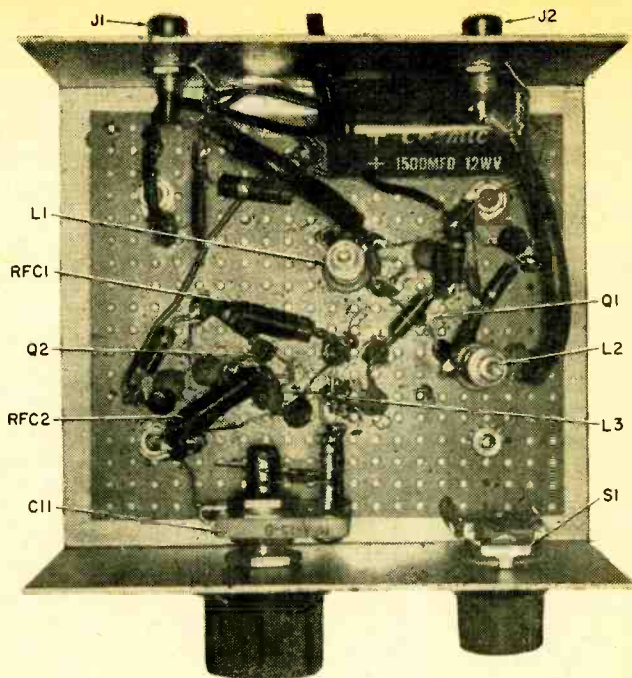

Placement of components is critical, due to high-frequency operation. L3 is a U-shaped coil, as shown in the schematic on the opposite page.

frequency between the signal and the oscillator) is fed from the Q1 drain (d) to the C5-L2 tuned circuit, and then to J2 and the FM-broadcast receiver.

The required DC power for the converter circuits is supplied by the PS1 9-volt supply, and additional filtering is accomplished by R4-C8.

Construction. The VHF converter is built in a 4-in. deep x 4½-in. wide x 2 5⁄8-in. high aluminum cabinet. Most of the components are installed on a 3¾-in. x 4-in. section of perforated board, with the remaining parts mounted on the front and rear cabinet panels. Because of the high-frequency operation, the component placement is critical. For best performance, follow our component layout as shown in the parts layout photo.

Variable capacitor C11 must be modified before installation. Remove rotor and stator plates until one rotor and one adjacent stator plate remains. Start construction by mounting C11 and S1 on the front panel in the same positions shown in the photo. Cut the PS1 cable hole and mount J1 and J2 on the rear panel. Mount the 3¾-in. x 4-in. perforated board section on the box bottom with ¼-in. metal spacers at each corner.

Fabricate L3 from a length of No. 18 bus wire as shown in the schematic diagram, and

mount with push-in clips close to the stator of C11. Make the connection between the C11 stator and L3 with a short length of No. 22 bus wire, then mount the oscillator circuit of Q2 and associated components closely around L3 as shown in the photo.

Position coils L1 and L2 and mount them inverted with push-in clips and short bus leads soldered to the coil terminals. Mount and wire the remaining circuit components as shown in the schematic diagram. Q1 is mounted inverted with short leads connected to push-in clips. Do not remove the shorting wire supplied by the manufacturer until all the wiring of the converter unit is completed. Use short lengths of RG-58A coaxial cable to connect the primary wind-

Suggested Frequencies for Listening

Service	Approx. Freq. (MHz)
2-Meter Ham Band	144-148
Tow Trucks	151
Taxicabs	152
Telephone calls	153
Fire	154
Police	155
Marine	157
Trucks	160
Weather	162

ing of coil L1 to J1, and the secondary winding of coil L2 to J2. These primary and secondary windings are made of one turn of No. 22 hookup wire, and are wound around the center of each of the L1 and L2 coils. Make all wiring as short and direct as possible, except the leads to S1. Position the S1 leads under the perf board and close to the box bottom.

Alignment and Calibration. Tune your FM receiver to a selected clear frequency at the low end of the band (our receiver was tuned to 88 MHz), and connect the converter's J2 to the receiver external antenna and ground terminals. Use coaxial cable for best results. If the receiver does not have

external antenna and ground terminals, wind one turn of hookup wire around the antenna loopstick and connect these leads to the coaxial cable to J2. Be sure that there is no connection to the chassis of a transformerless (AC-DC type) receiver to prevent possible electrical shock. Connect P1 to the AC line and set S1 to ON.

Connect a signal generator to J1, and adjust the generator controls for a 150-MHz modulated output. Most FM receivers employ a ratio detector and will detect a strong AM modulated signal. Therefore, a standard AM-modulated signal generator will be OK for alignment of this converter. Adjust C11 until you hear the signal in the FM receiver,

PARTS LIST FOR VHF HIGH-BAND CONVERTER

- C1,C2—5.25-pF, 12-volt ceramic disc capacitor
- C3,C4,C6—300-pF, 12-volt ceramic disc capacitor
- C5—27-pF, 12-volt ceramic disc capacitor
- C7,C16—500-pF, 12-volt ceramic disc capacitor
- C8—1500- μ F, 12-volt electrolytic capacitor
- C9,C10—5000-pF, 12-volt ceramic disc capacitor
- C11—Modified Hammarlund HFA-15-B (original capacity 2.8 to 16 pF), plates removed to leave 1 rotor and 1 stator (see text). Lafayette 40F28411 or equiv.)
- C12,C13,C14—200-pF, 12-volt ceramic disc capacitor
- C15—3.3-pF, 12-volt ceramic disc capacitor
- J1,J2—Phono jacks
- L1—0.088 to 0.12- μ H coil (J. W. Miller 20A107RB1 or equiv.)
- L2—0.108 to 0.18- μ H coil (J. W. Miller 20A157RB1 or equiv.)

- L3—see text
- P51—9-volt DC power supply (plug-in module type) (Calectro N4-057 or equiv.)
- Q1—3N141 field-effect transistor (RCA)
- Q2—HEP-56 transistor (Motorola)
- R1—120,000-ohm, 1/2-watt resistor
- R2,R3,R5,R8—220-ohm, 1/2-watt resistor
- R4—51-ohm, 1/2-watt resistor
- R6—10,000-ohm, 1/2-watt resistor
- R7—4700-ohm, 1/2-watt resistor
- RFC1,RFC2—0.82- μ H RFC (J. W. Miller RFC-220 or equiv.)
- S1—SPST rotary switch (Calectro E2-159 or equiv.)
- MISC.—4 x 4 1/2 x 2 5/8-in. aluminum cabinet (LMB 442 or equiv.), perforated board, push-in clips, 1/4-inch metal spacers, No. 18 and 22 bus wire, hookup wire, knobs, ground lugs, RG-58A coax.

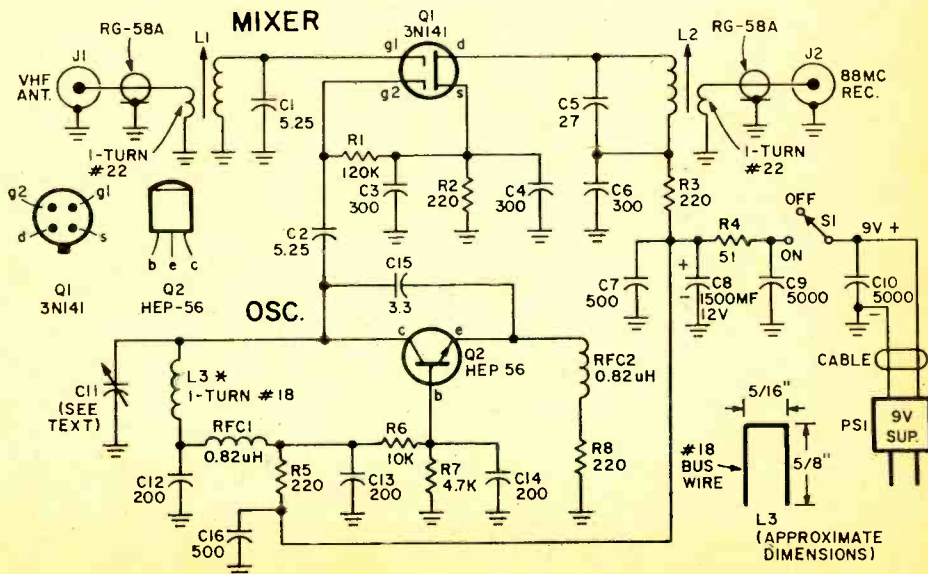

e/e VHF HIGH-BAND CONVERTER

then adjust L1, L2 for maximum signal. Tighten L1 and L2 tuning screw nuts.

Tune C11 from maximum to minimum capacity and calibrate the converter dial with the signal generator. Our converter unit is calibrated from 135 MHz to 175 MHz. The tuning range is dependent upon the circuit wiring and size of L3. If necessary, change the size of L1 to cover the range.

Operation. For best signal reception, use a ham 2-meter ground-plane antenna, or a

commercial antenna that is designed to cover the 135 to 175 MHz range. The antenna should be mounted as high as possible, with a coaxial cable feed to J1. A whip antenna can be used to receive strong local signals.

The reception sensitivity and selectivity is dependent upon the FM receiver used with the converter unit, and a stable drift-free receiver is best for long-term monitoring. Generally, a transistorized FM receiver should be best. It can be tuned as a band-spread dial to separate crowded FM signals. Signals may not be on constantly, so tune slowly and monitor each frequency for a considerable length of time.

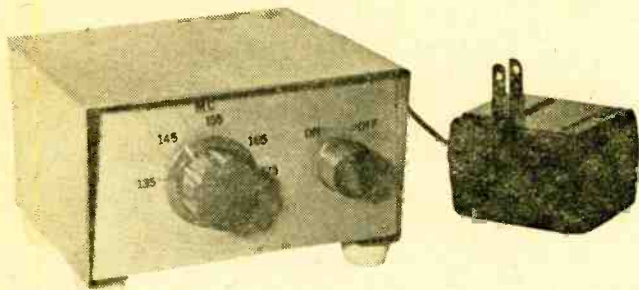

The converter gets its power from a 9-volt plug-in module, which simplifies the construction.

REGULATED 9-VOLT POWER SUPPLY

Providing 9 volts at approximately 250 mA, this lab-type power supply will handle many experimenter projects including the VHF high-band converter above. Actually, T1 can be a 6.3-V imported filament transformer since they usually give approximately 12-V peak at less than 500 mA output. Change the Zener diode to 12 or 6 volts (and possibly the value of R1) and you get a regulated 12- or 6-volt supply. For 12 volts, use a 12-V filament transformer. Filtering is very good since the equivalent capacitor equals the value of C2 times the gain of Q1. It can add up to thousands of uFs. For lab use, put in an aluminum cabinet.

PARTS LIST FOR REGULATED 9-V POWER SUPPLY

- C1—500- μ F, 25-VDC electrolytic capacitor
- C2—100- μ F, 15-VDC electrolytic capacitor
- D1—Motorola HEP-175 50-PIV diode bridge rectifier
- D2—Motorola HEP-104, 9.1-V Zener diode
- Q1—Motorola HEP-240, 10-watt npn transistor
- R1—560-ohm, 1/2-watt resistor
- T1—12-V filament transformer (see text)
- 1—Aluminum cabinet, select size to fit components or wire into existing project
- Misc.—Wire, hardware, perfboard, line cord, solder, on/off switch optional, etc.

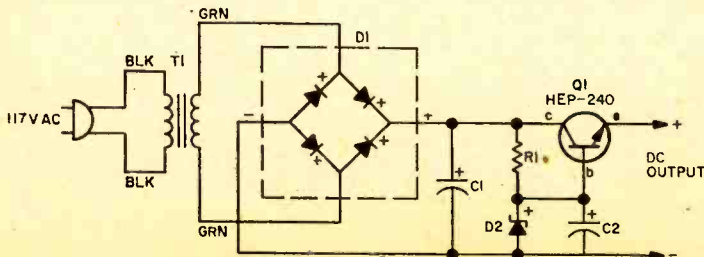

Most of the heat generated by this circuit comes from the iron losses in T1. Be sure to allow for a few vent holes above and below T1. An on/off switch may be added to T1's primary circuit.

Hounded
by tough dogs?
Troubleshoot
with

Like Man's proverbial "best friend", a good signal tracer can track down all bones of electronic discontent in your various pieces of gear. Problem is, many commercial signal tracers are complicated and rather expensive. While these two disadvantages have limited the widespread use of signal tracing techniques in the shop, our *Mini-Trace Signal Sniffer* forever dog-naps both tracing toubles.

To begin with, it's an uncomplicated instrument—the inclusion of a volume control on the amplifier means the *Mini-Trace Signal Sniffer's* easy to use. Secondly, it's an inexpensive instrument—ten bucks buys you the joys of signal tracing with our *M-TSS*. And, *Mini-Trace Signal Sniffer's* battery operated and portable; two plumes no commercial sig tracer's hat can sport!

How M-TSS Works. This signal tracer is built around a pre-fab amplifier module. By building around one of these modules,

a lot of wiring time and trouble has been eliminated. There's a hitch with using this type of ready-built amp, though. Seems the input impedance is too low for the job of signal tracing. Remedy: add a FET amplifier stage. That way the author increased *M-TSS'* input impedance, and ultimately decreased the loading of the circuit under test.

In operation, signals picked up by either probe pass through components C1 and R1, In-

put voltages then pass through coupling capacitor C2 to the gate lead of the field-effect transistor, Q1. Resistor R3 serves as the FET's drain load. In this circuit, the input impedance is (nominally) the value of the input resistance—about 1 megohm.

Module AM1 contains a preamp, driver, and push-pull output stage. This module has more than enough oomph to bring signals up to speaker level. The module specified in the Parts List, or any other ready-to-run amplifier module you can lay your mitts on, will do an adequate job.

The power supply consists of 9-volt battery supply B1, and decoupling components R4 and C4. Both components prevent undesired audio feedback through the power circuits. Power for the tracer is supplied by any 9-volt source; a battery was considered most convenient.

Solder Signals. The tracer's wiring layout is relatively non-critical. All leads should be kept as short as possible. This must be done to minimize hum pickup and possible instability. Re-

MINI-TRACE



SIGNAL SNIFFER

by Gary McClellan

e/e MINI-TRACE

member that you are working with a very high gain amplifier, so do your wiring accordingly.

The author built his prototype unit into an Allied Radio Shack mini utility case. This was done for appearance sake only; it was desired that the tracer would match some other test equipment he already had. While this technique can be followed, the author strongly suggests that you build your unit in an all-metal box.

Start construction by working on the box, itself. Note from our photo that all parts are mounted in the cover of the box. You might want to build your unit the same way. Install the speaker, volume control, and input jacks as shown. Amplifier module AM1 is mounted sideways between the speaker and volume control. The author soldered two long solder lugs to the positive foil on the amplifier circuit board. Then he bent them outward and bolted the entire assembly in place.

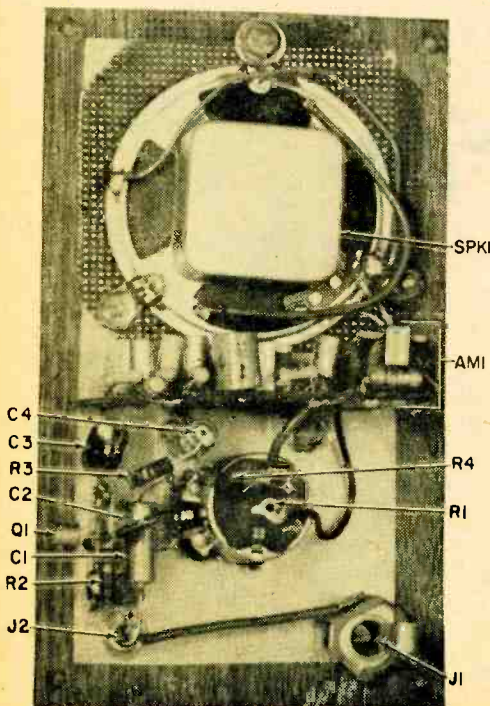

This prototype of the amplifier unit looks good in a plastic case, but would be better in a metal box, to minimize hum and noise.

The FET circuitry goes in place next. Mount a three-lug terminal strip; then start the wiring of all associated components. Be sure to keep all leads *short* in this section. Finish the amplifier wiring by in-

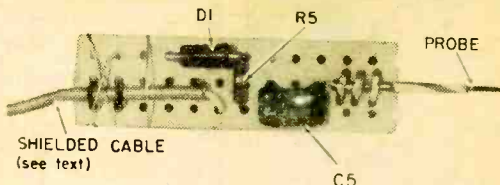

The RF test-probe components are mounted on a small piece of perf board, with a nail as the probe tip, all inserted in a cigar tube.

stalling the battery connector. Now check over your wiring, and, if all's well, button up *M-TSS'* case.

Testing the Probe. Chances are you won't be able to exactly reproduce the author's prototype probes—especially his RF test probe. The author homebrewed his RF probe from an aluminum cylinder (the kind expensive cigars are packaged in), a nail (it served as the probe, itself), the cap came from a plastic pill container, and topped off with a strip of perf board. A length of shielded audio cable terminated by a 1/4-in. phone plug completed his RF probe, as shown on page 73.

For your own test probe construction, start out by thumbing through GC Electronics's catalog FR71-72. It lists all sizes and styles of test proddery. Another source of test probe kits is EICO; choose the type you want to start with from their catalog. Then build your own accordingly. Your last source could even be the local five-and-dime store. Seems you can always turn up some kind of tin box there. In any case, follow *Mini-Trace Signal Sniffer's* schematic for proper test probe components selection and circuit placement.

Hounding an All-American 5. Note our schematic of a typical transistorized super-heterodyne BCB receiver. Most of the transistor rigs that will eventually wind up on your bench utilize a design similar to the schematic of the one we've shown; it's a case of you've-seen-one-you've-seen-'em-all! The differences are minor.

Supposing the complaint is that the radio doesn't play at all. After checking the line cord and power supply components to make sure that the rig's being energized, look at the printed-circuit board for any possible cracks in the foil. Flex the pc board, foil

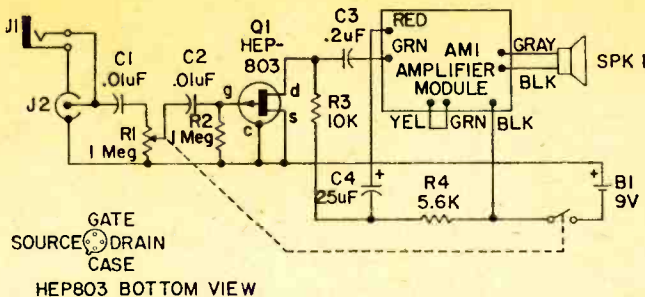

PARTS LIST FOR MINI-TRACE SIGNAL SNIFFER

- AM1—amplifier module, .1-watt minimum output rating (Lafayette 99F90425 or equiv.)
 B1—9-Volt battery (Eveready type 216 or equiv.)
 C1, C2—.01 μ F, 1,000-Volt disc ceramic capacitor (Lafayette 32F01969 or equiv.)
 C3—.2 μ F, 75-volt capacitor (Lafayette 33F 69097 or equiv.)
 C4—25 μ F, 16-volt capacitor (Lafayette 34F 85497 or equiv.)
 C5—.001 μ F, 1,000-volt disc ceramic capacitor (Lafayette 32F01829 or equiv.)
 D1—general purpose small signal diode, 1N34A or equiv.
 J1— $\frac{1}{4}$ -in. phone jack (Lafayette 99F62135 or equiv.)

- J2—single-hole mounted RCA-type phono jack (Lafayette 99F62341 or equiv.)
 Q1—P-channel field effect transistor, Motorola HEP-803 or equiv.
 R1—1,000,000-ohm audio taper potentiometer with switch (Lafayette 99F63521 or equiv.)
 R2, R5—1,000,000-ohm, $\frac{1}{2}$ -watt resistor
 R3—10,000-ohm, $\frac{1}{2}$ -watt resistor
 R4—5,600-ohm, $\frac{1}{2}$ -watt resistor
 SPK1—2 $\frac{1}{2}$ -in. replacement speaker (Lafayette 99F60972 or equiv.)
 1—3 $\frac{3}{4}$ x 6 $\frac{1}{4}$ x 2-in. bakelite utility case (Allied Radio Shack 270B627 or equiv.)
 Misc.—Battery connector, phone plugs, 3-lug terminal strip, solder, wire, etc.

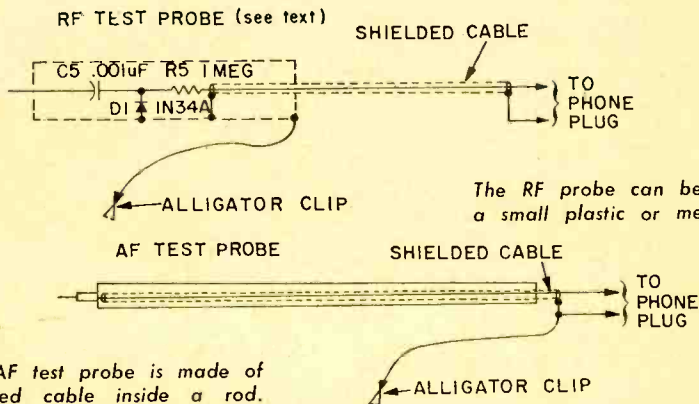

side facing you, with a high-intensity study lamp shining through toward you on the other side of the pc board. You'll detect any cracks in the pc board or board foil almost immediately. If this eyeballing doesn't work, whip out your *M-TSS*:

Signal tracing a rig—any radio, for that matter—can proceed from the speaker to the antenna, or the other way around. The key to servicing with a sig tracer is that you work through the receiver methodically; that is, in one direction *only*. For illustration's sake, we've lettered the All-American

5's schematic sequentially, starting at the antenna (A), and working toward the speaker (E).

You'll be working with the RF probe from points A-C; the AF probe comes in handy from points D and E. Attach the RF probe to your *Mini-Trace Signal Sniffer*, crank up the volume control and find point A (or its substitute in your rig). You should hear a received signal, but only very faintly. Tune the radio to a known station on the dial—preferably one knocking out the strongest signal on the BCB dial in

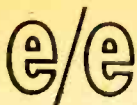

MINI-TRACE

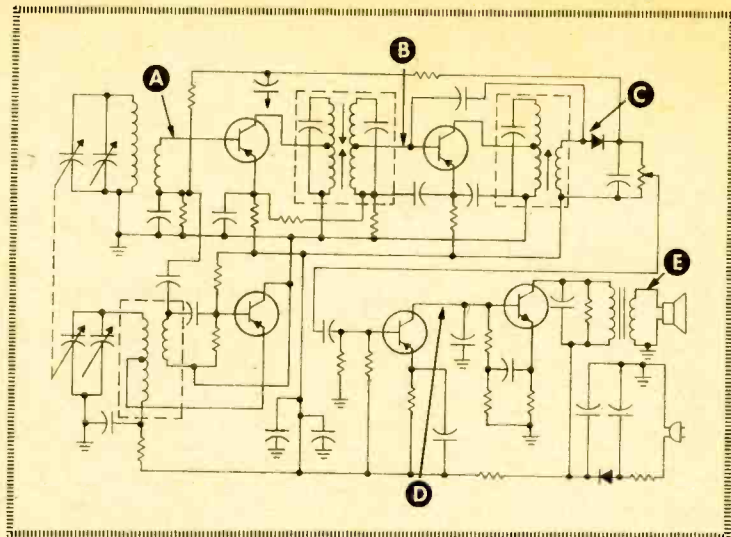

your vicinity. Proceed to point B; listen for a signal. Ditto procedure for point C.

At point D, we stop, look and listen for a signal. None to be had! Starting at the detector diode, you can trace the signal's path until it disappears at point D proper. If the diode junction is open, the signal stops dead in its tracks. If the coupling capacitor located between the junction of the volume control and the audio driver stage opens, or the capacitor located at the junction of the audio driver collector and the output transistor's base shorts to ground, the signal is, again, diverted away from the speaker.

Of course, another prime suspect in our hunt for the missing signal is the audio driver stage transistor, itself. Open base-emitter junctions in particular play blooey with all AC or DC signals!

Lastly, check point E—carefully. The speaker voice coil often “opens up.” To complete this check, unsolder the voice coil leads from the audio output transformer secondary winding, and look for DC continuity with a VOM. Reason is, you could hear signals bursting forth from your *M-TSS*, yet none emerge from the speaker because the output transformer is working.

Decide to work from the speaker back to the antenna terminal? You'll also need a modulated signal generator. Connect your gen to the speaker leads, and set its controls to deliver an audio signal. Proceed from points E through A, while leaving the

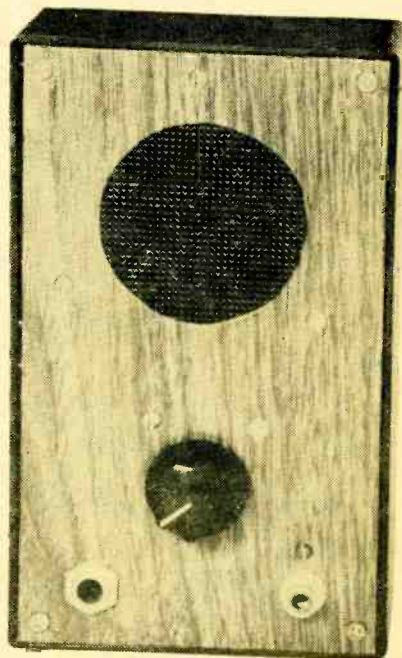

The letters on the transistor-radio schematic diagram indicate points to be tested with the *M-TSS*, which looks like this from the front.

audio test probe of your *M-TSS* clipped across the speaker leads. Switch the generator to tone-modulated RF at point C; work with appropriate RF frequencies as you work toward the antenna terminals. ■

Build a Better Fish Finder

Thermocliner's the name,
and sport fishin's the game!

by Charles E. Bryson

The dream of any fisherman is to know where the fish are. Astute angling and fly-tying abilities cast aside, the project discussed here will not always tell where the fish are. Rather, it will tell the fisherman where the fish are *not!* The *Thermocliner*, our fish finder's name, is a rugged electronic thermometer. Slipping into your tackle box, *Thermocliner* is capable of measuring temperatures of the briny deep, thanks to a small thermistor probe located at the end of a 60-foot-long cable. The name *Thermocliner* comes from the instrument's ability to locate the thermocline of a body of water. Essentially, this particular depth of water, sometimes quite deep beneath the surface, is the layer where the water's temperature drops markedly in only a few feet of depth. Generally, almost all of the game fish in a lake will be caught at this depth.

e/e FISH FINDER

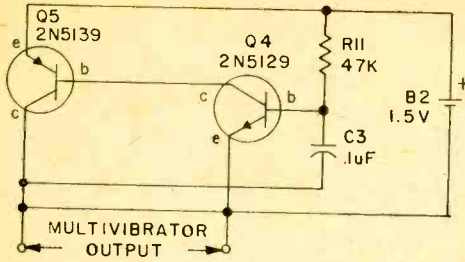

This astable multivibrator, based on transistors Q4 and Q5, provides power for the Wheatstone bridge in the *Thermocliner*.

Bridge over Salty Waters. Our *Thermocliner* is a combination of an AC Wheatstone bridge with a thermistor (or thermal-sensitive resistor) placed into one of the bridge's legs, and an audio amplifier. Bridge power is provided by transistors Q4 and Q5, connected as an astable multivibrator. The mv's output frequency is determined by resistor R11 and capacitor C3.

The bridge proper consists of the thermistor RT, resistor R8 in one leg, and potentiometer R10 completing the other leg. When the bridge is out of balance, a signal will develop between the wiper of R10 and the junction of R8 and thermistor. This "error" signal is coupled through capacitor C1 to the audio amplifier made up of transistors Q1, Q2, Q3, and associated components.

When the wiper of R10 is adjusted to bridge balance, no signal is developed. The

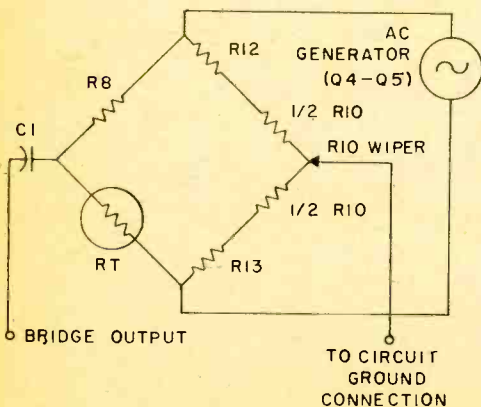

In the *Thermocliner's* bridge, R12 and R13 are trimming resistors, and thus do not enter into the text discussion of the bridge operation.

position of the wiper is really a measure of the thermistor's resistance, and is therefore, directly reading the temperature of the thermistor itself.

Filet of Sole-der. *Thermocliner's* circuit was originally assembled on a printed-circuit board by the author. Alternately, a similarly-sized perf board can be used for mounting the components; parts placement is non-critical. A plastic case houses all of *Thermocliner's* internals. If the speaker is to be mounted using the printed-circuit board as a clamp, be sure to place the foil side of the pc board downwards with 1/2-in. spacers. Place a piece of insulating material—waxed kitchen paper, or household mylar sandwich wrap—over any part of the circuit board to prevent it from being shorted by the speaker.

Mount batteries and phone jack with suitable hardware to one side of the box. Next, mount potentiometer R10 and switch S1 to the cover panel. While wiring all pc board-mounted components to R10 and S1, be sure to make your wire leads between these components and the pc board long enough.

The Prototypic Probe. Generally, it will only be necessary to protect the thermistor from mechanical damage and to provide insulation for the leads. Especially if the probe is to be used in water. Since the author's prototype *Thermocliner* was specifically built for locating fish, the thermistor was first attached to a 10-fathom (or, in landlubber lingo, 60-foot) length of speaker hook-up wire. The cheaper type with thin insulation is better; it tends to float less. Then the thermistor was epoxied into a length of scrap tubing. Care was taken to keep the thermistor's glass bead free of epoxy, and not touching the tubing. In this way, good thermal contact with the water was insured. For convenience, the author felt it was desirable to connect the cable end to the circuit box through a miniature audio-type jack.

Calibrating Thermocliner. Once all parts are mounted, and the probe cable assembly is finished, calibrate your *Thermocliner*. You'll need the following items for calibration: a liquid-type thermometer, a glass of hot water, and some ice cubes. It is desirable that the calibrating thermometer be accurate to 1.0 degree Fahrenheit and better if possible. *Thermocliner's* accuracy will be determined by the quality of the thermometer used, and to some extent, the patience

of the person doing the calibration. Start by connecting the probe cable assembly to the control box, turn power on/off switch S1 to its "on" position, and dunk the probe into water which is as hot as to be encountered. For fishing, 100 degree F is plenty!

Water temperature is adjusted by placing small amounts of ice into hot water, and then stirring gently until the ice melts. Periodically, take a new temperature reading, adding more ice as necessary. Overall calibration of our *Thermocliner's* temperature scale is in 10 degree F intervals, from 120 to 40.

Adjust *Thermocliner's* temperature knob for lowest speaker volume, making sure you mark the pointer's position accurately. Proceed to the next lower temperature. When your *Thermocliner* is only going to help you catch one particular fish species, mark the calibrating scale in increments of 1 degree F or better at the expected thermocline level.

If the desired temperature range occupies too small a range of potentiometer rotation, this range can easily be extended with

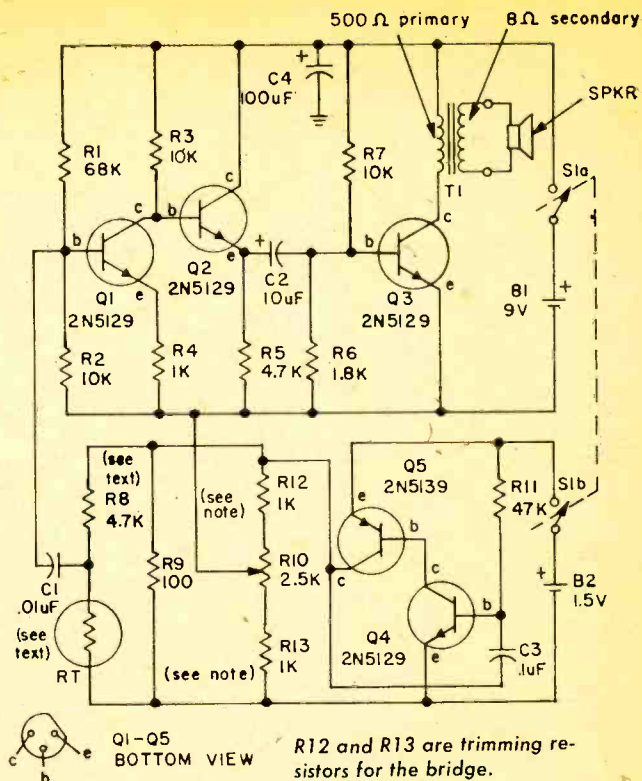

trimming resistors. Note in *Thermocliner's* schematic that the author inserted two trimming resistors (R12 and R13) in series with R10, one at each end of the pot. Make
(Continued on page 97)

PARTS LIST FOR THERMOCLINER

- B1—9-volt battery (Eveready type 216 or equiv.)
- B2—1½-volt battery (Mallory MN-1500 or equiv.)
- C1—.01 uF @ 1,000 volts disc ceramic capacitor (Lafayette 32F01969 or equiv.)
- C2—10 uF @ 25 volts electrolytic capacitor Lafayette 34F85620 or equiv.)
- C3—.1 uF @ 600 volts capacitor (Lafayette 34F 82700 or equiv.)
- C4—100 uF @ 25 volts electrolytic capacitor (Lafayette 34F85687 or equiv.)
- Q1-Q4—2N5129 transistor (see note below)
- Q5—2N5139 transistor (see note below)
- R1—68,000-ohm, ½-watt resistor
- R2—10,000-ohm, ½-watt resistor
- R3—10,000-ohm, ½-watt resistor
- R4—1,000-ohm, ½-watt resistor
- R5—4,700-ohm, ½-watt resistor
- R6—1,800-ohm, ½-watt resistor
- R7—10,000-ohm, ½-watt resistor
- R8—4,700-ohms, ½-watt resistor (see text)
- R9—100-ohm, ½-watt resistor
- R10—2,500-ohm linear taper potentiometer (Centralab type HMS or equiv.)
- R11—47,000-ohm, ½-watt resistor

- R12—1,000-ohm, ½-watt resistor
- R13—1,000-ohm, ½-watt resistor
- RT—2,000-ohm @ 25 degrees Celsius thermistor (Fenwal type GB 32P8) see text
- S1—double-pole double-throw type switch Calctro E2-118 or equiv.)
- SPK1—10-ohm replacement miniature speaker Lafayette 99F60352 or equiv.)
- T1—Audio transformer: primary, 500-ohms; secondary, 8-ohms (Lafayette 99F61293 or equiv.)
- 1—plastic case 3¼ x 6¼ x 2-in.) Allied Radio Shack 270B627 or equiv.
- 1—miniature bakelite plug and matching jack (Allied Radio Shack assortment 274B335 or equiv.)

Misc.—miniature speaker cable (Allied Radio Shack 278B1509 or equiv.), battery connectors, hardware, hookup wire, solder, perf board, push-in clips, knob, clear lacquer spray, decals, etc.

Note: Q1-Q5 may be purchased from Southwest Technical Products, 219 W. Rhapsody, San Antonio, Texas 78216

Clip Book Circuits

GABBER GRABBER

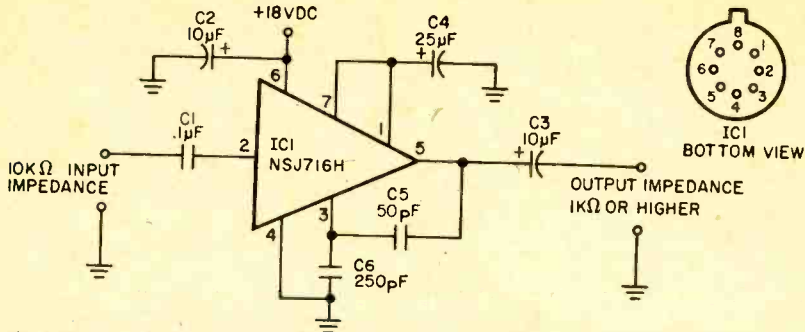

Gabber Grabber works best with 10K mikes and telephone pickup coils. It provides 20 dB gain, and is ideal when a single microphone is used for conference recording or when remote telephone monitoring through a pickup coil is desired. The 18V power supply can be two-series connected 9V transistor radio batteries. IC leads should be kept short.

PARTS LIST FOR GABBER GRABBER

- C1—0.1 uF, 25 VDC
- C2, C3—10 uF, 25 VD C
- C4—25 uF, 25 VDC
- C5—50 pF
- C6—250 pF
- IC1—Fairchild NSJ716H

CB BOOSTER

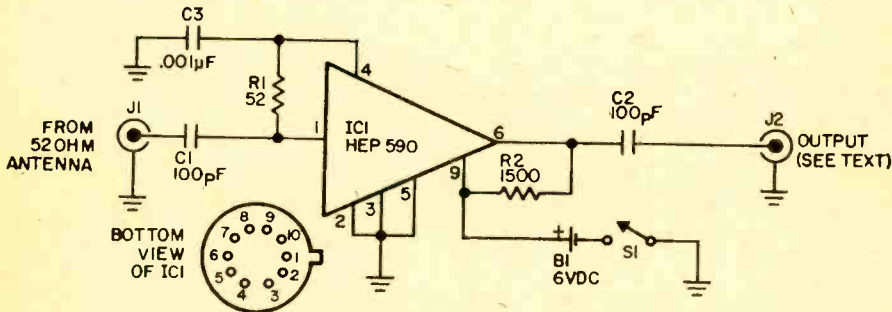

Connect CB Booster ahead of a low cost receiver, and you'll hear CB signals as if they were coming from your back yard. Using no tuned circuits, the CB Booster delivers approximately 15dB overall gain—that's about 3 S-units! Only restriction is that this little rf amplifier be used with a communications-type receiver having an antenna trimmer. It cannot be used in front of a low-impedance-input type CB transceiver. Seems the low impedance antenna input common to CB transceivers will sharply reduce the booster's gain.

Typical of all RF amplifiers, the booster requires very short connecting leads. In

particular, solder capacitor C3 right at pin 4. Integrated circuit IC1 can be soldered directly into the circuit or an IC socket can be used.

PARTS LIST FOR RCB BOOSTER

- B1—6V battery, Z4 type or larger
- C1, C2—100 pF, 15VD C
- C3—0.001 uF, 15VDC
- IC1—HEP-590
- R1—52-ohms, 1/2-watts, 10%
- R2—1,500-ohms, 1/2-watt, 10%
- J1, J2—Phono or coaxial jack
- S1—SPST switch
- B1—6V battery



all *NEW* BASIC COURSE in ELECTRICITY & ELECTRONICS *



PART 1 UNDERSTANDING POWER SUPPLIES

What You Will Learn. In this part you will learn about the purpose behind the power supply, and the components found in a typical AC-to-DC power supply. You will also learn what the rectification principle is, and why filters are found in power supplies. Finally, you will learn about the two types of electronic rectifiers found in most kinds of power supplies, and the similarities and differences between each type of rectifier. In part 2 "Understanding Power Supplies", you will learn about the various configurations that filters take, and how power supply output variations are smoothed out, or regulated.

* This series is based on *Basic Electricity/Electronics*, Vol. 2, published by Howard W. Sams & Co., Inc.



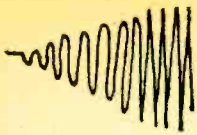

PURPOSE OF A POWER SUPPLY

Some source of electrical power is required for the operation of all electronic equipment. This can be a **prime power source** such as a battery or a generator. Most electronic equipment, however, cannot make direct use of prime power sources. For such equipment, it is necessary to convert the output of a prime power source into an electrical form suitable for the particular piece of equipment. The devices used to do this are known as **power supplies**.

COMPONENTS OF A DC POWER SUPPLY

The three major components of a typical AC-to-DC power supply are the **voltage control**, the **rectifier**, and the **filter**. The voltage control serves to adjust the output of the power supply so that the delivered voltage is correct for the circuits that the power supply feeds. The rectifier serves to change the incoming AC voltage into a pulsating DC voltage. (A rectifier may be a vacuum-tube diode, a semiconductor diode, or a metallic-oxide rectifier.) The filter changes the pulsating DC from the rectifier into a smooth or, ripple free, DC.

COMPONENTS OF AN AC TO DC POWER SUPPLY

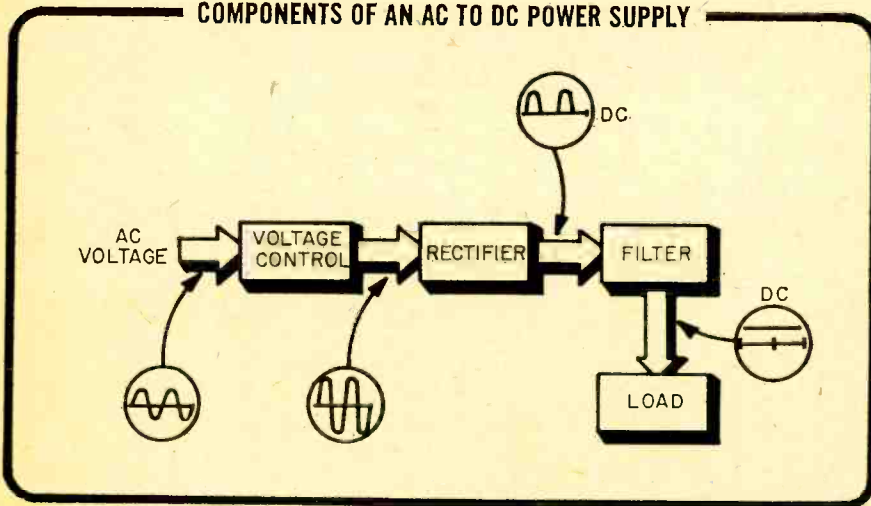

The basic functions of a power supply are to **rectify** and **filter**. The voltage-control function is actually incidental to the operation of the power supply. Once you learn to separate the rectifier and filter circuits from the power supply, you will see that the leftover components are in the voltage-control portion.

THE RECTIFICATION PRINCIPLE

The rectification principle is very simple to understand. If it is desired to change an AC voltage to a pulsating DC voltage, a unidirectional current-control device must be used. Any device that accomplishes this result is called a **rectifier**. The diode is such a device.

The principle of rectification is shown on the next page. An AC voltage is applied to a unidirectional current-control device. In the illustration, the rectifier is connected to the load so that the current flows only during the positive portions

of the input signal. The output voltage is therefore composed of only the positive portions of the input. This positive polarity output is called **pulsating DC**.

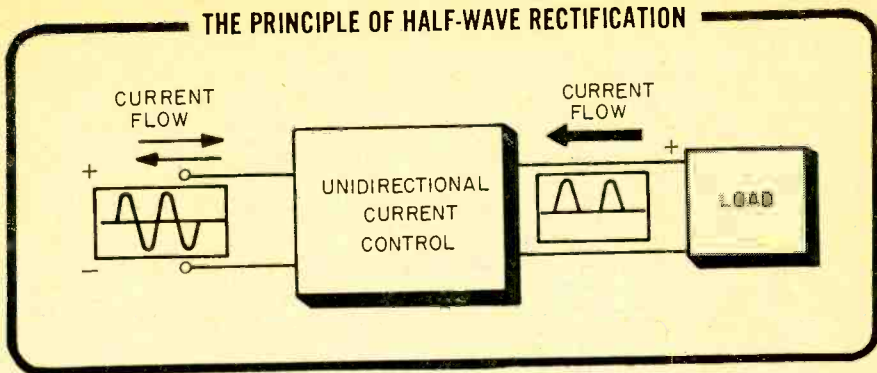

The two most common rectifier configurations in use are the **full-wave** and **half-wave**. The differences between the two are obvious from the figure. When an AC voltage is applied to a half-wave rectifier, only half of each cycle is made available to the load. You will see later that not only is this type of rectification inefficient, but it also makes it more difficult to obtain the non-pulsating DC voltages required by some electronic circuits.

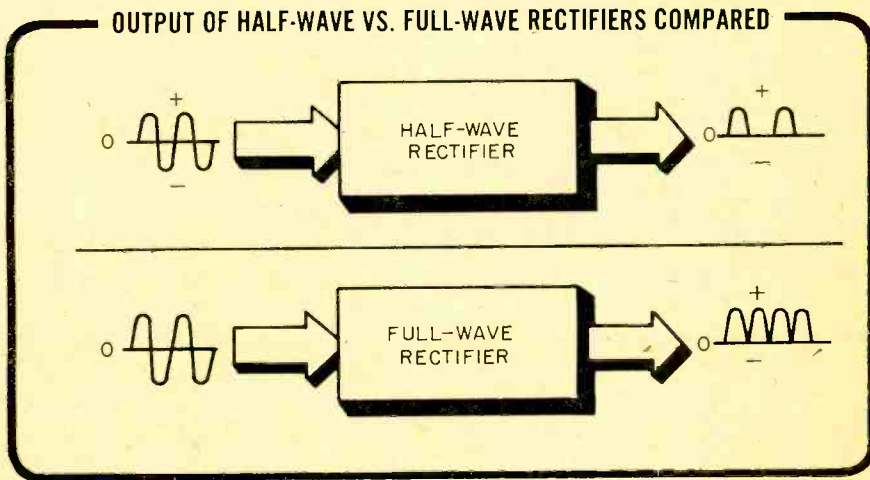

When AC voltage is applied to a full-wave rectifier, the load receives current during both half cycles. Notice that the negative half cycles have been inverted so that all the half cycles are positive at the output of the rectifier. This type of pulsating DC is much easier to filter than the output of the half-wave rectifier. Thus, smaller and less expensive components can be used in the filter section.

- Q1. An AC voltage is converted into a DC voltage by a
- Q2. The two major functions of a power supply are to
and
- Q3. The component of a power supply that changes AC voltage to a pulsating DC voltage is the
- Q4. The component of a power supply that smooths out pulsating DC into almost pure DC is the

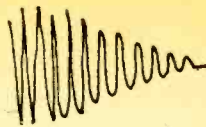
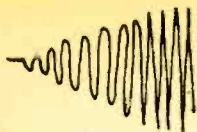

Your Answers Should Be:

- A1. An AC voltage is converted into a DC voltage by a **rectifier**.
- A2. The two major functions of a power supply are to **rectify** and **filter**.
- A3. The component of a power supply that changes AC voltage to pulsating DC is the **rectifier**.
- A4. The component of a power supply that smooths out pulsating DC to become almost pure DC is the **filter**.

FILTERING ACTION

The function of the filter is to smooth out the pulsating DC and provide an almost pure DC. You can see in the figure that the actual output is not quite pure DC. The amplitude of the ripple is the factor that determines how close the

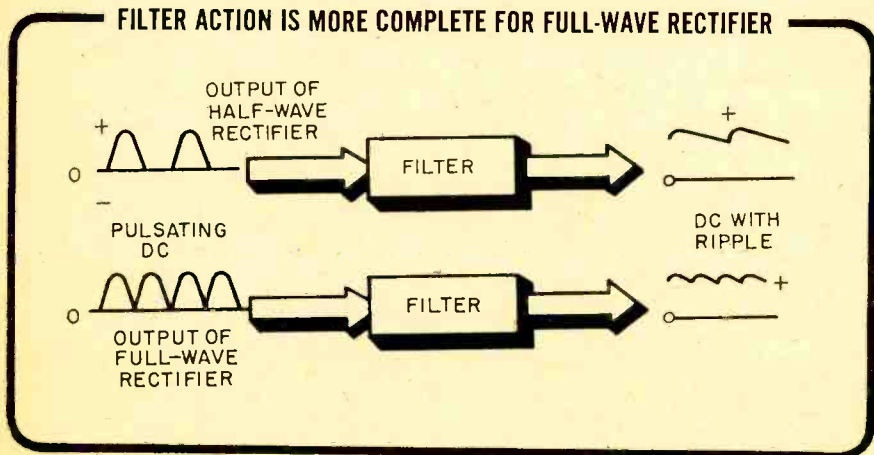

output is to DC. The higher the amplitude of the ripple voltage, the farther the output is from DC.

VOLTAGE CONTROLS

Several types of voltage controls are used in power supplies. The figure on the next page shows the locations they may have in a power supply. The types of voltage control can be roughly divided into two classes—**automatic** and **manual**. Either type serves the same function, to supply the correct voltage to the load.

The voltage control used at point 1 in the illustration is the power transformer. It may be some sort of transformer equipped to deliver a variable output, that can be manually controlled to provide the desired output voltage. Or it may be a power transformer with several windings, each of which provides a different voltage.

The power transformer in the figure has an input winding (1 and 2), a 5-volt filament winding (5 and 6) for the rectifier, a 6.3-volt filament winding (7 and 8) for the vacuum tubes in the equipment, and two step-up voltage windings to supply voltage to the rest of the load. One of these windings (3 and 4) provides

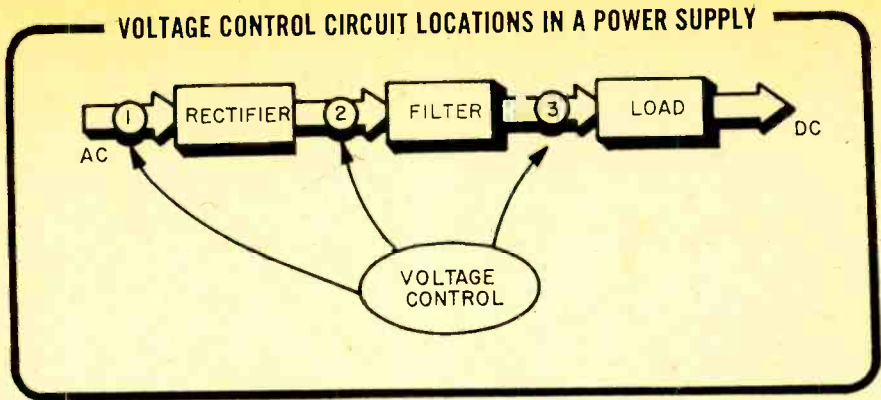

150 volts AC, and the other (9, 10, and 11) provides 200 volts AC with a center tap. The use of this center tap will be explained later.

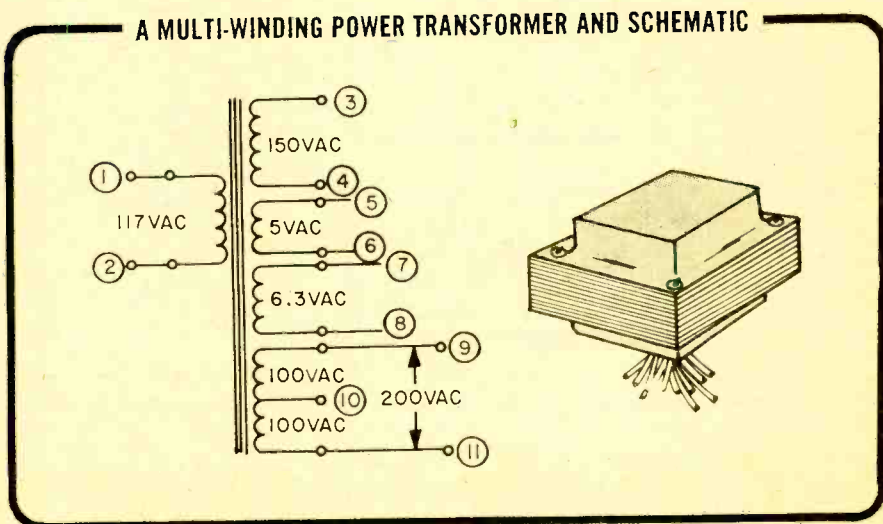

- Q5.** The function of a filter is to ----- pulsating DC.
Q6. Voltage controls can be either ----- or -----.

Your Answers Should Be:

- A5.** The function of a filter is to smooth pulsating DC.
A6. Voltage controls can be either automatic or manual.

The type of voltage control used at point 2 (see the figure at the top of the page) is capable of making automatic voltage changes. This is accomplished by using various types of rectifier circuits that may double, triple, or even quadruple the input voltage.

The type of voltage control used at point 3 can vary the output voltage either automatically or manually, and is called a **regulator circuit**. Its main function is to maintain a steady output voltage from the power supply. A power supply using a regulator is called a **regulated power supply**.

For example, an unregulated power supply is fed by a line voltage of 115 volts AC. It provides an output voltage of 140 volts DC to its load. Now suppose the line voltage changes to 120 volts AC.



When there is an increase in the line voltage, there is a corresponding increase in the output voltage. In the example given, it happens to be an increase of 10 volts DC. Many electronic circuits are not affected by this much change. Others are affected only slightly. However, many circuits are disturbed considerably by this type of change, and a voltage regulator must be used to correct it.

The power supply shown below has a voltage regulator. When the line voltage increases 5 volts, the output voltage remains at 140 volts DC. Changes in the load current will also change the output of a power supply. Voltage regulators

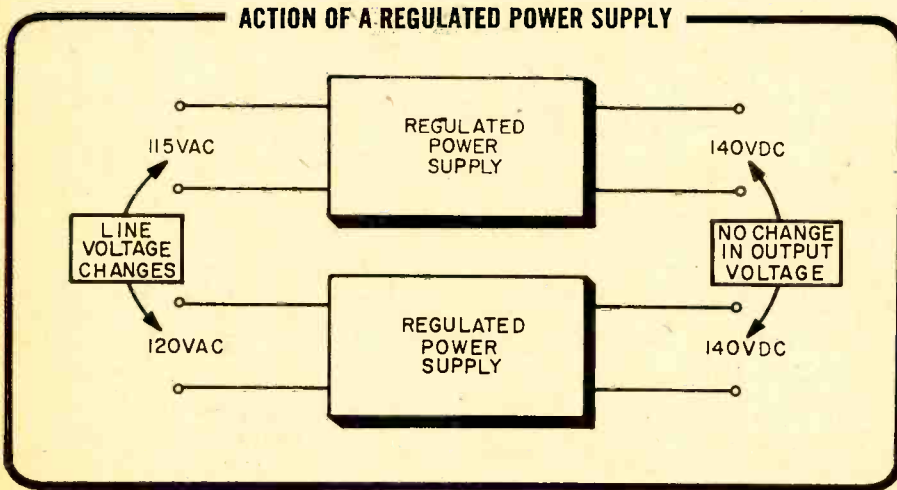

are designed to prevent changes under these conditions as well. Notice that many voltage regulators can be manually controlled, incorporating an adjustment used for selecting a particular voltage output.

VACUUM-TUBE AND SEMICONDUCTOR RECTIFIERS

A diode, whether it is a vacuum tube or semiconductor type, is sensitive to the polarity of an applied voltage. A positive voltage applied to the plate, or anode, causes a diode to conduct readily, while a negative voltage applied to the same point results in no conduction (in the case of the vacuum diode) or very slight conduction (in the case of a semiconductor). It is this unidirectional property that makes a diode useful as a rectifier.

- Q7. In an unregulated power supply, the output voltage when the input voltage changes.
- Q8. The output voltage of an unregulated power supply (changes, does not change) when the load current changes.
- Q9. A is used to keep the output voltage of a power supply constant.
- Q10. A diode conducts only when its plate, or anode is

Your Answers Should Be:

- A7. In an unregulated power supply, the output voltage changes when the input voltage changes.
- A8. The output voltage of an unregulated power supply changes when the load current changes.
- A9. A voltage regulator is used to keep the output voltage of a power supply constant.
- A10. A diode conducts only when its plate, or anode is positive.

Half-Wave Rectifier Circuits

A half-wave rectifier converts an AC voltage into a pulsating DC voltage. It does this by removing either the positive or negative half cycles from the input voltage. In other words, only half of each sine-wave cycle is used to provide power to the load. It can readily be seen that this type of supply is relatively inefficient.

HALF-WAVE RECTIFIER USING SEMICONDUCTOR DIODE

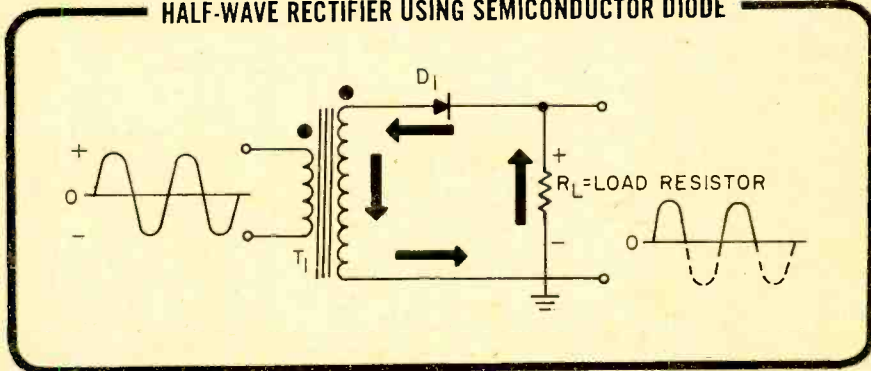

Above is a typical half-wave rectifier with a power transformer in the input. Notice the dots at the top of each winding of T_1 . These dots indicate that the transformer is wound in such a fashion that the voltages at the ends of the windings marked with the dots are in phase with each other. Therefore, when the top of the primary is positive, the top of the secondary is also positive.

When the positive half cycle of the input voltage is applied to the primary winding of T_1 , there is a positive voltage applied to the anode of semiconductor D_1 , causing it to be forward biased. Diode D_1 , then conducts, causing a current flow and a voltage drop across the load resistor R_L . During the negative half cycle, D_1 is reverse-biased and very little current flows. There is very little voltage dropped across R_L during this half cycle.

A half-wave rectifier can also utilize a vacuum-tube diode. Such a circuit is shown in the figure below. The small secondary winding is a filament winding to

HALF-WAVE RECTIFIER USING VACUUM TUBE DIODE

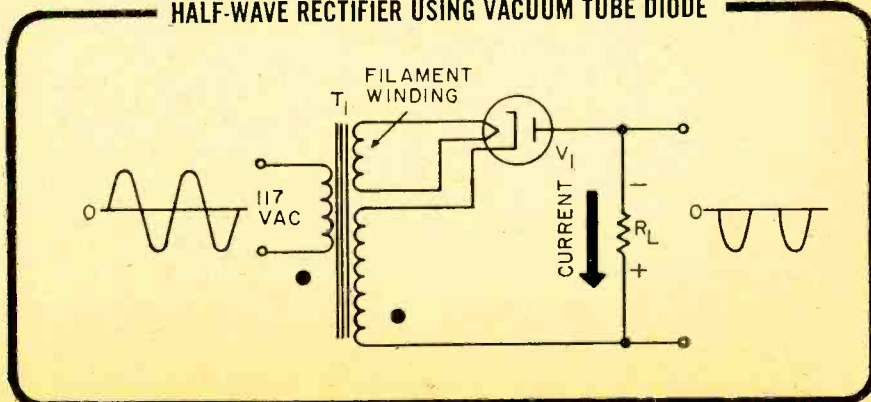

Let Bell & Howell Schools help you get ready for a rewarding Color TV Service Business of Your Own

This new Program brings you a series of Bell & Howell Schools materials that are fully integrated with the Heathkit components you will receive a step at a time. The Color TV kit offers an ultra-rectangular 25" diagonal picture tube with 315-sq. inch screen. Lets you view more of the transmitted image. 25,000 volts. 45 transistors, 55 diodes, 4 advanced IC's. 3-stage, solid-state IF. Solid-state VHF/UHF tuners. Automatic fine tuning and many other quality features.



BUILD, KEEP, USE ALL FOUR OF THESE PRECISION QUALITY KITS

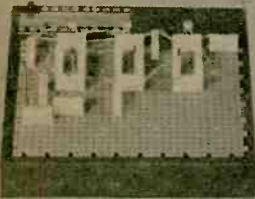

INCLUDES—
Design Console with built-in power supply, test light and speaker. Plus patented plug-in Modular Connectors.



INCLUDES—
Portable 5-inch, wide-band oscilloscope calibrated for peak-to-peak voltage and time measurements.



INCLUDES—
Transistorized Meter combines most desired features of vacuum-tube voltmeter and quality multimeter. Measures very small current values.

FREE! MAIL CARD TODAY FOR ALL THE FACTS
No Postage Needed



Exclusive!

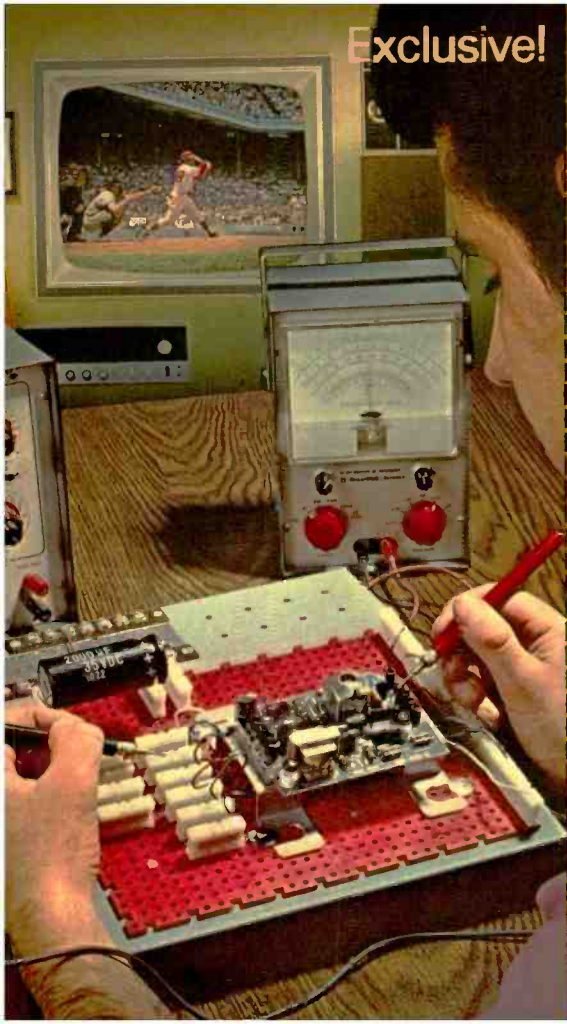

(Detach here)

Build, keep this 315-sq. inch SOLID-STATE COLOR TV with rectangular screen as you prepare for a **PROFITABLE TV SERVICE BUSINESS OF YOUR OWN!**

YES! Please send me complete details about how I can prepare for a profitable Color TV Service Business of my own and about your new 315 square-inch Solid-State Color TV kit I build and keep.

NAME _____ (please print) _____ AGE _____

ADDRESS _____

CITY _____ STATE _____

ZIP _____ PHONE _____

APPROVED for VETERANS' BENEFITS MB1NA

Check here for latest information on 32

G. I. Bill Student Loans



BELL & HOWELL SCHOOLS

MAIL TODAY—No Postage Needed

Exclusive!
**FIRST 315-sq. inch
SOLID-STATE
COLOR TV KIT**

you build yourself
as you prepare for

**A PROFITABLE
SERVICE
BUSINESS
OF YOUR OWN
IN COLOR TV**

(Detach here)



FIRST CLASS
PERMIT NO.
4148
CHICAGO, ILL.

BUSINESS REPLY MAIL

No Postage Necessary if Mailed in the United States

Postage will be paid by



BELL & HOWELL SCHOOLS

4141 Belmont Avenue
Chicago, Illinois 60641

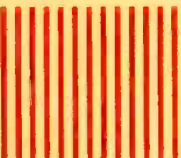

YOU'LL BE READY FOR COLOR TV . . . B&W AND MOST HOME ENTERTAINMENT ELECTRONICS DEVICES

This exciting new program offers you the *first* 315-sq. inch Solid-State Color TV available for at-home training.

As you follow the simple, step-by-step assembly procedures, you become thoroughly familiar with the most advanced solid-state TV circuitry. And as you build this kit you'll prepare yourself for a profitable Color TV service business of your own—either full or part time.

Why Color TV pays better.

Today, Color TV is the big seller. As Color Television goes completely solid-state, the man who has mastered this type of circuitry will be in demand. Obviously, this is where the money is going to be made.

This new Bell & Howell Schools program will also give you an in-depth knowledge of the basics as well as TV circuit theory and analysis. You'll get the theory and practical experience you need to handle radios, hi-fis, stereos, and tape recorders.

You will also receive three precision quality instrument kits which you assemble and keep. These are highly sensitive professional instruments which you'll use constantly.

**EXCLUSIVE ELECTRO-LAB®
IS YOURS TO KEEP, USE**

This unique at-home laboratory comes to you in 16 shipments and includes a remarkably instructive *design console*. You can rapidly "breadboard" a great variety of circuits without soldering. The *Oscilloscope* offers 3-way jacks to handle test leads, wires, plugs. Images on screen are bright, sharp. Your *Transistorized Meter* is fully portable, features a sensitive, 4-inch, jewel-bearing d'Arsonval meter movement. It registers the slightest power surge or lag on a large, easily read dial.

CONSIDER THESE ADVANTAGES:

Bell & Howell Schools' Electro-Lab-at-Home Plan gives you the most thorough background possible in solid-state Color TV. Everything

Note: TV picture is simulated.

comes to you by mail and you go at your own speed. You'll be prepared not only for a service business of your own but for many positions in the Electronics and Television industries. All without missing a paycheck!

When you have completed your program our *Lifetime National Employment Service* will help you locate in an area that interests you. This service is available at any time—now or in the future.

Approved for G.I. Benefits

If you've had six months continuous active duty, you're probably eligible for Veterans' Benefits. If you're a Vet, check the appropriate space in the card at left for full details. Our programs are approved for Veterans' Benefits.

Student Loans now available

If you are a non-veteran and need financial assistance, you may qualify for Student Loans, which are also available.

Special Help Sessions. These are scheduled regularly (Saturdays) at seven Bell & Howell Schools and in many other cities. Here you can get expert guidance by top instructors to help you over the rough spots.

Bell & Howell Schools offer you even more. Once you have finished your program at home, you may decide you want more advanced preparation. In this case, you may transfer to any one of our seven schools which are located all across the country.

Mail the postage-free card today for all the facts. There is no cost or obligation of any kind.



BELL & HOWELL SCHOOLS

4141 Belmont, Chicago, Illinois 60641

321

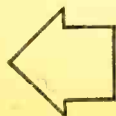

FREE! MAIL CARD TODAY FOR ALL THE FACTS
No Postage Needed

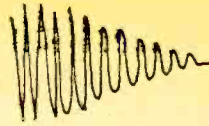
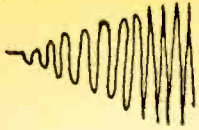

supply heating current to the filament of V_1 . (Notice that this winding was not needed for the semiconductor diode.) Observe the negative voltage output shown in the figure. This is obtained by connecting the diode so that it permits current to flow down through the load resistor (R_L). Therefore, the diode plate is connected to the top of R_L . The bottom of R_L is connected to the bottom of T_1 , and the cathode of V_1 is connected to the top of T_1 . The diode could just as easily be connected in the reverse direction to give the opposite polarity.

In its operation, this circuit is very similar to the semiconductor half-wave rectifier. On the positive half cycles, a positive voltage is applied to the cathode of the diode, and the diode will not conduct. On the negative half cycles a negative voltage is applied to the cathode, and the diode does conduct. Current flows down through R_L , producing an output of the polarity shown. Thus, only negative half cycles appear at the output.

- Q11. A half-wave rectifier passes current to the load during (one half, both halves) of each cycle of applied voltage.
- Q12. A half-wave rectifier can be made using a or diode.
- Q13. Output-voltage polarity depends on the connections to the

Your Answers Should Be:

- A11. A half-wave rectifier passes current to the load during one half of each cycle of applied voltage.
- A12. A half-wave rectifier can be made using a semiconductor or vacuum-tube diode.
- A13. Output-voltage polarity depends on the connections to the diode.

Full-Wave Rectifier Circuits

A full-wave rectifier differs from a half-wave rectifier in that it utilizes both halves of the input-voltage cycles for its pulsating DC output voltage. Such a rectifier is shown in the figure below.

ELECTRON FLOW DURING POSITIVE HALF CYCLE IN FULL-WAVE RECTIFIER

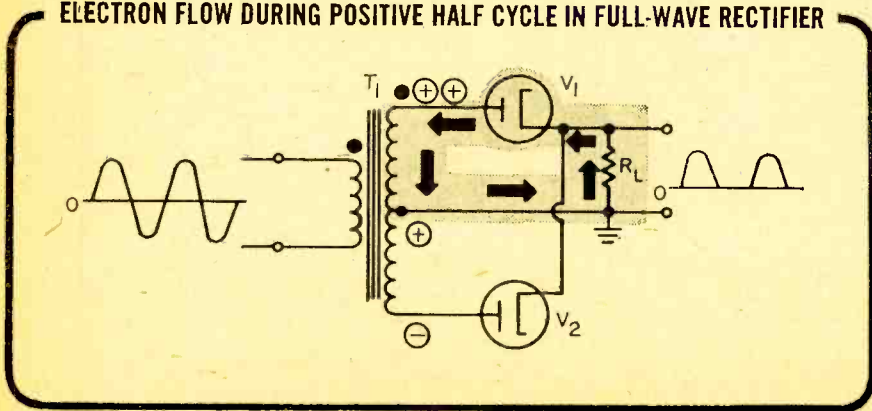

Two diodes are employed in this circuit. A transformer with center-tapped secondary winding is used; its center tap is connected to one side of R_L and

ground. When the dot side of T_1 is positive with respect to the center tap, V_1 will conduct. The plate of V_2 is connected to the other end of T_1 , which is negative with respect to the center tap. Thus V_2 will not conduct. The output of the circuit is as shown in the figure. Compare this output with that of the half-wave rectifier.

On the negative half cycle, the top of T_1 is negative with respect to the center tap, so V_1 will not conduct. The bottom of T_1 is positive with respect to the center tap, and V_2 will now conduct. Notice the direction of current flow—through V_2 , to the bottom of T_1 , out of the center tap, **up through R_L** , and back to the cathode of V_2 . Current flows through R_L in the same direction as it did for the positive half cycle. This results in the output half cycles all being positive. The effect is just like passing the positive half cycles and inverting the negative half cycles.

NEGATIVE HALF CYCLE ELECTRON FLOW IN FULL-WAVE RECTIFIER

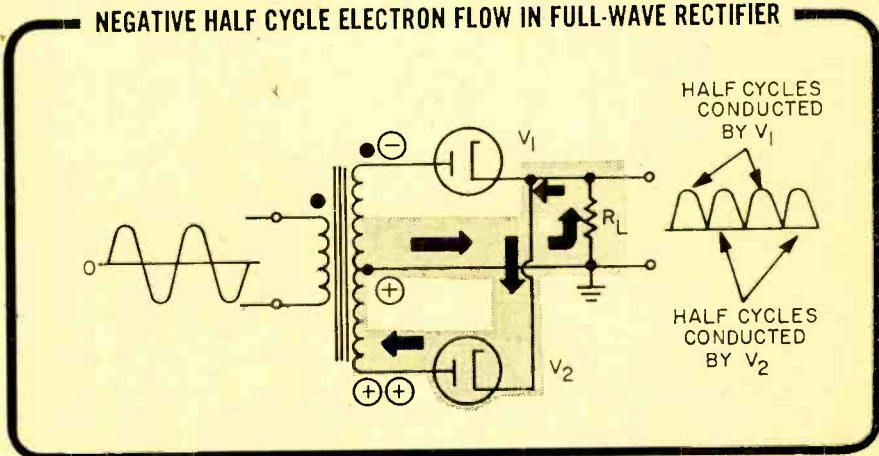

Notice the difference between the pulsating DC from a half-wave rectifier and from a full-wave rectifier. The variation in the output from the half-wave rectifier has half the frequency of the variation from the full-wave rectifier.

A full-wave rectifier can, of course, be made using semiconductor diodes. The circuit below shows this. Although the position of R_L on the diagram has been changed, the circuit is still the same.

SCHEMATIC OF FULL-WAVE SEMICONDUCTOR RECTIFIER

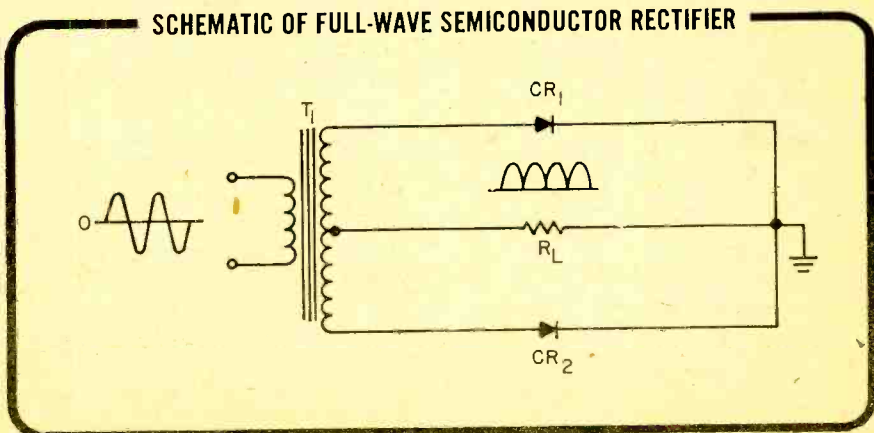

- Q14. A full-wave rectifier uses a transformer with a secondary.
- Q15. A full-wave rectifier conducts during (one half, both halves) of the applied-voltage cycle.

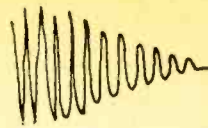
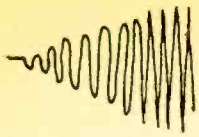

Your Answers Should Be:

- A14. A full-wave rectifier uses a transformer with a center-tapped secondary.
- A15. A full-wave rectifier conducts during both halves of the applied-voltage cycle.

Bridge Rectifier Circuit

There is a type of full-wave rectifier circuit that does not require a transformer with a center tap. Instead, it uses four diodes. This circuit is called a **bridge rectifier circuit**.

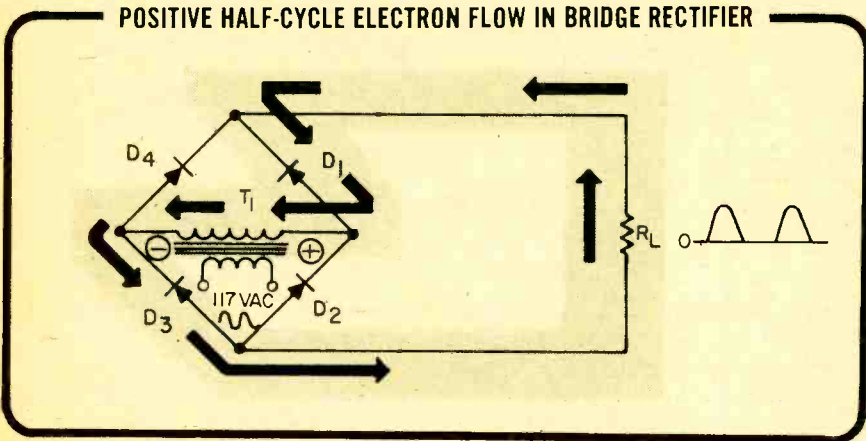

On the positive half cycle, current flows through D_3 , up through the load resistor, and back through D_1 . Diode D_2 and D_4 are reverse-biased and act like open switches.

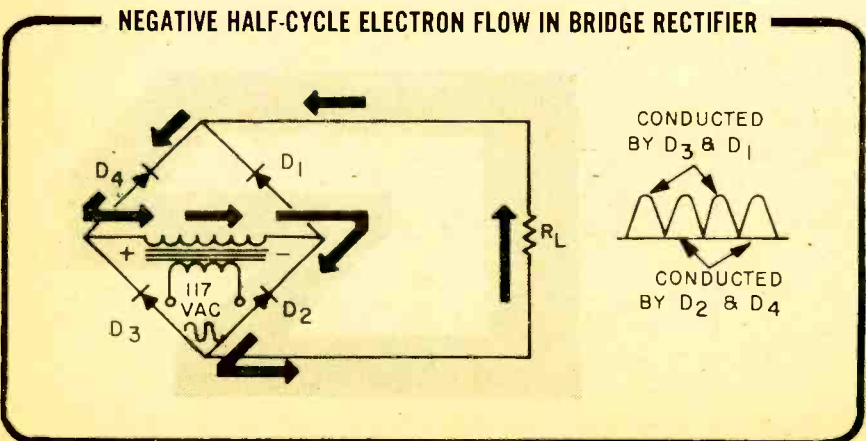

The figure above shows the current direction for the negative half cycle. The bridge rectifier is found in power supplies that must deliver a large

amount of current. Since some semiconductor diodes are not adequate to carry large currents, special selenium or copper-oxide metallic rectifiers are employed.

WHAT YOU HAVE LEARNED

1. Power supplies convert AC input voltages into DC output voltages.
2. The components of a DC power supply are: voltage control, rectifier, and filter.
3. A power transformer provides AC at desired voltage values to the input power supply.
4. A diode (or combination of diodes) converts AC into pulsating DC.
5. There are basically two types of rectifiers—half-wave and full-wave.
6. A bridge rectifier is one particular type of full-wave rectifier.

NEXT ISSUE: Part 2—Understanding Power Supplies

This series is based on material appearing in Vol. 3 of the 5-volume set, BASIC ELECTRICITY/ELECTRONICS, published by Howard W. Sams & Co., Inc. @ \$19.95. For information on the complete set, write the publisher at 4300 West 62nd St., Indianapolis, Ind. 46268.

Kathi's CB Carousel

Continued from page 46

tenna jack, PA and external speaker jacks, antenna loading control, S-meter zero set, and the microphone gain control.

B&K's Cobra 25 receive-half is double conversion with three tuned circuits and a ceramic filter contributing to this rig's selectivity. The conventional transmitter, the lab crew informs me, uses a form of modulation limiting for both overmodulation protection and compression. Both transmitter and receiver sections are fed by a regulated power supply.

Figuring that some CBers like to doodle with their rig's innards, *B & K* made both modulation limiting and power supply output adjustable by the owner.

Snake Charmer's Performance. The *Cobra 25's* input sensitivity measured 1.1 μV for a nifty dB S+N/N ratio. Selectivity measured 60 dB adjacent channel rejection. Actually, the selectivity is greater than 60 dB; a signal 60 dB above 1 μV —and that's equivalent to a very weak but usable signal—desensitizes the input. If you were receiving a moderate-to-strong signal, the desensitization would be insignificant since realized selectivity would be greater than 60 dB.

Image rejection was an unbelievably high 86 dB. The AGC action was a superb 3 dB for a 2 to 10,000 μV input signal range.

Because of front-end desensitization, signal levels higher than 10,000 μV wind up being compressed into the 3 dB AGC range. I'd bet my last false eyelash that your ears won't shatter because a local CBER's signal pounced on top of an adjacent weak signal!

It takes 20 μV for the S-meter to slide upscale into S9 country. All other readings, however, are relative; there is no fixed value for each S-unit.

The transmitter half of the *Cobra 25* delivered 3.8 watts into a 50-ohm load. Heaps of reserve microphone gain—and any mike we tried—combine to bring the *B & K Cobra 25* up to essentially 100% modulation. Even with my whisper voice level, modulation reaches, and is limited to, 100%.

The modulation meter is darn accurate when monitoring speech. It did not give accurate results with test tone modulation, but then, this characteristic is common to all CB modulation meters. Fact is, for all CB rigs, modulation tests and measurements should be made with mike and voice only.

Overall performance of *B & K's Cobra 25* is very good. Which is the reason why this rig slips so easily into the Ultimate Gift slot on my Christmas list. Want to know more about the *B & K Cobra 25*? Circle number 49 on the Reader Service Page. *B & K* will be happy to oblige.

Our readers will be happy to know that other B&K products plus *mucho* more CB gadgets will be discussed in our upcoming 1972 CB YEARBOOK. Watch for it! ■

Photog's Third Eye

Continued from page 44

bracket. Push the button plugs into the recesses in V1; solder the other end of V1's cathode lead to the center terminal on potentiometer R1. The 10-megohm is soldered from the pot's end to one lug of the terminal strip. Solder the shutter cable to the appropriate terminal strip; the last component soldered into the circuit is the SCR. Lastly, fashion a bracket or strap from sheetmetal to hold PTE to your slave strobe.

Testing PTE. Plug your completed *Photog's Third Eye* into the socket on your slave strobe. Set R1 to its maximum resistance setting. Turn on the strobe, and wait until it charges. Back R1 off slowly: the strobe will fire at some point. Adjust the control back a trifle further. PTE is now adjusted so that ambient light does not

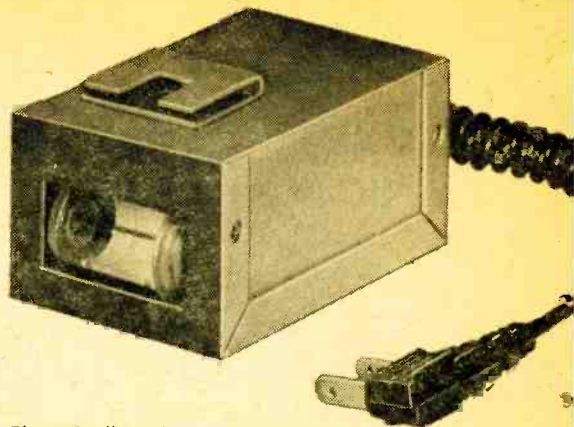

The PTE all finished and set to slave away. Aluminum clip at top mounts unit.

affect it. Your PTE will now respond each and every time to its master's bidding. And, it'll reward you with shadow-free snaps at your next bash. ■

Electrosleep

Continued from page 53

of these pioneer electric devices were on the right track, but lacked knowledge of natural electrical processes of the human body as well as ability absolutely to control the input of power impulses.

Alpha Waves. Electrosone 50 yields a squarewave pulse of very brief duration and very low voltage. Because such a wave closely approximates the all-important natural alpha wave of the brain, it can be regarded as an electronic equivalent of synthetic chemicals that are patterned after naturally occurring ones.

Whether "synthetic electrical impulses for the body" will ever have an impact equal to that of synthetic chemical compounds remains to be seen.

Also debatable until much more clinical experience has been assessed is the question of direct influence of electricity versus influence of suggestion plus confidence in a radical new type of treatment.

The F.D.A. Joseph B. Davis, M.D., director of the F.D.A.'s division of clinical and medical devices, remains in the cautious corner. Until 1938, the agency had no control whatever over mechanical and electrical devices. Today the reins are getting tighter, and restrictive legislation is being urged by many

persons who fear exploitation of the public by quacks. Dr. Davis' agency can presently move against medical devices only through sections of the Food, Drug, and Cosmetic Act—permitting court action only if the equipment is being marketed through false or misleading advertising, has been adulterated, or proves dangerous to health.

Davis himself notes that use of electrosleep machines sometimes leads to "adverse eye effects" that may last half an hour. "What is being done to the enzymatic and humoral systems, and whether the nervous system's chemical-electro impulses are being overridden" needs to be known.

Paul Williamson, M.D., is making medical news from the unlikely spot of McComb, Mississippi. Interviewed by telephone recently, Dr. Williamson predicted "astonishing progress" in electrosleep therapy within the seventies. Himself an American pioneer in the field, he now spends much of his time lecturing to professional groups whose members wouldn't have given him the time of day a decade ago.

Other important work is being done by Dr. William Dement, director of the Stanford University Sleep Research Laboratories. Along with Drs. Rosenthal and Wulfsohn, plus others who are beginning to experiment but haven't yet put their findings into print, these men are going to make certain that Space Age man finds out whether push-button sleep is a fact or a fancy. ■

Fish Finder

Continued from page 79

sure that both resistors are *not* different values. Otherwise, the temperature corresponding to the center of rotation of the pot will shift in the direction of the ohmically larger of the two resistors. For a fishing thermometer where a range of from 32F to 100F is desired, make each trimming resistor equal to 1,000-ohms. For his own *Thermocliner*, the author chose a

thermistor with a resistance of 3,500-ohms at 25 degrees Celsius (Fenwal type GB 34P8) and a 4,700-ohm resistor for R8.

Should you run into trouble locating a similar thermistor, substitute a 2,000-ohm unit. See the Parts List for an alternate thermistor. You'll also have to fiddle with R8's value, in order to maintain the same thermistor resistance versus potentiometer mid-scale position. Start out with a 3,900-ohm resistor, and adjust its value up or downwards as needed. In any case, get the 80 degree F mark to coincide with pot R10's mid-scale rotation point. ■

Shortwave Listening

Continued from page 35

es). Broadcasting stations are listed in White's Radio Log, published semiannually in COMMUNICATIONS WORLD—this includes AM, FM, TV and Short Wave Broadcast station listings.

Like the old fisherman told the freckle

faced youngster, "I can only bait the hook, you'll have to catch them yourself," I can tell you that the foregoing information should get you well on the way to serious SWLing; but how far you go in the hobby depends solely on your own ingenuity and tenacity. Patience may be a virtue, but it is the by-word of SWLing, it may actually take *years* for you to hear one particularly elusive station that you seek—but that's half the fun! Good fishing! ■

DX Central Reporting

Continued from page 15

years of listening under their belts. Here's an inside tip. Listen for Libya's Arabic language home service on this off-beat channel during the afternoons until 2300 sign off. . . . **10,010**

—*South Vietnam Liberation Radio*, actually the clandestine voice of the Viet Cong, now has a daily English language newscast at 10:30. Lately they've been answering reports, even from "Imperialist Warmongers," if they're addressed to 39 Avenue Georges Mandel, F-75 Paris 16, France. . . . **11,920**—France doesn't exactly go overboard when it comes to English language programs, but you can catch the news to Africa from *Office de Radiodiffusion-Television Francaise* at 0515. . . . **15,410**—When not in Rome, do as Stateside DXers do, listen to the North American service of *Radiotelevisione Italiana* at 0045.

(Credits: Dan Ferguson, West Virginia; Carroll Patterson, Georgia; William J. Penn, New Jersey; Alvin Sizer, Connecticut; Gregg Calkin, Mexico; Gladys Martin, New York; Larry Magne, Pennsylvania; David Williams, Oregon; North American SW Association, Box 989, Altoona, Pennsylvania; SPEE-DX, Box 321, Santa Ana, California)

Backtalk. Antarctica, the seventh continent, seems to hold a special attraction for DXers.

Steve Martin of Upper Marlboro, Maryland, passes along three frequencies used by Antarctic military utility stations. They are 7,370, 13,975.5 and 21,277 kHz. Steve says the latter one is used by the Palmer Station station at 2015 GMT.

Canadian reader, Frank Eimer of Calgary, Alberta, asks about shortwave broadcasting from Iceland, frequencies and times to tune.

Sorry, Frank, but the SWBC station at Reykjavik, Iceland, is no longer on the air. If some of you readers managed to bag this one a few years ago, congratulations. Your QSL is a "rarie!"

Speaking of stations leaving the shortwave broadcast band, word is out that the Fiji Broadcasting Corporation also is soon to abandon the higher frequencies. So now's the time to try for this one on 3,284 kHz during the wee hours of the morning.

"I regularly receive Radio Nacional de Brasilia on 15,445 kHz." writes Joseph Straub of Pittsford, New York. "But I can't get a QSL because I haven't been able to decipher the address. Can you help?"

Sure can, Joe. Send your reception report to Radio Nacional de Brasilia, Caixa Postal 1472, Brasilia, Brazil. Program producer Luthero Toledo is a good guy when it comes to QSLing listener's reports.

This month we focus the DX Central spotlight on another fine shortwave clubs, the up and coming Midwest DX Club. (turn page)

Though MWDXC's emphasis is on the short-wave frequencies, the broadcasters, the utility communications stations and the ham bands, medium wave listeners are not neglected. Its monthly bulletin, MWDXC Journal also includes plenty of interesting feature articles and a useful propagation column, telling you when and where to tune for optimum reception.

Like the other DX clubs spotlighted in this column, MWDXC is affiliated with the Association of North American Radio Clubs. If you'd like information on other DXers organizations, write to ANARC, 2110 West 74th Street, Prairie Village, Kansas, 66208.

If the Midwest DX Club sounds like your cup of tea, or if you'd like more information about the organization, use the handy form on

MIDWEST DX CLUB
6636 Davis Street
Morton Grove, Ill. 60053

I read about MWDXC in ELEMENTARY ELECTRONICS "DX Central Reporting." (Please check one.)

I want to join. I am enclosing \$3.00 (third class mail) or \$5.00 (first class mail) for one year's membership.

Please send me more information about MWDXC.

Name: _____

Address: _____

City: _____ State: _____ ZIP _____

this page. Please send it directly to MWDXC, not to DX CENTRAL REPORTING. ■

Bookmark by Bookworm

Continued from page 16

how to isolate troubles to a specific unit with extreme accuracy, based on his keen observation of waveforms and precise voltage measurements possible only with an oscilloscope and a vectorscope. It is these "scopes" that are really the "eyes" of a modern troubleshooter. Published by Tab Books.

Circle No. 43 on Reader Service Page

Brain Book. Consisting of an integrated description on intelligent machines, a new book—*Artificial Intelligence* by James R. Slagle—shows that computers can mimic the behavior



Hard cover
 196 pages
 \$8.95

or performance normally associated with human intelligence. This book is primarily intended for students of computer science. Published by McGraw-Hill Book Company.

Circle No. 44 on Reader Service Page

Mini Reviews—

● *101 TV Troubles from Symptom to Repair* by Art Margolis—an invaluable cause and cure guide to the solution of most TV troubles—both color and B&W. Published by Tab Books: hard cover, 224 pages, \$7.95.

● *Semiconductors—Physics, Devices, and Circuits* by Michael M. Cirovic—contains funda-

Book Publishers' Addresses

Hayden Book Co., Inc.—116 West 14th Street, New York, NY 10011

McGraw-Hill Book Company—Public Information Dept., 330 West 42nd Street, New York, NY 10036

Prentice-Hall, Inc., Englewood Cliffs, NJ 07632

Tab Books—Blue Ridge Summit, Pa. 17214.

mentals needed to understand the devices that revolutionize electronics, from the physics of semiconductors to basic amplifier circuits using semi-conductor devices (a college-level text). Published by Prentice-Hall, Inc.: hard cover, 420 pages, \$13.50—student's edition.

● *How to Read Electronic Circuit Diagrams* by Robert M. Brown and Paul Lawrence—a modern guide of practical value to hobbyists experimenters, students and others who want to upgrade their knowledge the easy way. Published by Tab Books: soft cover, 256 pages, \$3.95.

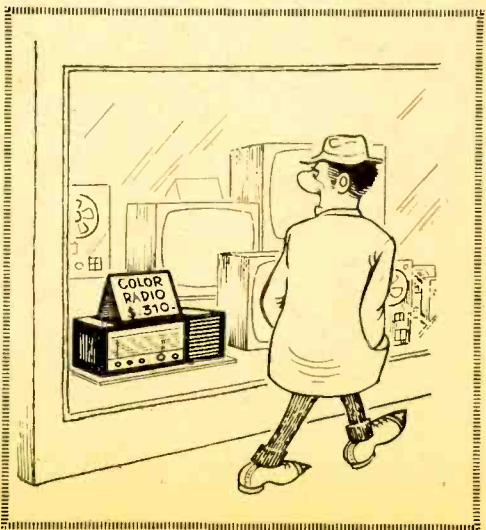

Stamp Shack

Continued from page 18

gold and black stamp showing just a telegrapher's key, surrounded by concentric lines symbolizing its communications service.

● The first telegraph was part of Prince Nicola of Montenegro's first social reforms and began when he and Austria signed a treaty on Feb. 18, 1860. The latter provided the technical know-how and equipment to enable service to begin a couple of years later.

● Begun as a purely national communications facility, the telegraph system eventually was linked with Austria and later through Vienna,

Ask Hank, He knows

Continued from page 24

are actually very low, TVI (TV interference) is the fault of your TV set. The strong transmitter signals overwhelm the front end of your TV set. You can add a degree of protection by installing a high-pass filter (available at parts stores and most TV dealers) at your TV and FM sets' antenna terminals. Such a filter is cheap. If it doesn't do the job, you can use an expensive CATV type filter (your parts store can order one for you), or buy a better TV set.

Front End Frazzle

What filter can I use between my 146-175 MHz VHF monitor receiver and my VHF antenna to get rid of FM BC stations?

—H.G., Detroit, Mich.

You've got a can of worms. Your problem is a lack of front-end sensitivity. Try building a high-pass filter using the circuit shown in the diagram. J1 and J2 are SO-239 coaxial recep-

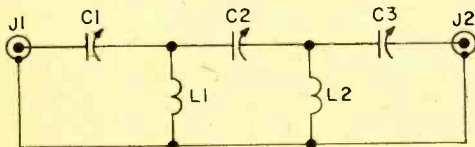

tacles or phono jacks. Coax to the antenna is connected to J1 through a matching plug. The receiver A-G terminals are connected to J2 through a short length of coax and a plug that fits J2. Capacitors C1, C2 and C3 may be 8-50 pf ceramic trimmers. L1 and L2 are 1- to 2-turn coils made of #12 solid copper wire wound on a pencil form. Put all of the parts in a small metal box. To tune the filter, get your hands on a VHF signal generator. If you don't have one, adjust C1, C2 and C3, and the spacing of the coil turns until you eliminate the

with other European nations.

● **What's New?** The H. E. Harris Co., Boston, Mass. 02117, has just published a "Starter Outfit," intended to enable one to begin stamp collecting. Priced at only \$1.98, it contains an album for 7,000 different stamps of the world, especially those related to Space exploration, a packet of stamps and a variety of necessary accessories.

Readers who chance to live in or visit the Boston area will find a visit to the Cardinal Spellman Philatelic Museum well worth while. Established by the late prelate, this magnificent building on the campus of Regis College, in Weston, contains displays of stamp collections and a library of books and magazines related to stamp collecting as well as other comfortable facilities. Admission is free. ■

FM BC stations and still get good reception in the 146-175 MHz band.

Uncle Sam's Good Book

How can I buy government-published books about electronics? I understand they're very good and also cheap.

—T.S.E., Baltimore, Md.

Write to Sup't. of Documents, Government Printing Office, Washington, D.C. 20402. Ask for catalog PL-82. Also ask to have your name placed on the mailing list to receive announcements of Uncle Sam's latest publications.

One-to-Three Phase

I need 3-phase AC power at low wattage, but only have single-phase power at my home. Is



there any way I can get 3-phase power without having the power company install a new line?

—F.A., Bronx, N.Y.

The hard way is to rig up a motor-generator set consisting of a single-phase AC motor and a 3-phase alternator. You could even use a

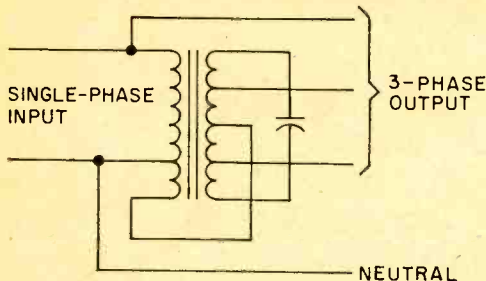

3-phase auto alternator, and step up the voltage with a transformer. An easier way is to use a Paraformer (parametric transformer) made by Wanlass Electric Co., 2175 S. Grand Avenue, Santa Ana, Calif., connected as shown in the diagram. It provides 4-terminal output (3 phases plus neutral).

Floatable Mobile

Can I use a CB walkie-talkie on board a ship when on a cruise?

—G.E.S., Miami, Fla.

Of course, provided you have the radio officer's permission. But, when you're within three miles of the U.S. shore be sure you have a CB

license. Beyond the three-mile limit, you're in no-man's-land. But, any licensed CB station communicating with you will undoubtedly be violating CB international regulations. And if you louse up the ship's navigation or radio system, the captain might move you from your stateroom to the brig. Leave your rig at home and enjoy!

TV Scope

I have an old television set. All the tubes are OK, and all but the tuning circuit is in good condition. Is it possible to convert the set into an oscilloscope? I have heard it can be done, but no one seems able to supply any information.

—F. E. K., Carroll, Iowa

While it could be done, the cost would probably be more than that of a scope kit complete with wiring and assembly instructions. Furthermore, why build a complicated piece of equipment with used parts? We suggest you pick up a Heath catalog and try a kit. It's more fun.

Penguin DX

I was told by a friend that there is a radio transmitting station at the Antarctica. He thought it was part of the Scientific Research Base. I said I never heard of such a thing. What is the word? He said that it could be received with a good SW set.

—S.F.T., Someplace, U.S.A.

Undoubtedly there is. They have no land line telephone service to the U.S. down there. And smoke signals don't carry very far. ■

Hey, Look Me Over

Continued from page 26

Numbers CWS102, S103 and S104 specify the increased power models. Input power requirements are 115 or 230 VAC. Prices start at \$129.95 to \$249.95.

Circle No. 36 on Reader Service Page

Reel Racer

An unusual, double-duty bulk Audiotex tape eraser, Model 30-140, is included in the GC Electronics' new general catalog. Priced at \$18.31.



GC-Audiotex Tape Eraser

the new eraser can be used both separately on a table-top and a hand-held unit. It will magnetically wipe clean audio tape reels, cassettes, cartridges and video tape. The eraser is powered by standard house current (117 volts AC) and draws four amperes in operation. The unit is turned on with an integral pushbutton switch. A single pass over the unit by a magnetic tape completely erases all program material and background noise—restoring the tape to "virgin" condition.

Circle No. 37 on Reader Service Page

Auto Stereo Center

Five completely new stereo 8-track tape players have been introduced by Panasonic Auto Products. At the top of the line is the Model CQ-909,

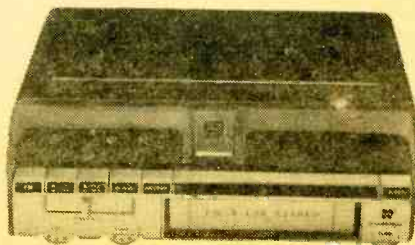

Panasonic CQ-909 Tape Player/FM Receiver

ELEMENTARY ELECTRONICS

The Riverside, a combination stereo-8 player/FM-stereo receiver for automobiles, featuring a slide-rule balance control, repeat button which provides for playing back any channel, automatic or manual program selection, eject button for releasing the cartridge from the player, bass/treble tone control, and flush cartridge fit for added safety and enhanced appearance. The FM-stereo receiver section of the CQ-909 features a mono/stereo switch, distant/local switch for greater selectivity, built-in AFC. Suggested retail \$119.99.

Circle No. 38 on Reader Service Page

Hidden Asset

A very sophisticated, yet surprisingly low cost, metal detector is available by mail through Edmund Scientific Co. With it, you can find hidden coins, jewelry and precious minerals at the beach, at a campground, or in your own backyard. You can operate this durable detector (weight: 10

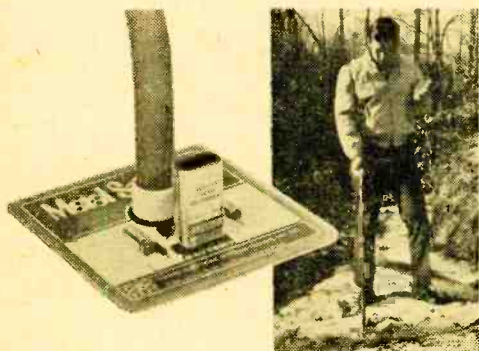

Edmund Scientific Metal Detector

ounces) for hours without fatigue, feeling only the excitement of discovering hidden treasure. It works in conjunction with any portable AM transistor radio (not included), thus eliminating costly extra circuitry and dangling wires which make other metal detectors so expensive and heavy, and operates on a 9 volt transistor battery. It costs just \$14.95 (Stock No. 71,395).

Circle No. 39 on Reader Service Page

CB Toting

The compact Messenger 125 Citizens Band two-way radio can be used as a battery-operated portable unit, thanks to the new "Porta-Pack" carrying case introduced by the E. F. Johnson Company. The Porta-Pack case allows the radio to be removed from a vehicle and converted into a portable unit within seconds. The Messenger



E. F. Johnson Messenger 125

125 slips easily into the leather Porta-Pack case, which contains its own collapsible whip antenna. Built-in high capacity nickel-cadmium batteries will power the Messenger 125 for six hours of normal use, and over eight hours if transmit time is held to a minimum. External jacks on the case are provided for recharging the batteries and connecting an external antenna. Suggested retail price: \$69.00.

Circle No. 40 on Reader Service Page

Super Scope

A brand new Heath EU-70A scope features complete dual trace and X-Y capability. Two separate

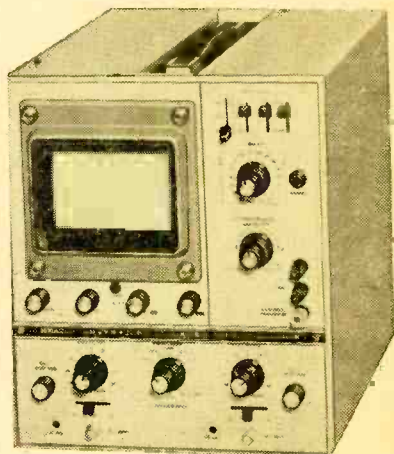

Heath Model EU-70A Oscilloscope

inputs can be individually displayed in Ch. 1 or Ch. 2 modes. Alternate and chopped modes allow both signals to be displayed at once for direct comparison. Alternate mode displays on alternate sweeps; in chop, both signals are sampled at a 100 kHz rate and appear as a function of the same time base. X-Y capability permits each input to be displayed as a function of the other, with Channel 1 controlling the Y axis and Channel 2 controlling the X axis. Both input channels are precisely balanced for less than 1% phase shift to over 100 kHz. The Heath EU-70A is sold factory assembled & tested, and is priced at \$565.00. ■

Circle No. 41 on Reader Service Page

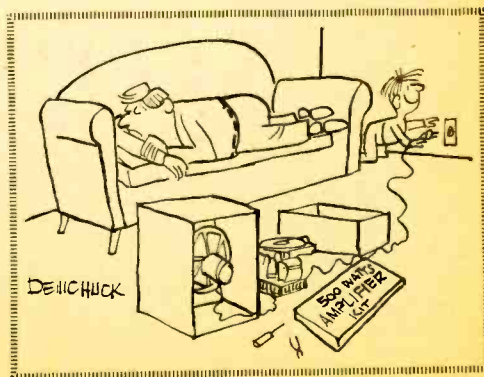

NewsScan

Continued from page 23

with X-rays, causing electrons to be ejected for identification and analysis of chemical elements. With the photoelectron spectrometer, scientists can test only to a depth of four to 30 angstroms (about 0.000000076-of-an-inch). If you touch the specimen before it goes into the machine, the only analysis you will get is of the sweat on your finger. Applied to organic structural chemistry, the spectrometer can help scientists quickly classify offensive or poten-

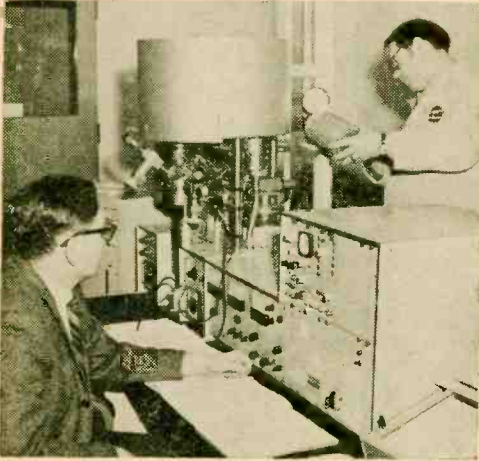

Liquid Nitrogen is added to the cooling system of Gulf Research & Development Company's photoelectron spectrometer by technician James B. Adamson while Dr. Richard R. Slater, supervisor, Chemical Physics Section, keeps a check on the instrument's control panel. This is the second unit of it kind in the world.

tially polluting elements in crude oil, such as sulfur, and assist in working out new refining methods to remove them. It also will test only the scaling in metal corrosion to better identify the cause and indicate how to stop it—helping, for instance, to develop improvements in motor fuels and oils to retard deterioration of vital engine parts.

The Bureau of Mines has shown an interest in the photoelectron spectrometer to help trace causes of *black lung*. By analyzing dust in the filters of miners' masks, they believe they can fingerprint coal, then determine from what part of the mine hazardous dusts originated.

PLASTIC RIVET

Radiation Technology, Inc. has developed the first plastic rivet for the hobbies market. The new noncorroding, thermoplastic fastener product known as *Radfast* will replace many ordinary uses for metal rivets, screws, bolts and nuts. With *Radfast*, no machining or injection

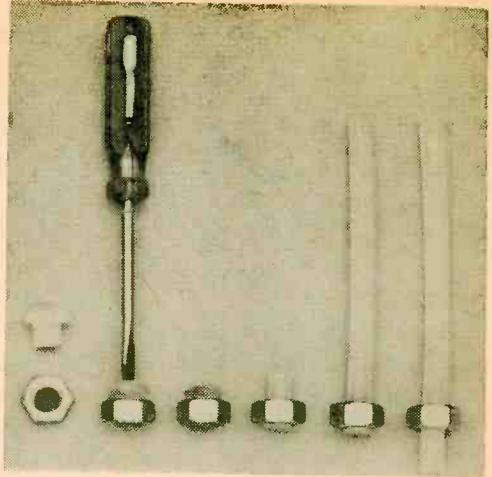

Through heating the non-corroding, thermoplastic *Radfast* rod, it can expand under heat to pre-determined size and shape, thereby creating tough rivets, plugs and all-purpose fastening devices.

molding is necessary to make a fastener. Threads are formed to exact dimensions during the fastening process. You no longer have to hunt for the right size rivet or screw. No tool except a common heat source such as a match, cigarette lighter, soldering iron or hot air gun is needed in the radfastening process. Threaded inserts or screws can be formed by heat ex-

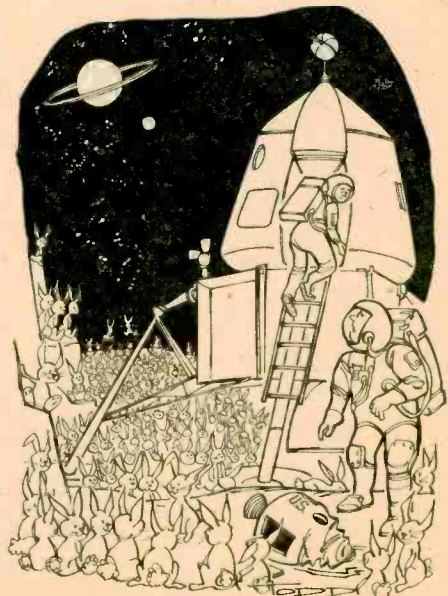

"Hey, Fred, remember that space probe back in the 60's when they ran out of monkeys and someone at NASA suggested using rabbits . . ."

panding the *Radfast* into tapped holes. Slotted, phillips or allen heads can then be formed while the material is hot. Spacer fasteners can also be formed, which is a totally new technique for plastic fasteners.

Radfast comes in flexible rods that can easily be cut to any desired insert length. Three rod diameters are presently available: $\frac{1}{8}$ " ; $\frac{3}{16}$ " ; and $\frac{1}{4}$ ". Sample *Radfast* kits are available at \$1.50 each by writing to Radiation Technology, Inc., Department J, Box 41, Hibernia, New Jersey 07842.

NO GLASS TO BREAK

Here's a better mousetrap—an electronic thermometer that will reduce hospital and nursing home costs sharply, eliminate the danger of cross infection and speed patient service. It's a fact that electronic thermometry is the first basic change in temperature-taking since Gabriel Fahrenheit invented the mercury thermometer in 1714.



A young patient is about to have her temperature taken with a new electronic thermometer. The thermometer accurately records temperatures in approximately twenty seconds and has a sterile disposable cover.

Each time a hospital patient's temperature is taken by a mercury thermometer, the cost per patient ranges from 4 cents to 8 cents depending on such factors as the cost of washing, packaging, cleaning equipment, breakage and the initial investment in thermometers. The LaBarge Electronic Thermometer reduces that cost to less than 1½ cents per patient, including the cost and operation of the instrument and the disposable cover.

The LaBarge thermometer utilizes a sterile, disposable cover which eliminates cross infection and re-infection. The standard mercury thermometer is a very real source of contamination in hospitals today. Scrubbing procedures are, at best, an effort to reduce the amount and types of bacteria. However, a disposable sensor cover can be absolutely sterile.

The operation of the LaBarge Electronic Thermometer is very simple. Hospital personnel were trained to use the thermometer in about fifteen minutes. During the hospital evaluation there was ready acceptance by the nursing staff, and there were no complaints from patients.

TO STOP A THIEF

United Air Lines has installed a special purpose computer system to check for stolen and counterfeit airline tickets at Los Angeles International Airport. The system utilizes 23 keyboard terminals, 17 located at boarding gates and six at the ticket counters of United's two airport satellite buildings. As passengers check in, the ticket number is put into the computer through a keyboard by a passenger agent. An instantaneous reply with a green light indicates the ticket is valid. A red light indicates the ticket may be stolen.

Because the computer gives an immediate response when a ticket number is entered, United officials said use of the system will not affect or delay service to passengers as they arrive for check in. Numbers of tickets stolen anywhere in the country can be checked. ■



Checking for stolen airline tickets at Los Angeles International Airport, United Air Lines passenger agent Lynne Overton keys in ticket number to a new computer. An instantaneous response by red or green light indicates whether ticket is good or stolen.

Oscillating Amps

Continued from page 64

and-conquer approach to this amplifier is to put feedback around only a pair of stages instead of three or more. This way, there are only two pairs of stray R's and C's lurking in the amplifier, and it takes at least three such pairs to make an oscillator.

The coupling capacitors, which combined to make a phase shifter in the very first example, can be prevented from ganging up on the amplifier and making it oscillate by making the product of each capacitor times its associated resistor (called the "RC Product") 5 or 10 times larger or smaller than the other RC products. For example, in a three-stage feedback amplifier which has all its base resistors the same values, you could make the three coupling capacitors $2\mu\text{F}$, and $10\mu\text{F}$, and $50\mu\text{F}$, respectively. Again, you have divided the coupling capacitors into three widely-separated values, and conquered the oscillation.

All these problems and solutions are by no means a comprehensive list of all the ways an amplifier can get into trouble, nor of all the tricks of the trade that can be used to bail them out. For that matter, we've

said nothing at all about the opposite problem—how to persuade a balky oscillator to "take off" and do its thing. But we've said enough to indicate that the cynic mouthing Murphy's Law would be well-advised to look to his basic theory and construction, because both amplifiers and oscillators answer to certain basic circuit laws, and will behave themselves impeccably if those laws are not violated. ■

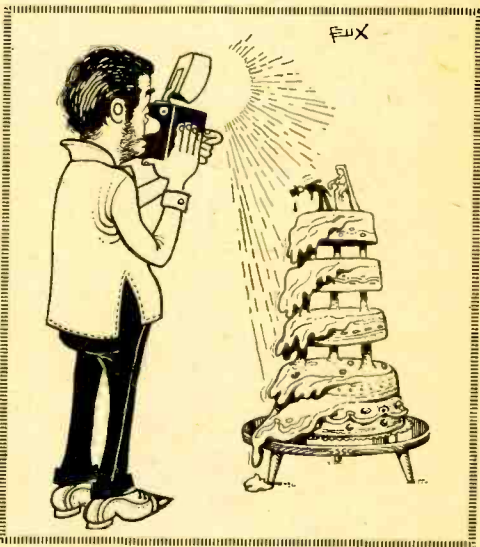

Heath Electronic Oven

Continued from page 48

marily of mounting electrical hardware such as the power transformer, switches and lights. Total construction time runs about 10 hours. Then the unit is ready for a final checkout.

During the final check the power transformer is made inoperative so the Magnetron cannot be accidentally placed in operation. All switches, lights and interlocks are checked out. Finally, there is the operational check. Very simply, it consists of verifying how long it takes to get 8 oz. of water to boil. If it boils in 3 minutes, you're ready to cook!

During operation, considerable heat is blown through the door. This heat, and the humidity built up during cooking, is vented by the Magnetron's cooling blower. No maintenance is required other than the periodic cleaning of the blower motor's

filter. Naturally, the frequency of cleaning will depend on how often the oven is used. If the filter becomes clogged, thereby reducing the blower's cooling efficiency, a front panel lamp will indicate excessive Magnetron heat. Periodically, the door seals should be checked and cleaned if necessary; the same as you would do with a standard oven.

Summing up. We found the *Heath Electronic Oven* to be an excellent performer. In fact, it was better than some commercial models which did not have an interior glass shelf to provide microwave radiation from under the food. *Heath's* supplied chart of recommended cooking times proved reasonably accurate. Should you want to modify cooking time to obtain a more rare or well-done cooked quality, *Heath's* recommendations will put you well inside the ballpark.

The *Heath GD-29 Electronic Oven* kit is priced at \$379.95. For additional information, circle No. 34 on the Reader Service Page located on page 17. It's guaranteed to make you hungry for one! ■

CLASSIFIED Market Place

FOR BIGGER PROFITS! NEW CAREER OPPORTUNITIES!
READ AND REPLY TO THESE CLASSIFIED ADS

Classified Ads 65¢ per word, each insertion, minimum 10 words, payable in advance. To be included in the next available issue of **ELEMENTARY ELECTRONICS**, copy must be in our New York Office by Oct. 1st. Address orders to R. S. Wayner, Manager, Classified Advertising, **ELEMENTARY ELECTRONICS**, 229 Park Avenue South, New York, N. Y. 10003.

BOOKS & PERIODICALS

FREE Circulars, unique books. Campbell's, 1800 B. E. Franklin, Evansville, Indiana 47711.

LEARN to read music in one evening! Amazing book shows how, only \$3.00 Money Back Guarantee. Dept. A-9, Blue Waters House of Thrift, 2636 5th Ave., Orville, Calif. 95965.

CHAMPAGNE and Winemaking Handbook \$ 3.99. Recipes, compete instructions, use kitchen utensils. Satisfaction guaranteed. Bausell Enterprises, Box 277-NSM, St. James, Missouri 65559.

BUSINESS OPPORTUNITIES

I made \$40,000.00 Year by Mailorder! Help others make money! Start with \$10.00—Free Proof! Torrey, Box 318-T, Ypsilanti, Michigan 48197.

MAKE Magnetic Signs. Big profits. Details. Universal, Lenora, Kansas 67445.

1000% PROFIT Bronzing Shoes. Free Details. NBC, Box 11069-0, Kansas City 64119.

DOUBLE Money Back if you can't beat horse races using my system! Strauss-AJW, Brooklyn, New York 11219.

HAVE your own Television Business. Even if you are not an expert. \$2.00. Redmond, P. O. Box 593, Daly City Calif. 94017.

JAPAN Hong Kong Directory. World products information. \$1.00 today. Seki Shogyo Annai, Hilliard, Washington 99207.

COINS, CURRENCY & TOKENS

TERRIFIC Bargain List! 25¢ Coins Wanted! Nelson, 346-M, Rye, New York 10580.

DO-IT-YOURSELF

BURGLAR—Fire alarm systems and supplies. Free Catalog. Informer Mfg. 200B S. Eden Street, Baltimore, Maryland 21231.

PRACTICAL tips for home, garden and workshop are in "1001 How-To Ideas." Send \$1.00 for your copy includes Postage. to 1001 How-To Ideas, 229 Park Avenue South, New York, N. Y. 10003.

EDUCATION & INSTRUCTION

UNIVERSITY Degrees by mail. Via Thesis. Experience. Home study. Norman, Dept. 63, Box 3199, Pasadena, Calif. 91103.

FARMS, ACREAGE & REAL ESTATE

MICHIGAN 10 to 160 ACRE TRACTS Lake Superior—Marquette area from \$99.00 Acre. Cabins, trailers, camping welcome. (Acreage Anywhere in Michigan). FREE PICTURES. Any Terms A-OK with BLOCH BROTHERS, write 3650 Dixie, Drayton Plains, 44 Michigan 48020.

HI-FI EQUIPMENT

"CB Tranceivers, linear amplifiers Free Catalog. Echotronics, Box 1215, West Babylon, N. Y. 11704"

HOME WORKSHOP SUPPLIES

NEW Revolutionary Screwdriver with built in light complete with 4 blades, regular driver, Phillips types, drill and-awl, Batteries available locally \$1.65. Jose Pacheco, Box 1724, NYC 10027.

INVENTIONS WANTED

WE either sell your invention or pay cash bonus. Write for details. Universal Inventions, 298-3, Marion, Ohio 43302.

MISCELLANEOUS

BEAT the horses—blackjack—bingo. Free details. Cappie, Box 5986-EE, Lighthouse Point, Florida 33064.

MONEYMAKING OPPORTUNITIES

MAKE THOUSANDS OF DOLLARS, raising rabbits, cavies, Chinchillas for us. Complete information \$1.00. Keeney Brothers, New Freedom, Penna 17349.

MEN—WOMEN! Start money-making Plastic Lamination business at home in spare time. Material costing 1¢ brings back \$2.58. No canvassing or selling but mail orders bring in \$20.00 a day. Write for full particulars free. Rush name on postcard to Warner, Room LC-107-AL, 1512 Jarvis, Chicago, Ill. 60626.

MAKE YOUR CLASSIFIED AD PAY. Get "How To Write a Classified Ad That Pays." Includes certificate worth \$2.00 toward a classified ad in S & M. Send \$1.25 (includes postage) to R. S. Wayner, Science & Mechanics, 229 Park Avenue South, New York, New York 10003.

MAKE \$1.00 PER SALE selling engraved metal Social Security plates. FREE SALES KIT. Engravaplates, Box 10460-7503, Jacksonville, Fla. 32207.

\$\$\$ UNLIMITED Addressing, mailing Circulars! Details, send 8¢ stamp. Happy, Box 1161-DV, Battle Creek, Mich. 49016.

OF INTEREST TO WOMEN

NEW Improved Electric Toothbrush, includes 4 extra fine Nylon bristles, plus Travel Case, Vertical brushing action—uses standard batteries \$7.90 Jose Pacheco, Box 1724, NYC 10022.

\$\$\$ UNLIMITED Mailing circulars! Details, send self-addressed envelope. Fay's, 182 N. Wood St.—(DDL), Battle Creek, Michigan 49017.

PERSONAL

ELIMINATE Debts Without Borrowing! Particulars Free. Helper, P.O. Box 9308, No. Hollywood, California 91609.

PERSONAL

POTATO Diet. Others fail. This satisfies. \$2.00. Dot Bertram, 2425 Moraine, Santa Clara, California 95051.

There is no charge for the Zip Code. Please use it in your Classified ad.

PROFITABLE OCCUPATIONS

CHINCHILLA income guaranteed. Terms 25¢—Bulletin \$1.00, Rainbow, 11DC, Port Richey, Florida 33568.

RADIO & TELEVISION

RADIO & TV tubes 35¢. Free Catalog. Cornell, 4217 West University, San Diego, California 92105.

FREE electronics catalog. Tremendous bargains. Edu-Kits, Dept. C-548-DJ, Hewlett, New York 11557.

EXCITING Listening! Police—Fire—Emergency calls on your broadcast radio. \$19.95 up. Also receivers, scanners, dual-band high/low, crystals. Saich Company, Woodsboro 1, Texas 78393.

"DISTANCE Crystal Set Construction" Handbook—50¢. "20 Crystal Plans"—50¢. Catalog, Laboratories, 754-G Cordone, Reno, Nevada 89502.

SWAP QSL's, KRN-8291 \$1.00. 1971 Knob Ct. Cincinnati, Ohio U. S. A. 45225

MOTOROLA-RCA-HEP transistors and integrated circuits for Elementary Electronics projects. Write stating devices needed for prices—or send for free price sheet. Also instant printed circuit materials. Circuit Specialists, Box 3047, Scottsdale, Ariz. 85257.

OLD RADIO PROGRAMS on tape. Catalog 25¢. Radio Days Forever, R. D. 2, Box 123 McVeytown, Pa. 17051.

REMAILING SERVICE

SAVANNAH Remails 20¢, monthly \$3.00. Dewico, Box 13063, Savannah, Ga. 31406.

NEW YORK REMAILS 25¢ each—\$3.00 Monthly. Foreign Accounts Welcome. M. Cassidy, 2845 University, New York, N. Y. 10468.

LAS VEGAS Remails 25¢. Forwarding \$2.50 Month. Casino cards 12/\$2. Global, 558E Oakey, Las Vegas, Nevada 89105.

SPECIAL SERVICES

INFORMATION On Anything! Authoritative! \$2.00 (deductible). Metzler Research, Box 2206ME, Long Island City, New York 11102.

TREASURE FINDERS—PROSPECTING EQUIPMENT

"BOUNTY HUNTER" Metal detectors. Free details. Wilkinson, Box 1385-B, Gray, Pennsylvania 15544.

THERE IS NO CHARGE FOR THE ZIP CODE—PLEASE USE IT IN YOUR CLASSIFIED AD

How to become a “Non-Degree Engineer”



Exciting careers in the new industries of the Seventies are waiting for men with up-to-date electronics training. Thousands of real engineering jobs are being filled by men without engineering degrees — provided they are thoroughly trained in basic electronic theory and modern application. The pay is good, the future is bright...and the training can now be acquired at home — on your own time.

ELECTRONICS, the Science of the Seventies, has created a new breed of professional man—the non-degree engineer. Depending on the branch of electronics he's in, he may “ride herd” over a sophisticated computer installation, run a powerful TV transmitter, supervise a law enforcement communications control center or work side by side with distinguished scientists fighting pollution or doctors seeking a medical break-through.

But you do need to know more than soldering connections, testing circuits and replacing components. You need to really know the fundamentals of electronics.

How can you pick up this necessary knowledge? Many of today's non-degree engineers learned their electronics at home. In fact, some authorities feel that a home-study course is the *best* way. *Popular Electronics* said:

“By its very nature, home study develops your ability to analyze and extract information as well as to strengthen your sense of responsibility and initiative.”

CIE Method Makes It Easy

If you do decide to advance your career through home study, it's best to pick a school that *specializes* in the home-study method. Electronics is complicated enough without trying to learn it from texts and lessons that were designed for the classroom instead of the home.

Cleveland Institute of Electronics concentrates on home study exclusively. Over

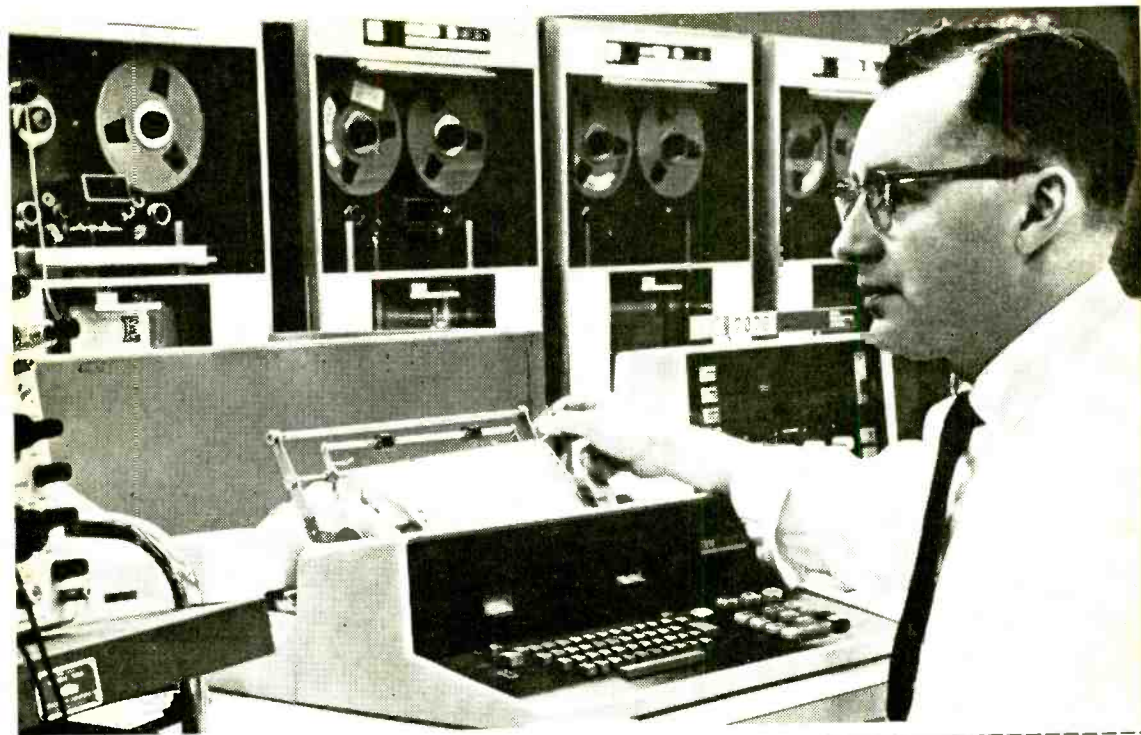

the last 35 years we have developed techniques that make learning at home easy, even if you once had trouble studying. Your instructor gives the lessons and questions you send in his undivided personal attention—it's like being the only student in his "class." He not only grades your work, he analyzes it. And he mails back his corrections and comments the same day he gets your lessons, so you read his notations while everything is still fresh in your mind.

Students who have taken other courses often comment on how much more they learn from CIE. Says Mark E. Newland of Santa Maria, California:

"Of 11 different correspondence courses I've taken, CIE's was the best prepared, most interesting and easiest to understand. I passed my 1st Class FCC exam after completing my course, and have increased my earnings by \$120 a month."

Always Up-To-Date

Because of rapid developments in electronics, CIE courses are constantly being revised. This year's courses include up-to-the-minute lessons in Microminiaturization, Laser Theory and Application, Suppressed Carrier Modulation, Single Sideband Techniques, Logical Trouble-shooting, Boolean Algebra, Pulse Theory, Solid-State Devices . . . and many more.

An FCC License . . . or Your Money Back
CIE'S AUTO-PROGRAMMED® Lessons are so successful that better than 9 out of 10 CIE graduates who take the FCC exam pass

it. This is despite the fact that, among non-CIE men, 2 out of every 3 who take the exam fail! That's why CIE can promise in writing to refund your tuition in full if you complete one of its FCC courses and fail to pass the licensing exam.

This Book Can Help You

Thousands who are advancing their electronics careers started by reading our famous book, "How To Succeed in Electronics." It tells of many non-degrec engineering jobs and other electronics careers open to men with the proper training. And it tells which courses of study best prepare you for the work you want.

Let us send you this 44-page book free. Just fill out and mail the attached postpaid card. Or, if the card is missing, mail the coupon, or write directly to: Cleveland Institute of Electronics, 1776 East 17th Street, Cleveland, Ohio 44114.

NEW COLLEGE-LEVEL CAREER COURSE FOR MEN WITH PRIOR EXPERIENCE IN ELECTRONICS

ELECTRONICS ENGINEERING . . . covers steady-state and transient network theory, solid-state physics and circuitry, pulse techniques, computer logic and mathematics through calculus. A college-level course for men already working in Electronics.

CIE Cleveland Institute of Electronics

1776 East 17th Street
Cleveland, Ohio 44114

Please send me without cost or obligation:
Your new illustrated 44-page book, "How To Succeed in Electronics."
Your book on "How To Get a Commercial FCC License."

I am especially interested in:

- Electronics Technology
- Electronics Technology with Laboratory
- Broadcast Engineering
- First Class FCC License
- Electronic Communications
- Industrial Electronics
- Electronics Engineering

Name _____ (please print)

Address _____

City _____

State _____

Zip _____ Age _____

- NEW REVISED G.I. BILL BENEFITS:** All CIE courses are approved for full tuition reimbursement under new G.I. Bill. If you served on active duty since January 31, 1955, OR are in service now, check box for G.I. Bill information.

Accredited Member
National Home Study Council

EL-30

If coupon has been removed, write to Cleveland Institute of Electronics
1776 E. 17th St., Cleveland, Ohio 44114

CIRCLE NO. 21 ON PAGE 17

BUILD YOUR OWN RADIO

Reg. U. S. Pat. Off.

and Electronics Circuits

PROGRESSIVE HOME RADIO-TV COURSE

Now Includes

- ★ 12 RECEIVERS
- ★ 3 TRANSMITTERS
- ★ SQ. WAVE GENERATOR
- ★ SIGNAL TRACER
- ★ AMPLIFIER
- ★ SIGNAL INJECTOR
- ★ CODE OSCILLATOR
- ★ No Knowledge of Radio Necessary
- ★ No Additional Parts or Tools Needed
- ★ EXCELLENT BACKGROUND FOR TV
- ★ SCHOOL INQUIRIES INVITED
- ★ Sold In 79 Countries



Training Electronics Technicians Since 1946

YOU DON'T HAVE TO SPEND HUNDREDS OF DOLLARS FOR A RADIO COURSE

The "Edu-Kit" offers you an outstanding PRACTICAL HOME RADIO COURSE at a rock-bottom price. Our Kit is designed to train Radio & Electronics Technicians, making use of the most modern methods of home training. You will learn radio theory, construction practice and servicing. THIS IS A COMPLETE RADIO COURSE IN EVERY DETAIL.

You will learn how to build radios, using regular schematics; how to wire and solder in a professional manner; how to service radios. You will work with the standard type of punched metal chassis as well as the latest development of Printed Circuit chassis. You will learn the basic principles of radio, using the standard type of RF and AF amplifiers and oscillators, detectors, rectifiers, test equipment. You will learn practice code, using the Progressive Code Oscillator. You will learn and work with trouble-shooting, using the Progressive Signal Tracer. You will learn and practice Progressive Dynamic Radio & Electronics Tester, Square Wave Generator and the accompanying instructional material.

You will receive training for the Novice, Technician and General Classes of F.C.C. Radio Amateur Licenses. You will build Receiver, Transmitter, Square Wave Generator, Code Oscillator, Signal Tracer and Signal Injector Circuits, and learn how to operate them. You will receive an excellent background for television, Hi-Fi and Electronics.

Absolutely no previous knowledge of radio or science is required. The "Edu-Kit" is the product of many years of teaching and engineering experience. The "Edu-Kit" will provide you with a basic education in Electronics and Radio, worth many times the low price you pay. The Signal Tracer alone is worth more than the price of the kit.

THE KIT FOR EVERYONE

You do not need the slightest background in radio or science. Whether you are interested in Radio & Electronics because you want an interesting hobby, a well paying business or a job with a future, you will find the "Edu-Kit" a worth-while investment. Many thousands of individuals of all

ages and backgrounds have successfully used the "Edu-Kit" in more than 79 countries of the world. The "Edu-Kit" has been carefully designed, step by step, so that you cannot make a mistake. The "Edu-Kit" allows you to teach yourself at your own rate. No instructor is necessary.

PROGRESSIVE TEACHING METHOD

The Progressive Radio "Edu-Kit" is the foremost educational radio kit in the world, and is universally accepted as the standard in the field of electronics training. The "Edu-Kit" uses the modern educational principle of "Learn by Doing." Therefore you construct, learn schematics, study theory, practice trouble shooting—all in a closely integrated program designed to provide an easily-learned, thorough and interesting background in radio. You begin by examining the various radio parts of the "Edu-Kit." You then learn the function, theory and wiring of these parts. Then you build a simple radio. With this first and trouble-shoot then you build a more advanced radio. Learn more advanced theory and techniques. Gradually, in a progressive manner, and at your own rate, you will professional Radio Technician.

Included in the "Edu-Kit" course are Receiver, Transmitter, Code Oscillator, Signal Tracer, Square Wave Generator and Signal Injector Circuits. These are not unprofessional "breadboard" experiments, but genuine radio circuits constructed by professional wiring and soldering on metal chassis, plus the new method of radio construction known as "Printed Circuitry." These circuits operate on your regular AC or DC house current.

THE "EDU-KIT" IS COMPLETE

You will receive all parts and instructions necessary to build twenty different radio and electronics circuits, each guaranteed to operate. Our Kits contain tubes, tube sockets, variable electrolytic, mica, ceramic and paper dielectric condensers, resistors, strays, selenium rectifiers, coils, volume controls and switches, etc.

In addition, you receive Printed Circuit materials, including Printed Circuit chassis, special tube sockets, hardware and instructions. You also receive a useful set of tools, a professional electric soldering iron, and a self-powered Dynamic Radio and Electronics Tester. The "Edu-Kit" also includes Code Instructions and the Progressive Code Oscillator, in addition to F.C.C. Radio Amateur License training. You will also receive lessons for Fidelity Guide and a Quiz Book, a Signal Tracer and the Progressive Signal Injector, a High Fidelity Service, Certificate of Merit and Discount Privileges. You receive all parts, tools, instructions, etc. Everything is yours to keep.

Progressive "Edu-Kits" Inc., 1189 Broadway, Dept. 551DJ, Hewlett, N.Y. 11557

UNCONDITIONAL MONEY-BACK GUARANTEE

Please rush my expanded "Edu-Kit" to me, as indicated below; Check one box to indicate choice of model

- Deluxe Model \$31.95
- New Expanded Model \$34.95 (Same as Deluxe Model Plus Television Servicing Course and valuable Radio & TV Tube Checker).

Check one box to indicate manner of payment

- I enclose full payment. Ship "Edu-Kit" post paid.
- I enclose \$5 deposit. Ship "Edu-Kit" C.O.D. for balance plus postage.
- Send me FREE additional information describing "Edu-Kit."

Name _____

Address _____

City & State _____

Zip _____

PROGRESSIVE "EDU-KITS" INC.

1189 Broadway, Dept. 551DJ, Hewlett, N. Y. 11557

FREE EXTRAS

- SET OF TOOLS
- SOLDERING IRON
- ELECTRONICS TESTER
- PLIERS-CUTTERS
- VALUABLE DISCOUNT CARD
- CERTIFICATE OF MERIT
- TESTER INSTRUCTION MANUAL
- HIGH FIDELITY GUIDE + QUIZZES
- TELEVISION BOOK + RADIO
- TROUBLE-SHOOTING BOOK
- MEMBERSHIP IN RADIO-TV CLUB: CONSULTATION SERVICE + FCC AMATEUR LICENSE TRAINING
- PRINTED CIRCUITRY

SERVICING LESSONS

You will learn trouble-shooting and servicing in a progressive manner. You will practice repairs on the sets that you construct. You will learn symptoms and causes of trouble in home, portable and car radios. You will learn how to use the professional Signal Tracer, the unique Signal Injector and the dynamic Radio & Electronics Tester. While you are learning in this practical way, you will be able to do many a repair job for your friends and neighbors, and charge fees which will far exceed the price of the "Edu-Kit." Our Consultation Service will help you with any technical problems you may have.

FROM OUR MAIL BAG

J. Statilatis, of 25 Poplar Pl., Waterbury, Conn., writes: "I have repaired several sets for my friends, and made money. The "Edu-Kit" paid for itself. I was ready to spend \$240 for a course, but I found your ad and sent for your kit."

Ben Valerio, P. O. Box 21, Magna, Utah: "The Edu-Kits are wonderful. Here I am sending you the questions and also the answers for them. I have been in the Radio for the last several years, but like to work with Radio kits and like to build Radio Testing Equipment. I employed every minute I worked with the different kits; the Signal Tracer works fine. Also like to let you know that I feel proud of becoming a member of your Radio-TV Club."

Robert L. Shuff, 1534 Monroe Ave., Huntington, W. Va.: "Thought I would drop you a few lines to say that I received my Edu-Kit, and was really amazed that such a bargain can be had at such a low price. I have already started repairing radios and phonographs. My friends were really surprised to see me get into the swing of it so quickly. The Trouble-shooting Tester that comes with the kit is really swell. It finds the trouble, if there is any to be found."

PRINTED CIRCUITRY

At no increase in price, the "Edu-Kit" now includes Printed Circuitry. You build a Printed Circuit Signal Injector, a unique servicing instrument that can detect many Radio and TV troubles. This revolutionary new technique of radio construction is now becoming popular in commercial radio and TV sets.

A Printed Circuit is a special insulated chassis on which has been deposited a conducting material which takes the place of wiring. The various parts are merely plugged in and soldered to terminals.

Printed Circuitry is the basis of modern Automation Electronics. A knowledge of this subject is a necessity today for anyone interested in Electronics.