

FUSES—The Blow that Saves You Money!

CC
elementary
MAY-JUNE
1971
75c
Electronics

**BASIC
COURSE**
Understanding
RC Circuits

INCLUDING *Science and Electronics*

**Get Your CB Signals
all put out!**

Match your antenna
to your receiver
and keep your
communications
out of hot soup!

THE FIRST

**Hi-Voltage
Solid-State
Receiver
Project**

Two transistor
BCB Regen circuit
operates off the
AC line like (as) a
table radio should!

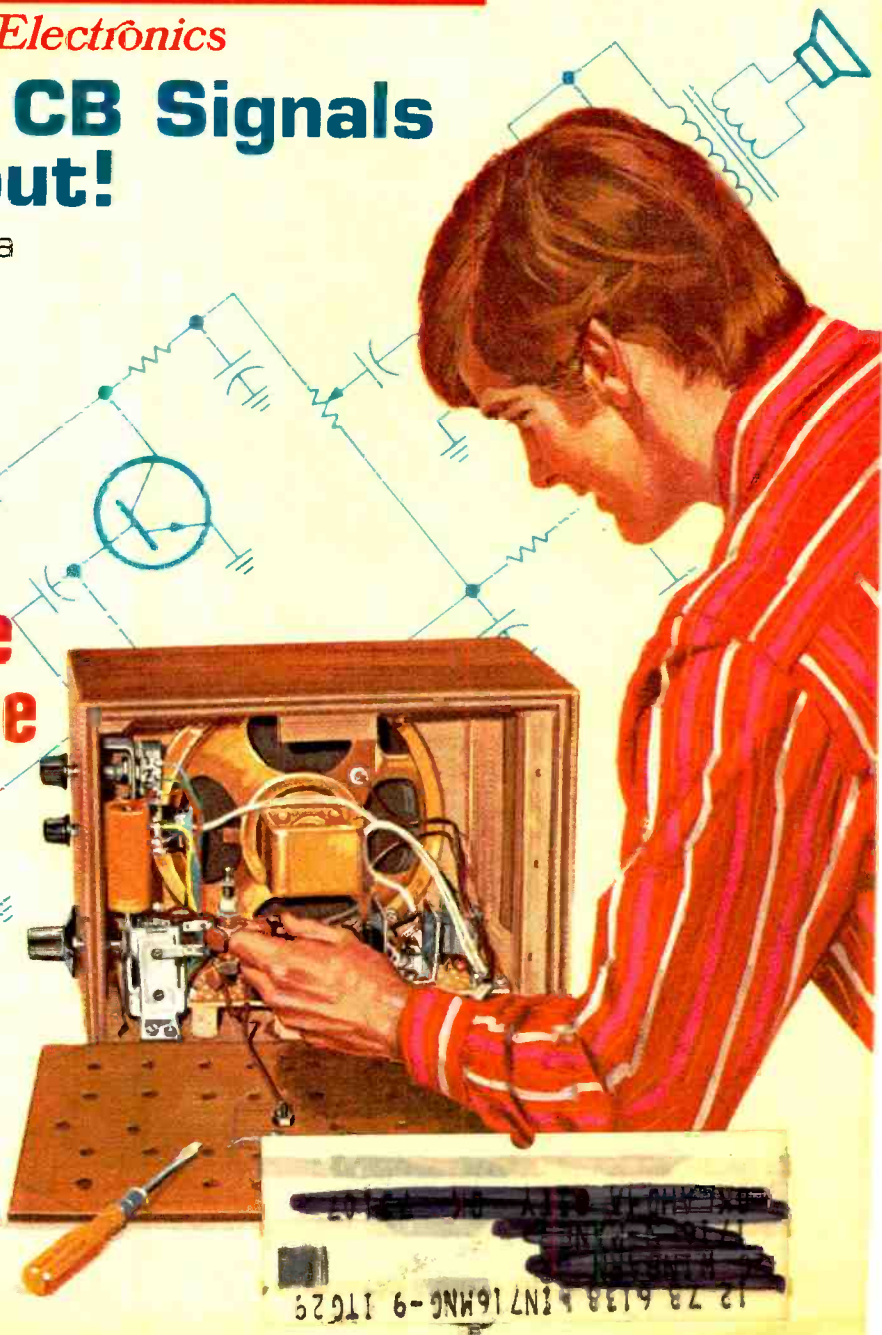

12 78 6138 4 IN716MNC-9 1TG29

Newest SAMS Books

Hi-Fi Stereo Servicing Guide

by ROBERT G. MIDDLETON. A complete guide to effective hi-fi and stereo servicing. Provides the basis for a full understanding of hi-fi tuner and amplifier circuitry and procedures for servicing this type of equipment. The proper use of audio test and measurement equipment and the basic principles of acoustics are also given. Covers all hi-fi components (except record players and tape recorders). Order 20785, only . . . \$3.95

ABC's of Avionics

by LEX PARRISH. Provides a basic understanding of avionics—the electronic equipment used to insure the safety of crew and passengers. The type of equipment and the techniques employed in private aircraft operations are featured. Discusses requirements for basic communications, navigation aids, instrument flight aids, weather guidance, and flight control safety devices. Order 20764, only . . . \$3.50

Mobile-Radio Systems Planning

by LEO G. SANDS. Here is practical, basic information about various types of mobile-radio systems, how they work, their capabilities and limitations, system requirements, licenses, channels, band and frequency selection, transmitter-receiver selection, antenna systems, and accessories. Includes an invaluable system-requirements form for planning a mobile-radio system. Order 20780, only . . . \$4.50

Transistor-TV Servicing Made Easy

by JACK DARR. This practical guide will help you become skilled in the special techniques of transistor-TV servicing. Covers tools and equipment required; transistors and transistor-servicing techniques; power supplies; horizontal and vertical sweep circuits; video i-f and output circuits; age and sync-separator problems; tuners; audio circuits; and selecting replacement transistors. Order 20776, only . . . \$4.95

Security Electronics

by JOHN E. CUNNINGHAM. Explains the operating principles of modern electronic devices and systems used to provide security against crime. Describes intrusion alarms and intrusion-detection devices. Includes chapters on the detection of hidden metal objects, announcement of detected intrusions, bugging, debugging, and speech-scrambling systems, and future developments. Order 20767, only . . . \$4.50

How to Hear, Police, Fire, and Aircraft Radio

by LEN BUCKWALTER. After World War II, police, fire, and aircraft radio moved to the less crowded vhf bands, and the "police band", which was found in many older radios, was silenced. Few listeners had receivers capable of covering the vhf band, because they were relatively expensive. With the advent of solid-state circuitry, a wide variety of relatively low-cost monitoring equipment is available. This book is a guide to the selection and use of vhf radio. Order 20781, only . . . \$3.50

101 Questions and Answers About Transistor Circuits

by LEO G. SANDS. Answers the most commonly asked questions about transistor circuitry. Explains transistor nomenclature, biasing, the three basic circuit configurations, input and output impedances, current and voltage gain, and other basic considerations. Covers power supplies and circuits; af circuits; rf circuits, and oscillators. Order 20782, only . . . \$3.50

1-2-3-4 Servicing Automobile Stereo

by FOREST H. BELT. This book first applies the ingenious "1-2-3-4" repair method to both mechanical and electrical equipment. It then proceeds to cover the electronic and mechanical principles of automobile stereo, fm multiplex and tape cartridge systems. Finally, the book shows how to apply the method to auto stereo systems. Order 20737, only . . . \$3.95

North American Radio-TV Station Guide, 6th Edition

by VANE A. JONES. Lists all radio and TV stations in the U.S., Canada, Mexico, and the West Indies. Includes operating a-m, fm, and television stations, as well as those that are about to start operating, or are temporarily off the air. Separate listings arranged by geographical location, frequency (or channel), and call letters make this guide the most useful one available. Order 20779, only . . . \$2.95



Aviation Electronics, 2nd Edition

by KEITH W. BOSE. This practical handbook for aircraft owners, pilots, technicians, and engineers explains the design, operation, and maintenance of aviation electronics equipment. Covers automatic direction-finders, distance-measuring equipment, omnirange, ATC transponders and weather radar, communications and instrument-landing systems, and related devices and systems used in aviation today. Order 20743, only . . . \$9.95

Questions & Answers on Short-Wave Listening

by H. CHARLES WOODRUFF. A helpful guide to the interesting world of listening afforded by short-wave receivers. Questions and answers cover international short-wave broadcasting, frequencies, and services; how short-wave is transmitted; how short-wave is received; and how short-wave receivers are constructed and operated. Order 20783, only . . . \$3.50

1-2-3-4 Servicing Transistor Color TV

by FOREST H. BELT. The "1-2-3-4 Method" is a simple, logical, step-by-step process that helps do the service job the right way and the easy way. In this book, the fundamentals of transistor color TV are covered, followed by a detailed explanation of how to apply the method for quick troubleshooting and easy repairs. Order 20777, only . . . \$4.95

HOWARD W. SAMS & CO., INC.

Order from your Electronic Parts Distributor, or mail to Howard W. Sams & Co., Inc., Dept. EE-041
4300 W. 62nd St., Indianapolis, Ind. 46268

Send books checked at right. \$ _____ enclosed
 Send FREE 1970 Sams Book Catalog

Name _____
Address _____
City _____ State _____ Zip _____

20785 20777
 20764 20767
 20780 20781
 20776 20782
 20743 20737
 20783 20779

CIRCLE NO. 1 ON PAGE 27

Your paycheck says a lot about you

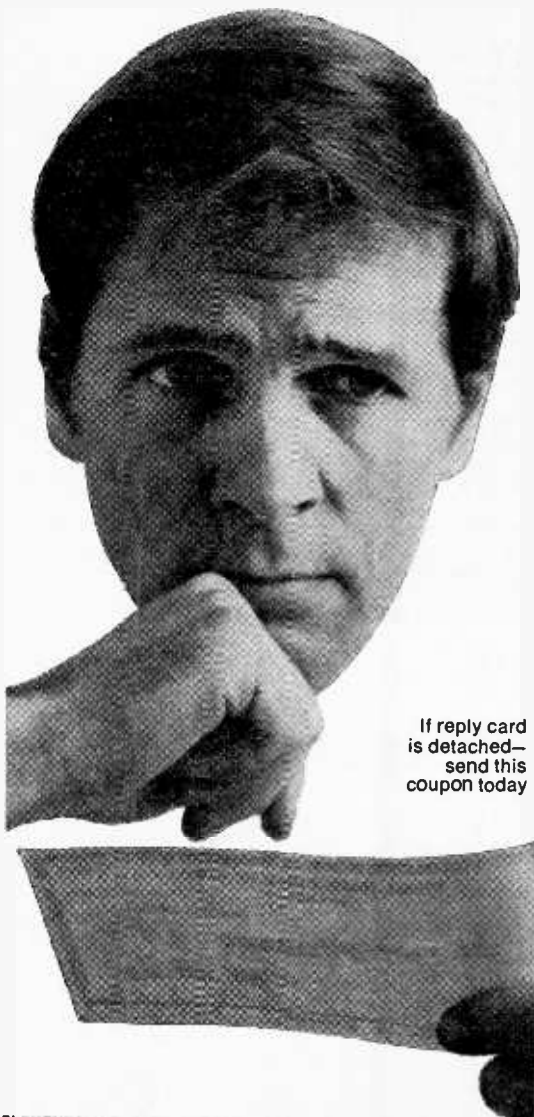

It tells you more than how much you make. It tells you how far you've come. And if your paycheck looks very much the same as it did last year, or the year before, it simply means that *you* look very much the same as *you* did last year and the year before.

But times change, and you should be changing with them. Old dull jobs are disappearing. New exciting ones are being created. There are challenging new fields that need electronics technicians...new careers such as computers, automation, television, space electronics where the work is interesting and the earnings are greater.

RCA Institutes has one of the nation's largest and most respected home study schools devoted to electronics. They can get you started even if you've had no previous training or experience. RCA Institutes has developed a faster, easier way for you to gain the skills and the knowledge you need for a fascinating, rewarding electronics career. And you don't have to quit work and go back to school. With RCA Institutes Home Study Plan you can do both. You set your *own* pace depending on *your* schedule.

Check over these RCA benefits:

- You get Hands-On Training—over 300 experiments and as many as 25 kits with some programs.
- You get RCA's unique "Autotext" method of learning—individual programmed instruction, the *easy, faster, simplified* way to learn!
- You get the widest choice of electronics courses and programs—everything from Electronics Fundamentals right up to Solid State Technology and Communications Electronics.
- You get a selection of low-cost tuition plans!

Sounds great, and it is! For complete information, without obligation, send in the attached postage card... or return the coupon below. That will say a lot about you.

Veterans: Train under new GI Bill. Accredited Member National Home Study Council. Licensed by N.Y. State—courses of study and instructional facilities approved by the State Education Department.

If reply card is detached—send this coupon today

RCA Institutes

Home Study Dept. 246-005-1
320 West 31st Street, New York, N.Y. 10001

Please rush me FREE illustrated catalog.
I understand that I am under no obligation.

Name _____ Age _____
(please print)

Address _____

City _____ State _____ Zip _____

Veterans: Check here

ELEMENTARY ELECTRONICS (Vol. 11, No. 2) is published bi-monthly by Science & Mechanics Publishing Co., at 229 Park Ave., S., New York, N.Y. 10003. One year subscription (six issues)—\$4.00 Second class postage paid at New York, N.Y. 10003 and at additional mailing offices.

CIRCLE NO. 2 ON PAGE 27



elementary Electronics

Dedicated to America's Electronics Hobbyists

- ☆ 29 **BONUS CONSTRUCTION PROJECT**
Mod Methuselah—a two transistor BCB regen rig that operates off the AC line like (as) a table radio should!
DX FEATURE FOR THE SWL-O-PHILE
- 10 DX Central—hot shortwave prospects from the Green Hell of Brazil
CONSTRUCTION PROJECTS FOR THE AUDIOPHILE
- 53 DMS—track down the gremlins in your stereo rig
- 59 U-Pick-It—twanging more now but enjoying it less? Here's an easily-built add-on that'll change a guitar's personality.
FROM e/e's CB DESK
- ☆ 37 Kathi's CB Carousel—the Lafayette Telsat SSB-25 reviewed
- 63 Get Your CB Signal All Put Out—boost your signal without spending a dime
ELECTRONICS 'ROUND THE WORLD
- 72 Pete's Car Gets The Message—it must be the ultimate bolt-on goody, eh chap?
- 74 Meet Midget Motors—Herr Leibl's motors are—jawohl—beetle sized
PROJECTS FOR THE BEGINNER
- 52 Clip Book Circuits—an ic active hum filter
- 76 Fuse Caddy—keep your fuses away from the tool box riffraff
FUNNYBONE FOIBLES
- 28 Technically Speaking—cartoon page
TOWARD A BETTER UNDERSTANDING
- ☆ 45 Fuses—The Blow That Saves You Money!
- 35 Frequency Is For Real—the sine wave, it turns out, is Nature's ever-changing constant
- 61 Discovering Prefixes and Exponents
- ☆ 77 Basic Course—understanding RC circuits
FEATURES FOR THE READER ON THE RUN
- 40 That Cop Is Your Dorm Buddy
- 42 Hey, Mr. Sandman—Gotch'a—the sweet dreams of youth may be telepathically yours
WHAT'S NEW AND DIFFERENT
- 14 Hey, Look Me Over—wallet teasin' workbench pleasers
- 24 Literature Library—eye zingers galore
- 57 e/e Checks Out the First Frequency Counter Kit—
- 75 e/e Checks Out a 4-Channel Stereo/Mono Mixer
- 94 Bookmark—by Bookworm
REGULAR DEPARTMENTS
- 8 Newscan—all that fits that's news to print
- 17 Ask Me Another—if you've got a question, we've got an answer
- 26 e/e Etymology—Berkelium, Decibel, Hall Effect explained
- ☆ 27 Reader Service Page—learn more about the products and services you've seen in this issue
- 93 Stamp Shack—pure philatronics
- 95 Great Men of Science—Augustus Kekule



Cover Highlights

Cover Art by Len Goldberg

AUTHORS IN THIS ISSUE

Walter S. Andariese, W2WLJ, Len Buckwalter, K1ODH, Herb Cohen, Norman Crawford, Steve Daniels, WB2GIF, Webb Garrison, Don Jensen, Ted Mann, Kathi Martin, Jack Schmidt, and the ELEMENTARY ELECTRONICS' editorial staff.



ROUND OUT YOUR TRAINING

266 ICS Courses



Earn more money, enjoy greater security and faster promotion—and gain all the satisfaction of doing a job well that you like to do. Check the list of 266 ICS career opportunities for a better future. You receive individual

instruction, success-proved training you can apply immediately. And you earn the famous ICS diploma. Don't waste time! Send the coupon today for FREE information on a brighter career the ICS way!



LEADERS IN THE ICS SUCCESS PARADE . . .

Automobile Engine Tune-Up
Introduction to Programming the IBM System/360 Computer
Business Administration Accounting
Civil Engineering
Practical Electrician

ACCOUNTING
Accounting (U.S.A.)
Accounting (Canadian)
Accounting for Business Programmers
Accounting for Man'g'm't Decisions
Auditing
Business Law (U.S.A.)
Canadian Business Courses
Cost Accounting
CPA Review (U.S.A.)
General Accounting
Income Tax (U.S.A.)
Industrial Accounting
Junior Accounting
Office Accounting
Practical Accounting
Public Accounting
Small Business Accounting (U.S.A.)
Starting and Managing a Small Bookkeeping Service (U.S.A.)

ARCHITECTURE AND BUILDING
Architectural Drawing and Designing
Architecture
Building Contractor
Building Estimator
Building Inspector
Building Maintenance
Carpenter-Building
Carpentry and Millwork
House Planning and Interior Design
Mason Painting Contractor
Reading Arch. Blueprints

ART
Amateur Artist
Commercial Art
Commercial Cartooning
Illustrating with Options: Magazine
Advertising Layout and Illustration
Interior Decorating
Oil Painting for Pleasure

Radio-TV Servicing
Architectural Drafting
High School Courses
High School Equivalency
Refrigeration and Air Conditioning
Aircraft and Power Plant Mechanics

Show Card and Sign Prod. Show Card Writing
Sign Painting & Designing
Sketching and Painting

AUTOMOTIVE
Automatic Transmission Specialist
Automobile Air Conditioning Specialist
Automobile Body Rebuilding & Refinishing
Automobile Engine Tune-Up
Automobile Mechanic
Automobile Technician
Diesel-Gas Motor Vehicle Engines

BUSINESS
Advertising
Business Administration
Business Practice (Cond.)
Canadian Business Course
Direct Mail and Mail Order Advertising
Industrial Psychology
Inventory Control
Magazine & Newspaper Advertising
Managing a Retail Business
Managing a Small Store
Marketing Management
Marketing Research
Modern Exec. Management
Office Automation
Office Management
Production Management
Purchasing Agent
Retail & Local Advertising
Retail Bus. Management
Retail Merchandising
Retail Selling
Systems and Procedures Analysis

BUSINESS: SALES
Creative-Salesmanship
Real Estate Salesmanship
Salesmanship
Sales Management

BUSINESS: SUPERVISION
Advanced Management
Basic Management
Industrial Foremanship
Industrial Supervision
Management, Salesmanship and Sales
Modern Woman as a Supervisor
Personality Development
Personnel-Labor Relations (U.S.A.)
Supervision

CHEMICAL
Chemical Analyst
Chemical Engineering
Chemical Laboratory Techn.
Chemical Process Equip. Design & Operation
Chemical Process Operator
Elements of Nuclear Energy
General Chemistry
Instrumental Laboratory Analysis

CIVIL ENGINEERING
Civil Engineering
Construction Eng'r'g Tech.
Highway Engineering Tech.
General Chemistry
Reading Highway Bl'prints
Reading Structural Bl'prints
Sanitary Engineering Tech.
Sewage Plant Operator
Structural Eng'r'g Tech.
Surveying and Mapping
Water Works Operator

COMPUTERS
Fundamentals of Computer Programming
COBOL Programming
Fortran Programming for Engineers
Programming for Digital Computers
Programming the IBM 1401 Computer
Programming the IBM System/360 Computer, Introduction

DRAFTING
Aircraft Drafting
Architectural Drafting
Design Drafting
Orbiting Technology
Electrical Drafting
Electronic Drafting
Introductory Mech. Drafting
Mechanical Drafting
Pressure-Vessel and Tank Print Reading

Sheet Metal Layout for
Conditioning
Structural Drafting

ELECTRICAL
Electrical Engineering
Electronics Option
Power Option
Electrical Appliance Ser. with Equipment Training
Electrical Contractor
Electrical Engineering Tech.
Electrical Home Maint. with Equipment Training
Electrical Instrument Tech.
Electric Motor Repairman
Industrial Electrical Tech.
Industrial Electrician
Industrial Maintenance Electrician
Power-Line Design and Construction
Power Plant Operator
Hydro Option
Steam Option
Practical Electrician with Equipment Training
Practical Lineman
Reading Elec. Blueprints

ENGLISH AND WRITING
Better Business Writing
English for Spanish (U.S.A.)
Free Lance Writing for Fun and Profit
Introductory Tech. Writing
Modern Letter Writing
Practical English
Reading Improvement
Short Story Writing

HIGH SCHOOL
High School Business
High School (Canadian)
High School General
High School Mathematics
High School Secretarial
High School Vocational
High School College Preparatory—Arts
Engineering and Science
Preparatory Course for High School Equivalency Test

MACHINE SHOP PRACTICE
Grinder Operator
Introductory Metallurgy
Lathe Operator
Machine Shop Inspection
Machine Shop Practice

Metallurgical Eng'r'g Tech.
Mechanic
Practical Millwrighting
Reading Shop Prints
Rigging
Tool & Die Making
Tool Engineering Tech.
Welding Engineering Tech.
Welding Process

MATHEMATICS
Advanced Mathematics
Math and Mechanics for Engineering Technicians
Math and Physics for Engineering Technicians
Modern Elementary Statistics

MECHANICAL
Mechanical Engineering
Aircraft and Power Plant Mechanic
Hydraulic and Pneumatic Power
Industrial Engineering
Industrial Eng'r'g Tech.
Industrial Instrumentation
Machine Design
Quality Control
Safety Engineering Tech.
Tool Design
Vibration Analysis and Control

PETROLEUM
Natural Gas Production and Transmission
Oil Well Servicing
Petroleum Production Operator
Petroleum Production Engineering Technology
Petroleum Refinery Oper.

PLASTICS
Plastics Technician

PLUMBING, HEATING AND AIR CONDITIONING
Air Conditioning
Air Conditioning Maint.
Domestic Heating with Gas and Oil
Heating
Heating & Air Conditioning with Drawing
Industrial Air Conditioning
Pipe Fitting
Plumbing and Heating
Plumbing & Heating Est.
Practical Plumbing
Refrigeration and Air Conditioning Servicing

PULP AND PAPER
Paper Machine Operator
Paper Making
Pulp Making
Pulp & Paper Eng'r'g Tech.

SECRETARIAL
Clerk-Typist
Commercial Secretary, Engineering Sec'y, Legal Sec'y, Medical Secretary, Professional Shorthand
Stenographic Typewriting

STEAM AND DIESEL POWER
Boiler Inspector
Industrial Building Eng'r
Power Plant Engineering
Stationary Diesel Engines
Stationary Fireman
Stationary Steam Eng'r'g

TEXTILES
Carding and Spinning
Dyeing and Finishing
Loom Fixing
Textile Designing
Textile Mill Superintendent
Textile Mill Supervision

TRAFFIC
Motor Traffic Management
Traffic Management

TV-RADIO-ELECTRONICS
Cable TV Installer
Electronics Technician
Fundamentals of Electronic Computers
General Electronics with Equipment Training
Hi-Fi Stereo and Sound System Servicing
Industrial Electronics
Numerical Control
Electronics & Maint.
Radio & TV Servicing with Equipment Training
Solid State Electronics
Telephony

APPROVED FOR VETERANS FOR TUITION REFUND
Accredited member, National Home Study Council.
Easy pay-as-you-learn plan.
Special rates to members U.S. Armed Forces.

ICS
International
Correspondence
Schools
Division of Intext

ICS, Scranton, Pa. 18515
Canadian residents: Send coupon to Scranton. Our affiliate in Canada will reply.

TAKE YOUR FIRST STEP . . . MAIL THIS COUPON TODAY—ICS, SCRANTON, PA. 18515 8M058D

I'm interested in a program of independent study. Send me, without cost, your booklet on the principles of success, sample text demonstrating famous ICS method, and your catalog for _____ (Print name of course. See list.)

Miss _____ Age _____
Mrs. _____ Age _____
Mr. _____ Age _____

Address _____ Apt. _____

City _____ State _____ Zip Code _____

Occupation _____ Employed by _____ Working Hours _____ A.M. to _____ P.M.

CIRCLE NO. 3 ON PAGE 27

KEEP PACE WITH SPACE AGE! SEE SPACE FLIGHTS, LANDINGS CLOSE UP!

AMAZING SCIENCE BUYS for FUN, STUDY or PROFIT

HELIUM BALLOONS MAKE A "BALL"



Anytime there's a balloon the air is festive. Especially when the "air" is helium, which makes a balloon peppy and adventurous. Now here's 25 times the fun—25 various colored balloons of 4, 5, or 6" diameter when inflated. With them, a pressurized (300 lbs./sq. in.) can containing 25 liters of helium to inflate all 25. For adults or kids' parties, giveaways, bazaars or just demonstrating "lighter than air". Helium is a safe non-toxic inert gas. Stock No. 71,289EK \$3.00 Ppd.

WHAT GOOD IS A DEAD BATTERY?

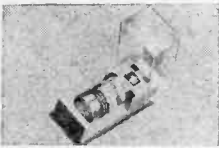

No good! So a genius invented this imported portable (2" x 4 1/2" x 1 3/4") Battery Tester whose built-in meter tells you at a glance if a battery is good, weak or should be replaced. Now it's a simple matter to check a flashlight or battery-operated toy and avoid frustration. Tester works without clips, wires or light attachments, and can be used for any "D", "C" or penlight 1.5 volt cells and 3 volt transistor radio battery. Instructions included. Stock No. 60,812EK \$5.00 Ppd.

JUST PRESS . . . AND COLORS "BLOOM"!



Liquid crystal pressure disc puts world of color under your thumb. Just press . . . and presto—full spectrum of colors magically bloom in ever changing shapeless patterns. More pressure—deeper the color. Change viewing angle—colors change again. The secret's the amazing liquid crystal—sealed in vinyl & 3" sq. plexiglass disc. Look like liquid—have structure of crystal. Great conversation piece, fantastic coaster, your own portable "wet show". Stock No. 41,272EK \$2.25 Ppd.

BE CREATIVE IN 3-D



Special-Art Kit spurs the imagination to run wild, creating 3-D shapes from 2-D Quads and Deltas. 140 3", 4 3/4" and 7 1/4" rings perforated on ten sturdy 12 1/2" sq. paper sheets scored for folding. Add color with paints, paper, glue-on sparkles, texture with dollies or lace over openings. Make lamp shades, Japanese lanterns, masks. Expressive experience from K to 9, challenging to artists. Complete instructions included. Stock No. 71,397EK \$3.50 Ppd.

1ST LOW-COST VACUUM PUMP!



Nothing like it! Top-quality hand-held pump produces & maintains 27" of vacuum. Has instant release tap, 1 3/4" diam. stainless gauge (0-30"). 100's of uses—siphon noxious fluids, evacuate bell jars and casting, clear retieves, lift sterile objects, demonstrate Mardeburg hemispheres, bleed fuel lines, check leaks, etc. Lifters (2 1/2" diam. cup)—much more w/ larger cup. Stock No. 71,301EK \$12.00 Ppd. No. 71,300EK (without gauge lifter) \$5.50 Ppd.

BIG BARGAIN CORNER



Unique and fascinating low-cost items include pen to read & write in dark; world's highest flying inflatable kite; 128 decal stars that glow; challenging hand puzzle; weather instr. that shows wind dir., speed, temp. & records rain-fall for week, month, year. Nitewriter Pen No. 1,928EK \$2.25 Ppd. Puffer Kite No. 41,279EK \$2.25 Ppd. Stars That Glow No. 9,298EK \$1.50 Ppd. Looney Loop Puzzle \$2.00 Ppd. No. 60,817EK \$2.00 Ppd. Weather Gauge No. 50,259EK \$2.00 Ppd.

Visit Our Factory Retail Store! 5 min. from N.J. Turnpike Exit #3. 15 Min. to Phila. 4,000 Unusual Bargains. Exclusive Store Items. Store Hours—8-5:30.

Order by Stock No.—Check or M.O.—Money-Back Guarantee
EDMUND SCIENTIFIC CO., 300 EDCORP BLDG., BARRINGTON, N.J. 08007



WRITE FOR FREE GIANT CATALOG 148 PAGES!—1000's OF BARGAINS

EDMUND SCIENTIFIC CO., 300 EDCORP BLDG., BARRINGTON, NEW JERSEY 08007. Completely new edition. New items, categories, illustrations. Dozens of electrical and electromagnetics parts, necessities. Enormous selection of unique lighting items. Astronomical Telescopes, Microscopes, Binoculars, Magnifiers, Magnets, Lasers, Lenses, Prisms. Many war surplus items: for hobbyists, experimenters, workshop, factory. WRITE FOR CATALOG "EK."

EDMUND SCIENTIFIC CO. 300 EDCORP BLDG., BARRINGTON, NEW JERSEY 08007
ORDER BY STOCK NUMBER • SEND CHECK OR MONEY ORDER • MONEY-BACK GUARANTEE

CIRCLE NO. 4 ON PAGE 27

elementary Electronics

INCLUDING SCIENCE AND ELECTRONICS

May/June 1971 Vol. 11/No. 2
Dedicated to America's Electronics Hobbyists

Editor-in-Chief

JULIAN M. SIENKIEWICZ, WA2CQL

Associate Editor

ROBERT WOLLINS

Technical Editor

STEPHEN B. GRAY

Citizens Band Editor

KATHI MARTIN, KA1Ø614

News Editor

CAROL J. BRUCKNER

Art Editor and Art Director

JIM MEDLER

Cover Art Director

IRVING BERNSTEIN

Assistant Art Director

ANDY STEIGMEIER

Art Associate

BARBARA ALTMAN

ANTONY BARONOWSKI

Advertising Director

DAVID J. MILLER

Production Director

CARL BARTEE

Production Manager

GERTRUD BORCHARDT

Assistant Production Manager

MARILYN VARGAS

Subscription and Marketing Manager

ROGER G. CAVANAGH

Newsstand Circulation Director

DON GABREE

Instruments Division Manager

WILFRED M. BROWN

Chairman of the Board

B. G. DAVIS

President and Publisher

JOEL DAVIS

Vice-President and General Manager

LEONARD F. PINTO

Vice President and Treasurer

VICTOR C. STABLE, KBØ681

ELEMENTARY ELECTRONICS is published bi-monthly by Science & Mechanics Publishing Co., a subsidiary of Davis Publications, Inc. Editorial, Business and Subscription offices: 229 Park Avenue South, New York, N.Y. 10003. One-year subscription (six issues)—\$4.50; two-year subscription (12 issues)—\$9.00; three-year subscription (18 issues)—\$13.00; and four year subscription (24 issues)—\$17.00. Add \$1.00 per year for postage outside the U.S.A. and Canada. Advertising offices: New York, 229 Park Avenue South, 212-OR 3-1300; Chicago, 520 N. Michigan Ave., 312-527-0330; Los Angeles, J. E. Publishers' Rep. Co., 8560 Sunset Blvd., 213-659-3810; Long Island: Len Osten, 9 Garden Street, Great Neck, N.Y., 516-487-3305; Southwestern advertising representative: Jim Wright, 818 Olive St., St. Louis, 314-CH-1-1965. Second-class postage paid at New York, N.Y. and at additional mailing office. Copyright 1971 by Science and Mechanics Publishing Co.

ELEMENTARY ELECTRONICS

Only RCA Institutes offers you all these advantages:

1 A broad range of courses to help you qualify for good-paying jobs in such rewarding fields as communications, color TV servicing, automation, nuclear instrumentation, space electronics, drafting, computer programming.

2 RCA's exclusive Autotext training method—the easy, faster, simplified way to learn electronics at home.

3 Personal supervision throughout your training.

4 Over 300 experiments and up to 25 kits in some programs

5 Easy monthly payment plan.

6 Over 60 years of leadership in technical training.

7 Recognition from leaders in the field as an RCA Institutes graduate.

All courses approved for veterans. Licensed by the State of New York. Accredited Member National Home Study Council.

Courses available in Canada too.

If you've ever thought about getting into electronics... you owe it to yourself to see what RCA home training has to offer.

This entire fold-over coupon makes a no-postage-required business-reply envelope. Fill in your name and address ...then cut out along dotted lines...fold, seal and mail.

246-005-9

RCA INSTITUTES, Inc., Home Study School
320 West 31st St., New York, N. Y. 10001

Please send me free illustrated home study career catalog.

Name _____ Age _____

(please print)

Address _____

City _____ State _____ Zip _____

- Check here if interested in Classroom Training.
 Veterans check here

NO STAMP NEEDED

You must seal (Staple, tape or glue) before mailing.

FOLD HERE

DO NOT CUT HERE

FIRST CLASS

Permit No. 10662
New York, N. Y.

BUSINESS REPLY MAIL

No Postage Necessary if Mailed in United States

Postage will be paid by

RCA INSTITUTES

Home Study School
320 West 31st St.
New York, N. Y. 10001

246-005-9

CIRCLE NO. 5 ON PAGE 27

**EXAMINE ANY OF THESE
FINE NEW BOOKS ON
10-DAY FREE TRIAL!**



COMPUTERS, ENGINEERING, BROADCAST

- Computer Circuits & How They Work—192 pgs.—\$4.95
- Solid-State Circuit Design & Operation—Hardbound \$9.95
- Pulse & Switching Circuits—256 pgs.—\$4.95
- Electronics Reference Databook—224 pgs.—\$4.95
- Transistor Circuit Guidebook—224 pgs.—\$4.95
- Computer Technician's Handbook—480 pgs.—\$7.95
- Electronic Designer's Handbook—294 pgs.—Hardbound \$9.95
- Circuit Consultant's Casebook—224 pgs.—Hardbound \$9.95
- CATV System Engineering—3rd Edition—Hardbound \$12.95
- The Man Behind The Mike—288 pgs.—Hardbound \$7.95

AUDIO AND HI-FI

- Servicing Modern Hi-Fi Stereo Systems—236 pgs.—\$4.95
- Handbook of Magnetic Recording—192 pgs.—\$4.95
- Installing & Servicing Home Audio Systems—256 pgs.—\$4.95
- Tape Recording for Fun & Profit—224 pgs.—\$4.95
- Audio Systems Handbook—192 pgs.—\$4.95
- Electronic Musical Instruments—192 pgs.—\$4.95
- Servicing Electronic Organs—196 pgs., 8 1/2 x 11—\$7.95

SEMICONDUCTORS & TEST EQUIPMENT

- Understanding Solid-State Circuits—192 pgs.—\$4.95
- 1970 Popular Tube/Transistor Substitution Guide—\$2.95
- Semiconductors From A to Z—272 pgs.—\$4.95
- PET Applications Handbook—2nd Ed.—Hardbound \$14.95
- Electronic Test & Measurement Handbook—224 pgs.—\$4.95
- The Oscilloscope—3rd Ed.—256 pgs.—\$4.95
- How to Use Test Instruments in Electronics Servicing—\$4.95
- 99 Ways to Use Your Oscilloscope—192 pgs.—\$4.95
- Working With the Oscilloscope—104 pgs., 8 1/2 x 11—\$4.95

BASIC ELECTRONICS, HOBBY & HAM RADIO

- 125 One-Transistor Projects—192 pgs.—\$3.95
- 104 Easy Projects for the Electronics Gadgeteer—\$3.95
- CB Radio Operator's Guide—224 pgs.—\$3.95
- Basic Electronics Problems Solved—192 pgs.—\$4.95
- 64 Hobby Projects for Home & Car—192 pgs.—\$3.95
- 104 Simple One-Tube Projects—192 pgs.—\$3.95
- Electronic Hobbyist's IC Project Handbook—160 pgs.—\$3.95
- 104 Easy Transistor Projects You Can Build—224 pgs.—\$3.95
- Simple Transistor Projects for Hobbyists & Students—\$4.95
- How to Read Electronic Circuit Diagrams—210 pgs.—\$3.95
- Radio Control Handbook—New 3rd Ed.—320 pgs.—\$5.95
- Beginner's Guide to TV Repair—160 pgs.—\$3.95
- Electronic Hobbyist's IC Project Handbook—160 pgs.—\$3.95
- How to Use Your VOM-VTVM & Oscilloscope—192 pgs.—\$3.95
- Amateur Radio Advanced Class License Study Guide—\$3.95
- Ham Radio Incentive Licensing Guide—160 pgs.—\$3.95
- 104 Ham Radio Projects for Novice & Technician—\$3.95
- VHF Ham Radio Handbook—176 pgs.—\$3.95
- Amateur Radio Extra-Class License Study Guide—\$4.95

SERVICING COLOR TV, RADIO & APPLIANCES

- Home-Call TV Repair Guide—144 pgs.—\$2.95
- How to Repair Solid-State Imports—160 pgs.—\$4.95
- Small Appliance Repair Guide—224 pgs.—\$4.95
- 101 TV Troubles—From Symptom to Repair—224 pgs.—\$4.95
- How to Repair Home & Auto Air Conditioners—208 pgs.—\$4.95
- How to Fix Transistor Radios & Printed Circuits—\$4.95
- Easy Way to Service Radio Receivers—176 pgs.—\$3.95
- Servicing the Solid-State Chassis—256 pgs.—\$4.95
- On the Color TV Service Bench—192 pgs.—\$4.95
- Sylvania Color TV Service Manual—196 pgs., 8 1/2 x 11—\$4.95
- G. E. Color TV Service Manual—196 pgs., 8 1/2 x 11—\$4.95
- Magnavox Color TV Service Manual—196 pgs., 8 1/2 x 11—\$4.95
- Philco Color TV Service Manual—196 pgs., 8 1/2 x 11—\$4.95
- Motorola Color TV Service Manual—178 pgs., 8 1/2 x 11—\$4.95
- Zenith Color TV Service Manual—196 pgs., 8 1/2 x 11—\$4.95
- RCA Color TV Service Manual—212 pgs., 8 1/2 x 11—\$4.95
- Admiral Color TV Service Manual—160 pgs., 8 1/2 x 11—\$4.95

SEE THESE HELPFUL BOOKS AT YOUR PARTS DISTRIBUTORS', OR CLIP THIS AD AND order on FREE 10-DAY Trial, or attach payment and save postage. Fully guaranteed or money back!

TAB BOOKS
BLUE RIDGE SUMMIT, PA. 17214

EL-51

CIRCLE NO. 6 ON PAGE 27

newscan

Electronics in the News!

Flaw It

Two physicists at the IBM development laboratory in San Jose, Calif., have found a shortcut for pinpointing the location of microscopic flaws that might cause computer disks to be rejected during testing. Until recently, flaws capable of causing recording errors were easily found and identified. As data became more densely packed on the disk, flaws previously too small to cause recording problems became significant, creating the need for new analytical approaches.

This technique, which makes use of a specially designed scanning electron microscope, finds surface defects on the disk in minutes instead of the hours or days typically encountered with other methods. In addition, characteristics such as the size and shape of the flaws can be seen on the screen of a cathode-ray tube. The approach could prove useful in the development of future disk coatings by allowing a fast comparison of new compositions and their ability

(Continued on page 96)

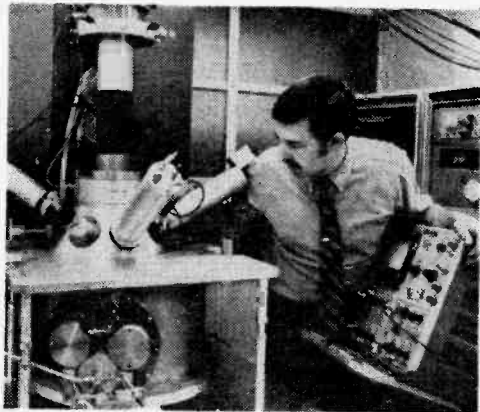

This IBM experimental microscope quickly locates microscopic flaws that might cause memory disks to be rejected during tests for magnetic recording errors. The approach also provides analytical information about a defect that with present methods can only be obtained by laboriously cutting small samples from the disk. Here, a technician focuses the electron beam that scans the flaw area. Electrons emitted from this area are captured by three detectors, and then converted to an image of the flaw that can be seen as a CRT display.

ELEMENTARY ELECTRONICS

If we knew you were coming, we'd have filled out your form.



And you'd get a guaranteed car.

When we know you're coming, we guarantee you a car and get you to that car the fastest way possible. That means most of the time-consuming paper work that used to be done

at the counter is filled out in advance.

We call this new reservation service Travelmax. You just call National: 800-328-4567, toll free. Call anytime, from any place, to guarantee a car anywhere.

We always know where every one of our cars is, thanks to Max,

our computer. So when we tell you a car is going to be there, you know it's going to be there.

Ride with us and be number 1
It's a great feeling!

NATIONAL CAR RENTAL

- Guaranteed, computerized reservations.
- 2400 U.S. and international locations. *Tilden-Rent-A-Car in Canada.
- S&H Green Stamps.
- We feature GM cars: Chevrolet, Pontiac, Oldsmobile, Buick and Cadillac.
- 800-328-4567 toll free.



© National Car Rental System, Inc. 1971

LAFAYETTE

RADIO ELECTRONICS

Free! Golden Jubilee Edition
1971 Catalog

468 PAGES



Stereo Hi-Fi ■ Citizens Band
■ Ham Gear ■ Tape Record-
ers ■ Test Equipment ■ TV
and Radio Tubes and Parts
■ Cameras ■ Auto Acces-
sories ■ Musical Instruments
■ Tools ■ Books

from the "World's Hi-Fi & Electronics Center"

Everything in Electronics for

■ HOME ■ INDUSTRY ■ LABORATORY

Lafayette Radio Electronics
Dept. 25031, P.O. Box 10
Syosset, L.I., N.Y. 11791

Send me my FREE Golden Jubilee Edition 1971 Catalog

25061

Name

Address

City

State

Zip

CIRCLE NO. 7 ON PAGE 27

FIND BURIED TREASURE

Powerful electronic detector
finds buried gold, silver,
coins, etc. 5 new models.
Write for free catalog.



RELCO, Dept. D-58 19⁹⁵

BOX 10839, HOUSTON, TEX. 77018

CIRCLE NO. 8 ON PAGE 27

PARTS! CORNELL TUBES!

FREE Send For FREE

CORNELL'S
New Color
Catalog

40 Pgs. New Items

33¢ per tube

IN LOTS OF 100

36¢ per tube

ORDER FREE
IF NOT SHIPPED
IN 24 HOURS!

4219 E. UNIVERSITY AVE. SAN DIEGO, CALIF. 92105

CIRCLE NO. 9 ON PAGE 27

"LISTEN IN" TO POLICE-FIRE RADIO CALLS IN YOUR CAR!

WORKS with ANY CAR—Portable or HOME
RADIO! Just PLUGS in—No wiring—1
minute hookup! Switch instantly from
regular to ALL POLICE-FIRE-EMERGEN-
CY-COMMERCIAL-TAXICAB-STATE-CITY-
GOV'T 2 way Radio calls in YOUR AREA!
DUAL-HI-LOW BANDS—38/50-150/175
MHz. OVER a MILLION Radio Cars/stations.
USE Everywhere—Anytime—always works!

SEND ONLY \$2.00 (cash Ck. M.O.) and pay post-
man \$7.99 plus COD pkg or send
\$9.99 for ppd Del in U.S. COMPLETE, ready to use with in-
structions. One Year service Warranty—10 DAY MONEY BACK
TRIAL (if rental) AMAZING OFFER (good only by mail—
WESTERN RADIO Dept. BE-5, NEARNEY, NEBR. 68847



CIRCLE NO. 10 ON PAGE 27

DX central reporting

A world of SWL info!

BY DON JENSEN

Brazil's Amazon basin is one of the last un-
explored frontiers. It is huge by any stand-
ards. Take most of the U.S. west of the Rockies,
toss in Alaska for good measure, and you'd still
have an area smaller than Brazil's Green Hell!
It is a wild land of tropical rainforests, inky
black and emerald-colored rivers and untamed
savages.

For about five years, the Brazilian govern-
ment has been seriously trying to open up this
untapped wilderness. Prospectors, ranchers, ad-
venturers and poor homesteaders from the
south have moved into the area, but still the
Amazon basin remains one of the most exotic
and least known corners of the world.

With more than 190 shortwave stations,
Brazil is a "radio-active" paradise for DXers.
But since it is virtually impossible to log all
these outlets, it's more fun to select a small
group, such as the Green Hell broadcasters, to
go after. Their programs, of course, are in
Portuguese, but they are tempting targets for
the venturesome SWL.

Gateway to the region is a beautiful river
town known officially as *A Cidade de Nossa
Senhora do Belem do Gran Para*—the city
of Our Lady of Bethlehem of the Great
River. The river, of course, is the Amazon, and
the city, 90 miles from the open Atlantic, is
usually called, simply, Belem.

Belem has two shortwave stations which can

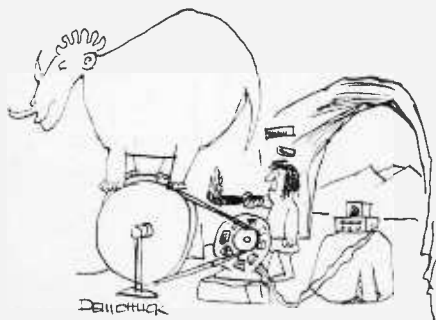

be heard by North American listeners. The more commonly logged is Radio Marajoara, which operated on 19 meters with a 10-kilowatt transmitter. Its name derives from the large island, Marajo, in the Amazon delta. The second station is Tadio Clube do Para, in the 60-meter band, which also has been heard by DXers recently. Para, by the way, is an alternate name for Belem.

Though not actually in Amazon country, Brasilia is the start of the overland route through the Green Hell. From the ten-year-old Brazilian capital snake two important roads into the wilderness, one almost due north to Belem, the other northwestward to Porto Velho and beyond.

The DXer's target here is Radio Nacional de Brasilia, a government operation that utilizes several frequencies. On occasion, the station has actually broadcast a few English language programs, but as with the other Brazilian short-wavers, Portuguese is the rule.

A thousand miles upriver from Belem is Manaus, a fascinating tropical city that is the hub of transportation and commerce for the Amazon valley. In the early 1900's, Manaus was a thriving rubber town, but it has gone downhill in recent decades. It still boasts a magnificent, but slightly down-at-the-heels,

opera house where the great Caruso once sang.

Entertainment is a bit more prosaic these days, though, and much of it is provided by a trio of stations, Radio Difusora do Amazonas, Radio Bare and Radio Rio Mar.

There are other stations in cities and towns located along the Amazon tributaries, such as Boa Vista and Porto Velho, but they're rarely, if ever, heard Stateside. For SWL's, the best bet is Radio Difusora Acreana, a one kilowatt operation at Rio Branco, far, far, far upstream.

Like most Brazilian shortwave stations, these are best heard during the very early morning hours, say 0930 to 1030 GMT, depending on individual sign on schedules, or during the evening.

GREEN HELL DX

4,805	ZYS8	Radio Difusora do Amazonas, Manaus
4,865	PRC5	Radio Clube do Para, Belem
4,885	ZYD9	Radio Difusora Acreana, Rio Branco
4,895	PRF6	Radio Bare, Manaus
6,065	PRL	Radio Nacional do Brasilia, Brasilia
9,695	ZYB22	Radio Rio Mar, Manaus
15,245	ZYE21	Radio Marajoara, Belem
15,445	ZYN32	Radio Nacional do Brasilia, Brasilia

Tip Topper. Here's an even half dozen specials for medium wave DXers this month. Thanks go to Page Taylor and Russ Edmunds, authors

New Cortina 2 Stereo Kits
The lowest-priced component quality high fidelity!
EICO 3780 50-Watt Silicon Solid State
FET 4M-FM Stereo Receiver
Kit \$109.95, Wired \$169.95
Separate Tuner, 50-Watt Amplifier, each:
Kit \$39.95, Wired \$109.95



New EICOCRAFT®
The electronic science project kits for beginners, sophisticated educators, 42 kits to date.
FM Wireless Mike
\$9.95



8 New Eicocraft Kits
Automotive "LIGHT-GUARD" • "VARI-VOLT" • DC Power Supply • "MOODLITE" Light Dimmer Control • "VARASPEED" Motor Speed Control • "LIGHTSHOW" Sound/Lite Translator • "SUPER MOODLITE" Remote Control Dimmer • "ELECTROPLATER"
From \$2.50 to \$14.95



New "ELECTRIC FIESTA" Audio-Color Organ Kit \$14.95



New Automotive Electronics
EICO 883 Solid State Capacitive Ignition System
Boosts gas mileage up to 25% life of points, plugs to 100,000 miles. Kit \$29.95
Wired \$39.95
EICO 888 Solid State Universal Engine Analyzer. Tunes and trouble-shoots your car/boat engine, the totally professional way
Kit \$49.95, Wired \$69.95



NEW SOLID STATE TEST INSTRUMENTS
The first and only solid state test equipment guaranteed for 5 years!

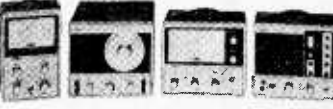

EICO 240 Solid State FET-TVM Kit \$59.95, Wired \$79.95
EICO 375 Solid State Sine/Square Wave Generator, Kit \$89.95, Wired \$94.50
EICO 242 Solid State FET-TVOM Kit \$69.95, Wired \$94.50
EICO 150 Solid State Signal Tracer Kit \$49.95, Wired \$69.95
EICO 330 Solid State RF Signal Generator Kit \$59.95, Wired \$84.50



Express Yourself
IN CREATIVE ELECTRONICS
Save up to 50% with EICO KITS & WIRED EQUIPMENT

New "Treasure Hunter"
Kit finds metals, pipes, several inches underground. Locates iron, steel, tin, gold, silver, copper, etc
Beep pitch increases as you near object

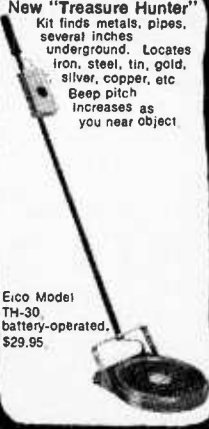

Eico Model TH-30 battery-operated. \$29.95

SOUND N' COLOR
Now see the music you hear! Color Organs by EICO transform sound waves into moving synchronized color images.
Model 3450 Giant (30" x 12" x 10") 4-Channel. Kit \$79.95
Wired \$109.95. Others from \$19.95.
Translators create audio-simulated light displays
From Kit \$24.95, Wired \$39.95
New Model 3477 Cube Strobe creates white light flashes in rhythm with audio with 3 colored lens filters. \$29.95.



FREE 1971 SILVER ANNIVERSARY EICO CATALOG
Fill out Reader Service Card for FREE catalog of 200 best buys offered by 2500 local EICO dealers who give you top brands, technical counsel, off-the-shelf service
25 Years of Leadership in Creative Electronics
EICO Electronic Instrument Co. Inc.
283 Maita St., Brooklyn, N.Y. 11207
(212) 949-1100



CIRCLE NO. 11 ON PAGE 27

DX CENTRAL REPORTING

of a fine article in the bulletin of the National Radio Club (P.O. Box 99, Cambridge, Mass.) for the information. NRC, by the way, is the world's oldest DX club for medium-wave listeners.

● Belize, formerly British Honduras, a newly independent country in Central America, has only one station, but it can be easily heard in most parts of the U.S. It operates on 834 kHz., and is best heard during the evening hours. The slightly "clipped" British accent is the tipoff.

● Surinam, the former Dutch possession on the northeastern coast of South America, has a high powered station on 725 kHz. It generally is audible in the U.S. under reasonable conditions. Programming is in Dutch, English, and the local language, Papiamentu. The musical fare varies from native tunes to rock and roll.

● In the Netherlands Antilles, the easiest catch is PJB, a mighty station running a half a megawatt worth of power on 800 kHz. Many languages are used and don't be surprised to hear the programs of Radio Nederland relayed.

● The island of Bermuda, in the Atlantic, boasts three medium wave stations, but the easiest to log is ZBM-1, on 1235 kHz. Listen for the accented English announcements and the easy-listening pop music. Again, the evening hours are best.

● Turning to the Latin Americans, Colombia is perhaps the easiest South American country to hear. There are many stations, all programming in Spanish, but one of the beginner's best bets is HJED, 820 kHz, La Voz de la Rio Cauca in the city of Cali. HJCK, 1160 kHz., is located in the capital and announces as "El Mundo en Bogota." It features classical music.

● Finally, another country which is reasonably easy to tune is Venezuela. If the San Antonio station, WOAI isn't causing too much interference, try 1200 kHz. for Radio Tiempo, YVOZ.

With that, let's see if you can't add some new countries to your BCB (medium wave) DXing totals!

Bandsweep. All times in GMT and frequencies in kHz. **3,300**—You can catch the short-wave version of Radio Belize, mentioned in the Tip Topper section above, on this frequency during the evening hours until about 0430. QRM can be rough at times though. . . . **4,890**—VTL4, Port Moresby, Papua Territory, on New Guinea, has been logged from around 1130 to 1200 with news and music. They verify in about one month. . . . **4,994**—You know, that weird Arabic chanting can be music to your ears, particularly when it comes from an exotic station like the Sudan Broadcasting Service at Omdurman. Not necessarily an easy one for the beginning SWL, but West Coasters should try around 1530. . . . **10,045**—If you dig the clandestine broadcasters, try here about 2300

OUR STORE
AT YOUR DOOR

Olson
ELECTRONICS
FREE
Catalog

Fill in coupon for a FREE One Year Subscription to OLSON ELECTRONICS' Fantastic Value Packed Catalog — Unheard of LOW, LOW PRICES on Brand Name Speakers, Changers, Tubes, Tools, Stereo Amps, Tuners, CB, and other Values. Credit plan available.

NAME _____
ADDRESS _____
CITY _____ STATE _____
GIVE ZIP CODE _____

If you have a friend interested in electronics send his name and address for a FREE subscription also.

OLSON ELECTRONICS
Dept. TQ 260 S. Forge Street Akron, Ohio 44308

CIRCLE NO. 12 ON PAGE 27

THOUSANDS OF BARGAINS TOP VALUES IN ELECTRONIC PARTS

Transistors, Modules, C. B., Speaker, Stereo, Hi-Fi, Photo Cells and Thousands of Other Electronic Parts. Send for FREE Catalogue

ELECTRONIC DISTRIBUTORS INC.



EDI
Dept. TA-2, 4900 Elston
Chicago, Ill. 60630
 RUSH CATALOGUE
Name
Address
City
State Zip Code

CIRCLE NO. 13 ON PAGE 27

**YOU'RE THE SOLUTION
TO WATER POLLUTION**

for the secret Voice of the Cambodian National United Front, a communist outlet. The language used is Cambodian. . . . 11,780—Lebanon's station has a habit of skipping around the bands a bit, but as this is written they're operating in English at 0230 on this frequency. . . . 15,110—Radio Tricolor is a new name for an old station, XERR, Mexico City. Send your reports to Organizaon Radiofonica Orfeon, Dr. Rio de la Roza 212, Mexico City. (Credits: Jerry Berg, Mass., Steven Handler, Ill., Bill Sparks, Cal., Gregg Calkin, Canada, Frank Peters, Ill., and Craig Koukol, Ill.)

Backtalk. "This really had me puzzled," writes Texan Del Hirst. "On South Africa's Radio RSA, one night, the announcer was recapping the headlines when suddenly he broke up, laughing or choking. After a few seconds of 'dead air,' he resumed, but sounded like he was trying in the worst way not to laugh."

The next day, Del learned what happened. The Associated Press carried the following story, datelined Johannesburg.

"Silence fell when radio newscaster Michael Todd was halfway through the headlines. Then he finished the program with great deliberation. He said later his upper plate had cracked in midsentence and 'it was a shattering experience in more ways than one.'"

Eugene Vonderembse, director of the long established Newark News Radio Club, 215 Market St., Newark, N.J., informs us that the organization's membership fee has been increased to \$7 a year, or \$9 for bulletins sent via first class mail. If you are considering joining this excellent radio club, sample bulletins are available for 50 cents.

For those who are waiting for the new Radio Nederland relay station being built on the island of Madagascar (Malagasy Republic), Al Niblack of Vincennes, Ind., tells us the station plans to begin tests with a high powered transmitter in October. Shortwave frequencies haven't been selected yet. ■



compact sets

SPEED DRIVING OF BRISTOL AND ALLEN HEX TYPE SCREWS

 No. 99PS-60
Bristol Multiple Spline Type
Screwdriver Set

4 and 6-flute blades
with diameters from
.048" thru .183"

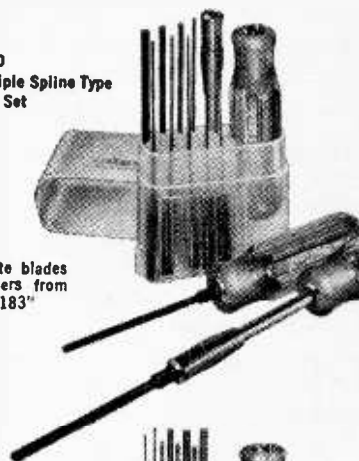

 No. 99PS-40 Allen Hex
Type Screwdriver Set

Hex diameters
from .050" thru 3/16"



Compact, interchangeable blade, Xcelite sets permit quick selection of the right tool for the job. With greater reach than conventional keys, these handy blade and handle combinations make it easier to get at deep set or awkwardly placed socket screws, simplify close quarter work.

Each set contains 9 precision formed, alloy steel, 4" blades; 4" extension; shockproof, breakproof, amber plastic (UL) handle with exclusive, positive locking device.

Sturdy, see-thru plastic cases fit pocket, have flat bases for use as bench stands.

XCELITE®

XCELITE INC. • 80 BANK ST., ORCHARD PARK, N. Y.
Send Bulletin N365 on 99PS-60 and 99PS-40 sets.

name _____

address _____

city _____ state & zone _____

CIRCLE NO. 14 ON PAGE 27

**SPECIAL HALF-PRICE
OFFER TO
INCOME OPPORTUNITIES
ONE FULL YEAR ONLY \$4.48**

(REGULAR SUBSCRIPTION PRICE \$8.95)

includes 12 reg. issues plus 2 directories
"I.O." brings you each month America's
best money-making ideas . . . in franchising
—specialty sales—mail order

-----MAIL COUPON TODAY-----

INCOME OPPORTUNITIES Dept. 801
229 Park Avenue So.
New York, N.Y. 10003

Please enter my subscription to "I.O."—for
only \$4.48. I save 50% off the regular sub-
scription price—includes 12 regular issues
plus 2 directories

- New Subscription Renewal Subscription
 Enclosed is \$ _____
 Bill me later

NAME _____
(please print or type clearly)

ADDRESS _____

CITY _____ STATE _____ ZIP _____

Buy . . .

U. S. SAVINGS BONDS

**MAIL EARLY
IN THE DAY!**



MR. ZIP
**ZIP CODE NUMBERS
BELONG**

IN ALL ADDRESSES



YOUR POSTMASTER . . .

**Hey,
look me over**

Showcase of New Products

45 Hub Cap

A new universal adaptor for playing 45 RPM records automatically, promises to eliminate the difficulties phonograph owners have experienced for years in locating a specific adaptor for a particular record player. "Omnidaptor" is a round plastic device adjustable to work on more than 90

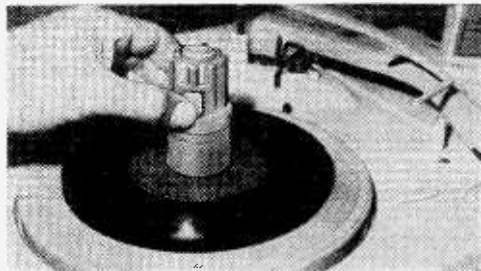

Omnidaptor for 45 Records

per cent of the changers in American homes. Once it is adjusted through a simple process taking a few minutes, it can be slid on and off the record changer spindle, just like any other adapter. If the owner acquires a new phonograph, he can re-set the "Omnidaptor" to the new model. Suggested retail price is \$3.95.

Circle No. 33 on Page 27

Real Hot Spot

The new Heathkit GD-29 Electronic Oven cooks with microwaves, similar to radar waves. These invisible microwaves instantly penetrate food and agitate the molecular structure, resulting in cutting cooking time by up to 70 per cent. A 3-hour roast, for example, can be cooked in just 45 minutes . . . baked potatoes take only 4 minutes. The oven features fail-safe operation. An exclusive door design prevents leakage of microwaves from the oven cavity. The dual door interlock system instantly shuts off the oven when the door is opened; and the interlock is both tamperproof and fool-

(Continued on page 16)

SPECIAL INTRODUCTORY OFFER

TO
SCIENCE & MECHANICS
One Full Year of "S & M" for only \$2.57
A Regular \$4.00 Value – You Save over 35%

HOT HOW-TO PROJECTS

Yes! Each and every issue of Science & Mechanics brings you hard-hitting informative reading, from space technology to new products – Science & Mechanics has the flair and flavor of right now. Every issue is written for the man who wants to keep ahead of this fast changing world we live in.

Every issue of Science & Mechanics is packed with these typical firsts: an expose of the famous Russian space walk films as frauds... why scientists are concerned over the possibility of a major California earthquake... how various auto diagnostic centers perform on a comparative basis.

HUNDREDS OF GREAT NEW IDEAS

Right now is the time to get with Science & Mechanics, the magazine that has the newest, hottest, and best in How-To Projects... not just great projects on how to build furniture, bookshelves, and decorative items for the home, but great new home projects like how to get started in model rocketry... how to build your own street buggies... how to stereo-ize your home and many more great and timely how-to projects that are not only fun but that can be profitable for you too. So make sure you

have the next issue and following issues of Science & Mechanics for action and entertainment.

GUARANTEE

Your subscription to Science & Mechanics will be sent to you with an unconditional guarantee. To get yours, fill out and mail the coupon below. When your first issue arrives you'll see why millions of readers across the country have read and enjoyed S & M for over 40 years. And we are so sure that Science & Mechanics will be welcomed into your home each and every issue that we make this unconditional guarantee – that if for any reason you are dissatisfied, we will cancel your subscription and you will receive a full pro-rata refund on the unused portion of your subscription... no questions asked!

LIMITED OFFER

We urge you to order your subscription to Science & Mechanics today, so that your copies will start coming right away. Orders will be processed so that you will receive the very next available issue. We will enter your subscription to S&M for only \$2.57, 1 full year – 12 issues... saving you over 35% of the regular price. This offer may not be repeated again.

SCIENCE & MECHANICS, Dept. 901
229 Park Avenue South
New York, N.Y. 10003

Please enter my subscription to "S & M" – for only \$2.57. I save over 35% on the regular subscription price.

- New Subscription Regular Subscription
 Enclosed is \$ _____
 Bill me later

Name _____ (please print or type clearly)
Address _____
City _____ State _____ Zip _____

NO STAMP NEEDED

You must seal (staple, scotch tape or glue) before mailing.

FOLD HERE

DO NOT CUT HERE



BUSINESS REPLY MAIL
First Class Permit No. 1050 (SEC. 34.9 P.L. & R.) New York, N.Y.



SCIENCE & MECHANICS

229 Park Avenue South

New York, N.Y. 10003

Dept. 901

A Complete Course in ELECTRONIC COMPUTERS for only \$2.95!

You get all the basics you need — at your own pace — whether you're entering the exciting computer field or your work is affected by computers. This giant book has all the latest, step-by-step learning aids; nearly 200 diagrams and circuits; full data on digital and analog computers — covering math background, servomechanisms, digital computer logic, programming, control and communication. PLUS handy glossary, self-review tests, summaries. All at a fraction more than a penny a page!

A Complete Course in ELECTRONICS for only \$1.95!

From fundamental electronic principles and devices right through their application in operating circuits, this famous, bestselling book covers everything — with major sections on electron tubes and transistors, amplifiers, oscillators, radio, TV, radar and electronic navigation, high fidelity, detection systems. With 227 diagrams and circuits — 191 big pages.



UNCONDITIONALLY GUARANTEED!

Elementary Electronics Book Club
Dept. DE-50
229 Park Avenue South, New York, N.Y. 10003

Please send me ELECTRONIC COMPUTERS @ \$2.95
 ELECTRONICS MADE SIMPLE @ \$1.95

I'm enclosing my check or money order for the price of each book ordered, plus a 15¢ shipping charge. If I wish, I may return the book(s) within two weeks for a prompt refund.

NAME _____

ADDRESS _____

CITY _____ STATE _____ ZIP _____

Offer available in U.S. only.

Hey, look me over . . .

(Continued from page 14)

proof. The GD-29 meets all new HEW standards for radiation leakage and all FCC regulations for radio frequency interfer-

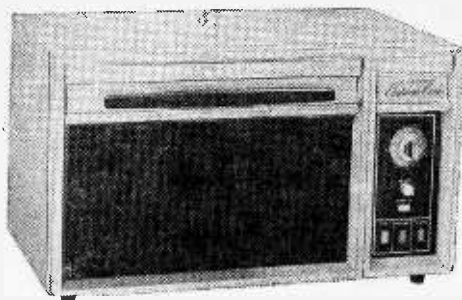

Heathkit GD-29 Microwave Oven

ence. The huge oven cavity, measuring 15½-in. W x 14-in. D x 7 5/16-in. H, is one of the largest in the industry.

Other features include fast, easy assembly; simple operation; attractive, easy-to-clean styling; a complete cookbook and 120 volt operation. Cost of kit: \$399.95.

Circle No. 34 on Page 27

Stick 'em

Silite 100, the first in a new family of silicone rubbers available from Devcon Corporation, is guaranteed to remain flexible for 10 or more years after it is applied. A translucent, non-sagging paste which can be applied to a vertical surface, this one stage material is ready to use—no mixing required. Small traces of moisture in the air, acting as a catalyst, begin curing Silite 100 almost immediately after it is applied. In ten minutes it "skins" over, and in one hour or less it is tack free. It cures to an extremely tough, durable, flexible rubber—a true elastic which will stretch many times its length before breaking—and remains flexible under extremes of temperature from -75°F. to 500°F.—higher on intermittent exposure. Silite 100 is used for insulating electrical wires and switch boxes in paper mills, tanneries, and other damp areas; sealing piping and hot air blower systems; making shock absorbing parts for machinery; dampening machine vibration; making vapor tight seals on machine tools and other equipment; fabricating gaskets right in place, and for general caulking and sealing. It also works as the potting agent for homebrewed, hermetically-sealed circuits. A 3oz. tube is priced at \$1.95.

Circle No. 35 on Page 27

ask me another

Discover by asking!

Send your questions to—
ELEMENTARY ELECTRONICS
Ask Me Another
 229 Park Ave. South
 New York, New York 10003

Extra Ears For Channel 9

Now that CB Channel 9 has been officially made an emergency channel, many CBers would like to build a very inexpensive receiver for monitoring this channel while listening for their regular calls on other channels. Please print a diagram showing an inexpensive monitoring receiver setup for this purpose.

—J. P. R., St. Louis, MO

You could build an inexpensive—no, downright cheap!—superregen rig that does nothing but listen for distressing yelps on Channel 9. But if rolling your own doesn't hack it in your head, buy a used CB base station transceiver and connect it to your regular CB rig through an isolator. You can probably pick up a used rig for a song and a dance. After you waltz the rig home, disable its transmitter by disconnecting the mike and PTT switch. Your normal CB

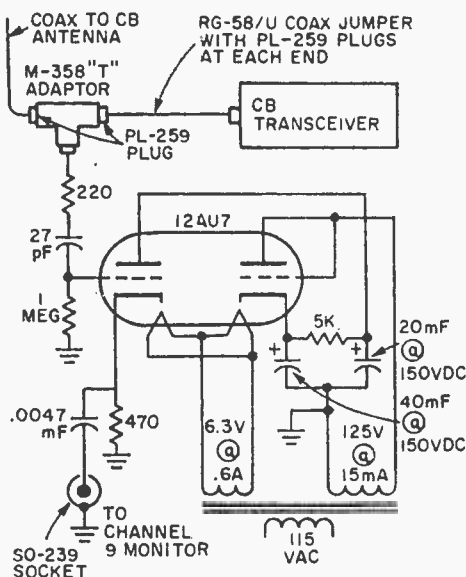

set is connected to the antenna through a coaxial "T" adaptor. Follow our diagram for proper hookup. Whenever you transmit with your normal CB rig, the isolator will electronically separate the Channel 9 receiver from your transceiver.

Strike Three on Eleven

I want to watch the New York Yankee baseball games being televised on channel 11 (New York City). My antenna is 42 feet above the ground, and it's feeding a signal booster. I am located in a valley west of Newton which is about 60 air miles from New York City. How do I get better reception on channel 11?

—F.A.E., Newton, NJ

We don't answer letters from non-Mets fans. Seriously though, you need to install a separate stacked-beam antenna cut to channel 11. Con-

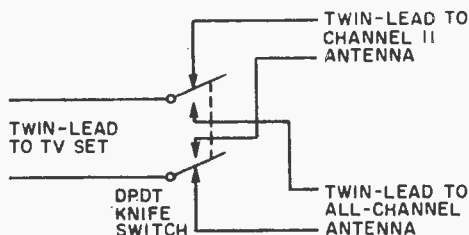

nect it to your TV set through a switch as shown in the diagram. And, as you found out with your other antenna, the higher you mount it, the stronger the signal will be at your TV's antenna terminals.

Body Talk For a Color Organ

I have a color organ which has two input wires and want to connect it to my stereo rig. How do I hook it up for best results? I don't want it to interfere with speaker performance.

—E.V., Edgewater, MD

The input impedance of your color organ should not present any unusual loading hassles to the stereo amp. Generally, the color organ's input impedance is several times that of the stereo amplifier's output impedance. It's a perfectly safe procedure to connect the color organ's input wires to the stereo amp's output terminals. Unless the color organ manufacturer warns you otherwise, connect the input wires to the 16-ohm and Common (or Ground) amplifier terminals. Set the input level controls of the color organ so that the lights are activated on musical passages of normal volume. If you're planning to connect one color organ to your stereo, then buy a "hybrid" transformer having three separate windings. Two of the transformer windings match the amplifier's output impedance; the third winding matches the color organ's input impedance. When properly con-

(Continued on page 22)



GR-371MX

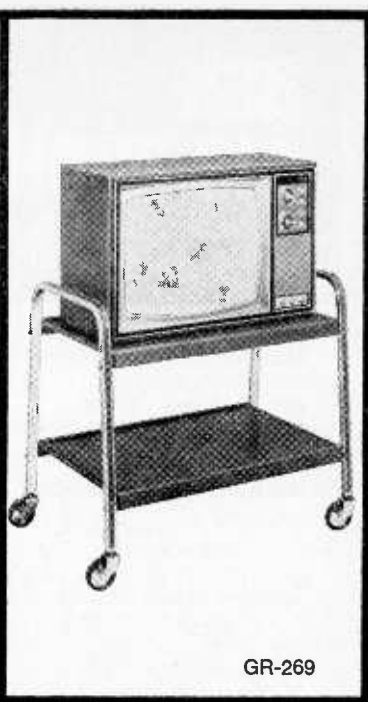

GR-269

You may have spent your last nickel on color TV service calls!

Only Heathkit solid-state TVs can be completely serviced by the owner — and over the life of the set that can mean a savings of hundreds of dollars! The famous Heathkit manual, Volt-Ohm meter included with every kit, built-in dot generator and tilt-out convergence panel make maintenance easy — even if you're a novice. You perform all normal periodic servicing, such as dynamic convergence and purity adjustments. You can even do alignment and diagnose, locate and replace faulty components.

And Heathkit TV utilizes modular design, with plug-in glass epoxy circuit boards to make maintenance even easier. Should you detect a malfunction in any one board, simply return it to Heath Company for 48-hour expedited service. During the 90-day warranty period, circuit modules will be replaced at no charge! With this unique at-home service capability, Heathkit solid-state receivers are the best color TV investment you can make!

GR-371MX— Heathkit 25" ultra-rectangular color TV. The Heathkit GR-371-MX is fast earning a reputation as the finest color TV on the market today! A feature-by-feature comparison with any other set made shows why.

Heath MTX-5 ultra-rectangular matrix picture tube. The new square-cornered design offers the largest picture in the industry — 25" diagonal measurement — displaying, for the first time, the complete transmitted image with no wrap-around at the sides. Specially formulated etched face plate cuts out unwanted glare, increases contrast without sacrificing brightness. Matrix screen around phosphor dots eliminates reflected light for clearer, sharper pictures.

"Top-of-the-line" features. High resolution circuitry for improved picture clarity, plus new adjustable video peaking that lets you select the degree of sharpness and resolution you desire; an exclusive solid-state VHF tuner with MOS Field Effect Transistor for superior reception even under marginal conditions; Memory Fine Tuning; 3-stage solid-state IF, factory assembled and aligned; Automatic Fine Tuning; VHF power tuning; "Instant-On"; Automatic Chroma Control; adjustable noise limiting and gated AGC; adjustable tone control; hi-fi sound output to your stereo or hi-fi system.

A choice of three beautiful cabinets. Pick either Mediterranean, Early American or Contemporary cabinetry. Or custom install the chassis yourself.

GR-371MX, chassis and all parts, less cabinet, 125 lbs. .579.95*

GR-269 — New Heathkit 18" "compact" color TV. The new GR-269 has the same highly sophisticated circuitry found in the GR-371MX, modified to accept the popular 180 sq. in. color picture tube, and put into a compact cabinet. It delivers console-quality performance, yet is a "middle-weight" that can easily be moved from one room to another.

Big-set features. Automatic Fine Tuning brings in perfect picture and sound at the touch of a finger; solid-state VHF utilizes MOS Field Effect Transistor for less noise, visibly better reception; 3-stage IF unusual in a "compact", provides increased signal gain for better all-around picture quality; switch-controlled degaussing circuit lets you demagnetize set after moving it from one area to another, thus assuring pure, clean color; "Instant-On" is standard.

Kit GR-269, chassis and all parts, less cabinet, 100 lbs. .399.95*

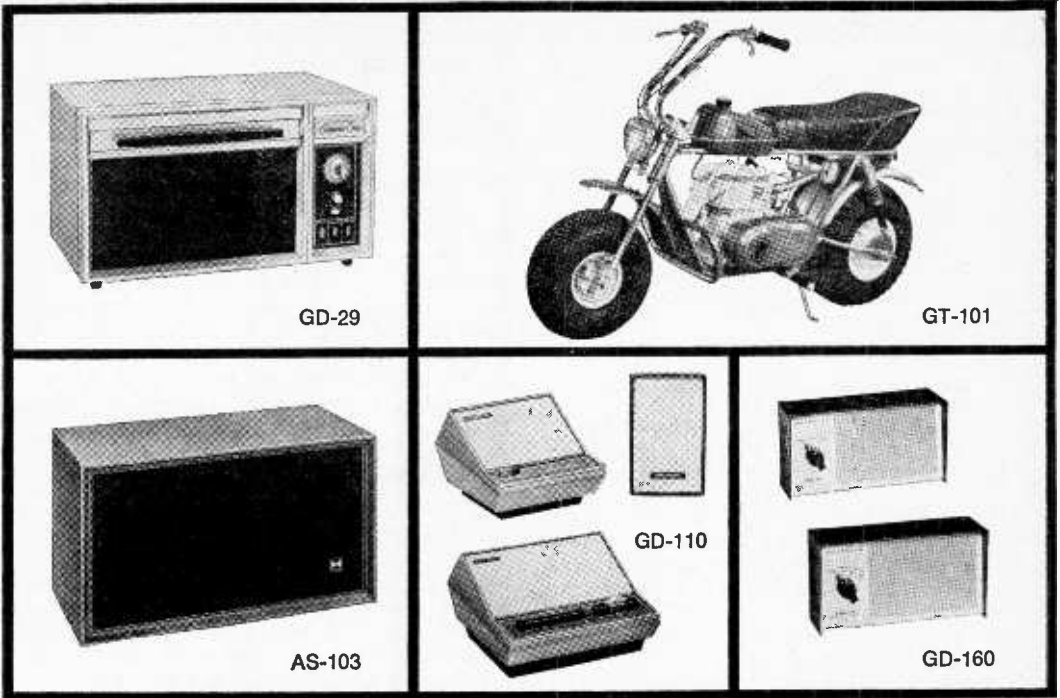

Self-service is built into every Heathkit design.

AS-103 — New Heathkit Sterec Speaker System.

No other stereo speaker system is so consistently rated "number one" by all audiophile publications. And now the famous Acoustic Research AR-3a is available in kit form! Provides acoustic suspension 12" woofer for superb bass response to the limit of human hearing, hemispherical dome tweeter and mid-range driver for unexcelled mid and H.F. dispersion. Has output level controls for independent control of tweeter mid-frequency level to match room configuration. Unquestionably the finest Heathkit stereo speaker system to date!

Kit AS-103, speakers, cabinet and all circuitry, 68 lbs. \$189.95*

GD-160 — New Heathkit Cab-lo-Camper Intercom.

Economical, two-way communication for the camping family on the move. Allows driver to converse with passengers in the camper or travel trailer, or monitor sleeping children. Master unit in cab has "Standby", "Talk" and "Monitor" positions. Remote unit in camper has "Standby", "Talk" and "Radio" settings, with the latter bringing music and news into the camper directly from the front-seat radio. Kit includes master and remote intercoms, 15' connecting cable. Quick disconnect coupling optional. Operates on 12 volt automatic system.

Kit GD-160, master, remote and cable, 5 lbs. \$25.95*

GD-110, 120, 130 — New Heathkit Home Intercom System.

With this amazingly flexible system you design your home intercom to your own communication requirements. Master unit provides six channels which allow two-way conversation with six remote units or six other masters. Master unit has "All-Call" button which opens all chan-



GT-101



GD-110

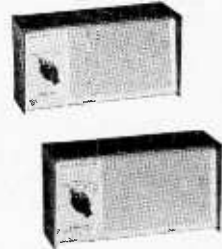

GD-160

nels; "Talk" which sends voice to any given station, and "Dictate", holding "Talk" button open for longer conversations. Master can be wired to monitor any four remote stations, or can be built to leave all remotes "private". Indoor remote intercom has "Talk" and "Dictate" switch positions. Outdoor remote unit is completely weatherproof — can be used to identify front-door visitors. All intercoms include mounting hardware.

Kit GD-110, master unit, 4 lbs. \$39.95*

Kit GD-120, remote unit, 3 lbs. \$12.95*

Kit GD-130, outdoor remote unit, 3 lbs. \$9.95*

GD-29 — Heathkit Microwave Oven.

There's no more modern way to prepare food. Microwave cooking gives you time-saving convenience of up to 70% faster food preparation, plus added nutrition through better retention of vitamins. The low-profile Heathkit Microwave Oven features one of the largest capacities in the industry, operates on standard 120 VAC household current. Kit includes specially prepared cookbook that gives a delightful introduction to the fascinating world of electronic cooking.

Kit GD-29, 97 lbs. \$399.95*

GT-101 — New Heathkit Hilltopper Trail Bike.

Here's a trail bike that combines portability with ride and handling characteristics found only in much larger machines. Features telescoping fork up front, adjustable shock absorbers at the rear wheel. Powered by a durable 5-h.p., 4-cycle Tecumseh engine, coupled to an infinitely variable torque converter that gives low-speed pulling power or 35 m.p.h. cruising at the twist of the spring-loaded throttle. Hefty two-wheel brakes give sure stopping power. Big 18x8.50-8" rear tire provides great traction on the steepest grades, over sand or snow. Fold-down handlebars and collapsible foot pegs make it a cinch to stow. Options include running lights, powered by alternator, and front-wheel snow ski.

Kit GT-101, 160 lbs. \$299.95*

See these and 300 other Heathkit suggestions at one of the following Heathkit Electronic Centers:

CALIFORNIA: Anaheim, 92805, 330 E. Ball Road; El Cerrito, 94530, 6000 Potrero Avenue; La Mesa, 92041, 8363 Center Drive; Los Angeles, 90007, 2309 S. Flower St.; Redwood City, 94063, 2001 Middlefield Rd.; Woodland Hills, 91364, 22504 Ventura Blvd.; COLORADO: Denver, 80212, 5340 W. 38th Ave.; GEORGIA: Atlanta, 30305, 5285 Roswell Road; ILLINOIS: Chicago, 60645, 3462-66 W. Devon Ave.; Downers Grove, 60515, 224 Ogden Ave.; MARYLAND: Rockville, 20852, 5542 Nicholson Lane; MASSACHUSETTS: Wellesley, 02181, 165 Worcester St.; MICHIGAN: Detroit, 48219, 18645 W. Eight Mile Rd.; MINNESOTA: Hopkins, 55343, 101 Shady Oak Rd.; MISSOURI: St. Louis, 63123, 9296 Gravois Ave.; NEW JERSEY: Fair Lawn, 07410, 35-07 Broadway (Rte. 4); NEW YORK: Jericho, L.I., 11753, 15 Jericho Turnpike; New York, 10036, 35 W. 45th Street; OHIO: Cleveland, 44129, 5444 Pearl Rd.; Woodlawn, 45215, 10133 Springfield Pike; PENNSYLVANIA: Philadelphia, 19149, 6318 Roosevelt Blvd.; Pittsburgh, 15235, 3482 William Penn Hwy.; TEXAS: Dallas, 75201, 2715 Ross Avenue; Houston, 77027, 3705 Westheimer; WASHINGTON: Seattle, 98121, 2221 Third Ave.; WISCONSIN: Milwaukee, 53216, 5215 W. Fond du Lac

Retail Heathkit Electronic Center prices slightly higher to cover shipping, local stock, consultation and demonstration facilities. Local service also available whether you purchase locally or by factory mail order.

HEATH COMPANY, Dept 139-5 Benton Harbor, Michigan 49022 a Schlumberger Company	
<input type="checkbox"/> Enclosed is \$ _____, plus shipping.	
<input type="checkbox"/> Please send model (s) _____	
<input type="checkbox"/> Please send FREE Heathkit Catalog. <input type="checkbox"/> Please send Credit Application.	
Name _____	_____
Address _____	_____
City _____	State _____ Zip _____
*Mail order prices; F.O.B. factory. Prices & specifications subject to change without notice. CL-405R	

ASK ME ANOTHER

(Continued from page 17)

nected, the color organ will simultaneously respond to both channels.

Zapped by a Zene-R

What value of resistor should I use with a zener diode in a voltage regulator circuit?

—L. M., Baltimore, Md.

It depends upon the maximum input voltage (E_{max}), the minimum load current (I) and the regulated output voltage (E_{out}). For example, if E_{max} (see diagram) is 15 volts, I_{min} is 20

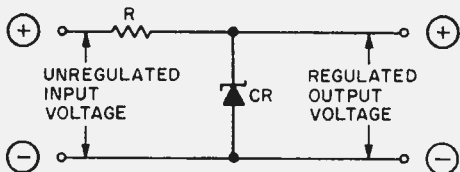

mA and E_{out} is 9.1 volts, you need a 9.1 volt zener diode (CR) and a 5.78-ohm resistor (R). First calculate the voltage drop across R which is $15 - 9.1 = 5.9$ volts. If the zener diode is a 10-watt type, its zener current will be approximately 1 ampere. Thus the current through R will be $1 + 0.02$ or 1.02 amperes. The value of R, therefore, should be 5.78 ohms since $R = E/I$, or, $5.9/1.02$. Also, it will dissipate 6.018 watts. Since a 5.78-ohm resistor is not standard, parallel a 10-watt 7.5-ohm and a 5-watt 25-ohm resistor. Now, if load current rises to 1 ampere, zener current would fall to 20 mA. Or, if input voltage dropped to 13 volts with load current at 20 mA, the voltage drop across R would be only 3.9 volts, and the zener current would drop to approximately 656 mA. Now, with reduced input voltage, if load current rises to 500 mA, the voltage drop across R would remain at 3.9 volts, and the zener current will drop to 156 mA.

Caught by a Pre-amp Propheteer

I bought a pre-amp chassis and need a power supply to operate it. The place where I bought this unit said I would need a power supply capable of delivering 150 VDC @30 milliamps. I hope you can give me a diagram for this supply.

—V. D., Joliet, IL

Judging by the schematic of the pre-amp you sent with your letter, a much wiser alternative would be to send the unit back where it came from. As an audiophile-turned-philosopher of note once remarked: "Garbage gear is garbage gear . . . ad nauseum."

Letter S Louse-up

I am strictly an amateur at the art of radio and electronics, and am now at your mercy for information about a transistor (Toshiba type 2SA93). Please tell me where I can buy this

transistor type, how much it costs, and what it does.

—H. K., Hamilton, Ont.

What you are really at the mercy of is an improper designation! We looked in Toshiba's catalog of transistor types, and found a type 2SA93 listed. The transistor type you wrote to us asking info for doesn't exist; a simple little problem like substituting an S for a 5 makes all the difference! To answer your last question, the 2SA93 is a pnp-type transistor, useful in BCB circuits. There are several replacement types for this transistor; try a 2N500, 2N1500, or 2N2180 if you can't find the 2SA93. You can buy the Toshiba transistor, or any of its equivalents, at any well-stocked electronics supply house.

Reed Switch Lowdown

A project I want to build calls for a reed switch. What is a reed switch?

—J. B., Carmel, CA

Reed switches are becoming very popular in hobbyist circles. A magnetic reed switch is a type of relay consisting of two ferromagnetic reeds sealed into a glass tube. Inside this tube is a controlled atmosphere. The reeds are insulated from each other by a small air gap. When placed inside a coil of wire which is series connected to a battery, the reeds become magnetized in opposite polarity and they make contact. By energising the coil you have an SPST switch. There are various ways to control the reeds. The advantage of magnetic reed relays lies in their high speed switching capability. Also, the contacts are highly reliable because they are hermetically sealed from the contact-killing oxidants found in the air we breathe. ■



THE AMAZING WORLD OF SOUND

ASTRO-COM TELEPHONE-AMPLIFIER

Transforms any ordinary telephone earpiece into a unique sound-control amplifier! It's a space-age electronic concept that assures the maximum in hearing range and comfort... attaches instantly and securely to any phone with a simple, snug-fitting band. Carry it in your pocket... or in purse, it's that portable! Especially suited for high-noise factory and office areas. And, it's a low-cost practical answer to public phone distractions. What's more, the hard-of-hearing, and elderly folks find it a definite aid, while guaranteeing privacy!

Precision-built for reliable performance, the ASTRO-COM amplifies any normal speaking voice up to five times. Complete with easily adjustable fingertip touch volume control.



Amplification: More Specification than 30db
Circuitry: 4 transistors
Case: High Impact Polystyrene
Battery: For best results, use Saxon #8-103 battery or equivalent. Battery life expectancy—25 hours.

only \$995
(less battery)

"SKY-SPY" NOW!! Add A New Dimension To Listening... Up!

Complete SKY-SPY only! \$1695
(less batteries)



Amazing... excitingly new! "SKY-SPY" allows reception from planes within a range of 75 miles; even permits reception from the aircraft tower itself within a 15 mile range.

Hear how aircraft are instructed to land, weather conditions, delays in launchings, etc....

This unique device uses 1.52 hearing aid batteries... giving it a 65 hour life span.

ASTRO-COM WRIST RADIO Transmitter

- Broadcasts your voice to any FM receiver within 50 feet in any direction.
- No wires! Powerful tiny silver oxide battery good for hours of broadcasting!
- Great for party fun; kids' games; keeps you in touch with playroom, bedroom, or sick room.
- Complete with replaceable silver oxide battery, nylon strap, rugged case, "whip" antenna, and tuning device.
- Electronic components designed by Saxon first in miniature electronic equipment.

SPECIFICATIONS: Frequency Response: 300 to 6,000 Hz.; POWER: 6 MW input; RANGE: Up to 50 feet, depending upon conditions; Frequency: FM broadcast band, (tunable — 3 megacycles through 88 megacycles); Audio Sensitivity: Normal voice at approximately 10 feet; Case: High impact polystyrene-electronics encapsulated in epoxy; Weight: 4 ozs.

SPECIAL INTRODUCTORY PRICE ONLY \$1400

THE BIG EAR

"HOMES IN" on faint sounds up to 100 feet away... twice as far over water.

Exclusive cordless Broadcast Accessory also available—increase sensibility tenfold.

- USE INDOORS OR OUTDOORS — from baby sitting to bird watching.
- ENTERTAINING, PRACTICAL AND INSTRUCTIONAL for young and old.
- THE LATEST IMPALID STATE CIRCUITRY.
- PROTECTIVE DEVICES to listen for Intruders at night.

The "BIG EAR" is an amazing electronic device which is completely portable. Basically it combines the principle of a parabolic microphone, a high gain amplification system and stethoscope earphone for intimate listening.

The "BIG EAR" comes complete with its own sturdy adjustable tripod base for convenient use anywhere... operates for hours on standard 9 volt-transistor battery.

Complete with Stethoscope \$1995 earphones ONLY (less batteries)

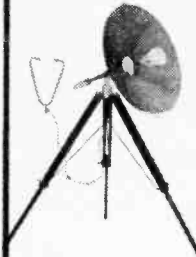

BIG EAR BROADCAST ACCESSORY

Plug in our exclusive cordless Broadcast Accessory and convert Big Ear into a group entertainment listening device. The "Big Ear Broadcaster" let you broadcast sound to any FM receiver up to 30 feet away. With it you hear everything, without connecting wires with 30 times amplification.

Stay indoors and listen to bird calls and animal sounds. Place it in a baby's room or near the baby carriage or use it as a sick room monitor.

BROADCASTER COMPLETE ONLY \$1495 (less batteries)



EYEGGLASS RADIO

Clips to your glasses, receives the whole AM broadcast band, can be used wherever you go 'cause it weighs a few ounces. Comes with earphone plug for privacy, convenient on-off and tuning knobs. Includes 1.5v. hearing aid batteries for many long hours of listening pleasure.

only \$1595

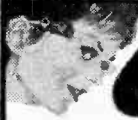

D & D SALES CO. DEPT. WS-60
60 E. 42nd Street
New York, N.Y. 10017

Please send me the following items on a full money back GUARANTEE, if I'm not completely satisfied.

I enclose my check (or money order) for \$_____.

ITEM	NUMBER OF UNITS	UNIT PRICE	TOTAL PRICE
BIG EAR		\$19.95	\$
BROADCASTER		14.95	
PHONE AMPLIFIER		9.95	
SKY-SPY		16.95	
WRIST RADIO		14.00	
EYE GLASS RADIO		15.95	

Plus Postage & Handling 1.50 per unit

New York State Residents add appropriate tax

TOTAL AMOUNT ENCLOSED



LITERATURE LIBRARY

1. Edmund Scientific's new catalog contains over 4000 products that embrace many sciences and fields.
2. Bargains galore, that's what's in store! Poly-Paks Co. will send you their latest 8-page flyer.
3. Custom Alarms reveals how inexpensive professional alarms can really be. Install one yourself. Circle 3 for exclusive catalog.
4. Get it now! John Meshna, Jr.'s new 96-page catalog is jam packed with surplus buys.
5. Troubleshooting without test gear? Get with it—let Accurate Instrument clue you in on some great buys for your test bench.
6. Burstein-Applebee offers a new giant catalog containing 100s of big pages crammed with savings.
7. Now available from EDI (Electronic Distributors, Inc.): a catalog containing hundreds of electronic items.
8. Pick Cornell's Electronics' 10th anni. catalog and discover yesterday prices. Tubes go for 36¢ and 33¢. Plus many other goodies!
9. Allied Radio Shack wants to introduce you to the colorful world of electronics. Discover great buys from wide selections. Get the details from Allied today!
10. It's just off the press—Lafayette's all-new 1971 illustrated catalog packed with CB gear, hi-fi components, test equipment, tools, ham rigs, and more—get your free copy!
11. Get all the facts on Progressive Edu-Kits Home Radio Course. Build 20 radios and electronic circuits; parts, tools, and instructions included.
12. Olson's catalog is a multi-colored newspaper that's packed with more bargains than a phone book has names.
13. Select the right tool for easy, speedy driving of Bristol Multiple Splined and Allen Hex socket screws from Xcelite's compact, interchangeable blade sets. Get Bulletin N365.
14. Before you build from scratch, check the Fair Radio Sales latest catalog for surplus gear.
15. Here's a free 20-page booklet that tells you how to improve your TV pic and a do-it-yourself approach to installing a Master Antenna TV (MATV) system. Mosley Electronics will wing it your way.
16. RCA Experimenter's Kits for hobbyists, hams, technicians and students are the answer for successful and enjoyable projects.
17. B&F Enterprizes has an interesting catalog you'd enjoy scanning. Goodies like geiger counters, logic cards, kits, lenses, etc. pack it. Get a copy!
18. Heath's new 1971 full-color catalog is a shopper's dream. Its 116 pages are chock full of gadgets and goodies everyone would want to own.
19. Get two free books—"How to Get a Commercial FCC License" and "How to Succeed in Electronics"—from Cleveland Institute of Electronics.
20. National Schools will help you learn all about color TV as you assemble their 25-in. color TV kit.
21. Bone up on CB with the latest Sams books. Titles range from "ABC's of CB Radio" to "99 Ways to Improve your CB Radio."
22. You can become an electrical engineer only if you take the first step. Let ICS send you their free illustrated catalog describing 17 special programs.
23. For success in communications, broadcasting and electronics, get First Class FCC license. Grant-ham School of Electronics will show you how.
24. CB antenna catalog by Antenna Specialists makes the pickin' easy. Get your copy today!
25. Kit builder? Like wired products? EICO's 1971 catalog takes care of both breeds of buyers at prices you will like.
26. Want some groovey PC boards plus parts for communication projects? Then get a hold of International Crystal's complete catalog.
27. H. H. Scott has a parcel of pamphlets describing their entire 1971 line of quality hi-fi products. They have Scottkits, too!
28. CBers, Hams, SWLs—get your copy of World's Radio Lab's 1971 catalog. Circle 28 now!
29. Hy-Gain's new CB antenna catalog is packed full of useful information. Get a copy.
30. Get your copy of Hallicrafters' "Shortwave Puts You Where It's At." Get started today on shortwave radio for more fun tomorrow!
31. Want a deluxe CB base station? Then get the specs on Tram's super CB regs.
32. Get the scoop on Versa-Tronics' Versa-Tenna with instant magnetic mounting.
33. Prepare for tomorrow by studying at home with Technical Training International. Get the facts on how to step up in your job.
34. Pep-up your CB rig's performance with Turner's M+2 mobile microphone.
35. CBers, Midland has come up with a neat colorful brochure on their line. Before you buy, check on Midland.

ELEMENTARY ELECTRONICS

Box 886

Ansonia Station

New York, N.Y. 10023

Please arrange to have this literature whose numbers I have circled at right sent to me as soon as possible. I am enclosing 25¢ to cover handling. (No stamps, please.)



561

1	2	3	4	5	6	7	8	9	10
11	12	13	14	15	16	17	18	19	20
21	22	23	24	25	26	27	28	29	30
31	32	33	34	35					

Indicate total number of booklets requested
Sorry, only 20 circled items maximum.

NAME _____

ADDRESS _____

CITY _____

STATE _____ ZIP _____

Not Valid After July 31, 1971

NEW 1971 CRAFT PRINT CATALOG



The new 1971 Craft Print Catalog has over 100 great easy-to-build plans . . . Sail boats . . . recreational travel trailer . . . Biplane . . . and many home projects you can order. With the 71 Craft Print Catalog you can get top mailage from your own craft skills . . . outstanding design . . . utility value . . . and ease of construction. Each Craft Print is fully illustrated . . . step-by-step construction procedures . . . and complete material list.

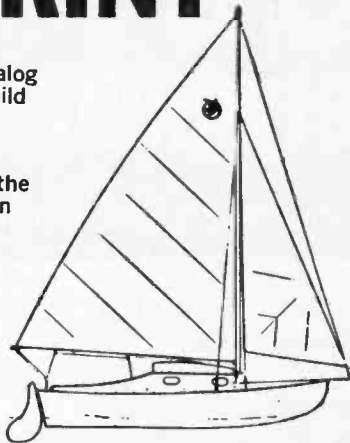

Here are just 3 of the many great Craft Prints Plans included in the catalog.



255. MINIMAX. For minimum cost and maximum performance you can't beat "Minimax." Actually, it was built in one day at a cost of less than \$30.00. It will carry two persons, take outboard motors ranging from 3 hp to 15 hp, and has a watertight air compartment that will support 900 lbs. even with the cockpit completely filled with water. As to performance, it will plane a 165 lb. man up to 15 mph with a 3 hp motor. With motors of 10 hp or more, "Minimax" just about rides on the engine's cavitation plate. Length, 8'; beam, 48"; weight, 68 lbs. Full size patterns No. 347 are available for "Minimax." \$12.00



334. EAA BIPLANE. Completely modern in design, but based on the traditional one-man flying machine of yesteryear, is the EAA Sport Biplane. It's a real plane, adaptable to home construction at a cost of less than \$2000 (with a used engine). She can carry a 230 lb. pilot at a rate of climb of 700' per minute to a ceiling of 11,500'. With an 85 hp engine, she can attain a speed of 130 mph. (Plans are \$15.)

106. PETREL. As a sailboat, "Petrel" fulfills the greatest possible variety of uses in one model. It can be built as an open cockpit racing craft, or as a cabin cruiser with accommodations for overnight trips and shelter on fishing excursions. Cockpit seats four. Either model is constructed from the same basic design, and possesses unusual seaworthiness, stability, trim attractive lines, speed, and ability to handle well. Construction is easy and inexpensive, utilizing marine or exterior grade plywood. An outboard of up to 6 hp can be used for auxiliary power. Due to the simplified construction, ordinary carpenter's tools and only average skill are required to build this boat. Length, 16'; beam, 6'; depth, 23" amidships; draft with fixed keel, 24"; draft with centerboard down, 30"; weight 650 lbs.

AMAZING OFFER

All Craft Prints are unconditional y guaranteed; if you are not completely satisfied you may return them and your money will be promptly refunded.

To order Craft Print or Catalog use the handy order form below.

MAIL TODAY

SCIENCE & MECHANICS/ Dept. CP-80
CRAFT PRINT DIV.,

229 Park Avenue South, New York, N.Y. 10017
Please send me _____ copy(s) of the 1971 Craft Print Catalog for only \$1.00 ea. . . . COMPLETELY REFUNDED WITH FIRST ORDER.

Please send me the following Craft Print Plan(s).

Craft Print(s) #255 _____ @ \$3.00 each
Craft Print(s) #334 _____ @ \$15.00 each
Craft Print(s) #106 _____ @ \$3.00 each

Enclosed is \$ _____

A FREE Catalog is included with each Craft Print Order. Sorry No C.O.D. orders accepted. First class mail . . . 50¢ extra

NAME: _____

ADDRESS _____

CITY _____ STATE _____ ZIP _____

SAVE! SPECIAL OFFER: Order 2 or more sets of Plans and you can deduct 10%—from the total price.

e/e etymology

How about a word with us?

Decibel

▲ Long before anyone became seriously concerned about "noise pollution," scientists recognized the need for a standard unit for measuring sound pressure level.

The task of establishing such a unit proved infernally complicated. In the end, international agreements settled on relative difference in power between acoustic and electric signals as a critical—and measurable—factor.

There was an attempt to use the common logarithm of the ratio of the two levels as a unit, but that proved too clumsy. So this ratio was divided by ten—a workable unit.

Once established, the unit had to have a name. The man who more than any other had changed the world's ways of transmitting sounds over long distances was an obvious candidate for honor. So from Alexander Graham Bell's surname plus the standard prefix for one-tenth, the term *decibel* was formed. Adopted early in this century, it remained in the vocabulary of specialists until hi-fi sets made the western world sensitive to the importance of the decibels falling upon a person's ears at a given instant.

Berkelium

▲ To the average American today, the name Berkeley is likely to be taken as a symbol pointing to student violence, hippies, the drug culture and anti-establishment movements.

Until comparatively recently, Berkeley was an obscure city known chiefly as a manufacturing center. Its factories produced food products, soaps, engines, inks, and foundry products.

True, the University of California had been established in 1855, but by comparison with the great schools of the east it was little known. Westward surge of population, with the school's enrollment climbing year after year, made it one of the world's biggest.

As the school grew, it attracted eminent teachers in the field of physics. Some of the world's costliest and most elaborate equipment was built there.

More than any other place in the world, Berkeley became famous for production of new elements. Neptunium was produced there in 1940, with the discovery of plutonium coming the same year. Americium and curium followed in 1944.

Late in 1949, Stanley G. Thompson, Albert Ghiorso, and Glenn Theodore Seaborg used the 60-inch cyclotron of the Crocker Radiation Laboratory to bombard americium with helium ions. This yielded another element. Its atomic number is 97 and all its isotopes are radioactive. Isotope 243, the first to be found, has a half-life of about 4.5 hours.

It seemed fitting to name the fifth artificial element produced at Berkeley in honor of its place or origin. *Berkelium*, which holds great promise for use in atomic medicine, didn't prove to be the end of the trail, though. In subsequent years Berkeley scientists have produced such exotic substances as californium, mendelevium, and lawrencium. Long after the student protest movement has been forgotten, the California city will be remembered for berkelium and other radioactive elements produced there.

Hall Effect

▲ In years after the U. S. Civil War a little-known experimenter began poking around with factors that affect capacity of a metal to carry electric current.

In 1879 he applied a magnetic field to the current flow at right angles without having any idea what (if anything) would happen. To his surprise he discovered that such a magnetic field causes an electric voltage to appear across the sample of metal in a direction that is perpendicular to both the direction of the current and of the magnetic field.

Neither he nor anyone else had the slightest notion of how to make practical use of this phenomenon. Still, it was duly named the *Hall effect* in honor of its discoverer and was reported in technical works.

Today the Hall effect is regarded as due to deflection of free electrons in the solid. These are affected by both the applied electric and the magnetic field, so move toward the edge of the sample. In equilibrium they distribute themselves non-uniformly across the sample and give rise to the observed voltage.

Purely academic?

Not on your life! One of today's most urgent problems is the development of new alloys with both high electrical conductivity and high tensile strength so that current can be transmitted long distances with low losses.

More than any other phenomenon, the Hall effect permits measurement of electron scattering by a foreign (alloyed) element. By use of it, research workers hope to find or develop new alloys that will help meet the world's need for electric power. ■

READER SERVICE PAGE

• The Editor of ELEMENTARY ELECTRONICS offers readers an easy way to get additional information about products and services advertised in this issue. Also, if you would like more information about any new product mentioned in our column "Hey, Look Me Over," it's yours for the asking. Just follow the instructions below and the material you requested will be sent to you promptly and at no cost.

• The coupon below is designed for your convenience. Just circle the numbers that appear next to the advertisement or editorial mention that interests you. Then, carefully print your name and address on the coupon. Cut out the coupon and mail to ELEMENTARY ELECTRONICS, Box 886, Ansonia Station, New York N Y 10023. Do it today!

Void after July 31, 1971

ELEMENTARY ELECTRONICS

Box 886, Ansonia Station, New York N Y 10023

Please arrange to have literature whose numbers I have circled at right sent to me as soon as possible. I understand that this is a free service offered by the magazine.

	1	2	3	4	5	6	7	8	9	10
	11	12	13	14	15	16	17	18	19	20
	21	22	23	24	25	26	27	28	29	30
	31	32	33	34	35	36	37	38	39	40
	41	42	43	44	45	46	47	48	49	50
	51	52	53	54	55	56	57	58	59	60

Name (Print Clearly) _____

Address _____

City _____ State _____ Zip Code _____



TECHNICALLY SPEAKING



by Jack Schmidt



"... then the frequency shifted causing the garage door to close while..."



"Top heavy?"

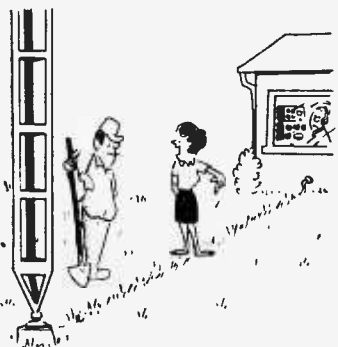

"... and the pool's center right here!"

4 HOUR
REPAIR
SERVICE



"I said, 'I think I've found the trouble.'!"

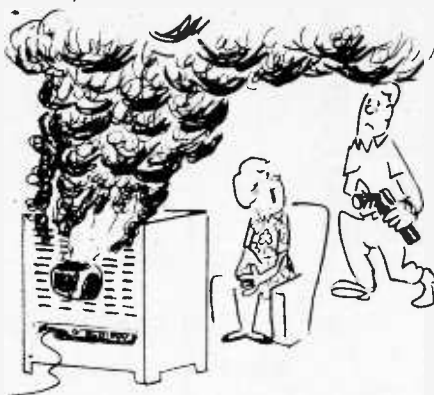

"Honest, honey, I thought it was the last of the cigarette commercials!"



"There's the goof, Daddy. The 5-uF cap is connected across the 10K pot!"

MOD METHUSELAH

Hark!
Ye olde tyme
BCB regen rig
grooveth anew
with
high-voltage
transistors

by Charles Green



Back in Radio's early days, receivers were practically chained down to heavy, unwieldy batteries for their circuit's electrical power. After a while, someone got the bright idea to convert the electrical energy coming from Mr. Edison's power plant to energy suitable for their radio. That economy-minded inspiration was one of the straws that broke the lead-acid-battery camel's back. For with the perfection of a-c to d-c power supplies came the universally-accepted receiver—one that could be played wherever line current was available.

Solid-state gear has followed the same power-supply evolutionary process. Remember how the first transistors sold to the experimenter literally fell apart at their junctions if you tried to juice them with an old radio B-battery you might have had lying around the shack? You soon got

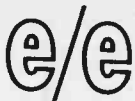

MOD METHUSELAH

the idea that those three-legged wonders could swallow but a mere 12 volts at one gulp. Soon after, the a-c power supply found its way to your transistorized-project laden workbench.

And today? Seems to us that the hero of today's shrinking solid-state world is the high voltage transistor. Especially a transistor that can easily withstand the peak voltages found at the business end of an a-c line cord.

You can check out the performance of these new high-voltage transistors—and easily, too.

Build our simplified, two transistor, regenerative rig, and discover one of the most popular receiver designs ever bench-tested! Called *Mod Methuselah*, it'll tune the Broadcast Band with a stability never before found in line-operated, regen receivers. No drift's only part of *Mod Methuselah's* story; our rig's powerful enough to drive a built-in 6½-in. speaker to room-filling volume. And, like the Biblical character our Aquarian-Age rig is named for, *Mod Methuselah* will find a place in your shack for, what appears to be, an eternity!

Magic Methuselah. Looking at *MM's* schematic, you'll see that signals from antenna jack J1 are fed to the primary of antenna transformer, T1. These incoming signals are coupled to the parallel-tuned cir-

cuit consisting of T1's secondary, and series-connected capacitors C3 and C4. Thanks to mutual inductance, the signal from T1's secondary is coupled to the transformer's base winding.

Now we've come to the point where the leading characters are introduced in this RF drama. Capacitor C5 and resistor R2 team up to play two parts at once. The capacitor provides a low-impedance path for the RF signal to the base of transistor Q1. It also acts as an integral part of the detection process found in every regenerative detector. The resistor R5 provides not only the proper dc forward bias for Q1. It also works as the other half of the grid-leak-detection component pair.

By now you must certainly be wondering what the heck is "grid-leak detection." The name, by itself, doesn't give the circuit's function away. If anything, it might serve only to confuse the electronics experimenter—there's really no *grid* involved here at all!

Grid-leak bias, or detection, harks back to *Mod Methuselah's* earlier days when electronics experimenters spent the better part of an evening building their own tubes and other components. This bias system is a means of developing a direct bias voltage between the base and emitter of Q1 by rectifying the incoming signal for the purpose.

When the a-c polarity of the incoming RF signal is such that Q1's base is positive with respect to the emitter, there is a current flow in the base. This current flow is limited

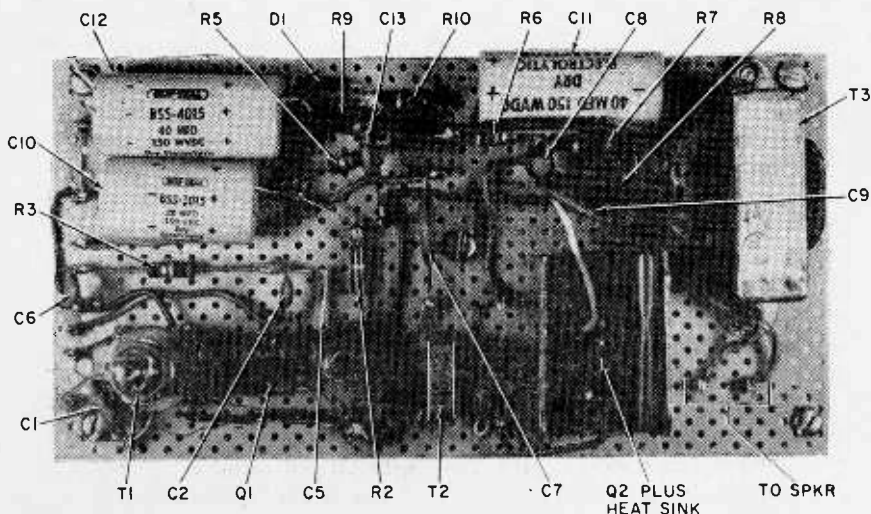

Author's pc prototype of *Mod Methuselah*. Capacitor C11's size is critical: grab smallest one you can buy. Flea clips at lefthand-most side of pc board terminate R1, R4 leads.

PARTS LIST FOR MOD METHUSELAH

- C1, C4, C13**—.005 μ F, 500 VDC disc ceramic capacitor
C2, C6—450 pF, 500 VDC disc ceramic capacitor
C3—10 to 365 pF, single-gang variable capacitor (Lafayette 32F11034 or equiv.)
C5—.1 μ F, 25 volt disc ceramic capacitor
C7, C9—.01 μ F, 400 VDC disc ceramic capacitor
C10—20 μ F, 150 volt electrolytic capacitor
C11—100 μ F, 150 volt electrolytic capacitor
C12—40 μ F, 150 volt electrolytic capacitor
D1—Silicon rectifier: 600 PIV @ 1 Amp (Motorola HEP-158 or equiv.)
I1—Fuse: 1/4 Amp @ 250 volts (Lafayette 13F10085 or equiv.)
J1—Fahnestock clip terminal (Lafayette 33F71028 or equiv.)
Q1—Silicon high voltage npn power transistor (Motorola HEP-244 or equiv.)
Q2—Silicon npn power transistor (Motorola HEP-240 or equiv.)
R1—5,000-ohms audio taper potentiometer with switch S1 (Lafayette 32F22510 or equiv.)

- R2**—10-megohms, 1/2-watt, 10%
R3, R5—10,000-ohms, 1/2-watt, 10%
R4—100K-ohms audio taper potentiometer (Lafayette 32F22536 or equiv.)
R6—47,000-ohms, 1/2 watt, 10%
R7—470-ohms, 1/2-watt, 10%
R8—56-ohms, 1/2-watt, 10%
R9—2,700-ohms, 1-watt, 10%
R10—100-ohms, 1/2-watt, 10%
S1—SPST switch (part of R1)
SPK1—6 1/2-in., 8-ohm extension speaker mounted in wood enclosure (Lafayette 99F02032W or equiv.)
T1—antenna coil; 540-1700 kHz (J.W. Miller A5495-A or equiv.)
T2—audio driver transformer; primary, 100,000-ohms; secondary, 1,000-ohms (Lafayette 99F61251 or equiv.)
T3—audio output transformer; primary, 10,000-ohms; secondary, 4-ohms (Stancor A3879 or equiv.)
1—fuse mounting assembly (Lafayette 13F62045 or equiv.)
1—perforated board cut to 3 1/4-in. x 6 1/2-in. (Lafayette 19F36061 or equiv.)
Misc.—sheet aluminum, flea clips, decals, AC line cord, knobs, solder, hookup wire, #28 enameled wire, 1/2-in. dia. wood dowel for spacers (see text), etc.

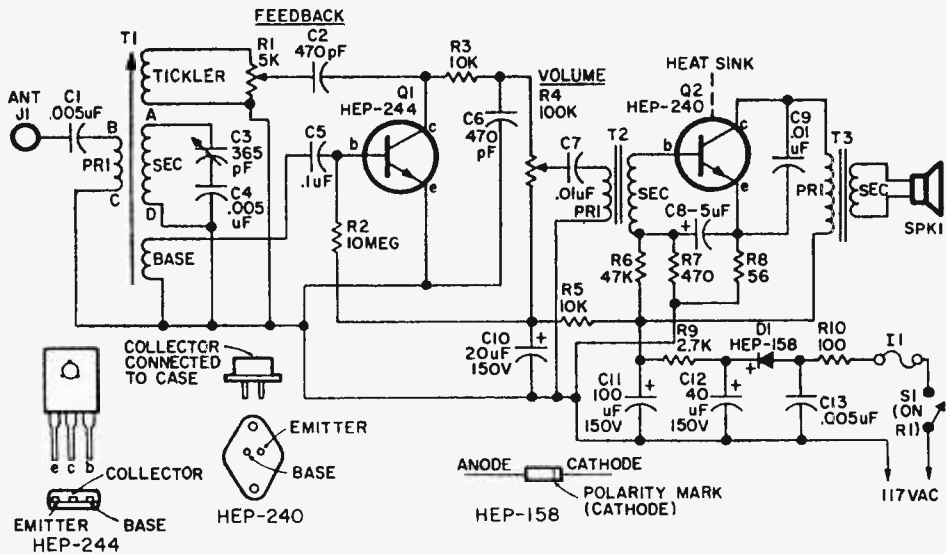

by the ohmic value of R2. A direct voltage is developed across R2.

Since the d-c resistance of the signal source (the base winding of T1) is, for all practical purposes, zero ohms, the capacitor C5 is in parallel with R2. The charge across C5 soon reaches the peak value built up across R2. Capacitor C5 discharges through R2 whenever the applied signal falls below the peak value. The base winding of T1 supplies just enough voltage to keep C5 re-

charged during each cycle.

Since the value of R2 (10 megohms) is large by comparison with the value of C5 (.1 μ F), and the time constant of the circuit is long in comparison with the time constant of one cycle of RF energy, the energy absorbed by the grid leak is small. As the incoming signal changes in level, the bias developed by components R2 and C5 changes automatically.

The alert experimenter has, by now, fig-

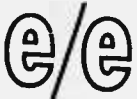

MOD METHUSELAH

ured out the key to *Mod Methuselah's* detection process. Since the incoming signal is amplitude modulated, the average d-c voltage level will exactly follow the peak envelope pattern of the RF waveform! Voila—recovered audio from the RF incoming signal!

A portion of Q1's output signal, derived at the collector of Q1, is fed back to the antenna coil's *Tickler* winding. Capacitor C2 acts as the feedback coupling capacitor, while potentiometer R1 controls the amount of regeneration—or positive feedback—returned to T1.

You'll find that if you've wired the tickler coil into the circuit properly, this feedback

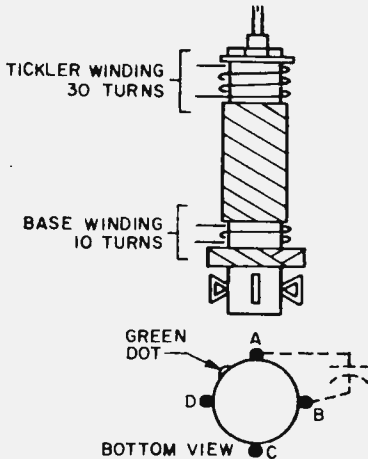

Remove capacitor (shown dotted) from T1 before adding base, tickler windings. Both consist of No. 28 enamelled wire.

signal is in phase with respect to the incoming voltage appearing at T1's secondary. Crank up the Regen control far enough, and enough feedback causes *Mod Methuselah* to break into that all-too-familiar regen rig "howl."

After the recovered audio signal emerges from Q1, it's routed through rf filter components consisting of R3 and C6. *Volume* control, R4, acts as Q1's audio-frequency load; the signal is coupled via components C7 and T2 to the base circuit of transistor Q2. Resistors R6 and R7 form a voltage divider supplying Q2's base drive. Resistor R8 provides a small degree of emitter self-bias which tends to stabilize Q2's current flow as it warms to the sounds of *Mod*

Methuselah's success. And finally, transformer T3 couples the audio signal to *MM's* speaker.

Mod Methuselah's power supply is as conventional as fireworks on the Fourth of July. It's a half-wave, transformerless affair; with only about six milliamperes being drawn from it, the power rectifier, D1, won't ever warm to your touch. Heaps of power supply filtering is used in *Mod Methuselah*. The results give our *MM* a sound almost as good as if this rig was battery powered!

Methuselah, Modly Manufactured. *Mod Methuselah's* physical layout and circuitry are relatively uncritical, 'cause we're only working with the medium RF frequencies. Take care, though, to use good wiring practices as you construct *MM*; keep the RF leads short, and remember to route audio output wiring away from the power supply section. For best results follow our layout as shown in the photos. And keep our patriarch's Number-One Rule uppermost in your mind: to prevent accidental electric shock, keep all wiring and components enclosed within the specified wood box!

Most of the rig's components are mounted on a 3/4 x 6 1/2-inch perf board section. Tuning capacitor C3, Regen control R1 and Volume control R4 are mounted in the author's prototype on brackets on the side of the box.

Capacitor C11 is critical, size-wise. After slogging through a couple of catalogs, the author finally decided upon Lafayette Radio Electronic's part number 34F55441. It's a 100 uF miniature electrolytic capacitor rated at the required 150 Volts. Any other size electrolytic capacitor will probably be too large to fit in its allotted space on the pc board.

Begin construction by cutting the perf board down to size. Then mount 1/2-inch long sections of 1/2-inch diameter wood dowel spacers at each board corner and board center with self-tapping screws.

Lay out, mount, and wire the perf board components as shown in the board photo and schematic. A handful of push-in clips help to secure the component's leads. Transistor Q2 is mounted upside down through a hole in the perf board; its heat sink is made from sheet aluminum as we've shown in the drawing. Transformer T2 is mounted on the perf board by bending its mounting tabs through holes in the board. Simple? You bet!

Transformer T3 is mounted on the perf

board with machine screws and nuts. Antenna coil T1 is anchored to the board by soldering flea clips to its terminals.

Unsolder the small capacitor that comes with T1 before mounting the antenna coil.

Then make the base winding from 10 turns of number 28 enameled wire on the coil form between the coil's original primary and secondary windings. Cement with a good grade of coil dope to hold the base winding in place. Leave approximately 1½ inches of wire hanging free to solder the leads to the rest of the circuit. The tickler winding is made by scramble-winding 30 turns of number 28 enameled wire on the top of the coil form adjacent to the top of the secondary. Again, a good grade of coil glop holds down this added winding. Remember to leave approximately 1½-inch leads for soldering purposes.

Fabricate the mounting brackets for pots R1 and R4, and tuning capacitor C3. The actual size and shape of the mounting brackets are up to you, so do your own metal mashing to suit yourself. Drill the holes and mount the components and brackets on the side of the box with small wood screws. Make sure that the wood screws do not protrude through to the outside world! If necessary, cut both potentiometer and tuning capacitor shafts to size before mounting. Reason is, you want all knobs to fit as close to the box surface as possible.

And, while we're on the subject, use knobs with recessed set screws, making sure to fill all recessions with wax to prevent body contact with the metal control shafts. All of these steps are taken to insure precaution against electrical shock.

Last, but not least, connect 6-inch leads to the flea clips which make eventual connection to both potentiometers and the tuning capacitor. Cement the perf board in place to the box bottom. The author found that hot glue squirted to the bottom of the wood dowel spacers worked for him, but any fast-acting cement does the job.

Make sure that the board is cemented in far enough. Otherwise, you'll never get the box's back cover to seat itself properly. After you've cut the board leads to size, connect them to the components as mounted to the box. The author mounted capacitor C4 on a terminal strip screwed to the tuning capacitor's frame.

Install fahnestock clip J1 on the box cover back panel and connect it with a 5-inch lead to capacitor C1. Run the AC line cord

through a hole in the cabinet's rear cover. Then knot the line cord and connect one lead of it to the power supply common lead and one to switch S1 located on the rear of R1.

Connect the other end of the AC line cord to the plug, and install fuse I1 in its holder. Install the rear cover on the box, making sure that it has been well endowed with ventilating holes. Take a deep breath—your construction chores are over!

Making Methuselian Music. After you've checked out our *MM*, connect an antenna to J1. For local stations, a 20 foot inside antenna is adequate. But if you're trying for distant station DX, try rigging a high, inverted-L antenna cut to the broadcast band.

Mod Methuselah obtains its RF ground through the AC power lines. Do not connect a ground lead to the receiver. As with all types of AC/DC power-transformerless re-

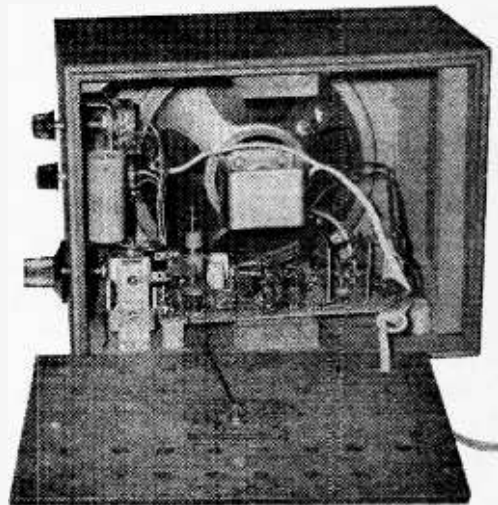

Potentiometers, tuning capacitor are mounted on aluminum brackets. Capacitor you see is larger C11 remounted off pc board.

ceivers, do not attempt to connect any grounded surface to the internal circuits.

With all of our warnings and *do-nots* staring you down, we want to tell you how to properly ground *Mod Methuselah*. First, plug *MM* into an AC wall socket and turn on the rig. Connect one lead of a VOM (set to read AC Volts) to the negative lead of capacitor C12.

Touch the VOM's free test probe to the metal screw holding the AC socket wall plate in place. If this isn't feasible, touch the free test probe to any metallic surface you know for sure is grounded. The VOM's meter

e/e MOD METHUSELAH

needle will either indicate full line voltage, or it will barely budge off zero Volts.

The trick is to get the VOM to indicate the lowest of the two readings with *Mod Methuselah* powered. Reverse the AC plug in the wall socket: the lowest reading obtained on your VOM indicates that the receiver's power supply common return is connected to your power utility's common, or "ground" lead. Okay, we've given you a good dose of the electric heebie-jeebies. Let's put *Mod Methuselah* through its paces.

Connect the AC line plug to the juice, and play switchies with the plug until you've properly grounded the rig the way we've instructed. Advance Volume control R4 fully clockwise and adjust Regen control R1 to its midrange position. After you've connected your antenna to J1, tune C3 from one end of its travel to the other end, adjusting the Regen control as necessary for maximum sensitivity and selectivity.

If the Regen control is turned too far, there will be strong squeal. Adjust the control until this squeal disappears. If no chirps or squeals are heard, reverse *only* the tickler winding connections on the antenna coil. Both Regen control and Volume controls have a certain amount of interaction; they'll both have to be adjusted for best reception as each station is received. This feature is typical of all regenerative receivers.

Tune to the high end of the broadcast

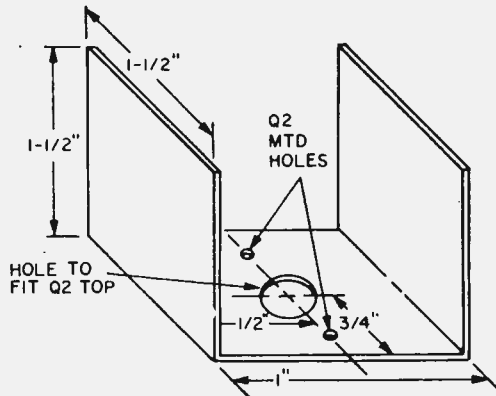

Make heat sink for transistor Q2 out of sheet aluminum. Deburr before mounting Q2.

band, and turn T1's slug with an insulated screwdriver until the volume of the station that you're tuned to (or the background QRM level) increases. Back off the Regen control as you adjust T1. Now tune C3 to the BCB's low end; adjust the trimmer on C3 for maximum sensitivity. You may also have to slightly re-adjust T1's slug to complete this test procedure.

With this initial—and only—test procedure taken care of, make a tuning scale for your rig. You may choose a suitable vernier logging scale found in any electronics catalog—Lafayette's model 99F25660 is as good as any. Finish *Mod Methuselah* by applying decals to both Volume and Regeneration controls. After you've applied the decals, calibrated and lettered the tuning scale, close
(Continued on page 96)

You can't ask for cleaner styling than what you see here from any homebrew project. In MM's case, however, form has to follow function; wood case, non-conductive knobs help to keep your mitts off *Mod Methuselah's* potentially "hot" innards! Author applied decals to finished model. He apparently chose not to calibrate dial scale.

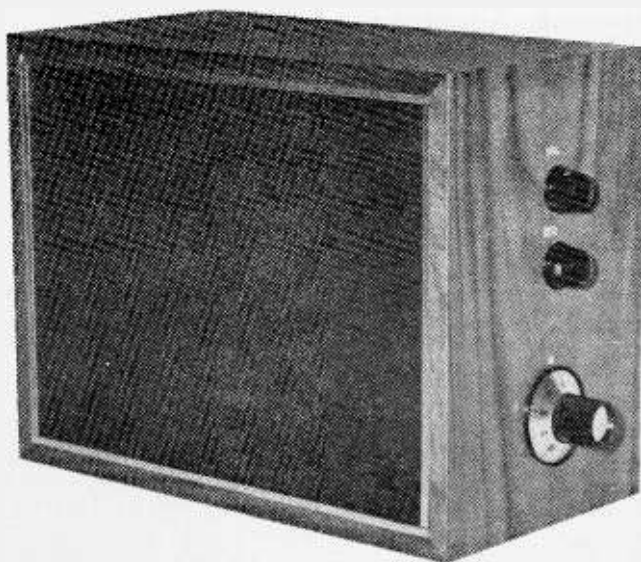

It was 4:00 a.m. and the thermometer read 15 degrees below zero. The squad car had to deliver the package without delay! Thanks to the flashing red light and the 2 kHz note screaming from the siren, the three miles from the bus terminal to police headquarters were covered in only 2½ minutes. The chief rushed out to get the package. He likes his coffee hot.

So the siren gave out a 2 kHz note. Is that anything like, say, the 60 Hz current which lights a table lamp or, maybe, the 27.155 MHz carrier a CBer sends out from his 5-watt rig? The answer is yes—and no! No, because the siren note is actually a *disturbance of the air* which surrounds the whirling siren. The 60 Hz current which lights the lamp is actually a *disturbance of electrons* in the lamp cord. And the CB carrier is actually a *disturbance in the electromagnetic field* which surrounds the transmitting antenna. But the answer is also yes because, in spite of their apparent differences, the siren note, the 60 Hz current, and the 27.155 MHz signal all have something in common—the characteristic way each of these “disturbances” go through their vibrations.

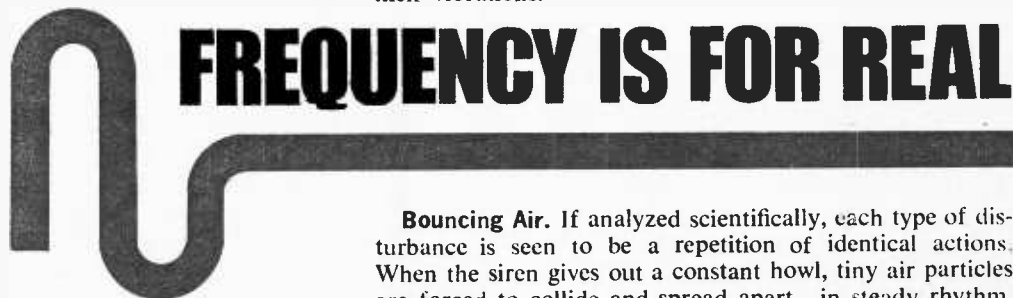

FREQUENCY IS FOR REAL

Frequency can be sensed in many ways but it usually takes only one shape

by Walter S. Andariese,
W2WIJ

Bouncing Air. If analyzed scientifically, each type of disturbance is seen to be a repetition of identical actions. When the siren gives out a constant howl, tiny air particles are forced to collide and spread apart—in steady rhythm. If the howl is a 2 KHz note, the colliding and spreading takes place 2000 times a second. Although the individual air particles move hardly any distance at all in their back and forth motion, the rhythmic collisions of these particles radiate from the siren in all directions, from particle to particle. This radiation is, of course, “sound” and travels through air at a speed of about 1100 feet per second.

Bouncing Electrons. Alternating current flows back and forth through a wire because electrons, in varying quantities, are made to push one another first in one direction and then the other—in steady rhythm. If this AC is 60 Hz current, such back and forth motion takes place 60 times a second. The individual electrons don’t move very far along the wire in either direction but their “bumping” travels through the wire at a speed of almost 186,000 miles per second. Naturally, this bumping action is made to change directions in step with the electrons that cause it.

Bouncing Fields. Basically, a radio signal is a disturbance in which the electric and magnetic fields surrounding a transmitting antenna are distorted, first in one direction and then the other—in steady rhythm. If this signal is a 27.155 MHz CB carrier, these fields are forced to change direction 27,155,000 times a second. This rhythmic, field-reversing action radiates from the antenna at the speed of light, 186,000 miles per second.

Feel the Vibrations. Now—it’s the changing nature of

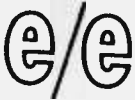

FREQUENCY IS FOR REAL

these three types of disturbances that we are really interested in! Aside from what is actually and physically happening, all three seem to follow the same pattern of change while going through their vibrations. True, the 27.155 MHz signal does its vibrating much, much faster than the other two but its vibration pattern is much the same.

Instead of using a lot of words to describe how each disturbance goes through its vibrations, let's use a helpful mathematical tool—the graph. The ancient Chinese said that *a picture is worth a thousand words* and that's exactly what a graph is and its worth. More important, a graph provides us with a *lasting* picture, a permanent record,

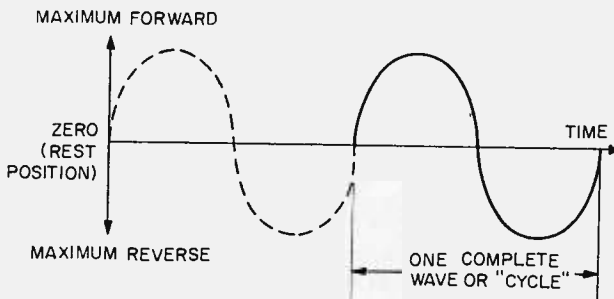

Whether you're trying to graphically picture ripples on a sylvan pond, or the unmodulated carrier of a Citizens Band RF voltage, the familiar sine wave is all you need to draw. All sine waves have peaks culminating in "maximum forward" points and "maximum negative" points, each occurring once each cycle.

of how these vibrations change their speed and direction.

Our graph is set up in the usual manner. First there are the two reference lines, the "vertical axis" and the "horizontal axis." In our graph, the horizontal axis is made to show the *passage of time*. How the vertical axis is used depends on which type of disturbance we are portraying. For the 2 KHz siren note, the vertical axis is made to measure *how far* each air particle moves during its back-and-forth motion. For the 60 Hz AC current, the vertical axis measures *how many* electrons are in mass movement along the wire during their forward-and-reverse motion. As for the 27.155 MHz signal, this axis tells *how much* and in what direction the electric and magnetic fields are being distorted.

So much for the preliminaries. Next comes* the most important item. It doesn't matter which disturbance we are graphing—for each *instant of time* that is represented on

the horizontal axis, there is a *point* above or below this axis which measures how far the vibration is displaced from its resting position. If all these individual points (and there are an unlimited number of them) are "plotted" on the graph, a continuous curve will appear. The amazing thing about this curve is that its shape looks pretty much the same for the 2 KHz note, the 60 Hz current and the CB carrier.

Study the special shape of this curve. While examining the curve (and this must be done from left to right, never from right to left!), notice that it rises abruptly, gradually tapers off, levels out for an instant, starts to fall, picks up downward speed, and falls below the horizontal axis only to repeat the process in upside-down fashion. The 2 KHz note will make 2000 of these waves in just one second while the 60 Hz current goes through only 60 of them. But the

CB carrier will turn out 27,155,000 of these double swings during each second.

You Had Better Believe. This curve we have been discussing is something very special! It is fundamental to many different areas of science and engineering. It is the famous *sine curve*. The current leaving a simple AC generator varies according to a sine curve. So does the output of a vacuum-tube or transistor oscillator in an AM radio. Even the pendulum on a grandfather's clock swings back and forth in accordance with a sine-curve pattern.

But it must be understood and understood well! The sine curve is only a graph which shows the changing character of sound waves, alternating currents, and radio transmissions, etc. To be sure, a sine curve is a picture but it is *not* a picture of sound waves, currents and radio signals as they really look (if, in some way, we could actually see them).

(Continued on page 99)



KATHI'S CB CAROUSEL

By Kathi Martin, KAIØ 614

EACH week letters by the hundreds sprawl across my desk from Citizen Band buffs like you and I. Some shed rays on a special CB brain stumper requiring, as it generally turns out, a simple solution to a seemingly brain-boggling problem. But, I'm also getting mail from more and more electronics enthusiasts who are discovering that Eleven Meters is where the action is, and are jumping head first into CB's pool. They send to me an ever-increasing pile of letters. Many asking about our Band. And, even more important—they want to know, equipment-wise, what CB's future holds for them.

Up until two or three years ago, the transmitter portion of all CB transceivers relied upon amplitude modulation, or *AM*, for short. Some CBers who were in the know referred to AM as "ancient modulation." And with good reason, too. While this kind of transmitting system—which dates back to my granddaddy's day—works well for single-tone signals, it falls way down in the performance department with voice signals.

Today, the technically with-it CBer can neatly sidestep the power-wasting problems of an AM rig with a *single-sideband* transceiver (that's *SSB*, in tech talk). An SSB-modulated rig's big advantage is its *ap-*

parent gain in signal range—it's something like being boosted four times over a conventionally-modulated rig's signal! But, for all of SSB's seeming cure-all qualities, SSB and CB weren't exactly ready for each other until now.

Return of the Wayward Rig. One of the reasons single sideband never became dear to the CBer's heart is that most manufacturers' early attempts turned out to be nothing more than an oversized "gold plated" base station rig. These monsters totally lacked the simple push-and-talk operation we're so used to with today's rig. "Fiddling with knobs" seemed to be the prime consideration with these first SSB rigs.

Now that some manufacturers have finally come to the realization that a single sideband-modulated transceiver should be as simple to operate as any conventional CB rig, we can expect the SSB-modulated transceiver to really become CB's rig of the future. For just the simple switch to sideband can easily increase your signal range up to four times! That's 80 miles of SSB talk power vs. 20 miles of AM.

Some Future Thoughts. I recently put a good example of this kind of futuristic SSB Citizens Band thinking through its paces. As

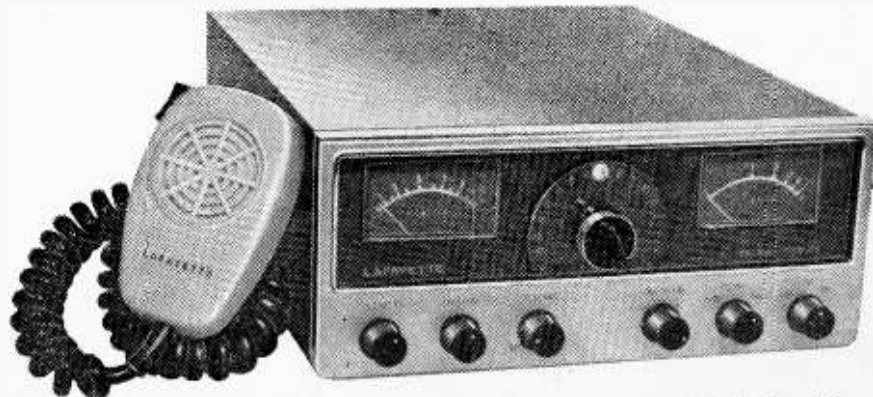

Zippy looking front panel, graced with easy to manipulate controls, make Lafayette's Telsat SSB-25 rig one beautiful transceiver to work with—either in your car or outdoors!

e/e KATHI'S CAROUSEL

far as CB sideband is concerned, *Lafayette's Telsat SSB-25* AM-Single Sideband transceiver offers a host of features. At first inspection it looks like any other CB transceiver. The *Telsat SSB-25* looked a little bit larger than other rigs in its 9"W x 3¾"H x 11½"D cabinet. The front panel control layout tells you right away that this rig is all business, with a 23-channel selector flanked by oversize S and RF output meters.

Along the bottom edge are grouped the usual transceiver controls for *Squelch*, *Volume* and *Fine Tuning*. Then you'll see three new ones not found on the conventional CB rig—*RF Gain*, another control marked *LSB/USB/AM* and one marked *NS, ANL* and *PA*. The *LS/USB/AM* markings stand for the transmission and receiving modes; *LSB* for *lower sideband*, *USB* for *upper sideband* (both referring to *Telsat's* single sideband capability), and *AM* for standard Amplitude Modulation.

The *NS/ANL/PA* selector determines which of two built-in noise limiters is used, or whether the transceiver functions as a PA system. When set to *NS*, a special *noise silencer* is cut into the circuit *in addition to* the *ANL*. The noise silencer is especially effective in beating down ignition impulse noise by literally punching "holes" in the transceiver's output corresponding to the noise pulses.

Though the rear apron resembles a miniature computer, all of those jacks and controls are necessarily there for maximum convenience. First, an 11 pin octal socket gracing the rear apron of the *Lafayette Telsat SSB-25* automatically switches the power supply from 120 VAC to 12 VDC. This depends upon which of two supplied

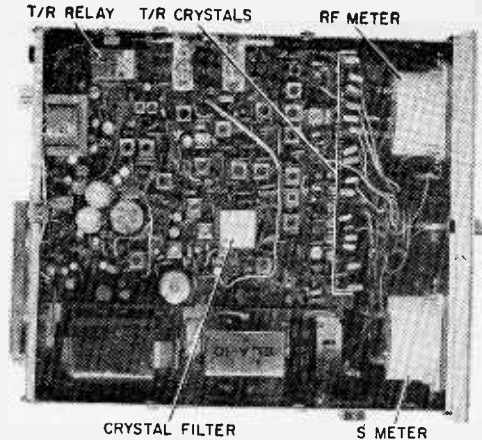

Individual Transmit/Receive crystals give clue to this rig's operating stability. I wish every rig had separate S, RF meters.

power cables is plugged into the rig.

There are jacks for a *PA speaker*, and *external speaker*. The *Telsat SSB-25* also has a jack for *external audio input*—the rig can even serve as an audio amplifier! A standard SO-239 antenna jack mates with any 50-ohm "stick" you can muster up. Topping off the goody list is a jack for plugging a tape recorder into the *Telsat SSB-25*. The *antenna loading* control and *TVI filter* are accessible through holes in the rear apron but I suggest that you leave these controls alone.

Finally, you will find two wires sticking out of the back. These are for, would you believe, your car's *burglar alarm*. You connect both wires into your car's horn or burglar alarm siren circuit. This burglar bungler works by sounding the horn or siren as soon as the intruder attempts to remove the right rear retaining screw.

Loaded Circuit. The *Telsat SSB-25's* circuit is—well, loaded! In addition to the two independent noise limiters, a crystal filter suppresses the unwanted sideband. Now add a highly effective ring modulator for carrier suppression.

Even mounted under my car's dash, all front panel controls were within my arm's reach. Noise silencer circuit was especially effective working mobile. Fine Tune control made reception of SSB signals easier than licking ice cream on a muggy June day!

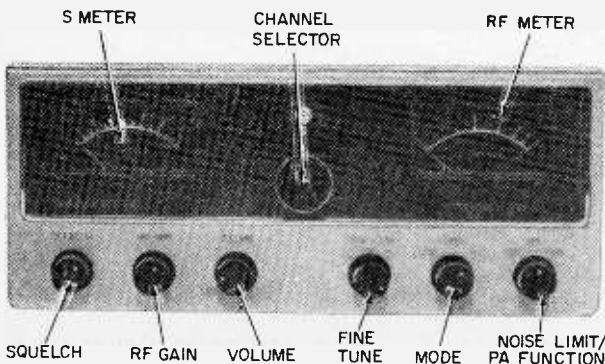

A mechanical filter enhances IF selectivity. There's range boost for amplitude modulation, a product detector for sideband reception, and a fine-tuning capacitor that "tunes" a crystal for stations not precisely on frequency.

Because there are no tuned frequency-control circuits, (all frequency conversions use crystal oscillators), the *Telsat SSB-25* is literally rock-stable in the SSB mode.

The *Telsat SSB-25's* AM sensitivity for a 10dB signal-to-noise to noise ratio measured 1.6uV. The minimum sensitivity for SSB reception using synthesized signal input was a mere 0.35uV. Sideband reception is always more sensitive, as our lab's test report shows.

The selectivity was better than 50dB adjacent channel rejection, while the image rejection was unmeasurably low. Automatic gain control action is so good that it appears to be almost unbelievable! With a test input signal range of 1 to 10,000 uV, the audio output variation was less than 3dB. In plain terms, this means that if you have the audio gain control cranked wide open to hear a weak signal, your socks won't be knocked off when the station down the block opens up.

A Hot Performer. *Lafayette's Telsat SSB-25's* S-meter is as hot as a pistol, reading almost S6 on signals less than 2uV strong. Anything higher than 2uV pushes the pointer almost to S9.

The transmitter slaps out a healthy 3.5 watts RF into a 50-ohm antenna load in the AM mode. The peak envelope power (PEP) for sideband was not measured—the test could result in the destruction of the output transistors. But a visual test using a scope indicated that the *Telsat SSB-25's* PEP is at least 10 watts.

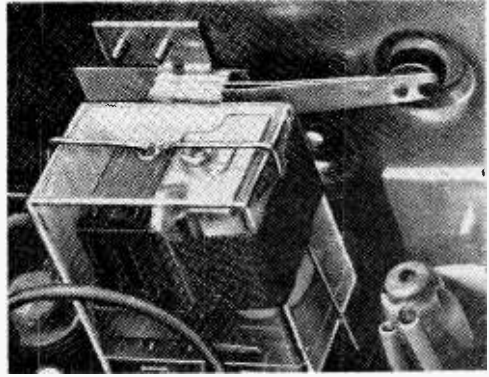

Plastic can houses Transmit/Receive relay. That blade-shaped thing above T/R can is Telsat SSB-25's burglar alarm contact.

In the AM mode I found that the transmitter had a -20dB sensitivity for 85% modulation; this represents an average reading. There is a very effective range boost speech compressor that handles even direct shouting into the mike without excessive distortion.

Actual operating sideband tests delivered excellent performance from *Lafayette's Telsat SSB-25*. Under normal conditions, there is no drift turning the reception of sideband signals into monkey chatter. Under severe vibration—there was a slight drift caused by the movement of the fine tuning capacitor. But the drift wasn't ever bad enough to interfere with reception; it sounded like a slight raising or lowering of the voice pitch.

The *Lafayette Telsat SSB-25*, priced at \$299.95, is for the CBER who wants to look to the future now. It includes a plug-in microphone, AC and DC power cables, a mobile mount and all crystals. For additional information, circle Number 32 on the Reader Service coupon on page 27. ■

Telsat's rear panel only begins to tell of rig's versatility. There are enough external inputs, outputs to keep even persnickety CBERs happy.

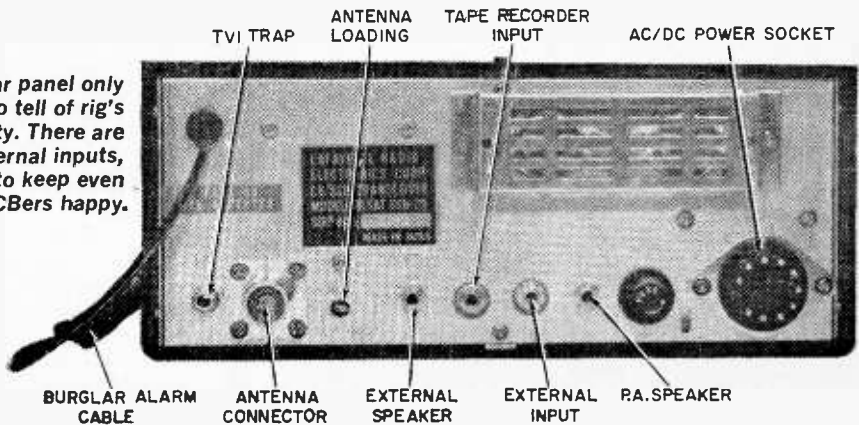

**THAT
COP
IS**

Students take the law into their hands as they assist University cops around the clock.

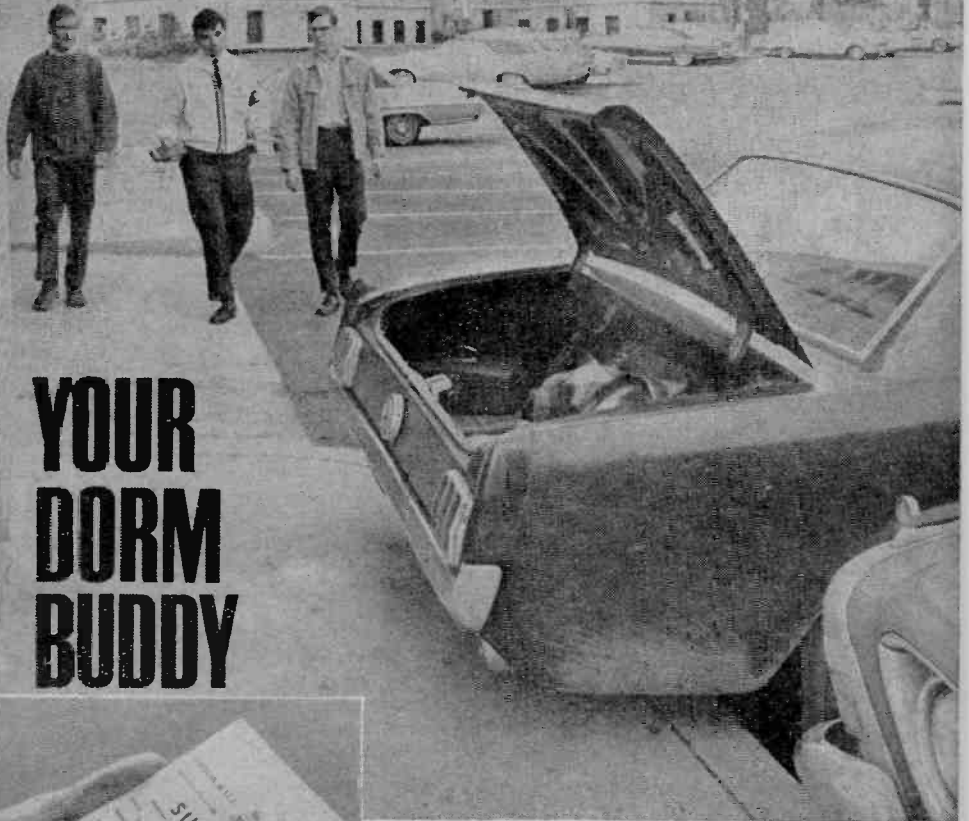

**YOUR
DORM
BUDDY**



It's turning out at Seton Hall University that Big Men On Campus don't go for panty raids any more—they've discovered parking raids, instead. Shown to left is sample of SCP at work; student who finds his car ticketed, has only his dorm buddy to thank.



Left—Walkie-talkies go hand in hand with parking lot patrols. Below—Few acts of vandalism go unnoticed as SCP's watchful eye guards campus grounds.

Everyone knows how Pupil Power often takes an occasional pot shot against the law-and-order clan. Question is, how do both sides work together? Donson W. Dessau hit upon a solution to his peace-keeping problem. Why not "deputize" students, he wondered, and make them a part of the Law?

The plan, implemented on the campus of Seton Hall University, where Dessau is the Security Division Chief, proved to be an ingenious one. It seems Seton Hall was being plagued by a rash of thefts and vandalism. "I thought students would make good law enforcers" says Donson. "After all, their cars were being broken into and their property being taken."

Dessau asked a student to organize the Seton Crime Patrol; fourteen students were soon accepted for duty. All were given instructions and sent out to patrol the campus parking lots and grounds. Members of the SCP were equipped with flashlights and walkie-talkies. After the flying tackle incident—two patrols caught two students breaking into a car—the word has spread. Students treat SCP "cops" with the respect due them. And, Dessau feels his Division has gained rapport with Seton's students.

SCP's worked out well all around. The patrols get paid for their work—albeit not a grandly larcenous amount. Other students feel that their property is being protected. And Director Dessau gets good help—so good, in fact, he thinks the program may become a model for other campuses.



Above—Many people are needed to coordinate efforts of Student Crime Patrol. Shown here is Mrs. Mary Delabar, Seton Hall U's communications dispatcher. Below—Student head of patrol. Keystone Kop buff himself, talks to member of patrol from his combination dorm room-command post. Efficient setup, eh?



Hey, Mr. Sandman -Gotch'a!

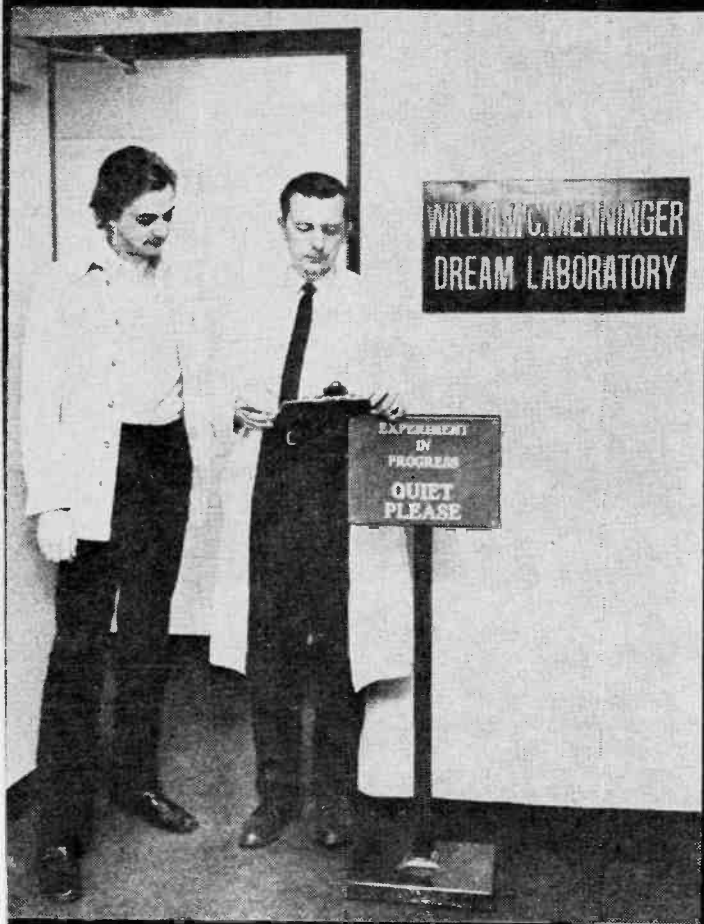

Two gates for ghostly dreams there are:
one gateway of honest horn,
and one of ivory,
Issuing by the ivory gate are dreams
of glimmering illusion, fantasies,
but those that come through
solid polished horn may be born out,
if mortals only know them.

Homer's Odyssey

Translated by Robert Fitzgerald

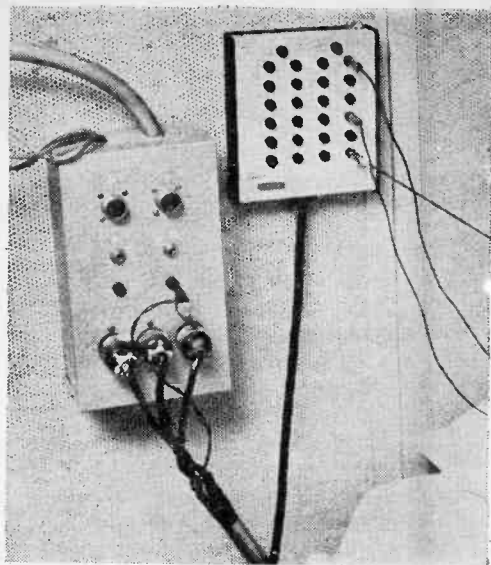

Scientists who traditionally experiment in the more tangible areas of science usually deal with the Material World. And then there are those lab-bound chaps who are fascinated by the illusory world—the one not so easy to gauge and scientifically predict. One such area that has only recently been explored is that of the human mind.

Once the private domain of poet, philosopher, and prophet, and now "legitimized" since the influence of Father Freud and his dream interpretations, the study of Man's mind is not only the subject of scientists, but also an interest to the general public. By now, most of us have heard the letters ESP bandied about. "Extra-Sensory-Perception"—that's what ESP stands for—is the study known to its practitioners as "parapsychology"—or the study of mental phenomena mostly unexplained by science's accepted principles.

What was once thought of as witchcraft is today a comparatively modern scientific discipline. The first formal documentation of paranormal, and supernormal phenomena began in 1882 in London with the Society for Psychical Research. This organization's early efforts were spent prying the realm of psychical phenomena from the

ELEMENTARY ELECTRONICS

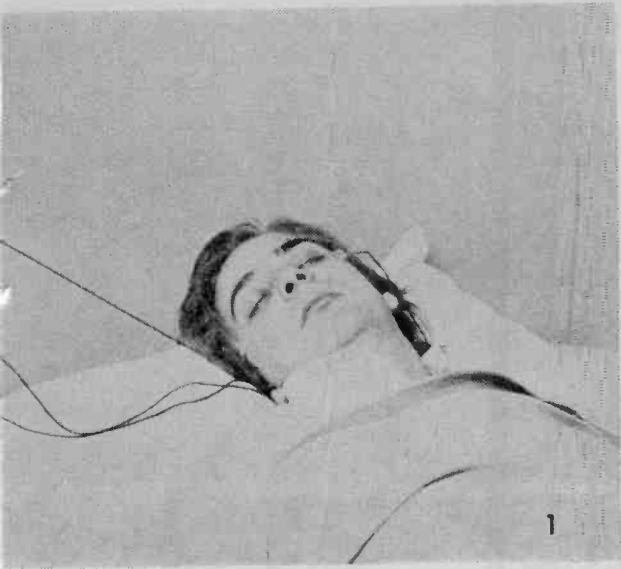

Victorian concepts of spiritualism and superstition. They began by investigating the claims of mediums and their so-called evoking of spirits and apparitions. But, times they are a'changin'; since the founding of the American counterpart of the London Society, the study of psychic phenomena has progressed to the stage of organized scientific research.

While most study has been in the area of ESP, the medical world has long been fascinated by yet another nether-world science—psychokinesis. The movement of physical bodies by the mind without the use of physical force spells out psychokinesis' meaning. This mind boggler relates to studies of a person's clairvoyance relating to an event, or condition, not yet experienced!

The most common techniques so far used to unlock the mysteries of psychokinesis have been either reliance upon card or picture guessing. But at the Maimonides Hospital Mental Health Center located in New York, attempts are being made to actually pin down the psychokinetic realm.

The William C. Menninger Dream Laboratory of the Department of Psychiatry at Maimonides Hospital, under the direction of Doctor Stanley Krippner, is carrying on a number of experiments in this very abstract but

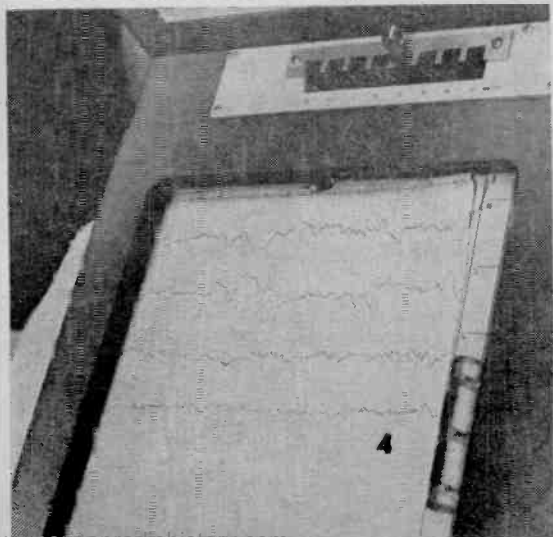

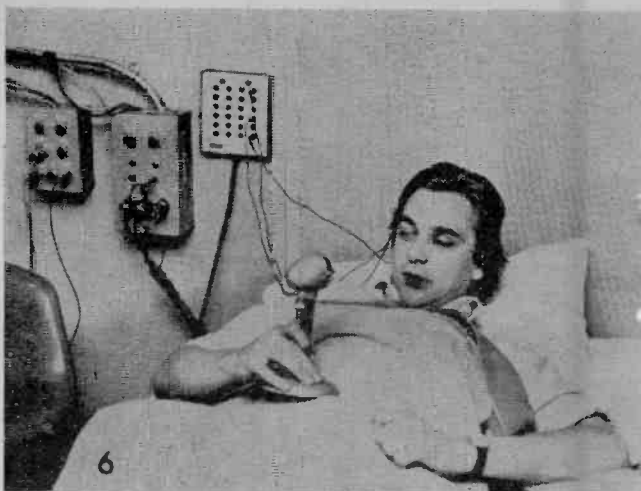

MR. SANDMAN

medically tangible field of study. But, what's not abstract are the glimpses we got of Dr. Krippner's Dream Lab.

The young man appearing to be wired (for sleep, we hope) in Fig. 1 is one of the doctor's many subjects. As he drifts to sleep, and begins to dream, his eyes will dart back and forth. Almost as if he were watching something! Eye movement is recorded electronically elsewhere. Our dream drama unfolds in Fig. 2, as we find, in a room several blocks away from the D-lab, a subject who is—very awake! As you can see, she's concentrating on a photo and telepathically conveying this image back to the Sleeper. Now, here's the rub; if our sleeping subject can describe the details of the picture that the girl was looking at, then he's scored a "hit," as the doc calls it! Figures 3 and 4 show the EEG recorder and graph, respectively. Data on the subject's eye movements are accurately analyzed, as we see Doctor Krippner doing in Fig. 5. The way Doc sees it, there's a link between dreaming and psychokinetic image transfer. To prove the point, the subject in Fig. 6 wakes up, tape records his dream, later picking out the picture he dreamt of in Figures 7 and 8. Hey, Mr. Sandman—Gotch'a! ■

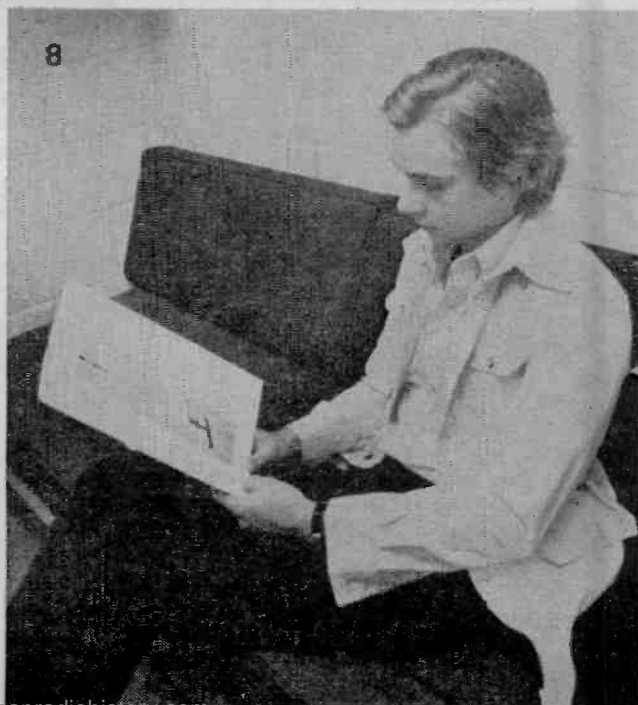

FUSES



The Blow that Saves You Money!

by Ted Mann

FOR two bits or less you can protect \$500 when you consider that an inexpensive fuse protects a costly color TV set. Would you believe ten cents worth of electric protection saves \$35,000? Fuses also keep the house from burning down. The little zinc links can *pop* in picoseconds or broil hours before blowing. Hundreds of fuses and circuit breakers safeguard electronic equipment against shortcircuit damage, momentary surges or slow overload. Pick the right one and you'll never put a penny in the fuse box, wrap cigarette foil around a glass fuse, or jump wire across cartridge clips—all dangerous dodges of those who refuse to *re-fuse*.

Thar' She Blows. Edison made the first fuse before 1900 by enclosing a thin wire in a lamp base. As an intentionally weakened part of the circuit, the wire acted as a safety valve which melted from excessive current. Trouble was, early fuses were nearly as dangerous as the condition they were designed to prevent. Fuse wire fashioned from copper, had to reach dangerous temperature before blowing. This is now cured by changing to metal alloys of lower melting point.

You can see another problem by observing how a fuse blows. See Fig. 1. The link begins to overheat in the slim center region. Overheating begins at this point since the wider ends of the link are better able to

radiate heat. Soon the melted center drops away.

This supposedly ruptures the circuit, but a second effect takes over. Circuit voltage is still applied across the narrow gap in the link and it strikes an electrical arc. This burns back metal toward each end until increasing electrical resistance kills the arc. That happens during a simple overload. But everything's vastly speeded up for a dead short.

You can see in Fig. 1 that a total short circuit explodes the link. The whole center section, in fact, suddenly vaporizes. And the vapor itself becomes a good electrical conductor—so the arc keeps snapping dangerously across the gap. Is that a safety valve?

Today's fuses are not lethal weapons because of certain refinements in construction. The larger, cartridge-type fuses contain a powdery filler material that quenches the arc through cooling and condensing the metal vapor. In smaller fuses, sturdy, insulated tubes of glass or porcelain provide necessary protection. See Fig. 2. One manufacturer states (with a Gothic turn of phrase) that today's fuse won't "belch fire."

Vengeful Volts. Most talk about fuses concerns amperage and how various types respond to current flow. Yet all fuses are rated by volts. This relates to the explosive fury of a fuse gone wrong. Although a fuse may have a well-insulated holder, certain

e/e FUSES

conditions may cause voltage to soar dangerously as the fuse blows.

If it's protecting a circuit that contains a coil, for example, sudden interruption may cause an "inductive" kick to feed back to the fuse terminals. It could be sufficiently high to shatter the holder. Voltage ratings assigned to fuses, though, are quite conservative.

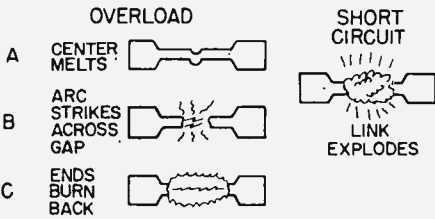

Figure 1. Major difference between overload, short circuit is amount of time it takes for fuse center link to melt apart.

When a fuse is rated at 125 volts, for example, it refers to a standard test performed by the manufacturer. He assumes that the fuse will not shatter on this voltage when subjected to a short circuit with the colossal current of 10,000 amperes! Unless you're protecting a private power generating plant, your electronic equipment subjects the fuse to a piddling fraction of those ratings. Thus circuit voltages may usually be higher than fuse voltage rating without undue hazard.

Twin Ratings. The job of choosing a fuse would be simple if it merely meant measuring a circuit you wish to protect, then selecting a type to blow on slightly higher amperage. A hi-fi amplifier might operate with AC line current of 1.4 amps, but a 1.5-amp fuse would be a poor choice. It would cause much "nuisance" blowing. Whenever you turned on the amplifier, a sudden inrush of current (to charge big filter capacitors in the power supply, for example) might cause the fuse link to let go. And some devices, like an electric motor, draw starting currents far greater than normal running amperage.

At the other extreme, a delicate test instrument might be destroyed if the fuse didn't speedily break the circuit. These variations introduce *time* as an element that's just as important as the number of amperes. Some fuses have a built-in mechanism that decides whether to blow fast or slow, de-

pending on circuit conditions.

But, first, what does a fuse rating actually mean? Simply saying that a fuse in a car radio is rated at 7½ amps doesn't tell the whole story. The 7½ amp figure means the fuse can carry that current indefinitely. Determining the current needed to melt the fuse must also reckon with overload time.

A typical automobile fuse might take fully four hours to blow when the fuse's rated current reaches 110 percent—which is amps times 1.1. This would happen as the radio drew 8¼ amps through the fuse (or 7.5 X 1.1). This is not a severe overload and the radio is still protected.

But if a short-circuit caused current to zoom to double the fuse rating—or 200 percent—the fuse promptly pops within 20 seconds. Higher percentages of overload would even speed up the process. Thus the radio continues to operate during minor surges. It won't blow the fuse unless overload current threatens irreversible damage to its components.

Not all devices need this brand of protection. To cope with a wide range of equipment, fuses are manufactured in three broad categories that relate to blowing times: *Medium Lag*, *Quick-Acting* and *Time Delay*. A look at these types reveals that fuses might have the same ampere rating but behave in quite different fashion.

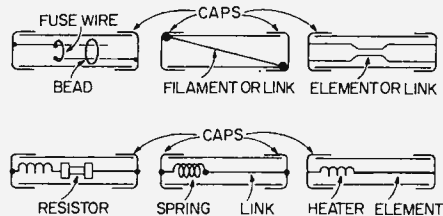

Figure 2. Construction variations between various fuse types gives each its own special set of characteristics.

Medium Lag. This is the most common type you're apt to encounter. It also goes under the name "Normal Lag" or "Standard." This is the fuse for auto and other radios, amplifiers, TV sets heaters and lighting circuits. If you want an idea of how such a fuse behaves, check the curve marked "Medium" in Fig. 3. It reveals, for example, that at 200 percent of rated current (two times), the fuse typically blows in about 5 or 6 seconds. The greater the overload, the faster the action.

Common fuses in the medium category

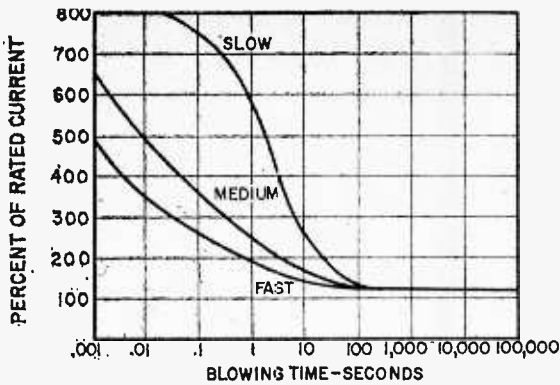

Figure 3. Note how slow-blow fuse takes considerably longer time for a current surge to open the circuit.

are the S.F.E. types (for automobiles) and 3AG by Littelfuse. There's also the AGC type made by Bussmann. The letters "AG", incidentally, originally meant "automotive glass".

As the "AG" number rose so did amperage rating and physical length. This was intended to foil any attempt to insert a fuse of excessive rating into a holder. So many new fuse types have appeared, however, that the system is all but abandoned. "AG" is no longer a reliable index of fuse size.

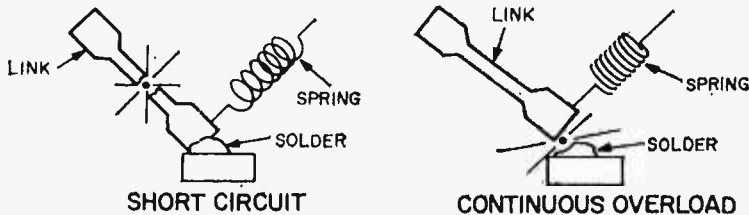

Figure 4. Dual-purpose mechanism of slow-blow fuse allows it to withstand momentary shorts, continuous overloads typically up to 400% of rated current in circuit.

Quick-Acting. This fuse category is also known as "Instrument" or "Fast-Acting." As the name implies, this kind of fuse blows faster than the medium type. It's useful for delicate instruments, meters and other devices that can't tolerate even small overload currents for any length of time. The fuse element is very fine and low mass causes it to melt at rates marked "Fast Blow" in Fig. 3. Note that at 200 percent rated current,

and sizes.)

Some fuses signal when they've blown, others are tightly enclosed to prevent radio-frequency interference pickup (a problem in space vehicles). There are sub-miniature fuses, as well as high-reliability types with gold-plated caps that survive high G forces.

One novel type found in many TV sets is the *fusible resistor*, a combination of fuse and resistor. It's often used where solid-



Figure 5. Three different fuse styles are shown, but each has its own current rating. Hint: NEVER substitute like-styled fuse of higher amp rating for lower-amps-rated one.

state rectifiers occur in the TV power supply. When the set is first turned on, a heavy inrush of current must be limited by a small-value resistor (usually less than 10 ohms) to protect the rectifiers. By making a resistance element with fuse-like qualities a single component, the fusible resistor does the job of two parts. The component is often mounted with plug-in pins for convenient replacement.

overload current to pass but tripping when the fault looks serious.

What happens, though, when a determined TV-viewer sees sound and picture fade just as the 5:40 comes roaring down on Millicent, tied to the track for not paying the you-know-what? Our viewer leaps behind the set, pushes the red panic button—and holds it down in an effort to restore the program. If the breaker had tripped on a severe short-circuit, not just a transient, our viewer might as well join Millicent. Yet the story has a happy ending since the breaker is viewerproof. The red button must be re-

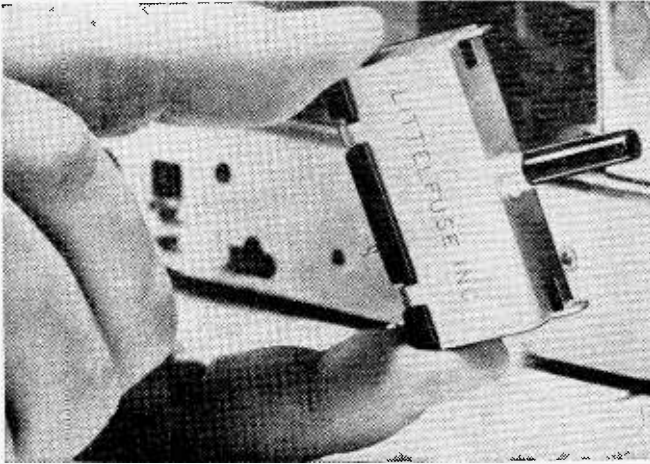

Figure 6. Forget that box of spare fuses you keep at arms distance from your tv. Circuit breaker eliminates need for replaceable fuse, can be reset as often as needed. Press cylindrically-shaped button located on top of circuit breaker after you find fault; your tv is once again protected. Circuit breakers come in many ampere ratings.

Circuit Breakers. A leading contender in the fuse field is the circuit breaker. See Fig 6. It's found on many major appliances and the newer TV sets. The attraction is obvious: you just press a red button after an overload. No need to hunt for a fuse.

As you can see by the curve in Fig. 7, the breaker behaves like a fuse, permitting brief

leased before the circuit breaker closes.

The chart in Fig. 8 shows typical ratings for several *Mallory* breakers. Note in all units that breaking the current is somewhat higher than operating current, but allowable surge current is much higher than either rating. Tripping time is ten seconds or less after breaking current is reached.

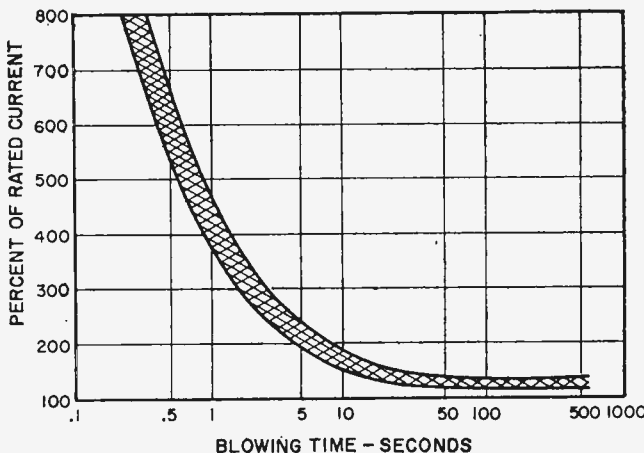
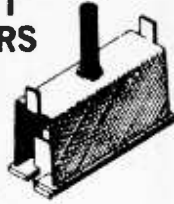

Figure 7. Curve of circuit breaker looks like medium lag fuse characteristic curve as shown in Figure 3. Current rating tolerance of circuit breaker is wider than that of normal fuse; crosshatching for this particular circuit breaker shows about 20% overall tolerance.

MALLORY RESET CIRCUIT BREAKERS

- Just Reset
- Not A Fuse—
A True
Circuit Breaker



Exact replacement circuit breakers for television and industrial applications. Button must be pressed to reset. Tripping mechanism is temperature compensating for constant protection. Normal tripping time is 10 seconds or less. All values above 3-1 amps have special heavy-duty contacts to withstand heavy surge currents. Twist tab mounting lugs. Adapter for bushing mount listed below. Shpg. wt., 4 oz.

Stock No.	Mfrs. Type	Break Curr. Amps	Oper. Curr. Amps.	Surge Curr. Amps	Net Each
33 F 14606	CBT050	0.5	0.325	2	.81
33 F 14614	CBT075	0.75	0.49	3	.81
33 F 14622	CBT100	1.0	0.65	5	.81
33 F 14630	CBT150	1.5	0.975	12	.81
33 F 14648	CBT175	1.75	1.14	12	.81
33 F 14655	CBT200	2.0	1.3	12	.81
33 F 14663	CBT225	2.25	1.46	12	.81
33 F 14671	CBT250	2.5	1.63	12	.81
33 F 14689	CBT275	2.75	1.79	12	.81
33 F 14697	CBT300	3.0	1.95	12	.81
33 F 14705	CBT310	3.1	2.1	25	.88
33 F 14713	CBT325	3.25	2.11	25	.88
33 F 14721	CBT350	3.5	2.2	25	.88
33 F 14739	CBT375	3.75	2.44	25	.88
33 F 14747	CBT400	4.0	2.6	25	.88
33 F 14754	CBT450	4.5	2.92	25	.88
33 F 14762	CBT500	5.0	3.25	25	.88
33 F 14770	CBT600	6.0	3.9	25	.88
33 F 14788	CBT700	7.0	4.14	25	.88
Type CBB adapter for bushing mount. Bushing 3/8"—32x1/4" with nut.					
33 F 14796					Net .18

Figure 8. Chart taken from page 328 of Lafayette's Catalog 710 gives brief listing of circuit breakers available from Mallory. Note three different amp ratings for each.

The circuit breaker is also replacing certain fuses in the automotive field. It's chiefly used in high-current circuits such as headlights, convertible top motors and window motors. The car breakers, however, automatically re-set themselves when the overload no longer exists. Not only is it convenient, but a bi-metal element of the breaker won't suffer a common fault of fuses in these circuits—fatigue. Fuses tend to fail when cycled repeatedly at high (though normal) on-off currents. (Fatigue also explains mysterious fuse failure in radio and TV sets when no circuit fault exists.)

How Many Amps? The equipment designer has already done the job of figuring the right fuse for his electronic gear. When the fuse blows—and the fault cured—the replacement fuse may merely duplicate the original. But if you home-brew equipment, you'll have to do some calculations to obtain the fuse rating. We've talked of *fuse* ratings but this is not the same as current consumed by the equipment being protected. To avoid nuisance blowing, the fuse almost always should be able to conduct more current than is drawn by the equipment.

It is considered good practice not to load a medium-blow fuse by more than 75 to 80 percent of its rating in amperes. To translate this into a practical value, you must know the number of amperes consumed by the

equipment during normal operation.

Let's say it is 4 amps. This number, therefore, should be 75 percent of the fuse rating. To find the answer, divide 4 by .75. The result is 5.3 amps, the fuse rating. This is an odd value, so select the next *highest* standard fuse size, which is 6 amps.

You'll find suitable types in the catalogs to fit into clips, an extractor post or to be soldered directly into the circuit with pig-tail leads. Most common physical size for electronic gear is the glass 3AG or AGC type (1/4"X1 1/4").

If you check commercial circuits, chances are you'll find that the fuse is operated at 50 (not 75 or 80) percent of its rating. This is another way of saying the fuse rating is double the load current. A car radio, for example, might draw 3 to 4 amperes, but the fuse is usually 7 1/2 or 9 amps.

You can also follow this practice, especially if your circuit is subject to temporary surges. This may seem like overfusing the circuit but the fuse should melt before anything is damaged (and it is less subject to nuisance blowing).

When equipment will certainly cause temporary overloads several times normal circuit current, then choose a time-lag or slow-blow fuse. Recall that it has a dual element to cope with this condition. It withstands brief overloads of several times normal

current. With this kind of surge protection, it is common practice to select the rating of a slow-blow at a somewhat higher figure than the medium type. It should be about 80 to 90 percent. To convert this into a slow-blow fuse rating, measure the circuit's normal current and divide it by .8 or .9 for the fuse amperage.

Figure 9. Fuse in power transformer primary circuit protects entire power supply including 6.3 VAC filament source. However, it's possible that short circuit in device, while not of sufficiently high amperage to blow fuse, will damage components in power supply like filter capacitor or choke.

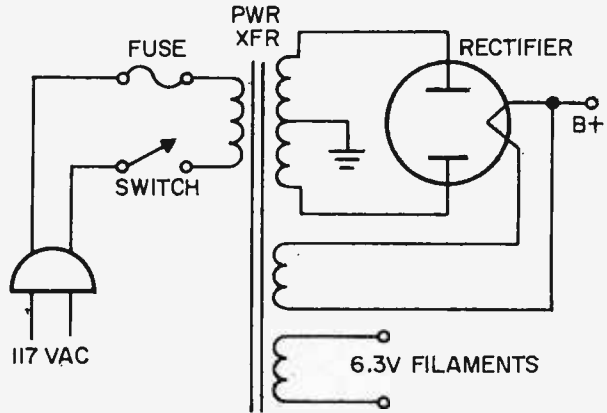

Where to Fuse. There's some compromise in where to locate a fuse for maximum circuit protection. Fig. 9, a typical full-wave power supply, shows why. The fuse is inserted in one leg of the incoming AC power line. Since the fuse is situated at the closest point to the power source, it provides overall protection. If a defect develops in some circuit, however, there's a chance the fuse will not blow for say, a shorted bypass capacitor that doesn't create enough excess fuse current. It could burn out a few resis-

tors in the process. The expensive power transformer, however, gets a reasonable degree of protection with this system.

More sensitive fusing occurs in Fig. 10. With the fuse in the center tap of the transformer, it responds only to changes in the B+ current. Since this bypasses high currents consumed by tube filaments, the fuse can be much smaller and is responsive to partial shorts in the remaining circuits. A variation of this is in Fig. 11; a half-wave supply that might be found in an AC-DC ta-

ble radio. Only here there's a fusible resistor of the type described earlier. Since you can obtain a fusible resistor locally or from electronic part houses, why not modify your table radio today!

This leaves the problem of fusing filaments. Although a conventional fuse can be used to protect the filaments you might borrow a trick used in some circuits.

Shown in Fig. 12 is the system used in some color TV sets, one of the more thoroughly protected home-entertainment de-

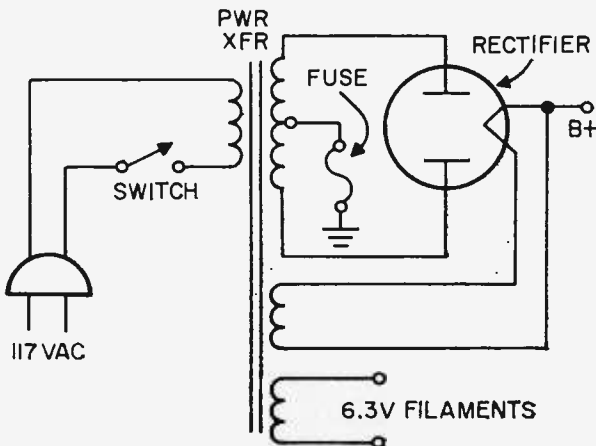

Figure 10. Secondary of power transformer is fused. Protection is for high voltage circuit only; filament supply's unfused.

vices. There are no less than three techniques to guard against overcurrent. In one leg of the primary lead is a thermistor. Although it is not a breaker-type device, it prolongs the life of the circuit by slowing the inrush of current when the set is first turned on. It might present 120 ohms when cold, thus limiting current, but electrically disappears when hot since it sinks to just 1.5 ohms after circuit warmup.

Next site of protection is a circuit breaker in the power transformer secondary. It trips during overload anywhere along the B+ leg in the receiver. (This is equivalent to the centertap fuse shown in Fig. 10.) The filament circuit has completely separate protection. It is merely a short link of No. 26 wire that melts when a short exists along the filament supply. There's little hazard since voltage is only 6.3VAC and serious arcing won't occur.

Fusing Transistors. There have been attempts to protect transistors by fusing, but fuses generally will not react fast enough. Techniques which use additional semiconductors (such as diodes) provide a better

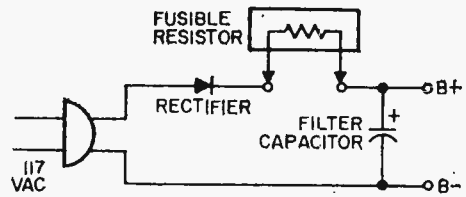

Figure 11. Fusible resistor combines surge-limiting resistor, fuse in one package shown here in AC/DC rig's power supply.

117 volts of Alternating Current.

Getting Clipped. How a fuse mounts is more important than is generally believed. Much trouble with nuisance blowing has been traced to defective fuse clips or holders. Poor contact between clips and fuse produces hot spots that blow the fuse prematurely. It may also introduce electrical resistance that upsets the circuit being protected.

One manufacturer suggests the following: you should hear a resounding "snap" when inserting a fuse into clips—it signals good grip strength. And you should have to pry a defective fuse from its clips. Since

Figure 12. Three points of protection on color tv power supply are thermistor in transformer primary circuit to limit surges, circuit breaker in B+ secondary circuit, wire-type fuse for filament.

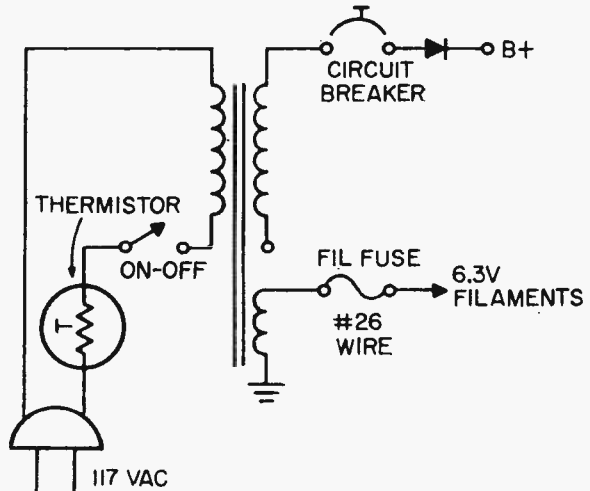

solution. There is, though, some consideration in fusing the power supply of solid-state equipment. Since transistor circuit voltages are significantly lower than those encountered in tube circuits, the resistance of the fuse becomes increasingly important. It may be an ohm or less, but this introduces a new element that might affect the operation of a delicate circuit. Two solutions are possible: use the largest fuse size consistent with circuit protection (since this reduces resistance) or install the fuse in the primary side of the power transformer where voltages are over

dirty clips are a frequent cause of trouble, shine them with contact cleaner. Just be sure to remove the AC plug from the wall outlet before touching any contact with your fingers. It helps reduce the con-fusion.

Always remember, fuses protect valuable equipment from going up in smoke and eliminate dangers to human life. By overriding an existing fuse circuit with a penny, jumper, or oversized fuse, you may be putting a hole in your pocketbook—or one in the ground. ■

Clip Book Circuits

ACTIVE HUM FILTER

Ever try to play back an important tape which somehow was recorded with an objectionably high hum level? This active hum filter is connected between the playback recorder and the amplifier. This hum filter will sharply notch out the hum frequency, with little effect on other low frequencies. The notch filter itself consists of components R1/R2/R3/R4 and C2/C3/C4. The values shown are for a 60Hz filter. If your tapes contain hum of a different frequency, say for example, 50Hz, the proper values for capacitors C2/C3/C4 (which are all the same value) can be calculated from the formula given.

Simply plug into the formula the new value for frequency "f". The answer is in Farads. If you come up with an unusual value for

PARTS LIST

- C1—0.2 uF, 100 VDC tubular or 75 VDC disc or Mylar
- C2, C3, C4—0.01 uF, 25 VDC, see text
- C5, C6—100 uF, 6 VDC
- C7—0.1 uF, 25 VDC
- IC1—RCA CA3032
- R1, R2—390,000-ohms, ½-watt, 5%
- R3—2,400-ohms, ½-watt, 5%
- R4—Potentiometer 1,000-ohms linear taper
- R5—Potentiometer, 10,000-ohms linear taper
- Rx—Potentiometer, 1 megohm audio taper

and the self-oscillation point. Adjust R5 for maximum hum suppression.

Potentiometer Rx is needed only if there is no way to control the level of the input signal to prevent overload. If the playback recorder has an output level control, Rx is

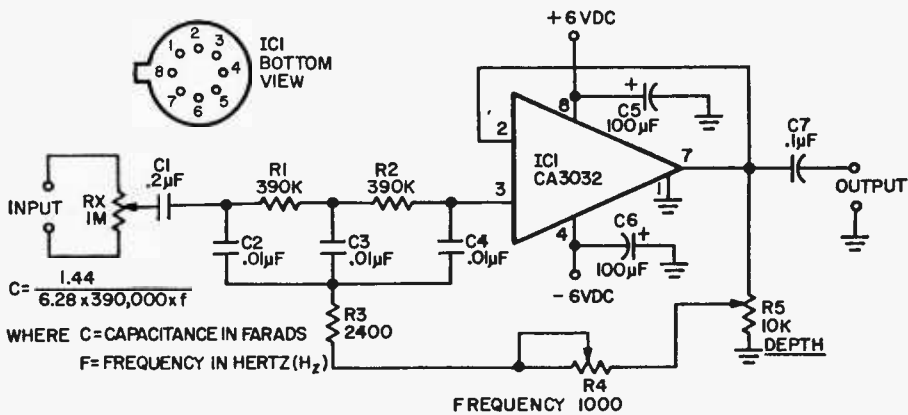

$$C = \frac{1.44}{6.28 \times 390,000 \times f}$$

WHERE C=CAPACITANCE IN FARADS

F= FREQUENCY IN HERTZ (H_z)

"C", such as 0.08 uF, simply parallel two capacitors to get the proper value. For example, a 0.05 uF capacitor in parallel with 0.03 uF equals 0.08 uF.

The notch filter's components need not be of precision tolerance because a slight amount of tuning is provided by Frequency control R4. Potentiometer R5 is the Depth control; it sets the degree of attenuation

not needed. Also, remember to connect one lug of Rx to system ground if the potentiometer's used.

The filter's input can be connected either to line level outputs or across speaker outputs. The filter's output should be loaded by 50,000 ohms minimum. The power supply can be two 6V Z4-type batteries in a bi-polar arrangement.

DMS

Suspect your hi-fi of sounds a-sour? Check it out with e/e's Distortion Measurement Set.

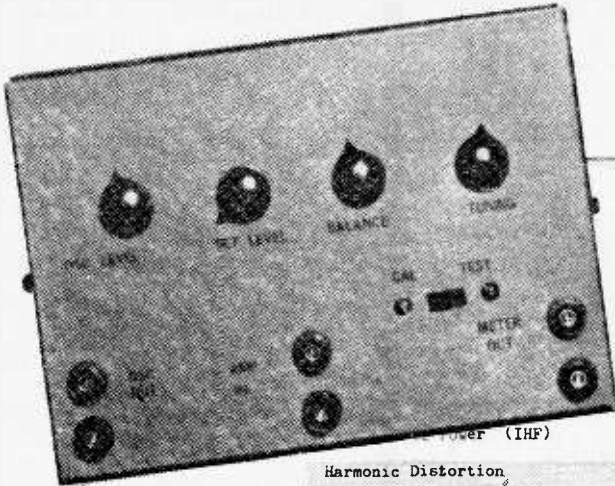

Harmonic Distortion

Intermodulation Distortion
(60 Hz & 7,000 Hz, 4:1)

Frequency Response
Main Amp Only
High Level Input

at any frequency from 20 Hz to 20,000 Hz

64/64 watts at 4 ohms load

58/58 watts at 8 ohms load

42/42 watts at 16 ohms load

41/41 watts at 4 ohms load

45/45 watts at 8 ohms load

34/34 watts at 16 ohms load

180 watts at 4 ohms load

170 watts at 8 ohms load

less than 0.5% at rated output

from 20 Hz to 20,000 Hz

less than 0.3% at rated output

or any level of less than rated

output or less than 0.1% at -3 dB

rated output

10 Hz to 50,000 Hz ± 1 dB

20 Hz to 50,000 Hz ± 1 dB

by Herb Cohen

Now that you've purchased that super duper hi-fi set and enjoyed its pure, distortionless(?) reproduction for nearly a year, you'd like to be able to check it out against its ballyhooed specs. Naturally, since you have become so interested in hi-fi, you've digested all the technical material that's been published. So now, you feel that you are technically qualified to run the required tests to prove out the equipment. If your ears tell you that your set no longer performs at its advertised level of performance, you'll want to correct it. Then you'll recheck your work to be sure you've brought it back up to snuff. But, you say, I don't have a distortion meter to prove that it's as good as it was originally. Or, now that I've "improved" it, how do I know it's working better, you ask. And besides, commercial

distortion meters are expensive and complicated to operate.

Why not build a distortion measuring set? Our *DMS*, as we call it, is easy to calibrate, easy to use, is reliable and, best of all, can be built for about \$50. Not only will our *DMS* permit you to check your audio equipment whenever you want, but, *DMS*' construction will also help advance your technical skill. The components for our *DMS* are relatively easy to find in an electronics supply house, and construction is not difficult.

Low Distortion Buzz. This test set is comprised of two sections; an ultra-low-distortion 1 kHz signal generator, and a Wein Bridge filter. And *DMS* has been designed around the latest Op Amps (Operational

Amplifiers) and FETs (Field Effect Transistors).

The signal generator portion of *DMS* employs an FET in an automatic gain control, or AGC, circuit and an Op Amp for signal generation, voltage gain, and rejection of power supply ripple. A "twin tee" filter, acting as a rejection type, serves as

a frequency-determining element for the oscillator by rejecting all frequencies but the desired one—1kHz in this instrument. With the filter, comprised of components R1, R4, R5, and C3, C6, and C7, placed in the negative feedback loop, it greatly decreases the gain for all frequencies except the one to which it is tuned. The Op Amp will oscillate at the frequency established by the "twin tee" filter because of its positive feedback loop consisting of components

PARTS LIST FOR DMS

- C1, C2**—250 μ F, 25 volt electrolytic capacitor (Lafayette 34F55235 or equiv.)
- C3, C7, C15, C16**—1500 pF, 500 volt, silver mica capacitor, 5% (Lafayette 30F35722 or equiv.)
- C4, C8**—5 μ F, 12 volt electrolytic capacitor, PC board leads (Calectro A1-103 or equiv.)
- C5**—0.04 μ F, 1000 volt ceramic disc capacitor (Lafayette 33F23425 or equiv.)
- C6**—0.003 μ F, 500 volt silver mica capacitor, 5% (Lafayette 30F35540 or equiv.)
- C9**—500 pF, 50 volt ceramic disc capacitor (Calectro A1-028 or equiv.)
- C10**—250 pF, 1000 volt ceramic disc capacitor (Lafayette 32F01720 or equiv.)
- C11**—0.001 μ F, 1000 volt ceramic disc capacitor (Calectro A1-064 or equiv.)
- C12, C14**—100 μ F, 12 volt, electrolytic capacitor, PC board leads (Calectro

- A1-111 or equiv.)
- C13**—50 μ F, 12 volt electrolytic capacitor, PC board leads (Calectro A1-109 or equiv.)
- D1, D2, D3, D4, D5**—Silicon rectifier, 50PIV @ 1 amp. (Motorola HEP 154 or equiv.)
- Q1**—n type FET, Motorola MPF 104 or HEP 801
- Q2**—n type FET, Motorola MFE 2093
- Q3**—Op Amp, Fairchild type μ A 709 (see note)
- Q4, Q5**—npn silicon, general purpose audio transistor, Motorola HEP 726
- R1, R4**—100,000-ohm, 1/2 watt, 5% resistor
- R2, R6**—1,000-ohm, 1/2 watt resistor
- R3**—3,000-ohm, 1/2 watt resistor
- R5**—51,000-ohm, 1/2 watt 5% resistor
- R7**—1-megohm, 1/2 watt resistor
- R8, R26**—10,000-ohm, 1/2 watt resistor

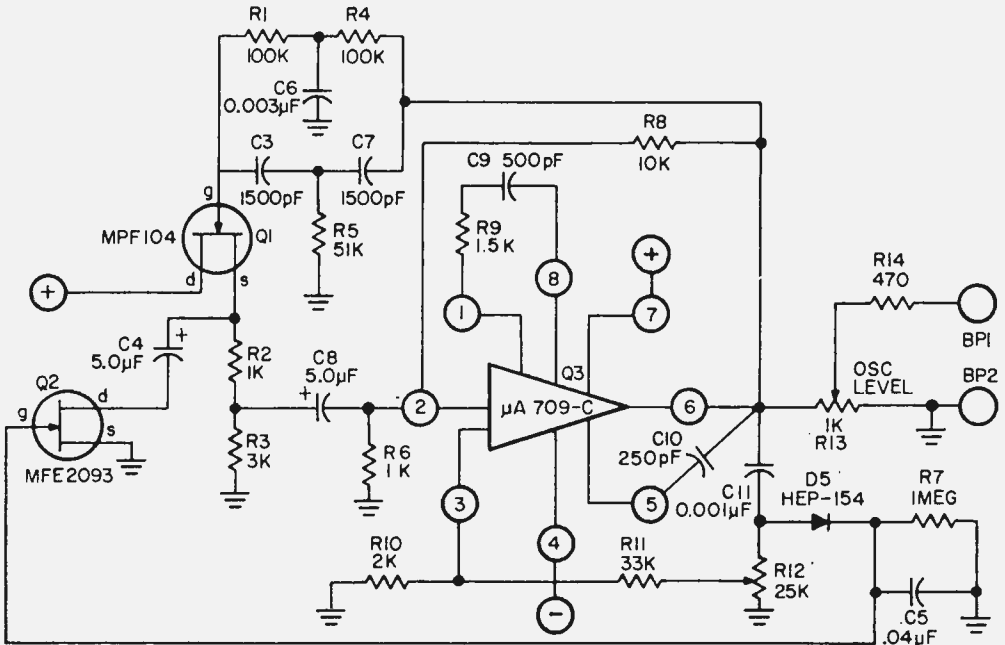

C11, R12, R11 and R10.

The AGC circuit stabilizes the output voltage waveform. Diode D5 rectifies a sampling of the output waveform, and, after filtering it through components C5 and R7, presents this smoothed-out voltage to the gate of transistor Q2. Since this voltage varies with the signal, it varies the drain-source resistance of the FET in direct proportion to the output voltage. Since this resistance is across the source of Q1, it will

vary the gain of the system. It's almost as if somebody's holding his hand on a potentiometer, keeping tabs on *DMS*'s output level. By adjusting R12 to provide a maximum output of 1.5V at R13 assures signal generator distortion of less than 0.2%.

The second half of *DMS* is a Wein bridge filter. Commonly used for measuring harmonic distortion, it works as a rejection filter cancelling out the fundamental frequency to which it is tuned. Since voltage

- R9—1,500-ohm, 1/2 watt resistor
- R10—2,000-ohm, 1/2 watt resistor
- R11—33,000-ohm, 1/2 watt resistor
- R12—25,000-ohm miniature potentiometer, printed circuit board mounting (Lafayette 33F16536 or equiv.)
- R13—1,000-ohm linear taper potentiometer (Lafayette 33F11149 or equiv.)
- R14—470-ohm, 1/2 watt resistor.
- R15—25,000-ohm potentiometer, linear taper (Lafayette 33F11313 or equiv.)
- R16, R17—68,000-ohm, 1/2 watt resistor
- R18—2,000-ohm, 1/2 watt resistor
- R19—5,000-ohm potentiometer, linear taper (Lafayette 33F11222 or equiv.)
- R20—5,600-ohm, 1/2 watt resistor
- R21—3,900-ohm, 1/2 watt resistor
- R22—5,100-ohm, 1/2 watt resistor
- R23, R25—91,000-ohm, 1/2 watt, 5% resistor
- R24—Dual 10,000 linear taper potenti-

- ometers (Allied Radio Shack 875-1301 or equiv.)
- S1—Spst slide switch (Calectro E2-104 or equiv.)
- T1—Power transformer: primary, 117 V 50-60 Hz; secondary, 12.6 V @ 0.1 Amps (Calectro D1-750 or equiv.)
- 1—7 x 5 x 3-in. Minibox (Lafayette 12F83928 or equiv.)
- 1—4 1/8 x 6 3/8-in. perfboard (Calectro J4-616 or equiv.)
- 4—Instrument knobs (Calectro E2-705 or equiv.)
- 3 sets—Red and black 5-way binding posts, insulated (Calectro F2-926 or equiv.)
- 1—Power cord and plug (Calectro L3-717 or equiv.)
- Misc.—Bolts, nuts, spacers, wire, solder, press on letters (Datak or equiv.) push-in pins, etc.

NOTE: Fairchild μ 709 is available from Custom Components, Box 153, Malverne, NY 11565 for \$5.00

Post Paid. New York State residents add sales tax, Canadian citizens add \$1.00 extra.

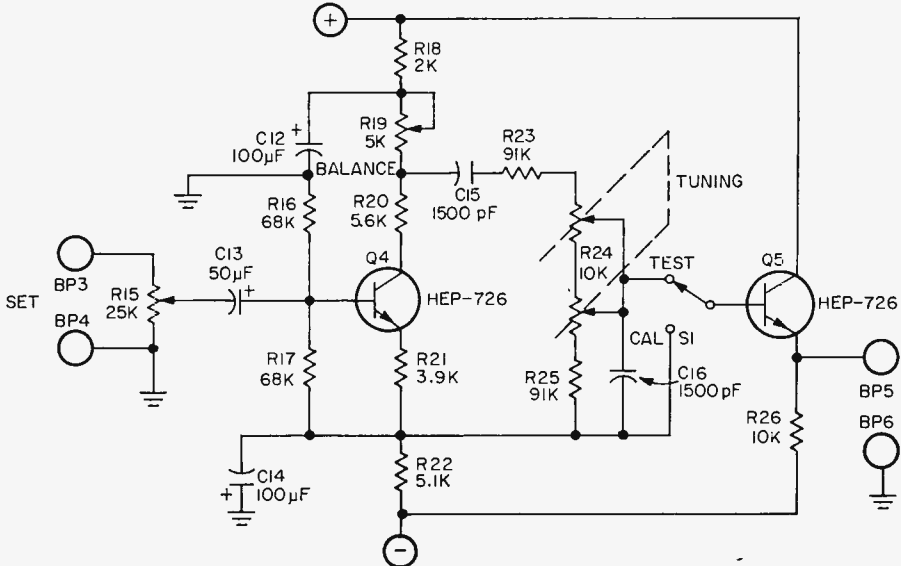

levels within this filter are very low. *DMS* requires an amplifier, transistor Q4, to provide two boosted voltages that are 180° out of phase and have an output ratio of 2:1. Potentiometer R19 is a *balance* control that sets this voltage ratio. Potentiometer R24 serves as a *fine tuning* control for the Wein bridge.

The *Cal/Test* switch, S1, switches the emitter follower amplifier from the source voltage into the Wein bridge to the output of the bridge. The ratio of difference of these two voltages expresses the percentage of distortion.

Drill, Mount, and Solder. We succeeded in stuffing all of the components, as well as a self contained AC power supply, into a 7x5x3-in. Minibox. Most of the components with the exception of the controls and binding posts are mounted on a 4 1/8 x 6 3/8-in. piece of perfboard. From our photos you can readily follow the basic layout.

Resistors, capacitors and transistors are self supporting by feeding their leads through the holes in the board and soldering

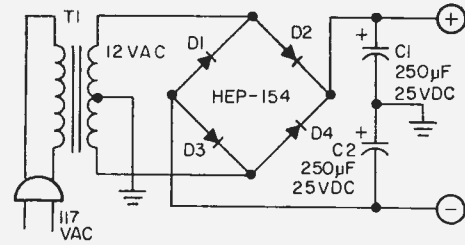

Power supply looks like bridge rectifier— but look closer. *DMS*'s ps is really two full-wave supplies connected back-to-back.

them to feeder busses or directly to each other where possible. You may prefer to use push-in pins as anchor and connection points.

The power transformer is held on the perfboard with small machine screws and nuts. The board itself is mounted to the bottom half of the Minibox with long machine screws and raised about 1/4-in. from the bottom to prevent shorts in the wiring. You can use either 1/4-in. spacers or extra lock nuts to hold the board above the bottom of the box.

Drill out the holes in the top half of the box for mounting the four potentiometers, the *Cal/Test* slide switch, and the six bind-
(Continued on page 101)

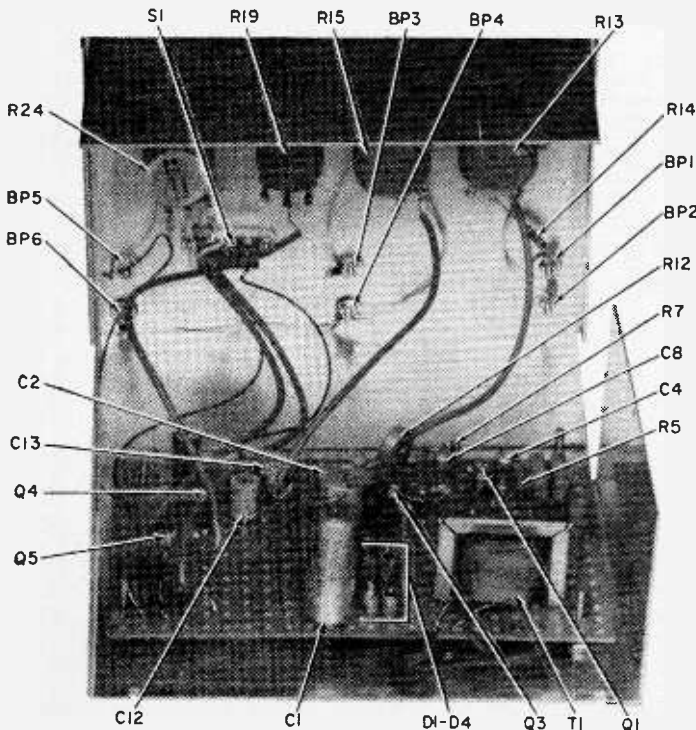

Here's what distortion measuring set should look like before cover's slid on, screwed into place. Ample use is made of shielded cable; runs lengths of Belden No. 8411 or equivalent between potentiometers, flea clips on pc board. Follow author's suggested parts layout. Otherwise, you might run into ground loops, power supply hum problems.

e/e
checks
out the
first...



Frequency Counter Kit

Heath's Model IB-101 counts from
One to 15,000,000 Hz with 0.002% accuracy!

Almost 25 years ago, the Heathkit Model 01 oscilloscope converted just about every hobbyist's shop into a potential moneymaker, for with the advent of TV and Hi-Fi the day of the *screwdriver technician* was over! You actually had to *see* the waveforms, and the only way to see them was with a scope. And the Heath 01 scope kit at under \$40 was just about the only one most hobbyists could afford.

Today, another era ends. Just seeing the waveform is not enough. You have to know the exact frequency of the waveform. For example, most modern hi-fi tape recorders require a precision set of the bias frequency as well as current. Have you got anything that will measure 71 kHz with any degree

of accuracy? And how about that color receiver. It's faster to check the crystal with a frequency counter than to replace it. And how about all that marine and CB service work going begging. Sure, you're technically capable to do the job, but have you got from \$500 up for a frequency meter? Electronic organ service is going begging; yet it pays good money. There's many a radio or TV tech who can handle organ repairs, but he can't hear the audio "beats" when tuning the oscillators. With a frequency counter the tune-up is a 5 minute, \$30 job.

The list of routine service work that requires a counter is almost endless, and to fill the void on your service bench, the Heath company has finally introduced their Model IB-101 Frequency Counter. Just as Heath put a scope within the reach of everyone 25 years ago, their new frequency counter at \$199.95 is similarly within reach of the small service shop and hobbyist.

A counter for \$200? Yes, by dropping off the circuits needed primarily by R&D labs, such as totalizers, event averaging and frequency difference, what is left is a straight frequency counter with a single operating control. In the Heath IB-101 it

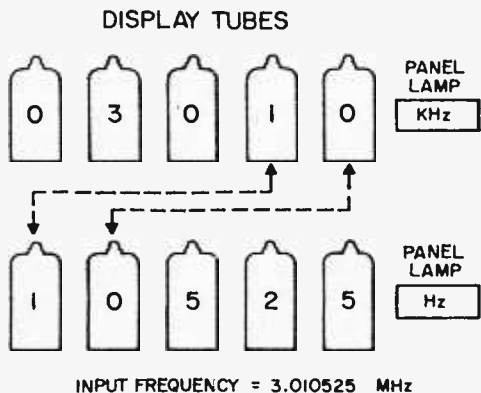

Reading Sample Diagram. With frequency switch in kHz mode, take first half of your reading. Switch to Hz mode; now read last three significant numbers.

e/e FREQUENCY COUNTER KIT

comes down to this: a 1-megohm-input impedance shunted by 20 pF; a 5 digit readout with 8 digit capability from 1 Hz to 15 MHz; a single operate control—the kHz/Hz selector switch! Three automatic panel lamps tell you if everything is working right. When the operating control is set to Hz, an HZ panel lamp is illuminated to indicate the readout is in Hz. When the operating control is set to kHz, the kHz panel lamp illuminates, indicating the 5 digit readout is in kHz. If a panel lamp labeled OVER illuminates, it means that though the instrument is set to Hz, the readout is only part of the total and you must reset the operating control to kHz.

Let's look at a practical example for a moment so you will be able to more closely understand the operation of the frequency counter. Keep in mind that the display is always in 5 digits as shown in the Reading Sample Diagram. With the counter set for kHz, it reads 03010 kHz when connected across an oscillator. 03010 kHz is 3.010 MHz. But this is only a 5 digit readout, so we switch the counter to Hz and the display changes (as shown in the diagram) to 10525 Hz. The "1" and "0" are the last two digits from the kHz readout, so we have added the 525 Hz for a total of 8 digits, and the actual frequency is 03010525 Hz

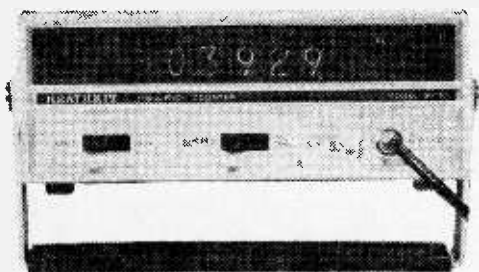

Integrated circuits (all 26 of 'em) play large part in keeping Heathkit's IB-101 Frequency Counter Kit down to \$199.95.

or 3.010525 MHz. How's that for accuracy!

How it Works. A frequency counter is a relatively easy device; it just takes a lot of flip-flop circuits. Basically, decade counters change the input pulses to a binary coded 8-4-2-1 output which is recycled on every tenth input pulse. The four bits of binary

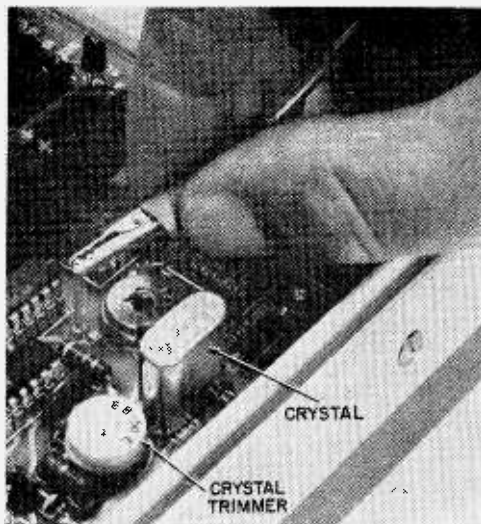

All you need to align counter is AM radio. Adjust crystal trimmer capacitor to "zero beat" against 1000 kHz BCB RF carrier.

information is stored and counted only on command from a "transfer" signal; the binary information is then translated into decimal form to drive the display tubes.

The timing signal which controls the counting mechanism is generated by a 1 MHz crystal-controlled "clock". Internal dividers count-down the 1 MHz to 1 kHz (1 millisecond) and 1 Hz (one second). The millisecond and second pulses—which are selected by the kHz/Hz switch—"gate" the counters so they count during a precise time period; for example, with the switch set to kHz, the readout is the total number of input pulses counted during the 1 millisecond period determined by the "gating" signal from the "clock".

Building the Kit. As you have probably guessed, many, many circuits are required to do the counting, storing and dividing. If discreet components were used, you could anticipate spending at least one month putting the whole bit together. And there would be endless room for error. In the Heath IB-101, however, with the exception of three non-critical circuits, everything is pre-packaged in ICs (integrated circuits): 26 ICs to be exact. All you do is solder the plug-in IC terminals to the printed circuit board and then plug in the ICs. For an experienced builder the complete kit construction including alignment should be only a long evening's project, 3 to 5 hours. A be-

(Continued on page 97)

Your axe swings to a different beat with a six buck gizmo we call . . .

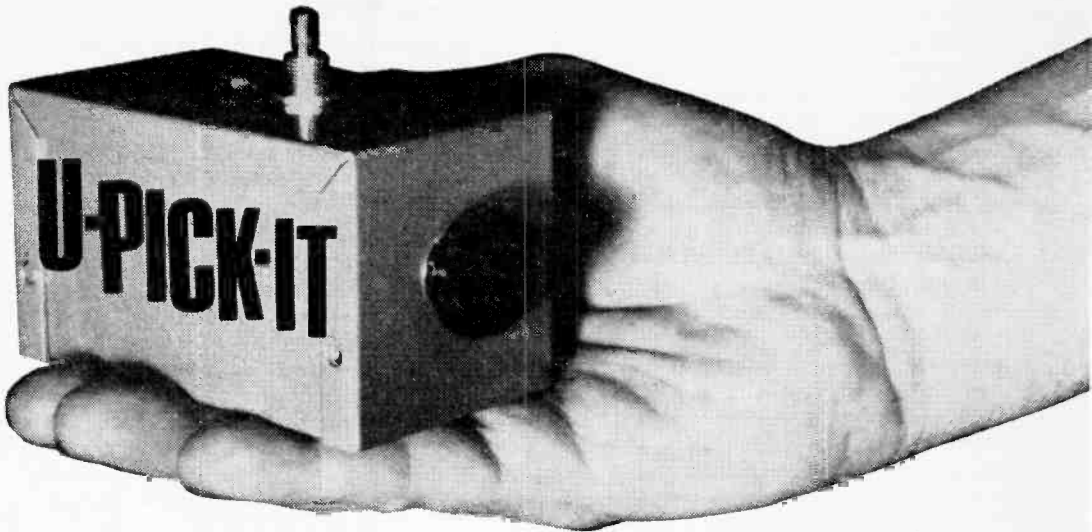

by Steve Daniels, WB2GIF

Would you spend about six bucks to tailor the sound of your guitar? Especially if you knew you'd have the great sound of that group you know is heading to the top. Or, maybe, you're not satisfied with the sounds you're getting, and want to be able to change the tone of your guitar to suit the mood of your music. We're not saying that our *U-Pick-It* will make a Segovia out of you. But it sure will make your guitar sound great, and who knows, maybe it will help you on to fame and fortune.

What does *U-Pick-It* do for your instrument? It gives you a choice of bass, treble or midrange boost just by turning a single knob. You can make that old guitar sound

twangy, smooth or raunchy at the twist of your wrist. Furthermore, *U-Pick-It's* bass boost will allow a regular guitar to be used as a string bass by giving those low notes an extra boost.

PSO With a Difference. Check the schematic; it will ring a bell for many of you. Basically, you'll see a phase shift oscillator with a few necessary changes. Note the network consisting of components R1, R2, and R3 isolates transistor Q1 from the loading effect of the guitar pickup. Also, potentiometer R6 is used to lower the stage gain to the point where the transistor will be amplifying rather than oscillating. The phase shift network peaks the response within a

Parts placement within *U-Pick-It* presents no problems got choice of switch S1 in Parts List.

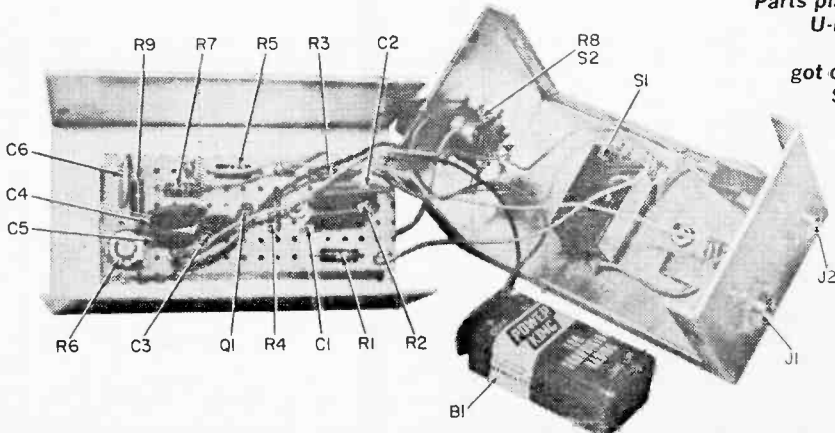

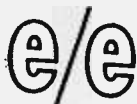

U-PICK-IT

fairly narrow range, depending on the setting of potentiometer R8.

You Pick it's parts. We housed *U-Pick-It*, including its own self-contained battery power supply (a 9 V transistor battery) in a 4 X 2¼ X 2¼-in. Minibox. All of the components with the exception of the input and output jacks, the *IN-OUT* switch, potentiometer R8 and the battery are mounted on a 3¼ X 1¼-in. piece of perfboard. Push-in clips are used for input, output, battery + and ground terminations.

Although the transistor doesn't have the usual triangular pin orientation, if you follow our layout, it can be mounted without having to cross over any of its leads. A word of caution now: this circuit won't work with low gain transistors. So please,

no substitutions! Besides, the one we used isn't expensive, so there really isn't a good reason to fiddle with dime-a-dozen transistors.

In the phase section, use good quality disc capacitors rated 50 VDC minimum or better. Seems we found that low voltage ones sometimes may leak too much for this application.

Drill mounting holes for the two jacks in one end of the bottom half of the Minibox. Whether you buy a commercial battery holder, or make one from a scrap of aluminum, locate the battery so that it will clear the other components when the Minibox is closed. Drill two mounting holes: one for the battery holder, and the other to support the perfboard that's raised ¼-in. off the bottom with a spacer.

IN-OUT switch S1 is located in the center of the top half of the Minibox. It's a push-
(Continued on page 102)

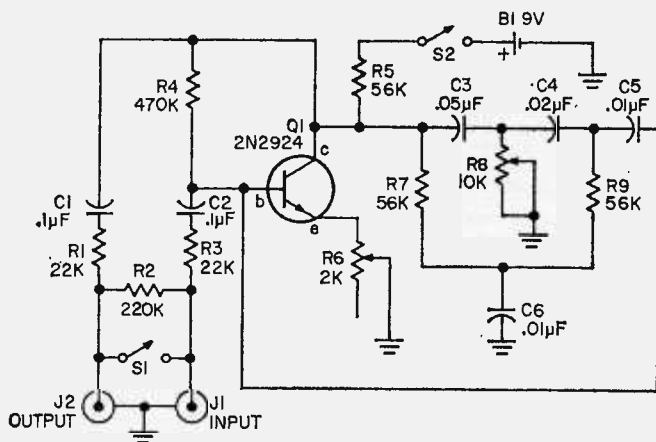

PARTS LIST FOR U-PICK-IT

- B1**—9 V transistor radio battery (Burgess type 2U6 or equiv.)
- C1, C2**—0.1 μ F, 75 V ceramic disc capacitor (Lafayette 33F69089 or equiv.)
- C3**—0.05 μ F, 75 V ceramic disc capacitor (Lafayette 33F69071 or equiv.)
- C4**—0.02 μ F, 75 V ceramic disc capacitor (Lafayette 33F69063 or equiv.)
- C5, C6**—0.01 μ F, 75 V ceramic disc capacitor (Lafayette 33F69055 or equiv.)
- J1, J2**—Standard open circuit phone jack (Lafayette 99F2135 or equiv.)
- Q1**—Silicon, npn, high gain transistor (GE type 2N2924 or Motorola HEP 724)
- R1, R3**—22,000-ohms, ½-watt, 10% composition resistor
- R2**—220,000-ohms, ½-watt, 10% composition resistor
- R4**—470,000-ohms, ½-watt, 10% composition resistor

- R5, R7, R9**—56,000-ohms, ½-watt, 10% composition resistor
 - R6**—2,000-ohms potentiometer, ¼-watt, linear taper (Lafayette 33F16452 or equiv.)
 - R8**—10,000-ohm potentiometer, 1-watt, linear taper (Lafayette 33F11255 or equiv.)
 - S1**—Spst rocker switch (Lafayette 34F34164 or equiv.) See text
 - 1**—4 X 2¼ X 2¼-in. Minibox (Lafayette 12F83878 or equiv.)
 - 1**—Battery holder (Keystone #203P or equiv.)
 - 1**—Battery connector (Lafayette 99F-62879 or equiv.)
 - 1**—3¼ X 1¼-in. piece of perfboard
- Misc.** Wire, solder, bolts, nuts, spacer, knob, push-in pins, etc.

pico
giga
milli
centi
kilo
nano

DISCOVERING PREFIXES AND EXPONENTS THE PRACTICAL LANGUAGE OF ELECTRONICS

mega
micro
deci
hecto
atto
femto
deka

by Norman Crawford

Anyone who's dipped his little toe into electronics is certain to have run across such terms as *microFarad*, *milliHenry*, and *milliAmpere*—not to mention *megaHertz*, *megOhm*, and *kiloHertz*. The prefixes here—*micro-*, *milli-*, *mega-*, and *kilo-*—are an important part of the electronic vocabulary. It follows, then, that anyone who wants to be proficient in electronics will have to develop skill in understanding and using them.

These prefixes are used to change the value of an electronic unit of measure. For example, if you see a resistor with the familiar brown/black/green color code, you *could* call it a 1,000,000 ohm resistor. Thing is, it's usually less awkward to call it a 1-megohm resistor. Putting the prefix *meg-* or *mega-* before the Ohm inflates the value of the unit. Ohm, by 1,000,000 times.

Similarly, one kiloVolt is recognizable as 1,000 Volts, and one kiloHertz as 1,000 Hertz, and so on. These prefixes are usually so automatic with electronics aficionados that they will invariably refer to a millionaire as a guy who has one megabuck!

The Debit Side. At the other end of the scale, the *milli-* and *micro-* prefixes are useful for shrinking units. A Farad, for example, is too big a unit to use in everyday electronics. In dealing with the real-life capacitors (the kind you solder into circuits), we normally use a basic unit of *one-millionth* of a Farad—a *microFarad*. The prefix *micro-* cuts up a unit into a million tiny slices, enabling us to use one such slice as a convenient-sized unit. A micro-

Ampere, similarly, is a millionth of an Ampere; a microVolt, one millionth of a Volt.

If you need larger slices, the *milli-* prefix is available, which provides a unit only one-thousandth the size of the basic unit. A milliAmpere, for example, is a thousandth of an Ampere: that is, it takes 1000 mA (milliAmperes) to equal 1 Ampere.

To handle these tiny slices of units, it's wise to spend a few minutes learning *scientific notation*, which is designed to make it easy to handle very large and very small numbers. Once you've mastered this technique, you can manipulate all the various-sized units of electronics as easily as you can add two and two!

Take, for example, the familiar *kiloHertz*, (known until recently as the *kilocycle*). A broadcasting station operating at 840 kHz (kiloHertz) in the broadcasting band is radiating 840,000 cycles of RF energy every second. To change from 840 kHz to 840,000 Hz, you can think of the "kilo-" as being replaced by "x 1000", thus:

840	kilo	Hertz
840	x 1000	Hertz
840,000		Hertz

But you can also write "1000" as "10x10x10". And you can write "10x10x10" as "10³". (Ten to the third power, or ten cubed). As we develop these ideas further, you will see how you can simplify greatly your future work in electronics by thinking of the prefix "kilo-" as being replaceable by "x 10³", thus:

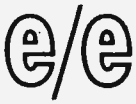

PREFIXES AND EXPONENTS

$$840 \text{ kiloHertz} = 840 \times 10^3 \text{ Hertz}$$

Similarly, a 6.8 megohm resistor, measured on an ohmmeter, will indicate 6,800,000 ohms. In this case, the prefix "meg-" can be replaced by "x 1,000,000":

6.8	meg	Ohms
6.8	x 1,000,000	Ohms
6,800,000		Ohms

But you can write "1,000,000" as "10x10x10x10x10x10" (six of 'em; count 'em), which is 10^6 . Thus, you should learn to mentally replace "meg-" with "x 10^6 ", so that 6.8 megOhms becomes a 6.8 X 10^6 Ohms. The 6 is called an *exponent*, and

shows how many 10s are multiplied together.

The Minus Crowd. What about the "milli-" and "micro-" prefixes? "Milli-", we've said, is one-thousandth; in a way, it is the opposite of the "kilo-" prefix. Make a mental note, then, that milli- can be replaced with " 10^{-3} " (read as "ten to the *minus* three power"), which is $1/10 \times 1/10 \times 1/10 = 1/1000$. Similarly, the "micro-" prefix can be considered as the opposite of "meg-", and replaced by 10^{-6} .

The beauty of this approach appears when you are faced with a practical problem, such as, "if 1.2 milliAmperes flows through 3.3 megOhms, what voltage appears across the resistor?" From our knowledge of Ohm's Law, we know that $E = IR$; that is, to get Volts (E) we multiply current

(Continued on page 98)

ELECTRONIC PREFIXES AND THEIR MEANINGS

Prefix	Pronunciation	Symbol	Exponent	Example
tera-	TEHR-uh	T	10^{12}	Frequency of infra red light is approx. 1 teraHertz
giga-	GIG-uh	G	10^9	Frequency of TV channel 82 is approx. 1 gigaHertz
mega-	MEG-uh	M	10^6	Frequency of typical shortwave broadcast station is approx. 1 megaHertz
kilo-	KILL-oh	k	10^3	Top note on a piano is approx. 4 kiloHertz
hecto-	HEK-toh	h	10^2	(not often used in electronics)
deka-	DEK-uh	da	10^1	(not often used in electronics)
deci-	DESS-ih	d	10^{-1}	A decibel is 1/10th bel
centi-	SENT-ih	c	10^{-2}	Wavelength of TV channel 82 is approx. 30 centimeters
milli-	MILL-ee	m	10^{-3}	Collector current of a typical small transistor is approx. 1 milliAmpere
micro-	MY-kroh	μ	10^{-6}	Base current of a typical small transistor is approx. 20 micro-Amperes
nano-	NAN-oh	n	10^{-9}	Time for a radio wave to travel 1 foot is approx. 1 nanosecond
pico-	PY-koh	p	10^{-12}	Collector-to-base capacity of a good high-frequency transistor is approx. 1 picoFarad
femto-	FEM-toh	f	10^{-15}	Resistance of 6 microinches of 0000 gauge wire is approx. 1 femtOhm
atto-	AT-toh	a	10^{-18}	6 electrons per second is 1 atto-Ampere

GET YOUR **CB** SIGNAL

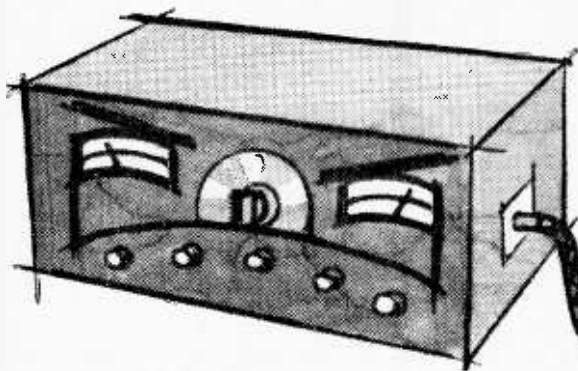

ALL PUT OUT!

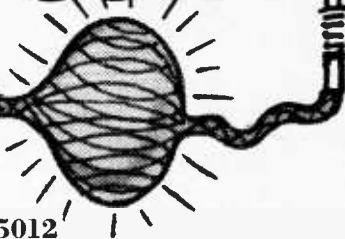

free—and legal ways—
to boost your CB signal

by Len Buckwalter, K1ODH/KQA5012

An old timer in the radio game once cleared up the mystery of CB antenna matching this way: "Imagine driving a car on an icy road. You gun the accelerator but the rear wheels spin uselessly and you don't go anywhere. Throw sand under the wheels and away you go. What you've done is matched power to load—just like matching a CB rig to an antenna."

There may be little connection between Edsels and electrons, but there's truth to the old timer's analogy. His spinning wheels represent the final radio-frequency amplifier acting as a power generator. Ice represents the load, or CB antenna, while sand is equivalent to a matching device which enables the wheels to bite into the ice—much like an amplifier delivering watts to an antenna. When matching is poor in either case (rig or car) the result is often useless heat.

The need for CB antenna matching springs from the differing impedance of various elements along the line. Measured in ohms, impedance is the AC resistance encountered by the radio signal in going from RF amplifier to transmission line to antenna, and finally to the air. Each element harbors its own characteristic impedance and maximum power transfer won't occur unless all impedances agree—which is to say "matched." What determines impedance

value is often the internal nature of the device. Fortunately, it's possible to tamper with impedances and electronically juggle the numbers. As a rule-of-thumb, a transmitter stage that operates at fairly high voltage and low current displays high impedance. Thus, the final stage of a tube-type CB rig is generally considered high impedance because plate voltage is about 250 and current flow only about 20 milliamperes. These conditions help drive impedance up to thousands of ohms. The impedance of a transistor output, on the other voltage is typically low and current flow high. These shifting possibilities challenge the CB designer, who must build his creations to feed a 50-ohm impedance. Why that figure?

Picks a Number. Fifty ohms is a standard value which grew out of fifty-odd years of two-way mobile radio. It's handy for several reasons. One is that a transmission line (connecting rig to antenna) can operate at low impedance, which gives it low operating voltage. The line can safely snake up to a roof or through the car trunk. Also, a standard mobile whip has an impedance of about 50 ohms and there's less of a matching consideration.

As you can see in Fig. 1, the main points for antenna matching start at the RF am-

CB SIGNAL ALL PUT OUT

plifier final. In this circuit there's a matching device between the output stage and the 50-ohm coaxial cable. The "matcher" is supplied inside the rig by the manufacturer and is usually adjustable by the buyer, but more on this in a moment. The circuit transforms high tube impedance down to the low value of the cable. The second "matcher" is shown as an optional component because, in many instances, coaxial cable hooks directly to the antenna. (Antenna makers also adhere to that 50-ohm value for input impedance of a CB antenna.) An optional matcher, however, could be used between the line and antenna. Some antennas (beams, for example) may need tuning, and accessory antenna matchers are sold for those who want to squeeze the last bit of energy out of the cable running to the antenna.

Figure 1. Matcher transforms impedance of final RF amp to that of antenna. Optional matcher lowers Standing Wave Ratio (SWR) of voltage within coax cable. Tune both matchers for lowest SWR reading with field strength meter.

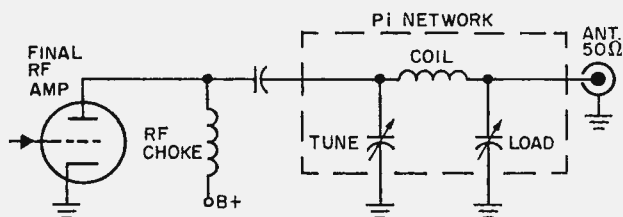
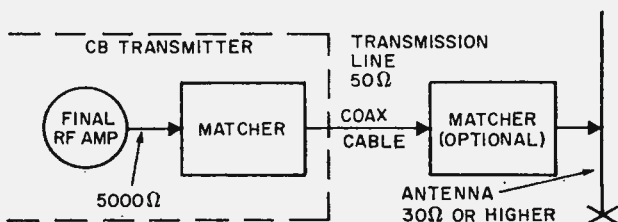

Figure 2. Schematic of pi-type output impedance matcher found in tubed CB transceivers. Network has two jobs; matching antenna to final RF amp, reducing second-harmonic content in output signal. Adjust load capacitor for lowest SWR.

Got a Match. Unless these major points are matched, maximum power cannot flow. For example, if a high impedance source directly feeds a low impedance load, there'll be a loss because the load acts to short-circuit the energy. If the condition is reversed—low to high connection—then the load can't absorb full power. Further, whenever a bad mismatch occurs, the system suffers "standing waves." These demons develop if power fails to be soaked up by the load. Signals reflect back to the transmitter and cancel part of the power.

Bad mismatch in a solid-state rig can

also blow the final transistors. This often happens as excessive voltages appear at transistor collectors and puncture the semiconductor material. Only through correct antenna matching will the 5-watt CB signal—weak enough to begin with—reach out for maximum range.

Have Some Pi. How designers accomplish matching from final amp to the line in a typical rig is shown in Fig. 2. It's the popular pi network formed by two variable capacitors around the final tuning coil. It permits an adjustable match between the tube and a reasonably wide range of impedances in the line. Impedance-transforming action occurs when the capacitors are varied and the output checked on a meter. You tune each control for maximum, being sure to repeat the adjustments several times back and forth to find the combination that produces best power output.

A similar circuit, found in transistorized circuits, is shown in Fig. 3; a double-pi network. The difference is that a tuning ca-

pacitor is joined by two coils with tunable slugs. The combination of components not only resonates the final amplifier to the desired output frequency (27 MHz) but transforms final transistor impedance down to that of the transmission line. A double-pi is used because it provides good opposition to the passage of second-harmonic signals from the final stage. These harmonics fall on 54 MHz and could cause considerable interference to TV channel 2.

In many instances, that's all the matching circuitry you'll find in a CB antenna system. Since line and antenna are each 50 ohms,

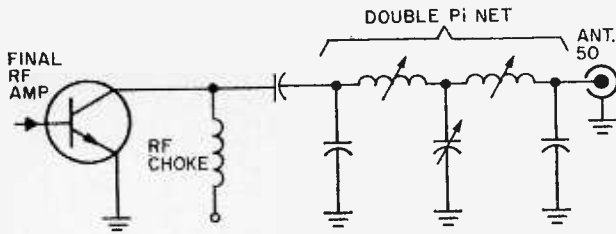

Figure 3. Schematic of pi-type output impedance matcher found in solid state CB transceiver. As with network found in Fig. 2, double pi network not only lowers impedance of output signal, it also resonates final amp to output frequency on CB band.

they connect directly together with no further matching. If the transmitter output adjustments are correctly done, the rig should be driving the antenna with maximum energy.

The Meter Dead-out. But are the matching controls properly adjusted? Manufacturers usually preset the rig's output controls for a 50-ohm load at the factory, but this might not be the precise value for your installation. The position of an antenna and cable may affect impedance so to be sure antenna adjustments are satisfactory, you'll need some touching up. Some rigs have output indicators (Fig. 4) which tell if the final is putting out maximum signal, but they read indirectly and could be misleading.

A field strength meter (Fig. 5) can more accurately reveal the effect of transmitter adjustments. It's actually a primitive receiver that gives steady indication of carrier strength. Try to place the meter as far as possible from the antenna while taking readings since it's possible to sense magnetic radiation from the antenna, and this energy doesn't contribute much to range. With the rig on, and the mike button keyed, tune the output controls (Fig. 6) for highest field strength. If you have a solid-state rig, don't turn any control more than a turn or so if there's no change in output. You don't want to risk a severe mismatch and possible damage to the semiconductors.

The field-strength meter suffices for tune-up, but an SWR (standing-wave ratio) meter will do an even better job. Its operation is based on the condition that when all components of the system are working at highest efficiency, SWR is lowest. The meter (Fig. 7) is inserted in the line and adjustments made for least SWR reading. When making these adjustments it's a good idea to also monitor relative output on the same meter (either reading is possible). You might mistake the controls enough to knock down RF output and believe efficiency is fine because of low SWR. A constant check on relative output prevents this error.

The SWR meter is also a handy trouble-

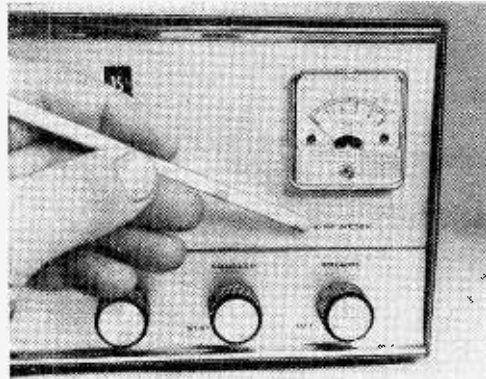

Figure 4. Indirectly-read S/RF meter can't tell you output SWR. Tune up this kind of rig with aid of field strength meter (FSM).

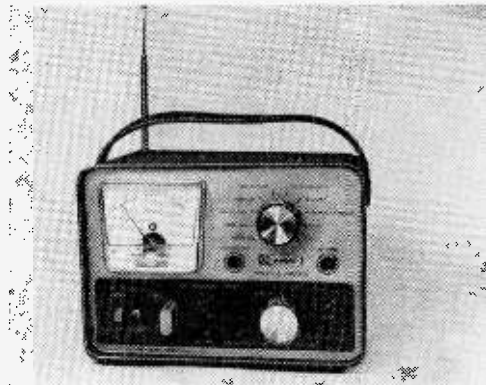

Figure 5. This mini test lab checks health of entire CB rig from mike connector to antenna. Shown is Knight's Ten-2 CB Checker.

shooter. If you develop a short circuit in an antenna element or transmission line, the SWR reading will shoot up and spell trouble. A perfect SWR ration is 1-to-1, but this is impossible in practical circuits. Anything below, say, 2-to-1 is acceptable and means that little power is wasted in the system.

Before the Antenna. There are a number of accessory antenna matchers on the mar-

e/e CB SIGNAL ALL PUT OUT

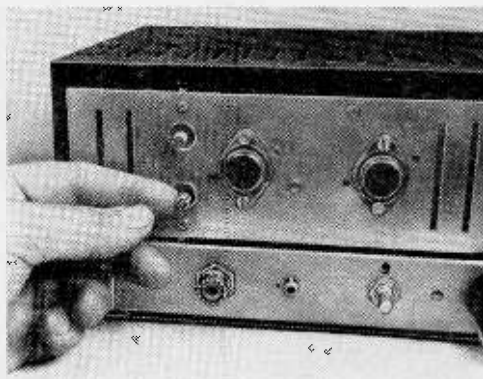

Figure 6. With your rig on, mike button depressed, adjust output loading, tuning controls for highest field, strength reading.

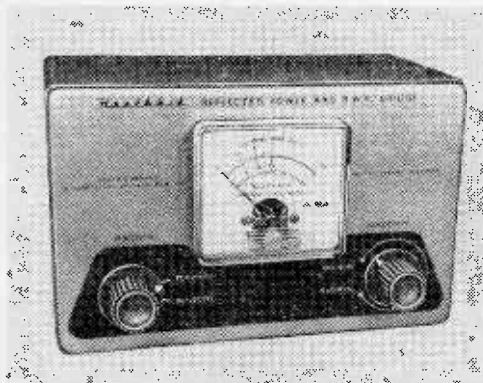

Figure 7. Keep tabs on your CB rig with Heathkit's Model AM-2 Reflected Power and SWR Bridge. Hams also find it useful.

ket and they can be installed by anyone who wants to squeeze the last milliwatt out of his rig (Fig. 8). They are similar to the matching circuits inside the CB rig: usually consisting of tuning capacitors and coils. The difference is that you can install a matcher at the point where the line connects to the antenna.

Inserting a matcher at the output of a transmitter shouldn't be necessary because matching adjustments are already provided by the manufacturer. A good spot for these external matchers is at the base of a mobile antenna (in the trunk, for example). The reason is that mobile whips are rated at 50 ohms, but the car's shape and the height of

the antenna may alter their value. In general, a whip suffers a mismatch because its impedance drops to below that of the coaxial cable when mounted on a car. A matcher can take care of this discrepancy by transforming impedances between line and whip until they agree. This is done by turning the matcher controls while observing either the RF output for maximum or for least SWR indication, as already described.

Coaxial Cable. There's a bit of controversy surrounding coaxial cable and how it's matched to the rest of the system. If you purchase the most popular cable—RG/58U—the manufacturer guarantees about 50

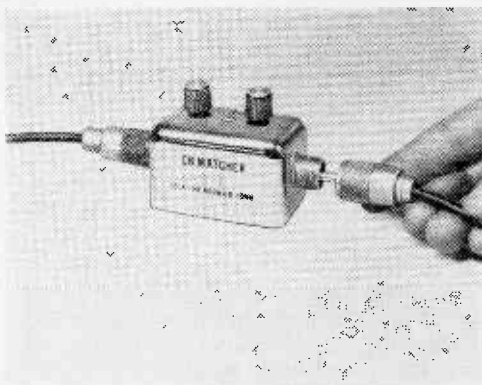

Figure 8. Think you can wring more power from your rig with an optional matcher? Here's one made by Gold Line.

ohms impedance. This is implicit in the cable's construction: its center wire and shield act electrically as a series of tiny distributed coils and capacitors. No matter where you cut the cable, it presents a 50-ohm value (at either end). For this reason, a transmission line doesn't have to be tuned or matched, but merely cut to any desired physical length.

Here's where the hassle begins. The cable is 50 ohms—but only if you connect it to 50-ohm devices at both ends. Unless your transmitter and antenna are each operating at 50 ohms, the cable is knocked for an electrical loop and runs at some other impedance. Standing waves created along the mismatched line rock those little coils and capacitors formed by the coaxial conductors. These problems should be cured when you tune the transmitter output controls, adjust the antenna (if possible in your model) or install an antenna-matching box.

Some authorities claim, however, that

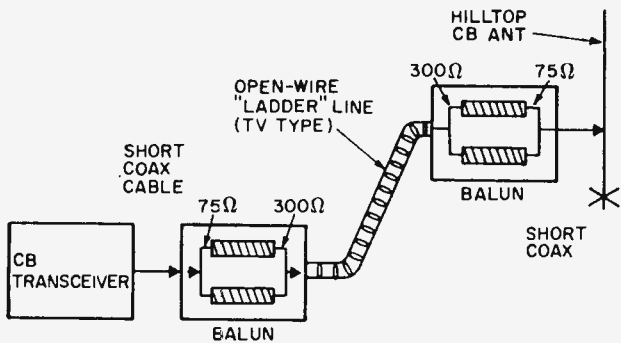

Figure 9. Open wire lead-in offers CBER one distinct advantage. Signal losses with this kind of lead-in are very low—hundreds of feet of cable can snake between rig, antenna without CBER encountering extreme signal loss. Only problem with "ladder" line is problem of impedance matching; easily solved with balun coils terminating cable at both ends. . . .

cutting the coaxial cable to a specific length cures some of the loss from cable mismatch in a system that's less than perfect. The cure is based on the fact that a coaxial cable can function as an impedance-matching device when cut to an electrical half-wave length of the signal. To turn this into practical numbers, you'd cut the cable to 11 feet 10 inches—or any multiple of that figure if a longer run is required. The next two length possibilities, for example, would be 23 feet 8 inches, then 35 feet 6 inches. You may not enjoy sensational improvement from this trick, but it should do no harm, and possibly overcome a problem of poor transmitter loading into the coaxial cable because of mismatch.

Over the Mountain. The unfortunate CB operator who lives at the bottom of a box canyon or is hemmed in by tall obstacles can leap-frog out of his dilemma by another matching trick. This is the case where you want to run a very long cable to an antenna which clears the obstructions—on an adjacent hill or other high formation. If the run is less than about 200 feet, the easiest way out is to install RG/8U cable. It's 50 ohms, but it operates at less loss per foot than the RG/58U style. But if you must run hundreds of feet, it would probably be cheaper

to try another possibility. It's "open-wire" line; a ladder-like pair of conductors spaced about an inch apart by plastic insulators (the "rungs" of the ladder). This feeder type is sold for TV use on UHF channels because its loss is extremely low. Remember, though, the first limitation of open-wire feeders is that they must be insulated by standoffs all along the way (coax can run anywhere).

The other pitfall is impedance matching. These lines reduce loss by wide spacing and impedances of several hundred ohms. It means you can't connect the feeder directly to a CB rig or antenna since standard ratings are 50 ohms. Yet, if you must run open line to keep cost and losses down, you can transform impedance at either end and come up with a good match. It's done by "balun" coils that are sold for TV tuner repair.

The term "balun" derives from "balanced-unbalanced." These coils enable you to connect together unbalanced devices (CB rig and antenna) to a balanced device (the open-wire line). Secondly, the baluns provide about a four-to-one impedance transformation to allow these various devices to connect together with no mismatch. We experimented successfully with some inexpensive

(Continued on page 102)

Figure 10. Tuning your CB transceiver for maximum watts per mile takes time, knowledge of test gear used. Here's complete test set-up—keep Field Strength Meter as far from antenna as is practicable.

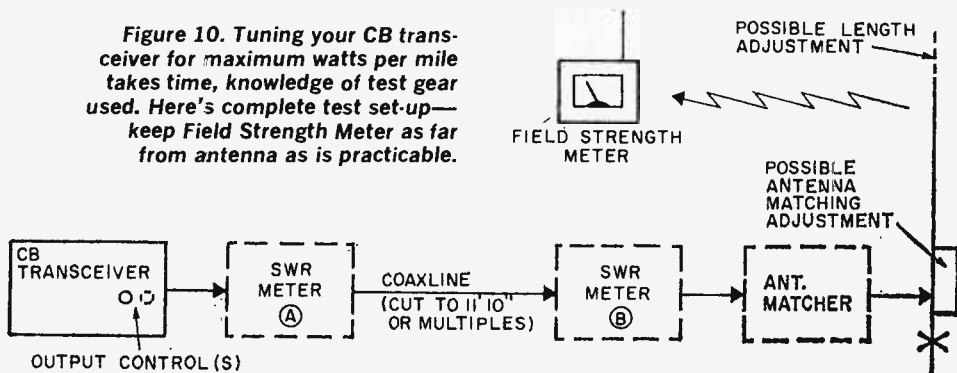

Discover the ease and excitement of learning Electronics with programmed equipment NRI sends you

When you train at home with NRI, you train with your hands as well as your head. You learn the WHY of Electronics, Communications, TV-Radio the NRI pioneering "3-Dimensional" way. NRI training is the result of more than half a century of simplifying, organizing, dramatizing subject matter, and providing personal services unique for a home study school. You get the kind of technical training that gives you priceless confidence as you gain experience equal to many, many months of training on the job.

NRI—The 53 Year Leader in Electronics Training



APPROVED UNDER NEW GI BILL

If you served since January 31, 1955, or are in service, check GI line in postage-free card.



*Earn \$5 or more an hour
spare or full time in*

TV-RADIO SERVICING

Color Television has arrived. Sales are soaring, along with the continuing popularity of other home entertainment equipment like portable radios, tape recorders, hi-fi sets, phonographs and auto radios. TV-Radio servicing is one of your best routes to spare-time earnings, a good paying job or a business of your own. NRI not only trains you quickly and expertly, but also shows you how to get started in Servicing soon after you enroll, earning as you learn. NRI trains you in today's methods of installing and repairing all Electronic equipment for the home—including booming Color TV. You even build, experiment with and keep to enjoy your own solid-state radio and your choice of black-and-white or Color TV receiver. Like thousands of others, you can be earning \$5 or more an hour extra in spare time starting soon.

*There's money and
success awaiting you in*

BROADCASTING— COMMUNICATIONS

The experience you gain from intensely practical NRI training in Complete Communications equals as much as two years of training on the job. With NRI, you can train for a choice of careers ranging from mobile, marine and aviation radio to TV broadcasting and space communications. You learn how to install, maintain and operate today's remarkable transmitting and receiving equipment by actually *doing* it. You build and experiment with test equipment, like a VTVM you keep. You build and operate amplifier circuits, transmission line and antenna systems, even build and use a phone-cw transmitter suitable for transmission on the 80-meter amateur band. Whichever of five NRI Communications courses you choose, you prepare for your FCC License exams, and you *must pass your FCC exams or NRI refunds your tuition in full.*

*Move ahead in America's
fast growing industry as*

ELECTRONICS TECHNICIAN

Electronics touches everyone's lives. This vast field of opportunity is open to you with NRI training. Industrial/Military Electronics training—like all NRI courses—prepares you quickly, thoroughly the practical "hands on" way. You build with, and learn to understand the functions of, today's miracle solid-state components like printed circuits, diodes and transistors. You build and experiment with Electronic circuitry used in automation, data processing, ultrasonics, telemetry. Whatever your interest in Electronics, NRI training can fill your needs. Prove to yourself what nearly a million NRI students could tell you . . . that you get more for your money from NRI. Check the postage-free card and mail it today for your FREE NRI Color Catalog. No salesman will call. NATIONAL RADIO INSTITUTE, Electronics Division, Washington, D.C. 20016.

YOU GET MORE FOR YOUR MONEY FROM NRI — Build, test, explore, discover. Everything you see here is included in one NRI course—including Color TV. Other courses equally complete. And you'll be surprised at the low tuition costs. Text for text, kit for kit, dollar for dollar—you get more for your money from NRI.

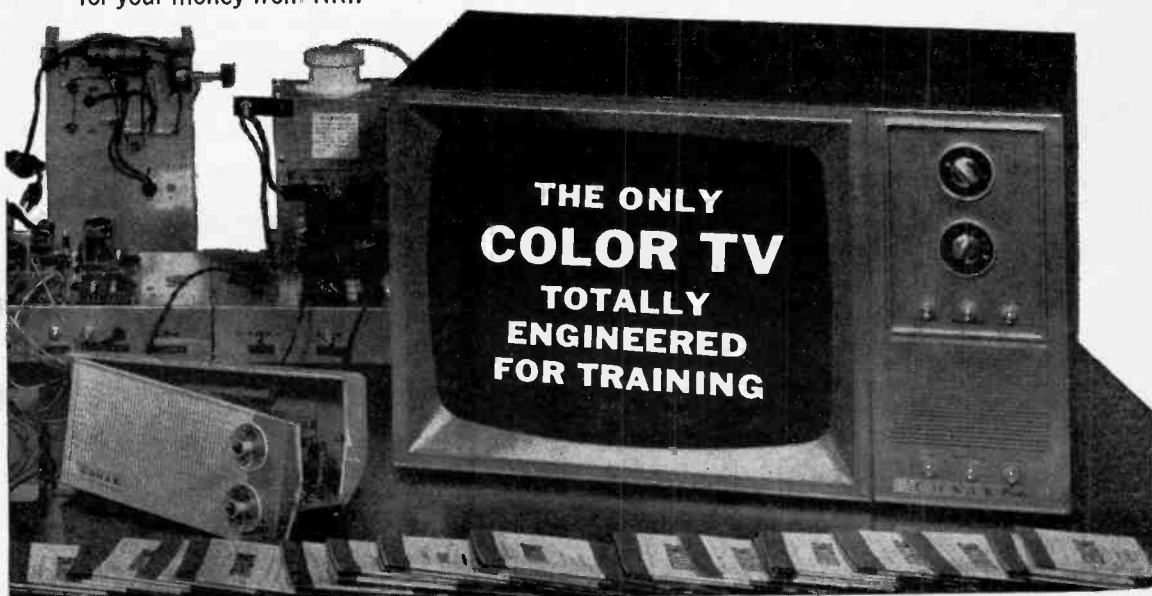

CIRCLE NO. 16 ON PAGE 27



PETE'S CAR GETS e/e looks inside a Cortina GT packed

IN A Blackpool street, a young man spoke briefly into a microphone. "Start, car!" said Peter Daykin, and fifty yards up the street, the starter whirred and the engine on his red Cortina GT purred into life. It had gotten the message, transmitted from Peter's walkie talkie set, to a receiver and "master controller" installed in the car's trunk.

But, this was easy stuff. Usually, Peter lies in bed in the morning, reaches under the pillow for his walkie talkie, issues his commands to the car in the garage, and it starts, and is warming up while he is brushing his teeth and shaving. "Very useful in the cold weather," grinned Peter. As well as

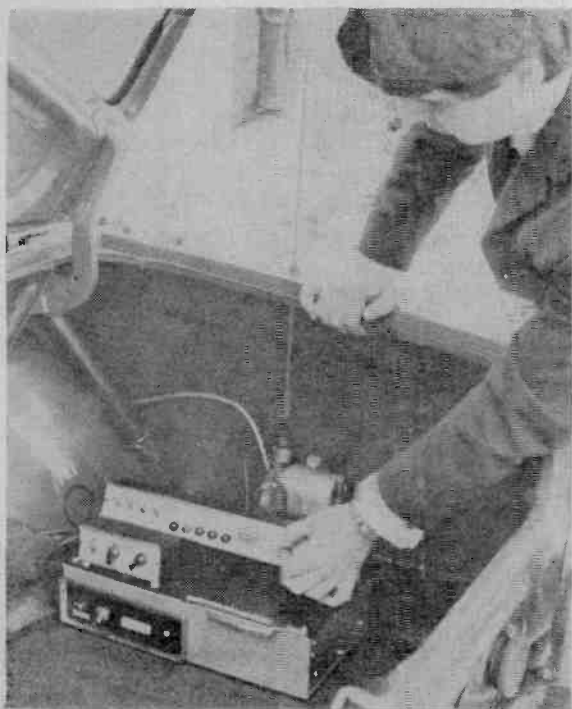

Nerve center, above, of Peter Daykin's remarkable Cortina. Shown is "master controller" which operates all devices in his car. Controller receives signals from his walkie-talkie, via rear-mounted antenna. Right—raindrops start windshield wipers.





Pete's car also has car-to-car transceiver. T/R's electronics really sit in car trunk; all Pete needs is push-to-talk mike. Pete's pointing to CdS cell. It turns on parking lights at dusk—another feature of his auto-car.

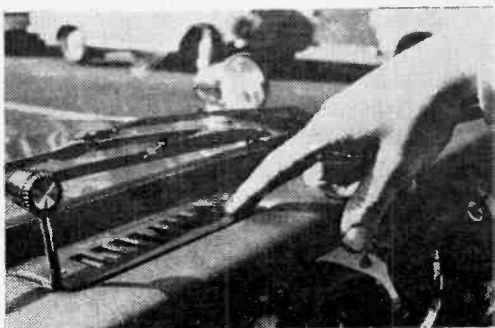

THE MESSAGE

with home brew electronic gadgets!

the remote starter. Peter has installed in his car—automatic sidelights that come on when the evening comes, automatically-dipping headlights that respond to other cars' lights, a warning beacon that transmits a radio signal that can be tracked if the car is stolen, a PA system that enables him to correct other drivers' errors (politely of course), and a device that switches on the windshield wipers when the rain comes pouring down.

Naturally, with all this, he has also a car-to-car transceiver. And, the electrically-powered windows come as no surprise. "This has cost me over \$2,100 to get this gear

working properly—although I had a lot of trouble to start with. Things like raindrops starting the radio up, and oncoming cars' lights started the windshield wipers . . . but it's OK now. I remember that when I was experimenting with the auto-starter, I had to talk to it for some time before it worked—in fact I recited poetry to it one cold morning, and I was in the middle of a speech from Henry V before it started. I'm working on a radar system now which will give warning of approaching vehicles in fog or stationary objects, too!"

Is a self-driven GT his ultimate goal? What say you, Peter! ■

Besides setting up car to start by itself, Pete is also dedicated sports car buff. He's got three gauges indicating engine head temperature, amps charge/discharge, plus oil pressure. Evident are various switches Pete's car needs to control all of his "goodies." Only conventional accessory in Pete's car is AM/SW rig atop gauges!

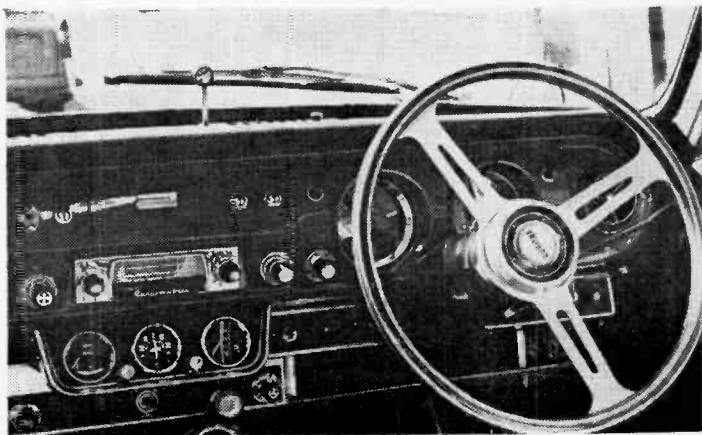

MEET MIDGET MOTORS

Karl Leibl prefers to talk only to reporters who are no more than an inch and a half tall. But, no Lilliput-sized journalists rapped on his shop door that day, so Karl told us about his work instead. At the moment, he's producing the smallest electric motors in the world. "I've been a precision mechanic all my life," said Karl. "And, for the last 20 years, I've specialized in tiny engines like this one." The motor he was talking about was roughly the size of a fingernail. Yet—like all of Herr Leibl's motors—it works perfectly. "The motors don't have any real practical uses," Leibl points out. "But I do get lots of orders from all over Europe. . . ."

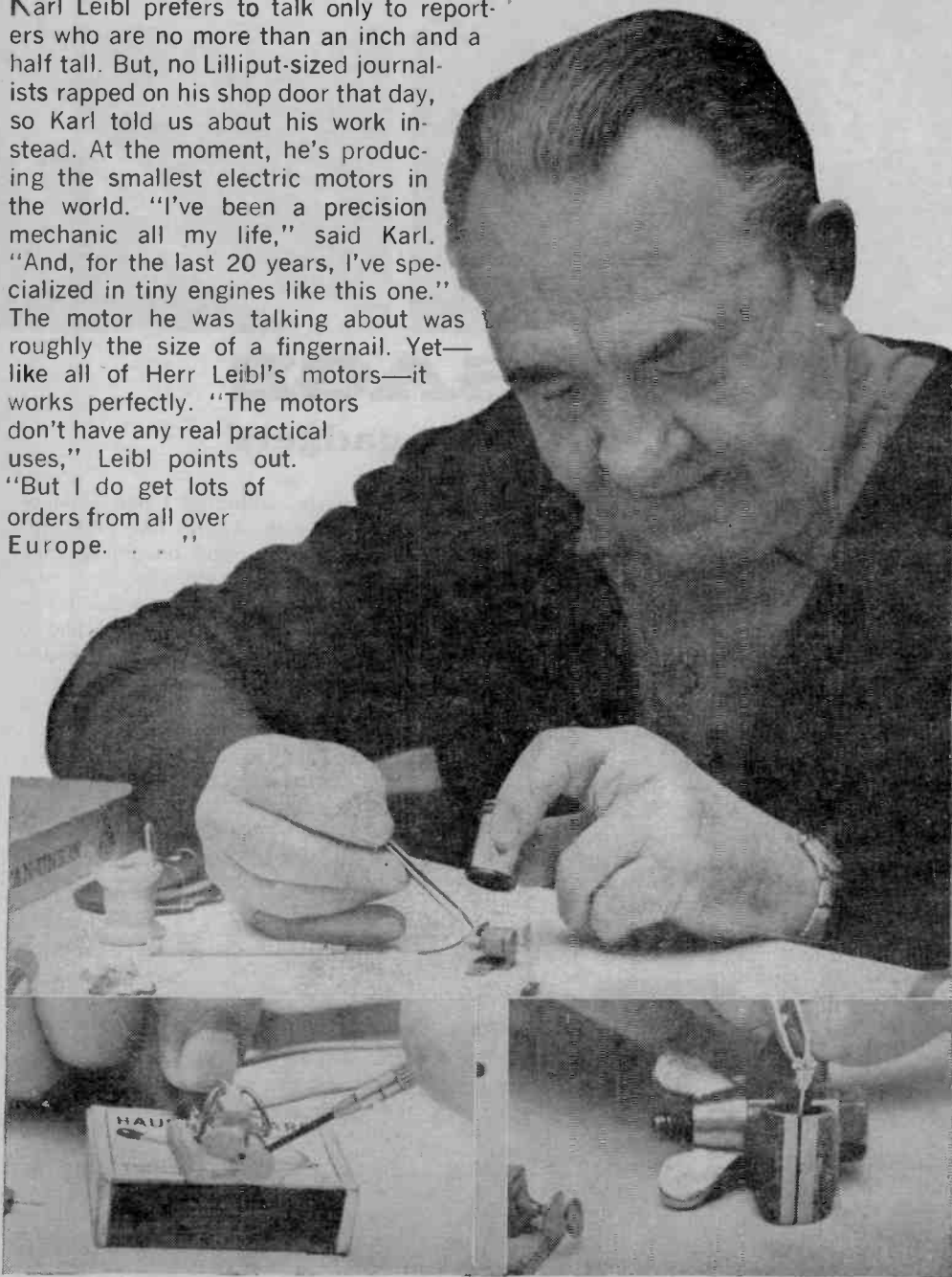

Above Left—Matchbox gives some idea of motor's proportions. Some of Karl's micro "engines", as he calls 'em, are capable of spinning at 3,000 rpm. **Above Right**—Mini vise holds rotor of mini motor. Most of Karl's engines power equally-tiny models.

e/e checks out a 4-Channel Stereo/Mono Mixer

**Switchcraft's Model 308TR Studio Mixmaster
brings to you professional audio mixing
at reasonable hobby prices!**

Professional quality recordings always require that more than one microphone be used so the various input sounds can be mixed for optimum balance and effect. Until recently, the average tape fan had his choice of a professional quality mixer priced well in excess of \$300 or a cheap "transistorized" mixer in the "under \$10" category that often generated intolerable hiss, not to mention distortion.

But now, through the use of the latest solid-state techniques, there is a professional quality mixer at hobbyist prices—the Switchcraft Model 308TR Studio Mixmaster.

The Mixmaster is both a stereo and mono mixer with a master gain control. When a rear panel switch is set to MONO, four input channels are available for mixing through a master gain control. When the switch is set to STEREO, channels 1 and 2 are mixed for the left output while channels 3 and 4 are mixed for the right output. The master level control then becomes a dual master, affecting both channels simultaneously.

The inputs of the 12-in. W x 2¾-in. H x

6¾-in. D Mixmaster can accommodate both low and hi-Z microphones and line-level inputs. Two of the microphone inputs can be used for magnetic phono pickups as slide switches provide the required RIAA equalization. Phone type jacks are provided for the microphone phono pickups; phono type jacks for the high-level inputs. The mixer's output can be terminated in any impedance from 600 ohms up; phono-type jacks are used for the output signals. When the mixer is set to the mono mode, the output is available at both output jacks.

Performance. Though the Studio Mixmaster is hobbyist priced, its performance is professional *all the way*. Gain controls are isolated, adjusting one control has no effect whatsoever on the other inputs. The overall frequency response of all channels measured "ruler flat", less than 0.1db variation from 20 to 20,000 Hz. The maximum distortion at normal operating levels was 0.1% THD at all frequencies, while the hum and noise measured —62 dB through the microphone inputs and —65 dB through the phono in-

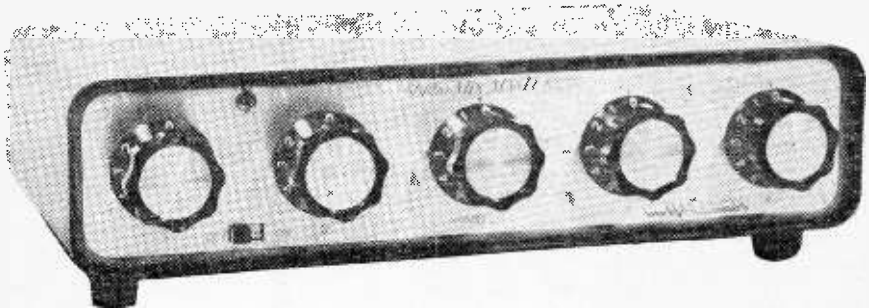

Switchcraft's Model 308TR Studio Mixmaster combines professional-grade performance with clean-cut good looks in a unit that sells for \$96—a hobbyist's price, all right!

e/e SWITCHCRAFT MIXMASTER

Left—Metal shield around power supply is Switchcraft's way of killing hum, noise.

puts (both essentially dead quiet).

The so-called *average* or *normal* microphone input signal level of 1 mV produced a 1.5 V output from the mono mode, a 3.4 V output from the stereo mode. The phono inputs required a 4 mV input to obtain the same output levels. These sensitivities were obtained with both the master and channel gain controls set to 80% open.

Both the microphone and phono inputs can take excessively high signal levels before distortion sets in; the overload point for both inputs is approximately 150 millivolts.

Construction. The construction of the Mixmaster contributes greatly to the notably low noise level. The microphone (and phono) preamplifiers are assembled on a printed circuit board that stretches across the back of the cabinet. The jacks and switches are actually part of the board assembly, hence, input leads are exceptionally short and direct.

The well filtered power supply and the high level output (line) amplifiers are mounted inside a heavily shielded cabinet that is attached to the bottom cover, well away from the preamplifiers. The result of this extra effort is fully professional signal-to-noise ratios.

Summing Up. Though hobbyist priced at \$96 the Switchcraft Studio Mixmaster has professional grade construction, uses professional quality components and delivers uncompromised professional grade performance. It is an important and worthwhile addition for any quality tape installation.

For additional information circle number 31 on Reader Service Coupon on page 27. Switchcraft will send you all the facts. ■

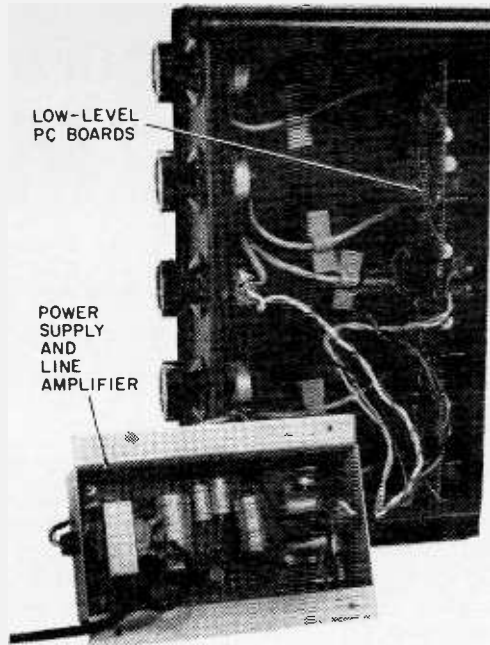

Top—You can mix phono, line, mic sources together with Switchcraft's Mixmaster. RCA-type plus standard 1/4-in. phone jacks solve plug-patching problem for audiophile. Bottom—Four Channel Level controls, Master Level control marks Mixmaster for pros!

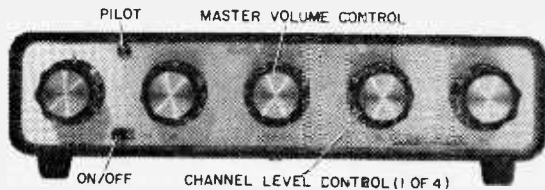

FUSE CADDY CORRALS THE SLO-BLOW SET

If you have saved up a collection of fuse boxes you can solder them together into a neat set of little drawers. You'll be surprised how they keep your fuses from getting lost in your tool box or covered by other objects on top of your workbench. Just stack the boxes and solder them together with a strip cut from a tin can providing clearance between individual boxes. Clean the paint off the side of the fuse boxes before trying to "sweat solder" the strip to the sides of the boxes. Make sure you don't leave any sharp edges to cut your fingers. Fuse ratings are already marked on the ends of the "drawers." ■



ELEMENTARY ELECTRONICS

EE'S

all *NEW* BASIC COURSE in ELECTRICITY & ELECTRONICS

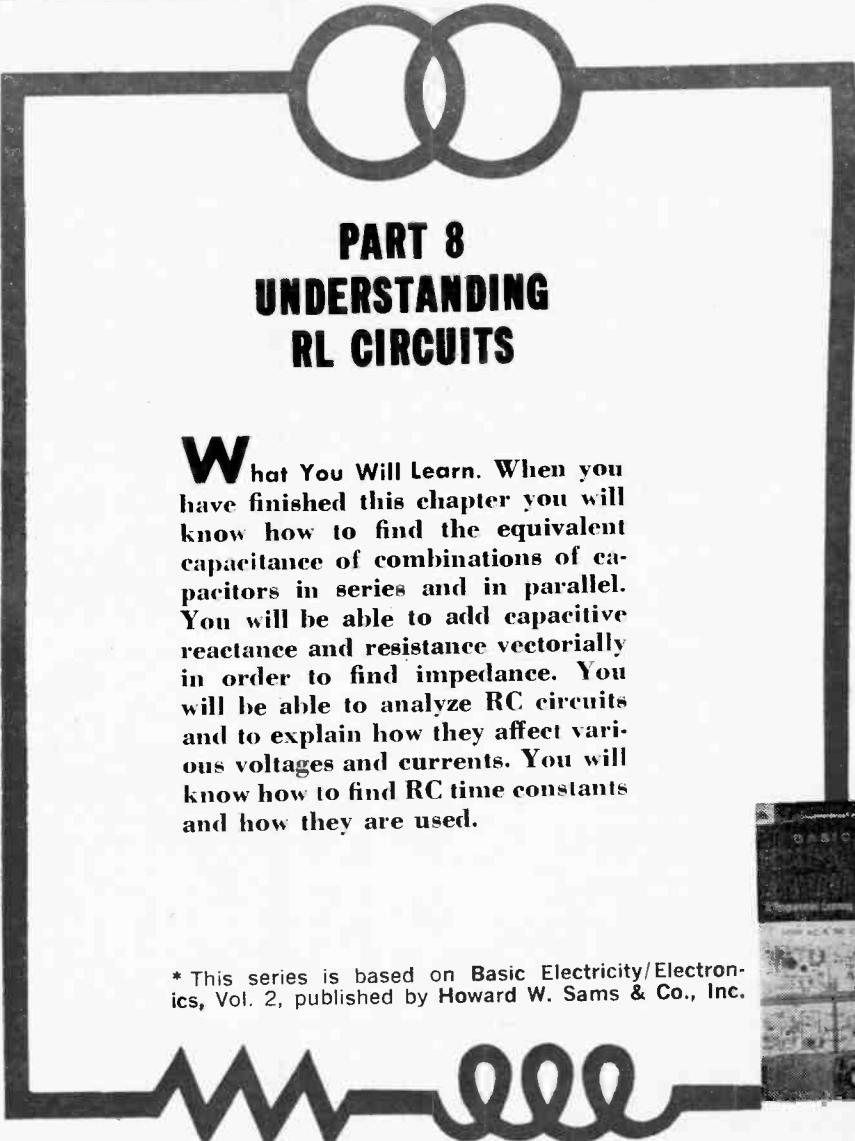

PART 8 UNDERSTANDING RL CIRCUITS

What You Will Learn. When you have finished this chapter you will know how to find the equivalent capacitance of combinations of capacitors in series and in parallel. You will be able to add capacitive reactance and resistance vectorially in order to find impedance. You will be able to analyze RC circuits and to explain how they affect various voltages and currents. You will know how to find RC time constants and how they are used.

* This series is based on Basic Electricity/Electronics, Vol. 2, published by Howard W. Sams & Co., Inc.



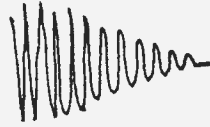
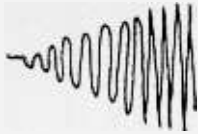

A BASIC CAPACITIVE CIRCUIT

First, let's review what you have learned about capacitance by applying it to this basic capacitive circuit.

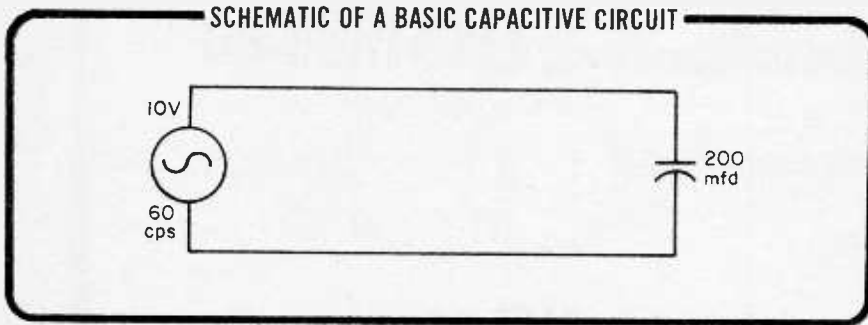

You have already learned that when a sine-wave AC voltage is applied, the current in a capacitor always leads the voltage by 90° . You have also learned that a capacitance consumes no power; all the energy it takes out of a circuit in one quarter cycle is returned in the next quarter cycle.

Both of the above statements are true, not only for a single capacitance, but also for any combination of capacitors. In fact, any circuit that contains only pure capacitances, no matter how many, can be simplified to include only one representative equivalent capacitance.

CAPACITORS IN COMBINATION

As you know, resistors and inductors add in series. Two resistors or inductors in series have the same effect as a single, larger, resistor or inductor.

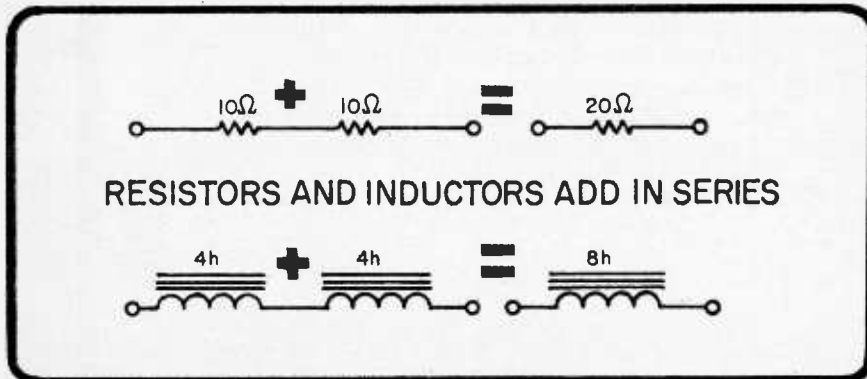

Capacitors in Parallel

Capacitors add in parallel. It is easy to understand why this is true if you remember that the more plates a capacitor has, the greater is its capacitance.

ADDITIONAL PLATES MEANS GREATER CAPACITY

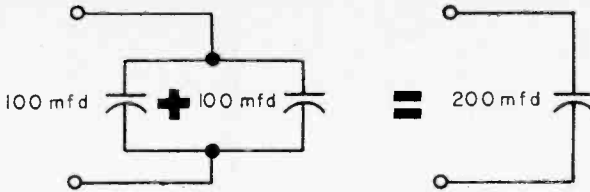

If two capacitors are connected in parallel, you can find their equivalent capacitance by adding their values.

CAPACITORS ADD IN PARALLEL

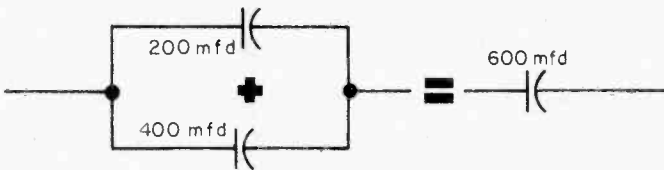

If a 200-mfd and a 400-mfd capacitor are connected in parallel, the equivalent capacitance of the combination is 200 mfd plus 400 mfd, or 600 mfd. This is also true with three, four, or any other number of capacitances in parallel.

Capacitors in Series

If two capacitors are connected in series, what is their equivalent capacitance? We cannot simply add C_1 and C_2 together. Instead, we use the relationship:

$$C_{eq} = \frac{C_1 \times C_2}{C_1 + C_2}$$

What is the total capacitance of 200 mfd and 400 mfd connected in series? Using the above relationship, the total capacitance is calculated to be:

$$C_{eq} = \frac{200 \times 400}{200 + 400} = 133 \text{ mfd}$$

Notice that this equivalent value is smaller than either of the two individual capacitor values.

EQUIVALENT CAPACITANCE OF SERIES-CONNECTED CAPACITORS

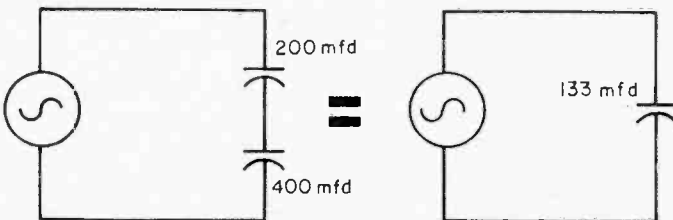

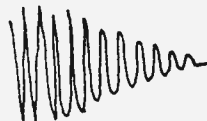
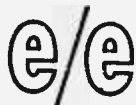

Q1. What is the equivalent capacitance of the following circuit?

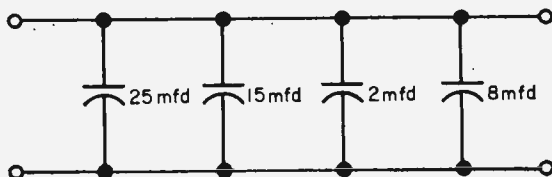

Q2. How would you replace a 500-mfd capacitor if you had available only 200-mfd and 300-mfd capacitors?

Q3. Would you expect two capacitors in series to have greater or less capacitance than the same two capacitors in parallel?

Q4. What is the equivalent capacitance of two equal capacitors in series?

Your Answers Should Be:

- A1. C_{eq} is $25 + 15 + 2 + 8 = 50$ mfd.
- A2. Connect a 200-mfd and a 300-mfd capacitor in parallel to get an equivalent capacitance of 500 mfd.
- A3. Two capacitors in series would have less capacitance than the same two capacitors in parallel.

IN PARALLEL, THE EFFECTIVE PLATE AREA IS INCREASED

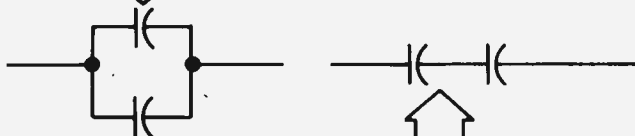

IN SERIES, THE EFFECTIVE PLATE AREA IS REDUCED

A4. The equivalent capacitance of two equal capacitors in series is always **one half** the capacitance of either one of them.

Complicated circuits can be simplified by analyzing them in steps as shown on the next page.

On the preceding pages, capacitance values were combined, not capacitive-reactance values. You must not confuse the two. To combine capacitive reactances, whether in series or in parallel, use the same rules that apply to resistance—add series values and combine parallel values by the formula:

$$X_{eq} = \frac{X_1 \times X_2}{X_1 + X_2}$$

CAPACITIVE CIRCUIT SIMPLIFIED STEP BY STEP

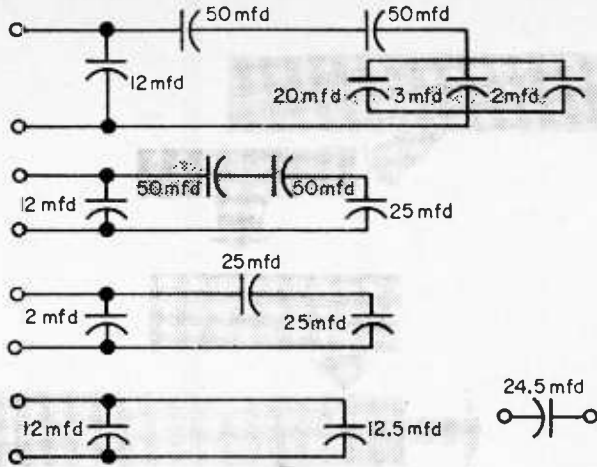

Always check to make sure that all the capacitive-reactance values are computed for the same frequency—otherwise the result will be wrong. In order to calculate the reactance of a capacitive circuit, it is usually better to compute the equivalent capacitance first, and calculate the capacitive reactance of the equivalent capacitance.

Q5. What is the equivalent capacitance of this circuit?

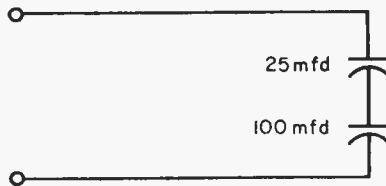

Q6. What is the equivalent capacitance of this circuit?

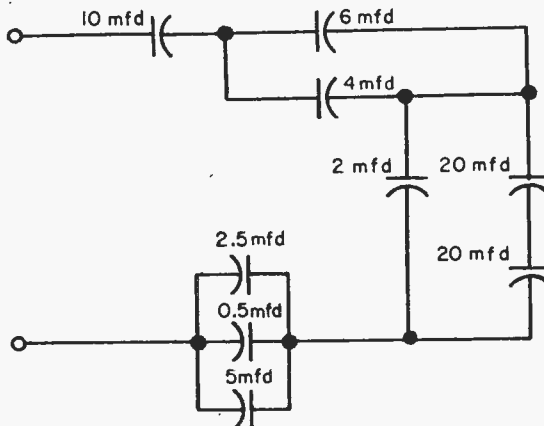

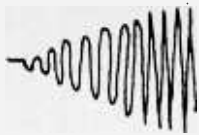

Your Answers Should Be:

A5. $C_{eq} = \frac{25 \times 100}{25 + 100} = \frac{2,500}{125} = 20 \text{ mfd}$

A6. You should have simplified the circuit to something like this:

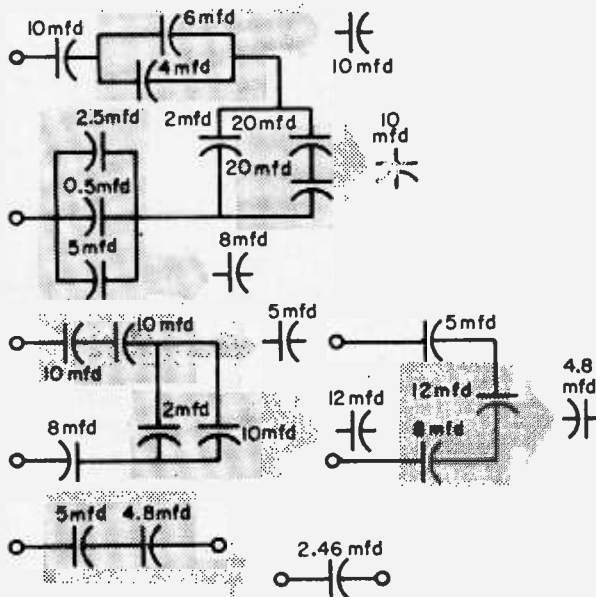

RC CIRCUITS

Actually, an entirely pure capacitance does not exist. The leads of capacitors have some small value of resistance. Also, the dielectric layer is never quite perfect; it has some extremely high value of resistance. So, if you wanted to be very accurate, you would represent these unwanted resistances by inserting their values in your circuit diagram, and treating them just as if they were actual resistors. For most practical purposes, however, you can disregard them.

Now let's see what happens if we put capacitors and resistors in the same circuit. As you already know, we cannot add resistance and capacitance, because they are two different quantities (resistance is measured in ohms, capacitance in farads). Instead, it is necessary to use capacitive reactance, which you learned about in one of the previous parts. However, just as with inductance, to add resistance to capacitive reactance it must be remembered that resistive current is in phase with the voltage, while capacitive current leads the voltage by 90°. So the two cannot be added directly—they must be added vectorially.

VECTORIALLY ADD CAPACITIVE REACTANCE AND RESISTANCE

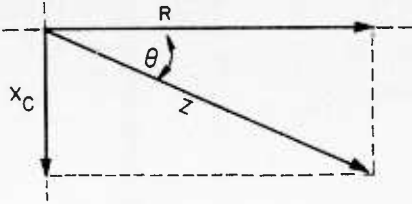

IMPEDANCE

The capacitive-reactance vector is 90° ahead of the resistance vector. The resulting quantity, an **impedance**, is somewhere between the two, and its length (quantity) is the diagonal of the rectangle they form. This is **capacitive impedance**, which is different from inductive impedance because it leads the resistance vector. The way to write capacitive impedance is $R - jX$; the minus sign tells the story. All inductive impedances are represented by a $+ j$, and all capacitive impedances by a $- j$ in front of the X.

- Q7. Inductive impedance leads, lags) resistance.
 Q8. Would an impedance of $15 - j20$ ohms be inductive or capacitive?
 Q9.

Draw a vector diagram on graph paper to find the impedance in the circuit above. Measure the phase angle with a protractor.

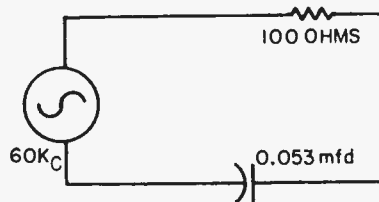

Your Answers Should Be:

- A7. Inductive impedance lags resistance.
 A8. An impedance of $15 - j20$ ohms would be capacitive.
 A9. The capacitive reactance is 50 ohms.
 Your vector diagram should look like this.

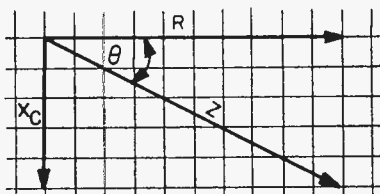

$$Z = 100 - j 50 \text{ ohms}$$

$$\text{or } 112 \angle -27^\circ \text{ ohms}$$

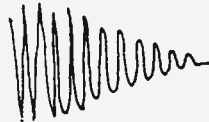
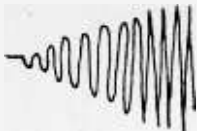

If you have a table of trigonometric functions, you can get more accurate measurements of the impedance, using the same formulas you used to find inductive impedance. Remember, these formulas apply to both inductive and capacitive impedance.

$$\begin{array}{lll}
 R = Z \cos \theta & X = R \tan \theta & X = Z \sin \theta \\
 R = \frac{X}{\tan \theta} & \frac{X}{R} = \tan \theta & Z = \frac{R}{\cos \theta} \\
 \frac{R}{Z} = \cos \theta & \frac{X}{Z} = \sin \theta & Z = \frac{X}{\sin \theta}
 \end{array}$$

Use a table of trigonometric functions to solve the following problems.

- Q10.** Find Z and θ for these values of X_c and R .
- (a) $X_c = 3$ ohms, $R = 4$ ohms.
 - (b) $X_c = 4$ ohms, $R = 3$ ohms.
 - (c) $X_c = 10$ ohms, $R = 10$ ohms.
 - (d) $X_c = 87$ ohms, $R = 50$ ohms.
- Q11.** Find X_c and R for these values of θ and Z .
- (a) $\theta = 45^\circ$, $Z = 10$ ohms.
 - (b) $\theta = 37^\circ$, $Z = 0.5$ ohms.
 - (c) $\theta = 15^\circ$, $Z = 1,000$ ohms.
- Q12.** If θ is 60° , will R be larger or smaller than X_c ?
- Q13.** If θ is 37° , will R be larger or smaller than X_c ?
- Q14.** Will a circuit with an impedance of 100 ohms and a phase angle of 75° dissipate more or less power than a circuit with the same impedance and a phase angle of 45° ?

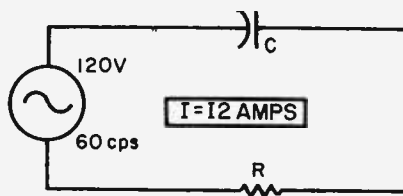

Suppose you now the input voltage, the frequency, and the current flowing in the above circuit. Also, suppose you know that the phase angle of the circuit is 60° .

- Q15.** What is the DC resistance of this circuit?
- Q16.** What is the impedance of the circuit?
- Q17.** What is the capacitive reactance of the circuit?
- Q18.** What is the resistance of the circuit?
- Q19.** How much power is dissipated in the circuit?
- Q20.** What will happen to the capacitive reactance of the circuit if the frequency of the input is decreased?
- Q21.** What will happen to the phase angle of the circuit if the frequency of the input is increased?

Your Answers Should Be:

- A10. (a) $Z = 5$ ohms, $\theta = 37^\circ$
 (b) $Z = 5$ ohms, $\theta = 53^\circ$
 (c) $Z = 14.14$ ohms, $\theta = 45^\circ$
 (d) $Z = 100$ ohms, $\theta = 60^\circ$
- A11. (a) $X_c = 7.07$ ohms, $R = 7.07$ ohm.
 (b) $X_c = 0.3$ ohm, $R = 0.4$ ohm.
 (c) $X_c = 259$ ohms, $R = 966$ ohms.
- A12. If θ is 60° , R will be less than X_c .
- A13. If θ is 37° , R will be more than X_c .
- A14. An impedance of 100 ohms will contain less resistance and dissipate less power at a phase angle of 75° than at a phase angle of 45° .

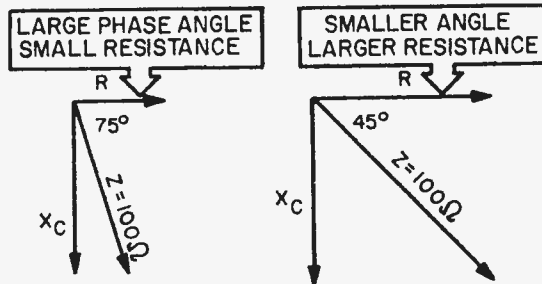

- A15. The DC resistance will be infinite because the capacitor blocks DC.
- A16. The impedance can be found by using the formula
- $$Z = \frac{E}{I} \cdot Z = 10 \text{ ohms.}$$
- A17. $X_c = Z \sin \theta = 8.66$ ohms.
- A18. $R = Z \cos \theta = 5$ ohms.
- A19. $P = I^2 R = 720$ watts.
- A20. X_c will increase if the frequency decreases.
- A21. The phase angle will decrease if the frequency increases, because X_c will decrease.

RC TIME CONSTANT

The ratio between R and C has an important effect on the characteristics of a circuit. The way this ratio affects AC voltages and currents is indicated by a **time constant**, in much the same way that the effects of combined inductance and resistance were indicated.

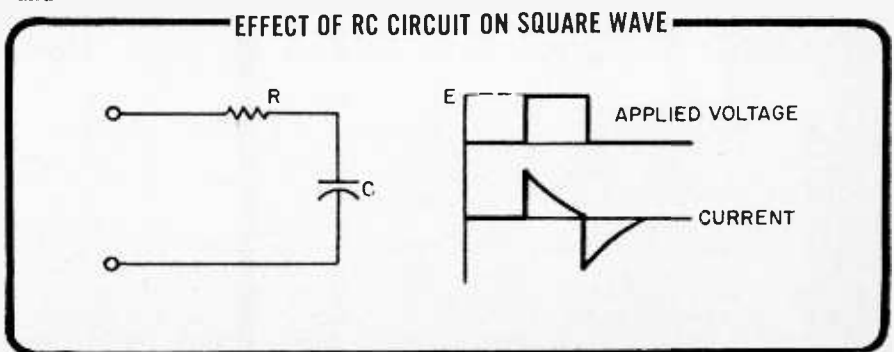

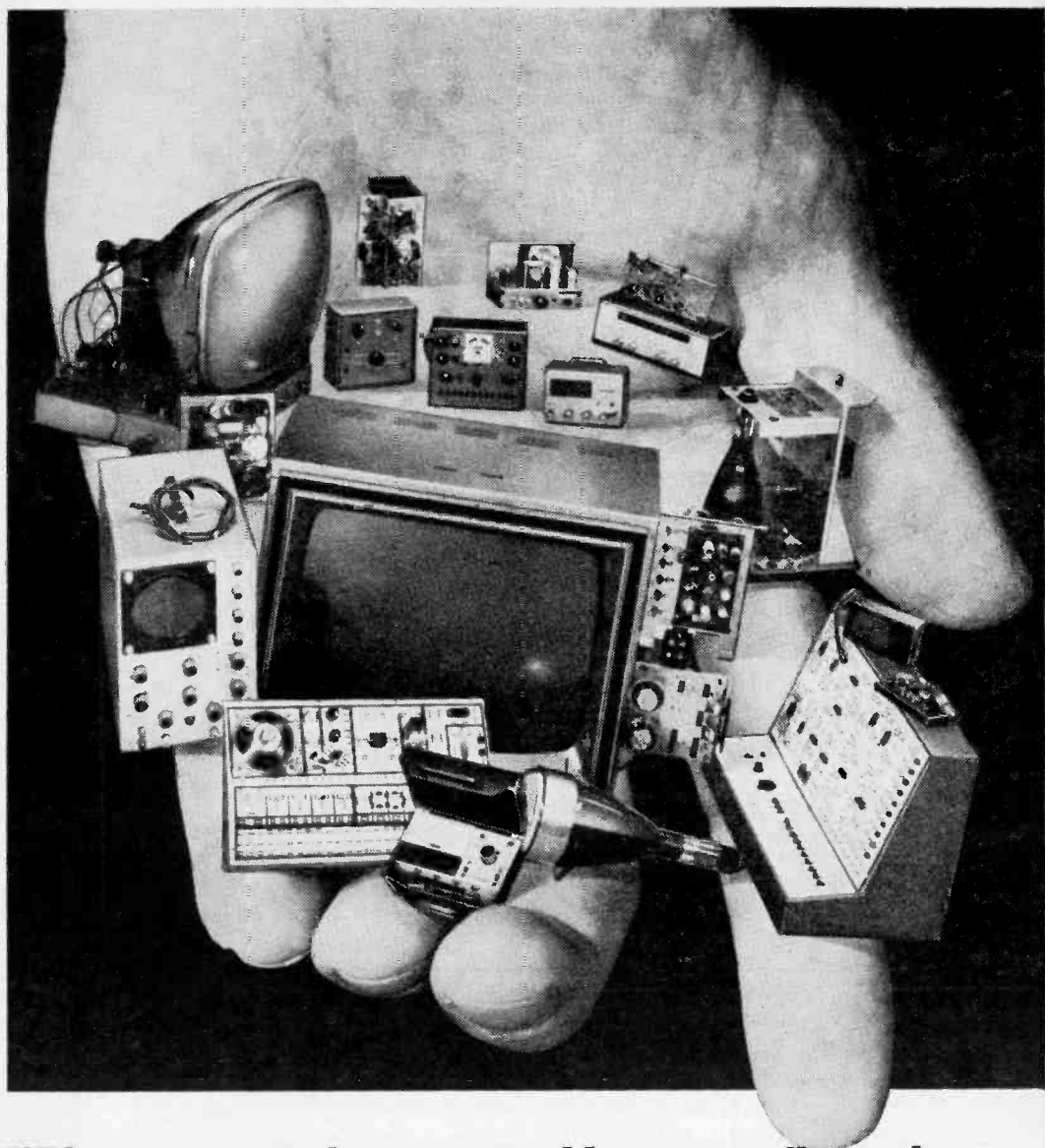

NTS puts a whole new world at your fingertips.

NTS home training can put a whole new way of life in the palm of your hand. A new, exciting job, a much bigger income is now easily within your reach.

NTS training is something special. We provide all the kits you need for the most effective training. National Technical Schools sends kits with every course, and teaches you to build and test a

wide range of professional equipment — the same kind of equipment you'll actually use on the job. That's the NTS "Project Method" — training that's practical and in-depth. You learn everything from fundamentals to the latest innovations. From beginning to end, NTS makes it fascinating and fun to learn this way. And all you need is a little

spare time and an interest in electronics.

Each year, men are moving into important new jobs, or their own businesses, straight out of NTS electronics training. NTS is what's happening to men everywhere. Check the coupon. Take hold of the career you want most. Do it now. No obligation. No salesman will call.

ELEMENTARY ELECTRONICS

We pack your electronics course with kits to make your training fast. You'll enjoy every minute of it.

NTS COLOR TV SERVICING

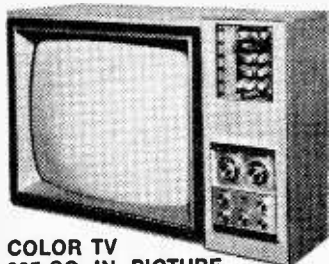

**COLOR TV
295 SQ. IN. PICTURE**

NTS training provides an easy way to become a professional home-entertainment service technician. You receive a big screen Color TV with many unique features. The unit even includes self servicing equipment that permits you to make all normal test operations. No additional test equipment is needed for adjusting your set. In addition you get an AM-SW radio, Solid-State radio, Field-Effect Transistor Volt-Ohmmeter, and Electronic Tube Tester. You learn about Electronic principles and trouble shooting, hi-fi, multiplex systems, stereo, and color TV servicing.

NTS COMPUTER ELECTRONICS

This is the future. And it's happening now. The number of computers will *increase many times* in the next few years.

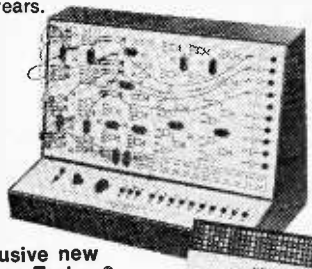

Exclusive new Compu-Trainer®

If card is missing check coupon and mail for free color catalog and sample lesson. Now.



National Technical Schools

4000 S. Figueroa St., Los Angeles, Calif. 90037
Please rush Free Color Catalog and Sample Lesson, plus information on course checked below. No obligation. No salesman will call.

NTS offers a solid grounding in computer operation, wiring, data processing and programming. One of the 10 important kits included is our exclusive Compu-Trainer®. It's a fully operational computer logic trainer — loaded with integrated circuits — the first ever offered in home study. It introduces you quickly to how, what, when and why of computers ... from theory to practical servicing techniques. This unit is capable of performing 50,000 operations per second.

NTS ELECTRONICS COMMUNICATIONS

Choose from two exciting courses to get into the big-paying fields of transmitting and receiving equipment: (1) The FCC License Course. (2) The Master Course in Electronic Communications (more comprehensive, with Citizens' Band Two-Way-Radio). Either Communications program qualifies you for your FCC First Class Commercial Radio-Telephone License — *NTS assures you will pass this FCC exam within six months after successfully completing your course or your tuition is refunded.* Kits include an Amateur-Phone 6 Meter VHF Transceiver — NTS exclusive, 6 transistor Solid-State Radio, Volt-Ohmmeter (fully transistorized).



5 Watt AM Transmitter/Receiver

NTS AUTOMATION/ INDUSTRIAL ELECTRONICS

Let NTS put you into the age of electronic controls. Systems Automation is rapidly becoming the emphasis of modern industry. Your NTS training in automation electronics includes equipment like a 5" wide band Oscilloscope. You also get the new NTS Electronics Lab. It's an exclusive NTS experimental laboratory — a complete workshop that simplifies learning about solid-state, miniature and integrated circuits.

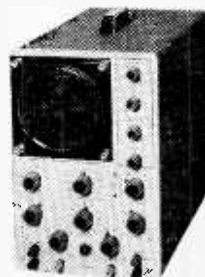

5" Oscilloscope

CLASSROOM TRAINING AT LOS ANGELES

You can take classroom training at Los Angeles in sunny Southern California. NTS occupies a city block with over a million dollars in facilities devoted exclusively to technical training. Check box in coupon.

NATIONAL TECHNICAL SCHOOLS

WORLD-WIDE TRAINING SINCE 1903

4000 South Figueroa Street
Los Angeles, Calif. 90037, U.S.A.

APPROVED FOR VETERANS

Accredited Member: National Association of Trade and Technical Schools; National Home Study Council.

- Master Course in Color TV Servicing
- Color TV Servicing
- Master Course in TV & Radio Servicing
- Practical TV & Radio Servicing
- Master Course in Electronic Comm.
- FCC License Course
- Master Course in Electronics Tech.
- Industrial and Automation Electronics
- Computer Electronics
- Basic Electronics

Name _____ Age _____

Address _____

City _____ State _____ Zip _____

- Check if interested in Veteran Training under new G.I. Bill
- Check if interested only in Classroom Training at Los Angeles

Dept. 222-051

CIRCLE NO. 17 ON PAGE 27

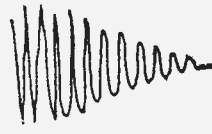
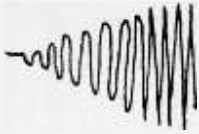

What happens if you apply a pulse, such as a square wave, to a series RC circuit? The capacitor will oppose the sudden change of voltage and will gradually **charge** to source voltage E . The rate of charge (the initial current that will flow) is limited by resistance R . In fact, the initial current will be $I = E/R$ and will gradually decrease to zero as the voltage **builds up** across the capacitor.

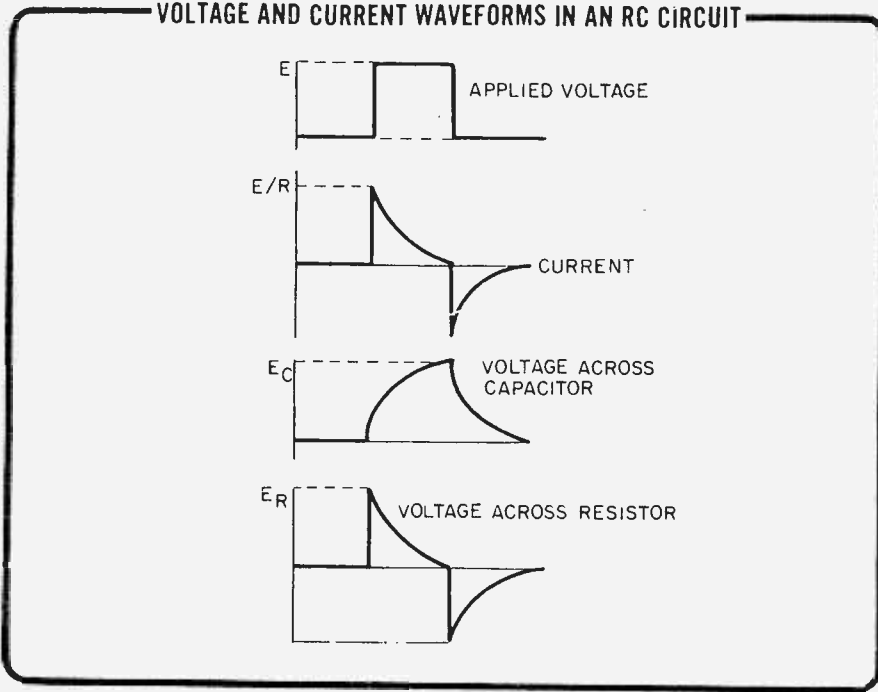

The voltage across the capacitor will start at zero and will build up smoothly until it equals source voltage E . The voltage across the resistor will, at any instant, equal the difference between the source voltage and the voltage across the capacitor: it will also be a spike as shown.

The rate of charging—the steepness of the capacitor voltage curve—depends on how much current the resistor will allow to flow. The higher the resistance, the less the current flow and the slower the charging rate will be.

This fact is expressed in numbers by the **time constant** of the circuit. The time constant of a series RC circuit is simply $R \times C$, where R is in ohms, C is in farads, and the time constant is in seconds. RC is the time it takes the capacitor to charge to 63.2% of the source's voltage.

For example, if R is 10,000 ohms and C is 10 microfarads,

$$RC \text{ is } 10,000 \times \frac{10}{1,000,000} = 0.1 \text{ second.}$$

When a capacitor has been charged, it actually contains a certain amount of stored energy. The stored energy is C times E coulombs, where C is the capacitance in farads and E is the voltage to which the capacitor is charged.

If a charged capacitor is connected in a circuit, its stored energy is released into the circuit. An example of this is a battery-capacitor, photographic-flash circuit.

CHARGE VS. DISCHARGE CURRENT IN PHOTOFLASH CIRCUIT

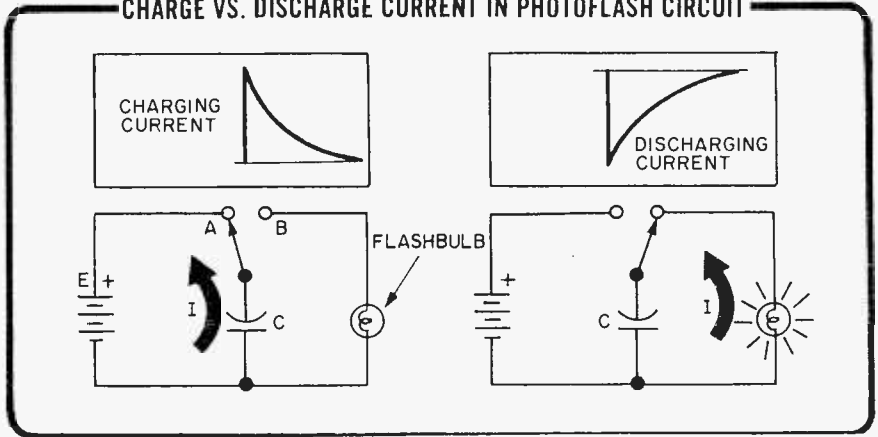

Capacitor C is charged up to the battery voltage by throwing the switch to position A. The rate of charge depends on the resistance in the battery circuit (wire resistance and internal resistance of the battery). When a flash is desired, the switch is moved over to position B. The capacitor, which is charged to full battery voltage (E), has no opposing voltage in the new circuit, and its discharge is limited only by the resistance of the flash bulb. The stored energy flows through the flash bulb and, in doing so, fires the bulb. The discharging current follows the curve shown in the figure; the speed of discharge again depends on the time constant of the circuit.

An RC series circuit can be used as a timing device. It is, in fact, often used this way (e.g., in television receivers).

TIMING CIRCUIT CONSISTS OF R AND C COMPONENTS

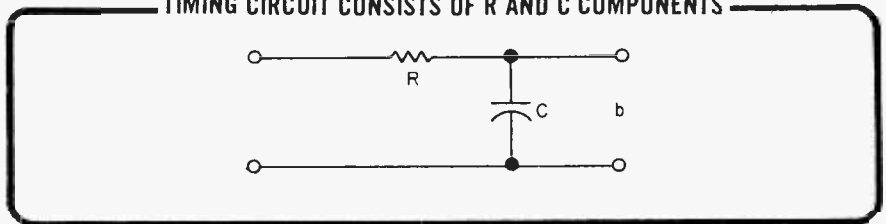

In the diagram showing a timing circuit, the length of time it will take for the capacitor voltage to rise to some given value can be calculated. If some device, which will be triggered only when this given value of voltage is reached, is connected across the output terminals **b**, the device, such as a gas diode, will be triggered after a predictable time delay from the time the input voltage (E) is applied.

The length of the time delay can be controlled by varying either the resistance or the capacitance. However, if the amount of energy stored is important, the delay can only be varied by changing the capacitance.

Q22. What is the time constant of the following circuit?

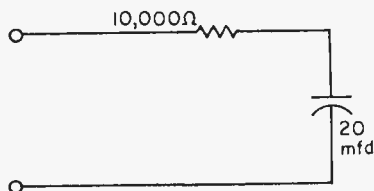

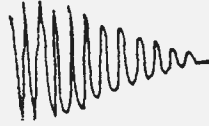
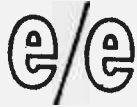
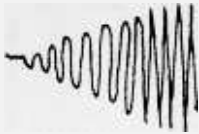

- Q23. How long will it take the circuit in Q22 on page 91 to charge to 63.2 volts if a 100-volt input is continuously applied?
- Q24. What will the time constant be for the circuit shown in Q22 if R is 1 megohm and C is 50 mfd?

Your Answers Should Be:

A22. $RC = 10,000 \text{ ohms} \times 0.00002 \text{ farad} = 0.2 \text{ second}$

A.23 It will take **0.2 second** for the circuit to charge to 63.2 volts.

A.24 $RC = \frac{50}{1,000,000} \times 1,000,000 = 50 \text{ seconds}$

WHAT YOU HAVE LEARNED

- 1. Capacitances add in parallel. They combine in series according to the formula:

$$C_{\text{eq}} = \frac{C_1 \times C_2}{C_1 + C_2}$$

- 2. Capacitive reactances add in series and combine in parallel exactly like resistances and inductances.
- 3. A circuit containing a complicated combination of capacitors can be converted to a simple equivalent circuit by a series of steps.
- 4. Capacitive reactance and resistance add vectorially.
- 5. The capacitive-reactance vector is in the opposite direction from the inductive-reactance vector and is represented in the impedance formula by $-j$.
- 6. Capacitive impedance can be calculated using trigonometric functions.
- 7. The time constant of a series RC circuit is found by multiplying R times C.
- 8. RC circuits can be used to store energy and/or to provide a time delay.
- 9. RC is the time in seconds it takes the capacitor to charge to 63.2% of the source voltage.

NEXT ISSUE: Part 11—Understanding RL Circuits

This series is based on material appearing in Vol. 2 of the 5-volume set, BASIC ELECTRICITY/ELECTRONICS, published by Howard W. Sams & Co., Inc. @ \$19.95. For information on the complete set, write the publisher at 4300 West 62nd St., Indianapolis, Ind. 46268.

stamp shack

Philatronics Today!

BY ERNEST E. KEHR

●●There's an old gag that went the rounds prior to World War II: "How does one say, 'sidewalk,' in Greek?" The reply, "You can't; they don't have sidewalks in Greece." That pretty much suggests the general telephonic conditions in one of the world's oldest civilizations less than a generation ago. As the Greeks themselves admit, this communications system was chaotic and disorganized only less than a generation ago. It all was caused by the war, occupation by Nazi forces and later, the Communist rebellion. Perhaps that is why Athenian postal authorities approved the release of to

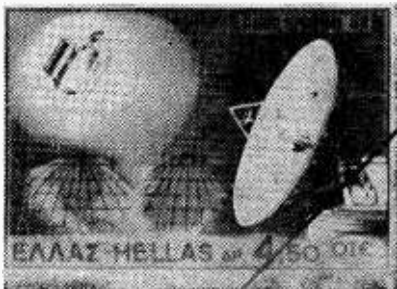

Greece Telecommunications Issue

stamps (2½ and 4½ drachmae) on April 21, 1970, to commemorate the 20th anniversary of the Organization of Greek Telecommunications (Organiismos Telepikoinion Ellados.)

● In 1949, there were only about 76,000 telephones in all of Greece, and service was primitive by any standards. It was then that the OTE was formed. Advised by American and European experts, they started on a campaign to develop a system of long-distance lines covering the entire country with installation of circuits fashed along the latest techniques, such as carrier frequency equipment, coaxial cables, broad-belt radio links, etc.

● The OTE automatized a system that is expected to be completed before the year is over. In the meantime, they purchased material and instruments, providing its citizens with some 870,000 telephones by the end of 1969. That figure enables one person in every ten to have telephonic service: a small ratio, but still ten times greater than it was two short decades ago.

● In addition to purely domestic improvements, this communications program was tied into the international network so that almost

instantaneous calls can be made to the outside world from any place in Greece.

● The improvements include the organization of a TELEX service, to enable businessmen in Greece to avail themselves of contact with this advanced mode of communications. Moreover, OTE has established in most large provincial cities a central telephonic cable facility whereby telegrams can be distributed by telephone.

● The OTE's work has reinforced the existing Coastal Radio Station of Athens with transmitters and receivers capable of keeping in touch with vessels at sea, by adding six new facilities of this kind.

● In more recent years, arrangements were completed with RAI, of Italy, whereby its TV programs are relayed to Athens and from there to Thessalonica and Patras for viewing by Greeks in almost every part of the nation.

● The most significant advance, however, was that of the construction of an Earth Station, "Thermopylae," which was dedicated by Prime Minister George Papadopoulos, on May 19, 1969.

● The station was formally put into service on April 21, and it was for this event that the pair of Greek stamps was released.

● Both of them depict the Thermopylae receiving disc, outline maps of the two hemispheres and Intelsat III, to which it is linked. The satellite, which is in fixed orbit above the Atlantic Ocean, is capable of bouncing telephone, telegraph and television signals off its complicated surface with 20th century speed and efficiency.

● So, while Greek communications service was virtually unheard of and deplorably miserable a bare two decades ago, it is today right up there among the progressive western nations in modernity.

●● Anyone who ever has watched one of the network weather forecasts is familiar with the pictures sent back to earth via satellites that show cloud covers from high above the earth.

● On March 23, 1970, Zambia issued a lithographed, multicolor stamp which depicts the US Weather Satellite, Nimbus III, which is the instrument that provides weathermen with all of these pictures. The 15-ngwee stamp, designed by Gabriel Ellison, is intended to represent the Central African nation's tribute to World Meteorological Day of 1970. (Zambia was the former British territory of Northern Rhodesia, before independence, which came on Oct. 24, 1964.)

Launched in April, 1969, Nimbus III circles the globe every two hours, and although it incorporates several experiments, its main function is the relaying of cloud cover pictures to the earth to enable forecasters to assess likely weather trends more accurately and easily. The pictures transmitted are picked up on the

(Continued on page 100)



BOOKMARK BY BOOKWORM

For Mr. Fixit. For those who know how, small appliance repair is easy . . . and profitable! Here in *Small Appliance Repair Guide* by Wayne Lemons & Glen Montgomery is all the information needed to learn how to repair dozens of small household appliances. This brand-new, down-to-earth authoritative guidebook contains no wasted words—just the facts on how to repair the scores of small appliances found in mil-



Soft cover
224 pages
\$4.95

lions of homes. Profusely illustrated with photos, schematics, pictorials, and wiring diagrams, the text tells how to find the cause of trouble in minutes . . . and how to go about making the required repairs. The reader will also pick up helpful hints on disassembly and assembly, one of the real "tricky" aspects of many appliance repair jobs. Published by Tab Books.

Circle No. 42 on Page 27

If the Bug Bit You. Sooner or later everyone tunes the shortwave bands on an inexpensive portable or table radio and discovers an exciting world listened to by millions everyday. If the bug bit you, then pickup a copy of *ABC's*



Soft cover
96 pages
\$2.95

of *Shortwave Listening* by Len Buckwalter. This book is written for non-technical readers—all subjects are clearly and simply explained, starting with what the shortwave signal is and how it travels from transmitter to the receiver. It continues by discussing the shortwave receiver, antennas, chasing DX (distant receptions), even a bit about signals from space. Published by Howard W. Sams & Co., Inc.

Circle No. 43 on Page 27

Chem Power. *Batteries and Energy Systems* by Charles L. Mantell is a first of its kind guide that encompasses both primary and secondary



Hard cover
221 pages
\$14.00

batteries as a single subject. Covering a huge amount of practical data in easy-to-use format, the text outlines the characteristics and advantages of commercial batteries in handy tables that compare their voltages, amperages and power capabilities. Published by McGraw-Hill Book Company.

Circle No. 44 on Page 27

Shingle and Wheel. Here's a guide to building dozens of practical electronic projects for use around the house and on the car. A variety of gadgets bound to please almost everybody—from the hobbyist to the engineer who likes to get into the thick of things! From an auto ice alarm to a vibrator rejuvenator, from an amazing electric candle that lights with a match to a splash alarm for the swimming pool, there's a host of fun-to-build devices, many of which are quite unique and simple. The title tells the complete story—*64 Hobby Projects for Home and Car*. For the home, there are 28 individual projects, for the car a total of 36, each accompanied

(Continued on page 100)

Publishers

McGraw-Hill Book Co., 330 West 42nd Street,
New York NY 10036

Radio Publications Inc., Box 149, Wilton CT
06897

Howard W. Sams & Co., Inc., 4300 West 62nd
Street, Indianapolis IN 46268

Tab Books, Blue Ridge Summit PA 17214

GREAT MEN OF SCIENCE

BY WEBB GARRISON

At the mid-point of the last century organic chemistry was in chaos. A great deal was known, but the fragments didn't fit together. The science was a bit like a jigsaw puzzle with all the pieces present but none attached to one another.

Suddenly, in 1865, all the fragments fell into place to reveal a coherent and meaningful picture. The man responsible for that picture was a highborn dreamer with an educational background that was spotty and inadequate even in his day.

Son of the Head Councillor in the War Office of the German state of Hessen, August Kekulé showed great promise very young. His proficiency in mathematics and drawing convinced the boy's father that he should study to become an architect.

August obeyed his father's wishes by going to the University of Giessen. He had no difficulty making good grades. But he found architecture dull. As a diversion, he studied chemistry in haphazard fashion.

Through the generosity of a wealthy step-brother he spent a period in Paris. His circle of friends included novelist Alexandre Dumas and chemist Charles Gerhardt—whose absorbing interest centered in carbon compounds.

Crossing the Channel, the young amateur took up residence in London. He worked as assistant to several scientists. His superiors found him brilliant, but "a bit erratic."

It was during this period that he experienced the first of a series of dream-like visions. Riding outside on the omnibus through deserted streets he fell into a reverie. Not quite asleep but no longer consciously directing his mind, he reported to incredulous colleagues that soon "the atoms were gambolling before my eyes."

In this state of trance, Kekulé noticed that frequently two smaller atoms united and that sometimes a big atom "embraced two smaller ones." These unions took place "whilst the whole kept whirling in a giddy dance."

World-renowned chemists, well aware that

Kekulé had no formal training in the science, snickered at his folly in publishing a paper based on what he had "seen" as he rode the bus. Psychiatrists today tend to compare the whirling, giddy vision with schizophrenic hallucination.

Regardless of how he got his insight, it added immensely to understanding of organic chemistry. Kekulé was invited to become a lecturer at the University of Heidelberg. Two years later, in 1858, he became professor of chemistry at Ghent.

One afternoon in August, 1865, weary from long experiments aimed at unravelling the structure of the benzene molecule, he turned his chair to the fireplace and according to his own account "fell half asleep."

Soon he saw another vision.

"Again the atoms gambolled before my eyes. My mind's eyes, trained by repeated visions of a similar kind, now distinguished larger formations of various shapes. Long rows, in many ways more densely joined: everything in movement, winding and turning like snakes. And look, what was that?"

"One snake grabbed its own tail, and mockingly the shape whirled before my eyes. As if struck by lightning I awoke: I spent the rest of the night working out the consequences."

Kekulé's "Consequences" solved the riddle of the structure of benzene. Though the concept of "valence" generally accepted by then, helped to understand such compounds as H_2O it did little or nothing to clarify organic compounds containing several or many carbon atoms.

Kekulé's serpent swallowing its own tail was the foundation of the theory according to which a benzene "ring" is a carbon chain. That chain forms as a result of the fact that carbon atoms "combine" with one another through part of their valences. Valences not used in forming chains serve to bind atoms of other elements or groups of atoms to the chains.

Many contemporary scientists scoffed at this notion as a "tissue of fancies." Today it is generally recognized as the most brilliant piece of prediction to be found in organic chemistry.

That serpent swallowing its own tail was a pictorial representation of the concept that revolutionized organic chemistry. From it the great German dye industry of the latter half of the 19th century came. Now refined and a great deal more sophisticated than it was when formulated by Kekulé, the concept of the "carbon chain" is the cornerstone of modern biochemistry.

When his achievements were recognized by elevation to the nobility, the self-taught genius added von Stradonitz to his name. He published a 4-volume textbook of organic chemistry, carried out important work on mercury and acids. But his place in the scientific hall of fame rests squarely on the most vivid and informative vision in the history of chemistry. ■

Mod Methuselah

Continued from page 34

up *MM's* rear cover with the supplied screws.

Mod Methuselah can easily be modified to suit your needs. For instance, an antenna tuner connected ahead of J1 would greatly enhance sensitivity. A standard phone jack

connected across T3's secondary adds head-phone provisions; so necessary when you're DXing during the early-morning hours! And a variable 10-365 picofarad capacitor wired in place of C1 will do wonders with a not-so-efficient long-wire antenna, especially if you can't get your hands on plans for a good antenna tuner. And last, but not least, a steady hand—with the patience of a Job—twisting C3 through its paces ensures maximum performance from *Mod Methuselah!* ■

NewScan

Continued from page 8

to produce error-free recording.

Currently, to evaluate the quality of a coating, the disk surface is first recorded with a series of binary bits. A magnetic tester then reads the recorded pattern to see if there are any missing bits or bits that remain after a previous record is erased. While either type of error signals the presence of a surface flaw, the exact physical location and description of the defect must be obtained with other instruments. This task is both tedious and destructive with conventional equipment since the disk must be cut into small samples for analysis, and cannot be retested for verification of results.

At IBM, modifying the sample chamber of the experimental scanning electron microscope to accommodate a disk or other large objects makes it possible to study the disk without damaging it in the process.

A single shaft, extending into the vacuum-sealed chamber and attached to a precision rotary table, positions the disk to allow the electron beam to strike any specific area on the surface with a high degree of accuracy. Tiny registration marks on the disk help to define the exact location desired.

As the beam scans the disk surface, it produces secondary and backscattered electrons which are collected by three special detectors. With this arrangement, considerable information can be gleaned from the coating, including a stereoscopic display of the surface and variations in composition.

Say That Again

A retired food-industry supervisor who had his larynx removed by surgery 23 years ago, James Webster Libby has for 18 years offered his teaching services free of charge to other laryngectomees who must learn to speak again.

"Losing your ability to speak is a starkly traumatic experience," Mr. Libby stated. "The prospect of never speaking again in many cases is more dangerous to a laryngectomee than the surgery performed. Many laryngectomees, un-

less they are given hope of being able to speak, entertain thoughts of suicide," he said.

A chance meeting with two executives of Educational Sound Systems, Inc., Melbourne, Fla., while Mr. Libby was vacationing in Florida, has resulted in the development of the first complete magnetic-tape teaching course for laryngectomees. Mr. Libby can now more rapidly teach more laryngectomees to speak. ESS's Sound Teacher, unlike other recorders, permits students to hear at will desired portions of the tape while exercising with a listen/record/compare routine.

Mr. Libby was a U. S. army first lieutenant in 1946, when he learned that he had cancer of the larynx. The army sent him to Walter Reed Hospital. There, a surgeon removed the cancerous larynx, including vocal cords and epiglottis, normally both used in speech. "My entire future seemed bleak," Mr. Libby recalls.

"Fortunately," Mr. Libby recalls, "I met Mrs. Paul A. Doehler at that time. Mrs. Doehler also had lost her larynx through surgery and



ELEMENTARY ELECTRONICS

was told that she never would speak again. She refused to accept the prospect of being mute. So she originated the method of uttering sounds by speaking through the esophagus while breathing through an aperture in the throat."

Speech through the esophagus sounds hoarse and unnatural, unless perfected through constant practice and comparison to normal speech. By 1952 he had refined his speech to such an extent that he felt he could help others learn the technique.

Today, Mr. Libby is one of the most accomplished laryngectomee speakers and teachers. He has taught dozens of larynx removal victims to speak.

Last winter in Florida he met Charles F. West and Bert H. Weber, computer equipment manufacturers who founded Educational Sound Systems, Inc., in Melbourne, Fla., to manufacture a revolutionary new tape teaching re-

recorder, the Sound Teacher.

Being used primarily for language teaching, the new recorder eliminates the shortcomings of ordinary tape recorders in special therapy and language teaching. The Sound Teacher allows the listen/record/compare sequence automatically and effortlessly, and permits students to pace exercises with a single lever.

Utterances of random length are recorded while the instruction tape automatically backspaces to the beginning of a lesson segment. Thus, when recording stops and the record lever is released, the recorded effort will play back once, and be followed by a comparison replay of the lesson model. This cycle can be repeated as often as necessary.

If you are interested in helping a laryngectomee learn of this new course, contact Education Sound Systems, 4965 W. New Haven Avenue, Melbourne, Fla. 32901. ■

Heathkit IB-101

Continued from page 58

ginner will take, at most, two evenings, assuming every step is double-checked.

The alignment itself takes about 5 minutes and requires no external test equipment other than a transistor radio. First, the radio is positioned near the counter's crystal and the crystal's trimmer capacitor is adjusted for a "zero beat" on a broadcast station monitored on the radio. Then the counter's input cable is connected to a built-in test point and an internal control is adjusted until the counter indicates 10.000 Hz; the counter is now adjusted for maximum sensitivity. That's the alignment procedure!

The final result is a frequency counter with an accuracy of 0.002%, or as they prefer when dealing with counters, an accuracy of ± 1 count \pm time base stability (time base is the "clock"). The upper frequency limit is 15 MHz *minimum*; our unit was accurate to 21 MHz.

The upper limit is determined primarily by the hand picked ICs, and if you're as lucky as we were, you might well get more than 15 MHz. How do you know if you're lucky? Easy. Connect a service grade signal generator to the counter and slowly sweep up from 15 MHz. As long as the counter more or less follows the generator's calibration you're "lucky". Suddenly the counter will run wild, a slight frequency increment will cause the counter to jump several hundred kHz; that's *it*, the upper limit has been reached.

Performance. The counter absolutely requires a 30 minute warm-up, just as Heath specifies. You cannot simply turn on the power and start counting, for during the first 5 to 15 minutes the counter might never give the same readout twice. And it might not reset to zero. But after the specified 30 minute warm-up the counter is rock-stable, and to be perfectly honest, it is every bit as good as a thousand dollar laboratory counter within its operating range. That is, the Heath will read to 1 Hz; don't look for a reading into the decimal area such as 1.52 Hz, the Heath simply can't do it and you have no need for such measurements.

The counter's input sensitivity checked out better than Heath's specified *worst case* sensitivity of 250 mV; we got consistent triggering at all frequencies to 20 MHz with only a 150 mV input.

Summing Up. The Heath IB-101 is a "dream" instrument. Whether you're a part time technician, ham or hobbyist, just as the scope was 25 years ago, the IB-101 counter is a "must have" instrument for every workbench provided you intend to keep up with modern technology.

It is only a shame that the IB-101 was not designed to 30 MHz so it could be used immediately by CB service shops. However, word has it that within a few months Heath will make available a *scaler* for the IB-101 that will extend the frequency range to 150 MHz. Then what will be *your excuse* for not having a counter?

For additional information on the IB-101 Frequency Counter circle number 30 on the Reader Service Coupon on page 27. ■

Prefixes and Exponents

Continued from page 62

(I) times resistance (R). Without the aid of scientific notation, the problem is to multiply 0.0012 Amperes by 3,300,000 Ohms, which is rather awkward to carry out. The same problem, however, is very easy in scientific notation, as can be seen below:

$$\begin{array}{r} 1.2 \times 10^3 \\ 3.3 \times 10^6 \\ \hline 3.96 \times 10^3 \end{array}$$

The answer is 3.96×10^3 Volts, or 3.96 kiloVolts. We obtained the answer by multiplying 1.2×3.3 to get 3.96, and adding the -3 exponent to the 6 exponent to get 3 for the exponent of the answer. The advantage of scientific notation is that the largeness and smallness of the numbers involved is indicated by numbers like 10^6 and 10^{-3} , and the largeness or smallness of the answer is found by *adding* the 6 and the -3.

What about a division problem? For the sake of a good illustrative example, consider the unlikely problem of finding the current when 4.8 megaVolts is applied across 2 kilOhms. The problem is written as:

$$\begin{aligned} I &= \frac{E}{R} \\ &= \frac{4.8 \text{ megaVolts}}{2 \text{ kilOhms}} = \frac{4.8 \times 10^6 \text{ Volts}}{2.0 \times 10^3 \text{ Ohms}} \\ &\quad 4.8 \div 2 = 2.4 \\ 2.4 \times 10^3 \text{ Amperes} &= 2.4 \text{ kiloAmperes} \end{aligned}$$

In division, then, finding the size of the answer becomes a *subtraction* problem, in which the exponent representing the size of the divisor ("bottom" number) is subtracted from the exponent representing the size of the dividend ("top" number).

A more practical division problem answers the question, "what current flows when 5 Volts is applied across 2.5 kilOhms?"

$$\begin{aligned} I &= \frac{E}{R} = \frac{5 \text{ Volts}}{2.5 \text{ kilOhms}} \\ &= \frac{5.0 \times 10^0}{2.5 \times 10^3} = \frac{5.0 \times 10^{(0-3)}}{2.5} \\ &= 2.0 \times 10^{-3} \text{ Amperes} \\ &= 2.0 \text{ milliAmperes} \end{aligned}$$

Note that it's perfectly legal to use 10^0 (ten to the zero power) to indicate a unit that has no prefix—in other words, one of anything.

For The Solving. Here are a few more problems:

1. The inductive reactance of a coil is given by

$$X_L = 2\pi fL.$$

What is the reactance of a coil whose inductance $L = 22$ milliHenries, when an alternating current of frequency $f = 1.5$ mega-Hertz is applied to it?

$$\begin{aligned} X_L &= 2 \times \pi \times (1.5 \times 10^6) \times (22 \times 10^{-3}) \\ &= 207.24 \times 10^3 \text{ Ohms} \\ &= 207.24 \text{ kilOhms} \end{aligned}$$

2. An oscillator is connected to a wavelength-measuring apparatus, and the wavelength of its oscillations determined to be 2.1 meters. What is the frequency of the oscillator?

$$\begin{aligned} F &= \frac{\text{speed of light}}{\text{wavelength}} \\ &= \frac{3.0 \times 10^8 \text{ meters per second}}{\text{wavelength}} \\ &= \frac{3.0 \times 10^8}{2.1 \times 10^0} = 1.4286 \times 10^8 \text{ Hertz} \end{aligned}$$

We wish this answer had come out with a "10⁶", instead of a "10⁸", because we can convert 10^6 Hertz directly to mega-Hertz. However, we can change the answer to 10^6 , by shifting the decimal point of the 1.4286. Remember this rule: To *lower* the exponent, shift the decimal point to the *right*. (Of course, the opposite rule is also true). Since we wish to lower the exponent by 2, we must shift the decimal point to the right by two places:

$$142.86 \times 10^6 \text{ Hertz} = 142.86 \text{ megaHertz}$$

3. A 3.3 microfarad capacitor is being charged from a 20-volt battery through a 6.8 kilOhm resistor. It charges to half the battery voltage in a time given by

$$T = 0.69RC$$

For the particular values given in the problem, what is the time taken to charge to half the battery voltage?

$$\begin{aligned} T &= 0.69 \times (6.8 \times 10^3) \times (3.3 \times 10^{-6}) \\ &= 15.4 \text{ milliseconds} \end{aligned}$$

Tera To Atto. Since scientific notation is so potent, you'll probably be interested in the meaning of *all* the prefixes used in the scientific community, not just the four—micro-, milli-, kilo-, and mega—that we've discussed so far. Very common in electronics is the *micro-microFarad*, which is $10^{-6} \times$

10^{-6} Farad, or 10^{-12} Farad. This is more commonly known as the *picoFarad*. Similarly, a thousandth of a microAmpere is $10^{-3} \times 10^{-6}$ Ampere, or 10^{-9} Ampere. This is known as a nanoAmpere. At the other extreme, 1000 megaHertz is called a gigaHertz. See the table of these prefixes on page 62, together with their meanings and pronunciations.

The jargon of electronics which has grown up around these prefixes is just as important as the prefixes themselves. Here are some examples of "jargonized" prefixes as they might appear in speech:

Puff—a picoFarad (from the abbreviation, pF)

Mickey-mike—A micro-micro Farad (which is the same as a **puff**)

Meg—A megohm. Also, less often, a megaHertz.

Mill—A milliAmpere

Megger—a device for measuring meg-Ohms

dB (pronounced "dee-bee")—A decibel, which is one-tenth of a Bel

Mike—A microFarad. Also, to measure with a micrometer.

So, if you understand the prefixes and know their corresponding exponents, you'll have command of another set of important tools to help you do practical work in electronics. In addition, you'll be ready for the inevitable wise guy who'll ask if you can tell him the reactance of a 100-puff capacitor at 200 gigaHertz. After calculating the answer in gigaseconds, reply in femtoOhms! ■

Frequency is for Real

Continued from page 36

Ironically (and students of electronics must not be misled because of this), there are sine-curve relationships in other fields of science where the physical occurrence actually looks like a sine curve. If a pebble is dropped into a calm pond, for example, ever-enlarging circles (ripples) will be seen leaving the splash. However, if these ripples are viewed from the side, at water level, a train of honest-to-goodness sine curves will be observed as they leave the splash area. As another example of real-life sine curves, if two persons suspend a rope between each other and one of them whips it up and down, a beautiful sine wave will run along the rope. Nevertheless, sine curves *don't* travel through electrical circuits, they *don't* travel through air as sound waves, and they *don't* radiate from transmitting antennas! Radio signals, AC currents and sounds vibrate in unison with sine curves but they *don't* look like them! However, a check of their graphs indicate they do!

Discovering Frequency. At this point, the true meaning of "frequency" should become clear. It doesn't matter if we are talking about sound waves, AC currents or radio carriers. Frequency is the number of times these various disturbances repeat their vibrations during *one second*. From a graphical standpoint, frequency is the number of times

each complete cycle of sine curve is repeated during *one second*. Either way you look at it, frequency can be classified by its number of "cycles per second." As everyone should now know, however, this once common designation for frequency has been replaced by, simply, "Hertz" (Hz) in honor of that great German scientist of the Nineteenth Century, Heinrich Hertz.

To Sum Up. The 2000 Hz sound energy from the police-car siren, the 60 Hz AC from the wall outlet, and the 27,155,000 Hz carrier from the CB rig are three different scientific phenomena. But they have the common property of being able to be described by sine curves and, because of this, all can be measured by a common yardstick—frequency.

But hold on! Are these three so-called disturbances really so different from each other? (After all, electronics wouldn't be electronics without sound and radio signals!) They are different but not as much as you would think. With the aid of a "transducer," one type can be *transformed* into another! Thus, a *microphone* will change 2 KHz sound waves into 2 KHz alternating current in a wire. A *loudspeaker* will change the AC back into sound waves. A *receiving antenna* will change 27.155 MHz electromagnetic energy into 27.155 MHz alternating current (AC) in a wire (the antenna feedline, that is). A *transmitting antenna* will make the opposite conversion.

That's it. If the interrelation between

sound, electrical and electromagnetic frequencies now makes sense to you, you've learned a tremendously important bit of electronics theory. And don't forget the almighty sine curve. The sine curve can be used to explain theory in many fields of sci-

ence, not just electronics. Nevertheless, keep clear in your mind just how the sine curve fits into electronics—what it is and what it isn't. Maybe you don't care whether your coffee is hot but you better stay *hot* on the *sine curve*. ■

Bookmark

Continued from page 94

by explanatory text where necessary (enough to help the reader iron out the kinks), plus a complete schematic and/or pictorial diagram and price list. The authors, Bob Brown and Mark



Hard cover
192 pages
\$6.95

Olsen have done an excellent job. Published by Tab Books.

Pocket Reviews

● *RCA Monochrome TV Service Manual* by Carl Babcoke: an up-to-date B & W service data volume for RCA TV receivers, amply illustrated; soft cover, 176 pages, 8½-in. by 11-in.. \$7.95. Published by Tab Books.

● *Better Shortwave Reception* by William I. Orr, W6SAI and Stuart D. Cowan, W2LX: a how-to book for SWLs, CBers, Hams and science students. A book for the serious DXer; soft cover, 160 pages, \$3.95. Published by Radio Publications, Inc.

● *1-2-3-4 Servicing Automobile Stereo* by Forrest H. Belt & Associates: a servicing guide every owner or technician should own; soft cover, 192 pages, \$3.95. Published by Howard W. Sams & Co., Inc.

● *Installing and Servicing Home Audio Systems* by Jack Hobbs: a "passport" to the lucrative field of audio equipment servicing, including sales and installation; soft cover, 256 pages, \$4.95. Published by Tab Books.

Stamp Shack

Continued from page 93

earth by any receiving station with the necessary equipment. Just how long Nimbus III will continue its service is questionable, but it is expected that it will exceed the wonderful

record of Nimbus II, which lasted just about 2½ years.

● What's New?

There isn't a collector alive who hasn't wished he could write an article about his stamps or hobby interests for one of the many philatelic periodicals that constantly look for such wordage. Aware of this universal desire, C. E. Foster, a member of the Philatelic Press Club, has produced a handy, informative booklet called, "A Writers' Guide." Published more as a labor of love than for any profit motive, this useful guide is available to "Stamp Shack" readers for a mere 25¢ plus a 6x9 inch, self-addressed, stamped envelope. Requests should be mailed to Mr. Foster, 317-D 15th Street, NW, Albuquerque, NM 87104.

It may not be generally known, but souvenir mail has been carried by experimental rockets in Europe, Cuba and Mexico frequently since the early '30's. Many of these are excessively rare today and command fancy prices when they are found and offered for sale on the aerophilatelic market. Sieger Verlag, of Lorch/Wurt., Germany, has just published a complete catalogue which illustrates, describes and prices all of the many hundreds of such covers. A copy of the fine handbook is available at \$2, postpaid, when \$2 in bills or international money orders accompany the request. ■



Zambia Nimbus Issue

DMS

Continued from page 56

ing posts for making external connections. Now you're ready to mount the controls and wire them to the parts on the circuit board. Use two conductor, shielded plastic jacketed, wire for leads from each potentiometer to its termination in the circuit. The plastic jacket will protect the assembly from shorts that may be caused by unjacketed shielding when the box is closed.

Press-on letters and numerals, such as Datak, make a neat way to identify the

sink when soldering the various semiconductor components into the circuit. One other check to make is the polarity of all diodes and electrolytic capacitors. As prolonged polarity reversal can ruin them.

Putting DMS to Work. Now that you've completed *DMS's* construction, you are anxious to put your errant hi-fi that started you off on this project through its paces. Adjust potentiometer R12 to assure signal generator output having less than 0.2% distortion by turning it until output signal amplitude *just* becomes stable. Connect the test set to your hi-fi to prove or disprove your suspicions about its supposedly ultra-low distortion.

In addition to *DMS* you'll need an AC vtvm, and a non-inductive load resistor across the output of the amplifier as a substitute for the speaker. This resistor is a necessity for accurate measurement, and it is especially

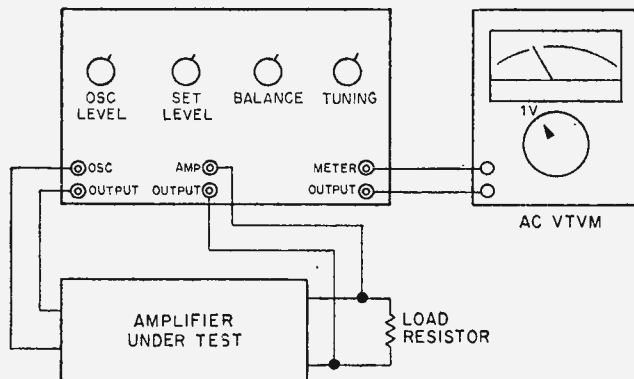

Here's how to connect DMS to AC vtvm, amplifier. Load resistor must match output impedance, RMS wattage of amplifier under test.

controls and binding posts. Before plugging in the power cord to check out your *DMS*, be sure there are no wiring errors. Double check the connections to all transistors before soldering. They are sensitive to too much heat and can easily be destroyed. A small alligator clip serves as a good heat

necessary to protect the output transistors if your amplifier is solid state. So be sure to connect to a 50-watt or higher resistor (of 4, 8, or 16 ohms depending on the impedance of your speakers) across the amplifier output before turning it on.

Connect your *DMS*, the AC vtvm and the load resistor as shown in our test set-up diagram. Place the *Cal/Test* switch, S1, in the *Cal* position. The VTVM should be set to read 1V full scale. Now, adjust R13, *oscillator output level* control, so that the output of your power amplifier under test is at the desired output power level. Now adjust *DMS level* control R15, until the voltmeter, connected to binding posts BP5 & 6 reads one volt full scale. *DMS* is now calibrated. Slide the *Cal/Test* switch S1 to *Cal* position. Adjust both the *balance control*, R19, and the *tuning control*, R24-R25, for the minimum reading on the voltmeter. This minimum reading is the distortion of the amplifier. Remember, 1 volt full scale is 100% distortion, 0.1 volt full scale is 10% distortion and 0.01 volt full scale is 1% distortion. ■

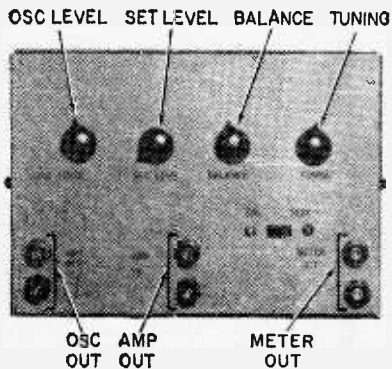

Front panel of DMS showing major control, binding post location. Vernier-type knob on Balance pot helps to get exact reading.

CB Signal All Put Out

Continued from page 67

Saxton Model BC-2 baluns ordered from Lafayette Radio-Electronics. If you try these coils, use the following schematic, supplied in the coil package; "Circuit A—75 ohm to 300 ohm". One pair of coils connects the 75-ohm side to the CB transmitter; the second pair connects the 75 ohms to the antenna base. (Although 75 ohms is specified, the coils operate at very low SWR at CB's 50 ohms.) The system is shown in Fig 9.

It's Round Up Time. Finally, whatever matching technique or adjustment you follow in your CB rig, don't run the "ratio race". Although standing waves should have the lowest ratio indicated on an SWR meter inserted in the transmission line, anything below 2-to-1 is all you need for good signals on both transmitting and receiving

sides. An overall look at the major matching points is shown in Fig. 10.

Antenna matching is a must for CBers. Admittedly you can transmit far beyond 150 miles on 5-watts input to your rig's final But, far too many stations can't get past the next hill because their radiated RF is used to heat up the coax line. Get with it and match up! ■



"I don't like the looks of this guy!"

U-Pick-It

Continued from page 60

button ON-OFF switch that we picked up in the electrical supply section of the local hardware store. This kind of switch is normally used on desk lamps and the like. We have listed in the parts list, however, a rocker-type switch because, on second thought, we feel it is more practical since you can tell at a glance whether it's ON or OFF. Don't care to make a rectangular opening to mount a rocker type, either? Then use a regular toggle switch mounted with a marker plate to indicate its status.

After mounting and wiring all of the components on the perfboard, check your work to be sure you've wired it correctly. Then mount it in position in the bottom half of the Minibox as shown in our photo.

Getting to the Gig on Time. Connect the battery, plug your guitar into the input jack, and connect the output jack to the *normal* guitar input on your power amplifier. Standard patch cords in varying lengths are available with a phone plug on one end to match the input jack on *U-Pick-It* and a choice of plugs on the opposite end so you can match the input jack of your amplifier.

Turn both units on, and open switch S1

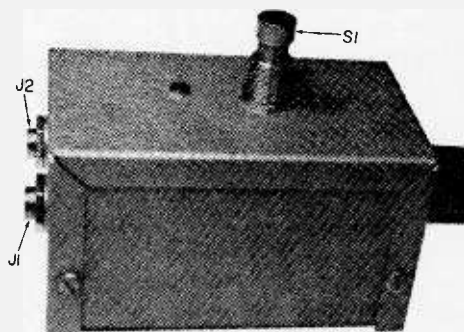

Author's U-Pick-It has input, output jacks mounted on minibox's end. We suggest you mount R6 so it's adjustable from outside.

so that the short circuit it places across *U-Pick-It's* input/output jacks is removed. After the amplifier has warmed up, adjust trimmer potentiometer R6 with a small screw driver to a point just below feedback with potentiometer R8 set at its midpoint position.

Once the setting is achieved, turning the knob on R8 to the right or left of center should now change the sound of the guitar. One extreme in rotation will favor bass and the opposite extreme will favor the treble while R8's midpoint setting will favor the midrange. ■

CLASSIFIED Market Place

Classified Ads 65¢ per word, each insertion, minimum 10 words, payable in advance. To be included in the next available issue of **ELEMENTARY ELECTRONICS**, copy must be in our New York Office by May 1st. Address orders to C. D. Wilson, Manager, Classified Advertising, **ELEMENTARY ELECTRONICS**, 229 Park Avenue South, New York, N. Y. 10003.

AUTO PARTS & ACCESSORIES

Life treatment for car engine—only \$6.00 from Skolka, Box S, New York 10011.

BUILD-IT-YOURSELF

PSYCHEDELIC LIGHTING MANUAL! Make strobes, kaleidoscopes, organs, etc. Send \$2.95 Lighttrays, 1315 N. Weaver, Philadelphia, Pennsylvania 19150.

BUSINESS OPPORTUNITIES

I made \$40,000.00 Month by Mailorder! Help others make money! Start with \$10.00—Free Proof! Torrey, Box 318-T, Ypsilanti, Michigan 48197.

FREE Book "999 Successful, Little-Known Businesses." Fascinating! Work home! Plymouth 411-Y, Brooklyn, New York 11218.

\$5,000.00 MONTHLY potential from \$650.00 Investment. Build own sponsoring organization. No inventory. Unlimited Free Details. Consultants. Box 504, Pinellas Park, Florida 33565.

We need Ginseng Growers! \$3,000-\$30,000 annually! We buy your crop. Send \$2.00 for seed sample and information. Glass Ginseng Exchange, Box 336, Rochdale Station, Jamaica, N.Y. 11434.

I MADE \$2,000.00 MONTHLY by mail-order—evenings only. You can too! Free Proof! Kingman, Box 7227DC, Erie, Pa. 16510.

MAKE Magnet Signs. Big Profits. Free Information. Universal. Lenora, Kansas 67645.

Your own business—details 25¢—Midwest, Box 84, Chesterland, Ohio. 44026.

BUY IT WHOLESALE

TOURIST Love only \$2.00. Caribbean hand made souvenir. Fco. Gomez Serrano. Baralt C94, Fajardo, P.R. 00648.

COINS, CURRENCY & TOKENS

RARE COINS! Pricelist 25¢ (Refundable) Premiere, Box 7776SM, Spokane, Washington 99208.

DO-IT-YOURSELF

BURGLAR—Fire alarm systems and supplies. Free Catalog. Informer Mfg. 2006 S. Eden Street, Baltimore, Md. 21231.

EDUCATION & INSTRUCTION

UNIVERSITY Degrees by mail. Free information. Write—Norman Publishing, Dept. 63, Box 3199, Pasadena, Calif. 91103.

FARMS, ACREAGE & REAL ESTATE

10 to 160 Acre tracts—Lake Superior, Marquette, Mich. area, from \$99 acre. Any terms A-OK. Cabins, trailers, camping welcome. Free pictures, write Hiawatha Forest Lake Acres 3650 Dixie, Drayton Plains, 44 Michigan 48020.

FRANCHISE OPPORTUNITIES

1,200 FRANCHISE OPPORTUNITIES in one volume. \$4.00. Franchise Annual, P.O. Box 1795, Newport Beach, Calif. 92663.

MAY-JUNE, 1971

GIFTS THAT PLEASE

UNUSUAL Gift Catalog—35¢ refundable, bonus gifts. Hampton House. 1520 Hermitage Place; Hampton, Virginia 23364.

GOVERNMENT SURPLUS

JEEPS Typically From \$53.90—Trucks From \$78.40—Boats, Typewriters, Airplanes, Multimeters, Oscilloscopes, Transceivers, Electronics Equipment. Wide Variety. Condition. 100,000 Bid Bargains Direct From Government Nationwide. Complete Sales Directory and Surplus Catalog \$1.00 (Deductible First \$10.00 Order). Surplus Service, Box 820-ELR, Holland, Mich. 49423.

HELP WANTED

MAIL Circulars. Details 25¢. Kronbergs, 1325 South 27th Street, Omaha, Neb. 68105.

HI-FI EQUIPMENT

\$50.00 KOSS Pro-4A Stereophones, \$28.00: Stereotapes, Recording Tapes, Cassettes. Catalog 25¢. Saxitone, 1776 Columbia Road, Washington, D.C. 20009.

HYPNOTISM

MASTERING HYPNOLOGY—The Hypnotic Science. Effective, Comprehensive. \$5.00. Moore, Box 22, RFD 5, Saugerties, N.Y. 12417.

INVENTIONS WANTED

WE either sell your invention or pay cash bonus. Write for details. Universal Inventions, 298-3, Marion, Ohio 43302.

MAGNETS

MAGNETS—All types, Specials—20 disc magnets, or 10 small bar magnets, or 8 assorted magnets, or 2 stick magnets. \$1.00. Maryland Magnet Company, 8825-R Allenswood, Randallstown, Maryland 21133.

MONEYMAKING OPPORTUNITIES

\$116 PROFIT from only \$12.00 investment. No other costs. Every woman a sure buyer. Details free. Specialty, Box 103A, Belleville, Pa. 17004.

INSTANT Money! Plastics are the wave of the future. Big profits now! At home! Spare time! Materials costing 11¢ bring back \$2.58 profits immediately! Free information. Rush name on postcard to: Warner, Room LC-107-AE, 1512 Jarvis, Chicago, Ill. 60626.

MAKE YOUR CLASSIFIED AD PAY. Get "How To Write a Classified Ad That Pays." Includes certificate worth \$2.00 toward a classified ad in S & M. Send \$1.25 (includes postage) to C. D. Wilson, Science & Mechanics, 229 Park Avenue South, New York, New York 10003.

OF INTEREST TO WOMEN

\$350 MONTH addressing Mailing Circulars! Details, send self-addressed envelope and 25¢. Happy, Box 1161-DV, Battle Creek, Mich. 49016.

PERSONAL

ELIMINATE Debts Without Borrowing! Particulars Free. Helper, P.O. Box 9308, No. Hollywood, Calif. 91609.

PERSONAL—Con't.

LIFETIME Ordinations. 25¢ for details. Church, 2207 Cardinal, Rolling Meadows, Illinois 60008.

STUTTER? STAMMER? LISP? New device designed to improve speech! A great aid to stop stuttering, stammering, and lisping speech impediments. Money Back Guarantee. Send \$10.00 to J. W. Rundane, Micro Wave Voice Corp., 433 Durman Street, Rochester, N. Y. 14621.

RADIO & TELEVISION

THOUSANDS and thousands of types of electronic parts, tubes, transistors, instruments, etc. Send for Free Catalog. Arcturus Electronics Corp., EME, 502—22nd St., Union City, New Jersey 07087.

RADIO & TV tubes 35¢. Free Catalog. Cornell, 4217 West University, San Diego, California 92105.

RECEIVING & INDUSTRIAL TUBES. TRANSISTORS. All Brands—Biggest Discounts, Technicians, Hobbyists, Experimenters—Request Free Giant Catalog and Save! Zalytron, 469 Jericho Turnpike, Mineola, New York 11501.

FREE electronics catalog. Tremendous bargains. Edu-Kits, Dept. C-545-DJ, Hewlett, New York 11557.

"DISTANCE Crystal Set Construction" Handbook—50¢. "18 Crystal Plans"—50¢. Catalog. Laboratories, 745-G Cordone, Reno, Nevada 89502.

STEREO—RADIO—TV Bargains. James Kaloustis & Co., 1175 Magie Ave., Union, New Jersey 07083.

OLD RADIO PROGRAMS on tape 6 hours for \$8.00. Catalog for 50. Thousands listed. Remember Radio Inc., 1926 Cherokee, Norman, Oklahoma 73069.

BUILD AM Wireless Transmitter Kit. Broadcasts to any AM Radio. 50 Feet away. Simple, educational to build. \$8.95—add 15¢ postage. Free Catalog. D. Electronics, 47225 45th NE, Seattle, Washington 98105.

INTEGRATED CIRCUIT & FET KITS—Catalog Free. Frazer & Associates, 3809 Surfwood Road, Malibu, California 90265.

EXCITING LISTENING! Police—Fire—Emergency calls on your broadcast radio. \$19.95 up. Crystals—receivers—scanners—dualband High/Low. Saich Company, Woodsboro 47, Texas 78393.

REMAILING SERVICE

CANADA Remails 50¢. Reliable. Robert, 110 Dagmar, Ottawa, Ontario, Canada.

SAVANNAH Remails 20¢, monthly \$3.00. Dewilco, Box 13063, Savannah, Ga. 31406.

STAMP COLLECTING

50 DIFFERENT Old U.S. Revenue Stamps \$1.00. U. S. Stamps, Suite 17F Bld. II, 280 Henderson Street, Jersey City, New Jersey 07303.

200 U.S.A. Commemoratives, Presidentials; 19th Centurys; 50¢. Hurry! Supply limited! Stamps, Gregory Parks Apts, Suite 17F, Gregory II, 280 Henderson Street, Jersey City, New Jersey 07303.

One of our students wrote this ad!

Harry Remmert decided he needed more electronics training to get ahead. He carefully "shopped around" for the best training he could find. His detailed report on why he chose CIE and how it worked out makes a better "ad" than anything we could tell you. Here's his story, as he wrote it to us in his own words.

By Harry Remmert

AFTER SEVEN YEARS in my present position, I was made painfully aware of the fact that I had gotten just about all the on-the-job training available. When I asked my supervisor for an increase in pay, he said, "In what way are you a more valuable employee now than when you received your last raise?" Fortunately, I did receive the raise that time, but I realized that my pay was approaching the maximum for a person with my limited training.

Education was the obvious answer, but I had enrolled in three different night school courses over the years and had not completed any of them. I'd be tired, or want to do something else on class night, and would miss so many classes that I'd fall behind, lose interest, and drop out.

The Advantages of Home Study

Therefore, it was easy to decide that home study was the answer for someone like me, who doesn't want to be tied down. With home study there is no schedule. I am the boss, and I set the pace. There is no cramming for exams because I decide when I am ready, and only then do I take the exam. I never miss a point in the lecture because

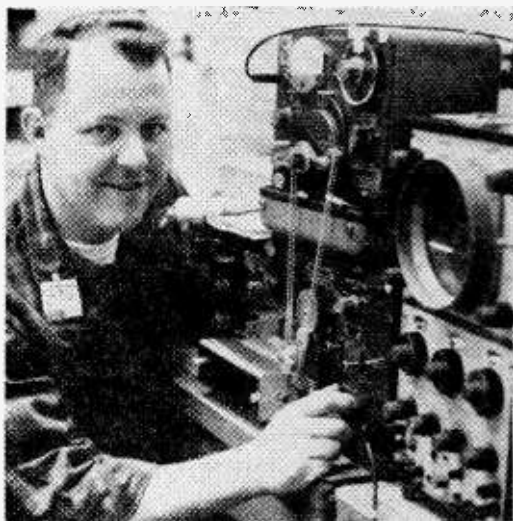

Harry Remmert on the job. An Electronics Technician with a promising future, he tells his own story on these pages.

it is right there in print for as many re-readings as I find necessary. If I feel tired, stay late at work, or just feel lazy, I can skip school for a night or two and never fall behind. The total absence of all pressure helps me to learn more than I'd be able to grasp if I were just cramming it in to meet an exam deadline schedule. For me, these points give home study courses an overwhelming advantage over scheduled classroom instruction.

Having decided on home study, why did I choose CIE? I had catalogs from six different schools offering home study courses. The CIE catalog arrived in less than one week (four days before I received any of the other catalogs). This indicated (correctly) that from CIE I could expect fast service on grades, questions, etc. I eliminated those schools which were slow in sending catalogs.

FCC License Warranty Important

The First Class FCC Warranty* was also an attractive point. I had seen "Q" and "A" manuals for the FCC exams,

*CIE backs its FCC License-preparation courses with this famous Warranty: graduates must be able to pass the applicable FCC License exam or their tuition will be refunded in full.

and the material had always seemed just a little beyond my grasp. Score another point for CIE.

Another thing is that CIE offered a complete package: FCC License and technical school diploma. Completion time was reasonably short, and I could attain something definite without dragging it out over an interminable number of years. Here I eliminated those schools which gave college credits instead of graduation diplomas. I work in the R and D department of a large company and it's been my observation that technical school graduates generally hold better positions than men with a few college credits. A college degree is one thing, but I'm 32 years old, and 10 or 15 years of part-time college just isn't for me. No, I wanted to *graduate* in a year or two, not just *start*.

If a school offers both resident and correspondence training, it's my feeling that the correspondence men are sort of on the outside of things. Because I wanted to be a full-fledged student instead of just a tagalong, CIE's exclusively home study program naturally attracted me.

Then, too, it's the men who know their theory who are moving ahead where I work. They can read schematics and understand circuit operation. I want to be a good theory man.

From the foregoing, you can see I did not select CIE in any haphazard fashion. I knew what I was looking for, and only CIE had all the things I wanted.

Two Pay Raises in Less Than a Year

Only eleven months after I enrolled with CIE, I passed the FCC exams for First Class Radiotelephone License with Radar Endorsement. I had a pay increase even before I got my license and *another* only ten months later. I'm getting to be known as a theory man around work, instead of one of the screwdriver mechanics.

These are the tangible results. But just as important are the things I've learned. I am smarter now than I had ever thought I would be. It feels good to know that I know what I know now. Schematics that used to confuse me completely are now easy for me to read and interpret. Yes, it is nice to be smarter, and that's probably the most satisfying result of my CIE experience.

Praise for Student Service

In closing, I'd like to get in a compliment for Mr. Chet Martin, who has faithfully seen to it that my supervisor knows I'm studying. I think Mr. Martin's monthly reports to my supervisor and generally flattering commentary have been in large part responsible for my pay increases. Mr. Martin has given me much more student service than "the contract calls for," and I certainly owe him a sincere debt of gratitude.

And finally, there is Mr. Tom Duffy, my instructor. I don't believe I've ever had the individual attention in any classroom that I've received from Mr. Duffy. He is clear, authoritative, and spared no time or effort to answer my every question. In Mr. Duffy, I've received everything I could have expected from a full-time private tutor.

I'm very, very satisfied with the whole CIE experience.

ENROLL UNDER NEW G.I. BILL

All CIE courses are available under the new G.I. Bill. If you served on active duty since January 31, 1955, or are in service now, check box on reply card or coupon for G.I. Bill information.

Every penny I spent for my course was returned many times over, both in increased wages and in personal satisfaction.

Perhaps you too, like Harry Remmert, have realized that to get ahead in Electronics today, you need to know much more than the "screwdriver mechanics." They're limited to "thinking with their hands"...learning by taking things apart and putting them back together...soldering connections, testing circuits, and replacing components. Understandably, their pay is limited—and their future, too.

But for men like Harry Remmert, who have gotten the training they need in the fundamentals of Electronics, there are no such limitations. As "theory men," they think with their heads, not their hands. For trained technicians like this, the future is bright. Thousands of men are urgently needed in virtually every field of Electronics, from two-way mobile radio to computer testing and troubleshooting. And with this demand, salaries have skyrocketed. Many technicians earn \$8,000, \$10,000, \$12,000 or more a year.

Send for Complete Information—FREE

Many men who are advancing their Electronics career started by reading our famous book, "How To Succeed In Electronics." It tells of the many electronics careers open to men with the proper training. And it tells which courses of study best prepare you for the work you want.

If you're "shopping around" for the training you need to move up in Electronics, this 44-page book may have the answers you want. We'll send it to you FREE. With it, we'll also include our other helpful book, "How To Get A Commercial FCC License."

To get both FREE books, just fill out and mail the bound-in postpaid card. If the card is missing, send the coupon below.

CIE Cleveland Institute of Electronics

1776 East 17th Street, Cleveland, Ohio 44114

Accredited Member National Home Study Council • A Leader in Electronics Training Since 1934



NEW COLLEGE-LEVEL COURSE IN ELECTRONICS ENGINEERING

for men with prior experience in Electronics. Covers steady-state and transient network theory, solid state physics and circuitry pulse techniques, computer logic and mathematics through calculus. A college-level course for men already working in Electronics.

Cleveland Institute of Electronics
1776 East 17th Street, Cleveland, Ohio 44114

Please send me without cost or obligation:

1. Your 44-page book "How To Succeed In Electronics" describing the job opportunities in Electronics today, and how your courses can prepare me for them.
2. Your book on "How To Get A Commercial FCC License."

I am especially interested in:

- | | |
|--|--|
| <input type="checkbox"/> Electronics Technology | <input type="checkbox"/> Electronic Communications |
| <input type="checkbox"/> Broadcast Engineering | <input type="checkbox"/> Industrial Electronics and Automation |
| <input type="checkbox"/> First-Class FCC License | <input type="checkbox"/> Electronics Engineering |

Name _____ (PLEASE PRINT)

Address _____

City _____

State _____ Zip _____ Age _____

Check here for G.I. Bill information. EL-26

CIRCLE NO. 18 ON PAGE 27

BUILD YOUR OWN 20 RADIO

and Electronics Circuits

Reg. U.S. Pat. Off.



Training Electronics Technicians Since 1946

PROGRESSIVE HOME RADIO, V. COURSE

Now Includes

- ★ 12 RECEIVERS
- ★ 3 TRANSMITTERS
- ★ SQ. WAVE GENERATOR
- ★ SIGNAL TRACER
- ★ AMPLIFIER
- ★ SIGNAL INJECTOR
- ★ CODE OSCILLATOR

- ★ No Knowledge of Radio Necessary
- ★ No Additional Parts or Tools Needed
- ★ EXCELLENT BACKGROUND FOR TV
- ★ SCHOOL INQUIRIES INVITED
- ★ Sold in 79 Countries

YOU DON'T HAVE TO SPEND HUNDREDS OF DOLLARS FOR A RADIO COURSE

The "Edu-Kit" offers you an outstanding PRACTICAL HOME RADIO COURSE at a rock-bottom price. Our Kit is designed to train Radio & Electronics Technicians, making practice and servicing. THIS IS A COMPLETE RADIO COURSE IN EVERY DETAIL. In a professional manner; how to service radios; how to wire and solder punched metal chassis as well as the latest development of Printed Circuit chassis. You will learn the basic principles of radio. You will work with the standard type of RF and AF amplifiers and oscillators, detectors, rectifiers, and equipment. You will learn and practice code, using the Progressive Code Oscillator. You will learn and practice trouble-shooting, using the Progressive Signal Tracer, Progressive Signal Injector, Progressive Dynamic Radio & Electronics Tester, Square Wave Generator and the accompanying instructional material.

You will receive training for the Novice, Technician and General Classes of F.C.C. Radio Amateur License. You will build Receiver, Transmitter, Square Wave Generator, Code Oscillator, Signal Tracer and Signal Injector circuits, and learn how to operate them. You will receive an excellent background for television, Hi-Fi and Electronics.

Absolutely no previous knowledge of radio or science is required. The "Edu-Kit" is the product of many years of teaching and engineering experience. The "Edu-Kit" will provide you with an excellent background for television, Hi-Fi and Electronics. Absolutely no previous knowledge of radio or science is required. The "Edu-Kit" is the product of many years of teaching and engineering experience. The "Edu-Kit" will provide you with an excellent background for television, Hi-Fi and Electronics. Absolutely no previous knowledge of radio or science is required. The "Edu-Kit" is the product of many years of teaching and engineering experience. The "Edu-Kit" will provide you with an excellent background for television, Hi-Fi and Electronics.

THE KIT FOR EVERYONE

You do not need the slightest background in radio or science. Whether you are interested in Radio & Electronics because you want an interesting hobby, a well paying business or a job with a future, you will find the "Edu-Kit" a worth-while investment. Many thousands of individuals of all

ages and backgrounds have successfully used the "Edu-Kit" in more than 79 countries of the world. The "Edu-Kit" has been carefully designed, step by step, so that you cannot make a mistake. The "Edu-Kit" allows you to teach yourself at your own rate. No instructor is necessary.

PROGRESSIVE TEACHING METHOD

The Progressive Radio "Edu-Kit" is the foremost educational radio kit in the world, and is universally accepted as the standard in the field of electronics training. The "Edu-Kit" uses the modern educational principle of "Learn by Doing." Therefore you construct, learn schematics, study theory, practice trouble shooting—all in a closely integrated program designed to provide an easily-learned, thorough and interesting background in radio. You begin by examining the various radio parts of the "Edu-Kit." You then learn the function, theory and wiring of these parts. Then you build a simple radio. With this first set you will enjoy listening to regular broadcast stations, learn theory, practice testing and trouble-shooting. Then you build a more advanced radio. In a progressive manner, and at your own rate, you will find yourself constructing more advanced multi-tube radio circuits, and doing work like a professional Radio Technician.

Included in the "Edu-Kit" course are Receiver, Transmitter, Code Oscillator, Signal Tracer, Square Wave Generator and Signal Injector Circuits. These are not unprofessional "breadboard" experiments, but genuine radio circuits, constructed by means of professional wiring and soldering on metal chassis, plus the new method of radio construction known as "Printed Circuitry." These circuits operate on your regular AC or DC house current.

THE "EDU-KIT" IS COMPLETE

You will receive all parts and instructions necessary to build twenty different radio and electronics circuits, each guaranteed to operate. Our Kits contain tubes, tube sockets, variable electrolytic, mica, ceramic and paper dielectric condensers, resistors, tie strips, hardware, tubing, punched metal chassis, Instruction Manuals, hook-up wire, solder, selenium rectifiers, coils, volume controls and switches, etc.

In addition, you receive Printed Circuit materials, including Printed Circuit chassis, special tube sockets, hardware and instructions. You also receive a useful set of tools, a professional electric soldering iron, and a self-powered Dynamic Radio and Electronics Tester. The "Edu-Kit" also includes Code Instructions and the Progressive Code Oscillator, in addition to F.C.C. Radio Amateur License training. You will also receive lessons for servicing with the Progressive Signal Tracer and the Progressive Signal Injector, a High Fidelity Guide and a Quiz Book. You receive Membership in Radio-TV Club, Free Consultation Service, Certificate of Merit and Discount Privileges. You receive all parts, tools, instructions, etc. Everything is yours to keep.

Progressive "Edu-Kits" Inc., 1189 Broadway, Dept. 544DJ, Hewlett, N.Y. 11557

UNCONDITIONAL MONEY-BACK GUARANTEE

Please rush my expanded "Edu-Kit" to me, as indicated below:

Check one box to indicate choice of model

- Deluxe Model \$31.95
- New Expanded Model \$34.95 (Same as Deluxe Model Plus Television Servicing Course)

Check one box to indicate manner of payment

- I enclose full payment. Ship "Edu-Kit" post paid.
- I enclose \$5 deposit. Ship "Edu-Kit" C.O.D. for balance plus postage.
- Send me FREE additional information describing "Edu-Kit."

Name

Address

City & State

Zip

PROGRESSIVE "EDU-KITS" INC.

1189 Broadway, Dept. 544DJ, Hewlett, N.Y. 11557

FREE EXTRAS

• SET OF TOOLS

- SOLDERING IRON
- ELECTRONICS TESTER
- PLIERS-CUTTERS
- VALUABLE DISCOUNT CARD
- CERTIFICATE OF MERIT
- TESTER INSTRUCTION MANUAL
- HIGH FIDELITY GUIDE • QUIZZES
- TELEVISION BOOK • RADIO TROUBLE-SHOOTING BOOK
- MEMBERSHIP IN RADIO-TV CLUB: CONSULTATION SERVICE, FCC AMATEUR LICENSE TRAINING
- PRINTED CIRCUITRY

SERVICING LESSONS

You will learn trouble-shooting and servicing in a progressive manner. You will practice repairs on the sets that you construct. You will learn symptoms and causes of trouble in home, portable and car radios. You will learn how to use the professional Signal Tracer, the unique Signal Injector and the dynamic Radio & Electronics Tester. While you are learning in this practical way, you will be able to do many a repair job for your friends and neighbors, and charge fees which will far exceed the price of the "Edu-Kit." Our Consultation Service will help you with any technical problems you may have.

FROM OUR MAIL BAG

J. Stataitis, of 25 Poplar Pl., Waterbury, Conn., writes: "I have repaired several sets for my friends, and made money. The "Edu-Kit" paid for itself. I was ready to spend \$240 for a Course, but I found your ad and sent for your Kit."

Ben Valerio, P. O. Box 21, Magna, Utah: "The Edu-Kits are wonderful. Here I am sending you the questions and also the answers for them. I have been in Radio for the last seven years, but like to work with Radio Kits, and like to build Radio Testing Equipment. I enjoyed every minute I worked with the different kits; the Signal Tracer works fine. Also like to let you know that I feel proud of becoming a member of your Radio-TV Club."

Robert L. Shuff, 1534 Monroe Ave., Huntington, W. Va.: "Thought I would drop you a few lines to say that I received my Edu-Kit, and was really amazed that such a bargain can be had at such a low price. I have already started repairing radios and phonographs. My friends were really surprised to see me get into the swing of it so quickly. The Trouble-Shooting Tester that comes with the kit is really swell, and finds the trouble, if there is any to be found."

PRINTED CIRCUITRY

At no increase in price, the "Edu-Kit" now includes Printed Circuitry. You build a Printed Circuit Signal Injector, a unique servicing instrument that can detect many Radio and TV troubles. This revolutionary new technique of radio construction is now becoming popular in commercial radio and TV sets.

A Printed Circuit is a special insulated chassis on which has been deposited a conducting material which takes the place of wiring. The various parts are merely plugged in and soldered to terminals.

Printed Circuitry is the basis of modern Automation Electronics. A knowledge of this subject is a necessity today for anyone interested in Electronics.

CIRCLE NO. 19 ON PAGE 27