

WINTER 1965 A 75c QUARTERLY

ELEMENTARY

8

**BENCH-TESTED
PROJECTS**

ELECTRONICS

By the Editors of **RADIO-TV EXPERIMENTER**

**SPECIAL
INTERCOM
SYSTEMS!**



**BUILD
NEON-MITE!**

Make a desk set
for \$11:
it'll blink for
two years!

**HOW TO
+ - × ÷
WITH BINARY
NUMBERS**

**How Ignition
Systems Work**

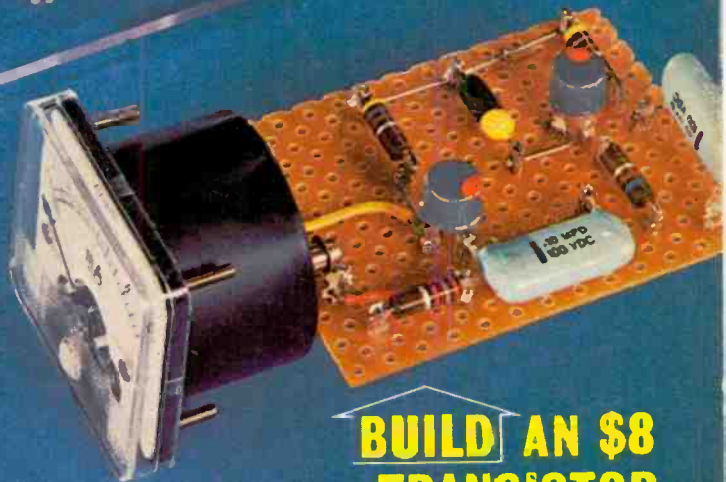

**BUILD AN \$8
TRANSISTOR
TACHOMETER!**

**FEEDBACK
FUNDAMENTALS
WITH 5
EXPERIMENTS!**

Discover how tachs count rpm's by
installing one in your own car!

NOW THERE ARE 67 RADIO SHACKS COAST TO COAST!

FREE!



1966 RADIO SHACK CATALOG

The World's Most Exciting

ELECTRONIC BARGAIN BOOK!

Choose from over 5,000 items like these! Shop by Mail or in Person at your nearest Radio Shack!

- CALIFORNIA**
 BAKERSFIELD — 1308 19th St., 322-8448
 LOS ANGELES:
 Anaheim — 501 W. Katella Ave., 776-9540
 Downey — Stonewood Shop. Ctr., 923-1709
 Mission Hills — 10919 Sepulveda Blvd., 365-3118
 Santa Ana — Bristol Plaza Shop. Ctr., 1212 South Bristol, 546-5700
 West L. A. — Pico Blvd. at Overland, 837-7141
SAN DIEGO (La Mesa) — Grassmont Shop. Ctr., 465-4062
 LONG BEACH — 3876 Atlantic Ave., 426-7514
 OAKLAND (San Leandro) — Bay Fair Shop. Ctr., 278-5200
 SACRAMENTO — 600 Fulton Ave., 483-2707
- COLORADO**
 DENVER — 798 South Santa Fe Dr., 733-7833
- CONNECTICUT**
 HAMDEN — Hamden Mart Shop. Ctr., 288-7911
 MANCHESTER — Manchester Shopping Parkade, 649-5247
 NEW HAVEN — 92 York St., 787-7121
 NEW LONDON — New London Shop. Ctr., 442-0522
 STAMFORD — 29 High Ridge Rd., 325-4371
 WEST HARTFORD — 39 So. Main St., 236-5441
- ILLINOIS**
 CHICAGO — Evergreen Plaza at 95th St., 636-9796
- MAINE**
 PORTLAND — Pine Tree Shop. Ctr., 773-7071
- MASSACHUSETTS**
 BOSTON:
 167 Washington St., 523-4719
 554 Washington St., 426-3431
 110 Federal St., 426-3897
 BRAINTREE — South Shore Plaza, 643-9200
 BROCKTON — Westgate Mall, 588-5327
 BROOKLINE — 730 Commonwealth Ave., 734-1000
 CAMBRIDGE — Fresh Pond Shop. Ctr., 481-2925
 FRAMINGHAM — Shoppers' World, 872-6569
 LOWELL — Central Shop. Plaza, 455-5469
 SAUGUS — N. E. Shop. Ctr., 233-5350
 SPRINGFIELD — 1182 Main St., 734-2189
 WEST SPRINGFIELD — Century Shop. Ctr., 732-4433
 WORCESTER — Lincoln Plaza, 757-9030
- MINNESOTA**
 ST. PAUL — 473 North Snelling, 222-4801
- NEW HAMPSHIRE**
 MANCHESTER — 1247 Elm St., 669-1303
- NEW MEXICO**
 ALBUQUERQUE — 6315 Lomas, N.E., 268-5722
- NEW YORK**
 BINGHAMTON (Vestal) — Vestal Shopping Plaza, 729-1525
 BUFFALO (Clarence) — Transitown Shop. Ctr., 632-7111
 NEW YORK — 1128 Ave. of the Americas, 687-4492
 SCHENECTADY (Rotterdam) — Shoporama Shop. Ctr., 355-9740
 SYRACUSE — 3057 Erie Blvd. East, 446-4990
- OHIO**
 CINCINNATI — 852 Swifton Ctr., 631-4570
- OKLAHOMA**
 OKLAHOMA CITY — Mayfair Shop. Ctr., 943-8491
 TULSA — 2730 South Harvard, 742-2255
- OREGON**
 PORTLAND — 1928 N.E. 42nd St., 281-4842
- PENNSYLVANIA**
 PHILADELPHIA:
 23276 Cottman Ave., Roosevelt Mall, 338-4711
 1128 Walnut St., 923-2198
- RHODE ISLAND**
 CRANSTON — 1301 Reservoir Ave., 942-6600
 EAST PROVIDENCE — Shoppers' Town, 434-5672
- TEXAS**
 ABILENE — 2910 North First St., 673-8169
 ARLINGTON — Collins at Park Row, 277-3151
 BROWNSVILLE — 847 E. Elizabeth St., 546-6156
 DALLAS:
 1601 Main St., 741-6279
 Medallion Center, 363-6236
 125 Wynnewood Village, 948-3201
- FORT WORTH:**
 1515 So. University Dr., 335-4705
 900 East Berry St., 927-7828
 3524 East Denton Highway, 831-1951
- HOUSTON:**
 8458 Gulf Freeway, 643-4731
 2315 Travis St., 523-0871
 322 Northline Mall, 697-7914
 Bellair — 4759 Bissonnet, 667-5190
- SAN ANTONIO** — 150 Wonderland Shop. Ctr., 735-9161
SHERMAN — 1620 Highway 75 North, 692-6553
WACO — 1016 Austin Ave., 752-7739
- VIRGINIA**
 ARLINGTON — Washington-Lee Shop. Ctr., 524-5422
- WASHINGTON**
- SEATTLE:**
 2028 Third Ave., 682-5280
 837 N. E. 110th St., 364-8670

ARCHER SURPRISE-PAKS

Special Buys for the Experimenter and Hobbyist!



\$1 EACH

FREE PAK with EVERY 10 YOU BUY - Specify Choice.

- | | |
|--|--|
| <input type="checkbox"/> 50 Plugs & Sockets: ideal bench assortment 27-1562 | <input type="checkbox"/> 20 Power Resistors: 5-25 watt; vitreous, wire-wound. 27-1202 |
| <input type="checkbox"/> 50 Tubular Capacitors: 100 mmf to .1 mf to 600 WVDC. 27-1568 | <input type="checkbox"/> 45 Mica Capacitors: famous-make 100 mmf to .01 mf. 27-1573 |
| <input type="checkbox"/> 8 Circuit Boards: pre-etched and pre-punched. 27-1572 | <input type="checkbox"/> 40 Coils & Chokes: RF, OSC, IF, peaking, other types. 27-1569 |
| <input type="checkbox"/> 8 Assorted Electrolytics: for radio and TV repair use. 27-1570 | <input type="checkbox"/> 8 Transistor Electrolytics: 5-100 mfd; assorted voltages. 27-1571 |
| <input type="checkbox"/> 150 Hook-Up Wire: six 25' rolls; solid, stranded; #18-22. 27-025 | <input type="checkbox"/> 4 Transistor Transformers: by UTC and Remington Rand. 27-1581 |
| <input type="checkbox"/> 50 Capacitors: ceramic, mylar, oil, paper, molded, etc. 27-1199 | <input type="checkbox"/> 35 Radio/TV Knobs: popular assortment. 27-1564 |
| <input type="checkbox"/> 35 Precision 1% Resistors: 1/2, 1, & 2-watt. 27-1196 | <input type="checkbox"/> 35 Disc Capacitors: ass't.; 10 mmf—.01 mf—6 KV. 27-1567 |
| <input type="checkbox"/> 48 Terminal Strips: 1-6 lugs; screw, solder types. 27-1555 | <input type="checkbox"/> 8 Sets, RCA Plugs & Jacks: perfect for all hi-fi uses. 27-1575 |
| <input type="checkbox"/> 30 2-Watt Resistors: film, carbon. Many 5%. 27-1211 | <input type="checkbox"/> 20 Mylar Capacitors: Sprague tubulars; axial leads. 27-1565 |
| <input type="checkbox"/> 50 Hi-Quality Resistors: 100Ω to 2 megs. 1/2, 1, 2-watts. 27-1563 | <input type="checkbox"/> 50 Ceramic Capacitors: discs, npo's, tubulars. 27-1566 |
| <input type="checkbox"/> 3 Infrared Ray Detectors: ideal for solar experiments. 27-704 | |
| <input type="checkbox"/> 40 1-Watt Resistors: Allen Bradley & IRC carbons. 27-1576 | |

\$25 SURPRISE PACKAGE! \$1
 All types of components; an incredible \$25 value! 27-1251.

Mail to Your Nearest RADIO SHACK Store

(See Addresses at Left)

Please send me, by return mail, the Archer-Paks I've checked above. (If order is for 10 or more, I have indicated my choice of FREE 11th Pak.) I enclose \$.....

EEW-65

NAME (please PRINT) _____
 STREET _____
 CITY _____ STATE _____ ZIP _____

Add 50¢ per order for postage and handling.

Clip coupon—and take your first big step to real success! I.C.S., Scranton, Penna. 18515

Accredited Member,
National Home Study Council

INTERNATIONAL CORRESPONDENCE SCHOOLS

Dept. 1171, Scranton, Penna. 18515

(In Hawaii: P. O. Box 418, Honolulu. In Canada: I. C. S. Canadian, Ltd., Montreal.)

Without cost or obligation, rush me "HOW to SUCCEED," the opportunity booklet about the field I have indicated below, and a sample lesson.
Name of the course in which you are interested _____

Mr. _____ Age _____ Address _____
Miss _____
Mrs. _____
City _____ State _____ Zip Code _____ Working Hours _____ A.M. to _____ P.M.
Occupation _____ Employed by _____

Low rates to members of U. S. Armed Forces!
Special training programs for industry

253 ways to win yourself a RAISE IN PAY



The average correspondence school graduate increases his income by \$22.50 a week! I. C. S. is the largest, most experienced correspondence school: 7,000,000 students since 1890. Choose from more than 200

job-related courses. Learn facts, theories, practical applications. New, updated texts are yours to keep! Complete lesson and answer service. Diploma to graduates. Send our coupon for three free booklets.



ACCOUNTING
Accounting for Business Programmers
Cost Accounting
C.P.A. Review
Estate & Trust Accounting
Executive Accounting
Federal Tax
General Accounting
Industrial Accounting
Legal Accounting
Office Accounting
Personal Income Tax & Social Security
Practical Accounting
Public Accounting
Small Business Accounting
Starting & Managing a Small Bookkeeping Service

ARCHITECTURE AND BUILDING
Architectural Drawing & Designing
Architecture
Building Contractor
Building Estimator
Building Inspector
Building Maintenance
Carpenter-Building
Carpentry & Millwork
House Planning & Interior Design
Mason
Painting Contractor
Reading Arch. Blueprints
Review in Arch. Design & Practice
Review of Mech. Systems in Buildings

ART
Amateur Artist
Commercial Art
Commercial Cartooning
Illustrating
Interior Decorating
Oil Painting for Pleasure
Show Card & Sign Prod.
Show Card Writing
Sign Painting & Designing
Sketching & Painting

AUTOMOTIVE
Automotive Transmission Specialist
Automobile Body Rebuilding & Refinishing
Automobile Electrical Tech.
Automobile Engine Tune-Up
Automobile Technician
Automotive Mechanic

Diesel-Gas Motor Vehicle Engines

BUSINESS
Advertising
Basic Inventory Control
Business Administration
Business Management & Marketing
Business Management & Production
COBOL Programming
Condensed Business Practice
Industrial Psychology
Managing a Small Store
Marketing
Modern Executive Management
Office Management
Programming for Digital Computers
Programming the IBM 1401 Computer
Purchasing Agent
Retail Business Management
Statistics and Finance
Systems and Procedures Analysis

CHEMICAL
Analytical Chemistry
Chemical Engineering
Chemical Engineering Unit Operations
Chemical Laboratory Tech.
Chemical Process Control Technician
Chemical Process Operator
Elements of Nuclear Energy
General Chemistry
Instrumental Laboratory Analysis

CIVIL ENGINEERING
Civil Engineering
Construction Engineering
Highway Engineering
Principles & Surveying
Reading Highway Blueprints
Reading Structural Blueprints
Sanitary Engineering
Sewage Plant Operator
Structural Engineering
Surveying and Mapping
Water Works Operator

DRAFTING
Aircraft Drafting
Architectural Drafting
Electrical Drafting

Electrical Engineering
Drafting
Electronic Drafting
Introductory Mechanical Drafting
Mechanical Drafting
Pressure-Vessel and Tank Print Reading
Sheet Metal Layout for Air Conditioning
Structural Drafting

ELECTRICAL
Electric Motor Repairman
Electrical Appliance Servicing
Electrical Contractor
Electrical Engineering (Power option or Electronic option)
Electrical Engineering Tech. (Hydro or Steam Option)
Electrical Instrument Tech.
Industrial Electrical Tech.
Industrial Telemetering
Power Line Design and Construction
Power Plant Operator
Practical Electrician
Practical Lineman
Reading Electrical Blueprints

ENGINEERING (Professional)
Chemical Civil
Electrical Mechanical
Industrial Management for Engineers

ENGLISH AND WRITING
Better Business Writing
Introductory Technical Writing
Modern Letter Writing
Practical English
Short Story Writing

HIGH SCHOOL
High School Business
High School College Prep. (Arts)
High School College Prep. (Engineering & Science)
High School General
High School Mathematics
High School Secretarial
High School Vocational

LANGUAGES
(Edited by Berlitz)
French
German

Italian
Spanish

LEADERSHIP
Basic Supervision
Industrial Foremanship
Industrial Supervision
Personality Development
Personnel-Labor Relations
Supervision

MATHEMATICS
Advanced Mathematics
Mathematics and Mechanics for Engineering
Mathematics and Physics for Engineering
Mathematics & Physics for Technicians
Modern Elementary Statistics

MECHANICAL
Industrial Engineering
Industrial Instrumentation
Machine Design
Mechanical Engineering
Quality Control
Safety Engineering Tech.
Tool Design
Value Analysis

PETROLEUM
Natural Gas Production & Transmission
Oil Field Technology
Petroleum Production
Petroleum Production Engineering
Petroleum Refinery Oper.
Pipeline Engineering

PLASTICS
Plastics Technician

PLUMBING, HEATING, AIR CONDITIONING
Air Conditioning
Air Conditioning Maint.
Domestic Heating with Oil & Gas
Domestic Refrigeration
Gas Fitting
Heating & Air Conditioning with Drawing
Plumbing
Plumbing & Heating
Plumbing & Heating Contractor
Plumbing & Heating Estimator
Practical Plumbing
Refrigeration

Refrigeration & Air Conditioning
Steam Fitting

PULP AND PAPER
Paper Machine Operator
Paper Making
Pulp Making
Pulp & Paper Engineering
Pulp & Paper Making

SALESMANSHIP
Creative Salesmanship
Real Estate Salesmanship
Sales Management
Salesmanship
Salesmanship & Sales Management

SECRETARIAL
Clerk-Typist
Commercial
Legal Secretary
Medical Secretary
Professional Secretary
Shorthand
Stenographic
Typewriting

SHOP PRACTICE
Drill Operator
Foundry Practice
Industrial Metallurgy
Lathe Operator
Machine Shop Inspection
Machine Shop Practice
Machine Shop Practice & Toolmaking
Metallurgical Engineering
Technology
Milling Machine Operator
Patternmaking
Practical Millwrighting
Reading Shop Prints
Rigging
Tool Engineering Technology
Tool Grinder
Toolmaking
Turret Lathe Operator
Welding Engineering Tech.
Welding Processes

STEAM AND DIESEL POWER
Boiler Inspector
Industrial Building Engineer
Power Plant Engineering
Stationary Diesel Engines
Stationary Fireman
Stationary Steam Eng.

TEXTILES
Carding
Carding and Spinning

Cotton Manufacturing
Dyeing & Finishing
Loom Fixing
Spinning
Textile Dyeing
Textile Technology
Textile Mill Supervisor
Warping and Weaving
Wool Manufacturing

TRAFFIC
Motor Traffic Management
Railway Rate Clerk
Traffic Management

TV-RADIO-ELECTRONICS
Communications Techn'lyg
Electronic Fundamentals
Electronic Fundamentals (Programed)
Electronic Fundamentals with Electr. Equip. Tr'n'g
Electronic Instrumentation & Servo Fundamentals
Electronic Principles for Adornment
Electronics and Applied Calculus
Electronics Technician
First Class Radiotelephone License
Fundamentals of Electronic Computers
General Electronics
General Electronics with Electronic Equip. Tr'n'g
Hi-Fi Stereo and Sound Systems Servicing
Industrial Electronics
Industrial Electronics Engineering
Industrial Electronics Engineering Technician
Practical Radio-TV Eng'g
Practical Telephony
Principles of Radio-Electronic Telemetry
Principles of Semiconductor-Transistor Circuits
Radio Servicing with Radio Equipment Training
Radio & TV Servicing
Radio & TV Servicing with Radio Equip. Tr'n'g
Second Class Radiotelephone License
Sound Systems Specialist
Teletony, Electronics and Radio Communications
TV Receiver Servicing
TV Technician

ELEMENTARY ELECTRONICS is published bimonthly at \$4.00 per year, by Science & Mechanics Publishing Co., 505 Park Avenue, New York, N. Y. 10022. Application for second-class postage rates is pending at New York, N. Y., and at additional mailing office. Copyright 1965 by Science & Mechanics Publishing Co.

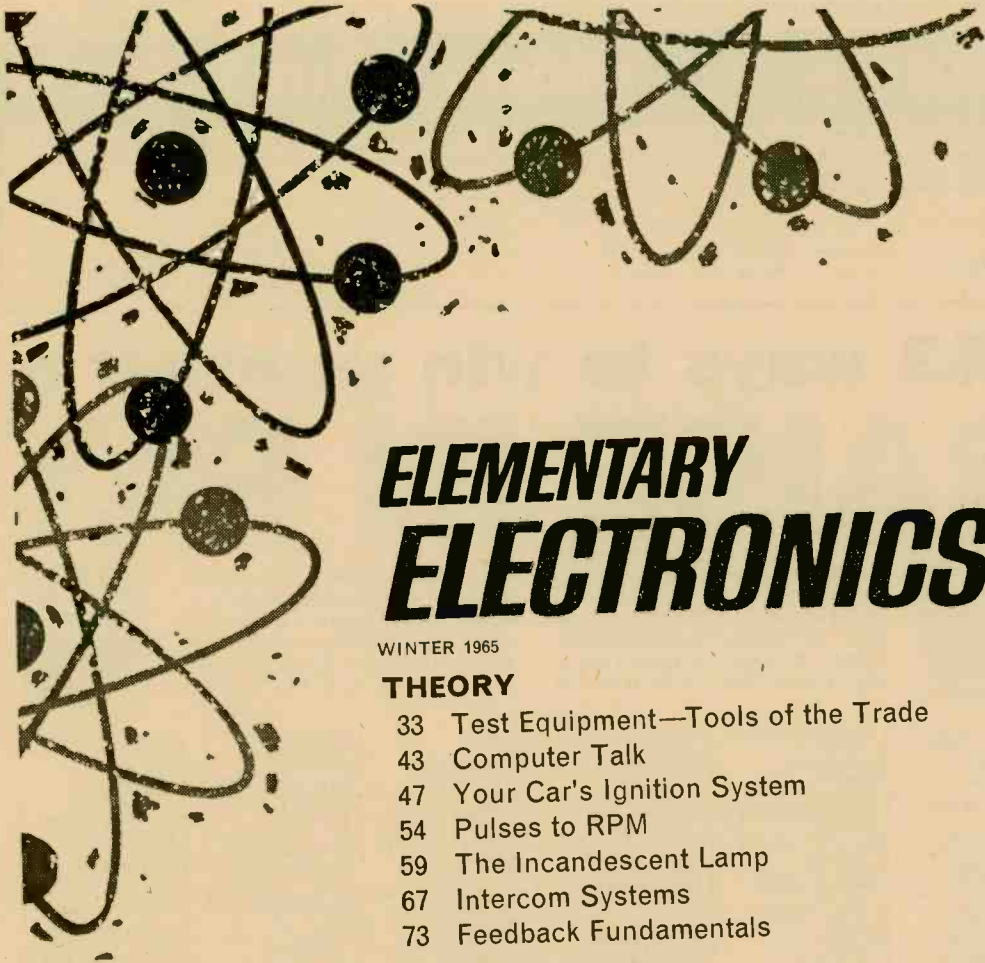

ELEMENTARY ELECTRONICS

WINTER 1965

THEORY

- 33 Test Equipment—Tools of the Trade
- 43 Computer Talk
- 47 Your Car's Ignition System
- 54 Pulses to RPM
- 59 The Incandescent Lamp
- 67 Intercom Systems
- 73 Feedback Fundamentals

CONSTRUCTION

- 81 Test Bench Synthetic Battery
- 85 New Boost for an Old Charger
- 91 The VHF Extender
- 100 Electronic Desk Set
- 103 SCR Lamp Dimmer
- 105 Ham-CB Voice Shaper
- 108 Canned Sound
- 110 Talk Via a Light Beam

DEPARTMENTS

- 12 Ask Me Another
- 18 NewScan
- 118 Literature Library
- 120 Classified Ads

Authors featured in this issue:

Waldo T. Boyd
Jack Brayton
Len Buckwalter, K10DH
Forrest Frantz, Sr.
James A. Fred
Hugh Gaugler
Kenith Jamison
Jim Kyle, W5PPE
Edward A. Morris, WA2VLU
Leo G. Sands, W7PH
Jim Speck, W5PPE
J. B. Straughn



Cover Photo by Don Lothrop

ELEMENTARY ELECTRONICS

LOOK!

A New Electronics Slide Rule with Instruction Course

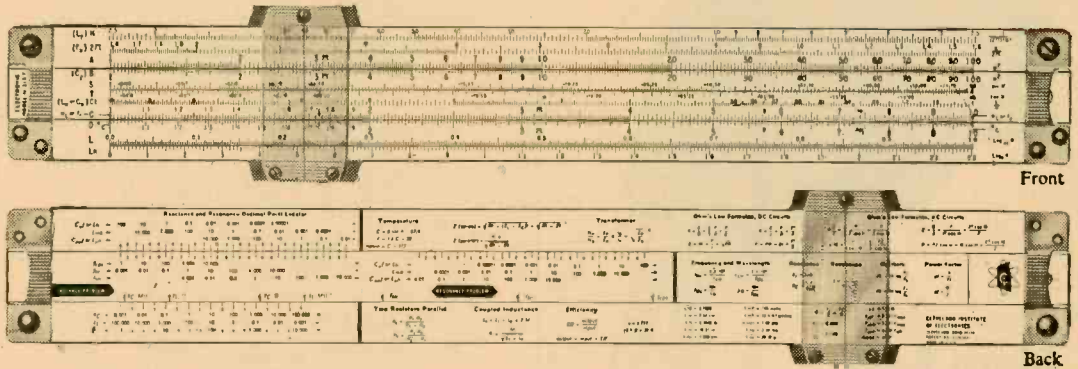

This amazing new "computer in a case" will save you time the very first day. CIE's patented, all-metal 10" electronics slide rule was designed *specifically* for electronic engineers, technicians, students, radio-TV servicemen and hobbyists. It features special scales for solving reactance, resonance, inductance and AC-DC circuitry problems... an exclusive "fast-finder" decimal point locator... widely-used formulas and conversion factors for instant reference. And there's all the standard scales you need to do multiplication, division, square roots, logs, etc.

Best of all, the new CIE Slide Rule comes with an Instruction Course of four **AUTO-PROGRAMMED** lessons. It includes hundreds of illustrations, diagrams and practice problems. You'll learn ingenious short cuts... whip through exacting electronics problems quickly and accurately. This course alone is worth far more than the price of the entire package!

Electronics Slide Rule, Instruction Course, and handsome, top-grain leather carrying case... a \$50 value for less than \$20. Send coupon for **FREE** illustrated booklet and **FREE** Pocket Electronics Data Guide, without obligation. Cleveland Institute of Electronics, 1776 E. 17th St., Dept. EL-102, Cleveland, Ohio 44114.

*TRADEMARK

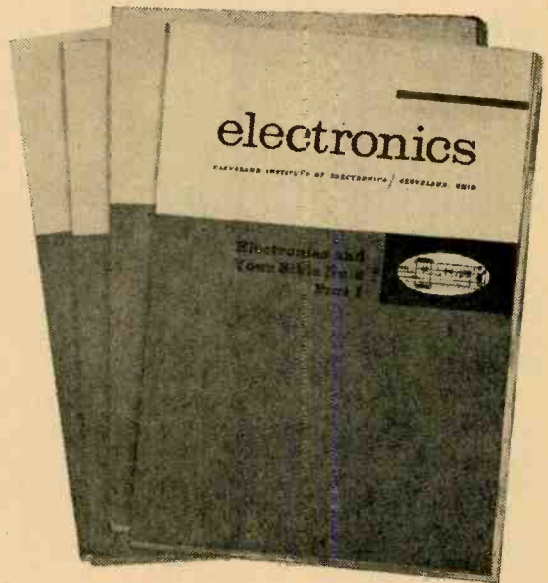

GET BOTH FREE!



Send coupon today →

Cleveland Institute of Electronics

1776 E. 17th St., Dept. EL-102, Cleveland, Ohio 44114

Please send **FREE** Illustrated Booklet describing your Electronics Slide Rule and Instruction Course.

SPECIAL BONUS! Mail coupon promptly... get **FREE** Pocket Electronics Data Guide too!

Name _____ (PLEASE PRINT)

Address _____ County _____

City _____ State _____ Zip _____

A leader in Electronics Training... since 1934.

ELEMENTARY ELECTRONICS

No. 763

Winter 1965 Edition



**More heat
where it counts
for greater
soldering efficiency →**

It's impossible to get the performance you expect from a soldering gun unless it converts its rated watts into heat at the tip.

Weller guns deliver the most heat per rated watt. They melt solder faster, and assure more reliable soldered connections than any other soldering guns.

For the most efficient heat, fastest heat, and exclusive trigger-controlled dual heat—insist on Weller.

Weller Dual Heat Guns and Kits come in wattage ranges from 100 to 325, priced from \$6.95 to \$12.95 list.

Weller[®]

WELLER ELECTRIC CORP., EASTON, PA.

In Canada: Kingston, Ontario. In England: Horsham, Sussex.

WORLD LEADER IN SOLDERING TECHNOLOGY

Editor

**JULIAN M. SIENKIEWICZ
WA2CQL, KMD4313**

Technical Editor

**WILLIAM HARTFORD
KKD7432**

Art Director

ANTHONY MACCARRONE

Assistant Art Director

JOSEPH DAVIS

Art Editor

RON STAFFIERI

Art Associate

LYNDA P. KALMAN

Advertising Director

ELLIOT S. KRANE

Advertising Manager

JIM CAPPELLO

Production Director

LEONARD F. PINTO

Production Manager

CARL BARTEE

Assistant Production Manager

HELEN GOODSTEIN

Promotion Manager

CLIFFORD SCHEARER

Cover Art Director

IRVING BERNSTEIN

Executive Editor

JOSEPH DAFFRON

President and Publisher

B. G. DAVIS

Executive Vice President and Assistant Publisher

JOEL DAVIS

Vice President and Editorial Director

HERB LEAVY, KMD4529

ELEMENTARY ELECTRONICS (No. 763) is published by SCIENCE & MECHANICS PUBLISHING CO., a subsidiary of Davis Publications, Inc. Editorial, business and subscription offices: 505 Park Ave., New York, N.Y. 10022. Advertising offices: New York, 505 Park Ave., PL-2-6200; Chicago: 520 N. Michigan Ave., 527-0330; Los Angeles: 6253 Hollywood Blvd., 213-463-5143; Atlanta: Pirnie & Brown, 3108 Piedmont Rd., N.E., 404-293-6729; Long Island: Len Osten, 9 Garden Street, Great Neck, N.Y., 516-487-3305.

EDITORIAL CONTRIBUTIONS must be accompanied by return postage and will be handled with reasonable care; however, publisher assumes no responsibility for return or safety of manuscripts, art work, or photographs. Contributions should be addressed to the Editor, Elementary Electronics, 505 Park Avenue, New York, New York 10022.

Choose Your Tailor-Made Course in N.T.S. "PROJECT METHOD" ELECTRONICS!

Now! N.T.S. — one of America's oldest leading home-study and resident technical schools — offers you **GREATER CAREER OPPORTUNITIES IN ELECTRONICS**. N.T.S. "Project Method" home training lessons are shop-tested in the Resident School in Los Angeles. You work on practical job projects, learn to use shop manuals and schematics. Your N.T.S. training is individual. You proceed at your own pace. The Schools' practical methods, plus more than 60 years of experience, have helped thousands of students all over the world to successful careers. Prepare now for a secure future in one of 8 N.T.S. Electronics Courses designed to fit your own particular needs.



Work on the electronic "brains" of Industry — computers, data processing and other automation equipment. Become a TV-Radio Technician, an electronics field engineer, or succeed in your own business.

CHOOSE YOUR FIELD — INSURE YOUR FUTURE!

- 1 ELECTRONICS-TV-RADIO-SERVICING & COMMUNICATIONS** A basic course thoroughly covering fundamentals of electronics, radio, TV servicing and communications.
- 2 MASTER COURSE IN ELECTRONICS-TV-RADIO, PLUS ADVANCED TV & INDUSTRIAL ELECTRONICS** This course covers everything included in Course No. 1 plus Automation and every phase of the Electronics industry.
- 3 FCC LICENSE** Preparation for this government license essential for interesting jobs in radar, radio, television, communications, guided missiles, many others. Upon completion of this course, if you do not pass the FCC exam for a 1st Class Commercial Radiotelephone License your tuition will be refunded.
- 4 RADIO SERVICING (AM-FM-Transistors)** Train for radio sales and service with dealer or distributor.
- 5 TELEVISION SERVICING (Including Color)** Covers installation, adjustment, repair and servicing of black and white and color television . . . prepares you for your own sales and service business.
- 6 STEREO, HI-FI AND SOUND SYSTEMS** A growing field. Prepares you to build, install and service modern sound equipment for home or industry.
- 7 BASIC ELECTRONICS** Gives you the fundamentals you must know to build on for a future Electronics career. Also offers an excellent background for Salesmen, Purchasing Agents, and others in Electronics.
- 8 ELECTRONICS MATH** Simple, easy-to-follow instructions in the specialized math you need in many electronics jobs.

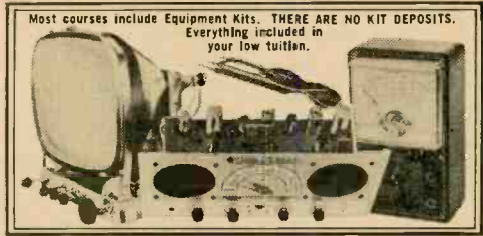

Most courses include Equipment Kits. THERE ARE NO KIT DEPOSITS. Everything included in your low tuition.

CLASSROOM TRAINING AT LOS ANGELES

You can take classroom training in our famous Resident School at Los Angeles in Sunny Southern California. N.T.S. is the oldest and largest school of its kind. Associate in Science Degree also offered in our Resident Program. Check Resident School box in coupon for full details.

HIGH SCHOOL AT HOME

Learn easily. New modern method. National also offers accredited high school programs for men and women. Take only subjects you need. Study at your own pace. Latest approved textbooks — yours to keep — everything included at one low tuition. Check High School box in coupon for information.



MAIL COUPON TODAY FOR FREE BOOK AND SAMPLE LESSON

In Field of Your Choice. You enroll by Mail — and Save Money. No Salesmen: This means lower tuition for you. Accredited Member N.H.S.C.



NATIONAL TECHNICAL SCHOOLS

WORLD-WIDE TRAINING SINCE 1905
4000 S. Figueroa St., Los Angeles, California 90037



NATIONAL TECHNICAL SCHOOLS

4000 S. Figueroa St., Los Angeles, California 90037

Please Rush FREE Electronics "Opportunity Book" and sample lesson on course checked below:

- Electronics-TV-Radio Servicing & Communications
- Master Course in Electronics-TV-RADIO Advanced TV & Industrial Electronics
- FCC License
- Radio Servicing (AM-FM-Transistors)
- Television Servicing (Including Color)
- Stereo, HI-FI and Sound Systems
- Basic Electronics Electronics Math

Dept. 222-105

Name _____ Age _____

Address _____

City _____ State _____ Zip _____

- Check here if interested ONLY in Classroom Training at L.A.
- Check here for High School Department Catalog only.



BECOME A RADIO

Build 20 Radio and Electronic Circuits at Home

ALL GUARANTEED TO WORK!

YOU DON'T HAVE TO SPEND HUNDREDS OF DOLLARS FOR A RADIO COURSE

The "Edu-Kit" offers you an outstanding **PRACTICAL HOME RADIO COURSE** at a rock-bottom price. Our Kit is designed to train Radio & Electronics Technicians, making use of the most modern methods of home training. You will learn radio theory, construction practice and servicing. **THIS IS A COMPLETE RADIO COURSE IN EVERY DETAIL.** You will learn how to build radios, using regular schematics; how to wire and solder in a professional manner; how to service radios. You will work with the standard type of punched metal chassis as well as the latest development of Printed Circuit chassis. You will learn the basic principles of radio. You will construct, study and work with RF and AF amplifiers and oscillators, detectors, rectifiers, test equipment. You will learn and practice code, using the Progressive Code Oscillator. You will learn and practice trouble-shooting, using the Progressive Signal Tracer, Progressive Signal Injector, Progressive Dynamic Radio & Electronics Tester, Square Wave Generator and the accompanying instructional material.

You will receive training for the Novice, Technician and General Classes of F.C.C. Radio Amateur Licenses. You will build Receiver, Transmitter, Square Wave Generator, Code Oscillator, Signal Tracer and Signal Injector circuits, and learn how to operate them. You will receive an excellent background for television, Hi-Fi and Electronics.

Absolutely no previous knowledge of radio or science is required. The "Edu-Kit" is the product of many years of teaching and engineering experience. The "Edu-Kit" will provide you with a basic education in Electronics and Radio, worth many times the complete price of \$26.95. The Signal Tracer alone is worth more than the price of the entire Kit.

THE KIT FOR EVERYONE

You do not need the slightest background in radio or science. Whether you are interested in Radio & Electronics because you want an interesting hobby, a well paying business or a job with a future, you will find the "Edu-Kit" a worth-while investment. Many thousands of individuals of all

ages and backgrounds have successfully used the "Edu-Kit" in more than 79 countries of the world. The "Edu-Kit" has been carefully designed, step by step, so that you cannot make a mistake. The "Edu-Kit" allows you to teach yourself at your own rate. No instructor is necessary.

PROGRESSIVE TEACHING METHOD

The Progressive Radio "Edu-Kit" is the foremost educational radio kit in the world, and is universally accepted as the standard in the field of electronics training. The "Edu-Kit" uses the modern educational principle of "Learn by Doing." Therefore you construct, learn schematics, study theory, practice trouble-shooting—all in a closely integrated program designed to provide an easily-learned, thorough and interesting background in radio. You begin by examining the various radio parts of the "Edu-Kit." You then learn the function, theory and wiring of these parts. Then you build a simple radio. With this first set you will enjoy listening to regular broadcast stations, learn theory, practice testing and trouble-shooting. Then you build a more advanced radio, learn more advanced theory and techniques. Gradually, in a progressive manner, and at your own rate, you will find yourself constructing more advanced multi-tube radio circuits, and doing work like a professional Radio Technician.

Included in the "Edu-Kit" course are Receiver, Transmitter, Code Oscillator, Signal Tracer, Square Wave Generator and Signal Injector circuits. These are not unprofessional "breadboard" experiments, but genuine radio circuits, constructed by means of professional wiring and soldering on metal chassis, plus, the new method of radio construction known as "Printed Circuitry." These circuits operate on your regular AC or DC house current.

THE "EDU-KIT" IS COMPLETE

You will receive all parts and instructions necessary to build 20 different radio and electronics circuits, each guaranteed to operate. Our Kits contain tubes, tube sockets, variable, electrolytic, mica, ceramic and paper dielectric condensers, resistors, tie strips, coils, hardware, tubing, punched metal chassis, Instruction Manuals, hook-up wire, solder, selenium rectifiers, volume controls and switches, etc.

In addition, you receive Printed Circuit materials, including Printed Circuit chassis, special tube sockets, hardware and instructions. You also receive a useful set of tools, a professional electric soldering iron, and a self-powered Dynamic Radio and Electronics Tester. The "Edu-Kit" also includes Code Instructions and the Progressive Code Oscillator. In addition to F.C.C.-type Questions and Answers for Radio Amateur License training. You will also receive lessons for servicing with the Progressive Signal Tracer and the Progressive Signal Injector, a High Fidelity Guide and a Quiz Book. You receive Membership in Radio-TV Club, Free Consultation Service, Certificate of Merit and Discount Privileges. You receive all parts, tools, instructions, etc. Everything is yours to keep.

SERVICING LESSONS

You will learn trouble-shooting and servicing in a progressive manner. You will practice repairs on the sets that you construct. You will learn symptoms and causes of trouble in home, portable and car radios. You will learn how to use the professional Signal Tracer, the unique Signal Injector and the dynamic Radio & Electronics Tester. While you are learning in this practical way, you will be able to do many a repair job for your friends and neighbors, and charge fees which will far exceed the price of the "Edu-Kit." Our Consultation Service will help you with any technical problems you may have.

J. Stataitis, of 25 Poplar Pl., Waterbury, Conn., writes: "I have repaired several sets for my friends, and made money. The "Edu-Kit" paid for itself, I was ready to spend \$240 for a Course, but I found your ad and sent for your Kit."

FROM OUR MAIL BAG

Ben Valerio, P. O. Box 21, Magna, Utah writes: "The Edu-Kits are wonderful. Here I am sending you the questions and also the answers for them. I have been in Radio for the last seven years, but like to work with Radio Kits, and like to build Radio Testing Equipment. I enjoyed every minute I worked with the different kits; the Signal Tracer works fine. Also like to let you know that I feel proud of becoming a member of your Radio-TV Club."

Robert L. Shuff, 1534 Monroe Ave., Huntington, W. Va.: "Thought I would drop you a few lines to say that I received my Edu-Kit, and was really amazed that such a bargain can be had at such a low price. I have already started repairing radios and phonographs. My friends were really surprised to see me get into the swing of it so quickly. The Trouble-shooting Tester that comes with the Kit is really swell, and finds the trouble, if there is any to be found."

PRINTED CIRCUITRY

At no increase in price, the "Edu-Kit" now induces Printed Circuitry. You build a Printed Circuit Signal Injector, a unique serving instrument that can detect many Radio and TV troubles. This revolutionary new technique of radio construction is now becoming popular in commercial radio and TV sets.

A Printed Circuit is a special insulated chassis on which has been deposited a conducting material which takes the place of wiring. The various parts are merely plugged in and soldered to terminals.

Printed Circuitry is the basis of modern Automation Electronics. A knowledge of this subject is a necessity today for anyone interested in Electronics.

NOW, TRAIN AT HOME

BUILD AND ELECTRONICS

ORDER DIRECT FROM AD . . . USE COUPON ON NEXT PAGE

RECEIVE FREE RADIO & TV PARTS JACKPOT

TECHNICIAN for only \$26⁹⁵

THE NEW IMPROVED DELUXE

Progressive Radio "Edu-Kit"[®]

is now ready



Reg. U.S. Pat. Off.

NOW INCLUDES

- ★ 12 RECEIVERS
- ★ 3 TRANSMITTERS
- ★ SQ. WAVE GENERATOR
- ★ AMPLIFIER
- ★ SIGNAL TRACER
- ★ SIGNAL INJECTOR
- ★ CODE OSCILLATOR

PRACTICAL
HOME
RADIO
COURSE

only

\$26⁹⁵

TRAINING ELECTRONICS
TECHNICIANS SINCE 1946

FREE EXTRAS

- SET OF TOOLS
- SOLDERING IRON
- ELECTRONICS TESTER
- PLIERS-CUTTERS
- VALUABLE DISCOUNT CARD
- CERTIFICATE OF MERIT
- TESTER INSTRUCTION MANUAL
- HIGH FIDELITY GUIDE • QUIZZES
- TELEVISION BOOK • RADIO TROUBLE-SHOOTING BOOK
- MEMBERSHIP IN RADIO-TV CLUB; CONSULTATION SERVICE • FCC AMATEUR LICENSE TRAINING
- PRINTED CIRCUITRY

SCHOOL INQUIRIES INVITED

Unconditional Money-Back Guarantee

The Progressive Radio "Edu-Kit" has been sold to many thousands of individuals, schools and organizations, public and private, throughout the world. It is recognized internationally as the ideal radio course.

By popular demand, the Progressive Radio "Edu-Kit" is now available in Spanish as well as English.

It is understood and agreed that should the Progressive Radio "Edu-Kit" be returned to Progressive "Edu-Kits" Inc. for any reason whatever, the purchase price will be refunded in full, without quibble or question, and without delay.

The high recognition which Progressive "Edu-Kits" Inc. has earned through its many years of service to the public is due to its unconditional insistence upon the maintenance of perfect engineering, the highest instructional standards, and 100% adherence to its Unconditional Money-Back Guarantee. As a result, we do not have a single dissatisfied customer throughout the entire world.

You Will Find That The Progressive Radio "Edu-Kit" Is Perfect

- • • FOR anyone who wishes to learn more about radio construction, theory and servicing.
- • • FOR anyone who is looking for an interesting hobby.
- • • FOR anyone who would like to learn radio but does not have time to attend regular school hours.
- • • FOR anyone who wants to start studying for a high-paying radio job.
- • • FOR anyone who wishes to start in Television.

- Send "Edu-Kit" postpaid. I enclose full payment of \$26.95.
- Send "Edu-Kit" C.O.D. I will pay \$26.95 plus postage.
- Rush me FREE descriptive literature concerning "Edu-Kit."

Name.....

Address.....

PROGRESSIVE "EDU-KITS" INC.

(ATTN: S. Goodman, M. S. In ED. Pres.)
1186 Broadway, Dept. 510-DJ, Hewlett, N. Y. 11557

WORTH \$15.00



ask me another

By Leo G. Sands

Elementary Electronics brings the know-how of an electronics expert to its readers. Leo G. Sands, columnist for *Radio-TV Experimenter*, will be happy to answer your question. Just type or print your unsolved problem on the back of a 4¢ postal card and send it to "Ask Me Another," *Elementary Electronics*, 505 Park Avenue, New York, New York 10022. Leo will try to answer all your questions in the available space in upcoming issues of *Elementary Electronics*. Sorry, Leo will be unable to answer your questions by mail.

Garbage Cans

I have an early vintage short wave receiver and a special short wave antenna which has a can, containing a coil or condenser, at each end of the transmission line. What is the correct way to hook it up?

—H. E. P., Cleaves, Ohio

Throw the antenna away and get a Hy-Gain SWL-4, SYL-7, SWO or Consolidated 635 or equivalent doublet antenna kit. The one you have was undoubtedly made long before the modern lead-in cables were developed. The cans you refer to are impedance matching transformers which were popular long ago.

Add An S-Meter

How can I add an S-meter to my CB set?

—H. C. R., Beloit, Wis.

The diagram shows the S-meter circuit used in the USL Contact 23. The meter is a 0-1 DC milliammeter connected between the cathode of an IF amplifier and the cathode of the AF power amplifier. When no signal is being received, the voltage drop across R1 is at a maximum since the AVC applies minimum bias to the grid of V1. The meter is set to read zero by adjusting R3 so that the voltage at the positive terminal of the

meter will be the same as at its negative terminal (equal to the drop across R1).

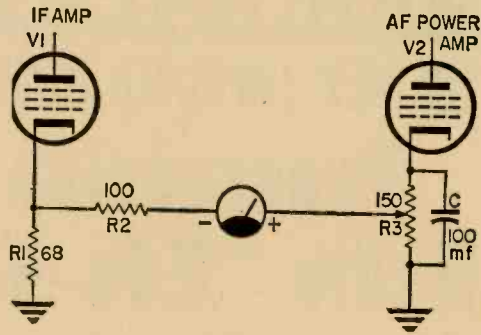

When a signal is received, the voltage drop across R1 falls off because V1's cathode current is decreased by the AVC voltage which is now higher. Hence, the voltage at the positive meter terminal is higher than at the negative terminal. The meter reading varies with the voltage drop across R1. The voltage drop across R3 remains steady. The value of R2 can be varied from the indicated value to calibrate the meter.

Bad Image

Why is it that I receive several local radio stations on other than their assigned frequencies with my 200 kc to 30 mc Brand "X" receiver? One operating on 1590 kc, for example, can be heard at about 670 kc and at other frequencies. I am told this is spurious radiation. Is this true?

—E. N., Jackson, Miss.

It is unlikely that spurious radiation is the cause if more than one station can be heard at two or more frequencies. It is more likely to be due to inadequate "image" rejection in your receiver. If your receiver has a 465-kc IF amplifier, the local oscillator is tuned to 1125 kc when the tuning dial is set to 670 kc. It is the 1590-kc signal getting through to the mixer, beating with the 1125-kc local oscillator signal, that causes a 465-kc IF signal to be produced, just the same as when the dial is set to 1590 kc and your local oscillator operates at 2055 kc to produce a 465-kc IF signal, except that the received signal is weaker.

Since you are experiencing this with several stations, a single, fixed tuned wave trap at the antenna won't do. Try shortening your antenna in order to reduce pick-up of the strong broadcast signals. Your set has an

(Continued on page 14)

FACTORIES ARE TURNING OUT MILLIONS OF APPLIANCES DAILY . . . WHO WILL REPAIR THEM?

START YOUR OWN BUSINESS!



ELECTRICAL APPLIANCE REPAIRING

There are over 60,000,000 families in the United States. They average 15 or more appliances each, and every marriage means another 15 appliances. Billions of dollars are invested in appliances, yet every year more appliances appear on the market. Eventually they all need adjustment or repair — that is why Electrical Appliance Repairing is such a profitable business today and will go on paying big cash profits for years to come.

EARN WHILE YOU LEARN

Since 1935 Christy Trades School has been teaching mechanically-inclined men the profitable Electrical Appliance Repair business. You learn by working with your hands — testing and repairing. We send you kits to assemble and keep, including the valuable Christy Electronic Trouble Tracer. We show you how to find trouble in refrigerators, automatic washers, irons and everything electrical, how to fix it quickly. We tell you what to charge, how to solicit business, where to get spare parts wholesale. We also teach you how to build power tools from spare parts, and how to do welding, house wiring, and other profitable businesses.

MAKE MONEY RIGHT FROM THE START

Many of our students pay for their entire course before they have completed their training! How? Because right from the very beginning they are shown how to make actual repairs! Thousands of Electrical Appliance Technicians can testify that the CTS course is a practical course written in simple, easy-to-understand language, profusely illustrated with hundreds of photographs and detailed drawings.

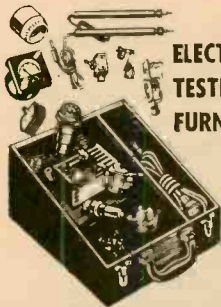

ELECTRONIC TESTING KIT FURNISHED



SEND COUPON TODAY!



SEND FOR FREE BOOK . . .

tells you how to do it!

PAY-AS-YOU-LEARN PLAN. Send TODAY for FREE illustrated book and special form for paying from earnings made while learning. See how you can soon own your own money-making business!

USE YOUR OWN BASEMENT, garage, or kitchen. You don't need expensive equipment. Work full or spare time, as you wish.

\$6 to \$7 AN HOUR are the going rates for making ordinary repairs and doing routine appliance service work. Think of the things you could have if you had your share of this money!

AGE IS NO BARRIER, nor is a minor handicap. The work is light and pleasant. Work when you wish — you're the boss!

RETIRED MAN BUILDS BUSINESS. Mr. Marion A. Pippin, 1139 E. Lincoln Ave., Decatur, Ill., writes: "I am now in the phone book in 4 places in the yellow pages. My business is getting better all the time." Mr. Pippin, now in his sixties and retired, is building a real business with solid security in his fix-it shop. You can do the same with CTS training.

CHRISTY TRADES SCHOOL INC.

Dept. A-5Y, 3214 W. Lawrence Avenue, Chicago, Illinois 60626

Please RUSH FREE book on America's fastest growing industry, Electrical Appliance Repairing, and special form for paying from earnings while learning.

Name _____

Address _____

City _____ State _____



ask me another

Continued from page 12

antenna trimmer with which you should be able to attenuate the unwanted image signal and accentuate signals at the frequency to which the dial is tuned. Image interference is less troublesome with more expensive receivers with more RF selectivity (ahead of the mixer).

Ham Exams

What source does the FCC use when preparing license exams? I am trying for the third time to pass the test for a general class ham license.

—R. G., Waco, Texas

FCC engineers undoubtedly make up the test questions. All they want to know is if you understand basic theory, basic laws and amateur practices. There are several good books on the subject. If you understand what is in any of these books you'll pass the test easily. Most electronic part supply houses list these books in their catalog. A better bet is to visit your local Ham supplier and thumb through the books he has to offer.

Get Off the Air, Quick!

Can I build my own FM wireless microphone for use in the 88-108 mc. FM broadcast band? I understand that the F.C.C. allows use of wireless microphones in this band.

—H. B. H., San Francisco, Calif.

Use of wireless microphones in the 88-108 mc. band is now permitted. However, homemade transmitters cannot be used. They must be "type approved" by the F.C.C. which requires costly and elaborate procedures.

CQ FCC

Where shall I apply for a "ham" radio license? What are the requirements and where can I get more information?

—L. M. Independence, Ky.

Several books about amateur radio license examinations are available at radio parts stores and mail order houses. You can get an amateur radio license guide free from EICO Electronic Instrument Co., Inc., Flush-

ing, N. Y. 11352. The code test and written examination for a novice license may be administered by a licensed ham. It is not necessary to go to an FCC office to take the test. You can get an amateur radio operator license application form by writing to the Federal Communications Commission, Washington, D. C. 20554.

Instant TV

How can I modify my TV set so it will turn on instantly like those advertised on TV commercials?

—V. G., Snohomish, Wash.

If your set has a power transformer and its tube heaters are not connected in a series string, you can add a switch (S2) in the secondary circuit of the low voltage power supply as shown at X in the diagram. The main switch (S1) is left turned on. The other switch (S) is turned on to make the set operative. But, get a schematic of your set and see if this circuit will work!

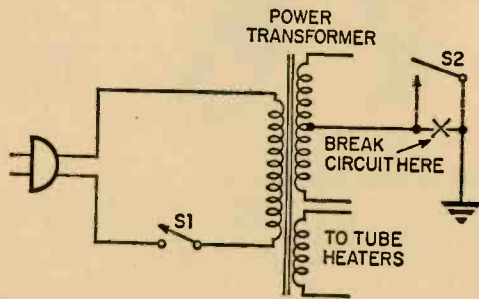

Fixing Up An Old Timer

My old radio has a magnetic speaker and my parents object to the noise. How can I connect an earphone jack so I can plug in a pair of phones and cut out the speaker?

—A. W., St. Peter, Minn.

It must be a very old radio since the electro-dynamic speaker superseded the magnetic types more than 35 years ago. This kind of set does not usually have an output transformer but has instead a choke (L) and a capacitor (C) as shown in the diagram to keep the B+ out of the speaker.

Mount a Mallory Type 5 jack (J) on the chassis or cabinet, break the circuit at X in the diagram and add R, a 10,000 ohm potentiometer, all connected as shown. When the phone plug is inserted in the jack, its 4-5 and 2-3 contacts open, disconnecting the

(Continued on page 16)

FREE CATALOG.

250 "Do-It-Yourself"
Electronic Kits At
Up To 50% Savings

WHY BUILD HEATHKIT ELECTRONICS? A desire for top-quality products at 50% savings, to be sure. But it goes beyond that. The reason people choose Heathkit is pride. Not just the pride of owning something new, but something a bit better that you have created yourself! From watching your Heathkit grow and take shape from your own efforts. It's a labor of love and a lot of fun. The large pictorial diagrams and simple, step-by-step instructions make it easy. And when you finish and turn it on you'll know that unique self-satisfaction that comes with "do-it-yourself." You will have joined the millions of people, from ages 11 to 79, people with no special electronic skills or knowledge, who successfully build Heathkits. People like you! Give it a try. Your FREE Heathkit catalog is waiting for you now.

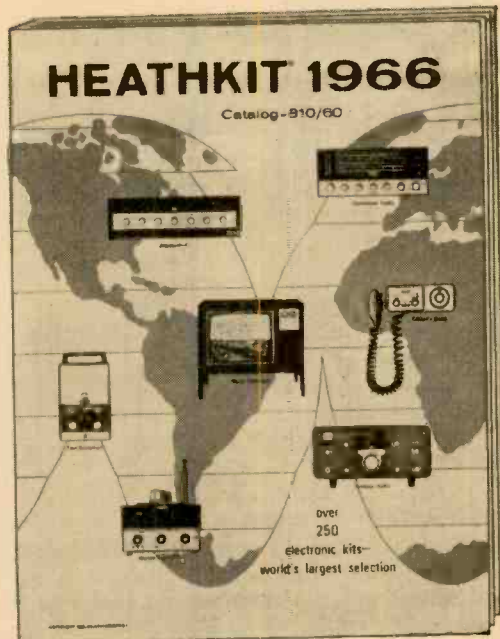

World's Largest Selection Of Electronic Kits



NEW Low Price On Heathkit
21" Color TV . . . Only \$375.00



NEW Transistor FM Stereo
Tuner That Assembles In 6
Hours Or Less . . . Only \$49.95



NEW Low Prices On
Many Heathkit Stereo/Hi-Fi
Components



NEW Deluxe Shortwave
Radio . . . Only \$84.95



NEW 23-Channel, 5-Watt
All-Transistor CB Transceiver . . .
Only \$89.95

- ★ See The Vast Selection Of Portable And Table Model AM, FM and Shortwave Radios
- ★ See The Famous Heathkit/Thomas Transistor Electronic Organs
- ★ See A Complete Selection Of Home & Hobby Items . . . Intercoms, Garage Door Opener, Automotive Kits, Tools, Color TV Sets
- ★ See All Heathkit Stereo/Hi-Fi Components . . . Tuners, Amplifiers, Speakers, Turntables, Cartridges, Furniture
- ★ See The Full Complement Of Heath Marine Electronics
- ★ See The Complete Line Of Citizen's Band Radio Gear . . . Transceivers, Walkie-Talkies, Accessories
- ★ See The Wide Selection Of Heath Educational Kits For Home Or Classroom Study
- ★ See The World's Largest Line Of Amateur Radio Gear
- ★ See The Full Line Of Heathkit Lab & Test Instruments For Home Workshop, Industrial & Educational Use



**MAIL
COUPON
FOR YOUR
FREE
COPY** ▶



HEATH COMPANY, Dept. 139-10
Benton Harbor, Michigan 49023
In Canada: Daystrom, Ltd., Cooksville, Ontario

Please send FREE 1966 Heathkit Catalog

Name _____

Address _____

City _____

State _____

Zip _____

Prices & specifications subject to change without notice.

CL-215

Continued from page 14

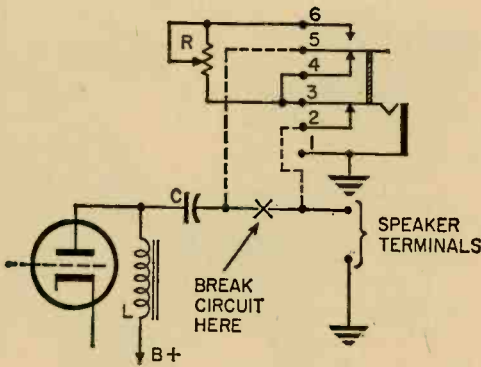

speaker. Its 5-6 contacts connect the audio output to the ungrounded headphone lead (tip of phone plug) through R which is connected as a series rheostat and serves as a headphone volume control.

Transistors to Diodes

Can a transistor be used as a diode?

—A. H., Aberdeen, Wash.

A transistor is a "triode" which, like a triode tube, can be connected as a diode as shown in the diagram. At the left a PNP transistor has its base and collector connected together. When the collector is made negative with respect to the emitter, the base is forward-biased. At the right the circuit for an NPN transistor is the same except that the collector is made positive with respect to the emitter. The base, here too, is forward-biased. The forward voltage drop (in the direction of conduction) is much lower than for a conventional diode.

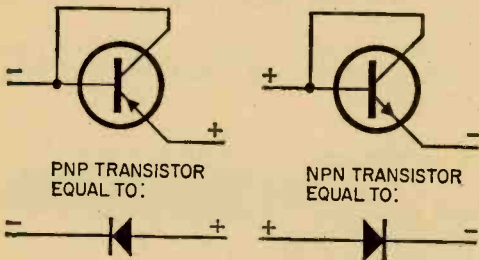

Quiet, Please!

How can I locate noisy vacuum tubes when all tubes check out OK on a tube tester?

—E. R., Mukilteo, Wash.

Connect an RF signal generator to the antenna and ground terminals of the receiver. If the set has a loop antenna or loop stick, connect the signal generator output to the grid of the first tube through a small capacitor (10-100 pf). Set the signal generator and receiver to the same frequency and turn up the signal generator output, with the RF signal unmodulated. Now, just tap the tubes and other components with the eraser on the end of a pencil and you will quickly detect the noisy ones.

Red, White and Blue Smoke

The screen bypass resistor in my record player blew and no circuit diagram was furnished. What value of replacement should I use?

—M. M., Westfield, N. J.

The screen resistor probably burned out as a result of shorting of the screen bypass capacitor (condenser). Unsolder both and take them to a radio parts store and buy re-

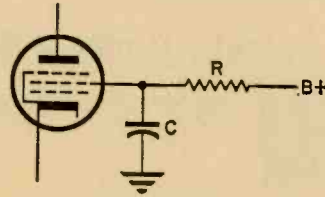

placements. The resistor should be color-coded to indicate its resistance. If the color code has been burned off, try various values from 50,000 ohms to 500,000 ohms until the sound is cleanest. Use an 0.1 mf. tubular rated at 200 volts or higher as the replacement bypass capacitor. Its value isn't critical.

TD-FM Radio Is No Help

How can I modify the TD-FM radio (June-July 1964 issue) for the 150-274 mc range?

—G. C. M., Jacksonville, Fla. & F. S., Wallington, N. J.

While it is possible to change the coils to alter the frequency range, you probably would not be pleased with the results. The 150-174 mc mobile radio band channels are spaced only 30 kc apart and the FM signals deviate only ± 5 kc. In the FM broadcast band, the channels are 200 kc apart and the signals deviate ± 75 kc. Even in the 2-meter amateur band (144-148 mc) the signals usually deviate ± 15 kc. Extremely good selectivity is required to separate the signals in

the 150-174 mc. band and an FM discriminator is required which will provide adequate audio recovery. Only a multi-stage superheterodyne receiver with a very sharp selectivity will provide satisfaction.

Coax Lead-In

How can I convert my end-fed antenna radio receiver so I can use a dipole antenna?
—N. S., Waterford, Wis.

How can I connect a dipole to a receiver with only one antenna terminal and one ground terminal?

—J. C., Decatur, Ga.

Use 75-ohm coaxial cable, such as RG-11/U, as the transmission line as shown in the diagram. Connect the center conductor of the coax to the antenna terminal and the shield braid to the ground terminal. If there is no ground terminal, connect the shield to the chassis—but not if it is an AC/DC set.

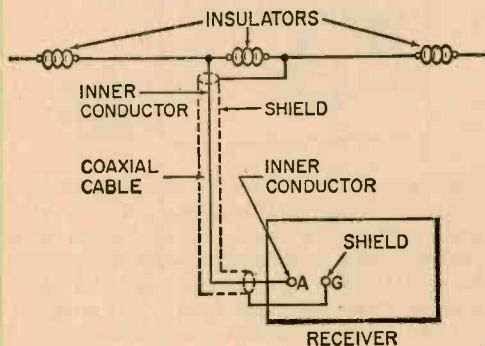

Long Wire Is Best

I have built an antenna for the 19 and 25-meter bands. When I connect it to the receiver, I get a bubbling sound. How can I eliminate it? Also, can you give me a plan for an all-band antenna?

—K. D., Wallingford, Conn.

I can't advise you on the bubbling sound without hearing it? Shep Fields isn't on the air any more. The most universally used all-band antenna is a single wire from 50 to 100 feet long. It won't suffer so badly from directional effects as a doublet and is less frequency sensitive.

new Allen type screwdrivers

work faster, easier . . . reach where wrenches won't go



fixed handle SCREWDRIVERS

11 hex sizes: .050" to 1/4"
Precision formed, alloy steel blades
Shockproof, breakproof, amber plastic (UL) handles

detachable BLADES

8 hex sizes: 1/16" to 3/8"
Fit all "99" Series handles
Available singly — as a set of six in free plastic pouch — or in roll kit with handle

XCELITE

XCELITE INC. • 80 BANK ST., ORCHARD PARK, N. Y.
Please send free literature N763.

name _____

address _____

city _____

state & zone _____



Bye-Bye SCR Price Barrier

General Electric has achieved a cost breakthrough that is expected soon to bring sophisticated, space-age, electronic control to a vast array of consumer products. The breakthrough results from automating the manufacture of a solid-state component called a silicon controlled rectifier (SCR). In large quantities, the units will sell in the 35-to-50-cent range to manufacturers of consumer and other products. The price to hobbyists in units of one will be higher but under one dollar. When G. E. first introduced the SCR eight years ago, it sold for about \$300.

Solid-state control of electrical equipment enables the user to dial speed, light and heat in the same way he has always dialed the exact level of sound he desired on his radio or TV set. The housewife, for instance, has been accustomed to—and limited by—two or three speeds for her electric mixer. Now she will be able to dial the exact speed required to mix anything from a milk shake to a thick cake batter. Moreover, due to the extreme sensitivity of the new electronic switch, it will now be economical to produce a mixer that will maintain a pre-set speed regardless of the batter thickness. This prevents the mixer from speeding up when the beaters are removed from the batter, a condition which can cause splattering.

Other examples of products that the low-cost SCR now makes possible at prices consumers will be willing to pay are:

- continuously variable heat control in electric ranges (currently, ranges mostly have only three or four levels of heat)
- electric tools and other household appliances that have continuously variable speed control instead of two or three settings
- the same kind of variable control for lighting—in table and floor lamps—as well as in built-in lighting

- automobile ignition systems that are trouble-free and long-lived
- sewing machines that can be used on canvas and silk with equal ease

In addition to the added utility and convenience that products such as these will have, solid-state control also will make more efficient use of electrical power. Non-electronic devices such as rheostats have been available for years to do this type of variable control work, but have not been widely used in consumer products because they waste power, are expensive and bulky.

The low priced SCR's may or may not be on the market when you are reading this news item. However, by January, 1966, the SCR's will be standard replacement parts available at most quality electronic parts dealers. And just in case you would like to use them in a construction project, here are a few worth trying. Note, all resistors are 1/2-watt except when indicated otherwise.

Universal-Motor Speed Control. The simple half-wave motor speed control shown in this circuit can replace the carbon pile rheostat commonly

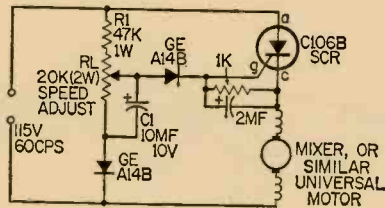

used for controlling the speed of sewing machine motors. It is equally effective for use with other small universal (a-c/d-c) motors, such as those used with food mixers and similar traffic appliances. Maximum current capability is 1.5 amps. Because speed-dependent feedback is provided, the control gives excellent torque characteristics to the motor, even at low rotational speeds where a rheostat and similar controls are completely ineffective.

The resistor-capacitor network R1, RL and C1 provides a ramp-type reference voltage riding on top of a DC voltage which is adjustable with the speed-setting potentiometer RL. This reference voltage is balanced against the residual counter EMF of the motor through the SCR gate element, g.

If the motor slows due to heavy loading, the counter EMF falls and the reference ramp triggers the SCR earlier in the AC cycle. More voltage, therefore, is applied to the motor to compensate for the loading; its speed increases again. Performance with the C106 SCR is particularly good, because the low trigger requirements of this device allows use of a flatter-topped ramp reference voltage which provides more feedback gain, hence closer speed regulation.

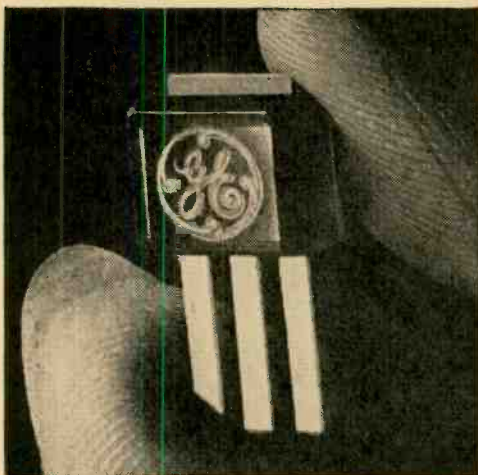

DIALABLE light can be as common as the three-way switch on table lamps, thanks to General Electric's new, low-cost silicon controlled rectifier. New solid-state electronic component halves current SCR cost. G-E unit is small enough so that entire control can be housed in lamp socket. Lamps designed with new SCR will "tunable" from full "ON" through a broad range of brightness to full "OFF" simply by turning the knob.

Time-Delayed Relay. The drawing below illustrates an extremely simple hybrid timing circuit capable of time delaying an output switching function (such as turning off the patio or garage lights) from .01 seconds to about 1 minute. The SCR functions as a very sensitive relay in this circuit; its purpose is to supply sufficient current to energize the low-cost but insensitive output relay coil, while it is being triggered by only a few microamps output current available from the timing network R1-C1.

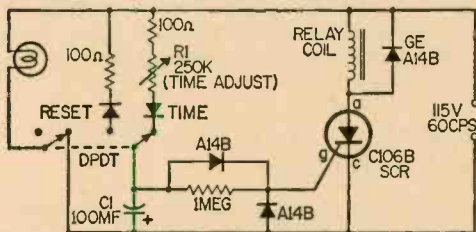

With the switch on "RESET" capacitor C1 quickly charges to the peak negative value of the supply voltage (X170 volts). In this position, the lamp load is off. When the switch is changed to "TIME," the lamp load comes on and C1 starts to discharge toward zero at a rate determined by the setting of R1. Since the time constant R1-C1 is numerically long and discharge current only flows for a short period each cycle, this process takes many complete cycles of the AC supply. When the voltage across C1

CONAR ELECTRONIC KITS



Your copy is waiting The do-it-yourselfer's newest catalog

Here's your new catalog of quality electronic kits and assembled equipment . . . your shopping guide for TV set kits, transistor radios, voltmeters, scopes, tube testers, ham gear, PA systems, and a host of other carefully engineered products. Every item in the Conar catalog is backed by a no-loopholes, money-back guarantee. It's not the biggest catalog, but once you shop its pages you'll agree it's among the best. For years of pleasurable performance, for fun and pride in assembly mail the coupon. Discover why Conar, a division of National Radio Institute, is just about the fastest growing name in the kit and equipment business.

CONAR

MAIL NOW!

CONAR

KV5C

3939 Wisconsin Avenue, Washington, D.C. 20016

Please send me your new catalog.

Name _____

Address _____

City _____ State _____ Z-code _____

NEWSCAN

finally drops to zero, reverses and reaches about 1 volt, the SCR triggers. At this point, the lamp load is de-energized via the relay.

Lamp Brightness Control. Low cost and compactness are featured in this simple half-wave phase control circuit. The exceptional gate sensitivity of the C106B SCR permits use of a five-cent neon bulb trigger instead of the costly silicon trigger devices required by other less-sensitive SCR's. The compact insulated flat-pack package of the C106B permits the whole circuit to be built inside the base of a conventional screwbase bulb socket.

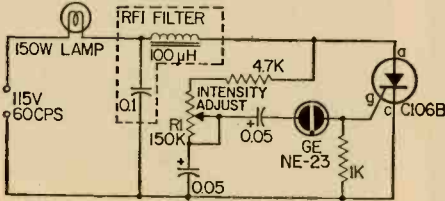

Lamp brightness is determined by the firing angle of the SCR, that is, the point during the a-c cycle when the SCR turns on and energizes the lamp. The firing angle of the SCR, in turn, is determined by the time-delay network R1 and .05 capacitors; the longer the time delay, the later the SCR fires and the lower the light output. Trigger energy for the SCR is provided when the neon bulb "fires" and discharges the two capacitors into the SCR gate.

Temperature Control. In this proportional temperature controller, a C106B SCR steplessly adjusts the voltage applied to a heater, so that heat supplied the liquid bath load exactly balances heat losses to the outside. In this way, bath temperature is held constant. This is a

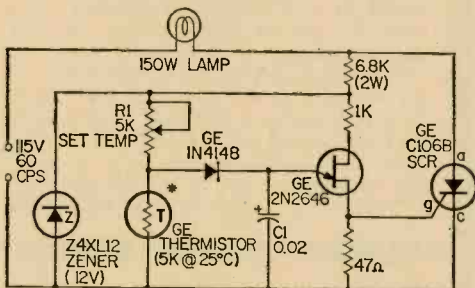

*REVERSE THERMISTOR AND R1 FOR COOLING LOAD
handy device to keep photo developer solution or aquarium water at the exact temperature.

Heater voltage is determined as follows: the earlier the SCR turns on during each cycle of the a-c supply voltage, the greater the voltage applied to the load. Conversely, the later the SCR "firing angle," the less the voltage applied. This principle is called "phase control."

SCR firing angle here is controlled by a sim-

ple R-C timed unijunction transistor oscillator. For a given potentiometer setting and capacitor value (R1 & C1), unijunction (UJT) frequency is determined uniquely by the resistance value of the load-monitoring thermistor. As the load temperature drops, the thermistor resistance rises, the UJT frequency rises and the SCR fires earlier in the a-c cycle. In this way the feedback loop is closed and more voltage is applied to compensate for the heat loss. By reversing the positions of R1 and the thermistor, the circuit will respond to a cooling (refrigerator-type) load.

Touch Switch or Proximity Detector. In the circuit below, the SCR is analogous to a simple wall switch that could be turned on by the weight of an alighting flea. Actually, the capacitance

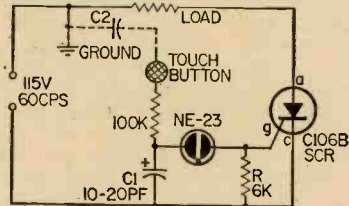

of the human body causes enough current to flow through the touch button to trigger the ultra-sensitive C106 SCR into conduction, thereby energizing the 150-watt load. Capacitor C1 and the body capacitance C2 of the operator form a voltage divider across the AC line. The voltage across C1 depends on the ratio of C1 to C2 and the line voltage. As soon as the voltage across C1 exceeds the breakdown voltage of the neon, capacitors C1 and C2 discharge through the SCR gate, causing the SCR to trigger and energize the load.

By making the area of the touch button much larger, the circuit will respond to the nearness (proximity) of an object, rather than to its touch. In this form, the circuit is suitable for such applications as burglar and other alarm systems, elevator and supermarket door openers and safety systems.

Shooting for the Moon With a Cube

Landing a light-reflecting cube on the moon's surface is being planned by both the United States and the U.S.S.R. in their space race. The device is called a corner reflector because it consists of half a cube, a small floor and two "walls" made of mirrors and precisely aligned. A corner reflector weighing only five pounds could do the job but one of 10 pounds would be more efficient.

The reflector would bounce back to earth an intense beam of laser light from the moon in the same way that radar waves are reflected from much closer objects—ships, airplanes and even satellites. The cube shape causes the light

to be reflected in exactly the same direction in which it entered. Since laser light is thousands of times more concentrated than the white light of a searchlight, the return from a corner reflector on the moon could easily be detected on earth. Picking up such a reflected laser beam would also be much more efficient for many important measurements than listening to the radio waves sent out by a microwave transmitter landed on the moon.

At least six experiments could be made by placing a corner reflector on the moon with one or more of the softlanding lunar vehicles now being planned. The experiments, reported in the *Journal of Geophysical Research* here, include:

1. *The size of the moon and its orbit.* A comparison of the measured and theoretical range over long periods can be used to measure the diameter of the moon at the position of the corner reflector and, also, to check on how accurately the lunar orbit is known. The accuracy of the moon's orbit as computed from earth is directly related to its composition.

2. *The size and shape of the earth.* Reflections of the laser beams from the moon made at the same time from several earth stations could show earth's size and shape more accurately than now available from globe-circling satellites. The laser ranging technique could also be used to establish a link between the U.S. and European geodesic networks.

3. *Wobble of the moon.* With three or more corner reflectors on the moon, whose ranges could be measured simultaneously from a single radar station, the amplitudes and periods of the moon's wobble or librations, could be measured with high accuracy.

4. *Determination of the world's standard of time, known as ephemeris time.* After the libations have been measured a corner reflector could be used as a reference point with respect to the background of stars in order to tell ephemeris time more accurately.

5. *Improvement of landing site location.* The laser light reflected from the device is returned essentially from a point, thus permitting accurate location of the reflector, relative to the known surface features, an aid in future landings.

6. *Detection of gravitational waves.* A series of measurements made over a long period of time could be searched for disturbances not otherwise accounted for by lunar theory. If such effects are found, they might be identified with gravitational waves.

New Automatic Dialer Uses Interchangeable Memory Tapes

A new automatic dialer with interchangeable cartridges holding 400 or 1000 telephone numbers is now being offered by the Bell System as part of its automatic dialer product line.

UNUSUAL BARGAINS

... MANY U. S. GOV'T SURPLUS

EXPLORE THE FASCINATING WORLD OF MAGNETISM



NEW 15 MAGNET SAMPLER KIT 11 SHAPES! MANY COMPOSITIONS!

Ever ripen tomatoes by magnetism—paint pictures using magnet as a brush and iron filings as paint? Surprising new ideas and uses for the bewildering forces of magnetism are continually discovered. Here, in one low-cost kit, you can learn and experiment with varied materials that obsoleted Magnetite—the natural magnetic ore. Terrific assortment includes ferrites, ceramics, flexible rubber, alnico in every shape imaginable—up to 20 lbs. pull. Used every day in the modern wonders of magnetic microphones . . . magnetic processing of bank checks . . . memory cores for electronic computers, flow meters, immense generators, transformers, motors, etc. All kinds of practical everyday uses, too. Make tool and knife holders, pick-up tools, bulletin boards, automatic stirrers, magnetic games and puzzles. Your own ingenuity can produce dozens of innovations—perhaps patentable.

Sizes range from $\frac{1}{4}$ " x $7/16$ " x $7/16$ " to 3" x 3" x $1/32$ ". Incl.: alnico w/handle, C-shaped alnico, three-2 sided ceramic, flexible strip, alnico bar, ceramic, alnico disc w/center hole, 2 lg. alnico cyl., sm. alnico cyl. flex. sheet, 2 baby alnico bar, 3-channel-type pole pieces for sm. ceramic magnets, bar magnet keeper, 2 disc magnet keepers, some info. and inst.

Stock No. 70,780-EK \$5.00 Ppd.

SOLVE PROBLEMS! TELL FORTUNES! PLAY GAMES! NEW WORKING MODEL DIGITAL COMPUTER

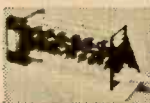

ACTUAL MINIATURE VERSION OF GIANT ELECTRONIC BRAINS

Fascinating new thought model computer actually solves problems, teaches computer fundamentals. Adds, subtracts, multiplies, shifts, complements, carries, memorizes, counts, compares, sequences. Attractively colored, rigid plastic parts easily assembled. 12 " x $3\frac{1}{2}$ " x $4\frac{3}{4}$ ". Incl. step-by-step assembly diagrams, 32-page instruction book covering operation, computer language (binary system), programming, problems and 15 experiments.

Stock No. 70,683-EK \$5.98 Postpaid

ASTRONOMICAL HEADQUARTERS U.S.A.

Keep Pace With the Space Age

Be ready for the moon shots. See the incredible wonders of the Universe. Choose the world's largest selection of telescopes and related equipment. Complete range of reflectors, refractors, panoramic, terrestrial, spotting, etc., ranging from advanced precision instruments to inexpensive build-your-own kits. Every accessory imaginable. Drives, mounts, finders, mirrors, eyepieces, lenses, filters, equipment for astro-photography, charts, maps, models, slides, study aids and classroom helps. Write for Free giant catalog "EK."

BRAND NEW, INDUSTRIAL SURPLUS NICKEL-CADMIUM CELLS AND BATTERIES BUY OF THE YEAR!

These hard-to-get, light-weight, 1.2V nickel-cadmium cells in rugged nylon cases have 4 amp. hour capacity. Hundreds of uses for hobbyists, amateur photographers, campers, model builders, etc. By connecting cells in series, you can make battery of any voltage in multiples of 1.2V. Excellent for rechargeable portable lanterns, cycle scooter, bicycle, and boat lights; camp lights; portable fluorescent and ultraviolet lights; electrical flash units. Model buffs will find cells perfect for powering model boats, cars, etc. Cells have almost unlimited life, will undergo thousands of discharge-charge cycles with practically no deterioration. Quick charge—1/2 hour with proper equipment, amount of electrolyte used; cell sealed to prevent loss. Delivers almost 100% of output at below freezing temperatures where output is reduced 50% in lead-acid cells. No corrosive fumes given off under any stage of recharge. Can't be damaged by accidental charging in reverse (but not recommended). Cell mass. 6 " x 2 " x $1\frac{1}{2}$ " thick. $8\frac{3}{32}$ oz. Stud-type terminals on top $1\frac{1}{8}$ " apart, marked for polarity; 6-32 thread, nuts and lock washers.

ONE 1.2 VOLT NICKEL-CADMIUM CELL
Stock No. 40,798-EK \$3.95 Postpaid

ONE 6-VOLT NICKEL-CADMIUM BATTERY

5-cells in stainless steel, strap-type casing. Convenient power source for Edmund's war surplus sniper scope (No. 85,157), 6 " x 2 " x 4 ". Wt. approx. 2 lbs.

Stock No. 70,776-EK \$15.00 Postpaid

7.2-VOLT NICKEL-CADMIUM BATTERY WITH CHARGER KIT

Assemble your own portable battery power supply with built-in charger. Excellent for portable movie light. Six-cell battery in stainless steel, strap-type casing; 12-volt transformer; charger circuit board with protective fuse; automatic recharging circuit (transistorized) consisting of rectifier and automatic regulator; Complete with wire, switch, line cord, hardware and instructions. 6 " x 6 " x 2 ". Wt. approx. 2 lbs.

Stock No. 70,777-EK \$25.00 Postpaid

Order by Stock No.—Send Check or M.O.—Money-Back Guarantee
EDMUND SCIENTIFIC CO., Barrington, New Jersey

MAIL COUPON for FREE CATALOG "EK"

EDMUND SCIENTIFIC CO., Barrington, N. J.
Completely New 1966 Edition. 148 pages.

Nearly 4000 Bargains.
Please rush Free Giant Catalog-EK

Name
Address
City Zone State



Magical dialer service enables calls to be made at the touch of a button and is designed to increase speed and efficiency in making phone calls. Names and telephone numbers are visibly indexed and easily recorded in the unit for automatic dialing. To make a call, first the desired name is located by use of a motorized scanner. The caller then lifts his receiver and presses the call button. The number is dialed automatically, eliminating both manual dialing and repeated searching for telephone numbers in a directory.

New names and numbers simply are written on the index and a handy plug-in dial is used to enter the number into the memory tape. Number changes are easily made by erasing the



MAGICALL automatic dialer service, now being offered by the Bell System, enables calls to be made at the touch of a button to increase speed and efficiency. Names and telephone numbers are visibly indexed and easily recorded in the unit for automatic dialing.

listing, writing in the new listing and dialing in the new number. In the process, the old number is automatically eliminated.

The Bell System reports that automatic dialing service by means of devices such as *Magical* makes telephoning easier and more accurate. It helps to organize telephone calling, reduce fatigue and increase efficiency. It is especially useful for sales and reservation personnel, dispatchers, wholesalers, bankers, brokers, retailers and others who use the telephone frequently. To one who makes an occasional call, the dial system is quite a convenience; but when a large part of your job is placing calls, it's another thing.

Magical service can be used to dial local, long distance or internal calls. It is available in colors to match present telephone equipment. Further information on the new *Magical* dialer can be obtained by contacting your local Bell System business office

Teaching Aids on Semiconductors and Crystals

Three new Bell System science teaching aids are now being introduced to the nation's high school teachers. The new science aids include two units designed for the teacher to use with the entire class, and a self-contained science experiment for the unusually able or interested student.

One of the new teacher-oriented units explores semiconductor physics, a subject of increasing importance in science and technology. It includes a book for teachers and students about electrical conduction, a manual of experiments designed to acquaint the class with the principles of electrical conduction and semiconductor action, and a device for demonstration of the basic properties of semiconductors, conductors and nonconductors.

A 15-minute color film, "The Genesis of the Transistor," has also been produced for the unit. The film tells the story of the discovery of the "transistor effect" and subsequent invention of the transistor. Done in direct, documentary style, it places emphasis on experimenting rather than on details of experiments.

The other teacher's aid being introduced in the new program is a rotary crystallizer tank, a precision apparatus in which a class can grow large, nearly perfect crystals of various water soluble salts such as sodium chlorate or nickel sulfate.

The new experiment for advanced students



DEMONSTRATION APPARATUS included in the semiconductor physics unit of the Bell System Aids to High School Science offering provides a simple means of showing the basic properties of semiconductors, conductors, and non-conductors. The device demonstrates phenomena such as the temperature coefficient of resistance, rectification, and thermal effects.

also concerns crystallography although it teaches about light as well. It is in kit form with parts the student can assemble into a simple polarizing microscope; samples of mica, calcite, ADP and several other crystalline materials with which the student can experiment; a book of experiments; and a reference book. The unit is called "Experiments with Crystals and Light."

Classroom materials introduced in the past three years are also available through local Bell Telephone business offices. These are called "Similarities in Wave Behavior," "Theory of Ferromagnetic Domains" and "The Speech Chain."

Other experiments for advanced students, also available through Bell companies, are "From Sun to Sound," "Solar Energy Experiment" and

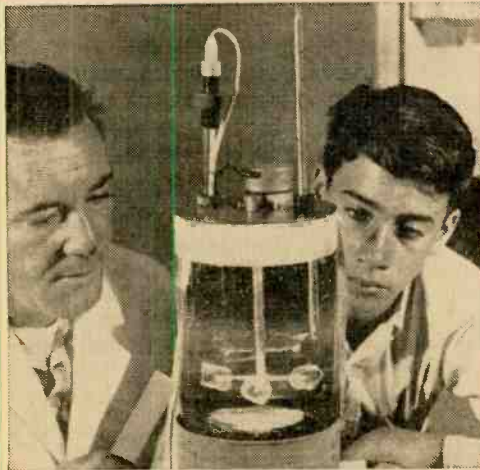

FOR USE in the study of crystallography, one of the new Aids to High School Science subject areas, this small "rotary crystallizer" tank is a precision apparatus which enables the class to grow large, nearly perfect crystals of substances such as sodium chlorate or nickel sulfate.

"Speech Synthesis Experiment." More than 120,000 of these three units already have been given by phone companies to teachers for their budding young scientists.

Bell's "Aids to High School Science" program last year won the National Science Teachers Association's Business-Industry Section award for "excellence in industrial aid to education."

Some independent telephone companies have also made arrangements to make the teaching aids available to schools in their communities. For more information about this program contact your local Bell Telephone office or write to Mr. D. A. Johnson, PR Dept., American Telephone and Telegraph Company, 195 Broadway, New York, New York 10007. Be sure to mention *Elementary Electronics*.

"TAB", SILICON 750MA* DIODES Factory Tested!

*NEWEST TYPE! LOW LEAKAGE Gtd.!

Piv/Rms 50/35 .05	Piv/Rms 100/70 .09	Piv/Rms 200/140 .12	Piv/Rms 300/210 .14
Piv/Rms 400/280 .15	Piv/Rms 500/350 .19	Piv/Rms 600/420 .23	Piv/Rms 700/490 .27
Piv/Rms 800/560 .35	Piv/Rms 900/630 .45	Piv/Rms 1000/700 .55	Piv/Rms 1100/770 Query

ALL TESTS AC & DC & FWD & LOAD!
1700Piv/1200Rms @ 750Ma \$1.20 @.10 for \$10
same 1100Piv/770Rms 75c @.16 for \$11

SILICON POWER DIODES STUDES & P.F.**

D.C. Amps	50 Piv 35 Rms	100 Piv 70 Rms	150 Piv 105 Rms	200 Piv 140 Rms
3	.08	.14	.17	.24
12	.30	.55	.70	.85
18**	.29	.30	.50	.75
35	.70	2.05	1.35	1.50
100	1.65	4.00	2.50	3.15
240	3.75	1.75	5.75	8.75

D.C. Amps	300 Piv 210 Rms	400 Piv 280 Rms	500 Piv 350 Rms	600 Piv 420 Rms
3	.29	.30	0	.48
12	1.00	1.35	1.45	1.70
18**	1.00	1.50	Query	1.70
35	2.15	2.45	2.75	3.33
100	3.75	4.60	5.50	8.00
240	11.70	19.80	27.90	Query

Battery Charger 6 & 12 V Charges up to 5 Amp with Circuit Breaker \$8 @.2 for \$15.
D.C. Power Supply 115v/60 to 800 Cys. Output 330 & Tap 165v up to 150Ma \$5 @.2 for \$9.
3000Piv/2100Rms @ 200Ma \$1.80 @.6 for \$10.
6000Piv/4200Rms @ 200Ma \$4 @.4 for \$15.
12000Piv/8400Rms @ 200Ma \$10 @.3 for \$25.
5U4 Silicon Tube Repl. \$1.90 @.6 for \$11.

"TAB" ★ SCR's ★ TRANSISTORS ★ DIODES!!!

Full Leads Factory Tested & Gtd! U.S.A. Mfg.
PNP/HiPower/15 Amp Round T036 Pckg! 2N441.
442, 277, 278, D5501 up to 50 volts VCBO \$1.25 @.5 for \$5
2N278, 443, 174 up to 80v @.2 for \$5
PNP Diamond/3A-2N155, 156, 235, 242, 254, 255.
256, 257, 301, 351, \$35 @.4 for \$1
PNP/Signal up to 350Mw T05 c25 @.8 for \$1
NPN/Signal IF, RF, OSC, TOS, OVS, c23 @.6 for \$1
PNP 2N670/300Mw c35 @.4 for \$1
PNP 2N671/1 watt c50 @.3 for \$1
Power Heat Sink Finned 100 Sq 51 @.6 for \$5
STABILISOR Diodes Fwd Regulators. .1 watt 5 for \$1
Zener Diodes up to One Watt 6 to 200v c70 @.3 for \$2
Zener Diodes Ten Watt 6 to 150v \$1.45 @.4 for \$5

Sil Preset 18A up to 100 Piv. .4 for \$1
Micro or MuSwitch CSD 35 Amp/AC-DC .3 for \$1

"SCR" SILICON CONTROLLED RECTIFIERS!

PRV	7A	16	25A	PRV	7A	15A	25A
25	.30	.50	.85	250	1.85	2.25	2.60
50	.50	.75	1.00	300	2.00	2.45	2.80
100	.90	1.30	1.60	400	2.50	2.90	3.35
150	1.00	1.65	2.00	500	3.25	3.60	4.00
200	1.30	1.90	2.30	600	3.50	4.35	4.60

"Volt-Tab" 600 watt "SCR" speed control 115 VAC \$4.50 @.2 for \$8.00

"TAB" TERMS: Money Back Guarantee! Our 20th year. \$2 Min. order F.O.B. N.Y.C. Add shpg charges or for C.O.D. 25% Dep. Prices shown subject to change.

111-W5 Liberty St., N. Y. 6, N. Y.
SEND 25¢ Phone: REctor 2-6245 for CATALOG

A JOB or a POSITION ?

The difference is **ELECTRONIC MATHEMATICS**

NOW! A NEW WAY TO LEARN—I. H. S. I. WAY. A complete home study course in electronic math to help you get the position you want—MORE MONEY—MORE RESPECT.
COURSE PREPARED BY COLLEGE PROFESSORS who have lectured to thousands of men on math and engineering. You learn at home quickly, easily—AS FAST as you want.
YOU SIGN NO CONTRACTS
Pay only if satisfied—you owe it to yourself to examine the INDIANA HOME STUDY INSTITUTE COURSE IN ELECTRONIC MATH.
FREE BONUS—if you join now, a refresher course in basic arithmetic.

Write for Brochure—No Obligation
THE INDIANA HOME STUDY INSTITUTE
Dept. EE-W, P. O. Box 1189
Panama City, Fla. 32402

HI-FI Devotees!

Send for the magazine you've been waiting for! The new "HI-FI BUYERS' GUIDE" gives impartial, complete test reports on new equipment. Yours for only \$1.25 (plus 25¢ for postage and handling). Write: Davis Publications, 505 Park Avenue, New York, N. Y. 10022.

Quartz Arc Lamp For Home Projectors

A new projection lighting system producing up to four times the screen brightness of current 8mm and 16mm systems has been developed by the General Electric Company's Photo Lamp Department. The new system called "MARC-300" consists of a two-inch-long, 300-watt quartz arc lamp and a power supply unit. The lamp itself, under development by General Electric for the past several years, is small enough to permit minimum redesign of current projectors for its use. It looks like an ordinary tubular quartz lamp except for a half-inch bulge near one end. The bulge is the "arc chamber" where the light is produced. The power supply unit, which starts the lamp and controls it during operation, weighs about 25 pounds. It may be used as a base under the projector or close to the projector. In screen brightness, MARC-300 "out-shines" current 1,000-watt incandescent systems by up to 400%.

The experience of seeing MARC-300 projection for the first time is truly exciting, even for professional users. The whites, in particular, are made so much more brilliant and crisp. All the



FOUR TIMES as bright as current 1,000-watt incandescent projection light sources is this new 300-watt quartz arc lamp developed by the General Electric Company's Photo Lamp Department. The lamp is part of "MARC-300", a revolutionary new G-E projection lighting system which includes the lamp shown here, a power supply unit and accessories.

darker colors seem to come to life too. Demonstrated in side-by-side tests with a standard 1,000-watt 16mm projector, MARC-300 shows its added brilliance most dramatically.

Because of its added brightness and smaller source size, MARC-300 will increase the range of applications of all projectors, both movie and still, in which it is used. 16mm projectors with MARC-300 would, for instance, be suitable for use in the smaller theaters. In this application, MARC-300 would reduce projection operating costs by eliminating the need for skilled projectionists and extensive maintenance procedures.

The lamp provides a brilliant source of light about the size of a drop of water. Because of

its ultra small arc chamber with its uniform brightness, MARC-300 permits smaller and less complex optics than other systems. Key to the high brightness of MARC-300 is the lamp's super-bright gaseous atmosphere caused by the intense level of electric discharge between two molten electrodes. In spite of its high brightness, MARC-300 requires little cooling. As a result, this 300-watt source permits more cooling air to be diverted to the film and projector parts than possible with 1,000-watt systems.

Intercontinental TV Comes First from an Early Bird

Television may be the catalyst that makes the average citizen and taxpayer feel that he has a personal stake in the space age. This is the feeling of Hughes Aircraft Company scientists in Los Angeles, who designed and built Early Bird, the world's first commercial satellite, for the Communications Satellite Corporation—better known as Comsat.

Because it is in high-altitude orbit synchronous with the earth's rotation, Early Bird can transmit TV at any time during the 24-hour day. Previous transatlantic TV transmission has been over medium-altitude satellites that swoop over the horizon so fast that they are usable only a limited amount of time. Comsat officials conducted a successful "sneak preview" television

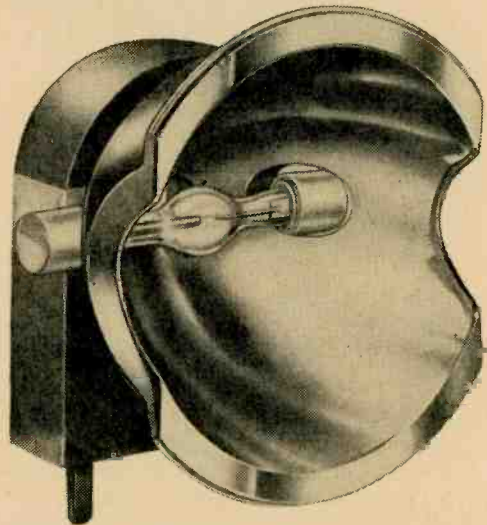

BUSINESS END of General Electric's revolutionary new "MARC-300" projection lighting system is the 300-watt quartz arc lamp shown here with its reflector and base. MARC-300 "out-shines" current 1,000-watt incandescent systems by up to 400% in screen brightness.

test over Early Bird a few days after launch to prove it was ready to carry the big inaugural TV show and later made further tests from the Andover, Me. ground station in preparation for continent-to-continent telecasting. The success of Early Bird's launch and delicate positioning into a stationary orbit followed similar space-age successes by the Hughes-NASA Syncoms 2 and 3, still operating over the Indian Ocean and the Pacific. Syncom 3, known as the "Olympic Star," carried live coverage of the Olympic Games opening ceremonies.

Dr. Harold A. Rosen of Hughes Aircraft, Early Bird's principal inventor, said that an advanced version of the satellite weighing 1,550 pounds could transmit perfect color or black and white TV pictures direct to home rooftop dish antennas to any area of the world, however remote. He added that a TV network could own and operate its own satellite for an investment of about \$10,000,000 including cost of launch and orbit support. That's less than it took to buy the New York Yankees, who also fly pretty high—except in 1965.

The currently-operating Early Bird can handle two-way television or alternately carry 240 two-way telephone conversations plus teletype and photo facsimile. . . . An advanced version with more capacity, now under development, will be able to handle TV, telephone calls, teletype and facsimile at the same time.

Early Bird provides 240 two-way telephone

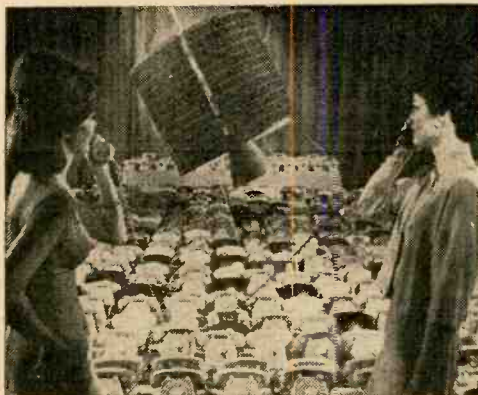

ALLO ALLO?; Pronto, Chi parla?; Wie geht es?; Digame?; Smith here; Hello --An international linguistic flavor is symbolized by two pretty misses and the Early Bird synchronous communications satellite, shown symbolically hovering over 480 telephones at Hughes Aircraft Company, Los Angeles, Calif. Hughes built "Public Satellite No. 1" for the Communications Satellite Corporation, agent for a world consortium of more than 40 nations, to provide 240 two-way telephone channels between Europe and North America, linking 85 per cent of the world's telephones 24 hours a day.

NOW — BUILD ANY CIRCUIT IN ONLY 2 EASY STEPS WITH VEROBOARD KIT MODEL BK-6

NO MORE ETCHING, WIRES OR TERMINALS!

Now — for the first time you can build circuits for ANY electronic project faster, easier and more economically than ever before and achieve real professional results.

Veroboard* is the newest, most advanced method of circuit construction yet developed — with Veroboard you design your component layout directly on the board and solder... that's all there is to it!

This all-new Veroboard kit contains 6 Universal wiring boards and spot face cutter with instructions for use.

Order your kit today — save hours of construction time.

AVAILABLE FROM LEADING DISTRIBUTORS OR DIRECTLY FROM VERO ELECTRONICS.

*Patented

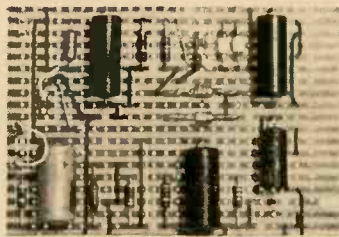

STEP NO. 1

Layout components on the back (plain) side of the Veroboard across the copper strips inserting leads into appropriate holes. You have now connected your components as required using the copper strips as your interconnectors. Leads may be soldered directly to the strips using a light, printed circuit type iron. Careful soldering will enable you to remove components and replace them if required.



STEP NO. 2

Break the circuit where required by breaking the copper strips with the Vero spot-face cutter provided in your kit. The cutter is a precision, hardened steel tool which has a pilot pin that fits into any hole, and two cutting edges. Simply turn the cutter several times and the copper strip in the area of the chosen hole will be removed. Your circuit is now complete.

\$5.95
COMPLETE

N.Y.S. Residents Add 2% Sales Tax

TO: VERO ELECTRONICS INC.

48 ALLEN BLVD., FARMINGDALE, N. Y.

PLEASE SEND VERO BK-6 KIT. I AM ENCLOSING CHECK (OR MONEY ORDER) FOR \$5.95.

NAME _____

ADDRESS _____

ZIP _____

NEWSCAN

channels between Europe and North America 24 hours a day, linking 85 per cent of the world's telephones. This traffic capacity is as much as the first three cables under the Atlantic, which required 10 years to lay. The next satellite of the Early Bird series, now under construction at Hughes Aircraft, would carry more telephone traffic than all the cables in all the oceans of the world.

Early Bird is a stationary satellite that orbits 22,300 miles high at a speed synchronous with the earth's rotational rate. It thereby appears to "hover" in a fixed position in the sky, visible 24 hours a day from ground stations. Three satellites of the Early Bird type, launched to positions equidistant around the earth, could provide round-the-clock communications that cover the globe except for the remote polar regions.

Ground stations that form part of the currently-operating Early Bird network are at Andover, Maine; Goonhilly Down, England; Pleumeur Bodou, France; Raisting, Germany; Fucino, Italy; and Mill Village, Nova Scotia. Another is being built in Spain.

The 80-pound drum-shaped Early Bird is only 24 inches high and 28 inches in diameter. It wears a coat of 6,000 tiny solar cells that convert the sun's energy into electrical power to operate the spacecraft's electronics. Its only moving

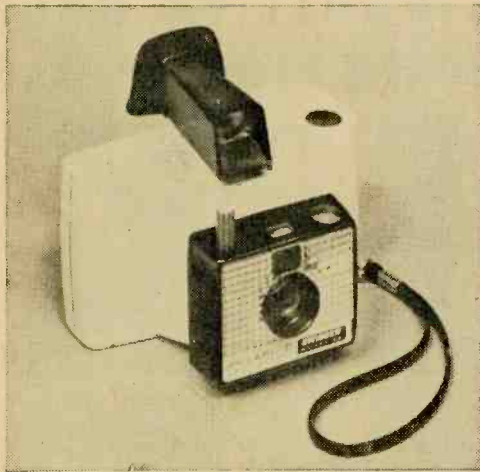

MEET THE SWINGER, the new Polaroid Land Camera for under \$20 which produces a finished, black-and-white picture in just 10 seconds. To take a picture, the user first looks into the lower of two windows in the viewfinder and squeezes a red knob on the camera. If he sees the word "NO," he simply turns the knob until the word "YES" appears, indicating exposure setting is correct. He then pushes down this same knob to snap the picture.

parts are four jet valves—a simplicity of design that provides great reliability.

Here's a Photometer In Your Eye

A unique system for determining proper picture-taking exposure was invented for the Swinger, the brand new Polaroid Land Camera, Model 120, which produces 2½ x 3¼" black-and-white prints in 10 seconds. The exposure setting system in the Model 20 Land Camera relies on a highly sensitive detector of comparative light intensities—the human eye. The camera uses a built-in standardized light source as a reference, for comparison with illumination from the scene to be photographed.

The photographer, whose eye is capable of detecting even slight differences in luminous intensities, compares the reference illumination with illumination from the scene, and balances the two to set the correct exposure. Shutter speed in the Model 20 is fixed at 1/200th sec.

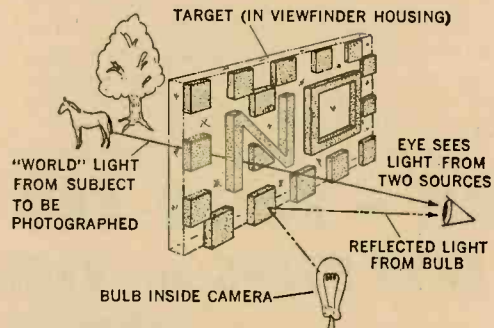

FIG. 1. The action of the integrating photometer is illustrated in this drawing. The eye compares the intensity of the light from the subject with light reflected from target.

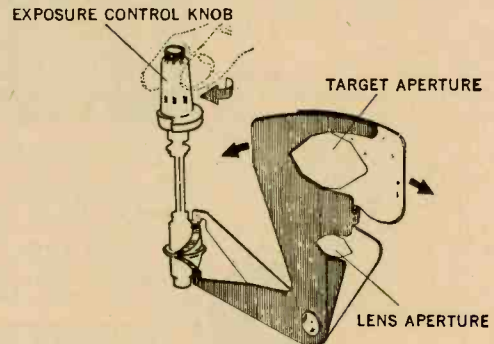

FIG. 2. The action of the exposure control knob is illustrated here. The target and lens aperture are ganged. When aperture is adjusted so target light intensity equals reflected light from bulb, the YES will become visible to the eye.

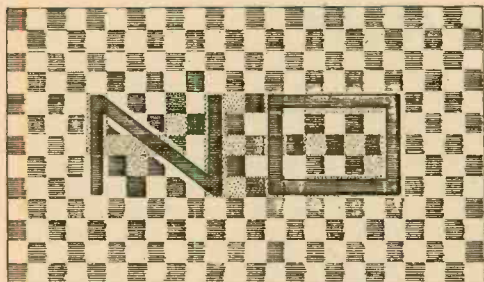

FIG. 3. With inadequate aperture opening, the camera "tells" you not to shoot your picture.

The aperture is continuously adjustable from $f/17$ to $f/96$.

To set the camera for correct exposure, the photographer looks into the lower of two windows in the viewfinder housing. The word *NO* is visible. The photographer then turns a red knob on the shutter housing until *NO* fades out and the word *YES* becomes clearly visible. That's when exposure setting is correct.

To perform this transformation, the Model 20 uses a built-in integrating photometer—an instrument for comparing the luminous intensities from two sources of light. Within the Model 20 is a tiny "grain of wheat" bulb which illuminates a special *YES/NO* target. The second source of light comes from the scene. This outside or "world" light enters the camera and strikes the opposite side of the target as indicated in Fig. 1. The "world" light is transmitted through portions of the target. The light from the bulb is reflected. The system relies upon the balancing of transmitted and reflected illumination to achieve the correct aperture setting.

Squeezing the exposure control knob closes a

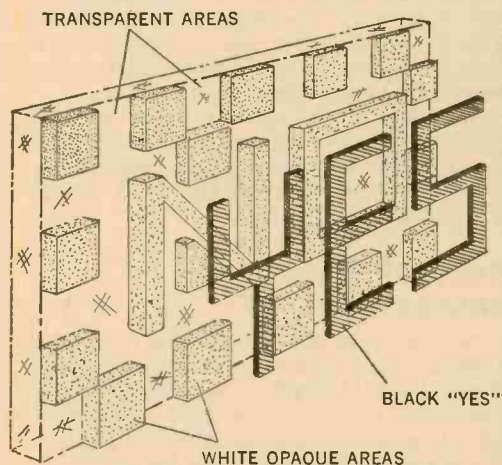

FIG. 4. The *YES* merges into prominence when the aperture setting is OK for thumbs-up shooting. With this new exposure setting technique it's impossible to goof a shot.

FREE GIANT NEW CATALOG

100'S OF BARGAINS NOT IN ANY OTHER CATALOG

TOP VALUES IN POWER & HAND TOOLS

TUBES PARTS ETC. AT LOWEST PRICES

EVERYTHING IN HI-FI AND STEREO

SAVE UP TO 50% ON CHOICE KITS

SAVE ON CAMERAS FILM & PHOTO EQUIPMENT

100'S OF BIG PAGES CRAMMED WITH SAVINGS

BURSTEIN-APPLEBEE CO.

Dept. EEX, 1012 McGee, Kansas City, Mo. 64106

Rush me FREE 1966 B-A Catalog.

Name

Address

City State

Please be sure to show your Zip No.

SEND FOR IT TODAY

FREE

Olson

* FREE

Fill in coupon for a FREE One Year Subscription to OLSON ELECTRONICS' Fantastic Value Packed Catalog—Unheard of LOW, LOW PRICES on Brand Name Speakers, Changers, Tubes, Tools, Stereo Amps, Tuners, CB, and other Values. Credit plan available.

NAME

ADDRESS

CITY ZONE STATE

If you have a friend interested in electronics send his name and address for a FREE subscription also.

OLSON ELECTRONICS INCORPORATED

404 S. Forge Street Akron, Ohio 44308

you're MISSING SOMETHING if you miss

RADIO-TV EXPERIMENTER

Each issue, and issue after issue of **RADIO-TV EXPERIMENTER**, keeps you posted on the latest innovations in the constantly changing and exciting world of electronics.

No matter what your electronic interest, whether you just dabble, or make your living at it, either way you'll find **RADIO-TV EXPERIMENTER** edited in a way that helps you best.

A subscription today will assure you of not missing anything that is interesting in electronics. For if it's interesting, it's bound to appear in **RADIO-TV EXPERIMENTER**.

ONLY \$4.00 PER YEAR. \$7.00 FOR 2 YEARS; \$10.00 for 3 YEARS

MAIL THE COUPON TODAY

RADIO-TV EXPERIMENTER
505 Park Avenue
New York, N. Y. 10022

EE-965

Please begin my subscription with the next issue for _____ year(s).

Payment enclosed

Bill me

Name (PLEASE PRINT) _____

Address _____

City, State, Zip Code _____

NEWSCAN

set of contacts, switching on a tiny battery-powered bulb, whose light reflects off the YES/NO target to the eye of the viewer. This reflected light does not change in intensity. Turning the same knob causes two apertures to open or close (Fig. 2). The two—the target aperture, and the lens aperture—are coupled. The target aperture controls the “world” light reaching the YES/NO target; the lens aperture is a factor (along with the shutter speed) in determining the exposure of the picture. The camera calibration is such that the correct lens aperture occurs when target illumination from transmitted “world” light and reflected “inside” light are equal. It is at this balance point that the NO portion of the target becomes indiscernible to the eye, leaving the YES to indicate correct exposure setting.

The key link in the system is the target. The NO image (with its accompanying checkerboard pattern) is both white and opaque. Superimposed over this is the YES, which is black. The remainder of the target is transparent. Figs. 3 and 4 below shows the elements of the target, exaggerated for clarity. The white opaque portion of the target reflects inside light and does not pass “world” light to the eye. “World” light does, however, travel through the transparent areas of the target, and by raising or lowering the intensity of this outside light, the brightness of the transparent area can be made to virtually match that of the reflecting area. The NO thus becomes indistinguishable to the eye.

The YES doesn't suddenly materialize at the correct exposure setting; it is always present, and hence must be “hidden” until needed. The shapes of the letters as well as the checkerboard pattern serve as camouflage. Even though the YES is always present, the elements behind it must blend into a nearly uniform backdrop to make YES clearly discernible to the eye.

To minimize the spectral (color content) problems inherent in matching outside or “world” light with the camera's tungsten filament light, the observer views the target through a red filter.

State-Wide Educational TV

The University of North Carolina is spending \$380,600 to provide a statewide microwave relay system for its educational television network. The North Carolina educational TV network will be one of the most extensive in the nation. It will stretch 460 miles across the state from the seacoast to peaks of the Great Smoky Mountains on the state's western border. The new system will employ 18 microwave relay terminals and repeaters to extend the program.

(Continued on page 32)

FREE!



send today for your

ALLIED 1966 CATALOG

508 VALUE-PACKED PAGES
world's biggest selection

SAVE MOST ON:

Stereo Hi-Fi

Tape Recording

CB 2-Way Radio

FM-AM & AM Radios

Portable TV • Phonographs

Short Wave & Ham Gear

Automotive Electronics

Test Instruments

TV Tubes & Antennas

Power Tools, Hardware

Parts, Tubes, Transistors

NEW in the wonderful world of *knight-kits*®

See the latest solid-state stereo hi-fi, advanced CB 2-way radios—complete selection of electronic kits for every need, including Hobby, Short-Wave, Amateur, Automotive, Intercom, Test Instrument—wonderfully easy to build.



SEND COUPON TODAY!

EASY TERMS:

Use the Allied Credit Fund Plan—over 24 months to pay.

*satisfaction guaranteed
or your money back*

ALLIED RADIO
world's largest electronic supply house

ALLIED RADIO, Dept. 51-K
100 N. Western Ave., Chicago, Illinois 60680

Send FREE 1966 Allied Catalog

Name _____
PLEASE PRINT

Address _____

City _____ State _____ Zip _____

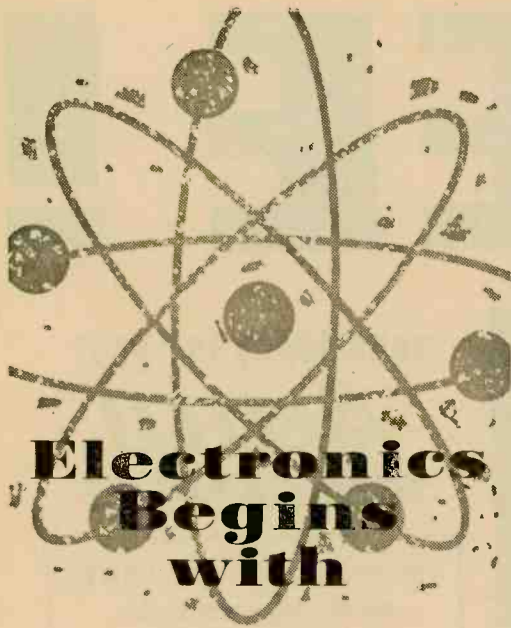

Electronics Begins with

ELEMENTARY ELECTRONICS

There's no better way of becoming acquainted, and keeping up-to-date on the exciting world that is electronics, than through the pages of

ELEMENTARY ELECTRONICS

And now this highly informative and easy-to-read magazine is being published more frequently—every other month!

So don't take a chance of missing a single copy of **ELEMENTARY ELECTRONICS**.

Subscribe today and save money! Only \$4. (\$4.50 at the newsstand)

MAIL THE COUPON NOW

Elementary Electronics
505 Park Avenue
New York, N. Y. 10022

EE-965

Urgent! Please begin my subscription with the next issue. 1 year: \$4; 2 years: \$7; 3 years: \$10.

Payment enclosed \$_____ Bill me

Name _____ (please print)

Address _____

City _____

State _____ Zip Code _____

NEWSCAN

(Continued from page 28)

ming of the state's present network which interconnects studios at Raleigh, Chapel Hill, and Greensboro with a transmitter in Chatham County. The new transmitting system will employ microwave relay stations on hilltops located from 14 to 44 miles apart.

Raytheon microwave equipment will make it possible for educational and cultural programs originating at the state university or other points along the route to be carried across the state so that other educational broadcasting stations can air the programs. The first of these additional stations are planned for Columbia, Concord, Linville and Asheville. Officials of the University of North Carolina, operators of the present network which is to be expanded statewide, hope eventually to make it possible for educational programs to be presented simultaneously in every classroom in the state (with uniform high quality) and homes in the area.



System engineering and construction of the equipment has begun at Raytheon Company's Communications and Data Processing Operation, Norwood, Mass. The microwave relay equipment to be supplied is an advanced solid state design. Through the use of infrared testing of component parts, the new relay equipment is covered by the industry's only five year warranty.

Starting at Columbia near the shoreline and within television range of Cape Hatteras, the chain of relay stations includes Plymouth, Williamston, Greenville, Farmville, Wilson, Smithfield, Raleigh, Chatham, Cane Creek, Greensboro, Lexington, Salisbury, Concord, Hickory, Linville, Clingman's Peak and Mount Pisgah, in the Great Smokies.

The Raytheon Company recently completed a similar system for the University of Maine where five educational television stations in Maine, New Hampshire and Massachusetts were linked together to extend educational TV programming in New England. ■

For outdoor fun, read CAMPING JOURNAL, Nov.-Dec. Issue. Only 75¢ at newsstands everywhere.

Test Equipment—

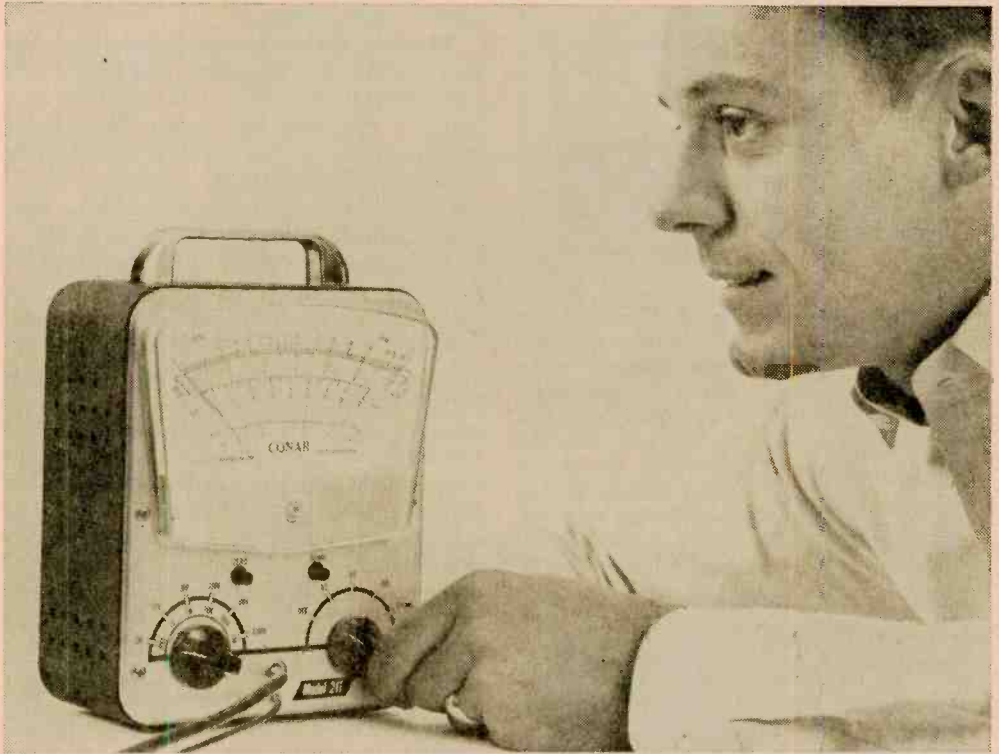

Tools of the Trade By J. B. Straughn

CHIEF, CONSULTATION SERVICE, NATIONAL RADIO INSTITUTE

Test instruments are as basic to your practical work as Ohm's law is to theory

■ Right in the middle of a long pass play to a six-six, fleet-footed end 45 yards down field—your TV *quits*. No smoke, no *pops* or *sizzles*, no bright arcs—nothing—the set just goes dead during the first five minutes of the first quarter of the year's biggest pro football game. The chances are one of the filaments in the series vacuum tube chain has opened. With an ordinary VOM you can find the defective tube in two minutes and replace it with a new one from the corner "drug" store in 15 minutes. Result, you only missed the first quarter and one 6 pointer. But if you are one of those "theory only" gents—bye-bye ball game. All the theory in the world can't help you if you don't own and know how to use basic test instruments such as the multimeter (VOM), VTVM, scopes, signal generators, tube testers and the like. We can't twist your arm and make you buy test

gear, but we can describe the most essential test instruments.

The Multimeter. The multimeter is four instruments in one, consisting of a voltmeter to measure DC voltage, a voltmeter to measure AC voltage, an ohmmeter to measure resistance, and a milliammeter to measure current. Some multimeters have, in addition, an ammeter to measure large DC currents.

Widely different voltage, current, and resistance values exist in radio and TV receivers. DC voltages may range from a fraction of 1-volt to as much as 650 volts; AC voltages from 2 to 700 volts; resistances from a fraction of an ohm to as much as 20-million ohms (20 megohms). It is impossible to read such widely different values on a single range, so most multimeters have a system of overlapping ranges to provide full coverage.

One of the major differences between mul-



Fig. 1. Various types of multimeters illustrate different methods of range selection. Inter-Tech unit in (1) uses different jacks; (2) has a selector switch; (3) has push-button switches. The V O Matic in (4) has selector switch.

timeters is the means used to convert them from one use and range to another. Some use a series of jacks into which the test leads are plugged, others use selector switches, push buttons, or combinations of these methods.

Several typical multimeters, all of which are adequate service instruments, are shown in Fig. 1. Whatever type you choose, you must know three things before you can use the instrument to test the circuit or a part. One: where to connect it; two: how to read the meter scale; and three: how to interpret the readings you get.

Interpreting the readings is sometimes simple, sometimes difficult, depending on

what you are testing. Let us concentrate here on how to handle the equipment, how to connect it to obtain proper readings and how to read the meter. Study and experience will enable you to learn how to interpret the results of your readings.

Reading Meter Scales. Before you connect a meter to any source and before you can interpret the results, you must be sure that you can read the meter. The pointer moves over a card on which are printed the various scales provided for the meter. Reading such a meter is really less difficult than telling time by clock, once you have had a little experience. Figs. 2A, 2B and 2C show three typical meter scales. They could be for either voltage or current values.

Naturally, you have no trouble reading the values that are marked, but there is not room enough to place the proper numerical values opposite each division on the scale. Thus, you must find out what each division represents before you can read values that fall between the numbers. To do this, count the number of division lines between any two marked divisions, starting with the line after one marked division and continuing through the next marked division. Then, divide this number into the numerical difference between the two divisions. This will give you the value of each division. In Fig. 2A, for example, there are ten divisions from the one marked 20 up to and including the one marked 30. The numerical difference between 20 and 30 is also 10. Hence, each of the line divisions represents 1 (10 divided by 10 = 1). If you want to find, say 23 on

Fig. 2. The scales in A, B, and C are representative of the types you will encounter on various meters. Determining the value of each division can be done at a glance once you have used a particular scale a few times.

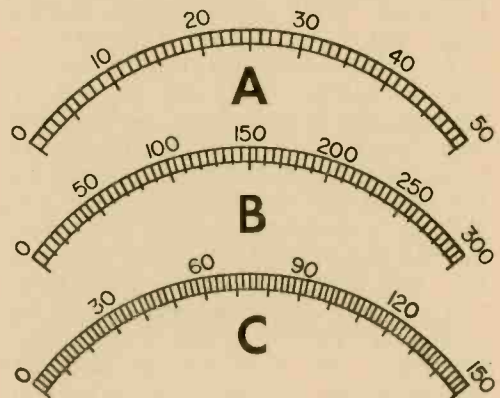

the scale, you need only count three divisions past 20.

In counting the marks, you will find that every fifth one is a heavier (thicker) line. This makes it easy to find points like 5, 15, 25, etc. Practice this on the scale by finding various values.

In Fig. 2B, we have a somewhat different scale. Let's see what each division represents, following the rules we just developed. Between 50 and 100 there are ten marks (including the mark for 100) and the numerical difference between 50 and 100 is 50. Dividing this difference by the number of scale divisions, we find that each division represents 5 (50 divided by 10 = 5). Thus, 65 is three divisions past 50, 205 is one division past 200, etc. Notice that every other division is made longer so that it is easy to find numbers like 60, 70, 80 and 90.

Take a look at Fig. 2C and figure out the value of the main divisions and the value of each scale division to test yourself before reading on.

Using the same method here as before, we find the difference between two numbered values, such as 60 and 90. The difference between these is 30. There are 15 divisions from 60 up to and including 90. Dividing 30 by 15 gives 2, so each division represents 2. Thus, reading each division from 60, we have 62, 64, 86, 88, and 90. The two heavy division lines are at 70 and 80.

Reading In-Between Values. Once you know what each division on a scale represents, it is easy to estimate the readings with the pointer in between two divisions. Suppose, for instance, the meter pointer moved to a position half-way between 90 and 92 (the first division to the right of 90 in Fig. 2C). Although there is no division line there, you know the reading must be 91.

As we will show, you need not read a meter too closely for service work. In fact, it is all right to estimate meter readings roughly when the pointer does not fall directly on a division line. Close meter readings are unnecessary because the value of voltage, current or resistance, in most cases, may be off as much as 20 percent from the rated value without affecting the operation of the circuit very much.

Multiple Ranges. In Fig. 3 we have the same scale as in Fig. 2C with a new 0-75 range added. (It is very common to find two or three ranges used with each scale of a meter.) To find the value of each scale division with the new range, proceed exactly

as before, forgetting all ranges except the one in which you are interested.

There are 15 divisions between 30 and 45 (on the 75-volt range) and the numerical difference between 30 and 45 is also 15, so each division represents 1. Thus, to find 34 on this range, you would count four divisions past 30. Each heavy division line represents 5.

Scale Multiples. Here is another point you should understand clearly. In Fig. 2A we have a scale marked 0 to 50, but the meter using it may have a 0-500 range in addition. Will there be another scale of 0-500? No, because this would unnecessarily clutter up the meter dial. You can use the 0-50 scale for the 500 range, simply by mentally adding a 0 to each reading. This is the same as multiplying each reading by 10. Thus 10 becomes 100, 20 is 200 and so on. The in-between values are stepped up by the addition of a zero, each division now representing 10 instead of 1.

In much the same way the 0-150 scale in

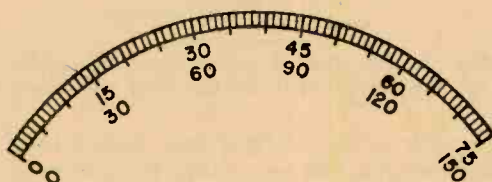

Fig. 3. Multiple range scales are the rule on meter faces; they allow greater utilization of the limited space. Just use the scale that corresponds to the range setting of the selector switch, pushbutton, or jack.

Fig. 2C may be used for 0-15. Here you should "knock off" a zero from your reading or, more technically, "move the decimal point one place to the left." Thus, each division, formerly equal to 2, is now equal to .2 (2/10), and the 30, 60, 90, etc., readings now become 3, 6, 9 etc. Starting at zero and going to 3 the values now are in increments of .2.

Non-Linear Scales. The scales in Figs. 2 and 3 are called linear scales because the divisions are spaced equal distances apart. That is, the distance between 100 and 150 in Fig. 2B is the same as that between 200 and 250, or between zero and 50 on this same scale. But, this is not always true, particularly in the case of ohmmeter scales on which the readings may be crowded or bunched up at one end of the scale. This is clearly shown in Fig. 4A; here the readings are spread out on the right half of the scale and are bunched

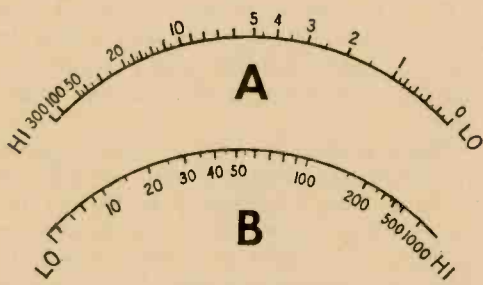

Fig. 4. You'll be measuring resistance on non-linear ohmmeter scale A or B (see text).

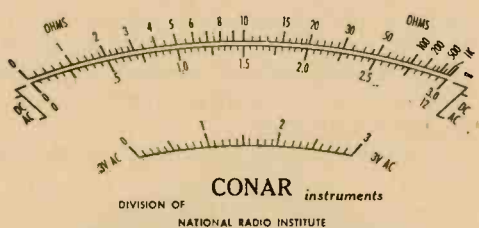

Fig. 5. This typical meter face has scales for measuring volts AC-DC, and resistance.

together at the left-hand end. Such a scale is read just like any other, but you must determine the values of the divisions in the region where the reading is being taken, since all the divisions do not have the same value. For example, from 1 to 2 there is one in-between mark, which must be $1\frac{1}{2}$. From 10 to 20, there are ten divisions, so each must equal 1. From 20 to 50 there are six divisions, so each equals 5. Thus, you must determine the division values for the section of the scale you are reading.

The scale in Fig. 4A is for a "series type" ohmmeter. Its scale has zero at the extreme right, the reverse of the usual voltage or current scale. This scale is marked 0-300, but on a typical meter using this scale, the ranges are actually 300,000 ohms, 3,000,000 ohms and 30,000,000 ohms, so when reading the meter you must add to your reading the correct number of zeroes for the range being used. For the 300,000-ohm range you add three zeros (000) and the 3,000,000 range calls for the addition of four zeros (0,000) to your reading and five zeros (00,000) are required when you use the 30,000,000 ohm range. The 30,000,000 is 30 megohms, so you can read the 0-300 scale in megohms by dropping the zero. Thus,

300 at the extreme left is 30 megohms; 10 is 1 megohm; 5 is .5 megohm, etc.

On some multimeter ohmmeters the low-ohm range is provided by a shunt-type ohmmeter. A scale of this kind is shown in Fig. 4B. Notice that zero on the scale is at the left-hand end. However, the modern trend is to use a series type ohmmeter even for the low ohm range; in this type of ohmmeter, all ranges have zero at the right-hand end of the scale. This applies only to multimeters. In vacuum tube voltmeters the zero for the ohmmeter scale is always at the left as in Fig. 4B.

Typical Meter Scale. Fig. 5 shows the important scales on the Conar Model 211 VTVM. Notice that zero on the upper scale (ohmmeter) is at the left. The scale at the bottom is for the 0-3 volt AC range only. All DC voltages and all AC voltages above 3 volts are read on the scales marked DC-AC.

Although there appears to be a number of markings on a dial of this kind, you do not have to worry about any of the markings except the ones on the scale that you happen to be reading at the moment. With practice you will soon learn to disregard all other scales.

In Fig. 5, notice the main voltage scales are 0-12 and 0-3.0. On an actual meter of this kind, the voltage ranges may be 0-3, read on the 0-3 volt scale directly; 0-12 volts, read directly on the meter; 0-30 volts, read on the 0-3.0 scale by moving the decimal point one place to the right, 0-120 volts, read by adding a zero to the 0-12 volt scale; and 0-300 volts, read by moving the decimal two places to the right on the 0-3.0 scale; and 0-1200 volts, read on the 0-12 scale by adding two zeros to each reading.

Once you obtain a test instrument and practice a little, you will find it surprisingly easy to read the meter scales.

Multimeter Connections. Now that you have learned something about reading the meter scales, let us see how to connect a multimeter in order to get readings. Fig. 6 shows the front panel of a typical modern multimeter.

A pair of test leads, one red and one black, are used to make connections between the tester and the circuit or part under test. One end of each lead is fitted with a pin connector which is plugged into the jacks mounted on the multimeter panel. The other end of each lead has a large insulated probe, which is used to make connections in the circuit.

At the right of the meter there are four

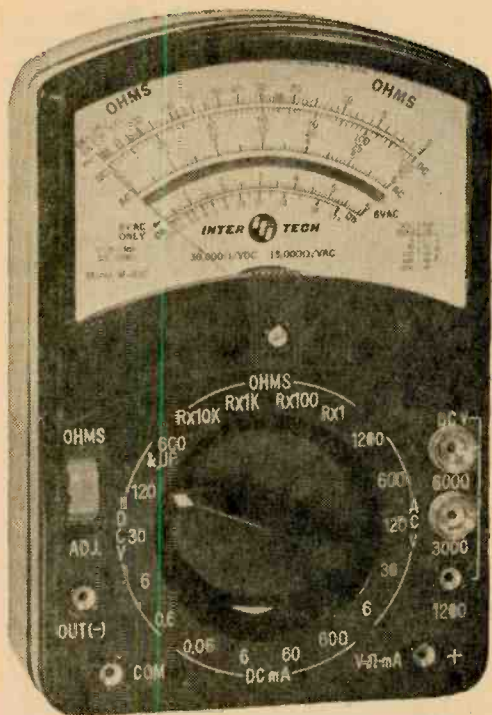

Fig. 6. Refer to the front panel of this typical multimeter while studying the part of the text discussing meter connections.

connecting jacks. The upper three are for high voltage DC measurements while the lower right hand jack is used for all other measurements and serves as the positive connection for the voltmeter and milliammeter DC ranges. The lower left-hand jack labelled COM is the *Common* jack that is used for all connections save for one exception. The black-colored test is plugged into the COM jack. Then, the red test lead is plugged into one of the right-hand jacks, depending on what is to be checked. For most purposes the red lead is plugged into the bottom jack marked positive(+). This is the jack for reading AC voltages, DC voltages below 1200 volts, resistance and current measurements. The other three jacks are for the 1200-volt, 3000-volt and 6000-volt dc ranges.

The exception to use of the COM jack is the jack at the left marked OUT (-) which connects to the common jack through a capacitor, so that the signal voltages may be read at the plate of a tube, to the exclusion of any DC voltages which may be present at that point. Details of using this jack to best advantage always appear in the Instruction Manual included with the instrument.

Measuring Resistance. Suppose you want to use this multimeter as an ohmmeter. First,

plug the black test lead into the COM jack and plug the red test lead into the lower right-hand jack. Now, turn the selector knob to the desired ohmmeter range. There are four resistance ranges, 6000 ohms, 600,000 ohms, 6 megohms and 60 megohms. These figures refer to the highest values that can be read on each range. Thus, you should always choose a range that is higher than the resistance you want to read.

To calibrate the ohmmeter properly, touch the tips of the test probes together, and turn the control at the upper left marked OHMS-ADJ until the meter reads zero at the right-hand end of the ohms scale. The instrument is now ready to use as an ohmmeter.

Continuity Testing. When we say that a circuit or a part has continuity, we mean that there is a continuous conductive path for the flow of direct current through the circuit. A circuit does not have continuity when an *open* (a break) occurs, for then the current path is incomplete.

A series type ohmmeter such as the one used in this instrument consists of a voltage source (an internal battery) and the meter in series. If the ohmmeter test probes are held together, the voltage sends current through the test probes and through the meter, causing the meter pointer to move to a full-scale position, indicating that there is no resistance between the test probes. Thus, on the series type ohmmeter, zero resistance between the test probes causes a *full-scale* reading. When the probes are separated or "opened" there is no deflection—the pointer remains at the left of the scale indicating an infinite resistance.

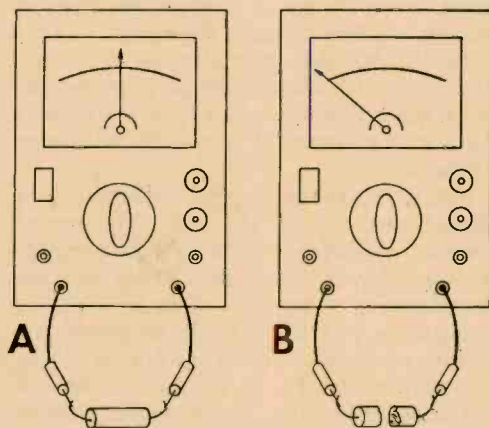

Fig. 7. The ohmmeter section of your multimeter is used for continuity checks in addition to measuring resistance. Continuity indicated in A; an "open" indicated in B.

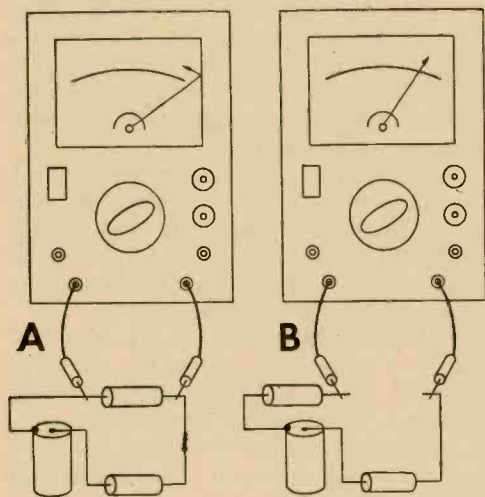

Fig. 8. Current readings must be made with the meter in series with the circuit. (A) shows wrong way, and (B) shows right way.

Now, when the test probes are held on the terminals of a good resistor, for example, the battery causes current to flow through both the resistor and the meter. Because of the resistance, the current flow is less than when the test probes are held together, so the meter pointer deflects to some position other than that for zero resistance. The higher the resistance of the part, the less the current that will flow and the less the meter pointer will deflect from its *open circuit* position. If the part has no continuity the pointer does not move from the *open* position because no current can flow through the break.

Notice that the ohmmeter has two uses: (1) it indicates whether the part (or the circuit) has continuity; and (2) if the scale is calibrated properly, it shows the resistance of the part.

When you are testing for continuity, you should use one of the higher ohmmeter ranges; you will then get a deflection regardless of the part's resistance, if the part has continuity. For example, when a resistor is being tested as in Fig. 7A, the ohmmeter test probes are touched to the resistor terminals. The ohmmeter battery sends current through the resistor, and the meter needle deflects to the resistance value.

When the ohmmeter probes are placed on the terminals of a defective resistor, as in Fig. 7B, no current can flow because the



Fig. 9. On the surface, the VTVM does not differ radically from the multimeter; but its indirect coupling with the circuit under test by way of a vacuum tube does make big difference. Voltage, is measured without loading down the tested circuit.



circuit is open (the resistor is broken), and there will be no deflection of the meter needle. In practice it is rare to find a part that is visibly defective as shown here for illustration. Furthermore, in electronic equipment, parts are frequently concealed by shield cans or other parts. In such cases, you could not possibly see a break, so you could check only by means of test instruments. This is one of the most important reasons for using an ohmmeter.

Much of your continuity checking inside electronic equipment will be between what are referred to as *reference points*—tube sockets, transistor terminals, the chassis, and the high voltage terminal of the power supply, for example. A number of parts may be checked at one time by making ohmmeter readings between these points.

Resistance Measurements. Continuity tests are made merely to find out if a complete circuit exists. If you don't try to read the meter, you just look to see if the pointer moves. Often, however, you will want to determine the exact resistance of a part or of a whole circuit. For example, you may find continuity through a short-circuited part, but, as a result, the resistance of the circuit in which the part is used will be lower than normal.

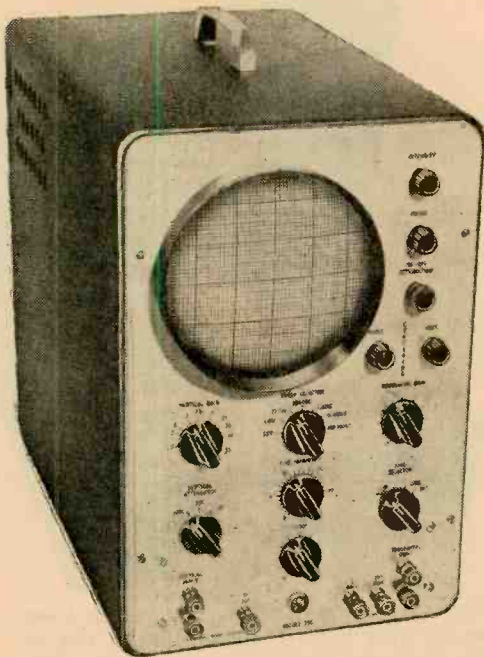

Fig. 10. The front panel of a typical oscilloscope contains many controls and jacks; among them are horizontal and vertical inputs, sweep adjustments, centering, and gain.

You can measure resistance, as well as check continuity, with the ohmmeter section of your multimeter. However, there are certain precautions you must take, and experience will enable you to learn the *do's and don'ts* of resistance measurement and quick use of the scales.

DC Voltage Measurements. A technician uses a DC voltmeter almost as much as he does his ohmmeter. Multimeters have a number of voltage ranges so that they can be used to measure voltages of widely different values. The meter shown in Fig. 6, for example, has eight DC voltage ranges. To use the instrument as a DC voltmeter, you should put the test probes in the same jacks as for the ohmmeter (to use the first five ranges). The black lead will go in the "COM" jack, the red lead in the jack marked "+", and then you should turn the center selector switch to the desired range.

Since some defect of the circuit you are checking may create an unexpectedly high voltage, always start with a range that can cover all contingencies and then shift to lower ranges when the readings indicate that it is safe to do so. Memorize this rule to safeguard your meter. Make a habit of turning the range selector switch to the highest DC position immediately after completing

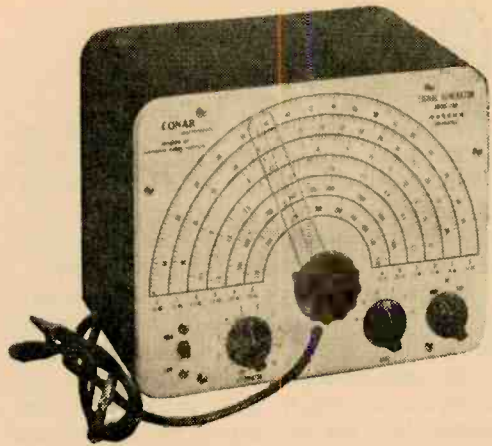

Fig. 11. RF signal generator is a piece of test gear that's indispensable if you plan to align or troubleshoot radio receivers.

the measurement. This will prevent your accidentally making another test later with the selector set at a low range.

You know that voltage exists between *two* points. In other words you cannot connect just one voltmeter probe to a single terminal and obtain a reading; both probes must be used and they must be connected to points of different potential.

For example, between the plate and cathode of a vacuum tube there is a DC voltage that may be several hundred volts. To measure this voltage, you must connect the negative voltmeter probe to the cathode socket terminal, and the positive probe to the plate socket terminal. (Take care that the black and red probes are in the proper test jacks, or the meter pointer will swing the wrong way.) With the proper test probe connections and the proper range, just read the plate to cathode voltage on the proper meter scale.

AC Measurements. To measure AC voltages with a meter like that shown in Fig. 6, set the center selector switch on the multimeter to the proper AC range and touch the test probes to the points between which the voltage is supposed to exist.

Technicians frequently measure the AC output signal voltage. However, in a piece of equipment operated from the power line, the only other AC voltages are those used to heat the filaments of the tubes, and the high AC voltage in the power supply (which is changed to the high DC voltage required to operate the other tubes).

Filament voltages are rarely measured, except in AC-DC types of equipment, for little can go wrong with the usual filament circuit.

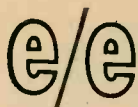

The high AC voltage applied to the rectifier is seldom measured because it must be all right if any tube has the correct DC voltage. Sometimes, however, you will want to measure the line voltage. This is done by inserting the test probes into the wall socket holes.

As in making other voltage measurements, always use the highest range of your meter first, switching to a lower range if necessary.

Current Measurements. It takes time and some unsoldering to make current measurements since the *ammeter* is always inserted in series with the circuit, so that the circuit current will flow through the meter. Failure to observe this connecting precaution may result in a burned-out meter, or at least in a bent meter pointer. Fig. 8 shows the right and wrong ways to measure current. As before, use the highest current range first, switching to a lower range if necessary.

Don't Burn Out Your Meter. The meters used in test equipment are fairly rugged and many have protective devices. But in most multimeters, too much voltage or current will burn out the meter coil or bend the pointer by making it hit the stop too hard. You can avoid such an experience by always observing the following rules:

- 1 The ohmmeter cannot be damaged unless the circuit under test is energized. Disconnect the set from its power source by pulling the plug out of the wall outlet before making measurement. (If it is a battery-operated piece of equipment, disconnect the batteries—just don't turn off the set.) A charged capacitor can furnish enough current to damage an ohmmeter, so wait a few moments after disconnecting the equipment from its power source to let the charge leak off the capacitors or short them to ground with an insulated screwdriver.

- 2 When using DC and AC voltmeters, always use the highest range of your meter first; switch to a lower range if it is safe to do so. Know what you want to measure and where to place your probes. If the meter pointer comes up with a rush and looks as if it will go off scale, take one or both test probes off the circuit quickly—use a higher range since the one in use is too low. Don't try to measure AC voltages with the selector set in a DC position. The meter will not read, but, if the AC voltage is higher than the meter range employed, the meter coil will burn



Fig. 12. A tube tester is a major investment; best bet is to use one at the corner drugstore until use warrants purchase.

- out. When you are through using some range of a multimeter, always reset it to the highest DC voltage value, or to the OFF position if there is one. If you don't form this habit, you may leave the multimeter set to a current range and try to measure voltage. This may ruin the meter. If the meter starts to read down scale, reverse the test probes.

- 3 When using the milliammeter for current measurements, don't make current measurements when voltage and ohmmeter measurements will do. Before connecting the milliammeter, satisfy yourself that the circuit has no defect that will cause excess current to flow. Break the circuit so that the meter can be placed in series with it. Never connect a current meter across an electronic part or across a voltage source. Always start with the highest range of the meter, being ready at an instant's notice to remove one or both probes if the meter needle shows signs of going off-scale. If the first range is too high for you to read easily, move the meter switch to a lower range. If the meter starts to read down-scale, turn off the circuit, reverse the test probes, and turn on the circuit again. As you know, all circuits in which current measurements are made have a source of voltage. The meter must be placed in the circuit, so that electrons will enter its negative terminal, hence the positive meter probe goes to the positive side of the voltage source.

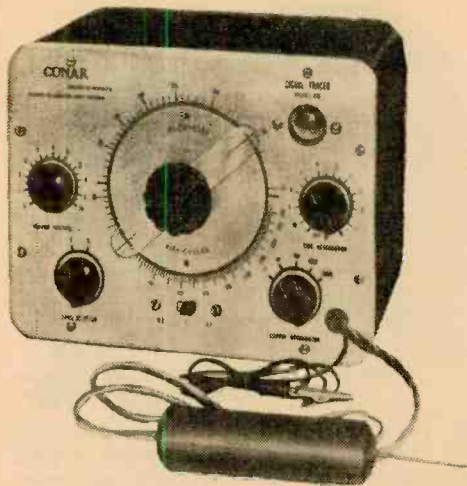

Fig. 13. Signal tracers can be very handy to have around for quick troubleshooting of both radio frequency and audio circuits.

The Vacuum Tube Voltmeter. This is the preferred instrument for taking voltage and resistance measurements. The meter is not coupled directly to the circuit under test but is fed through a tube which protects the meter movement at all times.

The VTVM, as it is called, will not measure current, but does everything else a multimeter will do, and does it better. What has been said about reading the scale of a multimeter also applies to the VTVM. However, the ohmmeter scale always starts at the left and the most accurate measurements are obtained from zero to about 75-percent of full-scale. Therefore, choose an ohmmeter range which will cause the pointer to read in this vicinity.

The average VTVM will check resistance values up to 1000 megohms, while most multimeters are not accurate above 50 megohms. While 1000 megohm resistors are not used in electronic equipment, the discovery of undesirable leakage paths requires ohmmeters with a sensitivity of at least several hundred megohms.

A couple of typical vacuum tube voltmeters are shown in Fig. 9. Like the multimeter, the chief difference between VTVMs lies in the means used to switch from AC to DC to ohms. Some use a number of leads which must be plugged into different jacks, some depend only on switches, while switches combined with extra leads or jacks are also available. The Conar Model 211, for example, uses only a single switch to change from function to function and only two test leads. Also it does not need an accessory probe to check high frequency AC voltages. This is

quite an advantage when you wish to measure the h.f. AC voltage in a transistor receiver to see if its local oscillator is working. All VTVMs as well as multimeters must use a special high-voltage probe to check second anode voltage (as high as 30,000 volts) on a TV picture tube.

Most experimenters, who have a VTVM and wish to measure current, usually get a multimeter equipped with current ranges as an accessory instrument or purchase a multi-range current meter.

The Cathode Ray Oscilloscope. The CRO, as this instrument is called, is also a type of voltmeter and the better models can be used to measure voltages with considerable accuracy. The real importance of the CRO, however, is that in addition to measuring voltage it will also display the signal under observation, giving an accurate picture of its waveshape. This feature is of real importance in experimental and design work as well as in servicing high-fidelity equipment and certain circuits in TV receivers.

The CRO is built around a cathode ray tube (CRT) which is similar to a TV picture tube but usually has a green face and electrostatic rather than electromagnetic deflection. The CRO has a built-in horizontal sweep generator, whose output after being amplified is applied to the horizontal deflection plates and sweeps the CRT beam from side to side, providing a horizontal line on the face of the tube. The signal to be observed is fed to the CRO's vertical amplifier through calibrated attenuators. When applied to the vertical deflection plates, the waveshape of the signal under test appears. The height of the display, combined with the attenuator settings can be translated into the peak-to-peak value of the voltage under test.

The horizontal sweep is run at a lower frequency than the test signal so that there will be time for two or more complete patterns to be formed around the horizontal trace. Also provision is required to *sync* or lock-in the horizontal sweep generator with the frequency of the test signal, so the display on the front of the CRT appears to be motionless.

A typical CRO is shown in Fig. 10. The chief difference between instruments is in the amount of test voltage required to give a recognizable pattern, the frequency response of the built-in vertical amplifier, and CRT brightness.

The Conar Model 250 oscilloscope, shown in Fig. 10, can be viewed without a light

shield under high-level fluorescent lighting. This is accomplished by using the maximum allowable voltage on the CRT. Because this intensification of the beam makes it harder to deflect, high-gain amplifiers are used in the vertical and horizontal sections of this CRO.

The Rf Signal Generator. As its name suggests, the signal generator supplies or generates a radio-frequency signal. It is a miniature broadcasting station but does not produce (technical men say "is not modulated by") words or music. Instead, it has a steady, low-pitched tone that will be heard when its signal is tuned in on a receiver.

A signal generator has a dial similar to that of a receiver and can be tuned like a receiver. You are probably familiar with all-wave receivers that pick up short-wave as well as broadcast band stations. Such receivers have a band switch to change from one wave band to another. Signal generators are similarly equipped.

Signal generators are used to adjust (or align) receivers so that stations will come in at the proper points on the receiver dials and to adjust receivers so that weak, far-away stations can be heard with adequate volume. Sometimes signals from broadcast stations can be used for this purpose, but in many cases they are not satisfactory, so plan to get a signal generator eventually if you want to work on radio receivers and TV sets. The Conar Model 280 signal generator, shown in Fig. 11, is a typical unit.

Signal generators have another important use. If you have a dead receiver, you already know that the trouble is caused by a defective part that blocks the signal in some stage. The rest of the stages may be all right, and if you can find the bad stage, your job is almost half done. The signal generator helps in isolating the bad stage. Just inject its signal into the various stages one at a time, working back a stage at a time from the output stage toward the input stage. As long as the signal tone is heard in the loudspeaker, all stages from the point of signal injection to the loudspeaker are in working order. When you pass through the dead stage, the speaker will be silent. From your signal generator Instruction Manual you will learn how to identify stages, how to tune your signal generator, and how to connect a signal generator to the different stages in a receiver.



Fig. 14. Checking capacitors to determine their capacity and leakage requires a good R-C tester; also reads accurate resistance.

There are also other specialized signal generators in use, such as sweep generators used for alignment of TV and FM receivers, audio signal generators and square-wave generators which are used for checking the frequency response and reproductive quality of relatively low-frequency amplifiers such as audio and video amplifiers in TV receivers.

Tube Testers. There is probably more difference between tube testers than any other piece of electronic equipment. Some tube testers are rather simple in the tests they perform, while others will make a much more complete test of the tubes. In general, the more elaborate the test that can be made, the more expensive the tester. However, elaborateness of tests is not always desirable—manufacturers are constantly bringing out new tubes. Sooner or later, tubes are developed that the tester cannot test without redesign. When enough tubes like this have been brought out, the technician is forced to junk his tester and buy a new one.

For this reason, the alert buyer chooses a simple, inexpensive tube tester that will check tubes for shorts or undesirable resistance, and for emission, the ability of a tube cathode to give off, or emit electrons. Modern testers of this type are made with controls and circuits that are adaptable to a wide variety of conditions. A good one, such as shown in Fig. 12, has individual selector switches for the various tube elements so that practically any arrangement of elements can be handled. With testers of this kind, only tubes with radically different sockets or with remarkably different characteristics require new instructions or changes in design.

Even so, it is more advisable to put off
(Continued on page 112)

COMPUTER

TALK

by Jack
Brayton

The computer's two-finger language answers math problems in seconds!

■ Computers talk! Yes, that's right, they actually talk. Oh, they don't say, "Good morning, George. Glad you could make it." No nothing like that, but in their own language, a mathematical language, they talk to each other and to their operators.

This computer language, called the *binary number system*, is a system where all numbers can be made up using only *zeros* and *ones* rather than *zero* through *nine* as with our familiar decimal system. As a result, instead of needing ten different values to represent one digit, a computer using the binary method needs only two values for each digit. In a computer these values are easily indicated by the presence or absence of a signal or by positive and negative signals or even by two different voltage levels. All it takes is the *opening* or *closing* of a relay, or the *conducting* or non-conducting of a transistor or vacuum tube to produce an on/off, yes/no, or one/zero to simulate the two values of the binary number system.

Lots of people have the idea that there's something difficult about the binary number system. This isn't true! So let's get down to business and sink our teeth into this computer language. Since the decimal number system is familiar to all of us, we'll tackle it first and work through to the binary.

Decimal vs. Binary. The decimal system or the conventional number system is based on *ten* and the *powers of ten*. This is illustrated in Fig. 1.

Of course, to read the number we automatically add all the ones, tens, hundreds,

thousands, etc. The total gives the number.

The binary system is based on *two* and the *powers of two*. Instead of having zero through nine for each digit only zeros and ones are used as mentioned earlier. To read the number in binary form, add all the columns together as in the conventional decimal system, the difference being, the columns have different values. See Fig. 2.

One of the first things you may ask is how do I read or say out loud the binary number 1101. It's easy—"one-one-zero-one." You may think that the correct method for reading the decimal number 9699 is "nine-thousand, six-hundred and ninety-nine," but you are wrong! It's "nine-six nine-nine." This is the only correct way to give the value of 9699. The first method uses our English "nick name" for the decimal number's correct value. In fact, since humans use numbers so often, each language has its own nick names for all decimal system numbers. Nick names will not be used in this article in order to reduce confusion.

Fig. 3 shows the similarities between the two number systems. The letters *LSD* mean "least significant (smallest) digit."

Converting to Binary. A question which arises when working with the binary system is how are decimal numbers converted to the binary form? There are two ways to convert the decimal number to the binary. The first is the *simplest*; all that it requires is dividing the decimal number by two a number of times. However, the alternate way can be *quicker*, once a person gets used to it.

Fig. 1. Powers of ten system.

DECIMAL
4-DIGIT
NUMBER

10^3	10^2	10^1	10^0
1000	100	10	1
9	9	6	1

Conventional ↑ LSD
 $9000 + 900 + 60 + 1 = 9961$

2^3	2^2	2^1	2^0
8	4	2	1
1	1	0	1

Binary ↑ LSD
 $8 + 4 + 0 + 1 = 13$

Fig. 3. Decimal and binary systems compared.

To illustrate the first or simplest method, we'll convert a few decimal numbers to binary numbers of the same value. First, let's take the number thirty-five. (see Fig. 4.)

Step 1. Divide 35 by 2 which gives 17 with a remainder of 1. The remainder is the key. Since the remainder is 1 write a 1 on the right-hand side which is the least significant digit or the ones column (2^0).

Problem:	101	Steps:	$1+1=0$ Carry 1
	+101		$1+0+0=1$ Carry 0
Answer:	1010		$1+1=0$ Carry 1
			$1+0=1$ Carry 0

Steps				Binary Number
1	$35 \div 2 = 17$	Remainder 1		1 LSD
2	$17 \div 2 = 8$	Remainder 1		11
3	$8 \div 2 = 4$	Remainder 0		011
4	$4 \div 2 = 2$	Remainder 0		0011
5	$2 \div 2 = 1$	Remainder 0		00011
6	$1 \div 2 = 0$	Remainder 1		100011

The operations in Fig. 4, above, illustrate decimal to binary conversion.

The three-dimensional block of Fig. 2, right, depicts powers of two system.

BINARY
4-DIGIT
NUMBER

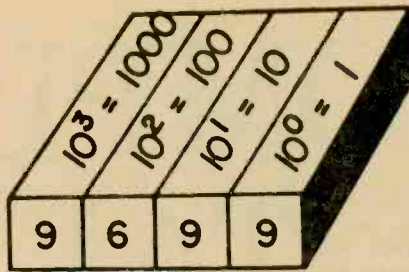

$9 \times 1000 = 9000$
 $6 \times 100 = 600$
 $9 \times 10 = 90$
 $9 \times 1 = 9$

 Total = 9699
 (Decimal)

Step 2. Divide 17 by 2 which gives 8 with a 1 remainder. Write a 1 in the twos column (2^1).

Step 3. Divide 8 by 2 which gives 4 with a 0 remainder. Write 0 in the fours column (2^2).

Step 4. Divide 4 by 2 which gives 2 with a 0 remainder. Write a 0 in the eights column (2^3).

Step 5. Divide 2 by 2 which gives 1 with a 0 remainder. Write a 0 in the sixteenths column (2^4).

Step 6. Divide 1 by 2 which gives 0 with a 1 remainder. Write a 1 in the thirty-seconds column (2^5).

The number now appears in the binary form of 100011 which is "thirty-five."

Every time the number is divided either a one or a zero is written down in its respective column. If the remainder is zero, then a zero is written down. See Fig. 5 and Fig. 6 for other examples.

As an example we will add the numbers 101 + 101 or five plus five. See below.

We start with the right-hand column, the ones column, and add one plus one equals zero carry one to the next column. One plus zero plus zero equals one. Third column from the right, one plus one equals zero carry one to the next column. There is nothing more to add.

Steps				Binary Number
1	$15 \div 2 = 7$	Remainder 1		1 LSD
2	$7 \div 2 = 3$	Remainder 1		.11
3	$3 \div 2 = 1$	Remainder 1		111
4	$1 \div 2 = 0$	Remainder 1		1111

Fig. 5. Converting "15" to binary number.

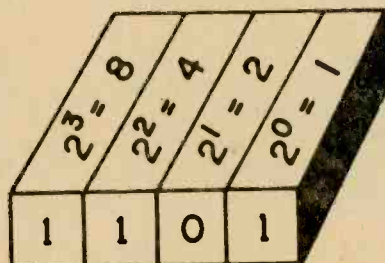

$1 \times 8 = 8$
 $1 \times 4 = 4$
 $0 \times 2 = 0$
 $1 \times 1 = 1$

 Total = 13
 (Decimal)

ing in the next column so we consider it as one plus zero which gives us one. The final answer being 1010 or the binary number for ten. See addition table in Fig. 7.

There's a special rule which applies to adding longer columns. As an example we'll add $101+101+101$ or *five plus five plus five*.

$$\begin{array}{r} 101 \\ 101 \\ +101 \\ \hline 1111 \text{ equals "fifteen"} \end{array}$$

The rule for adding longer columns is: If the amount of *ones* in any single column exceeds *two* then divide the number of *ones* by *two*. The number of times that *two* will divide into the number of *ones* is the amount of *ones* carried to the next column. If the number of *ones* divides evenly by *two* then a zero goes directly under this column, however, if it doesn't divide out evenly but has a one remainder, then a one goes under this column.

In the above problem we have $101+101+101=?$ In the first column we have *one plus one plus one* or three *ones*. Using the above rule we divide *two* into the three *ones* which gives us *one* (to be carried to the next column) with a remainder of *one*. Since the remainder is *one*, we write a *one* in the first column. The problem now appears:

$$\begin{array}{r} 1 \\ 101 \\ 101 \\ +101 \\ \hline 1 \end{array}$$

In the second column we have *one plus zero* which equals *one* with no carry. We write a *one* in the second column from the right and go on to the third column. We now have:

$$\begin{array}{r} 101 \\ 101 \\ +101 \\ \hline 11 \end{array}$$

The third column has three *ones*. Again we divide the three *ones* by *two* which divides *one* time with *one* remainder. Write a

2^8	2^7	2^6	2^5	2^4	2^3	2^2	2^1	2^0
256	128	64	32	16	8	4	2	1

Binary Number
For Decimal 77

1 0 0 1 1 0 1

Fig. 6. Binary 1001101 visualized on chart.

one in the third column and carry a *one* into the fourth column.

In the fourth column we have *one plus zero* equaling *one* which we write in the fourth column. The problem is now solved:

$$\begin{array}{r} 101 \\ 101 \\ +101 \\ \hline 1111 \text{ equals "fifteen"} \end{array}$$

How to Subtract. For subtraction we have to use another simple table which is shown in Fig. 8. Subtraction isn't difficult. We will work a couple of problems to illustrate this. First, let's take the problem *ten minus five* or 1010 minus 101 .

$$\begin{array}{r} 1010 \\ - 101 \\ \hline 101 \end{array}$$

In the first column we have *zero minus one* which equals *one* and borrow *one* from the next column. We write a *one* in the first column.

In the second column we have *zero minus zero* due to the fact that we borrowed the *one* which was actually there. According to the table in Fig. 8 *zero minus zero* equals *zero*. As a result we write a *zero* in the second column.

In the third column again we have *zero minus one* which, of course, equals *one*, bor-

$1+1=0$	Carry 1
$0+1=1$	
$1+0=1$	
$0+0=0$	

$1-0=1$	
$0-1=1$	Borrow 1
$1-1=0$	
$0-0=0$	

Figs. 7, 8, and 9 show the operation tables for addition, subtraction and multiplication, respectively.

$1 \times 1 = 1$
$0 \times 1 = 0$
$1 \times 0 = 0$
$0 \times 0 = 0$

row *one* so we write a *one* in the third column.

Since we have borrowed the *one* out of the fourth column we have the equivalent of *zero minus zero* which equals *zero*. We now have the final answer of 101 and *five*.

Time to Times. Multiplication is the easiest of all the functions and is much easier than using the decimal system. The multiplication table is given in Fig. 9.

With multiplication we don't have to go through it step-by-step because it's almost self explanatory. We only have to remember one thing and that is; whenever the bottom number is a *one* the whole top number, *zeros* and *ones*, is written down and whenever the bottom number is a *zero* then only *zeros* are written down. Of course we shift and add as we do with the decimal number system:

$$\begin{array}{r}
 101 \\
 \times 101 \\
 \hline
 101 \\
 000 \\
 101 \\
 \hline
 11001
 \end{array}$$

First we have *one* times the number *one-zero-one*. Since the bottom number is *one* we just write the top number down which is *one-zero-one*. Then we have *zero* times the top number *one-zero-one*. We shift the number one digit and write only *zeros* down on the second line. Once again we have *one* times the number *one-zero-one*, so we shift one more digit and write *one-zero-one*. Now all that remains to be done is to add the columns to get 11001 or "twenty-five."

Division. The only function which remains to be covered is division which in a digital computer is usually a function of subtraction. By that, I mean, if the computer had to divide *twenty-five* by *five* it would subtract *five* from *twenty-five* counting how many times it subtracted until there was nothing left or in the case that there was a remainder it would compare the two until the remainder was smaller than *five*.

However, we can divide on paper much the same way that we do in the ordinary decimal system. However, division is relatively unimportant in the field of digital computers. Here is a typical problem:

$$\begin{array}{r}
 11 \\
 101 \overline{) 1111} \\
 \underline{101} \\
 101 \\
 \underline{101} \\
 000
 \end{array}$$

101 goes into *111* one time so we write a *one* above the last digit of *111*. We subtract *101* from *111* which gives *10* and we bring down the last *one* which gives us *101*. *101* goes into *101* one time so we write a *one* over the last digit which gives us the final answer of 11 which equals "three." By the way, *1111* is "fifteen" and *101* is "five."

We've completely covered the binary number system including addition, subtraction, multiplication and division as it's used in digital computers and once these rules are learned you have taken your first step toward understanding *computer talk*. ■

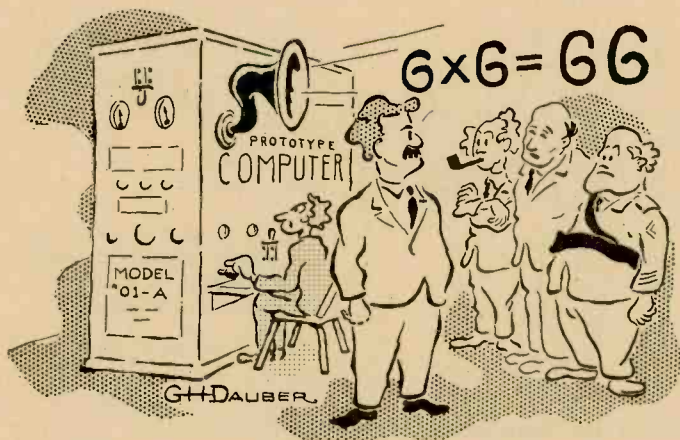

"As you see, simple problems may not always come out exactly on the nose."

Understanding and Maintaining Your Car's Ignition System

By Len Buckwalter

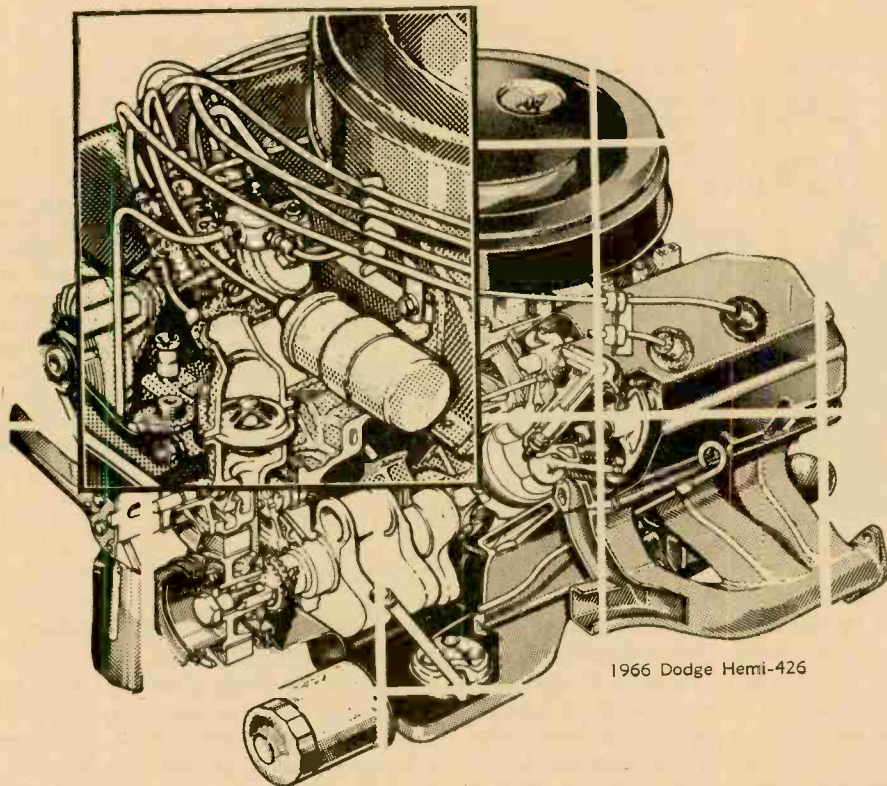

1966 Dodge Hemi-426

■ Imagine driving a car just 100 feet. Then the motor conks out. You step out and fiddle under the hood. The vehicle is ready for another 100-foot trip. Is this some lemon rescued from the scrap heap? Far from it. It's a fair description of one of the earliest cars and how it operated. It was built by Frenchman, Nicolas Cugnot around 1769, and it sure had ignition problems. A massive steam engine had to be fed and fired for each 100-foot trip. Yet, his feat can't be underestimated. Cugnot got up enough steam to roll along at 2½ m.p.h.—before anyone else.

Today's auto isn't a wood burner, but it's

still powered by igniting fuel to unlock heat energy. Ignition, however, is fast and continuous. By 1905 the spark plug permitted the gas engine, powered by convenient liquid fuel, to develop rapidly. Plugs create hot electrical sparks. Firing at some 10,000 volts, they repeatedly ignite the engine's fuel mixture. Exploding gases do the rest—driving down the pistons with great force. This is the final step in the ignition process. To discover the source and timing of the spark it's necessary to go back to the car's primary reservoir of electricity—a 6- or 12-volt battery.

A Voltage Source. It's impractical to

e/e IGNITION SYSTEMS

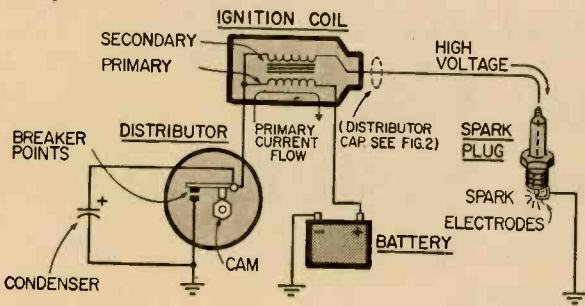

Fig. 1. Combination pictorial and schematic diagram of your automobile's ignition system shows how low DC voltage of the battery is transformed into the high voltage that jumps gap of the spark plug.

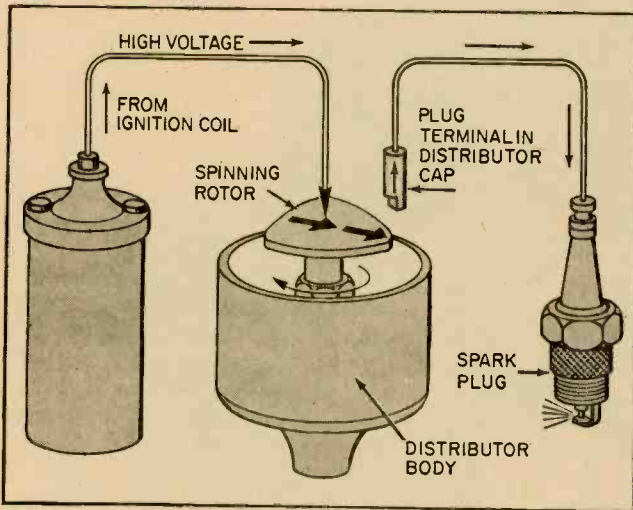

Fig. 2. In this drawing we see how the high voltage from the secondary of the ignition coil is distributed to each of the spark plugs. The spinning rotor under the distributor cap makes connection with the leads to each of the plugs in your engine. The connection, however momentary, is enough to fire plug to ignite fuel-air mixture.

build a 10,000-volt battery to directly fire the plugs. Such a battery would require an outlandish 5,000 cells to generate 10,000 volts (each battery cell is only 2 volts). A feasible system utilizes a step-up transformer. This transformer is your car's ignition coil which is constructed of primary and secondary winding of wire. Six (or 12) volts supplied to the primary emerge as 10,000 volts at the secondary.

But transformers can't work on pure direct current, as supplied by the battery. For the ignition coil to increase voltage, the electrical source must vary. A rise and fall of current produces shifting magnetic fields to provide the step-up action. The problem's solved by breaker points found in the distributor. Placed in the path of battery current flowing to the coil, the points act as an electrical switch; opening and closing the battery circuit. These interruptions provide the electrical changes required by the ignition coil.

The points effectively "chop" battery current into a series of pulses.

Battery to Plug. Shown in Fig. 1 is a view of the basic car-ignition system. A flow of current from the battery is applied to the primary winding of the ignition coil. As current attempts to return through the coil, back to the battery, it encounters the breaker points. If the points are closed at this time, the path is complete. Current can flow through the primary. This creates a magnetic field in the coil. Now consider the points open. (The cam, seen at the center of the distributor, operates the points. It is geared to the spinning engine.) Open points interrupt battery flow, causing the magnetic field in the primary to collapse. The field cuts across the secondary winding and induces high voltage there. Thus, point operation achieves the desired effect: moving magnetic fields which establish high voltage in the secondary winding.

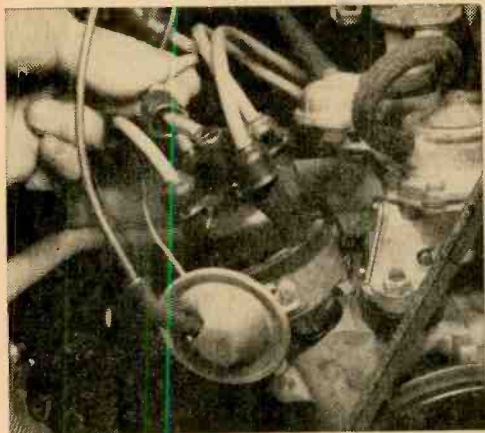

Fig. 3. Center lead is removed by pulling it out of the top of the distributor cap.

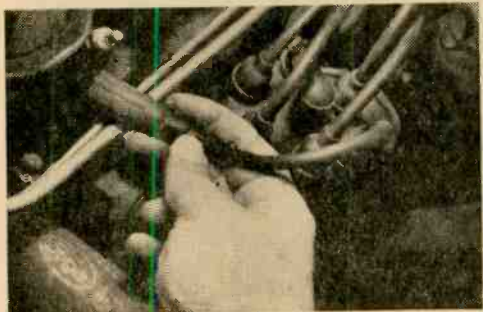

Fig. 4. Plugs can be checked individually.

High voltage is next fed to the spark plug. It flows down the center electrode, then crackles across the gap in the outer electrode. The fuel-air mixture is ignited. The electrical circuit is completed through the metal threads of the plug. Screwed into the engine block, they provide a path back to the ground terminal of the battery. For the sake of clarity in this simplified drawing, the plug is shown connected directly to the ignition coil. In the actual car, the high voltage is naturally distributed by the distributor. As will be shown in a moment, a spinning rotor inside the distributor feeds spark to the correct plug at the right instant.

Some Capacitance. A refinement in the breaker-point arrangement is the condenser. It solves two problems. As current surges in any coil, the coil sets up a certain amount of opposition. Instead of a fast rush of current, there's a slow build-up in the coil. So the magnetic field set up by current is unable to move fast enough to create sufficient high voltage. Condenser action, however, assures that coil current will change quickly. It causes the magnetic field to collapse fast

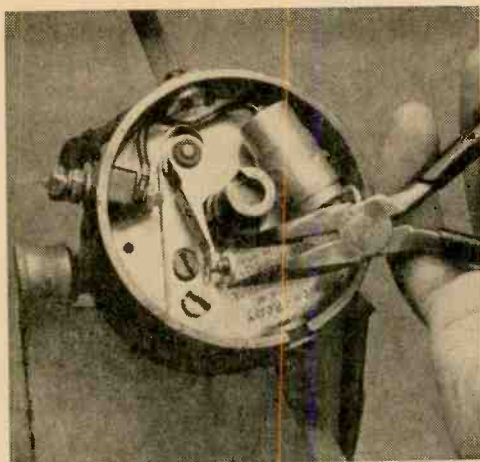

Fig. 5. Aligning points is a precision job.

enough to generate ample high voltage. The condenser's second job is to protect the points against burning. It short-circuits high voltage that tries to feed back from coil to points.

As we have seen, the breaker points are located inside the distributor. Also found here is the reason why the device is termed *distributor*—it distributes high voltage to the spark plugs at the correct time and in proper firing order.

Inside the Distributor. High voltage from the ignition coil is led into the top of the distributor (Fig. 2). Here it is applied to a spinning rotor (driven by the engine). The rotor applies high voltage, in turn, to each of the terminals positioned around the edge of the distributor. The number of terminals is equal to the number of cylinders of your engine. Since the terminals are connected to the spark plugs, each plug receives a burst of high voltage from the spinning rotor. The rotor does not make direct contact with the terminals. To reduce friction and wear, a small air gap occurs between the rotor tip and each terminal. The high voltage jumps across this gap, consuming about 2,000 to 3,000 volts in the process. This reduces high voltage somewhat, but achieves the key advantage of longer distributor life.

This, then, is the basic layout of the car's ignition system. Most surprising is that it has remained nearly unchanged since early in the century. Even today's transistorized ignition doesn't disturb the fundamental principle. The transistor mostly extends breaker-point life. Instead of the points interrupting heavy battery currents to the ignition coil, they merely turn the transistor on and off.



Fig. 6. The lock screw is loosened and the points are adjusted to specification. Carefully tighten screw without moving points.

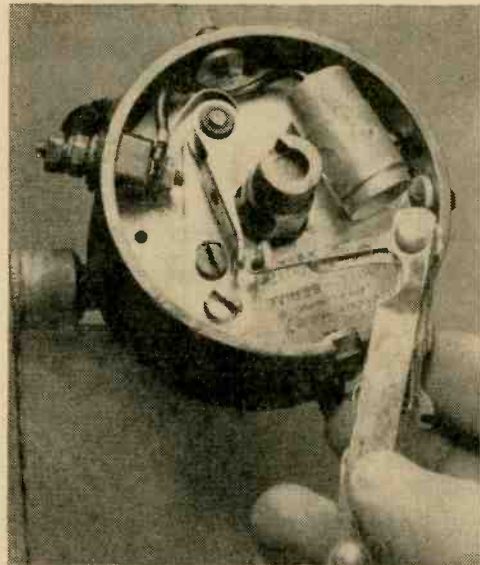

Fig. 7. The points are adjusted so that a slight drag is felt on the feeler gauge when it is slowly pulled from between them.

The semiconductor material of the transistor switches battery current electronically and doesn't suffer mechanical wear. One big change in ignition systems could occur in the turbine engine now being developed. Since fuel is burned continuously—not in a series of explosions—the hot gases themselves will ignite the incoming charge of fuel. But until that time you'll have to tune, adjust, and maintain your conventional ignition system to insure top performance.

Ignition Troubleshooting. We'll assume that car battery and starting system are in good condition and jump directly to the major components. Since most ignition troubles tend to fall into one of three categories it's best to begin by isolating the problem. These areas are primary circuit, secondary circuit and engine timing. In general, the primary circuit is from the battery, through the distributor and into the ignition coil. The secondary circuit is concerned with the high voltage—as it leaves the distributor and jumps across the spark-plug gaps. Some quick checks help pinpoint the area.

One helpful test on the complete primary circuit can be done in a few seconds. It proves whether the ignition system is capa-

ble of producing high voltage. As shown in Fig. 3 lift out the center lead from the distributor cap. Hold the metal tip of the cable about a quarter-inch from any nearby mass of metal; the engine block, for example. (Be careful to keep your hand well away from the cable tip to avoid shock.) If the cable is old and worn, don't hold it, it could cause a shock to bare fingers. Avoid a shock by using an insulated screwdriver. The metal shaft is touched to ground, while the screwdriver tip is held near the end of the cable. Now have someone switch on the ignition and crank the starter. You should see a bright blue spark snap across the quarter-

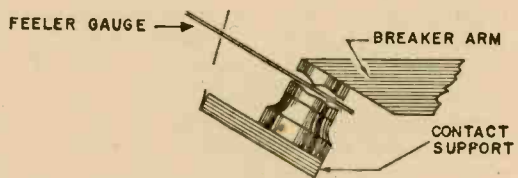

Fig. 8. As shown in this side view of worn distributor points, use of a flat feeler gauge can give you an erroneous measurement.

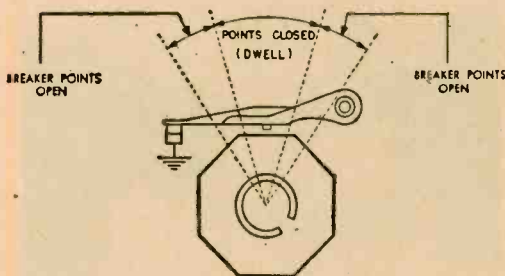

Fig. 9. Dwell angle refers to cam rotation.

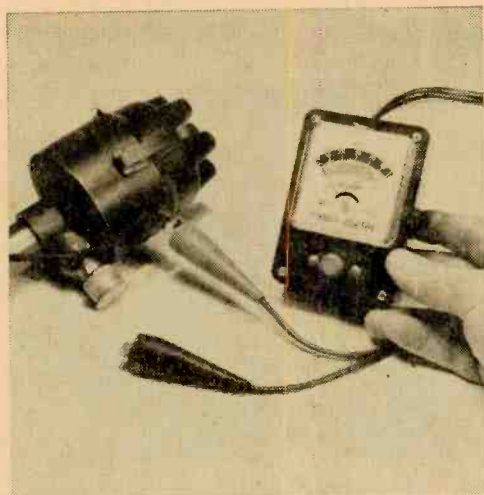

Fig. 10. Meter reads dwell angle directly.

inch gap. It should repeat without missing a beat. No spark, or a feeble one, suggests trouble in the breaker points, condenser or defective primary wires between distributor and ignition coil. It could also mean that high voltage is being generated, but isn't jumping the gap from distributor rotor to the plug terminals in the top of the cap. Look for a cracked or dirty distributor cap.

Secondary Circuit Problems. A fat spark during this test, on the other hand, suggests that defects in the secondary circuit are causing uneven engine operation. High voltage could be leaking from aging high-tension cables. In many cases, spark plugs fouled with oil or incorrect plug gaps prevent high voltage from producing an effective spark. There are two simple checks on the secondary, or high-voltage, side. A fouled spark plug can usually be pinpointed by allowing the engine to idle. Listen closely to the rhythmical engine sound. If one or more plugs are not firing properly, there will be a rolling sound as the engine "misses." To pinpoint the bad plug, remove each plug cable, where it clips to the top of the spark plug (see Fig. 4). This is done one at a time while listening carefully. As each cable is disconnected there should be a definite change in sound from the idling engine. If *no* difference is heard, chances are that the particular plug is not firing properly. The second check must be done in the dark. Leaking or worn high-tension cables frequently give off a blue light or actual sparks that show up in the dark.

Whether you're just troubleshooting or intend on giving the ignition system a complete tune-up, consider the major steps, from distributor to spark plugs. Some steps can be

used in case of emergency breakdown, such as cleaning dirty points that prevent the engine from starting. Other measures to be described can stave off trouble and keep the car's ignition system in like-new condition. Car makers recommend different schedules but, in general, a minor ignition tune-up can be performed each 6,000 miles. Here, the complete system is carefully inspected, cleaned and adjusted, as described below. Each 12,000 miles suggests a major tune-up. At this time, certain parts are automatically replaced, regardless of condition; points, condenser, and spark plugs. Replacing all high-tension cables should be done once a year, especially where climate is apt to be humid.

Breaker Points. A close examination of the points can be revealing. First remove the distributor cap, then tap the starter a few times to cause the cam to drive open the points to their widest gap. Normal color of point surfaces is a light gray. Blackening indicates that grease or oil have leaked onto the points. Blue color usually means excessive heating, caused by poor point alignment. Pitting or roughness is due to electrical arcing. Some transfer of metal from one point to another will almost always be present, causing a hill-and-valley appearance. The points should be replaced if the *hill* buildup is equal to the gap between points. In less severe cases, or where the points are not extremely rough, the surfaces can be cleaned and restored.

Never use sandpaper or emery cloth to clean points. It should be done with a point file or burnishing tool made for the purpose. In using such a tool don't attempt to get the points looking new and smooth. If you have

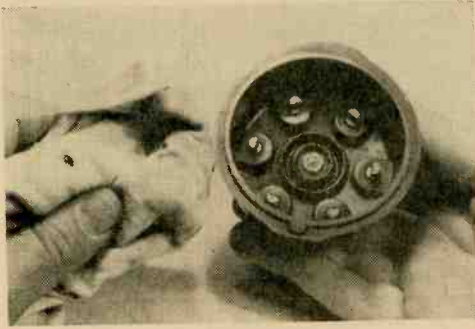

Fig. 11. Inspect distributor cap closely.

to take off more than just surface scale and dirt, it means that new points are required. Trying to remove too much point surface will introduce another problem; misalignment. Hand-filed points simply can't equal a factory-machined fit. So use a burnishing tool for surface clean-up only.

After points are in good condition, carefully clean the area around them with a stiff brush and some solvent. Many point failures are directly due to oil or grease on the contact surfaces. It's usually from excessive lubrication of the cam or its cotton wick (under the rotor). New points will quickly fail if the cause isn't cured.

Point Gap. Engine performance heavily depends on correct point gap, so special care should be taken during this step. If the gap is too small, points burn out prematurely; too wide and high voltage falls. Both conditions also upset engine timing. First step in adjusting the points is to check alignment. The surfaces must mate square and true in the closed position. If old points appear to be askew, don't attempt to straighten them. New points should be installed. If new points don't mate perfectly, carefully bend the *fixed* point, not the movable one. This can be done by grasping the support of the fixed point and bending carefully, as shown in Fig. 5.

Adjusting the gap is next. Be sure the points are at their widest opening, resting on a high point of the cam. Loosen the lock screw, shown in Fig. 6. Now, as the adjusting screw is turned, the gap is set with a feeler gauge according to the manufacturer's specifications (Fig. 7). Two gauges are available for this purpose; wire and flat types. The wire type is recommended for points

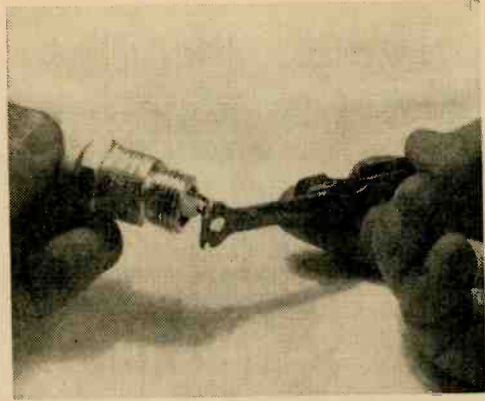

Fig. 12. Gap's best adjusted with gauge tool. Be very careful when bending the outside electrode so that insulation doesn't crack.

that are not new. Slight roughness on the point surface could cause the flat gauge to indicate an incorrect setting (Fig. 8). Once the gap is determined it should produce a slight drag on the gauge when pulled through the open points. The lock screw is then tightened. Be sure to recheck the gap to see if the adjustment is still correct.

Dwell Angle. A more accurate system for point adjustment is with a dwell meter. The instrument eliminates the problem of slight point misalignment or roughness. Instead of measuring the point gap, the meter indicates the amount of time the points are closed (as the engine rotates). Specifications for a particular car might state, for example, that dwell is 38 degrees. This figure (typical for a 6-cylinder car) indicates how long the points remain closed in terms of degree of cam rotation (Fig. 9). By adjusting for this figure on the meter, the points are gapped under actual operating conditions. The dwell meter clips to ground and the electrical terminal on the side of the distributor body, as shown in Fig. 10. A few seconds of starter operation is all that's needed to take a dwell reading. The distributor cap may remain off during this time, permitting gap adjustments to be made.

The dwell meter is also valuable for quick checking of point adjustment at a future time. The leads are simply clipped in place and the engine idled. If dwell reading is too low, it indicates that point gap is too wide. This might explain why the engine does not run well at higher speeds or misses during acceleration. Too high a dwell reading means the points are too closely spaced and early point failure can occur due to burning. Also,

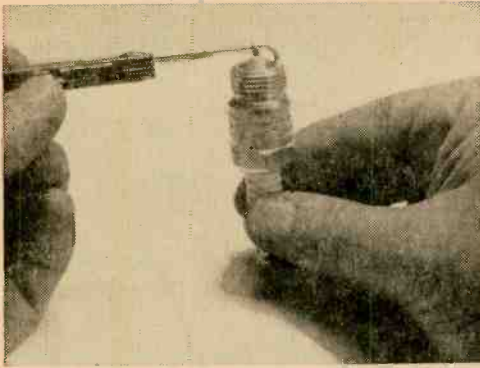

Fig. 13. As with the distributor point gap, spark plug gap must be adjusted precisely.

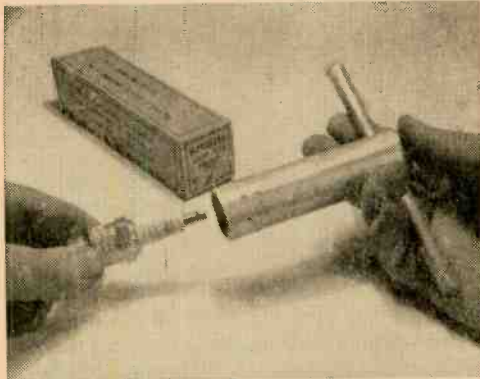

Fig. 14. Spark plug wrench is necessary because plug is recessed in the engine head.

the dwell reading should remain fairly constant as the engine is revved up. More than a few degrees variation in dwell suggests excessive wear in the distributor's mechanical moving parts.

Condenser Check. The condenser is customarily replaced when points are renewed. It can be attacked by oil vapor or grease. You can check the condenser with your ohmmeter. First, the center lead of the condenser is touched to the metal case to discourage any stored current. Then, the meter probes are touched to the center lead and condenser case. The meter should be set on its highest ohms scale. A normal condenser causes the needle to first dip down the meter scale, then slowly rise as the plates charge up. The final reading on the meter should come to rest at about 5 megohms or more and stay there.

Voltage Losses. A possible cause of weak spark is the distributor cap. Rather than jump normally from rotor to each plug

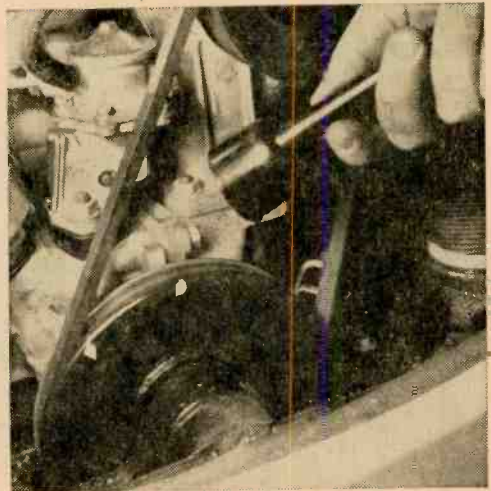

Fig. 15. Timing light is shined on the timing mark which is visible on the fan pulley.

terminal, high voltage may find an easier leakage path to ground. Remove the cap and inspect its inside surfaces (Fig. 11). Dirt, carbon tracks or burned terminals should be cleaned. Carefully inspect for any hairline cracks which could leak away high voltage. Replace cap if any are found.

Next is the cable assembly carrying the branching high-tension leads from distributor to spark plugs. Any sign of cracking or wear demands complete replacement. High-tension wire is frequently available by the foot, but it's far wiser to purchase a set designed for the car. One reason is that many cars employ resistance elements inside the cables to reduce radio interference. If your cables end in plastic caps, always grasp the caps, not the cable. Otherwise, internal connections could break or the weather seal be damaged.

Spark Plugs. Like breaker points, spark plugs give tell-tale signs of their condition. The area around the center electrode should be a medium gray or tan color. Black sludge is a sign of oil fouling. Very light gray indicates the carburetor mixture is too lean; a dark gray appearance suggests too rich a mixture. If the plug electrodes are not badly burned they can be restored. (Plug life is estimated to be from about 10,000-15,000 miles.) Examine the porcelain insulator, especially where it joins the metal body of the plug. Any cracks in the porcelain mean the plug must be discarded.

(Continued on page 96)

Pulses to

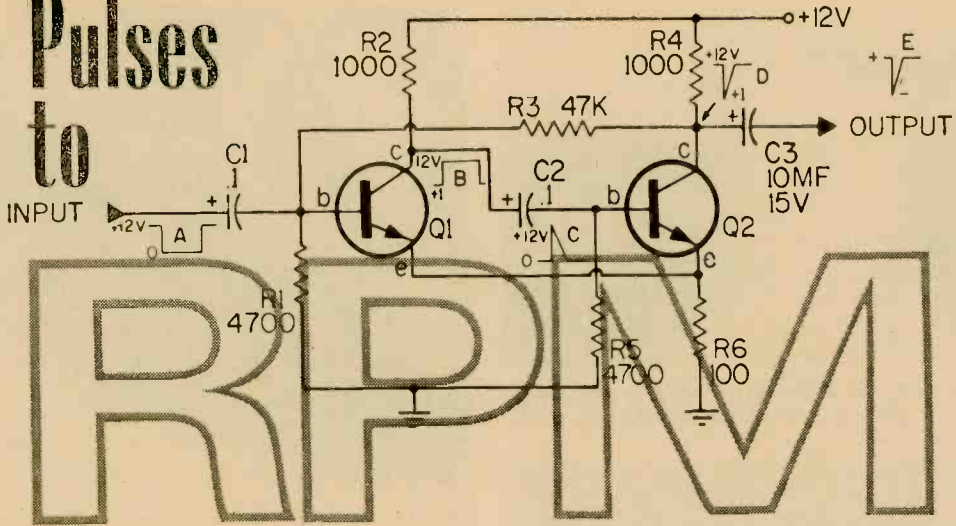

By Kenneth Jamison

One of the more popular, humorous *motto cards* says, "Blessed are they who go around in circles, for they shall be called the big wheels."

Be that as it may, the *big wheel* of automobile instruments is the one which "goes round in circles," measuring revolutions per minute—the tachometer. Long known as a necessity for high-performance vehicles such as racing cars, the tach is coming into prominence for the everyday driver, too, with the introduction of many inexpensive electronic versions.

The *why* of how a few simple electronic components can determine the speed of an engine, though, isn't too well known—and many enthusiasts have little or no knowledge of what goes on inside a tach. This is unfortunate, since the circuits are extremely simple. In fact, you can build one for yourself at a handsome savings over the already low-priced kit models! Let's see how they work, and take a look at one you can build.

The Earliest Tachometers. The logical starting point for this trip is the beginning; originally, the tachometer was mechanical.

One of the very first tachometers—and still popular for many non-automotive applications—was a simple gear-box driving a needle across a dial, very much like the works of any clock. The gears stepped down the motion of the shaft whose rpm were to be measured, so that (for instance) 1000 revolutions of the shaft would drive the needle 10 divisions across the dial.

The operator held the device in contact

with the rotating shaft for exactly one minute, using a clock with a sweep-second hand, and at the end of that time noted the number of revolutions from the dial.

This, obviously, has a number of drawbacks. Aside from the inconvenience of having to hold the instrument against the shaft—which could be escaped by proper design of an engine—one of the biggest was that it would tell only the *average* rpm over a minute. If the shaft speeded up or slowed down, this method wouldn't tell you about it for quite some time.

The Flyball Tach. Another mechanical version, this one giving instant readout, was the "flyball" type shown in Fig. 1; this is

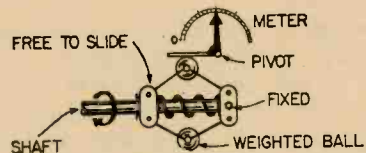

Fig. 1. Weights of flyball tach move out as shaft rpm increases; and meter is deflected.

similar to the speed governor used on many fixed engines (your power lawn mower probably has one). The faster the shaft turns, the farther out from the shaft the balls will try to fly. The outward motion is then linked to the indicating needle.

This type of instrument has high accuracy, and represents the tops in mechanical tachs. Other types, also, have been used, including one which works the same way as a speed-

ometer but is calibrated in rpm rather than in miles per hour.

But along about this time someone realized that it would be possible to put a small electrical generator on the shaft with a voltmeter on the instrument panel reading the output of the generator—and this would get rid of many moving mechanical parts, always a source of potential problems. And that moved us into the era of electrical tachometers.

For many applications, especially in a shop where the rpm figure is relatively low, the generator-voltmeter tach (Fig. 2) is ade-

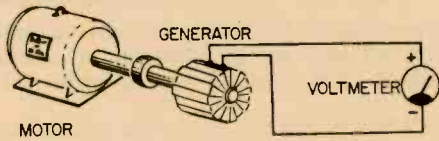

Fig. 2. Generator voltage increases with motor rpm; voltmeter is calibrated in rpm.

quate. It eliminates the need for a rotating shaft from the device being measured to the measurement point. But at high rpm, readings become a bit uncertain. Something better was needed for auto racing and aircraft.

Having made the step over to electrical readout, the designers weren't eager to trade back to anything requiring a rotating flexible shaft. Therefore they looked for other characteristics they could use to measure rpm—and they found one in the ignition circuitry of the auto engine.

Ignition Circuitry and RPM. At first it may sound rather unlikely that anything could be hooked into the ignition circuit and indicate rpm, but the notion isn't as wild as it might seem.

The whole purpose of the ignition system, after all, is to deliver a spark to the proper cylinder at the proper point in the crankshaft revolution—so spark generation is directly tied to crankshaft rpm!

Every time a cylinder fires, the ignition circuit has had to produce the spark to fire it. This means that there's an electrical pulse produced in the primary of the ignition coil for every cylinder firing.

In a four-cycle engine, each cylinder fires only on *alternate* revolutions of the crankshaft. This means, then, that the number of pulses produced during every revolution is just half the number of cylinders in the engine. A six-cylinder engine will produce three pulses per revolution, an eight-cylinder

will give four pulses per revolution, etc.

When we talk about *pulses* in electronic terms, we usually talk about the number of pulses *per second*. Engine speed, on the other hand, is described in revolutions *per minute*. Since a minute has 60 seconds, we can relate pulses-per-second to revolutions-per-minute if we multiply by 60.

Taking both these bits of information, we come up with a simple formula that says rpm is equal to $(60 \times 2 \times \text{PPS})$ all divided by the number of cylinders. For a 6, this becomes $\text{RPM} = 20 \times \text{PPS}$, and for an 8, it is $\text{RPM} = 15 \times \text{PPS}$.

So what does all this mean? It means that we can now take *any* kind of audio-frequency meter which will indicate the number of pulses-per-second produced in the ignition system, and multiply its reading by a fixed number to read rpm.

The Electrical Tachometer. When the step from mechanical tachs to the electrical variety was first taken, the transistor and its low power requirements had not yet arrived. The designer therefore had to make use of simple electrical pulse counters.

One of the simplest—in theory at least—is that shown diagrammed in Fig. 3. Here,

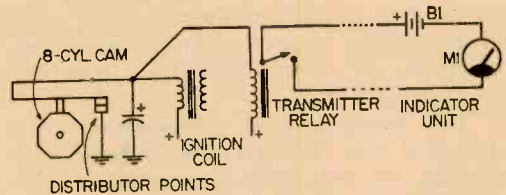
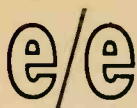

Fig. 3. Theoretically simple tach is rendered impractical by need for expensive relay.

a sensitive relay specially built to keep its contacts closed for the same length of time every time it is actuated is connected to the ignition points of the vehicle, so that every time the points close the relay operates and produces a standardized pulse.

Whether the incoming pulses are far apart or close together, the pulse coming from this *transmitter* relay has the same width. This is essential—and this special relay is the reason the simplicity of this device was emphasized as being theoretical. In practice, the *transmitter* units cost around \$50 each!

This pulse from the transmitter applies voltage from the small battery B1 (the auto battery isn't used, because the voltage must also be kept constant—present versions of this unit employ mercury cells), to meter.



TACHOMETERS

Every time a pulse comes along, the meter attempts to deflect upscale. It fails to reach the pin because the pulse doesn't last long enough for the needle to overcome its own inertia. It will, however, get part way upscale—and before it can fall back down very far another pulse gives it another kick.

If the pulses are far apart, the needle will ride low on the dial. If the pulses are closely spaced, however, the needle will ride near the top of the dial because it has almost no time at all to fall back between pulses.

When voltage, meter mechanical characteristics, and pulse width are all properly chosen, the result is a completely linear scale—which is then, of course, calibrated in rpm.

This type of tach is still in wide use among professional drivers; one of the best-known units based on this circuit is the *Sun* electrical tach (though *Sun* also makes electronic models which are tending to replace the electrical version).

We noted above that the item which complicates this approach is the special transmitter relay. With the rise of transistors, a circuit was developed which would do the same thing for less money—and that led to the electronic or transistorized tach, now the most popular kind.

The Transistorized Tachometer. Although it wasn't the first of the transistorized circuits, the one which corresponds to the electrical version above shows most clearly how transistors were able to take over. After describing it, we'll look at the even simpler circuits made possible by transistors.

Computer designers, working with transistors, came up with a circuit they call a *monostable multivibrator* and refer to it colloquially as a *one-shot*. This circuit, shown with the title of this story, delivers a single standardized output pulse for every *trigger* received at the input. The shape or length of the trigger is unimportant; output pulse will be same every time.

Here's how the one-shot works; references are to schematic (p. 54). Transistors Q1, Q2 are identical units, such as type 2N1302 (npn transistors can also be used by reversing supply-voltage polarity). Both are supplied with collector voltage through R2 and R4, respectively. Q1 is also supplied base current through R3, and so can conduct—but if Q2 is conducting heavily its collector

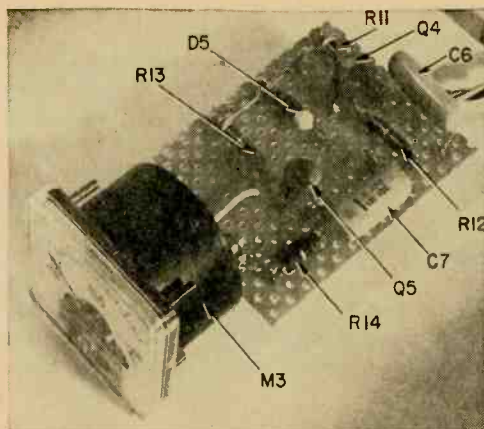

This practical \$8.00 tachometer can be fabricated for your car by following schematic in Fig. 6 and referring to the parts list.

voltage will be too low to provide current for Q1, so that at all times one of the two transistors is conducting and the other one is not.

Normally, the current through R3 keeps Q1 on, while Q2 stays off because its base gets no current. Emitter resistor R6 helps things along by keeping the base of the *off* transistor reverse-biased; the circuit will also work without R6 but not so reliably.

The Trigger. When a trigger, such as a square wave is applied (waveform A), it drives the base of Q1 negative, turning Q1 off. The collector voltage of Q1 then rises to the supply level, and this change in voltage

PARTS LIST

- B1, B2—9-volt batteries
- C1, C2, C4-C7—0.1-mfd, 400-volt paper capacitors
- C3—10-mfd, 15-volt miniature electrolytic capacitor
- D1—1N459 silicon junction diode
- D2, D3—1N34 general purpose diodes
- D4—1N712 Zener diode, 8.2 volts, 400 mw
- D5—1N706 Zener diode, nominally 5.1 volts, 400 mw
- M1, M2—See text
- M3—0-1 millimeter (Lafayette Radio TM-400 or equiv.)
- Q1-Q5—2N1302 transistors (see text)
- R1, R5, R8, R10, R12—4700-ohm, 1/2-watt resistors
- R2, R4, R7—1000-ohm, 1/2-watt resistors
- R3—47,000-ohm, 1/2-watt resistor
- R6—100-ohm, 1/2-watt resistor
- R9, R15—See text
- R11, R13—470-ohm, 1/2-watt resistors
- R14—2200-ohm, 1/2-watt resistor (see text)
- Misc.—Perforated phenolic chassis board, hookup wire, hardware, solder, etc.

Estimated cost (Fig. 6 circuit): \$8.00

Estimated construction time (Fig. 6): 2 hours

(waveform B) passes through C2 to the base of Q2, providing current to turn Q2 on. So long as C2 is charging, Q2 will remain on. See top of page 54.

Once Q2 begins to turn on, the base-current source for Q1 disappears, so that even if the trigger were removed before C2 were fully charged, it would have no effect on the one-shot.

The value of C2 controls the width of the output pulse; current cannot flow through it indefinitely, and as C2 becomes fully charged the current for Q2's base drops to zero (indicated by waveform C's fall). When this happens, Q2 turns off again. At this time, current for the base of Q1 again becomes available through R3, which restores the circuit to its original condition.

Even if the input trigger is still present, it will have no effect so long as C1 is equal to or smaller than C2; the DC level of the trigger is blocked by C1, so only the initial change of level gets through to start the cycle.

Waveforms D and E show how the output pulse appears. At D, the pulse is DC of varying level. Capacitor C3 blocks the DC, but allows the AC pulse to pass.

If the input terminal is connected to the hot breaker point of the auto distributor, and the one-shot is powered from a separate battery, this circuit alone can be used as the transmitter of an electrical type system. Fig. 4 shows how it's done.

Here, the diode simply blocks the positive portions of the output of the one-shot, letting the negative pulse peaks through. Meter M1 is kicked upward by each pulse just as described earlier. The battery has now been moved to the one-shot circuit. This is one high-precision transistorized tach circuit.

However, linearity still depends largely on

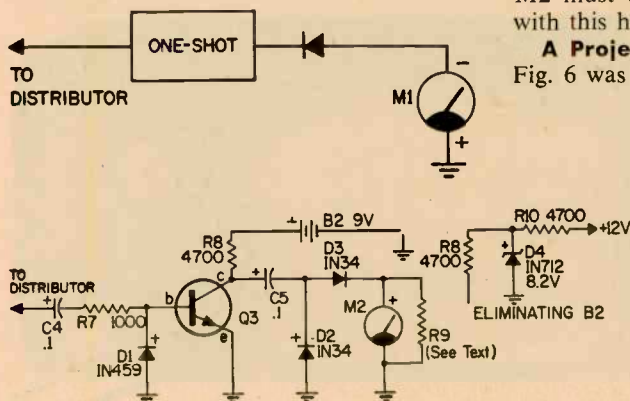

Fig. 4. Negative pulses from one-shot are passed by diode and kick meter to rpm reading.

Fig. 5. This single-transistor tachometer uses npn transistor for negative ground vehicles.

the meter's mechanical characteristics. In addition, the unique properties of transistors let us make the circuit much simpler yet still get good results.

Single-Transistor Circuit. In fact, we can get by with a single transistor and a sensitive meter, if we like. One circuit for doing this is shown in Fig. 5. This is similar to the circuit used in the Knight-Kit tachometer, for negative-ground vehicles. To adapt it for positive-ground use, substitute a PNP transistor, reverse all diodes, the battery, and the meter.

In this circuit, C4 blocks the DC voltage of the ignition circuit but allows the pulse to pass. R7 and D1 (a silicon diode) form a limiter which holds the peak of the pulse to approximately 0.6 volt.

Each pulse turns Q3 on for the duration of the pulse. Its collector voltage is almost zero when it is on, and rises to 9 volts when Q3 is off. This action makes a rectangular wavetrain out of our series of pulses.

C5, working into the low resistance offered by the diodes and meter, differentiates this waveform into a series of alternate negative and positive pulses, each of constant width (fixed by the value of C5). The battery ensures the pulses have constant height.

D2 shorts negative-going pulses to ground, while D3 routes the positive-going ones through the meter. M2 pumps to a constant indication for any given number of input pulses per second just as previously described; R9 is a calibration control.

To eliminate the need for a separate battery, Zener diode D4 and resistor R10 can be added as shown. However, the supply voltage for the circuit must be regulated in some manner.

The major disadvantage of the simple circuit in Fig. 5 is that the pulses are very small when they reach the meter. In consequence, M2 must be a 0-50 microammeter; meters with this high sensitivity are very expensive.

A Project Circuit. The circuit shown in Fig. 6 was designed to overcome this disad-

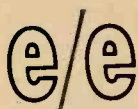

TACHOMETERS

vantage. It's about as simple as a tachometer circuit can be; one version of this has been built, complete, on a printed-circuit board which mounts on the back of a 1½-inch meter and is no larger than the meter barrel. It's the one recommended for your car.

Here, C6 blocks the DC from the distributor. R11 serves mainly to keep Q4 turned "off" in the absence of input pulses. The collector of Q4 remains at supply voltage until a pulse arrives, then drops to almost zero. This change is passed through C7, which differentiates the level changes into alternate spikes.

The diodes aren't necessary since a negative-going spike will only turn Q5 more off than normal; only a positive-going spike will turn Q5 on. Whenever Q5 turns on, it dumps current through M3; M3's indication depends on the spacing of the spikes—the closer together in time, the higher the reading.

R14 serves to both calibrate and linearize the meter indication. Since we're getting current amplification in Q5, we can now use a relatively rugged O-1 milliammeter for M3; Zener diode D5 regulates supply voltage for the entire circuit to 5.1 volts. This makes

the circuit usable for either 6-volt or 12-volt applications; for 6 volts, R15 should be 100 ohms and for 12 volts, 680 ohms.

Calibration. All tachometers, like any other instrument, need to be calibrated from time to time. If you build one, calibration must be the first step. Fortunately, the transistorized models don't care what kind of input trigger they get, so use 60-cps AC.

This gives you 60 pulses per second, and when we plug this value into our calibration formula relating pps to rpm, we find that it is equal to 900 rpm for an 8-cylinder vehicle or 1200 rpm for a 6.

With the circuit of Fig. 5 or Fig. 6, or with a commercial unit, calibration need be made only at one point. With other circuits, it's usually worth while to check several points in the range. To do this, use the formula again. Or, compare with a tach of known accuracy. ■

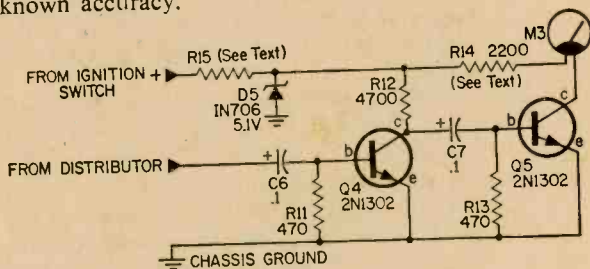
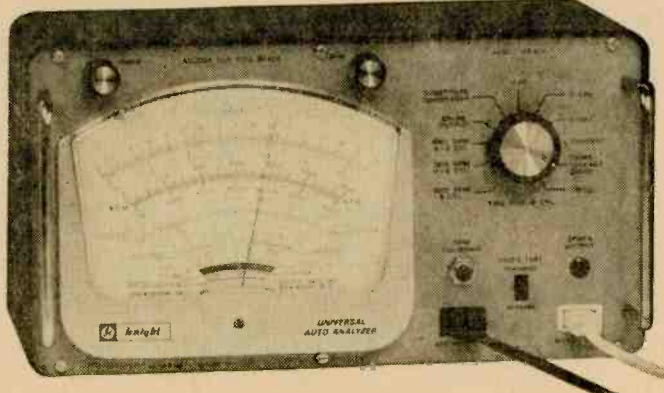
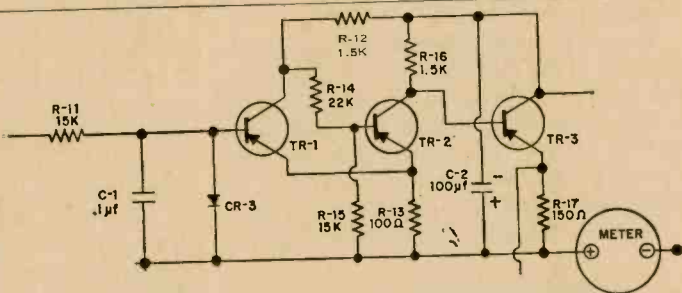

Fig. 6. Schematic diagram for project tach.

Schematic diagram at the right shows portion of 3-transistor heart of tachometer circuit in Knight-Kit Auto Analyzer Kit.

Pulses are fed through filter circuit R11 and C1 and applied to square wave generator circuit comprised of TR1, TR2 and associated components. Output of generator has constant amplitude, the frequency of which depends on number of pulses applied to circuit. TR3 amplifies square wave before it goes to a pulse counting circuit comprised of 3 diodes. One of the diodes is CR3 which also prevents reverse pulses from damaging TR1. Unconnected leads in schematic go to switches.

Analyzer also has ammeter, voltmeter, ohmmeter, dwell, spark and diode test, condenser test circuits.



Incandescent Lamp

By Len Buckwalter

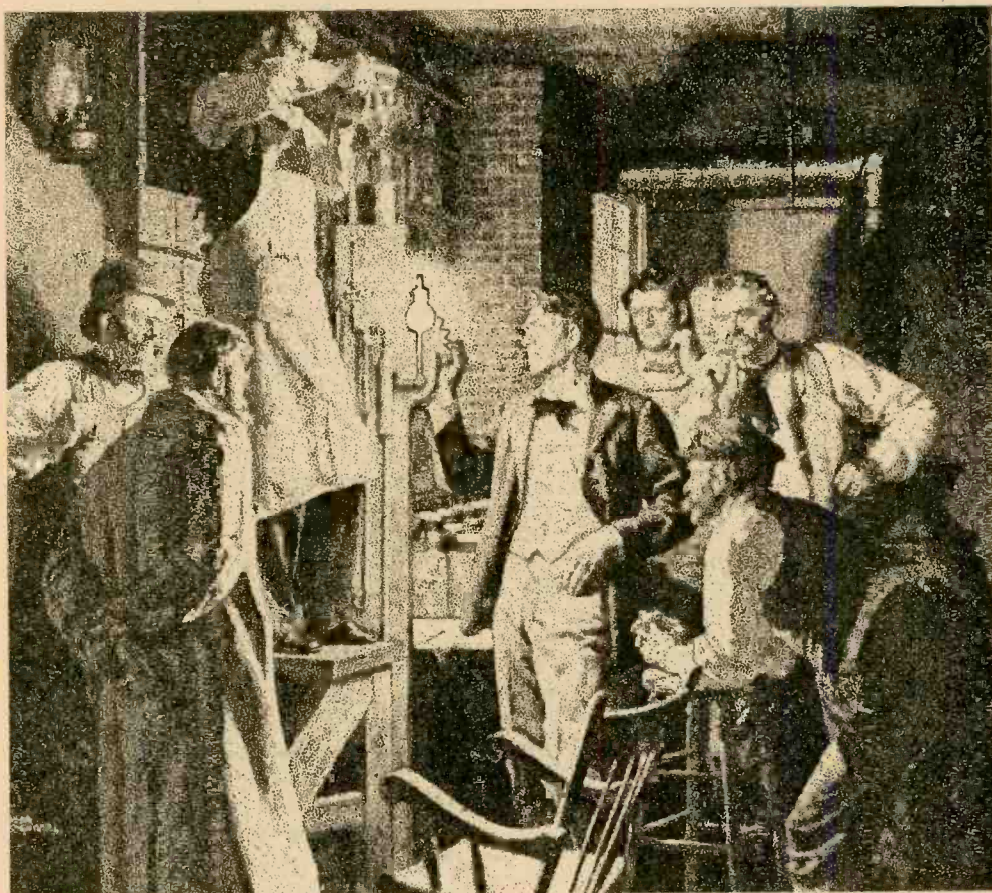

Edison's genius, aided by a capable laboratory staff, "flicks" on the first practical incandescent lamp in 1879, realizing an age-old dream

■ The search for artificial light is at least 30,000 years old. It is believed to have started when primitive man pulled a flaming faggot out of a fire, thereby creating the first torch. But in the year 1650, a German scientist discovered that light could be produced not only by combustion, but through electrical means as well. In spinning a globe of sulphur, von Guericke observed a glow of light. Friction generated electricity which somehow caused the sulphur to glow.

The next significant advance was not to occur for some 150 years. But it was far more practical. Sir Humphrey Davy in England placed two charcoal sticks four inches apart, then impressed them with high voltage. (His electrical source was a battery consisting of 2,000 cells.) A brilliant flame sparked across the two elements. The carbon arc lamp was born. At about the same time (early 1800's) there appeared yet another approach to converting electricity into

e/e INCANDESCENT LAMP

useful light. It was incandescence; the passing of electric current through a substance heats it. As temperature went up, substance went from a dull red, to orange to white, and gave off increasing amounts of light. Serious difficulties, however, hampered early attempts at constructing the lamp. How, for example, is the hot, glowing substance prevented from burning up?

The first patent granted in England for an incandescent lamp reveals how this was solved. In 1841, Frederick de Molyns devised a unique apparatus; a glass sphere from which air had been removed. Inside were two platinum wires joined by a bridge of powdered charcoal. As electrical current passed through the wires, the charcoal was heated to incandescence. The absence of air in the sphere prevented the carbon from rapidly burning up. A major technological feat it was, but there were still difficulties to be solved. The inside surface of the glass sphere quickly blackened and made the lamp useless.

The experiment soon triggered further investigation by scientists around the world. In a variety of designs were attempts to bring the incandescent lamp to commercial reality. None, however, achieved more than limited success. Either lamp life was too short, materials too expensive or reliability simply not good enough. And the carbon-arc lamp was starting to enjoy increasing application. But it was the incandescent lamp that held the greatest promise. It could be small in size, easy to install, not require high voltages—if it only worked.

The answer came in 1879. After expending more than \$40,000 and over 1,000 attempts, Thomas Edison produced the first completely practical incandescent lamp. With a filament of carbonized cotton thread inside a vacuum, it glowed brightly and steadily for two days. This was soon extended to several hundred hours with an improved filament of carbonized bamboo. Edison's lamp was quickly established as a commercial success.

Edison's design was rapidly improved. The greatest single advance was the introduction of the tungsten filament in 1907. Carbon filaments worked, but they could not operate hot enough to be very efficient. Tungsten filaments, and other improvements to be de-

FIG. 1:

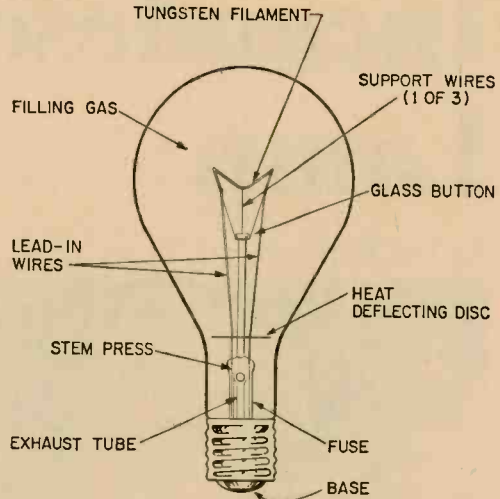

Shown here are the parts of the filament lamp—one of the greatest bargains of modern technology. The gas is a mixture of argon and nitrogen. Exhaust tube is sealed after air is exhausted and bulb is filled with inert gases. Fuse opens circuit if filament arcs and saves blown house fuses.

scribed, enable a modern lamp to produce about 65 times more light per penny than Edison's first commercial model.

Lamp Parts. Today's incandescent lamp, though simple in appearance, is a product of elaborate, often painstaking design steps. The more obvious parts are shown in Fig. 1. A tungsten filament is strung across supporting wires. During manufacture the supporting wires are pressed into a heated glass button which cools and locks the wires in place. Two lead-in wires bring power from the base of the lamp up to the tungsten filament.

Note how the wires pass through the stem press, a glass supporting element. A special alloy called Dumet wire expands and contracts at the same rate as glass to preserve an airtight seal at this point. Near the bottom of the lamp is an exhaust tube which projects beyond the glass bulb before the base is attached. Depending on the lamp type, air is pumped out—or other gasses pumped into the bulb. The fuse, in one leg of the lead-in wire, serves the same function as a common fuse. It provides an added safety feature against the possibility of the bulb cracking which might occur if the filament sputters metal against the glass. It also prevents the house fuse from blowing when the lamp fails due to short circuit. Finally, the base makes the connection into power source.

FIG. 2:

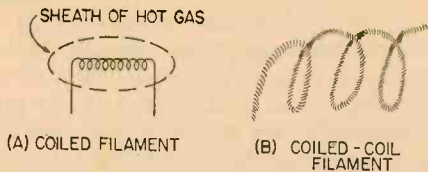

By using a coiled filament as in (A), heat loss through sheath of hot gas was found to be decreased. Further reduction in heat loss was obtained by coiling the coil as in (B).

Vacuum Vs. Gas-Filled. In early lamps, the filament was protected against failure by removing air from the bulb. The vacuum kept gasses from attacking or oxidizing the filament. But even a perfect vacuum, cannot assure unlimited filament life. A hot filament continuously throws off particles and, in time, it evaporates. Blackening of the bulb is also caused by filament evaporation. Particles deposited on the inside wall of the bulb reduce light transmission.

Instead of a vacuum, why not use some inert gas that can't react with the hot filament? With increased pressure tungsten evaporation could be retarded and the blackening problem, too, minimized. Early attempts at filling the bulb with gas were disappointing, especially in the lower-wattage lamps. Introducing nitrogen into the bulb actually reduced efficiency. The reason was traced to a new condition caused by the gas. It was the transfer of heat through convection and conduction. The gas provided bridge through which filament heat could leak away.

And lost heat caused less light.

Irving Langmuir in 1913 discovered a way to make the gas-filled lamp practical. He had observed that a glowing filament was surrounded by a stationary sheath of hot gas. What's more, heat had to penetrate that sheath to reach the outside. If the filament diameter could be increased, heat loss through the encircling gas sheath would be relatively less than before. By coiling the filament, Langmuir succeeded in producing an apparent increase in diameter. (See Fig. 2.) His lamp was twice as efficient as older ones.

Ar & N. Many of today's lamps are filled with argon and nitrogen. Introduced into the bulb at slightly less than atmospheric pressure, the lamp's operating heat increases this to atmospheric pressure. The filament may now operate as high as 5,000°F and produce little bulb blackening due to tungsten evaporation. But not all bulbs can be gas-filled. Lamps below 40 watts are still of the vacuum type. Heat loss through the gas offsets any advantages gained in terms of longer filament life. This, again, is the problem mentioned earlier; filament diameter must be large in comparison to the surrounding gas sheath to lower heat losses. One solution is the use of gas which is a poor heat conductor. Krypton is one possibility, but it's still too expensive for general use (though practical for a special application such as the small lamp on a miner's cap).

Lamp Operation. How, then, is it possible to build a bulb which combines all the

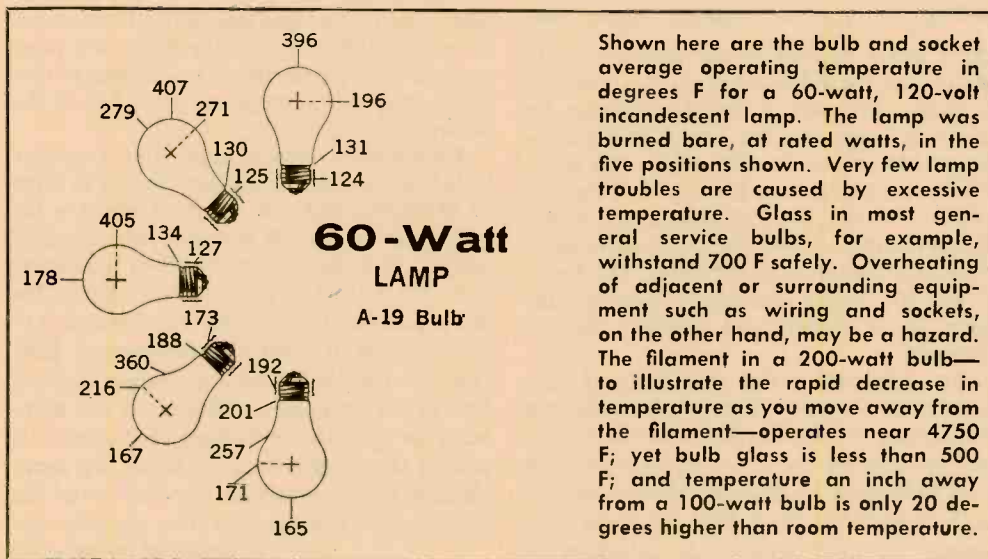

Shown here are the bulb and socket average operating temperature in degrees F for a 60-watt, 120-volt incandescent lamp. The lamp was burned bare, at rated watts, in the five positions shown. Very few lamp troubles are caused by excessive temperature. Glass in most general service bulbs, for example, withstand 700 F safely. Overheating of adjacent or surrounding equipment such as wiring and sockets, on the other hand, may be a hazard. The filament in a 200-watt bulb—to illustrate the rapid decrease in temperature as you move away from the filament—operates near 4750 F; yet bulb glass is less than 500 F; and temperature an inch away from a 100-watt bulb is only 20 degrees higher than room temperature.

desired features of high efficiency, long life, and low cost? Like trying to juggle the family budget, the modern incandescent lamp is product of several compromises. For example, some floodlights used in photography are rated for a life of less than 10 hours. This is due to very high filament temperature; the tungsten evaporates at a high rate. But take a look at the efficiency of such a lamp—its ability to convert watts into light, as measured in lumens. Efficiency for high-wattage lamps is much greater than for smaller household lamps. The reason is filament temperature; the hotter it runs, the more light it produces. Consider this comparison. One studio flood lamp listed in the catalogs is 10,000 watts. Its life is rated at a short 75

FIG. 3:

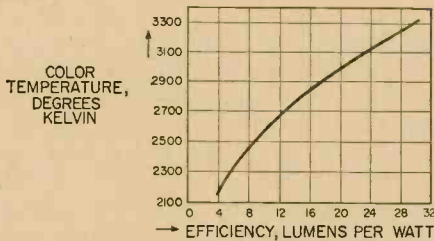

When filament temperature is plotted against lamp efficiency in lumens per watt, the fact that efficiency increases with temperature becomes very apparent. Of course, lamp life decreases too, so a compromise is made according to type of lighting application.

hours. Yet it has one of the highest efficiencies of any incandescent lamp. It's rated at 33 lumens per watt. A tiny 3-watt lamp, on the other hand, has the lowest efficiency—about 4 lumens per watt. But that small lamp, with its cooler-running filament will operate not for 75 hours, but 3000 hours! In playing off one quantity against the other, lamp manufacturers compromise at about 750 hours of life for lamps commonly used in the home. It's a middle road between life and efficiency.

How efficiency varies with filament temperature is shown in Fig. 3. Although the temperature is rated in degrees "Kelvin"—used to describe the color of light—it also is an indication of filament temperature. It can be seen in the chart that a relatively cool filament at 2100 degrees K functions at

about 4 per cent efficiency. This, however, rises to nearly 32 percent for hotter rating.

Where Wattage Goes. Another interesting aspect of lamp operation is how its input electrical energy is consumed. As you may suspect, all the current flowing into the lamp is not turned directly into light. In fact, most power is converted to heat. Consider how the energy divides in a 60-watt lamp:

As Light—7.5% This is the useful portion, radiation which falls in the visible spectrum.

As Infrared—73.3% This is the heat component, which takes the biggest toll.

Thus far, 80.8 per cent of the energy is radiation which leaves the bulb as heat or light. The remaining percentages are consumed by certain losses;

Gas Loss—13.5% This results from circulation of the gas within the bulb. Gas moves past the filament, picks up heat, then transfers it to the glass wall. Cooling of the filament in this manner drops its light-producing efficiency.

End Loss—1.2% Not much loss here. This is energy surrendered by the filament to other internal parts of bulb. Heat is conducted down the filament supporting wires, to cooler parts in the base.

Bulb and Base Loss—4.5% Some energy is radiated from filament to bulb or through the base, and causes heating of the surrounding air.

This accounts for 100 per cent of the input wattage. The significant figure is 7.5%—the portion which represents light. In higher-wattage bulbs, for reasons covered earlier, efficiency can rise to 12.1% (for a 1000-watt lamp). And gas loss in the 1000-watt is considerably less since the filament is large compared to the sheath of gas around it. Gas loss is only 6%, compared to 13.5% in the 60-watt.

Data Chart. Now to apply these concepts to lamps now on the market. Shown in table of Operating Data on standard lamps is the specifications for 26 standard incandescent lamps. You can see how various characteristics are related to each other. Two of the more noteworthy columns are "Rated Lumens Per Watt" and "Rated Average Life, Hours." Just look down the column showing lumens per watt and you'll see how this number goes up with the wattage of the bulb. It reveals that higher-wattage bulbs are more efficient light-producers. But shift over the life-in-hours column and the opposite oc-

(Continued on page 66)

SOMEONE SHOULD DEVELOP AN EASY WAY TO LEARN ELECTRONICS AT HOME

RCA INSTITUTES DID!

RCA introduces new CAREER PROGRAMS—beginning with the student-proved "AUTOTEXT" Programmed Instruction Method—the faster, easier way to learn. You start to learn the field of your choice immediately. No previous training or experience needed.

Pick the career of your choice—and RCA Institutes will do the rest! RCA's new, revolutionary "Career Programs" help you go directly to the career you want! You waste no time learning things you'll never use on your job! Each Career Program is designed to get you into the kind of job you want in the fastest, easiest possible way!

SEPARATE COURSES

In addition, in order to meet specific needs, RCA Institutes offers a wide variety of separate courses which may be taken independently of the above Career Programs, on all subjects from Electronics Fundamentals to Computer Programming. Complete information about these courses will be sent with your other materials.

CHOOSE A CAREER PROGRAM NOW your first step to the job of your choice!

- Television Servicing
- Telecommunications
- FCC License Preparation
- Automation Electronics
- Automatic Controls
- Digital Techniques
- Industrial Electronics
- Nuclear Instrumentation
- Solid State Electronics
- Electronics Drafting

RCA INSTITUTES BONUS EXTRAS

Only RCA Institutes offers you a Liberal Tuition Plan, one of the most economical ways to learn. Plus, you get top quality equipment in all kits furnished to you with your courses—yours to keep and use on the job. And now, RCA's NEW PROGRAMMED ELECTRONIC BREADBOARD GIVES YOU LIMITLESS EXPERIMENTATION—scientific laboratory procedures

right in your own home! You build a working signal generator, AM Receiver, Multimeter, Oscilloscope, and other valuable equipment—ALL AS A PART OF YOUR COURSE! Get the facts today!

Classroom Training Also Available. Day and Evening Classes are available to you in New York City at RCA Institutes Resident School. You may be admitted without any previous technical training; prep courses are available if you haven't completed high school. Coeducational classes start four times a year.

SEND ATTACHED POSTCARD TODAY FOR COMPLETE INFORMATION. NO OBLIGATION. NO SALESMAN WILL CALL. FREE BOOK INCLUDED. CHECK HOME STUDY OR CLASSROOM TRAINING.

RCA INSTITUTES, INC., Dept. EA-05

A Service of the Radio Corporation of America
350 West 4th St., New York City 10014



The Most Trusted Name in Electronics

e/e INCANDESCENT LAMP

Continued from page 62

FIG. 4:

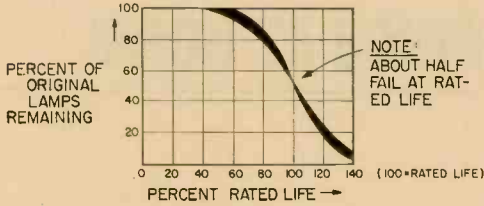

This lamp mortality curve from General Electric shows that about half of their lamps fail before or at rated life, but other half continue burning well past the rated life.

cur. The bigger the lamp, the shorter its average rated life in hours.

Lamp Life. Although lamps are rated for a given number hours, say 750 or 1,000, they do not automatically fail at the end of this period. In fact, they begin to deteriorate before rated life is over. This is due to filament evaporation which causes the tungsten filament to grow thinner with time. Narrowing of the wire reduces current flow into the bulb and light output is therefore reduced. Also, some blackening of the bulb tends to cut down light output. (Photoflood users may have noted the lamp manufacturers' suggestion; to increase the camera diaphragm opening after lamps are a few hours old.)

FIG. 5:

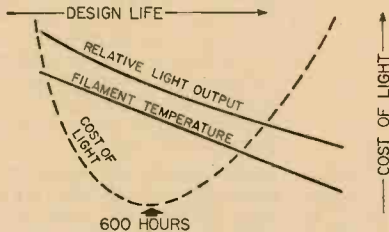

When you turn on your lamp and it fails with a bright flash, you replace it. But for high quantity users who are purchasing light, it is advantageous to replace lamps before failure. See text for graph interpretation.

After testing hundreds of thousands of bulbs, manufacturers have come up with a mortality curve. It's a chart which shows how bulbs actually fail in relation to their rated lives. A typical chart is shown in Fig. 4. It is seen that half the number of bulbs fail by the end of rated life. For the typical lamp-

(Continued on page 115)



CANDELABRA: Uses include show case, optical, appliance, indicator, sign, and decorative lamps. This is the smallest base for 120-volt lamps.



INTERMEDIATE: Applications include appliance, indicator, sign, and decorative lamps.



MEDIUM: This base is standard on general service lamps of 300 watts and under. A high degree of interchangeability in lamp applications is possible because the medium base is so widely used.



MOGUL: Normally used on 300-watt lamps and up. Also applied on special lower wattage lamps, particularly where low voltage design means a high current.

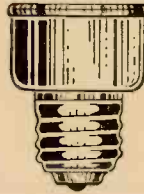

SKIRTED: Used on lamps where the neck is too large to fit into the desired size base, or where additional space between the filament and lamp terminals is desired.



BAYONET: Applied on specialty lamps, such as, for vacuum cleaners, sewing machines, etc. Also used on low-voltage lamps.



PREFOCUS: Used where accurate positioning of the filament is necessary such as in spotlights, optical lights, etc.

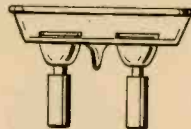

MEDIUM BIPOST: Used for higher current lamps.

Lamp bases are either brass or aluminum, and, as shown here, most are either screw-type, bayonet, prefocus, or bipost. Other types are side-prong, telephone slide, and screw terminal which is familiar if you have ever replaced your car's sealed beams.

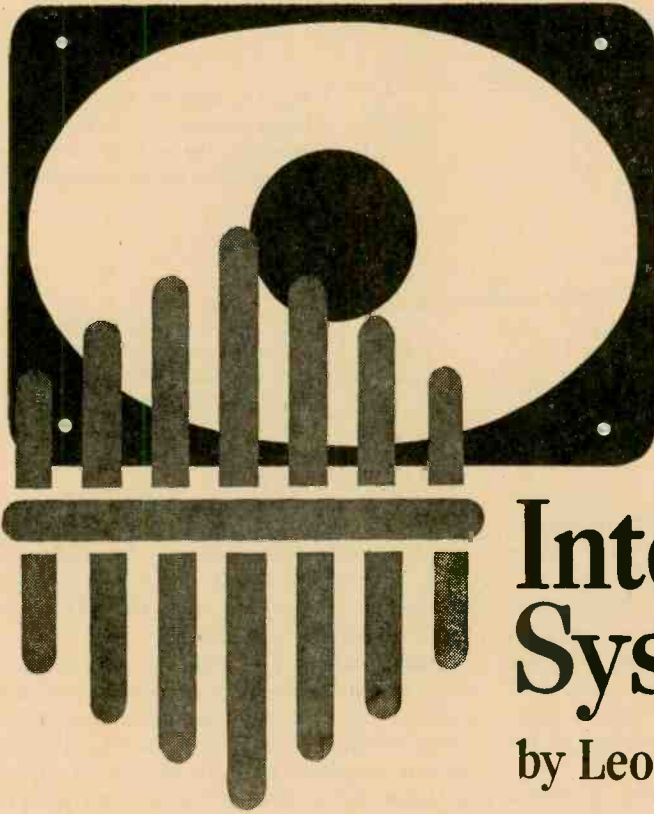

Intercom Systems

by Leo G. Sands

Find out what they're all about—then you can buy wisely or build your own!

■ Intercom is a generic term which is normally used when referring to an inter-communications system employing loudspeakers. While office telephones and speaking tubes found on naval vessels provide inter-communication, the term intercom is usually not applied to them. There are many kinds of intercom systems. They are used for two-way voice communication between two or more points, usually in the same home, store, office, or even between adjacent homes, using wires or radio as the transmission medium.

Starting with Basics. The simplest kind of intercom system consists of one *master unit* and one *slave unit* as illustrated in Fig. 1. The master unit consists of an audio amplifier (amp), a talk-listen switch, S1, and loud-speaker A which alternately functions as a microphone and as a loudspeaker. The slave unit is simply loudspeaker B which functions alternately as a microphone.

When the master unit switch S1 is in the

"listen" position, as in Fig. 1(A), slave unit speaker B functions as a microphone. It is connected through a pair of wires and the talk-listen switch to the input of the amplifier whose output is fed to the master unit loudspeakers. Nearly all of the sounds in the vicinity of the slave unit will be amplified and heard through speaker A.

To initiate a call, the talk-listen switch is set to the "talk" position. This connects the master unit speaker to the amplifier input and the slave unit to its output, as in Fig. 1(B). Words spoken in the vicinity of the master unit speaker will be broadcast from the slave unit speaker.

A person in the vicinity of the slave unit can respond without doing anything but speaking up when the master unit talk-listen switch is reset to the "listen" position. Usually, this is a spring return switch that automatically reverts to the "listen" position when finger pressure is removed. Also, the slave

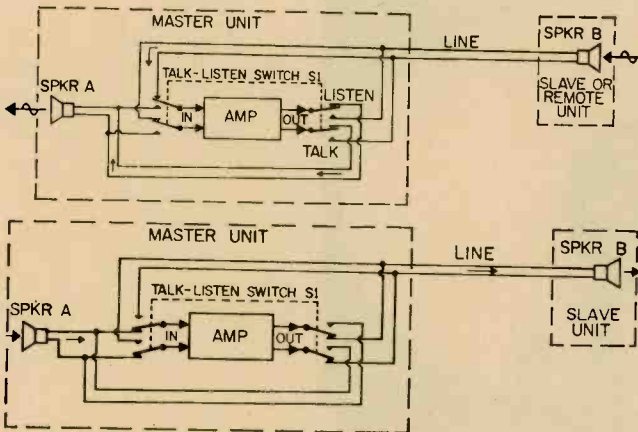

Fig. 1A. With the intercom talk-listen switch S1 in the listen position, the remote unit (Spkr B) functions as the microphone.

Fig. 1B. A call is initiated by setting the talk-listen switch in talk position; speaker A functions as system microphone.

unit has no controls. Calls can be originated from a slave unit by simply talking near it, if the master unit volume control is not turned down too low.

Lines. The interconnecting wires (line) may be a twisted pair without a shield, as shown in Fig. 2(A), with a shield, as shown in Fig. 2(B), or a shielded single conductor cable, as shown in Fig. 2(C), may be used. The inner conductor serves as one of the wires, the shield as the other.

While zip cord could be used, a twisted pair is better since it picks up less hum and noise. A shielded twisted pair is even better since the shield still further suppresses pick-up of hum and noise.

Hum and noise pick-up is minimized when the line circuit is balanced with respect to

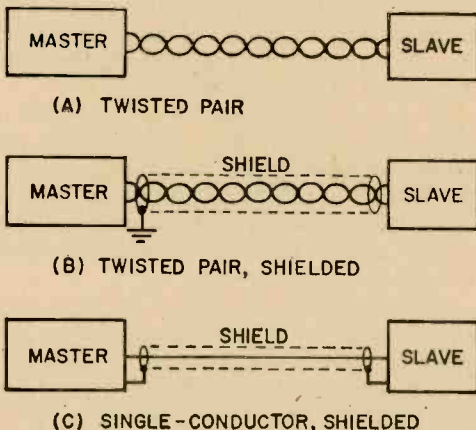

Fig. 2. Various interconnecting lines used.

ground, as shown in Fig. 3(A). However, for convenience and economy, an unbalanced circuit, with one side grounded, is used, as shown in Fig. 3(B). When a single conductor cable is used, as in Fig. 3(C), the line is necessarily unbalanced.

Amplification. The amplifier may employ tubes or transistors, and usually delivers one watt or less which is generally ample for room volume. The circuit of a tube-type intercom amplifier is given in Fig. 4. Both an input and an output transformer are required in order to match the low impedance of the speakers. Some systems employ 3.2-, 4- or 8-ohm speakers. Others use 45-ohm speakers because of the lower power loss in the speaker lines.

No transformers are used in the transistor-type amplifier whose circuit is given in Fig. 5. The input and output of the amplifier are designed to work directly into and out of 4-ohm speakers. This amplifier may be operated from a 12-volt battery or an AC power supply, such as the one whose circuit is shown in Fig. 6. Here, an optional electronic filter (Q1) is used to minimize hum.

More Than One. A master unit may be used with any number of slave units by providing a slave-line selector switch, as shown in Fig. 7. When switch S1 is set to "A", only slave A is connected, and so on. Thus, the operator can set the selector switch to listen in on what is going on around each slave unit. He can also page selectively and communicate with persons in the vicinity of any of the slave units. Unfortunately, persons in areas served by slave units cannot initiate

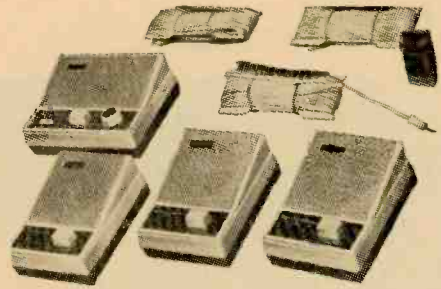
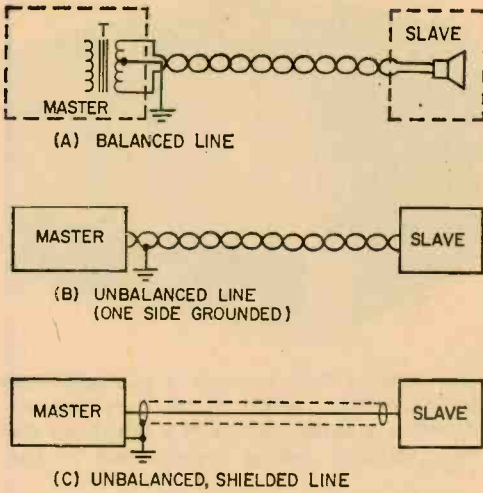

Fig. 3. Balanced and unbalanced lines are shown at the left. Transformer in (A) represents intercom inputs and outputs. Shown above is Lafayette Radio's 4-station solid state intercom system; it comes ready to go.

calls to the master unit unless the master unit selector is set to pick up sounds through their slave unit. This can be overcome by providing additional circuits to the slave units.

For example, a normally open, pushbutton call switch (S1) can be added at each slave unit, as shown in Fig. 8. Closing S1 momentarily causes relay K1 to pull in and lock up through its own contacts. Lamp I1 glows as long as the relay is energized. When the master unit operator responds, he depresses S2 opening the ground circuit holding relay K1 closed. The relay de-energizes and I1 goes out.

No Snoopers. Eavesdropping in even a two-unit system can be prevented by equipping both the master and the slave with spring-loaded, talk-listen switches, as shown

in Fig. 9. Both units function as masters but only one amplifier is needed.

Two or more units may be bridged across the same line as shown in Fig. 10. All units hear all transmissions on the line, but none can eavesdrop since every unit is a master. A typical unit of this type is shown on page 70. Actually, this unit is used normally for controlling a mobile radio system base station—one of the many practical applications for intercoms.

Wireless Intercoms. The same basic operating techniques used by line-connected intercoms are used in wireless intercom systems employing *simplex* operation (sequential transmit and receive). A wireless intercom unit actually consists of a radio transmitter and receiver, as shown in Fig. 11. Instead of radiating the radio signal through

Fig. 4. Schematic, below, is tube amplifier.

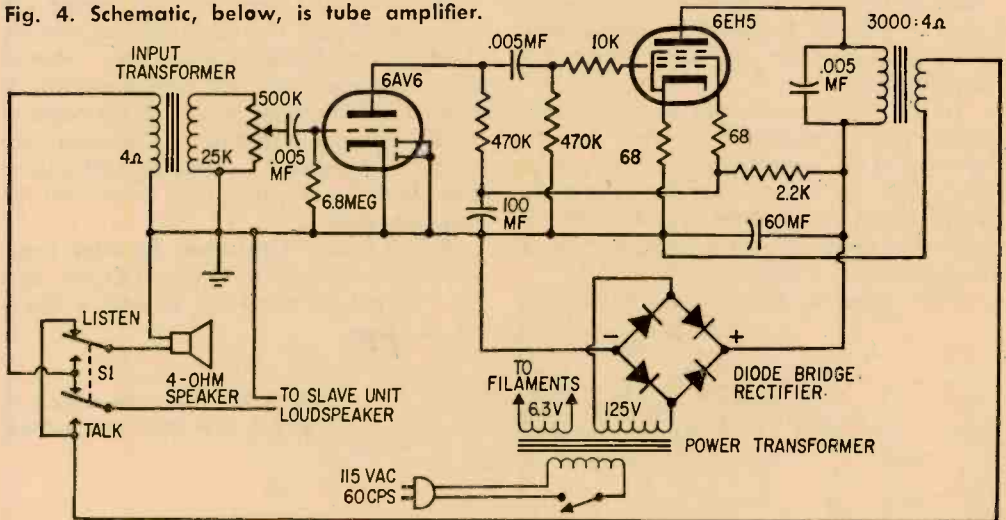



space, it is transmitted over the building's AC power line. This principle is used in power line carrier systems operated by electric utilities.

Wireless intercom systems may be operated at any frequency, but usually perform better at low radio frequencies. Most operate at around 175 kc. The main problem is to get the most RF power into the line without causing the signal to radiate into space beyond the limits imposed by Part 15, FCC Rules and Regulations. This headache falls into the domain of the manufacturer and units are type tested to insure FCC OK.

Any number of wireless intercom units, all operating on the same frequency, may inter-communicate with each other over the same power line. Communication between units in different buildings is possible when both are served by the same distribution transformer.

Hence, wireless intercom systems provide "party line" communication when all units operate on the same frequency. To operate more than one system over the same power line without inter-system interference, the individual system should operate on different frequencies as illustrated in Fig. 12.

Tone Squelch. Selective calling of indi-



This DuMont intercom unit is normally used for controlling mobile system base station. At left is a master unit with a telephone dial type selective calling arrangement in use.

vidual wireless intercom units operating on the same frequency may be provided by employing *tone squelch*. For instance, if unit A is equipped with a three-tone encoder and units B, C and D are equipped with single-tone decoders, each responsive to a different tone, A can talk privately to B, C or D. But, A can hear all transmissions from B, C and D.

The tone encoder may consist of an oscillator whose frequency is determined by any of three reed-type resonators selected by push buttons, as shown in Fig. 13. The selected tone is turned on whenever the talk-listen switch is in the "talk" position and is transmitted simultaneously with voice.

Each of the other units is equipped with a vibrating reed relay, responsive to one of the tones transmitted by unit A. Units B, C and D all intercept any of the three tones, but only the one whose vibrating reed relay is responsive to the tone being intercepted will be unsquelched. The relay contacts vibrate, opening and closing at a fast rate. Hence, a resonant-reed relay, K2, shown in Fig. 14, is used. Momentary closure of the contacts of K2 causes K1 to pull in. Capacitor 2mf charges and holds K1 pulled in until a short time after the incoming tone ceases and K2 stops vibrating.

Split Channel Operation. Selective communication from A to B, C and D may also be achieved by providing A with a *three-*

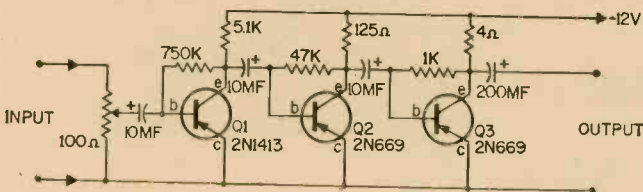
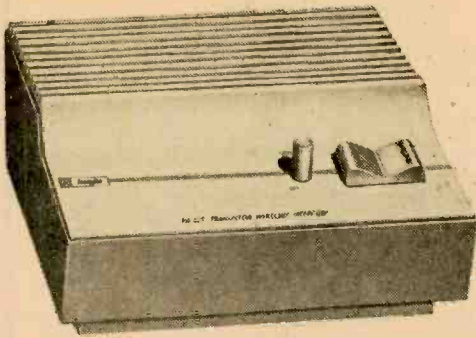
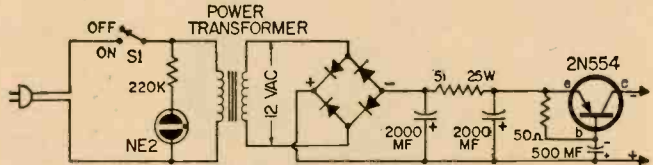

Fig. 5. This 3-transistor circuit is for a 4-ohm input and output.



Knight KG-225, above, is example of wireless intercom.

Fig. 6. Schematic diagram of 12V supply; 2N554 cuts hum.



channel transmitter and a single-channel receiver. Units B, C and D all transmit on the same frequency (unit A receive frequency) but each receives on a different frequency as shown in Fig. 15. Unit A can hear all transmissions from the other units. They can hear unit A and only when it is set to their frequency. Hence, they can communicate only with A, but without being overheard by the other units. This type of operation is not new; it has been used by the other radio services for many, many years.

The range of wireless intercom systems depends upon the transmission circuit, the carrier frequency, transmitter power, receiver sensitivity and noise. Generally, transmission is better over open knob and tube wiring or unshielded plastic power cable than over wiring inside conduit or flexible metal armor (BX cable). Modern apartment houses and conduit wiring limit useful communications to one apartment as a rule.

It is not necessary to use a power line as

the transmission medium. Twin-lead TV antenna cable, coax or twisted pair telephone wire can be used. However, if wire is to be strung for this purpose, you might as well transmit audio instead of RF unless you want to operate two or more systems over the same wires at different radio frequencies.

All of the above types of intercom systems employ wires as the transmission medium, even the so-called "wireless" types. True wireless intercom systems transmit radio signals through space.

Other Frequencies. Radio intercom sys-

tems may be operated without an FCC station license in the 160-190 kc, 550-1600 kc (broadcast band) and 26.96-27.26 mc (Citizens Band) bands. The technical standards of Part 15, FCC Rules and Regulations must be met. Wireless microphones may also be operated without a license within the 88-108 mc FM broadcast band.

Licensed operation of radio intercom systems is permitted in the Citizens Radio Service in the 26.96-27.26 mc and 460-470 mc bands. For business purposes, radio intercom systems may be licensed in the Business Radio Service for operation on assigned low-power industrial channels in the 25-50 mc, 150-174 mc and 450-470 mc bands, as well as on the catch-all frequencies, 27.235, 27.245, 27.255, 27.265 and 27.275 mc, just above the Class D citizens band.

Part 15. A radio intercom system may consist of two or more walkie-talkies of the less-than-100 milliwatt variety operated in the Citizens Band without a license. The

At the right is Heathkit's wireless intercom, Kit Model GD-51. Below is Lafayette's 2-channel solid state wireless intercom, Cat. No. 99-4556. Build or buy, as you choose.

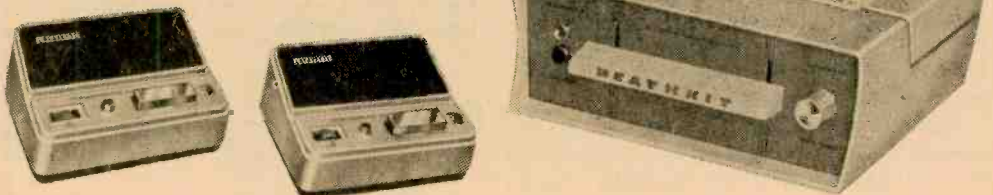

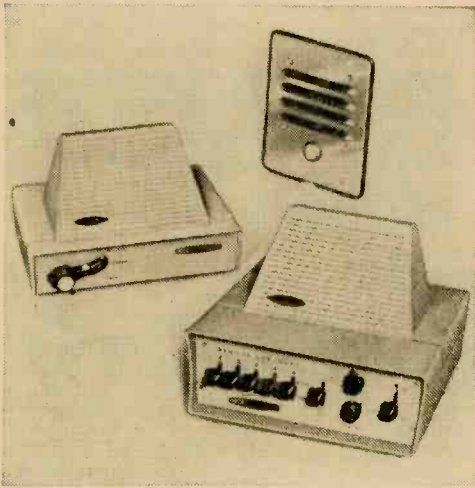

sets may be placed on a desk, strapped to a wall or carried by people. When greater audio output is required, the receiver audio output from the set's headphone jack may be fed to an amplifier.

This enables other units to page over the unit equipped with an amplifier and speaker. Unlike a wired intercom system, the paged person must operate the transceiver's press-to-talk button in order to reply.

Citizens Band. Conventional Class D CB sets may also be used as unlicensed intercom units when modified to prevent transmitter power from exceeding 100 milliwatts input. When licensed, the CB sets may be operated at 5 watts input and with a more effective antenna system, in accordance with Part 95.

All of the sets may operate on the same channel for party line operation. Or, all can be set to a designated calling channel for intercepting calls and then switched to another channel for exchanging information. Since 23 channels are available, 11 separate two-unit systems can be operated simultaneously.

A selective radio intercom system can consist of multi-channel CB sets. Each is normally set to monitor its own designated channel. When A wants to call B, for example, A switches his unit from Channel 1 to Channel 2 if B normally monitors Channel 2. Unit B replies on Channel 2. To call C, A switches to Channel 3, and so on.

Selective Calling. Tone squelch, as described earlier, can be used to provide selective calling. Unit A, for example, can be

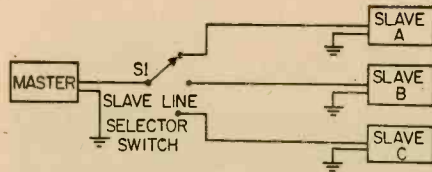
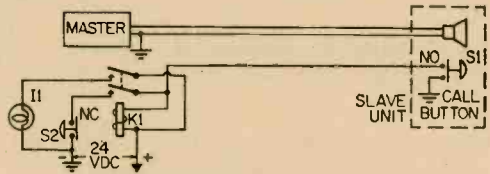

Fig. 7. Block diagram illustrates operation of slave line selector switch. At left is Heathkit's indoor-outdoor intercom system.

Fig. 8. Schematic diagram of call switch wiring.



equipped with a three-tone encoder and units B, C and D with decoders, each responsive to one of the tones. All units can transmit and receive on the same radio channel.

Or, the master unit can be equipped with a telephone dial pulse encoder (Fig. 16) and the other units with dial pulse decoders. When the encoder dial is operated, a train of tone pulses is transmitted which contains as many pulses as the number dialed. The decoder at each of the other units counts the pulses but reacts only to the number of pulses to which it has been preset. Another type of tone encoder is the Amphenol 524 Select-Call which is a unit that transmits four consecutive tones. Up to 24 tone sequence variations can be preselected. Complete details appear in the October, 1965 issue of RADIO-TV EXPERIMENTER.

Obviously, a radio intercom system operated in the Citizens Band is subject to interference from nearby CB stations, particularly in populous areas. None of the intercom units may be lawfully connected to a public address amplifier when licensed in the Citizens Radio Service.

(Continued on page 99)

Fig. 9. When master and slave stations have listen-talk switches, one amplifier suffices.

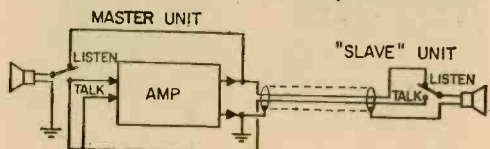

Feedback Fundamentals

By Jim Kyle, K5JKX

Perform five experiments and find out how feedback works for you!

■ Even if you're the barest beginner in electronics, chances are you've heard at least a little about "feedback." This phenomenon, once dreaded like the *black plague*, but since recognized as a most useful tool, is now found in almost every branch of the electronic arts.

But while the term itself is widely known and used, the nature of feedback isn't nearly so generally known. Properly employed, feedback can reduce noise and distortion in audio circuits, stabilize the gain of any kind of amplifier, make voltmeters indicate their readings in brightly lit numerals, operate a computer, or generate AC power. The question remains, "How do we employ it properly?"

To apply feedback, the experimenter must have a clear knowledge of just how it works, and what it will and won't do. He has two basic routes to obtain this knowledge; he should use both.

One is to study the *theory* of feedback in books and magazine articles; while some articles on feedback seem to bristle with complicated-looking mathematical expressions, there are also many which avoid the algebra and give equally clear understanding (you might say more clear, sometimes) of the theory involved.

The other is to gain practical experience by conducting a planned series of experiments. The five simple experiments described here, together with the accompanying explanations of the theory involved,

should give you a satisfactory working knowledge of the fundamentals of feedback.

What you'll need. In addition to the parts listed in the accompanying table, you'll have to have at least a little test equipment. As a minimum, you must have some means of measuring AC voltage. An audio-frequency signal generator is needed for several of the experiments, but if you can't borrow one you can skip these—if you carefully study the theory of them.

The author used test gear obtained from Lafayette Radio Electronics, and recommends it as having definitely good quality at reasonable price. The signal generator was a model TE-22, and the meter used was a model KT-174 VTVM. Any other makes of equipment can be used, also. If a VOM is used rather than a VTVM, some readings may be far different from those listed in the tables—but this won't have any effect.

To simplify construction details as much as possible, we used a modular amplifier. If you already have an audio amplifier, you can use it instead by adding the transformer and feedback-resistor network shown in the basic schematic, Fig. 1.

All components in the amplifier unit are of the least expensive quality obtainable. If you want the best knowledge of feedback, do *not* substitute higher-quality transformers or loudspeakers. The inexpensive units show up the reasons why feedback amplifiers use top-quality ones.

Assembling the set-up. Assemble the

e/e FEEDBACK

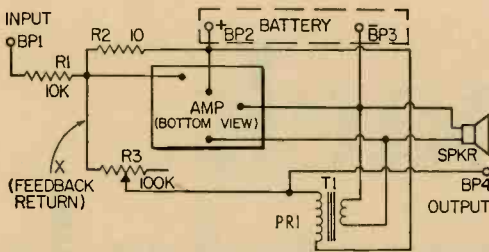

Fig. 1. Schematic of demonstration unit; X marks disconnection point of feedback line.

amplifier unit, transformer, speaker, resistor network, and clips for input, output, and battery leads on any type of breadboard, following the wiring shown in Fig. 1 and the general layout shown in Fig. 2.

To mount the speaker and adjustable feedback resistor R3, make small angle brackets from scrap aluminum. When wiring the transformer, check for proper connection of the speaker leads by applying power. If a squeal results (with R3 set for maximum resistance in the circuit), transpose the leads from transformer to speaker. The proper connection is the one which has no apparent effect on sound output.

Power for the experiments *must* be supplied from batteries. Four size-D flashlight cells, in holders, are convenient, but the author used a collection of lantern batteries to provide a choice of 3, 4½, or 6 volts power. A line-operated power supply will introduce too much hum.

When not actually making measurements, disconnect power from the amplifier. If power is applied for more than 5 to 10 minutes at a time, the modular amplifier unit heats

up and its characteristics change; you must let it cool down before proceeding. This is especially important when using 6-volt supply levels.

When you're ready to begin, turn on the VTVM and the signal generator and let them warm up for about 30 minutes before starting the experiments. When this was done, using the instruments mentioned earlier, the author found output of the signal generator to be essentially constant from 50 cps up to 200 kc, and there was no need to measure the input voltage to the amplifier before each step of each experiment. When using other signal generators, or when working during the warm-up period, input voltage should be checked immediately prior to each output-voltage measurement.

While the author's results are shown for each experiment, don't expect your readings to match exactly. Various amplifier units—not to mention various meters—will differ enough in characteristics to give widely varying readings. Now let's get down to the fundamentals of feedback.

EXPERIMENT 1: Feedback's Effect on Frequency Response and Gain.

The basic feedback hookup is shown in Fig. 3; all it amounts to is taking a part of the amplifier's output and *feeding it back* to the input. If the feedback portion of the output is connected in such a manner that it *increases* the effective input voltage, the feedback is said to be positive or regenerative. If it *decreases* the effective input voltage, the feedback is said to be negative or degenerative. We're working primarily with negative feedback.

Set up the amplifier unit and connect the signal-generator output to its input terminals. Using the VTVM, adjust the voltage across

TABLE A. FEEDBACK'S EFFECT ON FREQUENCY RESPONSE AND GAIN

		100	180	300	500	1000	1800	3000	5000	10 kc	18 kc	30 kc	50 kc	
Yours	feedback no fbk	1. Freq												
		2. Output												
		3. Db												
		4. Db/1 kc					0							
		5. Output												
		6. Db												
		7. Db/1 kc					0							
Author's	feedback no fbk	2. Output	—	0.1	.36	.59	.9	1.1	1.4	1.65	1.9	1.85	1.52	.84
		3. Db	—	0	11.1	15.4	19.1	21	23	24	25.6	25.5	23.5	18.5
		4. Db/1 kc	—	-19.1	-8	-3.7	0	+1.9	+3.9	+4.9	+6.5	+6.4	+4.4	-0.6
		5. Output	.02	.14	.25	.3	.36	.38	.41	.44	.47	.52	.72	1.8
		6. Db	-14	2.9	8	9.5	11.1	11.6	12.3	12.9	13.4	14.3	17.1	25.1
		7. Db/1 kc	-25.1	-8.2	-3.1	-1.6	0	+0.5	+1.2	+1.8	+2.3	+3.2	+6	+14

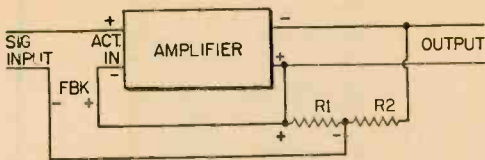

Fig. 3. Basic feedback circuit. Equations show how gain is computed: 1 through 5 show derivation of gain equation; 6 defines Beta; and gain equation, 7, is the one to know.

$$1. \text{VOLTAGE}_{\text{FBK}} = \left(\frac{R_1}{R_1 + R_2} \right) \text{VOLTAGE}_{\text{OUT}}$$

$$2. \text{VOLT}_{\text{OUT}} = \text{VOLT}_{\text{ACT. IN.}} \times \text{GAIN}_{\text{AMP}}$$

$$3. \text{VOLT}_{\text{ACT. IN.}} = \text{VOLT}_{\text{SIG}} - \text{VOLT}_{\text{FBK}}$$

$$4. \text{VOLT}_{\text{SIG}} = \text{VOLT}_{\text{ACT. IN.}} + \text{VOLT}_{\text{FBK}}$$

$$5. \text{GAIN}_{\text{TOT}} = \frac{\text{VOLT}_{\text{OUT}}}{\text{VOLT}_{\text{SIG}}} = \frac{\text{V}_{\text{ACT}} \times \text{G}_{\text{AMP}}}{\text{V}_{\text{ACT}} + \text{V}_{\text{FBK}}} =$$

$$\frac{\text{V}_{\text{ACT}} \times \text{G}_{\text{AMP}}}{\text{V}_{\text{ACT}} + \left(\frac{R_1}{R_1 + R_2} \right) \text{V}_{\text{OUT}}} =$$

$$\frac{\text{V}_{\text{ACT}} \times \text{G}_{\text{AMP}}}{\text{V}_{\text{ACT}} + \left[\left(\frac{R_1}{R_1 + R_2} \right) \times \text{V}_{\text{ACT}} \times \text{G}_{\text{AMP}} \right]}$$

$$6. \frac{R}{R_1 + R_2} = \beta$$

$$7. \text{GAIN}_{\text{TOT}} = \frac{\text{GAIN}_{\text{AMP}}}{1 + \beta \times \text{GAIN}_{\text{AMP}}}$$

the input terminals to exactly 1/10 volt. Set the signal generator frequency to 1000 cps, disconnect the feedback line at the point marked "X" in Fig. 1, and set the VTVM to its 1.5-volt AC scale. Connect the VTVM across the output terminals. Apply 4½ volts power to the amplifier unit. You should hear a clear tone coming from the speaker.

Adjust the tuning of the signal generator to the various frequencies shown on line 1 of Table A, and read output voltage at each frequency from the VTVM. You may have to readjust signal-generator output to maintain 1/10 volt across the input terminals at all frequencies; the author did not find this necessary. Enter output voltage readings on line 2.

Now re-connect the feedback line at "X" and set the value of R3 at maximum resistance, 100,000 ohms. Repeat the frequency sweep from 100 cps to 50 kc, entering your output voltage readings on line 5. Disconnect power after the final reading.

To convert the voltage readings on lines 2 and 5 to decibels, use the graph in Fig. 4. Decibel readings of output level are far more meaningful than are voltage readings,

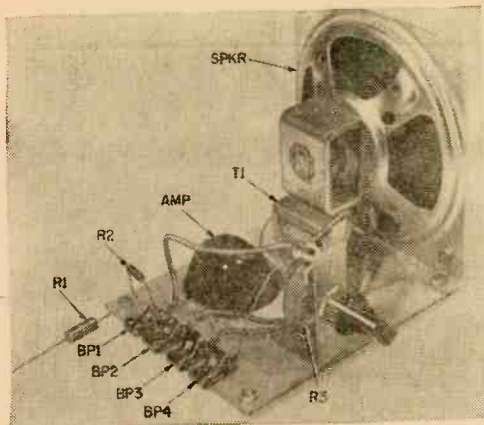

Fig. 2. Assemble the demonstration unit by following schematic diagram and parts list.

since our ears respond to *ratios* of loudness rather than to absolute loudness itself. Enter the decibel readings on lines 3 and 6, respectively, beneath corresponding voltages.

The final entries of Table A show the amount by which gain of the amplifier *changes* with changes of frequency. The decibel level at 1000 cps is used as the reference, and the 1000-cps block in lines 4 and 7 show "0" as a result. Whenever line 3 contains a value greater than the 1000-cps value, subtract the 1000-cps value from it and enter the difference on line 4 as a positive value. If the line 3 value is *less* than the 1000-cps reading, subtract it from the 1000-cps reading and enter negative difference on line 4.

PARTS LIST

- R1—10,000-ohm ½ watt resistor
- R2—10-ohm, ½ watt resistor
- R3—100,000-ohm linear-taper potentiometer
- AMP—Amplifier module, "Telephone Amplifier," DeCordova model TA-9
- SPKR—3-4 ohm PM speaker, replacement type
- T1—"50L6" output transformer, 5000 ohm primary, 3-4 ohm secondary, replacement type
- Misc.—Perforated board about 4" x 5" for chassis; 3 angle brackets (bent from scrap); 4 rubber feet; 4 Fahnestock clips (BP1-BP4); 4-36 machine screws and nuts; hook-up wire; solder; etc.

POWER SOURCE:

- 2—Double battery holders for Size D cells, Keystone type 176 or equiv.
- 4—Size "D" flashlight cells
- OR
- 4—1½-volt general purpose dry cells, Eveready "Ignitor" No. 6 or equiv.

TEST INSTRUMENTS (See Text):

- 1—Audio Generator, Lafayette TE-22 or equiv.
- 1—VTVM or 20,000-ohm-per-volt VOM, Lafayette KT-174 or equiv.

Looking at the Results. Note that without feedback (lines 2, 3, and 4 in Table A) the gain of the amplifier changes rather drastically as the input frequency is varied. When feedback is added, the *total gain* of the amplifier becomes less, but the *variations in gain* with frequency are reduced greatly.

This shows up in Fig. 5 and Fig. 6 as a much smoother curve for the feedback case, though at a lower level. Fig. 7, which shows only the variations in gain with frequency (corresponding to lines 4 and 7 of Table A), emphasizes the smoothing but does not show the overall loss in gain.

The measurements show more than just the smoothing out of the response. Without feedback, the amplifier response (poor at best) fell off sharply at around 500 cps on the low end and climbed to a peak around 20 kc at the high end, falling off as frequency increased above that. With feedback, the gain remained reasonably high down to 300 cps at the low end and was still reasonably close to its mid-frequency value as high as 18 kc.

Remember that input voltage was kept at 1/10 volt for all frequencies. This means that any time the output level *with* feedback is greater than that *without* feedback, something has to be happening inside the amplifier to increase gain rather than decrease it.

The only thing this "something" can be is a change in the feedback from negative to positive—yet we changed nothing in the circuit at all. Our only change was in the frequency of the signal applied to the unit.

And this is the answer. At certain critical frequencies, both high and low—the exact values of the frequencies depend on the particular circuit and components used—the characteristics of the amplifier change in such a manner as to convert our negative feedback into positive feedback instead.

With the author's setup, the effects could be noted at both the low end and the high. The 180-cps reading with feedback is greater than that without, indicating a change at the low end, and the drastic increase at 50 kc indicates a much more important change at the upper end. We'll go into this some more in Experiment No. 3.

Table A isn't through telling us more about the theory yet. You can see from lines

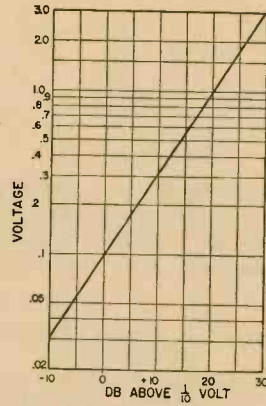

Fig. 4. This logarithmic plot is graph for converting output voltage readings to db.

2, 3, and 4 that the amplifier alone changes its gain seriously as frequency is varied, and from lines 5, 6, and 7 that addition of feedback tends to stabilize this gain. Why?

Pencil Works. To see how it works, we have to do a little arithmetic. Let's start by using the values for 1 kc input signals. We feed into the circuit 1/10 volt, and without any feedback we measured 9/10 volt out. The gain of an amplifier is defined as "output voltage divided by input voltage," so the gain without feedback is 9 times.

When the feedback resistor was connected, for the same 1/10 volt in we measured 36/100 volt out, or a gain of 3.6 times.

Now move on to the 3000-cycle figures, and by the same process we find that gain without feedback was 14 times, and with feedback was 4.1 times.

This is the time to go back and look again at Fig. 3. The *actual* input voltage to the amplifier itself, you can see, is equal to the voltage at the input terminals, *minus* a fraction of the output voltage. The size of this fraction is determined in our case by the value of the feedback resistor. Plugging in figures, we find that the actual input voltage

TABLE B. FEEDBACK'S COMPENSATION FOR VOLTAGE CHANGES

		3	4.5	6	
Yours	1	Supply Voltage			
	2	Output level (no feedback)			
	3	Output level (feedback)			
	4	Db (no fdbk)			
	5	Db (feedback)			
Author's	2	Output (no fdbk)	.42	.9	1.7
	3	Output (fdbk)	.21	.36	.51
	4	Db (no fdbk)	12.5	19.1	24.6
	5	Db (feedback)	6.4	11.1	14.2

at 1 kc is $1/10$ volt without feedback, for an output of $9/10$ volt. With feedback, the input is $1/10$ volt *minus* some fraction of the output; this actual input is still multiplied 9 times to become the measured output voltage of $36/100$, so we can divide $36/100$ by 9 to find the actual input voltage. The value is $4/100$. Since we applied $1/10$ (or $10/100$) volt and came out with $4/100$ volt, the feedback voltage in this case must be the difference or $6/100$ volt. To find the fraction of output fed back, we can divide $6/100$ by $36/100$, and come up with $1/6$. Thus, with a 100,000-ohm feedback resistor, we feed back $1/6$ of the output voltage to the input.

Now let's move on to the 3000-cycle figures. We feed in $1/10$ volt, and know that the gain without feedback is 14 times. With feedback, the input is $1/10$ volt *minus* some fraction of the output, and the internal gain is still 14 times. We divide the $41/100$ -volt output with feedback by 14 to find the actual input voltage for the amplifier, which is approximately $3/100$ volt. Subtracting this from the $10/100$ volt applied signal gives us $7/100$ volt of feedback. Dividing $7/100$ by $41/100$ to find the fraction fed back, we come up with $7/41$ which is close enough to $1/6$ to call it that (our figures have been rounded off several places, and meters aren't always completely accurate either).

Looking at the Results. What does all this figuring show? It shows, for one thing, that the feedback fraction is *constant* regardless of what happens in the amplifier itself. With the feedback fraction constant, then anything which tends to increase the gain of the amplifier will also increase the feedback voltage—but with the input voltage kept constant, an increase in feedback voltage will also cause a *decrease* in the voltage actually applied to the input of the amplifier.

In fact, if amplifier gain were high enough, the gain of the feedback circuit would be determined *entirely* by the feedback fraction; internal gain changes would have no effect.

This leads to the conclusion that, with gain not quite high enough to make total gain entirely dependent on feedback, anything which increases amplifier gain will tend to be cancelled out—but anything which decreases amplifier gain won't be taken care of so well. Next experiment illustrates this conclusion.

EXPERIMENT NO. 2: Feedback's Compensation for Changes in Supply Voltage.

Follow the same basic hookup as for Ex-

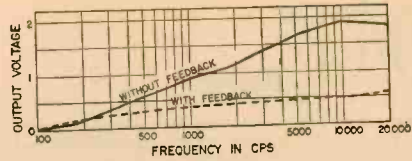

Fig. 5. This graph shows the effect of feedback on the output voltage-frequency curve.

periment 1. Set the signal generator output level to $1/10$ volt and the frequency to 1000 cps. Disconnect feedback line at X. Apply 3 volts to the battery terminals, and measure output voltage. Enter the reading on line 2 of Table B, under the 3-volt heading.

Increase supply voltage to $4\frac{1}{2}$, and again measure output. Enter the reading on line 2. Repeat the process with 6 volts supply; take care to disconnect power after taking the reading.

Reconnect the feedback resistor and set it for maximum resistance, 100,000 ohms. Apply 3 volts and measure output level, entering the reading on line 3. Repeat at $4\frac{1}{2}$ and 6 volts. Disconnect the battery.

Using Fig. 4, convert the voltage readings of lines 2 and 3 to decibel values, and enter those from line 2 and line 4 and those from line 3 on line 5.

Note that increasing supply voltage from $4\frac{1}{2}$ to 6, without feedback, caused the gain of the amplifier to almost double in value (6 db increase in voltage gain is a two-times increase). Reducing voltage to 3, from $4\frac{1}{2}$, cut gain in half.

With feedback, the voltage increase didn't cause near so much change in gain, although the voltage drop to 3 volts shows little difference.

This illustrates the dependence of feedback's effects on having sufficient internal gain. At $4\frac{1}{2}$ volts, the gain of the amplifier module is barely sufficient for feedback to prove noticeable. Dropping the voltage to 3 cuts gain in half, and feedback's effects can hardly be determined. Increasing the voltage, however, increases the internal gain (from line 2), and the feedback acts to hold back this gain increase from showing in the output.

This reduction in the amount of change produced by a change in supply voltage is one reason many types of amplifiers use negative feedback. Keep in mind that the changes we made here represent enormous percentages of the normal voltage; we dropped to half, and increased by 33 percent.

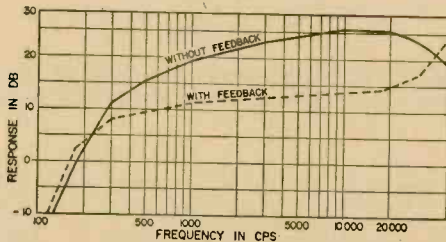

Fig. 6. Amplifier gain is illustrated by db response with and without circuit feedback.

Normally, voltage changes in an operational piece of equipment will be far smaller—and the effect of the feedback will virtually iron them out of existence.

This experiment also illustrates that the effect of feedback is made more noticeable by high internal gain (the term usually used is “open-loop gain,” meaning the gain measured when the feedback “loop” is opened, as we did when we disconnected point X). We do not yet know, however, whether there is a limit to the amount of open-loop gain or of feedback which can be employed. Experiment No. 3 will show us both.

EXPERIMENT NO. 3: Feedback's Limiting Factors, Part 1.

Again, follow the same basic hookup as for Experiment 1. Set the signal generator output to 1/10 volt at 1000 cps; leave R3 connected, however. Apply 6 volts power and connect the VTVM to measure output voltage.

While watching the output voltage indication closely, reduce the resistance of R3. At some point, the output voltage will rise sharply and drive the meter off-scale. If you measure the voltage by changing scales, you'll find up to 50 volts present.

And when this happens, you've gone just a mite too far. Increase resistance of R3 slightly, until the voltage drops back. You'll find a

point at which output voltage is lowest; as resistance is reduced from this point, the voltage will begin to skyrocket. This point is the setting we want.

With R3 adjusted as described, take gain readings from 100 cps to 50 kc as we did in Experiment 1, entering output voltage readings on line 2 of Table C. With the aid of Fig. 4, convert these voltage readings to db and enter the db values on line 3, and finally compute the deviations in gain from the 1000-cycle figure—just as in Experiment 1—and enter them on line 4.

As in Experiment 1, these figures can be used to draw a response curve, and the author's response curve appears in Fig. 8. Note that this curve is even flatter than the flattest of the two curves in Fig. 7, indicating that the increased feedback obtained by lowering the value of R3 has improved the amplifier's response.

However, examine carefully the 50-kc readings. In Fig. 7 (Experiment 1) feedback caused an actual increase in output voltage, indicating that the feedback was positive instead of negative in this region. In Fig. 8, the increase is even greater.

If enough output is fed back to the input, in the positive-feedback arrangement, the amplifier will become an oscillator since no other input except the feedback will be necessary.

That's what happens when the feedback voltage is increased past the critical point; that's why the measured output voltage skyrocketed when the critical point was passed while we were setting up this experiment.

You can verify this by applying power to the unit again, reducing R3 slightly until voltage goes up, then disconnecting the signal generator. The voltage at the output will remain almost unchanged! Our amplifier is now generating AC, and will continue to do so until we remove power.

Oscillators. While this effect might be thought undesirable at all times, it happens to be the basis of the *oscillator*, and as such makes radio as we know it possible. In an oscillator, the hookup is arranged to get posi-

TABLE C. FEEDBACK'S LIMITING FACTORS, PART 1

Yours	1	Freq											
	2	100	180	300	500	1000	1800	3000	5000	10 kc	18 kc	30 kc	50 kc
	3												
	4					0							
Author's	2	Output	.05	.28	.34	.36	.38	.39	.42	.43	.45	.52	3.
	3	Db	-6	8.9	10.6	11.1	11.6	11.8	12.5	12.7	13.1	14.3	17.4
	4	Db/1 kc	-17.6	-2.7	-1	-5	0	+2	+9	+1.1	+2	+3.2	+6.3
													+18.5

tive feedback at the desired frequency; in our experimental hookup here, the feedback becomes positive "by accident" at a frequency which is determined by the particular amplifier module and output transformer used.

Higher-quality components don't show this effect so clearly, but excessive feedback will always manifest itself as instability in one form or another. One of the biggest problems faced by hi-fi designers was the control of this effect, so that appreciable amounts of feedback could be added to audio amplifiers, without danger of oscillation.

The amount of feedback which can be applied to an amplifier is determined in part by its open-loop gain, and we'll examine this in more detail in the next experiment. Before we move on to this, though, let's look a little more closely at the facts revealed by Table C and Fig. 8.

You can note that the mid-range gain, from 500 to 5000 cps, is about the same in Experiment 3 as it was with feedback in Experiment 1. The swings in gain as frequency varies are a bit smaller, but in no case is the difference large enough to be heard by ear.

However, both at the low and upper ends of the audio range, the increased feedback in Experiment 3 has extended the bandwidth of the amplifier. Where Experiment 1 gave us a bandwidth of 300 cps to 18 kc before gain was more than 3 db away from the 1000-cycle value, Experiment 3 gives us a range from below 180 cps up to the same 18 kc at the upper end. With higher-quality components to minimize the high-end peak which appears at 50 kc, and with the measurements extended out to around 200 kc, we would find a similar one-octave extension of the high-end limit.

Since mid-range remained almost unchanged, we can assume that at both 4½ and 6 volts open-loop gain is high enough that the feedback is providing tight control of gain.

When we compare the curve of Fig. 8 with

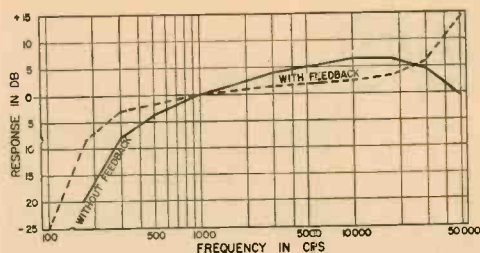

Fig. 7. Variation in gain with frequency is plotted with a reference level of 1000 cps.

the no-feedback curve of Fig. 7, we can see an appreciable extension of bandwidth due to feedback. The price we pay for this extra bandwidth is lower gain—and this is always true when negative feedback is used. However, gain is usually easier to get than bandwidth, so the price is well worth while.

Experiment 3 has shown us that the amount of feedback which we may use is limited by our components, which can change the negative feedback to positive and thus create oscillations. It is also limited by open-loop gain; Experiment 4 will demonstrate this, and show how.

EXPERIMENT NO. 4: Feedback's Limiting Factors, Part 2.

Set everything up exactly as in Experiment 3 and adjust the value of R3 to the critical point. Disconnect power, and measure the resistance of R3. Enter the measured value under the 6-volt heading in Table D, on line 2.

Reduce supply voltage to 4½, and reduce the value of R3 some more until the new critical point is reached. Read output voltage and enter it under the 4½ volt heading, on line 3. Disconnect power and measure R3; enter this value on line 2.

Reduce supply voltage again, to 3 volts, and repeat the process. Enter output voltage on line 3 and the value of R3 on line 2.

Bring the output-voltage figure for 6-volt supply down from Table C, and then convert all voltage figures to db, entering results on line 4.

Now it's time to examine the results. We know from Experiment 2 that reducing the supply voltage will reduce open-loop gain. Now Table D shows us that as supply voltage is reduced, the feedback may be increased. This indicates that the lower the open-loop gain, the more feedback we can use before running into oscillation problems.

The additional feedback reduces gain also, and with the open-loop gain cut back our

TABLE D. FEEDBACK'S LIMITING FACTORS, PART 2

Yours	1	Supply voltage	3	4.5	6
	2	Value of R3			
	3	Output voltage			
	4	Db gain			
Author's	2	Value of R3	20K	50K	75K
	3	Output voltage	.16	.20	.38
	4	Db gain	4.5	6	11.6

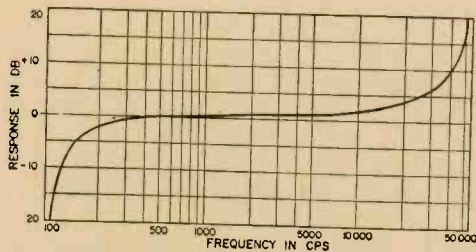

Fig. 8. Graph shows variation of gain with frequency, with 6-volt supply, and maximum feedback; reference is to 1000 cps level.

total gain is reduced at two separate points. Thus the author measured a gain of only 1.6 times with 3-volt supply and critical feedback, but the feedback fraction was larger than could be used at higher gain.

While no frequency-sweep is included as part of this experiment, you may want to check the effect of the increased feedback on the amplifier's bandwidth. To make a quick check, set the signal generator to 1 kc and adjust input voltage until the VTVM needle rests opposite "0" on the db scale usually located near the bottom of the meter face. Then tune the signal generator lower in frequency until the needle indicates "-3" db, and note the frequency at which this happens. Tune higher until the needle indicates "-3" db again, ignoring any peaks you find, and note the frequency. The two frequencies mark the bandwidth of the amplifier as it is usually expressed, between the "3-db points."

If you run this check, you will find the widest bandwidth is obtained with low voltage supply and maximum feedback, and the narrowest bandwidth with high voltage supply and no feedback at all.

The reason the open-loop gain affects the amount of feedback which may be used before oscillation sets in isn't too easy to see. Basically, for a feedback circuit to oscillate, its loop gain must be greater than 1 at the frequency at which feedback changes from negative to positive. At higher voltages, the

TABLE E. FEEDBACK'S EFFECT ON DISTORTION

	Yours	Author's
Output level without feedback		7.5
Output level with feedback		10

open-loop gain is higher at any given frequency—and the feedback fraction must consequently be kept lower in order to keep loop gain less than 1 at the critical frequencies. For example, we worked out in Experiment 1 that with a 100,000-ohm value for R3, the feedback fraction was $\frac{1}{6}$. This means that if the open-loop gain of the amplifier is 6 or more at the frequencies at which feedback changes from negative to positive, oscillation will result.

You can tell from the fact that the critical value for R3 was very close to 100,000 ohms, that the gain at the critical frequency was just under 6 with a 6-volt supply.

With a 4½ volt supply, however, open-loop gain is cut almost in half at almost all frequencies—which means that we can use twice as large a feedback fraction before the loop gain (feedback fraction times actual open-loop gain) becomes equal to 1. Table D bears us out with a 50,000-ohm value.

And when supply voltage is cut back to 3, open-loop gain is halved again, allowing us to double the feedback one more time. As a result, with lower loop gain, we can use five times as much feedback—and get five times as much benefit from it, at the cost of low total gain.

We've been talking about the "benefit" of feedback, but the only benefits we've seen so far are the stabilization of gain as voltages change, and the flattening of response over the frequency range. These in themselves are appreciable, but we haven't yet touched upon the main reason for such wide use of feedback today. That's Experiment 5.

EXPERIMENT NO. 5: Feedback's Effect on Distortion.

Disconnect the feedback line of the amplifier at point X, and connect to 4½ volts power. Set the signal generator to 1000 cps and connect to the amplifier.

While listening carefully to the output tone, increase output level of the signal generator. At one point, a second tone will become audible; it will sound approximately one octave higher than the primary tone.

This second tone is second-harmonic distortion, generated in the amplifier module by over-driving it. Adjust signal generator output until you are just able to detect the distortion product. It will *not* be a clearly defined point; the second tone builds up gradually, and is usually rather strong when you first become aware of its existence.

When you have the signal generator out-

(Continued on page 116)

Test Bench Synthetic Battery

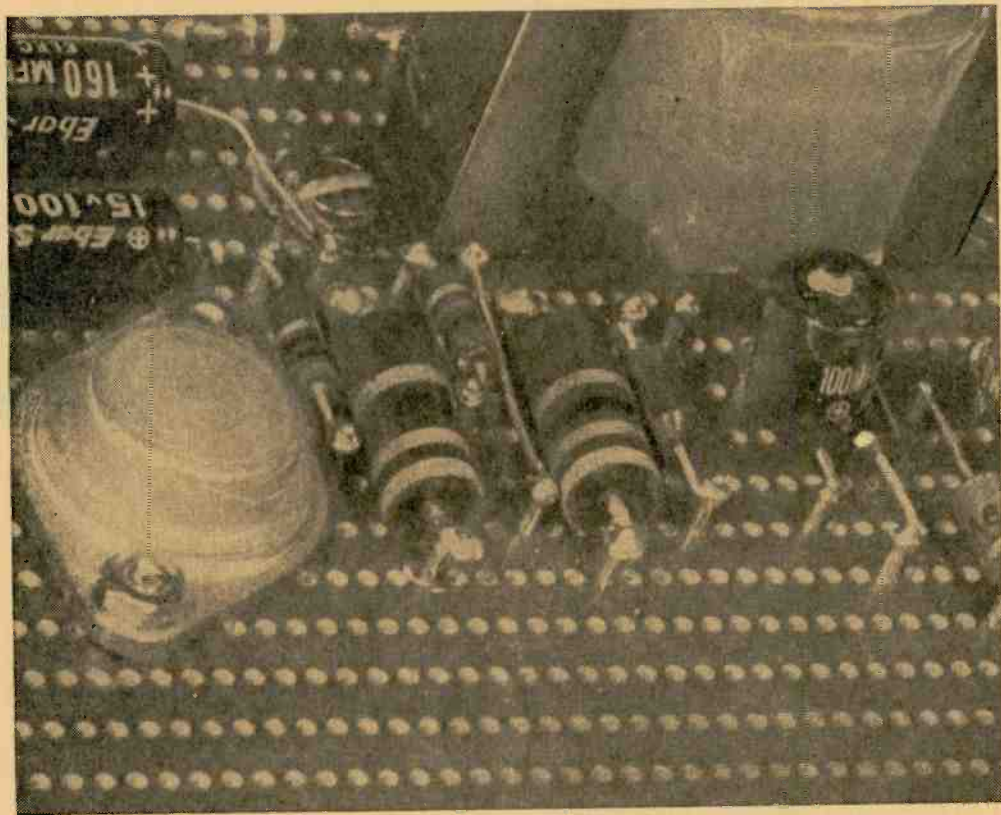

By Jim Kyle, K5JKX

A new twist in construction gives this regulated supply a pre-wired "chassis"

■ Have you yet put together an experimental transistor project using a 9-volt battery which just happened to be on hand, gotten it working, then plugged in a new battery and found it no longer worked?

While the portability offered by battery power is one of the transistor's great advantages, batteries *do* run down in time—and the one which just happens to be available on the bench may have an actual voltage anywhere between 3 and 9 volts.

If you build this *synthetic battery*, though,

you'll never again be faced with such problems. In addition, it can take the place of short-lived batteries when you're using transistors where AC power is available. Costing only about \$5 total and taking only a couple of hours to build (thanks to a relatively *new* construction technique), it outperforms just about any battery available to the experimenter.

The Specs. The *synthetic battery*, or battery eliminator, provides nominal 9-volt output at all load currents from zero up to more

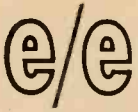

SYNTHETIC BATTERY

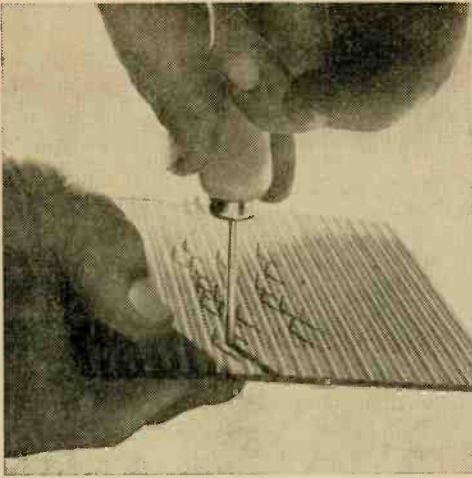

At the left, the first step in construction is performed; the terminal pins are inserted in the board using the insertion tool. You can save by just pushing the lead ends into the board's holes and soldering directly to the copper strips. Below, spot face cutter is used to "open" a copper strip.

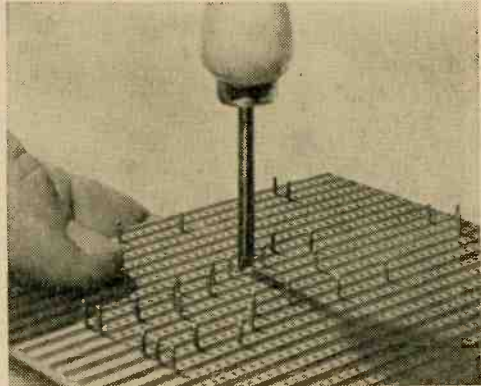

than 150 ma. (try taking that much current out of the ordinary 9-volter without pulling voltage down). Hum and noise in the output voltage measure a total of 0.02 volt at maximum load and are not audible in headphones connected directly across the output terminals. If even the 0.02 volt of noise is too much, you can reduce it at slight extra cost.

So far, the specifications wouldn't be too hard to meet with any transistor-regulated power supply (for that's what the synthetic battery actually is)—but now we come to the big one. The output can be short-circuited with no harm to any part of the unit! With most regulated supplies, a shorted output will destroy at least one relatively expensive transistor; in this one, the transistors actually run cooler when the load is heaviest.

This seeming "miracle" is due to the use of "shunt" regulation instead of the more conventional "series" circuits. The transistor draws enough current through a resistor to hold output voltage steady. The more current demanded by the load, the less must pass through the transistor for the same output voltage. When the load gets too heavy, all that happens is that the transistor loses control and the output voltages begins to fall. With 165 ma. drawn from the supply, the output falls only .4 volt from no-load level.

Let's Build It. The secret of the speedy construction and highly professional appearance is a new material called "Veroboard"; originally developed for industrial users, for construction of prototype models and one-of-a-kind circuits in digital computers, it is

now available to the experimenter. Veroboard Kit containing 6 boards and spot face cutter tool can be obtained from Vero Electronics Inc., Dept. E, 48 Allen Blvd., Farmingdale, N.Y.: \$5.95 postpaid.

Veroboard consists of a phenolic sheet similar to etched-circuit stock, with rows of copper conductors bonded to one side. The phenolic is perforated, and the conductor strips connect all perforations in one row.

Using a special tool (part of the Veroboard kit), double-ended terminals are pushed through the holes as shown in the photos. Two terminals are used for each component—one to support each end. If two terminals are placed in the same row, they are automatically connected together; this eliminates wiring for many circuits.

The Detail Diagram shows the terminal layout for the synthetic battery, as viewed from the underside (conductor side) of the board. Each dot indicates a terminal pin, with the exception of the "e" and "b" dots for Q1. While exact location of the terminal pins is not critical, in some cases there is a problem of making things fit into the available space. Installation of terminal pins is easy—just push into hole until half way in. Follow the photo and count unused perforations to duplicate the author's version.

At times it is necessary to place compo-

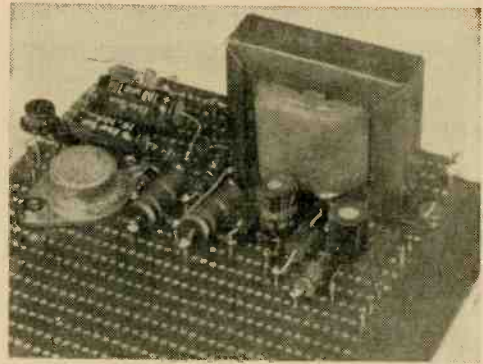
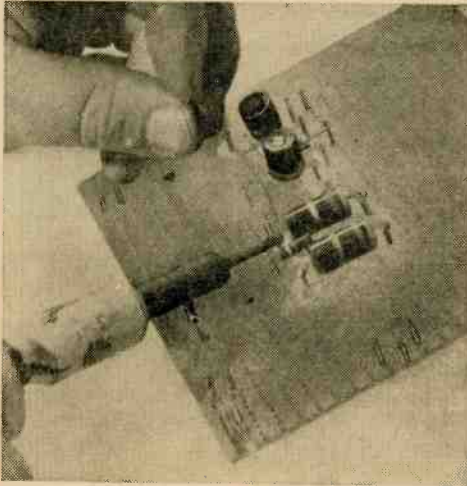

Several components can be mounted and then soldered all at once using a low-watt iron. Thick flange of transistor Q1, above, is sufficiently thick to act as a heat sink.

is a 2N107 in the author's model, but a 2N404 would be both less expensive and safer (the 2N107 gets alarmingly warm after an extended period of no-load operation).

The zener diode came from the same semiconductor assortment as Q1; any unit of the proper voltage (9.2 down to 8.5) can be used since current flow through it is only a few milliamps at worst. The transformer actually has twice the current rating necessary, but was chosen for wide availability and low cost.

Hum. To reduce hum level lower than the original model, as mentioned previously, you can increase the capacitance of C3 and C4. If this doesn't suffice, you can add another unit identical to C4 in parallel with the two. In the model shown, the third capacitor reduced hum to unmeasurable levels, but increased both cost and bulk and so was omitted in the final version.

When all components are mounted in

place on the terminals, solder. The author found that for reliable operation, it was necessary to solder each terminal to its copper strip also; in the early testing stages, this was not needed. Then connect a line cord to the 115-volt input terminals, and suitable connectors to the output terminals, and your synthetic battery is complete.

If you like, you can put it into any kind of case. The author used none, intending to mount the unit out of sight on the bottom of the workbench and bring up long connecting leads with alligator clips on them.

How It Works. In case you're interested in the theory, here's how it works.

The transformer, together with diodes D2 and D3 and capacitors C1 and C2, changes the 115-volt AC input to approximately 15 volts unregulated DC output. The diodes and capacitors form a full-wave voltage doubler so that an inexpensive 6-volt filament trans-

(Continued on page 117)

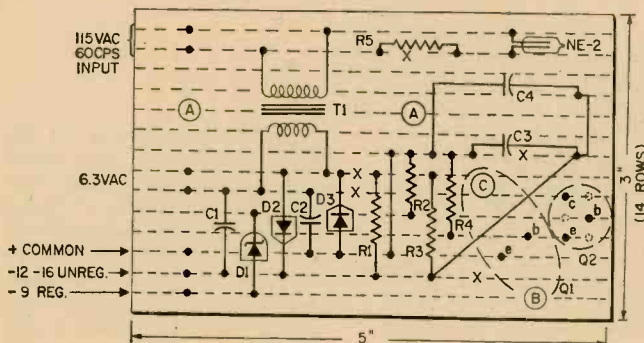

Detail diagram of underside (conductor side) of Veroboard shows location of perforations used. The X's indicate breaks to be made in conductor strips. Two holes for mounting T1 are marked (A); holes for collector connections for Q1 are marked (B) and (C). Note that the hardware for hole (C) bridges two conductor strips. If 2N404 is used for Q2, transpose holes as marked by dotted lines.

New Boost for an Old Charger

Waldo T. Boyd

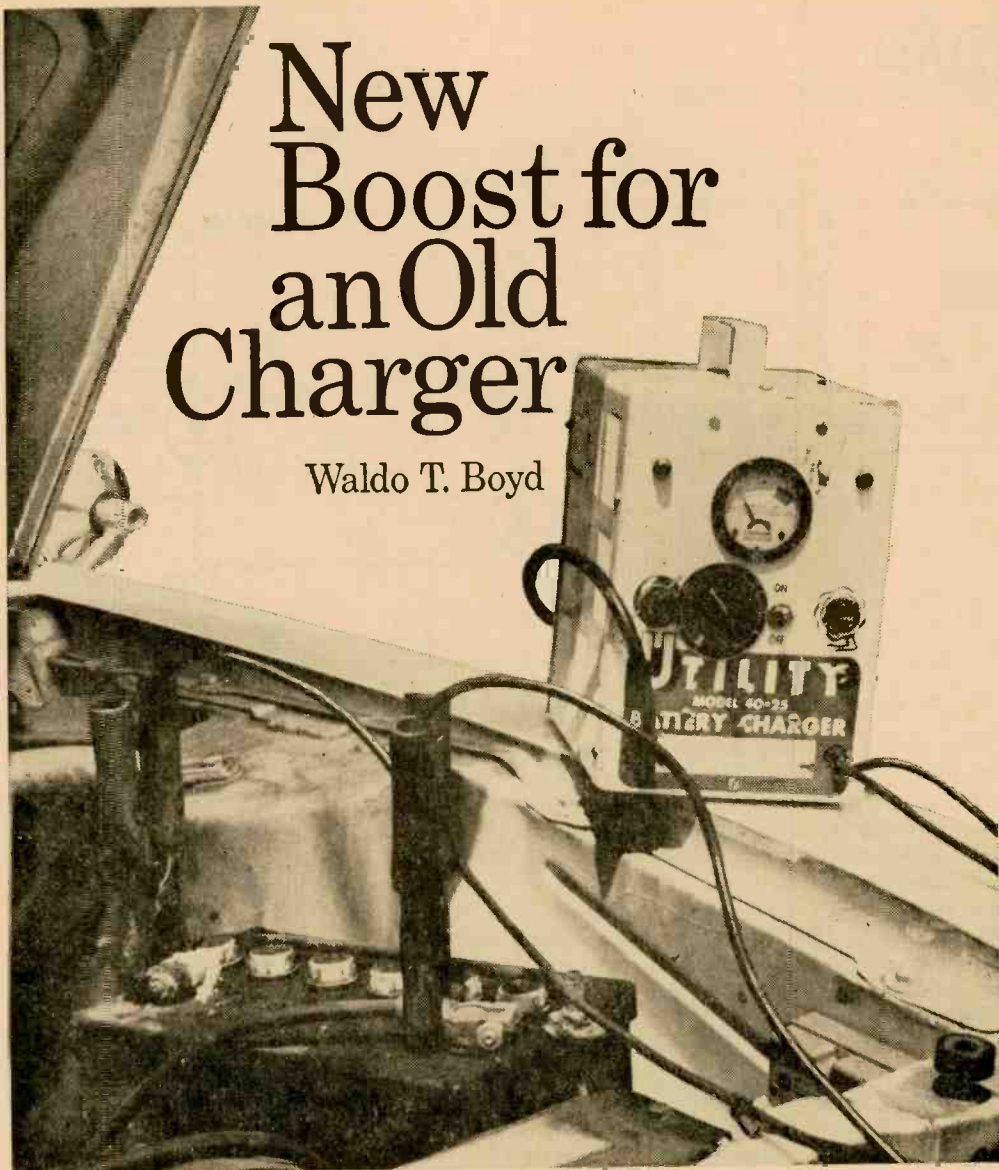

Rebuild an old charger using an SCR circuit, and put an end to cooked batteries!

■ Nearly every garage and junk yard has at least one old straight-line charger that's just ripe to be given a new lease on life. In these days of automation no one likes to keep a weather eye on the charging battery to keep it from boiling dry, not when a simple, inexpensive SCR (silicon controlled rectifier) will automatically bring a full charging rate down to a trickle as the battery voltage rises. And because not everyone knows how easy it is to update old chargers, you can get them at auctions and junk yards for give-away prices—if you don't already have one of your own.

Save What You Can. Three items make the old charger well worth salvaging—the transformer, the case, and the charging leads. If even only the first two are in fair condition it is economically good sense to update. And if you have one with a working ammeter and fan, so much the better.

If the transformer primary is burned out, it would be a challenge to rewind, for a savings of from 12 to 20 dollars. Not all old chargers will need even the secondary rewind. Many six-volt models were designed for full-wave centertap rectification, and will deliver as high as 18 volts.

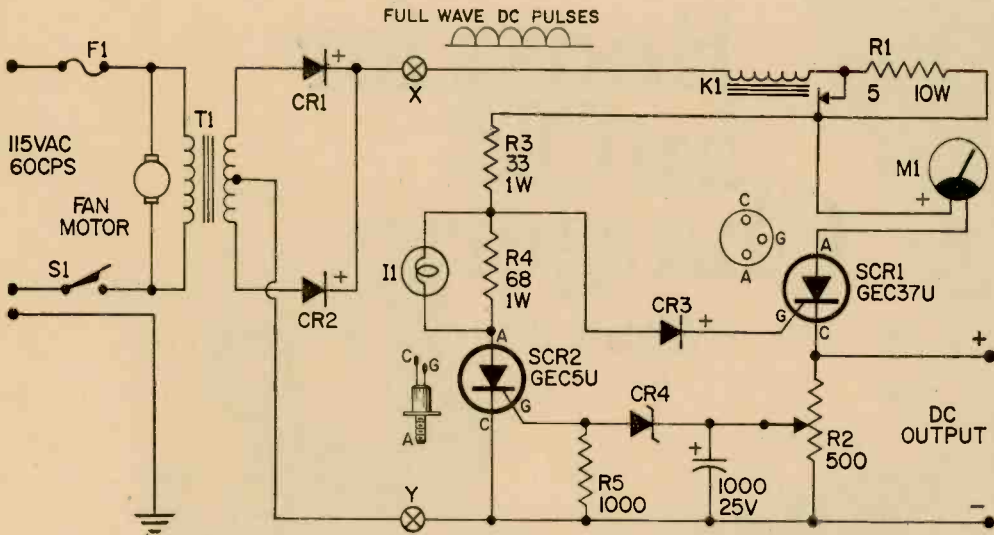

Fig. 1. Schematic diagram of the up-dated charger illustrates the SCR controlled circuit.

With silicon rectifiers instead of selenium, you will only need about 14.5 volts to charge a 12-volt battery, since heat losses are far less. So don't try to salvage the old rectifier—throw it away and either use the SCR as a half-wave rectifier, or one of the full-wave options shown in the schematic diagrams, Figs. 1 and 2. The efficiency of the older units is so low that often more than 50 percent of the power is wasted in heat.

In most instances you will end up with a case, a good heavy-duty transformer, charging leads, and sometimes an ammeter and fan. Except for those items you may already have in your junk box, it is good sense to buy the additional parts as shown in the parts list. This will give you a fully automatic charger for as low as \$10.00—hard to beat!

How It Works. The schematic diagrams show three optional inputs to the automatic charging circuit. The inputs of Figs. 1 and 2A will produce 120 positive pulses per second between points x and y. Circuit 2B presents raw AC to the SCR, which will act as a half-wave rectifier while simultaneously controlling the charging level. This is the least desirable circuit, but it will do the job.

With positive pulses at point x, over-current relay K1 remains closed unless the total output at the charging leads exceeds 12 amps. Current passes through the ammeter to the

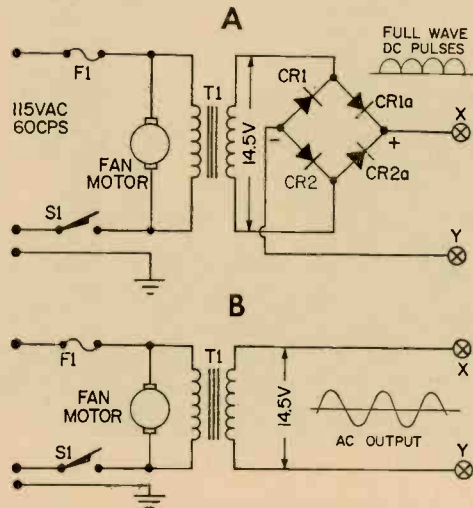
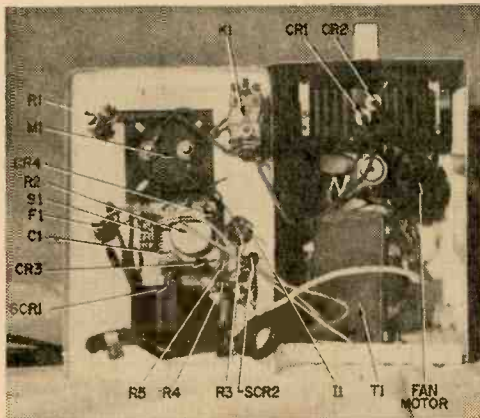
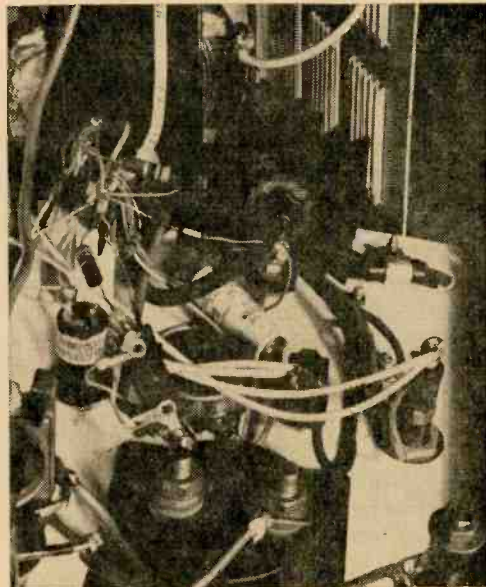

Fig. 2. A and B show two additional input options; if used, break circuit at x and y.

SCR1 solid state switch. When the battery voltage is down a half-volt or more, SCR1 is triggered full on every cycle through R3 and CR3, delivering full charging current. When the battery voltage rises to a pre-set level, as determined by R2, SCR2 will conduct. SCR2 conducting places a voltage across R4 which drops the trigger voltage of SCR1 below cathode potential, and SCR1 ceases firing. It will fire again when the battery volt-



Component layout within the charger case is entirely up to you and the case you're working with; layout logic is the only must.



As shown here, most of our components and wiring are on the back of the front panel; note the radial heat sink that mounts SCR1.

age drops below the pre-set level, which happens less and less frequently as trickle charging continues.

As the battery voltage rises and drops with each series of pulses, a point of equilibrium is reached at which SCR1 triggers only about once a second, for perhaps the duration of one or two positive input cycles. The charger will continue to pulse at this rate, which is in effect a *trickle* or sustaining charge, since average current will be only large enough to offset battery internal losses. The point at which this occurs is selected by R2.

CR4 is a Zener diode, providing a reference voltage for the SCR2 trigger. The Zener will not conduct until its voltage exceeds 8.2 volts, at which time a voltage will appear across R5, and SCR2 will trigger on. Potentiometer R2, across the battery, selects the maximum charging point at which the battery ceases to charge further, by acting as a voltage divider for the Zener.

Lamp I1 lights when SCR2 turns on, indicating that the heavy charging has begun to taper. At first, the lamp will flicker so rapidly that it will appear to be dim. As the battery continues to rise in voltage, the lamp will light more brightly, and the flicker will occur less and less frequently, until finally it will flicker only about once per second.

Revamping and Construction. This article describes the conversion of a typical

- C1—100-mfd., 25-volt electrolytic capacitor
- CR1, CR1A, CR2, CR2A—Silicon rectifiers, 20-ampere rating (GE A40F or equiv.)
- CR3—Low-current diode rectifier (GE 1N536 or equiv.)
- CR4—Zener diode (GE 4JZ4X8.2 or equiv.)
- F1—5-ampere fuse and holder (Littelfuse 3AG and 342001, respectively, or equiv.)
- I1—Indicator lamp assembly and bulb (Dialco 810M or equiv. with T-3¼ bulb)
- K1—Automotive current regulator (see text)
- M1—0-15 panel ammeter (see text)
- R1—5-ohm, 10-watt resistor
- R2—500-ohm potentiometer
- R3—33-ohm, 1-watt resistor
- R4—68-ohm, 1-watt resistor
- R5—1000-ohm, ½-watt resistor
- S1—S.p.s.t. toggle switch, 10 amperes @ 115 VAC
- SCR1—Silicon controlled rectifier (GE C37U or equiv.)
- SCR2—Silicon controlled rectifier (GE C5U or equiv.)
- T1—Power transformer, 12 ampere min. output @ 29 volts CT (see text and Table) (Allied Radio 62G335)
- 1—Heat sink for CR1, CR2; 2 req'd for bridge rectifier (Wakefield NC403K or equiv.)
- 1—Heat sink for SCR1 (Wakefield NC301N or equiv.)
- 1—Fan and motor assembly (optional)
- Misc.—Terminal strips, standoffs, dial plate, assorted mounting brackets, silicone compound, assorted gauge hookup wire, hardware, solder, etc.

Estimated cost: From \$10 to \$30 (see text)
Estimated construction time: 6 hours

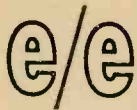

TABLE 1. TRANSFORMER OPTIONS

ORIGINAL CHARGER TYPE	ORIGINAL TRANSFORMER	YOUR OPTION	RECOMMENDATION
Full-wave CT, up to 40 amps, for 12-volt batteries.	Large, very heavy if not fan-cooled. May be much bigger than needed. Up to 40 volts across secondary.	You can use as is, but not advisable for this project.	Either rewind for 29 volts CT, or save for a future heavy-current project and find a somewhat lighter transformer for this charger.
Full-wave CT, up to 15 amps, for 12-volt batteries.	Medium size, up to 35 volts across secondary; may have many voltage taps.	Usable as is, or secondary can be rewound to 29 volts.	Use as is, but be careful not to overload SCR.
Full-wave CT, up to 24 amps for six-volt batteries.	Secondary from 14 to 18 volts total.	Use as a full-wave bridge, or rewind secondary for full wave CT.	Either way OK.
Half-wave, up to 24 amps for 12-volt charging.	Secondary from 14 to 25 volts; may have various voltage taps, but not likely a tap in exact center.	Use as a full-wave bridge, or rewind secondary for full wave CT.	Either way OK.
Half-wave, up to 24 amps for six-volt batteries.	Secondary from 7 to 10 volts.	You must rewind if you intend to charge 12-volt batteries.	Rewind for 29 volts CT.

vintage *brute force* charger. It had a good case, good meter and charging leads, and a small exhaust fan still worked perfectly. The transformer had been burned out, and the two large selenium single-plate rectifiers had been moisture-damaged long since. The first job toward rebuilding was to strip the chassis of all parts and wires, and wash the case with detergents. If a spray paint gun is handy, a fresh coat of enamel will make your case like new.

A Knight 12-amp transformer was at hand, so it was mounted in the same position previously used by the old transformer. If your transformer is not suitable as is (See Table 1) you can rewind quite easily and save from 12 to 20 dollars. Suitable transformers can be found in surplus stores if you don't want to rewind the old one, often for

less than a quarter the cost of a new one.

Assuming that you will rewind, if the primary is intact connect the transformer to the AC line before removing laminations, and measure the secondary voltage with a good AC voltmeter. Record the exact voltage. Then dismantle the transformer, removing laminations as necessary to get at the windings. Remove the secondary winding only, and carefully count the turns. Record this number. Measure the wire size with a wire gage and record this item as reference in case you rewind with different size wire.

Divide the number of turns by the voltage that was measured across the secondary. The answer will be the turns-per-volt your transformer requires. For example:

Original voltage: 30

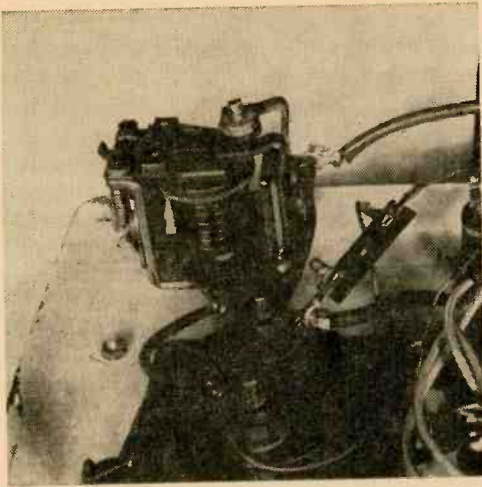

Relay K1, above, an automotive current regulator, adds an extra measure of safety for the SCR. Visible at the right are CR1 and CR2 mounted in the case on their heat sink.

Original winding: 45 turns
 $45 \div 30 = 1\frac{1}{2}$ turns per volt

To rewind for full-wave center-tapped rectification with silicon rectifiers, you will need 29 volts center tapped—that is, 14.5 volts each side of the center tap. Therefore, multiply the turns-per-volt figure by 29, and the answer will be the exact number of secondary turns for that voltage. Add one turn extra each side of the center tap to compensate for wiring and transformer losses.

If you want to settle for a half-wave charger and eliminate the rectifiers (other than the SCR's) multiply the turns-per-volt by 14.5 and add a half-turn if the answer does not come out even. However, balancing the added danger to the SCR from transient voltages and overload, against the small savings afforded, the half-wave circuit is not recommended.

Some transformers have ample winding space for far more turns than were originally on the transformer. For these, you can rewind with the same wire, or wire of the same size. But if all space is filled, the full-wave, center-tap rewind job will require wire that is at least three wire-gage sizes smaller than that removed from the secondary. The size of the core and primary wire size determines the current output capacity, so using larger wire on the secondary will not necessarily give you more current than was available originally. In fact, if the transformer was wound for six-volt charging, and you rewind for 12, the current will be half that originally available, but no doubt still ample

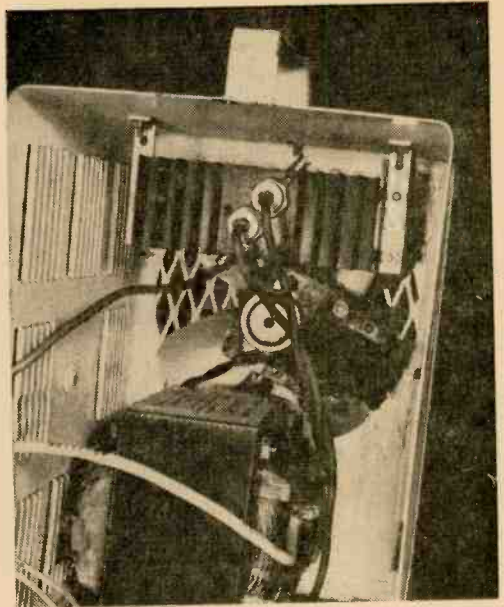

for the current needs of 12-volt charging.

Whichever option you exercise, the output of the completed charger cannot exceed 12 amps average current as measured by an ammeter, using the SCR called for in the parts list. If higher current output is desired, a larger SCR may be used with this circuit, but triggering voltage and current may have to be increased somewhat. Consult the engineering data sheet on any alternate SCR you select, for triggering (gating) requirements. But remember, prices on larger SCR's go up sharply above 20 amp ratings.

Relay K1. The SCR is a highly efficient switching device. However, it is quite sensitive to abuse. It will not stand overheating, or overvoltage. It will not repair itself once it has ruptured, as a selenium rectifier sometimes does.

With the SCR's sensitivity to abuse in mind, it would be well to make your charger as *foolproof* as possible. That is, proof against accidental short circuit or reversed battery polarity. If you feel confident that you will never let the leads short together with the charger on, or will never clip the leads to the wrong battery posts, you can leave out relay K1 and wire straight through.

But since the buzzing of this relay will alert you that a mistake has been made, or that the battery you are about to charge has been completely discharged or has a shorted cell or two, it is well worth including in the circuit. It is not an absolute protection, but serves as notification that an abnormal situation threatens the SCR, and

e/e AN OLD CHARGER

therefore the effort of preparing and installing it in the circuit can be repaid many times over.

Relay K1 is a current regulator taken from an old generator regulator relay box. Either a six-volt or 12-volt regulator may be used, since it is current we are concerned with. Some regulators have relays that are bolted to the bottom of the box instead of riveted—for easiest removal try to find one of these, and while being selective, pick one that has adjustable contacts. Auto junk yards have them for 25 to 50 cents each, from old 1941 to 1950 cars.

Remove the center of the three relays from the box. It is wound with heavy wire only, and its contacts open when current flows through the solenoid. Solder one end of the solenoid to either one of the relay contacts.

The relay was originally set for from 20 to 30 amps for use in the automobile. You want it to break at about the maximum rating of the SCR. Therefore, use a storage battery, a variable resistor of suitable wattage, and an ammeter, to set the contacts to break and begin buzzing at 12 amps. Since you want the relay to be more sensitive than it was, (that is, to act with lower current flowing) begin by moving the armature closer to the solenoid. Then loosen the spring tension tending to hold the contacts together, until buzzing takes place just as the ammeter comes up to the 12-amp mark. Note that the SCR is good for up to 20 amps under ideal conditions; 12 amps has been selected as carrying sufficient margin of safety to protect the SCR against most overheating that might occur.

Mount the relay conveniently in the charger, (see detail photograph), taking note of the fact that most relays of this type utilize the frame as one of the contact conductors, which means you may have to insulate the relay from the charger chassis.

Heat Sinks. Depending upon the space available within your charger box, select a suitable heat sink for the SCR, and another for the rectifiers. Select them large, but within reason. Be sure to use silicone grease when mounting SCR1 and the rectifiers on their respective heat sinks, for good thermal conduction. The smaller SCR will not require a heat sink, and can be mounted by soldering its leads to tie points. CR3 and CR4 likewise

do not require heat sinks, but CR1 and CR2 must be sink mounted; both can be mounted on one sink, however.

With all required parts before you, arrange a good layout within your chassis, using the front panel for mounting, as well as the case floor and top. Drill mounting holes as required, with an eye for outside appearance. Use insulated tie points for mounting small parts. Wire according to the schematic diagram, and check your work very carefully. Solid state devices such as SCR's and diodes are completely unforgiving of mistakes, and can be ruined in an instant by a wrong connection.

Test and Operation. When you are absolutely certain all connections have been correctly made, and no component is grounded when it should be insulated from chassis, connect the charger power input lead in series with a 60-watt bulb. Do not connect to a battery yet. Turn on the power; the bulb should burn dimly—about half brightness if you have a cooling fan, rather dimly if not.

Rotate R1—the green pilot lamp should come on at the far end of potentiometer travel, somewhat dimly because of the reduced primary voltage. This will be the low voltage end of the potentiometer scale.

Turn the power off. Connect the charging leads to a known good, but discharged, battery. **Caution:** make certain that polarity is correct, positive charger lead to positive battery terminal. Turn the power on again. Rotate R1 to a point where the green pilot lamp lights steadily. Then remove the 60-watt bulb from the primary power circuit. Turn on the primary power.

The green light should be lighted, indicating that the SCR is not firing. Slowly turn R1 in the higher voltage direction, until the lamp goes out. The charger is now charging at full rate, but under 12 amps, if K1 is not buzzing. If K1 buzzes violently, check the battery condition—it may be necessary to keep R1 just a little lower for a while, until the battery picks up a little.

As you find desired settings for R1, such as the trickle charge setting for a completely charged 12-volt battery, make a suitable mark at the indicator dial of R1 so you can return to that setting at any time in the future. If you often charge batteries that are completely discharged you will want to mark a beginning charge position for R1 and a finish position, to avoid buzzing relay K1.

(Continued on page 113)

the VHF extender

By Jim Kyle and Jim Speck

K5JKX

W5PPE

Build this plug-in front end and extend your listening past that 30 mc dead end!

Any radio buff worthy of the name knows there's a world of excitement to be found in the VHF (very high frequency) range of the radio spectrum, but all too few of us have had a chance to get in on it. General-purpose receivers, for a number of good reasons, usually stop at about 30 megacycles—and the VHF receivers currently available as do-it-yourself projects or in military surplus hardly compare in performance with that we're used to on lower bands.

The VHF Extender is a device which can change all that for you, and let you get in on the fun for a minimum outlay of cash. Performance will be equal to that of your present SW receiver, since the purpose of the VHF Extender is simply to *extend* the frequency range of your present rig into the VHF region.

The VHF Extender can be used for any 4-megacycle-wide segment of the spectrum between 30 mc. and approximately 170 mc. and with only slight extra expense can be modified at will to cover a new slice should you tire of your first choice. This feature lets you listen to police, fire-department, air-craft-radio, or ham operators at will.

Theory Before Hookup. Before we get into the construction details of the VHF Extender, let's take a brief look at how it works. This will help you when it comes time to make the various parts-value choices needed in construction.

The VHF Extender is, primarily, a *new front end* for your receiver, which connects

into the line between antenna and receiver itself. It translates the VHF signals down into the range covered by your existing receiver, so that while the on-the-air signal may be at a frequency of 136.040 mc. (for example), the signal fed into your existing receiver is at a frequency of 640 kc.—in the broadcast band.

Since the *translating* frequency is determined by a crystal-controlled oscillator, you can rely upon the dial calibration of your receiver. Thus should you be hunting a satellite signal at 136.050 mc., you could set your receiver dial to 1,050 kc. and use a 45-mc. crystal in the VHF Extender. Any signal appearing in the receiver would have to be a 136.050-mc. signal at the antenna

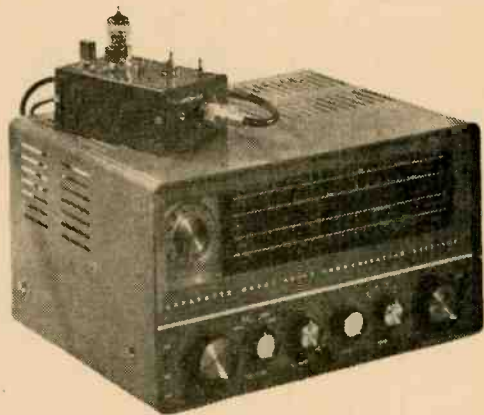

VHF Extender connects between antenna and receiver to expand your listening world.

The VHF Extender is an advanced project for the SWL experimenter. Part location is critical and should be followed closely. See photo at right and below. To make your unit identical with the author's, follow the detail drawings given in the article and follow the text without alterations.

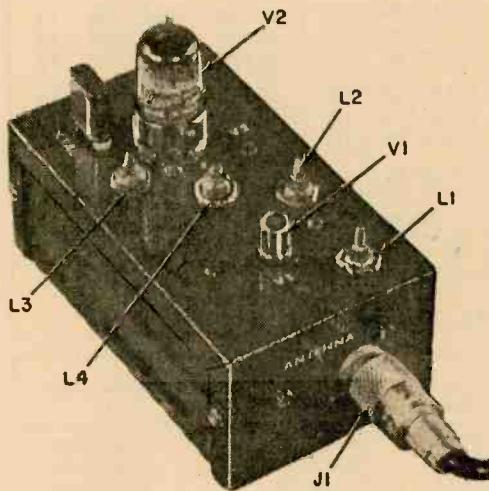
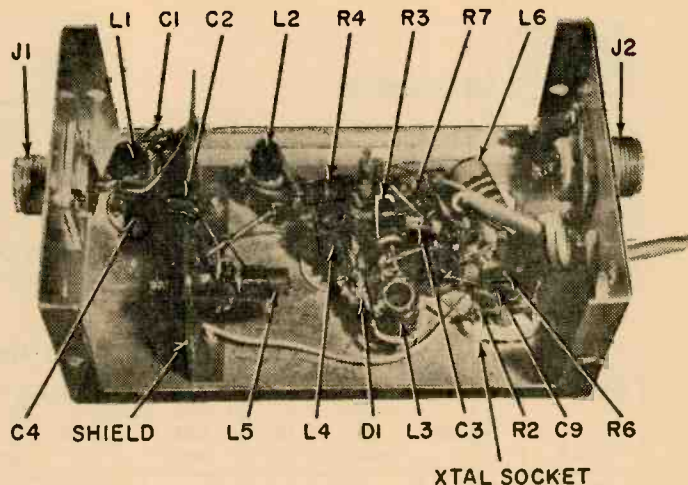

Wire the filament leads as shown on the schematic diagram before installing the copper shield partition on the 6DS4 socket, and mount the two coax connectors, J1 and J2, in place. Then mount the partition (which must be made of copper or brass; this can usually be located at an auto-supply wholesaler under the name of 3-mil shim stock) and make the rest of the connections to the tube sockets. Refer to shield detail drawing to fabricate piece.

Note from the photos that all leads must be kept as short as possible and no wiring is "fancy". Everything must take the most direct route. This makes the lower layer of wiring tough to get to later on, so check and

double check at every step to make certain your connections are correct. If your wiring looks like a tight-knit rats nest—you're doing a good job.

Wiring Differences. With all coils in place and all tube-socket-connections made, the final stages consist of wiring the coils in and connecting the links between them. Only two of these are particularly unusual. Note how the long lead from the 1N69A diode, D1, is used as its own coupling link to L3. The other end of the diode wraps around L4 in the same way. Diode D1 and L4 are omitted on the 30 to 70 mc. models; this is the "extra expense" mentioned earlier to switch to other frequency bands. The other unusual connection is the twisted-wire "gimmick", C13 coupling L4 to the 6U8A pentode's grid. In the 30-70 mc. model, this wire connects to the top of L3 instead of to L4 as shown in the schematic diagram. Be extremely careful that the two wires do not short-circuit together; they form a low-value capacitor through which oscillator voltage is injected into the mixer stages, V2A.

Turn It On. When all connections are complete and rechecked, you can apply power to the VHF Extender. The 6U8A filament should light immediately, and the 6DS4 should feel warm to the touch after a few seconds. If it is hot, remove power quickly and check wiring, especially near L5.

If all proceeds well, connect a coaxial cable from the output jack of the VHF Extender to the antenna terminals of your receiver and tune to about 7 mc. Briefly disable the 6U8A mixer, V2A, of the VHF Extender by shorting pin 3 to ground with an insulated screwdriver. Noise output from

e/e VHF EXTENDER

the receiver should diminish at the same time. If it does not, tune L3 until the noise rises sharply and suddenly. Adjust L3 carefully for maximum noise, then repeat the previous test. Don't be worried if a few 7-mc. short-wave signals come through during all this;

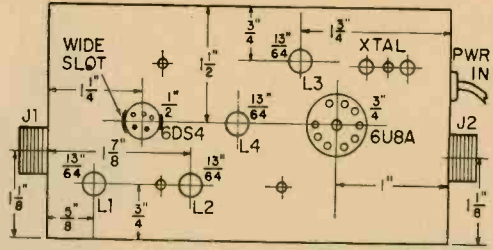

Detail drawing of chassis top part's layout.

COIL TABLE FOR 30-70 MC.

VHF Band (MC.)	L1, L2	C1 (mmf.)	L5	7-11 Mc. Output			BC-Band Output		
				XTAL (mc.)	L3	C3 (mmf.)	XTAL (mc.)	L3	C3 (mmf.)
30-34	20A156RBI	10	4205	23.000	20A106RBI	20	29.400	20A106RBI	20
34-38	20A156RBI	10	4205	27.000	20A106RBI	20	33.400	20A106RBI	15
38-42	20A106RBI	10	4204	31.000	20A106RBI	20	37.400	20A106RBI	15
42-46	20A106RBI	10	4204	35.000	20A106RBI	15	41.400	20A827RBI	15
46-50	20A687RBI	10	4204	39.000	20A106RBI	15	45.400	20A827RBI	10
50-54	20A687RBI	10	4204	43.000	20A827RBI	15	49.400	20A827RBI	10
54-58	20A687RBI	10	4204	47.000	20A827RBI	10	53.400	20A687RBI	10
58-62	20A687RBI	10	4204	51.000	20A827RBI	10	57.400	20A687RBI	10
62-66	20A687RBI	4.7	4203	55.000	20A687RBI	10	61.400	20A687RBI	4.7
66-70	20A687RBI	4.7	4203	59.000	20A687RBI	10	65.400	20A687RBI	4.7

Coil numbers are J. W. Miller Co. part numbers. Wind two-turn link of No. 22 hookup wire around grounded end of L1. BC-Band XTAL frequencies are for lowest megacycle of 4 Mc. VHF bands; add one mc. to XTAL for each higher megacycle desired. For instance, to cover 41-42 mc., table gives 37.4-mc. XTAL but this is upper megacycle of VHF band; add 3 mc. to XTAL frequency and use 40.400-mc. crystal.

COIL TABLE FOR 70-172 MC (7-11 MC OUTPUT)

XHF Band (MC.)	L1, L2	C1 (mmf.)	L5	7-11 Mc. Output Only			
				(mc.)	L3	C3	L4
70-74	20A477RBI	4.7	4203	21.000	20A106RBI	27	20A156RBI
74-78	20A477RBI	4.7	4203	22.333	20A106RBI	20	20A156RBI
78-82	20A477RBI	4.7	4203	23.667	20A106RBI	20	20A156RBI
82-86	20A477RBI	4.7	4203	25.000	20A106RBI	20	20A106RBI
86-90	20A477RBI	4.7	4202	26.333	20A106RBI	20	20A106RBI
108-112	20A227RBI	4.7	4203	33.667	20A827RBI	15	20A106RBI
112-116	20A227RBI	4.7	4203	35.000	20A827RBI	15	20A106RBI
116-120	20A227RBI	4.7	4203	36.333	20A827RBI	15	20A827RBI
120-124	20A227RBI	4.7	4203	37.667	20A827RBI	15	20A827RBI
124-128	20A227RBI	4.7	4203	39.000	20A827RBI	15	20A827RBI
128-132	20A227RBI	4.7	4202	40.333	20A827RBI	15	20A827RBI
132-136	20A227RBI	4.7	10T#	41.667	20A827RBI	15	20A827RBI
136-140	20A227RBI	4.7	10T#	43.000	20A827RBI	15	20A827RBI
140-144	20A227RBI	4.7	8T#	44.333	20A827RBI	15	20A678RBI
144-148	20A227RBI	4.7	8T#	45.667	20A827RBI	15	20A687RBI
148-152	20A227RBI	4.7	8T#	47.000	20A687RBI	10	20A687RBI
152-156	20A227RBI	4.7	6T#	48.333	20A687RBI	10	20A687RBI
156-160	20A227RBI	4.7	6T#	49.667	20A687RBI	10	20A477RBI
160-164	20A227RBI	0	6T#	51.000	20A687RBI	10	20A477RBI
164-168	20A227RBI	0	5T#	52.333	20A687RBI	10	20A477RBI
168-172	20A227RBI	0	5T#	53.667	20A687RBI	10	20A477RBI

Coil numbers are J. W. Miller part numbers. L5, for bands above 132 mc. is wound on a Miller 4200 coil form with No. 24 wire, with the number of turns shown in the table. 0 value for C1 indicates part is not required.

COIL TABLE FOR 70-172 MC (BC-BAND OUTPUT)

L1, L2, L5, and C1—same as given in Coil table for 70-172 mc. with 7-11 mc. output.

L3—J. W. Miller type 20A106RBI from 70 mc. to 86 mc.; 20A827RBI from 86 to 140 mc.; and 20A687RBI from 140 to 172 mc.

C3—20 mmf from 70 to 86 mc.; 15 mmf 86-140 mc.; and 10 mmf 140-172 mc.

L4—Miller 20A156RBI from 70-78 mc; 20A106RBI 78-112 mc; 20A827RBI 112-136 mc.; 20A687RBI 136-152 mc.; and 20A477RBI 152-172 mc.

XTAL—23.133 mc. for 70-71 mc.; 23.467 mc. for 71-72 mc.; 23.800 mc. for 72-73 mc.; 24.133 mc. for 73-74 mc.; 24.467 mc. for 74-75 mc.; etc., increasing by 333 1/3 kc. for each megacycle increase of VHF band. For 136-137 mc. coverage (satellites) Xtal is 45.133 mc., and for 145-146 mc. (Novice portion of ham 2-meter band) use 48.133 mc. Output will be from 600 to 1600 kc. on BC band, with 600 kc. equal to lowest frequency in band (136.000 mc. on satellite band; 136.040-mc. satellite would come in at 640 on BC dial).

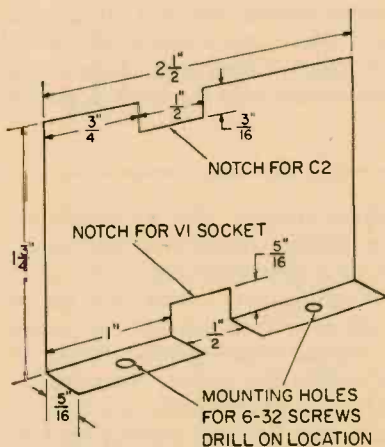

Detail drawing of the copper shield partition installed inside the VHF Extender. Dimensions may vary slightly depending upon how accurately Nuvisor socket is placed.

they won't when the bottom cover of the VHF Extender is in place.

Before proceeding, you will have to locate a signal in the VHF region you're interested in. Tune it in as best you can; it may have an extremely ragged or "whistling" sound which is due to regeneration in the 6DS4 stage of the VHF Extender. Adjust the slug of L5, using an insulated tuning tool, to remove all distortion. Then tune L1 and L2 for best signal strength. You may find that readjustment of L3 (and L4) will strengthen the signal still more.

Next, unsolder either end of the 100,000-ohm resistor, R4, in the 6DS4 plate circuit, while still tuned to the VHF signal. This adjustment is best made with the strongest VHF signal you can find. Readjust L5 until the signal (with resistor disconnected) is as weak as you can get it. **DO NOT READJUST**

PARTS LIST

C1, C3—See Coil Tables for values—select ceramic disc NPO type capacitor
C2, C4—180-mf., 300 WVDC or better, disc or tubular ceramic NPO type capacitor
C5, C8, C9, C10, C12—.001-mf., 1000 WVDC or better, disc type capacitor
C6—.001-mf., button-bypass, standoff capacitor (Erie Ceramicon 323X5U101M or equiv.)
C7C11—100-mmf., 1000 WVDC or better, disc type capacitor
C13—Gimmick capacitor (See text)
D1—1N69A diode (Sylvania)
J1, J2—UHF coaxial connector, receptacle chassis type (Military No. SO-239 or 49194, Amphenol 83-1R, or equiv.)
L1, L2, L3, L4, L5—See Coil Tables
L6—RFC choke, 10-millihenry, ferrite core for 7-11 mc. output. Use 100,000, 1/2-watt resistor in place of RFC for BCB output
R1—47,000-ohm, 1/2-watt resistor

R2, R5, R7—100,000-ohm 1/2-watt resistor
R3—4700-ohm, 1-watt resistor
R4—100,000-ohm, 1-watt resistor
R6—1000-ohm, 1/2-watt resistor
V1—6DS4 Nuvisor (RCA)
V2—6U8A tube (GE)
XTAL—See Coil Tables for value. Select type with .050-in. diameter pins spaced .486-in. apart, .01% (.005% preferred)
1—XTAL socket (National CS-7 or equiv.)
1—2 1/2" x 3" x 5/4" aluminum chassis box (Bud CU-2106A or equiv.)
1—Nuvisor socket for 5-contact tube
1—9-pin miniature tube socket with tube shield base
Misc.—Cable, wire, hardware, grommet, dials, copper shield, cement, solder, etc.

Estimated cost: \$20.00

Estimated construction time: 12 hours

e/e VHF EXTENDER

ANY OTHER COILS. Then reconnect resistor R4, put on the bottom plate, and you're ready to enjoy the VHF Extender.

Switching Bands. To change to another frequency band, should you tire of your first choice, replace the crystal with one of proper frequency (see coil tables) and retune the VHF Extender as described above. If the move in frequency is not very far, you may not need to change the coils. However, if the frequency change is more than half a dozen megacycles or so, you will probably have to replace coils L1, L2, L5, and possibly L4.

To change from low-band to high-band operation, you must either add D1 and L4.

Don't be alarmed at the thought of using the VHF Extender and a standard short-wave receiver to listen to the FM signals of most

commercial VHF communications gear. The VHF gear must now use restricted bandwidth for its transmissions, and as a result you can get very clean copy from the FM signal with an AM receiver simply by tuning a trifle to one side of the signal itself.

Going Mobile. And the VHF Extender can be used with auto radios, too, by using the "BC-Band" component values in the coil tables and supplying 150 volts DC from an external supply.

It should be pointed out that VHF projects are the most difficult to construct and require considerable skill and craftsmanship on the part of the builder. The VHF Extender is not a beginner's project and should not be attempted by a novice experimenter. Cleanliness counts—use just enough solder; scrape off excess rosin; beware of cold solder or rosin joints. Construction time is not important—do not race the clock to get the job done. ■

Ignition Systems

Continued from page 53

Professional plug cleaning is done on a standblaster. If none is available, a fairly good job can be done with a stiff brush. Clean the plug threads, too. A small file can be used to remove small pits in the electrode surface. And be sure to wipe clean the porcelain insulator. Carbon or other deposits should be removed from the plug hole on the engine.

To re-set the gap on each spark plug, it's helpful to use the simple bending tool shown in Fig. 12, frequently supplied with the spark plug gauge. Always adjust the side electrode, *never* the center one. A wire-type feeler gauge is recommended for setting the gap according to the car maker's specifications (Fig. 13). The flat-type gauge is apt to give misleading results if used on older plugs.

If yours is a late-model car, there's a chance that spark-plug gaskets are not required. If gaskets are used, you should use a new one when re-installing old plugs. Avoid overtightening since it could change the gap as the plug is installed. In many instances, you won't be able to use an ordinary wrench for tightening plugs for chances are the plugs are sunk into a well in the engine block. A special spark plug wrench (Fig. 14) is inexpensively available for the job.

Ignition Timing. This is the final step in ignition tuning. It assumes that plugs and points are in good operating order. The purpose of timing is to assure that the points open and produce a spark at the precise instant. The car maker provides timing marks on the engine for making adjustments. In some cars, it is under a small inspection cover located on the flywheel housing (just to the rear of the engine block). In others, the mark appears on the fan pulley as shown on the Volkswagen in Fig. 15. In any case, the mark rotates as the engine idles, passing a stationary reference point. By shining the ignition timing light at this point, the rotating mark will appear to stay still. A stroboscopic action occurs as the timing light flashes each time the moving mark passes the fixed reference point.

The timing light is powered by one spark plug lead, usually to No. 1 cylinder. A check of the car maker's literature is required to locate the correct hookup. The light is then aimed at the appropriate marks as the engine idles at normal operating temperature. If marks do not line up perfectly, the usual technique is to loosen a lock screw at the base of the distributor. This permits the distributor housing to be rotated slightly. There should be a position that causes the spinning mark to center at the fixed point. The lock screw is tightened and the engine considered properly timed. ■

FREE!

Mail This Card Today For Your
FREE
1966 Lafayette Catalog 660

LAFAYETTE 1966 Catalog 660



*Now
BETTER
THAN
EVER*

Over
500
Pages

Featuring Everything in Electronics for

• HOME • INDUSTRY • LABORATORY

from the
"World's Hi-Fi & Electronics Center"

Use Lafayette's Easy-Pay Budget Plan
No Money Down... Up to 24 Months to Pay
Satisfaction Guaranteed or Money Refunded

STORE LOCATIONS

NEW YORK
Brooklyn
Syosset
Manhattan
Jamaica
Scarsdale
Bronx

NEW JERSEY
Newark
Paramus
Plainfield
MASSACHUSETTS
Boston
Natick

MARYLAND
Mt. Rainier
(Wash. D.C. Area)

Mail the Coupon Today for Your **FREE** 1966
Lafayette Catalog 660

LAFAYETTE Radio ELECTRONICS
Dept. DEEJ-5 P.O. Box 10
Syosset, L.I., N.Y. 11791
Send me the Free 1966 Lafayette Catalog 660

Name

Address

City State

Zip

(Please Give Your Zip Code No.)



Name

Address

City

State

Zip

Dept. DEEJ-5

(Please Give Your Zip Code No.)

Mail This Card Today for Your Friend's

FREE
1966 Lafayette Catalog 660



Friend's
Name

Address

City

State

Zip

Dept. DEEJ-5

(Please Give His Zip Code No.)

Dept. DEEJ-5

LAFAYETTE RADIO ELECTRONICS
P.O. BOX 10
SYOSSET, L.I., N.Y. 11791

PLACE
STAMP
HERE

Dept. DEEJ-5

LAFAYETTE RADIO ELECTRONICS
P.O. BOX 10
SYOSSET, L.I., N.Y. 11791

PLACE
STAMP
HERE

Live Better Electronically With

LAFAYETTE RADIO ELECTRONICS

Mail The Card Today for Your

FREE!

1966 Catalog 660



Shop At The
"World's Hi-Fi &
Electronics Center"
For Widest Selection,
Low Prices

Stereo Hi-Fi • Citizens
Band • Ham Gear •
Tape Recorders • Test
Equipment • TV and
Radio Tubes and Parts •
Cameras • Auto Acces-
sories • Musical Instru-
ments • Tools • Books

Everything In Electronics For
Home • Industry • Laboratory

Exclusively Yours at Lafayette

A Complete Assort-
ment of Musical
Instruments



New! 25-Channel,
Solid-State C.B.
Transceiver
Model HB-600



New! Criterion Hi-Fi
Bookshelf Speakers



No Money Down • Up to 24 Months to Pay

70-Watt AM-FM
Stereo Receiver,
Model LR-800



New! Lafayette U.S.
Army-Look-a-Like
2-Way Radio,
Model GT-3

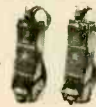

New Criterion 1000B
—Pushbutton 4-
Track Stereo Tape
Recorder in Teak
Case



Satisfaction Guaranteed or Money Refunded

New! Lafayette
Mobil-Ade™ 12-
Channel Solid-State
CB Transceiver,
Model HB-555



50-Watt Solid-State
Stereo Amplifier,
Model LA-248



New Complete Line
of Lafayette
TV Antennas



Do A Friend A Favor...

Have a friend interested in hi-fi or electronics?
Send us his name and address and we will send
him his own personal copy of the 1966 Lafayette
Catalog 660.

FREE! MAIL THE CARD TODAY!

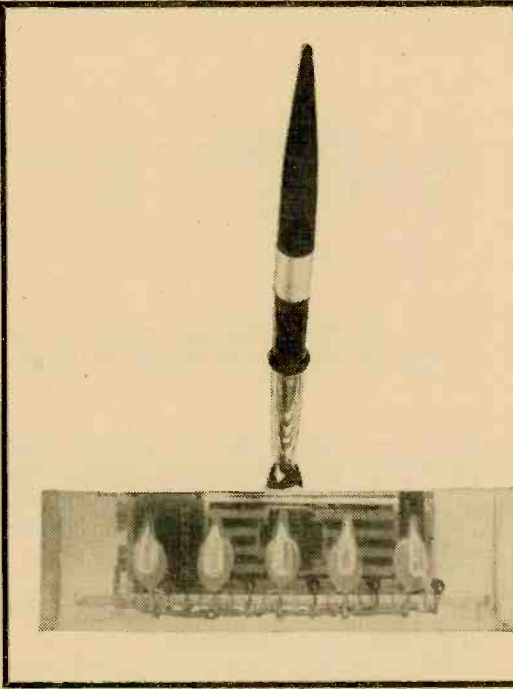

Electronic

■ Easily built from a handful of parts, this electronic desk set really commands attention! Its unique appearance and operation make it an ideal gift for the "man who has everything." Although you will probably have to build a few for envious friends, we bet that yours stays on *your own* office desk!

This desk set departs from the run-of-the-mill variety in that it's really a *working elec-*

tronic circuit, cast in a transparent plastic resin! Five randomly flashing neon bulbs are powered by two built in batteries. These batteries can be expected to last several years in this type of service. The total cost? Less than \$11.00, and that's using all new parts!

About the Circuit. The circuit used is a standard relaxation oscillator. Batteries B1 and B2 are connected in series, and they

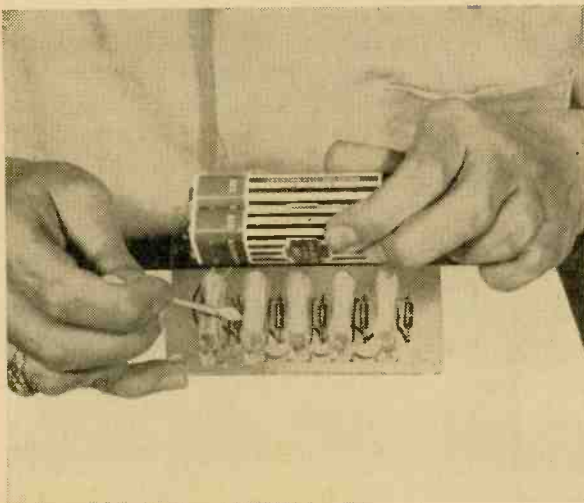

Before the completed circuit is encapsulated in plastic, remove all traces of resin from around the solder connections to insure a good bond between the plastic mounting base and the poured plastic mold. Ordered layout of parts, at the right, shows capacitors C1 through C5, resistors R1 through R5, and neons I1 through I5 all lined up in relaxation oscillator circuit with its power supply, two 45-v. dry batteries B1-B2.

An encapsulated oscillator forms an intriguing, blinking, do-nothing circuit that is topped off with a practical pen set to make a great gimmick!

Desk Set

By Edward A. Morris

charge capacitors C1-C5 through resistors R1-R5. When the voltage across the capacitors becomes high enough, the neon bulbs connected in parallel with these capacitors will fire. This discharges the corresponding capacitor, and the cycle begins all over again.

The rate at which the neon bulbs flash is controlled by the values of resistance and capacitance in the circuit. The more resistance or capacitance, the slower the rate. Of course the opposite is also true, that the less resistance or capacitance in the circuit, the faster the bulbs will flash on and off.

Construction. Cut a piece of $\frac{1}{8}$ inch clear plastic to $4\frac{3}{8}$ by 3 inches. This sheet of plastic will be used as a base for the components, and will become invisible when it is part of the finished casting. Center punch and drill the spots where holes are called for. Use a minimum of pressure when drilling the plastic to avoid cracking it. Sand the edges smooth with 320 grit sandpaper. Pass the leads of the components through the holes in the plastic base, and make a loop in each of the leads to serve as a solder terminal. The parts layout can be seen in the photographs.

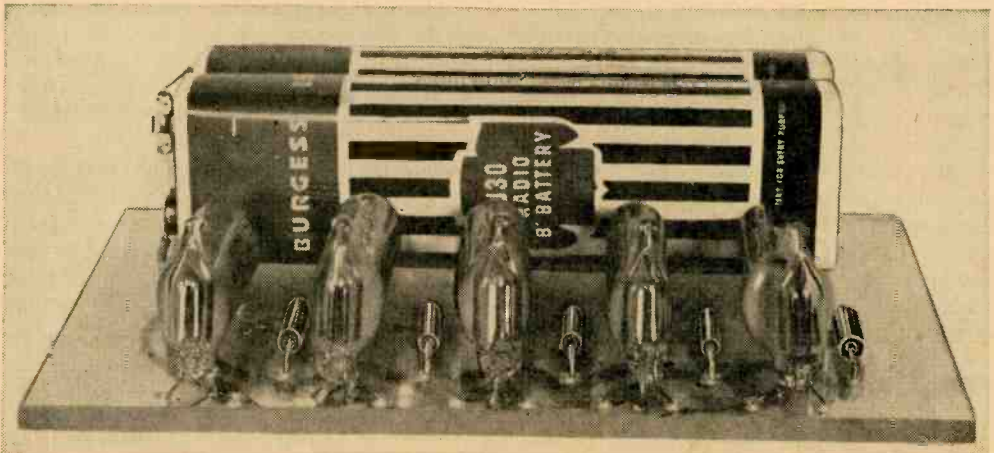

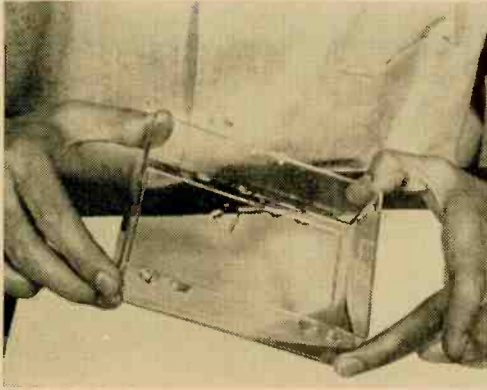

As shown above, pour some mold release in the mold box and swish it around to coat all the surfaces. The plastic resin hardener is then placed in your mixing container at 12 drops per ounce of resin, resin is added, and initial base layer is poured in mold and gells.

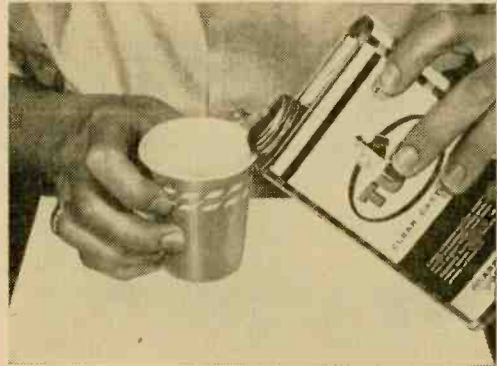

Cement the two 45-volt batteries side to side as shown with a little Duco cement. Set aside to dry. Wire the unit according to the schematic diagram. Use a well tinned 25- to 40-watt iron to avoid charring the plastic base. Make connections as quickly as possible.

Lightly cement the batteries to the plastic base in the position shown in the photographs. Next wire the batteries into the circuit. If the neon bulbs don't start to flash within a second or two, quickly disconnect the lead of the battery and determine the trouble. When the circuit is operating, remove all traces of resin around the soldered joints with a cotton swab moistened with rubbing alcohol. Now you're ready to permanently encapsulate the entire circuit, blinking neons and all, in a hard plastic block.

Casting. Although the mold the author used was a plastic box, any container with suitable inside dimensions may be used. A quick look through your local 5&10 cent

store should turn up something. The bottom half of the box used here measured $5\frac{1}{8}$ inches by $3\frac{3}{8}$ inches and was $1\frac{1}{2}$ deep.

The inside of the container to be used as a mold is coated with mold release. Pour a small amount of the liquid release agent into the mold and swish it around until all inside surfaces are coated. Pour the excess back into the original container. Invert the mold and allow it to dry for at least 45 minutes. Make sure the release agent is completely dry before the mixed plastic is poured in the mold.

At this time it might be best to point out that the entire casting process should be carried out in a dust free area, as entrapped dust particles will spoil the appearance of the finished casting. The temperature of the room where the casting is to be done should be at least 75 degrees F. to ensure proper curing of the mixed plastic resin.

Base Layer. Mix enough resin and 12 drops of hardener per ounce of resin to first
(Continued on page 112)



SCR Lamp Dimmer

by James A. Fred

A twist of a potentiometer shaft drops your lighting to the glow of a candle!

Picture yourself at a table set for two with polished silverware, sparkling glasses, and your lovely wife or girl friend seated across from you at your dimly lit table. No! you don't have to go to an exclusive supper club for that atmosphere. If you make the small device that we are about to describe you can have that setting every night.

The lamp dimmer that we are about to describe is a second generation device. It uses no expensive diodes, iron core coils, or variable wire wound controls. It can be built in one evening, using the main component of all dimmers, the SCR. An inexpensive neon bulb is used to trigger the SCR into conduction. The device will dim up to 600 watts of incandescent light.

Choice of Switches. Actually the photographs show two different, although alike, units that were built. The unit shown with

the student lamp was built first. The variable control in this unit has a reverse action switch, in other words the switch is off until the control reaches the clockwise end of rotation and then snaps on. The net effect of this action is that the lamp is dim at the start of CCW rotation and gets brighter as the control is rotated. At full rotation the lamp will light to about 70 percent of full brightness, then the switch closes and puts full line voltage on the bulb. This is a fine arrangement and one used by most commercial lamp dimmers.

But a conventional variable control with a s.p.d.t. switch can also be used. You can have full brightness at the CCW (counterclockwise) end of rotation and dim light at the CW (clockwise) end of rotation. Choice of switch depends on what you have in your junk box, perhaps, or which type is readily available. A third type is listed in the parts

Schematic diagram of lamp dimmer shows how NE83 in SCR gate circuit triggers device into conduction. Outlet J1 connects to lamp.

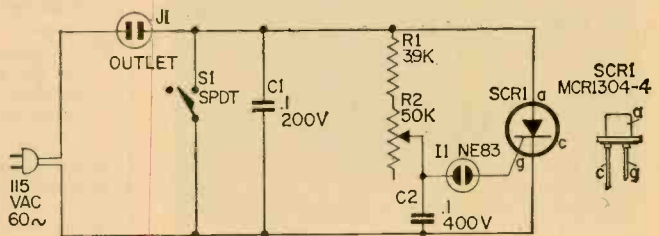

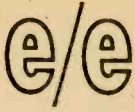

LAMP DIMMER

list since it is conveniently ordered with control R2. It is a push-on stay-on switch which can be activated regardless of the setting of R2.

Choice of Packaging. This dimmer is housed in a metal cover from a can of spray paint. The cover was painted with satin black lacquer and decals applied. As you can see in the parts photograph, all the components were wired and soldered in place outside the housing. Three holes were punched in the housing, before painting, one at top center for the control and one on each side for the line cord. A round disc was cut from 1/2-inch plywood, sprayed with black paint, and used as a bottom for the housing. It is held in place by two small wood screws.

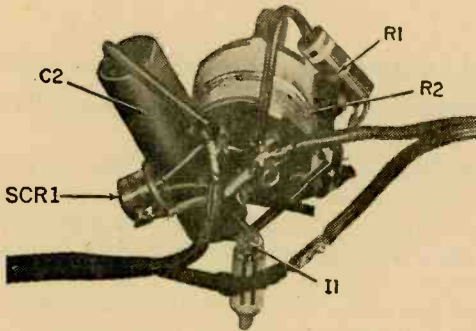

All components are wired before being installed in their spray can cover enclosure. Potentiometer R2 serves as a subchassis for the parts since it is secured inside the cover.



Of course, any number of housing arrangements are possible. Perhaps you want something that will blend with your room decor. Or, maybe you have an eye to mounting the components behind a console panel that controls all the electric and electronic equipment in your den. Either way, the choice is yours.

Wiring the Dimmer. Be careful when soldering the lead to the SCR that you do not overheat the case. The SCR is rated at 8 amperes so no heat sink will be needed unless you intend to dim more than 300 watts. All components are supported by their own leads and wiring is quite simple and straight forward.

The schematic diagram shows an additional .1 mfd., 200 volt capacitor across the line to suppress radiation from the neon bulb.

The line cord is cut into two pieces and each end put through a rubber grommet inserted into the side holes in the housing. A knot is tied in the wire to keep it from pulling out of the housing. One end of each cord goes to the switch terminals (the two terminals that are on at the extreme CCW end of rotation) and the other end of each cord is spliced together.

The lamp that the dimmer will be used with will have its own off-on switch so none is needed on the dimmer housing. The dimmer itself will draw no current if the lamp is turned off so it can be left connected.

After your romantic dimly lit dinner, as you retire to the living room for coffee, your wife will probably put in her request for several more dimmers for other rooms in the house. And chances are you'll agree. ■

PARTS LIST

- C1—.1-mfd., 200-volt tubular capacitor
- C2—.1-mfd., 400-volt tubular capacitor
- I1—Neon circuit control lamp, 60-100vdc start voltage, 10ma (G.E. NE-83 or equiv.)
- J1—AC outlet (part of line cord)
- R1—3900-ohm, 1/2-watt resistor
- R2—50,000-ohm linear taper potentiometer with s.p.d.t. switch (Mallory U-35 and U5-28, respectively or equiv.)
- S1—S.p.d.t switch (see R2)
- SCR1—Silicon controlled rectifier (Motorola MCR1304-4 or equiv. Order from Allied Radiol)
- Misc.—Spray can cover or equivalent housing for the dimmer, plywood, 6-foot line cord complete with plug and outlet, hardware, solder, etc.

Estimated cost: \$4.00

Estimated construction time: 2 hours



ham- CB voice shaper

By Jim Kyle, KEG3382/K5JKX

Your voice may go out at a tenor pitch rather than your usual deep bass, but that's the price you pay for increased intelligibility!

■ "KEH 5891, this is KEG 3382 calling"
"Roger, KEJ 3382, this is KEH 5891, go ahead."

"No, no, old man, this is KEG 3382. That's G as in George."

Do you have this problem consistently, with most of your on-the-air voice contacts? After a couple of years of having other hams come back to him as "K5KKX," "K5JKS," "K5JJS," and all the other possible ways in which his call could be misunderstood, and similar problems with his present CB call, the author did a bit of study. It couldn't *all* be in

the other fellow's ear, he felt.

The Intelligibility Problem. It wasn't, either. He found that his voice was particularly lacking in the high-frequency components which make the difference between many letter sounds. What's more, he found that he wasn't alone in the problem. The average adult male voice is fairly low in high-frequency energy—and it seems that half the operators on the air have voices lower-pitched than average.

The author, having made this discovery, promptly modified the audio sections of all

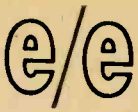

VOICE SHAPER

his rigs to add boost to the weak highs, with a correspondingly spectacular increase of intelligibility as the result. When the rest of the gang heard the results of the modifications, they asked for some type of device which would do the same for them.

The result was the *Voyshap'r*. This device, housed in the smallest available size chassis box, plugs between the mike and the rig and provides the treble boost. No modification of the rig is necessary.

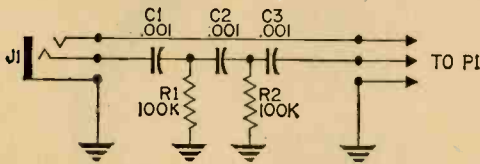

Schematic diagram of the Voice Shaper has a very familiar appearance since its circuit is a basic high-pass filter. Series capacitors have low impedance at high frequencies.

It must be emphasized at the outset that when the *Voyshap'r* (or any other similar device) is used, the transmitted voice will no longer sound "natural." In the process of boosting the highs, the circuit cuts down the low-frequency energy, and it's this low-frequency component that gives the voice its individual sound.

When the *Voyshap'r* is doing its job, the transmitted voice will sound very much like that you hear over long-distance telephone circuits. It will be crisper and more understandable than before, but you may not be recognized so readily without your call letters!

The Circuit. The *Voyshap'r* consists of a three-section high-pass resistance capacitance

Fig. 1. This logarithmic plot of frequency vs. db shows the power distribution of an average male voice; note peak at 300 cps.

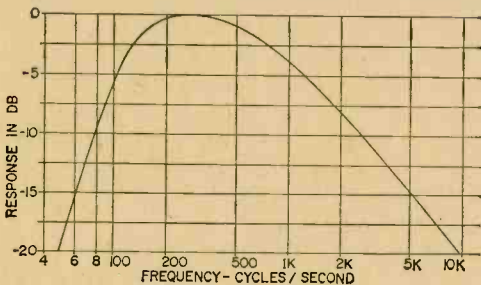

filter, at relatively high impedance. It's designed for use with either crystal, ceramic, or dynamic microphones. It's best used in conjunction with an *outboard* clipper or pre-amplifier accessory, since if used alone it has a very slight (almost undetectable) loss which the clipper or preamp will make up.

The series capacitors, C1, C2, and C3, in the *Voyshap'r* (see schematic diagram) vary in impedance depending upon the frequency of the signal applied to it. At low frequencies, their impedance is high in comparison with the fixed shunt resistors. At high frequencies, their impedance is low.

Thus at very high frequencies, near the top of the audio range, the capacitors are effectively short-circuits, and the circuit is effectively only two resistors connected in parallel across the mike line. The only effect of this is to cause a slight reduction in audio because of the power shunted around the output through the resistors; this effect is negligible.

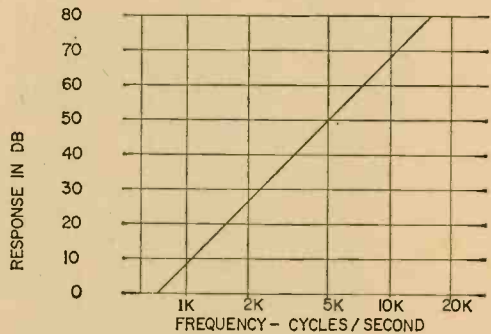

Fig. 2. When frequency vs. response in db is plotted for Voice Shaper, we get a linear response of 18 db/octave. Changing component values gives even greater response.

At very low frequencies the capacitors look like almost open circuits. Specifically, at 16 cycles per second, the impedance of each capacitor is 10 megohms. This impedance acts as a voltage divider, together with the resistor in each section, to reduce the output voltage by a factor of 100 *per section*. Thus, at 16 cycles, the *Voyshap'r* will reduce the output signal to 1/1,000,000 of its original value (100 x 100 x 100). This amounts to 120 db loss.

From Bass to Tenor. In the important middle audio range, from 300 to 3000 cps, it isn't quite so simple. At 1600 cps, the capacitors and the resistors have identical impedance (100,000 ohms). At first you might think the voltage-divider action would

reduce output signal to $\frac{1}{8}$ that of the input ($\frac{1}{2}$ per section, times three sections)—but this neglects the effect each section has on the preceding one. In practice, the reduction is modified by the shunting effect of the later sections. Throughout the useful audio range, the *Voyshap'r's* output signal increases with frequency at 18 db per octave.

Fig. 1 shows the average power distribution of the human male voice; Fig. 2 shows the 18-db-per-octave response of the *Voyshap'r*. Combining these two gives us Fig. 3, which is the output power distribution of the *Voyshap'r* with an average voice. The excess highs go to make up the difference for those of us who have less treble than "average" in our voices.

Construction. The most difficult part of the construction job is drilling the holes in the chassis box—that's how simple the device is! Lay out $\frac{3}{8}$ -inch holes centered on each end of the box as shown in the photos, and use the terminal strip as a template to mark $\frac{5}{32}$ -inch holes on the top.

Then mount the terminal strip in place with 6-32 by $\frac{1}{4}$ " screws. Resistors R1 and R2 mount on the lower parts of the terminal strip. Capacitor C1 runs from input jack J1

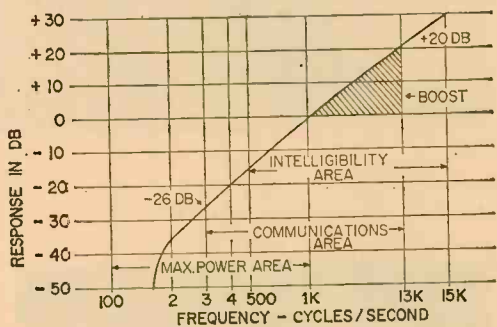

Fig. 3. When we plot the combined effect of Fig. 1 and Fig. 2, we get the output power distribution of the Voice Shaper working with the voice of our average ham or CB'er.

PARTS LIST

- C1, C2, C3—.001-mf. ceramic disc capacitors
- J1—3-conductor, $\frac{1}{4}$ -inch, open circuit phone jack (Mallory 702B or equiv.)
- P1—3-conductor, $\frac{1}{4}$ -inch phone plug (Littell-Plug 260 or equiv.)
- R1, R2—100,000-ohm, $\frac{1}{2}$ -watt resistors
- 1— $2\frac{3}{4}$ " x $2\frac{1}{8}$ " x $1\frac{1}{8}$ " aluminum chassis box (Bud CU3000A or equiv.)
- Misc.—3-terminal terminal strip, 2-conductor shielded output cable, hardware, solder, etc.

Estimated cost: \$2.50

Estimated construction time: 1 hour

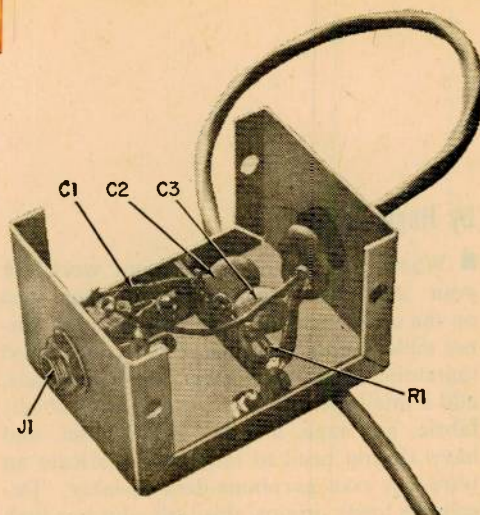

Aluminum chassis box for the Voice Shaper can be the smallest you can find. Terminal strip supports the filter components all of which are visible except for resistor R2.

to the terminal strip, while C2 and C3 both mount on the strip itself. The push-to-talk wire of the output cable connects directly to J1, while the audio wire of the cable connects to C3 at the terminal strip. The shielding is grounded at the strip.

The photos show a switching-type jack at J1; this was used simply because it was the only type on hand when the unit was built. The switch is an unnecessary expense.

If your mike uses a different type of connector, J1 should of course be changed to correspond with it. Alternatively, the 3-contact phone plug can be used by removing your mike connector from the mike cord and putting it on the output cable of the *Voyshap'r*, then putting the phone plug on the mike cable so it will plug into J1. However, this will prevent you from taking the *Voyshap'r* out of the line when desired.

Added Boost. Should the treble boost effect not be great enough to suit you, you can replace R1 and R2 with resistors of just $\frac{1}{10}$ the specified value. This will almost completely eliminate all traces of bass response. However, a preamp will probably be necessary if this is done, since the *Voyshap'r* loss will be some 10 times greater and will probably cause a noticeable reduction of audio on the transmitted signal.

The preamp or clipper, if used, should be between the *Voyshap'r* and the rig. No other accessory should be connected *ahead* of the *Voyshap'r*, for maximum effect. ■

Canned Sound

By Hugh Gaugler

■ When you arrive home from work for your next free evening, leave your coat on the chair, take the wire hanger to the dinner table, empty two cans of beans or stewed tomatoes, enjoy your meal, wash the cans, add a small speaker, some wire, foam rubber, fabric, and tape, and you'll be all set, and have all you need to relax and fabricate an ultra-low cost earphone-desk speaker. Despite its lowly origins, this little unit has such a professional look, it could have come from an NBC sound studio.

The First Can. Remove one end from a can about 4 inches high with a 3-inch diameter and mark it with horizontal and vertical lines as shown. The middle horizontal line should be about ½-inch above the little speaker when it is set in the can cone up. The line above should divide the remaining part of the can in half. The vertical lines should be about ½-inch apart; make sure a line does not fall on the seam of the can. Cut down each vertical line to the second line and fold each resulting strip in half. Squeeze fold line with pliers.

Mount the 3-inch diameter replacement speaker, which you could get from Lafayette Radio (99G6099) for about \$1.50, in the can by drilling two holes in the bottom of the can and a third in the side for the speaker wire. Tie a knot in the wire near the speaker and place a grommet in speaker wire hole.

The Second Can. To make the perforated cover for the speaker, take the second can and, using a nail and hammer, punch holes in its bottom. Then push the bottom outward from the inside since it will have curved in from punching the holes, and cut it out with a can opener. Place the cover over the mounted speaker, after the speaker cone is covered with a piece of dark grille material, and bend every other strip in half again and fold into the can to hold the perforated cover in place.

Foam Rubber Pad. Wrap a ¼-inch thick, 3-inch wide foam rubber strip around the circumference of the can and cut to fit. Then, after scribing a line the length of the strip ¾-inch from the top, fold the strip in

This tin-can trick will revive the status the tin can lost when you discarded your boyhood walkie-talkie

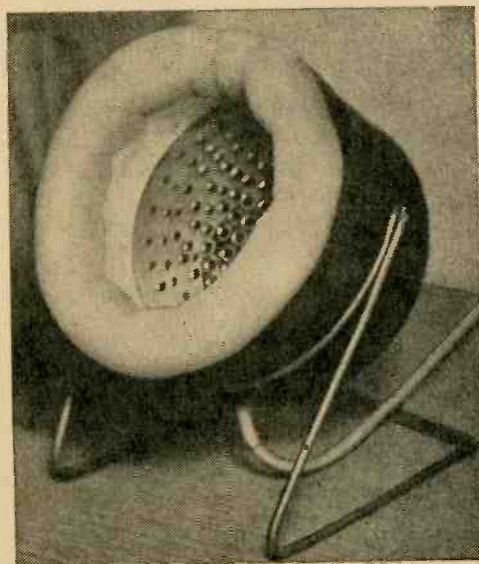

half along its length and sew or staple the two halves together along the scribed line. Then carefully cut off *one* of the tag ends.

Holding the rubber around the end strips of the can, mark the rubber on each side of the strips and thread a piece of hookup wire through as shown in the photo. Also, thread a wire through the roll of foam rubber that will form the ear pad; this will firm its shape. The foam pad is now placed on the can and pushed down on the protruding strips. Tie the ends of the support wires together and fold down the remaining strips.

Professional Polish. Now tape the foam tag end around the can, and also run tape around inside the earpiece to cover the folded strips. Cover the entire unit with a suitable fabric, securing it with glue. Finish by fashioning a table stand and headset holder from the coat hanger you hijacked from the closet, and terminating the speaker wire with plug or connectors to suit your applications from your spare parts box.

Now put your earphone-desk speaker to good use knowing that tomorrow night you won't have to eat out of a can. ■

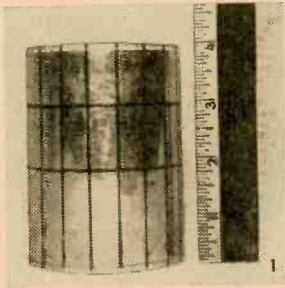

After removing the top of the first can, mark it as shown in (1) and cut down the vertical lines to the second horizontal line. Fold each of the strips as shown in (2) and begin the installation of the speaker. Fabricate a perforated cover for the speaker using a second can and following the instructions in the text.



Then place the cover over the speaker and secure it in place by folding every other strip as shown in (3). The foam rubber strip (4) is folded in half and stapled or sewn along the line. Then, after one of the tag ends is cut off, wrap the foam ear pad around the can and mark it on each side of the remaining strips (5) so a wire lacing can be threaded through to secure it.

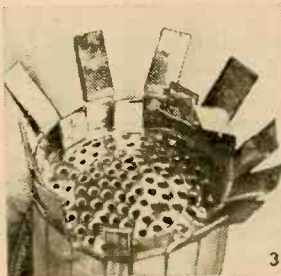

Before mounting the pad, run a wire through the center (6) to firm its shape. Then lace the pad (7) and place it on the strips (8). Tie the lacing wire ends together and fold down the strips. Run tape around the foam tag end (9) and then just cover the speaker with a material of your choice. Finish up by making a table stand and headset from coat hangers.

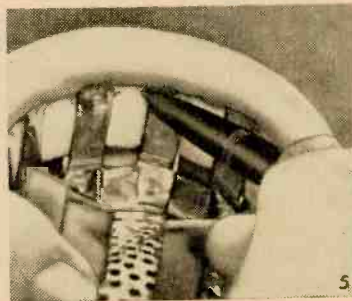
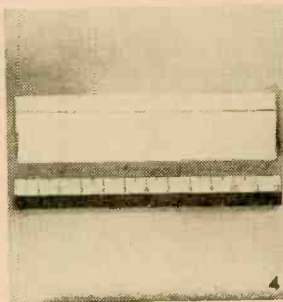
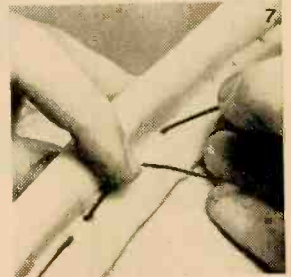

talk on a light beam

By Forrest Frantz, Sr.

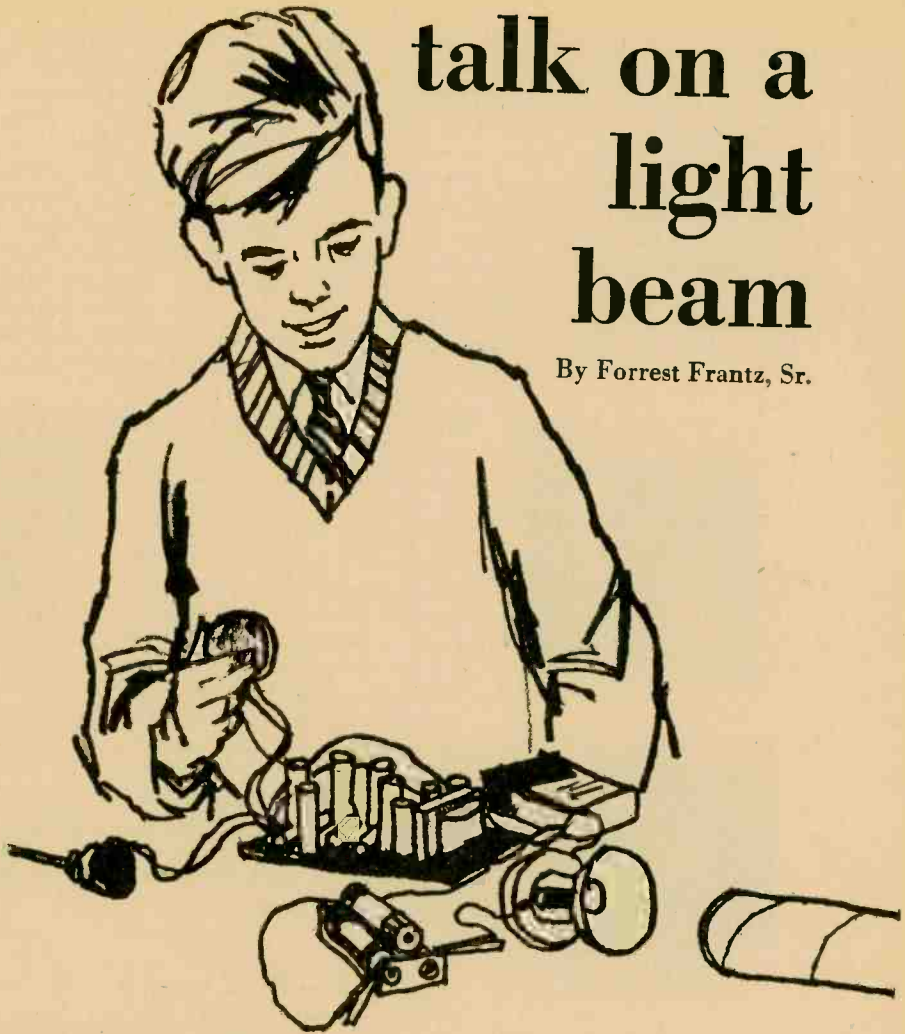

You've read a lot about the possibilities of using laser-beam communications, but did you know that ordinary light could be modulated to carry messages also? You can set up a simple light-beam communications demonstrator in about half an hour and for less than \$15, and all the components can also be used for other experiments and gadgets later.

How It's Done. The basic techniques for light-beam communication consists of converting sound energy to electrical energy and then using the electrical energy to modulate a beam of light. The modulated light beam is picked up by a photocell, and converted back to electrical energy. The electrical energy serves to drive a speaker which produces sound energy at the receiving end of the apparatus.

The complete apparatus that is shown in the photos is intended for demonstration

purposes only, and will not work over long distances. To simplify construction two ready-made low-cost (\$3.75 each) transistor amplifiers were used, one for the transmitter and one for the receiver.

Refer to the photo of the transmitter setup, the schematic drawing and parts list. Although the photo shows only one 1.5-volt bias cell in the transmitter's lamp circuit, experiments have proved that 3 volts worked better and two series-connected dry cells should be used. No need to observe polarity when connecting lamp bias cells. The reason for using the bias battery in the output-lamp circuit deserves mention. The bias battery sets a steady light level. This light level serves as a carrier for the audio signal from the amplifier just as radio frequencies serve as the carrier in a radio transmitter. Another reason for the bias is that the lamp will respond better to the amplifier signal when

The secret of communicating on a radio wave is modulation and demodulation—that's also the secret of talking on a light beam!

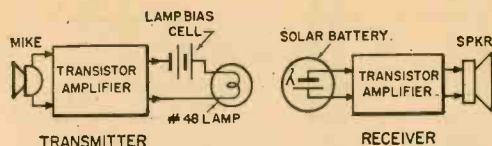

Block diagram for a simple light transmission system. No need for exotic lenses.

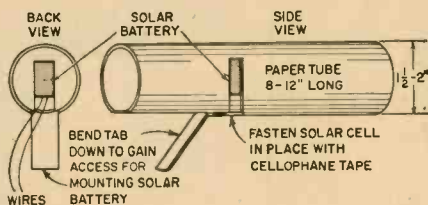

Paper tube from 8 to 12-inches long serves as shield for photo cell—conserves gain.

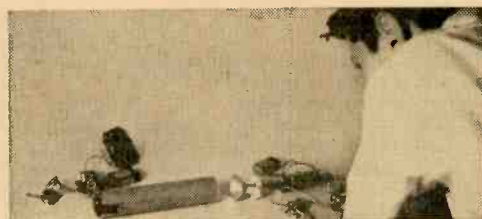
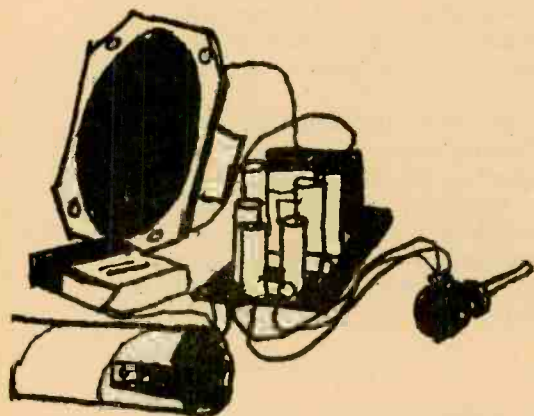

All set up and ready to go! For Science Fairs, mount system on shellacked blocks.

it is biased. The transistor-amplifier connections are explained on the data sheet that comes with the amplifier.

Putting It Together. In the actual setup, it is desirable to add a parabolic reflector to the lamp. The author used a reflector from an old flashlight and glued it to a lamp socket as shown in the photo.

The receiver employs a solar battery as a sensor whose output is fed to an amplifier that drives a loudspeaker. The solar battery is mounted in a mailing tube (for shielding against "light noise") that is pointed toward the lamp. The paper tube's diameter isn't critical—1½ or 2 inches is fine. Length should be 8 to 12 inches. Cut two slits about ½-inch apart and about 2-inches long in the tube and bend down the resulting tab. Fasten the solar battery in the tube with cellophane tape as shown in the drawing with the tab replaced. Try reversing the solar

PARTS LIST

- 2—Amplifier, 3-transistor (Lafayette 99G9039 or equiv.)
- 1—Microphone, crystal (Lafayette 99G6019 or equiv.)
- 2—5000-ohm volume control with switch
- 1—Socket, miniature screw-type pilot lamp
- 1—Pilot lamp, #48
- 2—9-volt transistor battery (Burgess 2U6 or equiv.)
- 2—1.5-volt penlight cells (Size AA)
- 1—battery holder for two AA cells
- 1—Reflector (See text)
- 1—Cardboard mailing tube (See text)
- 1—2½-inch speaker, 8-10 ohms (Lafayette 99G6097)
- 1—Solar battery (IRC B2M or equiv.)

Estimated cost: \$15.00

Estimated construction time: 2 hours

battery leads—output may be increased somewhat.

If you own an amplifier with sufficient gain, you may use it in place of one of the amplifiers but if it has too much power it may blow out the #48 bulb.

Getting More Range. The arrangement described is for demonstration purposes and
(Continued on page 113)

Desk Set

Continued from page 102

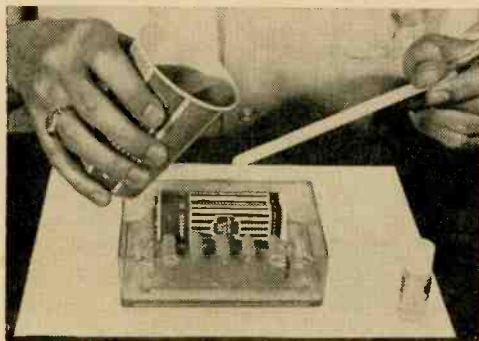

PARTS LIST

- B1-B2—45-volt batteries (Burgess U30 or equiv.)
- C1-C5—.1-mfd, 400-volt capacitors (Mallory PCV Mylar or equiv.)
- I1-I5—NE-2 neon bulbs
- R1-R5—22,000,000-ohm, 1/2-watt resistors
- 1—Tuff Clear plastic resin casting kit No. CR-KP (includes all necessary casting materials and pen set; cost: \$4.95. Order from Glass Plastics Corp., Lynden, N. J.)
- Misc.—Plastic chassis, hookup wire, sandpaper, solder, etc.

Estimated cost: \$11.00

Estimated construction time (exclusive of curing time): 2 hours

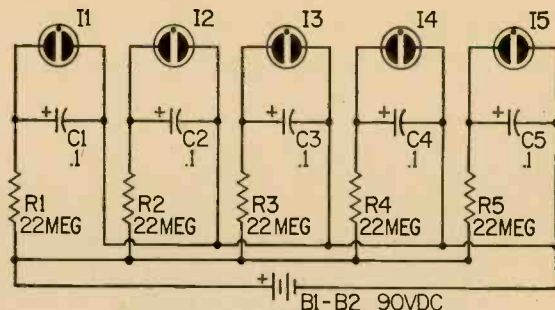

The schematic diagram of the desk set relaxation oscillator is your guide to wiring.

When base layer has gelled, mix remainder of resin and complete the plastic casting.

provide a 1/8- to 1/4-inch thick base layer for the casting. When the base layer has gelled, which will take about 45 minutes, mix the remainder of the resin needed to complete the casting with 8 drops of hardener per ounce of resin.

Dip the electronic circuit board into the mixed plastic to ensure that no air bubbles will be trapped in the finished casting.

As a final touch, cement the pen holder to the casting with a drop or two of epoxy cement, then set the creation on your desk where it will silently blink day in and day out for years. ■

Test Equipment

Continued from page 42

the purchase of a tube tester as long as possible, then purchase the very latest style. It is never advisable to waste money purchasing some out of date, second-hand tester.

Transistor Testers. The inexpensive transistor testers will usually tell you if a transistor is defective but not always how good it is. In most cases a check with an ohmmeter will show if the transistor is faulty and if its base will control emitter and collector currents. When in doubt, substitution of another transistor is the final check.

Signal Tracers. The tracer is important because it speeds up trouble shooting of receiver circuits. Also it aids you in understanding circuits since you can see and hear exactly what is going on within the circuit. You will find a tuned type signal tracer, Fig. 13, which will help you to investigate high frequency as

well as audio equipment, very desirable.

R-C Testers. Another supplementary instrument found in many shops is the R-C Tester (Fig. 14). This device is most commonly used to check capacitors to determine their capacity and leakage values. Although this tester is not an absolute necessity, it can speed up your experimental or troubleshooting work by making a direct test, when otherwise you might have to make an indirect or more time consuming test to find the exact same answer.

Looking Ahead. A workbench equipped with the test gear mentioned here is adequately supplied for just about any experimenting, troubleshooting and repair work you might encounter. Certainly, we haven't covered the entire field of test equipment, but we've hit the basic gear essential to the electronics technician—whether amateur or professional. So, start with a meter and grow from there as your knowledge and skills increase. ■

New Boost

Continued from page 90

A word of caution: *always* turn charger power off before connecting or disconnecting charging leads. A charging or discharging battery generates hydrogen, which can be ignited with a tiny spark, blowing up a cell and spattering acid on clothing and skin.

SCR Cutoff. The point at which the SCR begins to cut off can be set anywhere between 6.5 and 14.5 average volts, by R1. However, when charging batteries of less than 12 volts rating, care must be taken that the initial charging rate does not exceed 12 amps. If you have included K1 in the circuit, it will warn of excessive charging current, and R1 can be rotated until buzzing stops.

If R1 is set below battery voltage, and gradually increased, the SCR will limit the charging current to a safe value. At the final, peak charge, the SCR will pulse once each second or less. Keep in mind that it is possible to severely overcharge a six-volt battery with this circuit, by setting R1 for a terminal charge voltage higher than the battery can possibly achieve.

It is emphasized that K1 is only a warning device. If buzzing occurs, corrective action must be taken at once to prevent ultimate damage to the SCR.

The green pilot light indicates the beginning of the tapering charge. You will note that as the battery becomes nearly charged, the light will come on, very dimly. This signals that the SCR is *dropping a few cycles*. As the battery charge increases, the green light will flicker, and brighten. It will pulse intermittently. Finally, after the battery has been on from six to 12 hours at the finishing rate, it will pulse at a very slow rate.

This is the clue to setting R1 accurately. Set it after the battery has trickle charged for at least six hours, such that the green light is on, and the tiny pulse flicker occurs about once each second. The charger can be left on indefinitely at this rate, and the battery will remain fully charged. If the battery is used with the charger while still in a circuit, the charging rate will increase automatically as the battery voltage drops. Or, if the charger is removed with R1 left at the setting, when the battery is reconnected charging will begin at the 12-amp rate, and will automatically shift to trickle charge when battery comes up to gassing stage. ■

Talk on a Light Beam

Continued from page 111

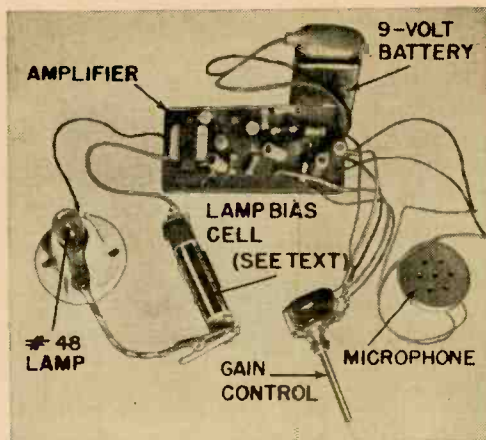
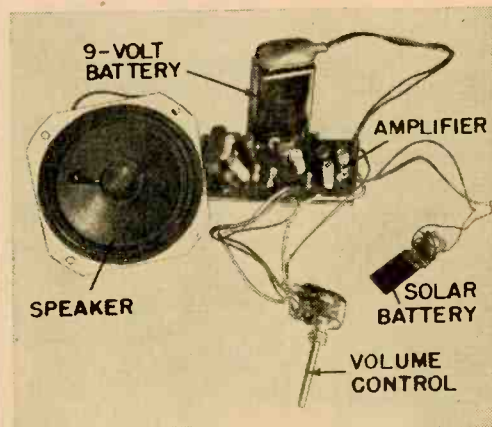

Table-top setup for talking on a light beam is shown in the photos. Above, the transmitter or light amplifier is shown, and below, the light-actuated sound amplifier.



shouldn't be expected to work at a range over a couple of feet. If you operate in a darkened room and go to some trouble in positioning the lamp and solar cell relative to each other, you can gain some range. For longer distances you need an amplifier with greater gain and power output handling capability and a larger bulb (perhaps a #47) with a better focusing system. For demonstration purposes at Science Fairs, you can use your hand as a volume control. Slowly place your hand between the lamp and solar cell. The volume of the signal transmitted on the light beam will be reduced and eventually eliminated. ■

Intercom Systems

Continued from page 99



Fig. 14. Schematic diagram shows how tone decoder can be set to respond to any of four frequencies depending on which contact of resonant reed relay is wired in circuit.

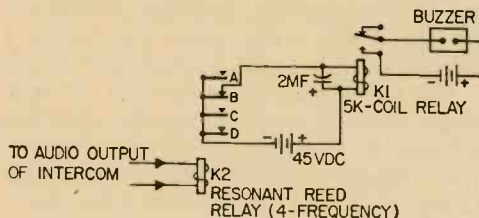

Dual purpose CB-wireless intercom at left.

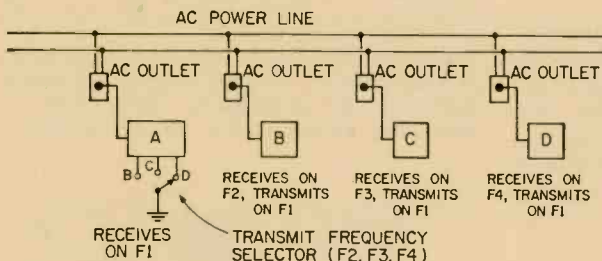

Fig. 15. Illustration of split channel operation. Unit A transmits on 3 frequencies, but receives on one. B, C, and D transmit on same frequency (F1) but receive on different frequencies.

connected to the wires. Each unit is connected to a loop of wire which provides inductive coupling to a wire line.

These systems generally operate at very low radio frequencies, below 200 kc, and

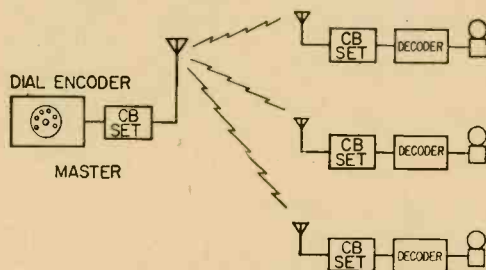

Fig. 16. Unit equipped with dial encoder.

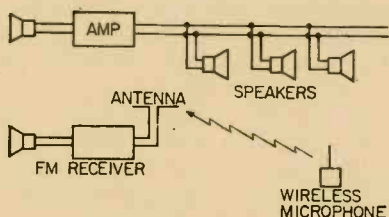

Fig. 17. Public address with radio reply.

require relatively high-power transmitters. No license is required, but radiation must be restricted to within the limits allowed by Part 15, FCC Rules and Regulations.

The possible intercom arrangements are myriad. An intercom unit is a combination transmitter and receiver, whether it works at audio or RF. Most employ *simplex* operation (sequential transmit and receive). Some employ *duplex* operation as in ordinary telephony enabling a person to talk and listen at the same time. When radio or wireless intercom is employed, duplex operation is achieved by transmitting and receiving simultaneously, but on different frequencies.

A duplex system is subject to acoustic feedback when loudspeakers are used for receiving. Hence, volume level must be kept low, or the microphone and speaker must be oriented so as to minimize pick up of sound from the speaker by the microphone.

Intercom equipment, both wired and wireless, are manufactured by numerous firms, and is also available in kit form. Speak to your local electronics parts dealer or thumb through a mail order parts catalog. Many experimenters like to design and build their own though. ■

Incandescent Lamp

Continued from page 66

buyer, however, this is no cause for alarm. Rated life is only an average figure; early failures are balanced by the lamps that live past their rated life.

Replacement. In the home, bulbs are usually replaced as they fail. Few people would change a lamp before this time. But this is precisely the procedure in many commercial lighting installations. What may appear supremely wasteful—replacing lamps *before* they burn out—frequently proves most economical for the big user. This can be shown by the chart in Fig. 5 which relates light output and cost.

Note, first, the factor which determines life. It is filament temperature and, as shown by its curve on the chart, the lower the temperature the longer will be lamp life. The amount of light output also varies with filament temperature. Now to tie this in with

the cost of producing light, which includes the price of the lamp and electrical power. The cost-of-light curve starts high, but drops down at about 600 hours. From this point on, cost again rises. The lamp is still burning, but light output is dropping with age. Such a lamp is more expensive to operate in terms of light, or lumens produced.

These relationships become especially important to the big industrial user. He is not buying lamps but purchasing *light*. This introduces other cost factors such as labor for lamp replacement, maintenance, cleaning, etc. When all factors are calculated, it becomes economically attractive to replace lamps—not as each burns out—but in groups. It's been found, for example, that replacement at 70 per cent average life can prove most economical. And this is true, even though more than 90 per cent of the lamps will still be burning when removed. The amount of light, however, from these aging lamps is the most costly, as shown in the chart. It is less expensive in the long run to periodically install new lamps in large applications. ■

STANDARD LAMP OPERATING DATA

Watts	Bulb Size	Volts	Amps	Approx. Initial Lumens	Rated Initial Lumens Per Watt	Rated Average Life, Hours
6†	S-6	120	.050	44	7.4	1500
10†	S-14	120	.083	80	8.0	1500
25†	A-19	120	.21	266	10.6	1000
40	A-19	120	.34	470	11.8	1000
60*	A-19	120	.50	840	14.0	1000
75*	A-19	120	.63	1,150	15.4	750
100**	A-19	120	.83	1,750	17.5	750
100	A-21	230	.43	1,280	12.8	1000
100	A-23	30	3.12	1,900	19.0	1000
100 (Proj.)	T-8	115	.87	1,950	19.5	50
150*	A-23	120	1.25	2,700	18.0	750
200**	A-23	120	1.67	4,000	20.0	750
200	PS-30	120	1.67	2,680	18.4	750
300	PS-30	120	2.50	6,000	20.0	750
300	PS-35	120	2.50	5,750	19.2	1000
500**	PS-35	120	4.17	10,500	21.0	1000
500	T-3	120	4.17	10,500	21.0	2000
1000**	PS-52	120	8.3	23,300	23.3	1000
1000	PS-52	230	8.3	18,600	18.6	2000
1000(Proj.)	T-20	115	8.7	28,000	28.0	50
1000(Spot)	G-40	120	8.3	22,500	22.5	200
1500	PS-52	120	12.5	33,000	22.0	1000
1500	T-3	240	6.25	33,000	22.0	2000
2000	PS-52	120	16.7	44,000	22.0	1000
5000	T-64	120	41.7	165,000	33.0	75
10,000	G-96	120	83.4	330,000	33.0	75

** Vertical Coil-coiled Filament

† Vacuum

* Coiled-coil Filament

Feedback

Continued from page 80

put adjusted for an easily-duplicatable level of second-harmonic distortion, measure the amplifier output voltage. Enter in Table E.

Now reconnect the feedback, with R3 set at 100,000 ohms. Note that the distortion is no longer audible. Increase signal generator output until the distortion appears again, with the same strength it had originally. Measure amplifier output voltage and enter the reading in Table E also.

Let's assume, for a moment, that instead of 1 volt of distortion in the output we have only $\frac{1}{3}$ volt. Of this, 20 percent, or $\frac{1}{15}$ volt, is fed back to the input with opposite polarity. Going through the amplifier, it is boosted 10 times, to become " $-\frac{2}{3}$ " volt at the output. The " $-\frac{2}{3}$ " volt and the 1 volt we originally expected add together to give us an actual distortion figure of $\frac{1}{3}$ volt.

Staying with the figures of our example, we have seen how the 1 volt of second-harmonic distortion was reduced to $\frac{1}{3}$ volt by addition of 20 per cent feedback.

However, when the second-harmonic distortion makes its trip through the amplifier to produce the $\frac{2}{3}$ volt of "cancellation" distortion, it too is subject to distortion, and we get some 4000-cps signal at the amplifier output. With the values used earlier, we would have $\frac{1}{3} \times \frac{1}{10} \times \frac{2}{3}$, or $\frac{1}{45}$ volt of this high-order harmonic.

While $\frac{1}{45}$ volt may not sound like much, it can be significant. Second-harmonic distortion can hardly be heard in music, since it produces tones which are exactly one octave higher than the original tones. Fourth-harmonic distortion produces tones two octaves higher, and this too is hard to detect.

But practical amplifiers also produce other harmonics, and when the second and third harmonics make their cancellation trips through, such things as sixth and ninth harmonics show up in the output. These are not present without the feedback. Sixth and ninth harmonic tones bear no musical relationship to the original signals, and so produce a discordant or "harsh" effect.

For this reason, good design practice demands that feedback be held to the minimum required for the desired results. The general rule is "Make it as good as you can *without* feedback, then use only so much feedback as you have to to meet the specs."

When you compare the two readings, you will see that greater output levels are obtainable for the same amount of distortion, when feedback is used. Conversely, for the same output level, the amount of distortion present will be reduced by feedback.

While you cannot measure it accurately with the equipment usually available to experimenters, the reduction in distortion can be measured in the lab—and it is exactly equal to the reduction in gain. Or, in other words, the amount of distortion reduction is controlled by the amount of feedback.

The theory is reasonable easy to see. Let's assume that we have an absolutely distortionless 1000-cps input signal, and that our amplifier (without feedback) has a gain of 10 times. Let's also assume that the amplifier produces 10 percent second-harmonic distortion, with a 1-volt input signal.

These figures immediately tell us that when we feed in 1 volt of our pure 1000-cycle signal, we will get out at the far end of the amplifier 10 volts of 1000-cps, and 1 volt (10 percent of 10 volts) of 2000-cps signal which didn't exist in the input.

Now let's feed back 20 percent of the output signal to the input. To get 10 volts out of the amplifier, with feedback, the actual input must still be 1 volt, and the feedback voltage is -2 volts, so we have to apply 3 volts to the input terminals. The gain has been reduced 10 times to $3\frac{1}{3}$ times.

We apply our 3 volts to the input, and we get at the output 10 volts of 1000 cps signal.

We would expect to still have 1 volt of distortion, but 20 percent of this 1 volt or $\frac{1}{5}$ volt is fed back to the input. The signal put into the amplifier didn't have any distortion in it, so the " $-\frac{1}{5}$ " volt of distortion goes into the input with such polarity that it tends to cancel out any distortion generated in the amplifier itself.

This " $-\frac{1}{5}$ " volt of distortion is amplified 10 times by open-loop gain, to give us -2 volts of distortion at the output instead of $+1$ as originally expected. The result is a -1 volt distortion—but when this feeds back through the loop again the figures are modified still more.

Other Experiments. The five experiments presented here, together with the theory discussions, should give you a good working knowledge of feedback and its effects. The possible number of experiments is limited only by your imagination. And every one will increase your understanding of that useful phenomenon, feedback. ■

Synthetic Battery

Continued from page 84

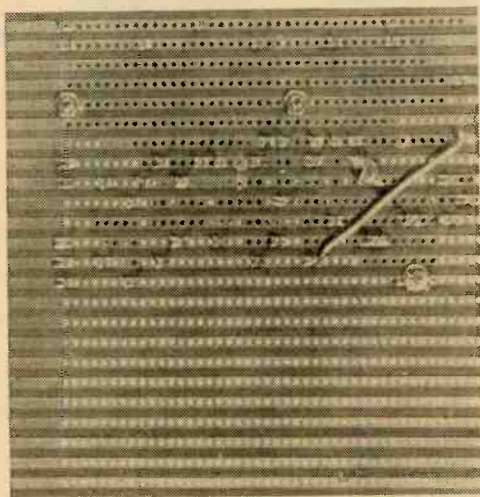

Bottom of completed unit shows jumper and hardware. Unused board can be trimmed off.

former can be used rather than a 12-volt.

Capacitors C3 and C4 filter this DC to reduce hum and also increase the output voltage capability under moderate loads.

The negative side of this 15-volt DC sup-

ply goes to the output terminal through a 24-ohm 4-watt resistor composed of R1 and R3 in parallel (it was done this way to reduce cost by using inexpensive composition resistors rather than a single 5-watt power unit). Transistor Q1 is connected across the output voltage and its base is driven by Q2.

D1 subtracts its rated zener voltage from the output level and delivers anything left over to the base of Q2. Thus, with a 9-volt zener, if 10 volts existed at the output terminal the base of Q2 would be forward-biased by 1 volt. This would reduce the collector-to-emitter resistance of Q2 almost to zero, putting heavy forward bias on Q1. (R4 serves to reduce the effects of leakage current in Q1; with many transistors, it is not necessary.)

The heavy forward bias on Q1 causes this transistor to conduct more current, which in turn increases the voltage drop across the 24-ohm resistor and reduces output voltage.

When the output voltage is reduced to 9 volts because of the increased current through Q1, the base drive to Q2 is reduced to zero since the 9 volts subtracted by D1 leaves nothing for the base. Q2 "cuts off" and removes bias from Q1. Q1 ceases its heavy conduction, which removes some of the voltage drop in the 24-ohm resistor R1+R3 and would let the output rise again.

In practice, of course, the output voltage stays just enough higher than the zener voltage of D1 to permit Q2 and Q1 to draw the necessary current. But anything which would tend to change output voltage, whether the sudden connection of a load, the presence of signal voltage from the load coming back into the power supply, or a change in 115-volt line voltage, is transmitted through to the base of Q2 without change except that 9 volts is subtracted from it first. This change then readjusts the current drawn by Q1, in a matter of a few milliseconds.

Shorting the output simply puts all the 15-volt supply voltage across R1+R3, and removes collector voltage from both transistors. With no load connected, however, Q1 must draw all the current needed to reduce output voltage to the desired level—and that's why the transistors run coolest with the heaviest load connected to the unit.

Q2 could be eliminated from the circuit if utmost economy is desired; R2 would also be removed then and D1 would connect direct to R4. Performance would be slightly degraded but would still surpass most 9-volt batteries. ■

PARTS LIST

- C1, C2—100-mf., 10-VDC electrolytic capacitor, upright mount
- C3—100-mf., 15-VDC electrolytic capacitor, axial leads
- C4—160-mf., 15-VDC electrolytic capacitor, axial leads
- D1—9-volt zener diode (Sarkes-Tarzian VR-9 or equiv.)
- D2, D3—500-ma., 50-PIV epoxy-covered diode (Radio Shack 27T1119 or equiv.)
- NE-2—lead-mounted neon bulb, type NE-2
- Q1—pnp audio power transistor such as 2N301A (See text for details.)
- Q2—pnp audio transistor such as 2N107 or 2N404 (See text for details.)
- R1, R3—47-ohm, 2-watt resistor
- R2—1,000-ohm, 1/2-watt resistor
- R4—10-ohm, 1/2-watt resistor
- R5—100,000-ohm, 1/2-watt resistor
- T1—115 VAC to 6.3 VAC @ 1.2 amp filament transformer (Radio Shack 27-050 or equivalent; 0.6-amp rating adequate)
- Misc.—Veroboard 3 x 5-inches, Veroboard terminal pins #2140 (optional), nuts, bolts, solder. Vero terminal pin insertion tool (optional), Vero spot face cutter tool. (Veroboard Kit: \$5.95, see text)

Estimated cost: \$5.00 (not including Veroboard)
Estimated construction time: 2 hours



LITERATURE LIBRARY



Numbers in heavy type indicate advertisers in this issue. Consult their ads for additional information.

ELECTRONIC PARTS

1. This catalog is so widely used as a reference book, that it's regarded as a standard by people in the electronics industry. Don't you have the latest *Allied Radio* catalog? The surprising thing is that it's free!

2. The new 516-page 1965 edition of *Lafayette Radio's* multi-colored catalog is a perfect buyer's guide for hi-fiers, experimenters, kit builders, CB'ers and hams. Get your free copy, today!

3. *Progressive "Edu-Kits" Inc.* now has available their new 1965 catalog featuring hi-fi, CB, Amateur, test equipment in kit and wired form. Also lists books, parts, tools, etc.

4. We'll exert our influence to get you on the *Olson* mailing list. This catalog comes out regularly with lots of new and surplus items. If you find your name hidden in the pages, you win \$5 in free merchandise!

5. Unusual scientific, optical and mathematical values. That's what *Edmund Scientific* has. War surplus equipment as well as many other hard-to-get items are included in this new 148-page catalog.

6. Bargains galore, that's what's in store! *Poly-Paks Co.* will send you their latest eight-page flyer listing the latest in merchandise available, including a giant \$1 special sale.

7. Whether you buy surplus or new, you will be interested in *Fair Radio Sales Co.'s* latest catalog—chuck full of buys for every experimenter.

8. Want a colorful catalog of goodies? *John Meshna, Jr.* has one that covers everything from assemblies to zener diodes. Listed are government surplus radio, radar, parts, etc. All at unbelievable prices.

10. *Burstein-Applebee* offers a new giant catalog containing 100's of big pages crammed with savings including hundreds of bargains on hi-fi kits, power tools, tubes, and parts.

11. Now available from *EDI (Electronic Distributors, Inc.)* a catalog containing hundreds of electronic items. *EDI* will be happy to place you on their mailing list.

12. VHF listeners will want the latest catalog from *Kuhn Electronics*. All types and forms of complete receivers and converters.

23. No electronics bargain hunter should be caught without the latest copy of *Radio Shack's* catalog. Some equipment and kit offers are so low, they look like mis-prints. Buying is believing.

25. Unusual surplus and new equipment/parts are priced "way down" in a 32-page flyer from *Edlie Electronics*. Get one.

75. *Transistors Unlimited* has a brand new catalog listing hundreds of parts at exceptionally low prices. Don't miss these bargains!

HI-FI/AUDIO

13. Here's a beautifully presented brochure from *Altec Lansing Corp.* Studio-type mikes, two-way speaker components and other hi-fi products.

15. A name well-known in audio circles is *Acoustic Research*. Here's its booklet on the famous AR speakers and the new AR turntable.

16. *Garrard* has prepared a 32-page booklet on its full line of automatic turntables including the Lab 80, the first automatic transcription turntable. Accessories are detailed too.

17. Two brand new full-color booklets are being offered by *Electro-Voice, Inc.* that every audiophile should read. They are: "Guide to Outdoor High Fidelity" and "Guide to Compact Loudspeaker Systems."

19. *Empire Scientific's* new 8-page, full color catalog is now available to our readers. Don't miss the sparkling decorating-with-sound ideas. Just circle #19.

22. A wide variety of loudspeakers and enclosures from *Utah Electronics* lists sizes shapes and prices. All types are covered in this heavily illustrated brochure.

24. Here's a complete catalog of high-styled speaker enclosures and loudspeaker components. *University* is one of the pioneers in the field that keeps things up to date.

26. When a manufacturer of high-quality high fidelity equipment produces a line of kits, you can just bet that they're going to be of the same high quality! *H. H. Scott, Inc.*, has a catalog showing you the full-color, behind-the-panel story.

27. An assortment of high fidelity components and cabinets are described in the *Sherwood* brochure. The cabinets can almost be designed to your requirements, as they use modules.

28. Very pretty, very efficient, that's the word for the new *Betacom* intercom. It's ideal for stores, offices, or just for use in the home, where it doubles as a baby-sitter.

30. Tone-arms, cartridges, hi-fi, and stereo preamps and replacement tape heads and conversions are listed in a complete *Shure Bros.* catalog.

TAPE RECORDERS AND TAPE

31. "All the Facts" about *Concord Electronics Corporation* tape recorders are yours for the asking in a free booklet. Portable battery operated to four-track, fully transistorized stereos cover every recording need.

32. "The Care and Feeding of Tape Recorders" is the title of a booklet that *Sarkes-Tarzian* will send you. It's 16-pages jam-packed with info for the home recording enthusiast. Includes a valuable table of recording times for various tapes.

33. Become the first to learn about *Norelco's* complete Carry-Corder 150 portable tape recorder outfit. Four-color booklet describes this new cartridge-tape unit.

34. The 1964 line of *Sony* tape recorders, microphones and accessories is illustrated in a new 16-page full color booklet just released by *Super-scope, Inc.*, exclusive U.S. distributor.

35. If you are a serious tape audiophile, you will be interested in the new *Viking* of *Minneapolis* line—they carry both reel and cartridge recorders you should know about.

91. A comprehensive analysis of *Uher* tape recorders and a complete listing of accessories are all in their up-to-date 16-page brochure.

HI-FI ACCESSORIES

76. A new voice-activated tape recorder switch is now available from *Kinematix*. Send for information on this and other exciting products.

39. A 12-page catalog describing the audio accessories that make hi-fi living a bit easier is yours from *Switchcraft, Inc.* The cables, mike mixers, and junctions are essentials!

KITS

41. Here's a firm that makes everything from TV kits to a complete line of test equipment. *Conar* would like to send you their latest catalog—just ask for it.

42. Here's a 100-page catalog of a wide assortment of kits. They're high-styled, highly-versatile, and *Heath Co.* will happily add your name to the mailing list.

44. A new short-form catalog (pocket size) is yours for the asking from *EICO*. Includes hi-fi, test gear, CB rigs and amateur equipment—many kits are solid-state projects.

AMATEUR RADIO

45. Catering to hams for 29 years, *World Radio Laboratories* has a new FREE 1965 catalog which includes

all products deserving space in any ham shack. Quarterly fliers, chock-full of electronic bargains are also available.

46. A long-time builder of ham equipment, *Hallcrafters* will send you lots of info on the ham, CB and commercial radio-equipment.

CB—BUSINESS RADIO SHORT-WAVE RADIO

48. *Hy-Gain's* new 16-page CB antenna catalog is packed full of useful information and product data that every CB'er should know about. Get a copy.

49. Want to see the latest in communication receivers? *National Radio Co.* puts out a line of mighty fine ones and their catalog will tell you all about them.

50. Are you getting all you can from your Citizens Band radio equipment? *Amphenol Cadre Industries* has a booklet that answers lots of the questions you may have.

52. If you're a bug on CB communications or like to listen in on VHF police, fire, emergency bands, then *Regency Electronics* would like to send you their latest specs on their receivers.

53. When private citizens group together for the mutual good, something big happens. *Hallcrafters, Inc.* is backing the CB React teams and if you're interested in CB, circle #53.

54. A catalog for CB'ers, hams and experimenters, with outstanding values. Terrific buys on *Grove Electronics'* antennas, mikes and accessories.

55. Interested in CB or business-band radio? Then you will be interested in the catalogs and literature *Mosley Electronics* has to offer.

90. If two-way radio is your meat, send for *Pearce-Simpson's* new booklet! Its 18 pages cover equipment selection, license application, principles of two-way communications, reception, and installation.

SCHOOLS AND EDUCATIONAL

56. *Bailey Institute of Technology* offers courses in electronics, basic electricity and drafting as well as refrigeration. More information in their informative pamphlet.

57. *National Radio Institute*, a pioneer in home-study technical training, has a new book describing your opportunities in all branches of electronics. Unique training methods make learning as close to being fun as any school can make it.

36. Prepare for a wide choice of careers with industrial organizations. Send for *Coyne Electronics Institute's* booklet on resident training.

59. For a complete rundown on curriculum, lesson outlines, and full details from a leading electronic school, ask for this brochure from the *Indiana Home Study Institute*.

60. Facts on accredited curriculum in E. E. Technology is available from *Central Technical Institute* plus a 64-page catalog on modern practical electronics.

61. *ICS (International Correspondence Schools)* offers 236 courses including many in the fields of radio, TV, and electronics. Send for free booklet "It's Your Future."

ELECTRONIC PRODUCTS

62. Information on a new lab transistor kit is yours for the asking from *Arkay International*. Educational kit makes 20 projects.

66. Try instant lettering to mark control panels and component parts. *Data's* booklets and sample show this easy dry transfer method.

64. If you can use 117-volts, 60-cycle power where no power is available, the *Terado Corp.* Trav-Electric 50-160 is for you. Specifications are for the asking.

67. "Get the most measurement value per dollar," says *Electronics Measurements Corp.* Send for their catalog and find out how!

92. How about installing a transistorized electronic ignition system in your current car? *AEC Laboratories* will mail their brochure giving you specifications, schematics.

TELEVISION

70. The first entry into the color-TV market in kit form comes from the *Heath Company*. A do-it-yourself money saver that all TV watchers should know about.

73. Attention, TV servicemen! *Barry Electronics* "Green Sheet" lists many TV tube, parts, and equipment buys worth while examining. Good values, sensible prices.

72. Get your 1964 catalog of *Cisin's* TV, radio, and hi-fi service books. Bonus—TV tube substitution guide and trouble-chaser chart is yours for the asking.

29. Install your own TV or FM antenna! *Jefferson-King's* exclusive free booklet reveals secrets of installation, orientation; how to get TV-FM transmission data.

SLIDE RULE

74. Get your copy of *CIE's (Cleveland Institute of Electronics)* 2-color data sheet on their electronics slide rule and information on their free "Auto-Programmed" 4-lesson instruction course.

TOOLS

78. Xcelite's Allen type hex screwdrivers reach where wrenches won't go. Bulletin N763 tells about fixed handle screwdrivers, detachable hex blades, pocket roll kits.

Elementary Electronics, Dept. LL-763
505 Park Avenue, New York, N. Y. 10022

Please arrange to have the literature whose numbers I have encircled sent to me as soon as possible. I am enclosing 25¢ (no stamps) to cover handling charges.

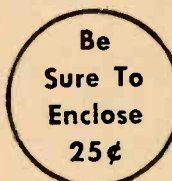

	1	2	3	4	5	6	7	8	10	11	12	13	14
	15	16	17	18	19	21	22	23	24	25	26	27	28
	29	30	31	32	33	34	35	36	37	38	39	40	41
	42	44	45	46	47	48	49	50	51	52	53	54	55
	56	57	58	59	60	61	62	63	64	65	66	67	68
	69	70	71	72	73	74	75	76	77	78	90	91	92

I am a subscriber

Indicate total number of booklets requested

NAME (Print clearly) _____

ADDRESS _____

CITY _____ STATE _____ ZIP CODE _____

"Pulling Power Is Amazing"

Classified MARKET PLACE



Classified Ads only 55¢ per word, each insertion, minimum 10 words, payable in advance. To be included in our next ELEMENTARY ELECTRONICS, copy should be in our New York Office by Nov. 10th. Address orders to C. D. Wilson, Manager, Classified Advertising, ELEMENTARY ELECTRONICS, 505 Park Ave., New York, N. Y. 10022.

ADDITIONAL INCOME

FREE Report: "609 Unusual, Successful Businesses," Box 51-SMC, Des Plaines, Illinois.

MAKE your classified ad pay! Get our booklet, "How to Write a Classified Ad That Pulls." This Handbook tells how—with examples; included is a Credit Certificate worth \$2.00 toward the cost of a classified ad in S&M. For a copy send \$1.00 to C. D. Wilson, Science & Mechanics, 505 Park Ave., New York, N. Y. 10022.

ADVERTISING SERVICES

FREE Advertising available in Playboy, True, others. Also: how to get started in mail order. Details free. Palmer Publications, Box 805J, High Springs, Florida.

AGENTS WANTED

WHOLESALE Magazine Subscriptions—Highest Commissions—Bonus, Magagencies. Box 151-KCW, Fresh Meadows, New York 11365.

CHRISTMAS Cards—Business and Personal. Customer's name imprinted. Earn unusually high commissions from this medium- and high-priced line. Free Sample Album, Process Corp. (our 44th year), 3452B S. 54th Ave., Chicago, Ill. 60650.

I'LL Send You full-size famous Blair home products for Free Trial, to help you make more money, spare time or full time. Show friends, neighbors, take easy big orders, make generous profits. Write Blair, Dept. 521BX, Lynchburg, Va.

THE Camping Club for the elite camper seeks area representatives. Free earnings and fun details. The Auto-Cabana Club, 422 Washington Building, Washington, D.C. 20005.

AUTHOR'S SERVICE

WANTED Writers! Short stories, articles, books, plays, poetry. Will help place, sell your work. Write today, free particulars! Literary Agent Mead, Dept. 22A, 915 Broadway, New York 10, N. Y.

PUBLISH your book! Join our successful authors publicity advertising promotion, beautiful books. All subjects invited. Send for free manuscript report and detailed booklet. Carlton Press, Dept., SMH, 84 Fifth Avenue, New York 10011.

AUTO PARTS & ACCESSORIES

NEW Auto Burglar Alarm, Fool Proof. Less than \$10.00. Free Details, LeRay, Dept. SM, Box 27, West Liberty, Kentucky 41472.

NEW—Spark Plug Gap Gauge—Gap Adjuster—\$1.00. For cars, trucks, motorcycles, lawnmowers, motorboats. Wrona Better Gauge, Box 5968, Chicago, Ill. 60680.

CAR Owners! Boost your car's performance; keep it in peak condition. Send for the new "Car Repair," Dept. 746, 505 Park Ave., New York, N. Y. 10022.

BATTERIES—GENERATORS

COMPLETE Rebuilding Manuals! Batteries \$3.00. Hydraulic Jacks \$3.00. Refundable. Bayer Publications, 938 Betty Ave., Neenah, Wis. 54956.

BIG MAIL

YOUR Name Listed with 1000 Malls, Publishers, Importers, etc. Our mailing each month \$1.00. Dixie Malls, King, North Carolina.

BOATS, MOTORS & MARINE SUPPLIES

BOAT Kits! Factory molded fiberglass or preassembled plywood. 50 models 12' to 30'. Free catalog. Luger Dept. AD-115, 9200 Access Road, Minneapolis 31, Minnesota.

FULL size, cut-to-shape boat patterns, blueprints. Send 50¢ for big New illustrated "Build a Boat" catalog includes Fishing Boats, Garves, Cruisers, Catamarans, Houseboats—Outboards, Inboards, Sailboats—7½' to 38'. "How to Build a Boat" booklet \$2.50. Cleveland Boat Blueprint Co., Box 18250, Cleveland, Ohio.

BOATCRAFT is the best! Don't be without this magazine. Order now, \$5.00 for one year. Boatcraft, 505 Park Ave., New York, New York 10022.

BOOKS & PERIODICALS

\$1.00 ONLY! Webster's New Illustrated Dictionary. 370 Pages, 5½x8. Free Catalog. Paul's Company, Box 2691, London, Ontario, Canada.

BOOKLOVERS. Seekers—Enjoy free—Ivory Tower Journal, 444-SM, Fort Lee, New Jersey 07024.

INTERESTING Magazine for Hobbyist-Collectors 25¢. Hobby Trade, Box 134, Clifton, N. J. 07015.

CATALOG of all Science & Mechanics Craftprints. Send 25¢ to cover postage and handling to Craftprint Div., Science & Mechanics, 505 Park Ave., New York, New York 10022.

BUSINESS OPPORTUNITIES

I MADE \$40,000.00 a Year by Mailorder. Helped Others to make money! Start with \$10.00—Free Proof. Torrey, Box 3566-T, Oklahoma City, Okla. 73106.

FREE Book "990 Successful Little-Known Businesses." Fascinating! Work home! Plymouth-811-M, Brooklyn, New York 11218.

MAIL Baby Catalogs. Imprinted with your address to New Mothers for Big Profits! Details, Catalog, 25¢. Volz-SM11, Ypsilanti, Mich.

AMAZING New Way to own your own business. Send for free copy of Booklet IO-1. Modern Franchising Magazine, 1085 Walnut Ave., Des Plaines, Ill.

IMMEDIATE Profits with no capital or experience. Take Orders for all magazine subscriptions. Friends and neighbors are your prospects. Write now for complete, free kit. McGregor Magazine Agency, Dept. IB5, Mount Morris, Illinois.

WANT To Make Big Money At Home? \$10.00 profit in an hour possible with Invisible Mending. Make tears, holes disappear from clothing, fabrics. Steady year-round demand from cleaners, laundries, homes. Details Free. Fabricon, 1513 Howard, Chicago 26, Ill.

VENDING Machines—no selling. Operate a route of coin machines and earn amazing profits. 32-page catalogue free. Parkway Machine Corporation, 715N0 Ensor Street, Baltimore, Maryland 21202.

EARN Big Money, invisibly reweaving damaged garments at home. Free information. Eastern Reweaving School, HR-8 Main, Hempstead, New York.

"D.O." has interesting local franchises. Write, Box 817D, Walla Walla, Washington 99362.

HOW To Get Finance Capital. Loans, Grants. Cash To Start A Business. Free Details. Counselor-2206, Harlingen 25, Texas.

BOOKKEEPERS Operate Bookkeeping Tax Service. Universal, Box 664-N, Springfield, Mo.

MONEY Makers! Spare-time profit plans! Dozens! Details. Best Books, 1175-B, York, Suite 18-E, New York 10021.

START Your Own Business On Credit. Your own boss. Hundreds of Dealers making \$100.00 to \$300.00 and more weekly. We supply stocks, equipment on credit. 300 home necessities. Sales experience unnecessary. Pleasant, profitable business backed by worldwide industry. Write Rawleigh, Dept. K-U-ICO, Freeport, Illinois.

TRAVELPAK Cartopper Camper, Fits most cars "Installation-Service" Distributorships Available. Write Cartopper, Box 123CJ, Napoleon, Ohio.

BUY IT WHOLESALE

FORDS and Dodges 1964 \$699.00, 1965 \$999.00 your use or profit, excellent buys ex-tax. Send for Free catalog to Cars, 194B Lauman Lane, Hicksville, N. Y. 11801.

BARGAINS! Buy Wholesale! Save Money! Free Catalog! Norris, Dept. 106, 273 Merrick, Lynbrook, N. Y.

CAMERAS & PHOTO SUPPLIES

CAMERAS, Lenses. Lowest prices. Free literature sent. Sumitomo Trading Company, P.O. Box 24, Higashinari, Osaka, Japan.

At last Build your own supersensitive light meter from complete kit with easy to follow instructions. Send \$24.95 to Kit Div., Science & Mechanics, 505 Park Ave., New York, N. Y. 10022. Money completely refunded if Kit returned within ten days for any reason.

CAMPERS, CAMPING EQUIPMENT & TENTS

CAMPING Equipment, unusual selection. Morsan's own quality Tents (200 styles) finer fabrics; Sleeping Bags (80 styles); every camping convenience imaginable. Free giant Catalog-Guide Handbook. Morsan, 810-B Route 17, Paramus, N. J.

ALL-METAL, all-new design Tent Stakes. Locke Mfg., 1200 Sabine, Huntington, Indiana.

INEXPENSIVE Nylon Tents. Instructions \$1.00. Stuart, Harriet Street, Centereach, N. Y.

PICKUP Camper, Trailer Or Pickup-Cover—Build Yourself, Save! Complete plans \$3.95 each. Bus Conversion (and Houseboat Interiors) Drawings \$2.95. Equipment Catalog \$1.00 (refundable). Satisfaction guaranteed. Details 10¢. Viking Camper Supply, 94-JC Glenwood, Minneapolis, Minn. 55403.

OUTDOORSMEN: Now enjoy dependable Tilley portable Light/Heat used by world-famous explorers, sportsmen for over 100 years. Operating cost only 5¢ for 12 hours. Precision-made; reasonably priced! Write Thacker Co. USA Distributor, Dept. D, Clermont, Florida. (Dealer Franchises open).

COINS, CURRENCY & TOKENS

CLEARANCE! Cents To Dollar! Tremendous Reductions. List 15¢. Fairway, 121-M, Rye, N. Y.

EARTHWORKS

BIG Money Raising Fishworms and Crickets. Free Literature. Carter Farm-O. Plains, Ga.

EDUCATION & INSTRUCTION

YOUR F.C.C. first class license (electronics, broadcasting)—prepare by correspondence or resident classes. Then continue, if you wish, for A.S.E.E. Degree. Free catalog. Grantham Engineering Institute, 1505 N. Western Ave., Hollywood, Calif. 90027.

SCIENTIFIC Simplified training by famous teacher develops dynamic voice. Zooms earning power! Terrific! Inexpensive. Free particulars. Voice, Box 667, Plainfield, N. J.

LEARN Auctioneering. Free Catalog! Missouri Auction School, 1330-144 Linwood, Kansas City, Mo. 64109.

Catalog of all Science & Mechanics Craftprints. Choose from over 90 different Craftprints. Send 25¢ to cover postage and handling to Craftprint Div., Science & Mechanics, 505 Park Ave., New York 10022.

FARMS, ACREAGE & REAL ESTATE

GOVERNMENT Lands... Low as \$1.00 Acre. Million Acres! For Exclusive Copyright Report... plus "Land Opportunity Digest" listing lands available throughout U. S., send \$1.00. Satisfaction Guaranteed! Land Disposal, 2230-3J Wisconsin Avenue, Washington, D. C. 20007.

FLORIDA LAND

FLORIDA Water Wonderland—Home, cottage, Mobilites. Established area. \$59.00 full price, \$9.00 a month. Swimming, fishing, boating. Write: Lake Weir, Box MP38, Silver Springs, Florida AD 6-1070 (P-1).

FOR INVENTORS

PATENT Searches—48 hour airmail service, \$6.00. Including nearest patent copies. More than 200 registered patent attorneys have used my service. Free invention protection Forms. Write Miss Ann Hastings, Patent Searcher, P. O. Box 176, Washington 4, D. C.

IMMEDIATE cash, for Patent Applications, free Patent Searches. Write for details. Universal Patents, 184-C, Marion, Ohio.

GIFTS THAT PLEASE

1,000 **NAME** and address Labels \$1.00. LaParl, 1513 Springwells, Detroit, Mich. 48209.

"**GOOD Luck**" Plaques of fabulous Roadrunner Bird \$4.88 Postpaid. Free Details Gudmund Martinson, Department SM-A, 3226 East 26th Street, Tucson, Arizona 85713.

GIVE the best reading in the Mechanical Field—give Science & Mechanics! The pros tell all about Automobiles, Science, Electronics. Another plus: the large new "TKIT" Section, \$4.00 for year's subscription. Science & Mechanics, 505 Park Ave., New York, N. Y. 10022.

GOVERNMENT SURPLUS

JEEPS—Typewriters—Walkie-Talkies—Guns—Boats—Binoculars. Uncle Sam's Bargain Prices. Write For Latest Exciting Details. Enterprises, Box 402-K2, Jamaica, New York 11430.

HOBBIES & COLLECTIONS

AUTOMOBILE miniatures! Exact scale, antique, modern. Fully assembled! Catalogue—Sinclair's, Drawer "P" (8), Pittsford, N. Y. 14534.

HYPNOTISM

NEW concept teaches you self-hypnosis quickly! Free literature. Smith-McKinley, Box 3038, San Bernardino, Calif.

INVENTIONS WANTED

WE here sell your invention or pay cash bonus. Write for details. Universal Inventions, 298-E, Marion, Ohio.

MAIL ORDER OPPORTUNITIES

INTERESTING Offers regularly. Useful sample \$1.00. New Products, Box 422, Danville, Ill. 61833.

MAKE Mail Order pay. Get "How To Write a Classified Ad That Pulls." This handbook tells how, with examples. Includes certificate worth \$2.00 toward classified ad in S & M. Send \$1.00 to C. D. Wilson, Science & Mechanics, 505 Park Ave., New York, N. Y. 10022.

MAILING LISTS

MAILING Lists most all kinds 1000 \$5.00. Free folder. Your circulars mailed \$4.00 1000. Dixie Mailers, King, No. Car.

MISCELLANEOUS

BLITZ Reducing! 5 pounds overnight! Guaranteed! Bijou, Box 1727-BS, Hollywood, California 90028.

OLD Time Choctaw Beer, Huckleberry, Cherry Wines, Formula \$1.00. Satisfaction Guaranteed. Joe's Formulas, P. O. Box 1115-S, Modesto, Calif. 95353.

CIGARETTES—12¢ package postpaid. Information—50¢. (Refundable) Box 19, Waverly, Mass. 02178.

MONEYMAKING OPPORTUNITIES

FOR Money Making Opportunities. Business Building Offers. Write Tojocar, 2907-A West 39th Place, Chicago, Ill. 60632.

WIN Contests! Free sample copy. Prize-winner. Box 11569, St. Petersburg, Fla.

OPERATE Home Import Business. Amac-Robins, Box 1312, Fremont, Calif. 94538.

HOT Money Making Line! Show line of business printing, advertising specialties, calendars. Watch orders pour in. All repeat items. Terrific commissions in full or spare time. No experience—No investment. Cash discounts to customers. Free bonus gifts to you. Free sales kits. Willens-David Lionel Press, Dept. W-14, Waukegan, Ill.

MAKE \$5,000 yearly, sparetime, raising milk, chinchilla, nutria, etc. Free Booklet! Proven plan. Write Furs, Dept. J, Bewdley, Ontario, Canada.

MOTION PICTURE PROJECTORS, FILMS, SLIDES & SUPPLIES

MISS America Slides! 20 Color Slides of the Pageant \$5.00. Request Brochure. Box 443, Atlantic City, N. J.

MUSIC & MUSICAL INSTRUMENTS

PIANO Parts Company, 21W030 Shelly Drive, Itasca, Ill. 60143. Free Information—Kits.

OFFICE EQUIPMENT & SUPPLIES

OFFSET, Letterpress, Vartypers, Typewriters, Mimeograph, Multigraph Machines, Bargains. DixieGraph, King, N. C.

PATENT SERVICE

PATENT Searches, \$6.00; For free "Invention Record" and "Important Information Inventors Need," write Miss Hayward, 1029D Vermont, Washington 5, D. C.

PATENT Searches—48 hour airmail service. \$6.00, including nearest patent copies. More than 200 registered patent attorneys have used my service. Free invention protection Forms. Write Miss Ann Hastings, Patent Searcher, P. O. Box 176, Washington 4, D. C.

PERSONAL

"**ANYTHING** In My Name." Jesus promised. Meaning? Read "For His Name's Sake" by Dean Rosco Brong, Lexington Baptist College. \$2.50, book-stores or postpaid U. S. Amen Books, 657 St. Anthony, Lexington, Ky. 40505.

SURPRISE Package Extraordinary—Childen—Grownups. Which? You'll be delighted! 25¢. Greyhouse, 7000 Monmouth, Ventnor, N. J. 08406.

PETS—DOGS, BIRDS, RABBITS, HAMSTERS, ETC.

MAKE big money raising rabbits for us. Information 25¢. Keeney Brothers, New Freedom, Penna.

DESCENTED skunks, pigmy skunks \$11.95. Baby raccoons, monkeys, Bobcats, birds, turtles, snakes, lizards, others. Catalog 10¢. Thompson Zoo, Clewiston, Florida.

PRINTING OUTFITS & SUPPLIES

RUBBER Stamp Outfits, Supplies. Kiewiet, 2025 Barney Road, Kalamazoo, Michigan.

PROFITABLE OCCUPATIONS

INVESTIGATE Accidents. Earn \$750.00 to \$1,500.00 monthly. Car furnished. Expenses paid. No selling. No college education necessary. Pick own job location in U. S., Canada or overseas. Investigate full time. Or earn \$8.44 hour spare time. Men urgently needed now. Write for Free information. Absolutely no obligation. Universal, CMH, 6801 Hillcrest, Dallas 5, Texas.

RADIO & TELEVISION

CONVERT any television to supersensitive, big-screen oscilloscope. No electronic experience necessary. Only minor changes required. Illustrated plans \$2.00. Reico-A30, Box 10563, Houston 18, Texas.

BEGINNERS Kits. Diode Radio \$1.50. Audio Amplifier \$1.50. Solar Powered Radio \$3.95. Wireless Transmitter \$4.95. Lectronix, Box 1067, Southgate, Mich. 48195.

McGEE Radio Company. Big 1966 Catalog Sent Free. America's Best Values, Hi-Fi, Amplifiers, Speakers, Electronic Parts. Send Name, Address and Zip Code Number to McGee Radio Company, 1901 McGee Street, Dept. EE, Kansas City, Mo. 64108.

CRAMMED with Electronics Articles of interest to novices and pros alike. Subscribe now: 6 issues for \$4.00. Order from Radio-TV Experimenter, 505 Park Ave., New York, N. Y. 10022.

SALESMEN & DISTRIBUTORS

EARN Big Commissions Full or Part Time. Show America's largest line low priced business printing and advertising specialties. Calendars in season. Big Free Sales kit samples hundred items used daily by business people. Build profitable repeat business. Start right now. National Press, Dept. 12, North Chicago, Ill.

PROFITABLE ways for Salesmen & Distributors to use Money-Making Ideas. Exclusive stories on businesses and selling secrets that made money for others. Get Income Opportunities. Send \$1.00 for the current copy or \$4.50 for a Bi-monthly Subscription. Write Income Opportunities, 505 Park Ave., New York, N. Y. 10022.

SPECIAL SERVICES

FACTS—Any Subject—Product.. Send \$1.00 Today for "Copyright Plan." Reports, Surveys, Research. SM, Box 1431, Greenville, S. C. 29602.

STAMP COLLECTING

50 **PICTORIALS** 10¢ With Approvals. Anaden, 6041 Columbus, Minneapolis 17, Minnesota.

FREE! 25 Egypt, 10¢ handling. Approvals. Bellet, SMG-Hazel Park, Mich. 48030.

TREASURE FINDERS—PROSPECTING EQUIPMENT

GOLD and Silver Locators. Electronic and Magnetic Kind. Write, Box 51, Plant City, Florida.

DIAMONDS, Gold, Silver Find Them. Pamphlet Free. George Simpson, 18788 Cajon Blvd., San Bernardino, Calif.

TRANSISTOR Treasure Detectors locate buried gold, silver, coins. Kits, assembled models, \$19.95 up. Free catalog. Reico-A30, Box 10563, Houston 18, Texas.

Anyone Can Build These High Quality Precision S&M Kits At a Substantial Savings



Precision Decade Resistance Box

Designed so the electronic experimenter can get any value of resistance at 1% accuracy. Made of precision components, this decade box offers such advantages as fast fingertip switching from any resistance value from 1 ohm to 1,111,110 ohms within seconds. Add or subtract as little as 1 ohm with 1% accuracy. And ordinary hand tools are all that's needed to assemble it in less than 2 hours.



All Purpose Shop Tachometer

This tachometer is guaranteed to outperform any \$50 tach available today or your money will be refunded. This tach belongs in the tool chest of every machinist, electrician, model maker, motor serviceman and inventor. A six position rotary switch enables you to select three speed ranges in either forward or reverse rotation. Three ranges—0—500, 5000 and 15,000—cover the gamut of rpms in the home workshop or laboratory on machine tools, such as lathe cutting speeds, motor rpm, drilling speeds and other motor driven tools where rpm is an important factor.

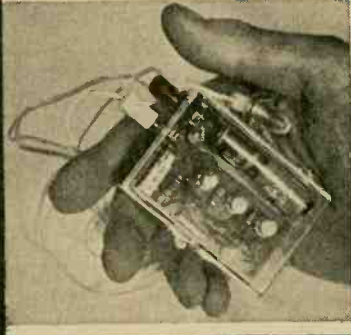

Pocket-Size Hearing Aid

New hearing aid design provides a minimum of 42 decibels of gain and is adequate for 75% of all cases of partial deafness. The aid weighs only three ounces and is smaller than a king-size cigarette pack. Uses latest electromagnetic earphone and miniature crystal microphone. Powered by a 10¢ pen light flashlight battery and has a switch for turning power off when not in use and a control that lets you adjust the volume to a comfortable sound level.

SCIENCE & MECHANICS, KIT DIVISION
505 Park Avenue, New York, N. Y. 10022

EE-965 106

Please send the S&M kits that have complete assembly plans, or the assembled and fully tested electronic aids checked below. I understand that if I am not completely satisfied I may return the kits within 10 days for a complete refund of the purchase price.

- | | | |
|-------------------|--------------------------------------|--|
| Hearing Aid | <input type="checkbox"/> \$24.95 Kit | <input type="checkbox"/> \$34.95 Assembled |
| Tachometer | <input type="checkbox"/> \$16.95 Kit | <input type="checkbox"/> \$21.95 Assembled |
| Decade Box | <input type="checkbox"/> \$24.95 Kit | <input type="checkbox"/> \$29.95 Assembled |

Add 10% for Canadian and Foreign orders. New York City residents add 5% for N.Y.C. sales tax.

NAME _____ (Please Print)

ADDRESS _____

CITY _____ STATE _____ ZIP CODE _____

- Check or money order enclosed, ship post paid. Enclosed \$3.00 deposit, ship balance C.O.D., plus postage and C.O.D. charges.

BUILD, EXPERIMENT, EXPLORE, DISCOVER WITH NRI CUSTOM-DESIGNED TRAINING KITS



BUILD YOUR OWN PHONE/CODE TRANSMITTER

This is just one of seven training kits programmed into NRI's Complete Communications course. You get actual practice in building your own crystal-controlled, phone/code transmitter and putting it on the air. You experiment with modulation, "clamping" circuits, key filters, other aspects of commercial transmitter operation. Can be put on the air simply by attaching an antenna and complies with FCC regulations. As with all NRI training kits, you get the most modern features and parts.

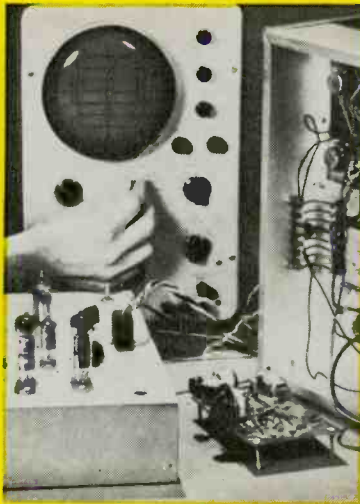

BUILD ACTUAL ANALOG COMPUTER CIRCUITS

Industry, business offices, the government and military all need trained Electronics Technicians. NRI's Industrial Electronics course prepares you. You progress through 10 carefully designed training kits, topping off your practical experience phase of training by experimenting with feedback control systems, analog computers and digital computer elements. You actually solve problems on this analog computer you build yourself. This is the *practical, fast* way to a good paying, career position.

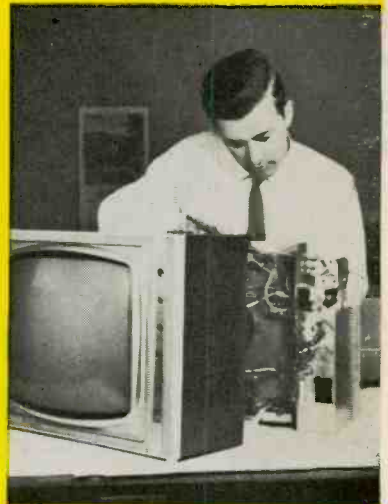

BUILD A CUSTOM-ENGINEERED TELEVISION RECEIVER

Want to earn \$3 to \$5 an hour in spare time? Want your own part-time or full-time business? In Radio-TV Servicing you learn to install, maintain, service radios, TV sets, hi-fi and stereo, other home Electronics equipment. In your training are eight training kits, including this complete, modern, slim-line TV receiver. You build it yourself, become familiar with components and circuits, learn servicing procedures . . . and earn extra money as you train. National Radio Institute, Washington, D.C.

Join the Thousands Who Gained Success with NRI



"I am Frequency Coordinator for the 11th Naval District. The course was priceless." J. J. JENKINS, San Diego, Calif.



"Many thanks to NRI. I hold FCC License, am master control engineer with KXIB-TV." R. L. WOOD, Fargo, N.D.



"I am a Senior Engineering Aide. Without NRI I would still be working in a factory at a lower standard of living." D. F. CONRAD, Reseda, Calif.



SEE OTHER SIDE ▶

FIRST CLASS
PERMIT
NO. 20-R
Washington, D.C.

BUSINESS REPLY MAIL

NO POSTAGE STAMP NECESSARY IF MAILED IN THE UNITED STATES

POSTAGE WILL BE PAID BY

NATIONAL RADIO INSTITUTE
3939 Wisconsin Avenue
Washington, D.C. 20016

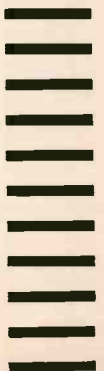

YOU GET MORE FOR YOUR MONEY FROM NRI

Below is an example of material included in just one NRI course. Other NRI home study plans are equally complete.



AMERICA'S OLDEST AND LARGEST RADIO-TV, ELECTRONICS HOME-STUDY SCHOOL

Compare if you like. You'll find—as have so many thousands of others—that NRI training can't be beat. From the delivery of your first lessons in the remarkable, new Achievement Kit sent the day we receive your enrollment, to "bite-size," easily read texts and carefully designed training equipment . . . NRI gives you more value. The picture above dramatically illustrates the material included in just one NRI course. Everything you see is included in low-cost NRI training. But NRI is more than kits and texts. It's also friendly, per-

sonal services which have made NRI a 50 year leader in the home study field.

Whatever your interest or need . . . whatever your education . . . there is an NRI instruction plan in Radio-TV Servicing, Electronics or Communications to fit your needs; tuition rates to fit your budget. Prove to yourself—your best home-study buy is NRI. Mail postage-free card today. No salesman will call. NATIONAL RADIO INSTITUTE, Electronics Division, Washington, D.C. 20016.

◀ SEE OTHER SIDE

National Radio Institute, Electronics Division
Washington, D.C. 20016 6-105

Please send me your catalog. I have checked the field(s) of most interest to me. (No salesman will call) PLEASE PRINT.

- | | |
|--|---|
| <input type="checkbox"/> Television-Radio Servicing | <input type="checkbox"/> Math for Electronics |
| <input type="checkbox"/> Complete Communications | <input type="checkbox"/> Electronics for Automation |
| <input type="checkbox"/> Industrial-Military Electronics | <input type="checkbox"/> Aviation Communications |
| <input type="checkbox"/> FCC License | <input type="checkbox"/> Marine Communications |
| <input type="checkbox"/> Basic Electronics | <input type="checkbox"/> Mobile Communications |

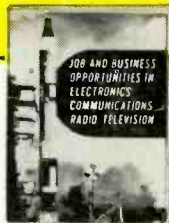

**NOW 10
WAYS to
train at home
MAIL CARD
NO POSTAGE
REQUIRED**



OVER 50 YEARS
OF LEADERSHIP IN
ELECTRONICS TRAINING

Name _____ Age _____

Address _____ Zip Code _____

City _____ State _____

ACCREDITED MEMBER NATIONAL HOME STUDY COUNCIL

