

ELEKTOR **ELECTRONICS** **USA**

THE INTERNATIONAL JOURNAL
FOR RECREATIONAL ELECTRONICS
NOVEMBER 1991

\$3.00 US
CANADA \$4.00

Class A amplifier

**Dissipation
limiter**

**Relay card for
universal bus**

**Product
Modelling**

**24-bit full-color
video digitizer**

Quadriform ferrite antenna

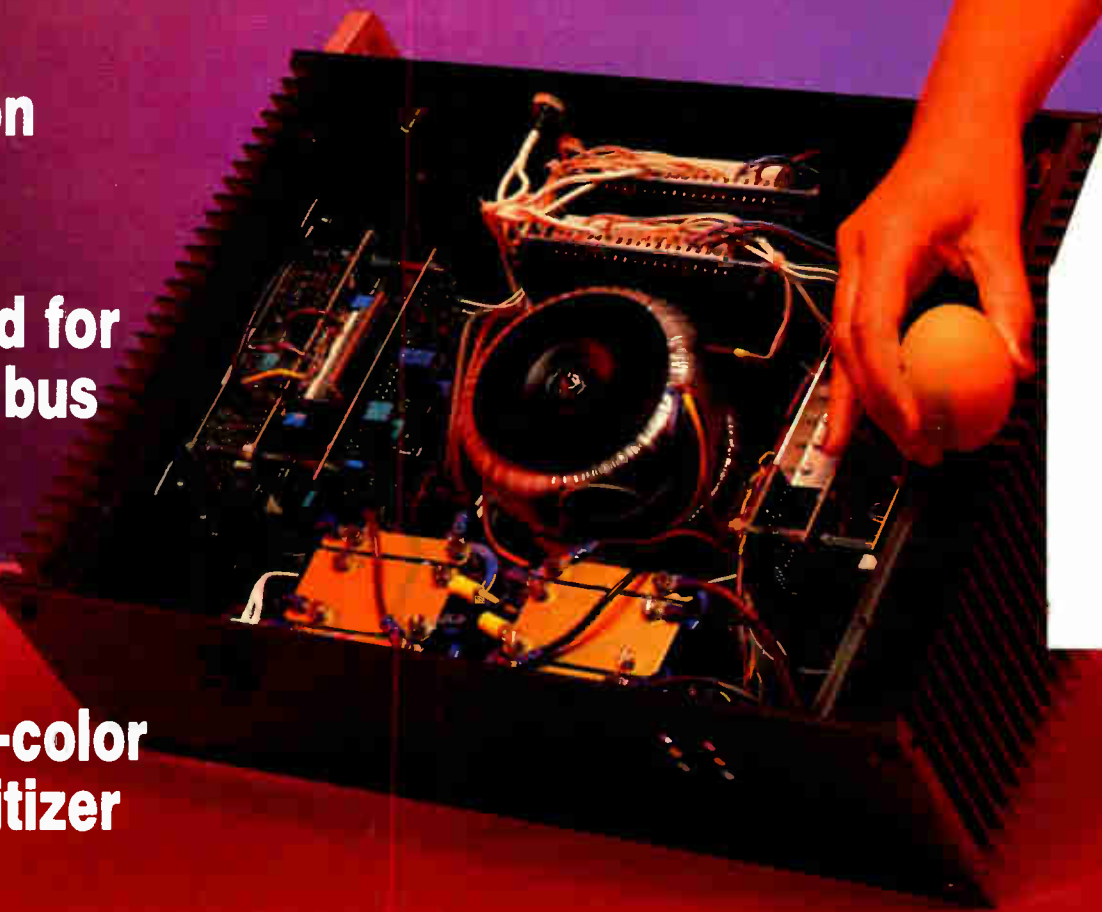

11am Kojasa
Box 267A Sunset Dr
P MD 21619

ELEKTOR ELECTRONICS USA

Subscriber Services



Complete the applicable section(s) below and mail to:
Elektor Electronics USA
 PO Box 876
 Peterborough, NH
 03458-0876

WOULD YOU LIKE TO . . . SUBSCRIBE?

YES! Just check the appropriate boxes in the "renew" section and fill in name and address.

RENEW?

Fill in the appropriate sections below. For faster service use your mailing label and subscriber number.

- 1 year at \$28 Check/MO enclosed
 2 years at \$50 Charge MC/VISA

Canada add \$8 per year postage
 Remit in US \$ only.

SUBSCRIBER NUMBER

NAME _____

STREET & NO _____

CITY _____ ST _____ ZIP _____

MC/VISA _____ EXP. _____

CHANGE YOUR ADDRESS?

Fill in your new address to the right and old address and subscriber number above.



MY NEW ADDRESS:

NAME _____

STREET & NO _____

CITY _____ ST _____ ZIP _____

GIVE A GIFT?

What a thoughtful idea! Fill out your name and address above, the recipient's name and address to the right. We'll even send a gift card announcing your gift.



NAME _____

STREET & NO _____

CITY _____ ST _____ ZIP _____

TELL YOUR FRIENDS ABOUT US?

Print their names and addresses below or photocopy this form for them. We'll take care of the rest.

NAME _____ NAME _____

STREET & NO _____ STREET & NO _____

CITY _____ ST _____ ZIP _____ CITY _____ ST _____ ZIP _____

COMPLAIN ABOUT YOUR SUBSCRIPTION?

Yes, it sometimes happens. We try to avoid it at all costs, but if you have a problem, we want to know. Call or write with all pertinent information.



YOU CAN CALL US

(603) 924-9464

Subscription Department

9-4 Business Days

Answering Machine

All Other Hours

FAX: (603) 924-9467

24 Hours

Front cover

For many years now, hi-fi equipment has almost exclusively used class AB operation. This method gives acceptable distortion and good efficiency, and the output amplifier remains relatively cool during normal operation. However, many designers and listeners prefer class A operation with its much lower distortion and consequent higher quality of sound reproduction. To meet their demands, we have revamped the LFA 150 power amplifier we published about three years ago. In the new design, a good compromise has been achieved between class A quality and the high heat dissipation that characterizes this type of operation.

In next month's issue

More than 60 construction projects and informative/educative articles including

- Connect 4
- FSK/RTTY decoder for PCs
- Function generator [3]
- Programmable filter ICs
- Class A amplifier [2]
- Temperature measurement techniques
- Economy power supply

Copyright © 1991 Elektor BV

ELEKTOR ELECTRONICS USA (US ISSN 1051-5690) is published monthly except August at \$28 per year; \$50 for two years by Audio Amateur Publications, Inc., 305 Union St., Peterborough NH 03458 USA. Second class postage paid at Peterborough NH and an additional mailing office.

POSTMASTER: Send address changes to **Elektor Electronics USA**, Caller Box 876, Peterborough NH 03458-0876. Return Postage Guaranteed.

EDITORIAL

- 11 Shall We Worms Turn?

AUDIO & HI-FI

- 37 **PROJECT:** Class A Power Amplifier Pt. 1 (of 2) by T. Giffard

COMPUTERS & MICROPROCESSORS

- 45 **PROJECT:** A Simple Watchdog Circuit by Akbar Afsoos
 50 Upgrade for MCS BASIC-52 V1.1 Pt. 2 (of 2) by Dusan Mudric and Zoran Stojavljevic
 54 **PROJECT:** Relay Card for Universal I/O Interface by A. Rigby

GENERAL INTEREST

- 32 Product Modelling by R.G. Evans
 42 Four-Terminal Networks Pt. 2 (of 2) by Steve Knight
 46 **PROJECT:** The Cipher Machine by Owen and Audrey Bishop

INTERMEDIATE PROJECT

- 52 Timer for Central-Heating Systems by J. Ruffell

POWER SUPPLIES & BATTERY CHARGERS

- 19 **PROJECT:** Dissipation Limiter by C. Zschocke

RADIO, TELEVISION & COMMUNICATIONS

- 16 **PROJECT:** 24-Bit Full Color Video Digitizer by J. Kortink
 57 **PROJECT:** Experimental Quadriform Ferrite Transmit/Receive Antenna by Richard Q. Marris

TEST & MEASUREMENT

- 14 Measurement Techniques Pt. 8 by F.P. Zantis
 22 **PROJECT:** Digital Function Generator Pt. 2 (of 3) by T. Giffard

MISCELLANEOUS INFORMATION

Electronics Scene 12, 13; Advertisers' Index 60; Classifieds 60; Readers' Services 61; Terms of Business 62.

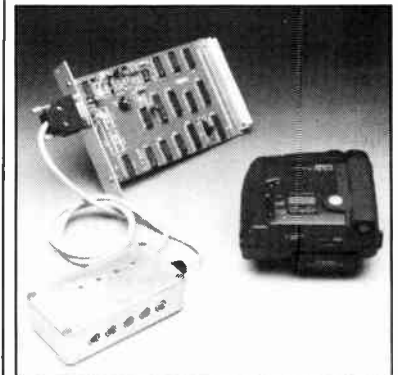

24-bit full-colour video digitizer – p. 16

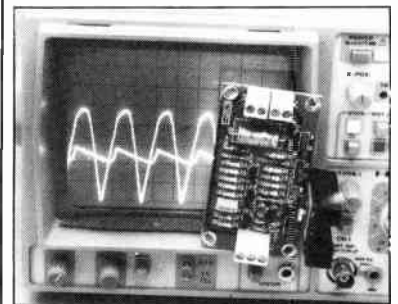

Dissipation limiter – p. 19

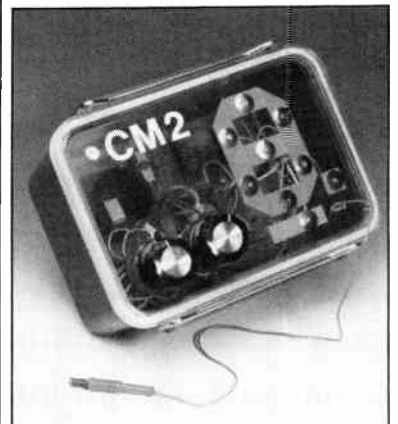

The cipher machine – p. 46

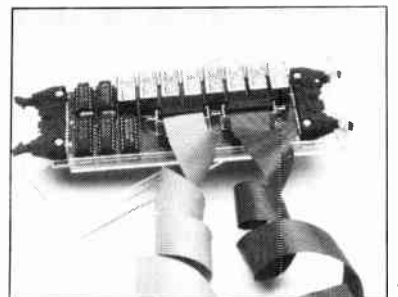

Relay card for universal I/O interface – p. 54

ANNOUNCING

LDC-IV

20,000 SOLD
WORLDWIDE

**LOUDSPEAKER DESIGN COOKBOOK
FOURTH EDITION**

by VANCE DICKASON

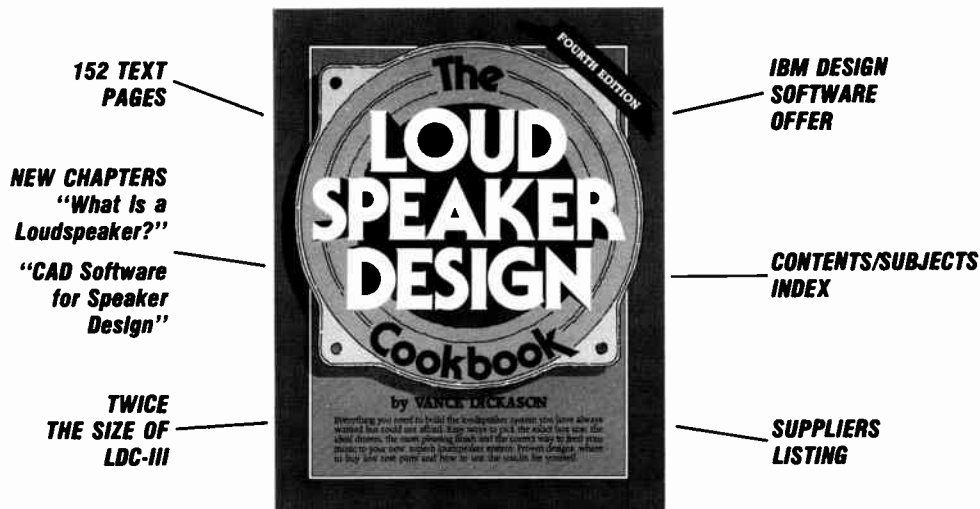

152 TEXT
PAGES

NEW CHAPTERS
"What Is a
Loudspeaker?"

"CAD Software
for Speaker
Design"

TWICE
THE SIZE OF
LDC-III

IBM DESIGN
SOFTWARE
OFFER

CONTENTS/SUBJECTS
INDEX

SUPPLIERS
LISTING

\$29.95

COMING TO AN ADDRESS NEAREST YOU

OCTOBER 15, 1991

AT YOUR DEALER OR

OLD COLONY SOUND LAB
BOX 243, DEPARTMENT E91
PETERBOROUGH, NH 03458



Send Me _____ copy(s) @ \$29.95 \$ _____

SHIPPING: Please add \$2 for first book; 75¢ each additional. Books are not returnable for refund.

Check/MO Charge Card MC/VISA

NAME _____

STREET & NO _____

CITY _____

ST _____

ZIP _____

MC/VISA _____

EXP. _____

PHONE: (603) 924-6371

FAX: (603) 924-9467

Project Pro

Call For FREE Catalog
Call (800) 800-3321 or (216) 425-8888

Project Pro brings a complete line of electronic enclosures, hardware, and tools to both the professional project engineer and the hobbyist. Everything you need to bring ANY project from development to finished product.

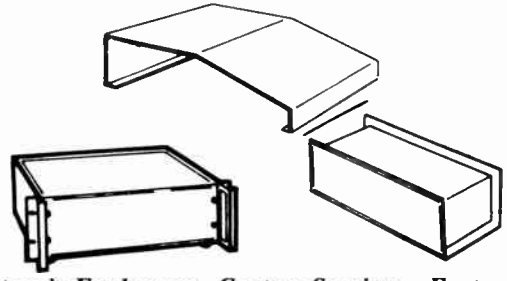

- | | | |
|------------------------------|------------------------|------------------|
| Electronic Enclosures | Custom Services | Fasteners |
| * Aluminum | * Fabricating | * Nickel Plated |
| * Steel | * Screening | * Black Zinc |
| * Plastic (ABS) | * 72 hour-turnaround | |
| Racks | Chassis | Tools |

1710 Enterprise Pky. Twinsburg, Ohio 44087

CRESTWOOD PRODUCTS INC.

40994 GIBBEL RD. HEMET CA. 92544
 ORIGINATOR, MANUFACTURER & DISTRIBUTOR
VU-THRU VCR DIAGNOSTIC TOOL
 1-800-544-8583

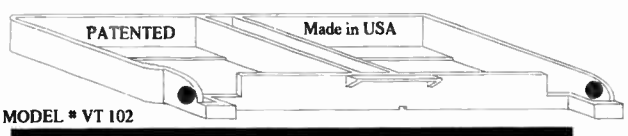

MODEL * VT 102

A CLEAR PLASTIC SHELL THE SAME SIZE & SHAPE AS A STANDARD VHS VIDEO CASSETTE

BY FAR MOST VCR MALFUNCTIONS ARE MECHANICAL. With the VU-THRU TOOL & 9 page ILLUSTRATED MANUAL you can get many VCR's back in working order without special tools or equipment



\$ 9.95 each
\$ 3.50 S&H
\$ 13.45 total

SPECIAL ORDER TWO FOR \$ 19.90 WE PAY S&H

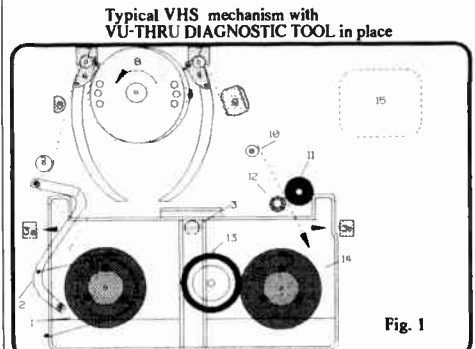

Fig. 1

With power on & the VU-THRU TOOL in place the following will happen in a normally working VCR when "PLAY" is pressed. The tape tension arm (2) will move to the left causing the tension band to apply to the supply spindle (1). Loading posts (4) will move forward carrying the tape to the video head (8) & stopping at loading post supports (7). The video head will be rotating CCW at 1800 RPM. The pinch roller (11) will move toward the capstan (12) & press tape between (11) & (12). The capstan will be turning CW pulling tape across video head. The idler wheel will be driving take-up spindle in a CW direction. THE ADVANTAGE OF THE VU-THRU VCR DIAGNOSTIC TOOL IS NOW OBVIOUS. Now you can SEE all of the above action without a video cassette blocking your view.

WANTED!! DEALERS OUTSIDE OF THE USA - WRITE FOR FULL DETAILS

Courteous Service • Discount Prices • Fast Shipping

ALL ELECTRONICS CORP.

P.O. Box 567 • Van Nuys, CA 91408

HIGHEST QUALITY METAL CASSETTES (ERASED)

Premium quality metal tape in C-60 and C-90 cassettes (30 or 45 min. per side). One of the finest "brand-name" tapes on the market, in durable, clear plastic transport mechanisms. Recorded and bulk erased, the record-protect tabs have been removed and therefore, need to be taped over to re-record. Audiophiles will appreciate the wide dynamic range of this tape. If your cassette deck has a "metal" setting you will hear the difference. A real bargain!

60 min. tape - CAT# C-60M \$1.25 each • 10 for \$10.00
 90 min. tape - CAT# C-90M \$1.65 each • 10 for \$15.00

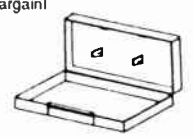

CASSETTE STORAGE CASE

Black, unbreakable plastic audio cassette storage case.
 CAT# CBOX 5 for \$1.00 • 100 for \$15.00

TOUCH DIMMER

The "brain" part of the "LITE TOUCH" touch dimmer, when connected to any lamp, will turn it on and off and change the brightness level when any metal part is touched. We don't have the wiring harness that originally connected this to the lamp, but we can provide a simple hook-up diagram and instruction sheet. The solid-state circuitry is contained in a thermo-plastic box 1.91" X 3.11" X 0.835".
 CAT# DMR-1 \$3.50 each



SWITCHES

SPDT Mini-Toggle (Flat Handle)
 (ON-ON)
 C&K # 7101 or equivalent. Standard size SPDT mini-toggle switch with flat lever handle. 1/4-40 threaded bushing. Solder loop terminals. Rated 5 amps @ 125 Vac.
 CAT# MTS-14 \$1.35 each

SPST N.O. Pushbutton
 SPST normally open p.c. mount pushbutton. 0.47" square mounting pad. Plunger extends 0.47" above surface. No pushbutton cap available. Ideal, inexpensive switch where look is not important. 4 p.c. pins on 0.2" X 0.5" mounting centers
 CAT# PB-35 5 for \$1.00

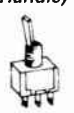

OPTO SENSOR

TRW/Optron # OPB5447-2 IR emitter/sensor pair in Rectangular package with 28" color coded leads.
 CAT# OSR-4 2 for \$1.00



Special Reduced Price PHOTOFLASH CAPACITOR

Rubicon CE 210 Mfd 330 Volt photoflash capacitor. 0.79" dia. X 1.1" high. These are new capacitors that have been prepped with 1.4" black and red wire leads soldered to the terminals. CAT# PPC-210 \$1.25 each
 10 for \$11.00 • 100 for \$100.00



AUDIO SLIDE POT

Dual 1K audio 3 1/2" long, 2 1/2" slide.
 CAT# ASP-1KD
 Reduced to 50c each • 100 for \$40.00



WALL TRANSFORMER

12 Vdc 500 ma.
 2.1mm D.C. power plug with center negative. White case
 CAT# DCTX-125W \$4.50 each

12 Vdc, 200 ma.
 2.1 mm D.C. power plug with center negative.
 CAT# DCTX-122 \$3.00 each



20 AMP RF/EMI FILTER

Corcom# 20B6 20 amp RF/EMI general purpose common-mode filter. Controls line-to-ground noise. Small size, low leakage. 3.46" X 1.16" X 2.81". UL and CSA listed.
 CAT# RFI-201 \$8.50 each



HEAT SINK COMPOUND

G C Electronics # 10-8109 - For effective transfer of heat between components and heat sinks. 29 silicone heat sink compound. CAT# HSC-1 \$2.00 per 1 oz tube

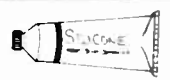

TOLL FREE ORDER LINES

1-800-826-5432

CHARGE ORDERS to Visa, MasterCard or Discover

TERMS: Minimum order \$10.00. Shipping and handling for the 48 continental U.S.A. \$3.50 per order. All others including AK, HI, PR or Canada must pay full shipping. All orders delivered in CALIFORNIA must include state sales tax (7 1/4, 7 1/2, 7 3/4 or 8 1/4%)

Quantities Limited. NO C.O.D. Prices subject to change without notice.
 CALL OR WRITE FOR OUR FREE 64 PAGE CATALOG

ALL ELECTRONICS CORPORATION
 P.O. Box 567 • Van Nuys, CA • 91408



IBM PC SERVICE CARD

This card was developed for assistance in the field of service, development and test. The card is used as a bus-extension to reach the measurement points very easy. It is also possible to change cards without having a "hanging computer"

Ready Assembled Module

\$145

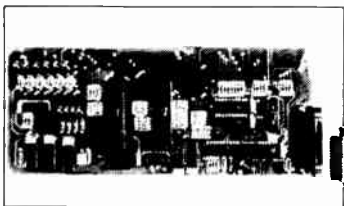

IC TESTER FOR IBM-PC-XT/AT

With the ELV IC tester logic function tests can be carried out on nearly all CMOS and TTL standard components, accommodated in DIL packages up to 20 pin. The tester is designed as an insertion card for IBM-PC-XT/AT and compatibles. A small ZIF test socket PCB is connected via a flat band cable. Over 500 standard components can be tested using the accompanying comprehensive test software. Complete Kit including Textool socket, connectors, sockets, Flat band cable, PCB, Software.

Ready Assembled Module

\$200

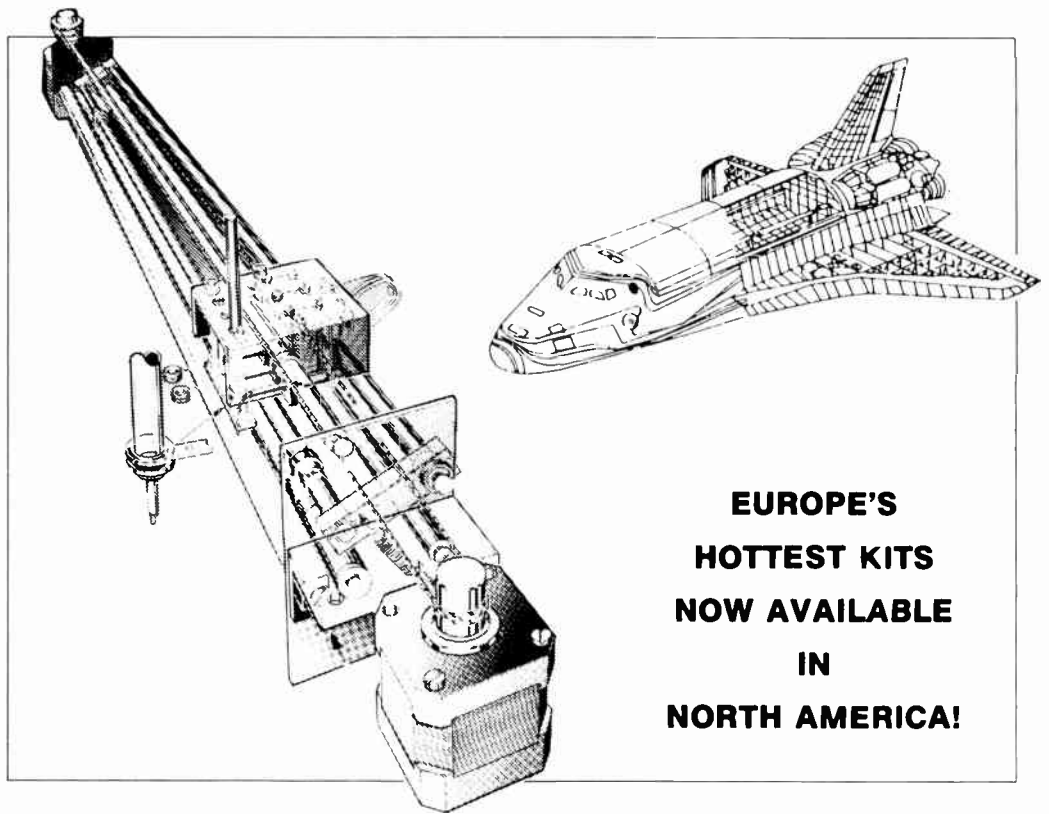

**EUROPE'S
HOTTEST KITS
NOW AVAILABLE
IN
NORTH AMERICA!**

PLOTTER MARK-II

completely reworked version: see Elektor Electronics March 1990.

- Max. width 50 cm.
- All mechanical parts supplied ready-drilled, filed and tapped, so get going at once.
- Complete kit, including 2 stepper motors, 3 pen lift solenoids, HPGL software on disk (IBM), stepper motor control board

100.100 **\$275**

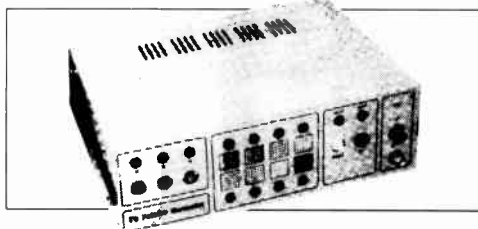

COLOUR TEST PATTERN GENERATOR

A PAL-compatible colour video source that supplies a number of test patterns for aligning television sets.

A test pattern generator is virtually indispensable for troubleshooting in television sets because it supplies a video signal that is known to be stable, and thus easily displayed and synchronized on an oscilloscope.

Inc. case and front

100.111 **\$175**



ELEKTOR P.C. i/o card

* 220.007 **\$175**

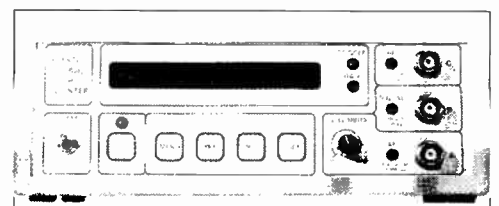

MICROPROCESSOR-CONTROLLED FREQUENCY METER

A professional grade multi-purpose frequency meter, designed by Elektor Electronics, that can be build by many at affordable cost. Described in Elektor Electronics December 1984, January & February 1985. U665B-based prescaler.

- Frequency meter: 0.01 Hz to 1.2 Ghz.
- Pulse duration meter: 0.1 to 100 s.
- Pulse counter: 0 to 10^9 pulses
- Period meter: 10 ns to 100 ns
- Sensitivity: Input A: 10 mV_{rms} ($Z_{in} = 2 M\Omega$); Input B: TTL or CMOS compatible ($Z_{in} = 25 k\Omega$); Input C: prescaler input: 10 mV_{rms} ($Z_{in} = 50 \Omega$).
- Auto-ranging and completely menu-driven.
- 6 or 7 digit accuracy.

Kit includes power supply, prescaler and enclosure.....100.112 **\$300**

BASIC COMPUTER
With Intel 8052AH-BASIC

100.117

\$160



ANALOG MODULE

eps 880162

100.113 **\$80**

DIGITAL MODULE

eps 880163

100.114 **\$55**

ADRESSECODER

eps 880159

100.115 **\$45**

S-VHS/CVBS-TO-RGB CONVERTER

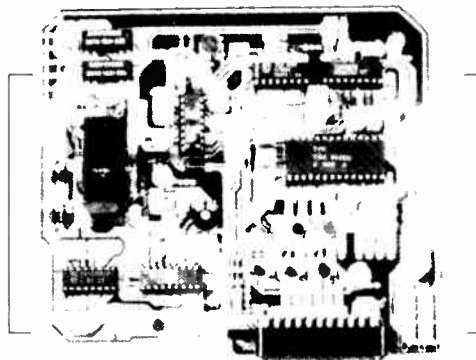

Following last month's introduction into the main characteristics of the Super-VHS system, we close off the article with details of a practical converter circuit that allows an S-VHS-VRC or camcorder to be connected to the RGB inputs of a colour TV or monitor. The circuit presented here forms a state-of-the-art approach to all-analogue picture standard conversion, and is based on the latest in IC technology available for this purpose.

220.039 **\$150**



THE HAGUE HOLLAND

AVAILABLE FROM:

OLD COLONY SOUND LAB

PO Box 243, Dept E91
Peterborough, NH 03458 USA
24-Hour Lines:
Tel. (603) 924-6371 FAX (603) 924-9467

- Check, money order, MC/VISA accepted.
- Please allow 6-8 weeks for delivery
- **SHIPPING:** Airmail shipping to USA included in price. Others: Please inquire.
- **CUSTOMS:** USA residents may be required to pay 5-10% customs duty. Others may vary.

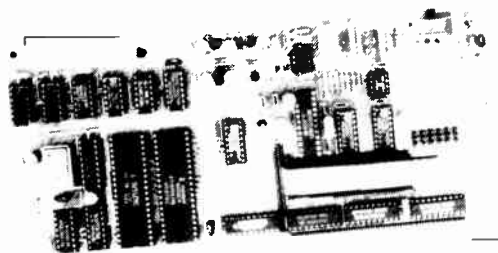

MULTIFUNCTION MEASUREMENT CARDS FOR PCs

The high-performance insertion card described in this article allows your IBM PC-XT, PC-AT or 100% compatible to measure direct voltage at 12-bit accuracy, as well as frequency and a host of other parameters related to pulse-shaped signals. The accuracy and versatility afforded by the card are of a level associated with much more expensive, industrially rated products. The menu-driven control software developed for this exciting project allows you to keep tabs on up to eight voltages quasi-simultaneously, while up to eight remaining inputs can be used for time-related measurements including frequency, duty factor and pulse duration, not forgetting the event counter. Connected to the sensors and timing devices of your choice, this card turns a PC into a powerful central controller in a complex measurement and control system.

220.040 **\$225**

SPECIAL PARTS SERVICE

We are the no. 1 suppliers of hard-to-find components for Elektor Electronics projects. Always contact us first if you see an unfamiliar component. Items include analogue & digital ICs (HCT, SMD), precision resistors (1%, 0.1%), capacitors (MKT/styroflex), inductors (Neosid, Toko), transducers, enclosures (Telet, OKW) and quartz crystals.

FOR FURTHER INFORMATION,
PLEASE SEND A BUSINESS-SIZE
SASE TO OLD COLONY SOUND LAB
(ADDRESS ABOVE), ATTN: MEEK IT.

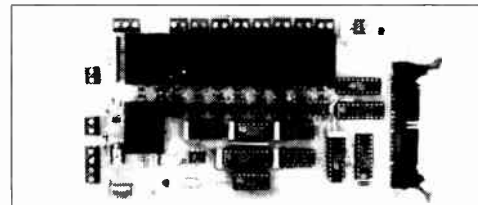

MICROPROCESSOR-CONTROLLED TELEPHONE EXCHANGE

The telephone exchange presented here allows up to eight pulse-dialling telephone sets to be connected, and has an option for connecting calls to or from an external (trunk) telephone line. The unit is controlled by the popular 8052-based BASIC computer we introduced a few years ago.

220.057 **\$190**

MAIN FEATURES

- 8 internal lines
- 1 external line
- memory for 10 numbers
- internal through connections
- versatile computer control
- automatic hold for external line
- simple to extend
- can be interfaced to a PC
- selective external call acceptance
- shortcut dial codes for external number
- works with pulse dialling telephone sets
- one optional relay for extra switching function

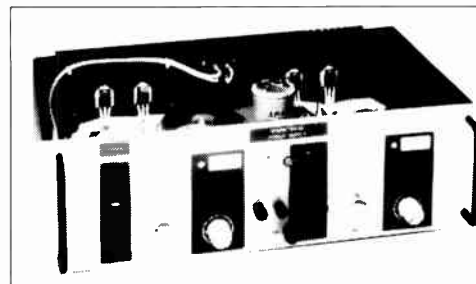

400-WATT LABORATORY POWER SUPPLY

Here is an all-purpose d.c. power supply for symmetrical as well as asymmetrical use, and capable of supplying high output currents and voltages. An all-analogue design based on discrete parts only, this 400-watt PSU deserves a prominent place on your work bench.

ex. case 220.036 **\$525**

MAIN SPECIFICATIONS

- **Mode: single**
one adjustable power supply with current and voltage controls
- Output 0 - 40 V at 0 - 5 A
- **Mode: independent**
two identical, electrically separated, power supplies
- Outputs 2 x 0 - 40 V at 2 x 0 - 5 A
- **Mode: Tracking**
two identical, series connected, power supplies
- Outputs + 0 - 40 V at 0 - 5 A
- 0 - 80 V at 0 - 5 A
- Voltage and current of slave follow master
- **Mode: parallel**
two identical, parallel connected, power supplies
- Outputs 0.6 - 39.4 V at 0 - 10 A
- **Maximum output voltage:**
0 - 40 V (at full load)
48 V (no load)
- **Maximum output current:** 5 A
- **Ripple:** 10 mV (no load)
50 mV (at full load)
- **Voltage difference in tracking mode:** 50 mV

NOW THAT YOU'VE SEEN OUR NEWEST TREASURE . . .

WHY NOT HAVE A LOOK AT THE REST?

GLASS AUDIO

The newest publication from the folks who bring you *Audio Amateur* and *Speaker Builder*

Glass Audio features the best vacuum tube designs for audio reproduction—past and contemporary. The new designs take advantage of improved components and control techniques that make the end results far superior to anything possible during the early days of audio's rebirth after World War II.

That's why tubes are having such a renaissance of interest as a perfectionist approach to good sound. And that's why tubes are reappearing in original equipment, in high end consumer and professional audio systems.

Published quarterly, *Glass Audio* will inform you about new innovations in the field and about parts sources. We'll also include modification projects, reviews of technical basics and regular columns such as Tube Troubles, Tube Tips and much more.

Subscribe today!



Audio Amateur

THE JOURNAL FOR AUDIOPHILE CRAFTS

The innovative, independent audiophile journal for the thoughtful and capable music lover

Audio Amateur's articles deal with how audio equipment works, as well as how to build or modify it. Construction and modification articles are plentiful, supplying all needed parts, performance and assembly details. Exceptionally high quality designs.

Audio Amateur offers a number of features in each issue that abound with useful ideas. The *Letters* column is an open forum for problem solving and information interchange; *Classic Circuitry* reprints schematics of state-of-the-art gear—old and new; *Audio Aids* relates readers' experience with simple modifications to equipment and construction techniques. We also feature many useful and practical hi-fi accessories you can build to further your audio enjoyment.

For a small investment you can make your music system sound better—very probably a lot better.

Speaker Builder

THE LOUDSPEAKER JOURNAL

The magazine that finally deals seriously with the art and craft of speaker building

The *Art* of building a speaker is to optimize that mixture of design and engineering to balance all the parameters for the most beautiful sound possible. The *Craft* is knowing how and why. *Speaker Builder* gives you knowledge—from driver parameters and crossovers to woodworking—to develop and refine your techniques, and to get the most out of your system.



Speaker Builder helps you explore new designs with how-to construction articles, and can show you how to modify your old speakers and make them sound better than ever. Learn from our writers who turn abstract theory into practical approaches, and from the experience of other readers who have been down the road before you. *Speaker Builder* is the best investment you can make in your system—six issues per year filled with stimulating and exciting ideas.

GLASS AUDIO

- Two years, (8 issues)
 One year, (4 issues)

\$35
\$20

Canada add \$4 per year postage

AUDIO AMATEUR

- Two years, (8 issues)
 One year, (4 issues)

\$35
\$20

Canada add \$4 per year postage

SPEAKER BUILDER

- Two years, (12 issues)
 One year, (6 issues)

\$45
\$25

Canada add \$6 per year postage

NAME _____

STREET & NO. _____

CITY _____

STATE _____

ZIP _____

MC OR VISA NUMBER _____

EXPIRE _____

AUDIO AMATEUR PUBLICATIONS

PO Box 576, Dept. E91, Peterborough, NH 03458-0576 • (603) 924-9464 • FAX: (603) 924-9467

Answering machine for credit card orders only: before 9:00 a.m., after 4:00 p.m. and weekends. Have all information plus MC/VISA available.



OLD COLONY SOFTWARE

SPEAKER DESIGNER

Stuart E. Bonney

SPEAKER DESIGNER is a loudspeaker system design aid and modeling tool for use with both closed and vented systems over the frequency range of 10–300Hz. The program computes and displays system frequency response, power handling capabilities, and relative sound pressure level (SPL) outputs for each of 26 discrete frequencies over this range. This package runs on any IBM PC/XT/AT, true compatible, or IBM PS/2 running MS/PC-DOS 2.0 or higher. Printer output compatible with any 80-column or wider printer. 1 x 5¼", 360K, DS/DD.

SOF-SPD1B5 SPEAKER DESIGNER for IBM **\$19.50**

STEPPED VOLUME CONTROLS

Joseph O'Connell

These ready-to-run Macintosh programs come on a 3½" SS/DD disk initialized as a 400K disk for compatibility with all machines. Also included are the Pascal source codes, should you wish to customize them for your own use. The package contains two programs:

RESISTOR SELECTOR (Program A): This program simplifies the math necessary to build stepped volume controls.

RESISTOR CHECKER (Program B): This program would be superfluous if it were possible to obtain every resistor value that the above program called for. But because you will be limited to the nearest standard values, or with series and parallel combinations, this program quickly calculates the taper that will result with different actual values. It can also show the effects of different source and load impedances on the taper. Both programs (contained on the same disk) allow you to save their output to a text file. From *TAA* 4/88, 3/89; article reprints included.

SOF-SVC1M3 STEPPED VOLUME CONTROLS for Macintosh **\$25.00**

THE LISTENING ROOM

Sitting Duck Software

This interesting program predicts standing wave modes in small rooms and is designed for positioning speakers--and the listener--in such a way as to minimize standing wave effects and other room-generated influences. With proper speaker/listener positioning, serious frequency response dips and peaks due to room influences can be kept to a minimum. The program allows for a full range of speaker and listener movement in 3D space and continuously updates a standing wave Pressure Versus Frequency display. 256K RAM, DOS 2.11 or higher required. CGA, EGA, VGA, or Hercules graphics capability required. LaserJet or dot matrix printer recommended. 1 x 5¼"; supplied on the diskette is a second version of the program which recognizes a coprocessor. Softbound manual.

SOF-TLR1B5G THE LISTENING ROOM WITH GRAPHICS for IBM **\$34.95**

THIELE/SMALL DRIVER PARAMETERS

David Long

This package was written in order to make easier and faster the job of determining the Thiele/Small parameters of raw drivers. The final display screen will show, in addition to the usual parameters, the effects of amplifier and crossover losses on the driver (Q_E , Q_T , Q_{ES} , Q_{TS} , and SPL), driver impedance at f_s , the driver's moving mass (M_{MD}), the driver's suspension compliance (C_{MS}), and efficiency.

This disk also contains programs for Q_{LA} , Q_{TC} , and room resonance. 1 x 5¼", SS/DD. From *SB* 1/89; article reprint included.

SOF-TSD1C5 THIELE/SMALL DRIVER PARAMETERS for Commodore 64 (disk) **\$25.00**

TWO-WAY ACTIVE CROSSOVERS PLUS

Gary Galo

This program will perform the necessary calculations for the eight common two-way active crossover designs described by Dr. Robert M. Bullock III in *Speaker Builder* 3/85 (article reprint is included). The schematics are drawn in the text mode using the IBM line drawing characters. No graphics adapters are needed to display them, but your printer must be set up to emulate the IBM ProPrinter in the alternate character set mode. As an aid to selecting op amps suitable for use in audio circuits, also included is a program for calculating op amp V_{TH} (input dynamic range), based on an article in *TAA* 3/86 (article reprint included). This program is particularly valuable since the demands of CD players have made V_{TH} such an important consideration in designing analog circuitry. DS/DD.

Purchasing options available:

SOF-TWO1B3 TWO-WAY ACTIVE CROSSOVERS PLUS 3½" for IBM **\$20.00**

SOF-TWO1B5 TWO-WAY ACTIVE CROSSOVERS PLUS 5¼" for IBM **\$20.00**

VENTWRK VENTED BOX CONSTRUCTION (PLUS)

George L. Augspurger

A short segment of a much larger loudspeaker analog program, **VENTWRK** is provided by one of audio's most famous names as a companion to his article "New Guidelines for Vented-Box Construction," which appeared in *SB* 2/91 (article reprint included). The program encompasses simple design rules developed by the author which enable f_B (resonance frequency) to be predicted reasonably accurately for typical vented loudspeaker enclosures. The Apple IIe version is written in Applesoft BASIC and runs on any member of the Apple II family having an 80-column card. It contains the **VENTWRK** program *only*. The IBM PC version is written in Turbo Pascal. The source code and the compiled .EXE program are included on the high density diskette. In addition to **VENTWRK**, the IBM version also contains the following two programs:

SPCONV: This program performs very fast interactive conversion between Thiele/Small parameters and basic specifications such as B1 factor and cone assembly mass.

BXCKT: This calculates and displays the R-L-C analog circuit values for Locanthi's analog circuit. Closed box, vented system, and passive radiator system are provided.

Purchasing options available:

SOF-VNT1A5 VENTWRK VENTED BOX CONSTRUCTION for Apple (not Mac) **\$9.95**

SOF-VNT2B5 VENTWRK VENTED BOX CONSTRUCTION PLUS for IBM **\$19.95**

WOOFER-SATELLITE OFFSET

Sitting Duck Software

When, due to aesthetic considerations, woofer systems are placed at

USE OUR EASY ORDER FORM BELOW!

distances from the listener which are different from that of the satellites, serious dips in frequency response may result. The magnitude, width, and frequency of the dips are a function of the distance differential and the crossover network in use. This program plots the frequency and phase response curve which results from user-determined offset differentials and network configurations. 256K RAM required. CGA, EGA, VGA, or Hercules graphics capability required. LaserJet or dot matrix printer recommended. 1 x 5 1/4".

SOF-WSO1B5G WOOFER-SATELLITE OFFSET WITH GRAPHICS for IBM \$34.95

SPEAKER BUILDER AND THE AUDIO AMATEUR INDEXES, 1980-1990

Russell Schoof

These eleven-year indexes, available separately and as a set, chronicle in a very user-friendly fashion the contents of *Speaker Builder* and *The Audio Amateur* magazines. The indexes are not stand-alone software; they require database management software such as PCFile:dB or Alpha Four for implementation.

These are dBASE III+ files and can be used by any program that either directly accesses or imports that type of file. Since dBASE is the *de facto* industry standard, though, most database and spreadsheet programs will work--even some word processors will. Since the index contents are

standard database files, the indexes themselves can be updated annually or otherwise modified by the user. Alternatively, registration of the index copy with the designer (card provided) will entitle the purchaser to a discounted price on professionally produced annual updates.

The *Speaker Builder* index comes on two 5 1/4" disks. The EDITORIAL CONTENTS disk contains more than 1000 entries for articles, columns, letters, and corrections. The DRIVERS disk contains more than 800 entries for raw drivers. It lists all raw drivers for which useful information is presented in articles, letters, and some advertisements. Further, it also gives data (when available) on the type, function, construction materials, voice coils, and use, as well as the other types of information published in *SB*. Occasionally, data has been supplemented by information from outside sources. The index for *The Audio Amateur* comes on one 5 1/4" disk and is presented in the same form and style as the *Speaker Builder* EDITORIAL CONTENTS.

Purchasing options available:

SOF-SBX2B5 SPEAKER BUILDER INDEX, 1980-1990, for IBM \$16.00

SOF-AAX2B5 THE AUDIO AMATEUR INDEX, 1980-1990, for IBM \$16.00

SOF-XXX2B5 SPEAKER BUILDER/THE AUDIO AMATEUR COMBINED INDEX SET, 1980-1990 \$30.00

----- DEALER DISCOUNTS AVAILABLE -----



OLD COLONY SOFTWARE EASY ORDER FORM

QTY.	ITEM NO.	PRICE EACH	TOTAL
_____	SOF-_____	\$ _____	\$ _____
_____	SOF-_____	_____	_____
_____	SOF-_____	_____	_____
_____	SOF-_____	_____	_____
_____	SOF-_____	_____	_____
<input type="checkbox"/> FREE CATALOG		SHIPPING	\$ _____
		TOTAL	\$ _____

NAME _____

COMPANY _____

STREET _____

CITY _____

ST _____

ZIP _____

DAYTIME TELEPHONE _____

PAYMENT BY:

- CHECK / MONEY ORDER
 MASTERCARD VISA

MC OR VISA _____

EXP. _____

SHIPPING:

USA: \$2 first item, \$.75 each additional.

Canada: \$4.50 first item, \$.75 each additional.

Overseas Surface: \$6 first item, \$.75 each additional

Overseas Air: \$9 first item, \$.75 each additional.

OLD COLONY SOUND LAB

PO BOX 243, Department E91
Peterborough, NH 03458-0243 USA

24-Hour Lines

Telephone: (603) 924-6371 or (603)924-6526

FAX: (603) 924-9467

SHALL WE WORMS TURN?

If a healthy infrastructure for the electronics enthusiast who likes to build things is ever fully revived in the United States and Canada, it won't be by folks who are content to curse the darkness.

Our supply problems, because of the size of our two countries, and the resultant elephantiasis of the electronics distributors, are due largely to two factors, as I see it. The obesity of those who should be doing the supplying, and the unorganized lassitude on the part of those who are eager to do some genuinely satisfying work building electronics projects. And electronic construction means something more complex, as one reader put it recently, than another solar night light.

I commend to you the example of reader Jan Rowland of Houston, TX. Like most Texans he believes in doing something about problems when they crop up. He wrote a strong letter to Jameco Electronics protesting their 1991 \$50 minimum order limit. His letter was eloquent and to the point, and perhaps it helped that he sent Jameco's people a copy of my editorial from the September '91 issue.

Jan got a reply. Jameco, according to John Rengstorff in the Customer Service department, will lower Jameco's minimum to \$30 beginning with the release of the 1992 catalog. A fresh copy of this new, handsome, and remarkably complete publication landed on my desk yesterday. They can well be proud of it, its usefulness and the kind of service I know they have provided since their earliest days in the 1970s. (To receive a free copy FAX them at (415) 592-2503 or call (415) 592-8097.)

The lesson here is that the action of a single customer can make a difference. There are now 10,000 of us who read and enjoy this magazine. If I have my way, at 1992's end, there will be twice as many of us. Most of you who write to me are having very nice things to say about the magazine's content. I believe the quality of what appears in these pages is far above average.

But the problem we face is telling the vendors of our two countries that we are here, and we are looking for goods. If they do not stock what we need, we need to ask them why they don't. If we find a good vendor who supplies our needs, we will do ourselves, each other and this avocation a favor by asking the vendor why his goods are not being advertised in *Elektor*.

No hobby flourishes without good vendors. We are doing a massive job of acquainting the electronics community with *Elektor Electronics USA*. But only you can tell them that you are a cus-

tommer, that you have needs, and that those needs are worth money to their enterprises.

I have had the pleasure over the last 22 years of founding four magazines. Three of them have built a whole range of new businesses which flourish by meeting the needs of those publications' readers. But it all came about because readers were vocal about their pleasures, their projects, their discoveries, and their hardware and tool needs. If you are an enthusiastic builder of electronics projects, you can enrich your enjoyment of it by becoming active.

If this sounds like huckstering to you, so be it. But I see no healthy hobby in North America which is without a vast array of specialized suppliers who are out to help the hobbyist find pleasure and satisfaction, and sell goods too, of course. Have a look at any magazine you wish to name that serves a hobby market and you'll find hundreds, sometimes thousands, of suppliers who provide an amazing variety of arcane and often highly imaginative products. Model railroads are a good example. Next time you are at a newsstand, have a look at *Model Railroader*. And there are hundreds more: *Telescope Maker*, *Guitar Player*, *Electronic Musician*, *Fly Tying*, *Truckin'*, *Low Rider*, *Street Rider*, and on and on.

We must begin thinking of ourselves as a market because that is what our wishes become in building the projects we wish to build. But the world will never know we are a market with needs unless we talk about it, act on it, write about how we feel, and what we want.

I said in the first North American issue of this publication that we are, collectively, a rich and incredibly talented resource group for each other. That, in the best sense, is what a publication does. It is a meeting place, an interchange point for the minds and ideas of all its readers. And the data is not all intellectual. Some of it involves excellent parts and supplies.

This issue marks the beginning of the second year of *Elektor's* North American odyssey. I hope you join me in recognizing that we are helping to rebuild something that has sunk to a very low ebb in our two cultures. For our own pleasure, enhancement and for the sake of ours and other's humanness, building with our two hands is a worthwhile pursuit. Talk to us. Talk to our advertisers. Talk to those who should be spreading their wares here. Your voice is essential, and your contribution is unique.

We have been worms far too long. It is time to turn.—E.T.D.

Published by Audio Amateur Publications, Inc.

Editor/publisher: Edward T. Dell, Jr.

Editorial Offices:

305 Union St., P.O. Box 876
Peterborough, NH 03458-0876 USA

Telephone: 603-924-9464 (National)

or +1 (603) 924-9464 (International)

FAX: (603) 924-9467 (National)

or +1 (603) 924-9467 (International)

Advertising: Donald B. Kennedy

Telephone: (617) 383-9059

FAX: (603) 924-9467

Subscriptions: Katharine Gadwah

Elektor Electronics USA

Post Office Box 876,

Peterborough, New Hampshire 03458

Subscriptions to *Elektor Electronics USA* are available ONLY in the fifty United States,

Canada, Puerto Rico, the Virgin Islands and those Pacific territories administered by the

United States of America.

European Offices:

Elektuur BV

Postbus 75

6190 AB BEEK

The Netherlands

Telephone: 011 31 4638 9444

Telex: 56617 (elekt nl)

FAX: 011 31 4637 0161

Managing Director: M.M.J. Landman

Overseas Editions:

FRANCE

Elektor sari

Les Trois Tilleuls

B.P. 59; 59850 NIEPPE

Editors: D.R.S. Meyer

G.C.P. Raedersdorf

GERMANY

Elektor Verlag GmbH

Susterfeld Strasse 25

5100 AACHEN

Editor: E.J.A. Krempelsauer

GREECE

Elektor EPE

Kariskaki 14

16673 Voula—Athena

Editor: E. Xanthoulis

HUNGARY

Elektor Elektronikai folyoirat

1015 Budapest

Batthyany U. 13.

Editor: Lakatos Andras

INDIA

Elektor Electronics PVT Ltd

Chhotani Building

52C, Proctor Road, Grant Road (E)

BOMBAY 400 007

Editor: Surendra Iyer

ISRAEL

Elektorcal

P O Box 41096

TEL AVIV 61410

Publisher: M. Avraham

NETHERLANDS

Elektuur BV

Peter Treckpoelstraat 2-4

6191 VK BEEK

Editor: P.E.L. Kersemakers

PORTUGAL

Ferreira & Bento Lda.

R.D. Estef-83-ni, 32-1°

1000 LISBOA

Editor: Jeremias Sequeira

SPAIN

Resistor Electronica Aplicada

Calle Maudes 15 Entlo C.

28003 MADRID

Editor: Agustin Gonzales Buelta

SWEDEN

Electronic Press AB

Box 5505

14105 HUDDINGE

Editor: Bill Cedrum

UNITED KINGDOM

Down House

Broomhill Road

LONDON SW18 4JQ

England UK

Editor/Publisher: Len Seymour

Printed in the United States of America.

ISSN: 1051-5690

IC-2410A/H DUAL-BAND MOBILES

Icom has announced the IC-2410A and IC-2410H 144 and 440MHz dual-band transceivers. The IC-2410A puts out a maximum of 25W on UHF and VHF. Maximum output power for the IC-2410H is 45W on VHF and 35W on UHF. Both offer high, medium, and low power settings. In addition to receiving two bands simultaneously, the mobiles also receive two frequencies simultaneously on the same band.

You can set the main band on VHF or UHF, enter memory or VFO mode, directly enter frequencies and memory channels, and select high or low power. The IC-2410A/H has crossband repeat capability with repeater offsets on both bands. Each band has 15 memory channels, two scan edge channels, and one call channel. The HM-56 microphone has 14 DTMF memory channels.

For more information, contact Icom America, Inc., 2380 116th Ave. NE, PO Box C-90029, Bellevue, WA 98009-9029, (206) 454-8155, FAX (206) 454-1509, TELEX 152210.

SILVER EPOXY KIT FOR ELECTRONIC CONNECTIONS

Planned Projects has introduced the 2400 Circuit Works Conductive Epoxy Kit for quick, solderless connection and conductive bonding applications in electronic design, prototype, and repair. Other applications include solderless surface-mount connections, circuit board trace repair, die attach, static discharge drains, shield bonding, and grounding.

The Circuit Works conductor is a two-part silver epoxy featuring electrical conductivity with resistivity typically 0.001Ω/cm and 10-minute room-temperature curing. The material approaches maximum bond strength in 24 hours. Bonding performance can be accelerated by mild heat curing at less than 100°C.

The kit sells for \$14.95. For more information, contact Planned Projects, 303 Potrero St., Suite 53, Santa Cruz, CA 95060, (408) 459-8088, FAX (408) 459-0426.



ELECTRONICS SCENE



THE VI SERIES OF AUTOMATIC A/V SWITCHES

R.F. Engineering has announced the VI series of automatic A/V switches. The VI allows two video devices (a laser disc player and a VCR) to be connected to a single monitor. It detects which source is delivering a signal and routes the signal to the monitor.

The VI can detect either video or audio signals, so it can be used as an expansion input on an audio preamp. The device is designed so that if both signals are present, it will give priority to the device on the Video B connection. A sensitivity adjustment allows the VI to filter out noise that can cause erratic switching. A delay adjustment is used to prevent switching on missing signals, such as between tracks on a CD.

The VI is available with RCA connectors at \$89.95 or S-VHS connectors at \$119.95. For more information, contact R.F. Engineering, Inc., 9215 Lowell Blvd., Westminster, CO 80030, (303) 430-8281, FAX (303) 430-4023.

CONCERT SOUND REINFORCEMENT WORKSHOP

The third in a series of Concert Sound Reinforcement Workshops will be sponsored by Synergetic Audio Concepts on January 14-16, 1992 in Orange, CA. Don and Carolyn Davis will host the workshop. Workshop Chairman, Will Parry of MSI, announced that Audio Analysts, Clair Brothers, Electrotec, and Showco will again be represented at the workshop. David Scheirman of Concert Sound Consultants will be the facilities coordinator.

For more information, contact Synergetic Audio Concepts, Rte. 1, Box 267, Norman, IN 47264, (812) 995-8212, FAX (812) 995-2110.

CHIP MAKES VIDEOPHONES COMPACT AND PRACTICAL

Low cost compact video telephone systems are now possible with the integrated circuit chip from PMC Products. The chip allows PMC to provide still frame, high resolution, black/white video units (Phonvu) for less than \$500. About the size of a paperback book, the unit lets you send still video images over ordinary phone lines to other locations in 12 seconds.

Possible applications include teleconferencing, videofax, video database retrieval, remote video surveillance, storing video images on audio tape, and sending video images by radio.

For more information, contact PMC Products, 4742A La Villa Marina, Marina del Rey, CA 90292, (800) 423-6377.

SURVEILLANCE TRANSMITTER KITS

Sheffield Electronics has available several transmitter kits and books. All transmitters tune from 65-305MHz FM. Line-of-sight transmitting distance measurements were made using Ace Communications' AR-2002 receiver. Alkaline battery operating times were calculated from Duracell's specification sheets (batteries not included).

For more information, contact Sheffield Electronics Co., 7223A Stony Island Ave., Chicago, IL 60649.

EPROM LABEL BLOCKS UV LIGHT

A UV opaque write-on label for programmable memory or PAL packages will be introduced at this year's WESCON show by DATAK Corp., Booth 1923. When used on EPROM packages, the label gives added assurance that the burned program will not accidentally be erased by stray light from fluorescent lamps or other UV sources.

The label can be written on with a typewriter, ball point pen, soft pencil, or any platen feed computer printer. It is permanent, but can be removed without leaving an adhesive residue.

Labels are available in sets of three sheets (cat no. EP-1), with 147 labels total, for \$4. DATAK Corp., 55 Freeport Blvd., #23, Sparks, NV 89431, (702) 359-7474, FAX (702) 359-7494.

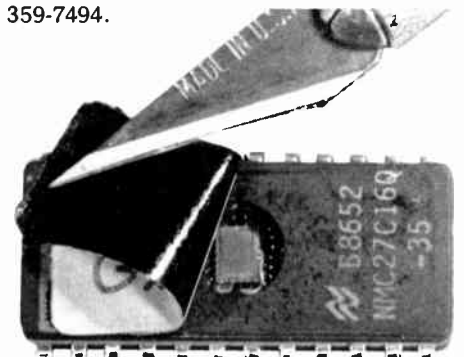

MONOLITHIC VCA WITH WIDE DYNAMIC RANGE/LOW DISTORTION

Analog Devices has announced the SSM-018 monolithic voltage-controlled amplifier designed for automated audio gain control. Professional audio applications include electronic volume control systems, mix consoles, dynamic range processors, compressors, limiters, and other noise reduction systems where remote, automatic, or computer control of gain and attenuation is desirable. It combines low distortion performance and wide dynamic range with the low cost of monolithic circuitry.

Maximum total harmonic distortion with gains of ± 20 dB (from 20Hz–20kHz) in Class A mode is 0.025%. Its patented design provides dynamic range to 118dB. An operational amplifier voltage controlled element (OVCE) architecture provides differential inputs and outputs that can operate in the voltage or current domain.

The 16-pin DIP version is \$3 (in 100s), the SOIC is \$3.25 (in 100s). For more information, contact Dan Parks, Analog Devices, Inc., Precision Monolithics Division, 1500 Space Park Dr., Santa Clara, CA 95052, (408) 562-7513.

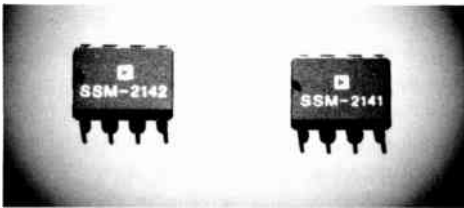

FULLY INTEGRATED BALANCED LINE DRIVER

Analog Devices' SSM-2142 is a highly integrated line driver system for audio, telecommunications, and industrial applications. This monolithic device replaces large, expensive transformer-based solutions and eliminates the need for expensive external trim circuitry.

The SSM-2142 is well-suited for a variety of applications that require superior noise immunity and common-mode rejection, including professional studio mix consoles, telecommunications, and industrial instrumentation. Total harmonic distortion plus noise from 20Hz–20kHz is 0.006%; output common-mode rejection is typically 45dB. When coupled with its companion, the SSM-2141 differential line receiver, the device offers a completely balanced low-cost, high-performance driver/receiver system for less than \$5.

The SSM-2141 and SSM-2142 cost \$1.95 and \$2.95 in 100s, respectively. For more information, contact Analog Devices, One Technology Way, PO Box 9106, Norwood, MA 02062-9106, (617) 329-4700, FAX (617) 329-1241.

ELECTRONICS SCENE



FREQUENCY COUNTER WITH 1mV SENSITIVITY

Optoelectronics has announced the Model 2810, a frequency counter with full-range operation, 1mV sensitivity, and resolution to display 10Hz in 3GHz. It detects frequencies up to 200MHz and resolves them to 1Hz in one second. Frequencies up to 900MHz are resolved to 1Hz and displayed in four seconds; frequencies up to 3GHz are resolved to 10Hz and displayed in 1.6 seconds. Four gate times (0.01, 0.1, 1, and 10 seconds) are available from the front panel selector switch.

The Model 2810 sells for \$259. The optional LCD backlight sells for \$45, the extra NiCad battery pack for \$24, and the ± 2 PPM TCXO for \$100. For more information, contact Optoelectronics, Inc., 5821 NE 14th Ave., Fort Lauderdale, FL 33334, (800) 327-5912 or (305) 771-2050, FAX (305) 771-2052.

ELECTRONIC SOURCE BOOK OF THE 1990s

The 1991 catalog from EasyTech features test equipment, connectors, enclosures, data books, soldering equipment, tools, designer boards, service aids, and many other items sought by electronics buffs. EasyTech also provides data sheets on most integrated circuits produced in the last ten years. They charge \$1 to have the data sheet included with an order or \$5 to have an individual data sheet printed and sent out on its own.

For a catalog, contact EasyTech at 2917 Bayview Dr., Fremont, CA 94538, (415) 770-2300, FAX (415) 770-2346.

INTERNATIONAL CONFERENCE ON INFORMATION ENGINEERING

An International Conference on Information Engineering will be held in Singapore December 2–5 at the Hyatt Regency. The conference will deal with the integration of computers and communication systems, emphasizing the networking aspects. Tutorial sessions will be offered on the first day. The conference will coincide with Singapore Information Technology Week and will precede the Singapore Informatics 91 Exhibition.

For more information, contact Secretariat, Associated Conventions & Exhibitors Pte. Ltd., 204 Bukit Timah Rd., #04-02 Boon Siew Building, Singapore 0922, Tel (65) 732-6839, FAX (65) 732-6309, TELEX RS 28615

DATABASE OF ELECTRONIC CIRCUIT ARTICLES

Circuit Search has announced Version 1.09 of their database of references to articles containing practical electronic circuit designs. This dBase III/III+ compatible database references nearly 13,000 articles and papers from more than 300 technical and scientific journals and magazines. As an interdisciplinary reference source, it can locate circuits by key words from journals in fields as varied as electronics, astronomy, agriculture, physics, chemistry, nuclear science, education, biomedicine, and many more disciplines where electronics can be applied.

The database is installed on a hard disk on an IBM PC or compatible. It occupies about 7Mb and comes on a series of disks. Circuit Search also provides copies (FAX or mail) of articles that qualify under Copyright Clearance Center (CCC) provisions, as well as update and revision services on a semi-annual basis.

Circuit Search sells for \$375 (US dollars), including one free semi-annual update/revision. Further updates cost \$40 for one or \$65 for two. A sample disk including 400 references, pricing, and additional information is available for \$7. Contact Peter Sawatzky, Circuit Search, PO Box 268, Breslau, Ontario, Canada, N0B 1M0, (519) 241-1252, FAX (519) 742-4594.

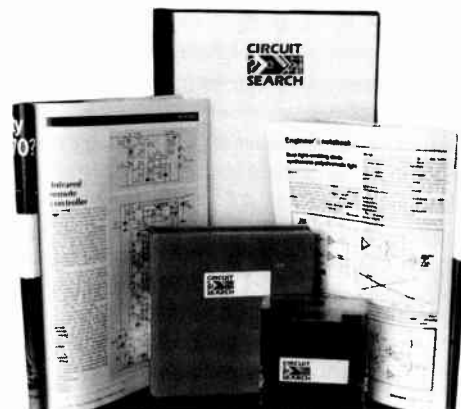

MEASUREMENT TECHNIQUES – PART 8

Measurements in digital circuits

by F.P. Zantis

MEAUREMENTS in digital circuits fall into two categories: (1) voltage, current and resistance; and (2) data. The first category presents no problems other than those already discussed in previous instalments of this article. The measurement of data and associated circuits will be described in this part in the series.

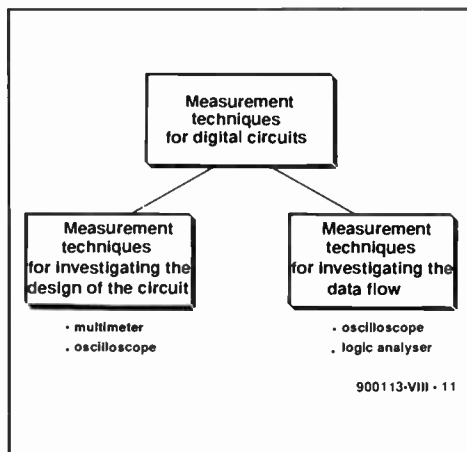

Fig. 1. Measurements in digital circuits fall into two categories.

Techniques for examining circuit design

Typical of digital circuit designs is the use of densely populated printed-circuit boards, whose tracks, owing to space limitation, are extremely thin. This makes faultfinding particularly difficult and it is, therefore, advisable to carry out a thorough inspection of the board before any work on it is begun. For this, an ohmmeter, multimeter, oscilloscope with component tester or a simple continuity tester is perfectly adequate.

Once the board has been populated, a multimeter is useful only for checking the various supply voltages. A component tester is also very useful: this quickly shows whether a component is all right or defect. Voltage levels and edges of digital signals can be checked with an oscilloscope.

Data pulses can cause problems with the triggering of an oscilloscope, however. Some oscilloscopes are, therefore, provided with special facilities, such as pre-trigger or hold-off. The pre-trigger function allows it to examine the trigger pulse just prior to its first mesial (see p. 41). In other words, the signal behaviour before triggering is displayed. The trigger pulse is then not shown at the left-hand of the screen, but in the centre, or

even at the right-hand.

The hold-off function allows the continuous lengthening of the delay between two time-base sweep voltages as shown in Fig. 2. Pulses or other spurious signals occurring during the hold-off time cannot influence the triggering, which is particularly useful in the case of aperiodic pulse bursts of constant amplitude. The oscilloscope can be triggered on different points of the waveform.

A digital storage oscilloscope is particularly useful for measuring an aperiodic signal. Note, however, that in moderately priced models short spurious pulses or glitches may not all be identified. The scanning rate and storage capacity limit the use of these oscilloscopes.

Examining the data flow

As is well-known, logic signals in digital engineering can only be 1 (high) or 0 (low). Errors caused by insufficient pulse voltage levels or resulting from too long a first transition duration of the pulse can be traced with standard test methods.

A typical problem encountered in measurements in digital circuits is that the ex-

amination of only one signal usually does not yield enough information about the functioning of the circuit. Generally, two or, in complex circuits, even more signals must be examined simultaneously.

For analysis of two signals, a dual-beam oscilloscope is required (not a dual-trace type, because that cannot capture two fast transient events). Examination of the data bus of an 8-bit microprocessor system requires an 8-channel oscilloscope. Even that is not sufficient if a control signal such as 'write' or 'read' must be triggered.

Some, rather expensive, oscilloscopes permit the simultaneous display of four signals—see Fig. 3. A dual-beam oscilloscope may be converted with a multi-channel adaptor to make relatively simple, qualitative test on a number of channels possible. The major disadvantage of such adaptors is their low chopping rate, which allows examination of relatively slow signals only.

In contrast to oscilloscopes, which measure voltage as a function of time, logic analysers are designed primarily for examining the data flow in complex digital circuits and microprocessor systems.

A logic analyser is suitable for testing hard-

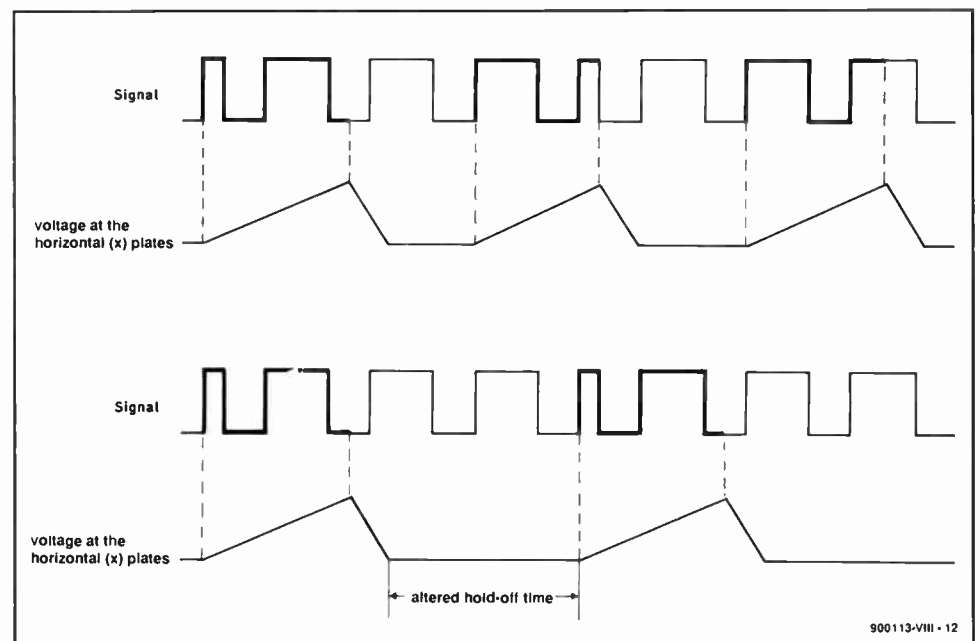

Fig. 2. Illustrating the hold-off function. At the top, this facility is not operating. The oscilloscope is then triggered when the electron beam is in its output position and a leading edge appears in the signal. The waveform in bold print is then shown on the screen; the picture runs across the screen. Analysis is not really possible. In the lower half, the hold-off time is altered in a manner that ensures that triggering always occurs at identical leading edges, so that the picture stands still. It is then possible to identify any glitches or other short, spurious pulses clearly.

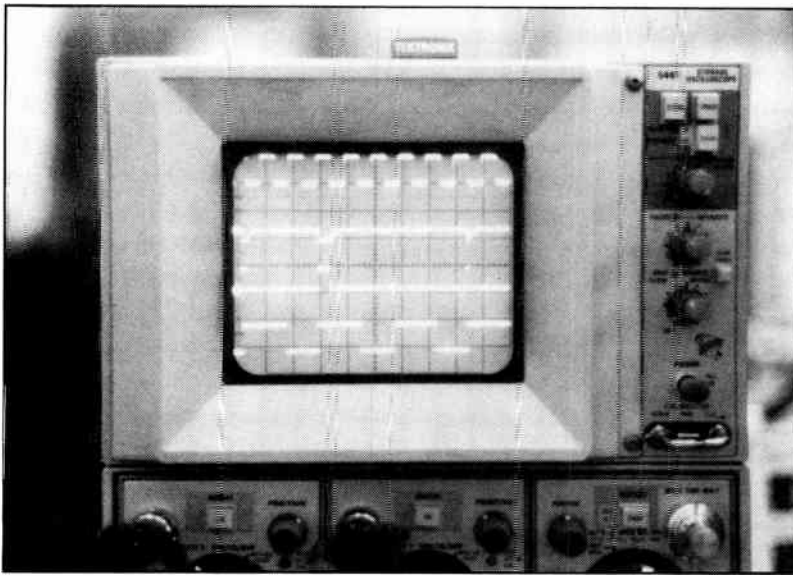

Fig. 3. Display of four logic signals on a 4-channel oscilloscope.

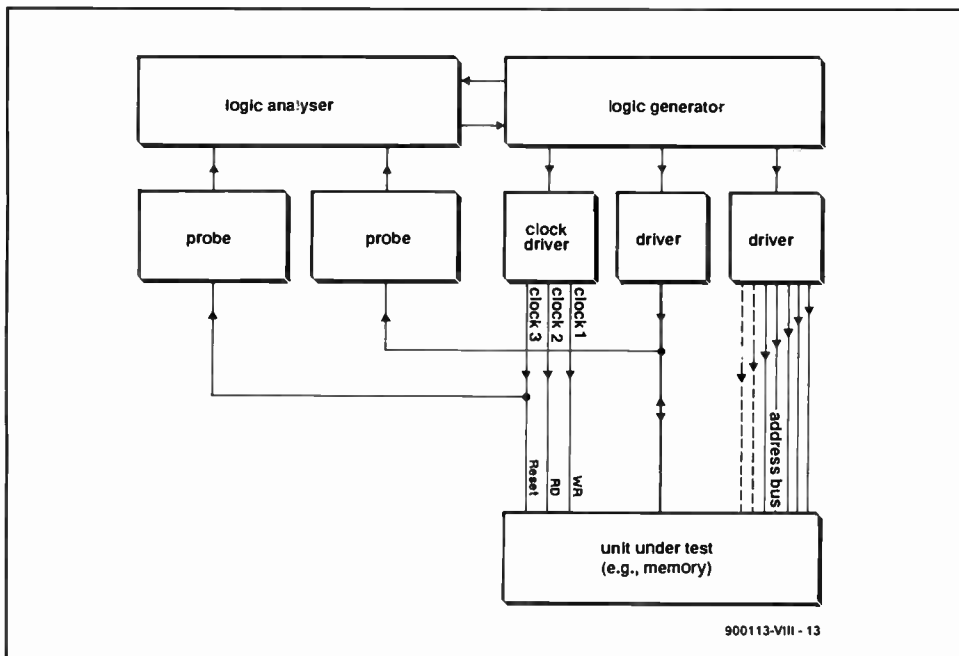

Fig. 4. Typical application of a combination of a logic analyser and a logic generator.

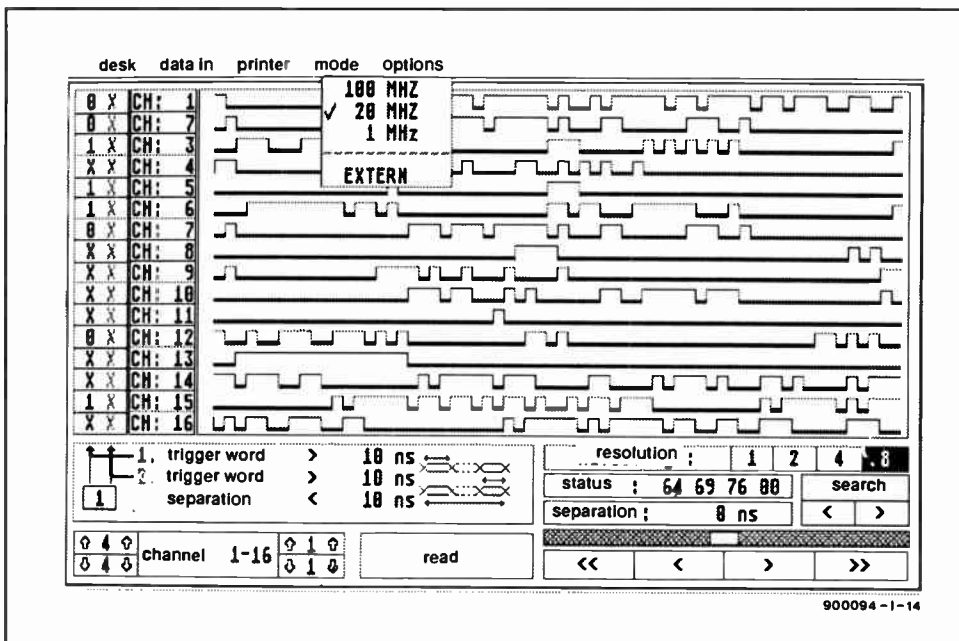

Fig. 5. Timing diagram displayed on a logic analyser.

ware as well as software; it measures data, that is, a pulse is considered as a bit with a value of 1 or 0, and not as a rectangular waveform with a certain amplitude. At the time of writing, logic analysers with up to 72 input channels are commercially available.

A combination of a logic analyser and a logic generator, which provides sample bits that can be fed to the circuit under test, is especially useful. It allows the analysis of circuit sections even when these are driven by external sources.

A typical application of such a combination is shown in Fig. 4, in which the unit on test is controlled via a data bus and an address bus. The logic generator provides the addresses, data input and clock, while the analyser records the test data.

The most important part of a logic analyser is the control computer, whose software serves to operate the analyser and to analyse and display the test results. In that process, it is necessary for the relevant information to be extracted from a vast mass of data. In the simplest case, it is only necessary for a given sample bit to be triggered. More complex systems permit triggering even when, for example, the operating conditions are normally set by one or a number of data buses.

Differences between various logic analysers, reflected in their price, are manifested particularly in the possibilities of data extraction and the way this is carried out.

The data display on the screen may take various forms. Apart from the usual timing diagram as shown in Fig. 5, which shows the behaviour of signals as a function of time, it is also possible for the status or the disassembler to be shown.

The status diagram shows the input channels in a circuit section that were determined previously by a configuration menu.

The disassembler diagram is particularly useful for an analysis of the interaction between hardware and software. The recorded data show the converted machine code of the computer system on test in mnemonic form. This process is called disassembly.

Every logic analyser is provided with special probes that facilitate proper connection of the many inputs to the unit under test. It is, of course, essential that fast pulse bursts be transmitted only via short lines that introduce no or negligible losses.

The probes contain drivers that amplify the signal prior to transmission to the appropriate analyser input.

Reference:

'Logic analyser' (5 parts), *Elektor Electronics*, January, February, April, June, July 1991.

24-BIT FULL COLOUR VIDEO DIGITIZER

The circuit presented here enables the Archimedes video digitizer described a few months ago to handle full-colour images at an impressive resolution of 24 bits.

by J. Kortink

THE idea to process colour pictures with the aid of the video digitizer was born shortly after the publication of Ref. 1. Although computer-based colour image processing is far from simple (even a super-VGA card can only show 256 colours at a time), there is a growing demand for digitized colour photographs. This is mainly on account of the widespread use of professional DTP (desk-top publishing) packages capable of supporting 24-bit colour illustrations with the aid of colour separation techniques.

The hardware and software described here was developed with DTP applications (on the Acorn Archimedes) in mind. The performance of the digitizer is quite impressive: it needs only 10 seconds or so to 'read' and display a colour photograph — much faster than many commercial products currently offered.

Colour images

For black and white screen images, only one 'ink' colour is used: usually black. A video image may be reproduced with digital means by scanning the image at a sufficiently high resolution (both as regards the number of pixels and the number of grey levels). The video digitizer has a resolution of 640×512 pixels at 256 grey levels. The reproduction on paper of the image requires the discrete grey levels to be transformed back into ink spots. On a computer screen, intensity modulation is used, while on paper grey levels are reproduced by controlling the size of the ink spots. Hence, the resolution of the printer attached to the computer determines the number of grey levels that can be reproduced. Most 300-dpi (dots per inch) laser printers are capable of reproducing 16 simulated grey levels. Professional image setting machines typically achieve 200 levels when

set to a resolution of 2400 dpi. Photographic paper has no such limitations, offering a virtually infinite number of grey levels.

In practice, 64 intensity levels are sufficient to faithfully reproduce a photograph. The 256 grey levels offered by the video digitizer are, therefore, ample for most applications.

Colour images on a computer screen are invariably made by 'building' individual picture elements from three primary colours. In the case of the video digitizer, use is made of the three additive primary colours red, green and blue (RGB model). By contrast, magazine and book printers traditionally use the subtractive primary colours cyan, magenta and yellow, to which is added black (CMYk model).

During the digitizing operation, the saturation of the three primary colours red, green and blue of each picture element is measured. This means that the image is actually scanned three times: once for the red components, once for the blue components, and once for the green components, the saturation of which is stored as a digital value in the computer memory. A digitized colour image is then obtained by combining the three scanned images containing the primary colours. This technique is not unlike that used in the graphics and printing industry, where colour separations are used to produce three or four plates (screens) that each represent a primary colour. The fourth plate represents black, and is used for the brightness information only. During the offset printing process, the images on the plates are printed over one another to give an image with composite colours. Note, however, that the individual picture elements are not printed on top of each other, but side by side with an accurately controlled distance (off-set). In this system, the black plate is theoretically not required, since black can be re-

produced with the three primary colours also. In practice, however, black so printed has a brownish hue. Grey levels are, therefore, printed with black ink, which avoids undesirable sub-colours.

Returning to computers, the number of colours is usually determined by the type of video card used. Fortunately, we may avail ourselves of mixing techniques to take the number of colours that can be shown on the screen over the number of colours actually available. This is achieved by dithering, or pixel combination. Unfortunately, dithering has the inherent disadvantage of reducing the overall picture resolution.

Dithering techniques are based on error distribution protocols developed by, among others, R.W. Floyd and L. Steinberg. These protocols allow the difference between the desired colour and that produced on the basis of the actually available colours to be made as small as possible. Unfortunately, we have to leave the subject of dithering at this brief description, since a discussion of the related techniques is beyond the scope of this article. The software developed for the present colour extension of the video digitizer does, however, provide pixel dithering routines.

The hardware

As already mentioned, the black and white video digitizer described in Ref. 1 is taken as the starting point. To be able to process colour images, the video information has to be supplied as RGB signals. Lacking an RGB output on your video equipment, existing composite video or S-VHS video signals have to be converted into RGB signals first. This may be done with a special converter — see Ref. 2. Cameras, video recorders, tuners and the like capable of producing RGB signals do not require an additional converter,

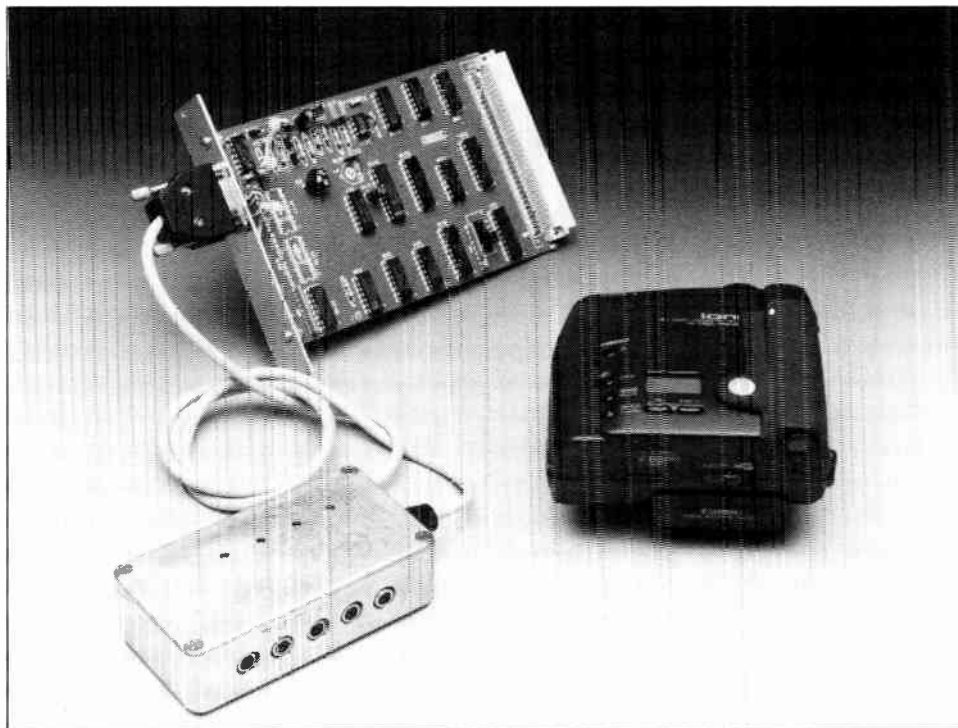

and can be connected direct to the input of the present circuit, which is basically an interface between the video source and the input of the video digitizer.

The circuit diagram of the RGB interface is given in Fig. 1. The circuit is really quite simple. Two control signals supplied by the digitizer select one of the four signal inputs via IC1a and four relays. As indicated, three inputs are used for the primary colours, and a fourth for a composite video signal, allowing black and white images to be digitized in a simple manner. The fifth input serves to pass the synchronization signals to the video digitizer. This input is not switched because the sync signals must always be present. Four LEDs are used to indicate which of the four video inputs is connected to the digitizer.

The printed circuit board used to build the interface is shown in Fig. 2. The construction is straightforward, and should not present problems to those of you who have already successfully built the video digitizer.

A small modification

The circuit of the video digitizer requires a small modification to be made before it can be used for the colour applications we have in mind. First, a 9-pin sub-D connector is fitted on the aluminium support bracket of the podule. This connector takes the place of the existing cinch or BNC socket. For the original black and white application of the digitizer, the video input is fed to the A-D converter (IC10) and the sync separator (IC11) via a buffer stage. Since for colour applications the synchronization and colour signals have to be applied separately, capacitor C18 is removed from the board, and a wire is sol-

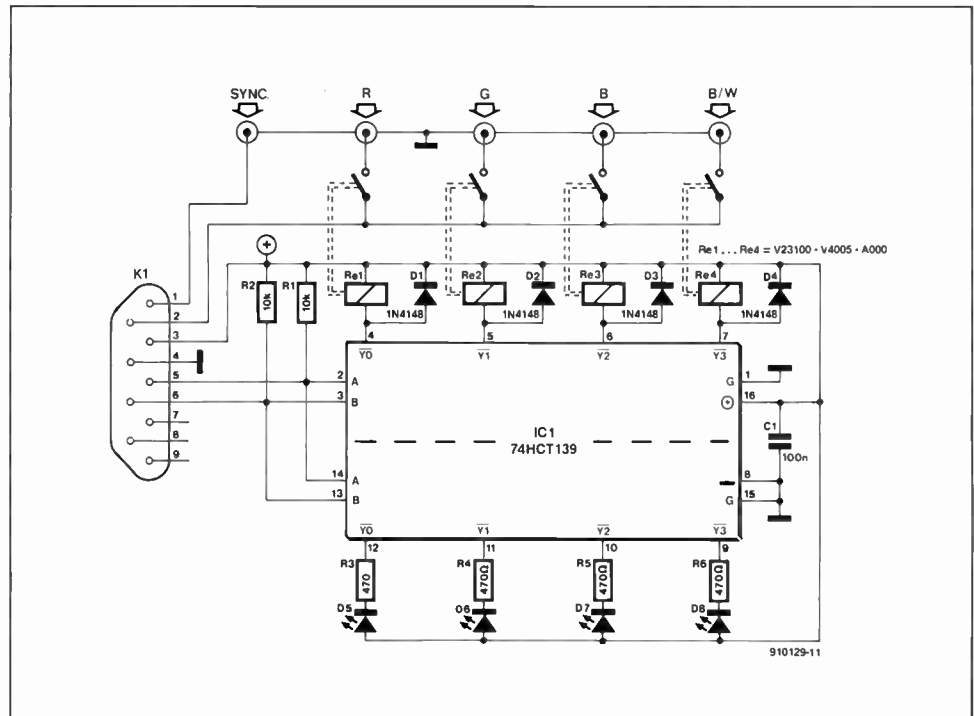

Fig. 1. Circuit diagram of the colour interface for the video digitizer.

dered to pin 2 of IC11. Next, a 100-nF capacitor (C18) is soldered between the free end of the wire and pin 1 of the D9 connector. The video signal is connected to pin 2, the power supply to pin 3, and ground to pin 4.

Finally, we need two control signals. These are supplied by IC15, a PCF8574 — one of the three optional I/O ICs on the podule. Fit this IC and the associated pull-up resistor array, R9, on the podule board. Output lines P0 and P1 (IB0 and IB1) are available on pins 1 and 2 of connector K2. These lines are connected to the D9 connector, for instance, to pins 5 and 6.

The colour interface is connected to the video digitizer via a 6-way cable terminated with D9 connectors at both ends.

The above modification still allows black and white images to be digitized without the interface when a video connector is used with a 9-pin D plug, of which pin 1 is connected to pin 2, i.e., the video signal is connected to these two pins, while ground is connected to pin 4.

Software: !GreyEdit

The control program for the colour version of the video digitizer is called !GreyEdit, and comes on a diskette (Archimedes format) supplied through the Readers Services under order number ESS 1631. All other functions in the program !VidiDigi (see Ref. 1) are also included on this disk.

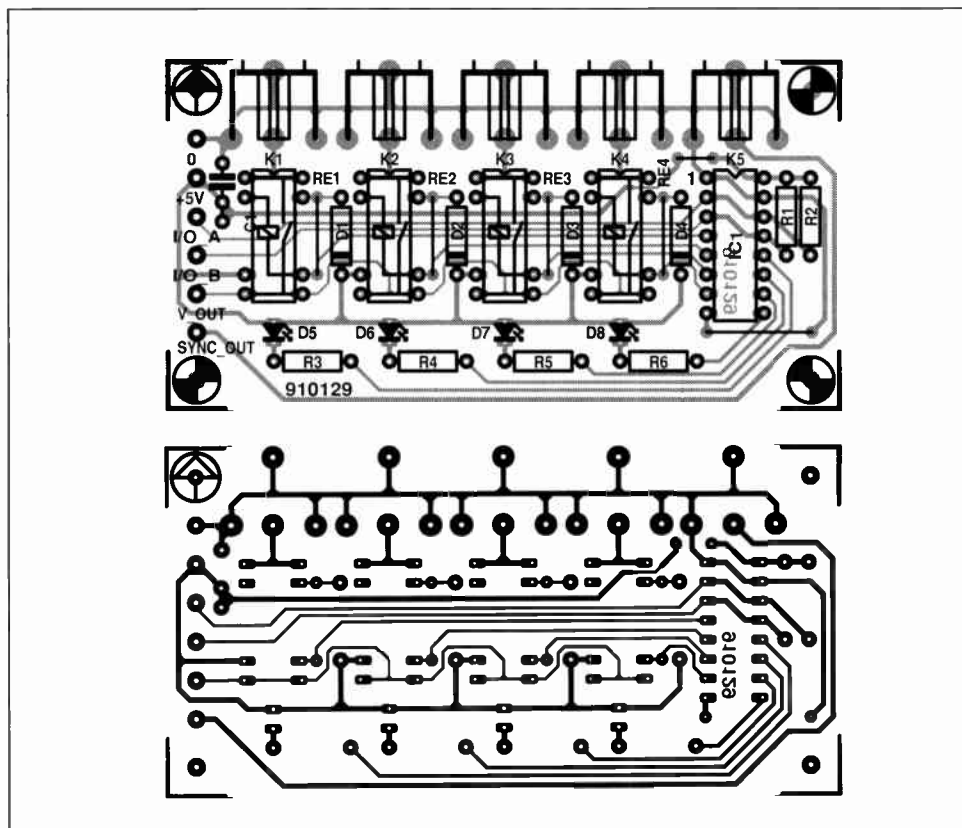

Fig. 2. Printed circuit board for the colour interface.

COMPONENTS LIST

Resistors:

2	10kΩ	R1;R2
4	470Ω	R3-R6

Capacitors:

1	100nF	C1
---	-------	----

Semiconductors:

1	74HCT139	IC1
4	1N4148	D1-D4
4	LED	D5-D8

Miscellaneous:

4	V23100-V4005-A000 (Siemens)	Re1-Re4
1	9-way sub-D plug, with hood	
1	9-way sub-D socket	
1	RCA (phono-) socket for PCB mounting	
1	enclosure, aluminium, size approx. 109x58x25 mm (e.g., Hammond 1590)	
1	control software on disk	ESS1631

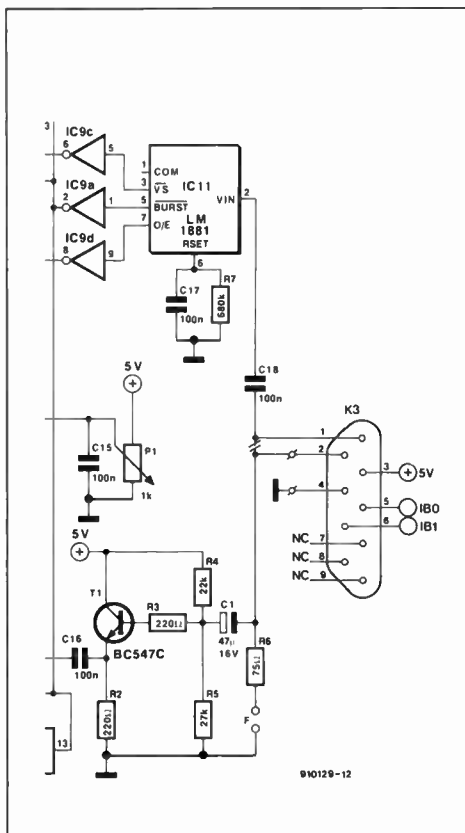

Fig. 3. The modifications to the original video digitizer are simple to make, while all functions are retained.

The digitizer functions are available via the 'digitizer' sub-menu. The buttons on the screen allow you to select one of the three primary colour signals, or the black and white signal. The selection must be indicated by the LEDs on the interface board. The program also has a utility that allows a colour image to be digitized automatically. On selecting this function, you are prompted to inform the computer where the digitized images are to be stored. Simply drag the icon to a directory on the diskette or hard disk. The digitizing operation starts immediately after this has been done. The files containing the red, green and blue information are stored successively in the indicated directory. The digitizing process is complete after

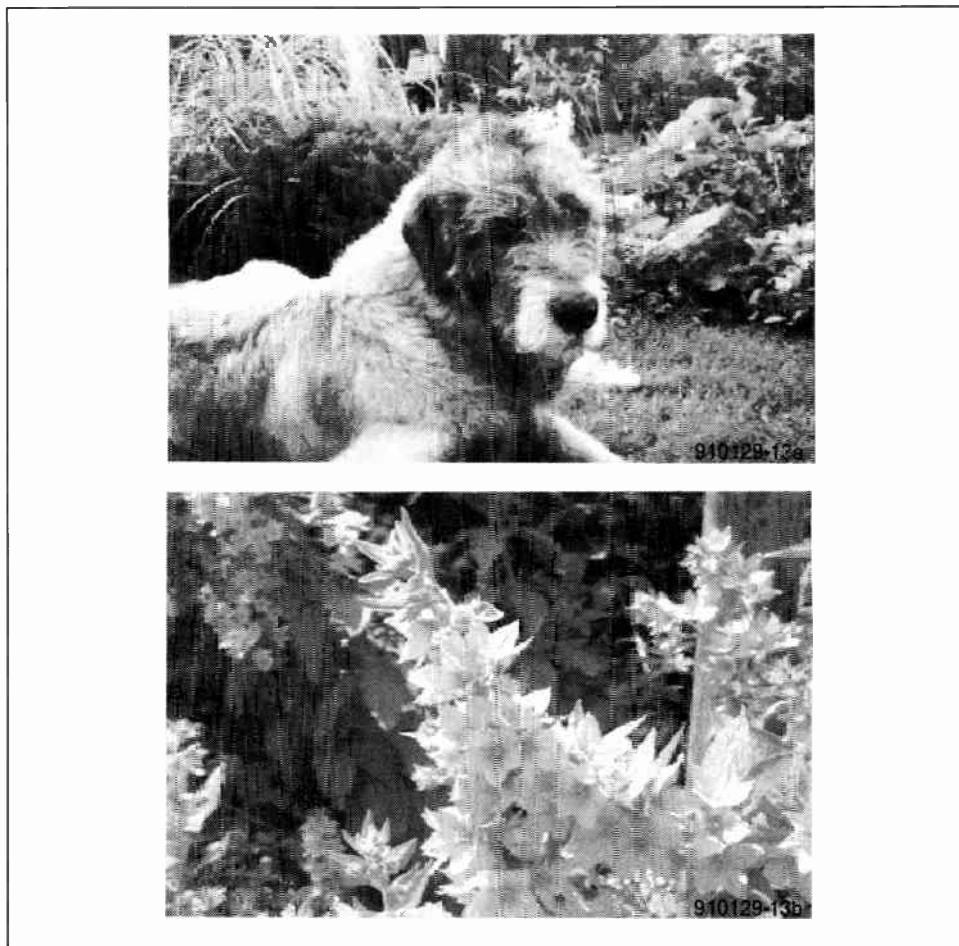

Fig. 4. Digitized photographs taken with a Canon ION. Use was made of the S-VHS output. Also, the picture was improved with the 'sharpen' function provided by the control software developed for the Acorn Archimedes.

three scans, and the R, G and B information is ready for combining into a new, larger, file. Drag the directory with the three primary colour files to the window marked !GreyEdit. Next, the program asks you where the photograph is to be stored (saved), and under what name. If everything works correctly, the colour photograph will be ready after a few seconds of number crunching activity. The photograph is written in the 'Clear' format and may be converted into a GIF, TIFF or PBM file with the aid of the !Creator utility. Mind you, the current versions of

the GIF protocol do not support 24-bit colours. It is, therefore, recommended to use the TIFF format to export files.

The picture may be edited with !Translator, which is supplied on the disk together with !GreyEdit and !Creator. Finally, note that the size of the image files requires a hard disk and a minimum memory of 2 MByte.

Black and white image enhancement

A couple of experiments with a Canon ION RC-260 camera showed that the quality of digitized black and white pictures can be improved considerably when a video source with an S-VHS (super-VHS) output is used. Where such a source is available, connect its luminance signal (pins 1 and 3) only to the digitizer. Results close to perfection may be obtained in this manner, particularly if the 'sharpen' function of !Greyedit is used. The two photographs in Fig. 4 were produced in this way. After digitizing, they were converted into Postscript, and printed on a Agfa Compugraphic Type 9800 photo typesetter. ■

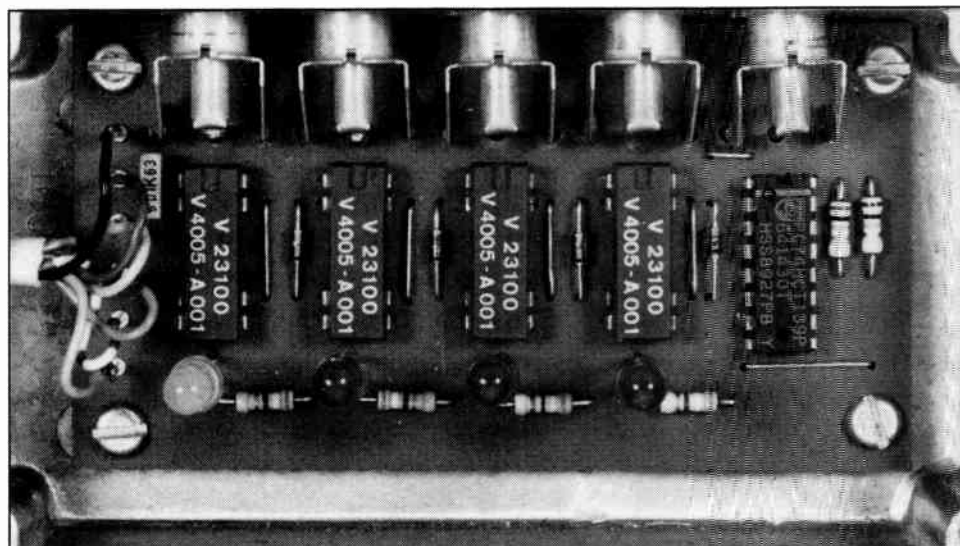

Fig. 5. Interface fitted in a compact enclosure. The unit is connected to the computer via a short flexible cable.

References:

1. Black-and-white video digitizer (for Acorn Archimedes). *Elektronics* July/August 1991.
2. S-VHS/CVBS-to-RGB converter. *Elektronics* September and October 1990.

DISSIPATION LIMITER

by C. Zschocke

THE secondary alternating voltage in power supplies stabilized with the aid of series regulators is normally calculated to ensure that with maximum output voltage and current the potential across the reservoir capacitor does not drop below the minimum voltage, U_r , required for satisfactory operation of the regulator. When the supply operates below maximum output voltage and current, the power that is then not required is converted into heat. Moreover, the design allows for maximum output voltage and current even when the mains voltage is at its lowest specified level.

The secondary voltage may well be specified too high, with the result that when the mains voltage is at its highest specified level and the power supply is open-circuited, the maximum permissible potential across the reservoir capacitor, and thus that at the input of the regulator, may easily be exceeded.

It is clear that in most power supplies, the specified voltage levels for the regulator and reservoir capacitor are needlessly high.

Possible solutions

The uneconomical design outlined above may be improved in several ways. It is, for instance, possible, with the aid of relays, to select secondary alternating voltages according to the load requirement. This is, however, possible only with a very special, and therefore expensive, mains transformer. Another possibility is to use phase gating control. This, however, requires fairly high switching currents and causes noise on the mains supply. Moreover, capacitors that can withstand high current pulses must be used and these are expensive.

A third method is used in the circuit presented here. In this, the charging of the reservoir capacitor is interrupted when a certain potential across the capacitor is reached. The circuit, which can be added to most existing

Dissipation in electronically regulated power supplies, manifested by heat, is a problem that is normally tackled by providing external heat sinks. The limiter presented here offers a more intelligent solution. It can be used as an add-on unit with virtually any power supply.

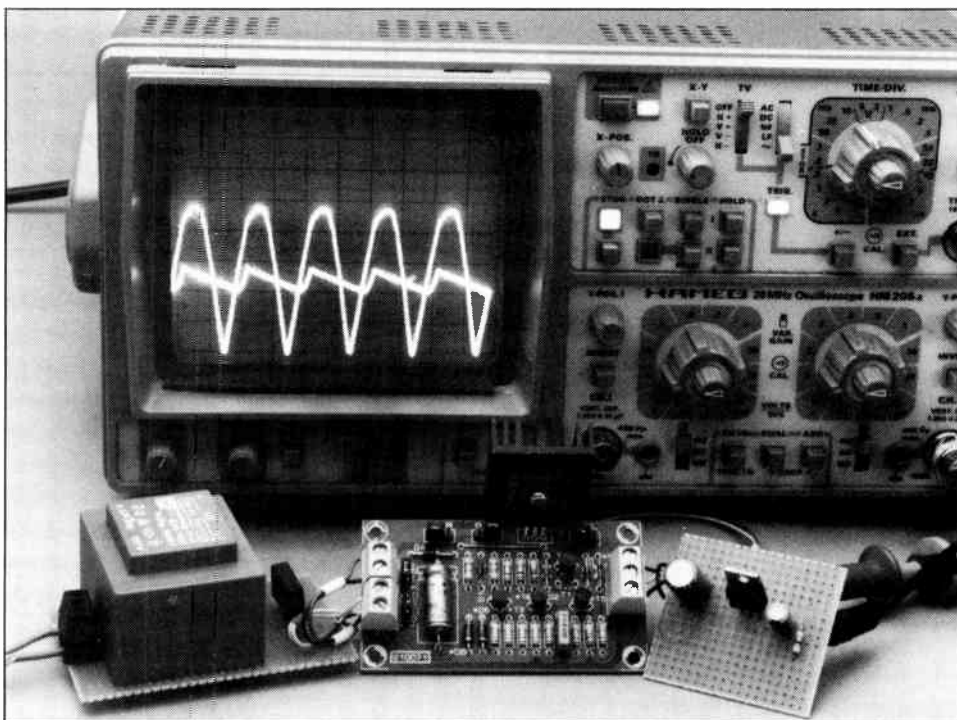

- regulated mains power supplies,
- minimizes the power dissipation;
- offers an additional reduction in dissipation during a short-circuit or during current limiting;
- is inexpensive to build;
- uses only standard, readily available components;
- needs only little space;
- is suitable for high-current supplies;

- can be used with positive and negative series regulators.

Principle of operation

In Figure 1, an electronic switch, for instance, a SIPMOS transistor, is inserted between the rectifier and the reservoir capacitor. At the start of each half cycle, the switch is on ($U_r > 3V$). A charging current flows into the capacitor

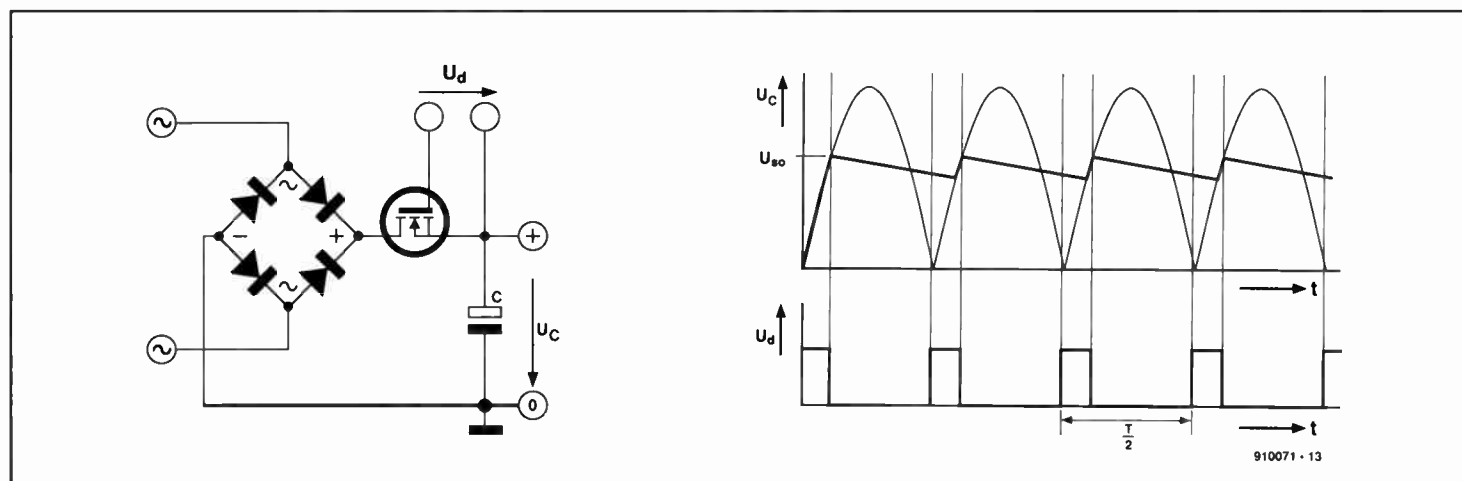

Fig. 1. Principle of operation of the dissipation limiter.

and the potential, U_c , across the capacitor follows the instantaneous level of the half-wave voltage. When U_c has reached the minimum level, U_{so} , required for the wanted output voltage, U_o , the charging current is switched off until the end of the half cycle. The level of U_{so} must be chosen to ensure that U_c does not drop below U_r until charging current begins to flow again at the start of the next half cycle. This voltage is the sum of the wanted output voltage, the drop across the regulator, U_d , and the voltage resulting from the discharging of the capacitor. The difference ΔU that is, the series switch-off voltage, $U_{so(m)}$, between U_r and U_{so} is easily determined, since it is directly proportional to the charging current; in fact, $\Delta U = It / C$, where I is the charging current, t is the time during which charging current flows, and C is the capacitance of the reservoir capacitor. Thus,

$$U_{so} = U_o + U_d + \Delta U$$

$$= U_o + U_d + It / C.$$

The time t is, in full-wave rectification, equal to a half cycle of the mains frequency, that is, $T/2$. Then,

$$U_{so} = U_o + U_d + IT / 2C.$$

If now the maximum permissible output current, $I_{o(m)}$ is substituted for I , the highest potential drop across the regulator (at the start of each half cycle) is

$$U_{so(m)} = U_{so} - U_o = U_d + I_{o(m)}T / 2C.$$

From this, the instantaneous dissipation, P_r , can be computed:

$$P_r = I_o U_{so(m)} = I_o [U_d + I_{o(m)}T / 2C - I_o T / 4C].$$

As an example: a power supply with a reservoir capacitor of 3300 μF is required to provide an output voltage of 0–15 V at a maximum current of 1 A. Since the potential drop across the regulator is 3 V, the voltage across the capacitor, U_c , must be at least 18 V. Without limiting, the maximum power loss, $P_{r(m)}$, in the regulator is $18 \times 1 = 18$ W (which is, for instance, the case when maximum current flows at very low output voltage as in a short-circuit condition).

With limiting, the voltage across the capacitor, U_{so} , needs to be only

$$U_{so} = U_o + U_d + I_o t / C =$$

$$= 0 + 3 + 1 \times 10^{-2} / 3300 \times 10^{-6} = 3.03 \text{ V.}$$

The maximum dissipation is reduced to

$$P_{r(m)} = I_o [U_d + I_{o(m)}T / 2C - I_o T / 4C].$$

Since $I_o = I_{o(m)}$,

$$P_{r(m)} = I_o (U_d + I_{o(m)}T / 4C =$$

$$= 1(3 + 1 \times 2 \times 10^{-2} / 4 \times 3300 \times 10^{-6}) = 4.5 \text{ W,}$$

which is an appreciable improvement.

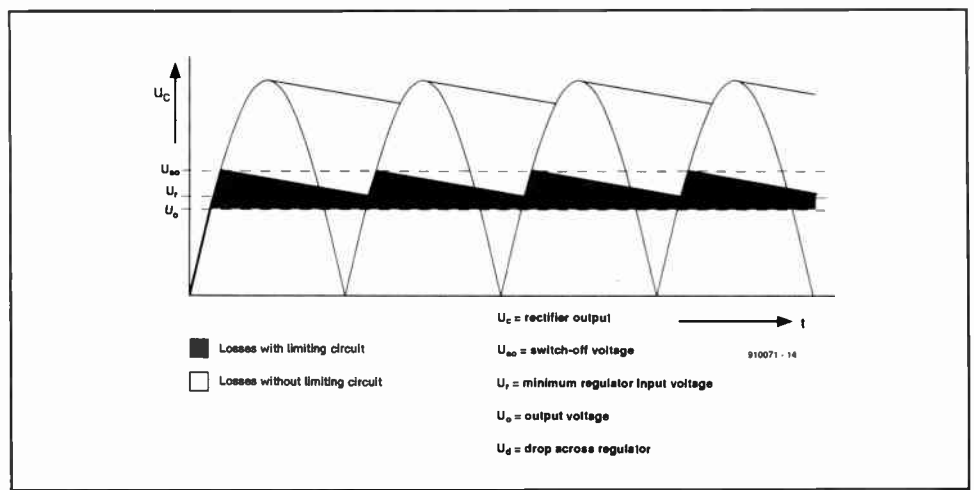

Fig. 2. Dissipation with and without limiter.

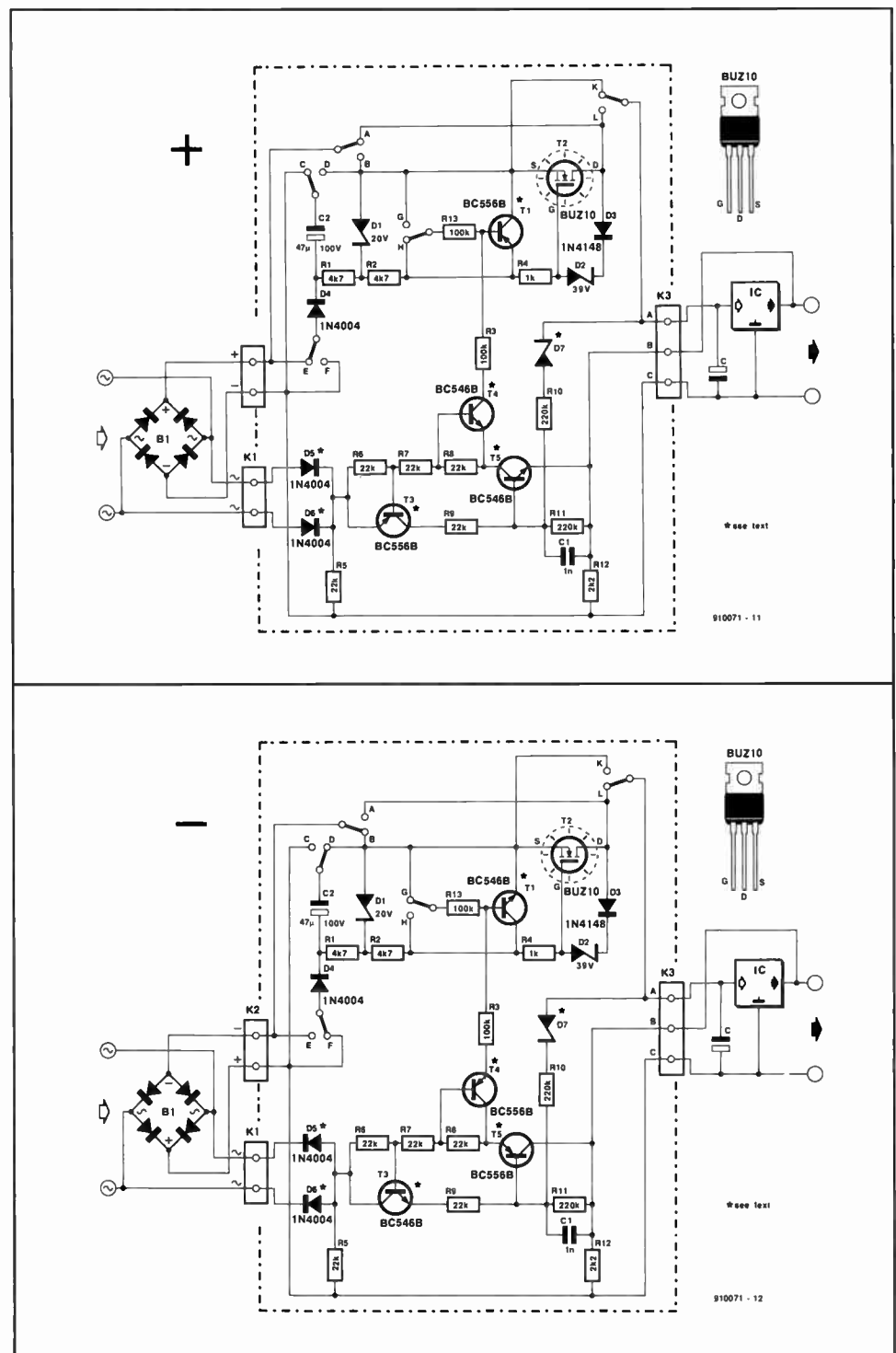

Fig. 3. Circuit diagram for both versions of the dissipation limiter.

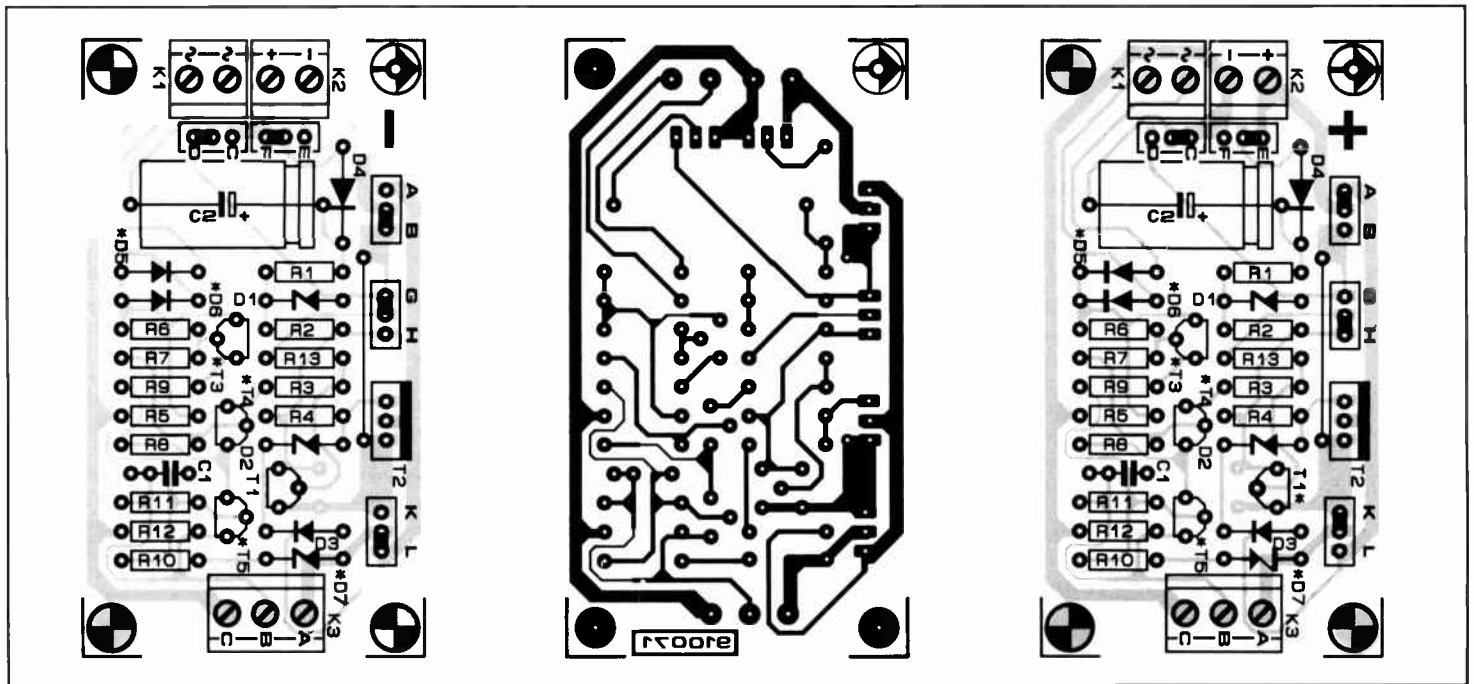

Fig. 4. Printed circuit boards are available for both versions of the dissipation limiter.

PARTS LIST

Resistors:

R1, R2 = 4.7 k Ω
 R3 = 100 k Ω
 R4 = 1 k Ω
 R5-9 = 22 k Ω
 R10, R11 = 220 k Ω
 R12 = 2.2 k Ω
 R13 = 100 k Ω

Capacitors:

C1 = 1 nF
 C2 = 47 μ F, 100 V

Semiconductors:

D1 = zener diode, 20 V, 400 mW
 D2 = zener diode, 39 V, 400 mW
 D3 = 1N4148
 D4-6 = 1N4004
 D7 = see text
 T1, T3 = BC556B (pos); BC546B (neg)
 T2 = BUZ10 or BUZ11 (see text)
 T4, T5 = BC546B (pos); BC556B (neg)

Miscellaneous:

Heat sink for T2
 PCB 910071

The practical circuit

The circuit in Fig. 3 may be split into the drive for the current switch, the switch itself (T_2) and a 'thyristor'. The thyristor is formed by transistors T_3 and T_5 ; its cathode is connected to the output terminal of the series regulator.

The thyristor is switched on via zener diode D_7 as soon as the voltage across the regulator exceeds the level fixed by the zener diode plus the b-e voltage of T_5 . It switches itself off just before the next zero crossing. To make certain that it does, it is decoupled from the rectifier and the inverse diode of T_2 via D_4 and D_5 , which are loaded by R_5 .

When the thyristor is on, T_4 switches T_1 on and this in turn switches T_2 off.

Transistor T_4 also serves, in conjunction with R_3 , to decouple the thyristor and the charging-current switch.

Diode D_4 and C_2 provide T_2 with the necessary switching voltage.

Zener diode D_1 protects the gate of T_2 against overvoltage.

The inductance of the mains transformer causes a high back e.m.f. when the charging current is switched off, and this may upset the correct operation of T_2 . This is prevented by D_2 and D_3 , which switch off T_2 as soon as the back e.m.f. exceeds the permissible reverse bias. A useful effect of the back e.m.f. is that it increases the potential across C_2 , which guarantees satisfactory switching of T_2 even when the output voltage is a maximum.

Resistor R_{12} ensures correct switching of T_2 when the output is not loaded (open circuit). It must be rated at $U_{o(m)}^2/R_{12}$ Watt. It may be omitted if the power supply is permanently loaded.

Transistor T_2 must be fitted, *insulated*, on its own heat sink or on that of the regulator.

Depending on the component values, the limiter may be used with secondary alternating voltages of up to 50 V_{peak}. It is not possible to say what the maximum load current can be without knowing the value of the reservoir capacitor and the specification of the mains transformer. What can be said is that the maximum charging current pulses must not exceed the maximum permissible current through T_2 , which is 19 A for the BUZ10 and 30 A for the BUZ11.

The limiter can be used without any problem in 5 A power supplies. The prototype operated satisfactorily with an output current of 10 A (reservoir capacitor was 10 000 μ F). It is always possible in doubtful cases to connect two or three SIPMOS transistors (T_2) in parallel.

Here are some tips for calculating the val-

ues or ratings of a number of components.

- The zener voltage of D_7 must be $U_{so} - 0.7$ V (U_{b-e} of T_5).
- The maximum reverse bias of T_2 must be greater than the peak value of the potential across the reservoir capacitor.
- The zener voltage of D_2 must be equal to the maximum reverse bias of T_2 minus 5 V.
- Capacitor C_2 must be rated at $U_{so(m)}$ plus 20 V (D_1).
- Transistor T_4 must be able to withstand voltages of $U_{so(m)}$ plus 20 V (D_1).
- Transistors T_3 and T_5 must have a reverse bias rating equal to the peak value of the secondary alternating voltage.
- Resistor R_{12} must be rated at $U_{o(m)}^2/R_{12}$ (watts).
- All connecting wires should be as short as possible and of appropriate thickness.
- The dimensions of the heat sink depend on the transformer, the reservoir capacitor and the maximum permissible short-circuit current.
- In most cases, it is possible to fit T_2 on the heat sink of the regulator.

Construction

The limiter described above is, of course, intended for positive voltages. One for negative voltages operates in a similar manner, but the polarity of some components must be reversed.

Whichever version is needed, it is best constructed on the appropriate printed-circuit board shown in Fig. 4. The differences between the two versions are indicated by an asterisk (*).

It is recommended to 'strengthen' the broad tracks by soldering thick, bare wire on them.

The completed unit is, as shown in Fig. 3, interposed between the rectifier and the reservoir capacitor. Short, heavy-duty wiring should be used. ■

DIGITAL FUNCTION GENERATOR – PART 2

by T. Giffard

THE ONLY connection between the PLL board and the discretely designed analogue parts of the generator is via plugs and sockets K_2 , K_5 , and K_8 . Pin 1 of these connectors carries the 32 Hz–3.2 MHz clock, which is converted in the various sections to a 1 Hz–100 kHz sinusoidal, rectangular or triangular signal. The other pins carry information about the selected decadic range.

Sine-wave converter

The conversion of the rectangular output signal of the PLL loop into a sinusoidal waveform takes place in three stages—see Fig. 17. The first of these is a digital-to-analogue (D–A) converter with serial input, IC_{26} – IC_{28} ; the second, a filter section that removes any unwanted harmonic frequencies; and the third, an output stage based on IC_{40} .

The D–A converter consists of two cascaded 8-bit shift registers, IC_{27} and IC_{28} , whose 16 outputs are fed via a single opamp, IC_{34} , to the filter section.

Before the first pulse arrives at the clock inputs of IC_{27} – IC_{28} , all 16 outputs of the registers are low, whereas inputs B are high. Input A of IC_{28} is low, but input A of IC_{27} is high, since the (low) level at pin 13 (QH) of IC_{28} is inverted by IC_{26d} . Therefore, when the first clock pulse is received, output QA

of IC_{27} goes high; on the second clock pulse, QB goes high (while QA remains high) and so on. When, on the eighth pulse, QH goes high, input A of IC_{28} becomes high, so that the outputs of this register also go high consecutively (QA → QH). After 16 clock pulses, all outputs of both registers are high, whereupon

input A of IC_{27} goes low, as explained earlier. The outputs then go low in succession until after a further 16 clock pulses the process repeats itself.

The high level at the outputs is 6 V and the low level is 0 V (earth). The values of the series resistors at the outputs have been cho-

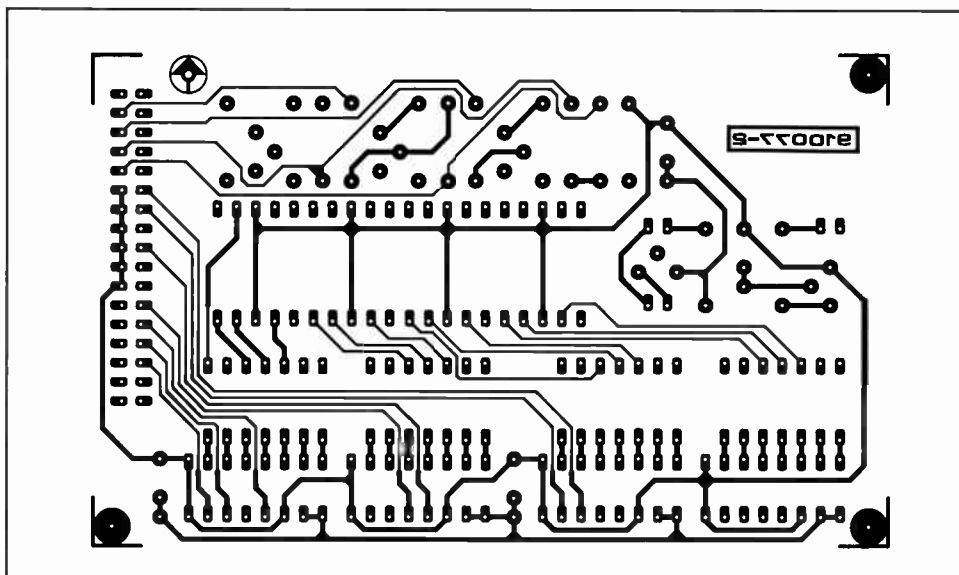

Fig. 13. Third overlay of the PCB for the analogue section of the function generator (belongs to Fig. 10)

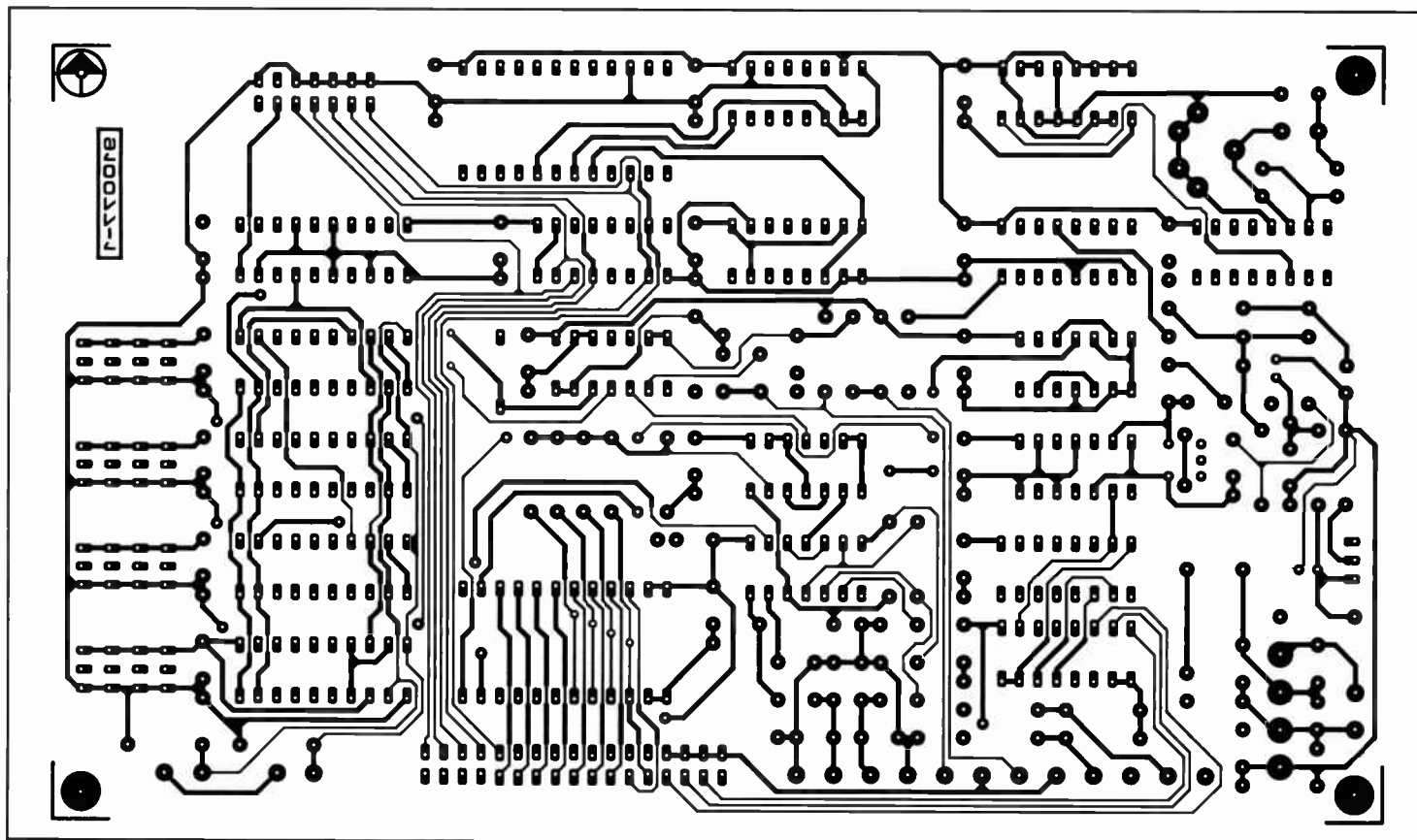

Fig. 14. Third overlay of the PCB for the digital section of the function generator (belongs to Fig. 7)

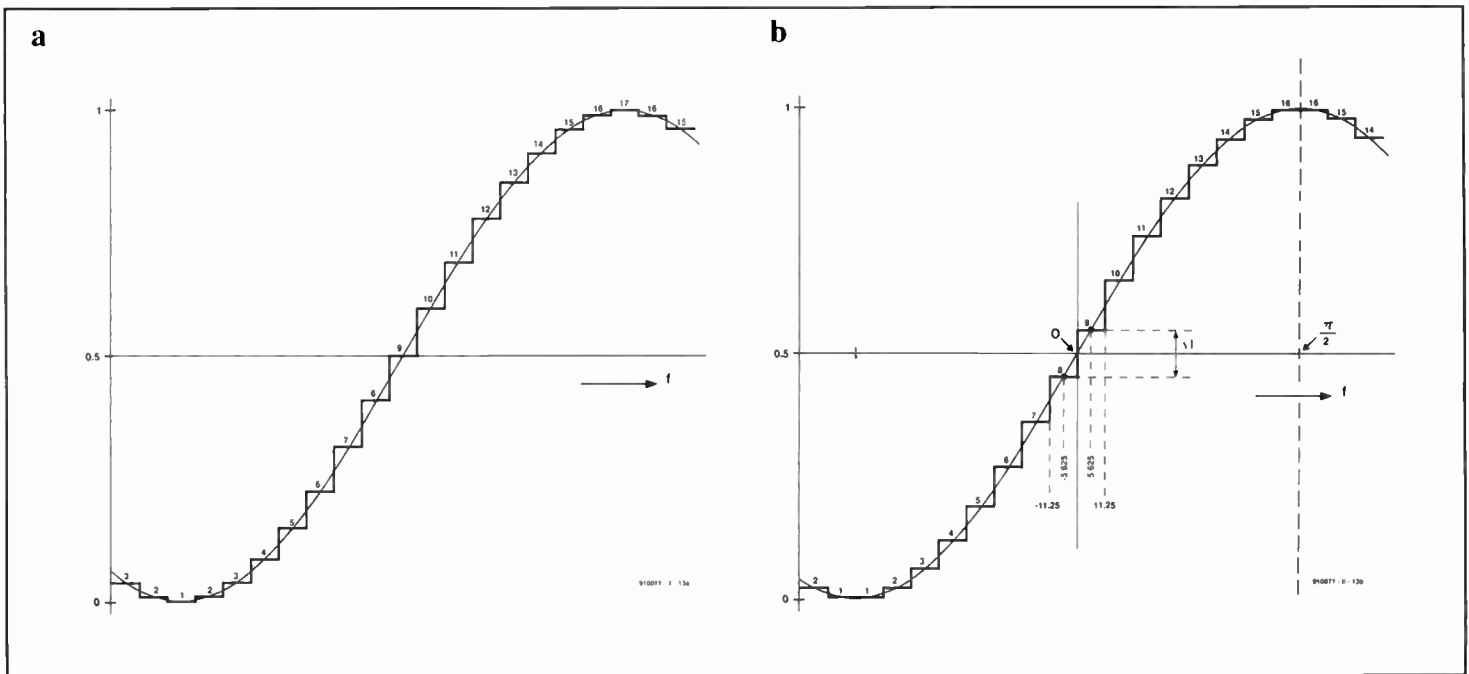

Fig. 15. Illustrating the two methods discussed to build up a sine wave from stepped voltages.

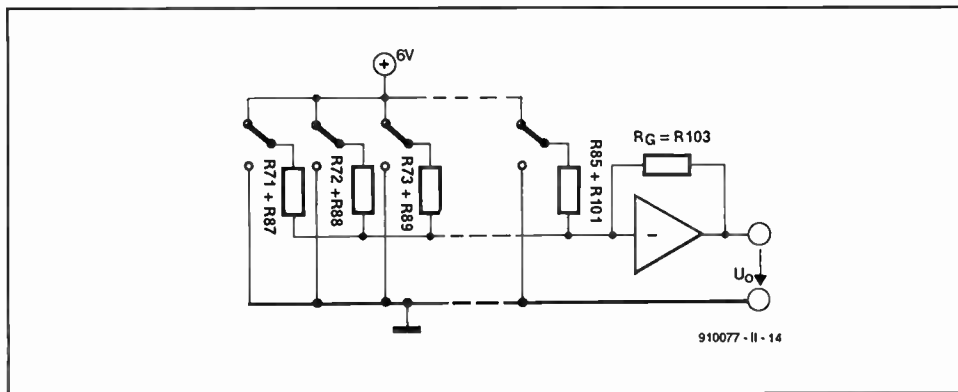

Fig. 16. Illustrating the fundamental operation of the digital-to-analogue converter.

Table 1

Data for computing the resistance networks in the digital-to-analogue converter

n	α_n	$\sin\alpha_n$	$\sin\alpha_n - \sin\alpha_{n-1}$	R_n
8	-5.625	-0.0980	0.1960	48 621.23
9	5.625	0.0980	0.1923	49 573.78
10	16.875	0.2903	0.1811	52 627.25
11	28.125	0.4714	0.1630	58 476.26
12	39.375	0.6344	0.1386	68 760.81
13	50.625	0.7730	0.1089	87 515.91
14	61.875	0.88119	0.0750	127 053.40
15	73.125	0.9569	0.0382	249 224.20
16	84.375	0.9952	0	
17	95.625	0.9952		

sen to ensure that the total current through the resistors is translated into a stepped output voltage as shown in Fig. 15. The computation of the resistance values is not simple, since more than one solution is possible.

The first method is also the most obvious: divide the sine wave into 32 equal parts, so that maximum and minimum values for the harmonic function are obtained. That means that 17 discrete values are required as shown in Fig. 15a. Fourier analysis shows that this method results in relatively high-level second and third harmonics.

An alternative method, used in the present design, is shown diagrammatically in Fig. 15b. It is based on the symmetry of a sine wave around the $\pi/2$ (90°) line. To the left and the right of this line, the corresponding steps are identical. Although the minimum and maximum values of the sine wave are not reached exactly, only a 16-step D-A converter is needed. Moreover, although the 31st and 33rd harmonic have roughly the same amplitude as those arising with the first method, the 2nd and 3rd harmonic are virtually absent.

The fundamental circuit for the second method is shown in Fig. 16. The maximum voltage is present when all resistors are connected to the 6 V source (high) and the minimum when all are at earth potential (low). In this method, resistors R_{86} and R_{102} in Fig. 17 are not used.

The computation of the resistance values is begun at a zero crossing (0°) of the sine wave. Then, one half of the resistors is at 6 V and the other half at 0 V. As an example, resistors R_{78} and R_{94} will be computed. First, the difference between the actual and the next higher value must be ascertained. After that it is only necessary to calculate the *additional* current that flows through the next higher resistance.

First, the period is divided into 32 equal intervals: $360^\circ/32=11.25^\circ$. From Fig. 15b, it is evident that the level of the output voltage between 0° and 11.25° must be the same

as the instantaneous value at 5.625° . Next, the sine of the angles $\alpha_n=5.625^\circ$ and $\alpha_{n-1}=-5.625^\circ$ is computed and the difference $\sin\alpha_n-\sin\alpha_{n-1}$ established. That difference is in direct proportion to the value of the resistance, that is, $R_{7n}+R_{94}$. In the above, n is the harmonic number.

The resistance is calculated in the manner used for an inverting opamp:

$$R_n = R_G U_{ref} / (\sin\alpha_n - \sin\alpha_{n-1}).$$

In the denominator, the value 0.196 (as given in Table 1) is substituted and multiplied by 1.4 (to obtain the r.m.s. value). Thus,

$$R_{7n}+R_{94} = 2224 \times 6 / 0.196 \times 1.4 = 48\,621.23 \, \Omega.$$

This value is roughly equal to preferred (E96) resistors of 47.5 k Ω and 1.1 k Ω in series. The small difference of just over 20 Ω is useful since the output resistance of the shift registers is 20–30 Ω . The higher resistance value (0.1%!) must be just *below* the nearest preferred value in the series. Table 1 gives the resistance values from the zero crossing up to the peak of the sine wave.

Since the sine wave is not only symmetrical around the $\pi/2$ line, but also with respect to the x -axis, the steps (1–8) in the negative half of the sine wave are identical to the corresponding ones in the positive half. It is, therefore, only necessary to compute the values for a quarter wave ($\pi/2$)—see the values of the appropriate resistors in Fig. 17. Note that the arrangement ensures that the minimum and maximum values of the output voltage remain constant for the duration of two clock pulses.

Operational amplifier IC₃₄ not only converts the current into a corresponding voltage, but also ensures that the 'zero' line is 1.2–1.8 V (set with P₁) above earth potential, so that a clean, symmetrical sine wave with an r.m.s. value of about 1 V is obtained. The amplifier is a BiFET Type AD711, which is characterized by a slew rate of 16 V/ μ s, low off-set voltage, low drift, good bandwidth-gain product (3 MHz at unity gain) and above all by an excellent transient response of $\pm 0.001\%$ in 1 μ s. Capacitors C₆₁ and C₆₂ remove any residual r.f. components from the signal and so ensure phase stability of the amplifier.

Locked filter

The filter consists of ten fourth-order low-pass sections, of which two are used for each decadic range. The discrete design offers real advantages as far as the harmonic spectrum is concerned over a simple switched filter with direct input of the clock pulses. The RC elements are switched on and off by analogue multiplexers Type 74HC4053, which have a very low transfer resistance. Each of the filter sections is buffered by a Type AD712 opamp.

The filter sections are fed with signals D1–D4 and the output of level comparator IC₁₇. It can be seen from Fig. 18 that the relevant section is active only when the corresponding decadic range D1–D4 is selected. The other sections are then short-circuited

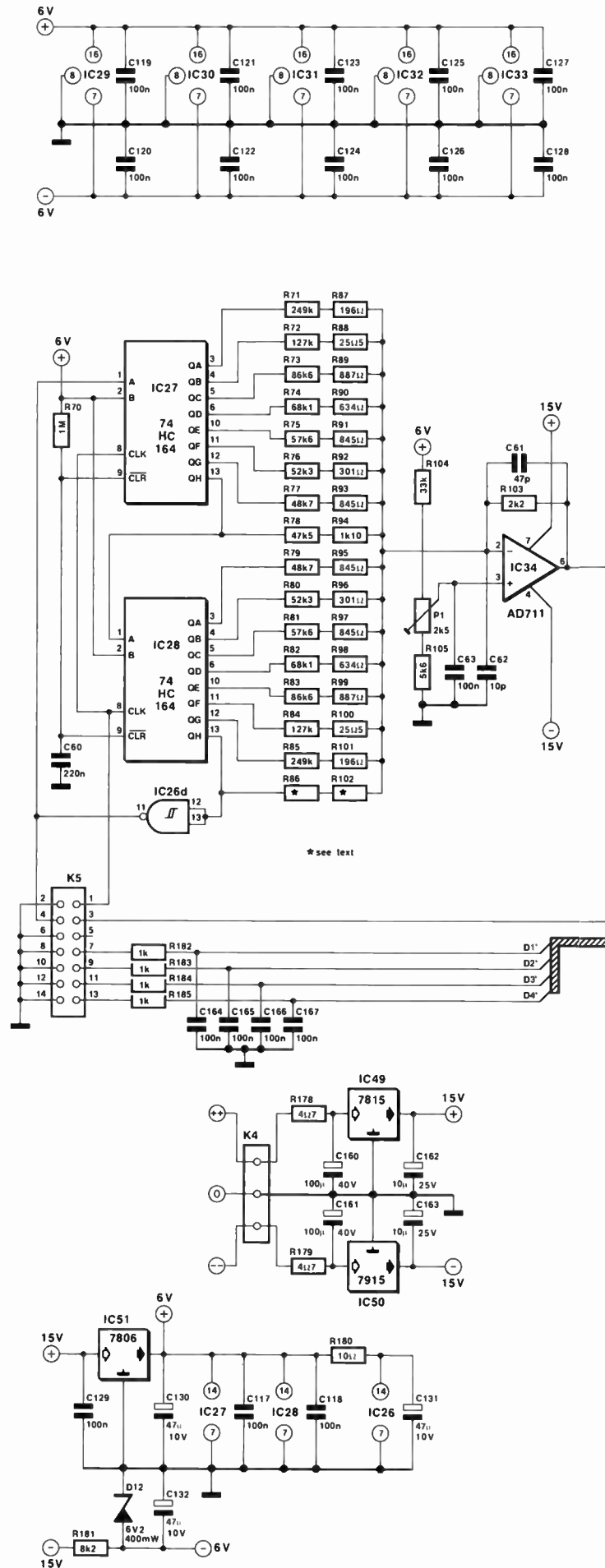
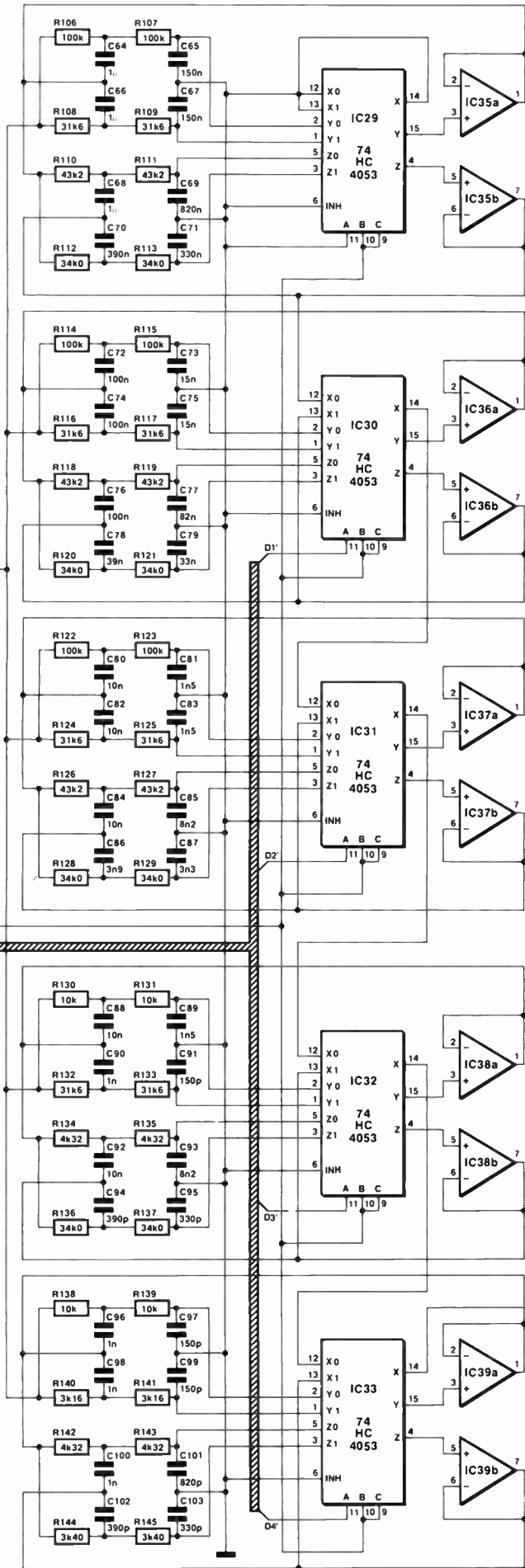
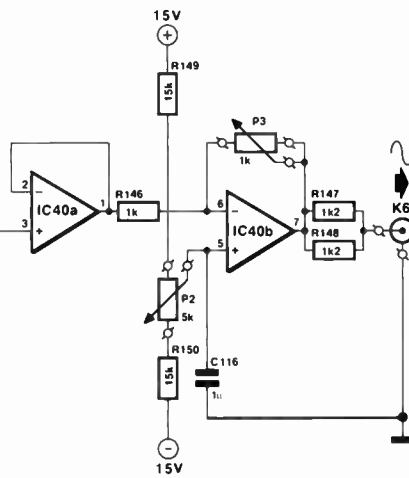
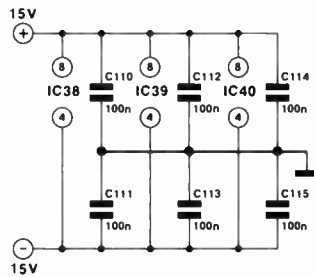
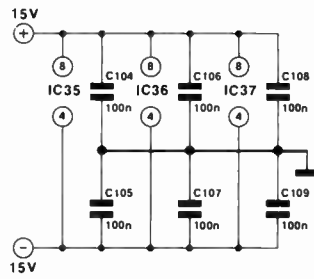
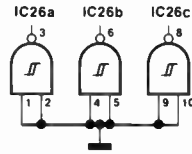

Fig. 17. Circuit diagram of the sine wave converter.



IC26 = 74HC132
 IC35 ...IC39 = AD712
 IC40 = NE5532



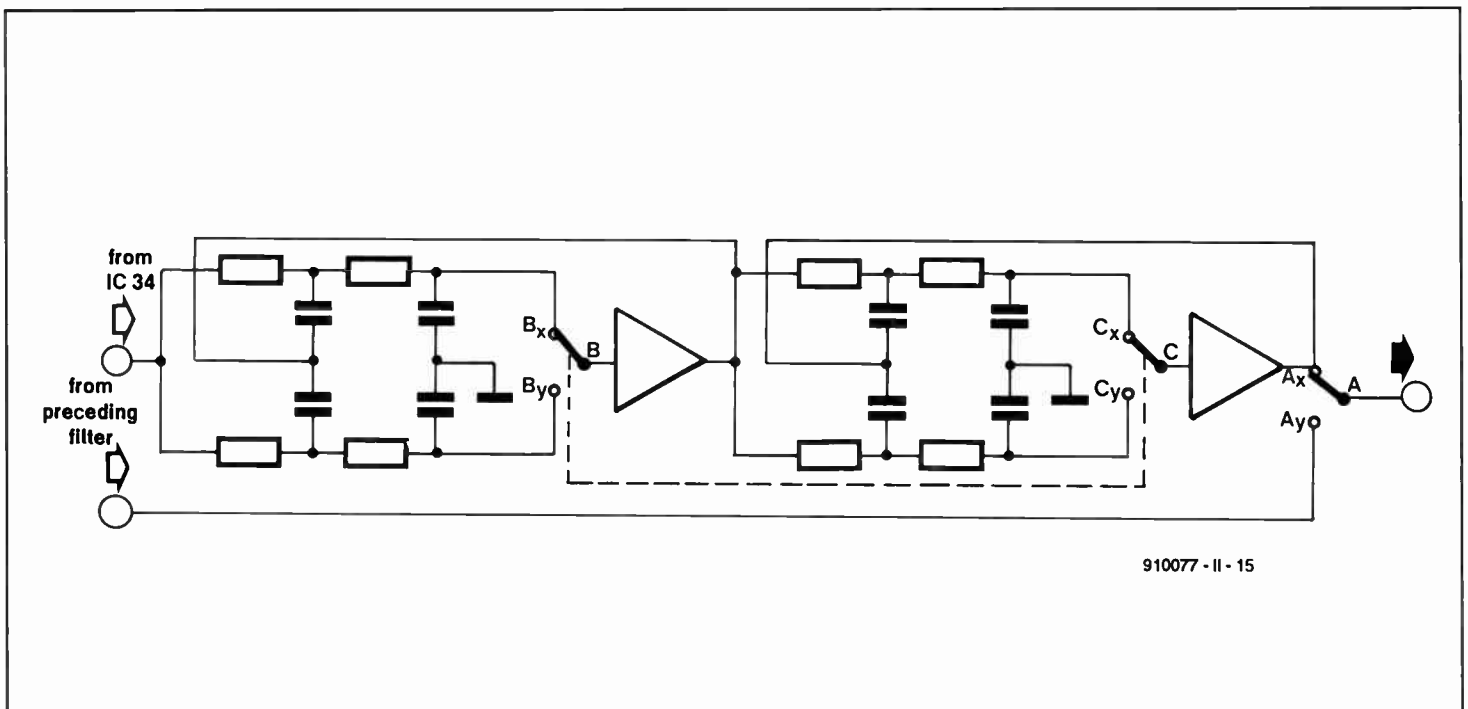

Fig. 18. Illustrating the fundamental operation of one of the five two-stage filter sections.

by switch A. The section for the lowest range is, however, always in circuit and, therefore, does not need signal D0. The other two switched inputs of the analogue circuit are strapped together.

When the ratio is lower than 3 200 (that is, when the frequency of the output signal is at the lower side of the decadic range), RC networks with different cut-off frequencies are switched in. In that way, the filter has an own frequency limit for the ranges $1-\sqrt{10}$ and $\sqrt{10}-10$ ($\sqrt{10}\approx 3.2$).

The main function of the filter is attenuating the harmonics. Theoretically, only the 31st and 33rd harmonics are significant. The 31st is 30 dB below the fundamental and is attenuated by a further 70 dB by the filter, so that ultimately it is -100 dB with respect to the output sine wave.

Unfortunately, the cut-off frequencies of the filter have to be calculated for the lowest signal frequency of the decadic range. This means that at higher frequencies the fundamental frequency may be attenuated by about 0.7 dB, owing to an inherent property of the Butterworth design used. This attenuation may be accentuated by the tolerances of the components. The top of the filter characteristic, therefore, has a ripple (≥ 0.7 dB). This may be remedied by using higher cut-off frequencies, which increases the distortion, or using a different filter design, for example, Chebishev with 0.1 dB ripple, which requires high-tolerance (that is, more expensive) components. Table 2 gives component values for a Butterworth filter with higher cut-off frequencies, which give an attenuation of the 31st harmonic of only 50 dB instead of 70 dB, but which guarantee a ripple of ≤ 0.05 dB.

The output stage, IC₄₀, uses the well-known Type NE5532 dual opamp. One part, IC_{40a}, functions as a simple impedance converter to decouple the filter. The other part, IC_{40b}, operates as an inverting amplifier. The off-

set voltage can be set between -4.75 V and +4.75 V with P₂.

The amplitude of the sine wave output can be set to 0-1 V with P₃. If a higher output level is required, P₃ can be replaced by a 2.2 k Ω type. The value of R₁₄₆ should not be reduced. Also, at higher amplification, it may be necessary to limit the off-set range by increasing the values of R₁₄₉ and R₁₅₀.

Rectangular and triangular waveform converter

The rectangular / triangular converter, whose circuit diagram is given in Fig. 19, is controlled by the clock from the sine wave converter that enters the circuit via pin 4 of K₈. That connector also feeds signals D0-D4 (con-

taining information on the selected decadic range) to the converter.

The clock signal is applied to the non-inverting input of opamp IC_{42b}, which transforms the asymmetrical 0-6 V to a symmetrical rectangular signal (± 15 V).

Circuit IC_{42b} is one section of a dual operational amplifier Type OP260. This is a rather special device that operates with negative current feedback—see Fig. 20. The inverting 'input' of this section is, in reality, the low-resistance output of a buffer amplifier, whose input is connected to the non-inverting input of the opamp. If the voltage at this input rises, the current through R₁ increases. Since the current drives an impedance converter, the output voltage also rises (in proportion to the increase in current). Consequently,

Table 2

Component values for higher cut-off frequencies

R106 = 100 k Ω	R107 = 113 k Ω	C64 = 680 nF	C65 = 100 nF
R108 = 31.6 k Ω	R109 = 35.7 k Ω	C66 = 680 nF	C67 = 100 nF
R110 = 37.4 k Ω	R111 = 38.3 k Ω	C68 = 820 nF	C69 = 680 nF
R112 = 14.3 k Ω	R113 = 14.7 k Ω	C70 = 680 nF	C71 = 560 nF
R114 = 100 k Ω	R115 = 113 k Ω	C72 = 68 nF	C73 = 10 nF
R116 = 31.6 k Ω	R117 = 35.7 k Ω	C74 = 68 nF	C75 = 10 nF
R118 = 37.4 k Ω	R119 = 38.3 k Ω	C76 = 82 nF	C77 = 68 nF
R120 = 14.3 k Ω	R121 = 14.7 k Ω	C78 = 68 nF	C79 = 56 nF
R122 = 100 k Ω	R123 = 113 k Ω	C80 = 6.8 nF	C81 = 1 nF
R124 = 31.6 k Ω	R125 = 35.7 k Ω	C82 = 6.8 nF	C83 = 1 nF
R126 = 37.4 k Ω	R127 = 38.3 k Ω	C84 = 8.2 nF	C85 = 6.8 nF
R128 = 14.3 k Ω	R129 = 14.7 k Ω	C86 = 6.8 nF	C87 = 5.6 nF
R130 = 10.0 k Ω	R131 = 11.3 k Ω	C88 = 6.8 nF	C89 = 1 nF
R132 = 31.6 k Ω	R133 = 35.7 k Ω	C90 = 680 nF	C91 = 100 pF
R134 = 3.74 k Ω	R135 = 3.83 k Ω	C92 = 8.2 nF	C93 = 6.8 nF
R136 = 14.3 k Ω	R137 = 14.7 k Ω	C94 = 680 pF	C95 = 560 pF
R138 = 10.0 k Ω	R139 = 11.3 k Ω	C96 = 680 pF	C97 = 100 pF
R140 = 3.09 k Ω	R141 = 3.40 k Ω	C98 = 680 pF	C99 = 100 pF
R142 = 3.74 k Ω	R143 = 3.83 k Ω	C100 = 820 pF	C101 = 680 pF
R144 = 1.43 k Ω	R145 = 1.50 k Ω	C102 = 680 pF	C103 = 560 pF

the current through feedback resistor R_2 also increases and this will result in an equilibrium in the current through the buffer amplifier. The OP260 thus operates with a very small buffer current. The design has the important advantage over conventional opamps of a very fast slew rate: $>1000 \text{ V}/\mu\text{s}$!

However, the operation is not entirely symmetrical as far as slope and amplitude are concerned. This is remedied by P_4 - R_{152} , which make the signal symmetrical, and R_{167} in conjunction with D_{18} - D_{21} which equalizes the negative and positive halves of the signal. This

arrangement ensures that the high slew rate is retained at very low signal levels.

The rectangular signal is available at relay contact re_1 .

The rectangular signal at the output of IC_{42b} is applied to operational transconductance amplifier (OTA) IC_{41a} via R_{154} . This amplifier has a slew rate of $125 \text{ V}/\mu\text{s}$; its operating point is set with P_6 . Because of the current source at its output (which sets an OTA apart from a 'normal' opamp), the OTA functions as a variable resistance. This means that in conjunction with a capacitor, C_{146} - C_{149} , it is

readily made into an integrator. The four capacitors each belong to a different decadic range; they are selected by two analogue integrated switches, IC_{45} and IC_{46} . Capacitor C_{146} is connected between the OTA and buffer amplifier IC_{42a} when the D_0 or D_1 line is active; C_{147} when D_2 is active; C_{148} when D_3 is active; and C_{149} when D_4 is active.

The use of a switch at either end of the capacitors is necessary, since the transfer resistance of the closed switch is not linear, but dependent on the supply voltage and the current through the switch. Switch IC_{45} is in

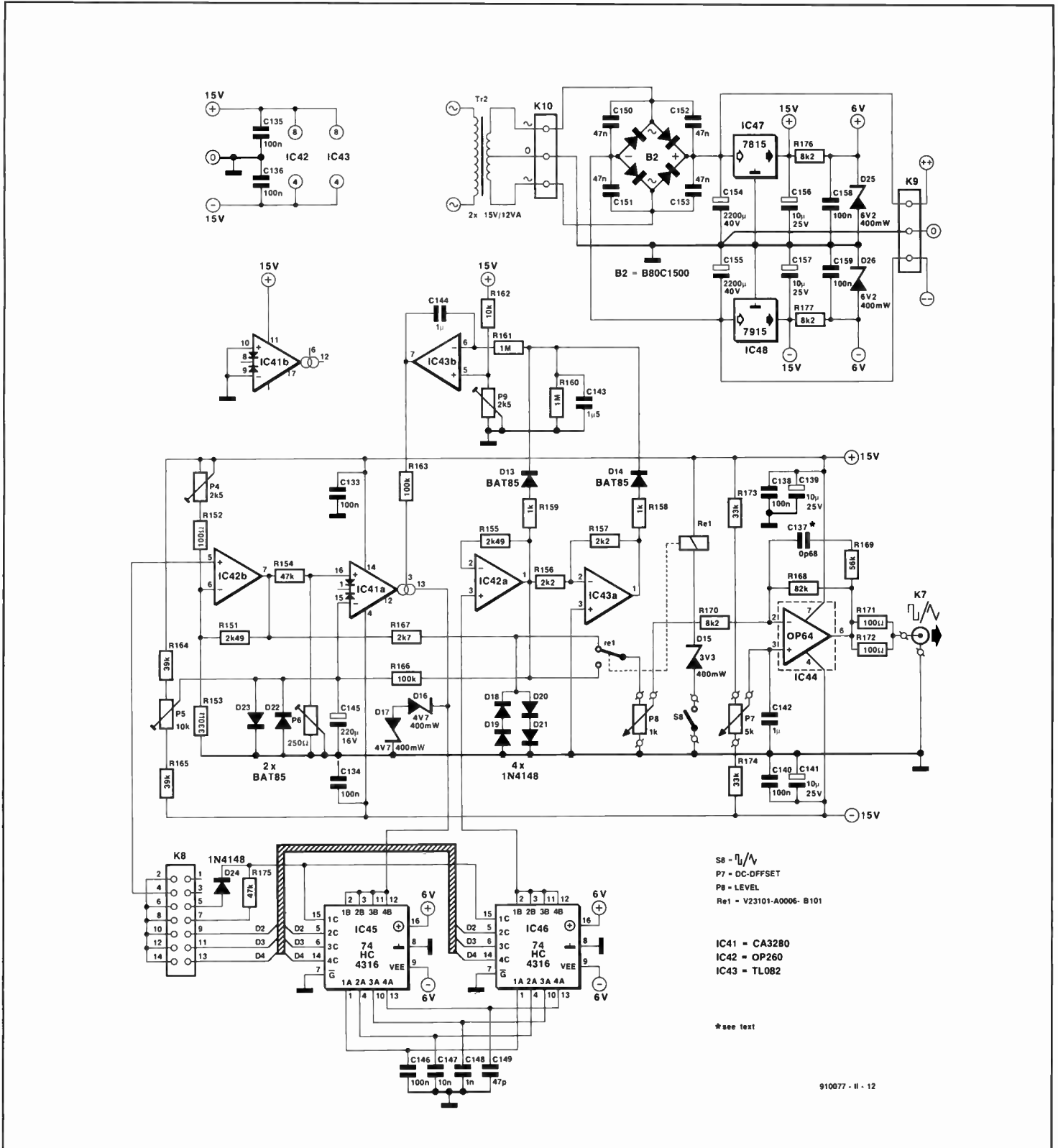

Fig. 19. Circuit diagram of the rectangular/triangular waveform converter.

the potential across C_{143} , the smaller the output voltage (=control voltage for the OTA). Since IC_{43b} tends to keep the voltage at its inverting input, and thus that across C_{143} , equal to that at its non-inverting input, the setting of P_9 will ultimately determine the peak value of the triangular signal.

A disadvantage of this design is that the regulating time, that is, the time span before the amplitude control operates correctly again

after a frequency change, is relatively long, because the time constant of the rectifier circuit has to be sufficiently long even at the lowest frequency. Since the regulating time also depends, to some degree, on the setting of P_6 , calibrating the two controls properly takes a little practice. This will be reverted to in the next instalment of the article.

The output of buffer IC_{42a} , like that of amplifier IC_{42b} , is applied to relay Re_1 . Which

of the two signals, rectangular or triangular, is fed to output stage IC_{40} , depends on the setting of switch S_8 .

The use of a relay obviates any problems with feedback of the rectangular/triangular signal to the sine wave signal (since both may be connected via one cable to the change-over switch on the front panel). One cable can, therefore, be used to take the signal to and from preset P_8 , which sets the peak value of

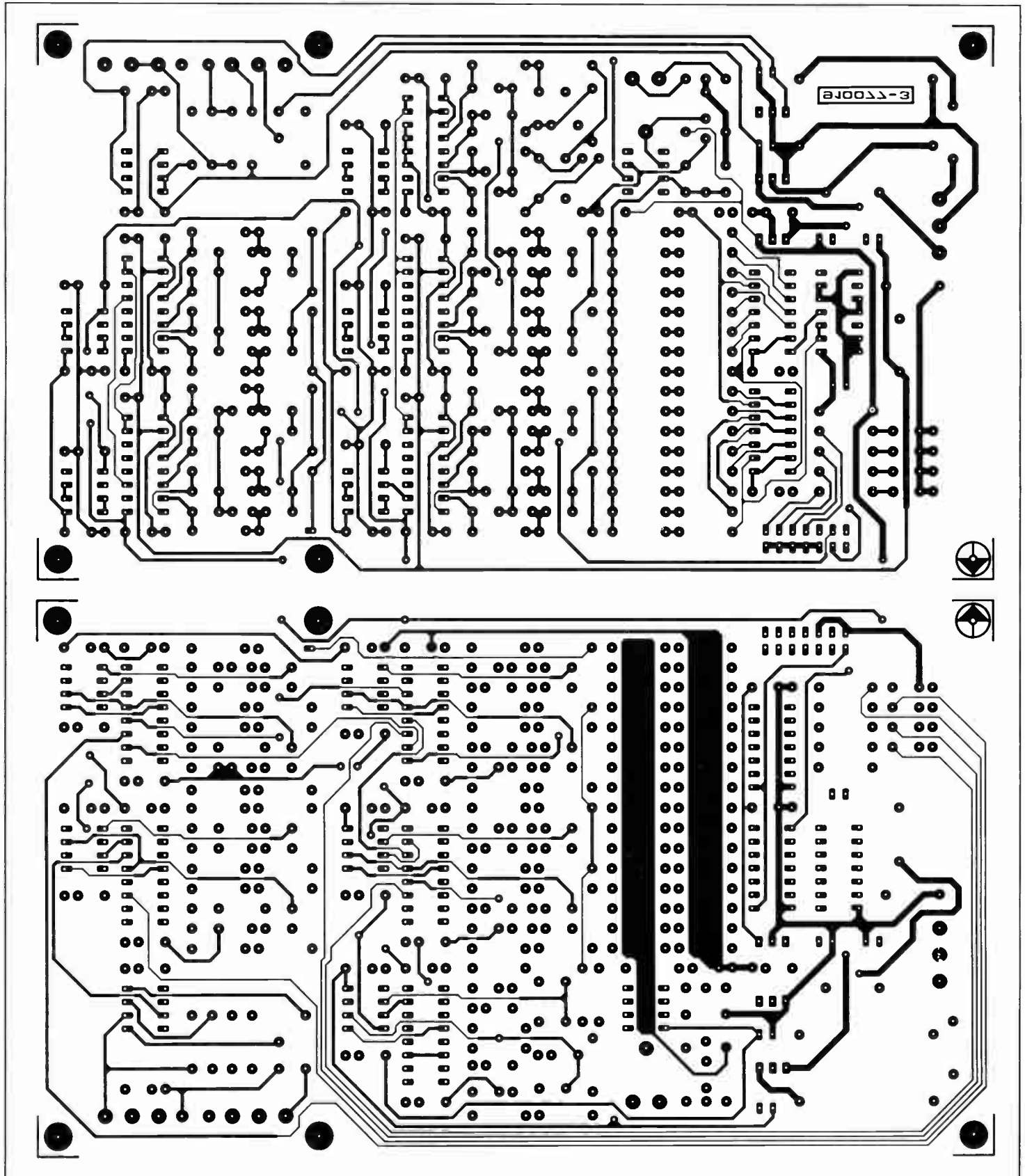

Fig. 22b. Printed-circuit board (track side and third overlay) for the rectangular/triangular converter.

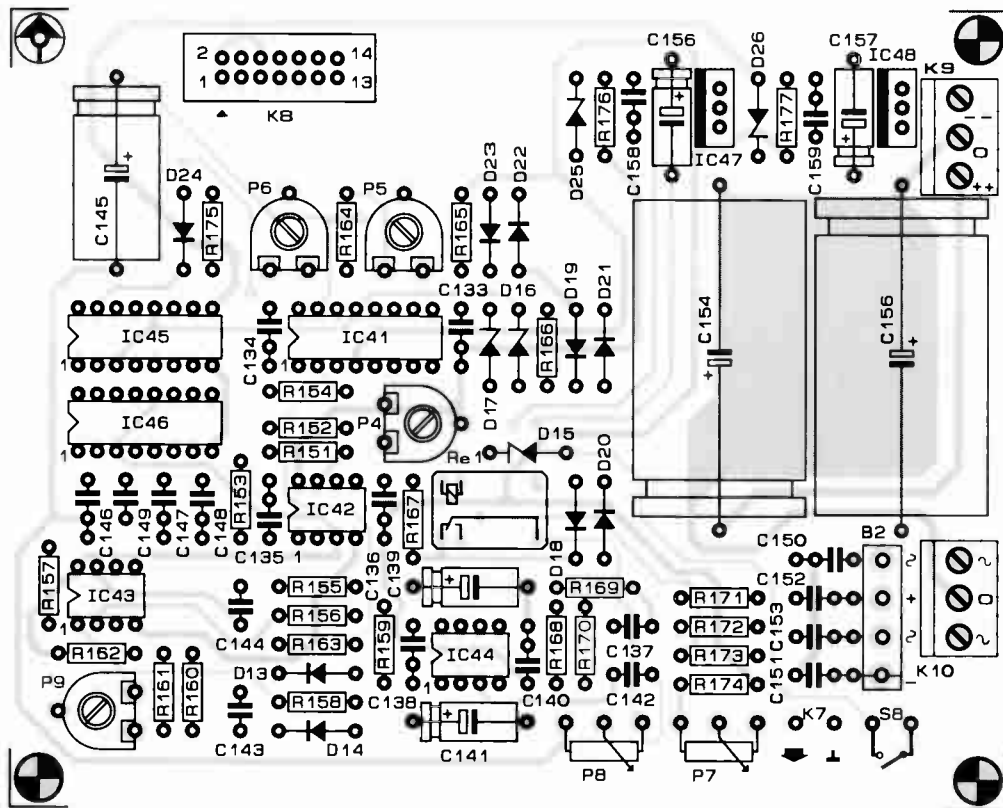

Fig. 23a. Printed-circuit board (component layout) for the sine wave converter.

Resistors:

R70, R160, R161 = 1 M Ω
 R71, R85 = 249 k Ω , 0.1%
 R72, R84 = 127 k Ω , 0.1%
 R73, R83 = 86.6 k Ω , 0.1%
 R74, R82 = 68.1 k Ω , 0.1%
 R75, R81 = 57.6 k Ω , 0.1%
 R76, R80 = 52.3 k Ω , 0.1%
 R77, R79 = 48.7 k Ω , 0.1%
 R78 = 47.5 k Ω , 0.1%
 R86, R102 = see text
 R87, R101 = 196 Ω , 1%
 R88, R100 = 25.5 Ω , 1%
 R89, R99 = 887 Ω , 1%
 R90, R98 = 634 Ω , 1%
 R91, R93, R95, R97 = 845 Ω , 1%
 R92, R96 = 301 Ω , 1%
 R94 = 1.1 k Ω , 1%
 R103, R156, R157 = 2.2 k Ω
 R104 = 33 k Ω
 R105 = 5.6 k Ω
 R106, R107, R114, R115, R122,
 R123 = 100 k Ω , 1%
 R108, R109, R116, R117, R124, 125,
 R132, R133 = 31.6 k Ω , 1%
 R110, R11, R118, R119, R126,
 R127 = 43.2 k Ω , 1%
 R112, R113, R120, R121, R128, R129,
 R136, R137 = 34 k Ω , 1%
 R130, R131, R138, R139 = 10 k Ω , 1%
 R134, R135, R142, R143 = 4.32 k Ω , 1%
 R140, R141 = 3.16 k Ω , 1%
 R144, R145 = 3.4 k Ω , 1%
 R146, R158, R159, R182–185 = 1 k Ω
 R147, R148 = 1.2 k Ω
 R149, R150 = 15 k Ω
 R151, R155 = 2.49 k Ω , 1%
 R152, R171, R172 = 100 Ω
 R153 = 330 Ω
 R154, R175 = 47 k Ω
 R162 = 10 k Ω
 R163, R166 = 100 k Ω
 R164, R165 = 39 k Ω
 R167 = 2.7 k Ω

PARTS LIST

R168 = 82 k Ω
 R169 = 56 k Ω
 R170, R176, R177, R181 = 8.2 k Ω
 R173, R174 = 33 k Ω
 R178, R179 = 4.7 Ω
 R180 = 10 Ω
 P1, P4, P9 = preset, 2.7 k Ω
 P2, P7 = potentiometer, 5 k Ω , linear
 P3 = potentiometer, 1 k Ω , log.
 P5 = preset, 10 k Ω
 P6 = preset, 250 k Ω
 P8 = potentiometer, 1 k Ω , linear

Capacitors:

C60 = 220 nF
 C61, C149 = 47 pF, polyester
 C62 = 10 pF, polyester
 C63, C72, C74, C76, C104–115,
 C119–129, C146 = 100 nF
 C64, C66, C68, C116, C142, C144 = 1 μ F
 C65, C67 = 150 nF
 C69 = 820 nF
 C70 = 390 nF
 C71 = 330 nF
 C73, C75 = 15 nF
 C77 = 82 nF
 C78 = 39 nF
 C79 = 33 nF
 C80, C82, C84, C88, C92, C147 = 10 nF
 C81, C83, C89 = 1.5 nF
 C85, C93 = 8.2 nF
 C86 = 3.9 nF
 C87 = 3.3 nF
 C90, C96, C98, C100, C148 = 1 nF
 C91, C97, C99 = 150 pF, polyester
 C94, C102 = 390 pF, polyester
 C95, C103 = 330 pF, polyester
 C101 = 820 pF, polyester
 C117, C118, C133–136, C138, C140, C158,
 C159, C164–167 = 100 nF, ceramic
 C130, C131 = 47 μ F, 10 V, tantalum

C132 = 47 μ F, 10 V, radial
 C137 = see text
 C139, C141, C156, C157 = 10 μ F, 25 V
 C143 = 1.5 μ F
 C145 = 220 μ F, 16 V
 C150–153 = 47 nF, ceramic
 C154, C155 = 2200 μ F, 40 V
 C160, C161 = 100 μ F, 40 V
 C162, C163 = 10 μ F, 25 V, radial

Semiconductors:

D12, D25, D26 = zener, 6.2 V, 400 mW
 D13, D14, D22, D23 = BAT85
 D15 = zener, 3.3 V, 400 mW
 D16, D17 = zener, 4.7 V, 400 mW
 D18–21, D24 = 1N4148
 B2 = B80C1500
 IC26 = 74HC132
 IC27, IC28 = 74HC164
 IC29–33 = 74HC4053
 IC34 = AD711
 IC35–39 = AD712
 IC40 = NE5532
 IC41 = CA3280
 IC42 = OP260
 IC43 = TL082 or TL072
 IC44 = OP64
 IC45, IC46 = 74HC4316
 IC47, IC49 = 7815
 IC48, IC50 = 7915
 IC51 = 7806

Miscellaneous:

K4, K9, K10 = 3-way PCB connectors
 K5, K8 = 14-way D-type plug
 K6, K7 = BNC socket, insulated
 Re1 = 12 V relay, 1 change-over contact
 S8 = miniature on/off switch
 Tr2 = mains transformer, 2x15 V, 12 VA
 Heat sink for IC44 (e.g., Fischer ICK14/16B)
 [Dau UK Ltd, phone (0243) 553 031]
 Enclosure, Telet LC970 (C-I Electronics, p.5)
 PCB 910077-3
 PCB 910077-4

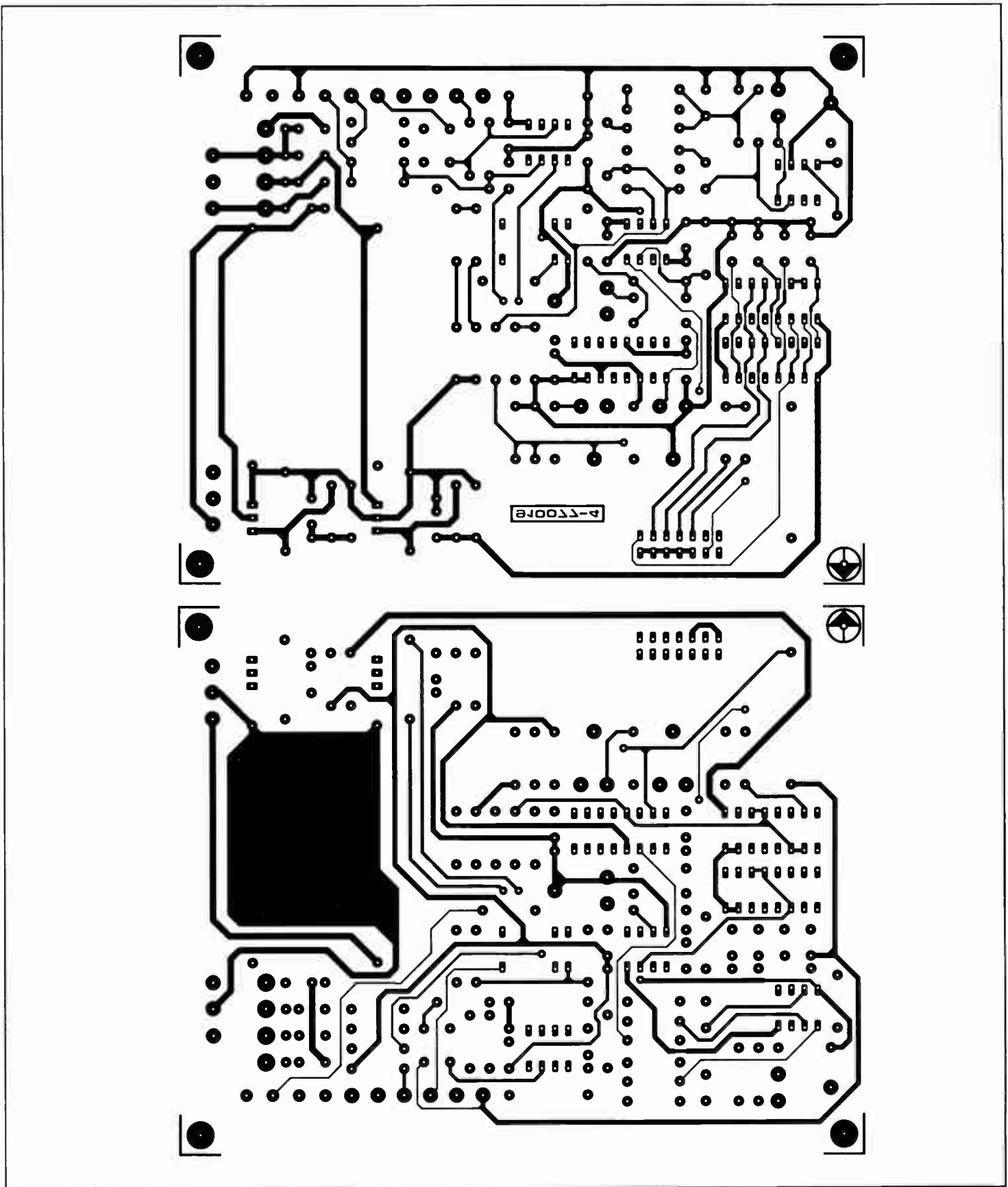

Fig. 23b. Printed-circuit board (track side and third overlay) for the sine wave converter.

the output.

The signal is amplified once more in IC₄₄. This opamp can provide a relatively high output current of ± 80 mA at a slew rate of 130 V/ μ s, so that no difficulties arise with loads down to about 150 Ω . Since R₁₇₁ and R₁₇₂ fix the output resistance at 50 Ω , the minimum load resistance may be as low as 100 Ω . Note that

the OP64 is *not* protected against short circuits and must be fitted on to a special heat sink (see parts list).

The OP64 tends to be overdriven by a rectangular signal. Network R₁₆₉-C₁₃₇ in the feedback loop, therefore, reduces the amplification at high frequencies (that is, the 'corners' of the rectangular signal) slightly.

Capacitor C₁₃₇ consists of two pieces of enamelled copper wire twisted together and cut to size as required.

The d.c. component of the output voltage, ± 12 V, is set with P₇. ■

The third and final instalment of this article will appear in our Special Large Christmas issue.

PRODUCT MODELLING

by R.G. Evans

EVER since I made my first circuit (a crystal radio) some twenty years ago, I have faced the problem of packaging the finished circuit. The methods I will describe can sensibly replace the aluminium or diecast boxes, the 'project boxes' sold by many of the mail order outlets, and at the same time provide very realistic cases tailor-made to your projects requirements, looking just like (or sometimes better) than the 'real thing'. It is perhaps worth mentioning that I teach Design & Technology in a secondary school (ages 11-18), and that my colleagues and I use this technique with our pupils aged 14 and above. The outstanding results obtained by these beginners should spur many of the readers of this magazine on to have a go themselves.

Basic tools and materials

I mentioned that I work in a school which has workshops and power tools, but these facilities are by no means necessary. Most electronics enthusiasts will have the tools required for making their own project box:

- A 'stanley' type knife with a scoring blade (or grind your own from a blunt ordinary knife). If this is not available, a suitable tool can be made from an old hacksaw blade suitably shaped and given a simple handle.
- A try square of any shape or size.
- A sanding board — any material that is flat will do, e.g., a piece of kitchen worktop, blockboard etc. It must be **flat**. To this glue a whole sheet of 120 grit 'wet or dry' silicon carbide paper, and leave it weighted down to dry.
- A workbench (kitchen table??) and, if possible, some form of vice, e.g., a Workmate or a wood or metal vice.
- A selection of files, or at least **one** (fairly coarse and fairly fine will do).
- A tenon-saw, although with care an ordinary hacksaw will suffice.

Useful, but by no means essential:

- A wood plane of any type, a small bandsaw and a sanding wheel (photo 1 shows a useful assemblage of the above).

Hopefully, the reader will have at least some of the above in his or her possession. The next thing to do is to acquire the essentials from which to make the boxes. Polystyrene is the type of plastic to get hold of (not the expanded ceiling tile stuff) Any colour will do, and two thicknesses are needed: 1.0 mm and 3.0 mm. Combinations of these thicknesses will cover most of our needs. The other main requirement is a suitable solvent with the name **dichloromethane**, also known as **methylene chloride**. This is available from laboratory chemical suppliers, some model shops (under the name of Plastic Weld), and from EMA

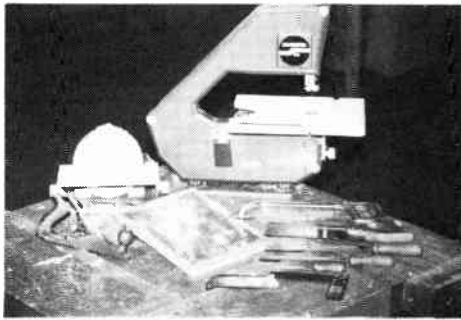

Fig. 1. Some of the basic tools you will need.

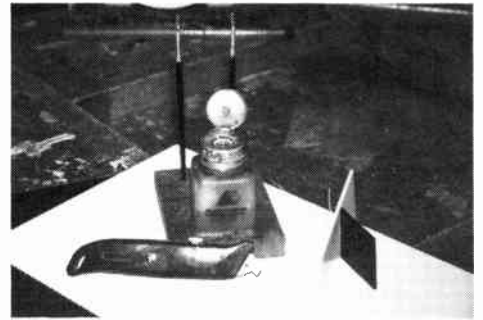

Fig. 2. The pump dispenser, a scoring knife and some plastic sheet.

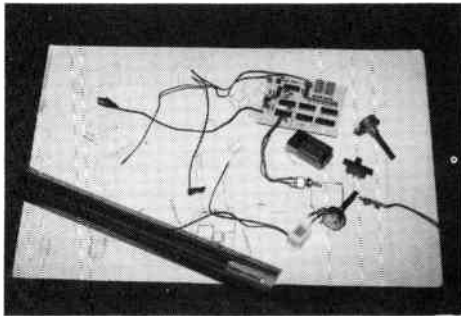

Fig. 3. Showing sensible planning of your work before you start.

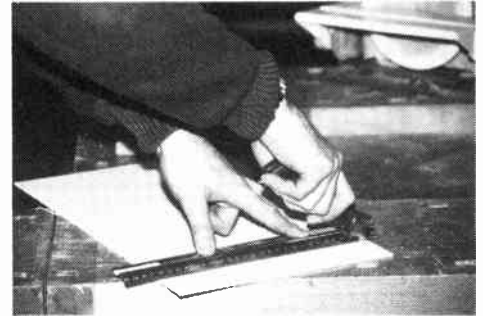

Fig. 4. Showing correct use of a safety ruler, scoring knife and the plastic sheet.

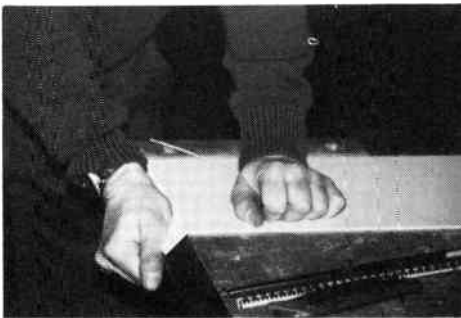

Fig. 5. Showing how to 'snap' the plastic cleanly over the edge of a bench.

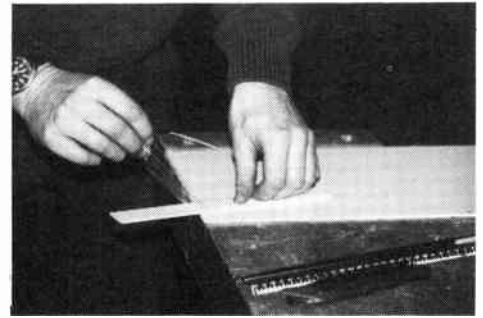

Fig. 6. Showing the removal of the protective plastic film before gluing.



Fig. 7. Edges may be squared up using a conventional wood plane.



Fig. 8. Edges may be squared up on a sanding board with equal ease.

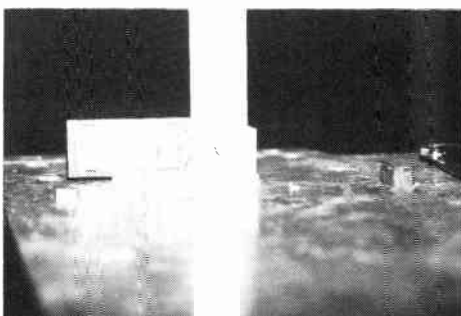

Fig. 9. Using a try-square to check the box shape.



Fig. 10. Adding solvent to each side (if possible) of the joint.

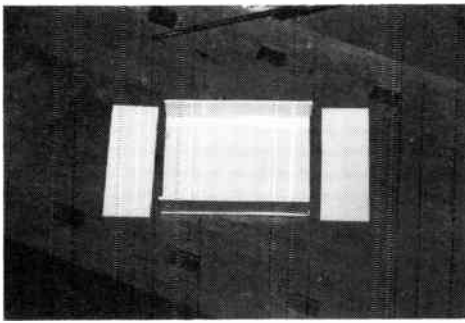

Fig. 11. Box with two sides, also showing slightly oversized end pieces.

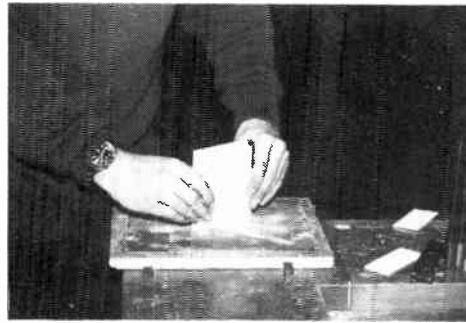

Fig. 12. Using a sanding board to square up the box ends.

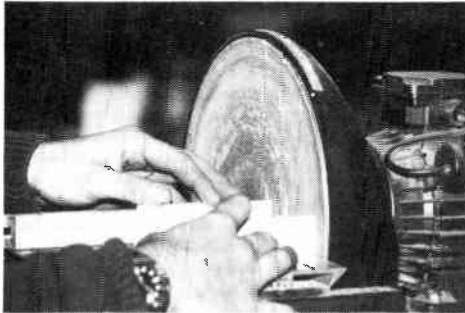

Fig. 13. A sanding wheel provides a quick alternative, but check its angle first!

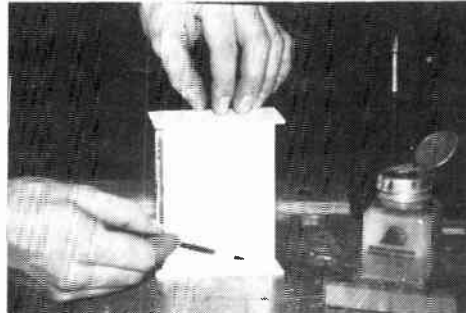

Fig. 14. Gluing the ends on to the box.

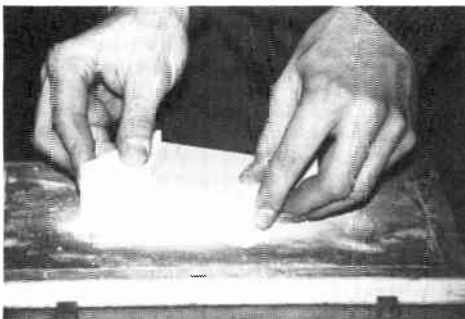

Fig. 15. Sanding the top of the box ready for the lid (shown upside down).

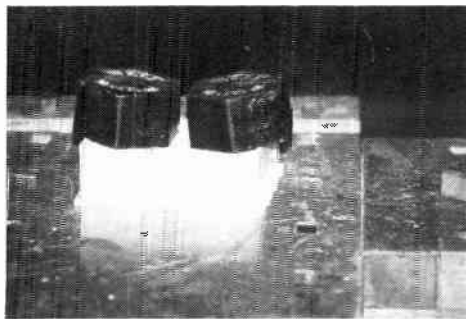

Fig. 16. After gluing the lid on, use some weights to keep it there for half an hour.

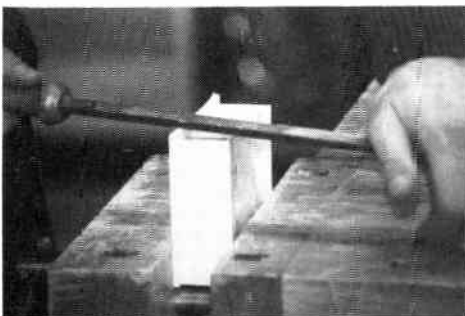

Fig. 17. Reducing the edges with a file — always work into the joint.

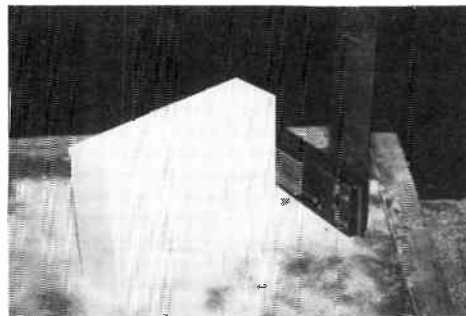

Fig. 18. A finished box, sanded smooth on all sides.

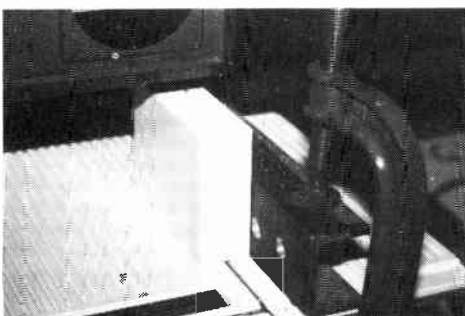

Fig. 19. Cutting the box on a band saw. Always use a fence!

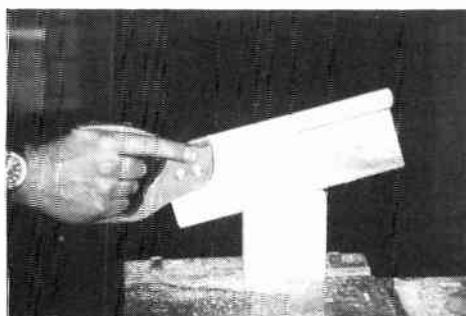

Fig. 20. With care, a tenon-saw can be used for the same task.

Model Supplies. The latter also supply a very neat pump dispenser which makes the use of the solvent much easier (see photo 2).

Planning

Having assembled the tools and materials, it is time to plan your box a little. I teach my students 'design based problem solving' which simply means that as much research and investigation should go into the generation of initial ideas as possible. There are several ways of packaging your circuit, and your first idea is unlikely to be the best. There are several things to consider, such as serviceability, replacement of battery, position and accessibility of the controls such as on/off switches, sensitivity adjustment and range switches. It is worth jotting down a few vital measurements at this stage (remember to leave plenty of room inside — I once had to squeeze a battery in a vice to get the lid on! Never again!), and to sketch a few ideas of the product (photo 3).

Box assembly

Once a few dimensions have been decided, construction can start. Mark out the base of the box (biro or pencil will suffice) on the 3-mm sheet of polystyrene. Cut it by using a ruler and a scoring knife (score to about 1/2 the plastic's thickness — photo 4). Place the scored line over the edge of a bench or table, and apply sharp downward pressure to both sides. The plastic will snap cleanly along the scored line (photo 5).

The secret of making these boxes lies in making good butt joints, for which a square edge is essential, and a little time spent here will make your job easier later on. Note that some polystyrene sheets have a protective layer of polythene on one or both sides. For our application, this layer should be peeled off (photo 6). Next, cut a strip of the required height, and twice the length of the box. Leave a few millimetres extra for squaring up. At this stage, only one long side of each piece will need squaring. Use a wood plane if one is available, or sand on the sanding board, taking care to keep it at 90° to the board as you do so (photos 7 and 8). Keep sanding until a uniform square edge is obtained.

Next, place this edge on top of the base in the required position, and hold it up to a set square (photo 9). Using a small paint brush (maximum size 5 mm), dip the bristles into the solvent (photo 10), and then run the brush along the inside of the joint. If it is a long joint, replenish the brush as necessary. Once the solvent has been applied, capillary action will put it into the joint area, and there is little to be gained by continued application of the solvent. If both sides of the joint are accessible, the solvent may be applied to both sides. Hold the two pieces together while ensuring that the joint is at 90° to the base.

After some 15 to 30 seconds, the joint will be capable of supporting itself, and the other side can be glued in a similar manner. Although there are several proprietary polystyrene cements on the market, none have the ease of use and speed of bonding offered by dichloromethane. Unlike other cements, however, dichloromethane is purely a solvent, and as such it does not have any gap filling properties. It is therefore well worth making sure that your butt joints are good fits for

best results. Gaps can be filled at a later stage, but it is a lot quicker and easier to get it right first time.

Leave the two sides and base to dry while you prepare the ends and lid of the box. This is where some planning will have paid off. For ease and speed of construction, it is a lot easier to overlap joints, and sand down after construction, than to get it all to fit first. The two ends need to overlap both sides and base (photo 11), so cut out some suitable pieces. As they will be glued onto the end of the sides and base, there is no need to give them square edges. Cut a lid out on the same basis, that is, overlap on both sides and ends.

By now the base and sides will be workable, and now is the time to square up the ends. Those of you with a disc sander will find this easy, although the plastic does tend to melt more than sand. Those with sanding boards only will have to carefully sand the ends square, taking care to avoid 'rocking', and consequent rounding of the box ends. This process can be made easier if (a) you did not leave that much spare in the first place (careful marking out!), and (b) if you drag the box across the board towards you, rather than attempting to work both ways (photos 12 and 13).

Once each end is square, the end pieces can be glued on as per the sides (photo 14). Here, no set square will be needed, and pressure can be applied by hand until the solvent 'bites'. Give both ends a chance to dry as the next stage will put them under strain!

Gripping the box firmly upside down, sand it backwards and forwards (and circular) on your sanding board, until an even top surface is obtained (full width of 3 mm all the way round — photo 15). At this point, the lid can be glued on with liberal application of solvent, as the inside will not be accessible.

Leave the box weighted down (photo 16), and forget about it for 12 hours or so. Whilst the solvent is drying completely, it is worth mentioning why the box needs leaving. Although the solvent sticks the plastic very quickly, and allows work to proceed, it does nevertheless cause softening of the plastic in joint areas, and if fine finishing of the box is attempted, 'plucking out' of this softened material will result, and there will be a depression left to fill later. Be patient!

Once the box is dry, it can be externally tidied up. Large amounts of plastic hanging over edges can be removed by using a sanding wheel, if available, or simply filed away (photo 17). People used to working with harder materials will find this plastic quick to file and shape. With only small lips remaining (less than 1 mm), the whole box can be sanded on the sanding board until each and every surface has been 'sanded' (including the middle of plain sheets, photo 18). This may seem a long process, but better results are obtained this way.

Back to the planning stage, and how the box will be divided. Thought needs to be given to fitting the controls, switches, displays, etc. It is preferable, but not essential, that they are all mounted in one half of the box, but for mains powered projects it may be preferable to fit the transformer and circuitry in the base, and have flying leads to the front panel controls. Plan ahead now to avoid disasters later!

Most project boxes can be cut around their height anywhere between $\frac{1}{3}$ and $\frac{2}{3}$ the total

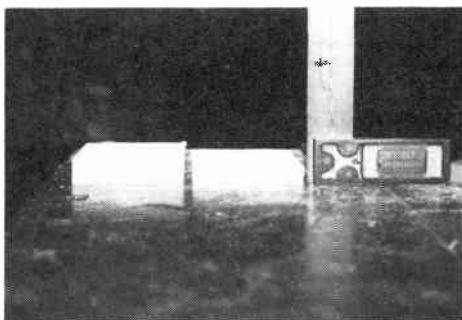

Fig. 21. You should now have two similar pieces of box. The heights can differ.



Fig. 22. Carefully sand the cut edges until they are free of saw marks.

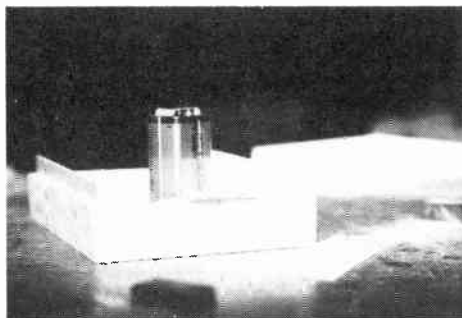

Fig. 23. The thin (1-mm) 'joining sheets' are shown resting in a box.

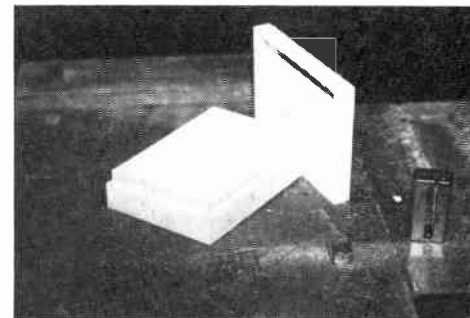

Fig. 24. All four thin strips fitted and glued.

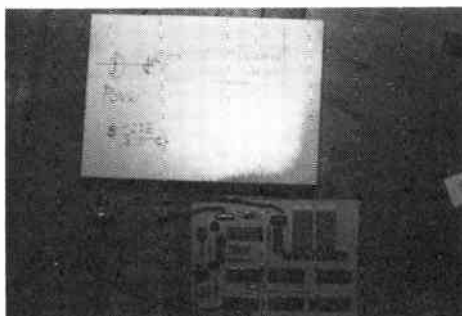

Fig. 25. Plan and mark out where your controls are going to be.

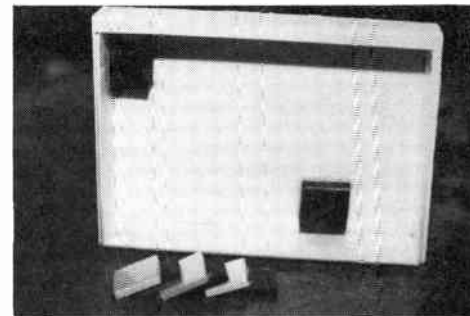

Fig. 26. Mounting pillars for PCBs are made by stacking small squares.

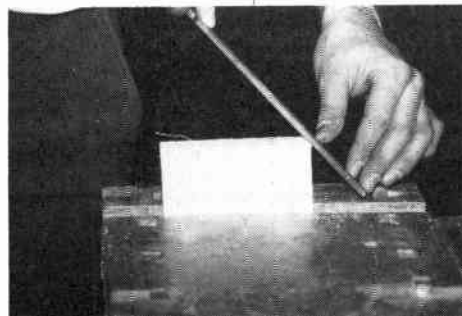

Fig. 27. Radius the box edges, starting with a file, then with wet and dry paper.

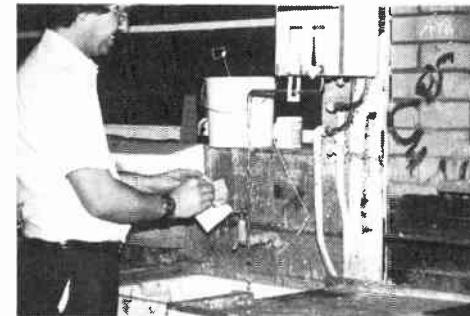

Fig. 28. Surface preparation is vital — use soap, water and wet or dry paper.

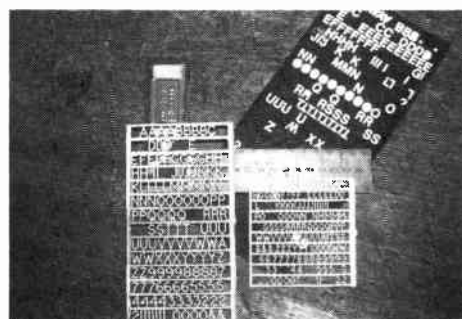

Fig. 29. There are two main types of lettering for surface detailing.

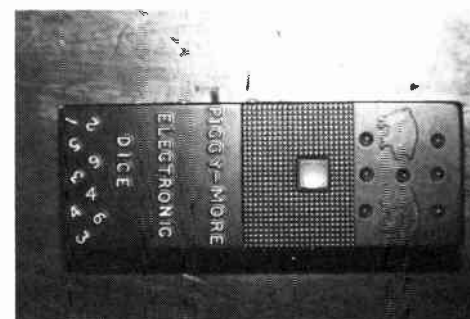

Fig. 30. A variety of effects can be achieved with relative ease.

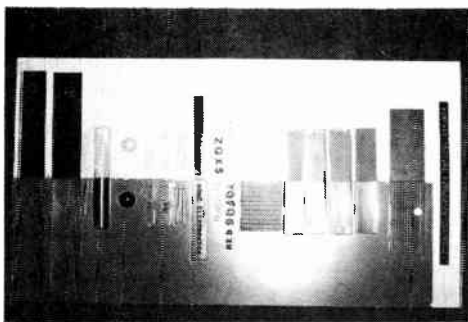

Fig. 31. All manner of 'things' will provide extra surface detail.

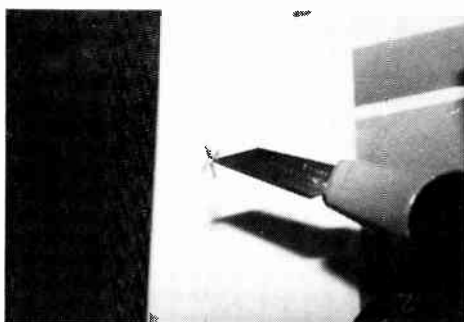

Fig. 32. Plasticcard letters are easily picked up using the tip of a knife.

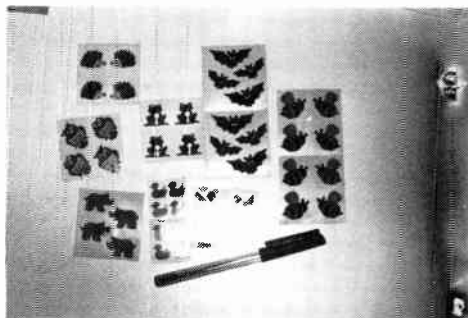

Fig. 33. A wide range of paper stickers are available.



Fig. 34. A range of suitable products to help finish your product.

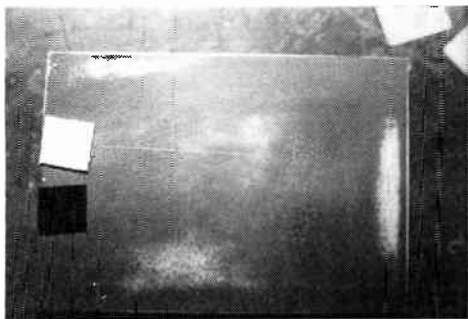

Fig. 35. Small patches showing through are not a problem — smooth finish is vital.

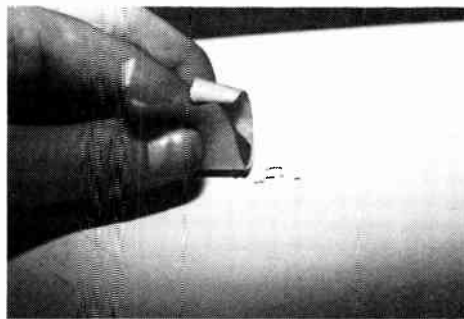

Fig. 36. Removing errant Letraset with a piece of masking tape.

height of the box. This is easily done with a small bandsaw, but take care and use a substantial fence to hold the box against (photo 19). Many boxes have been spoiled by the saw wandering off, so be careful! Those of you without a bandsaw will find that a tenon-saw (fairly fine toothed — see photo 20) will suffice, or failing that, a conventional hacksaw will work but may prove difficult to control directionally.

Assuming your box has now been cut into two (photo 21), the cut surfaces are sanded smooth on the sanding board once again, until any marks from the sawing have gone (photo 22). Take care to sand as evenly as possible, otherwise your box may develop a list. Using the 1-mm polystyrene sheet, cut a strip, or strips, of sufficient length and width to fit around the inside of the box, from the base up to nearly the full interior height. Using the solvent again, secure the two long sides first in the deeper part of the box, and then the two ends (photo 23). Squareness and close fits are not so important inside, and gaps for things like switches can be left in the thin strip. Leave all these to dry for 10 minutes or so. Then reassemble your box, and hopefully you should still have a reason-

ably square 'shape' (photo 24). If there are small discrepancies between the top and the bottom of the box, these can be sanded out on the sanding board before the next stage.

Fitting up

With the basic box finished, the fitting up can begin. Holes for switches, dials, controls, cables and the like should be added (photo 25). Inside the box, battery compartments can be fabricated quickly by using suitable pieces of plastic and solvent, as can PCB pillars made from small 'piles' of 3-mm plastic glued on top of each other (photo 26). The PCB and the pillars can then be drilled to suit suitable self-tappers which happily cut their own thread in the core diameter pilot holes. Please note that unlike acrylic (perspex), polystyrene does not take fine threads particularly well, so it is best to stick with self-tappers.

These pillars of material can also be used to good effect if you wish to 'sink' securing screws below the surface. In this way, results very similar to commercial injection moulding can be achieved. Simply build up a suitable thickness of

material in the area that you wish the screw to be sunk (probably around 12 mm). Drill a hole of sufficient depth and diameter to clear the screw head (allowing for paint and perhaps screwdriver size). Drill a clearance hole right through to allow the self-tapper to sit in the recess so created.

Next, build up a suitable pillar on the opposite side of the box, to the required height for the self-tapper to screw into. Take care to get the pillar height correct, or box distortion can occur. Whilst this provides a secure method of holding your box together, you will often find that the thin strips inside provide more than enough force to hold things together, especially non-critical items like small battery-powered test equipment, torches, etc. If all this sounds too much, countersunk self-tappers may be used.

Appearance!

With all the fitting and bracketry finished, the exterior of the box can now be finally prepared. Radiusing the edges and corners of the box will help its appearance, and, if it is hand-held, its 'touchability'. Use a fine file with caution, and aim for an even radius all over the box, just to take the sharp edges off (photo 27).

The next stage requires warm soapy water and several grades of wet-and-dry silicon carbide paper. Starting with 220 grit, rub the box all over, using plenty of water to avoid clogging the paper. This is the time to finally blend in the radiusing work that you may have done earlier. When you are sure that the whole of the box has been covered by this grade, move on to 320 grit and repeat the process. At this stage, you will probably be able to 'feel' the surface through your finger tips better than by visual inspection.

When you are sure the whole box has been covered by the 320 grit, move on to 400 grit and repeat the process. Finally, go over the whole box with 600 grit, feeling and looking for any scratches left over from coarser papers. If any are found, remove them gently with the appropriate grade, and then move on to 600 grit (photo 28).

With care you will have got this far, and have a very smooth box. If, however, there are some large holes, these can be filled with ordinary P38 car body filler or cellulose putty. It is much easier, however, to avoid them in the first place, which is not as difficult as it may sound. Give the box a final rinse inside and out in warm to hot water, pat it dry with a lint free cloth, and leave it somewhere warm and dry for a few hours.

Lettering

While the box is drying out (especially in the joint areas), some thought needs to be given to any surface detailing that you may wish to add. Simple things will help make your product look more convincing, and can make all the difference. Raised lettering can be added to give the impression of embossed or moulded-on letters. There are two main types, Plasticard polystyrene letters (usually sold to model railway enthusiasts) in several sizes, and Edding self-adhesive vinyl letters. Of the two, the latter are fairly low-profile, but are useful to give a 'maker's name' to the product, as they will be painted over later, and so will form part of the product. The Plasticard letters are high-profile, and can be painted over also. The

tops of the letters can be carefully sanded clear of paint to create an additional effect should you so desire (photos 29 and 30), but their higher profile means that they are ideal for identifying important controls such as on/off switches, without being as obvious as, say, the devices' 'names' which can be added later in Letraset.

Other features that you can add include 'grips' made by gluing (with liberal amounts of solvent) strips or pieces of 180/220 wet or dry paper, and spraying over them later. This creates very effectively the 'moulded-on' appearance. Using coarser grades of paper spoils the effect. Embossed self-adhesive metal film is also available from EMA (details further on), and 'pin-stripe' tape as sold in motor accessory shops can provide a useful way of breaking up large flat surfaces. This can either be sprayed over, or added later as a colour feature. It does not need much to make the product look real, so take care not to get carried away! (photo 31).

To get perfect edging on some of the items mentioned may necessitate going back to a *fine* file and the range of wet-and-dry papers, just to blend in an overhanging edge. This usually produces better results than just cutting a piece out and sticking it on.

The Plasticard polystyrene letters can be cut out and trimmed with a suitable craft knife. The tip of this knife is the best tool to pick the letters up and put them in place (photo 32). A dab of solvent on their rear immediately prior to placing each letter produces good results. Positioning the letters dry, and then applying solvent tends to leave a mark, so be careful. Getting all the letters in a neat line is also important, and a pre-drawn faint pencil line at 90° to an edge will help a lot here. The vinyl letters mentioned are self-adhesive and may be positioned similarly. If you are making a 'novelty' product for perhaps a child, it may be worth a visit to your local craft and stationary shop. These often have rolls and rolls of small paper stickers that can also be added to the surface of your product, and then sprayed over (photo 33). In this way, a variety of themes could be imparted on your model.

Painting

After the surface detailing is complete, the next stage is to paint the object. For this, aerosol paints as sold by car accessory shops are ideal (photo 34). The two halves of the box should be separated, and can then be given the first coat of grey cellulose primer. A reasonable covering should be given by starting the spray to, say, the left of the object, moving across it and clear to the right before returning. If you wish, you can stop spraying at either end, although some brands of aerosol tend to 'spit' a little when used in this fashion. Spraying this way helps prevent uneven paint buildup and runs! Leave the primer to dry overnight, and then **very carefully** rub down the surface with 800 grit wet-and-dry paper used with lots of soapy water. It is not necessary to re-expose the plastic underneath, just to achieve a silky smooth surface ready for the top coat (use your finger tips). If small areas of plastic re-appear, don't worry. So long as the preparation was good, the primer does not have a lot to do, and the small gaps in the coverage are not a problem (photo 35). When the box has been 'flatted' all



Fig. 37. A selection of finished articles.

over, a final rinse in water is needed (inside and out), and then the box can be dried.

The top coat of paint is also aerosol cellulose car paint, and so there is an almost endless variety of colours. If you want black, choose Satin black, which shows fingerprints less than either gloss or matt. Metallic colours are also very effective, but choose carefully after looking at commercial products. Probably the best is Ford 'Graphite', Ford 'Pearl Grey', and one or two others, notably the blues.

A useful tip to improve the spray power of aerosols is to place them in hot water (max. 50°) for a few minutes. This raises the internal pressure, and helps them spray better for longer. Make sure that the whole aerosol is completely dry, as a single drop of water will play havoc with your smooth mirror-like surface!

If you want an ordinary colour, try and stick with primary colours rather than sickly mixes. Some aerosols (especially the metallics) are what is known as '2-pack', which means that they need a coat of lacquer to give them the final gloss. If you intend to use any Letraset, then this will be needed anyway, and should not be feared.

After the paint has had time to dry, Letraset or similar dry transfer lettering can be added. Given that these dry transfer letters sometimes transfer themselves at the wrong time to the wrong place, the following may be useful. Take a piece of ordinary masking tape, and rub the sticky side against a cotton T-shirt or similar. This will help reduce its stickiness. Use this treated piece of masking tape to provide the baseline for your rub-down lettering. If any do come unstuck, they will probably be on the masking tape, which can be **carefully** removed after you have finished. Do take great care not to press it down too hard, or pull it off too briskly — you may find it brings the paint with it! If, despite this precaution, the odd letter does appear in the wrong place, or you make a mistake, do not despair, as individual letters can usually be removed by the careful application of a small piece of masking tape (untreated), wrapped around a finger tip, and 'dabbed' at the offending letter (photo 36). If this fails, it should be possible to remove it with the

aid of a scalpel or craft knife, and a scraping motion, although this method is likely to leave a mark.

If you have used a dark colour to spray your box, then white or red lettering can be used to great effect. Controls can be labelled, and some form of product name added. Very often code numbers at the bottom of the Letraset sheets provide convincing model numbers. It all adds to the realism of the finished article, and will make people look twice or even thrice in their attempt at determining the origin of the 'device' they see.

Finally, a coat of clear lacquer needs to be applied. Car accessory shops sell this as clear cellulose lacquer. Be careful how much you spray on in one coat. Sometimes the solvent attacks the Letraset, causing it to wrinkle up, and destroy all your hard work. Apply just enough to 'flow' into a gloss (allow it to stand a few seconds before adding more!), and spray it somewhere warm to help the solvent evaporate quickly.

Add extra coats as needed until you are happy with the appearance of the finished object (photo 37). All this paint will take quite a while to harden, depending on the number of layers present. I have known some objects (admittedly heavily laden with lacquer) to take up to a week to dry sufficiently to not take fingerprint impressions when handled. If you get the odd fingerprint, it can usually be polished out by using 'T-cut' colour restorer (also from your car accessory shop). That concludes the description of the process — it probably takes as long to read it as it does to make a box! ■

* EMA Model Supplies, 58-60 The Centre, Feltham, Middlesex TW13 4BH. Telephone: (081-890) 5270. Fax: (081-890) 5321.

CLASS-A POWER AMPLIFIER – PART 1

by T. Giffard

The power amplifier presented is a revamped version of the LFA-150 we published in late 1988. It provides rather less power than its popular predecessor, but retains its class A quiescent-current setting up to -3 dB below its clipping limit. The aim of the design was to find a good compromise between class A quality and the dimensions of the necessary heat sinks.

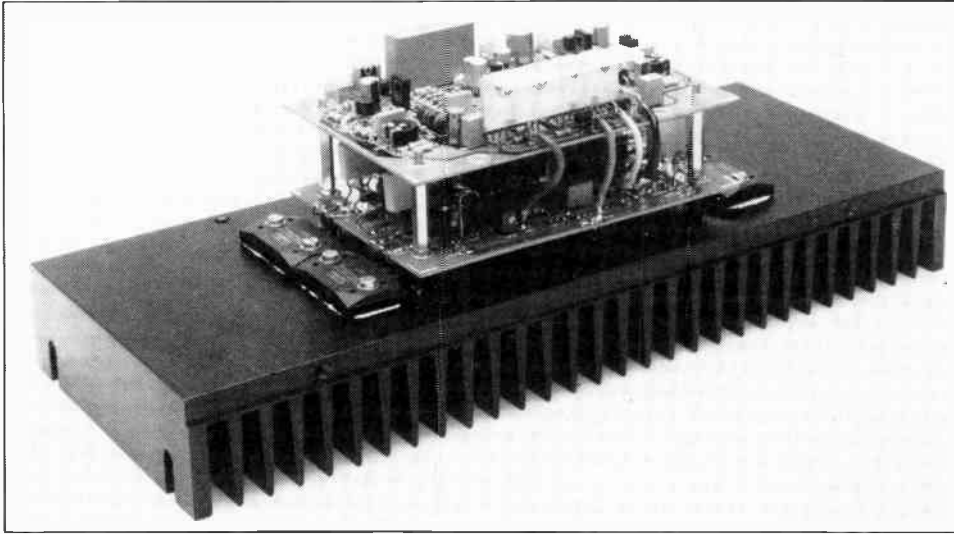

Fig. 1. Prototype of the class A amplifier.

TECHNICAL DATA

Power output (at 1 kHz)	48 W into 8 Ω 83 W into 4 Ω 122 W into 2 Ω
Music power (500 Hz burst, 5 periods on, 5 periods off)	50 W into 8 Ω 90 W into 4 Ω 150 W into 2 Ω
Power bandwidth (48 W into 8 Ω)	1 Hz–270 kHz (+0 dB, -3 dB)
Slew rate	>45 V/ μ s
Signal-to-noise ratio (1 W into 8 Ω)	>105 dB (A-weighted)
Harmonic distortion (25 W into 8 Ω)	<0.005% (1 kHz) <0.02% (20 Hz–20 kHz)
Intermodulation distortion (50 Hz: 7 kHz; 4:1)	<0.03% (25 W into 8 Ω) \leq 0.005% (1 W into 8 Ω)
Dynamic IM distortion (rectangular wave 3.15 kHz; sine wave 15 kHz)	<0.015% (25 W into 8 Ω)
Input sensitivity	1.1 V r.m.s.
Input impedance	25 k Ω
Quiescent current	1.25 A

ALTHOUGH most of our readers will know what is meant by class A, AB or B, it may be useful for others to recapitulate the properties of these classes of operation.

Most modern a.f. output amplifiers are designed as a push-pull configuration. In this, two power transistors (or valves) are connected in series between the positive and negative power supply lines, and the loudspeakers are connected to their junction. The transistors are driven by opposing signals, that is, when one conducts, the other is switched off.

The transfer characteristic (I_b/I_c curve) of a transistor is, unfortunately, not a straight line: particularly at its lower end, when the currents are low, it is very curved. In principle, the characteristics of two transistors in push-pull complement one another nicely, but the base-emitter transfer voltage puts a spanner in the works.

To prevent distortion, therefore, use is made of a bias that causes a small constant current to flow through the transistors. The result of this is that the curved part of the characteristic is not used. If virtually no current flows through the transistors, class B amplification is obtained, which is characterized by cross-over distortion. Nowadays, this method is used only in inexpensive, portable equipment where economy of battery usage is the prime requirement.

For many years now, class AB operation has been used in hi-fi equipment. In this, a small quiescent current flows through the output transistors, which makes them work in class A when the drive is small (say, 0.1 W) and in class B at higher drives. This method is characterized by acceptable low distortion and good efficiency (about 75%). Moreover, heat dissipation depends on the energy of the drive signal, so that the amplifier remains fairly cool during normal operation.

Many designers and listeners do not find AB operation good enough and prefer class A. In this, such a large quiescent current flows through the transistors, that even at maximum drive neither of the transistors switches off (as happens in class AB). The disadvantages of class A operation are its low efficiency (<50%) and large heat dissipation. Even during quiescent operation, a class A amplifier uses about twice its nominal power. Naturally, commercial class A amplifiers are

available at many hi-fi retailers, but, although their superior quality cannot be denied, they are very expensive, have very large heat sinks or fans to get rid of the dissipated heat, and provide only a modest power output. These factors make it easy to understand why a 25-50 W class A amplifier is not exactly the most popular item in the hi-fi trade.

In the present design, we have tried to combine class A operation with an acceptable heat dissipation. Output power was specified at 50 W into 8 Ω. In true class A, that would mean a dissipation of rather more than 100 W per channel. To get rid of more than 200 W of heat in normal enclosures without the use of fans is virtually impossible. Fans are, however, anathema, because even the best ones can be heard, particularly during soft music passages.

The design is, therefore, near-class A, that is, the quiescent current is set to a level that ensures that the amplifier can deliver half its nominal power to the loudspeakers. The class A range is thus 25 W, which means that in actual use the amplifier operates in class A up to -3 dB below full drive. The dissipation then amounts to about 140 W and that can be got rid of with 'normal' heat sinks (based on an ambient temperature of not more than 35 °C and a maximum heat sink temperature of 75 °C).

It should be noted that a class A amplifier operates in its class only into its specified load impedance, normally 8 Ω. It is, of course, possible to provide more power into 4 Ω or 2 Ω, but that will not be in class A. This points to a serious disadvantage of class A amplifiers that is hardly ever highlighted: *into a lower than specified load, it operates in class AB*. Since the input impedance of virtually all modern loudspeakers varies between 4 Ω and 10 Ω, amplifier manufacturers have the near impossible task of designing an amplifier that remains in class A over this range of impedances. The power required to operate a class A output stage into a 4 Ω load is twice that for operating it into an 8 Ω load. A 25 W class A amplifier designed to operate into 8 Ω dissipates more than 100 W, but to enable it to operate in class A into 4 Ω, the quiescent current would have to be increased to a level where the dissipation would exceed 200 W.

The real requirement of a top-quality a.f. output amplifier is that it can deliver a reasonable power, say, not less than 10 W, into an impedance varying between 4 Ω and 10 Ω. That will meet the demands of all hi-fi listeners in 95% of the time. The present design provides 25 W into 8 Ω; 12.5 W into 4 Ω and rather more than 6 W into 2 Ω, all in class A. At the other 5% of the time, in class AB, it gives 48 W into 8 Ω, 83 W into 4 Ω and 122 W into 2 Ω.

The revamped circuit

The renovating of the LFA-150 started with a lowering of the supply voltage from ±56 V to ±29 V to ensure an appreciable lowering of the dissipation.

Next, a number of transistor were replaced, partly because some of them were no longer

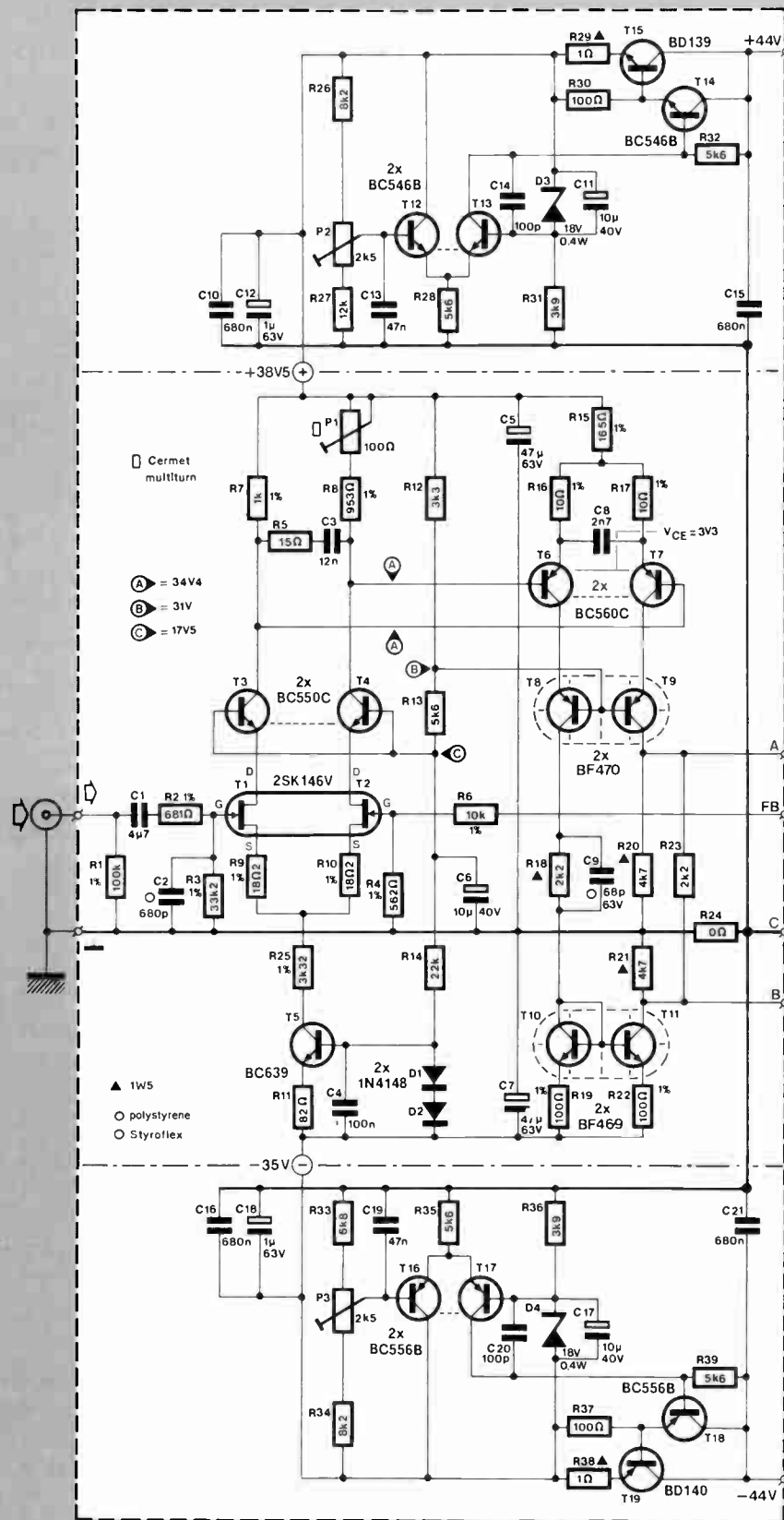
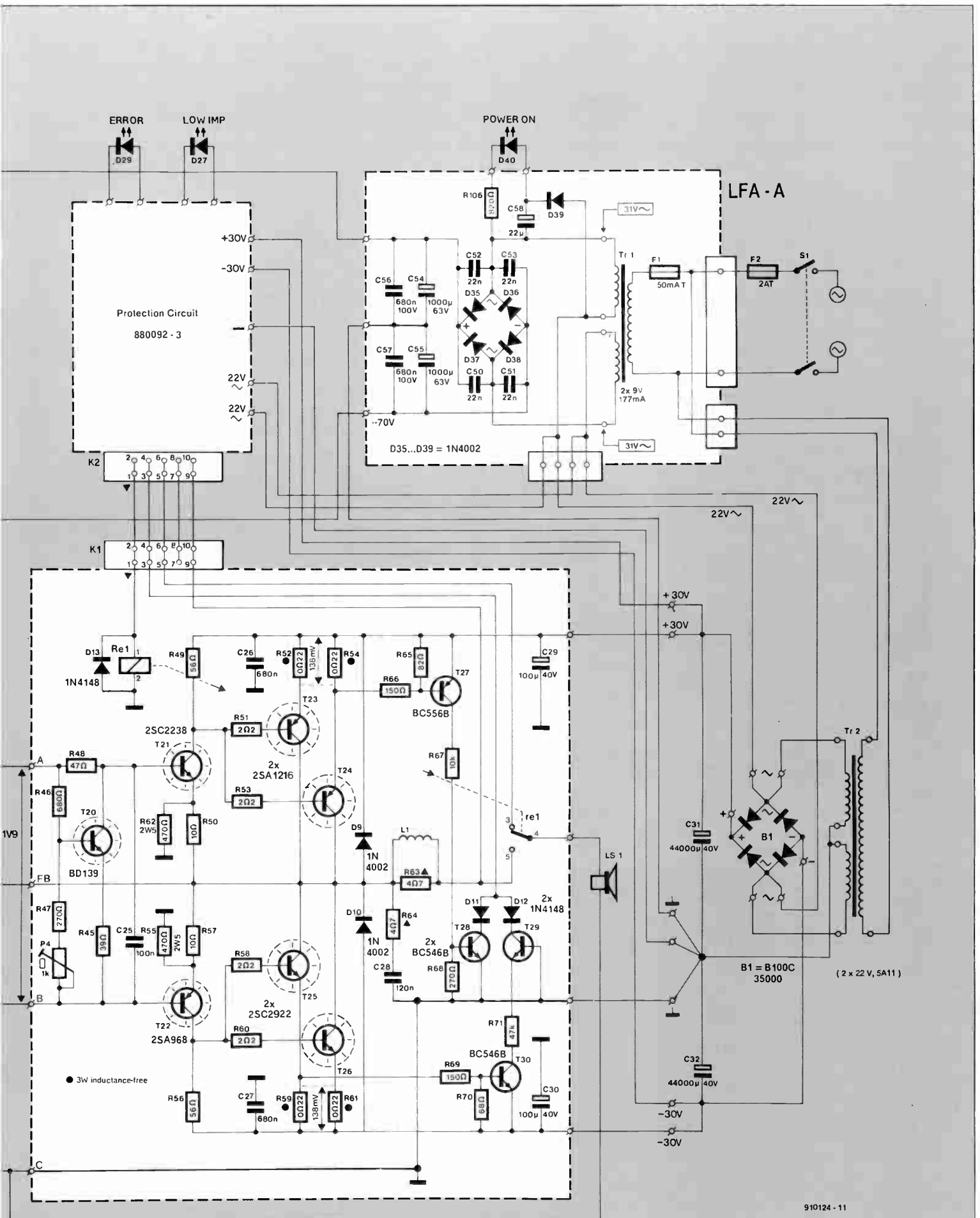

Fig. 2. Circuit diagram of the class A amplifier.



910124 - 11

available. Motorola's BF762 and BF759 have been replaced by the BF470 and BF469 respectively, while Sanken's Types 2SC2922 and 2SA1216 have been substituted for Toshiba's 2SC2565 and 2SA1095 output transistors.

Third, the amplification of some stages has been altered. The gain of the first differential

amplifier is now 19 dB instead of 11 dB, while that of the second differential amplifier has been reduced by 6 dB. This results in the open-loop amplification rising from 2300 to 3000, which lowers the distortion to even lower levels than in the LFA-150.

Finally, the compensation and d.c. oper-

ating points have been changed at a number of places.

Because of all these alterations, the values of many components in the original LFA-150 have had to be changed. The amplifier is constructed on four PCBs: two for the output stages, one for the protection circuit, and one

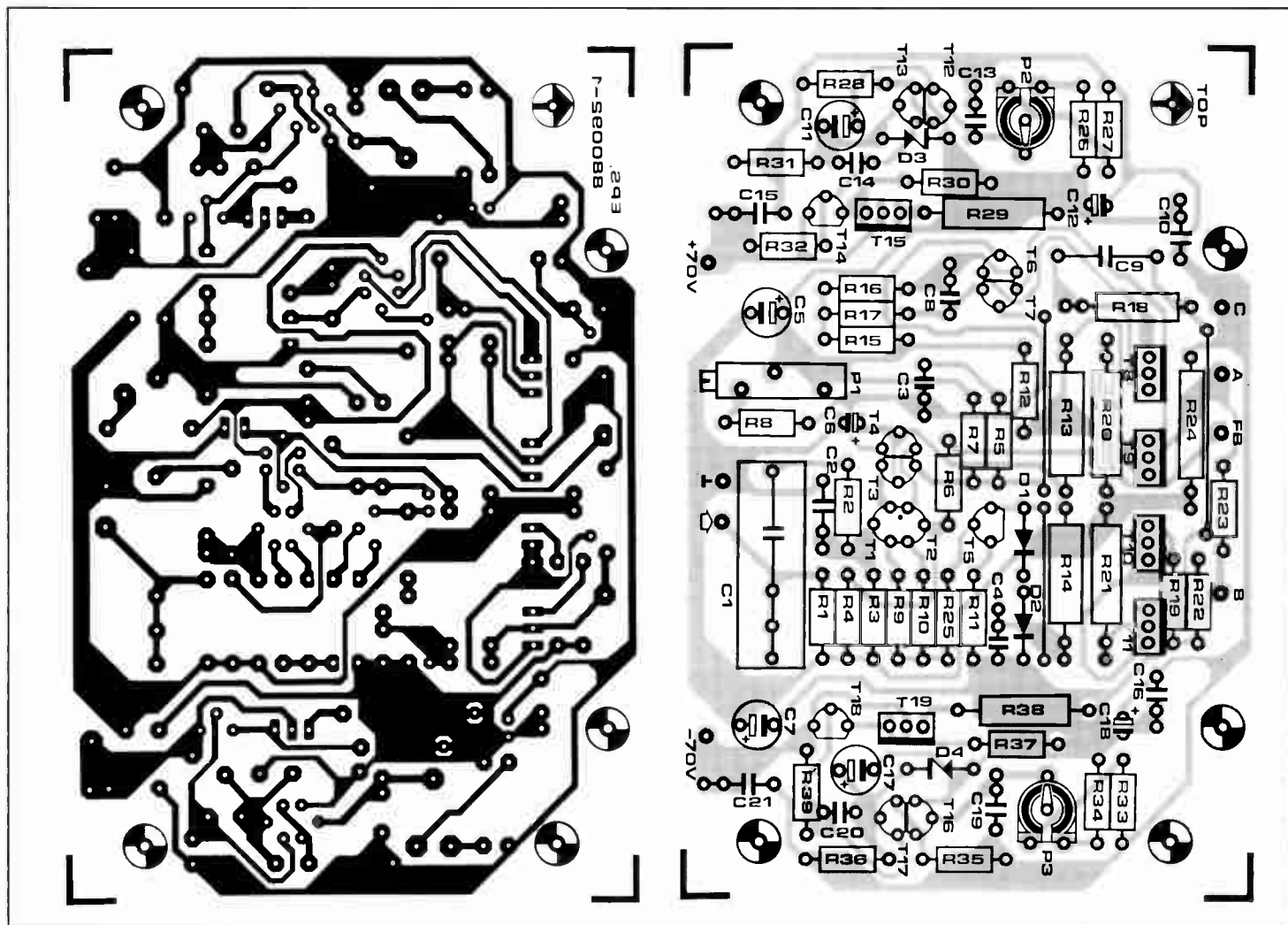

Fig. 3. Printed circuit board for the voltage amplifier.

Resistors:

R1 = 100 k Ω , 1%
 R2 = 681 Ω , 1%
 R3 = 33.2 k Ω , 1%
 R4 = 562 Ω , 1%
 R5 = 15 Ω
 R6 = 10 k Ω , 1%
 R7 = 1 k Ω , 1%
 R8 = 953 Ω , 1%
 R9, R10 = 18.2 Ω , 1%
 R11, R65 = 82 Ω
 R12 = 3.3 k Ω
 R13 = 5.6 k Ω
 R14 = 22 k Ω
 R15 = 165 Ω , 1%
 R16, R17 = 10 Ω , 1%
 R18 = 2.2 k Ω , 1.5 W
 R19, R22 = 100 Ω , 1%
 R20, R21 = 4.7 k Ω , 1.5 W
 R23 = 2.2 k Ω
 R24 = wire bridge
 R25 = 3.32 k Ω , 1%
 R26, R34 = 8.2 k Ω
 R27 = 12 k Ω
 R28, R32, R35, R39 = 5.6 k Ω

PARTS LIST

R29, R38 = 1 Ω , 1.5 W
 R30, R37 = 100 Ω
 R31, R36 = 3.9 k Ω
 R33 = 6.8 k Ω
 R45 = 39 Ω
 R46 = 680 Ω
 R47 = 270 Ω
 R48 = 47 Ω
 R49, R56 = 56 Ω
 R50, R57 = 10 Ω
 R51, R53, R58, R60 = 2.2 Ω
 R52, R54, R59, R61 = 0.22 Ω ,
 3 W, inductance-free
 R55, R62 = 470 Ω , 2.5 W
 R63, R64 = 4.7 Ω , 1.5 W
 R65 = 82 Ω
 R66 = 150 Ω
 R67 = 10 k Ω
 R68 = 270 Ω
 R69 = 150 Ω
 R70 = 68 Ω
 R71 = 47 k Ω
 P1 = 100 Ω multiterm preset

P2, P3 = 2.5 k Ω preset
 P4 = 1 k Ω , multiterm preset

Capacitors:

C1 = 4.7 μ F, MKT
 C2 = 680 pF, polyester
 C3 = 12 nF
 C4, C25 = 100 nF
 C5, C7 = 47 μ F, 63 V
 C6, C11, C17 = 10 μ F, 40 V
 C8 = 2.7 nF
 C9 = 68 pF, 63 V, polyester
 C10, C15, C16, C21, C26,
 C27 = 680 nF
 C12, C18 = 1 μ F, 63 V
 C13, C19 = 47 nF
 C14, C20 = 100 pF
 C28 = 120 nF
 C29, C30 = 100 μ F, 40 V

Semiconductors:

D1, D2, D11-13 = 1N4148
 D3, D4 = zener, 18 V, 400 mW

D9, D10 = 1N4002

T1, T2 = 2SK146V
 T3, T4 = BC550C
 T5 = BC639
 T6, T7 = BC560C (match!)
 T8, T9 = BF470
 T10, T11 = BF469 (match!)
 T12-14 = BC546B
 T15, T20 = BD139
 T16-18 = BC556B
 T19 = BD140
 T21 = 2SC2238
 T22 = 2SA968
 T23, T24 = 2SA1216
 T25, T26 = 2SC2922

Miscellaneous:

Re1 = 24 V for PCB mounting
 with 1 change-over contact
 L1 = 6 turns, I/D 15 mm, of
 1.5 mm enamelled copper wire
 K1 = 10-way straight header
 Heat sink, 0.4 kW (see Part 2)
 PCB 880092-1
 PCB 880092-2

for the auxiliary power supply,

Only an outline description of the circuit in Fig. 2 will be given—for more details, see Ref. 1.

The input signal is applied to differential amplifier T₁-T₂ via C₁ (the only capacitor in the signal path) and low-pass filter R₂-C₂. The filter has a cut-off frequency of 340 kHz to prevent transient intermodulation distortion (TIM). The d.c. operating point of the two FETs is set by a constant-current source based on T₅.

Transistors T₃ and T₄ and the FETs form a cascode circuit that has an amplification of about 9.2 (=gain of about 19 dB). Preset P₁ serves to eliminate any inequalities (off-set) in the d.c. operating points.

Lag compensation is provided by R₅-C₃.

The amplified signal is fed to differential amplifier T₆-T₇ that together with T₈ and T₉ form a second cascode circuit to keep the bandwidth as large as possible. The ampli-

fication of this section is 308 (nearly 50 dB).

The output of T₈ is fed to the current amplifier via current mirror T₁₀-T₁₁.

The power supply for the voltage amplifier is taken from discrete voltage regulators T₁₂-T₁₅ (positive) and T₁₆-T₁₉ (negative). The supply voltage for this section is higher than that for the current amplifier, so that the voltage drop across the output transistors remains small, even at maximum drive levels.

The current amplifier consists of a quiescent-current control based on T₂₀, and drivers T₂₁ and T₂₂, followed by power transistors T₂₃, T₂₄, T₂₅ and T₂₆, which are connected in a compound configuration. In contrast to the usual emitter-follower, this design provides some voltage amplification and combines very low distortion with a low output impedance. The output signal is fed to the loudspeakers via an inductor and a protection relay.

When the load current exceeds 15 A (peak),

transistors T₂₇ and T₃₀ switch on and actuate the protection circuit via T₂₈ and T₂₉. That circuit then de-energizes the relay.

The power supply uses two mains transformers in series, Tr₁ and Tr₂. Note that Fig. 2 shows the power supply for a mono amplifier; two (housed in one enclosure) need to be built for a stereo amplifier. The supply for the current amplifier is around ±30 V, and that for the voltage amplifier, ±44 V. The voltage amplifier, however, operates from +38.5 V and -35 V, because its voltage drop on the positive line is about 3.5 V higher than that on the negative line. This supply arrangement ensures that the positive and negative drive levels are exactly equal. ■

Reference.

"LFA-150: a fast power amplifier", *Elektronik*, November 1988, pp. 20-26; December 1988, pp. 42-46.

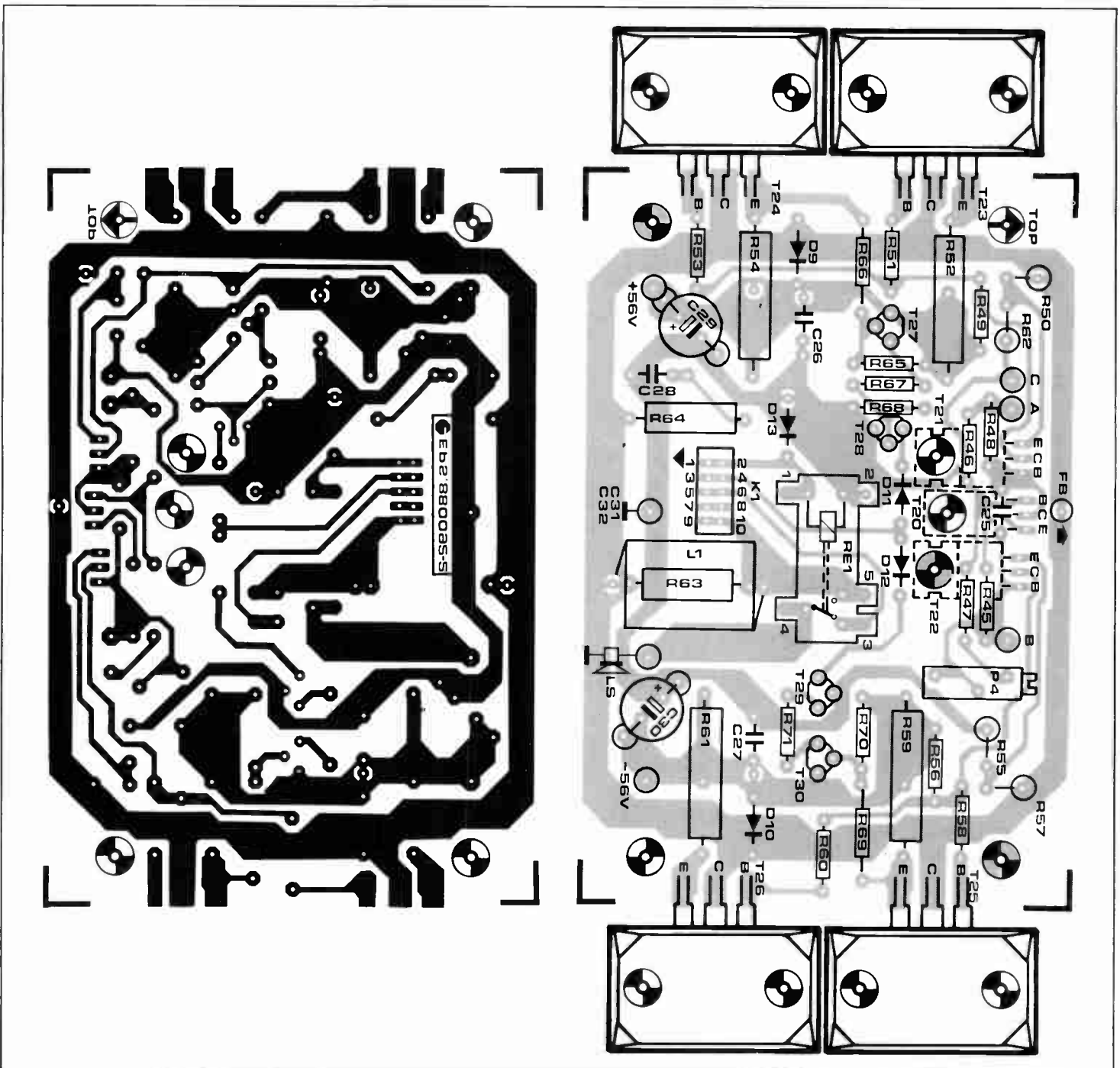

Fig. 4. Printed circuit board for the current amplifier.

FOUR-TERMINAL NETWORKS - PART 2

The design of attenuators

by Steve Knight, BSc

In this second and final part of our investigation into the design and uses of four-terminal attenuator systems, we shall first of all derive some simple relationships between the characteristic resistance of an attenuator T-section and the degree of attenuation provided by the section in terms of the resistive elements that make up the section.

THE calculations are not difficult, and those readers with an arithmetical bent might like to confirm some of the answers. We will relate our results with those of the π -section, consider insertion loss, and have a look at the practical design of attenuators.

Finding values

For the properly terminated symmetrical T-section shown in Fig. 8, we let the attenuation be expressed as $N=U_1/U_2$, in which numbered subscripts are used for conve-

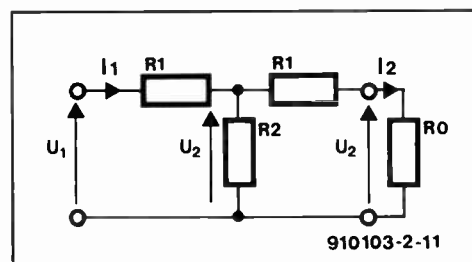

Fig. 8. Deriving the attenuation factor of a section.

nience. Since the input resistance is R_0 , the input current, I_1 , must be U_1/R_0 and the voltage, U , across the centre shunt arm will be

$$U = U_1 - I_1 R_1.$$

Hence,

$$U = U_1 - U_1 R_1 / R_0 = U_1 [1 - R_1 / R_0].$$

But the output voltage, U_2 , is clearly the proportion of U developed across R_0 , given by

$$U_2 = U [R_0 / (R_1 + R_0)],$$

whence

$$U_2 = U_1 [1 - (R_1 / R_0)] [R_0 / (R_1 + R_0)].$$

From this, the ratio

$$U_1 / U_2 = N = (R_0 + R_1) / (R_0 - R_1).$$

This gives the attenuation factor in terms of R_0 and R_1 . What we need now is a relationship involving R_1 and R_2 in terms of R_0 and N . Working from this last result, we find that

$$R_1 = R_0 [(N-1) / (N+1)].$$

Using the earlier result that

$$R_0 = \sqrt{R_1^2 + 2R_1 R_2},$$

we get

$$R_2 = R_0 [2N / (N^2 - 1)].$$

When R_0 and N are known, these simple expressions enable an attenuator to be designed that gives a desired signal reduction and the proper matching conditions for the circuit system concerned. Figure 9 illustrates the meaning of the two formulae.

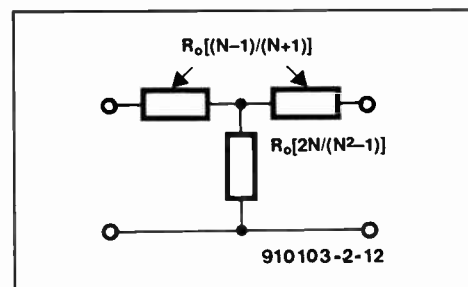

Fig. 9. Relationships to determine the elements in terms of R_0 and N .

Trying things out

A couple of examples will show how we can apply these results to solve some elementary design problems.

First, suppose we want a symmetrical T-section network to match into a 300Ω line and have a voltage attenuation of 14 dB; what values of resistors do we want?

Well, the attenuation factor $N = \text{antilog } 14/20 = \text{antilog } 0.7 = 5$. In other words, the output will be one fifth of the input. We thus get

$$R_1 = 300 [(5-1) / (5+1)] = 300 \times 4/6 = 200 \Omega;$$

and

$$R_2 = 300 [(2 \times 5) / (25 - 1)] = 300 \times 10/24 = 125 \Omega.$$

Figure 10 shows the completed section.

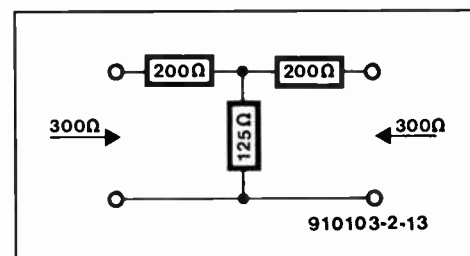

Fig. 10. Example of an elementary T-section design.

Suppose now that the output stage of a small transmitter has an internal resistance of 600Ω and is intended to supply current to a 600Ω load. We need to design a T-section which, when inserted into the line connecting generator and load, will reduce the load current to one third of its initial value.

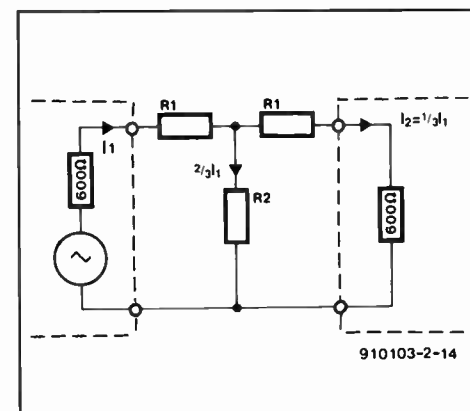

Fig. 11. A further design example relating to correct matching procedures.

This situation can be illustrated after the manner of Fig. 11. The section matches between equal impedances of 600Ω and should, therefore, have $R_0 = 600 \Omega$ also. The attenuation factor, N , is 3, so that

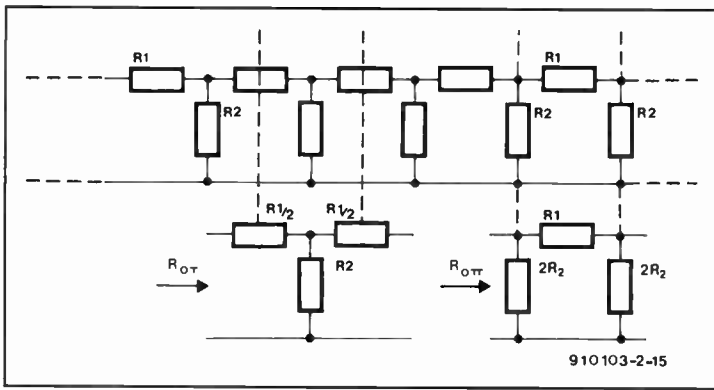

Fig. 12. These attenuator sections have the same total series and shunt resistances; then, $Z_{OT}Z_{O\pi} = R_1 R_2$.

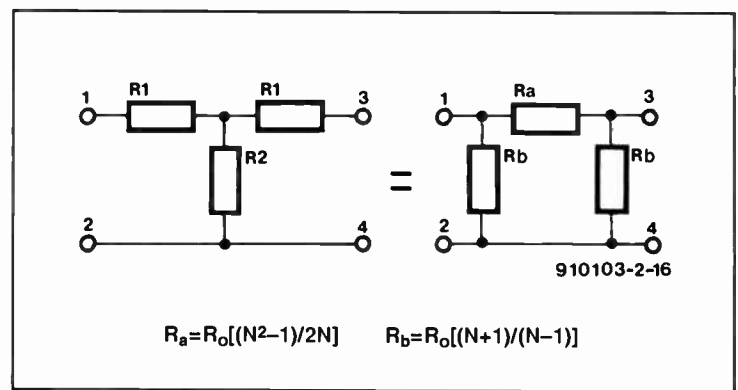

Fig. 13. Finding the element relationships between the T- and π -sections.

$$R_1 = 600[(3-1)/(3+1)] = 600 \times 2/4 = 300 \Omega$$

and

$$R_2 = 600[(2 \times 3)/(9-1)] = 600 \times 6/8 = 450 \Omega.$$

In a case like this, it is important to notice that current I_1 supplied by the generator is the *same* whether the section is in circuit or not. In both cases, the generator sees a resistive load of 600 Ω . With the section connected, the 'unwanted' current ($2/3 I_1$) flows along the shunt arm, as an application of Ohm's law will immediately verify.

The π -section

It might appear that the π -section has been rather neglected, but there is a circuit relationship between the T-section and π -sections that makes an analysis of the π -section quite easy. Figure 12 shows a ladder network of series and shunt resistances; from an examination of this network, is it a chain of T-sections or π -sections? The answer is that it depends how you look at it. For, either a T-section can be taken from the network by considering the line division AA, or a π -section taken by considering the line division BB. The T-section cuts through the centre of each of the series elements R_1 , while the π -section effectually splits the shunt element into two parallel parts, each of value $2R_2$. Hence, the ladder can be viewed as a string of T-sections or π -sections.

We might expect, therefore, that there would be little difference between the relationships derived for the two types of section, but for the matter of *equivalence* it isn't

just a job of halving the series arms and doubling up the shunts as this last analysis might have led us to believe.

We can make an exact comparison between the sections by looking at Fig. 13. Here, we use letter subscripts for the π -section resistors to avoid confusion.

For the two networks to be equivalent in their characteristics, the resistance seen between terminals 1 and 2 of both networks must be equal, as must the resistance between terminals 1 and 3 of both networks, with the output on open circuit. This means that $R_1 + R_2$ on the T-section must equal $R_b(R_a + R_b)/(R_a + 2R_b)$ on the π -section. Also,

$$2R_1 = 2R_a R_b / (R_a + 2R_b)$$

or

$$R_1 = R_a R_b / (R_a + 2R_b).$$

Substituting back for R_1 in the first expression then gives us

$$R_2 = R_b^2 / (R_a + 2R_b).$$

These relationships provide us with the elements of the T-network such that this will correspond to a given π -network.

It is also not too hard to demonstrate that for the basic π -section shown in Fig. 13

$$R_o = R_a R_b / \sqrt{(R_a^2 + 2R_a R_b)} = \sqrt{R_{oc} R_{sc}}$$

and that

$$R_a = R_o [(N^2 - 1) / 2N]$$

and

$$R_b = R_o [(N + 1) / (N - 1)]$$

where the bracketed term is simply inverted from that of the T-section and R_a and R_b are themselves swapped over.

A useful relationship follows from the first of these: since $\sqrt{(R_1^2 + 2R_1 R_2)}$ is the R_o of a T-section (R_{OT}), we can deduce that for sections having the *same total series and shunt resistances* (see Fig. 12 again)

$$R_{o\pi} R_{oT} = R_1 R_2 = R_a R_b.$$

Don't confuse this with the equivalence relationships.

So, fundamentally there is no difference in the functions of these alternative forms of the sections and either may be used in a particular situation. The actual choice depends upon which form, given a particular value of characteristic resistance R_o , yields the more readily obtainable values of resistance for the elements.

In general design work, where stringent conditions are not of vital importance, the use of 5% resistors is quite acceptable; the resulting variation in attenuation will normally be no more than 0.5 dB and the mismatch in the characteristic resistance itself of the order of 5%. We will return to these points a little later on.

Insertion loss

The important thing in designing attenuators for general bench use is not to bother too much about getting exact answers to the calculations. It is no use working out a resistance to three or four decimal places and

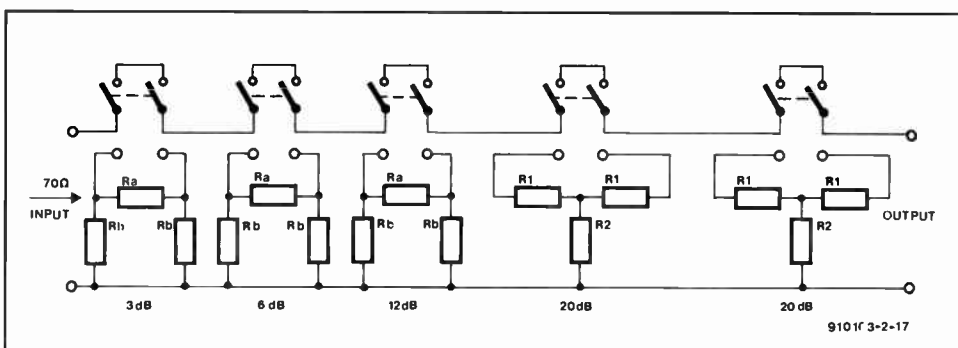

Fig. 14. Designing an attenuator knowing R_o and the required attenuation.

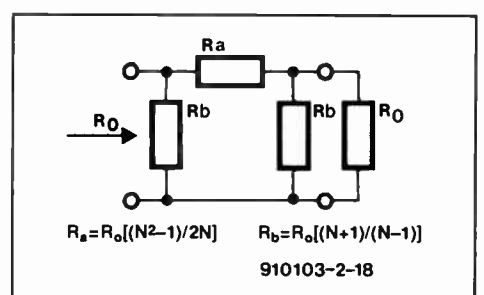

Fig. 15. The relationships should be compared with those for the T-section given earlier.

then discover that you've got to use a preferred value anyway. The attenuation factor can often be rounded off in the same way; 6 dB, for instance, is a voltage ratio of 1.9953... but we wouldn't put this into a formula: we use the nice round figure of 2. Of course, things don't always work out quite so conveniently, but anything beyond two decimal places is a waste of effort.

Let us now design a 5-section attenuator for a 70-Ω line giving switched positions of 3 dB, 6 dB, 12 dB and two 20 dB reductions. For interest, let the first three stages be derived from π-sections and the last two from T-sections. The job will look like Fig. 14, which also shows the appropriate switching.

Look first at the 3-dB section; the required attenuation is 3 dB for which attenuation factor N is found to be $\text{antilog } 3/20$ or 1.41. Using the relationships shown for convenience in Fig. 15, and with $R_0=70\ \Omega$, we find that $R_a=24.8\ \Omega$ and $R_b=410\ \Omega$. The last value is a bit of a problem, since it falls between 390 Ω and 430 Ω in the E24 range. One way out is to parallel 9.1 kΩ with a 430 Ω or get hold of a 412 Ω from the E96 precision range. Otherwise, use 24 Ω and 390 Ω in series; the mismatch is not very serious: R_0 then works out at 66 Ω.

Going through the same procedure for the 6 dB ($N=2$) and the 12 dB ($N=4$) π-sections, we find for the elements the respective values: $R_a=52\ \Omega$; $R_b=210\ \Omega$; $R_a=131\ \Omega$; $R_b=116\ \Omega$. Practical values here would be 51 Ω; 220 Ω; 130 Ω; and 120 Ω. Amuse yourself by calculating the above three ranges in terms of T-sections; do the resistance values fit any better?

For the two T-sections, we require an attenuation of 20 dB ($N=10$); hence, for $R_0=70\ \Omega$, we find

$$R_1 = R_0[(N-1)/(N+1)] = 70 \times 9/11 = 57\ \Omega$$

and

$$R_2 = R_0[2N/(N^2-1)] = 70 \times 20/99 = 14\ \Omega.$$

Practical values here would be 56 Ω and 13 Ω. The completed attenuator is shown in Fig. 16.

Now, try designing a series of five T-sections with switched ranges of 1 dB, 2 dB, 4 dB, 8 dB and 16 dB; this enables a maximum at-

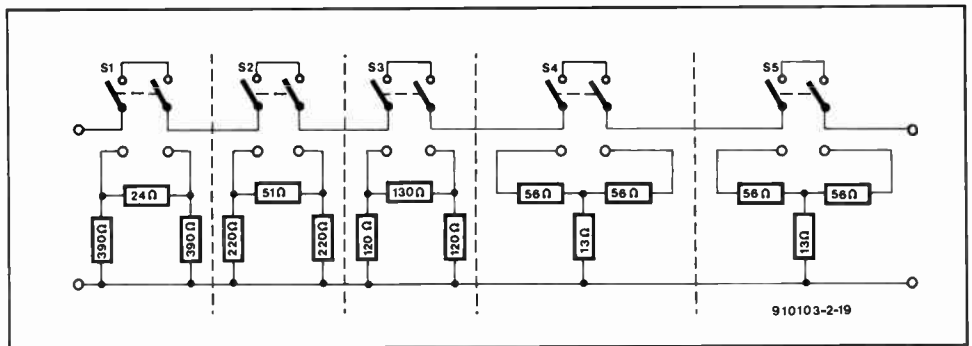

Fig. 16. The completed design.

tenuation of 31 dB to be achieved in 1 dB steps. The R_0 should suit your own particular fancy. As a help, the respective N values are 1.12; 1.26; 1.58; 2.45 and 6.30.

Practical considerations

When we talk about purely resistive attenuators, we are, of course, in the realms of fantasy; it is not possible to make up an attenuator system having a number of sections in tandem without introducing some inductive and capacitive elements. The object of any design is to keep these to their absolute minimum, just as in filters, where inductance and capacitance are the necessary elements, we try to eliminate resistance.

It is necessary, then, to keep all interconnecting leads as short as possible and to avoid the proximity of these leads, as well as the resistances themselves, to any surrounding metal parts. Further, there must be no capacitive coupling between the sections or certain frequency components of the signal will sneak through without the desired attenuation, but with definite phase shifts. The resistances should not, for obvious reasons, be wirewound, though types with a non-inductive construction might be used.

Simple aluminium boxes are available nowadays that can be used to house bench-type attenuators. Types measuring some 120–150 mm in length with perhaps 50 mm width and a depth of about the same are ideal. Figure 17 shows the general method of assembling such attenuators.

The box is divided up into the required number of compartments by cross screens that can be made of thin aluminium or tin-

plate. If aluminium is used, the screen will have to be flanged and screwed to the side walls of the box, but with an all tinplate construction, soldering is the best approach.

Small holes are drilled centrally in each screen (before fitting!) to permit the series-arm resistors to feed through, and the shunt-arm resistors are returned either directly to each screen or to a convenient position on the box floor itself. A relatively heavy common wire running through the screens sometimes makes dependence on the box metal unnecessary.

Slide or miniature toggle switches are used for the attenuation selection, though it is possible, with certain forms of construction—see Fig. 18—to use rotary switches. It is often easier to use the base of the box to carry the terminals and switching, the actual lid being fitted last and becoming the working base. This avoids having long leads to connect the switches which would then be separated from the rest of the network in the body of the box.

Attenuators that are to be housed inside equipment, such as a signal generator for example, can be built into the general internal design method, but a divided-compartment assembly is still necessary if the best results are to be obtained. For less stringent work, the resistances can often be simply mounted directly to the tags on a rotary switch wafer or wafers as they could for the system shown in Fig. 18. Most simple 'dividers' are assembled this way.

The power ratings of the resistors used in attenuators must, of course, be such as to ensure that no appreciable temperature rise can occur in normal use. ■

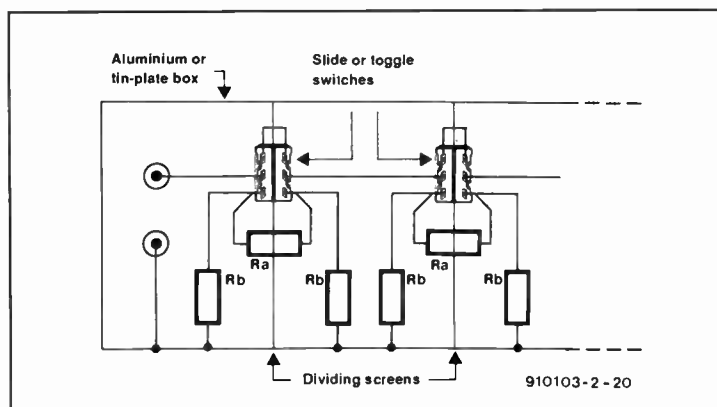

Fig. 17. Practical method of assembly.

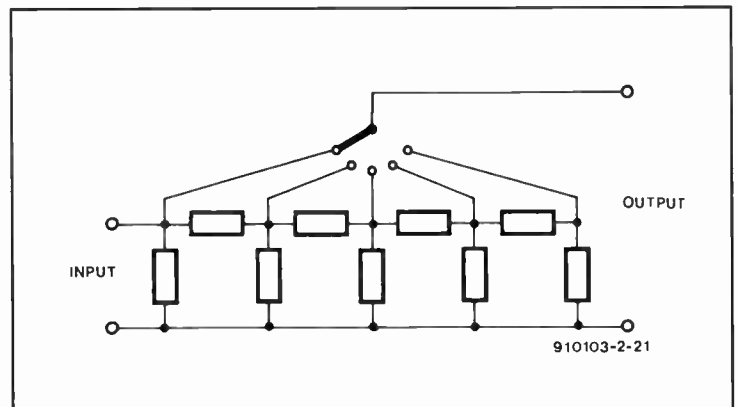

Fig. 18. An alternative switching system—more difficult to screen adequately.

A SIMPLE WATCHDOG CIRCUIT

by Akbar Afsoos

SINGLE-CHIP microcontrollers have been designed and optimized for specific applications such as industrial control and automotive applications. The Intel MCS-51 family of microcontrollers is a popular and typical example.

The presence of various types of electrical noise and interference in the above mentioned applications is by no means taken for granted, but generally accepted as hard to avoid. By virtue of some special features, such as powerful Boolean processing capabilities, single-chip microcontrollers are mostly used in industrial control applications which are known as electrically noisy environments.

In spite of a well-designed power supply, a shielded enclosure, and adequate decoupling provisions, noise may still enter a microcontroller system, upsetting the normal operation, or even causing a system crash. These situations are usually marked by the microprocessor going into its static state, or performing unpredictable operations. In such a case, normal operation can be restored only by a hardware reset (PC users know this as BRST — Big Red Switch Time).

A problem occurs when the microprocessor system operates unattended, which is usually the case in industrial applications. A total lockup of the system can then disrupt a production line, or cause expensive 'down time'. In such applications, hardware resetting must be performed automatically on detection of a software malfunction. The circuit described here (Fig. 1) provides a simple method to accomplish this.

Circuit description

The watchdog circuit consists of a power-up reset, a gated astable multivibrator, and a failure detector circuit. In fact, the total circuit simulates a retriggerable monostable

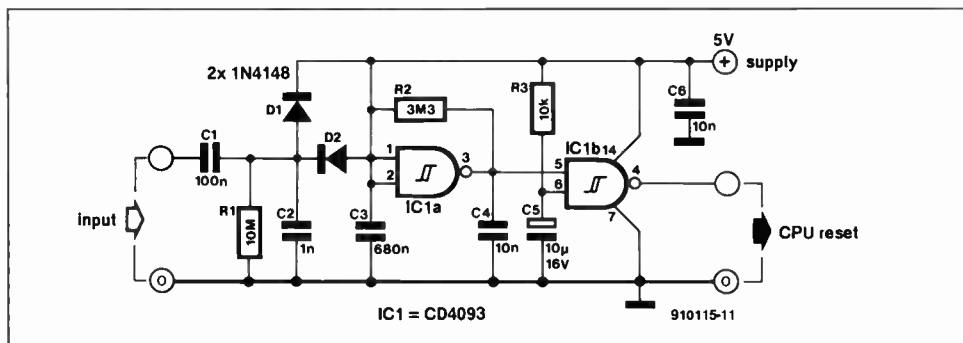

Fig. 1. Circuit diagram of the watchdog. The input is connected to a CPU port line.

multivibrator, which detects a software upset whenever it is not triggered at a proper rate.

In the MCS-52 family of microcontrollers, PX.X can be any pin (bit) of the ports 1, 2 or 3. Ports 2 and 3 may not be used when performing their secondary functions. Components R3 and C5 form a power-up reset circuit that applies a reset pulse to the CPU via gate IC1b, whenever power is applied.

During normal operation, and in the main loop of the program, a periodic pulse must appear on port line PX.X. The frequency of this signal must be at least 10 Hz. The software determines which port line is used to keep the watchdog triggered. In 8051 assembler code, this is simple to implement by the instruction CPL PX.X, where X.X is the port line identification, e.g. 1.0 (bit 0 of port 1).

The software failure detector consists of C1, R1, D1 and D2. The pulse train applied to the PX.X input of the circuit continuously discharges C3 via D2 and C1. As a result, the gated bistable around gate IC1a is disabled, and its output goes high. Hence, during normal program execution, the two inputs of IC1b are high, so that the CPU reset line is held low.

As soon as a software upset occurs, the

CPU very likely leaves the main loop of the program. This means that the pulses on PX.X fail, so that the port line takes on a static level. This enables the astable circuit which consists of IC1a, R2 and C3. After C3 has been fully charged by R2, the output of IC1a goes low. Consequently, a logic high reset pulse appears at the output of IC1b.

Because IC1a functions as an astable multivibrator, C3 is discharged again after about one second, so that the output of IC1a goes high. This causes the CPU reset line to revert to logic low, and the control program is executed starting at the reset address. The CPU has enough time (about one second) to restart the pulse train on PX.X, and resume its normal operation.

The reaction time of the watchdog may be shortened by using a smaller capacitor in position C3. Capacitors C2 and C4 reduce the effect of noise on the operation of the circuit. If a reset key is required, you can connect a pushbutton in parallel with capacitor C5.

This circuit may also be used with any of the devices in the Intel MCS-48 family of single-chip microcontrollers. This, however, requires an inverter gate to be inserted between the output of IC1b and the CPU reset line, because these controllers have active-low reset inputs. ■

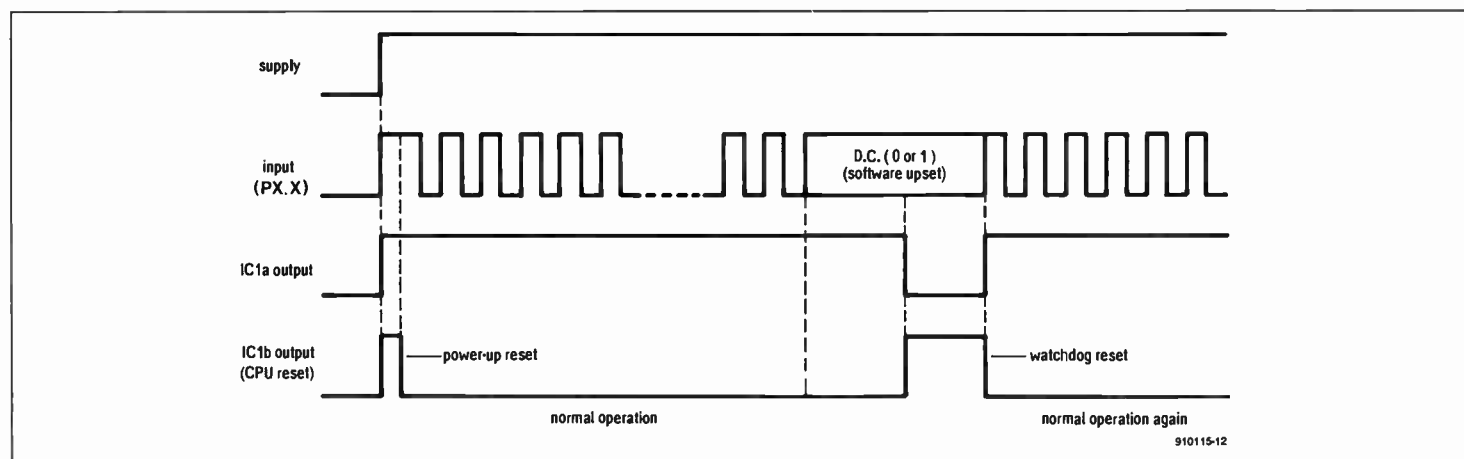
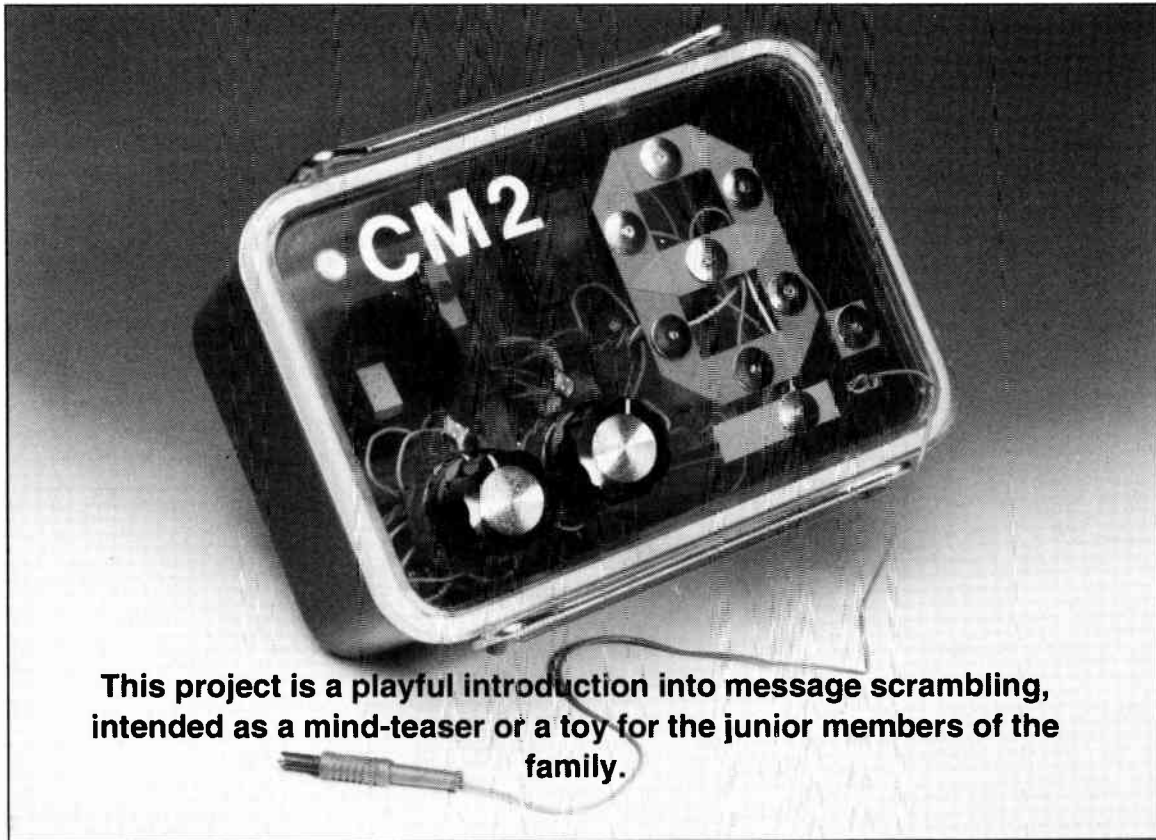

Fig. 2. Ideal waveforms illustrating the operation of the watchdog circuit.

THE CIPHER MACHINE



This project is a playful introduction into message scrambling, intended as a mind-teaser or a toy for the junior members of the family.

by Owen and Audrey Bishop

SINCE antiquity, the scrambling of the letters in a message has been a popular though elementary method of encryption. One of the earliest techniques was to write out the message in the rows of a square, or rectangular array of prearranged shape and size:

THISIS
ISNOTA
HIGHLY
SECURE
SYSTEM

The message is then written out by columns:

TIHSSHSIEYINGCSSOHUTITLRESAYEM

Needless to say, anyone who knows anything at all about ciphers will have no difficulty in breaking such a simple scrambled message. Another well-established method is to group the letters of the alphabet into pairs, and then exchange one member of a pair for the other when writing out the message. The pairs are usually determined by beginning with an agreed key-word, followed by the remaining letters in order:

MACHINEBDFGJK
LOPQRSTUVWXYZ

To encrypt the message, letters in the top row are exchanged for those in the bottom

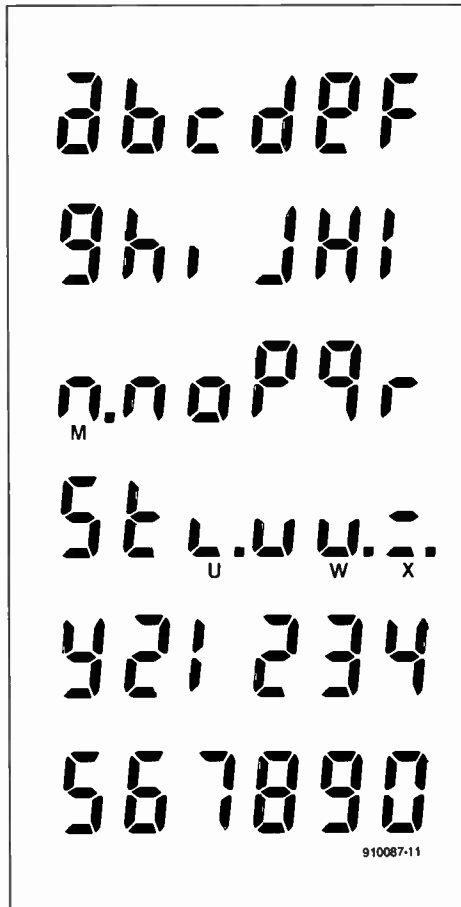

Fig.1. Representing letters and numerals on a 7-segment LED display.

row, and the other way about.

Message:

ALSO FAIRLY EASY TO BREAK

Cipher:

OMNA WORIMJ TONJ EA UITOZ

In this project we carry the idea of transposition into the letters themselves. We take the strokes used to write the letter, and scramble them by swapping them in pairs. The result is either a different letter or a weird and unrecognizable symbol. Most alphabetic and numeric characters can be written using the 7-segment matrix commonly employed in pocket calculators and digital clocks. Unfortunately, there are some problems in representing certain letters such as 'M', 'W' and 'X'. For these and a few others, a 16-segment 'starburst' matrix gives a better image, but such devices are expensive. This is intended to be a cheap, easy-to-wire, project for you to build for the youngsters. You may even want to build two, so that they can exchange messages.

So we have settled for a 7-segment display, even though there are difficulties with a few of the more 'awkward' letters. The scheme works better if we use a lower-case alphabet (Fig. 1). We make use of the eighth segment of the display, the decimal point, to distinguish 'm', 'u', 'w' and 'x'. This is used to represent a central vertical segment in the bottom half of the array.

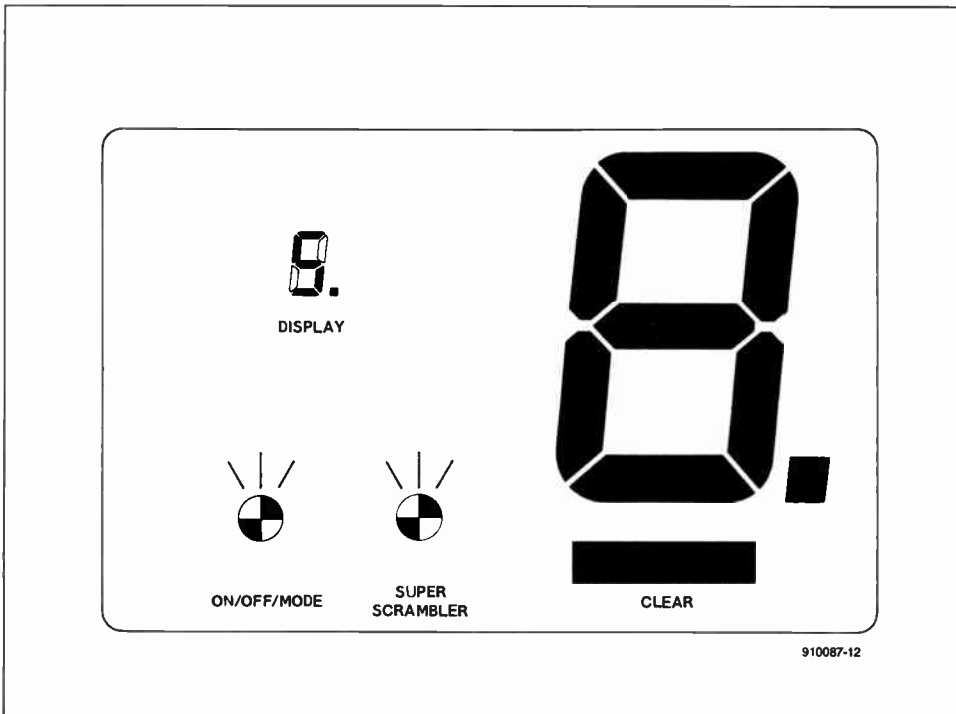

Fig. 2. Suggested layout of the panel of the Cipher machine.

Practical use

The Cipher machine is used as follows. The letters or numerals of the message are entered one at a time by touching the appropriate segments of a 7-segment key-panel with a stylus (See Fig. 2.). The scrambled version of the character appears on a 7-segment LED display, and this is copied down onto paper. The receiver of the message has a Cipher Machine with identical wiring (or uses the same machine), and enters the symbols on to the key-plate. The machine unscrambles the segments, reproducing the original letter or numeral on the 7-segment display.

Choice of display

The original version of this project simply scrambled the segments, producing characters such as those in Fig. 3. The weakness of this technique lies in the fact that the scrambled character has the same number of segments as the regular character. This is a clue

to the identity of the letter. For example, a 3-segment symbol obviously comes from a 3-segment letter, either 'c', 'n' or 'v'. It is usually easy to decide, for other reasons, which one of these it must be. Worse still, if the letter has only a few segments (for example, 'c' in Fig. 3), when the symbol tends to end up as a number of disconnected strokes. Such symbols are difficult to write convincingly. They also further advertise the fact that the system depends on interchanging segments.

To make unauthorized deciphering more difficult, the Cipher Machine logically inverts the scrambled segments when there are fewer than four. For example, the letter '1' (or figure '1'), has only 2 segments, but is displayed as a 5-segment symbol (Fig. 4). This procedure has the advantage of increasing the average number of segments making up the symbols, giving them a more 'connected' appearance. There are a few exceptions to this inversion routine, for reasons which will be explained later.

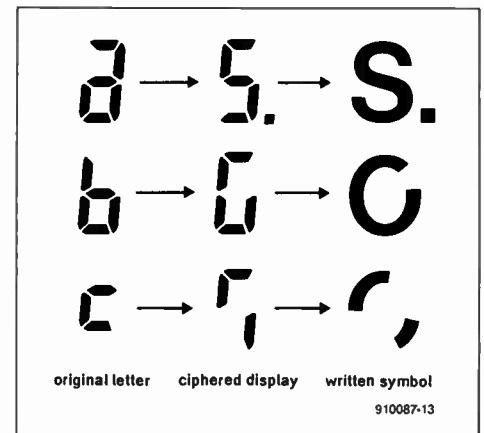

Fig. 3. Simple scrambling.

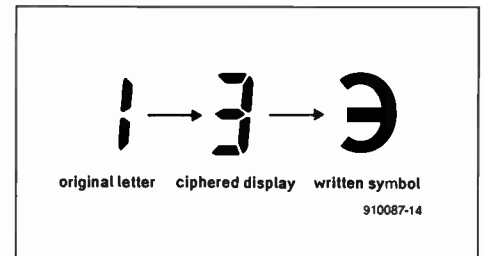

Fig. 4. Scrambling with inversion.

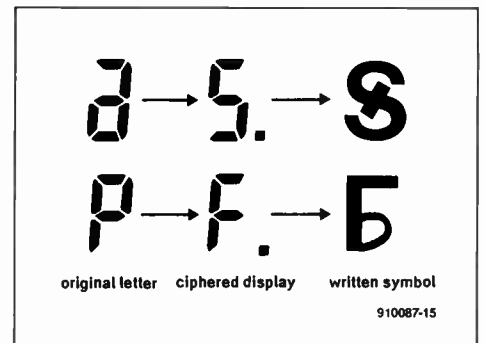

Fig. 5. Use of the 'wild card' segment.

Scrambling twists

Another twist to confuse the snooper is the way we use the decimal point (segment *h* of the display), when this comes up as one of the scrambled segments. We think of this as a 'wild card' which can be added to the symbol anywhere that is not part of the 7-segment matrix, as in Fig. 5. You can add the 'wild card' in different places each time it occurs, producing a confusing set of variations that all represent the same letter.

Finally, there is the super-scrambler option. This consists of a 3-position switch that varies the scrambling of four pairs of segments. This switch is set to a given position before ciphering begins. The authorized recipient knows the setting, and uses this when deciphering. All sorts of routines can be used by prior agreement, such as to alter the switch at the start of each paragraph, or even for each word or letter, according to a regular system.

Circuit details

The eight segments of the key-panel are connected to the SET input of a set-reset bistable (flip-flop) (Fig. 6). The SET input is normally held logic high by a pull-up resistor, R1-R8.

Table 1. Ciphering rules

Case	Original character	Ciphered symbol	<i>b</i> lit?
A	1, 2 or 3 segments, not including <i>h</i>	All segments inverted	Yes
B	1, 2 or 3 segments, plus <i>h</i>	<i>h</i> inverted, rest not inverted	No
C	4 to 7 segments, not including <i>h</i>	None inverted	No

Table 2. Deciphering rules

Case	Ciphered symbol	Deciphered character	<i>h</i> lit?
A	4 to 7 segments, including <i>b</i>	All segments inverted	No
B	1, 2 or 3 segments, not including <i>b</i>	<i>b</i> inverted, rest not	Yes
C	4 to 7 segments, not including <i>b</i>	None inverted	No

When a segment is touched by grounded stylus, the low input to the corresponding bistable causes its Q output to go high. The RESET inputs of these bistables are all connected to a single CLEAR pad on the key-panel, and are held logic high by R9. Touching the CLEAR pad with the stylus resets all the bistables, and their outputs go low. Thus, the bistables store the segments that make up the character.

The output of each bistable goes to one input of an XOR (exclusive-OR) gate. When the inputs of the gates are low, the output of each gate has the same state as the corresponding bistable. If the other inputs are high, the output of each gate is the inverse of the bistable outputs. For example, if pad *a* is touched, the first bistable in IC1 is set, and its

output, pin 13, goes high. If pin 2 of IC3 is low, pin 3 of IC2 goes high, and the LED segment *g* is lit. If pin 2 is high, the segment is not lit. The pads and the LED segments are in exchanged pairs so that, for example, touching pad *a* lights (or turns off) segment *g* on the display. Conversely, touching pad *g* lights (or turns off) LED segment *a*.

The circuit diagram shows just one permutation for scrambling. The super scrambler switch, S1, gives a variable pairing between segments *c* to *f*. This part of the circuit is open to modification. Many different combinations of any four of segments *a* to *g* can be wired to the super scrambler switch, and those four segments not so wired can be paired in three different ways. The only restriction is that *h* and its partner may not be

wired to the super scrambler switch. If you want to be able to use one machine for ciphering, and another for deciphering, both machines must be wired exactly alike.

The lower part of the circuit diagram shows the logic switch that decides when segments are to be inverted. The logic is summarized in Table 1.

In case 'A' we obtain a symbol with five to seven lit segments, plus *b* (assuming that *h* has been scrambled with *b*, as in the schematic). The letters included in case 'B' are the 'm', 'u', 'w' and 'x', all of which require the use of the *h* segment. Since we rely on the state of *h* (scrambled to *b*) when deciphering, we have no compromise by not inverting the segments of these few letters. Case 'C' includes all other letters with three or fewer

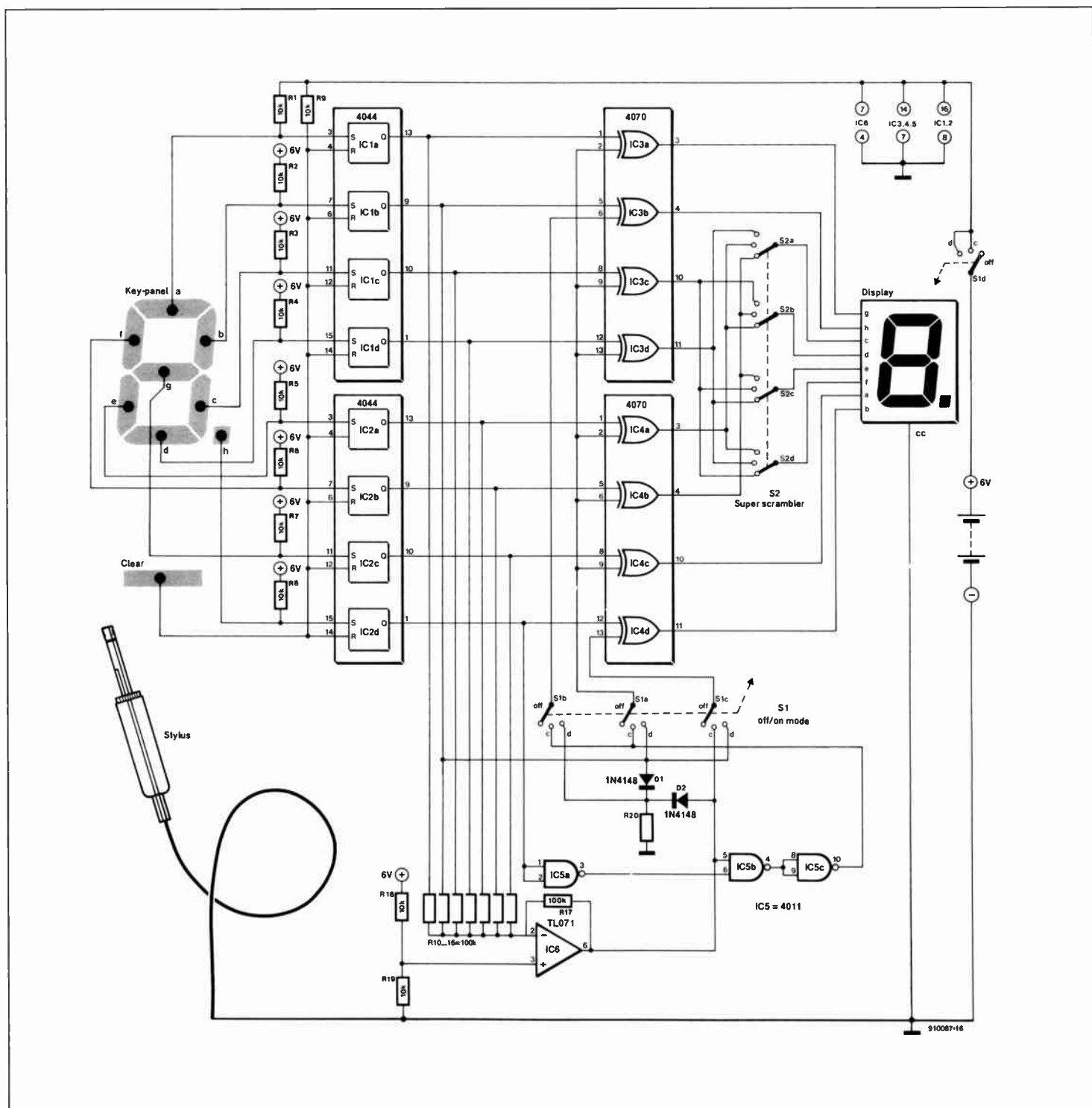

Fig. 6. Schematic diagram of the Cipher machine.

Elektor Electronics USA

World Class Tested Electronic Construction Projects

**ELEVEN
PROJECT PACKED
ISSUES—ONLY
\$28**

Now you can test your electronics know-how...apply your skills to useful, interesting projects...stretch your imagination...and put the fun back into electronics! *ELEKTOR ELECTRONICS* magazine brings you an average of 14 world class electronics construction projects every issue--PLUS two 36-page Bonus Issues with more than 50 projects--complete with the circuit cards, diagrams, parts lists, sources and everything else you need to understand and build them!

- YES**, send me one year (11 issues) of *Elektor Electronics USA*
@ \$28.00 Canada add \$8 postage
- Bill me Check enclosed VISA/Mastercard

MC/VISA

EXP.

NAME

STREET & NO.

CITY

STATE WorldRadioHistory





PLACE
STAMP
HERE

Elektor Electronics USA

PO Box 876, Dept. ELI
PETERBOROUGH, NH 03458-0876



WorldRadioHistory

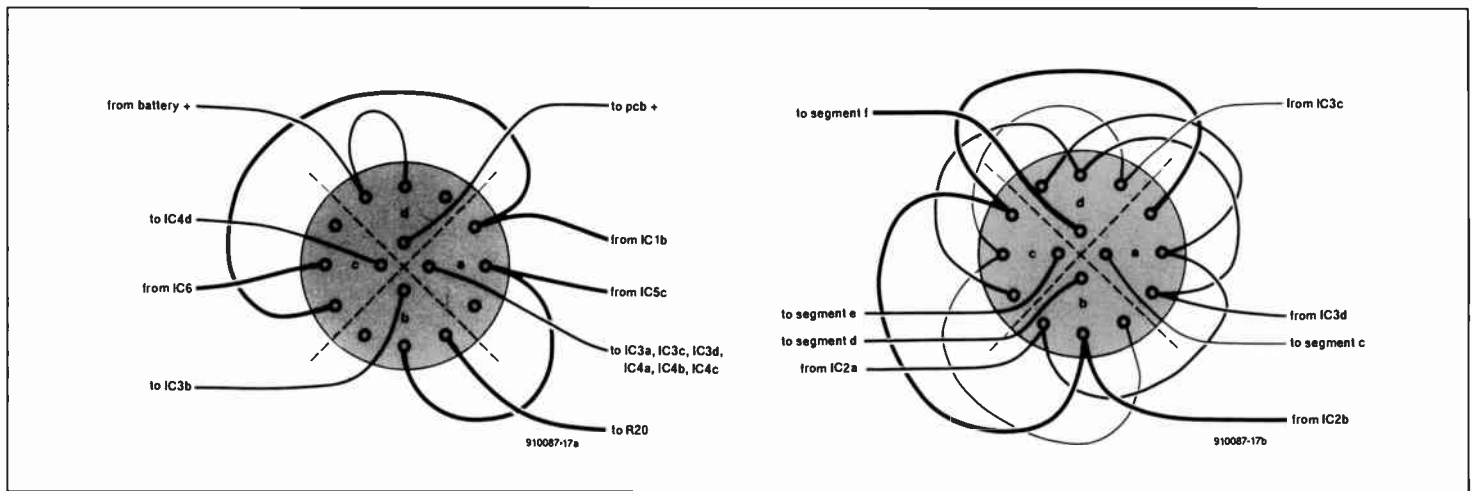

Fig.7. (a) Wiring of S1, as seen from the rear. (b) Wiring of S2, as seen from the rear.

segments. There are no characters that have four to seven segments and *h*.

From Table 1, we establish three rules for ciphering:

1. Invert *a* and *c* to *g* if there are one to three segments of *a* to *g* set, and *h* is not set (case 'A');
2. Invert *b* for the same conditions as in Rule 1 (Case 'A');
3. Invert *h* if there are one to three segments of *a* and *c* to *g* set (case 'B').

The number of segments set is 'counted' by an operational amplifier, IC6, wired as a summing amplifier. We could have used a digital equivalent, but no 7-input gate is available 'off-the-shelf'. This substitute is considerably less complex to wire up than a digital version made of discrete gates. The summing action is also accompanied by inversion. When three or fewer bistables have a high output, the output of the operational amplifier swings fully high. When four or more have a high output, the amplifier swings fully low.

When there are one to three segments lit, the output of IC6 is high; this is fed by way of S1c to IC4d, the XOR gate for segment *h*, which is thus inverted, causing segment *b* to remain off. This complies with Rule 3 above. The output of the *h* bistable is inverted by IC5a, so its output is high when *h* is not set. The output of IC6 is high when one to three segments are set. The two high inputs to the NAND gate, IC5b, make its output go low, and this is inverted by IC5c. Through switches S1a and S1b, this causes high levels at the inputs of the XOR gates, inverting segments *a* to *g*, and conforming to Rules 1 and 2.

The rules for deciphering are slightly different, which is why we need S1 to switch between ciphering (C) and deciphering (D) modes. The conditions for deciphering are given in Table 2. The logic for Rules 4 and 6 is effected by S1a and S1c connecting the output of the *b* bistable to the inputs of the XOR gates *a* and *c* to *g*. The outputs of IC6 and the *b* bistable need to be ORed together to perform deciphering Rule 5. Instead of installing an extra IC to provide an OR gate, we have used 'Mickey-Mouse' logic: the two diodes D1 and D2, and a 10-k Ω pull-down resistor, R20.

Construction

Since the Cipher Machine was intended as a not-too-serious toy for the junior members of the family, the prototype was built in a brightly-coloured novelty form (see the introductory photograph). The enclosure is a food storage box with a clear snap-on lid. This exposes the 'works' for all to see, so the battery holder, PCB, switches, ICs and other components are painted in red, blue and yellow. We also bought plastic knobs for S1 and S2.

There is no limit to the variety of the colour schemes you can employ but, if you prefer a rather different image, the project could be realized as a rugged all-black 'military-look' device. Alternatively, you could disguise it as a radio set, or even as a bound volume to hide away on the bookshelf.

The circuit should not be too difficult to build on a piece of Veroboard or stripboard. The battery holder is glued to the bottom of the enclosure, and special self-adhesive PCB mounting strip is used for the circuit board. The area around the display is shielded from direct light by a cylinder painted matt black inside, and a bright tint outside. The cap from a spray can makes a suitable shield.

The key-pads are laid out as an array of strips of coloured PVC insulating tape. A narrow hole is drilled at the centre of each strip, and through the lid below. A brass thumb-tack is pushed into each hole to form the contact for the stylus. Wire is wrapped around the pin of each tack, and soldered to it. The lid of our enclosure was made of high-impact polystyrene or similar plastic, so care was needed not to shatter it by over-enthusiastic drilling. The two switches are also mounted on the lid. Their decorative effect is enhanced by looping out the connecting wires in the shape of flower petals, as shown in Fig. 7. A hole is drilled in one side of the enclosure for the lead to the stylus.

There are no alignment problems: if correctly assembled, the Cipher Machine should work first time. The detailed description given above should help you iron out any discrepancies. ■

OPERATING INSTRUCTIONS

Ciphering

1. Switch on and turn to cipher mode (C).
2. Set the super-scramble switch to any one of the positions you have agreed with your correspondent.
3. Touch the stylus to the CLEAR pad.
4. To encipher the first letter or numeral of the message, touch the stylus to the segments that contain it (Fig. 1).
5. Copy on to paper the symbol that appears on the display. If possible, make it more 'rounded' like a hand-written character. If the decimal point on the display is lit, add a stroke anywhere you like, but not where the seven segments of the display are located.
6. Repeat steps 3 to 5 for each character of the message. Leave a space between words, or devise a special 'space' symbol, making sure it is not one that decipherers into a regular letter or numeral.

Deciphering

1. Switch on and turn to decipher mode (D).
2. Set the super-scramble switch to the position that you have agreed with the sender of the message.
3. Touch the stylus to the CLEAR pad.
4. To decipher the first symbol, touch the stylus to the segments that it contains. If it includes a 'wild card' stroke, touch the decimal point.
5. Copy on to paper the character that appears on the display. If the decimal point is lit, it indicates one of the letters 'm', 'u', 'w' or 'x', depending on which other segments are lit.
6. Repeat steps 3 to 6 for each symbol of the message.

UPGRADE FOR MCS BASIC-52 V.1.1 (Part 2)

Following last month's dealings with the floating-point nucleus and the hex-to-BCD conversion routine in the MCS-52 BASIC interpreter, the authors now tackle some problems with multiplications.

by Z. Stojavljevic and D. Mudric

Continued from the October 1991 issue.

INCONSISTENCIES in the multiplication of two numbers as performed by version 1.1 of Intel's MCS BASIC-52 interpreter can be demonstrated by running the following three small programs, all of which produce wrong results.

```
10 a=1.E-65
20 b=1.E-65
30 ?a*b           (result: 1.0E+126)
```

```
10 a=1.E-65
20 b=1.E-64
30 ?a*b           (result: 0)
```

```
10 a=1.E-64
20 b=1.E-64
30 ?a*b           (result: 1.0E-0)
```

In all three cases, the interpreter should have produced

ERROR: ARITH. UNDERFLOW - IN
LINE 30

The above examples point to inconsistencies in limit cases when two numbers are multiplied. On investigating the operation of Intel's BASIC interpreter, a multiplication algorithm of the type shown in Fig. 1 was found. Apparently, the inconsistencies brought to our attention by the above example programs were caused by the exponent adjustment routine, which is listed in Fig. 2. Unfortunately, the errors found in this routine cannot be corrected in BASIC-52 machine code, because some expansion of the machine code is in order. This means that a number of lines should be added to the assembler source file for compensation.

A problem occurs when the result of the instruction SUBB A,#81H is 0FFH, which

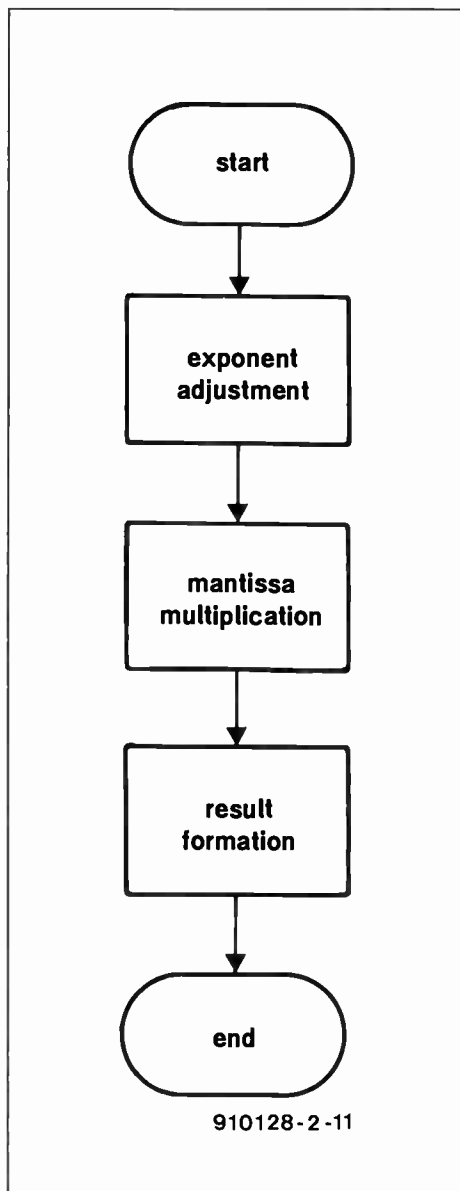
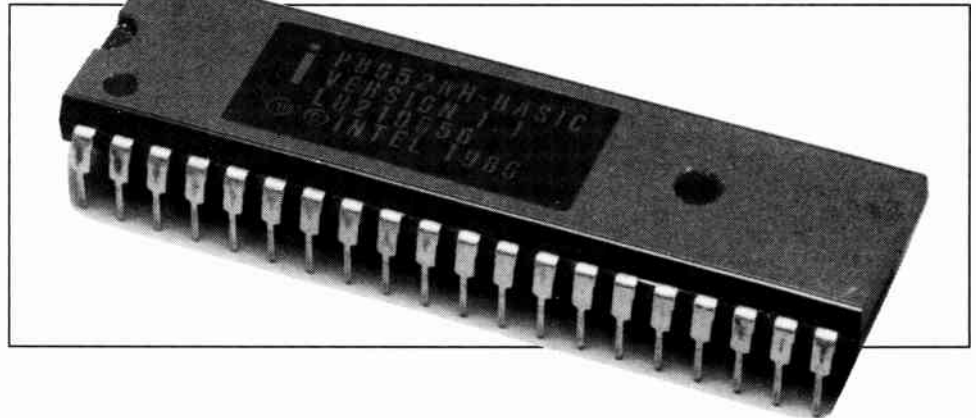

Fig. 1. Flowchart of the routine that handles multiplication of two numbers.

equals exponent E+127. If the program part for mantissa multiplication includes a result that begins with a 0 after the decimal point, the exponent is not incremented but remains

```

1A9AH 9175      ACALL  1C75H
1A9CH BE0002   CJNE   R6, #00H, 1AA1H
1A9FH 61B8     AJMP   1B88H
1AA1H 0D2F     MOV    2FH, R5
1AA3H EF       MOV    A, R7
1AA4H 60F9     JZ     1A9FH
1AA6H 2E       ADD    A, R6
1AA7H 20E705   JB     ACC.7, 1AAFH
1AAAH 10D706   JBC   CY, 1AB3H
1AADH 61B2     AJMP   1B82H
1AAFH 5002     JNC   1AB3H
1AB1H 61A1     AJMP   1BA1H
1AB3H 9401     SUBB  A, #01H
1AB5H FE       MOV    R6, A
1AB6H 718B     ACALL  1B8BH
1AB8H 7B04     MOV    R3, #04H
1ABAH AC01     MOV    R4, #01H
1ABCH 0C01     MOV    01H, R4
1ABEH E3       MOVX  A, @R1
1ABFH FA       MOV    R2, A
1B30H 7834     MOV    R0, #34H
1B32H E6       MOV    A, @R0
1B33H FE       MOV    R6, A
1B34H 6003     JZ     1B39H
1B36H 717F     ACALL  1B7FH
1B38H 18       DEC    R0
1B39H 08       INC    R0
1B3AH 7408     MOV    A, #08H
1B3CH F9       MOV    R1, A
1B3DH 28       ADD    A, R0
1B3EH F8       MOV    R0, A
1B3FH 860500   CJNE  @R0, #05H, 1B42H
1B42H 4013     JC     1B57H
1B44H D3       SETB  C
1B45H E4       CLR   A
1B46H 18       DEC    R0
1B47H 36       ADDC  A, @R0
1B48H D4       DA    A
1B49H D6       XCHD  A, @R0
1B4AH 30E409   JNB   ACC.4, 1B56H
1B4DH D9F5     DJNZ  R1, 1B44H
1B4FH 18       DEC    R0
1B50H 7601     MOV    @R0, #01H
1B52H 717F     ACALL  1B7FH
1B54H 0006     SJMP  1B5CH
1B56H 19       DEC    R1
1B57H E9       MOV    A, R1
1B58H C3       CLR   C
1B59H C8       XCH  A, R0
1B5AH 98       SUBB  A, R0
1B5BH F8       MOV    R0, A
1B5CH 792B     MOV    R1, #2BH
1B5EH E6       MOV    A, @R0
1B5FH C4       SWAP  A
1B60H 08       INC   R0
1B61H D6       XCHD  A, @R0
1B62H 4206     ORL   06H, A
1B64H F7       MOV    @R1, A
1B65H 08       INC   R0
1B66H 09       INC   R1
1B67H B92FF4   CJNE  R1, #2FH, 1B5EH
1B6AH EE       MOV    A, R6
1B6BH 7003     JNZ   1B70H
1B6DH 753000   MOV    30H, #00H
1B7FH 0530     INC   30H
1B81H E530     MOV    A, 30H
1B83H 70F9     JNZ   1B7EH
1B85H D0E0     POP   ACC
1B87H D0E0     POP   ACC
1B89H 61A1     AJMP  1BA1H
  
```

910128-2-12

Fig. 2. Original program part for exponent adjustment.

```

ORG      1A9AH

; TOS - Top Of arithmetic Stack
; NXTOS - NeXt TOS (position behind)

; TOS_MUL1
; routine for multiplication of two FP numbers, one of which
; is located on TOS and the other on NXTOS (NXTOS*TOS)

TOS_MUL1:ACALL  PREP_MUL; clearing of FP working space and reg. prep.
CJNE      R6,#0,NXTNM_0 ; is NXTOS equal 0?
TOSM_0:  AJMP   ZERO_MANTISSA ; in case TOS or NXTOS are 0
NXTNM_0: MOV   SIGN,R5 ; result mark in SIGN
MOV       A,R7 ; is TOS equal 0?
JZ        TOSM_0
ADD       A,R6 ; addition of exponent degree (exp. multipl.)
JB        ACC.7,CMPM_EXP ; exp. with different mark or overflow?
JBC       CY,CORM_EXP ; result is bigger than 0.1
AJMP     UNDERFLOW ; in this case exp. sum is < -127
CMPM_EXP:JNC  CORM_EXP; in this case result is smaller than 0.1
OVER_MD: AJMP  OVERFLOW; in this case exp. sum is > 127
CORM_EXP:CLR  MUL_LIMIT_CASE ; flag of multiplication limit case
SUBB     A,#82H ; exp. multipl. results are within the limits
INC       A ; deduction with 82H because of reduced
JNC      NMARK_L ; conditions
SETB     MUL_LIMIT_CASE ; limit case
NMARK_L: MOV   R6,A ; exp. adjustment to real value
ACALL    BCD2_1 ; disassembl. of TOS mantissa in LEN_MANTISSA
MOV      R3,#LEN_BYTE ; acc. (one number in each byte)
MOV      R4,AR1 ; R1 is pointer of NXTOS
MUL_NOOV:MOV  AR1,R4 ; @R1 contains few numbers and disassembled
MOVX    A,@R1 ; mantissa is successively multiplied by each
MOV     R2,A ; of them in argument accumulator (R2 is
; auxilliary register)

-----

; TRANSFER
; routine for adjustment of multiplication and division
; results of FP numbers in argument stack and mantissa
; conversion in BCD packed format in argument accumulator

TRANSFER:MOV  R0,#ASCII_DEC ; pointer to MSB result number
MOV  A,@R0 ; MSB result number is in acc.
MOV  R6,A
JZ   MSB_EQ_0; is MSB result number equal 0?
INC_EXP ; exp=exp+1 because from the start it was
DEC R0 ; taken that MSB result number is equal 0
MSB_EQ_0:INC R0 ; pointer to MSB-1 number
MOV A,#LEN_MANTISSA ; positioning to LSB-1 number
MOV R1,A ; R1 is counter
ADD A,R0
MOV R0,A ; R0 contains the address of LSB-1 number
CJNE @R0,#05,ROUND1 ; test of remainder to rounding
ROUND1: JC NO_ROUND; in case remainder is smaller than 5 there
C_BCD: SETB C ; is no rounding
CLR A ; carry takes one because of rounding
DEC R0 ; transfer of carry into higher byte
ADDC A,@R0 ; addition of 1 to higher byte
DA A ; adjustment to BCD format
XCHD A,@R0 ; result storing in higher byte
JNB ACC.4,NO_C_BCD ; transfer in higher BCD nibble?
DJNZ R1,C_BCD; is @R0 the address of MSB number?
DEC R0 ; transfer memorizing in the place MSB+1
MOV @R0,#01
ACALL INC_EXP ; transfer is outside decimal point frame
SJMP BCD1_2
NO_C_BCD:DEC R1
NO_ROUND:MOV A,R1 ; address return in R0 to the first bigger BCD
CLR C ; number which is not equal 0
XCH A,R0
SUBB A,R0
MOV R0,A
BCD1_2: MOV A,EXPONENT ; test of exceeding in limit case
JNB MUL_LIMIT_CASE,N_LCASE
JZ UNDER_MD; message about underflow
INC A
JZ UNDER_MD; message about underflow
N_LCASE: MOV R1,#ARGUMENT_ACC; repacking of BCD number in one byte
XFER_1: MOV A,@R0 ; in two BCD numbers in one byte
SWAP A ; higher number in BCD packed format is in
INC R0 ; upper nibble
XCHD A,@R0 ; BCD packed format is in ACC
ORL AR6,A ; the indication if mantissa is 0 is in R6
MOV @R1,A ; packing in argument accumulator mantissa
INC R0 ; two BCD packed numbers in one byte
INC R1
CJNE R1,#SIGN,XFER_1
MOV A,R6
JNZ RESULT_MAT_OP_TOS ; is mantissa equal 0?
MOV EXPONENT,#0

-----

INC_EXP: INC EXPONENT; exp. adjustment by 1 (consequence of
MOV A,EXPONENT ; transfer after addition)
JNZ EXP_OK ; test of exponent exceeding
POP ACC ; removal from return address stack
POP ACC
JBC MUL_LIMIT_CASE,UNDER_MD ; in limit case it is
AJMP OVERFLOW; underflow
UNDER_MD:AJMP UNDERFLOW

```

Fig. 3. Source code of the improved multiplication routine. The vertical bars indicate lines that correct the limit case multiplication errors mentioned in this article.

OFFH. After the result formation (see Fig. 1) and the serial output (display) routine, this gives an exponent $E+126$.

To avoid inconsistencies, and eliminate errors in limit case multiplications, the program listed in Fig. 3 was developed. The lines marked by vertical bars in particular correct the limit case multiplication errors.

On the basis of the information contained in this and last month's instalment, the authors developed an improved, error-free floating-point (FP) arithmetic for the 8051, on the basis of the FP nucleus extracted from the 8052AH-BASIC. The new FP nucleus uses a modified way of accessing the arithmetic stack, and has faster, shorter code for a number of algorithms. It allows the length of the mantissa of a FP number to range from 2 to 16 digits, while the entire memory map of the FP arithmetic variables is located in the internal memory space of the 8051 microcontroller. ■

PREVIEW Audio Amateur

Issue 4, 1991

- A new control preamplifier
- The IR remote slave
- Improving power supplies
- Build a video test generator

AZ-07

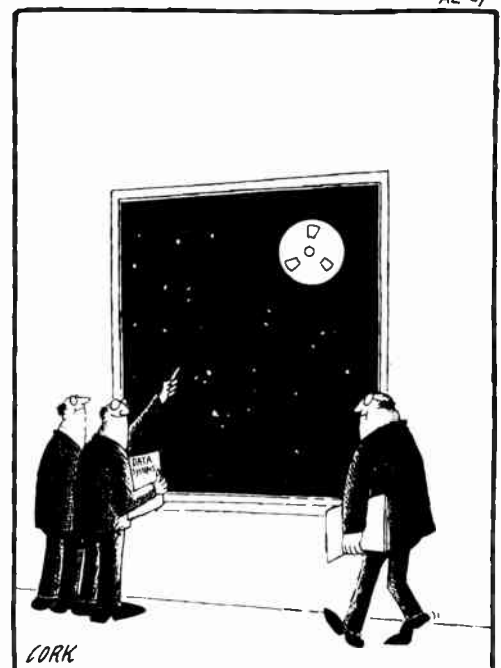

INTERMEDIATE PROJECT

A series of projects for the not-so-experienced constructor. Although each article will describe in detail the operation, use, construction and, where relevant, the underlying theory of the project, constructors will, none the less, require an elementary knowledge of electronic engineering. Each project in the series will be based on inexpensive and commonly available parts.

TIMER FOR CENTRAL HEATING SYSTEMS

To achieve a comfortable room temperature quickly it is often required to switch on the central heating (CH) boiler for ten minutes or so, for instance, in the morning, or when you get home from work. Unfortunately, most CH systems can be switched on only by turning up one of the room thermostats. This works, but if you forget to turn it down again, the resultant hothouse is not only unhealthy but also a waste of energy.

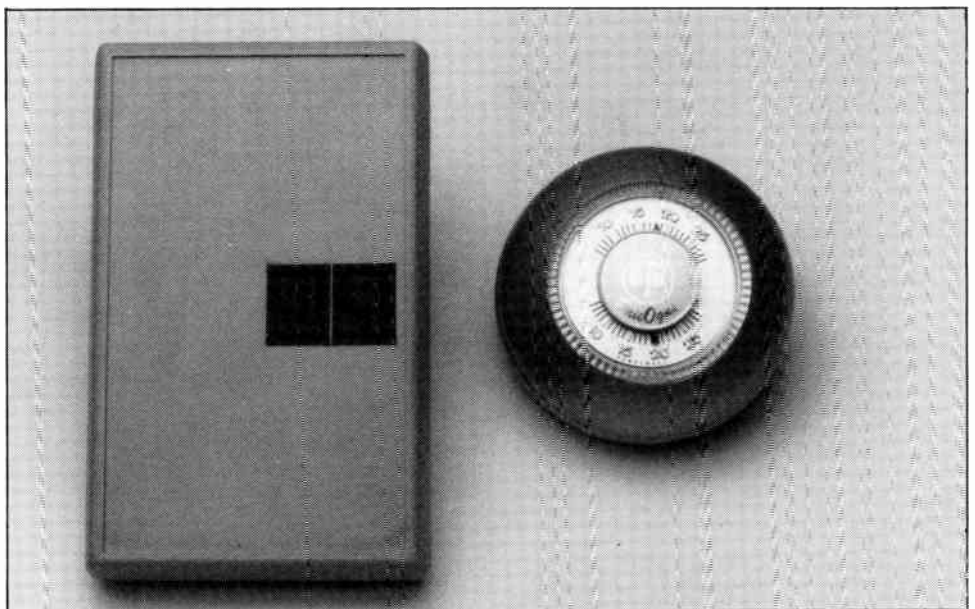

by J. Ruffell

THE circuit described here is a timer that can be connected to most types of CH room thermostats, including the well-known Honeywell types and look-alikes (see the above photograph). Its function is to actuate the CH boiler (and pump) for a certain period, overriding the thermostat output. Unlike you, it is not in the habit of forgetting to turn the boiler off again — all you have to do is press a button to start the timer. The circuit is simple to build, and conveniently fitted next to the room thermostat.

How it works

The timer is actually a monostable multivibrator with an adjustable on-time. The circuit diagram in Fig. 1 shows that a 4060 ripple counter IC is used as the timing device. The 4060 has an on-board oscillator,

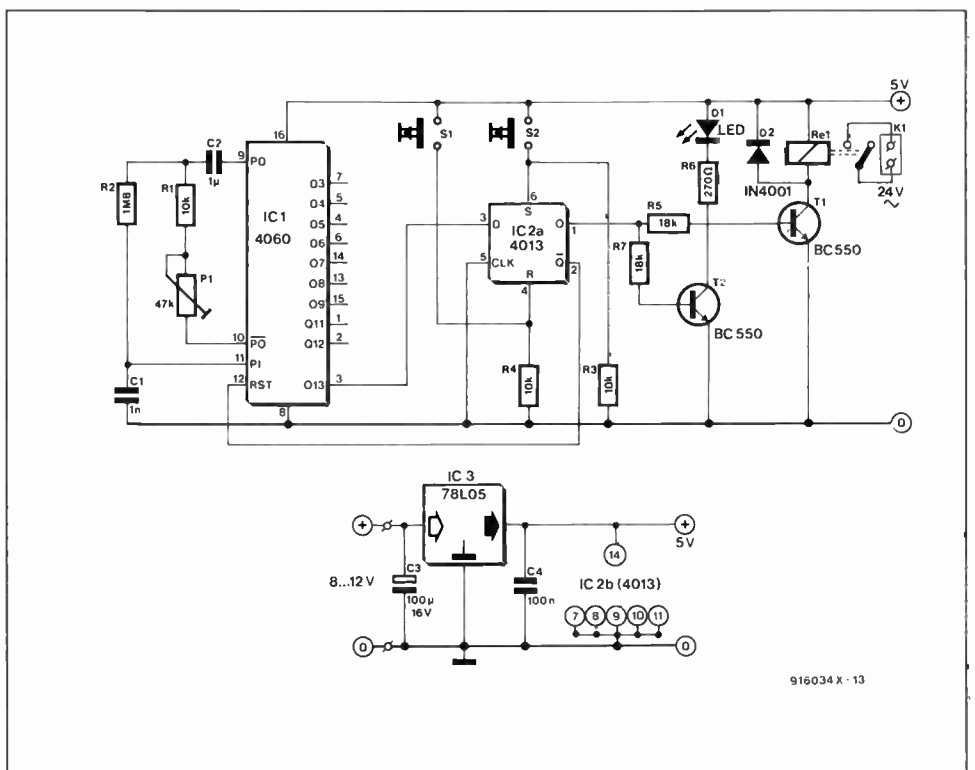

Fig. 1. Circuit diagram of the central heating timer.

916034 X - 13

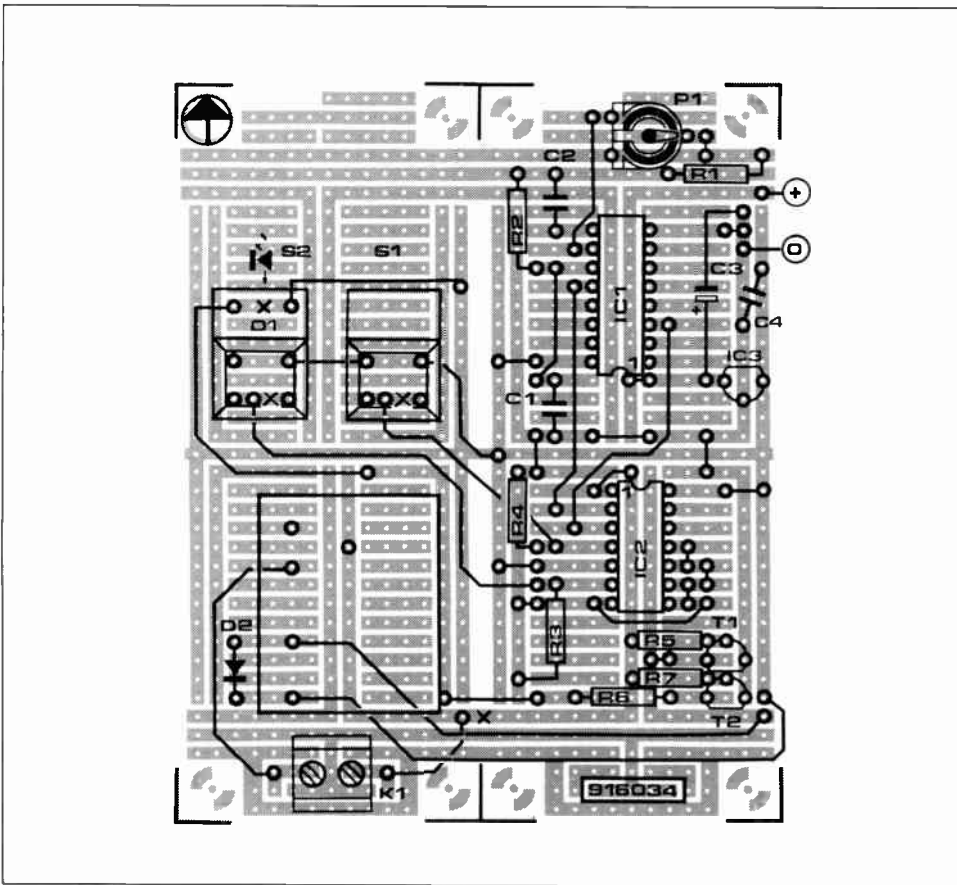

Fig. 2. Component mounting plan on board UPBS-2.

COMPONENTS LIST		
Resistors:		
3	10kΩ	R1;R3;R4
1	1MΩ	R2
2	18kΩ	R5;R7
1	270Ω	R6
1	50kΩ preset H	P1
Capacitors:		
1	1nF	C1
1	1μF solid MKT	C2
1	100μF 16V axial	C3
1	100nF	C4
Semiconductors:		
1	4060	IC1
1	4013	IC2
1	78L05	IC3
2	BC550	T1;T2
1	LED	D1
1	1N4148	D2
Miscellaneous:		
1	V23127-A0001-A101 (Siemens) or similar 5-V PCB-mount relay	Re1
1	push-button with LED hole	S1
1	push-button	S2
1	2-way terminal block	K1
1	printed circuit board	UPBS-2

which is connected here to a resistor-capacitor network, R1-P1-R2-C1-C2. These components, connected to the PO (phase out), P \bar{O} (phase out inverted) and PI (phase in) pins of the 4060 determine the oscillator frequency. Preset P1 gives the oscillator a frequency range of about 6 Hz to 27 Hz. The Q13 output of the 4060 goes high after 2¹³ (8,192) oscillator clock pulses, that is, after 5 to 20 minutes depending on the setting of P1.

The ripple counter in the 4060 operates only if the reset input of the IC is held logic

low, which is the case when bistable IC2a is set. This happens when push-button S2 is pressed. When the Q13 output of the counter goes high, the logic level at the data (D) input of the bistable is clocked ('latched'). Since the D input is permanently connected to ground, a logic low is clocked, which has the same effect as resetting the bistable (note that resetting is also possible by pressing push-button S2).

The resetting of the bistable halts the counter. This happens either when the preset

time has lapsed, or when the user presses S2 while the timer is still counting down. If the Q output of the bistable is high (i.e., when the counter is active), transistors T1 and T2 are switched on via R5 and R7 respectively. T1 in turn switches on a relay whose contacts are connected in parallel with the room thermostat contacts. The closed contact causes the CH boiler (and pump) to be switched on. At the same time, T2 turns on a LED that indicates the activity of the CH timer.

The timer has an internal 5-V supply based on a 100-mA 5-V regulator Type 78L05. The direct input voltage of between 8 V and 12 V may be supplied by a mains adaptor.

Construction and connection

The CH timer is built on a universal prototyping board size-2 (UPBS-2), which may be obtained through our Readers Services. A suggested component mounting plan is shown in Fig. 2. The two ICs are best fitted in sockets. Do not forget any of the wire links, and observe the polarity of the diodes and the electrolytic capacitors. Make sure connector K1 is soldered securely to the board to prevent it coming loose when the connecting wires cause strain. If you want a front panel control instead of the preset on the board, simply replace P1 by a 47-kΩ linear potentiometer. A simple timing scale may be provided around the pot by measuring the on-time of the relay at a few settings. Finally, the timer is connected to the CH system wiring as shown in Fig. 3

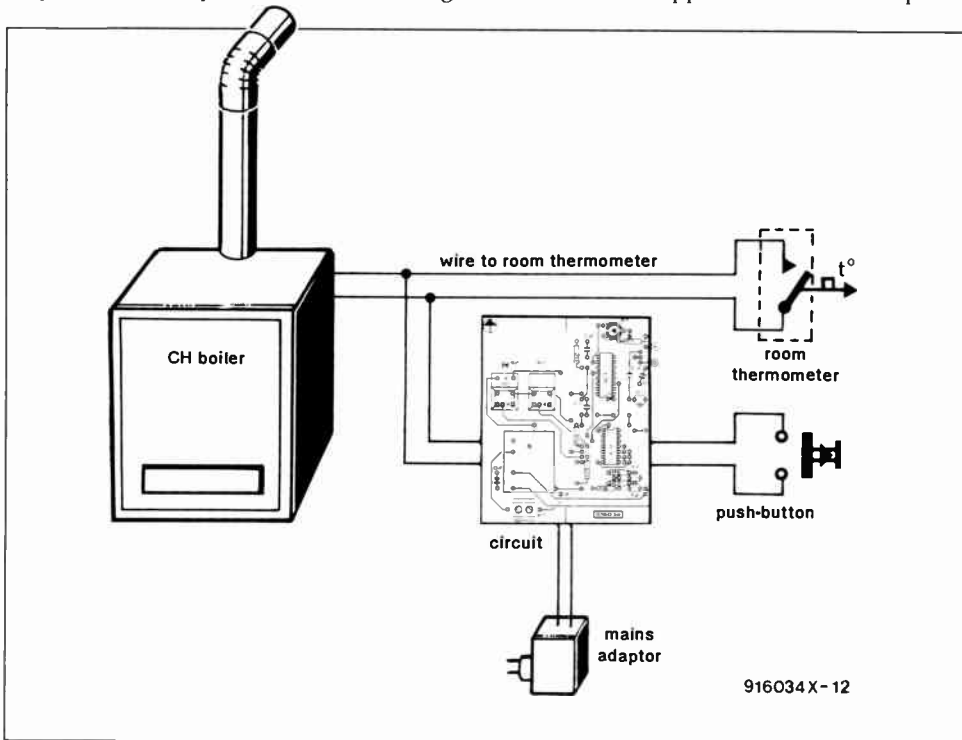
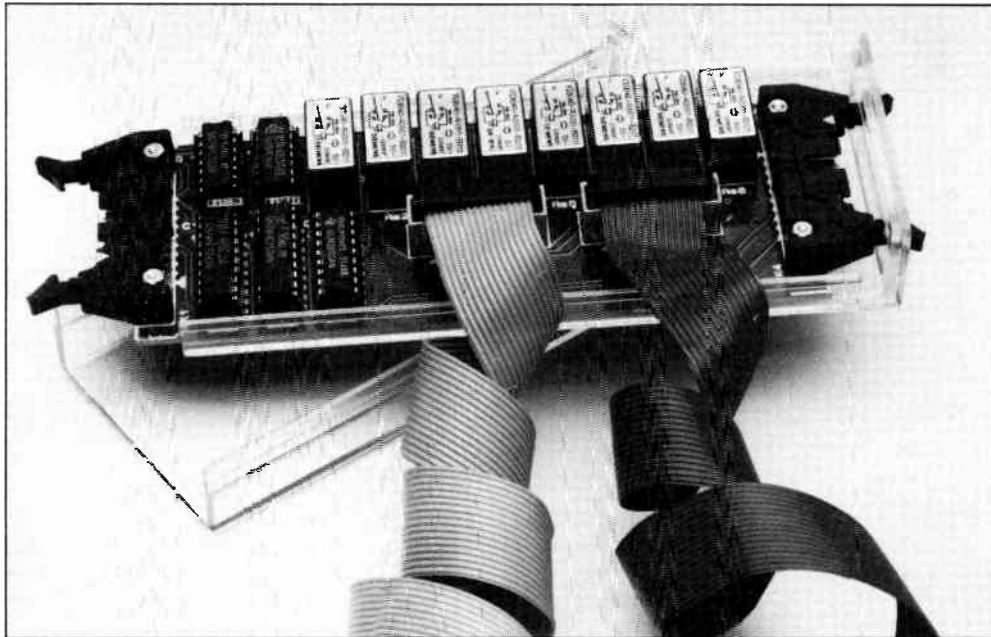

Fig. 3. Connection of the unit to the CH wiring.

RELAY CARD FOR UNIVERSAL I/O INTERFACE



This relay card connects to the universal I/O interface for IBM PCs described in the May 1991 issue. Simple to build and program, it offers a safe and easy way of controlling all sorts of equipment by means of a PC.

by A. Rigby

ALTHOUGH the relay card described here is designed specifically as an extension for the PC I/O interface (Ref. 1), its input control signals are readily found, or made, in non-IBM (PC) computers.

The circuit diagram of the relay card, Fig. 1, shows that it is linked to the I/O card via connector K1. It is also seen that the I/O card signals are buffered and fed to connector K4, which allows up to four extension circuits to be connected in series. Only two signals 'change' between K1 and K4: address lines A0 and A1 are interchanged on K4 (with respect to K1), and A0 is inverted. This allows all extension cards connected to the PC I/O interface to make use of a single, simple, address decoder. All cards connected in this way respond internally to address 00 (binary), but the successive interchanging of A0 and A1 causes their actual address to be determined by the order in which they are connected. Table 1 shows the address assignments.

More relays than ICs

The data flow between the PC I/O card and the relay extension is controlled by a bidirectional buffer, IC2. Although a unidirectional buffer would have been in order for the relay card (which functions as a write-only exten-

Table 1. Address overview

Address	Relay card
base address + 0	1
base address + 1	2
base address + 2	3
base address + 3	4

sion), bidirectional buffering is applied because two-way data flow may be required by other cards in the system.

The actual relay interface starts at register IC4, which is used to latch data when the relay card is addressed. The addressing is accomplished via the \overline{ENABLE} and \overline{WR} lines. When both are low, the output of IC1b is low also. To ensure that the data are stable at the input of the register, they are latched when the output of IC1b reverts to logic high. The logic pattern stored in IC4 is fed to driver IC5, which controls the relay coils. The relays are actuated by a logic high data bit written to IC4, so data inverting is not required.

The relay contacts are brought out to pins on connectors K2 and K3. Connector K2 carries the mother contacts and the normally open (NO) contacts of the relays, and K3 the mother contacts and the normally closed (NC) contacts.

Table 2. Relay specifications

Siemens V23040-A0001-B201 Contact specifications	
Max. switching voltage:	150 V d.c. 125 V a.c.
Max. switching current:	2 A
Max. continuous current:	2 A
Max. switching power:	35 W d.c. 60 W a.c.
Max. switching frequency:	100 Hz
Mechanical lifetime:	10^8 s.o.
Mechanical lifetime with contacts loaded:	$10^3 - 10^8$ s.o.
s.o. = switching operations	

Building and testing

The relay extension is built on a double-sided, through-plated printed circuit board, of which the track layouts and the component overlay are given in Fig. 2. The construction is mostly straightforward soldering work. The completed card is connected to the PC I/O interface via a 20-way flatcable with IDC connectors at both ends.

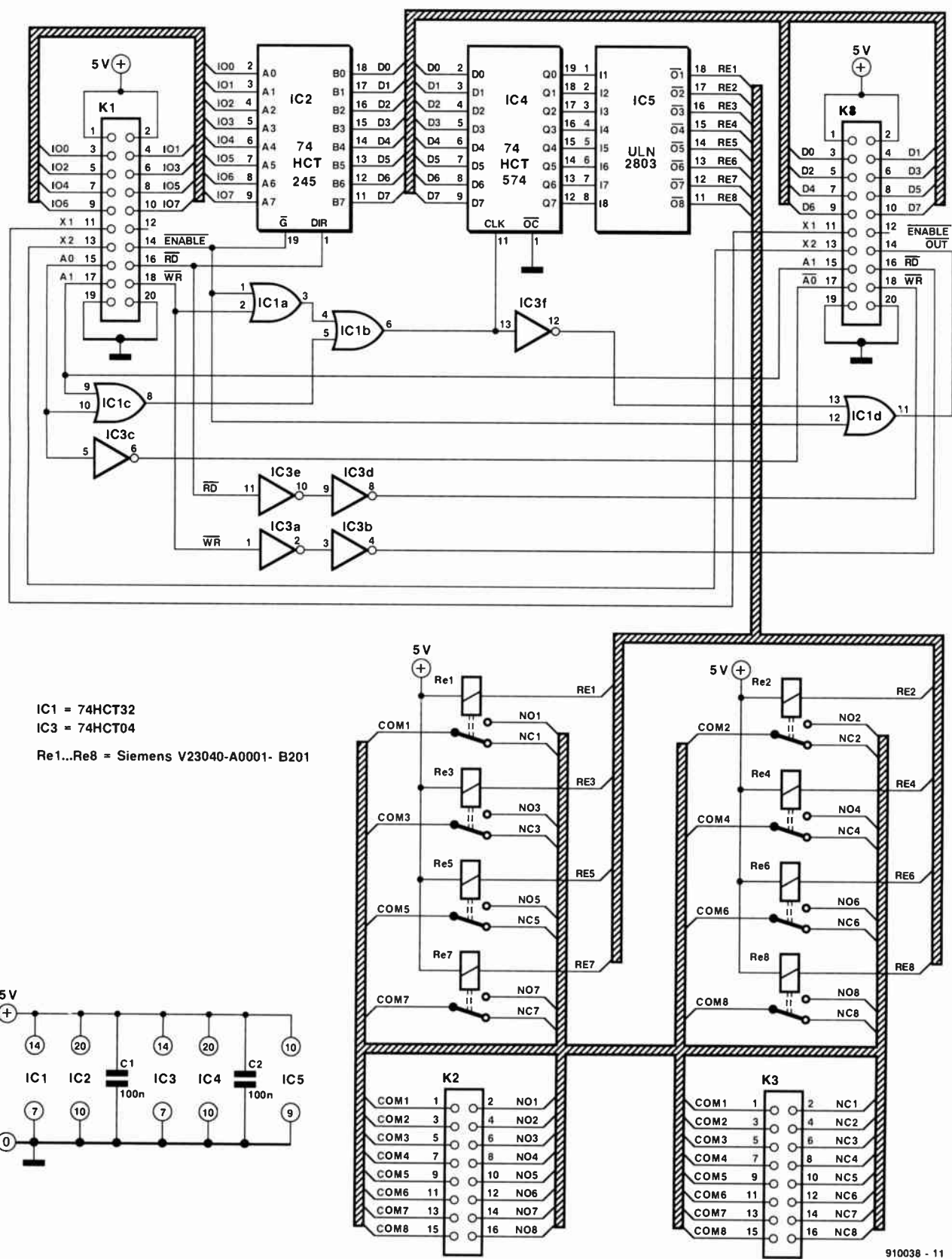

Fig. 1. Circuit diagram of the relay extension. Up to four of these circuits may be connected in series and controlled by a PC.

The current consumption of the relay card is determined by the number of actuated relays. When all relays are actuated, the current consumption is a little below 150 mA.

The switching functions of the relay card may be tested with the aid of the program

listed in Fig. 3. When run, this program causes the relays to be actuated and deactivated in succession. The program may be used to test up to four relay cards connected in series.

Because of the track layout of the printed circuit board, the maximum voltage that

may be switched by the relays is 42 V a.c. or 60 V d.c. This means that the relay card may not be used to switch mains loads directly. ■

Reference:

1. Universal I/O card for IBM PCs. *Elektor Electronics* May 1991.

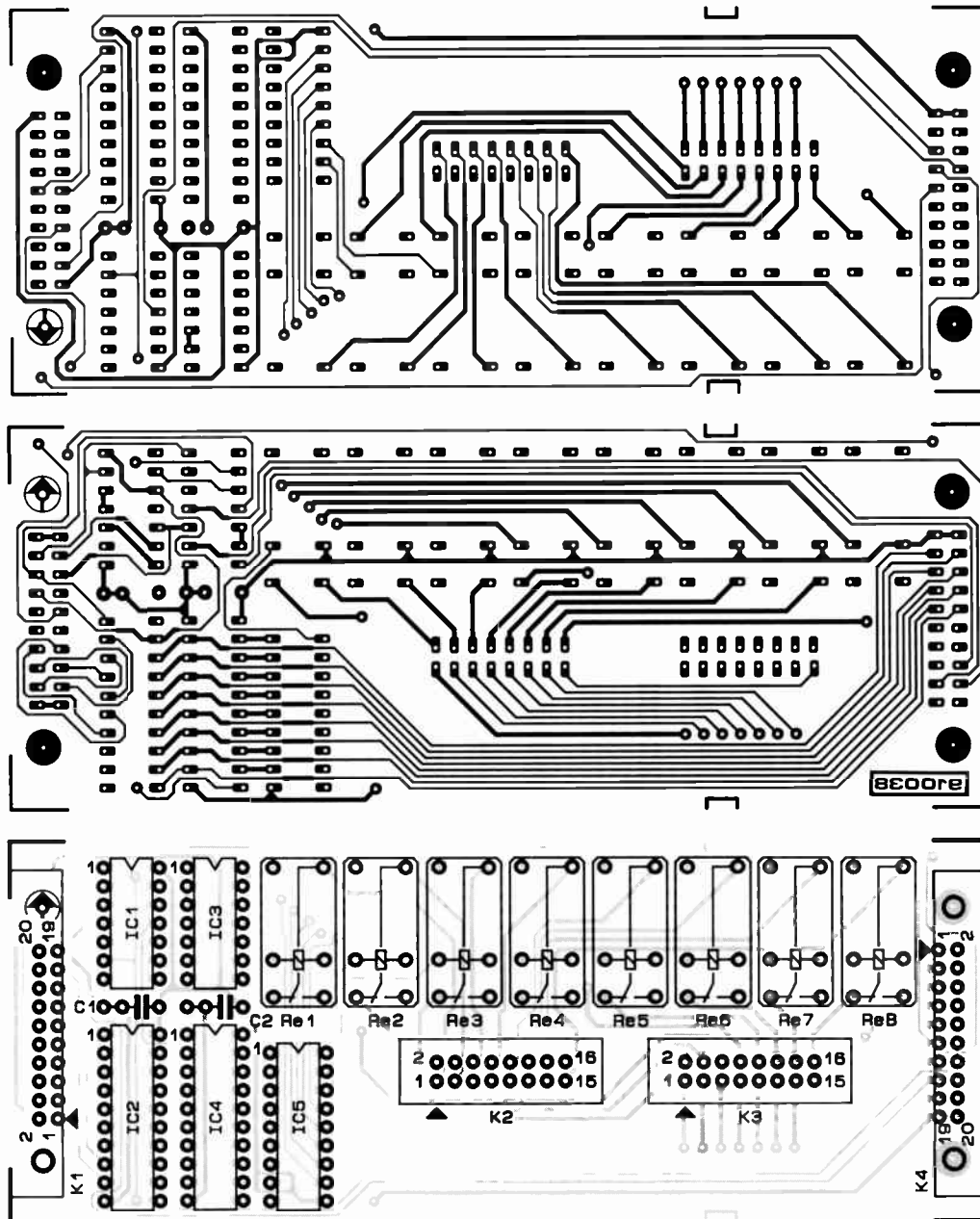

Fig. 2. Printed-circuit board for the relay card. Note that this board is double-sided and through-plated.

```

10 CLS
20 ..... ibmio interface test
30 X=0 ..... address definition
40 ..... X=0: &H300-&H303 X=1: &H304-307 X=2: &H308-&H30B X=3: &H30C-30F
50 ..... X=4: &H310-&H313 X=5: &H314-317 X=6: &H318-&H31B X=7: &H31C-31F
60 X=&H300+X*&H4
70 ..... addresses
80 A1=X+0: A2=X+1: A3=X+3: A4=X+2: ..... I/O addresses
90 ..... A1 - A4 = relay card 1 to relay card 4
100 ..... test of I/O ports
110 CLS
120 PRINT "Testing I/O"
130 FOR I=0 TO 7
140 OUT A1,2^I ..... close relay number i of card 1
150 OUT A2,2^I ..... close relay number i of card 2
160 OUT A3,2^I ..... close relay number i of card 3
170 OUT A4,2^I ..... close relay number i of card 4
180 GOSUB 280 ..... wait
190 NEXT I
200 FOR I=0 TO 7
210 OUT A1,255-2^I ..... open relay number i of card 1
220 OUT A2,255-2^I ..... open relay number i of card 2
230 OUT A3,255-2^I ..... open relay number i of card 3
240 OUT A4,255-2^I ..... open relay number i of card 4
250 GOSUB 280 ..... wait
260 NEXT I
270 GOTO 130 ..... return for next cycle
280 ..... subroutine to execute a wait period
290 FOR J=0 TO 1000:NEXT
300 RETURN

```

Fig. 3. Run this little BASIC program to test one to four relay cards.

COMPONENTS LIST

Capacitors:

2 100nF C1;C2

Semiconductors:

1 74HCT32 IC1
 1 74HCT245 IC2
 1 74HCT04 IC3
 1 74HCT574 IC4
 1 ULN2803 IC5

Miscellaneous:

2 20-way pin header with side latches K1;K4
 2 16-way pin header K2;K3
 8 PCB mount relay Re1-Re8
 V23040-A0001-B201 (Siemens)
 1 enclosure (e.g., Heddic 222)
 1 Printed circuit board 910038

EXPERIMENTAL QUADRIFORM FERRITE TRANSMIT/RECEIVE ANTENNA

by Richard Q. Marris, G2BZQ

The quadriform is an experimental 3.5 MHz transmit/receive antenna of mini dimensions, consisting of four high-grade robust ferrite rods in a 9 in \times 9 in (230 \times 230 mm) loop configuration.

Chambers 20th Century Dictionary defines quadriform as "fourfold; having four forms or aspects".

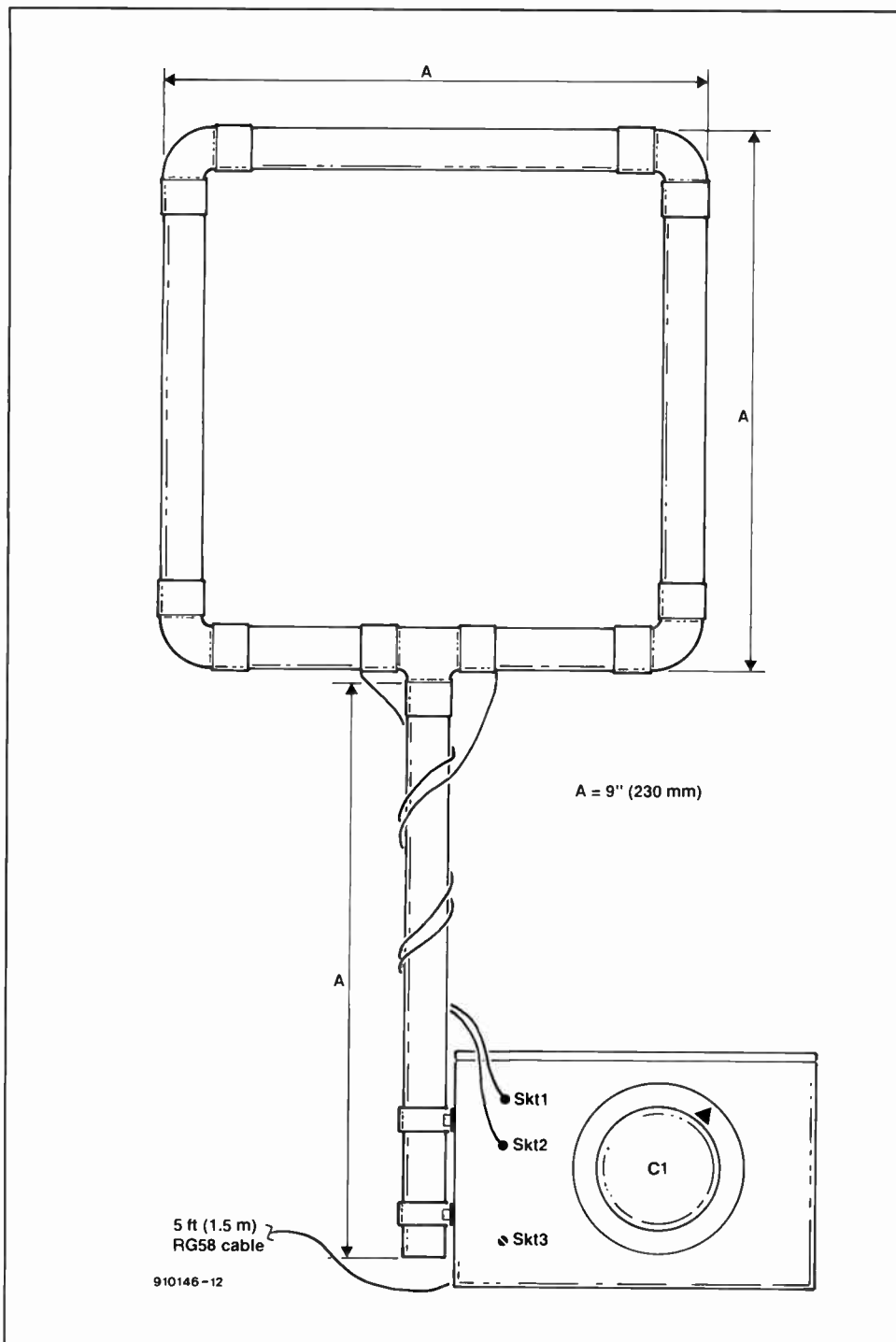

Fig. 1. Assembly of the quadriform ferrite transmit/receive antenna.

WHEN, a decade or so after the end of World War II, the transistor and ferrite rod antenna made their entry on the market, they quite revolutionized the domestic LW/MW radio scene with the arrival of small portable receivers with built-in aerials. One might have expected that ferrite antennas would also be used extensively for transmission, but this was not to be for various reasons. Obviously, however, experiments were taking place, especially in the American defence industry, but little or nothing has been published on the subject.

Nowadays, ferrite rod materials can be divided broadly into manganese-zinc mixtures and nickel-zinc mixtures. The former are used invariably for VLF and LF receiving applications between 1 kHz and 1 MHz, and there are several different mixtures. Nickel-zinc rods, again in several mixtures, have appeared with permeabilities between 40 and 850. In the latter types, apart from their use in domestic LW/MW radios, it has become possible over the years to obtain rods that can be used as HF band receiving antennas. An excellent booklet ⁽¹⁾ is available from Amidon Associates (USA), which gives the full characteristics and sizes of many types of manganese-zinc and nickel-zinc rod. It may well enlighten the reader as regards ferrite rods for reception, but the contents are not geared to use of the rods for transmission.

Of particular interest are the Amidon Type 61 nickel-zinc rods, which are quoted as being suitable for use in receiving antennas for frequencies of 0.2–15 MHz. However, I have used these rods experimentally for reception in the VHF bands with acceptable results. I have also made several experimental single rod transmitting antennas from Type 61 ferrite material which gave widely varying results. A brief report on a small part of earlier experiments was published in Ref. 2. For convenience, all ferrite transmitting antennas used in my 'on the air' experiments have been designed for the 3.5 MHz (80 metres) amateur band.

Some of the problems that revealed themselves as the experiments progressed during the design of ferrite rod transmit antennas are listed here.

1. The difficulty of locating small supplies of sufficiently large and robust rods suitable for high frequencies and, most importantly, for transmission.
2. How to couple the transmitter to the ferrite antenna: to feed RF power into the antenna? And then how to persuade the antenna to radiate that power over satisfactory distances to other stations?
3. Solving the serious problem of saturation of the core. As power into such an antenna is increased, a point is reached quickly where core saturation occurs. This saturation manifests itself by the heating up of the core, which appears to produce the following effects:
 - (a) de-resonating the antenna from the selected frequency;
 - (b) harmonics that cause interference and TVI;
 - (c) general instability, similar to (b).

It must be stressed that these findings are based entirely on the results of my own experiments.

Assuming that these problems can be solved, a tremendous advantage appears in that we have a tiny antenna—only a few inches long—compared with a traditional wire antenna: on 3.5 MHz, a wire dipole is about 140 ft (almost 43 metres) long!

It has been discovered that the main difficulty is that of core saturation, even when a suitable rod for h.f. transmission has been found. Experiments have shown, however, that this problem can be overcome to a large extent by leaving a large gap between the ferrite rod and the wire turns and distributing the turns over the entire length of the rod. From these findings, it was decided to try to produce a realistic unidirectional ferrite transmitting antenna with reasonable gain. The result is the Quadriform Ferrite Antenna.

Description

From Fig. 2, it is seen that the antenna consists of a 9×9 in. (230×230 mm) loop with small inductances, L₁–L₅, in each side. The wire sides are formed around a 7.5×0.5 in. dia. (190×12.5 mm) high-grade nickel-zinc (Type 61 material) rod enclosed in a plastic tube as shown in Fig. 3. It is fed at the bottom, between L₄ and L₅, with leads to plugs P₁ and P₂ that mate with appropriate sockets, Skt₁ and Skt₂.

The loop is resonated by a 100 pF ceramic, insulated, variable capacitor, C₁. The feed to and from the transmitter/receiver is a Type RG58 coaxial line via C₂ (a 150 pF ceramic, high-voltage disc type). Capacitors C₂ and C₃ form the actual coupling and impedance matching element to match the loop to a 50 Ω impedance. Socket Skt₃ is an optional earthing connection. The antenna is unidirectional.

The general layout is shown in Fig. 1. The loop is supported vertically by a 9 in (230 mm) long piece of plastic tube fastened with wall clips to the front vertical edge of the side of a 6×4×4 in (150×100×100 mm) aluminium box that houses the variable capacitor and some other components. The box is large and heavy

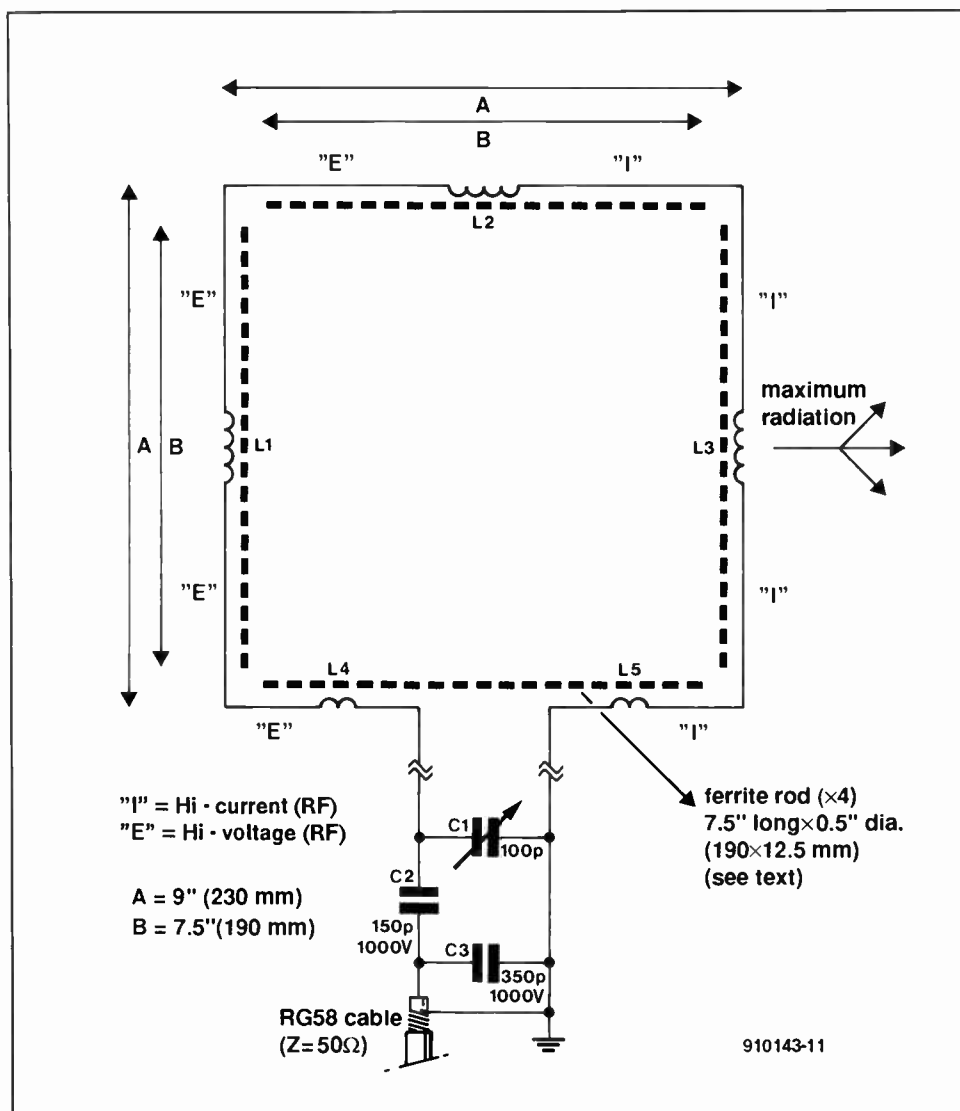

Fig. 2. Circuit diagram of the quadriform antenna.

enough to act as a base that stops the loop tilting. Sockets Skt₁–Skt₃, together with C₁, are mounted on the front panel; the RG58 cable exits through a grommet at the rear. The box is a two-piece interlocking double 'U'; the loop is clipped to the removable lid.

Care is needed in winding the inductors. First, cut three 7.5 in (190 mm) lengths of the 1 1/16 in (17.5 mm) dia. tubing and two pieces of about 2.5 in (63 mm). The two shorter lengths, when fastened together with a standard T junction, form the bottom side that should also be 7.5 in long. The 9×9 in square is completed with four standard 90° plastic elbows. All plastic tubing and junctions are readily obtainable from most DIY stores (in the UK under the name POLY-YORC). A 7.5 in (190 mm) long, 0.5 in (12.5 mm) dia., ferrite rod is inserted into each side before the corner elbows and T junction are fitted. It is necessary to wind a couple of turns of masking tape round the ends of each rod to ensure rigidity in the tube—see Fig. 3. The loop windings are made from PVC covered, single-strand, 1/0.6 mm wire, 1.2 mm o.d., rated at 1 kV, 1.8 A. They are wound as shown in Fig. 3. The wire linking inductors L₁ and L₅ is taped close along the outside of each of the tubes; over the 90° elbows it is held in place by a small 'V' filed in the outside radius of each elbow.

Black tubing, black PVC wire and black PVC tapes were used throughout.

The whole wire length, including the small coils, forms part of the ferrite-cored loop. Inductors L₁–L₅ are close wound, clockwise throughout.

Variable capacitor C₁ is mounted at dead centre of the front panel of the base box and it and the other few components are hard wired. A 9 in (230 mm) length of tube is inserted into the T junction of the finished loop; the bottom end of this is clipped to the front edge of the side of the lid of the box with two standard plastic wall clips—see Fig. 2.

CAUTION! It is essential that the specified ferrite rods are used—see parts list. They should be treated with great care. If they are dropped on to a hard surface, they may break, chip or suffer from core destabilization. They are expensive! At the time of writing, they cost \$15.00 (about £8.50) each plus \$8.00 for airmail shipping direct from Amidon. Delivery is by return mail and is usually within three weeks from airmailing the order to Amidon. Master Card and Visa are accepted.

Testing, operation and results

Initial testing of the antenna is carried out with a receiver tuned to 3600 kHz. Capacitor C₁ is

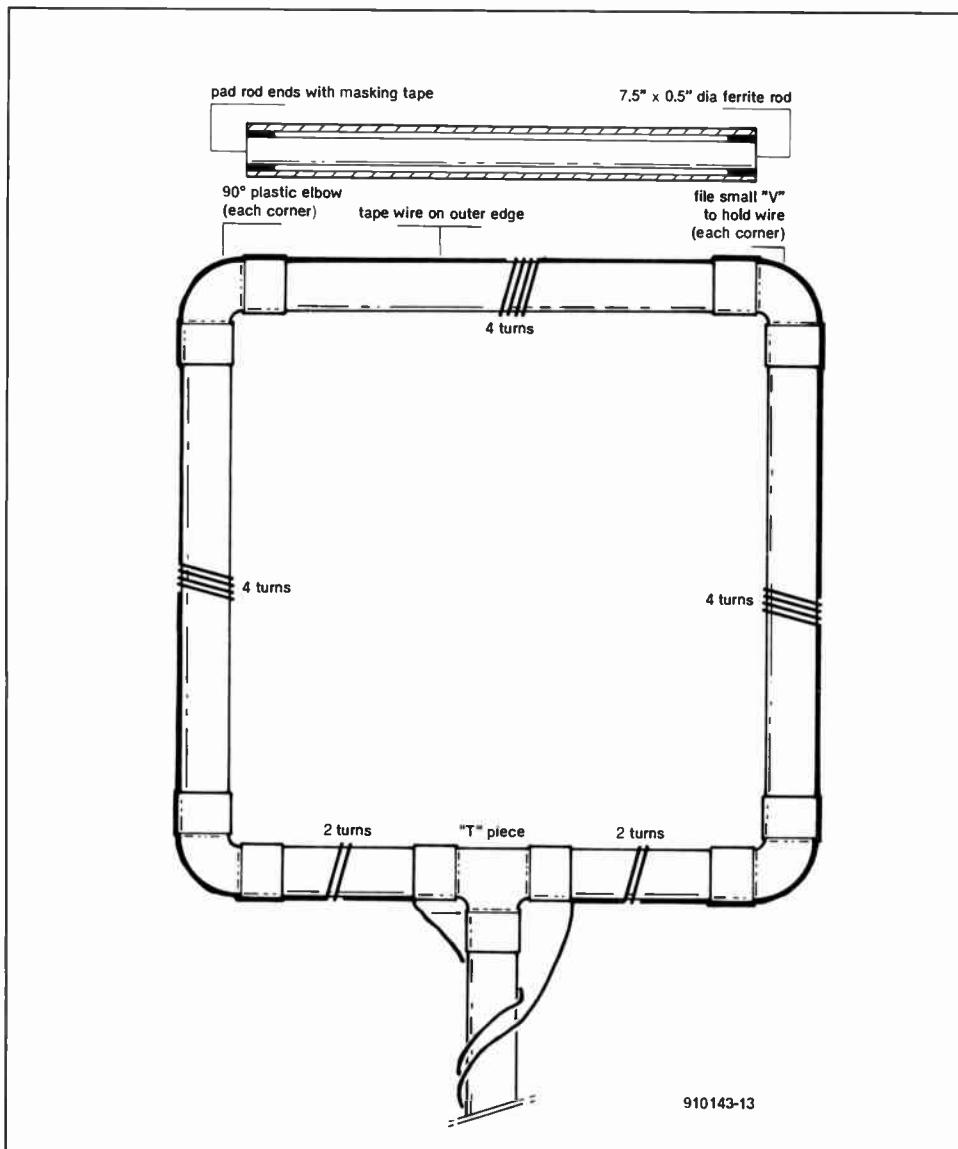

Fig. 3. Assembly details.

rotated for resonance, which is indicated by an increase in signal strength. The plates of the capacitor should then be enmeshed about 50%. The 3500–3800 (or 4000) kHz band is accommodated without any problem.

The polar diagram of a single horizontal ferrite rod antenna is a figure 8 off the two long sides. The polar diagram of the Quadriform is rather more complex and not easy to establish indoors, possibly owing to reflections off walls, and so on. However, it is, to all intents and purposes, unidirectional with one very large lobe off one end, which reduces interference appreciably. This lobe can be moved through 180° by reversing Pl_1 and Pl_2 in sockets Skt_1 and Skt_2 , which is a simple way of achieving all-round operation. If necessary, further small adjustments can be made by a small rotation of the antenna. This radiation pattern holds good on transmit and receive.

Before the antenna can be tested for transmission, it is necessary to first set up the transmitter into a 50 Ω dummy load at the desired frequency. The antenna is then resonated with the receiver, at the same frequency, and subsequently substituted for the dummy load. It should be fully loaded by the transmitter on low power, after possi-

ble minor adjustments of C_1 . The usual bandwidth on transmit, without readjusting C_1 , is about 25 kHz.

The antenna is essentially a low-power device. In my experiments, it has been driven by over 20 watts RF without detectable core saturation. However, it is intended for use indoors near the transmitter/receiver, where a transmitter power of <10 watts has been used

'on the air' with very satisfactory results. There was no detectable harmonic or TVI radiated. The use of an RF earth connection made no apparent difference.

WARNING!

IN THE INTERESTS OF DOMESTIC SAFETY,
THE TRANSMITTER OUTPUT SHOULD NOT
EXCEED 10 WATTS.

References

Iron-powder and Ferrite Coil Forms, published by Amidon Associates, P.O. Box 956, Torrance, California 90508, USA.

"Fe-ONE Experimental Transmitting Antenna" by Richard Q. Marris, *Practical Wireless*, January 1989.

PARTS LIST

- 4 nickel-zinc rods, 7.5 in. long by 0.5 in. dia. (190 x 12.5 mm), available from Amidon Associates Inc. P.O. Box 956, Torrance, Ca. 90508, USA; Tel. +1 213 763 5770; Fax +1 213 763 2250.
 - 1 aluminum box 6 x 4 x 4 in. (153 x 102 x 102 mm) order code Box/J10 from Marco Trading.
 - 1 variable capacitor, 100 pF, Jackson Bros Type 11 or equivalent style and quality plus knob to suit.
 - 1 ceramic disc capacitor, 150 pF, ≥ 1 kV.
 - 1 ceramic disc capacitor, 350 pF, ≥ 1 kV.
 - 2 4 mm banana plugs
 - 3 4 mm banana sockets
 - 1 m Poly-Yorc (or similar) black tubing, o.d. 0.7 in. (18 mm), i.d. 0.6 in. (13 mm); available from many DIY stores.
 - 4 90° elbows to match the black tubing.
 - 1 T junction to match the black tubing.
 - 2 wall clips for fitting the black tubing.
 - 5 ft RG58 coaxial feed line; $Z = 50 \Omega$, plus coaxial plug to suit transmitter/receiver. PVC covered, single strand 1/0.6 mm wire (black), 1.2 mm o.d., rated at 1 kV and 1.8 A. Order code CBL/EW1/black from Marco Trading.
- Black PVC tape and masking tape as required.

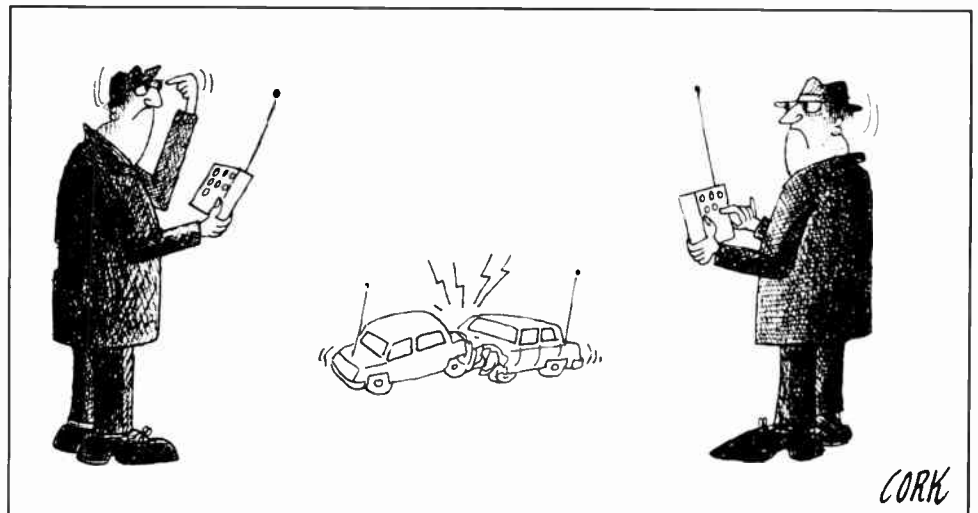

CLASSIFIEDS

FOR SALE

VIC-20 computer, power supply plus two plug-ins, asking \$50; 115 vacuum tubes, all types, asking \$119; Nintendo video game with four Arcade games, cost over \$200, asking \$100. No returns. Peter Mendez, 3924 N.W. 5th St., Miami, FL 33126, (305) 649-1857

NAD 7220 PE, \$224.95; NAD 3020, \$149; Sony NR-500 Dolby C, \$149; Hafler DH-200, \$224.95; Proton 600T with remote, \$199; Sony SL2000/TT2000 Beta VCR, \$249; Audiosource LS-ONE shielded loudspeakers, \$89 pair; Onkyo T-15 silver tuner, \$89; Sony 3/4-inch U-Matic VO-2600, \$399; Sony KV-1746R TV with great remote, \$199. Michael, (703) 641-5824.

STATEMENT OF OWNERSHIP, MANAGEMENT AND CIRCULATION. (Required by 39 U.S.C. 3685.) Date of Filing, Sept 12, 1991. Title of Publication: ELEKTOR ELECTRONICS USA. Frequency of issue: Monthly except August.

Annual subscription price \$28. Location of the headquarters or general business offices of the publishers: 305 Union St., Peterborough, NH 03458. Publisher: Edward T. Dell, Jr., PO Box 876, Peterborough, NH 03458; Managing Editor: Robin Florence. Owner: Edward T. Dell, Jr., PO Box 876, Peterborough, NH 03458. Known bondholders, mortgagees, and other security holders owning 1 percent or more of total amount of bonds, mortgages or other securities: None.

	Average # copies	
	each issue during preceding 12 months	Single issue nearest to filing date
Total # copies printed	9,438	11,500
Newsdealer sales	90	129
Mail subscriptions	6,938	7,854
Total paid circulation	7,028	7,983
Free distribution complimentary	96	121
Total distribution	7,124	8,104
Office use, leftover	2,314	3,396
Return from news agents	0	0
Total	9,438	11,500

I certify that the statements made by me above are correct and complete.

Publication No. 006148

Karen Hebert, General Manager

TRADE

GET YOUR "FCC COMMERCIAL GENERAL RADIO-TELEPHONE LICENSE." Electronics home study. Fast, inexpensive! Free Details! **COMMAND PRODUCTIONS**, D-266, Box 2824, San Francisco, CA 94126-2824. T1/92

RADIO-TV RECEIVING, TRANSMITTING, C.R.T. TUBES, SAM'S FOTOFACTS AND MORE. P.E.M. TUBES, 8005 Florin Road, #10, Sacramento, CA 95828, (916) 383-9107. T3/92

CLUBS

AUDIOPHILES IN THE DAYTON/SPRINGFIELD, OHIO AREA: We are forming an audio club. Please contact me if you're interested in construction, modifications, testing, recording or just plain listening to music. Ken Beers, 1756 Hilt Rd., Yellow Springs, OH 45387, (513) 767-1457.

AUDIO SOCIETY OF MINNESOTA. Audiophiles, music lovers, scratch builders, record collectors, tube freaks, digital freaks—we've got 'em all! Monthly meeting, tours, audiophile concerts, special guests, etc. Now in our 13th consecutive year! Write ASM, PO Box 32293, Fridley, MN 55432.

INDEX OF ADVERTISERS

All Electronics Corporation	5	Fall Kit Specials	61
AUDIO AMATEUR PUBLICATIONS		<i>LoudSpeaker Design Cookbook IV</i>	4
Audio Amateur Publications	8	Meek It Kits	6, 7
Elektor Electronics Dealers	60	Software	9, 10
Elektor Electronics		PC Boards	CV III
Subscriber Services	CVII	Electronics Scene/New Products	
Speaker Builder	CV IV	Analog Devices	13
Borbely Audio	CV III	Associated Conventions & Exhibitors	13
Crestwood Products	5	Circuit Search	13
Hampshire Industries	5	DATAK Corp	12
Kelvin Electronics	CV III	EasyTech	13
Meadowlake Corp	CV III	Icom America, Inc	12
Mondo-tronics	CV III	Optoelectronics, Inc	13
MoTron Electronics	CV III	Planned Products	12
OLD COLONY SOUND LAB		PMC Products	12
Books	62	R.F. Engineering, Inc	12
Elektor Parts Sources	60	Sheffield Electronics	12
EPROMS	61	Synergetic Audio Concepts	12

FIND THE LATEST ISSUE OF

**ELEKTOR
ELECTRONICS
USA**

AT THESE LOCATIONS

Cody Books Ltd.
1122 Fir Ave
Blaine, WA

Gateway Electronics
8123 Page Blvd
St Louis, MO

Gateway Electronics
9890 Westpark Dr
Houston, TX

HSC Electronic Supply
3500 Ryder St
Santa Clara, CA

Henry Radio
2050 S Bundy Dr
Los Angeles, CA

Tapco Engineering
1639 47th St NE
Cedar Rapids, IA

RP Electronic Co
2113 W 4th Ave
Vancouver, BC
CANADA

RJM Electronics
4204 Overland Rd
Boise, ID

Gateway Electronics
9222 Chesapeake Dr
San Diego, CA

Gateway Electronics
5115 N Federal Blvd
Denver, CO

HSC Electronic Supply
4837 Amber Lane
Sacramento, CA

Tri-Tek
9014 N 23rd Ave 11
Phoenix, AZ

Powell's Technical Books
33 NW Park
Portland, OR

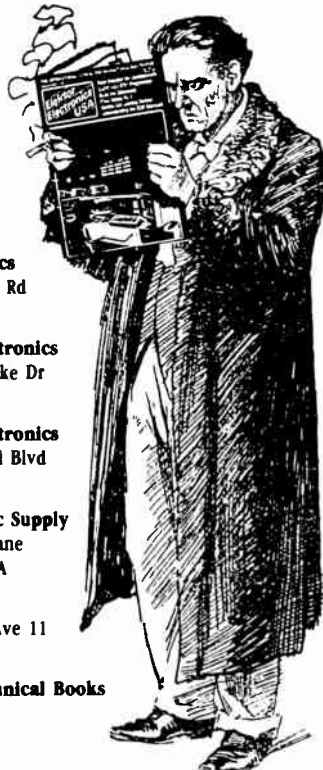

If you prefer home delivery use the handy subscription card enclosed.

RECOMMENDED SOURCES FOR
ELEKTOR ELECTRONICS USA
EUROPEAN PARTS

Borbely Audio
Erno Borbely
Melchior Fanger Strasse 34A
8031 Neu-Gilching
Germany
Tel 49-8105-8891
Fax 49-8105-24605 (24H)

Meek It Electronics
Rob Planken
Paveljoensgracht 35A
2515 BL Den Haag
The Netherlands
Tel 31-70-609554
Fax 31-70-397-9707

C-I Electronics
PO Box 22089
6360 AB Nuth
The Netherlands
Fax 31-45-241877

ELV France
BP 40
F-57480 Sierck-les-Bains
France
Tel 33-82-85-72-13
Fax 33-82-85-81-80

Technomatic
Technohouse
486 Church Lane
London NW9 8UF
United Kingdom
Tel 44-081-205-9558
Fax 44-081-205-0190

Bull Electrical
250 Portland Road
Hove
Sussex BN3 5QT
United Kingdom
Tel 44-0875-203500
Fax 44-0875-25077

Note: Although some numbers above may seem to be too long/short, they are correct as shown. USA residents need to preface calls with "011".

TERMS OF BUSINESS

PRICING

Prices, except as noted, include shipping in the continental USA. The minimum order is \$10. A \$2 service charge will be added to orders of less than \$10. Prices are subject to change as our costs change. WE RESERVE THE RIGHT TO MAKE PRICE CHANGES WITHOUT NOTICE.

TELEPHONE ORDERS

Telephone orders are welcome between the hours of 9:00 a.m. and 4:00 p.m. EDT, Monday-Friday. Orders for parts are to be made on the ORDER FORM provided. Payment for telephone orders is by MC/VISA only. Our TELEPHONE ORDER NUMBER IS (603) 924-6371 or 924-6526. Our answering machine for MC/VISA orders during non-business hours is (603) 924-6371. FAX: (603) 924-9467 (24 hours).

PAYMENT

All remittances MUST BE IN US FUNDS DRAWN ON A US BANK. Payment for telephone orders must be made by MasterCard or VISA. Mail order payment may be made by MC/VISA, money order, cashier's check or personal check. If payment is made by personal check, allow up to 2 weeks for clearance before order is shipped. Should check be returned for any reason, there will be a \$10 charge.

SHIPPING

Unless noted, freight is prepaid by Old Colony. All orders shipped USPS first class mail or by UPS.

Allow two to three weeks for delivery. Please inquire about appropriate funds for special handling (UPS next day or second day). UPS requires a street address. If you cannot receive UPS delivery, please include an extra \$2 for insured service via Parcel Post. We cannot accept responsibility for safety or delivery of uninsured Parcel Post shipments. Absolutely no COD shipments.

BOOKS, RECORDINGS, CDs, and SOFTWARE
The shipping/handling charge for the US is \$2.00, plus 75¢ each additional item. In Canada, please add \$4.50 for the first item, 75¢ each additional. **No returns.** According to the Connecticut Dept. of Revenue Services, Regulation #27, Section 12-426-27, in order to sell software to residents of Connecticut, we must register with the department as well as collect taxes for the state from the purchaser. We regret to inform our customers that we will not sell software to anyone from Connecticut, as it will prove to be too costly and burdensome.

OVERSEAS ORDERS

For orders to be shipped outside North America, add 20% to the total order to cover shipping.

RETURNS

If you wish to return all or part of an order for any reason, please call or write first. If we are in error, correction will be made promptly, without charge.

WARRANTY

We warrant that all items sold conform to the qual-

ity and specifications set forth. We make no representations. We accept no responsibility whatever for further use by the customer. We accept no monetary liability in excess of the original cost or replacement of the material if originally defective or damaged in transit.

COPYRIGHT

All drawings, photographs, articles, printed circuit boards, EPROMs, software, and cassettes published in our books or magazines (other than in third-party advertisements) are copyright and may not be reproduced or transmitted in any form or by any means, including photocopying and recording, in whole or in part, without the prior permission of *Elektor Electronics USA* in writing. Such written permission must also be obtained before any part of these publications is stored in a retrieval system of any nature.

Notwithstanding the above, printed circuit boards may be produced for private and personal use without prior permission.

LIMITATION OF LIABILITY

Elektor Electronics USA shall not be liable in contract, tort, or otherwise, for any loss or damage suffered by the purchaser whatsoever or howsoever arising out of, or in connection with, the supply of goods or services by *Elektor Electronics USA* other than to supply goods as described, or at the option of *Elektor Electronics USA*, to refund the purchaser any money paid in respect of the goods. ■

BOOKS FROM ELEKTOR ELECTRONICS USA

301 CIRCUITS

This book follows the theme of the first in this series, *300 Circuits* (now out of print). It contains over 300 assorted circuits first published in the 1979, 1980, 1981 summer issues of *Elektor Electronics*.

The circuits range from the simple to the more complex and are described and explained in straightforward language. The book is a comprehensive source of ideas and construction projects for anyone interested in electronics.

ISBN 0-905705-12-2

BKAA11 Price \$12.50

302 CIRCUITS

The popularity of this book is shown by its having been reprinted no fewer than three times. It offers a selection of the most interesting articles from the 1982, 1983, 1984 summer issues of *Elektor Electronics*.

In it you will find circuits for audio and video; car, cycle, and motorcycle; home and garden; receivers and aeriels; hobbies and games; measuring and testing; oscillators and generators; current sources and power supplies; microcomputers and music electronics; and a miscellany of other interesting subjects.

ISBN 0-905705-25-4

BKAA12 Price \$12.50

303 CIRCUITS

Like its predecessors, *303 CIRCUITS* offers a comprehensive collection of practical ideas, concepts, and developments in the gamut of electronics. Unlike its predecessors, the book is arranged in 11 subject sections to make it easier for the reader to find that long-sought circuit.

In well over 300 pages, the book offers 32 Audio and Hi-Fi projects; 14 circuits for Car and Bicycles; 43 Computer & Microprocessor circuits; 11 Electroponic projects; 24 HF and VHF circuits; 16 circuits for a number of hobbies and pastimes; 54 projects for Home and Garden; 29 Power Supply circuits; 29 circuits for Test and Measurement equipment; nine TV and Video projects; as well as 42 Design Ideas.

ISBN 0-905705-62-2

BKAA13 Price \$15.90

DATA SHEET BOOK 2

Like its predecessor (now out of print), this book offers concise, relevant, and rapidly accessible information, which is both practical (e.g., the pin-out of a device) and informative.

The book contains data on integrated circuits as well as on discrete transistors and diodes. Moreover, it gives an introduction to fast (HCMOS) devices and a review of the new symbolic logic as laid down in British Standard BS3339:Section 21 (IEC Standard 617-12).

The final part of the book deals with a number of computer chips, such as memory devices (including programming information for these) and I/O circuits. This section also includes data on a number of non-digital discrete and integrated devices, such as op amps, as well as on some microprocessor peripherals (e.g., the 6522 VIA, the 6580 ACIA, and the 8355A PPI).

ISBN 0-905705-27-0

BKAA14 Price \$16.50

DATABOOK 3: PERIPHERAL CHIPS

This book lists the most important design data of peripheral chips whose type numbers and functions relate them unambiguously to a microprocessor in the same family. All listed devices form part of families based on widely used microprocessors or microcontrollers. Their most evident application will therefore be in conjunction with the associated microprocessor. This should, however, not be taken to mean that a peripheral cannot be used in another ap-

plication. Far from it, as witness the familiar type MC146818A real-time clock and the type MC6845 cathode-ray tube controller. It deserves a place on the bookshelf of anyone concerned with the design, maintenance and servicing of microprocessor-controlled electronic equipment.

ISBN 0-905705-30-0

BKAA15 Price \$17.95

MICROPROCESSOR DATA BOOK

This book has come about because of a need by *Elektor Electronics* engineers, technicians, and editorial staff of a ready reference work on the most important microprocessors. This implies that it does not only contain information on the latest devices, such as the transputer, but also on older, well-established types, such as the Z80 and the 6800.

A general description, hardware block schematic, software structure, DC characteristics, and instruction sets are given for over 70 microprocessors. To prevent the book from becoming unwieldy (and to keep costs down), timing diagrams and AC characteristics have, however, been omitted. The detailed information on all manufacturers mentioned will, however, enable any additional information to be obtained quite readily.

Included in the book are, among others, the 68000 series; the 6502 family; the Z80, 8080, and 8085; Intel's 8086, 80186, 80188, 80286, and 80386; the NS32XXX series, and the INMOS transputers.

ISBN 0-905705-28-9

BKAA16 Price \$17.90

DATABOOK 4: PERIPHERAL CHIPS II

This final volume in *Elektor Electronics' Microprocessor Data Book* series deals with general peripheral chips that, at least as far as their type-coding is concerned, do not belong to a specific family of microprocessors. There are so many of these, however, that only a portion of them can be dealt with in one book. Those contained in this collection have been chosen carefully on the basis of their practical application and frequency of use. Complete data are given for coprocessors from the 80 series (AMD, Cyrix, ITT, Intel, Weitek); real-time clocks from MEM, OKI, Statek, National Semiconductor, and Dallas Semiconductor; transmitters and receivers of serial interfaces RS232, 422, 423, 485 from Motorola, Newport Components, Maxim, Texas Instruments, National Semiconductor, Dallas Semiconductor, and Linear Technology; UARTS, DUARTS, and QUARTS (i.e., programmable ICs intended for data transfer); and the CS8221 set of ICs from Chips & Technology that are used in a great number of PC mother boards (also included is the data sheet of associated software LIM 4.0 for the management of the Extended Memory System).

Apart from the actual data, the book contains much other useful information, such as comparisons between and second sources for all important IC families; addresses of manufacturers and their representatives; and overviews of all peripheral chips (including many that could not be included in this book) that are available from various manufacturers.

ISBN 0-905705-32-7

BKAA17 Price \$17.95

SPECIALS!

BKAAZ/1 BKAA11, 12, 13: all 3 for \$35 (Save \$5.95!)

BKAAZ/2 BKAA14, 15, 16, or 17: ANY THREE for \$45 (Save \$7.35!)

(BE SURE TO SPECIFY!)

BKAAZ/3 Complete *Elektor* library: all 7 for \$85 (Save \$26.20!)

These books are all available direct from *Elektor Electronics USA* through the Readers Services, from a number of bookshops and electronics retailers in the US and Canada, and from selected bookshops throughout the world. Special prices are those of EEUSA only.

MAKE CIRCUIT BOARDS THE NEW, EASY WAY

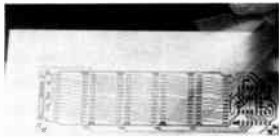

WITH TEC-200 FILM

JUST 3 EASY STEPS:

- Copy circuit on TEC-200 film using any plain paper copier or laser printer
- Iron film on to copper clad board
- Peel off film and etch

SATISFACTION GUARANTEED

convenient 8 1/2 x 11 size
 5-Sheets for \$3.95 10-Sheets only \$5.95
 add \$1.50 postage NY res. add sales tax

The MEADOWLAKE Corp.
 Dept F, P.O. Box 497, Northport, NY 11768

B O R B E L Y A U D I O

of Germany

can supply all the "HARD-TO-FIND" European components for your ELEKTOR projects. We have good access to all major manufacturers of semiconductors, resistors, capacitors and mechanical components. We also stock a large number of semiconductors and other components from Japan.

Write or FAX your specific requirements to us, quoting the issue number and the title of the project for which you need the components. If you don't have any specific project in mind, just ask for our general price list. Please send two IPCs (available from your post office) for the postage.

We accept VISA and MC/EUROCARD.

B O R B E L Y A U D I O

Melchior Fanger Strasse 34A ■ 8031 Gilching ■ Germany

Tel. INT + 49/8105/5291 (From US: 011/49/8105/5291)

FAX INT + 49/8105/24605 24 Hours (From US: 011/49/8105/24605)



KELVIN PRO 400
\$69.95

30 DAY MONEY BACK GUARANTEE!

FREQUENCY COUNTER TO 20MHZ IDEAL FOR TROUBLE SHOOTING AC/DC VOLTAGE RANGES AC/DC CURRENT RANGES 5 FREQUENCY RANGES 5 CAPACITANCE RANGES

LOGIC TEST CONTINUITY TESTER/BUZZER DIODE CHECK TRANSISTOR hFE TEST LED TEST VERIFY GOOD/BAD DISPLAY - 3 1/2 DIGIT LCD ACCURACY - 0.5% IMPEDANCE - 10 Mega Ohm

PROTECTIVE CARRY CASE for PRO 400 Stock No. 990094 \$9.95 ea

2 YEAR WARRANTY

BEST BUY NEW Series II

FLUKE 79 with Capacitance \$169

FLUKE 87 True RMS \$269

NEW! SCOPEMETER™ 90 SERIES
 HAND HELD, 50 MHz, DUAL CHANNEL

FLUKE 93 ScopeMeter \$1095

FLUKE 95 ScopeMeter \$1395

FLUKE 97 FULLY LOADED \$1695



KELVIN Electronics VISA M/C AUTHORIZED DEALER
 7 Fairchild Ave Plainview, NY 11803
(516) 349-7620 • 1(800) 645-9212 • FAX (516) 349-7830

HEAR THE TONES...SEE THE NUMBERS!

TOUCH-TONE DECODER/DISPLAY AND ASCII CONVERSION BOARD



***EIGHT DIGIT DISPLAY**
***32 CHARACTER BUFFER**
***ASCII SERIAL OUTPUT**

Model TDD-8 decodes and displays all 16 DTMF digits and provides an ASCII serial output. Digits are displayed on eight LED's. 32 character memory can be scrolled. It will accept almost any audio source such as a tape recorder, telephone answering machine, scanner, etc. Perfect for remote computer data entry using a telephone keypad. Serial output can be connected to your computer. IBM compatible software included for displaying, storing/printing time, date and number for automatic logging. **Ideal for automatically logging your auto-patch traffic!**

TDD-8 DTMF DECODER/DISPLAY/ASCII	\$99.00	MoTron Electronics
CAB-1 AUDIO & COMPUTER CABLES	\$20.00	310 Garfield St., #4
PS-12 110VAC TO 12VDC POWER PACK	\$10.00	Eugene, OR 97402
add \$5 S/H - VISA/MC ACCEPTED		

TEL: 800-338-9058 503-687-2118 FAX: 503-687-2492

(Touch-Tone is a trademark of AT&T)



Motorless Motion!

Connect Muscle Wires to a battery or other power source and watch them *contract in length!* Remove power, and they relax and are ready for millions more cycles.

Muscle Wires let you create direct *linear action* without heavy gears, coils, or motors. Use them in robots, models, planes, railroads - anywhere you need small, strong *motion*.

Get our new 96 page Book and Muscle Wire Sample Kit - it has everything you need to get moving today! Toll free:

800-374-5764

Visa, MC, check, MO

Mondo-tronics

2476 Verno Court
 San Leandro, CA 94577
 Phone: 510-351-5930
 Fax: 510-351-6955

Book and Sample Kit only

\$29.90

Plus \$4.00 P&H
 CA orders add tax

PCBboards

P-C-B ARTWORK MADE EASY !
 Create and Revise PCB's in a Flash

- * HERC, CGA, EGA, VGA, SUPER-VGA
- * HELP SCREENS
- * EXTREMELY USER FRIENDLY
- * AUTO GROUND PLANES
- * DOT- MATRIX, LASER and PLOTTER ART
- * GERBER and EXCELLON OUTPUT
- * CREATE YOUR OWN FILMS with 1X ART
- * LIBRARIES
- * DOWNLOAD DEMOS from 24 hr. BBS!

REQUIREMENTS: IBM PC or Compatible, 384K RAM DOS 3.0 or later. IBM compatible printers, HP Laser

PCBoards - layout program	99.00
(PCBoards HP or HI PEN PLOTTER DRIVER	49.00)
PCRoute - auto-router	99.00
SuperCAD - schematic pgm.	99.00
Demo Pkg. - (includes all 3 programs)	10.00

Call or write for more information

PCBoards

2110 14th Ave. South, Birmingham, AL 35205
 1-800-473-PCBS / (205)933-1122
 BBS / FAX (205)933-2954

Your Ideal Loudspeaker Hasn't Been Built YET



Loudspeaker theory is younger, spottier, and more volatile than almost any of the fields of audio electronics. And the changes come almost daily. Twelve years ago, we decided that loudspeakers were a topic worthy of their own periodical. Since then loudspeaker enthusiasts, from neophyte beginner to folks with doctorates working in space or defense have been meeting regularly in *Speaker Builder* to explore, design, build and share their enthusiasm and expertise.

The result is a truly remarkable magazine. *Speaker Builder* goes bi-monthly to over 10,000 subscribers all over the globe. The friendly atmosphere of interchange shapes the articles, the hundreds of letters, the updates of older designs and the new breakthroughs, whether you are talking about Thiele/Small design software, a \$50 measurement mike good enough to compare with the professionals, a Doppler radar gun to check what the cone of the driver is doing, or whether wool or synthetics are better stuffing material for a new PVC pipe transmission line.

Speaker Builder is full of news about new drivers made all over the globe: from matched pairs of woofers, ribbons, inverted dome tweeters and much, much more.

The loudspeaker enthusiast sees a rich variety of parts, crossovers, drivers, boxes, connectors—indeed, everything he or she needs to build just about anything that can be hooked to a power amp to make beautiful sound.

No loudspeaker format except perhaps gas flames have been neglected in *Speaker Builder's* pages: electrostatics, ribbons, closed and vented boxes, transmission lines, horns, Isobariks, subwoofers of every sort, as well as wall-mounted, automotive, and ambience enhancing surround types. The shapes too are legion: pipes, polygons, dipoles, triangular, folded and even stiffened kraft corrugated boxes.

We're so sure that if you are a loudspeaker enthusiast you'll love *Speaker Builder* that your subscription is covered by our **ironclad guarantee: All your money back if you are not satisfied with the magazine.** Fill in the form below and mail or FAX it to us to begin your *Speaker Builder* subscription. Then, very probably, the loudspeaker of your dreams, can become a reality. Do it today.

Send me *Speaker Builder* _____ one year (six issues) for \$25. _____ two years for \$45

_____ I'm enclosing check/money order.

_____ Use my Mastercard or VISA.

I understand that my subscription will start with the first issue published in 1992, and that each year's subscription will end with the last issue of that year. Canada add \$6 postage per year. Remit in US \$ only.

NAME _____

STREET & NO. _____

CITY _____

STATE _____

ZIP _____

MC/VISA _____

EXP. _____