

OCTOBER 17, 1958

electronics

business issue

A MCGRAW-HILL PUBLICATION • VOL. 31, NO. 42 • PRICE FIFTY CENTS

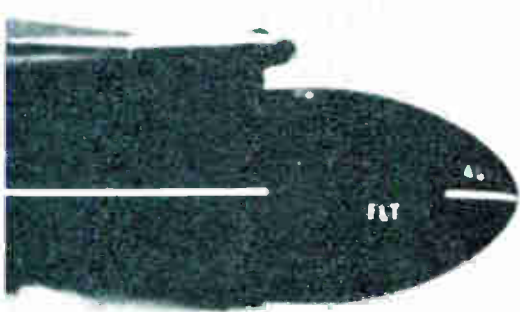

Air-to-Air Missiles: Big Reorder Field

This year alone 900 new fighters need
ammunition and husky stockpiles...p 13



U.S. Radio Weak in Mideast

Lone shipborne station holds the line but more help is on the way....p 17



Raytheon — World's Largest Manufacturer of Magnetrons and Klystrons

ENGINEERING STRENGTH

This towering figure represents 3,300 Raytheon people at your service, helping to develop and produce magnetrons, klystrons and special purpose tubes—the most complete line in the industry.

The heart of this Raytheon division is our famous Research and Development Laboratory with 1,065 specialists, of whom 207 are professional engineers.

Put this dependable source of engineering manpower to work on your problems. Call on Raytheon's Application Engineering Service. Write for complete data booklet. There is no cost or obligation.

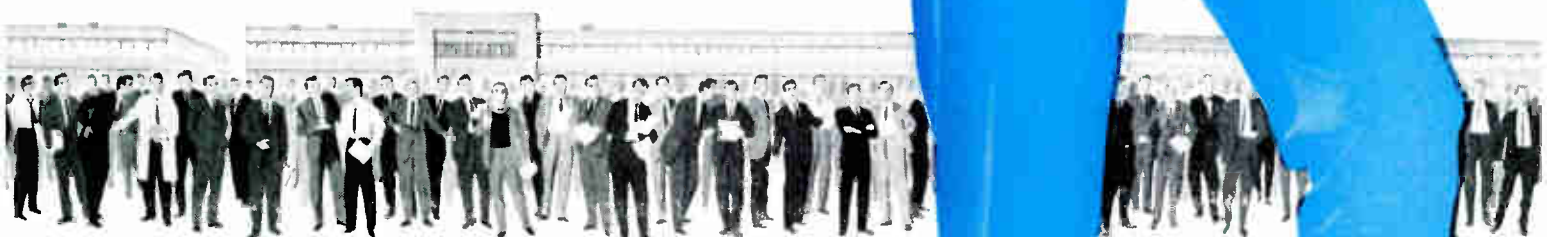

**RAYTHEON MANUFACTURING
COMPANY**

**Microwave and Power Tube Division
Section PT-40 Waltham 54, Massachusetts**

Excellence



in Electronics

Regional Sales Offices: 9501 W. Grand Avenue, Franklin Park, Illinois
5236 Santa Monica Blvd., Los Angeles 29, California

Raytheon makes: Magnetrons and Klystrons, Backward Wave Oscillators,
Traveling Wave Tubes, Storage Tubes, Power Tubes, Miniature and
Sub-Miniature Tubes, Semiconductor Products, Ceramics
and Ceramic Assemblies

Industry's plan for 1959:

Modernize now for growth and profits

The electronics industry probably exceeds all others in its growth potential. Our industry doubled factory output in the last five years. It will likely double its output again in the next five. But are our design, production and testing facilities equal to the task before us? If they are not, what can we do to bring them up to date next year? Because 1960 may be too late.

Next week ELECTRONICS
will give you the answers.

During the last six months, Associate Editor Sideris, backed up by New England Editor Maguire, Midwestern Editor Harris and Pacific Coast Editor Hood, visited dozens of manufacturers of electronic equipment and components.

Then their notes were carefully sifted and boiled down into a 12-page report packed with information that will not only tell you what this industry is doing to meet the challenge of the future but also bring you dozens of concrete, time- and money-saving suggestions that you can put to work right away—in your production plant, development laboratory or test area.

Here are a few money- and time-saving
developments you will read about next
week:

- ▶ **Automatic soldering equipment that eliminates jiggling by making circuit boards move against a flow of molten solder**

(over)

- ▶ **A single-station automatic assembly machine that can mount up to 50 components**
- ▶ **A barrel-sized centrifuge that eliminates voids in potted circuits**
- ▶ **A tape-programmed machine that drills 60 printed-circuit boards every minute**

And we will bring you detailed case histories telling:

- ▶ **How a quartz-crystal maker uses vacuum metallizing to adjust the frequency of 70 crystals at once**
- ▶ **Why a transistor manufacturer built a plant with the "basement" between the first and second floors**
- ▶ **How a switchmaker saved 1,100 sq ft of production space by buying a new milling machine**
- ▶ **Why a radar manufacturer dips some of his parts in molten salt**
- ▶ **In our October 24 issue, you will also learn:**

How to pay for plant modernization. How to get a tax advantage by modernizing your plant now. What special problems makers of military equipment face in modernizing plants.

It is with no little pride that the editors of ELECTRONICS invite you to join us next week for a wide-ranging and thoroughly detailed look at the electronics industry as it prepares for coming challenges of the electronic age.

THE EDITORS

electronics business issue

A MCGRAW-HILL PUBLICATION • VOL. 31, NO. 42 • OCTOBER 17, 1958

H. W. MATEER, *Publisher*

JAMES GIRDWOOD, *Associate
Publisher*

W. W. MacDONALD, *Editor*

Managing Editor, John M. Carroll.

Feature Editor, John Markus.

Associate Editors: John M. Kinn, Jr., Frank Leary, Michael F. Tomaino, Howard K. Janis, Sylvester P. Carter, Haig A. Manoogian, Roland J. Charest, William P. O'Brien, George Sideris, Edward DeJonph, John F. Mason, William E. Bushor, Ronald K. Jurgen, Thomas Emma, Patrick J. Lahey, Samuel Weber.

Pacific Coast Editor (Los Angeles) Harold C. Hood; *Midwestern Editor* (Chicago) Harold Harris; *New England Editor* (Boston) Thomas Maguire.

Art Director, Harry Phillips, Roy Thompson.

Production Editor, John C. Wright, Jr., Bernice Duffy, Jean L. Matin.

Research, Charles B. Graham, Marilyn Koren.

Editorial Assistants: Gloria J. Filippone, Arlene Schilp, Patricia Landers, Catherine McDermott, Eleanor Schaefer.

JAMES GIRDWOOD, *Advertising Sales Manager*, R. S. Quint, *Assistant Advertising Sales Manager and Buyers' Guide Manager*. Fred Stewart, *Promotion Manager*. Frank H. Ward, *Business Manager*. George E. Pomeroy, *Classified Manager*. Hugh J. Quinn, *Acting Circulation Manager*.

New York: Donald H. Miller, Henry M. Shaw, Martin J. Gallay. *Boston*: Wm. S. Hodgkinson. *Philadelphia*: James T. Hauptli. *Chicago*: Bruce Winner. *Cleveland*: Warren H. Gardner. *San Francisco*: T. H. Carmody, R. C. Alcorn. *Los Angeles*: Carl W. Dysinger, D. A. McMillan. *Denver*: J. Patten. *Atlanta*: M. Miller. *Dallas*: Gordon L. Jones, Robert T. Wood. *London*: E. E. Schirmer. *Frankfurt*: Michael R. Zeynel.

Issue at a Glance

- Convertibles Popular.** Growing demand for convertible debentures presents attractive financing opportunities for electronics firms.....p 5
- Shares and Prices.** Publicly traded convertible debentures.....p 5
- Mergers, Acquisitions and Finance**.....p 6
- Figures of the Week**.....p 6
- Washington Outlook**.....p 8
- Executives in the News.** Mallory of Mallory & Co.....p 10
- Comment**.....p 10
- Fighter Arms Stockpile Swells.** Air-to-air missiles are as expendable as the machine gun and cannon fire they're replacing. Big production is expected to continue—even after the 900 USAF and Navy fighters being bought this year are equipped.....p 13
- Home Stretch Looks Good.** Hopes for the fourth quarter in consumer electronics stem from third-quarter pickup, anticipation of Christmas buying and enthusiastic reception of new product lines.....p 15
- Rising Sales Predicted at NEC.** The National Electronics Conference held in Chicago this week tells much about the industry. And this story tells you.....p 16
- Production and Sales.** Sales Increase Coming in Tape Recorders.....p 16
- U.S. Radio Weak in Mideast.** In region where most radio listeners are medium-wave fans, a lone 150-kw shipborne medium-wave transmitter combats round-the-clock broadcasts of United Arab Republic and Soviet Union. It may be a year before Voice of America goes on the air with a 500-kw transmitter.....p 17
- Firms Push Market Research.** Many electronics companies are organizing special departments. Others are enlarging existing groups. Here's a wrap-up on this new wave of activity and what it means—or can mean—to you.....p 18

DIGEST CONTINUED ON NEXT PAGE

Engineering Reportp 21
 Man May Enter Space in Two Years Technical Digest
 More Space Studies Due Meetings Ahead
 Program Control Uses Transistors

Components and Materialsp 24
 Explosive Forming Lead and Zinc Imports Pared

Nike-Zeus Orders Coming. Over 43 subs and hundreds of suppliers will soon
 feel impact of new \$135-million contract.....p 26

Military Electronicsp 26

Contracts Awardedp 26

New Productsp 29

Literature of the Week.....p 33

Color Tv Keeps Climbing. Shifting patterns in technology, research and con-
 sumer spending are factors in encouraging trend.....p 34

FCC Actionsp 34

Station Moves and Plans.....p 34

British Computer Hopes High. Exhibition next month will stress technical
 progress, new uses and practical business experience.....p 36

Developments Abroadp 36

Exports and Imports.....p 36

Plants and People.....p 38

News of Reps.....p 40

Index to Advertisers.....p 40

Published weekly, with alternating engineering and business issues and with a BUYERS' GUIDE issue in mid-June, by McGraw-Hill Publishing Company, Inc., James H. McGraw (1860-1948) Founder.

Executive, Editorial, Circulation and Advertising Offices: McGraw-Hill Building, 330 W. 42 St., New York 36, N. Y. Longacre 4-3000. Publication Office: 99-129 North Broadway, Albany 1, N. Y.

See panel below for directions regarding subscriptions or change of address. Donald C. McGraw, President; Joseph A. Gerardi, Executive Vice President; L. Keith Goodrich, Vice President and Treasurer; John J. Cooke, Secretary; Nelson Bond, Executive Vice President, Publications Division; Ralph B. Smith, Vice President and Editorial Director; Joseph H. Allen, Vice President and Director of Advertising Sales; A. R. Venezian, Vice President and Circulation Coordinator.

Single copies \$1.00 for Engineering Issue and 50¢ for Business Issue in United States and possessions, and Canada; \$2.00 and \$1.00 for all other foreign countries. Buyers' Guide \$3.00. Subscription rates—United States and possessions, \$6.00 a year; \$9.00 for two years; \$12.00 for three years. Canada, \$10.00 a year; \$16 for two years; \$20.00 for three years. All other countries, \$20.00 a year; \$30.00 for two years; \$40.00 for three years. Second class postage paid at Albany, N. Y. Printed in U.S.A. Copyright 1958 by McGraw-Hill Publishing Co., Inc.—All Rights Reserved. Title registered in U. S. Patent Office. BRANCH OFFICES: 520 North Michigan Avenue, Chicago 11; 68 Post Street, San Francisco 4; McGraw-Hill House, London E. C. 4; 15, Landgrat-Wilhelm, Frankfurt/Main; National Press Bldg., Washington 4, D. C.; Six Penn Center Plaza, Philadelphia 3; 1111 Henry W. Oliver Bldg., Pittsburgh 22; 55 Public Square, Cleveland 33; 856 Penobscot Bldg., Detroit 26; 3615 Olive St., St. Louis 8; 350 Park Square Bldg., Boston 16; 1321 Rhodes-Haverty Bldg., Atlanta 3; 1125 West Sixth St., Los Angeles 17; 1740 Broadway, Denver 2. ELECTRONICS is indexed regularly in The Engineering Index.

Subscriptions: Address correspondence to: Fulfillment Manager, Electronics, 330 W. 42nd St., New York 36, N. Y. Allow one month for change of address, stating old as well as new address. Subscriptions are solicited only from persons engaged in theory, research, design, production, management, maintenance and use of electronics and industrial control components, parts and products. Position and company connection must be indicated on subscription orders.

Postmaster: please send form 3579 to Electronics, 330 W. 42nd St., New York 36, N. Y.



Member ABP and ABC

VIBRATION and SHOCK CONTROL thru design

a **TEAM*** project

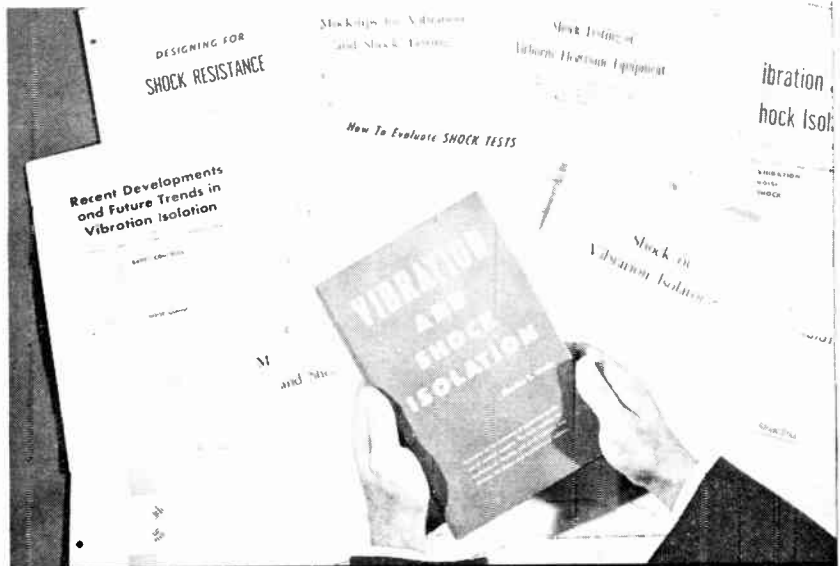

COLLINS RADIO CO.
hired the engineering team
that wrote the book
... and here's the result

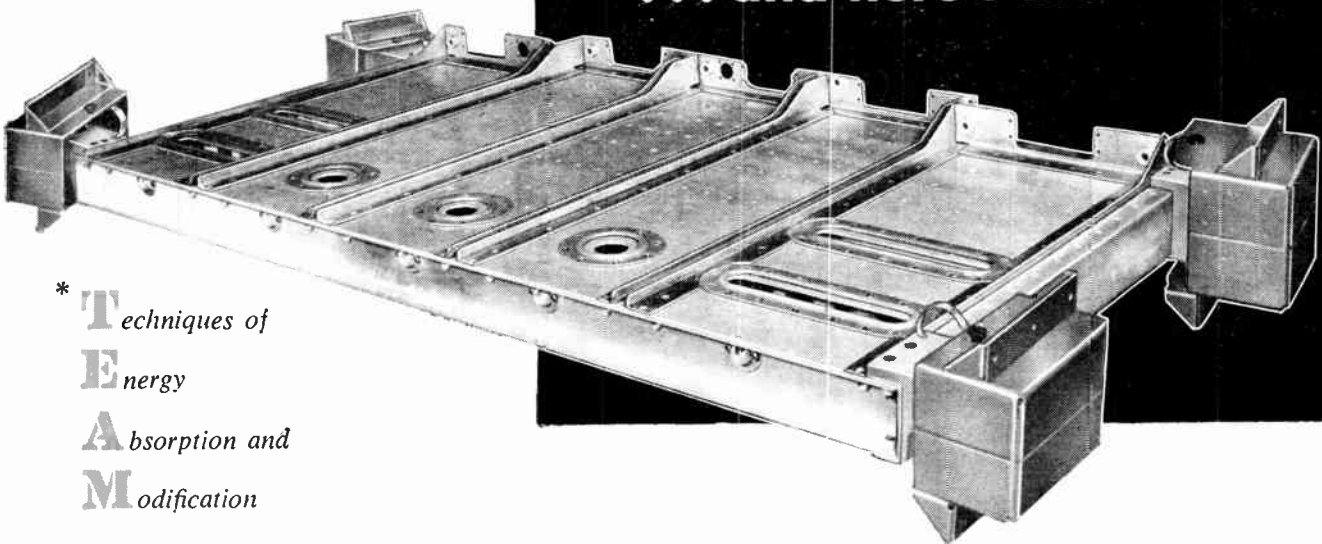

* **T**echniques of
Energy
Absorption and
Modification

In this typical TEAM* project, engineers of Collins and the airframe manufacturer specified the performance of a support for a 180-pound "integrated electronics system" consisting of five equipments.

Then the Barry engineering team working with them integrated the factors of weight reduction, structural reliability, heat dissipation, space saving, and vibration and shock protection in a pressure-sealed, plenum-chambered shelf.

All the way, success of this approach demanded the closest kind of engineering liaison, consulting and reporting — from feasibility study through design, redesign, prototype construction, and production.

This TEAM* approach makes the most of the combined experience of your engineers and ours, for an economical design solution. Barry's engineering team handles any phases of the work: feasibility study, design, development, testing, project engineering — and reporting to your engineers. The result; control of vibration and shock *thru design*.

We invite your inquiry on Barry TEAM* capabilities. You can gain most from consulting us when your project is in its earliest stages — write or phone, or call in your local Barry representative.

A report on plenum-shell design is available in limited quantities. Reprints of the technical articles written by Barry engineers are free on request. The textbook shown is available at technical bookstores.

WESTERN
DIVISION
BURBANK
CALIFORNIA

BARRY
CONTROLS
INCORPORATED

707 PLEASANT ST.
WATERTOWN 72,
MASSACHUSETTS

• Sales representatives
in all principal cities •

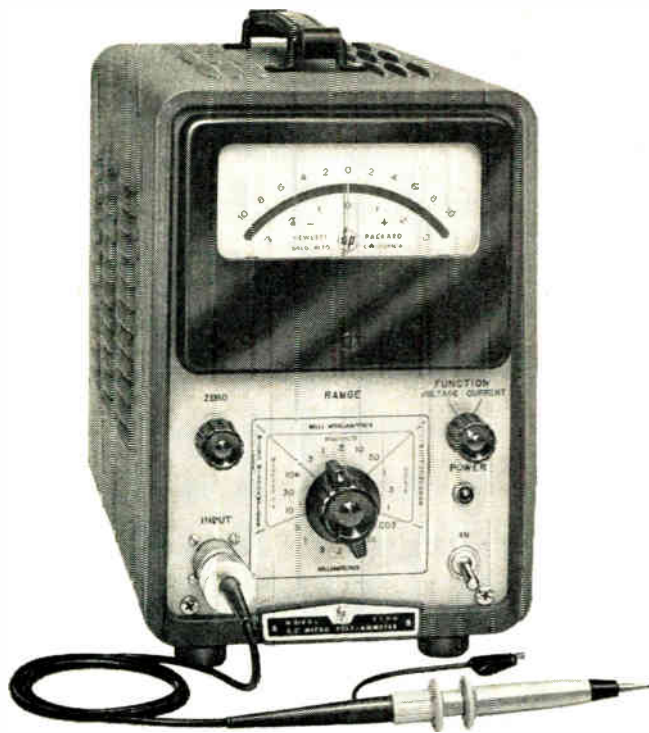

READ DIRECTLY

1 μ ma
and
1 μ v

10 times previous accuracy, drift less than $\pm 2 \mu$ v, noise less than 0.2 μ v!

New 425A Microvolt-Ammeter

Now make these difficult measurements quickly, easily

Engineering—minute dc potentials, difference voltages, nulls; resistances from milliohms to 10 megmegohms (with external dc source). Also use with Esterline-Angus, other recorders

Physics, Chemistry—grid, photomultiplier circuits, vacuum ion levels, thermocouple potentials, voltaic currents in chemicals

Medicine, Biology—voltages in living cells, plants, seeds, nerve voltages

Use of a photoelectric chopper instead of a mechanical vibrator, insuring low noise and drift. Protection against 1,000 volt momentary overloads. New probe minimizing thermocouple and triboelectric effects. Heavy ac filtering.

Above are but a few of the reasons why the new *-hp-* 425A does the work of complex equipment arrays faster, more simply and with 10 times previous accuracy.

In addition to extremely small voltages and currents, Model 425A measures resistances from milliohms to 10 megmegohms, in conjunction with an external constant current.

Get complete details today from your *-hp-* representative, or write direct.

SPECIFICATIONS

MICROVOLT-AMPLIFIER

Voltages: Pos. and neg. 10 μ v to 1 v full scale. 11 ranges, 1-3-10 sequence.

Current: Pos. and neg. 10 μ ma to 3 ma full scale. 18 ranges, 1-3-10 sequence.

Input Impedance: 1 megohm on voltage ranges, 1 megohm to 0.33 ohms on current ranges.

Accuracy: $\pm 3\%$ full scale.

AMPLIFIER:

Frequency Range: dc to 0.2 cps

Gain: 100,000 maximum

Output: 0 to 1 v, adjustable

Output Impedance: 10 ohms, 1,000 shunt

PRICE: \$500.00 f.o.b. factory

Data subject to change without notice

HEWLETT-PACKARD COMPANY

5026A PAGE MILL ROAD - PALO ALTO, CALIFORNIA, U.S.A.

CABLE "HEWPACK" - DAVENPORT 5-4451

FIELD REPRESENTATIVES IN ALL PRINCIPAL AREAS



presenting 30 basic new instruments in one year!

Convertibles Popular

Growing demand for convertible debentures presents financing opportunities for electronics firms

MORE AND MORE investors are turning to convertible debentures as the best answer to inflation trends, unsettled market conditions and high margin needs.

Convertible debentures are unsecured bonds with fixed interest payments and guaranteed repayment of principal which give holders right to exchange debentures for stock and share in growth profits.

Stock conversion privilege gives investors a hedge against inflation. Fixed interest payment provision creates a floor under convertible prices and protects against a sudden market break. Recent raise in margin requirements on stocks, which does not apply to debentures, led many margin traders to shift from stock to convertible investment.

Result, increasing numbers of electronics and other growth firms are taking advantage of the current favorable market conditions to issue "converts" at attractive rates and terms.

Electronics firms are attracted to convertibles today because they need money and these hybrid bonds give them the opportunity to sell "stock" at a higher price, points out Belmont Towbin, partner in C. E. Unterberg Towbin Co. He has been active

as a financial adviser to a number of New England electronics firms.

Convertible debentures are called hybrid bonds because the issuing firms are really offering stock today at the price it will command tomorrow.

The debentures are especially tailored for electronics industry financing because the fundamental requirement of a successful issue is good growth prospects which will be translated into higher common stock prices in the future. Stock conversion price is commonly pegged at 10 to 20 percent above the price of common at time of issue.

Large electronics firms are in the best position to publicly issue convertibles, Wall Street leaders say. Dealers like large firms which can offer an issue of \$5 to \$10 million, since large issues help to make an orderly market. Investors like large firms with well-established earning records because of the protection given to interest payments. Table below lists a number of publicly traded convertibles of electronics firms.

Smaller firms which need to raise only \$1-\$2 million can still take advantage of today's active commercial debenture market through private placement, Towbin says. Opportunities for privately placing convertibles closely parallel opportunities in the public market, he claims.

Ling Electronics and Electronics Specialty Co. are examples of two moderate-sized companies which recently completed private placements of convertibles.

SHARES and PRICES

FOLLOWING LIST of publicly traded convertible bonds of electronics firms illustrates some of points in above discussion. Smallest amount

outstanding for any firm in list is \$3 million. For most, the amount is well over \$5 million. International Tel. & Tel. data shows how rising stock prices also boost convertible price. Debenture was is-

sued in May with a conversion price of 37 when common stock was selling in low 30s. Since then, stock price has moved up to around 47 while the debentures climbed from 100 to 129.

Amount Outstanding (\$ Millions)	Typical Convertible Bond Issues	Interest Rate Percent	Recent Price	1958 Price Range	Current Bond Yield	Recent Stock Price	Conversion Price	Traded	
								Bond	Stock
3.5	Amer. Electronics	5¼	91½ ¹	5.7	11¼	15.40	OTC	ASE
5.9	Amer. Mach. & Fdry.	4¼	146	109¼-148	2.9	46⅞	31.25	NYSE	NYSE
184.4	Amer. Tel. & Tel.	4¼	147½	124¾-147½	2.9	191⅝	142 ²	NYSE	NYSE
6.0	Burroughs	4½	114½	108⅞-119¾	3.9	37	38.96	NYSE	NYSE
7.9	Collins Radio	5¼	92½	5.7	18⅞	26½	OTC	OTC
7.7	Daystrom	4¾	119¼	106½-121½	4.0	36¾	33.13	NYSE	NYSE
3.4	Emerson Electric	5½	127 ¹	4.3	39½	31.00	OTC	NYSE
3.0	Fansteel Metallurgical	4¾	116	112½-122½	4.1	47½	47.13	NYSE	NYSE
3.2	Fischer & Porter	5¼	94½ ¹	90 - 94½	5.6	14¼ ¹	21.00	OTC	NYSE
9.8	I-T-E Circuit Breaker	4¼	111¾	106 - 113	3.8	40¾	39.22	NYSE	NYSE
28.7	International Tel. & Tel.	4⅞	129	110⅝-129	3.8	47⅞	37.00	NYSE	NYSE
8.2	Northrop Aircraft	4	102¾	83 - 105½	3.9	27¼	27.25	NYSE	NYSE
99.9	Radio Corp. of America	3½	93¼	92 - 98½	3.8	37¼	50.00	NYSE	NYSE
4.2	Smith-Corona	6	121	104 - 124	5.0	20⅞	18.00	NYSE	NYSE
20.0	Sylvania Electric	4½	114⅞	104¼-114⅞	3.9	44	41.40	NYSE	NYSE
19.7	Thompson Products	4⅞	116¾	106¾-118¼	4.2	56	75.00	NYSE	NYSE

¹ bid

² includes cash payment \$420 per bond

MERGERS, ACQUISITIONS and FINANCE

• **Marquardt Aircraft**, Van Nuys, Calif., which recently acquired the assets of **Associated Missile Products Division of American Machine & Foundry**, privately places a \$1-million issue of 10-year 5½-percent first mortgage bonds with warrants. The warrants give bondholders rights to purchase 13,000 shares of capital stock at \$30 per share. Stock was recently traded in the over-the-counter market at 30 bid, 32 asked. Marquardt bonds with warrants provide investment benefits and opportunities which are essentially similar to convertible debentures, described in story on preceding page.

• **Central Scientific**, manufacturing subsidiary of **Cenco Instruments**, Chicago, Ill., sold \$2,250,000 of 15-year 5½-percent notes to **Massachusetts Mutual Life Insurance Company** last month. CS makes scientific educational equipment and instruments for military and industrial customers. Notes will be repaid with annual install-

ments ranging from \$100,000 to \$175,000 from 1964 through 1972, plus a final installment of \$425,000 before maturity in 1973. This single obligation will replace three **Central Scientific** debt issues totaling \$1,223,250. Balance will be added to working capital.

• **General Dynamics** concludes arrangements to sell \$75 million of 20-year 5.2-percent promissory notes to **Prudential Insurance Co. of America**. Proceeds will be used to reduce short-term borrowings and for general corporate purposes. The loan was negotiated directly between **Prudential Insurance** and **General Dynamics**.

• **Sanborn Co.**, of Waltham, Mass., maker of medical and industrial electronic equipment, plans to issue 118,530 shares of common stock. Some 100,000 shares will be offered publicly through an underwriting group headed by **Paine, Webber, Jackson & Curtis**. Remaining shares will be offered in

exchange for outstanding shares of 6-percent cumulative preferred stock. Financial information sources give little indication of price to be set on the common offering since the stock is not traded publicly at present. Fact that 18,530 shares of common will be exchanged for about 8,300 shares of 6-percent \$25-par preferred indicates the general price range, however.

• **Small Business Administration** expects hundreds of new investment companies will be chartered shortly after the **Small Business Investment Act of 1958** goes into effect. **Albert C. Kelly**, deputy administrator of SBA, says major banks and financial institutions seem to be leading others in forming investment companies. The act authorizes the SBA to license and give financial assistance to small business investment companies organized to help small business firms with their equity-type and long-term financing needs.

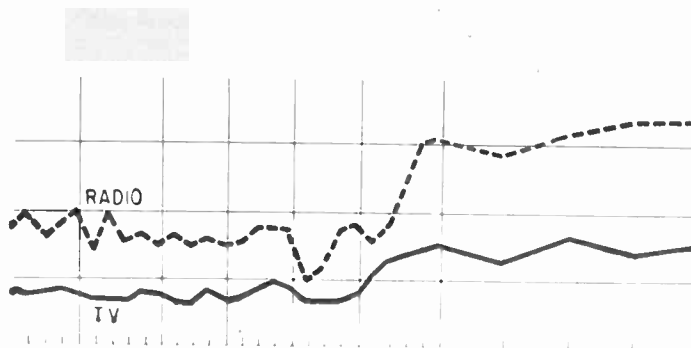
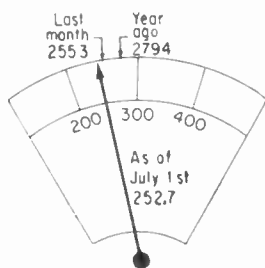

FIGURES OF THE WEEK

RECEIVER PRODUCTION

(Source: EIA)	Sept. 26, '58	Sept. 19, '58	Sept. 27, '57
Television sets, total	128,358	118,811	180,725
Radio sets, total	305,230	309,962	380,732
Auto sets	101,196	109,901	105,895

STOCK PRICE AVERAGES

(Source: Standard & Poor's)	Oct. 1, '58	Sept. 24, '58	Oct. 2, '57
Radio-tv & electronics	59.52	59.48	45.26
Radio broadcasters	69.55	69.12	56.13

FIGURES OF THE YEAR

	1958	1957	Percent Change
Receiving tube sales	221,201,000	251,252,000	-13.0
Transistor sales	21,064,218	12,902,300	+63.4
Cathode-ray tube sales	4,239,404	5,306,594	-20.1
Television set production	2,442,929	3,082,799	-20.8
Radio set production	5,582,834	7,799,882	-28.4

LATEST MONTHLY FIGURES

EMPLOYMENT AND EARNINGS

(Source: Bur. Labor Statistics)	July, '58	June, '58	July, '57
Prod. workers, comm. equip...	339,400	339,700	395,600
Av. wkly. earnings, comm.	\$81.35	\$82.39	\$75.85
Av. wkly. earnings, radio.	\$80.99	\$81.60	\$75.05
Av. wkly. hours, comm.	39.3	39.8	39.1
Av. wkly. hours, radio.	39.7	40.0	39.5

TRANSISTOR SALES

(Source: EIA)	July, '58	June, '58	July, '57
Unit sales	2,631,894	3,558,094	1,703,000
Value	\$6,598,762	\$8,232,343	\$4,216,000

TUBE SALES

(Source: EIA)	July, '58	June, '58	July, '57
Receiving tubes, units	30,795,000	36,270,000	33,077,000
Receiving tubes, value	\$26,927,000	\$31,445,000	\$27,042,000
Picture tubes, units	549,817	725,846	491,935
Picture tubes, value	\$11,109,048	\$14,203,381	\$9,835,586

you can get the best earth instruments from NEELYLAND



HEWLETT-PACKARD COMPANY
Palo Alto, California



VARIAN ASSOCIATES
Palo Alto, California



ELECTRO-MEASUREMENTS, INC.
Portland, Oregon



KIN TEL
San Diego, California



SANBORN COMPANY
Waltham, Massachusetts



DYMEC, INC.
Palo Alto, California

Of course you know Neelyland covers California, Arizona, Nevada and New Mexico . . . and the earth people living there are among the happiest in the Solar system. Particularly those lucky engineers who get to work with those fantastic instruments produced by the best known electronic companies on the whole Planet.

Earth men know . . . you can depend on Neely Enterprises for complete service.

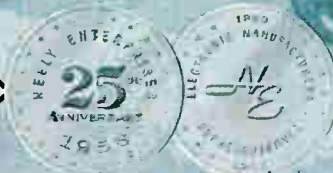

NEELY ENTERPRISES

electronic manufacturer's representatives

<p>NORTH HOLLYWOOD OFFICE 3939 Lankershim Blvd. Phone: STanley 7-0721 TWX: NH 7133</p>	<p>SAN CARLOS OFFICE 501 Laurel Street Phone: LY 1-2626 TWX: San Carlos - Belmont CAL 94</p>	<p>SACRAMENTO OFFICE 1317 Fifteenth St. Phone: GI 2-8901 TWX: SC 124</p>	<p>SAN DIEGO OFFICE 1055 Shafter St. Phone: AC 3-8106 TWX: SD 6315</p>	<p>ALBUQUERQUE OFFICE 107 Washington St., S.E. Phone: AL 5-5586 TWX: AQ 172</p>	<p>LAS CRUCES OFFICE 125 S. Water St. Phone: JA 6-2486 TWX: Las-Cruces NM 5851</p>	<p>PHOENIX OFFICE 641 E. Missouri Ave. Phone: CR 4-5431 TWX: PX 483</p>	<p>TUCSON OFFICE 232 S. Tucson Blvd. Phone: MA 3-2564 TWX: TS 5981</p>
---	---	---	---	--	---	--	---

**FOR ULTRA PURE WATER
IN ELECTRONICS WORK
BARNSTEAD MAKES BOTH
WATER STILLS AND
WATER DEMINERALIZERS**

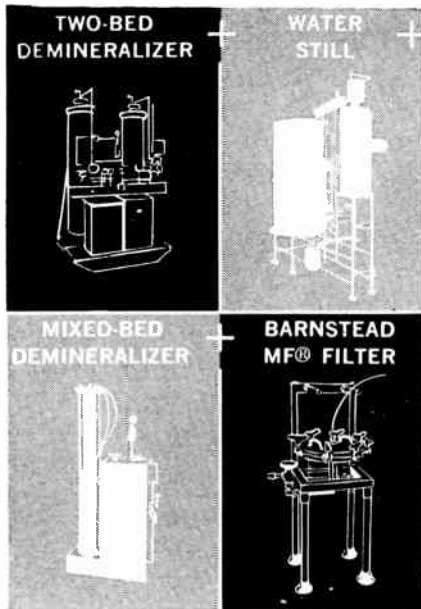

**THIS BARNSTEAD EQUIPMENT
EMPLOYING DEMINERALIZA-
TION, DISTILLATION AND SUB-
MICRON FILTRATION PRODUCES
PUREST WATER—HOH ABSOLUTE
IN PRODUCTION QUANTITIES**

The above combination of Water Demineralizers, Water Still, and Barnstead MF Filter, operated in series, will produce 15,000,000 OHM Water in production quantities . . . free of bacteria, organics and submicroscopic particles. Write for Catalog 127, and Bulletin 141.

NEW: TRANSISTOR WASHER

This apparatus washes and rinses transistors and other small electrical parts in hot distilled, demineralized water. New repurification process conserves thousands of gallons of demineralized water each day.



WRITE FOR BULLETIN #146



BOSTON Jamaica 4-3100	NEW YORK Kingsbridge 8-1557	CLEVELAND Academy 6-6622
CHICAGO MUIberry 5-8180	PHILADELPHIA Locust 8-1796	LOS ANGELES RYan 1-6663
JOHNSON CITY 3113	SAN FRANCISCO Templebar 2-5391	CHATTANOOGA 6-5863

84 Lanesville Terrace, Boston 31, Mass.

FIRST IN PURE WATER SINCE 1878

CIRCLE 4 READERS SERVICE CARD

WASHINGTON OUTLOOK

MILITARY ELECTRONICS contractors will get increased protection for trade secrets under the Pentagon's new procurement regulation on proprietary rights.

Up to now, there has been an almost universal requirement for such information. The Defense Dept. now will spell out when such data must be furnished.

In most cases, the contractor is no longer required to provide proprietary data for so-called standard commercial products bought under advertised procurement.

He must provide data only when a clear government need is established and announced in the bid invitations.

Under research and development contracts, however, the contractor must continue to furnish the military with all data resulting directly from the project. But for standard commercial products bought for R&D projects, the contractor may elect to furnish only details on performance specifications, sources and other facts which would allow the military to practice the process or to procure the part or an adequate substitute.

Another change specifically exempts from the proprietary data requirement products incorporated as components in R&D models which were developed at private expense and previously sold on the open market.

Finally, the regulations set up a new clause to be added to all military supply contracts stating that, unless specifically instructed, contractors do not have to provide proprietary data if specifications are outlined in the contract.

- Electronics projects figure prominently in the Pentagon's new drive to weed out competing R&D projects, so-called back-up projects which have been run as insurance for vital programs.

Projects under the scrutiny include (1) rival Air Force and Army programs to develop world-wide communications systems based on scatter, and other techniques; (2) competing projects to produce electronics-laden, all-weather fighter-interceptor aircraft—such as McDonnell's F-101B and Convair's F-106 for the Air Force, Chance Vought's F8U-3 and McDonnell's F4H for the Navy; (3) Army and Air Force competing efforts in the antimissile field (already partially resolved by changing the Air Force's Wizard from a weapon system project to a more limited component study program); and (4) the rival IRBM and ICBM projects.

The outlook is for eventual cutbacks in such contracts. Some of the major decisions will be made over the next two months as work is completed on the fiscal 1960 defense budget. Most of the cuts may not be reflected until after next July 1 when new funds are required to continue current work.

Then, some projects will be discontinued outright. The scope of others will be reduced while the project remains alive. The Pentagon's big problem now is to balance advantages of duplication, such as achieving rapid and imaginative results, against the higher costs duplication entails.

For the study and initial design stages of R&D projects, duplicating efforts will still be tolerated—even encouraged. For the later development stages where expenditures are higher, the new economy policy will be pushed.

**NEW
PERFORMANCE
FEATURES**

**NEW
OPERATING
CONVENIENCE**

TYPE 543 DC-to-30 MC OSCILLOSCOPE

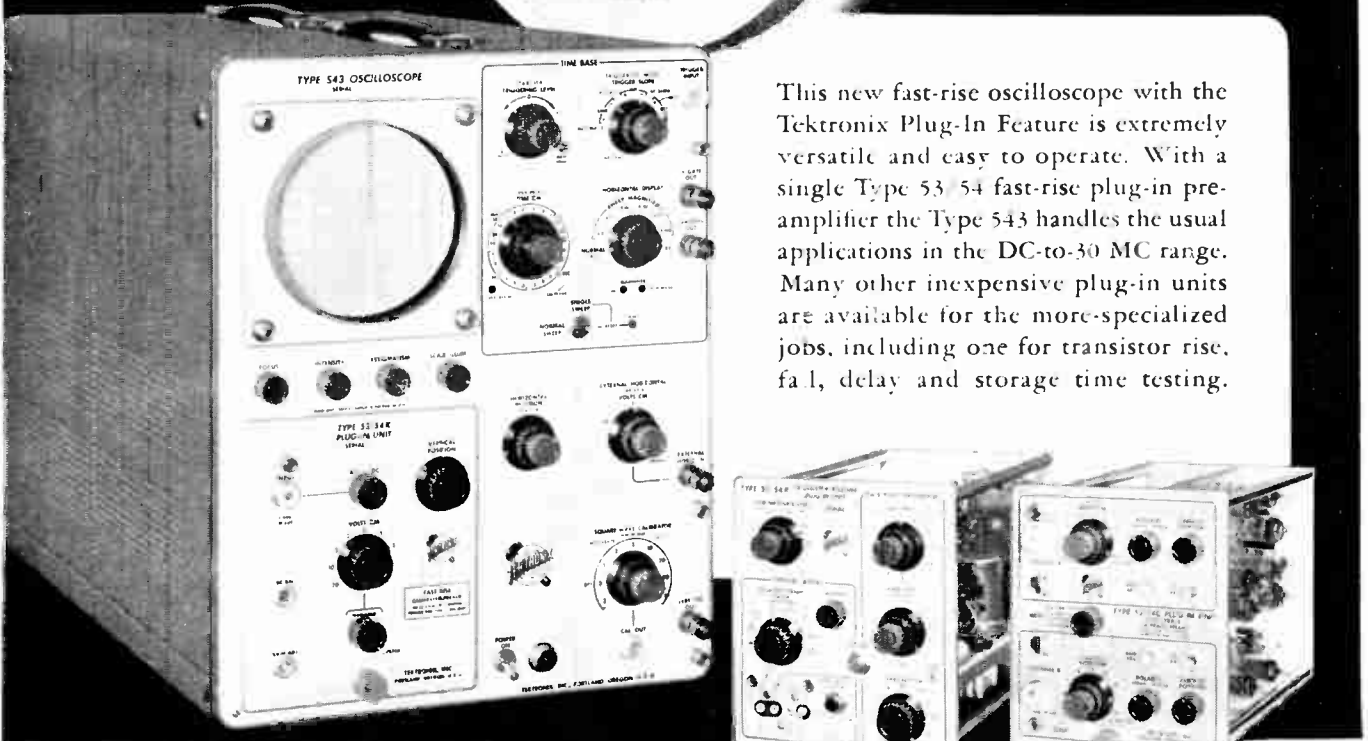

This new fast-rise oscilloscope with the Tektronix Plug-In Feature is extremely versatile and easy to operate. With a single Type 53/54 fast-rise plug-in pre-amplifier the Type 543 handles the usual applications in the DC-to-30 MC range. Many other inexpensive plug-in units are available for the more-specialized jobs, including one for transistor rise, fall, delay and storage time testing.

MAIN CHARACTERISTICS

VERSATILITY

Nine Available Plug-In Preamplifiers—Wide Band, Dual Trace, Low Level, Differential, and others for specialized applications.

HIGH PERFORMANCE

DC to 30 MC with fast-rise plug-in units.
DC to 24 MC with dual-trace plug-in unit.
0.02 μ sec/cm to 15 sec/cm sweep range.

EASY OPERATION

24 Calibrated Direct-Reading Sweep Rates.
Sweep Magnification—2, 5, 10, 20, 50, and 100 Times.
Preset Triggering—Eliminates triggering adjustments in most applications.
Single Sweep Operation—Lockout-Reset Circuitry for one-shot recording.

HIGH WRITING RATE

250 cm/ μ sec. 10-kv accelerating potential assures bright trace for operation in single-sweep applications, and with low sweep repetition rates.

ENGINEERS—interested in furthering the advancement of the oscilloscope? We have openings for men with creative design ability. Please write Richard Ropiequet, Vice President, Engineering,

TYPE 543 PRICE, without plug-in units.....\$1200

Type 53/54K Fast-Rise Unit.....\$125
Type 53/54C Dual-Trace Unit.....\$250
Type 53/54R Transistor Test Unit.....\$300

Prices f.o.b. factory.

Please call your Tektronix Field Engineer or Representative for complete specifications and, if desired, to arrange for a demonstration of your convenience.

Tektronix, Inc.

P. O. Box 831 • Portland 7, Oregon

Phone CYpress 2-2611 • TWX-PD 311 • Cable: TEKTRONIX

TEKTRONIX FIELD OFFICES: Albertson, L. I., N.Y. • Albuquerque • Bronxville, N.Y. • Buffalo
Cleveland • Dallas • Dayton • Elmwood Park, Ill. • Endwell, N.Y. • Houston • Lathrup Village,
Mich. • East Los Angeles • West Los Angeles • Minneapolis • Mission, Kansas • Newtonville,
Mass. • Palo Alto, Calif. • Philadelphia • Phoenix • San Diego • Syracuse • Towson, Md.
Union, N. J. • Willowdale, Ont.

TEKTRONIX ENGINEERING REPRESENTATIVES: Arthur Lynch & Assoc., Ft. Myers, Fla.,
Gainesville, Fla.; Birns & Coldwell, Atlanta, Ga.; High Point, N.C.; Hawthorne Electronics,
Portland, Ore.; Seattle, Wash.; Hytronix Measurements, Denver, Colo.; Salt Lake City, Utah.
Tektronix is represented in 20 overseas countries by qualified engineering organizations.

Here's a laboratory camera that can photograph any size subject...

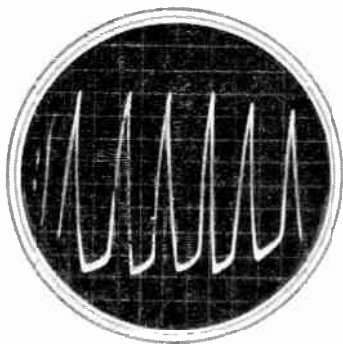

from a
PIP...

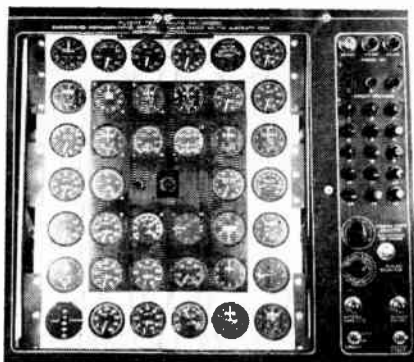

to a
PANEL

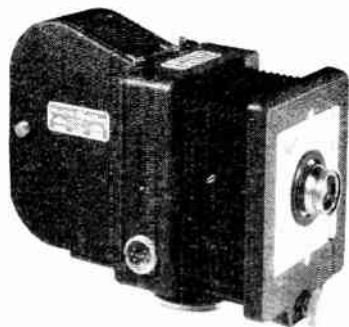

THE BEATTIE VARITRON MODEL E data recording camera is automatic, electric, and achieves great versatility through interchangeability of lens and magazine combinations. Bellows construction gives wide focusing capability. 100 ft. roll film magazines for both 35 and 7 mm in a variety of aperture sizes are available. Varitron Model E systems are powered by either 115 volt 50-60 cycle AC or 28 volt DC.

For more information write to

B BEATTIE-
C COLEMAN inc.

1000 N. Olive St., Anaheim, California
CIRCLE 6 READERS SERVICE CARD

10

EXECUTIVES IN THE NEWS



Mallory: logic of law

NEW MAN in our industry (with an old familiar name) is G. Barron Mallory, who became administrative v-p for Indianapolis component-maker P. R. Mallory & Co. the first of this month.

The election to what amounts to a chief-of-staff's job came as an unsought surprise to the second-generation Mallory, who has cut out his own career in the practice of law. The directors were under no compulsion to elect him: his family owns only about 15 percent of the firm's stock. But the board felt he had, besides financial interest and an outsider's objectivity, enough of an insider's knowledge: he was a partner in the law firm which serves as Mallory & Co.'s counsel, and has been a director since 1955.

Mallory, a slim, wiry 39, was born in Portchester, N. Y., educated in France and Switzerland (with finishing touches from fashionable Kent School in Connecticut), and took a B.A. in physics (Yale '41). While in the Navy during the war, he became interested in law: "I was impressed," he relates, "with the logical, orderly minds of lawyers I met, and the way they could absorb facts." So he returned to Yale and got his law degree in 1947. On his admission to the bar, he went with the New York law firm of Brown, Wood, Fuller, Caldwell & Ivey, counsel to Mallory & Co.

Aware of the new job's responsibility (Mallory sales dropped off 5 percent this year) and challenge (he hopes to push them back up and over the \$100-million mark "soon"), he went through an agonizing appraisal before accepting. New research developments, expanding international operations, and the widening horizons of electronics were what finally sold him.

Mallory and his wife spend most of their hours together with their four children, ages 7 through 13. "Four is a handful," he grins by way of explaining why he gave up golf, but he and Mrs. M. still play tennis. In his new—as yet unselected—home in Indianapolis, he figures on giving up home carpentry projects, picking up golf again.

COMMENT

Nuclear Navy

Your story on the nuclear submarine *Triton* ("Undersea Radar

Station," p 20, Sept. 19) mentions that the ship is the largest submarine ever built and says that "she's over 100 ft longer than many destroyers." It seems to me that the Japanese built a submersible

aircraft carrier that must have been bigger than the *Triton*. And aren't our destroyers over 400 ft long?

Furthermore, you say that her radio and radar antennas "will sink into her sail (70 ft long, 18 ft abeam and 34 ft high) while she's submerged." Is this "sail" what we used to call a conning tower?

ELLIOT R. HOPKINSON

MARIETTA, GA.

The Japanese I-400, which carried three seaplanes, was formerly the record submersible. She was 400 ft long to *Triton's* 447 ft, 5,700 tons surface displacement to *Triton's* 5,900 tons. And according to *Jane's Fighting Ships*, our longest destroyers, the Forrest Sherman class, are 418 ft long; but most of our fleet is made up of vessels in the Gearing (390 ft) Sumner and Fletcher (376 ft) Mayo (348 ft) and Gleaves (341 ft) classes.

Lastly, yes—the Navy no longer calls the superstructure on a submarine a conning tower, since the tower is only a small part of the entire sail.

Defense Business

I've been much impressed with both your business and engineering issues, but in glancing over the Sept. 19 issue I notice a lot of emphasis on the defense side of business. There was the intercepter missile article, the cold-war story ("Radio Crashes Iron Curtain," p 17) the article on the *Triton* and many other short and long items on defense business.

Even your Executive in the News was a fighter in the cold war, just back from negotiating with the Soviets at Geneva ("Fisk: Yankee at the Summit," p 12).

Doesn't your staff have any other interests?

GENE C. GOODMAN

PHILADELPHIA

We call 'em as we see 'em. After all, a large percentage of the electronic business is in defense areas, and many—if not most—of the hottest new technological developments take place in the same areas. As much as possible, we've always tried to report the news, not make it up as we go along.



**precision...
accuracy...
performance**



Motor-generators

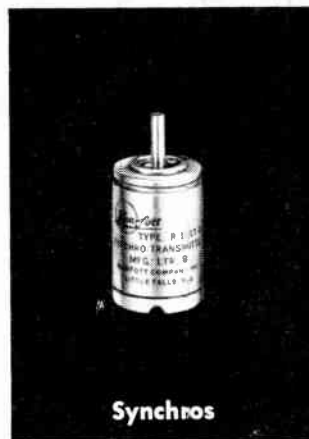

Synchros



Servomotors

Maximum precision, performance, and accuracy are inherent in all Kearfott components. Superior performance under the most adverse environmental conditions is assured.

Synchros: Sizes 25 through 8
Errors as low as 20 seconds

Motor-generators: Sizes 15 through 8
Linearity better than 0.01%

Servomotors: Sizes 25 through 8
Wound for transistorized amplifiers

Components are available to withstand high temperatures (up to 200°C), severe vibration (to 2000 cps), and shock (to 50 G). Corrosion resistance and light weight are further reasons for the extensive use of Kearfott components in operational and developmental missiles and aircraft. Write today for engineering data.

Engineers: Kearfott offers challenging opportunities in advanced component and system development.

Kearfott

GENERAL PRECISION EQUIPMENT CORPORATION
GPE

KEARFOTT COMPANY, INC., LITTLE FALLS, N. J.

A Subsidiary of General Precision Equipment Corporation

Sales and Engineering Offices: 1378 Main Ave., Clifton, N. J.

Midwest Office: 23 W. Colendar Ave., La Grange, Ill. South Central Office: 6211 Denton Drive, Dallas, Texas

West Coast Office: 253 N. Vinado Avenue, Pasadena, Ca if.

rugged and reliable...

KENNEDY'S 40' RADAR ANTENNA



DEVELOPED and manufactured by Kennedy, this 40-footer is being used extensively by the CAA for air traffic control.

Ruggedness and reliability are two important reasons. It operates in winds to 80 knots with no ice, or to 40 knots if loaded with ice to 7 lbs. per square foot. When not operating it withstands 110-knot winds with no ice or 90-knot winds with 7 lbs. per square foot of ice.

Each of the 7 aluminum sections is interchangeable with corresponding sections of the same model. Weight of the sections is light enough to be easily handled during erection. Total weight is just over 1000 lbs.



ANTENNA EQUIPMENT

◦ **D. S. KENNEDY & CO.**

Route 3A, Cohasset, Mass. EVergreen 3-1200

West Coast Affiliate...

SATELLITE-KENNEDY, INC. of CALIFORNIA
Rancho Laguna Seca, Monterey-Salinas Highway,

P.O. Box 1711, Monterey, California - FRontier 3-2461

OCTOBER 17, 1958



New air-to-air guided missile, Falcon GAR-3 (left), brings total USAF-Navy inventory to six types operational and three developmental as . . .

Fighter Arms Stockpile Swells

Air-to-air missiles are as expendable as the machine gun and cannon fire they're replacing. Big production is expected to continue—even after the 900 fighters being bought this year are equipped

NELLIS AFB, NEV.—Spectators here at the Tactical Air Command's week-long Annual Weapons Competition, which began on Sunday, are getting a live look at performance capabilities of the Sidewinder air-to-air missile now being used by Chinese Nationalist pilots against Communist MIG-17's.

Here, the heat-seeking Sidewinder is turned loose by its F-89J carrier, hot on the tail of a 5-in. unguided rocket, fired a few seconds before.

After the competition finishes tomorrow, the second phase, staged by Air Defense Command, will begin at Tyndall AFB, Fla., on Monday and continue for 10 days.

Special significance of the two-phase meet is that supersonic aircraft, guided missiles and drones are being used for the first time at an Annual Weapons Competition. Purpose, besides providing practice maneuvers for TAC and ADC, is to show the competency of new equipment, bombing and missilery techniques and of the performing personnel.

At Tyndall the F-102A will fire the Hughes GAR 1, the F-89J will fire the Douglas Genie MB-1 (with practice warhead) and the F-86L will fire FFAR rockets. Target for the shoots will be a Ryan

drone, the Q-2A Firebee. Air-launched from a B-26 and recovered by parachute, the Q-2A will be controlled from the ground by an AN/APW-11A radar command control system.

A 4-lb Dage tv camera carried in a PF-102 will follow the rockets to the kill, televising the show back to the base. Camera tests to date have resulted in good reception 125 mi away.

Every day at noon a fly-by will take place. Performing will be F-101B's, F-105's and F-106's.

Besides missiles fired in the competition, industry's weapons display on the ground will show Hughes' new semiactive radar-guided Falcon GAR-3. (At left in photo; missile on right is GAR-1-D.)

Due to efforts against duplication, the combined USAF-Navy assortment of operational air-to-air missiles amounts to only six. All but Sparrow 1 are still in production. Major business for this small family of birds—as expendable as the machine gun and cannon fire they are replacing—is in large repeat production orders.

Kind of electronic equipment used in these mass production weapons, and where to sell it, can be

seen from a look at the individual missiles, their prime contractors and the services using them (see chart below).

Air Force, Navy and Marines are all using Sidewinder. USAF also has operational three Falcons and the unguided Genie (directed prior to launch by Hughes' MG-12 fire control system.) Navy has Sparrow III, as well as its completed stockpile of Sparrow I.

Three more missiles are under development: a guided version of Genie, the long-range Falcon GAR-9 for the F-108 and the Eagle for the A2J. (Budget problems have held up the Eagle.)

Big factor in kind of electronic gear used lies in the missile's guidance type. The six currently operational missiles employ four systems:

Beam rider, which limits the aircraft's maneuverability until the missile reaches the target, is used only in Sparrow I, now out of production.

Active radar homing, used in two missiles, calls for a radar transmitter, receiver, computer, servo-mechanisms to actuate missile controls and a fuzing device.

Prior to launch, the interceptor pilot acquires a target on his radar and the fire control system computes a fire control solution. After maneuvering into a good position for firing, he slaves the missile's radar to the target he selects. When the missile radar acquires the target, or else has a good chance of doing so immediately after firing, the pilot launches the missile and breaks away.

Automatic systems that pass the target from the interceptor's radar on to the missile radar without

aid from the pilot free him from tedious work at a critical moment. Precautions must be taken here, however, to prevent the pilot's jockeying into position for one target as the missile barrels off after another.

Disadvantages in an active radar system are: additional weight, space of transmitter and its power supply system and, consequently, range. Since the missile illuminates its own target, it must be close enough to "see" the target when launched or shortly thereafter. To double the range, peak power must be increased by a factor of 16. Economical disadvantage is one-shot use of expensive transmitter gear.

Semiactive radar homing is used in the new Falcon GAR-3. Since the target is illuminated by the interceptor's radar, and carries no transmitter of its own, the missile avoids some of the weight, space and power supply problems of active homing missiles. It can be smaller, lighter, more active and—by using the strong radar of the interceptor—not as myopic. For this reason, long range USAF Falcon GAR-9 and Navy's Eagle will probably use semiactive radar guidance.

Disadvantages: the aircraft must continue to track the target until missile impact; also it can handle only one target at a time.

Passive homing (infrared) is used by two missiles. Before launching, the missile's infrared guidance system is slaved to the target by the interceptor's fire control radar system. After launching, the pilot is free to break away, as with the active radar homing system. Limitations are created, however, by fog and haze.

GUIDANCE SYSTEMS IN AIR-TO-AIR MISSILES

Missile	Service	Guidance Contractor	Prime Contractor	Air Frame Contractor	Status
BEAM RIDER					
Sparrow I	Navy	Sperry	Sperry	Douglas	not in 1959 budget
ACTIVE RADAR HOMING					
Falcon GAR-1-D	USAF	Hughes	Hughes	Hughes	op., F-89, F-106, F-102
Sparrow III	Navy	Raytheon	Raytheon	Raytheon	op., will replace Sparrow I
SEMIACTIVE RADAR HOMING					
Falcon GAR-3	USAF	Hughes	Hughes	Hughes	prod.
INFRARED					
Falcon GAR-2-A	USAF	Hughes	Hughes	Hughes	op., carried with GAR-1-D
Sidewinder	USAF, Navy, Marines	GE Philco	GE Philco	Hunter-Douglas	op., F-100, F-104, F-105
UNKNOWN					
Falcon GAR-9	USAF	Hughes	Hughes	Hughes	dev., for F-108, nuclear warhead
Eagle	Navy	Douglas	dev., for Grumman A2J, nuclear warhead
Genie	USAF	dev., guided version
UNGUIDED					
Genie	USAF	NONE	Douglas	prod.
Zuni	Navy	NONE	*NOTS	Hunter-Douglas	also air-to-surface

* Naval Ordnance Test Station

op.—operational

prod.—in production

dev.—in development

Home Stretch Looks Good

Hopes for the fourth quarter stem from: third-quarter pickup, anticipation of heavy Christmas buying, enthusiastic reception of new product lines. Here's the industry-wide picture

FOR ALL the recession and the much-discussed changes in the public's taste, the consumer part of the electronics industry seems to have weathered this year pretty much as predicted ("1958: Year of the High Plateau," *ELECTRONICS*, p 13, Jan 10).

Expectations for a good fourth quarter—abreast or ahead of the like 1957 period—stem from current business pickup and anticipation of Christmas sales. Across the nation, manufacturers voice a cautious optimism.

Sales for the first nine months are mixed: monochrome tv is off 20 percent in unit sales, radio is running just about even, stereo is booming and color tv, although still climbing slowly, has had a fairly disappointing year.

Production curves began to turn up in August, and they're still going up. Manufacturers, on the basis of this pickup, hope the fourth quarter will bring overall 1958 sales close to or equal 1957's.

Although factory production of monochrome tv sets badly lagged last year's first nine months, the dollar figures were less depressing. This was partly due to what most setmakers consider to be "more realistic" pricing. "Selling up" in price was also partly responsible.

Strangely enough, the principal problem in slow sales during the first nine months of the year did not seem to be entirely one of price. Many a setmaker reports more sales in his luxury line than in the less expensive sets. And stereo systems, hardly cheap by anybody's standards, are the brightest spot in the entire consumer electronics industry.

This indicates that all the sombreness in the color-tv picture can't be blamed on price. A West Coast setmaker states "originally it seemed to be price. Now it's the quality of the programming . . ."

On the other side of the nation, another manufacturer adds "color doesn't mean as much as the original introduction of tv meant. And the added advantage isn't enough to outweigh the cost for most people as long as picture quality remains poor and programming remains skimpy."

(Broadcasters, on the other hand, state that they

cannot sell a nonexistent audience, blame the quality of programming on the dearth of color sets.)

At least two big manufacturers are keeping their engineering on color sets up to date just to hedge their bets, but "absolutely not" manufacturing sets this year or tooling up for next year.

Radio sales in the first half of 1958 lagged the like 1957 period by about 25 percent. The August pickup in radio production was even sharper than the increase in tv production, and now factory sales reported by most of the big manufacturers are only a hair behind last year's figures.

Portable radios, reports one setmaker, are running faster than table models. Big difference this year is a drop in sales of tube-powered radios in favor of all-transistor units.

Just about every manufacturer noted that the introduction of a new line brought fast consumer reaction in the form of cash in the till. And new gadgetry, such as remote-control units, seems also to catch the jaundiced eye of the consumer. But one after another, setmakers told *ELECTRONICS* "selling is the only answer."

"People have money in the bank," says one maker. Adds another: "We're all back to selling again . . . dealers are 'selling up' in price. We can't make enough models in the high end of the price scale."

"The industry is selling a higher-priced unit generally," comments a big midwestern manufacturer. "The 21-in. screen is the dominant size on the market. We expect most tv sales to be in the \$200-300 range in the months ahead."

Trend in consumer taste is toward simplicity in design, reliability in operation. "People nowadays feel that their purchases must have inherent value," says a thoughtful California manufacturer. "They're not shopping price alone."

One distinct advantage of this past year, over the last two sales years, has been that no major manufacturer has gone out of business. Dumping of discontinued lines was one of the major causes of softness during 1956 and 1957. Spared this in 1958, the market was left to adjust itself to demand.

Rising Sales Predicted at NEC

CHICAGO—The National Electronics Conference held here this week told as much about the industry as a chart recorder tells about a test unit. Analysis of the big confab and show, which had more than 10,000 registrants and 250 exhibitors, showed:

(1) Business was described as good. (2) Reliability of components was a big talking point for sales. (3) Manufacturers are pinpointing specific types of sales targets. (4) Recruiting of engineers goes on, at a slowed pace, with less job hopping and, on part of employers, more selectivity. (5) Standards of papers were high.

Many sales were made at the show, but emphasis was on the follow-up. The "shotgun" approach in

sales was secondary. Prospects were given pitches more tailored to their individual needs and preferences. The men on the floor stressed quality and reliability in talking up their products, paid less attention to price appeal.

As at Wescon, components, production equipment and instruments received the big push from exhibitors. Recruiting of engineers went on as usual, but the pace was less frantic than it was a year ago. Both engineers and potential employers were more cagey than usual. Selection standards for jobs were very high on part of employers. Men looking wanted opportunities "with the greatest potential, both financially and professionally."

PRODUCTION and SALES

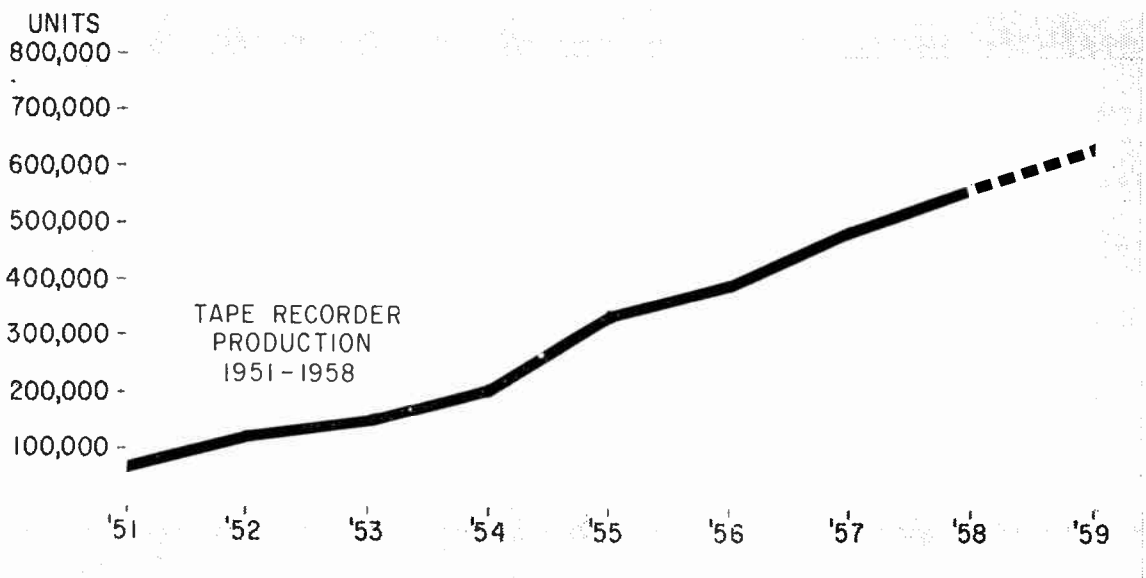

Sales Increase Coming in Tape Recorders

Tape recorder annual production has increased steadily from 25,000 units 10 years ago to half a million in 1957. A temporary letup is ahead. Then, say manufacturers, will come an upturn skyward in six months to a year or so.

Production drop is due to consumer confusion over three recent developments. These are (1) stereo disks, (2) slow-speed, four-track stereo tape and (3) the new tape cartridge.

Industry spokesmen see these developments as the key to a real mass market for tape machines, hitherto purchased largely by audio-philosophers, hobbyists and music enthusiasts.

After players for four-track tape are field tested and widely available, recorder sales are expected to climb sharply. Within three years, annual sales are expected to top the one-million mark.

Previous industry estimates had

placed 1958 sales at over 600,000. It now appears that figure will not be met. By next fall, however, the market picture should be clarified and sales for 1959 should pass 650,000 units.

Tape recorder production at present is 85 to 90 percent home-type recorders retailing at \$100 to \$300. Two-thirds of the rest are semiprofessional models priced over \$300. Balance are studio and broadcast recorders priced over \$600.

U. S. Radio Weak in Mideast

In region where most radio listeners are medium-wave fans, a lone 150-kw shipborne medium-wave transmitter combats round-the-clock broadcasts of United Arab Republic and Soviet Union. It may be a year before Voice of America uses a 500-kw transmitter

RADIO PROPAGANDA WAR in the Middle East sees the United States fighting a losing battle so far against the transmitters of the United Arab Republic and the Soviet Union.

Although most listeners in the Middle East and Africa can pick up only medium-wave broadcasts, the U.S. answers daily propaganda in many languages and dialects with one Voice of America 150-kw medium-wave transmitter.

For want of a suitable ground station, this lone transmitter is located on board the Coast Guard cutter *Courier*, anchored off the Isle of Rhodes in the eastern Mediterranean (see cover).

Short-wave broadcasts from the U.S. are relayed to the Middle East by the VOA's Tangier station, and by short-wave gear on the *Courier*.

Most powerful official UAR stations—Cairo Radio, Voice of the Arabs in Cairo and Damascus Radio—are high-power medium-wave stations. Other medium-wave stations are low-power. Cairo's short-wave stations are said to be 50 kw at the most.

One source says that 14 transmitters are in operation in Cairo and Damascus alone. Two of the newer ones reportedly came from the Soviet Union; others are British and German.

The UAR is reliably reported to be beaming some 60 separate programs each day to the Middle East and Africa. Other programs are broadcast by clandestine stations such as the "Jordanian People's Radio," believed to be broadcasting from Syria.

"The Voice of Free Lebanon" and "The Voice of Free Africa" are other clandestine stations.

Soviet Union is also broadcasting daily in Arabic, Kurdish and in many African languages.

Voice of America Plans

Last year Congress appropriated \$4 million for a VOA medium-wave station in the Middle East. Diplomatic negotiations are still going on to obtain a site. VOA hopes to be on the air in about a year with a 500-kw medium-wave transmitter, and is considering the leasing of an existing facility until the new installation is ready.

Congress is being asked to approve additional funds for VOA next year, to complete a planned three-year expansion program totaling \$27 million. These proposals have been made by VOA:

- Project Paul. This would be an additional 500-kw medium-wave station for the Middle East costing \$5.1 million.

- Project Larry. This is a proposed \$7.2-million 100-kw station to reach short-wave listeners on the African continent. But Larry's main purpose would really be to relieve some of the load on VOA's Tangier relay, freeing it for more broadcasts to the Soviet bloc.

In the meantime there are these further indications of the extent of the UAR's radio offensive:

- Cairo reportedly acquired two new transmitters recently from Czechoslovakia, boosting the strength of one of its stations, the Voice of the Arabs, to about 600 kw, the strongest signal in the Middle East.

- UAR plans to get new Soviet gear for the Damascus station, boosting it to about 300 kw.

Jamming

Most jamming in the Middle East is on medium-wavelength, but the Soviet Union is also jamming the Voice of America, BBC and Turkish broadcasts on short-wave from stations in Bulgaria.

Jamming of Cairo broadcasts in Lebanon began only this year (ELECTRONICS, p 16, June 13). Now a 100-kw m-w jammer is used. Lebanon also recently contracted with Siemens for a new radio station to step up Beirut's 4-kw output.

Cairo reportedly jams Israeli broadcasts in Arabic to Arabs both in and outside of Israel.

A recent clandestine broadcast said British troops in Jordan recently received jamming gear. Apparently propaganda broadcasts to Jordan have not been jammed so far. Recently the Jordanian Broadcast Authority ordered two Marconi 100-kw transmitters, one short-wave and one medium-wave, to beef up its Amman station.

Iraq stopped her jamming of UAR broadcasts shortly before last summer's revolution.

Firms Push Market Research

Many electronics companies are organizing special departments. Others are enlarging existing groups. Here's a wrap-up on this new wave of activity and what it means—or can mean—to you

MARKET RESEARCH activities by electronics firms are growing by leaps and bounds.

In a nutshell, market research is the job of getting facts about sales and markets to help management improve its batting average on decisions in these areas.

Most information is usually obtained from published statistics, company records, customers, prospects and others. Opinion-type information is obtained by phone or personal interview and direct mail questionnaires.

Several years ago, only a handful of industry firms took sufficient interest in market research to assign one full-time man to the job. And these were mostly large firms with sales of \$50 million or more.

In recent weeks, merely in the course of preparing this article, *ELECTRONICS* ran into a score of firms and company divisions that were organizing marketing research departments.

Other signs of growing market-research activity:

At a recent American Management Association industrial marketing research conference, 25 percent of those attending were from the electronics industry. Most were present to prepare themselves for initiating market research in their companies.

A survey last year among 22 instrument manufacturers found 12 employing full-time market specialists. Nine of the firms with market-research departments employed from 2,000 to 5,000. The three other firms with market-research departments employed between 250 and 1,999 employees.

Electronic Industries Association is increasing its budget for gathering industry sales statistics and is adding to its market planning staff. Consultants report big increase in demand for marketing services by electronics firms.

Sparking this trend are:

- Parallel growth in industrial market-research activity throughout American industry.
- Desire by many firms in our industry to strike a balance between commercial and military business.
- Huge cost of new-product development today.

The trend to market research is of intimate and vital concern to engineers because the prime interest

of electronics firms is to use it as a tool in new-product planning.

Electronics management wants to know if customers want a new product, what performance and reliability characteristics they desire, how many units they can be expected to buy.

In many cases market-research efforts begin at the R&D level. Before management invests large sums on engineering, it wants to know if it is developing a product that will win customer preference.

Also, the market-research trend is opening a career opportunity for engineers, and former engineers now in other departments, who hanker for a future in marketing and management.

Many industry execs feel the best source of personnel for new electronics market-research groups are engineers and other technically knowledgeable people. Big virtue is that "engineers like to talk to other engineers" and will open up when interviewed by fellow professionals, experts say.

The more a firm's market-research interest centers around new-product development, the stronger will be its need for technically trained market-research personnel, they add.

Consensus of opinion is that a market-research manager can command from \$10,000 to \$25,000 per year, and in some cases more.

For an analyst, a professional assistant to a marketing manager, \$7,500 to \$9,500 is accepted as the general salary range.

Market research, even in electronics, is not entirely confined to aiding new-product development.

Market research is an expensive business, estimated to cost a minimum of \$25,000 for a one-man department (after clerical and other expenses). Many firms plan to make broad use of such departments to justify the expenditure.

Other work these departments do includes forecasts of company, industry, product-line and individual product sales; analyses of distributor, rep and salesman performances; helping to set quotas for sales personnel and the like.

Some firms are extending marketing research into the economics area to get analyses of general conditions, merger and acquisition situations.

NORTH RVF ROTARY SWITCH GIVES YOU

GREATER APPLICATION FLEXIBILITY

30 INPUTS AND 30 OUTPUTS PER LEVEL give you a flexibility in circuit approach unmatched by any other stepping switch! For application to programming, sequence control, routing, impulse counting, tallying, or as a memory device, the completely dust enclosed North RVF Switch is the most versatile, flexible, reliable Stepping Switch on the market!

INDUSTRIAL DIVISION

NORTH ELECTRIC COMPANY
8410 SOUTH MARKET STREET • GALION, OHIO



Available in Canada through Ericsson Telephone Sales of Canada, Ltd., Montreal 8, P. Q.

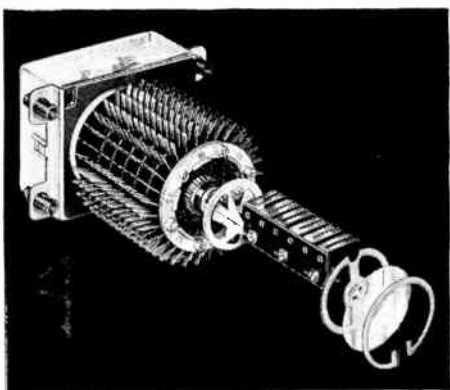

For circuit applications requiring up to 30 points per level, the switch is provided in 2, 4 or 6 levels with single rotor. For circuit applications requiring up to 12 levels with 15 points per level, the switch is furnished with a dual rotor. Bank contact ratings: 1 amp at rest; .2 amp. resistive when stepping. Off normal contact ratings .4 amp. resistive. Switch may be driven self-stepping or externally. Gold plated bank contacts and wipers are available for low level switching. Available with 12, 24, 48, 110 V. D.C. coils. Built-in spark suppression on 24 and 48 volt switches. Mounting dimensions: 1.968" x 3.661" O.C. Overall height: 4 $\frac{3}{4}$ " height above mounting, 3 $\frac{1}{2}$ " (max. dimensions for 6 level switch). Weight: 1.32 lbs.

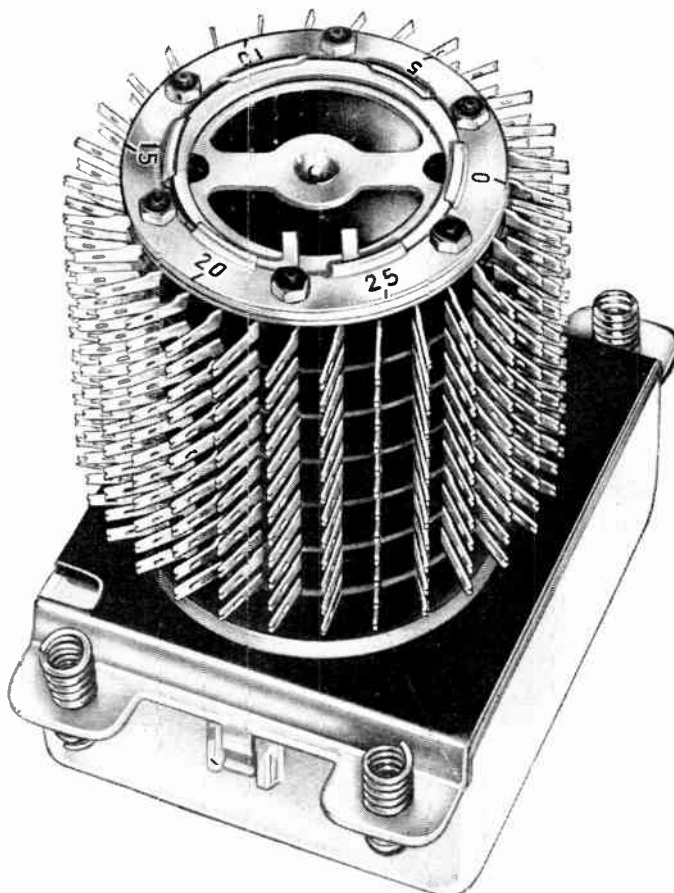



THE WIRE YOU NEED

- for EVERY ELECTRONIC application
- Correctly Rated—Quality Controlled

- for positive performance
- for the most complete line for all electronic applications
- for most advanced construction designs, insulations, and shieldings correctly service-rated
- for dependable uniformity under strictest quality control
- for complete information in an easy-to-read catalog
- for fast service

You Can Depend on Belden . . . Ask Your Belden Jobber

One Wire Source for
Everything Electrical & Electronic

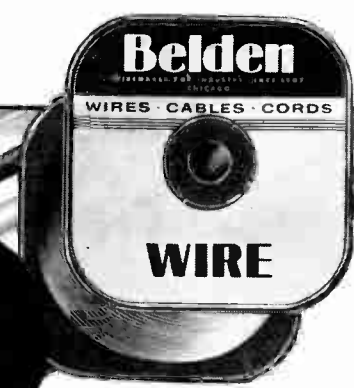

Magnet Wire • Lead Wire • Power Supply Cords,
Cord Sets and Portable Cord • Aircraft Wires
Electrical Household Cords • Electronic Wires
Welding Cable • Automotive Wire and Cable

08A0218

Man May Enter Space in Two Years

MANNED SPACE EXPLORATION may begin in 24 to 36 months, Roy W. Johnson, director of Advanced Research Projects Agency said last week at dedication of new CBS Laboratories Research Center. First trip would attempt one full orbit of the earth; second trip would last 24 hours.

- Johnson also said 1/3 of current \$600-million federal space budget goes for electronics. He added that \$40 million is now earmarked for National Aeronautics and Space Administration, but there's hope of making it \$60 million next year. Main problem in space electronics right now is communications.

- Johnson also predicted development of non-lethal electronic weapons that may win wars without bloodshed.

- Presence of representatives from Lockheed Aircraft and Eastman Kodak at the CBS shindig indicated to some observers that the three firms may be making substantial progress with Air Force's top-secret Project Sentry, formerly Pied Piper. This will reportedly be an unmanned transistorized television reconnaissance satellite.

NAVY next week will unveil a multimillion dollar electronic warfare simulator at the Naval War College in Newport, R. I. Officials will see a special demonstration of the facility. Pentagon says a complete war game will be graphically presented under the most realistic training conditions

possible. Navy declines to release additional information prior to the demonstration.

ENGINEER SHORTAGE is worsening, and fears are widespread throughout industry that it will persist. Recent report by U.S. Office of Education and Bureau of Labor Statistics to National Science Foundation concludes that all industry will need 50,000 engineering graduates come June, with only 39,000 being graduated. Missiles and the space technology are principal irritants to the situation; electronics engineers will be in greatest demand. To compound the problem, Office of Education says student interest in engineering courses is dropping. With general enrollments burgeoning, engineering enrollments are barely even with last year's.

SOVIET INFORMATION RETRIEVAL machine is being developed at a laboratory of the USSR Institute of Scientific and Technical Information. Tass report says machine will handle more than four million pages of Russian text an hour. Information is apparently stored in the machine on metallized sheets which are pressed into large blocks. Report indicates that retrieval system includes an automatic electronic translator for foreign books fed into it, but gives no technical details or explanation of how the system works.

TECHNICAL DIGEST

- Faulty joints and poor connector contacts in electronic equipment can be located quickly with new Telefunken instrument that feeds choice of 13 frequencies between 3 kc and 1.45 mc into circuit to be tested. Each joint in turn is then touched with test finger having vibrating tip. When on bad joint, mechanical vibration serves to modulate basic test frequency and produce tone in loud-speaker connected to demodulator through transistor amplifier.

- Microphone mounted behind small hole cut in front part of satellite gives accurate measurement of atmospheric density and pressure

up to at least 300 miles in space. Gas molecules in space produce impact pressure on diaphragm, measured by chopping beam of molecules so microphone feeds a-c output to amplifier and phase-sensitive detector. Since satellite velocity is independently known, density can be calculated. Transverse movement of microphone behind hole gives measurement of thermal spreading of beam, proportional to square root of absolute temperature of air.

- Radar for Britain's new supersonic all-weather fighter is housed in bullet that fits in center of engine air intake, where it does not interfere with aerodynamic design

of plane. Ferranti-developed radar, called AIRPASS (Airborne Interception Radar and Pilot's Attack Sight System), also gives automatic warning to break off attack when there is danger of colliding with target.

- Hazard of breakdown in electronic medical equipment is eliminated by placing high-value resistor in each input lead to patient, with low-voltage Zener silicon diode in shunt from lead to ground. Diode limits voltage to about 0.5 v in one direction and Zener level in other direction, so there can be no dangerous voltage and no operating-room spark hazard.

More Space Studies Due

ELECTRONICS may soon add new information to man's rapidly growing knowledge about the space around the earth. The U. S. Naval Research Laboratory is working on instrumentation to be incorporated in a satellite that will provide more data on the earth's magnetic field.

James P. Heppner of the laboratory explained the objectives of the program to ELECTRONICS. Scientists will try to determine the existence of an electric current ring at distances of several earth radii. They will also see if a significant electric current flows in the newly discovered radiation belt surrounding the earth. The experiments will include measuring field variations caused by currents in the ionosphere. Finally, a map will be made of the earth's field at high altitudes.

Determination of an electric current ring around the earth and measurements of field variations will be accomplished by comparing variations of the field at the satellite with variations measured on the ground. Currents between apogee and perigee will be evident from changes in field with altitude.

Precise measurements required will be made with a proton precessional magnetometer. This instrument, developed by Varian Associates, measures frequency of a

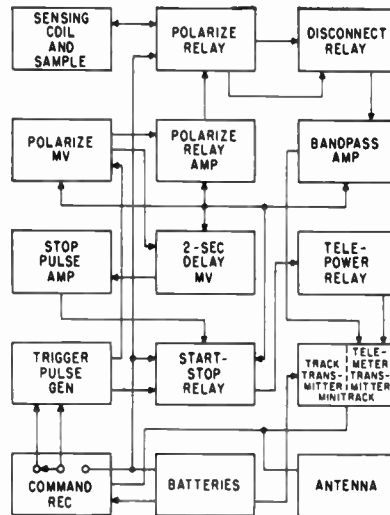

Instrumentation planned by Naval Research Laboratory will use proton precessional magnetometer to determine field characteristics in space around earth. Interrogation arrangement should permit battery life of three months

proton's gyromagnetic precession in the earth's field to an accuracy of 10^{-5} gauss. The formula $F = 4257.8 H$, where H is field in gauss, relates frequency to field strength.

The precession is created by polarizing a liquid sample with a strong magnetic field. The field is cut off, leaving the protons free to precess. The precessing protons induce a signal in the sensing coil, and the signal is amplified and telemetered back to the ground.

Program Control Uses Transistors

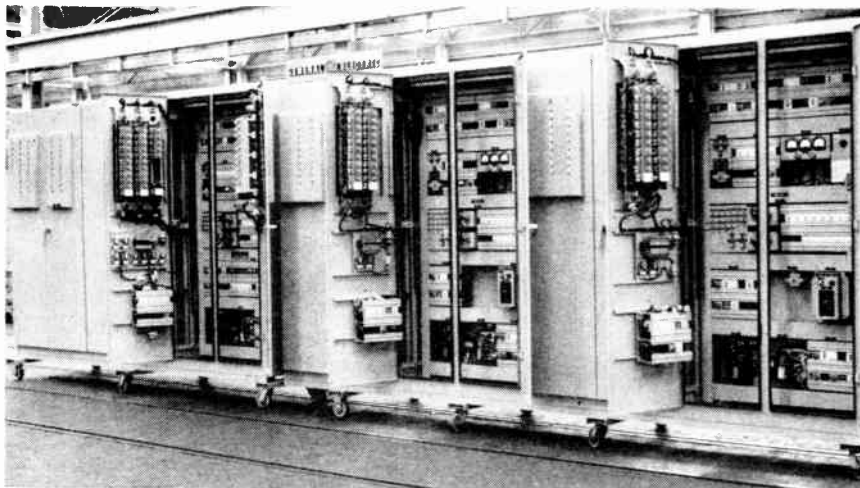

Redesigned program control system for metal-rolling and processing industries uses only solid-state devices. Other improvements in the GE system include a photoelectric card reader that eliminates contact-making brushes and is said to reduce maintenance requirements. The basic system can be easily modified for a variety of applications

MEETINGS AHEAD

- Oct. 20-21: Aero Communications Symposium, Fourth National, PGCS, Hotel Utica, Utica, N. Y.
- Oct. 20-21: USA National Committee, URSI Fall Meeting, Penn State Univ., University Park, Pa.
- Oct. 20-24: Society of Motion Picture and Television Engineers, 84th Convention, Sheraton-Cadillac Hotel, Detroit.
- Oct. 26-31: American Institute of Electrical Engineers, Fall Meeting, Penn-Sheraton Hotel, Pittsburgh, Pennsylvania.
- Oct. 27-28: Aeronautical and Navigational Electronics, East Coast Conf., Lord Baltimore Hotel, Baltimore.
- Oct. 27-28: Electronic Industries Assoc., Radio Fall Meeting, Sheraton Hotel, Rochester, N. Y.
- Oct. 29-30: Fifth Annual Computer Applications Symposium, sponsored by Armour Research Foundation, Morrison Hotel, Chicago.
- Oct. 30-31: Aircraft Electrical Society, Pan Pacific Auditorium, Los Angeles.
- Oct. 30-31; Nov. 1: Electron Devices Meeting, PGED, IRE, Shoreham Hotel, Wash., D. C.
- Nov. 6-7: Prof. Group on Nuclear Science, IRE, Fifth Annual Meeting, Villa Hotel, San Mateo, Calif.
- Nov. 17-20: Magnetism and Magnetic Materials, Fourth Annual Conf., AIEE, APS, IRE, AIME, ONR, Sheraton Hotel, Philadelphia.
- Nov. 17-20: Radar Conference, Seventh Annual, Univ. of Miami, Miami Beach, Fla.
- Nov. 19-20: Northeast Electronics Research and Eng. Mtg., NEREM, Mechanics Bldg., Boston.
- Nov. 19-21: Electrical Techniques in Medicine and Biology, ISA, IRE, AIEE, Nicollet Hotel, Minneapolis, Minnesota.
- Dec. 3-5: Global Communications, Second National Symposium, AIEE, IRE, Colonial Inn-Desert Ranch, St. Petersburg, Fla.
- Dec. 9-11: Mid-America Electronics Conf., Municipal Auditorium, Kansas City, Mo.
- Jan. 29-30: Long-Distance Transmission by Waveguides, IRE, London, England.
- Feb. 12-13: Solid-State Circuit Conf., IRE, AIEE, Univ. of Penn., Philadelphia.
- Mar. 3-5: Western Joint Computer Conf., IRE, AIEE, ACM, Fairmont Hotel, San Francisco.

LIONEL

says . . .

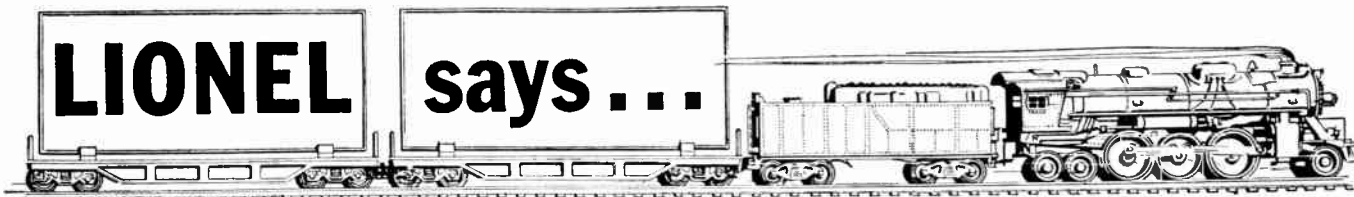

"Jones & Lamson Comparators help us make difficult inspection jobs easy. Delicate, intricately-shaped parts are inspected speedily and accurately. Our savings in time and money are substantial."

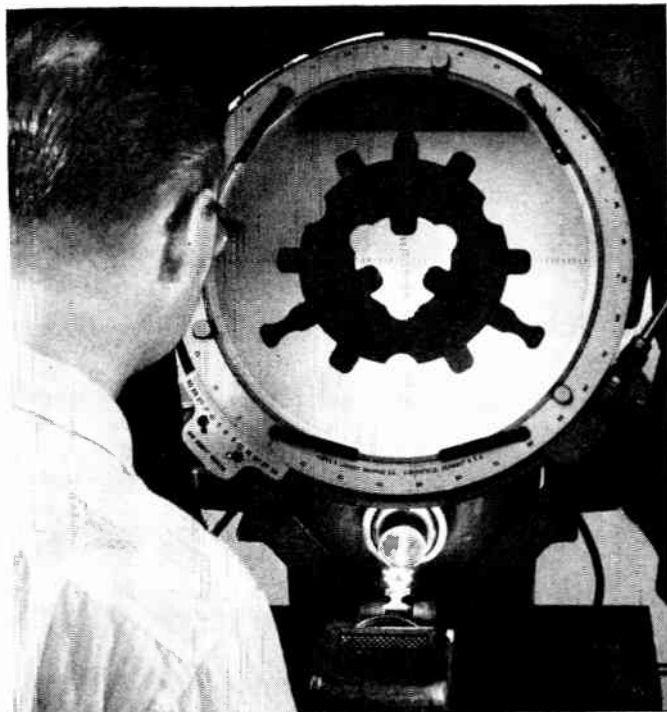

checking the critical dimensions of an armature commutator

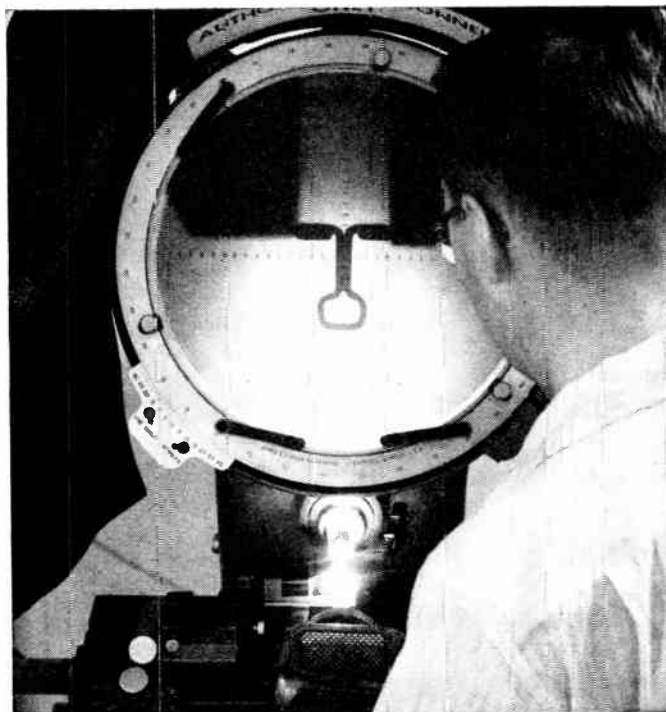

new "T" rail is one of many parts held to very close tolerances

Many manufacturers of mass-produced precision parts and components face these demanding inspection requirements: — *Speed*, to keep pace with production; *Extreme accuracy*, for tolerances as close as .0001"; *Flexibility*, because of variety of parts, and different types of inspections and measurements needed; *Reliability*, for sure quality control; *Ease of operation and maintenance*, for steady day-in, day-out performance.

THE LIONEL CORPORATION is but one of many, many firms that have found Jones & Lamson Optical Comparators fill all these requirements.

J&L Optical Comparators are available in a range of 13 different models, both bench and pedestal types. Write today for our new Comparator Catalog LO5700.

"World's oldest and largest builder of precision optical comparators"



JONES & LAMSON

JONES & LAMSON MACHINE COMPANY, Dept. 710, 539 Clinton Street, Springfield, Vermont



MODEL PC-14

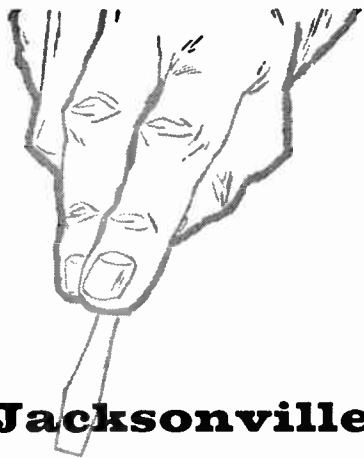

Jacksonville,
Florida has
Skilled manpower
in abundance

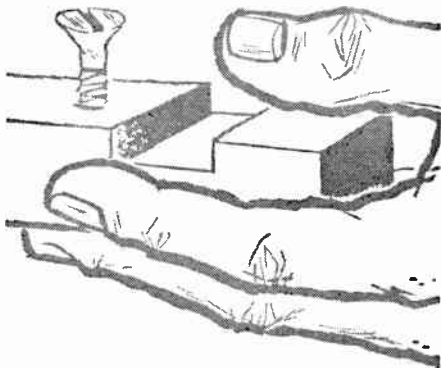

Workers skilled in plastics, electronics and aeronautics are included in Jacksonville's large reserve of manpower. Further, a Jacksonville location is strongly attractive to technicians elsewhere.

Jacksonville also has all the elements of good living—ideal year-round climate, good schools, medical facilities, churches, museums, a symphony orchestra, little theatres, ample housing, exceptional salt and fresh water fishing, hunting and other sports.

Rail, air, highway and water transportation and a deep water port make Jacksonville a distribution hub for a wide area and a gateway to Latin America.

Look closely at JACKSONVILLE when thinking about a southern plant, branch plant, branch office or warehouse. Write today for "THE JACKSONVILLE STORY," a condensed, factual outline of Jacksonville's advantages. Or ask for a special confidential survey tailored to your needs.

IDEAL EVERY DAY FOR WORK AND PLAY
The CITY OF JACKSONVILLE, FLORIDA
Electric & Water Utilities
The Committee of One Hundred
Jacksonville Area Chamber of Commerce
604-E Hogan St. Tel: ELgin 3-6161
CIRCLE 12 READERS SERVICE CARD

COMPONENTS and MATERIALS

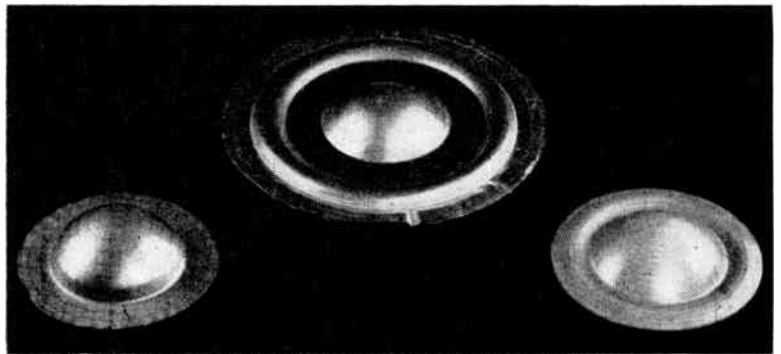

Experimentally-produced parts show how dish antennas, other formed metal parts can be made by

Explosive Forming

Aircraft firm finds that dynamite and underwater arcs shape sheet metal without machinery

EXPLOSIVE FORMING can now simplify fabrication of dish antennas, waveguides, chassis boxes, shaped laminations and other sheet-metal components, according to researchers at General Dynamics' Convair-Fort Worth plant.

Tests show that Dynaforming—as Convair calls it—can duplicate virtually all conventional forming operations. It has been experimentally used to stretch, shrink, bend, shear, emboss, inlay, pierce, weld, laminate and join.

Two methods may be used. For large shapes and resistive material, an explosive charge is set off in a pool of water. The sheet to be shaped is placed over a form at the bottom of the pool. The shock-wave in the water contours the part over the form. Or, high-voltage discharge from a capacitor bank is used to make an underwater arc which generates an intense pressure wave.

The electrical method can be precisely controlled and can be used inside a plant, according to R. H. Wesley, a geophysicist who is manufacturing research engineer on the project. Dynamite is used outdoors for added safety. Wesley's estimates of electronic production use are:

- Dish antennas and similar

shapes could be formed without difficulty.

- Waveguides could be made to tool accuracy if they are suitable for rough forming and loading into female dies or for insertion of meltable mandrels. Only short waveguides can be made easily.

- Chassis boxes can be preshaped on a box brake and lowered into a female die. All socket holes, screw openings, tabs, bosses, dimples and lances would be formed in one operation.

- Complex core lamination shapes could be blanked on dies of carbon steel resting on plain steel backups. Designs may also be proofed before heavy investment in automatic press tooling.

Convair is seeking an alternative

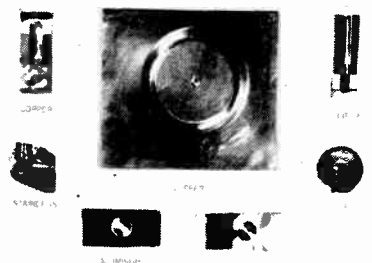

Impressions made in copper and stainless steel by arc four inches above workpiece

to machining large, severely contoured aircraft parts and exotic metals which are difficult to form. The process has been tried on a variety of metals, including aluminum, stainless steel, copper, titanium and magnesium-thorium. The idea stems from deformation observed in ships' hulls after underwater explosions during wartime.

The process, Wesley warns, is not a cure-all. Much application study remains to be done. Elasticity, elongation and other mechanical properties of metal remain essentially the same in a workpiece under the relatively slow and uniform loads of conventional forming methods. The loads which explosions produce are sudden and severe.

Data on the effects is not complete. Mechanical and metallurgical studies are being made and tables and graphs are being prepared so that results can be predicted. The mathematics of explosions and deformation is also being studied.

Lead and Zinc Imports Pared

FEDERAL QUOTA system on the import of lead and zinc was put into effect Oct. 1. Metal industry observers are expecting price boosts, once the effect of heavy prequota purchasing wears off.

Lead prices fell from 16 cents to 13 cents a pound in 1957 and zinc from 13.5 cents to 10 cents.

The prices last month were 11 cents a pound for lead and 10 cents a pound for zinc. In the first few days of October, however, prices began to advance in fractions of a cent on the wholesale market.

The new quotas will allow shipments from foreign countries at a rate of 80 percent of the 1953-58 average. Shipments in excess of a country's quota during October-December will be warehoused until the next quota period beginning Jan. 1.

The White House announced late in September that it would impose a quota system, to counteract the troubles of the domestic mining industry. The Customs Bureau is administering the system.

THE NEW HEAVY DUTY, 1/4"

American Beauty

ELECTRIC SOLDERING IRON

#3125 FOR *out-of-this-world*

PERFORMANCE!

American Beauty soldering irons have led the field in quality and production performance since 1894. There is a model to meet every soldering requirement.

Write for our 16 page catalog, showing our complete line, their use and care.

AMERICAN ELECTRICAL HEATER COMPANY



176-H

DETROIT 2, MICHIGAN



Electricity went to work early here

now it works harder than ever for your plant

V NORTHERN VIRGINIA



With the click of Artist Morse's telegraph, amperes and volts ceased to be the playthings of natural philosophers. They went to work . . . and nowhere much earlier than in Northern Virginia. In 1847, one of the first telegraph lines in the world began its southward march in this key area.

Today, the electronics industry is finding a most congenial home here. So are many other light, or technical industries. And building ahead of their growth, Vepco's electric power network now has 640,000 kilowatts more generating capability under construction—to step up its total to 2,171,900 kw by 1960.

If you plan a plant or laboratory, consider the advantage of being close to the research facilities of the Nation's capital . . . in an area where the educational level of workers is 30% above the U.S. average. For more facts, or for confidential site-finding help in this land of mild climate, top transportation, friendly government, and delightful living . . . write, wire or phone Vepco, serving "The Top of the South" in Virginia, West Virginia and North Carolina.

VIRGINIA ELECTRIC and POWER COMPANY

Clark P. Spellman, Director—Area Development, Electric Building, Richmond 9, Virginia • Phone: MILton 9-1411

NEW PRODUCTS

Torque Motor low-cost unit

AMERICAN MEASUREMENT & CONTROL, INC., 240 Calvary St., Waltham 54, Mass. Model 106 industrial torque motor is used primarily to actuate hydraulic servovalves and other electromechanically-actuated

devices. It measures 4 by 3 $\frac{1}{4}$ in. by 2 $\frac{1}{4}$ in. and weighs 3.4 lb. It delivers a 15 lb output force at midposition, and can be driven from vacuum tubes, transistors, or magnetic amplifiers. Input power is 4 w; stroke, 0.020 in.; hysteresis, less than 2 percent. **Circle 50 on Reader Service Card.**

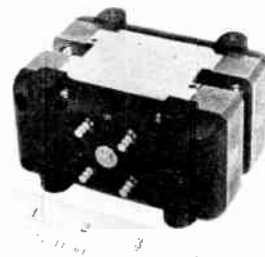

Time Delay Relay instant recycling

MASTER SPECIALTIES CO., 956 E. 108th St., Los Angeles 59, Calif. A time delay relay, factory preset to give delay times from 50 milliseconds to 50 seconds, has been designed for airborne or ground use, and offers instantaneous recycling.

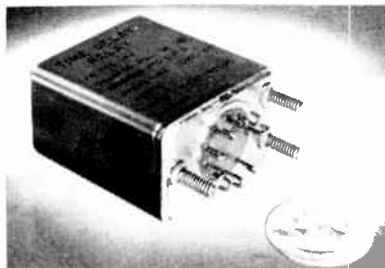

Unit has a transistor control circuit, with a relay contact as the only moving part. Miniature, and weighing 4 oz, this time delay relay is accurate from 18 to 32 v d-c, and -55 C to +71 C. The relay can be delayed pull-in, or delayed drop-out. Contact rating is 5 amp resistive. **Circle 51 on Reader Service Card.**

Retaining Rings crescent-type

INDUSTRIAL RETAINING RING CO., 57 Cordier St., Irvington 11, N. J. Series 2000 crescent-type retaining rings provide shoulders on grooved shafts to position pins, shafts, bearings, bushings, gears and other product components. Radially ap-

plied they are particularly suited to applications which do not require a large shoulder, where space is limited, or where axial access is difficult or impossible. Rings are available in 25 sizes to fit shafts from $\frac{1}{4}$ in. to 2 in. in diameter; in carbon spring steel, stainless steel, phosphor bronze and beryllium copper. They may be ordered bulk-



packed or stacked for faster one-at-a-time dispensing. **Circle 52 on Reader Service Card.**

Miniature Relay for r-f switching

POTTER & BRUMFIELD, INC., Princeton, Ind., has developed a miniature telephone type relay with a ceramic switch stack for r-f switching applications. Ceramic spacers and pushers minimize intercontact capacitance to levels that permit

switching signals of several mc. Capacitance ratings are: 1.5 $\mu\mu\text{f}$ between contacts in an open relay, 6.0 $\mu\mu\text{f}$ between contacts and 4.0 $\mu\mu\text{f}$ between contacts and case in a sealed relay. The relay is equipped with palladium contacts rated for 1 ampere at 115 v, 60 cycle resistive loads. **Circle 53 on Reader Service Card.**

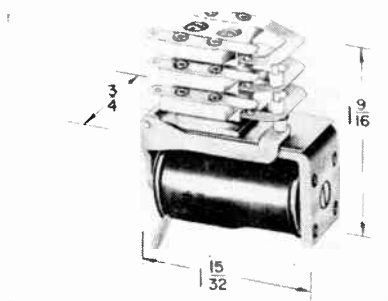

C-Band Circulator for data link uses

KEARFOTT CO., INC., 14844 Oxnard St., Van Nuys, Calif., announces the model W269-2A-1 C-band ferrite differential phase shift circulator. Unit operates over the common carrier (fixed) and mo-

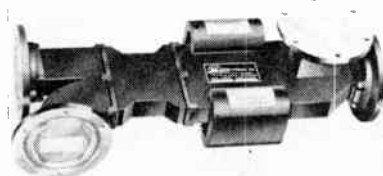

bile bands between 5.975 kmc and 6.425 kmc. Isolation is better than 20 db between any input terminals and arbitrary output terminals—while insertion loss is less than 0.7 db over the entire range. Vswr is less than 1.25 at any input terminal over the band. Peak power handling capability is 1.0 kw. Average

Need Lint-Free Acid-Resistant Synthetic Uniforms?



Angelica "engineers"
your uniform problems



GOWNS
CAPS
HOODS
BOOTS
GLOVES
COVERALLS
SHIRTS
TROUSERS
DRESSES
SMOCKS



Angelica has worked with hundreds of electronic parts manufacturers, "engineering" their lint or acid problem. Angelica, the world's largest manufacturer of washable uniforms, has sales representatives in all major cities, trained to discuss your problems, to assure you of getting uniforms that meet your specific needs. Write or call the nearest Angelica Regional Sales Office today.

Angelica
UNIFORMS

1427 OLIVE ST., ST. LOUIS 3, Mo.
107 W. 48th ST., NEW YORK 36, N. Y.
177 N. MICHIGAN AVE., CHICAGO 1, ILL.
110 W. 11th ST., LOS ANGELES 15, CALIF.

CIRCLE 16 READERS SERVICE CARD

powers may be handled up to 20 w, making it ideal for data link applications. Circle 54 on Reader Service Card.

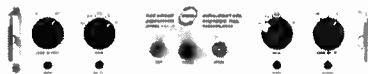

Recorder Amplifier dual-channel unit

DATA-CONTROL SYSTEMS, INC., 39 Rose St., Danbury, Conn., announces model GGA-2 dual-channel, power-output, recorder amplifier to be used to drive h-f galvanometers. Designed specifically to amplify the output of the company's subcarrier discriminators for use in f-m/f-m telemetry systems, it is useful in all applications requiring relatively large current outputs over a wide range of audio frequencies (0 to 25 kc). The chopper-stabilized unit is capable of delivering up to 200 ma at 0 to ± 10 v, d-c or peak a-c, in each channel. Gain is adjustable from 0.1 to 2.0. Panel size is 3½ in. by 19 in. Circle 55 on Reader Service Card.



Subminiature Pots three new series

DAYSFROM PACIFIC, 9320 Lincoln Blvd., Los Angeles 45, Calif. The series 314 high-temperature, single-turn pots (illustrated) provide resistances from 50 ohms to 25 K over a temperature range from -55 C to $+250$ C in a ½ by ¾ in. case. Series 341 ten-turn pots measure ½ in. by 1 in. Series 319 is comprised of wire-wound, gangable pots ½ in. in diameter. They are said to solve phasing, reliability, resolution, and linearity problems in missile and aircraft applications. Circle 56 on Reader Service Card.



Power Supply strain-gage type

NEFF INSTRUMENT CORP., 2211 E. Foothill Blvd., Pasadena, Calif. Two versions of the 2-300 transistorized airborne strain-gage power supply provide one or three amperes at 5, 10, or 15 v. Output voltage varies less than ± 0.1 percent for line variations of ± 10 percent or for load changes from no load to full load. Output voltage change is less than ± 0.1 percent from -55 C to $+85$ C. Unit will operate to these specifications under 20 g vibration and 50 g shock up to 70,000 ft. Output ripple and noise is less than 1 mv with an output impedance of less than 5 milliohms. Circle 57 on Reader Service Card.

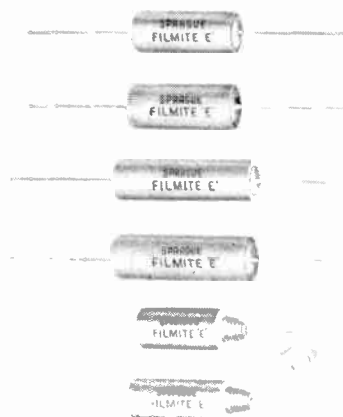

Capacitors polyester film

SPRAGUE ELECTRIC CO., 35 Marshall St., North Adams, Mass. An improved capacitance vs temperature stability curve, the result of a

change in processing technique, is now available for Filmit E hermetically-sealed metal-clad polyester film capacitors. Also, units from 0.001 to 0.0022 μ f at 2,500 v d-c have had their length decreased by $\frac{1}{2}$ in. Complete technical data are given in Engineering Bulletin 2410B, available on letter-head request.

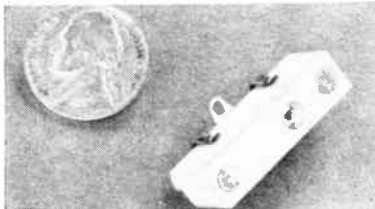

Miniature Switch snap action

MELETRON CORP., 950 N. Highland Ave., Los Angeles 38, Calif. The MELEX miniature snap action switch operates in temperatures from -300 to $+500$ F and will withstand a shock of 40 to 50 g at vibrations of 50 to 2,000 cps. Switch is housed in a glass bonded mica case which incorporates a glass plunger that permits the switch to withstand severe humidity and temperature variations. Circle 58 on Reader Service Card.

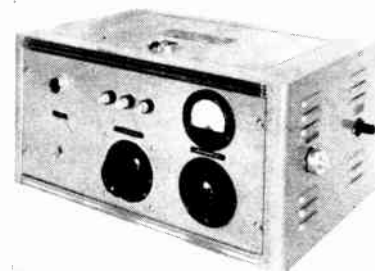

Magnet Supply low ripple

MANSON LABORATORIES, INC., 207 Greenwich Ave., Stamford, Conn. Model M-25 power supply is usable as a magnet supply for high power twt's, or as a medium-power general purpose lab supply. Output is 0 to 250 v d-c at 100 amperes. Ripple is 0.5 percent peak to peak. Input is 208 v, 3 phase, 60 cps, 2.7 kva. Complete unit is priced at \$395. Circle 59 on Reader Service Card.

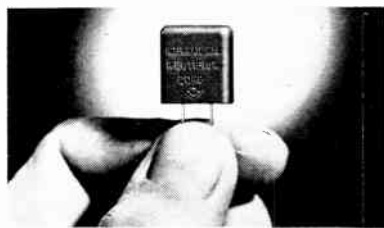

Silicon Zener Diode double anode

INTERNATIONAL RECTIFIER CORP., 1521 E. Grand Ave., El Segundo, Calif. This miniature device provides symmetrical dynamic clipping characteristics on such applications as rate feedback limiting in servo control systems, maintaining the output of a gyro pickoff at a prescribed level, oscilloscope calibration, and similar functions. It is especially suitable for automated insertion into p-c boards. Providing 600 mw dissipation, and available in zener voltage ranges from 4.3 to 30 v, the unit is also highly suitable for arc suppression and circuit protection uses. Circle 60 on Reader Service Card.

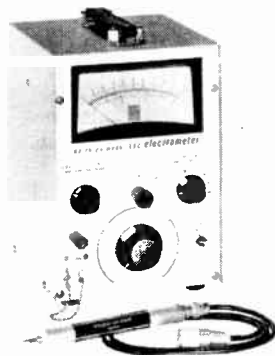

Electrometer multipurpose unit

KEITHLEY INSTRUMENTS, INC., 12415 Euclid Ave., Cleveland 6, Ohio. Model 600 portable electrometer has 53 ranges to blanket the field of d-c measurement. It is a battery-operated multipurpose instrument. The unit measures: (1) voltage, 10 mv to 10 v full scale; (2) current, 10^{-14} ampere to 3 amperes full scale; (3) resistance, 200 ohms to 10^{13} ohms full scale. It also serves as a d-c preamplifier with precise gains from 0.1 to 100. Circle 61 on Reader Service Card.

need high vacuum components?

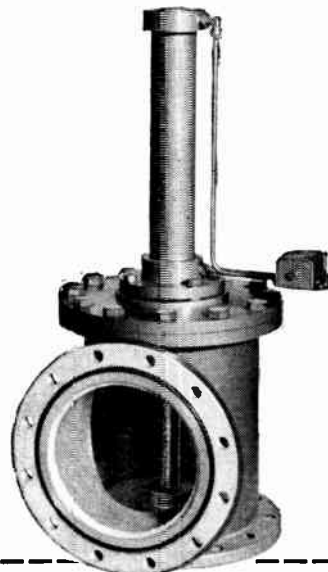

The Stokes Model 217 High Vacuum Poppet Valve features a quick-acting positive air cylinder and is absolutely leak-free. Fully opening valve design provides maximum conductance. Disc and body are corrosion-resistant plated... actuating stem is chrome plated... flanges are standard. 4-, 6-, 10-, 16-, 24-, 30-, and 36-inch sizes.

STOKES makes a complete line of vacuum components . . . advance-designed and engineered to help make your vacuum systems more productive. Each unit reflects Stokes' unparalleled experience, pioneering leadership and wealth of basic vacuum technology.

The product list includes: Diffusion Pumps, Vapor Booster Pumps, Mechanical Pumps, Mechanical Booster Pumps, Vacuum Gages, and Valves.

Send for technical data on any or all . . . without obligation.

High Vacuum Division
F. J. STOKES CORP.
5561 Tabor Road, Phila. 20, Pa.

STOKES

CIRCLE 17 READERS SERVICE CARD

From Normandy to Eniwetok, P. F. C. Joseph Willie Kilroy was there . . . and he'll be out there somewhere when man in space is commonplace! Today, the top astroscientific and missile engineering teams in the country are already at work on the fundamental problems of space exploration and the manned orbit vehicle. One of those top teams is at Martin—with 30,000 engineering man-years of experience in missile and space system pioneering.

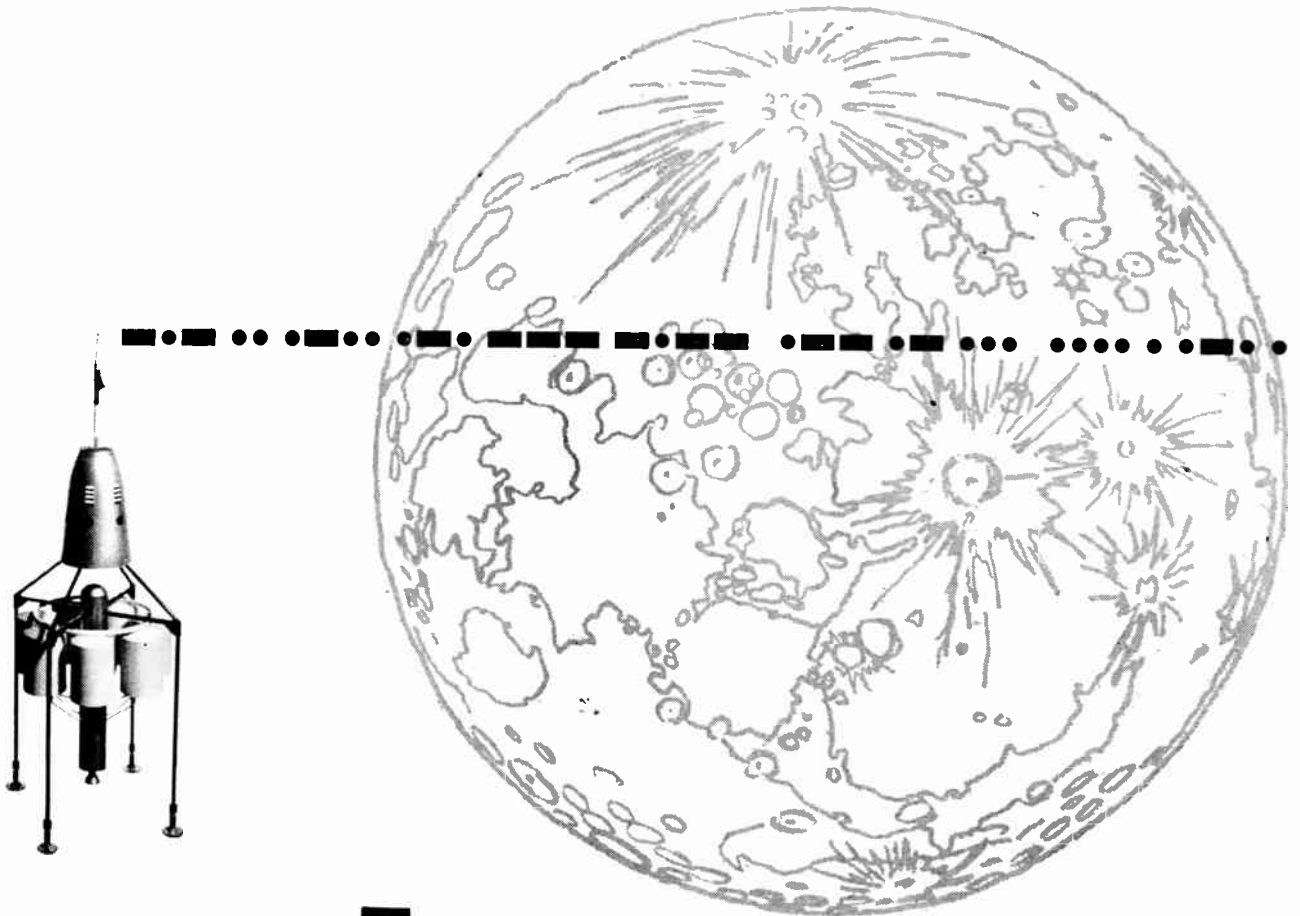



Literature of the Week

MATERIALS

Copper Wire. Aero-Marine Development Corp., 110 Summit Ave., Chatham, N. J. A detailed bulletin on Teflon-insulated OFHC (oxygen-free, high-conductivity) copper wire and cable is now available. Circle 75 on Reader Service Card.

COMPONENTS

Wire-Wound Resistors. Cinema Engineering, 1100 Chestnut St., Burbank, Calif., displays its entire line of precision wire-wound resistors in the completely illustrated 20-page catalog 14RC. Circle 76 on Reader Service Card.

EQUIPMENT

Computer Language Translator. Electronic Engineering Co. of California, 1601 E. Chestnut, Santa Ana, Calif. A 4-page brochure describes the application, operation, and economical building block design principle of the computer language translator system. Circle 77 on Reader Service Card.

Insertion Loss Test Set. Weinschel Engineering, 1053 Metropolitan Ave., Kensington, Md. Application Notes No. 4 is an 8-page bulletin illustrating and describing the company's dual channel insertion loss test set. A bibliography is included. Circle 78 on Reader Service Card.

FACILITIES

Facilities Brochure. Model Engineering and Mfg., Inc., 50 Frederick St., Huntington, Ind., has published an 8-page brochure providing information on its four major divisions, identifying its top executives and illustrating a few of its plant facilities. Circle 79 on Reader Service Card.

MARTIN
BALTIMORE · DENVER · ORLANDO

CIRCLE 19 READERS SERVICE CARD

Color Tv Keeps Climbing

Shifting patterns in technology, research and consumer spending are factors in encouraging trend

LATEST TALLY on number of color tv receivers in use is over 350,000. This exceeds last Fall's total by more than 142,000. In 1956 there were only 115,000 color sets in use.

Big question now is whether one million sets will be in use by 1960. The leading color set manufacturer says yes, but other firms frankly report less optimism. Some even admit switching plant facilities to other products while awaiting a breakthrough.

Basic roadblock, according to almost unanimous opinion, is price. Color sets introduced this year range from \$495 to about \$900. These figures won't get any lower, say industry spokesmen, until the cost of making picture tubes comes down. Research is continuing on a tube that will cost less than the present three-gun type, but to date no mass production alternative has been announced.

In spite of this, most manufacturers are confident that the next 5 to 10 years will see sales of color receivers equal or pass black and white volume. Many firms feel that when the one-million set barrier is broken, the \$350 receiver will become a salable reality.

From all indications, set size manufacture will

continue at 21 in. Most firms will continue to train servicemen at company expense.

One frequently-voiced opinion is that more color programming would boost receiver sales. Check of the tv stations reveals that almost 300 are equipped for color transmission in varying degrees.

All 57 NBC basic affiliate stations can rebroadcast the network color signal. Of these, 44 can also broadcast slides and film, while 23 can originate live color shows. The NBC stations have two hours of network color programming available daily. In addition to the World Series, major football games and several spectacles are planned.

Of the 61 CBS basic affiliates, all but two stations can rebroadcast color network signals. Slides and films can be handled by 16 stations, and six are equipped to originate live color shows. The CBS network does not have a regular weekly schedule of color transmission. Plans have been made, however, to do some broadcasts of a popular travel feature in color, as well as a Christmas spectacular.

No color programming is planned by the ABC network, although 23 of the system's 25 affiliates can handle slides and film while 12 can originate live shows.

Programmers say broadcast costs rise from 5 to 10 percent above black and white expenses when color is transmitted. Exact amount of increase depends on existing studio facilities.

FCC ACTIONS

- Extends time to Oct. 29 for filing comment on "Clear Channel" proceedings in response to requests for deadline delay.

- Grants petition by National Committee for Utilities Radio to extend deadline to Oct. 31 for filing statements in connection with inquiry into allocation of frequencies between 25 and 890 mc to nongovernmental services.

- Invites comment by Oct. 31 on proposal to exempt class B, C and D Citizen Radio stations—operating only to attract attention-attracting devices—from requirement that a minimum of 25 ft shall separate antenna and transmitter.

- Denies petition by Daytime Broadcasters Association asking that all daytime-only a-m broadcast stations be allowed to operate from 5 a.m. or local sunrise (whichever is earlier) to 7 p.m. or local sunset (whichever is later), in lieu of present sunrise-to-sunset rules.

- Announces dates which will constitute the composite week for preparation of program log analyses in connection with applications for licenses expiring in 1959. Dates are: Monday, Jan. 20; Tuesday, March 18; Wednesday, April 9; Thursday, May 15; Friday, July 25; Saturday, Sept. 13; Sunday, Nov. 17. The Sunday date applies to 1957, all others to 1958.

STATION MOVES and PLANS

WTYN, Tryon, N. C., files for permit to change frequency from 1,580 to 1,550 kc, increase power from 250 w to 1 kw, install new transmitter.

KLUF, Shreveport, La., applies for voluntary transfer of license from Twin City Broadcasting Co. Inc., to Kenwil Inc.

KSTN, Stockton, Calif., seeks additional time to complete plans to erect a third antenna tower for daytime operation, increase power, install new transmitter, change directional antenna pattern.

WGTA, Summerville, Ga., plans

power increase to 5 kw and installation of new transmitter.

WAKE, Atlanta, Ga., seeks permission to install new type transmitter as alternate main to be operated at 250 w, unlimited hours.

WKBB, Iron River, Mich., files for c-p to increase daytime power from 250 w to 1 kw, install new transmitter.

WELO, Tupelo, Miss., requests change in c-p to extend completion date for change in frequency, transmitter location and antenna.

KRNS, Burns, Ore., asks for modification in license to change hours of operation from unlimited to specified time.

WSOY, Decatur, Ill., files application for renewal of standard broadcast license.

WRNL-FM, Richmond, Va., seeks c-p to install new type antenna, increase antenna height from 240 to 322 ft., change antenna-transmitter location.

WTVO, Rockford, Ill., files application for renewal of broadcast license.

WWTW, Cadillac, Mich., seeks change in corporate name from Sparton Broadcasting Co. to Fetzner Television Inc.

WNEP, Scranton, Pa., begins broadcasting on channel 16 from former site of channel 34, with 446-ft antenna tower.

WGTV, Athens, Ga., (educational) files for extension of completion date for new noncommercial television station.

KEED, Eugene, Ore., receives c-p for new class B f-m station to operate on 93.1 mc, erp 1.10 kw, with 90-ft antenna.

WOPA, Oak Park, Ill., seeks c-p to increase daytime power from 250 w to 1 kw, install new transmitter to operate by remote control.

MINIATURE AND SUB-MINIATURE

relays by **Hi-G**

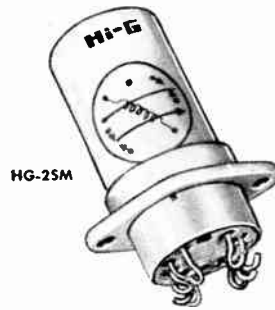

HG-25M

Rugged and reliable relays are manufactured at Hi-G in a wide range of standard units... and to customer order with special designs to meet your particular requirements.

Complete experimental and prototype facilities permit Hi-G engineering personnel to study and evaluate your relay needs.

New, complete illustrated specification sheet available. Write for your free copy today.

And for information on special relay units, send your specifications to Hi-G for study and recommendations at no obligation.

rugged / reliable / shock and vibration resistant

A FEW OF THE WIDE RANGE OF HI-G STANDARD RELAYS

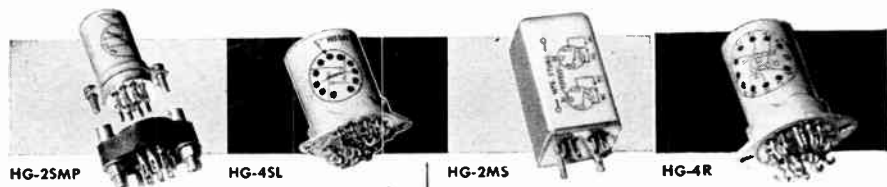

HG-25MP

HG-45L

HG-2MS

HG-4R

Hi-G Inc.

BRADLEY FIELD

WINDSOR LOCKS, CONN.



CIRCLE 18 READERS SERVICE CARD

Beauty

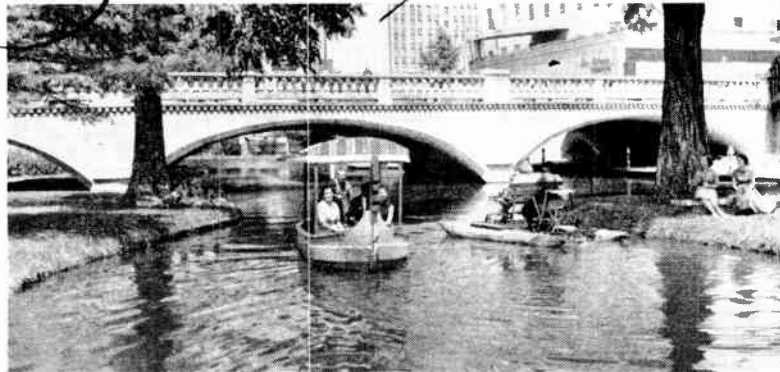

...and industry

Good living and productive industry go hand in hand. The San Antonio River winding tranquilly through downtown San Antonio is just one of the reasons San Antonio is a wonderful place to live and work. Add an ideal outdoor

living climate, good government, banks that support industry, abundant water, natural gas and electricity, excellent sites, good transportation, to the happiest labor picture in the country and you have a near-perfect situation for locating your industry.

SAN ANTONIO



For a detailed study of your specific needs write Greater San Antonio Development Committee, 153 Navarro, P.O. Box 1628, San Antonio, Texas. All communications confidential.

British Computer Hopes High

Exhibition next month will stress technical progress, new uses and practical business experience

LONDON—MORE THAN 40 British manufacturers of electronic computers and allied equipment will participate in the Electronic Computer Exhibition to be held in London from Nov. 28 to Dec. 4 amid high hopes that new markets will open at home and abroad.

On display will be complete systems of automatic electronic data processing equipment, including digital and analog computers; new magnetic input and output equipment; high-speed printers and telemetering systems.

The exhibition is being sponsored by a joint committee of the Radio Communication and Electronic Engineering Association and the Office Appliance and Business Equipment Trades Association.

Symposium on computer applications to business and industrial problems will be held Dec. 1-3 in conjunction with the exhibition. Executives from both private enterprise and government organizations will discuss their use of computers and data processing techniques for the benefit of management men.

Just before the exhibition—from Nov. 24 to 26—a

scientific symposium will be held at Teddington, Middlesex, England, sponsored by the National Physical Laboratory.

It all adds up to a concerted effort by both trade interests and the government to spur the growth of Britain's computer and data processing industry, already one of the fastest growing sectors of British electronics. This ties in with the current trend among electronics manufacturers in Britain of linking future growth to production of capital, rather than consumer, goods.

Two years ago the building of electronic computers was considered a new sphere of activity. By the end of 1957 there were more than 150 digital computers on order from British firms. Coincidentally, that was also the first year that total value of capital-equipment electronics exceeded that of consumer products.

Exhibition will emphasize the fast progress made by British manufacturers in development and use of computers and data processing systems, particularly medium-sized units.

Among the exhibitors will be subsidiaries of U.S. companies.

One sign of the importance the nation has attached to the British computer industry is the fact that the exhibition is being held under the patronage of the Duke of Edinburgh.

DEVELOPMENTS ABROAD

• In France commercial tv may come before long, if opposition from the French press can be overcome. This was stated recently by Christian Chavanon, director of the government radio and tv authority, Radiodiffusion Television Francaise (RTF). Chavanon said a commercial tv project is being studied by the RTF, but that it will not be adopted without approval by the press, which has up to now opposed the idea on grounds it would force newspapers out of business by cutting off vital advertising revenues. Chavanon also said the French tv network would be extended to enable 80 percent of the population to tune in tv by the end of 1959. At present, fewer than 60 percent of

French families live in areas served by tv. The government also plans to develop French f-m and short-wave networks, he added.

• In South Africa some observers believe American manufacturers of electronic business machines stand on the threshold of a dynamically expanding market. There is little doubt that the Union's legislature will enact within the next few months a measure to decimalize the country's coinage. After this is done many millions of dollars are expected to be spent on new business equipment of every type, with the lion's share probably going to U. S. firms that already have a strong hold on the Union market.

EXPORTS and IMPORTS

Sweden has placed an order for Britain's Bristol-Ferranti Bloodhound guided missile system. It's Britain's first guided missile sale abroad. For security reasons, Bristol was asked not to disclose size of the order or delivery dates. Bloodhound is now going into service with the RAF as its first surface-to-air guided weapon system. It's said to be in quantity production, is also undergoing acceptance trials in Australia.

In Canada the Canadian Broadcasting Corp. has ordered six Marconi Mark IV cameras, bringing to 70 the total supplied by the British firm to the CBC. New gear is for the CBC studios at Montreal and

Toronto. Cameras use either a 3- or a 4½-inch image orthicon tube; camera channels include normal black stretch circuits and automatic alignment circuits to reduce camera set-up time.

Yugoslavia has ordered 24 pieces of terminal equipment from a British firm, Automatic Telephone & Electric Co. Equipment will operate on wide-band radio links and will provide 12 circuits in the 6-54 kc band, or 24 channels in the 6-108 kc band. Each circuit is provided with an out-of-band signaling path suitable for a ring down or dialing operation. Similar type equipment with a total of 180 circuits has been ordered by Canadian National Telegraph for a microwave radio system linking Newfoundland and Nova Scotia.

In Britain the BBC has placed an order for 12 f-m vhf transmitters with EMI Electronics of Hayes, Middlesex. Transmitters use frequency modulation to give improved signal-to-noise ratio and lower harmonic distortion. Direct f-m occurs on the oscillator operating at half carrier frequency, with audio frequency feedback from a frequency demodulator also fed from the oscillator. An independent feedback circuit gives center frequency stability control.

In Australia Marconi of Britain, through its subsidiary, Amalgamated Wireless (Australia) Ltd., has obtained a \$1.2-million order for three new tv stations at Brisbane, Adelaide and Perth.

Venezuelan Ministry of Communications has awarded a contract to Marconi for preliminary work on a nationwide vhf telecommunication system. Firm will carry out trials with portable equipment to obtain specifications data for bidding on the first stage of the system early next year. The first links, scheduled for completion by early 1960 at an estimated cost of \$4.5 million, will provide telephone and telegraph service between Caracas and principal cities of the interior. Nationwide system will eventually cost an estimated \$90 million.

Compare ALL your distribution costs...



You'll find
DELTA
Air Freight
costs less
than you think!



Call Delta Air Lines,
or write General Offices:
Atlanta Airport, Atlanta, Ga.

AIR FREIGHT
DOOR-TO-DOOR

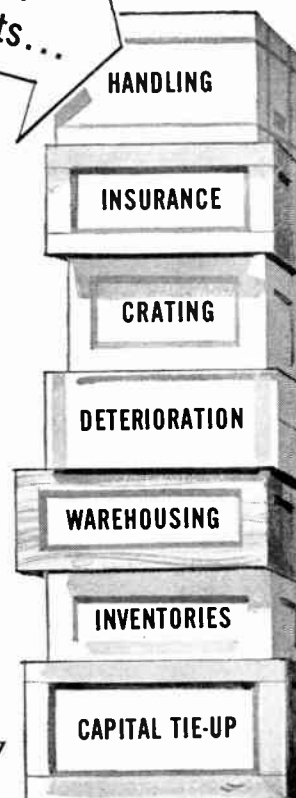

MOST COMPLETE ALL-CARGO SERVICE TO AND THRU THE SOUTH

CIRCLE 20 READERS SERVICE CARD

Available
in Oregon

EE's with a broad background in radar receiver design and development—including experience with pulse circuitry, timing circuits, and radar indicators—are available. Younger types of this select species are also being graduated regularly by the State's superior educational system. Oregon, with many ideal plant locations, is full of men with unusual technical accomplishments who want to live here, where well-trained labor and friendly management work together to take advantage of natural resources, research, recreation and room to grow. For the data on the potentialities Oregon offers the electronics industry, let us hear from you. Your inquiry will be kept confidential.

Julius R. Jensen, Director
OREGON Department of
Planning and Development
722A State Office Building
Portland 1, Oregon
Capitol 6-2161

CIRCLE 21 READERS SERVICE CARD



**TRANSISTOR
OSCILLATOR**

Complete, compact, precise plug-in signal source providing fixed temperature and humidity environment for transistor, crystal, and circuitry elements. Frequency stability: (24-hr. period) 1 part in 10⁶ or better. Write for complete data.



**THE
JAMES
KNIGHTS
COMPANY**

Sandwich 1, Illinois

CIRCLE 22 READERS SERVICE CARD

An Engineer Speaks Out...

Here's the EASY Way to Work Up A Nyquist, A Bode and A CPC

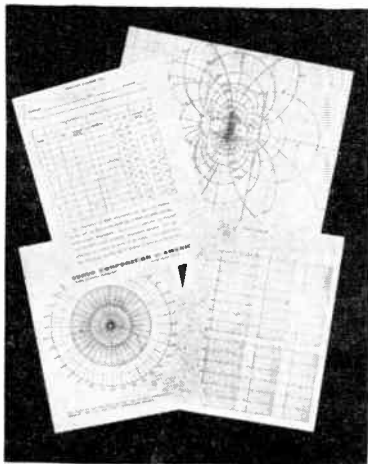

If you're working on servosystem test or design, you'll want to have these FREE chart forms... a wonderful time-saver! The coordinates are already lettered and the legend imprinted. They are transparent "masters". Almost any duplicator assures you of an immediate supply of charts at any time.

When you get the frequency, phase angle, and amplitude loci plotted on these worksheets, you've got a "standardized" permanent record of the system you are checking.

The Complex Plane Conversion Chart, Worksheet #104, should be particularly helpful. On it are plotted the loci of constant closed-loop gain (in units of voltage ratio) on the horizontally axial circles, and the constant-loop phase (in degrees) on the vertically axial circles. These loci are plotted over Cartesian coordinates, the ordinate of which represents the unreal, and the abscissa the real, component of the gain vector.

Suggestions for an uniform procedure in working up the different curves are included.



20-20 Jericho Turnpike, New Hyde Park, L. I., N.Y.

For your free SERVO Work Forms, call your nearest Servo Corporation representative, or write directly to Servo Corporation of America, Inc., Room E11, New Hyde Park, New York.

CIRCLE 23 READERS SERVICE CARD

Operations of Sylvania Electric Co., Williamsport, Pa., where he was chief engineer.

SMPTE Award Goes to Rose

THIS YEAR'S recipient of the SMPTE David Sarnoff Gold Medal Award will be Albert Rose, senior member of the technical staff, RCA Laboratories, Princeton, N. J.

The award, given yearly by the Society of Motion Picture & Television Engineers for outstanding technical work in the field of television, was bestowed upon Rose for "basic contribution to the development of the orthicon, image orthicon and vidicon television pickup tubes".

Presentation of the award will take place at the SMPTE's 84th Semi-annual Convention, October 20-24, at the Sheraton-Cadillac Hotel in Detroit.

News of Reps

THREE new reps are appointed by Eldorado Electronics, Berkeley, Calif. L & M Associates, Inc. will cover New York City, Long Island, New Jersey and western Pennsylvania. In New England, Eldorado will be represented by George Gostenhofer & Associates, Inc. The line will be handled by Charles W. Fowler Co. in California, Arizona, Nevada and New Mexico.

Two new reps are announced for General Hermetic Sealing Corp., Valley Stream, N. Y. J. J. Gray will cover the California, Denver, Col., and Portland, Ore., areas. East Coast Engineering Sales & Service Co. will represent the firm in Massachusetts, Connecticut, New York, Pennsylvania, New Jersey, Maryland, Missouri, Ohio, Michigan, Iowa and parts of Canada.

Cashin-Tipton and Associates is new factory representative for Cinema Engineering Div., and sub-rep for Aerovox-Pacific. Area to be covered represents San Diego County, Calif.

INDEX TO ADVERTISERS

*American Electrical Heater Co.....	25
*Andrew Corporation	3rd Cover
Angelen Uniform Co.....	30
*Burnstead Still & Sterilizer Co.....	8
*Barry Controls Inc.	3
Beattie Coleman Inc.	10
Belden Mfg. Co.	20
Delta Air Lines	37
Greater San Antonio Development Committee	35
*Hewlett-Packard Company	1
*Hi-G Inc.	35
International Business Machines Corp...	39
Jacksonville Chamber of Commerce...	21
Jones & Lamson Machine Co.....	23
*Kearfott Company Inc.	11
*Kennedy & Co., D. S.	12
*Knights Company, James.....	37
MacDonald Inc, Samuel K.....	40
Marquardt Aircraft Co.	38
Martin Co.	32, 33
Mississippi Agricultural and Industrial Board	27
Neely Enterprises	7
*North Electric Company	19
Oregon Dept of Planning & Development	37
*Radio Corporation of America...4th Cover	
*Raytheon Manufacturing Co.....2nd Cover	
Servo Corporation of America.....	40
Stokes Corp., E. J.....	31
Tektronix Inc.	9
Virginia Electric and Power Co.....	28
MANUFACTURERS REPRESENTATIVES	40
CLASSIFIED ADVERTISING E. J. Eberle, Business Mgr.	
EMPLOYMENT OPPORTUNITIES...38, 39	
*See advertisement in the 1958-1959 ELECTRONICS BUYERS' GUIDE for complete line of products or services	



MANUFACTURERS' REPRESENTATIVES
IN THE ELECTRONIC INDUSTRY
CONTRACT RATES GIVEN ON REQUEST. WRITE
ELECTRONICS

SAMUEL K. MACDONALD, INC.
Manufacturers representatives over 25 years
1531 SPRUCE STREET, PHILA. 2, PA.

Territory: Pennsylvania • New Jersey Delaware • Maryland Virginia • West Virginia District of Columbia	Other Offices: Pittsburgh Baltimore Washington, D.C.
--	---

Get out your pencil and . . .

Help yourself to

electronics' READER SERVICE

it's free—it's easy—it's for your convenience

Each Advertisement and New Product item is numbered.

For more information, simply . . .

- (1) Circle number on postpaid card below that corresponds to number at the bottom of Advertisement, or New Product item.
- (2) Print your name, title, address, and firm name carefully. It is impossible to process cards that are not readable.

*FOR SPECIFIC ITEMS IN MULTI-PRODUCT ADVERTISEMENTS

Certain multi-product advertisements contain Reader Service numbers for each product.

For multi-product advertisements that are not keyed for Reader Service, indicate in box on postcard marked with asterisk (*) ad circle number(s) and specific product(s) on which you want more information.

Additional postage MUST be added to cards for all FOREIGN MAILINGS

OCT
17 • 58
CARD
EXPIRES
DEC • 17TH

electronics • BUSINESS ISSUE • READER SERVICE CARD •

PLEASE PRINT CAREFULLY

(NAME) _____
(POSITION) _____

(COMPANY) _____

(ADDRESS) _____

CIRCLE THESE NUMBERS ONLY WHEN YOU ARE INTERESTED IN ALL ITEMS SHOWN OR DESCRIBED

1	2	3	4	5	6	7	8	9	10	11	12	13	14	15	16	17	18	19	20	21	22	23	24	25	26	27	28	29	30	31	32
33	34	35	36	37	38	39	40	41	42	43	44	45	46	47	48	49	50	51	52	53	54	55	56	57	58	59	60	61	62	63	64
65	66	67	68	69	70	71	72	73	74	75	76	77	78	79	80	81	82	83	84	85	86	87	88	89	90	91	92	93	94	95	96
97	98	99	100	101	102	103	104	105	106	107	108	109	110	111	112	113	114	115	116	117	118	119	120	121	122	123	124	125	126	127	128
129	130	131	132	133	134	135	136	137	138	139	140	141	142	143	144	145	146	147	148	149	150	151	152	153	154	155	156	157	158	159	160
161	162	163	164	165	166	167	168	169	170	171	172	173	174	175	176	177	178	179	180	181	182	183	184	185	186	187	188	189	190	191	192
193	194	195	196	197	198	199	200	201	202	203	204	205	206	207	208	209	210	211	212	213	214	215	216	217	218	219	220	221	222	223	224

INSIDE FRONT COVER
INSIDE BACK COVER

Circle No.	Products *

OCT
17 • 58
CARD
EXPIRES
DEC • 17TH

electronics • BUSINESS ISSUE • READER SERVICE CARD •

PLEASE PRINT CAREFULLY

(NAME) _____
(POSITION) _____

(COMPANY) _____

(ADDRESS) _____

CIRCLE THESE NUMBERS ONLY WHEN YOU ARE INTERESTED IN ALL ITEMS SHOWN OR DESCRIBED

1	2	3	4	5	6	7	8	9	10	11	12	13	14	15	16	17	18	19	20	21	22	23	24	25	26	27	28	29	30	31	32
33	34	35	36	37	38	39	40	41	42	43	44	45	46	47	48	49	50	51	52	53	54	55	56	57	58	59	60	61	62	63	64
65	66	67	68	69	70	71	72	73	74	75	76	77	78	79	80	81	82	83	84	85	86	87	88	89	90	91	92	93	94	95	96
97	98	99	100	101	102	103	104	105	106	107	108	109	110	111	112	113	114	115	116	117	118	119	120	121	122	123	124	125	126	127	128
129	130	131	132	133	134	135	136	137	138	139	140	141	142	143	144	145	146	147	148	149	150	151	152	153	154	155	156	157	158	159	160
161	162	163	164	165	166	167	168	169	170	171	172	173	174	175	176	177	178	179	180	181	182	183	184	185	186	187	188	189	190	191	192
193	194	195	196	197	198	199	200	201	202	203	204	205	206	207	208	209	210	211	212	213	214	215	216	217	218	219	220	221	222	223	224

INSIDE FRONT COVER
INSIDE BACK COVER

Circle No.	Products *

MEMO:

NEW PRODUCTS RELEASES

TO: ALL MANUFACTURERS

FROM: electronics

electronics publishes all new product items of interest to makers and users of electronic and allied equipment.

The reverse side of this card provides a service to subscribers by facilitating the flow of additional information between manufacturers and our readers.

Take advantage of Reader Service--and the readership of electronics...keep the industry informed about your New Products and New Literature via their mention in the editorial pages of electronics.

BUSINESS REPLY MAIL

NO POSTAGE STAMP NECESSARY IF MAILED IN THE UNITED STATES

6¢ Postage Will Be Paid By

ELECTRONICS
Reader Service Dept.
330 West 42nd Street
New York 36, N. Y.

FIRST CLASS
PERMIT NO. 64
(SEC. 34.9 P.L.&R.)
NEW YORK, N. Y.



BUSINESS REPLY MAIL

NO POSTAGE STAMP NECESSARY IF MAILED IN THE UNITED STATES

6¢ Postage Will Be Paid By

ELECTRONICS
Reader Service Dept.
330 West 42nd Street
New York 36, N. Y.

FIRST CLASS
PERMIT NO. 64
(SEC. 34.9 P.L.&R.)
NEW YORK, N. Y.





ANDREW

ANTENNAS • ANTENNA SYSTEMS
TRANSMISSION LINES



Space Surveillance
Calls For
New
High Power

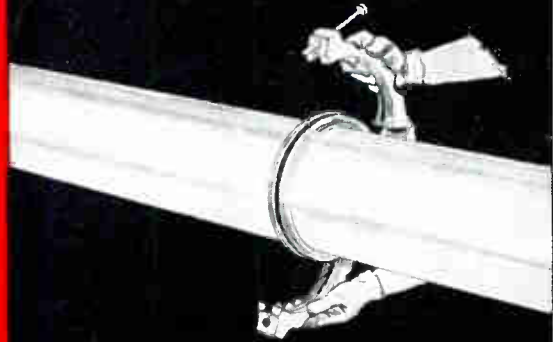

9" TRANSMISSION LINE
WITH SINGLE BOLT FLANGE CLAMP

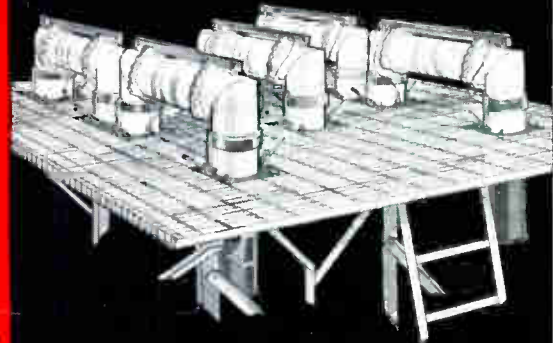

PATCH BAY FOR SWITCHING 9" LINE



21" ALUMINUM WAVEGUIDE
WITH BRANCHING SWITCH

ANDREW CORPORATION offers a wealth of engineering experience in the field of super power RF transmission devices. A broad line of standard equipment is offered and ANDREW facilities for the development and production of special equipment are without equal.

Available on a production basis is antenna equipment in all of the new, very large waveguide and transmission line sizes, including high power coaxial lines designed with specially shaped inner conductors and insulators to substantially increase voltage ratings.

Typical too, of this equipment are patch panels such as the 9" line model

shown above, used for occasional rearrangement of antenna and transmitter connections.

For high speed circuit switching, ANDREW has developed peak reliability, non-contacting waveguide switches such as the 21" model above. Similar switches are also supplied with transitions for use with coaxial line.

Of definite advantage to you is the completeness of the ANDREW line which permits a systems approach with integrated equipment for best performance of the overall system.

Our newly expanded production facilities assure prompt deliveries.

We would welcome your inquiries for product information and engineering assistance on:

Antennas • Feed Horns • Switches • Patch Panels • Duplexers • Power Dividers • Filters • Coaxial Line • Waveguide • Transitions • Adaptors • Bends • Hangers • Dehydrators

WRITE FOR BULLETIN

Andrew
CORPORATION
363 EAST 75TH STREET • CHICAGO 19
New York • Boston • Los Angeles • Toronto

RCA TRANSISTORS

Specifically Designed for Switching Applications in ELECTRONIC COMPUTERS

RCA GERMANIUM ALLOY-JUNCTION TRANSISTORS FOR COMPUTER APPLICATIONS

Type	Typical Alpha-Cutoff Frequency-Mc	Typical DC-Current Transfer Ratio Value at Collector Ma.	Maximum Collector Ma.
<i>n p n Types for Medium-Current Switching Applications</i>			
2N356*	3	30 at +100	+500
2N585*	5	40 at +20	+200
<i>n p n Types for High-Current Switching Applications</i>			
2N357*	6	30 at +200	+500
2N358*	9	30 at +300	+500
<i>p n p Types for Medium-Current Switching Applications</i>			
2N581*	8	30 at -20	-100
2N404*	12	40 at -20	-100
2N582*	18	60 at -20	-100
2N583	8	30 at -20	-100
2N269	12	40 at -20	-100
2N584	18	60 at -20	-100
<i>p-n-p Types for High Current Switching Applications</i>			
2N578*	5	15 at -400	-400
2N579*	8	30 at -400	-400
2N580*	15	45 at -400	-400
<i>p-n-p-Type for High-Voltage (105 Volts) Switching Applications</i>			
2N398*	0.7	60 at -5	-100

*Jefec TO-9 Case

...a comprehensive line offering
superior performance in computer designs

RCA's line now includes 14 types specifically designed to meet the demand from computer manufacturers for electrically *uniform and reliable* transistors. Your RCA Field Representative or your authorized RCA Semiconductor Products Distributor will be glad to discuss with you the many advances being made by RCA in this area of electronics. Specify RCA transistors for *your* computer designs. For technical data on specific types, write RCA Commercial Engineering, Section J-19-NN-3 Somerville, N. J.



RADIO CORPORATION OF AMERICA
Semiconductor and Materials Division
Somerville, N. J.

RCA FIELD OFFICES

EAST: 744 Broad Street
Newark 2, N. J.
Humboldt 5-3900

NORTHEAST: 64 "A" Street
Needham Heights 94, Mass.
Hillcrest 4-7200

EAST CENTRAL: 714 New Center Bldg.
Detroit 2, Mich.
Trinity 5-5600

CENTRAL: Suite 1154, Merchandise
Mart Plaza
Chicago 54, Ill.
Whitehall 4-2900

WEST: 6355 E. Washington Blvd.
Los Angeles 22, Calif.
Raymond 3-8361

GOV'T: 224 N. Wilkinson Street
Dayton, Ohio
Baldwin 6-2366
1625 "K" Street, N. W.
Washington, D. C.
District 7-1260