

A MCGRAW-HILL PUBLICATION

THREE DOLLARS

Electronics

THE WORLDWIDE TECHNOLOGY WEEKLY

FEBRUARY 24, 1986

FAIRCHILD IS BACK!

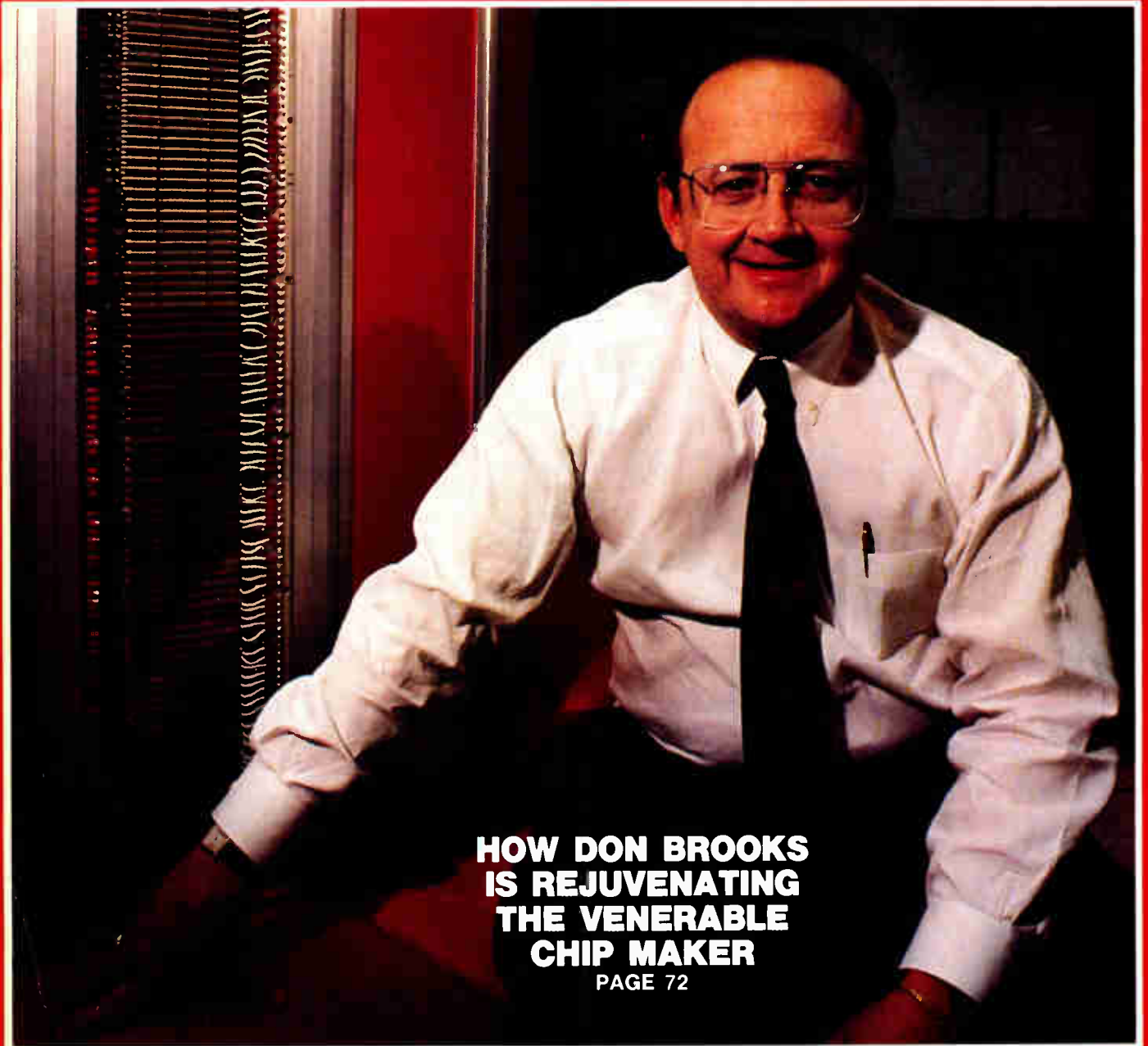

**HOW DON BROOKS
IS REJUVENATING
THE VENERABLE
CHIP MAKER**

PAGE 72

**SELF-TESTING ICs BEGIN TO EMERGE—TENTATIVELY/33
RELIEF IS ON THE WAY FOR DOCUMENTATION HEADACHES/76**

REGISTERED TRADEMARK OF NATIONAL SEMICONDUCTOR CORPORATION.
© 1988 AT&T BELL LABORATORIES



"We did it!"

"I knew we'd close that sale.
Did you see their faces?"

"It's our competitors' faces
I want to see. We've really cracked
this market now."

"Looks like we made all the
right decisions at the right
times."

"Like National's 32-bit
microprocessor family."

"You can't build a system out
of data sheets and promises.
National had it, they delivered it,
and they got us here first."

While you're still dreaming about success, Sequent is delivering it. With National's Series 32000 family.

On January 17, 1983, eighteen people started a new company called Sequent Computer Systems. They had no product, no plan, no backing. Only a dream.

Two years later, that dream came true. They delivered their first system—a sophisticated parallel processing computer. A full year ahead of their competitors.

How'd they do it? Hard work. Calculated risks. Belief. And a critical decision. They chose the Series 32000™ microprocessor family.

It offered them a *complete* 32-bit microprocessor family, including demand paged virtual Memory Management. Floating Point, and other peripherals with full UNIX™ support.

But the Series 32000 wasn't just the right engineering decision, it was the right *business* decision. It helped Sequent get their system to market fast. First.

Sequent hit their window of opportunity. And that window is still open—for now. So find out how the Series 32000 can help you build your own success story. Contact National Semiconductor today.

National's Series 32000, MS 23-200
P.O. Box 58090
Santa Clara, CA 95052-8090



**National
Semiconductor**
We're doing it.

Circle 1 on reader service card

THE SUPERMINI ON A CHIP



Help Wanted

- Dependable worker.
- Minimum wages.
- High compatibility a must!
- Works unsupervised after hours.
- Able to travel.

MITEL CMOS MODEM ICs FIT THE JOB!

Today's modems must be more durable, smaller and, of course, more cost-effective than before. Mitel fills these requirements with 300 or 1200 bps CMOS modems that meet Bell 103/113 and 212A standards for North American products and also CCITT V.21 and V.22 standards for international markets.

The MT3530 Monolithic 300 bps Modem

The MT3530 is an ISO²-CMOS™ single-chip, full duplex, asynchronous, FSK modem. For complete applications flexibility, this IC operates in many modes:

- Auto-Answer/Organate modes for smart modem applications.
- Manual mode for stand-alone RS-232C modem applications.
- Pass-through mode for protocol independence.
- Test mode for analog and digital loopback.

This IC has on-chip transmit and receive filters, a 4.8 KHz UART clock output, and is TTL compatible.

The MT35213/212A 1200 bps Modem Set
The MT35213 is a single-chip, full duplex 1200 bps, PSK modem with a 300 bps FSK fallback mode for operating in adverse signal conditions. This IC has a 48 dB dynamic range and has loopback capability in both analog and digital.

The MT35212A Modem Filter uses switched capacitor techniques to implement both the filtering and equalization requirements of Bell 212A and CCITT V.22 modems. For CCITT V.22 applications, this device supplies a notch filter that provides selectable 1800 or 550 Hz rejection. This IC offers on-chip answer/originate mode selection and includes half-channel compromise amplitude and group delay equalizers; two uncommitted op amps can be used for anti-alias filtering.

These parts are available in plastic or ceramic dual-in-line packages. Contact your local Mitel sales office for further information.

Circle 2 on reader service card



MITEL SEMICONDUCTOR

UNITED STATES - San Diego, California. Telephone: (619) 276-3421. San Jose, California. Telephone: (408) 249-2111. Oakbrook, Illinois. Telephone: (312) 655-3930. Boca Raton, Florida. Telephone: (305) 994-8500. **CANADA** - Kanata, Ontario. Telephone: (613) 592-5630. **UNITED KINGDOM** - Portskewett, Newport, Gwent, South Wales NP6 4YR. Telephone: +44 291-423355. **ASIA** - Tsuen Wan, Hong Kong. Telephone: +852 0-463641. **EUROPE** - Denmark. Telephone: +45 1-612566. Milan, Italy. Telephone: +39 2-8245222/8245177. West Germany. Telephone: +49 711-7701522.

TM, ® - Trademark of Mitel Corporation
© Copyright 1986 Mitel Corporation

Electronics

NEWS

Newsletters**Technology, 13**

- Aluminum oxide speeds up Josephson junction circuits
- E-beam machine writes on wafers at a record rate
- 32-K 3-ns SRAM uses polysilicon in base and trench

Electronics, 15

- Hughes Aircraft moves to strengthen its ailing Ground Systems Group
- Troubled Zymos sees a big boost in deal with Korea's Daewoo
- Satellite TV network aims programming at business computer users

ICs, 18

- A new trend in partnerships points to a shakeout in the ASIC business
- Texas Instruments sets timetable for 1- μ m cells

Fiber optics, 19

Diode laser from NEC lights the way to long-span fiber links at 1.55 μ m

Work stations, 20

Apollo fights back with a new product lineup

Automotive, 21

Electronic steering system from TRW heads for the road

IC testing, 22

- A new way to measure submicron line widths
- Laser plus microwaves spot chip defects

Military electronics, 24

DOD seeks a standard 32-bit instruction set

Optoelectronics, 24

Routing light signals with no bandwidth loss

Telecom, 29

ITT reins in its troubled System 12 digital exchange

INSIDE TECHNOLOGY

Self-testing ICs begin to emerge—tentatively, 33

Chips that test themselves are slowly gaining favor as the solution to the cost and complexity of checking out the highly dense new designs, according to this special report

A smart-modem filter that's economical and small, 61

Switched-capacitor techniques and a 3- μ m dual-metal CMOS process implement a 1,200-b/s smart-modem filter from Exar. The chip is half the size of comparable filters

How Compaq redesigned its popular portable, 64

Meeting user needs for a smaller, lighter version of its highly successful portable computer—without sacrificing features—was the mandate to Compaq engineers. They succeeded with a 15% weight reduction and a 30% shrink

PROBING THE NEWS

Relief nears for documentation headaches, 76

The newest electronic publishing systems can automate the chore of documenting complex engineering projects

Will French firms return to private hands? 79

It once looked as though the March 16 French election would reverse the Socialist government's nationalization of the electronics industry. Now, denationalization is not so certain

COVER

**Fairchild is back! 72**

Don Brooks, the president of the venerable chip maker, has brought it a long way back from its decade of decline. Now he has a new management team, a vigorous product-introduction program, and a far-reaching new strategy: to convince customers to develop their systems in parallel with Fairchild's device and technology development

Cover by Tony Coluzzi

NEW PRODUCTS

Newsletter, 17

- Intel Corp. opens its development-system net to other makers' computers
- Calma Co. system's test patterns suit prototyping and production
- Olivetti adds two models to personal computer line

Electronic publishing, 88

Context Corp.'s automated documentation system speeds up the design process

Test software, 88

Conversion software from IMS lets engineers use the same test patterns in prototyping and production

Signal processors, 89

Analog Devices introduces a CMOS single-chip digital signal processor

Software, 91

A multitude of software vendors jumps on the IBM RT PC bandwagon

DEPARTMENTS

Publisher's letter, 5**Books, 8****Companies, 81**

Micropolis succeeds where others fail in the disk-drive business

Bottom lines, 82**Electronics index, 83****People, 84**

- Context's Michael Bosworth aims to make life easier for EEs
- Bernard Resnick of GTE handles \$4.3 billion with aplomb
- People on the move

Meetings, 87**Letters, 93****Electronics week, 96**

- U. S., UK, and Japan will get ISDN link
- Japan leads in developing optoelectronics, says NBS

The new AD538 ACU executes roots and powers, simultaneous multiplication and division in the fastest time. Real time.

Now it's yours. The most efficient way to solve classical computation problems. Real-time fast, analog simple.

Transfer Function: $V_{OUT} = V_i(V_i/V_x)^m$
 Accuracy: $\pm 0.25\%$ of reading $\pm 100\mu V$
 Wide Dynamic Range: $>1000:1$
 Exponentiation: $m = .2$ to 5

Some applications where you might design-in the AD538 with great expectations are transducer linearization, division (signal normalization), log ratio computation as well as precision AGC.

For all the information on solving complex computational problems contact your local Analog Devices sales office.

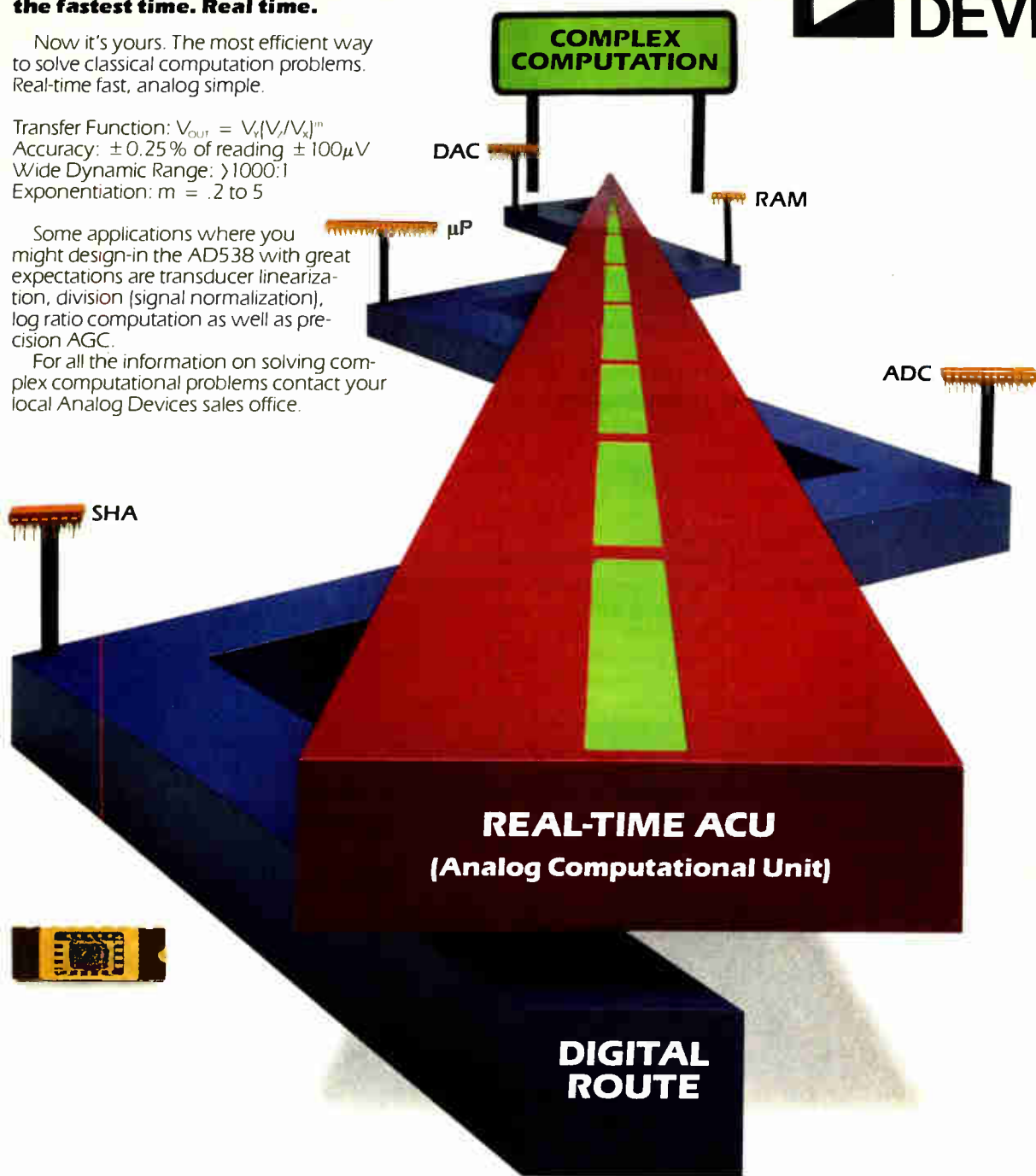

We just put complex computation on the fast track.

Analog Devices, Inc., Two Technology Way, Norwood, MA 02062-0280. Headquarters: (617) 329-4700. California: (714) 641-9391. (619) 268-4621. (408) 947-0633. Colorado: (303) 590-8906. Illinois: (312) 653-5000. Maryland: (301) 992-1994. New York: (716) 425-4101. (315) 437-5277. Ohio: (614) 764-8795. Pennsylvania: (215) 643-7790. Texas: (214) 231-5094. (713) 664-6704. Washington: (206) 251-9550. Belgium: (3) 237 48 03. Denmark: (2) 845800. France: (1) 687 34-11. Holland: (1620) 81500. Israel: (052) 28995. Italy: (2) 6883831. (2) 6883832. (2) 6883833. Japan: (3) 263-6826. Sweden: (8) 282740. Switzerland: (22) 31 57 60. United Kingdom: (01) 9410466. West Germany: (89) 570050

Circle 121 on reader service card

International edition

EDITOR-IN-CHIEF

Robert W. Henkel

EXECUTIVE EDITORS

Samuel Weber (technical), Arthur Erikson (news)

ASSOCIATE MANAGING EDITORS

Howard Wolff, Benjamin A. Mason

ASSISTANT MANAGING EDITORS

Tom Manuel, Jeremy Young

ART DIRECTOR

Fred Sklenar

DEPARTMENT EDITORS

Business: Robert J. Kozma

Communications: Robert Rosenberg

Computers & Peripherals: Tom Manuel

Government & Military: George Leopold

Industrial & Consumer: David M. Weber

New Products: Steve Zollo, Ann Jacobs

Packaging & Production: Jerry Lyman

Semiconductors: Bernard C. Cole (Palo Alto)

Software & Microsystems: Alexander Wolfe

Test & Measurement: Jonah McLeod (Palo Alto)

NEWS EDITORS

John F. King, Jesse J. Leaf

EDITORIAL PRODUCTION

Charles D. Cialto (Mgr.), June Noto

COPY EDITORS

Susan Levi Wallach (Chief), Jay J. Iorio,

Bill McIlvaine, Jim Taibi

ART

Sachiko Soskin (Associate Director),

Annamaria Palma

NEWS BUREAUS

Boston: Craig D. Rose (Mgr.), Debra Michals

Chicago: Wesley R. Iversen (Mgr.)

Dallas: J. Robert Lineback (Mgr.)

Los Angeles: Larry Waller (Mgr.), Elie Aguilar

New York: Tobias Naegle (Mgr.)

Palo Alto: Clifford Barney (Mgr.),

Eve Bennett

Washington: George Leopold

Frankfurt: John Gosch (Mgr.)

London: Sarah Miller

Paris: Robert T. Gallagher (Mgr.)

Tokyo: Charles L. Cohen (Mgr.), Mari Matsushita,

Michael Berger (World News Chief),

Jonathan Joseph

EDITORIAL ADMINISTRATION

Denise Giaimo (Administrative Assistant),

Laura Aspery, Ina Gruber, Josephine Ortiz

PUBLISHER

Laurence Altman

DIRECTOR OF OPERATIONS

Thomas E. Vachon

CIRCULATION MANAGER

Leon Irgang

PRODUCTION DIRECTOR

Thomas Egan

RESEARCH MANAGER

Elda Vale

SALES ADMINISTRATOR

Evelyn Schmidt

All the major semiconductor companies in Silicon Valley, and many of the minor ones, can trace their ancestry to Fairchild Semiconductor Corp.

"The old Fairchild always used to be good copy," recalls Palo Alto bureau manager Cliff Barney, who wrote stories in the 1960s concerning the exodus of Charles E. Sporek to found National Semiconductor, Robert N. Noyce and Gordon Moore to found Intel, and W. J. Sanders III to found Advanced Micro Devices.

But the Cupertino, Calif., company itself has been in eclipse since Schlumberger Ltd. purchased it in 1979. During its restructuring under a Schlumberger-appointed chief executive officer, Thomas C. Roberts, Fairchild kept a low profile and talked to the press only rarely and carefully.

Then, last January, Donald Brooks, a veteran semiconductor executive from Texas Instruments Inc., replaced Roberts. In the past year, reports have been trickling out of Silicon Valley about exciting new developments at Fairchild.

Our cover story this week gives the first broad look at the details of how Fairchild, with a new management team, intends to build a new high-performance semiconductor market.

Fairchild, Cliff reports, is becoming good copy again. And he cites support for that view from former chief executive C. Lester Hogan, one of the best copy-providers of the past. Hogan, who led a well-publicized exodus of semiconductor executives from Motorola Inc. in Phoenix, Ariz., to Fairchild in 1969, offers this appraisal of the new crew from



BARNEY: Veteran Fairchild watcher.

TI: "The rebirth of Fairchild under Don Brooks will be the story of the decade." It begins on p. 72.

One of the most important stories of the year is the emergence of the electronic technical publishing industry. As Wes Iversen points out in his Probing the News on p. 76, there are about 100 companies in the suddenly crowded field, all making systems that speed the work of documentation.

Wes says he found that "complex technical documentation is woven into the engineering fabric of a large project, from proposals to the production of manuals, brochures, and other technical materials. And there are constant changes, each of which may affect previous documents, sometimes amounting to thousands of pages that must be searched and revised."

Numbers like that lead one to believe that electronic technical publishing's time has come.

February 24, 1986 Volume 59, Number 8
94,515 copies of this issue printed

Electronics (ISSN 0883-4989). Published weekly by McGraw-Hill Inc. Founder: James H. McGraw 1860-1948. Publication office: 1221 Avenue of the Americas, N.Y., N.Y. 10020; second class postage paid at New York, New York and additional mailing offices. Postage paid at Montreal, P. Q. Registration Number 9034.

Executive, editorial, circulation, and advertising addresses: Electronics, McGraw-Hill Building, 1221 Avenue of the Americas, New York, N.Y. 10020. Telephone (212) 512-2000. Teletype 12-7960 TWX 710-581-4879. Cable address: MCGRAW HILL L N E W Y O R K.

Subscriptions limited to professional persons with active responsibility in electronics technology. No subscriptions accepted without complete identification of subscriber name, title or job function, company or organization, and product manufactured or services performed. Based on information supplied, the publisher reserves the right to reject nonqualified requests. Subscription rates: the United States and possessions \$32 one year, \$55 two years, \$76 three years; company addresses and company libraries \$40 one year, \$67 two years, \$93 three years; Canada and Mexico \$34 one year, \$57 two years, \$78 three years; Europe \$50 one year, \$85 two years, \$125 three years; Japan, Israel, and Brazil \$85 one year, \$140 two years, \$200 three years; Australia and New Zealand \$95 one year, \$170 two years, \$240 three years, including air freight; all other countries \$50 one year, \$85 two years, \$125 three years. Limited quota of subscriptions available at higher-than-basic rate for persons able to field served. Check with publisher for these rates. Single copies: \$3.00. Please allow four to eight weeks for shipment.

Officers of McGraw-Hill Information Systems Company: President: Richard B. Miller, Executive Vice Presidents: Frederick P. Jannot, Construction Information Group; Russell C. White, Computers and Communications Information Group; J. Thomas Ryan, Marketing and International. Senior Vice Presidents: Francis A. Shinal, Controller; Robert C. Violette, Manufacturing and Technology. Senior Vice Presidents and Publishers: Laurence

Altman, Computers and Communications; Harry L. Brown, Computers and Communications; David J. McGrath, Construction. Group Vice President: Peter B. McCuen, Communications. Vice Presidents: Fred O. Jensen, Planning and Development; Margaret L. Dagner, Human Resources. Officers of McGraw-Hill Inc.: Harold W. McGraw Jr., Chairman; Joseph L. Diorio, President and Chief Executive Officer; Robert N. Lankau, Executive Vice President and Secretary; Walter D. Serwatka, Executive Vice President; Publishing Services; Shel F. Asen, Senior Vice President, Manufacturing; Ralph R. Schulz, Senior Vice President, Editorial; George R. Elsing, Vice President, Circulation; Ralph J. Webb, Vice President and Treasurer.

Title registered in U.S. Patent Office. Copyright 1986 by McGraw-Hill Inc. All rights reserved. The contents of this publication may not be reproduced in whole or in part without the consent of copyright owner.

Where necessary, permission is granted by the copyright owner for libraries and others registered with the Copyright Clearance Center (CCC), 21 Congress Street, Salem, Mass. 01970, to photocopy any article herein for the base fee of \$0.50 per copy of the article plus \$0.25 per page. Payment should be sent directly to the CCC. Copying done for other than personal or internal reference use without the express permission of McGraw-Hill is prohibited. Requests for special permission or bulk orders should be addressed to the publisher. ISSN 0883-4989/86 \$C, \$D - 25.

Subscribers: The publisher, upon written request to our New York office from any subscriber, agrees to refund that part of the subscription price applying to copies not yet mailed. Please send change-of-address notices or complaints to Fulfillment Manager; subscription orders to Circulation Manager, Electronics, at address below. Change-of-address notices should provide old as well as new address, including zip codes. Attach address label from recent issue. Allow one month for change to become effective. Subscriber Service: call (201) 356-7980, 9 a.m. to 4 p.m. EST. Postmaster: Please send address changes to Electronics at: Fulfillment Manager, CV 808, Marlinsville, N. J. 08836.

Editorial department phones: Administration (212) 512-2645, News and New Products (212) 512-2685, Technology (212) 512-2666. **Bureaus:** Boston (617) 262-1160, Chicago (312) 751-3811, Dallas (214) 458-2400, Los Angeles (213) 480-5234, New York (212) 512-3322, San Francisco/Palo Alto (415) 958-2712, Washington (202) 463-1650, Frankfurt 72-5566, London 493-1451, Paris 720-2070, Tokyo 581-9816. **Business departments:** (212) 512-3469 (Business departments follow the Advertisers' Index).

Leading The new

V40/V50 – System performance integrated on chip. The new NEC V40 and V50 microprocessors offer full 16-bit CPU performance combined with on-chip peripheral functions. Designed to meet the demands of a wide range of applications, these large-scale integrated CMOS devices can operate at 8 and 10 MHz and feature 3 programmable 16-bit timers, a programmable interrupt controller, a serial interface, an on-chip clock generator and 4 DMA channels. 1 Mbyte address space

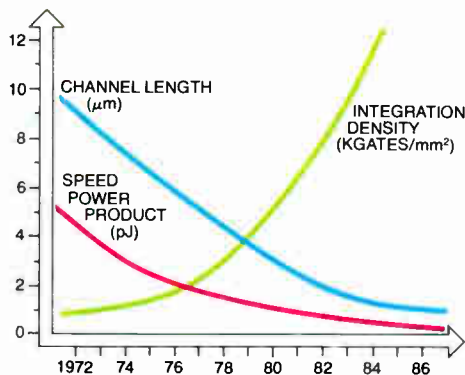
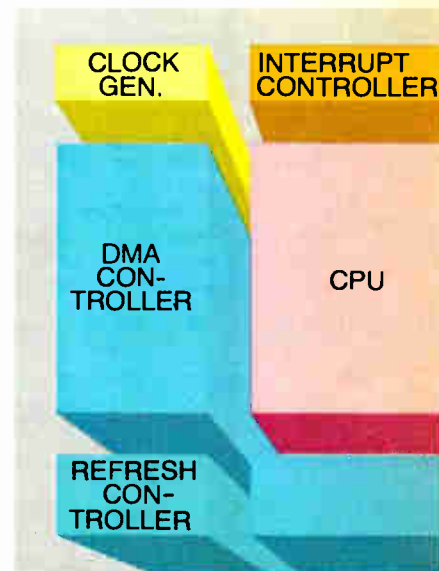

plus 64 Kbyte I/O space can handle all system requirements. For applications with heavy computational loads the V40/V50 microprocessors can be coupled to a floating point processor.

NEC is firmly committed to CMOS technology. This technology packs more than 90,000 transistors on a single chip to provide the power, speed and reliability demanded of

modern LSI devices. The low power consumption allows flexibility in device packaging.

NEC microprocessors safeguard hardware and software investments. The V40/V50 microprocessors provide compatible path for software developed on V20/V30* machines. The on-chip peripherals are either fully compatible or a subset of standard peripherals

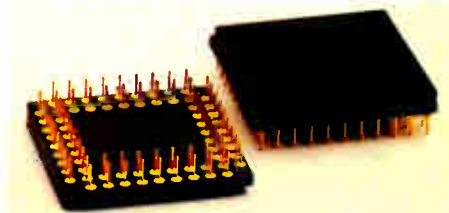

the field

V-Series.

V40/V50
16-BIT
MICROPROCESSORS

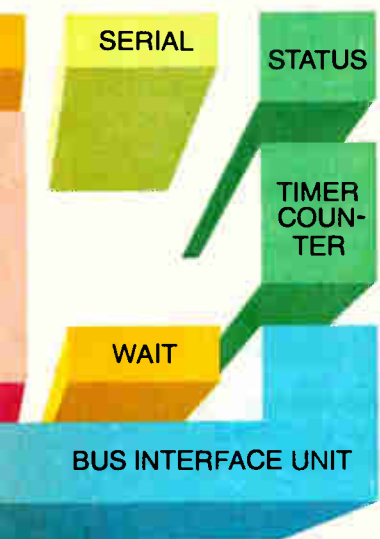

for easy adaptation of existing systems. I/O addresses are programmable, allowing programs tied to particular hardware configuration to run without modification. Cascadable DMA and interrupt controllers guarantee system expandibility.

Full and flexible development support. NEC has designed powerful development tools such as the in-circuit

emulator with integrated floppy drives, and a monitor allowing on line symbolic debugging, assembly and disassembly. The in-circuit emulator can be connected to industry-standard hosts using standard operating systems such as MP/M-86**, CP/M-86** or MS-DOS**.

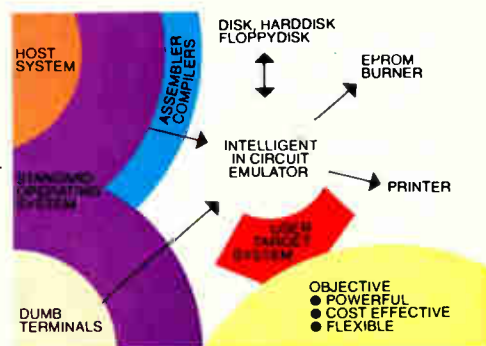

The 32-bit future. The V60/V7X super-micros with up to 700.000 transistors on-chip are already in an advanced stage of development.

NEC ORIGINAL MICROPROCESSORS

Vseries

The V-Series. Powerful and flexible products from a world leader in microelectronics. Backed up by a world-wide manufacturing, sales and service organization.

* V20/V30 NEC's 16-bit CMOS microprocessors have an instruction set which is a super set of the μ PD 8088/8086 microprocessors.

** MP/M-86, CP/M-86 are registered trademarks of Digital Research Corp. MS-DOS is a registered trademark of Microsoft Corp.

West Germany: Düsseldorf 02 11/65 03 01, Telex 8 58 996-0

The Netherlands: Eindhoven 0 40/44 58 45, Telex 51 923

France: Paris 01/39 46 96 17, Télex 699 499

Italy: Milano 02/67 09 108, Telex 315 355

Sweden: Täby 08/73 28 200, Telex 13 839

UK: Motherwell 06 98/73 22 21, Telex 777 565

Circle 6 on reader service card

NEC

IEEE-488

MULTIBUS



VMEbus

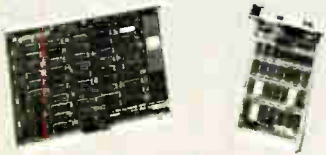

Interfaces & Software for Multibus & VMEbus

Hardware Flexibility

- High performance applications
 - 500K bytes per second
 - Hitachi HD 68450 LSI DMA controller
- Low cost applications
 - Programmed I/O
 - Multiple IEEE-488 ports per slot
 - Polled or interrupt driven transfers

Software Support

- Real-Time Operating Systems
 - Versados, MTOS
 - PDOS, iRMX
- UNIX

Other IEEE-488 Products

- Interfaces & Software for
 - IBM PC & compatibles
 - DEC Q-bus & UNIBUS
 - STD & S-100 bus
- General GPIB Products
 - GPIB Bus Testers
 - GPIB Bus Extenders
 - Stand-Alone Controllers



12109 Technology Boulevard
Austin, TX 78727
1 800 531-GPIB
In Texas: (800) IEEE-488
Telex: 756737 NAT INST AUS

BOOKS

COMPUTERS AND COMMUNICATIONS: A VISION OF C&C

Koji Kobayashi
The MIT Press
\$16.95/206pp

Kobayashi, who for 56 years has been an employee of NEC Corp. and for the last 21 its chairman of the board and chief executive officer, sets forth his vision of a world united by computers and communications, rooted in semiconductor technology. The result is part personal philosophy, part company history, and always most interesting where these two aspects create a dialogue.

C&C, as presented by the author, is both process and goal. As computers move toward higher-order systematization that will culminate in intelligent processing, digitized communications will become increasingly sophisticated until the ultimate is achieved—a global integrated network. Very large-scale integration supports both systematization and digitalization at the point where they merge, says Kobayashi. Humans enter the path through a loop that also contains software and man-machine input/output interfaces.

The author foresees entertainment, education, and telecommuting in the home coexisting with large local-area networks in the workplace, branching to wide-area and metropolitan-area networks including integrated services digital networks. Considering NEC's position in the industry and that Kobayashi has committed the company to his philosophy, his vision of C&C could turn out to be a self-fulfilling prophecy.

SURFACE MOUNT TECHNOLOGY

Electronic Trend
Publications
\$1,250/250pp

Subtitled "A strategic report analyzing the application and impact of SMT on equipment design," this survey is directed to both engineering and nonengineering personnel. The report is decidedly pro-SMT; for some qualifications of this viewpoint, see "What's Holding Back Surface Mounting," *Electronics*, Feb. 10, 1986, p. 25.

Chapters on SMT applications, use of components, design, assembly techniques, inspection, and repair give an overview of the process. Design and fabrication equipment are described in two chapters, and a list of vendors and their addresses by type of equipment fills 60 pages.

One chapter, "The SMT Market," contains projections for the consumption of major package types and components through 1990. Engineers already work-

ing in SMT may not learn much that is new from this report; however, its tight organization and clear writing will recommend it to managers and sales personnel who need an overview of the technology.

LINEAR AND INTERFACE CIRCUITS APPLICATIONS

Texas Instruments Inc.
Engineering Staff
McGraw-Hill Book Co.
\$36.95/267pp

The sections of this book, which are largely self-contained, cover operational amplifier and comparator applications and theory, video amplifiers, voltage regulators, switching power-supply design, IC timers, display drivers, and data transmission. Each of these product categories begins with basic theory followed by a description and applications.

The circuit examples were selected based on customer inquiries and related laboratory simulations, but they do not necessarily give complete design solutions. A table gives an overview of the device-numbering system. The book's projected audience includes not only design engineers but also engineering managers and marketing people with some technical background.

MONOLITHIC MICROWAVE INTEGRATED CIRCUITS

Robert A. Pucel, Editor
IEEE Press
\$69.95 (\$41.95 members' price;
\$2 shipping)/501pp

This up-to-date collection of papers explores an area with a history of less than a decade. From a modest beginning in the S-X bands, the editor points out in his preface, MMICs' range of applicability has been extended to frequencies as low as 50 MHz and as high as 100 GHz.

The volume opens with an overview of design considerations, then moves on to review gallium arsenide and its processing. Broadband and power amplifiers are described in detail as mainline applications for MMICs. The higher frequency bands receive serious consideration in the section on millimeter-wave circuits; here, according to Pucel, MMICs perform better than hybrids because they are less affected by parasitic signals. The collection concludes with a section on computer-aided design, measurement, and packaging techniques.

Robert A. Pucel is a member of the editorial board of the MMT Society and is a Registered Professional Engineer in Massachusetts. He is a consulting scientist in Raytheon Co.'s Microwave Semiconductor Devices and Integrated Circuits Program.

Don't leave good connections open to chance - ever!

You only need to think of wiring up multipole connectors. It's amazing how easy it is to make wiring errors and faulty terminals. Which can only be eliminated with considerable time and effort. The only proper answer to bring about an improvement is one which is efficient both from a technical and economic point of view.

So if you don't wish to leave the reliability of your connections open to chance you should employ a system which will save time and money. The HARTING Series SEK with insulation displacement termination can provide up to 64 connections in a single procedure. A reliable technique and economical to use. Designed to meet the following specifications:

DIN 41 651
MIL-C 83 503
D 2632, BT 224
HE 10, NFC 93-428

What is more, your costing system will be forever grateful: testing is quick and easy and fitting connectors to flat cable is exceptionally efficient. It is not without good reason that HARTING-technology is the most popular.



HARTING ELEKTRONIK GMBH
Postfach 1140 · D-4992 Espelkamp
☎ (0 57 72) 47-1
Tx 9 72 310-11 he d
Telefax (0 57 72) 33 02

HARTING - the experienced electronic component specialists.

Subsidiary companies:

Austria: HARTING elektronische Bauelemente Ges. mbH, Himberger Straße 25, A-1100 Vienna. **Belgium:** N.V. HARTING ELEKTRONIK S.A., Industriezone Doornveld, Schapenbaan, B-1730 Relegem. **France:** HARTING ELEKTRONIK S.A.R.L., BP 24, F-94121 Fontenay-sous-Bois Cedex. **Great Britain:** HARTING ELEKTRONIK LTD., GB-Biggin Hill, Kent TN 16 3 BW. **Italy:** HARTING ELEKTRONIK S.P.A., Via Como, 2, I-20096 Poglieto (Milano). **Japan:** HARTING ELEKTRONIK Co. Ltd., Nishi-Gotanda K-1 Bldg, 8-2-2, Nishi-Gotanda, Shinagawa-ku, Tokyo. **Netherlands:** HARTING ELEKTRONIK B.V., Mon Plaisir 89D, Industrieterrein Vosdonk, NL-4879 AM Elten-Leur. **Norway:** HARTING ELEKTRONIK A/S, Nils Hansens vei 13, Bryn, N-0810 Oslo 6. **Sweden:** HARTING ELEKTRONIK AB, Fagerlagatan 3, S-163 53 Spånga/Stockholm. **Switzerland:** HARTING ELEKTRONIK AG, Eschenstrasse 2, CH-8603 Schwerzenbach.

Foreign representatives:

Brazil: ER COMERCIO E INDUSTRIA LTDA, P.O.B. 2456, 30.000 Belo Horizonte MG. **Denmark:** Knud Wexoe A/S, P.B. 35, DK-2840 Holte. **Finland:** SKS Suomalainen Kone Oy, Laurinmaenkuja 3, P.O.B. 40, SF-00440 Helsinki. **South Africa:** Bowthorpe-Hellermann-Deutsch (Pty) Ltd., 80 Mimetes Road, Denver Ext. 9, Johannesburg. **Spain:** Elion S.A., Farell, 9, E-08014 Barcelona. **Bulgaria, CSSR, Hungary, Poland, Rumania, Yugoslavia:** Gebhard Balluff GmbH & Co., Kampstraße 1, A-2346 Maria Enzersdorf-Sudstadt/NO.

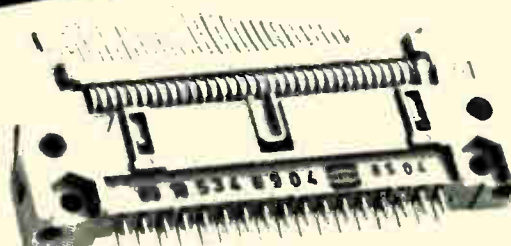

Dimensions monitored by electronic measuring equipment.

Please pay us a visit at the
Hannover Fair between 9th and 16th
April 1986, Hall 12, 2nd Floor,
Stand No. 2159/2258

Circle 125 on reader service card

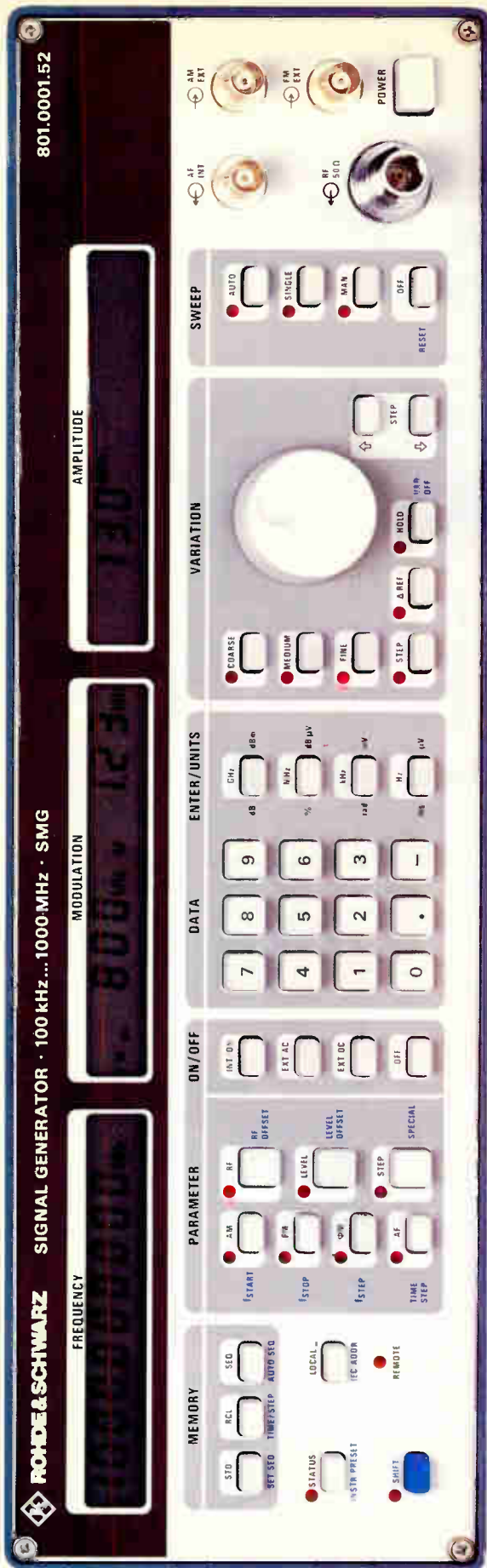

Signal Generator SMG

SMG is our latest allround signal source. Add up the superior characteristics and you arrive at a whole new standard for signal generators in the range 100 kHz to 1000 MHz with 1 Hz resolution.

- AM, FM, M and pulse modulation
- low residual FM: <1 Hz up to 250 MHz in line with CCITT
- 15 ms setting time
- low phase noise: -140 dBc/Hz 20 kHz from carrier at 100 MHz
- digital, phase-coherent sweeping

Write or call for full details
of **SMG Signal Generator**

**... the pure source
at the right price**



Can your ASIC company answer a few simple questions?

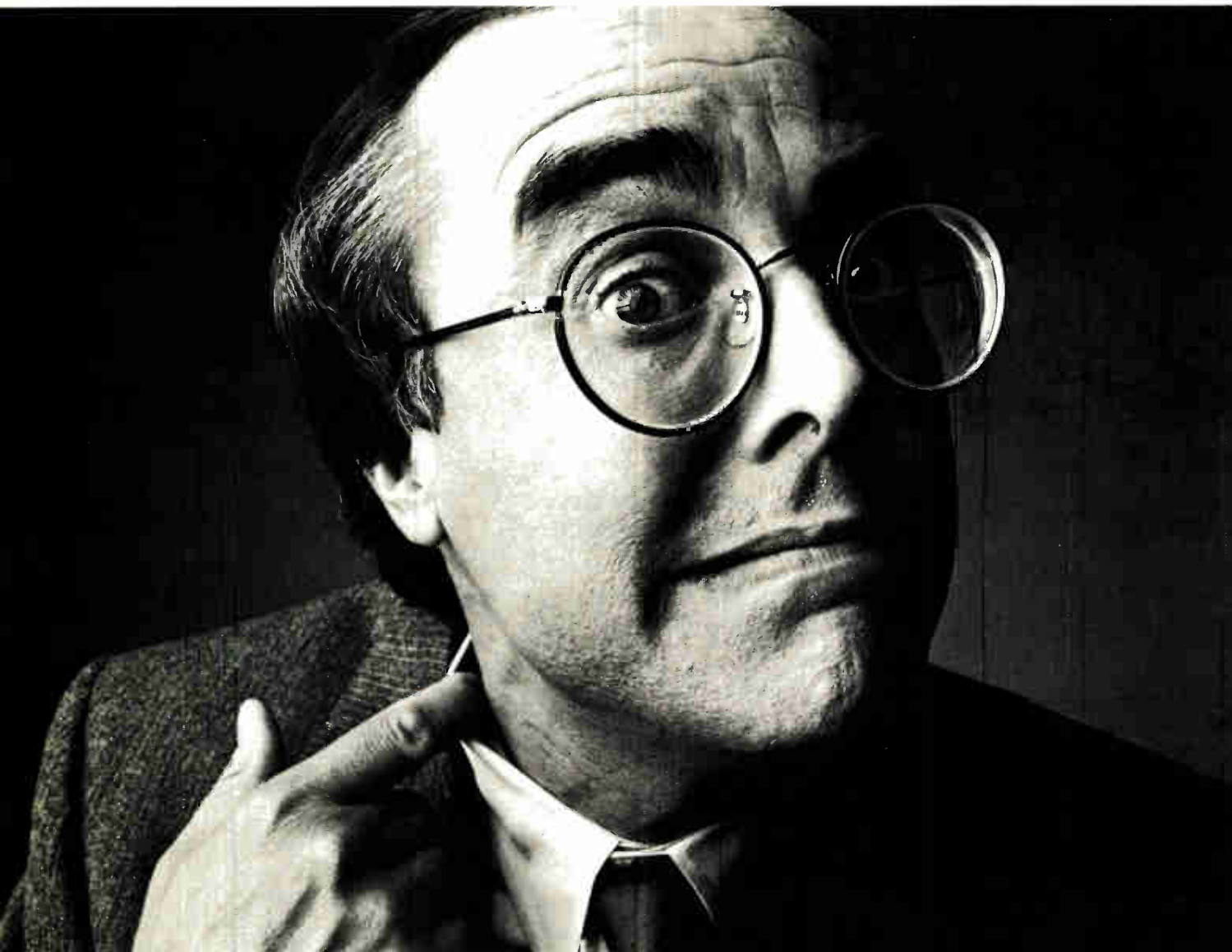

Ask about producibility. Support. Technology.
Fabrication capability. Success rate.
Then ask CDI.

We can tell you about our history of tested and delivered semicustom designs. Production proven, high-performance channelless ASIC technology. Risk-free conversion to standard cell. Plus our major commitment to 2 and 3 micron fabrication with mask making, and CAD design facilities that deliver working prototypes faster, at less cost—with more control for you.

But don't just ask us. Ask our customers, too.
You'll get the answers you need. Without question.

CDI CALIFORNIA DEVICES INC.

California Devices, Inc.
Attention: Marketing Services Data
2201 Qume Drive, San Jose, CA 95131.
Telephone (408) 945-5026.

ASK CDI TODAY.

- Please send me information on your channelless semicustom technology.
- Please send me information on your channelless standard cell technology.

Name _____

Title _____

Company _____

Address _____

City _____

State _____ Zip _____

Telephone _____

Circle 9 on reader service card

WEEK 18

If you've been looking for the best route into local area networks, our new Am7996 Transceiver may prove doubly useful.

On the one hand, it's a full-function, fully-supported Cheapernet transceiver. One chip for transferring data in both directions and for handling collision detection and spurious transmissions.

Am7996

It works both ways.

Combine it with the rest of our networking family—the Am7990 LANCE controller and the Am7992B Serial Interface Adapter—and, together, you've got the cheapest Cheapernet hook-up imaginable.

Then look at it this way.

The Am7996 Transceiver fully supports IEEE 802.3 systems. In fact, the entire chip set is 100% Ethernet compatible.

As a result, your Ethernet interface logic can carry everything except a high price tag. While your Cheapernet connections will meet the performance and quality levels of the world's most widely-recognized local area network standard.

The Am7996. It makes sense no matter which way you're going.

WEEK 19

No matter what size DRAMs you're using, from 16K to 1M, you'll find our new Am2976 Dynamic Memory Driver pretty impressive.

With its wide, 11-bit data path, the Am2976 is a natural for reducing the parts count in large, MOS memories. Just two chips, for example, handle not only the 9 address lines, but also the RAS, CAS and WE signals for a 1 Megaword system.

Still not impressed? Then consider this.

Am2976

Memory driver cuts a wide path.

With RAS and CAS driven from the same chip, there's minimum skew time between signals. A balanced output impedance makes rise and fall times symmetrical. Built-in collector resistors restrict undershoot to $-0.5V$, maximum. And power-up and power-down are glitch-free.

Why, even the pinout's impressive. In both the slim DIP and surface mount LCC/PLCC packages, corresponding inputs and outputs are directly opposite each other. A simple arrangement which makes board layout easier and manufacturing cheaper.

The Am2976. Give it some room in your next design.

WEEK 20

If you're serious about competing in the high-end 32-bit systems game, it's time to sign up for the first register file, and the first microprocessor family, designed for high-performance. We're talking about the Am29334. Our new 64-word, Four-Port, Dual Access register file. It's the first chip in a set that will soon be found at the heart of tomorrow's hot, new 32-bit systems, our Am29300 family.

Like the other Am29300 family members, the Am29334 boasts speed a plenty. In this case, 80ns cycle and 24ns access times. So it won't slow down your 32-bit hardware.

Am29334

Register for the 32-bit performance race.

In the long run, though, the Am29334's high-performance architecture is just as important.

Four data ports (two input and two output) allow simultaneous read or write access to two 16-bit data words in the same cycle. So you can fetch a full 32 bits with no performance penalty.

Or you can easily cascade Am29334s to handle 32-bit words. Or 64-bit words. Or larger words if you like. And at the same time, you can increase the depth to 128 words, 256 words and beyond.

What's more, each Am29334 word contains two parity bits to support fault detection/correction schemes (like the one in our Am29300 family) to keep your system going at full speed.

And, like the rest of the family, the Am29334, will be available in CMOS and ECL, in addition to the current TTL version.

The Am29334 guarantees winning performance no matter how you plan to run the race.

WEEK 21

Our new 256K CMOS DRAMs give you more than just the bits you need to build large, high-speed memory systems. So much more, in fact, you might want to grab a pencil and paper.

For openers, put down "power." Not just "stand by power," although ours is as low as $100\mu\text{A}$, but "data retention power," as well. By pushing the refresh cycle out to 32ms, we've pushed the retention current down to $230\mu\text{A}$. So you can finally combine the density of DRAMs with the reliability and portability of battery back-up.

Am90C255/256/257

More than enough to remember.

Then write down "speed." With their 100ns access times, these DRAMs will keep pace with your systems.

Don't put the pencil down yet. There's more:

There's a choice of 3 addressing modes. Nibble mode (Am90C255), enhanced page mode (Am90C256), or static column mode (Am90C257). The last two with continuous data rates of over 18MHz.

If all that seems like a lot, then just write down "CMOS DRAMs—AMD."

That's really all you need to plug into your memory.

On October 1, 1985, Advanced Micro Devices committed to deliver fifty-two new products in one year. One a week. Every week. On the shelf. In volume.

After 13 weeks, our customers could reduce networking costs, modernize old state machines, revive fading memories and see graphics in a whole new light.

If you haven't seen the solution to your problem yet, the game has just begun.

Watch this space for thirty-nine more new products. One a week. In volume. On the shelf.

That's not a promise. There are too many promises in this business. That's a commitment.

The International Standard of Quality guarantees a 0.05% AQL on all electrical parameters, AC and DC, over the entire operating range.

INT STD 550



Advanced Micro Devices

For more information, contact the sales agent nearest you or write the word "Twenty-one" on your letterhead and mail to Advanced Micro Devices, Mail Operations, P.O. Box 4, Westbury-on-Trym, Bristol BS9 3DS, United Kingdom.

FOR BILL CHANGERS, VENDING MACHINES AND BANKING SYSTEMS

- For bill changers
- For automatic vending machines
- For automatic cash dispensers
- For credit-sales systems
- For automatic gates
- For card readers
- For card ECRs
- For cash deposit dispenser machines

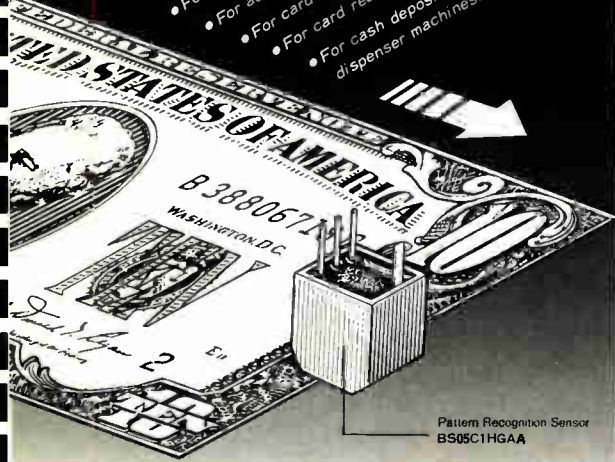

Pattern Recognition Sensor
BS05C1HGAA

- Consists of a semiconductive magnetoresistor and a permanent magnet.
- When the magnetic pattern changes, a signal is generated, enabling readout from both stationary and fast-moving objects.
- Outstanding sensitivity, resolution, gap characteristics and abrasion resistance.
- A Magnetic Pattern Detection Signal

■ Pattern Recognition Sensor

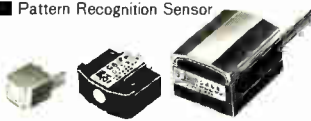

BS05C1HGAA BS05C1HGAA BS05D3IFAA

※ Other semiconductive magnetic sensors

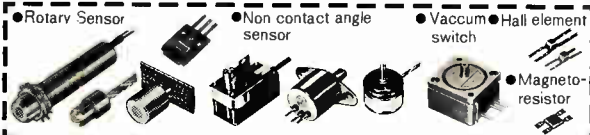
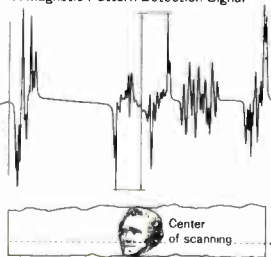

PATTERN RECOGNITION SENSOR

For further information, contact:



HEADQUARTERS
26-10, Tanjin2-chome, Nagaokakyo, Kyoto 617 Japan Phone:075-951-9111 Telex:64270 MURATA J

MURATA ERIE NORTH AMERICA, INC. Phone:404-953-1799 Telex:542329
3002 Kingston Court, S.E., Marietta, GA 30067, U.S.A.

MURATA ERIE ELEKTRONIK GMBH (West Germany) Phone:0911-66870 Telex:623763
Kreuzateinstr. 1A D-8500 Nürnberg 52, West Germany

MURATA ERIE ELECTRONIQUE S.A. (France) Phone:024-6767 Telex:699954

MURATA ERIE ELECTRONICA S.R.L. (Italy) Phone:688-4833 Telex:330385

MURATA ERIE ELECTRONICS (UK) LTD. (England) Phone:0252-523232 Telex:858971

MURATA ELECTRONICS SINGAPORE (PTE) LTD. (Singapore) Phone:2584233 Telex:21127

TAIWAN MURATA ELECTRONICS CO., LTD. (Taiwan) Phone:042-91-4151 Telex:11348
(Taipei Office) Phone:02-562-4218

MURATA COMPANY, LTD. (Hong Kong) Phone:0-4992020 Telex:5 62 0 8

MURATA MFG. CO., LTD. Seoul Branch (Korea) Phone:720-7605/720-7321 Telex:2 5 8 5 8

NEW EDITION

Complete and Unabridged
American and International

DATA COMMUNICATIONS STANDARDS

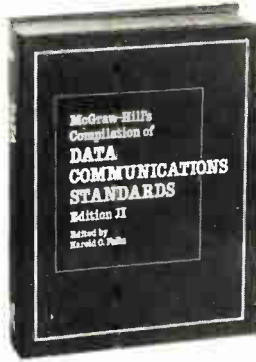

All standards
are new, revised,
or reaffirmed
since the
previous edition

1,923 pages
illustrated

Edited by Harold C. Folts

Presents all 123 interface protocol standards set by:

- International Telegraph and Telephone Consultative Committee (CCITT)
- International Organization for Standardization (ISO)
- European Computer Manufacturers Association (ECMA)
- American National Standards Institute (ANSI)
- Electronic Industries Association (EIA)
- U.S. Government (NBS and NCS)

Special feature for instant access:

Cross-reference tables of the standards of each group corresponding to those published by the others.

An essential reference for all who are exploring, planning, developing, manufacturing, or using data communications equipment or networks.

Return Coupon to:
Data Communications Standards II
Electronics Magazine Books
McGraw-Hill Intl. Publications Co.
European Circulation Center
Maidenhead, Berks. SL6 2QL, UK
(Tel. (0628) 23431; Telex 848640)



Send me _____ copy (copies) of R100-DATA COMMUNICATIONS STANDARDS EDITION II at \$295. U.S. orders please add local sales tax. McGraw-Hill pays regular shipping and handling charges on prepaid orders. Ten-day money-back guarantee applies.

- Check enclosed Bill me Bill company
 Company Purchase Order enclosed.

Name _____

Title _____

Company _____

Address _____

City _____

State/Zip (U.S.) _____

Country (outside U.S.) _____

ELV

TECHNOLOGY NEWSLETTER

ALUMINUM OXIDE SPEEDS UP JOSEPHSON CIRCUITS

Superfast Josephson junction circuits may become even faster with a new combination of materials unveiled by Hitachi Ltd. engineers at last week's International Solid State Circuits Conference in Anaheim, Calif. The system uses aluminum oxide dielectric sandwiched between niobium electrodes for a 4-by-4-bit multiplier and results in a saving of 69 ps in carry-to-carry delay time over a similar multiplier made from niobium nitride sandwiched between lead-alloy. The multiplier is fabricated with 1.5- μm design rules and has a carry-to-carry delay time of 210 ps while consuming 3 mW. A divide-by-eight counter can clock up to a frequency of 11.9 GHz—compared with 2.2 GHz for NbN—and has a power consumption of only 0.4 mW. The use of threshold logic in these devices allows combinatorial and sequential circuits to be built with close to the minimum number of gates. □

E-BEAM MACHINE WRITES ON WAFERS AT RECORD RATE

Perkin-Elmer Corp. intends to go to market with an electron-beam machine that rates as the world's fastest, according to a senior research executive at Hughes Aircraft Co. The machine, a joint development by the Norwalk, Conn., company and Hughes's Malibu, Calif., Research Laboratories, has a throughput rate between 10 and 12 4-in. wafers per hour and can handle feature sizes down to 0.5 μm . The companies developed the machine under a contract in Phase 1 of the Pentagon's Very High Speed Integrated Circuits program. The goal was a throughput of only four wafers an hour. Perkin-Elmer and Hughes came in well above that, largely because they used a shaped beam to fill features having triangular, rectangular, or square shapes. Hughes will take delivery on the first commercial unit. □

32-K 3-NS SRAM USES POLYSILICON IN BASE AND TRENCH

IBM Corp. claims a record bipolar speed-density ratio for an experimental 32-K static random-access memory chip designed and fabricated at its General Technology Division in East Fishkill, N.Y. Polysilicon contributed doubly in the device. The material is used for the transistor bases in a chemical-vapor-deposition process that results in low resistance for high switching speed—the access time is 3 ns. The high density comes largely from deep, narrow polysilicon trench capacitors. Measuring 6.6 mm on a side, the square chip is fabricated in 1.5- μm technology and could serve as a cache or for control storage in large computers, IBM researchers reported at last week's ISSCC conference in Anaheim, Calif. □

MINISUPER MAKER IS DELVING INTO PARALLEL PROCESSING

Better algorithms for high-performance parallel processing of quantum optics and lithospheric data will be the focus of a new research center established by minisupercomputer maker Convex Computer Corp. and the nearby University of Texas at Dallas. Convex also is looking to the center for insights into possible parallel-processing hardware and as a source of supercomputer programmers. The program, called Advanced Supercomputing Technology Research Associates, has installed a Convex 64-bit C-1 system on the school's campus. The C-1, with its Cray-like architecture, will be used to develop software for a more powerful and much more expensive Cray X-MP/24 supercomputer, which is slated to be installed soon in Austin at the University of Texas' System Center for Performance Computing. The \$500,000 C-1 will be attached to a variety of IBM, Digital Equipment, Prime, and Sun Microsystems equipment over an Ethernet local-area network. A DEC MicroVAX II will be used as the communications processor to the Cray. □

The industry's leading coverage of international technology.

In Electronics.

Electronics is back—with the industry's top reporting on international electronic technology. In the first half of 1985 alone, Electronics—with its worldwide bureau of correspondents—published more than 140 articles on international technology. Important articles with news and analysis that leaders in the field can't afford to be without, such as:

January

Philips Uses MBE for Lasers
Siemens Readies Commercial ISDN
Japanese Chemical Firm Moves from Soap to Floppies
Italian Firm Seeks Allies to Crack U.S.
Japan Pursues Role in Space
Bellman Switches on Italtel for Expansion
Robots get Smart in Japan
ITT Invests in European Units Crack U.S.

February

Europe's Esprit Finally Sets Sail
LSI Logic Counts on Sandfort to make its Mark in Europe
Upstart Vendor Makes Waves in Japan's Robot Market
NEC Fashions New Fab Process
Olivetti's Viti Directs ET Designs that Marry Bus & Art
German Startup's Success Surprises Europeans
Britons Seek Tolerant Chips
OBI Rains on IBM's Parade
Mega's Friedrich Aims to Cut Asian Lead in Memories

March

British GaAs Chips Go to Market
NEC's CPU Leapfrogs IBM
Hitachi CPU Challenges IBM
France's Lansat Rival Set for Fall Launch
Olivetti Stakes Claim in Video Typewriters
Italian VLSI Chip has the Right Accent
Koreans Try for VCR Replay
Germans Push X-ray Exposure
There's Life in Resistors, German Company Finds
UK Beats a Path for Europe's Race

April

German System Meets New ICAO Standard
West Germans Squabble Over Choice of IFF
Britain Promotes Open Architecture
US Makes Progress in Japan Telecom Talks
Japan's Lead in Optical Disks: It's Part of the System
Daisenberger Guides US Firms through Red Tape
Asia: It's No Longer Just Japan That Threatens US Markets
Malaysia: Top Shipper of Discretes
Indonesia: Domestic Sales are the Lure

May

Thomson's VCR System Clears Up Doubts
ICL Banks on Networks and Japanese Chips
Min Blazes Bright Path for Korea's Gold Star
Asia: The Four Dragons Rush to Play Catch-up Game
Singapore Casts Lot with Software
Philips' Eurom Chip Finally Debuts
Sagging Prices Sting Japanese Producers
British Telecom Spreads Its Wings with Mite!l
South Korean IC Maker Seeks World Markets

June

Plessey Switches Off Flash ADC, Saves Power
Sony Campaigns Hard for BMM Camcorders
Japanese Quit on IBM Software, Turn to UNIX
Apple Tries Again to Blast Off in Japan
Has the End Come for European Chip Makers?
SIA Protest May Not Stem Trade Tide
Now It's Korea's Turn in the Robot Market

And that's only in six months!

Readers depend on us for this full scope of technology coverage worldwide. Shouldn't your selling message be in Electronics' environment of pivotal technology reporting and analysis?

Put your advertising where the electronics attention is. Call Electronics today, at 212/512-3140, to reserve your ad space. Outside the U.S. contact your sales representative.

Electronics is back. Shouldn't you be back as well?



ELECTRONICS NEWSLETTER

HUGHES MOVES TO STRENGTHEN GROUND SYSTEMS GROUP

The surprise appointment last week of C. Blaine Shull as president of Hughes Aircraft Co.'s Ground Systems Group means the new General Motors Corp. operating unit is shoring up what some observers call major weaknesses. The group, one of Hughes' largest operating units, with annual sales in excess of \$1 billion, reportedly has continuing production problems in several of its contracts for military command and control systems. Observers say Shull's appointment is only the first of several top-level moves intended to upgrade manufacturing at Hughes, a giant in defense electronics with more than \$6 billion in sales for 1985. Shull played the dominant role in correcting manufacturing and quality troubles during 1984 and 1985 at the Tucson, Ariz., missile operation. Hughes watchers got another surprise earlier this month: the appointment of Malcolm R. Currie, Hughes' executive vice president and a veteran manager of large-scale systems programs, as president of GM Hughes Electronics Corp., which includes the former GM Delco division. □

TROUBLED ZYMOS SEES BIG BOOST IN DEAL WITH KOREA'S DAEWOO

Look for Zymos Corp. to get a shot in the arm if a preliminary agreement with Korea's Daewoo Corp. goes through. Zymos and Intermedics Inc., the Angleton, Texas, biomedical-devices maker that owns 47% of Zymos, signed a letter of intent to sell the controlling interest in the Sunnyvale, Calif., semiconductor maker to the diversified Korean manufacturer. A final pact could be completed by April; the purchase price was not disclosed. Zymos, which had losses of more than \$8 million last year, says Daewoo plans to fund its efforts in the chip business. It also will use Zymos as a supplier of chips for the Korean manufacturer's personal computer, telecommunications, and automotive products. "We're pretty excited about the deal," says Zymos marketing vice president Dave Guzeman. "It's not often that you get significant cash and a major customer at the same time." Sources in Korea say Daewoo will use Zymos as a way to participate in the custom semiconductor business. □

SATELLITE TV PROGRAMMING IS AIMED AT COMPUTER USERS

A new Schaumburg, Ill., company is launching a satellite-based TV network that it thinks will give business computer users the level of support and product information that it claims neither retail computer stores nor published media can provide. The company—called Computer Distribution Network Inc.—will beam the signal nationwide starting March 3 over a channel on the Galaxy II C-band satellite owned by Hughes Communications Co. Programming will include advertisements, product demonstrations, and training sessions put together by computer systems manufacturers, who will pay to be on the network. The unscrambled signal will be available to any computer user who has access to a satellite dish. □

JAPAN'S OPTOELECTRONIC PROJECT IS WINDING DOWN

Japan's seven-year \$84 million Optoelectronic Project is winding down with some interesting developments from a three-month experiment in fiber-optic systems. The Japanese Ministry of International Trade and Industry is sponsoring the experiment at a Nippon Mining Co. oil refinery near Kurashiki City. Fourteen firms are using the plant as a testing ground for the various fiber-optic technologies they developed as part of the project. Especially noteworthy are Hitachi Ltd.'s 1-Gb electro-optical integrated circuit and Sumitomo Electric Industries Ltd.'s optical-fiber sensor, which can remotely transmit 250,000 images for extremely high-resolution imaging on a screen. □



Fred Molinari, President

Only one man could create a full line of VME boards this fast.

Yes, me.

VME is still in the cradle and already we're offering you a complete line of twelve analog and digital I/O VME boards.

If you're looking for a single-board solution, there's the DT1401 series. Up to 32SE/16DI analog inputs, two analog outputs, 16 lines of digital I/O, and a programmable clock. Options include 12 or 16-bit resolution, programmable gain, high-speed and simultaneous sample and hold.

We have analog output boards for both industrial and scientific applications complete with voltage outputs, current outputs, or for current loop control. There are also 16-bit deglitched output versions for precision applications like speech and music synthesis.

In the area of low-cost products, we can provide a data acquisition subsystem that includes 16-channel A/D, a programmable clock, and 16 lines of digital I/O for \$395. We have digital I/O with 32 I/O lines for \$225.

All this plus a wide variety of screw terminal panels and signal conditioning equipment.

It's no miracle. We just work like crazy people and no resting on Sundays.



See our new 646 pg. catalog/handbook or see us in Gold Book 1986. Or call for your personal copy today.



Call (617) 481-3700

VME Model Series	CLASS	A/D			D/A			DIO (lines)	Clock
		Channels	Resolution (bits)	Speed (KHz)	Channels	Resolution (bits)	Speed (KHz)		
DT1401	General Purpose	32 SE/16 DI	12-16	2.5-50	2	12	50	16	Yes
DT1402-F	High Speed	32 SE/16 DI	12	125	-	-	-	16	Yes
DT1405	Low Level	32 SE/16 DI	12-16	0.16-6.7	2	12	50	16	Yes
DT1408	Simultaneous S/H	4SE	12	100	2	12	50	16	Yes
DT1406-8V	Voltage Output	-	-	-	8	12	125	-	-
DT1406-8M	Current Output	-	-	-	8	12	28.5	-	-
DT1406-8CL	Current Loop	-	-	-	8	12	28.5	-	-
DT1403	High Resolution	-	-	-	2 or 4	16	100	-	-
DT1414	General Purpose	16SE	12	25	-	-	-	16	Yes
DT1417	Digital I/O	-	-	-	-	-	-	32	-

DATA TRANSLATION

World Headquarters: Data Translation, Inc., 100 Locke Dr., Marlboro, MA 01752 (617) 481-3700 Tlx 951 646

European Headquarters: Data Translation, Ltd., 13 The Business Centre, Molly Millars Lane, Wokingham Berks, RG112QZ, England Tlx 851849862 (#D)

International Sales Offices: Australia (61) 2-5635289; Belgium (32) 2-7352135; Canada (416) 625-1907; Chile (2) 2-253689; China (408) 727-8222, (86) 87214017; Denmark (02) 187188; England (44) 0734 793838; Finland (358) 0-372-144; France (33) 146306839; Greece (30) 031-527039, (30) 13-614300; Hong Kong (852) 3-324563; India (91) 2-231040; Israel (972) 3-324298; Italy (39) 2349751; Japan (81) 3-502-5550, (81) 3-348-8301, (81) 3-355-1111; Korea (82) 753-3101; Malaysia (60) 3-36299; Morocco (21) 9-30-6949; Netherlands (31) 70996360; New Zealand (61) 2-663-5289; Norway (47) (02) 559050; Peru (51) (14) 31-8060; Philippines 818-0103, 818-3073, 818-4230; Portugal (351) 1545313; Singapore (65) 271-3163; South Africa (27) 12469221; Spain (34) 14558112; Sweden (46) 87617820; Switzerland (41) 17231410, (41) 22360830; Taiwan (86) 2-721-7864, (86) 2-531-2434; West Germany (49) 89809020.

PRODUCTS NEWSLETTER

INTEL OPENS ITS DEVELOPMENT-SYSTEM NET TO OUTSIDE COMPUTERS

Intel Corp. is introducing a range of products that allow customers to add other makers' computers to the Intel OpenNET microprocessor development-system network. From Intel's Development Systems Operation in Hillsboro, Ore., the products enable customers to set up development networks with transparent access to shared files, and to distribute jobs across systems. The products include the OpenNET Network Resource Manager file server that costs \$14,995 with the minimum 40-megabyte capacity. The resource manager supports the \$7,500 VAX Link R2.1 and the \$1,250 OpenNET PC Link, which integrate DEC VAX machines and IBM Personal Computers, respectively, into the network. All the products are available now. □

CALMA TEST PATTERNS GO FROM PROTOTYPING TO PRODUCTION TESTING

Calma Co.'s new Logic Examiner test-development and -verification system generates test patterns for IC prototyping—and, once the design is set, passes the patterns along to production testers. The Logic Examiner, which is built around the new Apollo Computer hardware (see p. 20), works with Calma's Logic Series computer-aided-design stations and with other work stations that use Calma's Tegas design language. When the Milpitas, Calif., company's Logic Examiner is available in June, it will support testers from GenRad and Sentry. On the monochrome Apollo 3000, the system is priced at \$50,000; on the Apollo DN570A, it is \$82,000. □

OLIVETTI TO EXPAND ITS PERSONAL COMPUTER LINES

Look for Ing. C. Olivetti & C., Europe's principal manufacturer of personal computers, to expand its offerings in the coming months. The Ivrea, Italy, company will add two models to its line of machines that are compatible with the IBM Corp. Personal Computer line. One is an entry-level model, designated the M-19, and the other is a Unix-based system, called the M-28, capable of supporting four users simultaneously. The company won't say if the models will be sold in the U. S. by AT&T Co. or Xerox Corp., both of which sell the M-24 line—AT&T as the PC 6300, Xerox as the 6064. Neither U. S. company would comment on future product plans. Prices were unavailable. □

DUPONT BOARD MATERIAL MATCHES CHIP-CARRIER'S THERMAL EXPANSION

This week E. I. du Pont de Nemours & Co. will introduce the Cor-Lam family of copper-clad laminates and prepregs that make it possible to tailor a board's coefficient of thermal expansion to that of a leadless ceramic chip carrier. Du Pont claims that the high strength-to-weight ratio of the material's Kevlar aramid fiber will result in a board weighing as little as half as much as a metal-restrained epoxy-glass board, which is the current way to match a board's coefficient to that of the carriers. In addition, Cor-Lam's dielectric constant—about 4—is attractive for high-speed applications. The new laminates will be unveiled at Nepcon West, in Anaheim, Calif. □

MOBILE GATE-ARRAY PLANT GOES TO CUSTOMER'S DOOR

Laser techniques for making gate arrays are going mobile. Starting with its laser pattern generators and prediffused wafers, Lasarray AG in Brügg, Switzerland, has developed a mobile semiconductor plant that allows operators to drive right up to a customer's premises and produce gate arrays on the spot. All fabrication and testing equipment is carried in three vans, totaling about 70 meters² of floor space. The plant can turn around a wafer in about 36 hours with production runs as small as 20 ICs. □

Electronics

A SHAKEOUT IS IN SIGHT IN THE ASIC BUSINESS

SQUEEZE IS ON FOR SMALL PLAYERS IN TOPSY-TURVY MARKET

DALLAS

Tremors are rippling through the application-specific integrated-circuit market, heralding shock waves that could topple some of the 200-odd companies in the business.

A sort of topsy-turviness underlies the ASIC market. Chip suppliers and their customers generally are moving toward tighter relationships. But at the same time, some suppliers are breaking up with their second-sourcing partners and signing strategic development pacts with other competitors. Revenues for ASIC design and engineering services show signs of slipping. All the while, a push toward denser circuits continues.

The combination bodes ill for borderline companies. "In our opinion, the big will be getting bigger and the little guys are going to be squeezed more and more out of the market," predicts Jack Beedle, president of market researcher In-Stat Inc., Scottsdale, Ariz. For the survivors, a huge prize may be in store. In-Stat estimates total U.S. ASIC sales in 1986 will be 15% of the total IC business, or about \$203 million. By 1990, ASIC segments will account for 26% of the IC business, or just over \$1 billion, says In-Stat analyst Bill Groves.

But "essentially, you are seeing the same kinds of products from four or five semiconductor companies," he points out. "What they are learning to do is compete by offering on-time delivery services, fast turnaround, and adding more value to the ASIC products."

As they do, "the nonrecurring engineering charges that customers pay for gate-array designs are now going for about \$10,000 to \$15,000 in the industry," says Michael H. Valek, ASIC marketing manager for Texas Instruments Inc. Those sums, he estimates, have fallen from about \$60,000 a year ago. The precipitous drop may sound the long-expected knell for the smaller ASIC houses.

TI, of course, sees itself as one of the survivors. And in the corridors at last week's International Solid State Circuits Conference, the Dallas company quietly disclosed plans for a standard-cell offering made from 1- μ m CMOS. In early 1987, TI is aiming to be the first to introduce a double-level-metal, 1- μ m CMOS library, based on technology pioneered by its 1-Mb dynamic random-access memory (see "TI sets timetable for 1-micron CMOS cells").

The battle for survival is spawning a new round of alliances

Other major ASIC suppliers are aggressively pushing their libraries below the 2- μ m barrier. National Semiconductor Corp. will apply a direct optical shrink to its current 2- μ m double-level-metal process, taking CMOS to 1.5 μ m and the performance level of many bipolar emitter-coupled logic arrays, says Fred Horne, vice president of customer-specific products. The Santa Clara, Calif., company began phasing out ECL and advanced low-power Schottky arrays last year, and it has steered most

of its bipolar customers to 2- μ m CMOS.

"The 1.5- μ m CMOS will give us the ability to migrate about half of the remaining customers from the bipolar process," says Horne. The 1.5- μ m technology will be introduced during the summer or fall of 1987. National is also preparing a new CMOS semicustom-chip technology that can be scaled from a starting point of 1.25 μ m to about 0.8 μ m, says Horne.

Another important move for National is its new partnership with customer Xerox Corp., which promised to buy a majority of its ASICs from the Santa Clara vendor. In return for the business, which will stretch well into the next decade, Xerox's Microelectronics Center in El Segundo, Calif., will receive National's CMOS processing technology, product designs, engineering tools, and the chip-packaging information necessary to fabricate in-house ASIC prototypes [*Electronics*, Feb. 17, 1986, p. 64].

GLUT OF SUPPLIERS. "Products are becoming much more complex, and technologies like ASICs are beginning to deliver on all the promises, but customers cannot deal with six or eight different companies," notes Horne, explaining the appeal of fewer component suppliers for major system houses. He promises Na-

TI SETS TIMETABLE FOR 1-MICRON CMOS CELLS

Texas Instruments Inc. and its standard-cell partners, NV Philips and its subsidiary Signetics, have a raft of products on the way to the semicustom market.

They plan to introduce in April a new 2- μ m library, dubbed SystemCell. The double-level-metal CMOS standard-cell parts will be scalable down to 1 μ m.

TI calls its CMOS logic process EPIC, for Enhanced Performance Implanted CMOS [*Electronics*, Jan. 27, 1986, p. 16], and officials of the Dallas company have committed themselves to a corporate goal of being the first on the

market with a 1- μ m standard-cell library.

The initial 2- μ m offering in the joint SystemCell library will have small- and medium-scale-integration logic blocks as well as a variety of memories and field-programmable logic arrays. As the library evolves toward 1- μ m geometries, TI will include a number of large-scale processors, including 8-bit cores, bit-slice units, multipliers, arithmetic logic units, barrel shifters, and even its 32-bit TMS320 digital signal processor.

Look also for TI to introduce a new line of gate arrays made from a process

compatible with the SystemCell twin-well CMOS. TI's current arrays are made under a second-source deal with Fujitsu Ltd., Tokyo. TI will continue to support Fujitsu's p-well CMOS gate arrays but wants a compatible line to team with its SystemCell library, says Michael H. Valek, ASIC marketing manager.

TI is also considering the introduction of a new emitter-coupled logic-array family. It would exploit the company's next-generation 1.5- μ m bipolar process, internally dubbed Tipsa, an acronym standing for TI polysilicon self-aligned process. —J. R. L.

tional will strike up similar partnerships with other major system houses.

Competitors contend National's pact with Xerox is merely one of many agreements creating closer bonds between chip suppliers and computer houses. The Xerox-National agreement is of no great significance, says John Carey, merchandising manager for Motorola Inc.'s ASIC division in Phoenix, Ariz. "It is a continuation of a business trend that is common in the application-specific marketplace. It is something that will become more prevalent in the industry as the nature of the products requires more intimate relationships."

Carey's view may be colored somewhat by the sharp parting of the ways that ASIC managers at National and Motorola had in the past year. After a comprehensive second-sourcing pact, announced in 1982 and covering CMOS, ECL, and TTL bipolar gate arrays, the deal failed to live up to its promise.

NEW PARTNER. The upshot was that National elected to drop its bipolar gate-array efforts entirely. Thus Motorola, seeking a strategic partner in the emerging standard-cell arena, inked a pact with NCR Corp. last summer. The result will be a new 2- μm standard-cell offering that teams NCR's high-density library with Motorola's high-performance designs. Carey promises a major product release this summer.

To Horne, the collapse of the arrangement between National and Motorola underlined a fundamental weakness in competitive ASIC second sources. "Partnerships between very large companies competing with similar product lines are very brutal," he says. "We had one with Motorola in gate arrays, and it could be described only as the clash of the titans. There was a tremendous shaking of the earth, and very little else."

Horne believes pacts similar to National's partnership with Xerox will replace the wide need for second-sourcing. But Motorola's Casey disagrees, claiming strategic alliances will still be necessary to advance leading-edge ASIC technology. He cites the joint-development effort of NCR and Motorola.

TI has had a number of interested customers—equipment houses with their own fabrication lines—inquire about licensing its fine-line processing technologies, something the company has refused to offer any of its second-source competitors. The processes—such as the 1- μm Enhanced Performance Implanted CMOS—are a spinoff of TI's steep investment in DRAMs.

"Some customers have asked us to help with their processes. We will be the alternate source for those products on the outside," says Delbert A. Whitaker, senior vice president in TI's Semiconductor Group. —J. Robert Lineback

FIBER OPTICS

LASER LIGHTS THE WAY TO LONG-SPAN FIBER LINKS

TOKYO

NEC Corp. is first out of the gate in what figures to be a high-stakes race for market share in hardware for 1.55- μm optical-fiber communications systems. That low-attenuation operating band looks likely to dominate fiber optics because it makes possible systems with double the repeater spacing of current 1.3- μm systems.

NEC has a diode laser on the market in Japan [*Electronics*, Feb. 17, 1986, p. 9] and will follow up in midyear with a distributed-feedback laser and avalanche photodiode. The Tokyo company has modified conventional fabrication techniques to achieve the wavelength characteristics needed for 1.55- μm -wavelength band.

These products can now be combined with optical fibers that have their zero-dispersion point—where there is no difference in velocity at which different wavelengths travel the length of the fiber—shifted to suit the longer wavelength. Cables housing such fibers are available from Siecior, a joint venture between Corning Glass Works, Corning, N. Y., and Siemens AG of Munich.

A team headed by Kuniakira Iwamoto, engineering manager of the Optical Semiconductor Department of NEC's 2nd LSI Division in Kawasaki, developed the new diodes. NEC calls the light source a double-channel planar buried-heterostructure laser diode. As for the indium-gallium-arsenide avalanche photodiode detector, it is a separate light-absorption and signal-multiplication type with a gain-bandwidth product of about 30 GHz. It provides excellent characteristics for data rates as high as 4 Gb/s.

NEC's new laser has a power output of 5 mW continuous wave, with selected devices providing a peak pulse output of 30 mW—which NEC says is a record. The half-power spectral width is only 4 nm when unmodulated, and the threshold current is a relatively low 40 mA.

Though NEC's laser diode does not have a problem with dispersion when modulated at moderately high repeti-

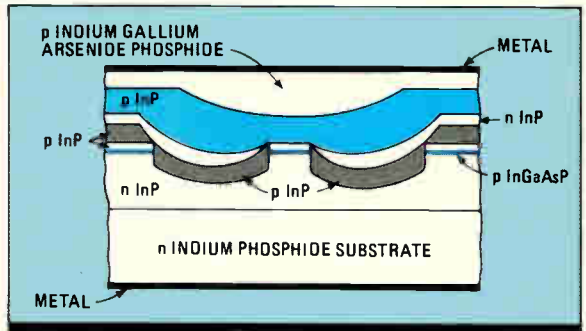

SHINING LIGHT. A record 30 mW is the maximum output from NEC's 1.55- μm twin-channel laser for the 1.55- μm bandwidth.

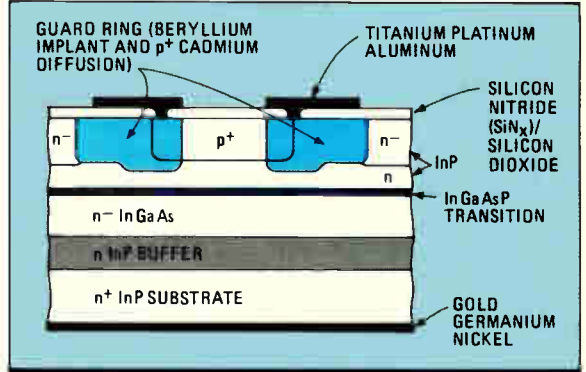

MINUS THE MESA. A guard-ring implant is key to the planar structure of the multilayer avalanche photodiode.

tion-rate signal frequencies, it is not the ultimate laser for the highest data rates. Increased spectral width at high modulation rates appears to be inevitable with lasers having a Fabry-Perot cavity formed by cleaving their ends.

As the laser's spectral width increases, signal degradation caused by dispersion rather than attenuation becomes a limiting factor in transmission span. So, by midyear, NEC expects to market a distributed-feedback laser for use in the 1.55- μm band at data rates in excess of 1 Gb/s over long spans.

BUILDING THE LASER. Fabrication of the double-channel laser now on sale begins in the same manner as for other long-wavelength lasers—with liquid-phase epitaxial growth on an indium-phosphide substrate. Grown in succession are the n-doped InP layer, the undoped indium-gallium-arsenide-phosphide active layer, and the p-doped InP layer that form the double heterostructure (figure, top). An extremely thin anti-meltback layer (not shown) lies between the active layer and the overlying InP layer to prevent unwanted diffusion into the active layer.

Conventionally, these processes would be followed by a mesa etch to define the

1.55- μm -wide active-layer stripe in which laser action occurs. In the NEC laser, however, double channels are etched, leaving the active layer and overlying clad layer intact along two edges of each chip on the wafer as well as down the center of the chip. The etch is followed by the growth of p- and then n-type current-blocking layers of InP over the entire chip except the laser-stripe region.

Subsequent growth of p InP fills in the central depression, and a cap layer of InGaAsP completes the semiconductor structure. The chip's size after cleaving the cavity edges and dicing is 300 by 300 μm .

HIGH-SENSITIVITY DIODE. The InGaAs avalanche photodiode provides 2 to 3 dB more sensitivity than germanium photodiodes, even in the 1.3- μm region, and still higher sensitivity in the 1.55- μm region. External quantum efficiency is 80%, a marked improvement over germanium. Dark current is only one tenth that found in Ge avalanche photodiodes, making for

an improved signal-to-noise figure.

Photons are absorbed in the n InGaAs layer and avalanche multiplication occurs in the InP n⁻ layer (bottom figure, p. 19). Between them is an InGaAsP transition region that prevents trapping of electrons in the built-in potential at the bandgap discontinuity of the materials between which it is sandwiched.

For its diode, NEC used a planar structure rather than a mesa configuration to reduce peripheral-leakage current. NEC achieves this by a lateral extended guard ring fabricated by two beryllium implantations and followed by annealing at 700°C. Lighter doping and shallower depth of the outer portion of the guard ring minimize high fields around the device's periphery. The p+ region of the avalanche layer is fabricated by zinc diffusion.

The diode laser sells for roughly \$2,800. The avalanche photodiode will cost about \$1,950 when NEC makes it available in June. —Charles L. Cohen

pact because they signaled IBM's entry into the work station market. But any ground gained by the RTs at the low end must now be seen as significantly under attack from the new Series 3000.

For its part, DEC has been crowing about sales of its MicroVAX II, with more than 12,000 sold since its introduction last spring. But just 2,000 of those units have been sold as the work station version, VAXstation II. "I would say that VAXstation II has not been a very successful product," says Lou Mazzucchelli, chairman of Cadre Technologies Inc., Providence, R. I., which designs automation tools for software engineers.

Mazzucchelli believes it's important for vendors to offer a work station priced around \$10,000. With VAXstation II typically priced well above \$30,000, he sees DEC with a significant price gap at the low end of the market.

EARLY TO MARKET. Apollo was the original work station vendor, starting in 1980, and parlayed its pioneer position into a nearly \$300 million business in five years. Banking on continued rapid growth, the company stumbled badly last year and registered a loss of \$1.5 million even though its revenues rose in excess of 35% from 1984.

Though it's generally conceded that Apollo's Domain system set the industry standard for networking technology, critics maintained that the company was triply doomed: its Domain network architecture was closed, it did not offer AT&T Co.'s Unix operating system, and its machines were priced too high. High turnover among corporate officers seemed to confirm the prognosis. Sun Microsystems, DEC, and more recently IBM, with its RT PC, were seen as quickly eroding Apollo's market share.

The Unix shortcoming caused the company to lose potential customers before it could sell on its traditional networking strengths, concedes Edward Zander, Apollo's vice president of corporate marketing, but "we fixed that problem" (see p. 96). "60% to 70% of our customers are buying Unix, and in many respects we're a Unix company."

Indeed, on its new work stations, Apollo offers a dual-port Unix using both the Berkeley 4.2bsd and System V versions along with its Aegis system. "Ultronix [DEC's version of Unix] is fine as is," says Andries van Dam, professor of computer science at Brown University. "But the set of products sitting on top of Ultronix is not as strong as the set of prod-

WORK STATIONS

APOLLO FIGHTS BACK WITH NEW WORK STATIONS

BOSTON

Rumors of Apollo Computer Inc.'s death as a front-rank work station vendor now seem greatly exaggerated. Last week the Chelmsford, Mass., company introduced an array of products that proved it still has strong vital signs [*Electronics*, Feb. 17, 1986, p. 17]. Perhaps most impressive is Apollo's low-end work station: It sets a price/performance level that could send other vendors scrambling to match.

The new low-end machine, called the Series 3000 Personal Workstation, features a Motorola MC68020 32-bit microprocessor and an MC68881 floating-point coprocessor. It is bus-compatible with IBM Corp.'s Personal Computer AT, so it can do PC tasks. Later this year, Apollo will bring out a coprocessor option that will allow the 3000 not only to run PC AT programs in a display window, but also to transfer data to other windows running in the Apollo Domain network environment. The bottom-of-the-line price is \$9,900 for the monochrome system and \$14,900 for color machines.

At the same time, Apollo announced new midrange work stations that boast the industry's fastest real-time three-dimensional graphics, running at speeds exceeding 100,000 transformed and clipped vectors per second. "The name of the game is 3-d and virtual-memory graphics," says David L. Nelson, vice president of research and development.

Capping the product lineup is an expandable parallel-processing computational server built by Alliant Computer Systems Corp., Acton, Mass. It can hit 94 million floating-point operations/s and 35 million instructions/s.

Apollo's new work station panoply should make the going rougher for IBM and Digital Equipment Corp., heretofore seen as gaining market share at Apollo's expense. The consensus on IBM's RT PC line, introduced last month [*Electronics*, Jan. 27, 1986, p. 14], was that although the machines are technically unimpressive, they had considerable im-



FAST ON THE DRAW. Apollo believes powerful 3-d graphics on its new high-end work station will make it a market winner.

ucts sitting on top of Apollo's Unix."

Apollo's work-station announcements appear to have put the ball in other players' courts for the moment. Surveying the work-station scene, Vicki Brown of International Development Corp., the Framingham, Mass., market researcher, says, "Sun will have to do something about their graphics." She expects Sun to introduce products similar to Apollo's

personal-computer-type products.

On the technical side, meanwhile, "Apollo is in the lead and they're going to start behaving as if they're in the lead," says Adam Zais, another analyst from International Development. "As the work-station market moves to a billion dollars, Apollo's share will slip, but it will be a major share of a higher market."
—Craig D. Rose

AUTOMOTIVE

ELECTRONIC STEERING HEADS FOR THE ROAD

PALM BEACH GARDENS, FLA.

TRW Inc. has found a new automotive target for electronics: the pump, hoses, and fluid used in hydraulic power steering systems. It proposes to replace these with an electronically controlled motor that it says will provide a cheaper, more responsive, and safer system. Other U.S. makers of power steering systems are working on similar units, though they're not as close as TRW to hitting the highway.

TRW, which ranks as the world's largest independent supplier of power rack-and-pinion steering, isn't saying who its first customers for the system will be. But the company has already lined up "various forms of agreements with six [automobile] manufacturers, predominantly in the U.S.," says William R. Price, vice president and general manager of the Steering & Suspension Division in Sterling Heights, Mich.

The Powertronic system will begin showing up in production vehicles during model year 1988, TRW says. "We anticipate manufacturing 30,000 units for 1988 model-year cars," Price says. "That figure should grow to 500,000 units annually by 1990, based on current customer interest." The company has installed prototype systems in cars that were available for test drives during last week's introduction at Moroso Motor Sports Park in Palm Beach Gardens.

MARKET IN THE MILLIONS? The company projects a major industry swing to electronic steering equipment by the early 1990s. By 1992, TRW says, about 5.7 million electronic steering systems will be manufactured for the North American market.

Others, however, aren't so sure about that timetable. "We don't see electronic [steering] systems being cost-competitive today," says Raymond Schultz, director of product engineering at General Motors Corp.'s Saginaw Division, which manufactures about 40,000 hydraulic steering systems per day.

The prices of power transistors and other components required to drive the

electric motor are still too high, Schultz explains. Based on falling component prices over the past five to six years, Schultz says, electronic systems should cross the cost line soon. "But some of the early systems in 1988 and 1989 will probably not be very cost-effective," he says. "It's a function of volume. And if electronic component costs don't come down, we don't see a very high-volume application."

GM does have "tentative plans" to introduce electronic steering in a GM luxury car "in the 1989 [model year] time frame," says Schultz. And the giant automaker is targeting model year 1988 or 1989 for introducing a hybrid steering system that will continue to use hydraulics but will rely on an electric motor to drive the hydraulic pump. This system will be used in midsize cars with transverse engines, such as the Pontiac Fiero, where space considerations make the mounting of hydraulic pumps difficult, Schultz explains.

Ford Motor Co., for another, has plans to introduce a steering system for

luxury cars that will rely on electronic control of the hydraulic system's valving. But as for electronic steering, "we're proceeding with caution," says Kenneth Obudzinsky, a product-design engineer with the technical planning department at Ford's Electrical and Electronics Division in Dearborn, Mich. For electronic steering in production models, "it looks like we're leaning toward the 1990 time frame," Obudzinsky says.

For its part, TRW contends that its Powertronic system will be competitively priced and will provide features and benefits not possible with hydraulic counterparts. Unlike hydraulic systems, which are coupled to the engine by a belt and consume power continuously, a system driven by an electric motor gets its juice from the battery and uses power only when needed for a steering maneuver. This results in horsepower gains and gives an estimated extra ½ mile per gallon.

What's more, the electronic system saves space and weight, knocking 7 lb off the heft of today's typical hydraulic system, which tips the scales at about 35 lb, TRW says. The Powertronic system has just three major parts, not the 18 pieces required to assemble a hydraulic system. That reduces the automaker's inventory handling of power steering parts by

The system uses electronic control of a motor

85%. Maintenance costs will also be reduced, TRW says, because leaky hydraulic oil systems account for nearly two thirds of steering-system warranty claims made to automakers.

Moreover, claims TRW, handling improves. The system can be programmed to provide speed-proportional steering, which gives the driver maximum power assist when it's needed, as in parking or slow maneuvering. On the highway, the system will decrease



SIMPLER AND LIGHTER. TRW's electronic steering actuator (top) has only three major parts and weighs 28 lb. The hydraulic unit it supplants has 18 parts and weighs 35 lb.

power assist for improved road feel and more precise handling, TRW says. In fact, the company plans to offer a version with a switch on the instrument panel that the driver can use to select one of three steering options—full-power, “manual,” or speed-proportional—depending on the road situation and the driver’s personal taste.

There’s also a safety argument for electronically controlled steering. Because the electric-motor-based system draws its power from the battery, steering assist is maintained even when the car engine stalls.

DOWNSIZING THE HARDWARE. The current version of the Powertronic system uses discrete components mounted on a printed-circuit board for control. However, TRW has some 15 million miles of road testing scheduled for this year and next. And by product-introduction time, the company plans to reduce the controller design to about the size of a minicassette tape recorder.

The controller will be based on a GM-designed CMOS microcomputer chip and is likely to use power MOS FETs from any of a number of suppliers, says Michael Behr, chief engineer for TRW’s

The new generation of power MOS FETs is essential

Transportation Electronics Division in Farmington Hills, Mich. A key to the feasibility of the system now is the emergence of MOS FETs that can provide the power needed to instantaneously change the rotation of the electric motor and to provide the precise amount of current necessary to meet torque requirements. TRW has not yet settled on a supplier, but is talking with a number of power MOS FET makers, including International Rectifier, Motorola, Siemens, and Siliconix, Behr says.

Steering-wheel movements in the TRW system are monitored by a sensor located on the pinion input shaft assembly. Movements of the input shaft change the electromagnetic flux path between the sensor and a set of magnets in the sensor assembly, and the movements are converted from micro-inches to variable voltage levels that the controller detects, Behr explains.

The sensor itself is a threshold-type device that has been modified to work linearly. Getting that linear performance within required tolerances and temperature ranges was no small task and relied on a proprietary technique, says Behr. The sensor approach is embodied in one of 15 patents TRW already has been awarded or has applied for in connection with the Powertronic system.

Another key to the system is a TRW design that places the electric motor on the same axis as the steering rack. That position overcomes two problems—of power loss and of steering equipment failing to return to its proper position—associated with earlier designs.

TRW says it has spent about \$15 million to develop the Powertronic system. The company plans to invest another

\$85 million over the next four years for additional development and capital equipment to manufacture the Powertronic system. TRW claims it has a lead of 18 months to two years over competitors like GM in developing electronically controlled, electrically driven power steering systems, and it hopes to parlay that advantage into a majority market share. —Wesley R. Iversen

IC TESTING

A NEW WAY TO MEASURE SUBMICRON LINE WIDTHS

GRENOBLE, FRANCE

The inexorable movement of integrated-circuit technology to submicron line widths is intensifying the need for more sophisticated ways of checking critical dimensions without destroying chips. Unfortunately, measuring equipment currently used in IC production is of only marginal use for dealing with lines so narrow.

But researchers at the Centre Norbert Segard, the microelectronics research arm of the Centre National d’Etudes des Télécommunications (CNET), are confident that they can improve the situation. By applying original signal-processing techniques and mathematical analysis, they have come up with a system that outdoes by several times the precision of conventional measuring devices. What’s more, the system’s precision is completely independent of the material being measured, and the setup can be used as easily by an unskilled person after a few minutes of training as by an operator well versed in the use of optical equipment.

THE JAGGED EDGE. Both the traditional ways of measuring microelectronic line widths and CNET’s method start with a magnified optical image of the line to be measured. This image is picked up by one of several available standard video or photometry systems.

Because the amplitude of the light re-

flected varies over the surface of the object to be measured according to its distance from the microscope’s objective lens, any line reflects more light than the surface on which it is deposited. Furthermore, a sudden change in amplitude registers at each line edge. The distance between these two amplitude variations corresponds to the width of the measured line.

The snag here is that such measurements are highly sensitive to both the optical parameters of the line, which change significantly with the material measured, and with the calibration of the microscope. Moreover, with this approach it is nearly impossible to measure line widths when they get down to 1 μm or so. At such small dimensions, interference at the edges of the line can play havoc with the accuracy of the overall measurement.

CNET’s answer to this dilemma is to replace the standard optical technique with a signal-processing scheme. Called MALT, a French acronym for automatic line-width measurement, the system is based on a Fourier transform of the microscope’s digitized output signal. Because the approach significantly enhances the performance of an optical microscope, Jean-Louis Buevoz, the CNET engineer who is coordinating the MALT project, believes that its development could well mark the debut of a new gen-

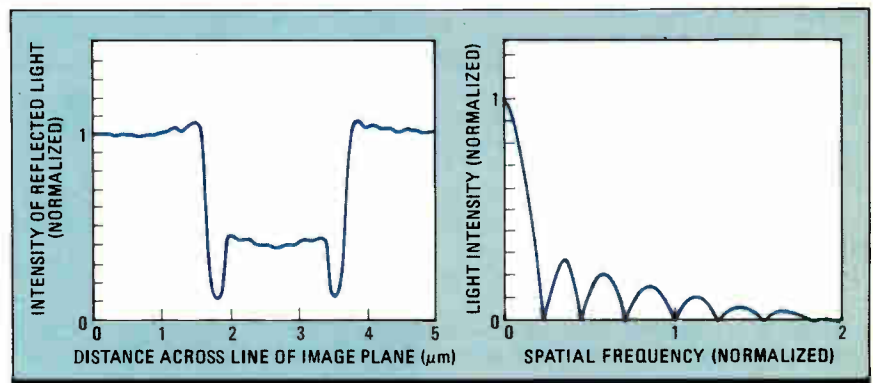

TAKING CURVES. CNET performs a Fourier transform on the intensity distribution of a microscope’s image (left) to get a frequency spectrum that is used to calculate the line width.

eration of optical control systems.

MALT begins with the same intensity-amplitude variation used in standard measurement techniques and analyzes the signal to obtain its Fourier transform. The resulting frequency spectrum contains all the data included in the original signal and enables calculation of the line width using the points at which the spectrum reaches zero as references (figure).

MATERIAL-INDEPENDENT. The calculation is based on the assumption that the object to be measured is rectangular and characterized by two optical parameters—relative reflectance and phase shift. After transforming the frequency spectrum into a linear combination of two simple functions and two material-dependent coefficients, the equation is developed until the material-dependent parameters are eliminated, making the line-width measurement independent of them. The line width then bears a sinusoidal relationship to the distance between any pair of points at which the frequency spectrum intersects with zero.

CNET's experimental equipment in-

cludes an optical microscope, a charge-coupled-device line-image sampler, a control module, and a standard micro-computer. The image of the line to be measured is formed by the microscope in the reflected-light mode, and the CCD array is positioned in such a way that it directly picks up only the image formed by the objective lens. This avoids any interference caused by the microscope mechanism.

The new method unites signal processing and mathematical analysis

After the operator introduces a window to extract the line image from the background, the light intensity generated by each pixel of the CCD is digitized by an 8-bit analog-to-digital converter, which is integrated into the control module. After the computer has made the Fourier transform, the zero points of the spectrum are extracted so that the line width can be calculated.

The number of zero points in the spec-

trum is the basis of the calculation of the width. A minimum of one pair of zeros is necessary, and with two the line width works out to $0.7 \mu\text{m}$. CNET has set the upper limit at $5 \mu\text{m}$ for two reasons. For one, there are so many zero intersections at that width that the calculation time would run as long as two seconds; for another, lines that wide can be reliably measured using conventional techniques.

Within that range, CNET achieves accuracy of 2% or better, depending on the thickness of the line to be measured and assuming measurements take an average of one second. The researchers proved the method's accuracy by cleaving measured samples and verifying their dimensions with a scanning electron microscope.

Perhaps most impressive is that repeatability of the measurement is better than $0.02 \mu\text{m}$, regardless of the operator. CNET proved this by combing its corridors for volunteers and finding that secretaries and technicians with no experience in such methods scored as well as the engineers who developed the system.

—Robert T. Gallagher

LASER, MICROWAVES SPOT CHIP DEFECTS

BERLIN

Beam a laser on a semiconductor, probe the semiconductor at the same time with microwaves, and then measure the reflected microwaves. That's the scheme a team of researchers at the Hahn-Meitner Institute for Nuclear Research in Berlin has worked out to check the quality of semiconductor materials and finished devices without attaching contacts or otherwise damaging them.

Because it does away with contacts, the technique has a decided advantage over other methods based on illumination and the popular electron-beam-induced current (EBIC) method, the Berliners claim. Attaching and removing test contacts can damage a sample or leave a chip unsuitable for its intended application, they point out. And with the EBIC method, the bombardment of electron beams can damage the chip. Even liquid rectifying contacts present a problem because of the chip's possible absorption of impurities.

No such problems exist with the Hahn-Meitner scheme, first proposed by Helmut Tributsch, head of the institute's Photoelectro Chemistry Department, and then implemented by Gerhard Beck and Marinus Kunst. The test results are picked up by the microwave field, and the laser beam's energy is too low to damage the sample. The only shortcomings are that the technique is

somewhat less sensitive than EBIC methods and that the measurements are not absolute but relative to a precalibrated sample.

In the Hahn-Meitner method, the laser beam generates excess charge carriers in the sample, altering its conductivity. As a result, the microwave field probing the sample is partially absorbed by an energy-exchange process that takes place between that field and the charge carriers. The amount of energy absorbed during the exchange is a function of the excess charge-carrier density.

The sample reflects the microwave field to a detector that measures the difference in the energy of reflections from illuminated spots and from nonilluminated spots. From this difference, the change in the photo-induced conductivity in the sample, and therefore its quality, can be deduced.

As Kunst explains it, a small change in the microwave signal means a short life of the excess charge carriers. This points to a large number of defects in the sample. A large microwave signal change, on the other hand, means that the extra charge carriers will stay longer. This, then, indicates the sample has few or no defects.

The researchers have brought their photo-induced microwave-absorption technique to a point where it could go commercial soon if a systems producer decides to implement the method in a marketable package. Such equipment could become a valuable tool for use on the production line and in the laboratory, for incoming inspection and in quality control.

To be sure, competing light-based contactless methods have been pro-

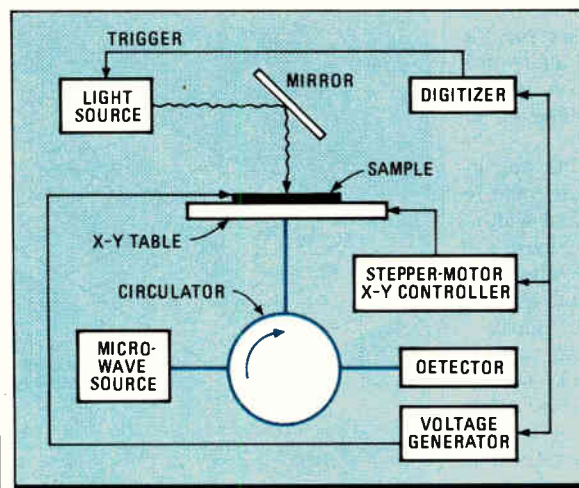

SAFE TEST. A low-energy laser beam and microwaves are the basis for a way to test semiconductors nondestructively.

posed in the U. S., Japan, and elsewhere, Kunst says. These measure the luminescence induced in the sample. But only those charge carriers that luminesce are evaluated. The Berlin technique, on the other hand, takes into account all locally produced excess charge carriers in the sample; so it is more reliable because a direct relationship exists between the quality of the material and the microwave signal.

In the team's experimental setup (figure, p. 23), a vacuum chuck holds the sample above an opening in an X-Y table. This opening is formed by the end of a waveguide for microwave frequencies from about 26 to 40 GHz. The laser, a helium-neon type, has an output between 10 μ W and 10 mW.

Microwave power from a Gunn oscillator is guided to the sample by a broadband isolator and circulator. When re-

flected by the sample, that power is detected with a point-contact diode, and the detector's output is fed to an amplifier. To prevent saturation of the detector diode, the reflected microwave power is attenuated to values in the order of about 1 mW.

The light from the laser, after passing through a lens system, focuses on a spot about 2 μ m in diameter on the sample. The incident laser power can be varied by filters and is always less than 3 mW, yielding a temperature rise of a negligible 1°C. Chopping the laser beam produces the reference signal for the amplifier.

The sample-carrying table is moved in 1- μ m steps relative to the light spot. The change in the light-induced signal at each sample position is either displayed on an X-Y recorder or sent to a computer for evaluation. —John Gosch

differences are that 1862 has orthogonal addressing modes, very much like the [Digital Equipment Corp.] VAX architecture has, with multiple operands for each instruction and multiple addressing modes for each operand. The V32 design is more of a register-to-register view. The addressing modes are handled as separate instructions. It's not quite a load-store instruction set, but it does have that flavor."

"We need a good 32-bit architecture," says Maj. Allan Kopp, deputy director of the AJPO. The impetus behind the 32-bit effort was the need to overcome the addressing limitations of 16-bit ISAs. Software written for 16-bit systems is limited in size because 16 bits can directly address only 64-K bytes of memory.

The AJPO is reviewing the preliminary V32 specification, which Tartan submitted last November after putting in about a year's effort. A 1750A users' group, under the auspices of the Society of Automotive Engineers, reportedly is also examining the V32 proposal. Says Kopp, "There are around 26 different vendors that build implementations [of the 1750A ISA] on their computers," so contractors will have plenty of companies to choose from. "That's the same kind of community that has been looking for a 32-bit choice. And what we're going to do, essentially, is hand them one and see if they're inclined to build to that architecture." —Alexander Wolfe

MILITARY ELECTRONICS

DOD SEEKS A STANDARD 32-BIT INSTRUCTION SET

NEW YORK

The 32-bit world has been largely off limits for developers of military software. Their standing order of the day has been to work with MIL-STD-1750A, the U. S. Air Force's 16-bit computer-architecture standard.

But soon that may well change. A new standardized instruction-set architecture (ISA) is taking shape at the Defense Department. Developed by Tartan Laboratories Inc., Pittsburgh, under contract to the Defense Department's Ada Joint Program Office (AJPO), the new ISA is sought as a successor to the existing Air Force norm.

Tartan's proposed architecture, dubbed the V32, used the Army's MIL-STD-1862B 32-bit ISA as a starting point. MIL-STD-1862B was intended to be implemented as a chip set for the Army's Military Computer Family program, but the hardware never got off the ground, reportedly because of its complexity and expense.

ARCHITECTURE ON CHIP. AJPO was interested in an architecture that could be put on a chip with 0.5- μ m line widths, the feature size targeted by Phase 2 of the DOD's Very High-Speed Integrated Circuits program, says Leland Szeverenko, Tartan's V32 program manager. "We tried to come up with something of the complexity of a Motorola 68000," which is significantly simpler than VHSIC chips. "We wanted to low-ball them [the AJPO] so they'd have the ability to get it into silicon reasonably rapidly." A simpler design would also have space for on-chip memory and floating-

point coprocessors in VHSIC versions.

Technically, the reduced hardware complexity comes from a simpler instruction set. The original 1862B design was completely revamped. "They're radically different," says Szeverenko. "The

OPTOELECTRONICS

ROUTING LIGHT SIGNALS WITH NO BANDWIDTH LOSS

STOCKHOLM, SWEDEN

How well telecommunications-equipment makers do in the next decade and thereafter depends largely on how soon their engineers can figure out how

to switch optical signals without reducing the original bandwidth. Such switches are crucial to the optical networks that should become the mainstay of telecommunications networks in the 21st century.

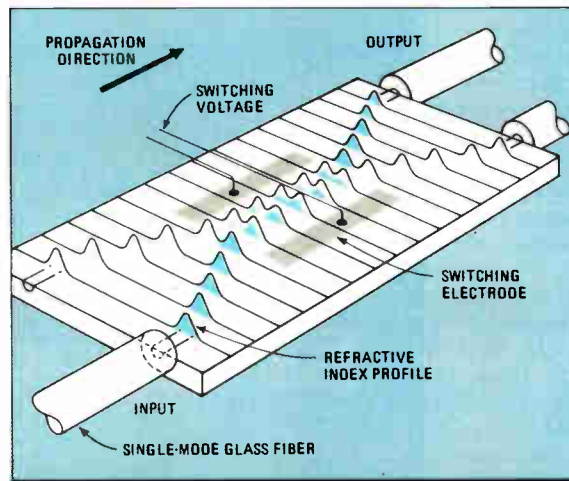

BUILDING BLOCK. Ericsson's matrix has 64 directional couplers that switch streams of optical data from input to output.

All major players in the field are hard at work on optical switches. But the front-runner at the moment appears to be LM Ericsson AB. The Stockholm company, working with its components-producing subsidiary Rifa AB and the Heinrich-Hertz Institute in West Berlin, has integrated an eight-by-eight optical switching matrix on a 60-by-5.4-mm lithium niobate chip. Until now, four-by-four matrices—by NEC Corp. in Japan and AT&T Bell Laboratories in the U. S.—were the state of the art

**When it's time to build
your ISDN system...**



SIEMENS

...Siemens new ISDN chips can set it all straight!

"Getting it straight" in the complex world of ISDN-based telecommunications systems hasn't been easy. Until now. That's because now Siemens offers two important "firsts" – two key ISDN chips specifically designed to meet your most demanding requirements:

- PEB 2070 – ISDN communications controller (ICC)
- PEB 2080 – S-bus interface circuit (SBC)

Designed to meet CCITT specifications, both chips are based on $2\mu\text{m}$ CMOS technology. In switching, transmissions, terminals, and telephone sets they offer maximum flexibility for the needs of today's telecom system suppliers by providing:

- IOM[®] interface for flexible allocation of ICs within a system
- Efficient use of the same chip for multiple system applications
- And much more!



Our new PEB 2070 and PEB 2080 are the nucleus of a family of VLSI chips for ISDN applications designed by Siemens in cooperation with major systems houses.

Get detailed information now. Write to Siemens AG, Infoservice 12/Z 004, P. O. Box 23 48, D-8510 Fürth, West Germany, quoting "PEB 2070/2080".

The key to digital communication systems



IOM® — ISDN Oriented Modular Architecture



Analog Devices packs unmatched functional density into a line of CMOS D/A converters.

Starting today forget about allotting board space to single DACs. Our line of multiple DACs is packaged in narrow 0.3" DIPs.

So, you save board space as well as component count and dollars. Furthermore, since the overhead logic and latches are shared by two to four DACs, you save on power dissipation. And you know what that means for reliability.

Analog Devices gives you the broadest line of space-saving multiple DACs in the industry. Everything from duals to quads and back again. There's a logical reason for this. Our advanced linear CMOS technology enables us to offer outstanding functional density and the reliability you get only in these high performance multiple DACs.

For more information on our multiple DAC family call your local Analog Devices Sales Office for specification sheets on the four DACs included here.

Then you can forget about ever being desperate for board space again.



**ANALOG
DEVICES**

AD7549 **NEW**
Model AD7549

Description Dual 12-bit Monolithic Multiplying DAC
Output Current
Package 20-pin, 0.3" narrow DIP

AD7225 **NEW**
Model AD7225

Description Quad 8-bit CMOS DAC with Output Amplifiers, Separate Reference Inputs for multiplying applications. Double Buffered Latch Structure for Simultaneous Update
Output Voltage
Package 24-pin, 0.3" narrow DIP

AD7528 **Model AD7528**

Description Dual 8-bit Monolithic Multiplying DAC
Output Current
Package 20-pin, 0.3" narrow DIP

AD7226 **Model AD7226**

Description Quad 8-bit CMOS DAC with Output Amplifiers, common reference input for all four DACs
Output Voltage
Package 20-pin, 0.3" narrow DIP



**When you're desperate
for board space,
try our multiple DACs.**

Analog Devices, Inc., Two Technology Way, Norwood, MA 02062-0280; Headquarters: (617) 329-4700; California: (714) 641-9391, (619) 268-4621, (408) 947-0633; Colorado: (303) 590-8906; Illinois: (312) 653-5000; Maryland: (301) 992-1994; New York: (716) 425-4101, (315) 437-5277; Ohio: (614) 764-8795; Pennsylvania: (215) 643-7790; Texas: (214) 231-5094, (713) 664-6704; Washington: (206) 251-9550; Belgium: (3) 237 48 03; Denmark: (2) 845800; France: (1) 687-34-11; Holland: (1620) 81500; Israel: (052) 28995; Italy: (2) 6883831, (2) 6883832, (2) 6883833; Japan: (3) 263-6826; Sweden: (8) 282740; Switzerland: (22) 31 57 60; United Kingdom: (01) 9410466; West Germany: (89) 570050

Circle 29 on reader service card

in fully optical switching.

In Ericsson's chip, light signals pass directly through at full bandwidth and with very little attenuation—from 5 to 7 dB. "The chip can route signal streams running at terabits [10^{12} bits] per second," says Hans Ecklund, deputy manager of Ericsson's Fiber Optic Development Department.

Ecklund expects the chip, now a laboratory prototype, will be upgraded to a practical switching element for routing optical signal streams in the next five or six years. But he predicts that matrices large enough to build fully optical telecom exchanges will come much later—in the late 1990s, at the earliest.

The matrix is built around 64 optical directional couplers. Each coupler carries a pair of $5\text{-}\mu\text{m}$ -wide integrated light waveguides (figure, p. 24). The waveguides are $360\text{ }\mu\text{m}$ apart at the ends of the coupler, leaving room to connect a

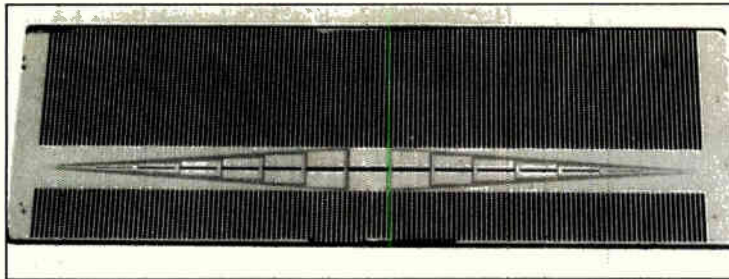

EIGHT BY EIGHT. The 60-by-5.4-mm integrated optical matrix routes light signals between input and output without converting them into electrical pulses.

pair of optical fibers. The guides fan in toward the center line of the chip and at the middle are only $8\text{ }\mu\text{m}$ apart; electrodes flank the guides at that point. Because the distance between guides is so small, light can be deflected from one guide to the other by applying 30-V peak-to-peak signals to the electrodes.

The underlying physical phenomenon is the change in the waveguides' refraction index because of the electro-optical effect in LiNbO_3 . The switching time is about 100 ns, Ecklund says.

At the outset, Ericsson's researchers

figured they would have to apply a fairly complex pattern of switching voltages to the 64 couplers on the chip. But it turned out that the matrix can function with the same voltage that is applied at the electrodes. Crosstalk is better than 22 dB for all couplers on the chip, except one.

Although the matrix is only a prototype, Ericsson already has ideas on where to take it next. One is to scale it up to a 16-by-16 matrix, which would open up more practical applications for it. Another is to do away with the switching signals. Changes in the index of refraction at switching points could be achieved by light beams exploiting the nonlinear optical characteristics of LiNbO_3 , Ecklund says.

Finally, Ericsson researchers want to free the LiNbO_3 chip of one of its few limitations: its polarity dependence. Ecklund won't hint on how they plan to do that.

—Arthur L. Erikson

TELECOMMUNICATIONS

ITT REINS IN ITS TROUBLED SYSTEM 12

NEW YORK

When chairman and chief executive officer Rand Araskog announced ITT Corp. was canceling plans to convert its System 12 digital exchange for the U.S. market, Wall Street analysts praised the move as a boon to the company's future earnings. But the move, which cost ITT \$105 million in write-downs against 1985 net income, raises broader questions about ITT's technological prowess and its future in world telecommunications markets.

ITT representatives here and abroad rebut reports that the project was canceled because of insurmountable technical barriers. They say that market opportunities in the U.S. didn't justify the expense and effort required to adapt the system. AT&T Co. and Northern Telecom Ltd. maintain a commanding lead in that market, and ITT was not interested in being No. 3.

TOO LATE. "It was stupid to anticipate coming into the North American market in the first place," says W. Spencer Rice of S&R Consultants Ltd. in Madison, N.J. "Any fool would have known two or three years ago what the product plans and schedules of AT&T and Northern Telecom were, and they have a lot more experience in North America than ITT."

ITT readily recognizes that it misread the U.S. market for digital switching. It was unprepared for the need for digital

systems on the part of regional operating companies, which "converted to digital a lot faster than everyone ever thought they would," says a company representative in New York. "They bought equipment from their traditional suppliers in 1984 and 1985, and that left very little room for newcomers who wouldn't be able to deliver product until 1987 and thereafter."

ITT invested 18 months and between \$100 million and \$150 million in the conversion without coming close to a marketable product. Completion would have

ITT recognizes it misread the U.S. market for digital switching

cost almost two more years and upwards of \$200 million, the company admits.

But the conversion wasn't ITT's only problem; the company has troubles on both sides of the Atlantic. Although it claims to have contracts for 12 million lines on 2,275 System 12 exchanges in 21 countries, analysts and the competition don't believe it. Rice thinks many of those orders will soon be canceled and says ITT should have concentrated its efforts on developing an integrated services digital network switch in Europe, where its failure to do so has locked it

out of markets in Great Britain, the Netherlands, and Germany.

Meanwhile, ITT maintains that more than 1 million System 12 lines have been delivered and that ending the U.S. conversion project will strengthen its ability to compete overseas by concentrating money and engineering talent in its traditional European turf.

BACKPLANE WOES. The conversion involves hardware and software changes. "It is not just a question of switching the power supplies from the European requirements to ours, though power plants aren't cheap," says Rice. "The biggest obstacle is the backplane problem. The System 12 never developed a line card to North American standards," which call for a 24-channel system as opposed to the 32-channel system in the CCITT standard used in Europe.

About 35% of the System 12 hardware had to be redesigned for use in the U.S., Rice says, adding that "the European version of System 12 was not originally designed for ISDN and least-cost-routing and other features" that are not popular in Europe but are demanded in the U.S. System 12 had to be retrofitted for those features. But the real nightmare was redoing software so the system could recognize the signals from the variety of telecommunications gear installed in North America. "When you're talking software," he says, "the sky's the limit." —Tobias Naeye

Gould... Innovation and Quality in Logic Analyzers

Gould proudly announces six new additions to its family.

A proud lineage continues.

Gould knew a good thing when they saw Biomation and its precedent-setting K100 logic analyzer. We've built on that heritage to bring you the industry's most comprehensive line of logic analyzers.

One Gould Logic Analyzer is exactly the right tool for the job you're doing. Why pay for more analyzer than you need? Or settle for too little? Also, you can trade up for more sophistication without trading away ease of use.

And now, six new models extend and enhance our line.

The new K20 and K40 make Gould performance affordable for service and repair applications, as well as jobs where portability is important.

The new K115 and K450 models set new performance standards. The K115 may well be the best μ P logic analyzer around. And the K450 has all high-speed channels for complex multi- μ P and VLSI problems.

The new K125 may look plain, but it's a beauty below the surface. Handles up to 80 channels per mainframe. It makes CAE/CAD faster, more productive and leverages your engineering investment into ATE production.

And yes, there is a doctor in the house—the PG110. It checks up on our logic analyzer family—including

the well-known K100/T12, K105, K205 and K500 units—to keep them up and running.

For details on Gould's New Generation in Logic Analyzers, call **TOLL-FREE (800) 538-9320, in Calif. (800) 662-9231**. Or simply write: Gould Inc., Design & Test Systems, 19050 Pruneridge Ave., Cupertino, CA 95014. Because a family that stays together pays.

***The New Generation
in Logic Analyzers***

"Congratulations, it's a GOULD!"



K450 Logic Analyzer



NEW

NEW K450. All high-speed channels: 10ns resolution across 48 channels at 100 MHz or 5ns across 24 channels at 200 MHz. 5ns glitch capture on all channels with no loss of memory. 4K memory depth. Unique Auto Save for saving failures in unattended mode.



NEW

NEW K115. "The μ P analyzer." Up to 72 channels for state/timing, 200 MHz on up to 8 channels. All key software/hardware integration tools, noise margin analysis, tolerance compare. "Trace Control." Multi-level "Help." Disassembler: for all popular μ Ps, incl. 68020.



NEW

NEW PG110. Pattern generator has 96 data channels with 1.5ns data skew. Built-in patterns for ease of use.



NEW

NEW K20. Low cost. Weighs only 9 lbs. 8-ch. timing analysis. 24-ch. software debug. 3-level triggering. "Help" key. Easy to use.



NEW

NEW K40. 32-ch. software or timing analysis. 4-level triggering. Setup/compare memories. Plus μ P option.



NEW

NEW K125. Use with CAE/CAD/ATE. 80-ch. capacity up to 200 MHz. ATE software packages, IBM PC controlled. Expand with multiple mainframes.



GOULD
Electronics

Circle 31 on reader service card

THE BEST.

..... in accuracy

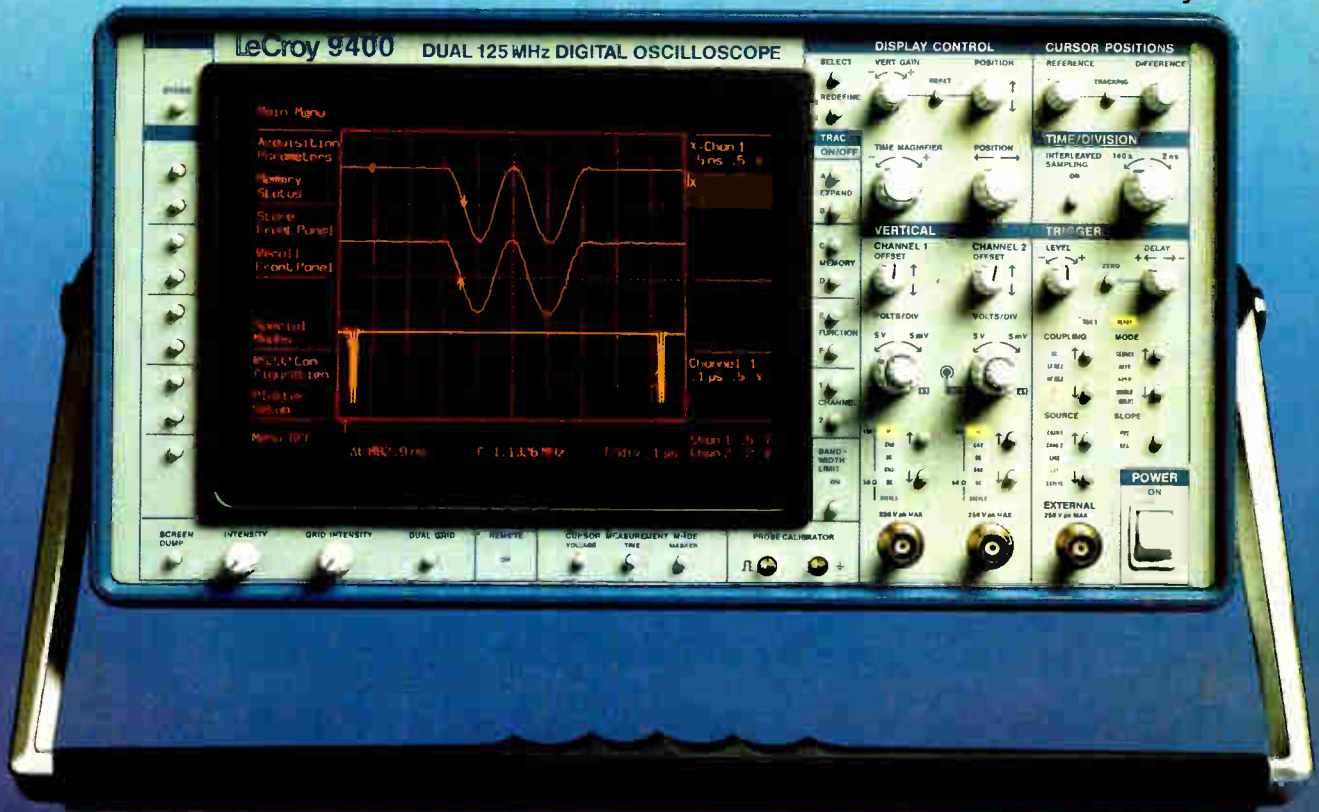

125 MHz BW; 100 MS/s ADCs; 5 GS/s Interleaved Sampling; 128 k Waveform Memory; $\pm 1\%$ Accuracy; Summation and Continuous Averaging; Arithmetic Processing; Fully Programmable.

TIME RESOLUTION. Ultra-precise timing measurements — often needed in digital circuit design, lasers, racars, PCM, fiber optics, ultrasound testing — demand the LeCROY 9400's 40 psec time resolution. No other scope meets this standard, set by the 9400's *crystal-controlled time base*, uniquely precise *100 MS/s ADCs*, deep *32 k memories* per channel and sophisticated *cursor facilities*. And 32 k words/ch of memory permit *segmentation* into 8 up to 250 partitions while still maintaining horizontal resolution similar to common DSOs.

ACCURACY. Time measurements can be done with *0.002% accuracy*. The vertical accuracy of a standard 9400 is $\pm 2\%$ or optionally even $\pm 1\%$. This means the 9400 is as much as *3 times* more accurate than any other scope today.

For detailed inspection of your acquired waveform, the 9400 features the exclusive *Dual Zoom* mode for up to 100 times expansion. Dual Zoom gives you two expanded traces per signal source - and when you increase the x-factor, precision and resolution improve, not deteriorate as in DSOs with shorter record lengths.

DISPLAY. The extra-high-resolution large display does full justice to the 9400's exceptional precision. *Vector graphics*, unlike raster scans, show continuous traces, finely detailed, razor sharp, without jaggies. The 1,000 x 1,000 point resolution even exceeds that of a normal analog scope.

★ And there is much more to say about this versatile and cost effective (\$9900 base*) DSO. Call us now...for details and a demonstration!!

*USA price list only.

LeCroy

700 S. Main St., Spring Valley NY 10977, (914) 578-6038; Geneva, Switzerland, (022) 823355; Heidelberg, West Germany, (06221) 49162; Les Ulis, France, (1) 6907-3897; Rome, Italy, (06) 320-0646; Botley, Oxford, England, (0865) 727275.

Representatives throughout the world.

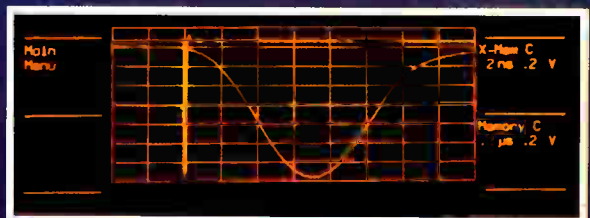
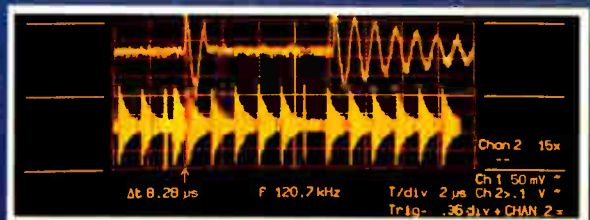

Top: Dual zoom and time cursors are applied to measure delay between double pulses with 100 ps resolution and 0.002% precision.

Middle: Channel 2 is segmented in 15 partitions of 2,000 words each. Expansion of event #3 appears on top.

Below: A 10 ns wide pulse is digitized with 5 GS/s interleaved sampling speed. Expansion to 2 ns/div shows outstanding time and screen resolution.

Circle 32 for information
Circle 124 for demonstration

INSIDE TECHNOLOGY

SELF-TESTING ICs BEGIN TO EMERGE—TENTATIVELY

ALREADY, DESIGNERS SEE A NEED IN ANY CHIP LARGER THAN 6,000 GATES

by Alex Mendelsohn

Very large-scale integrated circuits that test themselves are here. They are emerging, however tentatively, as a solution to the cost and complexity of testing such big chips as large VLSI arrays—some of which have reached 20,000 gates—and semicustom gate arrays and standard cells, which are also reaching unprecedented densities as users look to use them in place of standard logic devices. Chips with built-in self-test circuitry test themselves—functionally, structurally, or both—and in some cases even offer on-chip automatic test-pattern generation.

Merchant and semicustom IC makers Motorola, Intel, National Semiconductor, and Honeywell are testing the water with standard products such as microprocessors or large custom gate arrays with built-in self-test capability. Captive IC makers Control Data Corp. and ETA Systems Inc. use patented built-in self-test techniques in-house and in turn license these techniques to the likes of Motorola, National, and Honeywell.

Self-testing ICs are at the leading edge of structured design-for-test methodologies, which are coming to replace ad hoc approaches to large-chip testing such as partitioning, bringing out buses, or adding test pins to certain products. Structured design for testability of very dense custom ICs, where internal gates are often extremely difficult to control and observe, has been on the rise at a number of large vertically integrated minicomputer and main-frame manufacturers to ensure testability as well as the manufacturability of these big chips.

Most built-in self-test schemes rely on signature analysis, a technique in which short, coded signals, or signatures, of an on-chip test pattern observed at specified nodes

1. SIMPLE. Motorola's MC6804P2 has built-in functional self-check capability (a). On-chip memory test (b) uses a cyclical redundancy check.

are compared against signatures from a known-good device derived during logic simulation. Linear-feedback shift registers usually are employed as the test-pattern generators or as pseudorandom number generators.

Built-in self-test exacts an average silicon real-estate penalty of about 12% in a large gate array, compared with the 15% to 20% required by other design-for-test techniques such as

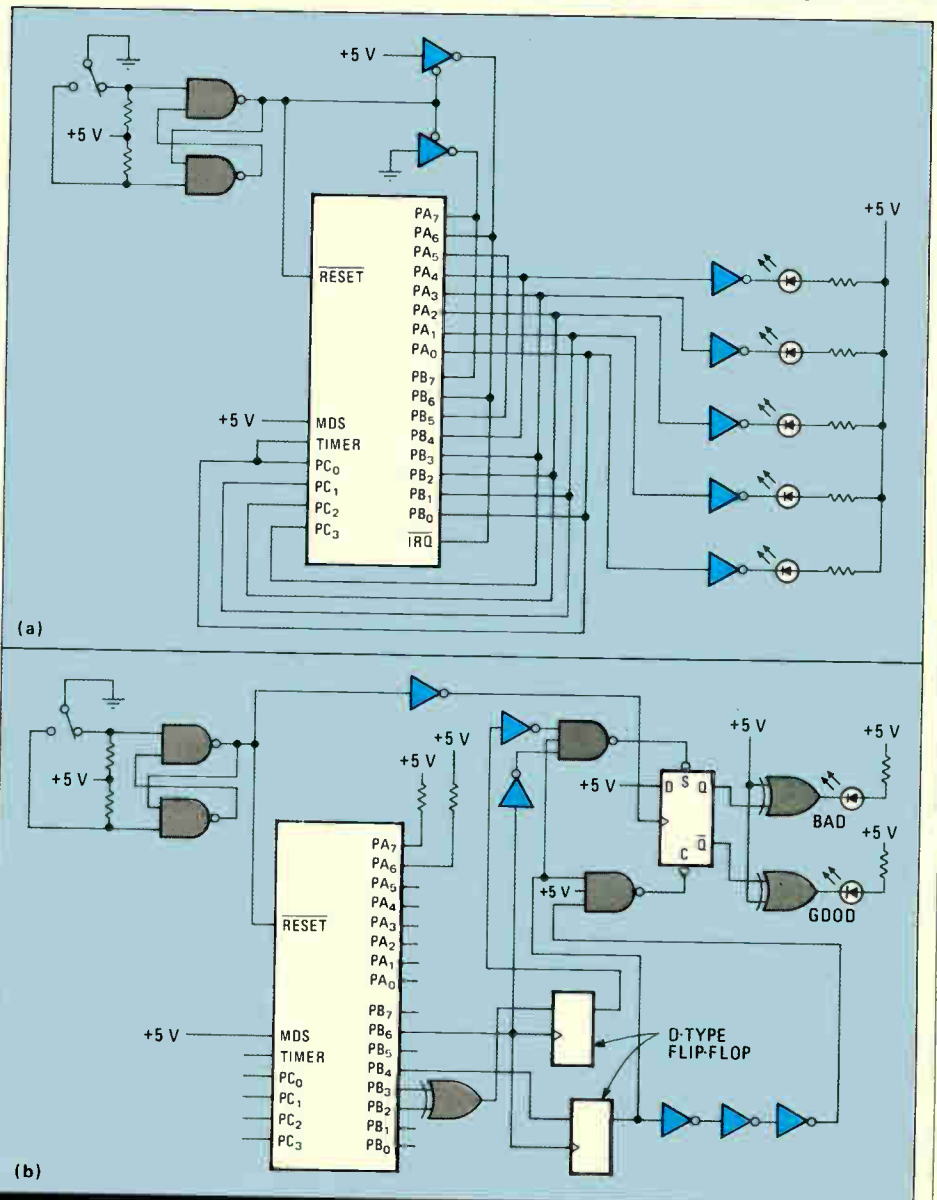

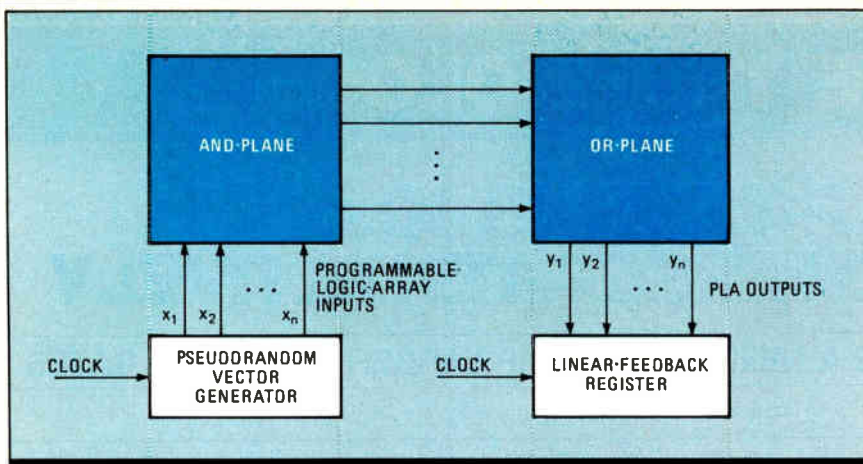

2. PLA TEST. To test large programmable logic arrays on Intel's 80386, pseudorandom input combinations are sequenced and the outputs fed into a linear-feedback shift register.

level-sensitive scan detection. And the costs of a custom chip with such specialized circuitry can be balanced against the engineering, packaging, and conventional-testing costs, making them potentially more cost-effective. Still, many designers are taking a wait-and-see attitude.

"Both merchant and semicustom semiconductor vendors are just beginning to crack the code on this," says Paul Bardell, manager of advanced engineering manufacturing at IBM Corp.'s Poughkeepsie, N. Y., facility. Bardell says that virtually all captive IC makers now consider on-chip test circuits part of the philosophy of designing an application-specific IC.

"Beyond 5,000 or 6,000 gates, having self-test circuitry on chip becomes mandatory," says Vince Liu, marketing manager for CMOS gate arrays and customer-specific products at National Semiconductor Corp., Santa Clara, Calif. "Companies are just beginning to catch on."

STANDARD PRODUCTS

For some time, forward-thinking standard-product vendors have used design-for-test techniques to ensure that their circuits, which often incorporate large programmable logic arrays, can be tested thoroughly and in a minimum amount of time. Most of this effort has been to ensure manufacturability and improve yields, but in some cases, users have access to the built-in self-test circuitry.

In microprocessors, for instance, Motorola historically has played a significant role in developing self-test capability for in-house testing as well as for end users. Motorola's design, test, and product engineering departments began working together on new-product development in the late 1970s. Out of this effort came products with read-only-memory-based self-test capabilities such as the MC6804P2-bit-serial single-chip microcomputer (Fig. 1a) and the 8-bit MC68HC11 CMOS central processing unit. These products let users perform exhaustive tests quickly at incoming inspection, at board test, and even in the field.

The MC6804P2 was the first Motorola product to use a signature-analysis technique to provide test-response evaluation. Because the MC6804P2 operates serially internally, shifting data to the output ports for parallel access, it is difficult to test conventionally.

The on-chip built-in self-test circuitry, which occupies only about 5% of the die, overcomes this problem. When the circuit is brought out of reset, a program in on-chip random-access memory starts a signature-analysis process that uses polynomial division to compress lengthy output responses. Two dedicated 8-bit shift registers perform a cyclical redundancy check

for signature analysis using a CCITT telecommunications-standard polynomial division process.

Common to many built-in self-test circuits, linear-feedback shift registers with serial inputs are used and certain outputs are exclusive-ORed together. Output taps on the linear-feedback shift registers correspond to the terms of the polynomial divisor. Input data is ORed with the data at the taps to form a new remainder on each successive shift-register clock.

Upon reset, the MC6804P2's program counter is cleared and initialization data—what is known as a seed value—is forced into the signature register. The machine then executes a two-cycle instruction, output data is shifted into the shift register, and a signature is shifted off-chip for verification. An additional ROM test can test both the customer's

code and the self-test ROM (Fig. 1b).

The MC68HC11 uses a boot-loader mode to automatically load an external ROM-based test program to a 256-byte RAM through the chip's serial communications port. Once the memory is loaded, the MC68HC11 jumps to RAM and executes the program. After the boot ROM code is forced into the memory, the contents are verified with a special Test instruction. This instruction performs a data dump, continuously incrementing the program counter and thus generating increasing sequential addresses. The MC68HC11 also includes special test bits, register locations, and ad hoc functions that allow self-test at the board or system levels.

Newer and more-complex Motorola products such as the MC68020 32-bit microprocessor and companion MC68881 arithmetic coprocessor incorporate self-test as a key to ensuring testability at a variety of points in the manufacturing process. Designers of the MC68020 used a combination of functional and structured testing to keep die size at a minimum and test times reasonably short. An execution unit is tested functionally; control logic uses structured test.

For testing control logic, bus partitioning and multiplexers with external test microcode provide input data rather than on-chip microcode for self-test. Some of the chip's PLAs use this deterministic set of test vectors that originate from an external tester.

Deeply buried PLAs in the 68020, however, use a special on-chip microcode incremented signature-analysis register to apply vectors to entry-point PLAs. The execution unit plus a signature register and multiplexer together create an exhaustive on-chip self-test capability. Although the special multiplexers were used to segregate the PLAs, the additional signature register makes the PLAs the only structures that are truly oriented for built-in self-test. The scheme doesn't rely on partitioning.

Rivaling Motorola in the 32-bit microprocessor market, Intel Corp. also hopes to win design-ins by offering products with user-oriented self-test capability. The Santa Clara company is also using its new 80386 microprocessor's built-in self-test capability as an internal aid during wafer fabrication and post-packaging test. Intel's advanced 32-bit product will give users access to the self-test capability (Fig. 2).

Intel figures that users will embrace the idea of linear-feedback shift registers generating random pattern sequences for each of the PLAs on the 80386 because they will not have to generate test vectors externally, as with the Motorola parts. Users will now be able to test these PLAs—which protect operating-system memory space and decode instruc-

National plans to offer built-in self-test across its product lines

tions—by cycling through a huge number of possible input combinations. The PLA outputs are then accumulated in another linear-feedback shift register to produce a compressed signature that is checked against a known-good value. The Intel chip also self-tests control ROM and microcode for the microcode engine with built-in self-test sequences generated by the linear-feedback shift registers.

The only limitation, according to Rakesh Agarwal, senior design engineer of the 80386, is that random logic cannot be tested this way economically. Thus the translation look-aside buffer and the content-addressable memory circuits are still tested using external microcode; the test patterns can be written with special instructions and two on-chip dedicated registers. The specialized test circuitry compares any data pattern (generated from an external source) against existing data in the translation look-aside buffer, testing its ability to match data output to test-vector inputs. Although this is not a completely built-in self-test system, without the additional testability circuitry on chip, the task would take too many entries and patterns, and would thus consume an inordinate amount of test time.

An idea born at Control Data Corp. is mitigating the high cost of testing VLSI gate arrays conventionally. Designed originally for use in the Minneapolis company's minicomputers and introduced about two years ago, the On-Chip Maintenance System is now embodied in high-density CMOS gate arrays marketed competitively by Motorola, National Semiconductor, and VTC. The On-Chip Maintenance System circuit (Fig. 3) generates test vectors internally by means of a linear-feedback shift register that functions as an on-chip pseudorandom-number generator. On-chip patterns are sequenced through the gate array's inputs; resulting data is routed through a data compressor, where signature analysis takes place.

For licensed vendors, this system helps customers sidestep costly test-pattern generation while testing devices thoroughly at operational speeds. Up until now, most designers tested only certain critical paths at high speed, possibly missing paths with delays that were buried deeper in a structure.

National Semiconductor's SCX6260 gate array uses the On-Chip Maintenance System, which brought board-level signature analysis to the commercial chip level. The silicon-gate CMOS chip, with 850-ps (typical) gate delay, is aimed at users of emitter-coupled-logic and slower TTL chip families.

The part has 6,000 gates in the matrix, 2,500 of which implement the On-Chip Maintenance System test circuitry. The die area for test, however, is only 12%, compared with the typical 15% to 20% required by level-sensitive scan-detection design. The chip's macro library includes eight macros for the On-Chip Maintenance System.

In a typical high-speed board-level im-

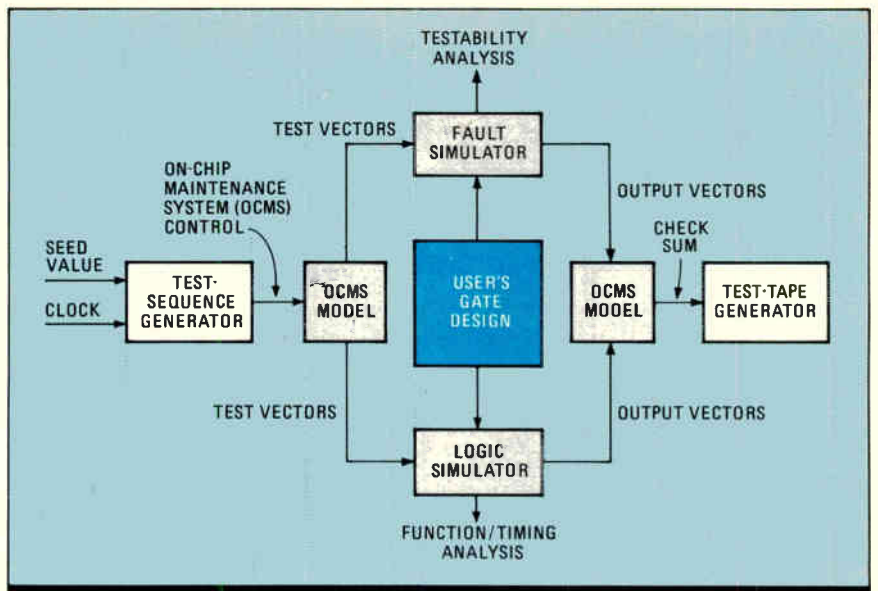

3. SYNERGISTIC. CDC's On-Chip Maintenance System provides a base for testability enhancement, locating sequence-dependent faults with simple software and a small data base.

plementation using the SCX6260, the known-good signatures would be stored in ROM or erasable programmable ROM. More than one gate array on a board can be tested by means of a single IC with the On-Chip Maintenance System.

The concept is still considered very advanced, Liu says. Though the SCX6260 is the only National Semiconductor product currently embodying built-in self-test, Liu says the same self-test features will be used across the company's emerging product lines in custom gate arrays.

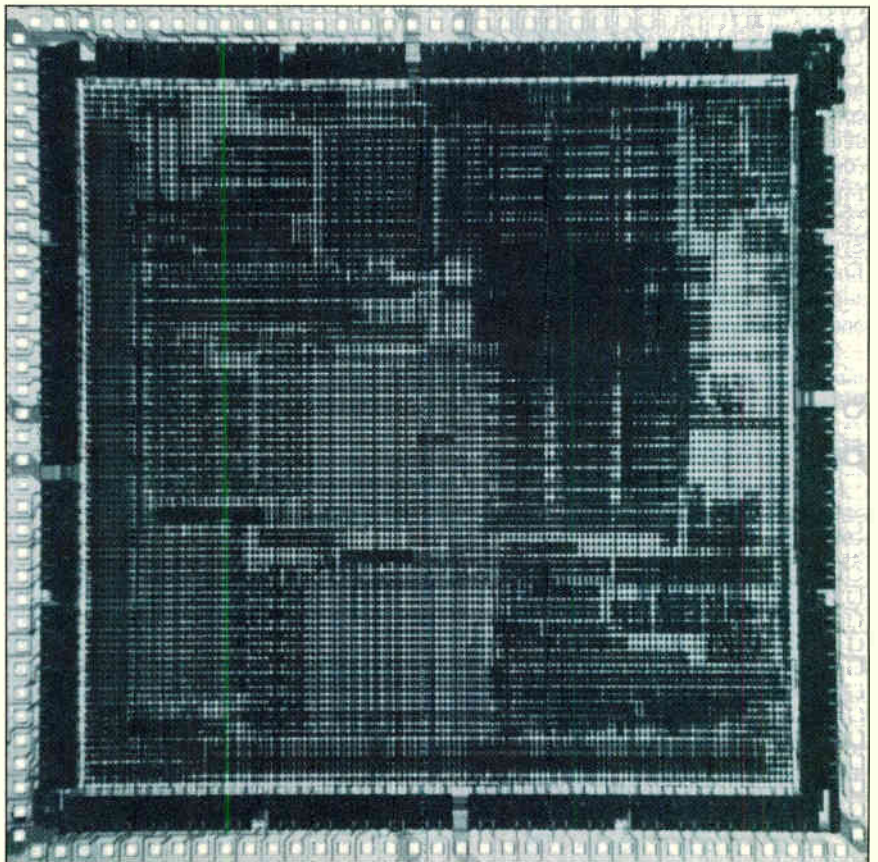

4. BIG ARRAY. Honeywell's commercially available HC20000 CMOS array features noncustomizable evaluation and self-test circuitry around the chip's periphery to aid testing by user.

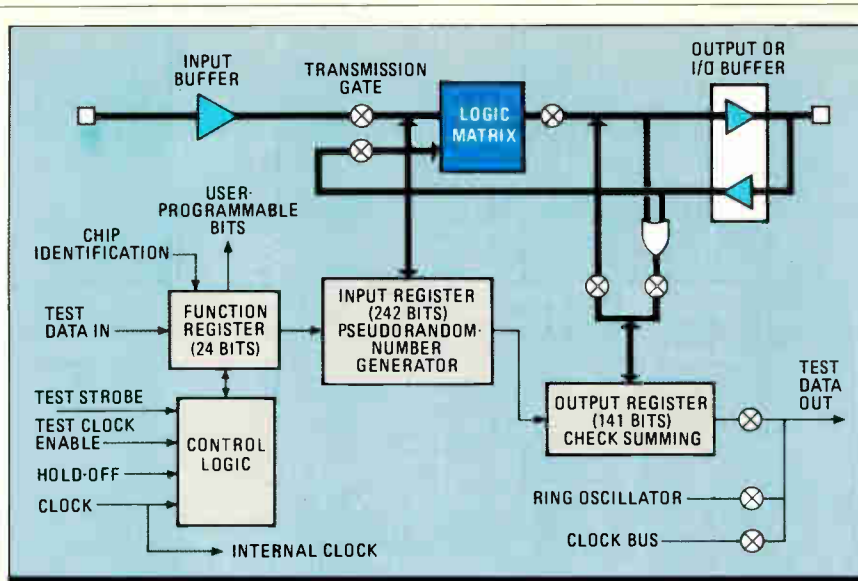

5. THE BEST. Honeywell's Built-in Evaluation and Self-Test system provides pseudorandom input to the logic, check summing of outputs, and dynamic monitoring through a ring oscillator.

But the competition is hot. Under the terms of the Control Data licenses, prospective customers of Motorola, National Semiconductor, or VTC must use Control Data's design-support services and its Modular Integrated Design Automation System. Midas provides design description and schematic entry, logic verification, and test functions for all three vendors' customers. Automatic fault-simulation software is part of the Midas design cycle. Working closely with the On-Chip Maintenance System, it ultimately produces place and route tapes that are readable by the silicon vendor. It also produces test tapes, eliminating the need for expensive translation of test operands into other data formats.

At the moment, these design-data files can be transferred over a Control Data Cybernet data network to a Cyber 180 computer system. With three vendors supplying the same silicon, and all customers developing circuits using identical computer-aided-design tools, the value-added service that each foundry provides plays a key role in the ultimate user acceptance of gate arrays equipped with the On-Chip Maintenance System. The same is true for Control Data. As users begin to find the approach acceptable, with good CAD support, it seems likely the way will be paved for future products embodying on-chip maintenance.

Motorola, for one, is optimistic. The company plans to promote the semicustom HD6260 with the On-Chip Maintenance System heavily in 1986.

SECOND GENERATION

Control Data's On-Chip Maintenance System is now spawning second-generation developments. The original Control Data patent was licensed to subsidiary ETA Systems Inc. of St. Paul, Minn. ETA used it to develop built-in self-test circuitry in a 20,000-gate CMOS array with subnanosecond gate delays using 1.25- μm feature sizes that Honeywell Inc. developed and fabricated at its Solid State Device Center in Plymouth, Minn. [*Electronics*, Feb. 25, 1985, p. 18]. The results are dramatic: with the technique, ETA has built supercomputers without a single testability engineer on staff, according to Dave Resnick, ETA senior technologist and the array's designer. Resnick uses the On-Chip Maintenance System gate arrays extensively in ETA's superminicomputers. "We don't have to generate test sequences. All our parts are tested to the same Sentry test."

ETA supplies seed values, which are different from part to part, for a pseudorandom-number generator. Circuitry for out-

put signature analysis looks for different expected signatures, but the test sequence is always the same. Subsequent test programs use the data that the array develops internally.

The built-in self-test logic also lets Resnick's 20,000-gate design perform parametric tests. High or low logic levels, or forcing a high-impedance three-state condition, can be done at any pin of the array, regardless of the function of the logic. ETA averages over 97% fault coverage, with many parts attaining a 100% coverage level.

Honeywell has taken the On-Chip Maintenance System approach a step farther and developed Built-in Evaluation and Self Test, or BEST. It is now available from Honeywell Inc.'s Digital Product Center in Colorado Springs. As a licensed vendor for the ETA built-in self-test design, Honeywell now markets the BEST superset of the On-Chip Maintenance System to other U. S. computer vendors in the form of uncommitted

Honeywell gate arrays.

Using BEST, incoming test of the Honeywell HC20000 array (Fig. 4) can be done economically. All that's needed is a simple low-cost tester having as few as 30 pins. Though the HC20000 has 238 input/output pins, only six signal pins are needed to implement built-in-evaluation tests. (Fig. 5). The built-in evaluation circuitry operates at the full system-clock frequency—up to 30 MHz—thus providing ac performance characterization of the entire system, as well as spotting functional errors.

This is a significant feature at such high clock rates, where stray capacitance and lead inductance can have deleterious effects. The effects of packaging thus become testable. System and field-maintenance tests are also straightforward at operational speeds.

The BEST circuits are located on the periphery of the array, just as in the predecessor, and take up only 6% of the HC20000's real estate. Using only 2,000 logic gates, this still leaves 18,000 usable gates for customization.

SOME RESERVATIONS

Still, not all vendors are ready to hop on a built-in-self-test bandwagon. One reason for the slow adoption of built-in self-test is that many engineers prefer using existing CAD and computer-aided-engineering tools for test-pattern generation during the developmental design stage. System software that extracts test-pattern vectors and other fault-simulation techniques is in wide use and well understood, says Bill Carney, LSI Logic Corp.'s manager of advanced logic arrays. Some LSI Logic customers have done built-in self-test design themselves, but Carney believes that no particular technology has become an accepted methodology. "Nothing has clearly evolved, but we are paying close attention to built-in self-test," says Carney.

Even Motorola is hedging its bets for now. Though it offers the On-Chip Maintenance System-equipped HD6260 in its semicustom product line, the company continues to educate users about level-sensitive scan-detection techniques.

But IBM's Bardell believes that built-in self-test has much to offer once designers become acquainted with it and equipment evolves to meet it. "The necessary CAE tools for successful semicustom design are just beginning to arrive," he points out. "As people begin to realize the enormous economic problem of transferring test vectors across design interfaces, built-in self-test schemes will become more appealing and vendors will make them feasible." □

CONNECTORS

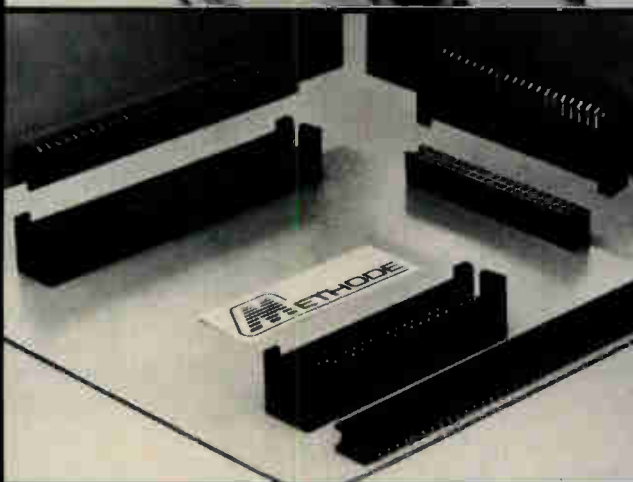
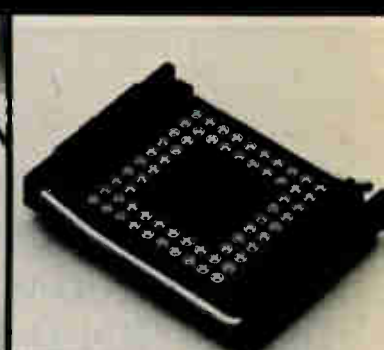
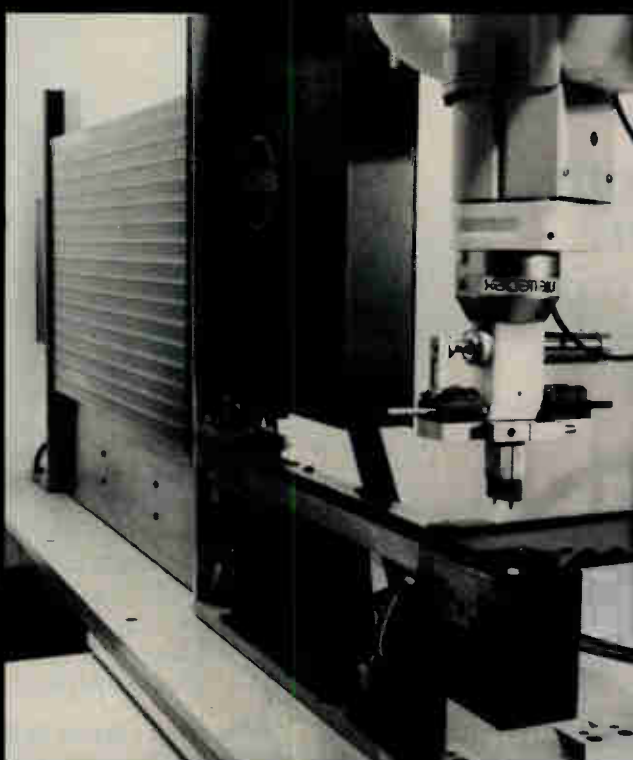

Electronics SPECIAL ADVERTISING SECTION

End time-wasting “hunt & poke” wiring!

IDC contacts offer more efficient high speed wiring of new RN D-Sub discrete wire connectors.

Insulation Displacement Contacts in these new DDM Series D-Sub discrete wire connectors cut wiring time, improve productivity over old “hunt & poke” wiring. No more clumsy wire stripping or inconsistent terminal crimping. Just push wire into pre-loaded IDC contact and you’ve made a fast, gas-tight, visually verifiable connection. And these new D-Sub connectors are available with selective contact loading to meet your specifications.

Because EMI/RFI shielding is so important, RN has incorporated flexible “grounding fingers” in the male D-Sub connector cowl. These new RN “grounding fingers” provide compliant fit to the mating cowl for reliable grounding and shielding effectiveness over extended connector cycling.

Application tooling.

RN offers economical tooling for individual wire insertion or mass termination. The arbor press, the hand tool, and a contact replacement kit are available.

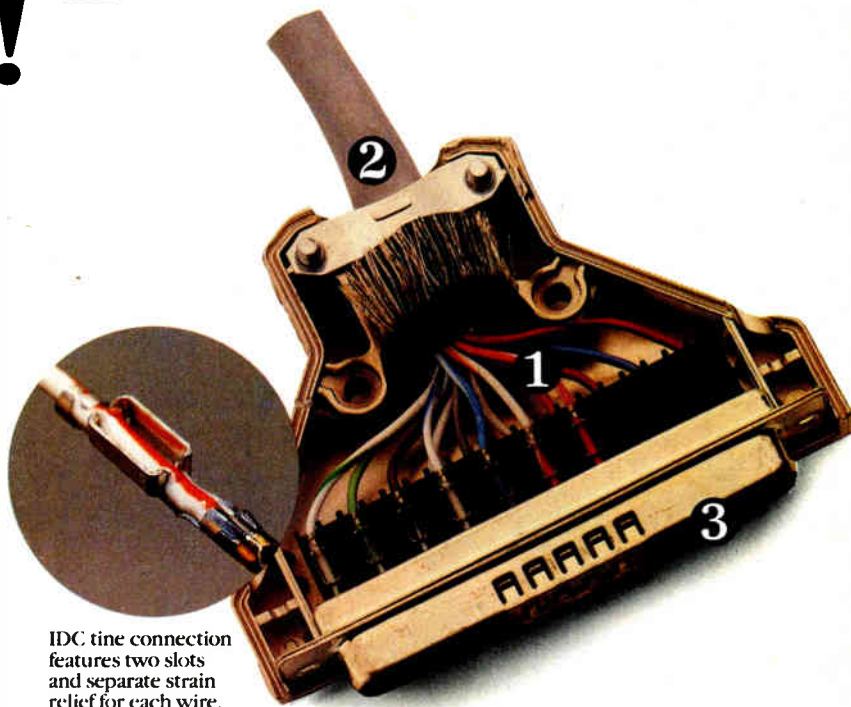

IDC tine connection features two slots and separate strain relief for each wire.

① “Selective Contact Loading.” You specify the contacts needed for your circuitry. RN pre-loads them into the insulator in your desired pattern. Pin push out problems are eliminated... “hunt & poke” wiring mistakes can’t happen with this foolproof discrete wire D-Sub connector.

② Separate Strain Relief and Shield Connection. These two critical functions are physically separated. This ensures reliable shielding even when the cable is flexed.

③ Flexible “fingers” offer better grounding. Where competitive connectors have simple dimples or no grounding at all, these RN “fingers” provide positive grounding and excellent EMI/RFI shielding over prolonged cycling.



WRITE TODAY for complete catalog on the full line of I/O CONNECTORS offered by Robinson Nugent. Contains data on real-life tests that provide assurance of field performance and long term reliability. Contact: Robinson Nugent, Inc., P.O. Box 1208, New Albany, IN 47150. Phone: (812) 945-0211.

CIRCLE NO. 110



More cost effective I/O Connectors to make the Robinson Nugent "Quality Connection"

CONNECTORS AND BACKSHELLS

Connectors available in both plug and socket versions with backshells (9, 15, 25 and 37 positions) supplied separately

CIRCLE NO. 111

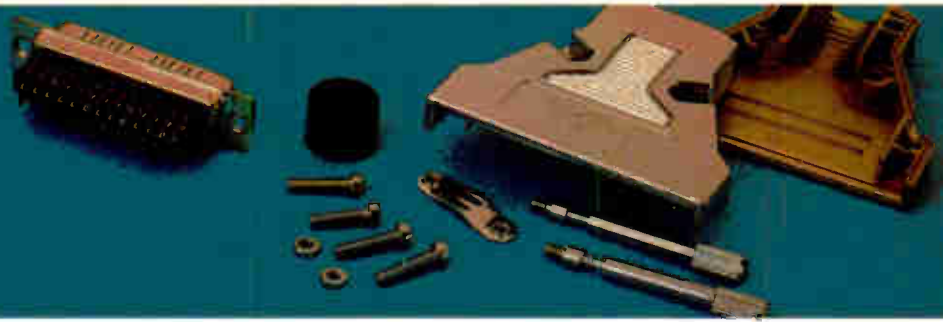

RN CABLELINK ASSEMBLIES

D-Sub Assemblies

CIRCLE NO. 112



Other post molded styles

CIRCLE NO. 113



PC MOUNT SOLDER TAIL CONNECTORS

CIRCLE NO. 114



Robinson Nugent

800 East Eighth Street, New Albany, Indiana 47150 • Phone: (812) 945-0211
In Europe: Rue St. Georges 6, CH 2800 Delemont, Switzerland • Phone: (066) 22 98 22

World Radio History

"Did you say .025" sq. posts?"

Yes, Samtec offers 95%
of all the .025" sq. post
interconnects you'll
ever need.



*When it comes to
SUDDEN SERVICE
Samtec really is
a different breed
of cat!*

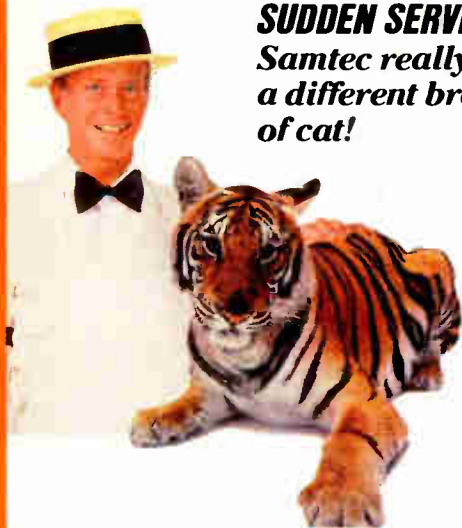

WRITE TODAY
for our new 72-page full line
catalog. It has been revised
and enlarged to include
many new products. And it
contains complete specifi-
cation data for fast, easy
ordering. Get yours today.

CIRCLE NO. 40



Right Angle Terminal Strips



Surface Mount Socket Strips



Right Angle
Socket Strips



Dual Terminal Strips



IDC Cable
Socket Strips



Socket Strips



Bottom
Mount Socket Strips

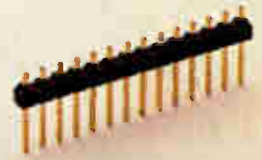

Terminal Strips

For use on board, board-to-board or cable-to-board, Samtec .025" sq. post interconnects provide reliable, gas-tight connections. A unique snap strip feature allows you to snap most strips to desired lengths. **CONNECT TODAY** with Samtec **SUDDEN SERVICE** for all of your .025" sq. post interconnect needs.

© Samtec, Inc. 1986
samtec

SUDDEN SERVICE

P.O. Box 1147 · 810 Progress Blvd., New Albany, IN 47150 U.S.A.
Phone: (812) 944-6733 · TWX 810-540-4095 · TELEX 333-918

CONNECTORS

SPECIAL ADVERTISING SECTION

NEW PRODUCTS AND NEW MARKETS BOOST CONNECTOR SALES, BUT COMPETITIVE PRESSURES REMAIN

The good times are coming back for U. S. connector manufacturers. In the year ahead, they should see close to 13% growth, according to market researcher Gnostic Concepts Inc. That's a lot better than 1985's gloomy numbers. But even last year's cloud had a silver lining: though production dropped about 3%, consumption rose by close to 8%. With all that inventory depleted, manufacturers are finding that everyone is ready to stock up again.

This year is already bringing some interesting developments. Among the most noteworthy is that, though both the military/government and computer/peripheral markets will grow, for the first time the government will overtake the computer business as the top buyer of connectors. Manufacturers are also keeping their eyes on the new and rapidly emerging markets for connectors—computer-aided design and manufacturing along with component test equipment.

Look for a lot of new products in 1986. Last year's slowdown gave manufacturers a chance to concentrate a little harder on product development, and the effort is paying off. Expected are new connector types, including surface-mountable, high-density, filter, and fiber-optic devices. In fact, fiber optics, which has drawn its biggest success so far from long-distance communications, will find many new applications this year. Longer term, fiber optics should show significant gains over at least the next five years. All these product segments should give 1986 sales a strong boost.

No one expects much in the way of price increases this year, mainly because of ongoing competitive pressures from domestic and imported goods. In fact, price cutting is likely.

U. S. production of connectors dropped 3% last year, but the Electronics Market Report found that consumption was up nearly 8%. With inventories low, U. S. production is expected to rise.

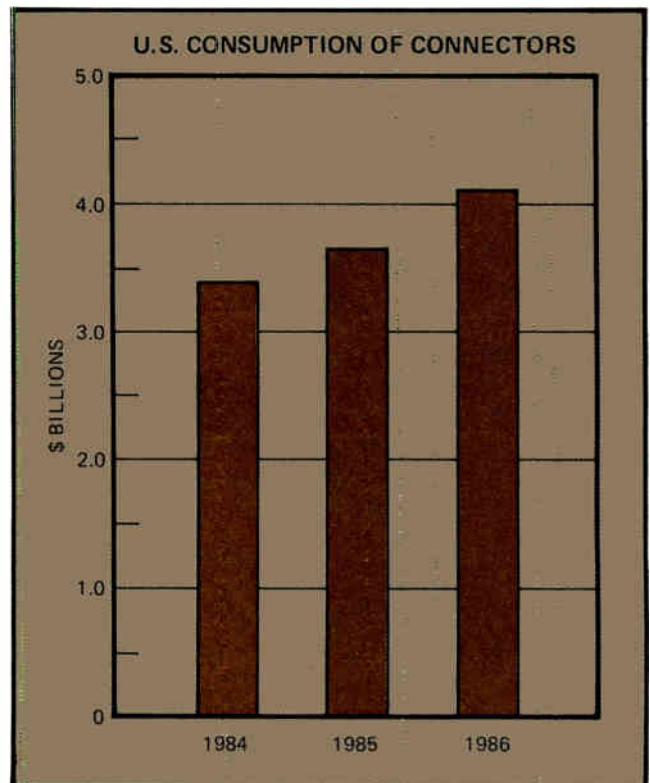

New beginning

The connector industry has an excellent chance in 1986 to make up for several tough years. This year, the markets for all 10 connector product types will improve, according to the *Electronics Market Report*, which projects consumption at a banner \$4.1 billion.

The market's resurgence is pegged to a number of factors. One is the plethora of new products, many of which are scheduled for introduction during the first half of the year. New commercial designs, partly a result of research and development efforts during last year's downturn, should be plentiful. In addition, automation is getting renewed emphasis, particularly in packaging. And pricing is very competitive. Large customers will look

for multiyear contracts as a guarantee against price increases and as a way to lock in delivery schedules.

Another boost will come from the strong military/government market that everyone is expecting. This sector should edge out the weakened computer industry as the largest buyer of connectors this year. Military-grade devices should account for an estimated 22% of U. S. connector consumption—and that doesn't include such products as specialty items for missiles and aircraft.

But the computer and peripherals market appears to be regaining some of its vigor, and this will pull up some connector segments. Marked for healthy sales increases in 1986 are coaxial connectors, including assemblies, as well as miniature-

cylinder, flat-cable, insulation displacement, pc-board edge, rack and panel, and special-purpose devices.

Though over the next three to four years the overall market for fiber-optic products should triple, the connector segment will likely remain at about 5%, according to estimates. But by the early 1990s, fiber-optic connectors should become a major force. The parts are ideal for applications in which electromagnetic and radio-frequency interference are dangers, such as in military and commercial computer products, because fiber optics are not affected by radiation.

Surface-mountable and high-density connectors will become increasingly popular with original-equipment manufacturers. In the high-density-connector segment—which includes printed-wiring, rectangular, and planar-cable devices, integrated-circuit sockets, and microminiature connectors—microminiature specialty devices reportedly are showing the greatest growth potential over the next three to four years.

This is true mainly because missiles, medical equipment, and computers require high density, small components, and high reliability. Planar-cable devices should show continued growth in low-cost, highly automated interconnections. In fact, Gnostic Concepts' analysis of production trends indicates that planar-cable connectors will double from 1984 levels to \$462 million in 1990.

Several companies have programs under way to develop surface-mountable products. By 1990, more than half the pc-board assemblies for electronic equipment will contain surface-mounted devices, both passive and active, predicts a study by market researcher Electronic Trend.

Automating installation

Because surface-mounted devices are tied so closely with automated manufacturing, a number of connector makers are working with robotics companies to develop techniques for delivering automatically installed connector packages.

ITT Corp.'s Cannon Division, Fountain Valley, Calif., for one, has a

Amp's data connector for IBM cabling systems has the self-shorting contacts required for IEEE-802.5 token-ring local-area networks. The four-position hermaphroditic device is suitable for snap-in panel mounting and for free-hanging cable use.



CONNECTORS

SPECIAL ADVERTISING SECTION

working agreement with Adept Technology, a Sunnyvale, Calif., maker of robotic assembly equipment, to offer a complete production system. Adept's integrated vision system, called AdeptVision, identifies loosely positioned connectors in their shipping tray. This feature allows a gripper to accurately select and pick up specific connectors without the aid of precise tooling or elaborate feeders. To date, ITT Cannon has developed two series of surface-mountable pc-board connectors. One is a version of the D-subminiature connector for use in pc-board assembly, the other is a chip-carrier socket.

Molex Inc. recently introduced surface-mountable connectors, complete with a choice of robotics. So far, the Lisle, Ill., company has designed four connector packaging and delivery processes, all of which are compatible with most robot input/output ports.

In one Molex process, an automatic tube magazine unloading system, connectors are packed side by side in individual tubes. Several filled tubes are stacked vertically and secured by end-closure skewers. The operator places the magazine in the Molex equipment and pulls out the skewers; within 15 seconds, the robot can load up to 750 connectors. The system unloads the tubes automatically and cycles empty tubes into a collection bin. A track feeds the connectors to a positioning device, where they are picked up by a robot or by a placement machine. The tube magazine, which is 2½ in. wide, adjusts easily to all circuit sizes. It supplies 30 connectors per minute and can be reloaded during operation.

Another packaging type offers a cost-effective alternative to tubes. Molex's automatic carton matrix unloading system unloads automatically, is adaptable to a variety of connector types and circuit sizes, and provides uninterrupted production, accurate part location, and a mounting base at one third the price of the tube magazine. The 6-in.-wide unit can be removed from the robot for service without having to reattach the pickup point.

The Molex reel pack delivers mass

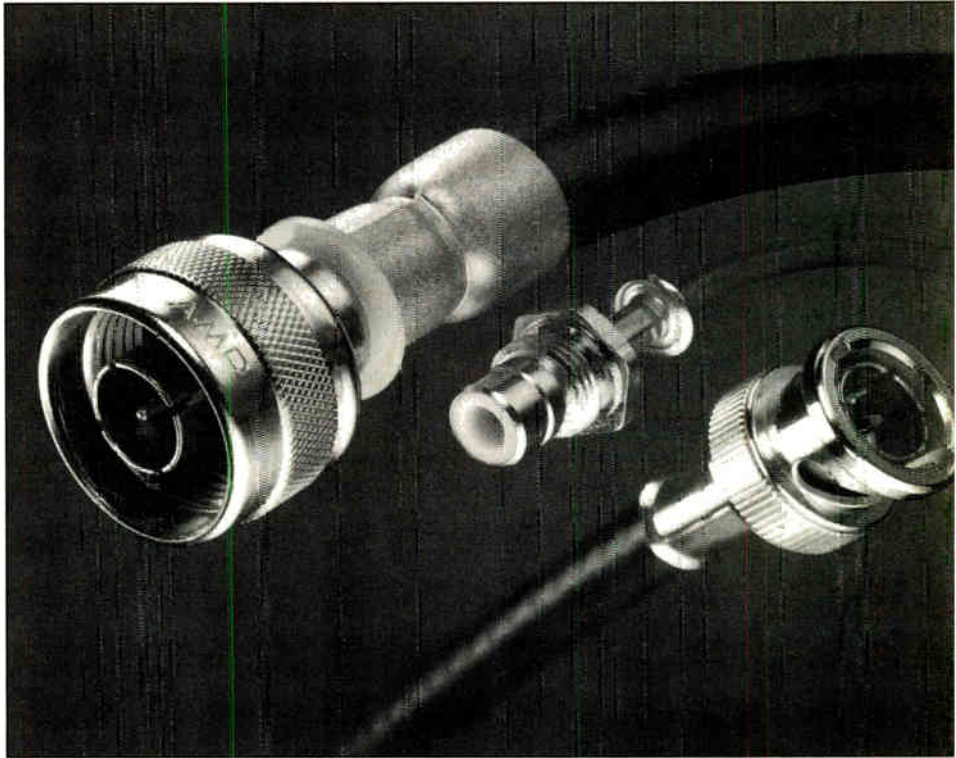

Amp has introduced 75-Ω coaxial connectors for network applications up to 2 GHz. The nickel-plated outer body houses a polypropylene dielectric and a gold-plated center contact that provides mechanical durability of 500 mating cycles.

quantities of components to an industrial robot or to a placement machine. Connectors are packed side by side between two strips of Mylar film, which are bonded between the rows to form pockets. The system then automatically removes the parts and positions them by the leads for pickup. The standard film is 4 in. wide; standard reels hold from 800 to 4,000 parts, depending on the size of the circuit.

For surface-mountable connectors, Molex has developed the standard-tape delivery system. The vacuum-formed carrier tape conforms to the EIA-ANSI RS 481A standard for 56-mm-wide tape. An 80-mm-wide version is available for larger connectors.

As the military and computer markets improve this year, cylindrical connectors, which represented close to 20% of all connector and IC-socket production a few years ago, should gain. And sales of coaxial connectors should come close to those of

cylindrical parts. Rectangular products, on the other hand, will continue to slide, losing share in the military and computer segments largely because of flat pricing in an overcrowded, intensely competitive market, according to Gnostic Concepts.

Among specialty connectors, elastomeric microminiature devices are projected to be among the fast growing devices, with production increasing an average of 20% annually through 1990. Future applications for elastomerics will be pegged for the most part to high-density connections.

Long-term opportunities

Gnostic Concepts predicts that the connector market will grow slowly over the next five years. Gains in such product areas as computer-aided design and manufacturing, component test equipment, and superminicomputers, however, offer potentially healthy new markets for connectors.

Like other electronic-industry

segments, the connector market will continue to feel the impact of imports. It's even likely that imports will actually gain market share in 1986. Meanwhile, connector manufacturers are building offshore production facilities or expanding existing plants to be closer to foreign-based U. S. systems houses.

Continuing market pressures could force further internal reorganizations along market rather than product lines, as companies begin to focus more on high-volume high-growth segments. With a wide variety of connectors to offer, these companies are targeting their resources at the larger OEMs in high-growth end markets. The industry has also experienced consolidation through acquisition. A typical example of this activity is the merger of Midland-Ross Corp. and Allied Corp. Similar deals are expected to come.

Another possibility is a realignment of distribution sources to take advantage of stronger market categories and to capture a larger share of some of the areas with smaller sales volumes.

Plenty of new products

On the plus side, product development is continuing apace. Samtec Inc. has a new line of dual-in-line-package sockets and adapter plugs molded with Du Pont Rynite, from E. I. Du Pont De Nemours, a polyester material suitable for vapor-phase and infrared soldering to 216°C. High-temperature DIP sockets and adapters are available with either a 0.10- or a 0.05-in.-thick profile. Lead sockets include a variety of surface-mountable designs and superlow-profile options that stand less than 0.10 in. above the board. Terminals are available in multiple pin lengths, styles, and terminations. The polyester bodies have Underwriters Laboratories 94V-O approval.

The New Albany, Ind., company also offers a variety of socket and terminal strips molded in the same high-temperature body material as the DIP sockets for vapor-phase or infrared soldering to the pc board. Standard sizes contain 20 or 32 connectors, but the product has strips that snap off to

shorten the device. Pin diameters of the new socket and terminal strips range from 0.018 to 0.080 in. in several styles—wrapped wire, solder pin, solder pot, and slotted head. Right-angle versions are available for board-edge or test-point connections.

Also new from Samtec is a line of high-reliability IDC flat-cable strips in plug and socket configurations. Both styles have an ultralow profile to meet the tightest form factors. Snap-off strips make it possible for the user to specify an exact pin count, maximizing board utilization and reducing cost.

Amp Inc.'s new four-position data connector, designed for IBM Corp. cabling systems, includes the self-shorting contacts required for IEEE-802.5 token-passing-ring LANs. Suitable for snap-in panel mounting or free-hanging cable use, this hermaphroditic connector permits axial, right-angle, or 45° cable entry and comes with a locking device that prevents accidental disengagement. The selectively plated gold contacts are rated for 1 A, maximum, at

A high-density standard metal-shell rectangular module from Malco-Microdot features up to 304 contacts in four rows on 0.05-in. centers. The connector, which is designed for surface and plated-through-hole mounting, can be set on 0.50-in. centers.

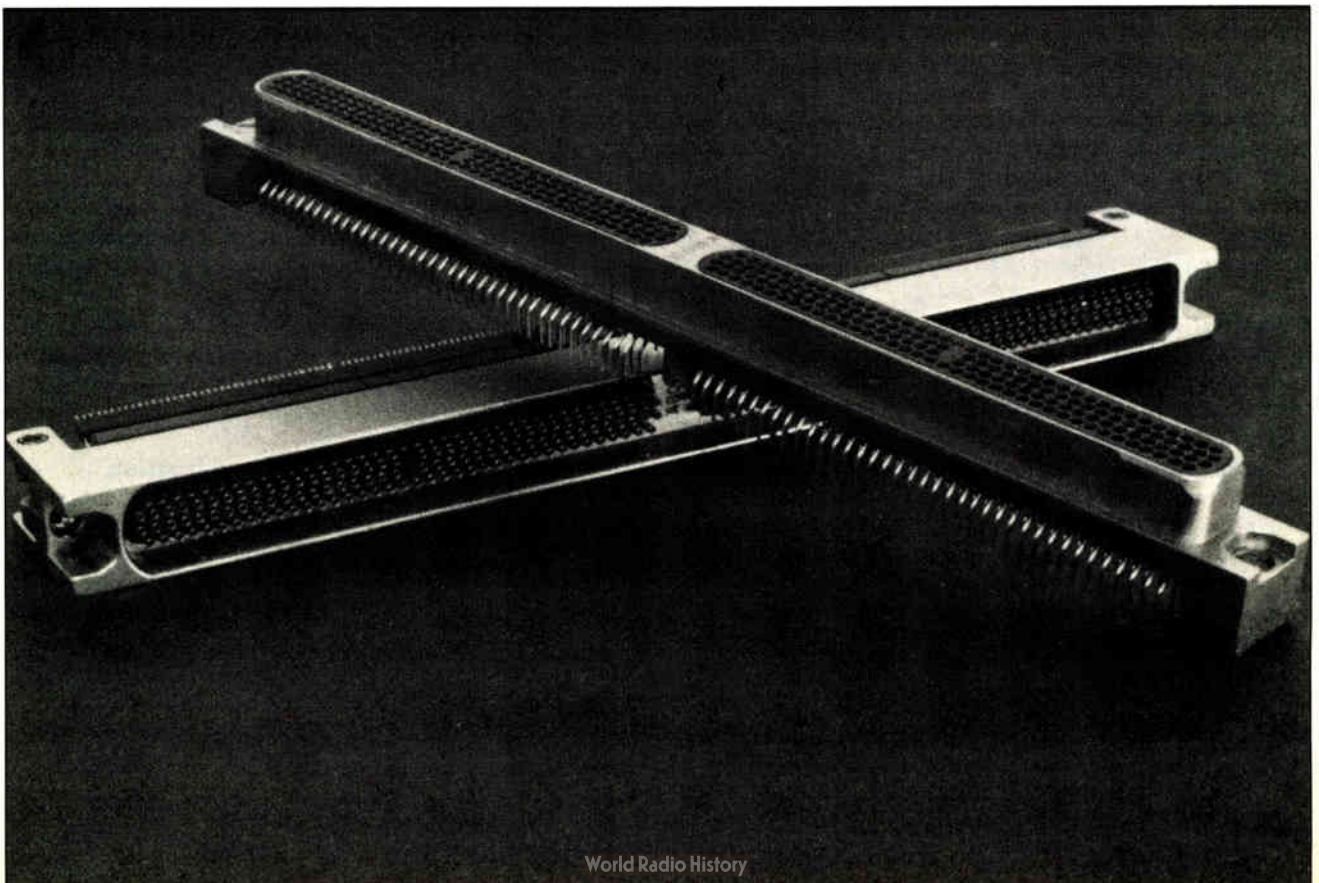

Efficient Connections.



Cost Driven Connectors. Low cost reliability.

Viking introduces the simple, complete answer to the problem of low cost reliability in card edge connectors: a combination cantilever beam contact and thermo-plastic insulator. We've designed an entire line of card edge connectors around this concept and automated its production. Then named it *Cost-Driven*. For obvious reasons.

This simple design brings prices down, yet retains the uncompromising quality for which Viking is known. This kind of reliability has resulted in accreditation, ship-to-stock, and Just-In-Time programs with major companies.

These connectors are preloaded to provide a minimum of 100 grams of normal force per contact, assuring reliable connections in worst case conditions. The bifurcated contacts provide added assurance through redundancy. And the connectors are U.L. listed, not merely "material approved".

Standard dimensions make them interchangeable with most connectors on similar grid spacings. And they're available in a variety of mounting styles.

For the IBM PC AT™ motherboard and compatible products, here's the simple, complete way to eliminate the need for two end-to-end connectors: Viking's 18 plus 31 position dual card slot connector. It reduces installation costs. Reduces material costs. And it can be packaged for automatic assembly.

Get complete details on Viking's "CD" connectors, along with specifications and prices.

Call or write today.

Efficient Connections With Viking

CRITON VIKING

*Criton Technologies
Electronics and
Defense Group*

Viking Connectors Co.
21001 Nordhoff Street
P.O. Box 2379
Chatsworth, CA 91311
(818) 341-4330
TWX: 910-494-2094



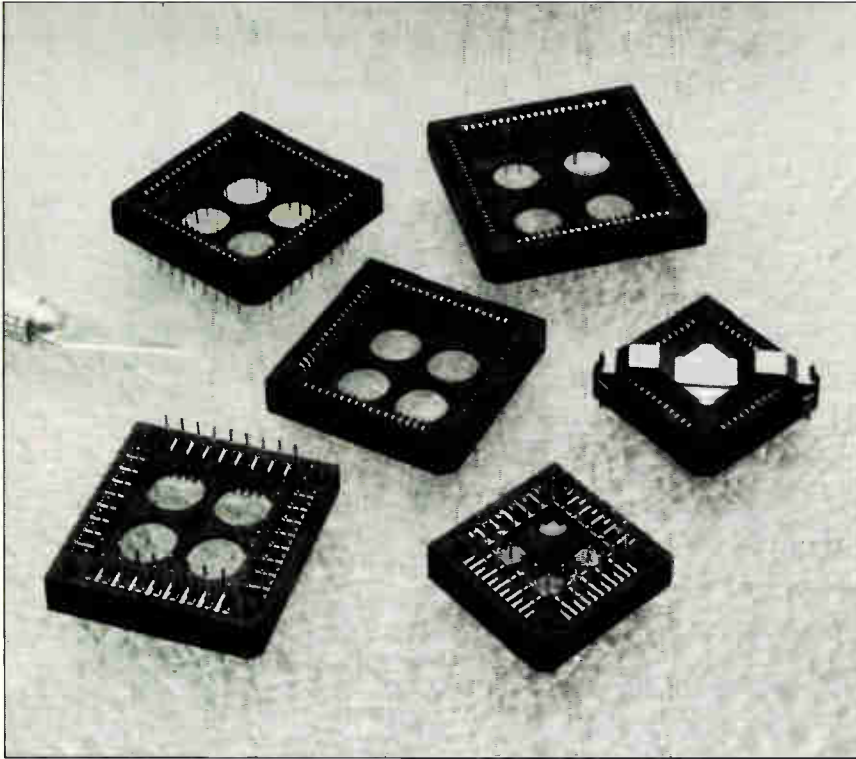

ITT Cannon has developed two series of surface-mountable pc-board connectors—a chip-carrier socket and an adaptation of the D-subminiature connector. The initial product will be a 68-position device, followed by parts with 84, 44, and 52 positions.

Samtec's DIP sockets and adapter plugs come with a 0.10- or 0.050-in.-thick low-profile body. They are molded with a polyester material that can withstand high-temperature soldering. Terminals are available in multiple pin lengths, styles, and terminations.

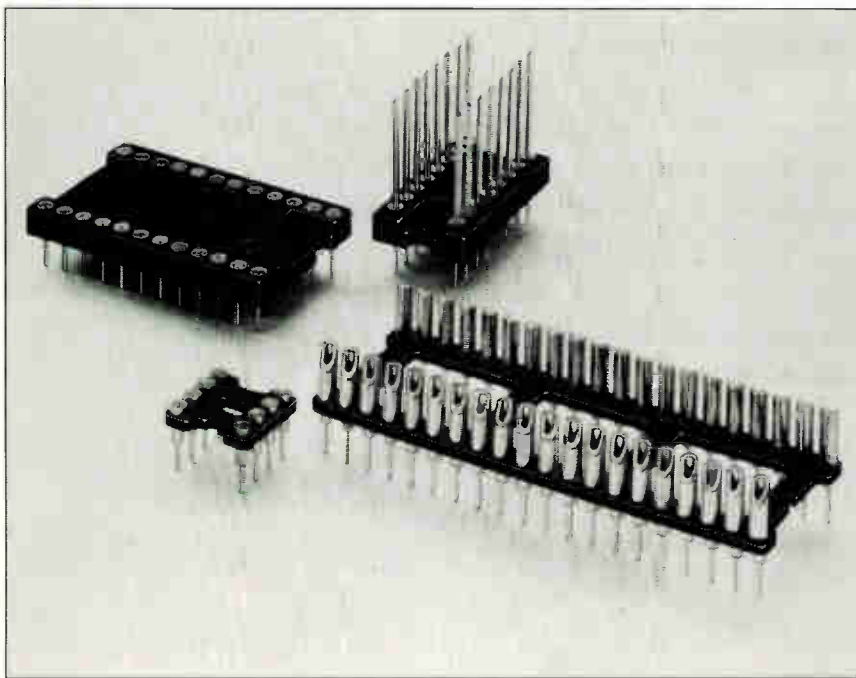

30 V ac. Shielding performance is specified to 1 GHz. The connector's durability exceeds 1,000 mating cycles. Thanks to insulation-displacing contacts, no special tools are needed to install the connector on shielded cable having two sets of twisted pairs.

For network applications up to 2 GHz, the Harrisburg, Pa., company has new cable, panel, and bulkhead-mounted 75- Ω BNC, SMB, and N-series coaxial connectors. These connectors, with a voltage standing-wave ratio of less than 1.3 and leakage of less than -55 dB (-90 dB for the N series), can be installed with hand tools or by automatic machines that can finish up to 200 cable assemblies per hour. The nickel-plated outer body houses a polypropylene dielectric and a gold-plated contact that provides a mechanical durability of 500 mating cycles.

New, low-profile, single in-line memory-module sockets from Amp mount the modules within 0.05 in. of the printed-wiring board's surface and permit modules to be mounted as close as 0.30-in. center to center. The products have a built-in retention latch that provides tactile and audible indications of module seating during insertion and permits removal of the memory module without special tools. Polarization and module guidance built into the socket prevent mismatching, and the socket has locating features for automatic insertion or robotic assembly.

The device has tin-plated, dual-leaf-spring contacts spaced on 0.1-in. centers. Because the contacts are free-floating and mate with both sides of the module, warped modules are not a problem. Available sizes include 22-, 30-, 35-, and 42-position versions.

Fiber-optic additions

Amphenol Corp., a leading maker of ion fiber-optic connectors, now produces single-mode couplers. Among the first of these products from the Lisle subsidiary of Allied-Signal Inc. is the Amphenol 945 Interfuse coupler, which is called a tree coupler because the optical signals branch out from the initial source. It uniformly distributes light signals between single-mode

Light years ahead.

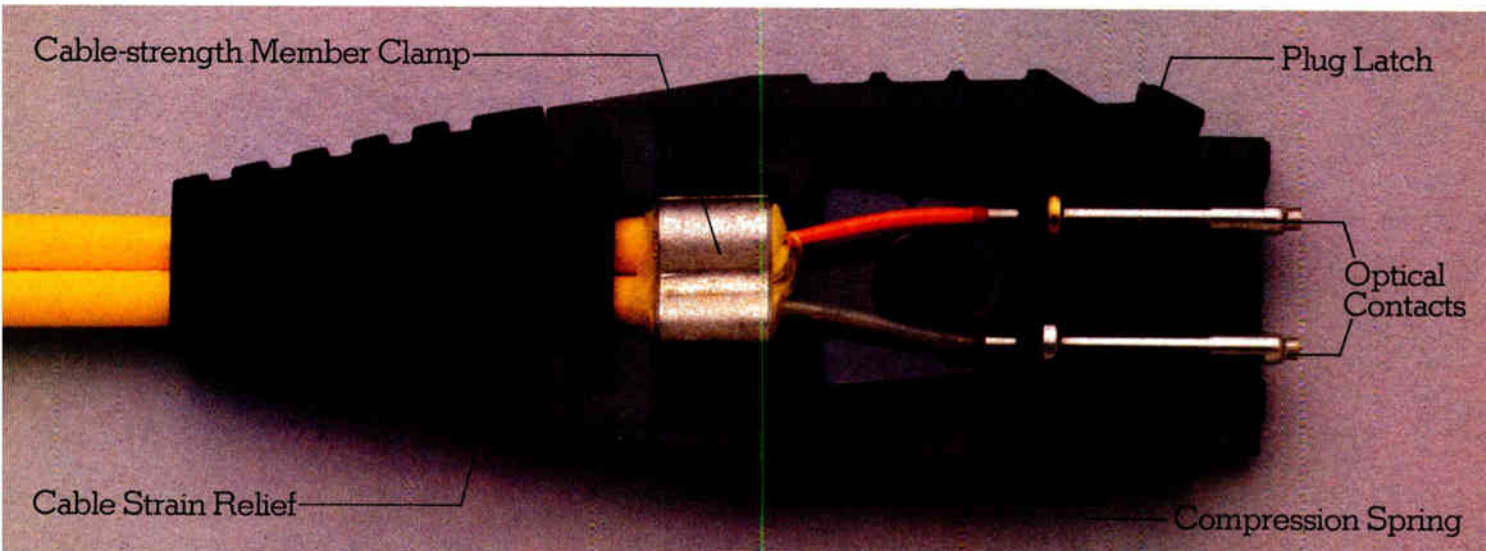

Let us shed a little light on fiber-optic connectors. The less light loss, the better the connection. And the lowest-light-loss connectors in the industry have been designed by ITT Cannon.

Our exclusive jewel ferrule alignment system geometrically centers the fibers in the contact. For a perfect, light-tight fit.

And, our duplex connectors are low-cost, polarized, and give you the option of using glass or plastic fibers. Plus, our positive-latching feature ensures a rugged, shock-resistant mating. Available in several configurations, including fiber-to-fiber and

Fiber-Optic Duplex Connectors.

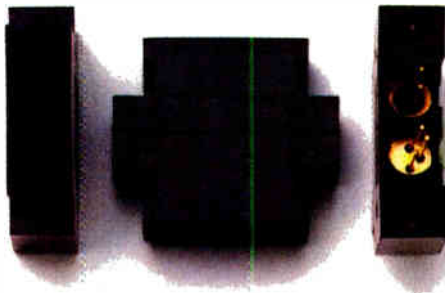

fiber-to-device. Receptacles will accommodate a range of device sizes from various manufacturers.

Cannon® duplex connectors. We're making sure the future of fiber optics is bright.

So call Cannon. You'll get more than great connectors.

For more information, call us at (714) 964-7400. Or write the Micro Division of ITT Cannon, a Division of ITT Corporation, 10550 Talbert Avenue, Fountain Valley, CA 92728.

CANNON ITT
The Global Connection

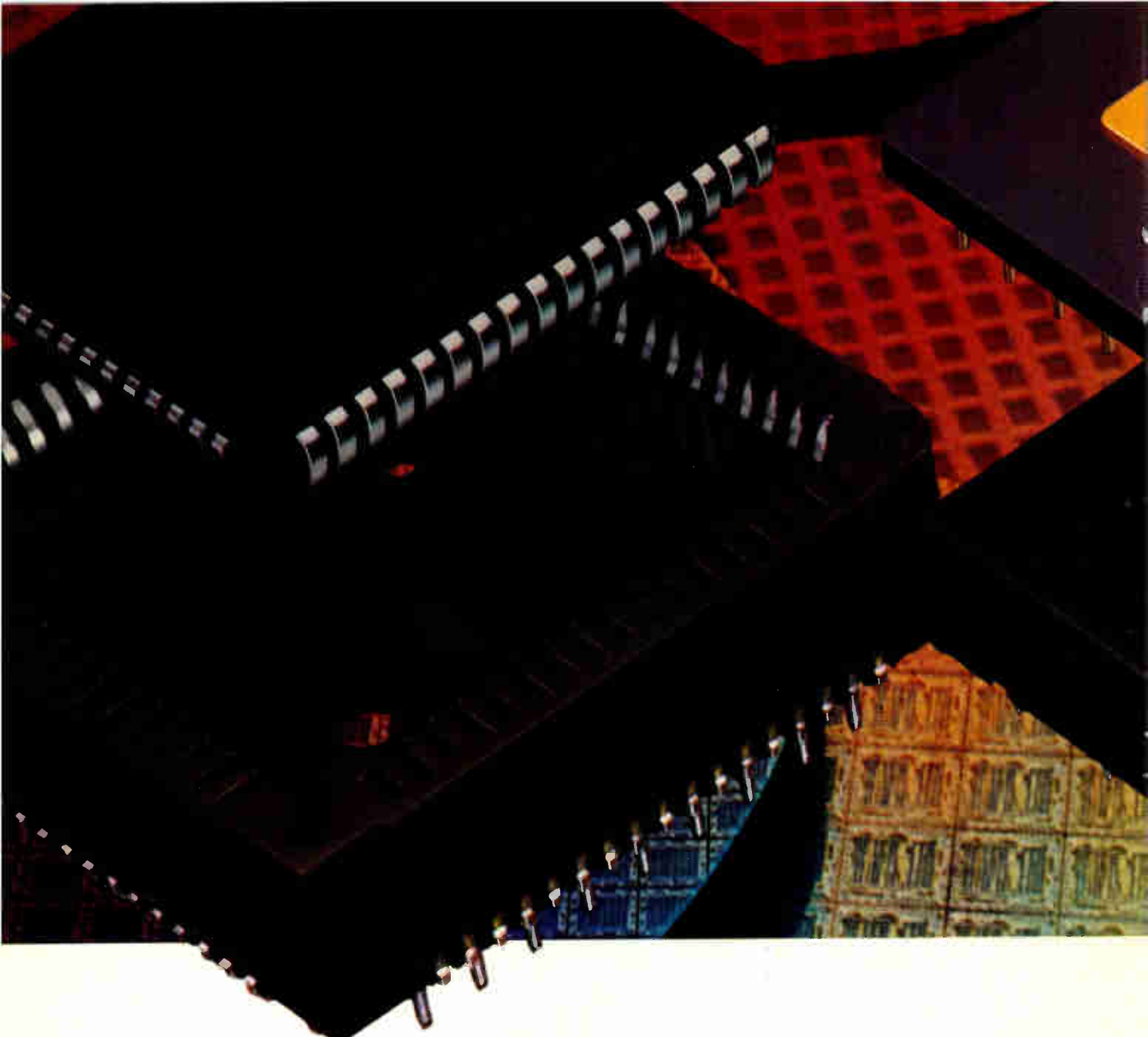

How we've made sure the chip's locked in, but you're not.

*ZIF and LIF PGA sockets,
plus our minimal profile
spring sockets in
PGA footprint.*

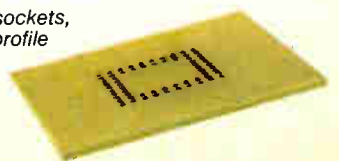

Circle 49 on reader service card

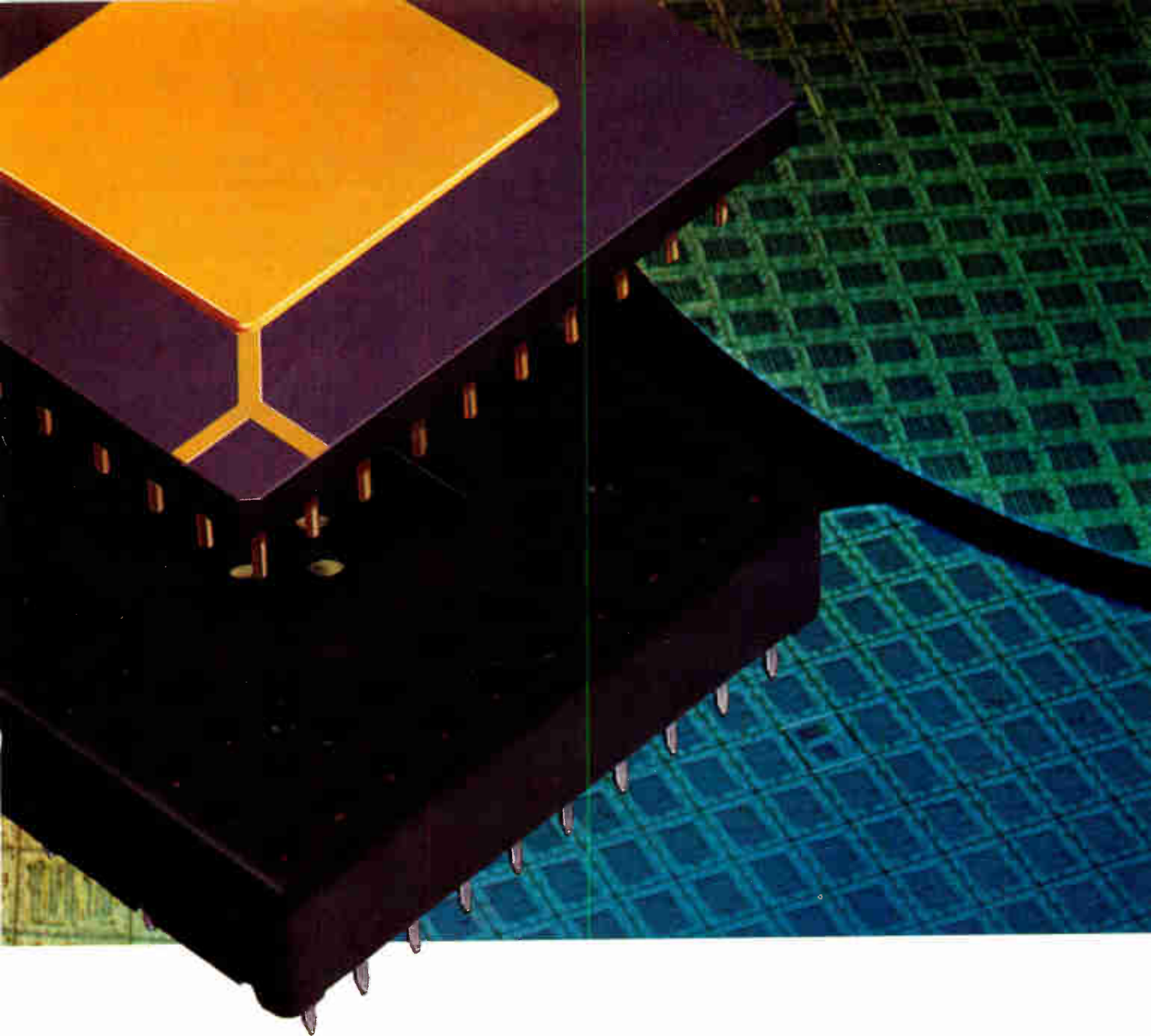

Whichever direction you take in microprocessor technology, AMP makes sure you have the socketing options you need to make it pay off.

Our high pressure tin sockets for plastic leaded packages come with an exclusive Positive Lock retention system that keeps chips secure during handling and shipping. Ceramic chip

carrier sockets feature duplex plated contacts and snap-on covers that accommodate heat sinks. Both are available in standard and surface-mount versions.

AMP offers you more: high-speed, surface-mount sockets on .020" centers. Gold-plated plastic carriers and sockets. For pin grid arrays, sockets in ZIF and

LIF styles, plus custom VHSIC capability.

Choose your technology. AMP makes it easy to implement, with full socketing support.

Call (717) 780-4400 and ask for the AMP Sockets Desk.
AMP Incorporated, Harrisburg, PA 17105-3608.

AMP Interconnecting ideas



Low-height sockets in all standard sizes (JEDEC A, B, D), with duplex-plated contacts for sure performance. High-speed, surface-mount sockets feature 0.5pF, 1.4nH contact characteristics.

Word characteristics.

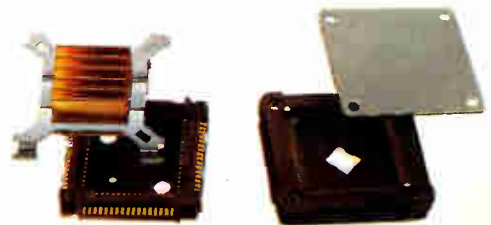

fibers with very low insertion loss, because the coupler is manufactured in-line and uses no splices. Two tree-coupler configurations are available with a maximum excess loss (the total optical power lost as light passes through the coupler) of less than 0.5 dB and 1.0 dB. The split ratio for the tree coupler with a 1-by-4 port configuration is 25%; for the device with a 1-by-8 configuration, it is 12.5%. Both couplers operate over a temperature range of -55°C to $+125^{\circ}\text{C}$.

The Interfuse couplers, which are designed for split or multiplexed optical signals, now have broader applications in test and measurement equipment, telecommunications, LANs, and advanced optical sensors. The couplers come in standard wavelengths—820, 1,300, and 1,520 nm—and can be packed specially for pc-board mounting or for severe

environments. Amphenol says that thanks to new, highly automated production techniques, it has been able to cut prices of the 945 series by 60%.

Further extending its D-subminiature connector line, Viking Connectors Co. has a right-angle, metal-shell, D-subminiature receptacle designed to reduce problems with electromagnetic and radio-frequency interference emanating from computers, peripherals, and other electronic equipment. The new low-cost connector, which is selectively gold plated to either 10 or 30 $\mu\text{in.}$, has rigid U-shaped contact tails for easy insertion into the pc board. It is UL listed and its materials are UL94V-O approved.

Also new from this Chatsworth, Calif., division of Criton Technologies is a dual-card-slot, 18- and 31-position connector. It's designed to fit the motherboard I/O slots in the IBM

Personal Computer AT or compatible products. By eliminating the need for two separate connectors, the one-piece dual-slot design saves connector and installation costs. Its housings are UL94V-O approved; its selectively gold-plated, cantilevered-beam contacts are bifurcated to provide points of contact.

In addition, Viking has revamped its JNK series of card-edge connectors to make them compatible with the IBM PC bus. These round-tail DIP-solder connectors have cost-effective semibellows contacts. The 0.026-in.-diameter DIP-solder termination provides an even 360° solder fillet in a standard 0.035-in.-diameter pc-board hole. A range of platings, mounting styles, and materials is available.

Extended pins

A series of connectors with selective loading of extended pins is the latest product in Robinson Nugent Inc.'s line of standard and inverse DIN-41612 products. The extended pins provide first to mate, last to break ground contacts that protect CMOS circuitry from static discharge and high-voltage shock. The RNE series connectors, which are UL listed, come with 32, 64, or 96 pins and either straight or right-angle mounting.

For daisy-chaining in backplane applications, the New Albany, Ind., company has a 64-pin C-form IDC DIN connector that mass terminates to a 28 AWG flat-cable connector and mates with standard DIN-41612-compatible headers. The lid, which incorporates cable-alignment scallops and strain-relief latches, also reduces assembly scrap and provides a rugged assembly.

Two new series of Centronics connectors from the company are intended for use as system interfaces. Connectors in the IDR series mass terminate to 28 AWG flat cable. They have bail-mount-latching mechanisms and a rugged strain relief where the cable and contact meet. The devices in the RPM series, which are for permanent mounting on a pc board, come in straight or right-angle versions and have a metal front shell for EMI shielding.

Robinson Nugent's IDD-M series of D-subminiature connectors also is

Rowe Industries' new subminiature in-line disconnect, high-voltage connector series provides maximum voltage capability in applications where space is tight. Uses include lasers, power supplies, and electronic countermeasure systems.

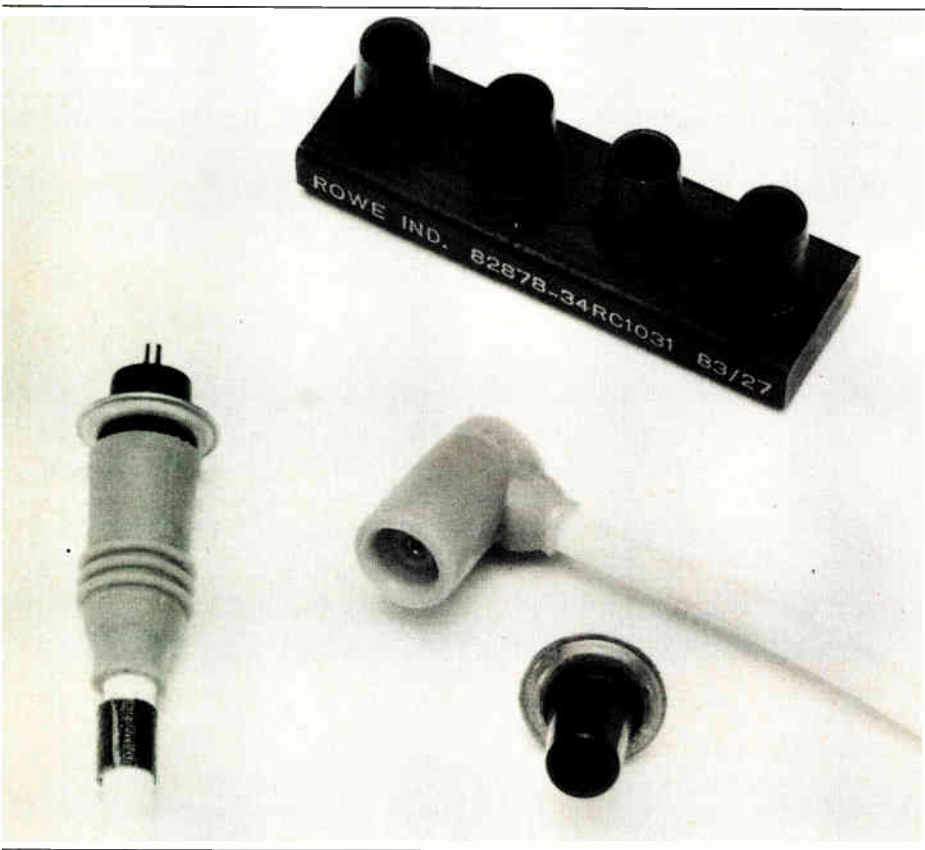

The *only* electronics directory you need...

1985-86 Electronics Buyers' Guide

Now available: 1985-86 Electronics Buyers' Guide. Completely new listings of catalogs, new phone numbers, new addresses, new manufacturers, sales reps, and distributors! The total market in a book—**three** directories in one!

1.

Directory of products.
Over 4,000 products, over
5,000 manufacturers.

2.

Directory of catalogs.
Includes six post-paid
catalog inquiry cards for
10-second ordering.

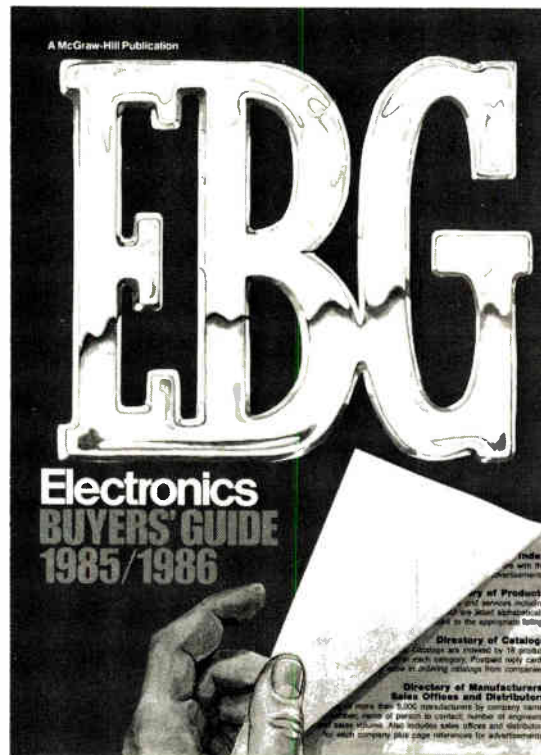

3.

Directory of
manufacturers. Local
sales offices, reps, and
distributors, with phone
numbers. Number of
employees and engineers,
dollar volume, name of
company contact.

The only book of its
kind in the field.

If you haven't got it,
you're not in the market.

To insure prompt delivery
enclose your check now.

Price: \$50 per copy
(Add \$30 for air mail)

Send order with payment to:
Barbara Copcutt
Electronics Buyers' Guide
McGraw-Hill House
Maidenhead SL6 2QL, England



Standardize



On Elco DIN for high density, military reliability and lowest cost.

If you're looking for low insertion force, metal-to-metal reliability and universal compatibility, standardize on DIN. For the broadest variety of DIN styles, terminations and mountings, standardize on Elco — the industry leader.

Elco standard and inverted DIN connectors offer the lowest cost solution to your high density requirements. Our standard DIN meets MIL-C-55302/131-134 and Elco is the only supplier of inverted DIN qualified to MIL-C-55302/157-

Circle 52 on reader service card

158. Our solderless press-fit versions, built around Elco's VARIPIN™ compliant pin, provide both the economy of press-fit assembly and the ease of simplified field service featuring individual contact replacement. All our DIN and expanded DIN Series are available with selective gold plating and up to 924 unique keying possibilities. Fully-tested DIN backpanels to VME and other buses are also available.

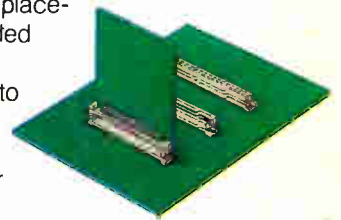

Free DIN Wall Chart! Get your large wall chart with application and ordering data, free by contacting your Elco representative or Elco Connector Division, Huntingdon Industrial Park, Huntingdon, PA 16652. (814) 643-0700.

 **Elco Corporation**

A Subsidiary of Wickes Manufacturing Company

designed with EMI shielding. These connectors incorporate a tin-plated metal front shell for metal-to-metal grounding of the mated connector. They are available with 9, 15, 25, or 37 contacts in tin-gold plating.

Also new is a DDM series backshell kit series for D-subminiature parts in 9-, 15-, 25-, and 37-pin counts. It can be ordered in an all-plastic style or in a shielded metalized plastic; both versions are compatible with standard D-subminiature connectors. The DDM series comes in a kit for one-connector assembly or in bulk packages with components for 100-connector assemblies.

Socket series

ITT Cannon is introducing the LCS socket series—large-scale- and very large-scale-integration interface connectors for Jedec types A and B plastic leaded chip carriers. The LCS series comes in layouts of 44, 52, 68, and 84 leads. It features either a 0.50-by-0.10-in. staggered-pin arrangement for easier routing of conductors between terminal pins or a 0.10-by-0.10-in. pin-grid arrangement to accommodate universal pc-board hold patterns. A surface-mountable version is also available.

Another ITT Cannon connector is the Solda D, a low-cost solder-type determination device for commercial applications. This connector features stamped rather than machined contacts. In addition, the company has expanded its line of optical contacts designed to be interchangeable with size-16 pin and socket contacts.

ITT Cannon has also expanded its line of optical contacts designed to be interchangeable with size-16 pin and socket electrical contacts. The additions should help ease the transition from electrical to fiber-optic applications in military, aerospace, and computer designs. The expanded line includes new optical configurations that can be interchanged with electrical contacts in a number of standard connectors: MIL-C-83723 series I, II, III; MIL-C-5015G; MIL-C-81659; Arinc 600; MIL-C-26482 series I and II; MIL-C-28840; and MIL-C-26500.

ITT Cannon also offers a configuration for MIL-C-38999 series I,

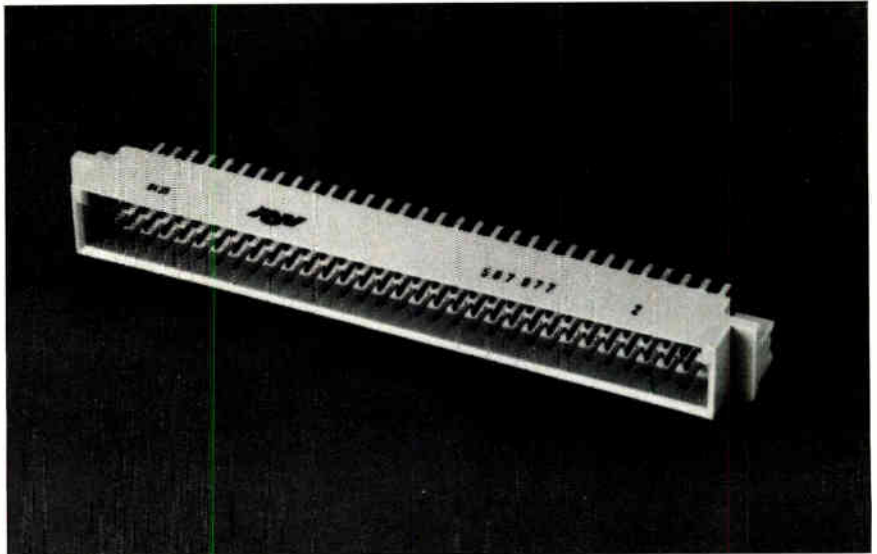

The latest connector in Robinson Nugent's line of standard and inverse DIN-41612 devices is this RNE series with selective loading extended pins. The connectors come with 32, 64, or 96 pins and with either straight or right-angle mounting.

Molex has developed four connector packaging and delivery processes that are compatible with most robot I/O ports. In the automatic tube unloading system, a robot picks up the parts from a positioning device.

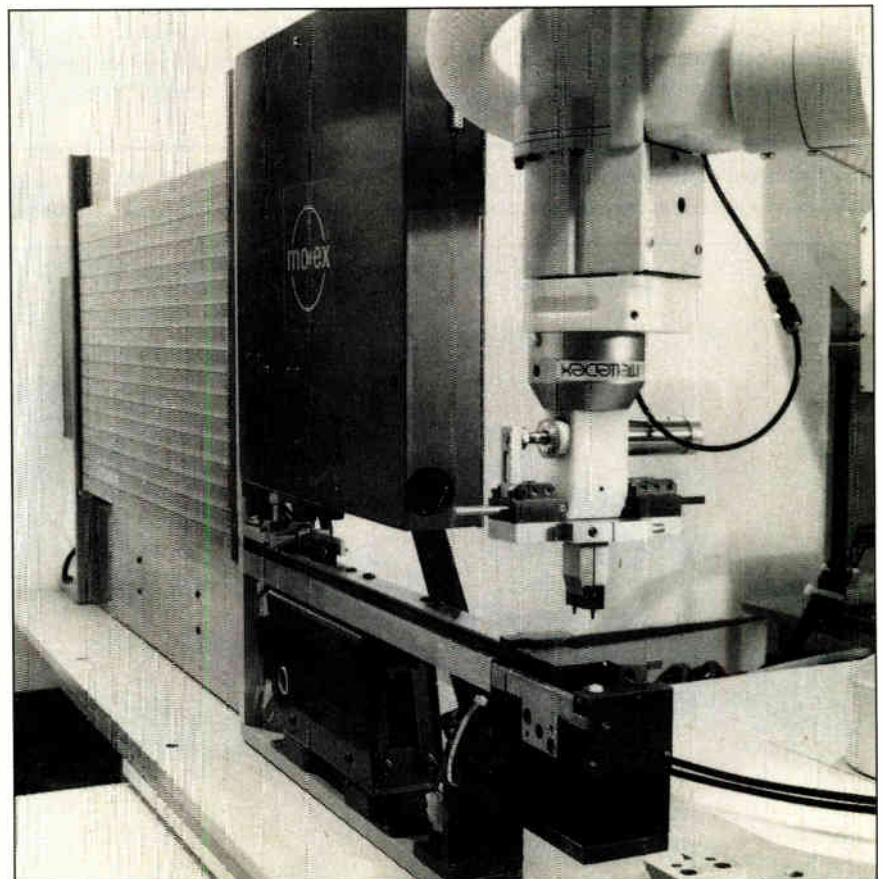

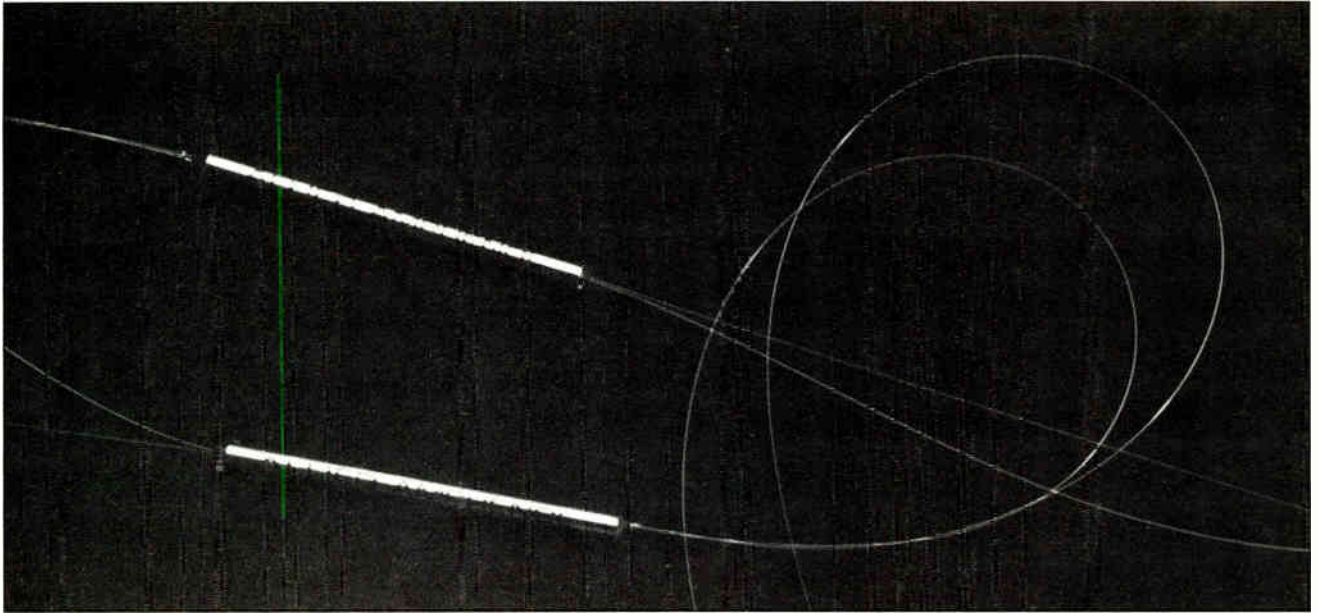

Amphenol Products' single-mode fiber-optic coupler is called a tree coupler because of the way the optical signals branch out from the initial source. It can distribute light signals uniformly with low insertion loss.

III, and IV. Features include a typical 1.0-dB optical-loss performance when tested with a 100/140- μm fiber that meets the EIA's FOTP-34 Method A.

Microminiature connectors with proprietary spring-pin contacts that

require less than half the insertion force of twist-pin contacts are available from Elco Corp., a Huntingdon, Pa., subsidiary of Wickes Manufacturing Co. The Microcon rectangular-D strip and circular connectors, which conform to

MIL-C-83513, have a stamped contact that provides a uniform nose design that Elco says is not possible with the welded-wire bundles of the widely used twist-pin contact. The result is an intermatable and competitively priced

New from Elco is a connector with spring-pin contacts that require less than half the insertion force of twist-pin contacts. The Microcon line, which comes with either 30 or 50 μm of gold plating, has a stamped contact that provides a uniform nose design.

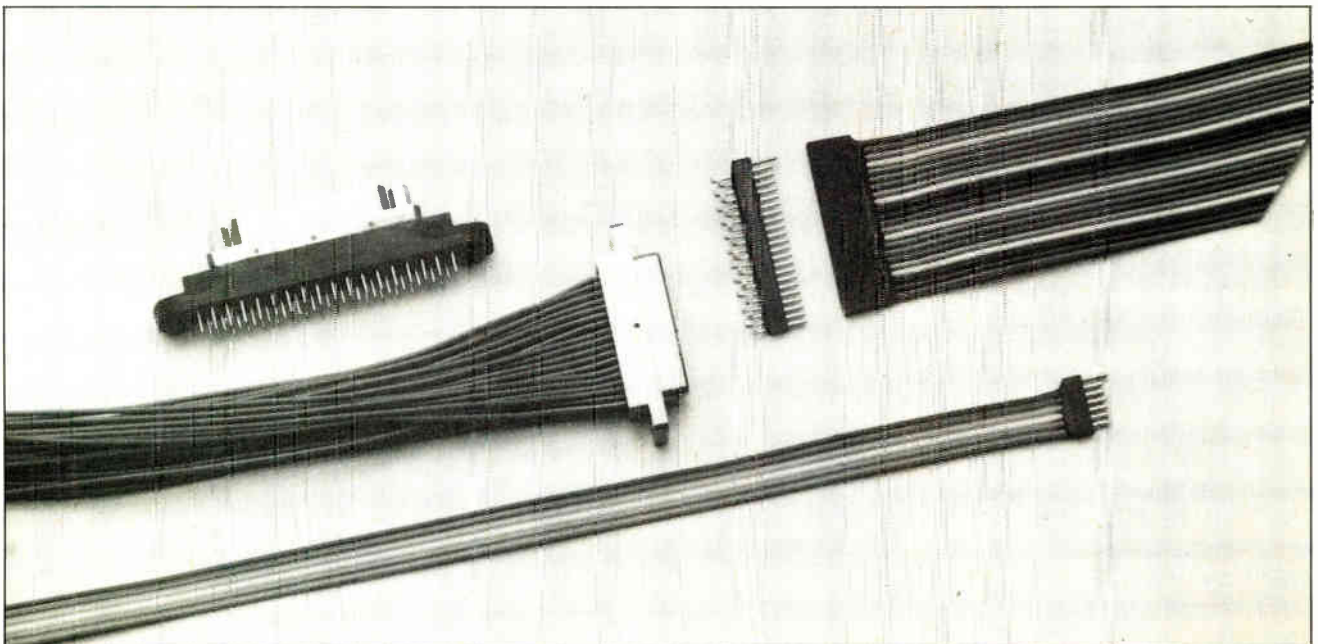

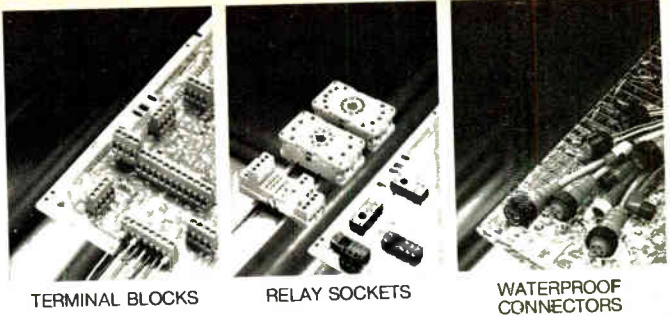

TERMINAL BLOCKS

RELAY SOCKETS

WATERPROOF CONNECTORS



**TOMORROW'S SOLUTIONS—
TODAY—THROUGH STATE OF THE
ART ELECTRICAL AND ELECTRONIC
CONNECTION AND
TERMINATION TECHNOLOGY**

LUMBERG, INC.

420 Southlake Blvd.
Richmond, Virginia 23236
U.S.A.

Tele: (804) 379-2010
Telex: 90-1037
Facsimile: (804) 379-3232

Circle 55 on reader service card

Ever notice how some people always seem to have the right answer? No matter what the situation, they always seem to be a step ahead. And they're successful...the first in line to lead an important project...the first in line for a promotion. It's certainly not magic. Usually it's a combination of hard work, brains, guts and desire. It probably means they read *Electronics*... regularly.

Electronics has helped propel many a manager and engineer to the front line...to the "leading edge" of the industry. And just as we've been providing many of your colleagues with the right information, the important information—when they need it most—so too can we provide it for you.

Every week an *Electronics* subscriber receives an issue crammed with the latest information on new products, developments, concerns and trends in the worldwide electronics industry.

When you become a subscriber, we'll supply you with the intelligence you need to make the big decision, or the every day decision to further your career and reap profits for your company. For a taste, just browse through the issue you're holding.

But, you really don't have to believe us. Just ask the person who's always a step ahead.

To become a subscriber, just complete and mail the insert card in this magazine. If subscription card is missing, write: Circulation Manager, *Electronics*, P.O. Box 511, Hightstown, N.J. 08520.

Electronics
The Voice of the industry



We're High Voltage Interconnection Problem Solvers

We design and manufacture sophisticated connectors and cable assemblies for continuous performance and reliability in extreme industrial and military environments. Voltages to 200 KV. Temps from -65°C to 200°C. Altitudes thru 70,000 ft. All corona-free. Our QC systems exceed MIL-I-45208 and are approved by many aerospace prime contractors.

We've solved hundreds of tough interconnection problems. Test us with yours.

Pictured:

1. E-2C (40 KV series)
2. ALQ-131 (RMC series)
3. AWG-10 (JA series)
4. ALQ-94 (RLA series)
5. ALQ-126 (Sub-miniature series)

Call or write. Dept. 293

ROWE
ROWE INDUSTRIES

Connectors • Cable Assemblies • Electronic Products
6225 Benore Road, Toledo, OH 43612, (419) 729-9761.
West Coast Office (415) 969-4831 or (213) 236-2070.

Circle 54 on reader service card

NEW EDITION

All standards are new, revised, or reaffirmed since the previous edition

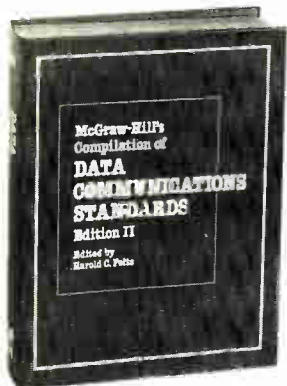

1,923 pages illustrated

Edited by Harold C. Folts

DATA COMMUNICATIONS STANDARDS

All 123 interface protocol standards set by:

- CCITT • ISO • ECMA
- ANSI • EIA
- U.S. Government

Special feature for instant access to the applicable standards:

Cross-reference tables of the similar and interfacing standards of each standards organization.

Electronics Magazine Books
P.O. Box 541
Hightstown, NJ 08520
(609)426-3070



Please send _____ copies of R100-McGraw-Hill's *Compilation of Data Communications Standards Edition II* at \$295 each.

Name _____

Title _____

Company _____

Address _____

City/state/zip _____

U.S. customers please add local sales tax. McGraw-Hill pays regular shipping and handling on prepaid orders.

DCT

CONNECTORS

SPECIAL ADVERTISING SECTION

offering compatible with 50-mil-center connectors. They're available with either 30 or 50 μ m. of gold plating.

Virtually all the products from Hughes Aircraft Co.'s Connecting Devices Division meet military specifications. Such products include high-reliability high-density connectors with 110 contacts to the square inch and seals on the contacts to meet environmental requirements. Typical of Hughes's multichannel fiber-optic devices is the MIL-C-28876, which meets military specifications.

New models and revised material specifications have been added to Rowe Industries' line of subminiature

in-line disconnect, high-voltage connectors. The connector receptacles come in several configurations, including flange mounted for oil-filled containers and vacuum environments, multiple strip mounted for potted enclosures and containers, and individually mounted for pc boards. The mating plugs are molded straight or at a right angle to adapt to any packaging constraints. Sizes range from 0.536 to 0.850 in. in length and 0.312 to 0.437 in. in diameter, excluding cable.

Other features of the series include low mating/unmating force, corona-free operation, vibration resistance in accordance with MIL-E-5272, shock

ITT Cannon's Solda D, a low-cost solder-type determination connector, is among the latest additions to the company's D subminiature product line. Thanks to an open, U-shaped, pretinned solder pot, the device has quick, easy solder termination.

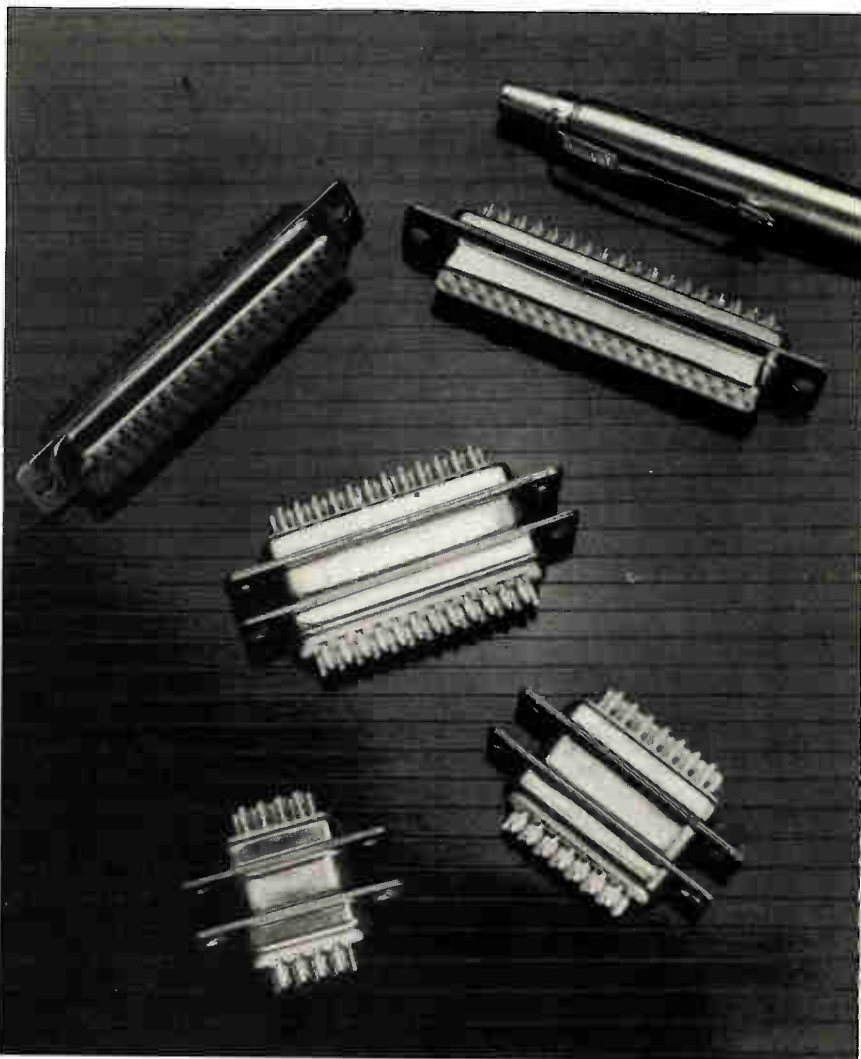

Brought to light: Another industry standard



New Amphenol® Interfuse™ single mode coupler—smaller, tougher, more affordable.

If you work with multi-mode fiber optics you know the connector that others design to is the Amphenol 905/906 Series connector. And after 10 years, the best "905/906 compatible" connector you can buy is still the original from Amphenol Products.

Now with the emergence of single mode technology, Amphenol Products sets a new standard in fiber optic components—the Interfuse 945 Series coupler.

To help you save valuable space, the innovative design of the new Interfuse coupler is 30% smaller in diameter than the current best selling coupler.

To insure stable performance in a wide range of environments, the Interfuse coupler features a durable stainless steel body.

Most importantly, to help you cut costs, our advanced manufacturing techniques enable us to offer these couplers at very attractive prices.

Couplers are available in popular 633, 820, 1300 and 1520nm wavelengths with standard 50/50 (3dB) or 90/10 (10dB) split ratios. Three grades provide maximum excess losses of less than 0.1, 0.5 or 1.0dB. Optional custom packaging and non-standard split ratios are available upon request.

To learn more about Amphenol couplers and connectors, and our commitment to innovative, more affordable fiber optic components, contact our nearest sales office or:

Call 1-800-323-7299

In Canada (416) 291-4401

Amphenol Products world headquarters:
Lisle, IL 60532



Coupler and 905/906
Series connectors
shown actual size.

©1986 Allied Corporation

ALLIED Amphenol
Products

Books of special interest to our readers



Circuits for Electronics Engineers

Almost 350 diagrammed circuits arranged by 51 of the most useful functions for designers. Taken from the popular "Designer's Casebook" of *Electronics*, these circuits have been designed by engineers for the achievement of specific engineering objectives. Pub. 1977, 396 pages, softcover. Order No. R-711, \$17.95.

Electronic Circuits Notebook

Contains 268 completely illustrated electronic circuits conveniently arranged by 39 vital functions, including amplifiers, audio circuits, control circuits, detectors, converters, display circuits, power supplies and voltage regulators, function generators, memory circuits, microprocessors, and many others, as published in *Electronics* magazine 1977-1980. Companion volume to *Circuits for Electronics Engineers*. Pub. 1981, 344 pages, softcover. Order No. R-026, \$17.95.

Design Techniques for Electronics Engineers

Expert guidance at every point in the development of an engineering project—making measurements, interpreting data, making calculations, choosing materials, controlling environment, laying out and purchasing components, and interconnecting them swiftly and accurately. Nearly 300 articles from *Electronics*' "Engineer's Notebook," with more than 500 diagrams and tables. Pub. 1977, 370 pages, softcover. Order No. R-726, \$17.95.

Microelectronics Interconnection and Packaging

Articles from *Electronics* include sections on lithography and processing for integrated circuits, thick- and thin-film hybrids, printed-circuit-board technology, automatic wiring technology, IC packages and connectors, environmental factors affecting interconnections and packages, computer-aided design, and automatic testing. Pub. 1980, 321 pages, softcover. Order No. R-927, \$15.95.

Microprocessors and Microcomputers:

One-chip Controllers to High-end Systems
Practical orientation to all aspects of microprocessors and microcomputers in 95 articles from *Electronics* covering low-end microcontrollers, mid-range microprocessors, high-performance 16-bit microprocessors, high-speed bipolar processors, peripheral support chips, signal processors, board-level microcomputers, software and applications. Pub. 1980, 482 pages, softcover. Order No. R-011, \$18.95.

Basics of Data Communications

This compilation of essential articles from *Data Communications* magazine includes chapters on terminals, acoustic couplers and modems, communications processors, networking, channel performance, data link controls, network diagnostics, interfaces, and regulations and policy. Pub. 1976, 303 pages, softcover. Order No. R-608, \$15.95.

Practical Applications of

Data Communications
Selected articles from *Data Communications* magazine cover architecture and protocols, data-link performance, distributed data processing, software, data security, testing and diagnostics, communications processors, and digitized-voice and data-plus-voice. Pub. 1980, 424 pages, softcover. Order No. R-005, \$17.95.

Personal Computing: Hardware and Software Basics

More than 50 articles from leading publications provide information on personal computing hardware, software, theory and applications. Pub. 1979, 266 pages, softcover. Order No. R-903, \$15.95.

Active Filters

Covers the theory and practical implementation of filter networks built with active elements. Includes design tables and computer/calculator programs, as published in *Electronics*. Pub. 1980, 133 pages, softcover. Order No. R-003, \$11.95.

Order today using this coupon!

Electronics Magazine Books
P.O. Box 541
Hightstown, NJ 08520
609/426-5070

McGraw-Hill Intl. Publications Co.
European Circulation Center
Maidenhead, Berks. SL6 2QL, UK
(Tel 10628123431; Telex 848640)

Order #	Qty	Price
R-		\$
R-		\$
R-		\$
R-		\$
R-		\$

Name _____

Title _____

Company _____

Street/PO address _____

City/State/Zip (Outside USA - City/postal code/country) _____

Payment enclosed (Payment must accompany orders under \$25 USA residents add applicable local tax)

Bill my company (or attach company Purchase Order)

Bill me

Ten-day money-back guarantee applies on all books



CONNECTORS

SPECIAL ADVERTISING SECTION

resistance in accordance with MIL-E-5400, and a broad temperature and altitude range.

The Toledo, Ohio, company also has new material specifications for its line of SC subminiature, coaxial, high-voltage connectors. These devices are designed for applications with limited space. The connector receptacles have O-ring seals for use in vacuum or high-pressure environments. Primary applications for these products are cathode-ray-tube displays, electronic countermeasure systems, lasers, power supplies, and X-ray equipment.

Malco-Microdot Co., a division of Microdot Inc. in South Pasadena, Calif., has a new line of high-density standard module connectors. In a metal shell, each connector has up to 304 contacts in four rows on 0.050-in. centers. The connector is designed for surface and plated-through-hole mounting and can be set on 0.500-in. centers. Malco-Microdot says the part can withstand vapor-phase and other surface-mounting soldering techniques. The basic design offers up to 304 high-reliability twist-pin contacts. The buyer can specify modular inserts, such as coaxial contacts alone or in different modular combinations.

Fifty-year-old Karl Lumberg GmbH, a Dusseldorf, West Germany, company specializing in electronic components for manufacturers of measuring and regulating instruments, autos, household appliances, computers, and telecommunications equipment, has opened Lumberg Inc. in Richmond, Va.

The new organization, which is headed by Jurgen Ebeling-Belt, introduced a line of termination and connector devices in February.

Actually, the parent company has been active in the U. S. market for several years but wanted to build up its marketing activities in the country by improving its ordering, delivery, and other service facilities for U. S. customers.

One of Lumberg's key products is a new communications/control/measurement application, called a Turn-o-lock connector. The device offers insulation displacement by turning to lock the system. The company will be announcing a number of new products later this month. ■

Let the Molex Multi-National Team
Help You Make The Connection Between...

GLOBAL & LOCAL BUSINESS CONTACT

From understanding changing global business methods to coordinating offshore procurement... Molex is there.

Coordinating the details of offshore manufacturing can be a challenge.

Is the part made in one country compatible with assemblies made in another?

Will the parts made overseas be consistent in quality?

Can tight delivery schedules be made?

Are there cultural differences to consider that may affect the job?

The questions, and the details, are many.



Molex is working to make sure your products are on time, on spec, and on budget virtually anywhere in the world.



The Molex Multi-National Account Team makes the overseas connection for Xerox, IBM, Apple, Delco Electronics, Seagate, and many others.

Molex provides these answers every day.

We're a leading manufacturer of interconnection devices.

We have the organization and experience to help today's companies achieve success in offshore manufacturing efforts.

Our Multi-National Team works with you and 32 Molex plants around the world to provide the service you need.

We'll coordinate the details of design, testing, production, purchasing, and delivery to provide quality interconnection devices and components virtually anywhere in the world.

If you've made the decision to manufacture offshore, Molex is ready to help.

Service To The
Customer... Worldwide.



Contact Don Davies and find out how the Molex Multi-National Account Team can help you make the connection.
Molex, Inc., 2222 Wellington Ct., Lisle, IL 60532, 312-969-4550.

FOR MORE INFORMATION:

Amp Inc.

Harrisburg, Pa. 17105-3608
(717) 780-4400

Circle No. 49

Amphenol Corp.

4300 Commerce Ct.
Lisle, Ill. 60532
(312) 983-3500

Circle No. 57

Elco Corp.

Huntingdon Industrial Park

Huntingdon, Pa. 16652
(814) 643-0700

Circle No. 52

Hughes Aircraft Co.

Connecting Devices Division
17150 Von Karman Ave.
Irvine, Calif. 92714
(714) 660-5701

Circle No. 51

ITT Cannon

10550 Talbert Ave.
Fountain Valley, Calif. 92708
(714) 964-7400

Circle No. 47

Lumberg Inc.

420 Southlake Blvd.
Richmond, Va. 23236
(804) 379-2010

Circle No. 55

Malco-Microdot Co.

306 Pasadena Ave.
South Pasadena, Calif. 91030
(818) 799-9171

Circle No. 60

Molex Inc.

2222 Wellington Ct.
Lisle, Ill. 60532
(312) 969-4550

Circle No. 59

Robinson Nugent Inc.

800 E. 8th St.
New Albany, Ind. 47150
(812) 945-0211

Circle No. 110 to 114

Rowe Industries

6225 Benore Rd.
Toledo, Ohio 43612
(419) 729-9761

Circle No. 54

Samtec Inc.

810 Progress Blvd.
New Albany, Ind. 47150
(812) 944-6733

Circle No. 40

Viking Connectors Co.

21001 Nordhoff St.
Chatsworth, Calif. 91311
(818) 341-4330

Circle No. 45



Malco gives you increased density ... takes less board space

You know the problems...less board space...increased density... more and varied I/O. The Malco H.D.S.M. (High Density Standard Module) connector may be the solution now and through the 1990's.

The versatile H.D.-S.M. provides a variety of contact types - signal - and coaxial and quantities - up to 304 High Rel Twist Pin contacts in 4 rows on .050 centers! Modular inserts allow the designer to specify a combination of

contact types within the standard .360 X 4.600 shell.

The H.D.S.M. can be mounted on .500 centers. It is designed for either surface mounting or plated-through-hole mounting. Other terminations options are available.

For more information regarding the H.D.S.M. solution, call or write: Malco, 306 Pasadena Avenue, South Pasadena, CA 91030, (818) 799-9171, TWX: 910-588-3768.



MALCO
A Division of
MICRODOT INC.

Malco is dedicated to quality

A SMART-MODEM FILTER THAT'S ECONOMICAL AND SMALL

EXAR SQUEEZES A LOT OF INTELLIGENCE INTO A 180-BY-150-MICRON CHIP

Modems, which modulate and demodulate digital data for transmission over analog telephone lines, are the simplest way to link a personal computer to a corporate mainframe or a commercial data base, and for thousands of users they are the only link to the world beyond the desktop. To build an intelligent modem—one that knows the difference, say, between a busy signal and a line that's out of order—a modem filter is needed. A separate filter designed without compromising space or features permits modems to operate on worst-case lines.

By applying switched-capacitor techniques and a 3- μ m dual-metal CMOS process, Exar Corp. has overcome this difficulty. Its new single-chip intelligent-modem filter, the XR-2129, mixes the analog and digital functions required to implement a 1,200-b/s smart modem with such features as call-progress monitoring, analog loop-back capability, phone-line status monitoring, and the ability to function over inferior telephone lines.

The Sunnyvale, Calif., company is calling its 2129 a second-generation modem filter. "The first commercially available Bell 212A-compatible modem filters were built using n-MOS processes, and at 50,000 mil² were much larger" than the Exar device, says Cecil W. Solomon, the company's manager of modem design. The high degree of integration and the CMOS process make the Exar chip a natural choice for system integrators building laptop computers or portable data-communications machines.

The 180-by-150- μ m chip is about one half the die size of comparable filters, its manufacturer says (Fig. 1). The product, which incorporates 51 CMOS operational amplifiers, is designed with an advanced switched-capacitor technique utilizing the matched-z transform, and with two complete low-band and high-band filters. The latter, which are centered respectively on the Bell standard 1,200- and 2,400-Hz frequencies, provide compromise line equalization.

The process of converting a traditional continuous-time RC filter to a switched-capacitor, sampled-data format can take several forms. A rudimentary design method sometimes used is to simply replace each resistor of the RC filter with a switched capacitor. But this technique yields a rough equivalent of the RC filter through function only. To ensure a closer approximation, it's necessary to use a mapping function that translates the s-

domain transfer function of the RC filter to the equivalent z-domain transfer function of the switched-capacitor filter. Bilinear mapping has proved unacceptable, because the resultant transfer function produces an extra term that renders it inaccurate. Exar's approach is to use a matched-z, mapped z-domain equivalent that corresponds exactly to the RC transfer function.

"Most people designing switched-capacitor filters are using a bilinear technique to accomplish the analog-to-digital mapping," says Gary Sellani, Exar's modem designer. Exar, however, chose to use the matched-z transform, he adds, because it makes it possible to attenuate specific frequencies to eliminate noise and interference.

FILTER COMPENSATION

The low- and high-band filters used by Exar are 20th-order switched-capacitor filters, each consisting of a 10th-order bandpass filter and a 10th-order allpass filter. An important characteristic of the bandpass filters is the amount of interband rejection, which attenuates the local transmit carriers in the modem. The allpass filters compensate for the group-delay variation of the bandpass filters and for half of the compromise line characteristics in order to lower the bit-error rate.

All logic inputs to the XR-2129 are TTL-compatible, making direct connections to microprocessors possible. To reduce chip count, the data-buffer functions can be implemented in the host microprocessor. A common and inexpensive 1.8432-MHz crystal is all that's needed to time the XR-2129. When used with the company's XR-212AS chip set—consisting of the XR-

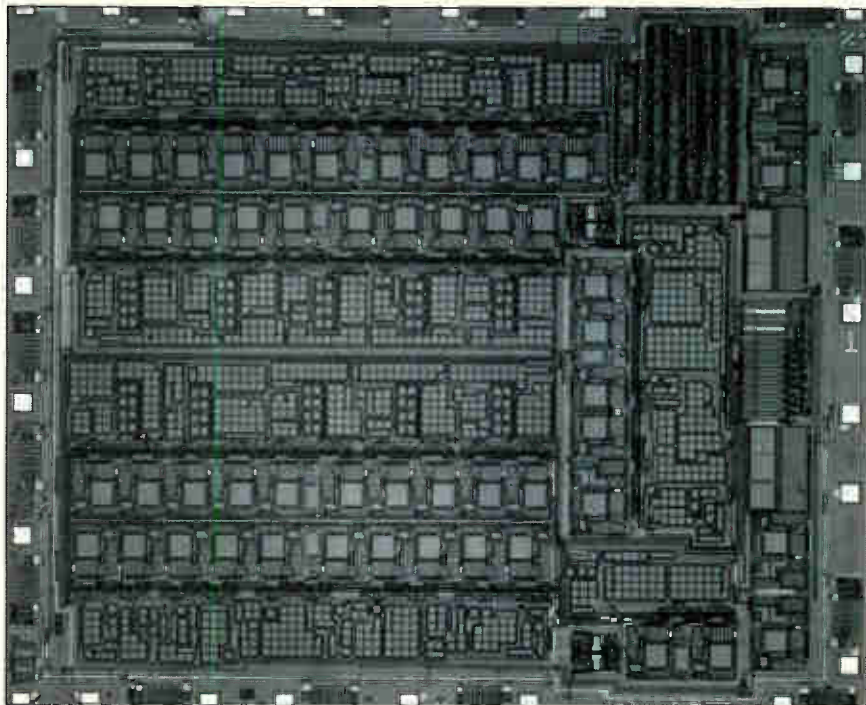

1. SMALLER DIE. The 180-by-150- μ m smart-modem filter is half the size of comparable devices, says Exar. It is implemented with a 3- μ m silicon-gate two-level-metal CMOS process.

TECHNOLOGY TO WATCH is a regular feature of Electronics that provides readers with exclusive, in-depth reports on important technical innovations from companies around the world. It covers significant technology, processes, and developments incorporated in major new products.

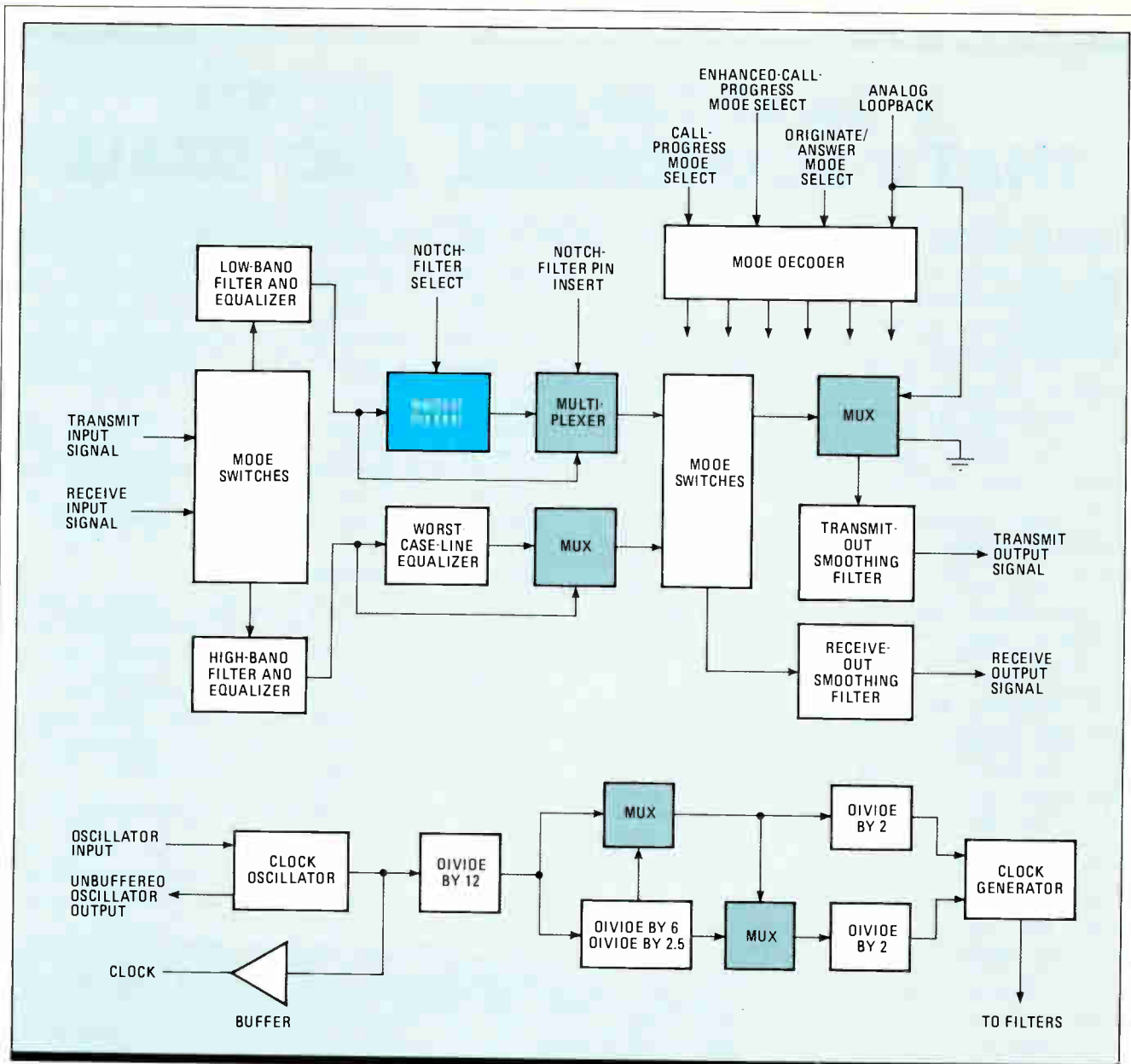

2. PIN CONTROL. Exar's filter meets the Bell 212A standard for 1,200- and 2,400-Hz transmissions in the U. S. In Europe, only a control pin inserted in the notch filter is needed to convert the filter for V.22 applications at 550 or 1,800 Hz.

2121 modulator, the XR-2122 demodulator, the XR-2125 data buffer, and a small amount of external circuitry—all the functions needed to realize the Bell 212A modem are in place. The XR-2129 can also be used with other modem chips or with proprietary board-level systems.

The Exar 2129 filter offers modem designers the most commonly required smart-modem features. "Any fully featured modem worth its salt must be able to implement call-progress monitoring to prevent blind dialing," says Solomon. This means detecting such telephone-line signals as dial tone, busy, ring-back, and modem answer tones. "If the telephone line is faulty or the central telephone office is overloaded, only the modem with call progress can detect a lack of dial tone after going off hook. It will not keep 'blind dialing' a telephone line that is out of commission," Solomon says.

Dual-tone multifrequency generation—the signaling used in tone-key phones—is another important modem feature. The tones can be generated by a microprocessor using a digital-to-analog converter, or by square-wave generation. In other filter designs, the output must be externally filtered, thus by-

passing the modem's transmit and receive filters. With the 2129's on-chip bypass mode, adding a DTMF signal requires no additional multiplexing. The unit also has a self-testing feature, which enables the transmit signal at the receive channel, making a local loop-back test possible.

While most modems perform well over telephone lines of normal or average quality, few exhibit acceptable performance over poor-quality lines with only full-channel compromise equalization. Modems typically require additional fixed or adjustable equalization; the Exar filter does not.

NOTCH FOR EUROPE

Besides a hefty array of smart modem features, modem designers want a filter that can be adapted easily to European standards. To comply with these standards, which are set forth by the International Telegraph and Telephone Consultative Committee (CCITT), the Exar modem is outfitted with a guard-tone notch filter (Fig. 2) that can be programmed to attenuate at 550 or 1,800 Hz, depending on the country's needs. A control pin inserts the notch filter for European V.22

applications and bypasses it for Bell 212A applications.

The notch filters are used when receiving in the low-band filter. They attenuate the feed-through of the transmitted guard tone as it travels through the transformer and into the answer modem's receive carrier input, bringing the guard tone to a level much lower than the receive-carrier input.

On the XR-2129, the guard-tone notch filter is implemented with a 4th-order switched-capacitor notch filter cascaded with the low-band filter. This device is programmed to select either the 550- or 1,800-Hz notch. The measured notch depth on the XR-2129 is about 60 dB over a frequency range of ± 10 Hz on both notches, as compared with 40 dB over a frequency range of ± 2 Hz on similar filters.

The fourth-order notch is designed to have little effect on the low-band group delay. Also, the wider notch depth gives the modem designer more flexibility in choosing the generated guard-tone frequencies. And unlike other filters, the XR-2129 requires no external multiplexers, logic circuits, or smoothing filter when the modem uses the guard-tone notches in the V.22 mode. Here as well, a control pin inserts the notch filter for V.22 applications and bypasses it for Bell 212A applications.

The XR-2129 filter can be operated in five basic modes. In the normal-data or originate mode, employed when a user is making an outgoing call, the transmit signal goes through the low-band filter and the receive signal goes through the high-band filter. In the answer mode, this process is reversed, with the transmit signal entering the high-band and the receive signal the low. Transmit and receive signal multiplexing is achieved on-chip.

In the self-test or analog loop-back mode, the transmit carrier output signal is looped back to the modem through the receive carrier output, and the transmit carrier output is muted. The muting out of this signal is unique to the XR-2129, says Sellani. "It is the best method for doing an analog loop-back test. By muting transmit carrier output, we prevent our test signals from being transmitted to another modem on the telephone line."

In the call-progress monitor mode, the filter operates in a normal or in an enhanced mode. In the normal mode, the center frequency of both low- and high-band filters is shifted down by a factor of 6. This shifts down the high-band filter to 400 Hz ± 80 Hz; the low-band filter is shifted down to 200 Hz ± 80 Hz. When the originate mode is selected, the receive signal will go through the scaled high-band filter, which now has a pass band of about 300 to 480 Hz, and will pass a precision dial tone of 350 to 440 Hz, as well as an audible ringing tone of 440 to 480 Hz. However, only a portion of the busy or reorder tone of 480 to 620 Hz will pass through. An energy detector circuit, combined with a method of cadence and timing determination, distinguish between different conditions on the line when establishing a call.

OVERCOMING DEFICIENCIES

Two deficiencies inherent in the normal state are overcome in the enhanced mode. First, the pass band is more accurately centered over the call-progress tone frequencies because the low-band filter is scaled down by a factor of 2.5. The low-band filter thus has a pass band of 290 to 670 Hz, which allows the busy tone to pass through completely. Second, because the high-band filter is not scaled, the modem answer tone (2,225 Hz for Bell 212A, 2,100 Hz for V.22) can be monitored easily. Also in this mode, the transmitter can be muted so that the transmit signal output can be eliminated during the handshaking sequence of the Bell 212A modem.

To monitor the status of the phone line, the filter goes into the bypass mode. When this happens, the low-band and high-band filters are bypassed by connecting the transmit carrier output to the transmit carrier input while the receive carrier output is connected to the receive carrier input through buff-

ered output smoothing filters. Besides monitoring the lines, this feature allows easy implementation of DTMF generation for tone-key service.

Another feature of the XR-2129 is the worst-case line equalizer. The optional fixed compromise (amplitude and delay) equalizer is used when the modem is receiving in the high band and line conditions warrant adding extra equalization to improve transmission quality. It is then cascaded with the high-band filter. This capability can be bypassed under normal line conditions.

Other features provided on the chip include complete transmit and receive output smoothing filters, as well as two uncommitted operational amplifiers. The smoothing filters are continuous-time, second-order Salen and Key type low-pass filters that reconstruct the time-sampled output signals and reduce clock feed-through of switched-capacitor filters. The two uncommitted op amps can be used in input anti-aliasing filters or in gain-control stages. □

SHRINKING A FILTER TO FIT

Modem designers Gary Sellani and Cecil W. Solomon know their way around switched-capacitor-circuit designs. Sellani, a 29-year-old native of Lansdale, Pa., graduated from the University of Utah's electrical engineering program with a specialty in linear-circuit design and is pursuing an MSEE at the University of Santa Clara. He is the principal designer of Exar Corp.'s second-generation modem filter.

Solomon, born in Nigeria 35 years ago, is Exar's design manager for modem integrated circuits and switched-capacitor filters. He worked for Cermetek Microelectronics, Sunnyvale, Calif., and E.G.&G. Reticon, also of Sunnyvale, before joining Exar in 1984. He had a key role in designing the first commercially available 1,200-b/s modem filter back in 1982.

Sellani, who first worked

with Solomon at Reticon, began design of the the XR-2129 nearly one year ago. "We had to design a filter that would work with our modem chip set and everyone else's," he says.

The aim of the design project was to build a filter that would become a universal second-source item. To bring such a complex task in on time, Sellani decided to use full electronic computer-aided-design verification.

"We made ECAD do things it had never done before," he says. "We started with Silvar-Lisko's schematic-capture package, then did our logic design on a different system. The tricky part was putting the two together," recalls Sellani.

To complete the verification, Sellani transferred both the analog and digital parts of the design to a Spice netlist format, then finished the connections by hand.



REFINERS. Modem designers Gary Sellani and Cecil W. Solomon (foreground) developed Exar's second-generation modem filter.

HOW COMPAQ REDESIGNED ITS TOP-SELLING PORTABLE

FULL-FEATURED MODEL IS 30% SMALLER AND 15% LIGHTER THAN ORIGINAL

When the time came to spiff up its original and highly successful Portable Computer, Compaq Computer Corp. again faced the challenge of cramming full IBM Corp. Personal Computer compatibility into a tight space. The Houston company's surveys revealed that most personal computer buyers are looking for a smaller, lighter box, particularly in portable machines. But users steadfastly refuse to trade away such features as a large screen, high resolution, and a full-size keyboard. With that checklist in hand, the redesign team compiled the lessons they had learned since the earlier model's debut and made free use of technologies that were not around the first time.

"We didn't go for a certain size and see how much functionality could be put in it," says Compaq president Rod Canion. "Instead, we specified the functionality, then proceeded to make it as small as possible." The just-unveiled Compaq Portable II is a top-to-bottom redesign. The most obvious differences are its size and looks, but the new machine also carries the latest in microprocessors, memories, and disk drives.

The new model, which is 15% lighter than the original Compaq Portable Computer, weighs in at 23 lb 9 oz with one floppy-disk drive and at only 25 lb 9 oz with two drives. With one floppy and a Winchester disk drive, the machine weighs 26.2 lb. The original weighs 28 lb with a single floppy-disk drive. Compaq shrank the machine by about 30% overall by replacing the display screen, revamping the keyboard layout, and using one-third-height floppy-disk drives (Fig. 1). The Portable II measures 17.7 in. wide by 7.5 in. high by 13.9 in. deep; the original Portable is 20 in. by 8.5 in. by 16 in.

The redesign effort also aimed to enhance the older model's portability. The trimmer model is lightweight, easier to carry

because it hangs closer to one's legs, and fits readily under airplane seats and in overhead luggage racks. Its sleek new look makes it an attractive desktop machine as well.

Compaq made changes to the technology inside as well. Primarily, these changes are evolutionary. The Portable II carries the Intel Corp. 80286 microprocessor, up to 1.5 megabytes of memory using 256-K chips instead of 64-K parts plus new controllers for all drives. The new integrated circuits for hard-disk-drive control and add-on memory allow the addition of these features without using up board slots—a very important consideration for users who want to add boards for myriad other functions.

Many packaging ideas came from lessons learned since the first machine was built, such as the use of surface-mounting technology in a new peripheral controller and power supply. And the engineers did not ignore the small operational details.

"The technology of portable [computer] construction has advanced since the first Compaq was built," says engineering vice president Jim Harris, who was one of the company's founders and the principal designer of the original portable. "For example, we have developed lightweight but rugged and rigid cross-braced aluminum structures." And by shrinking the sizes of many components, Harris and his team were able to move things around a lot.

One major challenge facing the redesigners was adhering to the Compaq dictum that, like its older brother, the Portable II be fully compatible with the IBM PC. At the same time, every effort in the redesign was aimed at reducing weight and volume without sacrificing functions. According to Harris, "the major controlling factors in reducing the size of a full-function PC-compatible machine are the length of standard IBM-compatible boards, the height of the screen, the length of

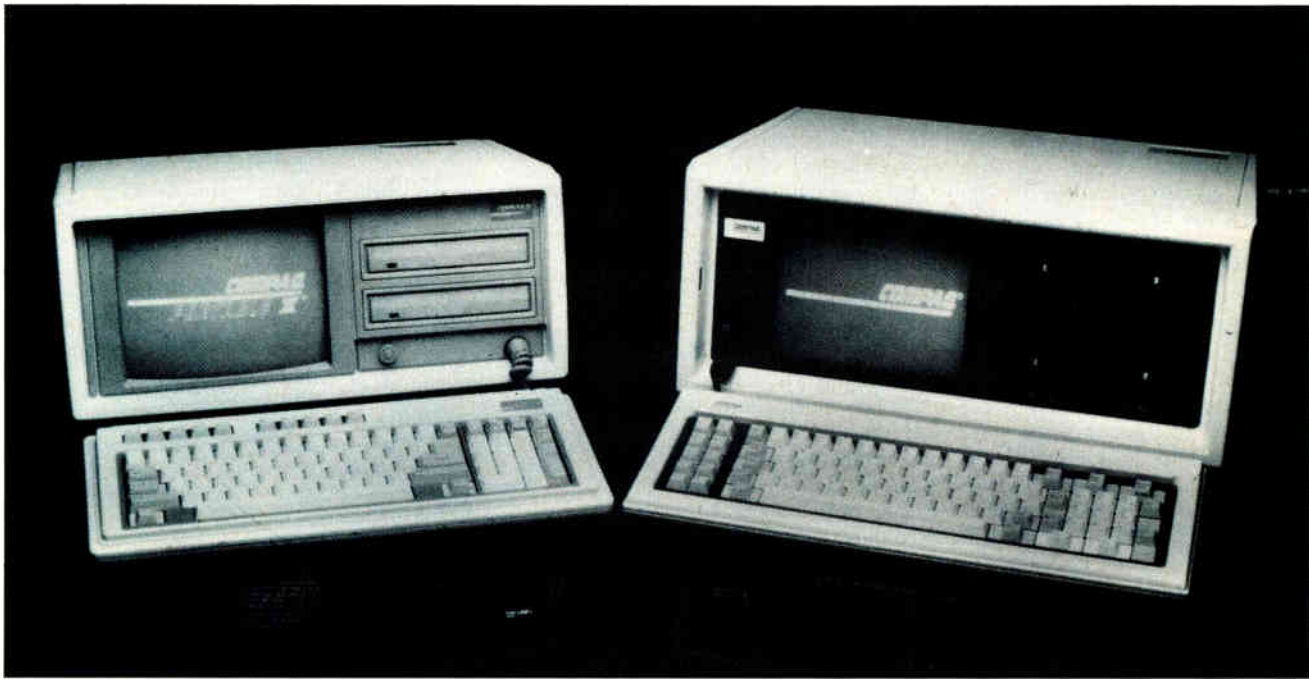

1. SMALL ONE. The new Compaq Portable II (left) is considerably smaller and easier to transport than its older brother.

a full-function keyboard, and the dimensions of 5¼-in. floppy-disk drives."

Little could be done on the first score, so the design team instead concentrated on freeing up slots on the backplane through several innovative features. For example, the redesigned memory-expansion board, which adds up to 1.5 megabytes, plugs into a special slot mounted on the bottom of the system board.

A SCALED-DOWN SCREEN

But the choice of a new display screen presented a major opportunity for scaling down the machine. Though Compaq achieved a significant height reduction—1 in.—with the new screen, it entailed no compromises in display area and resolution. The new cathode-ray tube is the functional equivalent of its 9-in. dual-resolution forebear, a Compaq requirement to keep it a full-function PC compatible. The flatter-faced, more compact CRT bottle saves considerable space, as does its surrounding shell, which forms an integral part of the main chassis. In the first portable, the display sat in a separate chassis assembly.

The new design saves space, yet the viewing area is actually a little larger than the old screen's. Because the flatter face produces sharp images right up to its edge, the whole screen area can be used effectively.

Harris and his design teammates made the new keyboard a little narrower by changing the position of the function keys. This helped them trim the width of the new product, yet it is still wide enough to accommodate 5¼-in. floppy disks, the standard for PC-compatible software. And the Portable II will accept the standard IBM PC-compatible boards.

Compaq solved the problem of mounting a Winchester disk drive in a portable computer in the earlier Compaq Plus—the first portable to successfully protect the delicate Winchester mechanism against the rigors of transportation. The extensive shock mounting proven in the Compaq Plus has been improved for the Portable II. A shock-mounted 3½-in. Winchester-disk-drive assembly slides into a storage module.

The storage module, which slips easily in and out of the machine through the front for easy maintenance, houses three disk configurations. It can accommodate one or two floppy-disk drives or one floppy and one Winchester drive. The storage module also holds the controllers for all disk drives. This eliminates the need for a separate controller board, which in turn frees a card slot on the backplane. The storage-module-mounted controller is made small and efficient by the use of surface-mounted integrated circuits.

Surface-mounting also plays a role in the modular power supply, which has a connector that plugs directly into the main system board. The absence of cables saves space and improves reliability. Space that would have been taken up by power cables is now available for an automatic line switcher beside the power supply.

This optional device automatically selects the correct line voltage when the computer is plugged in—a boon to world travelers. Voltage is distributed to all components, including the disk drives and display, through the multiplane system board. One plane is devoted basically to power distribution.

There are many differences in the case and cabinet. For example, four screws secure the cover instead of a pop-open case. Other little improvements include a quieter fan, two-position adjustable feet for tilting the keyboard, a longer keyboard cord that is not as springy as the old one so that the keyboard is moved more easily away from the unit, and even as small but important a detail as an easier-sliding door on the fan and power-cord openings. The outer skin of the machine is a high-impact polycarbonate plastic molding that can withstand great stress.

Three computer models are now available. The model 1 has a single 360-K-byte 5¼-in. floppy-disk drive and 256-K of memory; it sells for \$3,499. The model 2, also with 256-K of memory, comes with two floppy-disk drives and sells for \$3,599. The model 3 boosts the standard memory to 640-K and comes with a 10-megabyte Winchester disk drive and a floppy-disk drive and sells for \$4,799. □

MARKET FEEDBACK DIRECTED REDESIGN TEAM

When the team led by engineering vice president Jim Harris set out to redesign the Compaq Portable, it found that market research already had taken care of half the problem—defining a machine that would sell. Compaq Computer Corp. has been doing extensive market and customer surveys since it started delivering its first product and enjoys a high return rate of buyers' information cards. New product ideas come from dealers, customers, and Compaq designers.

The major goal was to produce a smaller and lighter computer, but one that also retained all the functions that make it compatible with IBM Corp.'s Personal Computer. The company's market research dictated that most portable computer customers are quite unwilling to give up these PC features, such as a large screen, high resolution, and a full-size keyboard.

For Harris and his engineers, as they considered new technology and techniques for shrinking the machine, this meant constant attention to the full-function requirements. Harris, one of the company founders, oversees the technical group that does all Compaq product development. The electrical engineering graduate from Texas A&M University led the development of the original Compaq Portable, was involved in the engineering decisions for all subsequent products, and directed the redesign efforts resulting in the Portable II.

Compaq management is convinced that the resulting Portable II is the right machine for the market right now, rather than a laptop or briefcase computer. "It's not that we don't think small computers are important," says president Rod Canion. But he believes "the amount of functionality that can be

put in a laptop [with current technology] is not able to serve the needs of a large volume of users." The results of Compaq's research efforts indicated that there aren't very many people who want low-function laptops. "The research was so clear," says Canion.

Compaq started producing the Portable II more than 90 days before the product's announcement to ensure a sufficient supply. True to form, Compaq did not announce the product until it had thoroughly tested it in full production. "The production and announcement scheduling were geared to have the machines on the 2,700 dealers' doorsteps" on the morning of Feb. 20, the announcement date, says Jeff Stives, director of corporate relations. □

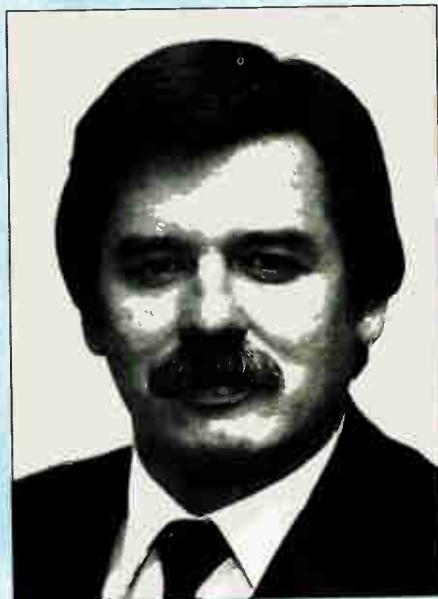

PORTABLE DESIGNER. Jim Harris's team shrank the Compaq Portable Computer without sacrificing functionality.

HALLEY'S COMET SPACE ENCOUNTER SET FOR MARCH.

The ultimate space encounter is about to begin. Halley's comet, making a brilliant comeback after 76 years, will soon provide scientists with a once-in-a-lifetime opportunity to shed new light on the origins of the solar system.

As part of a global research effort, Japan's Institute of Space and Astronautical Science, the Ministry of Education, has sent out a welcoming mission of twin interplanetary probes—SAKIGAKE (Pioneer) and SUISEI (Comet)—which are due to intercept Halley's comet in March '86 soon after its closest approach to the sun.

The two deep space explorers will obtain invaluable new data on solar wind—waves of plasma emitted by the sun—and its effect on the comet. Simultaneously, SUISEI will reveal the 3-dimensional structure of the hydrogen cloud surrounding the coma with an ultraviolet TV camera and beam the image data to the earth up to 170 million km away.

For its part, NEC's involvement in these space probes included system design, system integration and the manufacture of major subsystems for telemetry and command, the antenna, power, data processing, attitude and orbit control.

With 20 years of experience in space development NEC has contributed, as a prime contractor or system integrator, to 20 of the 32 satellites placed in space by Japan since 1970.



Photos courtesy of the Institute of Space and Astronautical Science, the Ministry of Education, Japan.

NUMBER 134

KUWAIT CHOOSES NEC CELLULAR MOBILE TELEPHONE.

NEC will install an integrated cellular mobile telephone system in Kuwait by the 3rd quarter of 1986, paving the way for truly high-grade services nationwide. NEC's total access communications system featuring 25kHz frequency spacing in the 900MHz band will initially serve up to 25,000 subscribers, and can be expanded to accommodate up to 100,000 subscribers.

Awarded by the Mobile Telephone Systems Company (MTSC) of Kuwait, the full turn-key contract calls for NEC to manufacture and install all key equipment, including an advanced digital switching system plus radio equipment for 21 base stations and 15,000 mobile telephones. MTSC is a shareholding company, 49% Government and 51% public, established to run all mobile communications in the State of Kuwait.

Moreover, NEC will also provide the latest microwave radio and fiber optic links to interconnect the central switching system and base radio equipment, and a medium-scale computer for message accounting and communications traffic control.

This massive project is well under way, drawing upon the integrated computer and communications technology of NEC and expertise of all concerned companies.

Upon completion, the new system will provide sophisticated services such as "Call Transfer", "Call in Absence" and "Privacy".

NEW TTC & M EARTH STATIONS FOR ARABSAT.

An advanced NEC satellite control network is now providing complete tracking, telemetry, control and monitoring (TTC & M) services for the Arab Satellite Communications Organization (ARABSAT) which is comprised of 22 Arab League countries.

The ARABSAT Satellite Control Network analyzes and processes satellite telemetry and tracking data, and commands and monitors operating conditions of the Arab



world's first series of communications satellites—the ARABSAT-1A and ARABSAT-1B.

This integrated control system consists of a primary earth station at Riyadh, Saudi Arabia, and a secondary station at Tunis, Tunisia. All necessary equipment including computer hardware and software systems, were developed and installed by NEC on a turn-key basis to assure optimum system performance and long-term reliability.

NEC's contribution to the growing ARABSAT network also includes the completion of three earth stations—one each in Jordan, Bahrain and Tunisia—and it is now manufacturing 7 more for use in other Arab countries.

The ARABSAT system can accommodate 8,000 simultaneous telephone circuits, seven television channels and a community television channel for isolated rural areas. It can also provide telex and data transmission services, and other specialized services.

4-BIT MICROS RIVAL 8-BIT POWER.

The new NEC 75000 Series of 4-bit CMOS single-chip microcomputers is the first to bring VLSI expertise and advanced architecture to the 4-bit realm for results that rival 8-bit performance.

The 75000 Series combines added on-chip memory up to 16k-byte ROM/4k-nibble RAM and higher speed—less than 1μs cycle time at 4MHz. Other high-end features include powerful on-chip hardware, outstanding expandability and an

enhanced instruction set.

The 75000 Series comes with a full kit of hardware/software development tools and it also inherits the software of our industry standard 7500 Series through easy conversion.

The first four members of the 75000 family are currently available—the μPD75104 and μPD75106 high-performance general purpose micro, the μPD75P108, an EPROM version, and the μPD75206, which incorporates a VF controller/driver.

NEC

Immediate

Apply within. No experience necessary.

That's another wonderful benefit of our exclusive EPLD technology. You can move right into user-programmable logic design. Right now. Because we have a complete family of high density products (from 300 to 2000 gates), plus the easy-to-use development software you need to turn your assignment into a working prototype. In a matter of days. And for a fraction of what you'd expect to invest.

Best of all, you no longer have to enter the frightening realm of gate arrays to get a high level of integration. Just look into our newest family member: the EP1800.

You'll work with 2000 gates. In a tiny J-lead package. Without worrying about speed (it has plenty), power (it desires very little) or noise (it's quite deaf).

What's more, design development is a breeze. Even on the EP1800. With our A+PLUS software and your IBM PC, prototypes can be produced in days. Sometimes hours. Modifications can be made in minutes. And with the software automatically placing your design into the right chip, you don't waste time figuring out what goes where.

One last step. Volume production. Also no problem. Because every one of our EPLDs is available as a One-Time-Programmable (OTP) plastic part. So you can get to market in less time. For a lot less money.

So apply today. We've got immediate openings for your design.

Call (408) 984-2800

ALTERA

3525 Monroe Street
Santa Clara, CA 95051

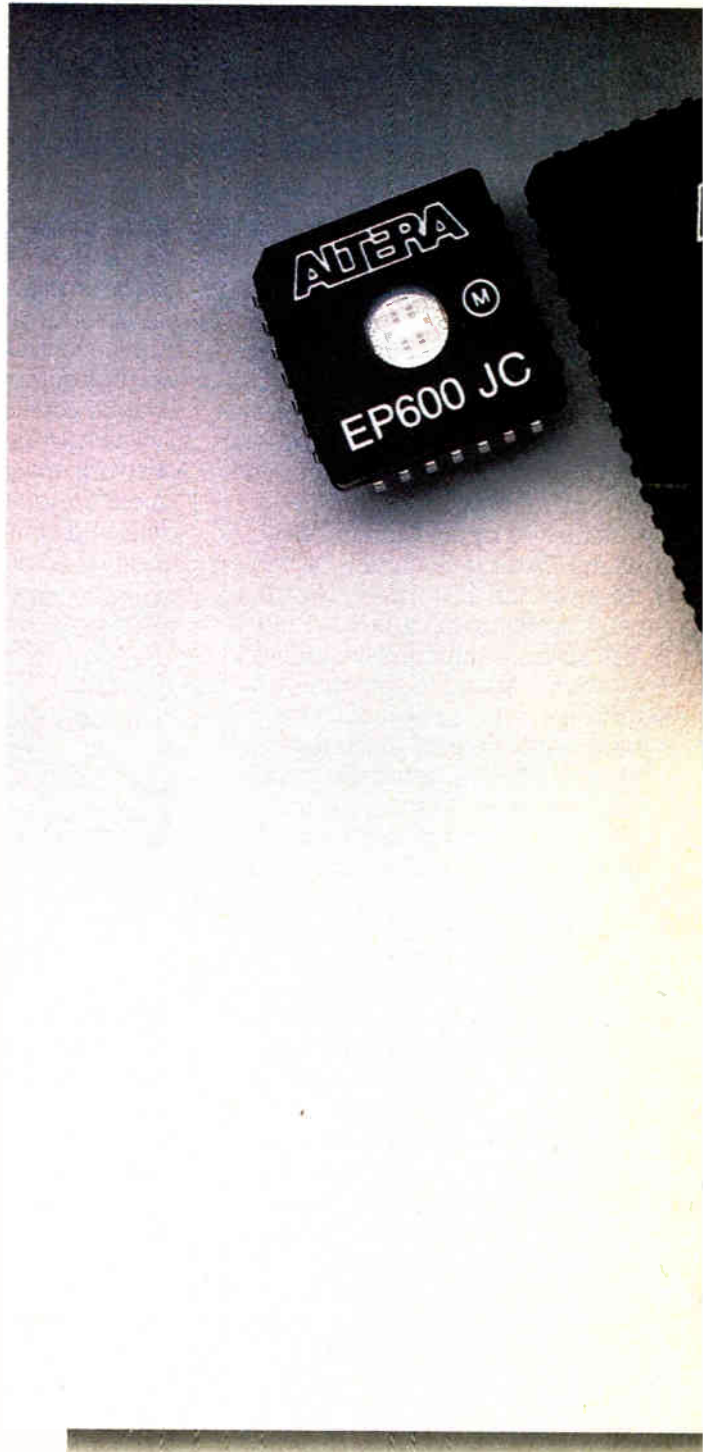

Circle 69 on reader service card

A+PLUS is a registered trademark of Altera Corporation.
IBM is a registered trademark of International Business
Machines Corporation. CHMOS is a patented process of
Intel Corporation.

Distributed in U.S. by Alliance, Pioneer, Quality
Components, Schweber and Wyle. In Canada by Future.

© 1986 Altera Corporation.

Openings.

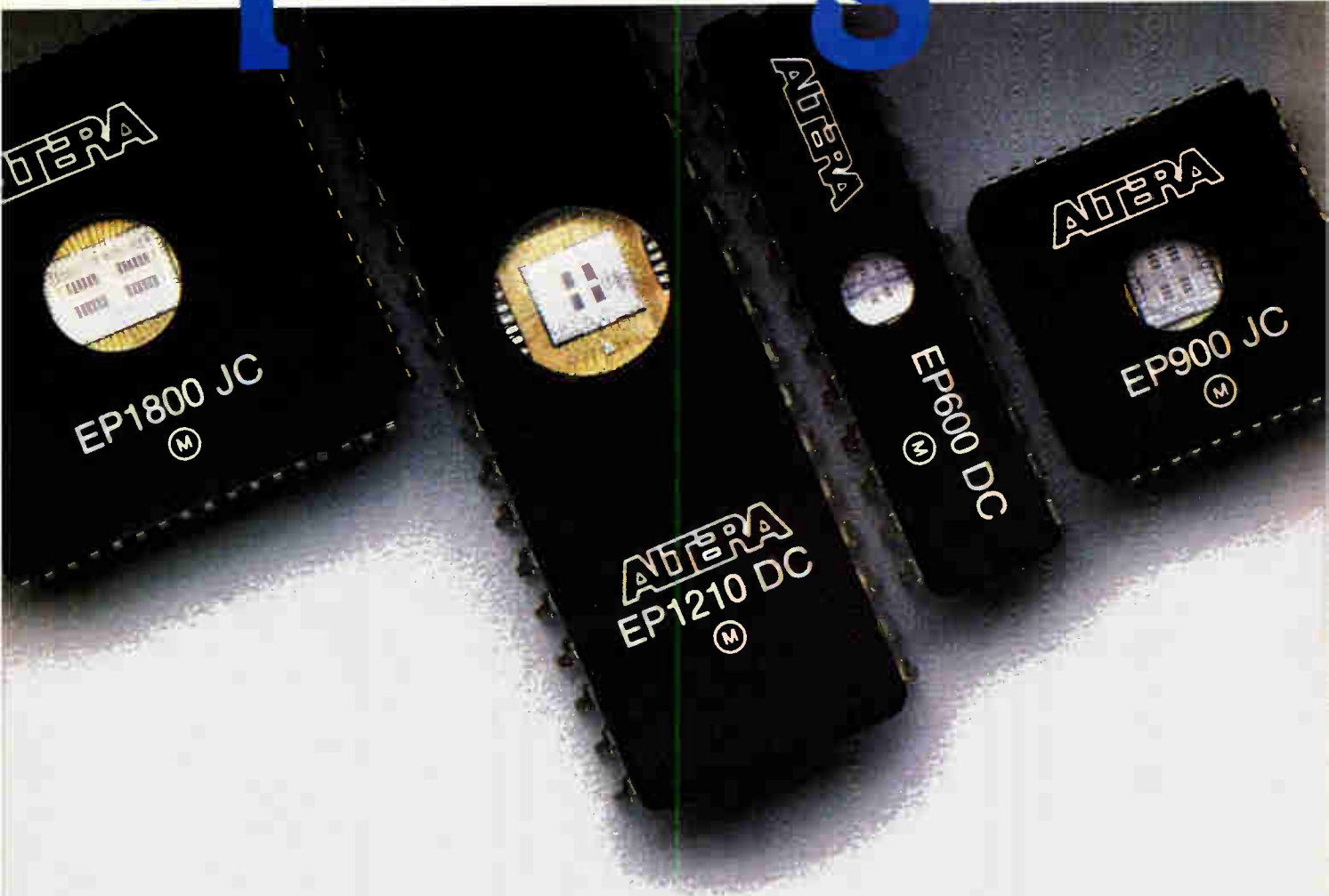

Yes, there is actually a laser here.
You just can't see it.
Because it's located in the Anritsu Optical
Calibration Laboratory.
Now, if you're reading this in an ordinary
home, office or factory, there are probably
thousands of microscopic particles — dust,
smoke, oil, etc. — in the air between you
and this page.
And if you aimed a laser beam through
that air, you'd probably see it. Because
the beam would strike enough dirt and
smoke and grime to make it visible.
But the environment in our Calibration
Laboratory is carefully filtered and climate-

controlled. So only a fraction of those
particles remain.
That's why you can't see the laser beam
here: because there's almost nothing but
pure air to deflect it.
Nothing to diffuse the beam and reduce its
power as it travels to its target. Nothing to
make it anything less than a perfect source
of light for calibrating optical standards.
Which means that each of the standards
we use for checking out our optical prod-
ucts is just that much more accurate.
That translates into more accurate meas-
uring instruments for fiber optic communi-
cations. More accurate optical spectrum

Can You Find in This

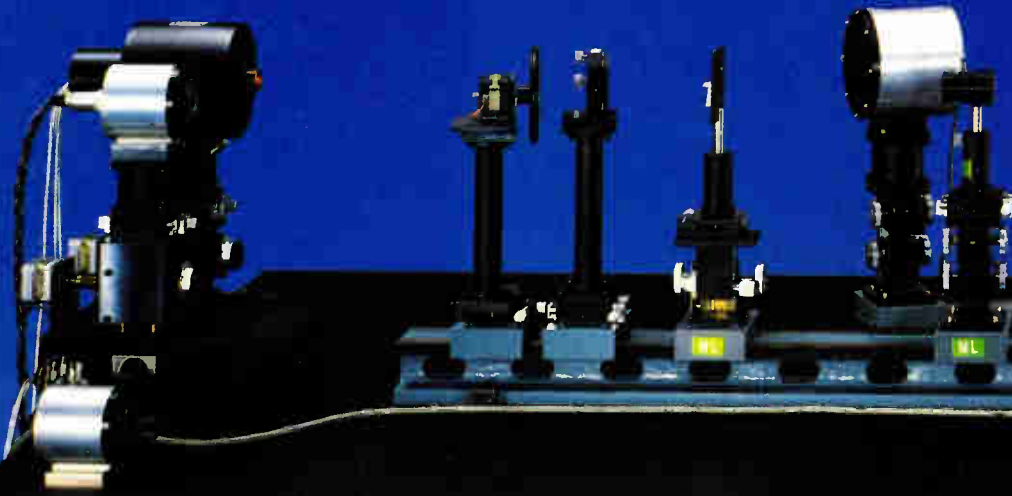

analyzers and optical time domain reflectometers. More precise optical power meters — the list goes on and on.

The Optical Calibration Laboratory is just one example of how Anritsu works to ensure the highest possible accuracy and reliability. In fiber optics, in radio and telecommunications equipment, in communications test instruments, in computers and data processing gear — in fact, in every single one of our more than 11,000 products and systems.

The right answer is always at Anritsu. Even if it's not immediately visible.

Anritsu
WE'RE ON THE MOVE. WORLDWIDE.

ANRITSU CORPORATION

10-27, Minamiazabu 5-chome, Minato-ku, Tokyo 106, Japan.
Phone: Tokyo 03-446-1111, Telex: 0-242-2353 ANRITU J

As of October 1, 1985, Anritsu Electric Co., Ltd. became Anritsu Corporation. Circle 71 on reader service card

the Laser Beam Picture?

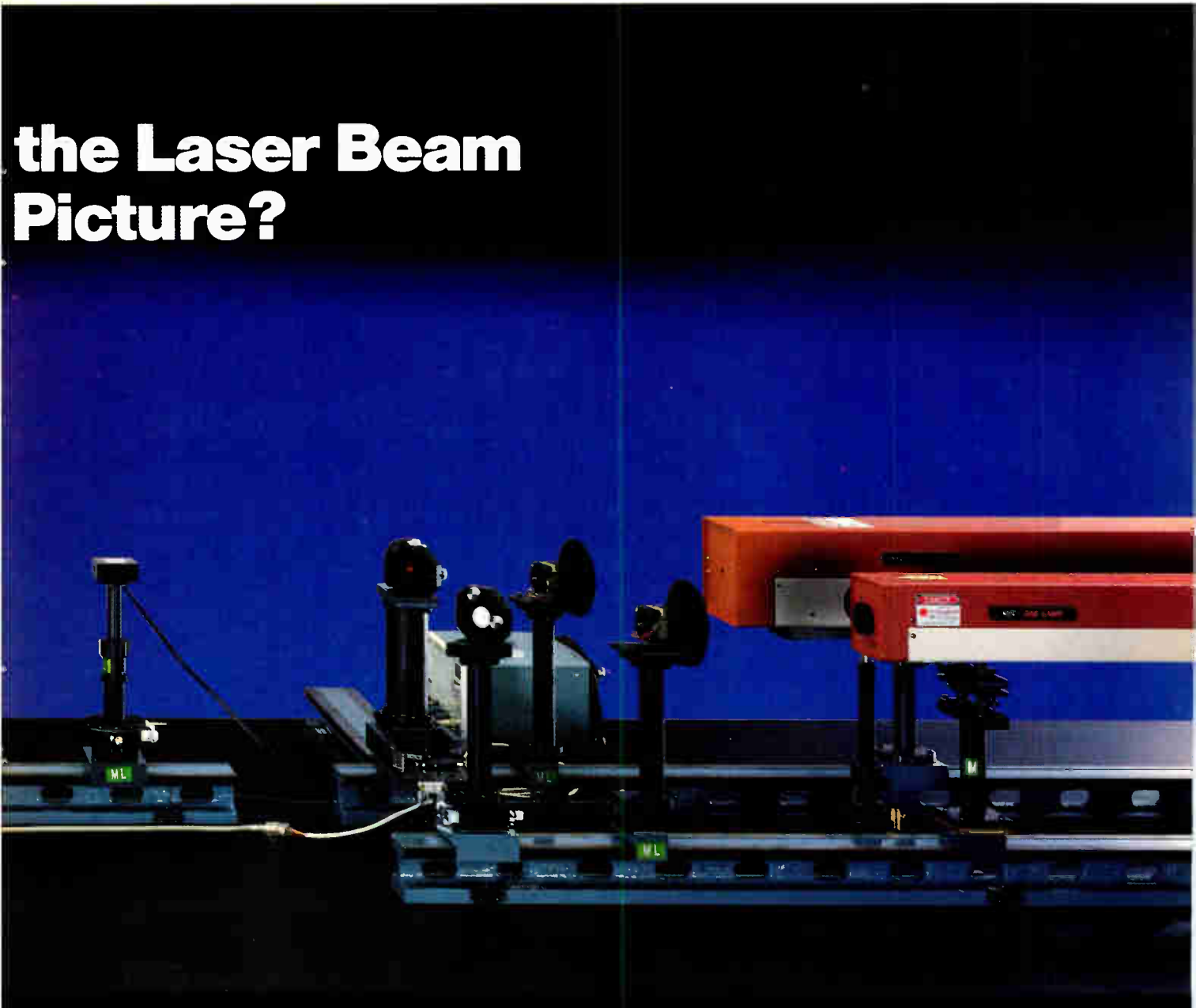

PROBING THE NEWS

FAIRCHILD IS BACK!

HOW DON BROOKS PLANS TO REJUVENATE THE VENERABLE CHIP MAKER

by Clifford Barney

CUPERTINO, CALIF.

Fairchild Semiconductor Corp., which launched the integrated-circuit revolution and was almost consumed by it, is ready to start the game all over again. After giving Schlumberger Ltd. financial indigestion for more than six years, Fairchild now has a new management team, a vigorous product-introduc-

tion program, and a new strategy for survival. After a decade of decline, during which it lost top management and fell behind technologically, Fairchild is trying to leapfrog the competition and emerge as a leading supplier of high-performance components for the next generations of computer equipment, from desktops to supercomputers.

Fairchild has always enjoyed success

in high-performance circuits; even in the 1960s, when it was second only to Texas Instruments Inc. as a semiconductor supplier, it specialized in high-speed custom logic and linear circuits. And during its long eclipse, its fast emitter-coupled logic line was a steady seller to the aerospace market and to makers of high-end computers.

But the plan now being implemented under Fairchild President Donald W. Brooks goes far beyond staking a claim to a high-performance niche market. Brooks is trying to convince Fairchild customers that their best chance of getting equipment to market in time to compete with Japanese manufacturers is to tie their systems' designs to Fairchild's device and technology development.

This ambitious plan builds on a restructured company that bears little resemblance to the one Schlumberger bought. The rebuilding went on with little fanfare; but over the past year, Brooks has been gradually unveiling the company's new profile. In 1985, Fairchild:

- Spent more than \$135 million on capital improvements, acquiring a Cray 1S computer and an electron-beam lithography system, and bringing to production three sub-2- μ m CMOS fabrication lines;
- Introduced a 32-bit CMOS microprocessor, the Clipper, whose performance runs rings around the market leaders;
- Brought nearly 100 products to market (a figure it will more than double this year);
- Moved past Signetics Corp. to become the sixth-largest U. S. IC maker;
- Reduced its management turnover from between 15% and 20% in 1984 to less than 5% (1% for top personnel).

Clearly, the long transition has been completed, and a different Fairchild is on the scene. And Brooks has industry watchers purring. "He's virtually bullet-proof," says Dean A. Winkelmann of Integrated Circuit Engineering Corp.,

JUMPING AHEAD. Fairchild CEO Donald Brooks wants to leapfrog the competition.

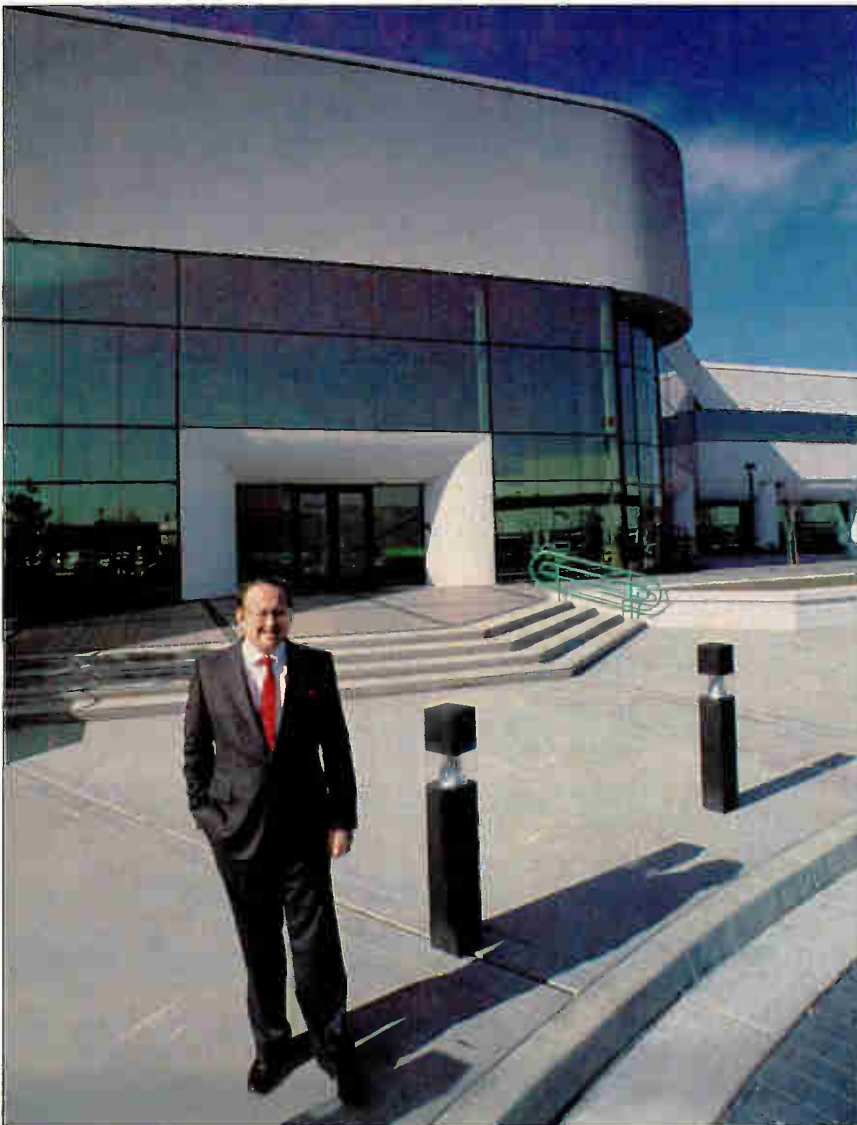

Scottsdale, Ariz. Although Brooks took over in time for the worldwide IC slump, he managed to weather it with an increased share of the market; and he is widely perceived as the architect of a strategy that gives Fairchild at least a fighting chance.

Brooks's plan to offer more and more services to customers appeals to Howard Bogert of Dataquest Inc. of San Jose, Calif. "It seems like a good strategy because the relation of systems houses and semiconductor companies is much deeper than ever," Bogert says.

"I am very positive about Fairchild," says semiconductor analyst Jack Beedle of In-Stat, another Scottsdale research firm. "They were stagnant; now they are growing. They have always been on the leading edge of bipolar. Now they have momentum. They have a new purpose." That purpose, Brooks says, is to make Fairchild a high-performance partner to systems manufacturers.

So quickly does Japan adopt new technologies that equipment makers must drastically reduce their design time or remain forever behind in price/performance ratings, Brooks says. He contends that designing system hardware and software in parallel with semiconductor technology can cut implementation from six years to three. "It's not really a U.S.-Japan issue, and it's not a technological issue," Brooks says. "It's about time-to-market."

TOO LONG. Usually, the design of a new equipment generation has to await the development and perfection of new semiconductor technology. Brooks says that takes too long, and he points to recent Japanese introductions of high-performance mainframes as evidence that the U.S. is losing ground.

Fairchild acknowledges that customers designing systems on the basis of untested technologies will run large

risks. To minimize those risks, Fairchild is willing to transfer its processes and design rules to customer IC lines, provide customers with its own computer-aided-design and -engineering tools, exchange personnel with them, and even let the customer into Fairchild's own computerized information networks.

Fairchild's plan to integrate process and system development is actually the extreme case of its general plan to offer high-performance hardware and services. It now offers a commanding array of devices: 1-ns CMOS and 200-ps ECL gate arrays; a military-standard microprocessor, the 15-MHz F9450; a single-chip Bell 212A modem; Fairchild advanced Shottky TTL (FAST) in a programmable logic version; a 1.25- μ m (effective gate length) advanced CMOS

The goal is to develop systems in parallel with IC technology

family called FACT; and its 33-MHz Clipper microprocessor, specified and priced far above the current 32-bit chips for work stations.

Fairchild considers its future to depend on putting supercomputer and near-supercomputer power into the hands of its customers. Advanced 1- μ m CMOS and 2- μ m bipolar circuits will power microprocessor-based systems past mainframes by 1988, Fairchild contends, and supercomputer performance will be pushed an order of magnitude greater (chart below, left).

Supercomputer capability is driving semiconductor technology and making it possible for supercomputing power to migrate down very rapidly, Fairchild says. "We have trouble even identifying general-purpose mainframes five years

out," says strategic marketing director Payton S. Cole. "They will be replaced by special-purpose processors," designed by supercomputers and minisupers.

In Fairchild's view, systems makers no longer can enjoy the luxury of waiting for a technology to mature in a product. Rather, they will have to adopt the Japanese process of defining system hardware and software at the same time as the semiconductor technology.

"We are now working on advanced processors in the 50,000- to 60,000-gate range," Cole continues. "That's about the boundary for standard products; but that technology won't cut it when you try to put a million- or 1.5-million-gate supercomputer on a desk."

JOINING FORCES. That's where Fairchild wants to join forces with its customers. "We are pushing many of our customers to get out of the serial path and into parallel development," says Cole. "But there is always the risk of a very great disappointment. We work in creative ways to solve that issue," he says, which is where the open-door policy comes in.

Within 18 months, Cole says, Fairchild's management information system will allow direct customer inquiry into virtually all of the operational data that Fairchild sees. Brooks cites gate-array manufacture as an example. "About a third of the way into the manufacturing process, wafers become unique to the user," he says. "At that point the user should have as good visibility as we do into the status of his materials."

Brooks's plan seems audacious in the light of Fairchild's performance in the past decade, during which it lost its position as a technology leader, almost fell out of the marketplace, and picked up a reputation as a managerial graveyard.

The story of Fairchild's decline has become one of the great Silicon Valley

HOW SYSTEM PERFORMANCE CLIMBS

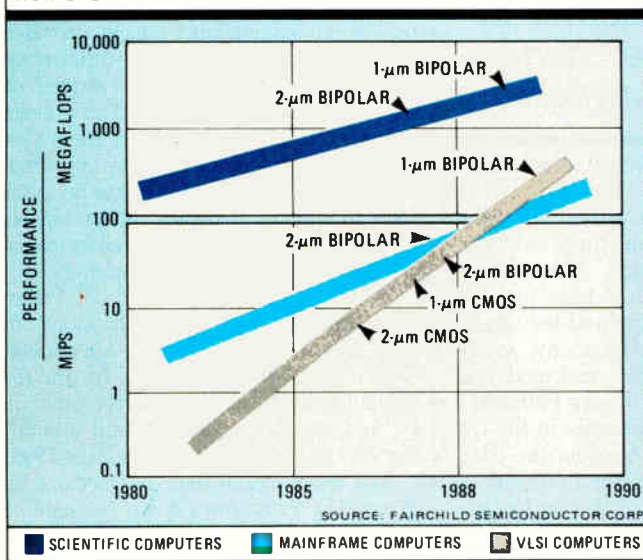

FAIRCHILD SEES ITS CHIP SALES RISING

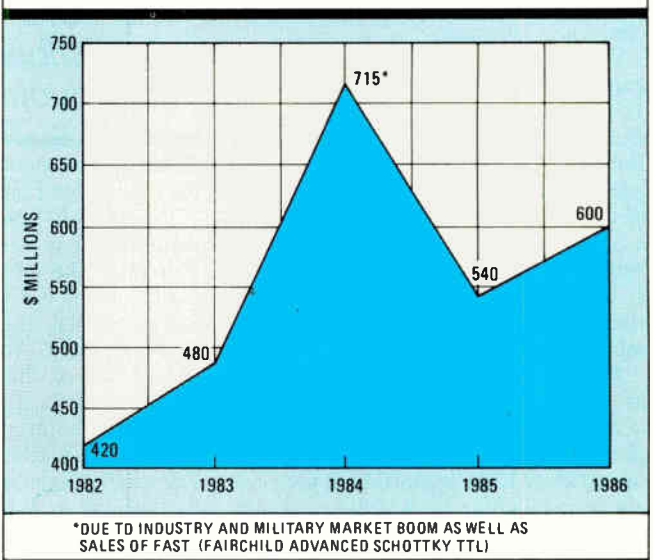

legends. Fairchild was, after all, a birthplace of the IC (an honor it shares with TI), and of the planar process by which ICs are made. In the 1960s it built the IC market by taking circuit design away from its customers and persuading them to design systems instead.

But the departure of much of its top management in the late 1960s dealt Fairchild a body blow from which it never really recovered. Charles E. Sporck started the exodus in 1968 by moving to the then-tiny National Semiconductor Corp.; founders Robert N. Noyce and Gordon E. Moore followed within a year to found the Intel Corp.

Fairchild's parent at the time, the Fairchild Camera & Instrument Corp., responded by hiring C. Lester Hogan and 10 top executives from archrival Motorola Inc. in 1969. But the Motorola influx only accelerated the departure of Fairchild executives. At least two dozen Silicon Valley companies can trace their ancestry directly to Fairchild.

During the 1970s, Fairchild made several unsuccessful attempts to develop an MOS capability and lost money on video game and watch circuits. Hogan was eventually deposed by one of his Motorola colleagues, Wilfred J. Corrigan, who presided over a cutback in research and development.

By 1979, Fairchild had lost its position as a market leader and was ripe for a takeover. Gould Inc. made an abortive attempt, but lost out to a \$425 million bid from Schlumberger, which saw Fairchild as an avenue into electronics.

Recognizing that Fairchild had lost its former luster as an industry leader, Schlumberger nevertheless saw the company as its technological gateway into the 21st century, when the oil-drilling and logging parent expects to evolve into a general-purpose information and electronics company.

Schlumberger quickly replaced Corrigan with one of its own executives, Thomas C. Roberts, provoking a great deal of industry skepticism because Roberts had no semiconductor experience. Roberts proceeded to justify some of that skepticism by investing money in a South San Jose, Calif., plant that was subsequently closed. But after this and a few other false starts, he started spending Schlumberger money to rebuild.

Roberts decentralized Fairchild's top-heavy organization and cut employment in half. He began replacing outmoded plants and equipment, and he restored the stricken R&D organization, persuading Schlumberger to contribute its own R&D director, Anthony J. Ley, to direct the rebuilding. Schlumberger also trans-



BIGGER. 60,000-gate ICs are in the works, says Cole.

ferred test equipment and subassembly operations into another division.

In 1983, Roberts lured Brooks from TI, reportedly with the promise of the eventual top job at Fairchild. Brooks was followed by a score or more of TI colleagues, returning Fairchild to the control of semiconductor veterans.

Reportedly, Schlumberger poured \$1.2 billion into restructuring Fairchild. Then, a year ago, Roberts resigned and Brooks took over as chief executive officer. At the time, Schlumberger said that Roberts had quit to take care of personal business; however, six months ago he

The 1979 takeover by Schlumberger started an arduous comeback

resurfaced as president of international operations for Control Data Corp.

Roberts left Brooks with a worldwide manufacturing system that will help Fairchild take advantage of local markets. Adding 6-in. CMOS lines to existing automated assembly and test plants in Wasserberg, West Germany, in the second half of this year, and next year in Nagasaki, Japan, will give Fairchild a solid manufacturing presence in the two biggest IC markets outside the U.S. Eventually, Fairchild plans to do 30% of its business in Asia and 20% in Europe.

On becoming CEO, Brooks stated that Fairchild had no intention of trying to

become a broad-line supplier of semiconductor products again [*Electronics*, Feb. 4, 1985, p. 39]. And although he said that Fairchild would bypass n-MOS and develop a strong CMOS capability, Brooks made it clear that the company would remain primarily a bipolar power for a long time to come. The reason is the company's commitment to the high-performance market. In the long term, Brooks says, some 70% of Fairchild's sales will be in this category.

Recently, Schlumberger created a stir by announcing that it is writing off \$486 million of its Fairchild investment, including \$250 million in goodwill. However, the company says it has no plans to divest itself of Fairchild (see "Schlumberger is still betting on Fairchild").

Response to Fairchild's proposal for codevelopment of systems and semiconductor technology has been slow, Brooks concedes. Systems houses are not all that willing to commit to a process before they even know what they are going to make.

But, Brooks says, there is no major systems maker, from minicomputer houses up, that will not acknowledge concern with the issue. "The chief engineers, who are making decisions about performance, technology, and time, recognize this problem and are frustrated by it," he says. "When we find these people, they know what we are talking about."

Fairchild does have some codevelopment programs in place for high-end systems. But even without codevelopment, it sees itself as becoming increasingly service-oriented for an emerging custom and semicustom market.

The Cray, which can perform a simulation in 11 minutes that might take 60 hours on a minicomputer, and the electron-beam equipment, which provides quick prototyping, have cut turnaround times to a matter of hours instead of days, Cole notes. But rather than provide a generic CMOS gate-array process that will allow a customer to build any product of choice, Fairchild wants to offer tools to support a 1.2- μ m, 100-ps bipolar process that offers great performance advantages in the systems market.

Because CMOS loses gain as design rules shrink, bipolar will continue to hold a tenfold performance advantage, Cole notes. "We see a long future for bipolar in terms of speed, drive capability, and cost." Bipolar will still account for 70% of Fairchild's business in 1988.

And when circuit densities become so great that ECL slows down because of heat-dissipation problems, Fairchild will have a mixed MOS-bipolar process wait-

ing. That's a highly sensitive subject, because the company considers its BiMOS process to be different from circuits now being introduced elsewhere.

Brooks will say only that Fairchild has had a research program in BiMOS for two years and that it sees a number of high-performance applications in memory and logic. "At least two of our manufacturing facilities will run these types of mixed processes," he adds cryptically.

SERVICE CENTERS. To provide access to its technology, Fairchild has established a network of support centers that provide a single contact point for all of its 11 divisions and many product lines. These centers are staffed by applications engineers and field product specialists. There are centers in California at Costa Mesa, Cupertino, and Milpitas; in Boston, Dallas, and Minneapolis; and in Tokyo and Britain. Fairchild will open additional centers this year in Hong Kong, Paris, and Orlando, Fla.

CAD capabilities include a variety of hardware, including the Cray, VAX clusters, accelerators such as Floating Point Systems array processors, and the popular design terminals from Daisy Systems, Mentor Graphics, and Valid Logic, as well as the IBM Personal Computer. Fairchild has its own design-entry, simulation, and routing software, and it will offer most of its product line—including the Clipper—as standard cells.

In addition to its forthcoming 6-in. CMOS lines in Japan and West Germany, Fairchild also has modern bipolar fab plants in Puyallup, Wash., and South Portland, Me., as well as specialized lines around Silicon Valley. Every fab area can also perform automated assembly, and seven of Fairchild's 11 assembly plants can handle surface-mount devices. The Puyallup plant reportedly cost \$200 million, and the Nagasaki and West German plants about half that amount.

To coordinate this network, Brooks is organizing Fairchild into business units



OVERSEAS. Norris is in charge of Asia.

that combine geography and markets. Last year, for instance, he combined the Asia semiconductor operation with the Puyallup-based Memory and High-Speed Logic division under vice president Ronald C. Norris. The Nagasaki CMOS line will be devoted mainly to producing the memory products, such as a 256-K static random-access memory being developed at Puyallup.

European operations, currently an independent marketing group, will eventually be merged with the West German production facility in a parallel move.

All of these trends are part of a transformation that will find Fairchild becoming ever more oriented toward high-performance, application- and user-specific products. Direct original-equipment-manufacturer marketing, which now accounts for 40% of Fairchild sales, will eventually merge into direct strategic and vertical marketing agreements with end users; these will account for 70% of Fairchild's sales, with the rest accomplished through distribution. Aerospace and defense circuits will remain a

significant 35% of company business.

Profitable in 1984, Fairchild took a bath last year with the rest of the semiconductor industry, as sales fell from \$710 million to \$540 million. Brooks forecasts a 10% growth this year and a return to profitability by the second half (right chart, p. 73).

Reportedly a hard-driving CEO, Brooks nevertheless is credited by many with restoring high morale to a company whose employees had been reading nothing but bad news about themselves for 10 years.

"It's like day and night," says Les Hogan, who still has a Fairchild badge and visits the plant regularly. "Don Brooks is a superb general manager who knows the business from A to Z and is full of fire and brimstone. He works hard, and he gets other people to do it too."

Brooks has apparently solved one of Fairchild's most severe management problems since its incorporation into Schlumberger: its inability to hold managerial talent with stock options. Now, "we have been 'incentivized,'" is how a jubilant Cole puts it.

BIG MONEY. Brooks won't say exactly how that incentive is structured. Not options but a kind of phantom stock tied to revenue and profits, the incentives are reportedly based on long-term performance. "The target date is 1991," says one Fairchild insider. "If they achieve long-term goals, even the middle managers will walk away with a million and a half dollars or more."

That would be the final step in restoring Fairchild, which directly spawned a score of Silicon Valley companies because it could not hang on to its management, to something like its former glory. But whether or not these goals can be reached, for the first time in years, the company has established itself as a market contender. With products, technologies, and management in place, Fairchild is definitely back. □

SCHLUMBERGER IS STILL BETTING ON FAIRCHILD

Fairchild Semiconductor has been a drain on Schlumberger Ltd.'s financial performance since 1979, when the New York-based oil giant came in as a "white knight" and rescued the chip maker from an unwelcome takeover bid by Gould Inc. Schlumberger paid \$425 million for Fairchild then and started pouring in more money to bring the troubled company back to life.

Though the acquisition was questioned by market analysts because of Schlum-

berger's inexperience in the semiconductor business—it's mainly an oil-field services company—Schlumberger executives defended the deal as being in the best interests of both companies. They say they still think so.

Earlier this month, Schlumberger formally cleared its books of much of the financial overhead associated with Fairchild and its operations. Schlumberger took a special charge of \$486 million against its 1985 fourth-quarter earnings. A spokesman

says the charge included a \$250 million write-off of goodwill—the difference between what Fairchild's book value is today and what Schlumberger paid for it. However, Schlumberger emphatically rebuts speculation that the write-off is a prelude to selling Fairchild.

Also included in the \$486 million charge was a \$187 million write-down for the disposal of certain Fairchild assets and the consolidation of facilities, which the spokesman explains was

"plant closings and the like" and \$49 million in assorted inventory write-downs.

In announcing the write-off, which resulted in a \$372.7 million loss in the final quarter of 1985, Schlumberger chairman Michel Vaillaud said the action would put the Fairchild subsidiary on "a realistic financial basis." He added that Fairchild, which is one of Schlumberger's five operating groups, is reporting "an encouraging order rate" so far this year. —Robert J. Kozma

RELIEF IS ON THE WAY FOR DOCUMENTATION HEADACHES

ELECTRONIC PUBLISHING SYSTEMS AUTOMATE THE CHORE

by Wesley R. Iversen

CHICAGO

After pouring three painstaking years into the development of the complex Z8000 16-bit microprocessor, Zilog Inc. engineers were in for a frustrating disappointment in 1979 when they finished the design. The product was ready to ship, but the accompanying manuals and technical documents were not. "It was 12 to 18 months after the chip was out before reasonable-quality documentation was available," recalls Bernard L. Peuto, the father of the Z8000 and Zilog's director of component design engineering at the time. Some blame this early lack of documentation in part for the chip's relatively poor market showing.

That experience is only one notable example of how crucial timely documentation is in complex engineering projects. However, relief may be in sight, judging by the number of vendors who are gearing up products to automate the technical documentation process.

The current generation of electronic technical publishing systems includes features such as interactive text and graphics manipulation and automatically generated tables of contents and page numbering. But coming on fast are more sophisticated systems that can easily handle such tasks as automated referencing and accessing data bases of computer-aided-design systems and files generated on word processors and personal computers. With these inputs, they can pull up drawings and text, modify them, and use them directly in a technical document. When coupled with a laser printer capable of producing camera-ready copy, these new systems can eliminate the rekeyboarding, re-drawing, and cut-and-paste activities necessary with conventional documentation techniques.

Clearly, electronic technical publishing is a technology-driven market, and the competition is starting to heat up. The early entrants into the field already are being jostled by the arrival of the big computer and work-station makers. Moreover, the new personal computers that can handle graphics tasks without a whimper are adding to the heat.

What many observers think is the



COST CUTTER. Caddex says its Technical Publishing System can cut documentation costs as much as 70%.

wave of the future comes this week from Context Corp., a spin-off of Mentor Graphics Corp., the Beaverton, Ore., work-station vendor. Context's initial product (p. 88) will run on the Apollo work-station platform used by Mentor.

ADDING SOPHISTICATION. The first Context product goes beyond most others on the market in its ability to handle sophisticated data-base management for very large engineering projects, notes Jonathan Seybold, president of a Malibu, Calif., newsletter on electronic publishing. This capability will be useful in handling the complex data structures

for large project documents which typically encompass thousands of pages, have multiple authors, and are frequently changed, Seybold observes.

Also, every time a design change is made, the Context system automatically makes corrections in a table or drawing every place the graphic appears, even across multiple documents, Seybold says. "And more than that, if you've got text that references the graphic, the system handles those changes too, which is a nightmare to do by hand," Seybold notes. The only other company promising similar capabilities, he says, is Woodinville, Wash., startup Caddex Corp., which announced its first

products designed for Digital Equipment Corp. VAX and MicroVAX-based networks last November.

The attraction—more than 100 companies have products in the business—is a market that most agree could become a multibillion-dollar business in a few years. Technical documentation and publication is one of two major segments of the electronic publishing market. The other is desktop office publishing, which is dominated by the personal computer.

Strategic Inc., a Santa Clara, Calif., market research outfit, pegs 1984's technical publishing side of the business at

COMPUTER-AIDED DESIGN AND ENGINEERING COMPANIES WILL PLAY A KEY ROLE

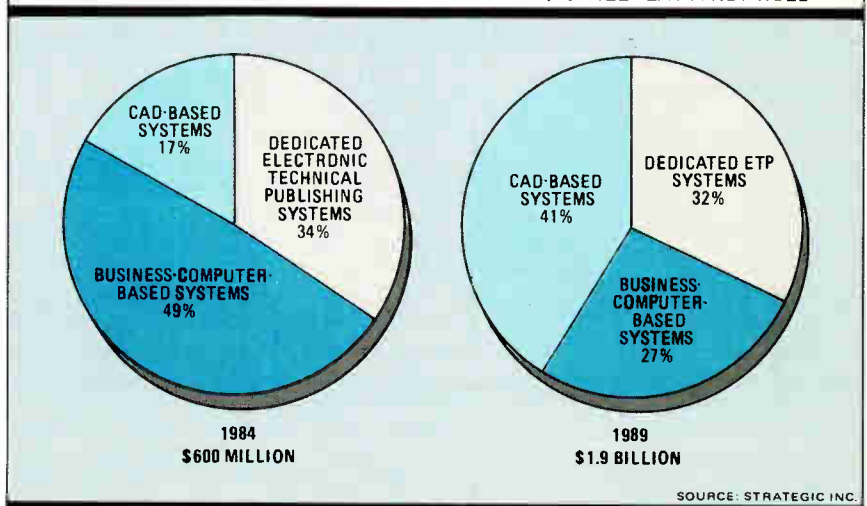

\$600 million in the U.S., rising to nearly \$1.9 billion by 1989. Other projections are more optimistic. "The market estimates I've seen vary widely, from \$3 billion to \$30 billion in 1990," says David A. Boucher, president of Interleaf Inc., a Cambridge, Mass., electronic publishing vendor.

With those kinds of numbers on the line, many industry observers think the action could heat up this year, as major players enter the business in force and a market-consolidation phase begins. "I'd say within the next 12 to 36 months, we're going to see a lot of companies dropping out, and in that timeframe, we'll get a pretty clear indication of who the major players are going to be," says Paul Lewis, a director at InterConsult Inc., a Cambridge company that tracks the electronic publishing business.

The contenders currently fall into several camps. A group of startup companies is already offering work-station-

As the big guys fight it out, personal computers will make inroads

based electronic publishing systems that streamline product documentation for large technical projects in aerospace, automotive, electronics, and government applications. Some, like Interleaf, are using systems designed to run on existing work-station platforms. Others, such as Tectex Corp. of Cambridge and Xyvision Inc. of Woburn, Mass., have designed dedicated systems based on proprietary 32-bit work-station hardware.

The startups will face increasing competition from other players, including the traditional vendors of computer-aided-design systems (chart, opposite). Many of these CAD houses—unlike Context—are initially using Interleaf software to provide documentation capabilities for their existing engineering work stations.

IBM MOVES IN. Heavy competition likewise will come from major computer companies and other systems houses. IBM got into the business last month when it introduced its RT Personal Computer [*Electronics*, Jan. 27, 1986, p. 14]. It includes an interactive electronic editing, composition, and pagination package supplied by Interleaf as part of its RT offering. Most observers expect IBM to move more aggressively into technical publishing, perhaps as early as this year.

Likewise, Xerox Corp. jumped into the fray last year with its XPS 700, based on the DEC VAX and MicroVAX, as did Eastman Kodak Co. with a high-end technical publishing system known as Keeps (for Kodak Ektaprint Electronic

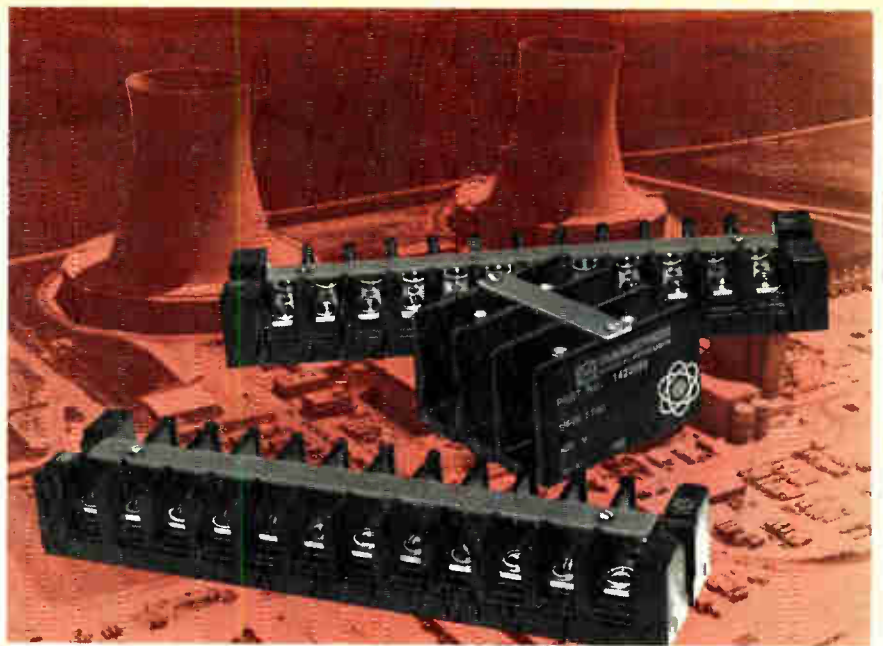

Plenco's O2000 and technical support helps Marathon maintain Nuclear Regulatory Commission certification for their NUC devices

Marathon Special Products, Bowling Green, OH, a subsidiary of Marathon Electric Manufacturing Corp., designs, engineers and manufactures high quality wire termination and circuit protection devices for the electrical and electronic component industry. Their NUC devices are used in nuclear generating plants throughout the country.

Marathon engineers explained, "Formerly, many nuclear plants used circuit devices made with unproved thermoplastics. They were unsatisfactory. To gain certification by the Nuclear Regulatory Commission for use within reactor containment areas, our NUC devices were subjected to an exhaustive series of tests for radiation aging, reactor coolant loss, earthquakes and other emergencies. With Plenco's

O2000 molding compound and technical support we gained several advantages. Plenco's compound is tough enough to pass the tests and still give us good processability."

The result, according to Marathon's marketing department, "Our NUC line is now qualified to meet the NRC and IEEE requirements and nuclear generator operating utilities are retrofitting with our NUC series terminal blocks to help provide an additional safety factor."

Plenco thermosets give you savings without sacrifice—a money saving choice for economy, performance and quality. Choose a Plenco thermoset molding compound. You'll be glad you did, instead of wish you had. Give us a call at (414) 458-2121.

PLENCO
THERMOSET PLASTICS

PLASTICS ENGINEERING COMPANY
Sheboygan, WI 53081

SEE US AT THE DESIGN ENGINEERING SHOW - BOOTH 3631

World Radio Circle 77 on reader service card

*thermoset plastic performance
for 50 years.*

Through Plenco research... a wide range of ready-made or custom-formulated phenolic, melamine-phenolic, alkyd and polyester thermoset molding compounds, and industrial resins.

DESIGN PROBLEMS?

**CIRCUITS AND SOFTWARE
FOR
ELECTRONICS ENGINEERS**
focuses strictly
on design problems!

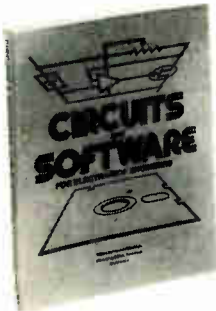

Access stimulating, clever approaches that can speed your creative design concepts.

This indispensable source contains hundreds of circuit schematics, block diagrams and computer programs that are conveniently organized into 25 vital categories by function.

Design appropriate circuitry to meet challenging specifications.

Save time by adapting proven circuits and software to a wide range of applications.

Save money and increase productivity by avoiding costly design errors.

Don't take the chance of being less than on top of the latest circuitry developments.

ORDER YOUR COPY NOW!

Electronics Magazine Books

P.O. Box 541
Hightstown, NJ 08520

or

McGraw-Hill Int'l. Pub. Co.

Attn: ECC

McGraw-Hill House

Maidenhead, Berkshire SL6 2QL

England

Send me _____ copy (copies) of R370
for \$19.95 each.

Payment enclosed

Send proforma invoice

Name _____

Company _____

Street Address _____

City _____ State _____ Zip _____

Allow 4-6 weeks for delivery.

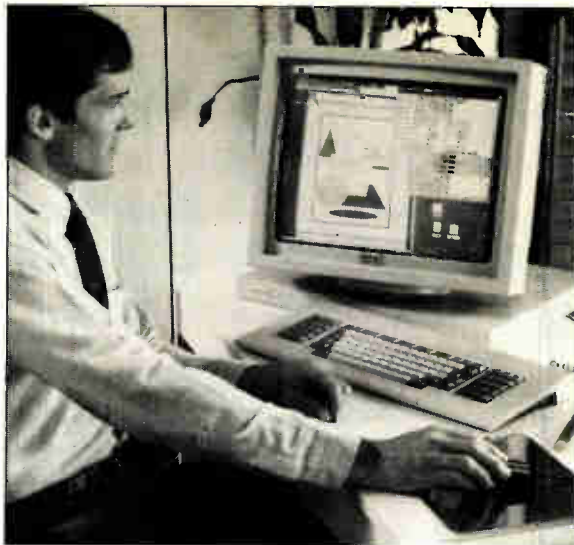

OUTSIDE HELP. Kodak's Keeps high-end publishing system uses Sun work station and Interleaf software.

Publishing System). Keeps relies on work stations from Sun Microsystems Inc. of Mountain View, Calif., and software supplied by Interleaf. Kodak has invested in both companies. Other large suppliers, including DEC and Hewlett-Packard Co., have also made a commitment to electronic technical publishing, industry watchers say. Product entries are expected soon.

PERSONAL COMPUTERS, TOO. While the big guys fight it out at the high end, continuing inroads at the low end are expected from systems based on personal computers. Up to now, they have been used primarily in tasks involving documents of fewer than 50 pages that are heavy on text. For complex jobs, they "come up short on the graphics side," Seybold says.

But that picture is starting to change, particularly for computers such as the Apple Computer Inc. Macintosh, with its rich graphics-handling capabilities. "There are thousands of companies now developing packages for the Mac," claims Roger A. (Al) Davis, a publishing systems analyst and consultant at Boeing Computer Services, Seattle. Davis estimates that the number of Macintoshes used in-house at Boeing for jobs including technical-document preparation has increased from fewer than 100 last June to more than 500 now, and will surpass 1,000 by the end of the year.

Among vendors of work-station-based systems, one of the most successful to date is Interleaf [*Electronics*, Dec. 9, 1985, p. 54]. The five-year-old company expects to hit \$20 million in revenues in the year ending March 31, only its first full year of shipping products for electronic technical publishing. The Interleaf system runs on existing work-station platforms including the IBM RT, VAX and MicroVAX-based systems, and

machines from Apollo and Sun. Interleaf has some 200 customers and about 2,000 work stations licensed for its product line, says Boucher.

Already, though, Interleaf is under siege from new systems like the one from Context. "Everybody's hot button right now is the ability to mix text and graphics, where you can get out of the mode of having thousands of people redrawing pictures," says Paul Needham, Context's marketing director. "But once you bring that on line, then you have the problem of trying to manage and keep all these documents properly configured."

As the competition in technical publishing heats up, some say the vendors that may have the toughest time are those with systems based on proprietary hardware. "Most of the people who designed proprietary hardware made a tremendous mistake," claims Seybold. Few will be able to produce systems that are cost-competitive with those that run on work stations built in high volume.

In fact, a number of dedicated hardware system vendors have already dropped out or are experiencing financial problems. One is three-year-old Viewtech Inc., Mountain View, Calif., which sought Chapter XI protection last September. Viewtech's principal founder was Bernard Peuto, the former Zilog official who recognized the need to automate the documentation process based on his experience with the Z8000.

STRUGGLING BACK. Peuto has resigned from Viewtech, is now doing consulting work, and declines to comment on Viewtech's difficulties. But Austin Ford, the company's national sales director and another Viewtech founder, blames the problems on, among other things, tardy product development and a consequent loss of financial support. He says Viewtech now expects its product to be ready for production within the next few weeks and plans to be out of Chapter XI soon.

Ford concedes the \$50,000 price tag envisioned for the company's 68010-based work stations is likely to be cut. Prices on Sun and Apollo hardware have taken a nose dive, and IBM's aggressive pricing on the RT Personal Computer (ranging from \$8,600 to about \$40,000) will drive industry prices down even farther, he says. It looks, then, as though the already tough competition in the technical publishing market is going to get even tougher.

WILL FRENCH ELECTRONICS FIRMS RETURN TO PRIVATE HANDS?

EVEN IF THE RIGHT WINS, THE INDUSTRY MAY STAY NATIONALIZED

by Robert T. Gallagher

All bets are off on the future of France's nationalized electronics industry. Not too many weeks ago, it looked as though the right would win the March 16 general election decisively and would reverse the Socialist government's nationalization of many key industries. But that is now in doubt as the Socialists are staging a modest comeback; the rightist parties bicker over power sharing; and doubts surface about the wisdom of denationalization.

Despite the strong conservative showing in the polls, many observers are now doubtful that the right wing will muster a large enough legislative majority to mount a full-scale denationalization program. The popularity of such a plan is further compromised by the simple fact that French industry overall—including

electronics—has been healthier since nationalization. Still, all indications are that reelection of a Socialist majority is an impossibility, and this means that nationalization is once again an open issue in France.

Nationalization was a keystone of President François Mitterrand's Socialist coalition, which set the program in motion immediately after forming its government in 1981. Today, just weeks before the vote, the conservative, right-wing parties lead the polls, and one of their principal planks is to reverse the Mitterrand policy and once again put industry ownership into private hands.

But there is considerable skepticism in France as to the viability of such a plan. Some critics point to the improved performance of the nationalized sector as an argument against denationalization, while others argue that the French financial markets do not command the equity necessary to absorb a massive sale of all the nationalized industries.

The list of electronics companies that would be affected by denationalization includes military and consumer giant Thomson SA; the Compagnie Générale d'Electricité (CGE), which controls telecommunications-equipment manufacturer Alcatel; computer and peripherals producer Bull; and the Compagnie Générale des Constructions Téléphoniques (CGCT), a former ITT Corp. subsidiary.

Whether or not these companies are put on the block depends largely on whether the conservatives win an outright majority in the National Assembly, and so attaining the legislative muscle to enact a denationalization bill.

If there is no clear majority after the vote, or if President Mitterrand is able to put together a working majority, denationalization will be all but impossible. A simple mathematical majority of conservatives could be insufficient to back the program because of interparty bickering on the right (see "The Socialists could stay in control").

The question of denationalization is a subject of hot debate among the French for a host of reasons, both emotional

and practical. For one thing, France had a tradition of nationalization long before the Socialist administration came to power. "Listening to the opposition, you would think that we invented the notion of nationalized industry," one Socialist strategist comments wryly. "But in fact the largest portion of French industry was nationalized under General de Gaulle." The largest French conservative party, under the leadership of the mayor of Paris, Jacques Chirac, considers itself Gaullist.

Adding an extra dimension to the debate is that many voters think government control of Thomson, CGE, and Bull has been a success. Thomson, which had losses of more than \$300 million in 1982, achieved profits of some \$70 million last year. Bull has a similar history, having overcome a \$200 million deficit in 1984



OPPOSITES. Former president Valéry Giscard d'Estaing (left) wants to unravel the nationalization of President Mitterrand.

to score a small, as yet undisclosed profit last year.

The CGE, which already was profitable when it was nationalized, has been even healthier since: the company has improved its profit margin by some 25%, chalking up \$150 million in profits last year. CGCT is the only one of the four nationalized electronics companies still in the red, but even here the outlook is promising. The company hit bottom in 1984 with a \$150 million loss; this deficit was trimmed to \$30 million in 1985.

Even conservative politicians reluctantly admit that the quartet of companies are in better condition than they were before nationalization. They maintain, however, that equal, or even more efficient, restructuring could have been achieved if the companies had remained private.

Not surprisingly, Socialist officials dispute the claim. "There is no way that we could have restructured the electronics industry in the sweeping way that we did without gaining 100% control of them," says an adviser to Mitterrand. He argues that grouping Thomson's beleaguered telecommunications unit with that of the successful Alcatel, giving Bull control over Thomson's and CGE's data-processing and office-automation units, and having Thomson take possession of CGE's military subsidiaries would all have been impossible had the companies been privately owned and independent of each other.

Still, say the conservatives, even if the companies' balance sheets are positive now, it's in their best future interests to fend for themselves without the shackles of government control. Behind that argument is the belief that private industry is inherently more efficient than state-controlled entities. For that



OPPOSED. Chirac opposes nationalization.

reason, the conservatives intend to sell controlling interests in most of the nationalized firms, starting with companies that are in the black.

Using this criterion, Thomson, Bull, and CGE would immediately find themselves on the selling block, along with such other nationalized industries as glass-and-packaging manufacturer Saint Gobain, chemicals giant Rhone-Poulenc, and aluminum producer Pechiney, as well as France's nationalized banks and

insurance companies. The sales would be spread over a long period, says Michel Noir, national secretary for industry with the Rassemblement Pour la République, the largest conservative party. The long lead time is an acknowledgment by the conservatives of the difficulty of trying to sell as much as \$14 billion worth of company shares in France today.

A strategist for the Parti Républicain, the party of former president Valéry Giscard d'Estaing, reckons that the best way to proceed is to sell the nationalized companies in "slices" spread over the five years of a French parliament. Many French financial executives and economists doubt that the nation's financial markets are capable of absorbing such a mammoth sale.

Interestingly, just as the denationalization debate rages around its ears, the Socialist government itself is rethinking its position on nationalization, to a point where it's more in line with that of the opposition. "We exclude *a priori* no possibilities in defining what strategy we may take in the future with the nationalized companies," says the Mitterrand adviser. "If it is in the

best interest of a nationalized company to sell some of its equity on the open market or for a foreign firm to take a minority share in it, that's open to negotiation."

This is clearly more than preelection bluff. The Socialists have already negotiated to sell a portion of the CGCT to AT&T Co. in a broad-ranging Franco-American mutual assistance pact in telecommunications [*Electronics*, Feb. 17, 1986, p. 16]. □

THE SOCIALISTS COULD STAY IN CONTROL

Three months ago, the results of France's upcoming general election seemed to be a foregone conclusion. Conservative opposition parties enjoyed enormous leads in the polls, and the question wasn't whether they'd command a majority in the National Assembly, but how big that majority would be. Now, no one is quite so sure.

The French economy is beginning to stage a comeback, with estimates of as much as a 3% growth in the gross national product this year against last year's 1.2%. Concurrently, inflation is slowing down to nearly 2%. Personal income and business investments are rising, and as they

do, the popularity of the Socialists and President François Mitterrand is rising along with them.

The general consensus is that the Socialists will not maintain their parliamentary majority after the March 16 vote, but suddenly a host of election results other than a clear victory for the opposition appears possible. Mitterrand reckons that he can hold together a minority government if his Socialists win 30% of the vote, a figure that would make them the largest single party in the National Assembly. The Socialists are currently at just that figure in the polls.

Giving the president lever-

age is the fact that the leaders of the three principal opposition parties—former president Valéry Giscard d'Estaing and two of his prime ministers, Raymond Barre and Jacques Chirac—disagree fundamentally on the role of the president, should they win a parliamentary majority.

Giscard and Chirac are in favor of "cohabitation," by which they would govern in tandem with a Socialist president. Barre, on the other hand, is adamant that Mitterrand should step down. Should Barre, the most popular of the opposition leaders, withdraw his support, it is unlikely that the other two

conservatives would be able to form a majority government. Never in France's Fifth Republic have the parliamentary majority and the president been of different parties.

Adding to the uncertainty is the fact that the French elections will, for the first time, be held on a proportional basis: the number of National Assembly seats won by a party will be in proportion to the vote it receives. In the past, the two highest vote-getters in each district faced each other in a run-off. The proportional system is widely seen as benefiting the Socialists, who passed the legislation. —R. T. G.

MICROPOLIS SUCCEEDS WHERE OTHERS FAIL

FOCUSING ON HIGH-PERFORMANCE HIGH-CAPACITY DISK DRIVES FOR MINICOMPUTERS AND WORK STATIONS PAYS OFF

CHATSWORTH, CALIF.

The disk-drive industry is littered with the remains of companies that couldn't make it—suppliers that couldn't deliver a product, that picked the wrong niche, that were priced out of the market by larger, more cost-efficient producers. Micropolis Corp., however, is one of the success stories. By carefully adhering to a savvy game plan, it has passed through the fires not merely unscathed but absolutely thriving.

That game plan has been simple: focus on the 5¼-in. Winchester disk-drive market; offer high-performance high-capacity products for high-end computer systems; deliver products to customers ahead of the competition; and concentrate on manufacturing technology. "It's a good strategy if you execute it well, and they have," says James N. Porter, president of Disk/Trend Inc., a Los Altos, Calif., disk-drive market researcher.

Micropolis has garnered a solid position in the disk-drive industry, and the payoff is already apparent. Its revenue zoomed by nearly 58% in 1985, and profits, which have ridden a roller coaster in recent years, are again on the upswing (charts). But profit margins have stayed low, in the 16% to 18% range.

There are players with more revenue in the disk-drive industry—such as Control Data Corp. and Seagate Technology—but there may not be any company that's better managed than Micropolis, Porter says. "Micropolis has been a very successful company. They've always had a penchant for being first



MABON: Picking the right niche was the start of Micropolis's success.

with a product. They don't have much interest in doing commodity items."

Micropolis chairman and president Stuart P. Mabon stresses that the niche market served by Micropolis has good potential and that the company has carved itself a strong position.

Mabon traces the beginnings of the company's present posture to mid-1983, when a \$40 million stock offering gave it the wherewithal to participate in the drive industry. "Before that, we were a bootstrap outfit that supported itself by making add-on, 8-in. floppy disks—hardly a promising thing," he says. The company had been started on a shoestring in late 1976, when Mabon and several partners left Per-tec Corp., then a leading disk maker, to strike out on their own.

When the personal computer boom hit in the early 1980s, Micropolis had already moved into Winchester disk drives, but it didn't have the resources to become a major supplier of the key 5- and 10-megabyte units that were a staple for the personal computer market. In retrospect, Mabon thinks this was an advantage, as the overproduction of personal computers in 1984 and 1985 not

only damaged their manufacturers but also affected many drive suppliers.

By this time, Micropolis had identified a market that promised to reward peripherals suppliers who were quick with the right products: new-generation minicomputers and their work-station brethren. Earlier systems of this type used the bulky, slow, 14-in. drives, but these drives proved unsuitable for the newer generations of products. Micropolis saw that the new machines would need the compactness and speed of higher-capacity 5¼-in. drives.

This hunch proved correct: the market for new-generation minicomputers and work stations has outpaced that for personal computers in the past several years. Micropolis sells to such leading suppliers as Apollo Computer, Digital Equipment, and Sun Microsystems.

However, coming up with the design and manufacturing facilities for the advanced drives to serve this target niche was a tough job that "took two years [into mid-1985] to put together," says Mabon. The basic challenge stems from the tight tolerances demanded in assembling the more complex drives; other factors include obtaining quality components, read/write heads, and positioning mechanisms. "The positioning of a 10-megabyte drive can be a millimeter off, but the positioning accuracy of our 1350 [a 170-megabyte drive] has to literally be at the wavelength of light," he says.

BIG CHANGE. Making this transition forced a wrenching change in company values as well, from an engineering/design outlook to an emphasis on production skills. "We can't just be bloody boy engineers anymore," says Mabon.

At the same time, Micropolis weeded out its earlier 8-in. floppy-drive lines, to carry out what Mabon calls "a narrowly focused strategy, but a good one in the 85- and 170-megabyte business." The company's first order of business was to produce its 1300 series of 52-megabyte drives through 1984. At the same time,

MICROPOLIS: GOOD GROWTH IN SALES...

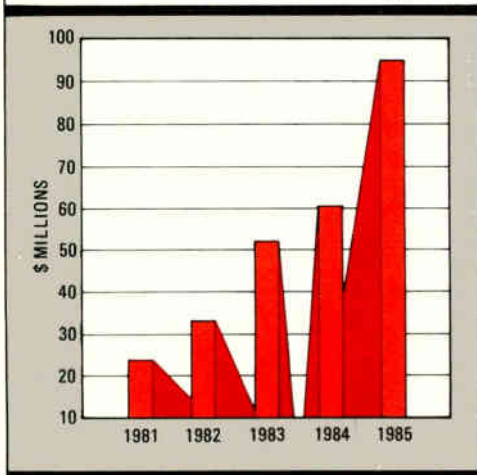

... BUT ERRATIC NET INCOME PERFORMANCE

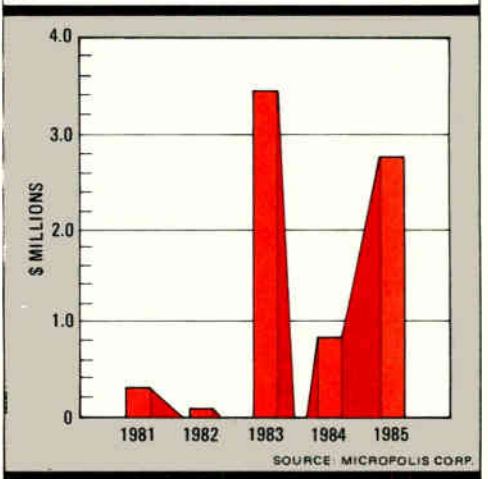

SOURCE: MICROPOLIS CORP.

it was preparing to build the 85-megabyte 1320 line in volume and establish this drive as the workhorse for minicomputers and work stations. Micropolis is now hard at work selling its new 170-megabyte 1350 series.

Reaching desired manufacturing levels at new plants where automated production was being installed proved a struggle that dominated executive attention well into 1985. Even as sales climbed, profits were held back by the expenses of expanding, by higher materials costs that couldn't be offset as competition drove prices down, and by investment in an augmented sales operation.

The result, however, has borne out the company's hopes; indeed, the 1320 series has snagged an estimated 60% of its market. "They've done a beautiful job on manufacturing," says industry-watcher Porter. And the end is nowhere in sight. As Micropolis adds impetus to selling the 1320, this peripheral could



HARD WORK. Micropolis is working hard to sell its 1350, a high-performance 170-megabyte drive.

well become the 10-megabyte drive for the personal computer industry, says Mark M. Obenzinger, a research analyst at Laidlaw Adams & Peck Inc., New York.

The only significant problem facing Micropolis is its relatively low profit margins. These have ranged from 16%

dropping his guard. For one thing, he worries, "there's no way our sales can keep growing at this rate." And he expects the battle for 170-megabyte business to rage unabated all year. "Just when you think you've won the rat race, a bigger rat comes along," the executive adds.

Even with the company's present good fortune, a wary Mabon has no intention of dropping his guard. For one thing, he worries, "there's no way our sales can keep growing at this rate." And he expects the battle for 170-megabyte business to rage unabated all year. "Just when you think you've won the rat race, a bigger rat comes along," the executive adds.

—Larry Waller

BOTTOM LINES

CRAY RAISES \$115 MILLION

Supercomputer manufacturer Cray Research Inc. has sold \$115 million of convertible debentures. The Minneapolis company says it will use the funds for capital investments and working capital and also to finance operating leases for customers. The debentures are convertible into Cray stock at \$84 a share.

ILC TECHNOLOGY BUYS SENSOR TECHNOLOGY

ILC Technology Inc., Sunnyvale, Calif., has agreed to acquire Sensor Technology Inc., Chatsworth, Calif., from its parent, Dyneer Corp. ILC said it will pay cash for Sensor Technology, with the amount still to be determined. The transaction is expected to close on April 1. Founded in 1966, Sensor Technology makes optical detectors, optical switches, and optical encoders and had 1985 sales of \$6 million. It was acquired by Dyneer in 1978, says ILC, which makes light sources and light sensors. ILC had sales in 1985 of \$25 million.

KOREAN CHIP DRIVE TO START THIS YEAR

South Korean chip makers will begin their assault on the world market in earnest this year, says a new study by

Benn Electronics Publications, Luton, UK. The campaign, targeted primarily at the memory market, should result in a fourfold increase in sales for Korean companies, to \$203 million from last year's \$47 million. Benn estimates Korean chip firms will garner up to 7% of the U.S. MOS memory market by the end of 1986, largely at the expense of Japanese vendors.

GaAs CHIP STARTUP GETS \$23 MILLION

Gain Electronics Corp., Somerville, N.J., says it has raised \$23 million in venture capital from a group of investors that includes Mitsui and Co., Tokyo. Gain, which plans to develop and market high-speed gallium arsenide integrated circuits, says the funds will be used to build its manufacturing operations. Gain will handle its own distribution in the U.S.; Mitsui will distribute its products in Japan.

SINGER AGREES TO BUY DALMO VICTOR

Singer Corp., Stamford, Conn., has agreed to buy the Dalmo Victor division of Textron Inc. for \$174 million in cash. Singer says the transaction should be completed by the end of the first quarter. Based in Belmont, Calif., Dalmo Victor makes electronic warfare systems. Singer says the acquisition is consistent with its plans to expand its aerospace

electronics business by acquiring operations that complement its current activities in that field. Singer has operations in aerospace electronics, including command, control, communications, and intelligence and electronic warfare.

\$4.2 MILLION IN NEW FUNDS FOR CADDEX

A third round of venture financing has raised \$4.2 million for Caddex Corp., Woodinville, Wash. The company, founded in 1982, is developing a system to integrate and automate the process of technical publishing for makers of complex aerospace, defense, and electronic products. The new funds will be used for ongoing product development, as well as for sales and marketing work.

R&D PARTNERSHIPS STILL ATTRACTIVE

While the U.S. Senate continues to debate reforming the U.S. tax code, one aspect of the tax plan continues to make good sense for companies and investors, says Price Waterhouse, the New York accounting firm. That aspect is research and development partnerships. These "will continue to provide an attractive method of financing technology research," the firm says, "because they provide distinct advantages over conventional financing methods, while significantly reducing the economic risks associated with new product development."

ELECTRONICS INDEX

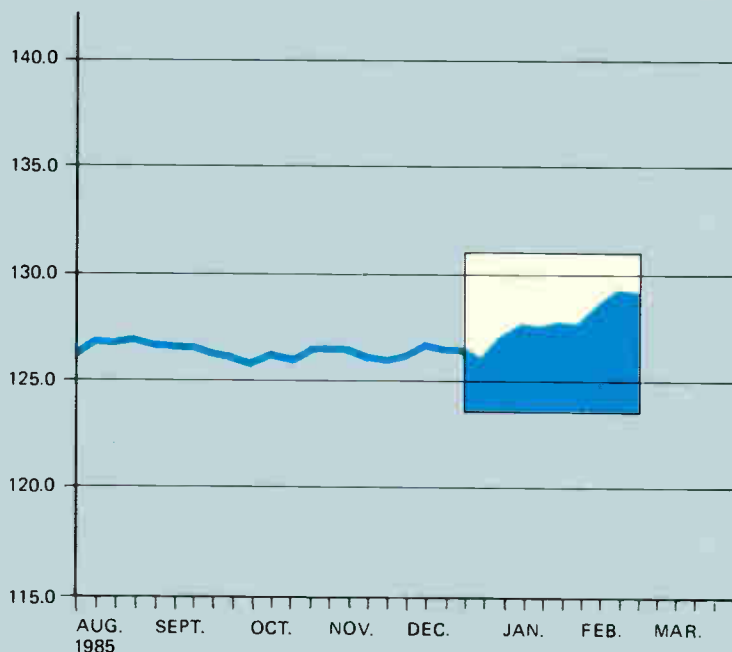
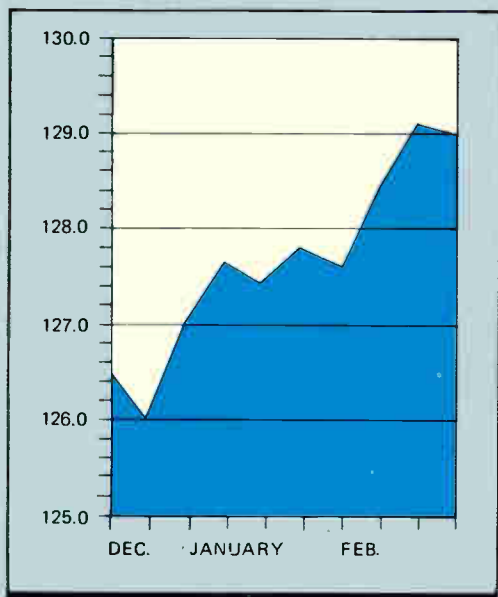

THIS WEEK = 129.0
 LAST WEEK = 129.1
 YEAR AGO = 130.2
 1982 = 100.0

The *Electronics Index*, a seasonally adjusted measure of the U.S. electronics industry's health, is a weighted average of various indicators. Different indicators will appear from week to week.

U. S. ELECTRONICS INDUSTRY EMPLOYMENT

	December 1985	November 1985	December 1984
Production workers (thousands)			
Office and computing machines	170.7	173.0	204.9
Communications equipment	287.5	286.6	293.9
Radio and TV receiving equipment	56.9	58.3	61.8
Components	347.6	349.0	410.6

U. S. GENERAL ECONOMIC INDICATORS

	December 1985	November 1985	December 1984
Average prime rate (%)	9.50	9.50	11.06
Retail sales (\$ billions)	117.862	115.620	110.519
Unemployment rate (%)	6.8	6.9	7.1

Business in the U. S. electronics industry may be improving, as recent statistics on rising equipment production and shipments suggest. But manufacturers are still cutting costs to keep their heads above water, and so employment fell for the 15th consecutive month in December. All sectors except communications equipment lost workers, and the greatest drop was in computers and office equipment.

The overall drop in production workers was only 0.5% from November to December, but that figure is down 11.2% from December 1984. For all of 1985, employment of production workers in the electronics industry fell 5.4% from the previous year—a dramatic reduction, given that industry employment grew 12% in the boom year of 1984, compared with 1983.

Not surprisingly, employment in the components sector was hard hit last year. Although December's 0.4% decline was this sector's smallest drop in the past 15 months, the number of workers dropped 8% for 1985 as a whole.

The largest drop last year, however, was for manufacturers of computers and office equipment. Not only was December's 1.3% decline the most drastic in this sector since September's 2.2% drop, but for every 100 workers employed in 1984, only 88 were working in 1985.

Communications equipment is the one area of the industry with any employment gains in December—0.3% over the previous month. This was a rebound from November's 0.6% drop. For all of 1985, the workforce in this sector rose 4%, compared with the 8.2% jump in 1984.

BOSWORTH AIMS TO MAKE LIFE EASIER FOR THE EE

BEAVERTON, ORE.

Michael Bosworth is setting out to carve a place in the fledgling electronic technical publishing industry, and he is using a pair of 40-year-old concepts—configuration management and hypertext—for managing and communicating a vast store of knowledge.

The company, Context Corp., a subsidiary of Mentor Graphics Corp., is introducing its entry in the business, the Documentation Workstation (see related stories, pp. 76 and 88). The work station is designed for electronics companies producing documentation and specifications for their products, often a Herculean task.

Bosworth explains the concepts on which Context has based the new workstation as "configuration management, a means of keeping track of all the changes in a document so that it can be reconstructed as it was at any one point, and hypertext, which is having annotations associated with the document, but not necessarily included in it." They were set out by Vannevar Bush in 1945 in an article, "As We May Think," in *Atlantic Monthly* magazine, in which he envisioned the use of computers as an aid in managing documentation. Bosworth calls the article seminal.

Bosworth sees his real challenge as gaining acceptance for the tool. The short-term obstacle is "educating the market in a new concept," says the for-

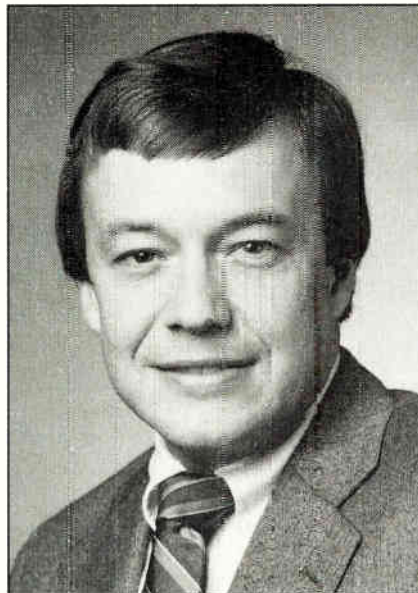

BOSWORTH: He plans to proselytize for electronic technical publishing.

mer vice president of Mentor's design and automation division. "It's not clear that the top managers will place a high enough importance in the capital investment in documentation tools as they do in the computer-aided design tools."

The most exciting aspect of the workstation for the buyer, Bosworth maintains, "is not the reduced cost of the printing of the manual, but the demon-

strable effect on the time to market for a product. If customers can cut one year off of the five years spent on preparing a product's specifications, they get a 20% decrease in time to market.

"The trend toward automated CAD tools increases the amount of data stored electronically, and the idea of an automated tool that integrates that data gets interest," he adds.

CALCULATORS TO CAD. Marketing savvy is one of the 38-year-old Bosworth's strengths. He holds an MBA from Harvard University as well as an electrical engineering degree from the University of Missouri. From 1975 to 1982, he was product marketing manager and later division sales manager at Hewlett-Packard Co., where he led the introduction of the HP-41C programmable calculator and HP's personal computers.

Later, at Mentor, Bosworth was instrumental in educating the public to the benefits of CAD, which Mentor helped pioneer. Now he believes his new endeavor holds as much market promise. Electronic technical publishing will be a \$1.9 billion market in 1989, compared with just over \$600 million this year, says Cupertino, Calif., market researcher Strategic Inc.

When he is not extolling the merits of electronic technical publishing, Bosworth is running 25 miles a week, skiing, or relaxing with his family. He is the father of a boy and a girl.

In his business life, Bosworth insists that his main aim for himself and for Context Corp. is quality. "Profit is a measure of quality, and I can relate everything back to that," Bosworth says. "That I learned from Hewlett-Packard."

—Steve Zollo

PEOPLE ON THE MOVE

OTTO M. GENUTIS

□ Zenith Electronics Corp. has appointed Otto M. Genutis senior vice president in charge of the Systems and Components Group. He replaces Joseph P. Fiore, who is retiring after 37 years with the Glenview, Ill., company. Since 1982, Genutis has served as vice president and general manager of color-picture-tube operations in Melrose Park, Ill.

DONALD E. FOWLER

□ Tandem Computers Inc. has named Donald E. Fowler to the post of vice president of strategy and corporate development, a new position for the Cupertino, Calif., maker of fault-tolerant computers.

Fowler, 47, will assume overall responsibility for the company's strategic planning. Before joining Tandem, he held key general management posts at the Bechtel Group and IBM Corp. Most recently, he led development of strategic plans for information technology and for technology in the defense and space industries at Bechtel.

JOSEPH A. SARUBBI

□ Tandon Corp., Chatsworth, Calif., has appointed Joseph A. Sarubbi senior vice president of manufacturing operations. Sarubbi's background includes managerial positions in manufacturing, product development, and technology with IBM Corp. Most recently, he was director of technology and systems architecture

for IBM's Entry Systems Division in Boca Raton, Fla. Previously, he was manager of operations of the group that launched the IBM Personal Computer and was responsible for development and manufacturing of the PC/XT.

GEORGE A. GASPARIAN

□ Epitaxx Inc., a Princeton, N.J., maker of long-wavelength optoelectronic components and test equipment, has named George A. Gasparian to the position of director of engineering. He comes to Epitaxx after nearly four years as director of optical engineering at American Photonics Inc., Brookfield, Conn. There he developed a line of single- and multimode

wavelength-division multiplexing optical couplers. Before joining American Photonics, Gasparian was a principal engineer for six years at ITT Corp.'s Electro-Optical Products Division in Roanoke, Va.

JOHN H. CURTIS

□ The new executive vice president, chief operating officer, and member of the board of directors at Stratus Computer Inc. is John H. Curtis. The company says it is giving Curtis the increased responsibilities in order that president William E. Foster might spend more time on product strategies. Curtis joined the Marlboro, Mass., company in 1980 and moves up from vice president of international sales.

RESNICK HANDLES \$4.3 BILLION WITH APLOMB

NEEDHAM HEIGHTS, MASS.

When GTE Government Systems Corp. won the contract to build the U.S. Army's new mobile radio system last November, Bernard Resnick took it all in stride. Resnick, the assistant general manager of the Army's Mobile Subscriber Equipment project says the big difference between MSE and his earlier projects is that "now I have six zeros added."

The additional zeros are required because the contract is worth \$4.3 billion. By the fifth year of the program, the contractors are slated to have delivered more than 31,000 new phones, 5,200 trucks, 4,400 generators, and 7,000 mobile radio terminals. The effort is so big that GTE has formed a new division—the Tactical Systems Division, in Needham Heights—to organize the final testing and production of the radio systems. The Mobile Subscriber Equipment system will, in effect, be a super mobile cellular phone system for the Army.

CLOSE TO THE ACTION. Resnick, 60, who was formerly business area manager for classified projects and a director of engineering at GTE Government Systems in nearby Waltham, now is near the center of the action on the Mobile Subscriber Equipment project. A native of Wayland, Mass., and a Navy veteran, Resnick holds a BSEE from Northeastern University in Boston and a master's degree in engineering from Yale University.

Surprisingly, Resnick emphasizes, little is different in organizing a venture of this size compared with smaller projects he has led in the past. Faced with a deadline of late 1987 or early 1988 for testing the radio system with a full Army battalion, and with full deployment by 1994, Resnick's main tasks are organizing the operation and acquiring resources, personnel, and facilities. "Everything is bigger, but the control techniques are the same," he notes.

The project's size doesn't change the control techniques



BERNARD RESNICK: Building the Army's new mobile phone system will be like other projects: just bigger.

To complete the contract, Resnick will help GTE coordinate the work of some 30 subcontractors on the project and oversee the construction of new factories in Taunton, Mass. At peak production, the facilities will employ nearly 1,000 workers and each month will build 100 radio shelters—truck-mounted command-post-type modules. They will use the latest in automated materials handling, bar coding, and just-in-time manufacturing techniques.

The MSE project is a primary example of the far greater responsibility the military is delegating to its civilian contractors than on similar projects in the past.

"The unique thing about this program is that we're handling all the Army logistics," says Resnick. "We're giving them a turnkey system. For example, we're building depots around the world."

The massive project also has been made somewhat easier because the military has stipulated that the system be built predominantly of off-the-shelf parts. "We're doing very little development work," says Resnick. "The only reason we took it on a fixed-price contract is because so little development work is required."

Resnick will have to work with existing technology because that's the way the Army prefers it—it is adequate for the job, and the military has "significant problems" managing some advanced systems because of the training required and personnel turnover. The Army is trying to reduce its manpower needs, and Resnick says that this requirement underlies the entire program. "The key to MSE is to reduce the number of people the Army has in green uniforms" and simplify the system's operation.

Besides, "the Army can't handle the technology they have today—why bring in new technology?" says Resnick. —Craig Rose



UNITED WE STAND TO SAY THANK YOU.

We are your neighbors, your friends, members of the community who benefit from your generosity.

Thank you for giving.

Thank you for caring.

Thank you for becoming united.



United Way

THANKS TO YOU IT WORKS FOR ALL OF US.

The Quality of our inductive components is never expensive - merely invaluable



Karlheinz Bretthauer, Klaus Jansen, Vacuumschmelze

At VAC the word quality means the ideal balance between technology and economy: tailor-made specifications at low cost. The value of this policy reveals itself in the high degree of reliability. Regardless of whether your apparatus or plant is in stationary or mobile service, in the arctic or the tropics - our components are absolutely reliable.

VAC inductive components! High quality for professional power electronics.

KI-01e



VACUUMSCHMELZE GMBH West Germany

Grüner Weg 37 · D-6450 Hanau 1 · Tel. (0 61 81) 362-1 · Tx. 4 184 863

Represented by: VACUUMSCHMELZE c/o Siemens Components, Inc.
186 Wood Avenue South · Iselin N.J. 08830 · Phone (201) 494-3530 · Tx WU 844 491

Circle 86 on reader service card



CIRCUITS FOR ELECTRONICS ENGINEERS

Almost 350 diagrammed circuits arranged by 51 of the most useful functions for designers. Taken from the popular "Designer's Casebook" of *Electronics*, these circuits have been designed by engineers for the achievement of specific engineering objectives.

Order your copy today! Send \$17.95 to:

Electronics Week Books
McGraw-Hill Inc.
Princeton Road
Hightstown, N.J. 08520
(Tel.) 609/426-5070

Ten-day money-back guarantee.
Allow 4 to 6 weeks for delivery.



McGraw-Hill
Int'l. Publications Co.
Attn: ECC
McGraw-Hill House
Maidenhead, Berkshire, SL6 2QL
England

EBG6

CUSTOM AND SEMICUSTOM VLSI: Survival Strategies For The New Era

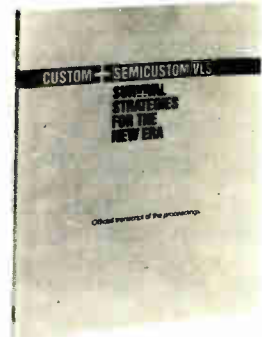

The semiconductor industry is changing. Are you equipped to meet the challenges of this ever-changing industry? Crucial decisions are at hand. *Electronics Magazine* and Gnostic Concepts Inc. sponsored this prestigious seminar and the transcript is now being made available to those who understand the challenge of these changes.

A panel of industry experts presents up-to-date, significant information that probes major technological concerns such as:

- Company benefits by custom design
- Economical appropriateness for tackling custom
- Evaluation of gate arrays and standard cells
- Alternate processes to explore
- Suitability of CAD systems to your particular company

The questions raised are ones of survival. And OPPORTUNITY.

Put this exclusive resource in your hands to help you make the right decisions.

Don't hesitate—Order your copy today!

Send \$150 or your company purchase order to:

Electronics Books
P.O. Box 541
Hightstown, N.J. 08520
(Tel.) 609/426-5070

Allow 4-6 weeks for delivery.
Money-back guarantee.



MEETINGS

EXPLORING AUTOMATION IN THE FACTORY

The Electronics Manufacturing Technologies and Systems Conference will explore the "impact of automation on manufacturing engineering," says program chairman Walter Trybula. With three major groups sponsoring the event—the Society of Manufacturing Engineers, the IEEE, and the American Society of Manufacturing Engineers—Trybula says the conference is unique because it combines aspects of manufacturing, electronics, and automation.

"Automation is a whole package," not just a matter of putting together a few robots and some software, says Trybula, a consultant with General Electric Co.'s Electronic Automation Application Center in Charlottesville, Va. Labor, which he says amounts to only 10% of the cost of electronics production, is only one target; automation can also affect materials handling and overhead, which account for 55%.

Aware that proper design is critical to

effective automation, the conference organizers have sought out speakers from large companies who could present their automation experiences "in a way people in smaller companies can use," says Trybula. Speakers from such firms as AT&T Bell Laboratories, General Electric, Hewlett-Packard, and IBM will share what their companies have done in areas like surface-mount technology, just-in-time manufacturing, machine vision, computer-integrated manufacturing, and the use of artificial intelligence.

The conference's 16 sessions will include time for questions and answers so the 450 to 500 expected attendees can ask about problems with each technology. Trybula says this is important because companies often automate without carefully exploring the benefits. For example, he says, there is a lot of pressure to get JIT into factories, but discussions might lead owners to conclude that it wouldn't work for them.

BIST: Built-In Self-Test Workshop, IEEE (Richard M. Sedmak, Self-Test Services, 6 Lindenwold Ter., Amber, Pa. 19002), Kiawah Island, Charleston, S. C., March 12-14.

ISDN '86: Integrated Services Digital Networks for the Future, Information Gatekeepers Inc. (IGI, 214 Harvard Ave., Boston, Mass. 02134), Marriott Hotel, Dallas, March 12-14.

Applications of Ceramics for Microelectronic Interconnections, Engineering Foundation (345 E. 47th St., New York, N. Y. 10017), Miramar Hotel, Santa Barbara, Calif., March 16-21.

VLSI Test Workshop, IEEE Computer Society (Gerald W. Gordon, Philadelphia Electric Co., 2301 Market St., Philadelphia, Pa. 19101), Bally's Park Place Casino Hotel, Atlantic City, March 18-19.

Southcon/86, IEEE (Electronics Conventions Management, 8110 Airport Blvd., Los Angeles, Calif. 90045), Orange County Convention Center, Orlando, Fla., March 18-20.

Emtas '86: Electronic Manufacturing Technologies and Systems '86 Conference, IEEE *et al.* (Anthony M. Corte, Technical Activities Division, Society of Manufacturing Engineers, 1 SME Dr., Dearborn, Mich. 48121), Hyatt Regency, Los Angeles, March 18-20.

Work Station Technology & Systems Conference, IEEE Computer Society (Helen Yonan, Moore School of Electrical Engineering, University of Pennsylvania, Philadelphia, Pa., 19104), Bally's Park Place Casino Hotel, Atlantic City, March 18-20.

International Spectrum U. S. A. '86, International Data-Base Management Association (IDBMA, 9740 Appaloosa Rd., Suite 104, San Diego, Calif. 92131), MGM Grand Hotel, Las Vegas, March 24-26.

Systems I, Computer and Business Equipment Manufacturers Association *et al.* (Society of Manufacturing Engineers, 1 SME Dr., Dearborn, Mich. 48121), Chicago Hilton and Towers, Chicago, March 24-26.

Washington Ada Symposium, IEEE Computer Society *et al.* (Connie Finley, Johns Hopkins University Applied Physics Laboratory, Johns Hopkins Rd., Laurel, Md. 20707), Johns Hopkins University, March 24-26.

Interface '86: 14th Conference & Exposition for Data Communications/Information Processing, *Business Week* and *Data Communications* magazines (The Interface Group Inc., 300 First Ave., Needham, Mass. 02194), Georgia World Congress Center, Atlanta, March 24-27.

Artificial Intelligence '86, Singapore Science Council (John Tagler, 52 Vanderbilt Ave., New York, N. Y. 10017), Hyatt Regency Hotel, Singapore, March 24-27.

Symposium Southeast on Optics and Optoelectronics, Society of Photo-Optical Instrumentation Engineers (P. O. Box 10, Beltingham, Wash. 98227-0010), Sheraton Twin Towers, Orlando, Fla., March 31-April 4.

Comdex/Winter, The Interface Group Inc. (300 First Ave., Needham, Mass. 02194), Convention Center, Los Angeles, April 1-3.

"YOU CAN HELP FREE ENTERPRISE WORK WORLDWIDE!"



David E. McKinney
President,
IBM World Trade
Americas/Far East Corp.

I'm a volunteer supporter of the International Executive Service Corps, a not-for-profit organization with a vital mission:

We build free enterprise worldwide by sending retired U.S. executives to help companies in developing countries. The executives receive expenses, but no salary.

Our main purpose is to help developing countries succeed in business. But the benefit doesn't stop there. These countries consume about 40 percent of U.S. exports.

With the support of over 800 U.S. companies, we have completed 9,000 projects in 77 countries. Our Board of Directors and Advisory Council include the CEOs of many of America's largest companies.

Join me in building free enterprise throughout the free world. Write to: David E. McKinney, President, IBM World Trade Americas/Far East Corp. at P.O. Box 10005, Stamford, CT 06904-2005.



International Executive Service Corps

Ad Council
A Public Service of
This Publication

NEW PRODUCTS

DOCUMENT AUTOMATION SPEEDS UP DESIGN PROCESS

WORK STATION LINKS WITH CAE AND CAD SYSTEMS

It's no secret that good documentation helps move a project along from conceptualization to production and then makes the product easy for customers to use. The mystery has been how to get good quality documentation.

Now Context Corp., a Mentor Graphics Corp. spinoff, has the key: automate the documentation task. The company's Documentation Workstation, built around an Apollo Computer Inc. work station, will link with Mentor's Idea series of computer-aided engineering and design systems, which are also built around Apollo computers. But the company plans support for other CAE and CAD systems.

"Documentation is essential for defining and proposing a product, through numerous design stages and revisions all the way through to the completed design, when manual production occurs," says Context president Michael Bosworth. "Automating the documentation process substantially accelerates the entire design project."

Context calculates that documentation takes 30% of the engineering time on a project. Design takes only 15% and analysis another 15%. CAE and CAD systems have already automated 30% of the project; with its new system, Context says it has automated another 30%.

The complete Documentation Workstation consists of one or more Apollo work stations strung along the Apollo Domain network, a mass-storage system, and a laser printer. Basic software includes DOC, the system's text editor and formatter, and the PicED picture editor. Because individual storage units can reach 1 gigabyte and the work stations can address 16 megabytes, there is no limit as to a document's size.

WHAT YOU SEE... Context takes a what-you-see-is-what-you-get approach. Integrated graphics and text are printed as they appear on the screen. The work stations come standard with utilities for creating interfaces to draw text, data,



FIRST CHOICE. Context Corp.'s system initially will tie in with the work stations from its parent, Mentor Graphics.

and graphics from other systems, and Context is working to provide a range of standard interfaces to mainframe formatters, dedicated word processors, and personal-computer-based packages.

Context's integration with CAD and CAE systems gives the documentation writer easy access to the designer's text and graphics. This increases documentation productivity while ensuring accurate, up-to-date data. In a project at Boeing Aerospace Co., Seattle, Context systems are being integrated into a custom-software-programming environ-

ment, which allows a programmer to work with documents synthesized directly from the engineering data base.

Context's system can partition a document across several disk drives on a network, so many authors can work on it simultaneously, developing, editing, and reviewing. For example, all members of a proposal team can review a document at once electronically, then work from a single on-line version with all the review comments merged at the bottom of the page. Then, the manager can incorporate or reject those comments at will.

Automated document management instantly reflects changes throughout highly structured documents. If an illustration is moved from one page to another, for example, the graphics-by-reference feature of Context's documentation processor makes sure all numbering, references, tables of contents, lists of illustrations, and indices are correct—with no need for manual checking.

Context argues that customers can better control a product's development by better controlling the documents that define the product. So the Context series supports the configuration management principle, which tracks and controls how documents change over time and through variants.

Prices of the Documentation Workstations start at \$16,900, with delivery in about 45 days.

—Steve Zollo

Context Corp., 8285 S.W. Nimbus Ave., Beaverton, Ore. 97005. Phone (503) 626-1173 [Circle reader service number 338]

TEST PATTERN HANDLES PROTOTYPING, PRODUCTION

Integrated Measurement Systems' Sentry Link conversion program ends a needless duplication of effort—the development of separate functional test patterns for prototyping and production testing. At the same time, the program improves the transition between design and test. Sentry Link does both by mak-

ing the test patterns the design engineer develops during prototype verification usable by the test engineer for full device characterization or volume production testing.

"We think Sentry Link will be a key element in breaking down the barrier between the designer and test engi-

Enter the new era of MICROSYSTEM DESIGN

MICROPROCESSOR SYSTEMS: Software and Hardware Architecture delivers a wealth of information about microcomputers, peripherals, networks, signal processing and software, that leads the field in the 80's!

This book is a comprehensive collection of technical articles, carefully detailed and presented, in exclusive reprints from *Electronics Magazine*.

Corporate Managers, Project Managers, Design Engineers, Market Managers: **MICROPROCESSOR SYSTEMS: Software and Hardware Architecture** is one book for all!

Six knowledgeable chapters examine:

- Significant trends in the development of new software systems and applications
- Technical articles on the manufacture of new microprocessors
- Approaches to memory management used by major chip manufacturers
- Conveniences of peripheral chips
- Alternative network methods from Ethernet to token-passing protocols
- Modular procedures for making digital signal processing systems

Engineers – Save precious time by eliminating a cumbersome series of software instructions.

Directed chiefly at design tactics, **MICROPROCESSOR SYSTEMS: Software and Hardware Architecture** helps you avoid errors and overcome all your architectural problems.

- Brings you the needed simplicity of design, without sacrificing performance of the finished system
- Offers a means of tapping microsystems into the power of mainframe machines
- Recounts major breakthrough in dedicated chips that handle math operations in record time

Here it is –

MICROPROCESSOR SYSTEMS: Software and Hardware Architecture - Let it design for you!

Don't be left in the dark: **MICROPROCESSOR SYSTEMS: Software and Hardware Architecture** illuminates the design process of an ever changing industry.

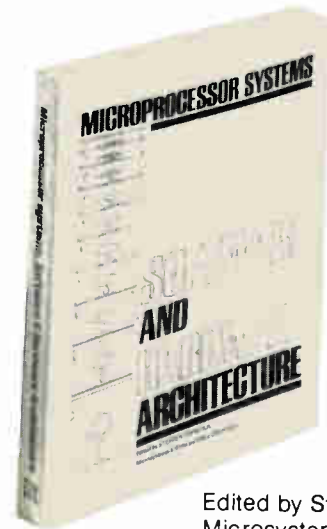

Edited by Stephen Evanczuk,
Microsystems & Software
Editor, *ELECTRONICS*

In one resourceful volume, **MICROPROCESSOR SYSTEMS: Software and Hardware Architecture**

lets you understand:

- Functions of hour end microprocessors and controllers
- Key microprocessors that trigger the personal computer revolution
- The importance of dedicated chips more sophisticated than mainframes of yesteryear
- Significant aspects of microcomputer software
- Efficiency of peripheral-control chips

**Don't delay -- order your
copy today!**

Use the coupon or send
in your company purchase
order.

MC GRAW-HILL PUBLICATIONS CO.

Attn: ECC
McGraw-Hill House
Maidenhead, Berkshire SL6 2QL
England
(Tel. (0628) 23431; Telex 848640)

Send me _____ copy(ies) of
**MICROPROCESSOR SYSTEMS: Software and
Hardware Architecture** for \$21.95 each. (U.S.
residents please include local sales tax).

- Payment enclosed (postage & handling included)
- Bill me (postage, handling & tax will be added) NOTE: All orders under \$30 will be sent a pro forma invoice requiring prepayment.
- Bill my company. Purchase order is attached.

Ship to:

Name _____

Company _____

Street Address _____

City _____ State _____ Zip _____

Country _____

McGraw-Hill knows you will be satisfied, but if for some reason you are not, there is a ten-day money-back guarantee that applies on all books. Allow four to six weeks for delivery.

TTL LEVEL BUBBLE MEMORY MODULES

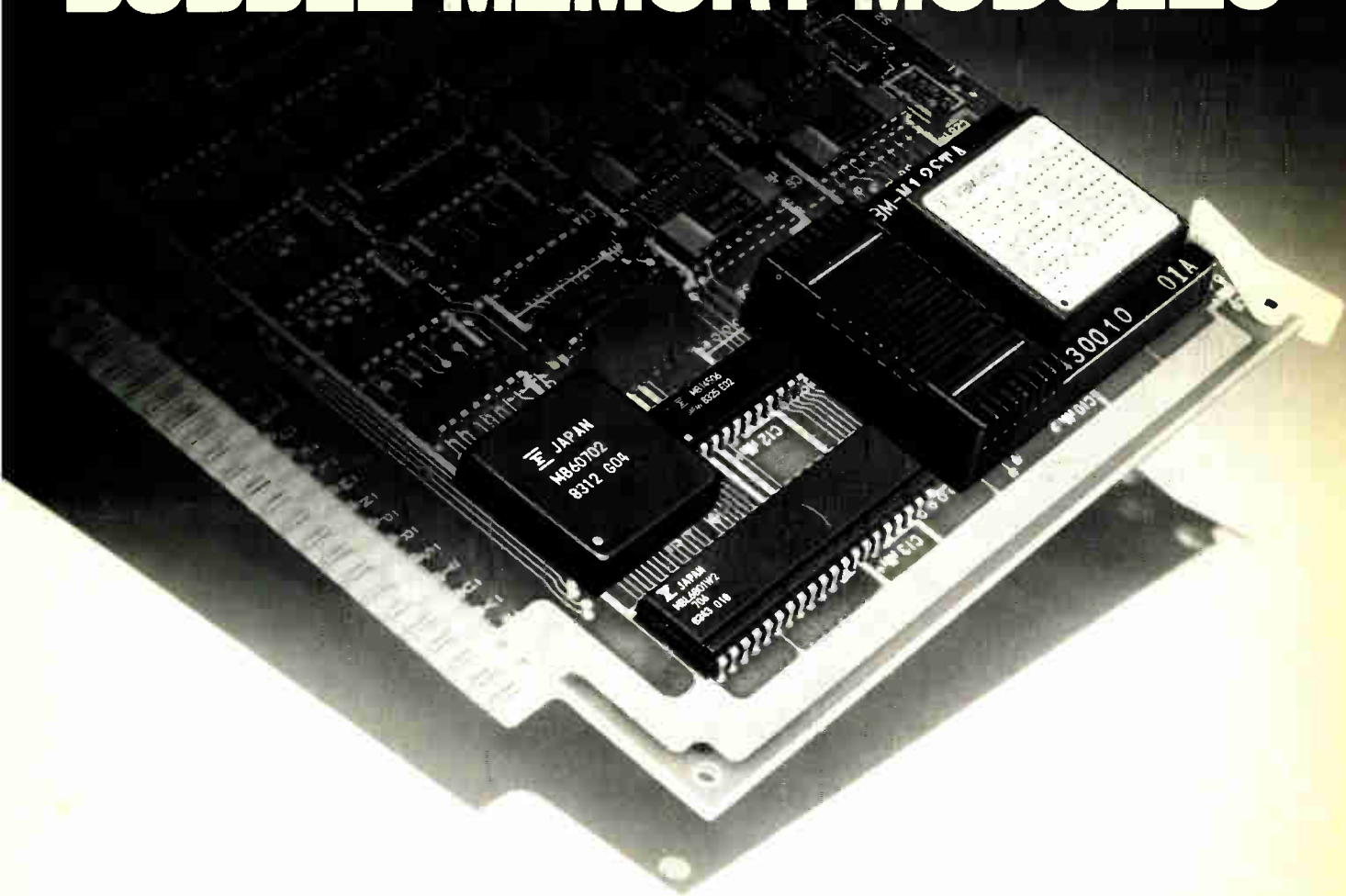

Fujitsu's BMM Series bubble memory modules let you design your own board.

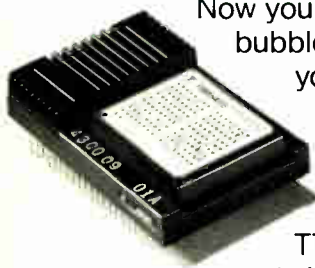

Now you can have Fujitsu's reliable bubble memory just the way you want it. These flexible new modules, consisting of bubble memory devices and peripheral linear ICs, work at the TTL level which means you

only have to add control LSIs to create solid-state file memory designed to your particular needs. Contact Fujitsu Component Europe, B.V. today for full details.

- Expandable from 128K to 4M bytes
- 11.2msec. average access time
- Non-volatile memory
- Maintenance-free design

Specifications

Model	FBM-M128TA	FBM-M128TC
Memory capacity	1,048,576 bits (128K bytes)	
Interface	TTL level	
Transfer rate	100K bit/s	
Access time	11.2ms	
Operating temp.	0 to 65°C	5 to 50°C
Storage temp.	-40 to 85°C	-30 to 75°C
Weight	75g	
Dimensions	43.5 x 65.5 x 13.7mm	

Fujitsu Component Europe, B.V.:

Rijnkade 19B, 1382 GS, Weesp, The Netherlands Phone: 02940-18748/18914 Telex: 11966 FUJCE NL

Fujitsu Component Europe, B.V. Niederlassung Deutschland:

Arabella Center, 12th Floor, Lyoner Str. 44-48, D-6000 Frankfurt/Main 71, West Germany Phone: 069-66320 Telex: 411963 FMG D

Fujitsu Limited (Components Marketing):

Furukawa Sogo Bldg., 6-1, Marunouchi 2-chome, Chiyoda-ku, Tokyo 100, Japan Phone: National (03) 216-3211
International (Int'l Prefix) 81-3-216-3211 Telex: 2224361 FTTOR J



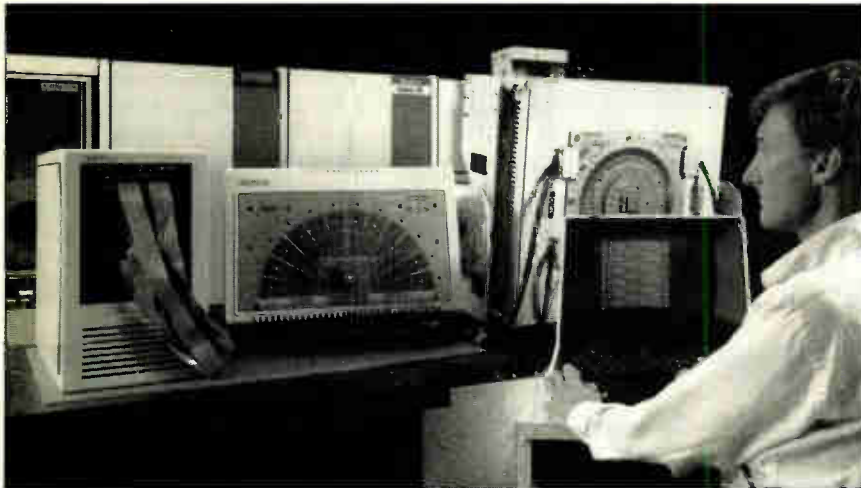

FAMILY TIES. With IMS' conversion package, both design and test engineers can work with the same functional test patterns, so they do not wind up duplicating each other's efforts.

neer," says Ken Lindsay, director of marketing for IMS. "In addition, being involved in the development of useful test patterns for the production floor gives the designer a direct pipeline into product quality."

Typically, the designer of a prototype IC creates functional verification patterns on the company's Logic Master design verification system [*Electronics-Week*, Oct. 22, 1984, p.108]; when the part is ready for production, the test engineer writes additional test patterns on the Sentry/Schlumberger Sentry tester.

Large testers such as the Sentry typically are overburdened with high-volume production test demands. But when Sentry Link joins the Logic Master, the company claims, the combination shortens the time needed for test-program development, freeing the Sentry for its optimum use, production testing.

The Logic Master series operates with

the simulator output from any CAE system. With it, the device designer can interactively make measurements to determine if a device has been correctly designed and implemented in silicon and to make sure it meets the requirements for high-volume production.

One command is all it takes to automatically convert test patterns to Sentry format when using the Logic Master's screen interface. Sentry Link supports Sentry test-system models 7, 8, 10, 20, and 21, and all the standard Sentry commands.

Priced at \$2,950, Sentry Link is available now. Logic Master customers can add Sentry Link by simply replacing an EPROM. No changes to the Sentry tester are required. —Steve Zollo

Integrated Measurement Systems, 9525 S.W. Gemini Dr., Beaverton, Ore. 97005. Phone (503) 626-7117 [Circle 339]

ANALOG DEVICES TO SELL 1-CHIP SIGNAL PROCESSOR

Analog Devices has entered the general-purpose single-chip digital-signal-processor market with a CMOS part that executes 24-bit instructions in 125 ns. The ADSP-2100 microprocessor combines a 16-bit arithmetic logic unit, a 32-bit barrel shifter, a 16-by-16-bit multiplier with a 40-bit accumulator, a program sequencer, and two data-address generators, all on a single chip.

The processor is fabricated in a 1.5- μ m double-metal CMOS process and consumes less than 500 mW. The ADSP-2100's architecture is designed to make efficient use of external memories for program and data storage, freeing sili-

con area to be devoted to increasing processor performance. With only five additional memory chips—three to store instructions and two to store data—designers can build a system that runs at 8 million instructions/s.

The company sees applications for the chip in the cost-conscious medium- to low-performance end of the DSP market. The high-performance end, where cost is less of an issue, is better handled by the building-block DSP chip approach, which Analog Devices also serves with its 64-bit multiplier and ALU and its 16-bit program sequencer and address generator [*Electronics*, Jan. 13, 1986, p. 72].

The medium-performance markets—such as data communications and computer imaging—are more cost-sensitive, and success in the market depends on overcoming the price/performance tradeoff between the building-block approach and the single-chip solution, says Sayuri Tung, a marketing specialist at the Norwood, Mass., company. Older, single-chip processors run out of steam, and the building-block approach can cost upward of \$2,000 and use more power than solutions that use the new ADSP-2100, she adds. The ADSP-2100 has the speed and price to exploit this market; samples will cost \$375.

In a single 125-ns cycle, the chip computes the next program address, fetches the next instruction, performs one or two data transfers, updates one or two address pointers, and performs an arithmetic operation.

ARCHITECTURE. The key to the ADSP-2100's performance lies in its architecture. Rather than using a microcomputer-like architecture with on-chip memory, Analog Devices chose a microprocessor architecture with off-chip program and data memory served by five buses. This enabled the chip's designers to use seven major functional units: the ALU, a multiplier-accumulator, a barrel shifter, a program sequencer, two data-address generators, and an instruction cache.

The architecture also enabled them to use separate data and program buses, both of which extend off the chip. The benefit of this is that instruction fetches do not interfere with data operations. Other single-chip processors use only one bus to go off chip.

"The chip is built with the idea that a lot of programming will be loops," Tung says, so the chip has been optimized for looping operations. For example, the instruction-cache memory becomes an alternate source for the instruction register when executing looped code. This frees the program-memory data bus for accessing data, effectively providing three dedicated buses for the looping operations, with one instruction bus and two data buses.

To harness all this power, software was important. The chip has an easy-to-use, flexible instruction set. Although it is an assembly language, it uses high-level-language syntax. For example, the contents of any register can be shifted to any other in a single cycle with one command. "Writing code is like using a high-level language," Tung says. "But the chip's instruction set supports multiple functions at the same time, which high-level languages do not."

Along with the chip come extensive development tools, such as an assembler, a linker, a simulator, and a stand-

alone in-circuit emulator. The software is available for use on either IBM Corp. Personal Computers or Digital Equipment Corp. VAX computers. Samples of the ADSP-2100 will be available this summer. *-Steve Zollo*

Analog Devices Inc., 1 Technology Way, Norwood, Mass. 02146. Phone (617) 329-4700 [Circle 372]

POWER MOS FETs SELL FOR AS LOW AS \$1.98

P-channel power MOS FETs, formerly difficult and expensive to produce, are now available in production quantities and at a competitive price. The product line, 26 devices in all, offers simplified

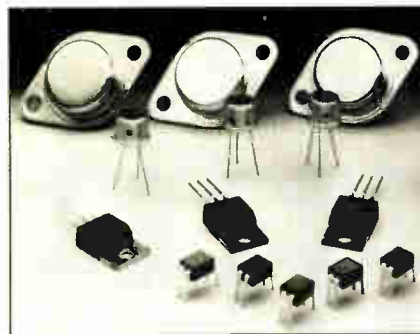

circuitry for motor drives and some power supplies such as high-power analog switches.

The power MOS FETs use proprietary Duramos, which delivers breakdown voltages from -60 to -200 V and on-state resistance ranging from 0.3 to 2.4 Ω. Package options include the military-grade hermetic TO-3 and a four-pin DIP for automatic insertion. The series consists mainly of industrial models, but high-reliability versions for military applications are also available.

Samples are from stock and production quantities take up to eight weeks. Unit prices, in orders of 100 to 999 pieces, range from \$1.98 to \$10.39.

Siliconix Inc., 2201 Laurelwood Rd., Santa Clara, Calif. 95054. Phone (408) 988-8000 [Circle 355]

CMOS OP AMP'S OUTPUT SWINGS ±14 VOLTS

The TSC915, a chopper-stabilized CMOS operational amplifier, works from the same ±15-V power supplies used to power bipolar op amps. Its low offset voltage, 10 μV maximum, and low voltage offset drift, 0.2 μV/°C, reduce key sources of error in less precise op amps.

User-transparent nulling circuitry operates over the op amp's entire -25°C to +85°C range, reducing temperature-induced errors. Power-supply current of the TSC915 is 1.5 mA maximum, and its

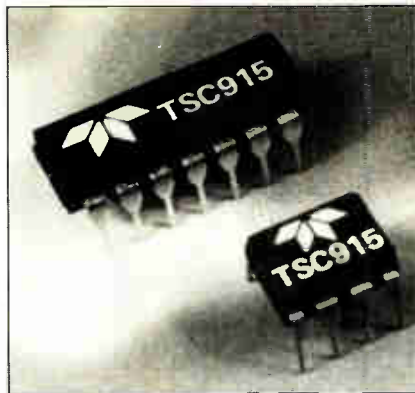

output will swing to ±14 V with a 10-kΩ load resistor.

The TSC915 comes in 8- and 14-pin DIPs; it is pin-compatible with 7650/7652 op amps. Prices in orders of 100 are \$4.50 and \$5.60, respectively, and samples are available from stock.

Teledyne Semiconductor, 1300 Terra Bella Ave., P. O. Box 7267, Mountain View, Calif. 94039. Phone (415) 968-9241 [Circle 356]

ONE LED DISPLAYS THREE COLORS

Depending on how voltage is applied to its three terminals, a single LED will emit red, amber, or green light. These tricolor LEDs, series PCX200-RAG, have applications as status indicators and for many other diagnostic purposes. The maximum forward current per LED is 30 mA.

Available from stock to four weeks, these components are priced at 75¢ each in quantities of 1,000.

Data Display Products, 301 Coral Circle, El Segundo, Calif. 90245.

Phone (800) 421-6815; in California, (213) 640-0442 [Circle 354]

SENSORS DETECT LOW PRESSURES

The SX series of IC pressure sensors includes 20 devices for measuring absolute, differential, and gauge pressures as low as 0 to 1 lb/in.² to a high of 0 to 150 lb/in.² Bridge impedance is 4.5 kΩ



and peak-to-peak noise is less than 2 μV.

Applications for the sensors are in portable and battery-powered equipment, medical equipment, computer peripherals, and industrial controls. Available now in quantity, the SX devices range from \$17.25 to \$20.25 each in 100-piece lots.

Sensym Inc., 1255 Reamwood Ave., Sunnyvale, Calif. 94089.

Phone (408) 744-1500 [Circle 357]

EMULATOR DEBUGS 68000, 8086 C CODE

The DE-1000, a portable development system, offers a full-feature C-language symbolic debugging system for the 68000 and 8086 microprocessor families. It comes in two versions—one for IBM Corp. and the other for Digital Equipment Corp. host computers.

Each package includes a chip-specific pod, host-compatible emulation software, and Slice, a nonintrusive source language for symbolic debugging of both C and assembly-level code.

Priced at under \$12,000 for use with the IBM Personal Computer/XT or PC



AT and at under \$16,000 for the VAX or MicroVAX, the DE-1000's delivery time is 30 days—60 days for the 68020-emulation model. A demonstration disk is free. Emulogic Inc., 1 Edgewater Dr., Brookside Park, Norwood, Mass. 02062.

Phone (800) 435-5001; in Massachusetts, (617) 769-2980 [Circle 366]

SOLDER INSPECTOR USES VISION SYSTEM

The Solder Process Inspector 2000 checks joints for insufficient solder, bridges, and holes. The machine-vision-based system inspects a typical board in 4 min, the manufacturer says, and it records and stores correction data throughout the inspection.

An SPI 2000 machine features four cameras, a universal board holder, and a motion subsystem. Peripherals include a keyboard, mouse, monitor, and printer for creating a hard-copy record of the



inspection results. The company will quote price and delivery information upon request.

Consolidated Controls Corp., Automation Products, 15 Durant Ave., Bethel, Conn. 06801. Phone (203) 798-3000 [Circle 365]

RF CIRCUIT SIMULATOR IS UPDATED

Release 1.4 of Touchstone, a simulation program for the design of linear radio-frequency and microwave circuits, offers an extensive array of new element models, the company says. Among them are asymmetric coupled-microstrip transmission lines, a proprietary via-hole model, six- and eight-finger interdigital couplers, and three microstrip bend models not previously available.

The software runs on the IBM Corp. Personal Computer, Hewlett-Packard Co.'s series 200 and Vectra machines,



and all VAX computers from Digital Equipment Corp. Touchstone 1.4 is available now for \$8,400.

EEsof Inc., 31194 La Baya Dr., Suite 205, Westlake Village, Calif. 91362. Phone (818) 991-7530 [Circle 350]

SOFTWARE VENDORS JUMP ON RT PC's BANDWAGON

Because the IBM Corp. RT Personal Computer seems guaranteed to become a big success, the software houses are rushing to climb aboard the bandwagon. With plenty of software support—19 packages were already available when IBM introduced the RT PC—a variety of end-user systems should emerge in no time at all. Now, an even greater variety of software is coming to aid value-added resellers.

IBM has helped cause the stampede by licensing the Virtual Resource Manager—the portion of the RT PC's Advanced Interactive Executive (AIX) operating system that IBM developed—to customers who are planning to develop programs that do not use the rest of AIX.

At the top of the list of RT PC boosters is Interactive Systems Corp., whose IN/ix operating system was used to create the RT PC's system. AIX combines Interactive's version of AT&T Co.'s Unix System V with IBM additions such as the Virtual Resource Manager virtual-memory feature. Interactive has adapted its Ten/Plus family of system-management software products to the RT PC, including networking and electronic-mail software. Interactive is also working on a version of Unix for Intel Corp.'s new 80386 32-bit microprocessor, which, it is rumored, IBM is planning to put into the RT PC.

Visual Engineering Inc.'s entire line of graphics development software is available for the RT PC. Included are Visual:GKS, a library of subroutines based on the Graphics Kernel System (\$695), and Visual:C-Chart, a presentation-graphics tool for programmers (\$1,500). Both use GraphCap, a knowledge-base system [*Electronics*, Feb. 10, 1986, p. 60] that lets customers use existing graphics peripherals or add new ones to their systems without software or hardware modifications.

Tartan Laboratories Inc., a compiler

company, will be bringing out an optimizing C compiler for the RT PC. Tartan claims its compiler produces code that's up to twice as fast as that produced by IBM's portable C compiler. Tartan's compiler will be available next month for \$1,000. An Ada compiler is on the way.

MicroSet 8086-family cross-development software from First Systems Corp. has also been adapted to the RT PC. The packages, used for developing real-time systems, include C-86, PL/M-86, Pascal-86, and Fortran-86 compilers, and Macro-86 Assembler. Microset says some packages are available now, and the entire line will be out by the end of March; the company will quote prices.

Teamwork/SA, a systems-analysis development software package from Cadre Technologies Inc., now runs on the RT PC. The project-library data base ties into IBM's relational data-base system. The \$8,900 package also operates over

the PC-Network, emulating an IBM 3270 terminal.

IntelliCorp's Knowledge Engineering Environment software lets users develop their own commercial artificial-intelligence applications. Prices were unavailable at press time.

A family of productivity tools from Oracle Corp. takes advantage of the RT PC's host-compatible Structured Query Language (SQL) data-base manager, which Oracle developed. The company has announced two packages for the RT PC: Pro-Fortran (\$600), an SQL precompiler for Fortran programs, and Pro-SQL (\$600), a call interface to SQL/RT that can be used with a variety of languages. Pro-Fortran will be released in March, Pro-SQL in the second quarter.

The Scientific Desk, from C. Abaci Inc., includes a library of math and statistical functions and subroutines for use in scientific programming. The site license fee is \$1,320. —Ann Jacobs



BULLISH. Judging from the support of software houses, IBM's RT PC will be a smash.

C. Abaci Inc., 208 St. Mary's St., Raleigh, N. C. 27605.

Phone (919) 832-4847 [Circle 341]

Cadre Technologies Inc., 222 Richmond St., Providence, R. I. 02903.

Phone (401) 351-5950 [Circle 342]

First Systems Corp., 865 Manhattan Beach Blvd., Manhattan Beach, Calif. 90266.

Phone (213) 546-5581 [Circle 343]

IntelliCorp, 1975 El Camino Real West, Mountain View, Calif. 94040.

Phone (415) 965-5500 [Circle 344]

Interactive Systems Corp., 2401 Colorado Ave., Santa Monica, Calif. 90404.

Phone (213) 453-8649 [Circle 345]

Oracle Corp., 2710 Sand Hill Rd., Menlo Park, Calif. 94025.

Phone (415) 598-8201 [Circle 347]

Tartan Laboratories Inc., 477 Melwood Ave., Pittsburgh, Pa. 15213.

Phone (412) 621-2210 [Circle 348]

Visual Engineering Inc., 2680 N. First St., Suite 200, San Jose, Calif. 95134.

Phone (408) 945-9055 [Circle 349]

COMPUTER SOFTWARE

FREE DEMO DISK

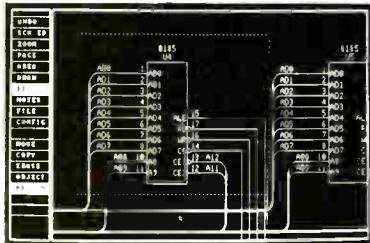

SCHEMA is a complete, integrated schematic drawing software package for IBM Personal Computers. Use SCHEMA with your PC to draw schematics and automatically generate design documentation such as Wire and Net Lists, Bills of Materials, Design Rule Checks, etc. SCHEMA is \$495 and supports most common PC hardware configurations. Call or write today for a free demo disk and brochure.

OMATION, INC.

1701 N. Greenville Ave., Suite 809
Richardson, TX 75081
(214) 231-5167

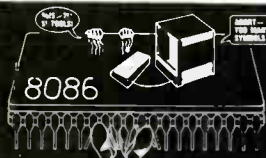

8086 Software Development Tools That Don't Pin You Down

MicroSET™ Tools

- Compilers for Pascal, C, FORTRAN, and PL/M
- Support for MTOS™, VRTX™, IRMX™
- Assemblers
- Linkers, Locaters, Librarians
- ✓ MicroSCOPE™ - A UNIQUE HIGH LEVEL LANGUAGE CROSS DEBUGGER
- Downloaders and Communications

Targets

- 8086/80186/8088/80188/8087
- 8080/8085/Z80/NSC800

Hosts

- DEC VAX/VMS™
- DG MVI/Family
- HP 9000/500 HP-UX

For advanced tools that get your job done faster and reduce your costs, call (213) 546-5581 today.

First Systems Corporation 865 Manhattan Beach Blvd.
Manhattan Beach, CA 90266
Telex: (RCA) 298086.

© 1987 First Systems Corp. MicroSET, MicroSCOPE, Digital Equipment Corp. DEC, VAX, VMS, Hunter & Pease, VRTX, Industrial Programming, MTOS, Intel, IRMX, First Systems Corporation

SPICE up your PC

Z/SPICE professional circuit simulation

Full version \$245 Student version \$79

ZTEC box 737, college place, wa 99362
(509)-529-7025

RELIABILITY PREDICTION SOFTWARE

ARE YOUR PRODUCTS RELIABLE?

RelCalc 2 automates MIL-HDBK-217D on your IBM PC!

Very easy to use. Demo package \$50.

T-CUBED SYSTEMS 31220 LaBaya Drive, #110
(818) 991-0957 Westlake Village, CA 91362

POSITIONS VACANT

Electronic Design Engineer — Research, analyze design & develop digital circuits for computer commun. networks. Req'd: M.S. in elec. eng. 6 mos. exp. in position or 1 yr. research exp. in elec. dig. circuits. 40 hrs. 5 days. \$33,000. per yr. Send resume: Job Service, Job Order #NC5832487, DOT code 003.061-034, 2005B S. Elm-Eugene Street, Greensboro, N.C. 27406, or nearest Job Service Office.

Murkett Associates — Technical Mgmt placement with national affiliates-fee paid Box 527, Montgomery, AL 36101.

POSITIONS WANTED

Electronic Expert For Hire. I do Micro-processor hardware/software, assembly language. Analog, digital design in my N.Y. lab or worldwide. Project rates. Mr. Barry Masel (718) 476-1516.

HOT LINE

To place your
Computer Software
Ad
in
Electronics

call Ilene Fader
at

212/512-2984

OPPORTUNITY WITHOUT RISK.

The biggest improvement in 40 years has made U.S. Savings Bonds an ideal investment.

A variable interest rate lets you share in rates offered by today's securities market. No limit on how much you might earn.

What makes this improved Bond ideal is that you're protected by a guaranteed minimum. And if the Bond is held to maturity, you'll double your money.

Take another look at this opportunity without risk.

Take stock in America.



A public service of this publication and The Advertising Council.

New variable rate U.S. Savings Bonds guarantee investment growth...

The employees at AT&T keep their future plans on target when they rely on the Payroll Savings Plan.



James Rodgers — "My daughter will be starting college very soon and the bonds will help finance her education."

Irene Butryn — "I have five grandchildren and I have been purchasing six bonds per month, one for each and one for myself, since 1974."

Director of Sales
U.S. Savings Bonds Division
Department of the Treasury
Washington, D.C. 20226

Take stock in America.

Yes, please send me Free information about the Payroll Savings Plan.

Name _____
Position _____
Company _____
Address _____
City _____ State _____ Zip _____

Ad Council A public service of this publication and The Advertising Council

LETTERS

Logic-device dispute

To the editor: The special report, "Field Programmable Logic: A New Market Force" [*Electronics*, Jan. 27, 1986, p.25], is an attempt to address this emerging market opportunity. I personally was disappointed with the editorial quality of this report. It is confusing, misleading, and, in many instances, factually incorrect.

Altera is the only company to develop and sell high-density CMOS erasable programmable logic devices (EPLDs).

Altera does not second-source Monolithic Memories Inc.'s PALs; PALs are bipolar, fuse-programmable, low-density, power-hungry devices.

Altera does not offer MegaPALs or variations. MegaPALs are also bipolar, fuse-programmable devices and have not been successful in the marketplace.

Altera is the only company offering a CMOS EPLD providing over 2,000 equivalent gates (EP1800), but it is not in a 20-pin package—it has 68 pins.

EPLDs can be 100% tested for programmability and ac performance before shipment (electrically erasable devices offer no advantage).

Intel Corp. has indeed entered the marketplace—by second-sourcing, under license, Altera products.

Rodney Smith

President and chief executive officer
Altera Corp.
Santa Clara, Calif.

Yes, Altera is the only company to develop and sell high-density CMOS EPLDs—although Intel is now offering pin-for-pin compatible versions of the Altera line. Moreover, other companies, such as VLSI Technology and Sprague, offer CMOS EPLDs of somewhat lower densities. And Xilinx, for one, offers equivalent or higher-density CMOS field-programmable logic devices using a different technology.

The statement that Altera second-sources PALs was incorrect and we regret the error. A better way to make our point would have been to say that some of Altera's products are functionally equivalent to PALs. The article never said that Altera offered MegaPALs; and as for MegaPAL market acceptance, MMI sources say that in the niche for which they are intended, MegaPALs are selling well.

Altera's 2,000-gate EP1800 was not formally announced until after the article appeared, and so it is not discussed there—at Altera's request. Finally, electrically erasable devices offer an advantage over EPLDs in that they can be erased and reprogrammed much more quickly.

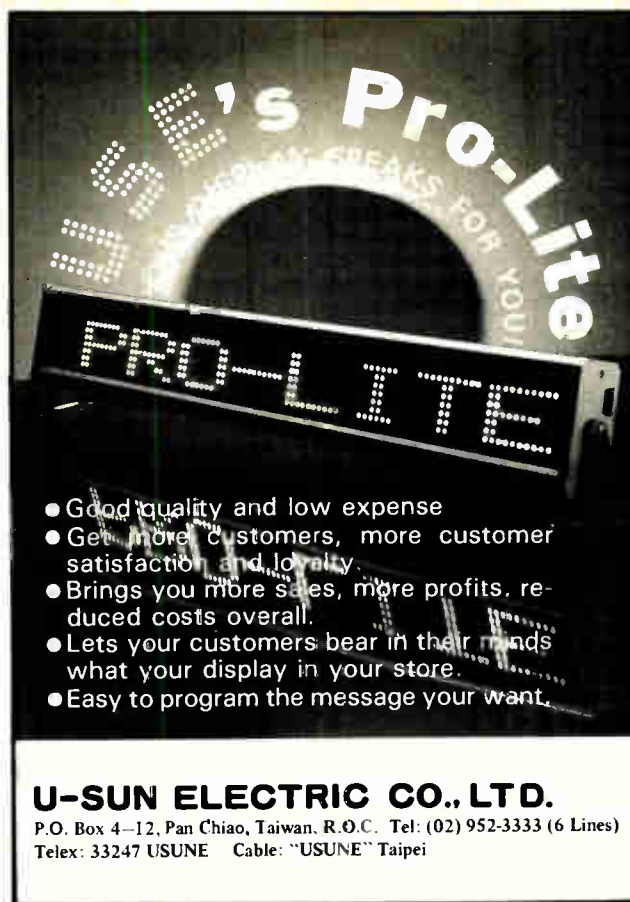

U-SUN ELECTRIC CO., LTD.
P.O. Box 4-12, Pan Chiao, Taiwan, R.O.C. Tel: (02) 952-3333 (6 Lines)
Telex: 33247 USUNE Cable: "USUNE" Taipei

- Good quality and low expense
- Get more customers, more customer satisfaction and loyalty
- Brings you more sales, more profits, reduced costs overall.
- Lets your customers bear in their minds what your display in your store.
- Easy to program the message your want.

Circle 93 on reader service card

DESIGN TECHNIQUES for ELECTRONICS ENGINEERS



Expert guidance at every point in the development of engineering project-making measurements, interpreting data, making calculations, choosing materials, controlling environment, laying out and purchasing components, and interconnecting them swiftly and accurately. Nearly 300 articles from *Electronics'* "Engineer's Notebook," with more than 500 diagrams and tables.

Order your copy today! Send \$17.95 to:

P.O. Box 541
Hightstown, NJ 08520
609/426-5070

OR

McGraw-Hill
Int'l Publications Co.
Attn: ECC
McGraw-Hill House
Maidenhead, Berkshire SL6 2QL
England



Ten-day money-back guarantee. Allow 4 to 6 weeks for delivery.

Advertisers Index

Advertising Sales Staff

Atlanta, Ga. 30319: Joseph Milroy
4170 Ashford-Dunwoody Road N.E.
[404] 252-0626

Boston, Mass. 02116:
M. E. "Casey" McKibben, Jr.
575 Boylston St.
[617] 262-1160

Chicago, Ill. 60611: William J. Walker
[312] 751-3738
645 North Michigan Avenue

Cleveland, Ohio 44113:

[216] 496-3800
Costa Mesa, Calif. 92626: Fran Cowen
3001 Red Hill Ave. Bldg. #1 Suite 222
[714] 557-6292

Dallas, Texas 75240: Harry B. Doyle, Jr.
5151 Belt Line Road, Suite 907
[214] 458-2400

Englewood, Co. 80112: Harry B. Doyle, Jr.
7400 South Alton Court Suite 111
[303] 740-4633

Houston, Texas 77040: Harry B. Doyle, Jr.
7600 West Tidwell, Suite 500
[713] 462-0757

Los Angeles, Calif. 90010: Chuck Crowe
3333 Wilshire Blvd.
[213] 480-5210

New York, N.Y. 10020:
Matthew T. Reseska [212] 512-3617
John Gallie [212] 512-4420

1221 Avenue of the Americas

Stamford, Ct. 06902:
Albert J. Liedel
777 Long Ridge Road, Bldg. A
[203] 968-7115

Palo Alto, Calif. 94303:
Larry Goldstein, Jeffrey C. Hoopes,
Lauren Scott

1000 Elwell Court, [415] 968-0280
Philadelphia, Pa. 19102: Joseph Milroy
Three Parkway, [215] 496-3800

Pittsburgh, Pa. 15222: Matthew T. Reseska
Suite 215, 6 Gateway Center, [215] 496-3800

Southfield, Michigan 48075:
4000 Town Center, Suite 770, Tower 2
[313] 352-9760

San Francisco, Calif. 94111:
Larry Goldstein, Jeffrey C. Hoopes,
Lauren Scott
425 Battery Street
[415] 362-4600

Frankfurt/Main: Fritz Krusebecker, Dieter Rothenbach
19 Liebigstrasse, Germany
Tel: 72-01-81

Milan: Savio Pesavento
1 via Baracchini, Italy
Tel: 86-90-656

Paris: Jean - Christian Acis, Alain Faure
17 Rue-Georges Bizet, 75116 Paris, France
Tel: (1) 47-20-33-42

Scandinavia: Andrew Karnig
Finnbodavagen
S-131 31 Nacka
Sweden

Tel. 46-8-440005

Telex: 17951 AKA S
Tokyo: Hirokazu Morita
McGraw-Hill Publications Overseas Corporation,
Kasumigaseki Building 2-5, 3-chome,
Kasumigaseki, Chiyoda-Ku, Tokyo, Japan
[581] 9811

United Kingdom: Art Scheffer
34 Dover Street, London W1
Tel: 01-493-1451

Business Department

Thomas E. Vachon
Director of Operations
[212] 512-2627

Leon Irgang
Circulation Director
[609] 426-5542

Roseann Lehmann
Office Administrator
[212] 512-3469

Linda Tamburello
Customer Service Manager
[212] 512-6643

Frances M. Vallone
Reader Service Manager
[212] 512-6058

Patricia Parks
Billing Specialist
[212] 512-2589

Thomas M. Egan
Production Director
[212] 512-3140

Carol Gallagher
Production Manager
[212] 512-2045

Evelyn Dillon
Production Manager Related Products
[212] 512-2044

Classified and Employment Advertising

[212] 512-2556

Advanced Micro Devices	10, 11	Plastics Engineering Company	77
Altera Corporation	68, 69	□ Robinson Nugent, Inc.	38-39
□ Amphenol Products, An Allied Company	57	* Rohde & Schwarz	2E
□ AMP Inc.	48-49	□ Rowe Industries	55
Analog Devices Inc.	4, 28	□ Samtec Inc.	40
Anritsu Corporation	70-71	Siemens AG	25-27
California Devices	9	U-Sun Electric Co. Ltd.	93
Data Translation	16	Vacuumschmelze	86
□ ELCO Corporation	52	□ Viking Connectors Co.	45
‡ Evans Findings Co. Inc.	93	Classified and employment advertising	
* Fujitsu Limited	4E	First Systems Corporation	92
‡ Fujitsu Microelectronics	6, 7	Hayes Microcomputer Products	3rd C
Gould Design & Test	30, 31	Omaton Inc.	92
* Harting Elektronik GmbH	1E	T-Cubed Systems	92
‡ □ Hughes Aircraft Company	51	ZTEC	92
‡ Hybricon Corporation	12	■ For more information of complete product line see advertisement in the latest Electronics Buyers Guide	
□ ITT Cannon - Fiber Optic Products	47	* Advertisers in Electronics International	
LeCroy Corporation	32	‡ Advertisers in Electronics domestic edition	
□ Lumberg Inc.	55	□ Advertisers in Special Advertising Section: Connectors	
□ Malco	60		
Matrox Electronic Systems Ltd.	4th C		
□ Molex Incorporated	59		
Mitel Corporation	2		
* Murata Mfg. Co. Ltd.	12		
National Instruments	8		
National Semiconductor	2nd C, 1		
* NEC Electronics (Europe) GmbH	6, 7		
NEC Corporation	66-67		

NEW EDITION

Complete and Unabridged American and International

DATA COMMUNICATIONS STANDARDS

All standards are new, revised, or reaffirmed since the previous edition

Presents all 123 interface protocol standards set by:

- International Telegraph and Telephone Consultative Committee (CCITT)
- International Organization for Standardization (ISO)
- European Computer Manufacturers Association (ECMA)
- American National Standards Institute (ANSI)
- Electronic Industries Association (EIA)
- U.S. Government (NBS and NCS)

Special feature for instant access:

Cross-reference tables of the similar and interfacing standards of each group corresponding to those published by the others.

An essential reference for designers, planners, operations managers, and all organizations exploring, developing, manufacturing, or using data communications equipment or networks.

Don't waste time and effort! With this landmark resource you can quickly and accurately determine exactly which standards apply to the project at hand, and speedily integrate those standards into your own data communications equipment or network plan.

Order your copy today!

Data Communications Standards II
ELECTRONICS BOOKS
McGraw-Hill Intl. Publications Co.
European Circulation Center
Maidenhead, Berks. SL62QL, UK
(Tel. [0628]23431; Telex 848640)

Send me ___ copy (copies) of **DATA COMMUNICATIONS STANDARDS EDITION II** at (U.S.) \$295. McGraw-Hill pays regular shipping and handling charges on prepaid orders. Ten-day money-back guarantee applies.

Ship To:
Name _____

Title _____

Company _____

Address _____

City _____

Country _____

Check enclosed.

Send Proforma Invoice

Payment must accompany order for immediate shipment.

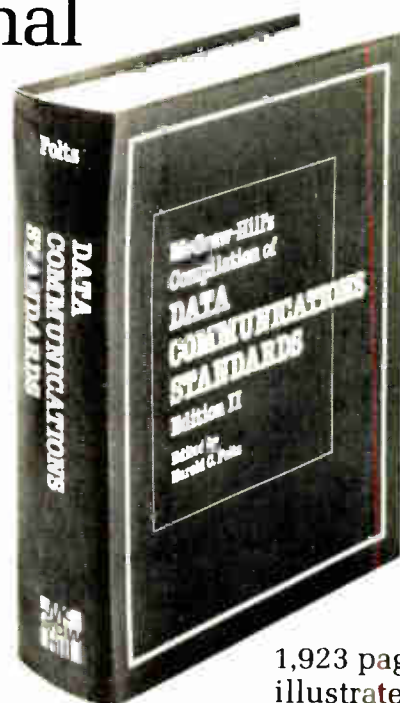

1,923 pages
illustrated

Edited by Harold C. Folts, the leading consultant on data communications standards and an active participant in the development of U.S. and international standards.

Published jointly by *Data Communications* and *Electronics* magazines.

ELECTRONICS WEEK

ISDN LINK PLANNED FOR U.S., UK, JAPAN

AT&T, British Telecom, and Kokusai Denshin Denwa, Japan's international telecommunications carrier, have agreed to establish an integrated-services digital network linking the U.S., Britain, and Japan. Service between Britain and Japan was digitized this month over commercial satellite, but Japan-U.S. service will not follow suit until the completion of a trans-Pacific fiber-optic cable in early 1989.

U.S. FALLS SHORT IN OPTOELECTRONICS

Japan leads the worldwide race to commercialize the optoelectronic products that are major components in fiber-optic and other information-handling systems, according to a report by the National Bureau of Standards. The report says the U.S. could use its superior scientific base to catch up with Japan, but only if industry and government work together to concentrate on bringing products to market more quickly. Also critical, says the agency, is industry investment in optoelectronic measurement equipment. Painting a gloomy picture, however, the NBS cites studies that suggest industry is likely to underinvest in such technology.

FUTURE BRIGHT FOR FIBER TEST GEAR

At the same time that the National Bureau of Standards sees gloomy days for the U.S. optoelectronics industry, a report from Market Intelligence Research Co., of Palo Alto, forecasts strong growth in worldwide sales of fiber-optic test equipment. The major factor will be expanded industrial and data-communications applications, rather than in telephone networks. The study says sales will grow from \$32 million in 1984 to more than \$500 mil-

lion in 1994, with unit sales in the period increasing from 6,100 to nearly 86,000.

FCC REORGANIZES TECHNOLOGY UNIT

The Federal Communications Commission last week completed the reorganization of its Office of Science and Technology into a new Office of Engineering and Technology. "The reorganization reflects the office's increased emphasis on spectrum engineering and technical analysis and decreased focus on more general technological and scientific matters," the FCC says. As part of the re-vamping, the agency has replaced the chief scientist's position with that of chief engineer. In addition, three divisions have been consolidated into the new Spectrum Engineering Division and the Authorization and Evaluation Division.

SHAREHOLDERS OK RCA MERGER

RCA Corp. shareholders approved the company's pending merger with General Electric Co. at a stormy meeting in which some of them bitterly criticized chairman Thornton Bradshaw for entering into the all-cash deal. Bradshaw was accused of "selling out" the shareholders by failing to negotiate a stock-swap option from GE. But RCA's proxy committee went to the meeting with more than 61% of the vote in favor of the \$6.28 billion merger, the largest in electronics industry history.

ITALTEL MAY GO PARTIALLY PUBLIC

Italy's principal producer of telecommunications equipment—Italtel Società Italiana Telecomunicazioni—may go public or merge with another company. Last week, Italtel announced a 60% increase in profits, making the state-controlled company eligible for

partial privatization. Government-owned companies that run in the black for three years, as Italtel has now done, can sell stock to the public. However, Italtel's parent company, the state-owned IRI-Stet group, is negotiating a merger of Italtel with Telettra SpA, a subsidiary of Fiat SpA. Italtel's sales last year were \$750 million, the same figure as 1984; the rise in profits is attributed to a reduced long-term debt and higher productivity as a result of employee cutbacks.

OLIVETTI, STRATUS REAFFIRM OEM PACT

Stratus Computer Inc. and Ing. C. Olivetti & C. have bolstered their already strong relationship with a joint agreement under which the Italian company will market the latest version of Stratus's fault-tolerant computers as an original-equipment manufacturer. The two companies signed a similar pact in 1982 covering Stratus's first computer system. Sales to Olivetti under that agreement accounted for about 10% of the Marlboro, Mass., company's revenue last year.

EUROPEANS EXTEND TELECOM DEAL

West Germany, France, Italy, and Britain have extended their joint telecommunications project, this time with the aim of developing compatible integrated circuits for digital-switching equipment. The agreement involves CIT-Alcatel of France, Italy's Italtel, Britain's Plessey, and Siemens of West Germany. The four companies' original pact, signed in January 1985, focused on developing analog subscriber-line and packet-switched interfaces for integrated-services digital networks. Now the companies will attempt to establish standards and specifications for very large-scale ICs to be used in digital-switching systems offered by all four.

APOLLO, AT&T SIGN UNIX AGREEMENT

Work station maker Apollo Computer Inc. is moving to open its Domain/IX operating system, based on AT&T Co.'s Unix System V, to multivendor networks. It has signed a contract with AT&T that will let it bring Domain/IX up to conformity with the System V Interface Definition. Apollo, of Chelmsford, Mass., also will sell design and electronic-publishing software from Omnicad Corp., Pittsford, N. Y., a company partly owned by AT&T.

MICROWAVE SEEN AS GROWTH AREA

From Fuzzbusters to satellites, microwave products for commercial and industrial use will show tremendous growth through the end of the decade, according to a study by New York market researchers Frost & Sullivan Inc. U.S. demand will grow from a 1984 level of \$5.4 billion to 1989 sales of \$8.9 billion, the report says. Much of this expansion will be fueled by such products as satellites, earth stations, point-to-point microwave radio, air-traffic-control systems, marine navigation, and microwave test equipment. The report doesn't discuss defense products, but it does acknowledge that they will have a "powerful influence on the development of microwave technology."

XIDEX BUYS MAKER OF THIN-FILM MEDIA

Xidex Corp., a producer of floppy disks, has acquired Trimedia Corp. with an eye toward expanding its use of thin-film-media technology. Trimedia, of Fremont, Calif., will become part of Xidex's Oktel subsidiary, also in Fremont and also producing thin-film media. Xidex traded 930,000 common shares, valued at about \$14.50 per share, for Trimedia's shares.

Telecommunications Engineers

HAYES... Leading A Telecommunications Revolution From Atlanta and San Francisco.



We've built a powerful engineering and technical team here at Hayes. It's been our strength and the reason for our success from the very beginning. Our focus has been on recruiting and developing the talent it takes to do more than merely compete, but to lead. The result has been a success story few in the industry can equal.

For those of you who have searched far and wide for just such an environment, where talent is provided the freedom and encouragement to grow, then perhaps it's time to take a good, hard look at Hayes, with opportunities in both San Francisco and Atlanta. There's a future in it.

- VLSI/DSP DEVELOPMENT ENGINEERS
- HARDWARE/SOFTWARE DESIGN ENGINEERS
- SOFTWARE PROGRAMMERS & ANALYSTS
- MANUFACTURING/TEST ENGINEERS
- PRODUCT DEVELOPMENT ENGINEERS
- COMPONENT/RELIABILITY ENGINEERS

Interested, qualified candidates should forward a confidential resume to: Hayes Microcomputer Products, Inc., Dept. 85-331, P.O. Box 105203, Atlanta, GA 30348. An Equal Opportunity Employer, M/F.

Hayes®
Say yes to the
future with Hayes.

FAST MicroVAX Graphics



- 1280 x 1024 x 8 display (QG-1280)
- 640 x 480 x 8 display (QG-640)
- 35,000 vectors/second drawing speed

- 1 million pixels/second image load
- 3D accelerator SPACE MACHINE[®] option
- MicroVMS and RSX drivers

Matrox now offers two new intelligent color graphics boards for the Q-Bus. The QG-1280 and QG-640 provide the speed and resolution necessary to upgrade DEC's MicroVAX and PDP computers into Professional Graphics workstations.

The QG-1280 has a resolution of 1280 x 1024. The board's drawing speed of 35,000 vectors/second means complex pictures are displayed in under a second. For solid modelling applications, an optional 3D accelerator module complete with Z buffer provides fast hidden surface elimination and shading.

The QG-640 is the perfect solution for OEM's requiring the same performance but with less resolution; 640 x 480, at 50% less cost.

Unlike conventional graphics terminals the QG-1280 and QG-640 are directly accessible from the Q-Bus. There are no slow serial communication links. **You "see" results immediately.**

Let our new generation graphics boards "speed up" your workstation design — today.

Call Toll Free: 1-800-361-4903



matrox

1055 St-Regis Blvd
Dorval, Québec, Canada
H9P 2T4
Tel.: (514) 685-2630
Tlx: 05-822798