

SEPTEMBER 11, 1980

SMART FIFO HOOKS FAST PROCESSORS TO SLOW PERIPHERALS/131

What gear will the new AT&T company need? / 100

Pullout guide to the world's communications satellites / 150



FOUR DOLLARS A MCGRAW-HILL PUBLICATION

Electronics®

OVERLAPPED TIMING

SPEEDS UP STATIC RAM

197A DEUSCH 44466 HATUC
CS OSBORNE - JR
PER:PHICOM
BOX 324
BEAVERTON OR 97075

HOW DEPENDENT SHOULD YOU BE ON THE ATE SUPPLIER?

Automatic board test equipment can provide a powerful solution to today's testing needs. But choosing the right system can be a complex and bewildering task, because of all the non-hardware factors to be assessed.

Purchase alternatives.

One factor is the question of system responsibility. At one end of this spectrum is a turnkey system. Here the ATE manufacturer assumes total responsibility and the user is dependent upon the supplier for hardware, software and system implementation. At the other end is the do-it-yourself system tailored to your exact application, in which case the user is almost self sufficient. Other alternatives also exist. So how can you choose the right one?

Some helpful criteria.

The three most important criteria are: your environment, departmental resources, and the system supplier.

Production environment is critical. How high is the PC board volume? Are the boards extremely complex? How many new products are anticipated? For example, if you have fairly simple boards and few requirements for changes, a turnkey solution may be your answer. But for highly complex boards and a stream of new products, you may wish to keep expansion and revision control in-house. What about departmental resources? Do you have the technical people to assemble and program a do-it-yourself system?

Finally, the

system supplier should be evaluated. Does the company have knowledge of your business and applications engineers familiar with your needs? Will service and support personnel be available when and where you need them?

The concept of shared responsibility.

HP's answer is shared responsibility . . . a concept that minimizes both start-up difficulty and your dependence upon outside suppliers (see chart below).

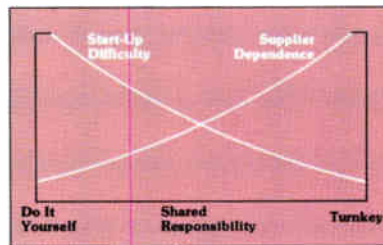

When you choose the HP 3060A Board Test System, you get a system designed to put you on the road to independence. Here's why:

First, you get two weeks of intensive training in system use and software development. Second, HP supplies the software aids that take the mystery out of programming. Non-technical people can easily program in-circuit tests by entering node numbers plus parts values and tolerances. HP's In-circuit Program Generator (IPG) does the rest, selecting appropriate test methods, determining uncertainty, generating the test program and more. Then, your technical people can easily master BTL (Board Test Language), using commands such as the one shown, to

program functional tests. Because they know the circuit best, testing becomes more thorough and more meaningful.

Third, you get reliable hardware that's ready to operate. Most systems are up and running the same day they're installed. And because the system is HP-IB compatible, you can modify and expand its capability right in your facility without a major software investment.

If you have problems, HP doesn't desert you. Our specialists are available to help. And with the self-diagnostics built into the system, you'll be up and running again quickly.

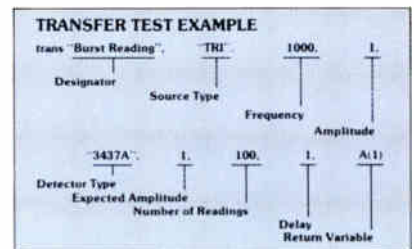

Supplier independence.

The net result is greater independence. With the HP 3060A, you learn to solve your own problems. That means faster response to changing needs. Direct control over expenses. And, generally, lower overall cost of ownership.

For additional information.

There are numerous other reasons to consider the HP 3060A (\$85,000* for standard operating system). To get complete details, write: Hewlett-Packard, 1507 Page Mill Road, Palo Alto, CA 94304. Or call your nearest regional sales office: East (201) 265-5000, West (213) 970-7500, Midwest (312) 255-9800, South (404) 955-1500, Canada (416) 678-9430.

*Domestic USA price only.

080/45

HP Circuit Testers —
The Right Decision

 **HEWLETT
PACKARD**



SURPRISE!

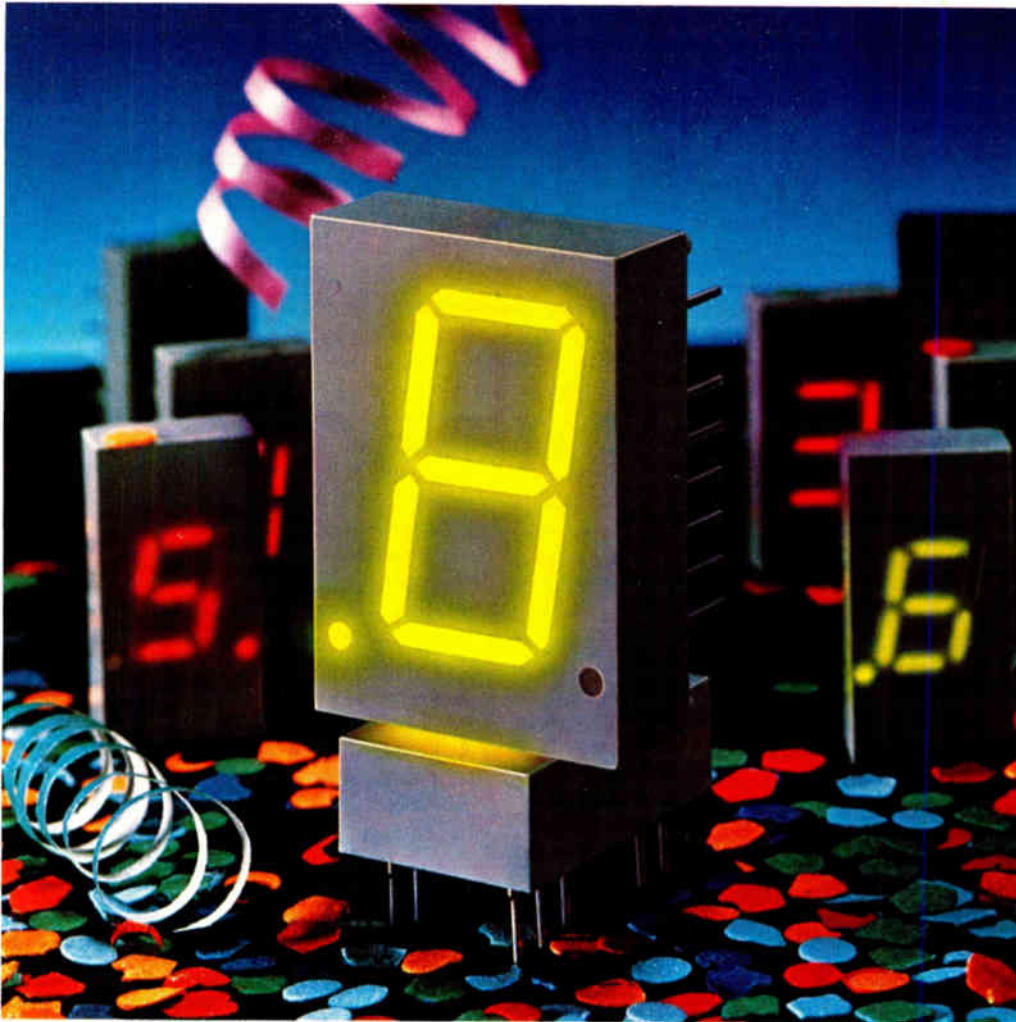

HP's New Display is a Big Yellow Show Off.

Yellow joins High Efficiency Red in HP's popular 20mm (0.8") high displays. Both can be viewed clearly from as far away as 10 metres. They show off well too, with excellent readability in bright ambient conditions because of their gray body color and untinted segments. This is HP's family of HDSP-3900 Series of red displays and HDSP-4200 Series of yellow.

IC compatible, they're ideal for electronic instrumentation, point-of-sale terminals, TV's weighing scales, digital clocks, and other applications where you need a big, easy-to-read display. And power requirements are low since they utilize a chip made from GaAsP on a transparent GaP substrate.

Units are priced at \$2.55* in quantities of 1000.

For immediate delivery, call any authorized HP components distributor. In the U.S. contact Hall-Mark, Hamilton/Avnet, Pioneer Standard, Schweber, Wilshire or the Wyle Distribution Group (Liberty/Elmar). In Canada, call Hamilton/Avnet or Zentronics, Ltd.



**HEWLETT
PACKARD**



HP introduces forms and graphics to desktop printing.

HP's new 7310A Graphics Printer mixes forms, text and graphics in any arrangement you need. And it prints text up to 500 lines per minute.

On demand from your terminal, the 7310A prints out your forms, and what goes on them at the same time. Work orders, assembly information, material lists, accounting reports, employee records, and all other forms with data, are printed and then

sized to your needs by an automatic paper cutter and page stacker.

Besides being fast and versatile, one of the printer's nicest qualities is just that. Printing quality. Readability can be enhanced with proportionally spaced type, reverse printing, and underlining. And programmable character height allows you to produce bold face headlines or titles in characters up to twice normal height.

In addition to supporting HP terminals and computers, four different interfaces let you adapt the 7310A to many other terminals and computers. For complete information, including OEM discounts, contact your local Hewlett-Packard sales office or write to Hewlett-Packard, Attn: Bill Fuhrer, 16399 West Bernardo Drive, San Diego, CA 92127; (714) 487-4100.

11001



**HEWLETT
PACKARD**

Circle 2 on reader service card

117 Technical Articles

MEMORIES

16-K static RAM takes new route to high speed, 117

COMPONENTS

Achieving stability in IC oscillators, 124

MICROSYSTEMS

Intelligent buffer reconciles fast processors, slow peripherals, 131

COMPONENTS

C-MOS makes voltage converter a paragon of efficiency, 141

COMMUNICATIONS

More communications in orbit, 148

MICROSYSTEMS

Handling exceptions gracefully enhances software reliability, 153

DESIGNER'S CASEBOOK: 136

ENGINEER'S NOTEBOOK: 158

39 Electronics Review

PHOTOVOLTAICS: Metallurgical silicon can work, 39

Thick-film process plus plating cuts cost, 40

MEMORIES: Overcoats protect RAMs from alpha particles, 41

MILITARY: P-i-n diodes steer silicon radar antenna, 42

SOLID STATE: Custom IC designers seek standard test chips, 44

BUSINESS SYSTEMS: Dictaphone doubles up on processors, 44

MICROWAVES: All's quiet on the military front, 46

MILITARY: 'Invisible' plane project has many goals, 46

NEWS BRIEFS: 46

CONSUMER: Processors control home drills, 53

COMPUTERS: Updated hardware boosts performance of minicomputer network, 54

COMMUNICATIONS: For AT&T, the hard part is still to come, 100

SOLID STATE: HP vetoes advanced SOS process, 106

171 New Products

IN THE SPOTLIGHT: 8-bit analog-to-digital converter has 12-bit linearity, 171

Computer has breadboarding space, 176

Manchester converter fits service bus, 186

INSTRUMENTS: Modular DMM starts at \$765, 188

SEMICONDUCTORS: FET-input operational amplifier slews at 120 V/ μ s, 197

PACKAGING & PRODUCTION: Production testers emulate disks, 200

DATA ACQUISITION: Cards termed universal, 208

SOFTWARE: Subroutines allow modular software, 214

MICROCOMPUTERS & SYSTEMS: Unit develops wide bit-slice CPUs, 218

POWER SUPPLIES: Battery puts out 5 kW peak, 226

NEW LITERATURE: 230

Departments

Highlights, 4

Publisher's letter, 6

Readers' comments, 8

News update, 12

People, 14

Editorial, 24

Meetings, 26

Electronics newsletter, 33

Washington newsletter, 59

Washington commentary, 60

International newsletter, 67

Engineer's newsletter, 162

Products newsletter, 229

New literature, 230

Career outlook, 237

Services

Reprints available, 54

Employment opportunities, 239

Reader service card, 259

67 Electronics International

WEST GERMANY: Aids for blind 'read' books, say temperatures, 77

JAPAN: New VLSI is focus of follow-on project, 78

BRITAIN: CCD imager fits 625-line TV systems, 78

JAPAN: Fast low-power RAM uses SOS, silicides, 80

WEST GERMANY: Universally applicable technique linearizes microwave power amp tubes, 82

FRANCE: 'Quasi-topological' OCR approach has over 80% success with handwriting, 84

93 Probing the News

ADVANCED TECHNOLOGY: Artificial intelligence is on the brink, 93

ELECTRONICS ABROAD: West German consumer houses face hard times, 97

EDITOR-IN-CHIEF: Samuel Weber

MANAGING EDITORS

Technical: Raymond P. Capece,
Alfred Rosenblatt
News: Gerald M. Walker
International: Arthur Erikson

ASSISTANT MANAGING EDITORS: Howard Wolff,
Margaret Eastman

SENIOR EDITOR: Ray Connolly

ART DIRECTOR: Fred Sklenar

ASSOCIATE EDITOR: Benjamin A. Mason

DEPARTMENT EDITORS

Aerospace/Military: Ray Connolly
Circuit Design: Vincent Biancomano
Communications & Microwave:
Harvey J. Hindin
Components: Roger Allan
Computers & Peripherals: Anthony Durniak
Industrial/Consumer: Gil Bassak
Microsystems & Software: R. Colin Johnson
Test, Measurement & Control:
Richard W. Comerford
New Products: Alan Serchuk,
Ana Bishop
Packaging & Production: Jerry Lyman
Solid State: John G. Posa

CHIEF COPY EDITOR: Margaret Eastman

COPY EDITORS: Mike Robinson,
Charlotte Wiggers, Jeremy Young

ART: Charles D. Ciatto, *Associate Director*
Paula Piazza, *Assistant Director*

EDITORIAL SECRETARIES: Maryann Tusa,
Arlan Kleinberger, Dawn Ramsay

EDITORIAL ASSISTANT: Marilyn B. Steinberg

REGIONAL EDITORS

New York: Pamela Hamilton (212) 997-2666
Boston: James B. Brinton,
Linda Lowe (617) 262-1160
Chicago: David Cook (312) 751-3805
Dallas: Wesley R. Iversen (214) 742-1747
Los Angeles: Larry Waller (213) 487-1160
Palo Alto: Bruce LeBoss, *Manager*
Martin Marshall, *Computers & Instruments*
(415) 968-2712
Washington: Ray Connolly (202) 624-7592
Frankfurt: John Gosch 72-5566
London: Kevin Smith 493-1451
Paris: Arthur Erikson,
Kenneth Dreyfack 720-2070
Tokyo: Charles Cohen 581-9816

McGRAW-HILL WORLD NEWS

Editor: Michael Johnson
Brussels: James Smith
Milan: Jeff Ryser
Moscow: Peter Hann
Stockholm: Robert Skole
Tokyo: Robert Neff

PUBLISHER: Paul W. Reiss

GENERAL MANAGER, DIRECT MARKETING
OPERATIONS: Horace T. Howland

CIRCULATION MANAGER: Herbert A. Hunter

RESEARCH MANAGER: Margery D. Sholes

PROMOTION MANAGER: Jane De Court

MARKETING ADMINISTRATION MANAGER:
Frances M. Vallone

BOOKS & SPECIAL PROJECTS MANAGER:
Janet Eyster

SERVICE REVENUE SPECIALIST:
Penny Reitman

Cover: Fast 16-K static RAM brings back circuit innovation, 117

New circuit techniques, rather than scaling, characterize an extremely fast 16-K-by-1-bit static random-access memory. Asynchronous bootstrap circuits, for one, help bring about a typical access time of 30 nanoseconds. What's more, the chip typically dissipates only 375 milliwatts when active. On the manufacturing side, a single level of polysilicon, 2.7-micrometer channel length, and redundant bits make it easy to build.

Cover design by Bob Strimban.

Artificial intelligence: moving out of the university, 93

The first annual National Conference on Artificial Intelligence, held last month at Stanford University, was marked by substantial participation by industry. Included were such notables as Hewlett-Packard, Texas Instruments, and Schlumberger, all of whom are actively investigating applications in this field. In addition, small companies, many of them spinoffs from university research projects, are springing up to exploit the commercial possibilities of artificial intelligence.

Smart buffer coordinates traffic for microprocessor systems, 131

An intelligent 128-by-8-bit first-in-first-out buffer synchronizes free-running devices that operate at different speeds. Accepting and delivering data at the same time and including programmable interfaces for various computers and input/output devices, it allows each one to work at its own speed. The buffer, designed for both 8- and 16-bit systems, works with multiplexed and nonmultiplexed address and data buses.

Voltage converter achieves unparalleled efficiency, 141

A dc voltage converter on a single complementary-MOS chip produces negative or positive multiples of any input from 1.5 to 9 volts to within 0.1%, and it does so with a power-conversion efficiency of up to 98%—all at the expense of a large number of discrete components and integrated circuits.

Bird population growing rapidly, 148

To help users cope with the growth of communications satellites—up by more than a third in less than two years—the guide originally published in the Oct. 12, 1978, issue has been completely updated. The fold-out wall chart contains both the new systems and the latest data on the old.

And in the next issue . . .

Local network links just about any computers or peripherals . . . a special report on arrays . . . a low-power microcomputer system . . . controlling operating junction temperature in semiconductors.

September 11, 1980 Volume 53, Number 20 102,517 copies of this issue printed

Electronics (ISSN 0013-5070). Published every other Thursday with an additional issue the April by McGraw-Hill, Inc. Founder: James H. McGraw 1860-1948. Publication office 1221 Avenue of the Americas, N.Y., N.Y. 10020; second class postage paid at New York, N.Y. and additional mailing offices.

Executive, editorial, circulation and advertising addresses: Electronics, McGraw-Hill Building, 1221 Avenue of the Americas, New York, N.Y. 10020. Telephone (212) 997-1221. Teletype 12-7560 TWX 710-581-4879. Cable address: MCGRAWHILL NEW YORK.

Subscriptions limited to professional persons with active responsibility in electronics technology. No subscriptions accepted without complete identification of subscriber name, title or job function, company or organization, and product manufactured or services performed. Based on information supplied, the publisher reserves the right to reject non-qualified requests. Subscription rates: in the United States and possessions \$18 one year, \$31 two years, \$46 three years; company addressed and company libraries \$23 one year, \$41 two years, \$58 three years; APD/FPD addressed \$35 one year only; Canada and Mexico \$19 one year, \$32 two years, \$47 three years; Europe \$50 one year, \$85 two years, \$115 three years; Japan, Israel and Brazil \$70 one year, \$115 two years, \$165 three years; Australia and New Zealand \$95 one year, \$170 two years, \$240 three years, including air freight; all other countries \$50 one year, \$85 two years, \$125 three years. Limited quota of subscriptions available at higher-than-basic rate for persons allied to field served. Check with publisher for these rates. Single copies: \$4.00; special Anniversary issue: \$9.00 each. Please allow four to eight weeks for shipment.

Officers of McGraw-Hill Publications Company: Paul F. McPherson, President; Executive Vice Presidents: James E. Boddorf, Gene W. Simpson, Group Vice President: Daniel A. McMillan; Senior Vice President: Editorial: Ralph R. Schutz; Vice Presidents: Kemp Anderson, Business

Systems Development; Stephen C. Croft, Manufacturing; Robert B. Doll, Circulation; James E. Hackett, Controller; William H. Hammond, Communications; Eric B. Harr, Planning and Development; John W. Patten, Sales; Edward E. Schwmer, International.

Officers of the Corporation: Harold W. McGraw, Jr., President, Chief Executive Officer, and Chairman of the Board; Robert N. Landes, Senior Vice President and Secretary; Ralph J. Webb, Treasurer. Title registered in U.S. Patent Office: Copyright © 1980 by McGraw-Hill, Inc. All rights reserved. The contents of this publication may not be reproduced in whole or in part without the consent of copyright owner.

Where necessary, permission is granted by the copyright owner for libraries and others registered with the Copyright Clearance Center (CCC), P.O. Box 8891, Boston, MA 02114, to photocopy any article herein for the base fee of \$0.50 per copy of the article plus \$0.25 per page. Payment should be sent directly to the CCC. Copying done for other than personal or internal reference use without the express permission of McGraw-Hill is prohibited. Requests for special permission or bulk orders should be addressed to the publisher. ISSN 0013-5070/80\$0.50+.25

Subscribers: The publisher, upon written request to our New York office from any subscriber, agrees to refund that part of the subscription price applying to copies not yet mailed. Please send change-of-address notices or complaints to Fulfillment Manager; subscription orders to Circulation Manager, Electronics, at address below. Change-of-address notices should provide old as well as new address, including zip codes. Attach address label from recent issue. Allow one month for change to become effective. Subscriber Service: call (609) 448-8110, 9 a.m. to 4 p.m. EST.

Postmaster: Please send form 3579 to Fulfillment Manager, Electronics, P.O. Box 430, Hightstown, N.J. 08520.

Available from stock.

HI-REL MIXERS with a 3-year guarantee!

\$8.95 SRA-1
(from 1500 qty)



Hi Rel

Five years ago, Mini-Circuits offered a two-year guarantee for its industry-standard SRA-1 hermetically sealed Double-Balanced Mixer. . . now used worldwide for a variety of military and industrial applications.

The two-year guarantee was made possible by the use of an accelerated-life screening test for diodes generally reserved only for space applications. The HTRB-screened Schottky diodes are subjected to a one-volt negative bias at 150°C for 168 hours, a stress designed to accelerate ageing and force time-related failures — thus screening out potentially unreliable diodes.

Mini-Circuits is proud to offer a three-year guarantee for the SRA-1 achieved by further stressing and testing the assembled unit. Each completed SRA-1 experiences:

1. Burn-in for 96 hours at 100°C with 8 mA at 1 KHz.
2. Thermal shock
3. Gross and fine leak tests (per MIL-STD 202).

And the three-year guarantee SRA-1 is still only \$7.95! Of course, the additional testing adds to our cost, but our continuing commitment is to offer performance and reliability unmatched for off-the-shelf Double-Balanced Mixers.

So, for space or rugged industrial applications, ensure highest system reliability by specifying SRA-1 mixers, the only Doubled-Balanced Mixers with a three-year guarantee. . . from Mini-Circuits where low price goes hand in hand with unmatched quality.

Model **SRA-1**

Freq. range (MHz)

| | |
|----------|---------|
| LO | 0.5-500 |
| RF | 0.5-500 |
| IF | DC-500 |

| Conversion loss (dB) | Typ. | Max. |
|----------------------|------|------|
| 1-250 MHz | 5.5 | 7.0 |
| 0.5-500 MHz | 6.5 | 8.5 |

| Isolation (dB) | Typ. | Max. |
|-------------------|----------|------|
| 0.5-5 MHz | LO-RF 50 | 45 |
| | LO-IF 45 | 35 |
| 5-250 MHz | LO-RF 45 | 30 |
| | LO-IF 40 | 25 |
| 250-500 MHz | LO-RF 35 | 25 |
| | LO-IF 30 | 20 |

Min. Electronic Attenuation (20 mA) 3 dB Typ.

Signal, 1 dB Compression Level + 1 dBm

Impedance All Ports, 50 Ohms

LO Power + 7 dBm

World's largest manufacturer of Double-Balanced Mixers

 **Mini-Circuits**

2625 East 14th Street Brooklyn, New York 11235 (212) 769-0200
Domestic and International Telex 125460 International Telex 620156

M7 COMMUNICATOR

A complete A/D and D/A Control System – Interface your computer to the analog world of process monitoring transducers and controlling actuator.



The M7 multiplexes analog and digital signals from your process sensors—temperature, pressure, level, flow, mass, strain, etc.—and continuously down-loads this data in digital form to your computer for display and processing. Simultaneously, command signals are transmitted to the control devices in your process.

Order a complete basic M7 System ready for round-the-clock process control—including a 16/32-Channel A/D Input Module (expandable to 512 channels), a Computer Interface Module, and a 4-Channel (expandable) D/A Output Module. Supplied complete with cabinet, power supply, and all necessary hardware and software for basic control. Bus accommodates eight additional modules. Specify computer make and model when ordering . . . each \$2,990

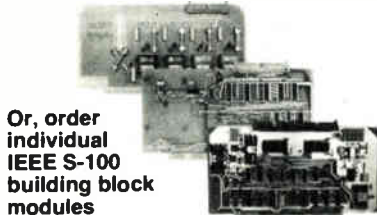

Or, order individual IEEE S-100 building block modules

Supplied complete with fundamental control software:

A/D Module, AIM-12—16/32 channel, 12-bit precision/accuracy, 30 kHz data rates, 1-1000 gain amplifier optional • **Thermocouple Compensation Module, THM-8**—16 inputs • **Signal Conditioners, SIG-1**—Long-line drive • **Additional Support Programs, PROG A,B,C**—Signal averaging, control functions, special display, etc. • **D/A Module, AOM-12**—4-channel (expandable), 12-bit precision/accuracy, Output: selectable voltage ranges and oscilloscope • **Control Output-Current Module, VIC 4-20**—4-20 mA standard industrial control output, 12-bit precision/accuracy, 4-channel, Use with AOM-12 • **Programmable Clock/Calendar Module, CLK-24**—Minimum 1 year back-up • **Parallel Output Module, REL-8**—8-channel on-off (bang-bang) control • **Add-On Nonvolatile Memory Modules**—4K and 8K bytes

DUAL system reliability
system integrity

DUAL SYSTEMS CONTROL CORP.
1825 Eastshore Hwy. Berkeley, CA 94710
(415) 549-3854

Publisher's letter

Launching itself into the static memory field, Inmos Corp. has taken a different tack for its first offering, and this issue's cover article will tell you about the approach the British-sponsored company took for its 16-K-by-1-bit random-access memory that boasts a typical access time of 30 nanoseconds. This speed, and a low typical power dissipation of 375 milliwatts, were realized through circuit, rather than process, innovation, write codesigners Rahul Sud and Kim C. Hardee.

"This is an area that has been neglected for a long time," says Sud. "There is a widely held feeling in the industry that circuit cleverness is dead and process innovation is the only thing that will allow us to go beyond very large-scale integration."

Working with John Heightley, vice president for memory products; David R. Wooten, manager of strategic marketing and applications; and others, the designers set out to make a part that is "very manufacturable," Sud says. And so the process parameters are conservative—2.7-micrometer channel lengths and a single level of polysilicon, notably.

What are the innovations in the Colorado Springs, Colo., company's first offering? As the article that begins on page 117 makes clear, the designers worked on circuit solutions to what Sud calls "some of the classic design problems with static RAMs."

For one, to realize the low-power and high-speed potential offered by bootstrap circuits, he and Hardee developed ways to counter the input transients that can plague them. Similarly, they designed actively precharged bit lines with loads that turn on only when needed, thereby avoiding continuous dissipation.

The bit-line design also aims at overcoming word-line delay, with overlap circuitry using that time to drive the lines to the equilibrium point between the old and new data states. "We buy over 30% of the access time of the memory right there," Sud says. Also, the column-select line is driven above the power-supply voltage, with circuitry maintaining that signal indefinitely.

Sud reports that he and Hardee worked with Michael J. Griffus on computer simulation, with James R. Adams and Richard M. Basecki on process development, and with Jay C. McBride and Arthur G. Smith on the chip's layout. "The first wafer probed from the initial lot out of our brand-new pilot production line yielded fully functional dice," he says happily.

A popular 1978 offering was "A user's guide to communications satellites," a handy wall chart, and its originator, Satellite Systems Engineering Inc., has revised it to reflect the latest developments in this fast-moving field.

As the introduction to the chart on page 149 notes, there is better than a third more of the birds flying around the earth—and that portends a crisis, says Wilbur L. Pritchard, president of Satellite Systems. "It's like the sword of Damocles hanging over our head; there is the finite resource of the geostationary orbit."

It won't be long before there is just no more room there, he continues. "So that means a move to other orbits and higher frequencies with more power and less bandwidth.

"Of course, higher power in the satellites means cheaper ground stations. On the other hand, the narrower bandwidth runs counter to the trend toward digital systems, which tend to use wider bandwidths."

Still, digital systems will flourish because they can exploit time-division multiple access, with its inherently superior capacity, a trend that undoubtedly will be reflected in our next edition. Pritchard reports that putting the chart together is a fairly easy task because his Washington, D. C., consulting firm publishes the Satellite Systems Digest, a continually updated reference tool from which our User's Guide is drawn.

“How did we manage to be first with intelligent analog peripherals? By working like madmen.”

Fred Molinari, President



We worked days and nights, weekends and vacations to develop the intelligent analog peripheral.

It was time well spent.

Because now we can offer you a complete microcomputer data acquisition system on a single Multibus™ board.

Decentralizing your computer function has finally become a practical possibility.

You see, this intelligent analog peripheral pre-processes data without involving the host CPU.

And thanks to a unique DMA controller, this peripheral also acquires analog data independently, at rates up to 125KHz.

Our new peripheral can function as an intelligent A/D slave. Or as a stand-alone microcomputer with A/D capabilities. Or as a remote system, transmitting data via a serial line.

Convenient? Our peripheral even includes a system monitor in pre-programmed ROM to communicate with the board, debug, and access A/D conversions.

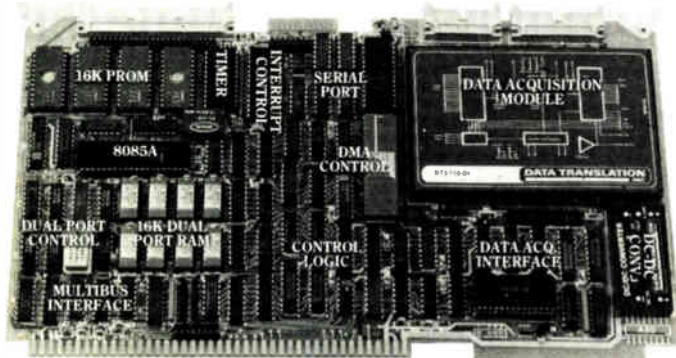

Our intelligent analog peripheral features: A dual port memory controller. A 8085 CPU. Four PROM sockets. Two programmable timers. A baud rate generator. A complete priority interrupt controller. 12 bit A/D with 125KHz throughput to memory. A 16K byte dual-ported dynamic RAM. A self-contained four-channel multi-mode DMA controller. And quite a bit more.

In short, we have brought high-speed capability down to low-end computers. And, we might add, we are the first to do so.

Working like madmen has its advantages. We hope you'll let us work like crazy for you.

We can be reached at 4 Strathmore Road, Natick, MA 01760. Or by phone at (617) 655-5300. Telex: 948474. In Europe: Data Translation Ltd., Reading, Berkshire/England. Phone (0734) 669-335; Telex: 847482.

DATA TRANSLATION

SALES OFFICES: AZ 602-994-5400; CA 213-681-5631; CO 303-371-2422; FL 305-791-9292; 813-725-2201; GA 404-455-7222; IL 312-960-4054; MA 617-655-5300; MD 301-636-1151; MN 612-441-6190; NC 919-723-8102; NJ 609-428-6060; NM 505-292-1212; 505-523-0601; NY 516-488-2100; OK 405-528-6071; OR 503-297-2581; PA 412-327-8979; TX 512-451-5174; 214-661-0300; 713-780-2511; 512-828-2251; UT 801-466-6522; WA 206-455-5846; CANADA 416-625-1907

Multibus is a trademark of Intel Corp.

MARKEM MARKING TECHNOLOGY

Your partner
in productivity.

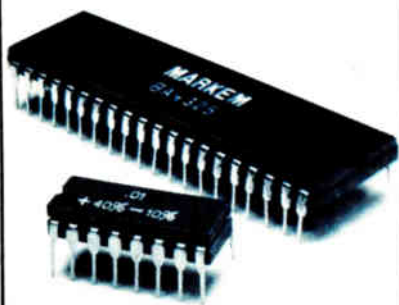

DIP Printing Systems

MARKEM'S Model 521 singulated DIP print/cure system was designed totally around the productivity idea.

That's why the 521 is designed for one operator. Its L-shaped work area is compact, just 2' x 2'.

That's why the 521 can handle up to 25 tubes of DIP's at one time.

That's why the 521 has special product control features which minimize damage to ceramic packages.

That's why there are few transfer points—and there's easy access to printing elements, the conveyor belt, tubes in magazine, and inking adjustments.

The 521 DIP printer is built for reliable, sustained operations and consistent throughput. And it is available with in-line UV curing.

Get the whole productivity story. Call Roger Langley in Keene at (603) 352-1130.

MARKEM
150 Congress St., Keene, NH 03431

Readers' comments

The software approach

To the Editor: Though "Development system networks: the last link in automated manufacturing" [July 3, p.134] was comprehensive, it should not dismiss software development systems. Our customers estimate that 80% of a project's development is performed before hardware integration. This is as true when using a BSO universal development system as when using a system from a semiconductor manufacturer.

Since BSO also specializes in microprocessor simulators, I must point out that though the simulator is a sophisticated and complex tool, it does not require excessively large computers if properly designed. We routinely sell simulators for DEC's PDP-11/23. With demand, we could even put a simulator on the PDP-11/03.

Also, I disagree that simulators rely on ideal operating conditions. Ours let a user set up interrupt and data-input/output simulation to a disk file or a peripheral device. The user can, in advance, set up any conceivable operating condition to test the program more exhaustively and more repeatably. The software will not be affected by environmental factors when running in the simulator, but that's exactly the benefit. First debug the software, then check out the hardware.

Further, BSO has 16-bit simulators and is developing very large-scale integrated simulators and multiprocessor system-debugging capability right now, unlike most emulator manufacturers.

BSO is using powerful and stabilized 16-bit minicomputers from DEC or Data General with operating systems and utilities proven over 15 years of user testing. Multimicroprocessor system testing will demand an independent development system manufacturer to ensure support over the different manufacturers. And a networked approach will not give the debugging and control capabilities a powerful, centralized CPU can provide.

Simon Wieczner
Boston Systems Office
Waltham, Mass.

NOW, THE BOOK

The editorial edition of
Electronics' 50th Anniversary
issue of April 17, 1980



AN AGE OF INNOVATION

The World of Electronics
1930-2000

by the Editors of *Electronics*

Beautifully casebound and
jacketed for your permanent
pleasure.

300 illustrations, many in full
color. 274 pages, \$18.50

The most exhilarating, compre-
hensible look at past and future
developments in electronics
that has ever been published.

Painstakingly researched and
written, AN AGE OF INNOVA-
TION gives you an unforgettable
overview of electronics. Every-
thing from the individuals
whose foresight and daring led
to the great advances... to the
origin of specific technological
breakthroughs you use in your
own work and home... to the
challenges and discoveries we
will face tomorrow.

Order today!

Electronics Magazine Books
P.O. Box 669
Hightstown, NJ 08520
Tel. (609) 448-1700, ext. 5494



Please send me _____ copies of AN AGE
OF INNOVATION @ \$18.50

Name _____

Company _____

Address _____

City/state/zip _____

McGraw-Hill pays regular shipping and
handling on pre-paid orders. Ten-day
money-back guarantee on all books.

ELT

Interested in higher performance software?

The Mark Williams Company announces **COHERENT™**, a state of the art, third generation operating system. The design of **COHERENT** begins with the basic technology of the highly-acclaimed Western Electric UNIX operating system. From this starting point, it goes on to include further substantial software innovation. The primary goal of **COHERENT** is to provide a friendly environment for program development. The intent is to provide the user with a wide range of software building blocks from which he can select programs and utilities to solve his problems in the most straightforward manner.

COHERENT and all of its associated software are written totally in the high-level programming language **C**. Using **C** as the primary implementation language yields a high degree of reliability, portability, and ease of modification with no noticeable performance penalty.

FEATURES

COHERENT provides **C** language source compatibility with programs written to run under Seventh Edition UNIX, enabling the large base of existing UNIX software (from numerous sources) to be available to the **COHERENT** user. The system design is based on a number of fundamental concepts. Central to this design is the unified structure of i/o with respect to ordinary files, external devices, and interprocess communication (pipes). At the same time, a great deal of attention has been paid to system performance so that the machine's resources are used in the most efficient way. The major features of **COHERENT** include:

- multiuser and multi-tasking facilities,
- running processes in foreground and background,
- compatible mechanisms for file, device, and interprocess i/o facilities,
- the shell command interpreter—modifiable for particular applications,
- distributed file system with tree-structured, hierarchical design,
- pipes and multiplexed channels for interprocess communication,
- asynchronous software interrupts,
- generalized segmentation (shared data, writeable instruction spaces),
- ability to lock processes in memory for real-time applications,
- fast swapping with swap storage cache,

- minimal interrupt lockout time for real-time applications,
- reliable power failure recovery facilities,
- fast disc accesses through disc buffer cache,
- loadable device drivers,
- process timing, profiling and debugging trace features.

SOFTWARE TOOLS

In addition to the standard commands for manipulating processes, files, and the like, in its initial release **COHERENT** will include the following major software components: **SHELL**, the command interpreter; **STDIO**, a portable, standard i/o library plus run-time support routines; **AS**, an assembler for the host machine; **CROSS**, a number of cross-assemblers for other machines with compatible object format with 'AS' above; **DB**, a symbolic debugger for **C**, Pascal, Fortran, and assembler; **ED**, a context-oriented text editor with regular expression patterns; **SED**, a stream editor (used in filters) fashioned after 'ED'; **GREP**, a pattern matching filter; **AWK**, a pattern scanning and processing language; **LEX**, a lexical analyzer generator; **YACC**, an advanced parser generator language; **NROFF**, an Nroff-compatible text formatter; **LEARN**, computer-aided instruction about computers; **DC**, a desk calculator; **QUOTA**, a package of accounting programs to control filespace and processor use; and **MAIL**, an electronic personal message system.

Of course, **COHERENT** will have an ever-expanding number of programming and language tools and basic commands in future releases.

LANGUAGE SUPPORT

The realm of language support is one of the major strengths of **COHERENT**. The following language processors will be supported initially:

- **C** a portable compiler for the language **C**, including stricter type enforcement in the manner of **LINT**.
- **FORTRAN** portable compiler supporting the full ANS Fortran 77 standard.
- **PASCAL** portable implementation of the complete ISO standard Pascal.

- **XYBASIC™** a state of the art Basic compiler with the interactive features of an interpreter.

The unified design philosophy underlying the implementation of these languages has contributed significantly to the ease of their portability. In particular, the existence of a generalized code generator is such that with a minimal effort (about one man-month) all of the above language processors can be made to run on a new machine. The net result is that the compilers running under **COHERENT** produce extremely tight code very closely rivaling that produced by an experienced assembler programmer. Finally, the unified coder and conformable calling sequences permit the intermixture of these languages in a single program.

THE OPERATING SYSTEM

In part because of the language portability discussed above, and in part because of a substantial effort in achieving a greater degree of machine-independence in the design and implementation of the **COHERENT** operating system, only a small effort need be invested to port the whole system to a new machine. Because of this, an investment in **COHERENT** software is not tied to a single processor. Applications can move with the entire system to a new processor with about two man months of effort.

The initial version of **COHERENT** is available for the Digital Equipment Corporation PDP-11 computers with memory-mapping, such as the PDP 11/34. Machines which will be supported in the coming months are the Intel 8086, Zilog Z8000, and Motorola 68000. Machines for which ports are being considered are the DEC VAX 11/780 and the IBM 370, among others.

Because **COHERENT** has been developed independently, the pricing is exceptionally attractive. Of course **COHERENT** is completely supported by its developer. To get more information about **COHERENT** contact us today.



1430 W. Wrightwood Ave., Chicago, IL 60614
TEL: 312-472-6659 TWX: 910-221-1182

You're designing an intelligent CRT terminal and you're looking for the best 16-bit CPU for your application.

Congratulations. Your search is over.

"The AmZ8000 is better at handling strings of characters or data words."

The AmZ8000 has special block I/O instructions that allow you to move from 1 byte to 64K bytes of data in a single instruction. Into or out of memory. Ascending or descending addresses.

With our standard 4MHz CPUs, you can

move a data item every 2.5 μ sec. And you can interrupt the instruction to take care of other business.

"The AmZ8000 has a better development system."

Our System 8/8 was designed especially for the AmZ8000.

It comes with 64K bytes of RAM, dual double-density floppy disks, an optional cartridge disk and piles of software. It's Multibus* compatible. And it's even got an optional in-circuit emulator that runs in real time: 4MHz. No wait states.



Rick McCarthy
Manager,
Field Applications,
Engineering

Only the AmZ8000 offers string instructions for exceptionally efficient I/O.

"The AmZ8000 is better for intelligent CRT terminals."

"The AmZ8000 has a better macroassembler."

The MACRO8000 has powerful macro and conditional assembly capabilities. And it generates relocatable output for either of the AmZ8000 CPUs.

For even more efficient programming, we'll soon be offering C, a powerful system implementation language, as well as PASCAL.

"The AmZ8000 is better because our peripherals are better."

Advanced Micro Devices has a whole family of peripherals to go with the AmZ8000. For example, we've got

DMA channel controllers and interrupt controllers and all kinds of high-speed, high-drive bipolar support circuits. We even have a powerful new linked-list CRT controller on the way.

And there's more: The AmZ8000's general-register architecture and efficient instruction set give you high throughput for sophisticated displays. The CPU directly addresses up to 8M bytes of memory. And we are still the only company that processes every part to the rigorous requirements of MIL-STD-883. For free.

If you're looking for a 16-bit CPU for your intelligent CRT terminal, look into the AmZ8000. It's available right now.

And it's the best 16-bit family for you.

*Multibus is a trademark of Intel Corp.

Advanced Micro Devices

901 Thompson Place · Sunnyvale, CA 94086 · Telephone (408) 732-2400
Right, from the start.

NOW...wideband analog and digital fiberoptic systems

LeCroy, utilizing its extensive experience in high-speed electronics, has evolved a line of reliable, cost-effective, wideband fiberoptic systems. The **FIBERCOM**[®] line excels in data communication, video transmission, and analog signal applications.

FIBERCOM digital fiberoptic systems are unique in providing response from DC to >50 MBPS-NRZ. All direct-coupled circuitry yields system performance which is independent of data statistics and eliminates the possibility of lost or false data due to coding-induced jitter or circuit calibration deadline. Additionally, time integrity is maintained to within nanoseconds, allowing use for clocking and other time-sensitive applications. Electrical interface levels may be TTL, ECL, RS-232C, RS-422, RS-423, MIL-STD-188B, or CCITT V.24. Meticulous optical interface design assures maximum coupled power for long hauls or applications demanding very low-bit error rate.

FIBERCOM analog fiberoptic systems offer signal bandwidths to 25 MHz for compatibility with a wide range of signal sources including analog transducers, frequency division multiplexers, as well as baseboard or vestigial sideband video generators. Typical systems transmit 1 volt peak-to-peak signals over 1,000 meter distances with better than 50 dB signal-to-noise ratio and 1% linearity. Heavily shielded cases with integral AC or battery power supplies simplify installation and provide excellent isolation from EMI.

For further information on the **FIBERCOM** line and our special system design capability, please contact the LeCroy Fiberoptic Systems Division, 1234 East Joppa Road, Towson, MD 21204; phone: (301) 296-7670.



DIGITAL SYSTEMS

| MODEL | DATA RATE | INPUT/OUTPUT | DISTANCE* | SPECIAL FEATURES/APPLICATIONS |
|-----------|--|----------------------------------|------------|--|
| FDS-1 | DC-1MBPS | TTL, RS-232, RS-423, MIL-STD-188 | To > 100 m | High performance, low-cost replacements for wire links between low-speed data terminal equipment/data communication equipment. Can also serve in general-purpose OEM data systems. |
| FDS-2 | DC-20MBPS | TTL | To 2 km | High-speed TTL links for computer-computer and computer-memory transfer. Applicable to fast data links and local data network. |
| FDS-3 | DC-50MBPS | TTL | To > 1 km | |
| DipLink-2 | DC-2MBPS | TTL/CMOS | To > 2 km | Low-cost, long-distance link for general-purpose data transmission. Less than \$100 in large quantities. |
| FCA-1 | 1.544 MBPS 3.152 MBPS 6.312 MBPS | Bipolar AMI @ 100 Ω Balanced | To > 2 km | Adapter set for T1, T1C, and T2 PCM channel banks to permit use of fiberoptics for critical applications with modest cost. |

*At Bit Error Rate of 10^{-8} or less depending upon system optical power margin.

ANALOG SYSTEMS

| MODEL | BANDWIDTH | INPUT/OUTPUT | S/N RATIO* @ DISTANCE | SPECIAL FEATURES/APPLICATIONS |
|-------|-----------------|------------------------------|-----------------------|--|
| FAS-3 | 15 Hz to 10MHz | 1 V p-p @ 50 or 75 Ω | 45 dB; 100 m | Low-cost, short-distance instrumentation. Available with ac or dc power supply option. |
| FAS-4 | 15 Hz to 25 MHz | 1 V p-p @ 50 or 75 Ω | 50 dB; 1000 m | Long-distance instrumentation applications. Available with ac power supply only. |
| FAS-6 | 15 Hz to 25 MHz | 1 V p-p @ 50 or 75 Ω | 60 dB; 25 m | Transmitter operates from built-in, rechargeable batteries. Small size and EMI resistant (> 100 dB). Receiver is ac-powered. Use over high voltage differences or for EM susceptibility testing. |
| FVS-1 | 15 Hz to 6 MHz | 1.5 V Composite Video @ 75 Ω | 55 dB; 1000 m | Video system for baseband color or B & W. Pilot AGC system, two-channel distribution amp in receiver and stand-alone or modular rack packaging. |

*Assumes cable loss of 8 dB/km—SNR may be higher or lower depending upon actual loss/km.

LeCroy Innovators in Instrumentation

FIBEROPTIC SYSTEMS DIVISION

1234 East Joppa Rd., Towson, MD 21204; (301) 296-7670. Offices in Spring Valley, N.Y.; Geneva, Switzerland; Heidelberg & Hamburg, W. Germany; Orsay, France; Wheatley, Oxford, England.

News update

■ On tap at TRW Inc.'s Microelectronics Center are fully operational bipolar chips with minimum line widths of 1 micrometer. Researchers at the Redondo Beach, Calif., facility have spent the last year or so putting experimental test chips through their paces, with encouraging results.

"We now have sufficient characterization data and processing ability to manufacture full-size chips," says Barry Dunbridge, manager of the center. The test chips [*Electronics*, Aug. 2, 1979, p. 52] held some 10,000 devices and were the first reported bipolar very large-scale integrated circuits with 1-μm minimum dimensions.

Parts. The first two products, containing about 20,000 devices, "are very ambitious in their complexity and will provide a new level of high performance for digital signal-processing functions," says Dunbridge. They have two immediate outlets: to support TRW's work on the Department of Defense's very high-speed integrated circuits (VHSIC) program and to appear in applications built by the neighboring LSI Products division.

Both chips will be completed within several months, Dunbridge says, in plenty of time to support the next VHSIC round, a follow-on proposal submission scheduled for December. For this, the chips provide basic building blocks for signal processing: a multibit, multistage convolver and an 8-bit analog-to-digital converter whose speed of 75 million samples per second bids to break the sound barrier for this type of job.

Better. The TRW manager reports that the new chips actually exceed requirements of the first phase of VHSIC. "They have a gate-clock-frequency product better than the specified 5×10^{11} gates-hertz called out by the DOD," he says.

Besides putting them into the early VHSIC brassboard subsystems, TRW expects the chips to become the basis for a whole new generation of products whose speed is ideally suited for such other defense systems as electronic warfare, radar, and missile guidance.

-Larry Waller



Thumb a wheel  push a button  flick a lever 

CHERRY'S GOT YOUR NUMBER

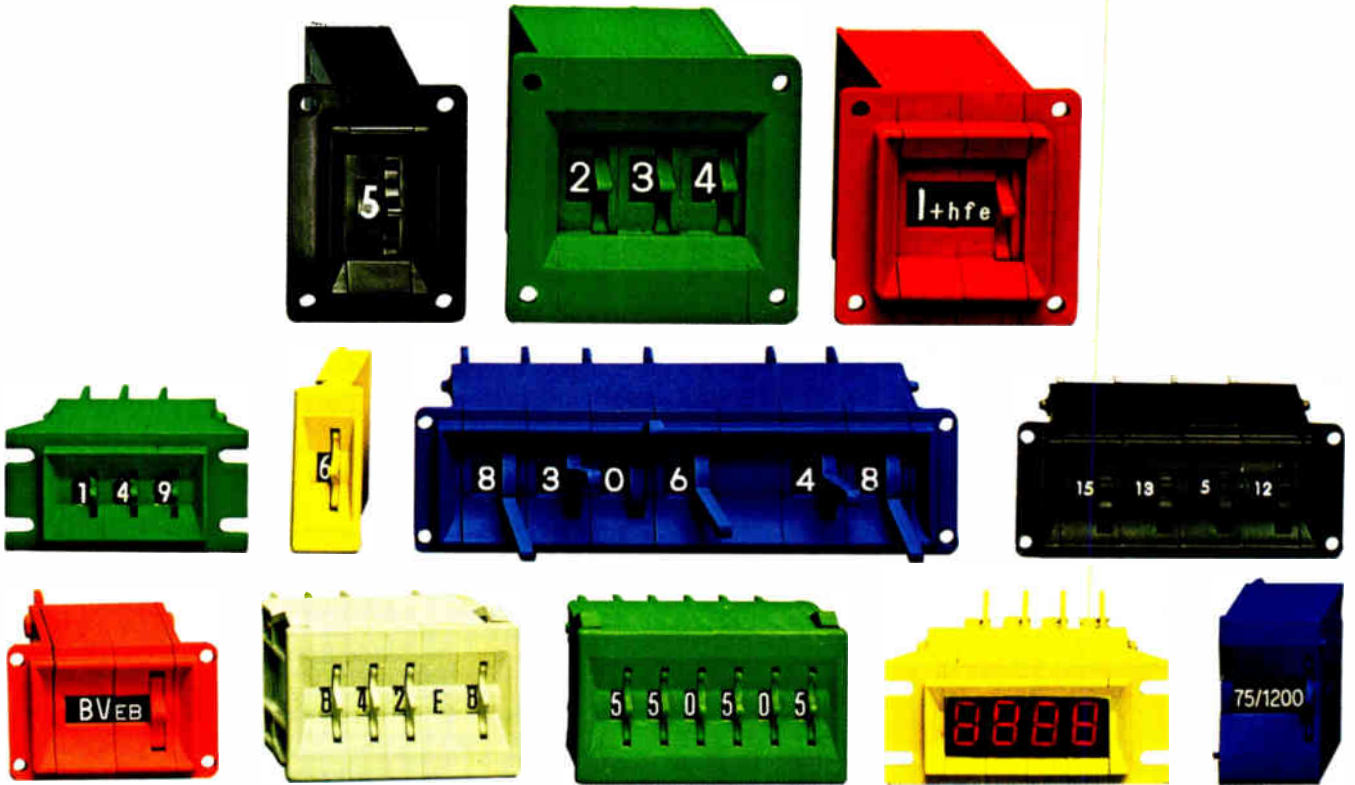

Take your pick from this colorful crop of remarkably versatile Cherry multi-position switches. All are light, tough, rugged. All can be used for both low level switching and encoding, yet consume no power. They read out their settings at all times. They offer basic choices like legend...lighted or non-lighted...dustproof models, too. In either standard black or extra-cost color.

- Choice of code: Dozens of standards. Specials, too.
- Choice of actuation: Thumbwheel, Leverwheel or button-indexed Pushwheel.
- Choice of mounting: Back

of panel, front mount or snap-in. • Choice of termination: PC board with parallel rows of holes, F-pins, J-pins... plus card-edge connectors. • Choice of size: From burly industrial size measuring 2.125" overall height right on down in size thru standard, miniature and .945" high subminiature...to sub-subminiature Pushwheels just .591" high.

All these choices in these hot numbers from Cherry.
Just call...write...or TWX for complete catalog.



MULTI-POSITION SWITCHES

CHERRY ELECTRICAL PRODUCTS CORP. 3608 Sunset Avenue, Waukegan, IL 60085 • 312/689-7700 • TWX 910/235-1572
Our worldwide affiliates and phone numbers: Cherry Semiconductor Corp., Cranston, RI, U.S.A., 401 483 8000 • Cherry Mikroschalter GmbH, Auerbach, Germany, 09 643 181 • Cherry Electrical Products Ltd., Harpenden (Herts) England, (05827) 63100 • Chercro Brasil Industria E Comercio Ltda., Sao Paulo, Brazil, 011 248 4343 • Mirose Cherry Precision Co., Ltd., Kawasaki, Japan, 044 933 3511



OPTICALLY COUPLED INTERRUPTER MODULES

TRW Optron OFFERS IMMEDIATE DELIVERY OF NEW, LOW COST SERIES

TRW Optron's new, low cost optically coupled interrupter module series combines non-contact switching and solid state reliability for applications requiring sensing of position or motion of an opaque object such as motion limit, paper edge or shaft encoding.

The new OPB 813, OPB 814 and OPB 815 consist of a gallium arsenide infrared LED coupled with a silicon phototransistor in an economical molded plastic housing. With a LED input of 20 mA, the OPB 813 and OPB 815 have typical unblocked current outputs of 2.0 mA and 3.0 mA, respectively. Typical output of the OPB 814 is 3.0 mA with a 10 mA input. The entire series is available from stock.

Background illumination noise is reduced by a built-in infrared transmitting filter and dust cover in each device type. The OPB 813 also is available with a 0.010 inch aperture for high resolution applications.

New TRW Optron optically coupled interrupter modules are interchangeable with similar products as follows:

| TRW Optron | GE |
|------------|-------|
| OPB 813 | H13A1 |
| OPB 813 | H13A2 |
| OPB 814 | H13B1 |
| OPB 814 | H13B2 |

Detailed technical information on these and other TRW Optron standard interrupter and reflective modules, as well as versions for specific applications is available on request.

TRW OPTRON
A DIVISION OF TRW INC.

1201 Tappan Circle
Carrollton, Texas 75006, U.S.A.
TWX-910-860-5958
214/242-6571



People

For BNR's Magelby, Canadian decision means challenge

The past decade has been one of growth for interconnection companies in the U. S.—growth triggered by the Supreme Court's 1969 Carterfone decision permitting non-Bell attachments to phone lines. It also created opportunities to sell private branch exchanges (PBX) into the market for firms such as Canada's Northern Telecom Ltd. Now Canada has opened up its own interconnection market and for Kay B. Magelby, that means a challenge ahead.

Magelby is the newly appointed president of BNR Inc. of Mountain View, Calif., a research arm of Northern Telecom and Bell Canada. "That [Canadian decision] means that BNR must develop interconnect systems," he says.

Keeping up with the explosion in telephone interconnection and phone-oriented office systems in the 1980s may be an ambitious enterprise, but it is consistent with Magelby's nature. His projects have included putting Hewlett-Packard Co. into the computer business, developing high-speed communications terminals for a fledgling Sycor Inc., steering Cushman Electronics into the digital microwave radio field, and, now, guiding BNR's office-automation efforts.

Though it is true that no single person can claim to have gotten HP into computers, Magelby is generally credited by his former colleagues there as the one most responsible. While working at HP Laboratories in 1963-64, Magelby interfaced instruments with a computer, which led to the development of an instrument-oriented computer. Since then, Magelby has concentrated his efforts in the communications field.

In addition to his June promotion to president of BNR, late last month Magelby was also given responsibility for the former Sycor laboratories in Ann Arbor, Mich., and the former Data 100 laboratories in Minnetonka, Minn.

Looking toward the office of the future, Magelby sees introduction



New field. Magelby sees new interconnect market opening in Canada for BNR.

soon of such items as voice-data switching PBXs, modem pools, and keyboardless terminals. "Local networking, including voice/data switching, will become an important part of the office, and we think it should be done in a way that avoids the duplication of a building's wiring system," Magelby asserts.

Moore of Cetec recalls 'wild and woolly' days

Involved in California's electronics industries since World War II, Hugh P. Moore, chairman of El Monte-based Cetec Corp., likes to reminisce about the early days of those industries' dazzling growth out West. "Wild and woolly, but in a gentlemanly kind of way," is the way he describes them. And now that Moore has turned over his chief executive's job at Cetec to president Robert A. Nelson, he will have more time to recall the good old days.

Moore, who will still serve as an advisor to the company while retaining 4.3% of its common stock, says that whether the civilized nature of the business, which demands a higher educational level than most others, is a cause or effect of such growth is not the point.

What is most important is that "it attracts a high type of person, and when you surround yourself with intelligent people there's a better

PDP11/23[®] ARRAY PROCESSOR SYSTEM



FIRSTAR[™] PDP11[®] FFS[®]

FIRST COMPUTER CORPORATION INTRODUCES A NEW CONCEPT IN COST EFFECTIVE HIGH-SPEED ARITHMETIC PROCESSING SYSTEMS

First Computer Corporation, one of the world's largest System integrators, has married Digital Equipment Corporation's advanced PDP-11/23 Computer Systems with the new Floating Point System's FPS-100 Arithmetic Processor. This complete packaged Array Processor System provides the power to tackle tough computational problems which were previously the domain of the "Super Computers".

SUPER COMPUTER COMPUTATIONAL SPEED

The FPS-100 is capable of up to eight million floating point operations per second with an effective throughput of up to forty million operations per second.

PROVEN ARCHITECTURE + REAL-TIME ENHANCEMENTS = UNBEATABLE PERFORMANCE

The FPS-100 is based on the proven parallel pipeline architecture of the FPS AP-120B. New enhancements such as extensive Real-Time capabilities provide maximum computational efficiency with a minimum host computer interaction. The cost-performance of the New FIRSTAR System is unbeatable in the universe.

EXTENSIVE DEVELOPMENT SOFTWARE—SAVES PROGRAMMING COST

With every FIRSTAR System you can select from an extensive library of easy to use software consisting of an Assembler, Debugger, Simulator, Utilities, Math Libraries, Signal Processing Libraries, Image Processing Libraries, and Host Executives. It's easy to start using your FIRSTAR System quickly.

NEW SUPER-100 MULTI-TASKING REAL-TIME SUPERVISOR

This new Real-Time Supervisor permits the execution of multiple Real-Time tasks on a priority basis. SUPER-100 can virtually place the FPS-100 in a stand-alone multi-tasking mode for the processing of multiple streams of input data with a minimum of host computer dependency.

CHOICE OF DEC HOST COMPUTER OPERATING SYSTEMS

Select the Digital Equipment Corporation Operating System which best matches your application needs. FIRSTAR is available with either the RT-11 Real-Time Executive or the RSX-11M Resource-Sharing Executive. All Operating Systems are fully supported by Digital.

INSTALLATION AND FIELD SERVICE WORLDWIDE BY DEC AND FPS

FIRSTAR Systems are jointly installed and maintained by DEC's and FPS's own Field Service Organizations. No third party maintenance to worry about.

*Registered trademark of Floating Point Systems Inc.



TM

TWX NUMBER 910-651-1916

first computer corporation

corporate square/825 north cass avenue/westmont, illinois 60559/(312) 920-1050

*Trademark First Computer Corporation

*Registered trademark of Digital Equipment Corporation

AP-1

Circle 15 on reader service card

These days, an American made relay is like money in the bank.

Think of the U.S. economy as a bank, one with too many withdrawals and too few deposits, and you've got a major cause for inflation. Putting your money into American made goods, like Wabash Relays, can help bring inflation under control.

Wabash relays are 100% American made. That says something special about our quality and our fast, dependable service and delivery. Wabash offers over 6,000 reed relay variations alone, at a price competitive with those manufactured outside the U.S.

For relays you can bank on, give Wabash a call. Just tell 'em Sam sent you.

Wabash Relay & Electronics
First and Webster Streets
Wabash, Indiana 46992
(219) 563-2191

wabash[®]
The Reed Relay Specialists



Circle 16 on reader service card

When Clear Displays Count

You can count on Ferranti-Packard's electromagnetic 7-Segment display module to give you the electronic compatibility you need plus the reliability and visibility your customers demand.

Performance-proven for over 5 years, the simple design and construction, backed by Ferranti-Packard research and engineering, gives you the combination of reliability, visibility and flexibility that no other read-out component can match.

When you design an electronic read-out system, Ferranti-Packard display modules will help you do it better. It's clearly the display module you should consider. See the difference for yourself, write or call us and we'll prove it.

**When clear displays count -
Specify Ferranti-Packard.**



Ferranti-Packard Electronics Ltd.



6030 Ambler Drive, Mississauga
Ontario, Canada L4W 2P1
Telephone: (416) 624-3020
Telex: 06-961437

16 Circle 119 on reader service card

People



Looking ahead. Moore recalls old days fondly, but looks forward to opportunities.

chance of success," he says.

Moore, who founded Cetec (then Computer Equipment Corp.) in the early 1950s, himself tried to tap these qualities in his company. "We wanted it to be small enough so an entrepreneur could get personal satisfaction, but big enough to be stable," he says.

With \$65 million in sales last year, the diversified firm (it handles component distribution and broadcast equipment, among others) hits this balance pretty squarely, Moore feels. He is proud of keeping many executives around for the long haul.

Well-known in the region because he toiled mightily in early Wema (now the American Electronics Association) and Wescon affairs, Moore is proud of his connection to one of the most glamorous electronic products of the 1940s. "I was production manager at Bendix Corp.'s North Hollywood plant that made 'Gibson Girls.'" (The Gibson Girl was a hand-cranked radio transmitter that downed pilots used to signal for help.)

The low-keyed executive enjoys looking back, but he would rather talk about the future and "believes opportunities are rife." The fact is underlined lately by eagerness to invest in high-technology companies, in contrast to most of the 1970s. "There has never been as much venture capital available as there is today, and one reason is the well-publicized big winners." □

70ns 8K STATIC

MK4801A:
The first high-speed
BYTEWYDE static RAM.

MOSTEK.



BYTEWYDE* memories have always meant RAM, ROM/EPROM compatibility, flexibility and upgradeability never before available. Now you can also add speed to the list. Because in addition to the economical MK4118 8K static RAM, Mostek* has an ultra-fast counterpart as well: the MK4801A. Incorporating the high reliability of the MK4118 and the advanced technology of the Poly 5* process, this 1K x 8 device boasts a scant 70ns access. That makes it the fastest wide-word high performance static RAM available. Nothing else even comes close.

The MK4801A also marks the beginning of a new second phase in BYTEWYDE memories. A phase that already includes a 90ns 8K static and a 55ns version coming later this year. Additional upgrades in both speed and density will also be forthcoming when our 2K x 8 and 4K x 8 static

RAMs become available.

That means you now have the option to use and plan for truly wide-word memories in high-speed cache, buffer control store and main memory designs.

The choice is yours. For slower systems and a lower cost-per-bit, the MK4118 is the proven solution. Over 2 years of volume production reliability are behind it. But when speed is important, specify our 8K MK4801A. It has twice the density and twice the word width of any fast 4K static you've been considering.

To find out more, contact: Mostek, 1215 West Crosby Road, Carrollton, Texas 75006 (214) 323-6000. In Europe, contact Mostek Brussels 660.69.24.

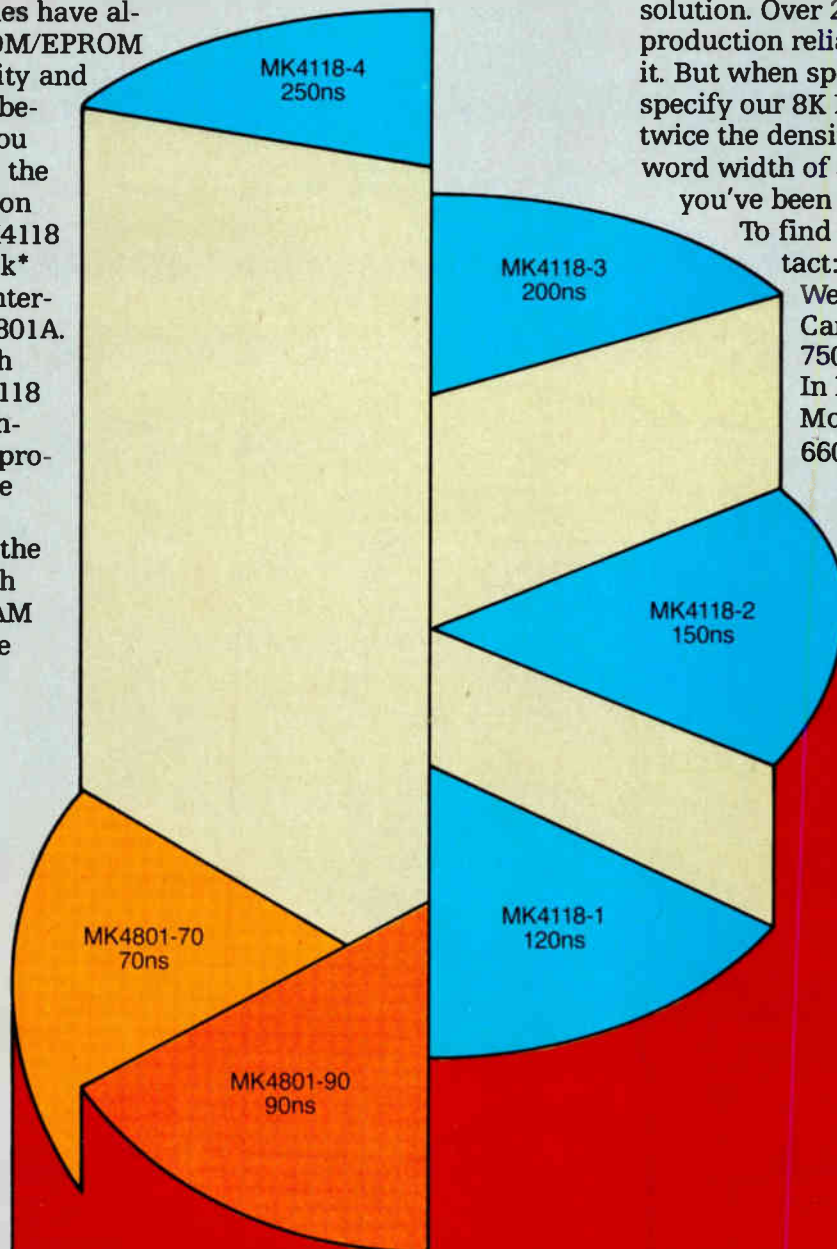

*BYTEWYDE, MOSTEK® and Poly 5 are trademarks of Mostek Corporation

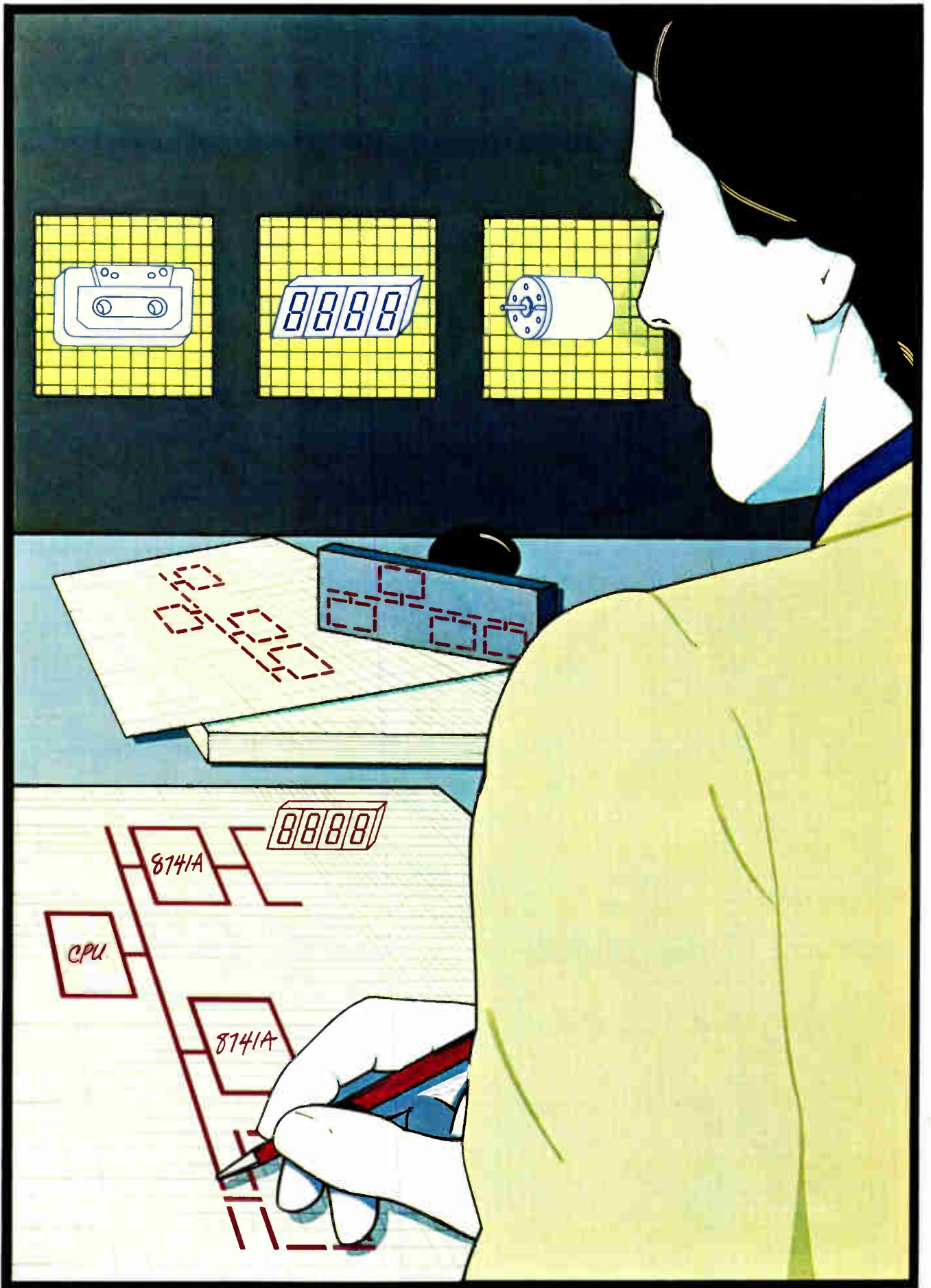

Consider the Options

Choose Intel's 8741A: the only peripheral controller with on-chip EPROM memory and unparalleled development support.

For almost any application where a system peripheral device interfaces to a microcomputer, Intel delivers the flexible design solution: our 8741A. It's the only UPI™ controller in the industry to give you EPROM memory and vital support that minimizes design and debug time. It's the proven peripheral controller available now . . . in your choice of ROM and EPROM versions.

Easy-to-instruct slave processor puts you in control.

If you demand more flexibility from your controller, our 8741A delivers. The 8741A assures that everything from keyboard control to complex process control tasks within your system design can now be efficiently developed as separate projects . . . simplifying your design and making your project more manageable.

Because Intel's 8741A controller is a true slave processor, it acts under control of the host processor. And it never monopolizes the system bus. By executing macro commands from the host, our UPI controller executes from on-chip program memory . . . operating in parallel with the host CPU and freeing the host CPU to do its job.

More than just an intelligent controller, our 8741A contains an 8-bit CPU, 1K byte program memory, 64 byte data memory, clock, timer/counter plus I/O ports. But the performance features of Intel's 8741A go way beyond that.

EPROM programmable memory helps stamp out high design costs.

In terms of both redesign and testing, Intel's 8741A with on-chip

memory offers freedom and flexibility to incorporate new features into the controller. No cost sacrifices or wasted time. Change your software as many times as necessary during development, or when new features are added to the product.

When your programs have been developed, just switch to our pin-compatible ROM version of the UPI controller, our 8041A . . . it's the economical solution for volume production usage.

A versatile controller with an easy instruction set.

If you're familiar with the instruction set for Intel's industry standard 8048, you've already made the investment in learning the instructions for our 8741A. The majority of the 8741A's instructions are control oriented, so you can easily program your controller to handle a wide range of I/O tasks.

The result? Our 8741A, a control-

lement system, you can locate design flaws and software bugs in even the most complex multiprocessor designs.

Consider Intel's ICE-41A emulator and Multi-ICE software as your direct diagnostic connection. With Intel ICE™ modules, you can debug the peripheral controller and an entire system . . . all in real time. You can also rely on Intel to deliver Multi-ICE software. This unique tool lets you have two ICE modules running in parallel, plus macro and compound command extensions to the ICE-41A software that reduce testing time, errors and inconsistencies.

The ICE-41A module lets you use English-like commands and symbolic debugging to monitor hardware and software operation. It lets you modify registers, memory locations and I/O ports. With ICE-41A modules, Intel delivers the only intelligent solution for designing intelligent controllers.

Intel's 8741A, the designer's choice.

If you want shorter design cycles, cost reduction, reliability and performance, you want Intel's 8741A. Proven in hundreds of designs worldwide, it's the best supported UPI controller you can incorporate into your design. And it's available in quantity now.

For more information, contact your local Intel sales office or distributor. Or write Intel Corporation, 3065 Bowers Avenue, Santa Clara, CA 95051.

intel delivers solutions.

Europe: Intel International, Brussels, Belgium.
Japan: Intel Japan, Tokyo. United States and Canadian distributors: Alliance, Almac/Strom, Arrow Electronics, Avnet Electronics, Component Specialties, Hamilton/Avnet, Hamilton/Electro Sales, Harvey, Industrial Components, Pioneer, L.A. Varrah, Wyle Distribution Group, Zentronics.

Circle 19 on reader service card 19

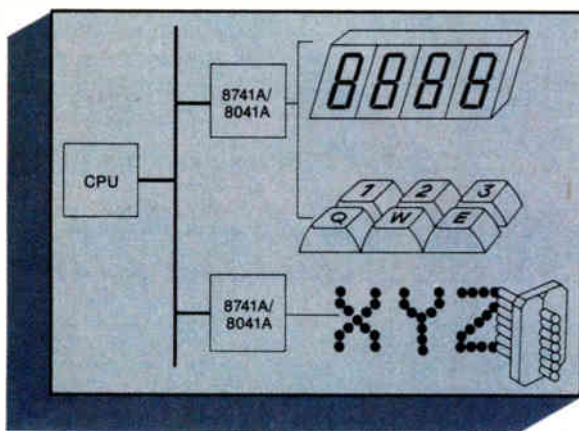

ler for peripheral devices that have no other "off-the-shelf" solution.

No other development support can serve you better.

Intel doesn't just deliver a powerful controller, we also give you powerful debug tools. With our ICE-41A™ in-circuit-emulator, Multi-ICE™ software package and Intellec® devel-

Connector That's Where

ENGINEERING AND DESIGN

This is where technology begins. Our engineering department is known for its design ability. This is evidenced by the more than 3800 custom connectors we have already developed. Our 'gold dot' welding process is another example of how we can achieve maximum performance with minimal cost.

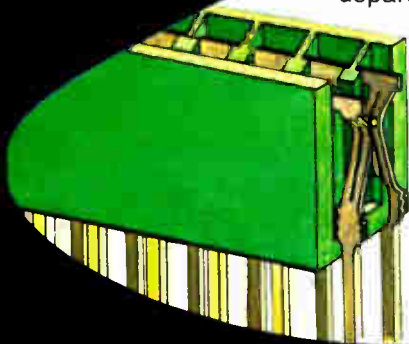

CONTACT FABRICATION

At GTE Products, we not only form our own miniature contacts from metal strip, ribbon and wire, but we draw and plate these materials as well. We also make our own dies, which means we can form even the most intricate shapes.



Complete in-house capability is GTE's greatest strength. This total control assures the highest degree of quality and performance while reducing connector applied costs. And since we control every aspect of the entire connector assembly, we're able to perfect it from all angles. That's why we're billed as "The Connector Perfector." For a better understanding of how this benefits you, send for our new brochure to GTE Products Corporation, P.O. Box 29, Titusville, PA 16354.

SYLVANIA

Technology. **GTE** Shines.

PLASTIC MOLDING

Having our own plastics molding facility enables us to design and tool precision molds as well as produce the connector body. Plastic technology is vital to the finished connector because the plastic compound selected must meet the environmental and physical requirements of the connector's end use.

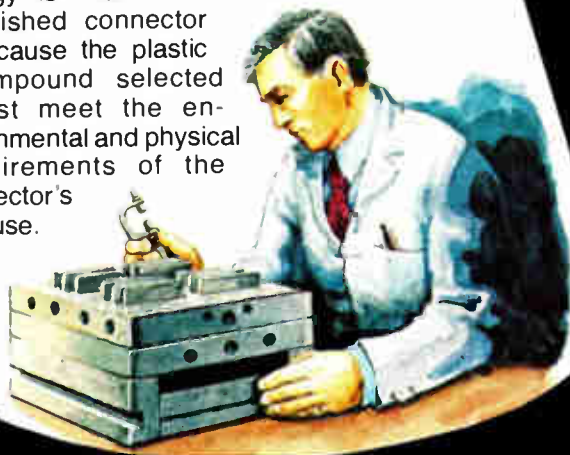

QUALITY ASSURANCE

Our total in-house capability gives us sole responsibility for quality. And we accept it. That's why we employ both visual *and* electronic monitoring devices through all phases of the manufacturing process . . . in an effort to assure you a perfect connector.



GTE

..The Connector Perfector

Announcing the HP 1000 Separate I/O processors let the

Our new HP 1000 L-Series is designed to give you outstanding processing performance—even in the most demanding applications.

The reason is our innovative distributed intelligence architecture. Each I/O interface has its own processor—made with our exclusive SOS LSI process—and its own direct memory channel. Which means each interface can control and monitor data transfers—without interrupting the central processor.

So the CPU can concentrate on its main job of computation.

And you get faster response, higher throughput and superior system performance.

But what's really surprising about the L-Series is that you get all this performance at prices

that start as low as \$1968 for our starter set.† Or \$15,510 for a complete disc-based system.††

Nobody makes processors like we do.

The key to the HP-1000 L-Series' impressive new architecture is our own Silicon-On-Sapphire technology. SOS lets us make CPU and I/O chips with extremely high circuit density, low power consumption, high processing speeds and high reliability—at a very low cost.

It's this combination of high performance and low cost that make the L-Series appropriate for the whole range of OEM and industrial appli-

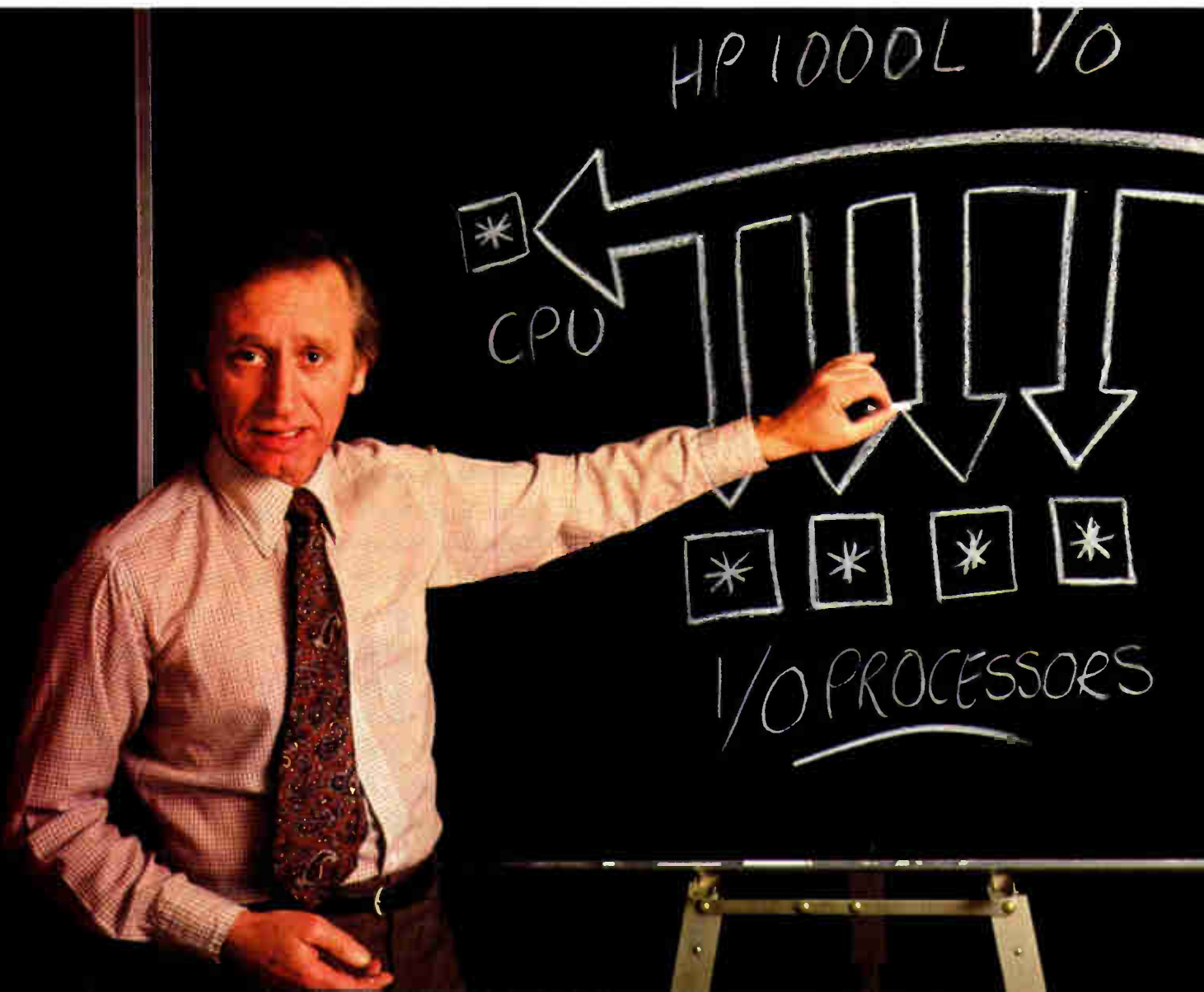

L-Series Computer. CPU concentrate on computation.

cations — including data management, process control and instrumentation.

And to insure you can get the exact configuration you need for your specific application, the L-Series is available in a wide choice of board, box and system packages.

The HP 1000 L-Series is a fully compatible member of our high performance HP 1000 family. Which means you can move up to a larger computer—all the way to our powerful F-Series—as your application grows.

It also means you can use any HP 1000 computer—and its sophisticated program development tools—to design programs for the L-Series.

The reliability is built in.

Like all HP computers, the HP 1000 L-Series is designed to give you outstanding reliability. Reliability that's significantly enhanced by our SOS technology — processor boards have fewer active parts, so

†Starter Set: CPU, 64KB memory, one I/O board.
††Disc-Based System: HP's new 12MB Winchester disc drive and 2621 display console.
(U.S. OEM prices in quantities of 100)

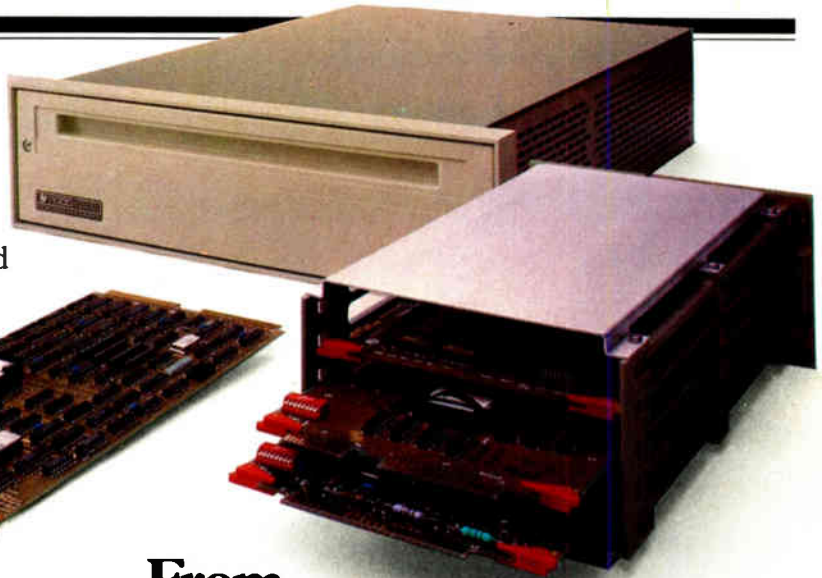

From
\$1968

fewer things can go wrong. In addition, the L-Series has its own self-test programs and diagnostics.

And, of course, the L-Series is backed by our full range of support and documentation services—including our worldwide service network.

For more information or a hands-on demonstration of our high performance, low cost L-Series, contact your nearest HP sales office listed in the White Pages or write to: Roger Ueltzen, Dept. 673, 11000 Wolfe Road, Cupertino, CA 95014.



**HEWLETT
PACKARD**

The NSA has no lock on computer coding

Scientists and the military establishment in peacetime are, more often than not, contestants on opposing teams in a tug of war. After all, the military is paid to prepare for and win battles; it believes it can do this best if its weapons are kept secret from any prospective adversaries.

The scientist, on the other hand, benefits from free exchange of information. Cross-fertilization of ideas is the most efficient and fastest way to solve scientific problems and apply those solutions to technology. Scientists like to think that they function irrespective of borders or other political hindrances.

That's the background for the contretemps involving the National Security Agency (the military) on one side and the National Science Foundation and those doing research on advanced computer coding on the other. The NSA has for some time been monitoring all cryptography-related research proposals submitted to the NSF. Now, in what is viewed by some as an attempt to sweep the whole field of computer cryptography under its cloak of secrecy, the military agency seems to be moving towards taking over and funding

any such research that in its judgment may turn out to be crucial to national security. And in such cases, it will withhold permission to publish—anathema to the academic community.

The tight-lipped folks at the NSA make their opposite numbers at the Central Intelligence Agency look like village gossips; it is no surprise that they would attempt to take over a field such as computer cryptography. But where does that leave the banks, insurance companies, and all the other commercial enterprises in this country that need advanced coding to keep their computers safe from penetration by outsiders? It is difficult to see how the records of, say, the Prudential Insurance Co. involve U. S. security. However, it is not difficult to see what could happen to such records with the NSA jealously hoarding the potential cryptographic safeguards for them. So-called computer crime grows as the applications of computers proliferate. For any agency, particularly one as routinely secretive as the NSA, to control research into computer cryptography would seem to be contrary to the best interests of the people charged with performing that research.

"Engineering designed this new counter with all the features our production people asked for."

You'd expect our production management to be biased in favor of our new 7250A Universal Counter/Timer. But when we challenged them, they told us why Fluke Counters are becoming

favorites on lines everywhere.

"This new Universal Counter is just what we asked for. A bench-top basic function 80-MHz instrument with the measurement modes our people use most. A

built-in switchable filter and a X1 to X100 continuously adjustable attenuator eliminate unwanted triggering. The input amplifiers feature the accuracy and reliability that only Fluke-designed thick-film hybrid circuits can provide. And Fluke's commitment to quality insures maximum uptime at a price that's right for the line — only \$699 U.S."

Built for  system automation.

"We're installing new automated test procedures. And the 7250A Universal Counter fits right in. By adding the 1120A Translator and the 7250A's talk-only interface option, we can build an inexpensive IEEE-488 system. The 7250A also uses the unique Fluke Portable Test Instrument (PTI) design for latching our instruments together in a neat, uncluttered package."

Convincing evidence.

Our production managers are sold on our new 7250A. How about you? For more information call toll free **800-426-0361**; use the coupon below or contact your Fluke sales office or representative.



IN THE U.S. AND NON-EUROPEAN COUNTRIES:

John Fluke Mfg. Co., Inc.
P.O. Box 43210 MS # 2B
Mountlake Terrace, WA 98043
(206) 774-2481
Telex: 152662

IN EUROPE:

Fluke (Holland) B.V.
P.O. Box 5063,
5004 EB Tilburg,
The Netherlands
(013) 673 973 Tlx: 52237

- Please send 7250A specifications.
- Please send information on Fluke's 125-MHz 7260A and 7261A Counters.
- Please send IEEE-488 Translator info.
- Please have a salesman call.

Name _____

Title _____ Mail Stop _____

Company _____

Address _____

City _____ State _____ Zip _____

Telephone () _____ Ext. _____

For technical data circle no. 25

MAGSTRIPE™

Readers and Reader/Encoders



Model 40 Reader

7.75" x 1.64" x 1.37" H

Model 44 Reader/Encoder

7.75" x 1.64" x 1.37" H

Field proven, economical means for reading and encoding magnetic stripe cards, badges and passbooks.

Our Magstripe™ product line of Readers, Encoders and Reader/Encoders features:

- Reading and encoding to ANSI X 4.16-1976; tracks 1, 2 and 3.
- Non-standard densities, including IBM's 127.5 BPI.
- LSI circuitry.
- Spatial decoding*; card velocity range 5-60 IPS; insensitive to acceleration, low amplitude and jitter.
- Rugged construction; permits outdoor installation; virtually maintenance free.
- **Unique Magstripe™ Heads***, independently suspended and gimbal-mounted. Minimum head and card wear. Highest reliability with warped and contaminated cards.

Proven, world-wide performance in a variety of applications including:

- Airline ticketing terminals
- Bank terminals
- Building access systems
- Bulk fuel dispensing terminals
- Data input for CRT terminals
- POS terminals
- Computer access devices
- Identification and badges
- Self-service gas stations
- Fare collection systems
- Time and attendance terminals
- Plant communication systems

MAGSTRIPE™ SYSTEMS — Readers and Reader/Encoders Available with RS-232C Interface

- DTE or DCE connection under EIA RS-232C and RS-449 standards; ASCII characters.
- Provide all control functions and ANSI formatting for Magstripe™ units.
- Baud rates to 2400; strap change to current loop.
- Available PCB only, or in enclosure with power supply.

*Patented



For more information, contact:

**American
Magnetics
Corporation**

2424 Carson St., Torrance, Calif. 90501
(213) 775-8651, TWX 910-349-6956
Circle 26 on reader service card

Meetings

Convergence 80—30th International Congress on Transportation Electronics and Vehicular Technology Society Conference, IEEE and Society of Automotive Engineers, Hyatt Regency Hotel, Dearborn, Mich., Sept. 15-17.

Essderc 80—1980 European Solid State Device Research Conference, Institute of Physics (47 Belgrave Sq., London SW1X 80X, England), University of York, York, England, Sept. 15-18.

Sixth European Conference on Optical Communication, Institution of Electrical Engineers (1 Savoy Pl., London WC2R 0BL, England), University of York, York, England, Sept. 15-19.

Euromicro 80, Institution of Electrical Engineers (L. R. Thompson, Hawker Siddeley Dynamics, Manor Road, Hatfield, Herts. AL10 9LP, England), Imperial College, London, Sept. 16-18.

FOC 80—Fiber Optics and Communications, Information Gatekeepers Inc. (167 Corey Road, Suite 111, Brookline, Mass. 02146), Hyatt Regency Hotel, San Francisco, Calif., Sept. 16-18.

Wescon/80, IEEE, Anaheim Convention Center and Disneyland Hotel, Anaheim, Calif., Sept. 16-18.

Eusipco—European Signal Processing Conference, IEEE *et al.*, Swiss Federal Institute of Technology, Lausanne, Switzerland, Sept. 16-19.

ACM Symposium on Small Systems, Association for Computing Machinery (Liza Loop, 3781 Starrking Circle, Palo Alto, Calif. 94306), Hyatt Rickey's, Palo Alto, Sept. 17-19.

30th Sicob—Salon International de l'Informatique, de la Communication, et de l'Organisation de Bureau (6 Pl. de Valois, 75001 Paris, France), Init—Paris La Défense, Sept. 17-26.

30th Annual Broadcast Symposium, IEEE, Washington Hotel, Washing-

ton, D. C., Sept. 18-19.

Eighth IBC—International Broadcasting Convention, Electronic Engineering Association *et al.* (1 Savoy Pl., London WC2R 0BL, England), Metropole Conference Center, Brighton, England, Sept. 20-24.

Sixth European Solid State Circuits Conference, Eurel *et al.* (G. Grunberg, Thomson-CSF, B.P.5., 92403 Courbevoie, France), University of Grenoble, Grenoble, France, Sept. 22-25.

Semicon/East 80, Semiconductor Equipment and Materials Institute (625 Ellis St., Suite 212, Mountain View, Calif. 94043), John B. Hynes Auditorium, Boston, Sept. 23-25.

1980 European Conference on Optical Systems and Applications, IEEE *et al.* (D. J. Kroon, Philips Research Labs, 5664 An Geldrop, The Netherlands), Jaarbeurs, Utrecht, The Netherlands, Sept. 23-25.

Compcon 80 Fall, IEEE Computer Society, Capital Hilton Hotel, Washington, D. C., Sept. 23-25.

1980 International Conference—Security Through Science and Engineering, West Berlin Technical University *et al.* (Sue McWain, Conference Coordinator, College of Engineering, University of Kentucky, Lexington, Ky. 40506), West Berlin Technical University, West Berlin, West Germany, Sept. 23-26.

Society for Computer Medicine 10th Annual Conference, SCM (1901 N. Fort Myer Dr., Suite 602, Arlington, Va. 22209), San Diego Hilton, San Diego, Calif., Sept. 24-27.

Fourth International Conference on Magnetic Bubbles, Magnetics Society of Japan (Hiroshi Kobayashi, School of Science and Engineering, Waseda University, Tokyo), Garusmuin University, Tokyo, Japan, Sept. 24-27.

Eascon 80, Electronics and Aerospace System Conference, IEEE,

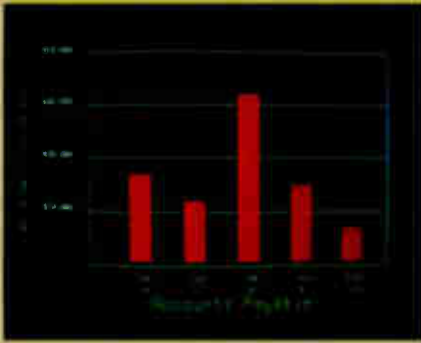

Management Information Display

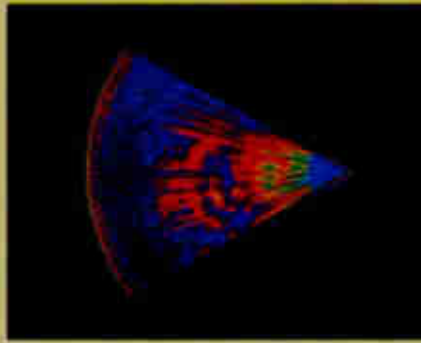

Ultrasonic heart sector scan

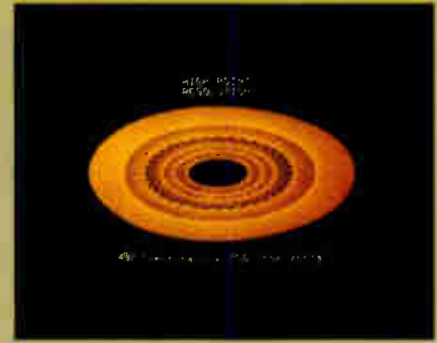

High-resolution display with alphanumerics

Get the professional color display that has BASIC/FORTRAN simplicity

LOW-PRICED, TOO

Here's a color display that has everything: professional-level resolution, enormous color range, easy software, NTSC conformance, and low price.

Basically, this new Cromemco Model SDI* is a two-board interface that plugs into any Cromemco computer.

The SDI then maps computer display memory content onto a convenient color monitor to give high-quality, high-resolution displays (756 H x 482 V pixels).

When we say the SDI results in a high-quality professional display, we mean you can't get higher resolution than this system offers in an NTSC-conforming display.

The resolution surpasses that of a color TV picture.

BASIC/FORTRAN programming

Besides its high resolution and low price, the new SDI lets you control with optional Cromemco software packages that use simple BASIC- and FORTRAN-like commands.

Pick any of 16 colors (from a 4096-color palette) with instructions like DEFCLR (c, R, G, B). Or obtain a circle of specified size, location, and color with XCIRC (x, y, r, c).

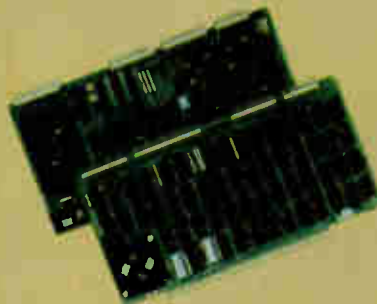

Model SDI High-Resolution Color Graphics Interface

HIGH RESOLUTION

The SDI's high resolution gives a professional-quality display that strictly meets NTSC requirements. You get 756 pixels on every visible line of the NTSC standard display of 482 image lines. Vertical line spacing is 1 pixel.

To achieve the high-quality display, a separate output signal is produced for each of the three component colors (red, green, blue). This yields a sharper image than is possible using an NTSC-composite video signal and color TV set. Full image quality is readily realized with our high-quality RGB Monitor or any conventional red/green/blue monitor common in TV work.



Model SDI plugs into Z-2H 11-megabyte hard disk computer or any Cromemco computer

DISPLAY MEMORY

Along with the SDI we also offer an optional fast and novel two-port memory that gives independent high-speed access to the computer memory. The two-port memory stores one full display, permitting fast computer operation even during display.

CONTACT YOUR REP NOW

The Model SDI has been used in scientific work, engineering, business, TV, color graphics, and other areas. It's a good example of how Cromemco keeps computers in the field up to date, since it turns any Cromemco computer into an up-to-date color display computer.

The SDI has still more features that you should be informed about. So contact your Cromemco representative now and see all that the SDI will do for you.

*U.S. Pat. No. 4121283

 **Cromemco**
Incorporated
280 BERNARDO AVE., MOUNTAIN VIEW, CA 94040 • (415) 964-7400
Tomorrow's computers today

Circle 27 on reader service card

coax & shielded cable

WIRE STRIPPERS

A versatile, compact 3 station stripper. This EXCLUSIVE 3 in 1 SWING BLADE model easily strips miniature coax, RG and shielded cable as well as hook up wires. Can handle constructions up to an O.D. of .265" (6.7mm). FREE catalog tells it all.

FREE WIRE STRIPPING SERVICE

Send a 3-5 ft. sample of your cable or wire and strip specifications. Stripped wire will be returned to you with a complete report and recommendations.

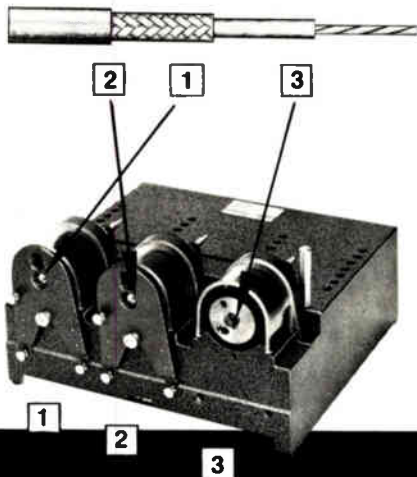

CARPENTER
MFG. CO., INC.

Fairgrounds Drive, Manlius, N.Y. 13104
(315) 682-9176

Circle 28 on reader service card



Our Printer's Strength Of Character Is Enhanced By Its Self-Control

Don't let the low price tag fool you; our DMTP-6 μ P is stronger on capabilities than any printer in its class. Its unique matrix impact print head lets you program any desired character pitch. You can print data or text, single-stroke or enhanced from 36 to 132 columns. And, print up to four copies without adjustment on standard 8 1/2" roll paper, fan-fold forms and labels.

What's more, it packs a built-in controller that includes all needle drivers and diagnostic routines, while providing a choice of interface functions-parallel ASCII, RS-232C/I-Loop, or switch-selectable baud rates from 110 to 1200. Now that's self-control worth having! Add the continuing economy of a 10-million character life ribbon and re-inking rollers, and you've got an unbeatable buy. Call or write for details. Ask for Bulletin 922A.



**PRACTICAL
AUTOMATION, INC.**

Trap Falls Road, Shelton, Conn. 06484/Tel: (203) 929-5381

28 Circle 121 on reader service card

Meetings

Sheraton National Hotel, Arlington, Va., Sept. 29-Oct. 1

International Symposium on Telecommunication Processing, Société des Electriciens, des Electroniciens, et des Radioélectriciens (Secrétariat Général du Colloque International sur la Planification des Réseaux, 11, rue Hamelin, 75783—Paris Cedex 16, France), Tour Oliver de Serres, Paris, Sept. 29-Oct. 2.

SPIE's Huntsville Electro-Optical Technical Symposium, Society of Photo-Optical Instrumentation Engineers (P. O. Box 10, Bellingham, Wash. 98225) *et al.*, Von Braun Civic Center, Huntsville, Ala., Sept. 29-Oct. 2.

ICCC 80—International Conference on Circuits and Computers, IEEE *et al.*, Rye Town Hilton Inn, Port Chester, N. Y., Oct. 1-3.

Sixth International Conference on Very Large Data Bases, IEEE, Hotel Méridien, Montreal, Oct. 1-3.

Information Processing Joint Exhibition, Japan Electric Industrial Development Association *et al.* (3-5-8 Shiba Koen, Minato-ku, Tokyo 105), International Fairgrounds, Tokyo, Japan, Oct. 3-8.

Info 80—Information Management Conference and Exposition, Clapp & Poliak Inc. (245 Park Ave., New York, N. Y. 10017), New York Coliseum, Oct. 6-9.

Eighth World Computer Congress, International Federation for Information Processing (U. S. Committee for the Eighth World Computer Congress, c/o Bowery Savings Bank, 110 East 42nd Street, New York, N. Y. 10017), Sunshine City, Ikebukuro, Tokyo, Japan, Oct. 6-9; Melbourne, Australia, Oct. 14-17.

Military Electronics and Defense Exposition, Industrial and Scientific Conference Management Inc. (222 W. Adams St., Chicago, Ill. 60606), Rhein-Main Halle, Wiesbaden, West Germany, Oct. 7-9.

64K BYTEWYDE ROM

MK37000: 4 to 1 density
upgrade expands RAM, ROM,
EPROM interchangeability
options.

MOSTEK®



Perhaps the best way to characterize the MK37000 is to think of it as everything you want in a 64K ROM. Because that's exactly what it has.

Fast access - 250ns (max).
Low power - 220mW (max) active
and just 35mW (typ) standby.
Quick, efficient prototype cycling
and code processing.
And of course, volume

availability, supported by 2½
years of production experience at
the 64K level.

But that's only part of the story. This 28-pin JEDEC-approved package and pinout is also fully compatible with the Mostek* family of n-words x 8 BYTEWYDE* memories. So now you'll only need one matrix of 28-pin sockets to design or upgrade a compact 8K, 16K or 64K array of RAMs, ROMs/EPROMs.

Interface is easy. Like all other BYTEWYDE

memories, the MK37000 interfaces directly with all present and future generation 8-bit and 16-bit micro-processors. An Output Enable control provides easy user control of the bus in all bus configurations. Together, the Output Enable and the Chip Enable control functions also prevent any bus contention problems.

If you want to simplify and streamline the design of your custom memory arrays, get all the facts. Ask for the BYTEWYDE Data Book and the MK37000 data sheet by contacting: Mostek, 1215 West Crosby Road, Carrollton, Texas 75006 (214) 323-1000. In Europe, contact Mostek Brussels, 660.69.24.

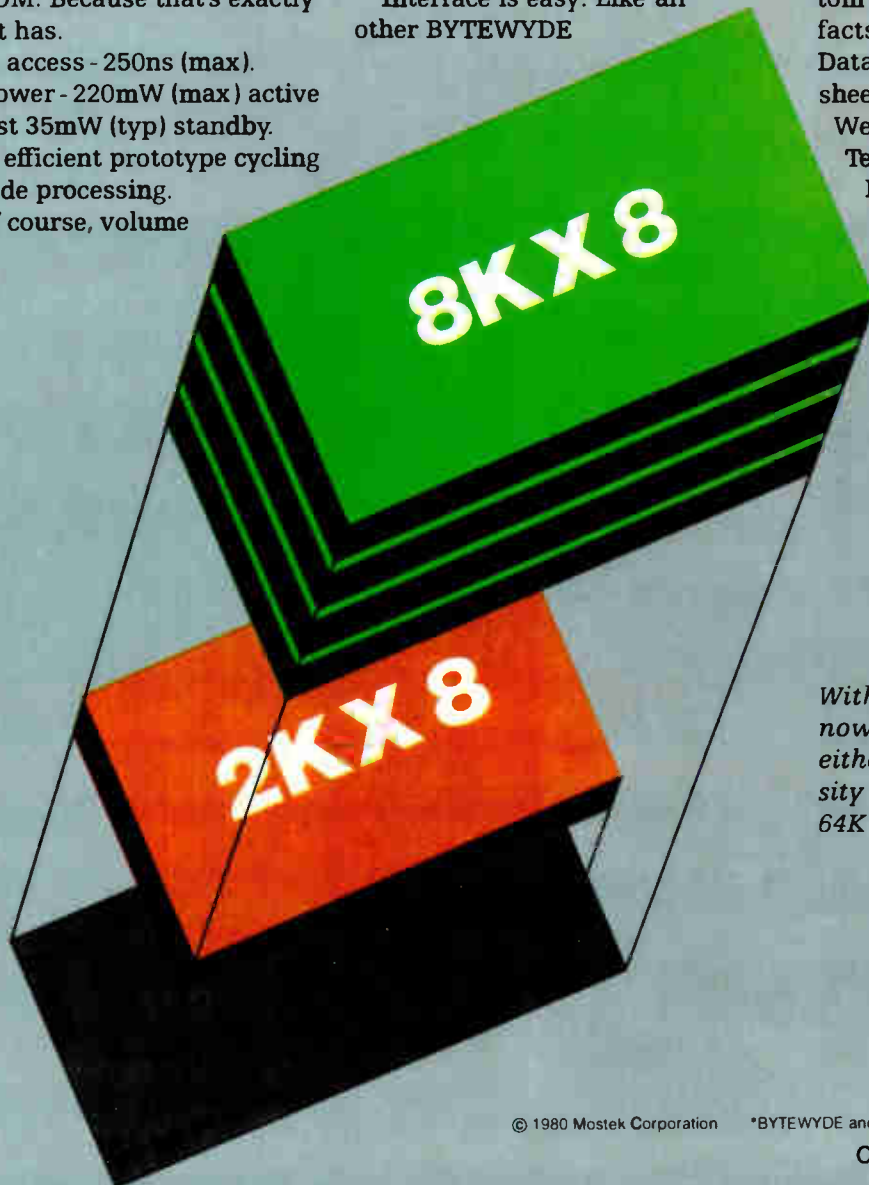

Within the BYTEWYDE family you now have a wide choice of ROMs: either a 16K ROM or a 4 to 1 density upgrade with the MK37000 64K ROM.

BIOMATION K7000-D



Compare this general purpose logic analyzer with the currently accepted industry standard.

The K100-D wins over Hewlett-Packard's 1615A hands down!

Logic designers have made Gould's powerful Biomation K100-D our fastest selling logic analyzer

mode to catch glitches as narrow as 4 ns. It gives you the most precise logic analysis for today's high speed minicomputer, main-frame and microprocessor systems. Best of all, you're already prepared for faster designs as they arrive.

Compare capacity.

The K100-D's 1024 word memory is *four times as deep as the 1615A's*. This dramatically extends the length of data you can trap from your system at any one time. And that means faster, more accurate debugging. In addition, the K100-D's standard 16 channel format can be expanded to 32 channels for work on the new generation of 16-bit micro-processors.

Compare your productivity.

Finally, the K100-D makes designers more productive with convenience features superior to those of the 1615A. The K100-D has a larger keyboard, plus an interactive video display. Comprehensive status menu. Data domain readout in hexadecimal, octal,

binary or ASCII. And the list goes on and on.

The final analysis.

To help you evaluate these two fine instruments before you buy, we've prepared a point-by-point *competitive comparison* of the two. If you're designing and debugging high-performance digital systems, you'll want to read this document carefully. To get your free copy, just use the reader service number or write Gould Inc., Biomation Division, 4600 Old Ironsides Drive, Santa Clara, CA 95050. For faster response, call 408-988-6800.

ever. You'll see why once you compare it to its nearest competitor, the 1615A from Hewlett-Packard.

Compare clocking speed.

With a 100 MHz clock rate, the K100-D gives you resolution to 10 ns—*five times better than the 1615A's*. Use the K100-D's latch



Hewlett-Packard 1615A
A very good logic analyzer



Speed: to 20 MHz
Resolution: 50 ns
Memory: 256 words
Channels: 8 timing & 16 data,
or 24 data

Biomation K100-D
The industry's finest logic analyzer



Speed: to 100 MHz
Resolution: 10 ns
Memory: 1024 words
Channels: 16 timing or 16 data,
or 32 data

 **GOULD**

An Electrical/Electronics Company
Circle 31 on reader service card

Intel® RAMs advance

Now at your command: Our full line of military RAMs.

In military and high-reliability applications, Intel's full line of MIL-spec RAMs continues to advance. Produced under our military products program, the RAMs listed below represent the pacesetters in memory devices, all built in full compliance with the Class B requirements of MIL-STD-883B, Methods 5004 and 5005.

**Intel® Military RAMs
(Class B, MIL-STD-883B)**

| Model | Organization | Maximum Access (ns) | Current Active/Standby (mA) |
|----------------------------|--------------|---------------------|-----------------------------|
| Static¹ | | | |
| M2115A | 1Kx1 | 55 | 125 |
| M2115AL | 1Kx1 | 75 | 75 |
| M2125A | 1Kx1 | 55 | 125 |
| M2125AL | 1Kx1 | 75 | 75 |
| M2114AL-3 | 1Kx4 | 150 | 50 |
| M2114AL-4 | 1Kx4 | 200 | 50 |
| M2114A-4 | 1Kx4 | 200 | 70 |
| M2114A-5 | 1Kx4 | 250 | 70 |
| M2148H | 1Kx4 | 70 | 180/30 |
| M2147H-3 | 4Kx1 | 55 | 180/30 |
| M2147H | 4Kx1 | 70 | 180/30 |
| Dynamic² | | | |
| M2118-4 | 16Kx1 | 120 | 25/2 |
| M2118-7 | 16Kx1 | 150 | 23/2 |

¹TA: -55° to 125°C

²TA: -55° to 85°C

For systems ranging from ship-board and ground communication systems to avionics and missile controls, these RAMs offer a way to forge ahead with cost-effective designs. And, because they're available now in volume, you can press them into service immediately.

The RAM brigade, HMOS company

Intel revolutionized RAM design when we introduced our proprietary HMOS* technology. With HMOS, power consumption and corresponding cooling requirements are drastically reduced — both critical factors in military applications. In the denser static RAMs (M2147H and M2148H), automatic power down on deselection further reduces system power dissipation — a very important power and reliability advantage in larger systems.

Furthermore, with RAMs like the M2115A, M2125A, and M2147H, you can achieve fast access times for cache memories and for systems that process data in real time.

For microprocessor applications also, you need all the performance you can muster. For those, Intel offers the low-power MOS microprocessor-compatible M2114A. Or the high-speed M2148H, suitable for fast random logic and

military customers: to continue to deliver the broadest line of LSI devices to military systems designers. From devices like the M8080A, the first microprocessor to receive JAN approval (QPL-listed as M38510/42001), through the M8085A, the world's highest performance 8-bit microprocessor, to the first military computer-on-a-chip: the M8048. And continuing on with other MIL-STD-883B products, such as EPROMs, bipolar PROMs, and microprocessor peripherals. We've shipped hundreds of thousands of these high-performance parts to vital military programs over the past four years. Proof of our commitment to remain the leader in military microelectronics.

Our military aid program

To ensure smooth, cost-effective designs, Intel supports its military customers with advanced development tools, such as the Intellec® development system and ICE™ in-circuit emulation modules.

So the next time you're on the lookout for state-of-the-art military LSI devices, look to the leader — Intel. For further information on Intel's advancing line of military products, contact your local Intel sales office/distributor.

Or contact Intel Corporation, 3065 Bowers Ave., Santa Clara, CA 95051. Telephone (408) 987-8080.

*HMOS is a patented Intel process.



bipolar microprocessor designs. And for very high density applications, you can call out the M2118. It provides 16K of dynamic storage in a 16-pin package. Plus it uses only a single +5-volt supply, which reduces space requirements and increases system reliability.

The vanguard in military microelectronics

Intel's advancing line of RAMs reflects our strong commitment to

intel® delivers solutions.

Europe: Intel International, Brussels, Belgium.
Japan: Intel Japan, Tokyo. United States and Canadian distributors: Alliance, Almac/Strom, Arrow Electronics, Avnet Electronics, Component Specialties, Hamilton/Avnet, Hamilton/Electro Sales, Harvey, Industrial Components, Pioneer, L.A. Varah, Wyle Distribution Group, Zentronics.

Inmos promises even faster 16-K RAM

Inmos Corp., the British-backed semiconductor house raising industry eyebrows with an n-MOS static random-access memory that accesses typically in 30 ns (see p. 117), will offer "significantly higher performance" 4-K-by-4-bit versions of that device next year. Unlike the 16-K-by-1 IMS1400, which exploits novel circuit design for high speed but with conservative, 2.7- μ m minimum features, the **1420 and 1421 follow-up chips will use process enhancements as well**—like scaling down to tighter geometries—for even shorter access times. Since it is committed to step-and-repeat equipment, shrinking geometries to 2 μ m would be no big feat for the Colorado Springs, Colo., firm. In addition, the 1421 will drop the automatic power-down feature to squeeze out another 5 to 10 ns. Intel Corp., now starting to ship samples of its 2167 16-K-by-1-bit fast static RAM, will also come out with a 4-bit-wide part. But at least for now, its Aloha, Ore., memory operation does not see a sufficient market for a 4-K-by-4-bit memory without power-down.

Fast C-MOS process for ULA family under development

A number of West Coast semiconductor firms are known to be working on low-power, high-speed processes similar to the Iso-CMOS popularized by Canada's Mitel Semiconductor, and now Semi Processes Inc. of Santa Clara, Calif., has developed a selective-oxidation, silicon-gate complementary-MOS process. Semi plans to use its technique in its first family of metal-mask-programmable uncommitted logic arrays, called Masterchips. **The initial offering from the supplier of custom wafer-processing services will be 1,000- and 544-gate versions with typical gate delays of 3 ns**, slightly faster than competitive ULAs made with the Mitel process. Semi achieves such speed with a 5- μ m process that, when scaled down to 3- μ m H-MOS geometries, is expected to yield subnanosecond gate delays.

STC to acquire Florida maker of high-speed printers

Storage Technology Corp., the Louisville, Colo., maker of high-performance tape drives and IBM-plug-compatible disk drives, has moved to broaden its coverage of the peripherals market. Itself the target in the past year of several acquisition and merger efforts, **Storage Technology has agreed to acquire Documation Inc.** of Melbourne, Fla., a maker of high-speed printers, for about \$52 million in stock. STC's revenue in 1979 was \$480 million; Documation's sales were \$90 million for the fiscal year ending Feb. 1, 1980, which reflected a loss of \$9.5 million.

HP entering market for power FETs with D-MOS line

Look for an introduction later this month of the first power field-effect transistors to be offered by Hewlett-Packard Co., Palo Alto, Calif. They will be produced using a double-diffused MOS process and **will have a guaranteed 450-v breakdown voltage and a surprisingly low on-resistance of 0.75 Ω** . Called H-Power, the product line will have HPWR model prefixes, and the first one being prepared is the HPWR-6501, packaged in a TO-3 can. Though prices have yet to be established, HP claims the line will be competitive with the 450-v, 1- Ω IVN6000 series recently introduced by Intersil Inc. [*Electronics*, July 17, p. 166]. The HP devices have a lower on-resistance, but their switching speed—below 50 ns—is somewhat slower. The devices are useful in switching power-supply systems, ac motor controls, and other high-voltage, ac-line applications.

NCR to receive masks for 68000 In Motorola deal

NCR Corp. of Dayton, Ohio, is acting as though it has big plans for the 68000 microprocessor. Hedging against the chance that its requirements will exceed Motorola Inc.'s capacity to produce the 16-bit devices, NCR will receive masks as part of its five-year contract for Motorola's flagship processor. Behind the concession by Motorola is the knowledge that **all of NCR's manufacturing plants are looking at the 68000 family**, and at least three—the Columbus, Ohio, plant, where point-of-sale equipment is made; Ithaca, N. Y.; and Raleigh, N. C.—have 68000-based projects under way for 1981 introduction. Under the deal, NCR is to receive mask sets for the 68000 and a minimum of three peripheral chips: the 68120 intelligent peripheral controller, the 68450 direct-memory-access controller, and the 68451 memory management unit. Up-front money also is involved.

Digital scope with difference to bow in 1981

Data Precision Corp., the Danvers, Mass., firm known for its digital meters, will introduce sometime in 1981 what insiders call a new concept in digital waveform analysis and display systems. The instrument, say knowledgeable sources, will "merge Data Precision's instrumentation know-how with [parent company] Analogic Corp.'s high-speed analog-to-digital conversion capability." **Data Precision sources do not even think of the unit as a digital oscilloscope**, feeling that it will mark a step in the state of the art beyond such devices. The instrument will fit a benchtop and be "very, very smart."

Wired city closer with experimental communications test

A new packet-switched local-area digital data-distribution system will begin operations in New York and San Francisco this November using a combination of existing cable TV lines and cellular radio communications. The service is a joint experiment by Satellite Business Systems Inc., Tymnet Inc., and LDC—a joint venture of M/A-Com Inc. and the Aetna Life & Casualty Co. [*Electronics*, April 24, p. 107]. The cities will be linked via an SBS satellite channel, Tymnet will operate the central node and switching systems in each city, and LDC (using hardware from another M/A-Com subsidiary, DCC Inc.) will coordinate the program and provide subscriber transceivers. **Local distribution is expected to get the most attention in the test.**

Digital, analog abilities due in Teradyne tester

The next generation of automatic test equipment from Teradyne Inc. will combine digital and analog in-circuit capabilities with emulation of final system environments for full functional testing of printed-circuit boards—a first, according to the Boston firm. Bowing at the Cherry Hill, N. J., test conference this November will be the \$500,000 L260, representing the middle range of Teradyne's planned L200 series and slated for first deliveries in March 1981.

Addenda

Mostek Corp. is jumping on the complementary-MOS bandwagon with a C-MOS version of its 3870 microprocessor family suitable for battery-operated equipment. Due from the Carrollton, Texas, MOS house is a pin-compatible 38C70 with two power-saving instructions; also being developed is a real-time clock peripheral chip. . . . **Intersil Inc. and General Electric Co. are believed to be discussing merger possibilities.** GE is said to have made an offer of \$35 a share.

**YES, THERE'S
A REASON
WE DELIVER
ROMs FASTER
THAN THE
OTHER GUYS**

Industry average delivery on ROM samples is 6 to 8 weeks. EA delivers 8K, 16K and 32K ROM samples in 4 to 5 weeks.

Industry average delivery on production runs is 10 to 20 weeks. EA delivers in 8 to 10 weeks.

How do we do it? By a unique process called "Contact Mask Programming." N-channel silicon gate ROMs generally require seven masking steps from raw through finished wafers. Other ROM manufacturers diffuse your bit pattern in the first mask, then take another 4 to 5 weeks just to finish the wafer. Not us.

We commit your bit pattern at the *fifth* mask. This allows us to pre-fabricate every wafer through the first four masks, and thereby have 70% of its fab cycle completed before you send us your bit pattern. You get your ROMs faster, we get more ROM orders.

Skeptical? Try us. Electronic Arrays, 550 East Middlefield Rd., Mountain View, CA 94043. (415) 964-4321; Philadelphia (215) 643-1447; Chicago (312) 858-8508.

**ELECTRONIC
ARRAYS**

**THE HOUSE
OF ROMs**



File your TTL data book.



Four new PAL[®] devices join the family that's making TTL logic obsolete.

They're here. Our 4 newest PAL (Programmable Array Logic) devices make a total of 13 in the instant custom logic family that replaces up to 90% of the entire 54/74 S and LS series logic. Meet PAL16L8, an Octal 16 Input AND/OR/INVERT Gate Array, PAL16R8, an Octal 16 Input Registered AND/OR Gate Array, PAL16R6, a Hex 16 Input Registered AND/OR Gate Array, and PAL16R4, a Quad 16 Input Registered AND/OR Gate Array. And soon MMI will introduce two additional PALs with arithmetic functions.

PAL — The Programmable Solution™ — saves you space, time and aggravation.

A single PAL 20 pin SKINNYDIP™ can replace from 4 to 12 TTL devices. But pc board space isn't all you save. Lower system cost, smaller inventory requirements, reduced parts

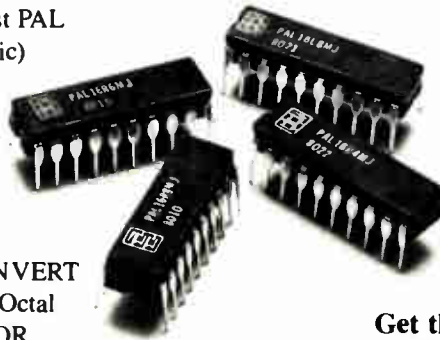

count and high-volume, off-the-shelf, multiple sourced availability,* make PALs the most cost-efficient logic devices on the market. And every PAL can be programmed by any PROM programmer with a PAL personality module.

Get the right data book. Free.

For your complimentary copy of the new Bipolar LSI Data Book and further information on the revolutionary PAL logic family, contact your local MMI stocking distributor or sales representative. Monolithic Memories, Inc., 1165 East Arques Avenue, Sunnyvale, California 94086.

PAL, The Programmable Solution, and SKINNYDIP are trademarks of Monolithic Memories, Inc.

*National Semiconductor Corporation is a licensed alternate source for PAL.

Monolithic Memories 

"360 panels an hour outstrips any aqueous system we've ever used."

Dana Schofield, Plant Manager, Hadco Printed Circuits, Owego, NY



A Riston® UAS-24 Ultrasonic Aqueous Stripper works hard at boosting Hadco's productivity.

Now that they're using a RISTON Ultrasonic Stripper, Hadco Printed Circuits of Owego, N.Y., can process double-sided, plated-through-hole boards with RISTON aqueous films at the rate of 4 to 6 panels a minute. That's up to 360 panels an hour.



The ALL-AQUEOUS UAS-24 is designed for high productivity and in-line operation with etching. It has an automatic panel transport mechanism which processes panels (up to 24" x 24") in one continuous operation.

Using ultrasonics, the UAS-24 removes resist cleanly and completely from plated boards with up to 6 mils of over-plate—even on fine-line circuitry down to 3 mil spacing. And the system is reliable and easy to service because it's operated by a programmable controller.

We've shown you how HADCO maximized their stripping productivity with the new RISTON Ultrasonic Stripper. We'd like to show you how *you* can, too. For more information and a brochure on RISTON all-aqueous film and equipment systems, write: RISTON High Productivity Systems, DuPont Company, Room 38132, Wilmington, DE 19898.

Innovations for Electronics



Circle 38 on reader service card

Metallurgical silicon comes into play for solar cells

by James B. Brinton, Boston bureau manager

Relatively impure silicon, cost-saving production processes are being tried

Metallurgical-grade silicon, plus more efficient crystal-growth and -slicing technologies, is brightening the prospects for much cheaper solar cells. The photovoltaic materials maker Crystal Systems Inc. is developing use of the relatively impure silicon and of its Government-funded cost-saving production techniques to help the industry reach the Department of Energy's 1986 goal of 70¢-per-watt cells.

In fact, Fredrick Schmid, president of the Salem, Mass., company, is so confident of the potential of the research effort that he is projecting 25¢/w cells, perhaps well ahead of the DOE's 1990 goal of 15 to 50¢/w. A major reason for this reduction would be the switch from costly semiconductor-grade silicon to metallurgical-grade material. Another possibility, which others are considering, is amorphous silicon [*Electronics*, Aug. 28, p. 40].

Purity. Semiconductor-grade silicon is typically better than 99.999% pure and sells for from \$65 to \$70 per kilogram. Metallurgical-grade silicon is usually about 99% pure—though many lots are purer—and costs only about \$1.20 a kilogram.

Schmid's firm has made solar cells using both types, achieving a 15% conversion efficiency with semiconductor-grade silicon and 12.33% with metallurgical-grade material. Since the work with the cheaper

material is still new, Schmid expects better efficiencies to emerge. Even if they fail to materialize, today's 2% to 3% efficiency difference is not a bad trade for a sixty-fold reduction in materials cost, he feels.

"If he can reproducibly use this inexpensive material to make cells, Schmid will have gone a long way toward meeting our price-performance goals," says Paul Maycock, head of the Department of Energy's photovoltaic energy systems division. "So far, he has shown that he can use it to make good single crystals and reasonable solar cells."

But reproducibility may be a problem. Crystal Systems often must request special lots of metallurgical-grade silicon with higher-than-average purity. Obviously, for production quantities of low-cost cells, supplies of this slightly purer metallurgical-grade silicon must be dependable.

"We can tolerate about 10 parts per million of impurities and still make good cells," he says. "But it is necessary to be selective; what's needed is an intermediate grade of silicon."

He says silicon vendors respond favorably when approached about such a new silicon grade. But he notes "a chicken-and-egg problem."

Dilemma. Solar cells are now such a small part of their business that it is hard to justify the capital expenditures an intermediate grade would dictate. "On the other hand, solar cells are a potentially huge market," he says. "Right now, vendors are falling between two stools."

Help may already be on the way, though. A source at the DOE's Solar Energy Research Institute, Golden, Colo., says that companies like the Dow Corning Corp., Midland, Mich., are attacking the problem by

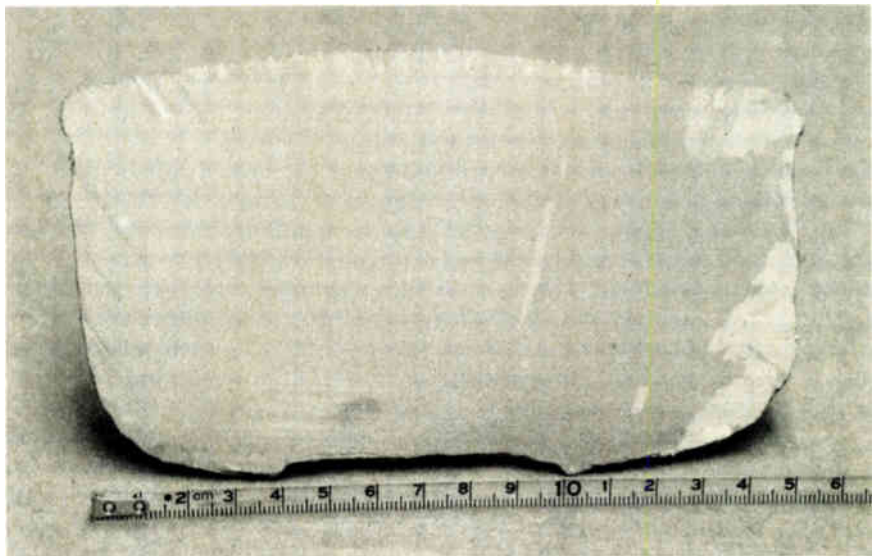

Solid stuff. Using metallurgical-grade silicon melt stock, Crystal Systems is manufacturing an ingot intended for photovoltaic use that is close to being single-crystal in structure.

using purer starting materials and cleaner production techniques.

Cheaper silicon alone will not make possible 15¢-to-50¢/w cells, says Schmid. His optimism is partly based on Crystal System's HEM, or heat-exchanger method, for making large ingots of single-crystal silicon [*Electronics*, Oct. 25, 1979, p. 12]. Not only is HEM said to save a third of the power, labor, and materials used in the more common Czochralski process, but it also allows production of ingots with a square cross section. Some are as large as 13 by 13 inches and weigh up to 110 pounds, Schmid says.

Stack. He already is producing square ingots and wafers for sale to makers of solar cells. Its present commercial stock is based on 8-by-8-in. ingots and is being sold to Arco Solar Inc., among others.

Arco Solar says it has bought evaluation quantities of the square wafers. The DOE's Maycock notes that square ingots are 25% cheaper

than round ingots and wafers, which must be trimmed to rectangular shape, wasting silicon.

Crystal System's other cost cutter is its FAST, or fixed abrasive slicing technique [*Electronics*, July 20, 1978, p. 44]. Though about a year away from commercial use, FAST already is capable of getting as many as 68 wafers from an inch of ingot, versus the 24 to 25 possible with current technology, Schmid says. He is looking for yields of up to 100 wafers per inch with FAST which could mean the equivalent of a fourfold materials-cost reduction.

Together, the move to lower-cost silicon, HEM's 30% efficiency edge and its square ingots' 25% cost benefit, and FAST's expected 400% improvement in wafer yield per inch of ingot make Schmid's price projections reasonable. But use of metallurgical-grade silicon may be the keystone; as one of Schmid's competitors noted, "if Fred can do that, he's got a big advantage."

Photovoltaics

Thick film, plating cut cost of laying down solar cell contacts and conductors

The struggle to cut the costs of photovoltaic cells has many facets, including cheaper fabrication methods for the metal conductors and contacts on the cells. A small solar-cell maker in Tempe, Ariz., may have developed just such a technique, which depends on using thick-film nickel contacts and electroplated copper conductors.

In Photowatt International Inc.'s method, there are many fewer steps than in evaporation techniques for forming thin-film contacts. What's more, there is no need for the expensive photolithographic techniques used to make thin-film conductors.

Screening. Instead, Photowatt uses a simple screening and firing of thick-film conductors, followed by a plating step. With thin-film methods, there can be five or six steps.

As the figure shows, the first step in the Photowatt method is to evapo-

rate an antireflective thin layer of silicon nitride over the diffused junction layer of a silicon solar cell. Then a special air-fireable nickel-based thick-film ink, developed by Photowatt with Thick Film Systems Inc., Santa Barbara, Calif., is screened on to form the contacts.

Then the nickel paste is fired, driving it through the silicon nitride into the diffused silicon and forming an ohmic contact. This step is carefully controlled through an exact, proprietary temperature-time relationship, says Clayton Olson, manager of Government contracts for Photowatt.

Finally, a copper conductor layer is selectively electroplated over the nickel surface. The method was developed at Selectrons Ltd., Waterbury, Conn., for repairing traces on printed-circuit boards. Vanguard Pacific Inc. applied it to the problem

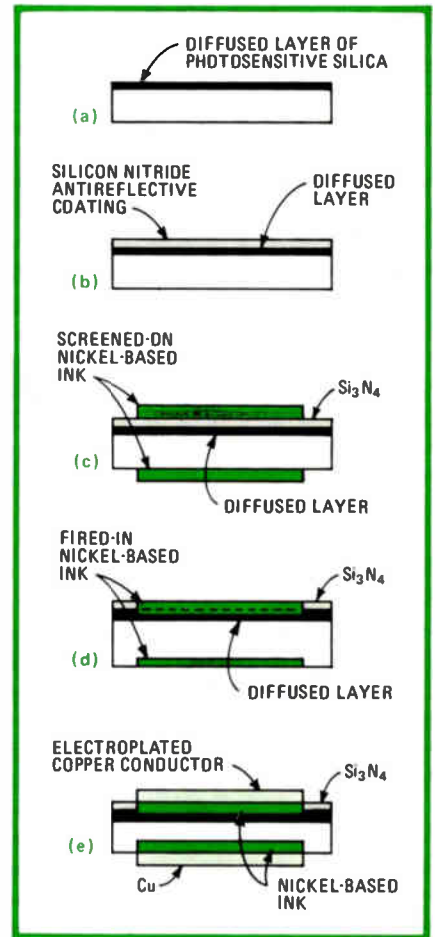

Simpler metalization. Photowatt International needs only three basic steps to fabricate solar-cell contacts and conductors: steps (c), (d), and (e) above.

of low-cost, high-conductivity solar-cell contacts. The anode is a graphite stylus wrapped with an absorbent material and dipped into an organic copper solution. The stylus traces the pattern of the nickel contacts, which act as a cathode in the process.

Copper. Previous attempts at screening on thick-film conductors could not use copper pastes because copper diffuses into silicon. Instead they have used silver or aluminum pastes, which have much lower conductivity—but which are compatible with silicon.

The Photowatt developers got around the problem by electroplating the copper. This method also costs much less than either screening or evaporation of metals.

Photowatt's development so far has been internally financed, but the

company is applying for funds from the Jet Propulsion Laboratory, Pasadena, Calif., to make the process commercially viable. The proposed program would result in a pilot line, and cell samples would be used in extensive life tests. **-Jerry Lyman**

Memories

Overcoats protect RAMs from alphas

Keeping those troublesome alpha particles at bay is forcing the semiconductor industry to apply protective coatings as random-access memories move to the 64-K level. Cleaner packaging materials, clever circuit design techniques, and other efforts aimed at reducing alpha sensitivity may not be enough to meet users' requirements.

Already, the list of 64-K RAM manufacturers who supply, or profess plans to supply, parts with protective die coatings includes Texas Instruments Inc., Motorola Inc., Hitachi Ltd., Toshiba Corp., Mitsubishi Electric Corp., and Fujitsu Ltd. Despite some disagreement, many RAM makers, including Intel Corp. and Inmos Corp., believe that die coats are likely to become a requirement for 64-K dynamic and 16-K static RAMs.

Natural. Ionizing alpha radiation emitted by naturally occurring trace thorium and uranium isotopes in packaging materials was first uncovered as a source of nondestructive soft error problems in charge-coupled-device and 16-K dynamic memories [*Electronics*, June 8, 1978, p. 42]. It is more of a problem as geometries and critical charge levels diminish.

"We have looked at 64-K parts from about a half-dozen manufacturers, some U.S. and some Japanese," says Dennis Wong, component engineer in charge of RAM qualification at Hewlett Packard Co.'s Data Systems division in Cupertino, Calif. So far, Wong says he has not seen any 64-K part without a die coat capable of meeting

HP's goals for resistance to alpha-induced soft errors.

"Almost universally, the 64-K vendors are going to die coats," says an engineer, who asked to remain nameless, at another large computer house. He reports test results that are similar to HP's.

In general, users are looking for 64-K parts that achieve alpha-tolerance levels at least equal to those measured on 16-K RAMs. That level is pegged at from 1,000 to 2,000 FITs—a designation for failures in 10⁹ hours.

Some RAM makers claim to have met that goal with their 64-K offerings, whereas others admit to falling significantly short. At Texas Instruments Inc. in Houston, MOS memory development manager Dick Gossen says the TMS4164 comes in at about

1,200 FITs on tests using an accelerated alpha source.

Gossen says the Dallas-based company will begin converting to a die coat on 4164 products during the fourth quarter this year to get even better reliability. He foresees more stringent user requirements on alpha sensitivity even for chips going into large systems that employ error-correction circuitry.

Shipping. At Motorola Inc.'s MOS Integrated Circuits operation in Austin, Texas, MOS memory strategic marketing manager David C. Ford indicates that even best-case projections show that his company's MCM6664/65 devices would suffer soft-error rates between 10,000 and 100,000 FITs without a protective die coating. Motorola began shipping 64-K parts using an organic poly-

Die-coating techniques diverge

There's no question that die coatings will help ward off the onslaught of alpha particles, but there is some question about the best techniques to use. Users have expressed concern over potential reliability problems associated with some of the coatings.

Though the semiconductor industry has examined a variety of coating materials including silicones and epoxies, an organic polyimide seems to be the most frequent material of choice. Motorola is applying a commercially available polyimide substance in liquid form to its 64-K RAMs during package assembly. The coating varies in thickness from about 1 mil across the array to about 5 mils around the edges of the device.

Hitachi uses a polyimide of its own development known as PIQ [*Electronics*, July 31, p. 103] and says that a thickness of about 2 mils will sufficiently reduce the energy of incoming alpha particles. The company has been using this type of resin for several years in linear circuits, both as an interlayer insulator and as a moisture shield for aluminum wiring. Toshiba and Mitsubishi say they will use a polyimide coating, and Fujitsu says it will use some type of resin coating but it will not specify the material.

In contrast, Texas Instruments Inc. has developed a technique that uses a polyimide film about 3 mils thick that is machine-cut and applied to the die with a silicone adhesive. Since the coating will be form-fit to cover only the array and sense amplifiers, TI officials believe the technique will be more uniformly reproducible and may avoid potential problems with some liquid application techniques in which the polyimide covers the bonding areas.

In the liquid approach, differing thermal expansion coefficients of the polyimide and the die could result in bonding wires being pulled off during the curing process or later in the field, TI says. Motorola's David Ford concedes that bonding integrity is a valid concern, but notes that some nine months of reliability testing done by his firm included thermal cycling tests that revealed no problems.

Other concerns involving potential for die contamination or corrosion were also allayed by the testing, he says. Motorola has developed a liquid application technique that ensures reproducible uniform coating thickness, he claims. The company also looked at using film but saw such potential difficulties as alignment problems, adhesion breakdown in the field, and higher cost than liquid application techniques, he reports. **-W. I.**

wide overcoat in July [*Electronics*, July 31, p. 33].

Still, there are some holdouts. Mostek Corp., for example, does not plan a die coat on its 64-K product scheduled for fourth quarter introduction. The Carrollton, Texas, company can add it if necessary, says Sam Young, a Mostek memory-marketing official.

"Coating is a step in the right direction," remarks Kirk MacKenzie, strategic marketing manager of Intel's Aloha, Ore., memory components division. But "it doesn't replace trying to reduce alpha sensitivity in the design."

The company has used a coating in a 16-K CCD memory, now discontinued. It has both a 64-K dynamic and a 16-K static RAM in the sampling stages, and as for coating them, "between now and the end of the year, we'll figure that out," says MacKenzie.

Inmos also has a 16-K static RAM (see p. 117) and a 64-K dynamic part planned for production, though the latter is not as far along as Intel's. The Colorado Springs, Colo., company has not yet settled the coating question, says David R. Wooten, manager of strategic marketing and applications. One point to consider, he says, is that even if 64-K cell sizes were as large as in 16-K dynamic parts, alpha particles still would cause trouble. -Wesley. R. Iversen

Military

P-i-n diodes steer silicon antenna

Electronical steering of antennas' output beams from millimeter-wavelength radars may be about to move from the realm of "nice ideas, but . . ." into the real world. Researchers at the U. S. Army Research and Development Command at Fort Monmouth, N. J., are working on such a replacement for expensive and slow mechanically steered antennas by using p-i-n diodes for steering the beam.

"Our development may lead to

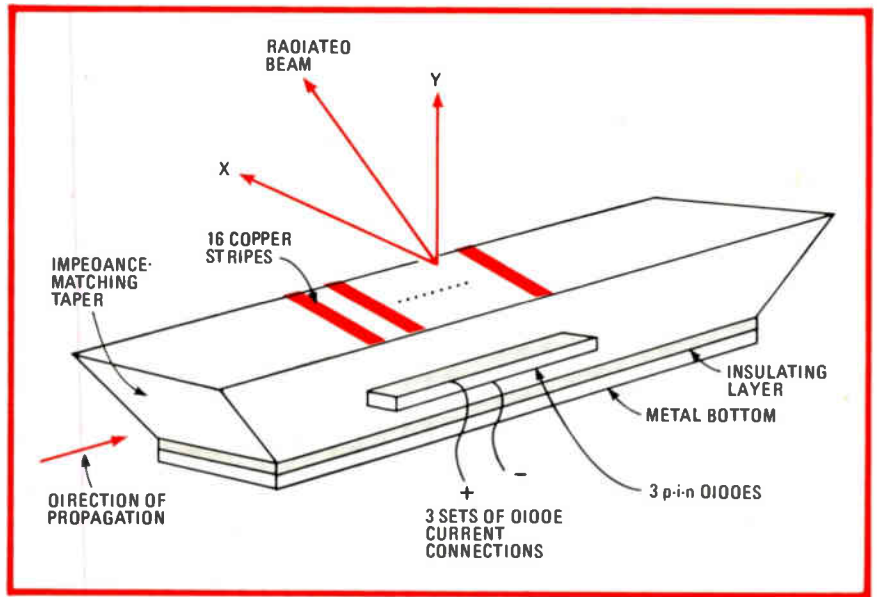

Silicon steering. Current in the diodes of this silicon-slab antenna steers the radiated beam. The reflecting metal bottom plate ensures that all power radiates from the top.

future beam-scanning antennas for operation at millimeter frequencies," says Harold Jacobs, millimeter-wave devices team leader at the Electronic Techniques and Devices Laboratory. "For now, it can be said that it is low-cost and easily fabricated and has a lot of potential for practical radar scanning."

Useful. Such attributes are important, for other attempts to design electronically scanned millimeter-wave antennas have foundered on the rocks of cost and complexity. The interest in these designs stems from the military's emphasis on developing millimeter-wave radars, because they have much better resolution than do lower microwave frequencies and so stand a better chance of identifying ever faster flying targets.

Jacobs and his colleagues Robert E. Horn, Elmer Freibergs, and Kenneth L. Klohn started with a 0.1-by-0.1-by-13-centimeter silicon rod with 16 copper foil strips cemented across the top (see figure). These strips direct the microwave energy that would otherwise propagate straight through the silicon dielectric slab into a beam that radiates off the rod at an angle.

This phenomenon is well known, and the innovation of the group lies in its having determined that the

spacing between p-i-n diodes on the rod's sidewalls and their impedance, plus the wavelength of the microwave energy within the silicon and several other parameters, interact to determine the angle of the beam.

"When the diodes are nonconducting or unbiased by an external voltage, the wavelength is some constant predetermined value, which in turn determines the radiation angle," says Thomas. To vary the wavelength and thus the angle, the researchers simply change the dc voltage on the diodes.

"When the diodes are biased in the forward direction, this is equivalent to the mechanical movement of a metal wall up the side of the silicon slab," he says. "This changes the wavelength of the energy inside the slab and varies the angle of the radiated energy beam."

Angles. Typical changes in the beam's angle are from 8° to 10° at 63 gigahertz with as much as 13° in some cases. A bias current of only 100 milliamperes is needed in each of the three diodes used.

The scanning angle in the patented device is not always a continuous function of the diode current. To obtain this analog scanning for more accurate target acquisition, the researchers are varying the rod dimensions, the copper strips, and the

KONTRON

Introduces The First GPIB Fully Programmable 20 MHz Transient Recorder With These Features!

NEW

TRANSIENT RECORDERS:

DL1080 Programmable Transient Recorder

See us at the
WESCON Show
Booth No's.
101 & 103



The DL1080 two channel transient recorder will aid the user in defining many types of spontaneous events from electrical insulation breakdown to power supply testing. Event parameters can be programmed, executed and transferred via the RS232 or GPIB. Recordings show both pretrigger and post trigger events. Settings can be stored for recall via EAPROM from the front panel. The DL1080 is easily adapted to systems use as well as in the hands of the user.

Standard Features Include:

- RS232, GPIB, DMA interfaces for full programmability
- All numeric values controlled via master knob with "analog" feel
- 20 MHz sampling/channel
- Dual 4096 x 8 bit memories
- 7 recording modes including real

- time zoom
- 2 cursors for data identification and numeric readout
- Full waveform expansion capability
- Integral magnetic tape cassette back up memory
- Versatile triggering including wide window mode
- CRT and plotter output
- Linear and quadratic interpolation for visual reconstruction of sample data
- Powerful waveform analysis and automatic sequencing options.

Get complete details and the name of a Kontron sales and service organization near you. Write or call:

Kontron Electronic, Inc.
630 Price Avenue
Redwood City, CA 94063
Tel: (415) 361-1012

TRANSIENT RECORDERS:

For data on Kontron® Computer/Controllers, Digital Multimeters, Counters, PROM Programmers, Logic Analyzer and Printers, call (800) 227-8834. In California call (415) 361-1012.



diodes. They have met with some success already, Thomas notes.

What's more, they are trying to expand the scan angle to 20° or so, thereby increasing the usefulness of their antenna, which even now has enough angle variability for some applications. **-Harvey J. Hindin**

Solid state

Custom designers seek standard test chips

Designers of custom integrated circuits are banding together in search of a standard for test chips, the patterns added to semiconductor wafers to check the quality of fabricated IC dice. Without the test patterns added to a wafer of custom ICs, they find they are facing costly and often imprecise testing procedures, stemming from the low production volumes of their designs.

Custom design by its nature produces nonstandard ICs and testing has always been a problem, though less acute with large runs that in effect become standard circuits. But a burgeoning user group of university research and development laboratories, government agencies, and small original-equipment manufacturers are ordering small runs of their own designs from semiconductor makers.

Meeting. Representatives of this group met recently on the Pasadena, Calif., campus of the California Institute of Technology and took the first tentative steps towards standard test chips. They also found themselves in debate with representatives of the IC production houses on the issue of process versus device testing.

"We need test chips in multipurpose chip runs to determine whether a fabricator has done his job in providing the devices the designer specified," says George Lewicki, organizer of the Cal Tech session and a staff member at Information Science Institute, Los Angeles, which coordinates design R&D for the Pentagon's Defense Advanced Research Products Agency. The need is for a check

Dictaphone doubles up on processors

Not one, but two single-chip microcomputers nestle inside Dictaphone Corp.'s new line of dictation/transcription equipment. The Rye, N. Y., subsidiary of Pitney Bowes Inc. has put processors in past products, but the new Dictamation line is the company's first double-barrelled use.

As before, the processors' primary functions are to provide the user with control features and information about the machine's operation. However, the degree of control and the amount of information is greatly expanded.

One of the microcomputers, a National Semiconductor Corp. 4-bit COP 420, controls up to 15 touch-sensitive function keys, including the row of 11 at the base of the machine in the photograph. "The processor controls the interrelationships among various functions, including a full remote-control microphone," says William R. Blash, director of program management.

The other chip, an 8-bit 3870 from Fairchild Camera & Instrument Corp., controls display functions by interacting with the 420 or by reading out tone-coded data indicating the beginning or end of a letter or the presence of special instructions entered on the tape by the dictater.

The light-emitting-diode displays run across the top of the machine and include a time-chart display that shows the times on the 30-minute tapes where letters begin and where special instructions have been dictated. An alphanumeric display shows such information as the length of a letter, and four LED rectangular lamps light to indicate the lack of a cassette and other warnings. Prices in the Dictamation product line will range from \$495 to 650, depending which control features are included.

An option on the new family also shown below is the Messagemaster telephone message center, a module that fits on top and includes another display and two function keys. Users may control it remotely, over the telephone line.

-Pamela Hamilton

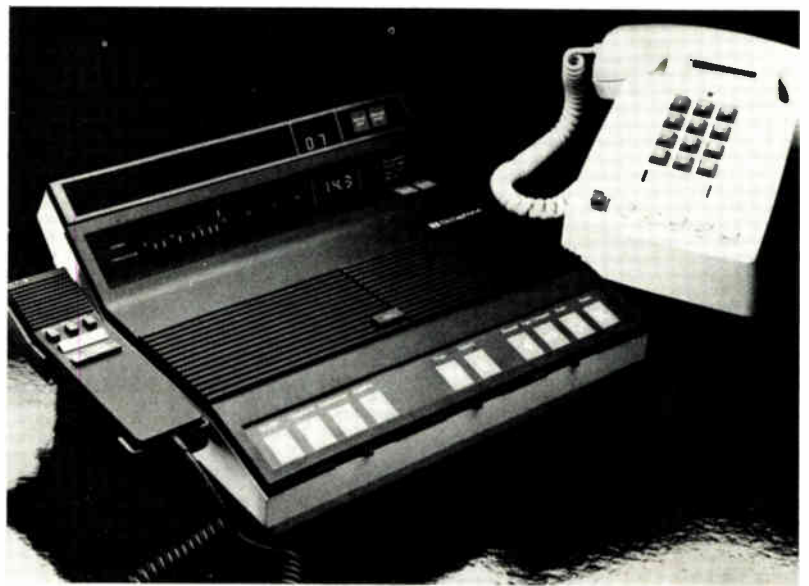

on device performance, not process parameters, said Lewicki and designers at the session.

Such a vision of the test chip runs counter to the accepted wisdom. For example, the National Bureau of Standards (another sponsor of the conference, along with the Jet Propulsion Laboratory at Cal Tech) has

developed a number of test chips to verify processing quality, and these work well for the semiconductor makers.

However, IC makers balk at disclosing their test methods, because they could reveal process secrets. Lewicki and others say that reluctance makes it difficult to get the



Don McCafferty

Choosing the right mechanical fastener

When choosing a mechanical fastener for a particular application, following past company design practices or an in-house preference list may cause you to overlook current "state of the art." When viewing an application, start fresh and consider the following:

MATERIAL COMPATIBILITY

between fastener and components is a must. If dissimilar materials are to be used, check a galvanic series chart to assure compatibility of base materials. Don't forget to investigate plating or other special finish options.

STRESS AND VIBRATION are factors that dictate type, diameter and number of fasteners, which, in turn, affect spacing. Spacing rules are: 1) On-center spacing between fasteners should be *no less* than three fastener diameters. 2) Fasteners should be placed no less than two diameters in from the edge of materials being joined.

USE A SINGLE FASTENER TYPE for comparable functions to save money.

SAVE ASSEMBLY COSTS by choosing a minimum labor fastener. Include cost of hole preparation, rework and "floor loss" in your calculations.

Can I help you with your fastener questions, especially those pertaining to blind fasteners? Write me at Cherry Commercial Fasteners, Townsend Div. of Textron Inc., Box 2157, Santa Ana, CA 92707.

Circle 44 on reader service card



Announcing a totally new rivet for electronics. The Cherry LBPP:

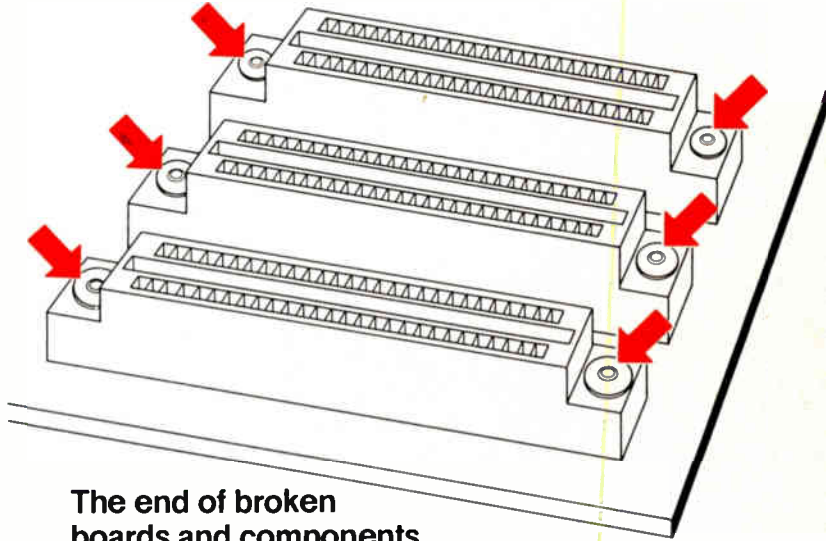

The end of broken boards and components.

The new Cherry LBPP rivet is especially designed to fasten tightly—*without breaking, cracking, crazing, or chipping fragile circuit boards.*



- Extremely low breakload for extremely low breakage.
- Softens the shock of installation.
- Positive mandrel retention: no popouts to interrupt circuit integrity.
- Excellent vibration resistance.
- Also ideal for fastening soft or breakable plastics of all types.
- Money-saving replacement for time-consuming threaded fasteners.

Stop breaking your boards. Start breaking some production records instead. Get new Cherry LBPP Rivets for Electronics.

CHERRY COMMERCIAL FASTENERS

Townsend Division of Textron Inc.
1224 E. Warner Avenue Box 2157
Santa Ana, California 92707



Townsend Division of Textron Inc.

Electronics review

specific performance data needed to build good test chips.

Actual working circuits cannot function as benchmarks when the custom ICs are few in number. Similarly, it would be impossible for each of the organizations at the Cal Tech conference to design its own test chips. "None can afford to invest enormous time or resources in test vehicles," says Lewicki.

Consensus. Thus standardized test structures holding devices that should meet known performance parameters are needed. The conference did not reach agreement on exact test chip configurations, but there was a consensus that the structures must give specific data on the performance of elementary devices like transistors and inverters.

Considering reactions from semiconductor houses, conference attendees decided they need to come up with test vehicles that provide useful data, not "jury chips" that can be used to determine the fate of an entire chip run. Also, "we have to make it clear that processing is the fabricator's business, and we have no interest in spotting any troubles," says Lewicki. **-Larry Waller**

Microwaves

All's quiet on the front for military uses

The U. S. military microwave market will march along at an annual growth rate of 15% to 20% in the next five years, but technologically the period will be at parade rest. In fact, there will be no radical shifts in components or systems, in terms of their dollar impact on the market, says a just published study from the New York consulting firm, Frost & Sullivan Inc.

Evolutionary technology—a continuing trend—means that established firms must look for growth by increasing share in their traditional markets, rather than by opening up new markets with technological breakthroughs. For new firms, which traditionally are born with a techno-

| Systems | 1980 | 1981 | 1982 | 1983 | 1984 | 1985 | Total |
|--------------------|------|------|------|-------|-------|-------|-------|
| Radar | 665 | 810 | 985 | 1,155 | 1,330 | 1,500 | 6,445 |
| Electronic warfare | 420 | 510 | 630 | 745 | 880 | 1,005 | 4,190 |
| Communications | 38 | 44 | 50 | 56 | 61 | 63 | 312 |
| Navigation | 48 | 55 | 65 | 73 | 80 | 88 | 409 |
| Other | 33 | 36 | 38 | 40 | 38 | 38 | 223 |

SOURCE: FROST & SULLIVAN

logically innovative product to offer, evolution means it will be difficult for them to make their mark.

"It is true the market will expand [see table], but this will be because of additional quantities of both present and gradually changing components," says Henry M. Berler, Frost & Sullivan's vice president for research. "Even if there were a significant technological change, by the time planning, funding, and development cycles are considered, we would be in 1987."

Decade. Since nothing technologically of note has taken place during the past five years, these time scales make it clear that the next five will be less than exciting, says the study. "Even the much heralded developments in microwave gallium-arsenide field-effect transistors are not an exception," Berler says.

"Sure, this is a growth area, but it is not a structural shift of any appreciable magnitude in the microwave components market." Of course, he is referring to dollar content, and not to the ultimate technological significance of GaAs FETs.

The consulting firm does expect better than a fivefold increase in sales of millimeter-wave parts, from \$20 million in 1980 to \$110 million in 1985. Yet the base is very small, it points out, and "even at the wildest prediction, total millimeter-wave sales will not exceed 5% of the military microwave market." By 1985, Frost & Sullivan expects applications in missiles and point-to-point communications.

The 1975-85 evolutionary trend indicates that microwave compo-

nents and systems are mature technologically. The parts available can do the jobs that users want accomplished. True, the standard evolutionary trends are there—ever-improving bandwidths, the endless search for lower-noise parts, and solid-state parts nibbling away at microwave vacuum tubes.

More. Add to evolutionary technology the industry's other problems, says Frost & Sullivan. There is a shortage of engineers, both because military procurement cycles have caused major personnel upheavals in the past and because engineering schools are turning out predominant digital designers.

Perhaps even more important is the classic inability of most microwave firms to attract large capital infusions so that they may fully adopt modern industrial engineering techniques to increase productivity. The great bulk of the companies, especially in the components end, remain mom-and-pop operations, garnering annual revenues of \$3 million or less. **-Harvey J. Hindin**

Military

'Invisible-plane' plan has many goals

"Invisible" aircraft that can defeat enemy radar are suddenly very visible, with the Carter Administration preparing for battle in this fall's presidential election. But, as interviews with Department of Defense and industry officials make clear,

Portability plus in communications counters.

Model 6243A
1,250 MHz

Model 6242A
512 MHz

Model 6241
100 MHz

100 MHz • 512 MHz • 1250 MHz

Systron-Donner's communications counters offer the latest technology in precision frequency measurement along with a battery pack option that lets you take them anywhere.

- **Tone measurement (opt.):** Allows measurement of low frequencies with high speed and resolution. For example, 0.01 Hz resolution measurements may be made in 1 second.
- **Overload protection:** Input fuse allows counter to withstand high input signal levels without damage.
- **Sensitivity:** 10mV rms for all three models.
- **Display:** 8 LED digits with excellent visibility, 0.1 Hz resolution.
- **Many options:** It's a simple matter to tailor an instrument to your needs for accuracy, stability and BCD outputs.

All models accept an *internal* battery pack that does not increase the size of these compact instruments. Battery power begins automatically when AC power fails or is removed.

In addition to communications applications, these counters are ideally suited for any use that requires high sensitivity and wide range frequency measurements.

For more information or sales assistance, contact your Scientific Devices office or Systron-Donner at 2727 Systron Drive, Concord, CA 94518. Telephone (415) 676-5000.



S-D: the frequency measurement people,
and a lot more.

SYSTRON DONNER

PUT OUR PERFORMANCE TO THE TEST

accelerated development is under way on a second-generation subsonic Cruise missile and pilotless reconnaissance planes employing a mix of technologies to make them virtually undetectable by ground or airborne radar or infrared systems.

A manned bomber is the ultimate goal. A secondary goal for the Stealth program is the development of manned tactical fighters and reconnaissance planes using a similar mix of advanced aerodynamics, absorbent plastics and ceramics, and other technologies. Such planes also would be enhanced by active electronic countermeasures considered too costly for missiles like the Cruise family.

History. The effects on radar of absorbent paints have been known since Hitler's Luftwaffe used them, and absorbent materials for radio-frequency and radar anechoic chambers and for aircraft have been available for more than two decades. Now the Pentagon is committing more than \$100 million a year to advance the technology.

"The problem is that an aircraft, or parts of it, either can act like an antenna, reradiating radar signals that strike it, or because of its design, say, around the air intakes, wing roots, tail, and so on, can act like a corner reflector, bouncing the incoming wave back in the direction from which it came," says M. William Frasca, sales manager of the microwave products group of Emerson and Cuming, Dewey & Almay Chemical. The Canton, Mass., subsidiary of W. R. Grace & Co. makes absorbers for anechoic chambers and absorbing material for aircraft applications.

However, "radar cross section is more than a matter of covering an airframe with an absorptive material," Frasca continues. "It has to take the physical relationships of the various parts into account to minimize re-emission and reflections."

Equally important are infrared emissions, for they attract radar-controlled heat-seeking missiles. One goal of Stealth is prototypes of a new Cruise missile class with movable forward-swept wings that conceal

News briefs

Amdahl seeks to sell 2,000,000 new shares

In a move that should raise over \$50 million in capital for the development of new computers, Amdahl Corp. of Sunnyvale, Calif., is planning to sell over 2 million new shares of common stock. The mainframe computer maker will sell about 1.35 million shares to the public and another 650,000 shares to its largest shareholder, Fujitsu Ltd. Although the official announcement specified only that the money would "be available for the expansion of working capital and to finance computer leases to customers, as required," a company spokesman suggested still other uses. Amdahl needs to add capabilities in the front-end processor and communications areas beyond its acquisition of Tran Telecommunications Corp. of Marina del Rey, Calif., in July, he said. Since the corporation does not see the right kind of company available for acquisition, it will probably build up its own capability. The financing of computer leases mentioned by the company, other sources indicate, points to the introduction of a new generation of computers. "They're just waiting for IBM to announce the H series next year," claims one expert. The company spokesman acknowledged that Amdahl is currently spending heavily on research and development for the new computers and that some of the new capital will be used there.

Photons help NBS, IBM study surface of solids

Researchers at the National Bureau of Standards in Washington, D. C., and International Business Machines Corp.'s Thomas J. Watson Research Center, Yorktown Heights, N. Y., have jointly developed an improved technique for studying the surfaces of solids, possibly including semiconductor crystals. In the new method, termed angle-resolved photon-stimulated desorption, selective cleaving of surface chemical bonds provides information about their angular orientation. Unlike electron-stimulated desorption systems, the quantized photons impart either all or none of their energy to a target surface atom. Using 8-to-120-electronvolt X rays derived from a tunable synchrotron, inner atomic-shell electrons that have absorbed photon energy are selectively stripped off, causing positive ions to be released from a crystal's surface. Low-energy electron diffraction has also been used to determine surface states, but a highly ordered crystal is required. What's more, the new technique will both locate and determine the angle of surface bonds for samples lacking such long-range order, and relatively little mathematical computation is required.

AT&T to replace Comstar satellites with Hughes-built Telstar 3

American Telephone & Telegraph Co. wants Federal Communications Commission approval for a June 1983 launch of the first of three high-capacity domestic communications satellites. The series, called Telstar 3, is to be built by Hughes Aircraft Co. under a \$137 million contract awarded at the end of August; FCC approval is expected this year. The satellites will handle 21,600 simultaneous conversations and have a 10-year design life, compared with the 18,000 links and seven-year lifetime of the Comstar satellites they will replace. The Comstar satellites are leased by AT&T from Comsat General Corp., the Washington, D. C., subsidiary of Communications Satellite Corp. Hughes will also build a new 13-meter antenna at AT&T's Hawley, Pa., tracking station to help place the satellites in orbit, as well as serve as a backup control for the three 30-meter antennas there. The second satellite is set for launching in 1984 and the third for 1985 or 1986.

Module turns scope into waveform recorder

To replace special-purpose units costing thousands of dollars, a small instrumentation company in Foster City, Calif., has developed a \$295 front-end module that transforms an ordinary oscilloscope into a waveform recorder. Dubbed the Wavesaver by Epic Instruments Inc., the module acts as a triggered 1,000-sample buffer that digitizes its samples with an 8-bit resolution accurate to within 1 least significant bit.

**You might have thought
our world was round**





Think again.

BELDEN FLAT CABLE & CONNECTOR SYSTEMS

Sorry, Columbus. When it comes to cable, round is not always right. And we should know, we make both round and flat cable.

For mass terminations, Belden Flat Cable and Connector Systems offer substantial improvements in installation time, serviceability and cost effectiveness when compared to round cable. What's more, Belden Flat Cable is worlds away from other flat cable. With tough, flexible insulations; uniform centers; easier breakouts; and much more. It's the kind of quality that keeps total end costs down to earth.

We offer a wide range of custom and standard flat cables—.050", .100" and .156" centers; laminated;

bonded; jumper cables in bulk rolls or pre-stripped lengths; and our unique twisted pair cable, Vari-Twist™

Vari-Twist is the only twisted pair cable which has both opposite direction lays—and varying length of lay—on each adjacent pair as a standard product.

Combine all our flat cable with dependable Belden connectors and accessories, and you have a complete flat cable and connector system. A complete system which is made even better by the full service and custom engineering capabilities you've come to expect from Belden.

Let us put our world of flat cable to work for you. You'll discover we beat the competition flat.

CIRCLE NUMBER 222 ON THE READER SERVICE CARD.



Belden takes the system approach

Quality Flat Cables

Belden makes flat cable for all types of applications.

Among our flat cable capabilities:

- Round conductors, (solid, stranded, or unistrand)
- Flat conductors (Mylar or Kapton insulation)
- Bulk and precut, prestripped jumper cables
- PVC solid or color-coded laminations
- Cable assemblies made to specifications
- Compatibility with all major makes of connectors
- Passes VW-1 Vertical Flame Test

Compatible Connectors

Belden connectors provide fast, easy installation; reliable connections; and long service life. Among the features offered by all Belden connectors:

- -55°C to +105°C temperature range
- 30V DC UL voltage ratings
- Phosphor-bronze (gold-over-nickel plating) contact materials
- Highly reliable U-contact (double action IDC) on all IDC connectors
- Solvent-resistant glass-filled PBT housings
- UL recognized 94V-0

Bonded Flat Cable

- 10 to 30 conductors
- 22, 24 and 26 AWG stranded
- 80°C temperature rating
- 300V voltage rating
- UL style number 2697



Headers

- .100" (2.54mm) grid contact/terminal spacing
- Selective plating (gold-plated contact and solder-plated terminal)
- Flex lock/eject hooks
- Many diversifications (10 to 60 pins, wire-wrap/straight/right angle)



Laminated Flat Cable

- .050" (1.27mm) spacing
- 10 to 64 conductors, 28 AWG stranded
- 105°C temperature rating
- 300V voltage rating
- UL style number 2651

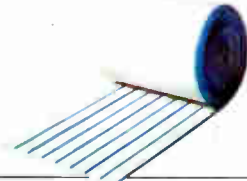

Socket Connectors

- .100" (2.54mm) contact spacing
- Double-cantilever contact
- Bottom-entry contact
- Many diversifications (10 to 60 pins, closed-end/through-end)
- Dual-beamed contacts
- Polycarbonate strain relief

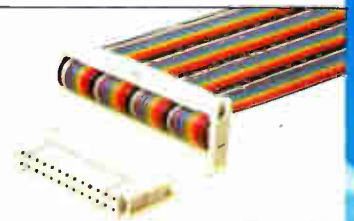

Rainbow Flat Cable

- .050" (1.27mm) spacing
- 10 to 64 conductors, 28 AWG stranded
- 105°C temperature rating
- 300V voltage rating
- UL style number 2884



Low-profile Socket Connectors

- .100" (2.54mm) contact spacing
- Double-cantilever contact
- Bottom-entry contact
- Dual-beamed contacts
- Many diversifications (10 to 60 pins)

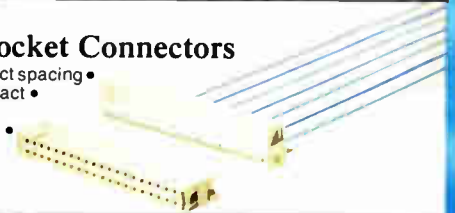

.100/.156 Flat Cable

- .100" (2.54mm) spacing, 2 to 28 conductors
- .156" (3.96mm) spacing, 2 to 24 conductors
- 22, 24, 26 and 28 AWG stranded
- (.100)/18, 22, 24 and 26 AWG stranded (.156)
- Rated to 105°C & 300V



Card Edge Connectors

- .100" (2.54mm) contact spacing
- Bifurcated contacts
- Many diversifications (10 to 60 pins; with ears, half ears or without ears; and with or without strain relief)

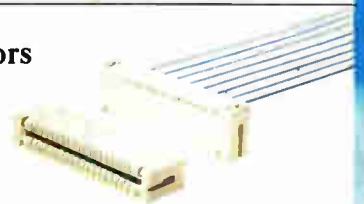

Vari-Twist™ Flat Cable

- .050" (1.27mm) spacing
- 5 to 32 pairs
- Adjacent pairs have opposite lays
- Lay length varies with each adjacent pair
- 105°C temperature rating
- 300V voltage rating



D.I.P. Connectors

- Plugs into IC sockets or can be soldered for permanent connections
- Low-profile installation on PC board
- Many diversifications (10 to 60 pins)



Write for our free Catalog

Belden Corporation, Electronic Division, P.O. Box 1980, Richmond, IN 47374. Phone: (317) 983-5200. Out west, call our regional sales office at (714) 833-7700. In the east, call our sales office at (617) 872-7846.

CIRCLE NUMBER 222 ON THE READER SERVICE CARD.

P.C.B. Transition Connectors

- Tinned pins for excellent solderability
- For reliable permanent PC board connections
- 1.6mm (1/16") standard thickness of PC board
- 14, 16, 24 and 40 position connectors

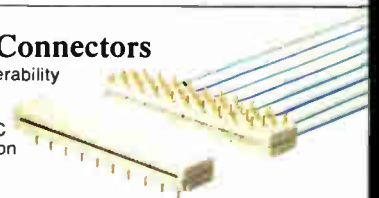

BELDEN

Coming through...

with new ideas for moving electrical energy

Printed in USA

Processors control home drills

Now it's going to be microprocessors in the home shop, as well as in the kitchen range, the bathroom scale, and the stereophonic receiver. Black & Decker Manufacturing Co. has a drill press (right) and a hand-held drill controlled by 8-bit 3870 microcomputers from Motorola.

"We wanted to improve the speed-control aspects of our tools," says John W. Casner, product manager for the Towson, Md., firm. "Most tools' torque diminishes at low speeds, but many situations require the low speed for the user to be in command of the tool. With digital control, we are able to maintain torque even at low speeds." The microcomputer uses a triac to control conduction of current to the motor. The 3870 monitors the motor's speed 120 times a second.

Both the 9413 drill press and the 7266 reversing drill have a shut-off controlled by the microprocessor, to stop them if incorrect speed or drilling pressure is used too long. "We've developed algorithms that model how a drill fails and use these instead of a thermocouple or heat sensor," says Casner. "They're better than a heat sensor that depends on heat transfer and that can't be put on a rotating armature anyway."

Under processor control, the drill

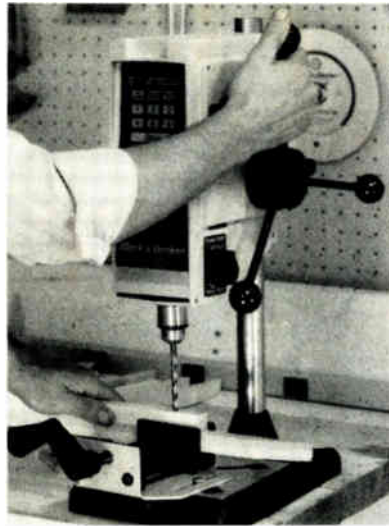

press indicates the depth of the hole being drilled in 20-mil increments, also storing in memory the last speed used. The user can check on the current drill speed as well. It will carry a suggested retail price of about \$180, while the reversing drill will sell for about \$100. For the drill press, that is roughly 20% more than comparable units without microprocessor control; the reversing drill has a number of features that other drills do not, so prices cannot be compared directly. **-Pamela Hamilton**

engine intakes and a minicomputer-controlled movable exhaust nozzle to deflect the IR output.

DOD funds are going to a handful of airframe, engine, and electronics firms participating in an effort guided by a Lockheed Aircraft Corp. team. Under Secretary of Defense William J. Perry acknowledges that Stealth's budget "is 100 times greater than when we decided to accelerate the program in 1977," but he declined to specify amounts. He did say that Stealth-like programs have been going on for two decades.

Perry said the Soviet Union "has built thousands of surface-to-air missile systems employing radars with high power and monopulse tracking systems, which are very difficult to jam. In the past few years, they have developed air-to-air missiles guided

by look-down radars that are capable of detecting low-flying aircraft in ground clutter."

Three years ago, he continued, the DOD concluded that the "invisible" technologies found in first-generation Cruise missiles could make manned aircraft "so difficult to detect that they could not be successfully engaged by any existing air defense system." Perry asserted that "existence of the Stealth program has become public knowledge because of the program's rapid growth and the consequent need to involve more people in Government and industry."

He claims "excellent success" for Stealth flight tests, and other DOD officials claim that two crashes so far in the program were not caused by technology failures. The result of

FREE

WORD PROCESSOR and REPORT WRITER when you buy this CADO COMPUTER!

Now... own a complete CADO business computer and word processor for about the cost of IBM's computer-only 5120. It's the only low cost system that's multi-tasking: you can actually enter your payables or receivables at the same time you print perfect letters or documents.

CADO is the perfect way to keep track of things, too: personnel, sales, purchase orders... everything. And only CADO has JUST ASK II—the simple, programmerless English language inquiry system. It's free, too. JUST ASK II works with Word Processing to automatically insert names and facts in your standard letters. And CADO has an application package just for you.

Get all the facts on the only computer with free word processor and report writer... from the world's fastest growing computer company... sold and serviced in over 150 CADO offices worldwide.

Send in the coupon NOW!

CADO SYSTEMS

CADO Systems Corporation
2771 Toledo Street • Torrance, CA 90503
(213) 320-9660 EL9

Please rush me more information on the CADO System 20/22.

NAME _____
TITLE _____
COMPANY _____
ADDRESS _____
CITY _____ STATE _____ ZIP _____

Mini-printers from C. Itoh.

The 500 series from C. Itoh contains some of the most reliable 40-column, dot matrix impact print mechanisms currently available to the industry. They should cost a lot more, of course.

But since they're from C. Itoh, they don't. There's the Model 512 40-column journal printer; two-stage 18-column journal and 18-column logo stamp; and the Model 542 40-column slip printer. All with a head life of 100

Small wonders.

and a mechanism MCBF of five million lines; all bi-directional with a print speed of 152 CPS. And, of course, all from C. Itoh, the name to trust in printers of any size. Detailed specifications on any or all three are yours for the asking. Write to us.

C. Itoh Electronics, Inc.

C. Itoh means excellence in printers.

5301 Beethoven Street, Los Angeles, CA 90066
Call: (213) 390-7778 · Telex: WU 65-2451
East Coast
666 Third Avenue, New York, NY 10017
Call: (212) 682-0420 · Telex: WU 12-5059

C. Itoh Electronics is part of the C. Itoh & Co. Ltd. world-wide trading organization.

Circle 54 on reader service card

FREE

Brochure describes Electronics editorial reprints, services, books...

- More than 70 article reprints in 15 subject categories
- Handy wall charts
- Custom-made reprint services
- Books especially for **Electronics'** readers
- Convenient postage-paid order cards



For your free copy, circle #275 on the reader service card.

Electronics review

the program may well be aircraft with re-emission and reflection signatures undetectable by present Soviet radars—but an open question is whether such planes will be invisible to future, more powerful detection gear.

-Ray Connolly

Computers

Updated hardware is route for mini net

With competition getting rough in the field of minicomputer-based distributed data-processing systems, manufacturers are busily upgrading their offerings. Among them is Computer Automation Inc., which is keeping intact all its proven networking software and upgrading its hardware.

"Our goal is to push for maximum hardware performance without going out onto any shaky technological limbs," says George Dashiell, who runs the Irvine, Calif., firm's Commercial Systems division. While the Syfa 2000 can operate with an IBM host computer, like the predecessor Syfa 1000, it adds processing muscle for more powerful remote data processing. Among the changes:

- A central processing unit based on the company's LSI 2/120 processor, rather than the earlier LSI 2/60.
- A cache memory for instructions, plus modules of 256-K instead of 64-K bytes, operating at 525 nanoseconds rather than 700 ns.
- Microprocessor-based front-end controllers for peripheral interfacing, data-base management, and communications protocols.
- A "semiconductor disk" that is in effect a cache for two disk drives.

The result is throughput at least twice as fast as the Syfa 1000. Interestingly, other minicomputer makers like Digital Equipment Corp. have found their route to upgraded distributed processing is improved software [*Electronics*, Feb. 14, p. 183]. The impetus for much of this upgrading is IBM's System 8100, the computer giant's maiden effort in the field.

-Larry Waller

The Pacesetter.

781 RO Receive-Only Printer

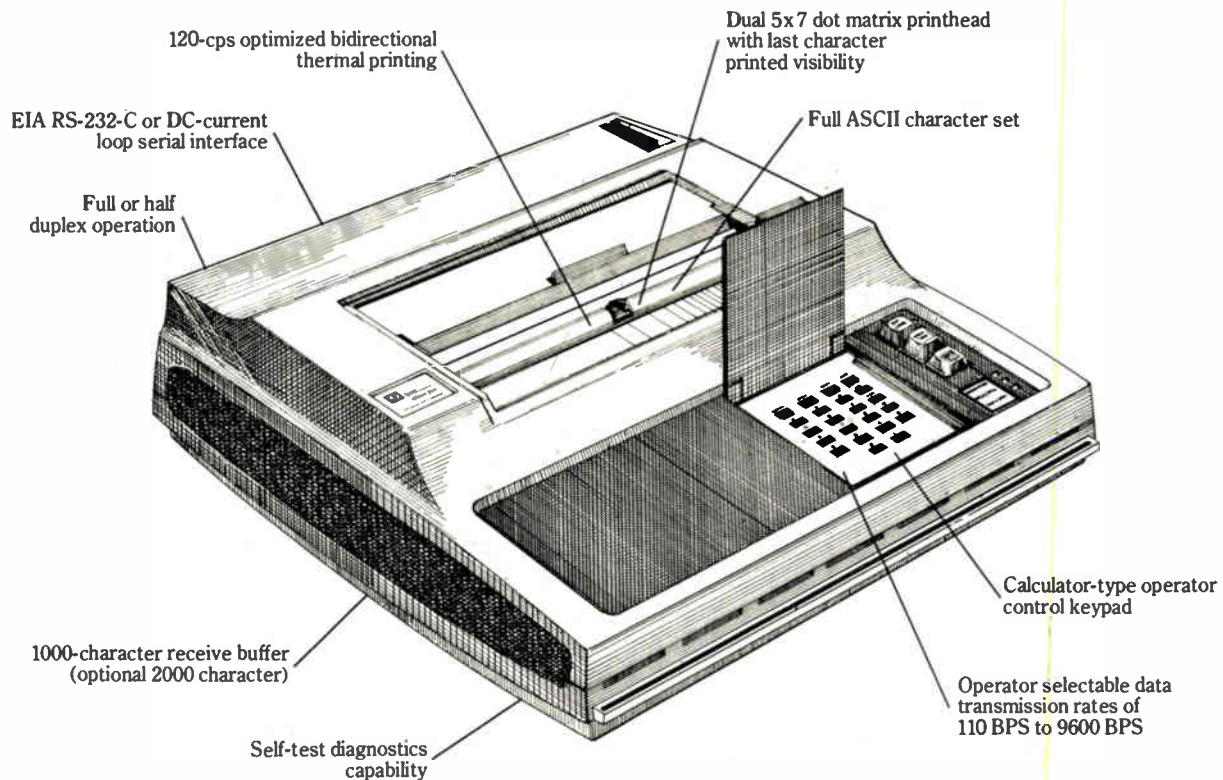

Fast and virtually silent, TI's *Silent 700** Model 781 RO Printer speeds through the toughest printing applications. The 781 RO's unique 120-cps dual-matrix thermal printhead cuts down on print cycle time to improve your printing capabilities. And its compact design makes it ideal for work areas, especially when space is limited. With its innovative standard features, the flexible 781 RO has set the pace for expanding

high output silent printing.

TI is dedicated to producing quality, innovative products like the Model 781 Receive-Only Printer. TI's hundreds of thousands of data terminals shipped worldwide are backed by the technology and reliability that come from 50 years of experience, and are supported by our worldwide organization of factory-trained sales and service representatives.

For more information on the 781 RO, contact the TI sales office nearest you or write Texas Instruments Incorporated, P.O. Box 1444, M/S 7784, Houston, Texas 77001, or phone (713) 937-2016. In Europe, write Texas Instruments Incorporated, M/S 74, B.P. 5, Villeneuve-Loubet, 06270, France.



*Trademark of Texas Instruments †Service Mark of Texas Instruments Copyright ©1980, Texas Instruments Incorporated

TEXAS INSTRUMENTS

We put computing within everyone's reach.

ICM7218: THE FIRST 8

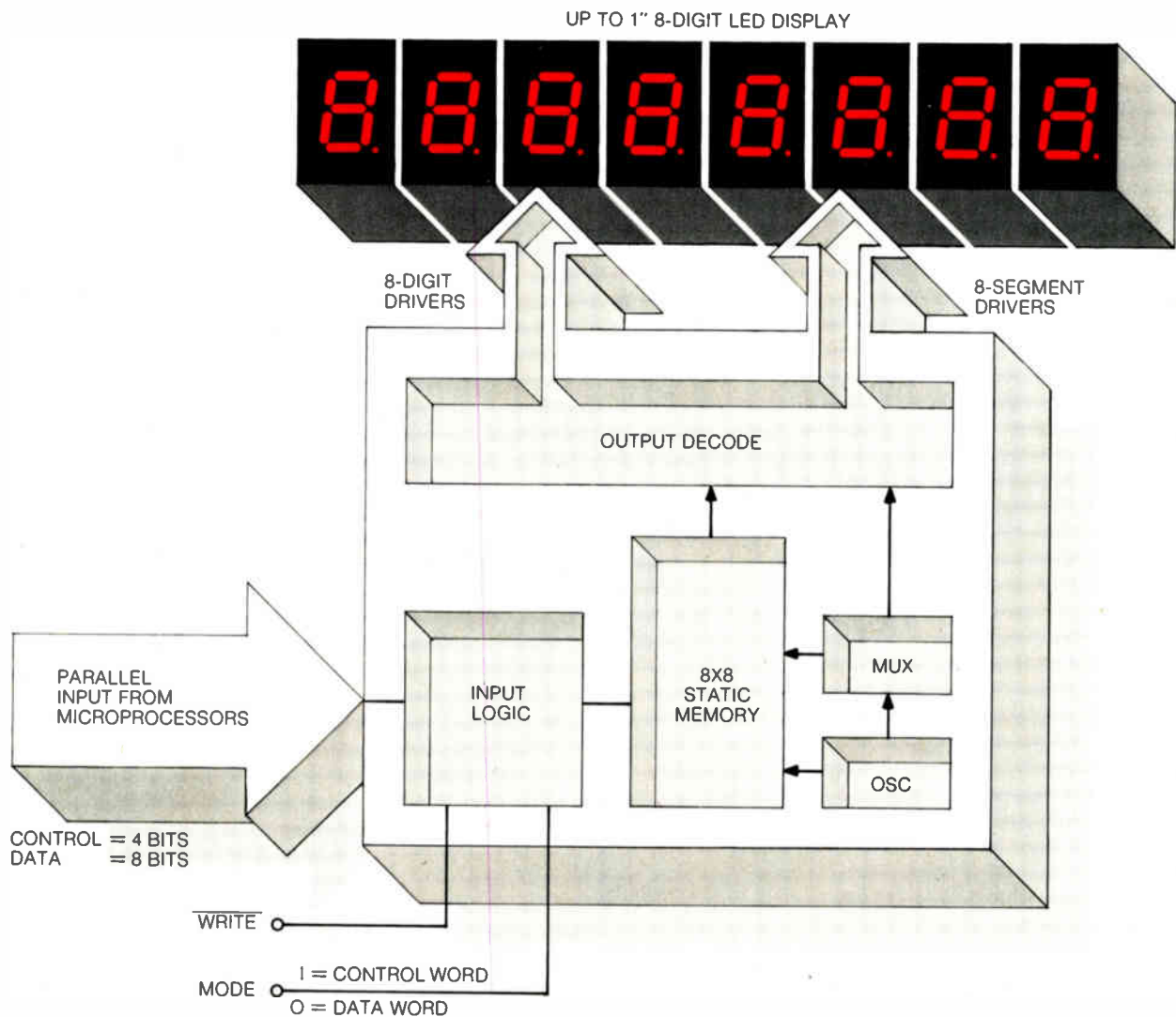

**YOU CAN BUY IT OUR WAY: MONOLITHIC.
YOU CAN BUILD IT THEIR WAY: WITH UP TO 20 DEVICES.**

MONOLITHIC. FROM INTERSIL.

The ICM7218 is the first 8-digit, 7-segment LED driver on a single chip. In fact, a whole series of display drivers driving up to 1" LED's. Common anode or common cathode. In low power CMOS for μ P or hardwired applications.

TEAR UP YOUR SHOPPING LIST.

Until now, when you wanted to interface an 8-digit display to a system, you made up a shopping list... 15 to 20 TTL packages. 15 to 20 opportunities for the system to go down. Not now. The ICM7218 series gives you the complete system. On a single chip. With all the power you need to drive up to 1" LED's.

DIGIT DISPLAY DRIVER ON A SINGLE CHIP.

BELLS.

A full 8 x 8 of static memory is included on-chip for storage of displayed information. And that too is a first. Even for Intersil.

AND WHISTLES.

On a single chip: Digit and segment drivers. All multiplex scan circuitry. Hexadecimal or Code B Decoding. Pin selectable choice of 7-segment decode or no-decode. A shutdown feature that turns off the display and puts the chip in a very low power mode while continuing to retain data. And, since they're manufactured in Intersil's MAXCMOS™ process, the ICM7218's operate on a single 5V supply.

MICROPROCESSOR READOUTS.

The ICM7218 A & B are intended for use with μ P-based systems and drive up to 1", 8-digit, 7-segment LED displays. Or, in the no-decode mode, you can drive 64 individually addressable "ON-OFF" LED's. Common anode or common cathode.

HARDWIRED SYSTEMS.

The ICM7218 C & D are intended for hardwired systems. Again, common anode or cathode. Both μ P-based and hardwired versions are available in 28-pin DIP's. The ICM7218E is a common anode, 40-pin version for hardwired applications. The "E" provides 4 separate lines for control information, 8 lines for data input and 3 lines for BCD digit address.

MAXCMOS™ PERFORMANCE. YOUR KIND OF PRICE.

| | PINS | PLASTIC PKG | CERDIP PKG | CERAMIC PKG | COMMON CATHODE | COMMON ANODE | MICROPROCESSOR READOUT HARDWIRED VERSION | 1-24 | 25-99 | 100-999 |
|-------------|------|-------------|------------|-------------|----------------|--------------|--|-------|-------|---------|
| ICM7218AIJI | 28 | x | | | x | x | | 9.45 | 7.55 | 6.30 |
| ICM7218BIP1 | 28 | x | | x | x | | | 9.00 | 7.20 | 6.00 |
| ICM7218CIJI | 28 | x | | | x | x | | 9.45 | 7.55 | 6.30 |
| ICM7218DIP1 | 28 | x | | x | | x | | 9.00 | 7.20 | 6.00 |
| ICM7218EIDL | 40 | | x | | x | x | | 12.75 | 10.20 | 8.50 |

THE UNEXPECTED IN MAXCMOS™ FROM INTERSIL.

The ICM7218 Series is just the latest in Intersil's

growing family of LED and LCD drivers-on-a-chip. CMOS systems that cost less, require less design-in time, less power, and, replace dozens of discrete devices. Monolithically. Because at Intersil, your way is our way.

AVAILABLE NOW.

Call your nearest Intersil Sales Office or Franchised Distributor for our 10 page applications booklet. Or, return the coupon below.

INTERISIL SALES OFFICES:

CALIFORNIA: Sunnyvale (408) 744-0618, Long Beach (213) 436-9261 • COLORADO: Aurora (303) 750-7004
• FLORIDA: Hollywood (305) 920-2442 • ILLINOIS: Hinsdale (312) 986-5303 • MASSACHUSETTS: Lexington (617) 861-6220 • MINNESOTA: Minneapolis (612) 925-1844
• NEW JERSEY: Englewood Cliffs (201) 567-5585 • OHIO: Miamisburg (513) 866-7328 • TEXAS: Dallas (214) 369-6916
• CANADA: Brampton, Ontario (416) 457-1014

INTERISIL FRANCHISED DISTRIBUTORS:

Advent (IN, IA) • Alliance • Anthem • Arrow • Bell Industries • Cardinal • CESCO • Component Specialties • Components Plus • Diplomat (FL, MD, NJ, UT) • Harvey (upstate NY) • Kierulff • LCOMP • Newark • Panda • Parrott • R.A.E. Ind. Elect. Ltd. • RESCO/Raleigh • Schweber • Summit • Western Microtechnology • Wyle • Zentronics

INTERISIL

Analog Products—Low Power
10710 No. Tantau Ave., Cupertino, CA 95014
Tel: (408) 996-5000 TWX: 910-338-0171

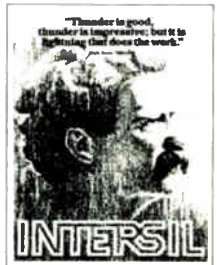

Gentlemen,

If you're willing to send me your 10 page applications booklet, I'm willing to tear up my shopping list.

And please include your 18 x 24" Mark Twain poster.

Name _____

Company _____

Address _____

City _____

State _____

Zip _____

Country _____

Phone _____

There's a powerful new source in the electronic fuse market.



We're Gould Shawmut®, and we've been making fuses exclusively for the electrical industry since 1893.

In fact, we manufactured the wire for the first fuse invented by Thomas Edison. In more recent history we introduced the first complete line of low voltage current limiting fuses in America. The first single element time delay fuse, the first miniature 1000 volt fuse for Nautilus class atomic submarine service and much more. Our leadership in fuse technology is recognized throughout the electrical industry.

Now we're extending our expertise into the electronics industry, so you have an alternative source: A new line of miniature fuses for low voltage, over-current protection. In stock. Ready for immediate

Circle 58 on reader service card

delivery. And made by Gould Shawmut.

You'll be hearing a lot from us in the future. For more information about our glass and miniature fuses write: Gould Inc., Electric Fuse Division, Newburyport, MA 01950.
Tel: (617) 462-6662, 462-3131/Telex: 94-7427.
In Canada: 406 Adelaide St., E., Toronto, Ontario M5A 1N4.
Tel: (416) 366-1981/Telex: 06-219717.

 **GOULD**
An Electrical/Electronics Company



Adapso battling Bay State tax plan for EDP services

Not since Colonial protesters dumped British tea into Boston Harbor has a tax proposal produced greater distress. This time the rebels are the 425 corporate members of the Washington-based Association of Data Processing Service Organizations (Adapso). They are fighting the proposed extension of a 5% Massachusetts sales and use tax to computer program transactions—including **most timesharing services, remote and batch processing, keypunching, and other forms of data conversion—and professional software services.** All of these, of course, are the corporate lifeblood of Adapso's members, who view the Massachusetts tax program's passage as part of a trend that could become a national threat. California, Connecticut, and Wisconsin already have software service sales taxes, and Tennessee imposes a property tax.

Thus, more than 100 industry members descended on Massachusetts Commissioner of Revenue L. Joyce Hampers at the end of August to vigorously protest the plan to tax computer program transactions. "The regulation exceeds the limits of Massachusetts law," argues Adapso attorney Ronald J. Palenski, **since the computer services offered by association members "are personal service transactions, within which sales of tangible personal property [now subject to tax] are either absent or inconsequentialy involved."** Purchasers are buying the professional or personal services that went into developing a computer program, Palenski contends, rather than property containing the program, such as a reel of computer tape.

Survey satellite with 10-terabit memory forecast

A highly automated earth-survey satellite with a 10-terabit memory is among the proposals to emerge from a National Aeronautics and Space Administration workshop. The 10-week summer session assessed potential systems for space in the next 25 years. Using its vast memory to store a periodically updated world model, **the satellite would report only exceptions to the model,** such as crop condition changes, ignoring established phenomena. This approach, concludes the workshop of engineers and scientists from NASA, universities, and industry, would result in a "major reduction in the amount of data that must be transmitted and analyzed."

Solarsat heating of ionosphere is negligible, says NTIA

Would microwave transmissions from a solar-power satellite (SPS) to a ground antenna for electricity production raise the temperature of the ionosphere, damage its value as a telecommunications medium, and alter the earth's environment? The threat is negligible, replies a new report by the Commerce Department's National Telecommunications and Information Administration following **simulations of ionospheric heating** at its Boulder, Colo., facility. The NTIA's Charles Rush, principal author of the report, says high-frequency radio waves were used, since less energy density is required to achieve the heating effect in the ionosphere. Then Omega (very low frequency), Loran-C (low frequency), am radio broadcasts, and other **known signals were monitored after passing through the heated ionosphere.** The impact on the signals was minimal, it says, as was the level of ionospheric heating that a solar-power satellite operating at 23 mW/cm² could be expected to produce. The NTIA report, number 80-37, by Rush and others at the Institute of Telecommunications Sciences is entitled "Impact of SPS heating on Vlf, Lf, and Mf Telecommunications Systems Ascertained by Experimental Means." It may be obtained for \$9 from the National Technical Information Service, Springfield, Va. 22161.

The politics of Stealth

Technology and politics are mixed regularly in Washington, but rarely with such a heavy hand as when Defense Secretary Harold Brown briefed the press on Stealth—the label assigned to the \$100 million-plus research and development effort to reduce radar detection of U. S. subsonic cruise missiles and aircraft (see p. 46). Brown and his under secretary for research and engineering, William J. Perry, are being accused of playing election-year politics with a top-secret program to bolster the Carter Administration's sagging defense image. And there is much evidence to support the charge.

After a story citing successful flight tests using the mix of technologies that make up Stealth appeared late in August in the *Armed Forces Journal*, a monthly publication with close ties to the military establishment, Brown got a lot of media mileage by confirming the program's existence, saying, "It alters the military balance [with the Soviet Union] significantly." Yet the fact that the Defense Advanced Research Projects Agency (Darpa) is heavily involved with the Air Force in the Stealth program is evidence that Brown was overstating the Pentagon's case. Darpa projects are invariably 7 to 10 years away from producing a deployable weapon. Darpa's role, as Brown himself put it in congressional testimony early this year, is "to explore the leading edge of technology."

Conning the Congress

Congress wants a new bomber, as it recently demonstrated by giving the Pentagon some \$300 million it had not requested for fiscal 1981 to begin exploring the parameters of such a weapon. At the same time, the legislators called on the President to decide by next March 15 whether the new bomber would be a stretched General Dynamics FB-111, a resurrection of the Rockwell International B-1 canceled earlier by President Carter, or an altogether new weapon employing advanced technologies.

The potential for Stealth's technologies—a complex mix ranging from super-strong absorbent plastics for new aerodynamic structures to computer-dispensed aerosols laden with particles to decoy enemy radar—is certainly excellent for the long term. But their use for a long-range manned bomber is more than a decade away, according to countermeasures specialists, whereas cruise missiles, followed by tactical reconnaissance aircraft, promise a much earlier payoff. Thus the Darpa-USAF program is pursuing the advanced cruise missile option, even though Pentagon leaders continue to give

the distinct public impression that Stealth's greatest promise is in bombers.

Political rhetoric aside, a computer-controlled flying bomb with extended range holds the greatest promise for balancing the military scales in the U. S.—USSR arms contest in the shortest possible time. Secretary Brown acknowledged in January that the Soviets now have some 12,000 surface-to-air missiles for bomber defense, plus about 2,600 manned interceptors. Moreover, the Soviets are developing what he calls "a significant look-down, shoot-down capability in some versions of the MIG-25," a plane with an exceedingly powerful radar. Says one Pentagon analyst: "We can buy a host of cruise missiles that could be indistinguishable in radar for the price of one highly visible bomber. And that should be made clear to Congress. It is going to take a lot of weapons to penetrate that [Soviet] air defense network, if we are ever forced to do that, and a new bomber is not the answer. The strategic bomber, like the battleship, is obsolete."

Changing ECM pattern

Such judgments are bound to upset makers of airborne electronic countermeasures hardware, for most ECM systems are now considered far too costly for one-shot cruise missiles. Cruise missile designers are now concentrating on Stealth's materials program to further reduce their radar detectability, which could eventually provide a boost to ECM producers. For tactical manned aircraft, ECM techniques developed under Stealth should keep the latter busy.

Even busier will be makers of airborne mini-computers that must be able to do much more than perform the primary role of guidance and navigation. With new lightweight materials for airframes and engines providing extended range, cruise missile computers must be programmed to carry out a variety of evasive actions on longer flights to targets. These functions, too, are a part of Stealth's technologies.

Under the guidance of Air Force Lt. Gen. Kelly H. Burke, deputy chief of staff for research, development, and acquisition, and Darpa director Robert Fossum, the Stealth program stands an excellent chance of reaching its targets. But they and the countermeasures community know—just as Secretary Brown and Under Secretary Perry know—that it will be some time before the military balance between America and the Soviet Union is altered by Stealth and the weapons improvements it promises.

-Ray Connolly

WE COVER THE BASES IN HI-PERFORMANCE AM-FM.

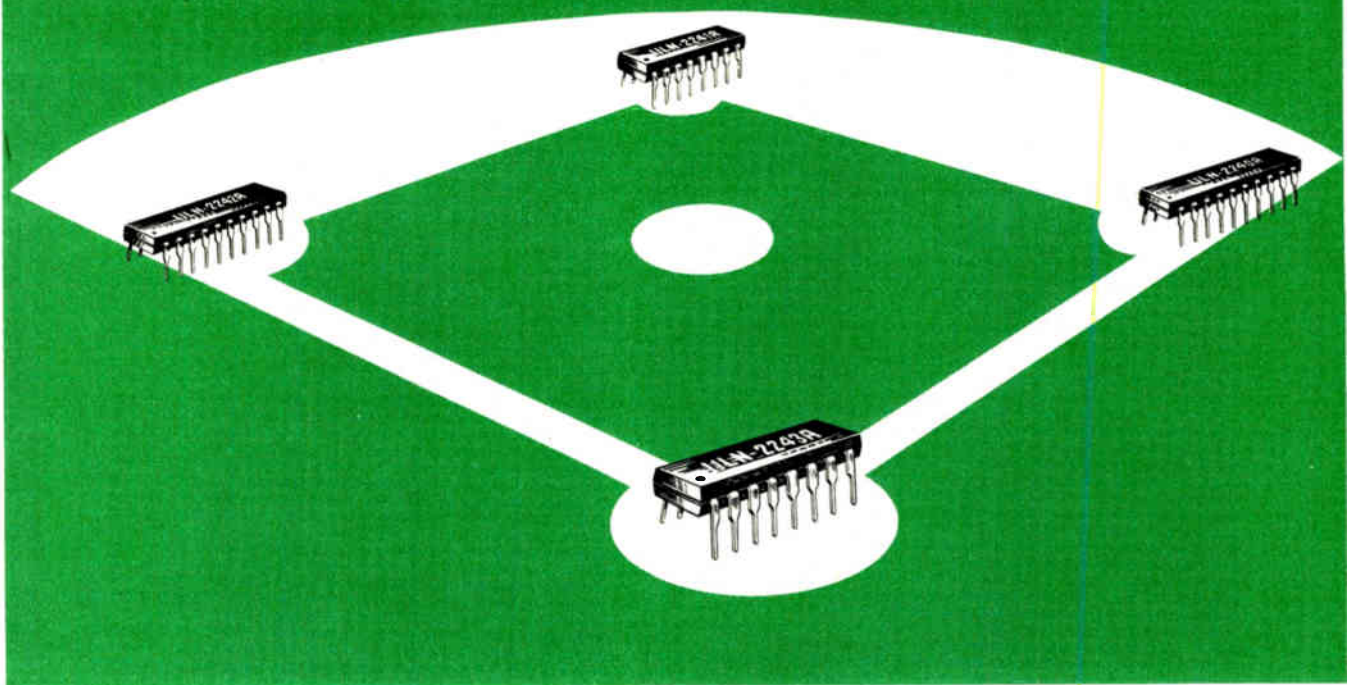

Four new additions to Sprague's IC line-up are ideal for automotive and home entertainment products.

At First Base: ULN-2240A AM/FM Signal Processing System features signal level muting and deviation muting for use in high quality Dolby® receivers.

At Second Base: ULN-2241A AM/FM Signal Processing System provides excellent performance while holding down total system cost. All FM/IF functions and all AM functions are performed by this *one-chip* receiver with minimum external parts count.

At Third Base: ULN-2242A Signal Processing System affords level muting, AFC output, and advanced circuit design without performance trade-offs.

At Home Plate: ULN-2243A Mixer/IF for FM radio applications, includes AGC detector for MOSFET R-F stage. It can be used with an inexpensive ceramic filter coupling and is capable of handling an extremely wide range of input signal levels.

For detailed information, write to: Technical Literature Service, Sprague Electric Co., 35 Marshall St., North Adams, Mass. 01247.

For application engineering assistance, write or call Ray Dewey or Roger Mailloux, Sprague Electric Company, Semiconductor Division, 115 Northeast Cutoff, Worcester, Mass. 01606. Telephone 617/853-5000

THE BROAD LINE PRODUCER OF ELECTRONIC PARTS



a subsidiary of **GK Technologies**
Incorporated

All electronic problems are



MS-180 FREON® TF Solvent – High purity, low surface tension and fast evaporation. For critical cleaning of electronic components.



MS-190 FREON TMC Solvent – Fast cleaning action removes all types of organic flux.

FREON is Du Pont's registered trademark for its fluorocarbon compounds.



MS-165 FREON TMS Solvent – Outstanding for removal of activated rosin flux, ionic soil and particulate matter.



MS-176 FREON TES Solvent – Offers long term compatibility with reactive metals and other solvent-sensitive materials.

cleaning not alike...



That's why we offer 15 different solutions



MS-160 FREON T-P 35 Solvent — Excellent for precision cleaning and water film displacement.

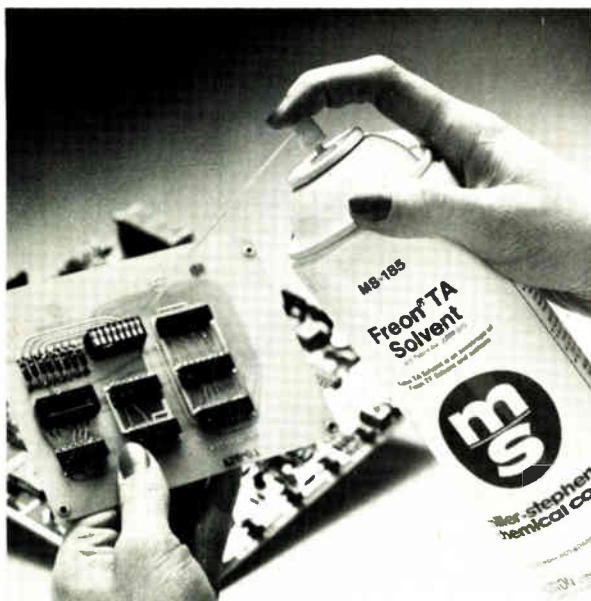

MS-185 FREON TA Solvent — Stronger solvent action for oil film removal and other tough cleaning applications.

We've developed and perfected 15 different precise solvent cleaners. Miller-Stephenson spray cleaners are specially designed to meet the toughest kind of cleaning problems you'll encounter on printed circuit boards or any other electronic application.

For years we've recognized industrial cleaning as a vital link in maintaining component and system reliability. That's why we take every possible precaution to make sure that every Miller-Stephenson product has the lowest residual contamination in the industry — some approaching 5-7 parts per million. The general industry range is 50-130 ppm.

We use only the highest grade manufacturer certified solvents and nonflammable propellants and we *double filter* our solvents and propellants, first with a 5 micron filter, then with a Millipore 0.2 absolute filter. The filtered product goes directly into seamless cans, eliminating any possibility of flux contamination from seamed cans. We have complete quality control, from tanker to customer.

Send for free Solvent Selection Guide...

To help you quickly and easily find the precise solvent cleaner for your particular application, we're offering a FREE booklet. Simply circle the Miller-Stephenson reader service form in this magazine — or write to us.

 **miller-stephenson
chemical co., inc.**

George Washington Highway, Danbury, CT 06810
Phone: (203) 743-4447

• LOS ANGELES • CHICAGO • TORONTO • DANBURY, CT.
WORLDWIDE DISTRIBUTION EM-9Y

Circle 63 on reader service card

Anyone can build great performance into a micro.
Only Digital helps you get it all out.



This Bridgeport CNC Vertical Milling Machine, controlled by Digital's powerful LSI-11/2 microcomputer, is cutting production times for customers by up to 85%.

In 16-bit micros, great hardware doesn't guarantee great performance.

You need high-powered software too.

And only Digital gives you both.

Because while everyone else is just getting started in high-performance micros, we've been shipping them for years.

So we give you all the software tools you need to make the most of great hardware.

We start where the others leave off.

Digital's LSI-11/23 micros offer the only double-precision floating point processor in the industry. Built right into the hardware so it doesn't cost you memory overhead.

You also get a memory management unit so efficient, you can run several real-time programs at once.

And you get the basic instruction set of our PDP-11 minicomputer family. It can do in one memory cycle what others would take four to accomplish.

But like we said, hardware is only half the story.

The industry's only high-performance micro software.

Digital's software systems are literally years ahead of the competition.

The RSX-11M operating system, for example, is the industry-standard real-time software for superminis.

Proven and refined over five years. And you can get it with our LSI-11/23 micros, with high-powered languages like an optimized FORTRAN IV-PLUS compiler and BASIC-PLUS-2.

And for your run-time software you can use RSX-11S, a streamlined version of 11M that takes up an incredibly small amount of memory.

Advanced development tools.

Digital's programming tools are easily the most advanced in the business. So you can concentrate on refining your application software, instead of struggling with it.

For example, you get an interactive debugger that's built right into the processor. With English diagnostics for the linkage editor, FORTRAN, and even MACRO, so you can catch bugs before your programs ever run.

And if you ever need help in your development work, Digital's Command Language will help you solve your problem with clear, English-like statements.

The total approach to micros.

At Digital, we look at micros with a systems understanding. Which is why we offer our microcomputer family – in boards, boxes and systems – with the most advanced high-performance software in the industry.

And why we offer hundreds of hardware tools, including memory and interface boards, complete development systems, peripherals and terminals. All backed by 13,000 support people worldwide.

It's the total approach to micros, only from Digital.

For more information, contact:

Digital Equipment Corporation, MR2-2/M65, One Iron Way, Marlboro, MA 01752.

Or call toll-free 800-225-9220. (In MA, HI, AK, and Canada, call 617-467-7000.)

In Europe: Digital Equipment Co.

Limited, Acre Rd., Reading, RG2 OSU, England. In Canada: Digital Equipment of Canada, Ltd. Or contact your local Hamilton/Avnet distributor.

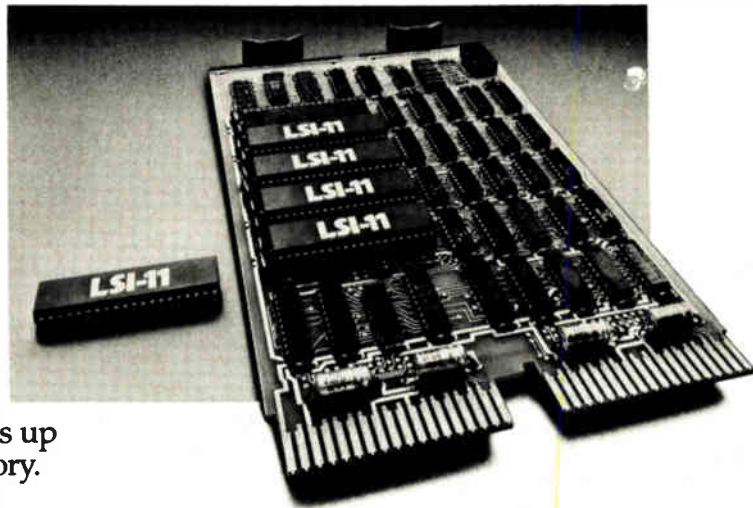

**It took the minicomputer company
to make micros this easy.**

digital

THE SUN NEVER SETS ON HYSOL.

TOKYO

 PITTSBURG, CA

 INDUSTRY, CA

ONTARIO 

SEABROOK, NH 

OLEAN, NY 

TOMS RIVER, NJ 

 ANDERSON, IN

 LONDON

PARIS 

MUNICH 

 MEXICO CITY

If you haven't tried Hysol epoxies yet, you're probably wondering how Hysol got to be the largest specialty epoxy company in the world.

Do we have to draw you a map?

Sure, we maintain one of the largest R&D efforts in the specialty chemicals field.

And sure, we make state-of-the-art epoxy encapsulants and adhesives for just

about every application around. Semiconductors. Aerospace. Electronic. Telecommunications. Industrial. You name it, we make it.

But there's one more important thing to remember about Hysol epoxies, and you won't find it on any spec sheet.

Hysol epoxies and epoxy products are manufactured at *eight* production facilities. In *five* countries. On *three* continents.

Supported by additional

customer service offices in *four* more cities. In *three* countries. On *two* continents.

So when you need an epoxy resource you can rely on for performance, service *and* delivery, you can be sure you've come to the right place when you come to Hysol.

Any place in the world.

 **HYSOL DIVISION**
THE DEXTER CORPORATION

15051 East Don Julian Road,
Industry, CA 91749.
Telephone (213) 968-6511.



International newsletter

UK moves to second-generation fiber optics . . .

British Telecom, part of the British Post Office, is likely to speed its move from first- to second-generation fiber-optic systems as a result of successful systems trials at its Martlesham Research Centre. In them, **optical data was transmitted in one hop on low-loss graded-index fiber over 49 km** with a margin of 3 dB remaining at the repeater. The data rate was the 140 Mb/s typical of first-generation systems now going operational. But by moving from a 0.85- μm to a 1.5- μm operating wavelength, fiber losses are cut by almost an order of magnitude to less than 0.5 dB/km, greatly extending the repeater spacing from the 10 km adopted in first-generation systems and enhancing the economic attractions of fiber-optic systems.

Trials have awaited the development of a suitable high-sensitivity detectors, and for this purpose p-i-n diode structures have been optimized for operation at 1.3- and 1.5- μm wavelengths. At 1.3 μm , a gallium indium arsenide diode on a gallium arsenide substrate from Plessey Co.'s Allen Clark Research Centre is used; at 1.5 μm , an indium gallium arsenide diode on an indium phosphide substrate is used.

. . . as first British fiber links cut over to public service

Fiber-optic systems are now moving from evaluation to routine operation on Britain's telephone network following the switchover last week of a 9-km, 8-Mb/s link carrying live traffic between Brownhills and Walsall. Engineered for the post office by Plessey Telecommunications Ltd., the system—to be followed shortly by the first section of General Electric Co. Ltd.'s Reading-to-London 140-Mb/s Link—is **one of 15 totaling 450 km and operating at 8, 34, and 140 Mb/s**. They have been ordered by British Telecom from Plessey, GEC, and Standard Telecommunications Laboratories Ltd. as part of its so-called shop-window fiber-optic program and scheduled for completion by 1982. Follow-on orders are expected shortly, with a likely first order for more advanced systems operating at a 1.3-to-1.5- μm instead of 0.85- μm wavelength and with intermediate repeaters spaced at 30-km instead of 10-km intervals.

Data processing boosts employment in West Germany

While West German entertainment electronics producers are plagued by slumping business, shorter work weeks, and other production curtailments, makers of data-processing equipment are wallowing in orders and facing production bottlenecks. For example, in "reacting to lively domestic and foreign demand," Nixdorf Computer AG is **resorting to overtime work and special weekend shifts** for 2,000 employees at its Paderborn manufacturing facility. Also, after adding some 1,400 new jobs last year, the firm has increased its work force by more than 1,000 in West Germany and abroad during the first seven months of this year, bringing the worldwide total to about 12,300. Siemens AG, too, is keeping up its hiring campaign to attract more people to its Munich-based data-processing equipment division. That division's work force increased by about 12% over that of a year ago and now stands at more than 20,000.

East Germans trade medical electronics with rest of Comecon

The policy of "socialist integration"—that is, joint research, development, and supply efforts in various economic and technical fields among Comecon Bloc countries—has of late been extended to medical electronics after having been practiced for some time in computers and communications. Among the latest results is an agreement whereby East Germany will deliver between 1981 and 1985 **such products as electrocardiographs,**

International newsletter

patient-monitoring systems, electroencephalographs, and fetal monitors to the Soviet Union and other East Bloc countries in return for medical apparatus from its Comecon partners. At the same time, cooperation in producing medical electronic subsystems and modules will be intensified now that Comecon-wide standards have been agreed upon.

IBM Japan Ltd. takes over IBM's business in China

International Business Machines Corp. has transferred its operations in the People's Republic of China to IBM Japan Ltd. to take advantage of the geographical proximity and support capability of the Japanese subsidiary. The business was formerly handled by IBM World Trade Americas/Far East Corp. The People's Republic now has one IBM computer, a 370/138 that was installed in April 1979 in the Shenyang Ventilator Works for production control. It is to be replaced by two 4331 mainframes. The First Ministry of Machine Building also has a 4341 on order. Furthermore, a **United Nations-supervised census scheduled to start next year will use 21 computers in the 4300 series—IBM will not say which model.**

NATO awards UK air defense contract to international group

A first-stage \$240 million contract for updating Britain's air defense system—known as Ukadge, or UK air defense ground environment—has been awarded by the North Atlantic Treaty Organization to an international consortium consisting of **Plessey Avionics and Communications, Marconi Avionics Ltd., and Hughes Aircraft Co., with Thomson-CSF as an equipment contractor.** Announced at last week's Farnborough International Air Show, the contract is the first of several expected to be awarded as NATO completes the modernization of its European air defense net.

New Siemens computer takes on jobs just beyond microcomputers

Look for Siemens AG to introduce at next month's Interkama exhibition in Düsseldorf a read-only memory version of its well-proven disk-based R10 computer, a member of the company's 300 systems family. The new R10, which extends the 300 series downward, is **intended for solving simple tasks in automated production** where existing microcomputer systems are limited in central memory capacity and processing speed. It has a 16-bit structure, boasts 16 universally applicable registers, implements more than 300 commands, and features an optional floating-point processor. The central memory may consist of erasable programmable and random-access memory modules, the latter expandable up to 40 kilowords. As for the ROM set, it is expandable up to 64 kilowords. The R10 programs are compatible with those for the Siemens 300 computer models.

Sweden to launch first satellite

The Swedish government has given final approval for the nation's first satellite. Named Viking, it will be used for research into the ionosphere and magnetosphere in northern latitudes and will cost \$25 million. **The main contractors will be Saab-Scania, which will supply electronics and instrumentation, and Boeing Co., which will provide the platform.** The satellite, to be launched by an Ariane rocket from the European Space Agency launching site in French Guyana in 1984, will be **in a polar orbit, with the highest point 15,000 km and the lowest about 800 km.** An on-board solar energy package will have an output of up to 80 w. Data transmission will be at 7,000 b/s.

FAIRCHILD

A Schlumberger Company

Fairchild's FAST family of Advanced Schottky TTL logic has arrived. Twenty-one products are currently available that deliver up to 75% more speed than Low Power Schottky, and up to 40% more speed than Schottky. At up to 75% reduction in Schottky power.

We owe all of these improvements over previous TTL families to one thing. Our proven Isoplanar process.

Take a fast look at what we have.

There are six multiplexers to choose from, with typical select to output of 8 ns at only 70 mW. Two flip-flops and two counters are available with toggling



capability in excess of 120 MHz. We have an ALU that's 40% faster than its Schottky counterpart, yet requires only 1/3 the power.

If you need a high-speed shift register, ours has a shift frequency of 150 MHz. Or an octal latch that has a propagation delay of less than 4 ns. An octal buffer with 1/2 the power of its Schottky counterpart and full 64 mA drive capability. Plus six gates to help put them all together.

When you want it fast, we've got it.

We've been shipping FAST parts for over a year. To order any of our

21 new products, or our new FAST Data Book, call (415) 962-FAST, or write Fairchild Semiconductor Products Group, P.O. Box 880A, Mountain View, California 94042. TWX: 910-379-6435.

Available Now :

| | | |
|-------|--------|--------|
| 74F00 | 74F153 | 74F253 |
| 74F02 | 74F157 | 74F257 |
| 74F04 | 74F181 | 74F350 |
| 74F08 | 74F190 | 74F352 |
| 74F10 | 74F191 | 74F353 |
| 74F32 | 74F194 | 74F373 |
| 74F74 | 74F244 | 74F374 |

Fairchild Camera and Instrument Corp



We've been in high speed to get FAST on the shelf.

Circle 68 on reader service card

DRESSED FOR SUCCESS.



SUCCESSFUL FRONT PANELS DRESS IN DIALIGHT.

Even the most demanding industrial designer or design engineer will occasionally take switches, indicators and optoelectronics for granted. That's a mistake. Because they are often the first components people see and the ones they use most frequently.

That's why so many designers insist on Dialight standard products and custom designs. They know that precision Dialight products will give their computer, machine or instrument the look and feel of quality.



Choose from over **1,500,000** indicator lights.

Dialight is the world's largest manufacturer of incandescent, neon and LED indicator lights. For over 40 years we've introduced new sizes, styles and colors.

So there's a good chance our collection includes exactly the light you need. If it doesn't, we'll be happy to work with you on an original. After all, we didn't create over a million different designs by refusing special orders.



Rockers and toggles for panel and PC board mounting.

Dialight meets your needs for miniature switches with thousands of different designs in rockers, toggles and levers. All are 100% tested and made in the U.S.A.

Our rocker and toggle line contains a wide selection of actuators,

terminations, mountings and contact ratings. Included are dozens of styles for mounting on front panels and sub-panels as well as styles for snap-in and printed circuit board applications.

If our catalog doesn't show exactly the switch you need, we'll design and build it to order. All it takes is a call to our Applications Engineering department.



100% testing of every illuminated switch.

Dialight offers a complete line of computer-grade illuminated switches at reasonable cost. And to make sure they all work perfectly, we test every switch both electrically and mechanically before it's shipped.

Other switch suppliers may settle for sample testing. That's like leaving reliability to chance. You don't take chances with your designs, and we never will with our illuminated switches.

Depend on Dialight to supply exactly the switch you need, either from our catalog or on special order. Since we manufacture the entire assembly ourselves, we can respond faster and still maintain complete quality control.



LEDs ready to mount on panels and printed circuit boards.

When it comes to optoelectronics, once again Dialight offers a wide



selection plus many unique advantages. For example, we now package LED indicators singly and in arrays for mounting on PC boards. As soon as you insert them into the board, they're precisely positioned and ready for wave soldering. Installation is far faster. And production costs are dramatically reduced.

For front-panel LED readouts, we package 7-segment displays with their associated decoder-driver circuitry and mounting bezel. The entire assembly, with as many digits as you need, is ready for instant panel mounting.

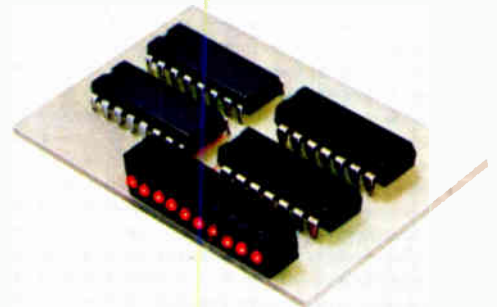

Dress your products for success.

Your products never get a second chance to make a good first impression. So send them into the marketplace looking their best. Dress all your front panels and PC boards in quality indicator lights, rockers and toggles, illuminated switches and optoelectronics from Dialight.

Dialight, 203 Harrison Place,
Brooklyn, New York 11237.
Phone: (212) 497-7600.

**DESIGN IN
DIALIGHT**
A North American Phillips company.

"See us at Wescon Booths 1042,44,46"

Circle 71 on reader service card

Introducing the world's most powerful

Our new S2200 introduces a whole new dimension in 4-bit microcomputers for control applications. With a combination of software and hardware features so incredible, you'll wonder how we got them all on one chip.

For starters, The Incredible MOS is the only 4-bit MCU with D/A and 8 channel, multiplexed A/D on chip. We've also included two interrupts (high and low priority), a ROM table look-up instruction and a programmable timer. All there to keep your systems costs way down.

But that's just the beginning.

The S2200 is designed so that you can individually test and clear any bit in the RAM. And we've equipped it with three subroutine levels, plus two more if you use the interrupt stack. What's more, you can run the S2200 on a 5V power supply. If you ever have a power problem, there's standby RAM capability and a power fail/detect interrupt for maximum protection of critical data.

With capabilities like these you can use The Incredible MOS for everything from appliance and home entertainment products to industrial controls and automotive instrumentation.

And we've come up with a clone (the S2300) that's perfect for distributed computing networks and intelligent terminals. It connects directly to a microprocessor bus and does all the handshaking automatically.



The INCREDIBLE

Powerful 4-bit MCU.

THE SUPPORT IS JUST AS INCREDIBLE.

AMI has put together a dazzling new support system for the S2200. It's the Phoenix 1™ and you can get it for about

| S2200/S2300 MICROCOMPUTER FAMILY | | | |
|----------------------------------|----------------|----------------|-----|
| | K/ROM BYTES | RAM NIBBLES | A/D |
| S2205/S2305 | .5 | 32 | |
| S2210/S2310 | 1.0 | 64 | |
| SA2210/SA2310 | 1.0 | 64 | X |
| S2215/S2315 | 1.5 | 96 | |
| SA2215/SA2315 | 1.5 | 96 | X |
| S2220/S2320 | 2.0 | 128 | |
| SA2220/SA2320 | 2.0 | 128 | X |

one-third the cost of any comparable system.

Phoenix 1 comes with everything you need for program development: CRT, keyboard, 48K of RAM, 3 mini disk drives, 2 RS232C ports, AMIX™ operating system, screen-oriented

editor and assemblers for the S2200 as well as AMI's S2000, S6800 and S9900. All for only \$5495.

In addition, the Phoenix 1 cross-supports most other standard microcomputers and microprocessors.

And S2200 software is cross-supported on the Tektronix 8002A™, the Motorola Exorciser™, the Intel MDS™ and Texas Instrument's 990/4™ development systems.

YOU ONLY PAY FOR WHAT YOU NEED.

We're building a whole family of incredible S2200s. With .5K to 2K of ROM and from 32 to 128 nibbles of RAM. So you can choose the exact size you need for your application. And you never have to pay for more memory than you want.

If the S2200 sounds like what you've been looking for, just call AMI Microcomputer Product Marketing (408) 246-0330. Or mail in the coupon and we'll send you complete information. Remember, we don't call it The Incredible MOS for nothing.

See us at WESCON, Booth #1108-1110.

Name _____

Title _____ Phone _____

Company _____

Address _____

City/State/Zip _____

Send to:
AMI S2200 Marketing
3800 Homestead Rd.
Santa Clara CA 95051

AMI
AMERICAN MICROSYSTEMS, INC.

E9-11

BLEMMOS

ABLE TO REPLACE THE

OUR AD7533 IS THE NEW INDUSTRY STANDARD IN LOW-COST, 10-BIT MULTIPLYING DAC'S.

Our third generation AD7533 is a pin and function equivalent to the industry standard AD7520, yet it offers better performance, improved specifications and lower price.

Ideal for new 10-bit DAC designs as well as old AD7520 sockets, the AD7533 is flexible enough to interface to TTL or CMOS, operate on a +5V to +15V power supply, and provide binary scaling for reference inputs of either positive or negative polarity. You can even use it with AC references.



7520 IN A SINGLE BOUND.

WITH SUPER PERFORMANCE ACROSS THE BOARD.

The AD7533 is a full four-quadrant multiplying DAC manufactured using our improved, smaller geometry, thin-film-on silicon CMOS wafer fabrication process. This means lower output capacitance for higher speed. It also means we can now guarantee $\pm 0.05\%$ ($\pm 1/2$ LSB) linearity referred to the endpoints. And since the AD7533 is latch-up proof, no protection Schottky diodes are required on the outputs.

THE SMALLEST CHIP SIZE MEANS THE LOWEST PRICE.

By scaling the FET and resistor geometries, we were able to make our new AD7533 chip significantly smaller than our old AD7520. And our old AD7520 chip was already smaller than the competition's. The smaller the chip, the higher the yield; the higher the yield, the lower the price.

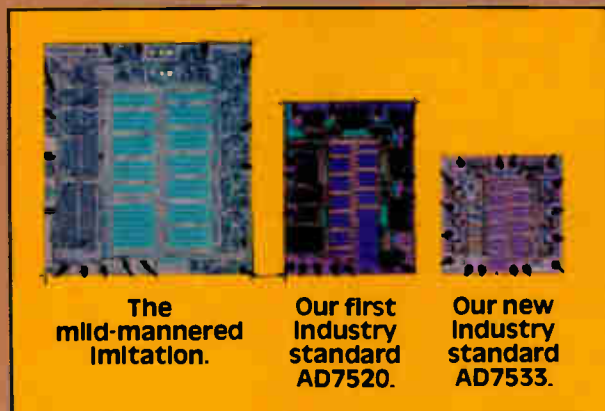

Approximately 10 times actual size.

YOU CAN COUNT ON OUR DELIVERY COMMITMENT.

In the design and manufacture of precision DAC's, no one comes close to Analog Devices, and we're committed to maintaining that predominance. With our new AD7533, we've got the advanced technology, the manufacturing capacity and the experience to meet your toughest delivery requirements. Try us!

For complete information and specifications on the super AD7533, contact Doug Grant or Don Travers at (617) 935-5565, or write Analog Devices, Inc., P.O. Box 280, Norwood, MA 02062.

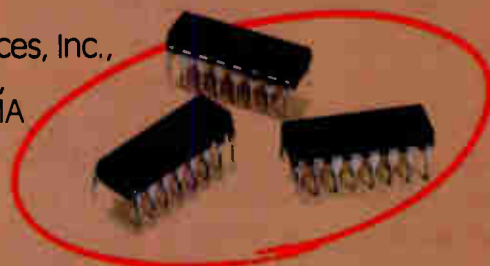

OUR SUPER DAC'S!



WAY OUT IN FRONT.

Better Benchmarks.

Philips scopes meet every measurement problem—head on and dead on. We build scopes for advanced or everyday electronic environments. But no matter what the application, each one is geared to produce the most efficient measurements possible.

Need a 100MHz dual trace universal oscilloscope? Our PM3262 is more than adequate for use with Schottky TTL and similar logic techniques. Its over 150MHz trigger bandwidth allows display of highspeed, current-mode logic signals.

Are you bombarded with complex data streams? Thanks to micro-processor control, our PM3263 is a 100MHz measuring whiz. It features dual delay for time interval, delay by events, and a direct readout of measuring results, including frequency.

If you need a four-channel 100MHz portable scope with delayed time base, check into our PM3264. It's the lightweight with all the

heavyweight features— $A \pm B$ and $C \pm D$ display, main and delayed time base can be triggered by any input channel, 17kV CRT. And, thanks to a high efficiency power supply it won't add heat to your lab or rack. Best of all, its monolithic construction saves you money.

Need a fast transfer storage scope? Choose our PM3266 100 MHz-5mV. It features storage time up to 1 hour, 1000div/ μ s writing speeds over the full screen, auto erase with variable viewing times, alternate time base display, and trigger view can be used as a third channel.

No matter which scope you choose, you'll discover that we built it to be better. So you'll get a better benchmark.



For nationwide sales and service information call 800-631-7172, except in Hawaii, Alaska, and New Jersey. In New Jersey call collect (201) 529-3800, or contact Philips Test & Measuring Instruments, Inc., 85 McKee Drive, Mahwah, NJ 07430.

From Philips, of course.



Test & Measuring
Instruments

PHILIPS

Circle 76 on reader service card

Aids for blind 'read' books, speak temperatures

by John Gosch, Frankfurt bureau manager

TV set add-on unit that turns teletext, viewdata information into braille is latest in series from West German firm

Troubled by his failure to find a reasonably priced braille-type calculator for his handicapped daughter, Lothar Limmer, an AEG-Telefunken engineer, persuaded his company to put one on the market three years ago. That was the first of the half dozen or so devices now being manufactured for the blind and visually handicapped at the West German firm's new technologies group in Wedel, near Hamburg.

Besides the table-top calculator with a braille output, various character-into-braille converters and readers are already on the market. A talking thermometer is among others to be introduced soon, points out Limmer, the project leader for such equipment at Wedel.

With such equipment, the Frankfurt-based firm has entered a market that by all indications—and quite unfortunately—is growing. Experts put the present number of blind people in West Germany alone at some 80,000 and see that number increasing at about 2% a year. In the U. S., they estimate, the number is around 437,000 and worldwide the estimate is for a staggering 42 million.

With its know-how in character recognition, speech synthesis, and the related software, AEG-Telefunken has advanced to a leading position as a producer of equipment for the blind. One character-detecting device is a reader that converts book

pages or single sheets in any typeface into braille and is scheduled to hit the market in 1982.

The page to be read is placed on the reader's scan window, and a special camera then scans the page character for character and line for line. The camera output is fed to pattern-recognition circuitry, where the characters are segmented, centered, normalized, and classified in a process similar to the one AEG-Telefunken uses in its mail-sorting and address-reading systems for West Germany's post office [*Electronics*, Dec. 21, 1978, p. 60].

A 40-digit braille line then appears on 40 field segments on a braille display. Electromechanically activated pins protrude through each segment so that the blind person can sense the braille configuration with

his fingertips.

Limmer figures the reader will sell for about \$11,000. Even so, he says, not only institutions for the blind but also private persons have expressed interest in it.

TV, too. Another piece of equipment from AEG-Telefunken's Wedel facilities converts viewdata and teletext information shown on a television screen into braille. An add-on unit interfaces with the TV set's viewdata or teletext decoder to produce braille on a display like that used with the reader. It will be made available to a selected group of blind people during viewdata trials this fall in Düsseldorf and West Berlin.

Instead of braille, synthetic speech is used in the TBS 80 thermometer, intended to measure body, room, and water temperature. When a button is

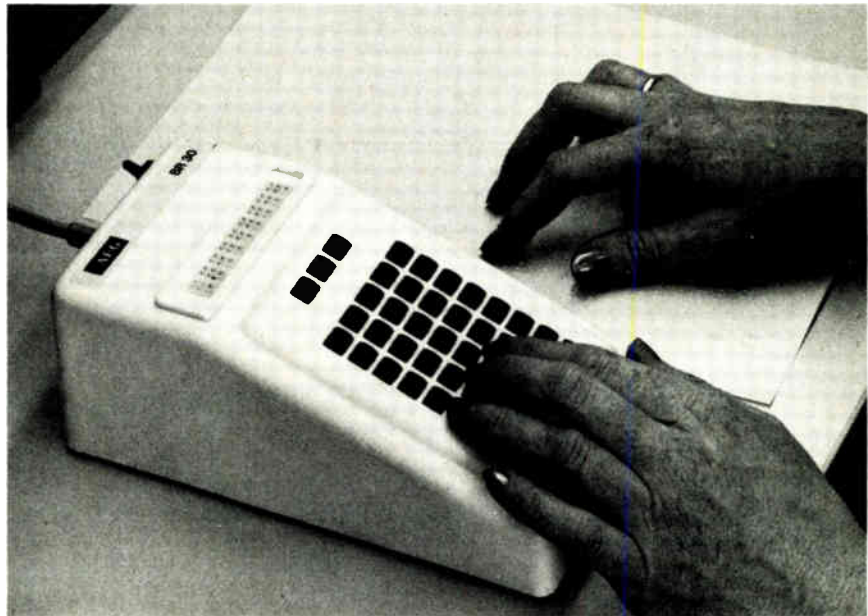

Braille calculator. Identifying keys by raised markings that indicate their figures or functions, blind person enters data from sheet at right, touches braille display for answers.

pushed on the handheld, battery-powered device, it announces the temperature measured in the form of tens, ones, decimal point, and tenths of a degree centigrade. The speech is produced by an integrated circuit from Telesensory Systems Inc. of Palo Alto, Calif.

The thermometer probe senses temperatures from 0° to 60°C. In the 0° to 42°C range, resolution is within 0.1°. When that range is exceeded or the 9-volt battery output falls below 4.5 volts, the probe says the word "error." The TBS 80 will be on sale for around \$480 early next year.

Already available to the blind for performing mathematical operations is AEG-Telefunken's braille desktop calculator. The unit has keys with raised markings, and the calculated results appear on a row of nine braille display fields—one for the sign and eight for the figures—that take the place of a regular calculator's light-emitting diodes.

Powerful. Selling for about \$890, the calculator has 47 functions, allowing the blind to solve even the complex technical-scientific problems engineers often encounter. A buzzing tone alerts the operator to conditions such as overflow and the like. A magnetic-tape cassette contains operating instructions and practice examples.

Another desktop calculator for the visually handicapped has an oversized LED display. The 2-centimeter-high figures are four times larger than those on a regular calculator. The display can be tilted for an optimum viewing angle, and a filter cuts down stray light from the environment.

Japan

New VLSI is focus of follow-on project

Japan's five major semiconductor manufacturers have been assessed \$45 million by the VLSI Technology Research Association to pay the first year's costs of an industry-sponsored three-year very large-scale integra-

tion project, with the goal of developing the crystal technology, production technology, and new devices that will be needed for the nation's next generation of computers.

This new project, administered by the same association as the recently completed four-year government-sponsored VLSI project, is but a shadow of the earlier one. Mainly it aims to show compliance with the spirit of the government project's provisions that the companies pay back its subsidies during the eight years following. The first three of the eight years is a period of grace, though.

Who's involved. The five companies paying for the three-year follow-on are Nippon Electric Co., Toshiba Corp., Hitachi Ltd., Fujitsu Ltd., and Mitsubishi Electric Corp. Two other companies, which have no income from the sale of semiconductors, will participate in the research and thus also be recipients when the funds are distributed. They are NEC-Toshiba Information Systems Inc., a joint venture of the first two companies on the list, and Computer Development Laboratories, a joint venture of the last three. NTIS sells computers to Toshiba's mainframe customer base, but CDL is merely a paper company. Research and development by both of these joint ventures is carried out in specially designated areas in their parents' laboratories and plants.

The four-year government project ended March 31. During it, government subsidies amounted to about \$135 million, while the companies spent another \$180 million of their own. Its accomplishments included the development of electron-beam, X-ray, and optical lithography systems; inspection systems; and basic crystal research.

The new three-year project, which nominally began on April 1, the start of Japan's fiscal year, will concentrate on developing practical devices and their production technology. From the profits made on those devices, the companies will be able to pay back the government during the five-year period extending from 1983 through 1987. **-Charles Cohen**

Great Britain

CCD imager fits 625-line TV systems

Closed-circuit and industrial television cameras using solid-state black and white imagers may emerge in Europe before next year, now that a British company has designed the first charge-coupled-device sensor capable of handling the 625-line systems standard there. The chip's U. S. and Japanese predecessors of course conform to the needs of the 525-line NTSC standard.

Developed by General Electric Co. Ltd.'s Hirst Research Centre in Wembley, Middlesex, the MA357 crams 220,000 elements into an area of 1 by 1.4 centimeters (394 by 552 mils). A monochrome prototype camera designed around it with no attempt at miniaturization occupies approximately 15 by 8 by 6 cm (5.9 by 3.1 by 2.4 in.), including power supply, uses 20 commercial packages, and consumes about 3 watts.

New market. To David J. Burt, who heads the CCD imager program in Wembley, the development seems likely to inaugurate a European market for solid-state imagers in industrial, professional, and military applications. The Hirst center is already supplying key customers with samples, and GEC is increasing capacity and upgrading its CCD line in advance of the expected demand. As the specification for the CCD imager was drawn up in collaboration with camera manufacturer and sister company Marconi Communications Ltd., the new part is likely to find its way into equipment before the end of the year.

In terms of complexity, according to Burt, the 385-by-576-element device bears direct comparison with Japanese and U. S. counterparts. Burt hopes to have out a color version in 1981, though at this stage it is still unclear whether a one-, two-, or three-chip configuration will provide the most economical solution.

The present device employs a three-level polysilicon-gate bur-

Get meaningful signal analysis through complete annotation of accurate data. Introducing the Gould ES 1000.

The new Gould ES 1000 electrostatic analog recorder automatically makes the exact chart notations you require for determining the nature of your signals. Chart speeds, amplifier sensitivity settings, units of measurement, real time, and test identification are all printed exactly according to your preprogrammed instructions. Even when you make additional, immediate notations through the auxiliary keyboard, there's no need to touch the chart or stop the recorder.

You'll also find the rugged, dependable Gould ES 1000 is a versatile performer whatever your application. Plug-in signal conditioners provide accurate monitoring of a wide range of input functions. There's even an optional plug-in digital converter. You get a peak capture capability of 40 microseconds and flat frequency response from DC to at least 10 kHz across all 16 channels.

For accuracy, the fixed electrostatic linear array of the ES 1000 generates its own grid pattern at the same time it is producing the high resolution 100 dots per inch trace. Traces overlap allowing all channels to record full scale across the 10" wide writing area. The unique 1000 electrode head eliminates pens, ink, and other moving parts that might have the potential for trouble.

Find out more about how meaningful your signal analysis can be with the new Gould ES 1000. Write Gould Inc., Instruments Division, 3631 Perkins Avenue, Cleveland, Ohio 44114. Or Gould Instruments S.A.F., 57 rue St. Sauveur, 91160 Ballainvilliers, France.



An Electrical/Electronics Company
Circle 79 on reader service card

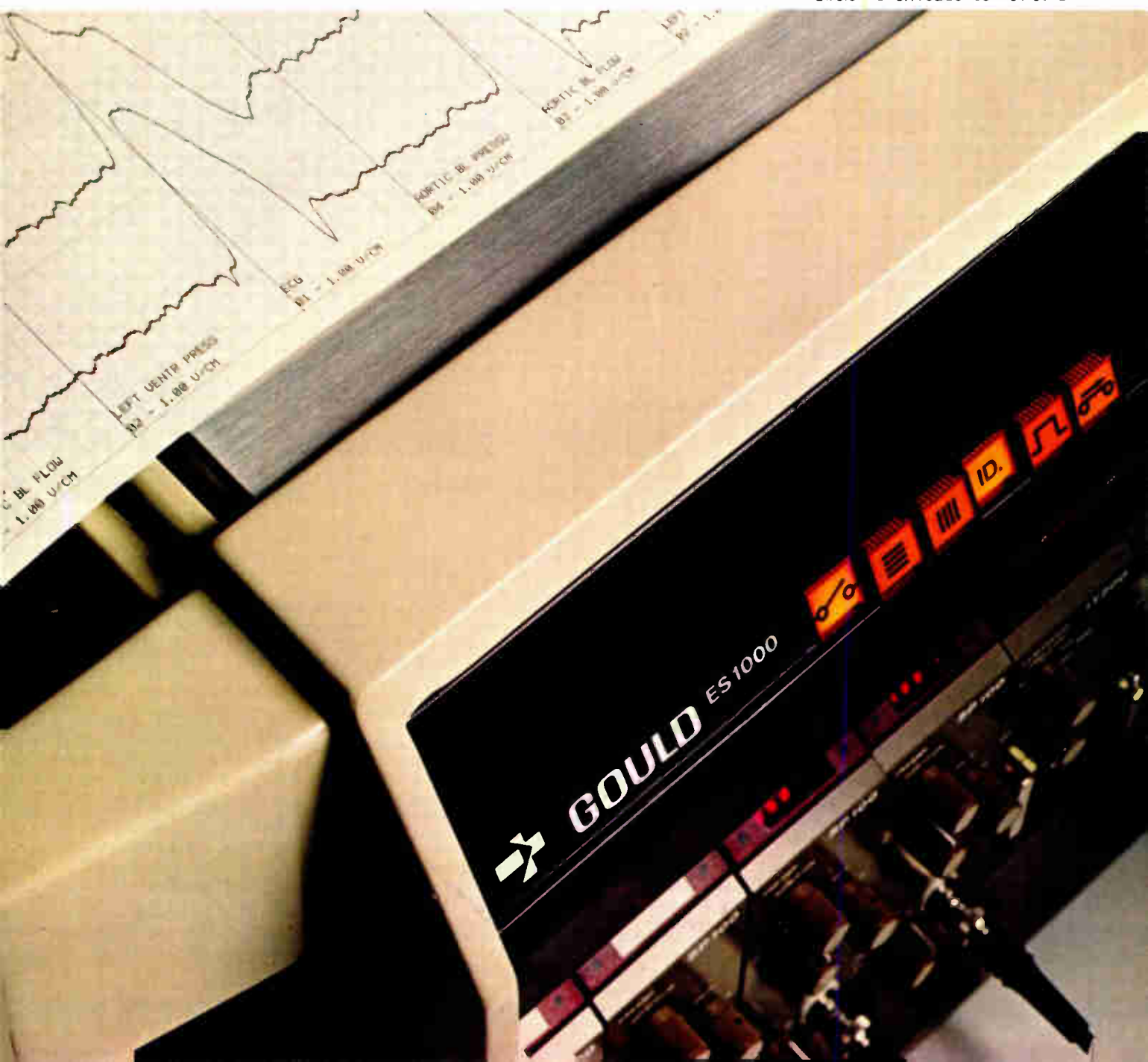

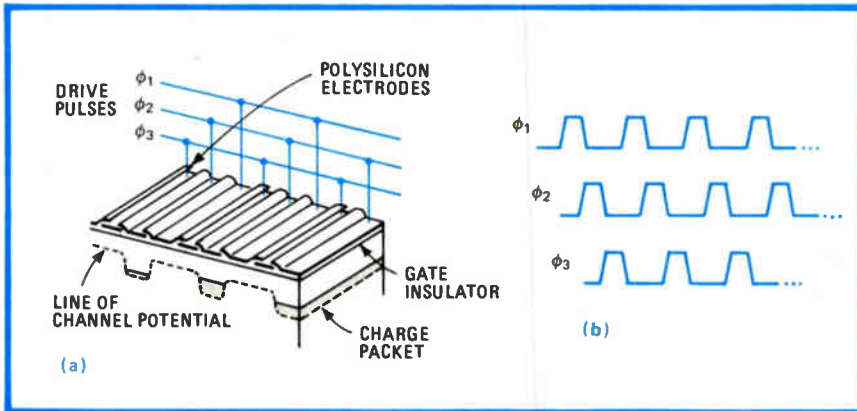

Double. CCD imager gets 576 lines out of 288-line frame by clocking out charge alternately from active electrode— ϕ_1 , in (a)—and from the other two, one of which is by then active (b).

ied-n-channel process. It operates in the frame-transfer mode and is split into an imager and a storage section with 864 horizontal electrodes. Image transfer from one section to the other takes place during the field-blanking period and is then read out a line at a time.

Because of the three-phase technique used to transfer packets of charge, the 864 horizontal lines actually produce a frame with 288 lines, or one third the number of electrodes. But by interlacing successive fields, the resulting horizontal resolution is twice that, or 576 lines. And since in a 625-line system 50 lines are used for the field-blanking period, the imager's 576-line output is directly compatible with European 625-line standards.

Turn and turn about. Interlacing is achieved by clocking out first the charge under every third electrode to generate one field and then the charge under the other two electrodes to generate the other field (see figure). In this way the center of charge collection is shifted up and down between fields to yield an effective 2:1 interlace. The number of columns employed—385—was chosen to give equal horizontal and vertical resolutions—about 67% of a TV studio broadcast camera tube. To match the tube, Burt believes the group will have to move from its present 8-micrometer geometries to 5- μm geometries.

But still other problems have to be overcome before the CCD imager can match the studio tube. For instance,

when the device is illuminated above peak white, an excess of carriers is generated and spreads to adjacent picture elements. In fact, the group has demonstrated experimental structures incorporating diffused drains in the image section. These in turn, operating like the overflow pipe of a domestic bath, permit highlights to be presented at 100 to 1,000 times peak white before spreading occurs.

According to Burt, these structures will be incorporated at a later date, despite their need to steal real estate from the sensitive area. His group is also working to improve the optical response of the device, particularly in the blue sector, to make possible the design of a color camera.

-Kevin Smith

Japan

Low-power RAM uses SOS, silicides

Cache memories for the next generation of computers may use complementary-MOS devices with metal silicide gates fabricated on silicon-on-sapphire wafers. A prototype 4-K-by-1-bit static random-access memory built at the semiconductor device engineering laboratory of Toshiba Corp. has a typical access time of 20 nanoseconds with a power dissipation of only 250 milliwatts when operating from a single 5-volt power supply.

In comparison, a 4-K RAM built

with Intel Corp.'s HMOS II process typically dissipates twice the power (500 mW) to achieve much the same access time (22 ns) [*Electronics*, Sept. 13, 1979, p. 124].

The new design features a negligible standby power drain without incurring the additional chip-select time typical of n-channel MOS devices operated in a power-down mode. Moreover, tests indicate that the lower resistance of the silicide word lines reduces the propagation delay and thus access time by about 6 ns compared with similar RAMs using polysilicon word lines.

The basic SOS process will also be used to fabricate microprocessors. But polysilicon gates will then be used because long connections in these chips are made using aluminum rather than the gate material, as in memories.

Solutions. By using enhancement-mode field-effect transistors in conjunction with double ion implantation under molybdenum silicide gates, the device succeeds in eliminating problems that have plagued earlier SOS devices, including anomalous drain currents and poor control of threshold voltage. Enhancement design, together with deep boron implantation in the n-channel transistors and deep phosphorus implantation in the p-channel transistors, eliminates current flow in the portion of the epitaxial layer close to the sapphire. This cuts off the leakage that would otherwise occur in this region, which has a high defect density.

Shallow phosphorus implantation in the n-channel transistors and shallow boron implantation in the p-channel transistors sets the threshold value in these devices. The high work function of the molybdenum silicide gates—about 0.5 to 0.8 V above that of polysilicon gates—biases both the n and p transistors off and thus makes it simple to adjust the thresholds with the shallow implants.

Foundation. The starting material for the devices is a 0.7-micrometer epitaxial layer of high-resistivity n-type silicon on sapphire. Gate oxide is 500 angstroms thick. The

Superior X-Y value.

Now, a high performance X-Y recorder without a high price. Introducing the Gould 3054, the X-Y recorder with value superior to any other analog recorder in its price or performance ranges. It's the first of an all-new series of high performance X-Y recorders designed to handle a broad range of applications in industrial, scientific, and biophysical measurement. For a much lower cost than you'd expect, the new Gould 3054 gives you the fast, sensitive response needed to provide precise, permanent records of the relationships between two analog variables.

The new Gould 3054 offers performance and features normally found only in much more expensive, less flexible instruments. The high speed drive system provides for high system fidelity with a minimum slewing speed of 85 cm/sec and

accelerations of 7700 cm/sec² in the Y-axis and 5100 cm/sec² in the X-axis. Advanced X- and Y-axis preamps with sensitivities down to 200 μ V/cm ensure recorder flexibility.

In use, a simple, disposable fiber-tip pen system provides a high quality fine line trace. Improved electronics servo protection ensures instrument reliability. Also included are calibrated zero offset, a switchable low pass filter, and switchable input polarity reversal. Plus, an optional time base is available.

Find out more today about what makes the new Gould 3054 superior to anything in its price or performance ranges by writing Gould Inc., Instruments Division, 3631 Perkins Avenue, Cleveland, OH 44114.

**For brochure call toll-free: 800-331-1000.
In Oklahoma, call collect: 918-664-8300.**

 **GOULD**

An Electrical/Electronics Company

Circle 81 on reader service card

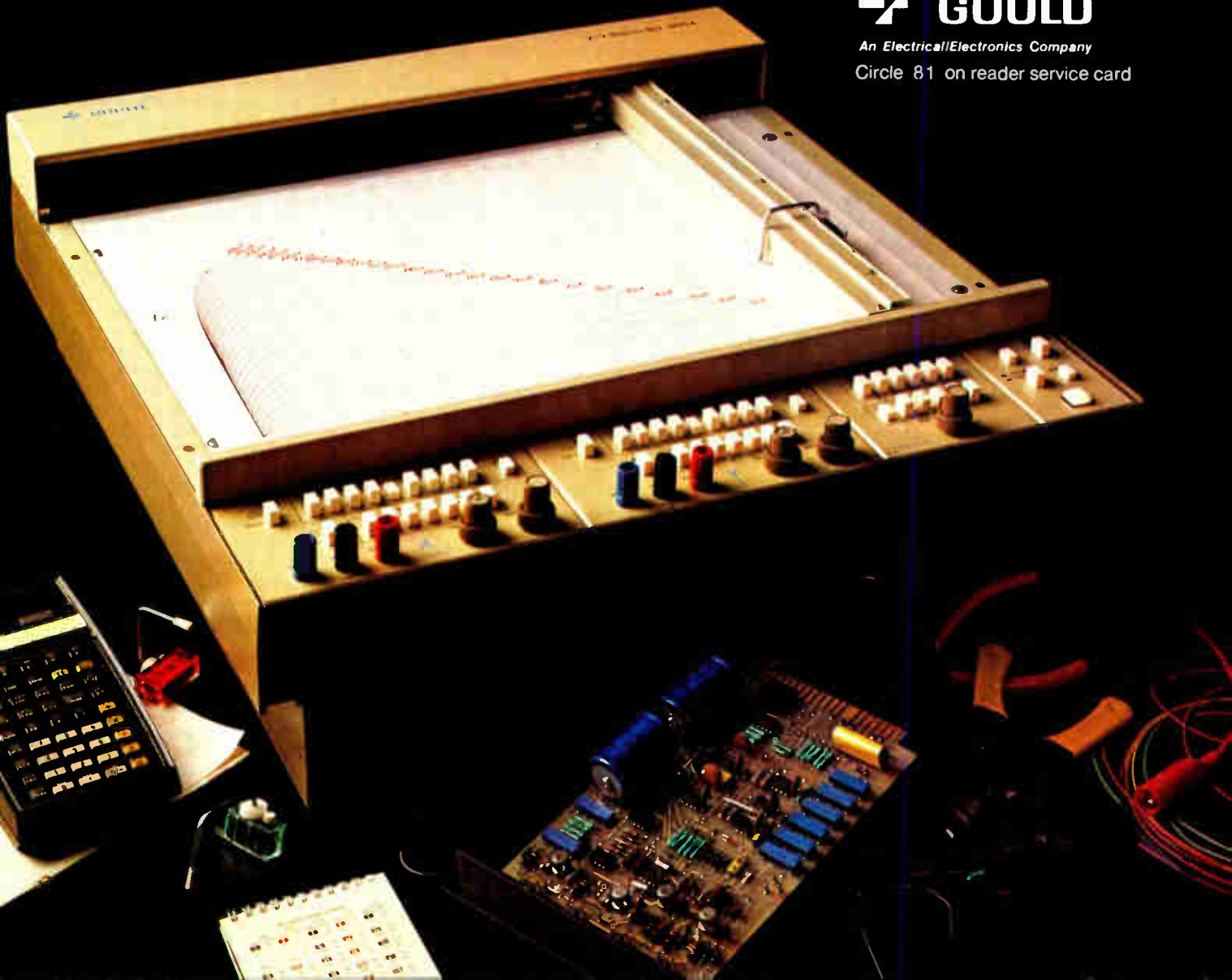

molybdenum silicide films are then deposited on the gate oxide using a magnetron-type sputtering apparatus. The target is made of hot-pressed molybdenum silicide, and the process is carried out at room temperature in argon at a pressure of 3.5³ torr. The silicide film typically has a thickness of 2,200 Å. Its sheet resistivity after being annealed for 30 minutes at 1,000°C is 3.5 ohms per square, about one tenth that of polysilicon.

The silicide film after annealing is polycrystalline, with a grain size of

about 2,000 Å. This is finer than the grain size of polysilicon and makes it easy to fabricate fine-pattern devices designed to 2- μ m rules. Photolithography and dry etching are used to define the silicide gates and word lines. The effective channel length in these devices is 1.5 μ m, which is large enough for devices operated from a 5-V power supply despite short-channel effects.

The cell size for this RAM is 36 by 36 μ m (14 by 14 mils) and chip size is 3.23 by 4.19 millimeters (127 by 165 mils).
-Charles Cohen

West Germany

Universally applicable technique linearizes microwave power amp tubes

Regardless of its input-versus-output characteristics, any microwave power amplifier tube can be linearized by a method developed by a research team at the University of Stuttgart's Institute of Radio Frequency Technology. Based on a new amplitude- and phase-predistortion technique, the method also allows linearization over virtually the whole output power range of a tube, points out Alois Egger, director of the institute and head of the team.

A subject of discussion at the Sept. 8-12 Tenth European Microwave Conference in Warsaw, the method is claimed to be superior to other predistortion linearization schemes, which must be tailored to specific tubes. What's more, the Stuttgart method linearizes the characteristics of, for example, a 20-watts power tube up to 16 W or so, whereas the others are limited to at most 14 W or so.

Radio and TV. Supported by the German Research Society, the work at the institute is being done with a view toward future cable distribution networks that are to give West Germans additional radio and television

Two steps. New predistortion technique for input signal's amplitude (a) and phase (b) can linearize the output of any microwave power amplifier tube.

programs. These programs, some to be transmitted to communications satellites and picked up at suitable ground terminals, will be fed to the cable networks over microwave links

operating at 2 and 11 gigahertz. The links will use single-sideband, amplitude-modulated transmissions to pack into a 105-megahertz band either seven TV channels, including sound, or five TV channels together with a number of radio programs. It is for possible use in the 11-GHz SSB/a-m transmitters that Egger and co-workers Manfred Horn and Vietnamese-born Tong Vien have devised their linearization method.

To ensure distortionless multi-channel SSB transmissions, the transmitter's power amplifiers and frequency converters must exhibit a very high linearity. Up to 1 GHz, the familiar negative feedback technique can achieve such linearity, but in the 11-GHz range, when a traveling-wave tube is used, it fails because of the delay the TWT would contribute to the feedback loop. The best way to obtain linearization, then, is by using the predistortion technique, Egger says.

In the transmitter, the SSB input signals are first converted into the

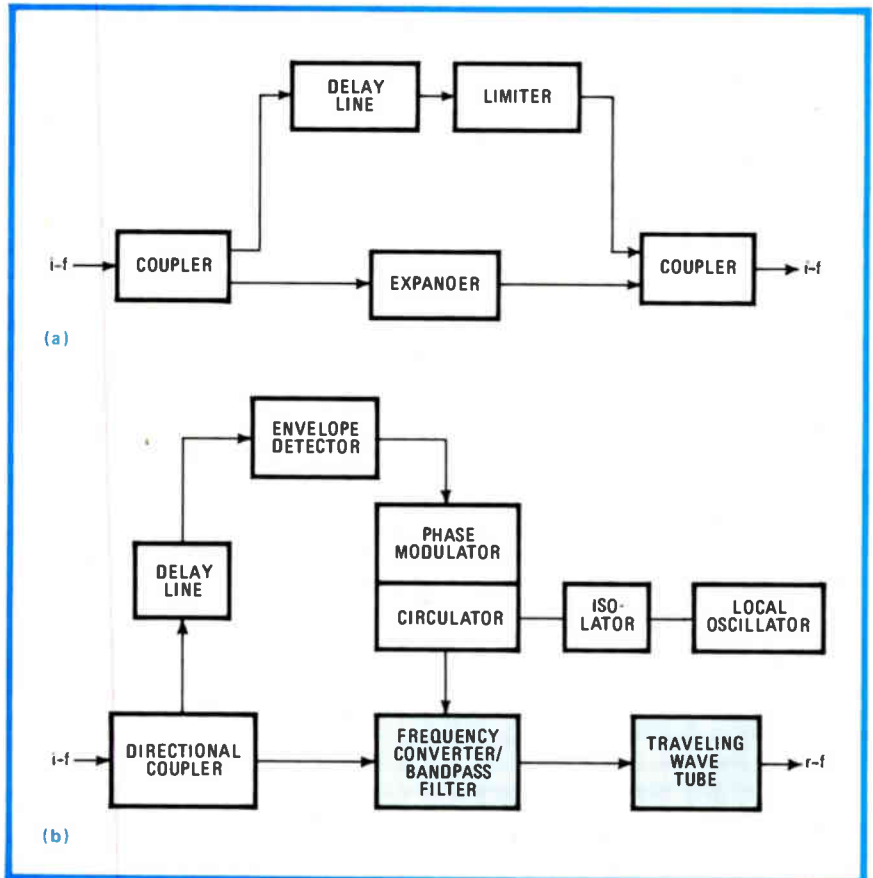

IF YOU LIKED THE ORIGINAL, WAIT TILL YOU READ THE NEW EDITION

STANDARD MICROSYSTEMS NEW 256 PAGE CATALOG

Write for your *Free* copy of Standard Microsystems' 1980 Data Catalog which includes information on:

- **Data Communications** — The latest and most advanced line of UARTS, USARTS and high-level, multiprotocol receiver/transmitter circuits accompanied by a full line of Baud Rate Generators.
- **CRT Controllers** — The industry's broadest line of state-of-the-art CRT Timing and Display Controllers.
- **Microprocessor Peripheral Circuits** — From Character Generators and Shift Registers to Floppy Disk and Cassette/Cartridge Controllers.
- **ROMS** — A new complete line of ROMS in 16K, 32K, and 64K configurations.

STANDARD MICROSYSTEMS CORPORATION

35 Marcus Blvd., Hauppauge, New York 11787 (516) 273-3100

STANDARD
MICROSYSTEMS
CORPORATION
**DATA
CATALOG
1980**

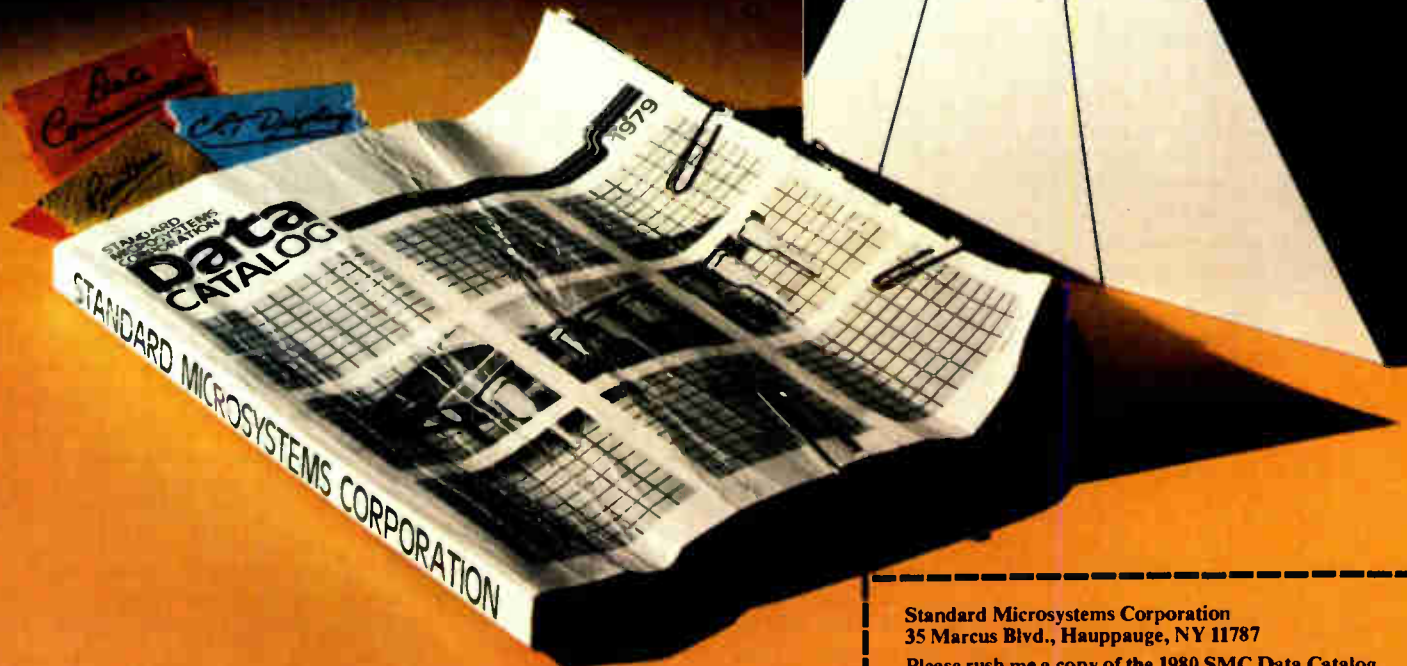

Standard Microsystems Corporation
35 Marcus Blvd., Hauppauge, NY 11787

Please rush me a copy of the 1980 SMC Data Catalog

Name _____

Title _____ Phone _____

Company _____

Address _____

City/State/Zip _____

My MOS/LSI area interest is _____

Circle 83 on reader service card

105-MHz intermediate-frequency band extending from 650 to 755 MHz. A frequency converter then transforms the i-f band into the 11-GHz radio frequency range. Finally a TWT boosts the signal amplitude to the required output level.

Nonlinearities are due to a tube's gain compression and relative phase shift between its output and input signals. Assuming that a 20-W TWT must be linearized up to a peak envelope power of around 16 W, then its corresponding input power must be raised (or "distorted") by more than 5 decibels and the input signal must be made to have a leading phase. By using these predistortion principles, the output becomes an ideally amplified replica of the input. In short, linearization is obtained.

Egger's method carries out the predistortion of the input's amplitude and phase in separate circuits (see figure). The gain compression in the TWT and the frequency converter is compensated with a nonlinear network exhibiting a gain expansion that is the inverse of the tube's gain compression.

In principle, such compensation could be achieved with a diode network by varying the diodes' bias. But a better way, according to Egger, is to use a bridge circuit with a gain expander—functionally the opposite of a compressor—in one branch and a network with compression characteristics—a limiter, for example—in the other. This circuit, designed for the i-f band, is diagrammed in (a) on page 82. It can be precisely tuned and improves the amplitude linearity of the complete transmitter—that is, of its i-f amplifier, frequency converter, and TWT.

For phase linearization, the necessary leading phase is achieved with the circuit shown in (b). After the amplitude predistortion process, a part of the i-f signal is shunted off, amplified, and detected by the envelope detector.

Change. The voltage obtained drives a phase modulator that changes the phase of the local oscillator signal and hence the phase of the rf signal at the output of the frequency converter. **-John Gosch**

France

'Quasi-topological' OCR approach has more than 80% success with handwriting

An optical-character-recognition system capable of distinguishing between nonstandard, handwritten characters at least 80% of the time has reached the prototype stage at France's central government telecommunications laboratory, the Centre National d'Etudes des Télécommunications. But internal politics and labor problems at the French postal and telecommunications authority have halted its further evolution there into a commercial product, and Morton Nadler, the American expatriate largely responsible for its development so far, wants someone else to pick up where the CNET left off.

Originally conceived to read postal codes, the system could also be adapted to industrial recognition applications like robot vision, notes Nadler, a free-lance consultant working out of his home in the Paris suburb of La Celle Saint-Cloud. Using an unconstrained randomly selected data base of 8,000 characters, taken from actual letters handled by the French mail, the system identified over 80% correctly and 5% incorrectly, rejected 4% as unreadable, and was unable to decide on a further 7% to 8%.

"The system needs to be perfected," admits Nadler, adding quickly that it is still the only OCR system known to him that can distinguish between the numerals 9 and 8 with the lower loop unclosed.

Vertical raster scan. At the heart of the system is a structural, or what Nadler calls a "quasi-topological," pattern analysis, done through a vertical raster scan, with pairs of adjacent columns scanned simultaneously from top to bottom and successively from right to left. At the CNET, the work was carried out on a scanner with a 2,000-photodiode array, with a resolution of 5.6 points per millimeter.

Significant changes in contrast between pairs of points in the adjacent columns are measured along four axes—vertical, horizontal, and two diagonals. This four-way comparison provides the data primitives necessary for calculating the eight quasi-topological codes, or QTCs, used to map the structure of the pattern to be recognized. The scanner data is fed into a preprocessor for code generation, with code processing handled by a computer—the CNET worked with a Hewlett-Packard 9640, but Nadler thinks a battery of microprocessors would do.

Contrast. A change in contrast from light to dark in the left column, while the right column stays light, indicates the start of a pattern. If the same data results from the following pair of points scanned, then the two dark points in the left-hand column are arranged vertically, and a vertical QTC is generated. Similarly, a change from dark to light in the left-hand column, while the right-hand column continues to read dark, results in a finish QTC. A change from dark to light along both columns at the same time generates not only a finish QTC, but also a horizontal QTC. Contrast changes along the two diagonals indicate convexity and concavity.

Although Nadler suggests 8- to 10-points/mm resolution for more accuracy, he says that even at 5.6 points/mm, quasi-topological analysis can recognize about three quarters of any random group of patterns. For example, a single vertical stroke, even if tilted somewhat, is readily recognized as the numeral 1. For recognition of more complex patterns, especially those where different writing styles can cause confusion, Nadler supplements structural analysis with a comparison of the relative positions of specific points on a character. **-Kenneth Dreyfack**



ComputerAutomation
Industrial Products Division

TERADYNE



GenRad

WHICH
OF THE TOP 3
TESTER COMPANIES
IS THE BEST BET
FOR SOLVING
YOUR TESTER
PROBLEMS?

No two problems are ever quite the same. So it follows that no one solution can ever be the best solution.

Which explains why there's a "big three" to start with. And why smart buyers get bids and presentations from all three.

Of course, the plain truth is that you really can't lose, no matter which one of the top three tester companies you go with; it's simply a matter of how much you're going to win.

Because even though all three "solutions" are known quantities

with proven performance, there are significant differences. In technology. Product modularity. And upward compatibility. In the software approach. In the ongoing support package.

And some of those differences can make a difference to you.

Which is why you owe it to yourself to talk to all of the top three tester companies.

And besides, if you don't get the complete picture, you just won't know what you've been missing...

Contact Computer Automation, Industrial Products Division, 2181 Dupont Dr., Irvine, California 92713, (714) 833-8830.

For productivity...today and tomorrow.

U.S. regional offices in Santa Clara, CA (408) 727-6800, Bensenville, IL (312) 860-1830, Bloomfield, NJ (201) 338-8870. District Offices in Newport Beach, CA, Boston, MA, Raleigh, NC, Dayton, OH, Dallas, TX. In Europe: CAI Ltd., Rickmansworth, Herts., England 011-449-237-7121. Offices in Frankfurt, Germany and Rue Fourmy, France.

Circle 85 on reader service card

CMOS One-Chip Microcomputer Family with Support: Now Production-Ready from OKI

New OKI Series 40: the first CMOS 4-bit MCUs in volume production with peripherals, memory and full development support.

Take it from OKI, life begins at 40 in low-power CMOS microcomputing. Available now in production quantity: the new Series 40 from OKI Semiconductor.

Series 40 is a family of 5 CMOS single-chip 4-bit microcomputers, 12 CMOS support circuits (including RAM, I/O and peripherals), plus a complete and powerful set of program development tools. A total problem-solving capability that gets CMOS MCU technology out of the just-talking stage...and directly into your live system application.

Designated the MSM5840, MSM5842, MSM5845, MSM58421 and MSM58423, OKI's five complete microcomputer circuits offer a range of RAM, ROM and I/O sizes, external ROM expansion, various display interface capabilities and upward instruction set compatibility. Unique options, uniquely easy to implement.

Series 40 support packages put you high on the learning curve because OKI program support is built around existing industry-standard development systems. Fully prepared and ready to go: 3 time/cost-efficient development package options.

MPSP-I is keyed to the ISIS® Intel system. MPSP-C is CP/M® based. If you have neither now in place, order MPSP-S, OKI's stand-alone development package.

With OKI CMOS program development tied into familiar procedures, you can plug in an OKI system board and start assembling code in hours.

For any application requiring low power consumption, battery power or battery back-up, OKI Series 40 product is available now...and the line is still expanding. 4-bit single-chip CMOS microcomputer and peripheral/memory devices today; 8-bit CMOS MCUs due soon. All backed by OKI Japan's 100-year record for strict quality and high reliability. With steady volume availability assured by OKI's current 40,000 4" wafer per month production rate.

As a leading designer and supplier of CMOS LSI, now shipping more than 3-million CMOS LSI consumer and memory chips every month, OKI's long-term experience and in-depth expertise in CMOS technology pays off to your advantage. Series 40 is so well thought out, you can pick up and run with it. Without the implementation hassles you expected. Without bogging down. Without investing huge chunks of time, manpower and capital on the development process.

OKI MSM5840 CMOS Single-Component 4-bit Microcomputer

The 5840 is the key device in the Series 40 family. The remaining 4 CMOS MCUs offer a wide selection of memory sizes to optimize the cost/performance of your application. Each 4-bit single-chip microcomputer has a CPU, ROM, RAM, I/O, a timer/counter on board, a crystal-controlled oscillator and 100% static operation. The byte-wide instruction word insures program efficiency, and the 8-bit bidirectional bus provides easy interfacing, code conversion and byte input/output. All are equipped with powerful, multifunctional instruction sets. TTL-compatible at 5V, the Series 40 operates from single supply voltages ranging from 3-6 VDC.

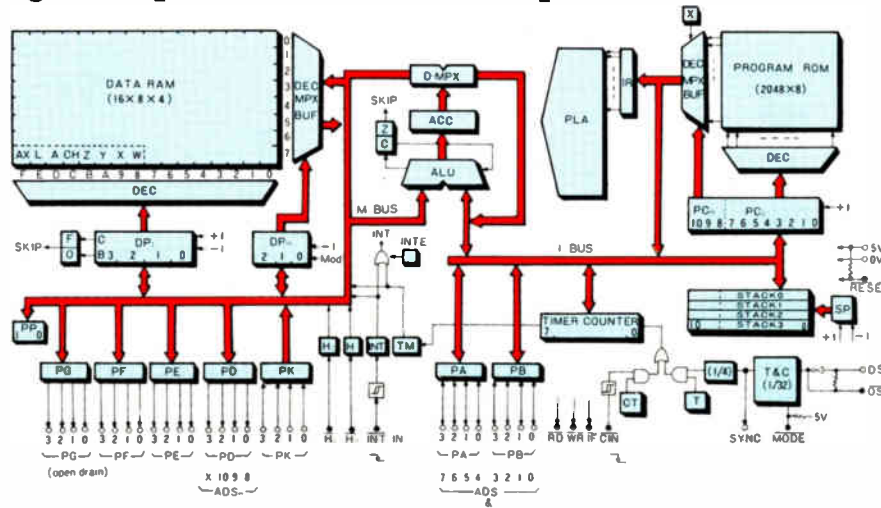

OKI SERIES 40 MCU FAMILY

| PART NO. | DESCRIPTION |
|---|--|
| CMOS Microcomputers | |
| MSM5840RS | MCU, 98 instructions, 2Kx8 ROM, 128x4 RAM. |
| MSM5842RS | MCU, 52 instructions, 768x8 ROM, 32x4 RAM. |
| MSM5845RS | MCU, 49 instructions, 1280x8 ROM, 64x4 RAM. |
| MSM58421GS | MCU, 52 instrcn, 1536x8 ROM, 40x4 RAM, 5-digit LCD driver. |
| MSM58423RS | MCU, 52 instrcn, 1280x8 ROM, 32x4 RAM, 12x12 matrix VF driver. |
| MOS EPROMS | |
| MSM2716AS | 2048x8 UV erasable, electrically programmable PROM. |
| MSM2732AS | 4096x8 UV erasable, electrically programmable PROM. |
| CMOS RAMS | |
| MSM5114RS | 1Kx4 low power static RAM. |
| MSM5115RS | 1Kx4 low power static RAM. |
| CMOS I/O PRODUCTS | |
| MSM5837RS | Serial to 12-bit parallel out converter and LED driver. |
| MSM5870RS | 4 line to 16 line output expander. |
| CMOS PERIPHERAL CIRCUITS | |
| MSM5201RS | Analog display driver for radio recvr freq. |
| MSM52821RS | Display driver, 4 digit VF. |
| MSM52822RS | Display driver, 4 digit VF/LED. |
| MSM52829GS | Display driver, 5 digit LCD. |
| MSM528291GS | Display driver, 5 digit VF. |
| MSM5832RS | Microprocessor real time clock/calendar. |
| MSM5838GS | Row scanning controller for LCD DOT matrix driver. |
| MSM5839GS | Column data register for LCD DOT matrix driver. |
| DEVELOPMENT AND EVALUATION SYSTEMS | |
| MPB201 | PC board emulator Series 40 MCU operation. Stand-alone or download. ROM based self-assembler, debug monitor. |
| MPB202 | PC board emulator MSM5840 operation. Stand-alone final program verification. |
| MPB203 | PC board provides MPB201 with EIA interface, 20MA loop interface or TTL compatible interface. |
| SYSTEM SOFTWARE | |
| SDP40-I | ISIS® based software development package. |
| SDP40-C | CP/M® based software development package. |
| SDP40-S | OKI Series 40 program development package, stand-alone. |
| DEVELOPMENT SYSTEM PACKAGES | |
| MPSP-I | Evaluation boards, software, complete User's Manuals — ISIS®. |
| MPSP-C | Evaluation boards, software, complete User's Manuals — CP/M®. |
| MPSP-S | Eval. boards, software, complete User's Manuals — stand-alone. |
| USERS MANUALS | |
| OLMS 40 | MSM5840 Users Manual |
| OLMS 42 | MSM5842 Users Manual |
| OLMS 45 | MSM5845 Users Manual |
| OLMS 421 | MSM58421 Users Manual |
| OLMS 423 | MSM58423 Users Manual |
| MPB 201/203 | MPB201 & MPB203 Users Manual |
| MPB 202 | MPB202 Users Manual |
| MPSP-I | SDP40-I Users Manual |
| MPSP-C | SDP40-C Users Manual |
| MPSP-S | SDP40-S Users Manual |

ISIS is a trademark of Intel Corporation.
CP/M is a trademark of Digital Research Corporation.

Total System Support for Your CMOS MCU Application

1

Take a look...



SERIES 40 FAMILY BROCHURE

Introduces the family members and facilitates selection of the parts appropriate for your application.



DATA SHEETS

Provides detailed specifications on each device.



USERS MANUALS

Give you full technical information to begin formulating your design.

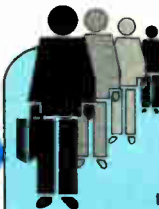

YOUR LOCAL OKI SALESMAN

Your key contact to assure your technical needs are filled. Available for further assistance in product selection.

2

Take your pick...

DEVELOPMENT AND EVALUATION SUPPORT

EVALUATION BOARDS

MPB201 — Series 40 MCU operation emulator.
MPB202 — MSM5840 operation emulator.
MPB203 — Interface for MPB201.



DEVELOPMENT SYSTEM PACKAGES

Purchase the package that best suits your engineering development environment:

- MPSP-I ISIS® based development system
- MPSP-C CP/M® based development system
- MPSP-S Stand-alone development system

INSTALLATION

A programmer can be assembling code within a matter of hours.

3

Take it easy...

PROGRAM DEVELOPMENT

Total assembler, download, debug, and execution support.

PROGRAM VERIFICATION

Final EPROM program verification using MPB201 or MPB202.

LOCAL OKI SALESMAN

Purchase order submitted along with any 2 of the following media

- EPROM (2716 or 2708)
- DISKETT (ISIS® or CP/M® format)
- PAPER TAPE (OKI format)

FACTORY VERIFICATION

Duplicate object program listing returned to you for verification.

FINAL PROGRAM VERIFICATION

Your written acceptance initiates ROM masking procedure.

4

Take it away...

ENGINEERING SAMPLES

10 actual production samples of your product delivered to you within 10 weeks.

FINAL APPLICATION VERIFICATION

Verify ROM based MCU in your system.

PRODUCTION QUANTITY SHIPMENT

Schedule closure with your local OKI sales rep.



Available now: Series 40 Brochure

- Please send _____ copies of the new 16-page brochure on the OKI Series 40 CMOS MCU family.

Name _____

Title _____

Attach coupon to company letterhead (jot down your application for a special deal), and return to OKI Semiconductor, 1333 Lawrence Expressway, Santa Clara, California 95051.

OKI
SEMICONDUCTOR

Call for immediate consultation:
ask for VP Larry Chalfan, (408) 984-4854.

*The foremost solution
when you're selecting capacitors...*

Monolithic and Disc Ceramic Capacitors

from

CENTRALAB



When you qualify Centralab as your supplier of ceramic capacitors, you won't need a second source. Centralab can supply all your needs. We offer you monolithics — chip; epoxy coated, radial lead; glass encapsulated, axial lead; molded, two pin dual-in-line and CK/CKR MIL-spec types. Or you can choose ceramic discs — general purpose, temperature compensating, or low voltage semiconductor types. It's a fact — no other U.S. manufacturer offers as great a depth and breadth of product to meet your needs.

When you choose Centralab you gain the momentum of 43 years of leadership in ceramic capacitor technology. To maintain that leadership, we've made a multi-million dollar investment and a commitment of major proportions to expand our capability. We're dedicated to meeting your growing needs for ceramic capacitors today and tomorrow as well.

Discover why we say the foremost source for ceramic capacitors is Centralab. Call your Centralab Sales Representative or write Centralab, Inc., a North American Philips Company, 5855 N. Glen Park Road, P.O. Box 2032, Milwaukee, Wisconsin 53201.

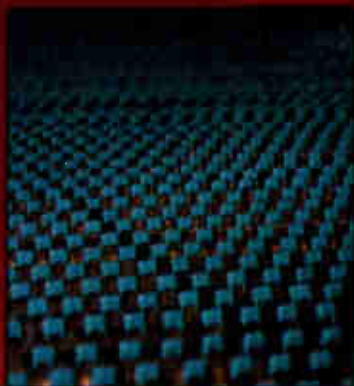

HIGH VOLUME CAPABILITY - When you need ceramic capacitors in any quantity, you can rely on Centralab. In May 1979 we initiated the first of a two stage increase in production capacity. By June we were producing over 7 million capacitors per day, well on the way to our target of over 10 million per day by the end of 1979. We have large scale manufacturing plants in five countries and a distribution system second to none. You'll find our high volume production gives you the best lead times in the business. When you need ceramic capacitors you can get them from Centralab.



AUTOMATIC INSERTION COMPATIBILITY - Our commitment to maintain leadership in ceramic capacitors recognizes the need to keep pace with new technology. That's why, today, we offer tape and reel packaging for use with vertical and axial automatic insertion equipment. Our monolithic capacitors are available for axial insertion, discs for both vertical and axial. Like our new Mono-Pak™ two-pin DIP capacitor, soon to be introduced, all Centralab ceramic capacitors will be made available in packaging compatible with the latest in machine-insertion production techniques. You can rely on Centralab for capacitors packaged the way you need them!



DISTRIBUTOR AVAILABILITY - Over 200 Distributors are waiting to serve you when you need ceramic capacitors. Availability starts with our Distributor Products warehousing facility in Milwaukee, where every one of our catalogued standard capacitor types are inventoried exclusively for distributor orders. This dedicated inventory, in addition to stocks maintained locally by Centralab Distributors is your assurance of the right capacitor when you need it. Your local Distributor can give you fast service on ceramic discs, monolithic ceramic capacitors as well as special application types.

Let your Centralab Sales Representative help you.

AL Huntsville
CARTWRIGHT & BEAN
(205) 523-1883

AZ Phoenix
CLINICK-NEENAN
(602) 275-9492

CA Full Auto
BROADS TECH. GROUP
(619) 328-3333
San Diego
CLEMICK-NEENAN
(714) 268-8540
Sherman Oaks
CLEMICK-NEENAN
(714) 990-2150
Tustin
CLEMICK-NEENAN
(714) 947-0558

CO Englewood
CENTRALAB
(303) 974-9993

CT Meriden
CENTRALAB
(203) 235-0756

FL Ft. Lauderdale
CARTWRIGHT & BEAN
(305) 735-4800
Orlando
CARTWRIGHT & BEAN
(305) 423-4331

GA Atlanta
CARTWRIGHT & BEAN
(404) 239-2888

HI Honolulu
DOUGHERTY INT.
(808) 843-4184

IA Cedar Rapids
JERRY VOSSE CO.
(319) 386-8723

IL Oak Park
CENTRALAB
(312) 674-4487

IN Indianapolis
JES M. DAVIS CO.
(317) 942-2386

KS Shawnee Mission
LOWELL-KINGSTY
(913) 431-2010

LA Metairie
CARTWRIGHT & BEAN
(504) 835-6222

MA Needham
CENTRALAB
(617) 484-4781

MD Columbia
BRESLIN ASSOC.
(301) 684-8880

MI Lansing Village
CENTRALAB
(313) 955-8006
St. Joseph
CENTRALAB
(810) 983-0233

MO Minneapolis
CENTRALAB
(612) 821-6212

MO St. Louis
LOWELL-KINGSTY
(314) 921-4000

MS Jackson
CARTWRIGHT & BEAN
(601) 982-0388

NY Albany
REAGAN/COMPAN
(518) 489-7408
Elmhurst
REAGAN/COMPAN
(516) 723-4742
Fairport
REAGAN/COMPAN
(716) 271-2230
Great Neck
CENTRALAB
(516) 488-0873
New Rochelle
REAGAN/COMPAN
(516) 782-2774

NC Charlotte
CARTWRIGHT & BEAN
(704) 237-5373
Raleigh
CARTWRIGHT & BEAN
(919) 791-4340

OR Beaverton
CENTRALAB
(503) 228-7220
Vancouver
CENTRALAB
(604) 498-2106

OR Bayswater
CENTRALAB
(503) 842-5144

PA Norristown
BRESLIN ASSOC.
(215) 688-5600

TN Knoxville
CARTWRIGHT & BEAN
(615) 592-7446
Memphis
CARTWRIGHT & BEAN
(901) 274-4442

TX Austin
CENTRALAB
(512) 454-8324
El Paso
CENTRALAB
(915) 778-3961
Farmers Branch
CENTRALAB
(214) 243-8776

VA Lynchburg
BRESLIN ASSOC.
(703) 684-8480

WA Bellevue
CENTRALAB
(206) 494-7754

WI Milwaukee
CENTRALAB
(414) 228-2122

PR Puerto Rico
Rita Ray
M. ANDERSON CO.
(809) 227-2328

CANADA
S.E. North Vancouver
ARWIN TECH SALES
(604) 992-4382

ONT Ajax
MURPHY ELEC.
(416) 682-5942

QUE Ste. Therese
Leves
HARRITT INT.
(514) 683-4384



CalComp Can Show You

New from CalComp... Graphic 7 Display System and Talos Digitizers.

With the broadest product line in the industry, CalComp represents a single source for almost every type of computer graphics device available. That means we have all the alternatives from which to choose.

Now CalComp brings you two more alternatives to help you meet your operational needs: The Graphic 7 stroke-refresh display system and Talos digitizers.

The Graphic 7 combines the latest technological features, including dual microprocessors, complete graphics support software and stroke-writing capabilities to give you all the benefits of interactivity, high quality image and operational ease.

Talos highlights its long line of fine digitizing devices with two new products, the Wedge and the 800 Series, each with advanced electromagnetic technology. The Wedge, with a five-degree sloped surface gives you greater operating ease. And the 800 Series, available in a variety of tablet sizes, allows for dual tablets, cursors and multiple interfaces for your varied applications.

Everything you need for most applications.

Whether for engineering, scientific, or business applications, you can be sure there's a CalComp product for you. Our family line of drum plotters includes a full range of sizes from desk tops, to our biggest drum plotter yet, the Model 1065 with an impressively large 72" drum.

For cut sheet applications, CalComp's full line of beltbed plotters delivers quality resolution and high throughput. Like our Model 970, the newest and biggest in our beltbed series, which gives you large 52" x 80" size plots usually associated with flatbed plotters.

Flatbed plotters still play an important role in dozens of applications. The CalComp Model 7000 high performance drafting system features our programmable controller for added flexibility.

If your operation handles large volumes of work, and you find more and more valuable time is spent performing job management functions rather than creative tasks, you may want to consider CalComp COM units. COM gives you all the advantages of organizing, compacting and storing

reams of output on readily accessible microfiche, 35mm aperture cards, or 35mm and 16mm film.

CalComp 11" and 22" electrostatic plotter/printers offer an affordable solution to many applications requiring high speed production, and can also function as a high-speed line printer, while clear mylar media furnishes finished drawing quality.

What's more, our extensive library of application software packages and CalComp supplies (we can provide all types of drawing media and pens), make us your true source for everything you'll need in computer graphics.

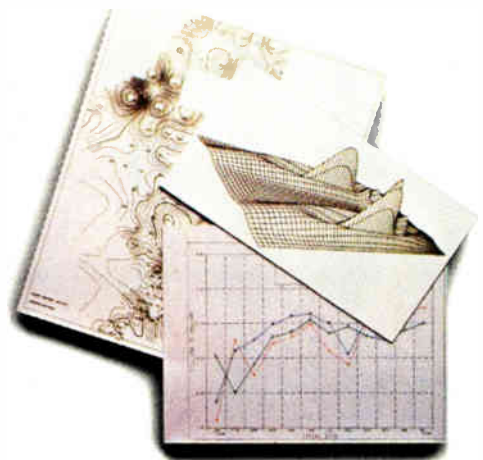



All the Alternatives.

CalComp support at any point.

The all-professional, factory-direct, CalComp team, starting with your CalComp sales representative, is there to give you all the help you may need at *any* point in your computer graphics operation.

From the beginning, your CalComp sales representative can analyze your operations and offer consultation and in-depth product information to help find the best alternatives for your immediate and long-range needs. CalComp field systems analysts — the largest such group in the industry — can help put your system into operation and show you how it can significantly increase productivity

to give you a fast return on investment.

Plus, CalComp offers the largest network of field service engineers in the industry to handle installations and to provide quality maintenance and repair service. With our unique one year warranty on parts and labor — that covers all CalComp products — you know you're getting the most complete service and support network there is. And because CalComp has sales and service offices throughout the world, we can give you the assistance you need — fast.

Choose the best of all alternatives: CalComp

You're getting the best of all alternatives with CalComp. The broadest product line, the broadest range of experience, and the broadest network of sales and service professionals in the industry. And that adds up to the broadest scope of possible solutions to your computer graphics needs.

We'd like to show you how any of the CalComp alternatives can help improve your operations. For a full line brochure highlighting the features and benefits of CalComp products, contact your nearest sales office. Or write:

California Computer Products, Inc.
2411 West La Palma Avenue
Anaheim, CA 92801

Graphics Sales Offices:

Tempe, AZ: (602) 894-9468;
Orange, CA: (714) 978-7111;
Santa Clara, CA: (408) 727-0936;
Englewood, CO: (303) 770-1950;
Norcross, GA: (404) 448-4522;
Schaumburg, IL: (312) 884-0300;
Shawnee Mission, KS: (913) 362-0707;
Metairie, LA: (504) 833-5155;
Waltham, MA: (617) 890-0834;
Southfield, MI: (313) 569-3123;
Bloomington, MN: (612) 854-3448;
St. Louis, MO: (314) 863-2711;
Woodbridge, NJ: (201) 636-6500;
Fairport, NY: (716) 223-3820;
Cleveland, OH: (216) 362-7280;
Dayton, OH: (513) 276-5247;
Tulsa, OK: (918) 663-7392;
Portland, OR: (503) 241-0974;
Pittsburgh, PA: (412) 922-3430;
Wayne, PA: (215) 688-3405;
Dallas, TX: (214) 661-2326;
Houston, TX: (713) 776-3276;
McLean, VA: (703) 442-8404;
Bellevue, WA: (206) 641-1925



CALCOMP

California Computer Products, Inc.
2411 West La Palma Avenue
Anaheim, California 92801
Telephone (714) 821-2011
TWX 910-591-1154

FAIRCHILD

A Schlumberger Company

We'll continue to supply parts to your specifications and JAN levels.

For the past twenty years, Fairchild has been supplying semiconductor parts for military applications. We've always gone to great lengths to make certain they're tested in accordance with either government specifications, or with your own when you've requested it.

Twenty years of work haven't gone unrewarded. Thanks to our efforts, we've become number one in linear JANs, with three times as many JAN qualified devices as all of our competition combined.

We're also a leader in Bipolar LSI. We've made it by being the first supplier to become JAN qualified for both RAMs and PROMs. And we're aiming for JAN qualification over our entire Bipolar LSI product line.

We haven't stopped there, either. Both of



these leadership areas are complemented by our extensive line of Digital, CMOS, MOS and discrete products.

Business as usual.

In spite of the fact that some other semiconductor manufacturers have decided to limit their military product lines to standard selection, it's business as usual at Fairchild. We're firmly committed to supplying products tested to your source and parts control drawings or to JAN and QB levels.

By continuing to do what's made us successful for the past twenty years, we can continue to help make you more successful. So you can keep shooting for the stars.

For more information about our Military product lines, write our Military Marketing Department, Fairchild Semiconductor Products Group, P.O. Box 880A, Mountain View, California 94042. Or call us at (415) 962-2311. TWX: 910-379-6435.

Fairchild Camera and Instrument Corp.

Our down-to-earth position lets you shoot for the stars.

Artificial intelligence: on the brink

New conference features first industrial applications of the concept and spurs predictions of rosy future

by Martin Marshall, West Coast Computers & Instruments Editor

Man has yet to fathom the depths of his own intelligence, but he has already begun to transfer the lower workings of that intelligence into his machinery. To describe this transfer of methods, reactions, interactions, and assimilations into metal, silicon, and plastic, researchers have adopted the term "artificial intelligence" for overlapping subsets called expert systems, knowledge representations, inference schemes, program synthesis, scene analysis, and robotics.

For 15 years, this small but rapidly growing body of researchers, based in the universities, has been developing concepts and theories about artificial intelligence, but now their work has begun to leak out into real-world applications. Giants of the electronics industries are beginning to develop programs employing their techniques, as are small specialty companies spun off from the academic community.

One sign of the industrialization of artificial intelligence appeared last month at the first annual National Conference on Artificial Intelligence, held at Stanford University in Palo Alto, Calif., where for the first time industrial applications were exhibited. The conference, sponsored by the newly formed American Association for Artificial Intelligence, was not the first ever held to discuss the concept, but it differed significantly from its predecessors in that it reflected strong industry involvement.

Aside from a number of panels describing developments at universities, the conference also featured reports of efforts in industry, including those of such giants as Hewlett-

Packard, Texas Instruments, and Schlumberger, as well as smaller specialty firms. HP has not yet offered equipment using artificial intelligence, notes Egon Loebner, manager of the data-base management department of HP's Computer Resources Laboratory, but it is preparing them. "There are three departments where we are applying AI research, including voice recognition and generation, providing a better environment for programmers, and in data-base management systems," he observes.

The HP programming effort, Loebner notes, includes "a very impressive set of software tools that give the programmer more power to do his job." Other sources added that the HP effort includes an inter-

active, autoprogramming system that allows the programmer to use very powerful "primitives" to assemble a program. Loebner confirmed that in his area of data-base management systems, HP is developing a quasi-natural language along the lines of the California Institute of Technology's Rapidly Extendable Language (REL) and Stanford's First Order Language (FOL).

TI in business. After a somewhat rocky start, efforts at Dallas-based Texas Instruments Inc. now involve more than 20 persons, with plans for rapid expansion. As a measure of its commitment, TI's manager of artificial intelligence research, Mark Miller, quotes TI vice president George Heilmeyer as saying, "We are in the AI business." To back up

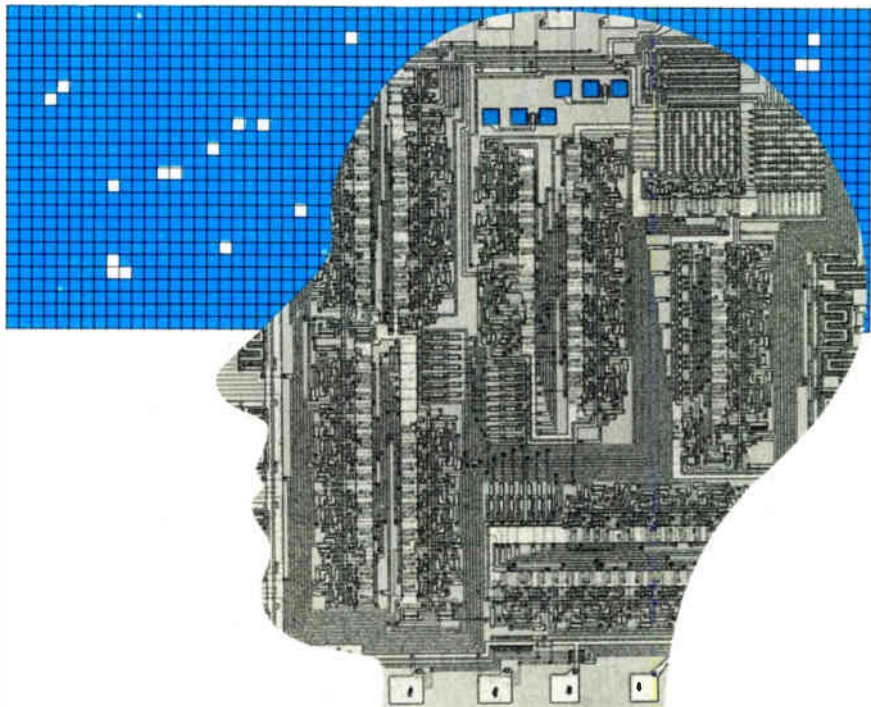

Probing the news

his statement, Miller points to TI's development of the Entice programming environment for its future personal computer system. Entice, which stands for Easy-to-use Novice-Oriented TI Computing Environment, will be used on computers developed for the mid-1980s and beyond.

Miller will not discuss details of Entice, but he does indicate the areas of computer research in which TI expects to make breakthroughs. "TI's involvement in speech I/O is well known, but you can also look for a very intelligent 'help' system on the computers, interactive color graphics, and new kinds of 'pointing devices' that will provide alternatives to keyboard design," he notes.

TI is also investigating the use of natural languages, for the development of robust parsing algorithms, as well as of a restricted natural-language system. "We want to choose a subset of English that optimizes intelligibility to both the user and the machine," Miller says.

Other work at TI is focused on developing expert systems for the design of very large-scale integrated circuits, as well as establishing a microprocessor architecture that is suited for artificial intelligence work. "The VLSI design project is just getting under way," notes Miller. "As

for the microprocessor architecture for AI, it will include a large address space and such things as tag architectures."

First steps. At Schlumberger Ltd., the commitment to artificial intelligence research comes straight from the top. As Schlumberger chairman and president Jean Riboud puts it: "We have hardly begun to understand what this abundant and cheap intellectual power will do to our lives. It has already started to change physically the research laboratories and the manufacturing plants. It is difficult for the mind to grasp the ultimate consequences [of artificial intelligence] for man and society."

Schlumberger's representative at the conference, David Barstow, the program leader for software research at Schlumberger-Doll Research in Ridgefield, Conn., indicates that the conglomerate is involved in a number of projects. With a primary emphasis on equipment for oil exploration, he notes, Schlumberger is putting much of its research money into the development of expert systems. The company is also involved in programs for automated design, automatic programming, robotics, deductive planning, and interactive environments. To expand its research capabilities—and to recruit personnel from the artificial intelligence community concentrated on the San Francisco Peninsula—

Schlumberger will establish a new artificial intelligence center this fall, to be housed at one of the Silicon Valley facilities of its Fairchild Camera and Instrument Corp. subsidiary in Mountain View.

Finding work. Between the theoretical concerns of the universities and the long-range projects of the electronics giants, the field is also spawning a number of small companies specializing in applications. One such is Machine Intelligence Inc. in Mountain View, whose president, Charles Rosen, asserts: "Almost any infusion of intelligence represents a great step up over present manufacturing machinery. Almost without exception, the machines used to manufacture automobiles in Detroit are deaf, dumb, and blind."

Rosen's firm develops, among other artificial intelligence products, "simple" vision systems for robotics applications. "Simple vision is a large subset of scene analysis that lends itself to computer analysis. Binary vision [reduction to pure black or pure white shades] is particularly useful, because it dispenses with the computing complexity involved in gray-scale analysis." Machine intelligence is also involved in developing expert systems at every level of manufacturing, as well as in work on language understanding by computers.

Another small company, Automatrix Inc. of Burlington, Mass., sees robotics from a software viewpoint. "While most AI companies have been heavy-equipment manufacturers, Automatrix has approached it from an information-systems orientation," observes company president Vic Scheinman. Scheinman, who developed an early robotics system called the Stanford Arm, now sees robots as terminals connected to a host computer system.

Put it together. In spite of the delineation of the different components that researchers use, artificial intelligence still seems to be the total combination of machinery, monitoring systems, and software that makes a useful, intelligent product. Thus, the distinction between knowledge-based systems, expert systems, and robotics blur when the research ends. □

IBM's Epistle reads the mail

How about a machine that reads the mail, understands it, digests it, informs, the recipient of its important parts, and even writes replies on routine matters? Well, it will be at least five years before such an electronic secretary shows up as a product, but International Business Machines Corp.'s Epistle, a system for the automatic analysis of business correspondence, is intended to do just that.

Epistle, which stands for Executive/Principal's Intelligent System for Text and Linguistic Endeavors, was described at the National Conference on Artificial Intelligence by Lance A. Miller, the manager of behavioral science and linguistics at IBM's Thomas J. Watson Research Center in Yorktown Heights, N. Y. As Miller sees it, applications of the Epistle software will include the synopsis and abstraction of incoming mail and a variety of critiques of newly generated letters, all based on the capability of the software to understand a natural-language text.

It will combine such aspects of AI research as semantic representations, parsing, meaning assignment, text interpretation, adaptation, abstraction, and critique—each performed by the software. The specific processes will relate to a set of "typical" business letters that are in the Epistle data base. When a letter is read, the planned system will provide surface syntactic parses for each sentence, interpret the meaning of each adjusted to the context of prior sentences, and synopsise the overall meaning of the letter. **-M. M.**

Cost Effective Systems for the Microcomputer OEM.

Ohio Scientific has been building small business microcomputers and personal computers since the beginning of the microcomputer revolution. Most Ohio Scientific products incorporate a bus architecture utilizing modular circuit cards mated to a multi-slot backplane. Ohio Scientific's 48 signal line bus is designed to effectively marry the versatility and modularity of bus architecture with the economies of consumer products producing an ultra-low cost yet reliable system. Many industrial users of microcomputers recognize the economy and versatility of Ohio Scientific's modular computer boards and utilize these boards and subsystems as well as customers who purchase complete computer systems on an OEM basis.

Ohio Scientific's New OEM Program

Ohio Scientific now recognizes the importance of the OEM marketplace and is introducing a complete program for the board level OEM user as well as the system OEM. The program starts with our standard products including three CPU boards, a broad range of static and dynamic memory boards, mini and 8" floppy disk controllers, printer controllers, multiple RS-232 port boards, a hard disk controller, and video interface with optional keyboard. Backplanes with two, four, eight or sixteen slots are available. These standard products are now being supplemented by a broad range of

products specifically for the OEM user including:

- New universal telephone interface board which has auto-dial capability, auto-answer capability, tone encoding and decoding, answer and originate 300 baud modem and voice I/O via tape recorder or optional phonetic voice output system.
- New calendar-clock with several month battery backup capability which can be programmed to automatically restart the computer or shut off the computer at set times. The circuit board also includes automatic power-fail restart capability.
- Instrumentation quality high speed, 12-bit analog A/D - D/A module with a 16-channel input multiplexer and two 12-bit D/A converters.
- A large range of parallel interface options including circuit cards containing 48 parallel I/O lines.
- New solderless prototyping board which connects to the computer system and allows rapid prototyping of new interface ideas.
- System PROM blaster which accepts 8K through 64K bit industry standard EPROMS and a universal EPROM-ROM card.
- A card edge extender, bus analyzer and bus compatible breadboards.

Documentation

All of Ohio Scientific major circuit boards are now fully documented by Howard Sams (the originator of the Sams Photo-fact series for Consumer Electronics) servicing manuals which include block diagrams, schematics, detailed pictorials, parts placement diagrams and parts lists

providing the designer, systems integrator and serviceman with detailed hardware information. Ohio Scientific is offering qualified OEM users its principal disk operating system (OS-63D V3.2) which supports multiple languages, mini-floppies, 8" floppies, printers, modems and other accessories in documented Source Code and machine readable form which can be reassembled on standard OSI computers. This gives the product developer the ultimate flexibility in integrating these components into his total system design.

Best of all is the Price

Because of Ohio Scientific's hundreds of thousands of boards per year volume for the consumer and small business market, these products cost a mere fraction of the corresponding LSI-11, SBC or S-100 bus boards. This economy allows you to utilize a floppy subsystem in your product at a total cost typically less than an EPROM based system from other vendors.

Ohio Scientific's reasonably priced universal telephone interface and voice output capabilities allow you to integrate advanced telecommunications, remote control capabilities and/or unlimited vocabulary voice response in your systems at the same price as a "bare bones" implementation with other bus architectures.

Easy to Start With

Getting started with the OSI bus architecture is now easy with documentation, off the shelf availability, and economical computer systems for in-house software development using Assembler, BASIC FORTRAN or PASCAL. Ohio Scientific's new OEM contract provides easy to start with terms and generous volume discounts.

For more information and the name and phone number of your local Ohio Scientific OEM representative call 1-800-321-6850 toll free. Please specify your interest as an OEM user.

OHIO SCIENTIFIC

1333 SOUTH CHILLICOTHE ROAD
AURORA, OH 44202 • (216) 831-5600



THE TELEPHONE DESIGNERS' COLLECTION

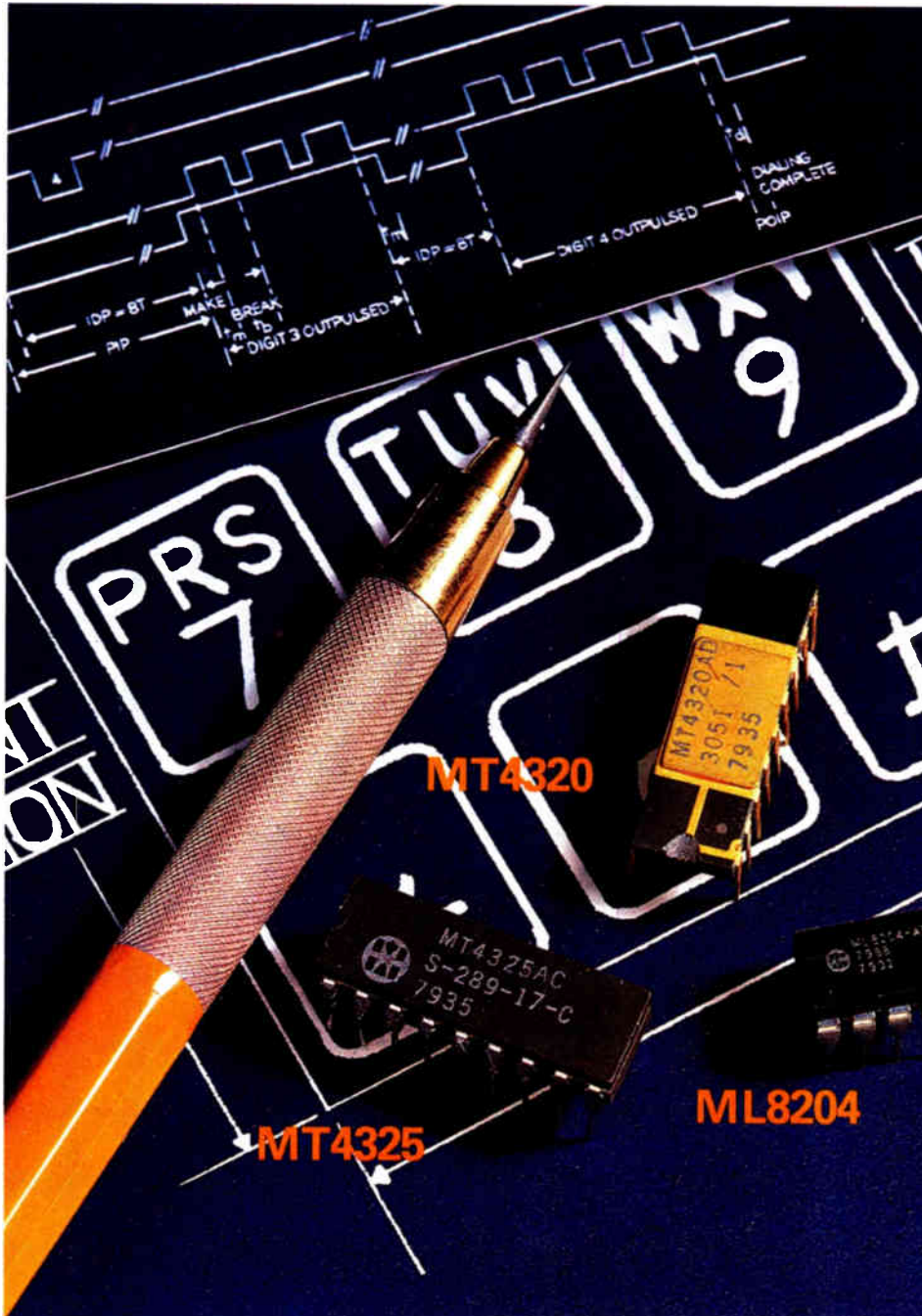

3 OF THE MOST INNOVATIVE TELEPHONE COMPONENTS IN THE WORLD

Our designers at Mitel Semiconductor know the telephone. That's because they work side by side with Mitel Telecom engineers. The application of our semiconductor technology to the telephone has produced the most efficiently integrated phone components in the world.

The MT4320 Pulse Dialer

The MT4320 allows the rotary dial to be directly replaced by a push button pad. This pin for pin equivalent to the industry standard DF320 has an operating voltage range of 2 to 7 volts, 250 μ W operating power dissipation, and a stand-by current consumption of less than 1 μ A. The MT4320 stores up to 20 digits, has last number redial, pin selectable line break/make ratio and pin selectable impulsing rate of 10, 16 or 20 PPS.

The MT4325 Programmable Dialer

The MT4325 has all of the features of the 4320. In addition it has an audible key tone and access programming for automatic dialing pause in redial mode.

The ML8204 Tone Ringer

This replacement for the telephone bell, with a minimum of external components, provides a pleasant warbling sound, and interfaces to the telephone line. The ML8204 has low power consumption, an on-chip regulator, positive switch-on and is packaged in an 8 pin minidip.

MITEL SEMICONDUCTOR, we've got the goods for you.



MITEL SEMICONDUCTOR

United States: 1735 Jefferson Davis Highway, Suite 1009, Arlington, Virginia, U.S.A. 22202. Telephone (703) 243-1600
1223 Westchester Pike, Havertown, Pennsylvania, U.S.A. 19083. Telephone (215) 449-5556.
2321 Morena Blvd., Suite M, San Diego, California, U.S.A. 92110. Telephone (714) 276-3421.

Canada: P.O. Box 13089, Kanata, Ottawa, Ontario, Canada K2K 1X3. Telephone (613) 592-2122, Telex: 053-4596, TWX: 610-562-8529.

18 Airport Blvd., Bromont, Quebec, Canada J0E 1L0. Telephone (514) 534-2321, Telex: 05-267474.

Europe: Hamilton Road, Slough, Berkshire, England SL1 4QY. Telephone 0753-36137, 0753-36138, Telex: 847730
Fredericiagade 16, Suite 309, 1310 Copenhagen K, Denmark. Telephone (01) 119302, Telex: 27246

Asia: TST P.O. Box 98577, Kowloon, Hong Kong, 3-318256, Telex: 64235-Mitel HX

Copyright 1979 Mitel Corporation

"VISIT US AT WESCON BOOTH 2743-2745"

Circle 96 on reader service card

Electronics abroad

German consumer firms face bad times

Japanese goods reducing economic miracle of 1950s to fond memory
as only big-screen TV sets are unthreatened—for now

by John Gosch, Frankfurt bureau manager

West Germany's entertainment electronics producers are facing a crisis widely regarded as the biggest since the country performed its economic miracle in the 1950s and early 1960s. Behind it is the fierce and unrelenting competition from the Far East, particularly Japan, which has made some fear that the entertainment equipment market may become as heavily Far East-dominated as that for motorcycles, cameras, and pocket calculators.

At least in one area, that assessment may be a bit too pessimistic. The production of large-screen color television sets, which accounted for more than 40% of West Germany's \$4 billion consumer electronics equipment market last year, is still firmly in domestic hands. Also testifying to the industry's strength in that sector is the large export volume: of the 3.3 million color sets made in 1978, more than a million were sold abroad. But even there a cloud hangs over the horizon: by the mid-1980s, when all PAL color-TV patents have expired, the Japanese are certain to start pecking away at Germany's big-screen market.

The manufacture of other products, however, either has been completely wiped out or is hurting considerably. For example, portable radio sets are no longer made in West Germany and neither are portable black and white receivers and cassette recorders. And few radio recorder combinations are produced, though—like cassette recorders—they were originally developed in Europe.

Hi fi, VCRs too. Still other product sectors are reeling. An estimated 40% of domestic high-fidelity equip-

ment sales are made by producers in the Far East, and 8 out of 10 video cassette recorders sold in the country come from Japan.

On top of the losses of market segments and sales shares comes another development: the acquisition of West German equipment makers by powerful foreign firms. Only recently, France's Thomson-Brandt SA took over Saba Werke GmbH [*Electronics*, April 10, p. 63]—after Nordmende KG the second German TV producer to wind up in Thomson's fold. Such acquisitions are a bitter pill to swallow, but most observers feel that a "European solution" to a company's financial problems is better than a Japanese takeover of the company.

These woes are a hard blow to the industry's pride. For many years, sales of TV sets and audio equipment outpaced those in telecommunications and industrial electronics, for example. Consumer hardware makers consistently gobbled up about half of domestic components production and provided much business even for foreign parts producers.

Technologically, too, the entertainment industry established standards of excellence or came up with notable firsts. One example is AEG Telefunken's TED radio disk system [*Electronics*, Aug. 3, 1970, p. 127]. Though it never became a market reality, it did point the way to a new medium for video information.

Acting as official spokesman for



Endangered species. Jobs of 100,000 workers at West German entertainment electronics plants are threatened by Japanese imports, says ZVEI, an industry trade association.

MISSING LINK FOUND!

Holy discoveries! ICS has just uncovered your missing link. This hot new device links the power of your computer to your IEEE 488 Bus compatible test equipment, develops test programs in the high level language your system uses, and controls remote test stations via a modem or serial communication line.

Get one of these little beauties from ICS.

\$1295.

Order today.

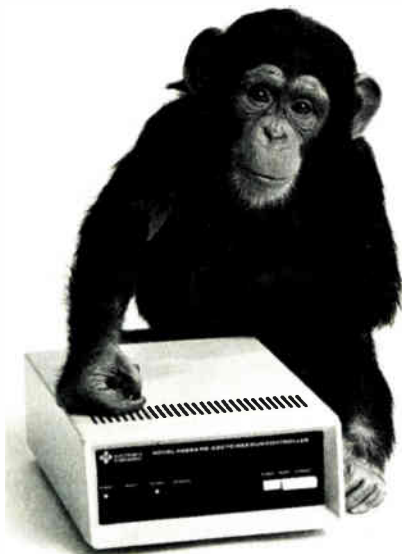

ICS **ELECTRONICS
CORPORATION**

1620 Zanker Road
San Jose, CA 95112
(408) 298-4844

Probing the news

the 100,000-employee entertainment electronics industry is West Germany's Central Association of the Electrotechnical Industry (ZVEI). In a report issued earlier this year, the Frankfurt-based ZVEI analyzes the industry's problems, points an accusing finger at the Far East, notably Japanese manufacturers, and clamors for measures to dampen the Far East export offensive.

The ZVEI talks of an "acute threat to the entertainment sector's innovative and competitive stance, job security, and economic future," a threat resulting from several negative factors: the industry's wages are among the world's highest; the numerous revaluations of the West German Deutschmark in recent years have made imports cheaper and exports more expensive; and the domestic market is the world's most liberal, amounting to a free-for-all for competitors from everywhere.

Excellent engineering, ever better product quality, and high productivity have not prevented Germany's position in entertainment electronics from deteriorating during the past decade, the report says. It adds that with many markets in Europe and elsewhere being regulated via orderly marketing policies or import restrictions, foreign producers are concentrating more and more on Germany's open market. "This has already caused irreparable damage

to the electronics industry, damage that equipment makers and components producers have to bear."

To support its complaints about marketing practices by Far Eastern producers, the ZVEI points out that while 37% of West Germany's total imports of entertainment electronics products came from Japan in 1978, that country accounted for only 0.0003% of West Germany's total exports of such products that year.

Mindful of the nation's own big exports of entertainment products, the ZVEI is not demanding that the Bonn government close its borders to Far Eastern imports. Neither does it want to regain lost ground via high import duties. What the association is seeking, however, is government help through some sort of orderly marketing agreement and in getting the Japanese to "rethink their restrictive import policies."

The Japanese, of course, have not let the ZVEI charges go unrebuted. In a sharply worded reply, the Düsseldorf office of the Electronic Industries Association of Japan (EIA-J) flatly states that the "difficulties the German consumer electronics industry is facing are not mainly due to Japanese competition," but to a number of other factors. One is that the industry has not spent heavily enough on research and development and new production technologies to stay competitive.

The West German industry, the EIA-J maintains, "has long enjoyed a quasi-monopoly market position in

Companies report bad news

The West German entertainment electronics industry's crisis, stemming from Far Eastern competition and being aggravated by a slump in consumer spending, is claiming a heavy toll. Hardly a week goes by without some company reporting a disquieting event. NV Philips Gloeilampenfabrieken, Europe's biggest consumer electronics maker with strong activities in West Germany, reports a decrease in profits in various sectors, including home video and audio. This, the Dutch company says, is "mainly due to losses in the manufacturing sector and to pressure on the selling price of important product categories."

Grundig AG, West Germany's No. 1 in entertainment equipment, recently announced some sharply curtailed operations. Following the news that it would close its 1,000-employee factor in Ireland (where it makes dictating machines and cassette-recorder-radio combinations) comes word that the company will shut down a car radio parts plant near Munich by the end of this year. Many other firms that make such products, among them Telefunken GmbH, Blaupunkt-Werke GmbH, and the ITT Consumer Products Group, have already curtailed production through plant shutdowns or shorter work weeks or are about to do so.

-J. G.

the most lucrative consumer electronics fields, namely color TV, which is still protected from Japanese competition thanks to the PAL patents." While the Germans were milking that field and doing little to open up new ones, "the Japanese established hi-fi equipment and video cassette recorder markets."

Easy out. Another factor responsible for its ills, the Japanese say, is that the German industry did not try to create new employment at home but, like the U.S., chose the easy way out by moving production to low-labor areas and by having equipment made by foreign manufacturers to supplement its own product range. Instead, the German industry should have made "audacious investments in new technologies and combined the technologies with its engineering capability and highly skillful labor force." Only lately is the German industry following the Japanese example and investing more in automation, the EIA-J says.

The charge that their market for entertainment products is closed to foreigners is unfounded, the Japanese contend. "Rather, it is open to all who try hard enough to go after it." But they ask how hard and how long the West German consumer electronics industry has tried to enter foreign markets. Japanese success in foreign markets, they say, "is simply a result of long-term efforts to understand local consumers' needs and to supply reliable products."

Thus far, the Bonn government has done little more than lend a sympathetic ear to the complaints of the country's entertainment electronics industry. And judging by recent statements by high government officials, it is unlikely that Bonn will readily advocate import controls for fear that they could boomerang.

Like Japan, West Germany is one of the world's biggest exporting countries, with one out of four jobs dependent on foreign sales. About half of its automobile production goes abroad, as does a substantial share of its output of machine tools, chemical products, electrical equipment, and other industrial goods. Under these circumstances, the Bonn government can hardly endorse restrictions on imports from its trading partners in the Far East. □

OUR BIG IDEA in IC FILTERS is Smaller

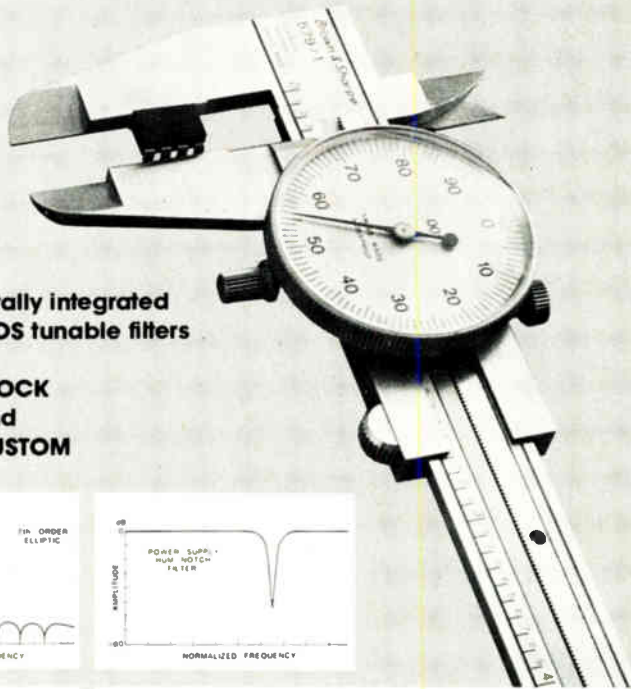

**Totally integrated
MOS tunable filters**

**STOCK
and
CUSTOM**

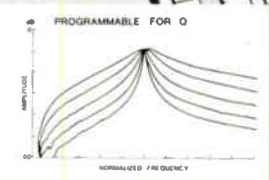
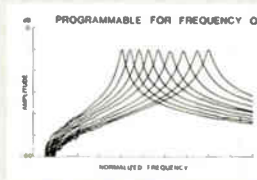
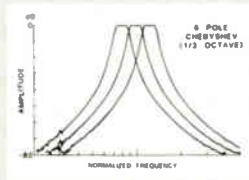
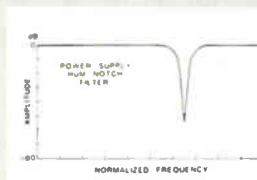
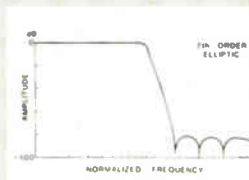

Many filters immediately available in stock, custom designs also available:

- Multiple filters in single package — up to 50 poles
- Classical polynomial & ladder designs
- Linear phase with sharp edge rates
- Programmable Q as well as frequency

For complete details on this broad line of standard filters or on a custom design and how they can improve your product and reduce costs, call your nearest RETICON field office now.

 **EG&G RETICON**

345 POTRERO AVENUE
SUNNYVALE, CA 94086
TWX: 910-339-9343

For assistance call: Boston (617) 745-7400, Chicago (312) 640-7713,
San Francisco (408) 738-4266, Tokyo, Japan 03-343-4411,
Wokingham, Berks, England (0734) 790772

Communications

For AT&T, hard part is still to come

Now that it has announced the birth of its subsidiary for unregulated businesses, details must be added and approved

by Ray Connolly, Washington bureau manager, and Harvey J. Hindin, Communications & Microwave Editor

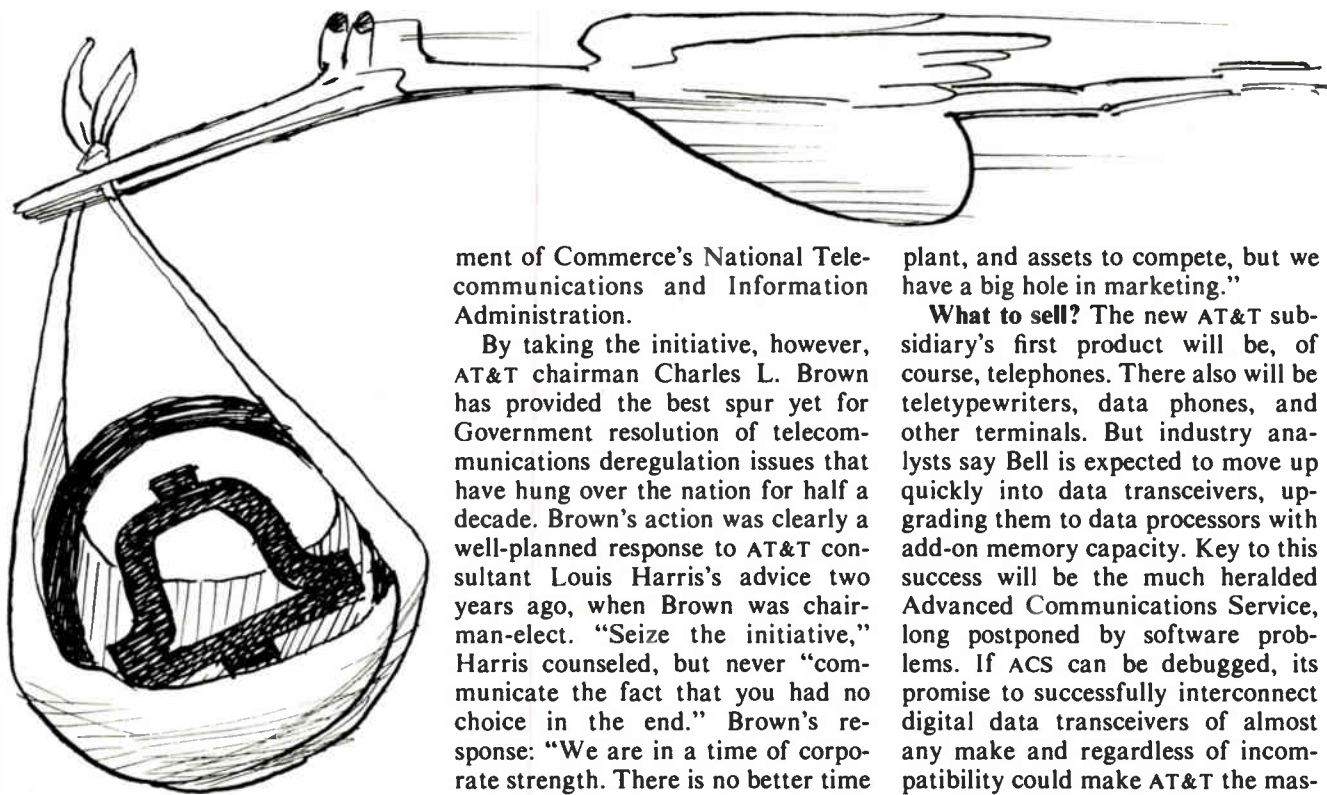

The hardest parts—the details—are yet to come for American Telephone & Telegraph Co. now that it has lifted the curtain on plans to compete in deregulated markets through a fully separate subsidiary [*Electronics*, Aug. 28, p. 59].

Before Bell's plans for its research, development, manufacturing, and marketing structure can be accepted, it faces political as well as technological challenges. One challenge is that new Federal legislation will be interpreted by such administrative bodies as the Federal Communications Commission, the Department of Justice, and the Depart-

ment of Commerce's National Telecommunications and Information Administration.

By taking the initiative, however, AT&T chairman Charles L. Brown has provided the best spur yet for Government resolution of telecommunications deregulation issues that have hung over the nation for half a decade. Brown's action was clearly a well-planned response to AT&T consultant Louis Harris's advice two years ago, when Brown was chairman-elect. "Seize the initiative," Harris counseled, but never "communicate the fact that you had no choice in the end." Brown's response: "We are in a time of corporate strength. There is no better time for change."

As AT&T gears up for next year's new congressional battle to restructure the FCC and deregulate most telecommunications except basic telephone service, Bell System insiders say there are a host of internal problems to resolve as well. Vice chairman James E. Olson, new head of what has been dubbed the FSS (fully separated subsidiary) that will incorporate a new AT&T international unit to compete overseas, "can be expected to begin heavy recruiting of good marketing talent from competitors soon," says one corporate insider. That source contends, "We have the best technology and engineers,

plant, and assets to compete, but we have a big hole in marketing."

What to sell? The new AT&T subsidiary's first product will be, of course, telephones. There also will be teletypewriters, data phones, and other terminals. But industry analysts say Bell is expected to move up quickly into data transceivers, upgrading them to data processors with add-on memory capacity. Key to this success will be the much heralded Advanced Communications Service, long postponed by software problems. If ACS can be debugged, its promise to successfully interconnect digital data transceivers of almost any make and regardless of incompatibility could make AT&T the master of a booming new market.

If successful, ACS could seriously undermine market opportunities for the IBM-backed Satellite Business Systems, which is set to begin operations next year after its first satellite launch this fall. Another potential loser would be Telenet, the special data-services carrier now owned by General Telephone & Electronics Corp.

AT&T clearly sees opportunities to compete also in the coming electronic mail market with the new call-answering-and-forwarding service—a store-and-forward service it is now trying out through its Pennsylvania Bell operating company. This is real-

THE LEADING MICROPROCESSOR OPERATING SYSTEMS FOR THE 1980s

MTOS 86

MTOS-80

Real-time operating system for the 8080. In service since 1976

MTOS-68

Real-time operating system for the 6800. In service since 1976

THE MULTI-TASKING OPERATING SYSTEM FOR THE 8086

Unlike some operating systems, the MTOS family is written in assembly language.

The result: compact, efficient programs.

MTOS is sold in source form; the user can specialize MTOS for his own applications.

MTOS-11

Real-time operating system for the PDP-11. In service since 1976

These MULTI-TASKING OPERATING SYSTEMS are sold under a liberal licensing policy which allows resale of the object program, when embedded within a product, without further charge.

In Israel:
CONTAHAL, LTD.
83 Gordon St., Tel Aviv
Telephone: 22 41 15

In Belgium:
BETEA S.A.
Chaussee de Louvain 775
B-1140 Brussels
Telephone: (02) 736 80 50

In West Germany:
ALFRED NEYE ENATECHNIK
Schillerstrasse 14
2085 Quickborn (Hamburg)
Telephone: 041 06 / 612-240

Call or write
for our FREE book
"On Operating Systems"



**i pi Industrial
Programming Inc.**
Software Specialists Since 1963

100 Jericho Quadrangle, Jericho, N.Y. 11753 • (516) 938-6600 • Telex 429808

Probing the news

ly a form of electronic mail, with the sender specifying phone numbers, the message, and the delivery time. As a service for both the home and office, it could compete with the U. S. Postal Service and other specialized forms of electronic mail.

Video test. AT&T has also been testing the waters of the videotext business with an eye to offering such products. To do this a selected group of customers in Albany, N. Y., has been hooked up to an electronic information service. This is simply a video access—connected by telephone lines, of course—to Bell's computers for directory information, weather, time, and sports updates.

No Yellow Pages or classified ads are being supplied with the Albany test, although AT&T is expecting to offer such services in the future, much to the dismay of newspaper publishers as well as cable television operators who are also interested. CATV may be added to the alphabet soup list of industries that opposes Bell's entry into their businesses.

Finally, Bell's new FSS may take over its cellular mobile telephone service for highway vehicles. This service has been tested in Chicago, and Bell, happy with the results, wants to pursue the issue. But among other problems, there are numerous private communications companies moving into this new business and FCC rules restrict the number of separate services that can be available in one geographic area. These rules are being challenged.

Big baby. AT&T says it is pushing for a single conglomerate for all of its deregulated home and business product sales—a giant that could have beginning assets of \$18 billion, competitors say, and initial annual revenues of \$10 billion or more. The prospect that this will lead to unfair competition scares them, as they have indicated in a sharp letter to White House assistant Stuart E. Eizenstat dealing with the pending rewrite of the 1934 Communications Act. The seven industry organizations signing the letter faulted the National Telecommunications and Information Administration's failure to support legislative amendments

microNOVA™ PRODUCTS ARE AVAILABLE THROUGH THE FOLLOWING DATA GENERAL STOCKING DISTRIBUTORS.

ALABAMA

Hall-Mark Electronics
Huntsville
(205) 837-8700

ARIZONA

Kierulff Electronics
Phoenix
(602) 243-4101

CALIFORNIA

Schweber Electronics
Irvine
(714) 556-3880
Kierulff Electronics
Los Angeles
(213) 725-0325
Kierulff Electronics
Palo Alto
(415) 968-6292

Kierulff Electronics
San Diego
(714) 278-2112
Kierulff Electronics
Tustin
(714) 731-5711

COLORADO

Kierulff Electronics
Denver
(303) 371-6500

CONNECTICUT

Schweber Electronics
Danbury
(203) 792-3500

FLORIDA

Schweber Electronics
Hollywood
(305) 927-0511
Hall-Mark Electronics
Miami
(305) 971-9280
Hall-Mark Electronics
Orlando
(305) 855-4020
Kierulff Electronics
St. Petersburg
(813) 576-1966

GEORGIA

Schweber Electronics
Atlanta
(404) 449-9170

ILLINOIS

Hall-Mark Electronics
Chicago
(312) 860-3800
Kierulff Electronics
Elk Grove Village
(312) 640-0200
Schweber Electronics
Elk Grove Village
(312) 320-3755

KANSAS

Hall-Mark Electronics
Kansas City
(816) 888-4747

MASSACHUSETTS

Schweber Electronics
Bedford
(617) 275-5100
Kierulff Electronics
Billerica
(617) 935-5134

MARYLAND

Hall-Mark Electronics
Baltimore
(301) 796-9300
Schweber Electronics
Gaithersburg
(301) 840-5900

MICHIGAN

Schweber Electronics
Livonia
(313) 525-8100
MINNESOTA
Schweber Electronics
Eden Prairie
(612) 941-5280

Kierulff Electronics

Edina
(612) 835-4388

Hall-Mark Electronics
Minneapolis
(612) 884-9056

MISSOURI

Hall-Mark Electronics
St. Louis
(314) 291-5350

NEW JERSEY

Kierulff Electronics
Fairfield
(201) 575-6750
Schweber Electronics
Fairfield
(201) 227-7880
NEW YORK
Schweber Electronics
Rochester
(716) 461-4000
Schweber Electronics
Westbury
(516) 334-7474

NORTH CAROLINA

Hall-Mark Electronics
Raleigh
(919) 832-4465

OHIO

Schweber Electronics
Beachwood
(216) 464-2970
Hall-Mark Electronics
Columbus
(614) 846-1882

OKLAHOMA

Hall-Mark Electronics
Tulsa
(918) 835-8458

OREGON

Almac/Stroum Electronics
Portland
(503) 641-9070

Kierulff Electronics
Portland
(503) 641-9150

PENNSYLVANIA

Schweber Electronics
Horsham
(215) 441-0600
Hall-Mark Electronics
Philadelphia
(215) 355-7300

TEXAS

Hall-Mark Electronics
Austin
(512) 837-2814
Hall-Mark Electronics
Dallas
(214) 234-7300

Schweber Electronics

Dallas
(214) 661-5010

Hall-Mark Electronics
Houston
(713) 781-6100

Schweber Electronics

Houston
(713) 784-3600

UTAH

Kierulff Electronics
Salt Lake City
(801) 973-6913

WASHINGTON

Almac/Stroum Electronics
Seattle
(206) 763-2300
Kierulff Electronics
Tukwila
(206) 575-4420

WISCONSIN

Hall-Mark Electronics
Milwaukee
(414) 761-3000
Kierulff Electronics
Waukesha
(414) 784-8160

CANADA

BRITISH COLUMBIA
R-A-E Industrial Electronics
Burnaby
(604) 291-8866
Future Electronics
Vancouver
(604) 438-5545

ONTARIO

Future Electronics
Ottawa
(613) 820-8313

QUEBEC

Future Electronics
Montreal

(514) 731-7441

WE'RE BUSTING THE COMPETITION'S BOARDS AGAIN.



Announcing MBC/2 and MBC/3, the newest members of Data General's growing family of microNOVA™ board computers. They're the best computers on a board money can buy. You get up to 64K bytes of memory, serial and parallel I/O lines, and software support from MP/OS, our famous micro operating system. You even get supporting languages like MP/PASCAL and MP/FORTRAN IV. See for yourself.

| | microNOVA | | | | |
|------------------|-----------|----------------|----------------|----------|-----------|
| | MBC/1 | MBC/2 | MBC/3 | LSI/11/2 | SBC/86/12 |
| RAM Bytes | 2K | 8K | 32K | 8K | 32K |
| PROM EPROM Bytes | 4K | 32K | 32K | - | 16K |
| Serial Lines | 1 | 2 | 2 | - | 1 |
| | | ASNYC/ SYNC | ASNYC/ SYNC | | |
| Dig I/O Lines | 32 | 32 | 32 | - | 24 |
| # Boards | 1 | 1 | 1 | 2 | 1 |
| Board Size | 7.5x9.5 | 7.5x9.5 | 7.5x9.5 | 8.5x5.2 | 6.75x12 |

The competition will always sing the praises of their little single board computers. But from now on they'll be doing it falsetto.

Data General Corporation, Westboro, MA 01580, (617) 366-8911. microNOVA is a trademark of Data General. ©Data General Corporation, 1980.

Data General

Mail to: Data General Corporation, Westboro, MA 01580.
 I don't need busted boards. Send complete information on the MBC product line. I hurt. Send a salesman ASAP.

Name _____
 Title _____
 Company _____
 Address _____
 City _____ State _____ Zip _____

Tel. _____

E 911

Circle 103 on reader service card

Discard 800 MHz problems!

Just draw one of our 45 MHz monolithic filters and match it with your 800 MHz receiver for winning performance and economy. What a pair! Two-pole and four-pole models offer 60dB attenuation. Models 2843A, 2844A and 4371F are now available in production quantities. No matter how tough your communications requirements, PTI has them pegged. Write or call for detailed data sheets.

The standard in monolithic crystal filters.



EXCELLENCE ACROSS THE BOARD

PTI

Piezo Technology Inc.
2525 Shader Rd., Orlando, FL 32804
(305) 298-2000

Circle 104 on reader service card

Concerned About Soft Errors On 64K RAMs?

Aehr's Model MBT-100
Could Save Both Your
Company's Reputation
and Your Budget!

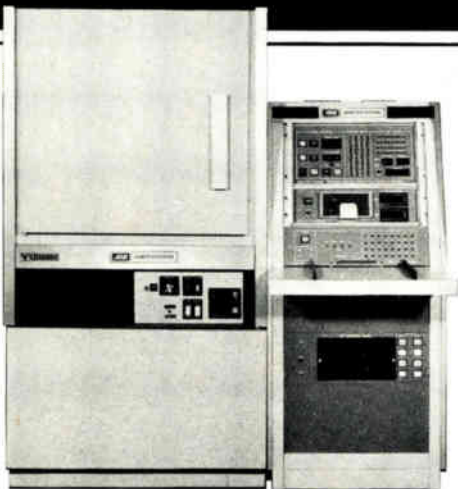

This monitored burn-in system for 64k RAMs is the answer to your worries about single bit or soft errors. It has the capacity to parallel test 832 dynamic or static RAMs at temperatures up to 200°C. Device failures are data logged and a hard copy print-out identifies the time and temperature of all failures.

The Aehr Model MBT-100 is a revolutionary new solution for collecting reliability data on memories susceptible to soft errors caused by alpha particles or pattern sensitivities. It's an economic answer to the long N² and data retention tests required for 64k and 4k static RAMs.

AHR For further information, write or call:
AEHR TEST SYSTEMS

160 CONSTITUTION DRIVE, MENLO PARK, CALIFORNIA 94025
Telephone: (415) 321-1580 Sales representatives throughout the world.

104 Circle 125 on reader service card

Probing the news

they believe are required for fair competition, which must:

- Give the FCC flexibility to control AT&T, including policing of cross-subsidies between regulated and unregulated entities.
- Prevent AT&T's creation of a conglomerate subsidiary with initial annual revenues of \$10 billion to \$20 billion "with unbridled opportunities in cross-subsidies internally."
- Require the AT&T subsidiary to be fully responsible for its own basic research and development, limit its ability to buy subassemblies and components from its parent, and prevent joint ventures with the joint use of property and joint institutional advertising programs.
- Control the "immense financial advantages available to the subsidiary in comparison with its competitors," including "at least a 2% difference in the cost of borrowing . . . and enormous tax benefits made available to regulated utilities" but not to competitors.

Signing the letter--which the White House calls "full of inaccuracies"--were the Ad Hoc Committee for Competitive Telecommunications, the Computer and Communications Industry Association, Data-point Corp., MCI Telecommunications Corp., the North American Telephone Association, the Association of Data Processing Service Organizations, and the Independent Data Communications Manufacturers Association.

AT&T has a distinct time advantage as its competitors, the White House, the Congress, Federal agencies, and the courts continue to haggle over details of new legislation. For example, chairman Lionel van Deerlin of the House Commerce communications subcommittee wants to know if the new FSS "will handle only marketing," as required by the FCC's Computer Inquiry II ruling, "or will it have independent research and manufacturing that pending reform, H. R. 6121, orders?" AT&T says it has not made that decision yet, indicating that it is ready to negotiate hard to limit any corporate changes to those that best serve its interests. □

Behind Every PIC... A Complete Support System.

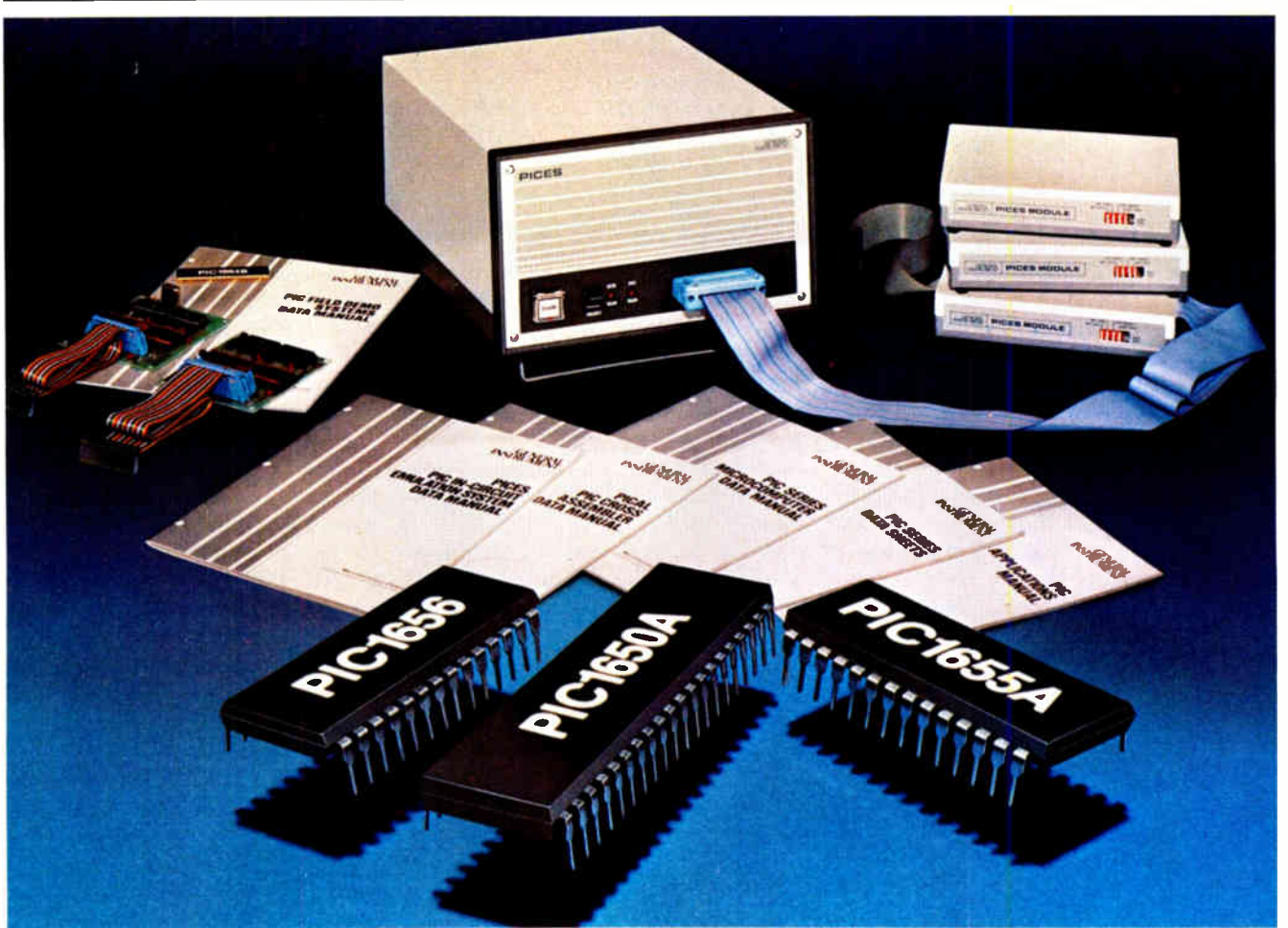

When you design with PIC microcomputers, we back you up with total, thorough support. Because we want you to stay with PIC, the 8-bit microcomputer with a powerful, efficient 12-bit instruction word that lets it do more for less.

Along with a complete library of applications literature, our PICES In-Circuit Emulation System provides all the hardware and software you need to develop your product quickly and easily. PICES can interface with any computer

from a main frame to a micro-processor development system.

Available for off-the-shelf delivery, PICES comes complete with our macroassembler, PICAL. Best of all, PICES carries an attractive \$2500 price tag, much less than other systems.

Whatever microcomputer controlled equipment you're designing...appliances, automotive, telecommunications, industrial, or business systems...you'll design faster, easier and more efficiently

with PIC. The high quality, low cost alternative. And that's why we deliver more microcomputers, because our microcomputers deliver more to our customers.

For more information right now, call 516-733-3107. Or, write to Microelectronics Division, General Instrument Corporation, 600 West John Street, Hicksville, New York 11802.

We help you compete.®

GENERAL INSTRUMENT

Solid state

HP vetoes advanced SOS process

But company emphasizes commitment to the technology, using metal-gate fabrication with 3-to-4- μm features

by Bruce LeBoss, San Francisco regional bureau manager

Becoming less bullish about the prospects of silicon-on-sapphire technology, Hewlett-Packard Co. has backed off from further developing SOS 2, its third-generation process. But the Palo Alto, Calif.-based computers and instruments manufacturer is charging ahead with an earlier process, SOS 1.5, with which it expects to build most, if not all, SOS circuits for at least another decade.

The management at HP's Technical Computer group concluded recently that SOS's earlier advantages over other MOS technologies will not be as pronounced for fabricating devices with smaller geometries as they are for those with larger ones. What's more, though management is optimistic about resolving technical problems that remain, SOS yields continue low, primarily due to leakage. However, the decision "not to pursue development of the third-generation process at this time is for business—not technological—reasons," states Paul C. Greene, general manager of HP's Cupertino, Calif., integrated-circuit operation.

SOS 2 is a polysilicon-gate complementary-MOS-on-sapphire process with 2.5-to-3-micrometer features. There are a number of reasons for halting its development, not the least of which is the fact that "we don't want to be supporting too many process developments, especially when you consider that market conditions are softening," he states.

But perhaps the most significant factor in the decision, Greene points out, is that the IC operation has now "made the transition from a mostly research-and-development facility producing small volumes into a large-volume manufacturing operation more concerned with costs, yield projections, and designing for manufacturability."

Also, because of the increased capital investment required to start operating an IC process, "we can't afford to have a whole bunch of IC operations," each supporting its own division, notes Douglas C. Chance, general manager of the Technical Computer group.

"In general, there were no major

HP SOS. One of the latest Hewlett-Packard chips is this 16-bit CPU with 2 K by 8 bits of on-board ROM for the HP 1000 series.

technical problems associated with SOS 2," Greene states. "We made good, if not great, technical progress with it and the old leakage problem was greatly reduced." Much of the development work on the SOS 2 engineering effort, he adds, is directly applicable to SOS 1.5, a second-generation aluminum-gate process with 3-to-4- μm features, as well as to one that HP calls n-channel MOS C. The latter is a new workhorse process that is expected to be better at meeting the requirements, in terms of good design turnaround and modest cost, of HP's terminals, peripherals, and low-cost computers.

Evolutionary steps. "Over the next five years, we will be investing a sizable amount of money in SOS process development to enhance the technology," Greene says. Rather than making step-function, revolutionary changes, he stresses, "we will incorporate unit steps into the existing manufacturing process."

Though some semiconductor manufacturers are dropping efforts to develop standard SOS circuits, or are emphasizing other processes, HP is increasing its SOS circuit development activity. "SOS will continue to make a contribution for many years where very high performance with low power dissipation is needed," says Chance.

At present, HP is using SOS to build many 16-bit microprocessors, as well as bus-controlled chips for the HP-IB (IEEE-488) in-

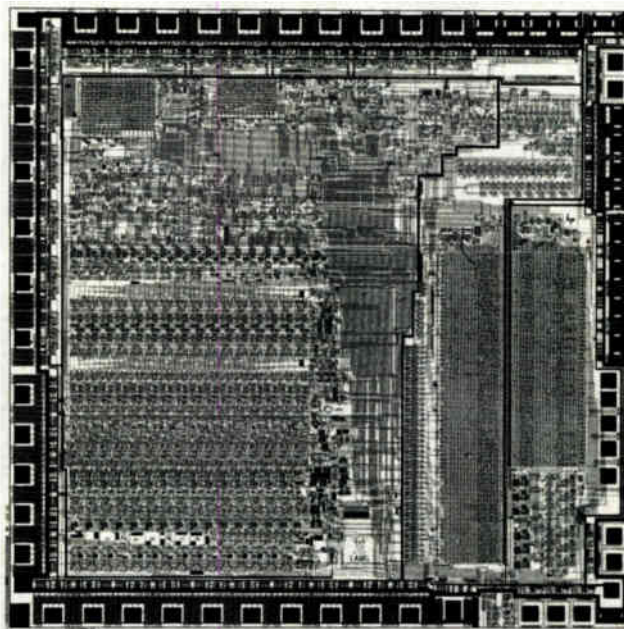

QTP™ ROMs... More Mileage From Your EPROM Dollar.



Simply switch to 16K and 32K QTP ROMs.

QTP ROMs are pin-compatible replacements for EPROMs. They offer the same performance at far less cost, plus the proven reliability of General Instrument's "dedicated" ROM facilities.

If you're using 16K EPROMs, consider the incredible cost advantages of ROMs. If you're designing with 32K EPROMs, consider the cost advantages and fast delivery of our QTP ROMs, and ask yourself, "Why not ROMs instead?"

QTP (Quick Turnaround Production) means we can start delivering your masked ROMs in quantity within 4 to 6 weeks. How can we do it? With vast dedicated ROM mask and wafer facilities, dedicated automatic assembly, dedicated and experienced QTP planning staff, and a personalized, computer verification service (ask about it!).

Check the pin-compatible replacement chart below. Then call 516-733-3107 for details. Or write Microelectronics Division, General Instrument Corporation, 600 West John Street, Hicksville, New York 11802. We'll help you get more mileage from your EPROM dollar.

| PIN-COMPATIBLE REPLACEMENT CHART | | |
|----------------------------------|---------------------|----------------------|
| QTP ROMs | | EPROMs |
| R0-3-9316 | 16K, 2K x 8, 24-pin | 2516 2716 2708 |
| R0-3-9333 | 32K, 4K x 8, 24-pin | 2732 |
| R0-3-9332 | 32K, 4K x 8, 24-pin | 2532 |



We help you compete.®

GENERAL INSTRUMENT

Our trimmer capacitor line keeps growing bigger

by getting smaller.

Sprague-Goodman's trimmer capacitor line is growing. With sub-miniature ceramic and sapphire dielectric Pistoncap® trimmer capacitors. The ceramics are as small as 3mm diameter and the sapphires have very high Q at UHF and GHz frequencies.

They're available off-the-shelf along

with our glass Pistoncaps,* Filmtrims* ceramic single turn, and Mica compression lines.

So the next time you need standard or custom trimmer capacitors, call us or your distributor and ask for Sprague-Goodman. The first and last name for trimmer capacitors.

**SPRAGUE
GOODMAN**

Sprague-Goodman Electronics, Inc.

(An Affiliate of the Sprague Electric Company)

134 FULTON AVE. GARDEN CITY PARK, N.Y. 11040 • 516-746-1385 • TLX. 14-4533

Circle 108 on reader service card

High Speed Analog Memories

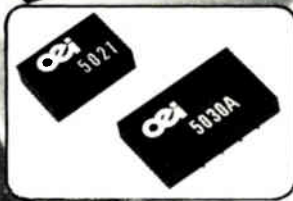

PEAK SENSE AND HOLD

Sinusoidal Bandwidth: DC-10MHz
Acq. Time, +10V Step, 30ns
Reset Time: 1μs Gate Time: 1μs

Model 5030A \$102.00 (3-9)
2.5" x 1.5" x 0.5" Module

MIL Packages also available
Request 72-page Op Amp,
Function Module Catalog.

Tr. Mode Bandwidth: 100MHz
Tr. Stew Rate: 150V/μs, Cx=0
Aperture Time: 3ns
Acq. Time, 10V: 1μs, Cx=100pF
Decay Rate: 100 V/sec, Cx=10pF

Model 5021 \$85.00 (3-9)
2" x 1" x 0.6" Module

oei

OEI • Box 11140 • Tucson, AZ 85734 • (602) 624-8358 • TWX: 910-952-1283

108 Circle 127 on reader service card

Probing the news

terface bus and other communications chips. Greene claims they outperform what is on the market commercially. One of the firm's biggest SOS chips, a logic device, is contained in its new 2626A terminal [*Electronics*, July 31, p. 130]. It also plans to continue developing higher-density and higher-speed SOS memories, beyond the 2-K RAM and 32-K read-only memory already developed. One is a 128-K ROM.

Varied routes. Even as HP continues to lead the parade of manufacturers pursuing SOS for commercial applications, the enthusiasm of some devotees is waning.

EFCIS (Société pour l'Etude et la Fabrication de Circuits Intégrés Speciaux), the French MOS manufacturer jointly owned by Thomson-CSF and the French Atomic Energy Agency, says it has all but dropped its efforts to develop standard SOS parts. The firm's market strategists estimate that substrate costs will keep them from being competitive.

Recently, RCA Corp.'s Solid State division in Somerville, N. J., disclosed it was partially deemphasizing its SOS efforts for commodity parts and adopting a dual-technology approach that would include a new bulk-silicon C-MOS process as well [*Electronics*, July 31, p. 82; Aug. 14, p. 8]. Meanwhile, Rockwell International Corp.'s Microelectronics division in Anaheim, Calif., perhaps most active in building SOS circuits for military applications, has yet to set a timetable to move the technology into the commercial market.

Japan's views. The outlook in Japan is cloudy. Toshiba Ltd. says it is ready to start sales of a C-MOS-on-sapphire microprocessor and static random-access memory next year. "These will be high-performance devices that cannot be built without using SOS," claims Yoshio Nishi, manager of MOS device technology at Toshiba's semiconductor device laboratory. Less optimistic is Fujitsu Ltd., which has made 1-K and 4-K SOS memories that were no faster than bulk silicon devices. Fujitsu researchers say they do not think SOS will be used for memories in the future. □

Electronics / September 11, 1980

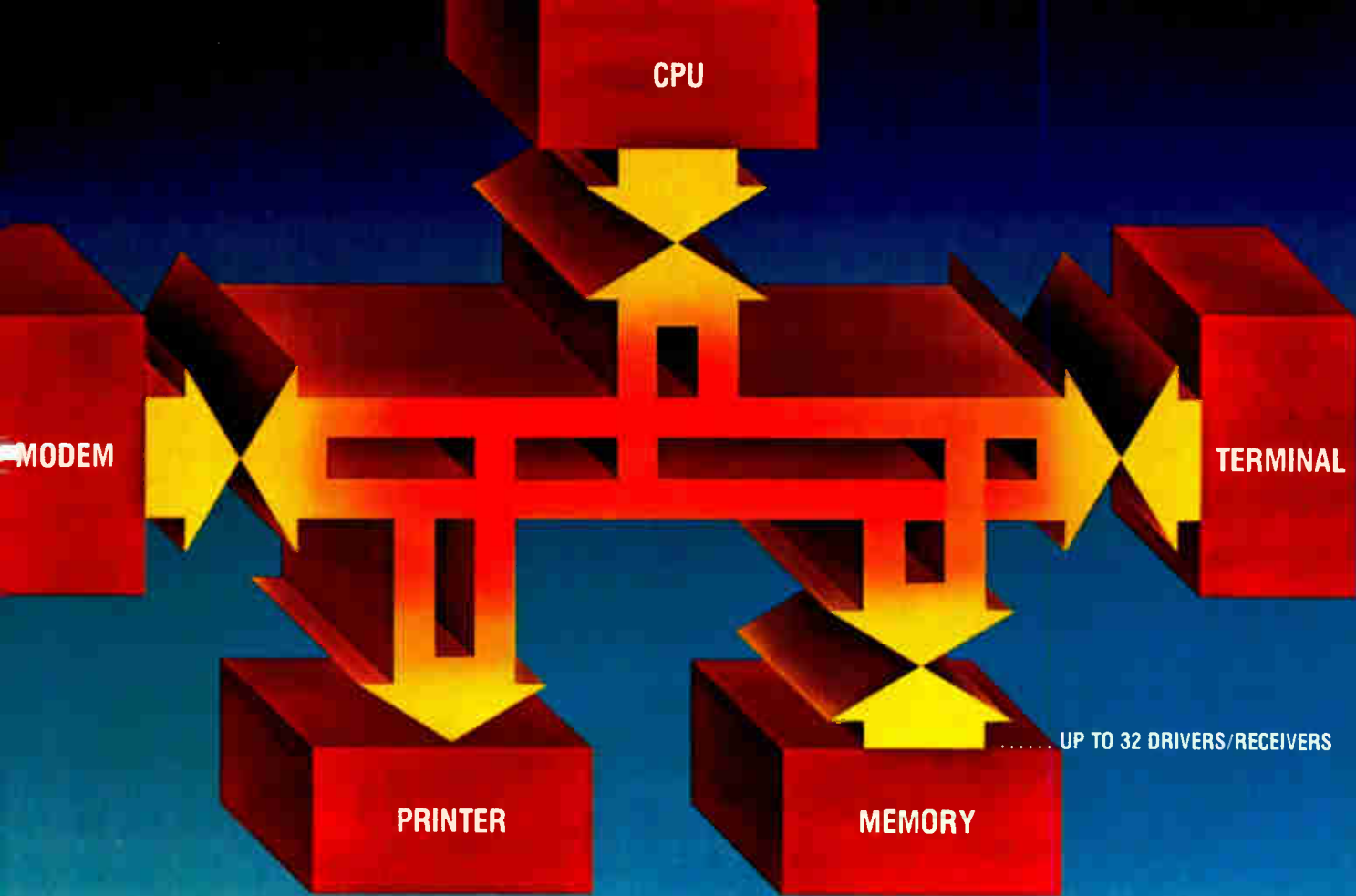

More linear firsts from TI . . .

RS422 drivers/receivers. For balanced multipoint communication.

Introducing four new interface ICs. Two quad drivers. Two quad receivers. The first interface devices to be designed specifically for balanced multipoint data bus transmission, and meet EIA-RS422 standard.

All of these devices feature broad positive and negative common mode range, operate from a single 5-V supply, have 3-state outputs and very low power requirements.

And, all of these devices are pin-compatible with popular RS422 devices second-sourced by TI, including AM26LS31/32A and MC3487/86.

Up to 32 driver/receiver pairs on a common bus. Another first. A significant innovation that provides an interface for balanced transmission of serial binary information between a host computer and various types of peripheral equipment. Like an input ter-

minal. Or a printer. At data rates up to 10M bits-per-second. Over distances as great as 4 thousand feet.

Significant features of SN75172/SN75174 drivers include high output impedance in the third state, over +12 to -7 volts common mode range with power on or off and up to 60 mA output drive capability.

Contention protection, for the case where two or more drivers are simultaneously enabled, is provided by positive and negative current limiting and thermal shutdown circuitry. Maximum standby power is a low 53 mW per channel.

Receiver circuits SN75173/SN75175, which meet RS423 as well as RS422, feature +/-200 mV input sensitivity over a common mode range of +12 to -12 V. There's also 50 mV of hysteresis

for increased noise immunity and 12 K ohms minimum input impedance.

These unique characteristics make the driver/receiver pairs ideally suited for party line applications in noisy environments.

Operating from 0 to 70°C, all four new devices are offered in a 16-pin plastic or ceramic DIP.

The 100-piece price for drivers SN75172/SN75174 in the plastic package is \$3.02*. For receivers SN75173/75175, \$2.23*.

Samples are available now at your nearest authorized TI distributor or local field sales office. For more detailed information, send for our free brochure. Write to Texas Instruments Incorporated, P.O. Box 225012, M/S 308, Dallas, Texas 75265.



TEXAS INSTRUMENTS
INCORPORATED

*U.S. prices, subject to change without notice.
© 1980 Texas Instruments Incorporated

Circle 109 on reader service card

82165

IEEE-488

MAXIMUM POWER
DISSIPATION PER CHANNEL (mW)

65% IMPROVEMENT
SPEED-POWER PRODUCT

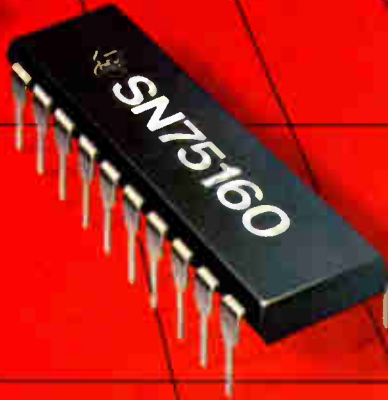

PROPAGATION DELAY TIME (ns)

*New industry standard
from the linear leader...
IEEE-488 products
from Texas Instruments.*

GPIB transceivers...

New SN75160A Series.

65% speed-power improvement.

Total IEEE-488 interface.

Just last year we introduced the SN75160 Series and it became the industry standard almost immediately.

One reason is because it offered an unprecedented 40% reduction in power and board space.

A tough act to follow? Not for the linear leader. Not for Texas Instruments.

Now: 65% speed-power improvement

That's right. 65%. The new SN75160A Series offers you a 65% improvement in speed-power product compared to the SN75160 Series.

The series includes one data bus transceiver, SN75160A, and two management bus transceivers, SN75161A and SN75162A. All are plug-compatible with and direct replacements for SN75160 Series devices. With 25% lower power dissipation. With drivers that are 25% faster. And, with receivers that clock in at a 60% faster rate.

Total IEEE-488 interface

The SN75160A, and either the SN75161A or SN75162A, can be used with GPIB controllers, including TI's TMS9914, to provide a complete microprocessor interface system.

The 8-line bidirectional data bus interfaces to SN75160A. The 8-line management bus is handled by the SN75161A in systems with one controller, or the SN75162A, if there are more than one.

No price increase

Imagine all this additional performance capability at no increase in



PARAMETER CHART

| PARAMETER | | SN75160 | SN75160A |
|---|----------|---------|----------|
| MAX POWER (mW) | UNLOADED | 761 | 525 |
| | LOADED | 953 | 717 |
| MAX SPEED (ns) | DRIVER | 35 | 25 |
| | RECEIVER | 50 | 20 |
| DRIVER I_{OL} (mA) | | 48 | 48 |
| MAXIMUM SPEED—POWER PRODUCT (μ J) UNLOADED | | 38050 | 13125 |

CURRENT AND TEMPERATURE CHART

| | | |
|---|------|------|
| MAX SUPPLY CURRENT (mA) | 145 | 100 |
| OPERATING FREE-AIR TEMPERATURE RANGE (°C) | 0-70 | 0-70 |

price. Here's the 100-piece price* list — see for yourself:

| | | |
|---------|--------|----------|
| SN75160 | \$3.60 | SN75160A |
| SN75161 | \$3.93 | SN75161A |
| SN75162 | \$5.04 | SN75162A |

SN75160A Series key features

- Built-in terminating resistors on drive outputs
- High impedance to bus during power down
- Enable control selects 3-state or open-collector driver output (SN75160A only)
- 3-state outputs on receivers
- Hysteresis on receiver inputs
- High impedance PNP inputs
- Compatible with SN75160 Series
- 100-mA maximum supply current
- 25-ns maximum propagation delay

Linear super source

The continuing introduction of innovative linear products maintains the powerful, positive thrust of TI's linear leadership. For state-of-the-art products, today and tomorrow.

The new SN75160A Series is available now at your nearest authorized TI distributor. For data sheets, or more information, write to Texas Instruments Incorporated, P. O. Box 225012, M/S 308, Dallas, Texas 75265.



TEXAS INSTRUMENTS
INCORPORATED

Circle 111 on reader service card

82172

Testing Micro-Based Systems?

We can help you ship only systems that work and slash service costs with an elegantly simple, economic new way of trouble-shooting:

Our MicroSystem Analyzer with FASTPROBE™

DIRECTED DEBUG

Micro-based boards are exceedingly complex, and demand new testing ideas. We have developed an entirely new philosophy of testing. Our MicroSystem Analyzer enters the board through a universal connector, the microprocessor socket. This allows us to check out the entire board in one set-up; more importantly, we have developed FASTPROBE™, a powerful new software package, that directs the MicroSystem Analyzer operator to the fault quickly. We call this philosophy *Directed Debug*. Here's how it works.

Directed Debug in Production Test.

The MicroSystem Analyzer combines, in one box, in-circuit emulation (ICE™), signature analysis and time-domain analysis — at a price of just \$5350. You can add support for another μP for as little as \$1375 more. ICE lets you do a thorough functional test in real time. Signature analysis speeds up fault isolation. And you can do transition counting, pulse width timing and frequency timing on the board with the MicroSystem Analyzer's time domain analysis.

When you team up our MicroSystem Analyzer with FASTPROBE and

your PDP-11,* you have the optimum resource for doing production test. First off, it simplifies the job of test development for your new micro-based system. You give it the partitioned diagnostics and board topology; it learns the signatures and generates the test set. So when your boards are in final test, you can do fast functional (GO/NO GO) sorting. NO GO boards can then be sent to a test tech who, under FASTPROBE direction, does

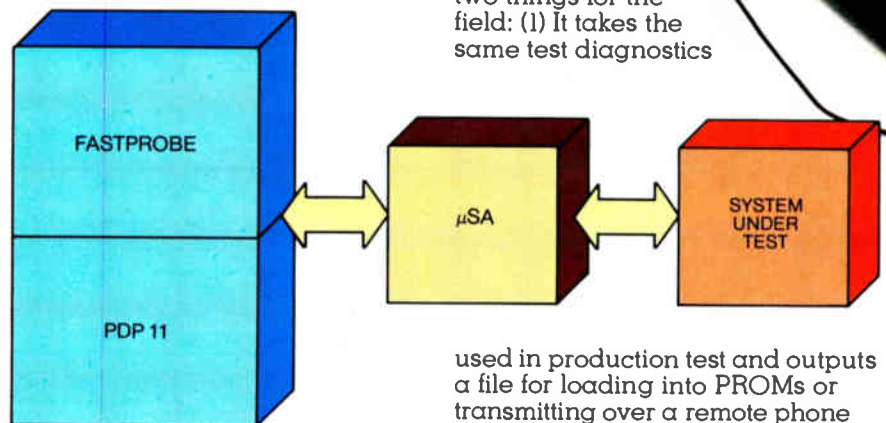

guided probe fault isolation and repair. All this on a network of MicroSystem Analyzers connected to the PDP-11. Field repair problems will diminish and you'll put more systems through test more quickly.

Directed Debug in the Field.

No matter what you do, though, field service will always be with us. You will still need to do fault detection, isolation and repair at some distance from home base. FASTPROBE does two things for the field: (1) It takes the same test diagnostics

used in production test and outputs a file for loading into PROMs or transmitting over a remote phone link. (2) It also prints out signature fault trees for the field engineer. This lets the 21-lb MicroSystem Analyzer function as a stand-alone diagnostic tool, with the features of Directed Debug. It provides the FE with a simple, intelligent front panel and does complete functional testing of the system.





Universality is the Key.

Today, the MicroSystem Analyzer has plug-in modules to support the Z80A, 8085A, 8080A, 6800, 8048, 8748, 8035, 8039, 8041A, 8741A, and 6802. Support for the 6801 and 6809 is coming soon. We'll keep up with all important microprocessors.

FASTPROBE and MicroSystem Analyzer training programs are now available. Ask us about them.

We help design and develop micro-based systems, too. Economically.

Our MicroSystem Designer (μ SD) is a low-cost (under \$2000)*desk-top design aid for evaluating, prototyping, debugging and training. Supports all the important 8- and 16-bit micros. And the Millennium MicroSystem Emulator (μ SE) provides Distributed ICE, a logical new concept that's in tune with today's economy. It's a low-cost (under \$7000) way to provide ICE throughout your operation by

downloading from your MDS or mini to μ SE's. Ask us for the whole story.

And that's the bottom line.

Economy. Performance. Universality. That's the bottom line in today's economy.

To get yourself started on the right test track, call or write Millennium Systems today and ask about μ SE. We'll send you data and a FREE reprint of our 30-page article, "Designer's Guide to Testing and Troubleshooting μ P-based Products." We're at 19050 Pruneridge Ave., Cupertino, CA 95014. (408) 996-9109.

See us at Wescon booth #2732 and 2734

We're Millennium

Circle 112 for DEMONSTRATION

The bottom line in micro support

Circle 113 for INFORMATION

Millennium is a subsidiary of American Microsystems, Inc.

*All prices quoted are single-unit, U.S. price only.

“Our business depends on engineering schedules. So we rely on the capabilities of the

THOMSON-CSF is an international leader in the fast-paced telecommunications industry. They've found Tektronix 8002A emulation and support keeps their projects on schedule.

Jean-Luc Gerner
System Engineer
THOMSON-CSF
Gennevilliers,
France

“Emulation is the quickest, and we think the only way to debug microprocessor designs.”

At Thomson-CSF microprocessor designs have to move quickly from concept to marketplace. That's why engineers like Jean-Luc Gerner prefer the emulation capabilities of the Tektronix 8002A. Says Mr. Gerner: “On paper emulation is supposed to be the same. But we've used other development systems and their emulation has crashed. Tektronix emulation works consistently.” The 8002A's three progressive stages of emulation provide a fast, simplified approach to microprocessor hardware and software integration.

With software development and debug, software/hardware integration, and prototype monitoring emulation modes, Thomson-CSF hardware and software engineers are able to use the same design tool to make changes and corrections right on the spot. “The time saving is incredible,” adds Mr. Gerner.

“We're using microprocessors from two different manufacturers in our application. But we only need one development system for both chips - the 8002A.”



on meeting tight depend on the emulation Tektronix 8002A."



Tektronix' extensive multiple microprocessor and multi-vendor support saves money. (We now support 25 chips.) That's because designs that need different chips from different manufacturers need just one 8002A, instead of two or more dedicated development systems. Tektronix multi-chip support makes you more productive because you don't have to learn a new command interface for each chip.

"The 8002A lets us remain flexible in microprocessor selection for future designs," says Gerner. With the widest list of microprocessor support available, you aren't tied down to a single chip or family of chips.

"Our Tektronix 8002As have been up and running upon arrival. We like that kind of reliability."

The 8002A is thoroughly pretested, so you can begin designing with it as soon as it arrives. Of course, we provide all the manuals and documentation necessary for installation. We'll even help with installation, if you'd like.

And if you should have any problems, a Tek service rep can be there in



48 hours or less. Our MDL service centers worldwide make sure your projects won't slip because of development system downtime.

"After using the 8002A for two years now," comments Mr. Gerner, "we're confident in it. We now spend less time and effort in the microprocessor development cycle."

For information on how you can keep your projects on schedule with the 8002A call us toll-free at 1-800-547-1512. Or ask your local Tektronix MDL Specialist.

U.S.A., Asia, Australia, Central & South America, Japan
Tektronix, Inc.
P.O. Box 1700
Beaverton, OR 97075
Phone: 800/547-1512
Oregon only 800/644-9051
503/644-0161
Telex: 910-467-8708
Cable: TEKTRONIX

Europe, Africa, Middle East
Tektronix International, Inc.
European Marketing Centre
Postbox 827
1180 AV Amstelveen
The Netherlands
Telex: 18312

Canada
Tektronix Canada Inc.
P.O. Box 6500
Barrie, Ontario L4M 4V3
Phone: 705/737-2700

Tektronix®
COMMITTED TO EXCELLENCE

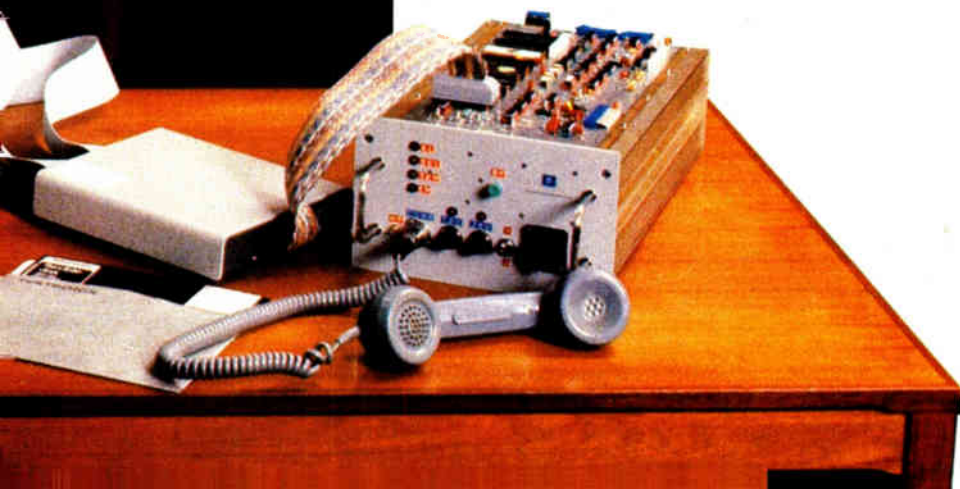

Tektronix MDLs now provide full software development and emulation support for the 8080A, 8085A, 8048, 8039, 8039-6, 8035, 8021, 8022, 8011A, 8049, 6800, 6802, 6808, 3870, 3872, 3874, 3876, F8, Z80A, TMS 9900, SBP 9900, 6800/1 and 1802. Now software development and prototype debug packages for the 8086 and Z8000.

Preprogrammed
remote control.

Serial Control Unit (SCU1)
simplifies development
of remote serial network.

MOSTEK.



For data acquisition, monitoring and control systems that require remote intelligence, there is no simpler solution than designing with our MK14007,* the SCU1.* This preprogrammed single-chip microcomputer pro-

vides remote I/O functions as well as network communications in a single 40-pin circuit. It also performs 19 preprogrammed functions on command.

In addition to asynchronous serial data transmission, the low power (275mW typ.), +5V only SCU1 also features user-definable I/O pins and a complete communications processor. A flexible and expandable data link protocol lets you communicate with multiple SCU1s over a single half-duplex serial link.

Within the simplified message protocol, parity and checksum redundancy insure that message interchange is highly error-resistant.

All of which adds up to less time and money. Less time because preprogramming means a much shorter design to production cycle. Less money because this single-chip solution reduces interconnection costs as well as external parts count.

The MK14007 SCU1 is available now from your Mostek* distributor. Or contact Mostek, 1215 W. Crosby Road, Carrollton, Texas 75006, (214) 323-6000. In Europe, Mostek Brussels 660.69.24.

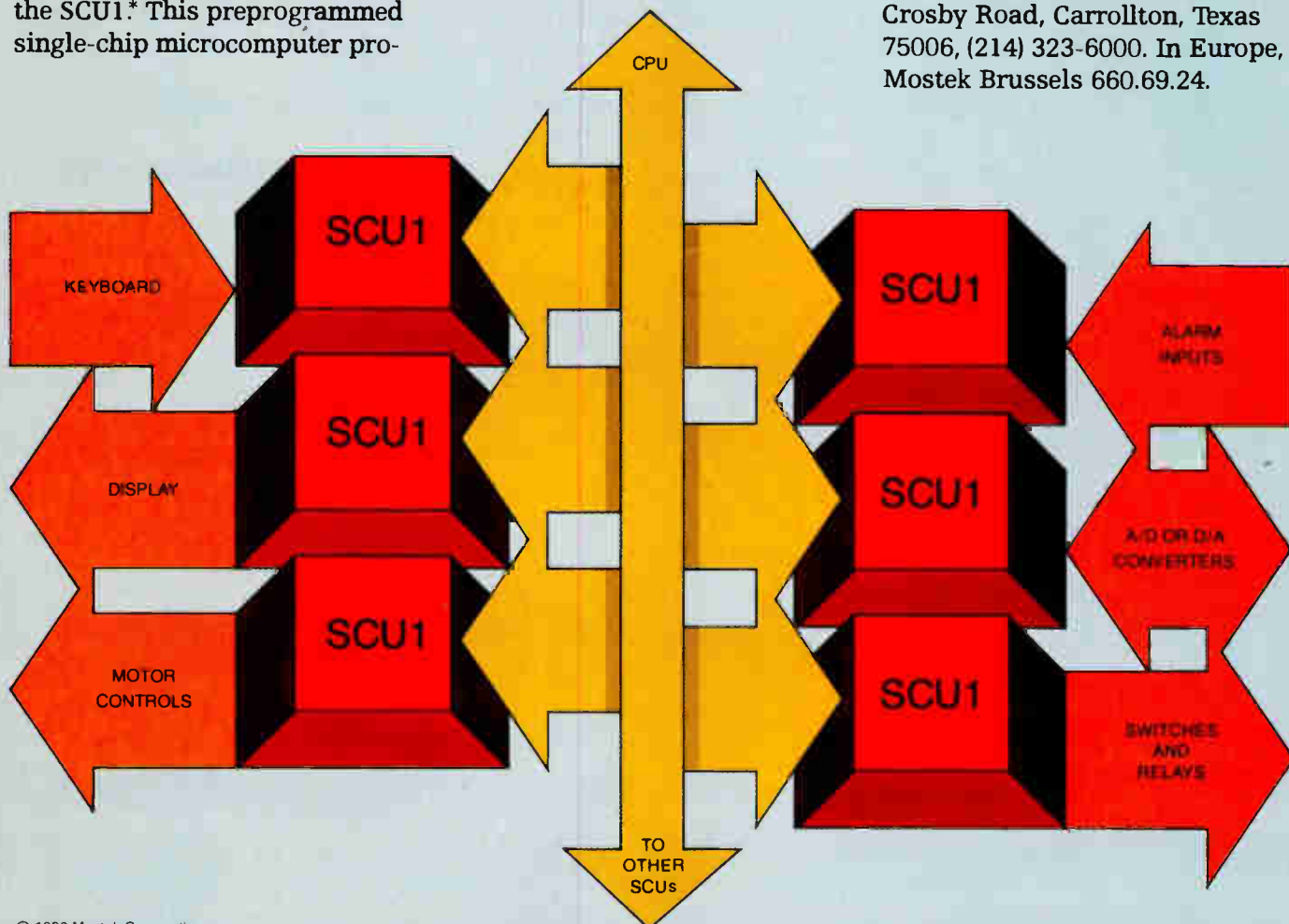

16-K static RAM takes new route to high speed

Novel circuit techniques instead of brute-force scaling achieve 30-ns, 375-mW typical performance; redundant bits and single-polysilicon process make part easy to build

by Rahul Sud and Kim C. Hardee,
Inmos Corp., Colorado Springs, Colo.

□ A very fast 16-K static random-access memory is proof that producibility need not be sacrificed to high performance. Brute-force scaling is not used. Instead, new circuit techniques overcome the classic problems in static RAMs and allow the use of novel asynchronous bootstrap circuits, which help the chip attain a typical access time of 30 nanoseconds despite its highly manufacturable single-polysilicon process.

Until now, scaling of transistor channel lengths down to 2 micrometers has been used to produce MOS static RAMs with speeds that rival those of bipolar memories. However, process control problems associated with these

tighter geometries have made the parts difficult to manufacture. The necessity for multiple threshold-adjusting implants and dual levels of polysilicon has made these MOS processes as complicated as complementary-MOS and bipolar technologies.

Departing markedly from conventional design approaches, the IMS1400 is a fully asynchronous 16-K-by-1-bit RAM fabricated with a 2.7- μm single-polysilicon process that uses one type each of enhancement- and depletion-mode n-channel devices and no zero threshold transistors (see Table 1). The problems of threshold variation, punchthrough, and subthreshold current asso-

TABLE 1: COMPARING THE IMS1400'S PROCESS WITH HMOS II

| Process parameter | HMOS II | IMS1400 |
|---------------------------------|------------------|-------------------|
| Channel length | 2 μm | 2.7 μm |
| Gate-oxide thickness | 400 \AA | 500 \AA |
| Number of polysilicon layers | 2 | 1 |
| Number of transistor thresholds | 4 | 2 |
| Zero-threshold transistors | yes | no |

SOURCE: INMOS CORP. AND INTEL CORP.

TABLE 2: COMPARING TYPICAL PERFORMANCE CHARACTERISTICS OF 16-K STATIC RAMs

| Specification | Intel 2167 | Inmos IMS1400 |
|--------------------------------|------------|---------------|
| Address access time (ns) | 40 | 30 |
| Chip-enable access time (ns) | 40 | 35 |
| Cycle time (ns) | 40 | 30 |
| Active power dissipation (mW) | 500 | 375 |
| Standby power dissipation (mW) | 75 | 35 |

SOURCE: INMOS CORP. AND ISSCC DIGEST 1979

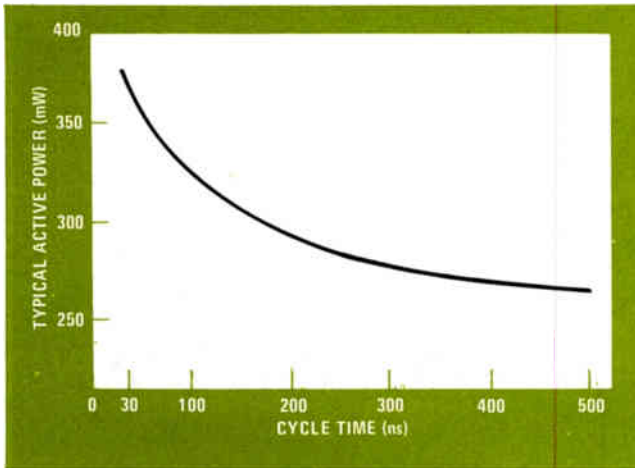

1. Reduced power. The IMS1400 dissipates typically just 375 milliwatts during active operation and only 35 mW during standby. A unique circuit design, quite unlike that of conventional static RAMs, automatically reduces its power requirements at longer cycle times.

ciated with short-channel transistors are avoided, because relatively conservative channel lengths are used.

Nor is very fast operation the only outcome of the innovative circuit design. The memory dissipates typically no more than 375 milliwatts of active power and just 35 mW during standby (Table 2). In fact, unlike conventional static RAMs, it actually needs less active power with longer cycle times (Fig. 1).

Direct stepping on wafer

Direct wafer stepping is used for all critical photolithographic operations, allowing a registration tolerance of better than $\pm 0.5 \mu\text{m}$ to be achieved in production. Ion implantation is used for threshold adjustment and resistor value control and to dope the source and drain regions. Plasma etching is used extensively throughout, especially where dimensional control is critical. Proximity printing is employed for noncritical photoresist levels, and phosphorus diffusion is used to selectively dope polycrystalline silicon for low-resistance areas.

The chip's architecture is illustrated in the die photograph of Fig. 2. The row decoders split the 128-by-128-bit memory array in half. The column decoders are at one end of the array, and adjacent to them are the column-address buffers, control circuits, substrate bias generator, and sense amplifiers. Located at the other end of the chip are row-address buffers and bit-line equilibration and precharge circuits. The memory contains

two spare columns, one on each side of the row decoder array, so that partially defective chips may be repaired electrically during wafer probing.

Housed in a standard 20-pin 300-mil-wide package, the IMS1400 has a pinout that is a simple extension of the 2147 4-K static RAM's. All inputs and the output have direct TTL compatibility. The RAM requires a single 5-volt ($\pm 10\%$) power supply; an on-chip bias generator supplies a negative voltage to the substrate. The memory has equal access and cycle times, and a chip-enable ($\overline{\text{CE}}$) pin is provided that, when taken high, puts the chip in its low-power standby mode.

Single poly will do

Over the years, efforts to reduce cell size and power dissipation have taken static RAM cells from saturated enhancement loads to depletion loads and now to polysilicon resistor loads. Further reductions in cell size were realized either with an extra level of polysilicon or by connecting the load resistors to a bit line [*Electronics*, July 20, 1978, p. 39; Sept. 27, 1979, p. 131].

Both techniques have limitations. The double-polysilicon approach suffers from reduced wafer yields because of the extra interconnection level and its associated buried contacts. Also, the increased vertical dimensions that result from a double-polysilicon process, together with the reduced lateral dimensions, adversely affect step coverage and high-resolution resist processing.

Connecting the load resistors to one of the bit lines does eliminate the V_{∞} line in the memory cell but at the same time severely complicates internal circuit timing and the associated peripheral logic. Even with this trick, cell size remains significantly larger than in the double-polysilicon cell configurations.

The IMS1400 has a unique layout that implements the cell with a single level of polysilicon while keeping it comparable in size to a double-polysilicon structure with the same layout rules. The cell size is 1.07 mil^2 ($689 \mu\text{m}^2$), which is smaller than any previously disclosed double-polysilicon cell. This results in a chip size of just $30,950 \text{ mil}^2$ (19.9 mm^2).

The memory cell uses the familiar cross-coupled flip-flop with four transistors and a pair of polysilicon load resistors that are tied to V_{∞} . The V_{∞} and the word lines are formed in polysilicon. The aluminum bit lines run vertically through the array, as in other static RAM designs. However, the key to the IMS1400's small cell size is to use polysilicon for V_{∞} and an n^+ diffusion for the ground or V_{ss} line.

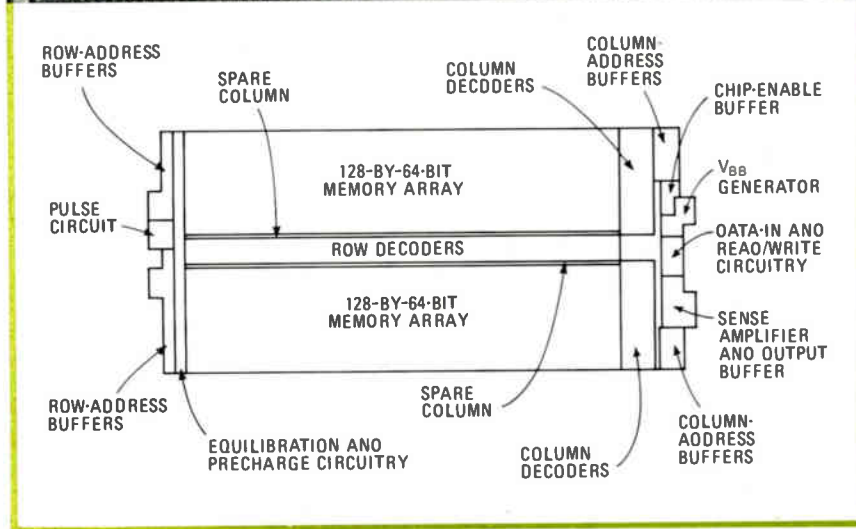
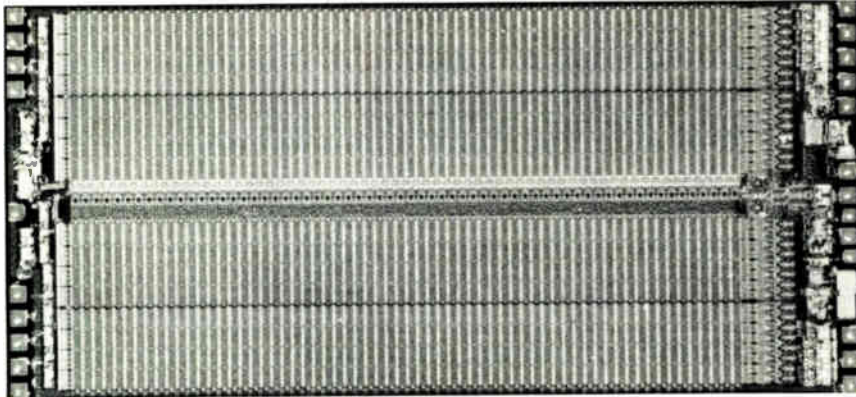

2. Speed with yield. The memory is made with a highly manufacturable 2.7- μm single-polysilicon process. Row decoders split the 128-by-128-bit array in half. A spare column on either side allows partially defective chips to be repaired during wafer testing.

The load resistors are conservative in length to eliminate problems resulting from lateral diffusion of the dopant in the polysilicon. The 2.7- μm transistor channel lengths minimize subthreshold currents, allowing very high-resistance loads to be used in the cell. This, in turn, provides for reliable operation of the cell while reducing the power requirements of the memory array.

Why wait?

A new circuit technique of the IMS1400 overcomes word-line delay and the delay associated with having the memory cell drive the bit lines. In conventional fast static RAMs, polysilicon-word-line delay may cost as much as 20% of the access time. Efforts are therefore being made in the industry to develop low-resistance materials to replace or augment polysilicon.

Another obvious—but unsatisfactory—solution is to use extremely short word lines. This approach has, in fact, been adopted by one manufacturer of a 16-K static RAM; it uses a 64-column-by-256-row memory array, split in half by the row decoders [*Electronics*, July 3, p. 175]. However, not only does this result in an undesirable chip aspect ratio of 3:1, but it also doubles the bit-line capacitance over that of a 128-by-128-bit array. As a result, part of the word-line delay is simply transferred to the bit lines since the cell now has to drive twice the capacitance.

The large bit-line capacitance also contributes to the other significant delay that occurs in conventional static

RAMs. When a memory cell is selected by the word line, it must drive the bit lines from their previous data state into the new data state. Since the memory cell devices are quite small and the bit lines exhibit relatively large capacitances, the time required for the bit lines to attain an equilibrium point may be inordinately long. Sensing of the data obviously cannot occur until after this equilibrium condition is reached and the bit lines begin to move in the direction of their new voltage levels.

Whereas other efforts have been directed toward reducing or eliminating the word-line delay, the IMS1400 uses this time to force the bit lines to an equilibrium point, thereby giving the memory cell a head start in driving the bit lines to their new data states. Referring to the block diagram of Fig. 3, an address-transition detector coupled to the row-address buffers senses any changes at the row-address inputs and activates a pulse generator. The pulse generator rapidly develops a self-timed pulse of a preset duration that tracks any change in polysilicon-word-line resistance, as well as changes in other device parameters.

This pulse forces the bit lines to an equilibrium state before the output of the row decoder has propagated all the way to the end of the word line. As shown in Fig. 4, since equilibration of the bit lines is accomplished concurrently with the word-line delay time, the time required for the bit lines to switch to their new data states is reduced by a period Δt . Sensing of the data can thus begin immediately after the row decoder output

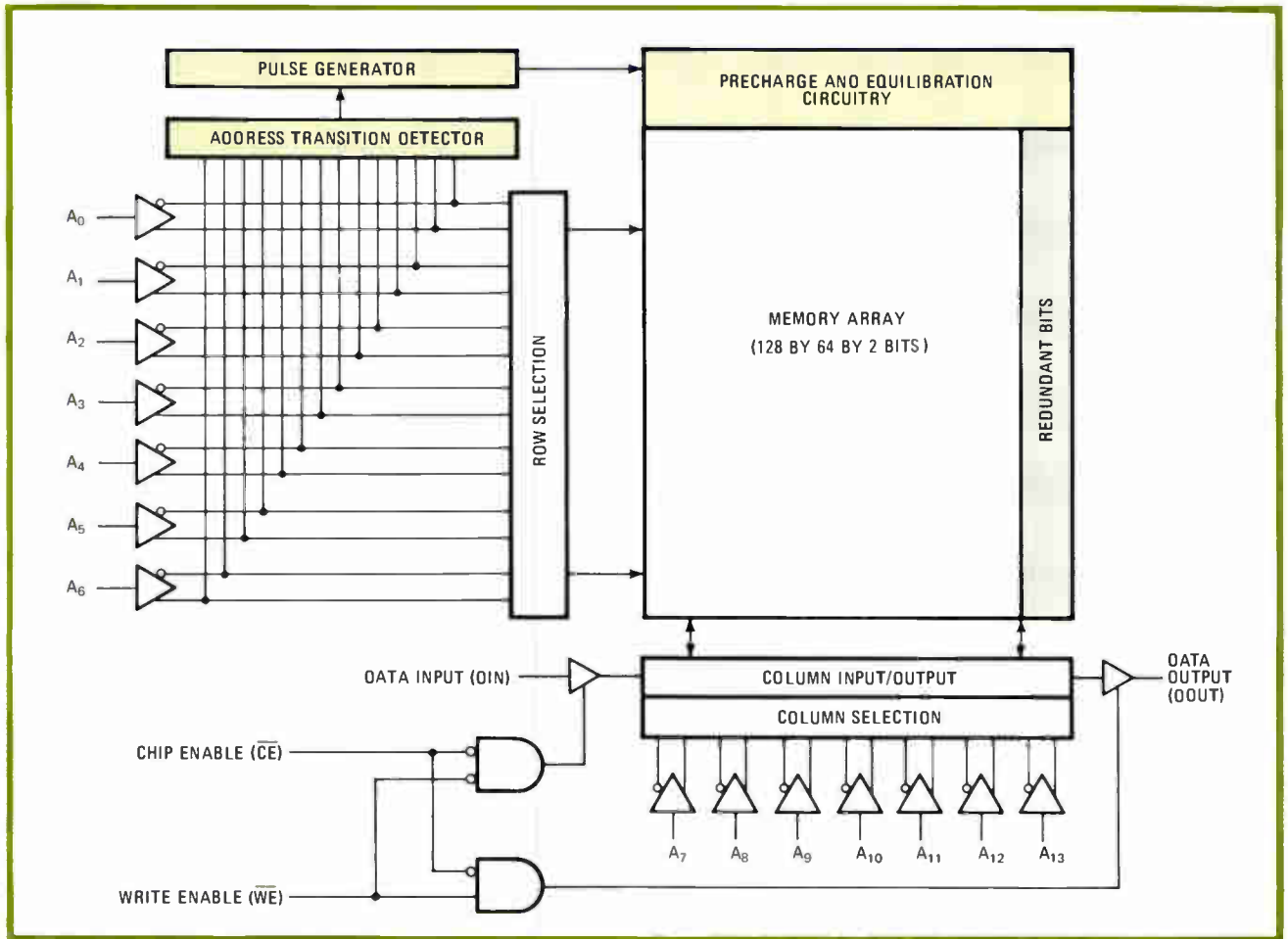

3. To good use. Instead of trying to eliminate the word-line delay, Immos has designed its IMS1400 to use that time to force the bit lines to an equilibrium point, thereby giving the cell a head start on its path toward a new state. A pulse generator activates the equilibration circuitry.

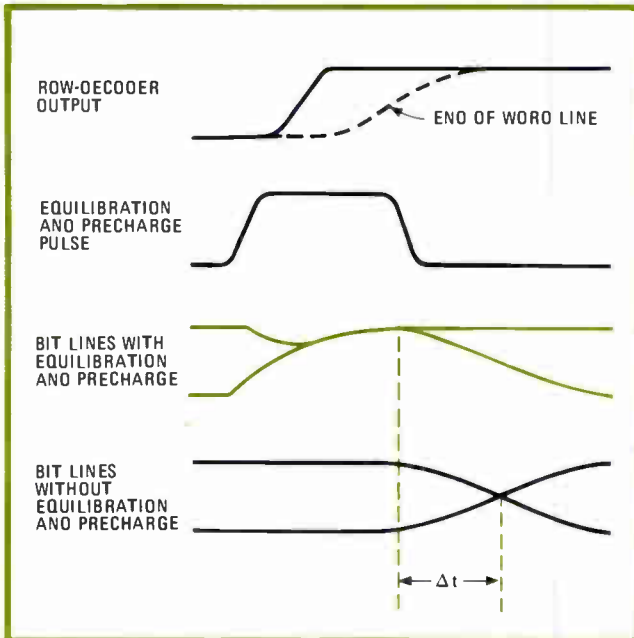

4. Overlapped timing. Since equilibration of the bit lines is accomplished during word-line delay, the time required for the bit lines to switch states is reduced by the period Δt . This technique can reduce the access time of the memory by more than 30%.

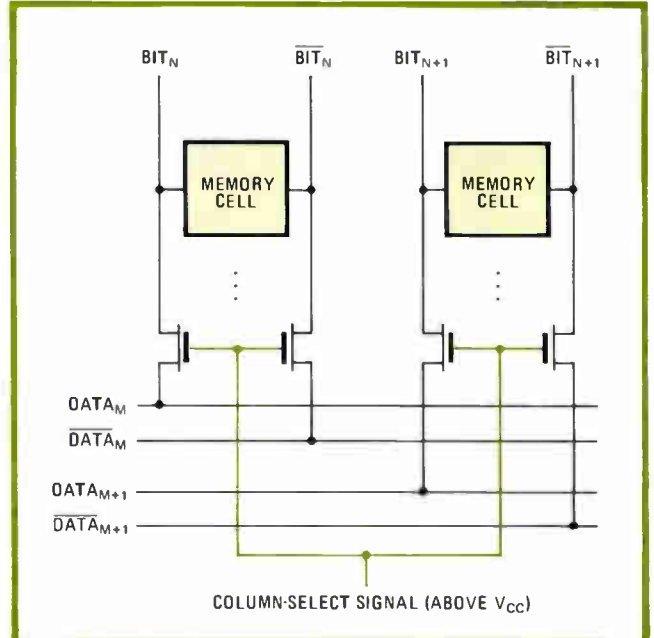

5. Bootstrapped and doubled up. Bootstrapping the column-select signal results in a stronger drive on the column-select gate, enhancing the transfer of data from the bit to the data line. An interleaved column-decode scheme reduces data-line capacitance.

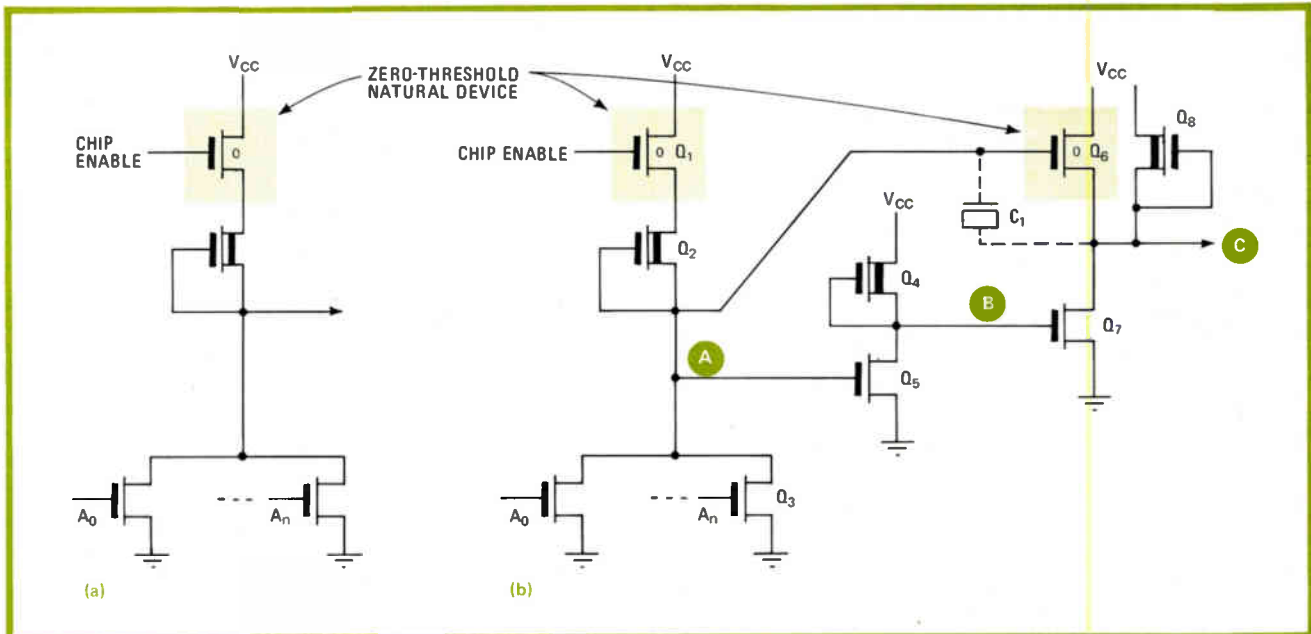

6. Goodbye to naturals. Decoders have evolved from the simple NOR circuit (a) to the buffered NOR with bootstrapping (b). The IMS1400's decoder eliminates zero-threshold devices, dissipates less power, is twice as fast, and operates reliably and asynchronously.

reaches the end of the word line instead of having to wait for the cell to drive the bit lines to an equilibrium point first. This technique can reduce the access time of the memory by more than 30%.

Active precharge keeps it cool

High-speed asynchronous static RAMs traditionally suffer from extremely high active-power dissipation. The 2147 dissipates almost 1 watt. Memories like the 2147 use saturated enhancement-load devices to pull one of the bit lines high in each column. The power dissipated by these load devices during the active cycle can amount to more than 35% of the total active power of the chip.

The IMS1400 uses active precharging to pull up the bit lines each time a row-address transaction is sensed. This precharging of the bit lines is initiated by the same pulse that accomplishes bit-line equilibration. As mentioned earlier, this pulse is designed to be self-terminating. Once the precharging is complete, the active bit-line loads are cut off altogether, thus reducing their power dissipation to zero.

Yet another delay that limits the speed of conventional static RAMs is associated with the column-select transistors connecting the selected pair of bit lines to the data lines (see Fig. 5). In previous designs, the column-select signal is driven to the power supply potential for column selection. Since the bit lines are initially at one enhancement threshold drop below V_{cc} , the column-select transistors are off until the selected memory cell begins to pull one of the bit lines to a level lower than V_{cc} . Since they are operating in a weak conduction mode (the gate drive is very small with such a minor gate-source voltage, V_{gs}), significant delays arise as data is transferred from the bit lines to the data lines.

A new bootstrapping technique drives the gates of the column-select transistors above V_{cc} . These devices must operate in a highly conductive mode to effect rapid

transfer of the data from the bit lines to the data lines. It has not been possible in the past to use signals above the power supply voltage to advantage in fully asynchronous static RAMs. However, the circuit used in the IMS1400 allows the column decoder output to remain at a voltage above V_{cc} indefinitely.

To reduce data-line capacitance, a fully interleaved two-stage column decoder is used. As shown in Fig. 5, adjacent columns are connected to separate pairs of data lines when a common column-select signal goes high. A second stage of decoding connects one of the two data-line pairs to the data bus. Since only one out of four column-select transistors is connected to each data line pair, and since the column-select transistors can be made smaller as a result of being driven with a signal above V_{cc} , the data lines see a significantly reduced capacitive loading. This makes the part even faster.

Asynchronous, glitchproof bootstrapping

Although the power and speed advantages of bootstrap circuits have been proven in dynamic RAMs, conventional configurations have not been used effectively in asynchronous static RAMs because of the following inherent limitations:

- A precharge setup time is required that cannot be guaranteed in an asynchronous environment.
- Input noise spikes, or glitches, may cause the bootstrapping action to fail, thereby resulting in speed loss or even functional failure.
- The bootstrapped node will eventually leak to a lower level, thereby eliminating the use of voltage above the positive power supply voltage.

Figure 6 shows the evolution of decoders in fast asynchronous static RAMs. The circuit in Fig. 6a is a simple depletion-load NOR decoder with the addition of a 0-V-threshold, or "natural," transistor used to power down the decoder when chip-enable signal CE is low. The

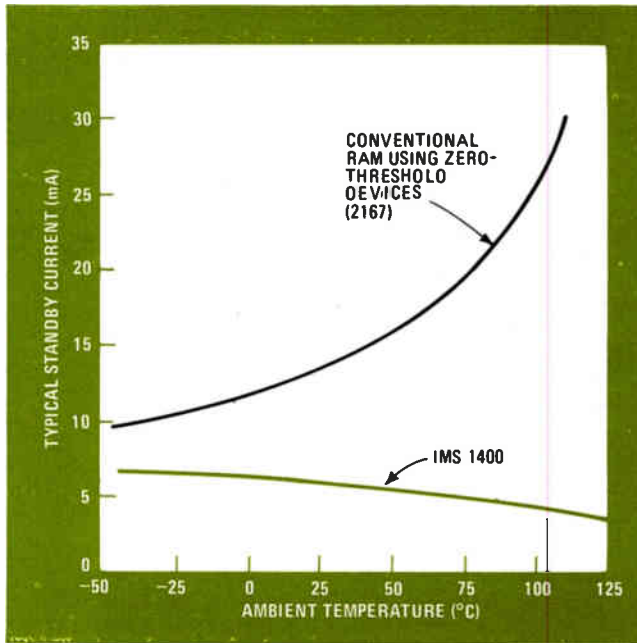

7. Inversely proportional. Other static RAMs use 0-v-threshold transistors as power switches to turn off circuitry for standby. But at elevated temperatures, these devices tend to conduct. Since the IMS1400 does not employ such transistors, its power stays low.

output switches to approximately V_{cc} when all address inputs are low, and it is pulled near ground when any address input is high. This type of circuit is used as a row decoder in the 2147 4-K static RAM.

To improve speed and reduce power dissipation, a buffered NOR decoder (Fig. 6b) is used as a column decoder in the 2147. The advantage of this circuit over the simple NOR decoder is that the power-consuming input stage is buffered from the output. Also, capacitor C_1 is added to bootstrap the gate of transistor Q_6 to improve the drive of the output stage.

Normal operation of the circuit in Fig. 6b may be described as follows. When one or more of the address inputs is high, node A is pulled to ground, node B rises toward V_{cc} , and node C—the output—is low. When the address input goes low, node A rises to create a voltage differential across C_1 . At this time, the bootstrap capacitor is said to be precharged.

Next, node B goes low, turning off Q_7 . (The delay through the inverter composed of Q_4 and Q_5 must be long enough to ensure that a sufficient voltage differential has developed across C_1 before Q_7 is turned off.)

Node C then rises, causing node A to be capacitively coupled—bootstrapped—above V_{cc} . Q_6 is therefore turned on hard, quickly pulling node C to V_{cc} . Q_8 , a high-impedance depletion-mode transistor (often called a keeper), is used to hold the output node C at V_{cc} potential in the selected state.

This circuit suffers from several basic problems. The bootstrapping action will actually fail if input glitches or random voltage transitions occur at the input. This failure mode may be understood by noting that the C_1 may not have a positive voltage across it when the decoder is in a selected state. Owing to junction and subthreshold leakage, this will happen when node A falls to V_{cc} while

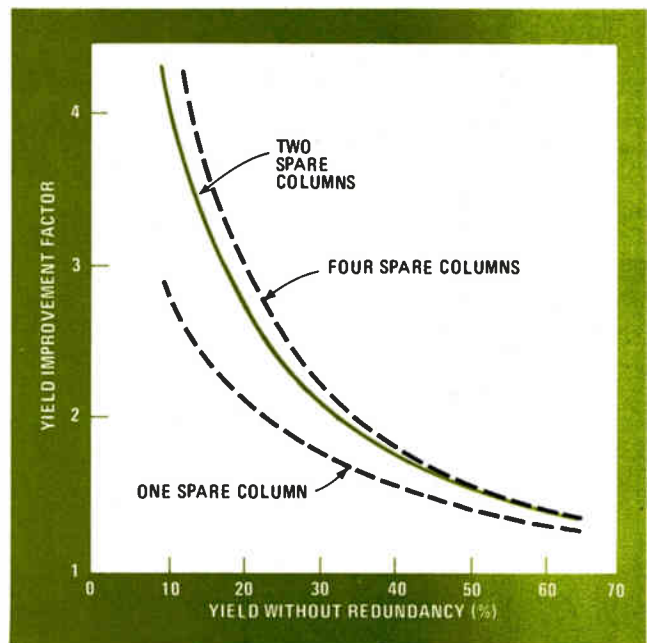

8. Redundancy. Up to two defective columns may be repaired in the IMS1400. Two spare columns are almost as efficient as four, and they occupy less area. In the IMS1400, the extra circuitry consumes less than 2% of the chip area and does not affect speed or power.

node C is still held at V_{cc} by Q_8 . When one or more address inputs go high, node A begins to fall immediately, whereas node C will start dropping after a delay through the Q_4 - Q_5 inverter.

Should the address inputs now go low, node A will rise, causing node B to fall, shutting off Q_7 . At this time node C may be between 0 v and V_{cc} and node A may be at a voltage equal to or less than the voltage at node C. Since C_1 does not have a positive voltage across it, the required bootstrapping action will not occur. The circuit will behave as if the capacitor did not exist, severely degrading the speed at node C.

Since in a fully asynchronous static RAM any random voltage transitions may occur, this bootstrap circuit will not function reliably at all times. Even when the bootstrapping action does occur, node A is not isolated from the large capacitance associated with the address gates, and the resulting capacitive divider action reduces the efficiency of the bootstrap, impairing circuit speed.

Bootstrapping in the IMS1400 is intended primarily for asynchronous environments. The circuits are faster, consume less power, and allow the use of signals above V_{cc} since the bootstrapped nodes are capable of maintaining their levels indefinitely. They place no precharge setup-time requirement on an input signal.

The bootstrapped nodes are isolated from the capacitance of the address gates, and new circuit techniques guarantee the existence of a sufficiently positive voltage differential across the capacitor at all times. Specifically, the circuits are insensitive to input glitches and will respond reliably to any input signal.

In addition to ordinary enhancement- and depletion-mode transistors, conventional fast static RAMs employ zero-threshold transistors to act as power switches. Their use allows nearly all peripheral circuitry to be powered

down with a single external control signal. In principle, the threshold voltage of these so-called natural devices is zero, so that they act as nearly ideal current switches. However, control of their threshold voltage is very critical to the performance of the circuit. On the one hand, if the threshold voltage is slightly negative, these devices cannot be turned off, with the result that standby power increases dramatically. If, however, the threshold voltage is slightly positive, loss of circuit speed results because of transistor current gain degradation and voltage drops on internal signals.

No need for naturals

In addition, wafer yield is affected because zero-threshold transistors necessitate an additional masking step and increased handling of unprotected gate oxides in the manufacturing process.

Besides having an adverse effect on yield and throughput, a significant system-level problem arises through the use of zero-threshold transistors. Even if the threshold voltage is exactly zero with back biasing, when power is initially applied, these transistors will be depletion-mode because the substrate is at 0 V. A large transient current will therefore occur until the on-chip bias generator has pumped down the substrate, and it could lock out the power supply servicing a large system that exploits the power-down feature.

The bootstrap drivers and circuit techniques used in the IMS1400 eliminate the need for zero-threshold transistors. In fact, only enhancement- and depletion-mode transistors are used (instead of the four different types of transistors used in some H-MOS II fast static RAMs). Not only are the technological and applications-related problems eliminated, but standby power at elevated temperatures is also significantly reduced.

Figure 7 compares the standby power of the IMS1400 with that of Intel Corp.'s forthcoming 16-K static RAM, which employs zero-threshold devices. Though the standby power of the other static RAM more than triples during a -50° to 115°C temperature excursion, the standby power of the IMS1400 actually drops at elevated temperatures. Part of this difference stems from the fact that the zero-threshold transistors become depletion-mode at higher temperatures and so do not turn off.

Just enough redundancy

The yield of memory chips is reduced by localized defects that affect a small number of single bits, rows, or columns of the array. To deal with this problem, multiple row and column redundancy schemes have been proposed. Previous techniques are hard to use (requiring, for instance, lasers), impair the performance of the circuit, or require too much chip area.

The fault-tolerant design of the IMS1400 can permanently correct up to two defective columns of memory cells. Figure 8 shows the impact of redundancy on yield, based on a statistical model of random defects. As seen from the curves, the optimal amount of redundancy is two extra columns. The use of two spare columns also enables the correction of a defect occurring on the boundary of two adjacent columns. This particular redundancy scheme uses less than 2% of the total chip

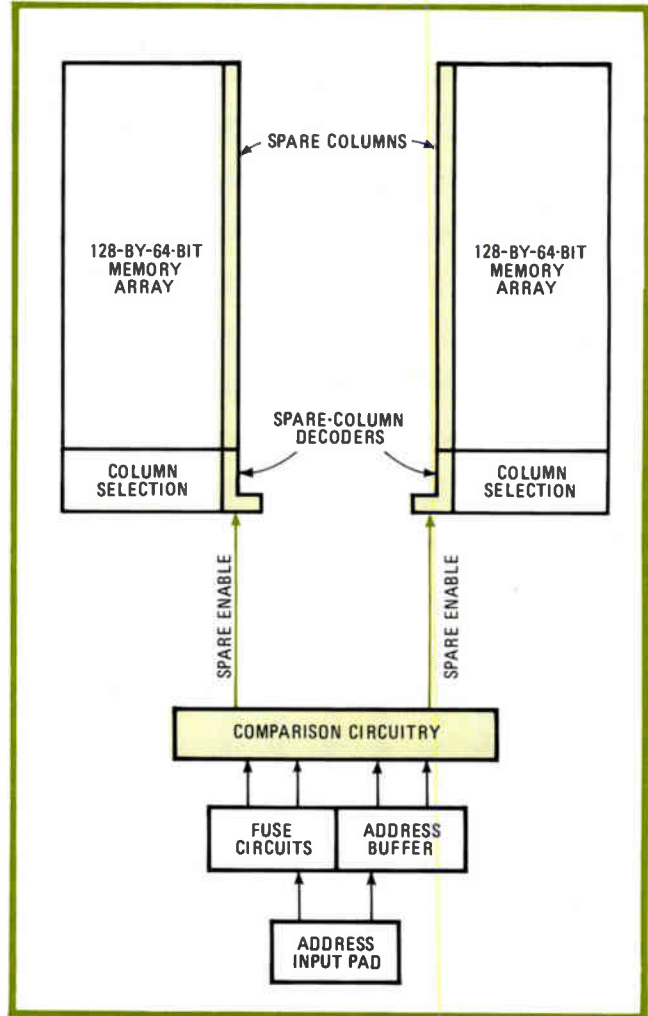

9. Swapping. Improving on hard-to-use or area-consuming schemes, programmable fusible polysilicon links store redundancy information. Since the column-access time is inherently faster than the row-access, spare-column selection does not slow the chip.

area, requires essentially no extra power, and does not impair the speed of the circuit.

Figure 9 presents the basic redundancy technique. The addresses of the defective columns are permanently stored on the chip using programmable polysilicon fusible links. During memory operations all incoming column addresses are compared with the stored fuse information. Should they match, a spare column is automatically selected instead of the defective column. Since the column access time of the memory is inherently faster than the row access time, selection of a spare column does not result in any speed degradation.

Just the beginning

The IMS1400 attains performance equal to or better than that of today's fastest MOS RAMs—like the 4-K 2147H—yet uses design rules that are significantly more relaxed than the $2\text{-}\mu\text{m}$ dimensions of such RAMs. Future products from Inmos will, in fact, further utilize direct-stepping-on-wafer photolithography to shrink device dimensions to $2\ \mu\text{m}$ and beyond, resulting in even more impressive performance and density. □

Achieving stability in IC oscillators

Waveform-generator chips that operate above 1 megahertz rely on emitter-coupled circuits needing sophisticated temperature compensation

by İlhan Refioğlu, *Exar Integrated Systems Inc., Sunnyvale, Calif.*

□ Monolithic waveform and function generators form the backbone of circuits in a wide range of applications—telecommunications, data transmission, and test-equipment design and calibration. These integrated-circuit oscillators are characterized by an output waveform that is well-defined, repeatable, and stable despite changes in ambient temperature and power-supply level.

Modern waveform- and function-generator ICs are overcoming the limitations of older IC oscillators like phase-locked loops and voltage-to-frequency converters. The latter type of device is limited in performance by the fact that it provides only pulse-train or square-wave outputs. Waveform and function-generator chips, on the other hand, provide a wider variety of output waveforms, and do so at lower cost.

A function-generator IC generally consists of a current- or voltage-controlled oscillator section that generates the periodic waveform and allows for frequency variation, a wave-shaping section—basically, a sine-wave shaper—and a modulator (Fig. 1).

The heart of any function-generator IC is the oscillator section. This circuit determines the chip's most important performance characteristics. These include stability

with power-supply voltage and temperature changes, frequency range, sweep linearity, and so on.

There are two major types of IC oscillators, differentiated mainly by their ability or inability to operate at frequencies above 1 megahertz. Oscillators that operate under 1 MHz generally employ lateral pnp transistors for switching and saturated logic. Their operating frequencies are limited in practice to several hundred kilohertz. But they also feature high stabilities of 50 parts per million per °C or less, thanks to careful compensation techniques employed in their designs.

Speed versus stability

Oscillators that operate above 1 MHz employ emitter-coupled multivibrators and npn transistors. They are inherently capable of operation up to 10 MHz. But they also suffer from frequency instabilities of more than 150 ppm/°C and low-frequency inaccuracy.

Figure 2a shows a basic RC multivibrator low-frequency oscillator circuit that has gained wide acceptance among IC oscillator designers. Capacitor C_0 is exponentially charged through resistor R_1 to the supply-voltage level. When the voltage across C_0 ramps up to

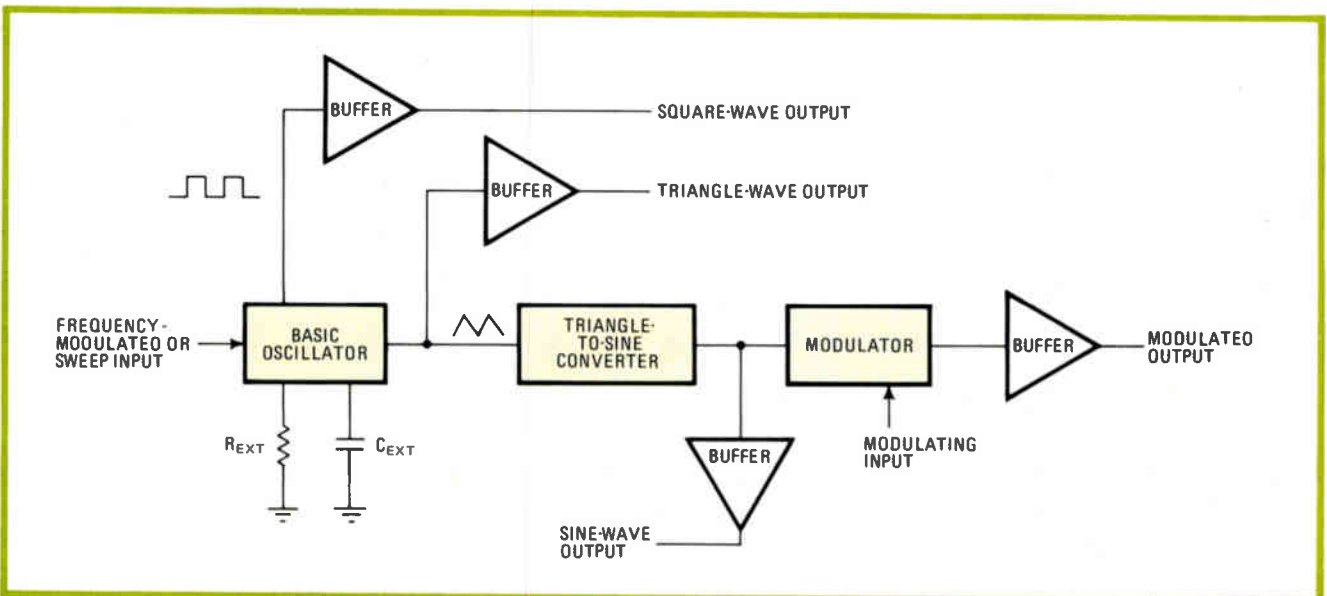

1. Functions. Generating waveform functions involves three major circuit elements: a basic oscillator to produce a periodic and variable-frequency wave, a wave-shaping section, and a modulator. The oscillator frequency is controlled by either a voltage or a current.

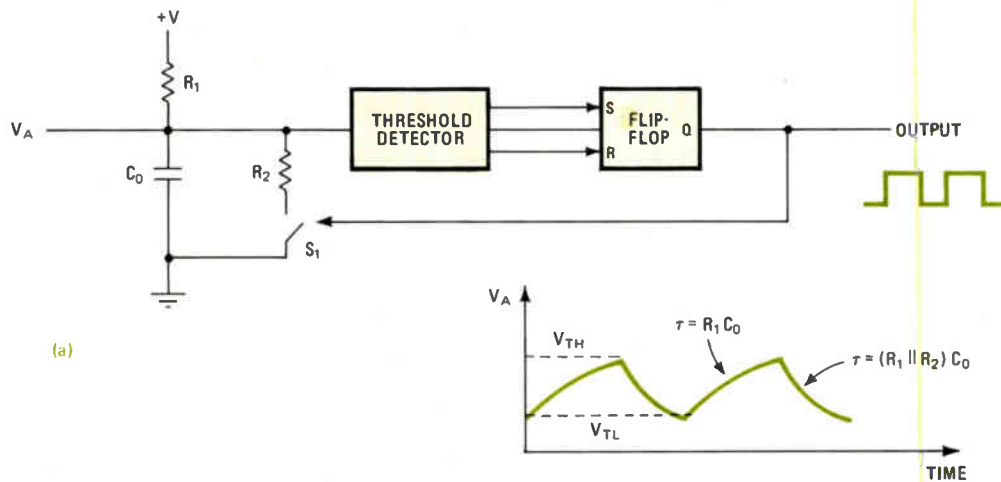

(a)

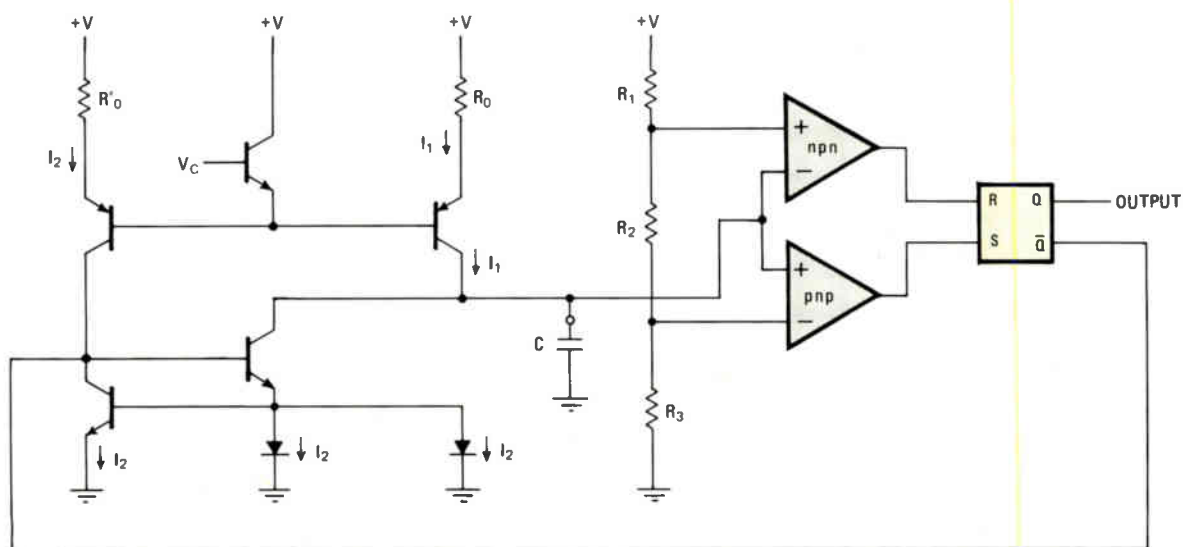

(b)

2. Stable. A basic RC multivibrator oscillator (a) offers high stabilities, but its lateral pnp transistors limit it in operating frequency to about 100 kilohertz. An implementation similar in concept (b) differs in that two current sources, I_1 and I_2 , are used in place of resistors R_1 and R_2 .

the higher of two threshold values, V_{TH} , the threshold detector changes the flip-flop's state, thus closing switch S_1 (usually a transistor). With S_1 closed, C_0 starts discharging its voltage exponentially to ground through the parallel combination of R_1 and R_2 . When C_0 's voltage reaches a lower threshold, V_{TL} , the threshold detector is once again activated, causing the flip-flop to revert to its original state, and the charging process is repeated. Note that if R_1 is small, an exponential sawtooth waveform is obtained. If R_2 is much larger than R_1 , the output waveform will be symmetrical.

A circuit similar in principle to that of Fig. 2a uses two current sources, I_1 and I_2 , in place of R_1 and R_2 to generate a linear ramp waveform across the capacitor. When current I_2 is equal to $2I_1$, a symmetrical-output triangular or square waveform is obtained. A practical implementation of this circuit is shown in Fig. 2b. This type of circuit is employed in the ICM8038 IC oscillator from Intersil Inc., Cupertino, Calif. Charging and dis-

charging of capacitor C are performed by currents I_1 and I_2 . I_1 and I_2 are equal to the supply voltage minus V_C divided by resistors R_0 and R'_0 , respectively. Although I_1 is always on, I_2 , which is doubled by the current mirrors, is switched on and off by the flip-flop's output. I_1 does the charging function while current $2I_2 - I_1$ does the discharging.

If resistors R_0 and R'_0 are equal, then I_1 equals I_2 and C is charged and discharged by identical currents, leading to symmetrical output waveforms. Oscillator frequency for this case is a constant value, k , multiplied by $I_1 C$. Since current is set up by a control voltage, this circuit is known as a voltage-controlled oscillator.

A different type of VCO circuit is the one used in the popular type NE566 function-generator IC from Signetics Corp., Sunnyvale, Calif., and others. It is also used as the VCO for the Signetics 565 phase-locked loop IC. The circuit and its implementation are shown in Fig. 3. The same voltage-controlled current, I_0 , is used to

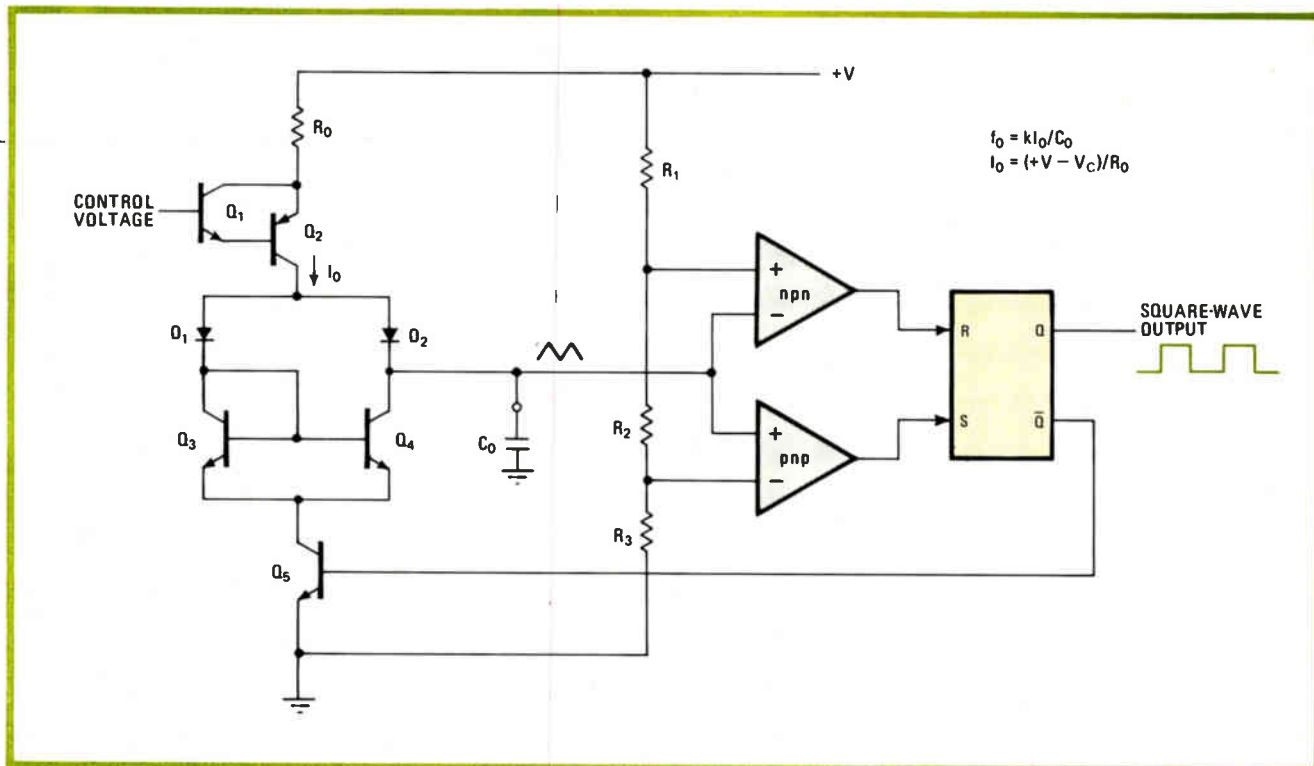

3. Voltage-controlled. This voltage-controlled oscillator is used in the popular 565 phase-locked-loop integrated circuit and in a function-generator IC, Signetics' NE566. Another astable multivibrator, it uses one voltage-controlled current, I_0 , to charge and discharge capacitor C_0 .

charge and discharge capacitor C_0 via the actions of the flip-flop circuit.

When transistor Q_3 is off, I_0 charges C_0 through diode D_2 . When the voltage across C_0 reaches the trip point of the comparator, the flip-flop changes state and Q_3 is turned on. At this point D_2 becomes back-biased and C_0 is discharged through Q_4 by the mirrored current, I_0 , until the voltage across C_0 reaches the lower threshold level. Then the flip-flop reverts to its original state, turning off Q_3 and repeating the charge-discharge cycle. Since the same current is used for charging and discharging, the circuit's duty cycle cannot be varied.

The oscillators of Figs. 2 and 3 are astable multivibrator circuits. They exhibit good stabilities, in the range of 50 to 100 ppm/ $^{\circ}$ C. Unfortunately, they are limited to a maximum frequency of about 100 kHz due to the use of lateral pnp transistors.

Emitter coupling for higher frequency

Figure 4a shows a simplified schematic of an emitter-coupled multivibrator oscillator capable of 20-MHz operation. This circuit is difficult to compensate for changes in temperature, however, for very good frequency stability at high operating frequencies.

Transistors Q_1 and Q_2 , resistors R_{L1} and R_{L2} , and the timing capacitor C form the heart of the multivibrator. The clamping action of D_1 and D_2 and the level shift of emitter-followers Q_3 and Q_4 (which are always conducting) keep the circuit from saturating and firmly establish the voltage swings. At a given time, either Q_1 and D_1 or Q_2 and D_2 are conducting, so that C is alternately charged and discharged by constant current I_1 , which is generated by Q_5 and Q_6 . When Q_1 is on, the output V_A is

constant at $V_{CC} - 2V_{BE}$ (where V_{CC} is supply voltage and V_{BE} is Q_1 's base-emitter voltage), and the output V_B is a linear ramp with a slope equal to $-I_1/C$, since Q_2 is off. When V_B is pulled low enough ($1 V_{BE}$ below Q_2 's base, which is at $V_{CC} - 2V_{BE}$) by I_1 , Q_2 turns on and regenerative switching occurs. The collector of Q_2 is pulled down to a diode drop below V_{CC} and the base of Q_1 is pulled down to $V_{CC} - V_{BE}$, turning off Q_1 and raising its collector rapidly by $1 V_{BE}$ to the supply level. This step of $1 V_{BE}$ appears at the emitter of Q_2 and is transmitted to the emitter of Q_1 by C . The emitter of Q_1 is now $1 V_{BE}$ above its base and must slew a full $2V_{BE}$ at I_1 , with a slope equal to $-I_1/C$, before the oscillator changes state again.

The waveforms generated by this oscillator circuit are shown in Fig. 4b. The voltage at the collectors of Q_1 and Q_2 are two symmetrical square waves, with peaks between V_{CC} and $V_{CC} - V_{BE}$. The differential output V_0 across diodes D_1 and D_2 corresponds to a symmetrical square wave, with a peak-to-peak amplitude of $2V_{BE}$. $V_A(t)$ and $V_B(t)$ are linear ramp waveforms with peak-to-peak amplitudes of $2V_{BE}$. They can be subtracted from each other to produce a linear triangular waveform, which is the voltage across the capacitor. Subtraction can be performed by a simple differential amplifier stage whose output voltage is a triangular waveform. The same differential amplifier circuit can also be used to obtain a sinusoidal output.

The frequency of oscillation f_0 of the emitter-coupled multivibrator of Fig. 4a can be expressed as:

$$f_0 = I_1 / (4V_{BE}C)$$

The frequency can be controlled by varying I_1 by means

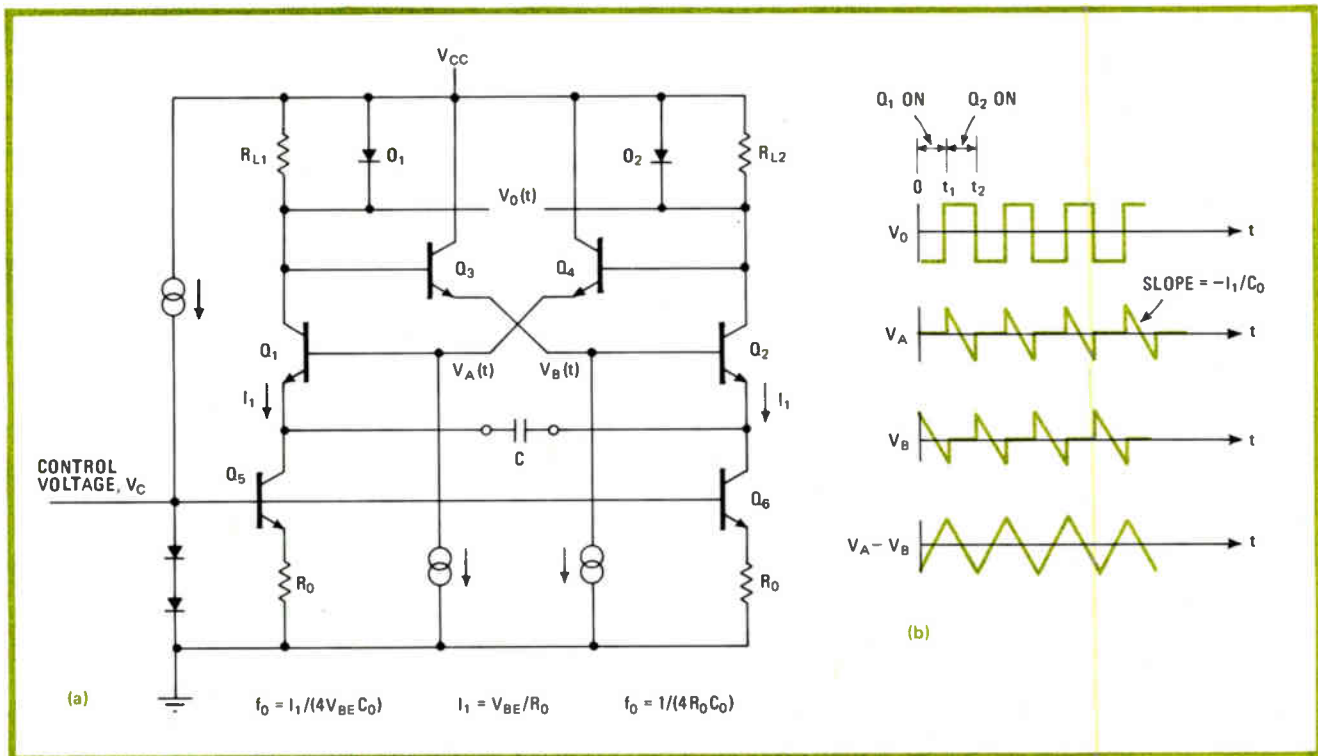

4. High frequency. An emitter-coupled multivibrator oscillator (a) allows the generation of waveforms (b) of up to 20 megahertz. Unfortunately, this type of circuit is difficult to compensate for changes in temperature, leading to poor stabilities at high frequencies.

of a control voltage, V_C . The symmetry of the triangular- and square-wave outputs can be offset by changing the ratio of emitter resistors of Q_5 and Q_6 . This ratio effectively changes the ratio of the current that charges capacitor C to the current that discharges it. In this manner, the triangular- and square-wave outputs can be converted to sawtooth or pulse waveforms.

The emitter-coupled multivibrator circuit shown is widely used for high-frequency applications. Oscillator types NE560 and NE562 from Signetics and others, as well as Exar phase-locked loops type XR-S200, XR-210 and XR-215, use it. The Exar XR-205 monolithic waveform generator also uses a similar emitter-coupled astable multivibrator design.

Strong temperature dependence

The frequency of this emitter-coupled multivibrator circuit is a function of V_{BE} , which in turn is strongly dependent on temperature. To overcome this strong temperature dependence, the timing current I_1 is also made a function of V_{BE} , such that $I_1 = V_{BE}/R_0$. Thus to a first-order degree, f_0 is temperature-compensated and is expressed as:

$$f_0 = (V_{BE}/R_0)/(4V_{BE}C) = 1/(4R_0C)$$

This compensation is only effective at the center frequency. Since the control current that modulates the frequency is not compensated, even very small control-current deviations degrade the temperature coefficient drastically (typically ± 300 ppm/ $^{\circ}\text{C}$ at $\pm 10\%$ current deviation).

Despite center-frequency compensation, the emitter-coupled multivibrator still exhibits a temperature coefficient

of 200 to 300 ppm/ $^{\circ}\text{C}$. The culprits are the charging-current imbalance in Q_1 and Q_2 near the switching thresholds and the switching transients. The transients depend on circuit resistances, transistor transconductances, and input resistances, which all are temperature-sensitive. Temperature drift of the circuit is inherent in its emitter-coupled multivibrators. There are other compensation techniques that can be used to make a high-stability (typically 50 ppm/ $^{\circ}\text{C}$ or less) oscillator out of the circuit in Fig. 4a, but this is usually achieved at the expense of speed.

Improving temperature compensation

Two very stable temperature-compensated oscillator configurations are used in Exar's XR-2206 and XR-2207 function-generator ICs as well as in the company's XR-2211 and XR-2212 phase-locked-loop ICs. They use a temperature-compensated emitter-coupled astable multivibrator circuit that has a typical temperature stability of 30 ppm/ $^{\circ}\text{C}$ (Fig. 5).

Timing current, I , set up by R_{ext} , flows in Q_2 , C , and Q_3 when transistors Q_5 , Q_7 , and Q_9 are on. The timing current is inverted by the current balance and establishes an identical emitter current density in Q_7 . The voltage at the control input B is thus held at 0 over a wide range of timing currents. At an optimum current value, point A is also at 0 V, eliminating the temperature coefficient introduced in this area. When the state changes, I flows in Q_1 , C , and Q_4 ; all the compensation transistors on the right are turned on; and I is inverted by a current balance. As a result, I establishes an identical emitter current density in Q_{10} .

The instability introduced by a shift in the regenera-

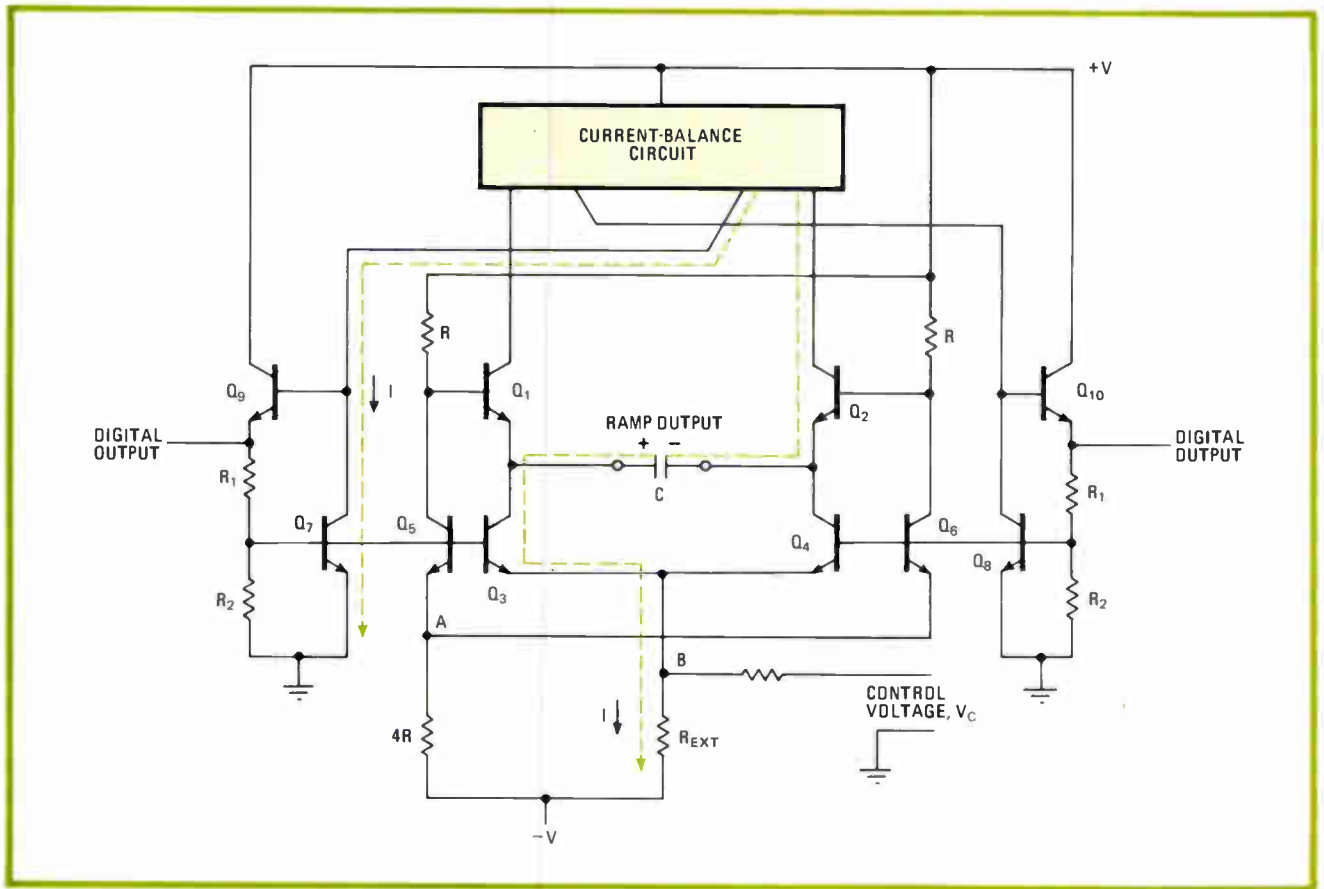

5. Compensation. Emitter-coupled astable multivibrators can be stabilized using this temperature-compensated circuit. Typical temperature stabilities of 30 parts per million per °C are possible. This circuit is used in Exar's XR2207 function-generator and XR2211 PLL chips.

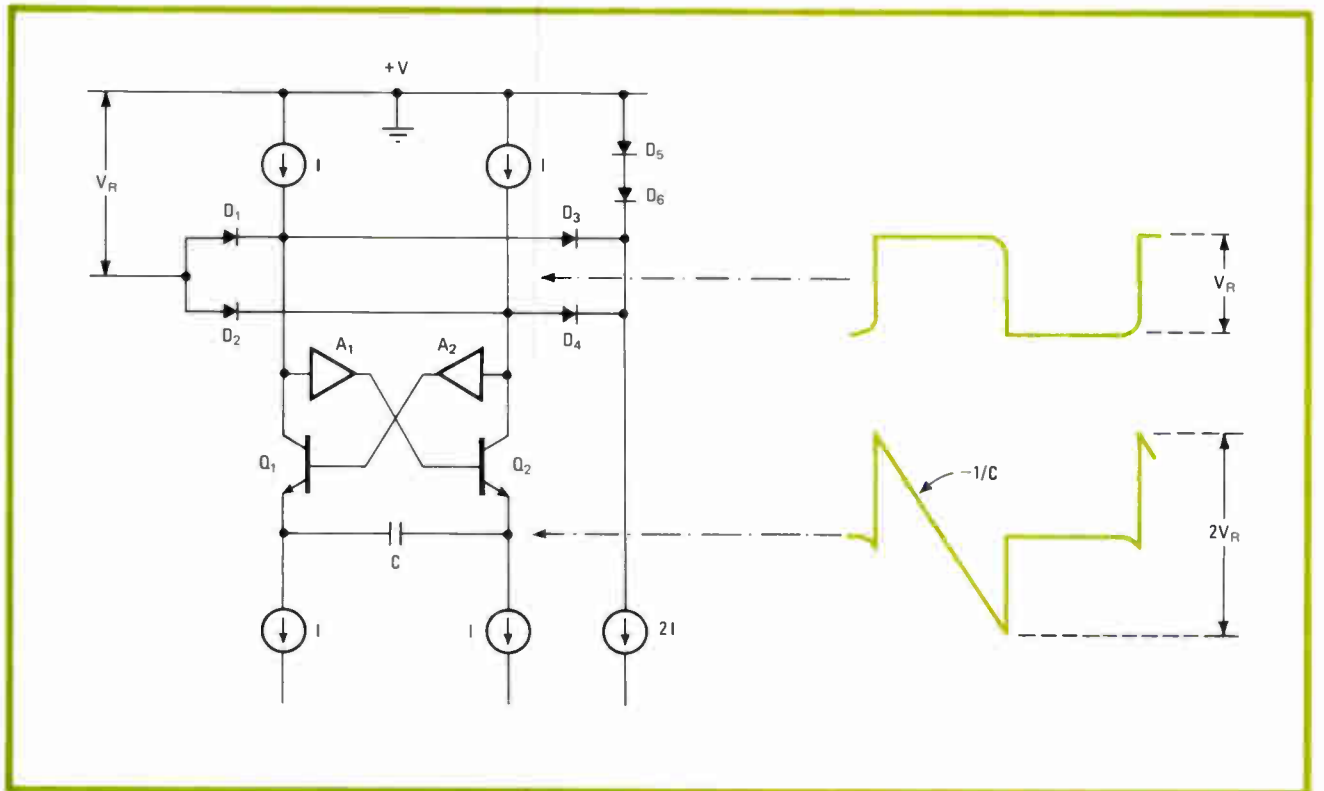

6. Clamped. The emitter-coupled multivibrator in Analog Devices' AD573 voltage-to-frequency converter relies on another temperature-compensation method. The collectors of Q_1 and Q_2 are clamped and a differential reference voltage across them charges capacitor C .

tion point arising from dV_{BE}/dT (where T is temperature) in Q_1 and Q_2 is minimized by the current balance, which forces the currents in these two transistors to be equal at the switching point.

The square-wave output is obtained differentially at the emitters of Q_9 and Q_{10} . A linear ramp is obtained across capacitor C . The frequency of operation is given by $f = 1/(CR_{ext})$ and can be controlled by modulating the current, I , via the control voltage, V_C , applied to control node B.

Clamped collectors

Another temperature-compensated emitter-coupled multivibrator, used in Analog Devices' AD537 voltage-to-frequency converter chip, is shown in Fig. 6. In this precision collector-clamping scheme, a differential voltage, V_R , generated by a bandgap reference circuit, appears across the collectors. V_R is independent of the current, the temperature, the absolute value of V_{BE} , and the supply voltage. This precise reference voltage is then transferred to the timing capacitor via two-stage emitter-followers A_1 and A_2 and transistors Q_1 and Q_2 . Thus, the capacitor charges to $2V_R$ twice each cycle, yielding a frequency expression of $f = 1/(4CV_R)$.

To compensate for the temperature drift mechanisms inherent in emitter-coupled multivibrators mentioned earlier, a small temperature coefficient in the opposite direction is deliberately added to the voltage reference V_R . Using this technique, excellent stabilities of around 20 ppm/°C are possible.

After the generation of a basic waveform such as a triangular or square wave, the next step is to convert the waveform into a low-distortion sine wave. A triangular wave is usually preferred over a square wave, since the former's harmonic content is significantly lower. This initial harmonic content is further minimized by using a symmetrical triangular waveform that has negligible even-harmonic content. Such a waveform can be converted into a sine wave by rounding off its peaks. This is generally accomplished in one of two ways, each of which is suitable to monolithic integration.

Converting into a sine wave

One method involves a piece-wise linear approximation using breakpoints to round off the triangle wave. This is usually done by diode-resistor or transistor-resistor circuits. A disadvantage of these types of wave-shaping circuit is that the input signal level, active device characteristics, and resistor ratios must be accurately controlled.

The other common method of converting a triangular wave into a sine wave is through the gradual cutoff of an overdriven differential transistor pair with an appropriate value of emitter resistance.

The differential gain state of the transistor pair used to generate the triangular wave can be adjusted to produce an overdrive condition by decreasing emitter resistance to a point where the input transistors are driven into cutoff. Figure 7 shows the voltage-current transfer characteristics of a such an overdriven circuit, with a triangular-wave input and a resulting sinusoidal output. The gradual transition between the active and

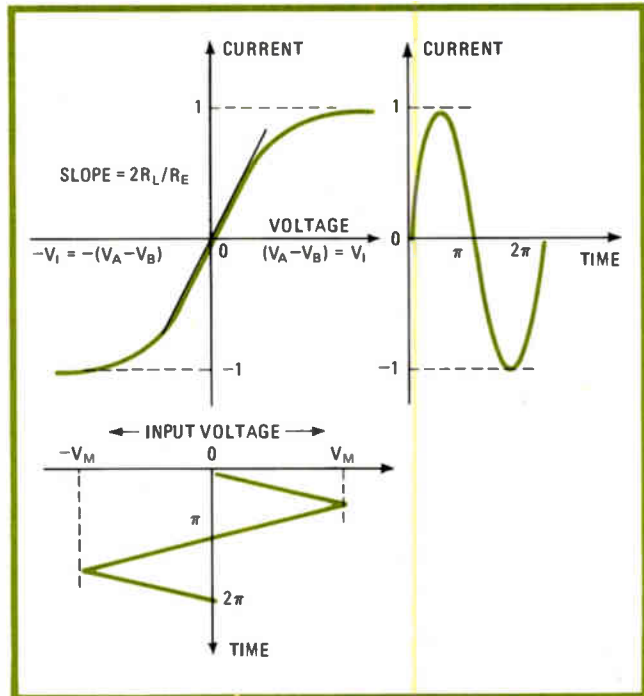

7. Sine shaping. A common method of converting a triangular wave (bottom left) into a low-distortion sine wave (right) is through the gradual cutoff of an overdriven differential transistor pair, whose transfer function is at top left, with an appropriate emitter resistance.

the cutoff regions is logarithmic. Thus the triangular wave is amplified linearly near the center but logarithmically at the peaks. As a result, the sharp peaks of the input signal are rounded off and it is transformed into the desired sine wave.

The advantage of the second approach is circuit simplicity. However, it also requires a constant-amplitude input adjustment for low distortion at a given emitter resistance. Both methods can, with adjustment, provide total harmonic distortions of less than 0.5%.

The last building block of the typical waveform generator in Fig. 1 is the modulator section. For function-generator applications, balanced modulators are preferred over conventional mixer types. Balanced modulators offer a high degree of carrier suppression and can be used for suppressed-carrier modulation, as well as for conventional double-sideband amplitude modulation. A simplified circuit diagram of a balanced modulator circuit is shown in Fig. 8a. It is used almost exclusively by manufacturers of this type of IC because of its versatility and suitability for monolithic integration. In addition to performing amplitude modulation, this circuit also functions as a linear four-quadrant multiplier and phase detector. The balanced modulator's phase and amplitude transfer characteristics are shown in Fig. 8b.

Timers also work like oscillators

The well-known 555 timer IC operates much like the RC multivibrator low-frequency oscillator circuit of Fig. 2a when in its astable mode. The only difference is that resistor R_2 is in series with R_1 , in place of R_1 alone. Switch S_1 is hooked up between ground and the connection between R_1 and R_2 . Again, operation is by the same

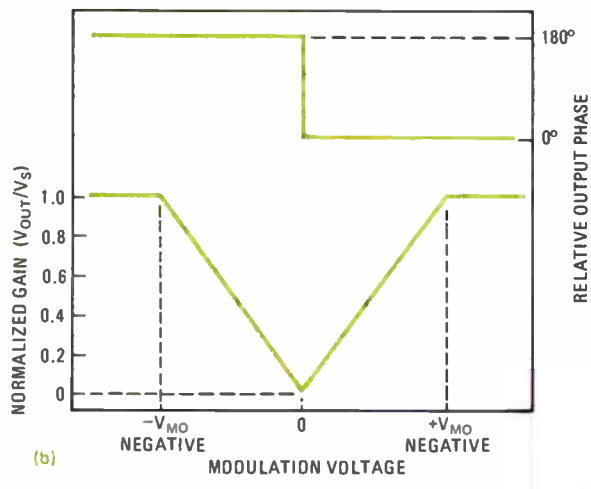
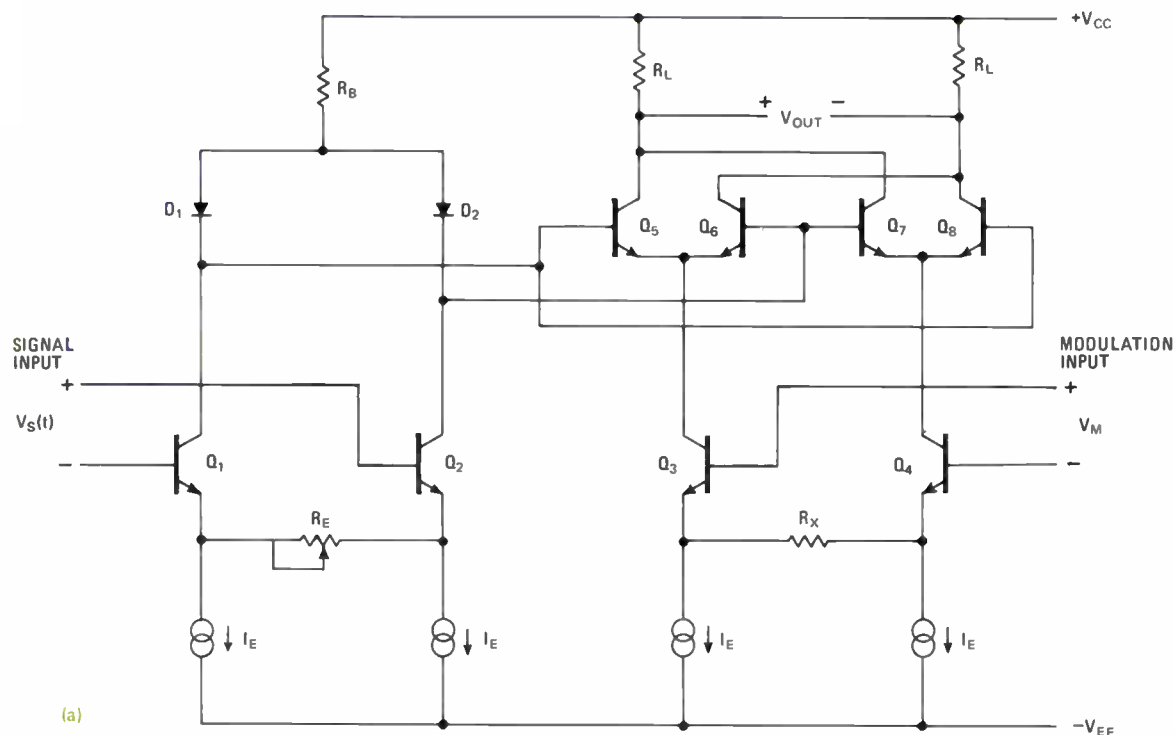

8. Modulation. For function generation, a balanced modulator (a) is preferred for its higher carrier suppression and flexibility. Used nearly exclusively by makers of IC function generators, this modulator has the phase and amplitude transfer characteristics shown (b).

the low-frequency oscillator circuit, the waveform across C_0 in a timer circuit is an exponential ramp.

When the circuit of Fig. 2a is combined with a one-shot multivibrator circuit, a voltage-to-frequency converter is the result. As shown in Fig. 9, the voltage comparator first compares the input voltage V_1 with V_B . When V_1 is greater than V_B , the comparator turns on the multivibrator, whose output will then go low for a timing period T , causing current source I_0 to turn on. At the end of the period, the multivibrator output goes high and I_0 is turned off.

V-f converter cycling

As long as V_B is not greater than V_1 , the multivibrator keeps turning on and off for T -length durations until a sufficient charge (determined by the product of I_0 and T) is injected into the R_B and C_B network to cause V_B to become higher than V_1 . When that happens, I_0 stays off and V_B decays until it equals V_1 . This completes one cycle, and the V-f converter runs in a steady-state mode.

In the steady-state mode, I_0 charges C_B fast enough to keep V_B equal to or greater than V_1 . Since the discharge rate of C_B is proportional to V_B/R_B , the frequency at which the circuit runs is proportional to the input voltage. The circuit's output is a series of pulses, with the length of durations, T , determined by the external RC components of the multivibrator. □

charge-and-discharge cycle of capacitor C_0 , except that the charging voltage is passed through the series combination of R_1 and R_2 , instead of R_1 only. The output of the timer circuit is thus determined by the total resistance of R_1 and R_2 divided by the capacitance of C_0 .

When the upper threshold of the timer circuit is reached, the circuit's output goes low and S_1 is turned on, discharging C_0 to ground through R_2 . When the voltage reaches the lower threshold level, the threshold detector is triggered to begin a new cycle. During the discharge period, which is determined by R_2C_0 , the output stays low, allowing a digital output waveform to be generated. If R_1 is made very small in value compared with R_2 , the output becomes a square wave. As it is in

Intelligent buffer reconciles fast processors and slow peripherals

First-in–first-out device speeds communication between multiple microprocessors and shared peripherals

by Daniel L. Hillman, *Zilog Inc., Cupertino, Calif.*

□ Putting two or more microprocessors to work on a given set of tasks is now a practical system design approach. Special input/output processors are used increasingly, as are those devoted exclusively to number crunching. But a way of coordinating their activities has been needed, and now the ZFIO, a special data buffer, has arrived to solve that problem.

Of course, software must be developed to segment and assign tasks, but equally important, hardware must synchronize devices that operate independently, often at different data rates. The ZFIO enhances system throughput as it accepts and delivers data simultaneously. Moreover, it generates interrupts to notify devices of data availability. The ZFIO is a 128-by-8-bit first-in–first-out (FIFO) buffer memory that includes programmable interfaces with various computers and input/output devices; it forms an elastic link that allows each device to read or write at its own speed. For example, a Z8000 can execute a high-speed block move to fill the ZFIO buffer. The data can then be read out on the other side of the

memory at the data rate of a slow peripheral such as a line printer or disk. But even when two devices can operate at the same data rate, it is not always possible for both to operate synchronously. The ZFIO chip provides the necessary data buffering in this case as well.

With its large data buffer, the device can reduce I/O overhead by as much as two orders of magnitude. It supports direct-memory-access (DMA) devices for high-speed data transfers, generates programmable interrupts, and coordinates fast asynchronous block data transfers. What's more, the depth of buffering can be increased to any desired depth in 128-byte increments by adding the ZFIFO, which is essentially the buffer portion of the ZFIO in a 28-pin package.

The chip manages data transfers on a multiplexed (address/data) bus, a nonmultiplexed bus, the standard two-wire (request/acknowledge) handshake port, or the three-wire handshake port used by the IEEE-488 instrumentation bus. Devices running at different speeds and using different interfaces can thereby transfer data.

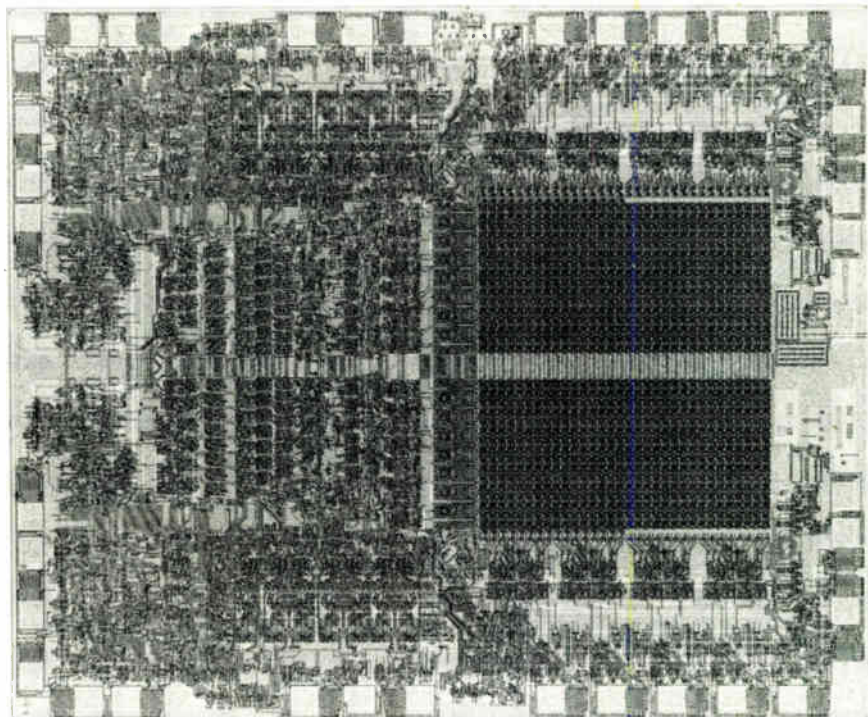

Built-in smarts. There is more to this chip than just a first-in–first-out memory; the die area taken up shows how much intelligence is built into the device. Control logic, as well as several internal control and message registers, make byte comparisons and generate programmable interrupts.

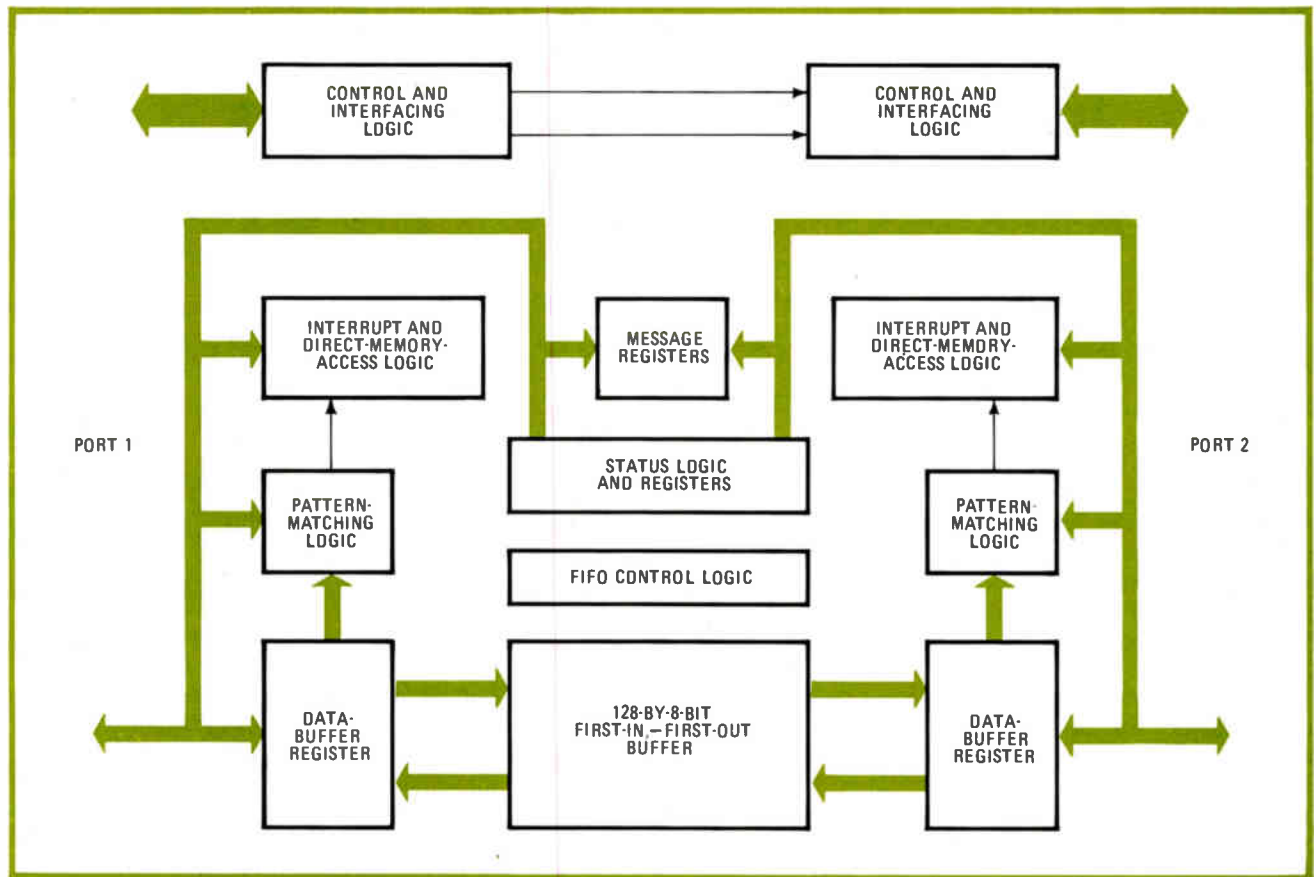

1. Details. The ZFIO contains a data buffer comprising 128 bytes of dual-port RAM, the interface logic for various buses, message registers for controlled communication, and the logic for generating unique interrupts under several different conditions.

The buffer (Fig. 1) is implemented with an internal dual-port random-access memory. The RAM is addressed by a read counter and a write counter, a technique that has the advantage of showing the exact number of bytes of valid data in the buffer as the difference between the read count and the write count. The exact number of bytes can be read out by either device. In addition, by comparing the difference with a programmable number in the byte-count register, an interrupt can be automatically requested or a DMA transfer started at a specified level of buffer fullness.

Bypassing the buffer

When two microprocessors are linked together, it is often necessary for them to exchange information other than blocks of data. Two message registers, IN and OUT, allow bypassing of the buffer. A message can be written by one microprocessor that causes an interrupt request, if enabled, to be sent to the other microprocessor. The message might be the length of the file being transferred or an end-of-file character to stop the transfer.

With the versatile ZFIO interface, the most common bus structures are supported by making the control pin definitions programmable (see table). Pins M_1 and M_0 program the port 1 side, and 2 bits, B_1 and B_0 , in one of port 1's registers, program the port 2 side. In all operating modes, the port 1 side is always a computer interface. It is possible to use port 2 as either as a computer interface or as an I/O port with handshake.

With the multiplexed address/data bus, the width of the memory can be increased beyond 8 bits (Fig. 2). The low-byte mode is used on AD_0 - AD_7 lines, the high-byte mode on lines AD_8 - AD_{15} . A 32-bit bus can be similarly accommodated. The A_0 - A_3 pins, which are attached to AD_0 - AD_3 on all high-byte ZFIOs, provide direct addressing of all internal registers.

An address-strobe (\overline{AS}) pin is used to latch address and chip-select information. A read/write pin and a data strobe pin are used just as in reading and writing normal memory locations.

In the nonmultiplexed version, the control/data (C/\overline{D}) pin is used to access the FIFO buffer directly (when $C/\overline{D} = 0$). Reading or writing into other control registers is done in two steps. First, the desired register number is written into the pointer register, with $C/\overline{D} = 1$. Secondly, the register indicated by the pointer register is read from or written into with $C/\overline{D} = 1$. The chip allows continuous monitoring of the status bits by doing a control read, where $C/\overline{D} = 1$.

Handling interrupts

The ZFIO supports Zilog's prioritized daisy-chain interrupt protocol as well. Each of its sides, when configured as a computer interface, can interrupt its respective microprocessor for any of the following reasons: a write into the message register (by the other microprocessor), a change in the direction of data through the buffer, a pattern match, a byte-count match, an overflow/under-

OPERATING MODES FOR ZFIO DATA BUFFER

| Mode | Port 1 programming | | Port 2 programming | | Port 1 pin definition | Port 2 pin definition |
|------|--------------------|----------------|--------------------|----------------|----------------------------|----------------------------|
| | M ₁ | M ₀ | B ₁ | B ₀ | | |
| 0 | 0 | 0 | 0 | 0 | multiplexed bus, low byte | multiplexed bus, low byte |
| 1 | 0 | 0 | 0 | 1 | multiplexed bus, low byte | nonmultiplexed |
| 2 | 0 | 0 | 1 | 0 | multiplexed bus, low byte | three-wire handshake |
| 3 | 0 | 0 | 1 | 1 | multiplexed bus, low byte | two-wire handshake |
| 4 | 0 | 1 | 0 | 0 | multiplexed bus, high byte | multiplexed bus, high byte |
| 5 | 0 | 1 | 0 | 1 | multiplexed bus, high byte | nonmultiplexed |
| 6 | 0 | 1 | 1 | 0 | multiplexed bus, high byte | three-wire handshake |
| 7 | 0 | 1 | 1 | 1 | multiplexed bus, high byte | two-wire handshake |
| 8 | 1 | 0 | 0 | 0 | nonmultiplexed | multiplexed bus, low byte |
| 9 | 1 | 0 | 0 | 1 | nonmultiplexed | nonmultiplexed |
| 10 | 1 | 0 | 1 | 0 | nonmultiplexed | three-wire handshake |
| 11 | 1 | 0 | 1 | 1 | nonmultiplexed | two-wire handshake |

flow error, or buffer-full and buffer-empty status. Each interrupt source can be independently enabled or disabled and can place a unique interrupt vector on the data-bus lines.

The ZFIO is particularly well suited to work with a DMA device in both multiplexed and nonmultiplexed modes. A transfer of data between the chip and system memory can take place every machine cycle, eliminating the typical two-cycle I/O-to-memory transfer sequence—that is, reading from I/O and then writing into memory. In addition, DMA can be used by both sides of the buffer simultaneously, with the DMA device supplying memory address and read/write information and the buffer supplying or receiving data. In this way, transfers can be made into and out of memory at nearly the full bandwidth of each bus—a desirable feature because it

reduces the time that I/O traffic ties them up.

A special pin (and mode) gives buffer-status information. When data is moved into the memory, the request pin (REQ) is active until the buffer is full. It then goes inactive until the number of bytes in the buffer is less than a value programmed in the byte-comparison register. REQ then goes active and the sequence begins again. When data is moved out of the device, the request signal is inactive until the number of bytes in the buffer is greater than the value programmed in the byte-comparison register. It then goes active and stays active until the buffer is empty. The request then goes inactive and the sequence starts over. The system designer can use this pin—and the byte-comparison value—to optimize the number of DMA requests issued.

An I/O subsystem may be linked to a main system via

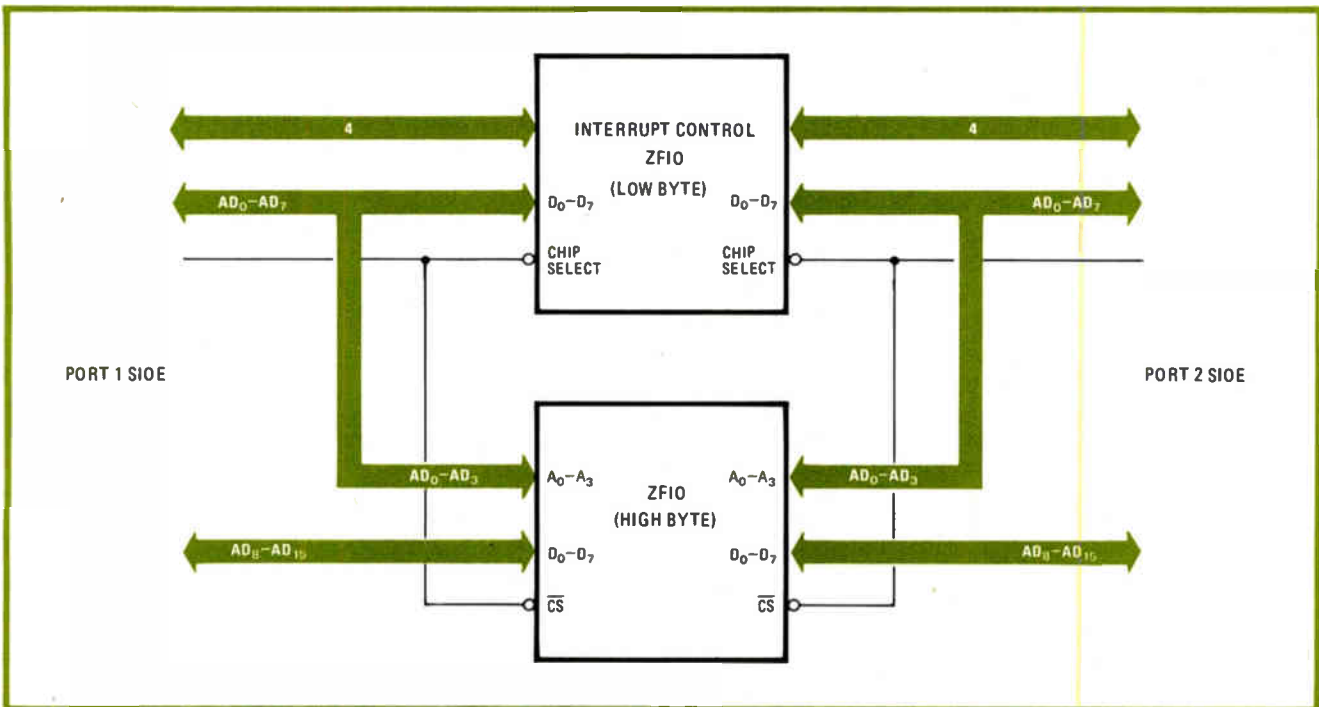

2. Parallel ZFIOs. Any data path that is a multiple of eight can be handled by adding more ZFIOs in parallel. Depth of buffering beyond 128 bytes can be accomplished by adding ZFIOs—essentially the same as the buffer portion of the ZFIOs but housed in 28-pin packages.

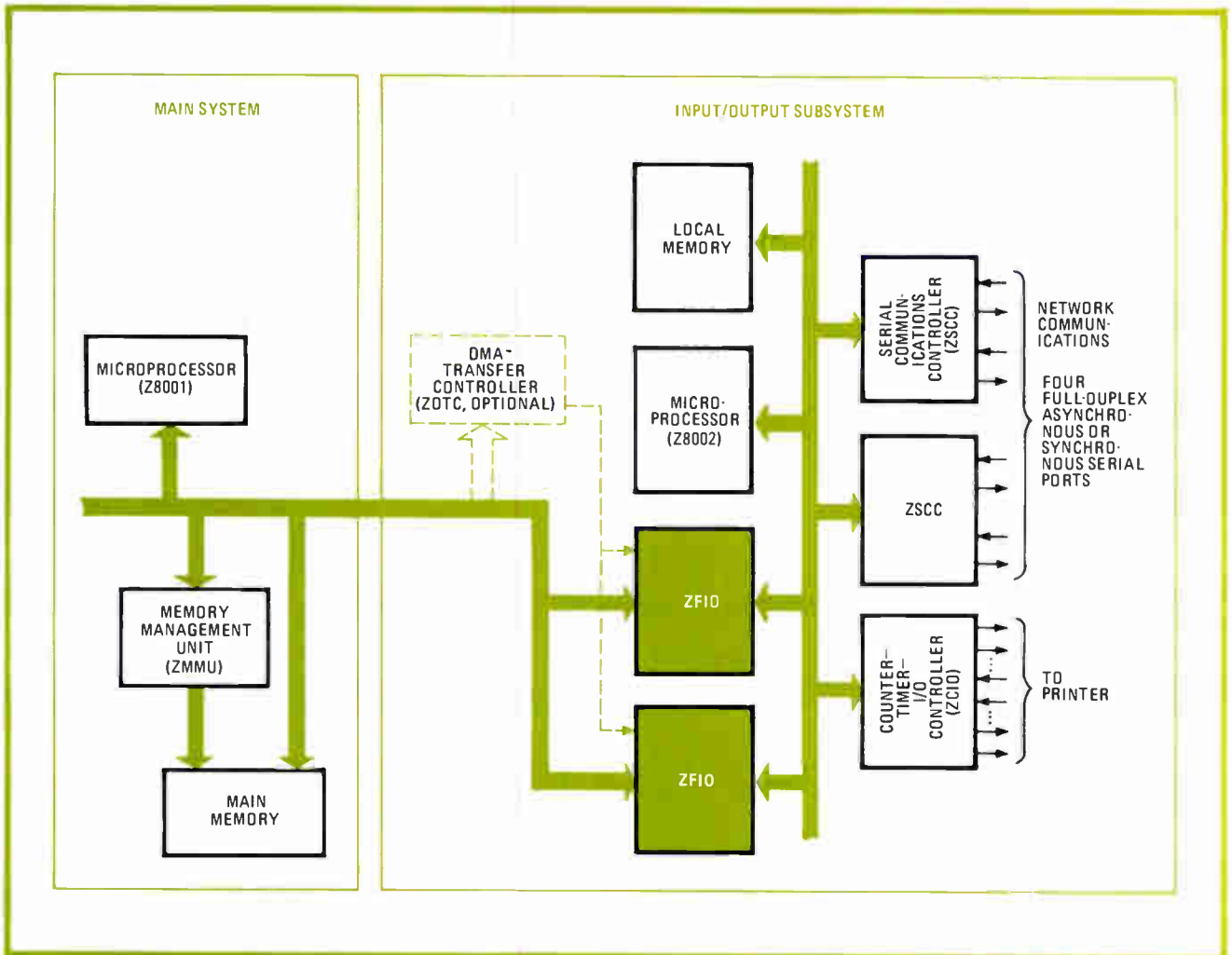

3. Building a high-end system. A single main processor (Z8001) uses two paralleled ZFIOs to communicate with the second processor (Z8002), which coordinates I/O subsystem data transfers. The ZSCCs provide four serial ports and the ZCIO handles the printer.

two ZFIO chips. In Fig. 3 a Z8002 is used as the I/O processor, handling all low-level peripheral control as well as buffering of data. Four full-duplex serial ports are supported by the ZSCC, which provides the network with synchronous and asynchronous communications. The ZCIO supports the I/O subsystem line printer. The main computer (Z8001) sends high-level commands to the I/O subsystem through the two message registers. These commands include intended destination of the data, block length, and other relevant information. The Z8001 and Z8002 can do a block-I/O move, allowing one instruction to transfer a block of data between an I/O device and memory. The main computer starts a block I/O move into the two ZFIO memories; if the subsystem is not ready at that time to read the data, the ZFIOs will interrupt the main computer when the buffer is full, suspending the block move and freeing it for other tasks until it is interrupted again. After the subsystem starts reading data, a second interrupt to the main computer will occur on byte-count-match when the buffer is emptied to a predetermined programmable level. The subsystem can use the ZFIO's interrupt capability in a similar fashion, to avoid waiting for data transfers from the main system.

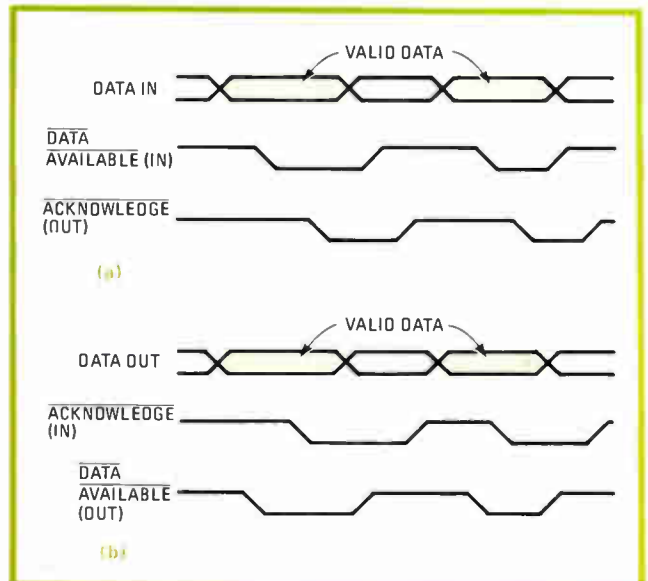

4. Two-wire handshake. Handshaking is available on the port 2 side. Request line (marked data available) for inputs (a) signals receiver that valid data is being transmitted. Outputs (b) also generate a request, and both wait for acknowledges before changing data.

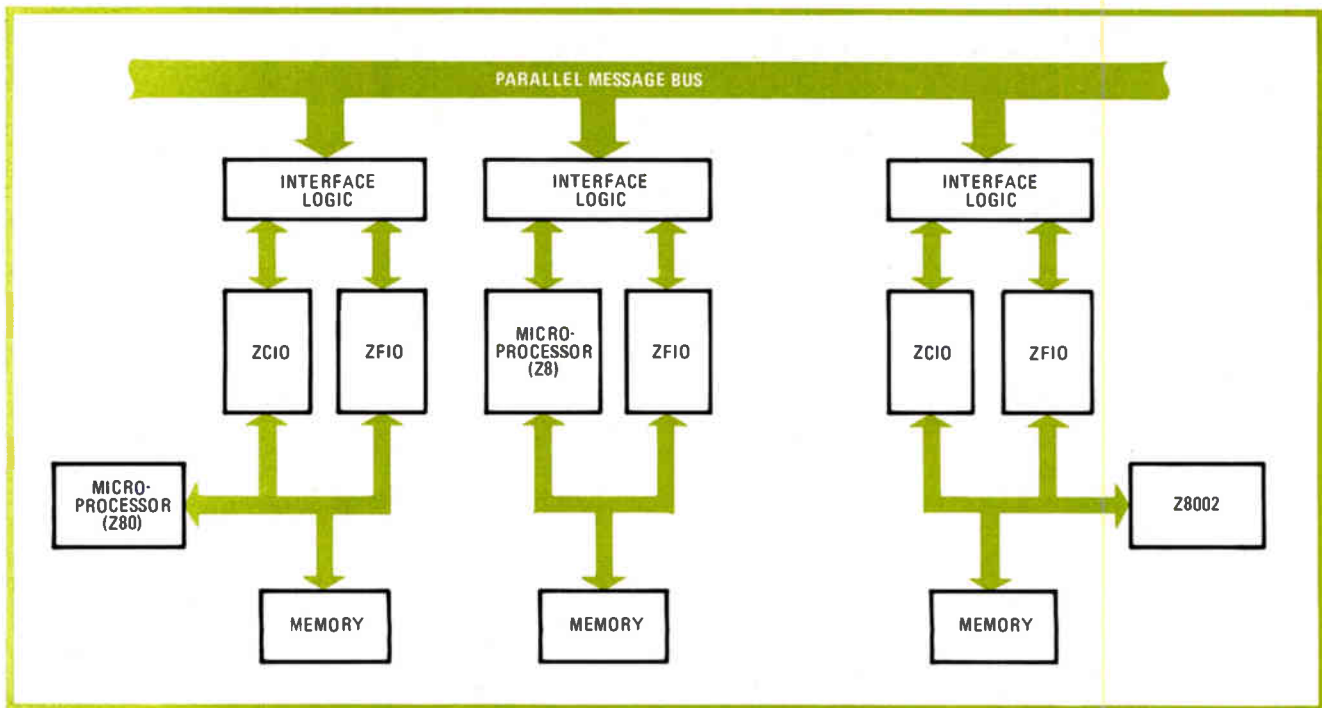

5. A multiprocessor application. In a loosely coupled multiprocessor situation, a very long message bus can be supported because it can run at relatively low speed. The ZFIOS handle the necessary speed conversion so that the processors are not slowed down during I/O.

A DMA transfer controller (ZDTC, shown as optional in Fig. 3) provides the fastest data transfer. The main system ZDTC can be set up and begin transferring data to the two buffers. When one is full, the request signal goes inactive, allowing the main system to do other tasks while the I/O system reads the data. This bursting of data can continue until the entire block is transferred. The chip can then activate a request signal when the buffer is nearly empty, allowing the I/O system to do a continuous block move of data.

Controlling communications

The data-direction bit controls the flow of data in the buffer. For proper system control, the port 1 computer programs the side of the memory that controls the data-transfer direction, in addition to enabling the interrupt signal.

In the computer-to-I/O mode, the direction of data transfer can be under software control by port 1 or hardware control by port 2. With data direction under port 1's control, port 2's data-direction pin is an output. This output is useful for managing other ZFIOS or external bidirectional bus drives. When it is controlled by port 2, the data-direction pin is an input giving control of the data flow to external hardware.

The clear bit zeros out the data buffer without resetting the ZFIO. For system control, port 1's computer programs the side that can clear the buffer. In the computer-to-computer mode, software controls the clear operation in both computers. In the computer-to-I/O mode, clearing can either be under software control by port 1's computer or hardware control by external logic. When port 1 controls the clear operation, port 2's CLEAR pin is an output. This output is useful to clear other ZFIOS or to initialize external logic. When the clear

operation is controlled by port 2, the CLEAR pin is an input that allows for external logic to clear the buffer.

In the two-wire interlocked handshake, the ZFIO's action must be acknowledged by the other half of the handshake before the next action can take place (Fig. 4). For example, an output handshake will not indicate that new data is available until the external device shows it is ready for the data. Similarly, an input handshake will not show that it is ready for new data until the data source indicates that the previous byte is no longer available, thereby acknowledging the input port's acceptance of the last byte. The two-wire handshake is useful for interfacing with typical I/O devices.

The three-wire handshake is for applications in which one output port is communicating simultaneously to many input ports. It is basically the same as the interlocked handshake, except that two signals indicate that an input port is ready for new data or that it has accepted the present data. In the three-wire handshake, the handshake lines of many input ports can be bused together with open collector drivers to form a wired OR. In this way they can indicate whenever any or all of the devices are ready. This handshake is used in the IEEE-488 instrument bus. Since the port's direction can be changed under software control, bidirectional transfers can be made.

In a loosely coupled multiprocessor application, the ZFIO chip gives the speed buffering necessary for a very long message bus (Fig. 5). The interlocked two-wire handshake for transfer between two systems only or the three-wire handshake for transfers among more than two systems can be used. The ZCIOS are used for address recognition and bit manipulation of other control signals. After the link is established, the data is transferred via the ZFIOS. □

Train speed controller ignores track resistance

by Stephen H. Burns
U. S. Naval Academy, Electrical Engineering Department, Annapolis, Md.

Because it keeps the voltage applied to any universal motor constant and independent of line resistance for a given line voltage, this circuit will be especially attractive for use with model trains, for which it will maintain speed independently of the resistive joints in the tracks. No modification of the speed-controlling transformer used with the trains is required.

This circuit rides within or near the locomotive and is inserted in the electrical path between the motor and the track pickup and return. Thus it is necessary to connect the ac input of this circuit to the track pickup and frame of the locomotive and to connect the dc output of the circuit across the motor windings. This way the circuit develops a constant average voltage across the motor for a given transformer setting.

This is accomplished with a four-section circuit, with block A containing the supply for powering the unit. Blocks B and C derive a gate pulse inversely proportional to the magnitude of the input voltage and a control

Rail tamer. Controller keeps driving voltage to model trains independent of the resistance in the track joints. Output voltage is derived from pulses whose widths are inversely proportional to the ac input, generated at zero crossings so that load variations on the line are disregarded. Timing diagram details the operation.

voltage proportional to the input signal so that motor speed can be set. Block D handles the power-switching function.

Diode bridge B₁, diodes D₁ and D₂, capacitor C₁, and Norton amplifier A₁ constitute block A, which is actually a three-stage supply. B₁ provides full-wave rectified dc for power stage Q₃ and D₁ and C₁ extract and filter power for A₁-A₄. Zener diode D₂ and A₁ provide a regulated 5 volts for current source Q₁ and to establish a switching reference voltage for amplifier A₂.

In operation, B₁ and Q₃ electrically disconnect the motor from the power source near each zero crossing of the ac input. At this time, a pulse is developed at the output of A₂, its width equal to $P = 2V_r/\omega V_i$, where V_r is the switching reference voltage, ω is 120π radians/sec,

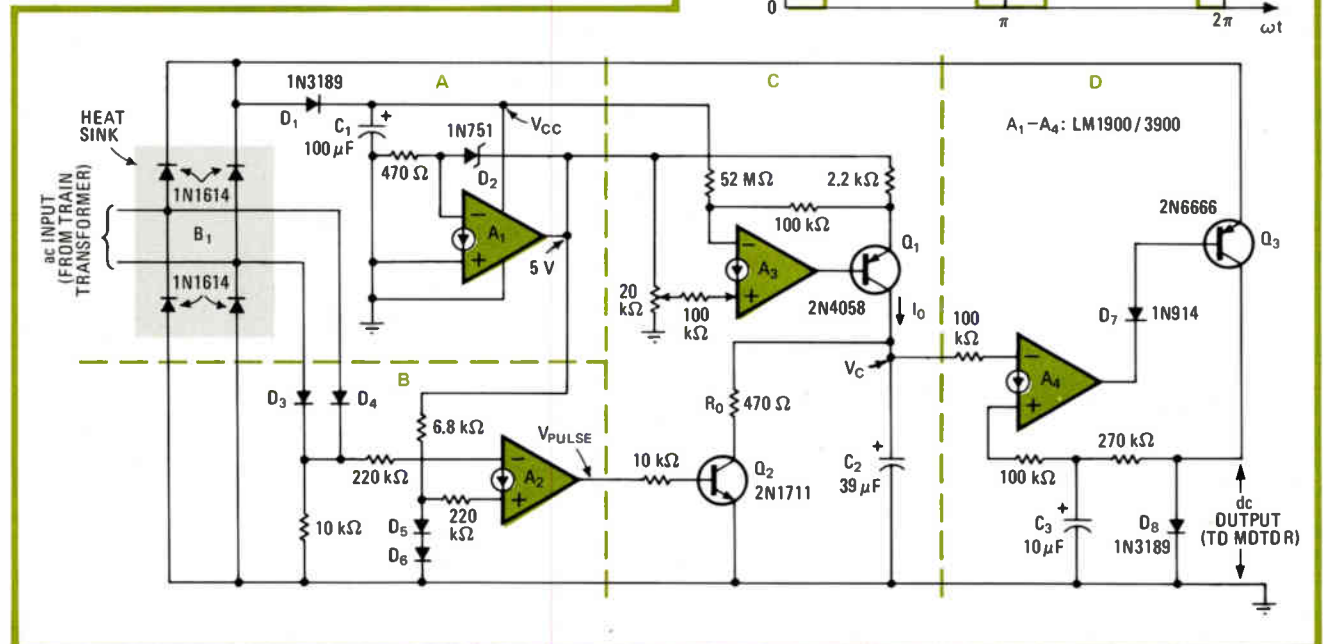
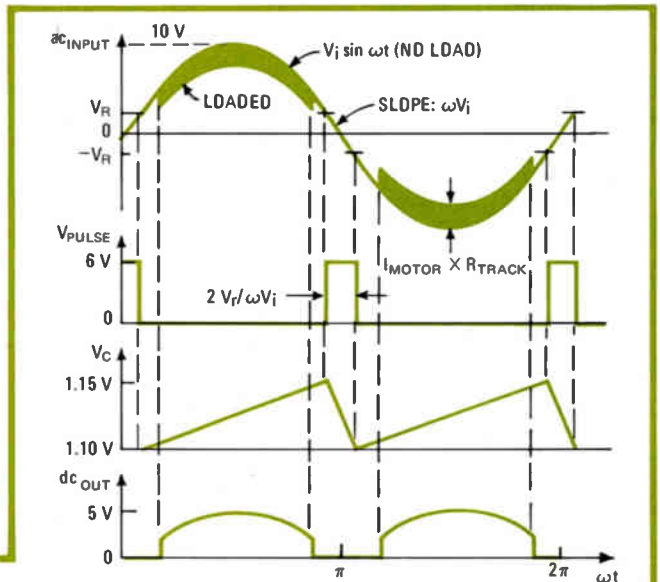

and V_i is the input voltage (see timing diagram). Note that by sampling near the zero crossings, the width of the pulse is made independent of the load on the ac line. One sense diode, D_3 or D_4 , reference diodes D_5 and D_6 , and one bridge diode set the switching threshold, V_r . This reference voltage is thus equal to four diode drops, or approximately 2 v.

A_3 , Q_1 , and Q_2 develop from the pulse a control voltage, V_c , whose average value can be expressed as $V_c = \pi I_o R_o V_i / (2V_r)$. A_3 and Q_1 constitute a 0.3-milliamper (I_o) constant-current source. A total resistance of 52 megohms placed in series between V_{cc} and the inverting input of A_3 was found best to compensate for

changes in I_o versus supply variations.

The power switching stage includes feedback capacitor C_3 , amplifier A_4 , isolation diode D_7 , damper diode D_8 , and Q_3 . C_2 and C_3 were selected so that Q_3 switches efficiently under all load conditions. Smaller values of C_2 result in more efficient switching but increase output resistance. Larger values of C_3 will result in greater overshooting in response to a transient.

With a source voltage of from 7 to 25 v rms and a load of 10 ohms, the circuit will generate an output of from 3 to 12 v. Increasing the line resistance from 0 to 4 Ω will cause a typical change in output voltage of only 0.1 v for a line drop of several volts. \square

Two-chip generator shapes synthesizer's sounds

by Jonathan Jacky
Seattle, Wash.

Generating the same adjustable modulating waveforms for a music synthesizer as the circuit proposed by Kirschman¹, but using only two integrated circuits, this generator also works from a single supply. It has, in addition, separate gate and trigger inputs for providing a more realistic keyboard response.

When gated or triggered, the generator, which is built around Intersil Inc.'s C-MOS 7555 timer, produces a waveform that passes through four states:

- An exponential attack.
- An initial decay, or fallback.
- A sustain, or steady dc level.
- A final decay, or release.

Each of these four parameters is continuously variable, so that waveforms having a wide variety of shapes can be generated.

The waveforms are generated by the sequential charging and discharging of capacitor C_1 . Here, the 7555 controls the sequencing while diodes switch the currents, unlike Kirschman's circuit where comparators and flip-flops control the stepping and analog switches steer the currents. Furthermore, the 7555 is well suited for handling the two logic signals provided by most synthesizer keyboards—the gate, which is high as long as any key is depressed, and the trigger, which provides a negative pulse as each key is struck. The gate and trigger features eliminate the need to release each key before striking the next to initiate an attack phase.

In the dormant state (the gate input at pin 4 of the 7555 is low), capacitor C_2 is discharged. When the gate goes high and a trigger pulse appears at pin 2, the 7555 output (pin 3) goes high and charges C_1 through R_3 , R_4 , and D_1 , producing the attack segment of the waveform. Note that diode D_2 is reverse-biased because pin 7 of the 7555 is high and that diode D_3 is back-biased by logic 1

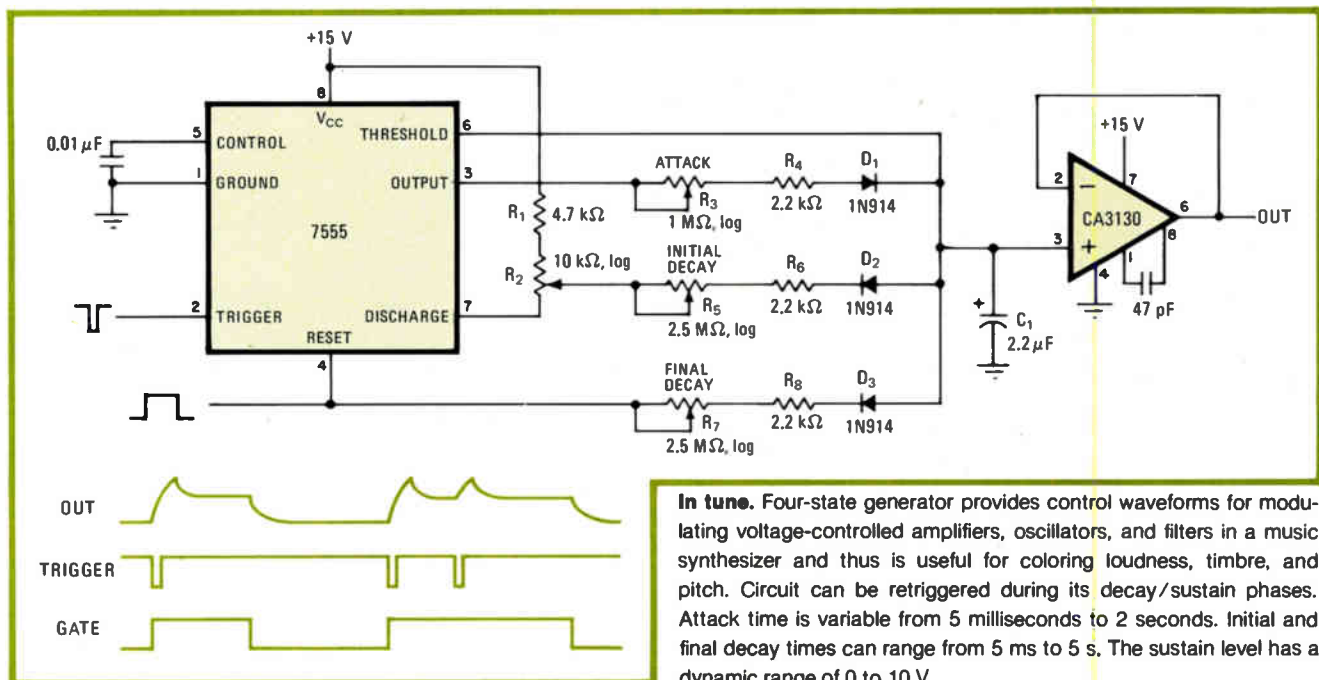

In tune. Four-state generator provides control waveforms for modulating voltage-controlled amplifiers, oscillators, and filters in a music synthesizer and thus is useful for coloring loudness, timbre, and pitch. Circuit can be retriggered during its decay/sustain phases. Attack time is variable from 5 milliseconds to 2 seconds. Initial and final decay times can range from 5 ms to 5 s. The sustain level has a dynamic range of 0 to 10 v.

Miproc processor speed is industry's right arm

The little processor with big computer power – that's Miproc, for process control, industrial robots, signal analysis, simulation and research.

When you're looking for the computer power of a big microcomputer like the DEC* PDP-11/70* but can't afford the size and price, you should think seriously about Miproc 16. Check out the facts and see why Miproc 16 is probably the computer you need.

| | PDP-11/70* | | Miproc 16 | |
|----------------------------------|------------|------|-----------|------|
| | Min | Max | Min | Max |
| ● Integer Add, from memory | 0.6 | 0.6† | .25 | .25 |
| ● 32 bit floating point Add | 0.9 | 2.52 | 1.25 | 3.50 |
| ● 32 bit floating point Multiply | 1.8 | 3.44 | 2.50 | 2.75 |

Min/max times, all in microseconds.
†Mode 1 source address.

- **Incredible I/O power**
10 megawords DMA or 1 megaword/second programmable
- **Memory up to 128k word of 16 bits**
- **Price**
Typical small system: CPU, 16k words, 2 parallel ports, 1 serial port, chassis and power, less than £6500.
- **Size**
480×460×220mm. And there's room for lots of expansion, or even a second processor system.

Get ahead of your competitors. Get the computer that's ahead of the rest. Miproc 16. From Plessey Microsystems, staying up front.

*Digital Equipment Corporation trademarks



PLESSEY
MICROSYSTEMS

Plessey Microsystems, Water Lane, Towcester, Northants NN12 7JN.
Telephone: Towcester (0327) 50312 Telex: 31628

France: Paris (01) 776 43 34. Holland: Noordwijk 01719 19207. Germany: Munich (089) 23621.

Japan: Eiji Kitahara, Tokyo 244 3782. USA: Gaithersburg, Maryland (301) 948 2791, Irvine, California (714) 540 9931.

Circle 138 on reader service card



In advanced industrial robotics, high speed processing with floating point accuracy is spot-on with Miproc 16.



The high-speed data acquisition and signal processing capabilities of Miproc provide wavepower energy researchers on-the-spot results. Fast.

Photograph courtesy Wavepower Limited/Dept of Energy

signal applied to the gate input.

When the voltage across C_1 reaches 10 volts, pin 3 of the 7555 goes low and pin 7 is grounded, terminating the attack phase. D_1 and D_3 are now reverse-biased and C_1 discharges through D_2 , R_5 , and R_6 to produce the initial decay. The sustain level reached is determined by the voltage divider formed by resistor R_1 and potentiometer R_2 . During this phase, a second attack can be obtained

by striking another key (see timing diagram). When the last key is released, the gate goes low and C_1 will discharge through D_3 , R_7 , and R_8 to produce the final decay. The CA3130 operational amplifier serves as a buffer to protect C_1 from excessive loading. □

References

1. Randall K. Kirschman, "Adjustable e^r generator colors synthesizer's sounds," *Electronics*, July 17, 1980, p. 123.

Multiplier increases resolution of standard shaft encoders

by Frank Amthor
School of Optometry, University of Alabama, Birmingham

The resolution that can be attained by two-channel shaft encoders of the type used in speed controllers and optical-positioning devices may be increased by employing a digital frequency multiplier to derive a proportionally greater number of pulses from its TTL-compatible outputs. In this way, an up/down counter, which is normally driven by the encoder in these applications, can position the shaft more accurately and is more responsive to changes in speed and direction. Only two one-shot multivibrators and several logic gates are needed for the multiplier circuitry.

The circuit works well with a typical encoder such as the Digipot (manufactured by Sensor Technology Inc., Chatsworth, Calif.). In this case, the 128 square waves that are generated per channel for each shaft revolution

Designer's casebook is a regular feature in *Electronics*. We invite readers to submit original and unpublished circuit ideas and solutions to design problems. Explain briefly but thoroughly the circuit's operating principle and purpose. We'll pay \$50 for each item published.

(with output from the other channel in quadrature) are transformed to 512 bits per cycle.

When the shaft rotates in a clockwise direction, the output from port A of the encoder always leads the output from port B by 90°, and the logic will generate pulses only to the up input of the counter on both edges of both channel outputs. Thus, four pulses per square wave are generated. Rotation speed is limited by the duration time of the positive-edge-triggered one-shots, which should be kept to a few microseconds or less. Note that both the count-up and the count-down inputs of the counter are normally held high.

On the other hand, when the shaft's rotation is in a counterclockwise direction, the output of B leads that of A by 90°. In this case, four pulses per square wave are presented to the down input of the counter. □

Increments. Pulse multiplier yields 512 count-up or -down bits for 128 square-wave cycles (one revolution) from two-channel shaft encoder, for more resolution in speed controllers and optical positioning systems. Eliminating tinted area yields 256 bits per revolution.

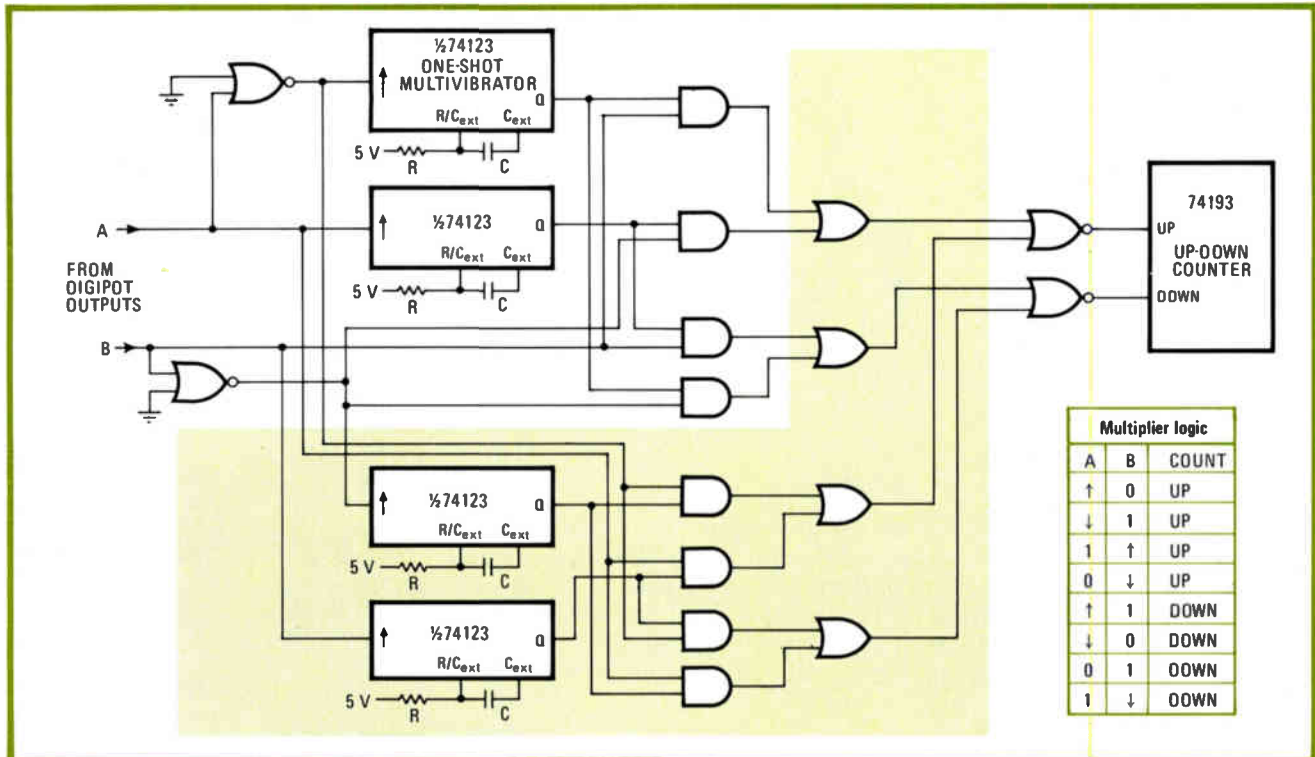

THE DSD 440. TOTAL DEC® RX02 COMPATIBILITY,

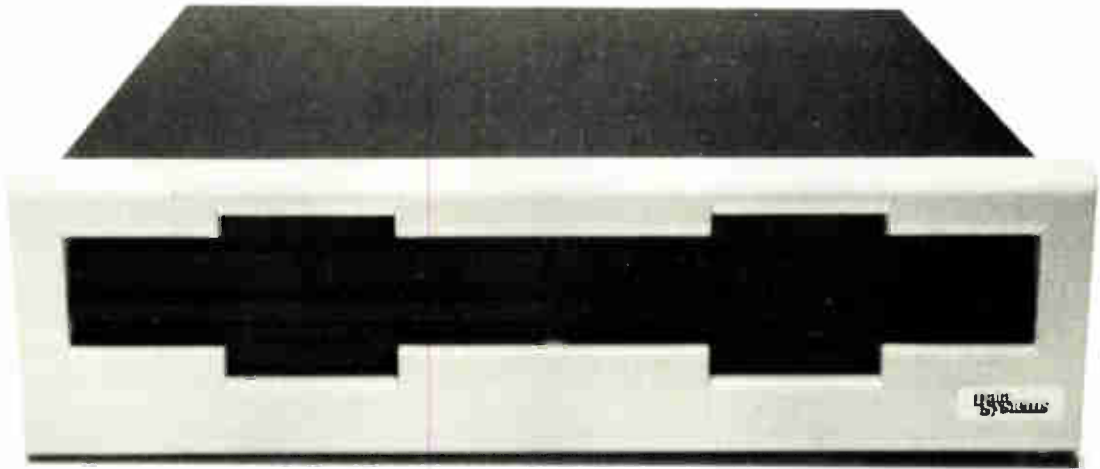

AND MORE.

The DSD 440 is the only alternative to the DEC RX02 that's 100% software, hardware and media compatible with LSI-11, PDP® -11 and PDP-8 computers, including those with extended memory. It can be configured as an RX02 for DEC double density or IBM 3740 single density recording, or as an RX01 for backward operating system compatibility.

MORE

A 512-byte hardware bootstrap is built into all PDP-11 and LSI-11 interfaces. It loads system software automatically from either single or double density diskettes. Extensive self-testing is DIP-switch selectable with the "Hyperdiagnostics" that run without being connected to a computer. The low profile 5¼-inch DSD 440 features write protection and diskette formatting.

FASTER

The optimized DSD 440 microcode increases system throughput when using the RT-11 foreground/background monitor. In particular, the DSD 440 with an LSI-11 runs fill and empty buffer operations 20% faster than an RX02.

FOR LESS

The DSD 440 is the RX02 compatible flexible disk system that combines high performance and advanced features with fast delivery... at a lower price. For further information, call or write Data Systems Design today. A data sheet and price list will be forwarded to you immediately.

® Trademark of Digital Equipment Corporation

Data Systems

EASTERN REGION SALES
Data Systems Design, Inc.
51 Morgan Drive, Norwood, MA 02026
Tel: (617) 769-7620 TWX: 710-336-0120

WESTERN REGION SALES
Data Systems Design, Inc.
2560 Mission College Blvd., Suite 108
Santa Clara, CA 95051 Tel: (408) 727-3163

CORPORATE HEADQUARTERS: Data Systems Design, 3130 Coronado Drive, Santa Clara, CA 95051
Tel: (408) 727-9353 TWX: 910-338-0249

Circle 140 on reader service card

C-MOS makes voltage converter a paragon of efficiency

With inputs spanning 1.5 to 9 V dc, single chip delivers negative or positive multiples to within 0.1% and at an efficiency of 98%

by David Bingham, *Intersil Inc., Cupertino, Calif.*

□ Single +5-volt power supplies are gaining in popularity. However, for circuits where input and output signals approach 10 v peak to peak—such as the new analog data-acquisition circuits using n-channel and complementary-MOS devices on one or more chips—an additional -5-v supply is needed.

Generating a -5-v supply is typically expensive and inefficient. Usually, a large number of discrete and integrated-circuit components (for example, timers and discrete resistors, capacitors, and diodes) are needed to convert the common +5-v line into a negative one.

Drawing upon its considerable experience in making C-MOS ICs, Intersil has come up with a dc voltage converter chip that eliminates the disadvantages of other voltage-conversion methods [*Electronics*, Oct. 11, 1979, p. 212]. Accepting inputs from 1.5 to 9 v dc, the ICL7660 delivers an output equal to the negative of the input voltage to within 0.1%. Capable of producing 20 milliamperes, the device has a power-conversion efficiency of about 98% for load currents of 2 mA and higher

and is aimed at low-power secondary power-supply lines like the -5-v line in ± 5 -v supplies. The use of two or more 7660s extends the device's capability.

Since the 7660 also multiplies a voltage, either positive or negative, by a factor of two, it can be considered a simple voltage doubler. It differs from most voltage doublers in that the usual blocking diodes are replaced by on-chip active n-MOS transistor switches. The 7660's high conversion accuracy is due to the transistor switches' low offset voltages and currents. Voltage-doubling accuracy approaches 100% with no loads.

Capacitors needed

The 7660 contains all the necessary conversion functions on chip, save for pump and output reservoir capacitors, which are needed externally. These capacitors are about 10 microfarads in value, and capacitors with such large values are unsuitable for integration on the same chip as the voltage converter.

The device is made with a low-threshold C-MOS tech-

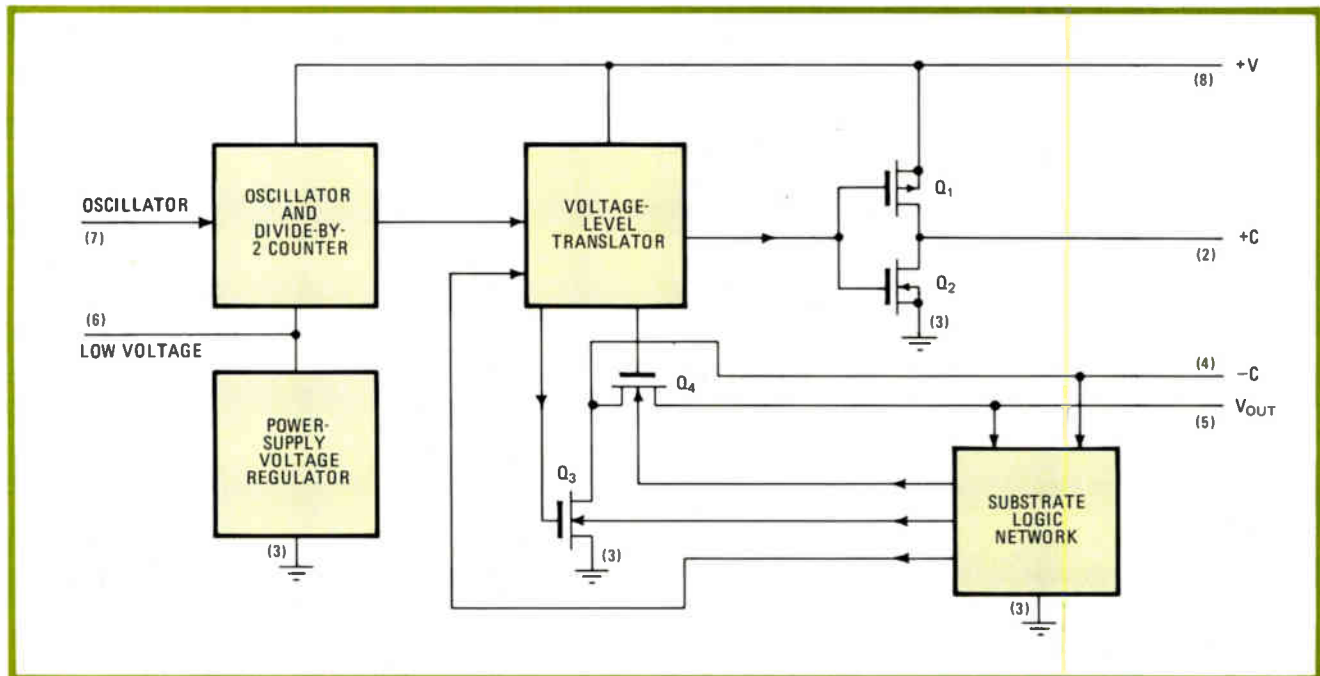

1. Efficient. Oscillator, level translator, voltage regulator, and substrate biasing for the ICL7660 reside on a single complementary-MOS integrated circuit. The device is designed to convert conventional +5-volt supplies to -5-v outputs accurately—to within 0.1%.

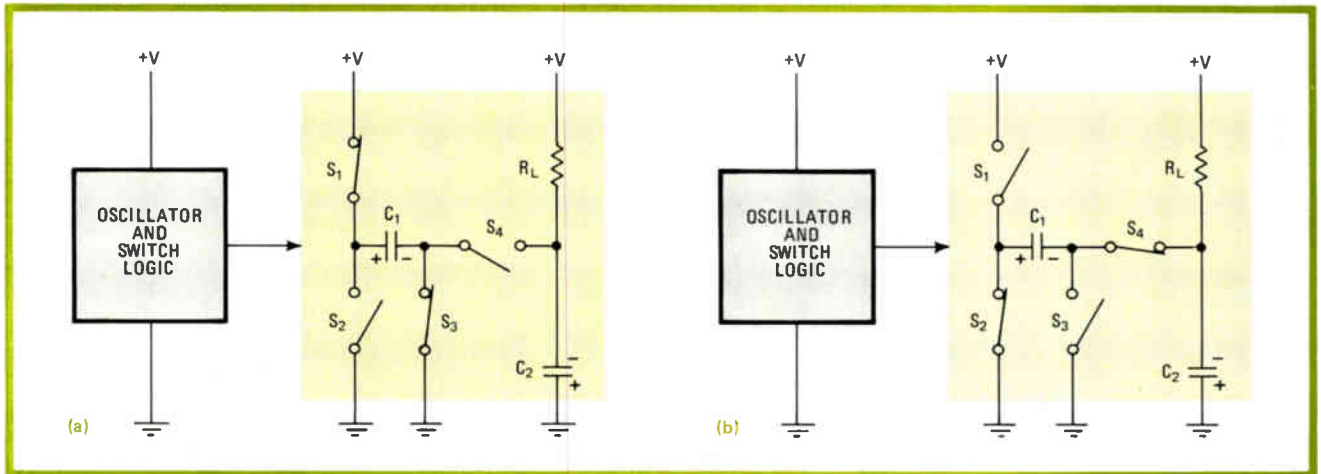

2. Doubler. The 7660 voltage-converter IC acts like a classic voltage doubler during charge (a) and pump (b) phases. Switches S_1 - S_4 correspond to transistors Q_1 - Q_4 of Fig. 1. In the classic voltage doubler, S_3 and S_4 are usually discrete silicon diodes and rectifiers.

nology using p- and n-channel transistors that turn on at 0.6 v. The low power dissipation, simplicity, and small chip size of C-MOS make it a near-ideal technology to use. The one C-MOS drawback of potential device failure due to its inherent latchup has been to a large extent solved in the 7660 and is not a problem for most operating conditions.

A problem

A C-MOS device is inherently a four-layer, or silicon-controlled-rectifier, structure. This structure can be turned on through the forward biasing of the inherent pn junctions, and unless external current-limiting circuitry is used, latchup and resultant failure can occur.

In a C-MOS structure, the n-channel transistor acts as

the cathode of the SCR, and the p^+ source of the p-channel transistor acts as the anode. With a positive potential of about 2 v or more across the anode and cathode, the SCR can have either a low-impedance (on) or high-impedance (off) state. For the on state to occur, three things must happen: the product of the transistors' current gains, or betas, must be at least unity; a current greater than the holding current must be present; and a trigger pulse must be applied to either gate of the transistors. Trigger signals may be caused by static discharge on the gates or by connecting either transistor's gate to G_1 or to the power supplies before connecting power-supply lines to the other terminals of the SCR. Even extremely high rates of voltage change across any two or more SCR pn junctions can produce latchup.

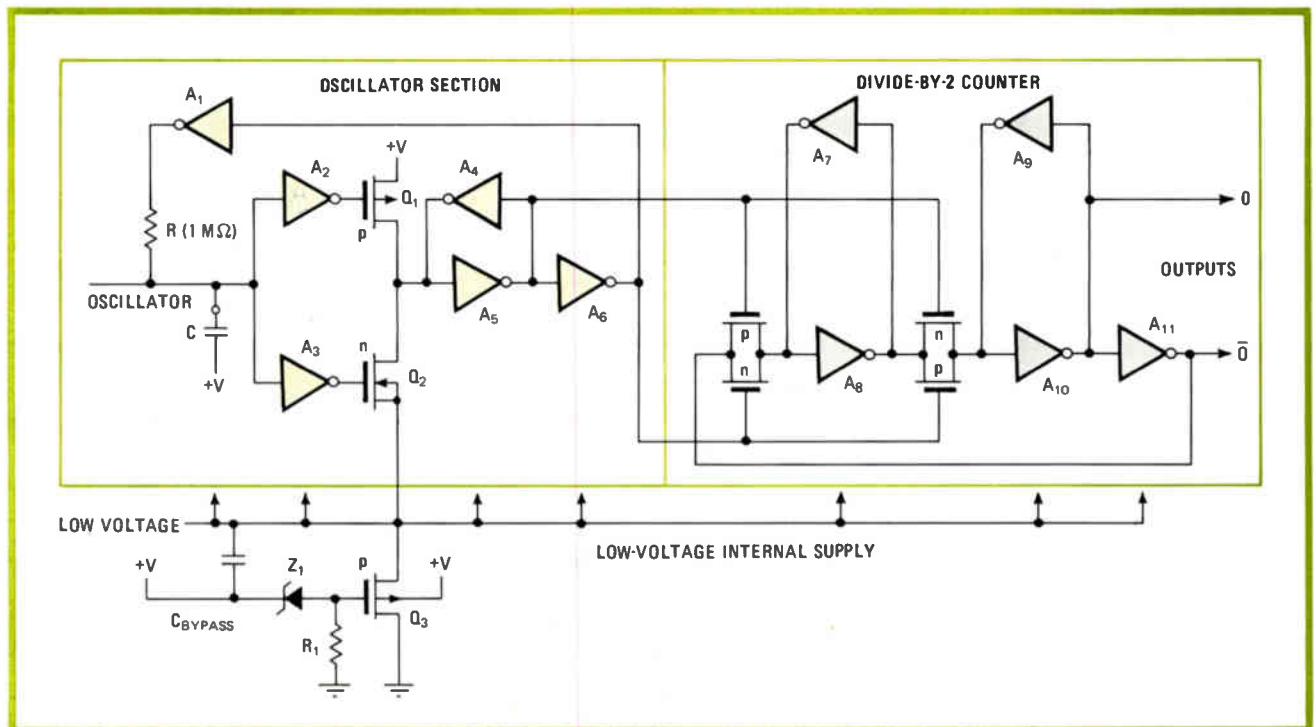

3. Oscillator. The 7660's oscillator, with a natural frequency of 10 kHz, drives a conventional divide-by-2 counter that supplies an output signal and its complement. The counter supplies a 50% duty cycle output (at one half the input frequency) to the level translator.

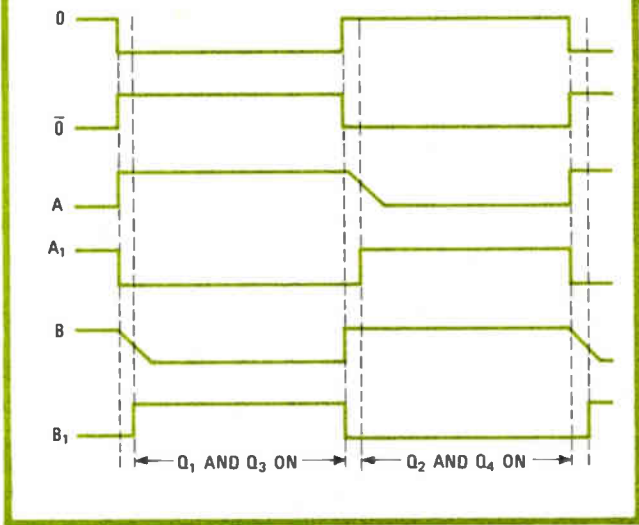
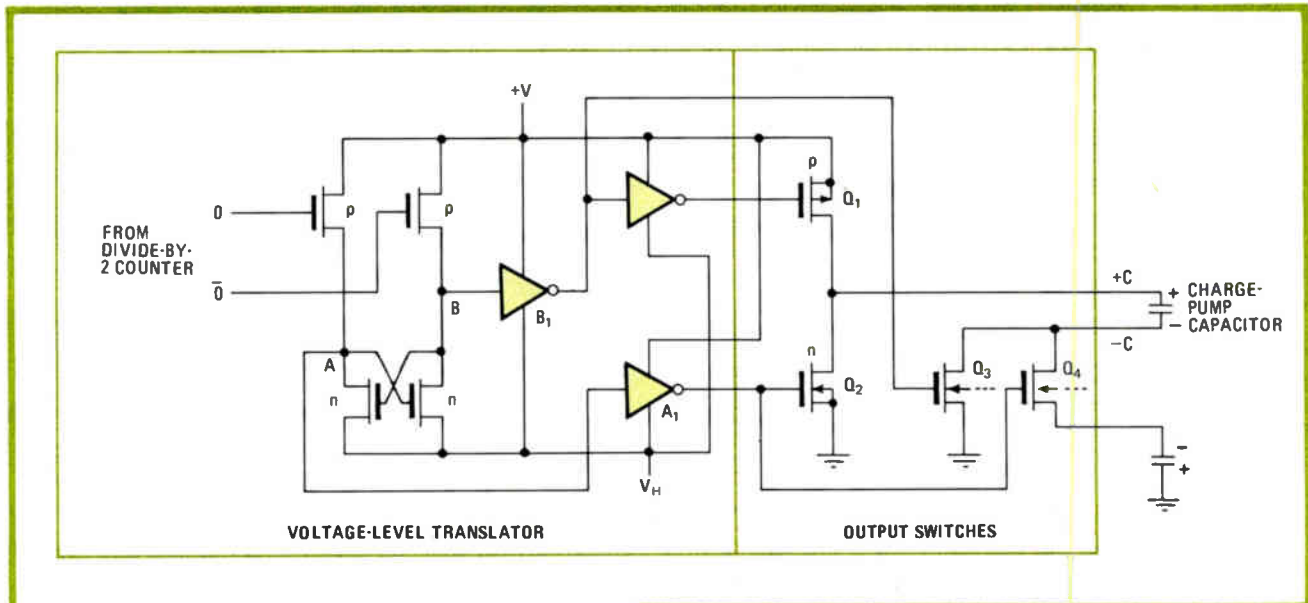

4. Translating. The 7660's output switches are driven by signals provided by the voltage-level translator circuit. The voltage waveforms shown for output transistors Q_1 - Q_4 are equal in amplitude to the sum of the output voltage and the power-supply voltage, $+V$.

transistors Q_1 through Q_4 in Fig. 1. The oscillator and voltage-level translator sections provide the control signals to the four switches such that, during the charge phase (a), capacitor C_1 is charged through S_1 and S_3 to a voltage nearly equal to the supply voltage, $+V$. In the pump phase (b), S_2 and S_4 are closed and the charge is pumped and transferred from capacitor C_1 to C_2 . Assuming no system losses, the voltage on C_2 is equal in value and opposite in polarity to $+V$ with respect to ground. This circuit is a classic voltage doubler, where S_3 and S_4 are usually replaced by conventional silicon diodes or rectifiers. The load, shown connected between V_{OUT} and $+V$, usually consists of operational amplifiers, comparators, and data-acquisition components; in some systems, the load may be ground.

The 7660's oscillator (Fig. 3) includes an RC network whose open-circuit natural frequency is about 10 kilohertz. The oscillator drives a conventional divide-by-2 counter whose principal function is to supply a 50% duty cycle output (at half the input frequency) to the voltage-level translator circuit. The conventional static counter requires a two-phase clock and supplies an output signal and its complement.

When the output of inverter A_1 is switched high, capacitor C charges positively until inverter A_2 (which has a high input-voltage trip point) switches its output low, to turn on transistor Q_1 . Q_1 in turn forces the ratioed-inverter latch A_4 - A_5 to switch its output low. C then discharges negatively until inverter A_3 (which has a low input-voltage trip point) switches its output high, turning on transistor Q_2 . The output of Q_2 resets A_4 - A_5 and restarts the cycle.

Since the oscillator has a high input impedance of about 1 megohm, either it may be driven from an external source such as a TTL gate or equivalent or its frequency may be lowered by the addition of an external

Triggering a C-MOS SCR causes it to present an extremely low impedance (1 to 100 ohms) across the power supply. Unless the power supply is current-limited, the device latches up and is often destroyed, usually by the vaporization of one of the bonding wires used to connect the C-MOS chip electrically to the leads of its package.

Preventing latchups

The 7660 is designed to minimize its susceptibility to latchup. It contains an RC oscillator, a series voltage regulator, a voltage-level translator, and a logic network (Fig. 1). The logic network senses the voltage on the sources and drains of the two output n-channel transistors Q_3 and Q_4 and ensures that their substrates are always correctly biased. Should the sources start to swing to more than -0.5 V with respect to the substrates, the substrate logic network acts to keep the substrate bias under $+0.5$ V and prevents the device from latching up.

The 7660's operation can best be understood by referring to Fig. 2. Switches S_1 through S_4 correspond to

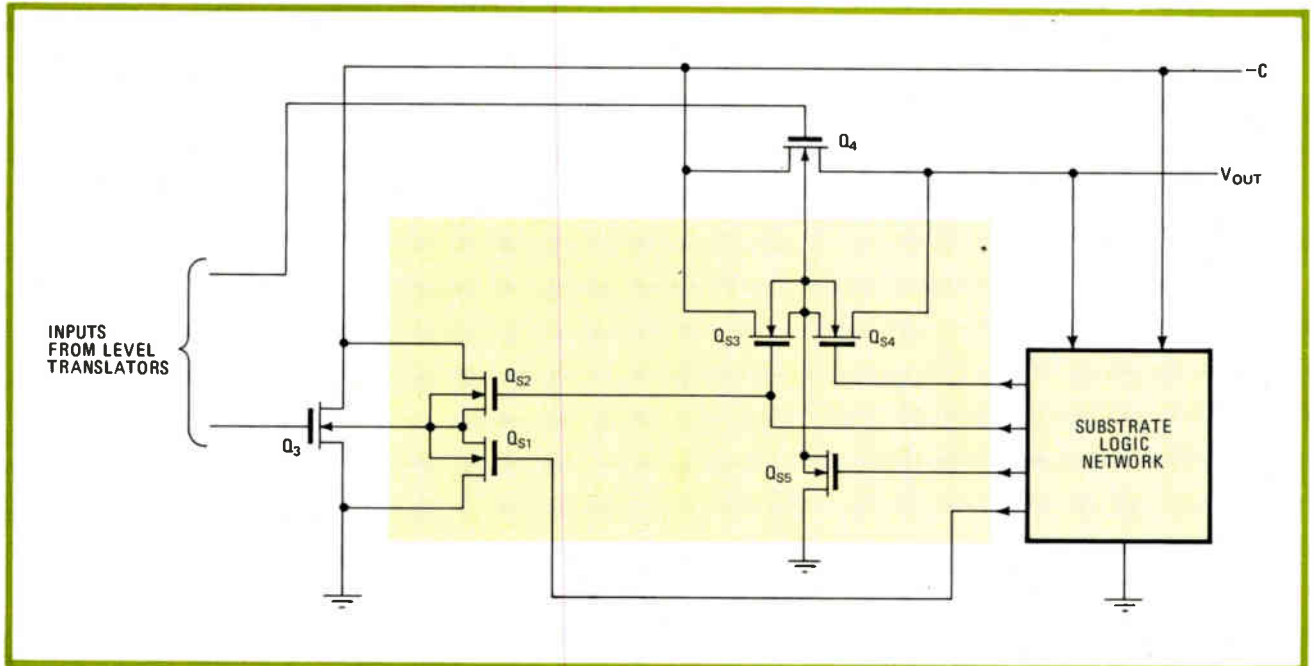

5. Steering. Transistors Q_{S1} – Q_{S5} , together with the substrate logic network, ensure that the substrates of output transistors Q_3 and Q_4 are correctly biased, to prevent device latchup. Latchup in a C-MOS device, if allowed to continue, can cause eventual device failure.

capacitor. At room temperature and with a +5-v supply, an external 1-picofarad capacitor results in a 10-kHz oscillator frequency. The frequency drops off with increasing capacitance values—to 5 kHz at 10 pF, to 1 kHz at 100 pF, and to about 15 hertz at approximately 10,000 pF (0.01 μ F).

A series voltage regulator consisting of zener reference diode Z_1 , resistor R_1 , and source-follower p-channel transistor Q_3 provides a partially regulated supply for all the low-voltage circuitry on the chip. The regulator can supply up to -5 v (with respect to the positive power supply) for input supply voltages of about 6 v and higher. Because of the modest size of Q_3 , the voltage regulator not only reduces power consumption at high supply voltages, but also limits the maximum current taken by the oscillator and the divide-by-2 counter to a value less than the holding current of the inherent SCR on the chip.

The level translators (Fig. 4) provide switching signals to the gates of the four output transistors Q_1 through Q_4 , with amplitudes equal to the sum of the output voltage and +V. They also ensure that a break-before-make sequence takes place, as switching alternates between pump-and-charge and charge-and-pump transitions.

A critical element

The substrate logic network is the most critical part of the converter chip. Its two main functions are to make sure that the substrates of Q_2 and Q_4 in Fig. 4 are never forward-biased with respect to their sources and drains and to establish the most negative voltage of any part of the circuit in either the charge or the pump cycles. This internal negative supply, V_H , is used to power the level translators. It drives the gate of either Q_3 or Q_4 to a voltage similar to that of the sources to ensure transistor turn off.

Transistors Q_3 and Q_4 require special drive considerations, since the sources and drains are inverted on each device during pump and charge phases. Consider Q_3 's operation, for example. During the charge phase, the most positive source/drain terminal is connected to the external charge-pump capacitor. This terminal is then by definition the drain, whereas the source which is more negative is connected to ground. To minimize Q_3 's resistance, it is desirable to also connect its substrate to ground and not to the output voltage or to V_H . This is because reverse-biasing the substrate of an MOS transistor with respect to its source increases its threshold voltage. Thus, for a given gate-to-source voltage, the effective turn-on voltage—that is, excess gate-to-source voltage over threshold voltage—is reduced, decreasing the transistor's resistance.

The pumping phase

During the pumping phase, the external capacitor's negative terminal is shifted negatively by a voltage approximately equal to +V. In this case, the most negative source/drain terminal is connected to the negative side of the external capacitor (and thus becomes the source of Q_3), and its drain is connected to ground.

Similar arguments can be made for transistor Q_4 concerning its source-drain reversals, except that here conditions are different for startup and output short-circuit operations than during normal operation. Sensing circuitry monitors the voltages on the external capacitor's negative side and V_{OUT} terminals and compares them with ground. The substrate of Q_4 is then connected to the most negative of the V_{OUT} , external-capacitor negative, or ground terminals. Figure 5 shows the substrate steering transistors for Q_3 and Q_4 . The steering transistors are relatively small n-channel devices and share Q_3 and Q_4 's substrates.

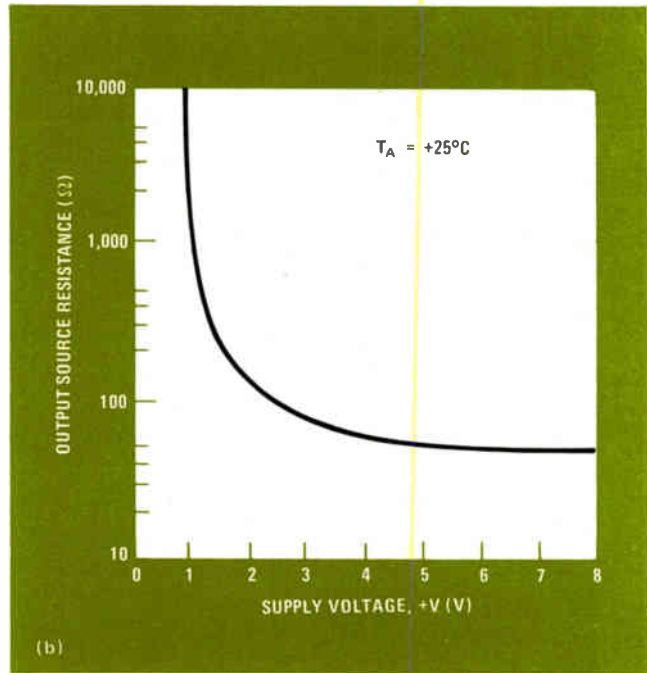
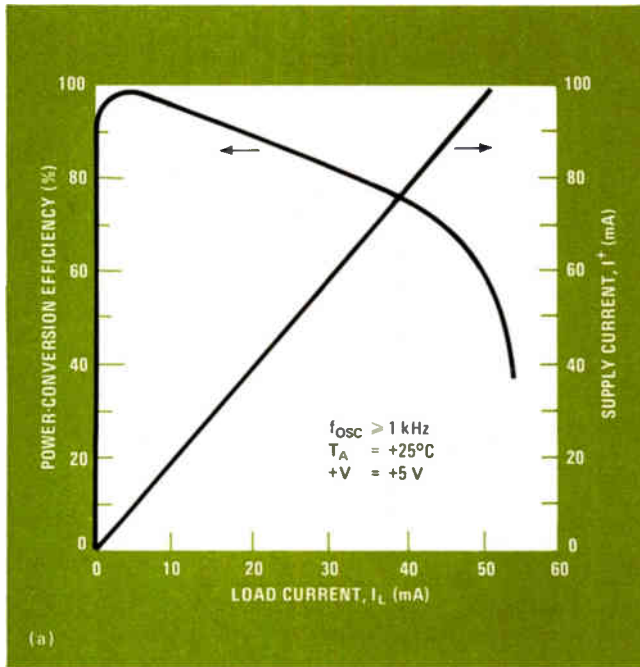

6. Efficient. When converting a +5-V supply into a -5-V one, the 7660 achieves efficiencies of 98%, as a function of the load current (a). The 7660 can be used down to 1.5 V, below which its output source resistance rises rapidly as a function of the supply voltage (b).

During the charge cycle (Q_3 on and Q_4 off), steering transistor Q_{S1} connects the substrate of Q_3 to ground and the substrate of Q_4 is connected to ground or V_{OUT} , whichever is more negative. During the pump cycle, the external capacitor's negative terminal is normally the most negatively biased point and is connected to the substrates of Q_3 and Q_4 by Q_{S2} and Q_{S3} . Fault conditions (for example, the capacitor's negative terminal connected to +V or V_{OUT} connected to +V) are also sensed and the substrates of Q_3 and Q_4 connected to the most negative of any of the three terminals—ground, the external capacitor's negative terminal, or V_{OUT} . Fault conditions can be handled by the 7660 for short periods of time. Prolonged fault conditions at high voltages, however, will cause excessive power dissipation, leading to eventual device failure.

Finally, both the timing interval between the signals applied to the gates of Q_3 and Q_4 and the reaction time of the substrate logic network should be short. This is achieved by slowing down the rate of rise and fall of the gate signals to Q_3 and Q_4 .

For the 7660 to be useful, as low an output impedance as possible is desired, so that useful output currents of several milliamperes can be achieved at high power-conversion efficiencies. Transistors Q_1 through Q_4 are therefore chosen as extremely large. At a 5-V gate-to-source drive, each has an on-resistance on the order of 10 Ω or less. The chip area of the four output transistors represent about two thirds of the total area.

Efficiencies of up to 98%

The effectiveness of the 7660's design can be seen from Fig. 6a, where power-conversion efficiencies for converting a +5-V into a -5-V supply can typically be as high as 98% for medium to low oscillator frequencies. At high oscillator frequencies, switching transient losses

of the output transistors and the substrate logic network reduce overall efficiencies somewhat. Figure 6b shows the 7660's output source resistance as a function of supply voltage. Useful operation can typically be achieved with a supply voltage as low as 1.5 V.

At first glance, the maximum power efficiency would seem to approach 50%. This is certainly true of any situation in which a capacitor is charged from 0 V up to some value, then discharged into a load. However, in the case where a capacitor is charged and discharged between two voltages, V_1 and V_2 , the energy lost is defined by:

$$E = C(V_1^2 - V_2^2)/2$$

where C is value of the capacitor in farads and E is the lost energy. If $V_1 - V_2$ is very small compared with V_1 , the percentage energy loss is also small, given as:

$$100(V_1^2 - V_2^2)/(2V_1^2)$$

At the limit, when $V_2 = V_1$, no energy is lost. If the values of C_1 and C_2 in Fig. 2 are made very large and their impedances at the switching frequency are very low compared with the load resistance, energy-conversion efficiencies approaching 100% can be obtained. Energy is lost only in the transfer of charge into and out of a capacitor during a change of voltage.

Although output-section switching transients are mainly capacitive, they inject currents into the substrate. At high input supply voltages, these transients can forward-bias junctions associated with the p^- well or the Q_4 substrate. This in turn may trigger the inherent SCR in Q_4 and the adjacent on-chip circuitry. The result is to discharge the reservoir capacitor rapidly.

After the reservoir capacitor is almost totally discharged and the current in the SCR has fallen below the capacitor's holding value, the device again operates cor-

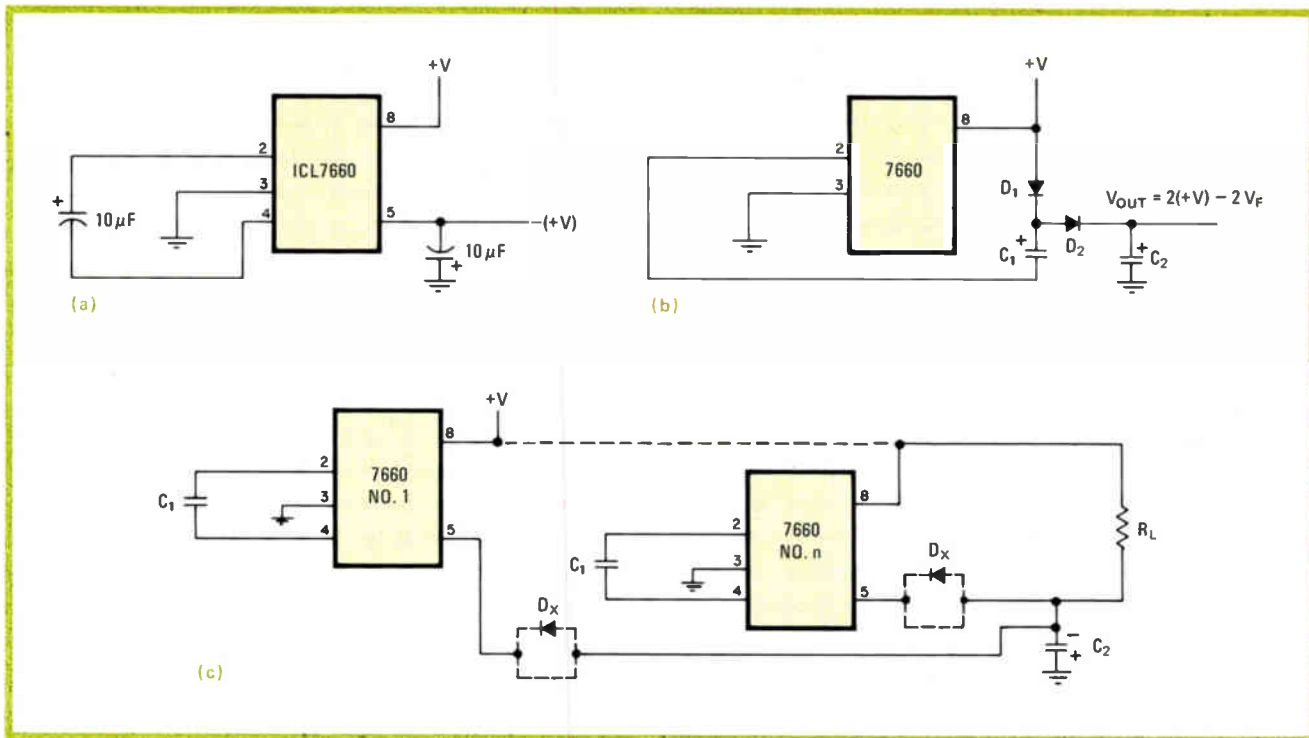

7. Hooking up. The usual 7660 configuration is a negative-voltage generator from a positive source (a). It can also do positive-voltage multiplication (b) and may be paralleled (c) for increased current output; diodes D_x are needed for V_{OUT} of 6.5 to 10 V.

rectly, until the output voltage (reservoir capacitance voltage) reaches the same critical value, and the latchup phenomenon starts again. Since this effect occurs only during the start of the charge cycle and not during the pump cycle, isolating the reservoir capacitor with an external diode at the V_{OUT} terminal prevents capacitor discharge. Connecting a 10- μ F capacitor from the V_{OUT} terminal to ground (the positive side of capacitor is grounded) results in a simple negative-voltage converter.

Also, the 7660 has a terminal that can be used to short out the on-chip series regulator for better operation at low supply voltages. With the low-voltage terminal connected to ground, operation with an input supply voltage as low as 1 V is possible. At higher voltages, however, it is mandatory that the low-voltage terminal be open, in order to allow the internal voltage regulator to stop device latchup.

Applying the 7660

The majority of 7660 applications involve the generation of a negative supply, particularly of -5 -v supplies. All that is required additionally are two capacitors. For applications requiring the doubling of 6 v, a diode is placed in series with the reservoir capacitor. This diode isolates the reservoir capacitor from the 7660 during the charge phase. (The diode is necessary to avoid capacitive feedthrough on chip, which is aggravated at high temperatures, causing the output section to momentarily latch up at the beginning of the charge phase and discharging the reservoir capacitor.) The choice of values for the pump and reservoir capacitors depends primarily on the desired output current and the peak-to-peak output voltage ripple. For oscillator frequencies below the natural oscillator frequency of 10 kHz, an

additional external capacitor connected to the oscillator terminal is required. For maximum efficiency, a low oscillator frequency of about 1 kHz is desirable. At this frequency, however, a tenfold increase in pump and reservoir capacitor values is needed for a given output voltage ripple.

Cascading for negative multiplication

Two or more 7660s may be cascaded to produce negative multiples of the initial supply voltage (V_{out} equals the number of 7660s times $+V$). Because of the finite efficiency of each device, however, the practical limit for light loads is about 10 stages. Note that each device is exposed to a maximum of twice the input supply voltage, and not the total output voltage.

The most common arrangement of the 7660 for generating a negative voltage equal in magnitude to a positive one is shown in Fig. 7a. The 7660 can also be used to obtain positive-voltage multiplication (Fig. 7b). There, the pump output driven at the external capacitor's positive terminal charges C_1 to a voltage level of $+V - V_F$, where V_F is the forward voltage drop of diode D_1 . During the pump phase, the voltage on C_1 and $+V$ is applied through D_2 to C_2 . The voltage thus created on C_2 becomes $2(+V) - 2V_F$.

Both positive- and negative-voltage multiplications can be combined using a single 7660. This approach is suitable for generating $+9$ and -5 v from a $+5$ -v supply. Furthermore, 7660s may be paralleled to increase the output current or to decrease the output source impedance (Fig. 7c). A single reservoir capacitor suffices, but individual pump capacitors are required for each converter. There is no limit to the number of devices that may be paralleled. \square

"Every time we ask a MOS/LSI company about their custom experience, they change the subject."

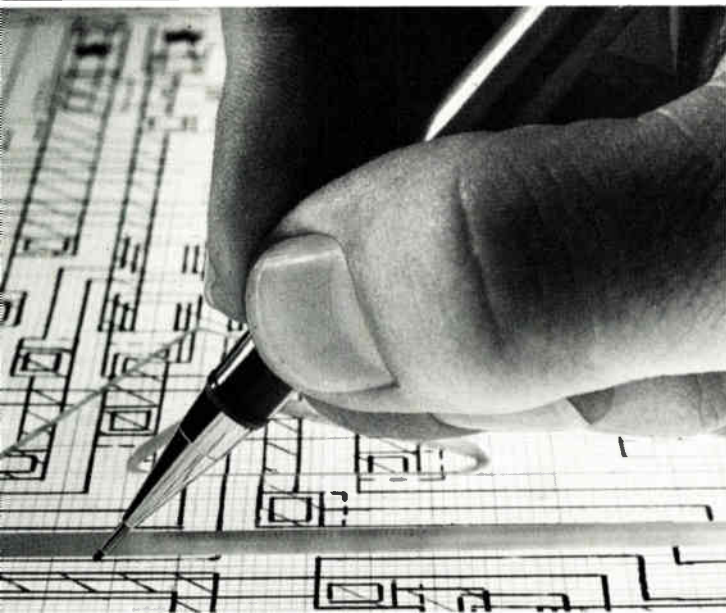

That's no surprise. Most MOS/LSI companies take on custom work only when market conditions force them to. And, no matter how big they may seem, they're usually only willing to handle a few limited jobs. So they really don't have much custom experience worth talking about.

AMI does. As the leader in the field, we have 14 years of successful custom work behind us. Since we opened for business in 1966, our engineers have designed over 1,300 LSI circuits. And for the entire period of time, custom has been the major — and most important part — of what we do.

We've designed circuits for appliance and consumer electronics companies, the telecommunications and EDP fields, the automotive industry and the military. In fact, we've created custom solutions for virtually every kind of company.

Which means that whatever business you're in, you can be just about certain that we'll understand your problems. And that we'll be able to offer you a MOS system solution tailored to the exact needs of your application.

We can design a MOS peripheral circuit for you that will interface with any standard micro-power memory and 4-, 8- or 16-bit microprocessor (ours or someone else's). Or we can offer you one of our own standard circuits customized to your specific requirements.

We've also designed complete systems on a chip with as many as 60,000 devices, and we're able to combine both linear and digital circuitry on the same piece of silicon. So if you need a chip with

switched capacitor filters, A/D and D/A converters and other linear type circuits, we can give it to you.

What's more, our SIDS (Symbolic Interactive Design System) is the world's most advanced design system. It's the reason we've been able to cut design time while producing increasingly more complex circuits.

We're very flexible. AMI's engineers work in 14 variations of the three major MOS processes: the very mature P-channel, high speed, state-of-the-art N-channel and CMOS. So when the time comes for you to choose the process you want, unlike other companies, we have no limitations to impose on you.

But AMI's flexibility doesn't end there.

If you want to design your own LSI circuits, we make it easy for you to work with us. We can interface with you at any stage of chip development, and we have the industry's only group specially organized to handle customer designed circuits. In six years, they've managed the production of over 750 of these circuits.

You'll be in good company. AMI's list of satisfied customers includes some of Fortune 500's biggest companies. But we work for a lot of small and medium size companies, too. That's another part of our flexibility. We're set up so that we can provide cost-effective, state-of-the-art results for just about any size company — and just about any size job.

If what AMI has to offer sounds like what you've been looking for, mail in the coupon. We'll send you two books that will help you decide if custom MOS is right for your application and tell you everything you should know about AMI's custom capability.

It's really the quickest way for you to start taking advantage of our experience.

I want to know more about AMI's custom LSI capabilities.

Send me the books. Have your applications engineer contact me.

Name _____ Title _____

Company _____

Address _____

City _____ State _____ Zip _____

Phone _____

What is your application? _____

Send to: American Microsystems, Inc.,
Dept. E9-11, 3800 Homestead Road,
Santa Clara CA 95051.

AMI
AMERICAN MICROSYSTEMS, INC.

Circle 147 on reader service card

More communications in orbit

Updated table gives operating characteristics
of orbiting satellites and those soon to be launched

by the staff of Satellite Systems Engineering Inc., Washington, D. C.

□ Over 75 active communications satellites are in geostationary orbit today—some 20 more than when Electronics first published this chart on Oct. 12, 1978. Others are fully designed but not yet launched or else still in the early planning stages. Four of the most important new systems (Anik-D, Palapa 2, Marecs, and Telecom 1) have been added to the chart; the now inactive systems (Marots 1, ATS-6, CTS, and Skynet 2B) have been dropped; and information on all the others has been updated.

The operational satellites handle 30 communications programs. The service each program offers is indicated by International Telecommunications Union designations and the band letters for its frequency. Specific frequency assignments, which vary from region to region, may be obtained from the system operator or from the Federal Communications Commission's Radio Regulations.

What's new?

The satellites in Canada's Anik-D series will replace the three now orbiting in the Anik-A series, which will near the end of their useful life in 1982. The D series is to be launched by the U. S. space shuttle, unless further slippage in this program should cause a change of plans.

In the program for ship-to-shore communications called Marecs (for maritime versions of the European Communications Satellite), the first two satellites are to be put into orbit in 1981 by the European rocket system Ariane. The complete program will call altogether for three Marecs and three Intelsat Vs with maritime payloads.

Europe will also have Telecom 1—a two-satellite system developed by France—in operation by 1983.

In Asia, the Palapa 2 satellites will replace Palapa 1, now supplying telecommunications to Indonesia and other members of the Association of South East Asian Nations (ASEAN). To be launched in 1983, these satellites will have twice as many transponders as Palapa 1 and twice its output power and will be placed in a longitude somewhere between 108° and 118° east.

Almost all the satellites are in a circular orbit in the plane of the equator and about 19,323 nautical miles above it. Their rotational periods of 23 hours, 56 minutes, and 4.09 seconds keep them in fixed positions

relative to any point on earth, or geostationary orbits.

Only the Soviet Union's Molniya System is different. It employs a highly elliptical orbit with a period of about 12 hours, an apogee of 40,000 kilometers, and a 63.4° inclination to the equator. In this alignment, the major axis of the ellipse does not rotate, the apogee remains over the Northern Hemisphere, and most of the time the individual satellites stay within view of the far northern reaches of the USSR. Tracking earth stations are required, however, as is periodic handover from one satellite to another.

More than one choice

The stabilization system for satellites is usually described as either spin or three-axis. But since spinning satellites with despun platforms are also stabilized along three axes as far as the antenna beams are concerned, it would be more accurate to describe the two types as drum- and wheel-stabilized. Except where noted, the mass is the initial weight on final orbit, including station-keeping propellant.

The primary power figure is the total wattage available from the on-board solar array during equinox at the beginning of the satellite's life. Typically requirements vary not only with total radiated power but also with receiver system, degree of redundancy, and service to be provided during a solar eclipse.

Only an approximate picture of transponders and antenna beams can be given because the system block diagrams show a great variety in redundancy, switching possibilities, and bandwidths. The number of transponders equals the number of rf channels with the bandwidths as shown in the row below.

Multiple values

Where the satellite figure or merit has more than one value, they apply to the different beams or transponders or bandwidths noted in the rest of the row. Similar considerations hold for some other specifications.

It is important not to confuse the rf carrier modulation system with the multiple-access scheme for many earth stations using the same transponder. Note also that the single-channel-per-carrier technique is a special type of frequency-division multiple access. □

Reprints of the chart opposite cost \$3 each. Write to Electronics Reprint Dept., P. O. Box 669, Hightstown, N. J. 08520. Copyright 1980 Electronics, a McGraw-Hill publication.

Electronics

A GUIDE TO COMMUNICATIONS SATELLITES

| System | Intelsat IV | Intelsat IV-A | Intelsat V | | Molniya 1 | Molniya 3 | Stationar | Anik A | Anik B | Anik C | Anik D | RCA Satcom | WU Westar | TDRS Advanced Westar | | Comstar | Indonesia Palapa 1 | S.E. Asia Palapa 2 | SBS | Comsat Marisat | Marecs | Insat | France Telecom I | Japan BS | Japan CS | Sirio | OTS/ECS | DSCS II | DSCS III | NATO III | Fleetsatcom | | | | |
|---|---------------------------|---------------------------|-----------------------------|-------------------|--------------------|--------------------|------------------------|-------------------------|-------------------------|-------------------------|----------------------------|------------------------|-------------------------|-------------------------|---------------------|------------------------------------|--------------------------------|--------------------------------|----------------------------|---|---|-------------------------|-------------------|---------------------|------------------------|---------------------|---------------------------------|---------------------------------------|---------------------------------------|----------------------|---------------------------------------|-----------------|-------------------------|----------|----------|
| System operator | Intelsat | Intelsat | Intelsat | | USSR/Inter-sputnik | USSR/Inter-sputnik | USSR/Inter-sputnik | Telesat Canada | Telesat Canada | Telesat Canada | Telesat Canada | RCA American Comm. | Western Union Telegraph | Western Union Telegraph | | Comsat General | Indonesian government/Perumtel | Indonesian government/Perumtel | Satellite Business Systems | Comsat General/RCA Global Comm./ITT World Comm./WUI | European Space Agency | Indian government | French government | Japanese government | Japanese government | Italian government | European Space Agency | U.S. government/Department of Defense | U.S. government/Department of Defense | NATO | U.S. government/Department of Defense | | | | |
| Service ¹ | fixed tel., TVD | fixed tel., TVD | fixed tel., TVD | | fixed tel., TVD | fixed tel., TVD | fixed | fixed tel. | fixed tel. | fixed | fixed tel., TVD, telegraph | fixed tel., TVD | fixed tel., TV, TTY | fixed | | fixed tel. | fixed tel., TV | fixed tel., TV | fixed tel., TV | mobile tel., TTY | mobile tel., telegraph | fixed TV and radionetry | fixed tel., TVD | | broadcast experimental | fixed experimental | fixed experimental | fixed | fixed military | fixed military | fixed military | mobile military | | | |
| Frequencies ² | C | C | C | Ku | C, uhf | C | C | C | C/Ku | Ku | C | C | C | C | C | C | C | C | C | Ku | L ship C shore | L ship C shore | S | C | C | Ku | Ku | K, Kc, C | Ku, Kc | Ku | X | X | X | uhf, X | |
| Launch vehicle | Centaur | Centaur | Centaur (shuttle or Ariane) | | A-2 Soyuz | A-2 Soyuz | A-2 Soyuz Proton SL-12 | Thor Delta 2914 | Thor Delta 3914 | Thor Delta 3910/STS | Thor Delta 3914 | Thor Delta 2914 | Thor Delta 2914 | STS | | Atlas Centaur | Thor Delta 2914 | shuttle or Thor Delta | Delta 3910 or STS | Thor Delta 2914 | Ariane | 3910 | | Ariane | Thor Delta 2914 | Thor Delta 2914 | Thor Delta 2910 | Thor Delta 3914 | Titan IIC | Titan IIC shuttle | Thor Delta 2914 | Atlas Centaur | | | |
| Prime contractor | Hughes | Hughes | Ford | | | | Hughes | RCA | Hughes | Spar Aerospace | RCA | Hughes | TRW | | Hughes | Hughes | Hughes | Hughes | Hughes | Hughes | British Aerospace Dynamic Group | Ford | | Matra | Toshiba/GE | Mitsubishi/Ford | Campagna Nazionale Aerospaziale | Hawker Siddeley Dynamics | TRW | GE | Ford | TRW | | | |
| Stabilization | spin | spin | 3-axis | | 3-axis | 3-axis | 3-axis | spin | 3-axis | spin | spin | 3-axis | spin | 3-axis | | spin | spin | spin | spin | spin | 3-axis | 3-axis | | 3-axis | 3-axis | spin | spin | 3-axis | spin | 3-axis | spin | 3-axis | | | |
| Mass (kg) | 731 | 790 | 1,020 | | 1,000 | 1,000 | 1,250 | 272 | 440 | 522 | 635 | 461 | 297 | 2,132 | | 810 | 300 | 628 | 546 | 326 | 466 | 1,054 (into transfer) | | 1,100 (at launch) | | 352 | 340 | 218 | 444 | 536 | 748 | 349 | 1,005 | | |
| Primary power (W) | 569 | 708 | 1,220 | | 500 | 500 | 700 | 260 | 840 | 925 | 1,000 | 770 | 260 | 1,700 | | 760 | 300 | 1,108 | 1,000 | 330 | 500 | 1,250 | | — | | 1,000 | 521 | 118 | 700 | 520 | 800 | 538 | 1,425 | | |
| Coverage ³ | global spot | global hemisphere spot | global hemisphere zonal | spot | global USSR | global USSR | global spot | Canada | Canada | Canada | Canada, northern U.S. | Conus, Alaska, Hawaii | Conus | Conus, Alaska, Hawaii | Conus | Conus, Puerto Rico, Alaska, Hawaii | Indonesia | S.E. Asia | Conus | global | global | India | | semi-global spot | France | Japan | Japan | North Atlantic, Europe spot | spot Europe A Europe B | global spot | global spot | Atlantic Europe | global | | |
| Number of transponders | 12 | 20 | 15 | 6 | 1 | 3 | 6 | 12 | 12/6 | 16 | 24 | 24 | 12 | 12 | 4 | 24 | 12 | 24 | 10 | 2 | 1 | 2 | 12 | 4 | 6 | 2 | 6/2 | 1 | 6 | 4 | 6 | 2 | 12 | | |
| Transponder bandwidth (MHz) | 36 | 36 | 36 41 72 77 | 72 77 241 | 50 | 50 | 40 | 36 | 36 72 | 54 | 36 | 34 | 36 | 36 | 225 | 36 | 36 | 36 | 43 | 4 | 5.9 ship to shore 4.75 shore to ship | 36 | 36 | 40 120 | 36 | 50 80 | 200 | 32 | 120 40 5 | 410 total | 395 total | 17 85 50 | 0.005 0.025 0.500 | | |
| Number of antenna beams | 6/4 | 7/3 | 5/5 | 2: east and west | 1 | 1 | 2-4 | 1 | 1 4/1 | 4/1 | 5 | 2 | 2 | 2 | 7 | 4 | 1 | 2 | 1 | 1 | 2 | 1 | 1 | 3 | 2 | 1 | 1 | 3 | 3 | 3 | multiple array | 2 | 1 | | |
| Polarization | circular | circular | circular | linear | circular | circular | circular | linear | linear | linear | linear | linear | linear | linear | linear and circular | linear | linear | linear | linear | linear | circular | circular | linear | | circular | linear | linear | linear | circular | circular | linear, linear, circular | circular | circular | circular | circular |
| G/T (dB/K) (figure of merit) | -18.6 | -18 -11.6 -11.6 | -18.6 -11.6 -8.6 | 0.0 E 3.3 W | -15.8 to -18.6 | -10 | -15.8 | -7 | -6/-1 | 3 | -37.5 -27 -28 | -5 -10 | -6 | -7 -12.5 -12.5 | -5 to 4.4 | -8.8 | -7 | -5 | 2 to -2 | -17 -25 | -12.8 ship to shore -16.5 shore to ship | — | | -13.6 | 6.5 | -8.2 | noise figure = 13 dB/9 dB | -22.2, -17.2 | 4.2 -4.8 -2.2 | 8.5 20.2 | -16 to -1 | -14.1 | -16.6 (uhf) | | |
| EIRP (dBW) (effective isotropic radiated power) | 22.5 34.2 | 22 26 29 | 23.5, 26.5 26, 29 29 | 41.4 E 44.4 W | 30 | 35 | 25 to 36 | 33 | 36 47.5 | 48 | 36 | 33 26 | 33 | 33 28 26 | 42 to 50.3 | 33 | 32 | 34 | 40 to 43.7 | 20-29.5 18.8 | 18.8 ship to shore 20, 26, 29.5 shore to ship | 34 | 42 | 26 34.6 | 49 | 55 | 37 29.5 | 24 | 45.8 36.5 42.0 | 28 40 | 23-40 | 35 29 | 26-28 (uhf) 27 | | |
| Modulation ⁴ | FDM/fm fm QPSK SCPC | FDM/fm fm QPSK SCPC | FDM/fm fm QPSK | FDM/fm fm QPSK | FDM/fm | FDM/fm | FDM/fm | FDM/fm QPSK, SCPC | FDM/fm QPSK, SCPC | FDM/fm QPSK, SCPC | FDM/fm fm/TV SCPC | FDM/fm QPSK SCPC | fm QPSK | fm QPSK | 250 Mb/s TDMA | FDM/fm | fm fm/SCPC | fm fm/SCPC | QPSK | fm BPSK | PSK fm, SCPC | fm QPSK | FDM/ fm | 25 Mb/s TDMA | fm and digital | 100 Mb/s digital | PCM-PSK and fm video | fm PSK | fm QPSK | fm QPSK | fm QPSK | fm QPSK | | | |
| Multiple access ⁵ | FDMA TDMA | FDMA TDMA reuse | FDMA TDMA reuse | FDMA reuse | FDMA | FDMA | FDMA | FDMA TDMA | FDMA TDMA | FDMA TDMA reuse | FDMA | FDMA | FDMA TDMA | FDMA TDMA | FDMA TDMA | FDMA TDMA | FDMA | FDMA | TDMA | TDMA FDMA | TDMA FDMA | FDMA | FDMA SCPC | TDMA | SCPC | TDMA | SCPC | TDMA | FDMA TDMA CDMA | FDMA TDMA CDMA | CDMA FDMA | FDMA | | | |

¹fixed - satellite service to specified fixed points
mobile - satellite service to ships, airplanes, and mobile ground terminals
broadcast - satellite service intended for reception by the general public
TTY - teletypewriter
tel. - telephone
TVD - television distribution

²P band or uhf - 200 to 400 MHz
L band - 1,530 to 2,700 MHz
S band - 2,500 to 2,700 MHz
C band - 3,400 to 4,200 MHz
4,400 to 4,700 MHz
5,725 to 6,425 MHz
X band - 7,250 to 7,750 MHz
7,900 to 8,400 MHz
Ku band - 10.95 to 14.5 GHz
Kc band - 17.7 to 21.2 GHz
K band - 27.5 to 31.0 GHz

³Conus - continental United States without Alaska and Hawaii

⁴SCPC - single channel per carrier
FDM - frequency-division multiplexing
fm - frequency modulation
PCM - pulse-code modulation

PSK - phase-shift keying
BPSK - binary phase-shift keying
QPSK - quadri phase-shift keying (four-phase-shift keying)
CPSK - coherent phase-shift keying

⁵CDMA - code-division multiple access
FDMA - frequency-division multiple access
TDMA - time-division multiple access
frequency reuse - same carrier frequencies assigned to different users through use of separate beams or polarizations

Handling exceptions gracefully enhances software reliability

The 68000 processor vectors to special routines upon encountering divide-by-zero operations and other exceptions

by Thomas W. Starnes, *Motorola Inc., Austin, Texas*

□ The main task of any computer system is to execute instructions. Illegal instructions and other exceptions to this process often cause unpredictable behavior unless the processor's design takes them into account.

The 68000 is uniquely well defended against such eventualities. When confronted with bus errors indicative of some kind of memory failure or with undefined operations like divide by zero, it vectors to a trap—a known memory location containing the user-supplied exception-handling routine. Such a routine might, for example, notify the operator of an attempt to execute an illegal instruction and then let the machine resume its normal activities. This feature, which greatly increases the 68000's reliability, is to be found on few other microprocessors.

In addition, the 68000 is exceptional in its handling of multiuser environments such as swapping user programs in and out of main memory. These kinds of tasks are conventionally serviced entirely in software, with program swapping, for instance, being handled by means of an executive subroutine that is either periodically called by the operating system or vectored to by an external interrupt. But in the 68000, built-in hardware supports a privileged, supervisory level of operation that makes this exception processing much easier to implement.

Traps also count as exceptions. Besides being caused by undesirable occurrences within the processor, they

may be called expressly by instructions or requested during the execution of certain instructions. Each type of trap is associated with a vector which points to a service routine. The old program counter and status register are restored after execution of the routine. Any task can call the trap and utilize the trap routine.

Finally, to ease software development, the 68000 supports a trace function, in addition to the usual single-step mode that utilizes the halt pin. Like the other new features, it aids the designer of sophisticated systems but may be left unused in less complex systems. Figure 1 shows the memory locations of all exception vectors.

User and supervisor levels

The 68000 operates at all times on one of two levels: supervisor or user. Operation at the supervisor level has certain privileges attached that are not permitted at the user level (Table 1). Programs other than those designed for system control execute for the most part at the 68000's user level. Operating system chores, such as task or context switching, should execute at the more privileged supervisor level. At this level of operation, the program's regular complement of instructions is available, allowing the operating system to vary the working environment of the microprocessor, service interrupts or act-on-error conditions caused by hardware or programs.

Whether the processor is at the supervisor level or at

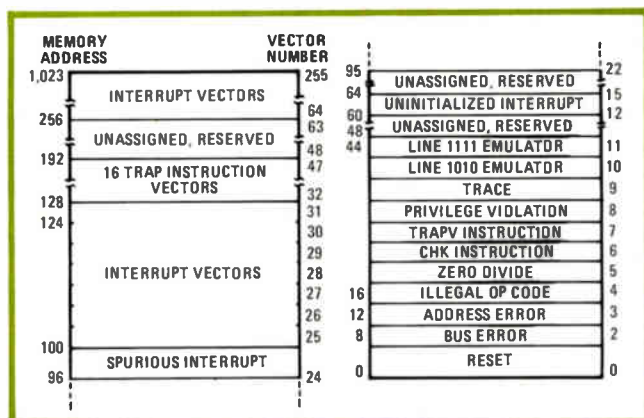

1. Exception-handling vectors. All exceptions cause a vector to be fetched from this map and loaded into the program counter. The old program counter and status register are saved on the supervisor stack and are restored at the end of the routine.

TABLE 1: PRIVILEGES OF THE 68000'S USER AND SUPERVISOR LEVELS

| | User level | Supervisor level |
|--------------------------------------|---|---|
| Enter level by | clearing status bit 'S' | recognition of a trap, reset, or interrupt |
| Function code output (FC2 =) | 0 | 1 |
| System stack pointer | user stack pointer | supervisor stack pointer |
| Other stack pointers | registers A0-A6 | user stack pointer and registers A0-A6 |
| Status bits available (read) (write) | C,V,Z,N,X,I ₀₋₁₂ ,S,T C,V,Z,N,X | C,V,Z,N,X,I ₀₋₁₂ ,S,T C,V,Z,N,X,I ₀₋₁₂ ,S,T |
| Instructions available | all, except those listed at right | all, including: STOP RESET MOVE to SR ANDI to SR ORI to SR EORI to SR MOVE USP to (ea) MOVE to USP RTE |

TABLE 2: EXAMPLES OF STATUS REGISTER OPERATIONS

| Executed at supervisor level | Action taken |
|------------------------------|---|
| MOVE #S0400, SR | Turn off trace; change to user level, clear condition codes; load interrupt mask with 100 |
| ANDI #DFFD, SR | Clear V; change to user level; no change: all others |
| EORI #S2000, SR | Change to user level; no change: all others |
| ORI #S8700, SR | Turn on trace; set interrupt mask to NMI; no change: all others |
| Executed at user level | Action taken |
| MOVE #S00C0, CCR | Set N, Z; clear X, V, C; no change: all others |
| ORI . B #S01, CCR | Set C; no change: all others |
| ANDI . B #S01, CCR | Clear C; no change: all others |
| EORI . B #S08, CCR | Toggle N; no change: all others |
| EORI . W #S8008, SR | Trap through privilege violation vector |

the user level is determined by the S/U bit in the status register. Transition from one level of operation to the other is accomplished in a number of ways.

The processor will go to the user level from the supervisor level if the S/U bit is reset by a MOVE, ANDI (and immediate), or EORI (exclusive or immediate) instruction (Table 2). Conversely, the trap instructions are the only means of getting from the user to the supervisor level in software. For example, certain instructions can cause such a switch to the supervisor level if particular conditions arise during the instructions' execution. In addition, a bus-error signal or any of the other hardware traps will also force the processor to the supervisor level, as will the servicing of an interrupt request.

If the microprocessor is at the user level before an exception is processed, then it will normally return to that level once the routine is closed with the RTE (return from exception) instruction. This instruction also serves to reset the S/U bit.

Traps

There are 16 user-definable trap instructions that, when executed, always direct program control to a designated trap routine at the supervisor level. These software interrupts are useful for calling the operating system, simulating interrupts during debugging operations, signaling the completion of a task, or indicating that an error condition has appeared in a routine.

Two additional instructions—trap-on-overflow and check—examine operating conditions and cause a trap if those conditions are not satisfied. Trap-on-overflow

(TRAPV) will cause a trap if the overflow bit in the status register is set (V = 1). A single routine at the operating system level may then handle every overflow occurrence. The check instruction (CHK) determines whether a chosen register's contents are within the bounds of zero and a specified upper limit and, if it finds the register is outside of the designated bounds, initiates a trap. It may be used to verify that a stack does not overrun, that a string of characters will fit into the allocated space, that an entry into an array is within the dimensions of the array, or that a task does not access data outside its designated space. Failure to remain within bounds causes a call by the operating system to the check service routine.

The two divide instructions—DIVS, which is signed, and DIVU, which is unsigned—can also cause a trap. The attempt to divide a number (dividend) by zero (divisor) is detected before the operands are modified, and a trap is taken automatically. This turns program control over to the supervisor for alternative action.

The divide instructions may encounter one other situation that will divert the normal divide operation—an overflow condition during the division. When this happens, the overflow bit (V) is set, but the result is not written to the destination and the original operands are left intact. Instruction execution continues with the next instruction, though a succeeding TRAPV instruction could call the supervisor for special processing.

Undefined instructions

The attempt to execute certain instructions not implemented in current versions of the 68000 can cause one of two traps to occur. These instructions have op codes whose first 4 bits are 1010 (A₁₆) or 1111 (F₁₆) and are reserved for future enhancements to the instruction set. In anticipation of the expanded instruction set, the "line 1010 emulator" and the "line 1111 emulator" traps are provided to allow the user to imitate the operation of future instructions with macroinstructions. When specific op codes become available for the additional instructions, those can be included in programs. Currently, when an instruction op code is fetched whose first 4 bits are 1010 or 1111, a trap is made to the emulator routine—the "line 1010 emulator" and "line 1111 emulator." When the operation becomes available as a machine primitive, the macroinstruction routine can be eliminated.

There are other op codes that would otherwise cause problems but instead initiate exception processing. Those, for example, that neither decode into valid instructions nor fall into the line 1010/1111 category are considered illegal, and the attempted execution of one will result in a trap. This is a particularly valuable exception because it helps to catch incorrect machine code. Most microprocessors perform some unknown or variable operation when an undefined op code is fetched, inviting the destruction of program or data. Software integrity is improved by forcing an operating-system call to be made upon receipt of an invalid op code.

Unlike most instructions, which may execute at either the user or the supervisor level, privileged instructions, listed in Table 3, may execute only at the supervisor

level. Privileged instructions are designed for system control; hence any instruction that modifies the entire status register is privileged. This privilege prevents a user-level program from turning on or off the trace feature, from changing the privilege level, or from changing the interrupt mask level.

The stop, reset, and return-from-exception instructions are also privileged. STOP suspends execution of instructions, loads the status register (including the interrupt mask), and awaits an external prompt (unmasked interrupt or reset). RTE is privileged, since all exception processing takes place at the supervisor level and hence the return instruction must also be on that level. Neither can RESET be used by a program operating at the user level, for this instruction holds the reset pin low long enough to initialize all devices tied to that line, which is clearly a supervisor operation. Any attempt to execute a privileged instruction while on the user level would be a privilege violation and would therefore result in a trap.

In addition, while operating at the supervisor level, the operating system can use both the supervisor stack pointer and the user stack pointer. That privilege allows it to change the user stack location in the course of switching from task to task.

To assist in program development and debugging, the

TABLE 3: PRIVILEGED INSTRUCTIONS

| Privileged instruction | Operation |
|------------------------|--------------------------------|
| RESET | reset external devices |
| RTE | return from exception |
| STOP | stop program execution |
| ORI to SR | logical-OR to status register |
| MOVE USP | move user stack pointer |
| ANDI to SR | logical-AND to status register |
| EORI to SR | logical-EOR to status register |
| MOVE EA to SR | load new status register |

trace feature is provided along with the standard halt feature. The trace routine is written by the programmer and might print out register and memory contents or whatever debug operation is desired. Instruction tracing is initiated by turning on the trace bit (T) in the status register. Once that is done, the execution of each instruction is followed by the tracing operation. This is done by the trace trap vector, which directs program execution to the trace routine.

Jumping to the trace routine is slightly different from jumping to the other traps. The program counter and status register of the main program are stored on the

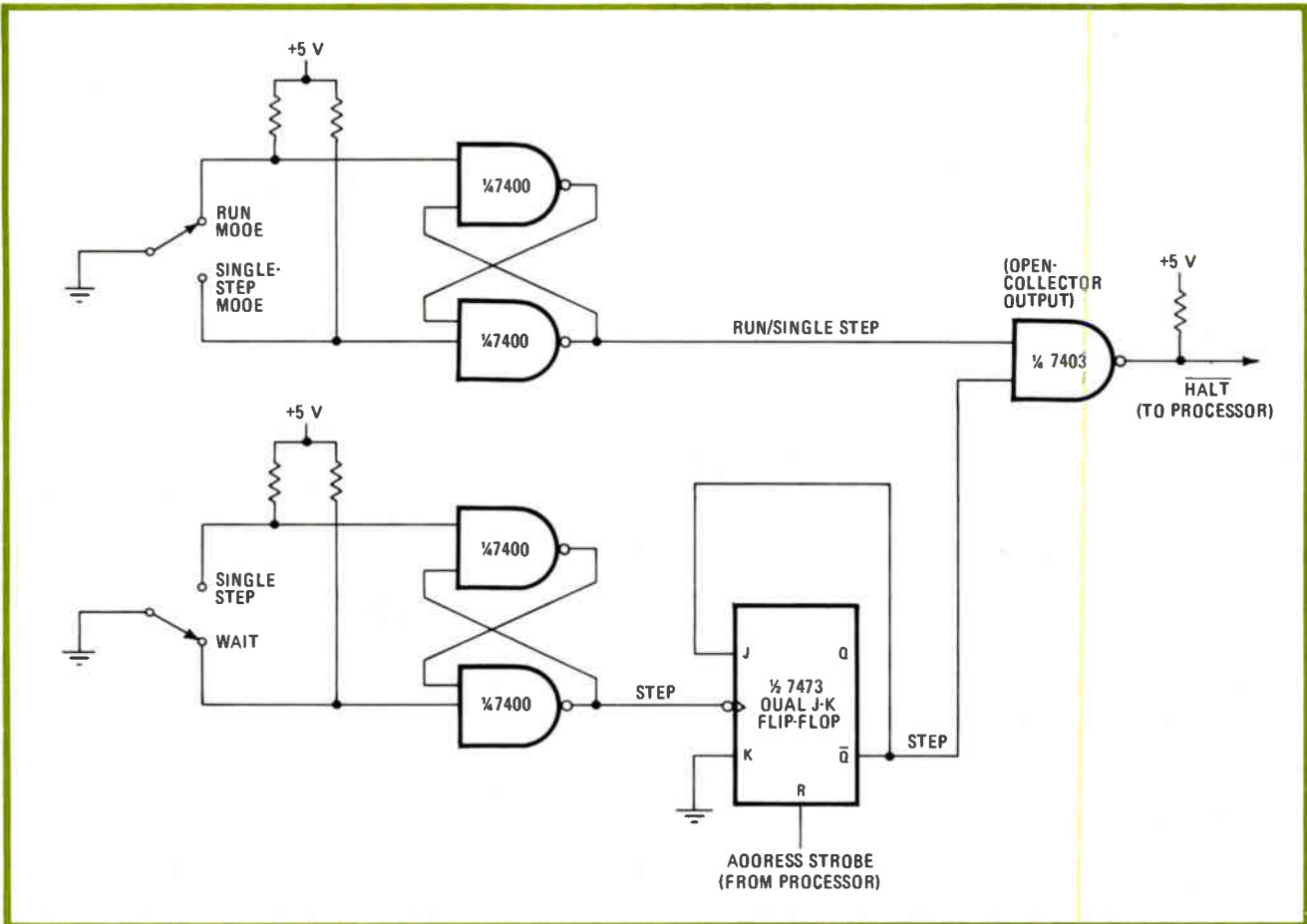

2. Single-step using halt. With this circuit, the operator can control memory accesses by stepping through them one at a time. Each time an address strobe from the processor is issued, it resets the flip-flop. If the upper switch is in the single-step position, then the processor will halt and remain halted until the lower switch is toggled. In this way the asynchronous buses can be exercised under manual control.

supervisor stack and the trace bit is turned off ($T = 0$), while the S/\bar{U} bit is set to the supervisor privilege level. The trace vector is then fetched and loaded into the program counter.

The trace routine is terminated, as are all exceptions, with an RTE, which causes the processor to fetch and execute the next instruction in the main program. To turn off the trace function, the stack location containing the saved status register must be modified to reset the T bit. Then when the RTE instruction pulls the program counter and status register from the supervisor stack, trace has been disabled, allowing normal instruction execution to resume.

The $\overline{\text{HALT}}$ pin on the 68000 may also be used in evaluating a program's execution. With the circuit shown in Fig. 2, the processor can be halted after each bus cycle is completed.

By delaying the data transfer acknowledge, $\overline{\text{DTACK}}$, signal with intercepting logic (Fig. 3), the buses will remain asserted by the processor indefinitely. The buses and control signals can then be inspected. When the examination is complete, the intercepting logic allows $\overline{\text{DTACK}}$ to propagate through to the 68000, completing the bus cycle.

On every memory access, after sufficient time has passed, the memory or peripheral uses the 68000's asynchronous bus to send the processor a signal acknowledging the data transfer. Should an error be detected during an access, a bus error ($\overline{\text{BERR}}$) can signal the processor

that the bus cycle should be aborted.

The faulty memory accesses that prevent a bus cycle's completion may be due to any of several conditions. External circuitry to detect parity errors or—in more sophisticated systems—Hamming codes or other techniques detecting single- or double-bit errors might activate the $\overline{\text{BERR}}$. In the absence of a $\overline{\text{DTACK}}$ from a block of memory, a timer should flag the processor with a $\overline{\text{BERR}}$ after the access time of the memory has been exceeded. The timer also notifies the processor whenever an interrupting device is not responding to an acknowledge signal, resulting in a trap to the spurious-interrupt routine. The uninitialized interrupt vector handles interrupts arriving from uninitialized peripherals.

Finally, memory management systems may decide that the memory access is outside of the memory or I/O space currently active and, if they take advantage of the function codes, that the access was not within the bounds of the space allotted to that type of program or data.

For example, the three function-code outputs on the chip provide information on the type of memory cycle about to take place and can activate the bus-error line if anything is out of order. The three pins ($\text{FC}_0\text{--}\text{FC}_2$) (Fig. 4) can be decoded to tell whether the processor is attempting to access writable memory or instructions and whether it is doing so while operating at the supervisor or user privilege level. They also may acknowledge interrupts for vectoring by device. By using a 74LS138 decoder, the type of access can be employed to partition

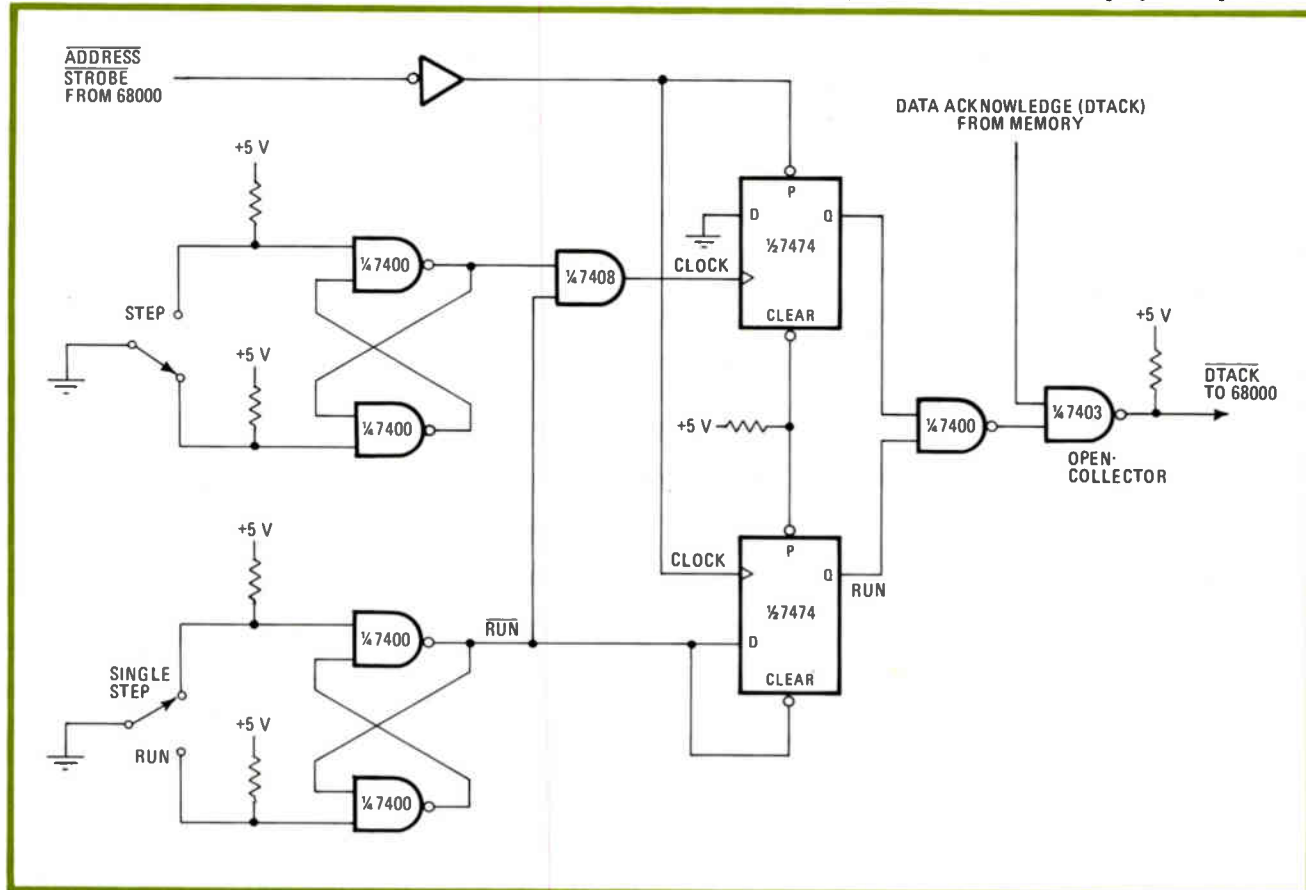

3. Single-step using $\overline{\text{DTACK}}$. Here the user can implement a single-step mode by delaying the data-transfer-acknowledge signal. In an error-correcting system, the upper manual switch might be replaced by logic that recognizes the proper bus behavior.

memory into blocks of supervisor code, supervisor data, user code, and user data. Data space is defined as being the memory locations containing variables, vectors, stacks, queues, strings, tables, lists, or any other type of data found separate from the instruction, and fixed (immediate) operands, which are found with the instructions using them. The failure of a memory access to remain within its allotted memory space can be indicated to the microprocessor using the bus-error ($\overline{\text{BERR}}$) signal.

Response to error

There are two forms of responses the 68000 might have to a bus error, depending on whether or not the halt line is asserted at the same time as $\overline{\text{BERR}}$. With both signals asserted, the 68000 will make an attempt to rerun the same bus cycle. The rerunning of the cycle will take place when the $\overline{\text{BERR}}$ and halt lines are released. Rerunning the bus cycle gives the memory system another chance to respond correctly. This type of bus error would be most useful for parity or other error-checking methods, in which noise or other extraneous signals might have caused the soft error.

When the $\overline{\text{BERR}}$ pin alone is asserted, the processor aborts the current bus cycle and initiates bus-error exception processing. Because a bus-error trap might be taken at any time, extra information is pushed onto the supervisor stack to ease recovery from the condition. Though currently the exact state of the processor cannot be retained to effect a complete recovery, sufficient information is stored to allow the operating system to determine the cause of the bus cycle failure. When a bus-error trap is taken, a copy of the program counter and status register is placed on the stack, as well as the op code being processed and the address on the bus at the time of the bus error. Also placed on the stack is whether or not an instruction was being processed, whether the access being made was a read or write, and the condition of the function codes when the $\overline{\text{BERR}}$ line was pulled.

From the information on the stack after a bus-error trap, the conditions leading to the error can be analyzed. Comparison of the address with the function codes might indicate that the wrong memory space was accessed. Further inspection of the address may reveal that the access was outside the range of the physical or active memory. Perhaps a virtual memory system needs to be reloaded. Possibly the section of memory accessed simply did not respond or is providing garbled data or instructions and should be deactivated and listed as bad memory. Maybe a stack or data space has grown out of its allotted block of memory and a new block needs to be allocated.

Examination of the op code may indicate that after the cause of the error is corrected, the instruction can be rerun—a possibility only if any operands or pointers used were all recoverable and if the condition codes did not affect the instruction execution, since it may not be known whether the condition code saved has been modified by the instruction. If it is determined that the instruction can be re-executed, further examination of the op code will indicate how much the saved program counter must be backed up. If data is lost, if the cause of

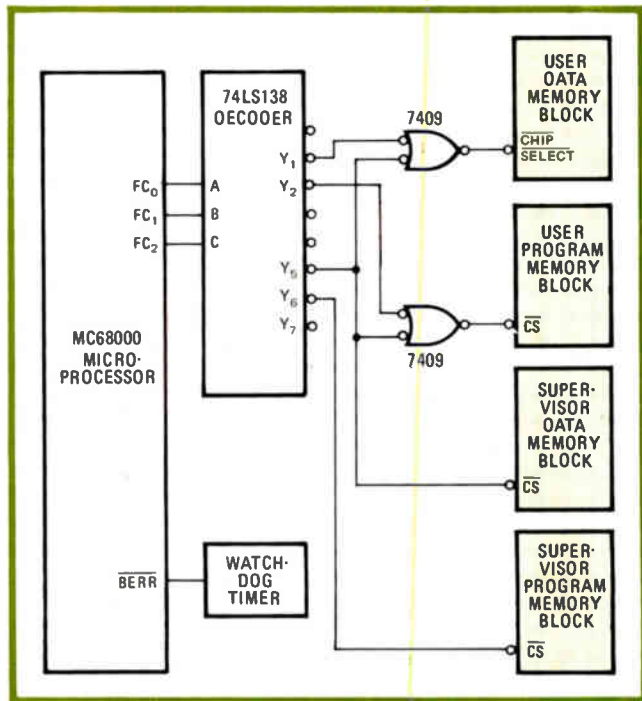

4. Simple memory segmentation. The function outputs are utilized here to separate memory into four areas. The "watchdog timer" notifies the processor of a bus error whenever an access is requested but a data-transfer-acknowledge signal has not been received within a reasonable time limit (say, 30 milliseconds).

a bus error cannot be determined, or if the software for one reason or another cannot continue normal processing, then the operating system will have to initiate a trouble call to an operator.

Current versions of the 68000 do not allow instructions, word (16-bit) data, or long-word (32-bit) data to be aligned on odd-byte boundaries; to do so would require an additional memory access to perform a read or write operation. Attempts to fetch or write an instruction, word or long word at an odd-byte address will cause a trap. This address-error trap lets the operating system realign data on even-byte boundaries or correct the program counter.

The same information saved during a bus-error trap is also saved when a trap is caused by an address error. This information is useful for recovering from the address error in much the same way as from a bus error.

Catastrophic halt

There are several situations that will cause the 68000 to discontinue all processing. These are the double bus errors and double address errors. The detection of a second error during the exception processing (including vector fetches) of a bus error, address error, or reset will shut down the microprocessor. When any of these conditions appear, the processor determines that correct processing is impossible, halts further execution of any operations, and, in a unique use of the halt line, drives it as an output to flag an operator. That response to double errors prevents the processor from running away and destroying data or other tasks when it knows the system has had a catastrophic failure. □

D-a converter also performs a-d translation

by Michael Parsin
Precision Monolithics Inc., Santa Clara, Calif.

Complex microprocessor-based systems that require both analog-to-digital and digital-to-analog conversion, such as gas-flow and motor-speed units and antenna positioners, will be simplified by using multiplexing one-chip converters such as PMI's DAC-76. One of the advantages gained is elimination of an a-d converter and the inherent interfacing problems between two converters that would normally exist. System accuracy is also maintained, because the a-d and d-a conversions are processed and controlled via the same chip.

As shown in Fig. 1, the DAC-76 logarithmic (companding) d-a converter is alternately switched from its encoding or measurement (a-d) mode to its decoding or control (d-a) mode by placing the appropriate signals at its E/D port. An 8085 microprocessor and an 8155

input/output port provide the digital data (see program table). Operational amplifier A₁, comparator A₂, voltage reference A₃, and sample-and-hold amplifier A₄ come into use during the a-d portion of the cycle.

The measurement is initiated when the E/D line goes high, and the bipolar 0- to 5-volt analog input signal is sampled. The 8085 then commands the d-a device to generate a ramp, which appears at the I_{oe} (+) port. When the ramp voltage equals the analog input, A₂ fires, generating an end-of-conversion signal. The processor's internal counter, which had initiated counting at the beginning of the cycle, is then frozen and its binary contents stored in a 1-byte memory location. Note that the DAC-76's companding feature makes it possible to compress 12-bit accuracy into a 7-bit format. This format, combined with a sign bit, makes it an ideal interface for the typical 8-bit microprocessor.

During the decode cycle, the data previously measured is compared with the control variable, which is stored away in a separate register, and the system acts to minimize the difference. For example, if the set point in a temperature controller has been adjusted at 100°, and the measured value is 110°, a correcting voltage that corresponds to the 10° offset must be generated for

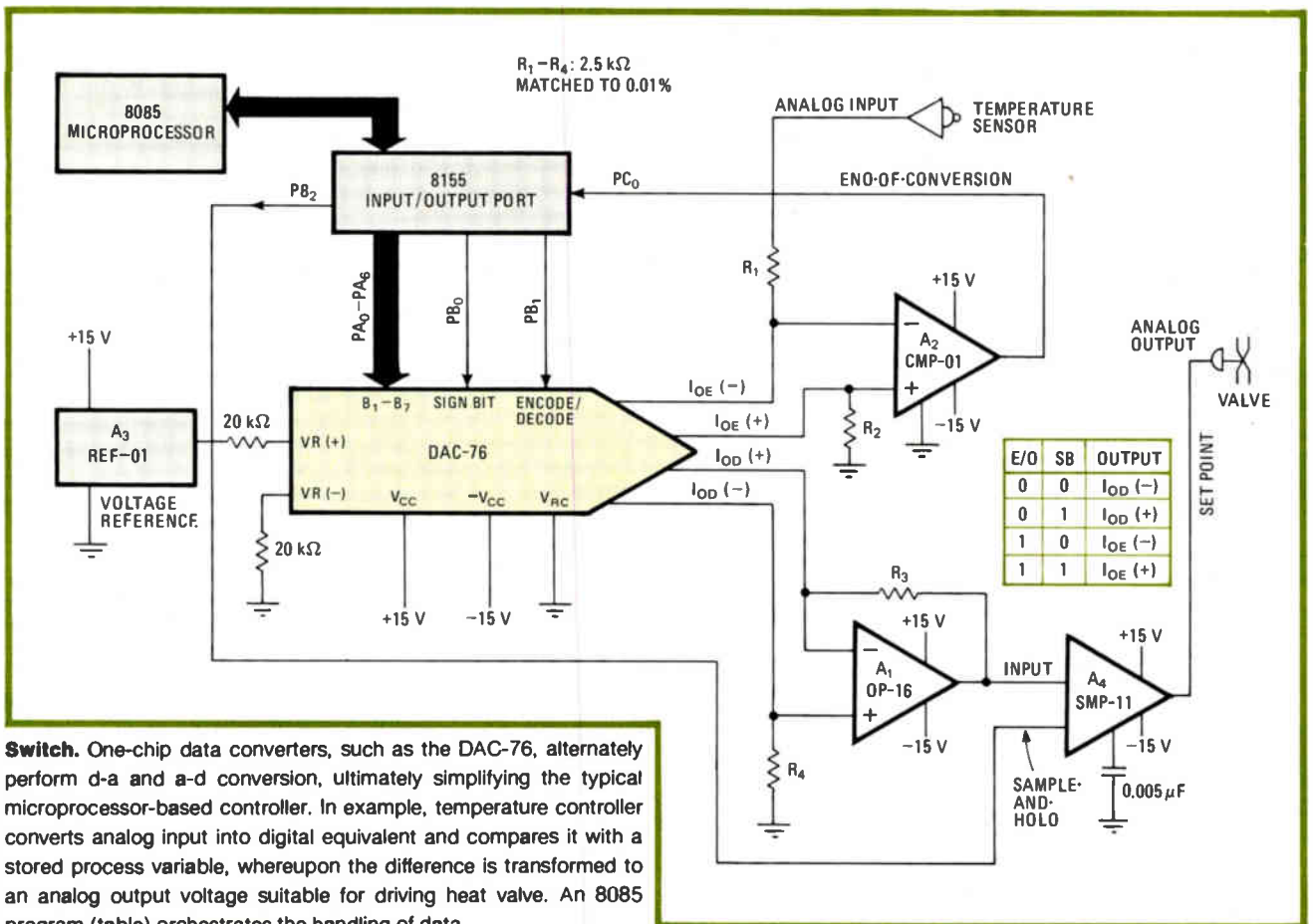

Switch. One-chip data converters, such as the DAC-76, alternately perform d-a and a-d conversion, ultimately simplifying the typical microprocessor-based controller. In example, temperature controller converts analog input into digital equivalent and compares it with a stored process variable, whereupon the difference is transformed to an analog output voltage suitable for driving heat valve. An 8085 program (table) orchestrates the handling of data.

8085 PROGRAM FOR DUAL DATA CONVERSION

| Location | Label | Source statement | Comments |
|----------|--------|------------------|---|
| 2000 | | ORG 2000H | |
| 2000 | BEGIN: | LXI SP,20C2H | ; INITIALIZE STACK POINTER |
| 2003 | | MVI A,03H | ; SET POINTS A AND B TO OUT AND C TO IN |
| 2005 | | OUT 20H | ; THIS SETS 8155 CSR |
| 2007 | ENCOO: | MVI A,07H | ; START ENCOOE |
| 2009 | | NOP | |
| 200A | | OUT 22H | ; SET ENCOOE/OECCOE (E/O) TO ENCOOE AND SIGN BIT TO (-) |
| 200C | LOOP: | INR B | ; INCREMENT UP COUNTER |
| 200D | | NOP | |
| 200E | | MOV A,B | ; COUNT TO ACCUMULATOR |
| 200F | | OUT 21H | ; OUT COUNT TO DAC-76 DIGITAL IN |
| 2011 | | IN 23H | ; MONITOR ENO OF CONVERSION |
| 2013 | | ANI 01M | ; MASK PC ₀ |
| 2015 | | JNZ LOOP | ; LOOP WHEN ENO-OF-CONVERSION IS HIGH |
| 2018 | | MOV A,B | ; MOVE RESULT TO ACCUMUALTOR |
| 2019 | | STA 203CH | ; STORE RESULT IN MEMORY 203C |
| 201C | | MVI B,00 | ; CLEAR B REGISTER |
| 201E | OECOO: | MVI A,7FH | ; START OECCOE |
| 2020 | | OUT 21H | ; OUT TO DIGITAL-TO-ANALOG CONVERTER ALL 1's +5 V |
| 2022 | | MVI A,01H | ; SET E/O TO OECCOE AND SHIFT BIT TO (+) |
| 2024 | | OUT 22H | ; OUTPUT TO SAMPLE-AND-HOLD (S/H) AND DAC-76 |
| 2026 | | MVI A,05H | ; S/H TO HOLD ANALOG OUT TO +5 V |
| 2028 | | OUT 22H | ; OUT TO S/H |
| 202A | | MVI A,00H | ; ANALOG OUT TO NEGATIVE |
| 202C | | NOP | |
| 202D | | NOP | |
| 202E | | OUT 22H | ; OUT TO S/H AND DAC-76 |
| 2030 | | MVI A,04H | ; S/H TO HOLD ANALOG OUT TO -5 V |
| 2032 | | OUT 22H | ; OUT TO S/H AND d-a CONVERTER |
| 2034 | | NOP | |
| 2035 | | NOP | |
| 2036 | | JMP ENCOO | ; START ENCOOE AGAIN |
| | | END | |

controlling the heat valve. The processor does this by addressing a lookup table to determine the required change in valve position that is proportional to the offset. The E/D line is then brought low, and a constant current is steered by processor control through the d-a converter's I_{od} (+) port and thus to the inverting input of the operational amplifier, A_1 .

Thus capacitor C_H of the sample-and-hold device charges linearly as long as digital signal PB_2 , which has been set low by the 8155 output port initiating data proportional to the offset voltage, remains low. When A_4 is placed in the hold state, the sampling period ends, and the voltage across the capacitor is transferred to the

analog output line in order to drive the valve and thus set its position.

The aforementioned stand-alone configuration represents one good example of a direct digital control system, where a single host computer can be placed at the hub of a multitude of remote controllers. It should be kept in mind, however, that this system could easily be made part of a distributed digital control network, where the host computer has many remote minicomputers that have a hand in presiding over the major control loops. □

Engineer's notebook is a regular feature in *Electronics*. We invite readers to submit original design shortcuts, calculation aids, measurement and test techniques, and other ideas for saving engineering time or cost. We'll pay \$50 for each item published.

Interfacing TTL with fast bipolar drivers

by J. A. R. Ball, P. J. Grehan, and P. Welton
Darling Downs Institute, School of Engineering, Queensland, Australia

Surprisingly, there are as yet no suitable integrated circuits for translating the 0-to-5-volt output swing of TTL into arbitrary bipolar levels. But even the discrete interfacing circuits that have appeared over the years will fall short in performance, especially if the requirement calls for a high-speed switch to drive the relatively

high capacitance of a power device or load. The solution lies in modifying the typical textbook interface with a circuit that acts to decrease the input-circuit storage time of the output transistors but does not appreciably affect any other interface parameter or specification.

A slightly modified ± 10 -V TTL interface is shown in (a), which will be suitable for relatively high-speed switching at low to medium current (below 100 milliamperes). In this circuit, Q_1 turns on and remains in the active region when the TTL output exceeds 1.5 V. Providing the current drawn out of the base is sufficient, Q_3 will saturate and the voltage applied to the load will be almost 10 V. When the TTL output falls sufficiently, Q_1 and Q_3 turn off, and charge stored in the base of Q_3 escapes via resistor R_3 . Transistors Q_2 and Q_4 compris-

You don't have to be an IBM to cash in on custom IC's.

Item: Of course, all the big guys are heavy users of custom IC's, but most of our clients have sales volumes from \$10 million to \$100 million per year.

Item: SSi can provide you with cost-effective custom circuits even when your annual usage is only \$100,000 per year.

Item: SSi does it all—from circuit concept through design and on-going production.

If you want it your way, call SSi, Director of Marketing, or send for our capability brochure today.

Silicon Systems incorporated, 14351 Myford Road, Tustin, California 92680. Phone: (714) 731-7110 or TWX 910-595-2809.

Silicon Systems

incorporated

ing the other half of the circuit act in a complementary fashion, conducting when the TTL output falls below 1.5 V and applying -10 V to the load.

One disadvantage of this circuit is that it is possible for Q_3 and Q_4 to be conducting at the same instant during a change of state to cause a supply current spike whose magnitude may exceed the nominal load current by more than three times. Also, most of the power lost in the output transistor will be dissipated during a change of state when both are in the active region. Thus, the average dissipation will be proportional to the switching frequency. These problems may be minimized by increasing the zener voltage, V_Z , so as to increase the dead zone between the input threshold levels of the circuit. Switching speed may be increased by optimizing the value of the speed-up capacitors C_1 and C_2 , operating Q_3 and Q_4 at very large base currents, and reducing R_3 and R_4 to minimize storage time.

This basic circuit can also be used to control far larger currents than 100 mA, providing appropriate output transistors are used. However, the storage time of these devices then becomes a major problem, and so speed is sacrificed. The circuit in (b) shows how to reduce the delay time by adding two transistors for supplying

reverse base current to whichever output transistor is in the act of turning off.

Here, when the TTL output goes high, Q_1 conducts and Q_3 saturates as before, while Q_2 turns off and Q_4 begins to come out of saturation. In addition, the emitter current of Q_1 turns on Q_6 , which provides a path for the escape of charge stored in the base of Q_4 . This effectively 'shortens Q_4 's turn-off delay.

When the TTL output goes low, then Q_1 and Q_6 turn off, Q_2 and Q_5 conduct, Q_4 saturates because of the base current supplied by Q_2 , and Q_3 is rapidly turned off because of the action of Q_5 . Discharge transistors Q_5 and Q_6 should be selected for high-speed saturated switching, so that they will not delay the turn-off of their associated output transistors.

Adding Q_5 and Q_6 will reduce the storage delay of the output transistors by a factor of from 2 to 4. The circuit in (b) provides a rise and fall time of about 80 nanoseconds for a load of 11 ohms (2-ampere load). The active pull-up output ensures the interface's low output impedance in either the logic 0 or logic 1 state. A further advantage is that the output voltage is specified within narrow limits in both states, unlike the case with totem-pole-type circuits. □

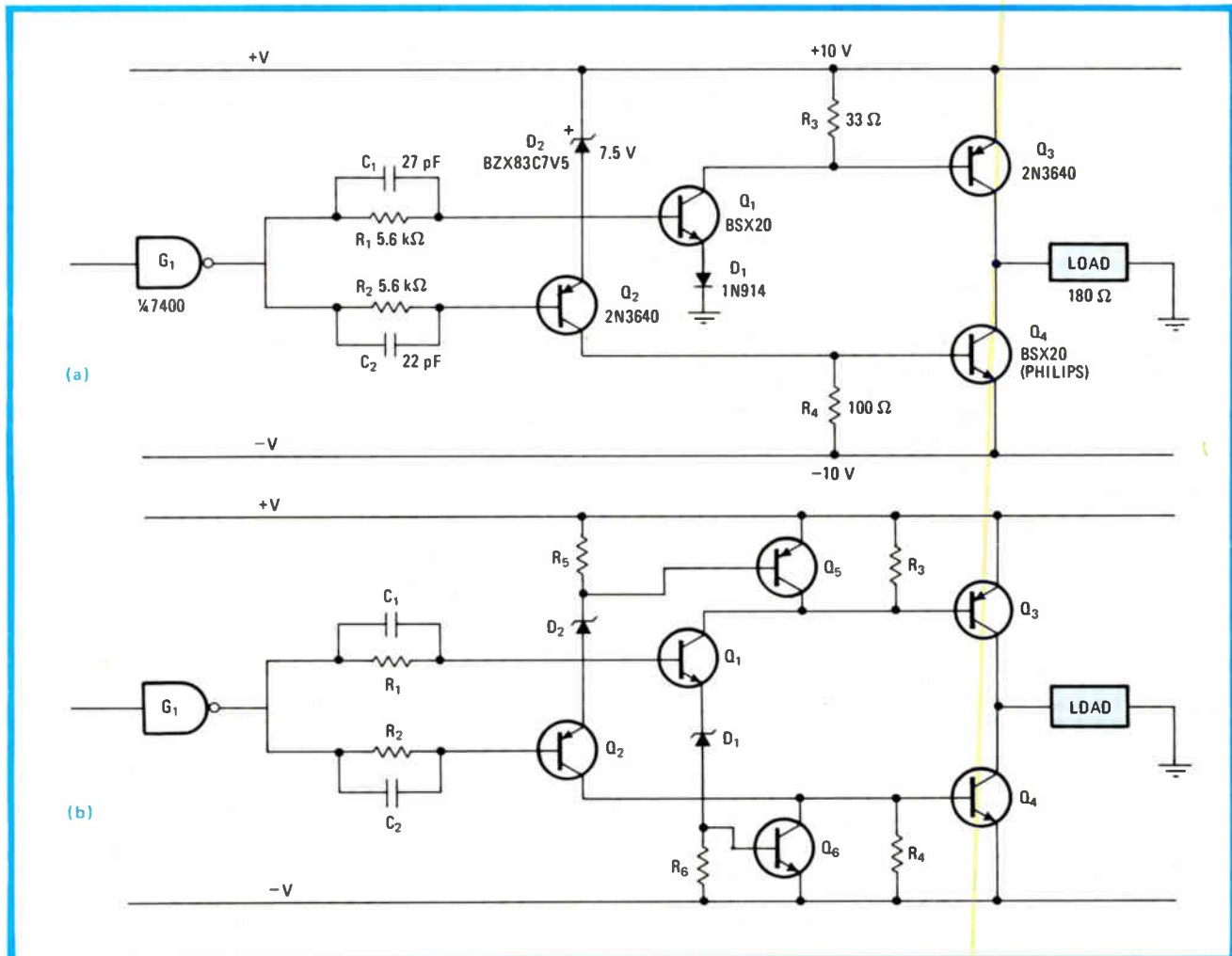

Conversion. Interface (a) for translating the 0-to-5-V TTL swing into arbitrary bipolar levels at moderate switching speeds works well at low load currents. For increased loads, circuit (b) offsets the large storage delay of the output transistors and reduces crossover switching.

Two pages pack in info on the 8080/8085

For engineers and programmers working with the 8080 and 8085 microprocessors, there's a useful new design aid and instant reference called a Micro Chart—two colored 8½-by-11-inch plastic sheets with punched holes for notebook use. Micro Chart 100A consists of useful software and hardware information for the two processors, including a full-page **instruction-set summary, a hexadecimal-to-operation-code conversion, software interrupts, the ASCII character set, hexadecimal-to-decimal conversion, status flags, restate instructions, and timing examples.** The price is \$2.95, plus \$1.00 for postage and handling. Write to Micro Logic Corp., Department CE, P. O. Box 174, Hackensack, N. J. 07602.

How to specify printed-circuit boards

Ever find that information on printed-circuit manufacturing and specifying is hard to come by? If so, you'll be glad to have a 16-page technical manual from Dynacircuits that gives a clear, concise description of single-sided board manufacturing. It has sections on the selection of laminates and laminate properties and two special sections in which over 30 typical **questions are answered about dies and tooling and how to design pc boards** in terms of artwork, legends, and solder resist. Contact Fred Stein, Dynacircuits Inc., 11230 Addison St., Franklin Park, Ill. 60131.

NBS offers standard measurement for optical line-widths

As integrated-circuit line widths head down, optical measurement of line-width accuracy on the photomask becomes ultracritical. The National Bureau of Standards is now offering a Standard Reference Material for calibrating optical microscopes used to measure line widths on IC photomasks. It is **made from an antireflective chromium photoplate using standard photolithographic techniques** and measures 6.35 by 6.35 by 0.25 cm (2.50 by 2.50 by 0.10 in.). For line widths in the 0.5-to-10- μm range and accurate to within 0.05 μm or better, it can be used for calibrating opaque lines on clear backgrounds or clear spaces on opaque backgrounds and for calibrating line spacings and line-to-line space ratios on video micrometer systems. It also includes a series of lines for checking for mechanical and optical errors in the measurement system. It is unsuitable for calibrating systems using partially transmitting systems such as iron oxide photomasks, opaque materials, or silicon wafers or for use with scanning electron microscopes. The optical microscope line-width measurement standard, SRM 474, is available for \$3,600 from the Office of Standard Reference Materials, National Bureau of Standards, Washington, D. C. 20234.

Frequency-response analyzers can solve mechanical problems

Frequency-response analyzers using digital signal processing can be a great help in solving mechanical problems encountered in vibration analysis, acoustics, and automatic control. Hewlett-Packard Co., Palo Alto, Calif., is presenting a free one-day seminar on this topic at 30 locations throughout the U.S. and Canada from September through December. The seminar will cover the details of basic measurements. Numerous actual case histories will be reviewed, emphasizing the benefits that can be derived from effective measurements. There will be **demonstrations of problem solving in nodal analysis, machine balancing, servo design, signature analysis of rotating machinery, and acoustic intensity,** all employing the frequency-response analyzer. For more information, contact the closest HP field sales office.

-Jerry Lyman

A major improvement over traditional I.C. packaging methods.

How a simple socket can mean greater reliability, greater design flexibility at a lower cost.

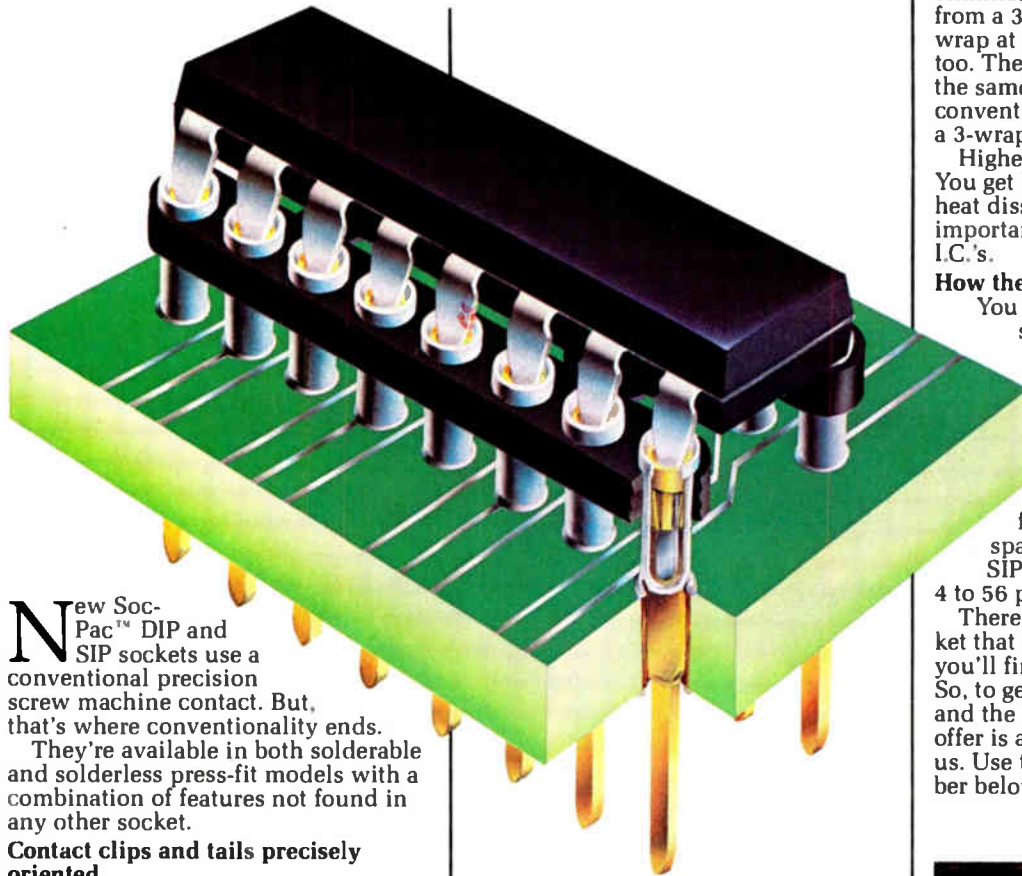

New Soc-Pac™ DIP and SIP sockets use a conventional precision screw machine contact. But, that's where conventionality ends. They're available in both solderable and solderless press-fit models with a combination of features not found in any other socket.

Contact clips and tails precisely oriented.

Tines of each contact clip are precisely oriented for perfect alignment with I.C. leads. The result — four contact points at every lead every time, a redundancy that costs you no more than conventional designs.

Also, each tail is oriented square and parallel with the others to easily accept mating connectors.

Selective gold plating.

The contact clip is plated with 30μ in. gold over nickel. The screw machine contact can be selectively plated starting from the tip of the tail (.250" minimum) — with the exact gold thickness you need. That can

mean significant savings.

Solderless press-fit advantages.

With solderless press-fit Soc-Pac sockets, you get the savings that eliminating the soldering step make possible. And, you get a gas-tight mechanical and electrical interface with the plated-thru hole in the PCB. There are still more advantages to the Soc-Pac design.

Get higher density, more flexibility.

Contrary to the trend to low profile sockets, Soc-Pac sockets stand relatively high on the PCB. There are very good reasons for that.

It allows us to reduce pad size to

0.055" on press-fit and 0.050" on solderable sockets. Which means you can run a trace between contacts for greater printed circuit density. And greater design flexibility. Additional printed circuitry translates to eliminating at least one tail wrap — from a 3-wrap tail to a 2-wrap, or no wrap at all. You keep compactness, too. The two-wrap tail allows about the same board to board spacing as conventional low profile sockets with a 3-wrap tail.

Higher sockets also add reliability. You get better air flow, thus better heat dissipation. That's particularly important with higher pin count I.C.'s.

How they come.

You can select either solderable or solderless press-fit Soc-Pac sockets in selective gold over nickel, tin, or nickel finishes.

DIP sockets come in 8, 14 and 16 pin counts for a 0.100" x 0.300" grid spacing and 24 and 40 pin counts for 0.100" x 0.600" grid spacing.

SIP Sockets come in strips from 4 to 56 pin counts.

There's no other socket on the market that combines all the features you'll find in the Soc-Pac™ socket. So, to get the savings, the reliability, and the flexibility Soc-Pac™ sockets offer is a simple matter of contacting us. Use the address and phone number below.

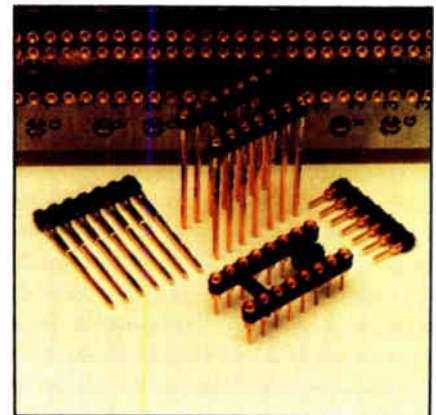

 **ELFAB**

The Leader in Press-fit Technology

P. O. Box 34555, Dallas, Texas 75234. 214-233-3033

Circle 163 on reader service card



**“AMP has revolutionized
transmission cable interconnects
with low-cost assemblies.”**

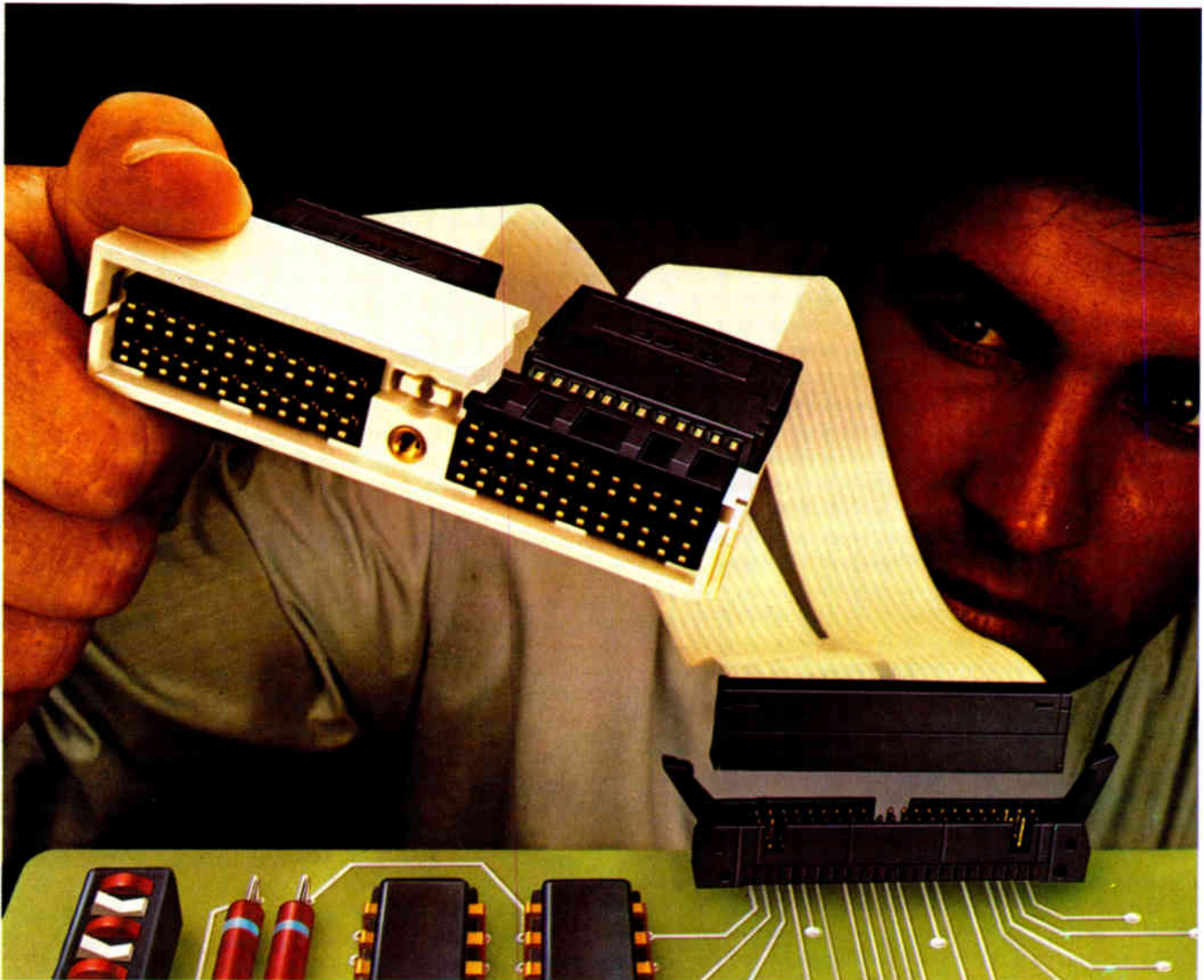

AMP transmission cable assemblies feature our unique solderless connector. So you don't need expensive high temperature cables.

Its mass termination design handles 100, 95, 75 and 50 ohm cables with signal conductors on .050" centers. Automatically commons the grounds to your specified pin out.

Physically separates and electrically isolates grounds from signal conductors. And allows us to offer you the most economical assemblies on the market.

All AMP transmission cable assemblies are equally cost and performance effective—and are available in different interconnect configurations to match your requirements.

The header receptacle, on .100 x .100 inch grid, is ideal for use with our

universal vertical or right angle eject headers. It comes in 10 through 50 positions, with or without center polarization.

The pinfield style, which mates to backplane posts on .100 x .100 inch grid, is stackable end-to-end or side-by-side. Post stops are optional to permit wrap-type interconnects on posts.

The SLT style, a 24-position unit with .125 x .250 inch spacing, interconnects with industry standard computer interface connectors.

For full details, call the Transmission Cable Assembly Information Desk (717) 780-8400. Or write us. AMP Incorporated, Harrisburg, PA 17105.

AMP is a trademark of AMP Incorporated

AMP has a better way.

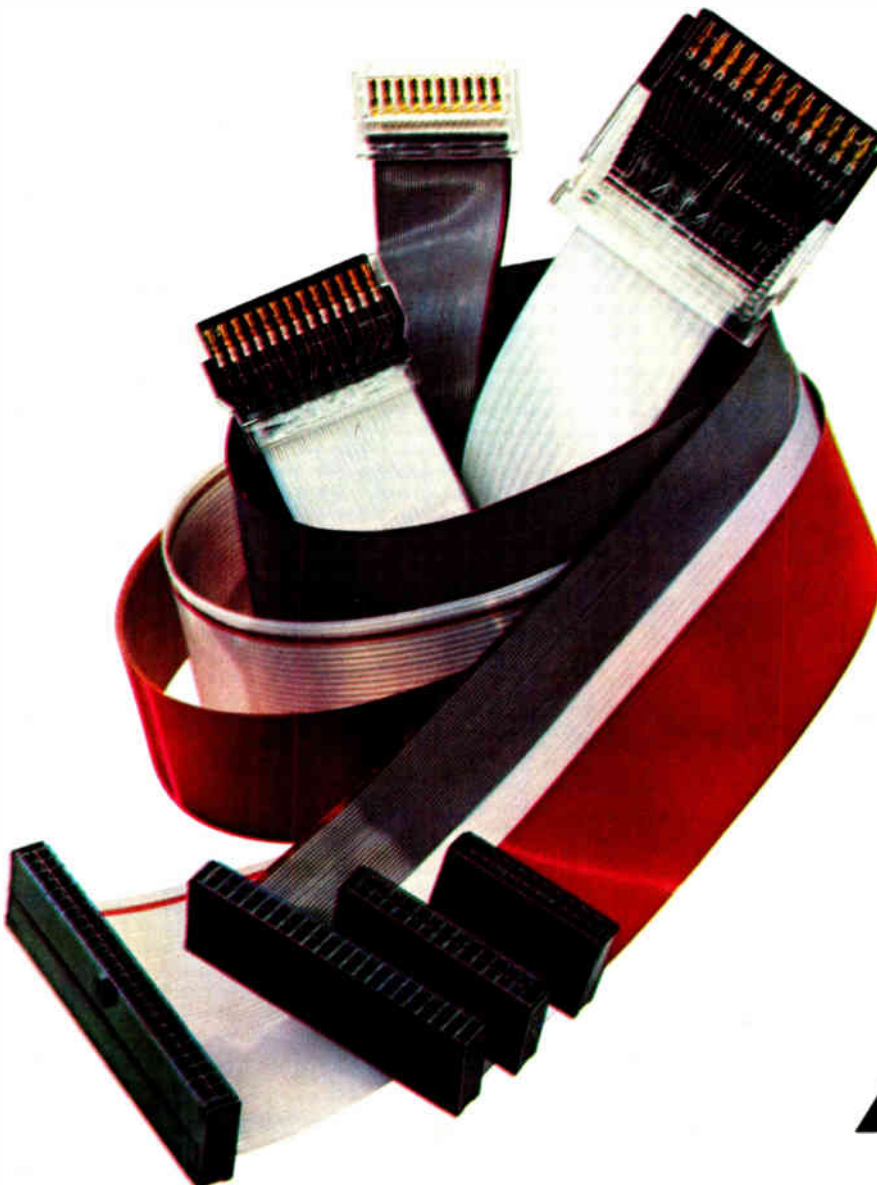

Some facts worth knowing about AMP Transmission Cable Assemblies

Mechanical

Mating Force. 8 oz. max./contact
Unmating Force. 1 1/2 oz. min./contact
Mating and Unmating. 200 cycles
Vibration. 15 G's, 10-2000 Hz
Physical Shock. 100 G's, 6 millisec

Electrical

Current. 1.0 ampere max./contact
Contact Resistance. 25 milliohms max.
Insulation Resistance. 5000 megohms min.
Dielectric Withstanding
Voltage. 500 volts RMS (sea level)

Environmental

Temperature. -65°C to 105°C
Thermal Shock. 5 cycles: -65°C to 105°C
Moisture Resistance. 10 days, 25°C to 65°C, 80-98% R.H.
Salt Spray. 5% solution, 48 hours
Industrial Gas. 10% SO₂, 24 hours

AMP

Circle 165 on reader service card

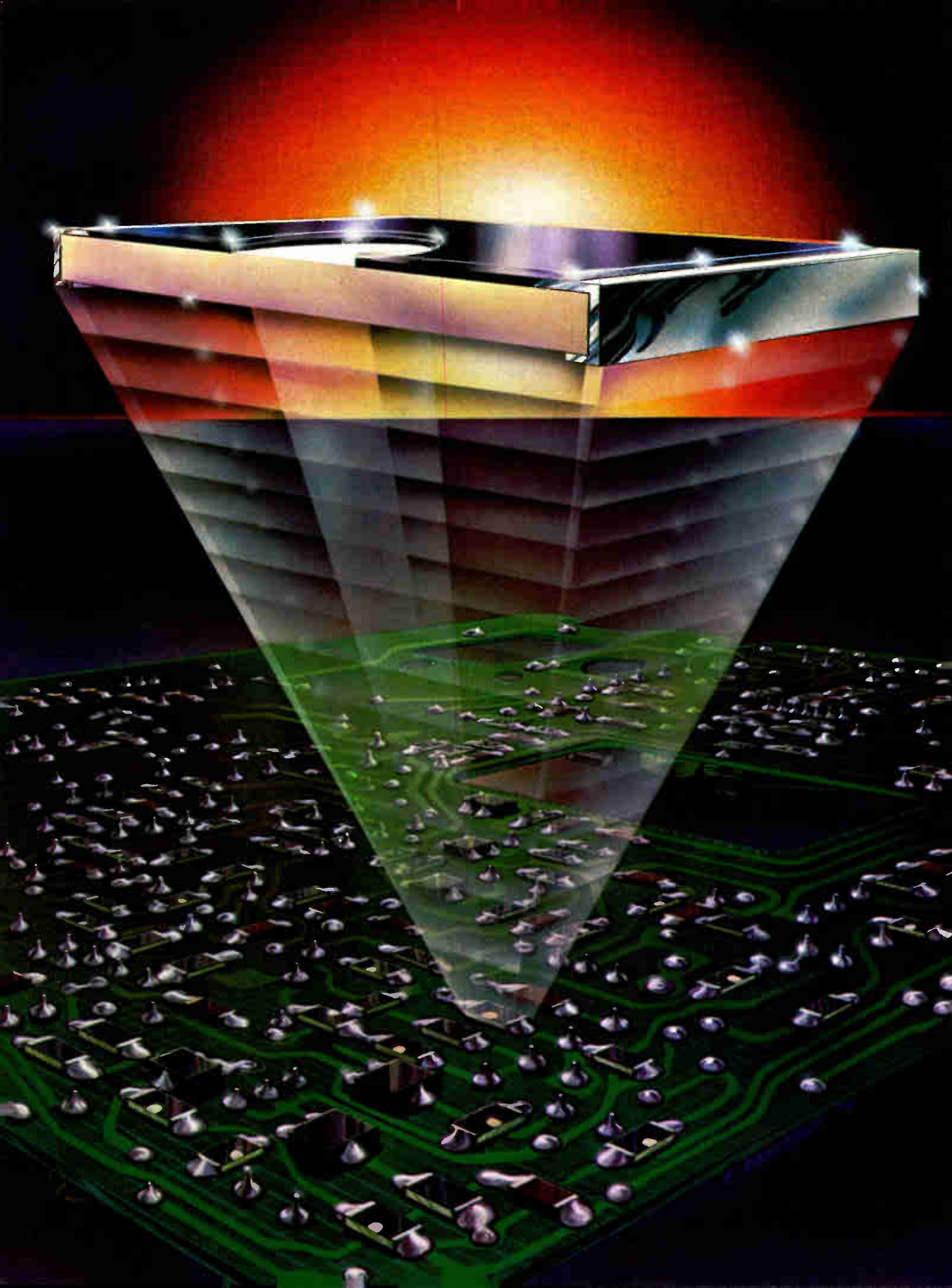

MOUNT AN ATTACK ON ASSEMBLY COSTS

WITH R-OHM'S NEW FLOW-SOLDERABLE CHIPS

Now you can slash your assembly costs and create thinner, smaller, more reliable products at the same time. How? With our new flow-solderable resistor and semiconductor chips.

Start using both sides of your PC boards

Hundreds of these new chip components can be attached to either side of your PC boards in seconds. Already in widespread use in Japan, these components have fostered the development of high-speed magazine loading and tape and reel attachment methods. Once attached, the chips can be flow-soldered along with axial or radial-leaded components. Together, these developments are making dramatic reductions in assembly and labor costs possible.

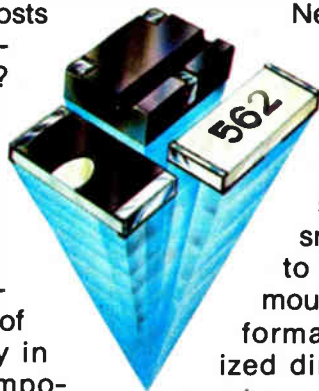

Nearly 200 chip resistors (1/16W) can be mounted in just four square inches. This great density, coupled with the fact that the chips can be mounted on both sides, drastically reduces PC board size. The end result is thinner, smaller, lighter products that cost less to produce. In addition, the ability to mount chips opposite IC's provides performance improvements. And, standardized dimensions are making board layout and product design faster and more straightforward.

Make a solid connection to reliability

Flow-soldering directly to the chip instead of to leads provides a solid, more dependable connection — a connection you can trust even in the most severe environments.

R-Ohm already offers a wide variety of dependable chip components. Chip resistors are available for 1/16, 1/8 and 1/4W applications with 2%, 5% and 10% tolerances over a wide range of ohmic values. Chip transistors and diodes are offered for a variety of functions and applications. Many more components are on the way.

This new generation of chips will alter forever the way you design, package and handle resistors and semiconductors. The impact may even change your mind about assembling offshore.



Rohm
QUALITY · RELIABILITY

R-OHM Corporation, 16931 Milliken Ave., P.O. Box 19515, Irvine, CA 92713
(714) 546-7750. Central offices: (312) 843-0404. Eastern offices: (215) 337-8877.
TWX: 910-595-1721.

A CONSTANT FORCE IN A CHANGING WORLD

Super D*



Rapid Solderless Termination on 4-point Contacts Eliminate Wire Stripping.



Super D Adaptor System For D-type Connectors.



Choose From Four Standard Super D Connector Sizes... 9 (on left), 15, 25, and 37 (right) contacts.

Technical Data

333-456789
1234-5678-9012-3456-7890
www.superd.com

A unique all plastic snap-locking connector system that costs less and does more than standard D-Subs.

Here's Why Super D* is "The D With The Difference".

Different? You bet! TRW Cinch's all new Super D connector system has the exclusive design features and cost saving benefits that move it to the top of any D-Sub line!

Let's begin with cost savings. Most D-sub's require soldering or crimping. Not Super D connectors. Our new pre-loaded pin/socket contacts provide solderless insulation displacement 4-point termination.

This unique contact also gives you twice as many contact points at mating end as other D-sub designs. All without wire prepping or stripping. Result? Immediate assembly time reduction and a positive cost savings with increased reliability!

But that's not all! Besides fast, solderless termination, Super D connectors also have snap-on plastic hoods that feature an exclusive Latch-N-Lock design for positive, audible locking with no additional tools, parts or labor. Just push to connect, squeeze and pull to disconnect. It's that easy!

To convert standard TRW Cinch D-sub's to the Super D system, ask us about our special adaptor system for D-type connectors.

Looking for style and design? Look no further. Super D's cost-effective all-plastic assembly is both smooth and functional to complement the styling of your computer, peripheral, data communication, instrumentation or video equipment.

This plastic design effectively insures against shock hazards.

Super D connectors employ selective gold plating only where it is needed. We've eliminated expensive gold from non-functioning surfaces. So you get performance without added cost.

The Super D connector is available in four sizes (9, 15, 25, and 37 contacts) for cable-to-cable and cable-to-panel modes. Each will intermate with existing D-type connectors. And, you'll be glad to know that the Super D system is designed to meet EIA Standard RS449 plus ISO4902 and 4903 for your DTE and DCE equipment.

To further speed your termination time, TRW Cinch has designed three terminating tools specifically for the Super D connector system. Use Auto-Clinch D* for high volume; Gerti-Clinch D* for moderate production and field installation; and Uni-Clinch D* for field repair.

So take a long, hard look at the D-sub's you're using now. Then take a look at Super D connectors. There is a big difference! To get the Super D difference, write or call your TRW Electronic Component Sales Office ... listed in EEM, or TRW Cinch Connectors, A Division of TRW Inc., 1501 Morse Avenue, Elk Grove Village, IL 60007. 312/981-6000



TRW CINCH CONNECTORS

See us at Mesco/80. Booth No. 1502, 1600, 1601, 1603, 1700.

Circle 159 on reader service card

Buy now and get FREE Solid State Software Libraries.

\$40
or more value
1 FREE module†
with purchase
of a TI-58C



TI Programmable 59 — \$300*

\$98
or more value
**2 FREE modules† &
PPX Membership**
with purchase
of a TI-59

TI Programmable 58C — \$130*

Choose from these.



TI Programmables lead the field in performance, quality and value. When you're choosing a programmable calculator consider: Power. Total software support. Flexibility. And price/performance. You'll discover a clear-cut answer. A TI Programmable 58C or 59.

The TI-59 has up to 960 program steps or up to 100 memories. Magnetic card read/write capability lets you record your own custom programs or those received from PPX (Professional Program Exchange).

The TI-58C features up to 480 program steps or 60 memories. And it has TI's Constant Memory™ feature that retains data and program information even when the calcula-

tor is turned off.

And now free modules give you that added productivity you need. From August 15 to October 31, 1980 is your special opportunity to purchase one of the world's most advanced programmable calculators. And get a minimum of \$40 worth of free software modules with a TI-58C. Or, when you buy a TI-59, get a minimum of \$80 worth of software modules and an \$18 one-year membership in PPX. This will allow you to select up to 3 programs (from over 2,500) written by professionals in your field.

Visit your TI retailer for more information, and let him help you select the TI Programmable and free software that's right for you.

I've bought a TI-58C, send me my free module. Here is my first choice and an alternate

I've bought a TI-59, send me my two free modules and my membership (which entitles me to select three programs from the source catalog at no charge). Here are my module choices and an alternate

1 _____ 2 _____

3 _____

Send to: TI Library Offer, P.O. Box 1984, Lubbock, TX 79408.

Return this coupon (1) with customer information card (packed in box). (2) a dated copy of proof of purchase, between Aug 15 and Oct 31, 1980 — items must be post-marked by Nov 7, 1980

Name _____

Address _____

City _____ State _____ Zip _____ EL

Calculator Serial Number (from back of unit) _____

Please allow 30 days for delivery. Offer void where prohibited. Offer good in U.S. only

TI reserves the right to substitute modules.

†U.S. suggested retail for all Libraries is \$40, except Farming, \$55, and Pool Water Analysis, \$45.

**For use with TI-59 only



Texas Instruments technology — bringing affordable electronics to your fingertips.

TEXAS INSTRUMENTS
INCORPORATED

*US suggested retail price.
© 1980 Texas Instruments Incorporated

Circle 170 on reader service card

8-bit a-d converter has 12-bit linearity

Error-distribution scheme and fast conversion time ensure reliable output in noise-filled environments

by Linda M. Lowe, Boston bureau

The ADC-881 successive-approximation analog-to-digital converter overcomes the effects of its own nonlinearity. It accomplishes this by effectively scattering linearity errors over its own full-scale range. Thus randomized, the errors average out over a large number of samples, just as noise does, to leave a high-quality signal.

Datel-Intersil Inc., which originally designed the ADC-881 for medical-imaging systems, reports that its method of diffusing nonlinearities makes the 8-bit unit better than 11 times more linear than comparable converters. In fact, its integral and differential nonlinearity, rated at 0.0087% of full-scale range (or 0.022 least significant bit), are specifications more likely to be found in a 12- or 14-bit device. [*Electronics*, Aug. 28, p. 33].

This, along with the converter's 1.5- μ s maximum conversion time, suits the ADC-881 to environments where analog signals may be buried in noise. Under such conditions, useful conversions usually depend on making many fast, repetitive measurements to improve certainty of the signal's level by averaging out random noise.

How they do it. In a standard device, such repeated conversions of the same analog input would build up a large, cumulative linearity error, since nonlinearities tend to cluster at the transition (also called major-carry) points of any conversion. If the analog input signal remains the same, so will the transition points. And that effectively confines errors to one narrow band of a converter's full-scale range, where they repeat with each successive

sample and combine to degrade linearity.

So the trick is to shift the transition continually, thus making errors occur at different parts of the full-scale range with each successive conversion. This the ADC-881 does by incorporating a pseudorandom sequence generator to produce a new 8-bit noise signal for each analog input (see illustration). A digital-to-analog converter changes that signal to analog form for subtraction from the input. Thus altered, each input goes into conversion, each transition point shifts slightly from those of other conversions, and linearity errors subsequently appear as random occurrences.

Following conversion, the sequence generator's original noise signal is added back in digitally. That

restores the complete input signal for digital output.

External techniques that average the results of numerous measurements include histograms compiled from digital outputs and autocorrelation. In the case of a histogram—a frequency distribution of sample data into discrete categories—the ADC-881's differential nonlinearity is so slight as to eliminate the computational processing of digital data generally needed to compensate for converter distortion, according to Datel-Intersil. The result is that the new converter can be used to perform real-time, statistically valid processing of analog data.

Where the markets are. The new and still developing field of medical imaging is one of many possible markets for the ADC-881, believes

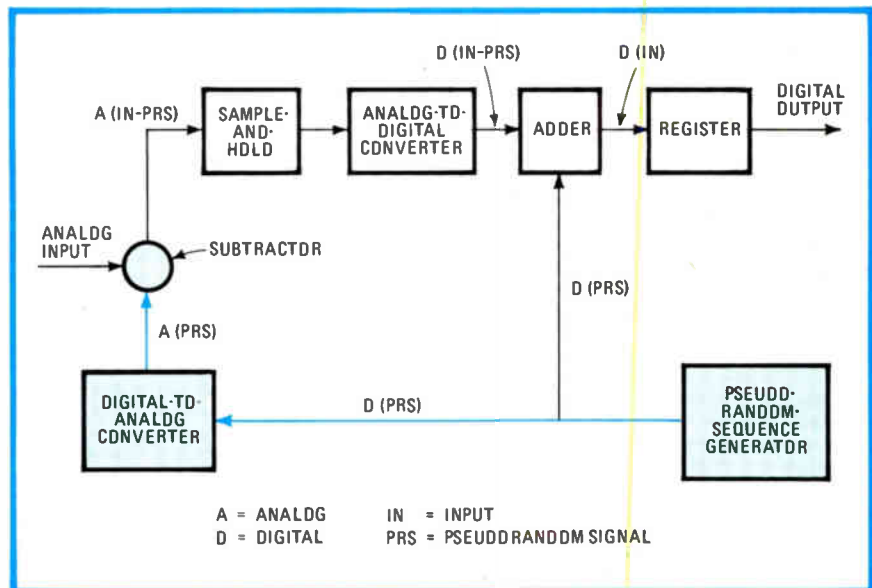

Error correction. Analog-to-digital converter uses noise to reduce linearity error. An 8-bit pseudorandom digital noise signal is converted to analog form and subtracted from analog input. Then each noise byte is added to result of a-d conversion.

TOTAL FREQUENCY CONTROL

FROM ERIE

HIGH FREQUENCY AT CRYSTALS



Erie AT Crystals are used over the frequency spectrum from 950 kHz to 200 MHz. Low temperature coefficient, extremely high Q, economical. Used in TCXO and VCXO oscillators, temperature controlled and, non-controlled oscillators, and filter applications. All size cans.

LOW FREQUENCY CRYSTALS



Low frequency crystals are available from 1 kHz to 1MHz in a broad variety of crystal holders and mounting configurations. Erie is a leading source for all types of high quality, Low Frequency Crystals.

CRYSTAL OSCILLATORS



Erie offers a broad range of economical as well as highly sophisticated Crystal Oscillators. These small size oscillators are available in a wide range of frequencies. Hermetically sealed crystals assure long term stability. Design assistance available.

CRYSTAL FILTERS

Erie quartz crystal filters are specified for use in communications receivers as well as for radar, sonar and space applications.



Write for brochure describing Erie Crystals, Filters, Oscillators and Ovens.

ERIE

ERIE FREQUENCY CONTROL DIV. OF
ERIE TECHNOLOGICAL PRODUCTS
Carlisle, Pa. 17013
717/249-2232

New products

Wayne E. Marshall, senior project engineer at Datel-Intersil. "Anywhere you have to cope with massive amounts of noise, requiring repeated measurements to obtain accuracy, this approach works without sacrificing throughput," he says. The firm looks for applications in a variety of areas, including signal and spectrum analysis, vibration analysis, industrial testing, sonar digitizing, and geographical research.

The ADC-881 will sell for \$445—high for an 8-bit converter, but not so out of line in Marshall's view, considering the unit's exceptional linearity. "You'd probably have to resort to a 14-bit converter to get comparable performance for the tasks we're addressing," says the project engineer.

Some of the specifications. The ADC-881 uses a magnetically and electrostatically shielded enameled-steel case measuring 3 by 5 by 0.375 in. Depending on the model, it operates at 0° to +70°C, or at -55° to +125°C. Maximum gain and offset temperature coefficients respectively are ± 30 parts per million/°C and ± 25 ppm/°C. Gain and offset errors adjust to zero, and internal (unaveraged) noise is 0.2% of full scale.

Able to accomplish an 8-bit sampling and conversion in a maximum of 1.5 μ s (1.3 μ s is typical), the ADC-881 may well be one of the fastest successive-approximation converters around, claims Datel-Intersil's Marshall.

It accepts analog inputs of ± 5 v. The output is in offset binary code, with an output-overflow logic signal flagging any values outside the unit's range.

Datel-Intersil intends the ADC-881 as the first of a line of linearity-enhancing devices. "This approach is applicable to other products, obviously," says Marshall. "We'll be paying attention to the experience and the responses we get with this first one to determine where to take the technique from here."

Delivery of the ADC-881 will take eight weeks. Quantity discounts will be available.

Datel-Intersil, Inc., 11 Cabot Blvd., Mansfield, Mass, 02048. Phone (617) 339-9341 [338]

Leaders in Electronics

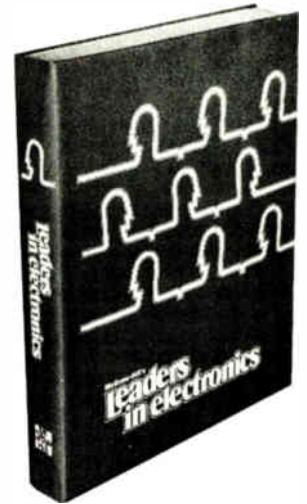

The only reference devoted solely to biographies of the most influential people in electronics

- corporate executives • technical managers • designers/developers • government and military officials • academics • consultants • editors/publishers • trade/professional group directors • securities analysts

Plus an 80-page index of biographies by affiliation, including independent consultants in every electronics specialty.

Prepared by the staff of Electronics magazine. 5,240 biographies. 651 pages, clothbound. \$39.50

Electronics Magazine Books

P.O. Box 669, Hightstown, NJ 08520

Send me...

_____ copies of *Leaders in Electronics* @ \$39.50 plus applicable sales tax. McGraw-Hill pays regular shipping and handling charges on pre-paid orders.

I must be fully satisfied or you will refund full payment if the book is returned after ten-day trial examination.

Payment enclosed Bill firm Bill me
Charge to my credit card: American Express
 Diners Club Visa Master Charge
Acct. No. _____ Date Exp. _____

On Master Charge only, first numbers above name _____

Name _____

Company _____

Street _____

City _____ State _____ Zip _____

Signature _____



Gene Lemons (upper left) and Steve Irving (lower left) first recognized the potential for plasma processing at Signetics. Their work in the 1960s with Richard Bersin (lower right), first at LFE and then at International Plasma, resulted in the first plasma etchers and strippers. In the 1970s, Alan Reinberg (upper right) at Texas Instruments explored plasma deposition and brought about wide-scale use of planar plasma reactors. Lemons' and Irving's early equipment (left) is contrasted with today's automated plasma systems.

No. 8 in a series

SEMI Presents... Great Moments in Semiconductor History

Plasma technology, which is replacing many wet chemical processes with more-controllable dry processes, had its first great moments in the early 1960s. While searching for an improved way to strip resists from silicon wafers, Stephen Irving and Gene Lemons at Signetics began exploring plasma equipment made by LFE Corporation for analysis of organic matter. The result, after a period of development with LFE's Richard Bersin, was a patent for Irving and Lemons and the first plasma photoresist stripper for LFE.

After founding International Plasma Corp., Bersin worked with the Signetics team on extending plasma chemistry to etching; in fact, Irving left Signetics to join in this effort. The result this time: another patent for Irving and Lemons and IPC's introduction of the etcher/stripper.

Other developments were taking place at Texas Instruments, where Alan Reinberg was pursuing the use of plasma for nitride deposition, based on exploratory work by Sterling and Swann at STL Laboratories in England. His efforts brought about the first wide-scale use of planar plasma reactors.

Now both Reinberg and Bersin are at Perkin-Elmer, pursuing future great moments in plasma technology. Many such advancements first surface on the exhibit floor or in the technical sessions at SEMICON—such as the upcoming SEMICON/East (where Dr. Reinberg will chair a technical session) and our new SEMICON/Southwest. Plan to be at one or both of these shows. Don't miss out on a single great moment in semiconductor history.

SEMICON/East
September 23–25, Boston

SEMICON/Southwest
October 8–9, Dallas

SEMICON/Japan
November 19–21, Tokyo



Semiconductor Equipment and Materials Institute
625 Ellis Street, Suite 212, Mountain View, CA 94043
(415) 964-5111, Telex: 171-977 SEMI-MNTV

You either have it,

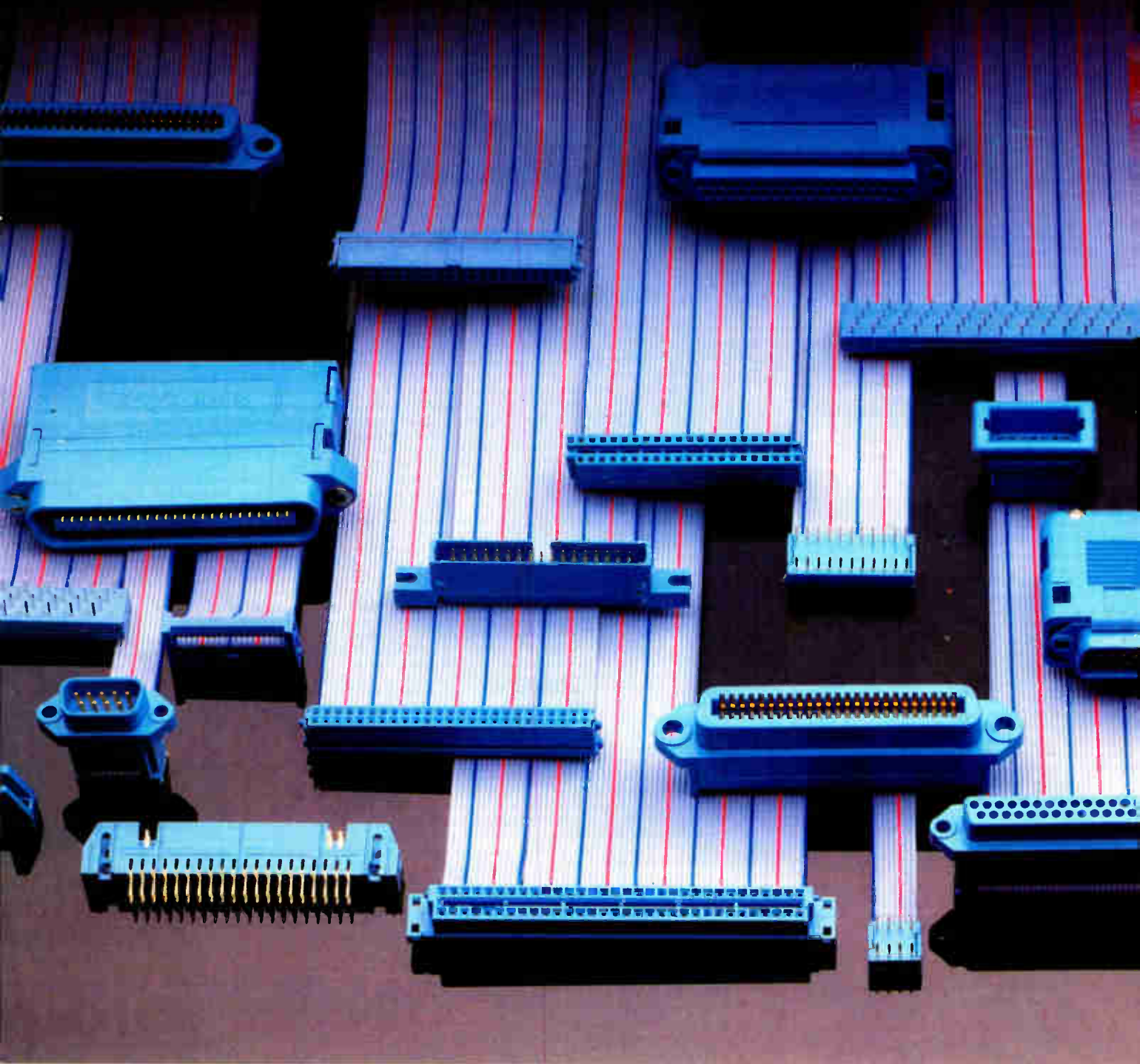

INTERNATIONAL OFFICES: AUSTRALIA, Dee Why West N S W (02) 982-3222 AUSTRIA, WEST GERMANY, Dreieich 06103-8-2021 CANADA, Ontario Quebec (416) 661-2761 ENGLAND, Luton, (0582) 597-271 JAPAN, Tokyo (3) 354 9661 MEXICO, (905) 562 2643 SINGAPORE, (65) 283 4244 SOUTH AFRICA, Benrose 61 46451 SPAIN, Barcelona (34) 3-3002252 SCANDINAVIA, Uplands Vasby Sweden 0760 86140

or you don't.

**We've got the
broadest line
of mass termination
connectors, flat cable
and tooling.**

Industry standard BLUE MACS® connectors for input-output applications. Connectors that can be soldered to boards. Back panel connectors for boards or cabinets. Connectors for dual in-line plug configurations. Connectors for board-to-board applications. Daisy chain applications. And many more!

A complete line of standard and jacketed BLUE MACS® cables for intra or inter cabinet wiring, cables for high flex life application, and a variety of cable structures for EMI and RFI protection requirements.

The industry's largest package of IDC mass termination hand tools, some with interchangeable dies, manual bench presses and pneumatic tooling.

So give us a call for complete information. Or send for our FREE 116-page catalog.

When your needs involve any kind of mass-assembled flat cable/connector system, contact the company that has it all.

T&B / Ansley
The mass termination company.

T&B/Ansley Corporation
Subsidiary of Thomas & Betts Corporation
3208 Humboldt St.
Los Angeles, CA 90031

TEL. (213) 223-2331
TELEX 68-6109
TWX 910-321-3938

Stocked and sold through
authorized T&B/Ansley distributors.

Circle 175 on reader service card

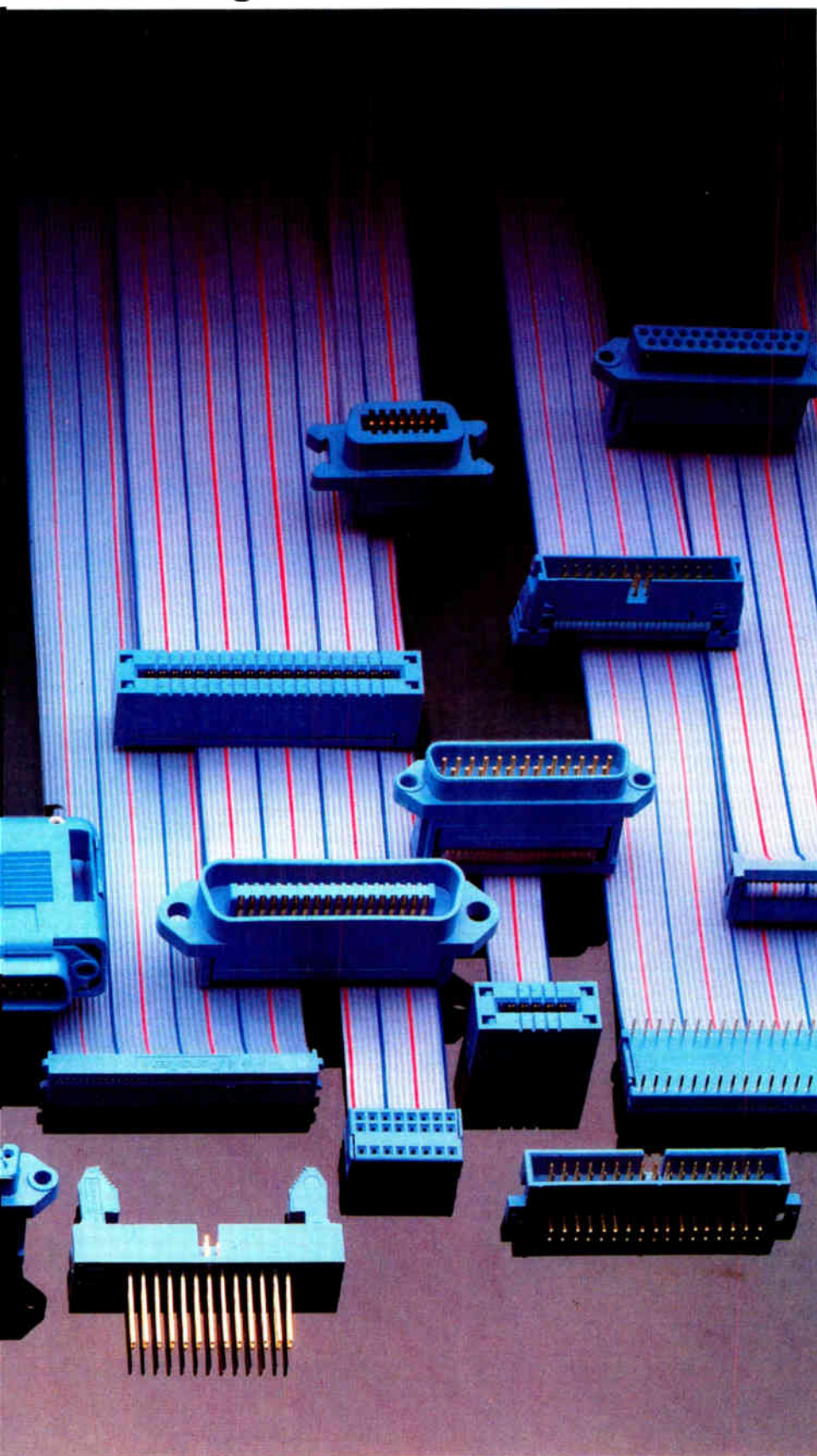

Computer board has room for more

A low-cost 8086-based single-board computer includes on-board area to accommodate user breadboard designs

by Martin Marshall, West Coast Computers & Instruments Editor

Filling a perceived gap in the Intel single-board-computer product line, a company founded by former Intel employees has created a unit based on an 8086 16-bit microprocessor that lets the user breadboard his application on the same card. "Generally, Intel is not interested in customizing boards or in consulting," asserts Microbar president Ray Burkley, "and that's where we come in."

The Custom-86 printed-circuit card conforms to Intel's Multibus form factor; it contains Multibus and RS-232 interfaces, a complete 16-bit computer, and a breadboarding area. What it does not have is the 32- to 64-K bytes of random-access memory, the interrupt chip, and some of the input/output and timer functions residing on Intel's 86/12B single-board computer. It also does not have the \$2,460 price tag of a fully loaded 86/12B. Instead, the Custom-86 sells for \$995 (in single quantities) in the 5-MHz processor

version with 4-K bytes of RAM or for up to \$1,395 for the 8-MHz version with 4-K bytes of RAM.

The Custom-86 provides two breadboarding areas on the card with a total space available for about 45 16-pin integrated circuits. One area, between the serial port and connector, is for additional memory. This section has connections for the 20-bit address and 16-bit data-bus lines of the microcomputer, all fully buffered.

A place for connections. A second breadboarding area above the microcomputer is intended primarily for I/O functions. Here are the connections for the microcomputer's control lines, interrupt control section, programable read-only-memory chip-selection lines, I/O chip-selection lines, and some prototyping interconnections that feed into the Multibus interface. At the top of this breadboarding section, connection points are provided for a 50-pin

wrapped-wire flat-cable connector.

Aside from the 2- or 4-K bytes of RAM in the microcomputer section, there are four sockets that can mix and match up to 32-K bytes more of RAM and PROM. An additional 40-pin socket near the 8086 is intended to hold an 8087 math-processor chip, if needed by the user. The serial RS-232-C port provided by the Custom-86 has user-selectable transmission rates, and it can have either a synchronous or asynchronous interface.

Also an upgrade. Building upon the features of the Custom-86, Microbar also offers the upgraded RS-86 development system for the 8086. This includes the Custom-86 board, an 8086 monitor program, a microprocessor disassembler, some additional firmware that allows the Custom-86 to function in a development system, some ISIS-compatible control software on a single- or double-density diskette, and an RS-232

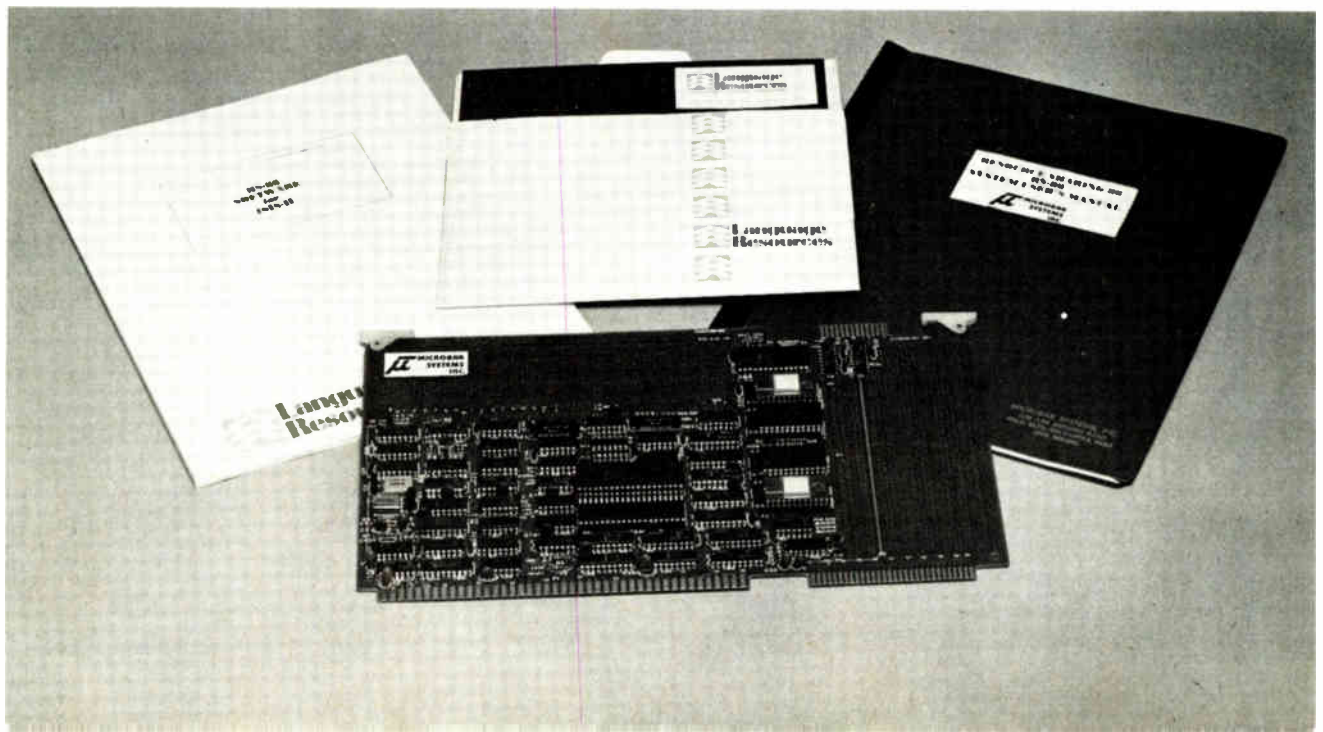

THIS is not a dream. You are heading toward Hong Kong harbour on an avenue paved in Italian stone. You pass a fountain, its plume as tall as a giant palm. You stop, very nearly at the shoreline itself.

And there it is, towering above you like some incredible glass and marble ocean liner. Through its walls you see the lights of the city sparkling beyond.

This is The Regent, Hong Kong's newest hotel. There has never been another quite like it. Anywhere.

Is it luxurious? Certainly. Attentive? Of course. But the essence of The Regent is to be found in a thousand remarkable details. Together they create a unique environment, and a genuine event in hotel history.

Half innovation, half tradition

From the moment you arrive, life at The Regent is a civilized blend of the best of old and new. The lobby is stunningly modern, with its 40-foot-high glass walls and its rosewood central counter. But the formally-dressed reception staff and concierge who greet you are reminders of another era.

Your registration form is filled out for you instantly, by a computer. You are shown to your room, and step to the window to admire the spectacular harbour view.

You scan the modern cargo ships, the ancient junks, the distant hills. And you begin to doubt that any of the room's future occupants will ever actually turn on the colour TV.

You look around the room, finding much to your liking. A full-sized desk. Telephones in all the right places. A door that isolates your foyer from the bedroom itself.

In the spacious bathroom, you note the marble tiling. The enormous tub. The separate shower.

You search for the mini-bar, and are

Once every generation Hong Kong acquires a great hotel



a bit surprised not to find one. But of course. One tends to forget that 24-hour room service can still exist. At The Regent each floor has its own private butler. When you ring for service, he's there in a matter of seconds.

For dining out, you'll find three outstanding restaurants right in the hotel. Book a table at the fabulous Plume. Indulge yourself at Hong Kong's only authentic Steak House. Or choose the casual elegance of Harbour-side any time of the day or night.

Before dinner you stop at the Mezzanine Lounge. You order and the waiter pours your drinks right at the table, just as they do at your private club.

You glance across to the lobby below. A limousine pulls up to the hotel entrance and its elegant passengers vanish up a sweeping marble staircase. This leads to the Regent Ballroom, largest ever built in Hong Kong and destined to be the room where the city will celebrate its great events of the 1980s.

A resort-sized pool

The better you know hotels in Hong Kong, the more you will appreciate The Regent's huge octagonal pool and its exotic garden setting. It is a true resort, in the very heart of the city.

But Hong Kong's favourite pastime isn't swimming. It's shopping. You'll find some of the best boutiques in town right in The Regent. (Or ask the concierge for a few of his secret addresses. You're just a few steps from downtown Kowloon so they're certain to be nearby.)

The Regent opens later this year. But it's not too soon to contact Regent International Hotels or ask your travel agent to reserve for you right now.

Hong Kong is about to discover its great hotel of this generation.

the
Regent

A REGENT INTERNATIONAL HOTEL

HONG KONG, BANGKOK, KUALA LUMPUR, MANILA,
COLOMBO, FIJI, ALBUQUERQUE, NEW YORK,
CHICAGO, HONOLULU, MAUI AND PUERTO RICO.

New products

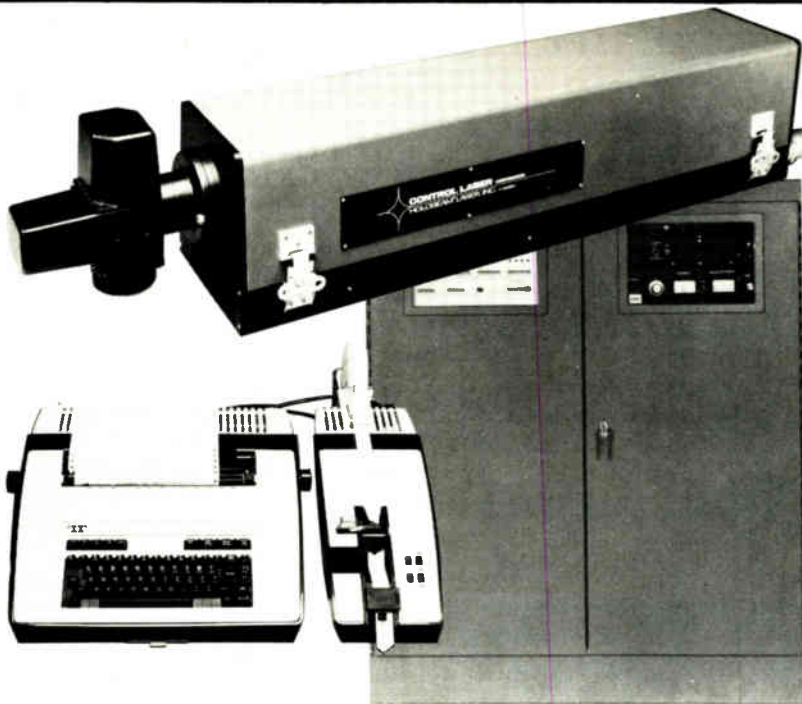

InstaMark Laser Engraver

**... combines speed, versatility,
flexibility, permanence, non-contact
operation, production adaptability
and operator simplicity!**

If you need to mark a product, consider the features of Holobeam's InstaMark Laser Engraving System. Because it is computer-controlled, InstaMark's laser beam has the full contouring capability necessary to inscribe alphanumeric characters, symbols and graphic designs at up to 8 in./second. In addition, computer control permits the system to be easily adapted to fully automatic operations, such as required for serializing components on a high-speed production line. Being a non-contact process, laser engraving does not apply pressure to the surface which could deform or fracture a workpiece. Through use of software programs and simple teletypewriter instructions, an operator trained only from a manual can put the system through its paces. If this sounds like the marker you should be using, contact one of our knowledgeable sales engineers.

CONTROL LASER CORPORATION

HOLOBEAM LASER, INC. - A Subsidiary

11222 Astronaut Blvd. ■ Orlando, Florida 32809
(305) 851-2540 TELEX ● 564407

connector and cable. The 8086 monitor program, MON86, is contained in two 2716-type ROMs. It provides a downloading file command, single-step execution, setting of up to two breakpoints, and the display, substitution, comparison, filling, and moving of memory. It can also receive or transmit through an I/O port and examine the registers of the microprocessor. The disassembler program, DIS86, resides in an enhanced version of the MON86 ROMs. It generates assembly-level instructions from 8086 machine code. Both the monitor and the disassembler can change relative jumps into absolute locations and then display those locations.

"Basically, the RS-86 provides an 8086 execution vehicle for a model 800 or series II Intellec development system for a much lower price than the Intel upgrade while also allowing the user to develop his software on the target system itself," notes Rod Allen, Microbar's vice president of engineering.

The comparison. The upgraded Intel 8086 (model 556) costs \$7,500, and Microbar's 5-MHz, 2-K-byte version of RS-86 costs \$2,450. These are not exact comparisons, however, since the Intel upgrade includes the added memory of the 86/12B processor board. Intel also offers more development capability in its ICE module (\$5,500 extra). "It's true that our RS-86 doesn't have the emulation capability of the ICE 86, but the primary use of that emulation would be in debugging the hardware of the Multibus interface and the microcomputer," notes Allen. "We already supply a debugged microcomputer and interface."

The RS-86 is aimed at the market for upgraded Intellec systems, but it can also be applied to other IEEE-796-Multibus-based development systems. With changes in its software only, the RS-86 could also be used to upgrade National's Starplex development system or the System 29 available from Advanced Micro Computers.

Microbar Systems Inc., 1120 San Antonio Rd., Palo Alto, Calif. 94303. Phone (415) 964-2862 [339]

FEAR OF FLYING?

THE OLD "SEAT-OF-THE-PANTS" FLYING CAPACITOR MULTIPLEXER.

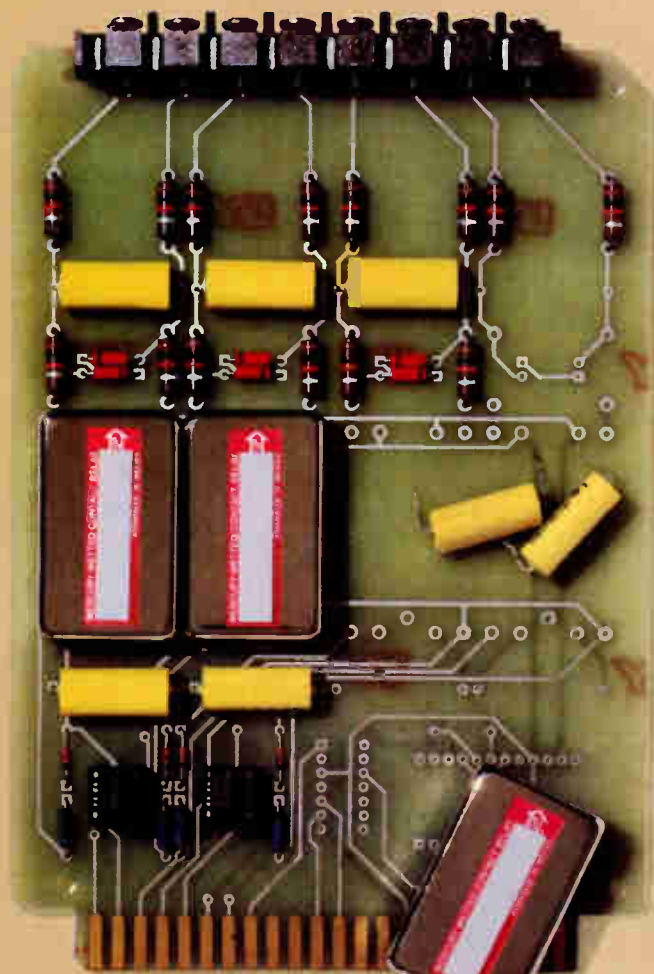

The good old flying cap mux may well be a thing of the past. Its reed relays can make it unreliable and economically hard to maintain. Its thermal drift is high, noise rejection is low, and scanning speed is slow. Its common mode rejection suffers and isolation can be a problem. Why take chances with a do-it-yourself thermocouple multiplexer, when we've done it all for you?

THE NEW SOLID STATE, ISOLATED, THERMOCOUPLE /- MILLIVOLT MULTIPLEXER.



The new 4-channel 2B54 was specifically designed as a high-performance, versatile and reliable alternative to the standard flying cap mux.

The 2B54 provides outstanding low drift, high noise rejection, high throughput, and 1000 V isolation. If you're looking for a low cost, high performance alternative to the good old flying cap mux, read on:

Specifications:

Low Drift: $\pm 1 \mu\text{V}/^\circ\text{C}$
(Max. 2B54B)
Amplification: To 1000 V/V
Isolation: $\pm 1000\text{V}$ dc
(chan/chan/ground)
Common Mode Rejection:
156dB @ 60 Hz

Filtering: -55dB @ 60 Hz
Multiplexing:
400 channels/sec
Open Input Detection
Low Cost: \$36/chan
(2B54A, 100's)
And Solid State Reliability!

OUR NEW 2B55 AND 2B56 ARE TWO OTHER GREAT WAYS TO GO.

If your application is high level signals (from $\pm 50 \text{ mV}$ to $\pm 5\text{V}$ or 4-20 mA), use our new 2B55. If you need cold junction compensation, our new 2B56 can be used directly with our 2B54.

For more information, call Robert Butler at (617) 329-4700 or write Analog Devices, Box 280, Norwood, MA 02062.



WAY OUT IN FRONT.

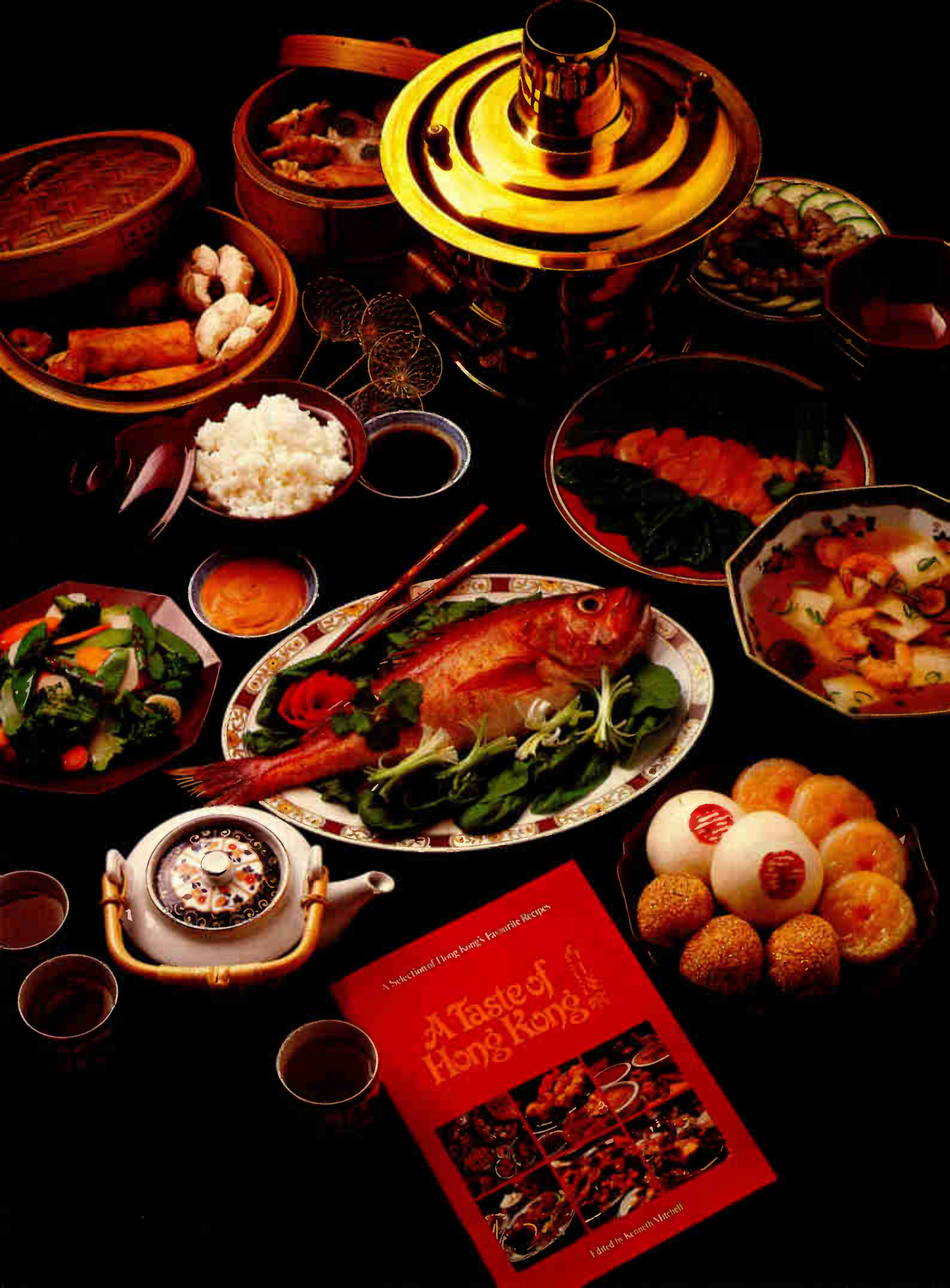

A Selection of Hong Kong's Favourite Recipes

A Taste of Hong Kong



Edited by Kenneth Mitchell

If we don't deliver your ROM's in five weeks, we'll take you to lunch. In Hong Kong.

That's a guarantee. If we don't ship your finished prototype ROM's within five weeks of the day you give us your programmed EPROM, codes or punched paper tape, we'll fly you to Hong Kong, take you to lunch... and fly you home.

Don't start packing. We're a totally integrated ROM house. From masking and waferfab to packaging, burn-in and shipping. That means we're on top of your order every step of the way. No subcontractors. No delays. Our job is to help you get your product to market while there's still a market.

Everybody talks about 64K ROM's. We're delivering. In quantity. Now. 2364's. And 2332's. And 2316's. All compatible with your 2700 Series EPROM's. Eight week delivery in production quantities. Five week delivery in prototyping quantities. Guaranteed.

Price? Competitive. Very competitive. Call us for a quote. 800-345-6386 is the toll-free direct line to MOS Technology. If you're in the West, call our regional sales office, 408-727-1130.

Want to know more? Return the coupon below for our Data Sheets and Hong Kong Dining Guide. We like to think you'll see Hong Kong again. But not on us.

East: Toll Free 1-800-345-6386 or 6387.

West Coast: (408) 727-1130 ext. 218

commodore
SEMICONDUCTOR GROUP

Valley Forge Corporate Center
Norristown, PA 19401
(215) 666-7950
TLX 846-100 MOSTECHGY VASFG

That's some guarantee.
Send me everything there is to know
about your 2316/32164 ROM's.
And the Hong Kong Dining Guide.

Name _____
Company _____
Address _____
City/State/Zip _____
Phone (_____) _____

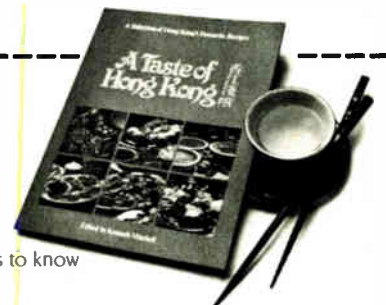

An evolutionary
idea from the creators
of the
StereoZoom[®]
Microscopes.

The New Bausch MicroZoom[™]

It solves
the hybrid and
packaged chip
inspection dilemma.

Now your inspectors can quickly scan packaged chips, then "zoom" each objective up to twice its power for closer examination. And that's just one of the many advantages of the new Bausch & Lomb MicroZoom Microscope.

Three long working distance objectives, giving total magnifications from 22.5X to 1000X—and higher—give ample working distances for chip inspection. There's virtually no chance of damaging chip or objective.

Erect, unreversed image for faster, easier inspections. Advanced vertical illumination with aperture control for true color rendition. And all this is standard. No costly add-ons.

But you can make it even more versatile than it already is. Add complete photomicrographic and CCTV accessories. A dual-viewing system for training. It's the only **complete**

microscope you can buy for chip inspections. The new MicroZoom Microscope. It's exactly what you would expect from Bausch & Lomb.

Bausch & Lomb Microscope.

Take a
closer look.

For a convincing demonstration or
free catalog, return this coupon today.

- Please call for an appointment
 Please send your new MicroZoom
Microscope catalog

Name _____ Title _____

Address _____

City _____ State _____ Zip _____

Bausch & Lomb
Dept. 6606
1400 N. Goodman St.
Rochester, N.Y. 14602



It has 3 long working
distance objectives,
each with exclusive
1X-2X zoom.

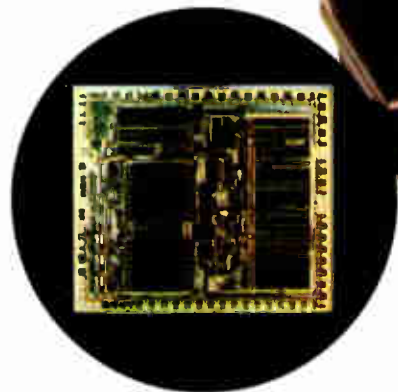

A full 1/4" chip can be
viewed at the lowest
magnification (22.5X).

Chip photo courtesy of Motorola Corp

Expedite your request
by calling toll-free:

800-648-5600

Ask for Operator 72
See the new MicroZoom™ Microscope
at SEMICON/East,
Booth 1303-1304.

BAUSCH & LOMB

Scientific Optical Products Division

Circle 183 on reader service card



The first functional PCB tester good enough to be called Fairchild.

It's the company behind Series 70 that puts it a generation ahead.

In the world of ATE, no name has so consistently been synonymous with innovative technology, dependable quality, and total systems support as the name Fairchild.



With the introduction of Series 70, Fairchild brings that long tradition of excellence to the functional board tester.

Series 70 offers true state-of-the-art hardware and software, developed for efficient and accurate board test and program simulation. It is modular in design for off-the-shelf economy and cost-effective expansion. It has a computer specifically designed for functional testing. It has a high-speed memory bus and a separate high-speed I/O bus. It can diagnose faults down to the component level with logic clip and probe capability. And it can test all of today's most advanced LSI devices — high-speed digital, analog and hybrid.

Without a doubt, Series 70 is the most complete, comprehensive and capable functional tester available today. And with the increasing complexity of today's PC boards, you can't afford a system that offers less.

And Series 70 is faster, smarter and easier.

While other testers operate at a leisurely 1.8 MHz, Series 70 gives you data rates to 5 MHz across all digital pins in parallel and collects probe data at full test speed. It

offers faster, more accurate fault isolation, and it lets you program timing increments with 20 ns resolution. You can even track bus-related faults at full speed with Series 70.

Thanks to MEDIATOR, Series 70 gives you a high-level conversational test program language instead of low-level code. And MEDIATOR is an English-like, multi-level language so you can write your own hybrid board programs easily and economically.

More accurate, more flexible, and more adaptable.

Compared to today's best known functional tester, Series 70 offers specifications that are truly impressive:

| | Series 70 | An older tester |
|-------------------------------|--|--|
| SPEED | 5 MHz | 1.8 MHz |
| PROGRAMMABLE PULLUP RESISTORS | Yes | No |
| COMPUTER | Specially designed dual bus architecture 16 bits 64 K words memory (128 K bytes) | PDP-8 12 bits 32 K words memory (48 K bytes) |
| SIMULATOR | High accuracy Can be run on tester | Longer debug time Have to add memory |
| MASS STORAGE | 12 or 24 MB disk | 2.4 MB or 4.8 MB disk |
| SOFTWARE | Virtual memory | Overlay & linking |
| EDITOR | Continuous on-line operation | Call-up mode |
| SYSTEM INITIALIZATION | Totally automatic | Boot from TTY |
| DIAGNOSTIC CAPABILITY | Fault tracing to the component level with FLO-TRACER | No equivalent |
| ADVANCED LSI TECHNIQUES | Live data compression | No equivalent |
| HIGH-SPEED CLOCKS | 8 phase with OR capability | No equivalent |
| HYBRID CAPABILITY | 6 bus dual-pole throughout | Limited scanner |

The world's first true hybrid tester.

Unlike other functional testers, Series 70 covers all types of boards—bus oriented microprocessors, dense dynamic memo-

ries, fast static memories, complex linear circuits and discrete devices. And it can handle boards from MOS and CMOS to TTL and advanced bipolar.

With Series 70, you also get a wide choice of fixturing systems—universal, edge connector, or optional Thinline® bed-of-nails interface.

And it's from the first family of ATE.

Like all Fairchild test systems, the Series 70 is backed by the largest support network in the industry. Training, applications software, special hardware configurations and maintenance are all part of the Fairchild support package. Together they provide a comprehensive, proven and state-of-the-art solution to your functional PCB testing needs today and tomorrow.

For more information on the new Series 70 Functional Board Tester from Fairchild, call or write for our new brochure:

Fairchild Test Systems Group
Fairchild Technical Center
Billerica, MA 01821
(617) 663-6562

FAIRCHILD

A Schlumberger Company

The First Family of ATE.

High accuracy simulator

Computer: 16 bits, 64 K words memory

6 bus dual-pole matrix

Fault tracing to the component level

12 or 24 MB disk

Dual IEEE bus

Live data compression

5 MHz data rate

Virtual memory



Manchester converter fits service bus

Intended for MIL-STD-1553 serial bus, device decodes data, then converts it from serial into parallel form

by Pamela Hamilton, New York bureau manager

A committee of Air Force, Navy, and Army representatives recently adopted the MIL-STD-1553 as a serial data bus to transmit information between electronic subsystems in military equipment. In order to convert this information from a serial format into a usable parallel format, ILC Data Device Corp. has designed the Bus-8937—a Manchester II converter—to be used with the MIL-STD-1553 data bus.

The 8937 accepts the serially encoded data from the company's Bus-8553 transceiver, decodes the Manchester data, and then performs a serial-to-parallel conversion. The device transmits this parallel data as a 16-bit TTL signal to the operational subsystem through internal double-buffered three-state outputs. When parallel data from the subsystem is presented to the 8937, the process is

reversed. Any data going to or from the subsystem is transferred over a common 16-bit bus.

The word length of the Manchester-encoded data used over the 1553 bus is fixed at 20 bits sent at a 1-MHz rate. The first 3 bits form a synchronization period and as such are an invalid Manchester signal. Next come 16 bits, compatible with microprocessor operations, carrying the information. Last is a parity bit. Each bit is sent in 1 μ s. "The decoder in the 8937 strips off the sync pulses and parity bit and sends the remaining data to the serial-parallel converter," notes Albert DiMarino, product manager.

Address recognition. Up to 32 subsystems may be hung from a single MIL-STD-1553 data bus. Therefore DDC has provided an address-recognition capability with its 8937. The

device incorporates 5-bit address decoding and can provide a valid-address signal to the subsystem once that address is verified. The unit is also equipped with a wraparound self-testing capability.

The 8937 is a hybrid device built to MIL-STD-883 and is screened to applicable portions of methods 5004 and 5008. The circuit contains 18 integrated circuits housed in a 1.7-by-1.1-by-0.2-in. package. The unit requires 200 mA maximum from a +5-v dc power supply. The operating temperature range of the device is -55° to $+125^{\circ}\text{C}$ measured at the case, with a storage temperature range of -55° to 150°C .

The Bus-8937 sells for \$450 in single quantities, with delivery from stock to 90 days.

ILC Data Device Corp., 105 Wilbur Place, Bohemia, N. Y. 11716 [340]

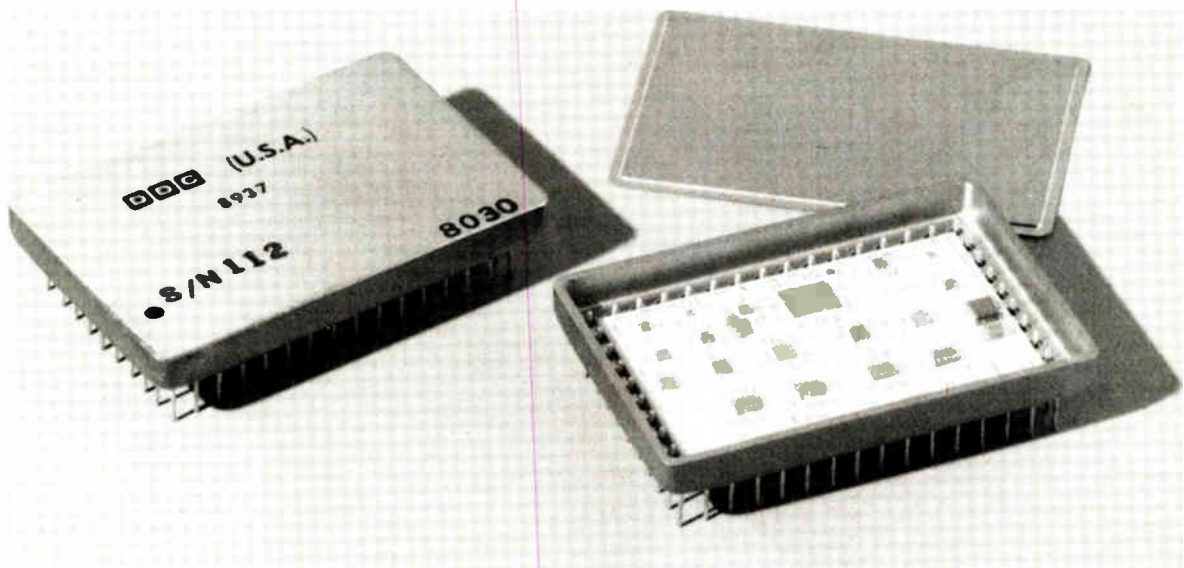

New
Kodastar
WASH-OFF PRODUCTS



© Eastman Kodak Company, 1980

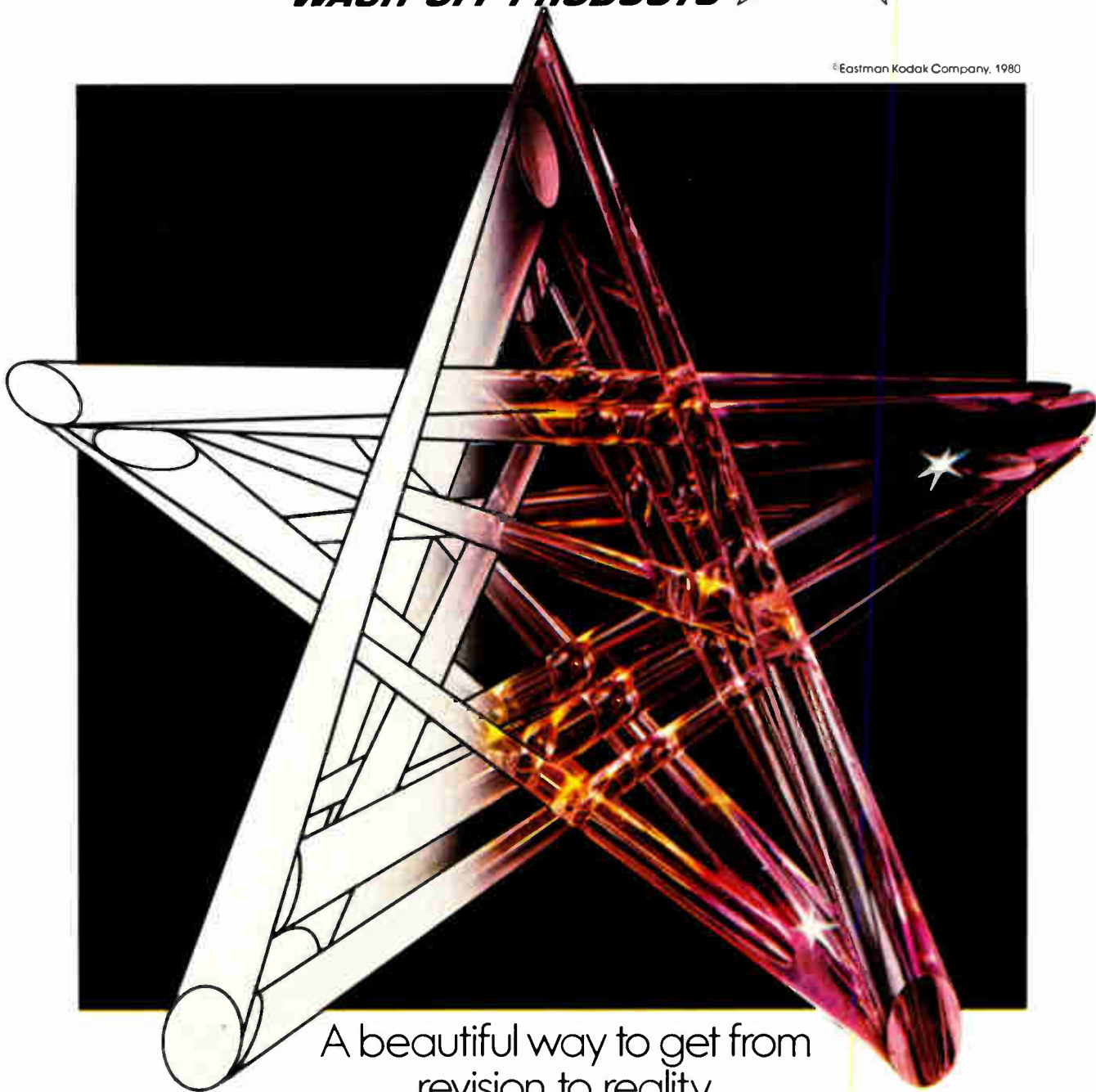

A beautiful way to get from
revision to reality.

Now there's a wash-off film that's mightier than the pen, pencil, and eraser.

A wash-off film that'll take revision, after revision, after revision.

With negligible or no ghosting. One that gives you reproductions so fresh and crisp, you may mistake them for originals. Reproductions that are dimensionally stable and that will not tear, crack, or grow brittle.

Excellent durability. Excellent stability. Excellent erasability. New **KODASTAR** Wash-Off Films. Now you've got an excellent choice.

SEND FOR A FREE SAMPLE OF NEW **KODASTAR** WASH-OFF FILM.

Prove to yourself you've never tried anything like it.

Eastman Kodak Company, Dept. GD018, Rochester, NY 14650



Circle 187 on reader service card

CURRENT MONITORS

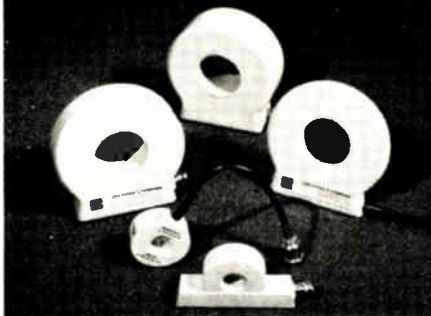

With our monitor and your oscilloscope, read fast pulsed currents (nsec to millisec) of any conductor. Prices range from \$75 for standard, in-stock models. Sensitivities from 1 V/A to .01 V/A; no physical connections required; readings without ground loops; BNC standard; specials upon request.

For further information write or call: Ion Physics Company, F.C. Box 416, Burlington, Mass. 01803. Tel. 617-272-2800.



Circle 188 on reader service card



Very High Voltage PULSE TRANSFORMERS

Pearson Electronics, Inc. specializes in design and manufacture of very-high voltage, high-power pulse transformers. Typical pulse transformers manufactured by Pearson Electronics, Inc. range in output voltage from 90 kV to 600 kV. Other Pearson pulse-modulator components include precision current transformers and voltage dividers. Inquiries in regard to your specific application and requirements are welcomed.

PEARSON ELECTRONICS, INC.
4007 TRANSPORT ST. / PALO ALTO, CA 94303
TELEPHONE (415) 494-6444 / TELEX 171 412

188 Circle 130 on reader service card

New products

Instruments

Modular DMM starts at \$765

8 plug-in cards adapt multimeter for a variety of tests and buses

Data Precision might well have called its new 5½-digit multimeter an MDMM, or modular digital multimeter. Although essentially a \$765 conventional DMM with most of its functions under microcomputer control, a library of eight modules can equip it to do quite a bit more than just measure dc voltage and make three-wire ratiometric dc voltage measurements.

The modules can be installed in the field into the half-rack-wide 3600. Though the use of some of them precludes the use of others, a fully equipped 3600 could perform a broad range of measurement chores. Among the features:

- Resistance measurement, 1 to 20 MΩ, for \$120.
- Average ac voltage measurement, 1 μV to 800 V, for \$145.
- True root-mean-square nonsinusoidal ac voltage measurement to 800 V in two versions priced at \$200 and \$325.
- Binary-coded-decimal remote-programming and data-output interface for \$100.
- IEEE-488 bidirectional bus interface for \$200.
- 1-GΩ impedance with an isolated,

four-wire ratiometric input costing \$200.

■ A rear-panel input jack set for an additional \$50.

Therefore "the user buys only as much meter as necessary," says Harold S. Goldberg, president. Later addition of a new function is a simple matter of inserting a card in an edge-connector slot reserved for it, plus calibration if needed.

Using the interface. No external translator is required for the IEEE-488 bus: the interface card is simply inserted and the unit's address keyed in with a miniature switch housed in a dual in-line package. As soon as the bus cable is connected, the system can begin operation.

Either the IEEE-488 or BCD input/output cards suits the 3600 to systems operation. These are especially low-priced options when compared with those for ac voltage measurement. The reason is the unit's 6500/1-based microcomputer; it gives some interface management to any instrument configuration purchased. But Data Precision's engineers have put the microcomputer to work in other areas, too, making use of its 2 K by 8 bits of read-only memory, 64 bytes of random-access memory, timer, counter, and four 8-bit ports.

"There is a complete self-test routine performed at turn on," says Goldberg. The unit's display, analog-to-digital converter, and other key circuits are exercised, and in the event of malfunction an appropriate code appears on the display. Typically, all a user sees is the unit counting down as its display is exercised. After this and between each



Superior Performance, Longer Life. The key to our Golden Touch[®] capacitive keyboard is our patented, hinged-moving-plate design. This unique feature gives our keyswitch greater capacitance, and that makes it virtually impervious to dust, debris and electrical noise. And that means better performance. It also means longer life — an MCBF rated at 250 million operations. That's why we guarantee a 1% AQL and give a two-year warranty. We design the Golden Touch exclusively for volume OEMs, so practically any combination of options, circuitry and configuration can be built-in. And with all this, the price is highly competitive. To learn more, just fill in the coupon or attach your card to this ad and mail it back to us.

DIGITRAN

The Digitran Company, a division of Becton, Dickinson and Company
 855 South Arroyo Parkway • Pasadena, California 91105
 Phone: (818) 449-3110 • TWX 910-588-3794

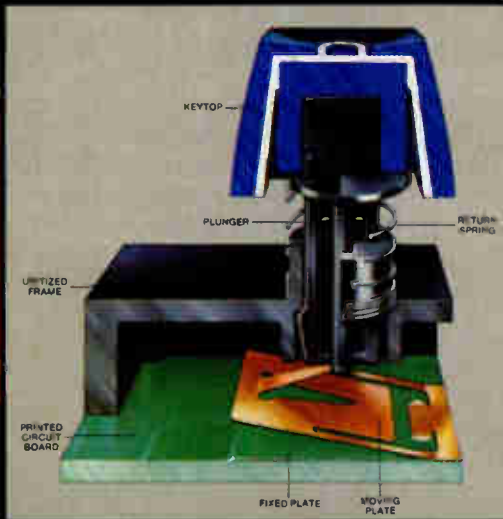

Keyboard Product Manager • The Digitran Company
 855 S. Arroyo Parkway • Pasadena, CA 91105

Please send brochure on Golden Touch[®] keyboard.

Name

Title

Company

Street Address

City State Zip

New products

measurement, the unit automatically zeros itself in analog fashion.

The microcomputer also is responsible for the unit's automatic-ranging function, called "opti-ranging." It reduces the search time associated with some other autoranging schemes and also eliminates the confusing displays that can flicker

across some DMMs as they range and then settle.

In the opti-ranging mode, the 3600 selects a middle range and, if there is no overload indication, backs down to ranges of increasing resolution, seeking the correct one. An overload indication triggers upward movement to a higher range. This

approach is quicker than the frequently used system of moving downward from the highest to successively lower ranges, according to Goldberg.

Right the first time. While ranging, the display is blanked; it is also blanked for a brief period while the meter and display settle. Thus the user's first reading will be the right reading.

Should a user try to measure a parameter the 3600 is not equipped for, the display reads out "error." There are error indications for almost all of the common mistakes possible with such instruments—wrong range selection, for one.

Three- or four-wire ratiometric measurements are simple: they can be set up with a push button. The standard three-wire capability enables the ratio of two voltages to be measured relative to a common point. The optional four-wire capability allows ratio measurements of dc voltage relative to separate points in a circuit offset by as much as ± 7 v. Users making frequent measurements in bridge-transducer systems will find this feature useful.

Delivery is from stock.

The Data Precision Corp., a division of Analogic Corp., Electronics Avenue, Danvers, Mass. 01923. Phone (617) 246-1600 [351]

Omnigraphic[®] Model 2000 The User's X-Y Recorder

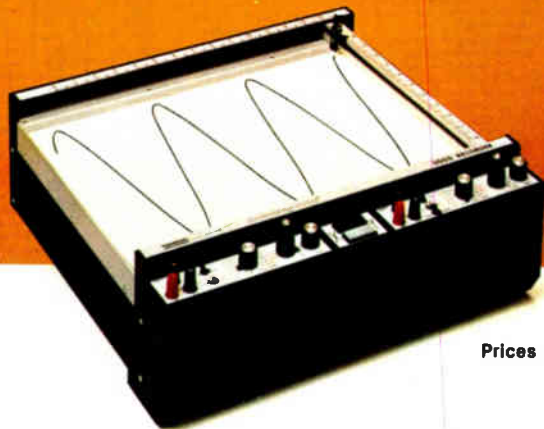

Prices start at \$1200.*

Changes as your applications change

The Model 2000's rugged die cast mainframe serves as the basic building block. The addition of any of a score of interchangeable plug-in modules allows you to tailor the recorder to meet your exact application. If your application changes it's no problem. By simply changing modules (it takes only minutes) the Model 2000 is ready to meet your new recording needs.

Unparalleled performance

In addition to its flexibility, the Model 2000 is the performance leader in X-Y recorders. It features speeds of 30 inches (76 cm) per second (40 inches [102 cm] per second available with high speed servo), overall inaccuracy of $< \pm 0.2\%$ full scale, repeatability of $\pm 0.1\%$ full scale, and non-linearity of $< \pm 0.1\%$. Recording can be on 11" x 17" (DIN A3) or 8½" x 11" (DIN A4) paper with convenient snap-on pens.

Economical

The economical price of the Model 2000 is only part of the story. The true economy becomes evident when you consider that by simply plugging in a different module, you can change the function of the recorder. One recorder with interchangeable modules can perform virtually all of your recording needs. It may be the only recorder you'll ever need.

For complete information contact Houston Instrument, One Houston Square Austin, Texas 78753 (512) 837-2820. Outside Texas call operator #2 toll free 1-800-531-5205. In Europe contact Houston Instrument, Rochesterlaan 6, 8240 Gistel, Belgium. Telephone 059/277445.

houston instrument
GRAPHICS DIVISION OF
BAUSCH & LOMB 

*U.S. domestic price only

• Registered trademark of Houston Instrument

\$235 benchtop 3½-digit multimeter has 31 ranges

A 3-lb, 4-oz benchtop 3½-digit multimeter for use in circuit design, production, and maintenance testing has a wide-angle light-emitting-diode display for ease in viewing. The model 4000 has a single range-selector switch and two input jacks to serve all functions and ranges. It also offers automatic zeroing and polarity selection when used for voltage and current measurement. Full scale ranges from 200 mV to 1 kV dc or ac. For current, full scale ranges from 200 μ A to 2,000 mA ac or dc; for resistance it is from 200 Ω to 20 M Ω . Input impedance is 10 M Ω on all ranges and accuracy is within ± 0.2 to $\pm 0.5\%$, depending on the range

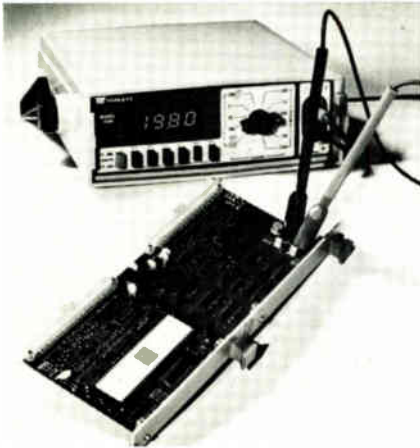

selected. The LED display is 0.43 in. high. Multiple fusing to 1 kV on 31 ranges is provided, with 1/8-A power-line, 2-A input, and 3-A high-energy-type fuses included in the \$235 price. The multimeter is available from stock and will be on display at Wescon.

Triplet Corp., One Triplet Dr., Bluffton, Ohio 45817. Phone (419) 358-5015 [353]

Microprocessor system analyzer sells for \$1,995

Without the need for user programming, the CT-150 microprocessor systems analyzer examines data in any of six operating modes and sells for \$1,995 with a probe. The analyzer is intended for the design, development, debugging, and testing of microcomputer-based systems. The instrument offers 128-by-30-bit data collection and storage through 30 channels. It can be used with either static or dynamic memory, operating on the user's system clock or on an external clock. The analyzer is available within 30 days after receipt of an order.

Creative Technology Inc., 14415 N. Scottsdale Rd., Scottsdale, Ariz. 85260. Phone (602) 991-1491 [354]

Three instruments included in 1-to-520-MHz service monitor

A rugged 1-to-520-MHz service monitor priced at \$5,920 in the U. S.

includes a lab-quality signal generator with a sweep-generator function, a frequency measurement system, and an oscilloscope. The signal-generator portion of the model 4200 is a synthesized source with 0.0001% (1 ppm) accuracy, 50-Hz resolution, and an output range of 316 mV to 31.6 nV. The measurement section

has an input sensitivity of 2 μ V and measures carrier frequency and modulation of externally generated signals, including off-the-air signals. The scope features a three-position vertical sensitivity selector and three sweep rates. Delivery is in 60 days. Wavetek Indiana Inc., 66 N. First Ave., P. O. Box 190, Beech Grove, Ind. 46107 [356]

Omnigraphic®

Model 2000

The OEM's X-Y Recorder

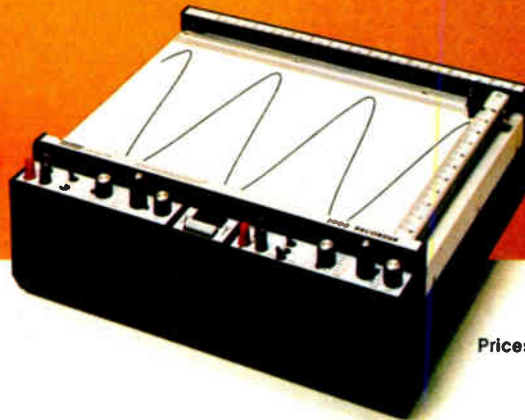

Prices start at \$1200.*

Custom design your own recorder

Add your choice of modules—there are over 20 to choose from—to the Model 2000's rugged die cast mainframe and you have a recorder that's custom designed to meet your specific recording need. If a standard module won't do the job, we'll work with you to develop one that will. And color is no problem...HI can deliver the recorders in whatever color you specify. We can also omit all modules and supply just the mainframe.

The performance leader

The Omnigraphic Model 2000 is the proven performance leader among X-Y recorders. It features speeds of 30 inches (76 cm) per second (40 inches [102 cm] per second available with the high speed servo) overall inaccuracy of $\pm 0.2\%$ full scale, repeatability of $\pm 0.1\%$ full scale, and non-linearity of $\pm 0.1\%$. Recording can be on 11" x 17" (DIN A3) or 8 1/2" x 11" (DIN A4) paper with convenient snap-on pens.

Economical

The Omnigraphic Model 2000's modular flexibility permits you to buy only the features you actually need. By selecting the proper modules, you can make the recorder as simple or as sophisticated as you want. It's the one X-Y recorder capable of meeting the needs of virtually every OEM.

For complete information contact Houston Instrument, One Houston Square Austin, Texas 78753 (512) 837-2820. Outside Texas call operator #2 toll free 1-800-531-5205. In Europe contact Houston Instrument, Rochesterlaan 6, 8240 Gistel, Belgium. Telephone 059/277445.

houston instrument

GRAPHICS DIVISION OF

BAUSCH & LOMB 

*U.S. domestic price only
*Registered trademark of Houston Instrument

THINK BAUSCH & LOMB QUALITY

Since 1959, when StereoZoom® Microscopes were first introduced, more electronic assembly, packaging, and inspection operations have put StereoZoom® Microscopes to work for them than any other instruments of their kind.

The reasons all relate to Bausch & Lomb quality. Like human-engineered design that has been use-tested for over twenty years for operator convenience. World famous Bausch & Lomb optics that have enabled production lines to increase thruput without sacrificing quality. And a dedicated effort to listen to you, our customer, that has produced such quality innovations as patented coaxial illumination, the high performance StereoZoom 7 Microscope, and now, tungsten-halogen illumination.

This constant attention to your quality needs has made us industry's first choice. Call or write today for detailed catalog, applications assistance, or a personal demonstration.

Precision. Value. Performance. Three good reasons to . . . THINK BAUSCH & LOMB QUALITY.

BAUSCH & LOMB 

Scientific Optical Products Division

Rochester, New York 14602 USA

716-338-6000, TWX 510-253-6189 TELEX 97-8231, CABLE: Bausch & Lomb



Consult Yellow Pages under "Microscopes"

Circle 192 on reader service card

FREE Washer Catalog



Catalog lists 3500 sizes of non-standard washers and spacers available without die charge

All metal washers are flat and tumble de-burred. They are made immediately to your order from existing dies. Materials certified if needed.

Boker's complete stamping capability includes tooling, welding, metallurgical lab, assembly, and quality control. Let us give you a quick quote.

See our ads in Thomas Register under STAMPINGS and WASHERS.

Satisfied customers from coast to coast.

BOKER'S, INC.

3104 Snelling Ave. So., Mpls., MN 55406 Phone 612-729-9365

Circle 131 on reader service card

OD's from
.086" to 1.936"
ID's from
.027" to 1.637"
Thicknesses:
.005" to .125"
Any stampable
material



From... **ovenaire** ...OVENS FOR T05 CRYSTAL, TRANSISTOR, IC OR OTHER Temperature Sensitive Component in T05 Case



Model T05P

Model T05C

- Solid state proportional control circuitry
- Miniature size—only 0.50" high X 0.75" diameter
- 5VDC to 28VDC heater voltage
- Select any oven cavity operating temperature from 35°C to 95°C in 5° increments.
- Low power—0.5 to 0.9W nom. at stabilized +25°C ambient
- Temp. stability ±3°C typical for -30°C to +60°C
- Warm up from -30°C—3.0 minutes max.
- T05P—component cavity opening in bottom of oven
- T05C—component cavity access by removing top cover

OVENAIRE-AUDIO-CARPENTER

Division of Walter Kidde & Company, Inc.

KIDDE

706 Forrest Street

Charlottesville, Va. 22901

804-977-8050 • TWX 510-587-5461

Circle 132 on reader service card

ASTRO-MED



New! AC-DC DASH II RECORDER

- Take anywhere rugged design
- Rechargeable battery or line operate
- Position feed-back galvos . . . 99.5% accuracy
- DC — 125 Hz.
- Crisp, clear traces . . . low cost thermal paper
- Simple to operate . . . years of trouble free operation

This new Dash II may very well be the final word in portable/lab high speed recorders. With rechargeable batteries and built in charger, you can take it anywhere — land, sea or air, and use it for 4 to 5 hours. Then, you can continue to operate *while recharging* the batteries. Accuracy? The patented (U.S. #4,134,062) Pathfinder™ galvo is *position feedback* with better than 99.5% accuracy. High stylus pressure delivers crisp, clear traces on low cost thermal paper.

Get all the facts. Call or write



ASTRO-MED DIVISION
ATLAN-TOL INDUSTRIES, INC.
Atlan-tol Industrial Park/West Warwick, R.I. 02893
401-828-4000



Circle 193 on reader service card

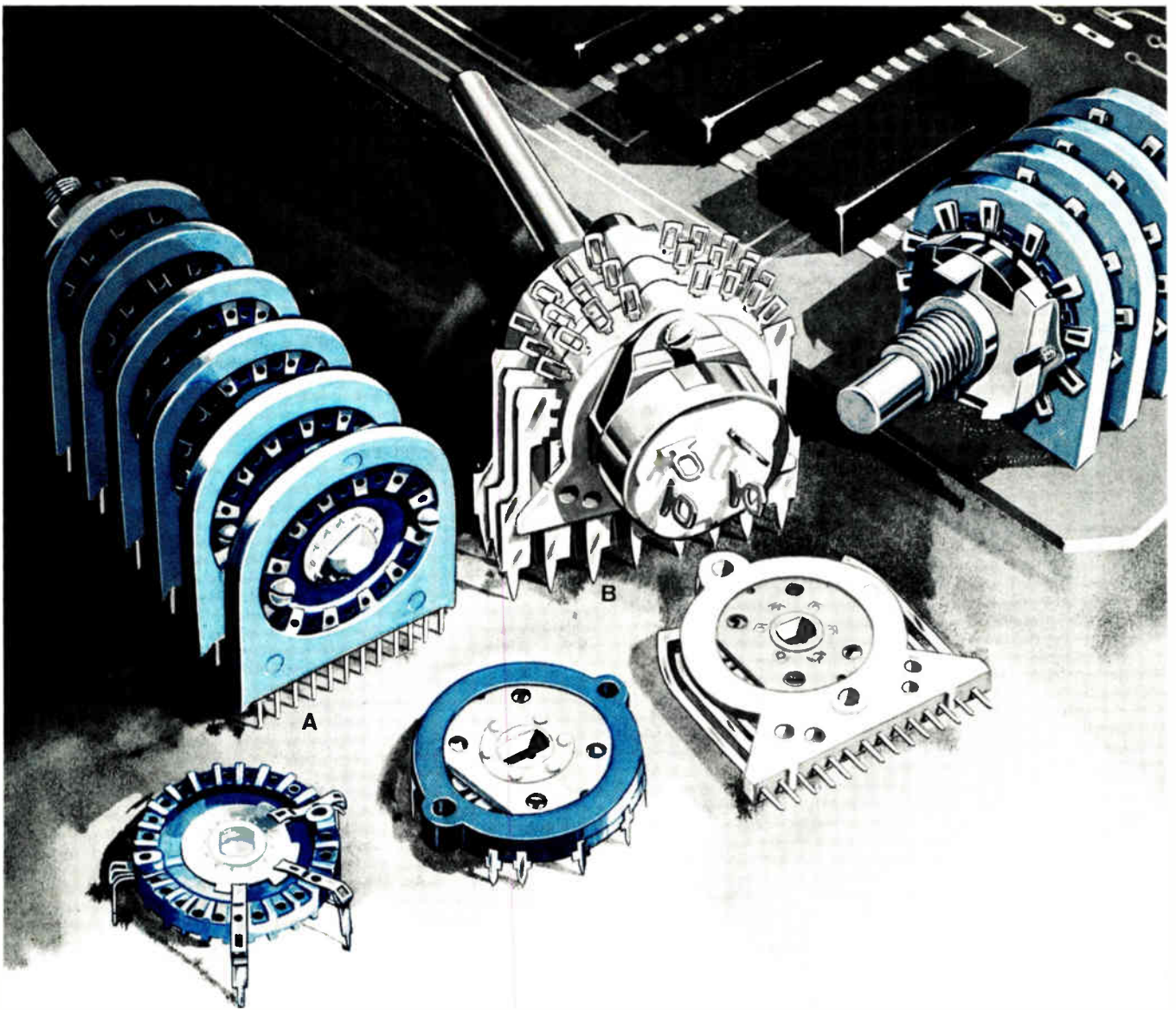

Handle most PC needs with rugged, compact CTS rotary switches.

Specify CTS and satisfy nearly every printed circuit switch mounting requirement. Cut production time, too. And at lower cost than with conventional wiring.

Choose from thousands of variations of shorting, nonshorting or mixed circuitry; plus a wide selection of index assemblies and wafer constructions for either perpendicular or parallel PCB mounting. Available in combination with AC power switches and variable resistors. You get a one-source supply for the complete switch package.

Two popular choices include the new CTS Series 223 parallel mount style (view A) measuring only $1\frac{1}{16}$ " wide by $1\frac{3}{8}$ " above the PC board permitting 12 PC terminals on .100" centers; up to 1-pole, 11-position circuitry. An optional 13th PC or solder lug terminal

gives a full 12-position switching capacity. Shown at (B) above is the CTS Series 227 rotary selector switch, which provides years of virtual problem-free performance in all kinds of applications. Parallel mount ...single or multiple wafer constructions...compact $1\frac{1}{16}$ " wide by $1\frac{1}{32}$ " above PC board. One and two wafer designs are also available with shaft axis perpendicular to board. Ask about our NEW 14-terminal 1-pole, 12-position or 2-pole, 6-position PC switches, too.

Made to your exact specifications CTS switches assure proven reliability, design flexibility and MIL quality. Call your CTS representative or write **CTS Corporation**, 905 N. West Blvd., Elkhart, IN 46514. Phone: (219) 293-7511.

CTS CORPORATION
ELKHART, INDIANA



COUNTERS



This is what they're all about.

MODEL 5845 150MHz Counter/Timer...\$325.

This new 8-digit universal counter/timer gives you all the functions you want, priced well below what you'd expect. The 5845 measures frequency up to 150MHz, resolves pulses occurring as close as 15nS, and also measures period, averaging up to 1000 periods, elapsed time (to the nearest msec) and counts total events. A versatile I/O option provides BCD data and status indication, plus remote start/stop control. TCXO is also available. Sensitivity is 10mV for sine waves, 30mV peak-to-peak for pulses. In period mode, you get 1 μ S resolution; 1nS by averaging. Selectable trigger level and switchable low-pass noise-rejection filter enhance your control. Large LED display reads directly in kHz or μ S.

MODEL 5801 520MHz Bench/Portable Frequency Counter...\$495.

Operating from optional rechargeable NiCd or C cell batteries, as well as AC line, this unit will meet most of your measurement requirements in the subaudio to UHF spectrum. The 5801 features direct reading in MHz for fast, error-free measurement over the frequency range of 10Hz to 520MHz, input sensitivity of 10mV (min), easy-to-read 0.43" 8-digit LED display, and external clock input capability at either 1 or 10MHz. Optional precision TCXO.

MODEL 5800...\$449.

This instrument has all the versatility of the 5801, without external clock input capability. A substantial economy for those with simpler needs.

MODEL 585 Portable 250MHz Frequency Counter...\$389.

This portable 8 digit, 250MHz Frequency Counter has a frequency range of 10Hz to 250MHz and an input sensitivity of 10mV (min). Features direct reading in Megahertz, switchable dual input impedance, and wide range attenuation. It's completely portable, powered by rechargeable NiCd battery or AC line. Optional precision TCXO is also available. The small package allows you to conveniently take it along.

Contact your Distributor or call: (800) 343-8150, (800) 892-0528 in Massachusetts.

*Prices U.S.A.

For demonstration circle #195
For additional information circle #133

 **DATA PRECISION**[®]
A DIVISION OF ANALOGIC CORPORATION

Data Precision Corporation, A Division of Analogic Corporation, Electronics Avenue, Danvers, MA 01923, (617) 246-1600, TELEX (0650) 921819. Visit us at Wescon, Booths 2306-2308-2310

Auto-ranging

POWER SOURCE

It Doesn't Cost More...

It Does More!

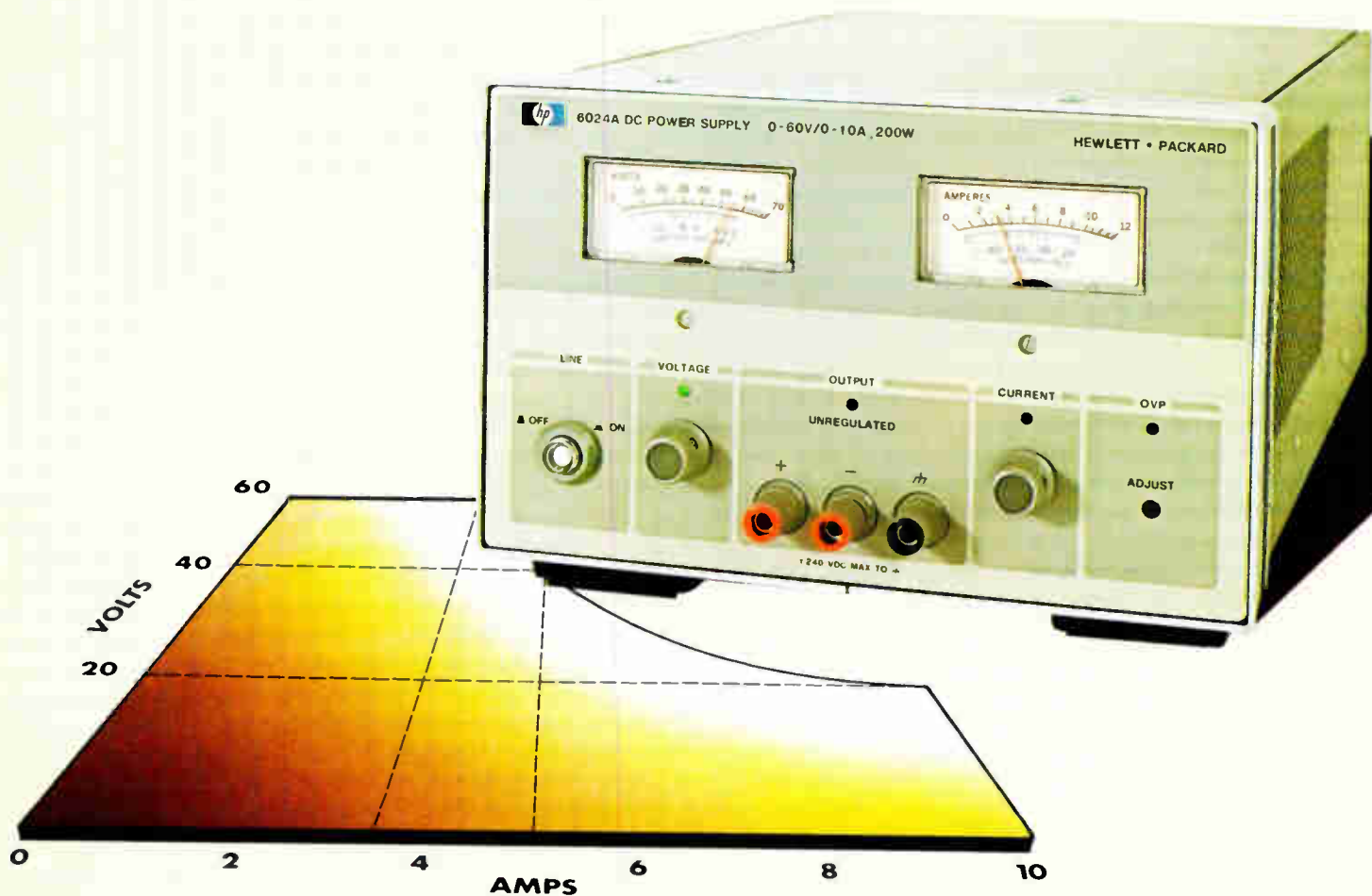

This autoranging supply uses high frequency switching technology to provide expanded capability in systems and laboratory applications.

Until now, you had to buy different power sources to satisfy your ever changing power requirements. Today, you have a better choice with the new HP AUTORANGING POWER SUPPLY. Autoranging provides you with continuous coverage — 200 watts from 0 to 60 volts at 0 to 10 amps — eliminating the need, cost and inconvenience of having many supplies. The circuitry, employing a switching regulator with state-of-the-art FET's, can be considered revolutionary. But what is more important is the versatility, high performance and features: 0.01% regulation; 3 mV rms/30 mV p-p noise; and status indicators for constant-voltage, constant-current and out-of-regulation conditions. All for only \$875 (domestic U.S.A. price only).

For more information on the many benefits of the 6024A Autoranging DC Power Supply, write to Hewlett-Packard, 1507 Page Mill Road, Palo Alto, CA. 94304. Or call the HP regional office nearest you: East (201) 265-5000, West (213) 970-7500, Midwest (312) 255-9800, South (404) 955-1500, Canada (416) 678-9430.



SYSTEM OPTION

Convenient system interfacing board allows complete remote control of output voltage and current — also provides isolated readback of supply status.



Autoranging Autoranging Autoranging Autoranging Autoranging Autoranging

gives a continuous range of voltage and current combinations

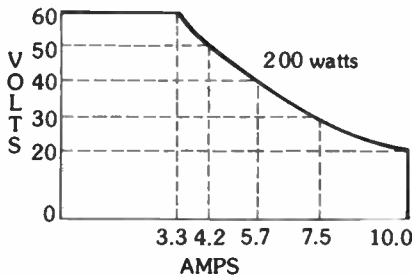

The HP 6024A Autoranging Power Supply provides maximum output power over a wide and continuous range of voltage and current combinations without having to manually select the proper output range. This feature, differs from conventional constant-voltage/constant-current power supplies which yield maximum output power at only one combination of output voltage and current. For example, an engineer would need a 20-volt 10-amp supply, a 40-volt 5-amp supply, and a 60-volt 3-amp supply to approximate the ranges available from the 6024A.

The HP 6024A is a convenient and cost-effective unit capable of satisfying many different dc requirements. Either in the lab or in a system, the consequent savings in space, interface complexity and equipment expense are significant.



21002

New products

Semiconductors

FET-input op amp slews at 120 V/ μ s

Unit has 1-MHz bandwidth, 100-MHz gain-bandwidth product, 20-ns rise time

The HA-5160 operational amplifier from Harris Corp.'s Semiconductor Products division offers input performance approaching that of the firm's chopper-stabilized HA-2905, but its dynamic specifications are more like those of the company's high-slew-rate and fast-settling operational amplifiers.

Using a new monolithic integrated circuit that combines a junction-field-effect-transistor input and dielectrically isolated bipolar transistors and employs on-chip laser trimming, the HA-5160 yields input characteristics like these:

- 2-pA typical offset current, 10 pA maximum.
- 20-pA typical bias current, 50 pA maximum.
- 1-mV typical offset voltage, 5 mV maximum.
- 10-to-20- μ V/ $^{\circ}$ C offset voltage drift.
- 10-T Ω input impedance.

All these specifications apply over a full operating temperature range of from -55° to $+125^{\circ}$ C.

The new op amp's 120-V/ μ s slew rate, 1-MHz full-power bandwidth, and 100-MHz gain-bandwidth product put it in a class with Harris's HA-2525 high-slew-rate device. Further, the 5160's 400-ns settling time (to 0.1%) is only somewhat less than 10 times that of Harris's HA-5195 fast-settling op amp; the 5160 has a typical rise time of 20 ns.

Thus the new device offers an offset voltage somewhat higher than on earlier high-performance units, but better input-current specifications and very good dynamic characteristics. And since input offset voltage can be trimmed to zero, there is little sting in this tradeoff.

Some of the 5160's input characteristics can be traced to the use of leakage-limiting dielectric isolation. This design feature also eliminates the phantom silicon controlled rectifiers sometimes caused by parasitic signals found in other monolithic op amps; consequently, Harris claims complete freedom from latchup for the 5160.

Satisfaction. Paul S. Smith, Harris's product line manager for linear products, calls the 5160 "the first FET-input op amp I have been really satisfied with" and adds that some of the techniques used to reach its levels of performance may be applied to the company's other bi-FET op amps, which combine bipolar transistors and FETs, in a future product improvement program.

He notes that the 5160's mix of specifications, plus its high gain of up to 150-kV/V input and its uncompensated closed-loop stability at gains of up to 10, suits it to a variety of applications in instruments, communications, process control, display terminals, and other areas.

According to Smith, there is no direct competition for the 5160. Though there are a number of JFET monolithic op amps available, the company's market research shows that the 5160 outslews potential competitors and may offer a higher gain or gain-bandwidth product; sometimes the difference is a factor of two or three.

Meanwhile, the 5160's input characteristics are at least comparable with those of other high-performance JFET op amps, and in many instances they are better.

Supply voltage may range from ± 10 to ± 20 v, and the unit dissipates about 225 mW. The typical power-supply-ripple rejection ratio is 86 dB.

The 5160 is offered in a variety of packages, including leadless chip-carriers, and in both commercial- and military-temperature-range models. It is manufactured in compliance with MIL-STD-883, class B.

Depending on quantity, package, and temperature range, the price ranges from \$4.98 to \$32.10. Limited production quantities are avail-

New products

able from stock in most package styles.

Harris Semiconductor Products, a division of the Harris Corp., P. O. Box 883, Melbourne, Fla. 32901. Phone (305) 724-7000 [411]

16-K E-PROM needs only one power supply

Only a single 5-v supply is required to run Motorola's new 16-K erasable programmable read-only memory, which is organized as 2 K by 8 bits. The series MCM2716 units have

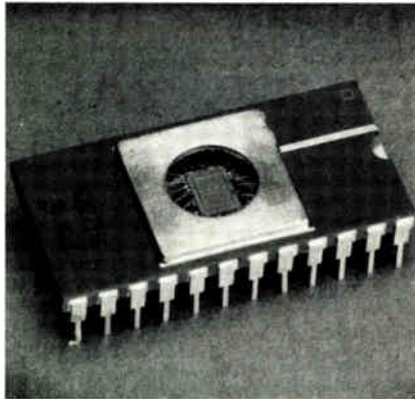

access times of 250, 350, or 450 ns. They come in standard- and low-power versions. Power dissipation in the former is from 50 to 70 mA—about half that of other 16-K E-PROMs. The E-PROM is available in a frit-sealed 24-pin, dual in-line package (C-suffix). In quantities of 100 or more, the versions in this type of package range in price from \$20.80 for the 100-mA, 450-ns MCM2716C to \$35.95 for the 70-mA, 250-ns MCM27L16C25. All parts are available from either factory or distributor's stock.

Motorola Semiconductor Products Inc., MOS Integrated Circuit Division, 3501 Ed Bluestein Blvd., Austin, Texas 78721. Phone David Ford at (512) 928-6660 [413]

Op amps combine p-MOS and bipolar transistors

The CA3193B, CA3193A, and CA3193 precision operational am-

plifiers employ both p-channel MOS and bipolar transistors on one chip to achieve a gain-bandwidth product of 1.2 MHz. The bi-MOS op amps are internally phase-compensated. Input voltage for the model B is 75 μ V maximum, 40 μ V typically, with a maximum temperature coefficient of 2 μ V/ $^{\circ}$ C. The noise at 0.1 to 10 Hz is typically 0.36 μ V peak to peak. The devices are all pin-compatible with the industry-standard 741 op amp and can serve as direct replacements for the 741 and as functional replacements for the 725, 108A, OP-5, OP-7, LM11, and LM714 op amps where nulling is not employed.

The CA3193 and CA3193A operate from supply voltages of \pm 3.5 to \pm 18 V, and the premium version, CA3193B, operates from \pm 22 V over the military temperature range of from -55° to 125° C. All the units are available in TO-5 packages in a variety of configurations. Depending on the model and packaging, they sell for between \$1.20 and \$4.75 apiece in 100-unit quantities.

RCA Solid State Division, Box 3200, Somerville, N. J. 08876. Phone (201) 685-6423 [414]

64 frequencies generated by programmable clock-pulse IC

The 8650 and 8651 programmable clock-pulse generator integrated circuits provide outputs at frequencies ranging from 0.0005 Hz to 60 kHz (one pulse every 33.3 minutes to one every 16.6 μ s) and from 0.00083 Hz to 100 kHz (one pulse every 26.5 minutes to one every 10 μ s). The 8650 has an output pulse frequency accuracy to within \pm 50 ppm, and the 8651 is accurate to within \pm 5 ppm. Every IC can generate 64 frequencies from the original frequency of its built-in crystal oscillator when programmed through a complementary-MOS divider. The operating current is less than 0.5 mA. Samples are from stock. The 8650s cost \$10 apiece; the 8651s, \$12.

Epson America Inc., 23844 Hawthorne Blvd., Torrance, Calif. 90505. [415]

- ALABAMA**
Hall-Mark Electronics Corp.
Huntsville
(205) 837-8700
- ARIZONA**
Cetec Moltronics
Phoenix
(602) 272-7951
Wyle Distribution Group
Phoenix
(602) 249-2232
- CALIFORNIA**
Cetec Moltronics
South Gate
(213) 773-8521
Kierulff Electronics
Los Angeles
(213) 725-0325
Wyle Distribution Group
El Segundo
(213) 322-8100
Cetec Moltronics
San Diego
(714) 278-5020
Kierulff Electronics
San Diego
(714) 278-2112
Wyle Distribution Group
San Diego
(714) 565-9171
Cetec Moltronics
San Jose
(408) 283-7373
Bell Industries
Sunnyvale
(408) 734-8570
Sterling Electronics
Santa Clara
(408) 727-7411
Wyle Distribution Group
Santa Clara
(408) 727-2500
Schweber Electronics
Irvine
(714) 556-3880
- COLORADO**
Newark Electronics
Denver
(303) 557-3351
Wyle Distribution Group
Commerce City
(303) 269-4631
- CONNECTICUT**
Connector Company
New Haven
(203) 624-0127
Wishire Electronics
Wallingford
(203) 265-3822
- FLORIDA**
Arrow Electronics
Palm Bay
(305) 725-1480
Kierulff Electronics
St. Petersburg
(813) 576-1966
Schweber Electronics
Hollywood
(315) 927-0511
- GEORGIA**
Arrow Electronics
Norcross
(404) 449-8252
- ILLINOIS**
Bell Industries
Chicago
(312) 982-9210
Newark Electronics
Chicago
(312) 638-4411
Ohm/Electronics, Inc.
Palatine
(312) 359-5500
Schweber Electronics
Elk Grove Village
(312) 364-3750
Klaus Radio, Inc.
Peoria
(309) 691-4840
- INDIANA**
Graham Electronic
Supply
Indianapolis
(317) 634-8202
Genesis Electronics
South Bend
(219) 267-2911
- KANSAS**
Wichita Aircraft
Wichita
(316) 838-1421
- MARYLAND**
Arrow Electronics
Baltimore
(301) 247-5200
Hall-Mark Electronics
Baltimore
(301) 796-9300
Pioneer Electronics
Gaithersburg
(301) 948-0710
- MASSACHUSETTS**
Kierulff Electronics
Billerica
(617) 935-5134
Schweber Electronics
Bedford
(617) 275-5100
Wishire Electronics
Burlington
(617) 272-8200
Industrial Components Corp.
N. Wiltbraham
(413) 596-3854
Gerber Electronics
Norwood
(617) 769-6000
- MICHIGAN**
RS Electronics
Livonia
(313) 525-1155
- MINNESOTA**
Arrow Electronics
Edina
(612) 830-1800
Nico Distribution Group
Minneapolis
(612) 331-6350
- MISSOURI**
Walters Radio Supply, Inc.
Kansas City
(816) 531-7015
Olive Industrial
Electronics, Inc.
St. Louis
(314) 426-4500
- NEW JERSEY**
Schweber Electronics
Fairfield
(201) 277-7880
Wishire Electronics
Clifton
(201) 340-1800
Radio Electric Service Co.
Pennsauken
(215) 925-6900
- NEW YORK**
Harvey Electronics, Inc.
Binghamton
(807) 748-8211
Genesee Radio
Parts Co., Inc.
Buffalo
(716) 673-9661
Summit Distributors
Buffalo
(716) 884-3450
Arrow Electronics
Farmingdale
(516) 694-6800
Progress Electronics Co.
Plainville
(516) 433-1700
Schweber Electronics
Westbury
(516) 334-7474
Simmons Electronics Corp.
Rochester
(716) 328-3230
- NORTH CAROLINA**
Arrow Electronics
Winston-Salem
(919) 725-8711
- OHIO**
Schuster Electric Co.
Cincinnati
(513) 489-1400
Pioneer Electronics
Cincinnati
(216) 587-3600
Schweber Electronics
Beachwood
(216) 464-2970
Pioneer Electronics
Oakton
(513) 236-9900
- OKLAHOMA**
Electro Enterprises
Oklahoma City
(415) 478-1752
- PENNSYLVANIA**
Almo Electronics Corp.
Philadelphia
(215) 698-4000
Pytronc Industrial, Inc.
Montgomeryville
(215) 643-2650
CAM/RPC Industries
Pittsburgh
(412) 782-3770
- TENNESSEE**
Electra Distribution Co.
Nashville
(615) 232-3971
- TEXAS**
Hamilton/Arnet
Electronics
Irving
(214) 659-4111
Sterling Electronics
Dallas
(214) 243-1600
Texas Instrument Supply Co.
Richardson
(214) 238-6821
Allied Electronics
Ft. Worth
(617) 336-5401
Sterling Electronics
Houston
(713) 627-9900
Hall-Mark Electronics
Dallas
(214) 234-7300
- UTAH**
Dipomat/Alta
Salt Lake City
(801) 486-4134
Standard Supply Co.
Salt Lake City
(801) 486-3371
- WASHINGTON**
Bell Industries
Bellevue
(206) 747-1515
Wyle Distribution Group
Seattle
(206) 453-6300
- WISCONSIN**
Electronic Expeditors, Inc.
Milwaukee
(414) 228-8100
- CANADA:**
Distributors in major cities

Coaxial switches. Every which way.

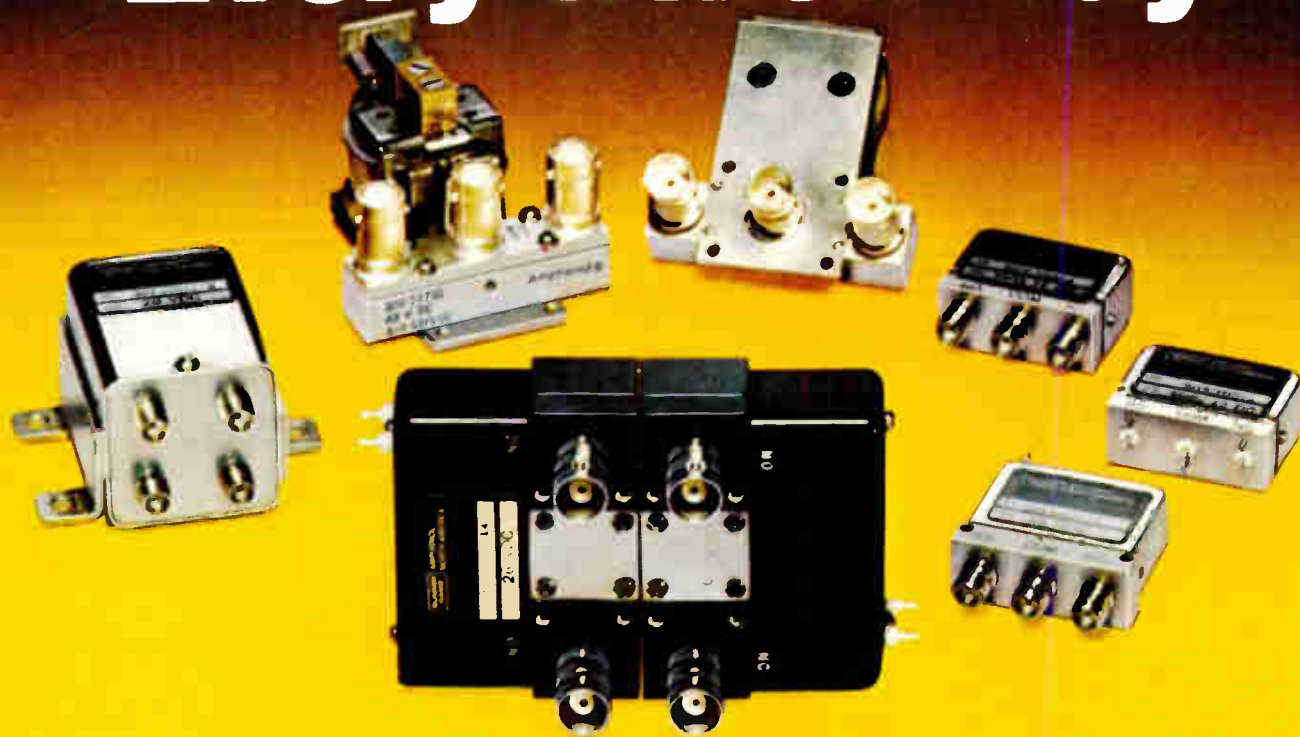

There's an Amphenol® switch that's right for you. Our frequency range is 0-18 GHz.

Whatever you're doing in communications, instrumentation, test equipment, or EDP switching, there's an Amphenol coaxial switch with the performance, the size, and the connector you want.

Which switch is right for you? If it's for remote 1P2T/2P2T operation, at frequencies up to 6.0 GHz, pick our DYNAFORM® 360 Series (shown above, foreground). BNC, TNC, or N connectors.

For broadband miniature switches, there's nothing better than the 303 Series. Included in this family is part number 303-10100-3, providing isolation of 100 dB at 18 GHz and supplied with our own SMA connectors. There's more, much more: multi-position, transfer, circuit insertion, high-power, hermetically sealed and remote and manual circular switches.

And whichever switch you order, you get Amphenol quality to depend on. Plus a delivery schedule that suits your schedule. For more information, call the sales office or distributor nearest you.



Miniature 303 Series
Shown 2/3 actual size

See us at
FOC/80
San Francisco,
9/16-18 Booths 78-79



AMPHENOL NORTH AMERICA

A Division of Bunker Ramo Corporation

Amphenol North America Division Headquarters: Oak Brook, Illinois 60521

Sales Offices: Atlanta (404) 394-6298 • Boston (617) 475-7055 • Chicago (312) 986-2330 • Dallas (214) 343-8420 • Dayton (513) 294-0461
Denver (303) 752-4114 • Greensboro (919) 292-9273 • Houston (713) 444-4096 • Indianapolis (317) 842-3245 • Kansas City (816) 737-3937
Knoxville (615) 690-6765 • Los Angeles (213) 649-5015 • Minneapolis (612) 835-4595 • New York (516) 364-2270 • Orlando (305) 647-5504
Philadelphia (215) 732-1427 • Phoenix (602) 265-3227 • St. Louis (314) 569-2277 • San Diego (714) 272-5451 • San Francisco (408) 732-8990
Seattle (206) 455-2525 • Syracuse (315) 455-5786 • Washington, DC (703) 524-8700

Canada: Montreal (514) 482-5520 • Toronto (416) 291-4401 • Vancouver (604) 278-7636 • International: Oak Brook, Illinois TELEX 206-054

Circle 199 on reader service card

Packaging & production

Production testers emulate disks

Electronic simulation replaces electromechanical standard head-disk interface

Production testing in much of today's high-technology industry demands just as much accuracy and sensitivity as in any laboratory. Thus, the disk-manufacturing facility and disk user's facility both need to calibrate the factory's media-related test equipment. Most commonly, a reference that characterizes the standard head-disk interface is generated. However, the electromechanical nature of such a standard introduces drift uncertainties. That's where a development from Media Test Associates comes in.

The model 550 signal simulator reproduces the standard head-disk interface response electronically, and with much more control over the variables. It simulates such events as an extra bit, negative modulation (a missing bit), or positive modulation.

These events, in turn, simulate defects in the disk like thin or thick coating, substrate gouges, and errors in the modulation of the coating jet spray. The length of the events are switch-programmable from 0 to 999 bits, with a resolution of 1 bit. The modulation range for missing pulses is from 25% to 90% of the average track amplitude, and positive modulation ranges from 100% to 150% of the average track amplitude. An extra pulse may be selected to have a base-to-peak amplitude of from 0.1 to 0.6 v.

Hard or floppy disks. The simulator can be used for both hard- and floppy-disk equipment, since it has a working frequency range of from 100 kHz to 6.4 MHz. This corresponds to a data transfer rate of 25 kilobytes/second, which is usable for floppy-disk equipment, to 1.6-mega-byte/second, which is characteristic of advanced hard-disk equipment. The user can specify from one (which is standard) up to an optional five crystal-controlled frequencies that can be internally generated by the simulator. An external signal generator may also serve as a frequency source.

Two outputs are provided. The first is a single-ended, 50- Ω output, and the second is a balanced, 50- Ω

differential output. The amplitude of the first output can be varied from 0 to 1.0 v peak to peak; the amplitude of the second ranges from 0.0 to 2.0 v p-p. Delays from either output can be varied from 0 to 100 μ s.

Modulation events are generated only after a trigger pulse is created either internally (in the free-running mode) or externally by the application of a TTL-level signal. The triggering slope may be selected as positive-going, negative-going, or both.

The price of the model 550 varies from \$3,950 to \$4,450, depending on the number of optional frequencies selected (\$50 each) and whether the optional termination module (\$250) is included. (The termination module interfaces the model 550 directly with the user's preamplifier and allows it to be connected directly into the head connector receptacle on the user's system.)

Media Test Specialists Inc., 761 Mabury Rd., Bldg. 14, San Jose, Calif. 95113. Phone (408) 295-8840 [391]

Tungsten probe tips have 5-mil diameters

Because the tungsten points of the model CW-100 Catwhisker probe tips have a radius of 0.2 μ m, they can test very large-scale integrated wafers and chips. The electrolytically etched tungsten point is shaped like an S spring and is 5 mils in diameter. Continuous reduction in shank diameter from tip to loop provides a spring action that protects the tip in normal usage. The Catwhisker probe is welded to the end of a 20-mil-diameter Dumet wire that is 1.375 in. long. The wire, made of a copper sheath welded to a nickel-iron core, is securely fastened to the

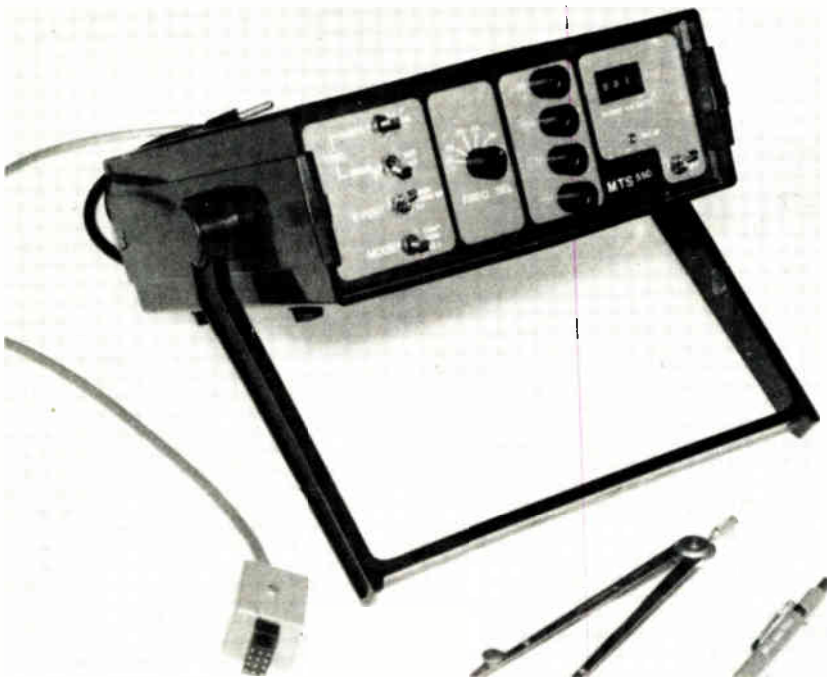

Think system. Grow systematically. HP-85.



A COMPLETE COMPUTING SYSTEM

Encapsulated in a mere 20 lb. package, is a complete computing system. Keyboard, tape unit, CRT with alphanumerics and integrated graphics, printer and read/write memory—all ready for instant use. Just turn it on. That's all. Its language is powerful HP BASIC. The HP-85 is simple to use. Extremely effective. Highly productive. In brief, very professional.

"INSTANT INTERFACE" FOR EASY GROWTH

Now the HP-85 can be configured even further to accommodate your increasing demands. Instantly. Just plug in the HP interface bus and handle up to 14 peripherals or instruments. There's no need to write special operating programs. HP's peripheral ROM's do it for you. Options available now include flexible disc drives, additional read/write memory, graphics plotter, full-width printer, many software Application Pacs. More options are under development. Indeed, Hewlett-Packard is committed to providing solutions that meet your varied and changing needs.

ONLY FROM HEWLETT-PACKARD

There is no comparable computing system in the marketplace that offers you this combination of power, sophisticated growth potential, software, lightweight portability, convenience and ease-of-use. In addition, HP maintains service facilities throughout the world. On-site service, if you wish. For details and address of nearest dealer, CALL TOLL-FREE 800-547-3400, Department 214G; except Hawaii/Alaska. In Oregon, call 758-1010. Or write Hewlett-Packard, 1000 N. E. Circle Blvd., Corvallis, OR 97330, Dept. 214G.

610/16

The Personal Computer For Professionals: HP-85 specifications: Memory—16K RAM expands to 32K, 32K ROM expands to 80K; CRT—32 chars./line, 16 lines; graphics—256 X 192 dots; thermal printer—2 lines/sec.; magnetic cartridge capacity—200K; I/O—HP-IB (IEEE 488), RS-232, 16-bit GP-IO, BCD; Application Pacs include Statistics & Regression Analysis, Finance, Math, Linear Programming, Text Editing, Waveform Analysis, Circuit Analysis, BASIC Training, & Games.

 **HEWLETT
PACKARD**

Circle 201 on reader service card

New products

probe arm. In quantities of 1 to 49, the probe sells for \$5 each; for 50 or more, it sells for \$4.50 apiece. Delivery takes one week from receipt of order.

Alessi Industries, 3195 Airport Loop Dr., Building C, Costa Mesa, Calif. 92626. Phone (714) 979-8912 [393]

Sonic-beam tester measures wafer flatness in 10 s

The Flatgage test instrument uses a high-resolution sonic technique to measure wafer flatness in as little as 10 seconds, offering a resolution of $\pm 0.1 \mu\text{m}$. It performs 32 individual measurements on the surface of the wafer every $\frac{1}{4}$ in. For every 100-mm (4-in.) wafer, the Flatgage takes 5,760 measurements, averages them, compiles them into 180 data points, and stores them in system memory. The sonic beam allows the tester to measure the wafer without contact regardless of its optical or electrical



properties.

The fully automated system has an optional cassette-to-cassette handling and sorting subsystem that virtually eliminates operator intervention. The wafer's flatness can be displayed digitally and graphically on a cathode-ray-tube screen.

The basic tester sells for \$65,000. Delivery will start in the fourth quarter of the year.

Tencor Instruments, 2426 Charleston Rd., Mountain View, Calif. 94043. Phone (415) 969-6767 [394]

8-slot Multibus chassis includes quad power supply

The ZX-660 8-slot Multibus chassis from Zendex is designed to be a direct form, fit, and function replacement for the Intel SBC-660. The ZX-660 features a four-output supply with 30 A available from the +5-V source. It also has NSC BLC-604/614 cardcase backplanes. Cooling is provided by fans.

The cardcase and supply may be reversed for front access to the cards, and the top and back panels can also be quickly removed. In quantities of one to nine, the ZX-660 sells for \$1,929 and is available immediately.

Zendex Corp., 6398 Dougherty Rd., Dublin, Calif. 94566. Phone Rick Main at (415) 829-1328 [395]

Conductive silicone rubber replaces metal in contacts

The series 300 and 400 contacts, made of conductive silicone rubber, can replace metal units. The devices are designed for such applications as watches, toys, calculators, and portable electronic equipment. Depending on the model, the devices have a contact-current rating of 5 or 500 mA and a contact resistance of from 100 to 1,000 or 0.5 to 5 Ω . The resistivity of the insulation used is $10^{14} \Omega\text{-cm}$. The devices have a mechanical life of 1 million cycles and a contact bounce of less than 5 ms. The operating temperature is from -40° to $+100^\circ\text{C}$. The contacts

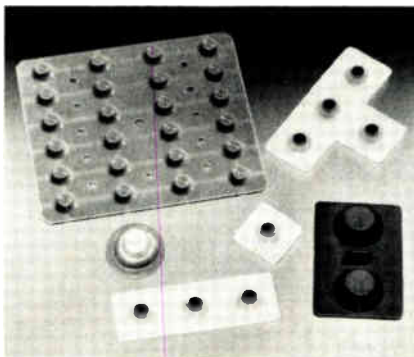

sell for from 10¢ to 20¢ each in quantities of 2,500.

Tecknit, 129 Dermody St., Cranford, N. J. 07016. Phone R. Ventimiglia at (201) 272-5500 [396]

Gauging plunger measures holes in less than 2 s

In less than 2 s the Zi-Check gauging plunger accurately measures the diameter of small punched, drilled, or reamed holes with an accuracy of within ± 0.0003 in. Useful for inspecting printed-circuit boards, as



well as electronic connectors and injection nozzles, it comes with English or metric dials and can check diameters from 0.010 to 0.330 in., or 0.25 to 8.35 mm. The price starts at \$145. Delivery is from stock.

Zi-Tech Division/Aikenwood Corp., 2151 Park Blvd., P. O. Box 26, Palo Alto, Calif. 94302. Phone Jeff Ziman at (415) 326-2151 [397]

Machine tapes component leads at 15,000/h rate

The model 2315 taping machine packages axial-lead circuit-board components for automatic board insertion at a rate of 15,000/h. The machine automatically trims and straightens leads, positioning components on double strands of pressure-sensitive tape that sandwiches the ends of the trimmed leads. Pricing starts at less than \$9,000.

Universal Instruments Corp., Kirkwood Industrial Park, Box 825, Binghamton, N. Y. 13902. Phone (607) 772-7522 [398]

THE ONLY PROGRAMMABLE FUNCTION GENERATOR THAT REALLY LEARNS

We call it The Teacher's Pet.

Intelligence... it distinguishes Krohn-Hite's new Model 5900 micro-processor-based programmable function generator from the other instruments in its class — that's why we call it The Teacher's Pet.

The Auto-programmer and Storage Registers give the 5900 autonomy. With or without a system controller, it can learn and execute entire routines (over 300 program steps), freeing your controller for other ATE tasks. Nine Storage Registers hold generator parameters, and a key-stroke command, or an order from the system controller, retrieves the information rapidly.

The Teacher's Pet earns a gold star in arithmetic and in auto increment and decrement functions. It provides precise linear sweeps over a 10,000:1 range, log sweeps over the entire instrument range, and nested loops which can intermix log and lin-

ear sweeps; it can operate on frequency, period, pulse widths, duty cycle, amplitude, DC offset, and burst cycle count. Over the frequency range of 100 μ Hz to 5MHz, the 5900 produces sine, square, triangle, pulse, and sawtooth waveforms. Modes include continuous, gated, triggered, digital lin/log sweep, and triggered burst.

You be the teacher. Call 617-580-1660 for a free demonstration of the 5900. Try your program on the 5900 and experience the only function generator that REALLY LEARNS. You'll agree The Teacher's Pet is the smartest one on the GPIB bus.

Krohn-Hite... Benchmark of Value in Programmable Function Generators

KH KROHN-HITE CORPORATION

Avon Industrial Park, Avon, MA 02322
(617) 580-1660 TWX 710 345 0831

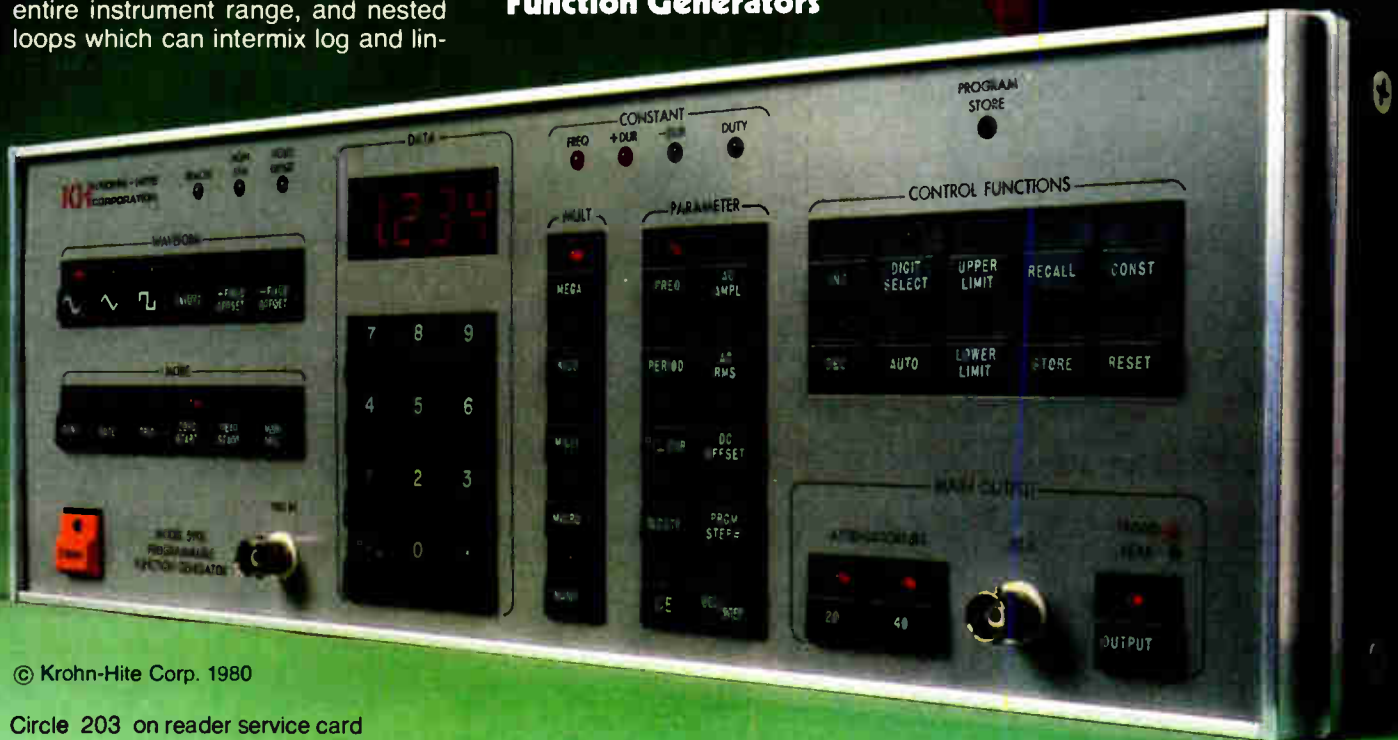

© Krohn-Hite Corp. 1980

Circle 203 on reader service card

AL, Huntsville (205)534-9771; AZ, Phoenix (602)279-1531; CA, Inglewood (213)874-8850, San Jose (408)292-3220; CO, Denver (303)773-1218; CT, Canton Center (203)693-0719; FL, Orlando (305)859-7450, Sunrise (305)742-2115; GA, Atlanta (404)455-1206; HI, Honolulu (808)941-1574; IL, Chicago (312)283-0713; IN, Carmel (317)844-0114; KS, Overland Park (913)649-8996; LA, Gretna (504)367-3975; MD, Towson (301)321-1411; MA, Chelmsford (617)256-9061; MI, Detroit (313)961-3042; MN, Minneapolis (612)635-4818; MO, St. Louis (314)569-1406; NM, Albuquerque (505)255-2330; NJ, Cherry Hill (609)482-0058, Englewood (201)871-3918; NY, Rochester (716)473-5720, Saratoga Springs (518)584-6519, Syracuse (315)437-8666; NC, Burlington (919)227-3639; OH, Chesterland (216)729-2222, Dayton (513)294-2476; OK, Jenks (918)299-2636; OR, Portland (503)297-2248; PA, Pittsburgh (412)261-2804; SC, Greenville (803)271-8543; TX, Dallas (214)661-0400, Houston (713)688-1431; UT, Salt Lake City (801)466-8729; VA, Falls Church (703)573-8787; WA, Bellevue (206)454-3400; WI, Milwaukee (414)545-8400; CANADA, Montreal, Quebec (514)744-5829, Ottawa, Ontario (613)725-1931, Toronto, Ontario (416)825-0600, Calgary, Alberta (403)278-7567.

THE NEW DIMENSION

Drop by the KYLEX Wescon suite for a look at the latest in dot matrix liquid crystal display systems. KYLEX manufactures the world's most advanced integrated flat screen display system, with direct I/O port interface capability. A whole new dimension in size, in low power drain, in low cost, in simple electronic interface.

See it for yourself at the Quality Inn in Anaheim during Wescon. Sept. 16-18, from 5-9 each evening. In the Groh Associates suite.

KYLEX

THE NEW DIMENSION IN FLAT SCREEN DISPLAYS
420 Bernardo Ave., Mt. View, CA 94043 (415) 969-5200

An affiliate of **EXON** ENTERPRISES INC.



Kylex at WESCON: See us at Quality Inn ■

For Wires
printers

Seitz

Seitz, c'est sûr !

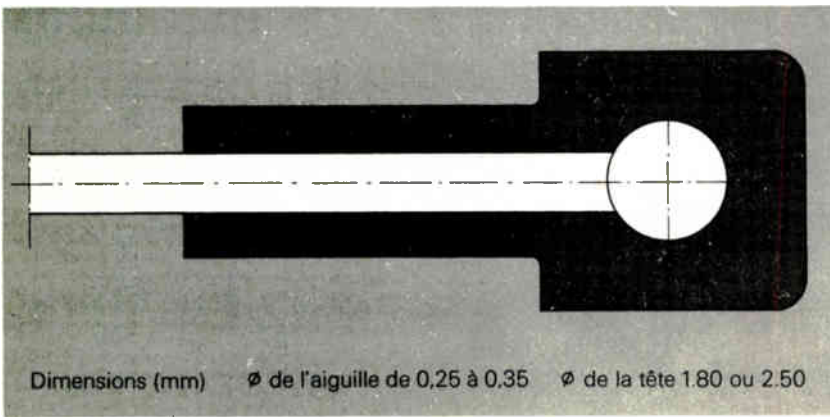
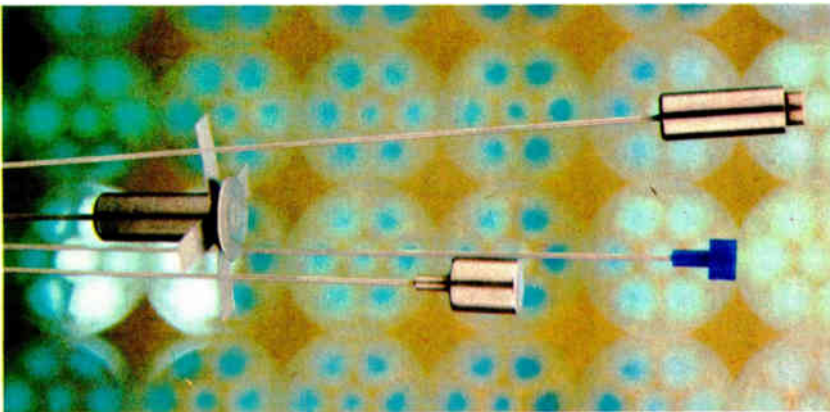

Dimensions (mm) \varnothing de l'aiguille de 0,25 à 0,35 \varnothing de la tête 1,80 ou 2,50

Seitz technology

Seitz experience in the machining of hard materials has contributed to the realization of wires enabling to print characters of a perfect quality.

The materials used for these wires are extremely hard. They make it possible to obtain a highly polished surface and a great precision. They are resistant to wear (less than 0.1mm per 30,000,000 characters), to chemical agents and heat. Seitz research and developing departments co-operate closely with the manufacturers of printing heads.

The booklet «Wires for printers and their guides» will give you detailed information.



Pierres Holding, Faubourg du Lac 6, CH - 2501 Bienne
Téléphone 032 / 22 65 11, Télex 34 566

Seitz SA, CH-2416 Les Brenets, Tél. 039/32 1112, Télex CH 35 505 SEITZ

Circle 205 on reader service card

MOTOR-ANALYSIS SYSTEM

with

NEW 3-WAY READOUT



FRICTIONLESS DYNAMOMETER
Power-absorption dynamometers utilize friction-free hysteresis brakes for longest life, precise repeatability, smooth torque application independent of speed. Models from 2.50 oz.in. to 200 lb.in., with English, metric, or SI calibration.

ALL-NEW INTERCHANGEABLE READOUT
Simultaneously and continuously displays speed, torque, and horsepower, with display hold for operator convenience. Simple plug-in operation, virtually error-proof.

All dynamometers and readouts offer many exclusive features and capabilities. Request information today.

see our catalog in
THE CAT
or call us toll-free at
800-828-7844
(except New York State)



MAGTROL, INC.

70 GARDENVILLE PARKWAY WEST BUFFALO, NEW YORK 14224 716-668-5555

Circle 206 on reader service card

7 Major Routes to Reliability, Provided by the RAC

- **System Reliability and Maintainability Consulting Services**
- **Customized Data Searches**
- **Semiconductor Device Reliability Databooks**
 - Digital Data
 - Linear/Interface Data
 - Memory/LSI Data
 - Hybrid Circuit Data
 - Transistor/Diode Data
- **Reliable Equipment Design Guidelines**
 - Design Reliability Handbook
 - Microcircuit Reliability Bibliography
- **Tutorial Reliability Courses**
- **Annual Electrostatic Discharge Symposium**
- **Periodic Reliability Seminars**



Reliability Analysis Center
RADC/RBRAC, Griffiss AFB, NY 13441

Phone 315-330-4151, Autovon 587-4151

*RAC is a DoD Information Analysis Center
Operated by IIT Research Institute*

Circle 134 on reader service card

Data Communications Books.

McGraw-Hill's Compilation of Data Communications Standards

Presents all 89 user-relevant data communications standards promulgated by CCITT, ISO, ANSI, EIA, and U.S. FTSC. Also includes descriptions of the standards organizations, plus relational charts of similar interfacing standards produced by different groups. Edited by Harold C. Folts and Harry R. Karp. 1133 pp., clothbound, \$165.

Data Communications Procurement Manual

The most authoritative and current information you need to turn data communications procurement into a smoothly running, cost-effective operation. Includes sample solicitation clauses and forms, specification checklists on 38 devices, and 8 useful appendixes. By Gilbert Held. 150 pp., clothbound, \$24.50

Practical Applications of Data Communications: A User's Guide

Articles from Data Communications magazine cover architecture and protocols, data-link performance, distributed data processing, software, data security, testing and diagnostics, communication processors, and digitized-voice and data-plus-voice. 424 pp., paperback, \$13.95



Basics of Data Communications

This compilation of essential articles from Data Communications magazine includes chapters on terminals, acoustic couplers and modems, communications processors, networking, channel performance, data-link controls, network diagnostics, interfaces, and regulations and policy. 303 pp., paperback, \$12.95

Order today, using this coupon!

Electronics Magazine Books
P. O. Box 669
Hightstown, NJ 08520
Tel. (609) 448-1700, ext. 5494

Please send me...

- ___ copies of *Data Communications Standards* @ \$165.
- ___ copies of *Data Communications Procurement Manual* @ \$24.50
- ___ copies of *Practical Applications of Data Communications* @ \$13.95
- ___ copies of *Basics of Data Communications* @ \$12.95

Payment enclosed (payment must accompany orders under \$25) Bill me Bill my company Ten-day money-back guarantee applies on all books. EL



Name _____ Title _____

Company _____

Street/P.O. address _____

City/state/zip _____

Our special designs... for your special designs.



Special Precision Potentiometers

Our customers have discovered that Spectrol's special designs often help make their special designs superior. If you have applications for unique potentiometers, here's why you should consult Spectrol: 25 years experience making both standard and special potentiometers... a strong applications engineering department... expertise in all technologies, wirewound, cermet, and conductive plastic... worldwide design and manufacturing facilities, backed up by UTC, one of the world's largest international companies. Let us quote your special designs - non-linear, sine-cosine, sectors, and linear position models. Let us help you meet "impossible" environmental operating conditions. Start with your local Spectrol representative, or call our applications engineering manager today.

Spectrol

SPECTROL ELECTRONICS GROUP

UNITED STATES Spectrol Electronics Corporation P.O. Box 1220, City of Industry, Calif. 91749, U.S.A. • (213) 964-6565 • TWX (910) 584-1314

UNITED KINGDOM Spectrol Reliance Ltd. Drakes Way, Swindon, Wiltshire, England • Swindon 21351 • TELEX: 44692

ITALY SP Elettronica SpA Via Carlo Pisacane 7, 20016 Pero (Milan) Italy • 35 30 241 • TELEX: 330091

GERMANY Spectrol Electronics GmbH Oberauerstrasse 15, 8000 Munich 70 West Germany • (089) 7145096 • TELEX: 52/3014

PUERTO RICO Spectrol Caribe Corporation Las Marias Industrial Park, Anasco, Puerto Rico • (809) 826-3012 • TELEX SCC PR 3452012

Circle 207 on reader service card

Data acquisition

Series of cards termed universal

Variety of functions

fit broad range of

computer-sensor needs

Computer Products Inc. is offering a new series of universal analog-input cards for use with its RTP line of data-acquisition and -control systems. Though universal may be a strong term, the new RTP7436 analog-to-digital converter and gate cards come in enough variety that, in combination, they should fit between computer and sensor in a wide range of applications.

One of the firm's gate cards and one converter card, for example, provide the user with analog measurement capability, while optional programmable gain stages in both card types allow them to accommodate both low- and high-level signals from such sensors as thermocouples, resistance temperature transducers,

pressure transducers, strain gauges, flow meters, and thermistors.

That's the least. But one gate and one converter card are a minimal configuration. The RTP7436 series allows users to insert several gate cards in front of a converter card, with their number limited only by converter throughput and the number of connectors in the controller. The maximum is 15 gate cards in the company's RTP7431 universal controller and 7 in its RTP7320 universal Procom II microprocessor-based controller. For larger applications, eight RTP controllers can be linked on a single parallel bus. Coordination of gating and conversion—timing, triggering, and so on—is supplied by the rack-mount controllers. Among the new cards are:

- A 12-bit successive-approximation a-d converter card capable of 25,000 samples per second, the /20, at \$630.
- A similar 12-bit converter capable of 50,000 samples/second, the /21, at \$1,575.
- A 14-bit successive-approximation converter card that samples at up to 38,000 Hz, the /22, at \$910.

Each converter is available with four programmable gain ranges (± 1.28 v to ± 10.24 v), a choice of

unipolar or bipolar output formats, and programmable single-ended or differential inputs. Typically there will be one such single-input converter card for each controller rack.

The gate in the middle. Between the a-d converters and the sensors are gate cards to select the sensor input to be converted. Here the user has a choice of six solid-state, fast-switching gate cards or two slower, relay-based gate cards. The solid-state gate cards have a variety of characteristics:

- The /40 offers a choice of 8 differential or 16 single-ended inputs under program control and a maximum sensor-to-sensor switching rate of 38,000 Hz. The price is \$180.
- The /41 has eight differential inputs only, samples at 200 Hz, and includes an 11-Hz single-pole, low-pass input filter. Its price is \$210.
- The /42 is identical to the /41 but uses a 7-Hz double-pole, low-pass filter to roll off high-frequency noise. The price is \$240.
- The /43 is similar to the /40 but samples at up to 50,000 Hz and lacks input filtering. The price is \$220.
- The /44 has eight differential inputs, a 750-Hz sampling rate, and an 11-Hz single-pole, low-pass filter. It costs \$270.
- The /45 is similar to the /44 but has a 7-Hz double-pole, low-pass filter. The price is \$300.

There are two relay-based gate cards: the /30 at \$425 has four differential inputs, programmable gain, a 3.3-Hz single-pole, low-pass filter and a 12.5-Hz sampling rate; its companion, the /31, is similar but has eight differential inputs and costs \$730.

All for flexibility. This combination of gate and converter cards allows considerable applications flexibility. Add to this the capability of the RTP universal controllers to interface with more than 25 different mini- and micro-computers and the system's versatility becomes apparent. In addition, there are 8- and 16-bit digital input cards, a variety of analog and digital output cards, multichannel a-d converter cards, and other cards for special purposes such as communications, memory,

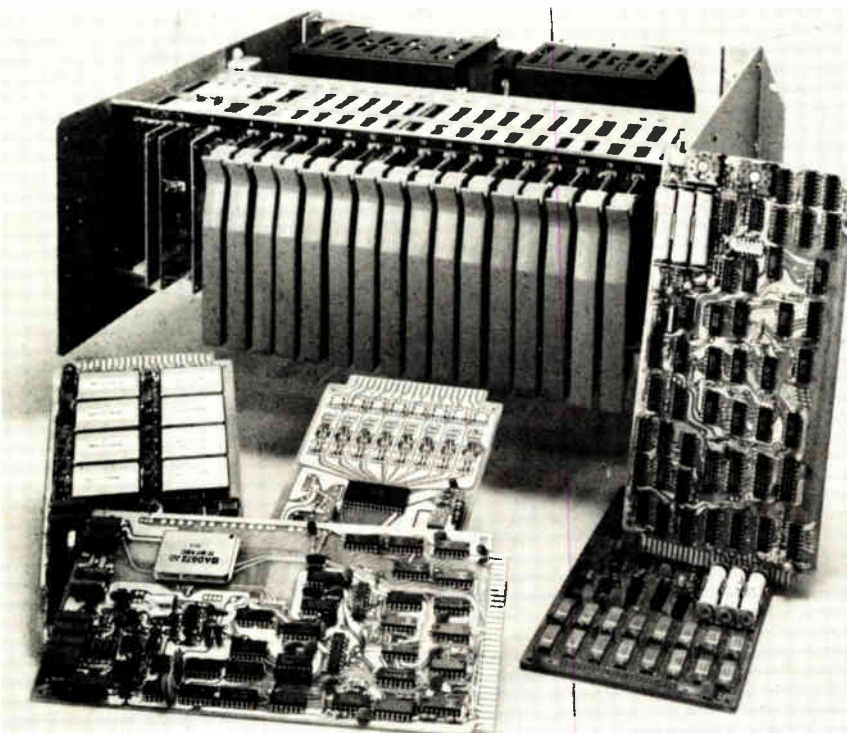

**Introducing
GenRad's 1731
A/D, D/A tester.**

**And how to turn
it into a complete
linear IC
test system.**

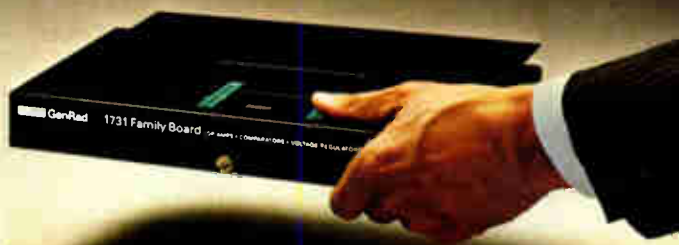

GenRad's 1731 is one linear IC test system you simply won't outgrow. You can start with the model for A/D, D/A testing. Though it's a benchtop tester, it gives you plenty of big system capabilities. Like microprocessor control for high throughput and easy, fill-in-the-blanks programming. You also get summary sheets, binning, and parametric measurement displays.

And unlike other A/D, D/A testers, GenRad's 1731 has both A/D and D/A capabilities on a single family board, so you don't have to constantly swap boards to run your tests.

But GenRad's 1731 doesn't stop there. Just by adding a second family board, you can upgrade it to test op amps, comparators, voltage regulators, voltage followers, and current mirror amplifiers.

And that makes GenRad's 1731 the most complete linear benchtop tester you can buy.

The 1731 comes with GenRad's worldwide service capabilities behind it, including local application support, handler interface expertise, and a free program library.

If you need an A/D, D/A tester with room to grow, call toll-free 1-800-343-4470. (In Mass. call 617-890-4900.) Or write: GenRad, Concord, MA 01742.



GenRad

Put our leadership to the test.

Circle 209 on reader service card

New products

interrupt, and counter applications.

Delivery of cards in the RTP7436 series takes about 120 days.

Computer Products Inc., 1400 N.W. 70th St., Fort. Lauderdale, Fla. 33307. Phone (305) 974-5500 [381]

Low-noise isolation amp works over 10-kHz bandwidth

The model IA297 isolation amplifier features both low noise and high input/output isolation over a bandwidth of 10 kHz. The amplifier operates at common-mode voltages of up to 5,000 v dc continuous. The common-mode rejection ratio is 170 dB from a balanced source impedance; with an unbalanced source, it is 160 dB. An instrumentation input provides approximately 120 dB of CMRR, but this is increased by an additional 60 dB by allowing the user to drive the amplifier shield by an active source within the unit.

The input voltage noise is held to 1.0 μ V over the bandwidth from 10 Hz to 10 kHz and current noise to 10 pA from 0.5 Hz to 1 kHz root mean square. In quantities of 1 to 9, the IA297 is priced at \$225. Delivery is from stock to six weeks.

Intronics, 57 Chapel St., Newton, Mass. 02158. Phone (617) 332-6835 [383]

Three boards expand channel capacity of analog inputs

Both hardware- and software-compatible with Digital Equipment Corp.'s LSI-11 dual-height Q-bus backplane, three dual-height expander boards increase the channel capacity of the DT2760 series of analog input systems. A single expander card can extend a 10-channel system to one with a 64-channel capability.

The model DT2772 dual-height single-board expander extends the DT2762 and DT2764 analog interface boards to factory-configured 64 single-ended (SE) or 32 differential input (DI) analog input channels. The DT2762 accepts full-scale in-

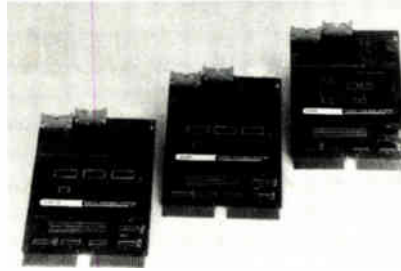

puts of ± 5 , ± 10 , or 0 to 5 v.

The model DT2775 extends the DT2765 flying-capacitor-isolated, low-level and wide-range analog interface board in increments of eight differential input channels per expander board.

In quantities of 1 to 9, the prices are broken down thus: the DT2772 sells for \$225 for 32 SE or 16 DI channels and for \$350 for 64 SE or 32 DI channels; the DT2774 with 64 SE or 32 DI channels is \$350; and the DT2775 expander is \$445 for 8 isolated DI channels. Delivery takes five days upon receipt of order.

Data Translation Inc., 4 Strathmore Rd., Natick, Mass. 01760. [385]

Digital-to-synchro unit has $\pm 0.05\%$ transformation ratio

With an accuracy of to within ± 4 minutes, the DSC5116 digital-to-synchro converter is pin-programmable for either 16- or 14-bit resolution with a $\pm 0.05\%$ transformation ratio. The device eliminates the need for a +5-v power supply and is useful for such applications as plan position indicators and radar display systems, for testing other synchro converters, and for optical alignment. With an output of 2 VA, it can directly drive control transformer loads from a power supply of ± 15 v. Its output is compatible with any three-wire synchro or four-wire resolver. The reference input can be either 26 v root mean square or 115 v rms at 60 or 400 Hz. Pricing starts at \$495 for orders of up to nine units. Delivery is from stock to 10 weeks.

Natel Engineering Inc., 8954 Mason Ave., Canoga Park, Calif. 91306. [384]

Plug-in card has four independent amplifiers

Selling for less than \$125 per channel, the model 540 is a single plug-in card that incorporates four independent direct-coupled differential amplifiers with optional strain-gage signal conditioning. It is designed as the front end in data-logging or data-acquisition and other systems where signal conditioning is required.

Common-mode rejection is 110 dB from dc to 60 Hz with 350- Ω unbalance; the operating common-mode voltage is ± 10 v including signal,

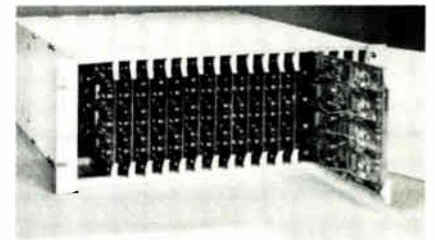

and overload is ± 50 v continuous without damage. The full power bandwidth is dc to 20 kHz, and the frequency response is dc to 80 kHz ± 3 dB. Delivery takes 60 days.

Ectron Corp., 8159 Engineer Rd., San Diego, Calif. 92111. Phone (714) 278-0600 [386]

12-bit d-a converter is fully compensated

The D/A 4000 is a 12-bit thin-film digital-to-analog converter that is fully compensated. Operating over the temperature range of -55° to $+85^\circ$ C and compatible with emitter-coupled logic, the device settles in 40 ns to within 1%. It contains an R-2R ladder network that is laser-trimmed to ensure optimum performance. The hybrid unit is housed with its own internal reference in a 24-pin hermetic dual in-line package. It can be screened to MIL-STD-883/B. In quantities of 1 to 49, it sells for \$215. Delivery time is two weeks.

HyComp Inc., 146 Main St., Box 250, Maynard, Mass. 01754. Phone (617) 897-4578 [387]



Component Software for Microprocessors: Newest way to cut software costs. From Texas Instruments.

At a fraction of what they would cost you to write, TI's new Component Software Series provides a library of statements common to most programs. You select only those functions you need, then combine them with the unique software for your application. Result: your savings can be more than two-thirds the cost of writing a typical application program.

The "software bus"

TI's Realtime Executive, the interface for the Component Software, serves, in effect, as a software bus. For less than 6K bytes, it handles the executive functions such as system initialization, concurrent process synchronization (multiprogramming), interprocess communication, interrupt linkage, memory management, and priority scheduling.

File Manager Software

The File Manager package operates with the software bus to perform file

management functions like: read/write to a floppy diskette. Install formatted volume. Open/close/read/write files. Random access to files. Rewind/forward, backspace to files.

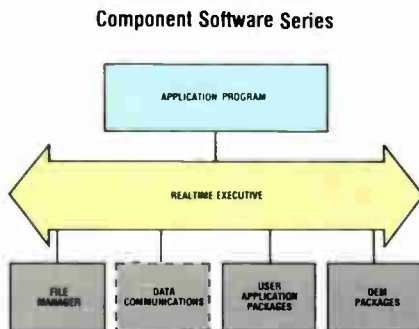

Customization capability

The Component Software Series includes source code in Pascal for unique customization of each package. The ob-

ject code is language independent, allowing execution of programs written in 9900 assembly, Microprocessor Pascal, or Power Basic. Once selection and customization are complete, your application program can even be ROM resident.

Available today, more to come

The Realtime Executive (TMSW330R) and the File Manager (TMSW340F) are available now at \$915.00* and \$860.00*, respectively, on either floppy or hard disk. Coming soon: HDLC Data Communication packages.

For more information, call your TI distributor or TI field sales office. Or write Texas Instruments Incorporated, P.O. Box 1443, M/S 6404, Houston, Texas 77001.



TEXAS INSTRUMENTS
INCORPORATED

WHY NEW YORK IS A SOLID STATE FOR THE ELECTRONICS INDUSTRY.

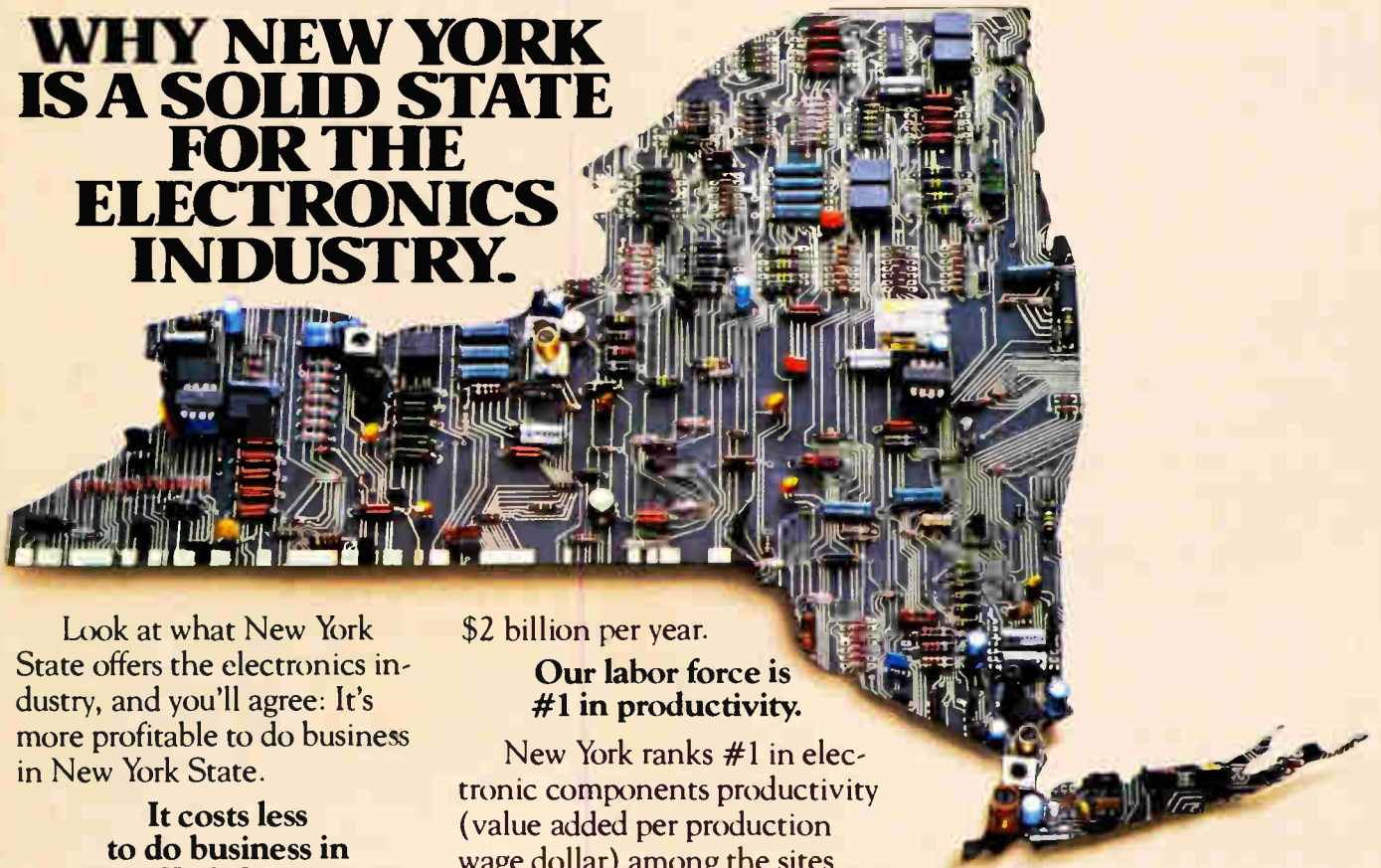

Look at what New York State offers the electronics industry, and you'll agree: It's more profitable to do business in New York State.

It costs less to do business in New York State sites than in San Jose, California. And we can prove it.

An independent study analyzed the four critical costs of taxes, wages, power and construction for a model new electronics firm. It showed that New York State offers sites where these costs are less than they are for choice electronics industry sites around the country.

For example, these costs would total \$7.6 million annually in San Jose, versus only \$6.4 million in, say, Brookhaven, New York.

New York has the best business advantages in America.

Our costs are lower because we have the best tax incentives and credits. We have on-the-job training and job incentive programs. Long-term, low-cost financing. And, we've cut personal and business taxes by

Circle 212 on reader service card

\$2 billion per year.

Our labor force is #1 in productivity.

New York ranks #1 in electronic components productivity (value added per production wage dollar) among the sites analyzed. And in the past five years, New York's number of idle man-days due to work stoppages was half that of the national average.

We graduate more electronics engineers than any other state.

Thanks to universities like RPI and Cornell – and dozens of other fine colleges – more electronics engineers are graduated each year in New York State than any other state including California or Massachusetts. And since many of the largest electronics firms are already doing business here – GE, IBM, to name only a couple – our graduates are quickly turned into seasoned professionals.

When you look into New York, you'll love New York.

We have an abundance of electric power. Lots of afford-

able housing for your employees. And our 30 million acres include thousands of available plant sites. Not to mention some of the most magnificent outdoors and year-round recreation on the American continent.

Tell me more about why New York is a solid state for business. I am particularly interested in information on:

- Electronic Components
- Small Computers
- Semiconductors

William D. Hassett, Jr.
Commissioner of Commerce
New York State Dept. of Commerce
230 Park Avenue
New York, New York 10169

Name _____
Title _____
Company Name _____
Address _____
City _____
State _____ Zip _____

MSEB

NEW YORK STATE.
The best place in the world to do business.

BECKMAN Announces Large Area LCD's For All Reasons

Thanks To The World's Largest Watchmakers.

So, what do Liquid Crystal watch displays have to do with other applications? Everything! Yes, for small instruments, clocks, appliances, even point-of-sale equipment. Here's why:

Early on, Beckman developed superior LCD's . . . because of an already extensive knowledge of materials. This helped win contracts with the World's largest watchmakers. So, when the



market opened for large-area LCD's, Beckman was there waiting . . . with the know-how, the resources, and the experience of performing for the best!

Today, Model 737 is aimed squarely at the clock market, while Models 741-3 and 741-4 are primarily for small instruments. The many versions of Model 739 can be used for either. More importantly, these latter types were joined recently by Models 740-56 and 742-58, six and eight

digit displays, respectively. The result: At least one large-area LCD for every application.

Meanwhile, there exists a huge custom capability . . . that can build an LCD for your application — just the way you want it.

All because Beckman got a head start in the watch business.



That experience also provided the know-how to maintain quality while reducing costs. And, it helped to develop these other advantages for Beckman LCD's:

- Low power consumption. CMOS compatible.
- Excellent contrast ratios; won't wash out, even in direct sunlight.
- Fewer drive components required.
- Choice of designs for night viewing.
- Long life expectancy.
- Fast (100 mS) Total Response time.

One clock manufacturer was so impressed that he wrote:

"Beckman LCD's are the best on the market. In a side-by-side comparison, any knowledgeable user would choose Beckman every time. The contrast ratio is better. Viewing angle (at 3V rms or above) is almost double that of the others. Switching time is almost instantaneous. And, besides, Beckman is a company you can rely on."

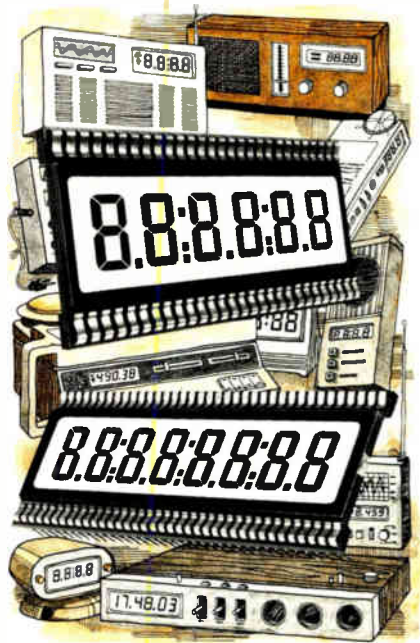

What more can we say, other than, "try Beckman large area LCD's . . . for whatever your reason — or, application!"

For complete details, write: Display Systems Division, Beckman Instruments, Inc., 350 North Hayden Rd., Scottsdale, AZ 85257. Phone: (602) 947-8371. TWX: 910-950-1293.

In Europe, Write: Beckman Instruments (Belgium) S.A., 14, Avenue Hamoir, 1180 Bruxelles, Belgium. Phone: (02) 275.44.30. Telex: 23577.

**Beckman Displays.
The Visible Edge.**

BECKMAN

Software

Subroutines allow modular software

Library includes 20 subroutines written in DEC Fortran IV/RT-11

As data-acquisition hardware advances, conversion times fall and sampling rates increase. Unfortunately, though, the software often cannot keep pace, slowing data acquisition or cutting flexibility. For instance, the software guiding the mini- or micro-computer in a data-acquisition system can impose excessive overhead penalties on the host. Or the needed software may not even exist, forcing a user to spend valuable time writing applications and routines.

Users of Data Translation Inc.'s hardware can take heart, though; the firm has announced a new library of real-time subroutines in Digital Equipment Corp.'s Fortran IV/RT-11 for use with the LSI-11, -11/2, and -11/23. Optimized at the machine-language level, the routines are said to be as much as 78 times faster than equivalent DEC software.

In addition to data-acquisition operations, DTLIB, as the library is called, supports high-resolution point plotting on either a CRT display or point plotter; light-pen interactive graphics can be programmed, and there is also support for auxiliary-display functions such as pen-up and -down on plotters, as well as erase, store-through, and other storage-CRT functions.

A completion-routine capability enables DTLIB users to write Fortran-IV and Micro-11 subroutines. They can be activated asynchronously upon completion of events like filling a data buffer.

Checks and reports. Finally, an error reporter checks for programming errors and reports those in syntax and usage, speeding correct entry. The routines also incorporate

flags to indicate attempts to operate data-acquisition or other interfacing gear in illegal modes; such attempts are flagged before loss of data or damage to equipment can occur.

DTLIB supports a wide variety of data-translation hardware, from analog input and input/output systems, real-time clocks, and point-plotter systems.

The library also supports up to four isolated, stand-alone analog-input systems for a total of 240 isolated input channels; Data Translation claims this feature is not available from DEC. Another unique feature is said to be DTLIB's direct-memory-access capability that allows it to work with very high-speed I/O peripherals.

DTLIB also operates with up to 124 kilowords of memory on the LSI-11/23, and up to 30 kilowords on the LSI-11 and -11/2. The same is true for DEC's extended instruction set/floating-point instruction set for these machines, as well as for the FPP-11 floating-point processor.

The DTLIB SP101 is available under license only, on a floppy diskette; the price is \$795. Software updates will be provided for a year

after purchase for the cost of the diskette alone. Delivery takes five days.

Data Translation Inc., 4 Strathmore Rd., Natick, Mass. 01760. Phone (617) 275-2846 [401]

CP/M benefits available in network configuration

CP/NET, an operating system for microcomputer networks, supports rapidly evolving network technology by allowing independent microcomputers access, via a network, to common facilities such as peripherals, programs, and data bases. It operates with CP/M and MP/M to support hundreds of CP/M-compatible products. CP/NET consists of one or more masters under which MP/M runs and one or more slaves under which CP/M or MP/M runs. It is network-independent; with simple modifications, a network may be constructed with any combination of shared memory, serial links, or parallel input/outputs with any protocol, such as X.25, Bisync or SDLC.

CP/NET will be licensed on a per-

A list of mix-and-match choices for the user

DTLIB includes some 20 subroutines that users can mix and match to form their own data-acquisition, -processing, and -display programs. The subroutines—with calls—are:

- IDAS: single analog-to-digital conversion.
- RTS: real-time sampling of a-d conversion.
- SETR: setting of real-time clock rate and mode of operation.
- HIST: real-time sampling of histogram time data or memory locations.
- IDIR: reading of a digital input channel or memory location.
- IDOR: loading of a digital output channel or memory location.
- DRS: clock- or event-driven real-time sampling of digital input channels or memory locations.
- DINP: clock-driven digital input polling and event latency measurements.
- IDAC: loading or reading an analog output channel.
- CLRD: scaling display data.
- DIS: continuous data display.
- DXY: continuous display of X-Y data pairs.
- SDIS: stop real-time data display.
- FSH: display of data once.
- FXY: display of X-Y data pairs once.
- KB2CD: conversion of 16-bit binary-coded decimal to INTEGER*2.
- KBBCD: conversion of INTEGER*2 to BCD.
- LWAIT: waiting for event.
- INT16: conversion of REAL*4 to unsigned 16-bit integer.
- FLT16: conversion of unsigned 16-bit integer to REAL*4.

ANNOUNCING THE FIRST OPTO SENSOR WITH BRAIN WAVES.



It's a logical breakthrough from Spectronics. We've designed the first opto detector IC offering compatibility with TTL, CMOS and other standard logic families.

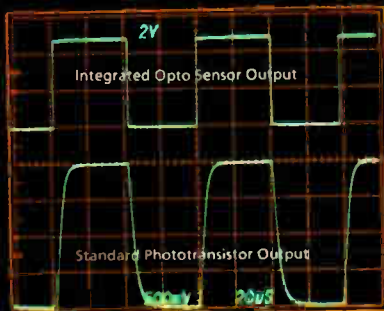

The SDP 8600 integrates a Schmitt trigger, voltage regulator, differential amplifier and photodiode onto the same substrate — replacing a complete PC board. This neat integration hasn't cost any performance. It has a propagation delay time of only 5 μ s and a 50 ns rise and fall time.

Designed for use with an infrared LED, it's ideal for sensing applications such as computer peripherals, toys and automatic cruise control systems. With significant benefits like improved

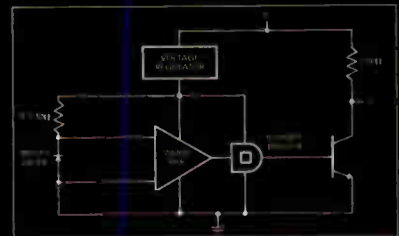

noise immunity, higher reliability and better performance.

The 8600 is just one example of a long line of optoelectronic firsts from Spectronics.

So, if you're looking for better design solutions, call Spectronics. We do smart things with light.

For more information, contact a Spectronics distributor. Or call us at 214/234-4271. Address: Spectronics, 830 East Arapaho Road, Richardson, Texas 75081.

Spectronics
A Division of Honeywell

Light years ahead.

Circle 215 on reader service card



LARGEST RADAR INVENTORY IN THE WORLD

SYSTEMS & SPARES

AN/ALT-6-7-8
AN-APG-33
AN/APG-51
AN/APN-69
AN/APN-102
AN/APN-169
AN/APQ-50
AN/APQ-55
AN/APS-20
AN/APS-31A
AN/APS-42-45
AN/APS-64
AN/ASB-4/9
AN/CPS-6B
AN/CPS-9
AN/DPN-32
AN/FPS-6-8
AN/FPS-14-18
AN/FPS-20-75
AN/FRC-39
AN/FRT-15
AN/GPA-30
AN/GPA-126
AN/MPQ-4A-10
AN/MPQ-29
AN/MPS-19
AN/MPX-7
AN/MSQ-1A
AN/SPA-4A
AN/SPA-8
AN/SPN-5
AN/SPS-5B
AN/SPS-6C
AN/SRW-4C
AN/TPN-12/17
AN/TPS-1D,E
AN/TPS-10D
AN/TPS-28
AN/TPS-34B
AN/TPS-37
AN/TPX-21
AN/UPA-25-35
AN/UPX-4-6
AN/UPX-14
HIPAR
MK-25
Nike Ajax
Nike Hercules
SCR-584

AUTOTRACK ANTENNA SCR-584 RADAR SYSTEM

360 deg AZ 210 deg EL, 1 mil. accuracy. Missile vel. accel. and slew rates. Amplidyne control. Handle up to 20 ft. dish. Compl. control chassis, ALSO in stock 10 cm. van mounted rad. system. Conical scan. PPI. 6 ft. dish. 300 pg. instr. bk. on radar. \$50.

RF SOURCES

17-27 KHz 200 W CW
125-450 KHz 4 KW CW
2-30 MHz 3 KW CW
4-21 MHz 40 KW CW
24-350 MHz 100 W CW
80-240 MHz 500 W 2-5 uS
175-225 MHz 300 KW 1, 20 uS
200-2000 MHz 40 W CW
210-225 MHz 1 MW 5 uS
385-575 MHz 1.5 KW CW
400-700 MHz 1 KW .03 DC
950-1500 MHz 1 KW .06 DC
900-1040 MHz 5-10 KW .006 DC
1.2-1.35 GHz 500 KW 2 uS
1.5-9.0 GHz 150 W CW
3.2-3.3 GHz 10 KW .002 DC
2.7-2.9 GHz 1 MW 1 uS
3.1-3.5 GHz 1 MW 1.3 uS
2.7-2.9 GHz 5 MW 2-3 uS
4.4-5.0 GHz 1 KW CW
5.4-5.9 GHz 5 MW .001 DC
6 GHz 1 MW 1 uS
6.2-6.6 GHz 200 KW .37 uS
8.5-11 GHz 40 KW 5-1-2 uS
9.375 GHz 40 KW 5-1-2 uS
8.5-9.6 GHz 250 KW .0013 DC
15.5-17.5 GHz 135 KW .33-1-3 uS
24 GHz 40 KW .15 uS
35 GHz 50 KW .1 uS

MODULATORS

25 KW 5.5 KV 4.5 A; .0025 DC
144 KW 12 KV 12 A; .001 DC
250 KW 16 KV 16 A; .002 DC
405 KW 20 KV 20 A; .1 DC
500 KW 22 KV 28 A; .001 DC
1 MW 25 KV 40 A; .002 DC
3 MW 50 KV 60 A; 30 uS
10 MW 76 KV 135 A; .001 DC
66 MW 160 KV 400 A; .00

TRACKING SYSTEMS

X BAND MONOPULSE 40 KW E-34
X BAND NIKE AJAX/HERCULES
X BAND HI-RES MONOPULSE MOD IV
X BAND GCA PAR II
X BAND FIRE CONTROL 250 KW M-33
X BAND MOBILE 40 KW AN/MPQ-29
X BAND BEACON 100 W AN/DPN-62
S BAND 10' DISH 500 KW AN/MPQ-18
S BAND 250 KW AN/MPQ-10A
S BAND 250 KW AN/MPS-9
X BAND HAWK MPO-34
X BAND HAWK MPO-33
C BAND 1.5 MW MPS-19(C)
S BAND 14' DISH PRELORT

SEARCH SYSTEMS

KU BAND AIRBORNE 135 KW B-58
X BAND WEATHER 250 KW AN/CPS-9
X BAND WEATHER 40 KW AN/SPN-5
X BAND 7 KW AN/TPS-21
X BAND CW DOPPLER AN/PPS-9/12
C BAND HGT FDR 1 MW TPS-37
C BAND 285 KW AN/SPS-5B/D
S BAND HGT FINDER 5 MW AN/FPS-6
S BAND COHERENT 1 MW AN/FPS-18
S BAND 1 MW NIKE AJAX/HERC
L BAND 40' ANT 500 KW AN/FPS-75
L BAND 500 KW AN/TPS-1D/GSS-1
UHF 1 MW HELIHUT TPS-28

C BAND TRACKER

Pwr: 1.5 MW Range: 250 miles
Recv: param Display 5" "A" scopes.
10' dish w/linear or circ. polarization.

NIKE HERCULES SPARES/MAINTENANCE

Over 10,000 major components in stock w/repairs and overhaul facilities incl: SHOP 1 & 2 MAINTENANCE VANS.

SEND FOR FREE 24PAGE CATALOG



Radio Research Instrument Co., Inc.

2 Lake Avenue Ext., Danbury, CT 06810
(203) 792-6666 • Telex 962444

New products

master basis for about \$200.

Digital Research, P. O. Box 579, Pacific Grove, Calif. 93950. Phone (408) 649-3896 [403]

Data-encryption system does binary or character processing

A generalized software system for the encryption of data and programs is available for use on a wide variety of minicomputers and mainframes. Psypher takes input files (binary and/or ASCII-EBCDIC) and puts them through either binary processing that transforms the files into a completely unintelligible stream of random-bit patterns or through character processing that produces random-character streams. The encoded binary file has records of random length; the character file is fixed. The file to be encoded is not altered. Each copy distributed has its own unique algorithm, so no two copies of Psypher are alike.

The system requires approximately 8-K 16-bit words to run; run time varies from machine to machine. Psypher is now available in load-module form for operation on Data General, Digital, IBM, and CDC hardware. Prices range from \$800 for minicomputers to \$1,800 for mainframes.

MBS Consulting, 6407 Irwin Ct., Oakland, Calif. 94609. Phone (415) 658-4622 [404]

Modular software upgrades Intel MDS hardware

P/B-MDS modular software is designed to upgrade the performance and utility of Intel's microprocessor development system. The software system includes a multiuser real-time operating system for 8- and 16-bit Intel microprocessors, a file management system, an interactive Basic interpreter, a Basic compiler, a text editor, and the ISIS operating system.

Panatec Inc., Dept. PB, 1527 Orangewood, Orange, Calif. 92668. Phone (714) 633-8961 [408]

Circle 216 on reader service card



If you'd like your career to prosper through New England winters and Cape Cod summers, don't miss the Massachusetts Career Opportunities Section in ELECTRONICS' upcoming September 25th issue.

SPEC STACKPOLE METAL FILM RESISTORS. IT MEANS MORE CHOICE.

Three series of high-performance resistors
help you balance function and price.

- "MP" Series
- "M" Series
- "RN" Series

A film product that offers you:

- Cost-effectiveness
- Product availability
- Product reliability
- Failsafe/flameproof specs available
- Packaging variations

Quality, Selection, Service

- General purpose
- Semi-precision
- Precision
- Ultra-precision

Versatility

- Power: $\frac{1}{8}$ to 2 watts
- Temperature coefficient: 25 to 200 ppm/ $^{\circ}$ C
- Resistance: 10 ohms to 5 megohms
- Tolerance: $\pm .1\%$ to $\pm 5\%$

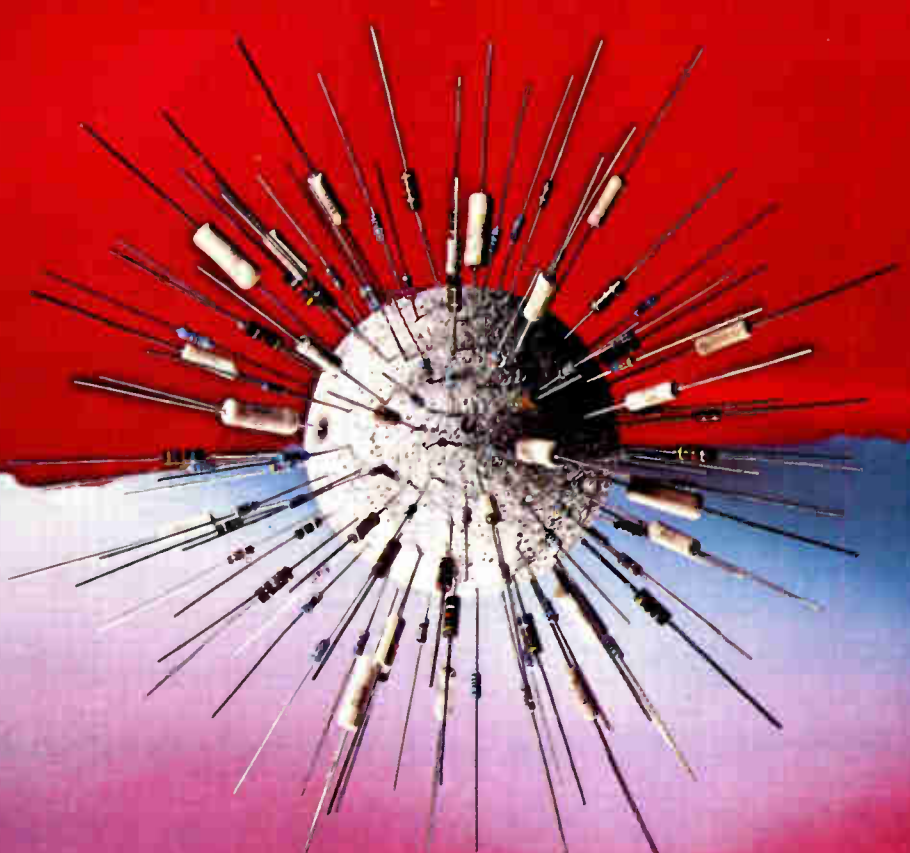

Make Stackpole your first choice in resistor products.
For complete information on our metal film and other resistor
products, call or write: Marketing Department,
Stackpole Components Co., Electronic Components Division,
P.O. Box 14466, Raleigh, NC 27620.
Phone: (919) 828-6201. TWX: 510-926-0520.

 **STACKPOLE**
Get to know us. We can help.

SPEC STACKPOLE METAL FILMS FROM YOUR LOCAL DISTRIBUTOR

CALIFORNIA

Lartronic
503-D Vandell Way
Campbell, California 90558
408-379-6454

FLORIDA

NRC
5549 Powerline Road
Fr. Lauderdale, Florida 33309
305-792-2600

TTI

7599 Currency Drive
Orlando, Florida 32809
305-859-1000

ILLINOIS

Pioneer/Chicago
1551 Carmen Drive
Elk Grove Village, Illinois 60007
312-437-9680

Bell Industries

3422 W. Touhy Avenue
Chicago, Illinois 60645
312-982-9210

Edmar

1275 Rand Road
Des Plaines, Illinois 60016
312-298-8580

Schuren

130 East St. Charles Road
Villa Park, Illinois 60181
312-941-9033

MASSACHUSETTS

Impact

200 First Avenue
Needham, Massachusetts 02194
617-444-3971

NEW JERSEY

General Radio

600 Penn Street
Camden, New Jersey 08102
609-964-8560

NEW YORK

Broadline Electronics

355 Oser Avenue
Hauppauge, New York 11787
516-231-4100

Fairmont Electronics

295 Oser Avenue
Hauppauge, New York 11787
516-231-3940

Rochester Radio

P.O. Box 1971
140 W. Main Street
Rochester, New York 14603
716-454-7800

Stock It

40 Nassau Terminal Road
New Hyde Park, New York 11040
516-437-4700

Summit

916 Main Street
Buffalo, New York 14202
716-884-3450

SAI

564 Smith Street
Farmingdale, New York 11735
516-293-2710

OHIO

Pioneer/Cleveland

4800 East 131st Street
Cleveland, Ohio 44105
216-587-3600

PENNSYLVANIA

Advacom

P.O. Box 296, 5620 West Road
McKean, Pennsylvania 16426
814-455-8110

Century

537 Foundry Road
Narristown, Pennsylvania
19403
215-631-5400

TEXAS

Pioneer/Dallas
113710 Omega Road
Dallas, Texas 75240
214-386-7300

TTI

1108 East Lancaster
Fort Worth, Texas 76102
817-429-1440

WASHINGTON

Zepher

919 SW 150th Street
Seattle, Washington
98188
206-241-1980

WISCONSIN

B. W. Electronics

2626 S. 162nd Street
New Berlin, Wisconsin
53151
414-784-4420

Microcomputers & systems

Unit develops wide bit-slice CPUs

Development system has 80-bit logic trace, new examine command

True to its name, the Step-3 development system provides a step up in development system capabilities for designers using bit-slice processors or other designs employing programmable read-only memory as a microcontrol store. The Step-3, which competes with Advanced Micro Devices' system 29 development system, contains a number of improvements on the Step-2 system introduced in early 1978 and the logic trace feature of the Step-2 introduced a year ago [*Electronics*, Aug. 30, 1979, p. 226].

The logic trace of Step-3 is 80 bits wide, compared with the 32 channels available in the Step-2. Moreover, the use of logic analysis for system tracing is greatly aided by a new command—examine—in the Step-3's repertoire. The command recalls 16 to 20 coding registers to the cathode-ray-tube screen. These registers contain the user's architecture-dependent coding commands needed

to implement the tracing function.

Two new control lines, one to indicate bus usage and the other to flag a last sample, have also been added to the logic analyzer's clocking circuitry. These allow the trace memory to be loaded only when the bus is valid, rather than recording one sample per system clock cycle.

The force. On the development system side, a new command—force—allows the designer, while the system is still in the monitoring mode, to create a new instruction that can last a programmable number of clock cycles. In the Step-2, the user could create such an instruction only by going to the editing mode, moving an instruction to location 0, creating the new instruction in its place, then reinserting the original instruction in its location later. Even then, the new instruction would last only for one clock cycle.

Another new feature of the Step-3 is its jam command, which lets the designer put new addresses into the instrument's writable control store. With this instruction, the system can ignore the address indicated by the program counter on the control store sequencer in order to force a direct jump to the specified address. Jamming, too, can be specified for a programmed number of clock cycles and is useful in creating pipelined architectures.

Like its predecessor, the Step-3 receives assembled code generated

by Step's transportable meta-assembler (TMA), which is run on a host minicomputer or mainframe. The Step-3 appears to the system under development as a memory containing this microcontrol code. A macro-TMA is also offered that contains the original TMA with an added list of features. The new assembler can generate multiple-microword instructions, allowing a single mnemonic to generate several lines of code. It can also produce one-line macrostatements, which themselves can contain several multiple-microword mnemonics.

Recursive call. Other features of the macro-TMA include a recursive call capability that lets a subroutine call itself and single-bit parity on individual microwords. In addition, the Step-3 system has a number of self-testing capabilities, including an optional real-time access test, sum checking, a galloping test pattern (galpat), a partial galpat, a fast-port function test, and an abbreviated access-time test.

Pricing varies significantly according to memory size, the width of the trace chosen, and whether the real-time access test is included. A minimum configuration costs \$8,450, and a maximum configuration with 96-bit-wide words is \$36,650. Delivery is stock to 30 days. Step Engineering Inc., Box 61166, Sunnyvale, Calif. 94088 [371]



Interface links GPIB to S-100 microcomputers

A universal interface connects the general-purpose interface bus (GPIB) with all microprocessor systems that use the S-100 bus. The interface complies fully with the IEEE-488 standard and the proposed IEEE-696 (S-100) standard, says the manufacturer. Configured for either polled or interrupt-driven input/output functions, the model 1020A interface allows users of S-100-based systems to integrate multiple instruments and devices for data acquisition. The 1020 unit also permits such systems to perform auto-

Mallory tantalum capacitors earn top MIL reliability ratings.

In solid tantalums, Mallory is now qualified to provide Level S, the highest reliability rating, for styles CSR 13 and CSR 91. Level S, under MIL-C-39003, means a life failure rate of only 0.001% per 1,000 hours. Here is our current QPL line-up in solids:

| MIL Style | Mallory Type | Life Failure Rates |
|-----------|--------------|--------------------|
| CSR13 | TER | M, P, R, S |
| CSR23 | TXE | M, P, R |
| CSR33 | TXR | M, P |
| CSR91 | TNR | M, P, R, S |

In wet slug tantalums, we have become the first source qualified at Level R, under MIL-C-39006, for style CLR69 — the extended capacity range wet tantalum, which makes our wet QPL list look like this:

| MIL Style | Mallory Type | Life Failure Rates |
|-----------|--------------|--------------------|
| CLR10 | XTM-XTK | L, M, P |
| CLR14 | XTL-XTH | L, M, P |
| CLR17 | XTV | L, M, P |
| CLR65 | TLX | L, M, P, R |
| CLR69 | TXX | L, M, P, R |

They're all available from authorized Mallory Distributors. Send for our latest QPL bulletins. Mallory Capacitor Division, Mallory Components Group, P.O. Box 372, Indianapolis, Indiana 46206. (317) 636-5353.

MALLORY

ELECTRICAL/ELECTRONIC GROUP

EMHART

Circle 219 on reader service card

Paydirt for VAX and PDP-11 users. One blue-chip card delivers 16 DZ lines per slot.

SELF TEST

(ON-BOARD LED DISPLAY)

Self test feature is unique. No other DZ has it.

Executes – at every power on.

Identifies – any malfunction and directs attention to the specific area of the DZ board affected. No lights, no problem.

Controls – fault isolation/repair by means of related options.

1

Key Features

2

3

CONFIGURATION CONTROL

(ON-BOARD ADDRESS/VECTOR PENCIL SWITCHES)

Complete configuration control – not matched by other DZ's.

Compatibility – assured with all DEC address/vector/interrupt level disciplines.

Easy Integration – no etch-cuts, no jumpers.

Priority Selection – plug provided just like with DEC.

Automatic Assignment – one setting establishes base address & vector for both logical controllers.

STAGGERED LOOP-AROUND

(BUILT-IN MAINTENANCE AID)

Another Able exclusive found only on the DZ/16

Complete Checking – provides the only way to effect total parity/framing error check. Uses one UART to drive another for fault isolation. Alternative internal loop-around gives partial check only.

Diagnostics – support loop-around capability which is built-in to DZ/16 panel. Connectors are built-in. Guess where the other kind are anytime you need them.

Now you can add twice as many DZ lines to your PDP-11 in half the space and at a lower cost than ever before. Our new DZ/16 is a microprocessor-based controller which fits 16 asynchronous communications channels into a single board but sells for much less than the two-board DZ11-E it replaces. There's no waiting either. You'll probably have your card plugged in and running less than 30 days after we get your order.

The unique multiplexer installs in any standard hex-width slot and presents only one load to the Unibus. It supports all DZ11 baud rates, provides modem control on all lines and is compatible with DEC diagnostic and operating system software. The data format is program-selectable for each channel.

This isn't the first time we've been first. It won't be the last. The advantages we've sent your way again and again will keep coming. Get the most out of your VAX or PDP-11. Write today for details on our remarkable line of memory, communications and general-purpose cards for use in the PDP-11 family.

Able, the computer experts

ABLE COMPUTER, 1751 Langley Avenue, Irvine, California 92714. (714) 979-7030. TWX 910-595-1729.

ABLE COMPUTER-EUROPE, 74/76 Northbrook Street, Newbury, Berkshire, England RG13 1AE. (0635) 32125. TELEX 848507 HJULPHG.

New products

matic device testing and to be used in laboratory applications. The 1020 interface sells for \$375, and delivery takes 30 days.

Dylon Corp., 3670 Ruffin Rd., San Diego, Calif. 92123. Phone (714) 292-5584 [373]

Desktop computer has fixed and removable disks

A 64-K-byte table-top computer system's \$16,500 price includes a 32-megabyte hard-disk drive with one removable and one fixed disk; its capacity can be expanded to 96 megabytes. The disks have an average access time of 30 ms and a maximum access time of 55 ms. The SD-700 can be configured as a single- or multiuser system. The latter can support up to 5 users with an expanded 256-K bytes of semiconductor memory partitioned into 48-K bytes per user (the operating system occupies 16-K bytes). The SD-700 includes two Z80 microprocessors and two input/output ports. Delivery takes 30 days.

SD Systems, P.O. Box 28810, Dallas, Texas 75228. Phone (214) 271-4667 [375]

Tiny \$2,600 computer makes dumb terminals smart

Selling for less than \$2,600, the Smarts Box is designed to make dumb terminals intelligent. Based on the LSI-11/2 processor, the 16-bit computer comes in a box measuring 5½ by 8 by 11¾ in. that includes all power supplies, cooling fans, interfaces, and memory necessary for stand-alone operation. The Smarts Box comes with two independent RS-232-C interfaces, 8-K bytes of random-access memory that can be expanded to 32-K bytes, space for 8-K bytes of read-only memory, a quartz-crystal clock with a 60-Hz output, and two vacant Q-bus-compatible card slots. Delivery time is three weeks for evaluation units and six weeks when ordered in quantity.

North Atlantic Industries Inc., 60 Plant Ave., Hauppauge, N. Y. 11787 [376]

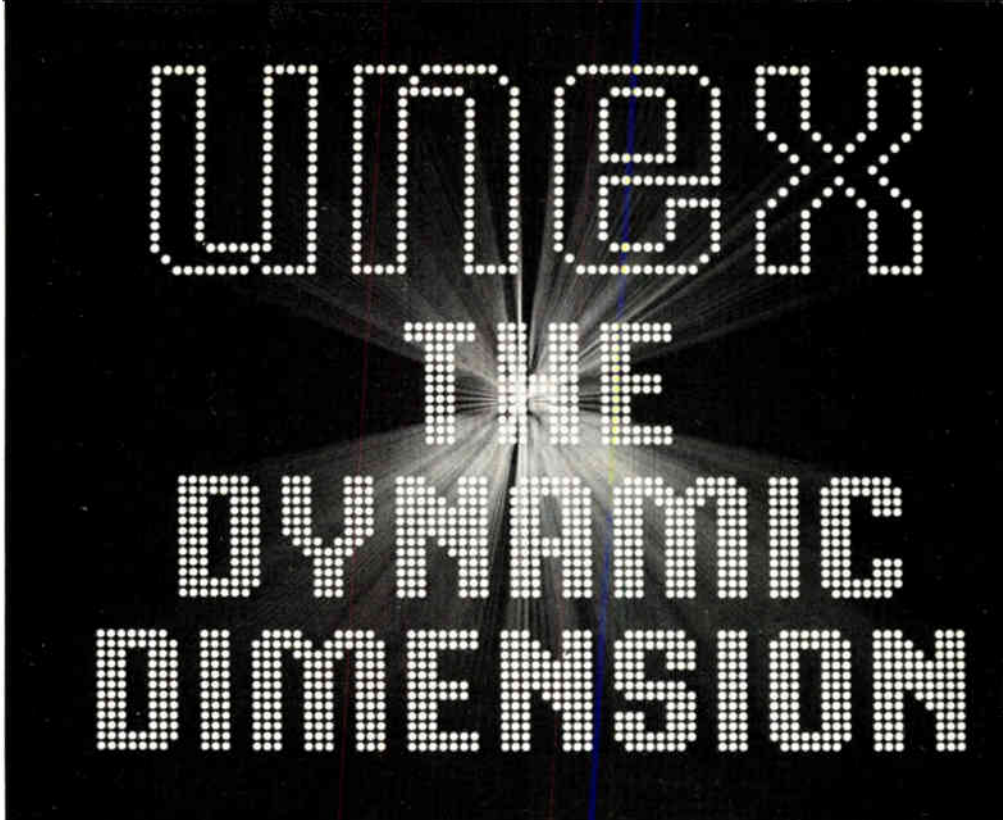

If you have the need to communicate production quotas, commodity prices, employee information, advertising messages, or whatever to big audiences, we've got great news — large scale computer readout visible from near and far indoors or out! Unex panels give you the dynamic difference you've needed in computer display information. No more fuzzy, little CRTs. Unex, ranging in size from 1x6 feet up to 6x39 feet, for the first time offers readout that can communicate to the masses. Unex, available exclusively from American Sign and Indicator Corporation, is capable of displaying various alphanumeric sizes and styles as well as high resolution graphics. Unex's thousands of light points create a matrix which displays pictures, products and symbols with remarkable clarity.

The communication benefits of Unex can be yours with a simple interface. This device, which is RS-232 compatible, may be operated from any computer which has a 9600 baud serial port. And since you can control each



point in the Unex matrix, programming possibilities are infinite.

Make sure your marketing and personnel management see this ad! In-house, public and advertising communication horizons can be broadened through computer interface with Unex — and you can bet they'll be mighty interested.

We'd be pleased to interface Unex with your needs. Call us today at 1-800-541-5680.



American Sign & Indicator Corporation

P.O. Drawer 2727 • Spokane, Washington 99220

TRANSISTOR SOCKETS



NEWLY DESIGNED SNAP-IN SOCKETS FOR TO-3 & TO-66



The most complete line of transistor sockets and mica insulators in the industry. Our sockets are designed for the TO-3 and TO-66 transistors. Available from stock. Introducing our latest design in printed circuit sockets plus an extensive line of snap-in sockets. Sockets are available in the latest UL approved materials.

NEW FREE CATALOG ON REQUEST



KEYSTONE

ELECTRONICS CORP.

TWX 710-581-2861 CABLE-KEYELCO

49 BLEECKER STREET, NEW YORK, N.Y. 10012 212-475-4600

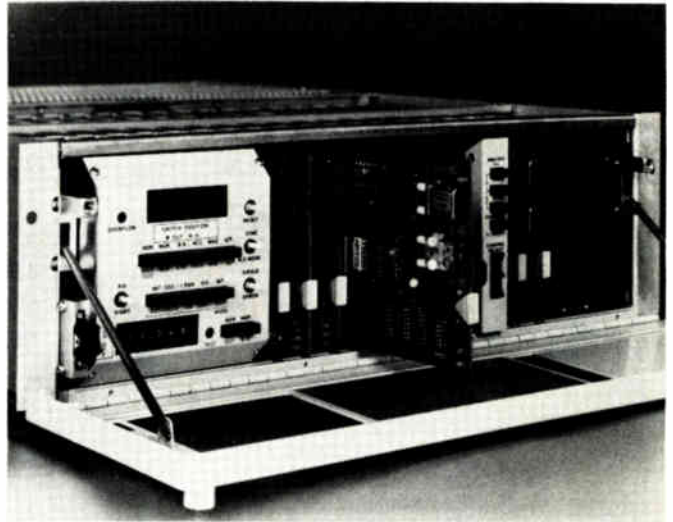

A 1 TO 10 CHANNEL MODEM THAT TAKES ITS OWN PULSE AND RUNS AT UP TO 5,000,000 BITS PER SECOND.

Use this unique unit as a self-standing modem on wideband telephone and signal circuits. It provides encode/decode capability between analog and digital information in M², Miller or Biphase-L codes, at rates as high as 5 mega-bits/second.

The Ampex M² Digital Encode/Decode Unit is available in channel capacities from 1 to 10, and offers a built-in test option that functions as an error counter with a digital readout. It displays number of errors in either 10⁶ or 10⁸ bits, and can be used by itself as a frequency counter.

Much more than a modem, this unit can also be used as a front end with an analog instrumentation recorder, providing instant digital data recording capability.

The compact package measures only 5¼ inches high by 19 inches wide, and the power supply is 115/220V, 47 to 400 Hz. Price ranges from about \$6000 to \$12,000, depending upon channel count and installed options.

Rene Chikhani can provide complete technical and performance specifications, and he'll work with you on custom system applications. Call Rene at 415-367-2758, or write to him at Ampex Data Systems, 401 Broadway, Redwood City, California 94063.

AMPEX

DYNA/CAM

Quick, reliable PC component insertion.
And quick, reliable payback.

Announcing Dyna/Cam, the incredibly fast, brand new microprocessor controlled manual assembly machine. The initial investment is modest, and the payback is fast. Because Dyna/Cam is revolutionary. A unique solid state light system shows the exact pc board insertion point from underneath. Overhead light and misinsertion due to the operator's interruption of the light

beam are eliminated. So the high expense of rejects is drastically reduced. Dyna/Cam's special bin system is synchronized to the machine, so the operator always reaches to the same spot, effortlessly. And since Dyna/Cam automatically cuts and clinches the leads, the cost of special handling or separate operations is eliminated. What's more, being microprocessor controlled, Dyna/

Cam is virtually self-programming, with optional tie-in for QC and production information (MIS). Send for our new illustrated brochure today. Or:

Call toll free:
1-800-543-3000

Ask for Operator 240. In Ohio, call 1-800-582-1364.

DYNA/PERT

Elliott Street
Beverly, Massachusetts 01915

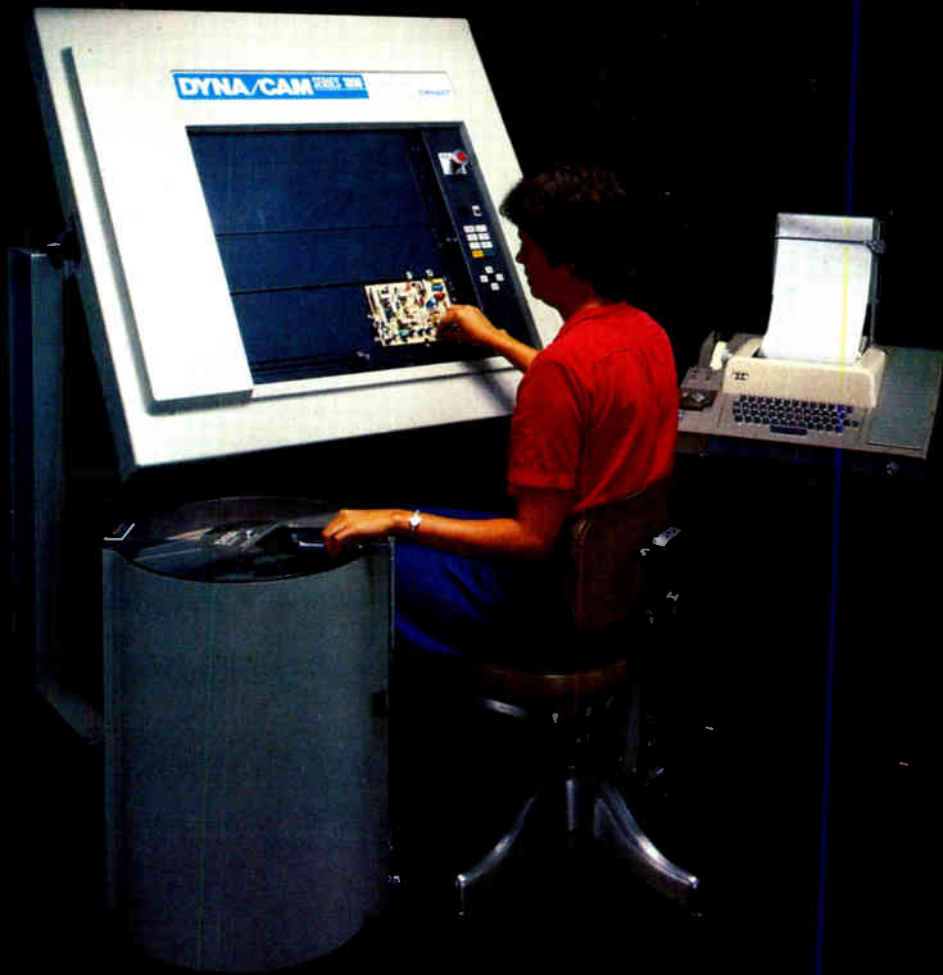



We ship your shape in 3 days.

The shapes we ship in 3 days come in sky blue with deep charcoal trim in addition to the popular beige with bronze color combination. And our Instant Optima in-stock program ships from key locations across the country. All these colors and shapes are beautifully close to you.

We make you look better faster

OPTIMA[®]
Scientific-Atlanta

2166 Mountain Industrial Blvd., Tucker, GA 30084, Tel: (404) 939-6340, 10039 Pioneer Blvd.,
Santa Fe Springs, CA 90670, Tel: (213) 949-9571, 2100 Route 208, Fairlawn, N.J. 07410, Tel: (201) 791-6455.

Circle 224 on reader service card

"VISIT OUR BOOTH 2443-2447 AT WESCON"

CUSTOM LSI

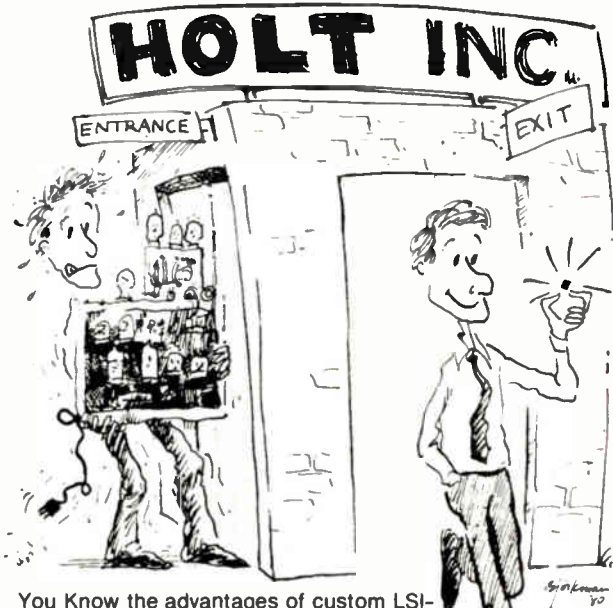

You Know the advantages of custom LSI—Size, Power, Cost - Now YOU can have CUSTOM LSI. Holt makes it fast, easy and inexpensive. Our wide design experience in analog/digital CMOS LSI makes us your best source.
Contact Gary Rawlings • (714) 754-1844 • 3303 D-5 Harbor Blvd • Costa Mesa CA 92626 • Telex 182704

HOLT Inc.
WE PUT YOU IN THE CHIPS

Circle 139 on reader service card

CRYSTAL CLOCK OSCILLATORS.

- We have more than 50 standard frequencies
- We can ship within 48 hours from receipt of your order.
- All Oscillators feature hermetic D.I.P. Packaging.
- Included are direct replacement for 16 manufacturers, such as the following series: K1100, MX0, X0, M1100, HS, CM, BW, 1300, 7400, and QT.
- Specify these Hytek Part numbers:

| | |
|--------|-----------------------------|
| TTL | HY 4550 - 250 KHZ to 75 MHZ |
| CMOS | HY 4560 - 600 HZ to 5 MHZ |
| Z80(A) | HY 4580 - 4 MHZ |

hytek microsystems
incorporated

16780 LARK AVENUE, LOS GATOS, CALIFORNIA 95030
PHONE (408) 358-1991 TWX 910-597-5393

Circle 141 on reader service card

A pushbutton panel should be designed for parts of the body besides fingers.

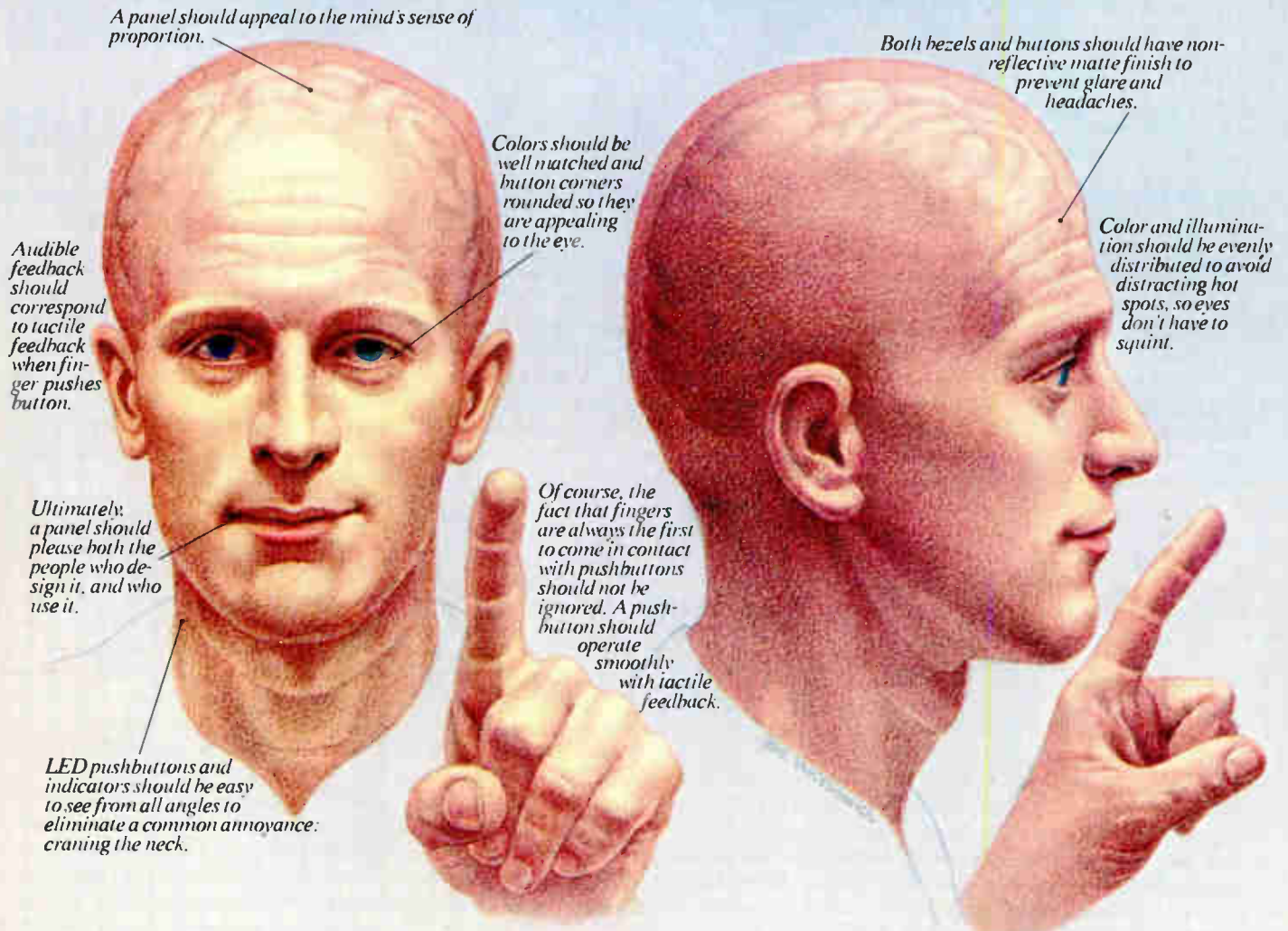

When we designed the Advanced Manual Line (AML), we included everything a designer could want.

Like a broad selection of pushbuttons, indicators, paddles and rockers. In a variety of shapes, sizes and colors. With LED, incandescent or neon illumination.

But what really makes AML unique is a small detail that others seem to have overlooked.

The people who use them. Which is why they're not only appealing to fingers, but other parts of the body as well.

That isn't to say we've neglected the person who puts the panel together. Because AML has single level termination for easy wiring and low installation cost. And electrical flexibility that ranges from solid state to electronic and power duty control.

With AML, you clearly design panels around people who use them, and not just their fingers.

For details, and the location of our sales offices and distributors around the world, write MICRO SWITCH, Freeport, Illinois 61032. Or call 815-235-6600.

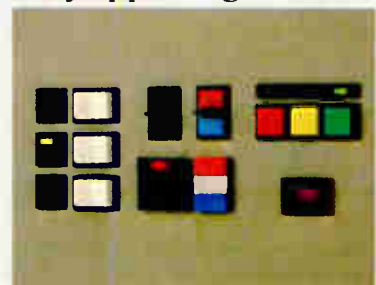

MICRO SWITCH
a Honeywell Division

Circle 225 FOR DATA

New products

Power supplies

Battery puts out 5-kW peak power

12-V, 55-Ah uninterruptible supply yields 200 cycles of full-depth discharges

In designing its 12-v, 55-Ah Gel/Cell lead-acid battery, the Globe Battery division of Johnson Controls kept in mind that a battery supplying uninterruptible power to a computer must be able to sustain short-term discharges of very high currents. Although some wet-cell batteries can do this, they are often limited in life to one or two years. Globe's new sealed battery, which uses a gelled electrolyte, not only has 5,000 W of available peak power, but its cycle life, says Richard J. Scarvaci, application engineer at Globe, is in excess of 200 cycles of full-depth discharges. Used as a standby supply, the battery lasts between four and six years.

"When the Globe Gel/Cell was introduced over 15 years ago, its design incorporated a lead-calcium grid alloy to give the battery a very low self-discharge rate and to significantly reduce water loss," Scarvaci says. The new battery is sealed, and all cells are connected through the partitions of its case by welding opposing cell connections. "This results in a very short interconnection path," he adds, "reducing the internal resistance and increasing the battery's mechanical strength."

Heat-sealed mating. The new battery uses a polypropylene container, which lets all mating container surfaces be heat-sealed. Also, the use of polypropylene makes possible thin cell partitions, increasing the useful internal volume and thus the power density—up to 830 A of current-carrying capacity calculated at half the voltage.

The battery comes in a standby-power version and one for frequent discharges. Since the rechargeable

battery is made with a gelled electrolyte, it can of course be used in any position—an advantage over wet-cell batteries, which must be upright. In production quantities, the 10-by-7-by-9-in. battery sells for approximately \$50. It will be on display at Wescon.

Johnson Controls Inc., Globe Battery division, 5757 N. Greenbay Ave., Milwaukee, Wis. 53209. Phone (414) 228-1200 [361]

Dc-to-dc converters come in dual in-line packages

The 500 series of dc-to-dc converters for both analog and digital applications comes in a 24-pin integrated-circuit package that allows each converter to be mounted directly on a printed-circuit board. The series provides a variety of isolated outputs from either 5- or 12-v inputs. Input to output isolation is 300 V dc minimum with an impedance of 10 M Ω . The 10 models in the series have both single-polarity outputs (5 V at 100 mA, 12 V at 80 mA, and 15 V at 65 mA) and dual outputs (± 12 V at 80 mA and ± 15 V at 65 mA). The temperature coefficient is $\pm 0.015\%/^{\circ}\text{C}$ over the full operating range of -25° to $+70^{\circ}\text{C}$. The single-output models sell for \$29, and the dual-output units sell for \$34. Delivery is from stock.

Power General, 152 Will Drive, Canton, Mass. 02021. Phone (617) 828-6216 [363]

1,500-W switcher comes in 750-, 1,000-W-sized package

A 1,500-w switching power supply made by Boschert comes in the 5-by-8-in. package that is the industry standard for 750- and 1,000-w supplies. Thus, the model HL 1500 can replace lower-power units in computers, test systems, and industrial controls, allowing the systems to be upgraded to levels that require more power without having to change the system housing to fit a larger-sized power supply.

The first model in the series is a

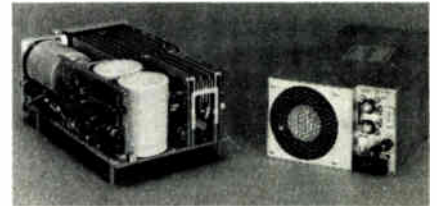

+ 5-v, 300-A unit. Power density is 2.5 W/in.³ at the nominal 5.0 V and over 2.8 W/in.³ at 5.75 V. Its efficiency is 82% at full load. The supply controls output voltage to within 1% during a 25% change in load and recovers to a flat output in 0.5 ms. Typical line regulation is 0.2% and load regulation is 0.3%. Line-power interruptions are masked by a 30-ms holdup. Brownout tolerance is wide: the ac-line power can vary from 167 to 250 V. The 5-v, 300-A unit is available within 60 days. U. S. prices are \$1,220 for a single unit and \$960 apiece in quantities of 100.

Boschert Inc. 384 Santa Trinita Ave., Sunnyvale Calif. 94086. Phone (408) 732-2440 [366]

Lab supplies offer dual or triple outputs

A range of compact laboratory power supplies manufactured by Sweden's Power Box AB that offer either dual or triple outputs are being marketed in the U. S. The supplies come in two series: the PB-3000 series, which offers three independent and floating output voltages, and the PB-2000 series which offers two. Both series are designed for inputs of 110 or 230 V ac, at 47 to 60 Hz. The dual or triple outputs are at 4 to 6 V, 11 to 16 V, 0 to 20 V, or 0 to 40 V in various combinations. The outputs—which can be connected in series and parallel or can float from ground—have 500-v isolation, with 2,500 V to chassis. The units are insensitive to radio-transmitter and other radio-frequency interference. Leakage current is less than 10 μA . Prices range from \$495 to \$845, depending on specifications.

Norman R. Sutherland & Associates Inc., 6290 Sunset Blvd., Suite 1126, Los Angeles, Calif. 90028. Phone (213) 463-5090 [365]

New iSBX™ Multimodule™ boards

Intel® introduces a whole new dimension in configuring single board computer systems.

Intel pioneered the concept of flexible microcomputer system design in 1976, with our family of iSBC™ single-board computers interfaced via the Multibus™ system bus—presently accepted as the industry standard.

Now we've extended this well-accepted concept to board-level design: A new generation of Multimodule boards interface to iSBCs via the new iSBX bus. So now you have a second design option. You can expand systems in large increments with Multibus boards. Or in smaller, more economical increments with Multimodules.

The key to configuration flexibility

The iSBX bus—the first physical/electrical interface for direct on-board expansion of iSBC systems—assures compatibility between these systems and the emerging Multimodule product line.

Present on all future Intel single-board computers, the iSBX bus saves design time and space, and facilitates fast, easy upgrading. System performance is

also improved because Multimodules tie directly to the iSBC internal bus. Connection to the iSBX bus is made with a set of rugged connectors—one on the iSBC board, the other on the Multimodule itself.

The new Multimodule family

Multimodules represent a whole new family of plug-in expansion boards. They allow you to add a variety of special performance features to your existing iSBC system. Currently available add-ons are shown below. Soon you'll also be able to add other Multimodules for D-to-A and A-to-D conversion, communications, peripheral interfaces—and more.

With those modules you can now respond

the more economical iSBX 331 or 332 math modules.

New Multimodule-compatible iSBC boards

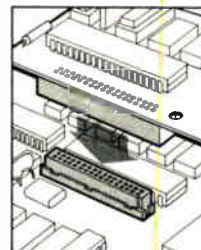

iSBX 960-5 Connector

Intel's new 8-bit iSBC 80/10B and 80/24 single-board computers are the first of many iSBCs to offer iSBX Multimodule expansion capabilities. Both

are improved versions of widely used iSBC boards. (See table).

Custom tailoring, too

For users who want to design their own Multimodule boards, Intel offers iSBX 960-5 connectors. When used in conjunction with the iSBX specifications, this set of connectors lets you create modular boards that meet your own unique requirements.

Available from Intel today are the first four iSBX Multimodules and two iSBX-compatible iSBCs. For further information, or to order, return this coupon or call your local Intel sales office or distributor. Or contact Intel at the address below.

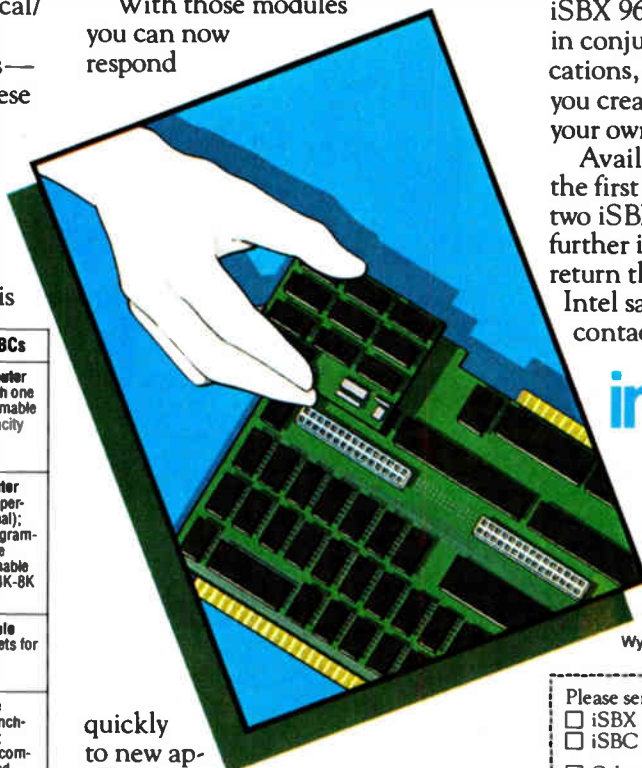

intel® delivers solutions.

Europe: Intel International, Brussels, Belgium.
Japan: Intel Japan, Tokyo. United States and Canadian distributors: Alliance, Almac/Strom, Arrow Electronics, Avnet Electronics, Component Specialties, Hamilton/Avnet, Hamilton/Electro Sales, Harvey, Industrial Components, Pioneer, L.A. Varah, Wyle Distribution Group, Zentronics.

| New Multimodules and iSBX Bus-compatible iSBCs | |
|--|--|
| | iSBC 80/10B Single Board Computer 8080A-based microcomputer with one iSBX bus connector; 48 programmable I/O lines; one USART; timer; capacity for 1K-4K bytes RAM; up to 16K EPROM |
| | iSBC 80/24 Single Board Computer 8085A-2 based microcomputer operating at 4.8 MHz (2.4 MHz optional); two iSBX bus connectors; 48 programmable I/O lines; one USART; three programmable timers; programmable interrupt controller; capacity for 4K-8K bytes RAM; up to 16K EPROM |
| | iSBX 350 Parallel I/O Multimodule 24 programmable I/O lines; sockets for inverting and noninverting transceivers |
| | iSBX 351 Serial I/O Multimodule Programmable synchronous/asynchronous communications channel; standard RS232C or RS449/422 compatibility; software-selectable baud-rate generation; two programmable 16-bit BCD or binary timers/event counters |
| | iSBX 331 Fixed/Floating Point Math Multimodule Fixed point single- (16-bit) and double- (32-bit) precision arithmetic; floating point single- (32-bit) precision functions; floating-to-fixed and fixed-to-floating point conversions; transcendental functions |
| | iSBX 332 Floating Point Math Multimodule Single- (32-bit) and double- (64-bit) precision arithmetic; compatible with proposed IEEE format and existing Intel floating point standard. |

quickly to new applications opportunities. Examples? Take data acquisition or industrial control: to add extensive I/O processing power, you simply plug in the iSBX 350 board. Or consider communications networks. Now there's no need to add entire USART boards; just use the iSBX 351 unit. In laboratory control applications, instead of an independent math processor, now you can choose

Please send information on:

- iSBX Multimodules iSBC 80/10B
 iSBC 80/24 Configuration Guide

- Other _____
 Please have a Sales Representative call.

Name _____

Title/Organization _____

Address _____

City/State/Zip _____

Phone _____

Intel Corporation, 3065 Bowers Avenue, Santa Clara, CA 95051. Telephone (408) 987-8080.

We offer a complete solution to your Analog Interface problem

Bringing analog data into the digital world is difficult, especially if you don't have the time or the resources. Zeltex has what it takes . . . the seasoned technical staff with in-depth analog and digital experience . . . a library of data acquisition, conversion and processing solutions . . . and all the manufacturing means, including high-volume offshore assembly. That's what it takes to solve difficult analog interface problems. To bring measurement accuracy into the electrically noisy digital world. To preserve system performance in hostile environs. To do the job cost-effectively.

We can design, build and deliver the module, interface I/O board or subsystem that matches your needs . . . form, fit and function. A solution that exceeds your performance expectations. Or we can augment your capabilities . . . by assisting with design, by taking your production overload, by becoming a reliable alternate source. Put an end to your interface problems. Contact us today. *940 Detroit Avenue, Concord, California 94518 (415) 686-6660 / TWX: 910-481-9477*

Zeltex Circle 228 on reader service card
INC.

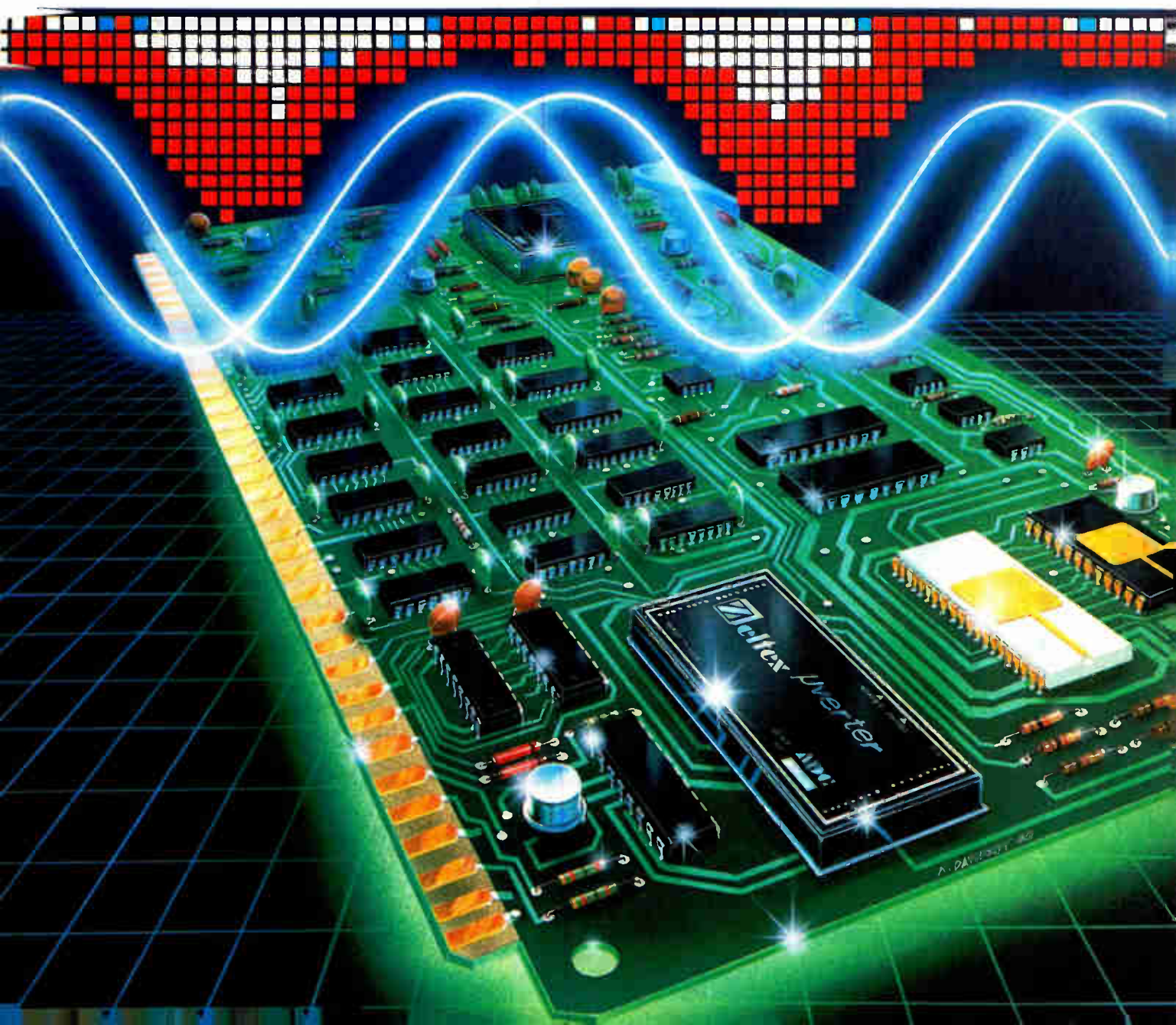

Phillips to unveil 4-channel, 100-MHz scope at Wescon

Look for Philips Test and Measuring Instruments Inc. of Mahwah, N. J., to introduce a 100-MHz, four-channel oscilloscope—the model 3264—at next week's Wescon. According to product manager Hans Toorens, **the \$4,995 scope's four channels make it "sort of an analog logic analyzer," with real-time, rather than clock-pulse, glitch display.** A 17-kV accelerating potential ensures bright display, and triggering and delay can be independently set by any channel or an external source.

Winchester drive has 675-megabyte memory capacity

The Computer Systems division of the Harris Corp. is about to introduce a 675-megabyte 14-in. Winchester disk drive, **said to have the largest capacity of any such drive offered so far.** The Fort Lauderdale, Fla., division's drive will feature an average seek time of 25 ms, an average latency time of 8.3 ms, and a data-transfer rate of 1,209 kilobytes/s. The model 5660/5661 is optimized for use with Harris computers and includes a controller capable of managing seven added stores for a system capacity of 5.4 billion bytes of data. The drive is priced at \$71,260, with deliveries starting in January.

GE adds to market for programmable industrial controls

Expecting the market for industrial programmable controllers to top \$250 million in orders this year, General Electric Co. is introducing its Series Six family of controllers priced between \$3,500 and \$100,000. Based on a 16-bit bit-slice processor, the models 60, 600, and 6000 from GE's Industrial Control Department in Charlottesville, Va., will have **scanning times ranging from 8 to 40 ms, 2- to 32-K (16-bit) words of complementary-MOS read-only memory or programmable ROM, and 512 to 4,000 input/output lines.** The family can handle networking and remotely distributed I/O. Deliveries begin in March 1981.

Floating-point library offered for 8080/8085, Z80

Formerly a custom software house, Cogitronics Corp. of Portland, Ore., is breaking into the open market with the FPAC floating-point library for original-equipment manufacturers' microprocessor systems. The library includes floating-point **capabilities for four-function arithmetic operations, trigonometric functions, exponentiation, and logarithmic functions.** It costs \$1,500 for a site license, which includes the right to distribute the library in machine-language form. The library is written in assembly-level source code and comes in two versions, one optimized for the 8080/8085, the other for the Z80.

Cipher doubles capacity of 1/2-in. magnetic tape

A new version of the Microstreamer streaming tape drive from Cipher Data Products Inc., San Diego, Calif., doubles the capacity of 1/2-in. magnetic tape. The Microstreamer 2 can store up to 92 megabytes of unformatted data on a 10 1/2-in. reel of tape at **a density of 3,200 bits/in. and can transfer at 160 kilobytes/s.** The higher density is optional at a new speed of 50 in./s. The drive will also operate at the standard 1,600 b/in. at 100 in./s in the streaming mode and at 25 in./s in the start and stop mode, making it compatible with two other types of drive. The new drive will be priced at \$2,350 in large quantities, with evaluation units to be available in December and production shipments to begin in early 1981.

Books of special interest to our readers



Applying Microprocessors

Reprinted from *Electronics*, completes the EE's transition from the old methods of electronic design to microprocessor engineering. Pub. 1977. 191 pp. Order #R-701, \$9.95

Basics of Data Communications

This compilation of essential articles from *Data Communications* magazine includes chapters on terminals, acoustic couplers and modems, communications processors, networking, channel performance, data link controls, network diagnostics, interfaces, and regulations and policy. Pub. 1976. 303 pp. Order #R-603, \$12.95

Circuits for Electronics Engineers

Almost 350 circuits arranged by 51 of the most useful functions for designers. Taken from the popular "Designer's Casebook" of *Electronics*, these circuits have been designed by engineers for the achievement of specific engineering objectives. Pub. 1977. 396 pp. Order #R-711, \$15.95

Design Techniques for Electronics Engineers

Expert guidance at every point in the development of an engineering project—making measurements, interpreting data, making calculations, choosing materials, controlling environment, laying out and purchasing components, and interconnecting them swiftly and accurately. Nearly 300 articles from *Electronics*' "Engineer's Notebook." Pub. 1977. 370 pp. Order #R-726, \$15.95

Microelectronics Interconnection and Packaging

Up-to-date articles from *Electronics* include sections on lithography and processing for integrated circuits, thick- and thin-film hybrids, printed-circuit-board technology, automatic wiring technology, IC packages and connectors, environmental factors affecting interconnections and packages, computer-aided design, and automatic testing. Pub. 1980. 320 pp. Order #R-927, \$12.95

Large Scale Integration

As published in *Electronics*, covers the entire range of design applications in sections on bipolar LSI, MOS LSI, new devices, system design, computer-aided design, testing, and applications. Pub. 1976. 208 pp. Order #R-732, \$12.95

Memory Design: Microcomputers to Mainframes

The technology, devices, and applications that link memory components and system design. How to apply the new technology to meet specific design goals. Edited from the pages of *Electronics*. Pub. 1978. 180 pp. Order #R-602, \$9.95

Microprocessors

The basic book on microprocessor technology for the design engineer. Published in 1975, articles are drawn from *Electronics*. 150 pp. Order #R-520, \$8.95

Personal Computing: Hardware and Software Basics

More than 50 articles from leading publications give you up-to-date information on personal computing hardware, software, theory, and applications. Pub. 1979. 266 pp. Order #R-903, \$11.95

Practical Applications of Data Communications: A User's Guide

Articles from *Data Communications* magazine cover architecture and protocols, data-link performance, distributed data processing, software, data security, testing and diagnostics, communications processors, and digitized-voice and data-plus-voice. Pub. 1980. 424 pp. Order #R-005, \$13.95

Microprocessors and Microcomputers: One-chip Controllers to High-end Systems

Practical orientation to second- and third-generation 8-bit devices, the latest 16-bit devices, one-chip microcomputers, and software for microprocessors in 95 articles from *Electronics*. Pub. 1980. 482 pp. Order #R-011, \$13.95

New literature

Measurement. A 32-page application note from Hewlett-Packard, "Accurate and Automatic Noise Figure Measurements," explains how to assemble an automated system that will make accurate noise-figure measurements. The system described consists of a microwave source and mixer used as a tunable down-converter, along with an HP model 436A digital power meter, a 346B 10-megahertz-to-18-gigahertz-noise source, and off-the-shelf components. Demonstration software routines in application note 64-3 include techniques for measuring the noise figure and gain of microwave components. The free booklet includes block diagrams and program listings. Hewlett-Packard Co., Inquiries Manager, 1507 Page Mill Rd., Palo Alto, Calif. 94304 [421]

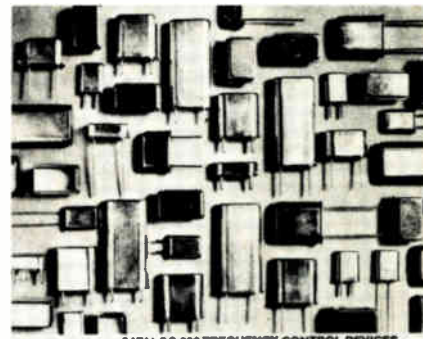

CATALOG 380 FREQUENCY CONTROL DEVICES
CRYSTALS • OSCILLATORS



Oscillators. "Frequency control devices" is a 16-page technical catalog designed to provide both purchasing and engineering information on quartz crystals and clock oscillators. All the popular crystal cuts are shown, with the advantages and limitations of each listed. The section on clock oscillators covers the critical performance parameters, as well as offering complete technical information. In addition, the booklet includes an extensive discussion on equivalent circuit and oscillator theory. Northern Engineering Laboratories Inc., 357 Beloit St., Burlington, Wis. 53105 [422]

Order today using this coupon!

Electronics Magazine Books
P.O. Box 669
Hightstown, NJ 08520
Tel. (609) 448-1700, ext. 5494

Name _____
Title _____
Company _____
Street/P.O. address _____
City/state/zip _____

Order # _____ Qty. _____ Price \$ _____

R- _____ \$ _____
R- _____ \$ _____
R- _____ \$ _____
R- _____ \$ _____
R- _____ \$ _____

Payment enclosed (payment must accompany orders under \$25)
 Bill my company (or attach company Purchase Order)
 Bill me Send a free copy of the *Electronics* Editorial Reprints brochure.

Total \$ _____

Ten-day money-back guarantee applies on all books.

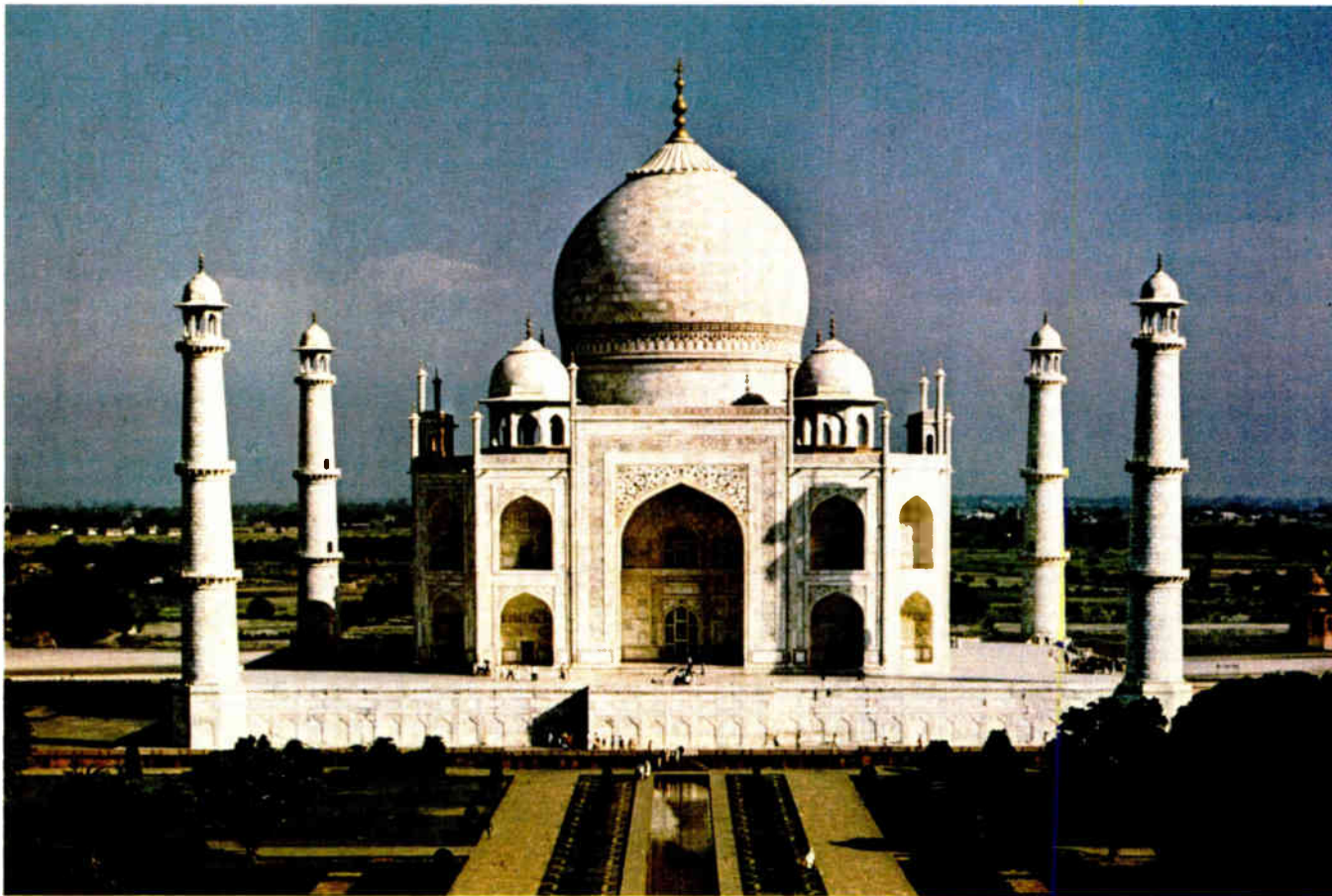

With 40 days' paid vacation every 12½ months, Aramco people can see the heart of Asia, from Delhi to Bangkok to Hong Kong, and still have time for an African game park, Paris in the spring, or ski trips in the Alps.

The money isn't the only reason so many top people are going to Saudi Arabia with ARAMCO

As great as the money is, it's the travel opportunities, the challenge, and casual living in American-style hometowns that make Aramco people stay on.

Aramco employees in Saudi Arabia have travel opportunities that most people only see in daydreams. They get 40 days' paid vacation every 12½ months. And in Saudi Arabia they are already halfway to wonderful places in Europe, Asia and Africa.

Equally as important as money and travel are the challenging jobs and secure, comfortable living conditions.

Aramco is the world's largest oil-producing company. Our projects and operations are huge, complex and professionally rewarding. Many are the largest of their kind ever undertaken.

We need more first-rate people to join the 4,000 North Americans who work for us. We have openings for qualified engineers, technicians and professionals of all types.

North Americans and Saudi Arabs have worked together for over 40 years

Since the early 1930's, North Americans have worked very closely and successfully with their Saudi hosts in developing the energy resources and infrastructure of this friendly, conservative nation.

These North Americans live in a



4,000 North Americans work for Aramco in Saudi Arabia. They're helping the Kingdom develop energy resources that are being used all over the world.

foreign country, yet they still find it a very comfortable place to live and work. American-style communities, housing, schools, medical services and recreation facilities have prompted a long line of Aramco professionals to stay on and on.

What kind of compensation package accompanies all this? Aramco employees earn a competitive base salary, plus a cost-of-living differential. They also get a tax-protected premium for overseas work of up to 40 percent of the base salary, and a one-time bonus of up to \$5,000 for signing up for overseas work.

Interested in more information about Aramco and Saudi Arabia; or in a job with us? Write: Aramco Services Company, Dept. ELT091180MCLA, 1100 Milam Building, Houston, Texas 77002.

ARAMCO
SERVICES COMPANY

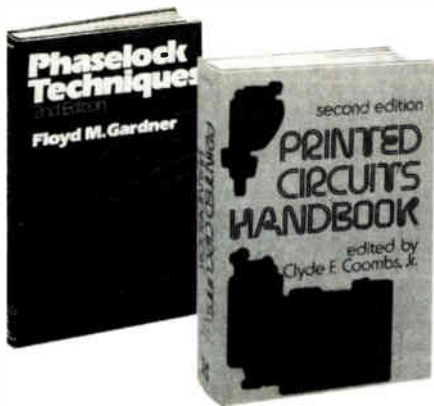

BUY ONE of these great professional books when you join McGraw-Hill's Electronics and Control Engineers' Book Club and GET ONE FREE (values up to \$62.50)

ELECTRONICS ENGINEERING FOR PROFESSIONAL ENGINEERS' EXAMINATIONS. By C. R. Hafer. 336 pp., more than 200 illus. Actually two books in one—a quick preparation manual to help you pass your P.E. exams on the first try and a rich source of practical electronics engineering information and know-how.
254/303 Pub. Pr., \$19.50 Club Pr., \$15.50

ELECTRONICS ENGINEER'S HANDBOOK. Editor-in-Chief, D. G. Fink. 2,104 pp., 2,026 illus. Huge in every sense, this instant-reference volume gives you every latest essential in the field. 2,100 formulas and equations, a 2,500-item bibliography, and every illustration you need to clarify all of modern electronics!
209/804 Pub. Pr., \$57.50 Club Pr., \$40.50

ELECTRONIC DISPLAYS. By E. G. Bylander, Texas Instruments Incorporated. 172 pp., illus. The book describes current electronic displays by family types, discussing their operation, application, and circuit requirements. You cover photometry and contrast enhancement, together with such critical components as mounts and drives, interface requirements, and other necessary engineering information.
095/108 Pub. Pr., \$24.50 Club Pr., \$18.50

HANDBOOK OF ELECTRONICS CALCULATIONS FOR ENGINEERS AND TECHNICIANS. Edited by M. Kaufman and A. H. Seidman. 653 pp., 725 illus. This first comprehensive tool of its kind includes hundreds of worked-out problems in analog and digital circuits. Includes more than 700 diagrams, curves, tables, and graphs.
333/920 Pub. Pr., \$24.50 Club Pr., \$18.95

MICROCOMPUTER-BASED DESIGN. By J. B. Peatman. Expanded 4th printing. 604 pp., over 400 photos and other illustrations. Do all your best day-to-day designs, as well as your supercreative and special designs, around the new microcomputers and the specific "how to" help you get here!
491/380 Pub. Pr., \$28.95 Club Pr., \$20.95

MICROPROCESSORS/MICROCOMPUTERS/SYSTEM DESIGN. By Texas Instruments Learning Center and the Engineering Staff of Texas Instruments Inc. 634 pp., illus., outsized 7 1/4 x 10 1/4 format. This practical, authoritative guide details the versatile, proved-in-action methods and technical features of the 9900 minicomputer architecture that can be employed to create outstanding products and systems.
637/58X Pub. Pr., \$24.50 Club Pr., \$19.50

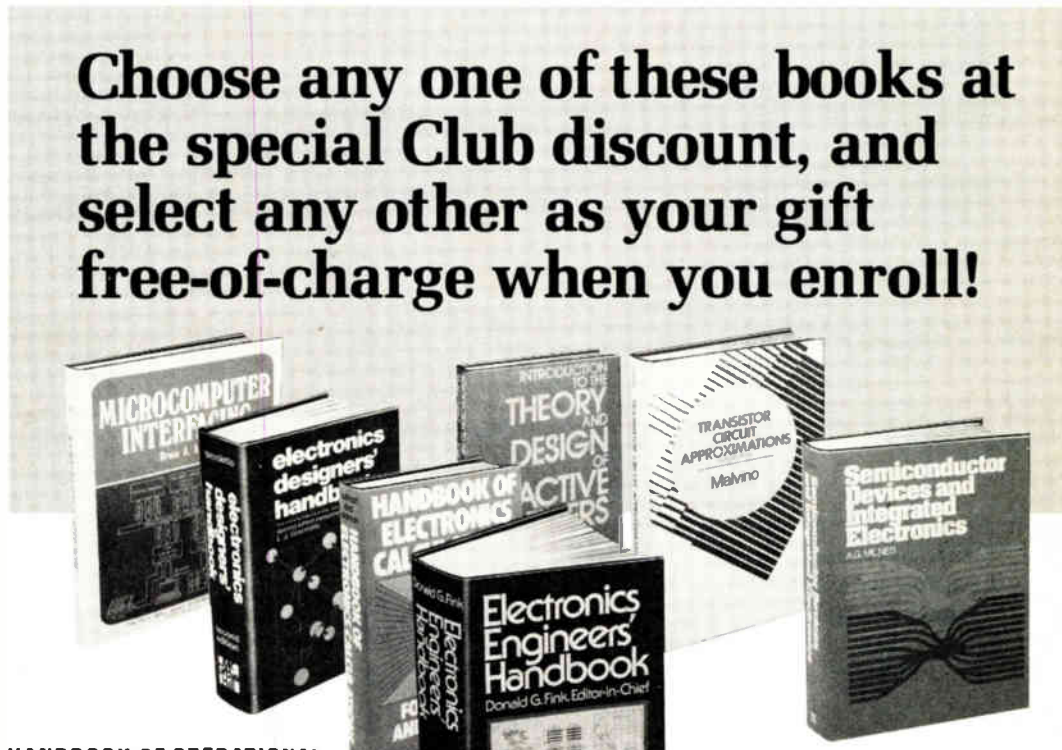

Choose any one of these books at the special Club discount, and select any other as your gift free-of-charge when you enroll!

HANDBOOK OF OPERATIONAL AMPLIFIER CIRCUIT DESIGN. By D. F. Stout; edited by M. Kaufman. 434 pp., 223 illus. Compact, concise, highly concentrated, and containing a storehouse of information, this one-stop volume will help you quickly solve any op amp circuit problem!
617/97X Pub. Pr., \$31.50 Club Pr., \$20.50

PRINTED CIRCUITS HANDBOOK, 2/e. By C. F. Coombs, Jr. 256 pp., 327 illus. Blueprints every important phase of printed circuitry. Provides the information you need to establish a production facility and control the processes. A virtual encyclopedia in the field, five major sections cover engineering, fabrication, assembly, soldering, and testing.
126/089 Pub. Pr., \$32.50 Club Pr., \$24.50

TRANSISTOR CIRCUIT APPROXIMATIONS, 2/e. By A. P. Malvino. 371 pp. Makes your arrival at an ideal solution to problems in your transistor work much easier than you ever dreamed! Using the "idealize and improve" approach, the book shows you how to arrive at a working degree of accuracy in the shortest time. All transistor topics—from power supplies and linear ICs to types of coupling, JFETs, and MOSFETs—are covered.
398/78X Pub. Pr., \$15.95 Club Pr., \$11.95

INTRODUCTION TO RADAR SYSTEMS, 2/e. By M. I. Skolnik. 698 pp., 244 illus. This new edition of a widely used text on radar from the systems engineer's point of view brings you full discussions of the many major changes that have occurred in the field recently.
579/091 Pub. Pr., \$34.95 Club Pr., \$27.95

MICROELECTRONICS: Digital and Analog Circuits and Systems. By J. Millman. 881 pp., 700 illus. This giant book takes you step by step from a qualitative knowledge of a semiconductor, to an understanding of the operation of devices, and finally, to an appreciation of how these are combined to form microelectronic chips.
423/27X Pub. Pr., \$28.95 Club Pr., \$22.50

BIT-SLICE MICROPROCESSOR DESIGN. By J. Mick and J. Brick. 320 pp., 230 illus. All in one place—the crucial information you've been needing about the 2900 family of bit-slice microprocessor components! A remarkable "first," this book designs right before your eyes not just one but two complete 16-bit machines!
417/814 Pub. Pr., \$18.50 Club Pr., \$14.50

MICROCOMPUTER INTERFACING. By B. Artwick. 352 pp., illus., 7 x 9 1/4 format. Here's your passkey to trouble-free, low-cost interfacing! The book gives you the data and describes the techniques you need to conceptualize, select, mate and match, build, and interface micro-computer systems—no matter what the application.
789/436 Pub. Pr., \$18.95 Club Pr., \$14.95

ELECTRONICS DESIGNERS' HANDBOOK, 2/e. Edited by L. J. Giacometto. 2,344 pp., 1,686 illus. Now doubled in size and with 90% of its material new, this famous classic (first edition by Landee, Davis, Albrecht) has been thoroughly revised and updated to give you not only the *how* and the *why* of all your design work but also the *how much* of every design step you take!
231/494 Pub. Pr., \$62.50 Club Pr., \$46.50

INTRODUCTION TO THE THEORY AND DESIGN OF ACTIVE FILTERS. By L. P. Huelsman and P. E. Allen. 430 pp., illus. Once you add active filter design to your repertory of specialties, you'll possess a skill that's in great demand today. Here's one of the best texts we know on the theory, design, application, and evaluation of modern active filters and the various techniques used today.
303/543 Pub. Pr., \$25.95 Club Pr., \$19.95

PHASELOCK TECHNIQUES, 2/e. By F. M. Gardner. 285 pp., illus. This edition of the standard working reference shows you not only better methods of analysis and better procedures for deciding on loop parameters, but also the circuits and the results.
582029-3 Pub. Pr., \$21.50 Club Pr., \$16.95

SEMICONDUCTOR DEVICES AND INTEGRATED ELECTRONICS. By A. G. Milnes. 816 pp., 605 illus. The main secret of this book's quick and tremendous success with engineers is the way its logical grouping and handling of the material builds and strengthens your in-depth grasp of the subject, plus its real-world application of just the right amount of theory.
789/487 Pub. Pr., \$26.50 Club Pr., \$20.95

ELECTRONIC COMMUNICATION, 4/e. By R. L. Shrader. 801 pp., 870 illus. This thoroughly updated edition offers all the theory and fundamentals you need to prepare yourself for the FCC commercial and amateur grade license examinations—and pass them the first time!
571/503 Pub. Pr., \$19.50 Club Pr., \$15.50

DESIGN OF SOLID-STATE POWER SUPPLIES, 2/e. By E. R. Hnatek. 640 pp., illus. A total revision and expansion of an essential, ready-to-use sourcebook on the design of power supplies, particularly of the switching variety. Incorporates the latest developments in the field while emphasizing the how-to help designers want.
582054-4 Pub. Pr., \$27.50 Club Pr., \$21.50

STANDARD HANDBOOK FOR ELECTRICAL ENGINEERS, 11/e. By D. G. Fink and H. Beaty. 2,448 pp., 1,414 illus. Today's most widely used source of electrical engineering information and data serves you as no other single work when you need detailed, timely, and reliable facts and how-to on the generation, transmission, distribution, control, conversion, and application of electric power.
209/74X Pub. Pr., \$54.50 Club Pr., \$41.95

Be sure to consider these important titles as well!

DIGITAL FILTERS. By A. Antoniou. 021/171 Pub. Pr., \$26.95 Club Pr., \$20.50

HANDBOOK OF ELECTRONIC SYSTEMS DESIGN. By C. A. Harper. 266/832 Pub. Pr., \$39.50 Club Pr., \$29.50

ELECTRONICS DICTIONARY, 4/e. By J. Markus. 404/313 Pub. Pr., \$24.50 Club Pr., \$19.50

ENGINEERING FUNDAMENTALS FOR PROFESSIONAL ENGINEERS' EXAMINATIONS, 2/e. By L. M. Polentz. 503/80X Pub. Pr., \$22.50 Club Pr., \$16.95

ENGINEERING MATHEMATICS HANDBOOK, 2/e. By J. J. Tuma. 654/298 Pub. Pr., \$24.95 Club Pr., \$19.95

RADIO HANDBOOK, 21/e. By W. Orr. 772/830 Pub. Pr., \$21.50 Club Pr., \$16.80

TRANSFORMER AND INDUCTOR DESIGN HANDBOOK. By W. T. McLyman. 788/755 Pub. Pr., \$35.00 Club Pr., \$26.50

CRYSTAL OSCILLATOR DESIGN AND TEMPERATURE COMPENSATION. By M. E. Frerking. 784/873 Pub. Pr., \$16.95 Club Pr., \$14.95

NATIONAL ELECTRICAL CODE HANDBOOK, 16/e. By J. F. McPartland. 458/909 Pub. Pr., \$19.95 Club Pr., \$14.50

NOISE REDUCTION TECHNIQUES IN ELECTRONIC SYSTEMS. By H. Ott. 769/63X Pub. Pr., \$27.95 Club Pr., \$20.95

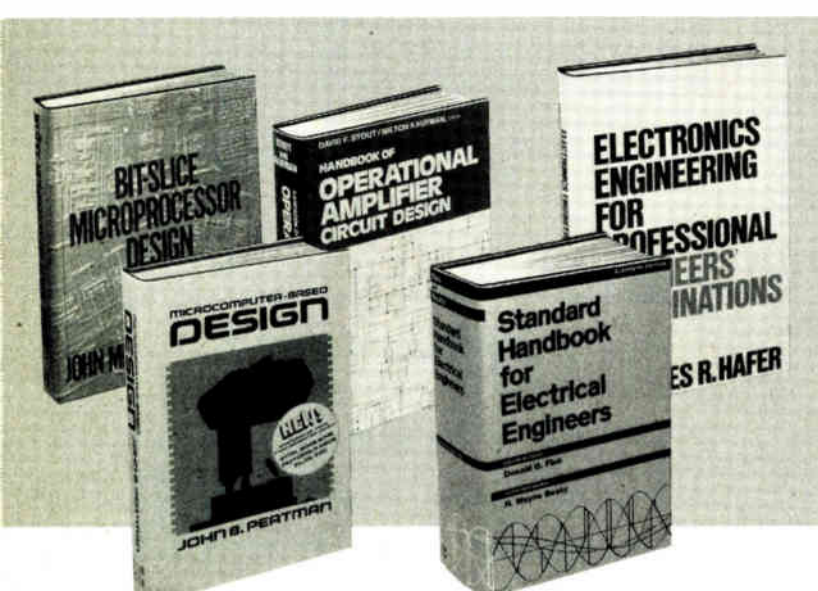

MAIL THIS COUPON TODAY

McGraw-Hill Book Clubs
Electronics and Control Engineers' Book Club
P.O. Box 582, Hightstown, New Jersey 08520

Please enroll me as a member and send me the two books indicated, billing me for my first selection only at the discounted member's price, plus local tax, postage and handling. If not satisfied, I may return the books within 10 days and my membership will be canceled. I agree to purchase a minimum of 3 additional books during the next 2 years as outlined under the club plan described in this ad. Membership in the club is continuous but cancellable by me anytime after the four book purchase requirement has been fulfilled.

Write Code # of FREE selection here Write Code # of FIRST selection here

Orders from outside the U.S. must be prepaid with international money orders in U.S. dollars.

Signature _____
Name _____
Address _____
City _____
State _____ Zip _____

This order subject to acceptance by McGraw-Hill. All prices subject to change without notice. Offer good only to new members. A postage and handling charge is added to all shipments.

E33425

Why YOU should join now!

- **BEST BOOKS IN YOUR FIELD** — Books are selected from a wide range of publishers by expert editors and consultants to give you continuing access to the latest books in your field.
- **BIG SAVINGS** — Build your library and save money too! We guarantee savings of at least 15% off publishers' list prices on every book. Usually 20%, 25%, or even higher!

BONUS BOOKS — You will immediately begin to participate in our Bonus Book Plan that allows you savings between 70-80% off the publisher's price of many books.

- **CONVENIENCE** — 14 times a year you receive the Club Bulletin FREE, fully describing the Main Selection and alternate selections, together with a dated reply card. If you want the Main Selection, you simply do nothing — it will be shipped automatically. If you want an alternate selection — or no book at all — you simply indicate it on the regular reply card and return it by the date specified. You will have at least 10 days to decide. If, because of late mail delivery of the Bulletin you should receive a book you do not want, just return it at the Club's expense.

As a Club member, you agree only to the purchase of four books (including your first selection) over a two-year period.

electronica 80

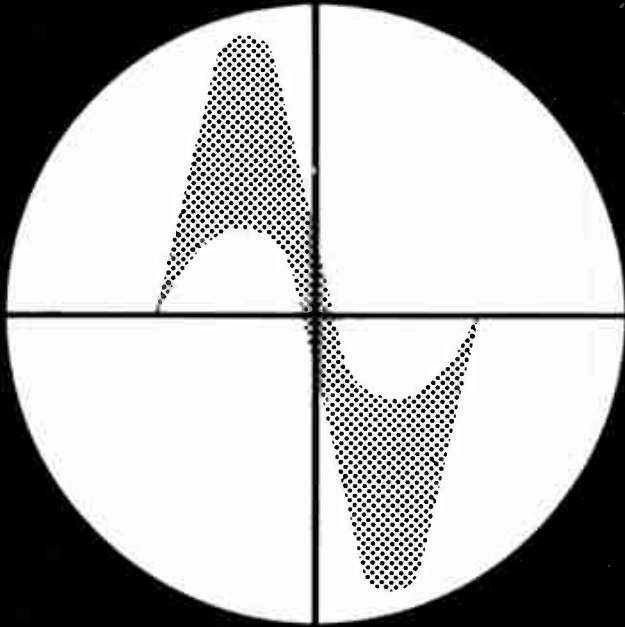

9th International Trade Fair
for Components and
Assemblies in Electronics

MUNICH

6 - 12 November 1980
Fair Grounds

Programme of specialist
conferences 5-7 November
9th International Congress on
Microelectronics
10-12 November



electronica 80 - Coupon

Please forward to my address detailed literature

Name

Address

Information: Gerald G. Kallman Associates, 30 Journal Square,
Jersey City, N.J. 07306, Tel.: (201) 653 3304,
Telex: 710-730-5380 Goodword jcty.

Postage Isn't Peanuts Anymore



Tough Problems Find Easy Solutions at Interface

A Problem For Scale Manufacturers

To provide business with some control over the high costs of postage and mail handling, scale manufacturers must design weighing systems that can weight a piece of mail, determine the correct rate classification, compute the postage by Zip zone, and charge the cost to the proper department.

The Solution

Smart scale manufacturers have found the easy answer at INTERFACE - design these complex weighing systems around Minibeam Load Cells. These primary components provided accurate measurements with high repeatability, compact size, easy installation, low cost, and no moving parts to wear. The ideal heart for postal and parts counting scales. INTERFACE Mini and Low Pro-



file, strain gage load cells are the modern answers to force measurement and weighing problems. Pioneering research, proprietary material technology, exacting standards, competitive prices, and fast product delivery have made INTERFACE the industry leader. Good reasons to contact INTERFACE with your tough problems in weighing and force measurement.

Interface

ADVANCED FORCE MEASUREMENT

7401 E. Butherus, Scottsdale, Arizona 85260 USA (602) 948-5555
Telex 668-394

Career outlook

GE faces age-bias charges

■ Charges of discrimination against the older electrical engineer are once again rearing up as the recession spreads. At Appliance Park in Kentucky, just outside of Louisville, General Electric Co. has had to lay off some 400 salaried workers in the last nine months. Of those 400 workers, about 130 are electrical engineers, and many are over age 40.

"The lack of work seems to have a disparate impact on older workers," notes Richard Caslin, an attorney representing some of the laid-off workers and himself a former GE employee. At present, Caslin has three Federal court actions pending against GE and has filed more than 10 age-discrimination complaints with the Kentucky Commission on Human Rights.

"The Kentucky Commission and I are trying to get the Federal EEOC [Equal Employment Opportunity Commission] to file a systemic, or class action, charge against the company on a nationwide basis," notes Caslin. "We have reason to believe that age discrimination is a deep-seated company policy," he adds.

A spokesman for GE notes that the company "looks at all possibilities for work within GE first in Louisville, then outside Louisville in Texas, Milwaukee, Bloomington, and anywhere else the Appliance division has manufacturing facilities. If the search inside is unsuccessful, then we have an outplacement service."

DOD fiber-optic papers. The Electronic Industries Association is calling for technical papers in preparation for a program for a joint Department of Defense and industry fiber-optics standards conference to be held next March or April. The conference—for which North Atlantic Treaty Organization participation has been requested—is to identify military fiber-optic standardization issues. Noncommercial, unpublished technical papers are sought in the following areas: real applications involving systems or installations; individual components such as fibers, cables, interconnections, trans-

ducers; instrumentation for testing components in the laboratory; field-testing considerations; and standard procedures. Persons wishing to offer a paper for consideration should by Sept. 15 submit eight copies of a 300-word summary, complete with the author's name, address, and telephone number in the heading. Send them to Steve Forish, EIA Headquarters, 2001 Eye St., N. W., Washington, D. C. 20006. Notification of acceptance will be made by Nov. 1.

Computer club affiliation. In addition to offering full membership to vendors, consultants, manufacturers, and end users, the National Computer Association now offers membership to computer clubs. With this membership, each club will receive all NCA publications for an annual fee of \$50 per year. The NCA is also establishing subgroups of 200 or more interested members along product and individual interest lines. Individual membership in the NCA is \$35 per year. For more information write to Floyd L. Burton, Director, National Computer Association, 1485 E. Fremont Circle S., Littleton, Colo. 80122, or call (303) 797-3559.

Troubleshooting microprocessors. Participants in the "Hands-on Microprocessor Troubleshooting" course 142, offered by Integrated Computer Systems Inc., will learn programming fundamentals for troubleshooting; bus, processor, and input/output basics; and systematic procedures for isolating hardware and software faults as well as methods for designing testable microprocessor systems. The four-day course costs \$795; it will be given in Anaheim, Calif., beginning on Sept. 23. Later this fall it will also be given in Washington, D. C., Boston, Houston, and other locations. For further information, write to Michael B. Sanson, Integrated Computer Systems Inc., 3304 Pico Blvd., Box 5339, Santa Monica, Calif. 90405, or phone him at (213) 450-2060.

Private practice trends. Looking at current trends in private practice, the National Society of Professional

The NEW Electronics Buyers' Guide is now available!

Completely new listings of catalogs, new phone numbers, new addresses, new manufacturers, sales reps, and distributors! The total market in a book—four directories in one!



**The only book of its
kind in the field.**

**If you haven't got it,
you're not in the market.**

**To insure prompt delivery
enclose your check with
the coupon now.**

Yes, please send me _____ copies of
1980 EBG.

I've enclosed \$30 per copy delivered in
USA or Canada. Address: EBG, 1221 Avenue
of the Americas, New York, N.Y. 10020.

I've enclosed \$52 for air delivery
elsewhere. Address: EBG, Shoppenhangers
Road, Maidenhead, Berkshire S16,
2Q1 England.

Name _____

Company _____

Street _____

City _____

State _____

Zip _____

Country _____

Circuit Control Lever Switches

- Up to 16 sets of contacts
- Millions of trouble-free cycles
- Custom designed contact assembly, including Form A, B, C, or D in combination or alone
- Easy mounting
- Positive detent feel for sure, easy-locking sensitivity

When your computer, test equipment or radio control demands quality switching... Switch to Capitol. Write or phone today for all the facts.

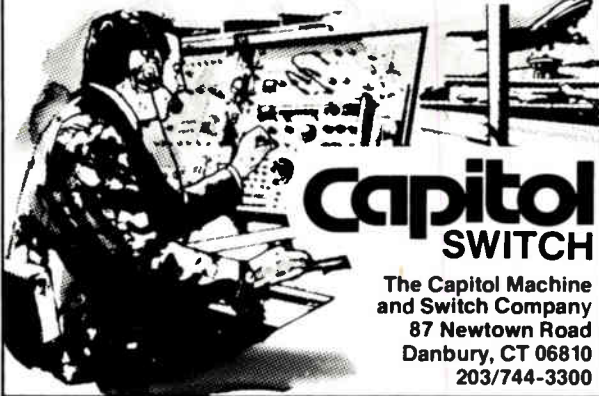

Capitol SWITCH

The Capitol Machine and Switch Company
87 Newtown Road
Danbury, CT 06810
203/744-3300

Circle 238 on reader service card See us at WESCON, Anaheim, CA—Booth 1057

Another Knock-Out from International Microsystems



IM1010 Universal PROM Programmer

- Programs BIPOLAR PROMs, EP-ROMs, Single Chip Microcomputers, FPLA's, PGA's, PMUX's etc.
- Full editing capability.
- Two serial interfaces standard for terminals, development systems and timeshare computers.
- PROM Emulation capability to test and edit programs before committing them to PROM's.
- Multi-PROM Programs may be loaded into RAM and entire PROM sets programmed.
- 4Kx8 RAM standard — 16Kx8 RAM or 32Kx8 RAM optional.
- Personality Module to assure future device capability.
- Personality Modules may be changed without affecting RAM data.

Mainframe \$2,095.00
Modules \$375-550.00.
CALL US TODAY
IMI
1154 C Avenue
Auburn, CA 95603
916 885-7262



Career outlook

Engineers will hold a series of conferences starting in Denver, Oct. 3-4. "Engineering in Tea Leaves—A Look at the '80s," will identify trends that concern engineers who are assuming management positions in private practice. Some of the areas that will be covered are: anticipating a firm's financial needs; identifying the types of technical people who will be needed; the staffing costs of a computer or word-processing installation; and the procurement trends and professional liability of engineers. Jean Robertson at the NSPE information center has more information; her address is 2029 K St., N. W., Washington, D. C., 20006, or call (202) 331-7020.

Pocket-sized computer. A Radio Shack hand-held computer has a 24-character liquid-crystal display with English language prompting and includes a 1.9-kilobyte random-access memory that retains information for the 300-hour life of the internal batteries. Ideal for those engineers who wish to carry computing power with them, the TRS-80 pocket computer weighs 6 ounces and is less than 7 inches long. It can be programmed in Basic, and pre-programmed tapes for real estate, civil engineering, personal finances, aviation, math drill, and a games pack are also available. These tapes may be loaded into the unit with an optional cassette interface. The TRS-80 may also be used as a powerful calculator with up to 15 levels of parentheses. The computer is priced at \$249.95, with the optional



cassette interface priced at \$49.00. A printer will also be available soon. Tandy Corp./Radio Shack, 1800 One Tandy Center, Fort Worth, Texas 76102.

Classified section FOR ENGINEERING/TECHNICAL EMPLOYMENT OPPORTUNITIES

HIGH VOLTAGE ELECTRICAL ENGINEER

Cambridge laboratory of rapidly growing instrumentation company requires creative electrical engineer with 3-5 years experience in design and engineering of high voltage power supply systems and high voltage switching circuitry for challenging R&D project. Attractive salary and benefit program. Intellectually exciting and congenial environment.

Contact:

Dr. Sohval or Dr. Hearn

elscint inc.

Cambridge Advanced Research Laboratories
143 Binney Street
Cambridge, MA 02142
617-661-0490

The Geophysics Program at MICHIGAN TECH. UNIVERSITY is looking for an ELECTRONICS TECHNICIAN/RESEARCH ASSOCIATE

The position requires a substantial understanding of modern electronics, including digital and analog principles, and practical experience in trouble shooting a wide variety of electronic instruments. The applicant will be expected to design and construct new equipment and interfacers for existing equipment. Familiarity with geophysical instruments and basic principles of physics and geology is desirable. An Associate or B.S. degree is encouraged. Candidates with a M.S. degree will also be considered. Salary is competitive and flexible, depending on experience and qualifications. Michigan Tech is located in the state's scenic Upper Peninsula. The area contains several historic towns with easy access to numerous lakes. Abundant snow favors enjoyable winter recreation. For application form and additional information contact:

Dr. J. Kallikowski, Head
Dept. of Geol. & Geol. Engrg.
Michigan Technological University
Houghton, MI 49931
(906) 487-2531

Michigan Tech is an equal opportunity educational institution / equal opportunity employer.

EXCLUSIVELY—EE

Research Associates specializes in the location and placement of engineers exclusively within the electronics industry. All fees company paid. If you are a talented degreed Electronic Engineer with either a casual or serious desire to investigate other engineering opportunities, call collect or send resume to:

RESEARCH ASSOCIATES
490 Old Toll Road
Madison, CT 06443
203-421-3088

YOUR CAREER STRATEGY

Could help you increase your income \$10,000 or more per year. This is the opportunity of your life. Free information.

MER
Box 2042
Bloomington, Ind. 47402

WE'RE THE FASTEST GROWING COMPANY IN OUR FIELD,

BUT YOU MAY NOT HAVE EVEN HEARD OF US.

We're the Electronics & Space Division of Emerson Electric . . . A St. Louis based highly diversified firm ranked among the best managed companies in America, and we're looking for forward-thinking engineers, operations, and financial people.

At E&S our people work in a division that operates like an independent

moderate-sized company. This means that individuals and their contribution are more easily recognized and rewarded.

Yes, you may not have heard of us, but organizations and governments all over the world have come to us for our broad range of mechanical and electronic products and systems.

Here are just a few of the many opportunities at E&S:

ATE

Design
Applications software/hardware

ENGINEERING SUPPORT

Scientific & business programmer
Failure analysis, fracture mechanics
Maintainability engineer
Maintenance engineer
Quality assurance
Program management
Manufacturing engineers
Operations people

DESIGN/ANALYSIS

Close combat weapons systems
Fire control systems
Air defense systems
Combat support systems for artillery

ELECTRONIC SYSTEMS

Electronics packaging design
SIGINT/EW Systems
Electrical/Optical tracker systems
Coherent radar systems
Analog and digital hardware design
RF and video circuit design



Interested in finding out more? Just call 1-800-325-0783 (In Missouri, call collect (314) 553-4303).

Or send resume to Personnel Resources, Station 4303, Dept. EW-PSI, 8100 W. Florissant, St. Louis, Mo. 63136.

Electronics ← Space Division

EMERSON ELECTRIC

8100 W. Florissant • St. Louis, Mo. • 63136

AN EQUAL OPPORTUNITY EMPLOYER

ENGINEERS

- Design
- Avionics
- Systems
- Test
- Communication
- Digital
- Analog
- Micro Processing

Our specialty is placing engineers with electronic and agricultural machinery companies. Engineering positions available anywhere in the United States. Companies pay for interview, relocation and fees.

Call or send resume in confidence to:

CORPORATE CONSULTING, INC.

2150 North Park Avenue
Winter Park, Florida 32789
(305) 628-0730

TEXAS SALES ENGINEER POSITIONS EE'S, CHEM E'S, ME'S

Fees and expenses paid. Our specialty is technical sales. Excellent positions now available. Send resume/goals to: Sherman Stone, RECRUITERS OF TEXAS, Personnel Recruiters, 4000 Medical Parkway, Suite 131, Austin, TX 78756 (512) 454-9546.

S.W. & SUNBELT

- System EE's
- Design EE's
- Product EE's
- Software
- Design ME's
- Communications

\$20,000 to \$50,000
100% Fee Paid

Specializing in placing technical people with data acquisition and peripheral equipment manufacturers located across southern U.S. Send complete resume, salary history and geographic preferences to:

J. Robert Thompson Companies, Inc.

Management & Employment Consultants
2200 West Loop South, Suite 800
Houston, Texas 77027 713/627-1940

Put yourself in a better position.

Join one of the fastest growing companies anywhere and make a career move with meaning for your future. Storage Technology Corporation is the world's largest manufacturer of high density tape data storage equipment, and a major manufacturer of disk subsystems. We have a rapid, stable growth that gives you greater opportunity for advancement. Currently we are in need of the following:

READ/WRITE ENGINEER

To be involved in the design of analog & digital magnetic recording circuitry. Responsibilities to include integrated circuits design, phase locked loop theory, design of linear filtering, low noise amplifications and logic design.

BSEE and five years experience, or equivalent, required.

INDUSTRIAL ENGINEER

Will perform methods analysis studies and operations research for major projects. Experience in long range planning for use of facilities, manpower and equipment is necessary, in addition to 2-4 years manufacturing experience.

MANUFACTURING ENGINEER

Interface with design engineering in both the development and production phase to assure manufacturable products; work with vendors to minimize vendor and receiving problems; design and build, or have built, assembly tooling/fixturing; write, validate, update, and revise assembly procedures as necessary to ensure finished products meet current engineering criteria; coordinate with other departments to ensure production schedules are met.

BS degree in an engineering science and 2-5 years related experience, or equivalent, required.

INDUSTRIAL ENGINEER

Duties to include work measurement methods improvement, cost reduction and cost control. In addition, you would be responsible for employing industrial engineering techniques such as standard data, watch study, work sampling, motion economy analysis, line balancing, material handling and flow tooling, manpower projections, cost estimating, cost analysts, make or buy analysis, etc., to achieve cost effective results.

BSIE and 2-5 years experience, or equivalent, required.

QUALITY ENGINEER

To work in the areas of equipment design and development preparing specifications and doing process studies. Requires working with conventional types of plans, investigations, surveys, structures and/or equipment with relatively few complex features.

BS degree in an engineering science and 2-5 years experience, or equivalent, required.

TEST ENGINEER

To develop test programs for new tape products, specify test equipment, write diagnostics tests, perform maintenance on unique test equipment and write test procedures. Microprocessor and programming experience desirable.

BSEE or BS Mathematics and 2 years experience, or equivalent, required.

INDUSTRIAL ENGINEER

Will perform methods analysis studies and operations research for major projects. Experience in long range planning for use of facilities, manpower and equipment necessary. Two to four years manufacturing experience required.

MANUFACTURING ENGINEER

Responsible for procedure and process definition, tool & fixture design, cost reduction. Should have 3-5 years experience, preferably in an electronics environment.

QUALITY ENGINEER

To be responsible for specification of acceptance criteria, analyzing defects, verification of tooling and manufacturing processes and providing technical direction for various support groups. Two to five years quality experience and good analytical skills a must.

STC offers an excellent compensation package including health and insurance benefits, stock purchase plan and more. For immediate consideration please send your detailed resume in Confidence to Willie Marrow, STORAGE TECHNOLOGY CORPORATION, Dept. E9/11, 2270 South 88th Street, MD#29, Louisville, Colorado 80027. We are an equal opportunity employer.



**STORAGE
TECHNOLOGY
CORPORATION**

TELECOMMUNICATIONS SYSTEM ENGINEERS

Tri-State, headquartered at the base of the Rocky Mountains, is a rapidly expanding power supplier for 25 rural electric cooperatives. We are seeking qualified individuals to accept challenges and opportunities in our Telecommunications Department.

A BSEE or Electronics Engineering Technology Degree and 2-5 years of microwave and 2-way radio systems design experience is required to perform detailed engineering of complex telecommunications facilities for total integration of our Energy Management System.

If you are one of the qualified individuals we are seeking, please send your resume and salary requirement to Tri-State Generation & Transmission Assn., Inc., P.O. Box 33695, Dept. BB, Denver, Colorado 80233.

An Affirmative Action/Equal Opportunity Employer



TRI-STATE
GENERATION & TRANSMISSION
ASSOCIATION, INCORPORATED

FREE Your dream job.

We hope you're happy in your current position, but there's always that ideal job you'd prefer if you knew about it.

That's why it makes sense to have your resume on file in the Electronics Manpower Register, a computerized data bank containing the qualifications of career-conscious ELECTRONICS readers just like yourself.

You'll benefit from nation-wide exposure to industry firms privileged to search the system, and since the computer never forgets, if you match up with their job requirements you'll be brought together in confidence.

To take advantage of this free service, mail your resume to the address below.

ELECTRONICS MANPOWER REGISTER
Post Office Box 900/New York, N.Y. 10020

ELECTRONICS ENGINEERS

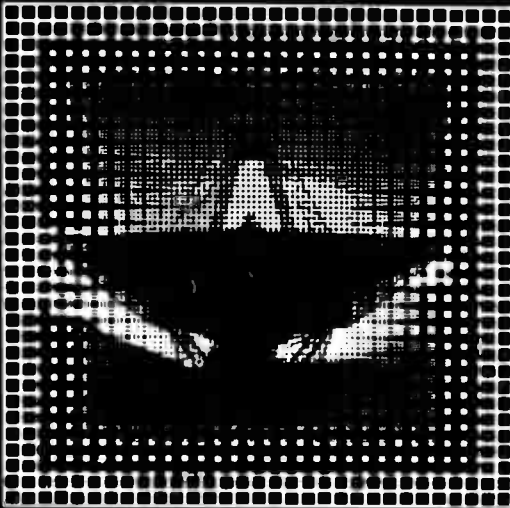

Discover just how far your expertise reaches.

At Lockheed Missiles & Space Company in Sunnyvale, California (on the beautiful San Francisco Peninsula), you'll have the opportunity for professional participation in a wide spectrum of scientific and technological programs.

Programs involve frontier technology in such diverse areas as deep sea vehicles, ocean mining, communication satellites, guidance and control, electro-optical R&D. And that's just a sampling.

Challenging career opportunities exist in the following areas:

COMMUNICATIONS

Wideband/Secure Communications systems. We need engineers to design systems involving spread spectrum, frequency hopping, and error correcting coding.

RADAR SYSTEMS

Positions available in systems and signal processor design involving SAR and other sophisticated concepts.

POWER SYSTEMS

Analyze requirements for and perform conceptual and detail design of satellite solar power systems. Familiarity with satellite power equipment including regulators, converters, and power supplies desirable.

GUIDANCE AND CONTROL

Plan and conduct performance analysis on advanced tactical guidance and flight control systems. Develop methods and simulation models to evaluate overall system accuracies, design limitations and effects of external disturbances.

NUCLEAR EFFECTS

Perform nuclear effects testing of electronic assemblies including planning, test requirements, test direction, and report preparation.

Design and develop state-of-the-art solid state active and passive devices suitable to withstand missile environments anticipated in the next ten years, including nuclear environments. Requires 2 years' experience in this field.

RF SYSTEMS

Perform RF Hazards and Electromagnetic Compatibility (EMC) Analysis and Testing. Duties will include establishing grounding, bonding and shielding (GBS) ground rules and monitoring product development for adherence to GBS practices and EMC.

Design antenna systems and perform analysis of antenna performance. Will conduct theoretical studies of electromagnetic phenomenon related to antenna design and RF systems, microwave theory and applications.

MICROELECTRONICS

Develop wafer fabrication processes for fabrication of GaAs, SOS, TTL, and MOS integrated circuits.

ELECTRONIC DESIGN

Design and development of specialized computer input/output devices, test systems, and airborne equipment. Positions available at all experience levels for engineers abreast of the state-of-the-art in digital technology. Experience with high-reliability, severe environment systems is desirable.

FIELD ENGINEERING

Several permanent and temporary field assignments are available, both foreign and domestic. Requires BSEE or expansive technical experience maintaining digital computers and associated peripherals. Some software knowledge preferred, but not required. Navy communications/electronics systems experience a plus.

Join us on the beautiful San Francisco Peninsula now, and find out why the Western way of life is so desirable.

For immediate consideration, please forward your resume indicating position of interest to **Employment Office, Dept. E-911, P.O. Box 504, Sunnyvale, CA 94086**. We are an equal opportunity affirmative action employer.

U.S. CITIZENSHIP IS REQUIRED.

At Lockheed, technical excellence is a way of life.

LOCKHEED
MISSILES & SPACE COMPANY, INC.

**CAULFIELD INSTITUTE
OF TECHNOLOGY,
MELBOURNE, AUSTRALIA**

**SCHOOL OF COMPUTING AND
INFORMATION SYSTEMS**

**Department of Robotics
and Digital Technology**

Principal Lecturer

(Ref: 80/58)

Applications are invited for the position of Principal Lecturer in Digital Technology.

The appointee will be responsible to the Dean of the School for the overall development of the new Department of Robotics and Digital Technology with respect to:

- the establishment of a Centre for Robotics;
- the establishment of a Laboratory of Digital Technology;
- the development of education in robotics;
- the formation of a research and development group to develop and design prototype robotic devices;
- the design and construction of facilities for the development and production of micro-electronic circuits and systems;
- the development of relevant education for training people in the manufacture and use of micro-electronic circuits and systems; and,
- liaison with government and industry to establish development and educational requirements.

A high qualification in computer science and/or digital electronic engineering is required together with specialisation in, and understanding of, artificial intelligence, and/or experience in digital control of mechanical systems or a proven working knowledge of digital technology.

The position may be filled under tenured or term contract conditions.

Salary: \$A27,843 p.a.

Intending applicants should obtain a job specification from the Staff Officer.

Written applications (in duplicate) quoting the reference number, and including personal and career details and the names and addresses of two referees, should be addressed to the Staff Officer to reach him by 10 October 1980.



Caulfield Institute of Technology,
900 Dandenong Road, Caulfield East,
3145, Victoria, Australia

VISIONARIES

General Electric's Lighting Business Group is developing advanced automatic visual sensing systems for use in inspection and control applications. A unique opportunity exists for a software Project Leader to work on the development of this exciting new technology. Responsibilities will include participation in the design of system architecture, the development of the necessary techniques and algorithms, and leading the implementation of the software.

Ideal candidates will have an MS or PhD in Electrical Engineering, Computer Science, Applied Mathematics, or Physics and have a strong background in such areas as digital signal processing, pattern recognition, image processing, and numerical analysis. Candidates should also have several years experience in the development of software for real-time signal processing or machine control application.

Please submit resume and salary history to:

Mr. J. S. Riddle
General Electric Company
Nela Park, Bldg. 314
Noble Road
E. Cleveland, Ohio 44112

An Equal Opportunity/Affirmative Action Employer, m/f/v/h.

GENERAL  ELECTRIC

NOTICE TO EMPLOYERS:

Why we can recommend our readers for the top jobs

The subscribers to this magazine have qualified professionally to receive it. They are also paid subscribers—interested enough in the technological content to have paid a minimum of \$18 for a subscription.

As subscribers to **ELECTRONICS**, our readers have told you several things about themselves. They are ambitious. They are interested in expanding their knowledge in specific areas of the technology. And they are sophisticated in their need for and use of business and technology information.

Our readers are now in senior engineering or engineering management, or they are on the road toward those levels. In either case, they are prime applicants for the top jobs in almost any area.

If you are interested in recruiting the best people in electronics, these pages are open to you for your recruitment advertising.

Our readers are not "job-hoppers". To interest them you will have to combine present reward with challenge and opportunity for future career advancement.

The cost of recruitment advertising on these pages is \$71 per advertising inch. For information call or write:

Electronics

Post Office Box 900, New York, NY 10020
Phone 212/997-2556

ALEXANDER HAD THE SPIRIT.

Communication.

Transmitting the human voice electrically. For the very first time.

A lone man pursued his dream and invented the telephone.

It was a unique moment in history. When dedication, curiosity and creativity converged to achieve the impossible.

The spirit of innovation that inspired Alexander Graham Bell to greatness lives on today—at Harris Semiconductor in Melbourne, Florida.

Where the simple transmission of electrical current has developed

into the highly complex world of microelectronics.

Where state-of-the-art IC technology and commitment to excellence are a way of life.

At Harris Semiconductor, we realize that real progress cannot occur without creative freedom in an environment that encourages and rewards achievement. And we are dedicated to providing just that for our engineering professionals.

Alexander Graham Bell's achievement opened the door to a future of electronic technology. Harris Semiconductor is the future of microelectronics.

You missed the first historic

communications connection. Don't miss this opportunity to make engineering history at Harris today.

If you have the spirit—fill out this confidential mini-application and rush it to **Ken Judson, Professional Staffing, Harris Semiconductor, P.O. Box 883, Dept. 259, Melbourne, Florida 32901.** (Openings also exist in our San Francisco and Poughkeepsie, New York, facilities.)



HARRIS
SEMICONDUCTOR GROUP

An Equal Opportunity Employer M/F/V/H

THE SPIRIT IS ALIVE.



NAME _____

ADDRESS _____

CITY _____ STATE _____ ZIP _____

HOME PHONE _____ HIGHEST LEVEL OF EDUCATION _____

PRESENT EMPLOYER _____

JOB TITLE _____

PRESENT DUTIES _____

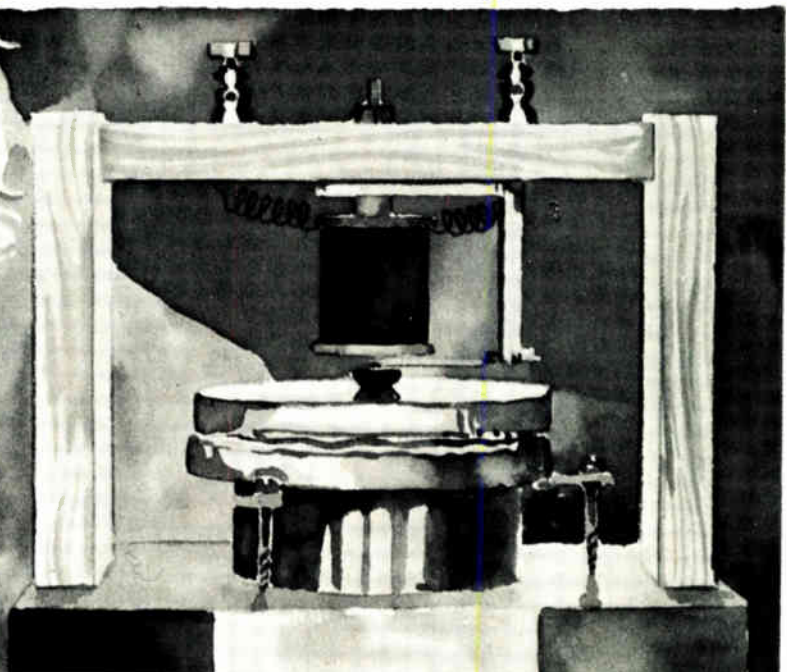

AT OHIO MEDICAL, MICROCOMPUTER TECHNOLOGY ISN'T JUST A PHASE WE'RE GOING THROUGH... IT'S HERE TO STAY!

Ohio Medical is a nationally recognized manufacturer of a diversified line of medical devices and supplies such as ventilators, incubators, anesthetics, disposables and anesthesia and pulmonary function equipment. Our market is extremely competitive and recession resistant. As we develop new products to keep pace with ever increasing demands for more sophisticated technology, talented and innovative electronic, mechanical, and biomedical engineers are required to design our products of the future and the machinery and manufacturing processes needed to produce them.

As we move into a new phase of growth and expansion we need the following professionals to help us achieve our goals:

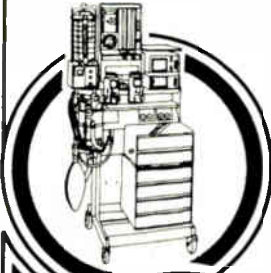

SPECIALISTS IN PRODUCT DEVELOPMENT

**DEVELOPMENT ENGINEERING
MANAGERS (EE/ME)**

**Respiratory Care
Advanced Anesthesia Systems**

SENIOR STAFF ENGINEER (EE)

MECHANICAL PRODUCT ENGINEERS (ME)

SPECIALISTS IN MACHINE & MANUFACTURING PROCESS DESIGN

GROUP MANAGER (EE/ME; MBA preferred)

ELECTRICAL MANUFACTURING ENGINEERS

MECHANICAL MANUFACTURING ENGINEERS

MANUFACTURING SPECIALIST

RELIABILITY ENGINEER (EE)

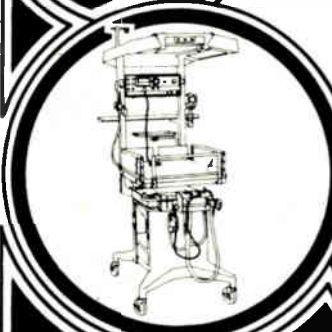

In addition to exceptional challenges, rewards and recognition, the professionals at Ohio Medical enjoy the excitement of participating in high impact development groups, where the results of individual efforts are immediately visible. Concurrently, we offer excellent compensation programs as well as attractive lifestyle possibilities in our all-American Madison, Wisconsin location. For further information, contact:

Manager, Industrial Relations Department
(608) 221-1551

Ohio Medical Products

P.O. Box 7550 / Madison, WI 53707

An Equal Opportunity Employer M/F



ENGINEERS

**BALL HAS
MAJOR PROJECT
ASSIGNMENTS
NOW!**



ENGINEERING PROFESSIONALS JOIN OUR TEAM and LIVE IN BOULDER, COLORADO

Ball Aerospace Systems, a Division of the Ball Corporation, is seeking engineers who want challenging career opportunities in the aerospace industry.

We have become a leader in the development of space science instrumentation, electro-optics, antennas, military electronics, satellite systems and subsystems.

We would like to talk to qualified individuals in the following areas:

**Electrical Engineers
Mechanical Engineers**

**Quality Engineers
Antenna Engineers**

Ball Aerospace Today: People and Ideas working together in Boulder — a community nestled in the foothills of the Rocky Mountains. Nearby you can hike, fish, hunt, ski and enjoy some of America's greatest recreational areas. You and your family will have time to relax in cool, colorful Colorado.

We offer an excellent salary and benefits package including medical, dental, life insurance, stock purchase plan, credit union, 100% tuition reimbursement and **FOUR WEEKS VACATION after one year**. If you are seeking a career with a leader in the industry, send your resume to the attention of Joni Coffin.



AEROSPACE SYSTEMS DIVISION

Employee Relations Department
P.O. Box 1062
Boulder, Colorado 80306
Call Collect: (303) 441-4111

Equal Opportunity Employer M/F

ELECTRONICS ENGINEERS

INTERESTED OR WITH EXPERIENCE IN

**ANALOG/DIGITAL DESIGN
ENGINEERING**

SOFTWARE DEVELOPMENT

SYSTEMS ANALYSIS

DATA ENGINEERING

**DESIGN TO UNIT PRODUCTION
COST PROJECT ENGINEERING**

RELIABILITY ENGINEERING

PARTS ENGINEERING

RADAR SYSTEMS ENGINEERING

**INERTIAL DEVELOPMENT
ENGINEERING**

Immediate and challenging positions now available in our 4-season location in Western New York State. Attractive area housing costs and a generous company relocation policy warrant investigation.

Please send resumes, in confidence, to Edward Weiser, Employment Supervisor, Bell Aerospace Textron, PO Box 1, Buffalo, NY 14240

Bell Aerospace TEXTRON

Division of Textron Inc.

An Equal Opportunity Employer M/E/Hc

NCR is making a massive investment in semiconductor technology...and in your career.



\$155 Million. That's how much NCR will invest during the next four years to *double* the space, and capabilities and professional staff of our microelectronics manufacturing and engineering centers in Miamisburg, Ohio; Fort Collins and Colorado Springs, Colorado. As a result, the portion of internally produced custom semiconductors used in NCR computers will grow from 40% to 60%.

This dramatic growth of NCR's microelectronics operations creates new opportunities for you to become involved in products that include MNOS non-volatile memories, high density RAM's, VLSI logic components, CMOS memory and logic devices, and technologies that include ion-implanted 2-micron geometry. Silicide development. Plasma etching. Fine line lithography. And computer modeling of devices and processes.

You'll have the resources . . . and strengths . . . of a giant, heavily semiconductor-committed, \$3 billion computer company behind you. In short, if your credentials include a BS or MS or PhD in Electrical Engineering, Solid State Physics or Chemistry, now is the time, and here are the places to make optimum use of your background . . .

Openings in Miamisburg:

- VLSI Logic Design Engineers
- VLSI Memory Design Engineers

Write to: Ms. Marcia Laderman,
NCR Corporation, Microelectronics,
Dept. E78, 8181 Byers Road,
Miamisburg, Ohio 45342.

Openings in Ft. Collins:

- CMOS Logic Designer
- CMOS Memory Designer
- Failure Analysis Engineer

Write to: Mr. Richard Veldhouse,
NCR Corporation, Microelectronics,
Dept. E78, 2001 Danfield Court,
Fort Collins, Colorado 80525.

Openings in Colorado Springs

IN SEMICONDUCTORS:

- CAD Analyst/Software Engineer
- Product Engineer
- Process Equipment Engineer, R&D
- Quality Assurance Engineer
- Device Modeling

IN ELECTRONIC DISPLAYS:

- Thick Film Process Engineer

Write to: Mr. Stanley Bloom,
NCR Corporation, Microelectronics,
Dept. E78, 2850 North El Paso Street,
Colorado Springs, Colorado 80907.

NCR

Complete Computer Systems

An equal opportunity employer

SOFTWARE ENGINEERS.

WITH US, YOUR PROJECT IS THE WHOLE PROJECT.



LOCK, STOCK AND BARREL.

At Coulter Electronics, we have a total systems approach to engineering.

You'll take special pride in your own projects. Because you're involved from start to finish. From concept to production to marketing.

It's an approach that's helped make us a recognized and expanding leader in biomedical electronics and instrumentation.

When you apply your **micro-processor/mini-computer experience in our top-down design, structured programming environment**—you'll see your ideas take full form.

When you utilize your degree in Math, Computer Science or Electrical Engineering — you'll be improving the state of health care worldwide.

It's a big job. A thorough, complete, far-reaching job. It could be your job.

Send your resume and salary history to: **Employment Manager, Coulter Electronics, Dept. E, P.O. Box 5-2794, Miami, Florida 33152.**

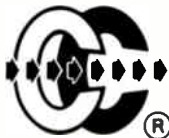

COULTER ELECTRONICS, INC.
INNOVATING A VITAL TECHNOLOGY.

An Equal Opportunity Employer M/F

SOUTH & SOUTHWEST POSITIONS

Engineering and Management positions throughout the South, Southwest and U.S. Employers pay all fees. Send resume or call Bob Hogue, P.E. (513) 658-3525.

SouthWest Technical

P.O. Box 33070,
San Antonio, Texas 78233



**Would
you hire
an engineer
who
couldn't
understand
this
magazine?**

Of course not. **ELECTRONICS** is the technical publication for technical people. If they can't understand it, they can't receive it. That's why, when you're looking for qualified engineers, you should consider our Classified Section.

For only \$71.00 per inch your recruitment advertising will reach 90,000 pre-screened electronics engineers—as they're reading to combat job obsolescence, while they're thinking about their future and bettering themselves.

There's no charge for typesetting and free layout service is provided.

For more information call or write:

ELECTRONICS

Post Office Box 900
New York, N.Y. 10020
Phone: 212/997-2556

ENGINEERS

ELECTRONICS ENGINEERS, \$60,000. Choice entry level to management positions immediately available in Pennsylvania & national locations. Reply in strict confidence to J. G. Weir, President, **WEIR PERSONNEL SERVICES, 535 Court St., Reading, PA 19603 (215/376-8486).**

ELECTRONICS ENGINEERS, \$18,000-\$40,000. Nationwide positions in digital, analog, microprocessor, microwave & instrumentation technology. For immediate confidential response, send resume w/ salary history to Glenn English, President, **GLENN ENGLISH AGENCY, 7840 Mission Center Ct., San Diego, CA 92108 (714/291-9220).**

DESIGN ENGINEERS to \$38K. Central Penna. & nationwide. Design connectors/terminals, microprocessors & controls. Reply in confidence to Z. A. Gonskowski, **MECK ASSOC. PERSONNEL, 1517 Cedar Cliff, Camp Hill, PA 17011 (717/761-4777).**

npc NATIONAL PERSONNEL CONSULTANTS

Engineers

- Design
- Development
- Project
- Software

\$20,000-\$50,000

Riddick Associates' Engineering Division specializes in placement of electrical and electronics engineers with top companies in the Southeast and throughout the U.S. We provide advice on careers, resumes and interviews for a position tailored to your skills. Client companies pay all fees. For details call or send resume in strict confidence to Phil Riddick, President.

Riddick Associates, Ltd.
9 Koger Executive Center
Norfolk, VA 23502
Area 804-461-3994

ENGINEERS

Engineers/MBA's with B.S. in technical disciplines.

**ELECTRIC ENGINEERS
MECHANICAL ENGINEERS
SYSTEMS ENGINEERS**
\$20,000-\$45,000 range.

Our clients seek experience in design and development of computer peripherals or similar electro-mechanical devices.

Forward resume to:

HOWARD BOND AND ASSOCIATES
1141 Hunting Drive
Palatine, IL 60067
Attn: Levi Lipscomb

RESUMES

Resumes—Complete instructions and examples: \$4. Consultants, Box 567—J. Bergenfield, N.J. 07621.

At the new Brazilian national telecommunication R & D centre several interesting development projects are now in progress.

These projects are being carried out with the aid of

international experts recruited (on contracts ranging from 2 months to 3 years) through the International Telecommunication Union – ITU.

At present there are several openings for high level telecommunication specialists in the following areas:



UNIQUE OPPORTUNITY IN BRAZIL

SPC TIME DIVISION SWITCHING

- Electrical/mechanical packing
- System testing
- Software testing
- Special components
- Operation and maintenance
- System reliability
- Production
- Documentation
- Software documentation

A minimum of 5 years experience with a major telecommunication industry and evidence of having completed at least one major switching product development in the field of speciality is required.

SATELLITE COMMUNICATION

- Design of Ground Control Equipment for Satellite communication

A minimum of 5 years experience is required in system design of GCE and SCPC/FM equipment.

ENGINEERING SERVICES

- Semiconductor component reliability
- Technical documentation

The right men will have experience in both setting-up and running respective laboratories for semiconductor reliability evaluation, modern technical information and/or technical documentation centres.

LOCATION

The R & D centre is located in Campinas in the State of São Paulo. Campinas was some years ago the coffee centre of the world, but it is known today as an important Brazilian scientific and cultural centre, where there is rapid growth of light industry. The town has some of the best medical service facilities in South America and excellent educational facilities (among the latter an excellent American school).

For information about the posts and contractual conditions please contact:

MRS. INA WICKIHALDER
Caixa Postal 1579
13 100 – Campinas
Brazil
Telex: 191 070

Have questions about Allen-Bradley's opportunity for Engineers?

We have answers ...
Just call toll free
1-800-321-6980
(In Ohio Call 1-800-362-6120)

Talk to Tom O'Brien about your skills and background. Our continuing growth creates openings for many engineering disciplines including ...

Software Engineers Capitalize on your Comp. Sci. or related degree and apply your software experience - assembly languages, PASCAL, FORTRAN. Utilize our VAX11/780, DEC11/34 or TEKTRONIX Development Systems to support your designs.

Hardware/Firmware Design Engineers Design NC and PC systems employing advanced digital techniques. Degree and 2+ years experience desired. Your involvement would include design verification using VAX11/780, DEC11/34 or TEKTRONIX Development Systems.

Application Engineers
Define customer control system requirements, prepare proposals and assist new product planning.

Product/Marketing Engineers Research and identify product opportunities based on industry requirements utilizing your degree and 2+ years of electronics or industrial experience.

We are a dynamic part of an international corporation employing over 17,000 people. Our products apply "leading edge" computer and microprocessor technology that increases productivity for all types of industry.

**Our careers are challenging and rewarding...
Let's Talk About It - Call Today!**

or if you prefer, send your resume to:



ALLEN-BRADLEY

747 Alpha Drive, Highland Heights, Ohio 44143

An Equal Opportunity Employer M/F



Your Ultimate Choice

COMMUNICATIONS ENGINEERS

Salary area \$36,000

Experienced communications specialists with E.E. degrees are being sought for Houston-based openings involving the design and application of communications systems. Areas of interest are micro-wave, LHF, UHF, and telephone switching. Working as a member of project team includes interfacing with vendors and contractors. May elect overseas tour at later date.

For further information contact
Glen Bixler or Bill McDaniel at
(713) 943-2860

All Fees Assumed By Client Companies

M. David Lowe
PERSONNEL SERVICES

436 Houston Natural Gas Building
1200 Travis
Houston, Texas 77002
(713) 943-2860

MANAGEMENT POSITIONS (Coast to Coast)

DIR. OF MANUFACTURING ... \$75,000+
Multi-plant, computer manufacturer
GENERAL MANAGER ... \$50,000
\$40MM mnfr. Prefer strong mfg. & fin. bkgd.
V.P. OPERATIONS ... \$45,000
Expanding consumer electronic mnfr.
NATIONAL SALES MGR. ... \$40,000
Report to Exec. V.P. - Audio equip.
PROJECT MANAGER ... \$45,000
Microcomputer manufacturer

Many other positions available for mid-management and executive level personnel in the Electronics Industry. 19 years service to industry. Our client companies assume all fees and expenses. Contact in confidence: Arnie Kins.

COOK ASSOCIATES, INC.
35 East Wacker Drive, Chicago, Ill., 60601
312/263-1119

R&S DATA SYSTEMS

*Specializing in Data Processing Field,
Service Engineers and Biomedical
Engineers*

We currently have several key positions with major companies that offer dynamic growth opportunities. For immediate and confidential consideration please forward your resume or call: Sylvia M. Fazer, Executive Search and Recruiting, P.O. Box 4242, Burbank, CA 91503 (213) 764-0107

EMPLOYMENT SERVICES

Electronic engineering growth positions with clients located nationally. Our service is enhanced by the fact that I am an EE with 20 years in industry and over 10 years in placing professionals on an employer fee paid basis. Send your resume to Joe Torcassi, Director, J. Anthony & Associates, PO Drawer AD, Lynchburg, OH 45142. 513/364-2305.

SPECIAL SERVICES

Arabic Technical Translations from English and French, electronics, radio communications, computers, related disciplines. Call (evenings) 312-693-2931.

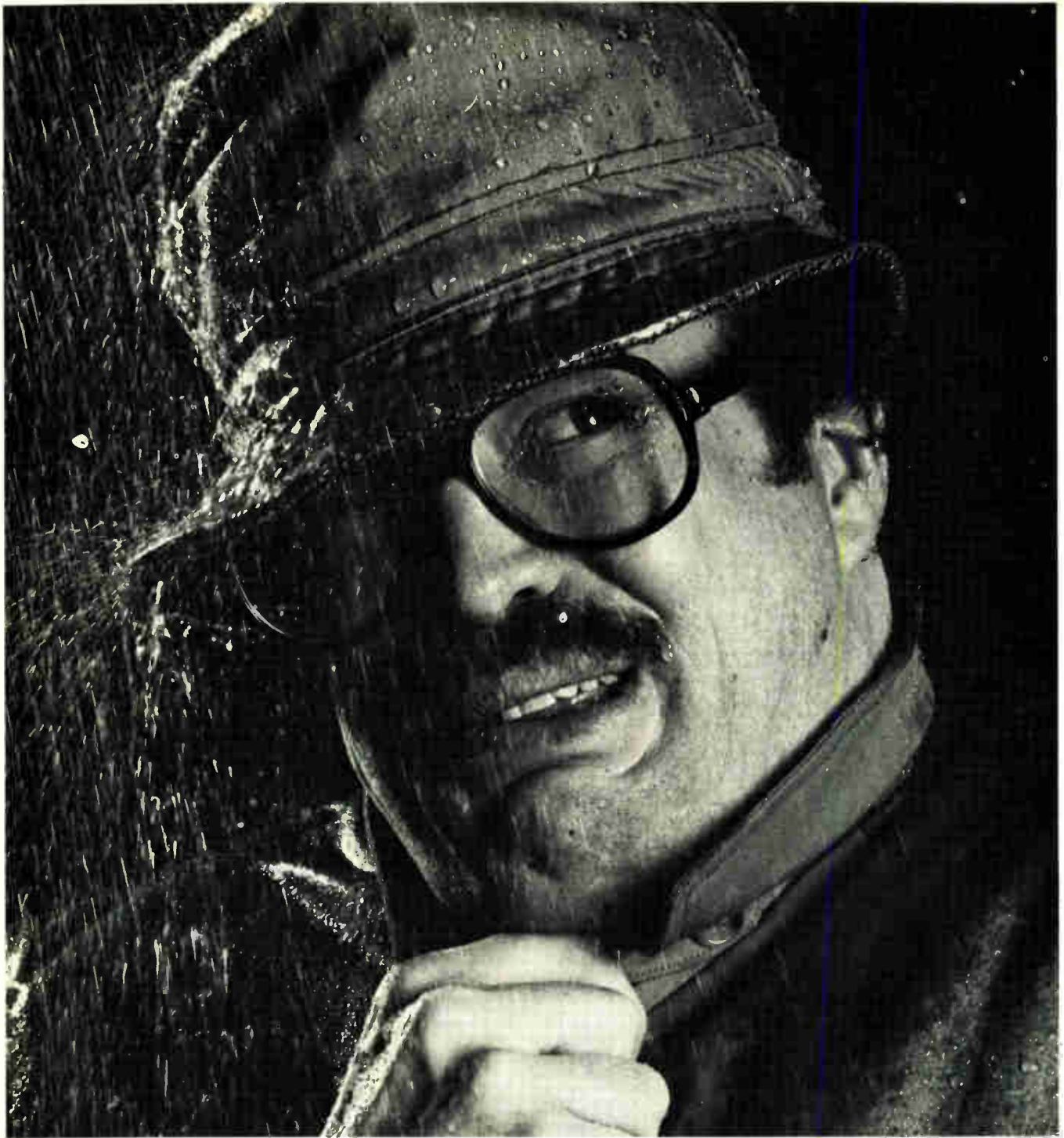

THE BIG MYTH ABOUT WORKING IN SEATTLE.

Myth: It rains all the time.

Fact: Seattle's total annual precipitation averages 34.1 inches. Less than in Cleveland, New York, Houston and a lot of other cities. Plus our climate is mild, the air is fresh and the grass is green all year long.

It's also a fact that, if you're an engineer, you should take a good look at Boeing in Seattle.

Because with two new airplanes to build — the 767 and 757 — plus a backlog of orders for 727s, 737s and 747s that extends well into the 80s, we have plenty of

opportunities for good people.

Rain or shine.

To find out more facts about Boeing, send your résumé to The Boeing Company, P.O. Box 3707-BCZ, Seattle, WA 98124.

An equal opportunity employer.

BOEING
GETTING PEOPLE TOGETHER

YESTERDAY'S INVENTIONS ARE TODAY'S STANDARDS

At Hitachi America, Ltd., our objective today is to develop telecommunications products that will be the standards for tomorrow.

To achieve this level of recognition, we have created a unique R & D environment where innovative and creative Telecommunications Engineers can be a part of the development of a new family of PBX and PABX equipment.

As a prestigious, worldwide manufacturer of advanced telephone switching systems, we can offer experienced Telecommunications Engineers an ideal career situation...exceptional growth potential and an ideal location in Atlanta, Georgia.

The individuals who join us in this unique environment must have a background which includes: a BSEE or BSCS with an advanced degree preferred and a minimum of 3-5 years of directly related experience in a manufacturing or R & D environment.

Successful candidates must have familiarity with development of system architecture, monitoring of hardware and software development programs and ensuring that systems requirements and architectures are achieved.

Positions available in areas of:

**Call Processing
Administration Software
Analog Interface & Voice
Transmission
Digital Interface and Data
Transmission
Maintenance Software
Virtual Computer
Physical Design
Reliability and Cost Analysis**

If you would like to learn more about the challenges and rewards that will exist in this dynamic environment, send your resume, including salary history, to:

HITACHI AMERICA, LTD.

Telecom R & D Division
6745 Peachtree
Industrial Blvd.
Atlanta, Georgia 30360

An Equal Opportunity
Employer M/F/H

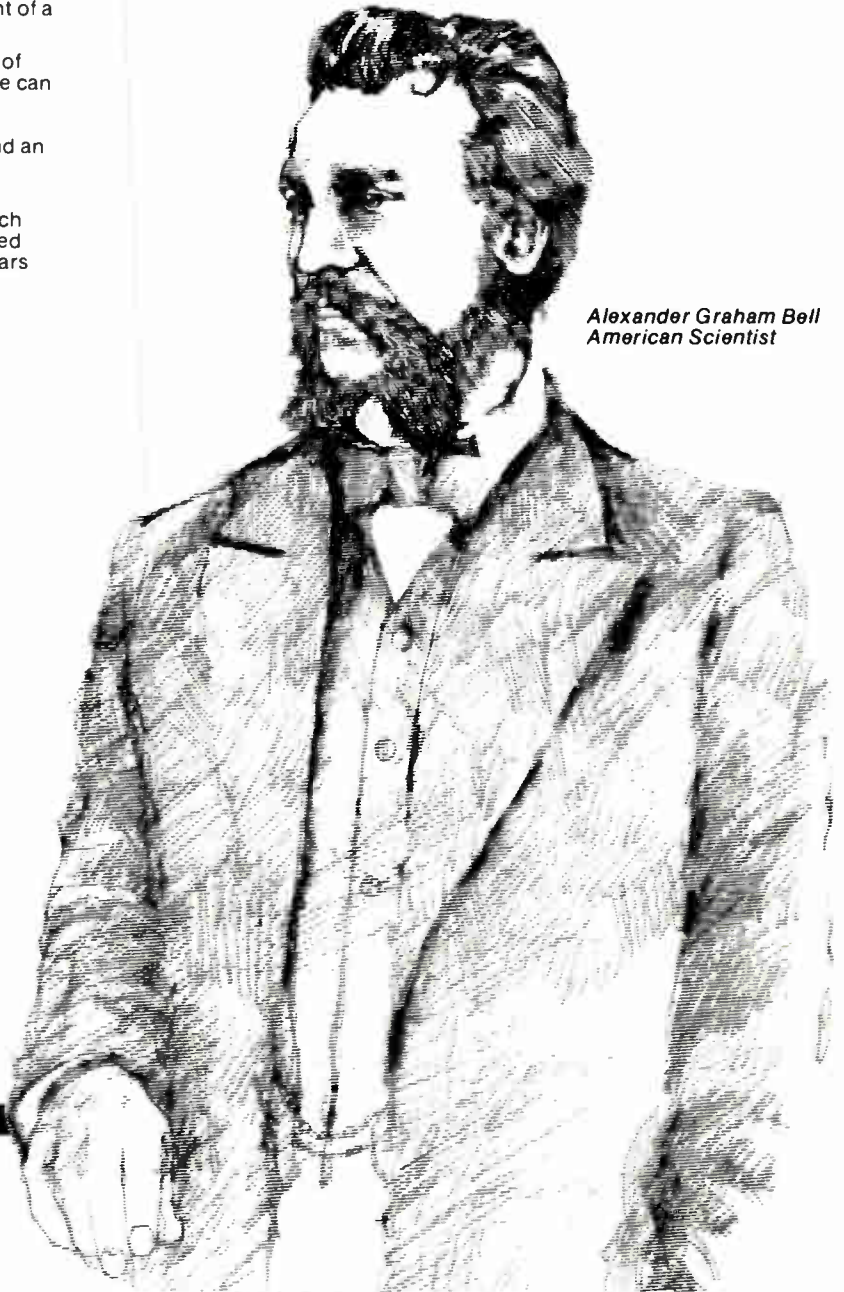

*Alexander Graham Bell
American Scientist*



THE CHALLENGE:

To apply advanced VLSI design concepts toward the development of custom fabricated semiconductor devices... to outperform the competition in R&D and process development... and to achieve ultimate cost effectiveness. We're shooting for number one.

That's the challenge.

Here's how we're gearing up at Sperry Univac Semiconductor to meet it head-on. We're assembling a nucleus of highly motivated technologically skilled professionals in just about every engineering and technical discipline, plus we'll be staffing for a substantial number of plant personnel as well.

It's a total commitment of over \$50 million that includes the creation of a brand new complex in suburban Minneapolis/St. Paul to house these accelerated activities. It's an exciting time for us. And it could be equally exciting for you.

SEMICONDUCTOR OPPORTUNITIES:

Our plans for the 80's set the pace for fast-track career advancement and unique individual involvements in the following key areas of engineering:

BIPOLAR.

Positions exist for Device, Product and Process Development Engineers to direct analytic investigations in ECL and Schottky Technologies.

Advanced process development programs include: Lithography (Projection and Step on Wafer), Plasma Etch, Plasma Deposition, Ion Implant and Sputtered Metallizations.

MOS.

Aggressively scaled NMOS and CMOS activities present a variety of opportunities for Design, Device, Product, and Process Development Engineers.

Principal responsibilities involve the design, development and testing of critical VLSI functions for both Data Processor and Signal Analysis applications. Excellent design/support facilities maximize opportunities for innovation and technical growth through the use of interactive graphics, automated design tools, and large scale engineering test systems.

Substantial efforts in the following areas of process development are paralleling current MOS design

activities: Photo Lithography (Projection and Step on Wafer), Dry Etch (Plasma, RIE, Parallel Plate and In-line techniques), Ion Implantation, Plasma Depositions, Diffusion and Sputtered Metallizations.

EQUIPMENT & FACILITIES.

The challenge here lies in building "from the ground up." Experienced Facilities, Equipment, and Mechanical Engineering professionals will be required to devote "hands-on" involvement in all phases of the planning and implementation to help get the Division's new state-of-the-art facility up and running.

SUPPORT.

Within the major areas of semiconductor support, several positions in Reliability, Quality, Test Engineering, or CAD are available.

THE BOTTOM LINE:

The ultimate decision is yours. Each position presents its own unique set of accomplishments to be mastered. And we invite you to explore them.

But there's one other major consideration... relocation. This, too, is a challenge... whether it's across town or halfway across the country.

The Twin Cities location of our new Semiconductor Division was selected for several very good reasons.

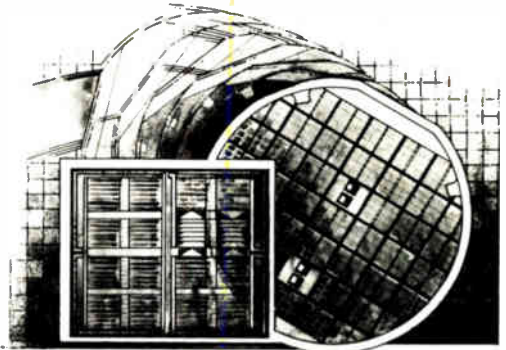

Statistically, Minneapolis/St. Paul ranks at or near the top in every major "Quality of Life" category: Theater, arts, recreation, fresh, clean air and all the things that help make for comfortable living. Plus, there's a refreshingly friendly and open attitude among Minnesotans that makes this a very special community.

These highlights are just a part of the total story. For some good firsthand information, call **BILL DAHLEN, COLLECT at (612) 456-2894**. Or send a resume to his attention at: **SPERRY UNIVAC SEMICONDUCTOR DIVISION (E), P.O. BOX 3525, ST. PAUL, MN 55165.**

SPERRY UNIVAC
SEMICONDUCTOR
DIVISION

"THE CHALLENGE IS HERE AND NOW."

An Affirmative Action Employer M/F

The Next Generation of Computer Technology

Become Part of IT at HEATH

Join an aggressive, innovative, productive team which is hard at work on solutions for the future.

Achieve in an environment where nearly one-third of our products are the direct result of our Engineer's ideas.

SENIOR SOFTWARE ENGINEER

BSCS and five or more years experience in software development and maintenance required. Project leadership would be desirable. Microcomputer background necessary.

QA SYSTEMS ENGINEER

BSEE or BSCS required. Will be involved in establishing software and hardware test routines; developing test and fixture requirements for circuit board assemblies; and identifying and analyzing component product and reliability problems.

Enjoy rewards that are professionally and personally satisfying. Salaries are definitely competitive. Benefits are generous. And our location affords a "quality of life" that is second to none.

DOCUMENTATION WRITER

BSCS and 2 years personal computing experience with ability to write 8080 or 2-80 code are essential. Must have good writing and communication skills, as well as ability to evaluate user applications software and prepare for distribution.

DIAGNOSTIC SOFTWARE ENGINEER

BSEE or BSCS and two years experience in writing hardware diagnostic routines for microprocessor-based products required. One year experience with 2-80 or 8080 assembly languages necessary.

For consideration, send a letter or resume in complete confidence to:

Wayne Petzke
HEATH COMPANY
St. Joseph, Michigan 49085
(616) 982-3369

An equal opportunity employer M/F



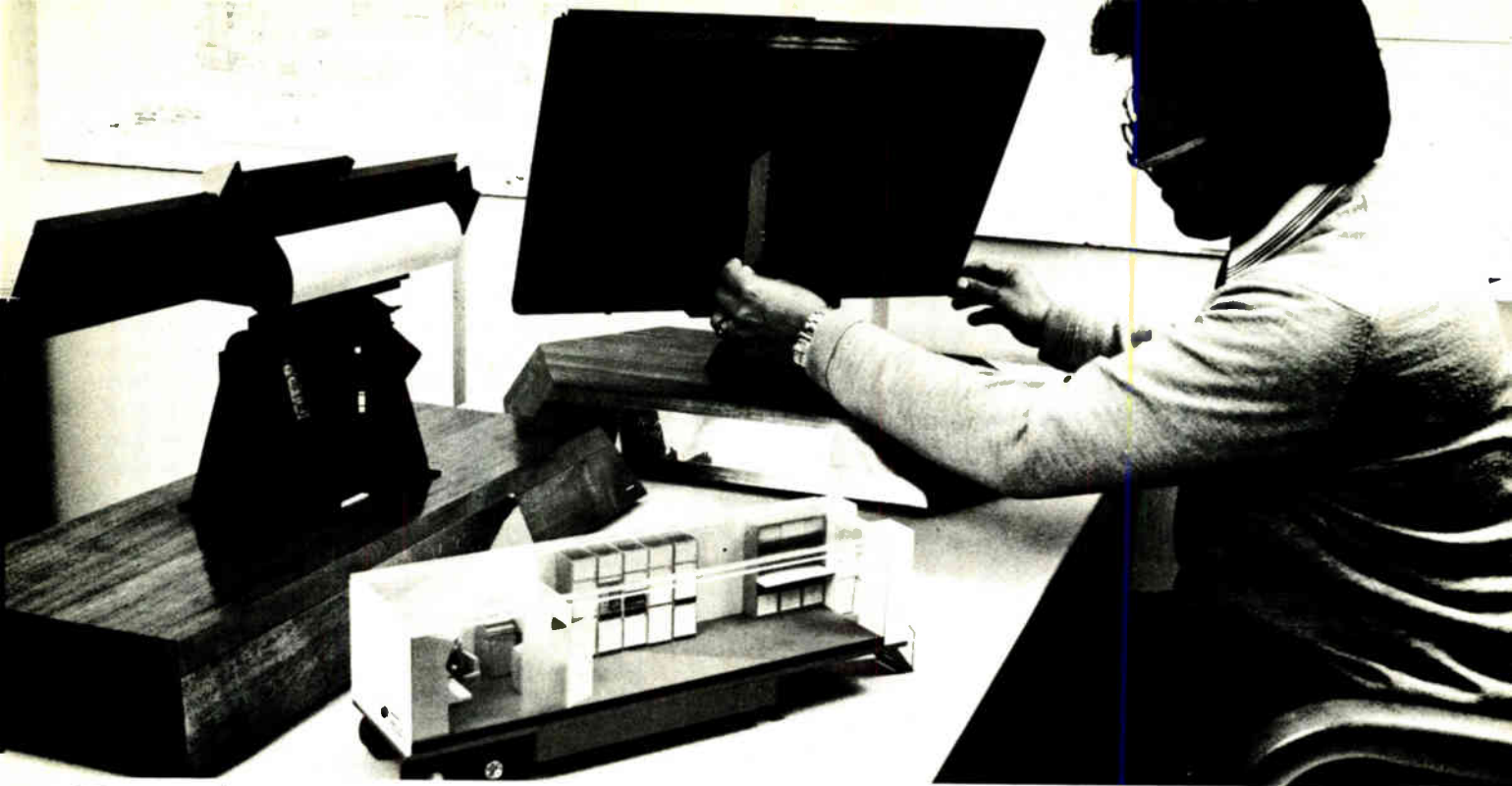

Look over our resume.

If you want to start at the state of the art, and move ahead from there—

Better make sure the place you go to work in the Eighties has a record of reaching beyond the ordinary.

We have.

Join us, and you'll be welcome to use everything we know.

About interactive CAD/CAM technology. Surface acoustic waves. Satellite antennas. Active sonar signal-processing with VLSI. High-resolution 2000-line displays. And much, much more.

We will pay you well, and advance you far and fast, if you can start—and not stop—at the present limits of our knowledge.

Item: We invented 3-D electronically scanned radar in the Fifties. Nowadays we make radar that can spot an artillery shell in mid-air and tell—before the shell lands—where it was fired from.

Item: We have become the world's leading developer of electronic air defense systems on a national scale and larger. (Our system for NATO stretches from Norway to Turkey!) In the process, we have learned a bundle about computers, integration of multiple sensors, communication . . .

And you can use our discoveries to help you make some of your own.

Our company has a 4½ billion dollar backlog—more than 1,500 high-technology projects. Many of the most challenging are here, at Hughes Ground Systems in Southern California's easy living Orange County.

If you are an electronic engineer, computer science graduate, mechanical engineer, mathematician, or physicist, we need you and your imagination.

Make us a job offer.

Now that you've read a couple of our credentials, please send us your own resume. Tell us what you've been doing lately, and what you'd like to be doing soon.

We think we have the combination of salary, outstanding benefits, and second-to-none education assistance to keep you content, while you help keep us in the forefront of one of our electronics specialties.

Address that resume of yours to:

Hughes Aircraft Company
Ground Systems Group
Professional Employment Dept. E-8B
1901 W. Malvern Ave.
Fullerton, CA 92634

*Developed at G.S.G. (L to R):
 I.P.D./T.A.S.*

(Improved Point Defense/Target Acquisition System) for use with shipboard missile and gun fire control systems against anti-ship cruise missiles.

Radar Operations Cabin,

For the surveillance and determination of proper retaliatory weapons selection.

Improved SPA-72,

Shipboard antenna system provides long range surveillance of enemy aircraft.

HUGHES

HUGHES AIRCRAFT COMPANY

GROUND SYSTEMS

U.S. citizenship required
 Equal Opportunity M/F/H/C Employer

The price of perfection.

Any company that sets perfection as its goal has a big job on its hands.

And in high technology areas especially, history is full of great technical ideas that didn't quite make it into solid business propositions.

But at INMOS, we recognize the true price of perfection and have sound funding and innovative management to meet the challenge.

For example, we've invested heavily in a total package of manufacturing equipment that no other IC manufacturer can match.

We've built our new, highly sophisticated technology center in a uniquely beautiful area. Because we know that people who expect a lot from their work expect no less from their leisure.

We've created a management structure with the emphasis on freedom and not on structure because we know ideas need room to breathe.

And we encourage every member of our team to contribute their thoughts because we know the best ideas come quietly down the hall when you least expect them.

If you can empathize with our ideals, and you're cut out for any of these jobs, you'll probably find that we are perfect for each other.

Engineering and Support Staff

Manager of Packaging Development Group

Prefer advanced degree plus 5 years I.C. experience. To develop assembly and packaging processes for state-of-the-art VLSI MOS memories and microcomputers.

Assembly/Test Manufacturing Manager

BA or BS with 5 to 7 years wafer fabrication manufacturing experience. With strong forecasting background both in people and capital expenditure for production.

Senior CAD Engineer

Prefer MS plus 3 to 5 years experience. To support and develop software to meet user requirements.

Failure Analysis Engineer

Prefer MS plus 3 years I.C. experience. To diagnose failure modes, probe rejected wafers, analyze stress tests.

Device Engineer

BSEE with knowledge of semiconductor devices. Familiarity with electronic measuring equipment and FORTRAN programming knowledge.

Marketing Staff

European Sales Manager

Bristol, England
Prefer BSEE + 5 to 10 years I.C. sales and sales management experience. To set up and run European sales organization.

Regional Sales Managers

Boston and Dallas
Prefer BSEE + 5 to 10 years I.C. sales and sales management experience. To set up and run regional sales offices.

Distribution Sales Manager

BS preferred plus in-depth knowledge of the I.C. distribution marketplace.

Central Marketing Group Staff

People with experience in advertising, product sales, customer service and strategic marketing definition.

Please send your resume to Denny Grady, Dept. EL/2, INMOS Corporation, P.O. Box 16000, Colorado Springs, Colorado 80935.

Honoring human resources in every respect we are an equal opportunity employer M/F.



We're building a great company. Together.

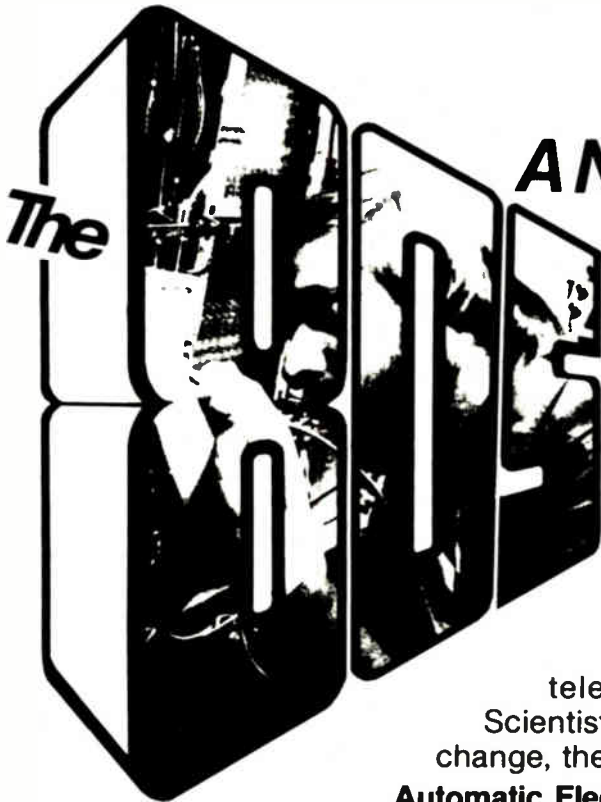

*A New Decade...
A New Generation...*

**BE PART OF IT...
AT GTE AUTOMATIC
ELECTRIC LABS!**

We can count on the 1980's to bring exciting and rapid change . . . especially in telecommunications. And for Computer Scientists and Engineers who want to be part of that change, there's no more exciting place to be than **GTE Automatic Electric Laboratories** in Phoenix.

At **GTE**, our engineers utilize the newest generation hardware and software technology. From our on-line, real-time control programs using the latest in structured programming, off-line support, and diagnostic software to our hardware support including IBM 3032/3033 systems, our environment offers a never ending source of professional challenge.

If you have a degree and experience in Computer Science, Electrical Engineering or related discipline, you owe it to yourself to find out more about **GTE**. Currently, we have openings in the following areas:

- **OPERATING SYSTEM SOFTWARE**
- **ON-LINE RECOVERY AND DIAGNOSTIC SOFTWARE**
- **TEST UTILITY SOFTWARE**
- **DEVELOPMENT SUPPORT SOFTWARE**
- **CALL PROCESSING AND ADMINISTRATIVE SOFTWARE**

As a leader in the design and development of advanced digital systems, **GTE** can offer you an excellent salary, complete corporate benefits package and a rare potential for personal and professional development. To be a part of it, send your resume to: **GTE Automatic Electric Laboratories, Manager of Employment, Department EM828, 11226 N. 23 Avenue, Phoenix, AZ 85029.**

GTE

Research and
Development

We are an equal opportunity employer m/f/h

| | | | | | |
|--|---------------|---|----------|--|---------------------------------|
| Able Computer Technology | 220 | ■ Data Precision | 185 | ■ Hewlett-Packard | 2C, 1, 2, 22, 23, 196, 197, 201 |
| Advanced Micro Devices | 10, 11 | ■ Data Systems Design | 140 | ■ P.R. Hoffman | 258 |
| Aehr Test Systems | 104 | ■ Data Translation | 7 | Holt Inc. | 224 |
| American Magnetics Corporation | 26 | ■ Dialight | 70, 71 | Houston Instrument | 190, 191 |
| American Microsystems Inc. | 72, 73, 147 | ‡ Digital Equipment Corp Microcomputer | 64, 65 | • Hubert and Suhner AG | 64 |
| American Sign & Indicator Corp. | 221 | ‡ Digitran Company | 189 | Hysol | 66 |
| Amp Incorporated | 164, 165 | ■ Dual Systems Control Corp. | 6 | ■ Hytek Microsystems | 224 |
| Ampex DpD | 222 | ■ DuPont Company Riston Ultrasonic Stripper | 38 | ICS Electronics Corporation | 98 |
| Amphenol North America | 198, 199 | ■ Dyna/Part Div. USM Corporation | 223 | Industrial Programming Inc. | 101 |
| Analog Devices | 74, 75, 179 | ‡ Eastman Kodak Co. Graphic Markets Div. | 187 | Intel MPO | 18, 19 |
| Analey Corporation | 174, 175 | ■ EG & G Reticon | 99 | Intel-Military | 32 |
| Aramco Services Co. | 231 | ■ Electronic Arrays | 35 | Intel OMS | 227 |
| Astro Med | 193 | ■ Electronics & Control Engineers Book Club | 232-235 | Interface Incorporated | 236 |
| Bausch & Lomb Scientific Optical Products | 182, 183, 192 | ■ Electronic Navigation Industries | 3C | International Microsystems | 238 |
| ‡ Beckman Instruments, Inc.—Displays | 213 | ■ Elfab | 163 | Intersil | 56, 57 |
| Belden Corporation | 49-52 | • Emulex Corporation | 213 | Ion Physics Co. | 188 |
| Bokers, Inc. | 192 | ■ Erie Technological Products | 172 | • Israel Aircraft Industries, Ltd. | 187 |
| ■ Bourne Inc. | 4C | ■ Fairchild (Semiconductor Operations Divisions) | 69, 92 | • Italtel/SIT | 177 |
| • Buckbee—Mears Company | 16E | ■ Fairchild Test Systems | 184, 185 | ITT Capacitors | 16E |
| • Burr Brown Research Corporation | 173 | ■ Ferranti-Packard Ltd. | 16 | C. Itoh | 54 |
| Cado Systems Corporation | 53 | ■ First Computer Corporation | 15 | • Iwatsu Electric Co. Ltd. | 178 |
| Calcomp (Graphic) | 90, 91 | • Five S.P.A. | 189 | ■ Keystone Electronics | 222 |
| The Capitol Machine & Switch Co. | 238 | • Fujitsu Limited | 11E | ‡ Kontron Electronics Incorporated | 43 |
| Carpenter Manufacturing Co., Inc. | 28 | ■ John Fluke Mfg. Co. | 25 | ■ Krohn-Hite Corporation | 203 |
| Centrablab Inc. | 88, 89 | • Gec M-O Valve | 14E | ‡ Kytex | 204 |
| Cherry Commercial Fasteners (Townsend Div. Textron) | 45 | ■ General Instrument Microelectronics | 105, 107 | LeCroy Research Systems | 12 |
| ■ Cherry Electrical Products | 13 | ■ Genrad, Inc.—Component Test | 209 | • LTX | 166, 167 |
| Computer Automation, Inc. Industrial Prod. Div. | 85 | ■ Gould Incorporated, Biomation Division | 30, 31 | Magtrol | 206 |
| ‡ Control Laser Corporation | 178 | ■ Gould Inc., Electric Fuse Division | 58 | Mallory Capacitor Company | 217 |
| Cromenco | 27 | ■ Gould Inc., Instruments Division | 79, 81 | Markem | 8 |
| ‡ Cts Corporation | 194 | ■ Greenpar | 8E | ■ Microswitch Division of Honeywell | 225 |
| Data General Corporation | 102, 103 | ■ GTE Sylvania/Connector Products Operation | 20, 21 | Millennium Systems | 112, 113 |
| | | | | Miller-Stephens Chemical Co. Inc. | 62, 63 |

| | | | |
|---|-------------|--|--------------------|
| ■ Mini-Circuits Laboratory | 5 | ■ Spectronics | 215 |
| Mitel Semiconductor Incorporated | 96 | Sprague Electric | 61 |
| Monolithic Memories | 36, 37 | ■ Sprague-Goodman Electronics | 108 |
| Mos Technology, Inc. | 180, 181 | ■ Stackpole | 217 |
| Mostek Corporation | 116, 17, 29 | Standard Microsystems | 83 |
| • Munchner Messe | 12E | Systron-Donner Instrument Division | 47 |
| Munich Fair Authority | 236 | • TEAC Corporation | 204, 10E |
| New York State Department of Commerce | 212 | Tektronix | 114, 115 |
| • Neohm Spa | 194 | ‡ Texas Instruments (Calculator) | 170 |
| State of North Carolina | 258 | Texas Instruments, Inc. (Digital Systems Div.) | 55 |
| Optical Electronics, Inc. | 108 | Texas Instruments Semiconductor | 109, 110, 111, 211 |
| OKI Semiconductor | 86, 87 | • Thomson CSF/DCM | 13E |
| Ohio Scientific | 95 | TRW Cinch Connectors | 168, 169 |
| Ovenaire (Division of Walter Kidde & Co) | 192 | TRW Optron | 14 |
| ■ Pearson Electronics | 188 | ■ Wabash Relay & Electronics | 16 |
| • Philips T&M | 4E, 5E | Mark Williams Company | 9 |
| ■ Philips TMI | 76 | Zeltex, Inc. | 228 |
| ■ Piezo Technology | 104 | • Zeltron | 170 |
| Plessey Company Ltd | 138 | | |
| Practical Automation | 28 | | |
| RAC Reliability Analysis Center | 206 | | |
| • Racal Dana Instruments Ltd. | 43 | | |
| ■ Radio Research Instrument Company | 216 | | |
| ‡ Regent of Hong Kong | 177 | | |
| • Rohde & Schwarz | 1E, 9E | | |
| ‡ Rohm Corporation | 166, 167 | | |
| Scientific-Atlanta | 224 | | |
| Seltz SA | 205 | | |
| ‡ Semiconductor Equipment & Materials Institute | 173 | | |
| • Siemens AG | 6E, 15E | | |
| Silicon Systems | 160 | | |
| • Solartron Ltd. | 2E, 3E | | |
| ■ Spectrol Electronics | 207 | | |

Classified and employment advertising

F. J. Eberle, Manager 212-937-2557

| | |
|---------------------------------------|-----|
| Allen-Bradley Co. | 248 |
| Bell Aerospace | 244 |
| Bell Aerospace Textron | 244 |
| Boeing Co. | 249 |
| Casfield Institute of Technology | 242 |
| Cook Assoc., Inc. | 248 |
| Corporate Consulting Inc. | 239 |
| Coulter Electronics | 246 |
| Elscint Inc. | 239 |
| Emerson Electric Co. | 239 |
| Executive Search & Recruitment | 248 |
| General Electric Co. | 242 |
| Gte Automatic Electric | 255 |
| Harris Semiconductor | 243 |
| Heath/Zenith Co. | 252 |
| Hitachi American Ltd. | 250 |
| Howard Bond & Assoc. | 246 |
| Hughes Aircraft Co. | 253 |
| Inmos Corp. | 254 |
| International Telecommunication Union | 247 |
| Lockheed Missiles & Space Co., Inc. | 241 |
| David M. Lowe Personnel Service | 248 |
| Mer Co. | 239 |
| Michigan Tech University | 239 |
| National Personnel Consultants | 246 |
| NCR Corp. | 245 |
| Ohio Medical Products | 244 |
| Recruiters of Texas | 239 |
| Research Assoc. | 239 |
| Riddick Assoc. Ltd. | 246 |
| Southwest Technical Personnel | 246 |
| Sperry Univac Semiconductor | 251 |
| Storage Technology | 240 |
| R. J. Thompson Consultants Inc. | 239 |
| Tri-State | 240 |

■ For more information of complete product line see advertisement in the latest Electronics Buyers Guide
 • Advertisers in Electronics International
 ‡ Advertisers in Electronics domestic edition

**If you
 need
 service
 on your
 subscription
 to ...**

Electronics

*Do you want to
 change your
 address?*

*Have you missed
 an issue?*

*Was your copy
 damaged?*

**Please call your
 representative**

(609) 448-8110*
For immediate help

*9 a.m.—4 p.m. EST





Semi-Finished Quartz Crystals

Choose from the largest inventory in the U.S.

P. R. Hoffman is one of the world's largest producers of semi-finished quartz crystal wafers. For nearly 40 years, we specialized in providing crystal blanks to finishers. Today we grow our own High-Q pure Z cultured quartz and process natural and cultured quartz to meet customer requirements for electronic and electro-optical applications. We supply crystal blanks lapped to the customers final frequency tolerances. We can also meet the most stringent specifications supplied with regards to dimensioning and orienting to precise angles.

P. R. Hoffman maintains an inventory of over 2,000,000 crystals and can often ship from stock to meet your requirements. For information and prices, send your specifications to:

P.R. Hoffman A Norlin Technology Co.
321 Cherry Street, Carlisle, PA 17013 Telephone: 717-243-2011

Circle 258 on reader service card

PICK THE TOWN THAT FITS YOUR BUSINESS.

We can provide detailed community profiles on hundreds of towns and cities in North Carolina that would love to have your company. We offer 10 cities with 50,000+ population. But more than 480 have 20,000 or less.

Indicate the community size that would fit your new plant. Our professionals will help you pick one that feels like home.

| | | | |
|---|--|-------------------------------------|-------|
| Population | | Type | |
| <input type="checkbox"/> 100,000+ | <input type="checkbox"/> MAJOR CITY | <input type="checkbox"/> RURAL TOWN | |
| <input type="checkbox"/> 50,000-100,000 | <input type="checkbox"/> SMALL CITY | | Other |
| <input type="checkbox"/> 15,000-50,000 | <input type="checkbox"/> SMALL COMMUNITY NEAR CITY | | _____ |
| <input type="checkbox"/> UNDER 15,000 | | | _____ |

NAME _____

COMPANY _____

ADDRESS _____

CITY _____

STATE _____

ZIP _____

NORTH CAROLINA

North Carolina Department of Commerce, Industrial Development Division,
Suite 1609, 430 N. Salisbury Street, Raleigh, NC 27611. Or call (919) 733-4151.

Advertising Sales Staff

Advertising sales manager: Norman Rosen
3200 Wilshire Blvd., South Tower
Los Angeles Calif. 90010 [213] 487-1160

Market managers:

Components: William Boyle, Rochester, N.Y.
Computers & Peripherals: Frank Mitchell, Boston
Test & Measurement: Don Farris, San Francisco
Semiconductors: Norman Rosen, Los Angeles

Atlanta, Ga. 30309: Peter Stien
100 Colony Square, 1175 Peachtree St., N.E.
[404] 892-2868

Boston, Mass. 02118: Frank Mitchell
607 Boylston St., [617] 262-1160

Cleveland, Ohio 44113: William J. Boyle
[716] 248-5620

Fort Lauderdale, Fla. 33308: Peter Stien
3000 N.E. 30th Place, Suite #400
[305] 563-9111

New York, N.Y. 10020
1221 Avenue of the Americas
John Gallie [212] 997-3616
Matthew T. Reseska [212] 997-3617

Philadelphia, Pa. 19102: Matthew T. Reseska
Three Parkway, [212] 997-3617

Pittsburgh, Pa. 15222: Matthew T. Reseska
4 Gateway Center, [212] 997-3617

Rochester, N.Y. 14534: William J. Boyle
Powder Mill Office Park, 1163 Pittsford-Victor Rd.,
Pittsford, N.Y. 14534 [716] 248-5620

Chicago, Ill. 60611
645 North Michigan Avenue
Jack Anderson [312] 751-3739
Robert M. Denmead [312] 751-3738
Detroit, Michigan 48202: Jack Anderson
1400 Fisher Bldg., [313] 873-7410

Dallas, Texas 75201: John J. Uphues
2001 Bryan Tower, Suite 1070
[214] 742-1747

Denver, Colo. 80203: Harry B. Doyle, Jr.
655 Broadway, Suite 325
[303] 825-6731

Houston, Texas 77002: John J. Uphues
601 Jefferson Street, Dresser Tower
[713] 659-8381

Los Angeles, Calif. 90010: Chuck Crowe
3200 Wilshire Blvd., South Tower
[213] 487-1160

Costa Mesa, Calif. 92626: Edward E. Callahan
3001 Red Hill Ave. Bldg. #1 Suite 222
[714] 557-6292

San Francisco, Calif. 94111: Don Farris,
Larry Goldstein, 425 Battery Street,
[415] 362-4600

Paris: Michael Sales
17 Rue-Georges Bizet, 75116 Paris, France
Tel: 720-16-80

United Kingdom: Simon Smith
34 Dover Street, London W1
Tel: 01-493-1451

Scandinavia: Andrew Karnig and Assoc.
and Simon Smith
Kungsholmsgatan 10
112 27 Stockholm, Sweden
Tel: 08-51-68-70 Telex: 179-51

Milan: Ferruccio Silvera
1 via Baracchini, Italy
Tel: 86-90-656

Brussels:
23 Chaussee de Wavre
Brussels 1040, Belgium
Tel: 513-73-95

Frankfurt / Main: Fritz Krusebecker
Liebigstrasse 27c, Germany
Tel: 72-01-81

Tokyo: Akio Saijo and Hirokazu Nakamura
McGraw-Hill Publications Overseas Corporation,
Kasumigaseki Building 2-5, 3-chome,
Kasumigaseki, Chiyoda-Ku, Tokyo, Japan
[581] 9811

Business Department

Thomas M. Egan
Production Director
[212] 997-3140

Carol Gallagher
Production Manager
[212] 997-2045

Betty Preis
Production Manager Domestic
[212] 997-2908

Thomas Kazlich
Production Manager Related Products
[212] 997-2044

Karen Walpole
Production Assistant
[212] 997-2843

Frances Vellone
Reader Service Manager
[212] 997-6057

Electronics Buyers' Guide

H.T. Howland, General Manager
[212] 997-6642

Regina Hera, Directory Manager
[212] 997-2544

Classified and Employment Advertising

Frank Eberle, Manager
[212] 997-2557

Never before... 200 watts of RF power with incredible versatility.

Now there's a completely solid state power amplifier that provides 200 watts of linear power over a frequency range from 250 kHz to 120 MHz. And at 175 watts, the range extends to 150 MHz.

Imagine the wide range of applications you can cover with this single Class A linear unit. All you need is any standard signal or sweep generator and you have



3200 L spans 250 kHz to 150 MHz.

the ultimate in linear power for RFI/EMI testing, NMR, RF Transmission, and general laboratory applications.

And, like all ENI power amplifiers, the 3200 L features

unconditional stability, instantaneous failsafe provisions, and absolute protection from overloads and transients.

The 3200 L represents a breakthrough in RF power versatility and packaging. Never before has there been anything like it commercially available anywhere!

Contact us for a demonstration of the 3200 L and our complete catalog on the other amplifiers in our wide line. ENI, 3000 Winton Road South, Rochester, NY 14623. Call 716/473-6900, or Telex 97-8283 ENI ROC.

ENI

The advanced design line of RF power amplifiers

Circle 901 on reader service card

Pièce de Résistance...



The trimmer gourmet's choice.

Feast your eyes on Bourns Trimpot[®] trimmers — the choicest and broadest trimmer line anywhere. A banquet of trimmers with outstanding quality and performance at cost-effective prices to please the most discriminating design connoisseur.

Le Plus Grand Menu

- Rectangular, square or round
- Sealed or open-frame
- Wirewound or cermet
- Single or multi-turn

Select the size, shape, type of element and method of adjustment to suit your taste. They're served in an assortment of resistance values and pin styles to satisfy all of your design needs.

Bourns is dedicated to serving all of your trimmer requirements . . . both now and in the future. Look for future innovations in down-sizing, increased performance and cost-effective

improvements. We're working on design solutions today for your application needs tomorrow.

Introducing the Trim Bin[™] Trimmer Kit. Here are some appetizers to tantalize your trimmer palate: A complete assortment of the most popular Trimpot trimmers and MFT[™] trimmers/resistors in a convenient package for just \$99.95*. A value of over \$200, the kit contains 127 parts representing 50 varieties of resistances and pin styles, plus adjustment tools and design aids. It's available from your local Bourns distributor.

Vive la Résistance! Call your Bourns representative or distributor for more information and for your new 94-page TR-1 trimmer catalog.



TRIMPOT DIVISION, BOURNS, INC., 1200 Columbia Avenue, Riverside, CA 92507. Ph: 714 781-5320. TWX: 910 332-1252.

European Headquarters: Bourns AG, Zugerstrasse 74 6340 Baar, Switzerland. Ph: 042 33 33 33. Telex: 78722.

*Domestic U.S.A. price only.



For Immediate Application—Circle 120 For Future Application—Circle 220

The last word in resistive components

BOURNS[®]