

JULY 6, 1978

A NEW CONSUMER INDUSTRY: ELECTRONIC PHONES/81

C-MOS erasable PROM uses single power supply/ 106

A guide to thermal resistance measurements in ICs/ 121

FOUR DOLLARS A MCGRAW-HILL PUBLICATION

Electronics®

**A minicomputer
architecture
for the next
generation**



1420 SHIHO CASAO DEC80
SE SAWICKI
DATA ACQUISITION SYSTEMS
105 N CHAPEL ST
TORRINGTON CT 06790

The World's First SIP Trimmer...

A new space saver from Bourns.

Now there's a new dimension in space savings... the Model 20 Trimpot® SIP Cermet Trimmer... a standard SIP, designed to meet your high density PC board needs.

With no sacrifice in performance, the Model 20 trimmer occupies only 25% of the precious board space used by comparable DIP configurations and only 50% of that used by conventional 3/4" rectangular trimmers. Featuring .100-inch spacing and a lower board profile... only .185-inches off the board... it's priced at a modest 75¢* in 1,000 to 4,999 quantities. And, it's available in 18 standard resistance values ranging from 10 ohms to 5 megohms.

Conquer your space problems. Send today for complete details on the Model 20 SIP trimmer... the latest of many space saving "firsts" from Bourns.

TRIMPOT PRODUCTS DIVISION, BOURNS, INC., 1200 Columbia Avenue, Riverside, CA 92507. Phone: 714 781-5050 — TWX: 910 332-1252.

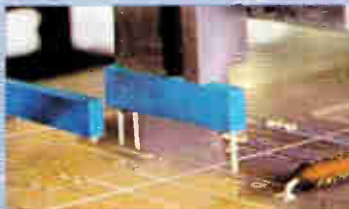

The Model 20 SIP trimmer... machine insertable and compatible with automatic test equipment for significant cost savings.

*Domestic U.S.A. price only.



BOURNS®

International Marketing Affiliates: European Headquarters — Switzerland 042/23 22 42 • Belgium 02/218 2005 • France 01/2039633 • Germany 0711/24 29 36 • Italy 02/32 56 88 • Netherlands 70/87 44 00 • United Kingdom 01/572 6531 • Norway 2/71 18 72 • Sweden 764/20 110 • Japan 0757921 9111 • Australia 02/55-0411 03/95-9566 • Israel 77 71 15/6/7

For Immediate Application — Circle 120
For Future Application — Circle 220

HP's new Graphics Translator brings the speed of soft-copy graphics to systems.

Faster display. Soft-copy graphics displays your system's output in a fraction of the time required by hard-copy devices. Improper scale factor, undesired system parameters, etc., are quickly spotted and corrected prior to making permanent records.

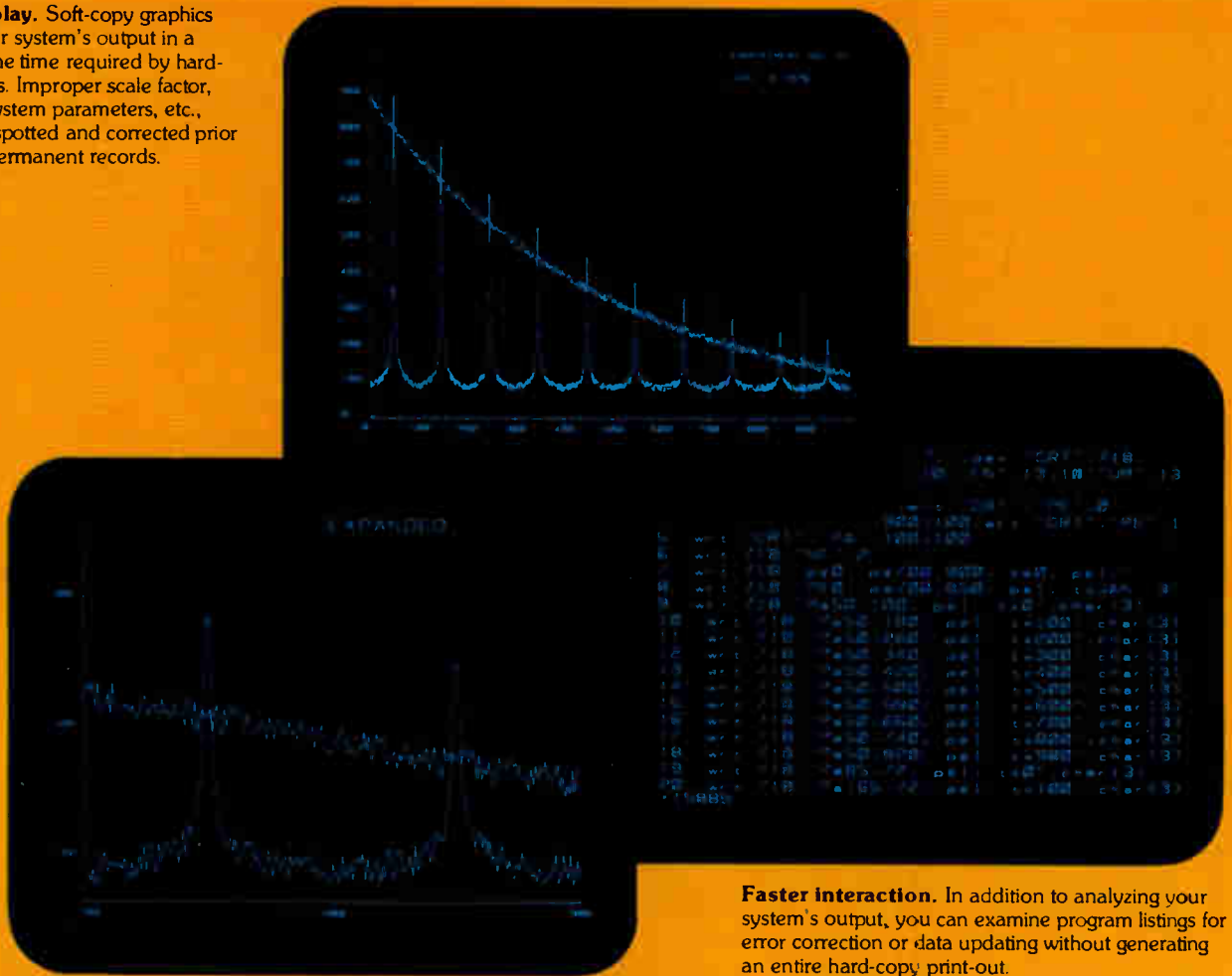

Faster interaction. In addition to analyzing your system's output, you can examine program listings for error correction or data updating without generating an entire hard-copy print-out.

Faster decisions. You can view a normal display plus an expanded display in much less time than it usually takes for one hard-copy output. That means faster analysis, quicker decisions and less paper usage.

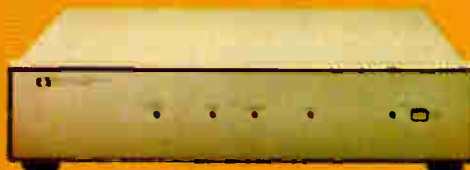

With HP's new 1350A Graphics Translator and one or more of HP's electrostatic CRT displays, you can more efficiently display system data . . . evaluate results . . . and interact to make changes.

Soft-copy graphics can save you reams of paper plus the time required to generate it. And the 1350A gives you added flexibility. You can selectively erase data, blank portions of a display and even repetitively flash specific graphic areas or alphanumeric characters on the screen to draw attention.

Programming is easy with controllers such as HP's 9825A. The 1350A can drive at least ten electrostatic displays and

provides four different presentations on multiple displays simultaneously.

Look into HP's new 1350A, priced at \$3,450**, for analytical instrumentation or engineering analysis systems. It's also ideal for HP's Data Acquisition and Network Analysis Systems; in fact, wherever you need high-resolution graphics of HP-IB data. Call your local HP field engineer for complete details.

* HP's implementation of IEEE Standard 486-1975.

** Domestic U.S.A. price only.

HEWLETT  PACKARD

1507 Page Mill Road, Palo Alto, California 94304

For assistance call: Washington (301) 948-6370, Chicago (312) 255-9800, Atlanta (404) 955-1500, Los Angeles (213) 877-1282

08117A

Circle 1 on reader service card

HOW COULD THE INDUSTRY STANDARD 5½-DIGIT DMM BE IMPROVED?

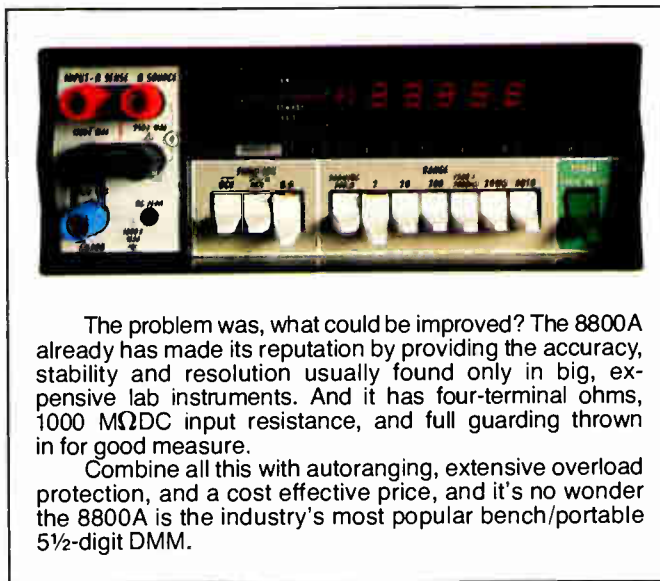

The problem was, what could be improved? The 8800A already has made its reputation by providing the accuracy, stability and resolution usually found only in big, expensive lab instruments. And it has four-terminal ohms, 1000 MΩDC input resistance, and full guarding thrown in for good measure.

Combine all this with autoranging, extensive overload protection, and a cost effective price, and it's no wonder the 8800A is the industry's most popular bench/portable 5½-digit DMM.

Now look at the 8810A.

It's modular! You can buy the lab-performance DC mainframe for only \$695.* Add the six-range ohms converter for \$175* any time you wish.

It's got true rms ac! Actually you can choose either the true RMS converter module for accurate measurements of most waveforms at \$275,* or the average-responding AC converter module at \$150.* Both are spec'd to 100 kHz.

For data recording, there's a data output option.

It's specified for one year! You know how much money you can save by eliminating the time and expense of shorter re-cal cycles. And this kind of long-term stability is just what you'd expect from Fluke.

So now, in addition to the industry standard 8800A, you have your choice of application-oriented and cost-saving configurations of the new 8810A, choices you'd expect only from Fluke.



Field-installable options snap-in when you need them.

CALL (800) 426-0361, TOLL FREE. Or, contact one of the more than 100 Fluke offices or representatives, worldwide. In the U.S. and all countries outside of Europe, contact: John Fluke Mfg. Co., Inc., P.O. Box 43210, Mountlake Terrace, WA 98043, U.S.A. Telex: 32-0013.

In Europe, contact: Fluke (Nederland) B.V., P.O. Box 5053, Tilburg, The Netherlands. Tel.: (013) 673973. Telex: 52237.

*U.S. prices

COMMAND PERFORMANCE: DEMAND FLUKE DMMs.



39 Electronics Review

LASERS: Diode operates with single-mode output, 39
SOLID STATE: Bidfet is key to new driver chips, 40
WORD PROCESSING: Software era opens for office systems, 41
PACKAGING & PRODUCTION: Circuitry devilry laid to "hook," 41
COMMUNICATIONS: Audio IC drops crosstalk down 83 dB, 42
COMPONENTS: Speed and voltage rise in power devices, 44
SOLID STATE: Sourcing, programmers brighten PAL outlook, 46
SOFTWARE: Patent issue is for Congress to decide, 46
TRADE: Court rejects Zenith protection bid, 46
NEWS BRIEFS: 50
EMPLOYMENT: Southern California desperate for EEs, 52

68 Electronics International

JAPAN: Display accesses 7,000 characters of Kanji alphabet, 68
GREAT BRITAIN: Microprocessor-based unit deadens If sound, 70
SWITZERLAND: Electronic control follows sun for thermal unit, 71
FRANCE: Small-ship monitor sorts incoming target information, 71
JAPAN: Hybrid packs in mobile communications components, 72

81 Probing the News

COMMUNICATIONS: New firms rush into new phone business, 81
ABROAD: Is E-beam the key for planned British firm? 86
CONSUMER: IC makers await a-m stereo bonanza, 88
COMPUTERS: Disk-drive makers load Winchesters, 90
ABROAD: France entices companies with Riviera, 92

98 Technical Articles

COMPUTERS: Minicomputer architecture links generations, 98
SOLID STATE: Erasable PROM saves power with C-MOS process, 106
DESIGNER'S CASEBOOK: Timer's built-in delay avoids false alarms, 112
Audio blanker suppresses radar and ignition pulses, 113
Four-function calculator times long intervals accurately, 115
PACKAGING & PRODUCTION: Automated finishing cuts IC costs, 116
SOLID STATE: Measuring thermal resistance keeps devices cool, 121
ENGINEER'S NOTEBOOK: Using the M6800 for automatic dialing, 128
Improved process program boosts a-d conversion efficiency, 129

135 New Products

IN THE SPOTLIGHT: Hybrid circuit includes single transformer, 135
PACKAGING & PRODUCTION: Ion implanter gets more reliable, 136
COMMUNICATIONS: Fiber-optics kit is versatile, 142
SEMICONDUCTORS: I²L chip handles fast video functions, 145
DATA HANDLING: IQ rises for data terminals, 148

Departments

Publisher's letter, 4
Readers' comments, 6
News update, 8
People, 14
Editorial, 24
Meetings, 26
Electronics newsletter, 33
Washington newsletter, 56
Washington commentary, 59
International newsletter, 63
Engineer's newsletter, 132
Products newsletter, 153
New literature, 154

Services

Reprints available, 152
Employment opportunities, 156
Reader service card, 163

Highlights

Cover: Architecture is key in 32-bit mini, 98

The 32-bit VAX-11 minicomputer family maintains compatibility with PDP-11 software, yet reflects future needs in such features as a 4-gigabyte virtual address space. Its architecture achieves both of these goals.

Cover is by Don Carroll.

Help wanted in California, please, 52

The big electronics firms in southern California are going to unusual lengths to fill their demand for engineers, including higher salaries, cash bounties, and other incentives.

Winchester-drive use grows, 90

Winchester disk-drive technology is spreading from mainframe computers to smaller systems. Makers of disk drives see the technology as a way of providing systems builders with eight times the storage capacity of cartridge drives.

C-MOS saves power in erasable PROM, 106

P-channel floating-gate complementary-metal-oxide-semiconductor technology gives a 4-K erasable programmable read-only memory its superior speed-power product. What's more, the new chip needs only a single-ended voltage supply.

Keep an eye on ICs' thermal resistance, 121

For the best possible performance, reliability and yield of integrated circuits, knowledge of thermal-design considerations, especially thermal resistance, is a must. Just as important is an appreciation of the measurement techniques available.

And in the next issue . . .

A hybrid isolation amplifier with a built-in flyback transformer . . . a proposed bus standard for microprocessors . . . software for the 8022 single-chip microcomputer.

EDITOR-IN-CHIEF: Kemp Anderson

EXECUTIVE EDITOR: Samuel Weber

MANAGING EDITORS: Arthur Erikson,
Gerald M. Walker

SENIOR EDITORS: William F. Arnold,
Ray Connolly, Lawrence Curran

ART DIRECTOR: Fred Sklenar

ASSOCIATE EDITORS: Howard Wolff,
Alfred Rosenblatt

DEPARTMENT EDITORS
Aerospace/Military: Ray Connolly
Circuit Design: Vincent Biancomano
Communications & Microwave:
Harvey J. Hindin
Components: Nicolas Mokhoff
Computers: Anthony Durniak
Industrial: John G. Posa
Instrumentation: Albert F. Shackil
New Products: Michael J. Riezenman,
Richard W. Comerford
Packaging & Production: Jerry Lyman
Solid State: Raymond P. Capece

CHIEF COPY EDITOR: Margaret Eastman

COPY EDITORS: Ben Mason, Mike Robinson

ART: Charles D. Ciatto, *Associate Director*
Paula Piazza, *Assistant Director*

EDITORIAL SECRETARIES: Janet Noto,
Penny Kaplan

EDITORIAL ASSISTANT: Marilyn B. Rosoff

FIELD EDITORS

Boston: Lawrence Curran (Mgr.)
Pamela Hamilton
Los Angeles: Larry Waller (Mgr.)
New York: Bruce LeBoss (Mgr.)
Palo Alto: William F. Arnold (Mgr.)
Robert Brownstein
Washington: Ray Connolly (Mgr.)
Frankfurt: John Gosch
London: Kevin Smith
Paris: Arthur Erikson
Tokyo: Charles Cohen

McGRAW-HILL WORLD NEWS

Editor: Michael Johnson
Brussels: James Smith
Milan: Andrew Heath
Moscow: Peter Hann
Paris: Andrew Lloyd
Stockholm: Robert Skole
Tokyo: Robert E. Lee

PUBLISHER: Dan McMillan

ADVERTISING SALES MANAGER:
Paul W. Reiss

MARKETING ADMINISTRATION MANAGER:
Wallis Clarke

CIRCULATION MANAGER: Karl Peterson

MARKETING SERVICES MANAGER:
Tomlinson Howland

RESEARCH MANAGER: Margery D. Sholes

While developing his story on the new consumer electronic telephones (p. 81), New York bureau manager Bruce LeBoss naturally took the opportunity to try the latest units soon to go on sale. The new generation is certainly different, Bruce relates.

"Actually all the new phones are feature-oriented, not just replacements for the traditional home instrument. One company, for instance, is selling the sound. Instead of a nerve-jangling ring, this one has a pleasant warble."

The main interest is in what the new phones can do that the traditional instrument can't. Yet the new models do not appear too complicated for consumers despite the raft of features tucked inside. "People are used to keyboards, programming, and digital displays from previously accepted products such as calculators and digital watches," Bruce says. "But, unlike the calculators and watches, there doesn't seem to be much possibility that cheap and dirty telephones will be introduced, because they have to meet performance standards in order to be compatible with the telephone systems."

Among the various features offered, the one that attracted Bruce was the ability to program the length of calls and disconnect at the end of the time limit. "For people with teen-aged kids or other long-winded relatives, it's nice to be able to cut them off," he chuckles.

Some designers are already beginning to think up new ones for the telephone. It will soon be possible for a consumer to call his or her own phone and turn on household accessories, such as air conditioners or

ranges, before returning. Another plan calls for turning the telephone into a security alarm capable of processing information from smoke detectors or intrusion sensors and automatically placing a special alarm call to the fire or police station.

The possible investment by the United Kingdom's National Enterprise Board in a new semiconductor production venture has caused mixed feelings in England, as London bureau manager Kevin Smith reports on page 86. Both supporters and critics agree that the project is risky. But, as Kevin says, the British semiconductor industry has a strong position in electron-beam technology, which would put any new government-sponsored firm into a keen competitive position.

"The key words mentioned in all the talk about the project have been electron-beam technology," he says. "It's the one point that fits the UK strategy of leaping past the Japanese and U. S. companies going into 64-k random-access memories."

In contrast to the total cooperation that the Japanese government has been able to obtain in its semiconductor and computer-development projects, not everyone in Great Britain supports this scheme. Essentially, a main criticism is that such a project would have to attract a talented engineering and marketing team and this type of talent is in short supply these days—not only in England, but worldwide.



July 6, 1978 Volume 51, Number 14 98,862 copies of this issue printed

Published every other Thursday by McGraw-Hill, Inc. Founder: James H. McGraw 1860-1948. Publication office 1221 Avenue of the Americas, N.Y., N.Y. 10020. Second class postage paid at New York, N.Y. and additional mailing offices.

Executive, editorial, circulation and advertising addresses: Electronics, McGraw-Hill Building, 1221 Avenue of the Americas, New York, N.Y. 10020. Telephone (212) 987-1221. Teletype 12-7960 TWX 710-581-4879. Cable address: MCGRAW HILL L N E W Y O R K.

Subscriptions limited to professional persons with active responsibility in electronics technology. No subscriptions accepted without complete identification of subscriber name, title or job function, company or organization, and product manufactured or services performed. Based on information supplied, the publisher reserves the right to reject non-qualified requests. Subscription rates: in the United States and possessions \$15 one year, \$26 two years, \$38 three years; company addressed and company libraries \$20 one year, \$36 two years, \$50 three years; APO/FPO addressed \$35 one year only; Canada and Mexico \$17 one year, \$29 two years, \$43 three years; Europe \$42 one year, \$71 two years, \$100 three years; Japan, Israel and Brazil \$70 one year, \$115 two years, \$165 three years; Australia and New Zealand \$95 one year, \$170 two years, \$240 three years, including air freight; all other countries \$45 one year, \$60 two years, \$112 three years. Limited quota of subscriptions available at higher-than-basic rate for persons allied to field served. Check with publisher for these rates. Single copies: \$4.00. Please allow four to eight weeks for shipment.

Officers of McGraw-Hill Publications Company: Gordon L. Jones, President; Paul F. McPherson, Executive Vice-President; Group Vice-President: Gene W. Simpson; Senior Vice-Presidents: Russell F. Anderson; James E. Boddorf, Planning & Development; David G. Jensen, Manufacturing; Ralph R. Schulz, Editorial; Vice-Presidents: Denis C. Beran, European Operations; David P. Forsyth, Research; Eric B. Herr, Economics; James E. Hackett, Controller; Robert L. Leyburn, Circulation; Edward E. Schirmer, Sales.

Officers of the Corporation: Harold W. McGraw, Jr., President, Chief Executive Officer, and Chairman of the Board; Robert N. Landes, Senior Vice President and Secretary; Ralph J. Webb, Treasurer.

Title registered in U.S. Patent Office. Copyright © 1978 by McGraw-Hill, Inc. All rights reserved. The contents of this publication may not be reproduced in whole or in part without the consent of copyright owner.

Subscribers: The publisher, upon written request to our New York office from any subscriber, agrees to refund that part of the subscription price applying to copies not yet mailed. Please send change-of-address notices or complaints to Fulfillment Manager; subscription orders to Circulation Manager, Electronics, at address below. Change-of-address notices should provide old as well as new address, including postal zip code number. If possible, attach address label from recent issue. Allow one month for change to become effective.

Postmaster: Please send form 3579 to Fulfillment Manager, Electronics, P.O. Box 430, Hightstown, N.J. 08520.

power supplies for your automatic test equipment

KEPCO
series*

ATE

* 38 Models from 50-1000 Watts;
0-6V to 0-150V. Programmable
from your GPIB/IEEE-488 Bus
using Kepco SN Programmers.

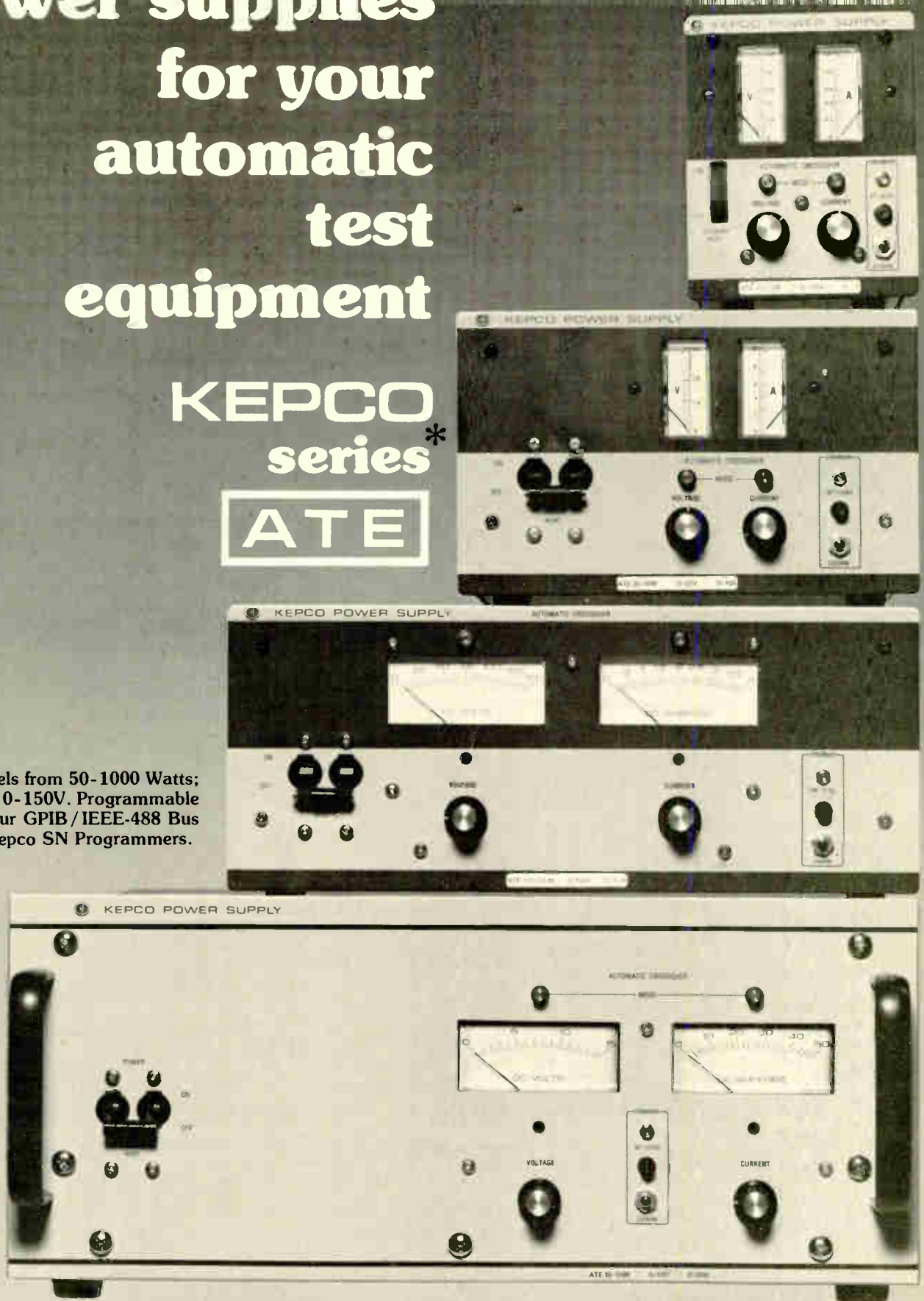

KEPCO®

For complete specifications, write Dept. CJF-14.

KEPCO, INC. • 131-38 SANFORD AVENUE • FLUSHING, N.Y. 11352 U.S.A. • (212) 461-7000 • TWX #710-582-2631 • Cable: KEPPOPOWER NEWYORK

Circle 5 on reader service card

The new era in ion implantation.

Introducing Challenger 200.

The new Kasper system that accelerates ion beams up to 200 KeV in a production environment.

Challenger 200. Designed for high throughput production line applications of wafers from 2" to 4" in diameter. Yet totally versatile so it can handle developmental and pilot lot work with great efficiency.

Challenger 200. The first ion implanter designed with a modular repair concept. Which means you never have to trouble-shoot at the component level.

Challenger 200. Available with cold cathode or optional filament ion sources. A fully automatic vacuum system and a choice of three wafer handling facilities—batch chamber, "Auto-line" continuous throughput chamber, and optional dedicated R & D chamber.

Challenger 200. The only ion implanter that does its own trouble shooting. If an interlock goes out of spec, the system stops and tells you what happened on its real-time display. And with its optional process printout, it

records all key implant data from system operation.

We're backing Challenger 200 with a new Kasper Application Laboratory—available with a full fledged system to support your own application and to advance the state of the art of ion implantation. Only Kasper has made such a commitment to the industry.

Get full details on Challenger 200 from your local Kasper office. Or write Kasper Instruments, 749 North Mary, Sunnyvale, California 94086, (408) 733-9800.

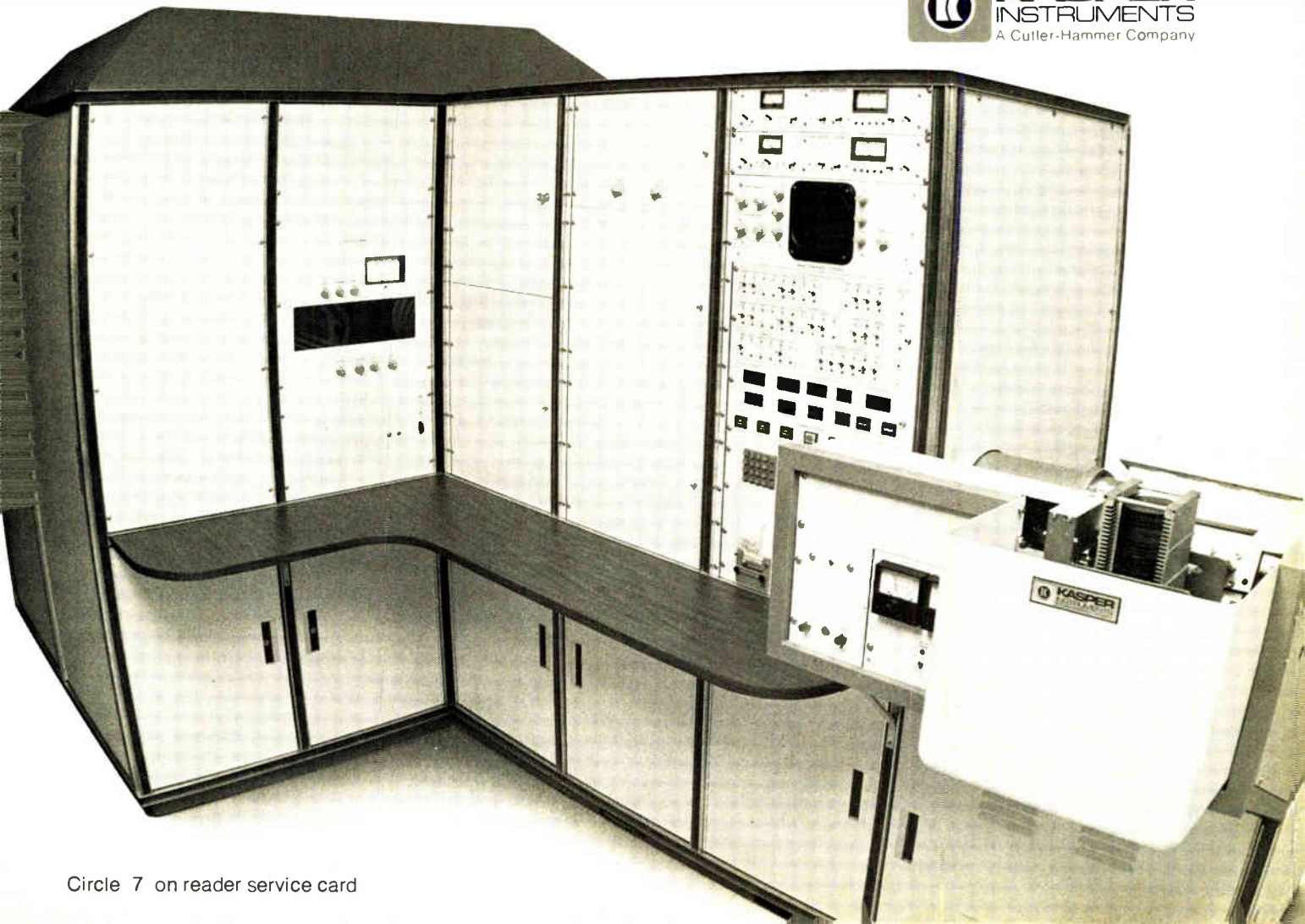

WIMA Capacitors

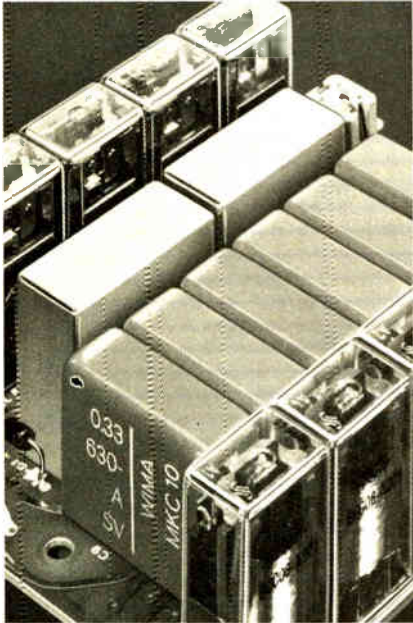

Reproduced by permission of Grundig AG, Fürth, Germany

RAY Circuit for motor control of a Video Recorder. Electronic control of the drives of a 4-motor gear unit. A total of 10 control relays monitor the following functions: Start, reverse wind, forward wind, search, record, pole change, accelerate, search in reverse mode, and tape tension switch-over. The two WIMA MKB S-C capacitors are used as phase compensation for an asynchronous motor which operates as a head drive. The WIMA MKC 10 capacitors are used for interference suppression.



WIMA Capacitors:
*High Quality Components
for Electronic Equipment*

WILH. WESTERMANN

Spezialvertrieb elektron. Bauelemente
P.O. Box 2345 · D-6800 Mannheim 1
Fed. Rep. of Germany

U.S. Sales Offices:
BOSL & ROUNDY · 3333, Delray Drive
Ft. Wayne · Indiana 46805
(219) 483-3378

THE INTER-TECHNICAL GROUP INC.
North Dearman Street · P.O. Box 23
Irvington · New York 10533
(914) 591-8822

TAW ELECTRONICS CO.
4215 W. Burbank Blvd., Burbank
California 91505 · (213) 846-3911

News update

■ A tactical air reconnaissance pod system mounted beneath a Grumman F-14 Tomcat is in flight tests at the Naval Air Test Center at Patuxent River, Md. The tests of the 17-foot-long Tarps, as it is called, are part of a program calling for the modification of about 50 F-14s to accommodate the pod [*Electronics*, Aug. 18, 1977, p. 36], thus converting the Tomcats into RF-14 reconnaissance aircraft.

According to John Michel, Grumman Aerospace Corp.'s Tarps program manager, three craft have been modified thus far to accept the 1,550-pound pod with a fourth scheduled for this month. Tarps carries three cameras and was developed by the Naval Air Development Center at Johnsville, Pa. The service expects to begin technical evaluation of Tarps within a few days and conclude flight tests in November. Michel estimates the total value of Grumman's F-14 Tarps contract at \$20 million to \$30 million.

■ The U.S. Army's Communications and Electronics Material Readiness Command at Fort Monmouth, N. J., has awarded a \$361,000-plus contract to International Telephone & Telegraph Corp.'s Electro-Optical Products division in Roanoke, Va., calling for the design and development of ultralow-loss optical-fiber cable assemblies. The development is considered a highly significant step toward the Army's target of replacing copper wires with optical fibers for tactical communications systems by the mid 1980s [*Electronics*, March 3, 1977, p. 65].

The 27-month contract is to result in 1-kilometer cable assemblies, including connectors, each enveloping six optical fibers. Losses are to be no greater than 6 decibels/km, and repeatable insertion losses for the six-fiber connector are to be held to 1 dB or less per connection. The program supplements the Army's plans to award a contract for manufacturing methods and technology for optical-fiber cable assemblies to be used in long-haul communications systems.

Bruce LeBoss

CABLE TESTING

THE WAY IT SHOULD BE

Quickly and inexpensively.

Tests 1 to 50 conductors with continuous readout. Locates shorts, open, pair reversals, intermittent connections, ground shorts and shield shorts.

All for under \$200. Call or write us for information.

CORECTOR 1000

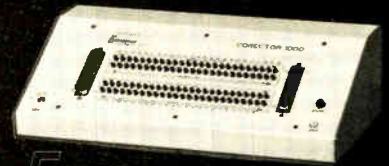

CONTROL ELECTRONICS

... cost savers in electronics

11035 Harry Hines Blvd, Suite 212
Dallas, Texas 75229
(214) 350-6714 or 350-6829

Circle 167 on reader service card

Just published: 1978 EBG!

Completely new listings of catalogs, new phone numbers, new addresses, new manufacturers, sales reps, and distributors! The total market in a book—four directories in one!



Electronics Buyers' Guide
1221 Ave. of the Americas
New York, N.Y. 10020

Yes, please send me _____ copy(ies) of 1978 EBG.

I've enclosed \$25 per copy delivered in the USA or Canada.

I've enclosed \$35 per copy for delivery elsewhere (\$47 if shipped by Air). Full money-back guarantee if returned in 10 days.

Name _____

Company _____

Street _____

City _____ State _____ Zip _____

Electronics/July 6, 1978

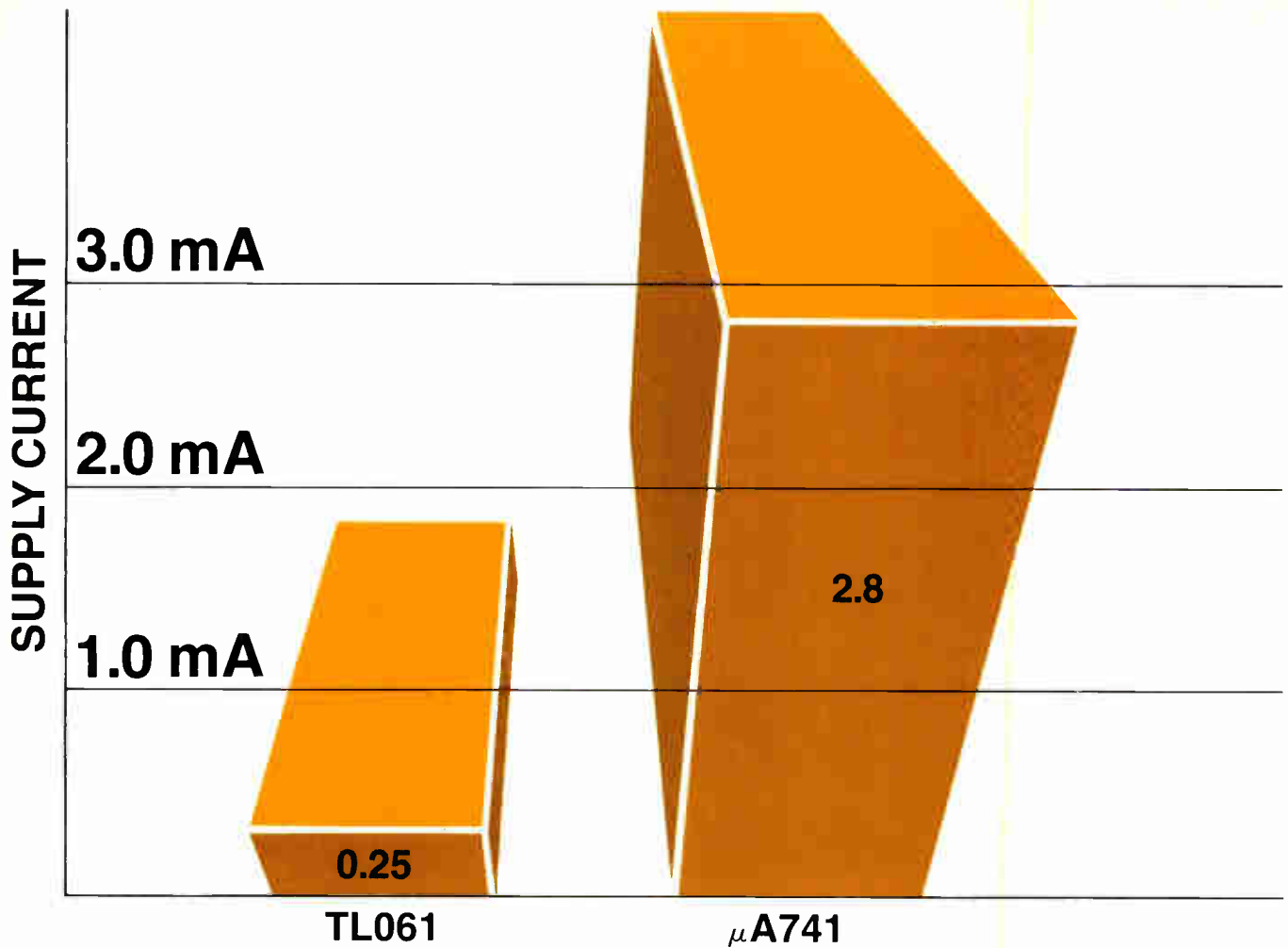

Exclusive from Texas Instruments. Low-power TL061 Series BIFET op amps.

Less than one tenth the power consumption of μ A741 or MC1458 op amps, these new op amps are ideally suited for battery-powered and similar applications requiring low power consumption.

0.25 mA max supply current

The TL061 utilizes the same pin-outs as μ A741's, TL081's and TL071's. Features include:

- Input resistance – $10^{12} \Omega$ typical
- Input bias current – 0.4 nA max
- Input offset voltage – 15 mV max
- Unity gain bandwidth – 1 MHz typical
- Slew rate – 3.5 V/ μ s typical
- 100-piece price \$0.46

Despite low power consumption, you get good transient response, wide bandwidth and low distortion.

Even lower power with TL066

An exclusive power-control pin on the TL066 permits power programming by connection of an external resistor to further reduce power consumption. With suitable resistors, the TL066 can operate on mere microwatts at supply voltages as low as ± 1.5 V.

Low-power duals and quads

The TL061 family includes duals and quads as well as single op amps

to increase circuit density and reduce weight and cost.

BIFETS for every purpose

The low-price, general-purpose TL081 and low-noise TL071 families combine with the low-power TL061 family to make up industry's broadest line of BIFET op amps. Fourteen leadership BIFET products to serve your needs. In a choice of three package types.

Send for data sheet

Ask for the latest TL061 Series data sheet. Call your nearest TI distributor or write Texas Instruments Incorporated, P.O. Box 225012, M/S 308, Dallas, Texas 75222.



TEXAS INSTRUMENTS
INCORPORATED

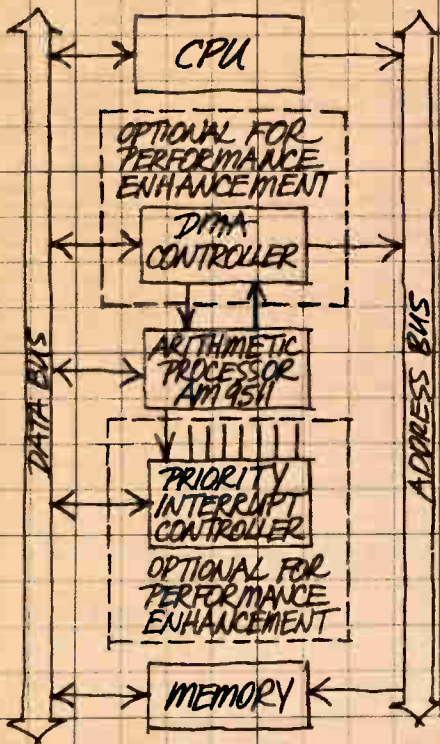

COMMAND IS ENTERED.
 OPERATES INDEPENDENTLY UNDER
 INTERNAL MICROPROGRAM CONTROL.
 REQUIRES NO CPU INTERVENTION.
 INTERNAL ARCHITECTURE HAS
 MANY FEATURES THAT EN-
 HANCE THE COMPUTA-
 TIONAL SPEED!

- ✓ DATA & STACK MANIPULATION
- ✓ COMMANDS.
- ✓ 16-BIT INTERNAL BUS
- ✓ VALU & STACK STRUCTURE
- ✓ HARDWARE ARITHMETIC SEQUENCING
- ✓ TWO-PORT STACK ORGANIZATION
- ✓ WORKING REGISTER SPACE.

J.B.—
 Saves a whole board
 of TTL! MIL-STD-883
 for free too.
 This one's a
WINNER!

The weakest link in your micro-processor-based system has always been software development. It's always taken weeks and dollars and headaches. But that's going to be different now.

MICROPROCESSING: THE WEAK LINK REMOVED.

ANNOUNCING THE AM9511 ARITHMETIC PROCESSOR.

It implements the following functions in high speed hardware, two orders of magnitude faster than the standard MPU software approach.

Simple: addition, subtraction, multiplication and division.

Complex: logarithms, square roots, powers, exponentiation, trigonometry and inverse trigonometry.

(The basic functions can be performed in 16-bit or 32-bit fixed point and 32-bit floating point format.)

As if that weren't enough, you pick the microprocessor. That's right. Not only is our Am9511 amazing, it's also compatible with all of the most com-

monly used microprocessors on the market—including the industry standard 8080/8085.

Increase your system throughput. Save weeks and months of software development. Reduce your chip count.

Remove the weak link. Call Advanced Micro Devices and ask for the data sheet and application note on the Am9511 Arithmetic Processor.

Advanced Micro Devices



Multiple technologies. One product: excellence.
901 Thompson Place, Sunnyvale, California 94086
Telephone (408) 732-2400



It's time to break up the old board float game.

"Fifty percent of our ten million dollar board float is defective. Trouble is, we don't know which fifty percent!"

People involved in the service and repair of microprocessor-based products know they are more than new and better; they're different. And to accomplish any effective doctoring requires a new breed of test instrument.

That's where we come to the rescue. Millennium has a revolutionary, highly



versatile diagnostic "test lab in a suitcase" for systems testing of any product type driven by the most common microprocessors.

Our new MicroSystem Analyzer is a royal flush in one unit—offering "real-time" in-circuit emulation, signature analysis, pulse count, pulse width, transition count, and much more. We can get into the game at the repair depot for everything from system verification to component fault isolation . . . at the customer's site for fast GO/NO GO system test . . . in production test as a stand-in for an expensive board tester . . . and in the lab

to off-load your development system.

Turn those mountains of floating "mystery" boards into healthy molehills in no time. For a whole new deal, ask for more facts about our MicroSystem Analyzer, or for a "live demo" real soon.

MILLENNIUM

19020 Pruneridge Avenue
Cupertino, CA 95014
(408) 996-9109

Circle 13 on reader service card



THE MICROSYSTEM ANALYZER

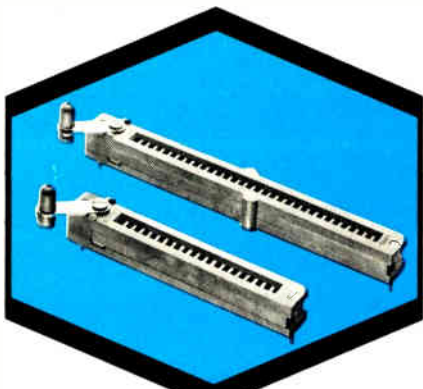

ZIP STRIP® TEST SOCKETS

Highly versatile TEXTOOL zero insertion pressure sockets allow "custom" installations for testing dual-in-line devices.

TEXTOOL's versatile ZIP STRIP sockets make it possible to "customize" socket installations for zero insertion pressure (ZIP) testing of dual-in-line devices with .100" spaced leads regardless of spacing between rows (.300" minimum).

Two ZIP STRIP sockets may be placed on any convenient centers, or several socket locking levers may be ganged together for easy mass testing of devices. Since all ZIP STRIP models feature zero insertion pressure, expensive and highly sophisticated circuits may be safely tested without fear of mechanical damage to the package.



Simple mechanical action plus a thoughtful system of ramps and bevels to guide device leads into

the contacts allow a device literally to be dropped loosely and with a simple flick of a locking lever be ready to operate with exceptionally good electrical contacts. A quick release of the locking lever lets a device be extracted with zero pressure being exerted on the leads by the socket contacts.

When ganged in an array, ZIP STRIP sockets easily accept dozens of devices and secure them with a single locking lever. Upending the array and releasing the lever unloads the devices since there is no contact pressure to retain them in the socket.

ZIP STRIP sockets are available in strips for 10, 20 and 32 leads on .100" spacing.

Detailed technical information on the complete line of TEXTOOL's zero insertion pressure sockets is available on request.



PRODUCTS, INC.

1410 W. Pioneer Drive • Irving, Texas 75061
214/259-2676

People

Goldman looks to Austin as microcomputer capital

It was probably no accident that Motorola Inc. picked production expert Murray A. Goldman to be its new group operations manager for microcomponents. Goldman, who joined Motorola in 1969, had for the past two years been in charge of manufacturing at the integrated-circuit division's metal-oxide-semiconductor production plant in Austin, Texas. It is under his guidance that Motorola is beginning to churn out the microprocessor parts it is committed to deliver in the tens of millions yearly by the early 1980s to the auto companies and others.

"There is no question that we can meet the [production] demands of the future," says the soft-spoken electrical engineering Ph.D. On July 1, he took over from Colin Crook, who resigned to return to his native England as managing director of Rank-Xerox Precision Industries Ltd.

But as he views his expanded responsibilities, which now include design and marketing, as well as manufacturing, he appears most excited about Motorola's design capabilities. He predicts that Austin will become the microcomputer capital of the world, and that will not be because of numbers of circuits alone.

"Our design group gives us the edge with chips like the 6801 and 6809," he says, referring to two of Motorola's newest products in its

6800 microprocessor family, scheduled to be available in sample quantities during the third quarter of the year. "The 6801 is a third-generation one-chip microcomputer—better performing than the 6800 and not a degradation like Intel's 8048 is to its 8080. The 6809 is a souped-up version of the 6800. Over 20 address modes and the features of a 16-bit microcomputer will make it the most powerful 8-bit microprocessor ever conceived." The real plus, he adds, is that both parts will run 6800 software, something other expansions of basic families cannot do.

Avnet rewards O'Melveny's success with microprocessors

He led Hamilton/Avnet Electronics into the brave new world of microprocessors two years ago when many questioned whether distributors could sell the sophisticated devices. But Richard O'Melveny sold them like crazy, with the result that the Culver City, Calif., division of Avnet Inc. is looking toward \$150 million in microprocessor sales by the early 1980s. Moreover, O'Melveny, 42, has a promotion from director of microcomputers to vice president and director of microcomputer marketing.

Despite the mystique that seemed to surround them, O'Melveny saw microprocessors from the start as "essentially a commodity just like other components that a customer wants *right now*." If there is a single secret to selling microcomputers, he believes it lies with the development system required to write software and debug the design. Early on, he realized an MDS "is a design tool on which the business depends, not an end sales item in itself." Though most engineers understand this, their management may not and "we have to help him convince his boss to spend the \$12,000 or so."

And O'Melveny, with six years at Hamilton/Avnet following five years at a competitive distributor, had to convince his bosses to install a demonstration center at each of 36



Taking over. Design expertise will make Motorola shine, says Murray Goldman.

OUR LOW-POWERED 4K STATIC V RAM. VROOM! What a combination! The new S2114 VRAM takes only 50 milliamperes to zip along at 150 nanoseconds. The secret is our patented VMOS technology, created to achieve the industry's best speed/power ratio. Low dissipation reduces your power supply and cooling needs. That means lower system costs and better performance. It's no surprise that this winning combination comes from AMI. Ever since we mass-produced the first MOS back in 1966, we've been coming up with new ways to solve your system problems. Check out our S2114 VRAM at your nearest AMI distributor. The quicker, the better!

AMI's new 1K x 4 Static VRAMs offer the best speed/power combinations available today. Just pick the one that does the job for you.

Speed	50mA	70mA	100mA
150 ns	S2114A-1	S2114L-1	S2114-1
200 ns	S2114A-2	S2114L-2	S2114-2
300 ns	S2114A-3	S2114L-3	S2114-3

For even faster buffer and cache memory applications, watch for our 70 nanosecond 1K x 4 S2114H, coming in September.

To find out all about our quick, cool 4K memories, including the S4017 and S2147 4K x 1 versions, write to AMI Memory Marketing, 3800 Homestead Road, Santa Clara CA 95051. Or call (408) 246-0330. You'll get more *VROOM* from our VRAMs.

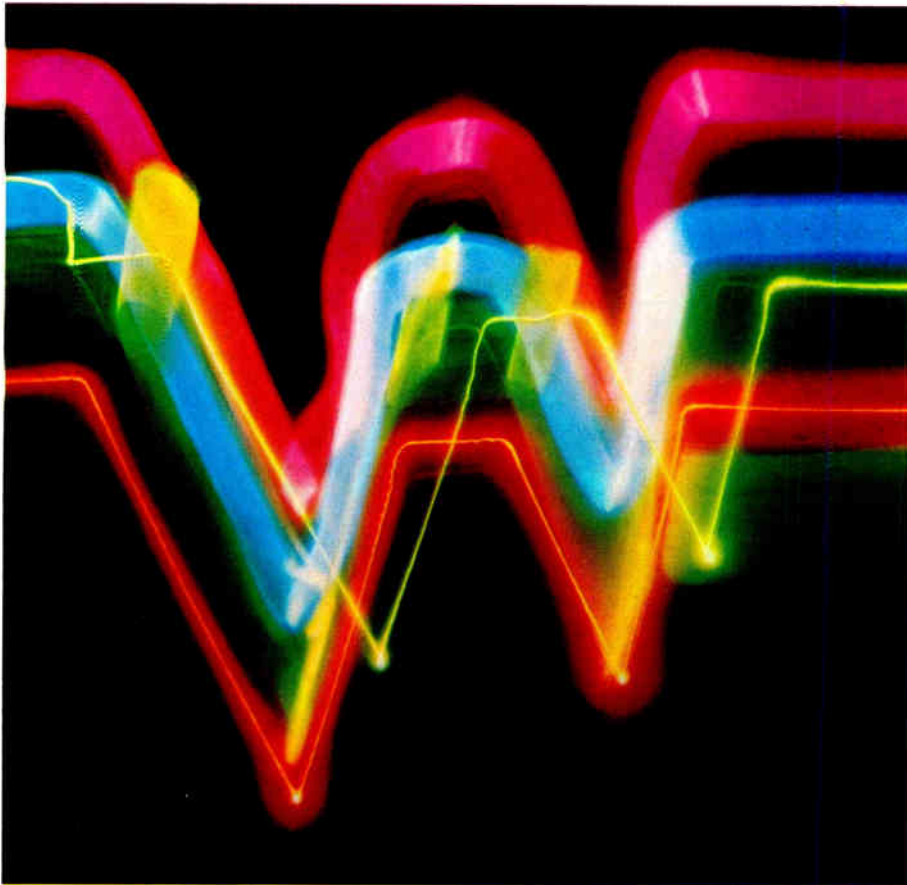

VMOS: the high performance technology from



There's a whole new approach to final test of digital products.



Biomotion's new DTO-1.

Just look at DTO-1's capabilities. It records and stores your test sequence on tape. Then plays it back to guide technicians. DTO-1 handles digital circuitry like a logic analyzer, troubleshoots analog circuitry like an oscilloscope and automates go/no-go testing. There's no better way to cut test costs.

DTO-1 is the fast, easy way to develop thorough test procedures for new digital products. Just step through your test sequence once and DTO-1 records reference logic traces for the entire program



It's easy to provide manufacturing with a test routine — just record it on tape with DTO-1

Then technicians simply follow the established test sequence during product checkout. DTO-1's powerful microprocessor compares logic traces with recorded reference traces and activates a "pass" or "fail" light on the probe.

When a fault is detected, a built-in scope helps determine if the problem is

analog or digital. It displays time domain logic traces and highlights points of non-conformance. And it can simultaneously display analog data on the same time base

Your technicians will love DTO-1. It

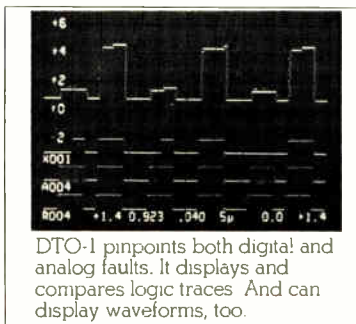

DTO-1 pinpoints both digital and analog faults. It displays and compares logic traces. And can display waveforms, too.

frees them from the monotony of the test routine and lets them concentrate on finding and fixing malfunctions.

Best of all, at \$8950* DTO-1 is a cost-effective solution. Give us a call at (408) 988-6800 to arrange a demonstration. Or



Microprocessor-controlled "pass" and "fail" lights on DTO-1's probe guide technicians through your test sequence

write for product data and a reprint of an eight-page article reprint about DTO-1.

Gould Inc., Biomotion Division
4600 Old Ironsides Dr., Santa Clara, CA 95050
(408) 988-6800

People



Distributor. Richard O'Melveny is doing nicely with microprocessors as commodities.

locations, complete with an applications engineer and substantial inventory that includes most microcomputer lines. The investment reached multimillion-dollar levels.

Two kinds. Typically, two kinds of engineer-customers come in to the demonstration centers to buy a microcomputer. "One guy walks in with a bias for a particular computer, and then it's a matter of servicing him," says O'Melveny. "But the other one expects to buy it for about \$9.90 because of some of the ads. We have to educate him with a learning tool, a microcomputer kit."

He is also surprised that many engineers "are not that aware of board microcomputers; they're ready to design with chips." So the first question his people ask is: "board or chip level?" Then the explanations start.

Concerning the oft-proclaimed microcomputer software bottleneck, O'Melveny sees "the void being rapidly filled." For overall operating software, or firmware, manufacturers are coming on strong, he says, while engineers themselves are doing their own application packages.

Has learning about microcomputers been a perplexing process for veteran design engineers? O'Melveny thinks not. "The individual engineer is coping very nicely," he says. "He is highly motivated and searching for information and alternatives, rather than simply for help in design." □

GOULD  **biomotion**

*US price only

SSR UPDATE

Now we've put Teledyne technology in this popular SSR package



If you have been designing around this solid state relay package simply because of multi-source availability, this is important news. You don't have to settle for less than the best anymore. Now you, too, can reap the benefits of Teledyne SSR technology.

For instance, the Teledyne 615 features a 40% reduction in component count. We don't need to spell out the cost and reliability advantages that gives you.

No black magic. We do it by using ICs to replace a significant part of the discrete circuitry. We designed the ICs ourselves. We build them ourselves. That gives us an exceptional degree of quality control. And it gives you reliability and performance you can really count on.

The Teledyne 615 Series is available in 10, 25 and 40 amp versions. Contact us for full technical details or see your local Teledyne distributor for off-the-shelf delivery.

 **TELEDYNE RELAYS**

3155 W. El Segundo Blvd., Hawthorne, Calif. 90250 • (213) 973-4545

Circle 17 on reader service card

Intel announces seven Now you can really

Hold the power, hold the clock, order the speed you need. Our 2141 family includes seven new low power, fully static 4K RAMs that give the designer the choice. Now you can get the speed/power product you want without the design complications of clocked RAMs. That's just what you need to simplify design of main, buffer, cache and control store memory systems, and speed your product to market.

HMOS, our new memory technology, is the key. Its active speed/power product is just one fourth that of previous processes. So while maintaining the highest performance in its class, the 2141 operates with as little as 40 mA. And automatic power down on deselection cuts standby power to 5 mA. In larger systems, where most devices are deselected at any given time, the combined power savings can reach 90% or more over other fully static 4K x 1 RAMs. That cuts cooling and power supply costs dramatically.

Faster, easier design is what Intel's HMOS is all about. Automatic power down is accomplished without a clock so the 2141 can be designed into either synchronous or asynchronous systems with equal ease. And the cycle times equal access times. That means higher data rates, as fast as 8.3 MHz for the fastest version.



new fully static 4K RAMs. have it your way.

For even greater speed, the seven 2141 parts are directly pin and function compatible with our three super fast 2147 HMOS parts. So you can have it your way from 55ns to 250ns using the 2141/2147 series, with a virtually identical speed/power product.

Both the 2141 and 2147 follow the industry standard 4096 x 1 bit, 18-pin pinout, and can replace conventional 4K static RAMs in both clocked and

unclocked systems. Both 2141 and 2147 are directly TTL compatible in all respects: inputs, output and operation from a single +5V supply. And both parts deliver the inherent reliability of HMOS. They've already achieved the same dependability as the 2102A.

For a copy of our HMOS reliability report and data sheets, write Intel, Literature Dept., 3065 Bowers Avenue, Santa Clara, CA 95051.

The 2141 is in production and available now. You can order directly from your distributor, or from your local Intel sales office. Just ask for the new 4K static RAM with everything on it.

intel® delivers.

Europe: Intel International, Rue du Moulin a Papier, 51-Boite 1, B-1160, Brussels, Belgium. Telex 24814.
Japan: Intel Japan, K.K., Flower Hill-Shinmachi East Bldg. 1-23-9, Shinmachi, Setagaya-ku, Tokyo 154.
Telex 781-28426.

US and Canadian distributors: Almac/Stroum, Component Specialties, Cramer, Hamilton/Avnet, Harvey, Industrial Components, Pioneer, Sheridan, Wyle/Elmar, Wyle/Liberty, or L.A. Varah, Zentronics.

4096 x 1 BIT HMOS STATIC RAMs			
DEVICE	Max. Access Time (ns)	Max. Active Current (mA)	Max. Standby Current (mA)
2141-2	120	70	20
2141-3	150	70	20
2141-4	200	55	12
2141-5	250	55	12
2141L-3	150	40	5
2141L-4	200	40	5
2141L-5	250	40	5
2147	70	160	20
2147-3	55	180	30
2147L	70	140	10



“We can use anybody’s .050” centerline cable with AMPLIMITE HDF connectors. And get mass termination efficiency.”

And there are no exceptions. **AMPLIMITE High Density Flexible connectors work with all .050” centerline 28-30 AWG round conductor ribbon cable.** You get an axial cable-to-connector interface second to none in strength and ruggedness.

AMPLIMITE HDF connectors provide complete packaging flexibility. They are available in 15-, 25- and 37-position sizes, and have through-cable capability for “daisy chain” applications. They intermate with other D-type connectors, including **AMPLIMITE all-plastic right-angle headers.** HDF connectors are at work in computer peripherals, modems, instrumentation, industrial controls, and word processing systems. They are completely compatible with transmission specification RS-232.

AMPLIMITE HDF connectors give you another plus. AMP technical assistance and support. It’s thorough, complete, professional aid you can call on even during project planning. It can help make sure your design will be efficient and effective right from the start.

There are more advantages with AMPLIMITE HDF connectors:

- Probe-ability for convenient circuit testing with connectors in place.
- Compatibility with “dead center” and “dead edge” designs.

- Matched application tooling assures highest production rates and lowest applied cost.
- Integrated cable strain relief.

For more information on AMPLIMITE HDF connectors, just call Customer Service at (717) 564-0100. Or write AMP Incorporated, Harrisburg, PA 17105.

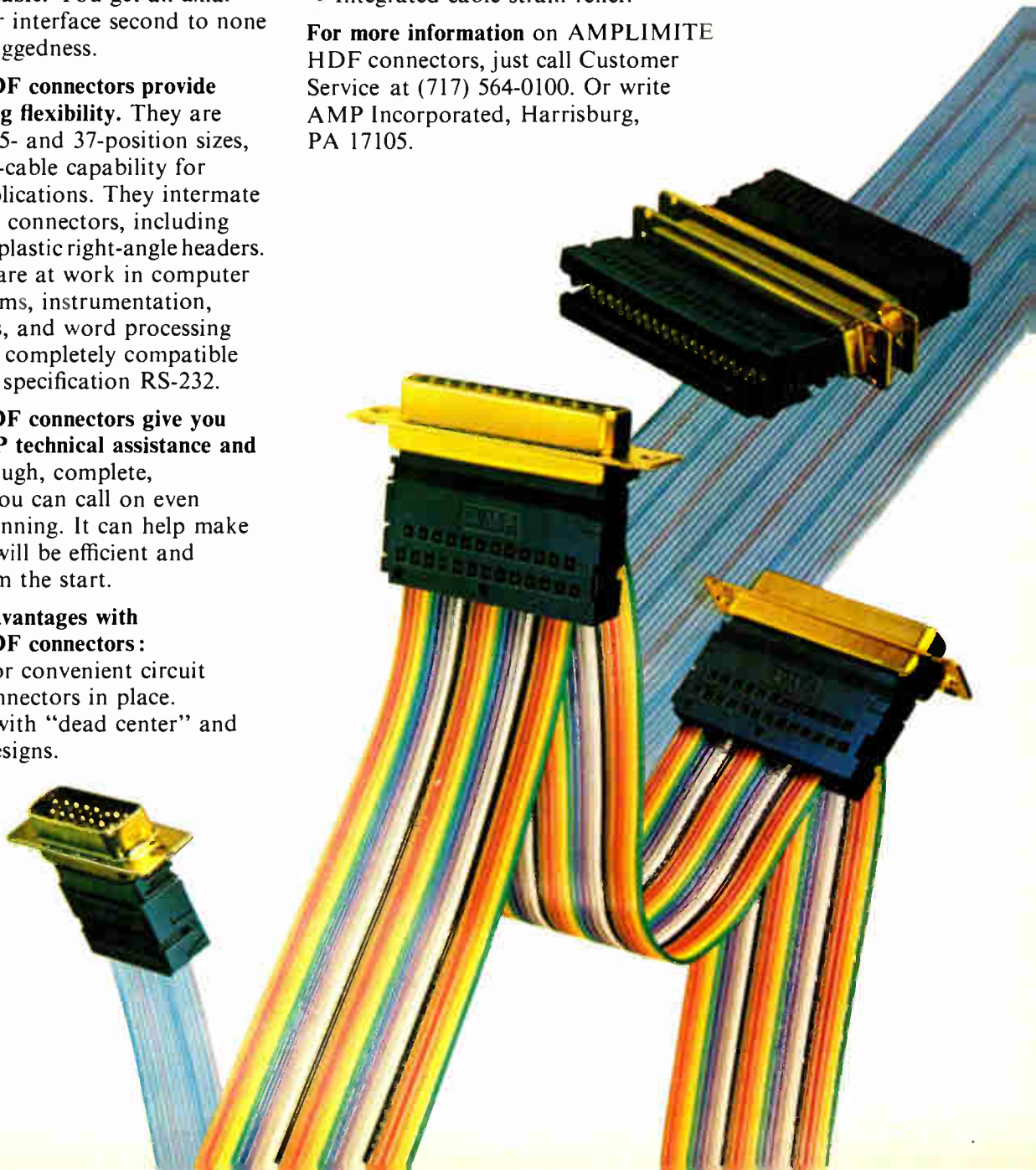

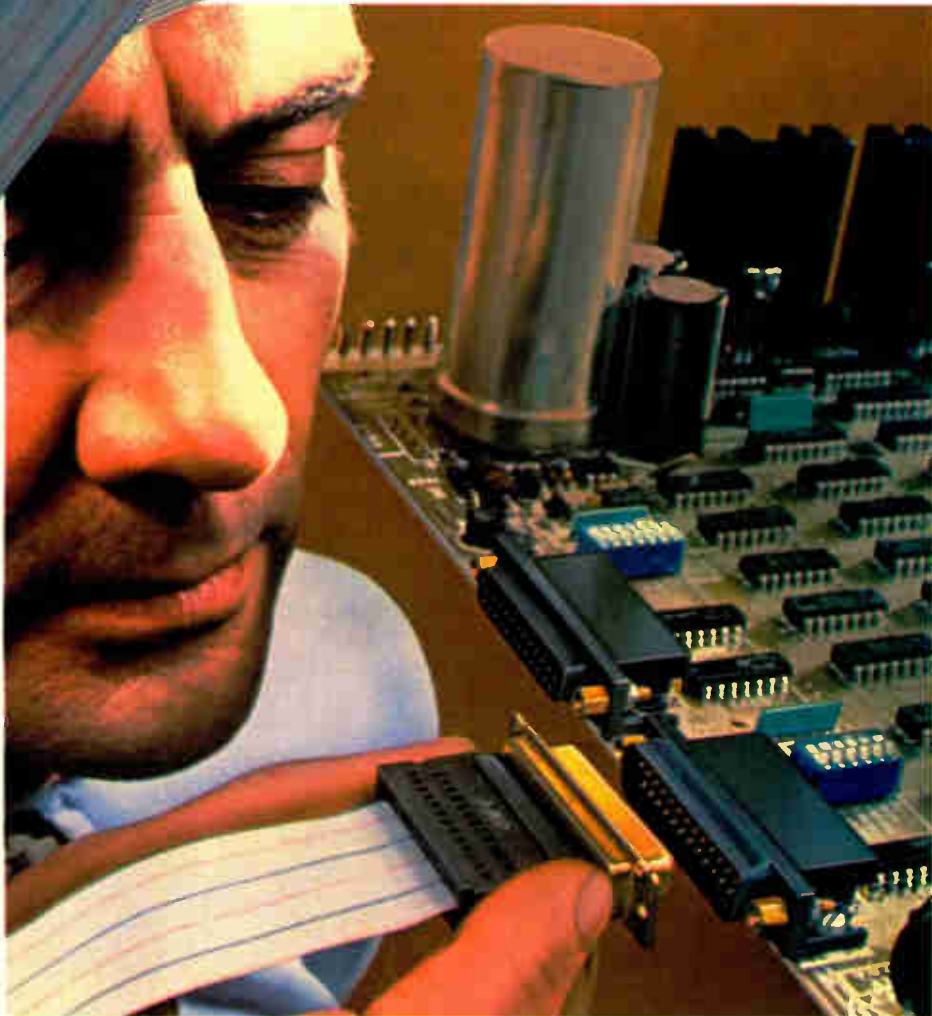
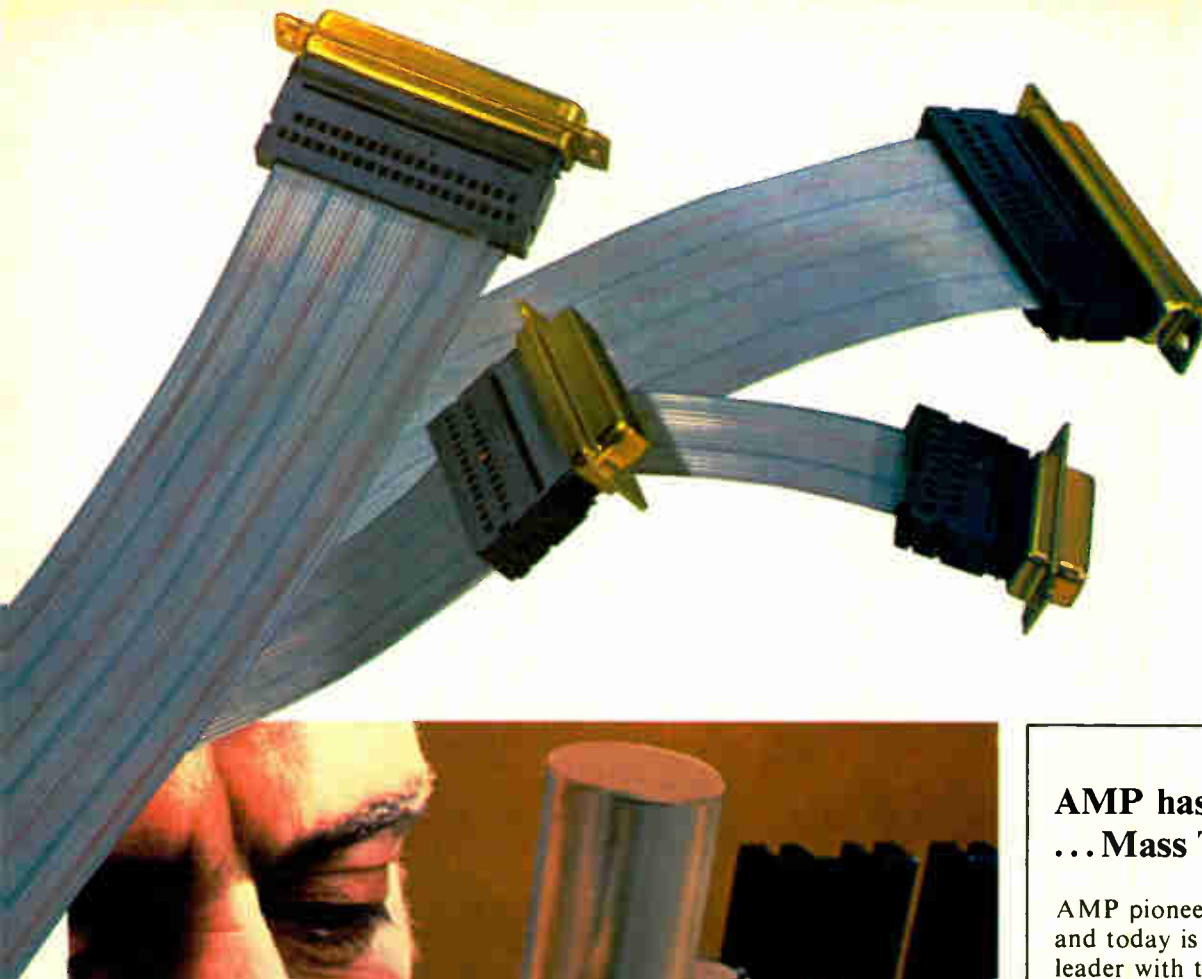

AMP has a better way ... Mass Termination.

AMP pioneered the concept and today is the acknowledged leader with the industry's widest range of application experience. We have mass termination connectors for discrete wire and virtually any type of cable: ribbon coaxial, flat etched, twisted pair, round conductor, flat flexible. All have preassembled contacts, eliminate costly wire preparation and offer productivity savings and benefits never before possible. If you would like details on any of our other mass termination ideas, call Customer Service at (717) 564-0100.

AMP & AMPLIMITE are trademarks of AMP Incorporated.

AMP

INCORPORATED

What the learning curve has done for Mostek's 16K RAM.

I. Availability

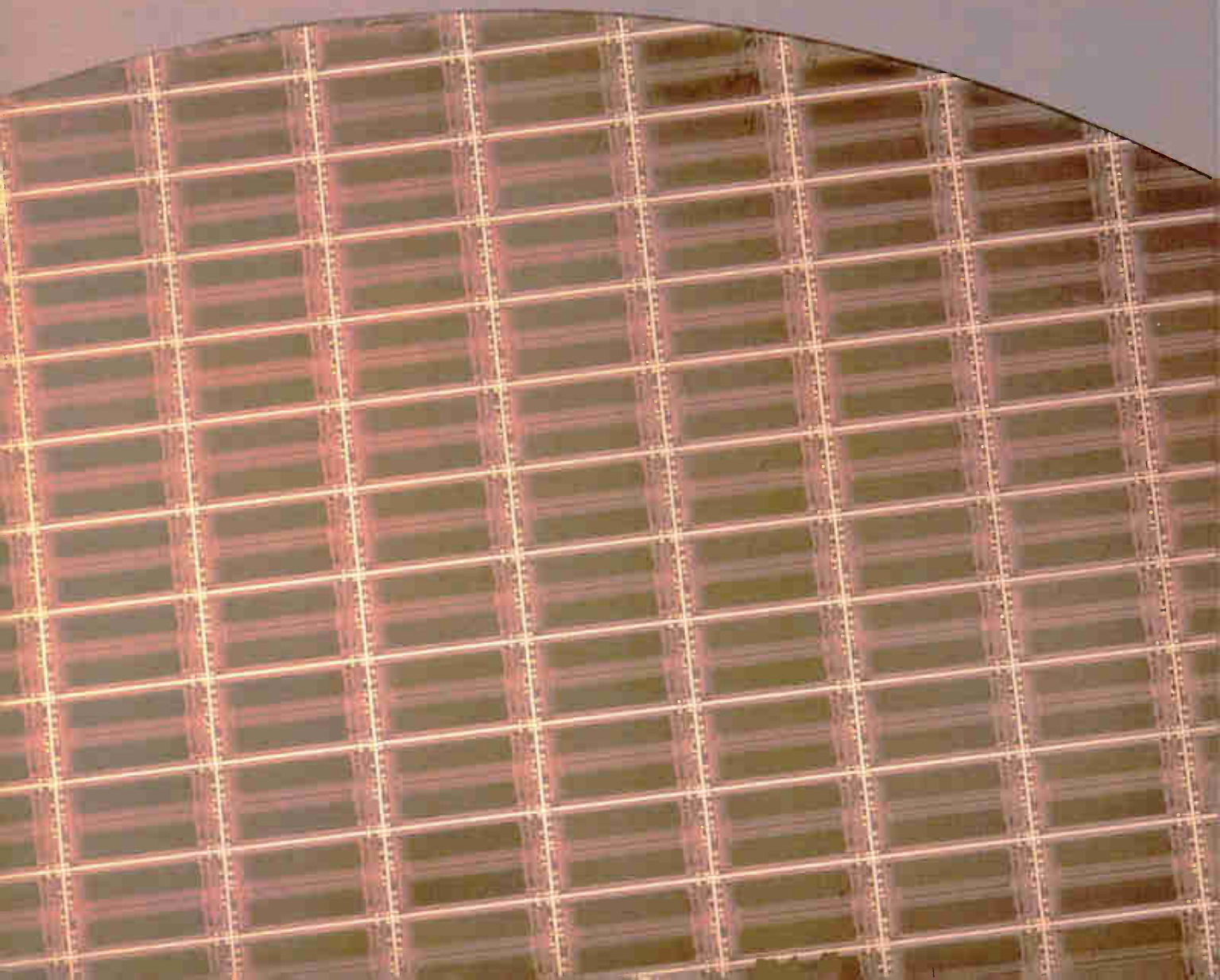

Production volumes are proving the learning curve again. Mostek has been manufacturing the MK 4116 16K RAM longer than any other supplier. During the first quarter of 1978 we delivered more 16K RAMs than we shipped in all of 1977. Our goal for 1978 is to deliver more than 5 million. With this increasing production momentum, Mostek is quickly solving the industry shortage of 16K RAMs.

2. Performance

Mostek's 4116 has always been the industry standard 16K RAM. Eleven companies have announced intentions to second-source our design, but no one has yet matched Mostek's performance or features.

Mostek 16K RAM	Access Time	Cycle Time	Active Power (MAX)	Standby Power (MAX)
MK4116-2	150ns	320ns		
MK4116-3	200ns	375ns	462mW	20mW
MK4116-4	250ns	410ns		

There are several new features in Mostek 16K RAMs. For flexibility in system design, V_{BB} power supply now operates over the range of -4.5 volts to -5.7 volts allowing -5V operation with TTL or -5.2V operation with ECL systems. In addition, cycle time has been reduced to 320ns for the 4116-2, improving system operating performance.

3. Reliability

Both the learning curve and our Poly-II™ process are key factors in Mostek's 16K RAM reliability record. Over 12 million circuits have been built using the Poly-I™ and Poly-II processes. During this time, quality and reliability standards have continued to lead the industry.

Comprehensive performance and environmental testing further ensure reliability in your system. Every 16K RAM we ship is

thoroughly tested to rigorous screens and stresses.

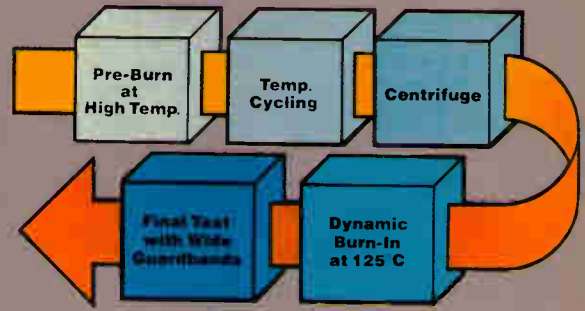

Take advantage of Mostek's industry standard performance and reliability now. Call or write: Mostek, 1215 West Crosby Road, Carrollton, Texas 75006; Telephone 214/242-0444. In Europe, contact Mostek GmbH, West Germany; Telephone (49) (0711) 701045.

MOSTEK®

Circle 23 on reader service card

Industry's smallest die, 22,000 square mils, now processed exclusively on 4-inch wafers.

Sound and fury of a new product

They're getting excited again. The people who brought us the portable radio and stereophonic sound and those who gave the world the computer on a board are about to combine for another one of those electronic marvels that periodically have market research people dancing with optimism.

What's got them going this time is a-m stereo broadcasting (see p. 88). The Federal Communications Commission is inching toward a decision on which of five proposed transmission systems will be selected as the official standard, a fiat that could come as early as January of next year. Meanwhile, the makers of radios and of the integrated circuits that will go into them are beating their drums for the new medium.

A-m stereo should turn up first on the highway, with auto makers including sets in their cars and ads, probably by the 1980s. No doubt Detroit is drooling at the prospect of being able to dangle such jewels as lower price and longer range than fm stereo before car buyers' eyes. After all, in a time of smaller, lighter, less powerful cars, accessories are the green in the bottom line.

After automobiles, the market target will be the American home. In short, what we have here is a can't-miss product. . . .

But maybe not. A lot of money and effort will go into building and promoting a-m stereo; the technology is sound; and the results should be good. Still, it would be well for the makers of ICs and sets and speakers to consider the software.

Has anyone out there tuned in to the average am radio station lately? The overlooked factor in the demand-supply equation might just turn out to be the low intensity of the average consumer's desire to listen to the Top 40 songs coming from twice as many speakers, and to the roaring machine-gun

delivery of the deejays.

The equipment makers ought to think hard about faddism and quick but short-term growth—most recently, the citizens' band radio boom and bust—before they commit too much time and money to this latest technological marvel.

The right number

Another convenience product spawned by electronic technology, helped along by the Supreme Court, is the feature-laden electronic telephone (see p. 81). Now that the high court has ruled that privately owned instruments may indeed be connected to Ma Bell's network, a host of companies is busily adding features like memory, calculator capability, and digital timepieces to another endangered species: the plain black telephone.

The new phones make available to the consumer market some of the data-based capabilities of the business phone. Moreover, the price is relatively reasonable and undoubtedly will come down as sales and manufacturing expertise grow.

This new consumer item does make sense. Although it's hard to tell if anyone really wants to look at the phone to see what time it is or use it to do algebra homework, some of the instrument's other newfound intelligence might be put to good work. Having a phone at home that remembers the numbers one dials most often is a swell idea. So is having the phone remember the last number dialed, so that the caller may just punch a button to try again after getting a busy signal.

Such phones should find a receptive market. Doubt that? Well, consider the fact that Bell will probably be out with its own version next year. This just could be an idea whose time has come.

Suppose someone with no axe to grind designed practical one-card microprocessor systems.

Pro-Log sifts through manufacturer's claims, selects the best parts, and designs them into simple, reliable systems...

... systems flexible enough to use in a wide variety of applications. Systems easy to build, easy to service. Systems in which every part—the microprocessor, every semiconductor, every connector, every miscellaneous component—is or soon will be a second-sourced industry standard.

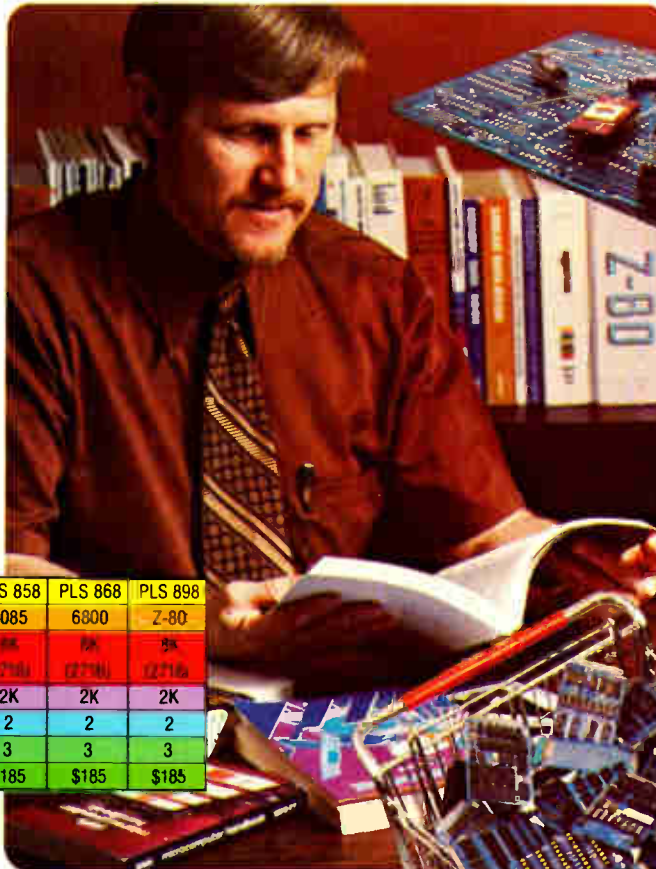

Card	PLS 881	PLS 888	PLS 858	PLS 868	PLS 898
Processor	8080A	8080A	8085	6800	Z-80
PROM* Capacity	8K (2708)	8K (TMS2710)	8K (2708)	8K (2708)	8K (2716)
RAM** Capacity	1K	2K	2K	2K	2K
Input Ports (8 lines)	2	2	2	2	2
Output Ports (8 lines)	3	3	3	3	3
100 Piece Price	\$165	\$185	\$185	\$185	\$185

*PROM not included. **1K of RAM included.

Pro-Log builds 8080A, 8085, Z-80, and 6800 microprocessors into one-card systems.

We use standard 4½-inch by 6½-inch 56-pin edge-connected cards. We've refined each system to fewer than 100 parts. To make sure our systems work when you get them, we test each system before and after power-on burn-in. We supply

complete documentation with every card. Buy 250 of any one card and we give you free the plans for that card and non-exclusive manufacturing rights. You can build cards yourself and use us as a second-source. Need more capability later? Upgrade to one of our equally well-designed multiple card systems.

Our comparison guide helps you avoid the pitfalls of microprocessor design.

Send for your copy today. Pro-Log Corporation, 2411 Garden Road, Monterey, CA 93940. Phone (408) 372-4593.

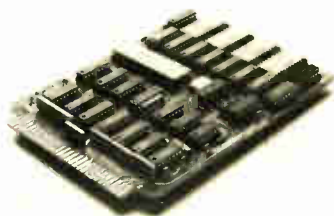

PRO-LOG
CORPORATION

Microprocessors at your fingertips.

Another breakthrough in cooling extrusion size and cost.

Here is the latest of the "High Fin Density" extrusions from EG&G Wakefield Engineering. Extrusion 5206 is the smallest and most economical of these remarkable cooling devices to be announced thus far. With a price of only \$1.00 per inch, this unit is less than half the price of competitive types with the same cooling capacity.

The skyrocketing cost of aluminum is creating a real need for a more efficient extrusion design. That's why Wakefield developed "High Fin Density" extrusions. By reducing the space between fins to as little as 1/10 their height, these revolutionary units have double the cooling efficiency of competitive types using substantially more aluminum.

And for the very ultimate in cooling efficiency, try the Series FCA-880. Combining two 5206 Extrusions in a package, it gives even more cooling performance for the amount of space required.

So if you want to cut your cooling costs, or the space required, write or call Wakefield. It pays to do business with the leader.

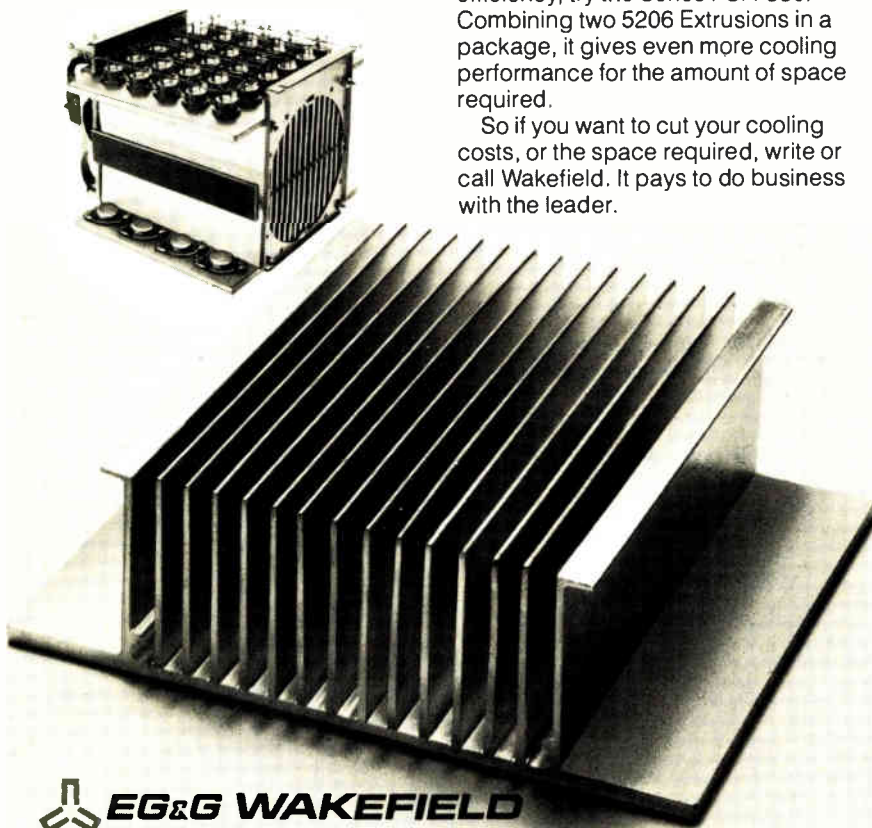

EG&G WAKEFIELD
Components Division
77 AUDUBON ROAD, WAKEFIELD, MA 01880 (617) 245-5900

Circle 26 on reader service card

From Electronics Magazine Book Series. Zero-risk trial offer.



New Product Trends in Electronics, Number One
From "New Products," state-of-the-art materials and equipment, arranged according to function. \$14.95

Name _____ Title _____

Company _____

Street _____

City _____ State _____ Zip _____

Signature _____

Electronics Book Series
P.O. Box 669, Hightstown, N.J. 08520

Send me _____ copies of "New Product Trends in Electronics, Number One" at \$14.95 per copy

Discounts of 40% on orders of 10 or more copies. I must be fully satisfied or you will refund full payment if the book is returned after ten-day trial examination.

Payment enclosed Bill firm Bill me

Charge to my credit card:

American Express Diners Club
 Visa Master Charge

Acc't No. _____ Date exp. _____

On Master Charge only, first numbers above name _____

Meetings

Fiber Optic Con West, Fiber Optic Communication and Information Society (Boston), San Jose Convention Center, San Jose, Calif., July 19-20.

Intersociety Energy Conversion Engineering Conference, IEEE, Town and Country Hotel, San Diego, Calif., Aug. 20-25.

Time and Frequency: Standards, Measurements, Usage, NBS, Boulder, Colo., Aug. 22-26.

Sixth Colloquium on Microwave Communications, International Union of Radio Science, Budapest, Aug. 29-Sept. 1.

International Optical Computing Conference, IEEE, Imperial College, London, Sept. 5-7.

CompCon 78—17th IEEE Computer Society International Conference, Capital Hilton Hotel, Washington, D. C., Sept. 5-8.

International Machine Tool Show 1978, National Machine Tool Builders' Association (McLean, Va.), McCormick Place, Chicago, Sept. 6-15.

Wescon/78 Show and Convention, Electronic Conventions Inc. (El Segundo, Calif.), Los Angeles Convention Center, Sept. 12-14.

Sixth Computer-Aided Design and Computer-Aided Manufacturing Conference and Exhibition (CAD/CAM VI), Society of Manufacturing Engineers (Detroit), Hyatt House, Los Angeles, Calif., Sept. 19-21.

Eascon—Electronic and Aerospace Systems Convention, IEEE, Sheraton International Hotel, Arlington, Va., Sept. 24-27.

Convergence 78—International Conference on Automotive Electronics, Society of Automotive Engineers (Warrendale, Pa.), Hyatt Regency Hotel, Dearborn, Mich., Sept. 25-27.

A dramatic sunset scene with a bright yellow sun partially obscured by a dark horizon line. The sky is a deep red, and the foreground is in shadow.

**The Age of the 8086
has arrived.**

**Intel introduces
the 16-bit evolution of our
8080 and 8085.**

From CPU to software, It's the beginning of a new

Intel's new 16-bit microcomputer is here. It's the 8086, designed to deliver ten times the processing power of our 8080.

More important, right now you can get CPU, memory, peripherals, software, development tools and design assistance. We've made MCS-86™ the most comprehensive microcomputer system ever introduced.

Our challenge was to build the most advanced 16-bit microcomputer. And to give 8080 and 8085 users a direct upgrade path. We accomplished it. The 8086 is the world's most advanced microprocessor. Yet it's a direct evolution of our 8-bit 8080 and 8085. It's software-compatible with both, supporting all their instructions in addition to its own advanced instructions. And the 8086 utilizes readily available Intel microcomputer peripheral chips and low cost, standard MOS memory.

8086 is an architectural triumph, etched in HMOS. The standard 8086 delivers 5 MHz speed. And it delivers direct addressability to a full megabyte of memory, with both 8-bit and 16-bit signed or unsigned multiply and divide in hardware. It gives you efficient byte-string operations and improved bit manipulation. Plus it provides capabilities never before supported by a microprocessor, such as dynamic relocation, reentrant code, position-independent programs and instruction look-ahead.

All in all, 8086 sets a new standard for microcomputer processing capabilities.

We designed MCS-86 for design flexibility. It can operate on a full set of 16-bit registers, or on an 8-bit subset which corresponds to the 8080 register set. That makes MCS-86 adaptable to traditional 8-bit applications as well as larger, more complex applications.

A minimum MCS-86 configuration includes only the CPU, the 8284 Clock Generator, two 8282 Octal Latches, 2K bytes of 2142 RAM and 4K bytes of 2716 EPROM.

MCS-86™ is here today. era in microcomputers.

For easy expansion, add our 8288 Bus Controller, which generates Multibus™ timing signals. And, using our 8286/8287 Octal Transceivers, MCS-86 interfaces with larger, buffered systems.

Get started with software now using our Intellec® development system and PL/M 86, an expanded version of our popular PL/M high level language. And, with the ASM 86 assembler, you can write assembly language programs for your MCS-86 designs and translate your existing 8080 and 8085 software to run on 8086. Both PL/M 86 and ASM 86 operate under ISIS-II, Intellec's advanced operating system.

MCS-86 components are available today. Order your MCS-86 Prototype Kit from your local Intel distributor. The kit includes all the essential components to begin your evaluation of this new era in microcomputers. Or, for more information, contact your local Intel sales office or write:

Intel Corporation,
3065 Bowers Avenue,
Santa Clara, California 95051.



intel delivers.

U.S., Canadian distributors: Almac/Stroom, Component Specialties, Cramer, Hamilton/Avnet, Harvey, Industrial Components, Pioneer, Sheridan, Wyle/Elmar, Wyle/Liberty, L.A. Varah, Zentronics. Europe: Intel International, Rue du Moulin a Pápler, 51-Bolte 1, B-1160, Brussels, Belgium. Telex 24814.
Japan: Intel Japan, K.K., Flower Hill-Shinmachi East Bldg. 1-23-9, Shinmachi, Setagaya-ku, Tokyo 154. Telex 781-28426.



“I hold that man closely in

“Today, the future is data acquisition.”

At Intersil, we know that one of the fastest growing segments of the electronics industry is data acquisition. In fact, we've done more than our share to make that future a reality. Not only in data converters themselves, but in peripherals and microprocessors.

AT THE STATE-OF-THE-ART TODAY.

Today, Intersil offers exceptional strength in the technologies associated with data acquisition devices: CMOS, BIFET, Standard Linear, Dielectric Isolation, Thin Film and Laser Trimming. This broad technological base allows us to take the lead in products such as the industry standard ICL7106 & 7107 A/D converters for $\pm 3\frac{1}{2}$ digit Data Display applications, the ICH8530 Power Op-Amp for motor drivers, and, the AD 7520 Series of 10 & 12 bit binary and 3 digit BCD D/A's. Plus, multiplexers up to 16-channel, sample and holds, IC voltage references better than 10 ppm/

°C...and...the only 12 bit CMOS microprocessor, the IM6100. All ideal for data acquisition applications.

BEYOND THE STATE- OF-THE-ART TOMORROW.

We're producing the building blocks of tomorrow's data acquisition systems today. And tomorrow, you'll find that our broad technological base will offer such products as 12 & 16 Bit A/D's, 12 & 16 Bit integrating D/A's and a broad spectrum of support products. Products designed to offer higher utility, greater accuracy, higher speed and lower costs. We'll be announcing them as they come into production. And, they'll be produced with full handshaking capabilities to the leading microprocessors.

is in the right who is most league with the future."

Henrik Ibsen,
1848-1906

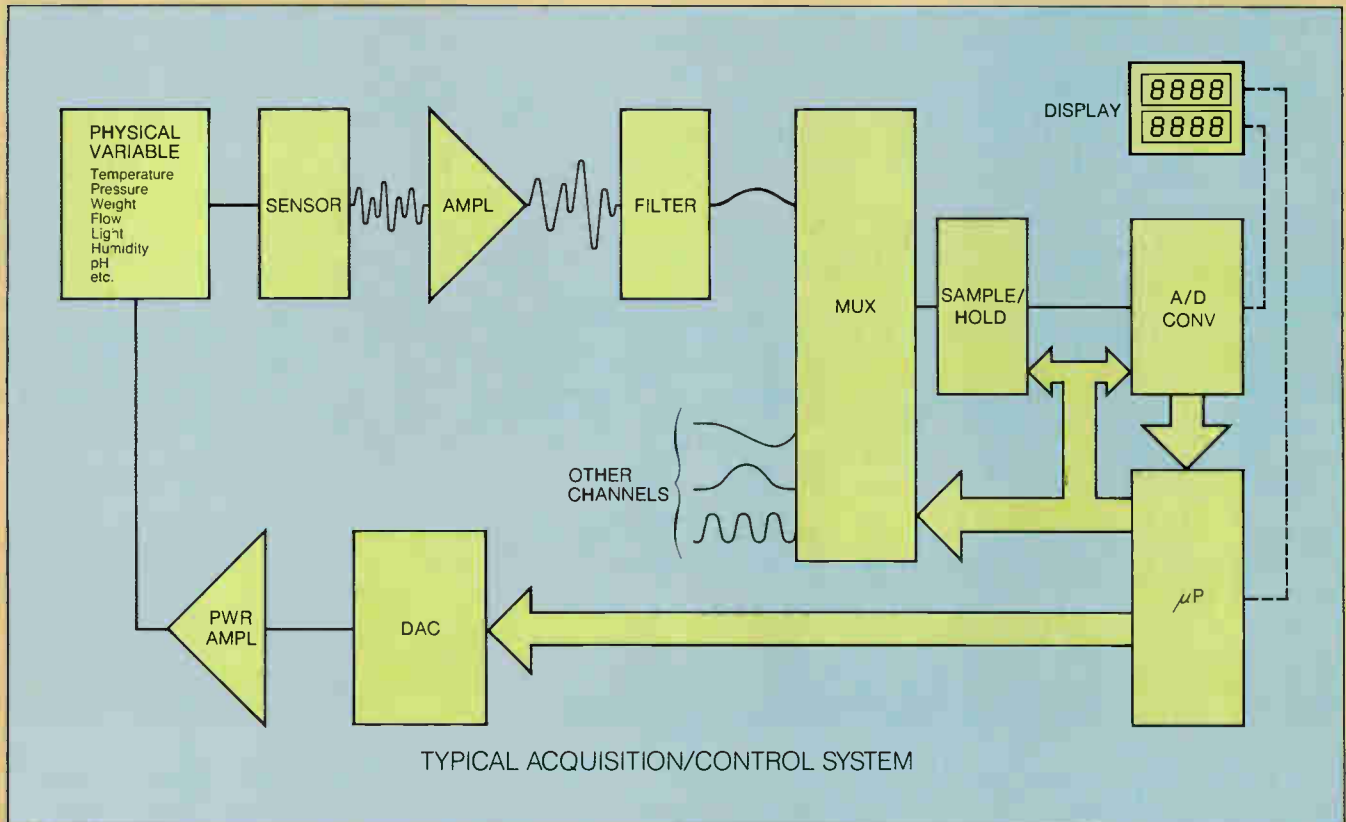

THE FUTURE? THE FUTURE IS NOW.

Data acquisition systems are here. Now. If you'd like to know more about the Intersil family of A/D's, D/A's, peripheral devices and their applications, contact your local sales office, or, return the coupon below.

CALIFORNIA: Santa Clara (408) 984-2170, Carson (213) 532-3544 • COLORADO: Denver (303) 750-7004 • FLORIDA: Fort Lauderdale (305) 772-4122 • ILLINOIS: Hinsdale (312) 986-5303 • MASSACHUSETTS: Lexington (617) 861-6220 • MINNESOTA: Minneapolis (612) 925-1844 • NEW JERSEY: Englewood Cliffs (201) 567-5585 • OHIO: Dayton (513) 866-7328 • TEXAS: Dallas (214) 387-0539 • CANADA: Brampton, Ontario (416) 457-1014

INTERSIL

E070678

Analog Products — Data Acquisition
Intersil, Inc.
10710 North Tantau Ave., Cupertino, CA 95014
Tel: (408) 996-5000 TWX: 910-338-0171
(800) 538-7930 (outside California)

Gentlemen,

___ Please send me product literature on Data Acquisition devices.

___ Please send me your new Henrik Ibsen poster.

Name _____

Company _____

Address _____

City _____ State _____ Zip _____

Country _____

Spread the word. Siliconix announces CODEC.



Siliconix introduces the ultimate man/machine interface: CODEC. Our DF331 coder is a high-speed serial output A/D converter — a complete subsystem-on-a-chip. Its counterpart, the DF332 decoder, converts high-speed digital bit streams into analog signals. Both devices operate logarithmically, giving our CODEC a wide dynamic range: 12-bit resolution (± 1 bit) for low-level signals, and 8-bit accuracy for high-level signals.

Designing with Siliconix' CODEC is a cost-effective solution to the problem of vocal interface with computers. Siliconix CODEC

minimizes external component requirements and system costs: serial output and sample-and-hold circuitry are all on-board. And CODECs will have many applications in telecommunications

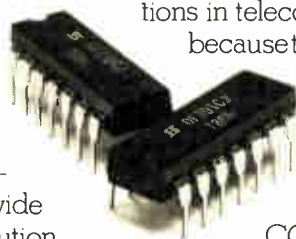

because they meet all D3 specifications and are compatible with the $\mu 255$ law for companding.

A key CODEC specification: signal to distortion is 28dB (Pin = -45dBmO) max.

Our CODEC set continues the Siliconix tradition of providing products that link the analog world to digital systems. We've been manufacturing monolithic analog-

to-digital converters for five years. And we're currently supplying the instrumentation industry with the latest in technological advances, such as our LD120/LD121 series $4\frac{1}{2}$ digit A/D converters, high-speed analog switches, and logic compatible VMOS transistors. Experience and expertise make Siliconix the logical source for CODECs. Spread the word. For details, call or write Siliconix, 2201 Laurelwood Road, Santa Clara, CA 95054; (408) 988-8000.

 **Siliconix**

**The Siliconix connection:
Innovative products linking the analog world to digital systems.**

HP adds systems to both ends of computer line

A high-end minicomputer, the model HP 3000 series III, and a low-end, floppy-disk—based computer for small businesses, the HP-250, promise to broaden the customer base and performance range of Hewlett-Packard Co.'s flourishing computer family. The new 3000 ranges in price from \$115,000 to \$175,000 and has quadruple the memory capacity, twice the throughput, and improved on-line business-transaction processing power compared with the HP 3000 Series II. **Moreover, the cost of memory has dropped, allowing HP to supply a megabyte of error-correcting memory for \$32,000, or 3.1 cents per byte,** according to William Krause, marketing manager at the Santa Clara, Calif., General Systems division. The Fort Collins, Colo., division is the source for the under-\$25,000 HP-250. Hardware includes keyboard, cathode-ray-tube display, 128 kilobytes of system memory, 32 kilobytes of user memory, two 1.2-megabyte floppy drives, and a 180-character-per-second impact printer.

IBM scientists report observation of 'light bubbles'

Mobile "light bubbles," which appear to be electrical analogs to magnetic bubbles, have been generated in magnesium-doped zinc-sulfide thin films, IBM scientists reported at the Electronic Materials Conference in Santa Barbara, Calif. The 1- μm bubbles appear when 10-kHz, 190-v ac current is applied to the film via sets of parallel 1-mm-wide metallic lines orthogonally placed on each side of the film. When voltage is applied to a pair of intersected electrodes, **the intersected area will emit light bubbles that appear to move in discrete steps**—and move faster when the frequency rises to 50 kHz. The alternating-current thin-film electroluminescence, or actel, lasts as long as an hour and can be used to form images on the film by stimulating different areas with light or an electron beam or by applying voltages across the film. However, before the technique becomes practical, much work needs to be done to direct the bubbles.

TI comes up with fully static 16-K memory

Texas Instruments Inc. says it has developed the random-access memory that microprocessor-system designers dream of—a fully static 2,048-by-8-bit RAM **that is pin-compatible with 16-k erasable programmable read-only memories** like TI's 2516 or single-supply 2716. The 150-ns RAM, which the firm's Houston operation will have available in sample numbers in September, allows designers to partition storage in microprocessor systems any way they would like between fixed and read/write memory. The package has the same Jedec-proposed standard 24-pin configuration as the single-supply 16-k electrically programmable ROMs. What's more, the die is super-small: 1.6 mil² per cell.

4-bit processors still doing job for TI, Rockwell

All the talk these days may be in 16-bit words, but the truly pervasive microprocessor uses a 4-bit length. Business has never been better for Texas Instruments Inc.'s TMS1000 and Rockwell International Corp.'s PPS-4 lines, the manufacturers report, and each is continuing to expand. Dallas-based TI **has begun building the parts with complementary-MOS logic**, which gets the power consumption down to 10 mw. Rockwell is sticking with p-channel MOS and is now using a design scheme that powers down most of the chip so that average dissipation is less than 20 mw. The Anaheim, Calif., company's edge for low-power use, it says, is its processor's wide supply-voltage range, specified at 6.5 to 11 v (versus 3 to 6 v for TI's part) that lets the PPS-4 work with standard 9-v batteries.

Electronics newsletter

Rf circuit on one chip due from TRW

A single chip that replaces discrete and hybrid components in radio-frequency circuits and equipment is now in sight, according to officials at TRW Inc.'s Microelectronics center, Redondo Beach, Calif. **The technology for integrating these analog and rf functions into monolithic form is an Isoplanar variation of high-density bipolar**, and the resulting device is called an oxide-aligned transistor. Scheduled for completion late this year, the preliminary demonstration chip uses silicon and operates in the 0.1-to-2 GHz range. Primary target for the circuit is the low-cost receiver required by users of the global positioning satellite. The TRW unit hopes to have one working in two years.

Help-wanted Index hits all-time high

Demand for technical personnel, as reflected in the Engineer/Scientist Demand Index compiled by consulting firm Deutsch, Shea and Evans Inc. of New York, hit an all-time high of 222.6 in April, surpassing the previous one-month high of 219.0 reached in May 1966. What's more, the average index through the first four months of this year stands at 186.5 and **the firm expects the index for all of 1978 to approach, if not surpass, the all-time high annual average of 190.3 achieved in 1966.** Although the index covers engineers and scientists in all disciplines, company officials note that it "is very heavily oriented toward the electronics industries, with particular emphasis on microprocessor applications."

Demise of 400 opens door to other vendors

The recent decision by Xerox Corp.'s subsidiary, Diablo Systems Inc., to cancel its Series 400 disk drive opens the door to other disk-drive makers that have combination fixed and removable media drives **aimed at the capacity gap between the traditional cartridge drives and the larger mainframe units.** Introduced in December 1975, the Diablo 400 promised capacities ranging from 13 to 52 megabytes and used a unique inertial actuator mechanism. But Xerox claims the actuator's technical design "proved unfeasible for manufacturing in high volumes."

New satellites seen triggering change in data distribution

Though they are years away, there will be changes in the way communications common carriers distribute data-processing power. That is the view of Cambridge, Mass., consultant Arthur D. Little Co., which says the high-frequency satellites proposed by Satellite Business Systems Inc. will have that big an impact. The broad-bandwidth, simultaneous reception provided by the new birds will cause changes in message routing and data-base distribution procedures **so that regional centers will be able to serve many local data bases.**

Addenda

David L. Britton has resigned as president of International Memories Inc. of Santa Clara, Calif., **in what is believed to be an internal dispute** rather than pressure from 3M Corp., which recently purchased a minority interest in the disk-drive company. . . . Loral Electronic Systems in Yonkers, N. Y., has beaten out Cutler-Hammer Inc.'s AIL division in Deer Park, N. Y., **for a \$2 million contract in the Navy's Compass Sail Clockwise program** to provide advanced radar warning receivers for A-7E, A-4, F-4, and F-14 aircraft. . . . The American Electronics Association, which has 975 active members and 200 associates, **sees a trend toward more mergers as it counts 40 involving member companies,** almost all this year.

The 2114. It's old hat to us



Most 2114s are new products with new product problems. Not ours. The SEMI 2114 is a member of the Royal Family of Static RAMs. It is, in fact, a new pin-out of an 18-pin, 5V, 1Kx4 static RAM that we've been delivering in production quantities for a year and a half.

The SEMI 2114 features low power (only 300 mw), TTL compatible I/O,

and all the speed you need for microprocessor applications.

If you'd like complete information on the SEMI 2114, or any other members of the Royal Family of static RAMS, see your local EMM/SEMI distributor, or contact us directly.

Memory at Work

EMM SEMI, INC.

A subsidiary of Electronic Memories & Magnetics Corp., 3883 N. 28th Ave., Phoenix, Arizona 85107 (602) 263-0202

ALABAMA: Gentry Associates, Huntsville 205/534-9771 • **ARIZONA:** EMM, Phoenix 602/263-0202 • **CALIFORNIA:** EMM, Hawthorne 213/644-9881; EMM, Los Alamitos 213/598-8705; EMM, Burlingame 415/692-4251; Varigon, El Segundo 213/322-1120 • **FLORIDA:** Gentry Assoc., Orlando 305/894-4401 • **GEORGIA:** Gentry Assoc., Atlanta 404/455-1206 • **ILLINOIS:** EMM, Des Plaines 312/297-7090 • **MASSACHUSETTS:** EMM, Lexington 617/861-9650 • **MINNESOTA:** EMM, Hopkins 612/933-7115 • **NEW JERSEY:** EMM, Cherry Hill 609/779-7911 • **NEW YORK:** EMM, Melville 516/423-5800 • **TEXAS:** EMM, Dallas 214/231-2539; Young Sales, Dallas 214/341-2900 • **WASHINGTON:** The Thorson Co., Bellevue 206/455-9180 • **CANADA:** Cantec, Ottawa 613/255-0363

Support, theirs.



Most CRT controllers require a great many support devices.

We've just introduced the least supported CRT controller ever—the National DP8350. Instead of the bagfull of support devices necessary with current MOS controllers, ours lets you off the hook with just one.

The reason is bipolar technology. It allows high frequency performance with high drive current outputs. So we can shift the

functions of extraneous support chips onto the controller chip itself. Functions like dot counter/decode logic, crystal oscillator and high current Tri-State™ memory address bus drivers. The only support required is one crystal.

Since there are fewer components, you get benefits like lower systems cost. Less complexity. Greater reliability. And we made

Support, ours.

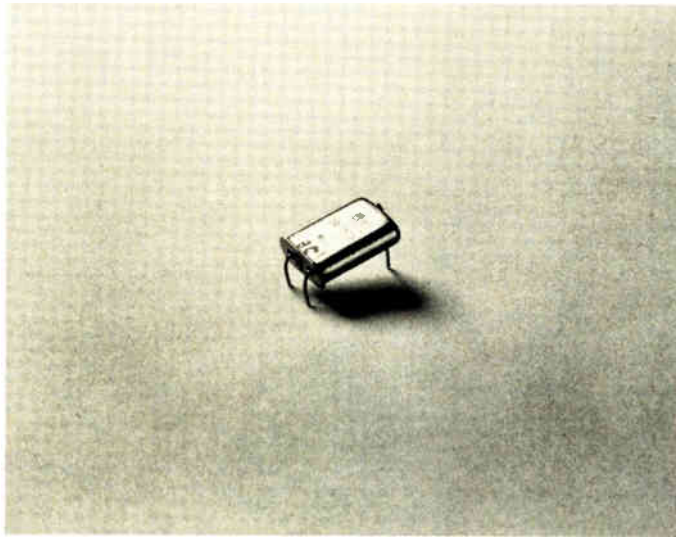

National's new DP 8350 CRT controller needs only one.

the DP 8350 mask programmable.

If you'd like to know more about the DP 8350, you're not alone. So we suggest you fill out the coupon today.

National's new DP 8350 CRT controller.

More complete.

Lower systems cost.

Only one support device.

And let the outmoded chips fall where they may.

National Semiconductor Corporation
2900 Semiconductor Drive
Santa Clara, CA 95051

E7/6

Gentlemen: I'd like to know more about non-support. Please rush me technical literature on your new DP 8350 CRT controller.

Name _____ Title _____

Company _____

Address _____

City _____ State _____ Zip _____

Telephone _____

 **National Semiconductor**



Others talk. We deliver.

While others talk about Telephone Subscriber Line Interface Circuits, we're delivering them in production quantities.

Our 3081 and 3082 circuits offer:

- flat frequency response, trans-hybrid loss ≥ 46 db
- battery feed
- power down feature
- switch hook detection
- ≥ 55 db CMR (longitudinal balance)
- central office and PABX versions
- excellent packaging density

You get constant resistive impedance at all four ports. There is high gain/loss stability over temperature. And there is no inductive crosstalk.

Closer board spacing, no magnetic shielding.

You will find these products have excellent cost effectiveness, reduced logistics problems, simplified system maintenance and reduced interconnect complexity.

Next time, specify ITT North.

We deliver.

More information? Write

Microsystems Division, ITT North Electric Co., 700 Hillsboro Plaza, Deerfield Beach, Florida 33441. Phone: (305) 421-8450. TELEX & TWX 510-953-7523.

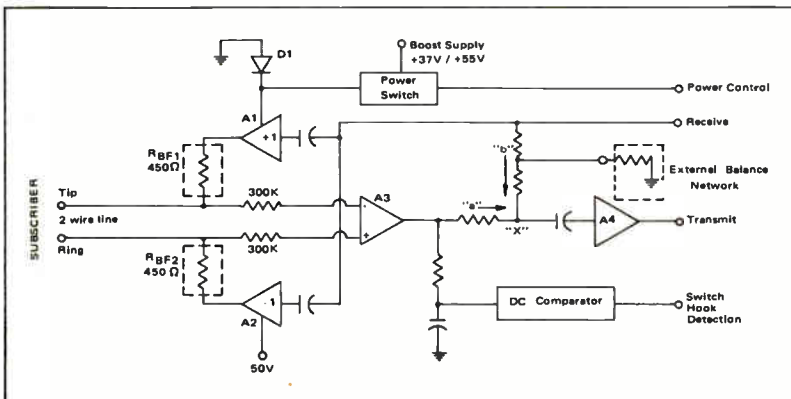

Laser diode operating in single mode yields broad linear output

Mitsubishi produces linear characteristic by holding active region to tiny area in double heterojunction unit

The Japanese have developed the first laser diode to operate with a single-mode output. This permits modulation over a wide signal-amplitude range.

Also, the small size of the light source produces a narrow spectrum that allows data-transfer rates on the order of gigabits, potentially boosting the efficiency of fiber-optic communications systems. Any non-linearity at the output is due only to the laser driving circuitry and is independent of diode characteristics.

The semiconductor laboratory of Mitsubishi Electric Corp. developed

the diode, which its semiconductor manufacturing department in Itami is making available this month in sample quantities. Price is high—between \$976 and \$1,463, depending on the package. But once it is in mass production, the company says the price could drop to the point where the diode is feasible for fiber-optic communications systems and for video and audio disk players selling for about \$500.

Conventional laser diodes now on the market produce an output that is linear with input forward current. But this linear range is much smaller than that of Mitsubishi's device because the output light switches between different types of transverse operating modes. This produces "kinks" in the output radiation characteristic, as shown in the figure.

Mitsubishi eliminates the kinks by constraining the area in which the

diode lases. Instead of lasing along the entire gallium-arsenide "sandwich filling," the diode is active in a much smaller region—the area of a p-type stripe that is only 2 micrometers wide and 0.3 μm high. The electromagnetic field here is such that the laser operates in only a single transverse mode.

Sandwich. The Japanese build their device around a double heterojunction sandwich, with all n-type doping consisting of gallium aluminum arsenide, gallium arsenide, and gallium aluminum arsenide again. The sandwich is implanted in a semi-insulating GaAs substrate that prevents current flowing vertically. A self-aligned diffusion process produces a narrow stripe with a lasing p region whose width is equal to the diffusion length of minority carriers from the n region. Recombination of carriers in the p region causes it to

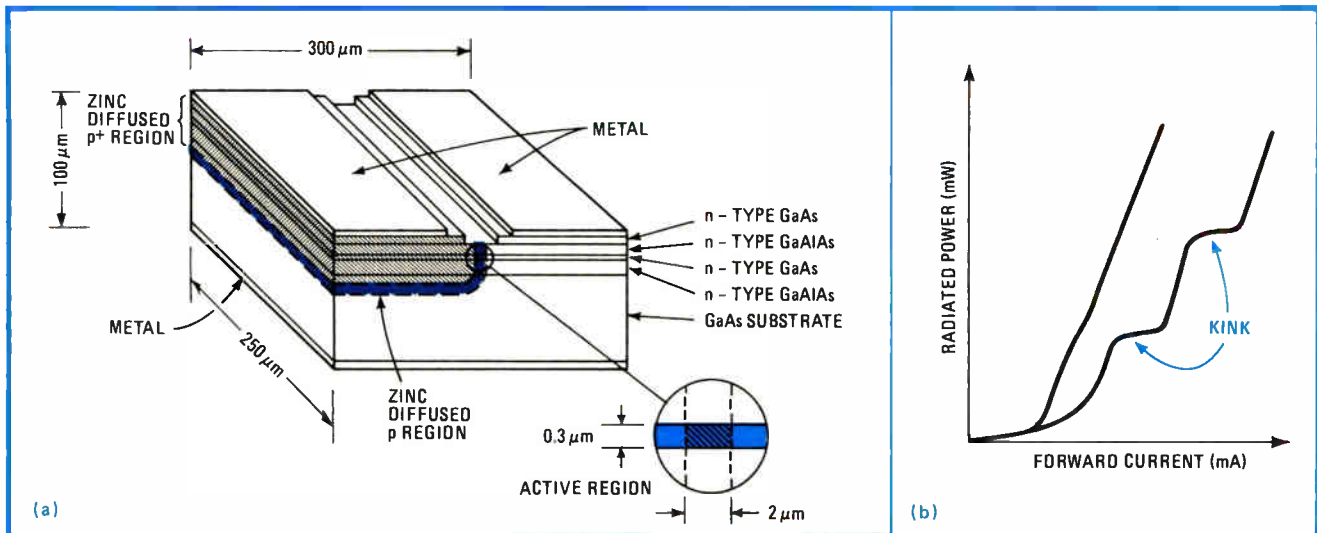

Diode. Active region in the laser diode from Mitsubishi (a) lies in the GaAs "filling" of the sandwich formed by the two GaAlAs "bread" layers. Lasing occurs in the striped p region lying between p₊ material to its left and n material to its right. Radiated power is linear with the input forward current (b) over a much greater range than in a conventional diode, which has kinks in its output.

lase, according to the company.

The laser region is delineated by a masked p⁺ zinc diffusion downward from the upper surface and extending from one edge of the chip to the center. The boundary of the diffusion runs vertically through the double heterojunction structure and into the semi-insulating layer.

The next diffusion drive-in produces a p region 2 μ m ahead of the p⁺ region. Thus, the 0.3- μ m-thick GaAs layer consists of p⁺ material followed by the 2- μ m stripe of p material, followed by n material.

P-type gallium arsenide has a higher index of refraction than either the adjacent n or p⁺ types, as well as a higher index of refraction than the top and bottom layers. Therefore, the lasing is restricted by this optical waveguide effect to the 2-by-0.3 μ m p-type gallium-arsenide stripe. The optical waveguide is essentially cut off for higher-order transverse modes, effectively suppressing mode changes. Second- and third-order harmonics are 40 and 60 decibels down, respectively.

The beam emerging from this active area spreads about 12° in the direction along the wide part of the stripe. Spreading by diffraction in the perpendicular direction is 50°.

Contacts. The construction of the laser diode is completed with ohmic contacts between the upper GaAs and metal layers on the p⁺ and n sides. Current flows transversely, concentrating in the GaAs layer, because its forward junction voltage drop is about 1.4 volts, compared with about 1.8 v for GaAlAs layers.

Typical output is 3 milliwatts at 40 milliamperes operating current. The cutoff frequency is in excess of 2 gigahertz, permitting modulation at rates above 1 gigabit per second.

Mitsubishi engineers predict a lifetime for the device in excess of 100,000 hours, based on an initial 10,000 operating hours with negligible degradation. They point to the low zinc concentration in the critical optical waveguide region. This allows the zinc atoms to substitute fully for atoms in the gallium-arsenide lattice so that they do not migrate and cause problems. □

Solid state

Bidfet is key to new driver chips

Large-screen plasma displays have apparently turned up in a big way in the crystal ball that Texas Instruments Inc. uses for planning its new products. In response, the Dallas giant is developing a pair of driving circuits that breaks new ground in combining more than one logic family on a single chip.

In a few months, the company will begin providing samples of two driver chips—one for columns, the other for rows—that will be the first commercial circuits to sport four kinds of logic. TI adds double-diffused metal-oxide-semiconductor and complementary-MOS technologies to bipolar transistors and junction field-effect transistors (just a few in the drivers) used in bi-FET devices and calls the result Bidfet.

“Like most new processes, Bidfet was born out of necessity,” says Pat Curran, product manager for display circuits. “The combination of high speeds and high voltages used in plasma displays demanded several technologies.”

Makeup. The two drivers are similar in makeup, both with C-MOS-compatible inputs, 100-volt output swings, and low-power (less than 40-milliwatt) quiescent dissipation. But because of the difference in row and column data, the 75500 X-axis (column) driver has a two-to-four-line decoder and an 8-bit shift register on board, whereas the 75501 Y-axis (row) driver has just a 32-bit static shift register. Both parts handle a data rate of 6 megahertz and have fast output transitions on the order of 200 nanoseconds.

Clearly, Bidfet technology offers the best of all worlds. Low-power, high-speed C-MOS is used in the shift registers and combinational logic; D-MOS, with its high breakdown voltage, drives the screen; and bipolar transistors, having high transconductance, are used for level-matching and input-buffer circuits. □

The question is, however, can Bidfet circuits be made economically? TI says yes, even though it acknowledges that the process is a complicated one, with many more steps than any of the constituent processes alone. It is keeping details of the new process under wraps until the patents come through. It says only that the process is not expensive, that it can make fairly large die sizes, and that the devices will be used in many forthcoming products requiring high-voltage interfacing and large-scale integrated logic at low power.

Panels. But where are the panels? According to Ramesh L. Gidwani, linear marketing manager in the firm's Integrated Circuits division, Japan's Fujitsu Ltd. and Nippon Electric Co., and France's Thomson-CSF are the main manufacturers of the displays. U. S. suppliers are nil. Owens-Illinois Inc. developed a display but is no longer in the business. The display's developers have since left Owens-Illinois and are forming a company in the Toledo, Ohio, area called Electro Plasma Inc. to make the displays.

Despite the current lack of a U. S. supplier, TI is apparently anticipating rapid growth in, and eventual takeover of cathode-ray-tube displays by, plasma displays in data terminals. It is bullish on the new displays for obvious reasons. A plasma display, which gets its name from the ionized gas that causes illumination of phosphors on the screen, is flat; it requires no heater and thus draws little power; and it has no flicker, distortion, or fuzziness, since the dots that make up its images are electrically addressed and sharply defined. Adds Curran, “I've seen some gorgeous colors on developmental displays.”

The chips are for use with ac plasma screens, rather than dc types. “Ac types will win out over dc,” Curran says, “for two reasons: much lower power and an inherent memory.” The memory means that only data that is changing need be sent to the screen—the last message on the screen remains there until it must be changed. □

Word processing

Software era opens for office systems

Like manufacturers in the computer industry to which they are related, makers of word-processing equipment are slowing the pace of hardware innovation in favor of adding sophisticated software and communications options and improving the price/performance ratio of their product lines. This was the view at the International Word Processing Association's Syntopian VI conference in Washington, D. C., last month.

The objective is to overcome sales resistance from potential customers who have hesitated to buy systems they perceived as too expensive, too difficult to understand and operate, and too inflexible.

"We're all reaching the critical mass as far as hardware is concerned," says one of the participants, Jack Gilmore, group product line manager for Digital Equipment Corp.'s word-processing computer systems in Merrimack, N. H. "It's becoming a question of features. Almost all those features are implemented in software, and most of us

are hurrying to add new ones."

Many of the new software refinements are aimed at making the manipulation of text easier and doing away with the complex codes that earlier machines used, the vendors agree.

Ned Salisbury, marketing vice president at Chatsworth, Calif.-based Lexitron Corp., says, "Hardware is not the name of the game. It's becoming like computers—dependent on software. With software, you can add features for customers much more inexpensively than you could with new hardware."

Down in price. The System 5 introduced at the conference by Wang Laboratories, Lowell, Mass., typifies the improvements in price/performance ratios. Priced at \$9,900 including cathode-ray-tube terminal, dual diskette drives, and a 40-character-per-second daisy-wheel printer, the System 5 comes in some \$4,000 under the older System 10A, which it replaces.

As for communications hardware, most vendors today offer some type of link between their own systems, and in some cases to mainframe computers. For example, DEC's Gilmore reports, "Of the stand-alone word-processing stations we ship today, 60% have communications options."

These options are pointing toward the linking of word-processor stations to implement electronic mail systems. But the drawback is that few of the existing communications options can operate simultaneously with an operator entering or editing text. However, refined software that will allow concurrent communications is in the works and will be in the next wave of new-product announcements.

International Business Machines Corp., which started the word-processing ball game with its magnetic-card typewriters, agrees that communications is in the spotlight today—although it will not say how many of its systems are equipped with such features. "Communications accelerates and increases the productivity of the decision-making cycle," says Richard L. Bisk, product marketing manager for communications products at IBM's Office Products division, Franklin Lakes, N. J., who was also at the conference. "You don't lose as much time in the document-transfer process." □

Packaging & production

Circuit devilry laid to "hook"

Any circuit designers out there ever bothered by the "hook" effect? You might have been and not even realized it if you have been working at frequencies up to about 10 kilohertz with high-impedance analog circuitry fabricated on epoxy-glass printed-circuit boards. It turns out that the boards may not be as stable as people think they are.

"Hook is the effect on a signal caused by a change in circuit-board capacitance with frequency," says Bill Mark, who is an instrument design specialist at Tektronix Inc., Beaverton, Ore. "It's particularly dangerous in high-impedance attenuators used in scopes and digital multimeters."

Distortion. Board capacitances may vary to the point where an attenuator fails to give an output truly



Cost trend. Part of the move in word processors toward lower-cost systems, Wang's new System 5 stand-alone, CRT-based work station is priced at \$9,900, or \$11,900 with printer.

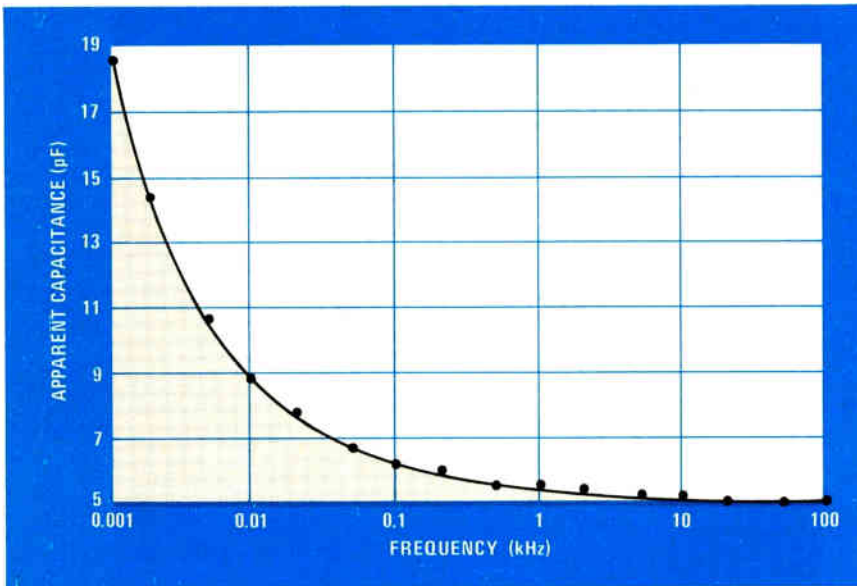

Hooky. Variation of capacitance with frequency of FR-4 glass-epoxy circuit-board laminate shows up in measurements made on a plated test pattern by Tektronix.

proportional to input. In scopes that means, of course, distortion in the waveforms being displayed. Ideally, a square wave would have no undershoot or overshoot. But, as the hook effect increases, the square wave peaks at its leading and trailing edges. In DMMS, accuracy on ac measurements may fall outside of tolerance.

Mark discussed the hook phenomenon last month at the Institute of Printed Circuits' convention in London in a paper he co-authored with his Tektronix colleague, Wallace Doeling, and with Paul Reichenbacher and Thomas Tadewald of the Norplex division of UOP Inc., a leading supplier of pc-board laminates.

Attenuators. The hook effect is most apparent in attenuator circuits with resistors larger than 500 kilohms, when the board's capacitance is an appreciable portion of the total circuit capacitance and the accuracy of the circuit must be better than 2% to 5%, Mark says.

Attenuators are frequency-compensated high-impedance voltage dividers built up out of discrete resistors and capacitors. The pc-board conductors that connect these discrete devices are separated by the dielectric of the laminate. The resulting unwanted capacitance shunts the attenuator, and this

capacitance varies inversely with frequency, as shown in the diagram. Above 100 kHz, the circuit-board capacitance remains constant.

Variation. Unfortunately for pc-board users, hook percentage can vary from batch to batch of laminates. "We still don't know exactly what causes this effect, but we're starting to find out what aggravates it," says Reichenbacher, director of research and development for Norplex in La Crosse, Wis. The percentage of resin and the amount of moisture seem to be factors.

Tektronix has been aware of hook for several years, but only recently have ways to measure it accurately been developed and suppliers like Norplex agreed to supply low-hook materials, Mark says. To overcome it, the company uses special materials and construction methods for its attenuator boards. It also had to develop a simple and accurate method of measuring board capacitance, since conventional capacitance bridges are fixed-frequency devices and therefore unsuitable.

Tektronix now measures hook and circuit-board capacitance on its pc laminates with a charge-amplifier circuit. A charge amplifier is an operational amplifier with a low input-bias current that uses capacitors as feedback elements for setting

amplifier gain. If the board capacitance acts as the input capacitor and the feedback capacitor is a high-quality device, then voltage gain is a function of the ratio of the two passive elements and the board capacitance can be measured over a range of frequencies.

In their paper, the authors offer some advice to circuit designers for minimizing hook. First, design the circuit and its layout to minimize the stray capacitance caused by circuit interconnects. If necessary, mount all critical components on Teflon standoffs. Also bake epoxy-glass material, like FR-4, at 325°F for 5 hours—insufficiently cured laminate can be noticeably hooky. Finally, ask the laminate vendor to agree to a capacitance specification. □

Communications

Audio IC chip drops crosstalk down 83 dB

A mere annoyance in casual telephone conversations, "crosstalk," or audio voltage coupling between communication lines, is a serious matter for military users. Sensitive data discussed over a supposedly secure voice link can be compromised if crosstalk causes it to creep onto adjacent open channels. Especially affected are radiotelephone systems on U. S. Navy ships, which are often shadowed by unfriendly vessels loaded to the gunwales with electronic scanning gear.

This problem worries the Navy planners upgrading to new fleet-level digital communications systems. They want a single radiotelephone network that, for switching efficiency, combines previously separate "red" (classified) calls with "black" (unclassified) voices from shipboard phones onto over-the-air trunk links. So to keep calls totally separate, the planners wrote a new, stringent crosstalk specification of 83-decibel channel-to-channel isolation at 10 kilohertz—a level said to be virtually unattainable with conventional discrete audio components. Making

Tektronix Covers the Frequency Spectrum with Versatile Performers.



20 Hz



TEKTRONIX FREQUENCY SPECTRUM



60 GHz



If you want top performance and versatility in frequency analysis, take a look at the plug-in spectrum analyzers from Tektronix.

They cover the spectrum from 20 Hz audio, through television channels, all the way up to 60 GHz in the microwave band. You'll have a hard time finding that much talent anywhere else.

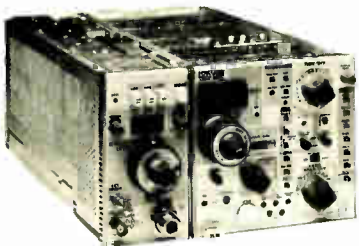

The microprocessor-aided controls of this 7L18 (1.5 GHz-60 GHz) make it easy to operate, plus you get digital storage and signal processing capabilities.

What's more, our high performance family of plug-in spectrum analyzers delivers the command performance you need: exceptional stability, 80 dB dynamic range, and resolution to 10 Hz.

Each plug-in slides in and out of any three or four hole 7000-series oscilloscope mainframe — rackmount, benchtop, or cart mounted

rollaround. Pull out the 1.5-60 GHz 7L18, slip in the 7L13 and tune in 1 kHz to 1.8 GHz with a single knob and full vertical calibration to boot.



Plug-in convenience and flexibility lets you combine a

7L5 (20 Hz to 5 MHz) with a tracking generator, both interfaced through the mainframe.



And there are other advantages . . . such as the ability to make time-domain measurements from the same mainframe, and transportability. So if you want to get your hands on high performance and versatility, give us a call.



When it comes to spectrum analysis, Tektronix has its act together.

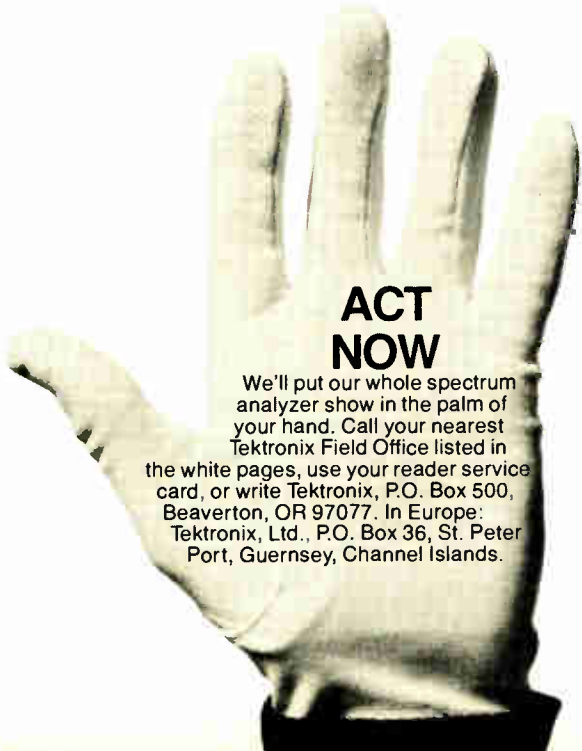

ACT NOW

We'll put our whole spectrum analyzer show in the palm of your hand. Call your nearest Tektronix Field Office listed in the white pages, use your reader service card, or write Tektronix, P.O. Box 500, Beaverton, OR 97077. In Europe: Tektronix, Ltd., P.O. Box 36, St. Peter Port, Guernsey, Channel Islands.

Tektronix
COMMITTED TO EXCELLENCE

For Technical Data circle #42 on Reader Service Card
For Demonstration circle #43 on Reader Service Card

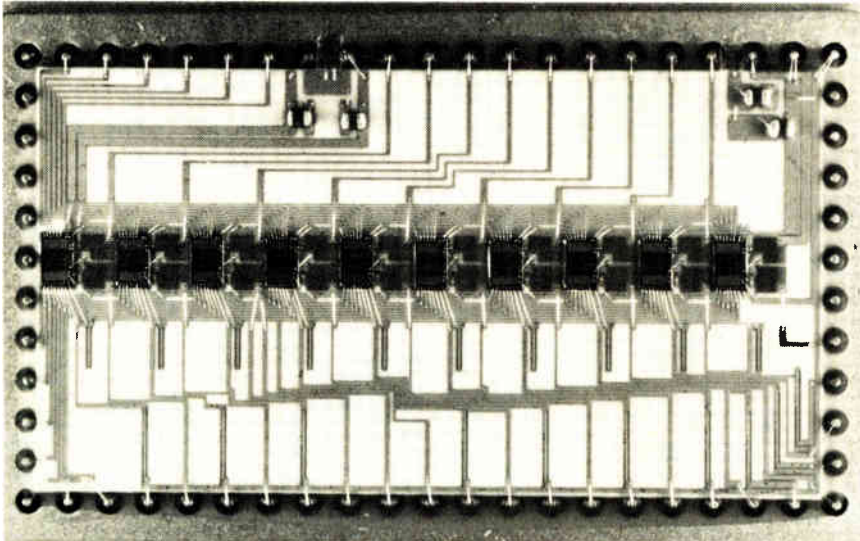

Switch. Hughes mounts 10 of its low-crosstalk chips on a 1.4-by-2.25-in. hybrid package. Six hybrids are placed on each of 24 circuit cards in the Navy's new switch.

matters even tougher is the size and complexity of what the Navy calls its new standard "single audio system," which meshes 108 shipboard phone lines into 66 radio trunk circuits at 7,128 duplex cross points.

Something old. The key to solving this potential crosstalk headache, it turns out, is an audio-multiplexer integrated-circuit chip employed in hybrid devices as a switching matrix. It was initially developed by Hughes Aircraft Co.'s Microelectronic Products division for simple audio switching in DC-10 and B-1 sound systems. But in 1976, Hughes dusted the chip off, improved it, and won the \$1.6 million contract for the Navy's low-crosstalk system.

"The trick of doing a low-crosstalk system obviously is starting out with an intrinsically low-crosstalk audio-switching chip," says James L. Gundersen, senior scientist for microelectronic systems at the Newport Beach, Calif., Hughes division. He directed development of the audio-switching component. Low crosstalk was a secondary consideration in the earlier audio systems, he says, where the main goal was to reduce wiring.

Crosstalk reduction to about 100-dB isolation at 1 kHz in the B-1 was a byproduct. "We knew this could be reduced further by tweaking at the chip, hybrid, and card level."

The layout of functions on the

chip separates high-level from low-level signals, which are susceptible to electrostatic coupling. High-level digital audio signals in the 10-volt range are routed on one side; low-level analog signals, down to 0.1-milliamperes, are on the other. "This virtually eliminates sneak crosstalk paths and noise coupling onto audio which are caused by device-to-substrate capacitance," Gundersen explains. Keeping device capacitances small also cuts audio signals on the substrate itself. Overall, the chip design gives control of coupling as small as about 3×10^{-5} picofarad, he says.

One on one. The p-channel chip, 0.130 by 0.78 inch in size, acts as a six-position, double-throw switch. Each handles one phone line and six trunks in full-duplex mode, requiring about 50 milliwatts of power and dissipating 30 mw. Ten chips go into a 1.4-by-2.25-in. hybrid package, six of which are arrayed on a single circuit card. Overall, the Hughes switch consists of 24 cards mounted in a single cabinet, allowing some redundancy with 72 trunks.

Gundersen puts improvement achieved in crosstalk isolation at about 20 to 40 dB over the B-1 chip. "But the real significance is that at the same time we have increased the wiring complexity from the B-1's 10 lines and 30 trunks," he says. □

Components

Speed, voltage up for power devices

Power-converter manufacturers are gearing up to produce switchers that operate at much higher frequencies than those that today are just above the 20-kilohertz range. Meanwhile, power-semiconductor producers are concentrating on ever more innovative high voltage- and current-switching components.

These trends surfaced at the annual Power Electronics Specialists Conference in Syracuse, N. Y., last month. The new designs described will boost speed and shrink the size of power devices, at the same time that new applications such as electric vehicles emerge.

As a result, significant new products with state-of-the-art technology are promised by the power-specialist laboratories. By the end of the summer, users can expect introductions in power-supply systems and transistors, silicon controlled rectifiers, and thyristors.

Higher frequencies. In the power-converter realm, emphasis is on pushing regulators and switching power supplies into the 500-kHz, 150-watt region. "With suitable driving circuitry to switch bipolar transistors on and off in 70 nanoseconds, we can achieve 300-kHz, 30-w multioutput converters, as well as 500-kHz, 150-w inverters," claims Rudolf Severns, researcher for the Power Conversion Electronics department at TRW Inc., Redondo Beach, Calif.

He points to one significant advantage of operating at much higher frequencies: the control-loop-gain crossover frequency can be substantially higher, so that the transient response becomes comparable with the performance of standard series-regulators.

Of course, higher switching frequencies also mean smaller packages. TRW achieved a 4:1 reduction in size for the power-conversion circuit by using smaller magnetic

Motorola's 8-bit, 10 ns video DAC explained:

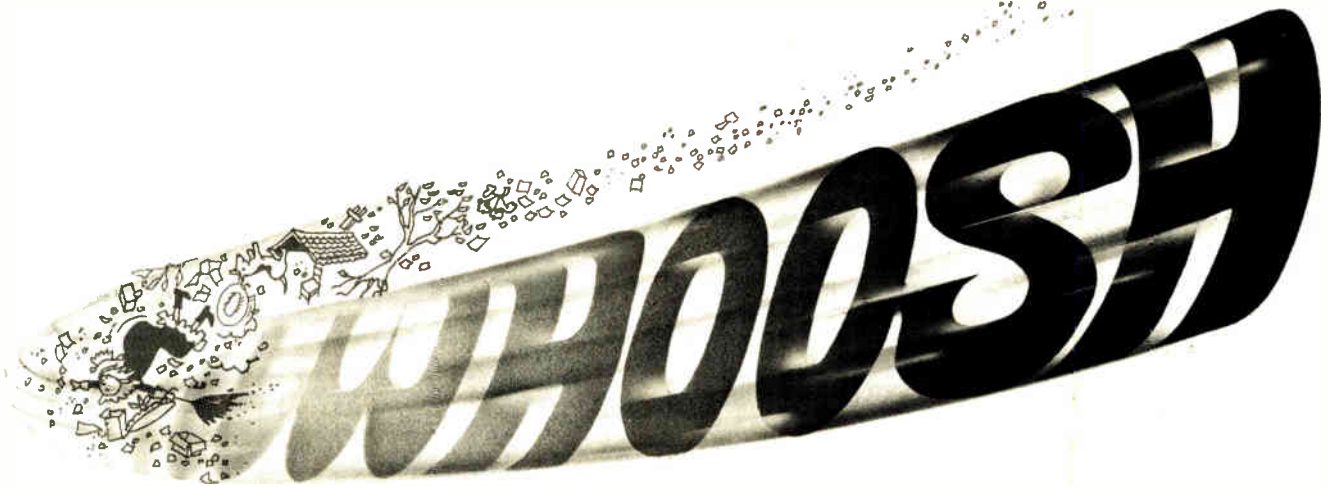

Designed for application in high-speed instrumentation, communication and TV broadcasting, the MC10318 monolithic MECL[†] DAC is—FAST. No other word describes operation at data rates above 25 MHz.

Inputs are compatible with MECL 10K series logic while the complementary current sink outputs feature current of up to 51 mA.

It's accurate to eight bits ($\pm 1/2$ LSB) and the outputs settle in typically less than 10 ns.

Availability's quick from stock, too, for things like CRT displays, storage oscilloscopes, radar signal conditioning and medical image processing. And you may not believe the price when we run it by you—\$26, 100-999, which may slow down the \$150-\$250 hybrid jobbies that have monopolized the market for too long.

Full scale current's 51 mA typical, output voltage compliance is -1.3 to 2.5 min/max and non-linearity's +0.19% maximum. The 16-pin ceramic package is standard.

... and then some

DAC	FUNCTION	100-999
MC3410L	10-Bit D/A Converter	\$ 7.95
DAC-08	8-Bit D/A Converter	•
MC1408L8	8-Bit D/A Converter	3.00
MC1403U	2.5 V Voltage Reference	1.75
MC1404-5	5.0 V Voltage Reference	•
MC1404-10	10.0 V Voltage Reference	•
MC3417L	CVSD Voice Encoder/Decoder	6.95
MC10318	8-Bit MECL D/A Converter	26.00

^{*}To Be Introduced

Contact Motorola Semiconductor Products Inc., P.O. Box 20912, Phoenix, AZ 85036 or your authorized Motorola distributor.

Quick. Before somebody passes you.



MOTOROLA

Semiconductor Group

[†]Trademark of Motorola Inc.

components such as amorphous alloys and by implementing smaller radio-frequency-interference filters and substituting ceramic or film capacitors for electrolytes.

Severns admits that regulation at high frequencies is still a problem. But it is attainable, as witnessed by two production supplies developed for military application, he notes.

Latching. In the component arena, General Electric Co.'s Semiconductor Products department in Auburn, N. Y., is implementing what GE refers to as the latching transistor. Packaged in a TO-3 metal can, the device exhibits the high turn-on gain of the power Darlington and the high blocking voltage of the thyristor.

The G64LS is a four-layer (pnpn) 800-volt, 25-ampere switching transistor that latches on at 1 A of base drive. Turning the device off is accomplished by a negative base pulse capable of handling 25 A of collector current.

"An extra advantage that the device exhibits is that it can be turned off in the same manner as a gate-assisted thyristor—that is, by using a diode—to produce a turn-off time of 2 microseconds," claims Ralph Locker, consulting application engineer. "This is sufficiently short for operation in 20-kHz resonant power supplies."

He contends that the latching transistor is an economical replacement for the power Darlington transistor, with features of the asymmetrical thyristor. The part will be available in sample quantities in September, competitive with Darlington's in the \$7-to-\$10 price range for large orders.

Switching vehicles. Also discussed at the conference was a significant breakthrough toward fulfilling GE's Government contract for a prototype electric vehicle by May 1979—a new Darlington transistor capable of switching 400 v and 350 A on or off in less than 1 microsecond [*Electronics*, April 27, p. 51]. Unique to the device is the minimal 0.1-A turn-on current required.

The breakthrough is largely due to GE's proprietary fabrication of the transistor silicon chip in direct

contact with the copper package, which is cooled from the top. The device is expected to play the key role in the regenerative braking system, which will recharge the prototype's lead-acid batteries. □

Solid state

PAL bandwagon may be rolling

A programmable device that reduces the hardware in the design of random-logic systems is stirring interest. Called the programmable array logic, or PAL, by its developer, Monolithic Memories Inc., Sunnyvale, Calif., the device has attracted a second source, Raytheon Corp.'s Semiconductor division. Moreover, two other sources are likely within a year, says John Birkner, the product planner responsible for the chip.

In addition, PAL's developers are getting a big boost from the two biggest names in programmer units for programmable read-only memories, Data I/O Corp. and Pro-Log Corp. PAL can be programmed much like PROMs, and these firms will support it with personality cards that plug into their own machines.

The PAL circuit configuration is a cross between a PROM and a field-programmable logic array (FPLA). It is designed to emulate all the logic functions of over 300 standard 54/74 series transistor-transistor-logic chips. According to how its fusible links are blown, it can shrink the chip count in a random-logic circuit by as much as a factor of four, Birkner says.

15 members. The PAL family consists of 15 bipolar products that are arrays of programmable AND and fixed OR gates. Nine are AND-OR gates arrays with different inputs and outputs; four have D flip-flops; and two, for rapid arithmetic operations, have exclusive-OR gates and registers. They come in 20-pin "skinny" dual in-line packages.

Birkner feels his PAL is borrowing from the best of two worlds: the programmability of PROMs and the

versatility of AND plus OR logic of the FPLA. The field-programmable array was an attempt shortly before microprocessors were introduced to produce arrays of logic gates on a chip with programmable interconnections. Its great drawback: because it includes both types of gates, it can not be programmed with PROM programmers. Instead, it needs special expensive programming units.

It is also difficult to design FPLA interconnects because there is a dearth of software aids to make the job simpler. Such an assembler language would accept logic statements as input and produce the format for programming.

Birkner believes he has gotten around these drawbacks. First, although PAL incorporates both AND and OR gates, the OR array is fixed; only the AND array is programmable. This means that the device can be handled on a conventional PROM programmer. This logic arrangement may lose some flexibility, but Birkner feels the loss is of little consequence with the kinds of random-logic applications it is aimed at.

To help in programming, Monolithic Memories has also developed the kind of software aid that the FPLA lacked. Called Palasm, short for PAL assembler, it is a Fortran IV program available through the National CSS Timeshare Inc. system.

As for the personality cards for the PROM programmers, Data I/O of Issaquah, Wash., already has one ready for \$575 to cover the 15-member family. A card for Pro-Log's programmer line will be ready by the fourth quarter of the year from the Monterey, Calif., company's production line. □

Software

Patent issue called a matter for Congress

Writers of software seeking to patent their work should look to Congress and not the courts for help, says the U. S. Supreme Court. In a 6-3 decision at the end of June, the Court

Now, everything you loved about the 2114 plus 125mW power down.

Memory retention at 2.5 volts V_{cc} — the 2114LV. 125mW stand-by vs. 350mW operating. Think of the power you save. And think of the complete 2114 family from Synertek. All fully static. No clocks or triggers using valuable system time. 200, 300 and 450nsec versions. The low power 2114L series — plus power down.

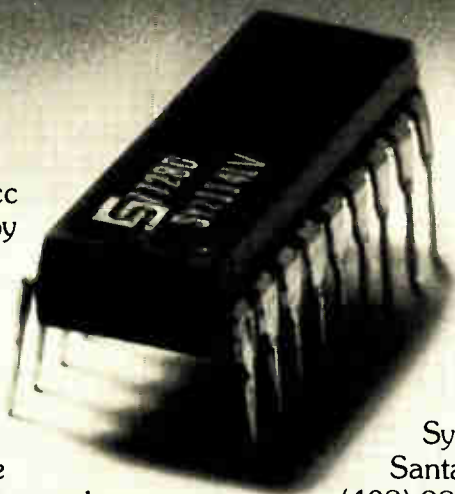

And Mil versions soon-to-come. The broadest family of 4K static RAMs available. From Synertek, now. For specs, samples and complete information, contact Larry Hester, Synertek, 3001 Stender Way, Santa Clara, California 95051. (408) 988-5600. TWX: 910-338-0135.

Synertek

Tested for Millions of Operations

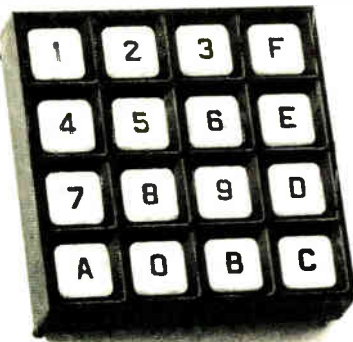

Grayhill 12 and 16 Button Keyboard Pads

choice of circuitry

- XY matrix
- single pole/common bus
- 2 out of 7 (or 8) coded output

choice of 1/2-inch or
3/4-inch button centers

Grayhill's 3 x 4 Keyboard Pads earned instant popularity for their positive tactile and audio feedback and performance. Now the line is broadened by the addition of 4 x 4 keyboards, featuring the same low profile, patented snap-action dome contact, and 3 million operation per button contact system life-rating. Readily interfaced with logic circuitry. Total button travel of only .015 inch. Standard post or flange mounting; top or sub panel mounting. Molded of tough ABS plastic; buttons with black on white molded-in legends a standard, other legend options available, including clear snap-on caps for user legending. Send for complete specifications, truth table, and information about our full line of Keyboard products, from Grayhill, Inc., 561 Hillgrove, La Grange, Illinois 60525. (312) 354-1040



Electronics review

Court rejects Zenith protection bid

Efforts to assess import tax penalties on consumer electronic products from Japan failed last month when the U. S. Supreme Court unanimously rejected the bid of Zenith Radio Corp. for protection. In a decision written by Justice Thurgood Marshall, the Court ruled that Japan's remission of its domestic commodity tax on exports is not excessive and therefore does not qualify as a "bounty or grant" requiring assessment of penalties under the U. S. Tariff Act of 1930. The Japanese tax ranges from 13% to 20%, depending on the product.

The Court upheld the view of the Treasury Department that Japan's remission of the tax is "a reasonable measure for avoiding double taxation of exports—once by a foreign country and once upon sale in this country." Marshall noted that this interpretation, first made in 1898, is still valid and has since been reenacted five times by Congress in tax laws.

The Carter Administration believes the ruling turns aside the threat of a crisis at world trade negotiations in progress at Geneva. However, House trade subcommittee chairman Charles Vanik (D., Ohio) warned U. S. negotiators that they must now push for an agreement that would preclude foreign subsidies that distort trade if congressional consent to a new agreement is expected.

The high court decision backed a 3-2 decision by the Court of Customs and Patent Appeals. That decision reversed a ruling in Zenith's favor last year by the U. S. Customs Court in New York [*Electronics*, April 28, 1977, p. 90]. At that time, the Treasury Department required importers to post bonds covering possible countervailing duties pending a Supreme Court decision. These bonding requirements will now be dropped, the department says. The Zenith case sought penalties on imports of television and radio receivers, phonographs, speakers, tape recorders, and various combinations thereof, as well as color TV picture tubes.

upheld the position of the commissioner of patents and trademarks that the software of Dale R. Flook, an employee of an oil company, Atlantic Richfield Co., is not patentable under existing laws.

However, the Court majority cautions that its decision should not be "interpreted as reflecting a judgment that patent protection of certain novel and useful computer programs will not promote the progress of science . . . or that such protection is undesirable."

When might software be patentable? Justice John Paul Stevens, author of the majority opinion, says only Congress can decide such "difficult questions of policy" by examining "current empirical data" not available to the Court. "It is our duty," Stevens writes, "to construe the patent statutes as they now read in the light of prior precedents, and we must proceed cautiously when we are asked to extend patent rights into areas wholly unforeseen by Congress."

The lack of precedent in the young computer industry is a handicap to the courts, Stevens says. "To a larger extent our conclusion is based on reasoning derived from opinions written before the modern business of developing programs for computers was conceived," he points out. "The youth of the industry may explain the complete absence of precedent supporting patentability."

Overtured judgment. The Flook decision overturned an earlier judgment in the case by the Court of Customs and Patent Appeals. It had held that the software was patentable despite earlier rejection by the U. S. Patent Office in line with a six-year-old policy.

Atlantic Richfield applies the software during the catalytic-conversion process in a refinery to update alarm limits on process variables such as temperature, pressure, and flow rates. The Supreme Court rejected the move for a patent because the algorithm, although developed by Flook, was within the boundaries of

5 DAY DELIVERY

Microcomputer Analog I/O Systems
with extensive software diagnostics

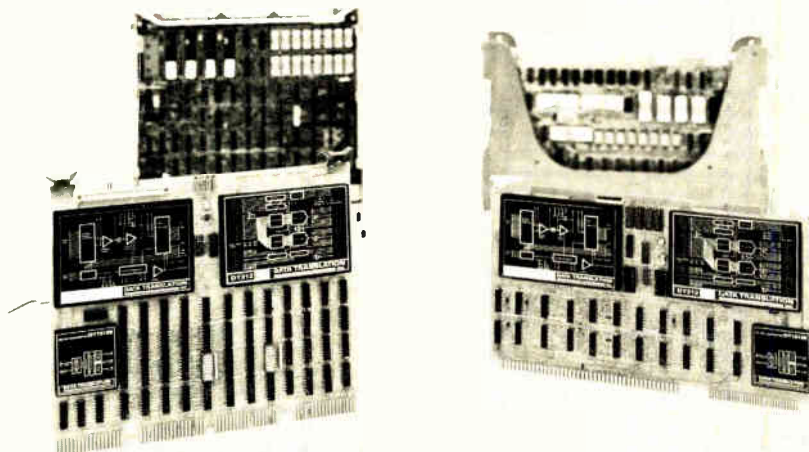

For:

INTEL SBC-80 Series (8080A)

ZILOG MCB Series (Z-80)

DEC LSI-11 & LSI-11/2

Computer Automation LSI 2,3 & 4 Series

National Semi IMP/PACE & BLC-80 Series

PLUS the widest selection of Data Acquisition Modules
anywhere. Concentrate on the Software and other key
system Requirements... and let us take care of Your
Analog Problems.

SEND for Full Technical Data or Call us.

GSA Contract No. GS-00S-64219

DATA TRANSLATION

INC

4 Strathmore Rd., Natick MA 01760

(617) 655-5300 Telex 94-8474

MORE POWER MORE BANDWIDTH LESS COST

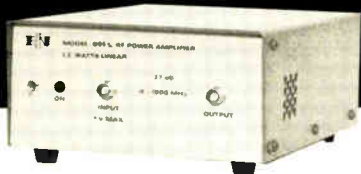

Our Model 601L is an ultra-wideband RF Power Amplifier whose wide range of frequency coverage and power output provides the user with the ultimate in flexibility and versatility in a laboratory instrument. Easily mated with any signal generator, this completely solid state unit amplifies AM, FM, SSB, TV pulse and other complex modulations with minimum distortion.

With a flat frequency response from 0.8 to 1000MHz the Model 601L will provide a linear class A output of 1.2 watts and a maximum saturated power output of 2 watts.

Constant forward power is continuously available regardless of the output load impedance match, making the 601L ideal for driving reactive as well as resistive loads.

Unconditional stability and instantaneous failsafe provisions in the unit provide absolute protection from damage due to transients and overloads.

Priced at \$1195 U.S.A.

APPLICATIONS INCLUDE:

- Laboratory Instrumentation
- RFI/EMI Testing
- NMR Spectroscopy
- TV Signal Distribution
- Communication Systems

For further information or a demonstration, contact:

ENI
3000 Winton Road South
Rochester, New York 14623
Call 716-473-6900, or
Telex 97-8283 ENI ROC

ENI

The world's leader in power amplifiers

Electronics review

News briefs

Nippon Electric to acquire Electronic Arrays

Electronic Arrays Inc. of Mountain View, Calif., and Nippon Electric Co. of Tokyo, have agreed in principle to the acquisition by the Japanese telecommunications and computer equipment maker of the U.S.-based manufacturer of memories for about \$8.6 million in cash. The agreement calls for the purchase of Electronic Arrays' 1,781,000 shares outstanding at a cost of \$4.82 per share. The purchase price might increase somewhat if, before the closing of the deal, Electronic Arrays hikes its reserves by selling its 3% interest in Monolithic Memories Inc. of Sunnyvale, Calif.

Electronics trade surplus up in 1977

The U. S. trade surplus in high-technology, electronics-oriented products rose 39% last year, reaching a level of \$1.2 billion, according to Washington Analysis Corp., a subsidiary of Bache Halsey Stuart Shields Inc. The sharp increase is largely due to net export gains of \$449 million in radio and television communications equipment and \$658 million in computers and related equipment. These more than offset net import gains of \$702 million in consumer electronic products and \$203 million in electronic components. Total exports of electronic products for 1977 were 14% above year-earlier levels, while imports for the period increased 11%.

Exxon unit acquires maker of point-of-sale terminals

Peripherals Corp. of Bohemia, N. Y., an Exxon Enterprises Inc. affiliate that makes telecommunications and voice response systems, has acquired a producer of point-of-sale terminals, EFTS Corp. of San Carlos, Calif. The terminal maker is unveiling a new family of terminals, the Series 100, designed for check authorization and verification of electronic funds transfers. Based on Intel Corp.'s 8085 single-chip 8-bit microcomputer, the family consists of four terminals ranging in price from \$500 to \$950, depending on features and quantities.

Video-cassette recorder sales on display

First statistics on U. S. sales of home video-cassette recorders to dealers by 11 manufacturers and importers show the market totaled 111,151 units for the first five months of the year, hitting a high of 27,994 in May. The new figures are now being developed monthly by the Electronic Industries Association's Consumer Electronics Group. Compilation of the statistics has just started, so there are no comparable figures for previous years. The monthly breakdown of unit sales shows the market turned up sharply in March (27,415) from levels recorded in January (13,567) and February (14,954).

Zenith flat panel gets another life

Former research-and-development men from Zenith Radio Corp. have formed their own company, Lucitron Inc., to develop Zenith's flat panel display. Zenith dropped development of the gas-discharge device, which produces TV-like pictures in color, when it closed its corporate research and development facility last year. Lucitron president Joseph Markin is chary about describing how the panel works. But he hopes to have a 5-inch (diagonal) panel, 3-in. thick, for demonstration shortly. The price of the display, whose details Markin declines to describe, is likely to remain high. Planned for the early 1980s are displays larger than 25 in., measured diagonally, costing upward of \$5,000. The two other ex-Zenith officers of the new Northbrook, Ill., company are Alan Sobel and Michael De Jule.

the existing state of the art.

However, the high court's reasoning on this point gave heart to legal specialists in software patentability, since Justice Stevens went on to conclude: "Even though a phenome-

non of nature or mathematical formula may be well known, an inventive application of the principle may be patented. Conversely, the discovery of such a phenomenon cannot support a patent unless there

THE WIDEBAND RMS VOLTMETER ONLY FLUKE COULD CREATE.

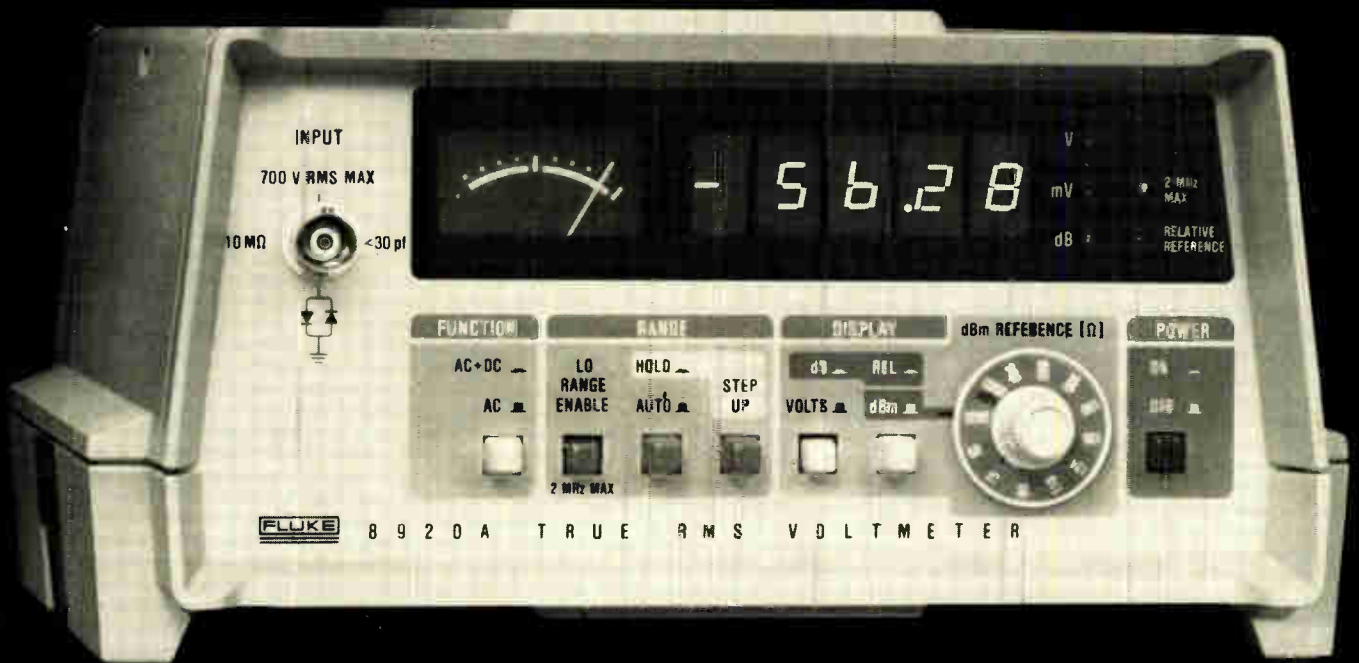

You're probably accustomed to using analog meters for audio-to-rf measurements. Maybe you've given up hope of going digital at a reasonable price.

Good news!

Fluke's new 8920A wideband true rms DMM is loaded with features—some you can't buy anywhere at any price, and it sells at an analog price: \$995*!

For starters, 8920A bandwidth is 10 Hz to 20 MHz for sub-audio to video AC measurements. Mid-band accuracy is 0.5%, compliments of an exclusive Fluke designed (and built) micro-electronic rms chip. Accurately measuring noise and non-sinusoidal waveforms is easy since the chip responds only to the heating effect of the waveform. You can select the AC + DC function for non-symmetrical waveforms like pulses that have a DC component.

We gave the 8920A dynamic range from 180 μ V to 700 volts, to measure from low noise levels to the output of powerful amplifiers. And, fast auto-ranging relieves you of the knob twisting chores!

Put the 8920A into dBV mode and measure from -75db to +57db (132db range), with 0.01db resolution. If you want your dBV reference somewhere else beside 1V, Fluke's

exclusive *relative reference* lets you store any voltage as the 0-db point. Imagine how simple your gain measurements can be!

To make the 8920A all things to all people, we've included a "dial-an-ohm" feature for dbm measurements. Instead of laboriously correcting each of your readings from a 600 ohm reference, simply dial 50, 75, 300, or one of nine *other* impedances up to 1200 ohms, and be right on every reading. There are several selections for broadcast, telephone, TV and RF applications.

An analog meter is standard, for convenient peaking/dipping/nulling, as is a linear analog output for continuous recording. Optional are logarithmic analog output and an isolated output to drive a counter. Soon, IEEE 488 interface will be available for systems use.

If you prefer an isolated banana jack input with full floating capability, specify the 8921A (also only \$995*). *U.S. Price

For more information, contact one of the more than 100 Fluke offices or representatives, worldwide. In the U.S., CALL (800) 426-0361, TOLL FREE. Residents of the U.S. and all countries outside of Europe, contact: John Fluke Mfg. Co., Inc., P.O. Box 43210, Mountlake Terrace, WA 98043, U.S.A. Telex: 32-0013.

In Europe, contact: Fluke (Nederland) B.V., P.O. Box 5053, Tilburg, The Netherlands. Telephone (013) 673973. Telex: 52237.

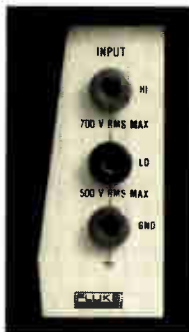

8921A's Isolated Banana Jack Input.



"Dial-An-Ohm"

2504-8118

FLUKE®

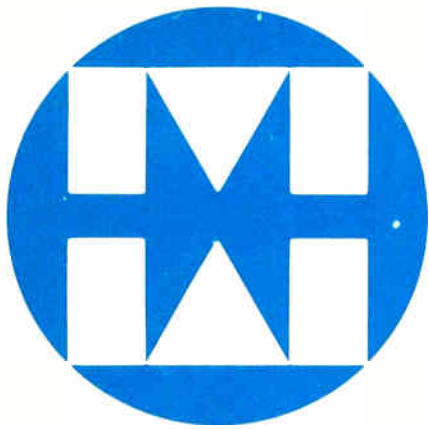

MITEL

HYBRID MICROPOWER TONE RECEIVER MH88200



A Natural For:

- Central Office Usage • PABX'S
- Modems • Tone-to Pulse Converters
- Mobile Radio • Remote Controllers

Featuring:

- Micropower CMOS/LSI Circuit
- Only one external 3.579545MHz Crystal Required
- Direct Connection to telephone lines
- AGC Ckt. for accurate twist detection
- 5th Order Elliptic Filters
- Three Output code formats available
- Digit "Acquisition" and "Release" times adjustable using external RC network

Contact the leader in tone receivers and CMOS technology for more information:



1745 JEFFERSON DAVIS HWY
SUITE 611
ARLINGTON, VA, 22202
TEL 703-243-1600

MITEL
Semiconductor

Electronics review

is some other inventive concept in its application."

That judgment is being read, says one Washington patent lawyer, "to mean that the 'right kind' of software is patentable—applications software that is inventive. I think there is a great deal of that around. What is needed now is to update patent law to accommodate it. This was a relatively uncomplicated case, yet the Court seems to go out of its way to urge Congress to act."

The disheartening aspect of the decision for software patent advocates is that Congress is unlikely to act quickly. Its legislative plate is already full and members are pressing for an early fall adjournment. □

Employment

Southern California desperate for EEs

The boom for bodies, from beginning electronics engineers to experienced practitioners, is on again in southern California, reminiscent of the hiring explosion that accompanied the space race over a decade ago. Although the demand for engineers has increased sharply across the country, companies in Los Angeles and Orange counties are particularly desperate because they need a large number of EEs at a time when supply is tight and the good life promised by the region has lost much appeal.

As usual, the prime candidates are recent graduates or EES with only one or two years' experience. However, some companies are also trying to lure experienced engineers away from other firms.

Thus, for the first time since the downturn at the beginning of the 1970s created widespread layoffs, engineers are in a seller's market. As a result, southern California companies are taking unusual steps to fill their needs:

- One electronics firm offers a \$1,000 bounty to employees who bring in prospects that are hired.

- At another company, EES who present themselves for an opening get a recruiter's fee of \$5,000 and up after a year on the job.

- To lure engineers away from rivals, electronics manufacturers are offering as much as 20% increases over present salaries.

- The opening salary for BSEE graduates from West Coast engineering schools is now commonly over \$17,000, up some \$2,000 since the beginning of the year.

Buildup. What happened to turn the job market up so sharply in this trend-setter section of the country? The reasons go beyond the general high business level the electronics industries are currently enjoying nationwide.

The head of personnel for an Orange county firm defines it as a classic supply-demand bind. "We're dealing with a finite market here: there's simply not enough to go

It's a seller's market again for EEs

Demand for electrical engineers has been growing across the country, though salaries and recruiting techniques have varied from region to region. While the Southern California electronics firms may have set the pace for innovative enticements, their counterparts in the San Francisco Bay area are no slouches. Competition is so fierce for talent in Silicon Valley that Fairchild, Intel, Intersil, and Memorex have resorted to recruitment commercials for EEs on local television and radio stations.

Opening salaries are also climbing, sometimes as high as \$18,000 for a fresh graduate; \$19,000 for an engineer with a year's experience. The situation is not much different in New England where the demand for EEs has increased while the supply of freshly minted graduates from the major engineering schools has been static. According to Ray Stata, president and chairman of Analog Devices, engineers are swapping jobs but that is only "robbing Peter to pay Paul," not solving the basic shortage.

Talk about a matched pair!

Just 3mV gate source differential *off-the-shelf.*



It's our new series of N-channel dual monolithic J-FETs. And its available off the shelf with a gate source voltage differential of only 3mV.

That's right. Off the shelf. Never before has the designer been able to buy a device this closely matched without paying extra, and running the risk of delivery delays or defaults.

Not only do you get the close match, you get a lot more besides. For instance:

- CMRR: 100 dB minimum
- Input Impedance: IG less than 25 pA
- Noise: 10nV/ $\sqrt{\text{Hz}}$ Typ @ 10Hz
- gos: less than 1 μmho
- Choice of hermetic TO-71 or 8-pin miniDIP with symmetric pinout for automatic insertion.

Typical applications for our new 2650 series of dual monolithic N-channel JFETs include low and medium frequency amplifiers, low noise input amplifiers, differential amplifiers, impedance converters, precision instrumentation amplifiers, and comparators.

For complete technical information, design assistance, or evaluation samples, contact us at the address below, or call Jerry Kramer, (415) 968-9241.

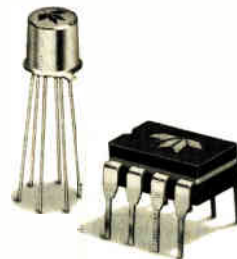

TELEDYNE SEMICONDUCTOR

1300 Terra Bella Avenue, Mountain View, California 94043 • (415) 968-9241

SALES OFFICES: DOMESTIC: Salem, N.H. (603) 893-9551; Stony Brook, N.Y. (516) 751-5640;

Des Plaines, IL (312) 299-6196; Los Angeles, CA (213) 826-6639; Mountain View, CA (415) 968-9241

INTERNATIONAL: Hounslow, Middlesex, England (44) 01-897-2503; Tiengen, West Germany 7741-5066;

Kowloon, Hong Kong 3-240122; Tokyo, Japan 03-403-8141

Optical waveguide fibers from Corning. Now available in production quantities.

Low-loss, high-bandwidth optical waveguides are now available from Corning Glass Works in unlimited quantities on a worldwide basis. CORGUIDE[®] fibers can be ordered from a broad range of standard products and to custom specifications at prices as low as 65¢ per meter.*

In more than a hundred installations around the world, optical waveguide fibers from Corning are demonstrating the practical advantages of lightwave communications. Continuing technical progress now makes them available in large quantities and at significantly reduced prices.

For full information, circle Number 100 on the reader service card or contact:

Telecommunication Products
Department

Corning Glass Works
Corning, New York 14830, U.S.A.
Tel: 607-974-8812
Telex: 932498, 932499

See listing on opposite page for distributors and Corning offices world-wide.

CORNING

(*F.O.B. Corning, N.Y.)

Product Summary

Numerical Aperture		.21
Core Diameter		63 µm
Cladded Diameter		125 µm
Coated Diameter		138 µm
Product Number	Maximum Attenuation (dB/km at 820 nm)	Minimum Bandwidth, MHz @ 1 km (-3 dB optical power)
4080	4	800
4040	4	400
5040	5	400
6080	6	800
6060	6	600
6040	6	400
8080	8	800
8040	8	400
8020	8	200
10020	10	200
Numerical Aperture		.24
Core Diameter		63 µm
Cladded Diameter		125 µm
Coated Diameter		138 µm
Product Number	Maximum Attenuation (dB/km at 900 nm)	Minimum Bandwidth, MHz @ 1 km (-3 dB optical power)
3081	3	800
3041	3	400
4101	4	1000
4041	4	400
5101	5	1000
5041	5	400
5021	5	200
7081	7	800
7021	7	200
10021	10	200

Distributors
of Corning
optical waveguides

Siecor GmbH
Attn: Wulf-Dieter Seiffert
Kistlerhofstrasse 170
D-8000 Muenchen 70
Federal Republic of Germany
Telephone 089-78-9688
Telex 5288263

Industrie Pirelli S.p.A.
Attn: L. M. Sansone
Cable Division
Telecommunication Group Sales
20124 Milan, Italy
Telephone (02) 62224320
Telex 31135 PIRELLI

BICC Telecommunication Cables Ltd.
Attn: Fred Wilkinson
P.O. Box 1
Prescot, Merseyside
L34 5SZ England
Telephone 051-426-6571
Telex 629 320 BICATEL
TWX BICALTEL PRESCOT

The Furukawa Electric Co., Ltd.
Attn: H. Murata
6-1 Marunouchi 2-chome
Chiyoda-Ku
Tokyo 100 Japan
Telex 2222365 Fectok J

Compagnie Lyonnaise de
Transmission Optiques
Attn: Arnaud Gobet
170 quai de Clichy
9211 Clichy, France
Telephone 739-33-32
Telex 620787

Corning sales offices

Corning Glass International S.A.
Export Sales Group
90/92 Rue Baudin
Boite Postale 227
92306 Levallois-Perret
France
Telephone 739-96-40
Telex 620014

Corning Glass GmbH
Hagenauer Strasse 47
6200 Wiesbaden-Biebrich
Federal Republic of Germany
Telephone (06-121) 2381
Telex 4186536

Corning, S.p.A.
Via Simone d'Orsenigo, 18
20135 Milan, Italy
Telephone 54.60.541
Telex (843) 34332

Corning Limited
(International Sales)
1 Prince's Street
Richmond, Surrey TW91 DZ
(London)
England
Telephone 01-9482137-38-39
Telex 928654

Corning K. K.
No. 16 Kowa Bldg., Annex 3F
9-20 Akasaka 1-chome
Minato-Ku, Tokyo, Japan
Telephone (03) 586-1051
Telex (781) 22165

Corning International
Services, S.A.
Room 607 Cathay Bldg.
Mount Sophia
Singapore 9
Telephone 324615/324720
Telex (786) 23483

Electronics review

around," says Jack Coke of Computer Automation Inc. in Irvine.

This shortage became acute around the first of this year, some say, when employers planning expansion found the EE pool virtually exhausted by last year's upturn. Smaller numbers of graduating EEs resulting from the poor job climate in the 1974-75 recession has also played a part. But the capper has been the reduction in the pipeline of engineers from out of state, whose desire to move to southern California has been the major source of new technical blood. Much-publicized high taxes and housing costs are the villains, recruiters contend.

On the other hand, feelings of veteran engineers who have been through two big recessions in 10 years, are aptly summed up by J. C. Hoagland, communications engineer at Rockwell International Corp.'s space systems group. "For the first time in a long time, I'm on top of the heap instead of the bottom, and I like it," he says. Hoagland, also vice chairman of the Los Angeles Council of the Institute of Electrical and Electronics Engineers, sees the imbalance in the EE's favor continuing for at least five years.

In mid-June, a development occurred that put what may be an unbearable strain on what is already a seller's market. Hughes Aircraft Co. made known it will need 1,700 engineers, mostly electronics engineers, before the end of the year. With 40,000 employees at eight southern California facilities, the company ranks as the state's No. 1 electronics employer.

Hughes's chances of getting this number today are considered slim. "Lots of luck" is the opinion voiced by Clifton R. Huxford, personnel consultant to TRW Inc.'s sprawling Electronics Group. Just one of the firm's divisions needs 50 engineers for work on digital telephone-switching equipment. Huxford admits paying a minimum of \$18,500 a year for new BSEEs with some experience. But he and other personnel experts think Hughes will not come close to filling its needs without raising salaries much higher. □

CORNING

Scientists cool to space processing of materials

Dreams of using the space shuttle to produce purer and less expensive semiconductor crystals are being challenged by a National Research Council study. After a year's analysis, a special committee made up of 12 leading U. S. materials scientists says it "has not discovered any examples of economically justifiable processes for producing materials in space and recommends that this area of materials technology not be emphasized" by the National Aeronautics and Space Administration. **Materials research and development, however, might be useful, the committee concludes,** "provided that problems proposed for investigation in space have from the outset a sound base in terrestrial science or technology." NASA's early program, the committee points out, "has suffered from some poorly conceived and designed experiments, often done in crude apparatus, from which weak conclusions were drawn and, in some cases, over-publicized." Chairman of the study group is Bell Laboratories' director of materials science and engineering, William P. Slichter.

Outlook bright for Senate approval of solar satellites

Solar-power satellite advocates are optimistic about Senate passage of a proposal to spend \$25 million on research and development for the energy craft in fiscal 1979 **now that the House has passed a similar measure by an overwhelming vote of 267 to 96 late last month.** The concept involves assembling huge arrays of photovoltaic solar cells in space, placing them in geosynchronous orbit, and then converting the electricity they produce into microwaves for transmission to earth stations for power generation [*Electronics*, April 27, p. 96]. First hearings on S. 2860, introduced by Sen. John Melcher (D., Mont.), are set for mid-July before the energy R&D subcommittee headed by Idaho's Frank Church (D.).

Federal standard for magnetic tape proposed by NBS

The National Bureau of Standards is proposing a magnetic-tape standard for Government computer users and says it expects to complete a magnetic-disk standard within a year in an acceleration of its lagging standards program [*Electronics*, Feb. 2, p. 39]. The proposed tape standard may be revised after evaluation by Government users and computer makers before final adoption as a Federal information-processing standard. Two previously published standards **covering the interfaces for input/output channels and power control** have already been revised. All are subject to revision within three years. The NBS's Institute of Computer Science and Technology expects the three standards will save Government computer users more than \$55 million over five years.

DOE picks five firms to operate 160 electric vehicles

The Department of Energy is funding five companies to buy and operate 160 electric vehicles in the first round of a 10-year demonstration program estimated to cost \$160 million [*Electronics*, Nov. 10, 1977, p. 49]. **Operators and the number of vehicles they will use include:** Long Island Lighting Co., New York, 60 for van pooling, service, and small fleets; New York's Consolidated Edison Co., 40 for field supervision, service, and computing; American Telephone & Telegraph Co., Los Angeles, 20 for repair service; Walt Disney World Co., Lake Buena Vista, Fla., 20 for motor pool and repair service; and Penn Jersey Subaru, Pennsauken, N. J., 25 for individual leasing and sales. The initial cost of \$4 million will be split 50-50 by the department and the operators.

TYPE 196P VITAMIN Q® CAPACITORS



WITHSTAND SCR SNUBBER APPLICATIONS

- Metal-clad paper capacitors, impregnated with exclusive inert synthetic polymer, for high-current, high-voltage, high-repetition-rate a-c applications.
- Built to take even greater extremes than the 600-to-800 volts peak a-c generally encountered in SCR snubber use.
- Capacitance values from .001 to 1.0 μ F. Voltage ratings from 100 to 1000 WVDC.
- Operating temperature range, -55°C to $+125^{\circ}\text{C}$.

Write for Engineering Bulletin 2110D to
Technical Literature Service, Sprague Electric Co.,
35 Marshall St., North Adams, Mass. 01247.

THE BROAD-LINE PRODUCER
OF ELECTRONIC PARTS



General
Cable
subsidiary

Circle 56 on reader service card

TYPE 627P METFILM® 'K' CAPACITORS



THE SMALLER 400 Hz CAPACITOR

- All the advantages of polycarbonate-film dielectric, yet smaller than previously available capacitors designed for 150 V_{RMS} 400 Hz operation.
- Low dissipation factor, high insulation resistance, high stability, minimum capacitance change with temperature, low dielectric absorption.
- Operating temperature range, -55°C to $+105^{\circ}\text{C}$ without voltage derating. Hermetically-sealed with glass-to-metal solder-seal terminals.
- Capacitance values from .18 μ F to 12 μ F. Standard tolerances, $\pm 10\%$ and $\pm 5\%$.

Write for Engineering Bulletin 2709 to:
Technical Literature Service, Sprague Electric Co.,
35 Marshall St., North Adams, Mass. 01247.

THE BROAD-LINE PRODUCER
OF ELECTRONIC PARTS



General
Cable
subsidiary

Circle 57 on reader service card

SERIES JX2000/3000 FILTERS



ULTRA-SMALL INTERFERENCE CONTROL COMPONENTS

- Qualified to Military Specification MIL-F-15733.
- High insulation resistance over operating temperature range of -55°C to $+125^{\circ}\text{C}$.
- Available in Feed-thru, L, PI, T, and 2L circuits.
- Current ratings from 0.1 to 15 amperes.

Write for Engineering Bulletin 8132 to
Technical Literature Service, Sprague Electric Co.,
35 Marshall St., North Adams, Mass. 01247.

THE BROAD-LINE PRODUCER
OF ELECTRONIC PARTS



General
Cable
subsidiary

Circle 173 on reader service card

SERIES JW33-4000 FILTERS

... For Audio/Signal Applications



THE FREQUENCY RESPONSE YOU WANT

- Low-cost pre-engineered devices constructed to meet your choice of attenuation characteristics, cut-off frequency (1 kHz and up), and operating impedance (250 Ω and up).
- Low-pass, high-pass, band-pass, and band-reject designs.
- Compact 2.000" x 2.000" x .562" case ideal for printed wiring board mounting.

Write for Engineering Bulletin 9100 to
Technical Literature Service, Sprague Electric Co.,
35 Marshall St., North Adams, Mass. 01247.

THE BROAD-LINE PRODUCER
OF ELECTRONIC PARTS



General
Cable
subsidiary

Circle 174 on reader service card

THE LSI-11/2 MICROCOMPUTER.

HALF SIZE ISN'T THE HALF OF IT.



AN \$1149* STATE-OF-THE-ART 64K MEMORY.

We took the world's most powerful 16-bit microcomputer, split it down the middle, and put the CPU and memory on two separate half-size boards.

After that, you'd think we would have called it a day.

Instead we went on to give it the most advanced 64K byte memory ever created. A state-of-the-art RAM with byte parity, onboard refresh, selectable I/O page boundary, and complete battery backup capability. Priced

at only \$1149.* And designed for total compatibility with the half-sized LSI-11/2.

Put it all together with a 270ns access time, PDP-11 software, and the comprehensive family of LSI-11 options and you've got more than just a new form factor to work with.

You've got a whole new dimension in power and flexibility.

Best of all, we can get it to you now.

The LSI-11/2.

Half size isn't the half of it.

For the whole story, call toll-free 800-225-9220 (in Mass. 617-481-7400, Ext. 5144), or write Digital Equipment Corporation, MR2-2/M70, One Iron Way, Marlborough, MA 01752.

Or call your local Hamilton Avnet stocking location.

*In 100's when purchased with the CPU. Prices apply in U.S. only.

digital
COMPONENTS
GROUP

Putting the U.S. on an exports offensive

The U.S. overall trade deficit set another record in the first five months of 1978, reaching \$14.8 billion for the first time. It is nearly 80% higher than for the comparable period last year, and no one in the Federal bureaucracy sees any sign that it will diminish significantly, despite the declining value of the dollar relative to stronger foreign currencies. In the face of the Carter Administration's unsuccessful attempts to reduce the deficit by calling for reduced oil imports, an increasing number of American industrialists are urging a more aggressive U. S. posture on exports.

The failure of the Government to develop a comprehensive national export policy to encourage foreign sales of U. S. electronics products and other high technologies is not the fault of President Carter. It is a problem with a long and complicated history. Nevertheless, the Administration has yet to give the deserved priority to the development of an affirmative, flexible export policy, although it does have a task force at work on the matter.

The EIA's new assessment

The Electronic Industries Association is among those calling for such a policy. As the EIA's International Business Council points out in a new position paper aimed at the Administration task force, "maintaining the favorable balance of electronics trade, currently in excess of \$2.5 billion, is becoming increasingly difficult. Both foreign and domestic actions have eroded the ability of U. S. companies to match zealous overseas competitors on an equal basis."

In one of the clearest summaries of America's export needs, the EIA calls first for creation of high-priority national policy separate from other national goals, rather than subsidiary or subservient to them. "Its purposes should be its own, not those of foreign political relations or domestic taxation. Its implementation through programs and administration should be consistent, not contradictory" the report says. "Its direction should be steady and continuing, not sporadic or perpetually shifting under the hands and whims of ever-changing administrators and regulators. In short, the policy should be one of firm commitment, appropriately served, to objectives that are reasonable and possible."

Though the association's position represents an ideal, it is not impossible to achieve. However, such a policy needs a relaxation of the traditional adversary relationship on exports between Government and business. To be competitive, American companies must be able to get Federal approval of export licenses and related financing quickly and simply. As the EIA report points out, delays in decisions lose export sales.

Some needed changes

Equally important, electronics manufacturers believe the Commerce Department's export promotion needs more timely intelligence on foreign markets and reorientation away from present programs that emphasize one-time or first-time sales and introductions. Those programs, the EIA contends, "do not and cannot provide the operational framework that is essential to export growth: the continuing organizational presence in a foreign market that provides customer service, applications engineering, sales administration, day-to-day solicitation, and the myriad interface requirements between a U. S.-based manufacturer and an overseas buyer."

The EIA alternative to the Government's weak support for exporters past their first foreign sale has four parts. Two would require relaxation of antitrust laws: permission for companies that compete in the domestic market to jointly own trading companies for export purposes, as well as allowing such companies to engage in trade-related banking operations. Similarly, the association believes that U. S.-owned foreign subsidiaries should be permitted to represent products of other U. S. exporters, even if they are in competing lines of business.

Financial incentives, including better credit programs and short-term financing for smaller transactions, make up the balance of the recommendations. For most exporters, the association maintains, overseas sales are not single-shot opportunities. Successful exporting embraces multiple economic processes. Thus "the best environment for expansion is stability and incentives to growth, both in rule and in economic policy, rather than the stop-and-go, year-to-year approach that is characteristic of present Government programs," the report concludes.

Ray Connolly

THE MEMORY BOOK



YOUR KEY TO SUCCESSFUL MEMORY DESIGN.

This newest book in the highly respected *Electronics Books Series* provides you with the most up-to-date and authoritative information compiled from the pages of *Electronics Magazine*. You'll learn exactly how to apply the new technology and components to meet specific design goals. And you'll be fully prepared to work with everything from small microcomputer-based systems to large memory-rich mainframes.

You'll have instant access to the NEW industry-standard memory devices.

- the 16-k RAM that offers high start-up reliability
- the 4-k static RAM that saves costs on power
- the speedy RAM that runs cool with power-down circuitry
- the dynamic injection logic random-access memory that competes with MOS designs
- the biggest erasable PROM that puts 16,384 bits on a chip
- the electrically alterable ROM that doesn't use nitride
- *and much, much more*

You'll learn all about the latest memory technology.

- the cheaper RAMs, reprogrammable ROMs, CCDs, and bubble memories that are being developed *now*
- five technologies that squeeze more performance from memory chips
- grooves to add new dimension to V-MOS structure and performance
- cutting costs and boosting performance with injection logic
- *and much, much more*

You'll discover specific applications to use NOW.

- flag potential problems with 4,096-bit RAMS
- ease memory design for mainframes and microcomputers with the 16-k RAM
- Expand a microcomputer's memory
- predict the real costs of semiconductor-memory systems
- check on the reliability of 4-k RAMS
- *and much, much more*

Solidly packed with usable, up-to-date, reliable data and guidelines, this is your key to successful memory design on any scale.

Order today, and don't forget the other valuable books in the *Electronics Books Series* listed on the coupon below.

Electronics Book Series

P.O. Box 669, Hightstown, N.J. 08520

1. Microprocessors

Send me _____ copies at \$8.95 per copy.

2. Applying Microprocessors

Send me _____ copies at \$9.95 per copy.

3. Large Scale Integration

Send me _____ copies at \$9.95 per copy.

4. Basics of Data Communications

Send me _____ copies at \$12.95 per copy.

5. Circuits for Electronics Engineers

Send me _____ copies at \$15.95 per copy.

6. Design Techniques for Electronics Engineers

Send me _____ copies at \$15.95 per copy.

7. Memory Design: Microcomputers to Mainframes

Send me _____ copies at \$12.95 per copy.

Discounts of 40% on orders of 10 or more copies of each book.

If after my 10-day free-trial examination I am not fully satisfied, I understand that my payment will be refunded.

Payment enclosed Bill firm Bill me

Charge to my credit card:

American Express Diners Club
 Bank Americard Master Charge*

Acc't No. _____ Date Exp. _____

*on Master Charge only, first numbers above name _____

Name _____ Title _____

Company _____

Street _____

City _____ State _____ Zip _____

Signature _____



Forget logic analyzers with short memories.

Moxon's new 745 tops them all with 32K.



The newest member of Moxon's Logical Team has the largest memory of any logic analyzer you can buy.

In fact, it has two separate memories, each able to handle data as 16 channels of 1024 bits or as 16,384 bits in serial.

Data received by the 745 goes into one memory, data entered by you goes into another, and differences between the two may be displayed. A halt on difference mode automatically stops the program when intermittent differences occur. You can literally walk away from the test.

A built-in keyboard makes programming easy. Data may be entered,

edited and displayed in hex, octal or binary, as well as parallel or serial timing diagrams.

Moxon 700 Series Data Generators share a bus with the 745 and eliminate the cost of CRT and keyboard duplication. For price and performance, you can't beat the Logical Team.

They're unforgettable.

For full details on this or our entire digital test line, call or write MOXON, Inc., 2222 Michelson Dr., Irvine, CA 92715. (714) 833-2000, TWX (910) 596-1362.

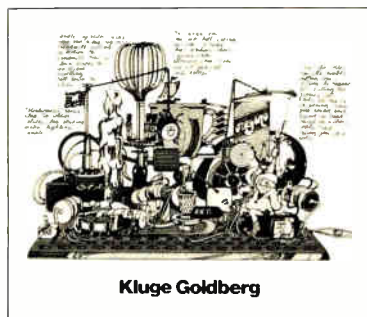

Kluge Goldberg

FREE KLUGE GOLDBERG POSTER.

Please send full details on Moxon's Logical Team (and a free color poster of the ultimate kluge).

NAME _____

COMPANY _____

ADDRESS _____

CITY _____ STATE _____ ZIP _____



MOXON, INC.
2222 Michelson Dr.
Irvine, CA 92715
714/833-2000 TWX (910) 596-1362

New RCA **SwitchMax**

Maximum effectiveness in the switching mode.

SwitchMax. A new series of RCA transistors designed and built for high performance in off-line power supplies, converters, and pulse-width-modulated regulators. SwitchMax transistors are hot-temperature tested. To give you new predictability under operating conditions. New efficiency in heat sink design.

Performance that starts with design.

These RCA n-p-n transistors have a multiple-epitaxial, double-diffused structure, fine emitter geometry, and a trimetal system. Which make SwitchMax transistors rugged. And give them excellent high-current and fast switching characteristics, with improved second breakdown.

Verified by worst-case testing.

Every SwitchMax transistor is tested at 100°C or 125°C against precise limits for all switching parameters. Including inductive turn-off time and saturation voltage. To give you switching characterization that lives up to RCA's reputation in second breakdown, safe operating area, and thermal cycling ratings.

As the table shows, SwitchMax transistors cover a wide voltage and current range. Send for our brochure detailing how to use them in your designs. Contact your local RCA Solid State distributor. Or RCA Solid State headquarters in Somerville, NJ; 1130 Brussels, Belgium; Sunbury-on-Thames, Middlesex, England; Quickborn 2085, W. Germany; Ste.-Anne-de-Bellevue, Quebec, Canada; Sao Paulo, Brazil; Tokyo, Japan.

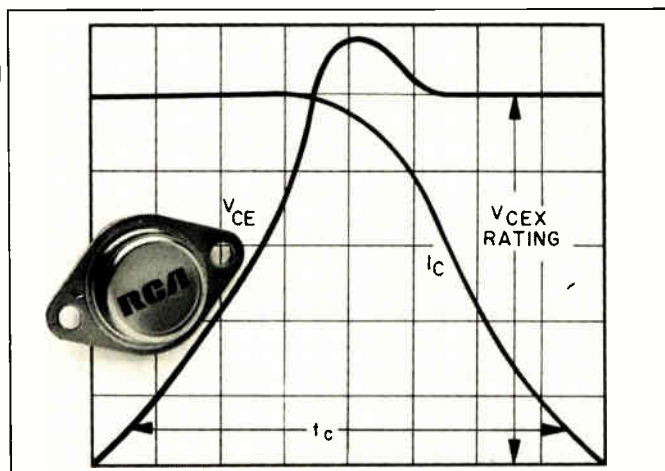

Types	V _{CEV} Rating	I _C (sat)	t _C (max) at I _C (sat) μs
2N6671	450 V	5 A	0.4 (25C)
2N6672	550 V		0.8 (125C)
2N6673	650 V		
2N6674	450 V	10 A	0.5 (25C)
2N6675	650 V		0.8 (100C)
2N6676	450 V	15 A	0.5 (25C)
2N6677	550 V		0.8 (100C)
2N6678	650 V		

RCA Power experience is working for you.

RCA

International newsletter

Fujitsu plans big addition to IC plant

The ambitious plans of Fujitsu Ltd. to switch its semiconductor division from strictly an in-house supplier to a profitable outside vendor are shifting into high gear. It is about to invest \$24.4 million to expand its semiconductor plant in Aizu, Fukushima prefecture, and turn out more 16-K random-access memories and other large-scale ICs for export. The plant will be highly automated and is designed to turn a profit when operating at 80% of capacity. When started up in January, the four-floor building will total about 90,000 ft². **At the same time, Fujitsu will beef up its existing facilities**, bringing its overall investment in semiconductor facilities during the fiscal year ending next March 31 to about 40% of its total capital investment.

Industry backs UK government's IC strategy

A report by British microcircuit industry and union executives and government representatives broadly endorses the Department of Industry's low-risk plan to aid the domestic industry [*Electronics*, May 11, p. 88]. The strategy, to be announced soon in the House of Commons, will cost in the region of \$430 million over five years from all sources, including industry. The Department of Industry will furnish \$145 million, and \$60 million to \$100 million will come from the National Enterprise Board in the shape of a new company and plant (see p. 86). **Pre-empted by the NEB and Fairchild-General Electric Co. projects (Fairchild-GEC talks are in an advanced stage)**, the National Economic Development Office report nonetheless welcomes a British-owned presence in the volume standard-IC market.

State-owned firm in Yugoslavia buys West German outfit

What industry observers have considered unlikely will take place in August when the state-owned Yugoslav household-equipment maker Gorenje buys West Germany's privately owned Körting Radio Werke GmbH, a family-owned 1,300-employee entertainment electronics company on the verge of bankruptcy. **The surprise \$10 million deal, which still needs the approval of Yugoslavia's central government**, follows months of speculation—and hopes—that Western firms, among them General Telephone and Electronics International Inc. of New York, would come to the rescue of the ailing West German company. By failing to do so, one industry insider says, "they have given yet another outside contender easy access to the lush West European radio and television market." With a production facility in West Germany, Gorenje, a 17,000-employee, \$500 million enterprise, is certain to make an impact on that market.

Japanese look to lateral-channel MOS for voltage

Engineers at Nippon Electric Co. are working all out to develop large lateral-channel MOS devices for a variety of applications. Among them: switching power regulators, audio-frequency amplifiers, and high-frequency amplifiers, including kilowatt-class broadcast transmitters. The devices have a shield plate similar to that of earlier devices developed by Hitachi to achieve a voltage rating several times that of V-groove MOS. With aluminum gates—rather than the polysilicon used by Hitachi—giving them faster response time, **the new devices should be particularly attractive for use in switching regulators operating at higher frequencies than are feasible with bipolar devices**. This will be especially true when the voltage rating surpasses the present value of 120 v. In the first experimental application, NEC and the technical research laboratories of NHK, Japan's

International newsletter

public-service broadcast network, have used a parallel array of 20 pairs of p- and n-channel devices to fabricate a class D amplifier with 1.37 watts output at broadcast frequencies. They are now designing a pulse-width modulator.

NEC, Mitsubishi build converters into processors

Japanese manufacturers of consumer electronics products should find microcomputer control more convenient with the introduction by domestic firms of 4-bit, one-chip models featuring on-board analog-to-digital converters from Mitsubishi Electric Corp. and Nippon Electric Co. **Both companies expect good yield and ease of programming because the devices are based on microprocessor series already in production—**Mitsubishi's on its series of 4-bit microprocessors used in calculators and other proprietary products, NEC's on its general-purpose series of 4-bit microprocessors.

Mitsubishi uses an a-d converter similar to the one on board the Intel 8022 microcomputer but includes a multiplexer for up to 15 analog inputs. In addition to logic drive outputs, there are decoded outputs that can directly drive either fluorescent or light-emitting-diode digital displays. NEC uses a newly developed charge-transfer a-d converter.

British push international computer protocol

The United Kingdom's Department of Industry is preparing to plow about \$1 million over four years into the development of machine-independent packet-switched networks. It will fund a national high-level protocol body at the National Physical Laboratory staffed by industry and the lab. Echoing recent French proposals [*Electronics*, June 8, p. 69] for a coordinated European-AT&T high-level protocol-development program, **the new national body would both coordinate and speed British Post Office standards and manufacturer activities and present a united voice at CCITT and International Standards Organization meetings.** The laboratory argues that BPO experience with its EPSS service was a powerful factor in the early definition and rapid implementation of the X-25 interface standard and that, without an equivalent program, partisan manufacturer and national interests could stymie the creation of an international protocol that would allow computers to exchange data regardless of maker.

Japanese soothe Britons with components deal

Fearing a backlash if Japanese penetration of the British television and audio markets continues, a Japanese industry delegation to the United Kingdom, headed by Sony's Noburo Yoshii, **has agreed in principal to the increased use of British electronic components in Japanese goods.** Backing its intentions, the delegation brought a shopping list of components to the meeting with the British Radio Equipment Manufacturers Association.

Production tool uses image converter and microprocessor

Using an image-converter-microprocessor combination, researchers at Siemens AG are working on a system that could be employed extensively as a checking or positioning tool on production lines. In operation, the image of the object to be positioned is projected through a lens onto the solid-state image converter. **The converter's output signals are digitized and fed to the microprocessor as a bit pattern.** Suitably programmed, the processor then determines whether the object is present, and if so, whether bit pattern is identical to the one it has stored.

BIPOLAR MEMORY

Buying
any other
4K static RAM
is a waste
of time.

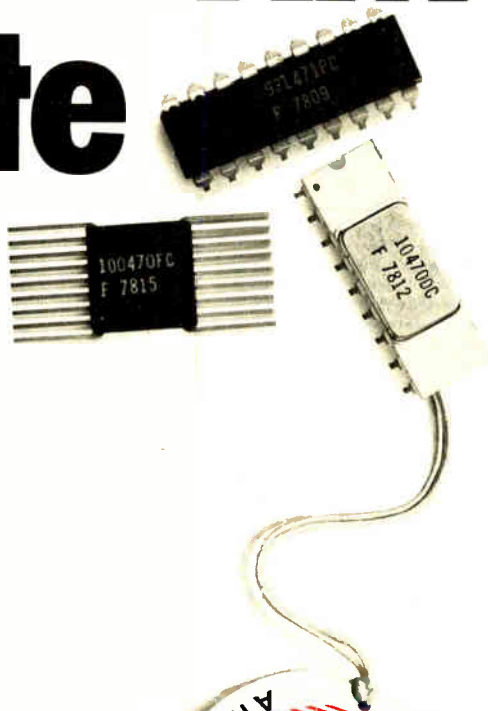

Fairchild's 4K static RAMs are the fastest ever made.

Nobody makes a 4K static RAM that's faster than ours. Nobody makes one that performs as well, either. And nobody can match our price. The reason is this: No other process technology in the industry is as advanced as our patented Walled Emitter Isoplanar process.

PART NUMBER	INPUT/OUTPUT	ACCESS & CYCLE	POWER DISSIPATION	STATUS
93470	TTL-OC	45 ns Max	650 mW Typ	Production
93L470	TTL-OC	45 ns Max	375 mW Typ	Samples
93471	TTL-3S	45 ns Max	650 mW Typ	Production
93L471	TTL-3S	45 ns Max	375 mW Typ	Samples
10470	ECL-10K	35 ns Max	800 mW Typ	Production
100470	ECL-100K	35 ns Max	800 mW Typ	Production

Our 4K static RAMs are organized 4096 x 1-bit and are available in 18-pin hermetic DIPs and flatpaks.

Data-out has the same polarity as data-in with full address decode accomplished on-chip. For easy memory expansion, there's a separate active-low chip select input.

And Fairchild 4K static RAMs are proven. Not only in laboratory tests, but in the real world of production runs. Using our

Isoplanar process which is years ahead of its time, we've already shipped millions of 1K RAMs. So our quality, reliability and ability to deliver is a matter of record.

You can't get any smaller.

Of all high-speed 4K static RAMs in production today, our die size is the smallest. By a full 20%.

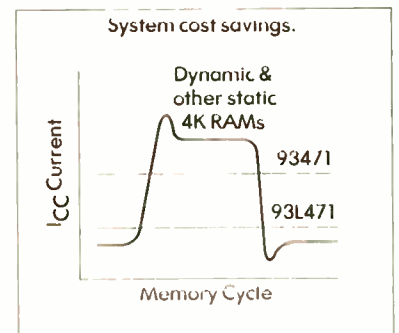
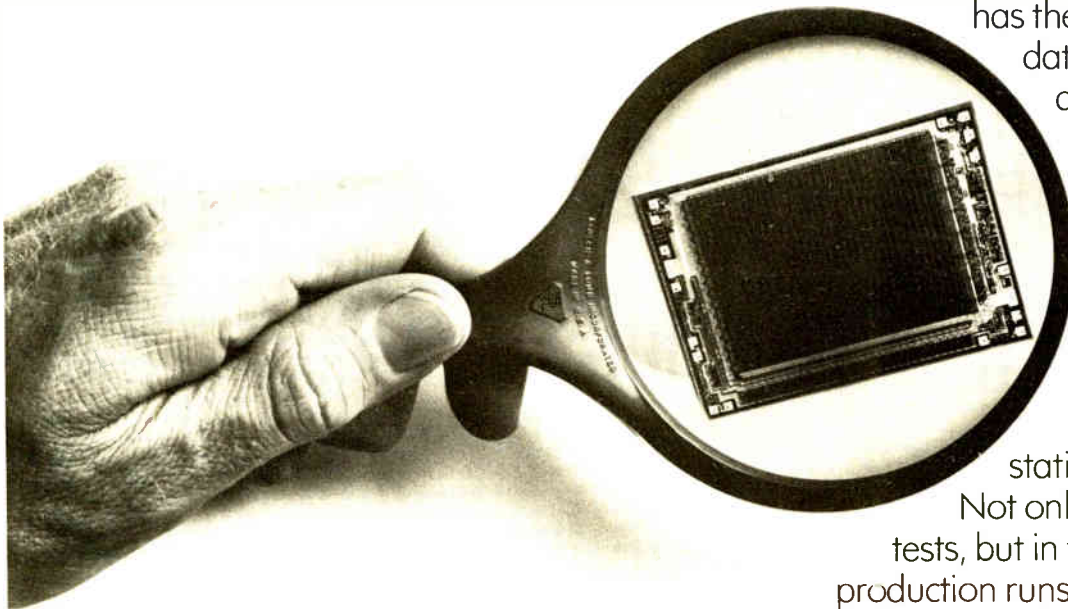

Which means easier producibility. And the easier they are to produce, the less they cost you. This makes it possible to get the high performance of a bipolar part on time and at the lowest possible cost.

And while Fairchild's 4K static RAMs feature low component cost, that's only part of the economy. They also make lower system costs possible. They don't require refresh logic and noncritical timing. And they don't need memory board capacitive decoupling like other 4K static RAMs that use automatic chip select power-down. This cuts system cost, and also means fewer parts and less board space.

Nobody has a better memory than we do.

We're the leaders in semiconductor memory. We pioneered bipolar memory technology by introducing the world's first commercial 1K bipolar memory in 1972. But we're not resting on past RAMs. We're dedicated to maintaining our position. That's why every year our

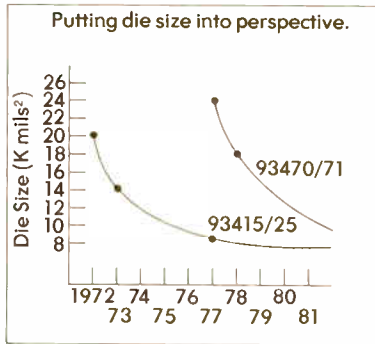

RAMs not only get faster, but smaller and less expensive, too.

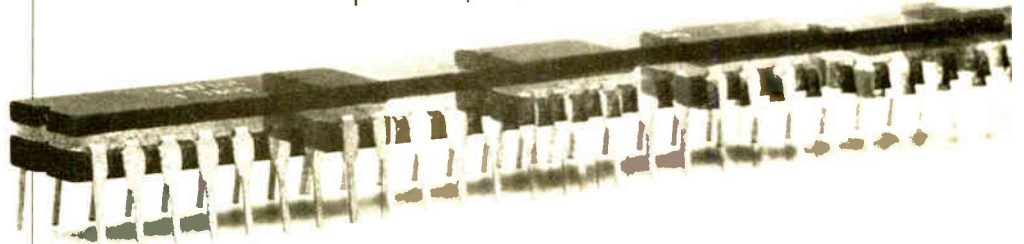
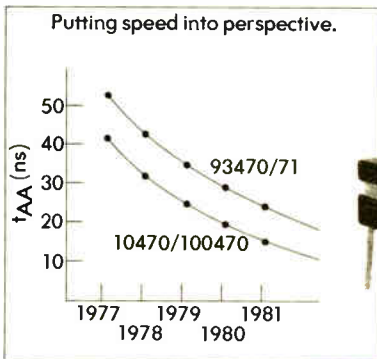

If you need military performance, our fully JAN certified production line is second to none. Radiation resistance is a built-in feature of the bipolar process. Just add "DMQB" to your order and get military temperature with hi-rel burn-in.

How to catch a fast RAM.

For more information on our 4K static RAMs, contact your Fairchild sales office, distributor or representative today. Or, use the direct line at the bottom of this ad to reach our VLSI Division. Fairchild Camera and Instrument Corporation, P.O. Box 880A, Mountain View, California 94042. Telephone: (415) 962-3941. TWX: 910-373-1227.

FAIRCHILD

**Call us on it.
(415) 962-3941**

Display accesses 7,000 characters of Kanji writing

Japanese system also offers other symbols, alphanumerics at cost low enough to make it attractive to many businesses

Japanese writing consists of thousands of ideographic characters based on Chinese. Thus the problem for designers of terminals and word processors is monumental: while 1,850 characters—which the Japanese call Kanji—is considered enough to write the straight prose section of newspapers and similar nontechnical publications, additional characters are needed for names of persons and places, special fields, or variant orthography. If that isn't enough, more than 100 phonetic syllabary characters plus about the same number for upper- and lower-case alphanumerics and symbols are also needed.

Now Fujitsu Ltd. has put on the market a display that permits its operator to access 7,000 separate

Kanji and other characters, each presented as a 32-by-32-dot matrix, at a comparatively low price. Commercially, such a machine should be a boon to Japanese government agencies and such businesses as financial institutions, insurance companies, and book and newspaper publishers. The financial people would be able to keep more precise records of customers (many Japanese names that are phonetically alike are written differently) and newspapers could use the display for editing.

Guidepost. But the system is perhaps more interesting as an indication of the state of the art in computer input in Japanese and of how close the Japanese are to word processors. The Fujitsu display is a giant step forward because early computers had difficulty adding just the Japanese syllabary (characters similar to the alphabet that represent whole syllables), and it seemed that mechanization of written Japanese in its natural form, including Kanji, as well as syllabary charac-

ters, was not in the cards.

The system is designed for as many as 16 individual cathode-ray-tube displays and can be connected to a variety of host computers ranging from Fujitsu's minicomputers through its largest mainframes. The heart of the system is a 1-megabyte disk with patterns for all characters. In large systems an optional 256-kilobyte random-access memory is loaded with the 2,048 most used characters, making it possible to access an average of 500 characters per second. The access rate for the disk alone is about 100 characters per second, which may make for queues in large systems.

The standard display has 21 lines of 32 characters each, whereas a special unit for newspaper editing has 25 lines of 32 characters each—both on 17-inch CRTs. In either case, characters measure 6 millimeters square. The operator works from a tablet with an electrostatically coupled pen; there are also 20 program-function keys and 20 display-control keys. The tablet shows a matrix of characters available, and the operator touches the pen to the character on the tablet to select it. In this respect, the tablet is similar to digitizers used to convert graphic information to digital input, but much rougher. One version has characters arranged as a matrix 64 wide by 48 high; another has a three-page tablet with 56 by 48 characters on each page.

Easy does it. Although this system permits interactive man-machine dialogue, it imposes virtually no load on the host computer. Editing functions, including character removal and insertion and interchange or

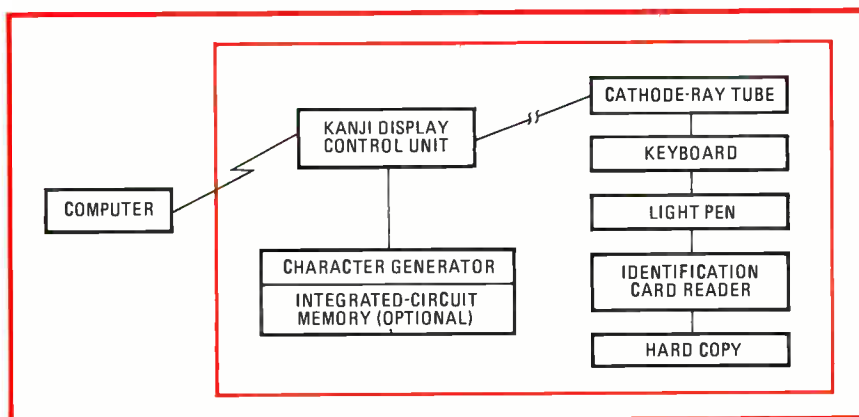

Getting the picture. A display system that can handle up to 16 CRTs has been developed by Fujitsu for the complex Kanji writing of Japan. The system accesses over 7,000 characters.

on target with
solid state
**REPAIR
COSTS!**

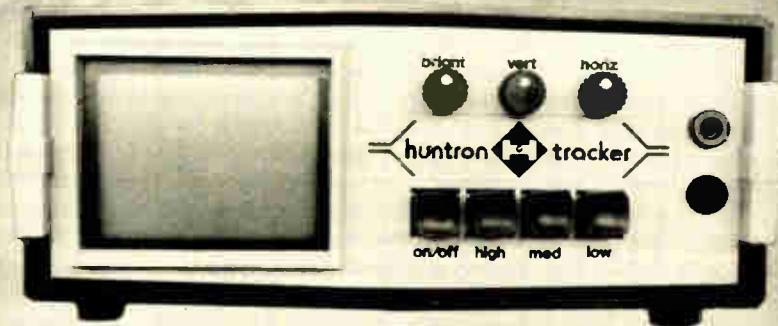

HUNTRON TRACKER

NOW! A SOLID STATE TEST INSTRUMENT THAT TESTS COMPONENTS IN THE CIRCUIT...WITH NO CIRCUIT POWER REQUIRED! This unique, patented test unit can help you get escalating service and repair costs back on target through time savings of 30...40...even 50%. Score a bullseye for COST-EFFECTIVE trouble shooting. Ask for a demonstration of the HUNTRON TRACKER and be ready for a surprise. This could be the most important purchase you've made since solid state arrived.

**HUNTRON
INSTRUMENTS**

exclusively by **HUNTRON SALES**
15123 Highway 99 North, Lynnwood,
Washington 98036 (206) 743-3171

CANADA

Cyprus Products, Inc.
7117 Tisdall Street
Vancouver, BC V6P 3N2
604-327-5663

ENGLAND

Texscan Instruments Ltd.
1 Northbridge Road
Berhamsted, Hertfordshire
04427 71138
Telex 8-2258

GERMANY

Texscan G.m.b.H.
Peschelanger 11
D-8000 Munchen 83
089-670 1048
Telex 5-22915

change of the position of portions of the text, are performed independently. It is also possible to access the computer and perform tabulation, headline and caption layout, and layout of boxes and the like.

The price in Japan for the basic system, including character generator, Kanji display control, and single

CRT display with tablet and keyboard console, is about \$3,000 per month for rental, \$125,000 for purchase. A similar system configured especially for newspaper editing sells for about \$135,000. Semiconductor character memory, ID card reader, hard-copy output, and up to 15 additional displays are extra. □

England

Microprocessor-based sound deadener cuts low-frequency noise up to 20 dB in tests

Although electronic amplification of sound may be accused of adding to the world's noise pollution, electronics may also come to the aid in the war against loud noises. A group of researchers at Essex University in England is testing an electronic "hush kit" that can deaden low-frequency sound—the noise element most difficult to combat with standard mechanical silencers—by as much as 20 decibels in a test arrangement simulating 200-to-300-horsepower diesel generators. Moreover, the Essex team contends that its still experimental technique could be extended to silence giant 2,000-hp diesel engines.

Comprising an amplifier-driven loudspeaker, a microprocessor-based sound synthesizer, a microphone, and a magnetic proximity transducer, the system produces a sound of the same magnitude and frequency as the noise source, only in reverse phase, so that the output generated cancels out the fundamental 1f components of the noise source.

"There's a nice trade-off between electrical and mechanical silencers at around the 250-hertz point," says Professor G. B. Chaplin, who is running the Essex project. "Above 250 Hz, conventional silencers are very effective, while our technique can silence the lowest exhaust frequencies."

The electronic silencer is not intended as a straight replacement for existing mechanical versions, according to Chaplin. Instead, it will open up new applications such as

kits for big standby diesel generators, railway locomotives, or earth-moving machinery. With further refinement, the technique could be used to quiet high-powered diesel truck engines.

Producing contra-sound to silence a noise source has technical difficulties. One problem is generating an accurate noise signature in the presence of both the polluting and the cancelling noises. However, the Essex researchers realized that diesel engines have a fundamental 1f noise signature that changes little from revolution to revolution. This fact enabled the developers to program a noise signature into the microprocessor-based sound synthesizer.

Quiet. In the experimental setup, the loudspeaker has an annular outlet surrounding the engine exhaust. The specially designed microphone picks up only the residual engine noise. In addition, the transducer senses the passage of engine flywheel gear teeth for computing revolutions per minute.

These sources provide input to a KIM 1 microprocessor board from Commodore Electronics, which divides the period for each revolution into 32 time slots. The microprocessor generates a noise signature synthetically by building a step wave of the engine sound, setting the noise level in each time slot to 1 of 32 levels. A noise signature for one complete revolution can thus be stored in a 256-bit random-access memory, which provides enough capacity for additional storage

should it be required. This information is fed to a digital-to-analog converter and then applied to the cancelling power-amplifier and loudspeaker combination.

The microprocessor in turn builds the cancelling sound wave progressively over several revolutions. First, level one in time slot one is set and its effect on the residual sound determined with the input from the microphone pickup and a linked sample-and-hold circuit. If the noise power is reduced, the level is retained; if it increases, the level is cleared. The sound level is built up step by step over several revolutions until the residual sound power is minimized. During subsequent revolutions, all 32 time slots are optimized.

The result is noticeable. Even on a small laboratory test rig using a 40-watt amplifier, 63-Hz noise is cut by 23 dB, and 125-Hz noise is cut by 18 dB. To silence a 2,000-hp engine would currently require a 1,000-w installation with speakers of present-day efficiencies, Chaplin says.

Refinements. At present, there is a 10-second delay before the cancelling noise signature can be synthesized over several revolutions. For standby engines running at constant speed it is not a problem. But for truck engines where rpm is constantly changing, the Essex team intends to refine the program by storing in read-only memory a noise signature for each engine-speed band. Each signature could be called as required and fine-tuned as described.

So far the Essex group has succeeded in demonstrating only the feasibility of the technique. Much work remains to be done, and additional financial backing must be found to produce a production prototype. In particular, a rugged, high-efficiency loudspeaker will be needed in a production version.

Refinements have already been built into the system, though. Initially, the microphone fed an analog sample-and-hold circuit, but now it feeds with a voltage-to-frequency circuit, the output of which is summed over a revolution and the count stored. A comparison is then

made with the count during the subsequent revolution and the lowest value between the two is retained.

In a parallel project, the Essex team is working with sound attenuators to deaden sound in heating

and ventilating ducts. In this case, the sound generated is random, but by recording at one point upstream in the duct and reinjecting the sound further downstream, it may be possible to adapt the silencer. □

Switzerland

Electronic control system follows the sun to help boost output of thermal collectors

Say "solar energy," and most electronics engineers will shout "photovoltaics." But there is more to the field, and more immediate returns at that. In the making is a substantial role for electronic control systems to boost the output of thermal collectors, an application of the sun's power that looks as if it will prevail over photovoltaics for some time.

A pioneer in this area is the Swiss firm Polisolar AG of Berne. Its hardware is based on paraboloidal mirrors that track the sun during the day. A sister company, Liebi LNC Ltd., took the equipment into the world market last year and has since done well: a \$1 million system to heat and cool a factory in Rome is under construction, and a \$500,000 pilot desalinization plant to supply 10,000 liters of drinking water daily

is slated for Jiddah, Saudi Arabia.

"The electronics for the tracking system run between 2% and 3% of the system cost," says Peter Ernst, a Polisolar engineer. Nonetheless, the automatic tracking is essential to the operation. The sun's radiation is absorbed in a tube centered on the focal line of each mirror. So, unless the mirror is pointed right at the sun, its radiation is not concentrated on the tube.

Efficient. With such concentration, the special black, star-shaped absorbers that Polisolar puts inside the tubes are much more efficient than comparable flat-plate collectors. They yield about twice as many kilocalories a day at 50°C outlet temperature for the carrier fluid. At outlet temperatures of 100°C, the yield becomes four or five times

better than for flat collectors.

Polisolar mounts its 320-by-58-centimeter mirrors in groups of 6 to 18 with a common rack-and-pinion drive for each group. Also tied into the drive is a fist-sized sensor that develops control signals for the drive motor, which has a 60-watt rating for a six-collector group.

Low profile. Convinced it has a head start on competitors, Polisolar will not talk much about its control circuitry. But Ernst does say that the sensor has two clusters of solar cells separated by a wall and connected in a Wheatstone bridge.

Unless the sensor unit is pointed straight at the sun, one cluster of its cells gets less radiation than the other. The difference in outputs upsets the Wheatstone bridge. Then the control circuitry produces an output about every 50 seconds, so that the motor drives the mirrors to point directly toward the sun. At that orientation, the output from the solar-cell clusters balances again.

Logic in the control circuit compensates for clouds and will defocus slightly if the temperature in the tube gets too high. After dark, when the sensors' output is nil, the system drives the mirrors all the way back to point fully east, waiting for the sun to rise. □

France

Naval monitor sorts targets

Navies today are almost as dependent on rapid data communications as they are on sophisticated weapons systems. However, like their civilian counterparts, naval data-collection and broadcasting systems have become more and more complex, and the sheer volume of output seems about to sink the fleets.

Typically, most data collection and processing of enemy vessels and aircraft positions is done on a command ship, which then retransmits the information to the smaller vessels that make up a combat unit. The trouble with this method is that

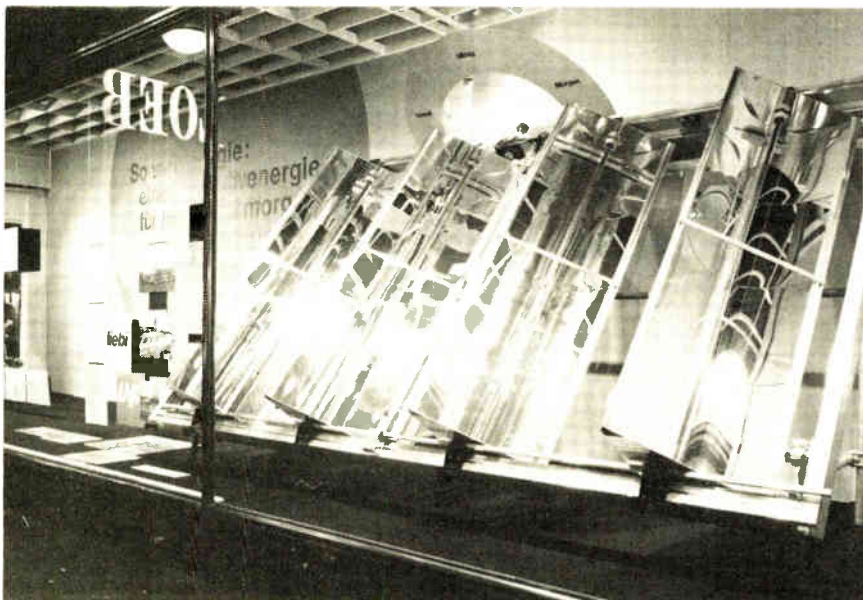

Hot time. Paraboloidal concentrating mirrors like the four shown have an electronic aiming system that relies on a photodetector sensor and a Wheatstone bridge for control signals.

often the smaller craft on the receiving end of the target-plotting information have no use for it because they are not directly involved. Thus, the many ships that make up a fleet are drowning in unwanted data, and more important, the information that is of use is difficult to sort because of the high volume.

A solution, says Georges Lauvray, sales director of ECA, a French firm based southwest of Paris, is to eliminate part of the information at the receiving-vessel end. "There is no way of processing the high-speed information that is available to the big ship collecting and sending the information," he says. "The answer is to set up criteria to select the information the receiving vessel needs and then present that information in a way the operator can use."

Monitoring. The ECA proposal is a semiautomatic system called Plotaid, costing about 10 times less than a fully automated system and suitable for vessels of approximately 1,500 to 2,000 tons. The Plotaid system is built around two units—a processor that monitors and selects relevant data and a large screen that displays the data using a novel laser approach. With the processor there is also a cathode-ray-tube display that gives additional details on the plotting data displayed on the screen. A teletype and a control panel complete the lineup.

The company is cagey about costs but intimates that the system could run less, perhaps significantly less, than \$326,000. Dimensions are roughly 180 by 150 by 15 centimeters for the display panel and 80 by 55 by 45 cm for the CRT and processing unit. Plotaid accepts data from any Link 14 data transmission, a widespread naval standard. It will also handle other formats given suitable software modifications.

The screen is made of yellow-green Perspex, an acrylic material, roughly 1 meter square. Its panel carries a double marking—X-Y axis lines and concentric circles. The helium-neon lasers that enable tracking data to be presented on the screen are situated close to the base of the panel on the sides. They are

oriented by a step-motor-driven set of cogs that control shutters and mirrors. When the lasers intersect within the panel, a bright point appears that can show, for example, the received position of a given target track. The servo system is of the semiclosed loop type, resetting to zero every 10 operations. There are three 2-milliwatt lasers, two for the plotting and one in reserve.

Programmable. The brains of the system is a Texas Instruments SBP 9900 16-bit microprocessor. The processor has a 2-kilobit 16-bit-word random-access memory to hold incoming tracking data and a 6-kilobit 16-bit-word read-only memory that holds the program. The processing unit receives incoming data from a Link 14 modem, plus information on speed and course from the vessel carrying the Plotaid unit.

Software is split into two parts that correspond in effect to an operating system and an application program. The latter carries out the selection of the information required by the carrying vessel.

Apart from the Perspex display and the processing unit, Plotaid also offers a conventional militarized teletype—a French Sagem unit is supplied, but any CCITT-2 standard international alphabet, five-moment, 75-baud unit would do. Completing the information display is the CIP, or complementary information panel. This unit is a CRT that can display a host of details, including the time, the number of tracks waiting but not yet processed, the number of tracks selected altogether, the scale of the display, and the course and speed of the carrying vessel. Also, for each track displayed on the Perspex screen, the CIP shows whether it is new; the time the data has been computed; the bearing, distance, altitude, and speed; and the identification of the tracked object (whether it is friend or foe).

The system is designed for easy operation. It displays a track automatically, holding the laser position for a preset interval. Then the shutters cut in until the operator calls for either a repeat of the last track or the display of the next selected track.

Lauvray believes that the system has other applications—for example, it could be land-based rather than aboard ship. But for the near future at least, ECA is concentrating on selling the naval version. □

Japan

Hybrid IC packs mobile components

Taking advantage of a new technique for producing uncased transistor chips for hybrid circuits, Mitsubishi Electric Corp. has just developed a series of hybrids that includes a majority of the components for the driver and output stages of mobile communications equipment. The single plastic-molded package, which measures 66 by 23.5 by 9.8 millimeters, is 20% to 30% smaller than the discrete circuits it replaces. It comes with either four or five leads arranged in a line along one side.

Wideband tuned circuits on thick film that require no adjustment are included in the package so that an equipment manufacturer need only supply a fractional-watt frequency-modulated signal source, a power supply (with decoupling), a 50-ohm strip line connected to a filter circuit and an antenna. The integrated circuits are aimed at mobile communications transmitters in the 150- and 400-megahertz bands.

New chip transistors developed for the hybrid circuits feature high-precision patterns with ion-implanted narrow base and shallow emitter for higher F_T . As a result, gain is typically 3 to 4 decibels higher than for discrete transistors. The new transistors have multilayer metalization with precious metals, including a top layer of gold for high reliability. The driver transistor chip (two in a cascade for 400-MHz-band units) is mounted on the ceramic hybrid-circuit substrate; the output transistor chip is mounted on a beryllia carrier that is attached directly to a copper heat sink that forms the bottom of the plastic molded package. □



How Intel's new CODEC takes the risk out of changing.

Imagine an electronic component smaller than your fingernail that can single-handedly convert the human voice to digital data—and simultaneously convert incoming digital data back into voice. That's Intel's coder/decoder—CODEC. Here's why it's sure to accelerate the telecommunications industry's changeover to an all digital network.



Proven performance

Telecommunications' reliance on Intel products began in 1970, with our semiconductor memory products. Since 1974, our microprocessors have found ever-broadening applications in telecommunications. Today we're a major supplier of both memory and microprocessors for the telecommunications industry.

Now you can depend on Intel for the industry's most advanced CODEC. Don't get caught having to change suppliers, technology or system design in the middle of the stream. Our new CODEC uses the same NMOS process we use to manufacture tens of millions of microprocessors and memory components every year. NMOS is the key to our CODEC's reliability, mass producibility and single chip design, too.

Worldwide compatibility

We designed our CODEC to rigidly adhere to the industry's accepted standards. Our 2910 PCM Codec conforms to North America's μ 255 law. Our 2911 version follows the inter-

national A Law standard. Both versions operate at standard digital systems voltages. And both versions provide maximum flexibility, so you can design your products to be directly compatible with the world's evolving digital network.

A technological breakthrough

Combining code and decode functions on one chip was the technological breakthrough necessary to cut system size, assembly time, component cost and to make wide-scale implementation of CODECs feasible.

We've gone even further, with built-in voltage reference to eliminate costly, precision external components. And we designed in on-chip computation of TDM time slots, to simplify interfacing several CODECs with a controlling microprocessor.

If you're designing central office switching systems, key telephone systems, PABX, remote concentrators, channel banks, automatic call distribution systems, or need A/D-D/A conversion in data acquisition, signal processing or telemetry applications, you can depend on Intel's new CODEC.

Both 2910 and 2911 CODECs are in production now. For more information, call us at (408) 984-0610. Or write Intel, 3065 Bowers Avenue, Santa Clara, CA 95051.

intel® delivers.

Circle 73 on reader service card



How Fairchild Takes the Thorns out of LSI Testing.

Choosing the right LSI test system is tough. There are many things to consider, and one of the most important is customer support. Here's how Fairchild makes the difference. Whether you buy our Sentry general purpose LSI tester or our Xincom memory test system, we'll back you with the largest and most professional service and support team in the industry.

Applications Engineering. Our team of applications specialists will program our systems to give you all the information you need about how to test your device. Whether you buy a system or not. If you do buy, all that information and programming are yours.

A world of training. Even the best system is only as good as the people who run it. To make sure your people know everything they have to about LSI testing, we've built the largest and most comprehensive training center in the world. With every Sentry or Xincom system, you're covered with course credits. Even before your system is installed, your people will learn operation and maintenance, basic programming and assembly language. They can also take special courses in programming and advanced LSI testing techniques. And they'll get all the hands-on training they'll need in our test lab.

On-site preparation. While your people are training at one of our centers in the U.S., Europe or Asia, our engineers are at your plant helping you get ready for delivery. Our product specialists help you find the best locations for your system. They make sure all your device programs have been checked out. And they make sure your system gets up and running fast.

Service is our specialty. No matter where you are, we've got you covered. More than 100 field engineers around the world assure fast response whenever you need help. You can choose from a variety of service con-

tracts. One gives you complete calibration and servicing, free parts replacement and a guarantee to be there within 24 hours. Another provides a spare parts kit that offers even faster turnaround. And if your operation needs it, we can provide a resident service or applications engineer.

We won't let you forget. If you need additional or special training, we can help. Our programmed learning center offers video tapes, audio cassettes and special workbooks. On-site courses can also be arranged. Nearly a hundred application notes are available to help you solve almost any LSI testing problem. There's even a User's Club, which gives you a chance to exchange programs and experiences with others in your field.

There's more. Whether you choose Sentry or Xincom, we'll make sure you don't get stuck. We'll help get rid of the thorns all along the way. Before, during and after your system arrives.

Find out more about Fairchild's total support program. Mail the coupon today. Or contact: Fairchild Systems Technology, 1725 Technology Drive, San Jose, CA. 95110 (408) 998-0123

Fairchild: First in LSI testing

Please have a representative call.

Send your Total Support brochure.

My test needs include _____

Name _____

Title _____

Company _____

Address _____

City/State/Zip _____

Area Code () Phone _____



FAIRCHILD



Sperry Univac minis are doing

In Portland, Oregon, Sperry Univac minis help the Police Bureau come to the rescue hundreds of times a day.

Because Boeing Computer Services has computerized all of Portland's emergency services with Sperry Univac Series 77 minis.

Now when a citizen reports a crime, our minis verify the address. Examine the surrounding area for similar calls, hazards, and temporary situations (such as streets under repair). And suggest which units should respond to the call.

This futuristic system coordinates dispatchers and officers and keeps them con-

stantly updated. Much of the paperwork required of field officers is eliminated. And the data base it generates is used for uniform crime reporting and resource allocation.

Boeing Computer Services has found that our minis are cost effective and can handle the job efficiently and with real-time speed.

The Sperry Univac minis used in Portland are just part of our complete family of minis. One and all of them are supported by our powerful software.

If you have a system application, we undoubtedly have a mini that's just right for it. Whether it be business data process-

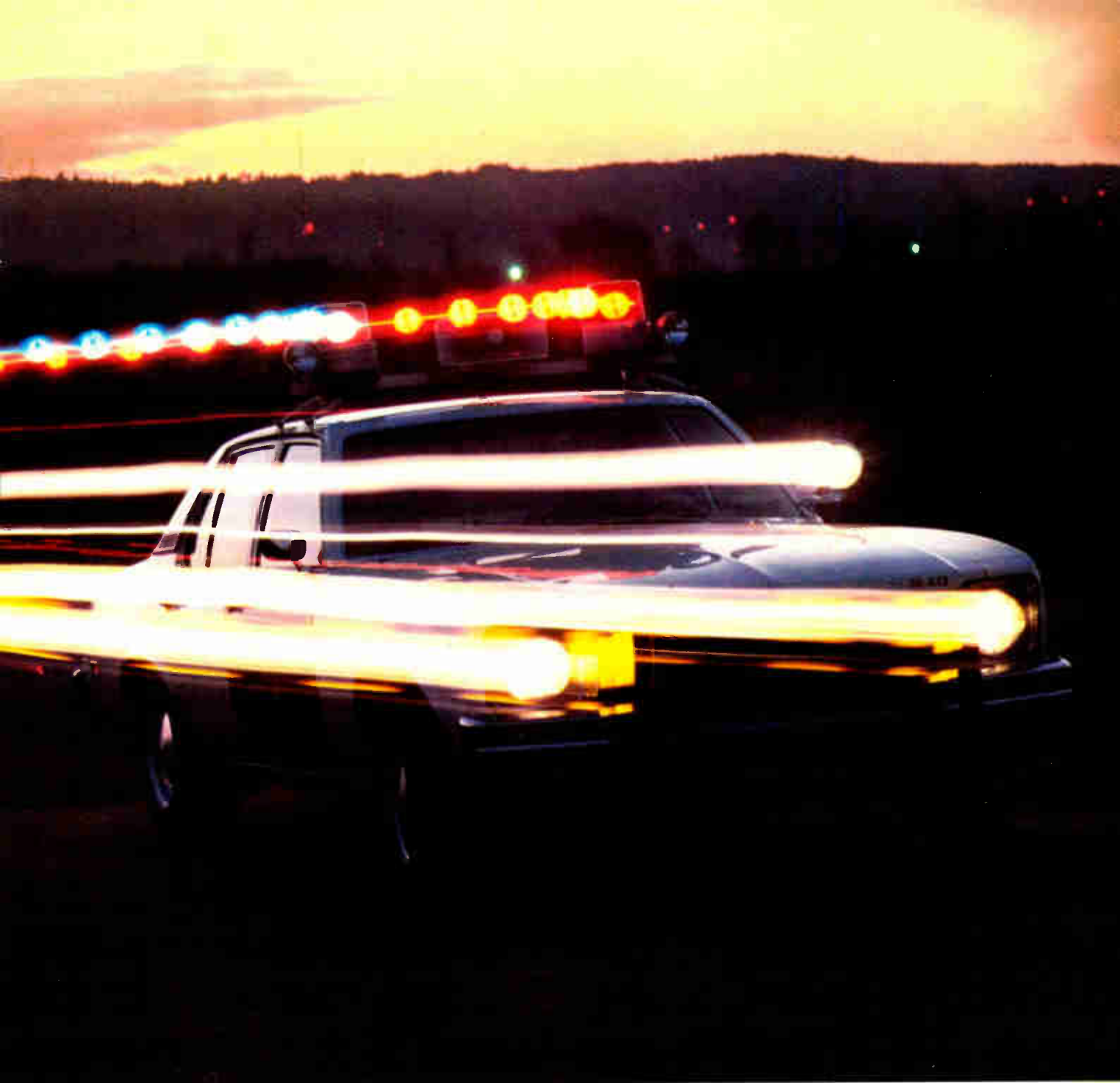

alarming things in Portland.

ing, scientific, instrument control, or data communications.

For more information, write to us at Sperry Univac Mini-Computer Operations, 2722 Michelson Drive, Irvine, California 92713. Or call (714) 833-2400.

In Europe, write Headquarters, Mini-Computer Operations, London NW10 8LS, England.

We'd like to hear from you. Even if your system application isn't as arresting as the one in Portland.

Circle 77 on reader service card



SPERRY  **UNIVAC**
SPERRY UNIVAC IS A DIVISION OF
SPERRY RAND CORPORATION

Design your smart product fast.

1 Start your microprocessor-based product with HP's 2649A.

It's an 8080 MPU, CRT, display subsystem, power supply and 15-slot backplane, all in a good-looking case.

You choose the RAM, PROM, ROM, serial or parallel I/O, dual cartridge tape drives or keyboard you need for your product.

Then take advantage of our standard firmware, including utility subroutines for data display manipulation, keyboard switch translation, data transfer and

communications protocol. It's software you don't have to write and debug.

2 Study our documentation to understand the 2649A.

Our 2649A hardware and firmware documentation was written by engineers who know the 2649A inside and out. Because they designed it.

For easy reference, its 1,800 pages are organized in two volumes like an encyclopedia. So, for example, if you need the pin assignments for our keyboard interface module, it's easy to look up. And you'll find the details in the words of the engineer who designed it.

The more you know about our product, the less time you'll spend on yours.



3 Write, assemble and debug your software on the 13290B Development Terminal.

The 13290B has a source program editor so you can quickly write 8080 assembly language programs. A resident assembler to convert source programs into 8080 object code. 64K bytes of RAM as a test bed for your software. And a friendly, interactive debug program that lets you watch your program run step by step, in mnemonics, not ones and zeroes.

And because the 13290B is a 2649A, your program runs in your product's environment, which is a big help if timing or execution speeds are important.

It's probably the only development tool you'll need.



4 Get hands-on experience at our 2649A workshop.

Monday morning we'll ask you about your product. Then we'll spend five days showing you how to use the 2649A, 13290B and documentation to make it.

Of course, in just five days you probably won't be able to design your product completely. But by Friday night you'll have a good head start.

5 Send us this coupon.

We'll tell you more about how HP's 2649A OEM Support Program will help you design your smart product fast.

Name _____ Title _____
Company _____
Address _____
City/State/Zip _____ Phone _____
My smart product is _____



Mail to: Hewlett-Packard, Attn: Ed Hayes, Marketing Manager,
Data Terminals Division, Dept. 626,
19400 Homestead Road, Cupertino CA 95014.

Teradyne finds the practical solution.
No. 6 in a series.

Daisy-chain backplane fixturing

Working wonders with a few wires and a few volts.

Testing backplanes for wiring errors should not be a very big deal. After all, the technology of finding opens and shorts is not the kind of thing you write your doctoral thesis on. Yet, until a few years ago, any backplane with a few thousand points or more was sure to represent hours, if not days, of testing time.

Well, not testing time, really. The problem was less the testing than the getting ready for the testing. Since one wire had to be connected from each backplane point to the tester, preparing a 10,000-point backplane for testing was a fearsome job in its own right. In fact, with a wire-per-point system the tester-to-backplane connections were often less reliable than the backplane wiring, and a whole new round of verification was necessary. The backplane testing was then performed via banks of clattering relays whose own reliability was less than gilt-edged. Clearly, to call this "automatic testing" was to abuse the language. But at the time there were no alternatives.

Teradyne, which had backplanes of its own to test, refused to accept wire-per-point connection and set about to find a better solution. The result was the "daisy-chain" approach now generally conceded to be the only way to test backplanes.

The idea behind daisy-chaining is to distribute a portion of the test electronics onto the backplane itself, via "fixture cards" inserted into the backplane's card-edge connectors. Then, through a combination of serial and parallel addressing, the system can access any pin connected to any fixture card for testing. The fixture cards are linked, daisy-chain fashion, by a quarter-inch cable carrying 14 leads. At each end of the daisy-chain the cable connects to the test system. That's the *only* connection to the system required, whether the backplane has 100 points or 100,000. One does have to plug in those fixture cards, but compared with wire-

per-point connection this is a trifle. (Besides, with two sets of fixture cards one can set up one backplane while another is being tested.)

Since four switches per point are required to carry off the multiplexing, the game is played in solid-state. But not just any solid-state. Turning 400,000 T²L switches loose on a 100,000-point backplane is a sure way to vaporize everything in sight. So the switches were designed in custom CMOS, where they run on a cool 350 milliwatts.

As the length of the daisy-chain varies with the size of the backplane and the number of fixture cards, the daisy-chain capacitance varies as well, and it was therefore necessary to design the system so that timing would be independent of daisy-chain length. Teradyne accomplishes this via a "handshaking" technique that ensures that each step is complete before the next is initiated.

The use of low voltage to test backplanes was initially taken for heresy by a world conditioned to define continuity in terms of what would pass 500 volts. However, where the idea is to find *wiring errors*, 10 volts proves to be just as effective as 500. The case for high-voltage testing rests chiefly on its use to predict insulation cut-through, but even here it's a shaky case at best, for the time window during which breakdown will occur at 500 volts and not at 10 is likely to be statistically insignificant.

Backplane errors are generally the least forgiving of all; a single missed connection can cripple an entire system. Yet many manufacturers sample-test their backplanes or bypass testing altogether until final system checkout. In the days when backplane testing presented a horrendous accessing problem, this may have been understandable. But not now. Testing backplanes today is as easy as picking daisies.

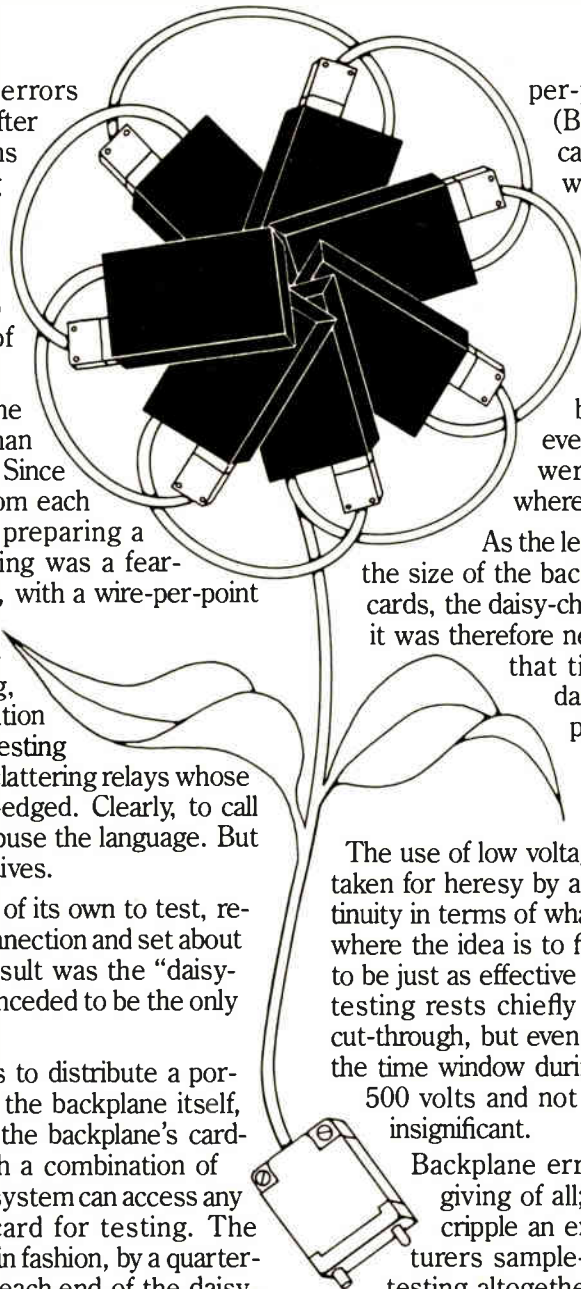

TERADYNE

New firms rush into new phone market

Consumer instruments with features based on latest electronic technology are starting to compete for pieces of \$170 million annual pie

by Bruce LeBoss, New York bureau manager

Don't look now, but the next consumer electronics market might well be the telephone. A host of companies is developing, producing, and marketing electronic telephones and their integrated circuits. Not only are the phones a new generation of equipment that relies heavily on advanced electronics to provide special features and functions, but many of the suppliers are members of a new breed that expects to give established firms a run for their money—in this case, a market estimated at \$170 million annually.

The competition and the companies might not exist were it not for a Supreme Court ruling nine months ago. The court tumbled the barriers to the home phone market by upholding a Federal Communications Commission ruling that permits consumers to attach their own phone equipment to the public network. Now the flood gate is open.

New models. Typical of the new firms is Tridar, which introduced its model S101 electronic phone at last month's Summer Consumer Electronics Show in Chicago [*Electronics*, June 22, p. 40].

The S101 has 90 electronic components, including four standard integrated circuits and three custom bipolar linear chips that perform preamplification, peak detection, and comparator functions. Hans R. Camenzind, who is Tridar's chairman and director of research and development, says the entire phone measures about 2 by 1.5 by 6 inches and weighs about an ounce less than the handpiece of a home phone. "This is possible because of the integrated-circuit design," says Alan V. Gregory, president of the firm.

The instrument may be used as an amplified speaker phone or as a conventional unit. It has volume control and a hold button with a light-emitting-diode indicator. Priced at the middle of the new market, the \$149.95 S101 plugs into any modular jack and is equipped for push-button service.

Founders. Among Tridar's founders are Camenzind, former chairman and founder of Interdesign Inc., recently acquired by Ferranti Ltd.; Gregory, former Fairchild Semiconductor vice president in charge of the metal-oxide-semiconductor division; and A. Crawford Cooley, a venture capitalist and former board member of Interdesign.

Camenzind says the consumer telephone market has three segments: rotary-dialer or push-button units that basically offer the same functions and styles as the current models from the telephone companies, decorator phones with the same standard functions, and what he describes as new-features phones.

"The special-features area is where the action is and where there is room for technology," he says. However, "the initiative for this won't come from the semiconductor manufacturers, but from small telephone- and technology-oriented companies that can apply the appropriate microelectronics."

Some of the bigger, traditional suppliers "may have difficulty in getting the entrepreneurial spirit" to develop these phones. (Not that Ma Bell would agree: see "Waiting for Bell to drop the other shoe," p. 82.) What's more, he adds, the circuitry and acoustic engineering call for technology to which the semiconduc-

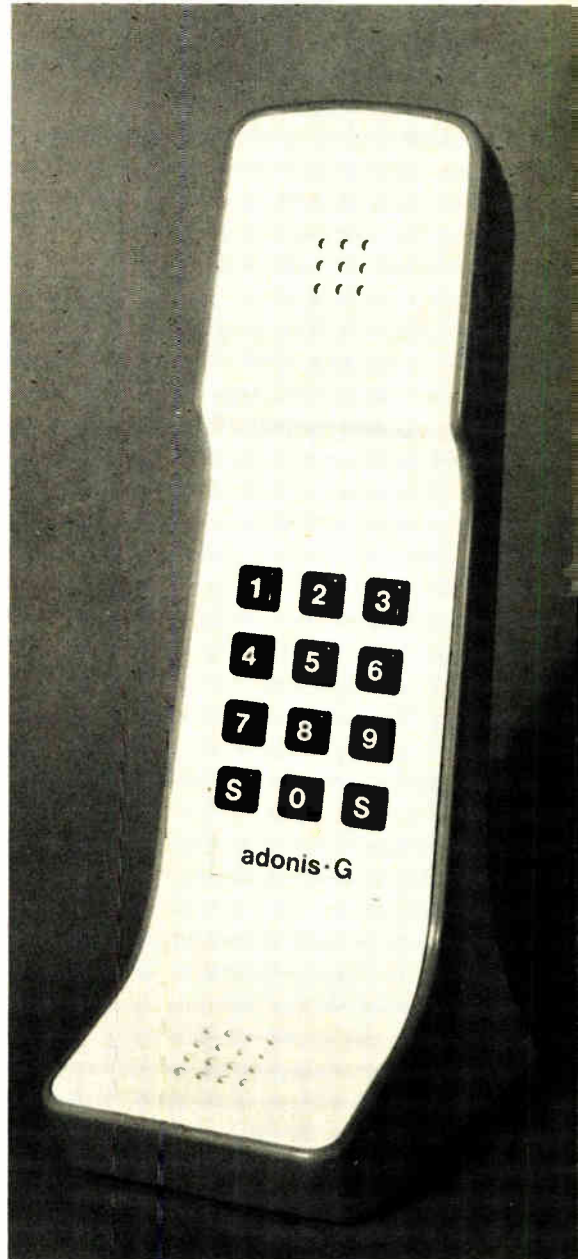

Fancy talk. Adonis-G from Allied Telecommunication sells for \$129 and stores last number called for automatic redialing.

Probing the news

tor industry is not accustomed.

Another newly formed company with ambitious ideas and some familiar names is Telecomputer Corp. of Opelika, Ala. Its market thrust is toward "telephone-oriented products and microprocessor-based telecommunications for the home and office," says W. Roland Matthews, vice president.

Last month the firm took the wraps off the TC 3200 Touch 'n' Talk, which has a 32-number memory dialer that can handle up to 16 digits per phone number. The unit is based on a custom 8-bit microprocessor manufactured by Intel using software and programming code developed by Telecomputer. The \$189.50 phone has tone- and pulse-dialing capability, emergency dialing capability, and a speaker unit. Housed in an 8.5-by-6-by-2.5-in. package, it is slated to be available in early August.

Genealogy. The firm is an offshoot of Magnetic Electronics Corp. of Opelika, a sister company with a common majority ownership and common founder and board chairman—John H. Orr. In addition to Orr and Matthews, who most recently was a vice president at Magnetic Electronics, the management team includes Doyce Beard, president.

Orr is recognized as a pioneer in the magnetic-tape-recording industry and is credited with bringing the tape formula to the United States after World War II. He formed Orradio Industries in Opelika, which now is Ampex Corp.'s Magnetic

Tape division. Beard spent 10 years with Ampex and five with Orrox, a sister firm that makes computerized tape-editing equipment.

By no means a newcomer to the consumer phone market is Allied Telecommunication Equipment Co. of New York, which is now taking orders for its first all-electronic telephone. Its unit, Adonis-G, has two custom ICs, one for voice and one for tone ringing, and has some 120 fewer parts than standard push-button phones. It is manufactured for Allied by Gfeller Telecommunications of Switzerland. The one-piece unit, which will be available in September at \$129, includes a silence button to make sure off-phone conversations stay confidential while keeping the line open to an outside party, and a memory circuit that stores the last number called for subsequent automatic redialing.

A unit of Metropolitan Interconnect Telecommunications Inc., Allied's management has been drawn from AT&T, as well as from independent interconnection companies and others that are involved in the design and technical aspects of telecommunications.

Familiar. Some of the established companies looking into the infant market include familiar names in the semiconductor industry. Among them is Fairchild Camera and Instrument Corp. of Mountain View, Calif., which has developed a dialer that has been privately shown to dealers to get their response. There are two versions: one stores 24 numbers, the other 40. Each has two memory chips that perform the first-digit store and scanning.

Before making a plunge into the consumer telephone market, Fairchild is reviewing its potential roles as a supplier of both components and end products, says John Donatoni, marketing director for the firm's Video Products division and the man who is overseeing the telephone project. "From an end-product standpoint, the decision on whether or not to enter the field has been put off until 1979," he says.

Other semiconductor makers see their role as a supplier of chips for the electronic telephones. One firm, General Instrument Corp.'s Microelectronics group in Hicksville, N. Y., has developed the TZ 2000 family of multifunction telephone controllers, based on its 1650 single-chip microcomputer.

The initial TZ 2001 controller converts push-button dialing to a pulse output, displays 12 dialed digits, stores 32 telephone numbers, and has a six-digit real-time clock and elapsed-time indicator, as well as provision for a five-function calculator. "Our products will be geared toward the special-features market," says Ron Hlavinka, GI's manager of telecommunications marketing. "The standard functions that are out there now aren't the only ones the consumer wants."

Meanwhile, the traditional telephone equipment suppliers are not standing still. GTE Automatic Electric Inc.'s Consumer Products division in Northlake, Ill., took the wraps off a miniature electronic phone, called Flip Phone, at the Chicago show and showed prototypes of two other electronic phones.

Other traditional suppliers, such as Stromberg-Carlson Corp. in Sanford, Fla., and International Telephone and Telegraph Corp.'s Consumer Specialty Products division in Clark, N. J., are showing interest in the GI devices. Additionally, Northern Telecom Inc.'s Advanced Telephone Products division in Nashville, Tenn., plans to introduce its first electronic telephone around the first of the year. According to division president Richard W. Lindsay, "Our phone won't just be an electronic replacement for the standard telephone; we'll add features that enhance others that are traditional telecommunications." □

Waiting for Bell to drop the other shoe

All this activity and optimism are fine, but the big question for the fledgling electronic home-phone industry remains: What is the Bell System doing?

A spokesman for Western Electric Co., American Telephone & Telegraph's manufacturing and supply arm, notes that the firm employs solid-state technology in three business phones, but declines to comment on efforts in the consumer area. However, he adds, "Bell Laboratories, in cooperation with Western Electric, has been working on the development of new electronic telephones for some time. Research is continuing and we expect to actively apply solid-state technology to other types of phones."

He characterizes the research-and-development effort as intense, but declines to say when the first fruits of that effort will be harvested. Nonetheless, industry observers believe Bell's first features-oriented electronic phone for the consumer market will make its debut next year.



Has your power supply vendor left you high & dry?

If you're involved in a program to replace a power supply that is no longer available or your previous supplier is no longer around or can't deliver, Powercube standard modular power circuits may be the answer.

Used for over a decade by contractors for major military and space programs, these proven 1" x 1" x 2" Cirkitblock® modules meet the toughest specs for size, weight, performance and environment.

We can optimize your design and save you money without getting bogged down in component selection, vendor delays or interface problems. Most Cirkitblock preregulators, power generators and output modules are available off the shelf.

Call the quick action company 617-891-1830 or circle the reader response number.



POWERCUBE® CORPORATION

214 CALVARY STREET, WALTHAM, MASS. 02154 (617) 891-1830
SUBSIDIARY OF UNITRODE CORPORATION

Digital's \$141,000 VAX vs. a multi-million dollar CDC 7600.



VAX wins two out of three.

Round one to the 7600: Speed.

The 7600 is still the speed king of the world with 9100 Whetstones per second.

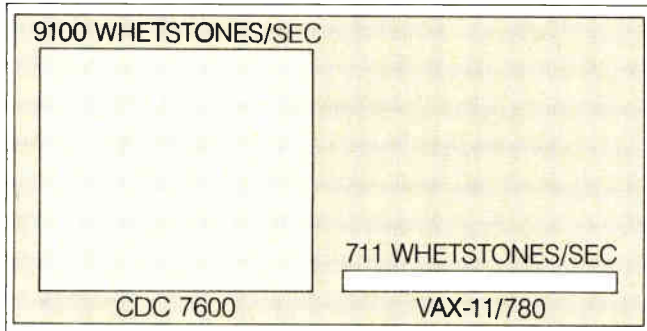

Round two to VAX: Price/

Performance. The 32 bit VAX is the world's fastest mini. A \$141,000 VAX system runs 711 double precision Whetstones. That's one twelfth the speed — at one twenty-fifth the cost. A dozen VAX systems could equal the throughput of one 7600 — and you'd still save literally millions of dollars.

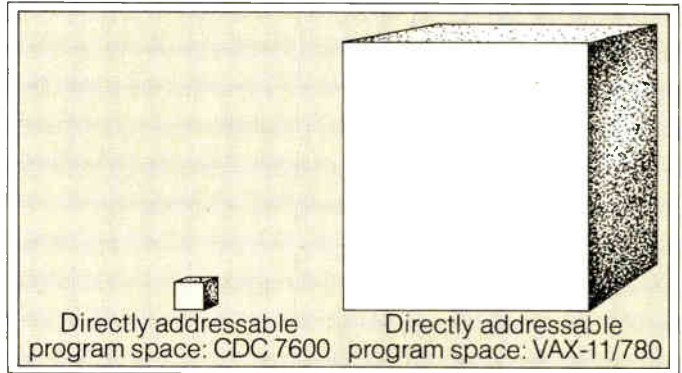
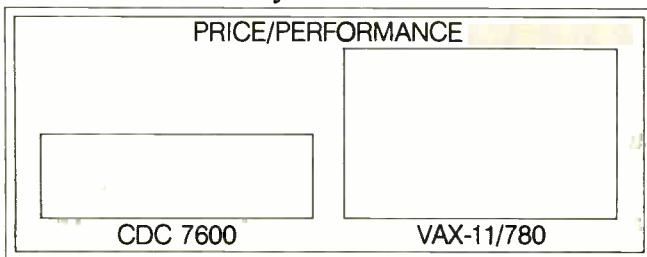

Round three to VAX: Program

size. Virtual addressing and a gigantic 32 bit address size, compared to the 18 bit address size of the CDC 7600, allows VAX a directly addressable program size that is — are you ready? — 1000 times larger than the CDC 7600.

Get the VAX facts: Get main-frame FORTRAN performance without waiting in a batch queue — or paying batch prices. If you have an application in aerospace computation, signal processing, simulation, educational computing, industrial automation, or any other big FORTRAN job, get the VAX facts today. Write for your copy of the VAX-11/780 brochure and complete technical summary.

Digital Equipment Corporation, PK3-2/M18, 129 Parker St., Maynard, MA 01754. European headquarters: 12, av. des Morgines, 1213 Petit-Lancy/Geneva. In Canada: Digital Equipment of Canada, Ltd.



Digital Equipment Corporation, PK3-2/M18, 129 Parker St., Maynard, MA 01754

Name _____
 Title _____
 Company _____
 Address _____
 City _____ State _____ Zip _____

VAX PRICES APPLY IN U.S. ONLY.

E768

Electronics abroad

E-beam could be the key

British apparently base plans for new memory company on native expertise in advanced wafer-making technology

by Kevin Smith, London bureau manager

There have been howls of outrage from some in the British semiconductor industry, and there has been skepticism about the possibility of luring British designers working in key Silicon Valley jobs back to the homeland. But as the shape of the United Kingdom's bold plan to enter the random-access-memory race by starting a new company becomes a bit clearer, the move appears to be a shrewd and well-thought-out one.

The National Enterprise Board's idea is to jump into the RAM business at the 64-K level by investing \$60 million to \$100 million in a new plant in the north of England plus a U. S. operation for marketing and possibly testing. Masterminding the scheme is Richard L. Petritz, president of New Business Resources in Dallas and a former research-and-development director at Texas Instruments Inc.

Hard facts about the scheme are difficult to come by. However, it is believed that Petritz proposes to build the company around six key engineers, preferably British, now working in the U. S. semiconductor industry. Each would chip in \$200,000 with the right to purchase up to 5% of the company—tentatively named K-MOS—at a nominal price.

There is also evidence that Petritz' proposal centers around leapfrogging Japanese and U. S. companies by going directly to electron-beam technology to manufacture the preci-

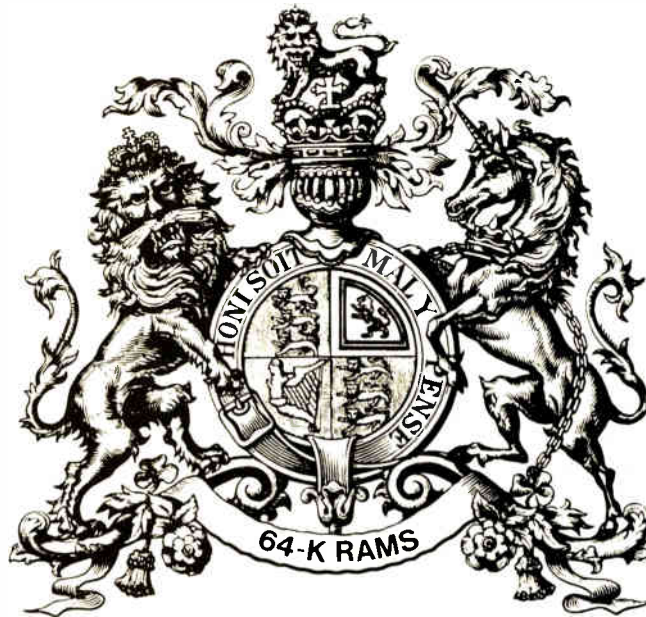

sion masks required, significantly an area in which British companies and engineers have a recognized expertise.

What's more, the proposal comes at a time when conventional mask-making techniques are reaching their theoretical resolution limitations: line widths of 2 to 4 micrometers. "You can just about make a 64-K RAM mask with conventional optical techniques" says Ian Crutwell, general manager of Cambridge Scientific Instruments Ltd.'s electron-beam program, "but it's a lot easier with electron-beam technology, and it's my view that it will be essential for the next generation of 256-K RAMS."

"Because the electron beam is driven by computer from the basic design tapes, reticle manufacture is cut from weeks to hours," he says.

And as an added advantage, the flexibility of the process means that different mask reticles can be incorporated on the same 4-inch-diameter master wafer by changing the electron-beam program after each mechanical step." This can further speed the design process, a factor that could be crucial, since the company has no plans to license a process or a mask design, according to industry reports.

"There're two ways you can go for 256-K parts," Crutwell continues. "You can paint with the electron beam directly onto the wafer, or you can produce electron-beam reticles and

get around the diffraction effect, which tends to blur the image, by going to X-ray illumination with its wavelength 100 times shorter."

He believes that the direct electron-beam technique is the way to go. But no matter what route wins, it is certain that a company in the leading edge of the memory market must have expertise in electron-beam technology.

Using muscle. The plan also fits some known British strengths. In addition to having supplied Japan's very-large-scale-integration program, the Cambridge group this month delivers the first of three electron-beam machines under the Department of Industry's electron-beam program to the British General Electric Co.'s Hirst Research Laboratories. One initial application for it at Hirst will be to manufacture 625-

Pros and cons

Reaction in Great Britain to the government's plan to spend up to \$100 million on a new random-access-memory company has been intense from politicians, industry, and the unions. Initial anger was expressed by Jack Akerman, managing director of Mullard Ltd., over the amount of money involved. On the other hand, Derek Roberts, managing director of Plessey Microsystems, is an ardent advocate of the scheme. He says that, given the right team, the money and the idea are right.

Now, the National Economic Development Office, a body with representation from industry and labor that has not yet seen the detailed proposal, has issued a preliminary report that doesn't condemn the scheme but warns, however, that "it would have to be seen as a long-range option with success evaluated over a five-to-seven-year program. It would require a particularly imaginative and astute plan, with wholehearted government backing to have any chance of success. It would have to concentrate on a few selected items, perhaps memories and microprocessors, where it would be confident of achieving a significant and profitable share of world markets. It would have to attract a particularly talented team of engineers and marketing staff. There are very few such people in Britain and not many throughout the world." Interestingly, Akerman is a member of NEDO, heads a subcommittee and was a member of the working committee on the plan.

line precision masks for GEC's charge-coupled-device imager [*Electronics*, June 22, p. 63].

So the company probably will be built around advanced electron-beam and ion-implantation technologies. But equally important is the blending for the very first time of an entirely new ingredient in the British microelectronics scene made up of talent and old-fashioned entrepreneurial capitalism, an irony that cannot be lost on the UK's Labour government. In fact, some of the industry anger that greeted the news was based on the belief that the cash could be better used to bolster established companies.

Commenting on the availability of the right talent, Ian Mackintosh, president of Mackintosh Consultants Co., says, "When you have traveled around the U. S. semiconductor industry as much as I have, you begin to realize how many UK engineers have key positions in the U. S. industry." He is convinced that the ingredients are right this time—in fact, his company did a study of the Petritz scheme for the NEB.

"You need three ingredients for success," he says, "the right people, the right funding, and the right strategy." With regard to the cash, "it's the biggest single venture-capital exercise I have ever heard of as a start-up exercise in the integrated-circuit industry." The one exception he can think of is the defunct Micro-

systems International operation.

As a possible reason for not funding established companies, Mackintosh says, "Existing UK microcircuit companies are heavily vertically integrated, highly structured operations and are entirely unsuited to the style of freewheeling entrepreneurial management essential to success in the IC industry. "Of the strategy, he says, "It's to go for leading-edge, highly defined products. There's no reason why the company should not be a leading supplier within five years with a \$100 million turnover. From that base, it can begin to broaden its product range later."

Dissent. There are other opinions. Some observers close to the situation believe that the project could founder because of its intention to recruit British nationals now working in the United States and because of its approach to technology. Says one, "There aren't too many UK engineers in the U. S. working on state-of-the-art memory products right now." As for technology, there is concern that the new firm's apparent insistence on going it alone with its own process rather than licensing technology could be fatal.

In any event, the venture remains a high-risk gamble in the best traditions of the semiconductor industry. It is a gamble that British private enterprise has not taken and it has been left to the government-backed NEB to do the job. □

The 1000L Series Amplifiers . . .



Model 1000L

**designed to
your needs
and our
standards**

- 1000 watts CW linear
- 4000 watts pulse
- 10 kHz to 220 MHz
- Instantaneous bandwidth
- Low harmonic distortion
- Adjustable gain
- Unconditionally stable
- Remote control operation
- Fully protected
- Human engineered

Powerful and uncompromising in quality and performance. These versatile high-power amplifiers are ideal for general laboratory use, EMI susceptibility testing, equipment calibration, biological research, NMR spectroscopy, ultrasonics, and many other applications. The series also includes Model 1000LM8 (1 to 220 MHz), Model 1000LM9 (1 to 200 MHz), and Model 1500LA (1 to 150 MHz) with a 1500-watt output. For complete information on our high-power amplifiers, call 215-723-8181 or write:

Amplifier Research
160 School House Road
Souderton, PA 18964

AR AMPLIFIER RESEARCH

Consumer electronics

A-m stereo getting mixed reviews

IC makers' reactions range from raves to pans, even as they prepare for what could be \$30 million market

by Robert Brownstein, San Francisco region bureau

With the Federal Communications Commission deliberating about which, if any, of five proposed a-m stereo approaches to bless, ripples are beginning to spread beyond the receiver makers and touch the manufacturers of the integrated circuits that would be needed. Receiver makers say that each radio would contain \$2 to \$5 worth of ICs, and 10 million to 12 million auto radios alone are manufactured each year. Add home systems, and the result is an estimated total annual market of at least \$20 million to \$30 million worth of circuits.

The impetus behind the a-m stereo issue is provided mostly by the National Association of Broadcasters, the National Radio Broadcasters Association, the Electronic Industries Association, and the Institute of Electrical and Electronics Engineers through the National A-M Stereophonic Committee, [*Electronics*, April 14, 1977, p. 82], with little if any demand for a-m stereo from consumers. The question

mark on sales makes some chip makers skeptical; others are unrestrained in their enthusiasm.

Neal Williams, consumer-products marketing manager at Signetics Corp. in Sunnyvale, Calif., is representative of the skeptics, saying flatly, "No one needs a-m stereo." Nevertheless, his company is researching an a-m stereo IC.

He says Signetics has rejected one of the five approaches, that of the team of Kahn Communications Inc. and Hazeltine Corp., as unwieldy and made a gentleman's agreement with Sprague Electric Co. of North Adams, Mass., to divide the others. Signetics wound up with the systems submitted by Motorola Inc. and Belar Electronics Laboratory Inc., while Sprague has those of Magnavox Corp. and Harris Broadcast Products. Once an FCC decision comes down, Signetics and Sprague will exchange data and both will produce the chosen design.

Enthusiasm. In contrast with Williams' view is that of his counterpart

at Sprague, Oliver Richards. Richards, manager of radio-circuit development at the Semiconductor division, is enthusiastic about a-m stereo's prospects. "It's the first thing that's happened to a-m in 50 years," he says, "and it's nice to see it happening to a stodgy old product."

The enthusiasm at the Consumer division of National Semiconductor Corp. in Santa Clara, Calif., falls between the responses of Signetics and Sprague. Also, the firm is not working with any other. Instead, says Timothy D. Isbell, consumer linear development manager, "We are going as far as we can with each proposal and will try to shift our efforts to the chosen one to get to the market quickly."

The problem faced by chip makers is that while there are two basic approaches, the five proposals differ enough so that it is virtually impossible to make a chip that could be used for all by suitable metalization changes. "We could probably do three of the systems with one IC,"

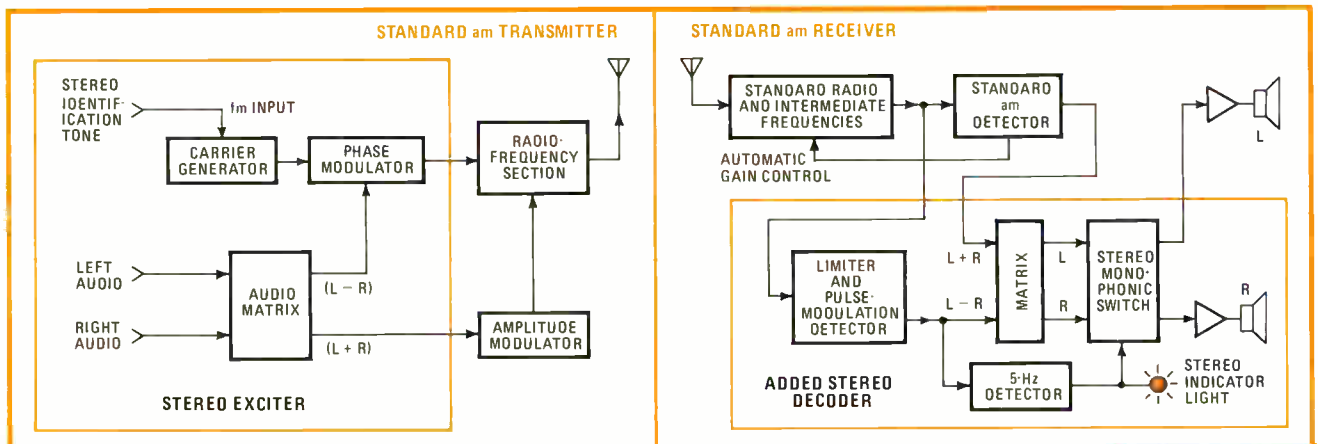

Getting together. One example of a-m stereo implementation is Magnavox's, shown here. Monaural receivers would still be able to detect the full program, but stereo receivers would separate signals into right and left channels.

says Lawrence R. Sample, radio-TV IC development engineer at National. "But the other systems might require three separate ICs to implement them." However, Richards believes that Sprague could do any of the systems (except Kahn-Hazeltine) with a single 16-pin device in a dual in-line package.

Still, the major differences are between the two basic systems. One involves amplitude-modulating a transmitter with left-plus-right channel information and simultaneously supplying a second a-m signal, modulated with left-minus-right information but transmitted out of phase with the first—30° out for Harris, 90° out for Motorola and Kahn-Hazeltine. This is a quadrature system (modified quadrature in the Harris case).

The second idea has the left-plus-right a-m signal, as in the quadrature approach, but uses the left-minus-right information to frequency- or phase-modulate the carrier (Magnavox and Belar). In all systems, receiver circuitry will separate the signals into left and right channels, producing a stereophonic effect.

Compatible. As with color television and fm stereo, the a-m stereo systems proposed must be compatible with existing receivers. Monaural a-m radio uses a single-channel audio amplitude that modulates a fixed-frequency carrier. A prospective stereo approach must retain that same full-program a-m carrier format but provide a means to transmit and later separate a dual-channel (left and right) signal. Each of the proposed systems will do so, but in the process, each distorts the original, monaural a-m signal.

One of the standards that the FCC will be called upon to establish is exactly what degree of distortion will be acceptable. It appears that the a-m plus frequency- or phase-modulated systems are more prone to distortion and signal-level sensitivity than the quadrature or modified quadrature designs. However, the quadrature systems are more complex, especially when trying to do it in an economical, discrete form, says Neil Madonick, consumer applications engineer at Signetics.

From a first-order technical standpoint, without regard to implementa-

tion, Isbell sees no clear-cut choice. "The specsmanship fight is being waged on the second-order level," he says. Isbell finds that ludicrous in view of the fact that a listener would be hard pressed to hear a difference in a favorable sound environment and could never tell the difference in an automobile, where the product is likely to be used most.

Robert R. Weirather, fm transmitter manager at Harris, expects the first a-m stereo receivers will be home-entertainment products. There is more flexibility in doing a discrete design for the more expensive home receivers, while awaiting ICs, than is the case in the under-\$200 automobile types, he says. Once ICs are available, he predicts, car units will sell for around \$125 versus \$180 for fm stereo units. Moreover, he believes the Japanese will market sets for the home for as low as \$50.

Good and bad. What are the advantages to the consumer in having a-m stereo? Assuming most listeners prefer the spatial separation effect obtained with two-channel stereophonic reproduction, the new radios would open up to the listener stereo programming devoid of the multipath distortion and limited range of fm stereo. The disadvantage, more noticeable in the home environment, is that the fidelity of a-m stereo reproduction would not be as good as that of fm because of the narrower bandwidths needed to house the numerous a-m stations in their lower frequency spectrum.

The FCC's decision, however, may not be technically based, Isbell says. Its choice may depend upon whether it gives more consideration to implementation of the transmitter or of the receiver, but he feels there is plenty of room for politics to creep in from the heavy transmitter makers. He believes that the choice should be keyed to the receiver, although a comprehensive system-level decision would be the least controversial.

There is also the possibility, Williams says, that the FCC may solicit more proposals or decide that there is no need for a-m stereo. "After all, the public isn't asking for it, the NAB is," he notes. Weirather believes, however, that it is in line with the FCC's charter to provide for upgraded services. □

MONOLITHIC CRYSTAL FILTERS



THE NEW RELIABLES

When a monolithic filter fails, it must be replaced. For your customers this can mean delays—equipment out of service while parts are being obtained. To prevent this, use the most reliable monolithic filters money can buy—IXF[®] and COMLINE[®] Monolithic and Tandem Monolithic Filters from PTI.

Here's one important reason Monolithic filter enclosures—like crystal cans—have been solder-sealed for many years. We're changing all that with electrical impulse "resistance" welding. Cleaner than solder sealing, resistance welding is also freer from leaks which can admit damaging water vapor. You may be seeing these new reliables from the rest of the industry in a few years, but we've got them now for most models and at solder-sealed prices.

UP FRONT

That's where many of our VHF monolithic filters find themselves. In the front-ends of paging receivers and other single-channel receivers they're used as high performance pre-selectors. As antenna filters in mobile and base-station receivers, they reduce front-end overloading and IM. In HF receivers and exciters they provide needed selectivity after up-conversion.

If you think the right monolithic filter will help you put your product up front, talk to us. We're monolithic specialists. We offer standard and custom models from 5 to 180 MHz.

Piezo Technology Inc.

2525 Shader Road, Orlando, Florida 32804
Phone 305/298-2000

The Standard in monolithic crystal filters.

Computers

Disk-drive makers load Winchester

New drives offer manufacturers of small computer systems eight times the capacity of cartridges at comparable prices

by Anthony Durniak, Computers Editor

Armed with a new generation of Winchester drives, an increasing number of disk-drive manufacturers are taking aim at builders of small computer systems. Their target is a share of that burgeoning original-equipment-manufacturer market.

Those computer makers are always looking for larger-capacity storage units to increase system capability. At the same time, however, they want to squeeze the larger storage units into the cabinets—and prices—of their systems.

Their most popular answer has been cartridge disk drives with capacities of 5 to 20 megabytes and prices ranging from \$4,000 to

\$8,000. But a better solution, say disk-drive makers, is to take the Winchester technology developed for mainframes and offer it in a package similar in both size and price to the small-system cartridge drives but with as much as eight times the storage capacity.

Entries. Some disk makers, such as Control Data Corp. in Minneapolis, Memorex Corp. of Santa Clara, Calif., and Kennedy Co. of Altadena, Calif., introduced Winchester drives over a year ago. Now, in the past three months, the number of small-system Winchester disk suppliers has more than doubled.

The new entries range from 14-

and 20-megabyte units priced under \$1,500 but offering a relatively slow 87-millisecond average access time to 170-megabyte drives selling for \$4,500 and operating at the typical mainframe average access time of 35 ms. The manufacturers of all these units claim that the higher recording densities and sealed head-disk assemblies used in Winchester drives (see "What's a Winchester?") substantially improve the price-per-byte of storage and drive reliability.

"Winchester technology allows us to put more capacity per disk surface than with 3330 technology," explains Norman Petersen, vice president for OEM marketing at Storage Technology Corp. "That means we can use fewer parts and get lower costs, thereby giving us price-per-byte advantages over cartridge disk drives." The Louisville, Colo., company recently introduced its model 2700 disk drive (see p. 149) with storage capacities of 33, 80, or 170 megabytes at prices ranging from \$3,000 to \$4,500 in quantities of 100 or more.

Reliable. Also introduced recently was Ampex Corp.'s DF-900 drive with capacities up to 87.8 megabytes selling for up to \$3,650 [*Electronics*, June 8, p. 230]. Larry Sarisky, Winchester product manager for the Redwood City, Calif., company, maintains that the new generation of drives offers the customer increased reliability.

"As hardware costs are decreasing, the price of service is going up. Winchester disks require no scheduled maintenance and offer increased reliability because of the sealed head-disk assembly, and the fixed nature of the media removes

What's a Winchester?

When a technology becomes popular, there is always the chance that the name will be misappropriated and applied to technologies that are not the genuine article. That could be a problem with Winchester disk drives.

Originally developed for the IBM 3340 disk drive, Winchester technology combines lightly loaded read/write heads, their mechanical support arms, and lubricated disk-recording media into a hermetically sealed plastic container called, logically enough, a head-disk assembly, or HDA. In previous disk technologies, such as those used on the IBM 2314 and 3330 disk drives, the heads retracted whenever the drive was stopped and the media package was removed—much the way the tone arm on a phonograph is placed on the side before the record is changed.

In Winchester technology, the disks are lubricated and the heads, which never leave the HDA, are made of ceramic so that they can land on the media when the drive is stopped. This approach eliminates the alignment problems associated with media separate from the head assembly. Also, it seals out contaminants such as smoke and dust that cause head crashes, thereby increasing the reliability of the drive.

With the alignment problem minimized, Winchester disk drives can record 300 tracks per inch as compared with the 192 tracks/in. typical of the early 3330-1 units. The elimination of the contaminants allows the heads to fly only 20 microinches from the disk surface, permitting recording densities of 5,636 bits per inch, compared with the 3330's 4,040 b/in. at a flying height of 50 μ in. Enhanced Winchester technology, in IBM's top-of-the-line model 3350 disk drive, gives a track density of 478 tracks/in. and a recording density of 6,425 b/in.

The dawn of high performance,
low cost counter timers.



Now you can have more capability and more flexibility for less money.

Racal-Dana 9900 Counter Timers offer you the most advanced technology in low cost universal counter timers. LSI construction permits precision measurement capability to 50MHz for as little as \$675, to 200MHz for \$795 and an optionally portable unit for under \$1000 complete.

Time interval averaging with 100psec. resolution, AC and DC channels, and bounce protection are standard on all units.

Proven reliability enables us to offer a full 2-year warranty.

Don't settle for yesterday's performance. A brand new day has begun. Call or write today.

Racal-Dana Instruments Inc., 18912 Von Karman Avenue, Irvine, CA 92715. Telephone: 714/833-1234.

Model	Frequency (MHz)		Sensitivity	Period, T.I.A., Ratio & Totalize	Trigger Level		Base Price (U.S. List)
	Direct	Prescaled			Var.	Fixed	
9901	50		10mV	*		*	\$ 675.00
9903†	50		10mV	*	*		\$ 850.00
9905	50	200	10mV	*		*	\$ 795.00

†Battery Option

RACAL-DANA
RACAL

Circle #176 for Product Demonstration
Circle #95 for Literature Only



Our new high-contrast RISTON* "Thousand Series" films help assure quality control, speed inspection and cut costs. Here's proof.

Everything about the new RISTON Thousand Series films is designed to give you the high-quality printed circuit board you want at the lowest possible cost in time, labor and materials. The Thousand Series are high-contrast, high-performance solvent and aqueous films with a lot of cost savings built in.

New color. The Thousand Series' light green color makes registration and setup remarkably fast. After exposure, the vivid blue print-out image makes inspection easy.

High productivity. This starts with rapid registration and inspection. Then, fast photospeed, developing and stripping provide more processing benefits.

Quality boards. The films' superior artwork reproduction gives you straight sidewalls and fine line resolution.

High yields. Easy inspection and excellent processing performance reduce rework and rejects.

DuPont films have never saved you more, in process and materials costs. Take a look at the new Series 1000, 1200 solvent and 3000, 3300 aqueous films. Call your DuPont RISTON Technical Representative, or write DuPont Company, Room 36358, Wilmington, DE 19898.

Registered U.S. Pat. & Tm. Off. for DuPont's photopolymer film, chemicals & processors.

RISTON



Circle 97 on reader service card

Technical articles

Minicomputer architecture links past and future generations

by Peter Christy, *Digital Equipment Corp., Maynard, Mass.*

□ The design and planning of a new series of minicomputers is a difficult problem, especially for a company with a large installed base of a highly successful family. And the problem is greatly magnified when the proposal is for the new family to overstep what were earlier regarded as a minicomputer's limits.

Thus, when Digital Equipment Corp. decided to extend its line into 32-bit mainframe territory, it set in motion a series of complex design decisions requiring a thoroughgoing reexamination of minicomputer architecture in the light both of likely user needs through the 1980s and of likely technological progress through the same period.

This article addresses some of the issues that guided the development of the VAX-11 architecture, the VAX-11/780 computer system, and the VAX/VMS operating system. The goal was to preserve compatibility with the existing large software investment in the PDP-11 minicomputer family yet to reflect future system needs, in particular by enlarging virtual address space to a huge 4 gigabytes. VAX, in fact, stands for virtual address exten-

sion, and VMS stands for virtual memory system.

The VAX-11/780 32-bit minicomputer system is the high end of the new family. A typical configuration costs between \$150,000 and \$200,000. Initial benchmarks show the machine's Fortran performance, using its fast-floating-point option, to be comparable to that of a modern upper-to-middle-range mainframe costing several times as much. Yet processor, optional floating-point unit, up to 1 megabyte of metal-oxide-semiconductor random-access memory, a Unibus medium-speed input/output controller, and two high-speed (Massbus) I/O controllers come in a single cabinet measuring 47 by 60 by 30 inches (Fig. 1). More memory and various options can be added in extender cabinets.

Parts

All this was implemented with conventional Schottky transistor-transistor logic and standard large-scale integrated memory circuits. Indeed, it was the ready availability of fast, high-density read-only memory that made it possible to design a complex processor without resort-

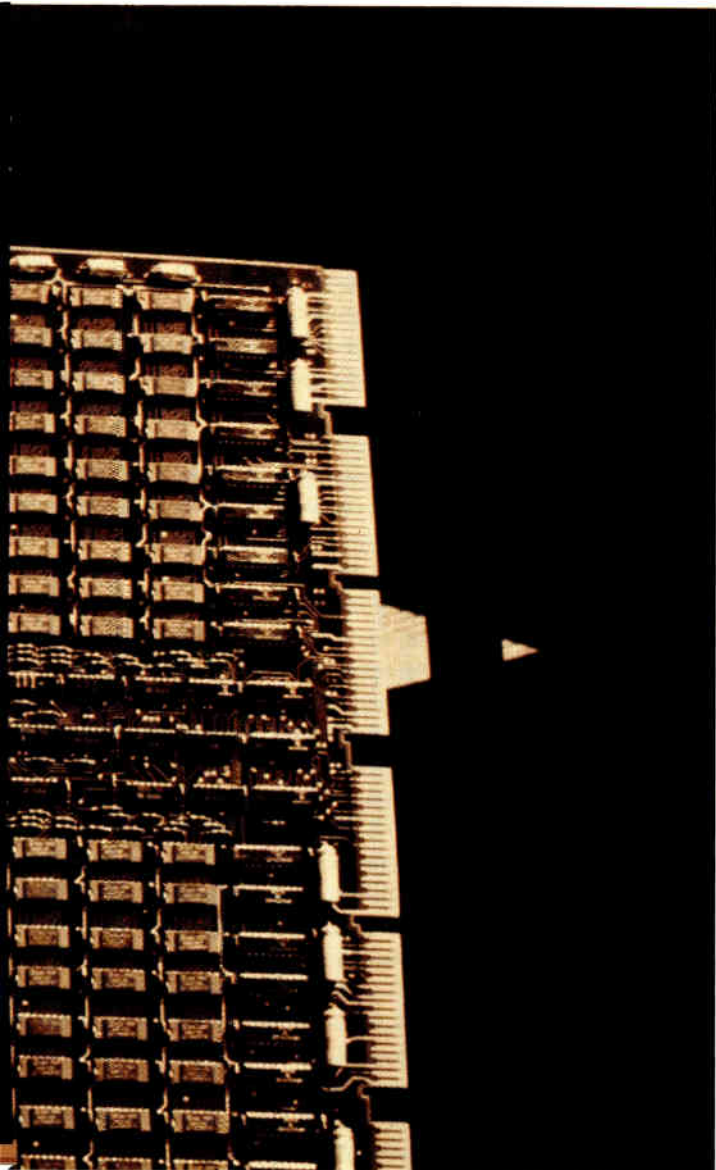

ing to anything more expensive than microcoding techniques. Besides the ROM control store, the central processing unit includes 12 kilobytes of RAM control store, which is used for diagnostic functions, some special instructions, and field microcode changes. A further 12 kilobytes of RAM control store is available as an option.

Other RAM parts are used throughout the system to increase performance. The CPU includes some in the form of an 18-kilobyte cache, which keeps the most recently used instructions and data quickly accessible to the processor. Also included in the CPU is a 128-entry address-translation buffer, which is functionally analogous to memory-mapping hardware: it keeps the most recently used translations between virtual and physical memory in high-speed registers, greatly reducing the memory management overhead. RAM is also used throughout the memory bus and I/O subsystem to increase the efficiency of the major bus mechanisms.

As for the new VAX/VMS operating system, it provides the VAX-11/780 minicomputer with the kind of func-

tions previously available only to mainframe computers. Examples are full virtual-memory management, demand paging, indexed data-access methods, and extensive interjob protection and sharing capabilities. VAX/VMS supports up to 64 on-line users simultaneously developing and executing programs in assorted high-level languages. In particular, a compiler for DEC's Fortran IV-Plus language (a superset of ANSI Fortran) has been developed to take full advantage of the extended instruction set of the VAX-11 architecture.

Compatibility with the PDP-11

Though the VAX-11/780 is not a 32-bit PDP-11, for reasons that will shortly be gone into at length, cost-saving compatibility with the PDP-11 and its associated software has been achieved as desired at the six most relevant user levels:

- Cultural compatibility, if such a term may be used to describe the stylistic similarity of the machines. Because of it, PDP-11 programmers can produce high-quality VAX-11 native-mode code with little training, and language compiler designs that generate PDP-11 code can be adapted to generate efficient VAX-11 code.

- Operating-system compatibility. Many of the VAX/VMS operating-system functions were modeled after the PDP-11 RSX operating systems (for example, in the type and form of system calls, the way in which tasks synchronize with each other and exchange data, etc.). Key VAX/VMS functions, such as the file system and record management facilities, are functionally identical to their RSX counterparts.

- High-level language compatibility. VAX-11 languages are designed to be compatible with the existing PDP-11 compilers. A calculation program written in Fortran IV-Plus for the PDP-11 runs unchanged on VAX-11.

- Direct processor support for user-mode PDP-11 programs. The VAX-11 architecture includes a PDP-11 compatibility mode, in which the processor behaves just like a user-mode PDP-11, except that it can simultaneously run 32-bit code jobs.

- Data compatibility. All PDP-11 data formats were brought forward to the VAX-11 architecture.

- Data-file compatibility. VAX/VMS is able to create and access disk files that are compatible with the PDP-11 RSX-11 operating systems.

Why not a 32-bit PDP-11?

During planning of the VAX-11, one idea that received serious consideration was in fact a 32-bit PDP-11. Most of the PDP-11 architecture is already independent of word length, and recent architectural studies had demonstrated that the PDP-11 is a bit-efficient architecture, even compared with mainframe architectures. In short, a PDP-11-like machine with an extended virtual address space would evidently be an attractive computer, today and tomorrow.

The most distinctive attribute of the PDP-11, and the basis for its architectural power, is the flexible way in which its registers can be used to form addresses. This flexibility permits the machine to be used effectively for many different types of computing, unlike most previous architectures, which tended to be good for one style of

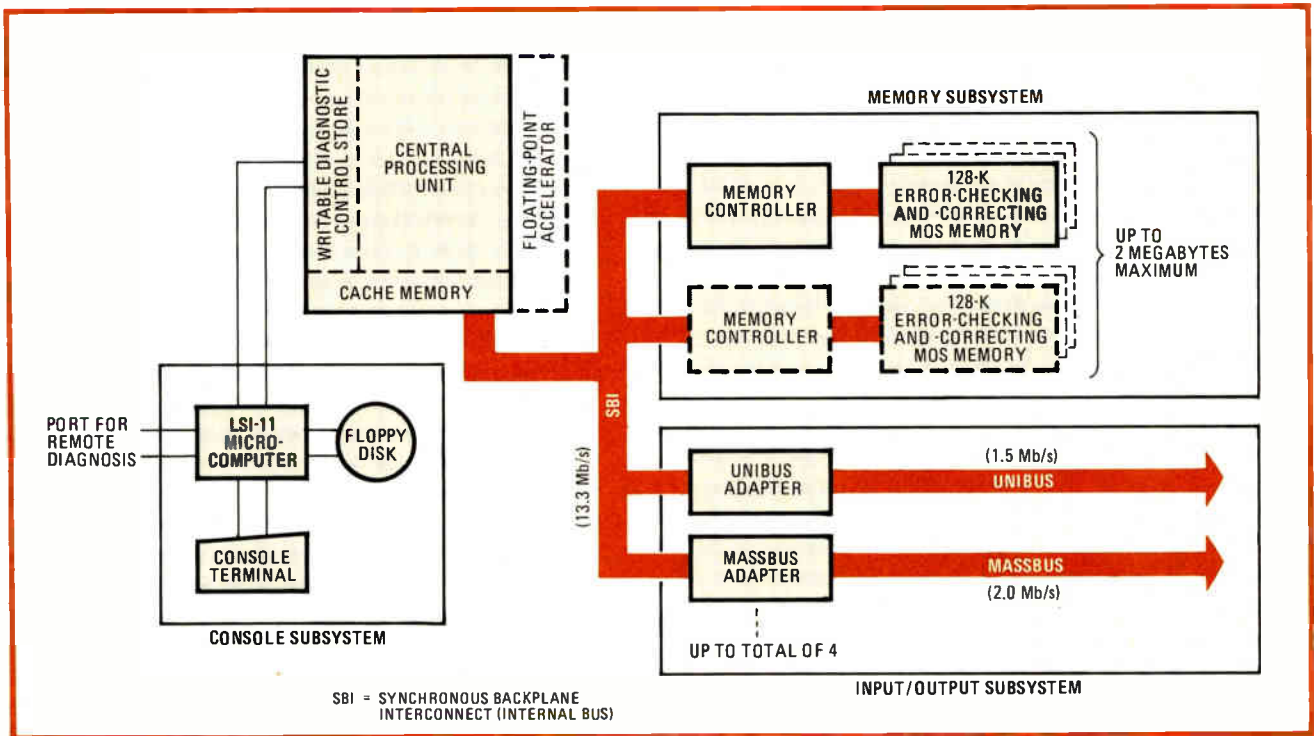

1. New generation. The VAX-11/780 computer system consists of the central processing unit, the console subsystem, which serves as an operating system terminal and system or diagnostic console, the main memory subsystem, and the I/O subsystem. All major hardware components, implemented by Schottky TTL and standard MOS memory devices, are connected through the SBI, an internal synchronous bus.

processing but poor for another. For example, a design that has many central registers but not stack-like characteristics is good for scientific calculation but poor for complex subroutine structures. Conversely, a machine designed around a stack architecture is good for program control but inefficient for intensive calculation. But the PDP-11 is able to take on either set of attributes, and others, whenever a task demands it.

However, a 32-bit PDP-11 would have meant extending the register width to 32 bits but keeping the instruction formats and encodings unchanged, and this turned out to be an impossibility. The idea would have been a machine that could execute existing PDP-11 machine code intermingled with 32-bit code that made full use of the 4-gigabyte virtual address space. But a careful examination of a 32-bit version of the PDP-11 uncovered some unsurmountable obstacles.

There turn out to be many ways in which a programmer can implicitly design the address length into a program. For example, before control is passed to a subroutine, parameters may be pushed onto the stack. The subroutine call itself leaves the return address on the top of the stack. Within the subroutine, the parameters are accessed with respect to a known displacement from the top of the stack. But unfortunately, changing the address length from 2 to 4 bytes makes these known offsets invalid. This and many similar problems ruled out the possibility of executing 16-bit code unchanged in a larger address space, or of automatically translating 16-bit programs into a 32-bit form.

Given the difficulties of directly extending the PDP-11 design to a 32-bit form, the next alternative was to see what improvements could be gained by a bit-level-in-

compatible, but otherwise highly similar, design. The result was the VAX-11, a substantially better design that, though not precisely like the PDP-11, is "culturally compatible" with it. Hardware and software were also developed that permit a large subset of existing PDP-11 programs to execute without any changes on a VAX-11 system, as described earlier.

Architectures and word lengths

The description of the VAX-11 as a 32-bit minicomputer and the PDP-11 as a 16-bit minicomputer implies that the essential difference between them is their word length. But any significant difference in the architectures would presumably be measurable in terms of their comparative bit efficiencies on important applications. As it turns out, the bit efficiency of the PDP-11 is excellent, and in most respects the PDP-11 is not restricted to a 16-bit word length.

The problem is that the term "word length" has too many meanings to be useful without qualification. In a typical computer system, many different word lengths can be identified. In this context, therefore, it is necessary to eliminate from consideration the word lengths that represent engineering decisions for specific implementations and to consider only those that are intrinsic to an architecture and affect all its implementations in the family.

Instruction length is a possible candidate here. But both the PDP-11 and the VAX-11 have instructions of variable length, ranging from 16 to 48 bits and 8 to 296 bits respectively. In both cases, the variable-length instruction format offers better bit efficiency than an equal-length format because common instructions can

The importance of bit efficiency

A good architecture is reflected in a computer's static and dynamic bit efficiency. Bit efficiency is a quantifiable measure of how well the investment in the computer system's components pays off in application-level throughput. In other words, if two systems are built with the same technology and the same complexity, then the one with the greater bit efficiency will be more cost-effective (assuming that the bit-efficient instructions can still be rapidly decoded and executed by the processor).

Static bit efficiency is the relative size of a program compared with the size of a program coded for an architecture defined as a standard. A good static bit efficiency reduces the requirements for central memory and program file storage and streamlines the tasks involved in program-moving overhead, such as initial program loading, fetching overlays, paging, or swapping.

Dynamic bit efficiency is a comparative measure of how many program bits must be fetched from memory to the processor to execute a program. If all machine instructions were used with the same frequency, then static and dynamic bit efficiency would be the same. In practice, some instructions and data types occur often and others occur rarely. Good dynamic bit efficiency reflects the fact that the most frequent instructions (such as loop control

instructions) have particularly good encoding.

The ideal way to compare bit efficiencies would be to take a specific set of application programs and measure their actual bit efficiencies on different architectures. Unfortunately, such an approach is impractical for a computer vendor because customers have many disparate applications and many architectures of interest are hypothetical.

Fortunately, there are ways to characterize typical applications. Those coded in common high-level languages, such as Fortran, Cobol, and Basic, may be related to studies of typical program behavior, which show that in each of these languages different statements and data types have a characteristic frequency of occurrence. With these statistics and with an understanding of the machine code generated for each common statement, it is possible to estimate the bit efficiency of real or hypothetical architectures.

Bit efficiency is a good general test of architectural effectiveness, since it diminishes with any difficulty in machine-level programming or compiler code generation. Good static bit efficiency reflects effective use of system components; good dynamic bit efficiency reflects effective use of memory system bandwidth.

have shorter encodings. No architecturally useful definition of word length can be derived from instruction length, therefore.

Both the PDP-11 and VAX-11 are byte-address machines, since all data types are addressed in main memory by the byte address at the beginning of the data item, regardless of whether the data is a 1-byte character or an 8-byte double-precision, floating-point number. So memory addressing is also no help in defining the architectural difference between the machines.

But the PDP-11 has 16-bit general registers, whereas the VAX-11 has 32-bit general registers. In both architectures the registers can be used for arithmetic on data items that are shorter than the register size (8-bit integers on the PDP-11, 8- and 16-bit integers on VAX-11) or can be used in multiples for data items that are longer than the register size. Register length as used in arithmetic is not an invariable word length, therefore.

Register length

However, register length as used in instruction address formation is another matter: it does define the essential difference between the PDP-11 and the VAX-11, since it determines the size of logical storage that a program can instantaneously address—the size of the virtual address space. Thus the PDP-11's 16-bit byte address creates a virtual address space of 65,536 bytes, whereas the VAX-11's 32-bit byte address creates more than 4 billion bytes of virtual address space. What's more, virtual address space limitations can affect bit efficiency.

At the time the PDP-11 was designed, it seemed unlikely that any minicomputer would need more than 65 kilobytes of *physical* (as opposed to virtual) memory. In retrospect, the designers realize they failed to anticipate how rapidly central memory costs would decline.

Early in the evolution of the PDP-11 family, hardware memory mapping was added to the top-range machines. PDP-11 mapping logically divides the 64-K virtual address space into eight 8-K pages, each of which can be located independently in physical memory and protected independently (Fig. 2).

The addition of mapping offered two major benefits:

- It permitted the design of multiprogramming software systems in which a user program is prevented from damaging another user program or the operating system code, since each program can address only those parts of central memory allocated to it.
- It permitted the design of configurations with more than 65 kilobytes of physical memory, since the mapping hardware can translate 16-bit addresses into physical memory addresses of arbitrary length. Thus a PDP-11/70 may have in excess of 4 million bytes of central memory by developing 22-bit addresses.

For most applications, the remapping overhead is insignificant. But there are calculation applications in which it induces noticeable bit inefficiency. Also, although today most minicomputer programs and their data fit naturally into a 65-kilobyte address space, the trend to larger central memories will surely lead to larger program sizes as well.

The need for large address space

Consequently, though the immense marketplace success of the PDP-11 and other minicomputer architectures demonstrates that limited address space has not so far been felt as a restriction, it might become one in the future. Since the need for large address space is felt first in large configurations, the VAX-11/780 was designed as a top-of-the-line minicomputer.

The fundamental need of VAX-11 was to solve the

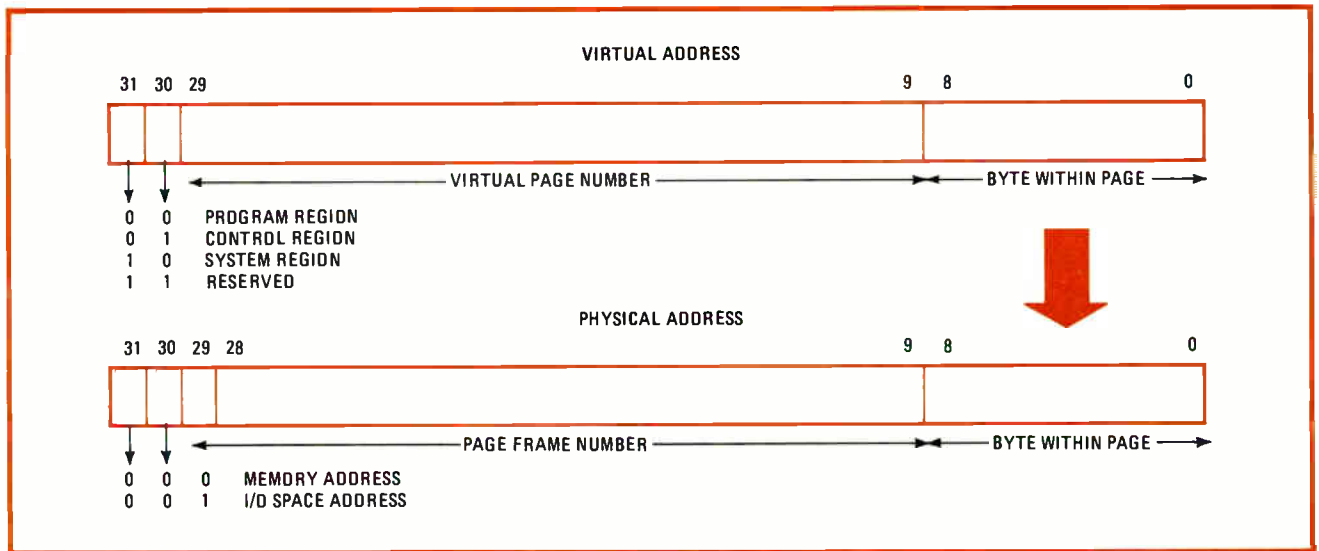

2. Address formats. Virtual addresses are 32 bits long in format shown at top. The virtual address space (memory space as it appears to a given process) is mapped onto the physical address space (lower format), which is the actual memory space existing in hardware. Memory-management logic controls the mapping and maintains in physical memory only portions of virtual memory being used.

addressing problem. Given the byte orientation of the PDP-11 and the need to do address arithmetic conveniently, the obvious address lengths to explore were 24 bits (16+8), 32 bits (16+8+8), etc.

Memory costs are roughly halving each year, and 1 more bit of physical address per year is needed. A 24-bit virtual address seemed too small. For VAX-11 the choice was 32 bits, representing a 4-gigabyte virtual address space (see Fig. 2 again). The next decision was to make this address space linearly addressable, meaning that there would be no further segmentation (many mainframes offer comparably large virtual address spaces but break them into many segments). This is large by any standard today, including mainframes, and should also allow a good decade of growth before the size of typical physical memories comes anywhere near the virtual address space. The very large, linear, virtual address space will also permit flexible evolution in software system design techniques, should that prove needed, for example, in advanced file or data-base management system designs.

Picking the virtual address size was a key decision, but a simple one compared with the total question of virtual memory design. Other issues included:

- Feasibility. It had to be possible to implement without adding a large cost penalty to the processor.
- Functionality. It had to be able to support sophisticated data-processing applications.
- Efficient use of control memory. The VAX-11 architecture had to exhibit a wide range of system performance without requiring large amounts of central memory for control tables.
- System efficiency. A virtual memory design would have to work well in real-time applications, yet be able to switch rapidly from one program to another while responding to external requests.

A 32-bit virtual memory design is totally different from a 16-bit one. For example, mapping a 65-kilobyte PDP-11 program consists of initializing eight internal processor registers. In contrast, mapping a 4-gigabyte

address space would mean specifying 8 million page relocations (on VAX-11, each page or separately mappable unit of virtual memory is 512 bytes). Obviously, no VAX-11 processor will have 8 million internal relocation registers!

Similarly, the operating system on a PDP-11 does little in the way of virtual memory management. Because programs are relatively small, they are typically swapped in and out in their entirety. But the large virtual address space on VAX-11 encourages programmers to build large, logically connected programs that may well be much bigger than the physical memory of the system. For example, a large computation that had previously been structured in overlays will simply be a big program on VAX-11. But making the virtual memory useful to the application programmer means that the operating system has to be much more active in deciding which pieces of an application program should be kept in central memory and which should be kept on disk-backing storage (called working-set management). This in turn means that the mapping mechanism must be efficiently controlled by operating system code and must provide as much useful information about the dynamic usage of virtual memory as possible.

Sharing virtual memory space

A key feature of the VAX-11 virtual memory design, which leads to efficient use of central memory and low overhead during execution, is the way in which the operating system shares virtual memory space with user processes. The entire 4-gigabyte virtual address space is logically divided into halves. The user process is limited to the use of the bottom half, and most of the operating-system code resides in the top half (Fig. 3). (Remember that this is just virtual memory; the decision about what virtual memory is made resident in central memory, including operating-system code, is made dynamically on the basis of actual need.) The mapping of each user process may be unique, or user processes may share program and data pages with one another, but in either

case the same virtual operating system is mapped with each user process.

Putting the operating system into a single address space rather than having pieces of the system code in multiple address spaces minimizes the need for system mapping control tables and makes intersystem communication more efficient. Having the operating system share the virtual address space of each user process simplifies requesting services from the operating system. The high-speed processor translation caches, which store the most recently used mapping translations, treat system and user mapping separately so that system mapping translations stay in the cache when the operating system switches to another user process, but the user translations are flushed out.

In a simple memory scheme, it would be risky to put the user programs in the same address space as the operating system, since their malfunctions could affect the system operation. In VAX-11, the system is totally protected from this by a separate access control mechanism. The processor executes in one of four modes:

- Kernel, for interrupt processing, physical I/O control, processor scheduling, and the like.
- Executive, for file management and similar functions.
- Supervisor, for functions such as interactive command processing.
- User, in which user programs are executed.

The accessibility of each page in the virtual memory space (whether the page can be read, written, or both) can be controlled for each of the processor execution modes. Thus the operating system can keep critical data in the user's address space and can access that data freely during execution of an operating system service (during which the processor runs in a more privileged mode), and yet the user's program may be restricted from reading the data, if that is inappropriate.

Compatibility mode

The VAX-11 user mode can be put into a compatibility mode, which makes it capable of executing many PDP-11 programs often faster than the PDP-11/70, the top-of-the-line PDP-11. The efficiency of PDP-11 emulation is due to the strong cultural compatibility between VAX-11 and the PDP-11. Thus a processor designed to perform VAX-11 instructions efficiently can also perform PDP-11 instructions well. Instruction execution of the VAX-11/780 is implemented with microcode (as is true of most computers today); PDP-11 compatibility-mode emulation was primarily implemented with a 10% increment of microcode.

This VAX-11/PDP-11 compatibility mode is worth exploring in some detail. Some earlier "compatible" emulation modes required that the computer be used only in one mode at a time. But although 16- and 32-bit code cannot be freely mingled within a single program on the VAX-11, compatibility-mode jobs and native jobs can run at the same time, sharing the resources of the VAX/VMS multiprogramming system. The two kinds of jobs can even cooperate with each other by exchanging messages or by sharing files.

Emulation modes have also been used in the past in the place of software development for the new architec-

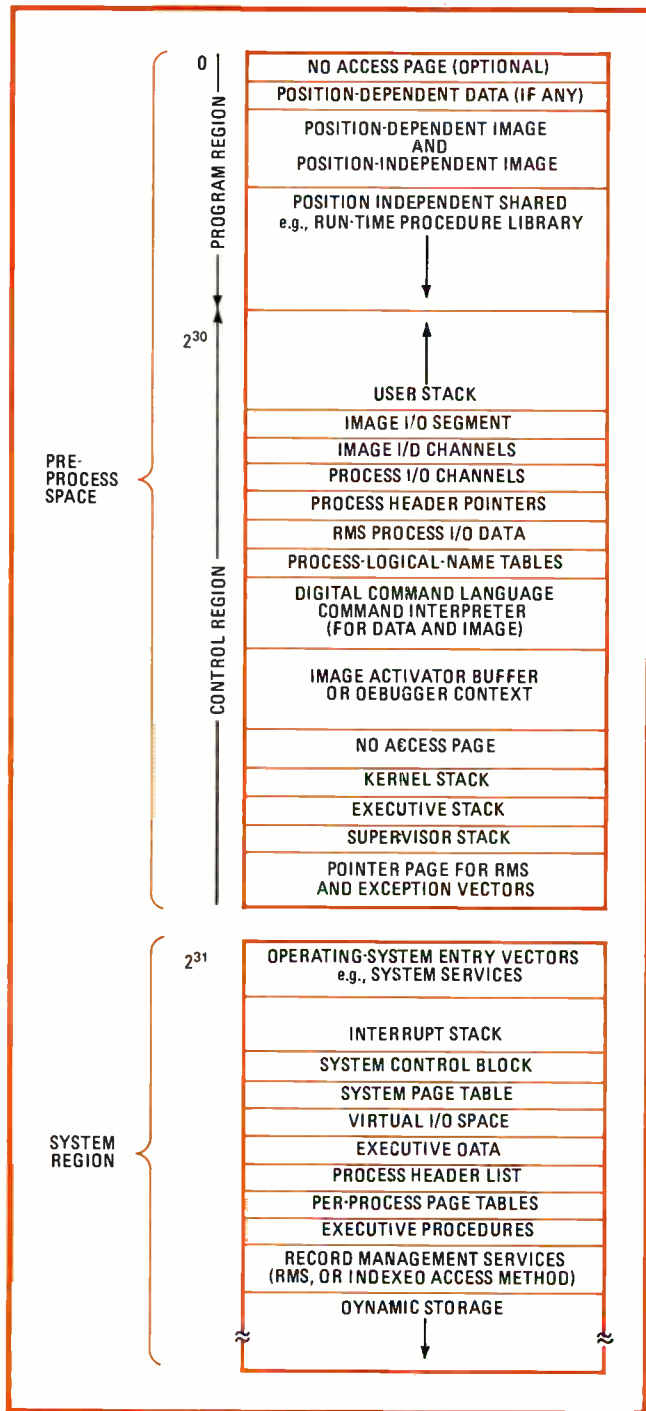

3. Allocation. Virtual address space is divided into halves. The lower address locations are limited to user processes, the upper to operating-system code. User processes may share program and data pages, but virtual operating system is always the same.

ture. However, in the case of VAX-11, the power of the enormous virtual address space and new instructions were intrinsic to the value of the system. So there seemed to be little value in a hardware-supported compatibility mode that would execute a complete PDP-11 operating system. Instead, as already indicated, the compatibility mode is limited to user-mode programs. Those operating-system utilities that are insensitive to the size of the address space have been taken from the earlier family's

DATA TYPES HANDLED BY VAX-11			
Data type	Size	Range (decimal)	
Integer		Signed	Unsigned
Byte	8 bits	-128 to +127	0 to 255
Word	16 bits	-32,768 to +32,767	0 to 65,535
Long word	32 bits	-2^{31} to $+2^{31}-1$	0 to $2^{32}-1$
Quad word	64 bits	-2^{63} to $+2^{63}-1$	0 to $2^{64}-1$
Floating point		$\pm 2.9 \times 10^{-37}$ to 1.7×10^{38}	
Floating	32 bits	approximately 7-decimal-digit precision	
Double floating	64 bits	approximately 16-decimal-digit precision	
Packed decimal string	0 to 16 bytes (31 digits)	numeric, two digits per byte sign in low half of last byte	
Character string	0 to 65,535 bytes	1 character per byte	
Variable-length bit field	0 to 32 bits	dependent on interpretation	

RSX-11M operating system and execute in compatibility mode transparently to the user.

The application migration executive is a subroutine package provided with VAX/VMS that emulates RSX-11M operating support for PDP-11 programs running in the VAX-11/PDP-11 compatibility mode. VAX/VMS has been designed to transfer control to the AME within 50 microseconds on the VAX-11/780 when a PDP-11 compatibility-mode program requests operating-system services. The AME executes as a VAX-11 program, in a 32-bit address space that includes the 16-bit address space of the PDP-11 program. The AME determines which RSX-11M system call is being requested by a PDP-11 program, translates it into VAX/VMS format, and issues the request to VAX/VMS. When control returns to the AME, it translates the results into RSX-11M format, stores the result in the compatibility-mode program data, and then returns control to the PDP-11 program via a VAX/VMS service.

Translators

Use of the AME permits a large collection of the RSX-11M programs to run unchanged on VAX-11 systems under VAX/VMS. Although the AME translates RSX-11M system calls, a similar program could be written to translate calls of other PDP-11 operating systems. A single VAX/VMS system could, theoretically, have translators for multiple PDP-11 operating systems.

The efficiency of compatibility-mode program execution under such a translator depends on how heavily the program uses operating-system facilities and how different the emulated operating system was from RSX-11M and VAX/VMS. Although the translation adds some overhead, the typical VAX/VMS service is faster than RSX-11M (run on a PDP-11/70) because of the increased functionality of the VAX-11. On balance, emulated PDP-11 programs run about as fast as they would in the PDP-11/70 under RSX-11M.

The PDP-11 was designed with 8 general-purpose registers. Since then, the cost increment of additional processor registers has gone down dramatically, and the

VAX-11 was given 16. Apart from cost, the penalties for additional registers are a need for extra system overhead to perform context switching and a reduction in bit-efficiency, since more bits are required to address a register. Nevertheless, these extra registers do provide better compiler optimization of generated code, lower overhead in subroutine usage, and efficient design of complex instructions.

The strength of the PDP-11 architecture is its inclusion of the best features of stack, multiple-register, and memory-to-memory designs because of the versatile way in which its general registers can be used to develop addresses. VAX-11 added to these addressing modes to increase the efficiency of program indexing into those tables that list multiple-byte data items like 4-byte floating-point values or 8-byte integers.

In the last decade the processing capacity of minicomputer systems has increased to the point where they are patently unsuited for very few applications. To support efficiently all likely forms of processing, new data types (forms of data for which processor instructions exist) were added to VAX-11, as shown in the table. VAX-11 implicitly does 32-bit address arithmetic, and instructions were added for explicit 32-bit integer arithmetic and Boolean logic.

Decimal arithmetic

Thirdly, VAX-11 permits arithmetic to be done directly in decimal form, instead of requiring that it be converted to binary form, to ensure that full data precision is retained, and because such data is more often moved intact between data records than used for calculation. Still other new data types are test string manipulation (where strings of characters can be moved, translated, and searched with specific instructions) and a complex editing instruction (to provide for the kinds of manipulations common in generating the typical data-processing report—for example, editing out leading zeros or adding a dollar sign). On VAX-11, direct processor support for 1- to 32-bit data fields has been implemented, increasing the bit efficiency of critical

The economics of compatibility

The last thing a computer user wants to do is to rewrite an existing program for a new hardware design. He would rather develop new software for all the profitable new applications it opens up. After all, if the hardware is costing him less, the cost of programming is still as high as ever. Worse yet, it may even be rising, since the number of computers to be programmed appears to be growing faster than the population of skilled programmers.

In view of this, a major design focus for the VAX-11 architecture was compatibility with the PDP-11. Accurate statistics are not available, but if as little as \$20,000 has been spent for software for each of the 50,000 PDP-11s produced this far, then the total investment is \$1 billion. Surely, this is a conservative estimate when it is remem-

bered that \$20,000 buys only a small amount of code.

The size of the entire existing investment in software is incomparably larger, and the need to preserve it might already have halted innovation in the computer industry were it not for the phenomenal rapidity with which computer technology is evolving. The new markets and applications continuously being opened up force architectural changes that compel some level of innovation even at the price of a devalued software investment. Nevertheless, the point has seemingly been reached at which no new computer—mainframe, mini or micro—can be designed without careful examination of the compatibility issue. Barring some remarkable breakthrough in software engineering, compatibility will continue to grow in importance.

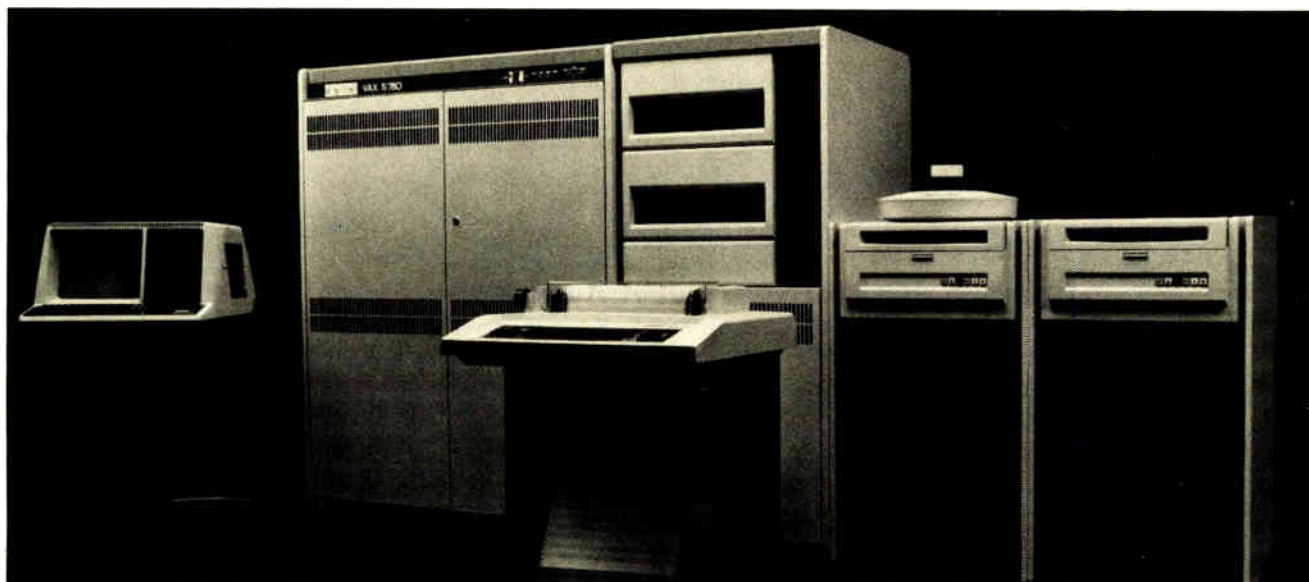

Compatibility. Design goal of the VAX-11/780 32-bit minicomputer system shown here was to preserve compatibility with the software developed for the existing PDP-11 family while anticipating future needs. It features greatly extended virtual address space.

operating-system code and like programs. Since field-bit position is specified by a 32-bit integer, very large (512-megabyte) structures can be linearly bit-addressed.

Although most of the added instructions were in support of the data types listed above, many other special instructions were added for operating system support, user programming support, and specific computation needs. For example, an instruction, POLY, has been provided to compute polynomial equations of the form:

$$y = C_1 + C_2x + C_3x^2 + \dots$$

in a single instruction, with the loop overhead handled in microcode. This instruction substantially speeds up the calculation of standard numerical approximation, such as the calculation of sine and cosine functions within a Fortran run-time library.

Future minicomputers

The implications of all these capabilities for the future of the VAX-11 minicomputer family can readily be assessed. The yardstick may be inferred from the appar-

ently constant rates of improvements in base technologies like semiconductors and magnetics and from computer designers' rules of thumb. For example, in a typical system the number of bytes of central memory is about equal to the number of instructions per second by the central processor. Such a system must also be capable of performing 1 bit of I/O for each instruction executed (these rules are sometimes attributed to Gene Amdahl). For any year in the near future, the technologies' price prediction for computer subsystems may be combined with the designers' predictions of the appearance of a balanced system, the constant price definition of minicomputers applied, and the range of expectable system configurations thus delimited.

Following such logic, a minicomputer priced at \$50,000 in the early 1980s should look much like today's mainframe in gross capability, having on the order of a million bytes of central memory, hundreds of millions of bytes of disk storage, and so on. That prediction, made some years ago, led to the VAX-11 design project and the development of the VAX-11/780. □

Single-supply erasable PROM saves power with C-MOS process

New ultraviolet-erasable 4-k programmable read-only memory uses p-channel floating-gate technology for superior speed-power product

by Gopal Ramachandran, *Intersil Inc., Cupertino, Calif.*

□ The erasable programmable read-only memory has quickly found its niche as a nonvolatile temporary storage medium. Such devices, built with either n- or p-channel metal-oxide-semiconductor technology, have served well in prototyping microprocessor-based systems. To enhance their usefulness in development and to extend their use into low-run production systems, the next design step is to move beyond these single-channel floating-gate erasable PROMs to an easy-to-use, low-power, complementary-MOS part that needs only a single-ended voltage supply.

Thus the ultraviolet-erasable 6603 and 6604 have come about. The superior speed-power product of C-MOS

is the key to the new 4,096-bit parts—they have a quiescent current of only a few microamperes and, even when cycling at 500 nanoseconds, draw just a few milliamperes from a 5-volt supply.

The floating-gate avalanche-injection MOS transistor and its stacked-gate cousin, the fundamental storage units in all previous UV-erasable PROMs, have proven reliable in both p-type configurations (the 1702A, for example) and n-type configurations (the 2708 and 2716, for example). So the decision was made to use the p-MOS device in the C-MOS design (see "The p-channel floating gate in a C-MOS PROM").

One significant need that the 6603/04 will fill is in the

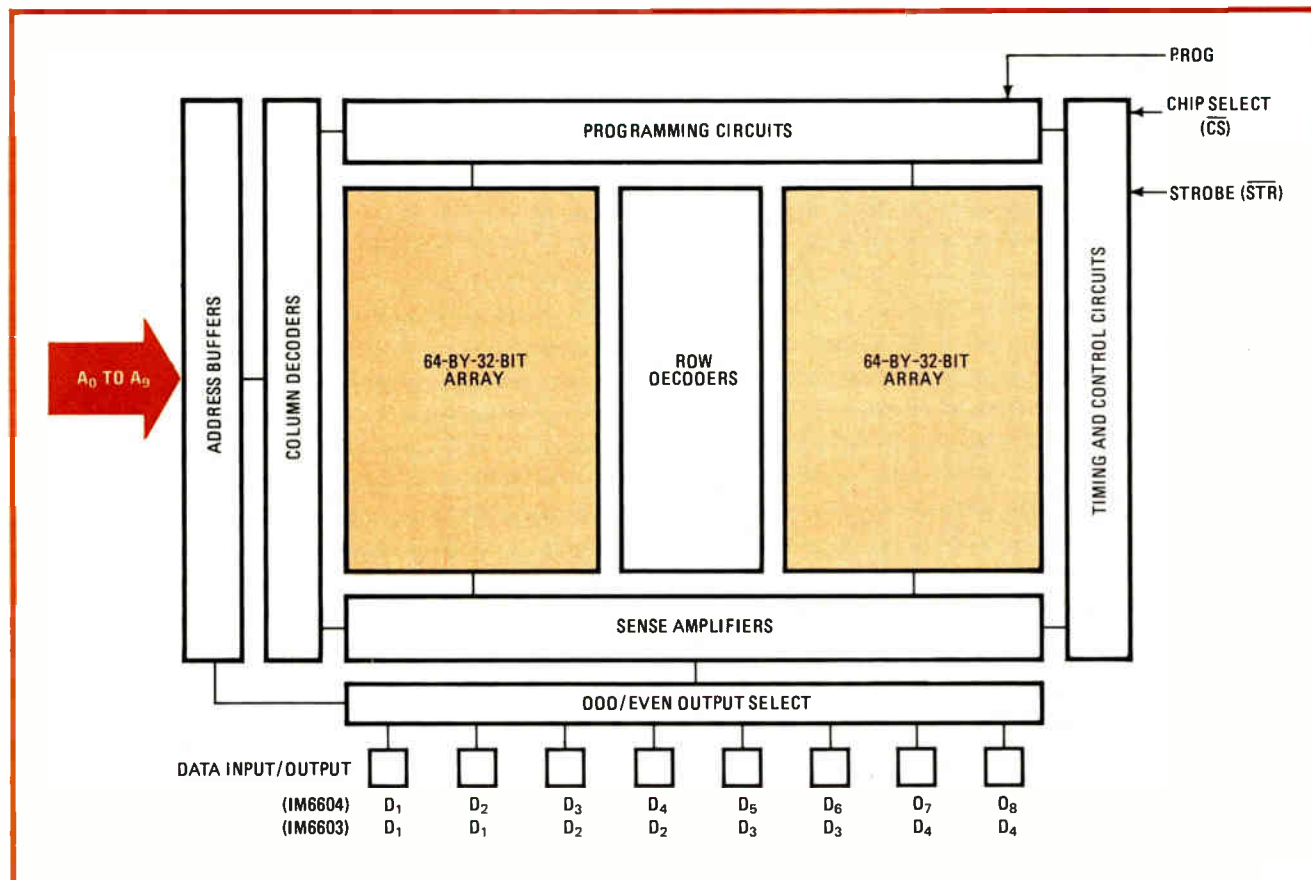

1. Two arrays. This 4,096-bit complementary-MOS erasable programmable read-only memory contains two 64-by-32-bit subarrays. The metal masking in the device's fabrication determines whether the chip is organized as 1,024 by 4 bits (the 6603) or 512 by 8 bits (the 6604).

The p-channel floating gate in a C-MOS PROM

Since the 6603/04 parts are built with complementary-metal-oxide-semiconductor technology, the floating-gate device that actually does the storing could be n-channel or p-channel material. The 1702 erasable programmable read-only memory, which has a 512-by-8-bit organization, is built with the p-channel floating-gate transistor shown at the left. The 2708 and 2716 erasable PROMs, which are 1,024-by-8- and 2,048-by-8-bit arrays, use the n-channel dual-polysilicon technology shown on the right. Intersil settled on the p-channel floating-gate transistor for the 6603/04 because of the simpler process required.

An early requirement was that the 6603/04 had to use conservative design rules and run on a standard high-volume, well-documented low-threshold ion-implanted silicon-gate C-MOS process. The idea was to bring a readily

manufacturable part to market quickly, then introduce enhancements as improved C-MOS processes came to the production line.

Such an improvement is scheduled for high volume soon—a new shallow-junction selective-oxidation process called Selox C. The process has already yielded two- to threefold improvements in access time for 1,024-bit random-access memories. What's more, the tightening of design rules and alignment tolerances coupled with optical-mask shrinks and improved double-layer polysilicon processes that together have contributed to cost, performance, and density improvements in random-access memories will soon be applied to C-MOS erasable-programmable-read-only-memory products, which are still in their infancy.

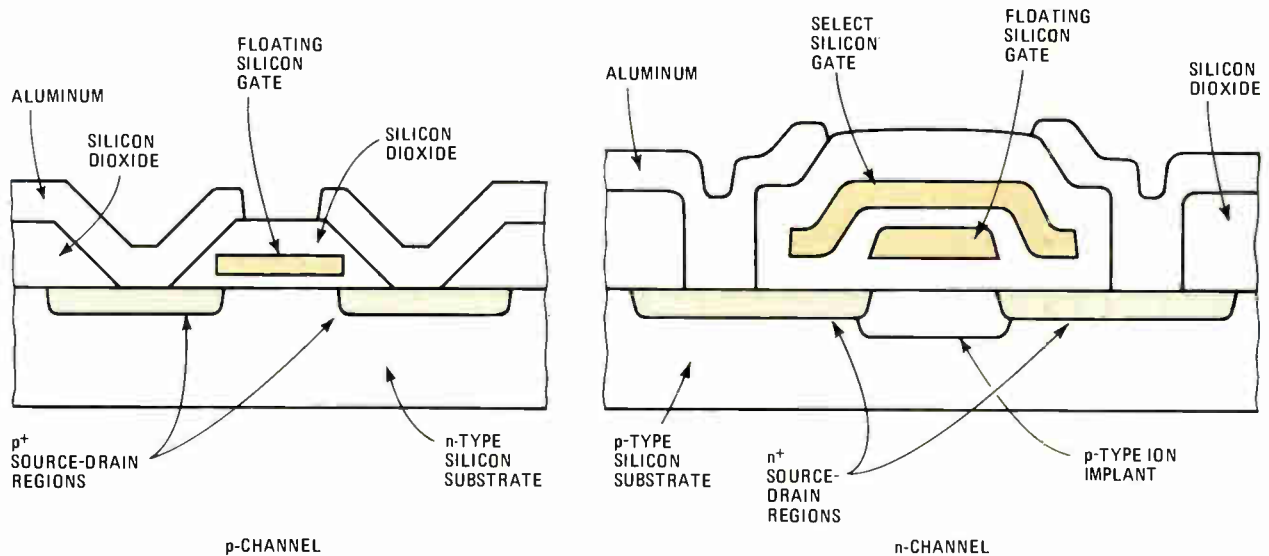

development of systems using single-supply C-MOS microprocessors. Until now, the designer has been faced with prototyping with power-hungry bipolar PROMs, or single-channel MOS PROMs requiring several supply voltages, or fusible-link C-MOS PROMs that lacked sufficient density and cannot be reused.

Organization

A metal-mask option configures the 4,096-bit devices (Fig. 1) either as a 6603, organized as 1,024 by 4 bits, or as a 6604, which is 512 by 8 bits. The memory elements in the 6603/04 are arranged as two 64-by-32-bit subarrays separated by row-address decoding logic.

Both devices have a 10-bit internal address latch. The six address bits, A_3 through A_8 , are used by the central row-address decoder to select one of 64 rows. Similarly the column decoders use A_0 through A_2 to select one of eight columns, which are connected to each of the eight sense amplifiers and data input/output buffers.

In the 6603, the 10th bit (A_9) is used as an odd/even select to steer data to and from the array. Since A_4 activates alternate columns and sense amplifiers, only 4 bits at a time are read out of the array, making it

effectively appear twice as deep: 1,024 bits instead of two 512-bit arrays. The 6604 needs only 9 bits for addressing, so it treats the 10th bit as a latched chip-enable input.

The two devices have an on-chip address register permitting use with bus-organized systems that multiplex data and addresses. As shown in the timing diagram of Fig. 2, valid address-line levels are required within a hold time following the falling edge of the strobe line, \overline{STR} . Because of the very fast regenerative address buffering, address-setup time is specified to be zero; in fact, it is a negative time—the address can be presented after the strobe line falls because of the differences in logic delays in \overline{STR} and address-input paths.

Operation

The 6604's chip enable treated as an address input is latched and activates the chip if it is low. In addition, a fast chip-select circuit ensures that \overline{CS} decoders may be used with an array of erasable PROMs with no sacrifice in access time.

The \overline{STR} line need only be low for the duration of an access. As soon as the microprocessor has acquired the

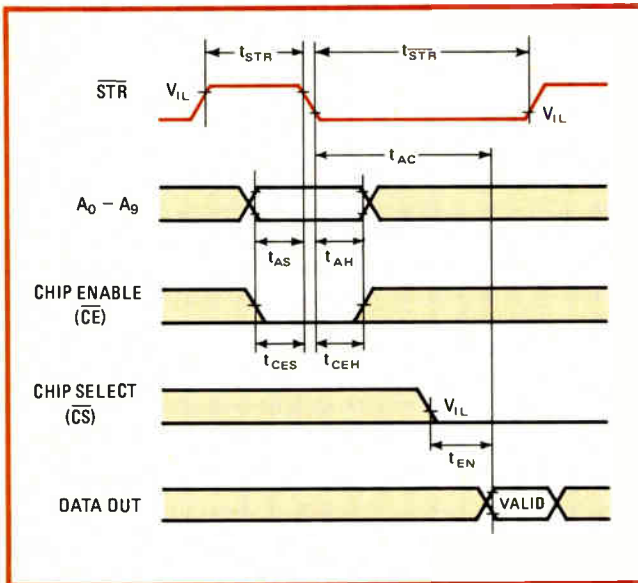

2. No setup. The very fast regenerative buffering used in the 6603/4 erasable programmable read-only memory means that valid address lines can be presented after the falling edge of the strobe line. Thus, setup time for addresses is actually negative.

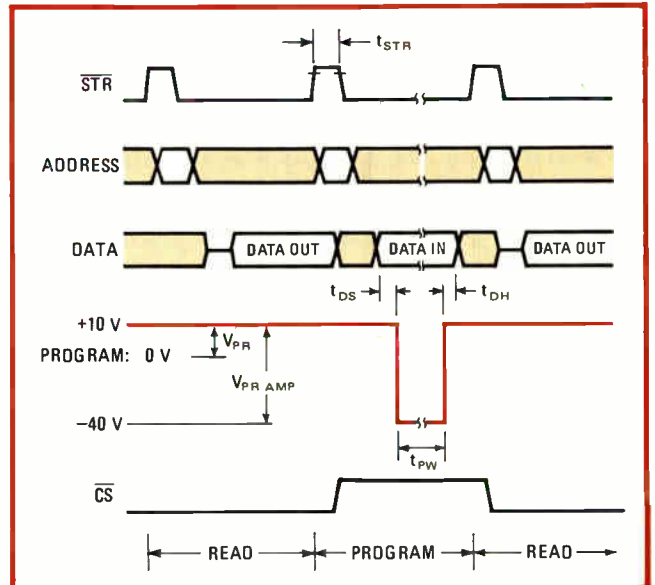

4. Programming. Once an address is strobed in, the cell is read to ensure it is not already programmed. When the chip select goes high, data is presented to the I/O lines. Pulsing the chip's program pin negatively from 10 V to -40 V stores the data.

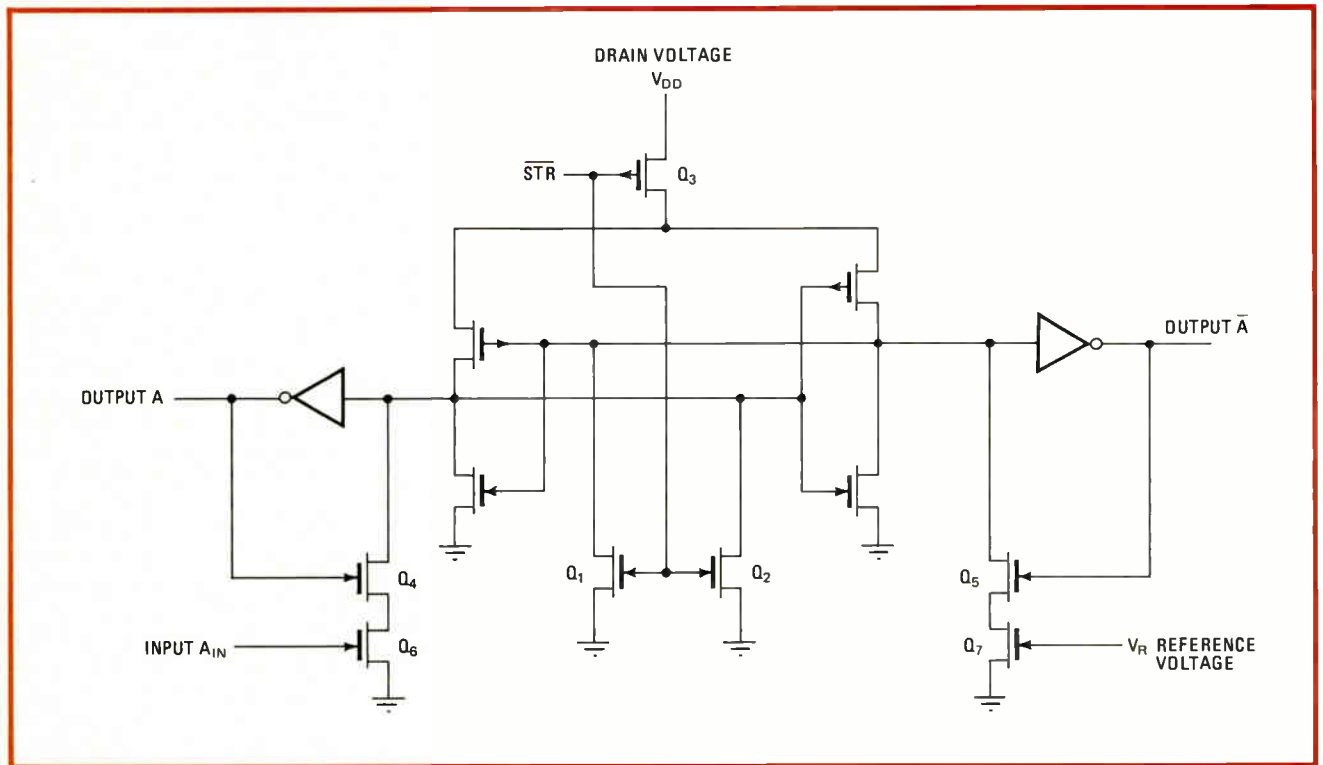

3. Address register. When the buffered address register's strobe line is high, complementary outputs A and \bar{A} are both initially high. When \bar{STR} falls, the circuit becomes extremely sensitive to the input signal A_{in} , and the high loop gain causes it to latch.

data, the strobe line can return high and subsequently cause the outputs to go to a high-impedance mode; however, it must remain high long enough for all columns to precharge.

Address registers

The very fast buffered address latch (Fig. 3) means, in typical devices, addresses need be stable only in a 10-ns

window at 25°C for a supply of 10 v. When its \bar{STR} goes low, Q_1 and Q_2 turn off, and p-type transistor Q_3 turns on, activating the latch. Because of its high loop gain, the latch is extremely sensitive to input-level changes. Its switching threshold is determined by the reference voltage, V_R , which is generated on chip; hysteresis depends on design variables and lateral asymmetry in the circuit.

When \bar{STR} is high, n-type transistors Q_4 and Q_5 are

conducting and thus connect the drains of the input and reference transistors Q_6 and Q_7 to the latch. These transistors have no effect, however, until \overline{STR} falls. Then the feedback latches the input address. Further transitions are incapable of switching the latch, and the address decoders are thus driven by complementary outputs A and \overline{A} .

Programming

A 10-v supply must be used to drive the array when programming, though both erasable PROMs can operate at 5V. The READ-PROGRAM-VERIFY sequence of Fig. 4 shows that in both programming and reading, a cell is addressed by strobing the desired address in. Reading the location verifies that it is unprogrammed; \overline{STR} is left low to ensure that the address does not change and then the chip is deselected. When \overline{CS} goes high, the data-output buffers turn off and the program data may be presented to the input/output pins.

With data at the I/O pins, the program pin is pulsed negatively from 10 v to -40 v, which alters the threshold of the floating-gate transistor in each cell and stores the data. The next positive strobe pulse is especially important, as it precharges the selected line up from somewhere below ground to the level for proper read operation. Exposure of the array to high-intensity UV light generates photocurrents that discharge the floating gates for reuse.

Operation

The C-MOS design differs significantly from other erasable-PROM configurations, as the simplified schematic of one of the floating-gate memory cells and its associated programming and data-sensing circuitry in Fig. 5 shows. When the strobe line is high, both complementary address-register outputs are high for all 10 bits (9 address bits and \overline{CE} in the 6604). Decoder Y outputs will be low; \overline{Y} and \overline{X} lines will be high.

These conditions ensure that p-channel devices Q_8 and Q_{11} , which connect the column to the sense amp and the programming cell, and the p-channel cell-select transistor Q_9 , will all be off, thus isolating all column lines. Because the strobe line is high, \overline{STR} is low, causing the column lines to be precharged to a known level.

A minimum positive strobe pulse width is important, since too small a pulse will not allow all lines to be uniformly precharged. If the column has not been allowed sufficient precharge time, a subsequent read from any of its memory cells may not yield valid data if the cell tried to discharge the column toward ground (the cell contained a 0).

On the other hand, the minimum access time is set by the maximum time required to allow a cell to charge a properly recharged column up to the level at which the sense amp can acquire it. This time depends on column-line capacitance, sense-amp gain, column resistance, transistor thresholds, and other factors.

With the strobe line high, the column is disconnected from the sense amp. Also, in the sense amp, the feedback loop of the data latch is broken by the turning off of the p-channel transistor Q_{12} , and the internal data output bus is high. Once the strobe line falls, internally gener-

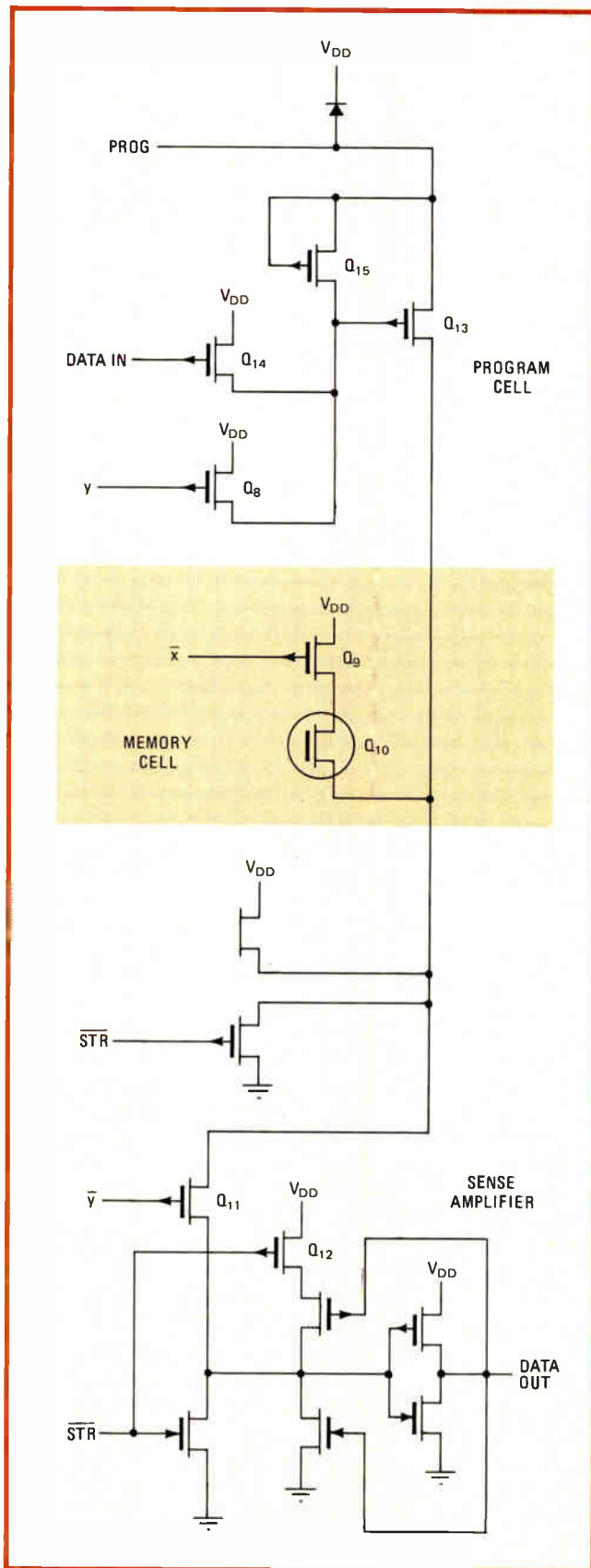

5. Addressing the cells. Column decoders generate the complementary Y and \overline{Y} signals and row decoders produce the \overline{X} signal. When strobe line is high, Q_8 , Q_9 , and Q_{11} are all off, and column lines are isolated for precharging. Chip is then ready for programming.

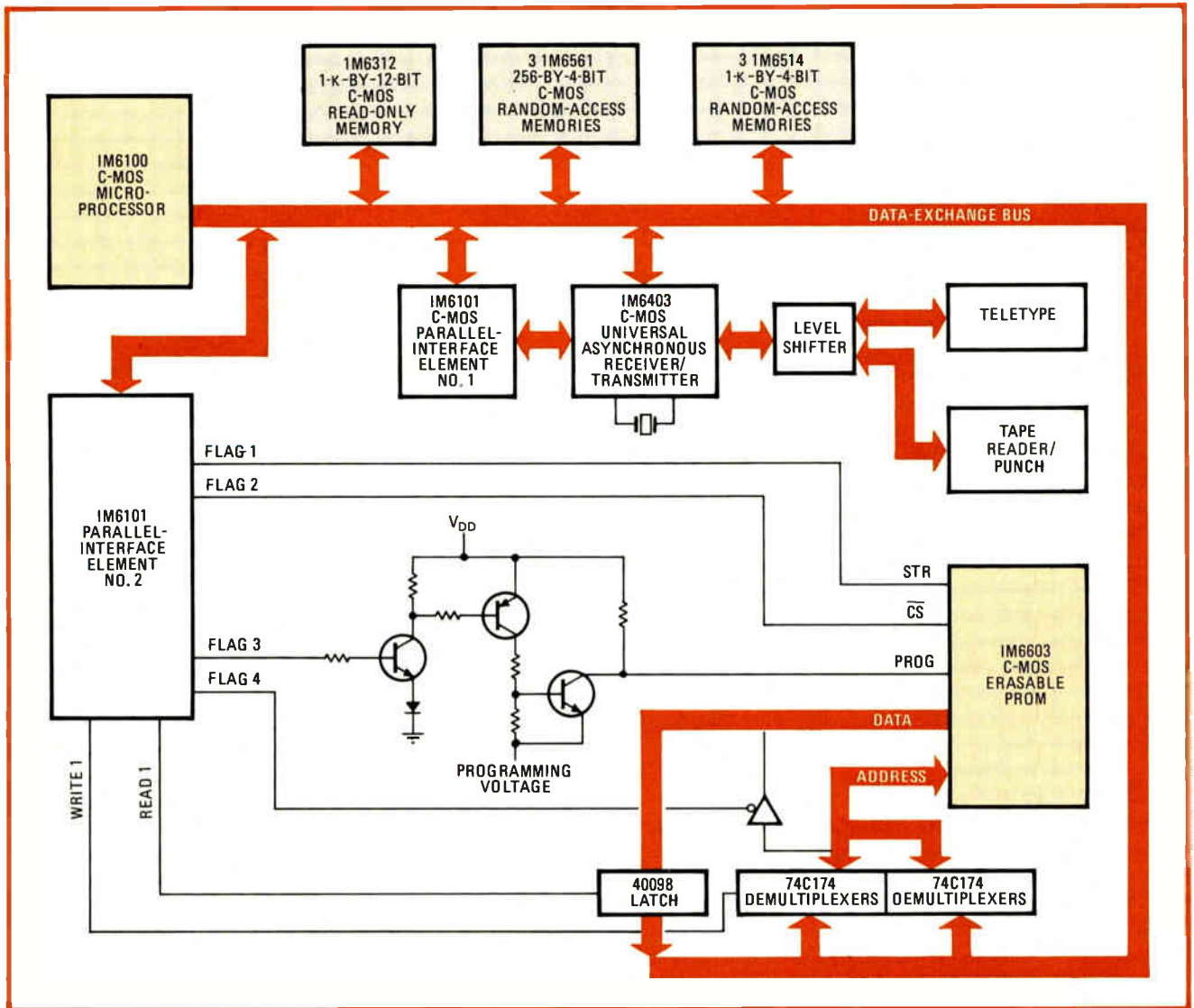

6. Intelligent programmer. A typical programmer for the 6603/4 is built around a 6100 C-MOS microprocessor and uses an ASCII terminal to edit, run, and debug programs. The desired program is stored in RAMs before programming into the erasable PROMs.

ated clocks time the following series of events:

- The address is latched.
- The address decoders are activated and a single word is selected to drive the columns.
- The columns are corrected to the sense amps, and the data is latched internally after an access time.
- If the chip is selected, the output-data buffers are turned on, and the internal data latch drives the outside world through transmission gates. If V_{cc} is less than V_{dd} , level translation also takes place.

Further features

The buffered address latch can work with many logic levels because it has been designed so that the input switching threshold varies very little with supply voltage. For a supply range of 2 to 12 volts, the minimum voltage that is needed to operate the latch varies only from about 1.6 to 2.6 v.

However, the 6603/04 are specified at a minimum of 2.7 v over their standard operating range. This specification allows the user to supply a higher drain voltage for

fast access and still drive the address lines with open-collector transistor-transistor-logic gates and resistive pullups to 5 v. Even TTL gates with totem-pole outputs will drive the address lines satisfactorily. When loaded by the $1\text{-}\mu\text{A}$ C-MOS inputs, their output high level is 3.5 v; the 2.4-v level guaranteed by TTL assumes a much heavier load of 10 TTL inputs, or $400\ \mu\text{A}$.

For a setup in which the address inputs are being driven by transistor-transistor logic, the data output can also be made TTL-compatible by tying pin 24 to a 5-v supply. The output drivers are transmission gates switching either ground or the V_{cc} supply, and they are independent of the drain voltage that powers the memory array. Of course, by connecting V_{cc} and V_{dd} together, an all C-MOS system is also possible. To take full advantage of high-speed operation while maintaining a TTL interface at the inputs and outputs, the strobe and chip-select lines should be driven by fast level translators, since they require the standard C-MOS threshold voltage of v.

The main advantage of C-MOS is, of course, its low power dissipation. The quiescent power in the 6604/03

TABLE 1: COMPARING POWER DISSIPATIONS

	Quiescent power per bit	450 ns cycle, 25° C active power per bit
1702A (2,048 bits)	160 μ W	160 μ W*
6603/04 at 5 V (4,096 bits)	0.0015 μ W	2 - 8 μ W
2704 (4,096 bits)	145 μ W	145 μ W
2708 (8,192 bits)	72 μ W	72 μ W
2716 (16,348 bits)	3 μ W	17 μ W

*1,500-ns cycle time

TABLE 2: COMPARISON OF POWER DISSIPATION IN A 32,768-WORD MEMORY ARRAY

32-K-by-16-bit, 1- μ s cycle time, 5-volt supply	2716	6604
Total number of devices	32	128
Standby power per device (P_S)	50 mW	6 μ W
Active power per device (P_A)	285 mW	4 - 16 mW
Total array power	$30 P_S + 2 P_A$ = 2,070 mW	$126 P_S + 2 P_A$ = 9 to 33 mW

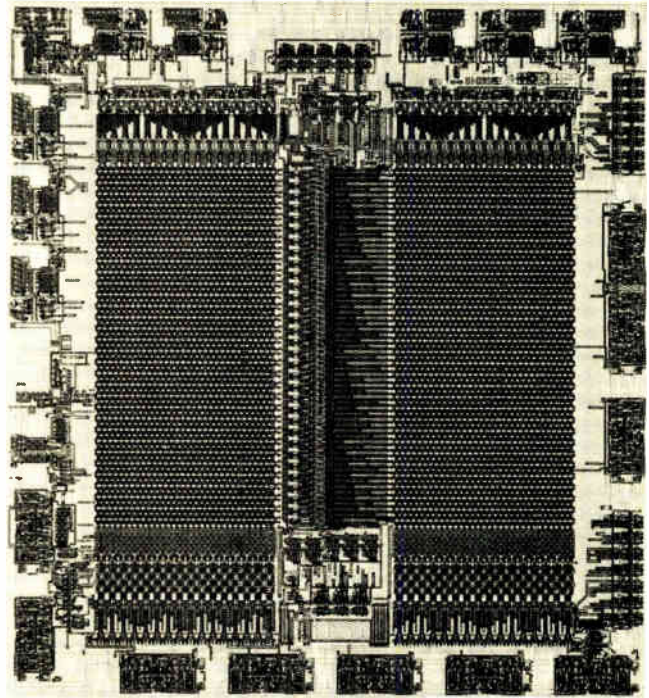

The chip. Both the 1,024-by-4-bit 663 and the 512-by-8-bit 6604 erasable PROMs use the same 167-by-180-mil silicon chip. The devices are housed in 24-pin packages with transparent lids that facilitate erasing of stored data with an ultraviolet lamp.

works out to a little more than 1 nanowatt per bit for a 5-v supply. When the device is cycling at 500 ns, the consumption climbs to 2 and 8 microwatts per bit.

The quiescent and active power dissipations of a variety of erasable PROMs are shown in Table 1. The p-channel 1702A, which uses a floating gate similar to the one in the 6604/03, is listed, even though its cycle time is 1,500 ns. It is the earliest erasable PROM made and draws the most power. The 2704, 2708, and 2716 use a more complex n-channel stacked-gate cell. What's more, most other erasable PROMs require multiple power supplies, while the 6603/04 require only one.

In use

A microprocessor-based programmer for the 6603/04 best illustrates the sequence of operations involved. Built around Intersil's 6100 processor, the programmer (Fig. 6) uses a monitor ROM that allows an ASCII terminal to be used to enter, edit, run, and debug programs. Other parts provide interfacing with a terminal and paper-tape reader.

Three 256-by-4-bit RAMs store the application program, and three 1,024-by-4-bit RAMs hold the data to be programmed into the erasable PROM. Under program control, tapes may be read into the data RAM. The application program may be written to read any of the following:

- 1,024 4-bit nibbles to program one 1,024-by-4-bit 6603 erasable PROM.
- 1,024 12-bit words to program three 1,024-by-4-bit 6603s, one at a time.
- 512 8-bit bytes to program one 512-by-8-bit 6604.

The application program can include several varia-

tions. It can use single-location programming and verification by entering addresses and data from a terminal. It can read or punch formatted tape, and the printer can be used for generating formatted truth tables. The program can even include stopping at or listing any address with a mismatch. The whole system runs at 10 v, and a -40-v supply is connected to the emitter of the programming pulse driver.

In actual practice, an interactive programming procedure should be used to ensure uniform avalanche injection into all locations. In other words, each location to be programmed would first be read to verify that it is erased, then successive program-read-verify sequences would be performed.

Though most erasable PROMs dissipate the same amount of power upon access and when idle, the 6603/04 (Fig 7) and the 2716 do not. Table 2 shows the ratio of active to standby powers for the two devices. In the 2716, the ratio is about 6:1, whereas in the 6603 or 6604 it is anywhere from 1,300:1 to 5,300:1, depending on the cycling rate. This substantial difference suggests that large erasable PROM memory arrays should be designed so that the majority of the devices are on standby; if so, the power consumption will asymptotically approach the power consumed by the number of devices needed for one memory word.

An example is a 16-bit airborne computer with a 15-bit program counter that requires 32,768 bytes of erasable PROM storage in standard configuration. If a memory-cycle time of 1 μ s is assumed, Table 2 shows that the total power consumed by 128 6604s is roughly a hundred times less than that consumed by only 32 2716s—9 to 33 milliwatts in the former vs 2,070 mw. □

Audio blanker suppresses radar-pulse and ignition noise

by Carl Andren

E-Systems Inc., St. Petersburg, Fla.

This simple audio-stage noise blanker will reject most repetitious, pulse-type interference, like radar and automobile ignition spikes, that often plagues a-m receivers. The circuit is both less costly and far less complex than the radio-frequency stage blankers employed in some of the more sophisticated receivers, and though not as effective in eliminating interference, it outperforms the more commonly used noise-limiting audio-clipping circuits.

The blanker shown in the figure detects whether the amplitude of an offending pulse train at the output of the receiver's envelope detector exceeds a set threshold and then disables the output stage if necessary. Waveform diagrams are shown at several circuit points to help clarify operation of the blanker.

A typical amplitude-modulated signal might appear at

the input of an a-m receiver as shown in the upper left of the figure, where a 20-megahertz radio-frequency wave, modulated 30%, is overridden by radar pulses 20 decibels greater in amplitude. A time-magnified portion of the a-m detector output, after passing through an inverting operational-amplifier stage, would appear as shown, where the maximum amplitude of the pulse would be limited by the saturating level of the intermediate-frequency amplifier. Only two offending pulses are shown for clarity, but this detected signal contains a pulse train of sufficient amplitude and repetition rate to generate a substantial pulse noise and so impair the readability of the signal.

The interfering spikes increase the effective modulation percentage to well over 100%. The blanker is triggered into operation when the modulation peak exceeds 140%, whereupon Q_1 and Q_2 switch on and disable signal-gate Q_3 for the duration of each spike. The 140% threshold has been experimentally determined as the point at which the interference caused by the blanking operation itself is still less than the interference generated by the offending pulse train. Note that to ensure that the blanking action occurs at the set modulation peak independently of signal-level changes, the receiver's automatic-gain-control signal is introduced at the

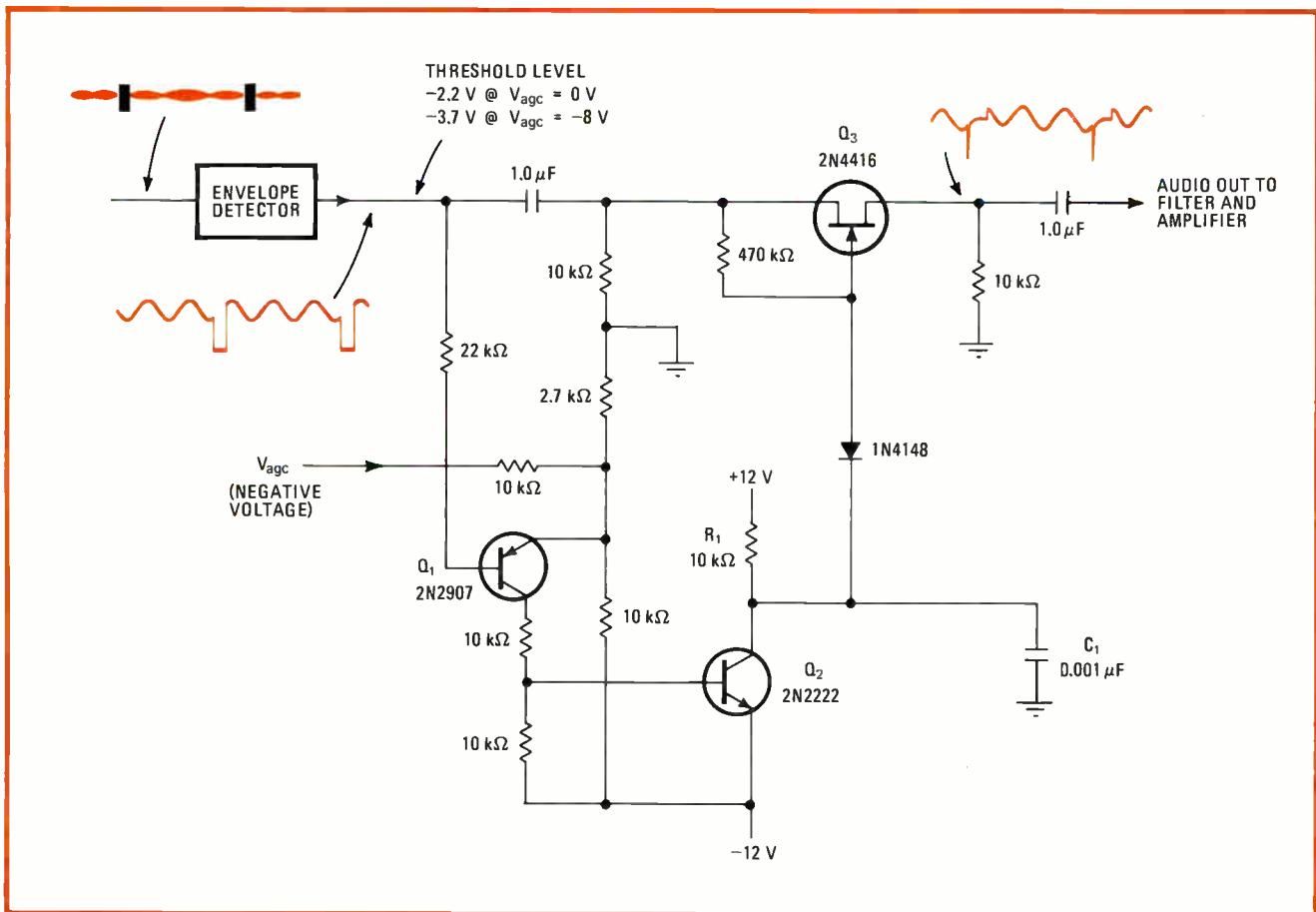

Spike eater. Audio-stage noise blanker, although not as effective at eliminating pulse-type interference as rf-stage blankers, outperforms noise-limiter/clipper circuits. Blanking occurs when spikes raise effective modulation percentage over 140%. Receiver's agc signal is introduced to emitter of Q_1 to ensure that the blanking action occurs at the set modulation point independent of input signal amplitude.

Coming through...

with better ways
to interface

NEW "GPIB" CABLES

Interface computer power with test and measurement hardware—without lots of time-consuming patchwork wiring.

Belden's new "General Purpose Interface Bus" cable assemblies will become essential tools for you in R/D, quality control and on-the-job trouble-shooting.

Interconnect up to 15 programmable instruments at once. In star or daisy chain networks. Cables work with counters, signal generators, calculators, digital multimeters—in fact, they can be used with any instrument equipped with standard IEEE 488 interfaces. That means hundreds of compatible products today and the hundreds more coming on-stream soon.

These new 24 conductor cables are built to last, too. Semi-rigid PVC insulation and PVC jacket offer good flex life. U.L. recognized self-extinguishing plastic connectors are designed to withstand constant make/break cycling. Contact pins featuring gold over nickel-plated beryllium copper deliver far better conductivity than designs using plain copper. Belden U.L. approved "GPIB" cable assemblies (with metric cadmium plated screws) are available right now in five standard lengths up to 16 m (52.5'). U.L. approved and CSA certified bulk put-ups are also available. Let Belden come through for you. Contact your local Belden distributor or Belden Corporation, Electronic Division, P. O. Box 1327, Richmond, Indiana 47374; 317-966-6661.

BELDEN

Coming through...

with new ideas for moving electrical energy



threshold bias point at the emitter of Q_1 .

Q_3 operates with no applied dc voltage so that no switching transients will be generated by the blanking action to impair circuit performance. Q_2 , R_1 , and C_1 have a fast-attack, slow-decay characteristic. Q_3 is thus gently turned on after a spike has passed so that the popping and clicking sounds that often accompany the

operation of a blanking circuit that processes a randomly occurring train of spikes will be further suppressed.

The results of the blanking action are shown at the output of Q_3 , where it is seen that only brief transients appear. The signal is slightly distorted, but the distortion is barely audible. There is a great improvement in noise reduction, however. □

Four-function calculator times long intervals accurately

by Steve Newman

Hospital of the Good Samaritan, Los Angeles, Calif.

Time intervals extending up to several years can be set with the aid of an inexpensive four-function calculator and an integrated-circuit divider. This timer is accurate to within a few seconds per year. The only requirements for the calculator are that it have at least an eight-digit display, a minus-sign indicator at the left-most position of the display, and a continued-operation mode, which allows subtraction of a given number repetitively by depressing a single key (usually the equal-sign button).

The time interval is set by keying in the desired value, expressed in seconds. For instance, if the timer is set to go off in 3 days, 10 hours, 54 minutes, and 33 seconds, the number 298,473 is entered. (With an eight-digit display, an interval of 10^8 seconds, or 38 months, can be set.) Next, the -1 command is keyed in. The calculator is now programmed to subtract 1 from the displayed value each time the equal-sign key is activated and then to display the new value.

To decrement the count at proper intervals, a precise

time base is required, and the calculator's keyboard pins must be made accessible. In this case, a divide-by-60 counter, the HEP C4055P, is used to derive a 1-hertz signal from the 60-Hz power line, as shown in the figure. This clock drives the transistor switch connected across the pins corresponding to the equal-sign key, which are closed when that key is depressed in normal operation.

The timing interval begins when the time base is activated. The displayed number is decremented for each pulse emanating from the C4055P, so that after N seconds the calculator will display zero, and after $N + 1$ seconds it will display -1 .

The minus-sign output, which is part of the display circuitry, provides a convenient way to detect the end of the set timing interval. Here, the g-segment pin corresponding to the minus-sign key is brought to one input of a NAND gate, G_1 , as is the lead corresponding to the left-most digit of the display. An identical gate, G_2 , follows, so that the entire logic function is that of an AND gate. This function is suitable for driving positive-logic circuits or devices.

Pulses emanate simultaneously from both the minus-sign pin and the last-digit driver port when the calculator first displays a minus value, and for every result thereafter. The first pulse may thus be used to turn on an alarm. Because many calculators scan the display at a frequency of a few hundred hertz, an audible output can be obtained if a loudspeaker is connected to G_2 . □

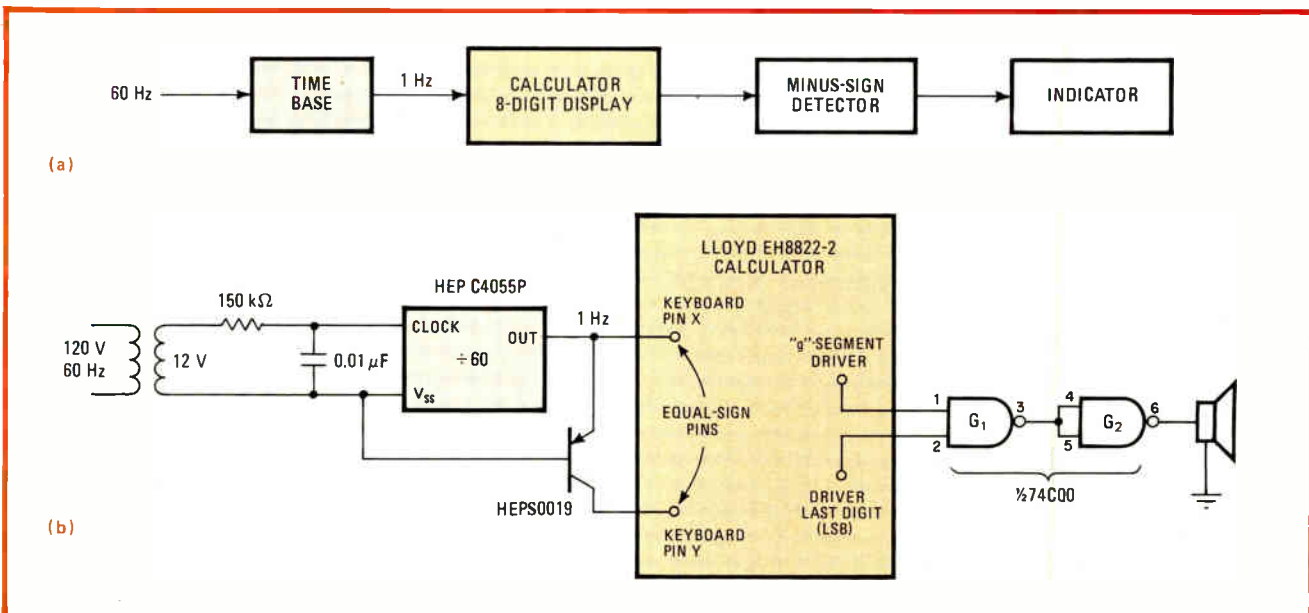

On the button. Precision, low-cost timer (a) can be built with most any four-function calculator and integrated-circuit divider (b). Keyboard pins corresponding to equal-sign button must be accessible. Circuit is accurate to within a few seconds per year.

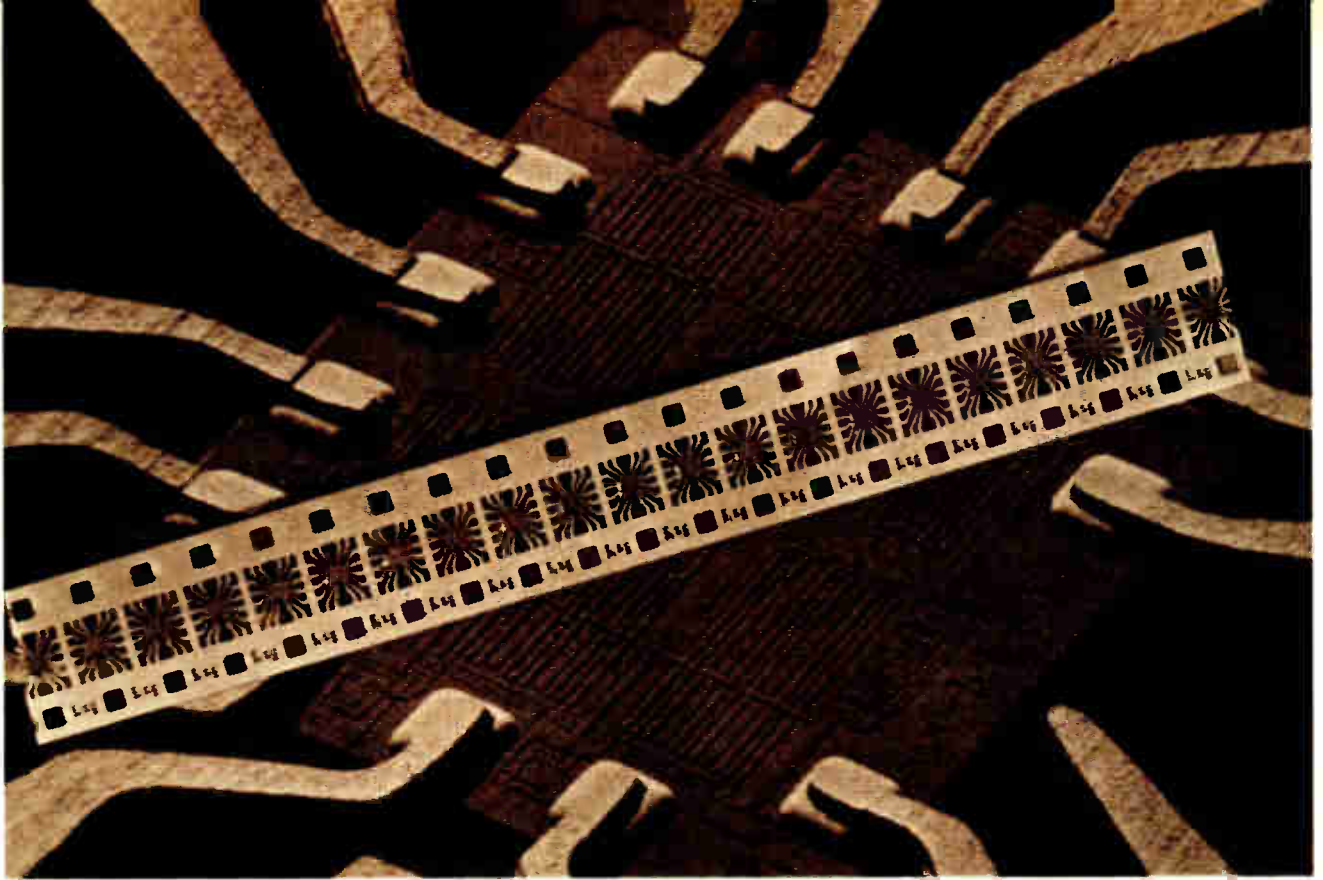

Beam tape plus automated handling cuts IC manufacturing costs

Fully automated finishing operations make it possible to bring plastic-encased small-scale integrated-chip assembly back home

by Doug Devitt* and Jim George, *Solid State Scientific Inc., Montgomeryville, Pa.*

□ Over the last five years tremendous advances in integrated-circuit manufacturing have occurred. But while wafer fabrication techniques and automated testing operations have leapt ahead, bonding, assembly, and other aspects of finishing have stayed close to the starting line.

An industry that is among the most technically sophisticated has attacked the problem of high finishing costs by shipping devices on a 12,000-mile round trip to have them assembled manually. That was done on the principle of reducing the cost per unit of labor. Now, a more viable approach for plastic-housed small-scale integrated circuits is emerging: reduce the amount of labor by applying a fully automated system built around the beam-tape method of assembly.

Assembly operations contribute significantly to the manufacturing costs of all integrated circuits. In fact, as Fig. 1 illustrates, for devices smaller than 80 mils per side, assembly operations represent the largest single

cost of manufacturing. And these devices, the so-called "jelly beans," are the high-volume ICs on which much semiconductor manufacturing is based.

Historically, the experience of the IC industry has been that any manufacturer who is not constantly working to reduce costs risks being undercut by his competitors to the point of bankruptcy. Continually searching for developing nations with low labor rates is not a long-term solution to the assembly-cost problem. In fact, it is a good bet that the cost of offshore assembly will actually rise because of increased airline freight rates, growing inflation in the Third World, and a trend toward higher import duties.

Because of the distance and the turnaround time involved, offshore assembly has two other disadvantages. First of all, a firm must tie up working capital to finance its inventory in the 12,000-mile-long pipeline. Secondly, the system is usually sluggish and responds poorly to changes in market needs.

Under the proper conditions, a better choice for both

*Now with Harris Corp., Semiconductor Division, Melbourne, Fla.

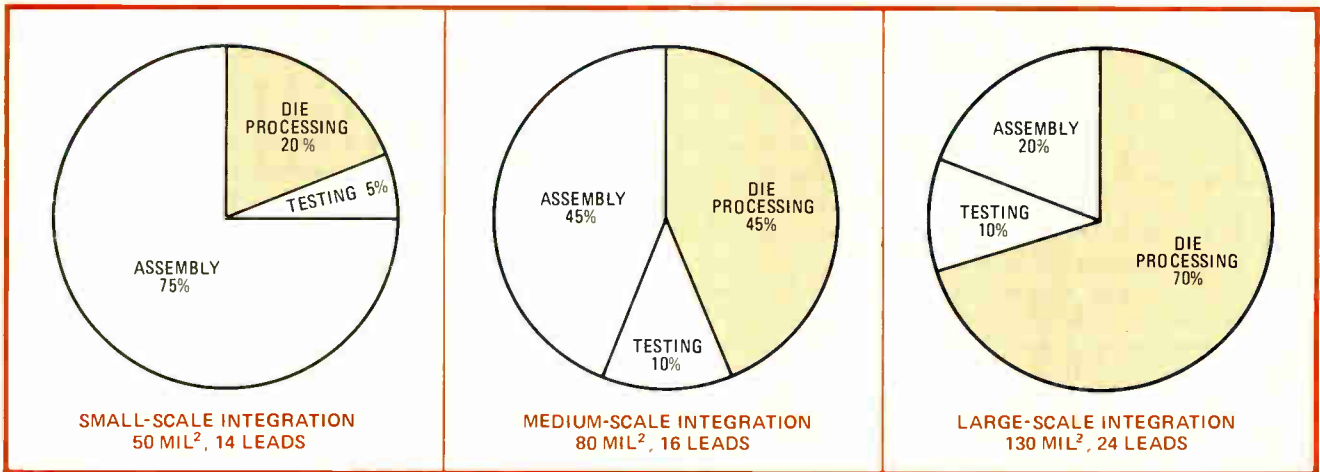

1. Manufacturing costs. As chip area increases, the cost of assembly becomes lower. In small-scale integration, assembly costs dwarf all others. Two methods of cutting these costs are offshore assembly and the use of a fully automated assembly line.

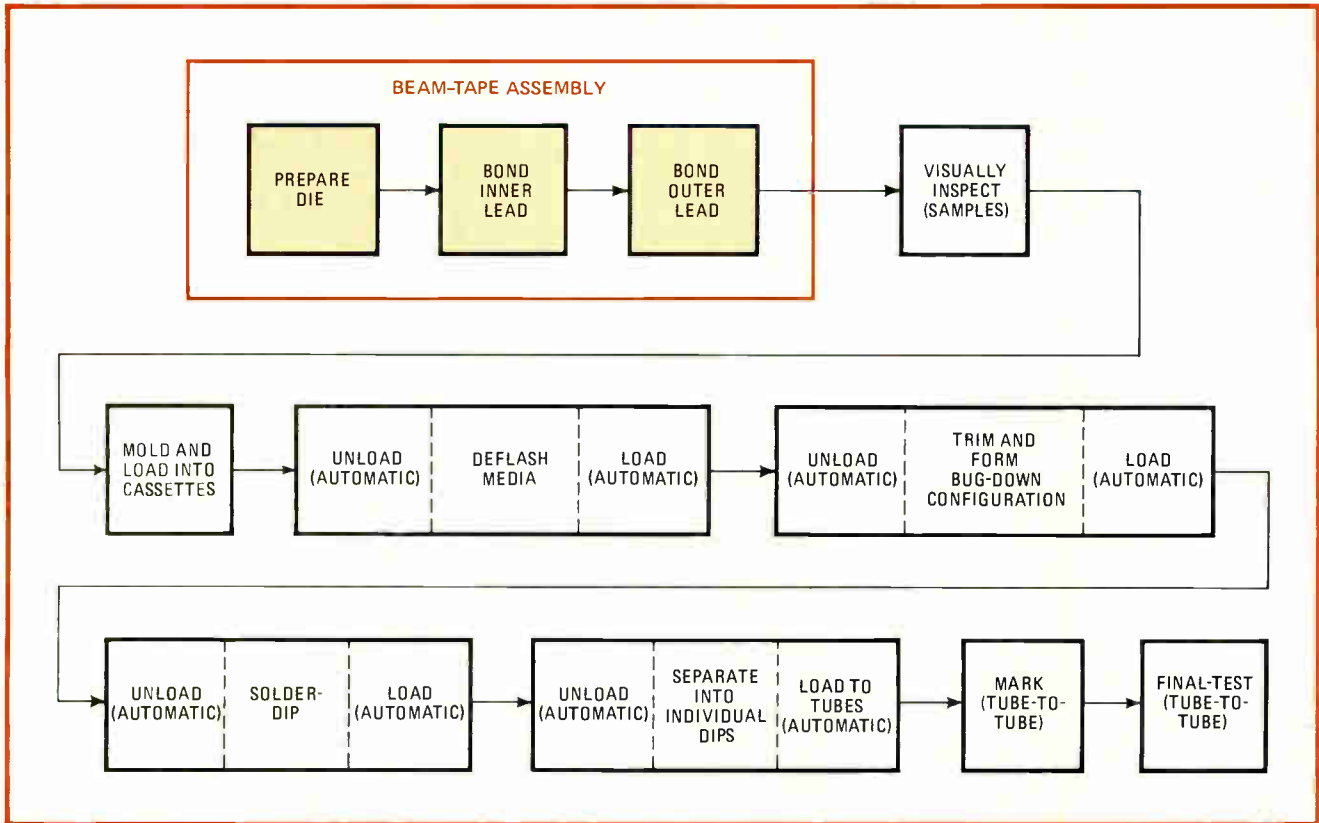

2. Automated assembly. The major steps in Solid State Scientific's automated assembly system involve automatic unloading, processing, and reloading at each step. The individual complementary-MOS chips are never handled by production personnel.

user and manufacturer would be to bring assembly operations back to the United States. What is required is that the manufacturer consider the entire assembly operation, from die attachment to final testing, as an integrated manufacturing system. This system can then be optimized for cost and efficiency.

Recent developments in beam-tape (film-carrier) interconnection systems have encouraged IC firms to re-evaluate their assembly operations. These systems use prefabricated metallic interconnection patterns on a sprocketed insulating film to provide automated, high-speed bonding of the interconnection to both the chip

and a lead frame. Integrated into the total assembly operation, such a system allows the IC maker to completely automate the back-end functions. An example of how beam-tape technology has been incorporated into a fully automated assembly line is Solid State Scientific's assembly system for packaged complementary-metal-oxide-semiconductor chips, which is diagrammed in Fig. 2.

In this assembly operation, wafers are given metallic "bumps" by electroplating a copper contact about 25 micrometers high over a chromium barrier (Fig. 3). The barrier prevents undesirable intermetallic compounds

LOOKING AT MAJOR ASSEMBLY TECHNIQUES FOR EPOXY DUAL IN-LINE PACKAGES

	Method of attaching die to lead frame	Remaining assembly steps up to final testing	Geographical location	Period in use
Manual or semiautomated die bonding plus semi-automated finishing	thermocompression by hand or slow machine, 200 – 500 units/hr or thermoccompressive gold-ball bonding, 60 – 110 units/hr	molding, deflashing, dam bar removal, tin plating, cutting and forming, tube loading; 500 units/hr (average) per step	low-labor cost areas of Asia	1965 to present
Automated die bonding plus semiautomated finishing	high-speed thermo-compression, 1,000 – 2,000 units/hr or programmable high-speed sequential wire bonding, 250 – 500 units/hr	same as above, except with newer equipment; slightly faster rate	low-labor-cost areas of Asia	1973 to present
Film-carrier die bonding plus semiautomated finishing	thermocompression using beam tape with inner lead bonding at 1,000 – 2,000 units/hr and outer lead bonding at 2,000 – 4,000 units/hr	same as above	low-labor-cost areas of Asia	1975 to present
Film-carrier die bonding plus fully automated finishing	same as above	same as above, except for automated loading and unloading, and high-speed trimming and forming plus solder dip; 5,000 units/hr	U.S.A.	1978

from forming between the copper contact and the aluminum metalization of the chip pattern.

Each wafer is then electrically probed, and rejected dice are inked. Following probing, wafers are mounted on a substrate, held in place by a thermoplastic material, and then sawed through to the substrate with a diamond saw. Because the wafers are attached to the substrate, separated dice maintain their original orientation after the sawing.

Chips on tape

Actual bonding takes place in two separate operations. In the first step, inner lead bonding, the dice are bonded to an 11-millimeter patterned tape. The tape consists of two layers—a copper interconnection pattern bonded to a sprocketed polyimide carrier for strength. Single-layer pure-copper tapes, which are simpler to process, are just starting to be used by a few firms. However, Solid State Scientific chose two-layer tape for its system because of its commercial availability and satisfactory field performance.

The chip-on-tape resulting from this first step is stored on reels until the second step begins. This procedure, called outer lead bonding, involves fixing the tape's IC microinterconnections onto the copper-based lead frames. After this step, the lead frames are cut into strips of 10 devices and loaded into a magazine for

subsequent processing. Devices are then inspected on a sample basis for unsatisfactory bonds and for manufacturing defects that are capable of causing electrical malfunctioning.

Automated procedures

The strip-mounted devices are next routed to a molding facility, where they are epoxy-molded and loaded into a special vertical holder, or cassette. The holder then goes to a deflashing operation. There, the devices are automatically unloaded, excess plastic is removed, and the devices are then automatically reloaded back into the cassette.

The first trimming and forming operation is next. After unloading, the strips are positioned beneath a multistage series of punches. Then, the epoxy between the dam bar and the main body of the device is removed. (A dam bar is a thin metal strip that shorts out all the leads on the lead frame. It prevents plastic from getting on the leads.) The dam bar itself is removed, and finally the devices are formed into the lead-down, or bug-down, configuration. Throughout this operation, the devices remain connected in strips by pins at each end of the package. The strips are then automatically reloaded back into the assembly magazine.

Next, a number of precleaning steps are performed and the devices are dipped in hot solder—all done auto-

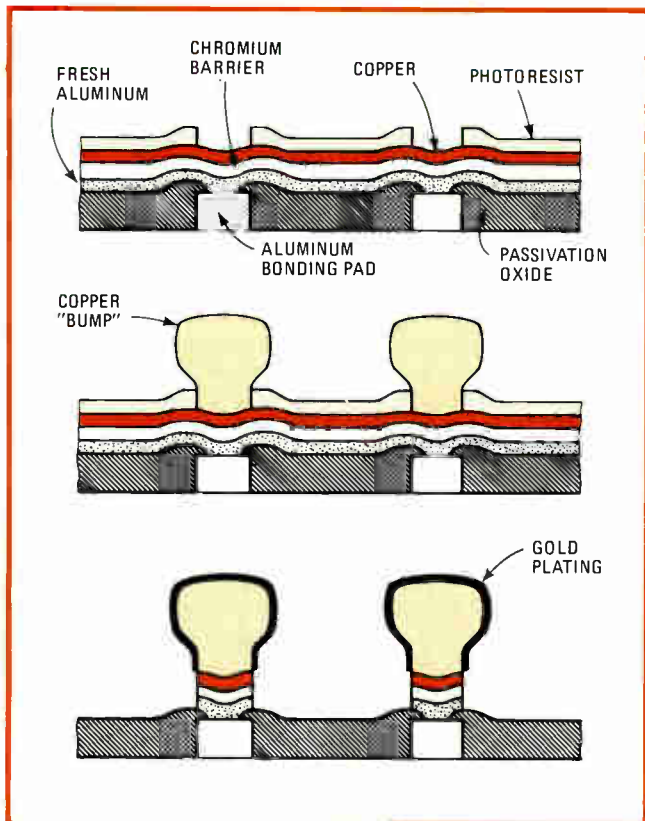

3. Bumped wafers. Bumps are formed by evaporating layers of aluminum, chromium, and copper over a wafer. The copper contact is electroplated up to 25 μm ; then the resist and unwanted metals are stripped. Lastly, the bump is gold-plated.

matically while the devices remain on the strips. Following the final drying step, magazine-loaded strips are transferred to the final trimming operation, in which the devices are separated from the strips and loaded into antistatic tubes. Devices in the tubes are ready either for marking or for final testing, depending on the specific process flow.

A key feature of this assembly system is the automated unloading, processing, and reloading at each step of the sequence. Throughout the entire assembly procedure, individual integrated circuits are never handled by production personnel, thereby eliminating the breakage that will sometimes occur in semiautomated and manual handling.

Automated assembly's impact

The table, which compares the major assembly techniques for dual in-line packages made of epoxy, attempts to put automated systems in perspective. Though not shown, the figure of merit of unit output per operator hour represents the approximate efficiency of the total system from die interconnection up to final testing.

Introduction of high-speed die bonding in 1973 resulted in a very impressive doubling of an operator's production rate from 20 to 40 devices per hour. As beam-tape interconnection systems were introduced, output increased fivefold to an unprecedented 200 devices per operator hour. Integrating beam-tape technology into a completely automated assembly facility



Beaming in. This is a view of the semiautomated equipment used at Solid State Scientific for gang-bonding the inner leads of each beam-tape interconnection pattern to the bumped I/O pads of an IC chip. Note that the TV monitor provides excellent visual control.

leads to a further 50% improvement in output.

For the user, automated assembly systems provide the obvious benefit of reduced costs for those high-volume devices adaptable to automated assembly. Of greater significance, however, is the fact that they equip the IC manufacturer to respond better to the marketplace. On the one hand, during an industry-wide downturn, the response of IC firms is sluggish because much of the work in process is already in the pipeline. The result is rapidly rising inventories, with their concomitant economic penalties.

On the other hand, a period of rising demand causes offshore assembly facilities to run at or close to 100% capacity. Therefore, increasing production during an upturn is extremely difficult and costly, with the result that lead times stretch out and deliveries slip.

Automated assembly can do much to improve this situation by giving the IC manufacturer much better control. In down periods, inventories can be adjusted much more quickly, and the capital that would otherwise be tied up in inventory will be available for other projects. When demand rises, production can be increased quickly by running up to three shifts, seven days a week. □

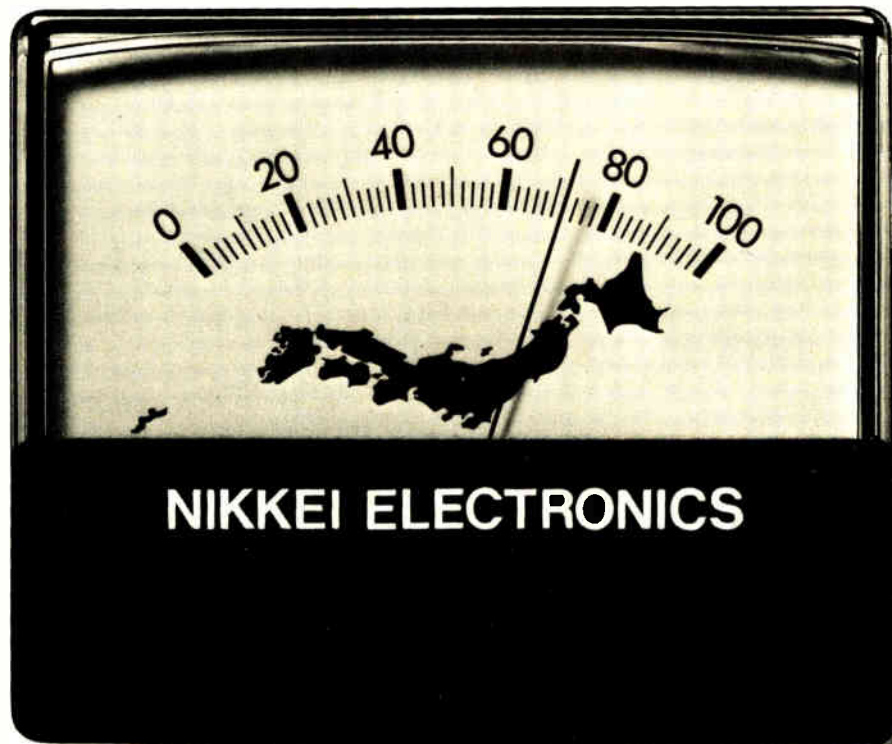

The Japan Output Check.

If the output isn't measuring up to your input in your approach to the Japanese market, it may be that you are switched to the wrong setting.

And since we are talking about a ¥164 trillion market, you can't afford to take chances.

You need to do things the right way in Japan.

And make your name known to the right people.

Which is where we come in.

As Japan's leading electronics magazine, we are in a unique position to help get your message across. A bi-weekly, Nikkei Electronics is delivered

direct to the desks of more than 37,000 key decision makers in the electronics industry.

Nikkei Electronics. For sure feedback from Japan.

Subscriptions: 36,550 (as of Jan. 23rd, 1978)
Regularly audited by the Japan ABC.

For further information, write to:
H.T. Howland, Marketing Services Manager,
Electronics, McGraw-Hill Publications Co.,
1221 Avenue of the Americas, New York,
N.Y. 10020, U.S.A. Tel: (212) 997-6642

Japan's foremost electronics publication

Nikkei Electronics

NIKKEI-McGRAW-HILL, INC.
The publisher of Nikkei Electronics
Wataru Makishima, Manager, Advertising,
Nikkei Annex Bldg. 2-1-2, Uchi-Kanda, Chiyoda-ku,
Tokyo, Japan. Telex: J26296 NKMGRAW

Circle 121 on reader service card

Measuring thermal resistance is the key to a cool semiconductor

To improve performance, reliability, and yield of integrated circuits, knowledge of thermal design considerations and of measurement techniques is a must for the user, as well as the manufacturer, of semiconductor devices

by Bernard S. Siegel, Sage Enterprises Inc., Mountain View, Calif.

□ Taking the heat off semiconductor devices is a sure way to improve their performance, reliability, and yield. For both user and manufacturer, a knowledge of their thermal properties and in particular their thermal resistance can spell all the difference between success and failure, whether in terms of equipment functioning or in relation to parameter yields. And new instruments are making this knowledge easier to come by.

Take performance. If an operational-amplifier chip capable of operation off an input bias current of 1 picoampere is not thermally packaged correctly, it may be unable to reach its bias specification. Yet in most attempts at improving electrical specifications, thermal design considerations come a poor second to changes in circuit design and fabrication methods.

As for reliability, numerous test programs since the transistor's invention have verified that every 10°C or so rise in junction temperature halves a device's operating life expectancy.

Finally, fluctuating yields at the manufacturing level and actual failures in users' equipment can often be traced to differences in parameter test results that are the direct consequence of variations in thermal resistance. In the case of most low-input bias op amps, for instance, a 10°C increase in junction temperature will just about double the input bias current required.

The ability to monitor both the absolute magnitude and manufacturing variations in thermal resistance in particular is clearly crucial. But first, it is as well to be clear as to the exact meaning of "thermal resistance."

Defining thermal resistance

Whenever electrical power is applied to a semiconductor device, some of the power is converted into heat, resulting in a rise in junction temperature. This occurs because the heat-generating portion of the device is separated from the outside world by the path shown in Fig. 1. The heat-flow path is made much more complex by the heat-removal paths associated with conduction and convection within the binding wires and by radiation from the heat source to the package. Such heat flow occurs with most semiconductor devices.

Each of the different portions of the path from the heat source (the active area or junction) to the outside world has two components. Of primary concern for most steady-state conditions is thermal resistance, shown as

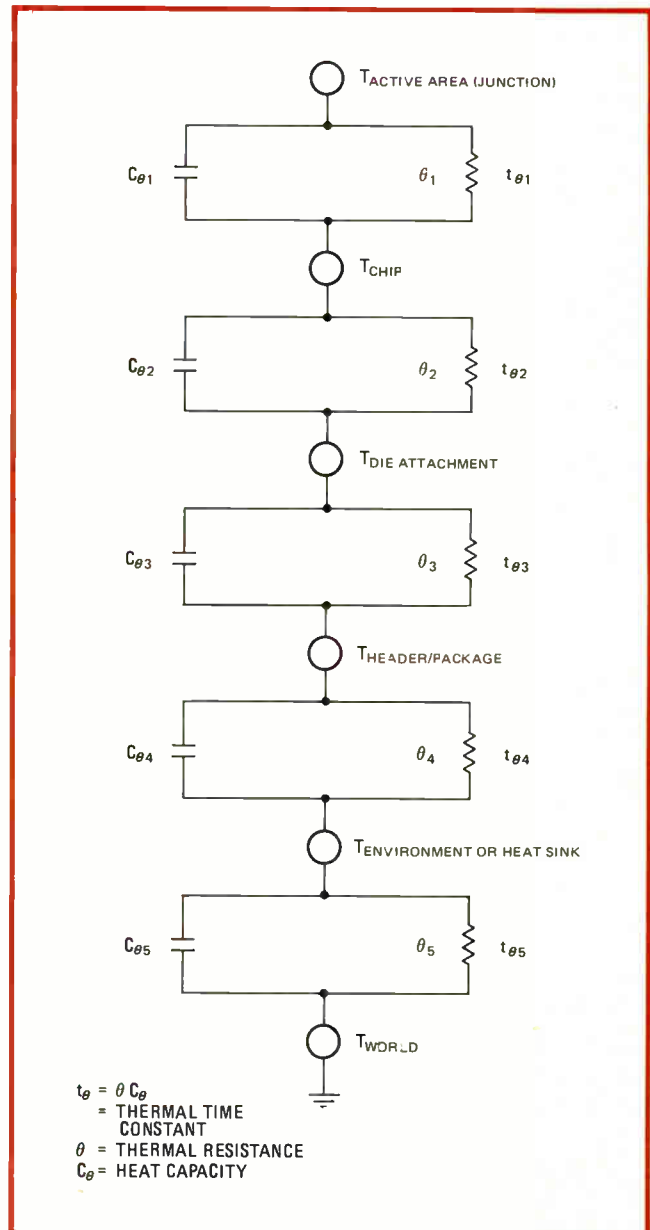

1. Thermal-equivalent circuit. The simplified electronic analog of the flow of heat from a semiconductor device to the outside world is a series of equivalent resistors and capacitors in parallel. For steady-state conditions, the thermal resistance is of primary importance.

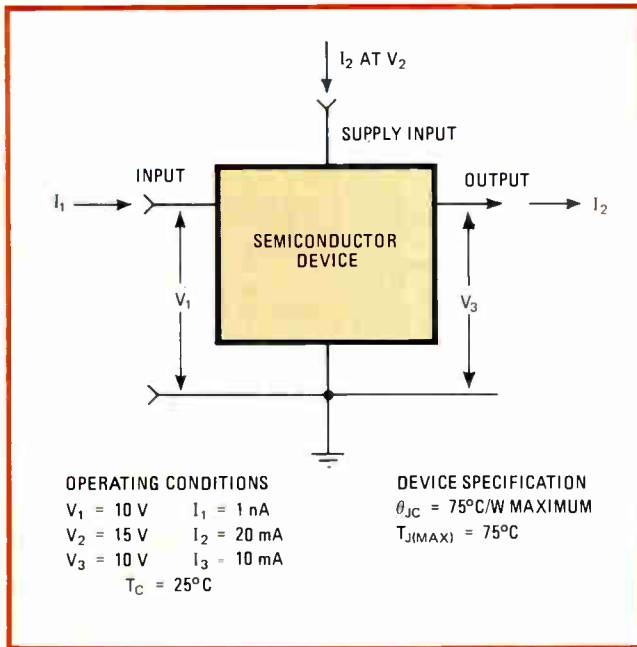

2. Junction temperature. With the operating conditions and device specifications shown, it is possible to calculate the device junction temperature, T_J . For the case shown, T_J equals 40°C , which is well below the maximum value of 75°C specified.

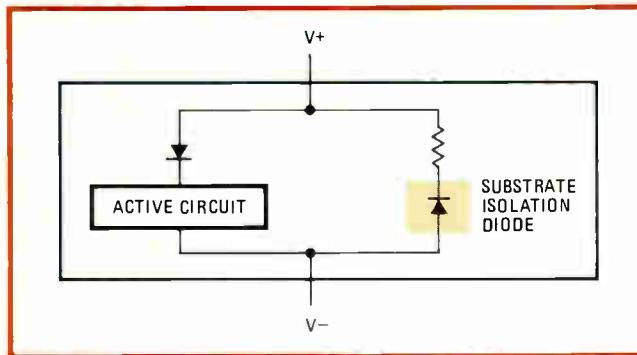

3. Substrate isolation. The forward voltage drop of the substrate isolation diode of most ICs can be used to make thermal measurements. An increase of power to the active portion of this circuit heats the substrate, decreasing the forward voltage drop of the diode.

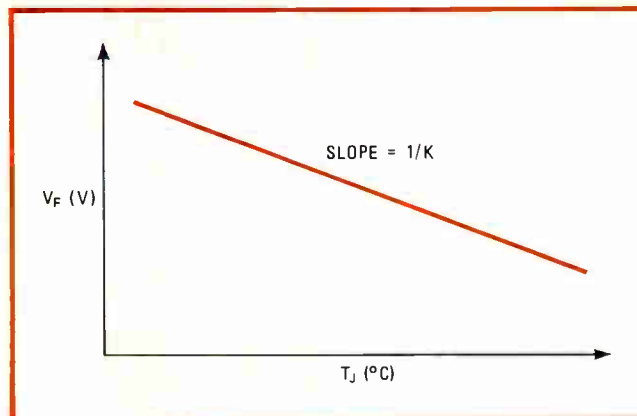

4. Negative slope. As junction temperature increases, there is a linear decrease in the voltage drop across a semiconductor junction driven by a constant current. The reciprocal of the curve's slope is directly proportional to thermal resistance.

θ in Fig. 1 but sometimes referred to as θ_{TH} or R_{TH} . The other component, heat capacity C_θ , becomes important when the device is subjected to pulse operation with short duty cycles, in which electrical power is applied for a period of time equal to or less than the longest thermal time constant.

Thermal resistance for any semiconductor is defined as the increase in junction temperature (T_J) due to the application of dissipative power (P_D) in the device:

$$\theta_{JX} = \Delta T_J / P_D$$

The two θ subscripts describe the points between which the thermal resistance is measured, with J always indicating junction and X being dependent on the reference point being used. For example, X could be C for case (header or package) or A for ambient or L for liquid. The two most commonly specified thermal-resistance parameters are junction to case (θ_{JC}) and junction to ambient (θ_{JA}).

Using the thermal resistance parameter

Deriving the thermal-resistance parameter is very simple provided that careful consideration is given to the power actually dissipated in the device. For a semiconductor device in the operating conditions of Fig. 2, junction temperature can be determined as follows:

$$\begin{aligned} T_J &= T_C + \Delta T_J \\ &= T_C + \theta_{JC} P_D \\ &= T_C + \theta_{JC} (V_1 I_1 + V_2 I_2 - V_3 I_3) \\ &= 25^\circ\text{C} + 75^\circ\text{C/W} [(10\text{ v})(1\text{ nA}) + \\ &\quad (15\text{ v})(20\text{ mA}) - (10\text{ v})(10\text{ mA})] \\ &= 25^\circ\text{C} + 15^\circ\text{C} \\ &= 40^\circ\text{C} \end{aligned}$$

In this instance, the case temperature could increase to 60°C before the $T_{J(\text{max})}$ device specification was exceeded. If the semiconductor device is assumed to be an op amp and 1 nanoampere is the maximum current that can be supplied for I_1 , then for a T_J of 40°C , the op amp should be chosen for input bias current of less than 350 picoamperes at 25°C .

Should θ_{JC} be specified as a typical value instead of a maximum, the thermal-resistance range must be estimated before it is possible to select a device properly. A range of 50° to 100°C/W causes a T_J variation of 10° to 20°C , dictating a maximum input bias current at 25°C of 250 pA. Also, I_1 will vary between 500 pA and 1 nA.

This simple example can be modified to cover a wide range of semiconductor devices, including discrete transistors and ICs, under varying operating conditions.

Comparison of measurement techniques

The advantages and disadvantages of the four basic techniques for the measurement of thermal resistances—optical, chemical, physical, and electrical—are summarized in the table. The power dissipation within the device is always measured electrically in each case, but junction temperature is measured differently.

Only optical and electrical techniques are in widespread use today. Infrared microscopes capable of resolving down to 0.5-micrometer spot sizes are particularly useful as an aid in the thermal design of high-power

FOUR TECHNIQUES OF THERMAL-RESISTANCE MEASUREMENT

Measurement technique	Procedure	Advantages	Disadvantages
Optical	infrared scanning of semiconductor chip surface	<ul style="list-style-type: none"> provides temperature profile across chip surface, indicating particularly troublesome hot spot areas is useful in device thermal-design efforts 	<ul style="list-style-type: none"> requires measurements be made on un-encapsulated devices requires careful setup and data analysis if meaningful results are to be obtained needs considerable expertise very time-consuming and expensive
Chemical	coating of semiconductor chip surface with thin layer of temperature-indicating chemical such as liquid-crystal material	<ul style="list-style-type: none"> same as above is relatively inexpensive 	<ul style="list-style-type: none"> requires measurements be made on un-encapsulated devices chemical material requires careful application and may contaminate chip has poorer resolution and accuracy than optical technique needs considerable expertise very time-consuming
Physical	mounting of extremely small thermocouple(s) (or other temperature-measuring device) directly on chip surface	<ul style="list-style-type: none"> is relatively inexpensive 	<ul style="list-style-type: none"> is not practical because of difficulty of mounting the thermocouple(s) presence of thermocouple affects heat source temperature can theoretically make temperature measurement as accurately as optical technique, but resolution is very poor requires measurements be made on un-encapsulated devices very time-consuming
Electrical	using precalibrated temperature-sensitive parameter of the device under test	<ul style="list-style-type: none"> fastest measurement technique — using correlation techniques, very suitable for high-volume testing applications entry-level operator can make accurate and repeatable measurements meets the intent of MIL-STD 883A, method 1012 measurements can be made on completely encapsulated devices 	<ul style="list-style-type: none"> provides weighted-average measurement, but lacks resolution of optical or chemical techniques requires some circuit and device expertise to properly interface to measurement circuitry may require individual device precalibration prior to actual thermal-resistance measurement test equipment is moderately expensive

devices to prevent the occurrence of hot spots within the chip active area. However, careful attention to the emissivity of the chip surface materials is required to obtain accurate readings.

The electrical technique is usually implemented with standard laboratory instruments or individually designed and built in-house test equipment. It has suffered from the lack of definitive measurement standards, but the advent of commercially available thermal-resistance testers will go a long way towards providing *de facto* standardization within the semiconductor industry, for their ease of operation and relatively low cost should appeal strongly to both manufacturers and users of semiconductors.

The electrical technique determines thermal resistance in an integrated circuit by using a sequence of voltage and current pulses to both heat the device and measure the change in junction temperature. As an indication of this change, a temperature-sensitive parameter, such as the forward-biased voltage drop of a diode under low-value constant-current conditions, is used.

There are several different temperature-sensitive parameters associated with ICs that can be used to make thermal-resistance measurements. The most commonly used is the substrate-isolation junction diode that occurs

in all semiconductors (bipolar, metal-oxide-semiconductor, and complementary-MOS) except for silicon on sapphire and dielectrically isolated units. Figure 3 shows a schematic representative of an IC for thermal-resistance testing purposes. If voltages of the proper polarity are applied to the voltage terminals, the active circuit, whether it be analog or digital, will be turned on and power dissipation will occur, causing the junction temperature to rise. If the substrate isolation diode is forward-biased by a small constant current insufficient to cause self-heating before power is applied, the diode voltage will be higher than a similar measurement made after heating, because of the V_F/T_J diode characteristic illustrated in Fig. 4.

Electrical measurement technique

Voltage waveforms across the device under test for a typical measurement are shown in Fig. 5. During period t_1 , a small reverse constant current is applied through the supply terminals of the device under test, causing the substrate-isolation diode to become forward-biased and produce voltage V_1 . Power is then applied to the device being tested during t_2 when the supply voltage goes positive to the heating voltage, V_H (shown as V_2).

At the completion of t_2 , V_H is quickly removed from

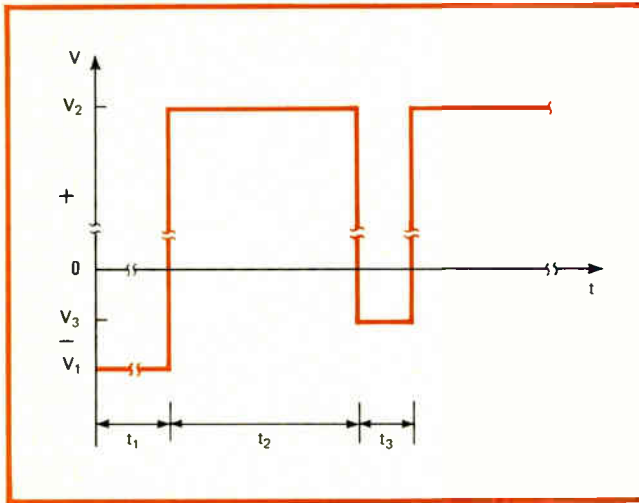

5. Timing. In a thermal-resistance measurement, the substrate diode is forward-biased during t_1 . Power is supplied to the active device during t_2 . Then it is shut off during t_3 when the diode is conducting. V_1 - V_3 is proportional to junction temperature rise.

the device under test, and reverse constant current is again applied during period t_3 . The diode voltage, V_3 , will have a new value because of the higher junction temperature. The difference between V_1 and V_3 is proportional to junction temperature rise through the characteristic shown in Fig. 4, that is:

$$\Delta T_J = K|V_1 - V_3| \quad (1)$$

where K is the reciprocal of the slope of Fig. 4. The power required to produce ΔT_J is the product of V_H and heating current I_H . The thermal resistance of the device under test from junction to some reference point (X) is:

$$\Theta_{JX} = \Delta T_J / P_D = K|V_1 - V_3| / V_H I_H \quad (2)$$

The X subscript mentioned above can vary, as described previously, depending on what temperature reference is used for the device.

If the reference point is the device case, then the temperature of the case must remain constant during the entire test cycle. Similarly, if an ambient like air is the reference condition, then the air conditions surrounding the device under test must remain constant during the entire test cycle.

The timing of the various current and voltage levels used in this measurement has a critical effect on the accuracy of the Θ_{JX} measurement. Heating period t_2 must be long enough to assure junction temperature stabilization for the heating voltage applied. The voltage measurement, V_3 , made during period t_3 must be made in a time interval as small and as close to the end of period t_2 as possible to avoid junction cooling effects. The transition between periods t_2 and t_3 must be very fast for the same reason.

Finally, t_2 must be very large compared to t_3 to ensure that the average and peak heating power are essentially the same, thus allowing direct computation of Θ_{JX} without a heating-power correction factor. Periods t_2 and t_3 should be repeated several thousand times to provide maximum system accuracy: period t_1 occurs only at the start of each test cycle.

A block diagram of a commercially available thermal-resistance tester, Sage's Theta 400, that uses the method previously discussed is shown in Fig. 6. The tester is built up out of seven basic blocks—heating source, measurement source, power supplies, switching, control logic, analog sampling and computation, and a display section.

Kelvin (four-terminal) contacts on the fixture holding the device under test eliminate the measurement errors caused by contact voltage drops under high current conditions. The heating and measurement sources feed the necessary test cycle voltage and currents required through one set of the contacts of the switch to the device being tested.

Voltage measurements are made across a second set of contacts and fed directly to the analog sampling and computation circuits. The display and indicators are driven by the control logic and analog sections. Test-cycle duration, voltage and current pulse timing, and display and indicator control circuits are all contained in the control logic section. The entire instrument takes up about 1 cubic foot of benchtop space.

Calibration

In order to measure thermal resistance, Θ_{JX} , it is necessary to insert a value of K , the reciprocal of the slope of the V_F versus T_J curve of a forward-biased semiconductor junction, into Eq. 2. The K parameter must be measured for a particular type of semiconductor and this value set into the thermal-resistance tester's K factor control. K is essentially the same for all semiconductors of the same type and number from the same manufacturer, even though the units may have been produced in several different manufacturing runs or batches. Typical variations in K are within 3% for devices within a given batch or from various batches.

The relatively constant value of K for a given device type and number allows it to be measured on a sample basis. Typically, once the average K value is determined for groups of 10 junction diodes taken from two or three different batches of semiconductor devices, then no further K -factor measurements are required except for periodic quality control.

The measurement system for the temperature-sensitive-parameter coefficient (K factor) is shown in Fig. 7. The current source should provide the necessary forward current, as specified by the thermal-resistance tester requirements, to an accuracy of $\pm 5\%$ or better. Forward voltage across the diode must be measured with millivolt resolution: a 3½-digit voltmeter with a 1-volt scale is recommended. The temperature monitor, which may be a thermocouple type or any other suitable instrument, should have a range of at least 150°C.

The linear nature of the temperature coefficient enables sufficient accuracy to be obtained from forward-voltage measurements at only two different temperatures. Room temperature may be one of them. The other can be some elevated temperature in the 75°-to-125°C range, depending on the type of parts to be measured.

The K factor for each diode is:

$$K = [(T_2 - T_1) / (V_{F2} - V_{F1})] I_F = \text{constant}$$

where K = the temperature coefficient in $^{\circ}\text{C}/\text{mv}$,
 T_1 = the lower test temperature (usually room temperature),
 T_2 = the higher test temperature (usually near the device maximum operating temperature specification),
 V_{F1} = the forward voltage at I_F and T_1 ,
 V_{F2} = the forward voltage at I_F and T_2 ,
 I_F = the fixed forward measurement current, required by the thermal-resistance tester.

Once the average K value is determined, it is set on a thermal-resistance tester's K factor control whenever devices of the same type and number are to be tested for thermal resistance.

Measurement problems

There are two major problems in the previous thermal-resistance test method associated with the choice of the temperature-sensitive parameter. First, the use of the substrate-isolation diode for such a parameter produces a weighted-average indication of T_J because not all portions of the IC dissipate the same amount of power. Junction temperature gradients occur across the chip, and a lower-than-actual value of thermal resistance results.

Secondly, some IC fabrication technologies, such as dielectric isolation and silicon on sapphire, require some other diode for their temperature-sensitive parameter, because they lack the substrate diode.

The first problem can be partly overcome by sensing a temperature-sensitive parameter in the vicinity of the hottest portion of the IC chip, typically the output region. Any junction-isolated region that has a transistor in it will have its substrate diode, either directly or through a diffused resistor, available for use as the temperature-sensing element.

Diode connection

The other problem can be overcome if some form of diode connection is available through the pins of the device under test and can be coupled and decoupled during various portions of the test cycle.

A third potential problem occurs when attempts are made to test static devices, such as random-access or read-only memories, that dissipate significant power only when making the transition from one binary state to the other. External circuitry may be required to cycle these devices during the t_2 heating period.

Fortunately, for the purposes of thermal-resistance measurements, the thermal time constants for the various portions of the circuit differ by one or more orders of magnitude. To refer back to Fig. 1, for instance, $t_{\theta 1}$ is typically in the range of high tens to low hundreds of microseconds, while $t_{\theta 2}$ is in the hundred-millisecond range. Each of the other time constants is correspondingly greater.

The interface between die attachment and head-

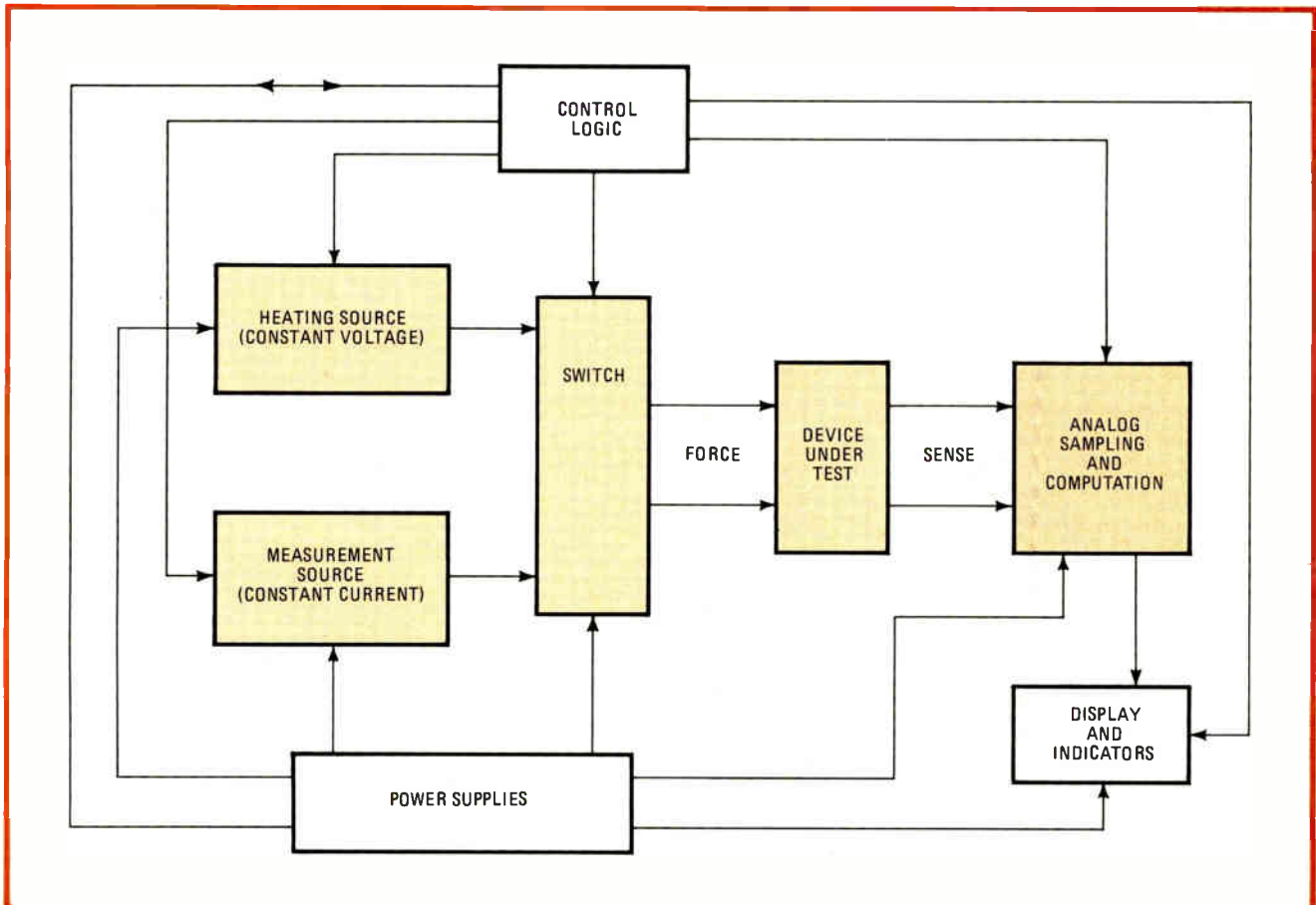

6. Thermal tester. Sage Enterprises' Theta 400 is an instrument designed for thermal-resistance measurement. All heating measurement sources, analog computation, and power sources are self-contained. Results are displayed digitally.

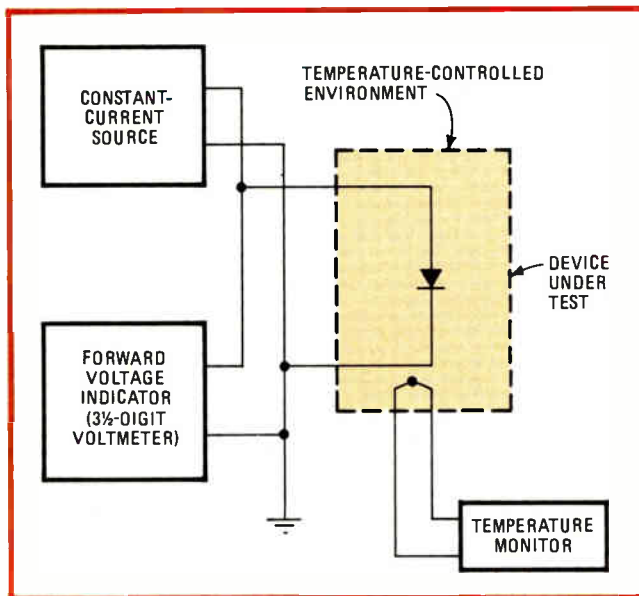

7. Temperature coefficient. The K factor, reciprocal slope of the V_F/T_J curve, is necessary to compute thermal resistance. Two measurements of diode forward drop—under constant current at room and at elevated temperature—are sufficient to calculate K.

er/package starts at the bottom of the chip and ends at the top of the header/package. For mounting configurations in which the header and package are not the same, as in hybrid circuits where the chip might be mounted on some form of substrate, Fig. 1 would be modified to show additional thermal interfaces and their corresponding thermal circuitry.

Junction temperature variances

The existence of differing time constants in the IC's thermal circuitry causes the junction temperature (or thermal resistance) of the IC to vary as a function of time from the initial application of power to the device as shown in Fig. 8. The relatively short time constants from the IC active area to header/package cause the initial plateau to occur within several seconds. Then, depending on the package-mounting configuration, this plateau will either continue if the header/package temperature is fixed (because of good heat-sinking) or will lead to a new plateau as t_{64} is exceeded and thermal equilibrium with the environment is reached. The second plateau typically occurs within 5 to 20 minutes when the environment is still air at room temperature.

The thermal circuitry from the header/package to the environment, whether the latter is still or moving air, liquid, or a heat sink, is relatively independent of the chip contained within the header/package. Thus, the thermal characterization of an IC chip/package configuration can be broken into two separate measurements: one for the IC active area-to-header/package, which only takes seconds for each measurement, and one for the header/package-to-environment configuration, which may take tens of minutes but does not have to be done for each device.

The semiconductor manufacturers should find thermal-resistance testers useful in many areas, including product characterization, manufacturing, and quality

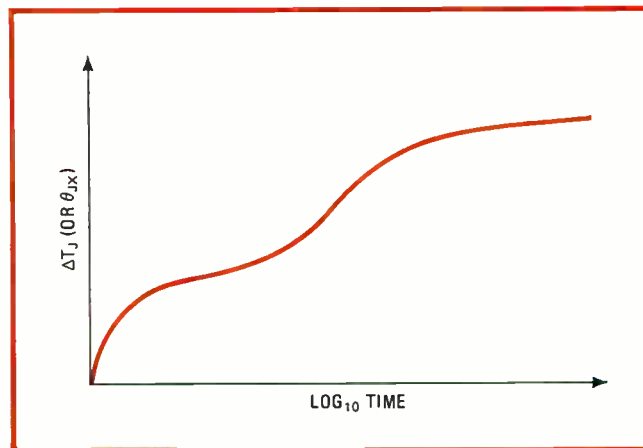

8. Temperature vs time. This curve displays junction-temperature change of a packaged IC as a function of time, assuming constant power dissipation. Differing time constants in the thermal circuitry cause junction temperature to vary as a function of time.

assurance. In the first area, thermal-resistance testers assist the device designer by providing thermal characterization of prototype devices as well as final versions. The effects of different packages (for instance, plastic versus ceramic dual in-line packages) can quickly be ascertained on meaningful sample sizes. The manufacturing area can use the thermal-resistance tester, or its derivatives, to quickly determine the consistency of die-attachment procedures and/or improvements. Quality-assurance operations would use the thermal-resistance tester to maintain an independent check on manufacturing and to insure conformity with high-reliability requirements.

The thermal-resistance tester can be equally well applied by semiconductor users. Once a satisfactory value of thermal resistance for an IC package in an actual module or subsystem has been established, the tester can be used to select suitable devices to meet the desired parameter range and to evaluate alternative vendors. Once specifications are set and a vendor or vendors are chosen, incoming inspection is required to monitor vendor performance. There is insufficient standardization among vendors, so users must select vendors and monitor them carefully to be sure of getting the thermal-resistance specification they want.

Instrument improvements

Efforts are already under way to provide more accurate, more flexible, and more versatile laboratory instruments. Ultimately an instrument accuracy of $\pm 5\%$ of reading should be possible, more than enough except in the most demanding device applications. For some semiconductor devices, a single heating voltage supply may not be adequate, necessitating an instrument capable of providing more supplies. Also, the problem of testing static memory devices can be overcome by clocking the inputs of the device under test. Versatility can be improved by building a single instrument with operator-controlled heating time to allow for package characterization, die-attachment evaluation, and paper-tape print-out of sequential data for time plots of increasing thermal resistance and/or junction temperature. □

Trust Ampex to save the data you waited a year to gather.

The forty by eighty foot wind tunnel at NASA's Ames Research Center in Mountain View, California. A very specialized experimental facility that's available to all bona fide researchers. But there's a long waiting list for the tunnel, and right now it's booked through the end of 1978.

That's why instrumentation data is so precious. And that's why so many experiments rely upon Ampex instrumentation recorders to save the data.

Ampex recorders, such as the PR2230, newest member of the PR2200 portable family, are ideal for on-location data recording. They record FM or direct signals. They offer seven channels or as many as 32 channels. They transport the tape slowly for maximum duration, or as fast as 120 ips for 2 MHz performance in the PR2230. They're all quiet, reliable and easy to use. And equally important, Ampex portable data recorders are built to give good service for a great many years.

NASA doesn't endorse any instrumentation recorders. That's not their job. They run this unique and beautiful facility and make it available to as many researchers as possible. And every now and then they buy another instrumentation recorder from Ampex.

Next time your plans call for multi-channel instrumentation recording, get in touch with the people who've been specializing in magnetic tape recording since the very beginning. Trust Ampex to save the data.



AMPEX

Ampex Corporation
Data Products Division
401 Broadway
Redwood City, California 94063
415/367-2011

Circle 127 on reader service card

Adapting the M6800 processor for automatic telephone dialing

by Moshe Bram

Allied Chemical Corp., Automotive Products Division, Mount Clemens, Mich.

A short program and a simple interface for a rotary-dial telephone enables the well-known M6800 microprocessor to dial stored telephone numbers on command. The versatile microprocessor thus becomes a viable alterna-

tive to commercial automatic dialers, which essentially perform only one function and are expensive—chiefly because they are in great demand.

The program for the M6800 is divided into two sections, as shown in the table. The phone numbers are stored in the lower locations of memory, the dialing subroutine in the upper sections. The only limit to the number of phone numbers that can be stored is the amount of memory available to the system. The operation of the entire program is explained by the comments column of the table.

To access any number, the user (or a subroutine) simply initiates the program at, or routes the program to,

M6800 PROGRAM FOR AUTOMATIC DIALING			
Location	Object code	Source statement	Comments
0000	C6 X1	LDA B X1	Load accumulator B with the first digit of phone number (X ₁)
0002	BD 01C8	JSR 01C8	Jump to dial subroutine located at address 01C8
0005	C6 X2	LDA B X2	Load accumulator B with the second digit X ₂
0007	BD 01C8	JSR 01C8	Jump to dial subroutine located at address 01C8
000A	C6 X3	LDA B X3	Load accumulator B with the third digit X ₃
000C	BD 01C8	JSR 01C8	Jump to dial subroutine located at address 01C8
000F	C6 X4	LDA B X4	Load accumulator B with the fourth digit X ₄
0011	BD 01C8	JSR 01C8	Jump to dial subroutine located at address 01C8
0014	C6 X5	LDA B X5	Load accumulator B with the fifth digit X ₅
0016	BD 01C8	JSR 01C8	Jump to dial subroutine located at address 01C8
0019	C6 X6	LDA B X6	Load accumulator B with the sixth digit X ₆
001B	BD 01C8	JSR 01C8	Jump to dial subroutine located at address 01C8
001E	C6 X7	LDA B X7	Load accumulator B with the seventh digit X ₇
0020	BD 01C8	JSR 01C8	Jump to dial subroutine located at address 01C8
0023	3F	SWI	End of dialed number
.	.	.	} Other numbers stored as required
.	.	.	
.	.	.	
.	.	.	
01C8	86 FF	LDA A FF	Initial clearing of data direction and control registers of the PIA.
01CA	B7 8004	STA A 8004	
01CD	B7 8005	STA A 8005	
01D0	B7 8006	STA A 8006	
01D3	B7 8007	STA A 8007	
01D6	86 01	LDA A 01	A "HIGH" (1) is loaded into A ₀ & B ₀ of PIA
01D8	B7 8006	STA A 8006	
01DB	B7 8004	STA A 8004	
01DE	CE 18FF	LDX 09FF	A counter is set allowing A ₀ & B ₀ to be high (1) during the count down.
01E1	09	DEX	
01E2	26 FD	BNE FD	
01E4	4F	CLR A	Data line A ₀ goes low (0).
01E5	B7 8004	STA A 8004	
01E8	CE 18FF	LDX 09FF	A counter is set allowing A ₀ to be low (0) during the count down.
01EA	09	DEX	
01EC	26 FD	BNE FD	
01EE	5A	DEC B	One cycle of pulse generation has been completed.
01EF	26 E5	BNE E5	A branch instruction to generate the next pulse cycle is executed. Line B ₀ goes low (0) at the end.
01F1	B7 8006	STA A 8006	
01F4	C6 02	LDA B 02	
01F6	CE FFFF	LDX FFFF	A counter is set allowing a time interval between dialed digits.
01F9	09	DEX	
01FA	26 FD	BNE FD	
01FC	5A	DEC B	
01FD	26 F7	BNE F7	
01FF	39	RTS	A return from subroutine instruction is executed to load the next digit for dialing.

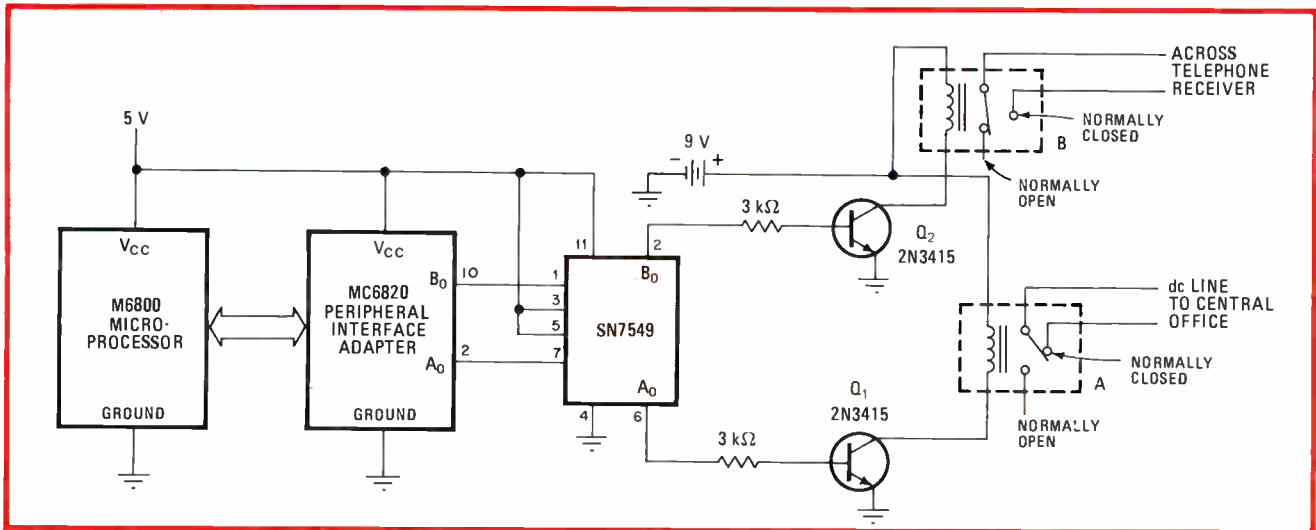

Command performance. Small program (see table) and simple interface adapt M6800 for automatic number dialing. PIA's output pulses are sent via relay A to central office, while telephone receiver is disabled by relay B to minimize annoying clicking sound in headset.

the location corresponding to the first digit of the number desired. For the sake of efficiency, program command time should be negligible with respect to the actual dialing time. Consequently, the command procedure should keep user interaction to a minimum—that is, it should be unnecessary to depress more than one key of an m-n matrix for each number desired.

Emanating from the 6820 peripheral interface adapter are seven groups of pulses corresponding to the number dialed (this may be extended to 10 groups or more if dialing into other area codes is contemplated). The program ensures that there is a suitable gap between each group of pulses so that the central office can differentiate between pulses belonging to separate digits.

The dial interface is a simple circuit connected between the PIA lines and the central office. It is

designed to open the normally closed dc line relay A for each output pulse from the PIA, thus transmitting the digit data to the office. The 7549 serves as a latch and buffer to transfer the PIA's dial-pulse information to switching transistor Q_1 , which has actual control of the relay. The output of port B_0 of the 7549 is high during the time the pulses are sent, and relay B is therefore closed in order to disable the headset receiver, minimizing the annoying clicking sounds that are heard in the receiver during dial-out.

The user is cautioned against connecting active-element relays, such as transistors, directly to the line. More likely than not, such an arrangement will require a small amount of power from the dc line to energize the active device, and even a load of only 2 milliamperes will be sufficient to cause trouble at the central office. □

Improved processor program boosts a-d conversion efficiency

by Tomasz R. Tański
Warsaw, Poland

Systems that use a comparator, a d-a converter, and a microprocessor-based successive-approximation algorithm for analog-to-digital conversion [*Electronics*, June 23, 1977, p. 133] may be speeded up by the use of a more efficient program. Specifically, the 8080 microprocessor program reviewed in the article mentioned can be shortened by 40% if one minor hardware change in the system is made.

The new subroutine performs the same 8-bit a-d successive-approximation as the former program implemented by Burr-Brown. In this technique, an analog input is compared with the known outputs of a d-a converter, as shown in part a of the figure. Under

microprocessor control, the most significant bit of a repeating 8-bit data stream whose value steps from 0 to 256 is introduced to the comparator through one half of an MP10 analog-output unit. This unit contains a d-a converter, an address decoder, and control logic. The output of the MP10 and the comparator are allowed to settle, and then the microprocessor reads the latter's status.

If the comparator indicates that the MSB input voltage at its inverting input—an analog signal—is smaller than the analog input to the noninverting port of the comparator, the MSB input to the d-a converter will remain on while the microprocessor turns on the next MSB. Next, a new comparison is made. If the comparator indicates that the converter's newly generated voltage is larger than the analog input, the microprocessor will turn this last bit off and the next MSB of the data input on. The cycle repeats until all 8 bits of the d-a converter have been tested. Thus the output of the comparator represents an 8-bit equivalent of the analog input signal.

This program utilizes the microprocessor's resources more effectively than the original program. For instance,

NEW AlphaNumeric Printers with a microprocessor brain!

from the makers of high-reliability printers

This series of designer-styled Digitec printers delivers high contrast, easy-to-read, fade-free matrix printout and quiet operation. The "smart" microprocessor provides versatility by simplifying systems interface and using the universally accepted ASCII code set.

- Choice of serial (RS-232-C and 20mA current) with baud rates to 1200, or 8-bit parallel bus input with data rates up to 1000 characters/second.
- Up to 24 characters per line
- Double font printing for special emphasis and variable formatting for easy data analysis.
- 24-hour clock and day/month calendar.

Contact us now for more information on our complete line of numeric and alphanumeric printers.

ATTENTION OEM's:

As a leading supplier of OEM printers, we're flexible to your requirements and offer generous OEM discounts.

Digitec.

**UNITED
SYSTEMS
CORPORATION**

918 Woodley Road, Dayton, Ohio 45403
(513) 254-8251, TWX (610) 455-1728



Model 6310 single quantity
ready-to-print price

\$595.

DIGITEC: Precision measurements to count on.

Information Only Circle 130

Demonstration Only Circle 131

Even ten feet away, the new Series X-70 Solid State Piezo Audio Indicator demands attention with its strong, strident tone. Only 1.2" (31 mm) deep and 2.1" (53 mm) wide, the X-70 can be specified with PC pins or wire leads. Get all the details on the X-70, and our entire line of Audio Indicators. Write or call Projects Unlimited, Inc., 3680 Wyse Road, Dayton, Ohio 45414, Tel. (513) 890-1918, TWX 810-450-2523.



85dbA@10ft.

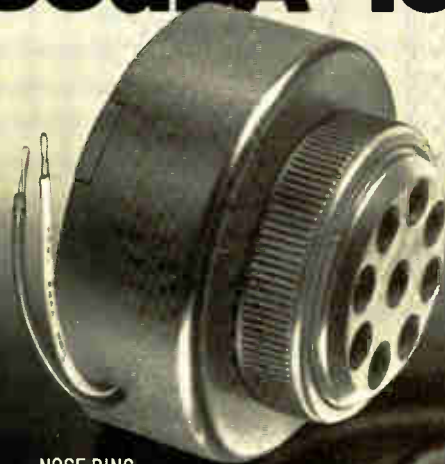

NOSE RING
IS REMOVABLE.

130 Circle 177 on reader service card

Paying More Than \$295 For Waterproof Load Cells?



Why?

Designing electronic weighing, force measuring or test systems for all weather use? You won't find a price this low for any other waterproof and barometrically insensitive strain gage load cell—especially one offering an error band of less than $\pm 0.04\%$!

Buy a definite competitive edge in price and performance with Sealed Super-Minis that operate in tension or compression—with capacities to 1,000 pounds.

For detailed specifications on 5 pound to 100 ton capacity load cells, call—write Interface, 7401 E. Butherus Dr., Scottsdale, AZ JSA 85260 (602) 948-5555, Telex 668-394.



Low Profile



Minibeam



Super-Mini

Interface
ADVANCED FORCE MEASUREMENT

Circle 178 on reader service card

8080 ANALOG-TO-DIGITAL PROGRAM

```

INIT:  MVI  A,89H    ; INITIALIZE
       STA  ADDR1   ; PPI
       MVI  A,80H   ; INITIALIZE
       STA  ADDR2   ; MP10
                               ; A-D CONVERSION SUBROUTINE
ENTER: LXI  0,0000H ; 0-RESULT, E-BIT POINTER
       STC          ; PREPARE BIT POINTER
LOOP1: MOV  A,E     ; SET NEW
       RAR         ; BIT POINTER
       RC          ; RETURN IF ALL BITS TESTED
       MOV  E,A    ; SAVE BIT POINTER
       ORA  D     ; NEW SUPPOSED RESULT IN A
       STA  ADDR4  ; OUTPUT TO DAC
       MOV  B,A   ; SAVE
       MVI  A,03H ; PREPARE FOR DELAY LOOP
LOOP2: OCR  A     ; DELAY
       JNZ  LOOP2 ; LOOP
       LOA  ADDR5 ; GET COMPARATOR OUTPUT
       ANA  A     ; TEST IT
       JP   LOOP1 ; IF TOO HIGH DON'T UPDATE RESULT
       MOV  D,B   ; SUPPOSED RESULT MATES
       JMP  LOOP1 ; TEST NEXT BIT
    
```

(c)

Software trimming. Well-known technique for performing a-d conversion with comparator, d-a converter, and microprocessor-based program (a) can be optimized for greater efficiency (see text). Flow chart (b) results in derivation of 30-byte program (c) having a running time only 60% that of its predecessor's.

the bit pointer (MOV A,E) is done only once before rotating it. It happens at the beginning of LOOP 1, as shown in the program in (c). In the Burr-Brown routine this instruction is executed before each jump to LOOP 1.

In this new program, also, the result of a given bit test is stored temporarily in register B of the 8080's central processing unit instead of a random-access memory as in the original system, and the previous test value is stored in register D. In the Burr-Brown program, only the latest test result is stored and in RAM, too. Thus any values stored must be fetched from memory, and the previous value derived, for the system to determine which MSB to turn on or off so that an a-d conversion can be performed. Also, the new program saves time, because test results do not have to be fetched from RAM.

Tying the comparator's output to line PC₇ of the 8255 programmable peripheral interface, instead of the PC₀ port, is the only hardware change required. This modification, in combination with program modifications that place the 8-bit data stream's MSB in an optimum register position for testing, enables the 8-bit test to be performed more quickly.

The 30-byte program requires a total of 497 to 557 microseconds to perform a single a-d conversion (depending on the measured voltage level), which is considerably less than the 833 to 933 μs it takes to run Burr-Brown's 51-byte program. Further run-time reductions may be achieved by using an isolated input/output instruction scheme for addressing the MP10. □

Engineer's notebook is a regular feature in *Electronics*. We invite readers to submit original design shortcuts, calculation aids, measurement and test techniques, and other ideas for saving engineering time or cost. We'll pay \$50 for each item published.

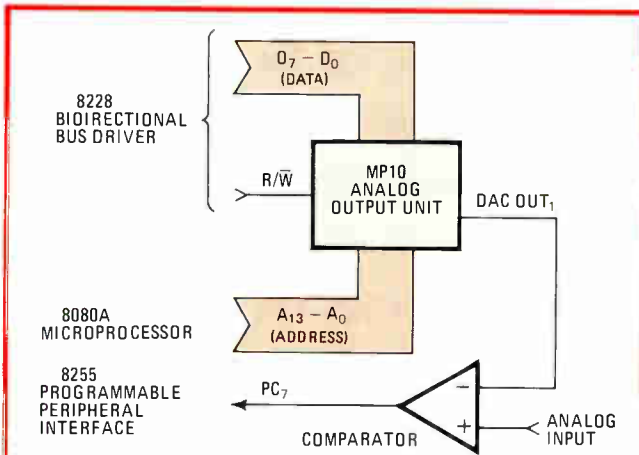

(a)

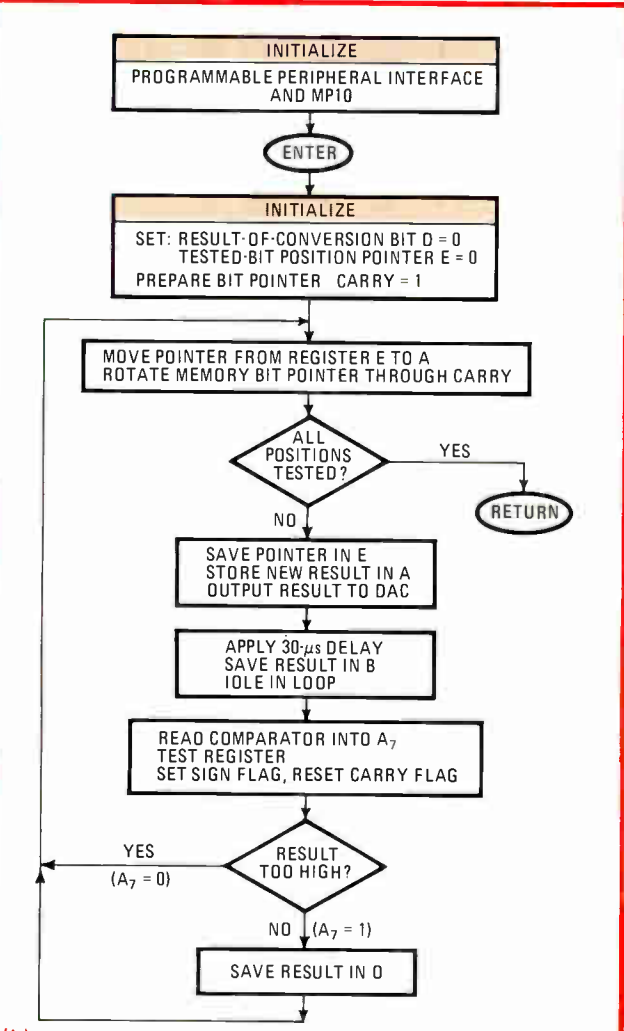

(b)

the initialization of the result-of-conversion bit and the tested-bit pointer is done by one instruction, as shown in the flow chart (b). But in the Burr-Brown program, three instructions are required because the intermediate results of an a-d conversion are stored in a random-access memory, so that two extra program steps are required to fetch the intermediate data.

Another step-saving measure is the fact that restoring

Engineer's newsletter

Keep It clean for fault-free tests, says Analog Devices

There's more to successful board checking with in-circuit automatic test equipment than just buying the tester and its special bed-of-nails fixture. So reports John Lang of Analog Devices Inc. in describing the Norwood, Mass., firm's teething troubles with its in-circuit ATE system. In the initial stages of the test program, apparently good boards were being rejected by the new Fault-Finder 101 in-circuit tester. **The trouble was soon traced to airborne solder flux from a nearby wave soldering line**, which was being sucked into the test fixture by the vacuum hold-down that presses boards against the test pins in the bed of nails. The flux caused high-resistance contacts on the plunger pins of the fixture, resulting in the false failures. Analog Devices solved this problem by building a separate air-conditioned and filtered room for the tester and its fixture. Lang reported on the troubleshooting at a recent Boston ATE seminar sponsored by Circuits Manufacturing magazine.

A reliable course, that's what Rome promises

Who isn't interested in designing reliability into equipment? The Reliability Analysis Center of the Rome Air Force Development Center expects a lot of interest in its \$375 four-day course on "Guidelines to Reliable Design." **To be given in Arlington, Va., on Nov. 13-16 and in San Diego on Feb. 15-18, 1979**, the course uses the Reliability Design Handbook (RHD-376) as its basic text. Topics covered include: introduction to reliability methodology, part selection and control, reliability evaluation tools, derating and redundancy for reliability, production and reliability, design simplification and electrostatic discharge, design to cost, and reliability data sources. For more information, write to the Reliability Analysis Center, RADC/RBRAC, Griffiss AFB, N. Y. 13441.

Hybrid society is pushing standardization

The International Society for Hybrid Microelectronics is organizing its members into technology groups to improve the society's standardization efforts. The seven areas are thick-film, thin-film, and hybrid technology, packaging, trim and test, reliability, and components—both active and passive. **In addition, the society is pushing final acceptance of hybrid-package standards reflecting the three basic packages: 0.04-in. center-leaded and leadless types, 0.05-in. center-leaded and leadless types, and minipaks.** Daniel I. Amey, chairman of the JEDEC JC 11.3.1 committee on hybrids, is coordinating the standardization activities to reflect the majority of hybrid-packaging techniques used by the society's members.

C-MOS phase-locked loops get their due in application note

The phase-locked loop, a versatile building block for many digital and analog applications, is the subject of a new application note, AN 112. The note describes the theory and application of micropower complementary-MOS monolithic PLLs. **It has an extremely thorough section on PLL fundamentals and design considerations**, as well as a circuit description of the ICs. AN 112 is offered free of charge by Solid State Scientific Inc., Montgomeryville, Pa. 18936.

Jerry Lyman

For OEM: All kinds of memory; one kind of quality.

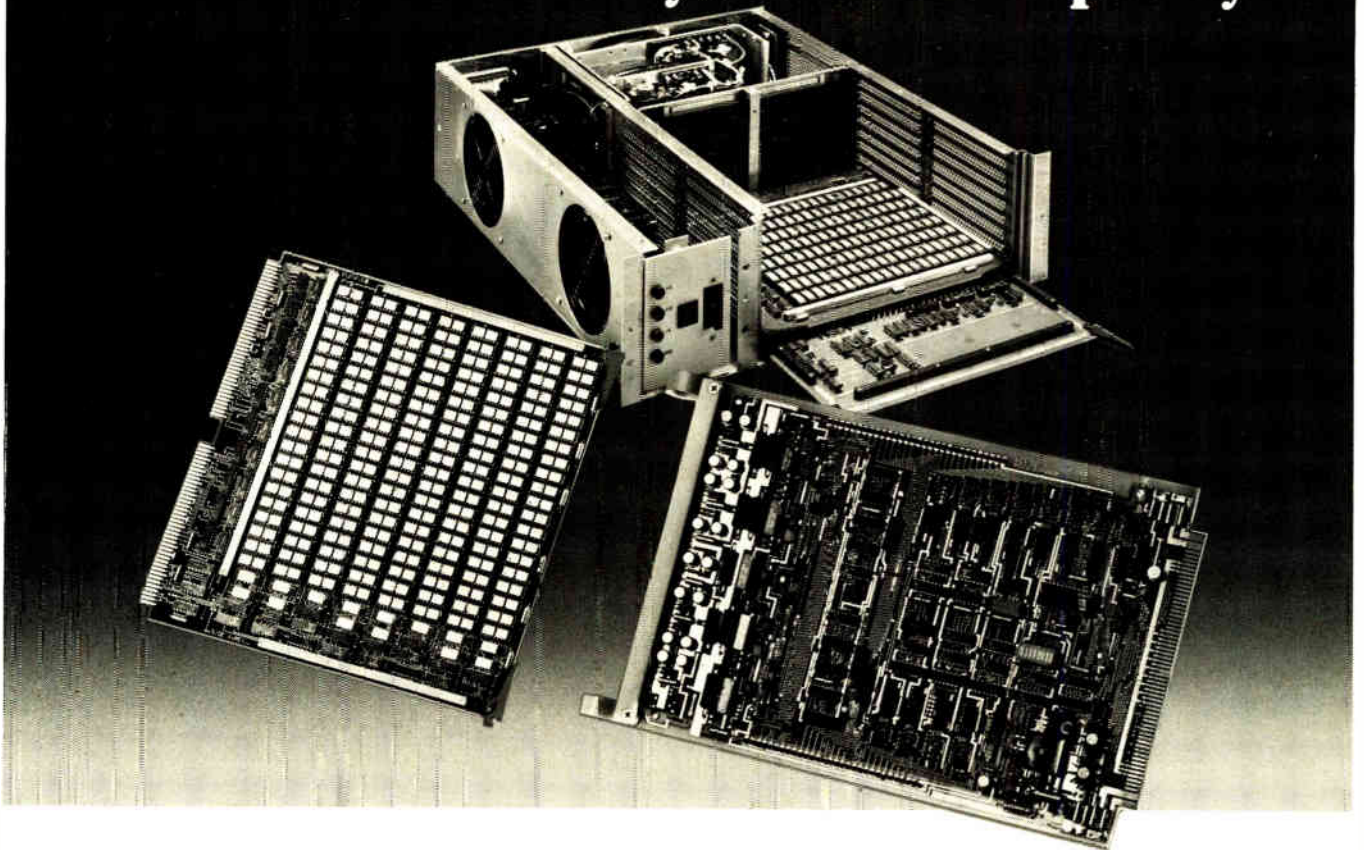

Control Data offers a complete line of semiconductor and core memory. Enclosures, too. And all are precision-engineered and built with the same concern for quality that goes into every product we manufacture.

Now with Error Checking and Correction

Expanding on our popular 94550 line of Semiconductor Memory, the "94552" is available as a single 64K x 22 array card (16 bit word with 6 bits of ECC). A single Timing/Control Card permits you to expand to 512K words by adding more storage module cards. All mount in an EIA 19" rack only 5 1/4" high.

New Core Compatible Semiconductor Memory

Available as a single board system, the 94553 with timing and control on one board is compatible with our multi-sourced industry standard 94300 core memory. Options are 32K or 128K of storage per board and variable word lengths of 16 to 20 bits. With expandability and modular field expansion of up to eight boards, system storages of 256K and 1024K are possible.

Ideal for Byte-Wide Minicomputers

Utilizing Unitemp temperature independent core, stable over the entire 0°—90°C MT range, the 94432, 94433 core memory is available as a 32K x 8/9 bit word. Offering a respectable 350 nanosecond access and 1 microsecond full

cycle, the memories are compatible with many popular minicomputers on today's market.

Put quality behind your nameplate. Call us at 612/830-6018 or if in Europe contact one of our European representatives. Or return coupon to:

Richard J. Koebler, OEM Marketing Manager
Computer Memory Manufacturing Division
8001 East Bloomington Freeway
Bloomington, Minnesota 55420

Please tell me more about your

Semiconductor Core Memories

Name _____ Title _____

Company _____ Phone _____

Address _____

City _____ State _____ Zip _____

GD CONTROL DATA
CORPORATION

More than a computer company

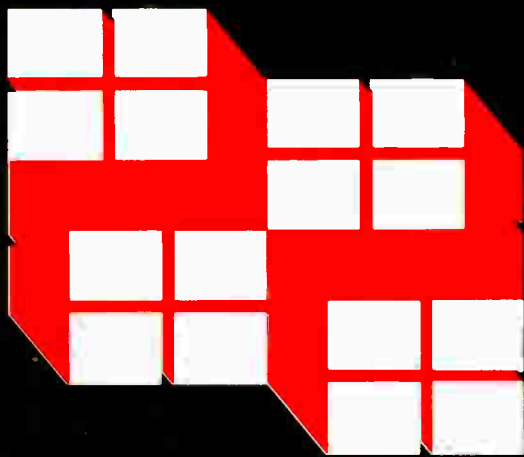

The Xebec Quad™

Patent Pending

The cartridge disk controller on one quad board...

Software transparent and hardware/format compatible with PDP® 11 and LSI® 11 systems...

- Reliability through design optimization
- 60% faster throughput with 2400 rpm drives
- 40 MB storage capacity

The Xebec Quad™. The high performance controller at an affordable price

XEBEC
SYSTEMS INCORPORATED

2985 Kifer Road, Santa Clara, Co. 95051
(408) 988-2550 TWX: 910-338-0130

*Registered Trademark Digital Equipment Corporation

7264 E

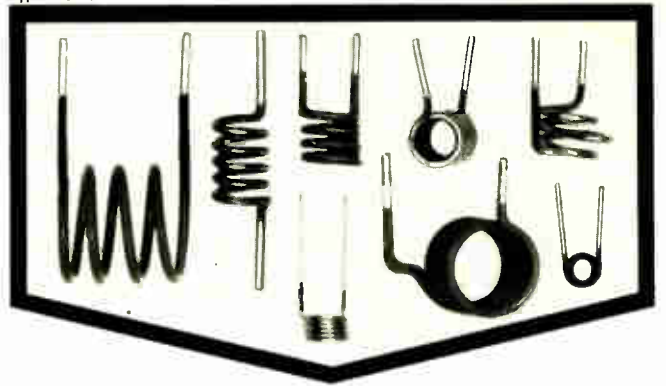

WAFIOS

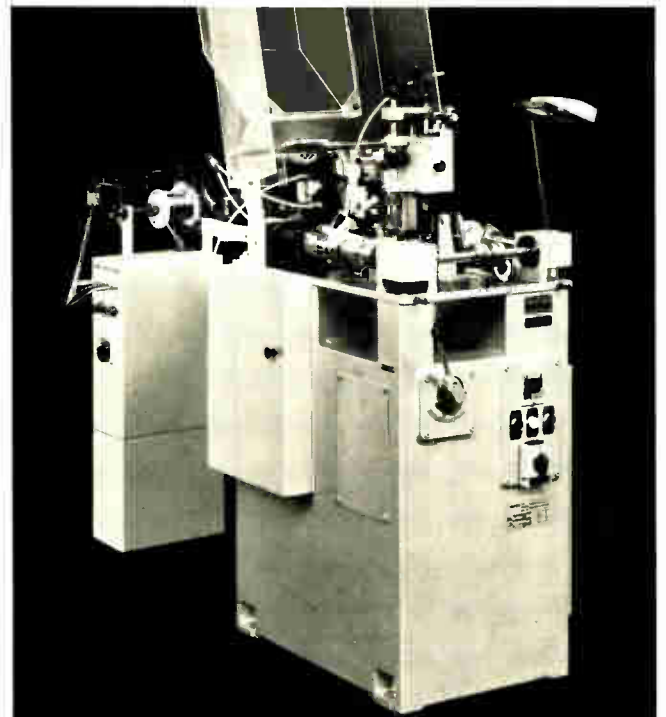

This automatic machine produces up to
50 coreless coils per minute
including stripping of both shanks

	FTU 0-97	FTU 1-97
wire diameter	0,2-1,0 mm	0,3-2,0 mm
inside diam. of coil	10 mm	15 mm
coil length	35 mm	45 mm
shank length	30 x 30 mm	48 x 50 mm
number of coils	55	70
maximum output	50 coils/min.	40 coils/min.

WAFIOS MASCHINENFABRIK

D-7410 REUTLINGEN 1/W.GERMANY

USA SALES OFF: WAFIOS MACHINERY CORPORATION
P.O. B. 148 · 25-35 NORTH EAST INDUSTRIAL ROAD · BRANFORD/CONN 06405 USA

WAFIOS CANADA LTD. 1145 BELLAMY ROAD UNIT № 19

SCARBOROUGH, TORONTO, ONTARIO M1H 1H5 · TELEX 065-25385

SELLING AGENCIES IN ALL IMPORTANT COUNTRIES

Hybrid circuit includes transformer

Isolation amplifier measures only 1.1 inch on a side, yet can withstand 8 kV; maximum nonlinearity is 0.1%.

by Richard W. Comerford, Assistant New Products Editor

Isolation-amplifier modules were at first fairly large components, measuring as much as 2½ by 3½ inches and relying on wound-wire transformers to provide isolation. Although bulky, these early units proved to be quite linear. Then various techniques including optical isolation were used to reduce module size—but in reducing size, performance was lost.

For the design engineer, this meant a choice between quality and size: a tradeoff that no one likes to make. But by using a novel approach to transformer design and operation, Burr-Brown Research Corp. "has been able to bring it all back together, giving users large-module performance in a very small package," according to Bill Olschewski, group leader for isolation products.

The model 3656 isolation amplifier is a hybrid-circuit module that measures about 1.1 in. on each side. Yet it contains two operational amplifiers, a 750-kHz pulse generator, a modulator, input and output demodulators, and separate rectifying and filtering circuits that can provide isolated power to each of the op amps. These individual circuits can be interconnected using external pins, allowing users to design configurations to match their applications. Furthermore, internal op-amp powering can be overridden by simply adding external supplies; isolation of supplies is maintained.

With its single, uniquely configured transformer, the model 3656 is able to operate with up to three completely independent grounds; one for the pulse-generation circuitry, one for the input, and one for the output. With the pulse-generation

circuit connected to output ground, input-to-output isolation is rated at 3.5 kv continuous and 8 kv for 10 s.

This kind of isolation capability is something that the medical profession has wanted in operating rooms, where defibrillators—the machines used to administer electric shock in the event of heart failure—can expose isolation amplifiers to very high voltages. "In the past," says Olschewski, "those in the profession had to be satisfied with amplifiers that had lower ratings, but they kept telling us, 'we'd really like to have 8 kilovolts.'"

Part of the secret in achieving that level of isolation is the use of a conformal-coating process developed for the aerospace and military industries. It employs parylene C, which has a dielectric strength of 5.6 kv per mil. Olschewski explains that to ensure a uniform coating of the

thickness needed, parylene C must be applied to the units in a vacuum for a two-hour period. "It's an expensive step," Olschewski admits, "but we feel we're buying a much larger market."

The module's specifications suit it to industrial as well as medical applications. Gain nonlinearity is a maximum of 0.1% for unipolar output and 0.05% for bipolar output when external supplies are used. Leakage current at 120 v, 60 Hz, is a maximum of 0.5 μ A. For small-signal conditions, \pm 3-dB frequency response is typically 30 kHz; settling time to 0.05% is typically 500 μ s.

In quantities of 100 or more, prices for the 3656 begin at \$33.80. Delivery for large quantities takes from 6 to 8 weeks.

Burr-Brown Research Corp., International Airport Park, P. O. Box 11400, Tucson, Ariz. 85734. Phone (602) 746-1111 [338]

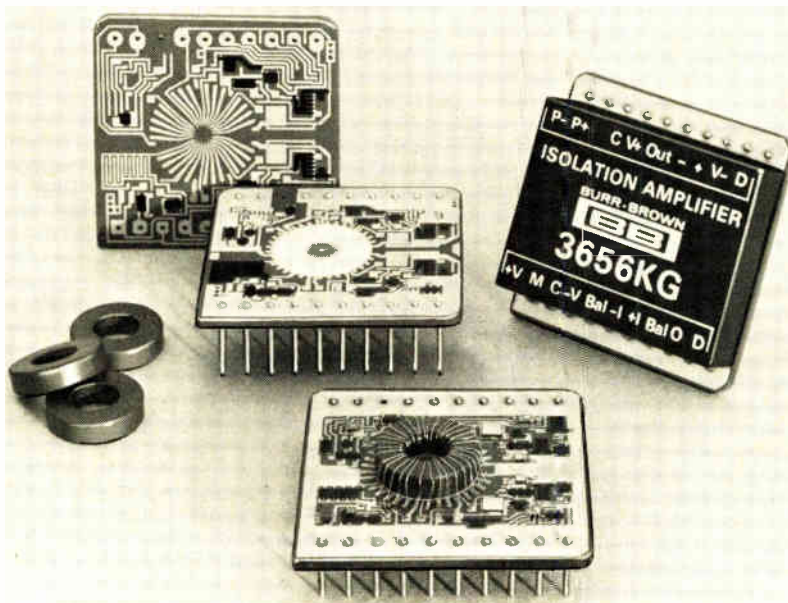

Packaging & production

Ion implanters get more reliable

Vibratory end station eliminates breakage and dust of inclined-plane units

The least-reliable parts of most ion-implantation systems are the automatic end stations that load and unload the semiconductor wafers. With the advent of 4-inch wafers, this problem is becoming more pronounced and has prompted GCA Corp. to develop a new type of end station that promises to improve overall system reliability.

There have been two generations of ion-implanter end stations: the first, a complex mechanical, marginally reliable system gave way to the second, a simple and more reliable gravity-feed, inclined-plane type. "These inclined-plane systems worked fine for the 2-in. and even the 3-in. wafers," Arthur A. Noeth, GCA's ion-product-line manager says, "but the 4-in. wafers present new problems."

As the wafers slide down the inclined track, they must be stopped at the ion-implant process site, processed, and then sent out again. A metal pin or rubber bumper is used to stop the wafer's descent. But 4-in. wafers have enough mass to be

damaged by the impact. "The edges are being chipped, and dust, resulting from pulverization of the wafer fragments, is settling on the surfaces and contaminating them," Noeth explains.

Instead of gravity, GCA's solution uses a 60-Hz vibratory motion to move the wafers gently along within the high-vacuum area. Before and after the high-vacuum chamber, the wafers are moved by a conventional air-bearing technique. "The advantage of vibratory motion is that we can stop the wafer by simply stopping the vibration. There's no impact with a pin and therefore no edge damage or dust produced," Noeth says. A 60-Hz oscillating coil, built by FMC Corp., provides the vibration. Because it is situated outside the vacuum chamber, it presents no reliability constraint.

"It is difficult to design moving parts within a vacuum area," Noeth points out. "Lubrication is out because it would simply evaporate, and the parts should be low-speed and low-load rotating types to ensure seal integrity." There are only five moving parts within the new system's vacuum chamber, and all fit those criteria.

Recently, there have been problems with the positive photo-resist coating on some wafers. As they slid down the plane, the coating would cause drag, and the wafer would stop short of the stop pin, sometimes causing the system to malfunction.

"Theoretically, the vibratory system should eliminate this problem,

Noeth says. "When a wave passes across the boundary between two materials with different transmission properties, there is reflection produced that tends to tear apart the junction formed by the materials. In this case, the silicon wafer is vibrating along an aluminum track, and any tendency for the wafers to stick together should be prevented by the vibrations." Operators—the "dirtiest part of the system," he says—need never touch the wafers because the end station is set up to accept the IBM and GCA standard wafer cassettes.

He admits that anyone could do an effective job of end-station design if they could charge \$75,000 to \$100,000 for that portion of the system. "The industry, however, will only tolerate an end-station price of about \$25,000," he declares. With that limit in mind, GCA's design team sought to develop an end station that would remain competitive while improving the system's reliability.

At \$179,500, the ion-implantation system compares favorably in price with inclined-plane systems, costing upwards of \$195,000. Noeth says one of the first systems will be installed soon, at Zilog's Cupertino, Calif., production line.

GCA Corp., 1050 Kifer Rd., Sunnyvale, Calif. 94086. Phone (408) 732-5330 [391]

Plasma reactor desmears printed-circuit boards

The model 4200-14536PCM can desmear printed-circuit boards in a single automatic step by using a low-temperature plasma to oxidize drill smear. This process is less hazardous, less expensive, and less complex than the acid-to-alkaline-to-wetting-agent process traditionally used to desmear pc boards, and it also simplifies waste disposal.

The system's desmearing process takes place in a sealed reactor in which the plasma is formed by ionizing oxygen and freon gases. Smear that is on boards placed in the reactor is turned to gas by the plasma, and the gas is then removed from the

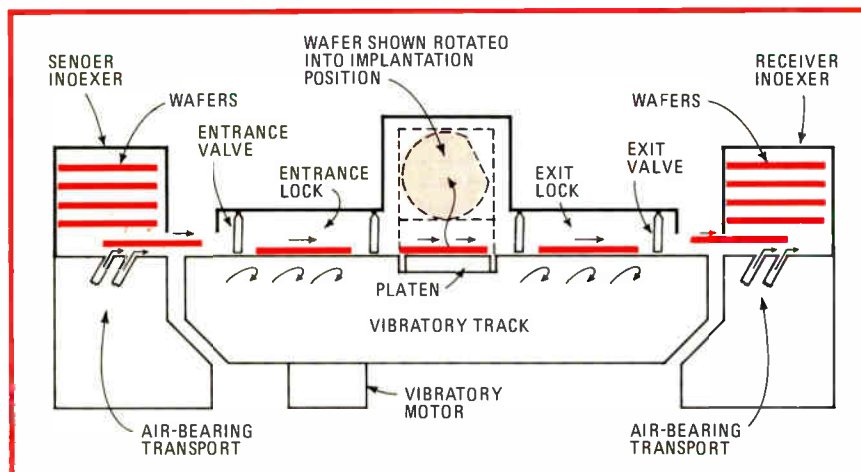

Set the world on its ear with a SuperPower Darlington.



Go ahead, break a convention. Set a new power circuit standard. You can do it with Motorola power Darlington.

There's no reason not to use them in place of discretes. They've proven themselves since we first introduced them 8 years ago. They're reliable. They don't require nearly as many associated components as discretes for the equivalent function. They have multiple sources. They're priced on the average only about 10% more than discretes.

You can achieve as high as 10,000 minimum gain with SuperPower* Darlington. Switch inductive loads as fast as 40 ns. Operate to 15 kVA RBSOA. Handle up to 50 amps or 300 watts of power. Design up to 50 amp complementary circuits. Select from 7 different packages. Pay 100-ups as little as 65¢.

And Motorola now offers 16 economical Switchmode* Darlington, including the new MJ10008/9 units with 20 A, 500 V capability, hot inductive crossover time of 1.6 μ s and minimum gain of 30 at 10 A. Darlington for general-purpose amplifiers and motor controls with 100 amp pulse and minimum gain of 400 at 50 A are available in the new MJ11028 through MJ11033. 100-ups start at only \$5. All state-of-the-art. All a bit earth-shaking.

Select from 132 Motorola SuperPower Darlington listed on the other side. The best there is for setting the world on its ear.

That's what you always wanted to do, isn't it?

*Trademark of Motorola Inc.



MOTOROLA
Semiconductor Group

TEAR ALONG PERFORATION FOR SELECTOR GUIDE . . . USE IT AS POCKET GUIDE, TACK IT UP, OR FILE IT.

Motorola SuperPower Darlingtons

I _C Cont Amps Max	V _{CEO} (sus) Volts Min	Device Type		h _{FE} @ I _C Min/Max	I _C Amp	P _D (Case) Watts @ 25°C	Case JEDEC/Motorola	
		NPN	PNP					
2	30	D40C1		10k/60k	0.2	10	TO-202/306	
		D40C4		10k/60k	0.2	10	TO-202/306	
	40	2N6548		5k min	1	10	TO-202/306	
		2N6549		3K min	1	10	TO-202/306	
			D41K3		1k min	1	10	TO-202/306
		MPS-U45	MPS-U95	4k min	1	10	/152	
		D40K1	K41K1	1k min	1.5	10	TO-202/306	
60	TIP110	TIP115	1k min	1	50	TO-220/221A		
80	TIP111	TIP116	1k min	1	50	TO-220/221A		
100	TIP112	TIP117	1k min	1	50	TO-220/221A		
4	40	MJE3300	MJE3310	1k min	1	15	TO-126/77R	
		2N6037	2N6034	750/1k	2	40	TO-126/77	
	60	MJE3301	MJE3311	1k min	1	15	TO-126/77R	
		MJE800	MJE700	750 min	1.5	40	TO-126/77	
		2N6038	2N6035	750/18k	2	40	TO-126/77	
		2N6294	2N6296	750/18k	2	50	TO-66/80	
	80	MJE3302	MJE3312	1k min	1	15	TO-126/77R	
MJE802		MJE702	750 min	1.5	40	TO-126/77		
2N6039		2N6036	750/18k	2	40	TO-126/77		
	2N6295	2N6297	750/18k	2	50	TO-66/80		
5	60	TIP120	TIP125	1k min	3	65	TO-220/221A	
	80	TIP121	TIP126	1k min	3	65	TO-220/221A	
	100	TIP122	TIP127	1k min	3	65	TO-220/221A	
7	300	MJ3041		250 min	2.5	100	TO-3/11	
	350	MJ3042		250 min	2.5	100	TO-3/11	
8	40	2N6386		1k/20k	3	65	TO-220/221A	
		MJ1000	MJ900		1k min	3	90	TO-3/11
			TIP100	TIP105	1k/20k	3	80	TO-220/221A
			2N6043	2N6040	1k/10k	4	75	TO-220/221A
			2N6300	2N6298	750/18k	4	75	TO-66/80
		2N6055	2N6053	750/18k	4	100	TO-3/11	
		MJE6043	MJE6040	1k/20k	4	75	TO-127/90	
	80	MJ1001	MJ901		1k min	3	90	TO-3/11
		TIP101	TIP106		1k/20k	3	80	TO-220/221A
		2N6044	2N6041		1k/10k	4	75	TO-220/221A
		2N6301	2N6299		750/18k	4	75	TO-66/80
		2N6056	2N6054		750/18k	4	100	TO-3/11
		MJE6044	MJE6041		1k/20k	4	75	TO-127/90
	100	MJE6045	MJE6042		1k/20k	4	75	TO-127/90
		TIP102			1k/20k	3	80	TO-220/221A
		2N6045	2N6042		1k/10k	4	75	TO-220/221A
		1400#	MJ10011†		20 min	4	80	TO-3/11

I _C Cont Amps Max	V _{CEO} (sus) Volts Min	Device Type		h _{FE} @ I _C Min/Max	I _C Amp	P _D (Case) Watts @ 25°C	Case JEDEC/Motorola	
		NPN	PNP					
10	40	2N6383		1k/20k	5	100	TO-3/11	
		MJ3000	MJ2500	1k min	5	150	TO-3/11	
		2N6387		1k/20k	5	65	TO-220/221A	
		2N6384		1k/20k	5	100	TO-3/11	
	80	MJ3001	MJ2501		1k min	5	150	TO-3/11
		2N6388			1k/20k	5	65	TO-220/221A
		2N6385			1k/20k	5	100	TO-3/11
	350	MJ10002†			30/300	5	150	TO-3/11
		●MJ10006†			30/300	5	150	TO-3/11
	400	MJ10003†			30/300	5	150	TO-3/11
●MJ10007†				30/300	5	150	TO-3/11	
MJ10012†				100/2k	6	175	TO-3/11	
12	60	2N6057	2N6050	750/18k	6	150	TO-3/11	
	80	2N6058	2N6051	750/18k	6	150	TO-3/11	
	100	2N6059	2N6052	750/18k	6	150	TO-3/11	
15	60	2N6576		2k/20k	4	120	TO-3/11	
	90	2N6577		2k/20k	4	120	TO-3/11	
	120	2N6578		2k/20k	4	120	TO-3/11	
	550	●MJ10013†		10/70	10	175	TO-3/11	
	600	●MJ10014†		10/70	10	175	TO-3/11	
16	60	MJ4033	MJ4030	1k min	10	150	TO-3/11	
	80	MJ4034	MJ4031	1k min	10	150	TO-3/11	
	100	MJ4035	MJ4032	1k min	10	150	TO-3/11	
20	60	2N6282	2N6285	750/18k	10	160	TO-3/11	
	80	2N6283	2N6286	750/18k	10	160	TO-3/11	
	100	2N6284	2N6287	750/18k	10	160	TO-3/11	
	350	●MJ10000†		40/400	10	175	TO-3/11	
		●MJ10004†		40/400	10	175	TO-3/11	
	400	●MJ10001†		40/400	10	175	TO-3/11	
		●MJ10005†		40/400	10	175	TO-3/11	
450		●MJ10008†		30/300	10	175	TO-3/11	
500	●MJ10009†		30/300	10	175	TO-3/11		
30	60	MJ11012	MJ11011	1k min	20	200	TO-3/11	
	90	MJ11014	MJ11013	1k min	20	200	TO-3/11	
	120	MJ11016	MJ11015	1k min	20	200	TO-3/11	
50	60	MJ11028	MJ11029	400 min	50	300	TO-3 Mod/197	
	90	MJ11030	MJ11031	400 min	50	300	TO-3 Mod/197	
	120	MJ11032	MJ11033	400 min	50	300	TO-3 Mod/197	
	450	●MJ10015†		10 min	40	250	TO-3 Mod/197	
	500	●MJ10016†		10 min	40	250	TO-3 Mod/197	

New products

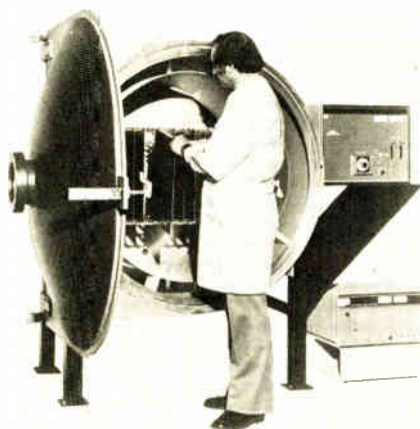

reactor by a vacuum pump.

This commercial system is available in two versions: one with a reactor measuring 24 in. in diameter by 36 in. deep, and the other with a 45-in.-diameter reactor of the same depth. Typically, the smaller unit will hold 20 pc boards measuring 12 by 12 in., and the larger can accommodate 16 18-by-24-in. boards. Prices for the units are about \$36,000 and \$45,000, respectively, and delivery takes approximately 12 weeks.

International Plasma Corp., 31159 San Benito St., Hayward, Calif. 94544. Phone (415) 489-3030 [394]

Bus bar stiffens printed-circuit boards

The Stiffener-bus bar not only provides electrical distribution for two-sided circuit boards, but also eliminates the need to use multilayer boards for mechanical stiffness.

Available in 25- or 42-mil thicknesses, the bars are also offered with a selection of pin spacings between 0.250 and 2.000 in. and in bright-

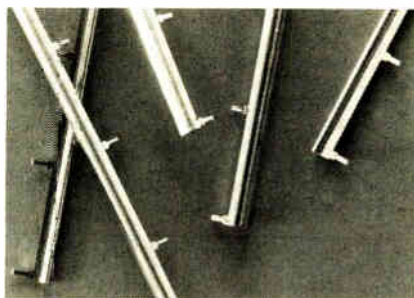

Electronics Magazine Book Series.

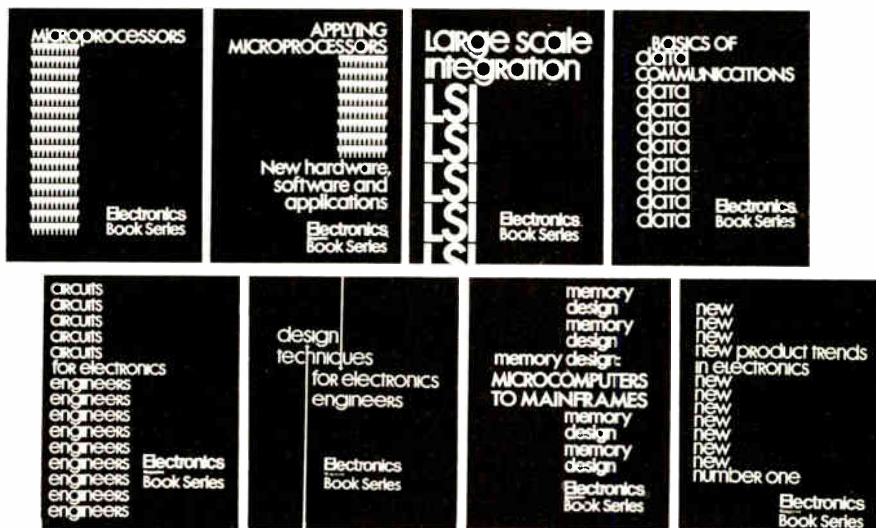

- 1. Microprocessors** What you must know about available microprocessor technology, devices, information, 4th printing. \$8.95
- 2. Applying Microprocessors** 2nd and 3rd generation technology. 26 detailed applications from data networks to video games. \$9.95
- 3. Large Scale Integration** Covers the basic technology, new LSI devices, LSI testing procedures, plus system design and applications. \$9.95
- 4. Basics of Data Communications** Includes 47 articles from Data Communications magazine covering more than 11 key areas. \$12.95
- 5. Circuits for Electronics Engineers** Contains 306 circuits arranged by 51 functions from Amplifiers to Voltage Regulating Circuits. Saves design drudgery. \$15.95
- 6. Design Techniques for Electronics Engineers** Nearly 300 articles drawn from "Engineer's Notebook." A storehouse of design problem solutions. \$15.95
- 7. Memory Design: Microcomputers to Mainframes** The technology, devices, and applications that link memory components and system design. \$12.95
- 8. New Product Trends in Electronics, Number One** From "New Products," state-of-the-art materials and equipment, arranged according to function. \$14.95

Electronics Book Series P.O. Box 669, Hightstown, N.J. 08520

1. Send me _____ copies of "Microprocessors" at \$8.95 per copy.
 2. Send me _____ copies of "Applying Microprocessors" at \$9.95 per copy.
 3. Send me _____ copies of "Large Scale Integration" at \$9.95 per copy.
 4. Send me _____ copies of "Basics of Data Communications" at \$12.95 per copy.
 5. Send me _____ copies of "Circuits for Electronics Engineers" at \$15.95 per copy.
 6. Send me _____ copies of "Design Techniques for Electronics Engineers" at \$15.95 per copy.
 7. Send me _____ copies of "Memory Design: Microprocessors to Mainframes" at \$12.95 per copy.
 8. Send me _____ copies of "New Product Trends in Electronics" at \$14.95 per copy.
- Discounts of 40% on orders of 10 or more copies of each book.

I must be fully satisfied or you will refund full payment if the book is returned after ten-day trial examination.

- Payment enclosed Bill Firm Bill me
 Charge to my credit card:
 American Express Diners Club
 BankAmericard/Visa Master Charge

Acc't No. _____ Date exp. _____

On Master Charge only, first numbers above name _____

Name _____ Title _____

Company _____

Street _____

City _____ State _____ Zip _____

Signature _____

THE GREAT ESCAPE

It's not only the 361 days of sunshine

It's also seagulls and beaches . . . and community leaders who recognize the importance of an industrial base for economic and cultural progress.

Pinellas County on Florida's West Coast offers all of these plus the things you always hope will be at an expansion site, or a relocation for your business — excellent transportation systems, low living costs, a skilled and productive work force, who take pride in a job well done, and the tenth lowest state in local taxes in the U.S.

The Pinellas County Industry Council is ready to assist you with your relocation or new location plans. Make your **Great Escape** to Florida's West Coast!



Pinellas County Industry Council

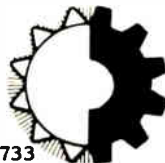

P.O. BOX 13000G St. Petersburg, Fl. 33733

Name _____
 Company _____
 Street _____
 City _____ State _____ Zip _____
 Telephone _____

In cooperation with the Division of Economic Development, Florida Department of Commerce.

Circle 140 on reader service card

Just published: 1978 EBG!

Completely new listings of catalogs, new phone numbers, new addresses, new manufacturers, sales reps, and distributors! The total market in a book—four directories in one!

To insure prompt delivery enclose your check with the coupon now.

Electronics Buyers' Guide
 1221 Ave. of the Americas
 New York, N.Y. 10020

Yes, please send me _____ copy(ies) of 1978 EBG.
 I've enclosed \$25 per copy delivered in the USA or Canada.
 I've enclosed \$35 per copy for delivery elsewhere (\$47 if shipped by Air). Full money-back guarantee if returned in 10 days.

Name _____
 Company _____
 Street _____
 City _____ State _____ Zip _____



New products

tin-plated brass or Olin 194 material. In quantities of 1,000, a 25-mil bar 12 inches long costs about a quarter. Delivery time is two to four weeks.

Bussco Engineering Inc., 119 Standard St., El Segundo, Calif. 90245. Phone (213) 322-6580 [396]

Cooling fixture increases

Wayflow wafer throughput

In the past, the throughput of Wayflow ion-implantation systems has been limited because the beam power had to be limited to less than 10 w to prevent appreciable wafer heating or degradation of the photoresist materials. With a new cooling fixture called Waycool, throughput can be boosted by as much as 500% to allow high doping levels.

In operation, the bottom of the wafer is held in intimate thermal contact with a heat-conducting substrate, or conformal heat sink, during implantation. Implant values of approximately 600 μ A at 200 keV can thus be achieved.

Varian Associates, Blackburn Industrial Park, Gloucester, Mass. 01930. Phone Dr. Andrew Wittkower at (617) 281-2000 [395]

System positions panels

precisely for wire wrapping

The Pin Finder is a precision X-Y positioning system for use when wrapping wire on connector panels. Pin-location coordinates from wire-run lists are used to position the X and Y slides. The user can then insert an appropriate wrapping tool in a notch on the Y slide to make a connection. The need to count off pin locations is thus eliminated.

The unit will accommodate panels up to 10 by 20 in. and features ball-bearing glide rollers, aluminum rails and slides, and a wooden base. It is priced at \$91.95, including shipping and handling.

Ultima Electronics Ltd., 73 Sherwood Ct., Huntington, N. Y. 11743. Phone (516) 423-3770 [398]

When you need LEDs or more than LEDs...



Dialight is the first place to look. We can help you do more with LEDs... because we've done more with them.

Discrete LEDs come in a variety of sizes, shapes, colors (red, yellow, green in clear or diffused), with or without built-in resistors.

Low cost logic state fault indicators for trouble shooting complex circuits. Designed for close density PC board mounting.

High-brightness bi-color LEDs (red/green) suitable for go/no-go situations. Designed with unique

lenses for the extra visibility you'll want for your most critical applications.

Snap-in mounting LED indicators reduce labor cost. Available in red, yellow or green with or without built-in resistors.

Whatever you need in LEDs, Dialight's probably got it already. For your free 60-page selector guide and listing of our nationwide stocking distributors, contact us today.

DIALIGHT
A North American Philips Company

Dialight meets your needs.

Dialight, 203 Harrison Place, Brooklyn, N.Y. 11237 (212) 497-7600

Circle 180 on reader service card

Communications

Fiber-optics kit is versatile

Joint offering from Motorola and AMP sells for \$285

Much has been discussed about fiber optics and its inherent features of electrical isolation, noise immunity, and transmission security, as well as freedom from short circuits, sparks, and fire. Thus, systems suppliers have been touting the performance and cost benefits of fiber optics for applications such as communications, medical electronics, point-of-sale terminals, and industrial control and security systems.

Needed, however, have been tools that allow designers of controllers and circuits to evaluate fiber optics and demonstrate how off-the-shelf components may be used to build dc control and communications systems. Now, AMP Inc. of Harrisburg, Pa., and Motorola Semiconductor Products Inc. of Phoenix, have joined to produce a kit that goes

beyond the traditional capabilities of fiber-optic instructional materials. Called the AMP Optimate Fiber-Optic Experimental Kit, the joint offering contains all the necessary semiconductor devices and printed-circuit boards, along with optical connectors and cables, to enable users to build six prototypes of complete fiber-optic data links that are compatible with transistor-transistor logic and complementary metal oxide semiconductors.

"Typically, more expensive conventional kits are preassembled and limited to building one communications-link component, presumably to prove the point that fiber optics will work," says William J. Hudson, manager of AMP's Signal and Components division. Marketed exclusively by AMP, the kit is being offered at an introductory price of \$285 until August 1, after which it will list for \$350. Delivery time is four to six weeks.

Included in the Optimate kit are 72 devices from Motorola that represent the active components in the transmitter and receiver circuits. Among these semiconductors are comparators, inverters, operational amplifiers, transistors, emitters, and detectors. Also in the kit are drilled circuit boards, 3 meters of cable,

connectors, tools, and instructions to build several different fiber-optic systems or as many as 10 optical-cable assemblies.

Experimenters can construct systems suitable for most low-frequency and short-length data links, Hudson notes. For example, links up to 20 m (for 1-megabit-per-second systems) and as long as 45 m (for 1-kilobit/s systems) can be produced.

"The kit will not produce salable systems, but it can bring an experimental fiber-optic link about 85% of the way to a final commercial design," he adds. Still needed are environmental-protection details, such as temperature compensation, "and the obvious repackaging for production economy," he says.

Six transmitter pc boards and six receiver boards are included as part of the package. The transmitter boards are all identical and provide a range from 1 kb/s to 1 Mb/s. The receiver-board configurations are necessarily more varied. Two receiver boards provide four-channel, 1-kb/s or 100-kb/s capacity. Two others provide one-channel, 10-kb/s capacity, and the final two offer one-channel, 1-Mb/s capacity.

According to Hudson, "All that the experimenter needs to learn fiber-optic systems design, in addition to the kit, is a selection of common capacitors and resistors, typical hand tools, and initiative."

AMP Inc., Harrisburg, Pa., 17105. Phone (717) 564-0100 [401]



Quickly readied modem makes good use of channels

The MPS 9601, the fastest member of the new MPS series of modulator-demodulators, uses a microprocessor-controlled digital equalizer and a high-speed training capability to provide a quick request-to-send/clear-to-send response time of 30 ms, even on unconditioned lines. The unit operates at a data transmission speed of 9,600 bits per second and is available with one to four ports.

Multiple-port versions of the mod-

em are equipped with an automatic port-allocation feature that distributes the full 9,600-b/s capability among the active ports. The primary port operates at full transmission speed until a secondary port is activated by a request to send from a terminal. When this occurs, the primary port's transmission rate is reduced to 7,200 b/s and the secondary port operates at 2,400 b/s.

Activation of additional secondary ports similarly decreases the primary port's transmission rate. When a secondary port becomes inactive, its channel capacity is reassigned to the primary port.

Both single- and multiple-port modems can be integrally configured with a port-sharing system that lets as many as four terminals share a single port sequentially. In multiport versions, this permits the user to dedicate one port to a high-priority terminal, which will always be able to access a data channel.

Other members of the microprocessor-based series are: the MPS 9269, a CCITT-V.29-compatible version of the MPS 9601; the MPS 7201, a 7,200 b/s modem with up to three ports; and the MPS 4801, with a transmission rate of 4,800 b/s and one or two ports. Limited quantities are available for 45-day delivery, the company says.

Racal-Milgo Inc., 8600 N.W. 41st St., Miami, Fla. 33166. Phone (305) 592-8600 [404]

Optical system

transmits TTL signals

The solutions that fiber-optic data-communications systems can offer to the problems of external interference on transmission lines and retention of data security has attracted the attention of many companies. Olektron Corp. has now introduced such a system for use with transistor-transistor-logic devices.

The system comprises a transmitter, an optical cable, and a receiver. The transmitter converts a TTL-level signal to a light pulse using a light-emitting diode. The cable consists of a jacketed fiber-optic bundle with

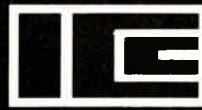

The leader in
Light Pens...even
before most people
knew what to do
with them



ICC. The leader in light pens since 1966. Now offering improved performance. Lower prices too. What are you waiting for? Write for full details or call, today.



INFORMATION CONTROL CORPORATION
9610 Bellanca Ave., Los Angeles, Ca. 90045 (213) 641-8520

Circle 143 on reader service card

If this magazine
is worth your time,
it's worth 58¢.

Drop off the routing list. Avoid the Perils of Passalong. Get your own fresh, unclipped copy mailed to your home or office. \$15 (58¢ per issue) for a one-year U.S. subscription. (\$17 in Canada.) Turn to the subscription card in the back of the magazine. If somebody beat you to it, write: Electronics, P.O. Box 430, Hightstown, N.J. 08520.

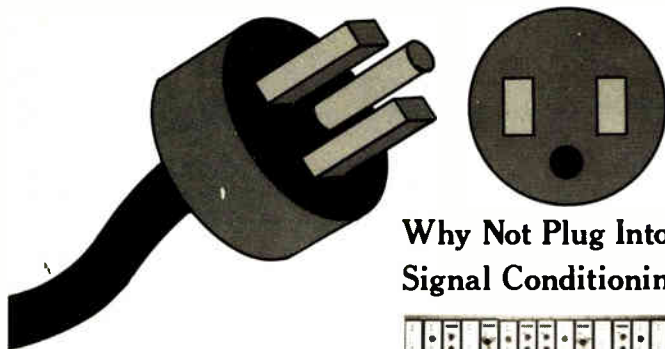

Same Old Measurement but a Better Approach

BELL & HOWELL
CEC DIVISION

CEC is a registered trademark of Bell & Howell
© Bell & Howell 1978

Circle 144 on reader service card

Why Not Plug Into CEC's Signal Conditioning Family



Plug-in versatility and compatibility . . . That's what you get as an added attraction with CEC's new family of differential and strain gage bridge conditioning amplifiers.

Plug in the gain you need — We cover from 0.02 attenuation to 1000 amplification for full scale output. Drive a tape recorder? An oscillograph? A high level A to D? Just plug it in!

Save space . . . Plug in 14 amplifiers in one 19" rackmountable case. Save time too with our color coded control panels, "direct dial" input, self calibration, multiple outputs, and more.

Let us "plug" you into our information bank, Contact us at 360 Sierra Madre Villa, Pasadena, CA 91109. (213) 796-9381.

New products

subminax-27-series connectors. The receiver uses a positive-intrinsic-negative photodiode to reconvert the signal.

With pulse repetition rates to 20 MHz, the system can handle pulse widths as narrow as 15 ns. Both the transmitter and the receiver require a 5-v power supply, and the receiver puts out signals with a logic low of less than 0.5 v and a logic high between 4.5 v and the supply voltage. Cables with losses of less than 5 dB/km are available.

As a pair, the transmitter and receiver are priced at \$1,295. Cables are priced at \$2/m in lengths over 300 m. Systems are available for delivery in four to six weeks.

Olektron Corp., 6 Chase Ave., Dudley, Mass. 01570. Phone Joseph Oleksiak at (617) 943-7440 [403]

2-kW klystron amplifier offers digital tuning

Intended for use in digital troposcatter communications systems, the 4k5SL-3 is a four-cavity klystron amplifier that operates between 1.7 and 2.4 GHz. The tube can be digitally tuned to any frequency within its operating range by adjusting each cavity to the corresponding value provided on the chart that accompanies each tube.

At a frequency of 1.7 GHz, typical output power, gain, and 1-dB bandwidth are 2.1 kw, 40.2 dB, and 9 MHz, respectively. For the upper frequency limit, the typical values are 2.05 kw, 40.1 dB, and 10 MHz. Required input drive power for the amplifier is 200 mw.

Palo Alto Microwave Tube Division, Varian Associates, 611 Hansen Way, Palo Alto, Calif. 94303. Phone (415) 493-4000 [406]

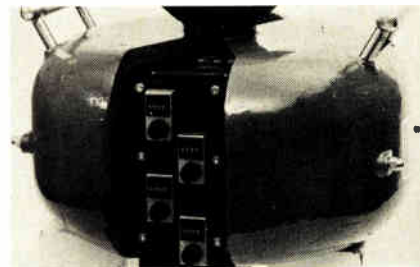

Take stock in America.

New products

Semiconductors

2L chip handles fast functions

Controller lets user scroll dot-character display or switch line for line

Using a proprietary process that combines high-speed Schottky transistor-transistor logic, dense integrated-injection logic, and linear bipolar devices on the same chip, the DP8350 cathode-ray-tube controller replaces not only the control logic portions handled by metal-oxide-semiconductor devices, but also high-speed logic functions such as dot logic. The controller puts an oscillator and complete timing, refresh, logic, and video control circuits in a single package, thus reducing the number of components needed in standard or custom terminal designs.

The unit's system-control input and character random-access memory are handled by a 12-bit bidirectional three-state bus and three on-chip 12-bit registers. The top-of-page register permits both display scrolling without external memory address adders and sequential addressing of the CRT memory.

Using the row-start register, memory can be addressed nonsequentially on a row-by-row basis. By changing the first address in each row, rows of characters can be swapped without rewriting the memory address in CRT random-access memory. The cursor register holds the present cursor address during changes.

An 11-line bus furnishes video and system output, including horizontal and vertical synchronization, vertical blanking, cursor enable, and all control signals for dot-character-generation circuits. An internal dot-rate oscillator controlled by an external 10.92-MHz crystal gives a dot time of 91.6 ns; character time is 641 ns.

The DP8350 supplies buffered

dot-rate clock output and accepts dot-rate frequencies from the CRT system. It also accommodates special video-display attributes, such as blinking and underlining, from external circuits, as well as two refresh frequencies: 60 Hz, which gives 260 scan lines per frame, and 50 Hz, which provides 312 lines per frame.

The unit can be purchased in a standard configuration or mask-programmed for special designs. The standard configuration has a 5-by-7-dot matrix in a 7-by-10 field. The overall display format is 80 characters wide with 24 rows per frame.

When mask-programmed, the unit's basic architecture remains the same; the major video characteristics are altered by changing information contained in read-only-memory blocks on the chip. The user may specify character and field size up to 16 by 16 dots, the number of characters per row from 5 to 110, and the number of rows from 1 to 64—within the constraints of the frame refresh rate. Horizontal and vertical synchronization pulses, cursor-enable output, and vertical blanking output are also programmable to meet special requirements.

Available now in sample quantities, the standard DP8350 is priced at \$49.

National Semiconductor Corp., 2900 Semiconductor Dr., Santa Clara, Calif. 95051. Phone Don Tarver at (408) 737-5873 [411]

8-bit a-d converter has low price tag

The μ A9708—a monolithic 8-bit, 6-channel analog-to-digital converter for microprocessor-based data systems—offers 300- μ s conversion time, built-in auto-zeroing, and can be calibrated at full scale. In plastic dual in-line packages, quantities of 100 or more units are priced at \$3.50 each.

The converter relies on a microprocessor system to provide the addressing, timing, counting, and arithmetic operations needed to implement a full conversion system. The unit is also available in a ceram-

ic DIP priced at \$4.35 in 100-and-up quantities. In either package, delivery is from stock.

Semiconductor Components Division, Fairchild Camera and Instrument Corp., 464 Ellis St., Mountain View, Calif. 94042. Phone (415) 962-3816 [414]

Driver buffers MOS circuits and gas-discharge panels

Designed to act as a buffer between the output of metal-oxide-semiconductor devices and the anodes of a gas-discharge panel, the XR-2272 is made up of seven independent digit-driver sections in a single monolithic package. The driver can be paired with the XR-2771 segment-driver for a two-chip display-driver system.

The XR-2272 operates with

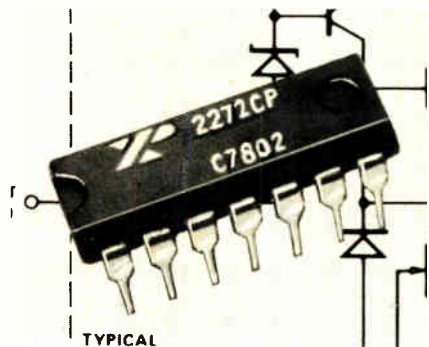

supply voltages of up to 60 v, can be interfaced with Panaplex II displays, and is available in both plastic and ceramic 16-pin dual in-line packages. In quantities of 100 or more, the plastic-packaged unit is priced at 86¢ apiece.

Exar Integrated Systems Inc., P.O. Box 62229, Sunnyvale, Calif. 94086. Phone Brooks Hamilton at (408) 732-7970 [415]

Switching transistors extend safe-operating limit

Designed to extend the turnoff safe operating areas for inductive switching applications, the GSTR120 and GSTR80 series consists of high-speed, high-power transistors of the triple-diffused npn type. The units are

Automatic Test Equipment Switching Matrix



From a long history of reliable switching systems, A.D. Data Systems offers the most versatile method of switching stimuli and measuring instruments for automatic test equipment.

FEATURES

- * IEEE 488 Compatible.
- * 16 Bit Computer I/O Control.
- * Microprocessor Control.
- * Expandable From 20 to 1000 crosspoints.
- * Matrix Configuration Flexibility.
- * High Frequency Signal Switching.
- * Power Switching.
- * Low Level Switching.

For further information and a solution to your switching problems, contact:

Harry Turner



A. D. DATA SYSTEMS, INC.
200 COMMERCE DR. • ROCHESTER, N.Y. 14623

PHONE 716-334-9649 • TWX 510-253-3246

Circle 146 on reader service card

The magazine you're reading now, could be your own.

Drop off the routing list. Get your own fresh, unclipped copy mailed to your home or office. Turn to the subscription card in the back of the magazine. If somebody has beat you to it, write: Electronics, P.O. Box 430, Hightstown, N.J. 08520.

New products

manufactured using a process that is called C^2R and provides surface stabilization for high-voltage operation and enhances long-term stability. At rated voltage, the GSTR120 has a safe-operating-area turnoff current of 12 A; the GSTR80 has a turnoff current of 8 A.

The GSTR120 series comprises three transistors, designated GSTR12030, 35, and 40, which have peak collector-to-emitter voltages of 300, 350, and 400 v respectively. The series is rated for a continuous collector current of 16 A and a peak current of 25 A. Collector saturation voltage is 0.8 v.

The three members of the GSTR80 series, the 35, 40, and 45, are offered with peak collector-to-emitter voltages of 350, 400, and 450 v, respectively. Their continuous collector current rating is 12 A, and their peak rating is 20 A. This series' collector saturation voltage is the same as that of the GSTR120 units.

The GSTR120 series is expected to replace 2N6546 and 2N6547 transistors; the GSTR80 series offers improved circuit performance in applications that have employed 2N6582, 83, and 84 units. In quantities of 100 or more the GSTR120 series ranges in price from \$9.90 each for the 300-v device to \$13.20 apiece for the 400-v unit. Price range for the GSTR80 in similar quantities is \$7.90 (350 v) to \$11.20 (450 v). Delivery is from stock to four weeks.

General Semiconductor Industries Inc., P. O. Box 3078, Tempe, Ariz. 85281. Phone Jim Williams at (602) 968-3101 [416]

Bigger package brings transistor cost down

The AT-4641, -4642, -4680, and -4690 are small-signal bipolar microwave transistors that provide the same specifications as earlier versions that were offered in 70-mil-square ceramic-metal packages. But by placing these units in 100-mil² packages, the manufacturer is able to realize savings in assembly costs that result in prices 30% lower than

those for the 70-mil² transistors.

The AT-4641 has a typical noise figure of 3.0 dB at 4 GHz, with an associated gain of 7.5 dB; its maximum available gain is 9.5 dB. The AT-4642 is a lower-cost version of the AT-4641.

For the AT-4680, the typical noise figure is 2.6 dB at 4 GHz, with 8.8 dB of associated gain; the maximum available gain is 12 dB. The AT-4690 has a noise figure of 2.8 dB, and over the collector-current range from 2.5 to 20 mA, that figure changes by only 0.8 dB.

The new microwave transistors can be purchased burned in and screened according to MIL-STD-750 procedures.

Avantek Inc., 3175 Bowers Ave., Santa Clara, Calif. 95051. Phone (408) 249-0700 [417]

Video output transistors withstand CRT arcing

The MDS20 and MDS21 high-voltage power transistors combine a 60-MHz current-gain-bandwidth product with the ability to withstand cathode-ray-tube arcing currents.

Gain for the transistors at 30 mA is a minimum of 40 and is linear from 1 to 40 mA. The MDS20 is rated for a collector-emitter breakdown voltage of 250 v; the MDS21 is rated for 300 v. Collector-base capacitance is a maximum of 3.0 pF.

In quantities of 100 and up, the MDS20 is priced at 50¢ and the MDS21 at 55¢. Both are available from stock.

Motorola Semiconductor Products Inc., P. O. Box 20912, Phoenix, Ariz. 85036 [418]

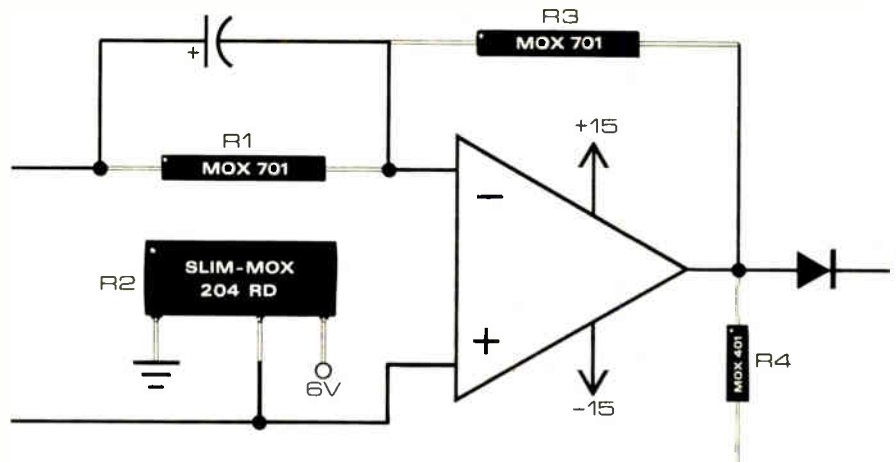
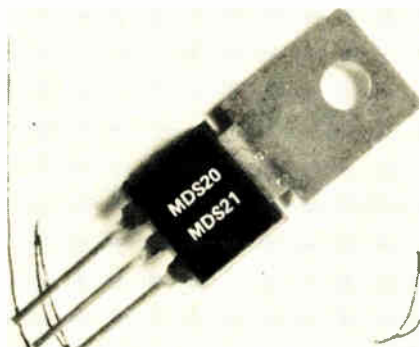

Our resistors stand out.

A superior resistor naturally stands out. And a resistor that combines low cost, inherent stability and reliability stands way ahead of the crowd. Our Commercial Performance Mox series does just that. And more. Its family of resistors now serves applications ranging from high impedance electrometer circuits to bleeder resistors. Developed through a refinement of our high voltage resistor technology, the CPM series provides the superior performance which you've come to expect from VICTOREEN, at a very accessible price. We've combined high technology, low price and delivery. Which is why our resistors stand out . . . and Our Customers Prefer Mox.



TYPE	VOLT RATING	POWER @ 70°C	"L" MAX
MOX 401	1.5 Kilovolts	0.5 Watts	0.500 Inches
MOX 701	3.0 Kilovolts	1.0 Watts	0.840 Inches
MOX 1101	6.0 Kilovolts	1.5 Watts	1.235 Inches

TYPE	RESISTANCE RANGE AND TEMPERATURE COEFFICIENTS			TOLERANCES
	100 PPM/°C	250 PPM/°C	500 PPM/°C	
MOX 401	100K-200M	201M-1000M	1001M-1500M	1,2,5 and 10%
MOX 701	100K-400M	401M-2000M	2001M-2500M	1,2,5 and 10%
MOX 1101	100K-600M	601M-2500M	NA	1,2 and 5%

VICTOREEN, INC.

10101 WOODLAND AVE • CLEVELAND, OHIO 44104
Phone: (216) 795-8200 • TWX: (810) 421-8287



Circle 147 on reader service card

Just published: 1978 EBG!



Completely new listings of catalogs, new phone numbers, new addresses, new manufacturers, sales reps, and distributors! The total market in a book—four directories in one!

**To insure prompt delivery
enclose your check with the
coupon now.**

Electronics Buyers' Guide
1221 Ave. of the Americas
New York, N.Y. 10020

Yes, please send me _____ copy(ies) of 1978 EBG.
 I've enclosed \$25 per copy delivered in the USA or Canada.
 I've enclosed \$35 per copy for delivery elsewhere (\$47 if shipped by Air). Full money-back guarantee if returned in 10 days.

Name _____
Company _____
Street _____
City _____ State _____ Zip _____

TOTAL FREQUENCY CONTROL

FROM ERIE

HIGH FREQUENCY AT CRYSTALS



Erie AT Crystals are used over the frequency spectrum from 950 kHz to 200 MHz. Low temperature coefficient, extremely high Q, economical. Used in TCXO and VCXO oscillators, temperature controlled and, non-controlled oscillators, and filter applications. All size cans.

LOW FREQUENCY CRYSTALS

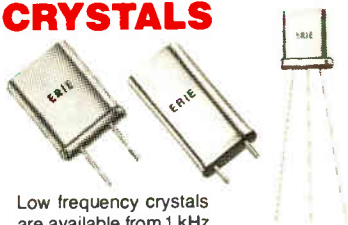

Low frequency crystals are available from 1 kHz to 1MHz in a broad variety of crystal holders and mounting configurations. Erie is a leading source for all types of high quality, Low Frequency Crystals.

CRYSTAL OSCILLATORS



Erie offers a broad range of economical as well as highly sophisticated Crystal Oscillators. These small size oscillators are available in a wide range of frequencies. Hermetically sealed crystals assure long term stability. Design assistance available.

CRYSTAL FILTERS

Erie subminiature quartz crystal filters are specified for use in communications receivers . . . as well as for radar, sonar and space applications.



Write for brochure describing Erie Crystals, Filters, Oscillators and Ovens

ERIE

ERIE FREQUENCY CONTROL DIV. OF
ERIE TECHNOLOGICAL PRODUCTS
Carlisle, Pa. 17013
717/249-2232

New products

Data handling IQ rises for data terminals

Trio of stand-alone units
built around LSI-11 can
control other terminals

With data terminals increasingly incorporating microcomputers, their traditional input/output role is being redefined to include stand-alone computing capability. One of the latest examples of this trend is the PDT-11 terminal family that was a big attraction at last month's National Computer Conference [*Electronics*, June 8, p. 36].

All three entries in the Digital Equipment Corp. family are built around the 16-bit LSI-11 microcomputer. Two of them—the PDT-11/110 and PDI-11/130—incorporate a new video display announced with the family, the VT100. The third unit, the PDT-11/150, comes with a choice of video display or printer.

The 130 has twin magnetic-tape storage units; the 150 has single or dual floppy-disk storage. The 110 has the family's basic 16,384 bytes of local metal-oxide-semiconductor memory, but it is expandable to the 130's 32 kilobytes, and both are expandable to the 150's 60-kilobyte maximum.

The terminals are sold with RTT, a run-time version of DEC's RT-11 operating system. All three units use the instruction set of DEC's PDP-11 minicomputers, permitting programs developed for the terminals to run on a PDP-11, or vice versa. "Each terminal has the power to do stand-alone jobs that previously required full computer systems," says Andrew C. Knowles, DEC's corporate vice president for marketing, "and each has the ability to drive three other unintelligent terminals, forming a system of their own."

The VT100 cathode-ray-tube display introduced with the family sells



by itself as a video terminal for \$1,900 singly or \$1,230 in quantities of 100. It has a detached keyboard with as much as 132 columns of double-width and double-height characters and includes reverse video, blinking, and underlining.

Knowles regards terminals like these—the first terminals designed to be compatible with the PDP-11 computer line—as representing the minicomputer packaging technology of the future. "They'll become almost like commodities, and a minimum entry into small-business systems," he predicts. He also looks for them to become central elements in word-processing systems.

The PDT-11/110's price is \$3,900 singly or \$2,890 each in quantities of 100. For the PDT-11/130, those same prices are \$5,000 and \$3,677, and the PDT-11/150 will sell for \$6,325 singly or \$4,322 in hundreds. Volume deliveries will begin this fall. Components Group, Digital Equipment Corp., 1 Iron Way, Marlboro, Mass. 01752. Phone Roger Bently at (617) 481-7400, Ext. 6085 [361]

Level 6 line gets new top and bottom models

Minicomputer users are often concerned with the physical size of the

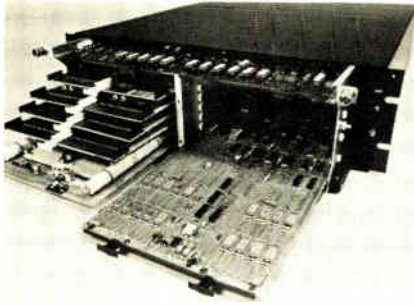

computers they buy and with the units' software compatibility with more powerful computers—concerns addressed by the model 23, the new entry-level unit in the Level 6 mini-computer line.

The rack-mountable model 23 has its central processing unit on a single full-width printed-circuit board, with 10 half-width card slots provided in the 5¼-in.-high card cage for memory or input/output cards. A basic model 23 configuration that includes 64 kilobytes of main memory, a single diskette drive and a cathode-ray-tube terminal is priced at \$13,500.

Main memory can be expanded to 128 kilobytes, and other peripherals such as matrix and line printers, are also available. The model 23 uses the same software that the larger model 33 uses and is software-compatible with the entire Level 6 line, Honeywell says.

On the other hand, the new top-of-the-line model 57 is a Cobol-oriented multiprocessor machine with 8 kilobytes of cache memory that can support from 32 kilobytes to 2 megabytes of main memory. It comes with a commercial-instruction processor, and, for users who want it to handle Fortran programs, it can accept an optional scientific-instruction processor.

A basic model 57 configuration with 256 kilobytes of main memory, a 67-megabyte disk drive, a tape drive, and a cathode-ray-tube display is priced at \$127,000. First deliveries of the model 57 are scheduled for September; the model 23 is available immediately.

Honeywell Information Systems, 200 Smith St., Waltham, Mass. 02154. Phone (617) 890-8400 [363]

32-bit mini priced and packaged for OEMs

Original-equipment manufacturers who have outgrown the performance of 16-bit minicomputers can now upgrade to the 32-bit performance of the SEL 32/30. Although similar in performance to the SEL 32/35, the new unit uses 16-k dynamic random-access memories instead of core memory and multilayer printed-circuit boards instead of wrapped-wire boards for packaging efficiencies that allow the computer and as much as 1 megabyte of main memory to fit into a rack-mountable cabinet that is 15¼ in. high.

Floating-point arithmetic firmware is standard, and the memory includes error-detection-and-correc-

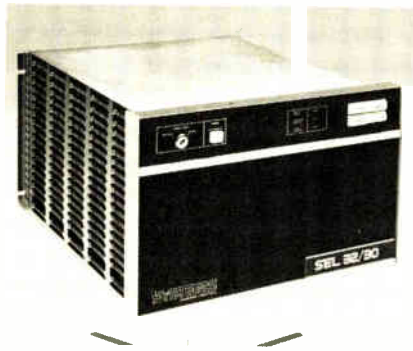

tion circuitry. A basic unit with 256 kilobytes of metal-oxide-semiconductor memory, a panel, chassis, and power supply sells for \$27,300. Quantity discounts are available.

Richard Rubin, product manager for small computer systems, claims that the 32/30 is the first true 32-bit minicomputer packaged for the OEM. First deliveries are scheduled for November.

Systems Engineering Labs, 6901 W. Sunrise Blvd., Fort Lauderdale, Fla. 33313. Phone (305) 587-2900 [364]

Small-system disk drives use 3350-type technology

The high storage densities and increased reliability of the fixed-

World's most popular —



MONOBLOC® Ceramic Capacitors

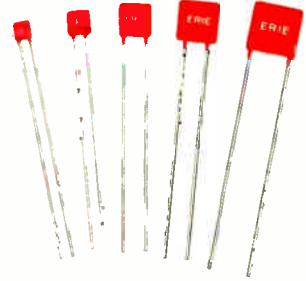

Temperature Compensating Stable and General Purpose

ERIE Red Cap Monobloc® Ceramic Capacitors are in a quality class by themselves and today represent a standard of excellence unequalled in the industry.

Monobloc capacitor elements, solid structures of fused ceramic, are produced in a wide range of capacitance values, characteristics and sizes. They offer inherent stability with conservative voltage ratings for long, trouble-free life.

The combination of Monobloc and "Weecon®" capacitors, under the famous Red Cap name, provide circuit engineers with unlimited design flexibility.

Best delivery in the industry for these popular Z5U values . . .

.1 .47 .68 1.0 2.2 4.7 μF.

- Capacitance range 100 pF. thru 7.5 μF.
- 25, 50, 100, 200, 500 Volts
- Broadest range of TC materials and tolerances

Write for catalog 8100



ERIE TECHNOLOGICAL PRODUCTS, INC.
State College, Pa. 16802
814-237-1431

ELECTRODYNAMIC VIBRATION TESTING SYSTEMS

Production Screening
Reliability Demonstration
Long Term Vibration Life
Engineering Evaluation
Mission Profile Testing
Transportation Simulation

"A shaker or a total system
to meet your
requirements"



Sine or random excitation up to: 5000 pound force
1800 pound payload, 2000 hertz frequency



Small Business Subcontractor of the Year • 1977 Region 5

THERMOTRON INDUSTRIES
DYNAMIC SYSTEMS DIVISION

KOLLEN PARK DRIVE, HOLLAND, MI. 49423
PHONE (616) 392-1492 / 396-1727

Circle 150 on reader service card

Just published: 1978 EBG!

1.

Directory of products.
Over 4,000 products, over
5,000 manufacturers.



2.

Directory of catalogs
Includes six post-paid
catalog inquiry cards for
10-second ordering

3.

Directory for manufactur-
ers. Local sales offices,
reps. and distributors, with
phone numbers. Number
of employees and engi-
neers, dollar volume
name of company contact

4.

Directory of trade names
of products and their
manufacturers. You can
trace a product by its trade
name only

**To insure prompt delivery enclose your check
with the coupon now.**

Electronics Buyers' Guide
1221 Ave. of the Americas
New York, N.Y. 10020

- Yes, please send me _____ copy(ies) of 1978 EBG.
 I've enclosed \$25 per copy delivered in the USA or Canada.
 I've enclosed \$35 per copy for delivery elsewhere (\$47 if
shipped by Air). Full money-back guarantee if returned in 10 days.

Name _____

Street _____

Company _____

City _____

State _____

Zip _____

New products

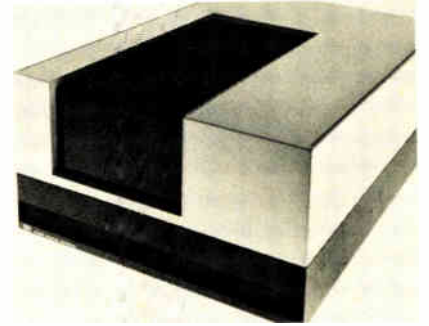

media IBM-3350-type disk drives, up to now used primarily by main-frame computer makers, are available to small-systems builders in the STC 2700 series of disk drives.

The latest of a variety of recently introduced disk drives that use Winchester factory-sealed head-disk assemblies, the STC 2700 also offers the higher recording densities of the IBM-3350 drive. Using recording densities of 478 tracks per in. and 6,380 bits per in., the STC drives offer capacities of 33, 80 or 170 megabytes, with an average access time of 35 ms in a package 16.9 by 23 by 8.6 in. The drives, which interface with the host computer by means of an adapter card, perform many of the functions usually handled by the controller.

First deliveries of the drives are scheduled for spring 1979. The 33-megabyte unit is priced at \$3,000 in OEM quantities; the 80-megabyte drive will sell for \$3,700; and the 170-megabyte unit carries a \$4,400 price tag.

Storage Technology Corp. 2270 S. 88th St.,
Louisville, Colo. 80027. Phone (303) 666-
6581 [365]

Okidata Winchester disks

available up to 80 megabytes

With the introduction of an 80-megabyte unit, Okidata has expanded the capacity of its 3300 series of Winchester disk drives. Starting with a 13.47-megabyte unit priced at \$2,460 in OEM quantities, the 3300 series now includes units with 26.94, 40.39, 53.86, 67.33, and 80.80 megabytes of storage.

Average access time is 38 ms, and

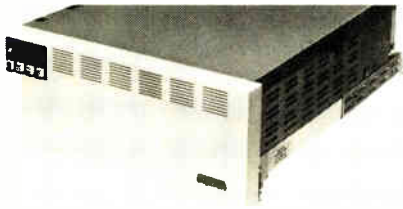

the data transfer rate is 7.97 megabits per second. The drives are packaged in an enclosure measuring 17¾ by 23½ by 7 inches.

Available 90 days after receipt of order, the new 80-megabyte unit is priced at \$3,390.

Okidata Corp., 111 Gaither Dr., Mt. Laurel, N. J. 08054. Phone John Capodici at (609) 235-2600 [366]

Microfloppy disk drives add dual sides and densities

The increased storage capacities afforded floppy-disk-drive makers through the use of modified frequency-modulated recording schemes and the use of both sides of the diskette are now being applied to the smaller members of the floppy-disk family. An example is Pertec's FD200 Microfloppy, which can store up to 437,500 bytes on a single 5.25-in. diskette.

Offering hard or soft sectoring and write protection as standard features, the drive is priced at \$325 in quantities of 100 and up.

Pertec Computer Corp., Pertec Division, 9600 Irondale Ave., Chatsworth, Calif. 91311. Phone (213) 882-9222 [367]

Wangco 5.25-in. floppy offers dual heads, densities

Using the dual-density, dual-sided techniques of its big-brother 8-in. floppy-disk drive, Wangco's 5.25-in. model 282 diskette drive can store 437.5 kilobytes of unformatted data at a rate of 125,000 bits per second.

In quantities of 1,000 or more, the model 282 is priced at \$317.

Perkin-Elmer Corp., Wangco Division, 5404 Jandy Pl., Los Angeles, Calif. 90066. Phone Dave Andersen at (213) 390-8081 [368]

Operating system eases OEM programming

The new Naked Mini operating system is a disk-based single-user program development system that employs a common real-time executive and file manager and is said to simplify software development for

original-equipment manufacturers. Supplied in object-code format on diskettes, the operating system, including a source editor, macro assembler, Pascal compiler, and linking and debugging modules, is priced at \$2,000. Deliveries have started.

Computer Automation, 18651 Von Karman, Irvine, Calif. 92713. Phone (714) 833-8830 [369]

\$24.95

...AND HOLDING

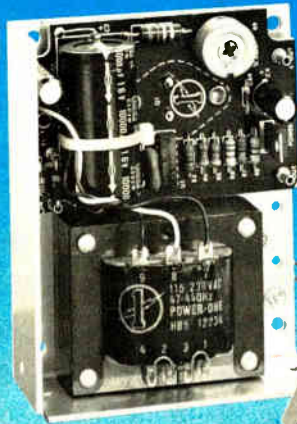

Model HB5-3/OVP

5V at 3A with Built-in OVP

Power One's B Case models started at \$24.95. Over 100,000 models and five years later, they're *still* only \$24.95!

- 115/230 VAC Input
- OVP Built-in
- .05% Regulation
- 2-Year Warranty
- 2-Hour Burn-in
- UL Recognized
- CSA Certified



Get all the details on our 84 standard open frames in our new 1978 catalog.

IN-STOCK NATIONWIDE... FOR IMMEDIATE DELIVERY

ARIZ.: Scottsdale, PLS Assoc. (602) 994-5461 CAL.: Pasadena, A-F Sis Engr. (213) 681-5631; San Jose, Richards Assoc. (408) 246-5860 COL.: Denver, PLS Assoc. (303) 773-1218 CT.: Litchfield, Digital Sis. Assoc. (203) 567-9776 FLA.: Orlando, Gra-Mar (305) 894-3351 ILL.: Chicago, Coombs Assoc. (312) 298-4830 IND.: Indianapolis, Coombs Assoc. (317) 897-5424 MD.: Lanham, Brimberg Sis. Assoc. (301) 946-2670; Baltimore, Brimberg Sis. Assoc. (301) 792-8661 MASS.: Waltham, Digital Sis. Assoc. (617) 899-4300 MINN.: Minneapolis, Engr. Prod. Assoc. (612) 925-1883 N.J.: Whippany, Livera-Polk Assoc. (201) 377-3220 N.M.: Albuquerque, PLS Assoc. (505) 255-2330 N.Y.: Roslyn Hts., Livera-Polk Assoc. (516) 484-1276; Syracuse, C.W. Beach (315) 446-9587 ORE.: Portland, Jas. J. Backer (503) 297-3776; Salem, Jas. J. Backer (503) 362-0717 TEX.: Dallas, Advance Technical Sis. (214) 361-8584; Solid State Electr. (214) 352-2601; Houston, Advance Technical Sis. (713) 469-6668; Solid State Electr. (713) 785-5436 WASH.: Seattle, Jas. J. Backer (206) 285-1300; Radar Elec. Co. (206) 282-2511 WIS.: Milwaukee, Coombs Assoc. (414) 671-1945 EUROPE: Hanex, L.A., CA (213) 556-3807 CANADA: Duncan Instr. Weston, Ontario (416) 742-4448

"Think
about

POWER-ONE INC.

D.C. POWER SUPPLIES

Power One Drive • Camarillo, CA 93010 • Phone: 805/484-2806 • TWX: 910-336-1297

SEE OUR COMPLETE PRODUCT LISTING IN EEM & GOLDBOOK

FEATURE ARTICLES FROM *ELECTRONICS* AVAILABLE IN REPRINT FORM

No. of
copies
wanted

New reprints

- ___ R-801 World market report 1978 24 pp \$4.00
- ___ R-734 Microcomputer families expand 20 pp. \$4.00
- ___ R-730 Special Report—Automotive electronics 10 pp \$3.00
- ___ R-728 Flexible circuits bend to designers' will 10 pp \$3.00
- ___ R-724 Special Report—Technologies squeeze more performance from LSI 22 pp. \$3.00
- ___ R-722 Demands of LSI are turning chip makers towards automation 12 pp \$3.00
- ___ R-720 How EEs Feel About Engineering—3-part series 26 pp \$5.00
- ___ R-718 Display makers strive to refine their technologies 8 pp \$3.00
- ___ R-716 Special report—Japanese wave in semiconductor technology 24 pp \$3.00
- ___ R-714 Special report—active filter technology 6 pp \$3.00
- ___ R-713 Electron-beam lithography draws fine line 10 pp \$3.00
- ___ R-712 Special report—large-scale integration 16 pp \$3.00
- ___ R-710 Personal computers mean business 8 pp \$2.00
- ___ R-708 So you want to be a consultant 6 pp \$2.00
- ___ R-706 Low-cost dual delayed sweep method 6 pp \$2.00
- ___ R-705 Powering up with linear ICs 12 pp \$3.00

Charts

- ___ R-516 Electronic symbols \$2.00
- ___ R-213 Electromagnetic spectrum (updated 1976) \$3.00
- ___ R-326 Optical spectrum (6-page report and chart) \$3.00

Books

- ___ R-803 New product trends in electronics—Electronics Book Series 333 pp \$14.95
- ___ R-732 Memory Design—Microcomputers to Mainframes—Electronics Book Series 180 pp \$12.95
- ___ R-726 Design Techniques for Electronics Engineers—Electronics Book Series 370 pp \$15.95
- ___ R-711 Circuits for electronics engineers: 306 circuits in 51 functional groups—Electronics Book Series 396 pp \$15.95
- ___ R-704 Thermal design in electronics \$5.00
- ___ R-701 Applying microprocessors—Electronics Book Series 191 pp \$9.95
- ___ R-608 Basics of Data Communications—Electronics Book Series \$12.50
- ___ R-602 Large Scale Integration—Electronics Book Series 208 pp \$9.95
- ___ R-520 Microprocessors—Electronics Book Series 154 pp \$8.95
- ___ R-011 Computer-aided Design 135 pp \$4.00
- ___ R-032 Active Filters 88 pp \$4.00

Other reprints

- ___ R-703 Special report—memories 16 pp \$3.00
- ___ R-702 World market report 1977 24 pp \$4.00
- ___ R-616 Special issue—technology update \$4.00
- ___ R-614 Power supply choices for sophisticated designs 8 pp \$3.00
- ___ R-612 Fiber-optic communications special report 24 pp \$3.00

- ___ R-610 Special report on hybrid-circuit technology 19 pp \$3.00
- ___ R-606 Special issue—microprocessors \$4.00
- ___ R-526 How reliable are today's components 16 pp \$3.00
- ___ R-600 World market report 1976 24 pp \$4.00
- ___ R-524 Special report on bipolar large-scale integration 12 pp \$3.00
- ___ R-522 Special report on power semiconductors 12 pp \$3.00
- ___ R-518 Special issue—productivity \$4.00
- ___ R-514 Eight ways to better radio receiver design 6 pp \$3.00
- ___ R-512 Design of circuits for dangerous environments 4 pp \$2.00
- ___ R-510 Bipolar advances with I²L microprocessor 8 pp \$2.00
- ___ R-508 Designing microprocessors with standard logic 12 pp \$3.00
- ___ R-506 The case for component burn-in 7 pp \$2.00
- ___ R-434 Designing systems with the standard interface 12 pp \$3.00
- ___ R-432 An update on communications satellites 8 pp \$2.00
- ___ R-430 Choosing the right bipolar transistor model for computer-aided design 20 pp \$3.00
- ___ R-428 Designing with low-cost lasers 6 pp \$2.00
- ___ R-424 Microprocessor applications 28 pp \$3.00
- ___ R-422 A microprogrammable minicomputer 8 pp \$2.00
- ___ R-420 Computerized text-editing and typesetting 8 pp \$2.00
- ___ R-418 Computer analyses of rf circuits 8 pp \$2.00
- ___ R-414 The ion-implanted n-channel process 6 pp \$2.00

Payment must accompany your order

Make check or money order payable to Electronics Reprints. All orders are shipped prepaid by parcel post. Allow two to three weeks for delivery. For additional information call (609) 448-1700 ext. 5494.

Back issues now available:
1960 to 1969, \$5.00 each
1970 to 1973, \$3.00 each
1974 to 1976, \$4.00 each

USE THIS PAGE AS YOUR ORDER FORM

Cost of orders \$ _____
Plus 10% handling charge \$ _____
TOTAL AMOUNT ENCLOSED \$ _____

Mail your order to:
Janice Austin
ELECTRONICS REPRINTS
P.O. Box 669
Hightstown, N.J. 08520

SEND REPRINTS TO

Name _____
Company _____ Dept. _____
Street _____
City _____ State _____ Zip _____

Products newsletter

Semicustom bipolar chips due from MOS semicustom supplier

International Microcircuits Inc., a Santa Clara, Calif., complementary-MOS specialist, is offering a bipolar, semicustom analog integrated circuit. Called Omnichip I, the IC can be used for gain-control, analog-switching, and current-source applications. Built on an 85-by-114-mil die, **the chip contains 400 components, including a pair of high-current npn transistors.** The 24-pin chip design is developed by the user from a linear parts kit. Price for the first 50 prototypes is \$3,150.

Probes added to logic analyzer

To support its new 532 intelligent logic-state analyzer, Paratronics Inc. is coming out with four probe accessories in the coming months. **One is a dedicated probe for the 8085 and 8086 microprocessors that clips right onto the processor package.** The San Jose, Calif., company will also offer a RS-232-C interface monitoring probe and a 10-ns glitch-capture probe capable of highlighting the word area following a glitch. In addition, there will be an IEEE-488 bus probe for monitoring bus transactions.

U. S. firm to sell power supplies from Japan

Semiconductor Circuits Inc., the Haverhill, Mass., manufacturer of power supplies, and Tohritsu Tsushim Kogyo Co. of Japan have entered into an agreement that makes SCI the exclusive marketing agent for several series of Tohritsu's line of switching power supplies. **Tohritsu, one of Japan's leading manufacturers of line switchers, will furnish SCI with 75- and 150-w supplies.** The agreement enables SCI to broaden the power spectrum of its existing product line, which now reaches to 76 w for switchers. Meanwhile, the U. S. firm will continue to develop its own in-house products in the under-100-w category.

Data concentrator gets option to switch data rates

Autobaud, a feature that allows data-communications channel data rates to be established dynamically at the beginning of a dial-up call, is now available for the Micro800 Data Concentrator produced by Micom Systems Inc., Chatsworth, Calif. **Since the feature eliminates the need to dedicate concentrator ports to a variety of different terminal speeds,** it should have appeal for use in timesharing systems. Terminals equipped with the Bell 212 modem, for instance, will be able to dial in to any Micro800 port whether the concentrator is operating at 110, 300, or 1200 b/s. Price for a Micro800 with eight Autobaud channels is \$3,900.

Option improves automatic testing

To provide a more efficient automatic test equipment system, Interstate Electronics Corp., Anaheim, Calif., has added a burst-count option to its SPG-800 programmable generator. **The option allows a selected number of test cycles from 1 to 19,999** and is well suited for testing shift registers, memories, counters, and other logic circuits. Coupled with the SPG-800, the burst-count option is also useful for frequency-response testing of digital-to-analog converter circuits.

Siemens disk testers to get U. S. source

Three Phoenix Co. of Phoenix, and Siemens AG's U. S. subsidiary, Siemens Corp., Cherry Hill, N. J., have signed an agreement under which **the Arizona firm will manufacture hard-disk memory testers for Siemens,** including the West German company's own proprietary types. Siemens will serve as distributor in the U. S. and certain overseas countries.

Gas Sensing Semiconductor

FIGARO TGS GAS SENSOR

quickly senses
even small
amount
of gas.

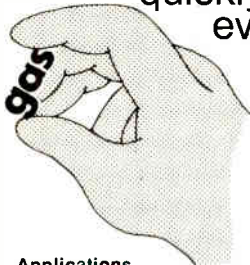

Applications

- | | |
|-----------------------------|---|
| 1. Natural Gas-Leak Alarm | combustible gases contained in smoke) |
| 2. Propane Gas-Leak Alarm | |
| 3. Carbon Monoxide Detector | 6. Alcohol Detector (Detector for drunken driver) |
| 4. Automatic Fan Control | |
| 5. Fire Alarm (Detecting | 7. Air Pollution Monitor |

Please contact any of the addresses below directly for catalogs and price/delivery information.

FIGARO ENGINEERING INC.

●Head Office: 3-7-3 Higashitoyonaka, Toyonaka City, Osaka, 560, JAPAN TELEX: 06286155 FIGARO J. CABLE: FIGARO TOYONAKA TEL: (06) 849-2156

●North America: 3303 Harbor Boulevard, Suite D-8, Costa Mesa, California 92626, U.S.A. TELEX: 678396 CABLE: FIGARENGIN COSTAMESA TEL: (714) 751-4103

Circle 154 on reader service card

New literature

Standards. The Electronic Industries Association is offering both a new and a revised standard. RS-195-B, "Electrical and Mechanical Characteristics for Terrestrial Microwave Relay System Antennas and Passive Reflectors," the new one, emphasizes devices operating above 890 megahertz. It includes antenna windload data and Federal Communications Commission standards for radiation patterns. The revised standard, "Measurement of Direct Inter-electrode Capacitances of Electron Tubes," RS-191-C, defines three standard measurement methods for use from 1 to 500 kilohertz. The standards sell for \$8 and \$4.75 per copy, respectively. Standards Sales Office, Electronic Industries Association, 2001 Eye St., N. W., Washington, D. C. 20006

Spectrum amplitude. A technical note discusses the concept of spectrum amplitude as applied to broadband signals and noise. Several ways of generating signals with broadband amplitudes, as well as techniques for measuring spectrum amplitude, are described. Each copy sells for \$2.75. SD No. 003-003-01865-1, Superintendent of Documents, U.S. Government Printing Office, Washington, D. C. 20402

Precision and measurement control. "Short Form Guide: Electronic Products for Precision Measurement & Control" lists more than 400 products, including digital-to-analog, analog-to-digital, voltage-to-fre-

Electronics Magazine Book Series



The Memory Book

Now available

The new technology, devices, and applications you can use to meet specific memory design goals. Compiled from the pages of *Electronics Magazine*. *Memory Design: Microcomputers to Mainframes*, 180 pages, \$12.95.

Order today, and don't forget the other valuable books in the Electronics Magazine Book Series listed in the coupon below.

Electronics Book Series
P.O. Box 669, Hightstown, N.J. 08520

- Send me _____ copies of "Microprocessors" at \$8.95 per copy.
- Send me _____ copies of "Applying Microprocessors" at \$9.95 per copy.
- Send me _____ copies of "Large Scale Integration" at \$9.95 per copy.
- Send me _____ copies of "Basics of Data Communications" at \$12.95 per copy.
- Send me _____ copies of "Circuits for Electronics Engineers" at \$15.95 per copy.
- Send me _____ copies of "Design Techniques for Electronics Engineers" at \$15.95 per copy.
- Send me _____ copies of "Memory Design: Microcomputers to Mainframes" at \$12.95 per copy.
- Send me _____ copies of "New Product Trends in Electronics, Number One" at \$14.95 per copy.

Discounts of 40% on orders of 10 or more copies of each book.

I must be fully satisfied or you will refund full payment if the book is returned after ten-day trial examination.

Payment enclosed Bill firm Bill me

Charge to my credit card:

American Express Diners Club
 Visa Master Charge

Acc't No. _____ Date exp. _____

On Master Charge only, first numbers above name _____

Name _____ Title _____

Company _____

Street _____

City _____ State _____ Zip _____

Signature _____

From Electronics Magazine Book Series. Zero-risk trial offer.



Memory Design: Microcomputers to Mainframes

The technology, devices, and applications that link memory components and system design. As published in *Electronics*. \$12.95

Electronics Book Series

P.O. Box 669, Hightstown, N.J. 08520

Send me _____ copies of "Memory Design: Microcomputers to Mainframes" at \$12.95 per copy

Discounts of 40% on orders of 10 or more copies.

I must be fully satisfied or you will refund full payment if the book is returned after ten-day trial examination.

Payment enclosed Bill firm Bill me

Charge to my credit card:

American Express Diners Club
 Visa Master Charge

Acc't No. _____ Date exp. _____

On Master Charge only, first numbers above name _____

Name _____ Title _____

Company _____

Street _____

City _____ State _____ Zip _____

Signature _____



New literature

quency, and frequency-to-voltage converters; sample-and-hold amplifiers; data-acquisition subsystems; and temperature transducers. Detailed specifications and prices are given. Analog Devices Inc., Route 1 Industrial Park, P. O. Box 280, Norwood, Mass. 02062. Circle reader service number 423.

Time-delay technology. For the experienced control designer, "Solid State Time-Delay Technology," a 48-page handbook, provides information on time-delay devices—both electronic and other. For engineers inexperienced in this technology, it explains what the devices are, how they work, and how to evaluate their performance. Several companies' solid-state time-delay techniques are explained. In addition, electromechanical, electrothermal, and electronic types of time-delay devices are reviewed. Other sections cover parameters and characteristics of time-delay relays. Several pages are devoted to solid-state time-delay relays, selection criteria, and illustrations. To obtain a free copy of this handbook, request it on company letterhead. Amerace Corp., Control Products Division, 2330 Vauxhall Rd., Union, N. J. 07083

Power devices. More than 1,200 solid-state power devices are covered in a 72-page catalog. It summarizes the characteristics of, and provides package information on, power transistors, power hybrid circuits, diacs, triacs, and silicon controlled rectifiers. It also lists the titles of all available application notes on RCA power devices. RCA Corp. Solid State Division, Box 3200, Somerville, N. J. 08876 [426]

RCA

Power Devices Directory



A NEW SERIES OF VACUUM RELAYS DESIGNED TO REPLACE THE HV REED.

Here's a new series of ground isolated vacuum relays that are ideal for HI REL applications in communications, medical and control electronics. Look at what this new series has to offer in either SPST, or SPDT configurations:

- Low contact resistance—less than 20 mΩ
- Higher power handling capacity than reed relays—up to 10 A rms at up to 7 kV, and operating frequencies from DC to 76 MHz.
- Available in both latching and non-latching models.
- High reliability—on the order

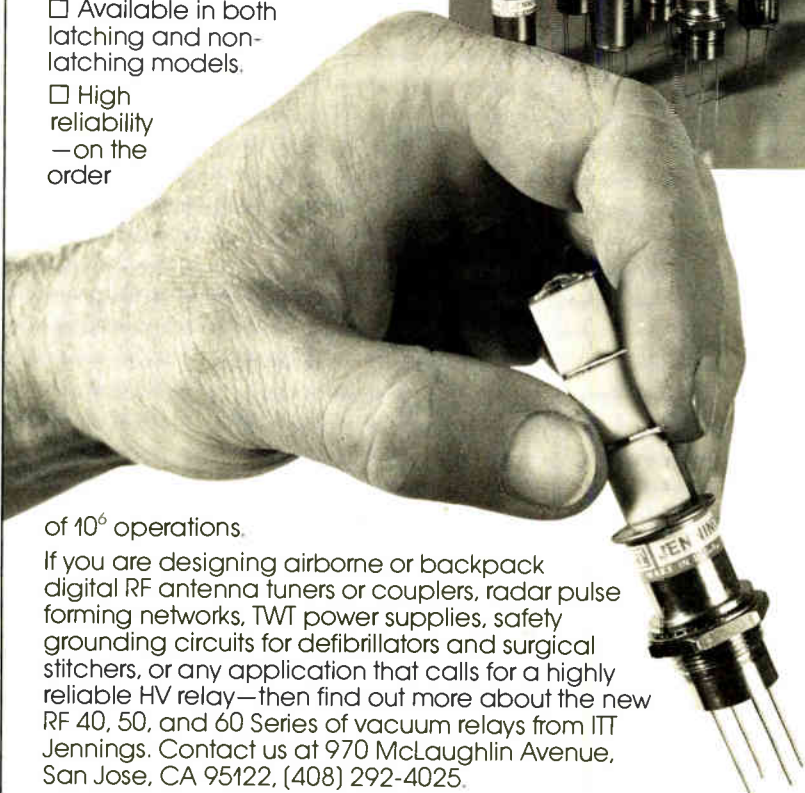
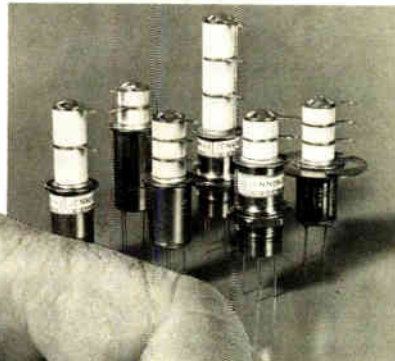

of 10^6 operations.

If you are designing airborne or backpack digital RF antenna tuners or couplers, radar pulse forming networks, TWT power supplies, safety grounding circuits for defibrillators and surgical stitchers, or any application that calls for a highly reliable HV relay—then find out more about the new RF 40, 50, and 60 Series of vacuum relays from IIT Jennings. Contact us at 970 McLaughlin Avenue, San Jose, CA 95122, (408) 292-4025.

JENNINGS IIT

VACUUM TECHNOLOGY FOR TOMORROW...HERE TODAY.

Circle 155 on reader service card

Just published: 1978 EBG!

Completely new listings of catalogs, new phone numbers, new addresses, new manufacturers, sales reps, and distributors! The total market in a book—four directories in one!

**To insure prompt delivery
enclose your check with the
coupon now.**



Electronics Buyers' Guide
1221 Ave. of the Americas
New York, N.Y. 10020

Yes, please send me _____ copy(ies) of 1978 EBG.
 I've enclosed \$25 per copy delivered in the USA or Canada.
 I've enclosed \$35 per copy for delivery elsewhere (\$47 if shipped by Air). Full money-back guarantee if returned in 10 days.

Name _____
Company _____
Street _____
City _____ State _____ Zip _____

Classified section FOR ENGINEERING/TECHNICAL EMPLOYMENT OPPORTUNITIES

CLASSIFIED SALES REPRESENTATIVES

Atlanta ... Jane Core ... 404/892-2868
 Boston ... Holt Buchanan ... 617/262-1160
 Chicago ... Bill Higgins ... 312/751-3733

Cleveland ... Mac Huestis ... 216/781-7000
 Dallas ... Mike Taylor ... 214/742-1747
 Denver ... Shirley Klotz ... 303/837-1010
 Detroit ... Mac Huestis ... 313/873-7410

Houston ... Mike Taylor ... 713/659-8381
 Los Angeles ... Stan Kassir ... 213/487-1160
 New York ... Larry Kelly ... 212/997-3594
 Philadelphia ... Dan Ferro ... 215/568-6161

Pittsburgh ... Dean Genge ... 412/391-1314
 San Francisco ... M.E. Kenny ... 415/362-4600
 Stamford ... Holt Buchanan ... 203/359-2860
 XEROX 400 TELECOPIER ... 212/997-6800

ENGINEERS

*Establishing goals that
 Challenge your abilities...
 Creates a sound beginning.
 Advancing beyond those objectives...
 Instills pride.*

At Northrop Defense Systems Division, a leader in advanced Electronic Countermeasures technology, we provide the guidance and professional freedom necessary for creative problem-solving and maintaining our leadership in the state-of-the-art.

We are currently seeking qualified professionals in the following areas to join our renowned team of Avionics Engineers:

ECM/EW MANAGERS

Program Managers
 Project Engineering Managers
 Systems Engineering Managers

SYSTEMS

Senior Engineers
 Project Engineers
 Engineers

DESIGN

- * 5-10 years experience in electronics and electromechanical high density packaging of military support equipment. Knowledge of investment casting and metal fabrication method processes.
- * RF design and analysis. Octave bandwidth MIC and stripline components. ECM TWT and equipment experience, plus familiarity with MIL-STD-38510 and 5400E requirements.
- * PROJECT ENGINEER with background in power supplies, modulators and high power TWT's required. Will be responsible for design and development of ECM transmitter.
- * PROJECT ENGINEER with analog/digital circuits and microwave components experience.

MICROWAVE

In addition to outstanding opportunities for career advancement, we offer an excellent salary/benefits package. Qualified individuals are invited to send brief letter or resume, in confidence, to:

Manager, Department E-7
 NORTHROP CORPORATION
 Defense Systems Division
 600 Hicks Road, Rolling Meadows, Illinois 60008

An equal opportunity employer m/f

NORTHROP

University of Illinois at Urbana-Champaign
 Department of Physics
**HIGH ENERGY PHYSICS
 RESEARCH GROUP (HEPG)**
 Research Electronic Engineer
 Position Available

Description

This position is a full time professional staff position. Work is performed mainly at the Urbana campus. Travel is required as needed to various National Laboratories to assist with HEPG experiments. This position requires knowledge in both digital and analog circuits with emphasis on "state-of-the-art," high speed electronics (esp.ECL). Ability to design and program micro-processor based controllers is useful. Also, the engineer may be required to attend schools, short courses, and seminars as required by the supervisor to meet the needs of this position. Salary commensurate with education and experience. Range—\$13,000-\$18,000.

Qualifications

Minimum qualification is a Masters Degree in E.E. or a P.S. in E.E. with two years experience in one or more areas described above. Due to the nature of high energy physics experimental equipment, knowledge of electro-optical and/or electro-mechanical systems will be considered as an added factor in the evaluation of a candidate for this position.

Duties and Responsibilities

Under supervision of the senior engineer this engineer must be able to:

1. Successfully complete design and development tasks for specific electronic parts or phases of the High Energy Physics Experiment.
2. Using standard engineering procedures, gather and correlate data for the purpose of testing and/or improving equipment designs.
3. Supervise technicians and student engineers.
4. Effectively interact with researchers throughout the various phases of the research project.

Starting Date: Summer 1978

Last Date for full consideration:
 June 30, 1978

Send resumes to:
 University of Illinois at Urbana-Champaign
 Attn: R. F. Borelli
 Department of Physics
 203 Loomis Laboratory of Physics
 Urbana, IL 61801

The University of Illinois is an Equal Opportunity Employer

POSITIONS VACANT

Electrical Engineering Technology—Expanding upper division E.C.P.D. accredited Bachelor of Technology Program seeks two visiting professors to teach in the linear and digital electronics areas. Courses to be taught include active filters, power electronics, basic digital logic, TTL digital design, and the 6800 and 8085 microprocessor systems. M.S. Degree in Electrical Engineering required with teaching and industrial experience desirable. Excellent salary and benefits. Ten month contract with Summer teaching possible. Position available Fall, 1978. Send resume and references to Professor J. Adams, Department of Electrical Technology, Rochester Institute of Technology, One Lomb Memorial Drive, Rochester, New York 14623. RIT is an Affirmative Action/Equal Opportunity Employer.

Communication, Radar, and EW Engineers—We are a search firm that specializes. Our client has retained us exclusively to locate the best. If you are looking for upward mobility, top benefits and salary, then send your resume in complete confidence to E.G. Jones Assoc. Inc., 51 Monroe St. Rockville, Md. 20850.

Companies

Norden, at 50, is feisty again

New emphasis on systems, focus on military work only, and exclusive minicomputer license lead to resurgence

by Bruce LeBoss, New York bureau manager

For Norden Systems Inc., life is beginning again at 50. The principal electronics subsidiary of United Technologies Corp., the once moribund firm is bursting with activity in its golden jubilee year. And as though to celebrate that anniversary the former division and subsidiary, Dynell Electronics, have just been consolidated.

In Norwalk, Conn., the firm has teeth as a supplier of insight for U.S. military aircraft. Over the years it developed an expertise in air-to-ground radar and airborne displays and became one of the largest U.S. defense contractors. By 1972, the firm had about 3,400 employees and an estimated \$100 million in revenues, most from major contracts for the F-15 fighter's displays and the F-14's radar, as well as weather attack

ever, the next few years were lean. Norden's major production programs tapered off, efforts to pick up commercial business bore little fruit, and employment plummeted. In 1975, soon after I arrived, it was obvious to me that the firm's capabilities were being eroded. The management that had diversified toward the commercial market and pruning several operations, such as selling Terminal Communications Inc., a \$30 million firm.

Scott's second key decision was to change Norden from a product- to a systems-oriented company. "Practically all of our past work involved

data gathering... Thus, it was... of our military... that business, the firm has two options: either develop its own standard computer or license technology from existing minicomputer names, a decision from the world's largest manufacturer of minicomputers, Digital Equipment Corp."

In February 1976, DEC licensed Norden to militarize, make, and market its small but highly successful commercial PDP-11 family. Nine months later, Norden introduced its initial offering, the middle-of-the-line PDP-11/34M [*Electronics*, Nov. 25, 1976, p. 50]. It has since expanded the line with militarized versions of the LSI-11 single-board microcomputer and high-end PDP-11/70.

New areas. The military computer was the key to Scott's overall plan to broaden its basic product line, which had been quite narrow. For starters, he found two new growth areas, automated battlefield systems and shipboard surveillance and fire-control system. He also expanded the scope of the firm's airborne weapons delivery system.

Peter L. Scott, Norden's president since 1975



If your specialty is listed below and you would like to consider a career with Norden Systems, call us or send your resume. We'll review your credentials and send you a reprint of the article depicted from Electronics Magazine. In this frank report, you'll read how our business has grown dramatically over the past three years... and why we changed from a product-oriented to systems-oriented company.

You'll get the facts on our recent merger with Dynell Electronics... now Norden Systems-Melville... a unit producing state-of-the-art radar and acoustical systems for marine usage, and Omega navigation systems for marine and aircraft usage.

You'll learn about the highly sophisticated programs at Norden Systems-Norwalk. And about our plans to continue expanding in areas such as command and control, militarized computers, shipboard electronic systems, and airborne weapons delivery systems.

Most important, you'll get a clear indication of the dynamic, secure future waiting for you at Norden Systems, Inc.—the principal electronics unit of United Technologies Corporation.

Openings in NORWALK for:

Display Systems Engineers

Experienced in overall display systems engineering including raster and stroke write display processing and generation, scan conversion, flat panel and CRT display indicators, computer interfaces, microprocessor technology and hardware/software tradeoffs.

Radar Systems Engineers

Experienced in advanced airborne radar including synthetic aperture radar. Strong background in translating customer requirements into system configuration and proposal preparation.

C3 Systems Engineers

Minimum 5 years experience in command, control, and communications systems. Knowledge of Army or Marine communications and artillery procedures desired.

Sr. Mechanical Design Engr.

8 years experience military electronics high density packaging. Know PC, power supply, core memory packaging. Supervisory experience required.

Power Supply Design Engrs.

Experienced with multi-output and high current switched mode supply techniques for military equipment. Proficiency with magnetics and high voltage/power design.

To apply for any of the above positions, send resume or call collect to Mr. James E. Fitzgerald, Norden Systems, Inc., 308 Helen Street, Norwalk, Connecticut 06856. (203) 838-4471.

NORDEN SYSTEMS



Subsidiary of

UNITED TECHNOLOGIES

Making it happen in systems technology

An Equal Opportunity Employer

engineers

For a change, join a people-oriented company that wants to work for you!

At GTE LENKURT an employee is first and foremost a human being and not a component.

Our customers depend on us for excellence in design, manufacture, and service of sophisticated video, voice, and data communications systems. You can trust us for a rewarding career, endless advancement potential, interface with the best and the brightest people in the industry, and personal growth and development in a dynamic organization.

If you wish to upgrade your position, send us your resume for a new career. If you don't have a resume, complete and clip our instant application below and mail it to us for prompt and confidential consideration:

instant- application ----- **Kazim Ali, . . .**

Employment Manager
GTE LENKURT, INC.
1105 County Road
San Carlos, Calif. 94070
(415) 595-3000

GTE LENKURT, INC.

Name _____
Address _____
City _____ State _____ Zip _____
Home Phone () _____
Bus. Phone () _____
Job Applying for _____ (Salary Reqs.) \$ _____
Present Employer _____ (Present Sal.) \$ _____
Dates Employed _____
Job Title _____
Duties _____
Previous Employer _____
Dates Employed _____
Job Title _____
Duties _____
Education _____
Other experience _____

----- **GTE LENKURT**

We Are An Equal Opportunity/Affirmative Action Employer

development engineers

Electrical Engineers at all levels for projects in subscriber carriers, signalling and VF equipment design, PCM carrier and switching as well as digital microwave radio. Experience is either linear, digital or microprocessor control circuit design.

SUBSCRIBER CARRIER CONCENTRATORS

Systems and circuit design Engineers to develop microprocessor controlled subscriber pair gain systems. Knowledge of PCM signal processing and digital switching techniques is desirable.

PCM TRANSMISSION

Responsibilities include circuit design of PCM line repeaters and office equipment. Position requires 1-5 years experience in analog and digital circuit design and BSEE minimum requirements.

VF EQUIPMENT

Openings at all levels for planning, design and development of voice band loop extension and conditioning equipment aimed at private line/special services applications.

FIBER OPTICS

We seek an experienced Engineer desiring to work on the design and circuit applications of fiber optics components such as laser diodes, light emitting diodes, avalanche photodiode receivers, single fiber connectors and cable-to-cable splicing.

FIBER OPTICS CIRCUIT DESIGN

You will design transmitters, receivers and line repeaters for medium and high bit rate Fiber Optics systems. You must have H.F. analog design experience. Fiber Optics experience desirable. BS with 2-5 years experience minimum requirements.

other openings at LENKURT

SEMICONDUCTOR TEST ENGINEER

We seek an Engineer with a BSEE (or equivalent) and 2-5 years experience testing and evaluating low and high frequency semiconductor components such as Diodes, Transistors, Linear and Digital Integrated Circuits. Knowledge of component failure analysis, Sentry II programming and some circuit design experience is desirable. (Job # HM-007)

TEST EQUIPMENT ENGINEER

Position requires experience in analog and digital circuit design, preferably in the area of test equipment. Some programming background desirable. Ability to convert engineering test requirements into finished production test equipment.

You must be able to analyze existing test facilities and processes, and design and implement cost effect improvements. BSEE or equivalent experience required. MSEE preferred. (Job # JC1)

SENIOR TEST ENGINEER

Responsibilities include the ability to test and troubleshoot thick film circuit hybrids, evaluate yield data and take corrective action in hybrid assembly operations. The engineer should have experience with computer controlled laser trimming and be capable of programming and evaluating of hybrid test equipment and complete controlled laser systems for functional trimming.

The position will require an Electrical Engineering degree or equivalent with three to five years of manufacturing experience. (Job # MCK2)

INDUSTRIAL: METHODS IMPROVEMENT

Responsibilities include methods improvement, equipment selection, facilities layout and work flow, materials handling and packaging, computer applications to manufacturing problems and solution of production problems during new product introduction. Electronic assembly experience desirable. Minimum BSIE or equivalent with 1-2 years experience desired. (Job # MCK1)

STAFF ENGINEER, TOOL & MACHINE ENGINEERING

BSME and 8 years of experience or Professional Manufacturing Engineer in the field of Electronics Manufacturing. Responsibilities include tool design for sheetmetal and small machined parts, the design of process and assembly equipment used for electronics manufacturing, and the design of unsophisticated production machines including electrical and air-hydraulic controls. (Job # HL1)

GTE Lenkurt benefits are an outgrowth of a feeling of responsibility toward the Employee that has always prevailed. Some benefits are entirely at the option of the Employee — as they should be. Others are automatic. Taken as a whole, they represent a comprehensive, competitive package that can offer a distinct advantage to the user.

Consider the following:

Excellent salaries; paid vacations and Holidays; Medical, Life and Disability Insurance; stock purchase; savings and investment program; 100% tuition refund; pension plan; Employee Store, Credit Union and Recreation Club privileges.

GTE LENKURT

A Part of General Telephone & Electronics Corporation on the beautiful SAN FRANCISCO PENINSULA

DIGITAL SYSTEMS

Responsible for defining characteristics, evaluating new applications and developing customer documentation on evolving multi line PCM subscriber pair gain systems, channel banks, multiplexers and repeatered lines. Should have electrical engineering background and be familiar with Telephone Operating Company switching and digital transmission plant.

MICROPROCESSOR HARDWARE DESIGN & TESTING

Position requires BS MSEE with interest in design and testing of microprocessor system hardware.

MICROPROCESSOR CHIEF PROGRAMMER

Real-time programming experience. Knowledge of structured programming. BS MSEE education with experience preferably in communications and/or telephone switching.

CUSTOM I.C. DESIGN

Development of Custom Integrated Circuits, Analog and/or Digital Design and computer simulation desirable. Willing to train an engineer with solid experience in discrete circuit design. Will work with Bipolar and N-MOS technologies.

PROCESS EQUIPMENT PROGRAMMING

Development of Automatic programs for high speed laser trim and test of hybrid circuits. Solid background in linear or digital circuit analysis and aptitude in mini-computer programming required.

DESIGN SUPPORT

Electrical Engineers at various levels to maintain, modify and assist the current production of electrical designs in various product lines.

EQUIPMENT DESIGNERS

For Physical design of Proprietary Products. Equipment Designers must have knowledge of electro-mechanical packaging and/or printed circuit board layout. No degree necessary.

PROJECT ENGINEER

Be responsible for analyzing contract orders for Microwave and Multiplex Systems. Determine exact details of equipment required to meet the contractual obligations. This includes office requirements for power, antennas, towers, and other ancillary equipment. This effort requires performing varying amounts of System Engineering, scheduling, contract interpretation and direct customer contact. BSEE degree desirable for an AA degree with equivalent experience. Technical experience in the following areas: Microwave Radio, Multiplex, Supervisory and Control and Switching Systems. Will consider some recent graduates for junior or entry level positions. (Job # GM-2)

FIELD SERVICE ENGINEER

BSEE (or equivalent Telecommunications Electronics experience.) You will work closely with Development Engineers and troubleshooting with customers via telephone or in the field. Position requires responsible person, capable of exercising good judgement in customer relations and able to make independent decisions as necessary. 20% travel involved. (Job # TI-4)

MICROCIRCUIT PROCESS ENGINEER

Position will include development and evaluation of thick and thin film materials and processes plus the development of microcircuit packaging techniques for semiconductors used in telecommunications equipment. Applicant should have BS/Chemistry, Chemical Engineering or Material Science. Experience in microcircuit technologies required. (Job # BW2)

ENGINEERING WRITER

This position requires a strong electronics background plus working knowledge of microwave radio for telephone systems. Min 2 years experience in writing commercial instructions, manuals or engineering level documents. (Job # FF-3)

SYSTEMS ANALYST

Bachelor's degree plus 1-5 years experience in analysis and design of computerized business information systems. Experience in data base/data communications-oriented applications for a manufacturing company desired. Must have sound knowledge of business functions and have strong verbal and written communications skills. (Job # SL1)

ANALYST PROGRAMMER

To work in an IBM 370-148 SVS environment. Must have indepth knowledge of COBOL, JCL, utilities, etc. BS or BA degree preferred, AA acceptable or related work experience. (Job # EC1)

DIGITAL DESIGN OPPORTUNITIES IN ADVANCED DEVELOPMENT

— San Francisco Peninsula —
Design Engineers: Plot your Future with
VERSATEC!

PROJECT ENGINEER

We're looking for an experienced professional to handle project responsibility and detailed logic design in our Advanced Development Group. You will be responsible for developing concepts and detailed digital design. Background should include systems level, micro-processor and detailed logic design techniques, along with min. 5 years experience in digital design. BSEE required.

SR. SYSTEMS ENGINEER

Opportunity for individual to assume overall responsibility for systems design and analysis in our Advanced Development Group. Background should include both software and hardware disciplines plus experience in systems design of computer peripheral equipment. BSEE required.

We'd like to tell you more about VERSATEC—our excellent compensation package which includes Dental and Retirement Plans, as well as our forecast for continued dynamic success. Please send your resume with salary requirement, in confidence, to Dean Hammer, Employment Manager, 2805 Bowers Ave., Santa Clara, CA 95051. 408/988-2800. An equal opportunity employer m/f.

VERSATEC
A XEROX COMPANY



Manufacturers of Communications
and Avionics Test Equipment

Our continued success,
rapid growth and expansion
have created numerous
career opportunities for
engineering professionals.

Electronic Design and Project Engineers

BSEE and Experience Required

Requires a creative individual who will assume project leadership in new project development from detailed concepts through design, fabrication, lab and field tests to customer use. Help make major decisions with a company that still permits individuality. A career that offers challenges...responsibilities...growth...opportunities...recognition...advancement...security...as well as rewards.

Let us discuss your technical qualifications and career opportunities. Competitive salary, excellent benefits, and a great place to live and rear a family.

Discover Wichita for the good life! Warm, friendly people... 4-seasons climate... culturally oriented community... variety of recreational activities including water sports, and the finest of educational systems—elementary thru university offering advanced engineering degrees.

Submit resume plus salary history to:

Virgil Ewy, Vice President, Engineering
4053 Navajo Lane
Wichita, Kansas 67210
316/685-9271 or 800-835-2350 (toll free)

All inquiries confidential
An Equal Opportunity Employer M/F

ELECTRONICS

SALES ENGINEERS

Go with a winner...Signetics! As one of the world's leading suppliers of integrated circuits, our growth has created several key career opportunities for top sales and applications people. These positions are available on both the east and west coasts.

If you have a technical degree and related experience in the semiconductor industry and want to get your career moving again, send your resume to Mike Oliver, Signetics Corporation, 811 East Arques Avenue, Sunnyvale, CA 94086. We are an equal opportunity employer m/f.

Signetics

a subsidiary of U.S. Philips Corporation

POSITIONS VACANT

Systems/or Analysts. MS/PhDs- Planning, analysis, operations research, engineering of new major AF weapon/ECM/avionic/space systems. Resume, Salary history to: ANSER, 400 Army-Navy Drive, Arlington, VA. 22202. AAP/EOE/M-F/Handicapped/Vietnam Vets.

The Department of Chemistry at Northern Illinois University is seeking a person with a background in electronics and scientific instrumentation (minimum B.S. in E.E. or Chemistry) to interact with a research-oriented staff. Experience with the design and maintenance of sophisticated equipment desirable, particularly in the areas of 100 MHz FT nmr, mass spectrometry, minicomputers and instrument interfacing. Interested applicants should send curricula vitae and at least two letters of reference to: Dr. Charles W. Spangler, Department of Chemistry, Northern Illinois University, DeKalb, Illinois 60115. NIU is an EO/AA employer.

TRANSLATIONS SERVICES

W. J. Grimes and Company, accredited by American Translators Assn., P.O. Box 55, Hingham, MA 02043.

EMPLOYMENT SERVICE

South? technical/professional placement network-fee paid. Murkett Associates, Box 527, Montgomery, AL 36101.

COLORADO

COMPANY PAYS ALL FEES DESIGN ENGINEERS

Our client companies require engineers with proven experience in one of three design disciplines: analog, digital or software. Prefer four years of "hands-on" experience. Company is a leader in its field, and offers excellent opportunity for future growth.

Contact:
U.S. INTERNATIONAL
RECRUITERS, INC.
445 Union Boulevard
Suite 127
Lakewood, Colo. 80228
303-986-9561

EMPLOYMENT SERVICE

Electronic engineering growth positions with clients located nationally. We would be glad to consider your resume. Joe Torcassi (EE), Director, R.J. Bushee & Associates, 1001 Carew Tower, Cincinnati, OH 45202. 513/621-2015.

M.E.s, I.E.s, E.E.s, Ch.E.s—Let our search firm represent you to our clients nationally and overseas. If you are seeking a more prestigious position with increased responsibilities and a better Future, send a resume or request a position profile and at no charge we will provide you with interview opportunities. Register in our exclusive Executive Search Program. All replies strictly confidential. All Fees employer paid at Management Recruiters, 1900 Point West Way, Suite 281, Sacramento, CA 95815. (916) 920-0441.

A.D. Data Systems, Inc.	146	Grayhill Inc.	48	* Ricken Denaki Co., Ltd.	14E
Advanced Micro Devices	10-11	■ Hewlett-Packard	78-79,1	Rockwell International Telecom Circuits	91
American Microsystems Inc.	15	Huntron Sales Inc.	65	* Rotron B.V.	13E
■ Amp., Inc.	20-21	Information Control Corporation	143	* SEPA S.p.A.	60
Ampex DpD	127	Intel Memory Systems	18-19	* Seacosem Thomson CSF	16E
Amplifier Research	87	Intel Telecommunications	73	* Sfernice	14E
Belden Corporation	114	Intel-Microcomputer Components	27-29	Siliconix	32
*■ Burr Brown Research Corp.	12E	Interface Inc.	130	Sperry Univac	76-77
CEC Division/Bell & Howell Company	144	Intersil	30-31	Sprague Electric	57
Biomation	16	ITT Jennings	155	Synertek	47
■ Bourns, Inc.	2nd c.	ITT North Microsystems Division	38	Systron-Donner, Concord	6
■ Clairex Electronics	4th c.	Kasper Instruments	7	■ Tektronix	43
■ Control Data Corporation	133	■ Kepco, Inc.	5	■ Teledyne Relays	17
Control Electronics	8	* Magneti Marelli (Servizio Immagine Promozione)	1E	Teledyne Semiconductor	53
■ Corning Glass Works	54-55	Millennium Systems Inc.	12-13	Teredyne, Inc.	80
Cramer	3rd c.	Mitel Semiconductor Inc.	52	Texas Instruments Components	9
■ Data Translation	49	Mostek Corp.	22-23	Textool Products Inc.	14
■ Dialight	141	■ Motorola Semiconductor Products	45, 137-138	Thermotron Corp.	150
Digital Equipment Corporation PDP	84-85	‡ Moxon	61	■ United Systems Corp. Sub Monsanto	130
Digital Equipment Components	58	* Munchner Messe	15E	Victoreen Inc.	147
E.I. Dupont De Nemours & Co. Inc.	96-97	‡ National Connector Div. Fabri-Tek Inc.	162	Wafios Maschinenfabrik Reutigen	134
E.G.&G. Wakefield	26	■ National Semiconductor Corp.	36-37	* Wavetek San Diego Inc.	11E
EMM-Electronic Memories & Magnetics	35	Nikkei Electronics	120	Wilhelm Westermann	8
Electronic Navigation Industries	50	* Phillips Eicoma	7E	XEBEC Systems Inc.	134
* EIP a Division of Danalab	2E-3E	■ Piezo Technology	89	Zero Corporation	94
■ Erie Technological Products	148-149	Pinellas County	140		
Fairchild (Semiconductor Operations Div.)	66-67,69	Powercube Corporation (Div. of Unitrode)	83		
Fairchild Systems Technology	74-75	■ Power One Inc.	151		
* FEME	8E	■ Projects Unlimited	130		
Figaro Engineering Inc.	154	Pro-Log	25		
■ John Fluke Mfg. Co. Inc.	2,51	* R 2E	4E		
* Ganz Measuring Works	10E	Racal-Dana Instruments, Inc.	93, 95		
* GEC M-O Valve	9E	RCA Solid State	62		

Classified and employment advertising

F. J. Eberle, Manager 212-997-2557

GTE Lenkurt	158-159
IFR, Inc.	160
Illinois University of	156
Northrop Systems	157
Northrop	156
U.S. International Recruiters, Inc.	160
Versatec	160
Signetics	160

■ For more information of complete product line see advertisement in the latest Electronics Buyers Guide

* Advertisers in Electronics International

‡ Advertisers in Electronics domestic edition

BACKPANEL SYSTEMS

FABRI-PAK™ multi-pin backpanel systems feature a complete line of electrical interconnectors mounted on a P.C. backplane. No external wiring or soldering. Press-fit, gas tight interfaces between contact and plated-thru hole. Up to 12 layers of multi-layer circuitry or 8 layers sandwiched construction.

Commercial: Unlimited choice of P.C. edgecard terminations. Grid spacing .100, .125, .150, .156.

Military: Blade and tuning fork; .100 grid; snap-in polarizing bushing; removable housing and pins.

Versatile, reliable, economical — FABRI-PAK is the answer to your backpanel requirements.

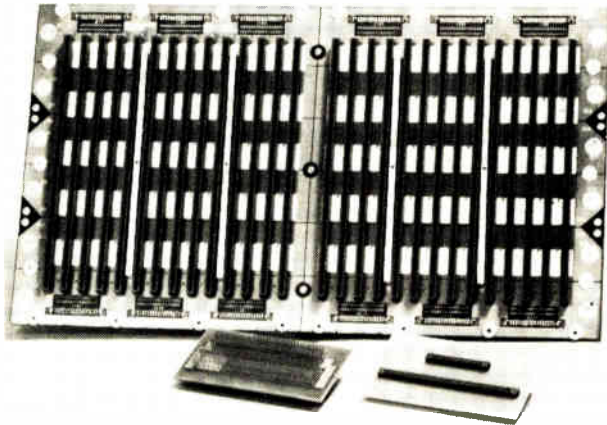

FABRI-TEK INC.
NATIONAL CONNECTOR DIVISION

9210 Science Ctr. Drive / Minneapolis, MN 55428 / (612) 533-3533

I'm interested in FABRI-PAK Commercial Military
Send literature Call me

NAME AND TITLE _____

COMPANY _____

ADDRESS _____

CITY _____ STATE _____ ZIP _____

PHONE _____

E

Advertising Sales Staff

Advertising sales manager: Paul W. Reiss
1221 Avenue of the Americas, New York, N.Y. 10020
[212] 997-4371

Atlanta, Ga. 30309: Michael Charlton
100 Colony Square, 1175 Peachtree St., N.E.
[404] 892-2868

Boston, Mass. 02116: Frank Mitchell
607 Boylston St.
[617] 262-1160

Chicago, Ill. 60611
645 North Michigan Avenue
Jack Anderson [312] 751-3739
Robert M. Denmead [312] 751-3738

Cleveland, Ohio 44113: William J. Boyle
[716] 586-5040

Dallas, Texas 75201: John J. Uphues
2001 Bryant Tower, Suite 1070
[214] 742-1747

Denver, Colo. 80203: Harry B. Doyle, Jr.
123 Speer Blvd. #400
[303] 837-1010

Detroit, Michigan 48202: Jack Anderson
1400 Fisher Bldg.
[313] 873-7410

Fort Lauderdale, Fla. 33306: Michael Charlton
3000 N.E. 30th Place
[305] 563-9111

Houston, Texas 77002: John J. Uphues
601 Jefferson Street, Dresser Tower
[713] 659-8381

Los Angeles, Calif. 90010: Robert J. Rielly
Robert E. Boedicker, 3200 Wilshire Blvd., South Tower
[213] 487-1160

Minneapolis, Minn. 55435: Robert M. Denmead
4015 W. 65th St.
[312] 751-3738

New York, N.Y. 10020
1221 Avenue of the Americas
Michael J. Stoller [212] 997-3616
Matthew T. Reseska [212] 997-3617

Philadelphia, Pa. 19102: Matthew T. Reseska
Three Parkway
[212] 997-3617

Pittsburgh, Pa. 15222: Matthew T. Reseska
4 Gateway Center
[212] 997-3617

Rochester, N.Y. 14534: William J. Boyle
1175 Pittsford-Victor Rd., Pittsford, N.Y.
[716] 248-5620

San Francisco, Calif. 94111: Don Farris
Dean Genge, 425 Battery Street.
[415] 362-4600

Paris: Patrick Mouillard
17 Rue-Georges Bizet, 75116 Paris, France
Tel: 720-73-01

United Kingdom & Scandinavia: Robert Ghey
34 Dover Street, London W1
Tel: 01-493-1451

Scandinavia: Andrew Karnig and Assoc.
Kungsholmsgatan 10
112 27 Stockholm, Sweden
Tel: 08 51 68 70 Telex: 179 51

Milan: Luigi Rancati
1 via Baracchini, Italy
Phone 86-90-656

Brussels:
23 Chaussee de Wavre
Brussels 1040, Belgium
Tel: 13-73-95

Frankfurt/Main: Fritz Krusebecker
Liebigstrasse 27c, Germany
Phone 72 01 81

Tokyo: Tatsumi Katagiri, McGraw-Hill
Publications Overseas Corporation,
Kasumigaseki Building 2-5, 3-chome,
Kasumigaseki, Chiyoda-Ku, Tokyo, Japan
[581] 9811

Business Department

Thomas M. Egan
Production Manager [212] 997-3140

Carol Gallagher
Production Manager International
[212] 997-2045

Betty Preis
Production Manager Domestic
[212] 997-2908

Roberta Cummings
Production Assistant [212] 997-2044

Frances Vallone
Reader Service Manager
[212] 997-6057

Electronics Buyers' Guide

H.T. Howland, General Manager
[212] 997-6642

Regina Hera, Directory Manager
[212] 997-2544

Roberta Cummings, Production Manager
[212] 997-2044

Frances Vallone, Reader Service Manager
[212] 997-6057

Classified and Employment Advertising

Frank Eberle, Manager
[212] 997-2557

High flexibility

Pragmatic. Asthetic.

From hard use lab assignments to easy going office jobs — the flexibility of Cramer Hi-Model is unlimited.

Cramer offers the options on a complete line of Hi-Models. Choose footings, posture backs, casters. All Hi-Models are available in a vast selection of decorator fabrics. Frames and legs in mirror, or brushed chrome. We offer Auto-Lift for immediate height changes — Posi-Lok for less frequent height adjustments.

Whatever the job type or individual need — Cramer is high in design and practicality.

CRAMER

 CRAMER INDUSTRIES INC.

625 Adams Street, Kansas City, KS 66105
Phone: 913/621-6700
Toll Free: 800/255-4096

Showrooms in spaces 982 to 985 Chicago Merchandise Mart
Kansas City, Los Angeles.

Circle Number 901 on Reader Service Card

PHOTO SENSORS

How they're tested at Clairex

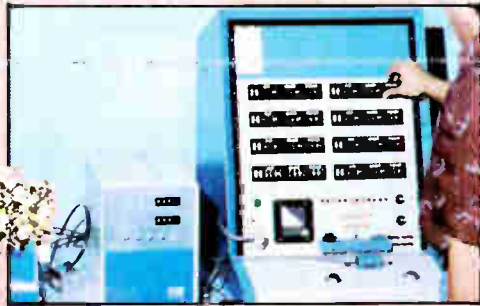

Some suppliers sample test. Some test first for light sensitivity. Clairex tests twice and then sample tests again at final quality control inspection. Only Clairex do we offer full partnership on the sensor. Ask a representative

What is a woman do while or do testing themselves. Our production laboratory has standards directly traceable to the National Bureau of Standards. You'll hear Clairex and "ears the

testing to us?" After 25 years we must be doing something right. Call (814) 664-6602 or write Clairex®, 560 South Third Avenue, Mount Vernon, New York 10550.

CLAIREX ELECTRONICS

A Division of Clairex Corporation

Circle Number 902 on Reader Service Card