

JANUARY 19, 1978

CHOOSING ANALOG BOARDS FOR MICROCOMPUTER SYSTEMS / 113

How design automation can optimize printed-circuit board layout / 102

Operating optical couplers in the linear mode / 121

FOUR DOLLARS A MCGRAW-HILL PUBLICATION

International

Electronics®

Tools for Systematic Software Design

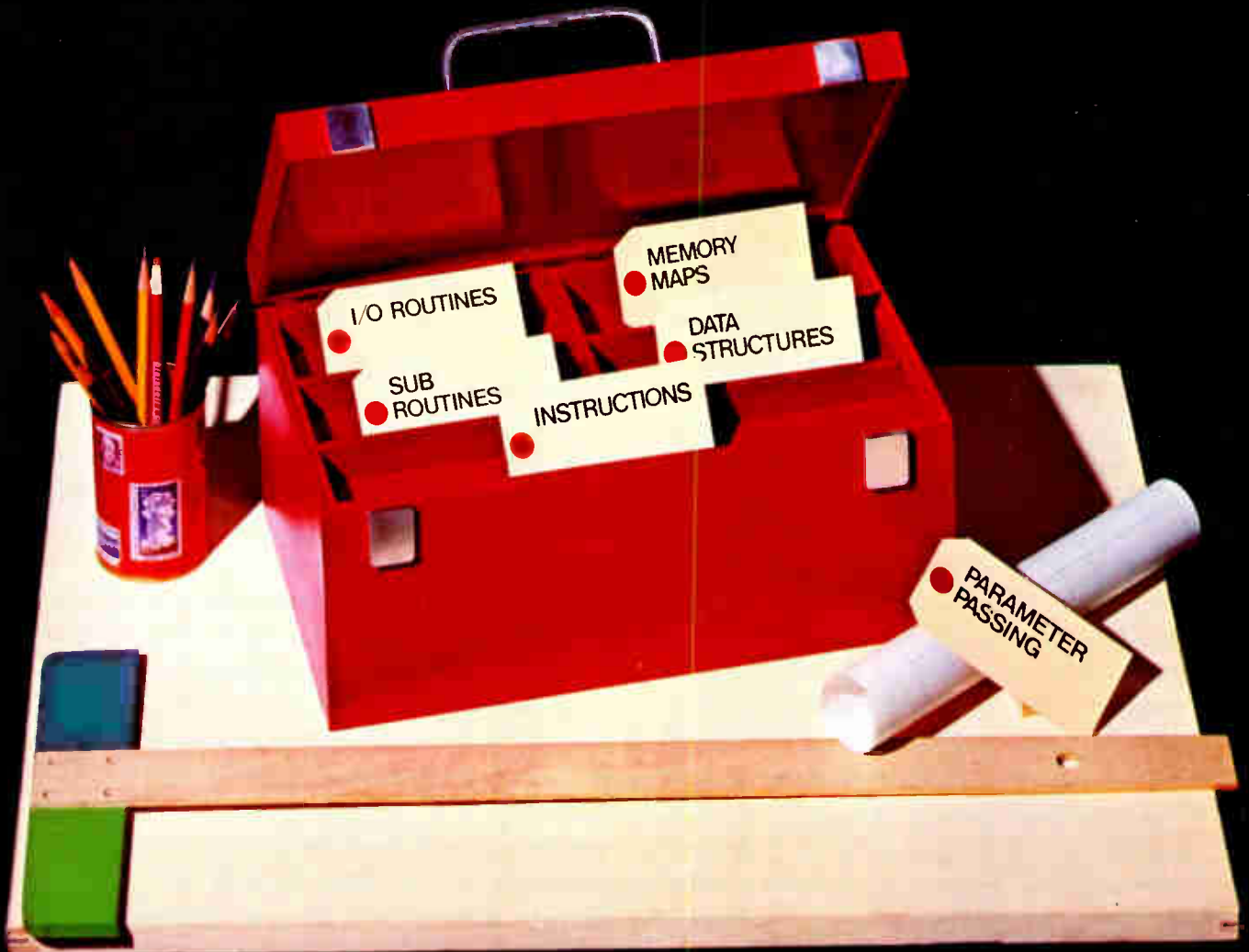



Bourns resistor networks

... for the "discreet" design engineer.

Sure, you've already made a smart decision, choosing networks over discrete resistors. After all, the cost per resistor in a network package can be 40% less; they require only 10-15% of the P.C. board space needed by discretes; and component count is reduced as much as 95% with resistor networks.

But, when choosing a network supplier, you should also consider these points:

1. Bourns has the broadest network product line in the industry — over 1000 part numbers in all. And our standard DIP circuits range from simple pull-up configurations to Thevenin-equivalent ECL terminators and memory interface circuits.
2. Bourns Krimp-Joint™ offers both a mechanical and electrical bond that lap or butt joint construction doesn't provide. The lead is crimped onto the network element and a high-temp, reflow-resistant solder is used to prevent failure during wave soldering and in circuit thermal cycling and vibration.
3. Bourns was the first manufacturer to offer a complete line of off-the-shelf, super low profile SIPs with demonstrated automatic insert ion capability.

These are the facts. So, now you can be even more "discreet". We're sure you'll specify Bourns Resistor Networks — direct or through your local distributor.

Send today for our new 1977 Resistor Networks Catalog.

TRIMPOT PRODUCTS DIVISION, BOURNS, INC., 1200 Columbia Avenue, Riverside, CA 92507, Telephone 714 781-5415 — TWX 910-332-1252.



International Marketing Offices: European Headquarters — Switzerland 042/23 22 42 • Belgium 02/218 2005 • France 01/20 66 63 • Germany 07 1 2 29 36 • Italy 02/32 56 88 • Netherlands: 70/87 44 00 • United Kingdom 01/572 653 • Norway 02 1 18 72 • Sweden 734/20 110 • Japan 075-921 9111 • Australia 02/55-0411 03/95-9566 • Israel 77 73 15/57

For Immediate Application — Circle 120
For Future Application — Circle 220

Most graphics terminals are too dumb for words.

Even expensive models get tongue-tied when it comes to alpha-numerics. But now there's a bright new graphics terminal that has a lot to say for itself.

Alpha-graphics: the perfect combination.

It's the Hewlett-Packard 2648A alpha-graphics terminal. For just \$5500*, it will dazzle you with a

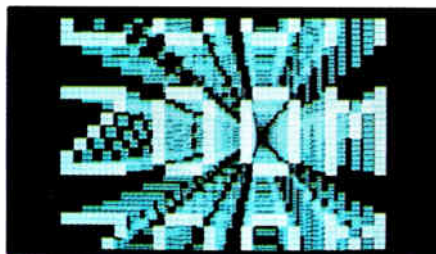

virtuoso display. You'll see zoom and pan, area shading, pattern definition, rubber band line, scientific plotting and graphics text composition. Having independent memories for graphics and alphanumeric, you can do auto-plots with or without words and figures on the screen.

And when you need a smart alphanumeric terminal for on or off-line work, stay right where you are.

Yes, give me the good words (and pictures) on the HP 2648A terminal.

I'd like a demonstration. Send me information.

Name _____ Title _____
 Company _____
 Address _____
 City/State/Zip _____
 Phone _____

Mail to: Ed Hayes, Marketing Manager,
 Hewlett-Packard Data Terminals Division,
 19400 Homestead Road, Dept. 314, Cupertino CA 95014.

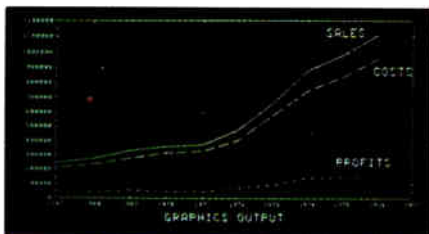

How smart is smart?

Ever seen a graphics terminal scroll 200 lines of interactive dialogue? And store up to 220K bytes of data (words and pictures) on twin cartridges? And cut out repetitive routines by storing up to 80 characters on each of eight "soft keys"?

The HP 2648A can also edit with the best of them. Communicate with a computer at rates up to 9600

baud. And accept a plug-in forms drawing mode to generate just about any form your company uses.

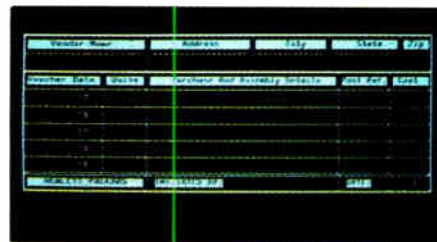

Strong as well as intelligent.

Like all our terminals, the HP 2648A has a clean, tough, modular design. Open it up like a suitcase, and you'll see the neat row of plug-in PC boards.

That makes it easy to add options or take care of maintenance. Not that downtime is a problem. Our terminals have such a good track record that we've lowered our maintenance price three times in the past two years. When you do need service, more than 1000 Systems and Customer

Engineers worldwide are ready to take care of you. So why settle for any dumb graphics terminal when ours can figure in your picture?

See for yourself by calling the Hewlett-Packard office listed in the White Pages. Or send us the coupon and give our 2648A alpha-graphics terminal a screen test.

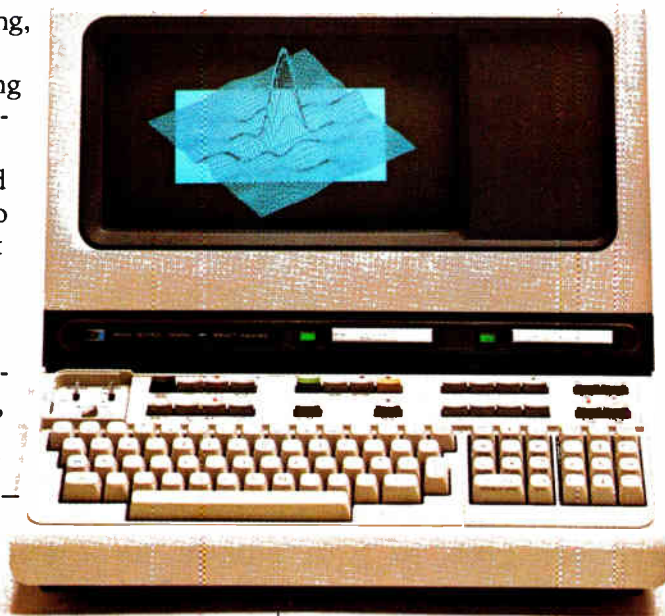

*U.S. domestic price

HEWLETT  PACKARD

42801HPT5

Circle 1 on reader service card

39 Electronics Review

MINICOMPUTERS: CDC to offer peripherals for IBM minicomputer, 39
LITIGATION: Intel sues U. S. Copyright Office, 40
PHOTOVOLTAICS: 60-kW installation largest so far, 41
SATELLITES: Japanese satellite goes live in March, 41
MICROPROCESSORS: Zilog to have the one-chip to beat?, 42
HOME COMPUTERS: Makers clash over best route to the home, 46
LASERS: IBM diode hits one and the same spot, 46
MILITARY: Alaska to get new surveillance radars, 48
NEWS BRIEFS: 50

61 Electronics International

GREAT BRITAIN: Associative processor on a chip due from lab, 7E
WEST GERMANY: Video game IC will work with wireless controls, 8E
JAPAN: Doubling up on resist and diffusion gives high-speed RAM, 10E
WEST GERMANY: Automobile seat control remembers positions, 14E
NEW PRODUCTS INTERNATIONAL: 19E

73 Probing the News

MEDICAL: Electronic pain killers gain wider use, 73
ABROAD: Britain prepares to break out black ink, 77
CONSUMER: Yen's rise helps U. S. stay competitive, 80
PACKAGING & PRODUCTION: Fine-line printed circuits catch on, 84

97 Technical Articles

MICROCOMPUTERS: Design microcomputer software systematically, 97
PACKAGING & PRODUCTION: Computers make pc artwork, 102
DESIGNER'S CASEBOOK: Current source damps load oscillations, 108
Exclusive-OR gate and flip-flops make half-integer divider, 109
Dc-dc power supply regulates down to 0 volt, 111
DATA ACQUISITION: What to look for in analog I/O boards, 113
COMPONENTS: Optical coupler hits new high in linearity, stability, 121
ENGINEER'S NOTEBOOK: Counter, scope measure time, 126
CALCULATOR NOTES: HP-67 aids design of microstrip elements, 127

137 New Products

IN THE SPOTLIGHT: A-d converter chip resolves 10 bits, 137
COMPONENTS: Solid-state relay price drops to \$2 in quantity, 138
SEMICONDUCTORS: Counters offer three-state outputs, 145
PACKAGING & PRODUCTION: Wire-bonding speed is increased, 148
DATA HANDLING: More I/O cards made for LSI-11/2, 154
MICROPROCESSORS: Single-board computer built around Z80, 159
INSTRUMENTS: Analyzer pinpoints IEEE-488 bus-line faults, 162
COMMUNICATIONS: Omnidirectional antenna covers 4 to 30 MHz, 168
MATERIALS: 172

Departments

Publisher's letter, 4
Readers' comments, 6
News update, 8
People, 14
Editorial, 24
Meetings, 26
Electronics newsletter, 33
Washington newsletter, 57
Washington commentary, 58
International newsletter, 63
Engineer's newsletter, 130
New literature, 178

Services

Reader service card, 25E
Reprints available, 146
Employment opportunities, 182

Highlights

Cover: Software design should be systematic, 97

The secret to software development is to see it as another form of system design. Just as with hardware, a step-by-step design approach pays off.

Cover designed by Associate Art Director Charles D. Ciatto and constructed by Bob Strimban.

Mighty fine, say pc-board users, 84

A fine-line printed-circuit process using ultra-thin copper foil is beginning to win fans. Yielding 5-to-10-mil-wide lines, the technique provides twice as much packaging density as conventional boards.

Choosing the right analog I/O board, 113

Deciding which of the many analog input and/or output boards is best for a microcomputer application is as much a matter of its architecture as its specifications. The wrong configuration can complicate system design considerably.

At last: a linear optical coupler, 121

A differential circuit technique applied to an optical coupler enables it to hit a new high in linearity and stability. This approach cancels most of the errors that are caused by the light-emitting diode.

And in the next issue . . .

A microcomputer family grows . . . dynamic RAM design can be painless . . . microcomputers take over input/output duties of minicomputers.

EDITOR-IN-CHIEF: Kemp Anderson

EXECUTIVE EDITOR: Samuel Weber

MANAGING EDITOR: Arthur Erikson,
International

SENIOR EDITORS: Laurence Altman, William F. Arnold, Ray Connolly, Lawrence Curran, John Johnsrud, H. Thomas Maguire, Stephen E. Scrupski, Gerald M. Walker

ART DIRECTOR: Fred Sklenar

ASSOCIATE EDITORS: Howard Wolff,
Alfred Rosenblatt

DEPARTMENT EDITORS
Aerospace/Military: Ray Connolly
Circuit Design: Vincent Biancomano
Communications & Microwave:
Richard Gundlach
Components: Lucinda Matterna
Computers: Raymond P. Capece
Consumer: Gerald M. Walker
Instrumentation: Stephen E. Scrupski
New Products: H. Thomas Maguire,
Michael J. Riezenman
Packaging & Production: Jerry Lyman
Solid State: Laurence Altman

CHIEF COPY EDITOR: Margaret Eastman

COPY EDITORS: Ben Mason, Mike Robinson

ART: Charles D. Ciatto, *Associate Director*
Paula Piazza, *Assistant Director*

EDITORIAL SECRETARIES: Janet Noto,
Penny Kaplan

EDITORIAL ASSISTANT: Marilyn B. Rosoff

FIELD EDITORS
Boston: Lawrence Curran (Mgr.)
Pamela Hamilton
Los Angeles: Larry Waller (Mgr.)
Midwest: Larry Armstrong (Mgr.)
New York: Bruce LeBoss (Mgr.)
San Francisco: William F. Arnold (Mgr.)
Washington: Ray Connolly (Mgr.)
Frankfurt: John Gosch
London: Kevin Smith
Paris: Arthur Erikson
Tokyo: Charles Cohen

McGRAW-HILL WORLD NEWS

Editor: Michael Johnson
Brussels: James Smith
Milan: Andrew Heath
Moscow: Peter Hann
Paris: Andrew Lloyd
Stockholm: Robert Skole
Tokyo: Robert E. Lee

PUBLISHER: Dan McMillan

ADVERTISING SALES MANAGER:
Paul W. Reiss

MARKETING ADMINISTRATION MANAGER:
Wallis Clarke

CIRCULATION MANAGER: Karl Peterson

MARKETING SERVICES MANAGER:
Tomlinson Howland

RESEARCH MANAGER: Margery D. Sholes

In this age of the microprocessor, organizing software design has become a part of the electrical engineer's job. But for many, learning how to handle this task has not been easy. William Dalton of Western Electric, who authored the article on this subject on page 97, is actually a software expert with a lot of hardware experience and a specialist in microprocessor technology.

He knows from experience the importance of the interface between hardware and software in microprocessor applications. In fact, at present he works in tandem with an engineer whose background is hardware with lots of software experience. "I think we will see more of this type of organization," Dalton says. "It now takes engineers with software understanding and engineers with hardware understanding to make a system work."

He points out that design techniques have progressed as rapidly in software as in hardware. "We're a long way from the Fortran we learned at school," he remarks. Yet many an engineer has not taken the time to get up to speed in these new techniques. "Today you wouldn't do a software design without an assembler just as you would not do a hardware design without an oscilloscope," he points out.

Another problem, he adds, is that engineering managers have not yet realized the complexities and inherent problems of software design. He suggests that managers need to realize that software design is in many ways more inflexible than hardware design, that decisions once put into a system are as difficult to change or correct as it is to redesign a piece of hardware. "On the surface

a change looks easy, but its impact on the total system will catch you every time. Putting data tolerance into software is the most complex design problem imaginable," he concludes.

With all the negative reports about what Japanese imports to the U.S.—from television sets to steel plate—have been doing to the nation's balance of trade and domestic companies, it is interesting to note that there is a bright side emerging. Like the swinging of a pendulum, an economic trend goes to an extreme, then eventually starts to swing back.

Take the Japanese yen as an example. Japan's expansive export efforts have led to trade surplus, and the yen has become so strong that it has put the dollar at a severe disadvantage in international money markets. Indeed, a dollar buys about 20% fewer yen than it did a year ago and makes the whole U.S. economy look a bit pale by comparison with Japan's.

Now the good news. With the yen commanding a premium, Japanese companies have to maintain their profits by raising the prices of their goods by that same 20% on the U.S. market. With the prices of their TV sets going up, then, some of the pressure is off the U.S. manufacturers. For details about this turnaround and about the new threats from such places as Taiwan and Korea, turn to the Probing the News article on page 80.



January 19, 1978 Volume 51, Number 2 97,122 copies of this issue printed

Published every other Thursday by McGraw-Hill, Inc. Founder: James H. McGraw 1860-1948. Publication office 1221 Avenue of the Americas, N.Y., N.Y. 10020, second class postage paid at New York, N.Y. and additional mailing offices.

Executive, editorial, circulation and advertising addresses: Electronics, McGraw-Hill Building, 1221 Avenue of the Americas, New York, N.Y. 10020. Telephone (212) 907-1221. Teletype 12-7950 TWX 710-581-4879. Cable address: MCGRAWHILLNEWYORK.

Subscriptions limited to professional persons with active responsibility in electronics technology. No subscriptions accepted without complete identification of subscriber name, title or job function, company or organization, and product manufactured or services performed. Based on information supplied, the publisher reserves the right to reject non-qualified requests. Subscription rates: in the United States and possessions \$15 one year, \$26 two years, \$38 three years; company addressed and company libraries \$20 one year, \$36 two years, \$50 three years. APO/FPO addressed \$35 one year only. Canada and Mexico \$17 one year, \$29 two years, \$43 three years; Europe \$42 one year, \$71 two years, \$100 three years. Japan, Israel and Brazil \$70 one year, \$115 two years, \$165 three years. Australia and New Zealand \$95 one year, \$170 two years, \$240 three years, including air freight; all other countries \$45 one year, \$80 two years, \$112 three years. Limited quota of subscriptions available at higher-than-basic rate for persons allied to lead served. Check with publisher for these rates. Single copies: \$4.00. Please allow four to eight weeks for shipment.

Officers of McGraw-Hill Publications Company: Gordon L. Jones, President; Paul F. McPherson, Executive Vice-President; Group Vice-President: Gene W. Simpson; Senior Vice-Presidents: Russell F. Anderson; James E. Boddorf, Planning & Development; David G. Jensen, Manufacturing; Ralph R. Schulz, Editorial; Vice-Presidents: Denis C. Beran, European Operations; David P. Forsyth, Research; Douglas Greenwald, Economics; James E. Hackett, Controller; Robert L. Leyburn, Circulation; Edward E. Schirmer, Sales.

Officers of the Corporation: Harold W. McGraw, Jr., President, Chief Executive Officer, and Chairman of the Board; Robert N. Landes, Senior Vice President and Secretary; Ralph J. Webb, Treasurer.

Title registered in U.S. Patent Office; Copyright © 1978 by McGraw-Hill, Inc. All rights reserved. The contents of this publication may not be reproduced in whole or in part without the consent of copyright owner.

Subscribers: The publisher, upon written request to our New York office from any subscriber, agrees to refund that part of the subscription price applying to copies not yet mailed. Please send change-of-address notices or complaints to Fulfillment Manager; subscription orders to Circulation Manager, Electronics, at address below. Change-of-address notices should provide old as well as new address, including postal zip code number, if possible, attach address label from recent issue. Allow one month for change to become effective.

Postmaster: Please send form 3579 to Fulfillment Manager, Electronics, P.O. Box 430, Hightstown, N.J. 08520.

from KEPCO by TDK

the series

RMX

25 KHz SWITCH-MODE DUAL INPUT POWER SUPPLIES

- 75% efficiency
- 115/230V a-c input
- $\pm 10\%$ output adjustment
- adjustable current limit
- adjustable overvoltage
- logic level on-off
- 1 millisecond recovery

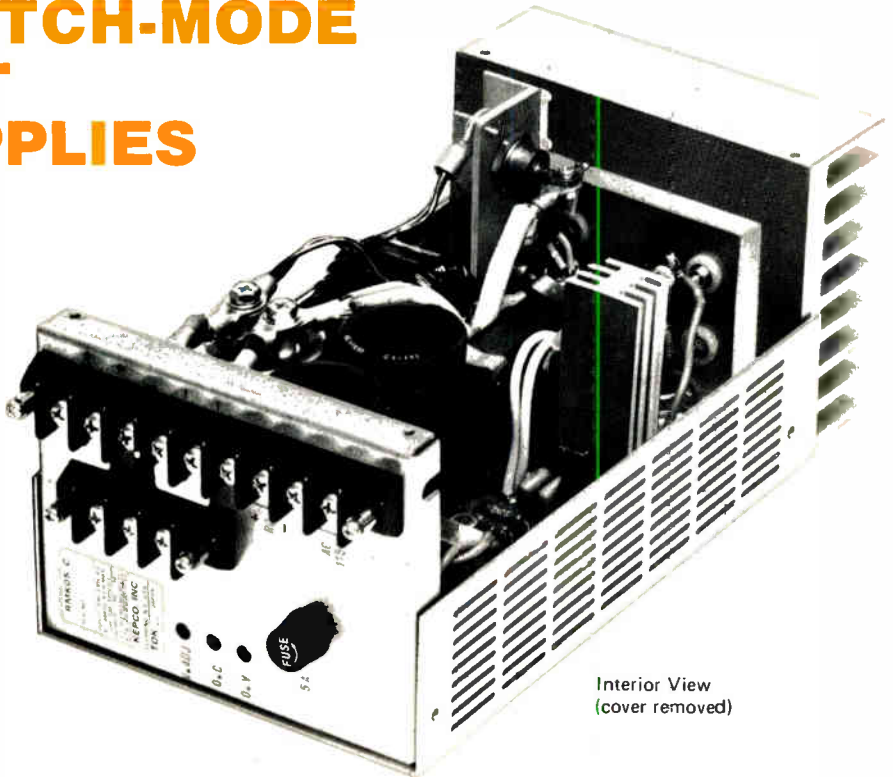

Interior View
(cover removed)

BLOCK DIAGRAM OF THE RMX SWITCH-MODE POWER SUPPLY

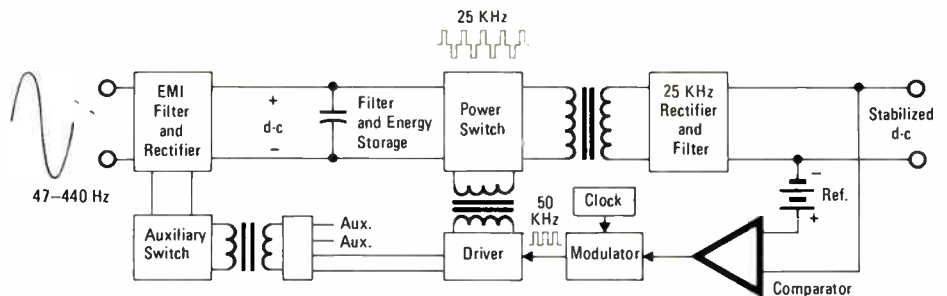

50°C OUTPUT RATINGS FOR THE KEPCO RMX POWER SUPPLIES

PKG.	5V	9V	12V	15V	24V	SIZE	WGT.
"A"	10.0 A	6.0 A	5.0 A	4.0 A	2.5 A	55 H x 130 W x 190 D mm.	6.6 kg.
"B"	26.0 A	15.0 A	12.0 A	10.2 A	7.5 A	83 H x 130 W x 222 D mm.	10.4 kg.
"C"	30.0 A	17.2 A	14.6 A	12.3 A	8.0 A	103 H x 130 W x 222 D mm.	11.5 kg.

Ask your Kepco Rep to show you the clean layout, and cool operation of the KEPCO/TDK switching power supplies. Compare performance, stability, noise, temperature rise. . . compare the Kepco 5-Year Warranty!

For complete specifications — contact your local Kepco representative:

AUSTRALIA: Elmeasco Instruments Pty. Ltd., 15 MacDonald Street, Mortlake, N.S.W. 2137, Tel.: (02) 736-2888 • AUSTRIA: Kontron GmbH & Co. KG, 114C Wien, Ameisgasse 49, Tel.: 94-56-46
 BELGIUM: C.N. Rood, S.A., Place de Jambline de Meux, 37, 1040 Brussels, Tel.: 02.35.21.35 • BRITISH ISLES: Techman, Limited, 58 Edgware Way, Edgware, Middx. HA8 8JP, Tel.: 01-958-5636 • DENMARK: Sophus Berendsen A.S., 10 Amaliegade OK 1256, Copenhagen, Tel.: (01) 148500 • FINLAND: Finn Metric Oy, PL 6 02101, Tapiola, Ahertajantie 6 D, Tel.: 460844
 Federal Republic of GERMANY: Kontron Elektronik GmbH, D8051 Eching-Postfach 105 Muenchen, Tel.: (08165) 7-71 • ISRAEL: Eastronics Ltd., 11 Rozanis Street P.O. Box 39300, Tel Aviv, Tel.: 475151 • JAPAN: Toyo Corp., P.O. Box 5014, International-Tokyo, Tel.: 279-0771 • NETHERLANDS: C.N. Rood B.V. Electronics, P.O. Box 42, Rijswijk, Z.H. 2109, Tel.: The Hague 99-63-60 • NORWAY: Teletinstrument AB, Hausmansgate 17, P.O. Box 9171 Vaterland, Oslo 1, Tel.: 02-201856 • PORTUGAL: Equipamentos de Laboratorio, Lda., P.O. Box 1100, Lisbon, Tel.: 97-65 51 • S.O. AFRICA: Protea Physical & Nuclear Instrumentation Pty. Ltd., P.O. Box 39127, Bramley 2018, Transvaal, Tel.: (2711) 786-1020 • SPAIN: Atajo Ingenieros S.A., Enrique Larreta 12, Madrid 16, Tel.: 733 05 62 • SWEDEN: Teletinstrument AB, Box 490, S162 04, Vallingby 4, Tel.: 08/38 03 70 • SWITZERLAND: Kontron Electronic AG, Bernerstrasse 169 (Sud) 8048 Zurich, Tel.: 01-62 82 82

KEPCO, INC. 131-38 SANFORD AVENUE • FLUSHING, N.Y. 11352 U.S.A. • (212) 461-7000 • TWX#710-582-2631 • Cable: KEPCOPOWER NEWYORK

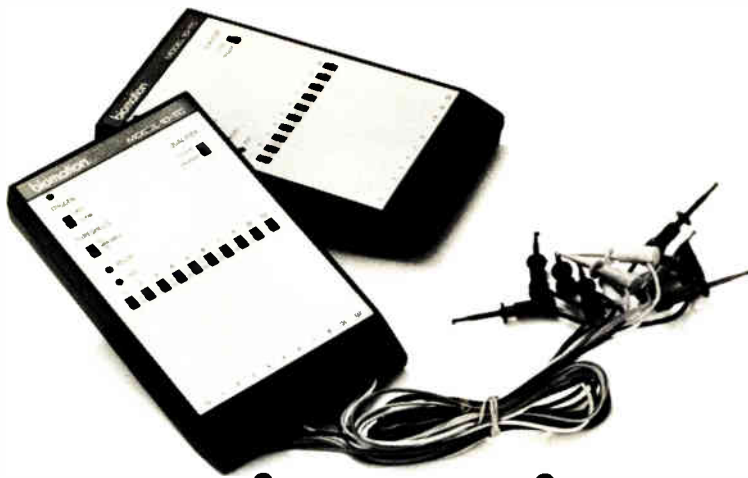

How 36 trigger points can simplify analysis of your microprocessor-based systems.

Designing 8- or 16-bit microprocessor-based systems? Plug in two of our 10-TC passive probe pods, and you can expand the triggering capability of our best-selling 16-channel, 50 MHz logic analyzer to trigger on words up to 36 bits long. That gives you the power to record and analyze up to 16 digital signals triggered from up to 20 additional locations.

Performance and versatility: That's what's made our 1650-D so popular with designers working on microprocessor system development, instrumentation interfacing or analysis of real-time digital circuits. With the 116 Display Control option, the 1650-D provides both timing and logic state displays, for simplified hardware/software debugging and integration.

Time domain: Select the time domain display and you get a timing diagram of sequential and simultaneous relationship between recorded signals. That simplifies hardware troubleshooting.

Data domain: This display is essential for troubleshooting software and

firmware. It displays logic states (1's and 0's), with hex or octal translation.

Compare these other important 1650-D features:

- Pretrigger or delayed trigger recording.
- Latch Mode, for recording glitches as narrow as 5ns.
- Map Mode, made up for an analog vector map of system activity.
- Display expansion, mixed or full, x5, x10 or x20.
- Mixed logic thresholds, ECL, TTL, MST or variable, independently selectable for channels 1-8, 9-16.

There's not room here to go into all of the 1650-D's capabilities. But we'll gladly send you detailed information on our entire line of logic analyzers, from the budget-priced 920-D to our ultrafast 200 MHz 8200. Or, at your convenience, we'll arrange a demonstration, in your lab. Write, phone or use the reader

service card. Biomation,
10411 Bubb Road,
Cupertino, CA 95014.
(408) 255-9500.
TWX: 910-338-0226.

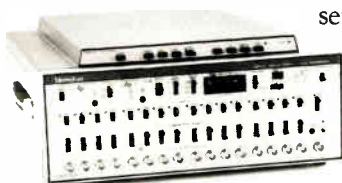

biomation

Circle #6 for information

Circle #194 for information & demonstration

Readers' comments

The U. S. grows big crystals, too

To the Editor: I read with interest the article on crystal-growing technology in Japan in the Nov. 10 issue [Electronics International, "Japanese laboratory is growing 5-in.-diameter ingots"]. Without discrediting the efforts discussed, it should be noted that much larger ingots have been produced in the U. S. in a low partial pressure of argon. Also, the vacuum pump problems have been resolved effectively for some time now.

In terms of ingot size, giant 8-inch-diameter crystals have been reported by Hamco [Rochester, N. Y.], and 6-in.-diameter ingots are produced routinely.

Vacuum pumps required to produce low clean-up pressure but also capable of sustained operation at elevated pressures in the presence of contaminants have been in successful operation for years. These pumps, with the necessary adaptive modifications and auxiliary equipment, are available from Kinney Vacuum Co.

I am certain domestic producers would be happy to sell their advanced equipment to Japan if they could break the tariff barriers.

Z. C. Dobrowolski
Kinney Vacuum Co.
Boston, Mass.

It's a wide, wide world

To the Editor: In your Oct. 27 editorial [p. 24], the issue of proper industrial or academic placement of engineers is once again addressed with the same old misconceptions and the same old conclusions.

Engineering studies at college are far different from actual engineering, a statement to which countless entrants into the field would attest. A college background enables an individual to become an engineer, but he can do other things: sales, small business administration, entrepreneurship—any thing that beckons any liberal arts major.

The learning process at institutions is not exercised solely in direct preparation for a career. Ask any English major.

Stacy V. Holmes
Arlington, Va.

New RCA kit makes it easy ...

Evaluate CMOS microprocessing for yourself.

Here's a microprocessor kit that lets you prove how cost-effective the all-CMOS RCA 1800 system can be.

You'll quickly see how the RCA COSMAC architecture and a repertoire of 91 powerful instructions give you maximum performance with minimal memory. And how you can take advantage of CMOS low power dissipation, single wide-range power supply, full operating temperature range, high noise immunity, and single-phase clock.

Multi-purpose Tool

Build this inexpensive kit to evaluate not only the benefits of its CMOS CPU, but also CMOS memory and CMOS I/O. Use it for easy prototyping and debugging. Exercise it with start, stop, and single-step controls. And, via the utility ROM,

generate, evaluate, and verify software.

The CDP18S020 Evaluation Kit comes complete with the RCA CDP1802 COSMAC CPU plus clock and control, display, memory and I/O sections, and all passive components needed for a low-cost microcomputer system. For just \$249. Add a power supply and I/O terminal and you're into CMOS microprocessing. The CDP18S024 EK/Assembler-Editor Design Kit allows assembly language software development.

To get your kit or more information, contact your local RCA Solid State distributor. Or contact RCA Solid State headquarters in Somerville, NJ; Sunbury-on-Thames, Middlesex, England; Quickborn 2085, W. Germany; Ste.-Anne-de-Bellevue, Quebec, Canada; Sao Paulo, Brazil; Tokyo, Japan.



RCA 1800. Cost-effective microprocessing.

Get the scope you need-Now!

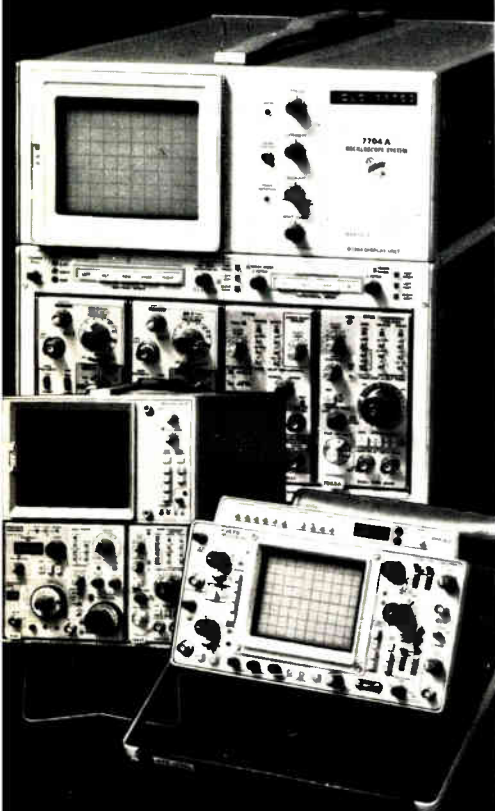

Our "Instrument Professionals" will tell you which scope will do the job best, at the lowest cost, make immediate delivery and guarantee performance.

Write or call for data on our other specialties: Instrument Leasing • Computer Peripherals • Equipment Sales • Instrument Service.

Circle 8 on reader service card

Call Continental Rentals

Get our FREE Catalog



Div. Continental Resources, Inc.
175 Middlesex Turnpike, Bedford, MA 01730 (617) 275-0850

FOR IMMEDIATE RESPONSE CALL:
N.E. (617) 275-0850; L.I. (516) 752-1622;
NY, NJ (201) 654-6900;
Gtr. Phila. (609) 234-5100;
Wash., D.C. area (301) 948-4310;
Mid West (312) 439-4700;
So. Central (214) 690-1706;
Costa Mesa, CA (714) 540-6566;
L.A., CA (213) 638-0454;
Santa Clara, CA (408) 735-8300.

News update

■ With Intel Corp.'s 8080A central processing unit becoming the first microprocessor chip and first large-scale integrated part to win approval as a military standard device [*Electronics*, Jan. 5, p. 48], the big push is on to provide military specifications for many other microprocessors, support chips, and memories. The intensive effort is part of a continuing program run by Rome Air Development Center, the U.S. Air Force's semiconductor watchdog, and aimed at ensuring the reliability of microprocessors and other LSI devices expected to find wide use in military systems over the next 10 years [*Electronics*, Oct. 14, 1976, p. 8].

"We will be spending about \$1 million during fiscal 1978 for electrical characterization of these parts," says Jerry Hilow, an engineer in RADC's Reliability branch. The next LSI addition to the qualified product list of MIL-specified devices is Motorola Inc.'s 6800 CPU, "expected to be qualified next month," he adds. The same MIL-M-38510 electrical characterization specification developed for the 8080 and 6800, Hilow notes, "is now being generated for the 2901, 9900, and 1802" CPU chips from Advanced Micro Devices Inc., Texas Instruments Inc., and RCA Corp., respectively. If all goes as planned, he adds, the 2901 will be qualified in December and both the 9900 and 1802 will follow a month later.

Support next. Once the specifications for the basic CPU chips are generated, says Hilow, "we will go all out to complete the job by picking up the popular support chips and generating specs for them." RADC already has rough specs for support chips in the 8080, 6800, and 2900 families and, he adds, will soon award a two-year contract worth several hundred thousand dollars to develop electrical characterization specifications for support chips in the 1802 and 9900 series, as well as for newer 8-bit CPU chips such as Intel's 8085 and Zilog Corp.'s Z80. Another two-year award, of comparable value, will ask for like specifications for some of the new single-chip microcomputers. **Bruce LeBoss**

Gas Sensing Semiconductor

FIGARO TGS GAS SENSOR

quickly senses even small amount of gas.

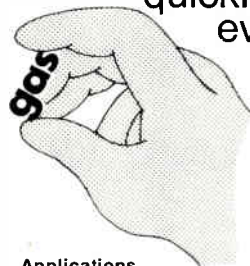

Applications

1. Natural Gas-Leak Alarm
2. Propane Gas-Leak Alarm
3. Carbon Monoxide Detector
4. Automatic Fan Control
5. Fire Alarm (Detecting)
- combustible gases contained in smoke
6. Alcohol Detector (Detector for drunken driver)
7. Air Pollution Monitor

Please contact us at the addresses below directly for catalogs and prices. Delivery terms on order.

FIGARO ENGINEERING INC.

● Head Office: 3-7-3 Higashitoyonaka, Toyonaka City, Osaka, 560. JAPAN. TELEX 05286155 FIGARO J. CABLE FIGARO TOYONAKA. TEL: (06) 849-2156

● North America: 3303 Harbor Boulevard, Suite D-8, Costa Mesa, California 92626, U.S.A. TELEX 678396 CABLE: FIGARENGIN COSTAMESA TEL (714) 751-4103
Circle 195 on reader service card

UNIQUELY MODERN THRIFTMETER!! A FUTURISTIC DPM

- LCD READOUT
- 0.01 WATT POWER CONSUMPTION
- THRIFTY LOW PRICE
- SINGLE CHIP ELECTRONICS

PM-351



Unit Quantity— \$66

More Great Features:

- 3-1/2 digits with 0.05% accuracy.
- Auto polarity & overload indication.
- Input voltage protection.
- Programmable decimal.
- No zero adjustment.
- Less than 1" high.
- MOS/LSI construction.



Non-Linear Systems, Inc.

Originator of the digital voltmeter.

Box N, Del Mar, California 92014

Telephone (714) 755-1134 TWX 910-322-1132

Circle 196 on reader service card

The world's only precision low-power op amps: PMI's OP-08 and OP-12.

When you have one of those demanding applications—like a piece of precision portable or space-bound equipment—you've probably hankered for an op amp that would give you lower offset voltage and lower offset voltage drift than the 108A. And, while we're at it, better overall specs.

By George, we've got it.

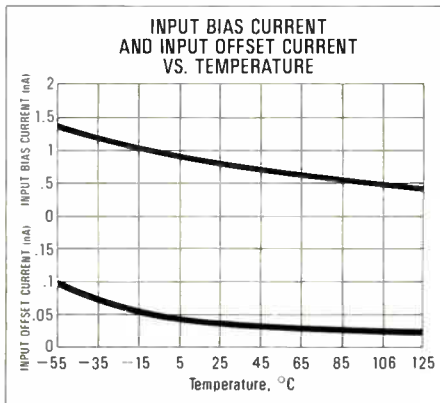

PMI's new OP-08's and OP-12's are the **only** precision, low-power, low-input-current op amps on the market. They are pin-for-pin replacements for 108A's and 308A's in all applications to give you even better performance. Here are the key specs:

Offset voltage of the OP-08 and OP-12 is three times lower than the LM108A. Voltage drift is two times lower. CMRR and PSRR are at precision levels.

And for battery and solar-powered systems, the OP-08 and its internally-compensated twin, the OP-12, each drive a 2kohm load—five times the output current capability of the 108A and 308A.

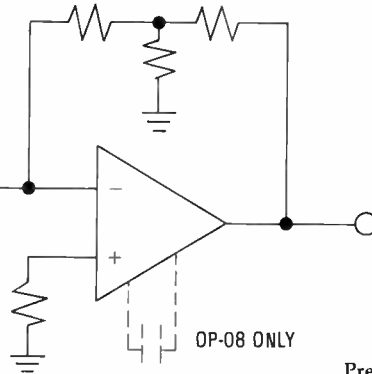

How did we come up with the OP-08 and OP-12?

How did we do it? By being fussier. By using our proprietary ion-implantation and zener-zap trimming processes. By careful design: completely balanced input stage and second stage, and proprietary output design to drive a 2Kohm load. By careful fabrication. And by QA like nobody else in the industry.

When you have to go quality and performance all the way, it's good to know that PMI's OP-08 and OP-12 are available—on your distributor's shelf—right now.

Hybrid Designers: You can order the OP-12 in chip form.

If you'd like to get your hands on an OP-08 or an OP-12, just write us (on your company's letterhead) and we'll send a sample and a data sheet. Be glad to, in fact. After all, when you make the only chip of its kind, it pays to advertise.

Precision Monolithics Incorporated
 c/o BOURNS AG
 Baarerstrasse 8
 6301 Zug, Schweiz
 Phone: 042-23 22 42
 Telex: 787-22

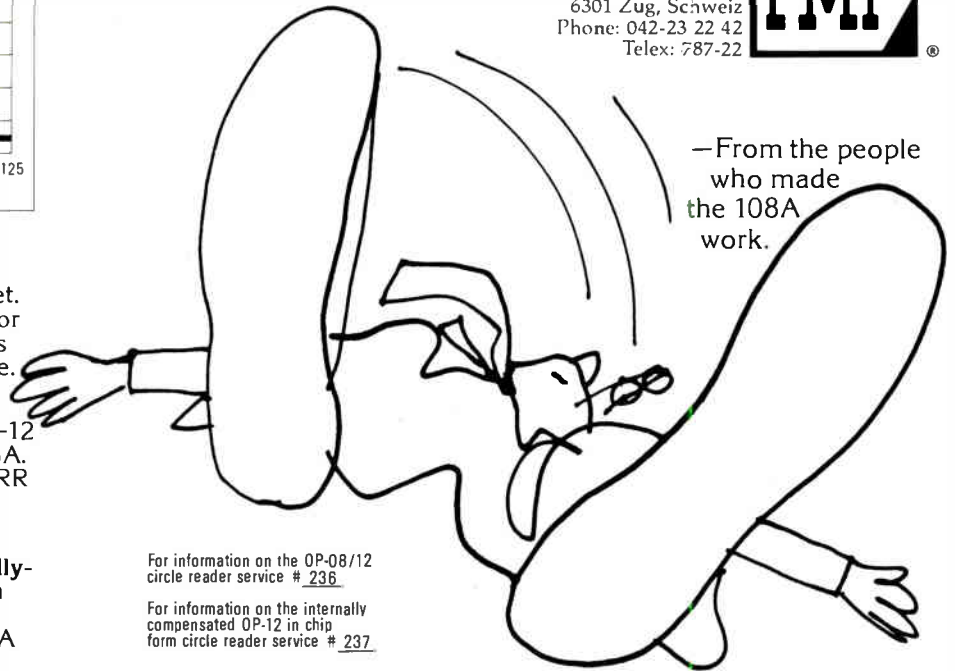

For information on the OP-08/12 circle reader service # 236

For information on the internally compensated OP-12 in chip form circle reader service # 237

Electrical Characteristics $V_S = \pm 15V$	OP-08A/OP-12A OP-08E/OP-12E			OP-08B/OP-12B OP-08F/OP-12F			OP-08C/OP-12C OP-08G/OP-12G			
Parameter	Min	Typ	Max	Min	Typ	Max	Min	Typ	Max	Units
Input Offset Voltage	—	0.07	0.15	—	0.18	0.30	—	0.25	1.0	mV
Offset Voltage Drift	—	0.5	2.5	—	1.0	3.5	—	1.5	10	$\mu V/^\circ C$
Input Offset Current	—	0.05	0.20	—	0.05	0.20*	—	0.08	0.50	nA
Input Bias Current	—	0.80	2.0	—	0.80	2.0*	—	1.0	5.0	nA
Output Voltage Swing $R_L = 2K$	± 10	± 12	—	± 10	± 12	—	± 10	± 12	—	V
Common Mode Rejection Ratio	104	120	—	104*	120	—	84	116	—	dB
Power Supply Rejection Ratio	104	120	—	104*	120	—	84	116	—	dB
Power Consumption	—	9	18	—	9	18	—	12	24	mW

*For OP-08B/08-12B

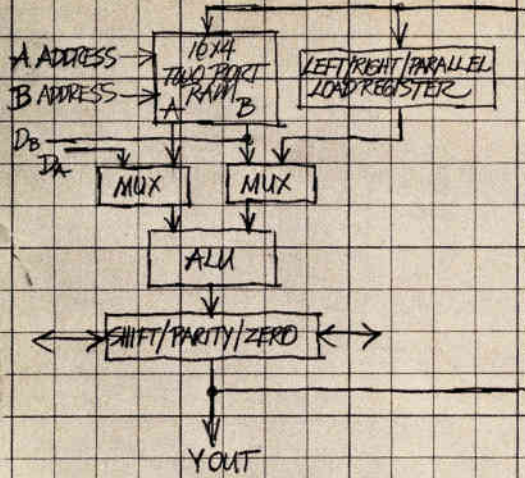

THE AM2903 HAS 2 DATA INPUT PORTS INSTEAD OF 1, AND THE DATA SHIFTER OCCURS IMMEDIATELY AFTER THE ALU INSTEAD OF AT THE RAM INPUT. THESE 2 CHARACTERISTICS MAKE THE REGISTER FILE EXPANDABLE, COMMON FUNCTIONS SUCH AS MULTIPLY, DIVIDE, NORMALISE, AND ARITHMETIC SHIFT ARE BUILT INTO THE PART, SAVING BOTH HARDWARE AND MICROCODE OVER OTHER DEVICES.

THE AM2903 ARCHITECTURE DIFFERS FROM THE AM2901 IN ONLY 2 WAYS.

Advanced Micro Devices' new Am2903. It's a four-bit CPU slice with sixteen internal working registers, two address architecture, multi-function arithmetic logic unit and shifting logic.

AND NOW, THE SUPERSLICE.™

And if that's not enough, hang on.

The Am2903's register file is expandable. If sixteen registers aren't enough, add as many working registers as you want and still retain the two-address architecture.

For those of you who think two-address architecture isn't enough, we made three-address operation possible in the Am2903. For those of you who hate using SSI and MSI, we put all the extra hardware to do 2's complement multiply and divide right inside the chip.

And we couldn't resist a few extra touches like built-in, floating-point normalize and parity.

Call, write or wire Advanced Micro Devices.

The magic word is Superslice.™

Advanced Micro Devices



Multiple technologies. One product: excellence.
901 Thompson Place, Sunnyvale, California 94086
Telephone (408) 732-2400

MARK IT!

R6500 offers innovative architecture and technology.

The 8-bit R6500 is produced with N-channel, silicon gate, depletion load technology and innovative architecture. The result is smaller, faster chips to keep your system costs down and performance up.

A family of ten software compatible CPUs in 28- and 40-pin DIP packages give you the most cost-effective fit for your application. Prove it to yourself — Price it!

R6500 is designed for greater memory and I/O efficiency.

Of the leading NMOS microprocessors, only the R6500 has 13 addressing modes and true indexing capability. More addressing modes coupled with an advanced instruction set makes programming the R6500 easy and efficient. Fewer program steps means lower memory cost and faster program execution.

R6500 memory-managed I/O eliminates performance bottlenecks associated with the separate I/O buses, I/O commands and register overhead required by other microprocessors.

A broad selection of memory, I/O and combination memory-I/O-timer circuits are available. And Rockwell is presently delivering the industry's first fully static 32K ROM — the R2332 — and the industry's fastest 32K ROM — the R2332-3.

SYSTEM 65 gets you started for less.

SYSTEM 65 Microcomputer Development System is efficient and easy-to-use and is equipped with dual mini-floppies. It's priced at only \$4800.

ROM-resident SYSTEM 65 firmware features a two-pass assembler, text editor and symbolic debug/monitor package. Current loop, RS-232C, printer and scope sync ports are also provided. The optional USER 65 (User System Evaluator) module extends the power of SYSTEM 65 for in-circuit emulation.

Other design support includes KIM-1, TIM, timesharing cross-assembler, complete documentation and extensive applications engineering.

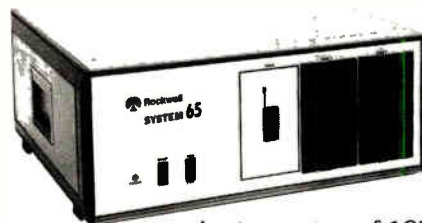

Industry researchers say the multiple-sourced 6500 outshipped the Z-80, 6800 and 8085 during the

last quarter of 1977. Benchmark it!

For more information, contact your nearest Rockwell distributor or Rockwell International GmbH, Microelectronic Device Division, Fraunhoferstrasse 11, D-8033 Munchen-Martinsried, Germany. Phone: (089) 859-9575. Or Rockwell International Overseas Corp., Ichiban-cho Central Building, 22-1 Ichiban-cho, Chiyoda-ku, Tokyo 102, Japan. Phone: 265-8808.

BENELUX
Famatra
P.O. Box 721
Breda, Holland
Ginnekenweg 128
(076) 13 34 57

FRANCE
REA
9 Rue Ernest Cognacq
92301 Levallois-Perret
France
(01) 758-11-11

ITALY
Dott. Ing. G. De Mico S.P.A.
Via Manzoni 31
20121 Milano
Italy
(02) 65 31 31

NORWAY, SWEDEN,
DENMARK, FINLAND
Micronor
Box 96
1321 Stabbekk, Norway
(02) 54 51 30

SPAIN
Comelta
Orense 9-5 0 Iza.
Madrid-20, Spain
(01) 254-3030

SWITZERLAND
Aumann & Company AG
Forchstrasse 282
8029 Zurich
Switzerland
(01) 53 54 00

UNITED KINGDOM
Pelco Electronics, Ltd.
Enterprise House
83-85 Western Road
Hove
Sussex BN31JB
England
0273-722155

WEST GERMANY
System Kontakt
Siemensstrasse 5
7107 Bad Friedrichshall
Germany
07136 5031

JAPAN
Matsushita Electric Trading Company
P.O. Box 18 Trade Center
6th Floor World Trade Center Bldg.
No. 4-1 Hamamatsu-cho 2-chome
Minato-ku, Tokyo 105
Japan
(03) 435-4552
Telex: J2 4647 (Matsuelo)

Marubeni Corporation
4-2 Ohtemachi 1-chome
Chiyoda-ku, Tokyo
Japan
Tokyo 282-3412

Matsushita Electric Trading Company
71 Kawaramachi 5-chome
Higashi-ku, Osaka 541
Japan
Osaka (06) 204-5563
Telex: J63380



Rockwell International

...where science gets down to business

Circle 12 on reader service card

TO-5 RELAY UPDATE:

Solve your energy crisis with TO-5 relays

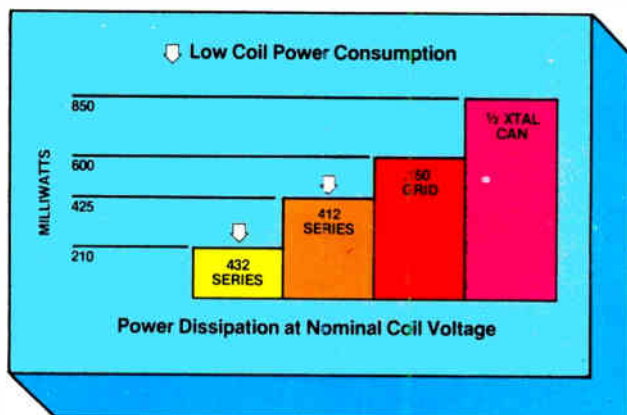

Subminiaturization and pc board compatibility — two obvious advantages of Teledyne TO-5 relays. But there's another outstanding advantage: low coil power consumption. This feature is best illustrated in the above graph which shows our TO-5 relay power savings compared to other miniature relays. The Teledyne 412 Series dissipates about 30% less power than the .150" grid relay, and 50% less than the 1/2 crystal can. Our sensitive 432 Series is 65% less than the .150" grid. And 75% less than the 1/2 crystal can.

This means you can save over 6 watts in a typical system using, let's say, ten TO-5 relays. In the end, you gain significant advantages in terms of thermal and power supply considerations that can help prevent an "energy crisis" in your system.

Our complete line of TO-5 relays includes military and commercial/industrial types, with virtually all military versions qualified to established reliability MIL specs. For complete data, contact Teledyne Relays — the people who pioneered the TO-5 relay.

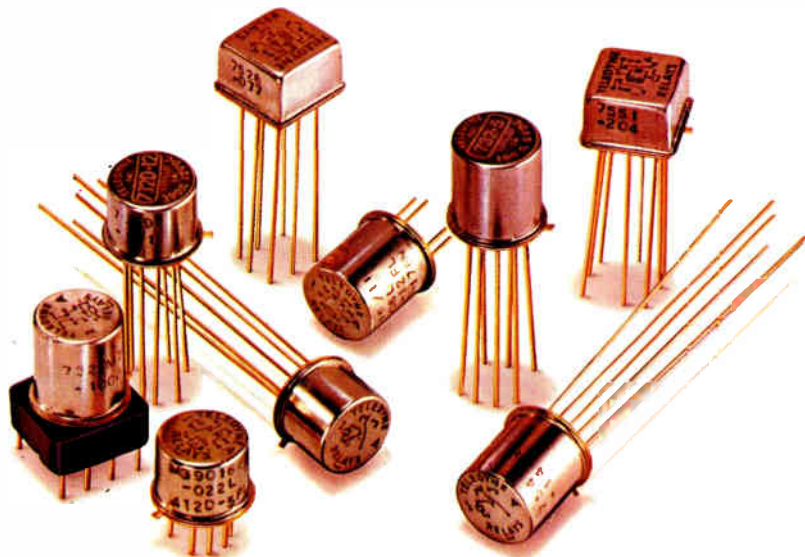

- **Hybrid "T" Series**
SPDT & DPDT types with internal transistor driver and suppression diode
- **"D" and "DD" Series**
Military and commercial/industrial versions with internal suppression and steering diodes
- **Maglatch Series**
SPDT, DPDT, and 4PST magnetic latching types
- **Centigrad® Series**
World's smallest relay — only .225" (5.72mm) high x .370" (9.40mm) square
- **Hi-Rel Series**
Screened versions for space flight applications (NASA qualified)
- **High Environment Series**
Hi-temperature, Hi-shock, and Hi-vibration types

 **TELEDYNE RELAYS**

3155 West El Segundo Boulevard, Hawthorne, California 90250
Telephone (213) 973-4545

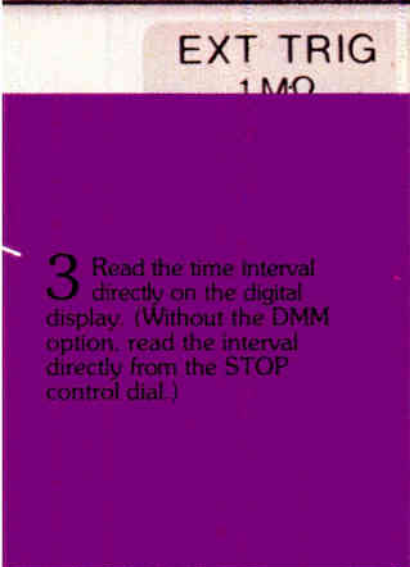

3 Read the time interval directly on the digital display. (Without the DMM option, read the interval directly from the STOP control dial.)

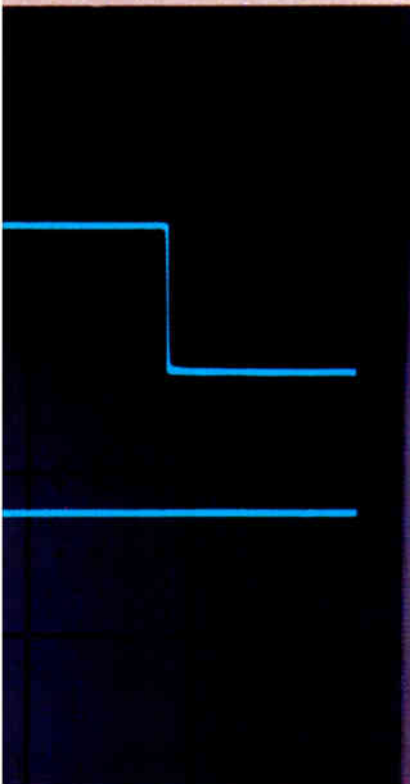

For improved Δ -time measurements, plus autoranging AC/DC volts, amps and ohms ...

HP's the Answer.

Now you can choose from two new scopes with improved Δ -time capability: The 200 MHz **1715A** priced at \$3100* or the 275 MHz **1725A** for \$3450*. Both offer an optional built-in DMM for direct Δ -time readout, plus autoranging AC/DC volts, amps, and ohms.

Δ -time measurements are now faster with the 1715A and 1725A. They're more accurate because scope and operator errors are significantly reduced. Plus you have switch selection of channel A or B as the starting point for Δ -time measurements, often eliminating the need to move probes and simplifying trace overlap for zeroing. But you can still select conventional delayed sweep with the flip of a switch, for brighter low-rep-rate traces and convenient trace expansion.

The optional autoranging 3 1/2 digit DMM is priced at \$325* factory installed. Or, for easy field installation, there's a kit priced at \$375*. Another option, HP's "Gold Button" for \$150*, gives you pushbutton selection of either time domain or data domain when the 1715A or 1725A is used with HP's 1607A Logic State Analyzer.

Like all new high-frequency HP scopes, the 1715A and 1725A have switch selectable 50 ohm or 1 Megohm inputs. And the 1725A, with 275 MHz

bandwidth, is the fastest 1 Megohm-input scope available. That reduces the need for active probes when working with fast logic near maximum fan-out.

The story with both of these scopes is user convenience—from front-panel controls to the minimum of adjustments for servicing. Your local HP field engineer can give you all the details.

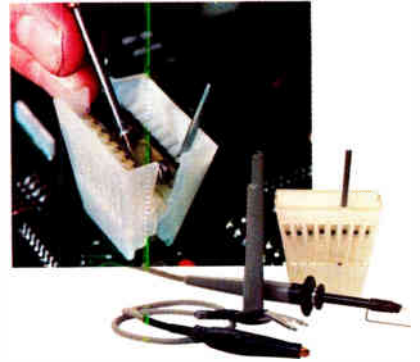

And here's something NEW for scopes. HP's **Easy-IC Probes**. A new idea for probing high-density IC circuits that eliminates shorting hazards, simplifies probe connection to DIPs and generally speeds IC troubleshooting. The probes are standard equipment with these two scopes.

*Domestic U.S.A. price only.

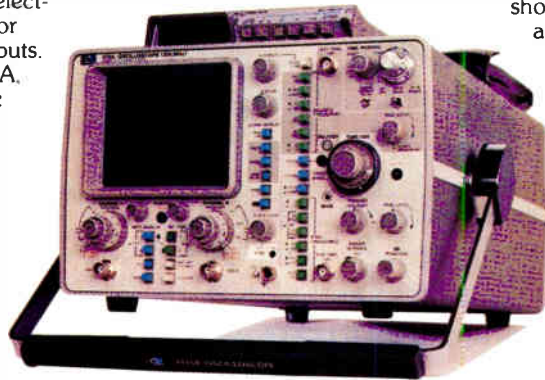

HEWLETT  PACKARD

1507 Page Mill Road Palo Alto, California 94304

For assistance call Washington (301) 948-6370, Chicago (312) 255-9800, Atlanta (404) 955-1500, Los Angeles (213) 877-1282

007/8A

Intel delivers the micro components designers

There's no more efficient way to solve your interface and control requirements for microcomputer-based systems than our peripheral components.

They're single-chip solutions to even the most complicated operations, integrating

"I can accomplish almost any I/O function with one chip using Intel's versatile peripheral interfaces and dedicated device controllers."



up to 22,000 transistors per chip to replace circuit boards full of discrete logic with a single component. Result: you cut parts cost, reduce package count and board space, and simplify both development and operating software.

We've designed each of these peripheral chips to be an intelligent, programmable component in your system and to perform most functions with minimal cpu supervision. The resulting decrease in cpu overhead provides your system with higher performance and increased throughput.

The dedicated function components below are available now, with more on the way. Here's a brief description of their versatility.

8271 Programmable Floppy Disk Controller. Provides full control of up to four standard or minifloppy drives. (Available early 1978.)

8273 SDLC/HDLC Protocol Controller. For SDLC and HDLC communications.

8275 Programmable CRT Controller. Provides fully buffered interface and control of almost any raster scan CRT display.

8278/8279 Programmable Keyboard/Display Interfaces. Keyboard/sensor array input scan, and output scan for LED, incandescent and other displays. 128-key or 64-key input.

8251A Programmable Communications Interface. Industry standard USART for synchronous or asynchronous serial data

transmission, including bisync.

8253 Programmable Interval Timer. Contains three independent 16-bit counters, programmable modes from dc to 2MHz.

8255A Programmable Peripheral Interface. General purpose I/O interface with 24 individually programmable I/O pins.

8257 Programmable DMA Controller. Provides four-channel, high speed direct memory access independent of CPU.

8259 Programmable Interrupt Controller. Handles eight levels of vectored priority interrupt. Expandable to 64 levels.

computer peripheral are talking about.

UPI-41™ is Intel's Universal Peripheral Interface, bringing distributed intelligence to microcomputer systems for the first time.

Actually a highly integrated, user-programmable microcomputer, UPI-41 is a new solution that obsoletes custom LSI and specialized discrete designs for interfacing most low and medium speed peripherals with an MCS-80™, MCS-85™ or MCS-48™ microcomputer.

Intel delivers UPI-41 in two versions that make it easy for you to implement your own designs. The 8741 includes an erasable and reprogrammable 1K-byte EPROM, for development, testing and low volume production. Then the 8041, with masked ROM, provides maximum economy in high volume.

We've taken the UPI-41 concept a step further with the 8278, described at left. The 8278 is the first of several preprogrammed 8041's that we've adapted to specialized applications.

Because UPI-41 is a microcomputer, we've given it the same high level of support we give all our microcomputers. UPI-41 is supported by our

Prompt™ 48 Design Aid, the Intellec® microcomputer development system with resident UPI-41/MCS-48 Macro Assembler. Plus appli-

“And, for my special I/O requirements, Intel's UPI-41 Universal Peripheral Interface is user programmable to control nearly any other peripheral device.”

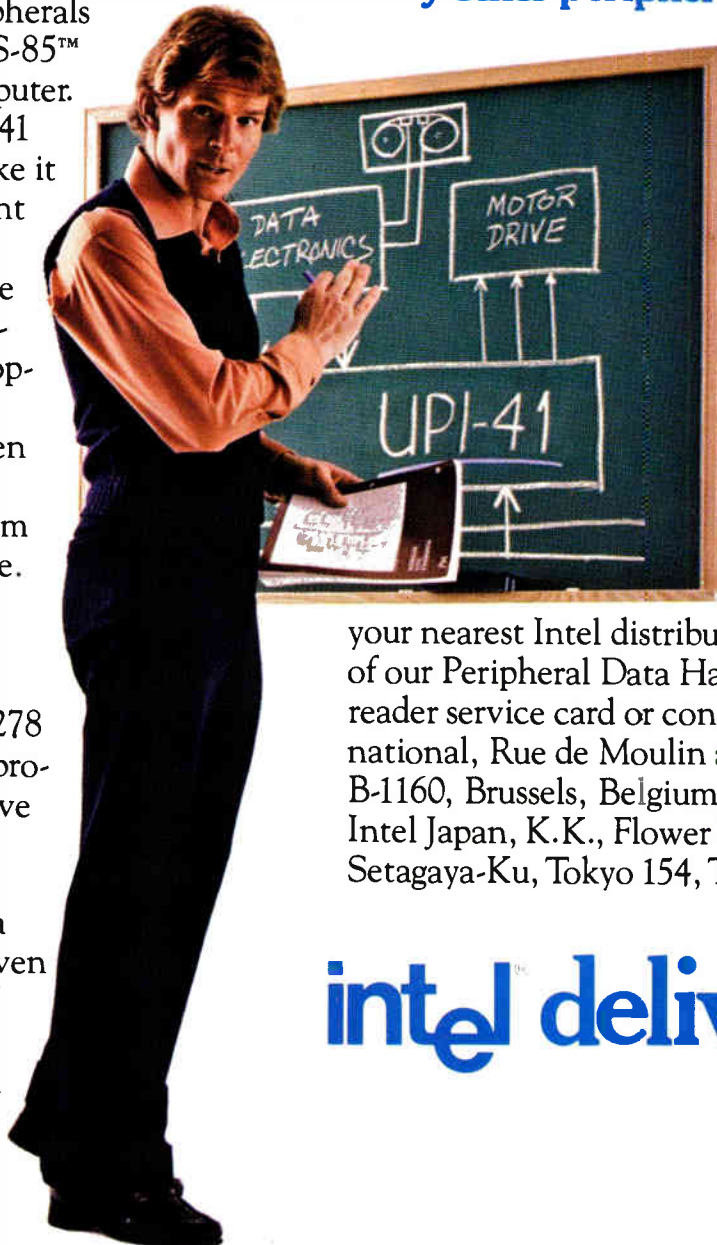

cations assistance worldwide, full documentation, training classes, design seminars and a rapidly expanding users' software library.

Intel's peripheral components, and the MCS-80, -85 and -48 microcomputers they support, are available through

your nearest Intel distributor. For your copy of our Peripheral Data Handbook use the reader service card or contact: Intel International, Rue de Moulin a Papier, 51-Boite 1, B-1160, Brussels, Belgium, Telex 24814; or Intel Japan, K.K., Flower Hill-Shinmachi, Setagaya-Ku, Tokyo 154, Telex 781-28426.

intel delivers.

Massachusetts, technology, and history

It is an economic story that has happened before and will happen again. Yet it is hard to accept the fact that Massachusetts, one of the prime spawning grounds for today's vital electronics technology, is now being called a "hostile environment" for innovative, high-technology companies.

High taxes and a shortage of trained, skilled workers are making corporate life very difficult for the scores of companies that, in self-defense, have banded together into the Massachusetts High Technology Council. The goal of the new group is a basic revamping of the economic climate of Massachusetts—turning around state policies that impede business expansion, convincing legislators of the long-term folly of some laws that treat short-term problems, and working in a host of other areas from education to recruitment.

The kind of problems that are facing electronics companies in Massachusetts are by no means limited to that state. For example, although it has an annual per-capita tax bite that comes to some 22% higher than the national average, New York and California, two other important states for the electronics industries, outpace the Bay State in tax levies.

History has a lesson here. Over the centuries, various emerging technologies have given rise to vital industries and enriched the

communities in which they grew—nearly always at the expense of older technologies and their communities. Massachusetts, with the rest of New England, grew strong on water power and the resultant textile, shoe, and related industries. But times changed, and other parts of the nation—even the world—proved to be more economically receptive to those industries.

That sort of repetition of history—and fairly recent history, at that—is what the High Technology Council wants to avoid while there is still time. The electronics industries are energetic, and some segments can truly be called dynamic. Thus, they can surmount economic obstacles that would hobble other, older industries. Yet no corporate executive wants to do that for long.

While many electronics centers have sprung up around institutions of advanced research, such as universities, there are few geographical limits on where the plants can be located. Thus, unless Massachusetts, New York, and California start taking a realistic look at what is causing the "hostile environment," the stage is set for another large-scale migration of industry.

It is to be hoped that the High Technology Council and similar groups in the other states will be heeded.

ATTACK the hours of work you hate.

Using spec sheets and manufacturer's catalogs to find semiconductor technical information is stealing your valuable time.

But now there's a system that can reduce your reference hours to minutes. Puts technical data on worldwide Microcomputers, Integrated Circuits, Discrete Devices and Optoelectronics components at your fingertips.

The D.A.T.A. BOOKS Electronics Information Series. D.A.T.A. engineers have successfully combined your data needs with standardized values, terms and definitions. Here are the tens of thousands of semiconductors manufactured in the U.S. and around the world—arranged by key parameters for your quick and easy comparison. Fast information that's accurate, dependable, up to date.

Just circle the reader response number. We'll send you our new 10 page brochure explaining the unique time-saving D.A.T.A. BOOKS™ System.

FREE

10 Page Brochure.

Tells how you can eliminate the hours of work you hate.

D.A.T.A. BOOKS

D.A.T.A., INC.

A Cordura Company

45 U.S. Highway 46, Pine Brook, New Jersey 07058

Telephone: (201) 227-3740

Meetings

CLEOS—Conference on Laser and Electro-Optical Systems, IEEE and OSA, Town and Country Hotel, San Diego, Feb. 7-9.

Wincon—Aerospace and Electronic Systems Winter Convention, IEEE, Los Angeles, Feb. 13-15.

International Solid State Circuits Conference, IEEE, San Francisco Hilton, San Francisco, Feb. 15-17.

Computer Science Conference, ACM, Detroit Plaza Hotel, Detroit, Feb. 21-23.

Fifth Energy Technology Conference and Exposition, U.S. Energy Research and Development Administration, Sheraton Park Hotel, Washington, D. C., Feb. 27-March 1.

Nepcon West and Semiconductor Hybrid Microelectronic Symposium and Exhibits, Industrial and Scientific Conference Management Inc. Anaheim Conference Center, Calif., Feb. 28-March 2.

Compcon Spring, IEEE, Jack Tar Hotel, San Francisco, Feb. 28-March 2.

IEA 78—12th Instruments, Electronics, and Automation Exhibition, Industrial & Trade Fairs Ltd. (Solihull, West Midlands), National Exhibition Center, Birmingham, England, March 13-17.

Industrial Applications of Microprocessors, IEEE, Sheraton Hotel, Philadelphia, March 21-23.

International Conference on Physics of SiO₂ and Its Interfaces, American Physical Society, IBM, ONR, and ARPA, IBM Thomas J. Watson Research Center, Yorktown Heights, N. Y., March 22-24.

28th Vehicular Technology Conference, IEEE, Regency Hotel, Denver, Colo., March 22-24.

Computer Architecture Symposium, IEEE, Rickey's Hyatt House, Palo Alto, Calif., April 3-5.

Interactive VAX-11/780: A new computer system with exceptional performance...

VAX-11/780™ is a new, virtual memory, multi-user, multi-language, multi-programming, interactive computer system with extensive batch and real time response capabilities.

It is the product of many man-years of effort layered on top of more experience and more success with interactive computers than that of any other company in the world.

Digital believes the VAX-11/780 is a landmark computer system. It believes the VAX-11/780 is the beginning – of new definitions, new standards, new expectations.

Take performance. Throughput.

Quantity and quality of useful work.

VAX-11/780 will take essentially *any* size program. It has a 32-bit word length, 2 million bytes of physical memory, and more than 4 *billion* bytes of virtual addressing space.

It will operate on that program quickly. Its big cache memory yields an effective cycle time of 290 nanoseconds. With its optional floating point accelerator, it performs double precision floating point 64-bit addition in 1.4 microseconds.

It will move the data with exceptional speed. Its synchronous backplane interconnect, which is its main

control and data path, has a bandwidth of 13.3 megabytes per second. And it checks for parity and errors on each 200 nanosecond cycle for data integrity.

And it even makes the programming efficient. Its new, powerful instruction set is a model of efficient code generation. A FORTRAN DO loop, for example, is one instruction. Calls to subroutines, and returns to the main programs combine up to 15 operations into just one instruction. And for time-critical applications, one instruction will store and another will restore the contents of all general-purpose registers simultaneously.



digital
VAX11
780

..unmatched reliability, availability, maintainability...

By design, the interactive VAX-11/780 is the most reliable, available, and maintainable computer system of its general class that has ever been built. It is another standard against which others must be measured.

Reliability, availability, and maintainability features are found in the hardware architecture, the software architecture, the individual component and board designs, and in the cabinetry — all supported by new and improved diagnostic aids.

Objective: keep the system running. If it fails, find the fault quickly, fix it, get the machine up and running again. Protect that data.

Four hierarchical access modes protect the system information. A diagnostic console contains an LSI-11 microcomputer. Automatic consistency and error checking detect abnormal instruction uses or illegal arithmetic conditions. Integral fault detection and maintenance features detect errors on memory, on disks, keep a history of recent bus activity, detect hung machine conditions, and allow automatic restart recovery.

Parity checking for the integrity of the data is performed on the synchronous backplane interconnect, the MASSBUS and UNIBUS adaptors, memory cache, address translation buffer, microcode, and writable diagnostic control store. There are fault tolerance features. There are remote



diagnosis capabilities. There are system verification test packages. There are functional and fault isolation diagnostics.

There are operating system consistency checks, redundant recording of critical information, uniform exception handling, on-line error logging, unattended automatic restart capabilities.

There are power loss, temperature and air flow sensors, cabling located away from the modules, a modular power supply with malfunction indicators...

Circle 29 on reader service card

World Radio History

digital
**VAX11
780**

Major Features of the VAX-11/780 system

CPU 32-bit word length • Can directly address 4 billion bytes of virtual memory • User program can be up to 32 million bytes • Powerful instruction set includes integral floating point and context switching instructions • Instruction set supports 9 fundamental addressing modes with single instructions simulating entire high level language constructs • 8K byte write-through memory cache results in effective 290 nsec memory access time • Supports state-of-the-art paging memory management with 4 hierarchical protection modes each with read-write access control • 16 32-bit general-purpose registers • 32 interrupt priority levels, 16 for hardware and 16 for software • 2 standard clocks, programmable real-time and time-of-year with battery backup for automatic system restart operations • 12K bytes of writable diagnostic control store.

The Console Subsystem Intelligent microcomputer LSI-11 with 16K bytes of read-write memory and 8K bytes of ROM, floppy disk, and terminal • Optional port for remote diagnostics • Fast diagnosis, both remote and local, simplified bootstrapping, improved distribution of software updates.

Main Memory Subsystem ECC MOS memory built using 4K MOS RAM chips • Memory controller includes request buffer, increasing system throughput, eliminating most need for interleaving • Minimum memory configuration 128K bytes – maximum up to 1 million bytes per controller, two controllers allowed per system, for total of 2 million bytes physical memory.

Input/Output Subsystems Synchronous Backplane Interconnect (SBI) is main control and data transfer path. SBI capable of aggregate throughput rate of 13.3 million bytes per second • Error and parity checking every cycle for data integrity • SBI protocol uses 30 bits for address, allows both 32-bit plus parity and 64-bit plus parity data transfers • UNIBUS connected to SBI permits interfacing of general-purpose peripherals and user devices • Buffered UNIBUS adapter pathway between UNIBUS and SBI has throughput of 1.5 million bytes per second • MASSBUS connects to SBI via buffered adapter, permits interfacing high performance mass storage peripherals with parity checking • MASSBUS adapter throughput rate is 2 million bytes per second • Four MASSBUS adapters permitted per system.

Software System Designed for many applications including scientific, time-critical, computational, data processing, batch, general-purpose timesharing • Process-oriented paging for execution of programs larger than physical memory, transparently to the programmer • Memory management facilities controlled by user – can lock pages into working set, never to be paged out, or lock into physical memory, never to be swapped out • Sharing and protection at page level (512 bytes) • Four hierarchical access modes • Interprocess communication through files, shared address space, or mailboxes • System management facilities • DIGITAL command language and MCR command language provided • File and record management facility includes sequential and relative file organization, sequential and random record access • Supports Files-11 on disk structure level 2 • Program development capability includes an editor, language processors, symbolic debugger • Support provided for FORTRAN IV-PLUS/VAX and MACRO/VAX in native 32-bit mode, COBOL-11 (V3) and BASIC-PLUS-2 (V1) in compatibility mode • Scheduler is priority-ordered, round-robin/time-slicing, event driven • 32 levels of software process priority for fast scheduling • Networking capabilities are supported through DECnet for process-to-process, file access and transfer, and down-line loading • Batch facilities include job control, multi-stream, spooled input and output, operator control, conditional command branching and accounting • Command procedures are supported by command languages.

PDP-11 Compatibility Provides system-wide compatibility supporting execution of the PDP-11 instruction set (with exception of privileged and floating point instructions) in compatibility mode • Applications Migration Executive allows RSX-11M/S non-privileged tasks to run with minimal or no modification • Host Development Package allows creation and testing of RSX-11M tasks • Same data format • Same source-level programs • High level languages • Files-11 on disk structure, level 1 • RMS file access methods including ISAM • DIGITAL Command Language and the RSX-11 MCR command language.

Reliability, Availability, Maintainability Remote diagnostics by means of integrated diagnostic console permits diagnostics, examination of memory locations from remote terminal • Automatic on-line error logging • Automatic restart capabilities after power failure or fatal software error • Users continue to use system with failed hardware components • Consistency and error checking detects abnormal instruction uses or illegal arithmetic conditions • Improved packaging and cabinetry increase hardware reliability and ease of maintenance • On-line diagnostics available and run under operating system.

digital

Digital Equipment Corporation
146 Main St., Maynard, MA 01754
Attention: Communication Services NR-2/2
I want to know more about Digital's VAX-11/780:

- send me your colorful, new VAX-11/780 brochure.
- send me your detailed System Summary.
- please have a Digital sales representative call me.

Name _____

Title _____

Company _____

Address _____

City _____

State _____ Zip _____

Telephone _____

VAX11 780

World Radio History

Circle 31 on reader service card

Data General to unveil powerful system

What's believed to be the most powerful computer system yet offered by Data General Corp. will be announced next week. Although officials of the Westboro, Mass.-based minicomputer maker are not talking in advance, the machine is believed to be called the Eclipse 600 **and to be competitive with medium-scale mainframes for up to 64 users.** The machine will probably be announced with 1 megabyte of main memory implemented in either MOS 4,096-bit random-access memories or core, whichever is desired. But a novel approach to input/output techniques is what will give the new Eclipse entry its high throughput for large numbers of users in batch and real-time programs. Part of the I/O approach is incorporation of a multiplexer link between main memory and fast peripherals that allows data transfer at up to 10 megabytes per second.

Another ingredient in the I/O scheme is a data channel that handles communications between medium-speed peripherals, such as magnetic tape and cartridges, and also functions as the interface between the main processor and a front-end processor that relieves the main unit of the task of buffering slow-speed peripherals. The main processor's instruction set includes 16-bit single-word and 32-bit double-word instructions.

First color CCD TV camera shown by RCA

Engineering models of the first color video camera to use charge-coupled devices were to be shown by RCA Corp. at the 39th National Audio-Visual Convention and Exhibit in Houston, Jan. 14–17. The camera, aimed at the audiovisual market, **offers four major improvements over vidicon models,** says RCA. First, it does not suffer from lag and image burn; second, it weighs only 3.6 pounds; third, it is completely solid-state and reliable; and fourth, it is low-powered.

Hard disks to appear as floppy replacements

This year will see the birth of a new computer peripheral—a disk-drive memory subsystem with a nonremovable hard platter. About the size of a standard floppy disk—8 inches—it **stores from 10 to 100 megabytes,** compared with about 1 megabyte for the floppies. At work on such a drive, which will occupy no more space than a floppy and cost under \$2,000, versus about \$700 for a floppy, are Shugart Associates Inc., IBM Corp., and at least two small firms. Although the approaches of the various manufacturers differ—some will use thin-film heads and media, while others will stick to standard Winchester technology—all have confidence in the success of the drive, since they believe it will replace the many less-reliable floppies backing up minicomputer systems for less per bit.

Laser trimmer for thick films to up throughput

A new \$100,000 laser trimming system for thick-film hybrids expected to be unveiled next month by Teradyne Inc. is designed to boost the already substantial throughput of its predecessor, the W311. The Boston-based manufacturer of semiconductor and circuit-board testing and manufacturing equipment had the updated unit operating unidentified and without fanfare at last October's Baltimore meeting of the International Society of Hybrid Microelectronics. In those tests, which simulated a production environment, the system trimmed more than 400,000 resistors and networks in less than 10 hours, Teradyne officials say. **That represents about \$1,500 in revenue for a thick-film hybrid supplier,** the officials add.

Data General to bring PL/1 to minicomputers

Under test for the last nine months at the University of California anthropological lab, a PL/1 compiler will be unveiled soon by Data General Corp. for the Westboro, Mass., firm's Eclipse minicomputers. The sophisticated high-level language, developed by IBM Corp., **combines some of the better features of Fortran and Cobol.** PL/1 has found its home mostly in batch-oriented mainframes, though IBM offers it for the Series/1. Now, Data General has optimized PL/1 for the mini, and it expects both of its major competitors—Digital Equipment Corp. and Hewlett-Packard Co.—to soon follow suit.

RCA to discuss flat-panel display at SID session

A 30-by-40-inch color TV flat-panel display about 2 inches thick is under development at RCA's David Sarnoff Research Center, Princeton, N. J. **The display uses internal electron multipliers to create free electrons, which are accelerated to strike the phosphor screen.** The display will be the subject of a full session at the upcoming Society for Information Display Conference in San Francisco, April 18 – 20.

2 European firms in deals with U. S. companies

Transatlantic electronics cooperation is getting another boost with a marketing agreement between the French firm Adret Electronique and the Comstron-Seg Corp. of Freeport, N. Y., and with the purchase of Interdesign Inc., Sunnyvale, Calif., by Ferranti Ltd. of Great Britain. Adret, a small instrument maker specializing in top-of-the-market frequency synthesizers, is teaming with Comstron to find a sizeable niche in the U. S. market. Comstron will distribute Adret's line of generator synthesizers and could start making them if sales warrant. They expect \$500,000 in synthesizer sales this year, 50% more than Adret managed on its own in 1977. With the Ferranti-Interdesign tieup set [*Electronics*, Jan. 5, p 62], **the British firm will market its new subsidiary's Monochip in Europe,** and its uncommitted-logic-array chips will be designed and its wafers masked in Sunnyvale. Interdesign founder Hans Camenzind is staying on as part-time consultant, while Robert W. Townley moves up to president and Alan Shepherd, formerly Ferranti's general manager for components, takes over the job of chairman.

Fast fax machines due from Burroughs

Graphic Sciences Inc., a subsidiary of Burroughs Corp., will announce soon two facsimile machines and a network communications protocol it calls Dexnet. The machines, according to International Resource Development Inc., a market-research firm, will transmit a page in less than a minute, joining such machines now supplied by Rapidfax, Dacom, and 3M. According to the New Canaan, Conn., research firm, the two new machines will be competitive with other U. S. machines. **However, even cheaper machines from Japanese manufacturers** including NEC, Panafax, and Hitachi, are expected to bow later this year.

Addenda

Sony Corp. hopes to open its **video technology center in the San Francisco Bay Area by year's end.** The center will specialize in nonconsumer applications of video cassette recorders. . . . Leeds & Northrup Co. of North Wales, Pa., **has acquired Hy-Cal Engineering of Santa Fe Springs, Calif.,** a \$2.5 million producer of temperature-measuring instruments.

abbott

POWER SUPPLIES

Come to the specialist.

We started out pretty small back in '61. But we were big on product quality and reliability. Had to be. Uncle Sam was our only customer. Over the years we stuck with our own technology. We grew. Became specialists. And we kept on improving our power supplies.

It all paid off. Just look at Abbott today.



Militarized Power Supplies — Our early bread-and-butter line has grown to over 1500 versions. Some we stock. Yet we're equipped to provide fast delivery on any number of high efficiency, hermetically sealed, single or dual output power supplies and switcher modules. That includes our popular 60 and 400Hz and DC versions with outputs from 3VDC to 740VDC, 1 to 250 Watts. And prices go as low as \$174 for 2-4 units.

For Catalog Circle Card Number 100

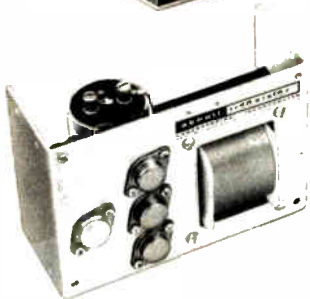

Industrial Power Supplies — Ours isn't a big line yet — only 279 models. But you won't find a better quality of OEM power modules anywhere. (It's just our hi-rel way of thinking.) We provide covered/open frame, AC to DC single, dual and triple output versions, with outputs of 5 to 36VDC, 0.5 to 320 Watts. Plus DC to AC converters with 50 to 60Hz outputs. Competitively priced? You bet. As low as \$35 for up to 24 units.

For Catalog Circle Card Number 101



Transformers — For the do-it-yourself power supply designer who wants our kind of quality for his own military, industrial and pcb application. If you're one of them, we offer over 800 standard transformers, with instructions on how to specify for your custom units. Included are 60 and 400Hz, single phase input versions. Prices start as low as \$5.10 for up to 9 pieces.

For Catalog Circle Card Number 102

See Power Supply Section 4000, and Transformer Section 5600, Vol. 2, of your EEM catalog; or Power Supply Section 4500, and Transformer Section 0400, Vol. 2, of your GOLD BOOK for complete information on Abbott products.

abbott transistor

LABORATORIES, INCORPORATED

General Offices
5200 W. Jefferson Blvd., Los Angeles 90016
(213) 936-8185 Telex: 69-1398

Eastern Office
1224 Anderson Ave., Fort Lee, N.J. 07024
(201) 224-6900 Telex: 13-5332



Hard soft- ware.

No, that's not a contradiction in terms.
It's a new ROM.

A ROM so big (65K) it can hold complete high level language interpreters.

Hardware that does the work of software. We call this concept Silicon Software.

Officially known as the MM5235 MAXI-ROM,[™] the little devil will hold more than enough programmed memory (8K Bytes) for most microprocessor applications.

A perfect match for 8-bit microprocessors such as our 8080A, the MAXI-ROM can be ordered pre-programmed with LLL (Lawrence Livermore Lab) BASIC interpreter for the SC/MP microprocessor system (order INS8295).

The 65K MAXI-ROM has completely static operation, and does not require a clock.

National offers a full line of ROMs, from 1K to 65K with a fast five-week turn-around (guaranteed) on low density units from the time the pattern code is received to delivery.

So get your pen out.

Don't forget now.

National Semiconductor GmbH
808 Fuerstenfeldbruck
Industriestrasse 10
West Germany

Gentlemen, please send me further information about your:

- new 65K MAXI-ROM
- entire ROM line
- 8298 LLL BASIC for 8080
- 8295 NIBL BASIC for SC/MP

Name _____

Address _____

City _____ State _____ Zip _____

 **National Semiconductor**

CDC to cash in on peripheral needs of IBM minicomputer

Range of units for Series/1 coming next June will be aimed at big end users; sales could reach \$250 million

Long the leading independent supplier of computer peripherals, Control Data Corp. has found a back door to the market in end-user minicomputer peripherals. It plans to offer a whole array of them for IBM Corp.'s Series/1. CDC figures that its breadth of products and services gives it an edge on its competitors, and it is spending several million dollars to insure that its designs underscore that advantage.

IBM opened the door for sales of the end-user miniperipherals when it announced its new minicomputer in November 1976. With it came the message that the Series/1 could accept a large variety of attachments and that interface details would be readily available to potential suppliers. For the first time, IBM was inviting independent firms to engage in hardware and software development for the machine. The new stance for the computer giant, which has always protected its products by trying to sell them in complete systems, is apparently key in a plan to boost its minicomputer market share from the present 4% to 15% by 1980, according to industry sources. The firm counts on the availability of peripherals from a maker like CDC to promote sales of its minicomputer.

"IBM may be playing in the same ballpark, but it's playing the game in a different way," says Phillip W.

Arneson, vice president of CDC's Miniperipheral Systems and Terminals division, a group set up in Roseville, Minn., a suburb of Minneapolis (see p. 14), to respond to the IBM lure. His new division will go after big sophisticated users—banks, utilities, retailers, and insurance and manufacturing companies—because "they usually have internal hardware and software capabilities and have been buying peripherals and miniperipherals from independent suppliers." Large companies like these own the bulk of the 3,000-plus Series/1s installed in the U.S. in 1977, says Lee Walther, a Cupertino, Calif., market consultant. He expects this year's shipments to exceed 5,000 in the U.S. and 3,000 more worldwide.

CDC will show in June at the National Computer Conference in Anaheim, Calif., what it claims will be the broadest line of high-performance peripherals for the IBM minicomputer. "We don't think anyone is positioned as well as we are," says Arneson, pointing to CDC's existing miniperipherals, which are now sold only to manufacturers of original equipment.

The opportunity to capitalize on the Series/1 probably knocks loudest on CDC's door. No other company has the financial resources, service network, and the broad product line, which includes printers, terminals, and disk and tape drives. But it is not going to be an easy sell—Control Data will have to persuade IBM users to split up their buys. Says

Custom I²L key to CDC challenge

To get ready for the Series/1 market, CDC has spent over \$1 million since last August on choosing a half-dozen or so miniperipherals from its OEM catalog and reconfiguring them, largely with new controllers for IBM end users. "And it will probably take several million dollars more," remarks Gordon R. Brown, senior vice president for marketing and planning for CDC's peripheral products organization. The money has gone primarily to develop microcircuits for the controllers necessary to interface the existing peripherals to IBM's mini. The firm decided to implement its controllers with large-scale integrated circuits, which will be able to fit onto a single card that can be slipped into the card cage provided by IBM, rather than requiring the stand-alone controllers that other Series/1 peripheral suppliers have usually been working with.

Each card consists of a Z80A microprocessor and four integrated-injection-logic chips that handle data and address buses, along with a handful of off-the-shelf circuits that dedicate the card to the peripheral being driven. The I²L chips will be built by CDC's Microcircuits division, a Minneapolis facility that produces about a million parts each month, although the firm is also searching out an alternate source. Controllers are in design now for a conventional keyboard display terminal, a floppy disk, 10- and 20-megabyte fixed-head disks, 80- and 150-megabyte storage modules, and 70-, 720-, and 1,130-line-per-minute matrix and band printers—the products that will be introduced in June.

consultant Walther: "CDC will now have to get in bed with systems houses, software houses, and contract-programmers—and that's expensive marketing."

The cornerstone of CDC's strategy is to sell the user a complete peripheral array—with maintenance—which it hopes will lock out other independent suppliers. "We think that most customers will want a complete product line with a single maintenance contract" that could include the mini, says Arneson. That is critical in the distributed-processing environment at which the Series/1 is aimed, where equipment is scattered over a wide distance.

Will it build a processor to emulate the Series/1? CDC says no. "Why should we go into a major design effort to build a minicomputer to compete with IBM when IBM has invited us to participate in the major part of the system?" asks

Larry Eaton, marketing manager for the new peripherals. Nor does Control Data plan to start selling mini-peripherals to non-IBM end users. "It would disrupt our OEM business," Arneson says.

CDC is clearly joining IBM in its fight against the dominant minicomputer firms like Digital Equipment Corp., Data General Corp., and Hewlett-Packard Co. At stake is a market that the industry figures will be massive. Estimates generated by independent research firms suggest that 50,000 to 100,000 Series/1 systems will be shipped in 1982. And CDC thinks its share of Series/1 business, with system prices averaging \$55,000, will be sizeable. "We expect it to be as large as our OEM business in about five years," asserts CDC's Gordon R. Browne, senior vice president. The firm's OEM revenues are estimated to be over \$250 million annually. □

Litigation

Intel sues U.S. Copyright Office over registering microprocessor chips

The cost of developing complex new devices has become so high that Intel Corp. is launching a legal war to protect its products from piracy. Intel fired its first shot on Dec. 21 in San Francisco's Federal District Court, when it filed suit to force the U. S. Copyright Office to grant it a registered copyright for its 8755 erasable programmable read-only memory.

By getting such copyright protection, Intel seeks as much legal muscle as possible to prevent unauthorized second sourcing, or "the photographic ripoff," as it calls it, and to force competitors to take the time to develop their own competing devices. The goal is to protect Intel's market lead in certain new products, says Roger S. Borovoy, the company's general counsel and secretary, at company headquarters in Santa Clara, Calif.

Warning to industry. He also fires a warning shot across industry's

bow. "The first unauthorized copy of Intel's current generation of products will be the next subject of Intel's lawsuit," he says. This means everything after the 8080 microprocessor, including the newer microprocessors and major supporting peripheral chips.

"The reason we are doing this is that the cost of developing new circuits is skyrocketing," Borovoy says, noting that Intel spent \$28 million on research and development for the fiscal year just ended, up from \$21 million a year ago. Obviously, if a competitor can copy a part instead of developing its own version, it can get into the market sooner and spend a lot less to boot.

Borovoy concedes that, except for one instance, Intel designs have not been pirated yet. However, "we're concerned that the equation will shift so that it will become advantageous for competitors to copy our designs rather than lay out their

own," he says. He knows of a Japanese company that can take a chip and return a full set of masks within 30 days for a mere \$20,000 to \$30,000.

What Intel is attacking with its suit is the Copyright Office's long-held position that chips themselves cannot be copyrighted. Intel wants not only a copyright but a registered copyright, which it feels will give it greater legal protection. To force this issue, Intel submitted a set of Mylar masks representing engineering drawings as an "unpublished work," which the Copyright Office accepted for registration. When Intel later deposited two 8755 chips as the "published work," the Copyright Office refused to accept them. Intel is suing to have the chips themselves copyrighted as published works.

Chipping away. If Intel wins, then "it chips away at the Copyright Office's position," Borovoy says. But he adds that Intel has another shot waiting to be fired. It also sent two 2716 erasable programmable read-only memory chips to the Copyright Office for a registered copyright without first submitting engineering drawings. As expected, the office refused to accept them, too, Borovoy says. He says he will wait with the 2716 issue until he sees what happens with two allied cases in other fields or "an infringer [or unauthorized copier] turns up." Borovoy expects his case in Federal District Court to go on for at least a year.

So far, the only chips that can be copyrighted are read-only memories containing computer programs, Borovoy says. These are treated like magnetic tape or disks, provided that the computer printout is submitted, too. Overall, Intel's plan is to get registered copyright protection under both the old law and the new Copyright Act of 1976, which went into effect on Jan. 1, for the appropriate products. Borovoy, a Harvard Law School graduate, is well armed to lead the effort. Before joining Intel, he was with Fairchild Camera and Instrument Corp., where he directed Fairchild's acquisition of patents for its planar process.

At Intel, he hopes the company's strong declaration of its intent to sue infringers will be sufficient to scare them off. "We have a war chest budgeted to fight this all the way to the Supreme Court, he says. "All we need is a defendant." □

Photovoltaics

60-kW station largest so far

Slated to be operating in southern California by the end of this year, a proposed solar photovoltaic power-generating station looks to break new ground for this kind of energy. At 60 kilowatts, it will be the largest station of its kind, with some 190,000 solar cells mounted in stationary panels covering half an acre.

In addition, to get maximum power at all levels of sunlight, its circuitry will closely match the impedances of the solar array and the subsystem that converts the direct current into alternating current, thus boosting output 25%. Also, any excess power generated will be fed into public utility lines.

Perhaps of even more interest is the little-known company that designed the system. Delta Electronic Control Corp. of Irvine, Calif., an eight-year-old firm with 65 employees and \$2.5 million annual sales, won the award from the Army's Mobility Equipment Research and Development Command against much larger competitors—Xerox Corp.'s Electro-Optical Systems division and Motorola Inc.'s Government Electronics division.

Circuit similarity. The Army will not say why it chose Delta over heavyweight opposition, other than "they're the best qualified." But Delta president Charles W. Jobbins thinks he knows the main reason. "It's the similarity of the solar station's circuitry to that of power inverters in our line of uninterruptible power systems," he says. Delta makes such units for computer, medical, and military installations.

The military's solar arrays

The 60-kilowatt solar station being built for the Air Force is the sixth and largest project in the Department of Defense's two-year program for military applications of photovoltaic systems. Even so, it is still too early to say whether the program has reached its goal: "to promote an awareness of the technology throughout DOD and the services," according to Donald Faehn, project manager at the Army's Mobility Equipment Research and Development Command, Fort Belvoir, Va.

One reason: photovoltaic options are not yet available to DOD users because of their high cost, he says. But in the meantime, the effort is giving the DOD pertinent experience so that when costs do come down, the services can start ordering with some idea of photovoltaic capabilities.

Earlier projects are: 35- and 74-(peak)-watt radio relay stations, including battery charging; a 150-W charger for nickel-cadmium batteries; a 12-kW generator for a remote radar at the Naval Weapons Center, China Lake, Calif.; a 10.8-kW array for a water purification plant at Fort Belvoir, Va.; and a 2.4-kW telephone-communications power system.

Ranging from 1 to 400 kw, the systems supply "clean power" (without line noise and variations caused by ac sources) and can switch to internal batteries when necessary.

"Peak power tracking" is what the photovoltaic industry calls matching a solar array to its load on spacecraft. But Jobbins notes his arrays do not actually move with the sun. "Rather, it refers in our case to tracking peak power available by matching impedances," he says. The change from hazy to bright sunlight, for instance, can cause impedances of the solar array and the load to vary by from 5 to 30 milliohms. "Our power supplies typically invert widely varying inputs in the same kind of problem," he adds.

Another important aspect of the Delta station is its ability to convert dc output of the solar array into ac for utility lines. Here, Delta has spent its own funds in work with Southern California Edison to iron out problems—reportedly, those of introducing excessive interference into utility lines. "This is a key point for the Army, and we had to demonstrate we can do it," says Jobbins.

JPL cells. Delta will start putting the station array and interface together as soon as it starts receiving solar-cell modules, which are among those purchased over the last year by the Jet Propulsion Laboratory for the Department of Energy. The 60-kw array will be assembled and

installed first at Delta's 11-acre Irvine site for a two-month shake-down test, scheduled for midsummer. Ultimate destination of the array is Mount Laguna Air Force Station, east of San Diego, where it is to provide about 10% of the 750-kw total power requirement for the radar installation.

The initial fixed-price, negotiated contract with Delta is for \$285,600. The total value, including Government-furnished materials, is about \$1.5 million, according to the company, and options could increase it further. The station's real significance is seen in its commercial potential, however, through establishing guidelines for such equipment. Delta's intentions, in fact, are "to quickly go very heavily into smaller systems" for commercial customers. □

Satellites

Japanese satellite goes live in March

Japan will join the club of communications satellite operators in March when it begins using its new CS spacecraft for telephone and color television coverage of the home islands. By then, according to the timetable, Japan's National Space Development Agency will have com-

Sweep your rf* device with a stable tracking generator

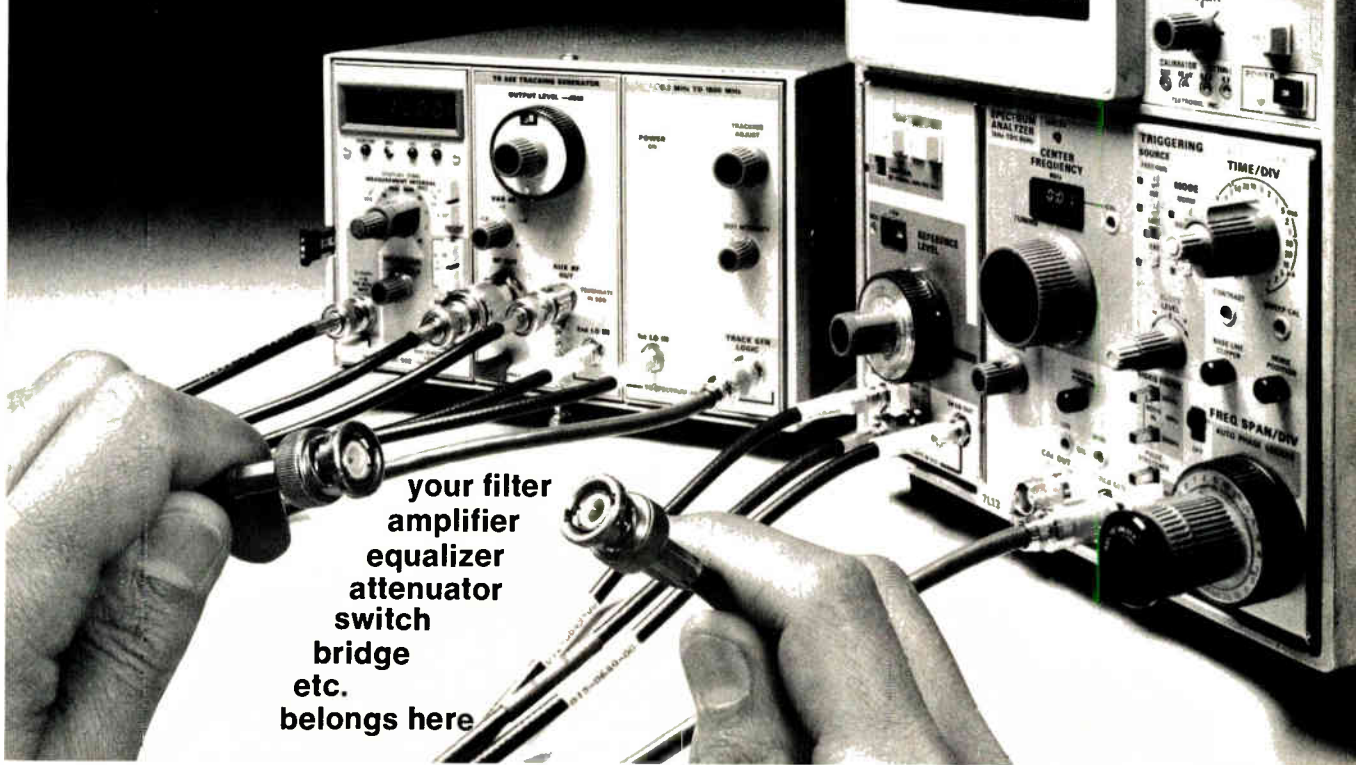

your filter
amplifier
equalizer
attenuator
switch
bridge
etc.
belongs here

The TR 502 and TR 501 tracking generators are working partners for 7L13 and 7L12 spectrum analyzers.

Make **frequency response measurements** on rf devices with the TR 502 and 7L13. This combination of a constant level, calibrated rf source and high performance spectrum analyzer provides you with a wide dynamic range (110 dB) and narrow resolution bandwidth (30 Hz) ideal for crystal filter or cavity measurements.

For **selective frequency counter** applications use the TR 502's Aux. R.F. output to drive a frequency counter.

Select and determine signal frequencies up to 1800 MHz with -128 dBm sensitivity at 30 Hz resolution bandwidth. When used with the DC 502 550 MHz Frequency Counter the spectrum display center frequency, indicated by a bright dot, is automatically counted.

In addition, the TR 502 and 7L13 form a **super-stable CW source**. The TR 502/7L13 system has 10 Hz stability in zero-span (non-swept) mode.

The TR 502 or TR 501 are powered with a TM 503 Power Module, leaving room for a DC 502 or other counter.

- TR 502 Tracking Generator \$4650
(recommended for use with 7L13)
- TR 501 Tracking Generator \$3900
(recommended for use with modified 7L12)

- TM 503 Power Module Opt 7 \$ 195
- DC 502 Digital Counter Opt 7 \$1195

See the TR 502 or TR 501 work in your application. Ask for a demonstration or more information. Write: Tektronix, Inc., Box 500A, Beaverton, Oregon 97077. In Europe, write: Tektronix Limited, P.O. Box 36, St. Peter Port, Guernsey, Channel Islands.

U.S. Sales Prices F.O.B. Beaverton, Oregon 97077

*Baseband and audio swept frequency systems are also available. Ask for information.

Tektronix[®]
COMMITTED TO EXCELLENCE

For Technical Data circle 42 on Reader Service Card
For Demonstration circle 43 on Reader Service Card

After the Z8, comes the Z8000

Later this year, after the Z8 bows, Zilog plans to introduce its powerful big brother, a full 16-bit microprocessor called the Z8000. Sharing many of the Z8's features, it will offer the speed of a PDP-11/45 coupled with some modern architectural capabilities usually found in 32-bit minicomputers, such as the ability to manipulate data words up to 32 bits long.

The Z8000 also will directly address an impressive 8 megabytes of memory, which can be enhanced with a separate memory management chip to provide relocation and memory protection. Because it is bus-compatible with the Z8, it can use a version of that microprocessor as a general-purpose peripheral controller. Like the Z8 and Z80, the Z8000 will be made with Zilog's standard n-channel metal-oxide-semiconductor process.

The firm aims for easy and efficient programming by designing the Z8000 with architecture and a large instruction repertoire of 418 instruction combinations, including 16-bit multiply and divide and powerful string manipulation instructions. In comparison, the Z80 has 158 instruction combinations and the Z8 has 130. All of the Z8000's 16 general-purpose 16-bit registers can be accumulators, and 15 of them can be used as index registers. Zilog also boasts advanced features to support interrupts, traps, and large multiprogramming applications.

the act in the single-chip category with its Z8, an 8-bit microcomputer.

It is the combination of features the Z8 is being designed with that will make it so tough for competitors like Fairchild's F8, Intel's 8048, Mostek's 3870, and Texas Instruments' 9940 in high-performance applications. That includes telephone handsets, consumer comput-

ers and high-powered games, and peripheral controllers in communications. Samples will be available in the summer.

Among the performance-boosting features of the Z8 is its internal 4-megahertz clock that makes the chip as fast as the Z80 itself and faster than other single-chip microcomputers. It can execute many instructions

in as short a time as 1.5 microseconds (with 2.5 μ s average) and has more computational power and memory address capability than the rest of the field. Moreover, it can execute a large, 96-instruction repertoire subset of the powerful Z80 instructions.

Lots of registers. To do it, Zilog designers are packing 144 registers and four 8-bit input/output ports on a chip. It also has 2,048 bytes of read-only memory and 128 bytes of random-access memory. That is as much ROM and more RAM as the best of the competition.

Another feature likely to interest communications systems designers in particular is the on-chip universal asynchronous receiver/transmitter, which comes in a standard format without external interface, according to James H. Gibbons, product manager for development systems and components. Gibbons stresses the "pin economy" of having the two in one 40-pin package. No other single-chip microcomputer has the receiver/transmitter capability, which means either they run the risk of bogging down the central processing unit, trying to make it act like a UART, or they tie up input/output lines connecting the processor to an external UART. Gibbons also points to a dual timer-counter feature, useful for such applications as automotive controls.

Other features include four handshake input/output ports that can be programmed to function in bits or groups of bits. This makes I/O management extremely flexible. The Z8's port 0, for example, is programmable into two groups of 4 bits, explains Peter Alfke, the new-product marketing and applications manager. This is useful where only half a port is needed to drive a seven-segment display.

Gibbons even expects the Z8 will compete in some applications with multichip systems like Intel's 8080 and Zilog's own Z80. This is because it can add externally another 62 kilobytes each of data and memory address storage to its onboard memory store. Also, the Z8's pipelining overlaps fetching of a new instruc-

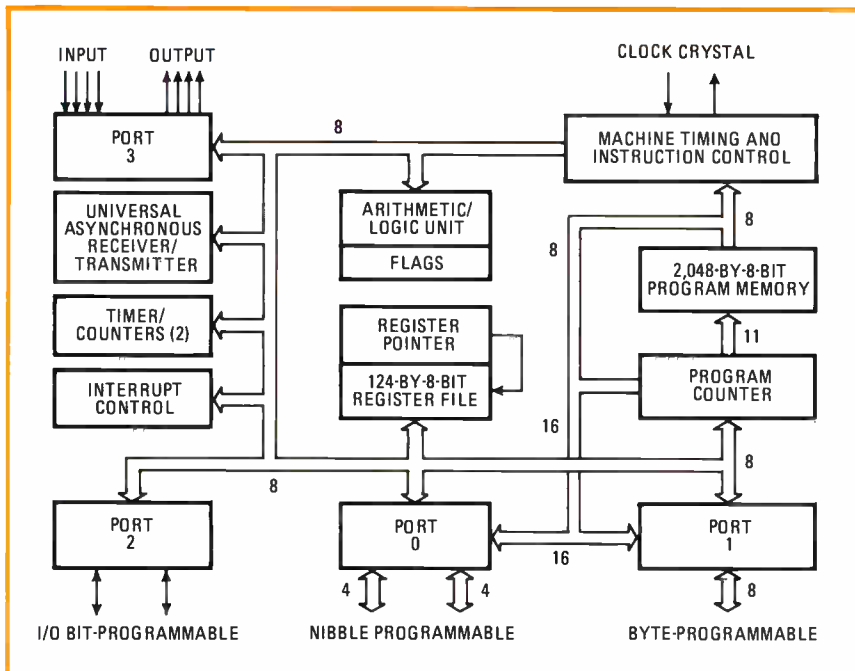

Chip to come. Bit, nibble, and byte programmability of the 8-bit input/output ports adds a lot of flexibility to Zilog's upcoming Z8 one-chip microcomputer. Also included as part of the chip is a universal asynchronous receiver/transmitter.

Now... the Coolest Fastest Biggest Bipolar Multipliers you can buy

*... feature MIL chips in commercial temperature ranges
(at no increase in price)*

MPY-8AJ
130 ns
8 x 8 bits



Only \$70 in 100's

MPY-12AJ
150 ns
12 x 12 bits



Only \$115 in 100's

MPY-16AJ
160 ns
16 x 16 bits



Only \$175 in 100's

We've cut out all excess power... to offer you MIL chip reliability and performance in commercial temperature range parts. Consider these advantages for Digital Signal Processing:

- low power
- no air flow requirement (0°C to 70°C in still air)
- high reliability (for example a recent test indicated an MTBF greater than 200 years at max. oper. temp.)
- reduced output delay

No increase in price! A great increase in reliability! We have the details in our new reliability brochure. For your copy, send the coupon today. Or you can call us at (213) 535-1831.

**ALL TRW LSI PRODUCTS ARE NOW IN STOCK AND
DISTRIBUTED EXCLUSIVELY BY HAMILTON /AVNET**

TRW LSI Products

An Electronic Components Division of TRW, Inc.

P.O. Box 1125
Redondo Beach, CA 90278

Please send Reliability Brochure and updated data on your "cool" Multipliers.

NAME _____

COMPANY _____

DIV/DEPT _____

MAIL CODE _____

ADDRESS _____

CITY _____

STATE _____

ZIP _____

E-1

TRW LSI PRODUCTS

For Digital Signal Processing

INTERNATIONAL SALES OFFICES: AUSTRALIA, Kingsgrove N.S.W. 500111 BELGIUM, Brussels 6600012 DENMARK, Bagsvaerd 986333 FINLAND, Helsinki 640641 FRANCE, Paris 7581111 GERMANY, Munich 503007 ISRAEL, Tel Aviv 444572 ITALY, Monza 360021 JAPAN, Tokyo 4615121 NETHERLANDS, Amsterdam 934824 NORWAY, Oslo 157550 SOUTH AFRICA, Capetown 457656 • Johannesburg 6181027 SPAIN, Madrid 2425204 SWEDEN, Vallingby, Stockholm 380370 SWITZERLAND, Zurich 429900 TAIWAN, Taipei 7512062 U.K., London 9025941 [World Radio History](#)

Circle 44 on reader service card

tion and execution of the old one, so there is only one machine cycle per instruction byte.

Rather than competing directly with the Z80, Gibbons feels that the Z8 is more likely to fit in areas where the Z80 cannot be used because of its larger physical size or power consumption. But is there a

risk in announcing now performance specifications for a part that will not be available for so many months? No, according to Zilog, because the Z8 is being built with the same n-channel metal-oxide-semiconductor process employing silicon gates and ion implantation that is standard for the Z80. □

Personal computers

Personal-computer makers clash over best route to the home

With the market for home computers barely off the ground, the makers of the hardware cannot agree over how to interest consumers. The lines were clearly drawn at the Consumer Electronics Show in Las Vegas early this month where the first truly home—as opposed to hobby—computers were being demonstrated. Essentially the disagreement among the hardware companies springs from the fact that nobody yet has a good enough insight into what will attract the mass consumer market to computers.

The disagreements involve:

■ **Point of entry.** Games makers like Bally Manufacturing Corp. and Coleco Industries Inc. are betting on selling their home computers, due out into the market late this year, through the consumer interest in games. But Apple Computer Inc., Commodore Business Machines, APF Electronics Inc., and CompuColor Corp. are banking on personal computers that handle data and have only incidental game capabilities.

■ **Hardware configuration.** Umtech Inc.'s new VideoBrain home computer [*Electronics*, Jan. 5, p. 60] uses the television receiver for display with the help of two custom-designed chips that sharpen color fidelity on the TV tube. Companies already involved in the hobby computer market sharply disagree with using the TV receiver, instead including a dedicated display with their hardware. Consumers will not want to tie up a TV set with a computer, they say, and the dedicated display

not only yields higher resolution but in addition does not need approval from the Federal Communications Commission.

■ **Software design.** The biggest controversy, however, has come up over software. Basically, the issue is whether the consumer will want fixed program packages or, instead, enough of an understanding of programming to do his or her own software. A related issue is whether buyers should be counted on to handle Basic as the standard programming language or should be given an easier-to-use, English-based language.

■ **Sophisticated users.** Competitors agree that the personal-computer market consists now only of relatively sophisticated consumers who already understand how a computer would be of use. The mass market has yet to be tapped. According to Robert Wickham, president of market research firm Vantage Research Inc., there are presently only about 2 million people likely to be able to use a machine constructively.

The question is how to push beyond this group. To David Chung, vice president of Umtech, the solution is to eliminate the need to program—nobody likes the work, he believes—and employ one of the consumer's most common instruments, the TV set. "The home computer will sell, not because it's a nice piece of engineering, but because the consumer can see a use for it and want to use it," Chung comments. VideoBrain has 12 fixed

programs available now, and it expects to have close to 50 available by year's end.

■ **Individual needs.** "The consumer must be able to program for individual, customized needs, not follow a set plan," counters Apple vice president Michael Markkula. "If a consumer is going to use a computer to handle a check book, he's going to do it his own way, not the way an Apple programmer decides." Adds Charles Peddle, director of Commodore's Systems division, "Part of the motivation in getting a home computer is interest in learning more about computers. This means learning to program."

However, Sy Lipper, president of APF Electronics, contends that Apple and Commodore are on the wrong track in their commitment to Basic as the programming language. "When calculators were introduced, there was a thing called Polish notation that only an engineer could use and understand. Calculators did not go anywhere in the mass market until algebraic input was possible. Then the consumer could use the calculator comfortably. English is the most common language, and that's why we have a software language that the consumer in the mass market will understand. Input is made the way people write. Interaction with the computer is plain English." APF's new Pecos One personal computer employs the JOSS language that was developed by Rand Corp. □

Lasers

Laser diode hits one and the same spot

For some people, the spot of light produced by a semiconductor laser diode is just not stable enough for fiber-optic systems used in communications, imaging, and printing. "Maintaining a round spot that doesn't vary in size or position is essential to couple power efficiently into low-loss optical fibers," says Eric Lean, manager of optical solid-

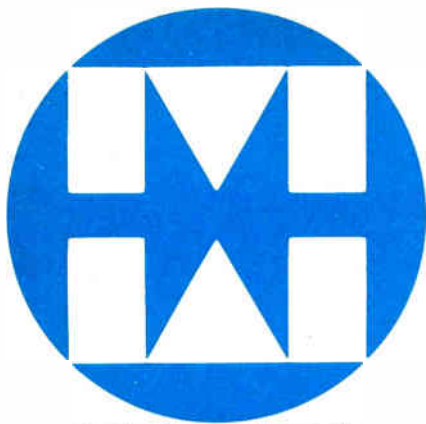

MITEL



**A 3 VOLT BATTERY WITH
450 MA/HR LIFE
IS SUFFICIENT
TO OPERATE...
256,000 BITS MILITARY OR
64,000 BITS COMMERCIAL OF
MITEL'S SIL1902A
1024-BIT STATIC CMOS RAM
FOR 24 HOURS UNDER
WORST-CASE SPECIFICATIONS**

Featuring

- 2.5V to 6V operation
- Pin compatible with 2102 type NMOS RAM's.
- Max. Access Time—800 ns.
- Address latches on chip for added system power savings.

For more information write or phone

18 AIRPORT BLVD.
BROMONT, QUEBEC, CANADA
JOE ILO
(514) 534-2321
TLX.: 05-267474



MITEL
Semiconductor

Electronics review

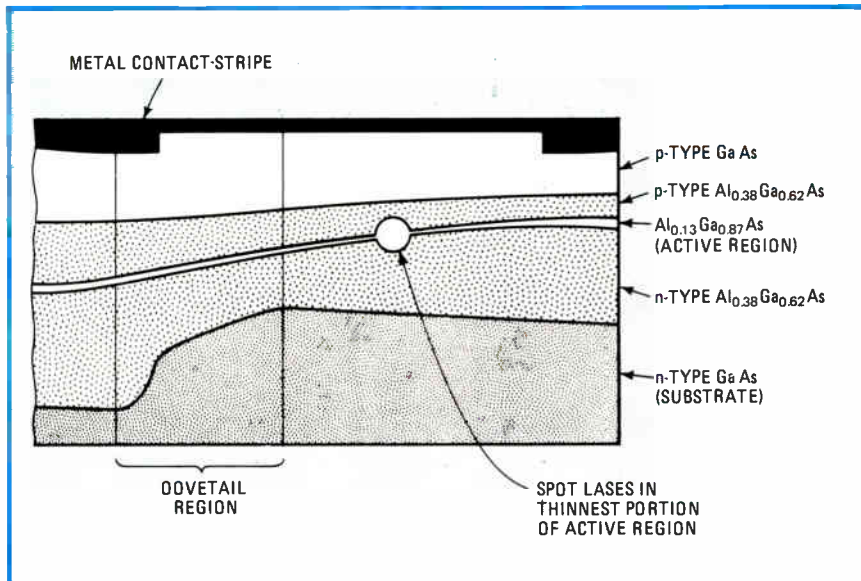

Bright and stable. Cross section of laser diode developed by IBM researchers indicates where the stable output is produced—at a constriction of the semiconductor layers.

state technology at IBM Corp.'s Thomas J. Watson Research Center in Yorktown Heights, N. Y.

Lean's group has therefore developed a gallium-aluminum-arsenide laser diode that produces a round spot, 2 micrometers in diameter, that remains stable in size and position up to power levels where the diode itself may fail catastrophically. It is also compatible with relatively simple systems using spherical lenses. Most semiconductor lasers have elliptical spots that require focusing by cylindrical lenses to produce the desired roundness. This wastes power and adds complexity.

The new device is a double heterostructure diode grown by a one-step liquid-phase epitaxy over a dovetail-shaped channel etched in the gallium-arsenide substrate. But its active or lasing region, instead of being the same thickness throughout, is constricted in the middle. This constriction occurs in the diode's active region, shown in the diagram, giving it a divergent-lens-like cross section: thinner in the middle than at both ends. The thinnest portion of the active region has the highest gain, and it is at this spot that the diode will lase when current is applied to it through the contact stripe.

What's more, the diode oscillates

in a fundamental spatial mode, which cuts into noise caused by mode jumping in diodes with conventional structures. The next job is to design a package that dissipates heat efficiently. □

Military

Alaska to get new surveillance radars

The Air Force is going to update its 1950s-vintage Alaskan Air Command surveillance radar system between now and 1984 in a program called Seek Igloo. Requests for proposals for design validation will shortly go to industry from the office of Lt. Col. Raymond McMillan, program director of the Seek Igloo minimal-attendance radar program at the Air Force Electronic Systems division, Hanscom Air Force Base, Bedford, Mass.

As is the case with so many of the command, control, and communications systems administered by the division, 20-year life-cycle costs will be hammered home to potential bidders, the list of which includes "just about every major radar manufacturer in the U. S.," says McMillan. In addition to a single three-

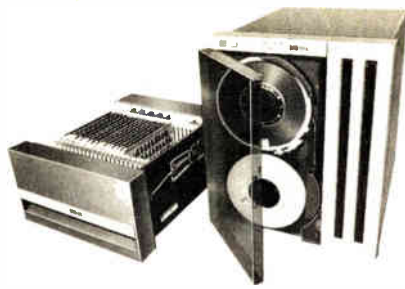

GCR TECHNOLOGY IS MOVING INTO THE MINI-COMPUTER MARKET.

We are now shipping our 6250 bpi STC 1900 high density magnetic tape subsystem to OEM mini-computer customers. The STC 1900 is a 19-inch rack mountable, low-cost tape subsystem that includes 1600 bpi as a standard feature.

This means that for the first time, mini-computers can offer the high performance features of much larger computers.

For the first time, you can offer 6250 bpi read-write capability with GCR format.



Now your customers can benefit from:

- **Increased throughput**
- **Almost four times the recording density of 1600 bpi**
- **Improved error correction (simultaneous two-track)**
- **Library interchangeability with other systems operating at 6250 or 1600 bpi densities**
- **100 megabyte disk dumps to one tape reel**

If improved system performance is important to you, the next move is yours. Call Frank Gunn toll free at 800-525-2940 or send coupon.



7-3877

STORAGE TECHNOLOGY CORPORATION

P.O. Box 6, Louisville, Colorado 80027

Please send me complete information about the new 1900 subsystem.

Name _____

Address _____

City _____

State _____ Zip _____

STC SHIPPING DEPT.



News briefs

IBM unveils small-business computer system

IBM Corp. next month will begin delivering a new desktop small-business computer system, the 5110, offering a range of storage capacities. Model 1 has up to 204,000 bytes per tape cartridge or 1.2 million bytes on a diskette. Model 2, with a diskette store only, has an on-line capacity of 4.8 million bytes. Prices range from \$9,875 for a basic model 1 to \$32,925 for a model 2 that includes 65 kilobytes of main storage and two programming languages, APL and Basic.

Hy-Gain files bankruptcy, idles 500 indefinitely

Citizen's band radio manufacturer Hy-Gain Electronics Corp. of Lincoln, Neb., has filed Chapter XI limited bankruptcy proceedings in U. S. District Court and laid off 500 production workers in Lincoln and at its facilities in Puerto Rico. In fiscal 1977, Hy-Gain lost more than \$24.5 million on sales of \$50.3 million, compared with a year-earlier profit of \$17.3 million on sales of \$96.9 million. Hy-Gain president Andrew A. Andros cites oversupply caused by "continual excess of CB imports from the Far East."

dimensional radar that combines search, height-finding, and Federal Aviation Administration beacon functions usable for Identification Friend or Foe at the 13 sites in the network, they will also have to propose radar systems that will work without operators. This means the units must incorporate automatic clutter processing, so that operators are not required to pick out the true target returns from echoes.

Finally, the radars will have to provide automatic fault isolation down to the level of a line-replaceable unit. "They'll have to detect 98% of the total faults," McMillan says, "and isolate 95% of them down to three LRUS or less."

McMillan says he knows of no present radar that combines all these features—the three-dimensionality, automatic clutter processing, minimal need for an operator, and stringent fault isolation—but he is quick to add that, taken individually, these requirements do not push the state of the art. The E-3A (Awacs) aircraft has similar fault isolation, and automatic clutter processors exist. Several FAA radars could meet the search (detection) requirements, but they are mostly two-dimensional systems that depend on a cooperative transponder for altitude data.

Manpower cut. The push for automaticity stems from an Air Force objective to cut the number of

support personnel from the 1,100 needed today to a scant 85. This will save the service \$500 million over 20 years, McMillan says.

All 13 Alaskan Air Command sites are now equipped with AN/FPS-93 L-band search radars built by Bendix Corp., and most of them have General Electric Co.'s AN/FPS-6/90 S-band height finders. The Seek Igloo radars will replace them, with 9 on the west coast of Alaska facing the Soviet Union, and 4 in the interior. All the radars will have a range of approximately 200 nautical miles and detect targets as high as 100,000 feet.

Design leeway. The request for proposals will not specify a frequency band. McMillan stresses that he wants to set forth functional requirements and let bidders propose a system that will satisfy them.

When installed, the Seek Igloo radars will digitize the received signals, eliminate the clutter, and transmit data, including target range, azimuth, beacon, and altitude, to a central station by radio. That station will be at Elmendorf Air Force Base near Anchorage, the Alaskan region operations control center in the Air Force's Joint Surveillance System.

The six-month design-validation phase precedes selection of a single contractor to carry out full-scale development. □

**SPRAGUE WORLD TRADE CORP.
SALES OFFICES**

- ■ ■
- Austria**
Elbatex GmbH, Breitenfurterstraße 381, A - 1235 Wien, Tel. 0222-86 91 58
- Benelux**
Sprague Benelux, B.P. 104, B - 9600 Ronse, Tel. 055-21 53 02
- Denmark**
Semicap, Gammel Kongevej 148,5, DK - 1850 Copenhagen V, Tel. 01-22 15 10
- Finland**
Field Oy, Veneentekijäntie 18, SF - 00210 Helsinki, Tel. 90-69 22 577
- France**
Sprague France S.A.R.L., 2, ave. Aristide Briand, F - 92220 Bagneux, Tel. 6 55 19 19
- Germany**
Sprague Elektronik GmbH, Friedberger Anlage 24, D - 6 Frankfurt/M, Tel. 0611-43 94 07
- Hong Kong**
Sprague World Trade Corp., Eastern Branch, 651 Kings Road, General Post Office Box 4289, HK - Hong Kong, Tel. 5-62 62 31
- Iran**
Unitec Co. Ltd., 15, Avenue Arfa, P.O. Box 33/369 Shemiran, IR - Teheran, Tel. 021-66 57 82
- Israel**
Racom Electronics Co. Ltd., 60 Pinkas Street, P.O. Box 21120, IL - Tel Aviv, Tel. 03-45 31 51
- Italy**
Sprague Italiana S.p.A., Via G.G. Winckelmann 1, I - 20146 Milano, Tel. 02-47 91 21
- Norway**
Hefro Teknisk A/S, Postboks 6596 - Rodeløkka, N - Oslo 5, Tel. 02-38 02 86
- Portugal**
Ditram Componentes e Electronica, Lda., Av. Miguel Bombarda, 133-1º, D, P - Lisbon, Tel. 019-4 53 13
- South Africa**
Allied Electric (Pty.) Ltd., P.O. Box 6090, ZA - Dunswart, 1508, Tel. 52-82 32
- Spain**
Bianchi S.A., Apartado 220, E - San Sebastian, Tel. 943-36 20 45
Bianchi S.A., Corredera Baja 8, E - Madrid 13, Tel. 1 221 13 77
- Sweden**
Interelko AB, Sandsborgsvägen 55, S - 12233 Enskede, Tel. 08-49 25 05
- Switzerland**
Telion AG, Albisriederstraße 232, CH - Zürich, Tel. 01-54 99 11
- Turkey**
Kapman Komandit, Plastic Han No. 1, Yanikkapi Sokak, P.O. Box 158, Beyoglu TR - Istanbul, Tel. 45 76 25
- United Kingdom**
Sprague Electric (UK) Ltd., 159, High Street, GB - Yiewsley, W. Drayton, Middx. UB7 7SY, Tel. 01-573 88 44
- Yugoslavia**
Belram S.A., 83 av. des Mimosas, B - Brussels 15, Tel. 02-734 26 19

There's a better way to measure or monitor mechanical motion—

magnetically-activated 'Hall effect' integrated circuits

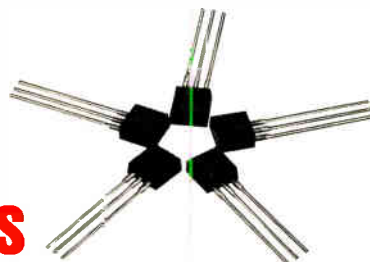

- Convert mechanical motion to electronic signals by sensing changing magnetic fields.
- Excellent for position sensing, thickness determination, weight measurement, speed control, pressure monitoring.
- Provide contactless switching—no contacts to wear, no contact welding.
- Highly reliable under adverse environmental conditions.

- None of the contamination problems suffered by mechanical or photo-electric switches.
- No moving parts to cause spurious signals often associated with conventional switches.
- Economical transistor-style package.
- Ideal interface between mechanical motion and electronic controls, counters, etc.

TYPE UGN-3020T DIGITAL SENSORS

TYPICAL APPLICATIONS

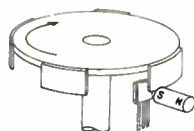

VANE INTERRUPTER
(ignition switch, etc.)



LIMIT SWITCH
(pressure monitor, etc.)

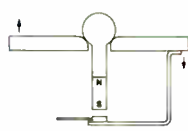

ANGLE SENSING
(tilt switch, etc.)

- Designed for use with readily-available samarium cobalt or sintered alnico VIII permanent magnets.
- Operate at any voltage from 4.5 to 24 VDC.
- Constant amplitude output, independent of frequency up to at least 100 kHz.
- Higher sensitivity, wider operating temperature range, smaller physical size, more economical than any other device of its type.

TYPE UGN-3501T LINEAR SENSORS

TYPICAL APPLICATIONS



CHANGE IN FLUX PATH
(notch sensor, etc.)

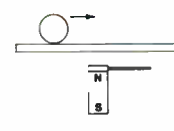

FERROUS METAL SENSOR
(pinball detector, etc.)

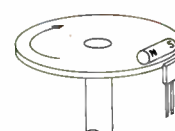

ANGLE OF ROTATION
(antenna position, etc.)

- Voltage output of these devices is proportional to magnetic field intensity.
- Will operate if slightest change in flux path is made.
- Operate at any voltage from 8 to 12 VDC.
- Hall cell and linear differential amplifier integrated in one monolithic device to simplify problems relating to handling of millivolt analog signals.
- Exceptional temperature stability.

SPRAGUE WORLD TRADE CORPORATION • 3 CHEMIN DE TAVERNAVY • 1218 GENEVA SWITZERLAND

SALES OFFICES **AUSTRIA:** ELBATEX GMBH, WIEN, TEL. 0222-869158 **BENELUX:** SPRAGUE BENELUX, RONSE, TEL. 055-215302 **DENMARK:** SEMICAP, KØBENHAVN, TEL. 01-221510 **FINLAND:** FIELD OY, HELSINKI, TEL. 90-6922577 **FRANCE:** SPRAGUE FRANCE SARL, BAGNEUX, TEL. 01-6551919 **GERMANY:** SPRAGUE ELEKTRONIK GMBH, FRANKFURT, TEL. 0611-439407 **GREECE:** EMITRON SA, ATHENAI, TEL. 021-3242188 **IRAN:** UNITEC CO. LTD., TEHRAN, TEL. 021 665782 **ISRAEL:** RACOM ELECTRONICS CO. LTD., TEL-AVIV, TEL. 03-453151 **ITALY:** SPRAGUE ITALIANA SPA, MILANO, TEL. 02-479121 **NORWAY:** HEFRO TEKNISK A/S, OSLO, TEL. 02-380286 **PORTUGAL:** DITRAM COMPONENTES E ELECTRONICA, LDA, LISBOA, TEL. 019-45313 **SOUTH AFRICA:** ALLIED ELECTRIC (PTY) LTD., DUNSWART, TEL. 52-8232 **SPAIN:** BIANCHI SA, SAN SEBASTIAN, TEL. 943-362045 **SWEDEN:** INTERELKO AB, ENSKEDJE, TEL. 08-492505 **SWITZERLAND:** TELION AG, ZÜRICH, TEL. 01-549911 **TURKEY:** KAPMAN-KOMANDIT, ISTANBUL, TEL. 417625 **UNITED KINGDOM:** SPRAGUE ELECTRIC (UK) LTD, VIEWSLEY, W. DRAYTON, MIDD. UB7 7SY, TEL. 01-5738844 **YUGOSLAVIA:** BELRAM SA, BRUXELLES, TEL. 02-7342619

48S-7131R2



a
General Cable
subsidiary

THE BROAD-LINE PRODUCER OF ELECTRONIC PARTS

Use our faster 8K ROM.

Monolithic Memories' new 6280-2 bipolar 8K ROM costs \$10 in volume and guarantees 55nS T_{AA}.

The 6275-1 bipolar 16K ROM, with 110nS access time, gives you the best speed/density product going.

You're no longer forced to specify a 4K ROM to get access speeds below 70nS. Our new 6280-2 1024x8 bit ROM ends that with 55nS maximum access time in commercial grade models, or 70nS access in MIL-temp models. Slower versions (6280-1 at 100nS max. T_{AA}) are available in volume at prices down to \$8.50.

For higher density applications we've got 9K (6260-1) and 10K (6255-1) ROMs, both with 100nS access.

Or for the ultimate in bipolar ROM density, look into our 6275-1 bipolar 16K ROM, the world's fastest at 110nS access. All are available in open collector or tri-state outputs and in commercial or MIL-temp ranges.

Flexible design with bipolar speed.

Already working with a 20-pin 4K ROM? That's okay.

Our 6280-2 is available in 20-pin, 22 or 24-pin packages, with pinouts designed as drop-in replacement for whatever you're using. And the 22 and 24-

pin versions have compatible PROMs available off the shelf. Add to this the inherent speed and simplicity of Monolithic Memories' bipolar technology for a total design package you can't beat.

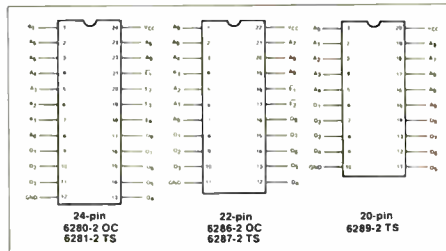

Design in now, plug in 5 weeks.

Delivery on most orders is five weeks from receipt of your bit pattern. Masking charge is only \$750 per pattern in minimum quantities of 100 pieces.

From the undisputed world leader in bipolar memories.

Every year since its incorporation in 1970, Monolithic Memories has delivered more bipolar read only memory than any other company in the world. We introduced the first 1K PROM, the first 2K PROM, the first 4K PROM and the first 8K PROM. Look for much more from Monolithic Memories. Call (408) 739-3535 TWX 910-339-9229 or write 1165 East Arques Avenue, Sunnyvale, CA 94086.

For technical assistance see your Monolithic Memories' area representative:

ALABAMA Huntsville Rep. Inc. (205) 881-9270	MINNESOTA Minneapolis Norlec Sales (612) 835-7414
ARIZONA Scottsdale Summit Sales (602) 994-4587	MISSOURI Ballwin Rush and West (314) 394-7271
CALIFORNIA Culver City Bestronics (213) 870-9191	NEW JERSEY Teaneck R T Raid Assoc (201) 692-0200
MOUNTAIN VIEW Thrusom Associates (415) 955-9180	NEW YORK Rochester L-Mar Associates (716) 328-5240
SAN DIEGO Littlefield & Smith (714) 455-0055	SYRACUSE L-Mar Associates (315) 437-7779
COLORADO Wheatridge Waugaman Associates (303) 423-1020	NORTH CAROLINA Raleigh Rep. Inc. (919) 851-3007
CONNECTICUT North Haven Comp Rep Associates (203) 239-9762	OHIO Cincinnati Makn Associates (513) 871-2424
FLORIDA Altamonte Springs Dyne-A-Mark (305) 831-2097	MENOR Makn Associates (216) 464-4330
CLEVELAND Dyne-A-Mark (813) 441-4702	OREGON Portland N W Marketing (503) 297-2581
FORT LAUDERDALE Dyne-A-Mark (305) 771-6501	PENNSYLVANIA Oreland CMS Marketing (215) 885-5106
GEORGIA Tucker Rep. Inc. (404) 938-4358	TENNESSEE Jefferson City Rep. Inc. (615) 475-4105
ILLINOIS Rolling Meadows Sumer (312) 394-4900	TEXAS Dallas West & Associates (214) 661-9400
INDIANA Indianapolis Electro Reps (317) 255-4147	UTAH Salt Lake City Waugaman Associates (801) 363-0275
IOWA Cedar Rapids S & O Sales (319) 393-1845	WASHINGTON Bellevue Northwest Marketing (206) 455-5846
KANSAS Olathe Rush and West (913) 764-2700	WISCONSIN Milwaukee Sumer (414) 259-9060
MARYLAND Baltimore Monolithic Sales (301) 296-2444	CANADA
ROCKVILLE Monolithic Sales (301) 340-2130	ONTARIO Milton Cantec (416) 624-9696
MASSACHUSETTS Needham Heights Comp Rep Associates (617) 444-2484	OTTAWA Cantec (613) 225-0363
MICHIGAN Grosse Point Greiner Associates (313) 499-0188	QUEBEC Pierre Ponds Cantec (514) 620-3121

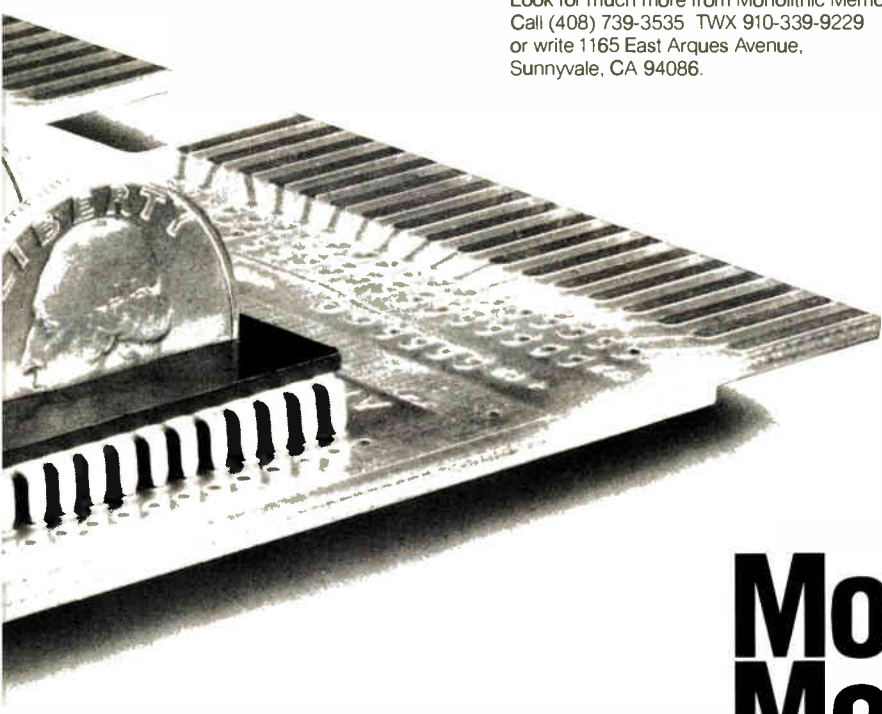

Monolithic Memories

Bipolar is our business.

A FORMIDABLE FORMULATOR.

And here's more good news.

Fairchild also makes designing easy. Just one investment in our formulator design aids allows you a common support system for F8 or F3870 designs.

Then, to check out your prototype/production board, Fairchild offers the Formulator F3870 Emulator Cable or F3870 Emulator Board with 2K EPROM (2708) storage.

USER SELECTIONS.

F8 Family Series		F3870 MicroMachine Series	
F3850	CPU/RAM/16 I/O	F3870	SINGLE CHIP MICROCOMPUTER
F3851	1K ROM/TIMER/16 I/O	F3871	TIMER (3870)/16 I/O
F3856	2K ROM/TIMER/16 I/O		
F3857	2K ROM/TIMER/SMI		
F3852	MEMORY INTERFACE-DYNAMIC/TIMER		
F3853	MEMORY INTERFACE-STATIC/TIMER		
F3861	TIMER/16 I/O		
F3854	DIRECT MEMORY ACCESS		
F3899	1K ROM ONLY		

A FAMILY WITH POWER AND INTELLIGENCE.

If controllers for communications, intelligent terminals, data processing or instrumentation systems are your problem, our F6800 microcomputer family is your solution.

Made specifically for controllers where requirements are RAM intensive and call for a full selection of intelligent LSI programmable peripherals.

The F6800 family is an established industry standard with a full range of intelligent programmable peripherals to meet a wide range of peripheral communication challenges and back-up with a complete selection of memory options.

MORE SELECTIONS.

F6800 FAMILY SERIES			
Processors			
F6800	CPU	F6802	CPU/RAM
Peripherals			
F6820/21	Peripheral Interfaces	F68488	INSTRUMENTATION BUS (IEEE)
F6850	ACIA, COMMUNICATIONS		CONTROLLER
F6852	SSDA, COMMUNICATIONS	F6846	2K ROM/TIMER/16 I/O
F6840	PROGRAMMABLE TIMER	F6854	AUTOMATIC DATA LINK CONTROLLER
Memory			
F6830/308	1K x 8 ROM	F2708	1K x 8 EPROM
F68316/317	2K x 8 ROM	F4027	4K, DYNAMIC RAM
F6810	128 x 8 RAM STATIC	F16K	16K, DYNAMIC RAM
F2102	1K x 1 RAM STATIC		
Interfaces			
μ A9708	6-CHANNEL, 8-BIT A/D CONVERTER		
Coming Soon			
F6843	CRT CONTROLLER	F3846	BISYNC/SDLC COMMUNICATIONS CONTROLLER
F6844	DIRECT MEMORY ACCESS		
F6845	FLOPPY DISK CONTROLLER	μ A9706	8-CHANNEL, D/A CONVERTER

A PLACE TO START.

To learn more about our Microprocessors, Formulators and Emulators, contact your Fairchild distributor or representative. Or, for immediate results, call your nearest Fairchild sales office.

France: Fairchild Camera & Instrument S.A., 121 Ave. d'Italie, 750013-Paris. Tel: 00331 584 55 66. Telex: 0042 200614.
Italy: Fairchild Semiconduttori S.P.A., Via Rosellini, 12, 20124 Milano. Tel. 02 6887451. Telex: 36522. Germany: Fairchild Camera & Instrument (Deutschland) GmbH, 8046 Garching Hockbruck, Daimlerstr. 15, Munchen. Tel: 089 320031. Telex: 52 4831 fair d. England: Fairchild Camera & Instrument (UK) Ltd., 230 High St., Potters Bar, Hertfordshire EN6 5BU. Tel: 0707 51111. Telex: 0051 262835. Sweden: Fairchild Semiconductor AB, Svartengsgatan 6, S-11620 Stockholm. Tel: 8-449255. Telex: 17759.

FAIRCHILD
CALL US ON IT.

Memories for any application:

Fujitsu's RAMs, ROMs, EROMs and PROMs.



Memory and memory-peripheral ICs. They are the most prevalent and critical part of today's digital systems and products—mainframes of all sizes, peripherals of all types, word-processing systems, terminals, point-of-sale units, communications systems and devices, business and scientific calculators. You depend on memory and memory-peripheral ICs. So you should know about Fujitsu's products and capabilities.

Just another 'me too' IC supplier? No way! Fujitsu is quite simply the world's most innovative IC manufacturer. Really? You bet!

Product-line breadth: ultra-high-speed ECL RAMs with access times down to 10 ns; bipolar RAMs, static and dynamic MOS RAMs, CMOS RAMs, n-MOS EROMs and ROMs, and bipolar PROMs, in the most-specified sizes, at the highest performance levels. Supported by a full line of interface devices—level shifters, drivers, receivers, sense amplifiers, buffers. In virtually all configurations and package types, at the industry's most competitive prices. No other memory-IC company has this broad of a memory product line.

Design and process leadership: in these two critical areas, Fujitsu leads the industry. So-called 'second source' ICs from Fujitsu aren't just pin compatible, copied from licensed masks. They're created from scratch to meet or exceed the original spec, to make them the superior 'first source' choice. Fujitsu innovations in bipolar and MOS technology have delivered the highest performance of any manufacturer, at higher yields, with superior operating reliability.

Reliability that doesn't quit gives you lowest lifetime cost—on top of all the other Fujitsu advantages. Fujitsu's edge in reliability is a matter of record, in millions of sockets in the field worldwide.

Find out the full story. Get Fujitsu's Memory Product Selector Guide and Catalog. They tell you all you need to know about the entire Fujitsu memory and memory-peripheral IC line. Each device is supported with data sheets, applications engineering and a reliability story that will set you straight on the most reliable IC product line in the world.

- Please send me the Fujitsu Product Selector Guide
- Please send me the Fujitsu IC Catalog
- Please send me the Fujitsu IC Reliability brochure
- Please send me the 4K dynamic RAM Ap. Note
- Please send me the 8K EROM Ap. Note
- Please call me about an immediate application

Name _____ Title _____

Organization _____

Address _____

City _____ State _____

Zip _____ Telephone: (_____) _____

FUJITSU
AMERICA INC.

1208 East Arques Avenue
Sunnyvale, CA 94086
(408) 739-3200
Telex: 346393 • TWX: 910-338-0047

House hearings set on British MLS charges

A House subcommittee will begin hearings Jan. 31 on British charges that the Federal Aviation Administration deliberately misled the International Civil Aviation Organization in order to get the ICAO to adopt a new U. S. microwave landing system instead of a competing UK system. The FAA rejects the British charges that it "totally misled" the ICAO by using "contrived" data on the time-reference scanning beam microwave landing system. **The TRSB/MLS has been proposed by the U. S. and Australia to the ICAO, which will decide at a Montreal meeting in April on adoption of a new worldwide standard all-weather approach and landing guidance system.** Rep. John Burton (D., Calif.) said his transportation subcommittee of the Government Operations Committee has scheduled hearings because "it is vital to explore this controversy now to clear the air, if you will, because American integrity is at stake."

Color TV imports rise despite cut in Japanese share . . .

America's color television imports rose 1.4% to a record 1.97 million units in the first nine months of last year, even though shipments from Japan declined as a result of its agreement with the U. S. to limit exports as of last July. **U. S. importers more than offset that 5.7% dip by shifting to supply sources in Korea, Taiwan, and Singapore.** But Japan remained the predominant foreign supplier, shipping 1.65 million sets through September, according to the Department of Commerce. The new figures show that total consumer imports reached \$2.84 billion, 13.4% above 1976's record \$2.51 billion for its first three quarters.

. . . as video, audio tape units show big gains

Video cassette recorder imports—almost exclusively from Japan—soared 104% to nearly \$89 million in 1977's first three quarters, the largest percentage increase of any electronics product. Shipments of audio tape recorders, the largest import product category, **rose to a value of nearly \$785 million, an increase of almost two thirds from the 1976 level.** Transceiver imports, primarily citizens' band radios, dropped sharply in the period—28.5% by value to \$475 million and 10% by unit count to a total of 14 million.

JEDEC wants to speed standardization via teleconferencing

The Joint Electron Device Engineering Council wants the National Science Foundation to fund an 18-month experiment to use computer conferencing as a means of compressing the months-long process required to develop standards for microcomputers and large-scale integrated products, particularly microprocessors. A joint effort of the Electronic Industries Association and the National Electrical Manufacturers Association, **JEDEC wants to use the NSF-sponsored Electronic Information Exchange System with teleprinter display terminals to speed up meetings and data exchange** between members of the standards committee. John F. Hessman, a council staff member, says limited observation and participation in sessions would be accorded to such other interested groups as computer scientists, professional societies, trade associations, the U. S. military, and the trade press.

Baruch's plan for cooperative technology

The Commerce Department is moving to establish two new national centers this year at the National Bureau of Standards. If blessed by Congress in the forthcoming annual budget rites, they will be known as the Center for Industrial and Commercial Technology and the Center for International Technology. They are projects of Jordan Baruch, assistant secretary for science and technology, who is gaining a reputation as a bureaucratic mover and shaker at the department. If they work, they should help the bureau shed its good-for-nothing-but-statistics image.

The CICT proposes to help American industry upgrade its competitiveness in world markets by identifying technological problems and opportunities and then managing responsive collaborative projects. The international technology center's goal is to strengthen the U. S. position in foreign trade by promoting the economic and social well-being of less developed countries so they can become better U. S. trading partners.

Not another MITI

Those companies uncertain about the Commerce department's goal and suspicious of more Government interference in the private sector say the centers are reminiscent of Japan's powerful Ministry of International Trade and Industry. But the program's proposers are quick to reject that.

The first principle of the CICT will be that industry must want Government assistance in dealing with a problem of opportunity and ask for it. Industry must also take the first steps to define the problem and the approach to a solution. Unlike MITI, says one official, "this is not the case of the Government telling you that you need to solve your problems."

Indeed, the placement of the new centers within the NBS is considered a plus by those in the Department of Commerce who are pushing the concept. Since its creation by Congress more than 75 years ago, the standards bureau has functioned successfully with virtually no regulatory or enforcement powers. It is perceived by industry as a body with high credibility, objectivity, and freedom from biases.

A principal goal of the Center for Industrial and Commercial Technology will be to work with industries so they may become more efficient producers through refining what NBS calls

infratechnologies—the basic knowledge and techniques and equipment that are commonly used for product design, procurement, and evaluation of manufacturing materials, controlling manufacturing processes, and product testing.

Semiconductor success

NBS has already demonstrated that such goals are achievable under its small but vigorous semiconductor technology programs used to resolve product measurement problems. Already it has come up with improvements in resistivity measurements, new wire-bonding procedures and controls, and better tests for thermal resistance, hot spots, and forward-biased breakdown that it says are quick, economical and nondestructive. The bureau has also developed new theory and procedures that improve both accuracy and precision in measurements of photomask line widths.

Baruch clearly believes NBS can make similar contributions to other segments of electronics and other high technologies. The department believes that industry typically underinvests in the development of infratechnologies. Moreover, it is not a field of interest in universities, which are searching for new breakthroughs and customarily subordinate their efforts to improve on old ones. Thus does the department justify the need for a new collaborative effort between industry and Government.

Call for support

But Jordan Baruch and Howard Sorrows of NBS, director designate for the National Centers for Cooperative Technology, still have a way to go before their concept becomes reality. Both want recommendations and questions from every quarter—industry, trade associations, industrial research institutes, and universities—about the operation of centers, particularly in this formative period, so they can function most effectively.

It is an opportunity that companies and their trade associations—distressed with past Federal inability to help them compete more effectively in the global marketplace—cannot afford to let pass. Effectively structured, the new Commerce Department program is one that might work and work well. But that will never happen without industry support from the outset.

Ray Connolly

IT'S TOUGH to be a ANALOG I/O SYSTEM from DATA TRANSLATION!

Each interface system is 100% computer tested...3 different times. 100% burn-in of all critical analog circuits...for 3 days. One million measurements made on each analog system. Extensive testing to assure long-life in your system.

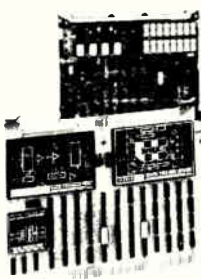
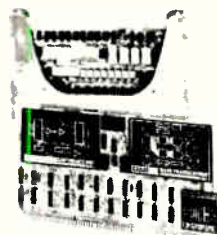

We design and manufacture each and every data acquisition module from the ground up to out-perform anything else... $\pm 35V$ overvoltage protection, full $\pm 0.03\%$ accuracy and up to 125KHz throughput rate for any of 7 different microcomputers.

**GUARANTEED
5 DAY DELIVERY**

Single Board Analog I/O Systems		DT1761	DT1762	DT1764	DT1765	DT1766	DT1767	DT1761	DT1741	DT1742	DT1744	DT1755	DT1841	DT1842	DT1843	DT1731	DT1732	DT1733	DT1734	DT1722	DT1723	DT1791	DT1795	DT1781	DT1782	DT1784	DT1785	
		DEC LSI-11						INTEL SBC-80 SERIES						COMPUTER AUTOMATION LSI 2 & 3			NATIONAL IMP & PACE		PCS SUPERPAC		ZILOG MCB SERIES (Z-80)							
Analog Inputs	16 channels																											
	32 channels																											
	64 channels																											
	10mV to 10V range																											
	0 to 10V, $\pm 10V$, $\pm 5V$ ranges																											
	1 to 5V (4 to 20mA) range																											
Analog Outputs	8 bit resolution																											
	12 bit resolution																											
	2 channels																											
	4 channels																											
	8 channels																											
	0 to 10V, $\pm 10V$, $\pm 5V$ ranges																											
Features	4 to 20mA range																											
	point plotting																											
	8 bit resolution																											
	12 bit resolution																											
	programmable gain																											
100KHz throughput																												
program I/O & interrupt																												
DMA interface																												
power required: +5V only																												

Take your pick. When you have a tough analog requirement, call Data Translation. We perform.

DATA TRANSLATION
INC
4 Strathmore Rd., Natick MA 01760
(617) 655-5300 Telex 94-8474

INTERNATIONAL SALES OFFICES: AUSTRALIA, Strathfield N.S.W. (02) 747-2731; BELGIUM, 1040 Brussels 02-352135; ENGLAND, Stockport Cheshire (061 236) 2321; BUC 956.31.30; GERMANY, 8031 Puchheim (089) 80 60 61-62; ISRAEL, Tel Aviv 54359; ITALY, Milano 34.93.041; JAPAN, Tokyo (03) 355-1111; NETHERLANDS, Rijswijk 70-996360; NORWAY, Oslo 0269 44 90; PORTUGAL, Lisboa 4 53 13; SPAIN, Barcelona (93) 301 78 51; SWEDEN, Vallingby 08 38 00 65; SWITZERLAND, Zurich 01/54 70 60.

Jan. 19, 1978

Electronics

International®

Associative parallel processor
on a chip due: page 7E

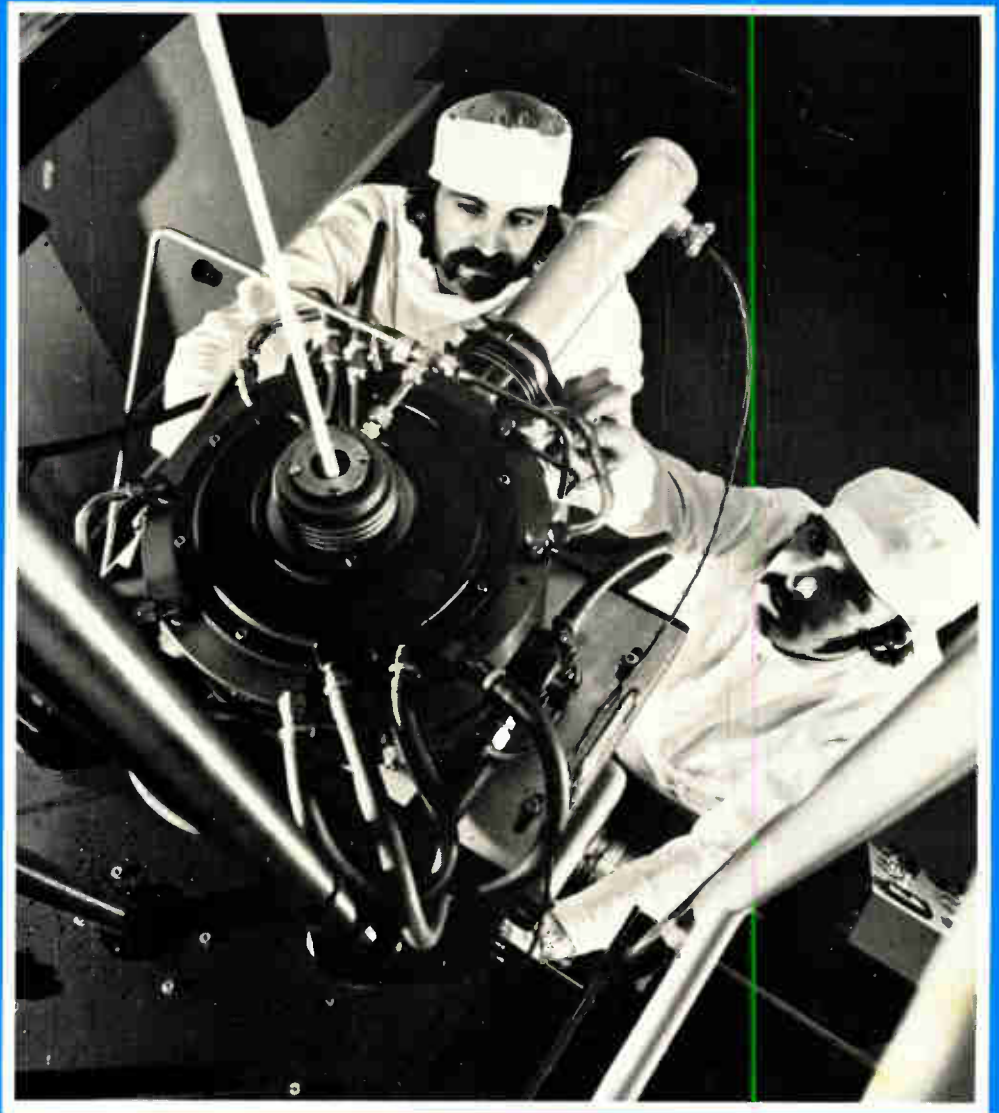

Optical-fiber production at STC and other British firms will grow, as the nation's electronics industries look for a good year: page 77

RCA first in CMOS.

First in CMOS microprocessors.

RCA 1800 combines elegant COSMAC architecture with CMOS benefits. Result: the performance you want — plus maximum flexibility with minimum parts count.

Cost-effective COSMAC architecture. Since our CDP1802 CPU accepts compact 1-byte instructions, you need less memory. Registers store data with 1-byte access. And they act as pointers, so individual instructions don't need addresses.

Built-in I/O. The CPU has interrupt, DMA, flags in and bit control out, so you need less I/O. And we offer a wide range of low-cost I/O devices, including our unique 2-mode UART.

Easily expandable memory. Build up to 65K without adding any address management parts. RCA offers the ROMs you'll need and CMOS RAMs as well.

Full-range design support. From the basic Microtutor learning tool to a complete COSMAC Development System with floppy disk. All geared to help you translate the CMOS advantage into true system cost effectiveness.

For more information, contact your local RCA Solid State distributor. Or contact RCA Solid State headquarters in Somerville, NJ; Sunbury-on-Thames, Middlesex, England; Quickborn 2085, W. Germany; Ste.-Anne-de-Bellevue, Quebec, Canada; Sao Paulo, Brazil; Tokyo, Japan.

When you say CMOS, say RCA first.

The RCA 1800 Microprocessor Family

CDP 1802	COSMAC CPU
CDP 1821S	1024x1 High-speed RAM
CDP 1822	256x4 Low-cost RAM
CDP 5101	256x4 Industry-standard RAM
CDP 1822S	256x4 High-speed RAM
CDP 1824	32x8 RAM
CDP 1831, 2	512x8 ROM (with or without latch)
CDP 1833, 4	1024x8 ROM (with or without latch)
CDP 1852	Byte I/O
CDP 1853	I/O decoder
CDP 1854	UART
CDP 1856, 7	Bus buffer/separators
CDP 1858, 9	Address latch/decoders
CDP 1861	TV interface

Coming in 1978

CDP 1823S	128x8 High-speed RAM
CDP 1851	Programmable I/O
CDP 1855	Multiply/Divide Unit

And these major parts: 4K RAM, 4K EPROM, 1-chip COSMAC microcomputers — all in CMOS.

RCA

Electronics / January 19, 1978

UK firm readies speech-Interpolation gear for satellite tests

Digital speech-interpolation equipment, which can double a communications satellite's traffic capacity by seizing and relocating channels during conversational pauses, will be installed at the UK satellite ground station at Goonhilly in time for April trials of the international time-division multiple-access satellite communications system [*Electronics*, Jan. 5, p. 47]. The **120-megabit-per-second equipment uses an array of five Texas Instruments 9900 16-bit microprocessors to monitor satellite channels and incoming ground lines and allocate speech signals to unassigned satellite channels.** Two processors assign satellite transmit and receive channels, and the others are in the operator console, the communications signaling system, and the communications signaling channel. Cambridge Consultants Ltd. of Bar Hill, Cambridge, is developing the gear under a \$216,000 British Post Office contract.

Matsushita to offer bipolar chip for VIR color control

An IC that uses the incoming vertical-interval-reference signal to control color saturation accurately will soon appear in Japanese television sets. The Matsushita Electronics Co. device will be in Panasonic sets from parent Matsushita and Quasar sets from its U. S. subsidiary and will be sold to other manufacturers. **The 3.2-by-2.9-mm bipolar chips has 481 elements arranged in both linear and digital circuits. It requires only about 60 peripheral parts and needs no assembly-line adjustments.** The first-generation VIR color-control circuit developed and used by GE in the U. S. has about 180 parts, including five ICs and 30 transistors, and needs production adjustments. Shipments of samples are beginning, with Japanese quantity prices slated to be between \$2.50 and \$2.90.

West Germany hikes electronics role in U. S. by 20%

For West Germany's electrical and electronics industries, the U. S. market turned out to be the most attractive for investments last year. By mid-1977, the industry's total outlays in the U. S. had jumped to nearly \$330 million, up from \$250 million 12 months before. **This 32% increase compares with a rise of about 11% for total foreign investments by the country's electrical/electronics sector.** Among the prime reasons for the American market's attractiveness, says the Frankfurt-based Electrotechnical Industry Association, are the higher value the Deutschemerk has attained against the dollar in recent years, the somewhat lower wages in the U. S., and that country's economic and political stability.

ICL is readying data processor with associative memory

Coming up from England's International Computers Ltd.: a data-base processor with a content-addressable memory for telephone directory use and similar applications. Final British Post Office directory trials on ICL's content-addressable file-store system should be complete within a year. Then the computer giant plans to market the system as a data-base processor. **Designed for simultaneously searching a number of files without involving the central processor, CAFS reportedly comprises an array of parallel processors linked to a disk subsystem, each processor searching its disk sector for matches for content rather than address.** Information retrieval systems so engineered offer low costs with fast response. Because CAFS is content-addressable, telephone inquiries giving only a part of a name, address, or location will call up a list of candidates.

BPO sees Viewdata serving users for message interchange

A service allowing persons to interchange typed messages over a television set and a linked keyboard will become a regular feature of the British Post Office's Viewdata service before the end of the year. Intended primarily for the deaf, the service will be in time for the later stage of the 1,000-set market trial due to start this June. The messages are typed on a full alphanumeric keyboard, instead of the usual simple numeric Viewdata keyboard. They appear in the top half of the screen, with the reply in the bottom. When either half fills, new space is automatically allocated by erasing earlier sentences. The BPO also is exploring other message-switching applications. **Fitted with a low-cost hard-copy printer and additional controls, the service has obvious commercial attractions as an extension of Telex service.** Viewdata will be a vast computerized data bank that users can interrogate through the telephone network and a domestic TV receiver fitted with a suitable decoder. It is compatible with the more limited Teletext news and information service broadcast by the BBC and the Independent Broadcasting Authority.

Cable TV plans to cover 80% of Viennese viewers

Vienna is on its way to becoming a "wired city," what with some 450,000 households in the Austrian capital slated to be tied to a cable-TV network within the next eight years. Financing and carrying out the \$140 million cable-laying project will be a newly formed company, 95% owned by Philips AG, the Austrian subsidiary of Philips Gloeilampenfabrieken of the Netherlands, and 5% belonging to the city. **Work on the project will begin this year, as will pilot programs in a sector in the city's outskirts.** Starting in 1979, about 65,000 households a year will be hooked to the system, so that by 1985 more than 80% of Vienna's populace will have cable TV. The system will enable a sizable percentage of Austrians in the eastern part of the country to receive programs from West Germany and Switzerland.

German train riders can direct-dial telephone calls

The West German Federal Railways, always known to go all out for electronic techniques to improve its services, has started something new: push-button, direct-dial telephone service from its intercity high-speed trains and its Trans-European-Express trains. The new service, begun Jan. 1, replaces a procedure whereby a railway employee had to call an operator at a nearby station to connect the caller to the wanted party. **The radio-telephone gear implementing the service comes from TE-KA-DE, a Nuremberg-based communications-equipment producer partly owned by Philips.** The service may be expanded to other types of trains. The Federal Railways also is improving the network with more trackside antennas for the radiophone signals. The move enables passengers to place calls from areas where good connections were impossible because of the topography.

Switzerland updating its TV transmitters

Swiss postal authorities have chosen West Germany's Rohde & Schwarz to supply 22 television transmitters to update the country's older TV stations operating in the very-high-frequency range. The transmitters, model NT314, **are completely solid-state except for the power tube.** They will be furnished with power outputs of 500 w and 1 kw and will be hooked into dual configurations, with one unit acting as a standby. Rohde & Schwarz has not disclosed the amount the contract is worth.

Calculator controls measuring of radio signals and interference



Automated VHF-UHF measuring setup for 25 through 1000 MHz controlled over IEC interface bus from Tektronix desktop calculator 4051. Interactive programs for essential applications plus basic software for producing user programs. Numeric and graphic display of results on storage screen.

The VHF-UHF selective test equipment MSU with test receiver ESU 2, frequency controller and panoramic adapter meets the needs of automated and manual measurement of radio signals and interference, of lab assignments and monitoring tasks.

The calculator 4051 governs the operating, measuring and checking routines, makes computations and produces test readouts and diagrams on its screen.

Interactive programs for primary applications:

- radiomonitoring with level measurement and – for the first time – remote frequency measurement

(using a frequency counter) acc. to CCIR Report 272-3

- search program for detecting signals
- measuring signal and interfering field strength with results allowing for antenna factors
- measuring interference to MIL specs and VG standards
- measuring radio-interference in line with CISPR and VDE (calculator-controlled for the first time)
- lab chores: measuring two-port attenuation and gain, harmonics and intermodulation

For more information quote **ESU 2 calculator-controlled**

Rohde & Schwarz
Postfach 80 14 69
D-8000 München 80
Fed. Rep. of Germany

Electronic Measurements and Radio Communications. Development, manufacture, sales and service. Known for "electronic precision". Independent concern (establ. 1933), represented in 80 countries.



ROHDE & SCHWARZ

IC technology and IC's you'll want now

Computer/Instrumentation

We have a range of comparators which includes the fastest available in the world. Also from Plessey Semiconductors are ECL 10K and ECL III circuits plus Sub-Nanosecond ECL.

If you require unique or second source high speed products at economic prices just ask Plessey Semiconductors.

ECL Logic Families

	Features
SP1600 Series 22 products	Standard second-source of Motorola MC1600 Series.
SP10100 Series 36 products	Standard second-source of Motorola MC10100 Series.
SP10200 Series 26 products	Typically 40% faster than standard SP10100.
SP10500 Series 17 products	Full military version of SP10100 Series.
Sub-Nano-second ECL 3 products	SP16F60 - 0.5nS Delay SP10F131 - 650MHz SP10S131 - 350MHz Clock Rate



Comparators

This range is expanding and includes the fastest comparator in the world - SP9685, a single latched comparator with I/P's and O/P's ECL compatible and offering the following performance:

Minimum Set-Up Time	1nS (max.)
Propagation Delay	2nS (max.)
Input Offset	±5mV

This device is pin-compatible with the AM685 but is 3 times faster.

The SP750B is a fast latched comparator with additional features to give minimum device count in ultra-fast A-D converters for high speed signal processing in video and radar systems.

A/D performance achievable by using the SP750B can be:

4 bit, 100 Megasamples/Sec.
8 bit, 30 Megasamples/Sec.

Circle 180

Telecommunications

We have a telecommunications design, production and marketing department providing a pool of expertise which most other manufacturers would find hard to match. This has resulted in one of the world's widest ranges of telecommunications ICs including, for instance, ranges of FDM, PCM and modem circuits which are probably the best available anywhere. And we understand active filters.

We provide highly cost effective custom devices for teleprinters, electronic exchanges, push button telephones and volume subscriber equipment. If required we will work from your logic layout, tape or masks or modify a standard circuit - and produce the devices in short or long runs using standard MOS and Bipolar technologies, and a couple of our own.

Whatever your requirement Plessey Semiconductors has a team who will understand your problem, know how to tackle it and provide the necessary capability.

Circle 182



Consumer

Plessey Semiconductors is a major supplier of ICs for consumer applications, covering many areas from television to automotive products. We offer the widest range of second source products available from any IC manufacturer.

Because our products are subject to military test procedures and quality control, our quality and reliability are of the highest order.

Examples of our capability include the most comprehensive range of standard TV circuits, the world's most advanced TV tuning system and the new Surface Acoustic Wave technology for producing at low cost and in high volume TV IF filters.

If you want top quality consumer ICs in large or small quantities we can supply them.

Circle 181



Radio Communications

No one supplier can match the Plessey Semiconductors range of ICs specifically designed for low power hand-held and mobile radio.

Cost effective, with full application support, these high quality devices are available in volume quantities.

Linears

SL660, SL664, SL665. These are IF circuits purpose designed for narrow band FM. Power consumption is only 1.5 mA at 6V. They have low external component count and feature adjustable squelch for different signal to noise ratios. They are ideal for low power IF/AF, narrow band FM and hand held and mobile radio.

Designed for use as complete IF amplifiers, detectors and squelch systems. They use both phase lock loop and quadrature demodulators. They can be used for Narrow Band FM applications with input frequencies up to 25MHz and deviations up to 10 KHz. The squelch systems detect carrier squelch and can be adjusted to operate at the required signal-to-noise ratio.

Synthesisers

We have a complete range of Prescalers and 2 modulus Dividers purpose designed for mobile radio.

All have extremely low power consumption, are ideal for VHF/UHF operation and have TTL/CMOS compatibility.

The SP8655, SP8657, SP8659 are fixed ratio (divide by 32, 20 and 16) low power counters for operation at frequencies in excess of 100 MHz. They consume a mere 50m Watt making them suitable for hand held battery operation.

The SP8690 can be programmed to divide by 10 or 11 which allows effective programmable division at VHF. The frequency of operation is 200 MHz and power consumption only 70 mW typical.

Circle 183



PLESSEY Semiconductors

A Business within the Microsystems Division of Plessey

Cheney Manor, Swindon, Wiltshire SN2 2QW, UK Tel: 0793-36251 Telex: 449637.
1641 Kaiser Avenue, Irvine, California 92714. Tel: 714 540 9979. Twx: 910 595 1930.

Benelux, Tel: Brussels 02 374 59 73. Telex: 22100. France, Tel: Paris 727 43 49. Telex: 62789.
Italy, Tel: Milan 349 1741. Telex: 37347. Sweden, Tel: Stockholm 08 23 55 40. Telex: 10558. Switzerland, Tel: Zurich 50 36 55/50 36 82. Telex: 54824.
West Germany, Tel: Munich 89 351 6021/6024. Telex: 5215322.

IN SEMICONDUCTORS, UNITRODE MEANS POWER.

Unitrode has just one major product line. Power semiconductors.

And with just one thing on our brain, we can put a whole lot of interesting things in our bag.

Start with our line of power transistors.

We've got NPN Power Switching Transistors up to 500V and up to 20A. And in packages to fit virtually any form factor and price requirement.

This product group is spearheaded by our new Barrier™ line. With fall times and E_{sw} figures that have re-defined the state-of-the-art for power transistors.

We've also got NPN Power Darlingtons up to 300V and up to 10A in both plastic and high-speed hermetic versions.

In rectifiers, our capability extends from 1 to 70A and up to 1,000V. With recovery times down to 25ns.

We even have switching regulator power output circuits that range all the way up to 20A and 80V.

Our thyristor line kicks off with our

unique ChipStrate® devices that have revolutionized SCR and Triac packaging.

They're available in ratings up to 55A and 800V. In addition, we have .5 to 5A planar SCRs and PUTs in both hermetic and TO-92 plastic packages.

And in zeners and transient voltage suppressors, we can give you products up to 400V and up to 5,000W peak power.

Of course, none of this product line breadth would mean very much without the reliability (clear up to high rel JAN spec products), competitive pricing, and responsive delivery that define our commitment to the market.

All of which means that in semiconductors, Unitrode doesn't just mean power.

Unitrode means business.

For our "Semiconductor Selection Guide," circle the reader service number. For a free copy of our 496-page "Semiconductor Databook," just write on your letterhead to: Unitrode Corporation, 580 Pleasant Street, Watertown, MA 02172. Tel. 617-926-0404.

™Barrier transistor is a trademark of Unitrode Corporation



UNITRODE

Available in Munich, EBV, 089-64-40-55; London, Walmore, 01-835-1228. Also, Brussels, J.P. LeMaire, 02-478-48-47; Capetown, Electrolink, 45-7656; Copenhagen, A.F. Pedersen, 01-19-4500; The Hague, Koning en Hartman, 67-83-80; Helsinki, Nores & Co., 13-360; Madrid, Comisa Ing., 254-29-01/04; Milan, Microel Italia, 02-47-94-87; Oslo, Neco, 25-93-10; Paris, Spetelec, 686-56-65; Stockholm, Swedish Electrolink, 08-96-76-60; Tel Aviv, S.T.G., 53459; Tokyo, Rikei, 03-591-5241; Zurich, Stolz, 057-54-655.

Associative processor on a chip due from British laboratory

Design will use I²L process; one masking operation will also give a two-chip version for assembling big processors

Retrieving data from memories by identifying its content, rather than by calling its addresses, has a lot of appeal for computer-system designers. Coupling such a content-addressable memory with a control processor can speed operations on texts and numbers. The memory performs parallel operations on data sets under control of the serial processor. In particular, microcomputer-sized processors with mainframe speeds would be attractive in information retrieval systems and as text compression devices in archival text-oriented storage.

But the additional complexity of the associative memory and related control logic has meant that few hardware components have appeared. For example, every bit cell has associated logic that compares its contents with the corresponding bit in the word calling up the data.

One designer wrestling the problem is R. M. Lea of the electrical engineering and electronics department at Brunel University, Uxbridge, England. Among other advances in the past five years, he has managed to simplify his speedy associative-memory design by reducing the gates per bit from 14 to 6.

Associative power. One-chip prototype of an associative parallel processor will include memory and control logic. It will be built with Plessey's proprietary I²L process.

Now Lea plans to fabricate a complete associative processor on a chip, incorporating a small content-addressable memory and the necessary microprocessor control logic to perform search-modify-write and search-modify-read operations in

less than 200 nanoseconds [*Electronics*, Jan 5 p. 75]. Key to this is a high-density integrated-injection-logic process from Plessey.

As a byproduct of this development, he is also laying out two building-block chips that will be used to

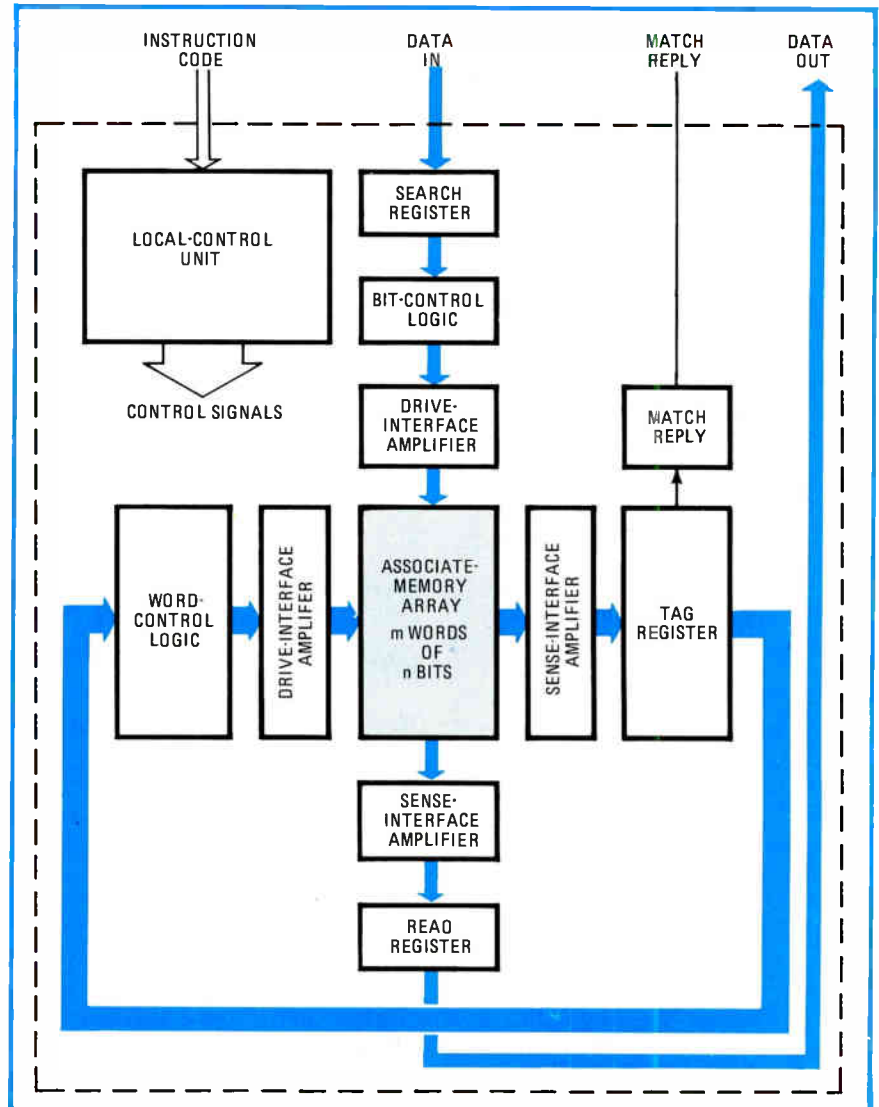

Radio communication, location and measurement

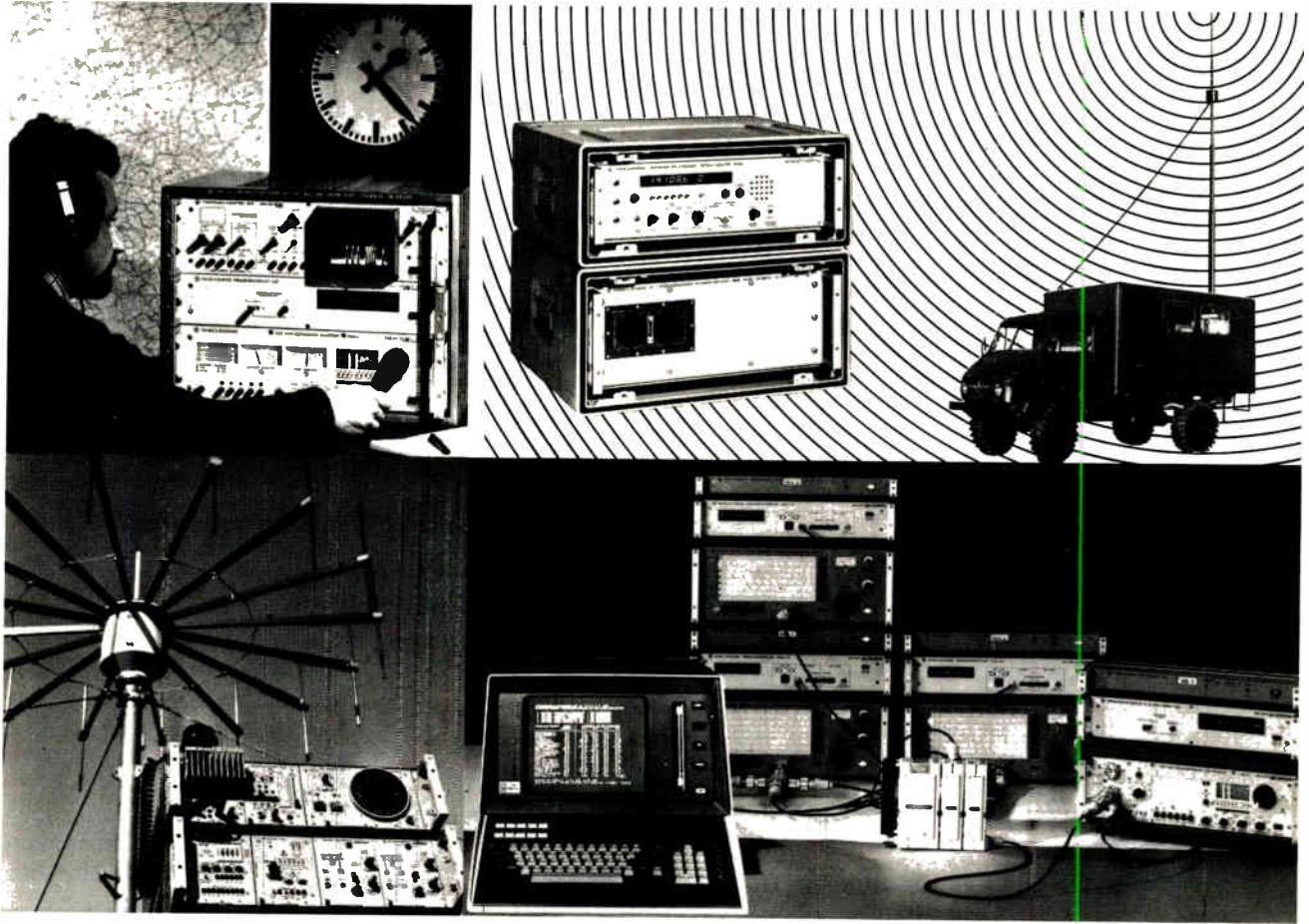

Everything from a single source for AF through SHF: equipment and systems of the highest quality and precision, featuring up-to-date technology, for stationary or mobile use, in line with international standards, and also for adverse climates. Furthermore: system planning, training, documentation and servicing. Examples:

Radio-detection receiving system (top left) for 25 through 1000 MHz. Broadband and IF panoramic display, remotely controllable. Connection of slave receivers and recording apparatus.

Transmitter/receiver system (top right) for telephony (A3J), telegraphy (A1) and RTTY (F1) from 1.5 to 30 MHz. Continuous transmitting power 100 W. Automatic antenna tuning with muting (no RF radiation) on rod, whip, longwire and broadband antennas; on any antenna without matching for emergency operation. Maximum availability through built-in microcomputer test

device and modular design, line- or battery-powered.

VHF-UHF Doppler direction finder (bottom left) for aeronautical and marine radio. Compact system with antenna diameter of only 3.3 m also suitable for rooftops and mobile applications.

Computer-controlled RF test assembly (bottom right) for 25 to 1000 MHz for automatically measuring intermodulation rejection acc. to DIN 45 004 and method K, cross-modulation acc. to method B and intermodulation by the difference-tone technique, plus gain and frequency response.

Rohde & Schwarz
Postfach 80 14 69
D-8000 München 80
Fed. Rep. of Germany

Electronic Measurements and Radio Communications. Development, manufacture, sales and service. Known for "electronic precision". Independent concern (establ. 1933), represented in 80 countries.



ROHDE & SCHWARZ

If you're not using Graphics perhaps you should be



In civil engineering - to take the expense out of mapping

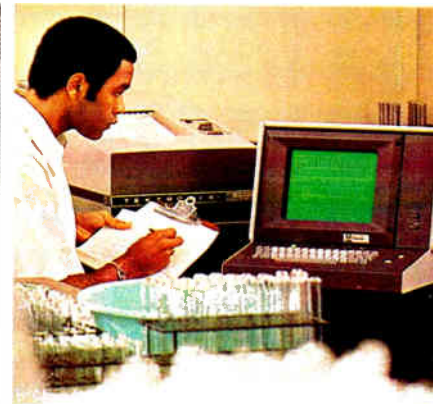

In analytical research - to eliminate the inaccuracies of manual analysis



In IC modelling - for interactive manipulation and debugging



In engineering design - to save time and money



In marketing and management - to speed up decision making

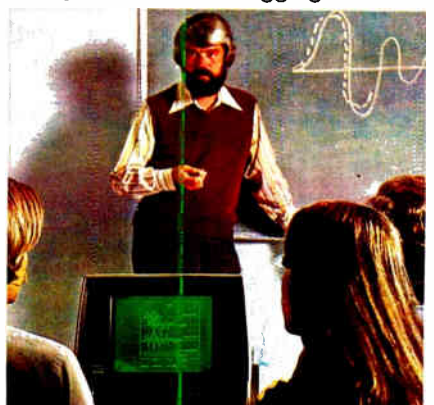

In education - to demonstrate complex theories 'live'

At Tektronix we've developed low-cost graphics for applications ranging from research and design to education and management. Graphics which can help you solve a lot of problems faster and more profitably than before.

So if you're not using display graphics perhaps you should be. You can start by finding out more on the opportunities available. Send for our free brochure 'Graphics' and see how your work can benefit from this essential technology. OEM terms and conditions are available.

Tektronix
COMMITTED TO EXCELLENCE

No 1 in display Graphics

TEKTRONIX DATATEK N.V.
Postbus 159, Badhoevedorp, The Netherlands.

I'd like to know more about how I can apply Graphics to my work. Please send me your 'Graphics' brochure.

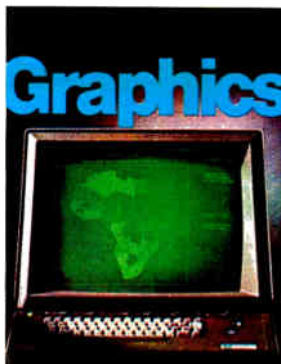

Name:
Position:
Company:
Address:
Telephone No:

Austria 0222-626141 · Belgium 02-771 9848 · Denmark 02-987711 · Finland 90-171123 · France 01-9077827 · Holland 02968-6155 · Israel 475122 · Italy 02-4996 · Norway 02-356110 · Spain 03-2576200 · South Africa 786-1020 · Sweden 08-830080 · Switzerland 42-219192 · United Kingdom 05827-63141 · USA (503) 644 0161 · West Germany 0221-77221.



CLARE CUP RELAY

The winner in quality and price.

Clare's new CUP relay combines traditional Clare quality with automatic production techniques to offer high performance at moderate prices. Heart of the CUP relay is the same Clare microreed capsule as used in conventional relays.

It has a switching capacity of 10 VA max. and a guaranteed life of 100 million operations at signal level loads, and 5 million operations at rated loads.

Designed primarily for industrial and telecommunications use, the CUP (Clare Universal Package) relay is available in a CUPS open version, a CUPC version with cover and

a CUPP version which is covered and potted to give a 2kV breakdown voltage.

It is available in contact configurations ranging from one to five poles with normally open and/or closed contacts.

For more information, contact:

C.P. CLARE INTERNATIONAL N.V.

102, rue Général Gratry
B-1040 Brussels - Belgium
Tel. 02/736 01 97 - Tx 24157



C. P. CLARE INTERNATIONAL N.V.

GENERAL INSTRUMENT CORPORATION

drain configuration. The depth of the diffusion at the contacts is more than 1 μm , but at the active regions it is less than 1 μm . □

West Germany

Auto seat control remembers positions

Yet another automotive control function where an electronic unit might displace a mechanical setup is seat positioning. Under development by two West German firms, a programmable system will provide as many as four adjustments of the seat, with the push of a button.

The system, from Robert Bosch GmbH and Keiper Automobiltechnik, is fairly simple. The driver adjusts the seat for the position he (or she) finds most comfortable. He

does this by manipulating a joystick controlling either three or four small electric motors in the seat frame. When the driver has found the position he wants, he pushes a button on an electronic control unit. This action feeds the position values, picked off each motor's spindle potentiometer and then digitized, into a digital memory in the control unit for permanent storage.

Another driver in the same car would go through the same procedure and feed the values corresponding to his most comfortable position into the memory. In this way, two or more seating positions are stored.

Return. To recall his position, the driver pushes his button. It kicks in relays applying power to the motors, which adjust the seat until the values stored in the memory are reached.

The position values are retained as long as the control unit is supplied with power from the car's battery. If

the battery is disconnected—during servicing, say—the memory will lose its contents.

The Bosch/Keiper system will probably come in two versions: one with three control motors for backrest and height adjustments as well as for fore and aft positioning, and the other with an additional motor, which will tilt the seat surface. Since the system is still in development, some technical details are not available. The firm is likely to use a standard metal-oxide-semiconductor random-access memory.

Cost. Nor are cost figures available, but a Bosch spokesman concedes that the system will not come at bargain prices, what with three or four motors needed for seat control. The Stuttgart-based firm thinks that automatic adjustment will prove to be a safety factor, since many drivers neglect to adjust the seat until the vehicle is under way. □

PROM-PLA PROGRAMMER



AB TELEMETER

Folkungagatan 16 - 18
S - 411 02 Gothenburg, Sweden
Phone: 031 - 15 70 40



Flexible software controlled Prom programmer with the following features:

- Program, verify and simulate PLA. Change from Prom to PLA by just changing family card.
- Software controlled gives few family cards with easy to change programming parameters.
- A number of interfaces for computers and peripherals.
- 14 different paper tape formats. As an option you can choose from 8 different paper tape formats by turning a switch.
- Software controlled fault finding board.



Cut your power bills by a factor of 10 ...with THOMSON-CSF's silicon-target vidicons!

Why continue burning up those kilowatts when, by replacing your conventional vidicons with THOMSON-CSF's silicon-target vidicons, you can reduce your lighting requirements by up to 10 times?

THOMSON-CSF can deliver ... from stock... 1" silicon-target vidicons that feature low blooming, burn-resistance, and a spectral sensitivity that extends out to the near infrared. Available tubes include direct plug-in replacements for some of the more commonly encountered standard vidicons.

Where direct replacement is not possible, conversion is usually only a matter of ten minutes work for the average qualified laboratory technician (if in doubt, please specify the camera, and the tube to be replaced, when ordering, and we will be pleased to indicate if, and where any modifications are required). Tubes are available in 160, 130 and 100 mm lengths, the last type featuring integral focusing and deflection coils. Ruggedized versions are available for severe environmental conditions.



THOMSON-CSF

DIVISION TUBES ELECTRONIQUES / 38, RUE VAUTHIER / 92100 BOULOGNE-BILLANCOURT / FRANCE / TEL. : (1) 604.81.75

Germany - THOMSON-CSF Elektronenröhren GmbH / Leerbachstr. 58 / 6000 FRANKFURT am MAIN 1 / Tel. : (0611) 71.72.81

Italy - THOMSON-CSF Tubi Elettronici SRL / Viale degli Ammiragli 71 / I - 00136 ROMA / Tel. : (6) 638.14.58

Japan - THOMSON-CSF JAPAN K.K. / TBR Building / Kojimachi 5-7 / Chiyoda-Ku / TOKYO / 〒102 / Tel. : (03) 264.63.41

Spain - THOMSON-CSF Tubos Electronicos S.A. / Alcalá 87 / 7ª Dcha / MADRID 9 / Tel. : (1) 226.76.09

Sweden - THOMSON-CSF Elektronrör AB / Box 27080 / S 10251 STOCKHOLM 27 / Tel. : (08) 225.815

United Kingdom - THOMSON-CSF Components and Materials Ltd. / Ringway House / Bell Road / BASINGSTOKE RG24 0QG / Tel. : (0256) 29.155 / Telex: 858865

U.S.A. - THOMSON-CSF Electron Tubes / 750 Bloomfield Avenue / CLIFTON NJ 07015 / Tel. : (201) 779.10.04

Circle 244 on reader service card



TOUGH COMPETITION:



The complete 125 ips package—beats anything in its class now moving tape.

Strong words. For strong capabilities, wrapped up in a strong new look. A totally new design in vacuum column drives houses the first *complete* high-speed package in the field.

The T1000 Series from Pertec.

No more compromising. No more shopping around. We've got it all. Together. Just for starters: 125 ips. Plus GCR. Plus auto-thread and auto-load.

You'll find everything you need to feed your powerful mini systems, in a T1000 configuration. These are not only our most advanced, most flexible tape transports produced today—they're built by Pertec to fit tomorrow's data processing applications to a T.

Ask for 6250 bpi GCR. In addition to dual NRZI/PE modes available, T1000 drives offer OEMs the only Group-Coded Recording at 125 ips—with a vacuum capstan to protect high-speed operations with a friction-free instant grip, for safer fast starts and stops.

Ask for operational convenience. T1000 makes life easier for your customers: *with* cartridge auto-load, automatic threading, and

automatic load point seek. *With* a built-in daisy-chain capability. *With* front access to all electronics to simplify maintenance.

Ask for internal data formatting. Intelligence can be built into T1000 NRZI/PE configurations (as well as our tension-arm 7" reel FT7000 and 10½" reel FT8000, and our 37.5-to-75 ips FT9000 vacuum column series). Pertec is now installing our Microformatter inside these units, on order, to simplify interfacing, and reduce system costs.

Now complete the picture: ask for Pertec. Making it still tougher on the competition, our broad line of tape transports covers the full spectrum of OEM requirements. *With* the same total commitment backing T1000: Pertec, the world's largest independent manufacturer of peripheral equipment, backs *all* its products with the international sales, support and service operations of Pertec Computer Corporation.

There's a Pertec service office near you... and your customer. With emergency assistance on-call, on a 24-hour 7-day basis, through our toll-free 800 line.

- Please send complete details on the Pertec T1000 Tape Transport Series.
 Send pricing information as indicated on the RFQ below (no obligation or cost).

Request for Quote

T1000 Model #	Data Format	Data Density (bpi)	Tape Velocity (ips)	Quantity Required	Date Wanted	Send Specs Only
T1640-98	PE/NRZI	1600/800	75-125			
T1940-96	GCR/PE	6250/1600	75-125			
FT1640-98 w/internal formatter	PE/NRZI	1600/800	75/125			

Name _____

Title _____ Phone _____ Ext _____

Please attach coupon/RFQ to company letterhead and return to Pertec, 9600 Irondale Avenue, Chatsworth, CA 91311.

For immediate requirements, call your nearest Pertec regional sales office:
 Los Angeles (213) 996-1333. Ann Arbor, Michigan (313) 668-7980. Hudson, New Hampshire (603) 883-2100. England (Reading) 582115.



a division of Pertec Computer Corporation

Self-calibration is built into 3½-digit multimeter

by John Gosch, Frankfurt bureau manager

Five-function instrument marketed by German firm carries \$250 price tag, measures currents to 10 A

A wide current range, a built-in calibration facility, and line-power-independent operation—all in a moderately priced instrument—are the prime features of a 3½-digit, five-function multimeter that West Germany's Kontron Elektronik GmbH is putting on the market.

Designed and now being produced for Kontron at Israel's Tabor, a Haifa-based electronics company partly owned by the West German firm, the DMM3020 carries a basic price tag of \$250. That buys a digital multimeter capable of measuring ac and dc currents up to 10 A. "Most other DMMs in this price range get up to only 2 A," says Dieter Hirschmann, product manager for digital instruments at Kontron. The 3020's wide current range—from 0.2 mA to 10 A—makes the instrument suitable for measurements not only in electronics but also in power engineering. Basically, the 3020 is accurate to within 0.1% of measured value.

Rarely found on digital multimeters of the 3020's price class, Hirschmann adds, is its built-in calibrator, which uses a special reference source in the instrument. With only three internal trimmers and several push buttons on the front panel, the user can check and recalibrate the instrument without the need for any external devices. A complete checkout, done according to a table on the bottom cover, takes

no more than two minutes. It includes not only a check of the voltage-, current-, and resistance-measuring circuits but also a segment test of the light-emitting-diode display and a check of the optional rechargeable batteries.

The battery option is available on a model that sells for an extra \$17, or \$267. The built-in nickel-cadmium batteries are rechargeable by the instrument's internal power supply. The batteries are four size D units that provide eight hours of operation after a complete charge cycle without the instrument's being connected to the power line.

Another option, this one available on the C version of the 3020, is a built-in, fully parallel binary-coded-decimal output. This option enables the user to make a permanent record of measurements on a digital data

printer or to feed the results to a computer or to peripheral equipment. The DMM3020C is priced at \$313.

All 3020 models take voltage, current, and resistance measurements in 28 ranges. Dc and ac voltages are measured in five ranges from 0.2 to 1,200 v with a maximum resolution of 100 μ v. The ac and dc currents are measured in six ranges with a maximum resolution of 100 nA. The instrument has six ranges for resistance measurements—from 200 Ω to 20 M Ω , with 100 m Ω the maximum resolution.

Well protected against transients and overloads, the 3020 can withstand up to $\pm 1,200$ v in any voltage range. The current ranges (except those for 10 A) are protected by a 2-A wire fuse. The 10-A ranges withstand inputs up to 15 A. All resist-

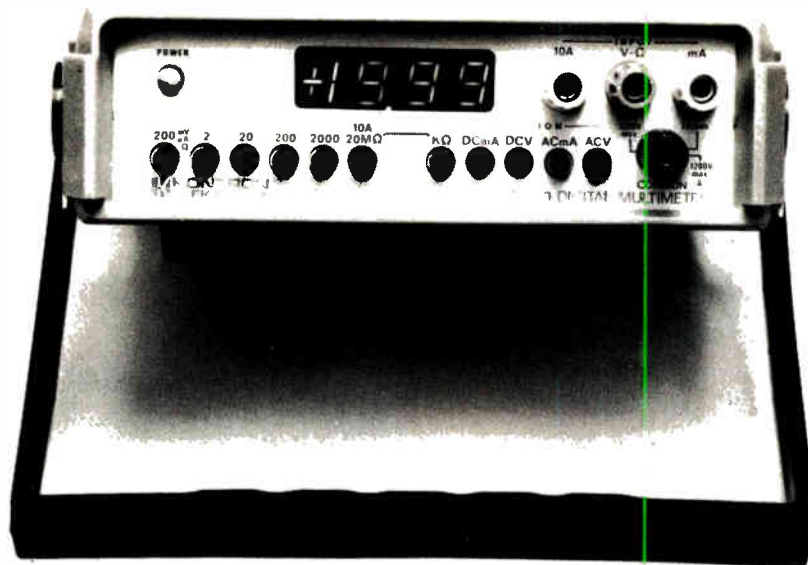

News from Philips

Integrated circuits • Semiconductors • Electron tubes • Components • Assemblies • Materials

HIGH PERFORMANCE JFET OP-AMPS

Signetics' new series of high performance operational amplifiers types LF355/355A/356A/357/357A are commercial temperature range versions of industrial versions LF255/256/257 and military versions LF155/156/157/A and employ the same well matched JFET input structures on the same chip with bipolar transistors.

Designed for use over the temperature range 0 to +70 °C, these amplifiers feature low input bias and offset currents of 30 pA and 3 pA, respectively. The input offset voltage is low, being only 3 mV (1 mV for the "A" versions) with a drift of only 5 $\mu\text{V}/^\circ\text{C}$ (3 $\mu\text{V}/^\circ\text{C}$ for the "A" versions). The devices are also designed for a high slew rate (50 V/ μs for the LF357/357A), wide bandwidth up to 20 MHz, and extremely fast settling time (1.5 μs for some types). Low noise is also a feature of the new op-amps, being as low as 12 nA/ $\sqrt{\text{Hz}}$ in some cases.

Intended for use with a supply voltage of ± 15 V, a low supply current of only 2 mA (typical) is required for the LM355/355A, and 5 mA for the other types.

Circle 271 on reader service card

ORGAN IC CUTS COMPONENT COUNT

The TDA1008 gating/frequency divider for electronic musical instruments is a monolithic bipolar integrated circuit based on I²L, with frequency dividers directly coupled to the gating matrix. In electronic organs using a top octave synthesizer directly coupled to twelve TDA1008s, only one busbar per manual is needed to obtain five octave-related tones per key.

In addition to simplification of key contact construction and tone generator designs, features like sustain and percussion can be obtained by adding only a few resistors and capacitors. Overall component count is reduced, with consequent greater reliability and easier servicing.

In the TDA1008, the outputs of the dividers, together with the input signal, are applied internally to nine gate inputs. By activating a key input, five successive signals out of the nine are selected and transferred to the outputs. Five key inputs are available, each selecting a different combination. The output voltage is proportional to the voltage on the key inputs; this output voltage has no d.c. component, so clicks and plops will never occur.

Circle 268 on reader service card

DUAL TRACKING VOLTAGE REGULATORS WITHOUT FRILLS

Where dual power supplies must track to close tolerance, the Signetics 5551 family of dual tracking voltage regulators provide high performance on-card regulation. Designed to produce continuously adjustable balanced or unbalanced output voltages from 5 V to 20 V with up to 300 mA output current, the 5551 family employ current limiting and thermal shutdown protection on the chip. Input voltage may be as high as ± 32 V.

Both regulators are differential amplifiers followed by a gain stage and a Darlington with current limit. The negative regulator is the complement of the positive with the exception that the output stage is a compound p-n-p and a zener controlled current source is used as reference with a forward biased diode for temperature compensation. The voltage dividers around the zener set the actual reference to 5 V and

allow positive and negative output voltages to be programmed conveniently. The resistor values obtained with different mask options enable standard fixed voltages to be obtained: ± 5 , ± 6 , ± 12 , ± 15 and ± 5 , -12 V. These can be made continuously variable by means of external balance and control potentiometers.

Tolerance on output voltage is 5%, with regulation 1%. The temperature coefficient is 65 ppm/ $^\circ\text{C}$, and the noise is 55 μVrms between 10 Hz and 10 kHz. Intended for use on op-amp supplies, analogue signal processors, MOS/LSI systems, sense amplifier supplies and communications circuits, the 5551 family is designed to provide a customer with a device intended for his needs without including costly redundant features.

Circle 270 on reader service card

2-CHIP MICROCOMPUTER FOR COST-EFFECTIVE PROFESSIONAL USE

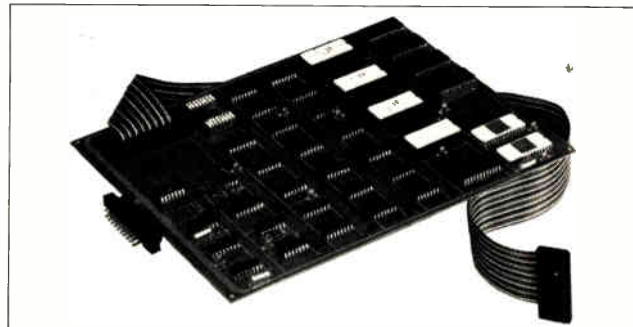

Signetics' 2650 8-bit N-MOS micro-processor and the new 2656 system memory interface (SMI) chip provide a 2-chip microcomputer with 2048 x 8 bits of ROM, 128 x 8 bits of RAM, an 8-bit input/output port, and an on-chip clock generator.

The programmable features of the new 2656 SMI are numerous. The individual pins of the 8-bit I/O port can be input, output, or generate chip enable signals for larger systems with more ROM, RAM and I/O. The RAM area may overlap the ROM area if the address overlap is intentionally mask programmed. The RAM can be disabled by a mask option. Both the ROM and RAM base addresses are mask programmable over the entire μP address range. The 2656 also features clock circuitry with crystal, RC, or external timing source. System

power-on reset output pulses are also provided.

The 2656 is supplied in a 40-pin dual-in-line package and it requires only a +5 V supply, like the 2650 micro-processor. All signals are TTL compatible.

For microcomputer applications where space is at a premium and yet flexibility is required, the combination of the 2650 and the 2656 can prove most cost-effective.

For prototyping purposes, Signetics has introduced the 2650PC4000 2656 emulator board. A 40-pin DIL connector at the end of a 60 cm cable fits into the 2656 socket of the final system. 2656 ROM and PGA (programmable gate array) patterns can be implemented on and tested with the PC4000 board.

Circle 269 on reader service card

HEAVY DUTY GEARBOXES FOR REVERSIBLE SYNCHRONOUS MOTORS

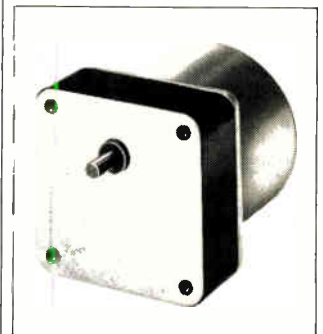

Our reversible synchronous motors are widely used as servo actuators in control and instrumentation equipment and our latest 9912 200... series of heavy duty gearboxes form a vital link in meeting the speed requirements. As many as 21 standard gear ratios are available; special ratios can be supplied on request, but require minimum order quantities.

The gearboxes are of rugged design with precision cut brass gears and impregnated bronze bearings pressed into the aluminium side frames to ensure a long trouble-free life. The side frames are shielded with a layer of stainless steel to prevent migration of the bearing oil. A dust cover encloses the gearbox assembly to protect the rotating parts from ingress of foreign particles.

Optimal versatility has been achieved by providing each gearbox with a number of different sets of threaded holes, two pinions, and a centring bush so that the user can combine these gearboxes with any of our reversible synchronous motors having a shaft diameter of 2 mm or 3 mm.

The gearboxes are rated at 3000 mNm maximum torque and can withstand a radial load of up to 50 N.

Circle 272 on reader service card

Philips Industries
Electronic Components and
Materials Division
Eindhoven - The Netherlands



Electronic
Components
and Materials

Salon international des Composants Electroniques 3-8 avril 78 - Paris

All electronic components + measuring instruments, material and products + equipment and methods specific to the manufacture and installation of electronic components.

Further particulars and free entrance cards on request: S.D.S.A. 20 rue Hamelin
F 75116 Paris
Tél.: (33-1) 505.13.17 - Tx 630.400 F.



Don't miss it, others won't.

Circle 229 on reader service card

FEATURE ARTICLES FROM *ELECTRONICS* AVAILABLE IN REPRINT FORM

No. of
copies
wanted

New reprints

- ___ R-718 Display makers strive to refine their technologies 8 pp \$3.00
- ___ R-716 Special report—Japanese wave in semiconductor technology 24 pp \$3.00
- ___ R-714 Special report—active filter technology 6 pp \$3.00
- ___ R-713 Electron-beam lithography draws fine line 10 pp \$3.00
- ___ R-712 Special report—large-scale integration 16 pp \$3.00
- ___ R-710 Personal computers mean business 8 pp \$2.00
- ___ R-708 So you want to be a consultant 6 pp \$2.00
- ___ R-706 Low-cost dual delayed sweep method 6 pp \$2.00
- ___ R-705 Powering up with linear ICs 12 pp \$3.00
- ___ R-703 Special report—memories 16 pp \$3.00
- ___ R-702 World market report 1977 24 pp \$4.00
- ___ R-616 Special issue—technology update \$4.00
- ___ R-614 Power supply choices for sophisticated designs 8 pp \$3.00

- ___ R-612 Fiber-optic communications special report 24 pp \$3.00
- ___ R-610 Special report on hybrid-circuit technology 19 pp \$3.00
- ___ R-606 Special issue—microprocessors \$4.00
- ___ R-526 How reliable are today's components 16 pp \$3.00

Books

- ___ R-711 Circuits for electronics engineers: 306 circuits in 51 functional groups—Electronics Book Series \$15.95
- ___ R-704 Thermal design in electronics \$5.00
- ___ R-701 Applying microprocessors—Electronics Book Series \$9.95
- ___ R-608 Basics of Data Communications—Electronics Book Series \$12.95
- ___ R-602 Large Scale Integration—Electronics Book Series \$9.95
- ___ R-520 Microprocessors—Electronics Book Series \$8.95
- ___ R-011 Computer-aided Design 135 pp \$4.00
- ___ R-032 Active Filters 88 pp \$4.00

Charts

- ___ R-516 Electronic symbols \$2.00
- ___ R-213 Electromagnetic spectrum (updated 1976) \$3.00
- ___ R-326 Optical spectrum (6-page report and chart) \$3.00

Payment must accompany your order

Make check or money order payable to Electronics Reprints. All orders are shipped prepaid by parcel post. Allow two to three weeks for delivery. For additional information call (609) 448-1700 ext. 5494

Back issues now available:
1960 to 1969, \$5.00 each
1970 to 1973, \$3.00 each
1974 to 1976, \$4.00 each

Mail your order to:
Janice Austin
ELECTRONICS REPRINTS
P.O. Box 669
Hightstown, N.J. 08520

Belling-Lee

DEF approved
STAN 05-21



filters

and

filter connectors

U.L. recognition

L 2400 Series
For the efficient suppression of thyristor, logic generated interference and to provide reliable protection from mains transients.
Low leakage characteristics
Colour coded terminals

Rating
15A at 250 Va.c., 50 Hz
Designed to meet requirements of BS 613 and VDE

L 2135 Series
A new filtered mains inlet connector designed to provide extra protection for medical instrumentation and equipment.
Low earth leakage current
Less than 10 μ A

Rating
6A
Fail safe circuitry

Applications
Oscilloscopes, recorders and plotters, VDU's, tape-decks, mini-computers, switch mode power supplies and thyristor controls.

U.L. recognition

L 2131B Series
A product of Belling-Lee's unique expertise in connector design and suppression technology. Protects equipments against mains borne voltage transients
Filter combined with standard CEE 22 mains inlet
End and side terminal styles

Rating
2 A and 6 A

Belling-Lee

Belling and Lee Limited,
Electronic Components Group,
Gt. Cambridge Road, Enfield EN1 3RY,
Middlesex, England.
Telephone : 01-363 5393. Telex : 263265

Electronics

Reader Service

For additional information on products advertised, new products or new literature, use these business reply cards.

Complete entire card. Please print or type.

Circle the number on the Reader Service postcard that corresponds to the number at the bottom of the advertisement, new product item, or new literature in which you are interested.

To aid the manufacturer in filling your request, please answer the three questions.

All inquiries from outside the U.S. that cannot reach Electronics before the expiration date noted on the Reader Service postcard must be mailed directly to the manufacturer. The manufacturer assumes all responsibilities for responding to inquiries.

Subscriptions & Renewals
Fill in the subscription card adjoining this card. Electronics will bill you at the address indicated on the card.

Electronics January 19, 1978 This reader service card expires April 19, 1978

NAME _____ TITLE _____

PHONE (_____) _____ COMPANY _____

STREET ADDRESS (Company or home check one) _____

CITY _____ COUNTRY _____

Was This Magazine Personally Addressed to You? Yes No

Industry classification (check one):

- a Computer & Related Equipment
- b Communications Equipment & Systems
- c Navigation, Guidance or Control Systems
- d Aerospace, Underseas Ground Support

- e Test & Measuring Equipment
- f Consumer Products
- g Industrial Controls & Equipment
- h Components & Subassemblies

- j Independent R&D Organizations
- k Government

Your design function (check each letter that applies):

- x I do electronic design or development engineering work.
- y I supervise electronic design or development engineering work.
- z I set standards for, or evaluate electronic components, systems and materials.

Your principal job responsibility (check one)

- t Management
- v Engineering

Estimate number of employees (at this location): 1. under 20 2. 20-99 3. 100-999 4. over 1000

1	16	31	46	61	76	91	106	121	136	151	166	181	196	211	226	241	256	271	348	363	378	393	408	423	438	453	468	483	498	703	718
2	17	32	47	62	77	92	107	122	137	152	167	182	197	212	227	242	257	272	349	364	379	394	409	424	439	454	469	484	499	704	719
3	18	33	48	63	78	93	108	123	138	153	168	183	198	213	228	243	258	273	350	365	380	395	410	425	440	455	470	485	500	705	720
4	19	34	49	64	79	94	109	124	139	154	169	184	199	214	229	244	259	274	351	366	381	396	411	426	441	456	471	486	501	706	900
5	20	35	50	65	80	95	110	125	140	155	170	185	200	215	230	245	260	275	352	367	382	397	412	427	442	457	472	487	502	707	901
6	21	36	51	66	81	96	111	126	141	156	171	186	201	216	231	246	261	338	353	368	383	398	413	428	443	458	473	488	503	708	902
7	22	37	52	67	82	97	112	127	142	157	172	187	202	217	232	247	262	339	354	369	384	399	414	429	444	459	474	489	504	709	951
8	23	38	53	68	83	98	113	128	143	158	173	188	203	218	233	248	263	340	355	370	385	400	415	430	445	460	475	490	505	710	952
9	24	39	54	69	84	99	114	129	144	159	174	189	204	219	234	249	264	341	356	371	386	401	416	431	446	461	476	491	506	711	953
10	25	40	55	70	85	100	115	130	145	160	175	190	205	220	235	250	265	342	357	372	387	402	417	432	447	462	477	492	507	712	954
11	26	41	56	71	86	101	116	131	146	161	176	191	206	221	236	251	266	343	358	373	388	403	418	433	448	463	478	493	508	713	956
12	27	42	57	72	87	102	117	132	147	162	177	192	207	222	237	252	267	344	359	374	389	404	419	434	449	464	479	494	509	714	957
13	28	43	58	73	88	103	118	133	148	163	178	193	208	223	238	253	268	345	360	375	390	405	420	435	450	465	480	495	510	715	958
14	29	44	59	74	89	104	119	134	149	164	179	194	209	224	239	254	269	346	361	376	391	406	421	436	451	466	481	496	701	716	959
15	30	45	60	75	90	105	120	135	150	165	180	195	210	225	240	255	270	347	362	377	392	407	422	437	452	467	482	497	702	717	960

Electronics January 19, 1978 This reader service card expires April 19, 1978

NAME _____ TITLE _____

PHONE (_____) _____ COMPANY _____

STREET ADDRESS (Company or home check one) _____

CITY _____ COUNTRY _____

Was This Magazine Personally Addressed to You? Yes No

Industry classification (check one):

- a Computer & Related Equipment
- b Communications Equipment & Systems
- c Navigation, Guidance or Control Systems
- d Aerospace, Underseas Ground Support

- e Test & Measuring Equipment
- f Consumer Products
- g Industrial Controls & Equipment
- h Components & Subassemblies

- j Independent R&D Organizations
- k Government

Your design function (check each letter that applies):

- x I do electronic design or development engineering work.
- y I supervise electronic design or development engineering work.
- z I set standards for, or evaluate electronic components, systems and materials.

Your principal job responsibility (check one)

- t Management
- v Engineering

Estimate number of employees (at this location): 1. under 20 2. 20-99 3. 100-999 4. over 1000

1	16	31	46	61	76	91	106	121	136	151	166	181	196	211	226	241	256	271	348	363	378	393	408	423	438	453	468	483	498	703	718
2	17	32	47	62	77	92	107	122	137	152	167	182	197	212	227	242	257	272	349	364	379	394	409	424	439	454	469	484	499	704	719
3	18	33	48	63	78	93	108	123	138	153	168	183	198	213	228	243	258	273	350	365	380	395	410	425	440	455	470	485	500	705	720
4	19	34	49	64	79	94	109	124	139	154	169	184	199	214	229	244	259	274	351	366	381	396	411	426	441	456	471	486	501	706	900
5	20	35	50	65	80	95	110	125	140	155	170	185	200	215	230	245	260	275	352	367	382	397	412	427	442	457	472	487	502	707	901
6	21	36	51	66	81	96	111	126	141	156	171	186	201	216	231	246	261	338	353	368	383	398	413	428	443	458	473	488	503	708	902
7	22	37	52	67	82	97	112	127	142	157	172	187	202	217	232	247	262	339	354	369	384	399	414	429	444	459	474	489	504	709	951
8	23	38	53	68	83	98	113	128	143	158	173	188	203	218	233	248	263	340	355	370	385	400	415	430	445	460	475	490	505	710	952
9	24	39	54	69	84	99	114	129	144	159	174	189	204	219	234	249	264	341	356	371	386	401	416	431	446	461	476	491	506	711	953
10	25	40	55	70	85	100	115	130	145	160	175	190	205	220	235	250	265	342	357	372	387	402	417	432	447	462	477	492	507	712	954
11	26	41	56	71	86	101	116	131	146	161	176	191	206	221	236	251	266	343	358	373	388	403	418	433	448	463	478	493	508	713	956
12	27	42	57	72	87	102	117	132	147	162	177	192	207	222	237	252	267	344	359	374	389	404	419	434	449	464	479	494	509	714	957
13	28	43	58	73	88	103	118	133	148	163	178	193	208	223	238	253	268	345	360	375	390	405	420	435	450	465	480	495	510	715	958
14	29	44	59	74	89	104	119	134	149	164	179	194	209	224	239	254	269	346	361	376	391	406	421	436	451	466	481	496	701	716	959
15	30	45	60	75	90	105	120	135	150	165	180	195	210	225	240	255	270	347	362	377	392	407	422	437	452	467	482	497	702	717	960

Electronics Reader Service

If the cards below have already been used,
you may obtain the needed information
by writing directly to the manufacturer,
or by sending your name and address,
plus the Reader Service number and issue date,
to Electronics Reader Service Department,
P.O. Box No. 2530, Clinton, Iowa 52734 . U.S.A.

Place correct airmail
postage here ... for
faster service.

Electronics

P.O. Box No. 2530
Clinton, Iowa 52734
U.S.A.

Place correct airmail
postage here ... for
faster service.

Electronics

P.O. Box No. 2530
Clinton, Iowa 52734
U.S.A.

READ THESE TEN CHAPTERS. AVOID CHAPTER 11.

 Data General

How To Handle The Ten Biggest Risks OEMs Take.



- I want to see how a computer vendor can help me. Send me your book today.
- I'm too busy to read another book. Have your salesman come and show me the way.

Name _____
Title _____
Company _____
Department _____ Phone _____
Address _____ City _____
State _____ Zip _____

Data General, Westboro, MA 01581, (617) 366-8911. Data General (Canada) Ltd., Ontario.
Data General Europe, 59-65 rue de Courcelles, Paris, France. Data General Australia, Melbourne (03) 82-1361.

 **Data General**

We make computers that make sense

© Data General Corp., 1977



Analysis of Variance



Engineering Analysis
& Schematics





Time Series Analysis



Regression Analysis

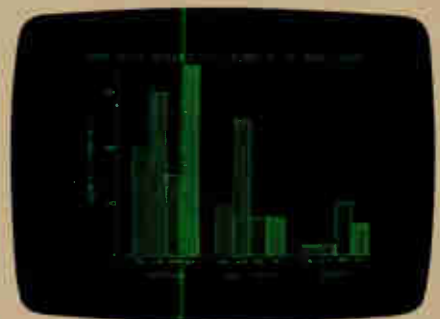

Business Analysis

With our new friendly computer, solving problems won't seem like work anymore.

Introducing System 45. Formally, it's called the HP System 45 Desktop Computer, but you'll come to regard it as a valuable friend. It fits in your workstation, ready to go the instant you have a problem. Gives you the ability to perform more thorough analyses, faster, and with less effort than you ever imagined.

System 45's friendliness comes from the integration of several problem-solving capabilities in one compact chassis. It puts powerful graphics, high performance I/O, big memory, and mass storage all together at your fingertips. Most important, System 45's design enables you to fully exploit these capabilities without getting involved in its internal operating routines.

The power to handle big tasks. Though small enough to go wherever your work demands, System 45 is big enough to handle 85 x 85 matrix inversions or tenth-

order ordinary differential equations. You can easily handle most of the problems you've been assigning to a big computer: Clin-lab data base management, thermal analysis, high-speed data acquisition and control, state variable analysis, structural analysis for virtually any geometry, production scheduling and control, or electronic circuit analysis—to name but a few.

Conversational Problem-solving. Solutions are straightforward because you communicate with System 45 in conversational BASIC. The dialog is so relaxed it seems almost human. Type in your data and commands and System 45 presents your formatted results on its high-resolution CRT. Need hard-copy? A single command exactly duplicates your plot, drawing or data table on the optional built-in printer.

A logical growth path. Like any true friend, System 45 will stick by you as your problems grow and change. You can expand the mem-

ory, add performance options, or plug-in your choice of peripherals, including floppy and hard discs. For more convenience and versatility, you can round out your system with a selection of programs from our growing software library.

Ask for an introduction. To learn more, drop us a line in Loveland, home of the friendly computers. Or call your local HP Sales Office for an introduction to the System 45.

Please have a salesman call. 1/19/78
Phone _____

Please send more information.
My application interest is:
 Engineering Design.
 Numerical Analysis.
 Data acquisition and control.

Name _____
Company _____
Address _____
City/State/Zip _____
P.O. Box 301, Loveland, Colorado 80537



P.O. Box 301, Loveland, Colorado 80537

For assistance call Washington (301) 948-6370, Chicago (312) 255-9800, Atlanta (404) 955-1500, Los Angeles (213) 877-1282

40777

Circle 67 on reader service card

Plug into our information systems for more profitable electronic systems design and production.

Would you like to win more competitive bids? Find data on available state-of-the-art components and materials? Establish alternate sourcing? Find off-the-shelf components instead of creating specials? Keep current with everchanging industry and Federal codes, specs and regulations? You can—if you make the information explosion work for you instead of against you.

We can help. We're Information Handling Services, creators of VSMF® and other information retrieval systems. It's our mission to help you manage a tremendous volume of rapidly changing information. New Products. Changing specifications. New materials. Plus revisions of government and industry standards, codes, and regulations. We can give you instant access to information you'd otherwise spend hours or days researching. And we update that information as often as every 15 days.

Using two large-scale computers, we can configure an information base and retrieval system—in a variety of media—tailored to the specific needs of nearly every function in your organization. Among them: R&D, design engineering, standards, quality control, purchasing, maintenance, and more.

Unique, computer indexing methods not only enable you and your staff to quickly find products, suppliers, specs, standards, and codes quickly, but also interrelate them. For example, locate a particular product or manufacturer and you're simultaneously directed to the appropriate current regulations. And vice versa.

We can provide the documentation to assist your supplier evaluation. To design and build a product, a system and related subsystems. Then we can follow-on with the documentation necessary to maintain the system throughout its service life. Of particular interest to you are our Integrated Circuit and Semiconductor Parameter Retrieval Services, as well as our Design Engineering Service; IEEE, EIA, ASTM, NEMA, ANSI and ISO/IEC Standards Services; Military Specifications Service; and Military Standard Drawings Service.

To complement your particular style of management, we can deliver information through these and other off-the-shelf systems, or we can design and implement custom information retrieval systems in a variety of media—electronic, microform, or hard-copy.

For a free brochure describing how you can apply electronic efficiency to more profitable systems design and production, clip your business card to this ad and mail it to IHS®. Or write or call Information Handling Services, World Headquarters, 15 Inverness Way East, Englewood, Colorado 80150, USA. Phone (303) 779-0600.

For information call toll-free: 1-800-821-3424, ext. 214
(In Missouri: 1-800-892-7655, ext. 214)

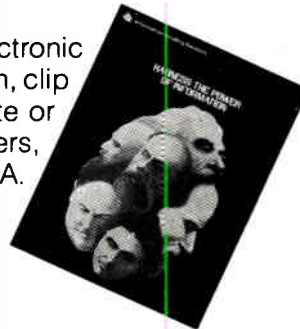

Information Handling Services

An Indian Head Company

COMPUTERIZED INFORMATION RETRIEVAL SYSTEMS WITHOUT THE COST OF THE COMPUTER

009-1

Because who has time to learn a new system when a better chip comes along?

Prototype control probe runs prototype hardware and software under control of the microprocessor lab while you maintain access to program activity.

JOB AFTER JOB, OUR SYSTEM STAYS WITH YOU.

We know time spent learning equipment is best spent on equipment that's going to stay around.

That's why we engineered the first development lab for designers like us who work with major microprocessors.

Now you can work with two or more chips. Without depending upon a single chip vendor. Without buying and learning an entirely new system.

THE BEST IDEAS

Our features are the kind of ideas you'd probably engineer for yourself. . . the kind of system you get from a chip user, not a chip vendor.

DISC BASED SYSTEM

Includes text editor, macro relocatable assembler, debugging software and file management utilities, to help simplify software preparation and debugging.

REAL TIME PROTOTYPE ANALYZER

This invaluable option lets you easily track down timing or program

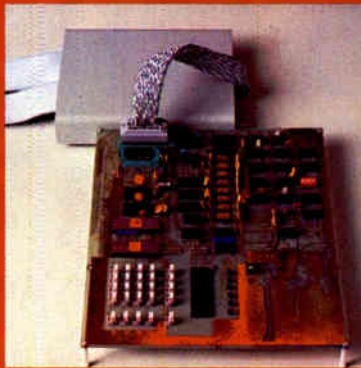

logic problems by dynamically monitoring the microprocessor bus in real time.

UNFIASHABLE ARCHITECTURE

Separate system and emulator processors and memory protect the operating system software should your program fail while emulating the target microprocessor.

PARALLEL DEVELOPMENT INTEGRATED TESTING

Hardware and software engineers can test, trace, and debug independently up to the point of integration. Then they can work together, productively.

If you're concerned about how you spend your time, take a close look at a design lab you can use time and again. . . even when a better chip comes along.

Contact your local Tektronix Sales Office, or write or call Tektronix, Inc., P.O. Box 500, Beaverton, OR, (503) 644-0161. In Europe, Tektronix, Ltd., P.O. Box 36, St. Peter Port, Guernsey, Channel Islands.

Tektronix
COMMITTED TO EXCELLENCE

**Tektronix
microprocessor
development labs.**

**Designed by
people on your side
of the bench.**

For Information circle 70
For Demonstration circle 71

*Teradyne finds the practical solution.
No. 1 in a series.*

Automatic circuit-board probing

Avoiding potholes on the road to higher throughput.

Ever since Teradyne introduced the concept of "guided probing" to circuit-board testing in 1972, anyone who thought about the subject could see that guided probing, for all its obvious benefits, was only a way station on the road to automatic probing. The human hand is, after all, no match for a well-designed x-y table when it comes to positioning speed (if God had only had money...), and even with the most competent operators, human error is an ever-lurking danger. So engineers have sought to automate the probing process for some years now, in the interest of both better testing and higher throughput.

The physical challenge of getting a probe from point to point in a hurry (and repeatably) wasn't especially frightening to an industry that had already mastered the mechanics of wafer probing and laser trimming. The real problem involved the integration of an automatic prober into a system in such a way that its high-speed positioning would be of real economic value. If, for example, a board-test system has to sit on each probe point for 2 or 3 seconds to allow a simulator and disc to operate, an automatic prober that zips from one point to another in milliseconds is hardly worth the effort.

Teradyne's L125 board-test system was under no such constraints. With all diagnostic data in CPU memory for straight look-up, the system can generate probing instructions fast enough to keep pace with any automatic prober. So the M150 Automatic

Prober was born, and those who have used it tell us that it's the only way to go.

An automatic prober has to know its way around each circuit board, naturally, which means that coordinates of all the probe points must be added to the software.

How does one get all that geometry into the test program? Very painlessly, it turns out. The x-y coordinates can be self-learned from a "walk-through," with the probe itself digitizing the locations, or they can be written into the job plan. In either case, the programming chore is simplified by software that, for instance, can translate the location of a single IC pin (plus package type and orientation) into the locations of all other pins on the IC.

As might be expected, the M150 is a real throughput-booster. Its advantage over manual probing is hard to quantify, being a function of handling time, yield, and test time, but reports of doubling and tripling are commonplace.

That means that a single test system with automatic prober can in certain applications outproduce two or three manual systems. That represents Big Money, and a competitive advantage that's hard to overlook. A growing number of major electronics manufacturers aren't overlooking it at all.

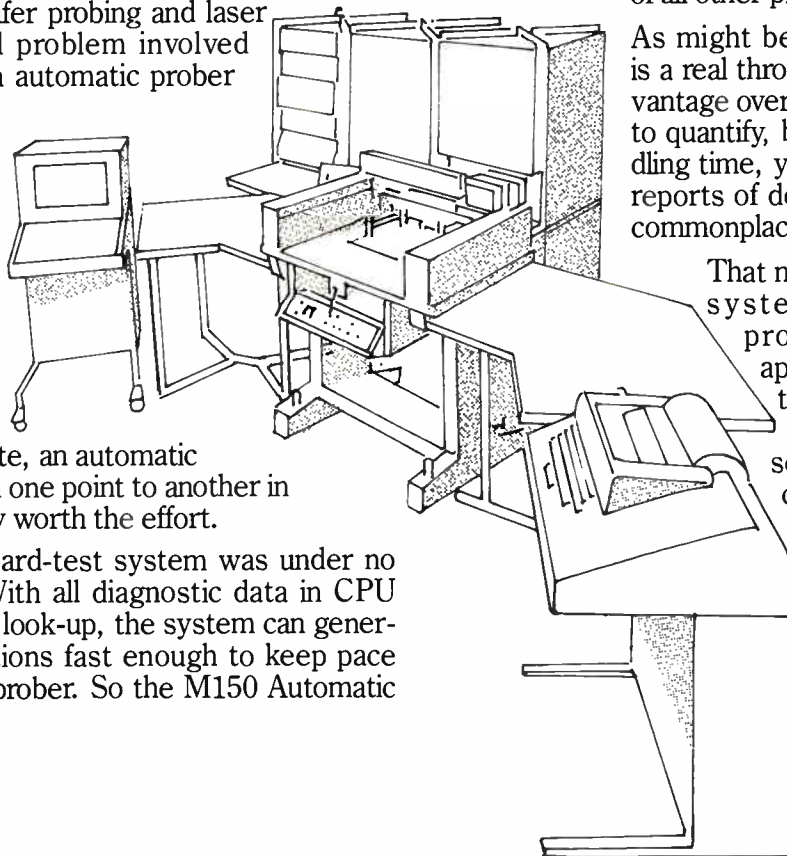

TERADYNE

TENS by the millions

That stands for transcutaneous electronic nerve stimulators, pain-killing devices that could become a \$500 million market

by Stephen E. Scrupski, Instrumentation Editor

Electronic technology, having proved its efficacy and reliability in controlling the human heart with electronic pacemakers, is moving into a new area—pain control. Upwards of 40 companies are now manufacturing transcutaneous electronic nerve stimulators (TENS)—electronic pulse generators that when attached to the skin, generate signals that in some way relieve pain.

"We are working very empirically at this time," says Patricia Garland, product manager for Stimtech Inc., a Minneapolis-based manufacturer of the stimulators. "The more the medical community finds out, the more we realize that we don't know exactly how they work." But basically, she says, the stimulators "interfere with the passage of pain signals along the nerve to the brain."

For whatever reason, they evidently do alleviate pain, and the potential market is large. "The University of Colorado Medical Center recently estimated that there are between 20 million and 40 million chronic pain patients in the U. S.," says Michael Halleck, general manager of Staodynamics Inc., Longmont, Colo., another major manufacturer of the electronic pain-control devices. Citing a recent report from market research firm Frost and Sullivan Inc., Halleck notes that the market was about \$9 million in 1976 and could grow to anywhere between \$100 million and \$500 million in the next five years. Thus, he says, "the surface hasn't even been scratched."

Medtronic Inc., Minneapolis, sees the TENS market growing at a rate that exceeds 50% per year. "There are 40 million patients that see a doctor for pain each year; 30 million

Marketing: a network of pain-control centers

One of the early workers in the electronic pain-killer field is a physician, C. Norman Shealy, now director of the Pain and Health Rehabilitation Center, LaCrosse, Wis. "The only way electronic stimulators will manifest themselves in the medical field is through independent pain-control centers that will fill prescriptions from physicians," Shealy says. "This will never be an office procedure, since the average physician probably does not see enough pain patients to justify training an associate in the use of transcutaneous electronic nerve stimulators, and also because he has limited time to spend with each patient and patient selection and education in the use of the devices can be time-consuming."

For example, Med General Inc., one of the leading manufacturers of electronic pain-killing devices, was instrumental in setting up Pain Control Centers Inc., which became a publicly held company in December. The company expects to have about 40 centers located across the country by the end of this year.

The devices also have been used to treat athletes—the National Football League, for example, approved their use in a game by the Detroit Lions' Charlie Sanders, who wore one under his uniform. In the National Basketball Association, the Philadelphia 76ers' Daryl Dawkins played a full game with a unit attached to his shoulder. According to Dr. Shealy, users have found the devices to be safe, in that they do not fully mask all pain and thus players do not run the risk of further damage that can be incurred because they are unaware of new injuries.

for chronic pain and 10 million for acute pain," points out Jerry Donahue, general manager for Medtronic's Roseville, Minn., Neuro division. Predicasts Inc., a Cleveland business information and market research firm, is more conservative in its estimate of growth for the TENS market, pegging it at about 25% per year. Even at that, rate, TENS devices would place at the top of the list as far as growth rates of biomedical equipment are concerned. They would outstrip, for example, computerized tomography and diagnostic ultrasound, each with an expected 13% growth rate.

Medtronic got into the pain-management business seven years ago with implanted nerve-stimulation devices and then developed its

transcutaneous nerve stimulator, called Neuromod, in order to screen patients for the eventual implants. The device now sells for \$350 to \$450, depending on features, and requires a physician's prescription.

There appears to be general agreement on the four leaders in the field, who together control about 80% of the market. They are three Minneapolis-based firms, Medtronic, Med General Inc., and Stimtech, plus Staodynamics. Their ranking, however, depends on which one you ask.

Pulse generators. In essence, the devices are simply pulse generators with variable pulse widths, levels, and repetition rates, all three parameters being independently adjustable by the patient. A typical Stimtech unit, for example, delivers constant

AMP EUROPE

Austria — AMP Austria. Branch of AMP Deutschland GmbH, Markgraf-Ruediger Str. 6-8, 1150 Vienna. Phone: 924191/92

Belgium — AMP Belgium. Branch of AMP-Holland B.V., Rue de Brabant 62-66, Brussels. Phone: 322.17.55.17

Finland — AMP Finland OY
Pastilakero 3, 00401 Helsinki 40
Phone: 90/584122

France — AMP de France, 29 Chaussée Jules-César, Boite Postale No. 39, 95301 Pantaise France. Phone: 030 82 20, 030 92 30

Germany — AMP Deutschland GmbH, Ampéstrasse 7-11, 607 Langen, 8. FFM., West Germany. Phone: (06103) 7091

Great Britain — AMP of Great Britain Limited, Terminal House, Stanmore, Middlesex, England. Phone: 01-954-2356

Holland — AMP Holland B.V., Papierstraat 2-4 5223 AW 's-Hertogenbosch, Holland. Phone: (073) 125221

Italy — AMP Italia S.p.A., Via Fratelli Cervi 15, 10093 Callegna (Tarina), Italy. Phone: 785-656

Spain — AMP Española, S.A., Apartada 5294, Pedra IV, 491, 495, Barcelana 5, Spain. Phone: 307-75-50

Sweden — AMP Scandinavia AB, Datavägen 5, 17500 Jakobsberg, Sweden, Mailing Address: Fack S-175 20 JARFALLA 1, Sweden. Phone: 0758/10400

Switzerland — AMP AG, Haldenstrasse 11, 6006 Luzern, Switzerland, Phone: (414) 235421, 235422, 235423

AMP NORTH AMERICA

Canada — AMP OF CANADA LTD., 20 Esna Park Drive, Markham, Ontario, Ph: 416-499-1251

Mexico — AMP de Mexico, S.A., Apartada Postal 179, Naucalpan de Juarez, Edo, de Mexico, Phone: Mexico City 576-41-55

Puerto Rico — AMP OF CANADA LTD., 677 Colé de Diego, Rio Piedras, Puerto Rico 00924, Phone: (809) 766-2346

United States — AMP Incorporated, Harrisburg, Pa. 17105, Phone: 717-564-0100

AMP SOUTH AMERICA

Argentina — AMP S.A. Argentina 4 de Febrero, 76 Villa Zagla — SAN MARTIN, Buenos Aires, Argentina, Phone: 752-4612

Brazil — AMP da Brasil Ltda., AV Comendador Martinelli 185, Lapa, Sao Paulo, Phone: 262-4353

AMP PACIFIC

Australia — Australian AMP Pty. Limited, 155 Briens Road, Northmead, N.S.W. 2152 Australia, Mailing Address: P.O. Box 194, Baulkham Hills, N.S.W. 2153 Aus. Ph: 630-7377

Japan — AMP (Japan), Ltd., No. 15-14, 7-Chome, Rappangi Minato-Ku, Tokyo, Japan, Ph: 404-7171

Products and services for many specialized industries are provided by the AMPLIVERSAL Division. In the United States, this division is known as AMP Special Industries.

For Amp products and services in other countries, write: AMP International Division, Harrisburg, PA 17105, USA.



Probing the news

currents between 0 and 50 milliamperes, pulse widths variable between 50 and 250 microseconds, and repetition rates variable between 10 and 150 hertz.

A new Stimtech unit is built around a custom bipolar integrated circuit that includes most of the device's circuitry, according to Stimtech engineer Dennis Digby (who will not reveal the manufacturer of the circuit). It comprises a multivibrator-type oscillator with a discrete output transistor to drive a step-up transformer that in turn drives the electrodes attached to the patient's skin. The unit uses rechargeable batteries and comes in two forms—single- and dual-channel. The second is useful to patients with low back pain, for example, who often complain of pain radiating down one leg and so require a second set of electrodes with independent adjustments to control the feelings at the second pain site.

Med General, on the other hand, uses commercially available components, except for custom batteries made by Gould Inc. The Med General instruments employ simple unijunction transistors as the oscillator elements. They need much less power than, say, a 555 timer, according to David Housen, Med General's director of new product ventures. However, Housen says that his engineers now are considering complementary-MOS circuits for future devices because they use less power.

Stadynamics says its patented method causes the patient to feel a tingling sensation for about the first 60 seconds. According to Halleck, the user sets the unit to the point where it produces slight muscle spasms and then backs off from this point slightly. As a result, the control affects pain transmissions but not muscular or sensory responses. Halleck says his company views the human body as an equivalent circuit of about 2.2 kilohms in parallel with about 0.05 microfarad, both in series with about 100 ohms. When this network is taken into account in the stimulus output circuitry and with a certain waveform, he says, the disap-



Relief. TENS device from Stimtech measures 4 by 2³/₄ by 1 inch and weighs 8 ounces.

pearing sensation effect can be achieved.

Others in the industry, though, consider this an oversimplified view of the pain-suppression process and the complex equivalent circuit presented to the stimulator by the body. Med General's Housen points out that there are many time constants involved in the path between the electrodes and the actual nerve sites. Even if the input pulse has sharp edges, he says, there is a lot of filtering to round off the edges, before it takes effect, and thus more work is needed before any definitive statements can be made about best waveforms.

But the electrode system remains the No. 1 problem, according to Dr. C. Norman Shealy, a pioneer worker with the nerve stimulators. Nothing is interchangeable, he notes, since each manufacturer uses different plugs, while the electrodes themselves also require improvement. Silicone rubber electrodes, the most commonly used, are a bit slimy to the touch, he says, but a significant number of patients cannot tolerate tape of any kind, since they develop skin blisters. He does add that there are many new electrode creams and gels coming on the market that help with this problem.

He also observes that some manufacturers have not made the equipment as refined as it could be. Knob turning on some units is terrible, he says. "Some patients actually find it painful to turn the knobs, which are often recessed and difficult to reach," he says. □

Electronics abroad

Britain ready to break out black ink

Infusion of North Sea oil could mean 3% growth in economy, with electronics industries forecasting growth of 11.6%

by Kevin Smith, London bureau manager

North Sea oil has started to take some of the squeaks out of the creaky British economy, and for the first time in years economists think the country might be ready to rattle ahead once more. They forecast that real growth in output of goods and services this year should run something like 3%. That is certainly not sensational, but all the same, it is a solid improvement over the next-to-nothing growth of the past few years.

But there is more needed than just North Sea oil—even though some 800,000 barrels of it are now pouring ashore every day—to fuel the growth. The turnaround that seems to have taken hold during 1977 was greatly helped by heroic wage restraints by the unions. However, if James Callaghan's Labour government can not persuade the aggressive miners' and electric-utility unions to accept raises close to its 10% guideline, the solid export-led growth that he wants could easily deteriorate into a short-lived domestic consumer boom.

The coming year, then, could be a critical one for Britain's economy. Even so, there will be reasonable growth for the major electronics equipment markets, color television excepted. *Electronics'* annual survey puts 1978 shipments at \$3.904 billion, up 11.6% over last year's figures. As for components, they are forecast to do a little better, up 13% to \$1.524 billion. (Throughout this article, pounds sterling were converted to dollars at an exchange rate of 55.5 pence to \$1.)

Entertainment. No one expects more than a marginal improvement this year in the color-TV market, which fared poorly in 1977. "Sales

will reach 1.6 million sets for 1977, 1.7 million in 1978, and 1.8 million in 1979," predicts David Benda, industrial and component market-research manager for Mullard Ltd., the Philips Group's parts-producing company in the United Kingdom. Derek Clark, product manager television at Thorn Consumer Electronics Ltd., concurs. "I'm taking a view of cautious optimism." But the kind of growth expected will not do much to solve the industry's long-term problems. Already, it is working at only 60% of capacity, and, to make matters worse, imports are rising, as is local production by Japanese set makers.

Military test. Racal Automation has started to make automatic test equipment. This is the ruggedized version of its Micro-CAFF RTL5M, for use in the field by the Army.

The audio market sounded loud and clear in 1977 and should do the same this year. Most of the decibels are coming from units combining a tuner-amplifier, a turntable, and a tape deck, priced between \$320 and



BRITISH ELECTRONICS MARKETS FORECAST (IN MILLIONS OF DOLLARS)			
	1976	1977	1978
Total assembled equipment	3,124	3,497	3,904
Consumer electronics	905	939	1,076
Communications equipment	900	1,021	1,166
Computers and related hardware	851	971	1,097
Industrial electronics	239	253	270
Medical electronics	126	150	172
Test and measurement equipment	80	39	97
Power supplies	23	24	26
Total components	1,152	1,347	1,524
Passives	612	682	757
Semiconductors	305	385	455
Tubes	235	280	312

(Exchange rate: \$1 = 55.5 pence; £1 = \$1.80)

Note: Figures in this chart are consensus estimates of consumption of electronic equipment obtained from a survey made by *Electronics* magazine in September and October 1977. Domestic hardware is valued at factory sales prices and imports at landed costs.

Now, the complete answer to the testing problems of tomorrow.

Our new MB7700 Series is the most comprehensive and advanced range of automatic test and fault-finding equipment ever produced by a single manufacturer. The range of systems offers you maximum versatility, compatibility and practicality for high performance testing, both now and in the future.

Keeping pace with fast-changing needs.

Today's digital PCBs have 100 times the logic-gate density of those five years ago. In the last two years alone there has been a factor-of-ten increase. To make production of these boards economically feasible computer-aided testing is essential.

Membrain have developed the new MB7700 Series to anticipate the next decade's needs in hybrid, analog and digital testing, taking into account the most advanced IC and semiconductor research.

For the first time a single family of test systems offers all this.

The MB7700 Series gives powerful test techniques. It meets the complete spectrum of PCB, LSI component analog and in-circuit test requirements.

It uses common operating procedures and test-program languages throughout the range.

It provides user-orientated operating systems and ergonomic design.

Better reliability – easier maintenance

Test systems, computer and peripherals are all made by Membrain, using fewer components than most systems. System diagnostics are built in.

For testing into the 1980's

For updating, the MB7700 Series can be augmented simply and economically.

Look at these features.

MB7730

Digital/hybrid PCB test systems. Range of options includes high-speed 8MHz parallel pattern capability for boards containing dynamic LSI, micro-processors, RAMs etc: fixed and programmable - level buffers. Range of instruments can be fitted, programmed through a general-purpose instrumentation bus (IEEE488). Basic machine can have 256 pins of high-speed parallel pattern capability. Logic simulation facilities included if required.

MB7710

This new, small transportable system has the capability to run test programs developed for the MB7730

Electronics/January 19, 1978

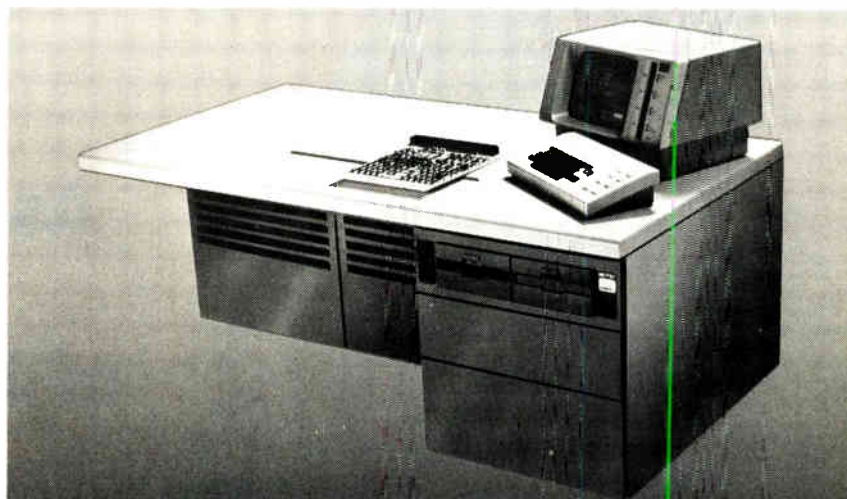

**New Membrain MB 7700 Series -
an advanced ATE Range that meets today's
and anticipates tomorrow's testing needs.**

system – including high-speed parallel pattern testing! Pseudorandom pattern generation and transition-count techniques offered for programming, or programs may be generated using simulation. Wide variety of configurations available.

MB7750

The MB7750 has combined in-circuit analog and functional test system with capability to expand to 1300 points. Powerful component measurement system using guarded measurement techniques offered in addition to standard range of instrument options.

MB7790

A new simulation and programming station employing two floppy discs and a 12-Mbyte rigid disc, plus Membrain's new ATE controller, used in all MB7700 systems. High-speed program generation is coupled with the capability to stack programs for overnight runs.

New software packages aid program preparation. Work in any one of three languages: ATLAS, MSL and MEMTEST 7. Using a single language on all your ATE means faster programming and simpler staff training.

Why bother with the MB7700 Series?

- Ask yourself these questions.
- Can your present ATE cope?
 - How are you testing microprocessor and LSI circuits?

- Are you concerned about ATE costs?
- Is ATE designed and built in-house really the most cost-effective?
- Have several manufacturers been supplying your ATE?
- Have you thought about the future? Look how far electronics has gone in the last few years.

If you're confident and happy about your answers, perhaps you don't need an MB7700 system – yet. If you've any doubts, contact Membrain or your local representative.

MEMBRAIN
European leaders in
Automatic testing

Membrain Ltd.,
Femdown Industrial Estate,
Wimbome, Dorset, England.
Tel. Femdown (0202) 893535
Telex 41436

Membrain Test Systems GmbH, Munich
Tel: (089) 376363 Telex: 5215014
Membrain SARL, Paris
Tel: (1) 687 0193 Telex: 202973

Circle 202 on reader service card

79

month. Overall, the boosts come to 8% to 10% over prices at the end of 1976, although actual price depends on individual models. For instance, one 19-inch color TV set that was \$281 is now \$298. The firm's vice president of sales, Ron Friedlander, points out that the end may not be in sight—today's rate of 240 yen to the dollar rate could go as low as 230 yen this year. "There's no question that today the yen is more of a problem to us than the TV quotas," he says. His company recently announced a joint venture with General Electric to produce TV sets in America, using GE's facilities in Portsmouth, Va.

Sony Corp. did not boost tags on TV during 1977, but will do so for audio products. "We did not increase TV prices because we could not have remained competitive," a spokesman admits.

Recorders. The situation is as troublesome to the video cassette recorder market. Sales just began to take off last year, as the Japanese producers began landing recorders of their own plus those made for U. S. companies. There was an almost immediate downward pressure on prices as companies sought to get a jump in the competition with tags reading under \$1,000. Now, even though everyone agrees that sales will increase far more rapidly at prices in the \$800 neighborhood, there is more pressure to increase prices. What is likely to happen, therefore, is that new models with additional features such as programmable timers or built-in monitors will be introduced at higher price points.

"The under-\$1,000 price should have been there in the first place," says Jack Sauter, marketing manager for RCA. "It helped move the product during 1977. This year I see no pricing shift; if anything, the yen change will provide pressure to move up. There will probably be little change due to technology, because VCR is an old technology not likely to provide dramatic changes in costs."

Dick O'Brion, head of marketing for JVC America Inc., agrees. "We expect stable prices for VCR with added features becoming available. VCR represents a big profit opportunity, if prices remain stable." □

1 In Conversion Efficiency: Fast-transition switching circuits and low-loss magnetics optimize efficiency for given size and weight. Thermal gradients closely controlled. No derating over full rated temperature range.

2 In Source/Load Isolation: Extremely high isolation permits complete separation of load circuits from input bus, even for high CMV.

3 In Freedom from Kickback: High-attenuation filters minimize inverter-switching spikes and reflected ripple current, protecting other loads across same DC bus. Many models include EMI/RFI shielding, permitting location of converter module near sensitive logic circuitry.

4 In Power per Unit Volume and Unit Area: Some conserve "real estate," others minimize total volume or height. Minimal case-temperature rise, with only free-air convection. No heat sinks or cooling fins required.

5 In Short-Circuit Protection: Positive protection is built in; type and limits are suited to the intended class of applications. Some include both automatic current-limiting and automatic restart; others "fold back."

6 In Static/Dynamic Regulation and Stability: High-frequency inverters and fast, high-performance regulators ensure excellent transient response. Superior thermal design ensures very low T.C. Static regulation, rated for "worst-case," is consistently superior to conventionally margined regulators.

FREE Send today for your copy of this 20-page straight-talk handbook on power supply selection and applications engineering. Review the complete data on all 78 standard Intronic designs. See why we say: Intronics builds in greater value.

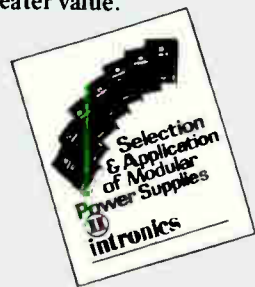

Are our DC-DC Supplies really better values?

Let's count the ways.

There's no such thing as a "routine" application for a DC-DC converter. Simple in concept, converters can create some very complex problems — reducing reliability margins, adding unforeseen costs, driving you to circuit "fixes," even to circuit redesign. But Intronics' DC-DC converters, like our AC/DC supplies, anticipate and prevent those problems. Modestly priced, their *true value* lies in what they save you *after* installation.



intronics

57 Chapel St., Newton, Mass. 02158 U.S.A.
Tel. (617) 332-7350. TWX: 710-335-6835.

Circle 81 on reader service card

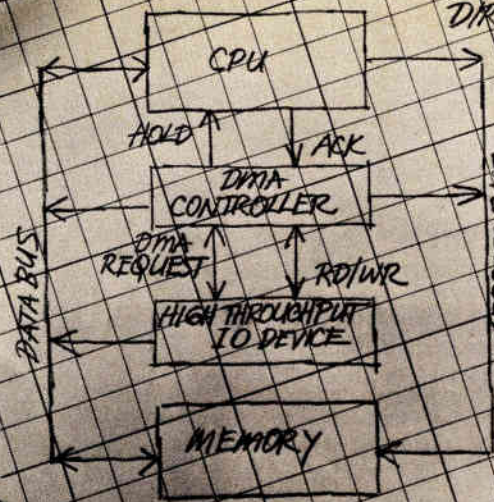

DIRECT MEMORY ACCESS (DMA)
 IS A TECHNIQUE FOR MOVING
 DATA WITHIN A COMPUTER
 SYSTEM AT VERY HIGH SPEED.
 THIS IS ACHIEVED BY MEANS
 OF A SUBSYSTEM CAPABLE
 OF TAKING CONTROL OF
 THE SYSTEM BUSES FROM
 THE CPU AND CREATING
 ADDRESSES AND READ/WRITE
 COMMANDS. IN THIS WAY,
 DATA CAN BE TRANS-
 FERRED DIRECTLY
 BETWEEN PERIPHERAL
 CONTROLLERS AND SYSTEM
 MEMORY WITHOUT
 CPU INTERVENTION.

Watch this space for a whole new family of proprietary peripherals from Advanced Micro Devices. They're built from your side of the board. They're microprocessor-based solutions from a system viewpoint. For example:

DMA WITH EVERYTHING ON IT.

Advanced Micro Devices' new Am9517. It's multimode DMA controller that lets you transfer information directly

**MOS
 MICROPROCESSING:
 WE'RE ON
 YOUR SIDE.**

from your peripheral controller to your system memory at blinding speeds of up to 2 million words per second. And that's just the beginning.

The Am9517 is a 40-pin, 5V only, N-channel, silicon-gate device that implements four fully independent DMA channels and includes provision for unlimited expansion.

Software control provides automatic reinitialization of all channels upon completion or external termination of a DMA transfer.

It's got everything: Memory-to-memory transfer, address increment or decrement and software DMA request capability offer powerful data manipulation options. Software control of the polarity of DMA

request and acknowledge signals—plus a simple interface—provide easy interfacing with a great variety of microprocessor systems. And, as always, MIL-STD-883 for free.

(For those designs that don't need everything, we supply the Am8257, a plug-in replacement for the Intel 8257.)

If you're looking for a DMA controller that looks at microprocessing the way you do, call us.

Advanced Micro Devices



Multiple technologies. One product: excellence.
901 Thompson Place, Sunnyvale, California 94086
Telephone (408) 732-2400

Packaging & production

Fine-line printed circuits catch on

Technique uses ultra-thin copper foil and yields much greater density than can be obtained with conventional packaging processes

by Jerry Lyman, Packaging & Production Editor

A printed-circuit process that produces much denser circuits than the current norm is beginning to win a following. In the fine-line process, 5- to 10-mil-wide conductors and spaces are subtractively etched from 5- to 10-micrometer-thick copper foil. Conventional techniques use 40-micrometer-thick foil to get elements 10 to 20 mils wide.

Sales figures from two of the largest producers of thin copper foils, divisions of Gould Inc. in Cleveland and Yates Industries Inc. in Beaumont, Calif., put such fine-line pc boards at 5% to 10% of the total pc market now. Most of these end up as densely packaged, high-speed digital boards in computers and computer peripherals. Eventually, the technique may also dominate specialized boards.

While the fine-line approach also

offers processing advantages, it is the increased density that brings a gleam to users' eyes. "This technique provides 20% more packaging density and capacity than a standard IC-socket wire-wrapped panel and achieves twice the packaging density of conventional two-sided boards," says Jeff Waxweiler, president at Algorex Corp., a Syosset, N. Y., firm that produces both the fine-line boards and computer-designed artwork for them. What's more, he adds, "the densities can equal or exceed those of more expensive techniques, like multilayer boards or multiwire. It's possible to use two-sided fine-line pc boards and still get more than two dual in-line packages into the square inch." With such a board, two to three conductors could be run between DIP leads—an impossibility with conventional pc traces.

At many independent pc firms like Multi-Circuits Inc., Manchester, Conn.; Metropolitan Circuits Inc., Franklin Park, Ill.; and Cirtel Inc., Irvine, Calif., 20% to 30% of the boards being produced are already fine-line types. In fact, Mike Busby, president of Cirtel, expects a third to a half of his company's output will be fine-line by 1980.

At Memorex Corp.'s operation in Eau Claire, Wis., where all of the firm's own and custom pc work is done, product control manager Jim Berry, says, "Fine-line is the way of the future." Memorex has already committed itself to the fine-line geometry in all of its new products with boards for high-speed logic. IBM Corp. and Western Electric are also heavily involved with it.

The process. The fine-line technique resembles the older, conventional process, based on 40- μ m foils, in most of its steps, but eliminates several of them (see chart). Its ability to produce finer lines is due to the speed with which the thin foil can be etched—fast enough not to undercut the final circuit pattern.

Additionally, the microfoil's thinness means less etching time is required, so costs of chemicals are reduced: process users indicate that time and costs are about 25% of those rung up with 40- μ m foils. Less etchant also means that waste treatment of the liquid is less of a problem than in standard production work.

Also indirectly responsible for the fine-line process's advantages is a copper or aluminum protective carrier about 2 mils thick that can be supplied with the copper foil. The carrier decreases drilling time, thus extending drill life, and the drill

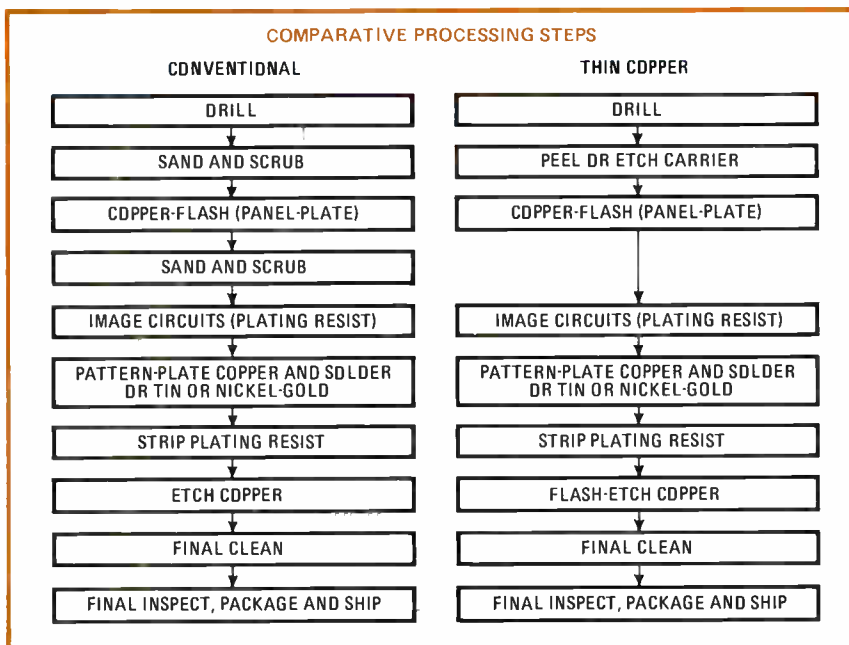

“Until now, we’d been mistaking access to processing for access to answers.”

Problem: It takes more than a desktop processor to organize output into its simplest, most usable form.

A personal computer can shave timeshare expenses, but do nothing about trimming the fat off alphanumeric answers. You can give up the power of a mainframe without the promise of more intelligent, instantly visible data.

Solution: Tektronix’ 4051. The one desktop unit that shapes information into usable graphics.



From interfaces and firmware to hard copy units, data storage devices, printers, plotters, graphic tablets and proven software, Tektronix provides plug-in capability to customize the 4051 to your special needs.

store data on built-in mag tape, and generate graphic reports—all at your own pace.

The 4051: Its Graphics keep working when other systems quit. Yet it can pay for itself in less than a year in timeshare savings alone. Call your local Tektronix Sales Engineer, or write:

Tektronix, Inc.
 Information Display Group
 P.O. Box 500
 Beaverton, OR 97077
Tektronix Datatek N.V.
 P.O. Box 159
 Badhoevedorp, The Netherlands

A graphics answer is the most concise of all possible solutions. The 4051 can eliminate the hand-plotting and mental gymnastics that users of alphanumeric-only systems take for granted. It lets you instantly unscramble data and interactively experiment with graphs, charts, maps and models. With exceptional simplicity. With almost the speed of thought.

You command up to 32K of off-line processing power. With a graphically beefed-up BASIC language. With complete editing and versatile graphic-oriented software.

You can tackle big programs on-line in any language,

Get the picture. Get straight to the point.



Tektronix
 COMMITTED TO EXCELLENCE

Circle 85 on reader service card

OEM information available
 Copyright © 1977, Tektronix
 All rights reserved

World Radio History

MAKING MEMORIES

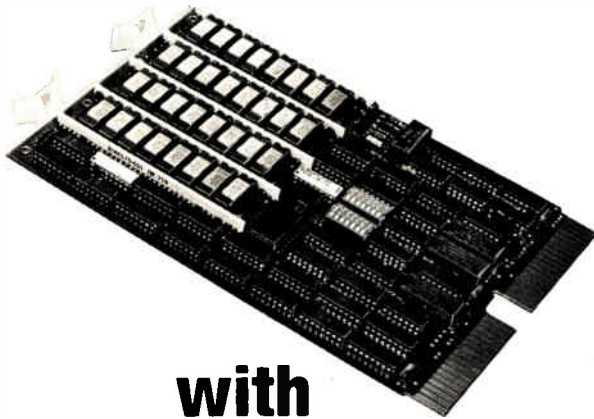

with MINI/BUS[®] PC BOARD BUS BARS

A high density add-in expansion memory for the DEC LSI-11, MSC 4601, packs up to 32K words of memory in a single option slot. Mini/Bus helps make it all possible, and with a mean time between failures of 100,000 hours.

Monolithic Systems Corporation engineers used Mini/Bus to solve size constraint problems, shorten assembly time, simplify testing, eliminate numerous filter capacitors, and increase reliability.

For more details on how Mini/Bus can handle your design problem, contact the Mini/Bus product specialist at

ROGERS

ROGERS CORPORATION

Chandler, AZ 85224
(602) 963-4584

See us at NEPCON
West Booth 3028

EUROPE: Mektron NV, Gent, Belgium JAPAN: Nippon Mektron, Tokyo

DEC and LSI-11 are registered trademarks of Digital Equipment Corp.

Probing the news

holes need not be deburred.

Finally, any circuit manufacturer can use thin-foil copper laminates with present subtractive equipment. He need only add machinery for carrier removal.

Dissenters. Not all pc-board companies are sold on the new process, however. One of the larger independents, Circuit-Wise Inc. of North Haven, Conn., is sticking to conventional subtractive and additive processes. "Our pc lines are highly automated—it simply would not be cost-effective for us to invest added capital in redesigned automated pc lines for fine-line," says vice president John Mettler,

Another independent resisting the trend is the Photocircuits division of Kollmorgen Corp., Glen Cove, N. Y. Its engineers use a semi-additive rather than thin-foil process for boards with fine-line conductors. John Dennis-Browne, its manager of technology sales and licensing, says that despite undeniable improvements in the subtractively etched thin-foil method, the semi-additive process is the less costly and also produces boards that can be reworked instead of having to be scrapped. He points out, too, that the thin-foil process can only be used with FR-4 (glass-epoxy) boards, while the semi-additive process is usable with many types.

The cost of the thin copper laminates is undoubtedly one factor holding back fine-line pc boards. Another is the added process step needed for carrier removal, and the fact that pc manufacturers have not standardized on any one method for it. The copper carrier/copper foil furnished by Yates must be mechanically stripped and the carrier is salvageable. An aluminum carrier/copper foil supplied by Gould is also mechanically strippable. A third material supplied by the Swedish firm Perstorp AB has an aluminum carrier that can be etched away.

Still others—pc firms like Cirtel and the Collins Radio Group of Rockwell International Corp., Cedar Rapids, Iowa—are successfully working with unprotected foil, eliminating the peeling step. □

Gould OS4000

Unlimited storage, plus hard copy option

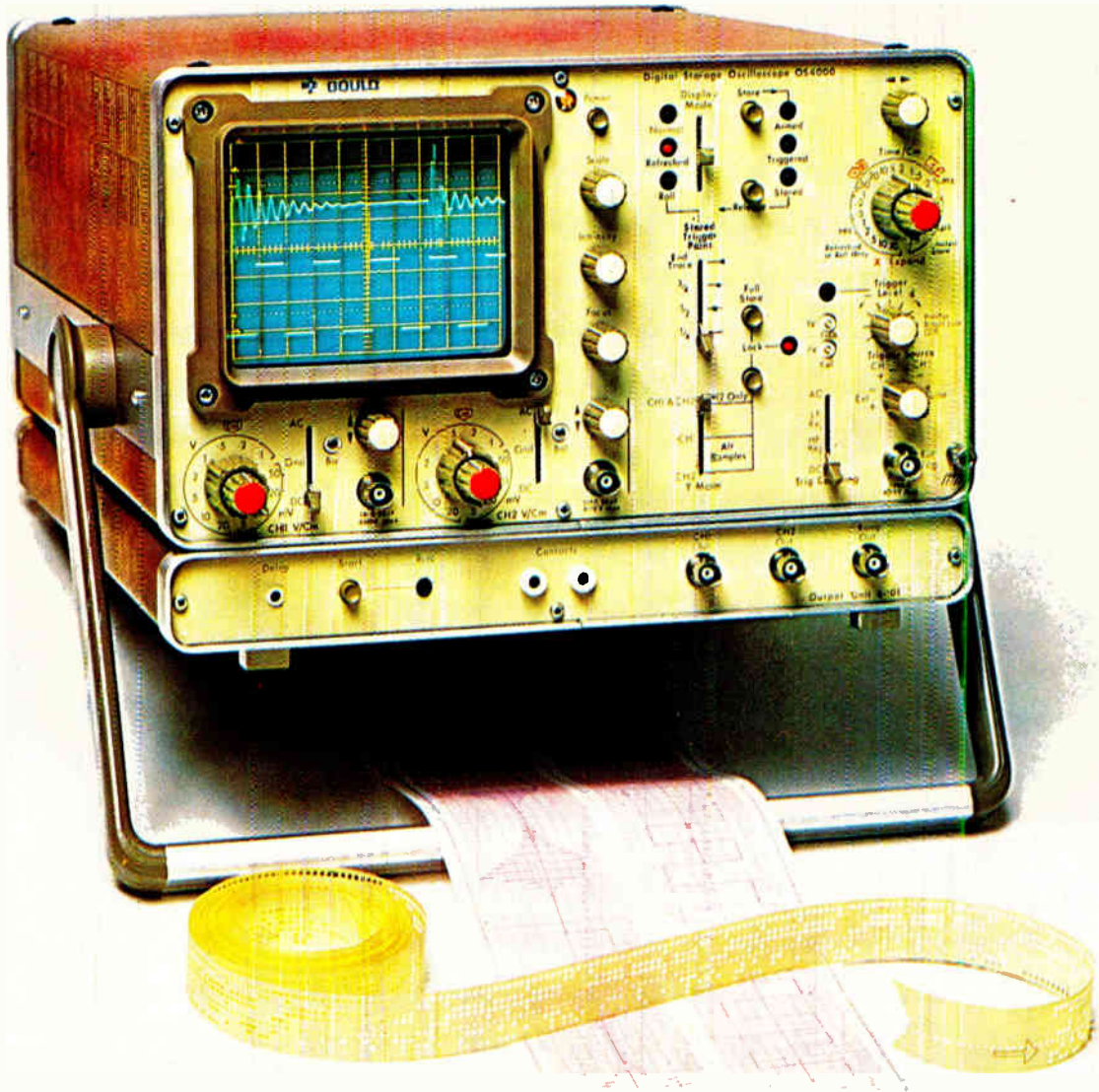

The OS4000 dual trace storage oscilloscope gives you unlimited storage time, providing a unique capability for examining waveforms. It is ideal for displaying and recording transient waveforms for medical, electrical, vibration, dynamic testing and pulse testing applications. In addition you get the full capability of a conventional DC to 10MHz dual trace oscilloscope.

Digital storage provides non-flicker viewing of ultra-low frequencies plus simultaneous viewing of stored and real-time signals, and allows examination of single events prior to as well as after the trigger point. By using the 4001 manual or 4002 automatic output options you can have hard copy output on any X-Y or T-Y recorder. Digital output also provided.

For full details on the OS4000 and the 4001/2 Output Options write: Gould Inc., Instruments Systems Division 3631 Perkins Avenue, Cleveland Ohio 44114. Or call the number below. **FOR BROCHURE CALL TOLL FREE AT (800) 325 - 6400 EXTENSION 77** In Missouri: (800) 342 - 6600



Gould Oscilloscopes

They have a name for reliability

Circle 87 on reader service card



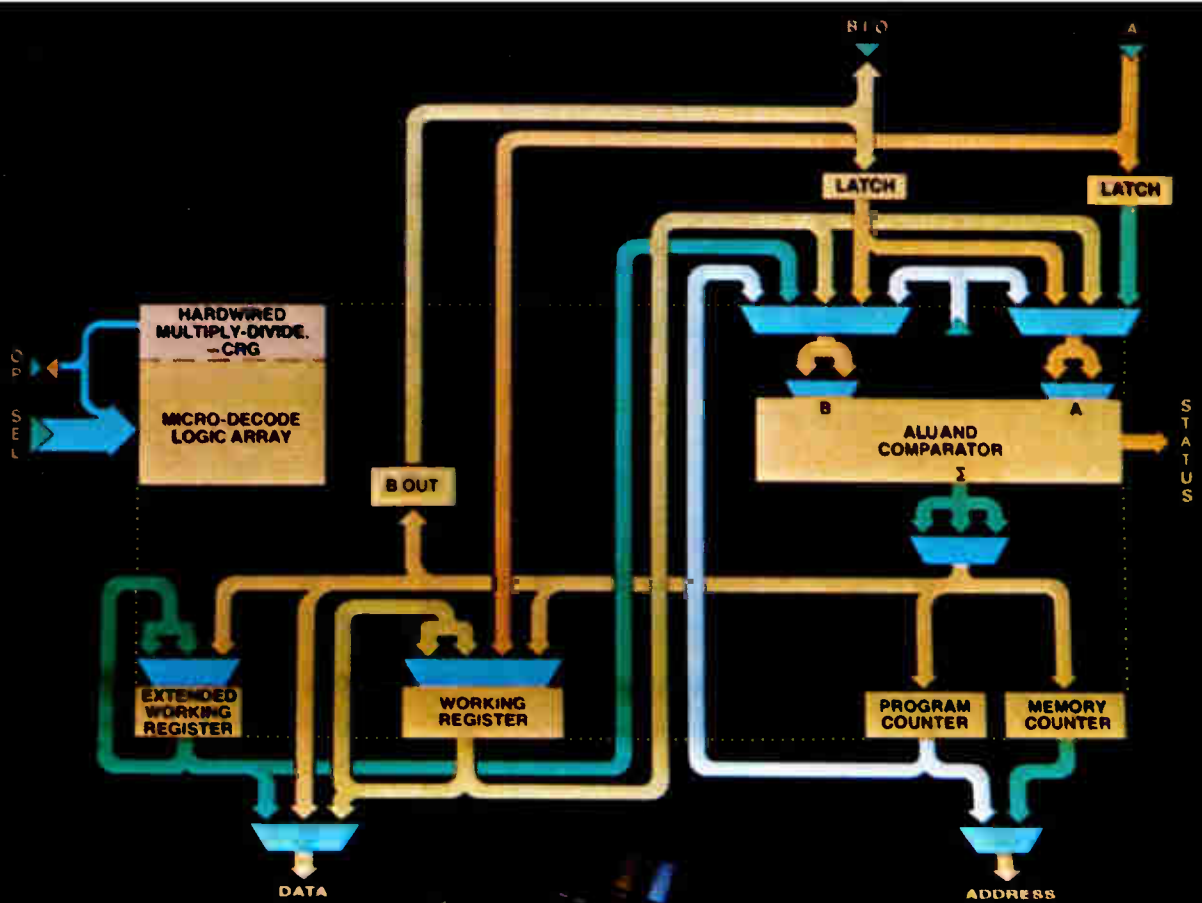

BIT SLICE

From Texas Instruments

The new dimension in fast four-bit slice systems design... the S481/LS481 processor element.

Just plug it in. To divide and multiply...fast. The S481/LS481 processor is actually the heart of a computer. The first bit-slice element having built-in computational algorithms.

Remarkable capability now in a choice of high-speed or low-power bit-slice processor elements. And a choice of packages. Giving you even greater precision and economy in matching your system de-

TI's 9900 First Family

Having the S481/LS481 microcomputer chip set among its members, TI's 9900 First Family offers you a completely integrated, standardized design capability. All the way from components through boards through systems. Having common hardware. Common software. Common support. Allowing you to move over a wide range of applications with greater economy. Greater software retention. Less relearning. Less obsolescence.

signs to applications using TI's pace-setting S481/LS481 microcomputer chip set.

The cost-effective set utilizes modularly expandable, Schottky TTL building blocks to achieve such advantages as:

- **Extremely fast throughput**—For example, 16-bit double precision signed multiply or divide in <2 microseconds (S481).

• **Effective software investment protection**—Complete microprogrammability lets you emulate existing hardware.

• **Improved memory efficiency**—You write instructions suited precisely to your application. Use memory more efficiently and reduce hardware costs substantially.

• **Increased flexibility**—With the S481/LS481 chipset building blocks, you select speed/power ratios and pick your packages to tailor your hardware more exactly. To gain the best combination of performance, board density and cost. In either commercial applications or military applications.

Processor performance choices

Both the S481 and LS481 are expandable, 4-bit slice processor elements. Both are micro and macroprogrammable.

Where maximum performance is your driving design criterion, use TI's S481 processor element. Clock frequency: up to 10 MHz for automatic multiply/divide.

For more power-conscious applications, use the LS481 processor element to cut supply current by 40 percent.

Choice of packages

Both processor elements come in a choice of packages. The space-saving, quad-in-line ceramic package (J suffix) permits maximum board density. The new 48-pin, dual-in-line plastic package (N suffix) offers a more economical cost.

Commercial-temperature (0°C to 70°C) versions of both the S and LS processor elements are available in either package. The low-power Schottky processor element is also available in a full-temperature (-55°C to 125°C) version in the ceramic quad-in-line package—the SN54LS481J.

Extraordinary capability

Each processor element recognizes, decodes, and executes 24,780 instructions.

For example, either element performs compound operations—select two operands, add, sign protected shift, generate status and update memory—all within a single clock cycle.

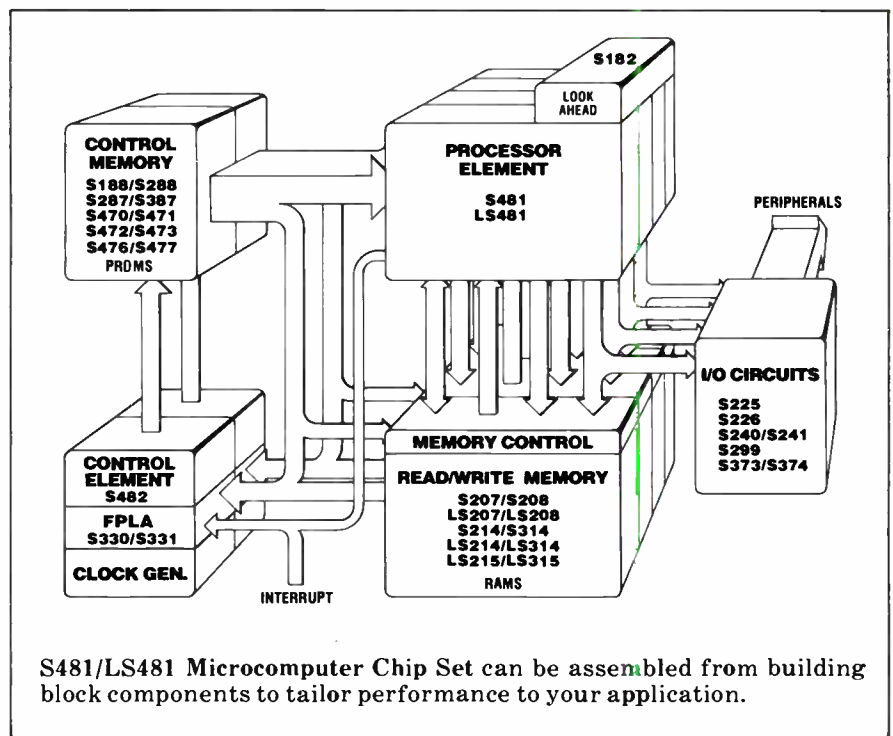

S481/LS481 Microcomputer Chip Set can be assembled from building block components to tailor performance to your application.

Only the S481/LS481 bit slice provides on-chip algorithms for automatically sequencing the iterative multiply and divide—both signed and unsigned. And cyclical-redundancy character update is also provided.

Advanced architecture

Behind this outstanding capability: TI's advanced Schottky TTL process technology. Plus TI's advanced 9900 Family memory-to-memory architecture.

This is a complete architecture that places register files in main memory. As a result, the number of available general-purpose registers is limited only by the size of the program memory. Instructions do more work, use less memory space. Interrupts are handled faster.

Other major architectural features include:

- Parallel dual input/output ports.
- Full function ALU with carry look-ahead capability and magnitude status generation.
- Double-length accumulator with full shifting capability, sign-bit handling, and impending overflow signal.
- On-chip dual memory address generators.

Performance-matched support functions

Complementing the speed and efficiency of the processor elements are these Schottky TTL support functions:

Device No.	Function	Package
S225	16W x 5B FIFO	N,J
S226	Latched transceiver	N,J
S240, S241	Octal bus drivers	N,J
S330, S331	12 input, 50 term, 6 output FPLAs	N,J
S373	Octal latch	N,J
S374	Octal flip flop	N,J
S482	Control element	N,J

The S481/LS481 chip set components are available now. For maximum speed. Maximum flexibility. Maximum efficiency. To implement advanced micro, mini and midicomputers. Controllers. And super processors.

To order the S481/LS481 bit slice, or any chip set building block, call your local TI sales office or nearest authorized TI distributor. For your copy of The Bipolar Microcomputer Components Data Book (LCC-4270A), write Texas Instruments Incorporated, P.O. Box 5012, M/S 308, Dallas, Texas 75222.



TEXAS INSTRUMENTS
INCORPORATED

Circle 89 on reader service card

93199

Dumb, it ain't.

Our new S2000 microcomputer contains more than 13,000 transistors on a chip less than .2" square. It was designed specifically to run appliances. Yet it's flexible enough for all kinds of products now dependent on electromechanical controls.

The S2000 is an entire microcomputer on a single chip, with expandable program ROM and versatile I/O. So you can implement or enhance your control schemes quickly and easily.

It's an amazingly efficient circuit, too. All 51 instructions in its powerful software set occupy just one ROM byte apiece. All but two execute in four microseconds, a single machine cycle. And this fast NMOS device can operate from one power supply.

For less than \$5 each in quantity, each S2000 contains:

1. The CPU, including Control Unit, Arithmetic Logic Unit, Registers and Program Counter.
2. 1Kx8 ROM (externally readable and expandable to 8Kx8).
3. 256-bit RAM.
4. 29 I/O lines.
5. 7-segment display (normal or inverted) decoder and LED drivers.
6. Triac drive capability.
7. Line frequency (50/60 Hz) timer.
8. TouchControl capacitive switch interface.
9. Three-level subroutine stack and two flags.
10. Power-on reset and clock oscillator.

Soon, other S2000 family microcomputers will have vacuum fluorescent display drivers and on-chip 2K ROMs. In addition, AMI welcomes modifications to the S2000 to meet your particular I/O requirements, making your system even more cost effective.

Our Microcomputer Development Center (MDC) contains a powerful array of hardware and software tools to get your product to the market fast. Its intelligent 6800 microprocessor system controls a CRT with a flexible text editor, a smart macro-assembler, and a built-in PROM burner.

The DEV-2000 Development Board lets you do hardware emulation and software debug at the same time. The SES-2000 Static Emulator Module plugs right into your prototype. Our Logic Analyzer gives you computer power to create your own diagnostic display layouts and formats. And we even have software that simulates the S2000 within the MDC.

What more could you ask, except for some Application Engineers to help you do a fast turnaround. We have those, too. Specialists in the S2000 are ready and waiting for your call at (408) 246-0330. Or simply write to AMI Marketing, 3800 Homestead Road, Santa Clara CA 95051. You'll be amazed how smart one dense little chip can be.



AMI
AMERICAN MICROSYSTEMS, INC.

Forget our products.

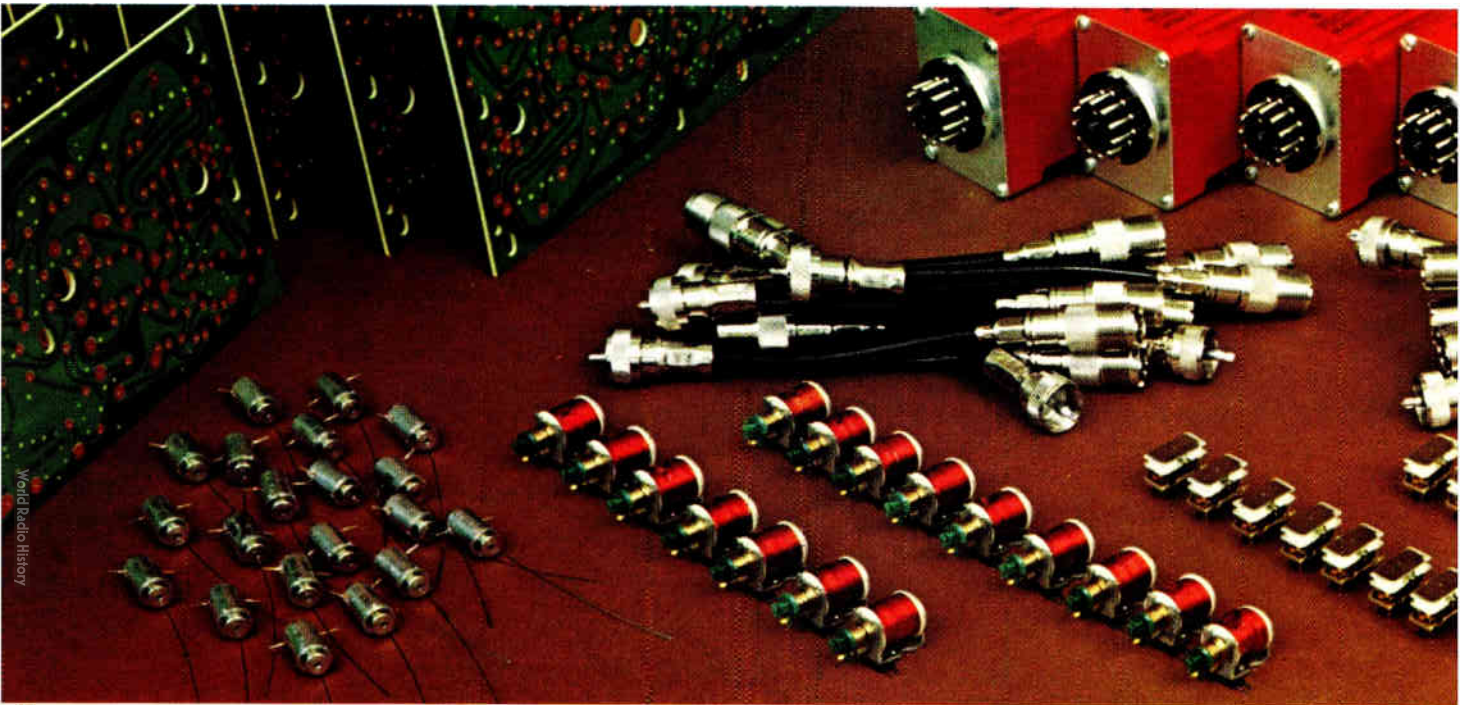

World Radio History

Major manufacturers forget them all the time. Polaroid. DEC. Honeywell. Tandy. Foxboro. Ford. Bendix. Our products are easy to forget. Because, once installed, all of

Hi-G's quality products (transformers, solenoids, timers, printed circuit boards and others) do what they are meant to do. Keep right on working.

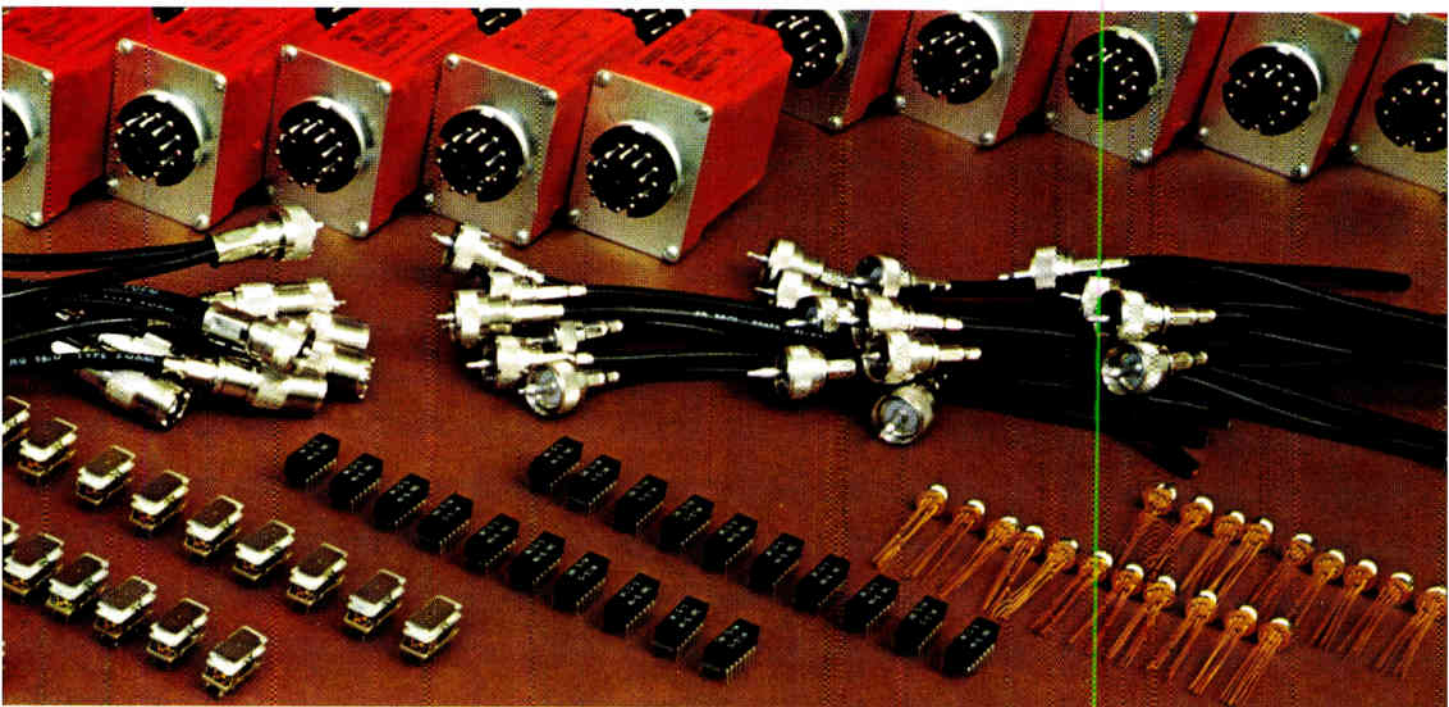

That's why Ingersoll-Rand depends on our time delay relays to preserve compressor life against insufficient oil pressure at start-up or on the job. Why the revolutionary 1978 Diesel Oldsmobile uses a Hi-G Magnetec solenoid to control the fuel supply. Why Tandy Communications Antennas/Radio Shack chooses communication connectors from Hi-G Cambridge Products for their CB radio antennas.

Our products work. And keep working. So it's fine with us if you forget them. Just remember our name. Hi-G Incorporated, 580 Spring Street, Windsor Locks, CT 06096.



Remember our name.



draw their own replacements.

data communications.

For more information, write to us at
Sperry Univac Mini-Computer Operations,
2722 Michelson Drive, Irvine, California 92713.
Or call (714) 833-2400.

Sperry Univac. Mini's that think like
mainframes.

They should draw your interest. Even if
you don't draw schematics.

SPERRY  **UNIVAC**
SPERRY UNIVAC IS A DIVISION OF
SPERRY RAND CORPORATION

How software modules communicate

When a software design is broken down into modules, those modules or subroutines have to be able to hand data to and fro among themselves. They do so by parameter passing. The types of parameter they pass range from simple data words, addresses, pointers, and flags/switches, to error and completion codes. Their methods of parameter passing use memory of different kinds in different ways that suit different interface needs.

The microprocessor registers are perhaps the most popular means (an example is use of the A register to pass a data byte). Implementation is easy, and interrogation of past data is straightforward but the amount of data that can be passed is limited unless a pointer is used.

The designer's main concern here is to ensure that the subroutine calling on the register preserves all the register's contents in order to be able on return to restore it to its entry value. Otherwise, the calling subroutine may receive values that cause problems. Alternatively, if the subroutine deliberately modifies the register's contents before returning them, this action must be accounted for so that the calling routine proceeds properly.

A fixed, global area of random-access memory may be set aside for parameter overlays, its location being known to all system modules. RAM requirements can thus be limited, provided that many routines can use the same

storage area without conflict. Examples are a fixed-location system output buffer or a scratchpad area shared by many routines.

The predefined technique of parameter passing employs known system addresses like input/output ports (memory-mapped I/O), flag or switch locations, and "mail boxes" (fixed locations that any subroutine can interrogate and/or set for information storage and transfer). Redefinition of the address will of course cause the using subroutine to fail.

Using a push-down stack to store the parameters makes them easily accessible to the calling subroutine but requires the microprocessor to have a control for balancing the stack. The approach provides an interrupt-driven system with trace capability (information on the changes effected by certain instructions) and routine re-entrancy (that is, the routine or subroutine can be interrupted and later reentered at that same point).

A combination of one or more of the above techniques may be required in complex systems that use interrupts, pointers, control blocks, and message passing in subroutines and/or task control. But being complicated, this should be done only as a last resort. On occasion, no parameters may need to be passed, and then the software has only a simple execute function to fulfill.

important as signal interface specifications in hardware design. Not only should the type of parameters be specified, including their characteristics, values, and number, but also the mode of parameter passing (see "How software modules communicate,").

The key to success in parameter passing is, as before, consistency. Once a method has been selected, stick with it. Changes can cause confusion and incompatibility at system integration time. In addition, keep the number of parameters required for a particular interface as low as possible, with three being the maximum for most cases.

Getting the I/O routines straight

The hardware and software in a microprocessor system meet in the I/O driver routines for that system. Microprocessor-based control systems are generally used to convert inputs from sensors, switches, converters, and terminals into output signals that control devices and machines, write messages to receiving devices, drive test equipment and even talk to other computers. In fact, the I/O drivers for a system will determine the total performance of that system in a dedicated control application.

These I/O routines can range from a single load or store instruction all the way up to the driver for an interrupt-driven, block-directed I/O controller with possible dynamic error correction. But, no matter how trivial or complicated the I/O routine, it must fit exactly the specific hardware interface to which it talks. Addresses, flags, data timing, system timing, data codes, and possible handshaking sequences (for data-transmission synchronization) are all part of the requirements for an I/O routine. The job of the hardware at the I/O interface is to make the physical connection between the system's I/O ports and the system data bus. The software routines will request all data transfers and/or process them and

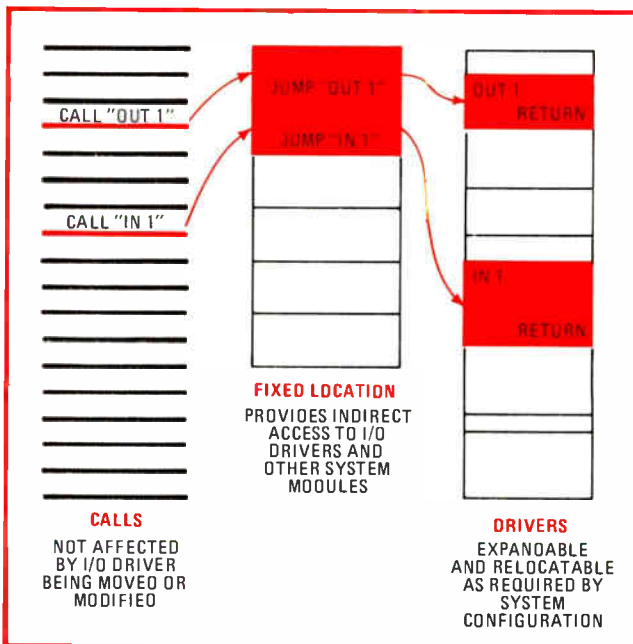

2. Making a jump. One of the software designer's most useful tools is the table-isolated input/output. Indirect access to system modules via a vector or jump table makes it possible to keep track of and modify the interface between the calling program and system drivers.

will return status information to the calling routines on completion of the requested data movement.

Because I/O routines are so basic to a microprocessor-based system, in that their characteristics determine its physical configuration, they should be provided with as much flexibility as possible. One way to do so is called table-isolated I/O (Fig. 2). This technique isolates the physical I/O drivers (subroutines) from the calling

tines and external data locations), I/O port names and addresses, and immediate data definitions. Next should come any required branch isolation tables (vector tables) for both internal and external routines. The internal entries are for use by other modules when branching into this source program, while external entries are for use by this module to get to external routines such as I/O vector tables. Then the main program follows with the main line first and the lower-level modules (subroutines) following. Finally, the areas of fixed and variable data follow, with separation of these areas as required by the ROM/RAM implementation of the module.

Without documentation, you're lost

Just as the schematic diagram and functional description are essential in hardware system design, the flow charts, memory maps, I/O specifications, and program description for a software system should contain all the information necessary to understand, modify, use, and above all to maintain the system on the selected micro-computer configuration. These documents, some of which have already been mentioned, should include:

- A master memory map.
- I/O port assignments within the initialization requirements for programmable I/O ports.
- The format of subroutine pass parameters.
- The functional specification for major system blocks and modules.
- Operational description of programs.
- Module memory maps where required.
- System I/O requirements to include timing constraints, data coding, and required hardware interfaces.
- External subroutine requirements.
- Module and/or system source listings in a standard format with comments.
- System and module flow charts.

In addition, because no software system is static forever, a change record should be included for the system to show all applied modifications and the current version of the system. Besides the obvious needs for good documentation, complete descriptions of programs and subroutines will make it possible to reuse them in future software design efforts.

Higher-level software tools

Because of the time and money involved in developing microcomputer software, the use of higher-level software tools is essential. Assemblers, macro-assemblers, linking/loaders, on-line editors, interpreters, and compilers can all make the software development task easier. Do not even consider using the old method of programming in machine language for any serious software development. Instead, the minimal level should be assembly language using a resident assembler or a cross-assembler or (one step up) a resident macro-assembler. The assembler allows code to be written with mnemonics and symbols, which it translates directly into object code for the target machine. A macro-assembler adds to the assembly process the capability of macro-definitions, which make it possible to produce several assembly language statements with one macro-instruction. It is a very useful tool for establishing standard system param-

SECTION	FILE	CONTENTS
HEADER	([5 lines])	TITLE, I/O REQUIREMENTS, USE, CURRENT VERSION AND CHANGE RECORD
SYMBOLIC CONSTANTS (EQUATES)	([3 lines])	SYSTEM ADDRESS AND IMMEDIATE DATA DEFINITIONS
BRANCH TABLES (INTERNAL AND EXTERNAL)	([3 lines])	FIXED ENTRY POINTS FOR SOFTWARE MODULES
MAIN PROGRAM WITH COMMENTS ON EACH STATEMENT	([5 lines])	SYSTEM INITIALIZATION ALONG WITH COMMAND PROCESSORS, POLLING SEQUENCES, AND SUBROUTINE CALLS
LOWER-LEVEL PROGRAMS (SUBROUTINES)	([3 lines])	FUNCTIONAL MODULES
STORAGE DEFINITIONS AND DATA TABLES	([3 lines])	SYSTEM CONSTANTS AND VARIABLE DATA LOCATIONS

4. Keeping track. Just like a standard drawing format, a standard source program layout is required for good software documentation. It provides for easier source program reading and makes modifications less of a hassle because the program structure is known.

eters and subroutine sequences in the program.

As software development continues, the need for a dedicated software development system will become more evident. The development system should contain executive software (an operating system) that supports a file system for storing and retrieving programs (most likely on a disk) and provides on-line editing capability for program development. This dedicated development tool and its supporting system software become the central element in any software development program. Investment in a good development system is worth the price for the markedly increased software productivity that it provides.

Although most microprocessor applications are today being written in assembly language, the trend is toward higher-level languages like MPL, PLM, Basic, and Fortran. This transition will make the software development effort easier for the engineer lacking experience in this area, for it will eliminate many of the details required at the assembly-language level and will thus shorten the design cycle for a given application.

The problem is that a higher-level language still has to be tailored to the dedicated control microcomputer environment: the language must contain a flexible and adaptable I/O structure, have the mechanisms for easy linking to subroutines written in assembly language and produce relocatable object code with the ability to separate fixed procedure and variables. Moreover, the compilers, interpreters, and related equipment needed to implement such a language do not produce as efficient code, either in size or execution speed, as assembly-level programming. Thus, assembly-language programming will still be required for dedicated I/O routines, time-critical applications, interrupt-driven systems, and most small dedicated applications. □

Computer-engineer partnerships produce precise layouts fast

With the evolution of design automation, a tool for the placement and routing of complex boards has been added to the designer's repertoire

by Richard Larson, *Automated Systems Inc., El Segundo, Calif.*

□ Mating the ingenuity of man and the untiring rapidity of the machine is an old story, but only now is it coming into full flower in the design end of electronics. As digital circuitry steadily becomes more complex and more densely packaged, designers are finding computer-controlled techniques to be invaluable tools in laying out their circuit boards.

These tools have progressed beyond the point where the computer simply functions as an assistant to the designer, as in computer-aided design techniques. In

many cases, the computers can take over the job of circuit routing, using design-automation techniques that have evolved to the point where software modules have given them a broad range of capabilities (Fig. 1).

The lineage of design automation can be traced directly back to nonautomated techniques. To solve the problems inherent in drawing highly precise artwork, digitizing techniques appeared. Then CAD techniques came along to meet the constraints of time, cost, and output that grew in importance as large-scale integration

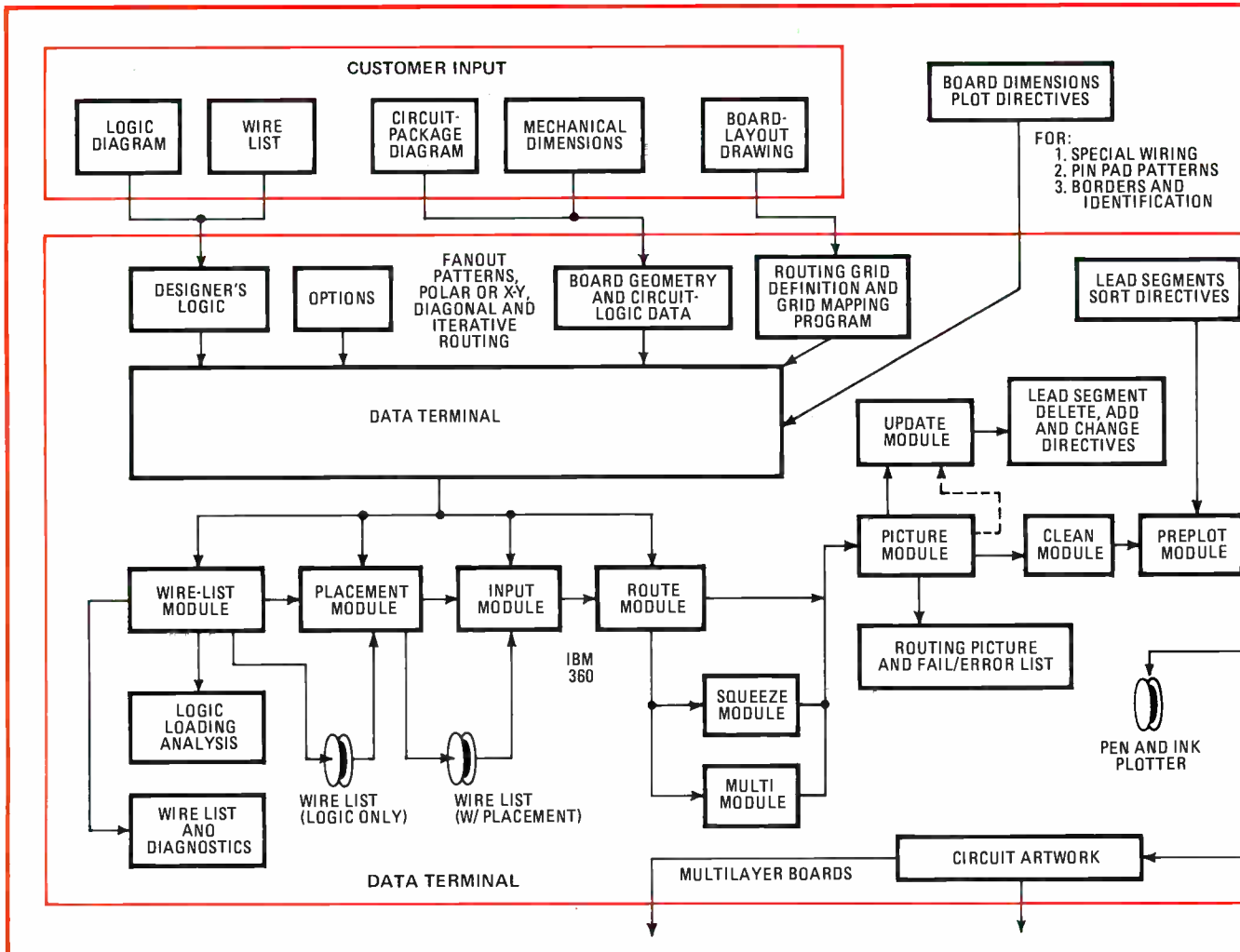

developed. Each of these alternatives has its place in present-day design depending upon the factors involved (table). However, assessing these factors does require some comparisons of the four approaches.

Design without computers

Most printed-circuit boards are designed by engineers working without computer-controlled tools. The designers at the drawing boards place components and route interconnections by trial and error. They prepare the finished artwork either with pen and ink or by hand taping. This preparation is a tedious and time-consuming task, and finished art is frequently less than exact. However, the nonautomated approach will do the job—given a board featuring 50 or 60 mostly discrete components, densities in the area of 0.13 square inch per interconnect, and ample tolerance in the precision of the artwork that must be turned out.

The introduction of big multilayer boards carrying large numbers of digital integrated circuits in dual in-line packages or flat packs has relegated the nonautomated method to the design of simpler boards. The multilayer board's artwork with its requirement for registration of multiple layers, its increased component density, and the complex routing of its interconnections requires a degree of precision that sorely taxes the

designer working without computer-controlled tools.

To meet the need for precision artwork in the design of these densely packed boards, digitizing evolved. Sitting at a large back-lit drawing board, a designer works from the printed-circuit layout he has developed. He uses a digitizing pen, a cursor, connected to a minicomputer that encodes the X and Y coordinates of each circuit feature. The resulting punched paper tape or cards can be used with a simple line plotter or a photoplotter to generate artwork of the required quality.

Checking with digitizing

The latest generation of digitizers can make some design checks. In fact, it is now possible to encode both the wire list for a board and its design specifications. After the design has been plotted, it can be taken to a computer to be checked against this input to be sure that all interconnections have been made correctly. It is also possible to check such specifications as minimum clearances between pads and lines and so on.

However, these are historical checks. If errors have been made, it's back to the drawing board and to the digitizing board for redesign and replotting. Because of this factor and because digitizing does not help the initial design of the board, this design tool is probably best suited for the simplest of today's complex boards.

The next step up in the design hierarchy is the interactive CAD technique in which a cathode-ray-tube terminal, keyboard, and a small digitizer combine with a computer or minicomputer. This combination gives the designer what amounts to an automated drawing board from which to work during the design process.

In a CAD setup, a designer places and routes a board and sees his result displayed on the terminal. If a design specification programmed into the computer is violated, that fact is announced in real time on the CRT. Some systems have refined this process, with software programs that enable the computer to make suggestions about routing to the designer.

CAD helps out

Such systems can work with varying amounts of input, ranging from simple mechanical dimensions of the board and descriptions of devices to complete design specifications and wire lists. This flexibility is especially useful in the case of a design of a single board. The designer can bypass some of the initial setup costs of more sophisticated design-automation systems. CAD systems are also useful for analog boards with components of a wide variety of sizes and shapes, since topographic placement problems can be solved by the engineer as the design evolves towards completion.

Anyone with a CAD system in house should probably be looking for boards that can be designed interactively in about a third the time otherwise required. To achieve a two-year payback, the design volume must keep the

1. Design flow. A design-automation system accepts the five parameters shown on the customer-input block. The system's primary output is 1:1 printed-circuit artwork, but control tapes for component insertion, numerically controlled drill tapes, solder-mask and assembly drawings, and diagnostics also can be produced.

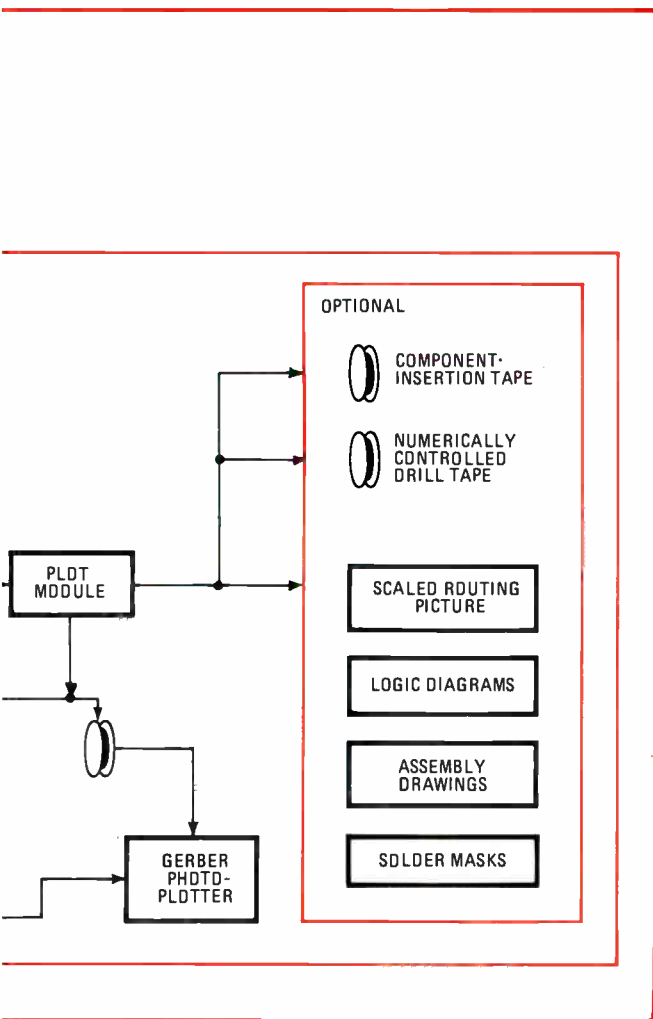

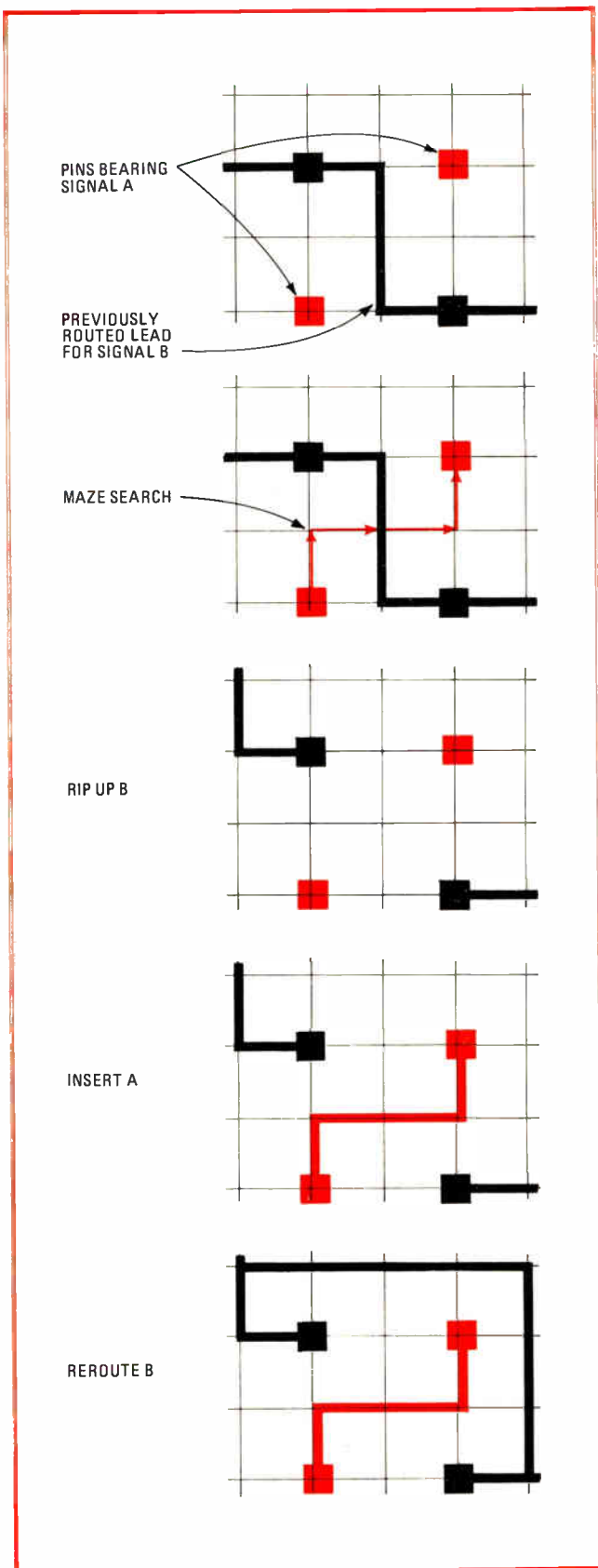

2. Software eraser. Iterative routing is a method for modifying computer-designed artwork. This scheme allows a design-automation system to rip up a previously routed lead to permit insertion of a new interconnection and the rerouting of the old path.

they send the decks of cards to the service bureau and get back decks that operate their photoplotters. Turn-around time is typically 10 days for a series of designs compared to 2 to 3 weeks for design automation alone, and cost savings are significant.

Assessing cost effectiveness

Because of the fixed overhead associated with computer-based systems, there is a threshold of design complexity before either design automation or CAD is cost-competitive with nonautomated design. Boards with fewer than 20 ICs usually should be laid out without the help even of digitizing. For boards with more than 150 ICs, design automation is imperative because of the difficulty of doing the layout by hand. The single exception to this rule is a design in which routing and use of via rules are so tight that it is impossible to place the components logically on a grid. Then the designer must do it himself or herself.

In the range between 20 and 150 ICs, several other factors influence the choice between design automation and CAD—for example, the number of boards of each type involved. In a one-board project, design automation can be ruled out as a cost-effective procedure. Every dimension and special ground rule of the single board must be described to the computer in detail as part of the start-up procedure. The cost of this process is typically about \$500, and, amortized over three or more boards, it becomes increasingly nominal. For a single board, it can be a major part of the expense. However, with computer-aided design, board parameters are simply drawn in, and so initial setup costs are low.

Conversely, the greater the number of boards in a group, the more likely a CAD system is to become a bottleneck to the rapid work. Once the front-end programming is complete, design automation can rapidly turn out one layout after another. Any given CAD system has a maximum capacity, and the last board takes as long to design as the first.

Another point to keep in mind is the percentage of discrete components per board. Design automation can assign logic elements to multielement packages or place DIPs or flat packs of uniform package types to minimize the length of interconnections. If pc boards contain 50% or more discrete components, it is better to go with placement by the designer, perhaps aided by CAD.

Tightness of the design ground rules is another consideration. The computer cannot employ discretionary "cheating" as a manual designer can. Therefore, where ground rules are discretionary rather than absolute and crossing counts indicate the board may be difficult to route, higher densities may be achieved with nonautomated or computer-aided design.

Quantity is a key

The cost effectiveness of design automation vs CAD vs manual design and artwork may be directly dependent on the number of boards to be fabricated from each design. For less than 5 or 10 boards per design, it pays to tell the fabricator to take extra care in producing the boards. High-precision artwork supplied by the designer is not as vital as it would be for larger production runs,

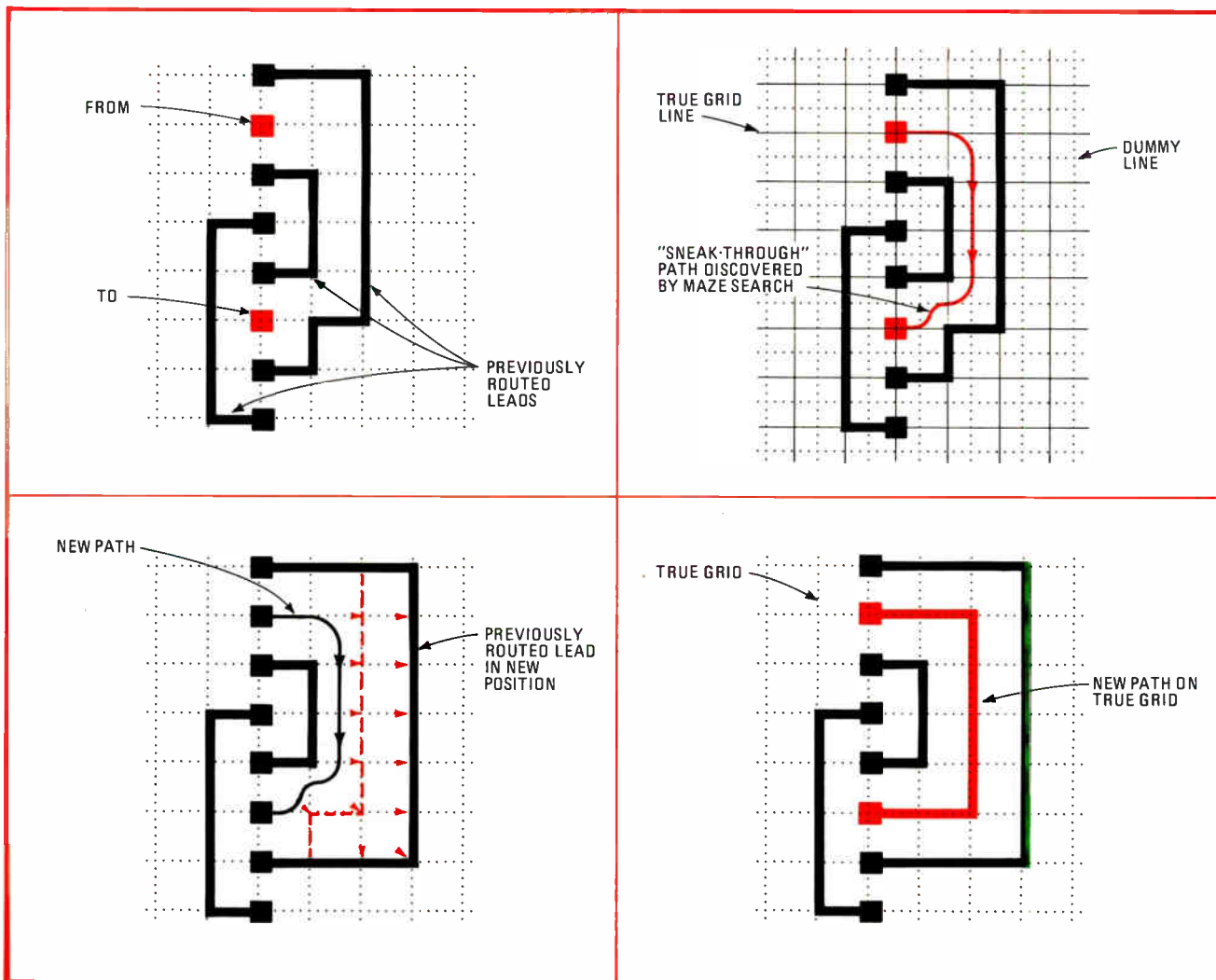

3. Squeeze. Another approach to inserting new paths is the "squeeze through" algorithm. This temporarily inserts an extra grid within an existing one (top right). Then previously routed lines are shoved aside (bottom left), and the new path is fitted to the new grid.

and design by hand may be adequate for the production of the boards.

With greater quantities, ease of manufacturability becomes a major cost-saving item. Computer input becomes the treatment of choice.

Using a designer

If there are more than 1,000 boards to be produced per design, manufacturing costs will be far lower if the board under consideration is limited to a two-sided, rather than a multilayer, design. Under these conditions, one can have a designer spend an additional month on a single design just to eliminate a few vias. (Given unlimited time and infinite patience, a skilled designer may be able to improve slightly on the densities achieved by design automation.) However, since very minor differences in the quality of the artwork can make big differences in yield, in all probability it will be valuable to digitize the design.

Firms that have tight delivery schedules cannot afford mistakes that demand extensive debugging and reworking further down the line. Therefore it is important to have diagnostic checks available along the way.

Computer-aided-design systems are usually limited to physical design checks, such as adherence to line-width and spacing requirements. Design automation assures adherence to these requirements automatically, and it also can check conductor traces for conformance to the original wire list.

Obviously few boards and few operations are going to fit precisely the ideal requirements for any one of the four basic approaches to pc-board layout. A designer must consider all the variables, including delivery schedules and design loads, to discover which approach or combination of approaches will be most generally cost-effective for his operation.

The choice

In general, the more complex and highly dense the board and the larger the group of mechanically similar boards, the more likely is design automation the best choice. Moreover, unless the task involves very simple boards (20 ICs or less) to be produced in small quantities (5 or 10 per design), it probably will be profitable to investigate the various degrees of help obtainable from today's computer technology. □

Split current source damps reactive load oscillations

by Yishay Netzer
Haifa, Israel

A standard bilateral current source of the type shown in the first part of the figure (a) will often generate oscillations in circuit loads that are grounded and have an impedance (Z_L) that is not purely resistive. Inductive loads such as cathode-ray-tube deflection yokes and torque motors are best driven by the modified circuit shown in the second part of the figure (b). Adding the differential amplifier and feedback network to the circuit eliminates undesirable responses while ensuring that the output current will be virtually independent of the load impedance.

When the load is reactive, it may cause the circuit's step response to be underdamped and consequently unstable, with the result that the output current will become dependent on the load impedance. As shown in the equation in (a), the output current is dependent on the circuit transfer function, which is:

$$G(s) = K \frac{\omega_o^2}{s^2 + 2\zeta\omega_o s + \omega_o^2}$$

where ω_o is the natural undamped frequency of the circuit, K is a constant, and ζ is the damping factor.

The various parameters are determined by circuit constants R , R_S , and Z_L . Of particular importance is the fact that once determined by the circuit configuration, ζ cannot be modified, and that is why oscillations can result. Furthermore, the oscillations may be impossible to eliminate in the standard circuit because adding components may affect the output impedance, making any type of compensation impractical.

The circuit in (b) circumvents the problem by splitting the current source into two parts:

- A balanced difference amplifier (A_1), which converts the load current into a single-ended voltage feedback signal.
- A power amplifier (A_2), which, aside from assuming its original function, reduces the effect of Z_L upon I_L by making use of the feedback voltage.

Note that by adding the feedback network, resistor R_C has been introduced to the circuit, and therein lies the major advantage of this circuit. R_C can vary (compensate) ζ right down to its optimum value ($2^{1/2}$ in this case), without disturbing the proportional relation of V_{in} to I_L throughout the useful range of the circuit; that is, below ω_o . The basic transfer function of the circuit is not

No oscillations. Standard current source (a) cannot drive inductive loads effectively because undamped circuit responses can occur and lead to oscillations. Adding operational amplifier A_1 and feedback network to circuit (b) enables R_C to adjust damping factor.

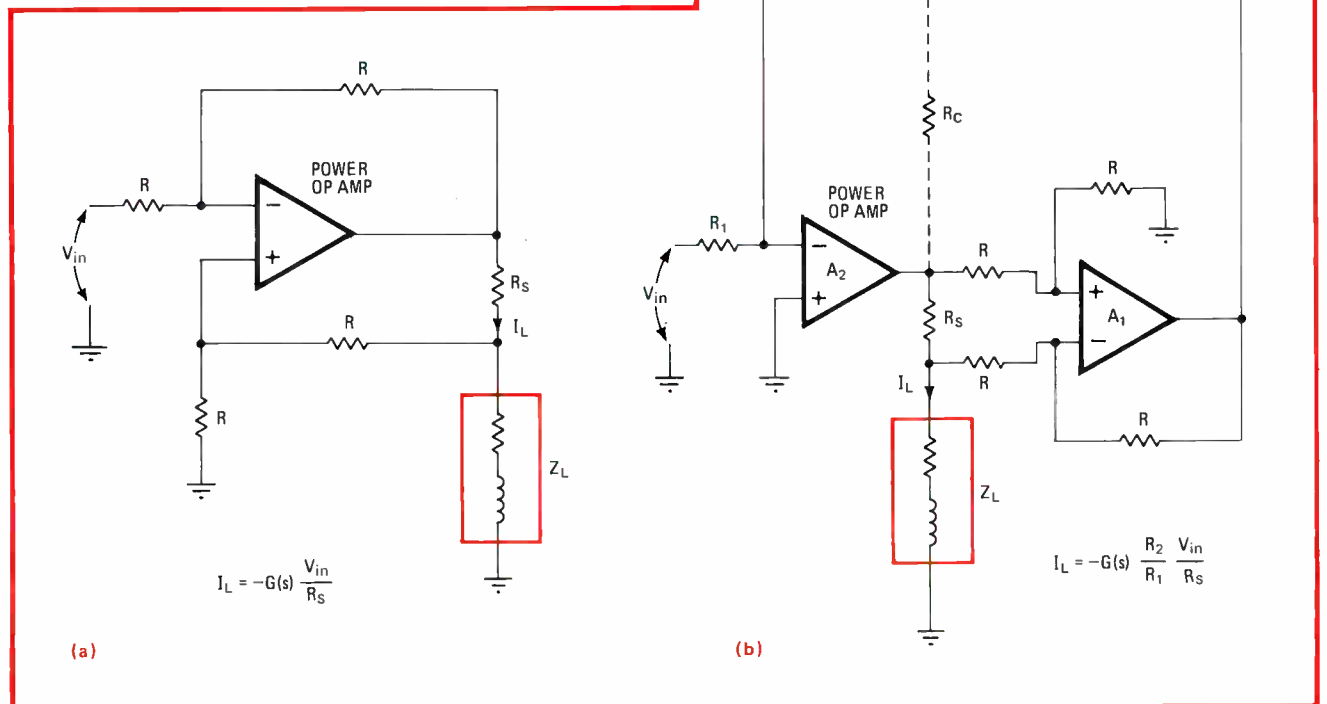

altered by the modified configuration, either.
 The value of R_C is best found experimentally while observing the circuit response to a square-wave input.

Note that the constant, K , in $G(s)$ will be slightly smaller than its original value because of the feedback currents through R_C . □

Exclusive-OR gate and flip-flops make half-integer divider

by Tung-sun Tung
 University of Illinois, Urbana, Ill.

A simple and inexpensive divide-by- $(N - 1/2)$ counter can be built with D flip-flops and an exclusive-OR gate. The circuit uses very few parts, largely because, unlike many such dividers, it does not rely on a collection of monostable multivibrators. Nor are there difficult timing considerations, which would also complicate the circuit and act to increase its parts count.

Various logic circuits need to be driven by what may be termed a half-integer clock signal that is derived from

a master clock. For instance, the MM-57100 video-game integrated circuit is driven by a 1.0227-megahertz signal, which the chip's manufacturer (National Semiconductor Corp.) recommends be derived from the television set's 3.579545-MHz color-burst crystal oscillator. This application requires a divide-by- $3\frac{1}{2}$ counter, which may be built by modifying a divide-by-4 circuit as shown in Fig. 1a.

Flip-flops A_1 and A_2 form the divide-by-4 counter. The master clock, C_{IN} , drives A_1 through the exclusive-OR gate, G_1 . However, the output state of G_1 is additionally controlled by A_3 .

As a result, A_3 converts the divider to a divide-by- $3\frac{1}{2}$ counter. A_3 is situated in the feedback loop such that it enables generation of a short pulse at C_O for every $3\frac{1}{2}$ counts of C_{IN} . The pulse is generated if C_{IN} either falls to logic 0 or rises to logic 1, which depends on the state of Q_C . Its shortness is due to the delay between the initial

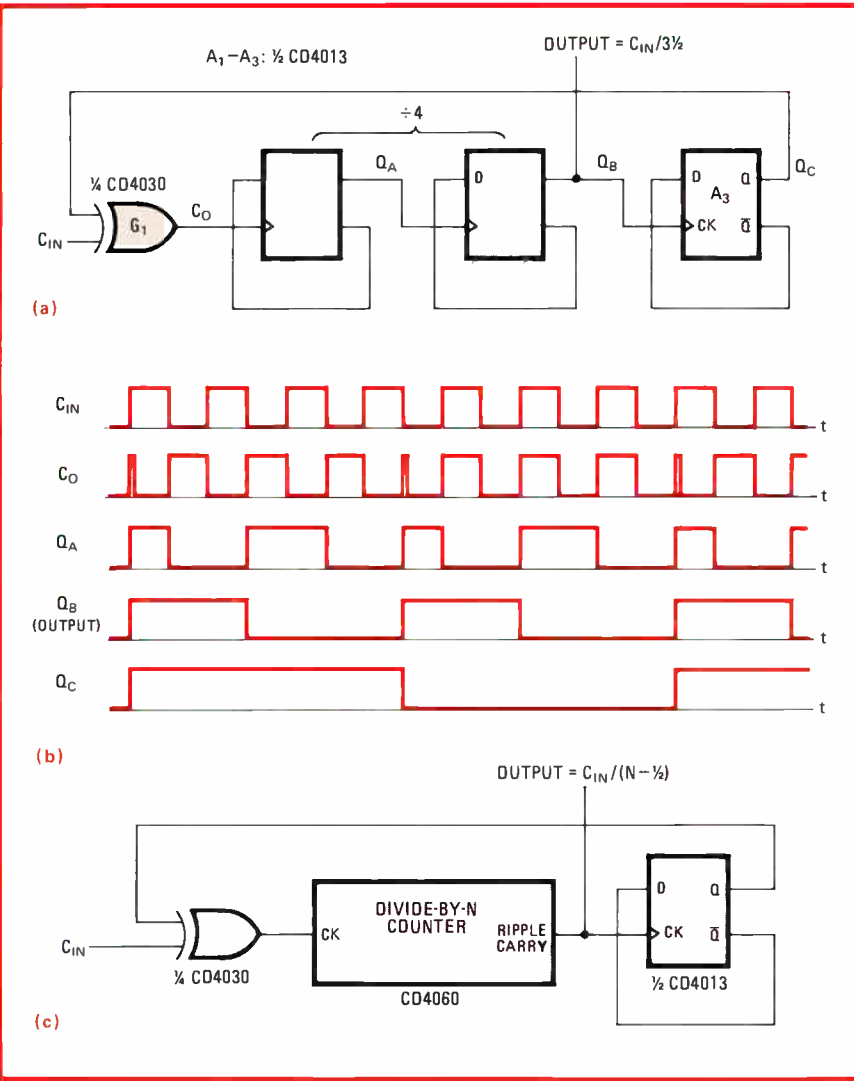

Half-integer divider. Divide-by- $3\frac{1}{2}$ counter is divide-by-4 circuit modified by flip-flop A_3 and exclusive-OR gate G_1 (a). Timing diagram details operation (b). Method may be extended to form a divide-by- $(N - 1/2)$ counter by replacing flip-flops A_1 and A_2 by ripple-carry, divide-by- N counter (c).

FOR THE RECORD:

The difference in HP's lowest price XY recorder is that you get full capability in the bargain.

When you look for an economical lab XY recorder, remember that certain things shouldn't be sacrificed at any cost. That's the way we build our lowest price XY.

Designed around HP's rugged one-piece casting, our Model 7015B gives you full capability without adding extra cost options.

Internal time base lets you make recordings vs. time without an external ramp generator. Matched input filters virtually eliminate troublesome noise in the trace. Remote pen lift permits precision timing for blemish-free rapid work by external command. And by accepting TTL or low current contact closures, the 7015B lets you interface easily with other equipment.

It's engineered to meet HP's own tough environmental specifications. Even the continuous duty servo motors are built to take plenty of punishment.

At \$1325 (domestic USA price), HP asks a little more for its lowest price XY recorder. The difference to you is full capability and rugged construction. And that's what we call a bargain.

11802

FOR THE RECORD, HP MAKES A DIFFERENCE

HEWLETT  PACKARD

1507 Page Mill Road, Palo Alto, California 94304

For assistance call: Washington (301) 948-6370, Chicago (312) 255-9800, Atlanta (404) 955-1500, Los Angeles (213) 877-1282

ONCE YOU'VE GOT IT DESIGNED, YOU'VE GOT IT MADE.

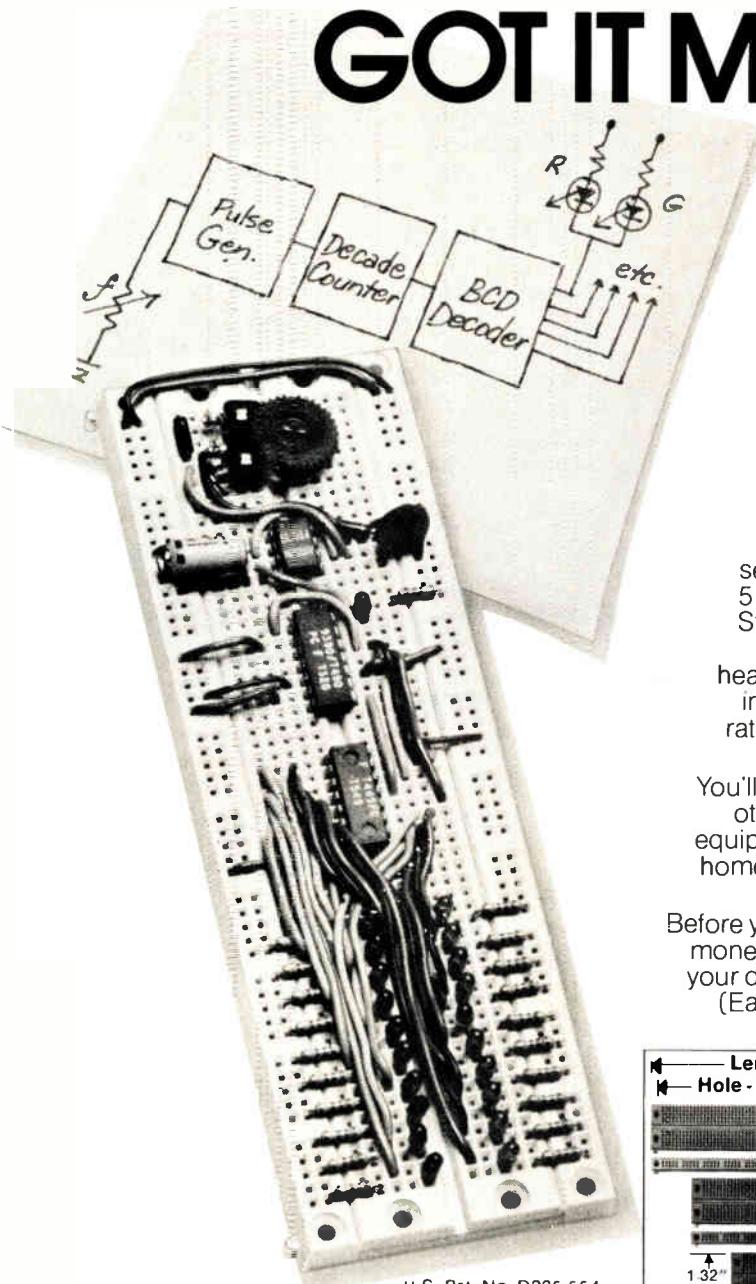

U S Pat No D235.554

It's that easy when you use CSC's QT solderless breadboarding Sockets and Bus Strips. Working directly from logic or block diagrams, you plug in IC's, transistors, resistors, capacitors, LED's – virtually any component – and optimize circuits stage-by-stage, literally as fast as you can think. (No special jumpers required, either – just ordinary #22-30 solid hookup wire.)

When you're done, you've got a highly-visible working layout that someone else can reduce to schematic, while you get other projects underway.

Available for as little as \$3.00,* QT units snap together into larger breadboards, and mount securely wherever you need them. Sockets have 5 interconnecting tie points per terminal and Bus Strips feature 2 separate rows of interconnecting terminals. And all QT models are built to last: heavy-duty prestressed nickel-silver contacts, vinyl insulated backing and glass-filled plastic sockets rated at better than 100°C insure optimum day-in-day-out performance.

You'll find QT Sockets and Bus Strips useful in lots of other ways, too. Mounted on power supplies, test equipment, bench or plug in cards, they're equally at home in lab, on production lines, in QC test jigs or in the field, for on-the-spot emergencies.

Before you start your next project, start saving time and money with QT Sockets. Pick up your phone and call your dealer – or order direct by dialing 203-624-3103 (East Coast) or 415-421-8872 (West Coast). Major credit cards and purchase orders accepted.

Length Hole-to-Hole	Length	Hole-to-Hole	Terminals	Unit Price \$	
	QT-59S	6.5"	6.2"	118	12.50
	QT-59B	6.5"	6.2"	20	2.50
	QT-47S	5.3"	5.0"	94	10.00
	QT-47B	5.3"	5.0"	16	2.25
	QT-35S	4.1"	3.8"	70	8.50
	QT-35B	4.1"	3.8"	12	2.00
	QT-18S	2.4"	2.1"	36	4.75
	QT-12S	1.8"	1.5"	24	3.75
	QT-8S	1.4"	1.1"	16	3.25
	QT-7S	1.3"	1.0"	14	3.00

All QT units are .33" thick.

CONTINENTAL SPECIALTIES CORPORATION

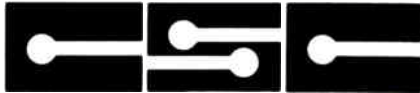

70 Fulton Terrace, Box 1942, New Haven, CT 06509
 203-624-3103 TWX 710-465-1227
 WEST COAST: 351 California St., San Francisco, CA 94104,
 415-421-8872 TWX 910-372-7992
 GREAT BRITAIN: CSC UK LTD
 Spur Road, North Feltham Trading Estate,
 Feltham, Middlesex, England.
 01-890-8782 Int'l Telex: 851-881-3669

See your CSC dealer or call
 203-624-3103 (East Coast) or 415-421-8872 (West Coast)
 major credit cards accepted.

*Manufacturer's suggested list Prices and specifications subject to change without notice
 Prices slightly higher outside USA.

What to look for in analog input/output boards

For a given microcomputer application, the architecture of an analog I/O board matters as much as its specifications

by Norman Bernstein, *Analog Devices Inc., Modular Instrumentation Division, Norwood, Mass.*

□ Analog input/output boards are riding high on the success of single-board computers. As a convenient and relatively inexpensive way of interfacing these machines to the real world, they are becoming steadily more and more popular with designers who must incorporate analog data functions into all sorts of instruments and control systems.

By now there is quite a variety of analog boards from which to choose a partner for a wide range of board-level microcomputers. Running in price from less than \$200 to over \$1,500, these subsystems come in input or output versions or even as combination I/O boards. Options abound, and architecture may differ greatly between the boards made by various manufacturers for the same microcomputer. So selecting the right board for a given application means the designer must understand the differences between the architectures and the advantages of the various options.

Input board for data acquisition

Although commercial data-acquisition or analog input boards vary greatly with respect to individual design details, most share the same basic architecture (Fig. 1). A multiplexer selects one of 16 or 32 input signals and routes it to an instrumentation amplifier. Besides amplifying the signal to the specified range of an analog-to-digital converter, the amplifier drives a sample-and-hold circuit, which tracks the signal between data conversions and holds it during the conversion. The a-d converter produces an 8-, 10-, or 12-bit digital representation of the input signal, and this result is then made available to the microcomputer's data bus. Interface logic controls the entire process, accepting commands from the microcomputer and actuating the control inputs of the data-acquisition elements.

While the basic architectures of all input boards are similar, the relative merits of a particular board cannot be assessed purely in terms of numerical specifications. The most linear a-d converter or fastest instrumentation amplifier is useless if the board architecture is not designed to take advantage of these properties.

Almost universally, input boards employ complementary-metal-oxide-semiconductor multiplexers for input channel selection, because these devices provide economy, low power, high speed, high density, and compatibility with transistor-transistor logic. In general, most

boards offer one or more multiplexer configurations, while some must be ordered with a certain configuration, and still others may be tailored by the user by means of jumpers or straps.

All about multiplexer configurations

The fundamental multiplexer configuration is the single-ended mode (Fig. 2a), in which each input is independently selected and assumed to be referred to the analog ground of the board. This architecture is optimum when the number of input channels must be maximum and all signals are measured with respect to system analog common.

For differential-mode operation, the multiplexers and the instrumentation amplifier are configured as shown in Fig. 2b, giving separate high and low connections associated with each input. In this mode, the multiplexers are simultaneously enabled to select both the high and low inputs of each channel, and the number of input channels is half that available with the single-ended mode. Differential operation is required in applications where several inputs are referenced to independent levels or where long signal leads would result in common-mode interference, such as 60-hertz pickup. With the differential mode, then, the selected channel can take full advantage of the common-mode rejection of the instrumentation amplifier.

Another useful mode is the pseudo-differential configuration, which may be employed if the board makes the inverting input of the instrumentation amplifier accessible, as noted in Fig. 2c. The pseudo-differential mode is useful in systems where all inputs are referred to a common potential that may, in turn, float with respect to the analog common of the data-acquisition board. Many applications can take advantage of this operating mode—for example, a number of sensors, all within the influence of a strong 60-Hz field, need not have independent returns, since the interference is common to all of them. With pseudo-differential operation, the virtues of common-mode rejection can be preserved without halving the number of inputs available.

Most boards offer some level of input protection to prevent damage to the C-MOS multiplexers. Those boards built with internally protected chips are usually safe for signals going up to ± 20 volts beyond the analog power supplies—a level that is adequate for most applications.

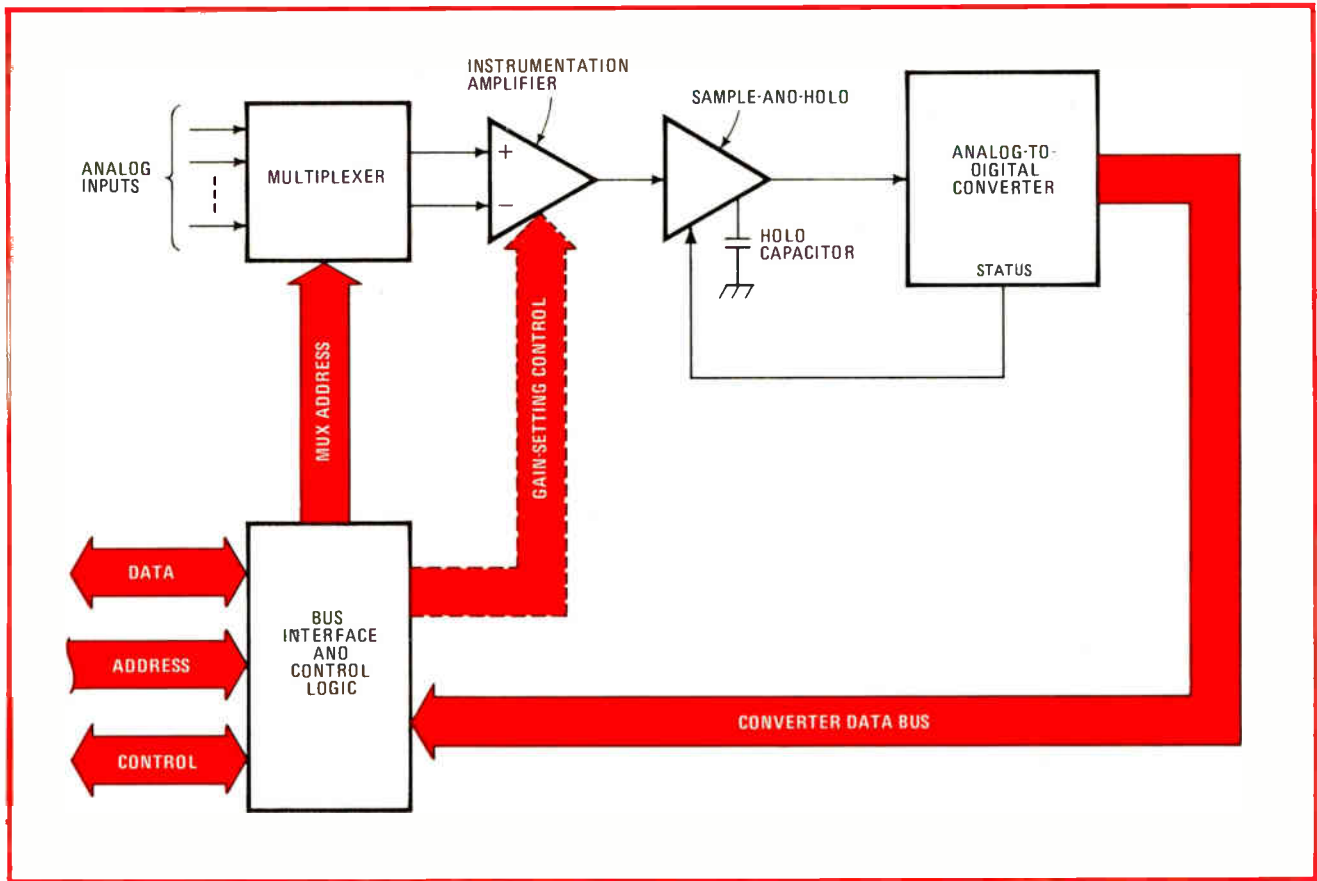

1. Input board. Most available analog input boards have this basic architecture, incorporating an instrumentation amplifier and a sample-and-hold circuit. The gain of the amplifier is usually adjustable, through either an external resistor network or software programming.

Some boards offer a more elaborate measure of protection, incorporating active input clamps and series fusing resistors that open in response to a catastrophic accident, like shorting a 60-Hz power lead to the input. Such series resistors also serve as input current limiters.

A closer look at the instrumentation amplifier

Nearly all analog input boards follow the multiplexer with an instrumentation amplifier. It provides front-end gain on a resistor-programmable or software-programmable basis, as well as common-mode rejection for a differential multiplexer configuration. The performance of this amplifier—its settling time, offset and gain drifts, noise, and common-mode rejection—is a very important factor in determining the board's overall performance.

With resistor-programmable gain, the resistance value selected by the user determines the gain of the amplifier. This method allows the user to optimize the front-end gain to suit a specific application, although all input channels will have the same gain. In general, the technique is best suited to applications where all input channels are driven from a similar type of signal source. Gains of from 1 to 1,000 are usually possible; however, very high gains may be impractical in certain situations.

Even under optimum conditions, high gains may reduce amplifier speed and accuracy. As gain increases, for instance, so does amplifier nonlinearity (as a function of full scale). Furthermore, settling time for step inputs may increase somewhat at high gains. The board's inter-

face timing should be capable of taking this increase into account so that the amplifier has sufficient time to settle before a conversion takes place.

Also, amplifier noise consists of two components—one that is independent of gain and one that is proportional to gain. At low gains, the gain-independent component predominates, but as gain increases, the gain-dependent component becomes larger and ultimately dominant. Consider, too, that externally generated input noise will be amplified proportionally. At a gain of 1,000, for example, 10 microvolts of system-induced noise on the inputs will amount to 2 or more least significant bits of the amplifier's full-scale output. As with noise, the amplifier's offset drift has a constant component and one that is proportional to gain. To achieve good drift performance at very high gains, the latter component must be quite low.

Changing gain through software

Some input boards offer true programmable gain, permitting the use of software to invoke precalibrated gains of 1, 2, 4, or 8—the user simply writes a specific code into one of the bytes (or several bits) of the micro-computer's I/O image. Software-programmable gain expands the dynamic range of the front end, an advantage in applications where several types of input signals must be acquired by the same board.

With software-programmable gain, though, the amplifier may need extra settling time, as its output must

swing by a factor of two for each increase or decrease in gain. A well-designed board should take this into account, calling on hardware mechanisms to delay the onset of conversion until the amplifier has had a chance to settle out after a gain change.

Gain-ranging software permits the user to extend the dynamic range of the system to 15 bits (assuming programmable gains of 1, 2, 4, and 8, and a 12-bit a-d converter). However, gain-ratio errors may degrade system accuracy for gains other than the one chosen as a reference. To preserve accuracy over the entire 15 bits, the amplifier's gain-ratio accuracy should be commensurate with the accuracy of the a-d converter.

Moreover, the I/O byte that determines gain should be allotted its own position within the I/O image of the interface, so as to allow for each gain change without the need for masking insignificant bits. Additionally, the gain byte should have read-back capability to permit the use of memory incrementing and decrementing instructions. In practice, the user should start from the lowest gain range and work upwards, lest he create an over-range condition that saturates the amplifier—and over-load recovery may take far longer than the amplifier's settling response.

To determine whether or not a change in the front-end gain is required, the microcomputer must read the two most significant bits of the a-d conversion data. (Two bits are needed because with bipolar data the MSB indicates sign rather than magnitude). An efficiently designed board should incorporate the 2 MSBs within the status word. Since this word is normally accessed after every conversion, the ranging data will therefore be available to the microcomputer without the need for a separate data-access instruction.

Sample-and-hold reduces possible errors

Coming just ahead of the a-d converter, the sample-and-hold circuit is a must for accurately digitizing signals that, in the time it takes to complete the conversion, may slew many LSBs. (Fast conversion times do not eliminate the need for a sample-and-hold, even though some manufacturers omit it on boards sporting converters that operate in the 2-microsecond range.)

Essentially, a sample-and-hold restricts data uncertainty to approximately 150 nanoseconds, which represents the sum of its errors, such as aperture uncertainty, jitter, and aperture width. Conversely, the lack of a sample-and-hold will result in errors if the signal is not completely static during the conversion. How long the conversion takes will determine the time uncertainty of the data. Obviously, a sample-and-hold is a necessity for the user who requires broad-bandwidth performance and who must know the precise moment of the sample.

Output boards for control

Separate analog output boards (Fig. 3) usually contain from two to eight independent d-a channels, while a combination I/O board has only one or two d-a channels. The analog outputs can be put to work driving oscilloscopes, chart recorders, servomechanisms, and transducers. Like the a-d input channels, each d-a output provides selectable ranges and data coding and has its

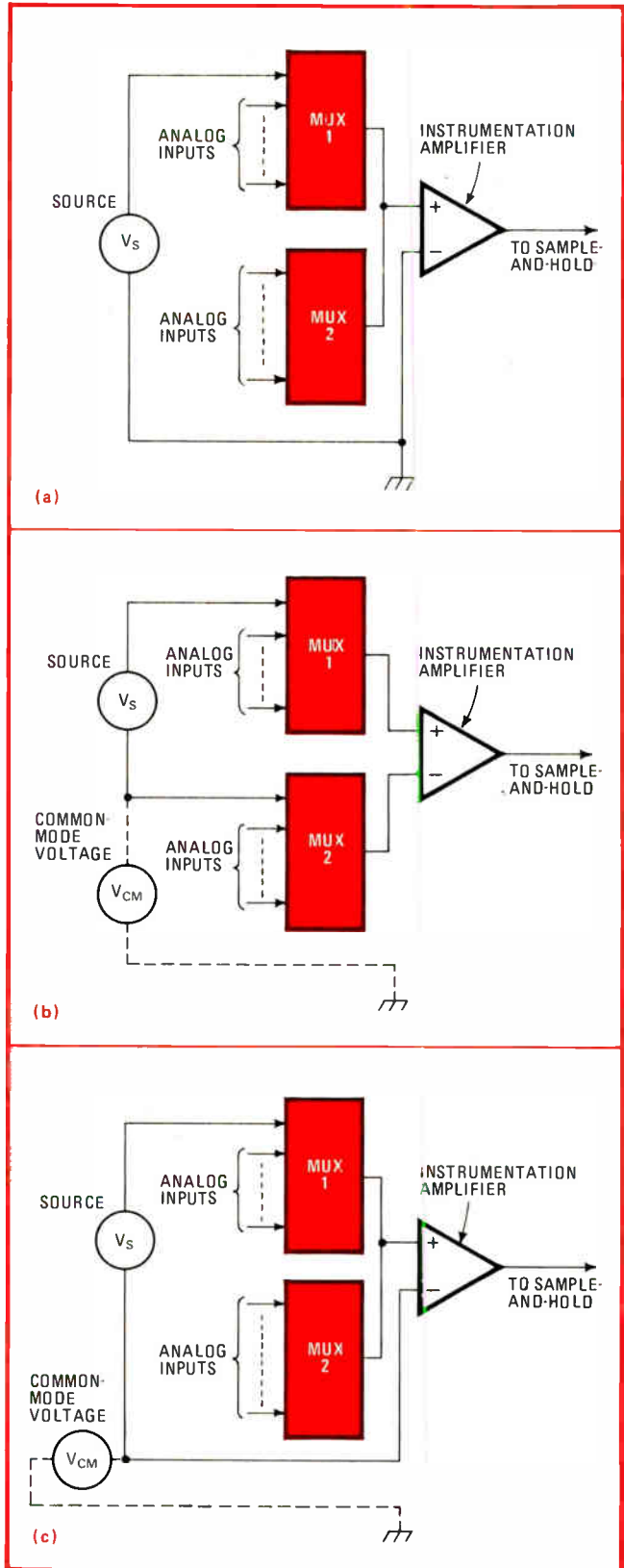

2. A trio of multiplexer configurations. With single-ended operation (a), all inputs are referred to the analog ground of the board. The differential mode (b) allows each input to float on a common-mode voltage but halves the number of channels. Pseudo-differential operation (c) preserves the virtues of common-mode rejection while retaining the same number of channels as single-ended operation.

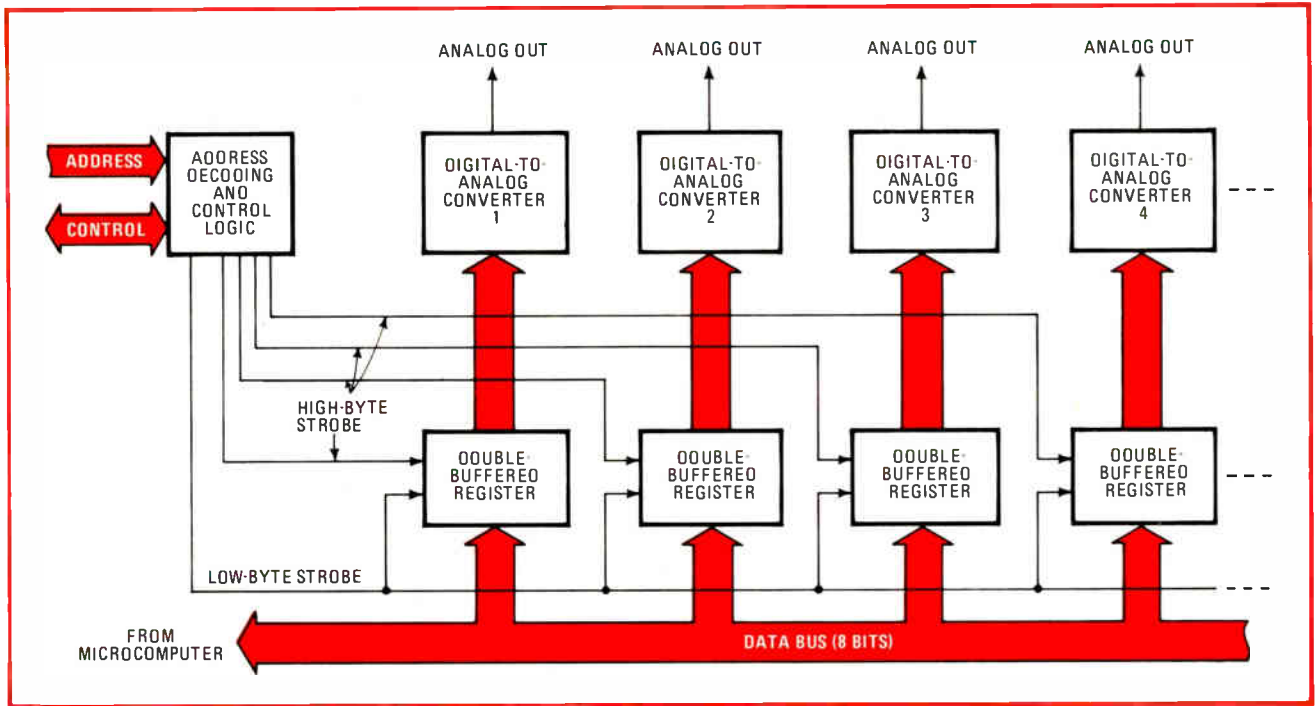

3. Output board. Providing up to eight independent byte channels, analog output boards are useful for driving oscilloscopes and recorders. When the data to be converted requires more than one byte, double-buffered registers are needed to prevent intermediate outputs.

own 1-, 2-, or 3-byte I/O image. To set a d-a converter for a given data point, the data is merely written into the appropriate address.

If the data will require more than one byte, as in the case of 10- and 12-bit resolutions, a double-buffering arrangement should be employed to hold the first byte of data until the second one is loaded. Then both bytes are presented to the converter simultaneously. Such double buffering prevents intermediate outputs from occurring and assures clean transitions from one output value to another. Some output boards also include a circuit that sets each converter output to zero when the power is first turned on or when the system is reset. This feature helps to minimize the effect of turn-on transients on devices connected to the output channels.

In general, these boards offer voltage outputs capable of driving 2-kilohm loads over ranges of 0 to 10, ± 5 , and ± 10 v. Each output, moreover, should be capable of handling moderately capacitive loads without oscillation, so as to allow for cabling capacitance. Some boards also provide remote-sense operation for minimizing voltage drops when heavy loads are driven over long lead lengths or through interconnects.

A single reference for good tracking

To assure good tracking between multiple converters on the same board, a single voltage reference should be used, thus reducing the effect of reference drift. In combination boards, tracking between the input and output ends will be enhanced if the same reference is used for the d-a converters and the a-d converter. When the output board contains converters capable of multiplying operation and provides inputs for external references, then the converters can be used as programmable attenuators, filters, and the like.

Some boards have optional voltage-to-current converters that provide a proportional output current of 4 to 20 milliamperes. Such converters can be extremely useful in industrial control applications, since many industrial transducers are designed for 4-to-20-ma operation. The current output, though, should have good compliance so that it can tolerate nonlinear loads, as well as the voltage drops associated with driving long lines. To give additional margin when driving high-impedance loads or several loads in series, the board should provide for operating the voltage-to-current converter with an external-loop supply.

Examining the interface

Every analog board must contain a bus interface that is functionally and parametrically compatible with the particular microcomputer bus structure for which it is intended, since microcomputers have different bus structures and software.

For several microcomputers—particularly those based on the popular 8080 8-bit microprocessor—there are two principal methods of I/O interface: accumulator I/O (or dedicated I/O) and memory-imaging I/O (or memory-mapping I/O). The latter technique (Fig. 4a) involves the use of all 16 address lines, along with the normal memory strobe signals. The analog board appears as a number of sequential bytes in the memory space and is accessed using any memory reference instruction. In contrast, with accumulator I/O (Fig. 4b), the data bus functions much the way it does for normal memory access, but only eight address lines are significant. There are separate strobe lines, and only specific I/O instructions may be used.

While accumulator I/O may seem simpler, in that fewer address lines need be decoded, it is not well suited

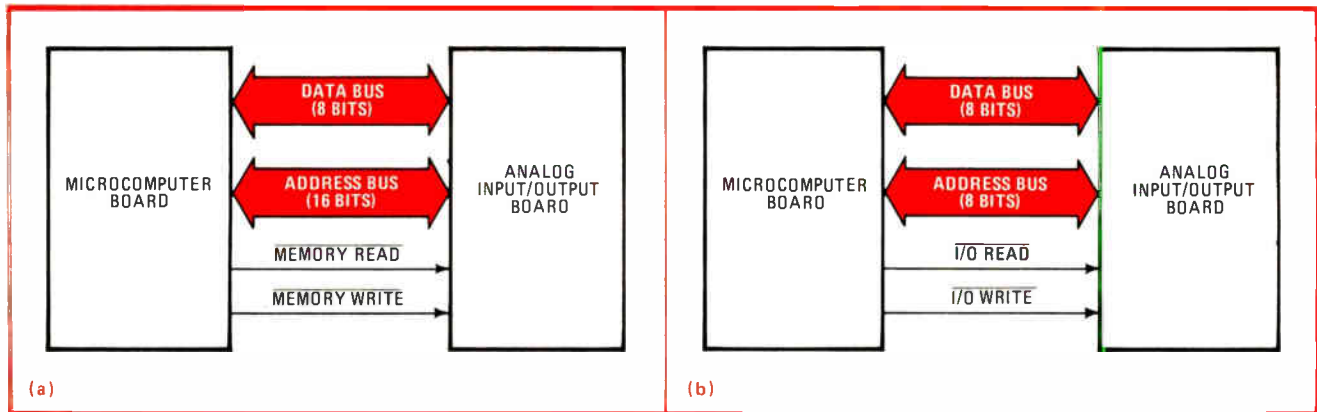

4. Choice of interfaces. Memory-imaging I/O (a) utilizes the same address, data, read, and write signals as conventional memory. In contrast, accumulator I/O (b) uses only a subset of the address lines and those read and write strobes specifically reserved for I/O.

to analog I/O interfacing. As it is inherently a single-byte technique, two instructions must be used to access 12-bit data. Since each instruction must go through the accumulator register of the microprocessor, extra instructions are needed to reserve the data between bytes. Also, because the control instructions are direct-addressed (the instruction contains the port address in the second byte), unnecessary overhead is carried when making repeated access to a single I/O port. Furthermore, the control instructions are comparatively slow to execute, limiting the speed of the interface.

Memory imaging, on the other hand, permits both direct addressing and indexed instructions to be employed. Since double-byte instructions are available, a 12-bit data word may be accessed in a single instruction. Moreover, execution is faster for memory reference instructions than for control instructions. Although memory imaging does decrease the room available for conventional memory, few applications require more than a few bytes of the total memory address space for the analog interface—a small fraction of the tens of thousands of bytes available.

As long as a memory-mapped analog board has provisions for strapping it into an unused address space, there is no need to worry about memory space. Since the user's utilization of memory (and therefore address space) will differ from application to application, the jumpering provision must allow for selection of a convenient address at which to place the I/O image. At least 4 bits of address jumpering are desirable, giving 16 possible positions for the interface.

Address jumpering

The jumpering may be implemented with a non-destructive technique, by means of a socket for a dual in-line package or wirewrap pins. Some boards have plated-through holes that must be drilled out to establish the card address, a technique that makes changes sloppy and more difficult. A DIP socket lets the user install a DIP switch that allows instant address modification. For permanent installation, a plug containing shorting pins can be inserted in the socket.

When more than one analog board is used in a single system, each board may be located at a different address and thereby exhibit a unique I/O image. However, a

software inefficiency may result because some microprocessors make extensive use of direct-addressed instructions. For instance, in a system having two separately addressed analog boards, the software routines containing direct-addressed instructions cannot be utilized for both boards. In this case, the user must either set up separate routines to access each board or use only indexed instructions.

There is an addressing technique, however, that neatly circumvents this problem and often dramatically reduces software. Called card select, the technique allows multiple boards to share the same address space, much as in memory paging.

Briefly, card select (Fig. 5) works like this. Each board is given the same address and assigned (by means of jumpers similar to the address jumpers) a unique 4-bit code. When an assigned code is written to a specified memory location within the I/O image, the board associated with that code is activated and has access to the bus. In effect, all other boards disappear from the bus but are listening for the microcomputer to write their code into the select byte. The unselected board does not interfere with the normal bus operation, however; most on-board processes, such as an externally triggered conversion, may take place.

Controlling the data process

Just as equipment controls should be logically arranged and easy to use, the organization and arrangement of the bytes that make up the control and interface to an analog board should not be so complicated as to cause confusion nor so simplified as to prevent the implementation of a sophisticated application. The most critical aspect of handling the digitized analog data is the arrangement of the data bytes coming from an input board or going to an output board. Since most boards deal with data that is 12 bits or less in length, the data may be either right-justified or left-justified within the 16-bit field created by two bytes. In general, board manufacturers opt for right-justified data, because trailing zeros would be meaningless.

The disposition of the leading bits in right-justified data depends on the type of data being accessed. For example, with unipolar data, the leading bit positions should read as zero. But when bipolar data is expected,

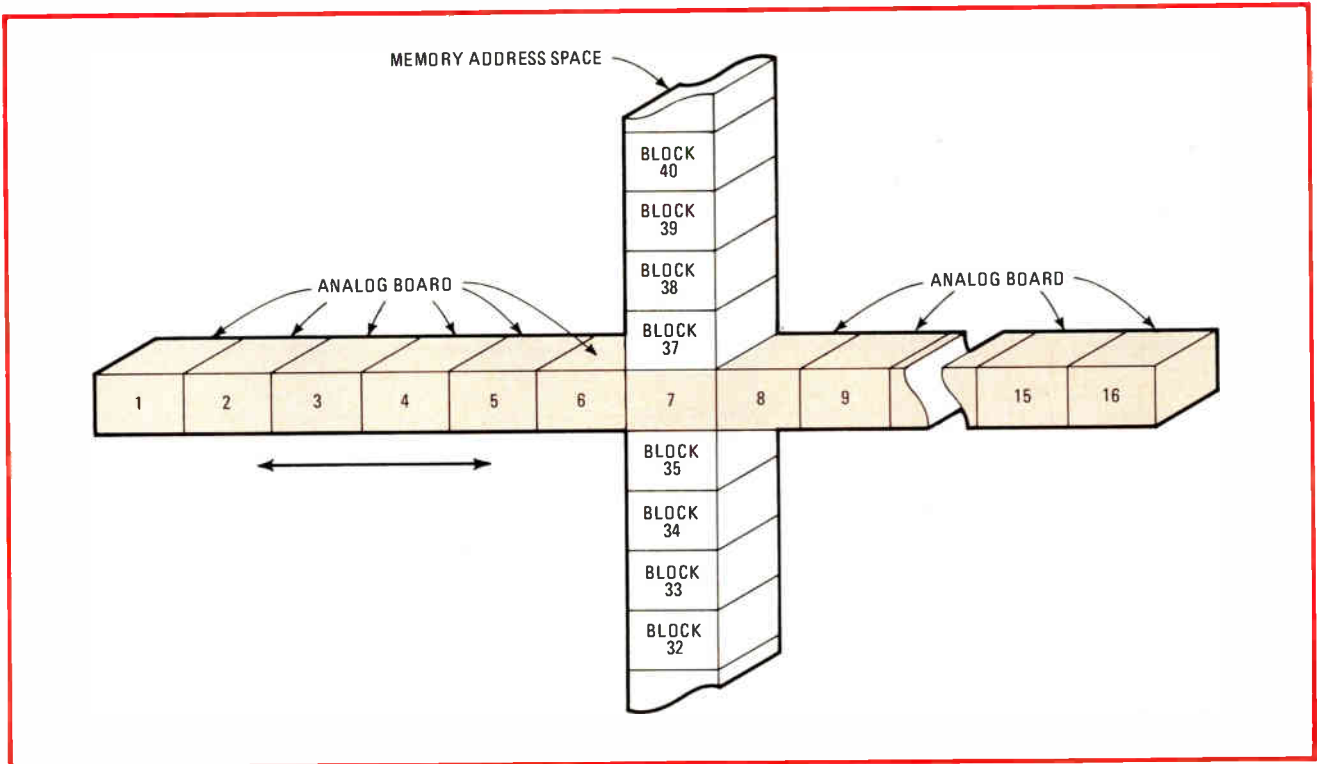

5. Sharing. Card-select feature permits a memory-imaged analog board to share a single block of memory space with a number of other boards in the same system. Direct-addressed instructions may be common to all boards, often making software reduction possible.

the MSB of data must be inverted and then extended into all leading bit positions. This brings it into conformity with the 2's complement notation that is generally used by microprocessors to execute arithmetic instructions. Of course, the board should permit the data coding to be configured independently of the range of the a-d or d-a converter and offset configuration, since some applications might call for bipolar analog signals to be represented as offset-binary data, rather than 2's complement.

Occasionally, an application for an input board might require access to an 8-bit representation of the data from the a-d converter. For example, data screening could be done much faster on a single-byte basis than if all 12 bits must be accessed. Some input boards allow for this truncation by incorporating an independent byte containing just the 8 MSBs. Such a feature saves a great deal of microcomputer time that would otherwise have to be spent in executing a data-shifting algorithm.

Accessing data

With an input board, before data may be accessed, the a-d conversion must be initiated, and the microcomputer informed when valid data is available for reading from the a-d converter. For microcomputer-initiated conversions, a separate, data-insensitive byte should be reserved that performs this function when activated. The data insensitivity makes it unnecessary to load data into the microprocessor's accumulator register before initiating the conversion. Once the conversion is in process, the microcomputer may examine the status byte to determine, among other things, the condition of the converter.

The most fundamental piece of information within the status byte is the end-of-conversion flag. Another piece

of information available in the status word could be a conversion-delayed flag, which invokes on-board mechanisms to delay the onset of conversion in the event of a recent change in multiplexer address or gain selection. In addition, a busy flag within the status word could signal that a conversion is currently taking place.

Channel selection is usually accomplished via a separate byte. To permit the use of memory incrementing and decrementing instructions, it is essential that the data be right-justified, as well as readable. The same criteria apply to the gain-select byte, on input boards offering software-programmable gain. Additional ancillary functions might include a byte to control the operation of any interrupt function or a byte to control any accessory driver outputs.

The sequence of the bytes is not random. Rather, for easy addressing, their arrangement should correspond to the normal execution sequence of standard data routines. For example, with an input board, the byte sequence of gain selection, multiplexer addressing, conversion initiation, converter status, and data accessing matches the order in which these routines are normally performed. Such an arrangement is conceptually convenient and also simplifies the use of indexed addressing, since the index register need merely be incremented between references to successive control and data bytes.

Memory map tells all

For a memory-imaged analog board, the interface bytes may be fully illustrated by a memory map, like the one shown in Fig. 6 for a typical combination board for the SBC-80 microcomputer. Such a map concisely depicts a board's architecture, indicating the address of

BYTE ADDRESS	BYTE FORMAT (CPU WORD)								BYTE NAME	OPERATION	
	7	6	5	4	3	2	1	0			
XFFF	ϕ	ϕ	ϕ	ϕ	S ₃	S ₂	S ₁	S ₀	CARD SELECT	WRITE	
XFFE	0	0	0	0	MSB	B ₁₀	B ₉	B ₈	ADC DATA	READ	
XFFD	B ₇	B ₆	B ₅	B ₄	B ₃	B ₂	B ₁	LSB	ADC DATA	READ	
XFFC	END OF CONV.	BUSY	CONV. DLYD.	MSB	B ₁₀	ϕ	ϕ	TIME MARK	STATUS	READ	
XFFB	ϕ	ϕ	ϕ	ϕ	ϕ	ϕ	ϕ	ϕ	CONVERT COMMAND	WRITE	
XFFA	ϕ_0	ϕ_0	ϕ_0	A ₄	A ₃	A ₂	A ₁	A ₀	MUX ADDR	WRITE, READ	
XFF9	ϕ_0	ϕ_0	ϕ_0	ϕ_0	ϕ_0	ϕ_0	G ₁	G ₀	GAIN SELECT	WRITE, READ	
XFF8	MSB	MSB	B ₁₀	B ₉	B ₈	B ₇	B ₆	B ₅	B ₄	ADC DATA	READ
XFF7	ϕ	ϕ	ϕ	ϕ	MSB	MSB	B ₁₀	B ₉	B ₈	DAC 1 DATA	WRITE
XFF6	B ₇	B ₆	B ₅	B ₄	B ₃	B ₂	B ₁	LSB	DAC 1 DATA	WRITE	
XFF5	ϕ	ϕ	ϕ	ϕ	MSB	MSB	B ₁₀	B ₉	B ₈	DAC 2 DATA	WRITE
XFF4	B ₇	B ₆	B ₅	B ₄	B ₃	B ₂	B ₁	LSB	DAC 2 DATA	WRITE	
XFF3	ϕ	ϕ	ϕ	ϕ	ϕ	ϕ	D ₁	D ₀	DRIVERS	WRITE	
XFF2	NOT USED										
XFF1	NOT USED										
XFF0	ϕ	ϕ	ϕ	ϕ	ϕ	ϕ	ϕ	ϕ	PACER SELECT	SETUP	

END OF CONV. INTERRUPT ENABLE PACER FUNCTION

- The symbol ϕ means the bit is ignored.
- Bits shown as ϕ_0 have the upper value for unipolar codes and the lower value for bipolar coding.
- The symbol ϕ_0 means that the bit is ignored during a WRITE, and read as a 0 during a READ.

6. Mapping the interface. For memory-imaged analog boards, a memory map like this concisely illustrates the interface bytes, indicating the address and format of each byte, as well as the sequence of execution, and such special features as a real-time clock.

each byte, the format within each byte, and the sequence of execution. It also shows all the special features available to the user, like the inclusion of a real-time clock for synchronizing the conversion.

Few signals in the real world are fully static, so it is often necessary to synchronize the conversion to real time or some external event. While some analog boards offer a choice of ways to initiate a conversion, most allow

for either microcomputer-generated or externally triggered conversions.

The former is useful when exact conversion timing is not important, such as the monitoring of dc levels or the acquisition of narrow-bandwidth signals like those from temperature transducers. In this case, the user generally performs a write instruction to a specified byte in the I/O image, thereby triggering the conversion. For situations where precise synchronization to an external event is required, the conversion should be externally triggered. The user supplies a TTL-compatible pulse that causes a conversion to occur, so that the relationship of the data to the synchronization pulse is known precisely.

Using a real-time clock

Such techniques are adequate for most applications. High-performance systems, though, generally require a real-time clock, sometimes called a pacer clock. Many a-d processes are inherently related to real time—for example, spectral analysis of a signal requires a series of precisely spaced data points. If the board has no real-time clock, the user must supply one himself—an extra that takes up room in the card cage and also adds to the cost of the system.

The real-time clock has two fundamental functions: to initiate conversions and to generate interrupts. Clock-generated conversions, which are precisely located in time with respect to one another, are useful for analyzing spectral characteristics, rate information (differentiation or integration), and the like. Clock-generated interrupts are useful when data-acquisition routines are executed in response to clocked interrupts. They can also be helpful in more general tasks, such as time-of-day clock maintenance and periodic keyboard or sensor scanning.

For data acquisition, there are three fundamental types of real-time clocks—crystal-controlled, RC-controlled, and externally controlled. Many clock-related functions require the precision and stability of a crystal, like Fourier analysis and time-of-day maintenance. Since most small-can crystals are only available for operation (in fundamental mode) from approximately 1 to 22 megahertz, a digital divider string must be employed to bring the clock rate down to a usable value.

On the other hand, the potentiometer-variable RC-controlled clock allows the user to adjust for those intermediate rates not available from the crystal type. It is useful for optimizing the response characteristics of microcomputer-linked servo loops without software parameters having to be adjusted. In a data-acquisition board containing a pacer system, it is conceptually convenient to treat the external trigger input as a real-time clock. If it is included along with the other clock sources, it can share the same control structure.

Of course, when there are several clock sources on one board, there must be a means of selecting both the source (crystal, RC, or external) and the effect (clock-triggered conversions or clock-triggered interrupts). These control functions constitute a byte within the I/O image. When used in conjunction with the status flags normally provided, the microcomputer can maintain complete control over the board's timing-and-synchronization characteristics. □

LITHIUM BATTERIES

THE POWER PACKAGE OF THE 80'S AVAILABLE TODAY

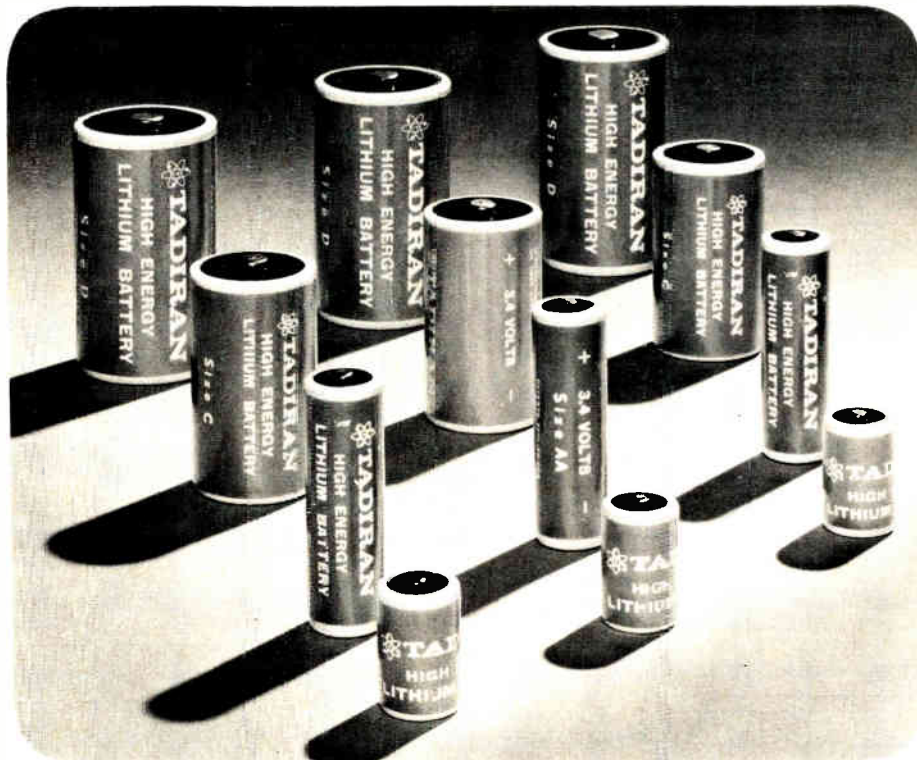

Lithium batteries is a general term used for any battery utilizing lithium as the anode material. This is where the similarity between Tadiran's and other lithium batteries ends and the difference starts.

- Tadiran lithium batteries utilize an inorganic electrolyte (SOCl_2) and exhibit a higher nominal cell voltage (3.4 volts) than any other lithium battery.
- Tadiran lithium batteries will not vent and release toxic gas or electrolyte if accidentally recharged or short-circuited.
- Tadiran lithium batteries are hermetically sealed, resulting in a ten-year shelf life, eliminating moisture penetration and preventing electrolyte leakage.
- The gravimetric energy density of the Tadiran lithium battery is over 40% higher than that of other lithium batteries (800 mWh/cm^3 & 420 Wh/kg)
- The internal construction is non-pressurized and no gases are generated during normal discharge.

And, of course, our batteries incorporate all the advantages associated with lithium batteries, including a wide operating temperature range (-40°C to $+70^\circ\text{C}$) and voltage stability. Currently available sizes include standard "1/2AA", "AA", "C" and "D".

The features of the Tadiran lithium batteries make them ideal for use in a wide range of industrial and military applications including portable communications, standby power for computer memories, telemetry and data logging equipment.

Our experienced engineers are available in solving specialized battery problems. To learn more about the Power Package of the 80's contact:



TADIRAN
ISRAEL ELECTRONICS INDUSTRIES LTD.

3 HASHALOM RD., P.O. BOX 648, TEL-AVIV, ISRAEL.
TELEX: 341692

Differential optical coupler hits new high in linearity, stability

For analog applications, pair of matched photodiodes in differential configuration cancel light-emitting diode's errors

by Bill Olschewski,
Burr-Brown Research Corp., Tucson, Ariz.

□ Although conventional optical couplers are fine for separating grounds and eliminating noise in digital systems, they do not always work well in analog applications because of their lack of stability and fairly high nonlinearity. The light-emitting diode is largely to blame, the photosensor less so. However, a differential circuit technique can correct for most of the inaccuracies, permitting the designer to couple analog signals optically while holding linearity error to as little as 0.01% and instability to better than 0.1%.

There are four chief sources of error. The conventional coupler owes most of its 1% to 5% nonlinearity to the nonlinear relationship between the LED's light output and its forward bias current. Its poor temperature coefficient is due to the LED's negative tempco, which exceeds the photosensor's positive one. Its high noise comes from the LED at forward currents above 1 milliamperere, the photosensor at currents below this. Finally, the coupler's characteristics change with time because the conversion efficiency of the LED degrades with age.

Two circuit techniques aim to get rid of these problems. The earlier and less successful, called the compensated technique, uses a matched pair of photodiode couplers to balance out the linearity and tempco errors, so that accuracy may be as tight as 0.15%. The improved, differential approach produces but a fraction of this linearity error. It puts a matched pair of photodiodes, illuminated by the same LED, in a differential configuration that cancels out the conventional coupler's four major shortcomings.

The three approaches to optical coupling are compared in Table 1. From the improved parameters, shown shaded in, it is obvious that the compensated version can be viewed as just an interim step to the ultimate, differential design. As of now, only RCA Corp. and Burr-Brown Research Corp. have such devices, but Hewlett-Packard Co. and Bell Telephone Laboratories are working on similar devices, and others are bound to appear on the market soon.

The key parameter

The current transfer ratio is the key parameter of all optical couplers. The conventional optical coupler consists of a single light emitter, usually an LED, and a single light sensor, which may be a photodiode, a phototransistor, or a photo-Darlington device (Table 2). The basic photodiode coupler has the lowest CTR, and

	Conventional	Compensated	Differential
Gain or CTR stability over 100,000 hours at 25°C	5 - 20%	3 - 13%	0.075%*
CTR vs temperature	-0.5%/°C	0.03 - 0.1%/°C	0.005 - 0.03%/°C*
Nonlinearity	1 - 5%	0.15 - 1%	0.01 - 0.2%*
Signal-to-noise ratio from 0.05 to 100 Hz	85 - 86 dB	65 - 86 dB	110 dB*
Frequency response at -3 dB	0.1 - 10 MHz	0.02 - 1 MHz	0.015* - 1 MHz

*Performance range of Burr-Brown 3650/3652 isolation amplifiers.

TABLE 2: COMPARING CONVENTIONAL OPTICAL COUPLERS

Emitter	Sensor	Key characteristics		
		CTR	Bandwidth	Noise
light-emitting diode	photodiode	0.1 – 0.3%	high	low
	phototransistor	30 – 100%	low	medium
	photo-Darlington	100 – 1,000%	very low	high

the Darlington types have the highest.

The CTR is determined by four factors: the conversion efficiency of the LED, the quantum efficiency of the photosensitive junction, transmission path losses, and the internal current gain of the coupler.

The temperature sensitivity of the CTR is mainly a function of the negative temperature coefficient of the LED and the positive tempco of the photodiode. The LED drift predominates, however, and this results in an overall CTR tempco of approximately $-0.5\%/^{\circ}\text{C}$ for most commercially available optical couplers.

The most stable CTR is achieved with simple photodiode couplers, since the quantum efficiency of a photodiode is inherently more stable than the current gain of a phototransistor or photo-Darlington. But the major causes of CTR instability are the noise and drift charac-

teristics of the LED. From the long-term stability data on some of the best LEDs available (Fig. 1), it is clear their stability is best at lower currents and temperature.

Unfortunately, a higher forward current would improve LED linearity—and as already stated, the nonlinear relationship between a LED's light output and its forward current is the main cause of CTR nonlinearity (Fig. 2).

Compensated couplers

Compensated optical couplers use negative feedback to cancel the errors in linearity and gain of two matched couplers. The compensated circuits that are shown in Fig. 3 are a current-to-current configuration and a voltage-to-voltage configuration.

In Fig. 3a, the LED in coupler 1 is driven by a current source of positive polarity and illuminates photodiode D_1 . The photodiode, in turn, develops a negative voltage between the inverting and noninverting input of operational amplifier A_1 , causing its output to go positive. The positive output drives a current through the LED of coupler 2, illuminating photodiode D_2 . The output of the op amp will remain positive until $I_{D1} = I_{D2}$. This, of course, assumes that the op amp's input impedance is very high and its bias current very low. The resulting transfer function is:

$$I_{out} = I_{in} (CTR_2/CTR_1)$$

The quality of the match between CTR_1 and CTR_2 determines the linearity of the overall transfer function. A nonlinearity of 1% can easily be achieved using couplers of the same type, and 0.15% is possible with careful matching of the couplers. If $CTR_1 = CTR_2$, of course, the circuit will have unity current gain.

Compensated optical coupling will also raise the gain-temperature stability well above that of individual couplers, since gain vs temperature of the CTR will track

Why specify current transfer ratio?

As with any four-terminal device, the optical coupler could be treated as a current-source that is current- or voltage-dependent or as a voltage source that is current- or voltage-dependent. Of these, the current-to-current function, or current transfer ratio (CTR), is the most linear because of the inherent characteristics of the coupler's light source(s) and detector(s)—its light-emitting diode(s) and photodiode(s) or phototransistor(s).

The current input of an LED bears a more linear relationship to its light output than does a voltage input. The current output of a photodiode or phototransistor bears a linear relationship to its light input, whereas its voltage output does not. The result is that a reasonably linear relationship exists between an optical coupler's input and output current. Since this linearity is an easy parameter to test and convenient for the circuit designer to apply, it has become a standard industry specification.

In more detail, the equation for the light source quantum efficiency (η_s) of an LED is:

$$\eta_s = \frac{q N_s}{I_F}$$

where N_s = the external photon rate
 q = the charge of an electron
 I_F = forward current.

This equation gives rise to a linear relationship between forward current and light output, but due to process limitations and material imperfections, present-day LEDs do have nonlinearities of several percent. However, errors found in the voltage-to-light mode are many times greater because of the nonlinear and indeed logarithmic relationship of the LED threshold voltage to the amount of light it gives out.

The photocurrent, I_x , of a photodiode is similarly a linear function of the incident illumination on the active optical junction. This relationship is given by:

$$I_x = I_o + \eta FqA$$

where

- I_o = dark (leakage) current
- η = quantum efficiency of the photodiode
- F = incident photons transmitted by the crystal
- q = charge of an electron
- A = area of active optical junction.

The collector current of a phototransistor I_c is also approximately linear with respect to the base current. In this case the photocurrent is expressed as:

$$I_c = (h_{FE} + 1)I$$

where h_{FE} = the current gain of the phototransistor.

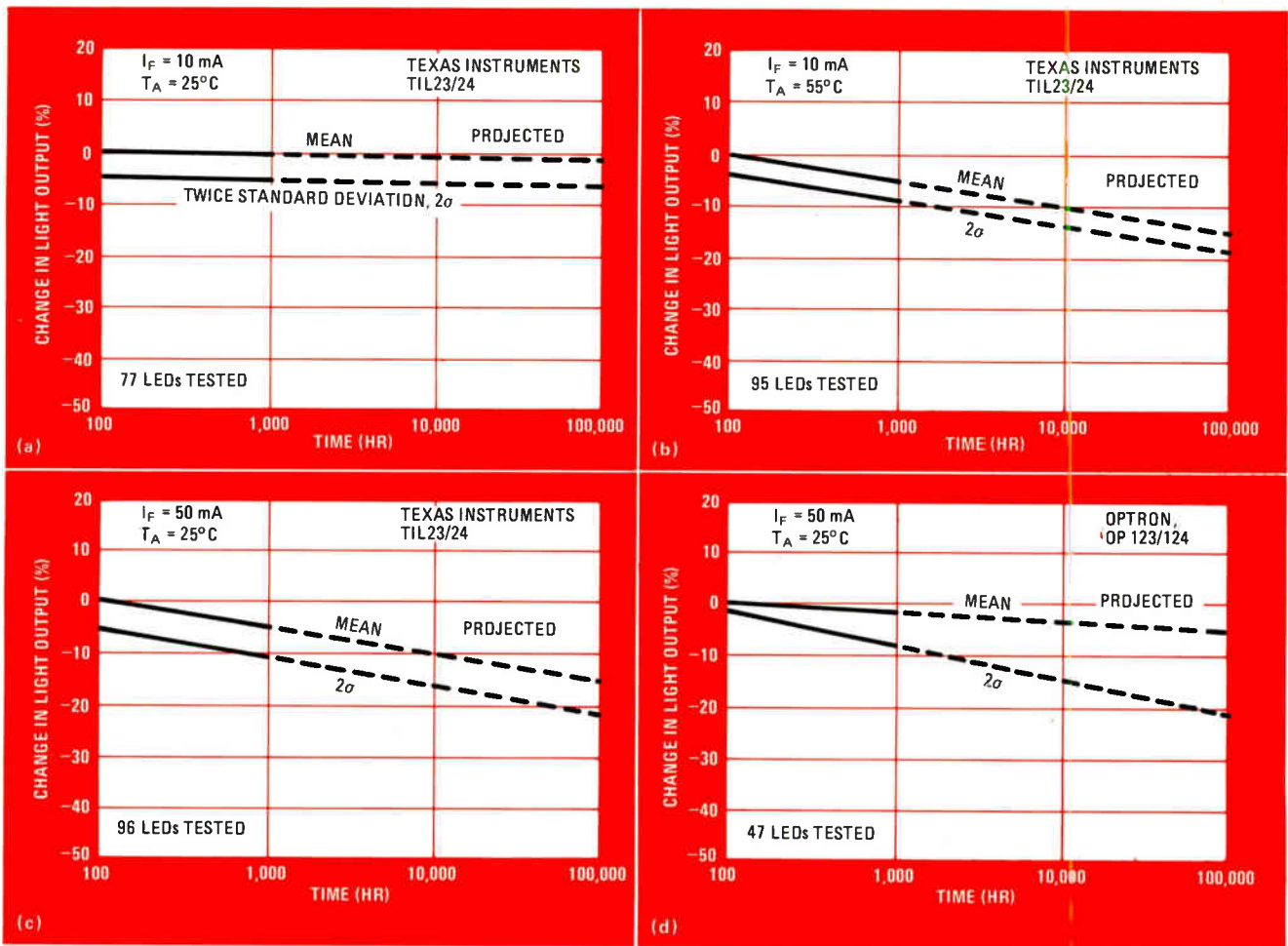

1. Long-term stability. Although the stability of LEDs varies from manufacturer to manufacturer, the curves shown are typical of commonly used LEDs, whose power output over operating life decreases more rapidly at higher input currents and at elevated temperatures.

to within a few percent. For very high temperature stability, however, the temperature coefficients of the two couplers should be matched.

A voltage-to-voltage transfer function is possible by adding two resistors to the basic compensated optical coupling circuit, as shown in Fig. 3b. This circuit is not as linear as the current-to-current configuration of Fig. 3a because of the nonlinear (natural log function) threshold voltage of the LED. However, with an input voltage in excess of 5 v and $R_{in} = R_{out}$, a circuit nonlinearity of 0.3% is possible.

Noise and long-term stability are not improved with the compensated coupler because the optical link of photocoupler 1 is outside of the feedback loop. And the frequency response of all compensated optical couplers is limited by the op amp's closed-loop bandwidth, which is determined by system stability requirements.

If bidirectional (positive and negative) signal operation or a more linear voltage-to-voltage transfer characteristic is required, the LEDs can be biased on with current sources. To further optimize linearity and stability, additional op amps can be employed in both the voltage-to-current and current-to-voltage conversation modes, as shown in Fig. 4.

Differential optical coupling improves in the performance of the compensated circuit and makes a major

advance in linearity and stability.

Figure 5 shows a very simple implementation of differential optical coupling using one LED, two photodiodes, and two op amps for both unidirectional (a) and bidirectional (b) operation. Unidirectional operation limits

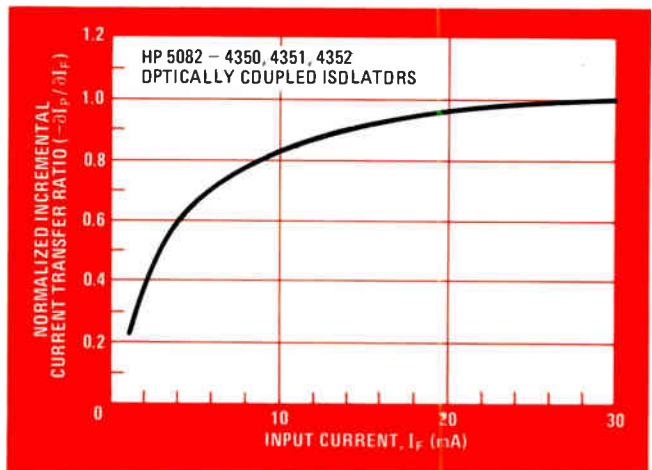

2. Key parameter. The main cause of nonlinearity in current transfer ratio, CTR, is the nonlinear relationship between the LED power output and the forward current through the LED. LED linearity is best at higher current, but this limits the device's operating life.

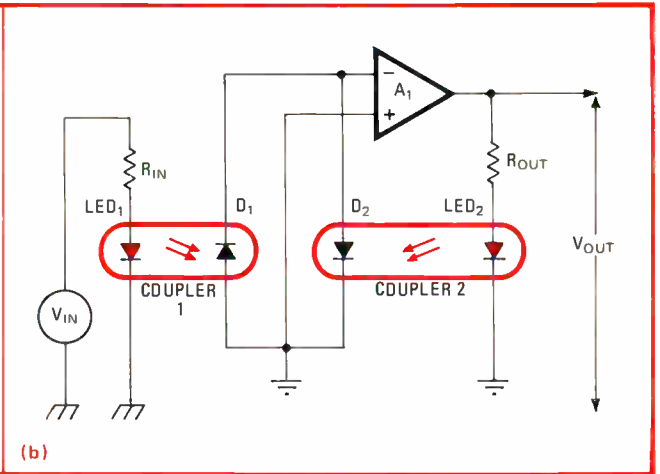
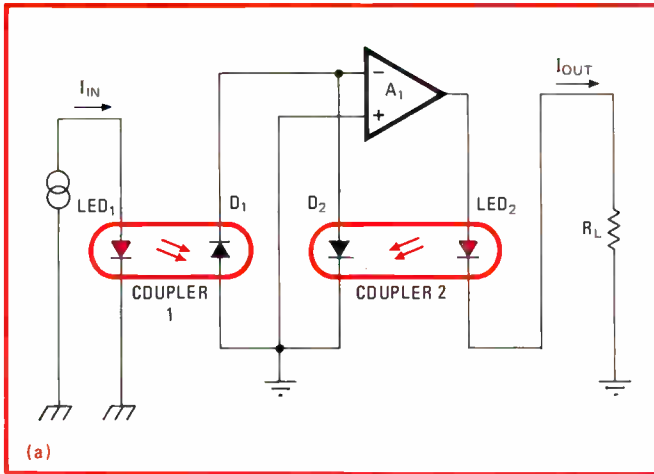

3. Compensated circuits. Negative feedback cancels errors in linearity and gain of the two matched couplers. The circuit shown in (a) operates in a current-to-current mode, but adding two resistors (b) allows it to function in a voltage-to-voltage mode.

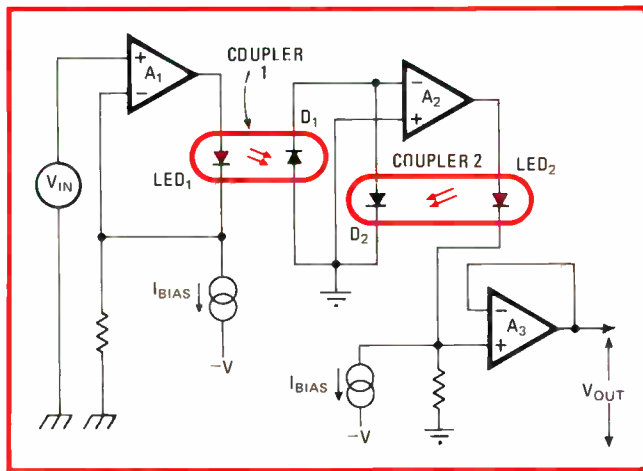

4. Improved linearity. Nonlinearity of optical couplers is lowest when the LED is driven from a current source. In this circuit both LEDs are biased from separate current sources, and an operational amplifier serves as a voltage-to-current converter.

amplification to positive signals only, whereas bidirectional handles both positive and negative signals by providing a bias current source for the photodiodes.

Circuit operation is straightforward. The LED infrared emitter is driven by A₁; diodes D₁ and D₂ are matched differential photodiodes receiving an equal amount of light from the LED. Diode D₁ closes the feedback loop around A₁, so that A₁ drives the LED until:

$$I_1 = I_{in} = V_{in}/R_G$$

where I₁ is the current generated by diode D₁ and amplifier A₁ is assumed an ideal op amp with infinite open-loop gain and zero bias current.

The current I₂ is generated by D₂, which is used to feed an equal current to the current-to-voltage converter on the output side of the optically coupled amplifier. The transfer function can be written as:

$$V_{out} = I_2 R_K$$

where R_K is the feedback resistance for amplifier A₂, which is assumed to be a perfect op amp. For equal light input, if the photodiodes are matched in quantum effi-

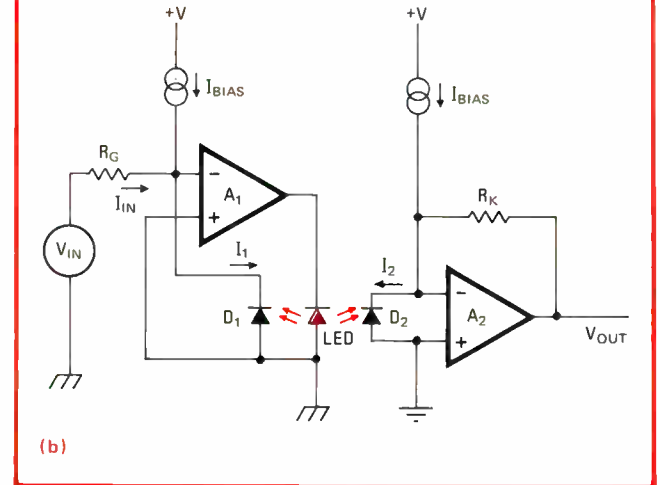
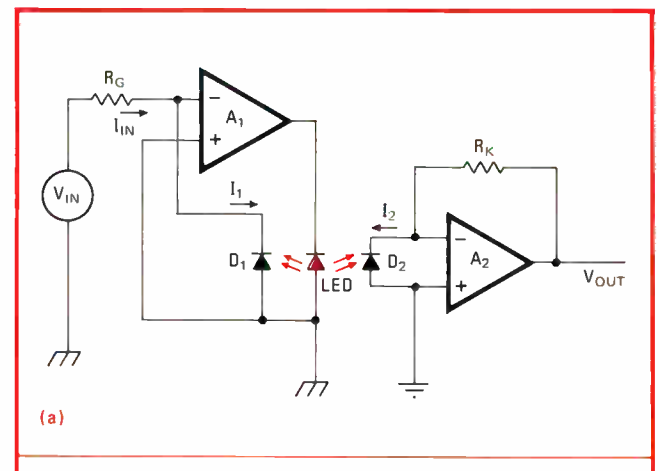

5. Better performance. Additional photodiode matched to the primary light source's sensor diode can virtually eliminate nonlinearity and temperature drift errors of an optical coupler. The circuit of (a) is for unidirectional operation; the one in (b) is bidirectional.

ciency, then I₂ = I₁ = I_{in}, and the transfer function for the entire circuit becomes:

$$V_{out} = I_{in} R_K = (V_{in}/R_G) R_K$$

This equation is independent of LED parameters, for

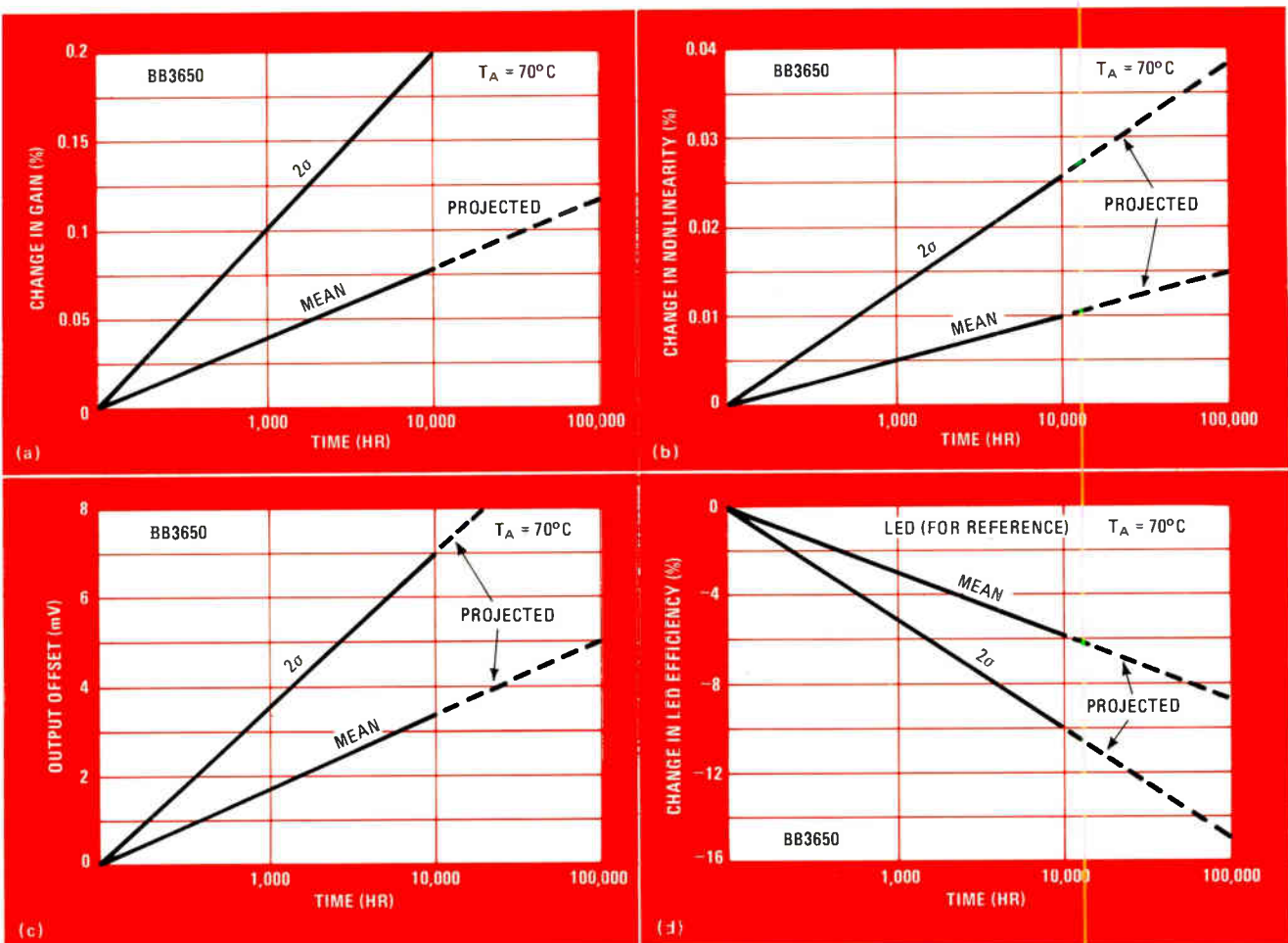

6. Long-term stability. Differential optical coupling improves stability by two orders of magnitude over conventional optical couplers. In these tests on a sample of 10 LEDs, although LED efficiency fell 6% over 10,000 hours (d), gain (a) and nonlinearity (b) changed much less.

the feedback loop is closed around the LED, so that its characteristics do not contribute to the errors of the circuit except to the extent that amplifier A_1 is imperfect. Therefore most detrimental characteristics of the LED such as nonlinearity, poor long-term stability, and high noise disappear.

The accuracy of the circuit depends only on the match of the photodiodes, the match of the light transmission paths, and the tracking of these matches over temperature. But all this can be controlled to a high degree.

The only circuit limitations imposed by the LED are frequency response, minimum efficiency near end of life, and unipolar input and output. The frequency response of the LED and the speed of available op amps limit the circuit's frequency response to less than 1 megahertz just as in the compensated optical coupling circuit. The minimum efficiency anticipated over the life of the LED forces the designer to provide a minimum (worst-case) output current from the op amp A_1 to avoid a reduced output swing capability due to a degradation in light output near the end of the LED's life. To overcome the unipolar nature of the LED and photodiodes, a bias current source can be employed as shown in Fig. 5.

Figure 6 shows the excellent long-term stability of Burr-Brown's optical isolation amplifiers 3650/3652, using differential optical coupling. Elevated temperature

(70°C) life tests of 10 standard 3650s were performed per MIL883 Method 1005, Condition D (± 5 -mA output, 1-kilohertz sine wave). The life test was interrupted at 168, 1,000, 2,000, 5,000, and 10,000 hours to retest the units on computerized in-house testers.

The results for gain, linearity and dc-offset stability are shown in Fig. 6a, 6b, and 6c, respectively. For reference, Fig. 6d shows the degradation in LED efficiency calculated from the measured increase in input supply current. The tests show that the stability of differential optical coupling is independent of LED aging. For example, the mean gain change of only 0.075% at the end of 10,000 hours does not correlate with the 6% degradation in LED efficiency. In fact, the gain change is mainly due to the instability of the thick-film resistors used in the current-to-voltage converter. □

For further reading

G. M. Katz and S. Steinberg, "Highly Linear Photon-Coupled Isolator," *Medical and Biological Engineering*, July 1974.
 Sigurd Waaben, "High-Performance Opto-Coupler Circuits" IEEE-ISSCC 75.
 Mark Hodapp, "Optical isolators yield benefits in linear circuits," *Electronics*, March 4, 1976.
 W. Olschewski, "Optical coupling extends isolation amplifier utility," *Electronics*, Aug. 19, 1976.
 Peter Vettliger, "Linear Signal Transmission with Opto Couplers," *IEEE Journal of Solid State Circuits*, June 1977.
 W. Olschewski, "Hybrid Implementation of Optical Coupling," *ISHM-International*, October 1977.
 I. Doshay and M. Kalashian, "Obtaining High-Reliability Performance from Commercial Quality Opto-Isolators," 27th IEEE Components Conference, May 1977.
 S. Yoneda, Y. Fukui, M. Miura, and T. Kasai, "Windingless Hybrid Repeating Coil using Photo Coupler," 27th IEEE Components Conference, May 1977.

Counter, scope team up for precise timing measurements

by Emory Harry
Tektronix Inc., Beaverton, Ore.

A universal counter, when combined with a dual-trace, delayed-sweep oscilloscope, can precisely measure the period, width, or time interval between nonadjacent pulses of any waveform. An oscilloscope alone can perform these measurements, of course, but not with the speed and accuracy of a counter. On the other hand, with the counter alone, most of these measurements are almost impossible to perform, because the instrument itself cannot isolate any one region of the waveform to measure. Uniting both instruments makes a superior measurement system.

For the counter to measure the period, width, or time interval between two given points of a specific waveform, the scope must isolate the interval of interest and so provide the gating necessary for counting. Thus a scope with a delayed-sweep option is required.

As shown in Fig. 1, the delayed-gate output of the scope (whose pulse width and position are identical to the portion of the input waveform that is intensified) is connected to one of the vertical input channels and the

waveform to be measured is connected to the other. The scope is then placed in the input channels' algebraic-add mode. With the scope's horizontal-mode switch in the intensified position, the portion of the waveform of interest is then selected with the delay-time multiplier control. The section of input waveform that the user has chosen to intensify will be elevated above ground potential (Fig. 2). It is then a simple matter to adjust the counter's threshold control to trigger at a selected point on the elevated section of the waveform appearing at the scope's vertical-signal output port.

The type of measurement performed dictates the positioning of the elevated pulses. For instance, to make a period measurement (Fig. 2a), the voltage pedestal produced should be positioned so that the entire period of interest is intensified (and thereby elevated). The counter should be adjusted to trigger on the first positive (A) or negative slope of the waveform that is intensified and at the same time on the next cycle (B).

To measure pulse width, the pedestal need only be wide enough to elevate the width of interest (Fig. 2b). Place the counter in the width mode. The time measured will be that between the point on the rising edge of the isolated waveform and a corresponding point on its falling edge, as shown.

To make a time-interval measurement, the procedure is noticeably different. Here, the elevated portion of the desired waveform serves only to initiate or terminate the count time. Also, full use must be made of the scope's

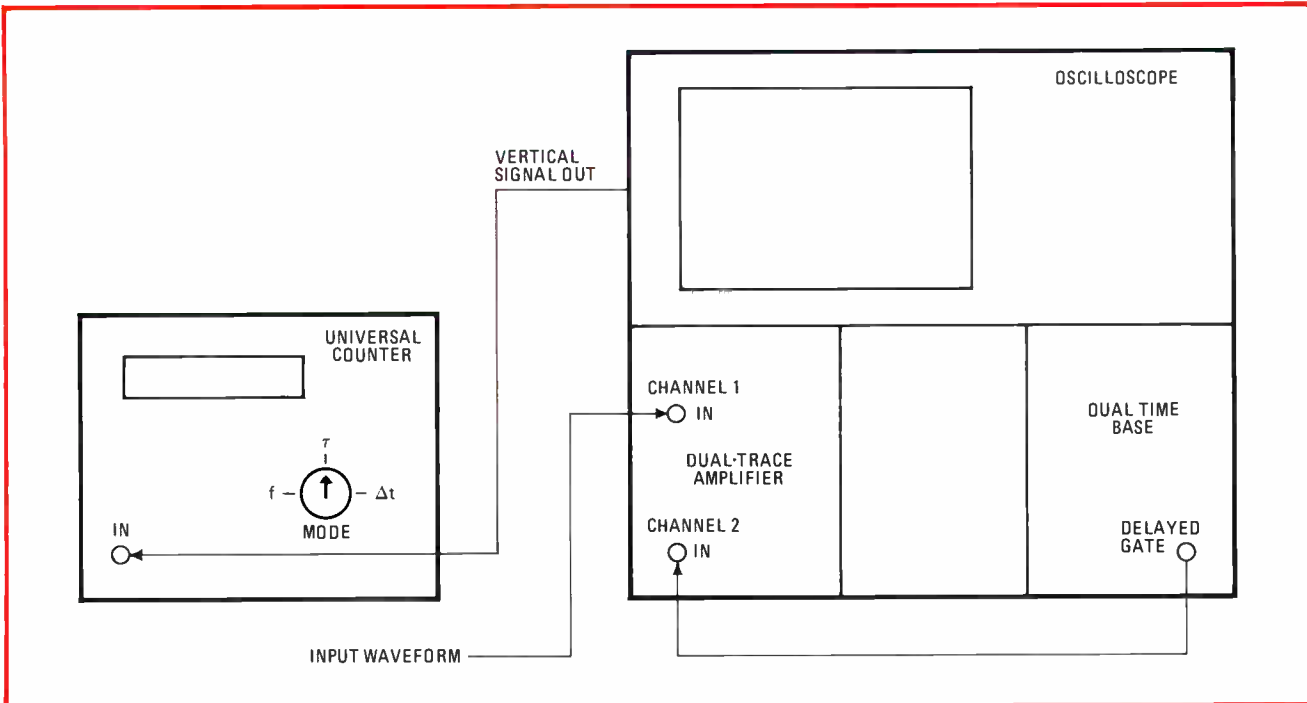

1. Precise readings. Together, a counter and scope can perform more types of measurements, more accurately, on waveforms than either instrument can alone. Scope's delayed gate option is used to initiate and terminate count by elevating interval of interest of given waveform above normal potential. Counter's threshold is then adjusted to appropriate trigger point for detecting elevated signal.

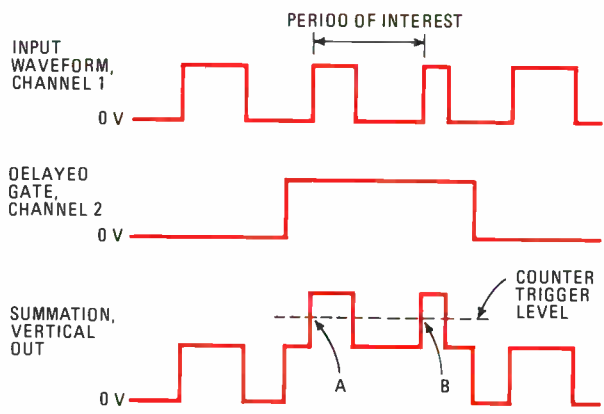

(a)

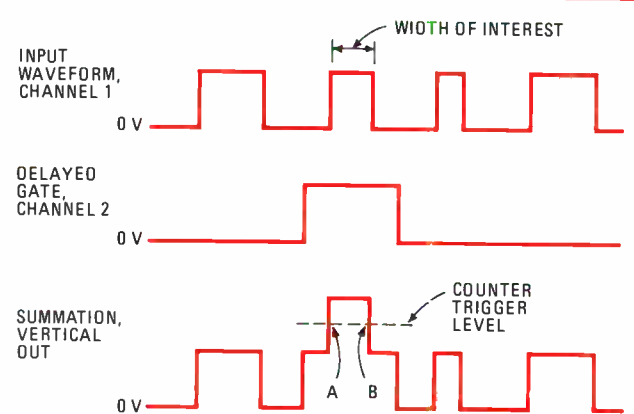

(b)

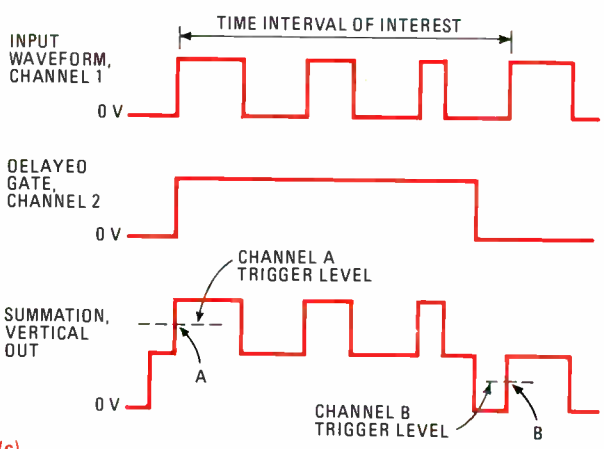

(c)

2. Application. The type of waveform measurement performed dictates the interval of interest isolated. To measure period or width between A and B, the entire cycle must be intensified, i.e., elevated (a, b). For time-interval measurements, independent scope-channel trigger levels are set (c), as detailed in text.

selectable slope and triggering-level options. Assume that the counter must measure the time between points A and B, as shown in Fig. 2c. Place the counter in its time-interval, or Δt , mode, and make sure that channel B of the counter will not trigger until channel A has done so. The threshold of each channel is set so that the first rising edge of the elevated waveform triggers channel A of the counter, and channel B triggers after the elevated pulse has returned to its normal level. Thus the middle region of pulses contained in the elevated waveform will be ignored by the counter. □

Calculator notes

HP-67 aids the design of microstrip, strip-line elements

by Albert E. Hayes Jr., Millerton, Calif.

This 93-step, HP-67/97 program will speed the design of microstrip and strip-line elements, two types of low-loss transmission lines that are often needed at microwave frequencies. When given the characteristic impedance of the line (Z_0), the substrate thickness (h or b), the conductor (trace) thickness (t), and the dielectric constant of the material separating the conductors (ϵ_r), the program determines the width (w) of the microstrip or strip-line trace required and the line's velocity factor (v.p.). Element dimensions are defined in the figure.

The program solves a transposed version of two equations contained in the MECL System Design Handbook. The equation for the microstrip circuits is given by:

$$Z_0 = \frac{87}{(\epsilon_r + 1.41)^{1/2}} \ln \left[\frac{5.98h}{0.8w + t} \right] \quad (1)$$

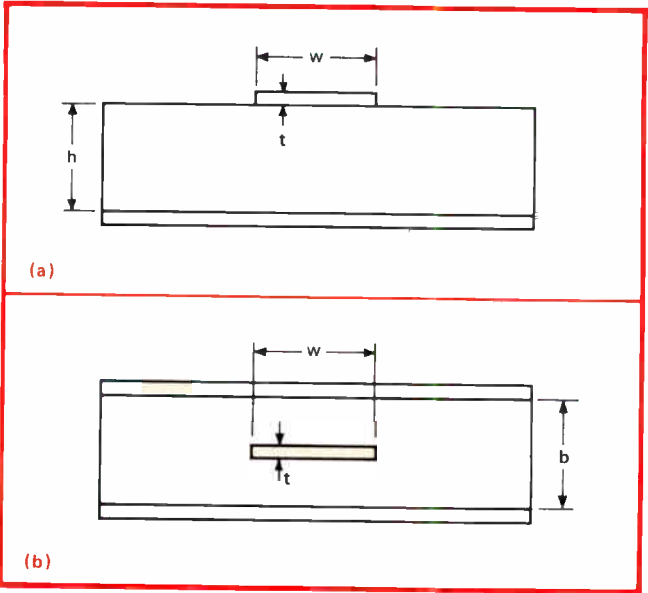

Microwave transmission lines. Cross-sectional view of microstrip (a) and strip-line elements (b) are shown. Program finds conductor width (w), given the distance separating conductors (h or b) and metal thickness (t). Impedance of line (Z_0) and dielectric constant (ϵ_r) of material separating conductors must also be known.

and the one for the strip-line circuit is:

$$Z_0 = \frac{60}{e_r^{1/2}} \ln \left[\frac{4b}{0.67\pi w (0.8 + t/w)} \right] \quad (2)$$

Unfortunately, the equations cannot readily be used, for the design engineer must find w , not Z_0 , given values for Z_0 , h or b , t , and e_r . Therefore Eqs. 1 and 2 have been manipulated thus, for the calculator to solve:

$$w_{ms} = 1.25 \left[\frac{5.98h}{\exp(Z_0(e_r + 1.41)^{1/2}/87)} - t \right] \quad (3)$$

$$w_{sl} = 0.59 \left[\frac{4b}{\exp(Z_0 e_r^{1/2}/60)} - 2.1t \right] \quad (4)$$

The relative velocity of propagation is also found from:

$$(v.p.)_{ms} = \frac{1}{(0.475e_r + 0.67)^{1/2}} \quad (5)$$

$$(v.p.)_{sl} = \frac{1}{e_r^{1/2}} \quad (6)$$

Microwave transmission lines may now be easily and quickly designed. As an example, assume a microstrip circuit has the following parameters:

$$Z_0 = 80, h = 0.06 \text{ in.}, t = 0.0015 \text{ in.}, e_r = 4.7$$

If 80, A, 0.0015, B, 0.06, C, 4.7, E, is keyed into the calculator, it is found that w is equal to 0.044 inch. Pressing R/S will yield the velocity factor, which is 0.59 in this case, or 59% of the speed of light.

For a sample case of a strip-line circuit with the following parameters:

$$Z_0 = 70, b = 0.1 \text{ in.}, t = 0.0015 \text{ in.}, e_r = 4.7$$

the procedure is to key in 70, A, 0.015, B, 0.1, D, 4.7, E. It will be found that w is equal to 0.017 inch, and the velocity factor is 0.46.

Note that the equations are valid for any consistent set of dimensional units, so h , b , and t may be expressed in inches or metric units. It should also be noted that upon entering the dielectric constant, e_r , the calculation for w is initiated, and therefore all data must be entered in the order specified in the instructions. □

References

1. "MECL System Design Handbook," William R. Blood Jr., Motorola Corp., 1972.

Engineer's notebook is a regular feature in *Electronics*. We invite readers to submit original design shortcuts, calculation aids, measurement and test techniques, and other ideas for saving engineering time or cost. We'll pay \$50 for each item published.

HP-97 PRINTER LISTING - MICROSTRIP OR STRIP-LINE PROGRAM

001	*LBLA	025	÷	049	*LBL1	073	1
002	STO1	026	e ^x	050	RCL5	074	.
003	RTN	027	RCL4	051	1	075	2
004	*LBLB	028	4	052	.	076	5
005	STO2	029	X	053	4	077	X
006	RTN	030	X ⇌ Y	054	1	078	DSP3
007	*LBLC	031	÷	055	+	079	R/S
008	STO3	032	RCL2	056	√X *	080	RCL5
009	SF1	033	2	057	RCL1	081	.
010	RTN	034	.	058	X	082	4
011	*LBLD	035	1	059	8	083	7
012	STO4	036	X	060	7	084	5
013	CF1	037	-	061	÷	085	X
014	RTN	038	.	062	e ^x	086	.
015	*LBLE	039	5	063	RCL3	087	6
016	STO5	040	9	064	5	088	7
017	F1?	041	X	065	.	089	+
018	GTO1	042	DSP3	066	9	090	√X
019	RCL1	043	R/S	067	8	091	1/X
020	RCL5	044	RCL5	068	X	092	DSP2
021	√X	045	√X	069	X ⇌ Y	093	R/S
022	X	046	1/X	070	÷		
023	6	047	DSP2	071	RCL2		
024	0	048	R/S	072	-		

INSTRUCTIONS

- Key in program
- Enter desired characteristic impedance of microstrip or strip-line element (Z_0), A
- Enter conductor or trace thickness (t), B
- Enter either the microstrip substrate thickness or the strip-line dielectric thickness (h), C or (b), D
- Enter relative dielectric constant (air = 1.0) (e_r), E
The trace width (w) will be displayed
- Press R/S to find the relative velocity of propagation (v.p.)
- Units of t , h , and b are arbitrary but must be consistent throughout run

HYBRID



IN A MARKET FULL OF DROPOUTS, OUR NEW REGULATORS ARE PHI BETA KAPPA.

Fairchild is introducing two new Linear regulators that are a study in efficiency. Our $\mu A78HO5ASC$ 5-amp positive voltage regulator. And our $\mu A78PO5SC$ 10-amp positive voltage regulator.

They're designed to provide extremely low dropout voltage — typically 2 volts at 5 amps on the $\mu A78HO5ASC$ and 2.2 volts at 10 amps on the $\mu A78PO5SC$. And as any student of regulators knows, dropout like this just isn't available with monolithic designs.

STRAIGHT "A" PERFORMANCE.

Since lower dropout voltage provides more efficient power supply designs, these regulators, like all Fairchild voltage regulators, require fewer components than traditional designs. And that reduces design time considerably.

Features include short-circuit and safe-area protection, thermal shutdown and hermetically sealed TO-3 packages. And all this at the same price you'd expect to be paying for regulators that graduate at the bottom of their class. In fact, you can start designing in our new regulators for as little as \$5.00 in quantities of 100 ($\mu A78HO5ASC$).

IF YOU HAVE QUESTIONS, PLEASE RAISE YOUR HAND.

For more details on our new enhanced voltage regulators, or information on our other Hybrid products, contact your Fairchild distributor or representative. Or, for immediate results, call your nearest Fairchild sales office.



FAIRCHILD
CALL US ON IT.

France: Fairchild Camera & Instrument S.A., 121 Ave. d'Italie, 750013 — Paris Tel 00331 584 55 66. Telex 0042 200614. Italy: Fairchild Semiconduttori S.P.A., Via Rosellini, 12, 20124 Milano. Tel: C2 6887451. Telex 36522. Germany: Fairchild Camera & Instrument (Deutschland) GmbH, 8046 Garching Hockbruck Daimlerstr. 15, Munchen. Tel: 089 320031. Telex: 52 4831 fair d. England: Fairchild Camera & Instrument (UK) Ltd., 230 High St., Potters Bar, Hertfordshire EN6 5BU. Tel. 0707 51111. Telex. 0051 262835 Sweden: Fairchild Semiconductor AB, Svartengsgatan 6, S-11620 Stockholm. Tel. 8-449255 Telex 17759.

Prices of digital panel meters hitting bottom?

The asymptote for prices of 3½-digit panel meters may be in sight. Their prices have been dropping steadily as suitable analog-to-digital converter and display driver chips have become available. In fact, a few semiconductor manufacturers have begun entering the market themselves with complete low-cost parts kits—Intersil's costs only \$15 in large quantities. In response some meter makers have cut prices to the bone: for example, Dattel Systems Inc. is selling its DM-3100L for only \$29 in hundreds, \$45 in quantities of 1 to 9. Others have spun off the chips for separate sales. Analog Devices' integrated-injection-logic driver chip for its AD2026 3-digit DPM sells for \$5.50 in 1,000-unit quantities.

The latest step has been taken by Fairchild Systems Technology of San Jose, Calif., with its model 30 DPM, **a one-board, 3½-digit unit that will initially sell for \$33 each in any quantity.** The key to that figure is the use of unpackaged LSI chips mounted directly on the printed-circuit board with a conductive epoxy and then covered with a simple plastic lid. Display light-emitting diodes are also mounted directly on the board, air-filled light pipes are added to form the display segments, and the entire board is given a moisture-proof coating.

How to get nearly 100% duty-cycle range out of the 555 timer

The 555 timer finds wide use in switching regulators, signal generators, and pulse-width modulators when it's wired as a variable-pulse-width generator. But you can get even broader duty-cycle variation from this circuit with a simple modification, says Glenn T. Darilek, a senior research engineer at Southwest Research Institute in San Antonio, Texas. As a bonus, the modification is likely to narrow the control-voltage range, too.

Instead of the timing resistor in the conventional configuration, **just use a high-value resistor in parallel with a series-connected low-value resistor and zener diode** (with its cathode facing the supply). According to Darilek, a 47-kilohm resistor shunted by a 1-kilohm resistor and a 4.7-volt zener extends the duty-cycle range from between 8% and 90% to near 0% and 100%, while decreasing the control-voltage range from between 0 and 9 v to 3.5 and 7.5 v. The only limitation on how narrow (or wide) the output pulse may be, he notes, is the timer's rise and fall times, which are typically 100 nanoseconds each.

Free bridge rectifiers for describing your application

If you have an application for silicon bridge rectifiers, Electronic Devices Inc. is willing to send you free samples of its new PB series to try out. **The units, which are rated at 25 A (300-A surge), withstand peak reverse voltages from 50 to 1,000 volts.** To get your sample, just outline your application in a letter to: Dennis Dean, Sales Manager, Electronic Devices Inc., 21 Gray Oaks Ave., Yonkers, N. Y. 10710.

Good news for users of HP-67/97 calculators

Volume users of blank programming cards for Hewlett-Packard's HP-67 and HP-97 calculators will be happy to know that the company is **reducing the price of the cards** by making them available in larger packages. A pack of 1,000 now costs only \$195 (card holders not included). At 19.5¢ each, that's a better price than 37.5¢ each for the \$45, 120-card pack. Delivery is three weeks. For more information, contact: Hewlett-Packard Co., 1501 Page Mill Rd., Palo Alto, Calif. 94304. **Lucinda Mattera**

There's a Simpson DPM that's right for your application

All Simpson DPM's feature:

- 0.1% accuracy
- 3-1/2 digit readout
- Automatic zero and polarity
- Dependable LSI circuitry
- Choice of 120/240 V AC or 5 V DC operation
- Panel cutout 1.682" x 3.622". Adaptors available for IEC/DIN and other domestic cutouts
- Input/output edge connector included
- Full 200 hour burn-in
- Backed by the Simpson one-year warranty



Model 2860

The Dedicated DPM

New Series 2860—high performance at a low price

from **\$4940***

- 9 stock ranges available
- Bright 0.43" LED readout

The Systems DPM

Deluxe Series 2850—printer/computer interfacing capability and options for custom applications

\$92*

- 9 stock ranges
- Specials available including AC ranges
- Choice of 0.43" LED or 0.55" planar gas discharge display
- BCD output standard

*100-lot OEM prices

Available From
Electronic Distributors
Everywhere

Write for Bulletin P612
containing complete
technical specifications.



Model 2850



Model 2852

SIMPSON ELECTRIC COMPANY

853 Dundee Avenue, Elgin, Illinois 60120
(312) 697-2260 • Cable SIMELCO • Telex 72-2416

IN CANADA: Bach-Simpson, Ltd., London, Ontario
IN ENGLAND: Bach-Simpson (U.K.) Ltd., Wadebridge, Cornwall
IN INDIA: Ruttonsha-Simpson Private, Ltd., Vikhroli, Bombay

KATY INDUSTRIES



INDUSTRIAL
EQUIPMENT
GROUP



your fingertips

at a price within easy reach

Until now, fingertip programmability wasn't available in a logic test system at *any* price.

Now it's yours for less than you might pay for an ordinary system.

So, instead of toggling for hours, you can program or edit in minutes.

The only system that compares transmitted and received data.

You can program what the data generator generates and you can program a "compare" memory for the analyzer to store.

When the analyzer receives an output from the unit under test, it simply compares it bit for bit against the stored program or the generated program. The test is automatically halted to show errors in reverse video on the CRT.

Since the compare program and the data generator program are known to be accurate, the test unit output can be analyzed any number of ways.

Analyzer and data generator share a common bus.

One reason you can get all this capability and flexibility so inexpensively is the common bus shared by both Moxon units.

From a cost standpoint, it means that the CRT

and keyboard serve double duty. Why pay for two CRT's when you only need one?

Run complete tests in days, not months.

Just setting up a test the usual way can take weeks.

But with the Moxon system, you're ready to start immediately, no matter what type of unit you want to test.

And don't be surprised if the tests are fully completed in less time than it's been taking you to prepare for testing.

It's that fast.

Applications unlimited.

The Moxon system is able to test a wide range of equipment.

It's able to trigger on *serial* data, up to 16-bit words, as well as parallel data.

And it can be formatted in hex, octal, binary and timing formats.

So, no matter what kind of computer peripherals or devices you want to test, just contact Moxon.

It's the logical thing to do.

Moxon, Inc., 2222 Michelson Dr., Irvine, CA 92715.
(213) 623-1892 (714) 833-2000 TWX (910) 596-1362

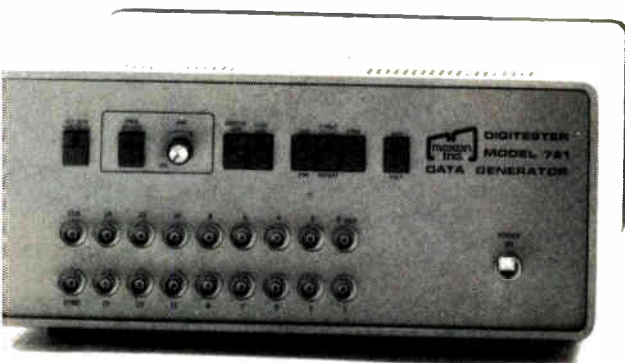

\$2750



\$3950 (complete with 18 probes)

microwave counter sweeper, too."

"I use my new EIP 371 Source Locking Microwave Counter two ways. First, I use it to automatically stabilize my sweepers. It does it over a broad frequency range, from 10 MHz to 18 GHz in 100 kHz increments. Secondly, I use it as an automatic frequency counter. It gives me frequency coverage from 20 Hz to 18 GHz, with -30 dBm sensitivity. FM tolerance is greater than 40 MHz. It has 2 watt burn-out protection, and multiple signal discrimination, too. And it has an IEEE Interface Bus available for remote programming and operation.

"To stabilize my sweeper, all I have to do is sample its RF output and connect the 371's 'phase lock out' to the sweeper's DC coupled FM input. I tune the sweeper to within 20 MHz of the frequency I'm after, enter that frequency on the 371's microprocessor-controlled front panel keyboard, and push the LOCK button.

That's all there is to it. I don't have to worry about the sweeper's FM input bandwidth and polarity. The 371 controls those automatically.

"The 371 phase locks my sweepers, and virtually any other signal source, to the same long-term accuracy and stability as the counter's timebase.

"The price? Only \$6,800, just slightly more than a dedicated counter alone. And a whole lot less than a counter and separate lockbox!

"There's only one place to get this unique counter. EIP. They're real microwave counter specialists. For more details or a demonstration, phone or drop them a line. Tell them you heard about EIP from a friend."



EIP, Inc. / 3230 Scott Boulevard, Santa Clara, California, 95051 / Phone (408) 244-7975.

In Europe: EIP International, Brussels, Belgium / Phone 2/660 48 70.

Circle 203 on reader service card

angular displacement converted to numbers

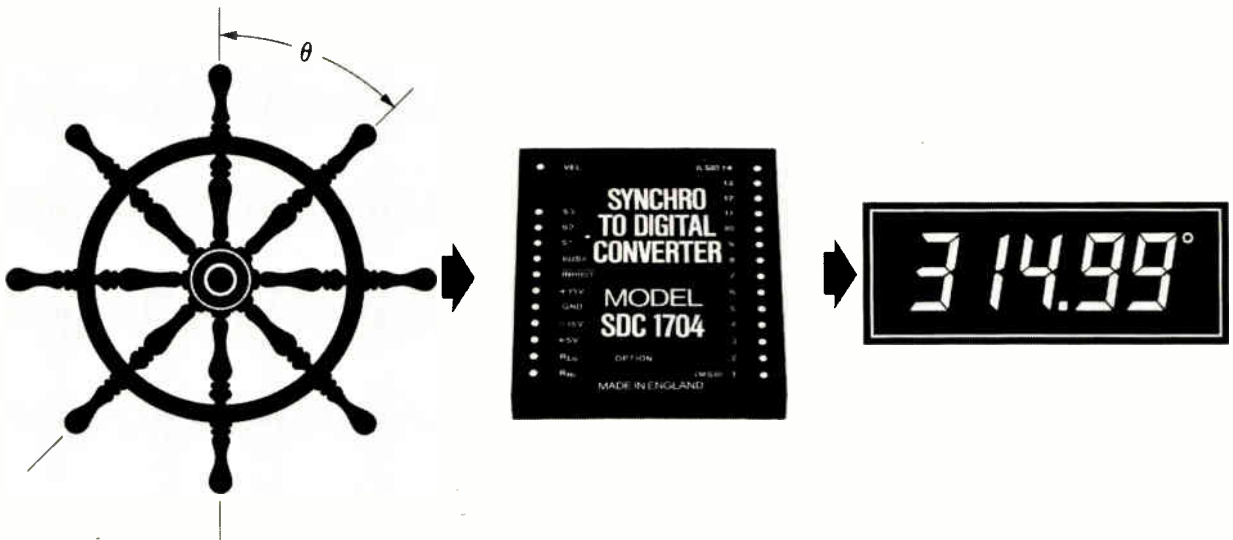

...to an accuracy of 2 mins. of arc

Numerical control, Retransmission systems, Fire control systems, Servo mechanisms, Coordinate conversions, Radar, Simulators, Navigation, Displays

The number of industrial and military problems which our synchro to digital converters can answer is endless — because most of the possible applications have not yet been perceived. Or they are currently being satisfied by other means which are probably less accurate.

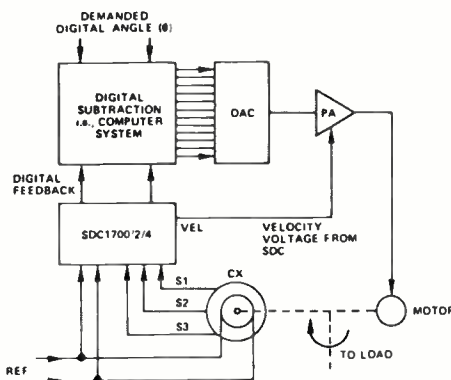

An SDC Being Used in a Digitally Controlled Feedback Loop

The SDC 1704 is a synchro to digital converter having a resolution of 14 bits, (1.3 arc-minutes) and an accuracy of ± 2 arc-minutes. Input isolation is provided by micro-miniature Scott connected transformers which are contained within the 10mm high module. These will work with 50 Hz references so that no external isolating transformers are required. Tracking conversion techniques employed use a Type 2 servo to provide high acceleration and wide velocity response. No trims, adjustments, or offsetting components are required.

12 BIT and 10 BIT VERSIONS AVAILABLE

Send for data sheet and prices now.



MEMORY DEVICES LTD.

Central Avenue, East Molesey, Surrey,
England KT8 0SN.
Tel: 01-941 1066

A-d converter chip resolves 10 bits

Monolithic self-contained device using successive approximation and built with I²L processing completes conversion in 25 microseconds

by Lawrence Curran, Boston bureau manager

Most monolithic successive-approximation analog-to-digital converters are 8-bit devices, and very few are self-contained. However, engineers at the Semiconductor division of Analog Devices Inc. have successfully married integrated injection logic with linear-bipolar processing to develop the industry's first complete 10-bit successive-approximation a-d converter in monolithic form. David Kress, product marketing specialist at the Wilmington, Mass., division, points out that the AD571 is also one of the first linear circuits to use I²L processing. Additionally, the chip is microprocessor-compatible, and it completes a conversion in 25 microseconds.

On the chip are: a d-a converter, buried-zener voltage reference, clock, comparator, successive-approximation register and output buffer—all on a single chip housed in an 18-pin ceramic dual in-line package. Important accomplishments in processing, wafer trimming by laser, and testing were necessary to produce the device, Kress says.

In processing, the ability inherent in I²L to invert the bipolar transistors was important to achieve fast switching, which contributes to the fast conversion time. The ability to put high-gain analog transistors on the same chip to get at least 8-bit resolution was also important. In addition, getting full 10-bit resolution required complex laser trimming of the ladder network at the wafer stage and fully automatic testing of each device over its temperature range, Kress points out.

He is not telling precisely how either is done for the 571. He says only that the semiconductor division

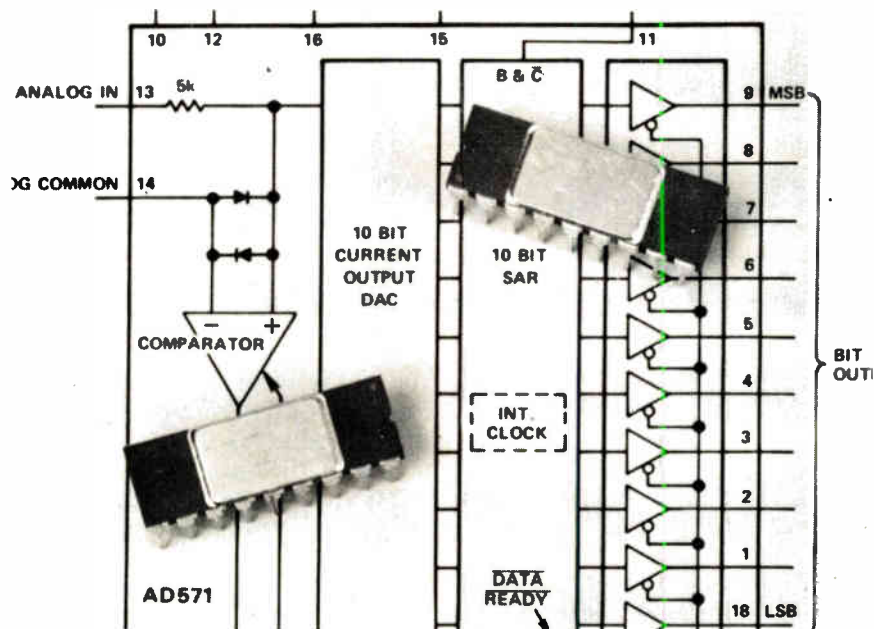

has enhanced its laser trimming to be able to measure the results more accurately, and that "we've figured out ways to test a fully wired device without unwiring it." Regarding the buried-zener reference, Kress adds that the company essentially has taken its AD561 d-a converter, which includes such a reference, "and built the comparator and successive-approximation register around it to come up with the 571." Surface zeners, says Kress, can hold long-term drift to 1% to 2%—not good enough for 10-bit converters—while the buried zener gives long-term stability to within 0.005%.

With a maximum accuracy error of 0.1% of full scale, the 571 is suitable for true 10-bit applications. It operates on supplies of +5 to +15 v and -15 v, and accepts unipolar analog inputs of 0 to +10 v and bipolar inputs of ± 5 v.

Three versions of the converter are available off the shelf. The AD571J and AD571K are designed for operation from 0°C to 70°C. The chief difference between the two is a slightly relaxed temperature coefficient for the J version. It will sell for \$24 each in hundred-or-more lots and the AD571K will be priced at \$35 apiece in those quantities. The AD571S, for the range from -55°C to +125°C, will carry a price of \$60 each for the same amounts.

Jerry Fishman, the division's marketing manager, looks for the a-d portion to be the fastest growing part of the converter market. "As the price differential between 8-bit and 10-bit converters closes, the market for devices like the 571 will be enormous," Fishman asserts.

Analog Devices Inc., Route One Industrial Park, P. O. Box 280, Norwood, Mass., 02062. Phone (617) 329-4700 [338]

Components

Solid-state relay price drops to \$2

Price applies to 10,000-lots; single in-line package has LED emitter, detector, triac

A line of solid-state relays from Theta-J Inc. may offer the first true challenge to mechanical relays because of their low price—\$1.99 in quantities of 10,000 or more for some models. The MX-100 line, which is rated at 90 to 140 v ac, and the MX-200 series, for use between 90 and 280 v ac, both specify optical isolation of 3,750 v ac rms, or 5,500 v peak.

Edward T. Rodriguez, chairman and technical director of Theta-J, says that at the right price today's market of \$25 million to \$30 million for solid-state relays could be greatly expanded because companies that now manufacture them in house would buy outside. "Ultimately," Rodriguez says, "the price has to compete with a mechanical relay at \$2. It's as simple as that."

The new units are housed in a molded-plastic, four-pin, single in-line package and contain only three components: a light-emitting-diode emitter, a cadmium-sulfide detector, and an output triac. Rodriguez maintains that the units can be assembled in less than a minute and that production speed, combined with eventual offshore assembly, accounts for the low prices.

The relays will withstand 100% overload for a full minute, which Rodriguez says is particularly good for motor-driving applications. They can be driven from any dc or full-sine-wave-rectified ac input above 1.5 v as long as a series input resistor limits the drive current to between 7 and 25 mA. The units carry a minimum dv/dt rating of 100 v per microsecond to minimize the need for external snubber networks. Response time is 16 to 32 milliseconds,

which makes them immune to false triggering by transients.

Rodriguez says Theta-J has spent more than a year developing a list of volume users, most of whom make their own relays, who have said they would buy in quantities ranging from 150,000 to 300,000 at the \$2 price. These users include makers of appliances, telephone equipment, and vending machines. "No one is infatuated with technology anymore," he continues, alluding to recent hybrid solid-state relays priced at \$4.95 in quantities of 1,000 and up. "Price has become the forcing factor."

The MX-100 series prices range from \$1.99 each in lots of 10,000 and above to \$3.40 each for 100-or-more pieces. The MX-200 series prices are, respectively, \$2.49 and \$4 each for those amounts. There is also an MX-1 series, rated at 4.8 to 72 v ac and aimed primarily at low-voltage residential and telephone systems. It is priced the same as the MX-100 series. Deliveries will begin in February, with three to four weeks required for delivery of moderate production quantities.

Theta-J Relays Inc., 1 De Angelo Dr., Bedford, Mass. 01730. Phone (617) 275-2575 [341]

Bulk Metal power resistor can dissipate up to 10 W

This hermetically sealed power resistor with a noninductive Bulk Metal design is well suited for high-frequency power circuits, as well as for voltage-sensing, current-limiting, and attenuator applications when



wire-wound power resistors are unsatisfactory. The model VHP-3 design results in a low temperature coefficient of resistance. Its power rating with a heat sink is 10 w; in free air it is 3 w. It is housed in a standard TO-3 case, which screw-mounts directly onto a metal chassis. The VHP-3's maximum working voltage is 750 v and the unit is available with standard tolerances to 0.01% and to 0.005% by special request.

Vishay Resistive Systems Group, 63 Lincoln Hwy., Malvern, Pa. 19355 [343]

Thumbwheel switches set digital time-delay relay

A compact, low-power solid-state time-delay relay set by direct reading thumbwheel switches operates from an input voltage of 12 v dc \pm 10%. The series 280 Digilay is capable of timing in on or off delay modes from 1 ms to 9,999 s.

An external frequency-modulation feature permits fine tuning of the oscillator's base frequency or, with an

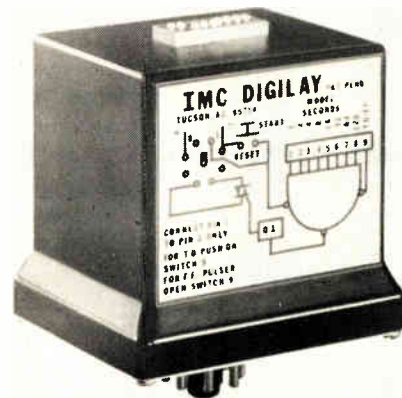

external waveform, actual modulation of the time delay. There are three switch options: single-pole, double-throw relay, spdt reed relay, and spdt triac. Reset and stop timing can be set manually or automatically. Input for test and reset functions are through a standard 11-pin base.

Single-unit price is \$79 and delivery time is about four weeks

Racal Analogue Recorders

Precise. Reliable. Versatile.

In all analogue recording applications where these qualities mean most – on land, sea or in the air – the Racal-Thermionic STORE range of tape recorders perform with absolute dependability.

Available with 4, 7 or 14 tracks, all models incorporate the

latest advances in electronic and mechanical engineering technology, including a unique tape-handling system which guarantees precise tape control and unrivalled performance under stringent environmental conditions.

For stress and vibration moni-

toring in vehicles, aircraft, ships, oil rigs and gas turbines, and for a multitude of applications in industry and the medical field, STORE recorders are in constant use around the world, setting new standards in precision and reliability.



Racal-Thermionic Limited
Hardley Industrial Estate
Hythe, Southampton
Hampshire SO4 6ZH
Telephone: Southampton (0703) 843265
Telex: 47600

RACAL

Racal-Thermionic the recording people

Circle 204 on reader service card

New products

after receipt of order, the firm says. International Microtronics Corp., 4016 E. Tennessee St., Tucson, Ariz. 85714. Phone (602) 748-7900 [344]

Tiny cores designed for filters and networks

What may well be the world's smallest adjustable pot core is now available from Siemens Corp. Measuring 4.6 by 4.1 mm, the core is used in filters and matching networks where extremely small size is essential. The

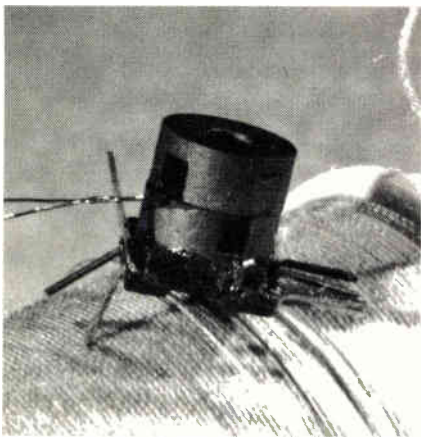

B65495 is available ungapped in N30 ferrite or gapped in N28, M33, K1, or U17 material. Adjustment parts, bobbins, and mounting bases for the cores are available. The cores are priced at 35¢ each in thousands. Delivery is from stock.

Components Group, Siemens Corp., 186 Wood Ave., Iselin, N. J. 08830. Phone (201) 494-1000 [345]

Switch-relay adapts to variety of applications

The LSR is an auxiliary relay that combines features of both a programmable remote relay and a manual override switch. It is adaptable to numerous applications and is capable of controlling up to 32 contacts in a single unit. The contacts are shock-resistant and double-wiping, with a knife-blade design. The LSR is rated at 10 A and is

Put a benchtop DMM in your pocket. Only \$169.

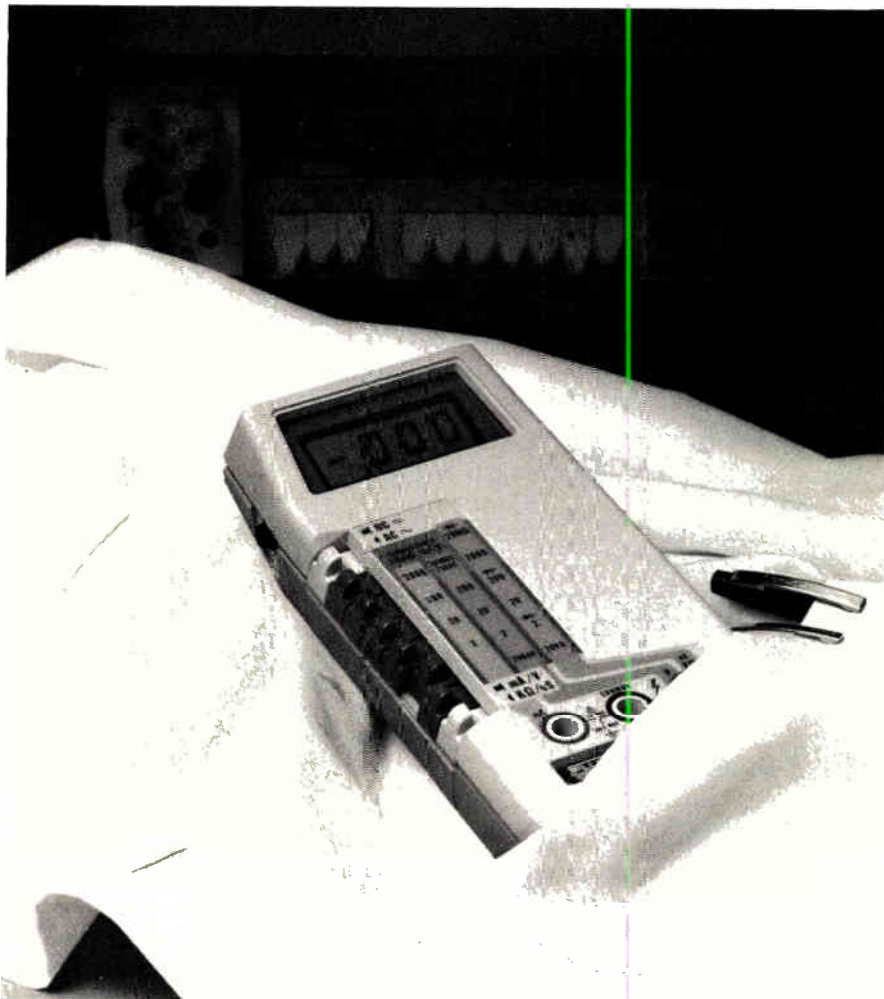

Our new 8020A digital multimeter puts typical benchtop-type measurement capability in your pocket, your briefcase or your tool kit. And it puts true Fluke value in your hand.

At only \$169,* the 8020A has features you won't find on any other multimeter, at any price.

Features like 26 ranges for seven functions, including conductance that measures leakage to 10,000 MΩ. Dependable CMOS LSI single-chip innovation, custom designed for the 8020A.

It's only 13 ozs. of reliable, shock-resistant measurement perfection. All guaranteed for a full year, including specs and its NBS-traceable calibration.

tion.

Benchtop performance for \$169.* And Fluke's dedication to after-sale support, with service centers located worldwide for fast, cost-effective support. A priceless combination.

Call (800) 426-0361, toll free. Give us your chargecard number and we'll put an 8020A in your pocket. Or, we'll tell you the location of the closest Fluke office or distributor for a personal feel for the best DMM value around. Put savings in your pocket too, and buy a "Ten-Pack" of 8020As for only \$1521*, and get ten for the price of nine!

*U.S. price only.

Command Performance: Demand the Fluke 8020A.

1809-7002

FLUKE[®]

New from Electronics... when you can't afford to reinvent the wheel.

Here's just a sampling of the vast range of useful information you'll have at your fingertips...

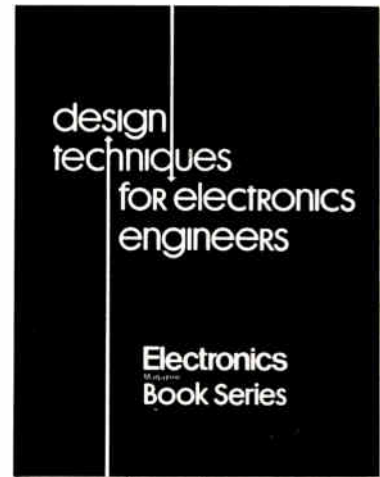

- How to use soluble masks to protect pc boards from solder.
- How to evaluate power dissipation in microcircuit design.
- How to hand-solder DIP circuits to save testing dollars.
- How to compare the power of C-MOS with TTL.
- How to really look at low-drift IC op amps.
- How to accurately trim closed resistor loops.
- How to drive LEDs directly from C-MOS logic outputs.
- How to convert coordinates and find SWRs graphically.
- How to compare coaxial-cable shielding effectiveness.
- How to calculate resistance for sum and difference networks.
- How to use a programmable calculator to analyze filter designs.
- How to compute response of RLC networks with a short program.
- How to eliminate stray signals in remotely gain-switched op amps.
- How to chart power losses for hybrid-combined amplifiers.
- How to reduce IC FET op-amp input bias currents.
- How to build timing circuits for noisy environments.
- How to approximate waveforms with exponential functions.
- How to increase an instruction set without increasing word length.
- How to extend the life of digital recording heads.
- How to add numeric readout to logic probe displays.
- How to pick the right film for better oscilloscope pictures.
- How to use a frequency counter to measure capacitance.
- How to evaluate high-energy pulse effects on materials.
- How to operate a logic gate as a flip-flop.
- How to choose the right detector for rf power measurements.
- How to measure the access time of bipolar read-only memories.
- How to test power supplies quickly and cheaply.
- How to get the most out of a digital multimeter.
- *And much, much more.*

Order today, and don't forget the other valuable books in the Electronics Books Series listed on the coupon below.

Electronics Book Series

P.O. Box 669, Hightstown, N.J. 08520

1. Microprocessors

Send me _____ copies at \$8.95 per copy.

2. Applying Microprocessors

Send me _____ copies at \$9.95 per copy.

3. Large Scale Integration

Send me _____ copies at \$9.95 per copy.

4. Basics of Data Communications

Send me _____ copies at \$12.95 per copy.

5. Circuits for Electronics Engineers

Send me _____ copies at \$15.95 per copy.

6. Design Techniques for Electronics Engineers

Send me _____ copies at \$15.95 per copy.

Discounts of 40% on orders of 10 or more copies of each book.

If after my 10-day free-trial examination I am not fully satisfied, I understand that my full payment will be refunded.



Payment enclosed Bill firm Bill me
Charge to my credit card:

American Express Diners Club
 BankAmericard Master Charge

Acc't No. _____ Date exp. _____

On Master Charge only, first numbers above name _____

Name _____ Title _____

Company _____

City _____ State _____ Zip _____

Signature _____

**DATELINE: LOS ANGELES, TOKYO,
BOSTON, MILAN, DALLAS, WARSAW,
MINNEAPOLIS, TEL AVIV,
SAN FRANCISCO, PARIS, CHICAGO,
BUDAPEST, HOUSTON, MOSCOW,
NEW YORK, MUNICH...**

Technological developments have never been contained by national boundaries. This is particularly true in electronics. To know what's going on in your profession, you have to know what's going on in your own country, in the U.S., and around the rest of the world.

Our editors are stationed around the world. Their assignment is worldwide coverage of the electronics technology, coverage you can't get anywhere else.

The International Edition of Electronics is the only way to keep up with the new worldwide technology wherever it originates. Please turn to the subscription card at the back of this magazine.

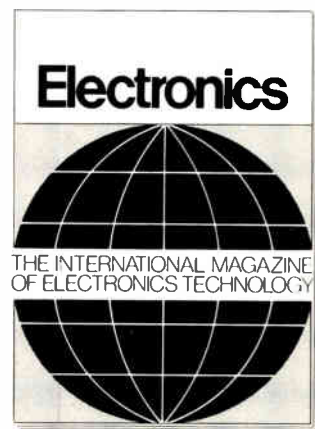

IN ELECTRONICS  HAS THE LINE...

DIP/IC INSERTION TOOL WITH PIN STRAIGHTENER

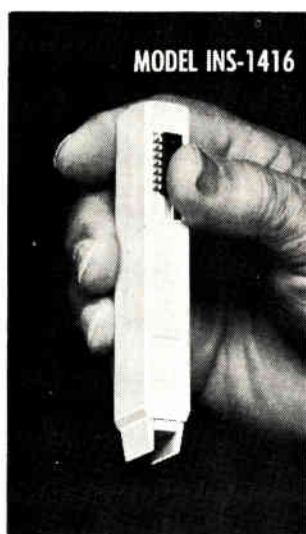

STRAIGHTEN PINS

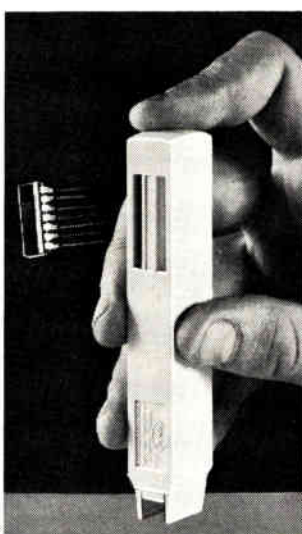

RELEASE

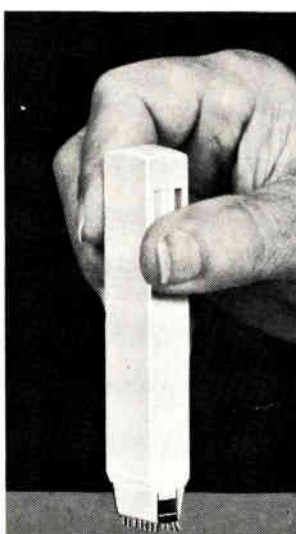

PICK-UP

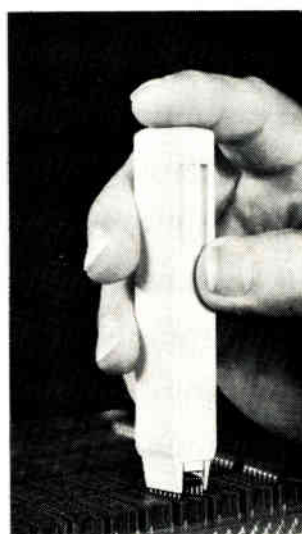

INSERT

OK MACHINE AND TOOL CORPORATION

3455 CONNER STREET, BRONX, NEW YORK, N.Y. 10475 U.S.A.
PHONE (212) 994-6600 TELEX NO. 125091

New products

Semiconductors

Counters offer 3-state outputs

Low-power Schottky devices work with bus-type systems built around microprocessors

Counters are usually the best-selling devices in any logic family of medium-scale integrated circuits, and low-power Schottky is no exception. Now, Advanced Micro Devices Inc. is introducing counters that combine the best features of existing high-selling low-power Schottky counters and add some extras.

The AM25LS2568 and 2569 up-down 4-bit counters feature synchronous presetting, three-state outputs, and a choice of asynchronous or synchronous clearing, all in a 20-pin package. Having a three-state output means that the counters, unlike competitors, will work with bus-oriented systems organized around a microprocessor or will drive light-emitting-diode displays without going through a multiplexing circuit.

"The significance of these counters is that more and more systems are being designed as bus-oriented systems with microprocessors," says David A. Laws, marketing manager for bipolar logic and interface products. To work with microprocessors, a designer used to have to buy a counter and a three-state buffer, whereas now he can get the buffer and counter in one package, he continues.

AMD claims that the 2568 decoding counter and 2569 binary counter are the only low-power Schottky three-state counters in the industry. These building-block circuits offer the engineer a design tool for new bus-oriented systems of all types, such as minicomputers, signal processors, and data-acquisition systems. They also are particularly adaptable for use as memory address registers in minicomputer central processing units, as well as address

generators where dual address control to the memory is needed, in addition to the event-counting functions normally performed by counters.

Up to now, a designer could choose the 25/54/74LS160-163 series of up counters, which feature synchronous preset with either asynchronous or synchronous resetting functions, or the 190-193 up-down counter versions, which have asynchronous presetting with either single or dual clock functions. Also available are the 168A and 169A parts, which combine the synchronous presetting features of the 160 with the up-down counting ability of the 190 series. But these two devices need extra circuitry, to get them to clear, for example.

Instead of sticking with the standard 16-pin counter packages, AMD chose a slim 20-pin pack in which to put the extra functions. What's more, the new chips occupy only 25% more board area than a conventional counter chip alone, while replacing up to four standard packages, he says.

Laws puts the maximum clock-to-output delay at 27 nanoseconds, which is comparable with the other low-power Schottky MSI counters. Other features include an internal look-ahead carry logic and two count-enable lines for high-speed cascaded operation, ripple-carry output for cascading, clock-carry output for convenient modulo configuration, and fully buffered outputs.

The 2568 and 2569 are made with the advanced technology used for AMD's second-generation high-performance AM25LS family of products but will work with almost any microprocessor family. As with all AMD products, they are processed to the screening requirements of MIL-STD-883, Class C, at no additional cost.

Price in 100-and-up quantities is \$2.90 for the plastic dual in-line package with the commercial temperature range. Preproduction parts are available now, and production devices will be available in February. Advanced Micro Devices Inc., 901 Thompson Pl., Sunnyvale, Calif., 94085 [411]

μ P Power Supplies® Save Your Chips!



Choose ...

- ☐ Output ratings from a large selection of models
- ☐ Input ratings from among DC/DC converters and line operated supplies
- ☐ Performance you NEED at a sensible price
- ☐ Low Unit Prices from \$23.95 to \$99.95

Get The Facts Fast Call or write today for Free Catalog. We'll also include your copies of our new power supply journal.

WATTS UP at sci



**SEMICONDUCTOR
CIRCUITS, INC.**

POWER SOURCES
DIVISION

306 RIVER ST., HAVERHILL, MA 01830
Tel. (617) 373-9104, TWX. 710-347-0269

ELECTRONICS REPRINTS

No. of
copies
wanted

New reprints

- ___ R-718 Display makers strive to refine their technologies 8 pp \$3.00
- ___ R-716 Special report—Japanese wave in semiconductor technology 24 pp \$3.00
- ___ R-714 Special report—active filter technology 6 pp \$3.00
- ___ R-713 Electron-beam lithography draws fine line 10 pp \$3.00
- ___ R-712 Special report—large-scale integration 16 pp \$3.00
- ___ R-710 Personal computers mean business 8 pp \$2.00
- ___ R-708 So you want to be a consultant 6 pp \$2.00

Charts

- ___ R-516 Electronic symbols \$2.00
- ___ R-213 Electromagnetic spectrum (updated 1976) \$3.00
- ___ R-326 Optical spectrum (6-page report and chart) \$3.00

Books

- ___ R-711 Circuits for electronics engineers: 306 circuits in 51 functional groups—Electronics Book Series \$15.95
- ___ R-704 Thermal design in electronics \$5.00
- ___ R-701 Applying microprocessors—Electronics Book Series \$9.95
- ___ R-608 Basics of Data Communications—Electronics Book Series \$12.95
- ___ R-602 Large Scale Integration—Electronics Book Series \$9.95
- ___ R-520 Microprocessors—Electronics Book Series \$8.95
- ___ R-011 Computer-aided Design 135 pp \$4.00
- ___ R-032 Active Filters 88 pp \$4.00

Payment must accompany your order

Make check or money order payable to Electronics Reprints. All orders are shipped prepaid by parcel post. Allow two to three weeks for delivery. For additional information call (609) 448-1700 ext. 5494.

Mail your order to:

Janice Austin
ELECTRONICS REPRINTS
P.O. Box 669
Hightstown, N.J. 08520

Back issues now available:

1960 to 1969, \$5.00 each
1970 to 1973, \$3.00 each
1974 to 1976, \$4.00 each

New products

Low-power IC aims at alarm and detector applications

Designed for use in battery-powered alarm and detector systems, the L911 is an analog integrated circuit that comprises a high-impedance input comparator, a trip-point comparator, a trip-point reference, an output driver, and a pulsing output oscillator. Since it draws less than 10 μ A from a 9-v supply, the L911 can be used in systems that are

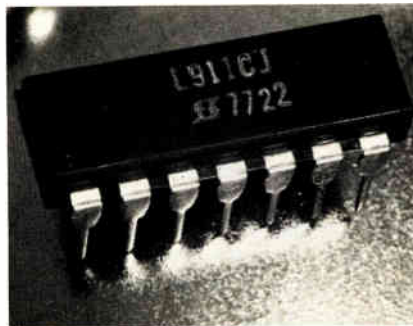

designed to operate for a year or more in the standby mode, from a single 9-v alkaline battery of the size commonly used in small portable radios. Key applications of the detector circuit include smoke detectors, burglar alarms, moisture sensors for both agricultural and home use, and temperature sensors of various kinds.

Among its more important specifications are an input resistance in excess of $10^9\Omega$, a common-mode-voltage range that extends from 0 to -4 v, and output-current limiting that can be adjusted from 0.5 to 30 mA. The device is housed in a 14-pin plastic dual in-line package and sells for \$2.18 each in hundreds. Delivery is from stock.

Siliconix Inc., 2201 Laurelwood Rd., Santa Clara, Calif. 95054. Phone Jim Graham at (408) 246-8000

Analog clock circuits work with quartz crystals

Five timing circuits, built with complementary-metal-oxide-semiconductor technology, are designed

to work with quartz crystals to develop signals for driving synchronous or stepping motors in a variety of analog clocks. The circuits, types CD22011E through CD22015E, differ primarily in output pulse width, duty cycle, and frequency of the quartz crystal. Output pulse repetition rates of 1, 2, 30, 60, and 64 Hz are available from crystal frequencies in the range of about 2 to 4 MHz. All five circuits include one or more zener diodes for transient protection and one or two output drivers. Prices range from \$1.30 to \$1.75 each in hundreds.

RCA Solid State Division, Route 202, Somerville, N. J. 08876. [416]

Schottky diode drops only 0.55 V at 30 A

Suitable for use in industrial switching power supplies, a Schottky-barrier power rectifier has a voltage drop of only 0.55 v at a forward current of 30 A. Its dc blocking-current rating is 45 v. The unit can operate at junction temperatures from -55°C to 150°C. Housed in a DO-203AA (formerly DO-5) package, it sells for \$5.25 in quantities of 100 to 999. Delivery time is four to eight weeks.

TRW Power Semiconductors, 14520 Aviation Blvd., Lawndale, Calif. 90260. Phone John Power at (213) 679-4561 [417]

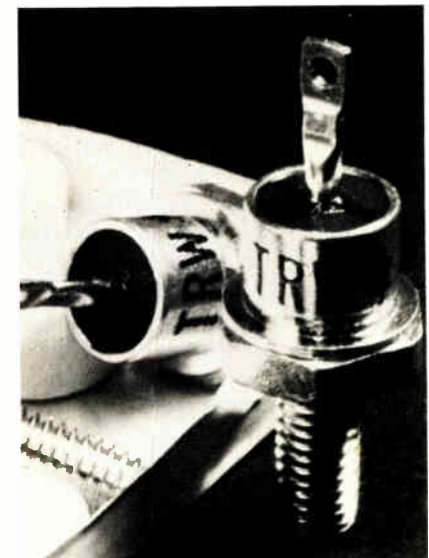

The Space Saver

10MHz Dual-Trace Oscilloscope

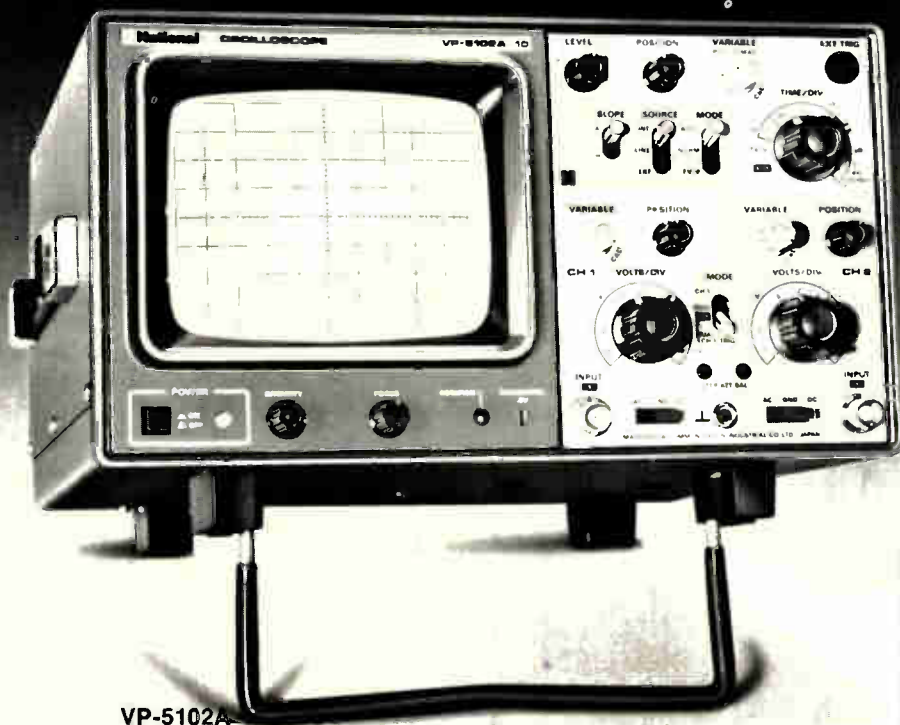

VP-5102A

Full Features in a 26cm Square

The National VP-5102A is a unique instrument designed to give you the greatest number of extra features while taking up the least amount of working space possible. Use of a newly-developed short-necked CRT enabled National to pack a dual-trace display with DC-10MHz bandwidth (-3dB) and calibrated X-Y operation, a built-in x5 sweep magnifier and an AUTO Trigger function into a cabinet that measures only 148 x 260 x 260mm and weighs only 5 kg.

Extra Sensitivity

Nor did National stop there. To guarantee 3 percent accuracy at 10mV/DIV, the VP-5102A employs an Internal Graticule CRT for this 10MHz oscilloscope. To ensure greater versatility, this unit also incorporates

a tilt stand for easier trace viewing, a built-in amplitude calibrator, a front-panel trace rotation control plus TV waveform triggering circuitry. All of which combine to make the VP-5102A a great little addition to your working equipment.

The VP-5100A

The National VP-5100A, like the 5102A, features an Internal Graticule CRT and compact (148 x 260 x 260mm) unit size. Other features include a sensitivity of 10mV, variable control

for vertical deflection factors and sweep rate plus STEP ATT BAL control.



VP-5100A

National

Circle 233 on reader service card

World Radio History

Matsushita Electric Trading Co., Ltd.
Sales Promotion Section
CPO Box 288, Osaka, Japan

Please send me information on VP-5102A and VP-5100A

Name

Name of Company

Address

Section

Two new ways to cut costs in isolated systems without sacrificing performance.

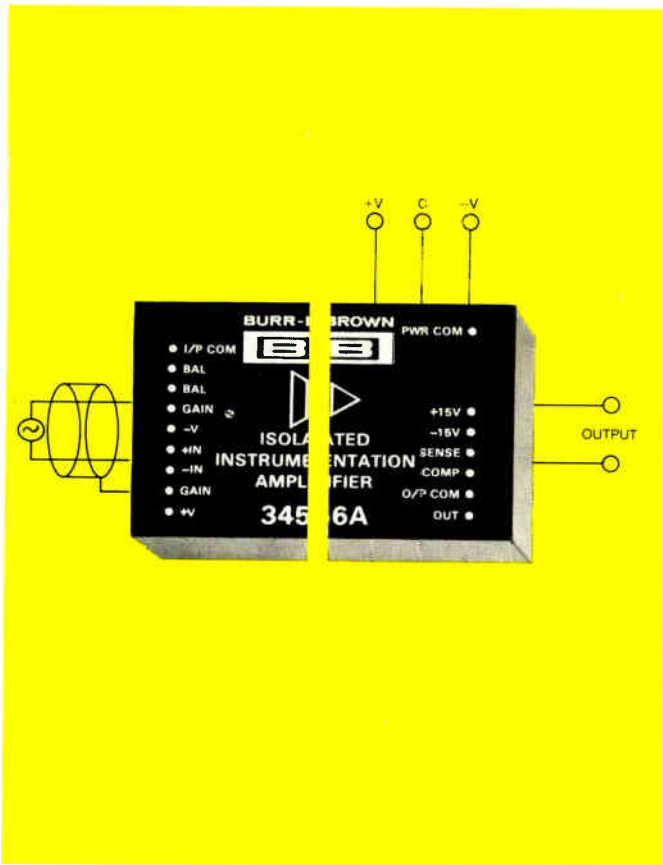

Choose Burr-Brown's new Isolated Instrumentation Amplifier with true three-wire input.

Burr-Brown's new 3456 gives you true three-wire instrumentation amplifier input with CMR of 110 dB min at $G=100$, $\pm 0.02\%$ max gain nonlinearity and $\pm 1 \mu\text{V}/^\circ\text{C}$ max input offset drift. And it provides input-to-output isolation rating of 2000V peak continuous (5000V test), isolation impedance of 10^{12} ohms in parallel with 14 pF and isolation mode rejection of 130 dB at 60 Hz.

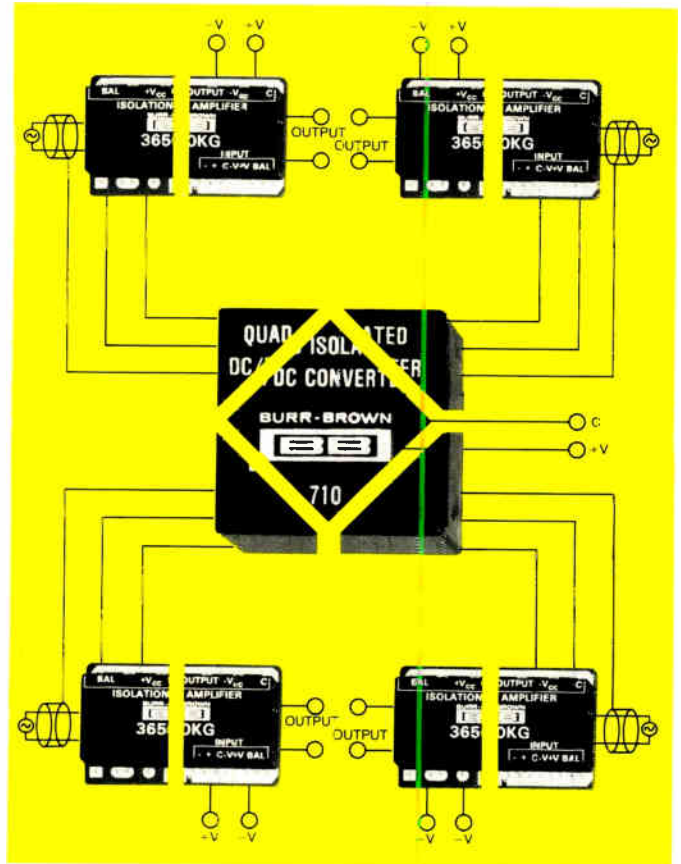

Power four optically-coupled isolation amplifiers with our new Quad Isolated Supply.

Combine Burr-Brown's new Model 710 with four 3650KG Optical Isolation Amplifiers and you get optical isolation at low cost per channel.

The 3650KG provides $\pm 0.05\%$ max gain nonlinearity and $\pm 5 \mu\text{V}/^\circ\text{C}$ max input offset drift. Combined with the 710, each isolated channel provides 600V continuous isolation voltage channel-to-channel and input-to-output rating (2200V test) and $1 \mu\text{A}$ max leakage current at 240V/60Hz.

To get full details on these isolation amplifier developments, contact Burr-Brown, International Airport Industrial Park, Tucson, Arizona 85734. Phone (602) 294-1431.



A revolution in price and size

in-depth support. from design to production.

opment cycle. And, because PL/M is resident in the Intellec system, you put an end to timeshare computer charges. You just can't get that kind of power and efficiency from any other system.

We've made Intellec easy to use. You communicate with the system in simple English-like statements. You can write application programs in small, manageable modules and link them together with other programs from the diskette library for loading into your microcomputer's PROM or EPROM memory.

To simplify hardware/software integration and system debugging, Intel's unique ICE modules give you a "diagnostic window" into the operation of your system. The ICE software system is the only one that lets you control, monitor and analyze all microcomputer functions using symbolic references for addresses



and data. And the new ICE-85™ provides expanded in-system emulation capability, extending the window to your entire microcomputer system.

You can count on Intel for in-depth support in other areas, too. Like user application assistance, complete documentation, training programs and design seminars worldwide, and a users' software library with over 275 programs and growing.

That kind of in-depth support is the reason more designers are using more Intel microcomputers and Intellec development systems than all others combined.

To find out how Intellec can get you on the road to faster and easier microcomputer development, contact your nearest Intel office or distributor. For a local demonstration or a copy of the Intellec brochure, contact Intel International, Brussels, Belgium, telephone (02) 660 30 10, telex 24814; or Intel Japan, Tokyo, telephone (03) 426-9261, telex 781-28426.

intel® delivers.

Circle 234 for technical information

Circle 235 for technical information and a demonstration

When you need indicator lights or more than indicator lights...



Come to the Number 1 supplier in the world—Dialight—for the widest choice of indicators for your every application.

You'll find the largest selection of UL & CSA listed, and QPL approved, indicator lights.

Whether small or large, LED, incandescent or neon, you have over 1,500,000 design combinations to choose from. And your choices include a full range of lens shapes, finishes, legends and colors from red, green

and amber to blue, yellow, white and clear. Designed for consumer, industrial and MIL-SPEC requirements.

We've developed a particularly easy way for you to find out exactly what you need out of the millions of indicators we have. It's a special 60-page Indicator Light Selector Guide. For your free copy, which includes a list of stocking distributors in the U.S. and Canada, contact us today.

DIALIGHT

A North American Philips Company

Dialight meets your needs.

Dialight, 203 Harrison Place, Brooklyn, N.Y. 11237 (212) 497-7600

World Radio History

Circle 155 on reader service card

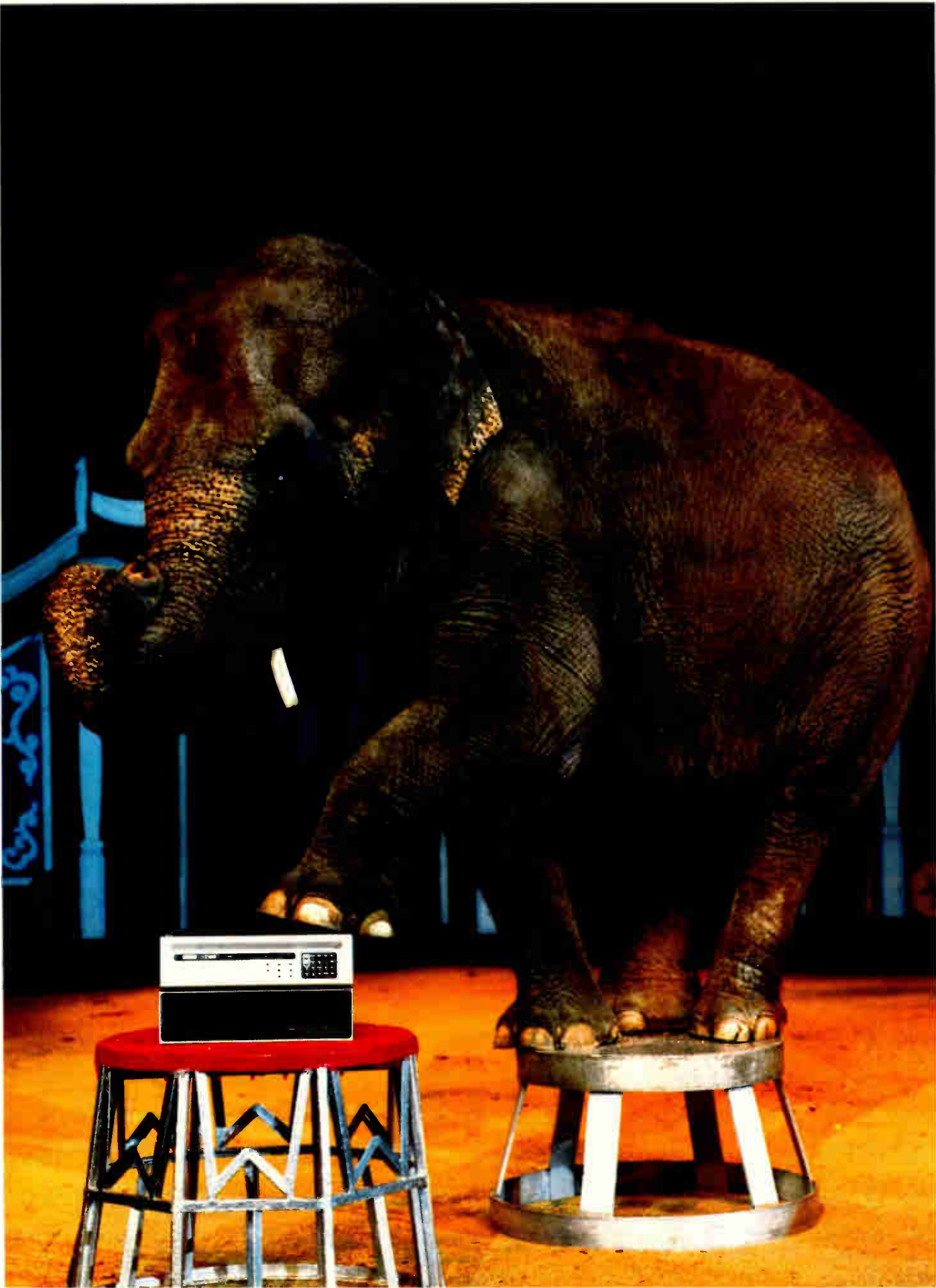

Digital announces a PDP-8 with an enormous memory.

Something big has just happened to the world's most famous small computer. In fact, something enormous.

Digital has just put 128K of memory into the PDP-8.

This act is brought to you by a powerful new memory management option called KT8-A. And by two new MOS memory modules that fit large amounts of memory into small amounts of space. Simply by adding these 16K or 32K modules in whatever combination you choose, you now expand your PDP-8/A into something bigger. What's even better, you can mix MOS and core. And that means you can protect your program in non-volatile core while you expand your data base in MOS.

And thanks to the KT8-A all this memory is under new management. Not only does the KT8-A let you address up to 128K words of memory, but it also offers you memory relocation and memory protection, while asking little in operating system overhead so you get faster system performance.

What's the cost of these enormous advancements? That's the next attraction.

The new PDP-8A MOS memory models are available at prices that are as crowd pleasing as their performance. Three models to choose from — the

8A205 with 16K, the 8A425 with 64K and the top of the line 8A625 with 128K.

They're the new big-memory Eights from Digital. Step right up.

Large memories aren't our only new trick.

New hardware and software improvements are also in the PDP-8 spotlight.

The VK8-A is a new low cost PDP-8A option that provides high quality video output plus keyboard and printer interfaces. Video character generation uses a super-sharp 9x9 dot matrix for high resolution on single or multiple CRT monitors up to one thousand feet away.

Also new for PDP-8 users is MACREL/LINKER — a sophisticated assembler with MACRO facilities that lets you implement, expand and update your system faster while reducing software development time.

And last but not least there's DECNET 8 — a series of software protocols that let you

form your own PDP-8 network.

The PDP-8. Bigger. Smaller. And better than ever.

A short while ago, we made big news with DECstation 78. A low-end system that set new highs for ease of use and simplicity.

Now we're expanding the PDP-8 family up, as well as down, and that means new opportunities for OEMs and end-users alike. Look into what's happening with PDP-8s. Call your nearest Digital sales office today.

Or send the coupon to PDP-8 Marketing Communications, Digital Equipment Corporation, 129 Parker Street, PK3-1/M34, Maynard, Massachusetts 01754. European headquarters: 12, av. des Morgines, 1213 Petit-Lancy/Geneva. In Canada: Digital Equipment of Canada, Ltd.

digital

PDP-8 Marketing Communications
Digital Equipment Corporation, 129 Parker Street, PK3-1/M34,
Maynard, MA 01754

Please send additional information about the PDP-8 family.

Name _____ Title _____

Company _____

Address _____

City _____ State _____ Zip _____

Phone _____ OEM _____ End-User _____

Application _____

The first thing we did was make it best. The best thing we did was make it first.

The first. The only. The award-winning, complete, self-contained digital to analog converter that offers true 18-bit resolution. That's 4ppm! The Analog Devices DAC1138.

The DAC1138K's superior specs, like a linearity of 1/2LSB and TTL-compatible inputs are packed in a compact 2" x 4" module. So it's ideal for a broad range of instrumentation applications requiring wide range measurement and control.

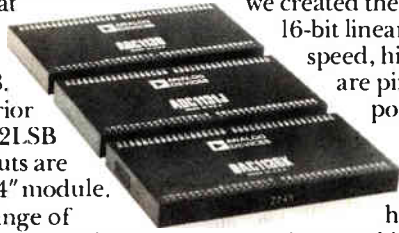

But we didn't stop there. For similar performance in a low cost 16-bit DAC we created the DAC 1136 with true 16-bit linearity. Both our high speed, high resolution DAC's are pin compatible with our popular QM Series.

On the analog to digital side, we rounded out the high speed, high resolution conversion capability with the Analog Devices ADC1131 modular analog to

digital converter. It features 14-bit resolution and a fast 12 μ s conversion time. The low cost ADC1130 14-bit ADC has a 25 μ s conversion time.

Get it best and get it first. For complete specs and prices, write Analog Devices, Inc., P.O. Box 280, Norwood, MA 02062



The real company in high resolution converters.

The 18-bit DAC.



(actual size)

New products

Microprocessors

Single-board computer built around Z80

A single-board computer features 8,192 bytes of static random-access memory and sockets for 8 kilobytes of erasable programmable read-only memory. Designated the MSC 8001, the computer is patterned around the Z80 processor with up to 4-MHz clock speed. The MSC 8001 is electrically and mechanically compatible with SBC-80 systems, operating as a master module in the Multibus scheme.

Using the Z80 processor, the computer provides 158 instructions including all 78 instructions of the 8080A for total compatibility. The two I/O ports consist of parallel peripheral interface circuits with buffers and terminators to protect the metal-oxide-semiconductor circuitry. The MSC 8001 memory is available with either 4 or 8 kilobytes of standard 18-pin, 4,046-by-1-bit static RAM. The computer is priced

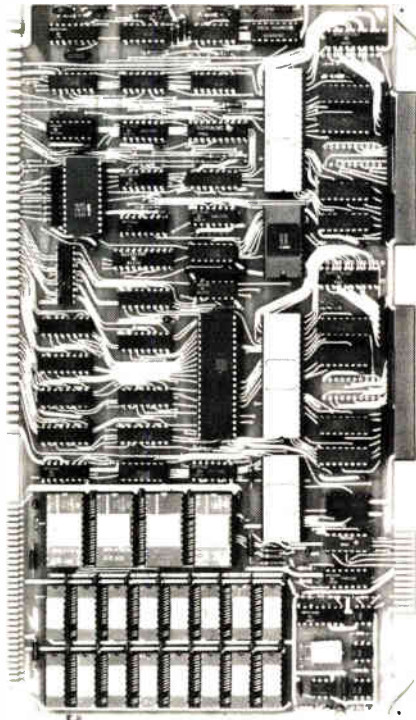

at \$845 with all interface elements. Monolithic Systems Corp., 14 Inverness Drive East, Englewood, Colo. 80110. Phone Dick Lorimor at (303) 770-7400 [373]

Data-acquisition system saves microprocessor space

The new MN7130 multiplexed sample-and-hold amplifier and ADC80 12-bit analog-to-digital converter have been combined to form a 12-bit, 16-channel data-acquisition system. The system, which is both physically and electrically compatible with microprocessor technology, is really built around the MN7130. This sample-and-hold unit provides

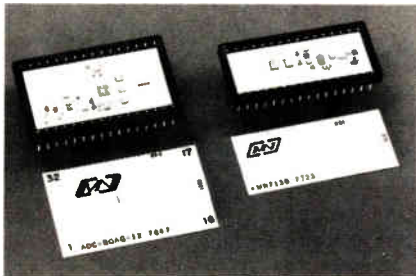

16 single-ended or 8 differential-input channels. These channels can be addressed with a single digital word and have a fast 8- μ S acquisition time. The MN 7130 is \$90, the ADC80 \$47.50 in hundreds.

Micro Networks Corp., 324 Clark St., Worcester, Mass. [374]

Low-level analog input fits Motorola microcomputers

A 12-bit, low-cost, plug-compatible, low-level analog-input interface with 8 or 16 12-bit channels has been designed for Motorola microprocessors. The MP7218 has input signal ranges from 10mV full scale to 5 v full scale, eliminating the need for external instrumentation amplifiers for low-level signals. The unit operates from the microprocessor's 5 v dc and 12 v dc supplies and is treated as memory by the central processing unit. Two memory locations are required for each 12-bit

750-Watt Switcher: UL-Listed* to Save You Time and Money!



It's compact, lightweight, and UL-listed. That's our MM-30 switcher, an 80% efficient unit that supplies 750 watts maximum. Priced at \$590 each (1-9 quantity), the MM-30 carries a 2-year guarantee and gives you all these advantages:

- Compact size — 5.1" H x 5.1" W x 12.75" L.
- Any one of seven output voltages. (750W max.)
- 0.4% line regulation over entire input range.
- 0.4% load regulation from no load to full load.
- 200 μ sec to 1% response time after 75% load change at 5 amp/ μ sec.
- 1% or 50 mv peak-to-peak ripple and noise.
- 0°C to 70°C operating temperature, derated to 60% at 71°C.
- Forced air cooling.



World's largest switcher manufacturer

LH Research produces the industry's broadest line of single- and multiple-output switchers. And nobody packs more power in smaller packages or offers more desirable features including 1 through 7 outputs, up to 2.26w/in.³, 80% efficiency, and 2-year guarantee. All at less than 65¢/w in quantity.

*File No. E52634



LH RESEARCH, INC.

1821 Langley Avenue, Irvine, CA 92714
(714) 546-5279

We're Second only to the N.B.S.

SOURCES — REFERENCES CALIBRATORS — STANDARDS

**DC Voltage
and Currents
Standards in**
12 models from

± 10 nV to ± 1100 Vdc. Differential Volt-
meter optional. Current 10 nA to 10 Amps.
Prices from \$695. Circle #

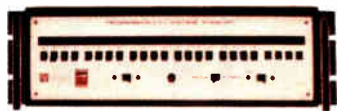
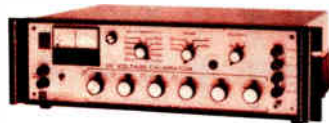

**Programmable
DC Standards**
from ± 0.1 μ V
to ± 200 Vdc,
current from
10 nA to 100 mA dc. Accuracy $\pm 0.005\%$.
Prices from \$1595. Circle #

AC Voltage and Current Sources 10 μ V to
1100 Vac @ 50 VA burden. Current 1 μ A to
10 Amp ac.
Frequency 50
Hz to 1000 Hz.
Price \$3695.
Circle #



Circa 1962

Electronic Development Corp.

11 Hamlin Street, Boston, Mass. 02127
(617) 268-9696

New products

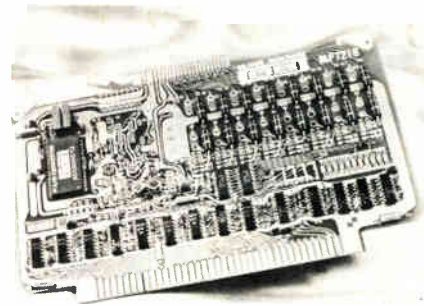

channel, and any memory reference
instruction may be used as input
data. The MP7218 is priced at \$495
in quantities of 1 to 9.

Burr-Brown, International Airport Industrial
Park, Tucson, Ariz. 85734. Phone C. R.
Teeple at (602) 294-1431 [375]

High-density memory boards expand SBC 80 computers

Three Multibus-compatible expansion
boards are now available for
SBC 80 single-board computers. The
high-density boards will reduce the
cost per bit for large systems.

The Multibus design uses 16, 384-
bit chips to get 32, 48 and 64 kilo-
bytes of data storage. Memory

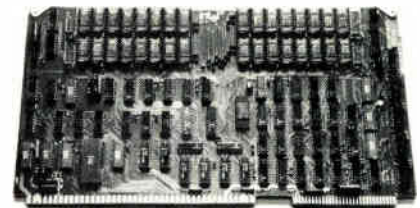

storage can be assigned to one
computer or shared by several. To
facilitate battery back-up, each
board also contains an auxiliary
power bus and protect control.

The boards are available from
stock at single-unit prices of \$1,650
for the SBC 032, \$2,300 for the
SRC 048, and \$2,950 for the SBC
064. OEM discounts apply to quanti-
ties of 10 or more boards.

Intel Corp., 3065 Bowers Ave., Santa Clara,
Calif. 95051. Phone Rob Walker at (408)
349-8027 [376]

HERE'S YOUR CHANCE TO TRY FIBEROPTICS.



Here for the first time is a reasonably priced, off-the-shelf fiber optic engineering kit with all the electronic and mechanical components necessary for use in TTL systems up to 5 mbps.

Augat developed it to give engineers a quick and easy way of evaluating the exciting new technique of fiber optic interconnection in their existing or prototype systems. The price

give you all you need to know to use it... even assuming no prior experience in fiber optics.

The kit contains a 5-meter length of Hytrel-f-jacketed cable terminated with ferrules that have precision ground and polished ends. All connector

5 mbps over a temperature range of 0 to 55°C without drifts or inadvertent comparator switching usually associated with non-temperature referenced pre-amps.



Cable Assembly

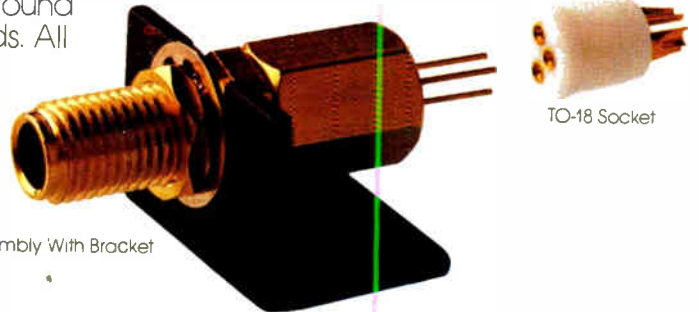

Detector Assembly With Bracket

TO-18 Socket

is right.* And the kits are in stock at Augat's nearly 200 worldwide distributor locations.

The combination of the kit's driver, emitter, cable assembly, pre-amp, and detector provide the necessary elements for a complete TTL-compatible digital fiber optic system. We've even included mounting brackets and sockets for convenience. And its comprehensive instruction manual will

elements feature gold-plated brass construction to ensure the integrity of shielded enclosures.

The temperature referenced pre-amp operates from dc to

All components of the kit are available separately. Standard accessories include butt splices, o-ring seals, and cables of other lengths. For more details and a list of Augat distributors, write Augat, Inc., 33 Perry Avenue, P.O. Box 779, Attleboro, Mass. 02703. Tel. (617) 222-2202



Driver and Pre-amp Modules

* Complete Kit (No. 698-CK-002) \$190. Kit less driver and pre-amp (No. 598-CK-001) \$99.50

† Dupont trademark

AUGAT[®]

Augat interconnection products, Isofonics microcircuit packaging, and Alco subminiature switches.

New products

Instruments

Analyzer pinpoints bus-line faults

Tester is built for instruments that are interconnected by IEEE-488 bus

When one of several instruments in an automated system interconnected by the IEEE-488 interface bus gets out of step or fails to carry out instructions, the culprit is often hard to find. To help in such situations, Fairchild Systems Technology, San Jose, Calif., has designed the model 4810 bus fault analyzer.

The unit can function as a controller as well as a passive listener. It operates at one of three speeds—single-step, two steps per second, or at a fast rate, about 400 kilohertz—and can issue commands at any of these speeds, under control of either the memory or the front-panel switches. Its 100-word memory can be used either to store control programs or to serve as a trace memory, holding up to 100 bus states. When storing a program, the

memory can be short-cycled—the program can be set up to return to its starting point or any other location without going to the end of the 100-word memory. This would be useful, for example, if a short preamble were written ahead of a program section that is to be repeated or looped, Fairchild engineers point out.

The instrument is manually programmed from the front-panel switches—eight for data, plus three for controls: SRQ (service request), EOI (end or identify), and ATN (attention). The switches are set to binary 1 or 0 for each step of the program and then stored in the memory. When running the program, the data switches are set to the first step of the loop.

In the listen mode, the analyzer will display the individual bus states in memory, storing the most recent 100 words. The data switches can be used to set the bus status on which the unit is to stop. A pulse-output connector for triggering an oscilloscope is available to the user at the rear of the instrument.

The fault analyzer is packaged in a desk-calculator type of enclosure with a sloping panel that measures about 2 inches high in front, rising to

4 in. or so at the rear.

About 12 in. wide and 10 in. deep all told, the unit also has a plastic slideout reference card, beneath the panel, containing a listing of the ASCII commands. Price of the 4810 is \$1,595.

Fairchild Systems Technology, 1725 Technology Drive, San Jose, Calif. 95110. Phone (408) 998-0123 [351]

Digital multimeters measure in current or dBm modes

Designed for use at the bench and in the field, a series of portable 4½-digit multimeters have maximum dc errors of either 0.02% of reading +0.01% of full scale or 0.05% of reading +0.05% of full scale and operate with a choice of current or dBm measuring modes. The four models feature auto and manual range selection. Ac voltage measure-



ments can be made from 100 mv full scale to 750 v in five ranges; dc voltage is from ± 100 mv to $\pm 1,000$ v in five ranges. In the resistance mode, measurements can be made from 200 Ω full scale to 20 M Ω . The dBm mode is offered in place of the five dc and ac manual current modes, which cover measurements from 200 μ A to 2 A.

The model 7141A (0.05%) and 7141B (0.02%) sell for \$395 and \$450, respectively, and the models 7142A and 7142B sell for \$445 and \$500, respectively. The latter two units include the dBm scales. Delivery time for all four instruments is





There are big differences in data logger performance. And it isn't just spec-manship. So it will pay you to investigate the Esterline Angus PD2064 before you buy any system to acquire analog and digital data from 1 to hundreds of channels

New Total Remote Programming feature lets you gather data precisely, under control of remote terminals, calculators or computers. Or with local keyboard you program the microprocessor, set and modify channel gains, select data correction functions, output units, and output device. PD2064 even includes the most powerful alarm package of any data system. In addition to the on board printer, output can be directed to nearby or remote tape recorders, calculators, data terminals, or computers.

Esterline also matches your application needs with data reduction options like true integration, and averaging. Inputs include thermocouple, RTD, and thermistor multiplexing with both high and low level MUX systems. AC/DC models for field use. In accountability technology, timing relationships are critical. That's why we use a buffered memory and crystal clock so scanning and measuring are independent of output rates. This exclusive feature avoids skewed data.

Esterline provides accountability. Ask for Bulletin B110 to keep the doctor away. Esterline Angus Instrument Corporation, Box 24000, Indianapolis, IN 46224. Tel 317-244-7611.

Check
data system
apples before
you bite



ESTERLINE ANGUS

AN ESTERLINE COMPANY

Circle 163 on reader service card

TEKTRONIX

4051* USERS

ADD-IN MEMORY



MAX 2000 is the low cost, fully compatible workspace memory that upgrades your 4051 to its top potential 32K byte operating capacity.

HIGH RELIABILITY . . . We provide a complete one-year warranty.

THE BENEFITS . . . Save at least \$1300—enough to enhance your 4051 with our ROM Packs . . . or invest your savings in one of our floppy disc systems.

THE PRICE . . . \$2500

*A product of Tektronix Inc.

SECOND SOURCE INDUSTRIES

735 ADDISON STREET • BERKELEY, CALIFORNIA 94710 • (415) 848 6600

Circle 164 on reader service card

Amazing AIRBRASIVE[®] “Wonder Tool”

It can cut or etch. Or strip and clean. Or drill and deflash. Amazing!

Try it. You'll wonder why you waited so long. You'll see why the versatile S.S. White Airbrasive tool is *the* low cost production tool for precision work on small electronic parts and components. It works on metals or glass, quartz or ceramics, the most delicate-to-handle semiconductor and crystalline materials. Airbrasive's stream of micro-abrasive particles gives you cool, shockless jet machining to the most critical tolerances. And at real savings in production time *and* labor costs. Wonder how much Airbrasive costs? Just \$825 for Model K—ideal for lab work, pilot runs, and similar light-duty, limited production. Model H, at \$1625, can deliver jet-machined production parts in high-volume to meet your most demanding production schedule.

Write for our illustrated brochure today. Or arrange for a demo and try the Airbrasive Wonder Tool on your parts. Write or call Jim McDonald, S.S. White Industrial Products, Pennwalt Corp., 151 Old New Brunswick Road, Piscataway, NJ 08854 (201) 752-8300.

®Trademark of Pennwalt Corporation

S.S. WHITE
PENNWALT
EQUIPMENT ■ CHEMICALS
HEALTH PRODUCTS

The “Wonder Tool”
AIRBRASIVE[®]



Precise and shockless enough to cut intricate patterns in an eggshell.

164

Circle 210 on reader service card

World Radio History

New products

currently running 30 days or less.
Systron-Donner Corp., Instrument Division,
10 Systron Dr., Concord, Calif. 94518 [354]

Fault finder locates shorted runs

A fault finder, the 911 Short Sniffer, enables technicians to locate and patch around shorted runs buried in multilayer circuit boards. This instrument can also be used as a diagnostic tool to aid in circuit-board failure analysis. Besides pinpointing the location of the short, the 911 will indicate the direction of the shorted conductors by issuing audible clicks that increase in frequency as the short is approached. The fault finder sells for \$275 and is available from stock to two weeks.

Idlewild Associates, P. O. Box 41, McMinnville, Ore. 97128 [355]

Meter with LCD needs little power

Using a liquid-crystal display, a low-power digital panel meter will draw only 3 mA from a 9-v battery and 6 mA from a 5-v battery. The model DM-3100U1 is a 3½-digit instrument that features balanced differential inputs but requires additional components to function as an ohmmeter, a current meter, or a voltmeter. It will display the following



unit labels: mA, A, mV, V, Ω, dc, and ac. Automatic zero correction eliminates temperature drift. An external reference source may be used for radiometric operation to scale to engineering units.

In quantities of 1 to 9 the DPM

Electronics/January 19, 1978

THE CENTRALAB EDGE in disc capacitors



Any Lead Variation You Need

At Centralab we are concerned with the same things you are – performance, reliability, on-time delivery. But any ceramic disc capacitor supplier can say that. We go that critical step further; we give you a choice of leads to help you cut your manufacturing costs.

Our standard leads include stand-off types to prevent solder damage; snap-in types to avoid fall-out during assembly; short leads for low profile; long leads for those hard-to-reach placements.

We'll go even further. On minimum OEM order, we'll make any lead configuration (under 3½") you need. Just tell us your manufacturing problem; we'll give you a cost-effective answer.

And don't forget our tape-and-reel packaging for automatic insertion.

Cost savings *in use*. That's the competitive edge you get from Centralab. The Centralab Edge.

Products you need from people who care.



CENTRALAB/USCC
Electronics • GLOBE-UNION INC.

7158 Merchant Ave., El Paso, TX 79915 (915) 779-3961

Circle 165 on reader service card

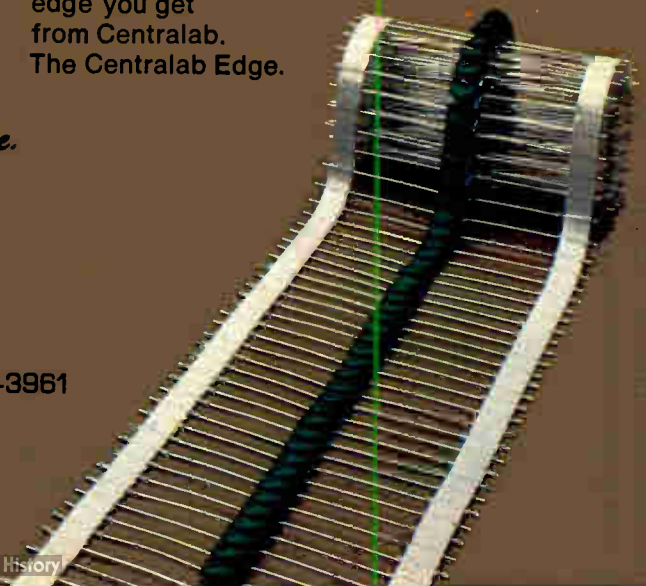

DESIGN BECKMAN TRIMMERS IN. DESIGN PROBLEMS OUT.

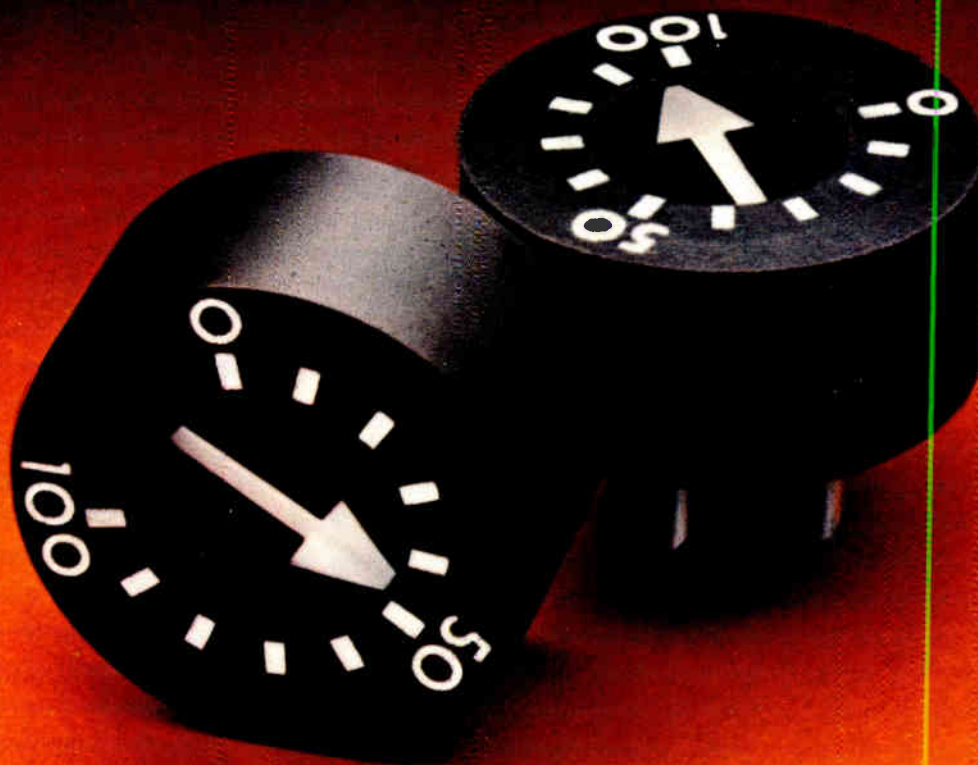

Presenting the 93P. Our new half-inch trimmer with its built-in dial is a turn for the better.

For the first time, you can have a cermet half-inch single-turn, with dial setting capabilities. A variable resistor that's somewhere between trimmer and precision pot, designed to save labor costs with position adjustability, and high-resistance capabilities.

Now you can write your manuals, and specify fast setting instructions. Using the 93P means reduced labor. It'll take less time to make that initial setting, less time to check the board. Calibration time is minimized. And the

93P has custom dial setting capabilities, too.

Cermet technology has many advantages over wire wound. With 10% tolerance, and 100 ohms to 2 meg

ohms resistance range, it wins hands-down at high resistances. Inductive problems are eliminated. And the 93P is sealed for environmental stability.

Why a larger cermet part? The longer the element, the more the power dissipation. And it stands to reason, you can get more marking and more adjustability.

Design in a trimmer that's not a trimmer as you've known it until now. The 93P.

Call your local Beckman Helipot distributor for free evaluation samples. To get his number, or immediate technical literature, call (714) 871-4848, ext. 1776. Start designing problems out today.

BECKMAN®

On top ...
even at
the bottom

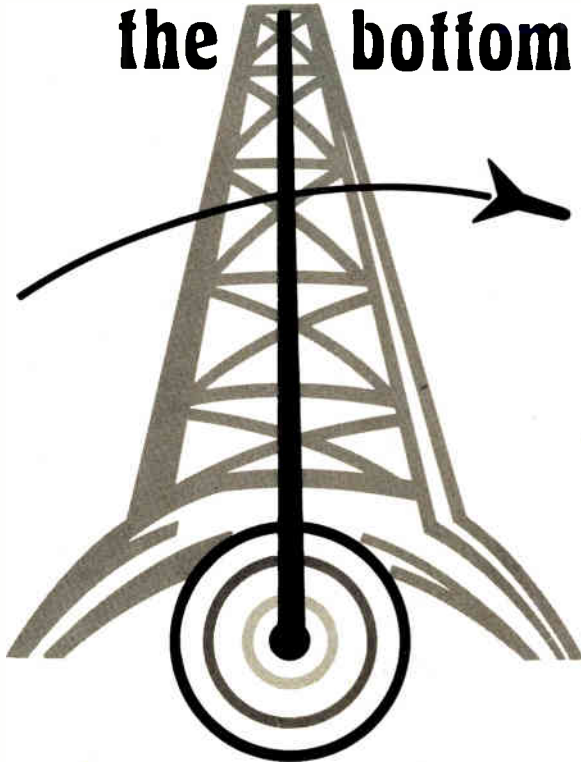

CEC® SPUTTERED GAGE PRESSURE TRANSDUCERS



From the measurement of pressure at the bottom of an oil well to the measurement of fuel system pressure on space vehicles, CEC Sputtered Gage Pressure Transducers have proven their ability to be the most consistently accurate, stable and reliable thin film transducers available.

Advanced materials and sputter deposition technology produce performance advantages over all other pressure transducers including superior accuracy, long-term stability and reliability . . . Even under the most severe environmental conditions.

Whatever your application, you owe it to yourself to learn more about CEC® Sputtered Gage Pressure Transducers. Please contact us at 360 Sierra Madre Villa, Pasadena, CA 91109. (213) 796-9381.

 **BELL & HOWELL**
CEC DIVISION

© Bell & Howell 1975

CEC is a registered trademark of Bell & Howell

170 Circle 170 on reader service card

World Radio History

New products

the streaming device. The model 835 MSD sells for \$550 and rents for \$50 a month on a two-year lease. Delivery time is 30 days.

Paradyne Corp., Largo, Fla. [405]

One-channel codec fits on two chips

The DF331 and DF332 are, respectively, a pulse-code-modulation encoder and decoder that together form a logarithmic companding codec designed to meet all Bell System

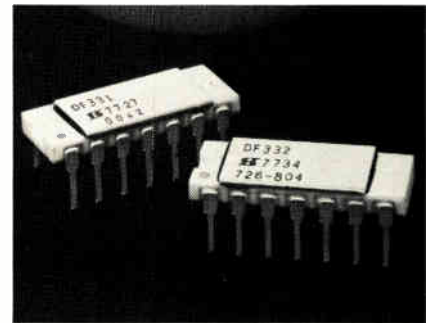

μ -255 specifications. The circuits, which are being made by Siliconix and second-sourced by Nitron, are believed to be the first such single-channel devices. Each circuit is housed in a 14-pin dual in-line package, and each requires only a single inexpensive external component to become operational. The coder requires a pull-up resistor, and the decoder requires a capacitor.

A key feature of both circuits is their complementary-metal-oxide-semiconductor technology, which gives them a typical combined power consumption of 135 mW. Not limited just to Bell System specifications, the circuits can be operated with data rates up to 3.088 MHz or to signal bandwidths as wide as 8 kHz. Pricing, in hundreds, is \$9.76 for the set. The components offered by Nitron will carry the designations NC331 and NC332.

Siliconix Inc., 2201 Laurelwood Rd., Santa Clara, Calif. 95054. Phone Jim Graham at (408) 246-8000

Nitron Inc., 10420 Bubb Rd., Cupertino, Calif. 95014. Phone Henri De Roule at (408) 255-7550, Ext. 208

Electronics/January 19, 1978

Safety. Gould Brush Recorders have it.

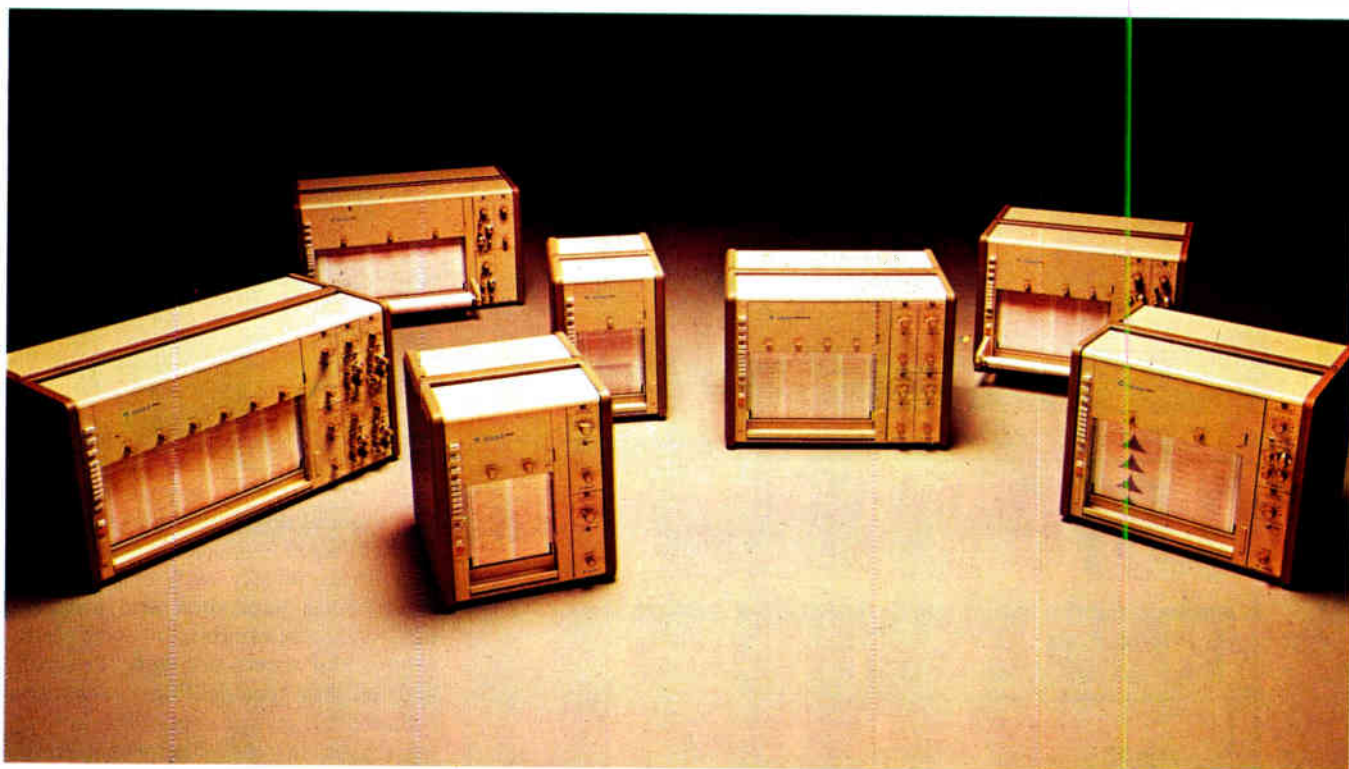

With UL 544 Listing.

The Gould Brush 2000 Series of direct writing recorders are Underwriters Laboratories Listed under U.L. 544 for professional medical equipment. They are listed for all channel configurations for both patient care and medical research application.

This extra measure of safety combines with features such as superior resolution of 99.65% linearity over the entire

channel width, uniform trace width at all writing speeds, pressurized fluid writing systems for smudge free traces and reliability through a proven modular design.

Channel choices range from 1 to 8 and the U.L. Listed signal conditioners fit every model in the 2000 Series. The Series 2000 is as versatile as your needs.

You get more with Gould

Brush 2000 Series Recorders. For details on the oscillographic recorders you should be using contact: Gould, Instruments Division, 3631 Perkins Ave., Cleveland, Ohio 44114 or Gould Allco S.A., 57 rue St. Sauveur, 91160 Ballainvilliers, France.

**FOR BROCHURE, CALL
GOULD TOLL FREE AT
(800) 325-6400 EXT. 77**
In Missouri: (800) 342-6600.

 **GOULD**

New BBN High Accuracy Accelerometers

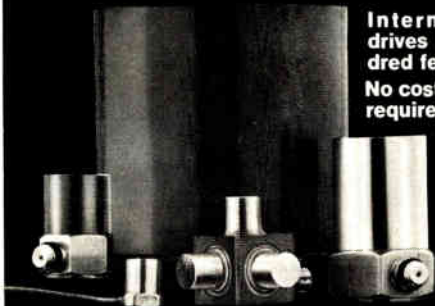

Internal preamplifier drives up to several hundred feet of cable

No costly charge amplifiers required

Complete freedom from cable noise errors associated with charge-coupled accelerometers

Available on GSA

- Miniature, low mass (2 grams), high frequency (to 20 kHz).
- Miniature Triaxial, low mass, high frequency (to 12 kHz).
- General Purpose, low cost.
- High Sensitivity (100 mV/g), low noise floor (0.0002 g rms).
- Seismic, very high sensitivity (8V/g), low frequency.
- New BBN Voltage-to-Charge Converter permits installation of our internally preamplified accelerometers into existing charge-amplifier based systems.

COMPLETE SPECS IN EEM, CEM AND GOLD BOOK

TOLL FREE 1-800-225-3333



BBN Instruments Company
50 Moulton Street
Cambridge, MA, 02138 U.S.A.
Phone: (617) 491-0091
Telex: 92-1470 Cable BBNCO

A Division of Bolt, Beranek and Newman, Inc.

Circle 172 on reader service card

1,070 LOW-COST SUBMINIATURE TOGGLE SWITCHES

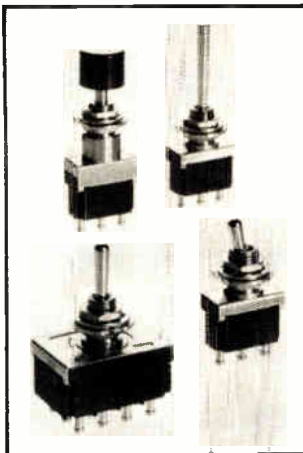

FEATURES:

- Molded-in contacts prevent flux from flowing into the switch enclosure
- Uniform height
- Creepage barriers
- Dimensions are common from SP to 4P
- Fine silver fixed and movable contacts
- Brass terminals and movable plate
- Stainless steel frames
- Gold flash on common and fixed contact terminals

SPECIFICATIONS:

- Rating 6A 125VAC, 3A at 250VAC
- Contact resistance: Less than .01Ω at 2-4VDC, 0.1A
- Insulation resistance: Over 100MΩ at 500VDC

IMPACT

325 Manville Road • Pleasantville, NY 10570
Telephone: (914) 769-2314

172

Circle 213 on reader service card

World Radio History

New products/materials

An aerosol cleaner-degreaser, Electro-Wash, is intended for electronic, electrical, and mechanical applications. It works optimally when combined with an aerosol-pulsating attachment, Vibra-Jet. The joint unit has the cleaning power of an ultrasonic bath, dislodging even encrusted contaminants. Moreover, Vibra-Jet can remove grease, dirt, and oxida-



tion without damaging the assembly. Electro-Wash is safe for plastics, evaporates quickly without leaving a residue, has good dielectric properties, is nonflammable for complete safety, and meets pertinent Federal and military specifications. It is also economical, giving users 97% active ingredient, instead of approximately 70% or less as with most other materials. Electro-Wash is available in 24-oz and 6-oz sizes.

Chemtronics Inc., 45 Hoffman Ave., Hauppauge, N. Y. 11787 [476]

A heat-resistant lead wire insulated with cross-linked polyethylene is designed for motor and transformer applications and is especially useful because it eliminates the processing problems of asbestos without sacrificing thermal, electrical, or mechanical properties. Polyrad 150 also does not irritate skin as does glass-braided silicone. This tough wire is available in 10 standard colors and in sizes from 30 to 4 AWG.

Brand-Rex Co., P. O. Box 498, Willimantic, Conn. 06226 [477]

Electronics/January 19, 1978

Processor growth: can your small computer make the upgrade?

Product	Our HP 1000 and 21MX Computers	Your old favorite
Computers	<p>21MX computers, with memory capacity of 1.8 million bytes, speeds up to 350 ns, and user microprogramming. All have compatible architecture, instruction sets, I/O and memory.</p> <p><i>K-Series</i> computer on a board: \$974*</p> <p><i>M-Series</i> low-cost computer: \$2,698*</p> <p><i>E-Series</i> high-performance computer: \$3,803*</p> <p>Instructions 70-100% faster than M-Series.</p>	
Systems	<p>HP 1000 includes 21MX-E computer, CRT console with soft keys and dual cartridges, RTE operating system. Fault control memory available to 1.8 million bytes. Easy to upgrade as your needs expand, with full selection of HP manufactured and supported peripherals.</p> <p><i>Model 20.</i> 64K-byte memory-based systems: \$21,000. 500K-byte flexible discs optional.</p> <p><i>Model 30.</i> 64K-byte disc-based system, 15M-byte disc storage: \$36,500. 5M and 50M-byte discs available.</p> <p><i>Model 80.</i> 128K-byte data base management system with 15M-byte disc storage. HP-developed IMAGE DBM software, mag tape and line printer: \$61,700. 50M-byte discs available.</p>	
Software	<p><i>One upward-compatible family of Real Time Executives:</i> RTE manages 1.8 million bytes of main memory. BASIC, FORTRAN, Assembly and Microprogramming languages. Distributed Systems Networks. Measurement and control support.</p>	

**OEM quantity 100. All other prices U.S. domestic list.*

If you've been having trouble making the upgrade with your old favorite, it's probably time you got a new one. So call your local HP sales office listed in the White Pages. Or write to Robert Puette, Hewlett-Packard, 11000 Wolfe Road, Dept. 612, Cupertino CA 95014. We don't think anyone should have to live with an incompatible family.



HEWLETT  PACKARD

Introducing the first Intelligent keyboard. It thinks like you do.

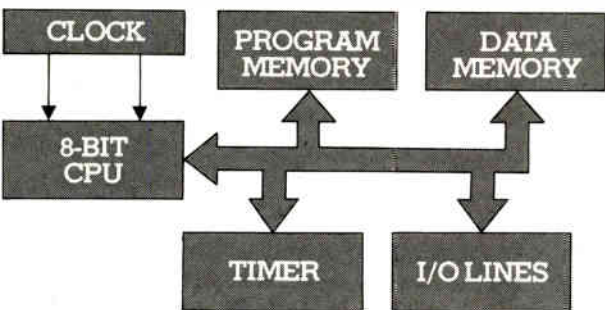

Designing a full-function keyboard for your system used to have a major problem. A full-function price.

MICRO SWITCH has changed all that with the intelligent keyboard. It's the first microcomputer-based keyboard. Ever.

Which means when you equip it with virtually every function you can think of, it still comes in for the price of a simple encoded keyboard. Because all the functions that used to require extra components are now available on a single micro-computer chip.

Besides traditional encoder functions, the chip can handle many others, such as parallel or serial data, multi-character storage and tri-stated outputs for direct data bus compatibility without using expensive I/O ports.

The intelligent keyboard can

perform more functions more efficiently because less hardware is needed. You get lower total system cost. Pin for pin compatible EPROM for faster design turnaround. Plus greater reliability since there are fewer components.

Just let us know what your particular needs are. And through MICRO SWITCH Value Engineering we'll work with you closely to create a cost effective solution that interfaces with your total system.

For more information about the intelligent keyboard, call 815/235-6600. It could be the smartest call you've ever made.



MICRO SWITCH

FREEPORT, ILLINOIS 61032

A DIVISION OF HONEYWELL

In Europe MICRO SWITCH has keyboard application engineers in Germany, England, France and Sweden.

Circle 175 on reader service card 175

When accuracy is more important than speed...

Specify Teledyne A/D Converters

In most A/D converter applications, high speed is a luxury you don't need, but often pay for. Inaccuracy, on the other hand, will almost always hurt you.

At Teledyne, we analyzed the trade-offs and decided to provide a family of A/D converters with ample speed (1 to 20ms) to handle 90% of industrial and instrumentation applications, but with the emphasis on linearity and immunity to noise. And we added a bonus: we made them easy to use; Just add 2 capacitors and 4 resistors — and you're converting.

So ask us about our 8700 series of monolithic A/D converters; 8, 10 and 12 bit binary with or without three-state outputs, and 3½ digits BCD. They are all available off the shelf; they are all reliable; they are all low power CMOS, and prices start at \$5.60 for 1K quantities.

For immediate information contact Michael Paiva at (415) 968-9241, X 241.

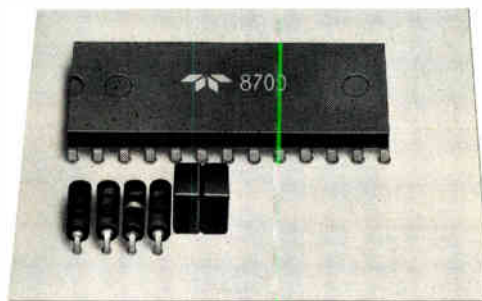

For specific information on individual A/D converters, please circle the appropriate Reader Service number, as indicated.

Binary, 8, 10 & 12 bits — 266
Three-state Binary, 8, 10 & 12 bits — 267
BCD, 3½ digits — 268
All of the above — 269

TELEDYNE SEMICONDUCTOR

1300 Terra Bella Avenue, Mountain View, California 94043 • (415) 968-9241

SALES OFFICES: DOMESTIC: Salem, N.H. (603) 893-9551; Stony Brook, N.Y. (516) 751-5640;
Des Plaines, IL (312) 299-6196; Los Angeles, CA (213) 826-6639; Mountain View, CA (415) 968-9241
INTERNATIONAL: Hounslow Middlesex, England (44) 01-897-2533; Tiengen, West Germany 7741-5066;
Kowloon, Hong Kong 3-240122; Tokyo, Japan 03-403-8141

Give your next great design idea the quality connector it deserves.

For example:

Miniature Circular Connectors – high quality at commercial prices in polycarbonate, quick disconnect, high-contact-density

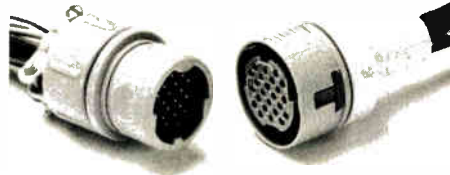

connectors that go just about anywhere. From computers and medical instrumentation where the compactness and reliability are essential – to marine and automotive use, especially where ruggedness, corrosion resistance and low cost are desired.

Relay Sockets – for just about every crystal can relay made.

Viking sockets are used for

relays with Babcock, C.P.

Clare, Deutsch, Electronic

Specialty, Hi-G, Leach, Struthers-

Dunn, Wabco and more. It's first

quality at competitive prices.

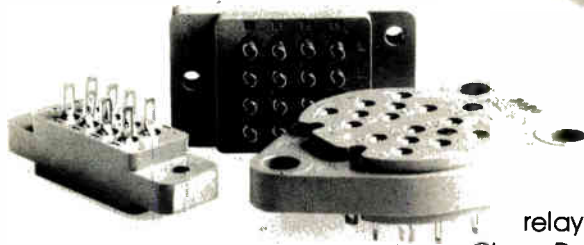

Printed Circuit Board

Connectors – one of the

broadest quality lines available. Contact centers range from 0.50 through .156, from 6 to 210 contacts, all contact designs including low insertion force, economical selective gold plating, and miniatures, to name a few.

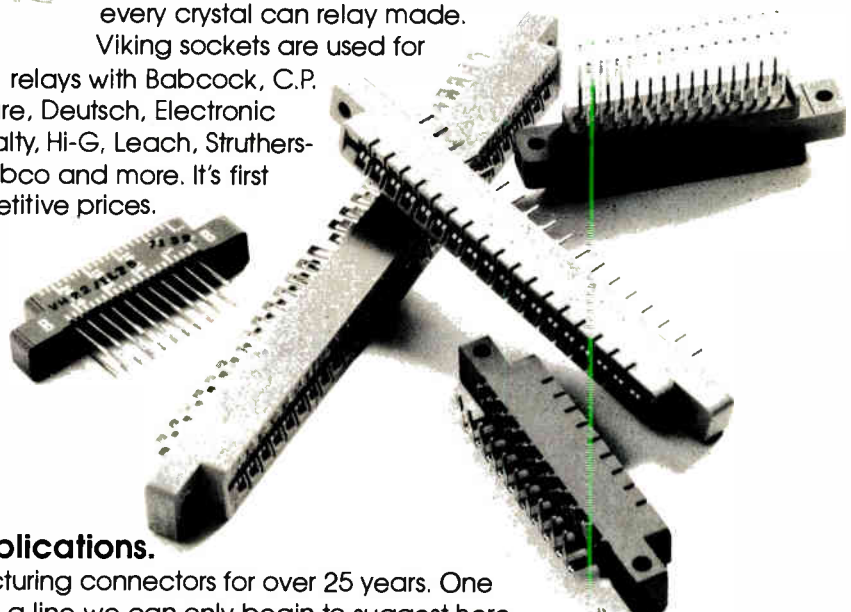

Special products for special applications.

We've been designing and manufacturing connectors for over 25 years. One result is our broad, deep connector line – a line we can only begin to suggest here. Another important result is our custom design and production capabilities with special experience in underwater, geophysical exploration and marine applications.

For full details, call our nearest representative.



Viking

CONNECTORS

Viking Industries, Inc., 9324 Topanga Canyon Blvd., Chatsworth, Ca. 91311, U.S.A. – Telephone: (213) 882-6275 – TWX 910-494-4912

New Zealand:
Terminal Distributors Ltd.
23 Edinburgh Street
Auckland, New Zealand

Switzerland:
Egli, Fischer & Co., Ltd.
Gotthardstrasse 6, Claridenhof
8022 Zurich, Switzerland

West Germany:
Selectron GmbH
Pappenheimstrasse 7/111
8 Munich 2, West Germany

Benelux:
Bodamer International BV
Havenstraat 8A
Zaandam, The Netherlands

South Africa:
Tecnetics (Pty) Ltd.
P.O. Box 56412
Pinegowrie 2123
South Africa

United Kingdom:
Viking Industries (U.K.) Ltd.
Barton Industrial Estate
Faldo Road, Barton-le-Clay
Bedfordshire, England
MK 45-4RS

Korea:
The Yeu-Da Ltd.
CPA Box 332
Seoul, Korea

Spain:
Difitronic S.A.
Provenza, 214, 5°, 2°
Barcelona 11, Spain

Sweden/Norway/Finland:
Gylling Teledata AB
Pepparvagan 27
S-123 05 Stockholm-Fersta,
Sweden

Italy:
Auriema Italia, SRL
Via Domenichino 19
20149 Milano, Italy

Israel:
Ira Curtis Ltd.
67 Brandeis Street
Tel-Aviv, Israel

Japan:
Daito Shoji Co., Ltd.
1-6 Kojimachi
Chiyoda-Ku, Tokyo 102,
Japan

Denmark:
Lars Valentin Elkington ApS
Stenlose Center 30A
3660 Stenlose, Denmark

Classified section FOR ENGINEERING/TECHNICAL EMPLOYMENT OPPORTUNITIES

CLASSIFIED SALES REPRESENTATIVES

Atlanta	Jane Core	404/892-2868	Cleveland	Mac Huestis	216/781-7000	Houston	Mike Taylor	713/659-8381	Pittsburgh	Dean Genge	412/391-1314	
Boston	Holt Buchanan	617/262-1160	Dallas	Mike Taylor	214/742-1747	Los Angeles	Stan Kassin	213/487-1160	San Francisco	M.E. Kenny	415/362-4600	
Chicago	Bill Higgins	312/751-3733	Denver	Shirley Klotz	303/837-1010	New York	Larry Kelly	212/997-3594	Stamford	Holt Buchanan	203/359-2860	
			Detroit	Mac Huestis	313/873-7410	Philadelphia	Dan Ferro	215/568-6161			XEROX 400 TELECOPIER	212/997-6800

POSITIONS VACANT

Industrial Electricity/Electronics
Professor. Theory and application teaching position. MS required. Industrial experience desired. Write Dr. Wendell L. Swanson, Chairman Dept. of Industrial Technology, Western Illinois University, Macomb, IL 61455. An E.O. and A.A. employer.

Junior Faculty Position in Integrated Circuits—Applications are solicited for a junior faculty position in the Department of Electrical Engineering and Computer Science at M.I.T. in the general area of semiconductor devices and integrated circuits. Duties include teaching in electrical engineering and/or computer science, and research and thesis supervision in integrated-circuit technology, device design and related areas. Prior industrial experience in integrated circuits will be helpful. Applicants should have the interest and ability to work with groups at M.I.T. that seek to apply semiconductor technology to a variety of fields, e.g., computer technology, signal processing, biomedical engineering, and communications. Ability to work with industrial organizations is highly desirable. Applications from women and minority candidates are encouraged. M.I.T. is an equal opportunity employer. Resumes should be sent to Professor Paul Penfield, Jr., Associate Head of the Department, Department of Electrical Engineering and Computer Science, Room 38-401, Massachusetts Institute of Technology, Cambridge, MA 02139.

EMPLOYMENT SERVICE

Electronic engineering growth positions with clients located nationally. We would be glad to consider your resume. Joe Torcassi (EE), Director, R.J. Bushee & Associates, 1001 Carew Tower, Cincinnati, OH 45202. 513/621-2015.

How To Get A Job Overseas 253 page Book! Only \$4. Transworld, Box 90802-HR, Los Angeles 90009.

OVERSEAS JOB GUIDE

Job Hunting Guide + Directory of 650 Firms. Details on job sources, resumes, taxes. US \$6.50—(US & Canada). To foreign address—\$7.50. Friar Books—EL, 8956 E. Ardenale, San Gabriel, CA 91775.

Micro Circuit Engineers

In support of our development and manufacturing of computer peripherals and instrumentation, Tektronix has for ten years designed and produced custom, in-house state-of-the-art MOS, bipolar and hybrid linear and digital IC's. The Microelectronics Components Group offers challenges and growth potential of the semiconductor industry and stability of a well established diversified corporation.

Product Engineers

Job responsibilities span all phases of circuit development from product proposal to production yield enhancement in the following areas:

- Linear—specializing in bipolar linear circuits
- Digital—specializing in LSI, preferably in NMOS or CMOS devices
- Hybrid—ranging from D.C. networks to high frequency modules

Test Engineers

Duties include design of test fixtures and/or small test systems and test programs and device and circuit characterization for these products:

- High Frequency—IC's and Hybrids
- LSI—testing PMOS, NMOS and CMOS devices
- Linear—complex linear monolithic or hybrid microcircuits

System Support Engineers

These positions have responsibilities to prepare hardware diagnostic aids for laser trimmers and automated test systems. The job also requires implementation of new hardware in conjunction with design groups and maintenance of equipment as needed.

Sustaining Test Engineer

These positions require a detailed working knowledge of automated microcircuits testing or laser trimming. Duties will include troubleshooting of production test/trim problems in conjunction with product engineers and maintenance engineers. The job will also include device characterization, data generation and analysis relating to design revisions, yield improvement and reliability tests.

IC Hybrid Reliability

Will design test equipment and circuits to measure reliability of IC and Hybrid devices and then analyze results and recommend action to improve reliability. Previous circuit design experience is necessary.

Process Engineer

Your responsibilities include implementation, process improvement and sustaining of silicon IC and/or thin film hybrids metal deposition processes. Several years experience in metal deposition, knowledge of high vacuum technology and thin film deposition processes is necessary.

Senior Process Engineer

You will be responsible for sustaining and process transfer for one or more of these processes: diffusion, photo-resist, metalization or chemical, vapor deposition. A thorough knowledge of high silicon wafer processing and a photoresist technology is necessary. Also, experience in a combination of the following areas is a plus: projection printing high resolution photo processing, solid state device physics, or high frequency IC technology.

Tektronix, Inc., is located near Portland, Oregon. Benefits include liberal insurance, educational support and profit sharing programs.

Send detailed resume and salary history to Roy Epperson, TEKTRONIX, INC., P.O. Box 500, M33, Beaverton, Oregon 97077 or call 1-800-547-1164.
An Equal Opportunity Employer M/F/H.

Tektronix
COMMITTED TO EXCELLENCE

Test Systems
Digital Test Instruments
Microprocessor Development Aids
Medical Instrumentation
Oscilloscopes
Spectrum Analyzers
Data Terminals
Logic Analyzers
Graphic Terminals
TV Products
Modular Test Instruments
Automated Test Systems
Digital Test Instruments
Microprocessor Development Aids
Medical Instrumentation
Oscilloscopes

Our vigorous growth spans the electronics field from Oscilloscope to RF Systems, Graphic Computing Systems, and Microprocessor Design Systems. Opportunity at Tektronix is definitely growing. To further advance the pace of new product development and support, we need more highly skilled professionals.

EVALUATION ENGINEERS

Working as a member of the design team, you evaluate products for compatibility, reliability, safety and completeness of design against design specifications. Evaluation will include analog, video, digital, firmware, and software products.

Experience in digital analog circuit design and familiarity with microprocessors and/or programming experience in machine, ASSEMBLY or high level languages desirable.

APPLICATIONS

Will provide technical support to customers and sales engineers on products ranging from oscilloscopes, Logic analyzers, and microprocessor systems to graphic and data terminals.

We offer competitive salaries and benefits and relocation to one of the most attractive areas of the Northwest. Our campus-like facilities are just minutes from your choice of urban, suburban or country living. Please send your resume to: Roy Epperson, TEKTRONIX, INC., P.O. Box 5000, C59, Beaverton, Oregon 97077.

An Equal Opportunity Employer M F H

LOGIC DESIGNERS

To design; logic analyzers, microprocessor development aids, graphic and data terminals, automated test systems, intelligent test instruments, controllers for disks, tape drives and printers and interfaces including RS232 and GPIB. Experience designing with analog, random or combinational logic, firmware, or microprocessors is desirable.

RELIABILITY ENGINEERS

Will collect and analyze future data to establish circuit, instrument and system reliability and will direct improvement of engineering and manufacturing practice to improve reliability.

ANALOG DESIGNERS

To design; wideband small and large signal amplifiers, DC coupled amplifiers, deflection and amplifiers for display devices, signal processing circuits, video circuits, highspeed, high resolution analog-to-digital converters, sample and hold circuits, and medical patient monitors.

Experience designing these and other circuits desirable.

POWER SUPPLY ENGINEERS

Will plan, design and test AC to DC and DC to DC power supply converters for use in our instrumentation systems. Configurations include traditional series pass and high efficiency methods. Design considerations must include EMI, thermal, reliability, U.I., and economic considerations. Previous experience in designing these types of supplies is desirable.

 COMMITTED TO EXCELLENCE

JR. & SR. ELECTRONIC ENGINEERS

If you are a BS, MS or PhD in EE or computer science with 0-7 years experience, we would like to talk to you. You are in desperate demand by electronic firms throughout the country. MAKE YOUR MOVE WHILE YOU ARE STILL YOUNG AND MOBILE.

Predictions indicate 1978 to be the most dynamic year in a decade for engineering employment. NOW IS THE TIME TO LAY THE GROUNDWORK FOR YOUR FUTURE. Don't regard your present position as a temporary holding pattern or a place to wait for a lucky break. Present positions are the action base for future moves.

RCI is a technical search firm with an outstanding reputation representing a broad base of nationwide clients serving the Electronics industry. If you are interested in advancing your career, call us or send your resume or a brief hand written description of your background including present salary and geographic preferences in confidence to:

Search Director-Room A
Regional Consultants Inc.

213 West 9th Street
 Cincinnati, OH 45202
 513/579-1513

Representing EEO Clients Only

UTILITY LOAD MANAGEMENT

AS&E is a frontrunner in power line carrier systems for controlling peak demand and automatic remote metering including time of day and load survey. As a result of our successful on-line systems, we have exciting new opportunities at all levels in sales and engineering for our ASEP™ Load Management Distribution Automation Systems.

Systems Sales Engineers

Develop the market, assist customers in determining system requirements and maintain good relationships with established customers. Requires successful record of systems sales and ability to interface effectively with technical management. An excellent opportunity for Applications Engineers with significant prior customer contact.

Electrical Engineers

Circuit analysis/design, as well as parts specification, evaluation of electronic hardware and manufacturing support. Senior and intermediate positions require BSEE and commercial and industrial product experience.

Submit resume including salary history or contact C. Lee Binnig at American Science and Engineering, Inc. 955 Massachusetts Avenue Cambridge, Massachusetts 02139. (617) 868-1600.

an equal opportunity employer m/f



SOFTWARE/HARDWARE DEVELOPMENT ENGINEERS

A workable, dual ladder promotion policy

...one of many reasons for joining
ITT Telecommunications Technology Center

Whether you choose to advance as a technical professional, or move into management, you'll have an equally rewarding career at ITT Telecommunications Technology Center. Our dual ladder promotion policy guarantees parallel promotion and salary increases.

Other reasons for joining us include our strong commitment to achieving state-of-the-art developments in telephony — in creating an advanced local digital switching system. For you, it all means a future of challenging assignments — always involving the latest technology in your specialty.

Salaries are highly competitive; benefits are excellent. Our Connecticut location provides ideal living conditions and easy access to varied cultural/educational facilities and mountain and shore recreational attractions. Apply now, and explore career opportunities in the following areas:

HARDWARE DEVELOPMENT

- Analog/Digital Interfaces
- Processor Design
- Physical Design
- Advanced Manufacturing Technology
- LSI Design
- Manufacturing Test
- Line/Trunk Circuit Design
- Microprocessor Application

SOFTWARE DEVELOPMENT

- Software Design Methodology
- Call Processing
- Signalling Systems
- Exchange Data Base
- Data Base Management
- Compilers, Loaders and Link Editors
- Operating Systems
- Microprocessor Emulation
- Test Systems
- Diagnostics and Administration

Please send resume, including salary history, in full confidence to

Mr. Robert A. VerNooy

ITT Telecommunications
Technology Center

1351 Washington Blvd., Stamford, Connecticut 06902

An Equal Opportunity Employer, M/F

IS ANYONE THERE?

Is there a better way to obtain interviews than by sending a resume out to "test the water"?

We know there is.

Changing employment to further your career can be a methodical, practical process. Another ingredient which makes the real difference is creativity. As in any field, the ability to see the normal in a unique way gets superior results.

This is the way we work to get you the interviews you need to determine whether you should make a change at this time. We will develop your long-range career path or we will simply find you a better position.

If you have a good academic record, or experience in the exciting field of Electronics—we will take it from there—in complete confidence write or call:

Mr. Gary Rocco

412/434-8484

**ROBERT CLIFTON
ASSOCIATES, INC.**

Suite 1625
301 5th Avenue
Building
Pittsburgh, PA 15222

No fees or obligations of any kind.

JOIN THE DIGITAL REVOLUTION AT TRW VIDAR

TRW Vidar is expanding rapidly... developing and marketing major new digital telephony products. Join TRW Vidar on the beautiful SAN FRANCISCO PENINSULA which encompasses the superb cultural environment of San Francisco and the unlimited year 'round recreational activities of scenic Northern California.

Our continued success and rapid growth have created numerous career opportunities throughout our organization:

ENGINEERING DUAL LADDER PROGRESSION Entry Level through Senior Scientists

SOFTWARE ENGINEERS

Microprocessor controlled design & development of software for digital switching systems (Real time assembly language).

ANALOG/DIGITAL DESIGN ENGINEERS

Requires min. BSEE and 2-10 years design experience in the following disciplines:

- PCM Transmission
- Digital Switching
- Radio/Mux/Modems
- Channel Bank
- Power Supplies

SALES ENGINEERING MANAGEMENT

Ever increasing acceptance of TRW Vidar class 4, 4½ and 5 digital switching has necessitated expansion of our field sales staff. Career opportunities exist for several key contributors possessing digital switch or related telephony sales and sales management experience. Openings exist in our MINNEAPOLIS, KANSAS, DALLAS, PITTSBURGH, ATLANTA, MT. VIEW OFFICES.

PRODUCT ASSURANCE

COMPONENT ENGINEER

Requires BSEE and 3-5 years component engineering experience, along with knowledge of IC technology and Mil Specs. Will evaluate and qualify telecommunications components, both electrical & physical characteristics, generate component specs, reports & procedures, interface with internal groups & outside vendors.

If you would like to join TRW VIDAR at this propitious time of rapid expansion, with the accompanying growth opportunities, please submit your resume, including salary history, to Jed Virts, Employment Manager, Mail Stop E01, TRW VIDAR, 77 Ortega Ave., Mt. View, CA 94040, (415) 961-1000 An equal opportunity employer M/F

MARKETING

NETWORK ANALYSTS

Requires 5-10 years telephony experience with at least 3-5 years of switching sales background. Responsible for the review and development of major telephony proposals, high level customer presentations, and creative input to marketing strategies for commercial government and international telephony markets.

PRODUCT MANAGEMENT

Several openings exist in our switching product management group. Responsibilities will include product planning and strategy development, product introduction, competitive analysis and pricing for commercial government and international telephony markets.

APPLICATIONS ENGINEERS

MICROWAVE

BSEE and 3-5 years applications engineering experience on microwave products. Responsible for systems analysis and equipment selection to support technical proposals. Familiarity with ancillary equipment such as towers, antennas, buildings and multiplex required. PCM experience desired.

SWITCHING=TRANSMISSION SYSTEMS

BSEE and 3-5 years application engineering and proposal preparation experience for central office PCM transmission and switching systems. Familiarity with trunk circuit application techniques desired.

PRODUCT SUPPORT

TECHNICAL WRITERS

Positions require AA/Electronics (or equivalent) and 2-10 years technical writing experience. Responsible for performing technical writing tasks to support high technology digital equipment and systems.

FIELD SERVICE ENGINEERS

You must have AA (or equivalent) and 2+ years telephony experience. Specific background in transmission, switching and/or Central Office Equipment Engineering highly desirable (30-50% travel).

TRW VIDAR



Stable, progressive expansion has created new openings in the following areas:

ELECTRONICS PACKAGING

B.S.M.E. or equivalent, in electronics packaging. Must be capable of assuming project responsibility for mechanical layout, design, and parts specification of electronic kits. Should be experienced in sheet metal design, plastic and metal parts casting, and have a knowledge of requirements for good RF shielding of electronic packages. Will also assist EE's in costing and scheduling products. Drafting ability essential, knowledge of high-fidelity audio systems helpful, but not required.

SOFTWARE DEVELOPMENT

Undergraduate or graduate degree in Computer Science, or equivalent experience. Must have a demonstrated ability to write operating systems, systems utilities, interpreters, compilers, and other systems desirable but not essential. This is an opportunity to write systems and applications for the new personal computers.

INSTRUMENTATION

BSEE with three or more years HF and VHF experience, for applications in oscilloscopes and test instruments. This is an opportunity for a good RF engineer with a strong interest in getting into oscilloscope and instrumentation design. Will initially share project responsibility for product design and development with an experienced instrumentation engineer, producing new products for one of the best known lines of low cost test instruments.

EDUCATION

Openings for writers of individual learning programs related to electronics and electronic servicing. Candidates for these positions should have some background in vocational education and training, writing experience, and course development. Teaching experience highly desirable. Writers with technical training backgrounds will find this position a natural one for their abilities.

In addition to a competitive salary and generous benefits package, the successful candidates can expect the finest professional surroundings. Our engineering facility features private lab areas, a relaxed atmosphere, and stable working environment. We're ideally located in a pleasant community on Lake Michigan with 90 minutes access to Chicago.

Send resumes, or call collect:

HEATH COMPANY
Benton Harbor, Michigan
49022
Attention: Ken Smith
(616) 982-3673



AN EQUAL OPPORTUNITY EMPLOYER M/F

Test and Trim Manager

This individual will manage analog and digital IC and hybrid circuit test, laser trim and test systems development groups for our custom in-house test devices. Responsible also for planning, developing and implementing necessary engineering and product test and trim capabilities.

Necessary background includes previous management experience; knowledge of present computer controlled device test, laser trim and data reduction systems; and an in depth understanding of design of analog and digital circuits and systems.

In support of our development and manufacturing of computer peripherals and instrumentation, Tektronix has for ten years designed and produced custom, in-house state-of-the-art MOS, bipolar and hybrid linear and digital IC's.

Tektronix, Inc., is located near Portland, Oregon. Benefits include liberal insurance, educational support and profit sharing programs.

Send detailed resume and salary history to Roy Epperson, TEKTRONIX, INC., P.O. Box 500, T39, Beaverton, Oregon 97077 or call 1-800-547-1164.

An Equal Opportunity Employer M/F/H.

Tektronix®
COMMITTED TO EXCELLENCE

Engineering Careers

You can get ahead faster with us than with anybody else. Here's why:

1 You are needed right now.

Our project teams are crying for good professionals who can grab hold fast.

2 You'll get a chance to prove how good you are.

Everybody is evaluated regularly; there are no missing persons at TI. If you're good, you move up fast. No matter how long the people above you have been there.

3 You'll be involved in state-of-the-art projects.

Advanced airport and airborne radars. New infrared and laser electronics applications. TI is the technological leader in literally scores

of product fields. This leadership has produced more than 7,000 patents.

4 You'll work on a complete system.

No threat of getting locked into a repetitious specialty. You'll work on a small project team. You'll interface daily with other disciplines and other phases of your overall program.

5 You'll work in a job-stable, multi-market situation.

We have a variety of products and markets. We're not heavily dependent on any one of them – and neither is your job.

Live in Dallas. The Southwest's largest and liveliest metropolitan area.

Discover all the glitter and glamour, spectacular sport and high fashion Dallas is famous for – yet an economical place to make a home. Cost of living is way below the urban U.S. average. And there's no state income tax. The country's 8th largest city has year-round sunshine plus lots of lakes and facilities to enjoy it. The area has 34 colleges, 102 major medical facilities, and a wealth of major media and entertainment.

Openings also in Ridgecrest, California.

All openings require a minimum of a Bachelor's degree and U.S. citizenship.

Software Engineers

Application and Assembly language programmers are needed for implementing control, signal processing, and auto-pilot algorithms.

RF Engineers

Engineers required in all microwave disciplines including antennas, receivers and microwave components.

Field Engineers

Will support evaluation testing of weapon systems and subsystems. Specialized experience in software/hardware design or microwave useful.

Design Engineers

Openings for all disciplines including:

- Mechanical/Structural
- Analog
- Digital

System Engineers

Will provide conceptual design definition for a wide variety of systems and subsystems.

Analysts

System analysts to work with system engineers in trade-off analysis to support system concept and definition.

Computer System Engineer

Requires MS or PhD in EE or CS and 5 years' experience in hardware and software design of real-time computer systems.

Technology Requirements Engineer

Requires MS in EE and 8 years' experience in the use of advanced semiconductor technology in system design.

Send your resume in confidence

to: Staffing Manager/P. O. Box 6015,
M.S. 222/Dept. E/Dallas, TX 75222.

TEXAS INSTRUMENTS INCORPORATED

An equal opportunity employer M/F

MEDICAL ELECTRONICS

Welch Allyn, Inc., a leader in medical diagnostic technology for over 60 years, has immediate career opportunities available for qualified engineers in our advanced systems research and development organization.

Our expanding R&D program is seeking key individuals with the following qualifications:

ANALOG SYSTEMS DESIGN ENGINEER

BSEE (or equivalent) plus experience in analog video systems. Responsibility for designing and developing state-of-the art circuits which include analog, RF, video, and high speed A/D converters. Should also have a working knowledge of CRT displays and camera systems.

DIGITAL SYSTEMS DESIGN ENGINEER

BSEE with experience in Logic and Circuit Design. Must have knowledge of TTL, CMOS, and high speed digital circuits. Should also have experience with microprocessor hardware and software systems.

Salary is open and based on experience and qualifications. Benefits include profit sharing and insurance programs with generous continuing educational support.

We are located close to the geographic center of the state, only thirty minutes from Syracuse. Our rural setting is near major universities, a major symphony, a number of excellent museums, and other cultural and entertainment opportunities. This area is famous for its winter and summer outdoor activities: Skiing, fishing, hunting, boating, etc.

If you have an interest in contributing to the advancement of medical technology, send us your resume including salary requirements to:
PERSONNEL DIRECTOR

WELCH ALLYN, INC.

Skaneateles Falls, N.Y., 13153 U.S.A.



AN EQUAL OPPORTUNITY EMPLOYER M/F

Product Marketing Engineers

The expanding Special Products Division of Intel Corporation, the memory components and microcomputer leader, has opportunities in the San Francisco Bay area for talented and experienced engineers.

You will handle the interface between field sales, customers and our Engineering staff in determining customer requirements. You will determine appropriate action to solve quality and reliability problems and to assure that all customer specifications are met. You will also coordinate customer plant visits, conduct product presentations and make occasional field trips. One of these opportunities will cover the Far East and requires fluent Japanese.

To qualify you should have a BSEE and 2-5 years product marketing experience on integrated circuit/MOS. For immediate consideration, please send your resume to Intel Corporation, Attn: John Bercen, 3065 Bowers Ave., Santa Clara, CA 95051. An equal opportunity employer m/f.

The
National
Personnel
System
Dunhill
Agency
of PORTLAND, INC.
806 S.W. Broadway
Portland, Oregon 97205 (503) 224-1850

PERSONNEL RECRUITING FOR THE ELECTRONICS INDUSTRY NATIONWIDE

Client companies nationwide from virtually every segment of the electronics industry use Dunhill of Portland to conduct talent searches.

Career opportunities are available at all levels in a wide variety of disciplines.

Forward your resume today for confidential consideration or phone:

KEITH NYMAN — (503) 224-1850
We are exclusively employer retained.

COMPUTER ENGINEER

To assist in organizing the development and hardware maintenance of our medical laboratory information systems. Experience in trouble shooting and maintaining mini computer systems (PDP-11 PDP-8) desired. Salary dependent upon qualifications. Good fringe benefits. Please submit resume to:

Carol Kopsa
Dept. of Pathology
144 M.L., University of Iowa
Iowa City, IA 52242

The University of Iowa is an equal opportunity affirmative action employer.

FOR WESTERN ACTION
Free resume preparation and distribution to exceptional fee paid opportunities. Send experience and salary history to:
The Wescott Agency
Box 4428,
Vancouver, WA 98662

We have been placing graduate
ENGINEERS
in **FEE-PAID** positions
THROUGHOUT THE U.S. since
'59. Over 1,000 client companies.
We are graduate engineers working full-time for you. Send resume & salary history today or request confidential application.
ATOMIC PERSONNEL, INC.
Suite L, 1518 Walnut St., Phila., Pa. 19102
An Employment Agency
For All Technical Fields

I'm my own boss.

I work for Schlumberger.

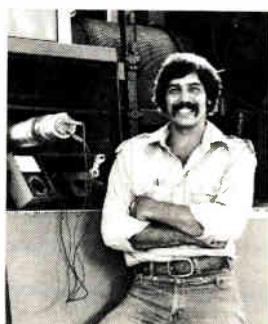

There's nothing routine about a career with Schlumberger. Just ask Larry Gutman who joined us a year ago.

"Working as a field engineer for Schlumberger is *everything* I thought it would be," says Larry. "I like to be outdoors. Work with my hands. And keep my own hours.

"I'm responsible for myself, my crew—and everything that happens on the job. It's really exciting to make things work out right.

"Some people aren't cut out for this. It takes a *special* person. I work long, hard hours—and sometimes it's tough to stay awake.

"But it's worth it. Because I'm satisfied

with myself and my work ...and you can't beat the money."

Ready for a challenge? Maybe this is for you. If you're fresh out of school with a degree in electrical engineering—or if you have no more than three years' work experience, let's talk. Just fill out the coupon and we'll tell you all about the career opportunities with Schlumberger.

Or call collect: (713) 928-4218. Openings are available in Louisiana, Texas and Oklahoma.

Schlumberger Well Services
P.O. Box 2175
Houston, Texas 77001

NAME _____
ADDRESS _____
CITY _____ STATE _____ ZIP _____
SCHOOL _____
DEGREE _____
GRADUATION DATE _____ GPA _____

**ELECTRICAL
ENGINEERS**

N

An Equal Opportunity
Employer M/F

■ Abbott Transistor Labs	35	Fairchild (Semiconductor Operations Div.)	129,54,55	‡ Profit By Air Inc.	142
• A B Telemeter	14E	Figaro Engineering Inc.	8	Pro-Log	38
Advanced Micro Devices	82,83 10,11	■ John Fluke Mfg. Co. Inc.	96,141,143	• Recal Thermionic Ltd.	139
■ Alco Electronic Products (Sub. of Augat)	166	Fujitsu America Inc.	56	RCA Solid State	7,62
■ Allen-Bradley	32	■ General Electric A & Sp Operation, Semiconductor	85	Rockwell Microelectronic Device Division	12,13
American Microsystems Inc.	90,91	■ General Instrument Microelectronics	25	Rogers Corporation	86
American Used Computer	178	General Magnetics	192	• Rohde & Schwarz	1E,9E
■ Amp., Inc.	74,75	■ Gould, Inc./Instrument Systems Div./T & M	171,87	• SDSA	23E
Ampex DpD	176	‡ Gould Inc. Electronic Components Division	60	Second Source Industries	164
Analog Devices	158	‡ Hamlin	144	■ Semiconductor Circuits	145
Ansley (Thomas & Betts)	169	■ Hewlett-Packard	66,67,18,19,1,173,110,	• Sfernice	60
■ Augat, Inc.	161	■ HI-G Incorporated	92,93	■ Simpson Electric	131
BBN Instruments Company	172	■ Hipotronics, Inc.	150	Slaughter Company	174
■ Beckman Instruments, Helipot	167	‡ Hughes Connecting Devices	136	Sperry Univac	94,95
■ F. W. Bell, Inc. Div. of Arnold Eng. & Allegheny Ludlum	166	■ Impact Electrical Products	172	Spirig	190
• Belling Lee Ltd.	24E	Information Handling Services	68,69	Sprague Electric	50,51
CEC Division/Bell & Howell Company	170	Instrument Engineering	189	Storage Technology Corp	49
Biomation	6	Intel-Microcomputer Components	152,153 20,21	Tadiran Ltd.	120
Bokers Inc.	190	Intronics	81	■ Tektronix	43
■ Bourns, Inc.	2ndC	ITAC	16	• Tektronix Datatek NV	11E
• Burr Brown	151	■ Kepco, Inc.	5	Tektronix-IDP	2
■ Cambridge Thermionic Corp.	3rdC	LH Research Inc.	159	Tektronix-MDA	70,71
Centronics	191	• Matsushita Electric Trading Company	149	■ Teledyne Relays	17
■ Centralab/USCC	165	• Membrain Limited	79	Teledyne Semiconductor	177
‡ Cherry Electrical Products	151	Memory Devices	136	Teradyne, Inc.	72
■ Clairex Electronics	4thC	Mercury Communications Inc.	16	Texas Instruments Components	88,89
• C. P. Clare International	13E	■ Micro Networks	47	• Thomson CSF	15E
Continental Rentals, Div. Continental Resources	8	Micro Power Systems	76	Thomson CSF Division D.T.E.	147
■ Continental Specialties	112	■ Microswitch, Div. of Honeywell	175	■ TRW LSI Products	45
■ D.A.T.A Books	26	Mitel Semiconductor Inc	48	• Unitrode Corporation	4E,5E
Data General Corp.	65	Monolithic Memories	52,53	Viking Industries	179
■ Data Translation (Datation)	59	Mostek Corp	22,23,	• Wandel un Goltermann	12E,18E
■ Dialight	155	Moxon	132,133	Wavetek San Diego Inc.	15
‡ Digital Equip Corp OEM 11 Group	134-135	■ National Semiconductor Corp	36-37	S S White Industrial Products	164
Digital Equipment Corporation PDP Communication	156-157	‡ NEC Microcomputers	139		
Digital Equipment Corporation	27-31	■ Non-Linear Systems, Inc.	8		
‡ Dow Corning Resins & Chemicals	149	■ O.K. Machine & Tool Company	144		
EIP a Division of Danalab	134,135	M.P. Odell Company	174		
‡ Eastman Kodak Company, Graphics Markets Div.	15	Optron, Inc.	14		
Elec-Trol, Inc.	140	• Pertec Ped	16E,17E		
■ Electro Scientific Industries	178	• Philips Elcoma	11E		
Electronic Navigation Industries	78	• Philips TMI	6E		
■ Electronic Development Corp.	160	‡ Philips TMI	79		
Essex Group Sub of United Tech	174	• Plessey Semiconductor	2E,3E		
Esterline Angus	163	■ Precision Monolithics Inc.	9		

Classified and employment advertising

F. J. Eberle, Manager 212-997-2557

AS&E	181
Atomic Personnel	186
Clifton Robert Associates, Inc	182
Dunhill of Portland, Inc	186
Heath Company	184
ITT Telecom. Technology Center	182
Intel Corporation	186
Iowa University of	186
Regional Consultants, Inc	181
Schlumberger Electrical Engineers	187
TRW Vidar	183
Tektronix	180,181,184
Texas Instruments, Inc.	185
Welch Allyn	186
Wescott Agency, The	186

■ For more information of complete product line see advertisement in the latest Electronics Buyers Guide
 • Advertisers in Electronics International
 ‡ Advertisers in Electronics domestic edition

IE MEANS ATE

We're the only ones with Field Proven Capabilities in High Speed Dynamic Testing

"The difference in software is the difference in testers."

AXIOMATIC

IE's automatic test system software is truly state of the art. More importantly, it is field proven for high speed digital/hybrid test applications.*

FEATURES

- Computer-Aided Design Capability
- Time-Domain Digital Circuit Simulation
- Atlas Programming Language
- On-Line Editing Capability
- Computer Guided Digital Probe
- Computer Guided Analog Probe

And the hardware that works with it has also been field proven for over two years.

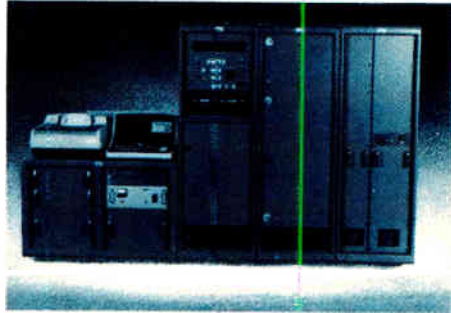

IE'S FLEXIBLE AUTOMATIC TEST SYSTEMS OFFER THE FOLLOWING FEATURES:

- REAL TIME HIGH-SPEED DIGITAL . . . for testing complex, microprocessor-based digital assemblies with multiple programmable data and strobe rates.
- REAL TIME DIGITAL INTELLIGENT PROBE . . . probe clip permits location of faulty components while functioning at high-speed data rates.
- REAL TIME ANALOG INTELLIGENT PROBE . . . analog probe permits location of faulty components, while unit under test is being exercised with dynamic functions.
- REAL TIME SIMULATOR . . . minimizes test programming costs and capable of simulating microprocessor assemblies with one nanosecond resolution.
- EXTENSIVE ANALOG CAPABILITY . . . stimulus and measurement devices which cover an extensive amount of analog capability are available in the IE system.
- INSTANT FIELD SERVICE . . . both hardware and software instantly serviced via telephone modem hookup. Exclusively by IE . . . matched by no one.

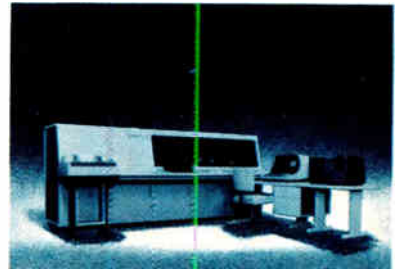

* SOME OF OUR USERS WHO HELPED US PROVE IT ARE:

NCR	8 Times
ITT	12 Times
Western Electric	10 Times
Xerox	13 Times
Siemens	9 Times
RCA	3 Times
Burroughs	2 Times
Hamilton Standard	2 Times
Sperry Rand	2 Times
Gould	2 Times

IE's automatic test systems are unrivaled for cost effective solutions to the most demanding test requirements. If you have complex testing requirements for digital, analog or hybrid assemblies, including microprocessor-based products, IE will define the most cost effective solutions. Write or call: Walter Mitchell, senior vice president, Instrumentation Engineering, 769 Susquehanna Avenue, Franklin Lakes, New Jersey 07417, 201-891-9300.



While others are talking,
we're doing it.



Our NEW CATALOG lists 3000 non-standard washers and spacers. Circle the number of this ad for your free copy.

SIZE RANGE: Available without die charge from any stampable material.
 OD: .086" to 1.935" Metal washers are tumble deburred.
 ID: .027" to 1.637"
 Thickness: .005" to .125"

For your convenience our complete catalog is now reprinted in ThoMcat. Look under Boker's in Volume 9.

BOKER'S, INC. Stamping Specialists since 1919.

3104 Snelling Ave. S., Minneapolis, MN 55406—Phone 612-729-9365
 Circle 190 on reader service card

1977 Answer Book. It makes your job easier. \$25.

"What companies make the products I need? How do I contact them locally? How do I get their current catalogs fast?"

Ask The Answer Book. Over 4000 products, more than 5000 manufacturers with their local contacts and distributors, directory of trade names and catalogs, post-paid inquiry "bingo" cards for 5-second ordering of current catalogs.

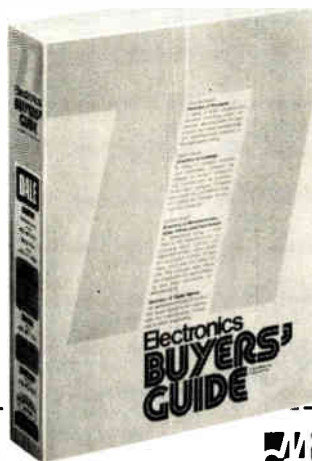

Electronics Buyers' Guide
 1221 Avenue of the Americas, N.Y., N.Y. 10020
 Yes, send me a copy of The Answer Book.
 I've enclosed \$25 (USA and Canada only,
 elsewhere send \$35). Full money back guarantee if returned within 10 days.

Name _____
 Company _____
 Street _____
 City _____ State _____ Zip _____

Advertising Sales Staff

Advertising sales manager: Paul W. Reiss
 1221 Avenue of the Americas, New York, N.Y. 10020
 [212] 997-4371

Atlanta, Ga. 30309: Michael Charlton
 100 Colony Square, 1175 Peachtree St., N.E.
 [404] 892-2868

Boston, Mass. 02116: Frank Mitchell
 607 Boylston St.
 [617] 262-1160

Chicago, Ill. 60611
 645 North Michigan Avenue
 Jack Anderson [312] 751-3739
 Robert M. Denmead [312] 751-3738
Cleveland, Ohio 44113: William J. Boyle
 [716] 586-5040

Dallas, Texas 75201: John J. Uphues
 2001 Bryant Tower, Suite 1070
 [214] 742-1747

Denver, Colo. 80203: Harry B. Doyle, Jr.
 123 Speer Blvd. #400
 [303] 837-1010

Detroit, Michigan 48202: Jack Anderson
 1400 Fisher Bldg.
 [313] 873-7410

Fort Lauderdale, Fla. 33308: Michael Charlton
 3000 N.E. 30th Place
 [305] 563-9111

Houston, Texas 77002: John J. Uphues
 601 Jefferson Street, Dresser Tower
 [713] 659-8381

Los Angeles, Calif. 90010: Robert J. Rielly
 Robert E. Boedicker, 3200 Wishire Blvd., South Tower
 [213] 487-1160

Minneapolis, Minn. 55435: Robert M. Denmead
 4015 W. 65th St.
 [612] 751-3738

New York, N.Y. 10020
 1221 Avenue of the Americas
 Michael J. Stoller [212] 997-3616
 Matthew T. Reseska [212] 997-3617

Philadelphia, Pa. 19102: Matthew T. Reseska
 Three Parkway
 [212] 997-3617

Pittsburgh, Pa. 15222: Matthew T. Reseska
 4 Gateway Center
 [212] 997-3617

Rochester, N.Y. 14534: William J. Boyle
 1175 Pittsford-Victor Rd., Pittsford, N.Y.
 [716] 248-5620

San Francisco, Calif. 94111: Don Farris
 Dean Genge, 425 Battery Street,
 [415] 362-4600

Paris: Patrick Mouillard
 17 Rue-Georges Bizet, 75116 Paris, France
 Tel: 720-73-01

United Kingdom & Scandinavia: Robert Ghey
 34 Dover Street, London W1
 Tel: 01-493-1451

Scandinavia: Andrew Karnig and Assoc.
 Kungsholmsgatan 10
 112 27 Stockholm, Sweden
 Tel: 08 51 68 70 Telex: 179 51

Milan: Luigi Rancati
 1 via Baracchini, Italy
 Phone 86-90-656

Brussels:
 23 Chaussee de Wavre
 Brussels 1040, Belgium
 Tel: 13-73-95

Frankfurt/Main: Fritz Krusebecker
 Liebigstrasse 27c, Germany
 Phone 72 01 81

Tokyo: Tatsumi Katagiri, McGraw-Hill
 Publications Overseas Corporation,
 Kasumigaseki Building 2-5, 3-chome,
 Kasumigaseki, Chiyoda-Ku, Tokyo, Japan
 [581] 9811

Business Department

Thomas M. Egan
 Production Manager [212] 997-3140

Carol Gallagher
 Production Manager International
 [212] 997-2045

Betty Preis
 Production Manager Domestic
 [212] 997-2908

Roberta Cummings
 Production Assistant [212] 997-2044

Frances Vallone
 Reader Service Manager
 [212] 997-6057

Electronics Buyers' Guide

H.T. Howland, General Manager
 [212] 997-6642

Regina Hera, Directory Manager
 [212] 997-2544

Roberta Cummings Production Manager
 [212] 997-2044

Frances Vallone, Reader Service Manager
 [212] 997-6057

Classified and Employment Advertising

Frank Eberle, Manager
 [212] 997-2557

Does "single source" make Centronics better than other printer companies?

NO. Although our 9 model 700 series of matrix printers, 4 model 6000 series of band printers, 760 series tele-

printers and new non-impact electrostatic printer give us the most complete line in the industry, it still takes more than breadth of line to be the leader.

Centronics has more. Competitive prices. The largest worldwide service organization of any printer company. Financial stability with a record of growth and strength unmatched in the business. And a track record of superior product reliability and customer support — whether OEM or end-user.

You know the advantages of a single source supply. You know the breadth of Centronics' line. And now you know why Centronics is the better printer company. Write or call today for the complete details of Centronics' full printer line. Centronics Data Computer (U.K.) Ltd., Petersham House, Harrington Road, London. Tel: 01-581 1011. Telex 8951373. Offices in Frankfurt, Paris and Milan.

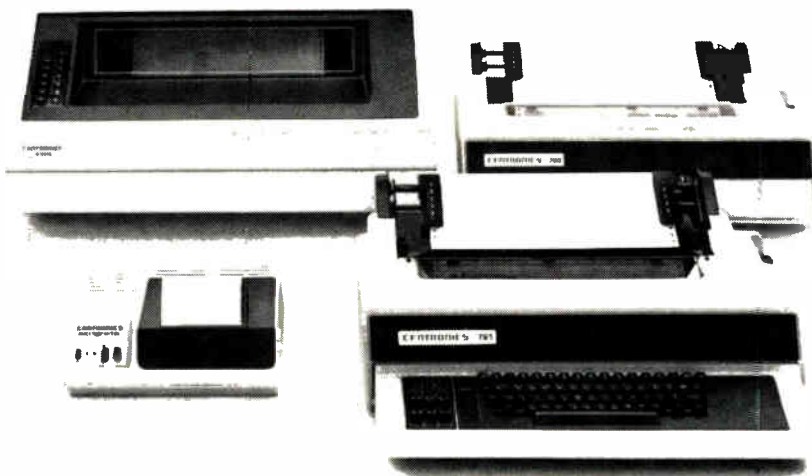

CENTRONICS® PRINTERS
Simply Better

Solid State D.C. To Synchro Converter

PROVIDES A THREE WIRE AC OUTPUT PROPORTIONAL TO A DC VOLTAGE INPUT

FEATURES:

- Develops a fully isolated 3-wire AC output proportional to a DC signal
- Maintains accuracy with tracking speeds as high as 720°/SEC
- Isolated reference input
- Accuracy is not affected by reference voltage or power supply variations
- Provides 0.5 VA output drive
- Three wire AC output developed with 15 minute accuracy
- Hermetically sealed metal package
- Package size and terminal configuration may be altered at no extra cost
- Units can be altered to meet your exact voltage and frequency requirements—in most cases at no extra cost
- Output remains constant for $\pm 10\%$ reference voltage variations
- Low output distortion ($<0.5\%$)
- Infinite resolution

SPECIFICATIONS: MAC 1562-1

- **Input signal** — 0 to $\pm 10V$ DC
- **Input signal resistance** — 10K minimum
- **Reference input** — 26V RMS $\pm 10\%$
- **Operating frequency** — 400 HZ $\pm 10\%$
- **DC power** — $\pm 15V \pm 1\%$
 $\pm 50MA$ no load
 $\pm 100 MA$ full load (139 Ω L-L)
- **Full scale output** — 11.8V AC line to line $\pm 2\%$
- **Power output** — 0.5VA max.
- **Transfer function**

$$S1-S3 = 11.8V \times \sin\left(\pi \times \frac{EIN}{10V}\right)$$

$$S2-S3 = 11.8V \times \sin\left(\pi \times \frac{EIN}{10V} + 120^\circ\right)$$

$$S2-S1 = 11.8V \times \sin\left(\pi \times \frac{EIN}{10V} + 240^\circ\right)$$
- **Accuracy***
 - 15 minutes of ARC (Max) at 20°C $\pm 10^\circ$
 - 30 minutes of ARC (Max) over the operating temp. range

* Accuracy is based on the following equation:

$$\theta = \tan^{-1} \left[\sqrt{3} \frac{(1-K)}{(1+K)} \right]$$

Where K is the measured ratio (S3-S2)/(S1-S2)

- **Tracking speed** — 720°/SEC
- **Operating temperature range** 0°C to 70°C
- **Distortion** 0.5% max.

For units to meet wider temperature range and other specifications please consult the factory.

Circle 192 on reader service card

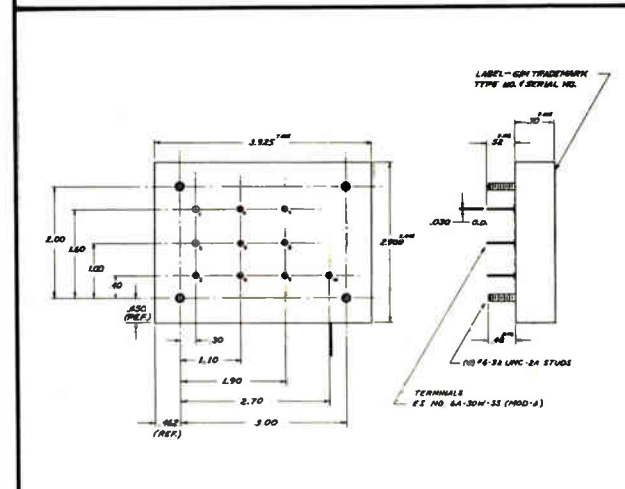
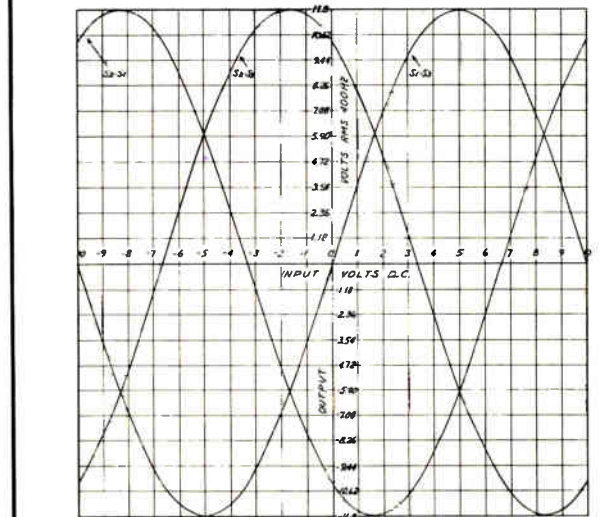

There is No Substitute for Reliability

GENERAL MAGNETICS, INC.
 211 GROVE STREET
 BLOOMFIELD, N. J. 07003

Electronics Reader Service

If the cards below have already been used,
you may obtain the needed information
by writing directly to the manufacturer,
or by sending your name and address,
plus the Reader Service number and issue date,
to Electronics Reader Service Department,
P.O. Box No. 2530, Clinton, Iowa 52734, U.S.A.

Place correct airmail
postage here ... for
faster service.

Electronics

P.O. Box No. 2530
Clinton, Iowa 52734
U.S.A.

Place correct airmail
postage here ... for
faster service.

Electronics

P.O. Box No. 2530
Clinton, Iowa 52734
U.S.A.