

SEPTEMBER 29, 1977

WHY SOVIET TECHNOLOGY IS BEHIND/77

One-chip multipliers aid signal-processing systems/93

Prototyping method eases breadboard design/104

FOUR DOLLARS A MCGRAW-HILL PUBLICATION

Electronics®

1420 N1L291 CAM6 NOV80
MATT NEILL
ELECTRONIC SPECIAL EFFECTS
3516 NE CLACKAMAS
ATLAND DR

97232

**A green
light
for auto
electronics**





Bourns resistor networks

... for the "discreet" design engineer.

Sure, you've already made a smart decision, choosing networks over discrete resistors. After all, the cost per resistor in a network package can be 40% less; they require only 10-15% of the P.C. board space needed by discretes; and component count is reduced as much as 95% with resistor networks.

But, when choosing a network supplier, you should also consider these points:

1. Bourns has the broadest network product line in the industry — over 1000 part numbers in all. And our standard DIP circuits range from simple pull-up configurations to Thevin n-equivalent ECL terminators and memory interface circuits.
2. Bourns Krimp-Joint™ offers both a mechanical and electrical bond that lap or butt joint construction doesn't provide. The lead is crimped onto the network element and a high-temp, reflow-resistant solder is used to prevent failure during wave soldering and in circuit thermal cycling and vibration.
3. Bourns was the first manufacturer to offer a complete line of off-the-shelf, super low profile SIPs with demonstrated automatic insertion capability.

These are the facts. So, now you can be even more 'discreet'. We're sure you'll specify Bourns Resistor Networks — direct or through your local distributor.

Send today for our new 1977 Resistor Networks Catalog.

TRIMPOT PRODUCTS DIVISION, BOURNS, INC. 1200 Columbia Avenue, Riverside, CA 92507, Telephone 714 781-5415 — TWX 910 332-1252.



International Marketing Offices: European Headquarters — Switzerland 042/23 22 42 • Belgium 02/218 2065 • France 01/2039633 • Germany 0711/24 29 36 • Italy 02/32 56 88 • Netherlands 70/37 44 00 • United Kingdom 01/572 6531 • Norway 2/71 18 72 • Sweden 764/20 110 • Japan 075/921 9111 • Australia 02/55-0411 03/95-9566 • Israel 77 71 15/6/7

For Immediate Application — Circle 120
For Future Application — Circle 220

**What would you get if you crossed
a rotary switch with a coded thumbwheel switch?**

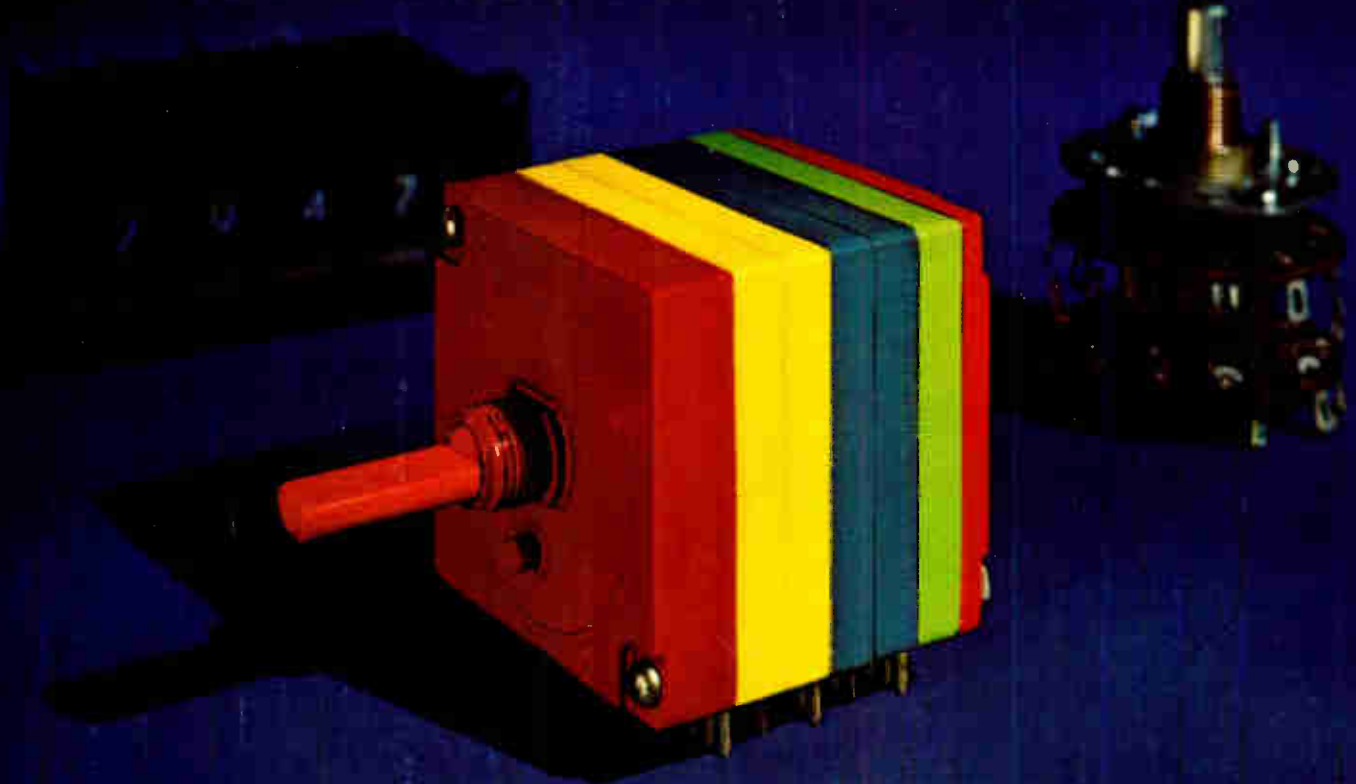

ROTOCODE A NEW KIND OF ANIMAL ALTOGETHER!

The shaft actuation of a rotary switch . . . with the coded electrical output of a thumbwheel switch. We call it Rotocode. You'll call it revolutionary! Ideal as a channel selector in CB, aircraft or marine radios and TV's. Perfect for item and price changing in vending machines. Great for quantity control in photocopy machines. Versatile enough to be modified and expanded to precisely the number of positions required . . . whether 1 or 23 or 40 or more. Modular design permits assembly of as many decks as needed for specific function. Superb for programming virtually any electronic instrumentation or equipment in place of conventional thumbwheel switches or multi-deck rotary switches.

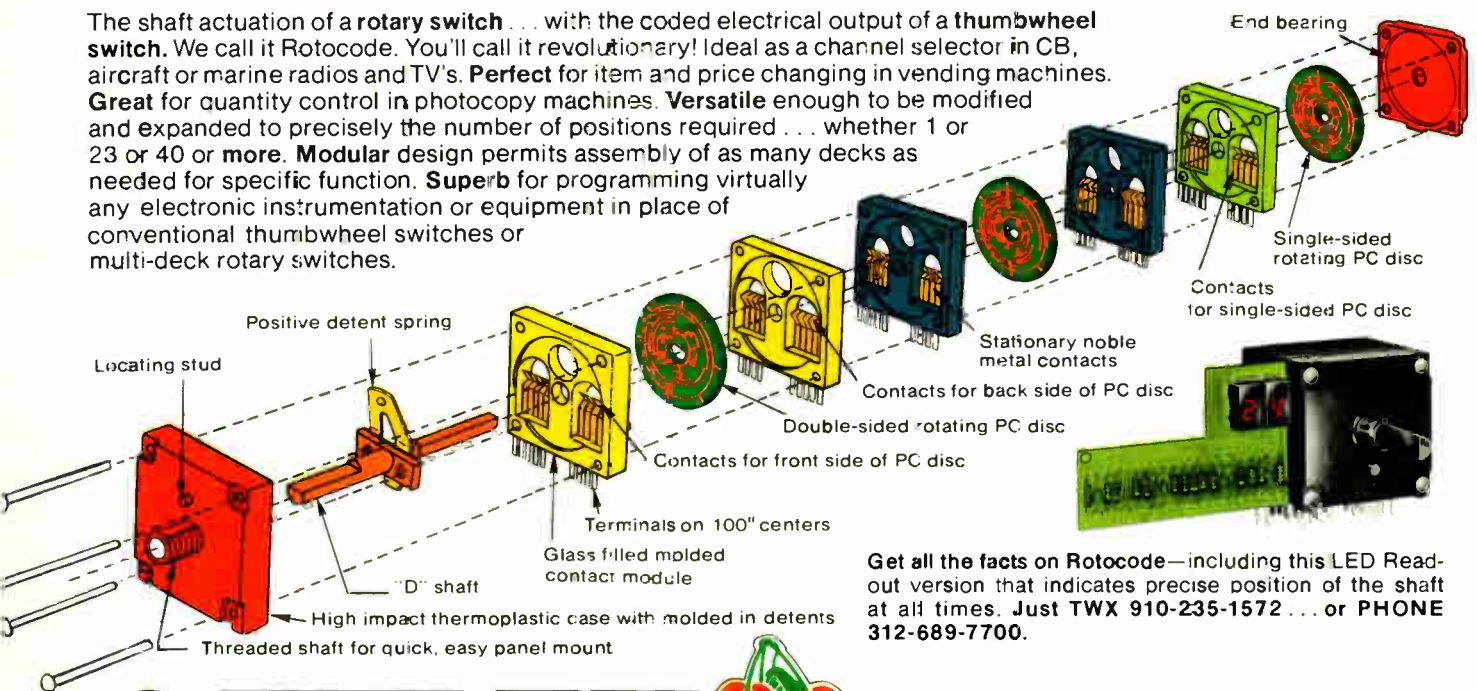

Get all the facts on Rotocode—including this LED Read-out version that indicates precise position of the shaft at all times. Just TWX 910-235-1572 . . . or PHONE 312-689-7700.



CHERRY ELECTRICAL PRODUCTS CORP.
3608 Sunset Avenue, Waukegan, Illinois 60085

SWITCHES and KEYBOARDS — Available locally from authorized distributors.

The advantages of being tiny.

At Entran, we've solved most of the problems you might encounter with pressure transducers by making them tiny. And nowadays, tiny is the state-of-the-art.

Being tiny means you don't interfere with the integrity of the system being measured.

Being tiny means less measuring surface to bear loads, and a more compact solid state density with no moving parts.

Being tiny means being insensitive to acceleration, vibration and shock, so you get flat pressure readings, both static and dynamic.

And, being tiny means greater handling ease in hard-to-get-at places. Which adds up to more applications flexibility.

Entran pressure transducers can usually be interfaced directly with scopes, recorders and milliammeters.

Our transducers come complete and ready to use. All you need supply is the excitation voltage on two leads and read output on the other two leads.

All units give you direct linear output in millivolts/psi and read both static and dynamic pressures. There's no need for charge or voltage amplifiers. Calibrations are traceable to The National Bureau of Standards.

Write Entran Devices, Inc., 145 Paterson Ave., Little Falls, New Jersey 07424. Phone: 201/785-4060, Telex 130-361.

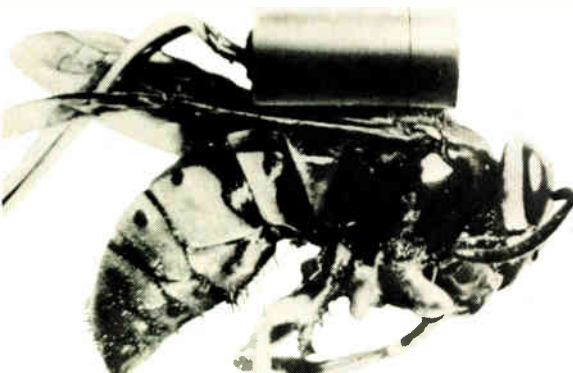

Only 0.080 in diameter (that's tiny), EPI-080.

This solid-state pressure transducer is 0.080" in diameter, 0.25" in length and occupies a volume of only 0.0013 cubic inches. Yet it gives accurate static and dynamic pressure readings like the big ones do. Its atomically bonded, diffused diaphragm with leads attached to the non-active area make this device virtually insensitive to acceleration, vibration and shock.

Typical ranges	25 psi	50 psi	100 psi	250 psi	500 psi
Sensitivity nom.	3 mV/psi	1.8 mV/psi	1.0 mV/psi	0.4 mV/psi	0.2 mV/psi
Useful frequency nom.	25 KHz	30 KHz	40 KHz	60 KHz	80 KHz

Excitation: 5V. Output impedance: 750 Ω nom. Repeatability: 0.5%.
Non-linear and hyst: \pm 1%. Resolution: infinite.

\$360⁰⁰

Must not be used in water or corrosive medium.

Tiny but easy to handle, EPS-1032

This easy to install pressure transducer is built with standard 10-32 UNF thread and is available in an optional M5 metric version. It gives flat pressure readings static and dynamic, in 5 to 5,000 psi ranges to as high as 90KHz. Has infinite resolution and is also insensitive to acceleration, vibration and shock. Made of stainless steel, and with its built-in "O" ring seal can be screwed in just about anywhere. However, for corrosive or water usage, order our "welded" version at \$50.00 extra.

Typical ranges	5 psi	50 psi	100 psi	250 psi	1000 psi
Sensitivity nom.	3 mV/psi	2 mV/psi	1.2 mV/psi	0.5 mV/psi	0.12 mV/psi
Useful frequency nom.	9 KHz	15 KHz	15 KHz	20 KHz	40 KHz

Combined non-linear and hyst: \pm 1% below 100psi, $\frac{1}{2}$ % 100 psi or above.
Excitation: 6V. Output impedance: 250 Ω nom.
Repeatability: 0.25%. Thread length: 7/16".

\$340⁰⁰

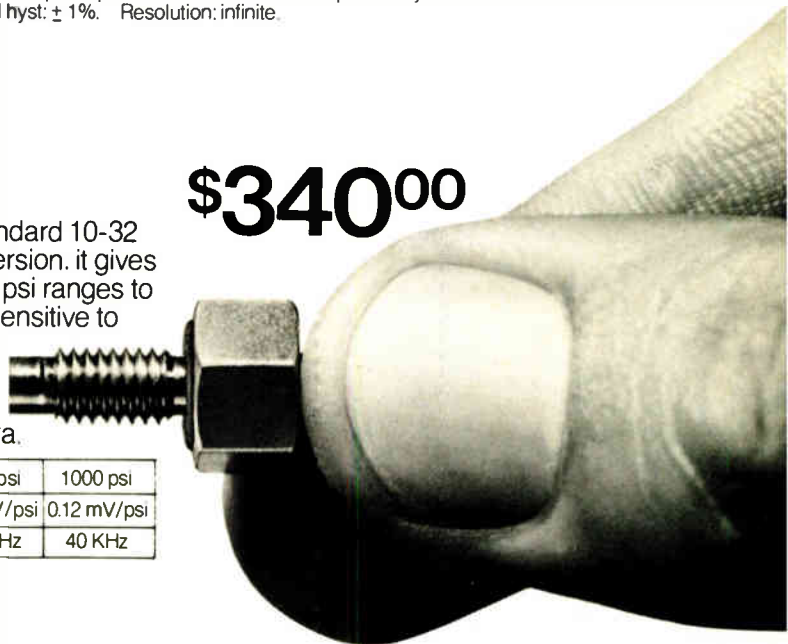

Entran Pressure Transducers.

(Today, miniature makes sense.)

- 41 Electronics Review**
MILITARY: Hologram, LCD are keys to Air Force head-up display, 41
AUDIO: Japanese readying ultrahigh-fidelity stereo, 42
TRADE: U. S. Importing more ICs from Japan, 43
MICROPROCESSORS: \$4,800 buys 6500 development system, 44
CONSUMER: Microcomputer tunes and holds frequencies, 46
NEWS BRIEFS: 48
DISTRIBUTORS: Schweber to sell Data General microcomputers, 50
INSTRUMENTS: 3½-digit multimeter hits \$49.95 low, 52
NAVIGATION: LSI-11 plays successful role in America's Cup, 52
- 65 Electronics International**
JAPAN: Multilevel storage packs bits into CCD memory, 65
GREAT BRITAIN: CCD-MOS chip makes high-performing correlator, 66
AROUND THE WORLD: 66
- 69 Probing the News**
MICROPROCESSORS: One-chip models offer new choices, 69
COMMUNICATIONS: New ITT unit has eye on the 1980s, 72
MILITARY: Navy merges San Diego labs, 74
ABROAD: Soviets rush to catch up, 77
- 83 Technical Articles**
SPECIAL REPORT: Automotive electronics gets the green light, 83
COMPONENTS: Multiplier chip advances real-time signal processing, 93
DESIGNER'S CASEBOOK: Buffer improves converter performance, 100
Timer and converter generate slow ramp for chart recorders, 103
PACKAGING & PRODUCTION: Complex breadboards without tears, 104
ENGINEER'S NOTEBOOK: Multivibrator gauges capacitor tolerance, 110
CALCULATOR NOTES: SR-52 solves second-order equations, 111
- 118 New Products**
IN THE SPOTLIGHT: Desktop computer challenges minis, 118
Dual technique pinpoints digital faults, 120
SEMICONDUCTORS: Multiplier built for on-line use, 122
PACKAGING & PRODUCTION: Tester checks all boards, 126
SUBASSEMBLIES: SCR bridges come in single packages, 132
MICROPROCESSORS: Computer serves many users, 136
MATERIALS: 142
- Departments**
Publisher's letter, 4
Readers' comments, 6
News update, 8
Editorial, 12
People, 14
Meetings, 30
Electronics newsletter, 35
Washington newsletter, 57
Washington commentary, 58
International newsletter, 63
Engineer's newsletter, 114
- Services**
Employment opportunities, 147
Reader service card, 167
Reprints available, 172

Highlights

Cover: The electronic auto is here (almost), 83

Electronic engine controls are a must to meet U. S. antipollution and fuel-economy requirements, but they are only part of Detroit's plans. Other evolving electronic systems include multiplexed setups for integrating the various sensing, control, and display subsystems and—eventually—radar-controlled cars.

Cover photograph is by Joe Ruskin.

ITT units cooperate on digital switch, 72

The new pulse-code-modulated electronic switching system from ITT-Europe is the product of centralized development by the firm's various national units. A contender for use in the digital-switching phone networks expected to predominate worldwide, System 12 will be produced cooperatively.

Digital multiplexer speeds signal processing, 93

Real-time signal processing, long the fiefdom of analog methods, is falling under the sway of digital techniques. The impetus: new devices such as the multiplier chips that speed the complex operations needed for the digital treatment.

Anyone can play, 104

Assembling a complex breadboard can be easy with a methodical approach that accounts for parts layout and power distribution. The key is an updated version of the bus bar called the power distribution element.

In the next issue . . .

Designing with mechanical filters . . . an update on computer-aided design . . . delta modulation is ready for the big time.

EDITOR-IN-CHIEF: Kemp Anderson

EXECUTIVE EDITOR: Samuel Weber

MANAGING EDITOR: Arthur Erikson,
International

SENIOR EDITORS: Laurence Altman,
Ray Connolly, Lawrence Curran,
John Johnsrud, H. Thomas Maguire,
Stephen E. Scrupski, Gerald M. Walker

ART DIRECTOR: Fred Sklenar

ASSOCIATE EDITORS: Howard Wolff,
Alfred Rosenblatt

DEPARTMENT EDITORS
Aerospace/Military: Ray Connolly
Circuit Design: Vincent Biancomano
Communications & Microwave:

Richard Gundlach
Components: Lucinda Matterna
Computers: Raymond P. Capece
Consumer: Gerald M. Walker
Instrumentation: Stephen E. Scrupski
New Products: H. Thomas Maguire,
Michael J. Riezenman
Packaging & Production: Jerry Lyman
Solid State: Laurence Altman

CHIEF COPY EDITOR: Margaret Eastman

COPY EDITORS: Ben Mason, Mike Robinson

ART: Charles D. Ciatto, *Associate Director*
Paula Piazza, *Assistant Director*

EDITORIAL SECRETARIES: Janet Noto,
Penny Kaplan

EDITORIAL ASSISTANT: Marilyn B. Rosoff

FIELD EDITORS

Boston: Lawrence Curran (Mgr.)
Pamela Hamilton

Los Angeles: Larry Waller (Mgr.)

Midwest: Larry Armstrong (Mgr.)

New York: Bruce LeBoss (Mgr.)

San Francisco: Bernard Cole (Mgr.)

Judith Curtis

Washington: Ray Connolly (Mgr.)

Frankfurt: John Gosch

London: William F. Arnold

Paris: Arthur Erikson

Tokyo: Charles Cohen

McGRAW-HILL WORLD NEWS

Editor: Michael Johnson

Brussels: James Smith

Milan: Andrew Heath

Moscow: Peter Hann

Paris: Andrew Lloyd

Stockholm: Robert Skole

Tokyo: Robert E. Lee

PUBLISHER: Dan McMillan

ADVERTISING SALES MANAGER:

Paul W. Reiss

MARKETING ADMINISTRATION MANAGER:

Wallis Clarke

CIRCULATION MANAGER: Karl Peterson

MARKETING SERVICES MANAGER:

Tomlinson Howland

RESEARCH MANAGER: Margery D. Sholes

The Soviet Union, most Moscow watchers agree, is quite a way behind the United States in applying electronics to national needs. There is no question, indeed, about the consumer electronics sector, where annual production of color television sets, for instance, accounts for only 1 million out of a total of 8 million TV sets, none of which boasts integrated circuits. In telephones, too, the Soviet Union is lagging, and it is just beginning to modernize its skimpy, decades-old system with electronic exchanges—but the first ones have had to be imported, from Britain.

The military area, to be sure, is where the Russians are doing their lion's share of electronics spending. They are not, however, telling the world much about their technological successes—and nothing about their failures, if any.

It was not an easy task, therefore, that we handed to Peter Hann, Moscow bureau chief for McGraw-Hill World News, when we asked him to report and write a profile of the Soviet Union's electronics efforts. For a view, then, of how Russian electronics endeavors are faring, turn to page 77. You'll find details on the Soviet-sponsored Comecon computer development program and some news about the country's communications satellite plans, among other things. One thing you won't find, though, is a feeling that the Soviet Union is about to close the technology gap. Indeed, reading between the lines, one might conclude that the gap is widening.

Breadboarding a new circuit almost always starts out one way and, after all the changes and second

thoughts, ends up as quite a complex assemblage of parts and interconnections. Then comes another headache: converting the prototype into production-line boards. One answer to these design hurdles is the bus-bar concept detailed in the article that begins on page 104.

Bernard Carey, author of the article, has been developing an undergraduate laboratory course in computer system design for the last two years. He was interested in finding a low-cost method for breadboarding microcomputer-based systems. Along with low cost, he wanted a physically and electronically reliable system that untrained students could easily apply. In the course of his investigation, Carey tried all the commercial breadboarding types and found them wanting.

Then, Carey was asked by Rogers Corp., Rogers, Conn., to analyze a Mostek dynamic memory board that used the company's printed-circuit bus bars as power distribution elements. As he analyzed the electrical characteristics of the Mini-Bus, Carey realized its potential for breadboarding microprocessor circuitry.

A group of graduate students, including co-author Harry Grossman, built the first low-cost breadboards based on the bus bars and Vector boards and compiled the data discussed in the article. Now this method is in regular use in the computer lab at the University of Connecticut.



September 29, 1977 Volume 50, Number 20 95,714 copies of this issue printed

Published every other Thursday by McGraw-Hill, Inc. Founder: James H. McGraw 1860-1948. Publication office 1221 Avenue of the Americas, N.Y., N.Y. 10020; second class postage paid at New York, N.Y. and additional mailing offices.

Executive, editorial, circulation and advertising addresses: Electronics, McGraw-Hill Building, 1221 Avenue of the Americas, New York, N.Y. 10020. Telephone (212) 597-1221. Teletype 12-7960 TWX 710-581-4879. Cable address: M C G R A W H I L L N E W Y O R K.

Subscriptions limited to professional persons with active responsibility in electronics technology. No subscriptions accepted without complete identification of subscriber name, title or job function, company or organization, and product manufactured or services performed. Based on information supplied, the publisher reserves the right to reject non-qualified requests. Subscription rates: in the United States and possessions \$14 one year, \$25 two years, \$35 three years; company addressed and company libraries \$20 one year, \$36 two years, \$50 three years; APO/FPO addressed \$35 one year only; Canada and Mexico \$16 one year, \$28 two years, \$40 three years; Europe \$40 one year, \$71 two years, \$100 three years; Japan, Israel and Brazil \$65 one year, \$115 two years, \$165 three years; Australia and New Zealand \$50 one year, \$70 two years, \$240 three years, including air freight; all other countries \$45 one year, \$80 two years, \$112 three years. Limited quota of subscriptions available at higher-than-basic rate for persons allied to field served. Check with publisher for these rates. Single copies: \$4.00. Please allow four to eight weeks for shipment.

Officers of McGraw-Hill Publications Company: Gordon L. Jones, President; Paul F. McPherson, Executive Vice-President; Group Vice-President: Gene W. Simpson; Senior Vice-Presidents: Russell F. Anderson; James E. Boddorf, Planning & Development; David S. Jansen, Manufacturing; Ralph R. Schulz, Editorial; Vice-Presidents: Denis C. Beran, European Operations; David P. Forsyth, Research; Douglas Greenwald, Economics; James E. Hackett, Controller; Robert L. Leyburn, Circulation; Edward E. Schirmer, Sales.

Officers of the Corporation: Harold W. McGraw, Jr., President, Chief Executive Officer, and Chairman of the Board; Robert N. Landes, Senior Vice President and Secretary; Ralph J. Webb, Treasurer.

Title registered in U.S. Patent Office; Copyright © 1977 by McGraw-Hill, Inc. All rights reserved. The contents of this publication may not be reproduced in whole or in part without the consent of copyright owner.

Subscribers: The publisher, upon written request to our New York office from any subscriber, agrees to refund that part of the subscription price applying to copies not yet mailed. Please send change-of-address notices or complaints to Fulfillment Manager; subscription orders to Circulation Manager, Electronics, at address below. Change-of-address notices should provide old as well as new address, including postal zip code number. If possible, attach address label from recent issue. Allow one month for change to become effective.

Postmaster: Please send form 3579 to Fulfillment Manager, Electronics, P.O. Box 430, Hightstown, N.J. 08520.

a multi-output* power supply

KEPCO

MPS 620M

a convenient bench-top power supply
offering voltage/current combinations
required for IC's and microprocessors

* 0 to 6 Volts, 5 Amps and 0 to ± 20 Volts, 1 Amp each

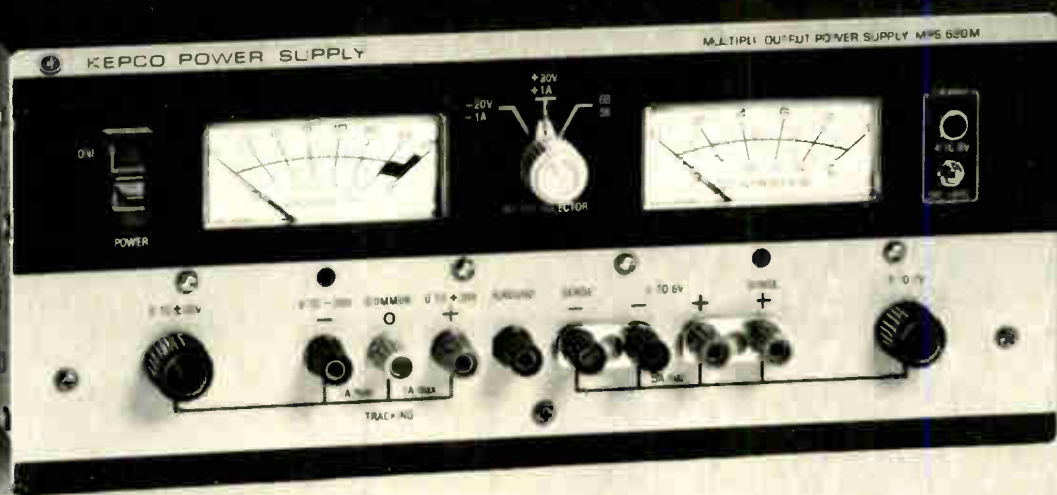

Call your local Kepco rep for a demonstration or write Dept. AZF-14.

KEPCO

KEPCO, INC. • 131-38 SANFORD AVENUE • FLUSHING, N.Y. 11352 U.S.A. • (212) 461-7000 • TWX # 710-582-2631 • Cable: KEPCOPOWER NEWYORK

World Radio History

Circle 5 on reader service card

CAN YOUR POWER SUPPLY RUN THE GAUNTLET?

Readers' comments

No ground

To the Editor: A potentially troublesome error appears in my schematic (Fig. 1) ["Wideband preamp and LSI pair form high-quality counter," Sept. 1, p. 108]. The left side of S_2 should not be connected to ground. The ICM 7207 contains an internal pulldown, and closing S_2 would short the power supply.

I have also noted that some of the ICM 7207s tested require a resistor of 1 to 5 kilohms from pin 12 to V^+ in order to scan the display.

James A. Mears
Dallas, Texas

Maintaining balance

To the Editor: For Mr. Nissink's bias-current network ["Bias-current network improves sample-and-hold response," Sept. 1, p. 111] to be effective, the LM307 would have to be individually selected to have nearly equal bias currents. The bias offset of this op amp is 50 nA maximum, with no minimum specified bias current. This means that the bias current in one input could, for example, be 1 nA while that in the other input is 51 nA, in which case Mr. Nissink's circuit wouldn't help much to minimize drift. Nevertheless, his idea is deucedly clever.

D. Hileman
Woodland Hills, Calif.

■ According to Bruno Walmsley, applications engineer at RCA, bias currents at the inputs of the LM307 are almost always balanced to within 5%. The condition cited by reader Hileman would be extremely unlikely.

Association vs union

To the Editor: Perhaps I am misinterpreting Mr. Pereda in Readers' Comments [Sept. 1, p. 6], but he appears to advocate unions for the protection of mediocrity in engineering. . . .

I don't know anything about the activities of the American Medical Association and I doubt that they are a union in the sense that most of us think of unions. Perhaps a similar organization for engineers would be very beneficial. . . .

Craig West
San Jose, Calif.

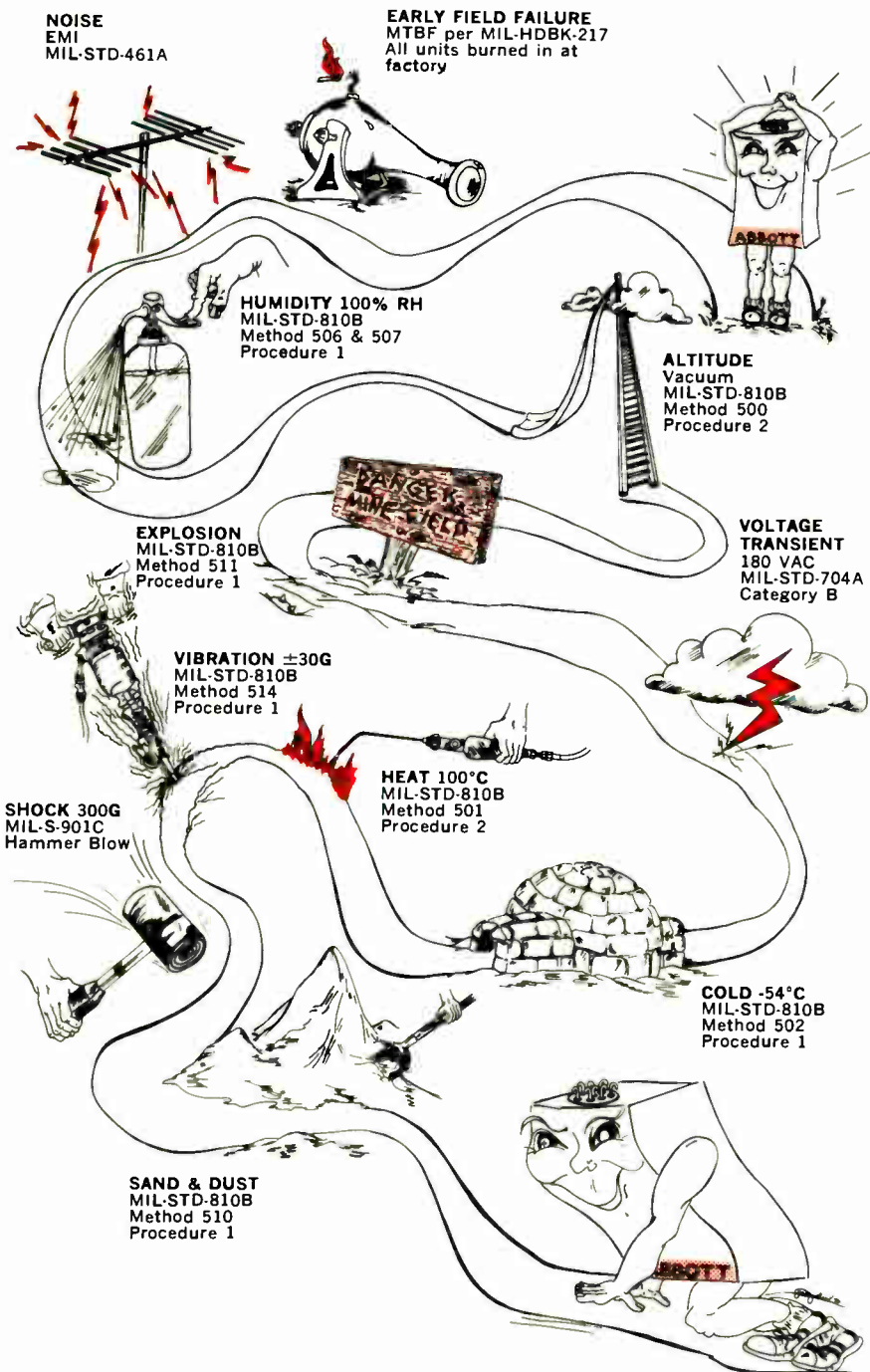

Abbott's hermetically sealed power supplies have run this gauntlet many times. Each and every unit is subjected to rigid quality control procedures and extensive testing at our factory to insure that it will pass the most important test — your gauntlet.

Please see pages 1836-1848 of your 1976-77 EEM (ELECTRON ENGINEERS MASTER Catalog) or pages 676-682 Volume 2 of your 1976-77 GOLD BOOK for information on Abbott Modules.

Send for our new 60 page catalog

abbott transistor
LABORATORIES, INCORPORATED

GENERAL OFFICES
5200 W. Jefferson Blvd.
Los Angeles, CA. 90016
(213) 936-8185
Telex 69-1398

EASTERN OFFICES
1224 Anderson Ave.
Fort Lee, N.J. 07024
(201) 224-6900
Telex 13-5332

The world's only precision low-power op amps: PMI's OP-08 and OP-12.

When you have one of those demanding applications—like a piece of precision portable or space-bound equipment—you've probably hankered for an op amp that would give you lower offset voltage and lower offset voltage drift than the 108A. And, while we're at it, better overall specs.

By George, we've got it.

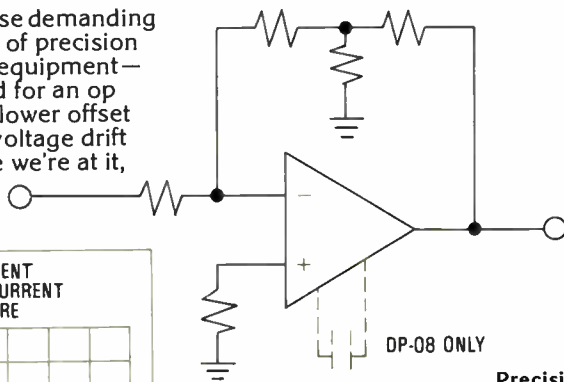
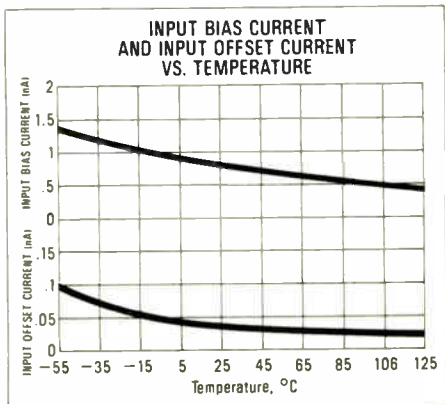

How did we come up with the OP-08 and OP-12?

How did we do it? By being fussier. By using our proprietary ion-implantation and zener-zap trimming processes. By careful design: completely balanced input stage and second stage, and proprietary output design to drive a 2Kohm load. By careful fabrication. And by QA like nobody else in the industry.

When you have to go quality and performance all the way, it's good to know that PMI's OP-08 and OP-12 are available—on your distributor's shelf—right now.

Hybrid Designers: You can order the OP-12 in chip form.

If you'd like to get your hands on an OP-08 or an OP-12, just write us (on your company's letterhead) and we'll send a sample and a data sheet. Be glad to, in fact. After all, when you make the only chip of its kind, it pays to advertise.

Precision Monolithics Incorporated
1500 Space Park Drive
Santa Clara, California 95050
Telephone: (408) 246-9222
TWX: 910-338-0528
Cable: MONO

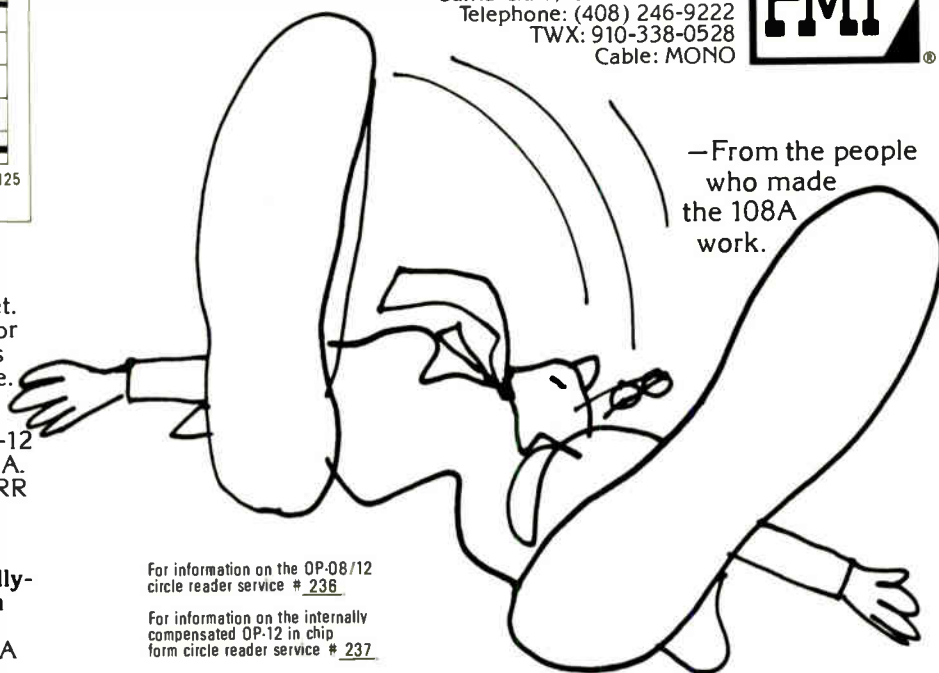
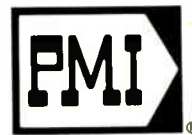

—From the people who made the 108A work.

For information on the OP-08/12 circle reader service # 236

For information on the internally compensated OP-12 in chip form circle reader service # 237

PMI's new OP-08's and OP-12's are the **only** precision, low-power, low-input-current op amps on the market. They are pin-for-pin replacements for 108A's and 308A's in all applications to give you even better performance. Here are the key specs:

Offset voltage of the OP-08 and OP-12 is three times lower than the LM108A. Voltage drift is two times lower. CMRR and PSRR are at precision levels.

And for battery and solar-powered systems, the **OP-08 and its internally-compensated twin, the OP-12**, each drive a 2kohm load—**five times** the output current capability of the 108A and 308A.

Electrical Characteristics $V_S = \pm 15V$	OP-08A/OP-12A OP-08E/OP-12E			OP-08B/OP-12B OP-08F/OP-12F			OP-08C/OP-12C OP-08G/OP-12G			Units
	Min	Typ	Max	Min	Typ	Max	Min	Typ	Max	
Input Offset Voltage	—	0.07	0.15	—	0.18	0.30	—	0.25	1.0	mV
Offset Voltage Drift	—	0.5	2.5	—	1.0	3.5	—	1.5	10	$\mu V/^\circ C$
Input Offset Current	—	0.05	0.20	—	0.05	0.20*	—	0.08	0.50	nA
Input Bias Current	—	0.80	2.0	—	0.80	2.0*	—	1.0	5.0	nA
Output Voltage Swing $R_L = 2K$	± 10	± 12	—	± 10	± 12	—	± 10	± 12	—	V
Common Mode Rejection Ratio	104	120	—	104*	120	—	84	116	—	dB
Power Supply Rejection Ratio	104	120	—	104*	120	—	84	116	—	dB
Power Consumption	—	9	18	—	9	18	—	12	24	mW

*For OP-08B/08-12B

Want 90 DVM's for 90 days?



At 90 different places? For short-term, peak DVM needs, call the "Instrument Professionals". They can put the models you need, when and where you want them. Rental is the economic answer to training, field retro-fit or other short-term DVM needs.

Write or call for data on our other specialties: Instrument Leasing • Computer Peripherals • Equipment Sales • Instrument Service.

Circle 8 on reader service card

Get our
FREE
Catalog

Call Continental Rentals

Div. Continental Resources, Inc.
175 Middlesex Turnpike, Bedford,
MA 01730 (617) 275-0850

FOR IMMEDIATE RESPONSE CALL:
N.E. (617) 275-0850; L.I. (516) 752-1622;
NY, NJ (201) 654-6900;
Gr. Phila. (609) 234-5100;
Wash., D.C. area (301) 948-4310;
Mid West (312) 439-4700;
So. Central (214) 690-1706;
Costa Mesa, CA (714) 540-6566;
L.A., CA (213) 638-0454;
Santa Clara, CA (408) 735-8300.

News update

Gas-discharge display terminals have taken a giant step toward direct competition with cathode-ray-tube types in military computer peripherals. This comes with first deliveries this month of "second-generation" gas-discharge, or plasma, terminals from Interstate Electronics Corp. of Anaheim, Calif. [*Electronics*, Feb. 17, p. 91]. The PD 2000 terminals are for Systems Development Corp. in nearby Santa Monica and will be integrated into a telemetry information processing system for the Air Force's Space and Missile Test Center at Vandenberg Air Force Base, Calif.

The plasma display has been the leading candidate to succeed the CRT ever since the first commercial gas-discharge panel was introduced in 1971. Yet terminal manufacturers were slow to adopt it, largely because the discrete circuitry needed to drive the display was too complex and expensive. But now that Interstate has incorporated microprocessors and other ICs in its designs, the picture for plasma terminals looks much brighter.

The ruggedized PD 2000 and a commercial-grade PD 1000, both available now and selling for \$10,000 and \$8,900 respectively, "are priced at a level competitive with CRT-based terminals of like performance," claims Sid Wing, Interstate's computer products marketing manager.

Weighing less than 50 pounds and occupying less than two cubic feet, both models have a maximum writing speed of 8,333 characters/second for a 5-by-7 character. They come with such standard features as dual-font, upper- and lower-case alphanumeric, full graphics capability, interface keyboard, and control command functions for over 70 different commands.

In addition to the SDC contract for 26 PD 2000s at a cost of over \$300,000, Interstate has orders for several other PD 1000s and 2000s. However, it has orders approaching 400 units for a new fully militarized model that can be mounted in a half-rack, the PD 3000, to enter full production after Jan. 1, 1978.

Bruce LeBoss



TOUCH TONE* ENCODERS ARE MICROPROCESSOR CONTROLLABLE MODEL 510 & MODEL 511

Provide
true sinewave outputs
low distortion < 1%
no external components
required
Low profile packaging
*Reg TM of AT & T
FDI also manufactures
Active Filters, Sinewave
Oscillators, Touch Tone* Detectors
and other Communications components.
Frequency Devices, Inc.
25 Locust Street
Haverhill, Mass. 01830
(617) 374-0761, TWX 710-347-0314

Circle 3 on reader service card

*Our Strict Production
Control System with
Full Automation Guarantees
Quality and Uniformity
of Products.
This is Our Everlasting Target.*



Miniature lamps: Sub-miniature lamps:
Various base caps: All other parts for lamps:
For further information and your problem settlement,
contact us immediately

SAKATA MANUFACTURING CO., LTD.

14-12, 3-Chome, Hatanodai,
Shinagawa-ku, Tokyo, 142, Japan
Cable Address: "SAKATABASE" TOKYO.
Tel: (03) 781-6078

Circle 7 on reader service card

With new solid-state options ...

RCA helps you make discoveries in power design.

New devices. New packages. New parameters. All from the Powerhouse, your source for the widest choice in SCRs and Triacs. They offer you the latest ways to improve design, reduce costs and increase performance.

A new way to heat. Solid-state induction heating is now entirely feasible, thanks to our new 40A asymmetrical SCR (ASCR). The RCA S7310 gives you 40 kHz frequency, high voltage and current. Plus high di/dt and dv/dt capability. No need for 50/60 hertz transformers and other bulky parts.

A new way to switch. Now you can design-out some of the problems you've had with big dc relays—such as too much cable bulk in cars. Use our new plastic G4000 Series gate turn-off SCRs (GTOs)—they can switch up to 15 amps with as little as -6V gate turn-off voltage.

A new source for the C106. This popular 4A general purpose SCR and corresponding sensitive-gate triac are now available from RCA. In the economical, easily mounted 3-lead Versatab package.

New design flexibility for you. From RCA.

Family	V _{nom} (V)	I _T (A)	I _{GT} (mA)	Description	Pkg.
S7310	50-600	40	50-100	Fast Asymmetrical SCR	T0-48
G4000	50-400	15	3	Gate Turn-off SCR	T0-220
S860	50-600	100	200	Gen. purpose SCR	1/2" stud
S5800	100-600	5	50	Fast switching SCR	T0-220
C106	15-600	4.0	0.200	4 amp gen. purp. SCR	T0-202
T2320	50-400	2.5	3-40	Sensitive-gate triac	T0-202
T6000	50-600	15	10-50	Gen. purpose triac	T0-220

A new source for circuit ideas. "Power Options from the Powerhouse" is a new designer's guide to the selection of optimum RCA solid-state devices for power circuits. It's arranged by application, with over 40 circuits shown. This makes it easy for you to choose the type best suited to the job.

For your free copy, contact RCA Solid State headquarters in Scmerville, NJ; Sunbury-on-Thames, Middlesex, England; Quickborn 2085, W. Germany; Ste.-Anne-de-Bellevue, Quebec, Canada; Sao Paulo, Brazil; Tokyo, Japan.

RCA Power experience is working for you.

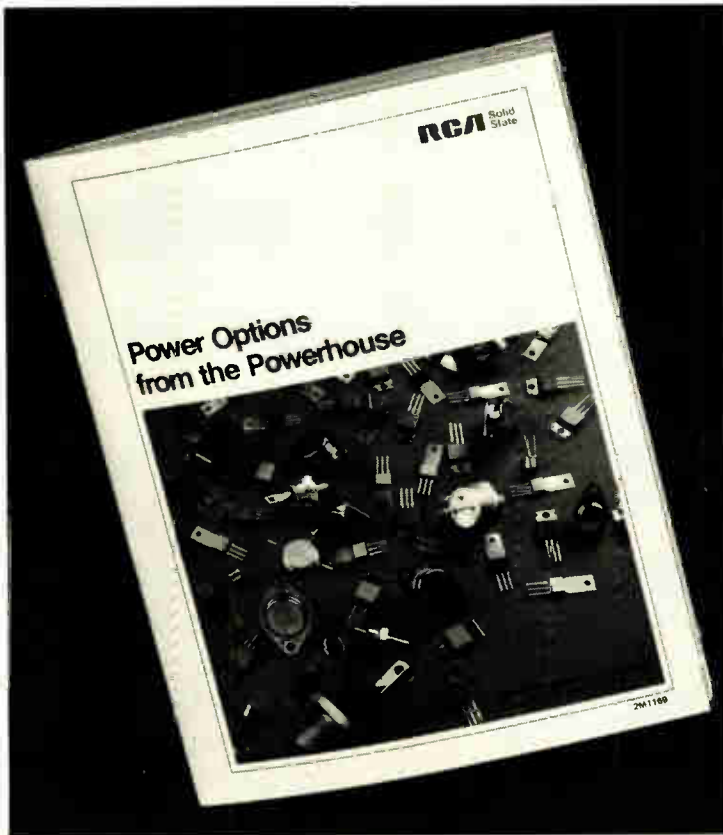

Circle 9 on reader service card

RCA

**8-bit
DAC's that
think
otherwise.**

They come in 8-bit packages. They cost an 8-bit price. We keep telling everyone that they're 8-bit DAC's. There's only one problem: they don't think so. They think they're 12-bit DAC's.

Advanced Micro Devices announces a new family of 8-bit, companding D/A Converters: Am6072/73 for telecommunications systems, and Am6070/71 for industrial control systems. (Am6070 and 6072 are built to μ -law specifications; Am6071 and 6073, to A-law.)

Their logarithmic transfer function consists of 15 linear segments, or chords. A particular chord is identified with a sign bit input and three chord select input bits.

Each contains 16 uniformly spaced linear steps determined by four step select input bits. This gives you a dynamic range of 72db—the same as a 12-bit linear converter!

The new industrial converters, Am6070/71 can be used in servo controls, digital recording, microprocessor oriented control systems, data transceivers, data acquisition and control, industrial controls, measurement, automation and pollution monitoring. Wow!

Plus Advanced Micro Devices, being the helpful and thoughtful servant we are, supplies a complete package of supporting components for our companding converter systems. (Neat stuff like Sample/Hold LF398, successive approximation registers and comparators.) And, we're the only guys who do.

The Am6072/73. Perfect for your low-cost telephone system. The Am6070/71. Perfect for your industrial control problems. You pay for 8-bits, but you get 12-bit capability, plus everything else you need, all under one roof. Send for the applications note. Just ask for the 8-bit DAC's that think otherwise.

Advanced Micro Devices

Bipolar LSI. N-channel, silicon gate MOS. Low-power Schottky.
Multiple technologies. One product: excellence.



Advanced Micro Devices, Inc. • 901 Thompson Place, Sunnyvale, California 94086 • Telephone (408) 732-2400 •
Distributed nationally by Hamilton/Avnet, Cramer and Schweber •
Distributed regionally by Arrow, Bell, Century, Future, RAE and Sheridan.

Circle 10 on reader service card

Gearing up for the auto market

Semiconductor makers have long looked wistfully at the automobile industry as a huge untapped mass market for their products. And no wonder. Take 10 million vehicles and multiply that figure by dozens of integrated circuits—now including microprocessors, their necessary add-on memory, and custom input/output chips. Then do that multiplication every year, inserting the relevant cost per device, and you come up with one of the most enticing long-term markets ever created. What's more, the fast-paced history of semiconductor development is full of cases where the technological progress achieved in meeting one market's needs has led to widespread growth in many other fields as well.

It is hardly a surprise, then, that the semiconductor makers are eager for Detroit—to say nothing of the other auto capitals of the world—to make the big jump to electronic controls. For years, they have been tempted by all sorts of talk about antiskid braking, ignition spark-timing controls, and indeed, by a whole new world of microprocessor-based vehicle-control systems.

It is no surprise, either, that they—the pacesetters in electronics technology—have been impatient with the auto industry's tradition of slow, if not quite glacial, movement toward change. Where five months might be the lead time to develop an important new electronic device, five years is more likely to be quoted when an auto executive is asked how soon some major change is likely to show up in cars.

The Federally mandated gas-economy and

emission-control regulations, however, are forcing Detroit into a higher gear. Yet, with a track littered with advanced-technology failures and ahead-of-their-time nonstarters, the auto industry has every reason to be cautious in how fast it applies technological advances from other fields.

Over the long run, too, semiconductor manufacturers may end up appreciating Detroit's step-by-step approach to letting integrated circuitry transform the car as we know it today. After all, it would be hard to recover from the black eye caused by the failure of premature, hastily designed electronic controls. Then, too, electronic controls might work just fine right now, but suffer a setback with the public if, say, sensing elements were not yet up to the job.

Functionally, electronic controls are up to the job. Yet to be resolved, however, are some problems peculiar to the automobile itself. One big need, of course, is for a fail-soft or limp-home capability so that motorists can drive, however slowly or inefficiently, to a repair shop. After all, even with 40,000-mile tires, the spare is still there in the trunk. Another important consideration, too, is the retraining of mechanics so that they can service cars that are going to be more dependent on electronics every year.

The real challenge to the electronics companies that hope to cash in on the automobile market is not producing the devices. The challenge is making them work so reliably that they are virtually invisible to drivers.

IE MEANS ATE

We're the only ones with Field Proven Capabilities in High Speed Dynamic Testing

"The difference in software is the difference in testers."

AXIOMATIC

IE's automatic test system software is truly state of the art. More importantly, it is field proven for high speed digital/hybrid test applications.*

FEATURES

- Computer-Aided Design Capability
- Time-Domain Digital Circuit Simulation
- Atlas Programming Language
- On-Line Editing Capability
- Computer Guided Digital Probe
- Computer Guided Analog Probe

And the hardware that works with it has also been field proven for over two years.



IE'S FLEXIBLE AUTOMATIC TEST SYSTEMS OFFER THE FOLLOWING FEATURES:

- REAL TIME HIGH-SPEED DIGITAL . . . for testing complex, microprocessor-based digital assemblies with multiple programmable data and strobe rates.
- REAL TIME DIGITAL INTELLIGENT PROBE . . . probe clip permits location of faulty components while functioning at high-speed data rates.
- REAL TIME ANALOG INTELLIGENT PROBE . . . analog probe permits location of faulty components, while unit under test is being exercised with dynamic functions.
- REAL TIME SIMULATOR . . . minimizes test programming costs and capable of simulating microprocessor assemblies with one nanosecond resolution.
- EXTENSIVE ANALOG CAPABILITY . . . stimulus and measurement devices which cover an extensive amount of analog capability are available in the IE system.
- INSTANT FIELD SERVICE . . . both hardware and software instantly serviced via telephone modem hookup. Exclusively by IE . . . matched by no one.



IE's automatic test systems are unrivaled for cost effective solutions to the most demanding test requirements. If you have complex testing requirements for digital, analog or hybrid assemblies, including microprocessor-based products, IE will define the most cost effective solutions. Write or call: Walter Mitchell, senior vice president, Instrumentation Engineering, 769 Susquehanna Avenue, Franklin Lakes, New Jersey 07417, 201-891-9300.

* SOME OF OUR USERS WHO HELPED US PROVE IT ARE:	
NCR	8 Times
ITT	12 Times
Western Electric	10 Times
Xerox	13 Times
Siemens	9 Times
RCA	3 Times
Burroughs	2 Times
Hamilton Standard	2 Times
Sperry Rand	2 Times
Gould	2 Times



While others are talking,
we're doing it.

COME ON UP TO...

"SIL-PADS 400":
THE SUPERB
SOLID STATE
HEAT SINK
INSULATORS...
TEST 'EM!

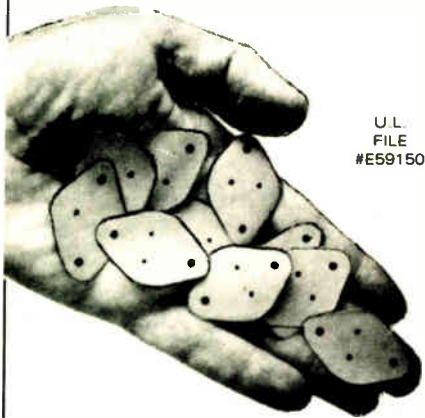

Overcome your heat-sink problems by using "SIL-PADS 400". Eliminate messy grease and fragile mica or plastic film by using this exclusive development of the Bergquist Company.

"SIL-PADS 400" are thin but tough layers of thermally-conductive silicone rubber and fiberglass (laminated together). Cut-through, tearing, and breaking problems are gone. Assembly time is reduced; no more solder contamination; consistent heat transfer performance.

"SIL-PADS 400" are successfully used in thousands of applications.

Many standard configurations; also custom capability.

**FREE SAMPLES,
TECHNICAL DATA,
and LITERATURE!**

BERGQUIST CO.
4350 WEST 78TH STREET
MINNEAPOLIS, MN 55435
(612) 835-2322
TWX 910-576-2423

People

Questions of organization face new EIA chief McCloskey

Even before Peter F. McCloskey takes over as president of the Electronic Industries Association on Oct. 1, the 42-year-old lawyer is looking for answers to some important questions. What kind of structure is most viable and most sensible for the Washington-based association of electronics manufacturers is the leading one.

Right now, EIA's eight divisions reflect the interests of many different businesses, ranging from citizens' band radios to electronic warfare. The issue of whether the varied and often unrelated interests of member companies might be more effectively served by a looser federation giving the divisions greater autonomy is one of long standing.

Participation. In addition, McCloskey is asking how the EIA can get more of its 280 member companies to participate at sufficiently high management levels so that, as he puts it, "policies are shaped by the policies of the companies and not the personalities of the people." Finally, he wonders whether the association can "pump some life into its Solid State Products division," which began to collapse when Texas Instruments Inc. quit the association in the summer of 1972.

McCloskey, who had been president since 1973 of the Washington-based Computer and Business Equipment Manufacturers Association, says he is assigning a high priority to restoring the association's role as the leading semiconductor manufacturers' association. Could this lead to a merger with the young Semiconductor Industry Association recently formed in California [*Electronics*, April 14, p. 50]? Too early to say, McCloskey responds, adding, "something like that might develop further down the road."

Relaxed and tanned, Pete McCloskey speaks with the soft reasonableness common to Washington lobbyists, a quality that should help him within the EIA as well as on Capitol Hill. He is a



Priority. McCloskey hopes to restore EIA as the leading semiconductor association.

believer in the general need to recognize and respond to change. An association, he says, can be viewed "as almost a living organism that has to adjust or adapt" to changing conditions in society if it is to survive, much less succeed.

More contacts. On the issue of increasing high-level corporate participation, he will begin by increasing contacts with members "to ensure that they are getting a perceived value" for their dues dollars. But, he adds, companies must recognize "that this is a two-way street, and that their representatives [at the association's meetings] must be in communication with the top management of the company" if the EIA is to be effective.

Seligman guides Data General to the small-business users

No single company dominates the market for small-business computer systems, says Lawrence Seligman, recently named director of the new Small Business Systems Development Group of Data General Corp., Westboro, Mass. That fact makes the 35-year-old former design engineer sanguine about the prospects for the minicomputer maker, with net sales last year above \$160 million, to capture a goodly chunk of the huge business market.

Of course, there are other reasons too. "We have the basic hardware

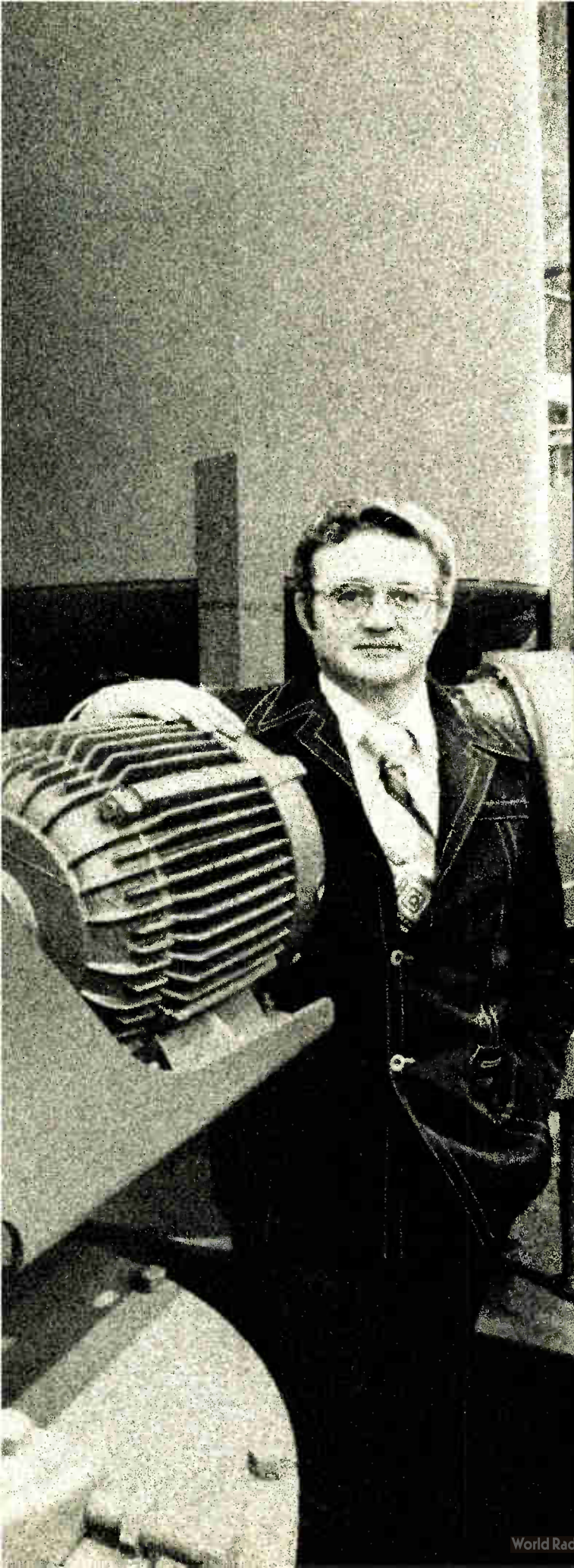

"Kodak helped us set up a reprographics program that could save us more than \$100,000 a year."

**Dennis Thurgood,
Document Control Manager,
EIMCO PMD Division,
Envirotech Corporation,
Salt Lake City.**

"EIMCO PMD is a leading manufacturer of pollution control equipment. Since much of this equipment has custom engineered features, we generate more than 2,000 drawings a month.

"We started working with Kodak back in 1973, expanding our microfilm capabilities. Most recently, we set up a reprographics center with a Kodak Startech processor. Doing the photoreproduction work internally has resulted in substantial dollar savings.

"Also, we have increased the individual drafter's capacity. Before, he was doing a basic pencil-to-paper operation. Now he comes to us and says, 'I need to get from here to here, can you help me?' And we can. Scissors drafting, opaquing, second originals via blowbacks from microfilm are all part of our capabilities. Making the drafter more efficient is probably the major justification for the installation.

"And it's certainly paying its way. We figure we'll save more than \$100,000 a year for the next five years. We've reduced cost by doing photoreproduction work internally; saved drafting time through reprographic techniques; and we've gotten our files under control with microfilm."

Reprographics can help you, too.

Send for more details about EIMCO'S use of reprographic techniques, plus a complete listing of Kodak products and other applications. Write: Eastman Kodak Company, Graphics Markets Division, Dept. R04803, Rochester, N.Y. 14650.

**VERSATILITY IN
REPROGRAPHICS**



Circle 15 on reader service card

Pulse withstand capacitors for colour T.V.

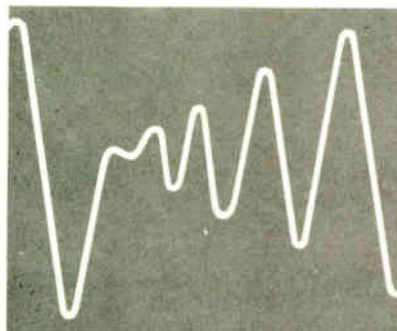

WIMA FKP 1

Polypropylene film and extended foil electrode capacitors encapsulated in cast resin. Self-healing properties. Suitable for sharp-edged or short rise time pulses in thyristor deflection circuits.

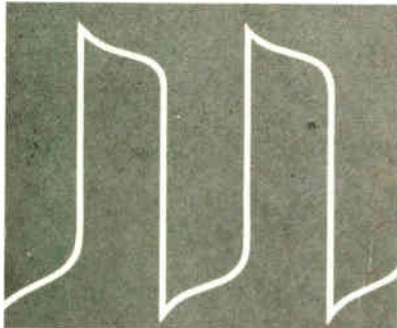

WIMA MKC 10

Metallized polycarbonate capacitors. Particularly suitable for stringent pulse and surge conditions. Low power factor at high frequencies. Self-healing properties. Plastic case design.

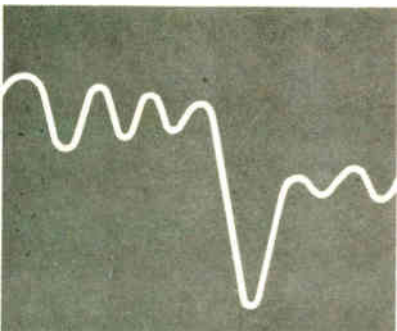

WIMA MKP 10

Metallized polypropylene capacitors in plastic cases. Self-healing properties. Suitable for both high current and pulse circuits owing to low dielectric losses.

- Other special capacitors in metal cases.
- One year successful field experience in equipment by leading manufacturers.
- Suitable for advanced solid-state equipment.
- For professional electronics.



WILHELM WESTERMANN

Spezialvertrieb Elektronischer Bauelemente
D-68 Mannheim 1
Fed. Rep. of Germany
Augusta-Anlage 56
P. O. Box 2345
Tel.: (621) 40 80 12

Write for our new catalogue.

People

and software we'll need already in the Data General product line," he says. "It's my job now to plan our product mix and to adapt our equipment to the needs of the business market."

The first move has already been made. As head of the Systems Products organization, Seligman, who joined Data General in 1969, helped bring to market the CS/40 business system priced in the \$30,000 to \$80,000 range (*Electronics*, May 26, p. 52). "But we have to go after a wider market," he says, although he declines to talk specifics. "Conceivably we'll be adapting our small microNova microcomputer and our large Eclipse line to small-business applications."

Cobol. A strong selling point for his firm, according to the articulate Seligman, will be the interactive Cobol language introduced with the CS/40. He points out that Cobol is the most widely used language in business data processing, but the interactive version has been available only on much more expensive systems. Its appeal is that it allows real-time transactions, such as order entry, instead of depending on batch processing to do the job. "An interactive computer cuts down on the busy work of card punching and other nonproductive steps required for batch operations."

Seligman feels that the human engineering applied to the Data General hardware to adapt it for the commercial market will be crucial to his group's success. This work is much more than just dressing up the equipment in a new package. "For the CS/40, for example, we needed a cathode-ray tube terminal more suited to the operator," he says. "So we came up with one that both swivels and tilts."

But his group will concentrate on adapting the company's general-purpose products to make them easier for small business customers to use. "We don't want to reinvent the wheel," he says, "and we don't want to disrupt the factory" to produce substantially different products from those the company already has.

hp MEASUREMENT COMPUTATION **NEWS**

product advances from Hewlett-Packard

SEPTEMBER 1977

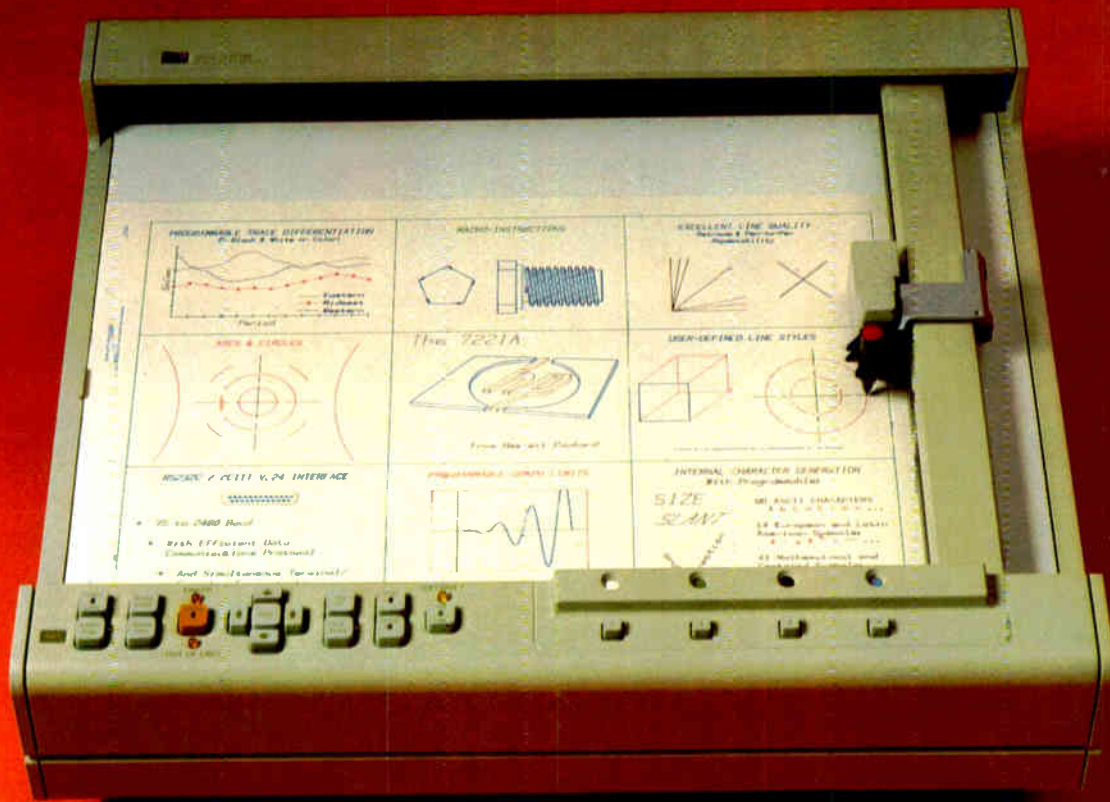

Multicolor plots are especially useful in engineering modeling, plots of more than one measurement, manufacturing production control, numerical control verification, and in wide areas of mathematics, physics, and chemistry.

New buffered plotter presents data in 4 colors, remotely

This new, programmable, microprocessor-based 7221A Graphic Plotter from Hewlett-Packard produces low cost, multicolor and high quality graphic plots from remote processing facilities.

Convenient and flexible operation of the terminal plotter is achieved through high-level commands designed to reduce the cost of data communications.

A built-in buffer allows the 7221A to store approximately 1150 eight-bit data bytes and can be expanded to 3080 bytes as an option. This saves time share computer and transmission costs since the computer no longer has to wait for the plotter to execute instructions. Portions of

the buffer storage can also be reallocated to store up to 64 user-defined macro-instructions. These can be frequently used shapes, such as a logo-type, and can be invoked at any time by a single command.

Six resident character sets, including three European and Latin American sets, and miscellaneous mathematical and centered symbols with program control of
(continued on third page)

IN THIS ISSUE

First SOS μ P product • Extensive triggering in new logic analyzer • Interactive graphics terminal

New graphics terminal has interactive alphanumeric capabilities, too



The latest in microprocessor and raster scan technology are combined in Hewlett-Packard's new 2648A Graphics Terminal to produce a high performance, low-cost and bright display terminal that aids the user in many graphic application areas.

Easy-to-use and flexible, the 2648A allows the user to explore new concepts and try out new ideas in two or three dimensional picture representations. The terminal's many advanced features make these representations easy to achieve. For example: the display-refresh technology enables users to erase and modify the display selectively, without having to redraw the entire image. This feature minimizes user's waiting time and CPU overhead, while reducing communications costs when working with a computer network.

Raster scan technology gives the terminal a continually bright display that is easy to read even in well lit work areas.

Not only can the terminal generate sophisticated graphics, it also has those characteristics of HP's data entry and communications terminals that make programming so much easier. And, dual mini cartridges provide mass storage capability.

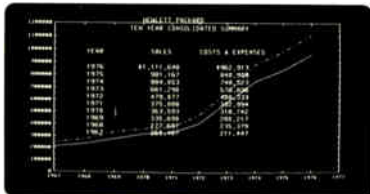

Even with little or no programming knowledge, you can Auto-Plot tabular data automatically. Enter your data parameters on the keyboard; a single keystroke plots the data instantly.

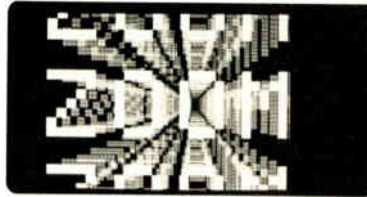

Hardware Zoom and Pan allows any portion of the graphics memory to be magnified up to 16 times. Concurrently, users may pan any portion of the magnified display not in the viewing window.

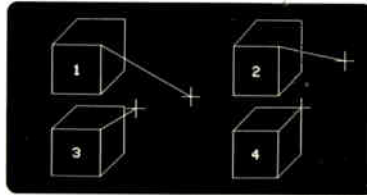

With the Rubber Band Line, trial graphics can be performed without CPU intervention. The user can draw a line to any length in any direction between a selected point and the cursor.

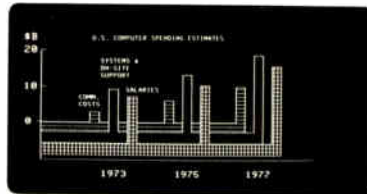

Added visual dimension to graphics is achieved through Rectangular Area Shading which enhances the shading of parts and assemblies, and facilitates differentiation of similar bar graphs.

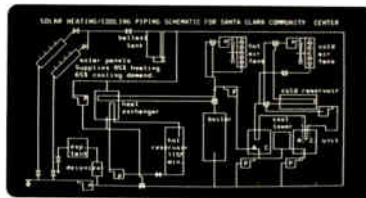

Graphic Text Composition allows the user to select a character size, direction and slant within the graphics memory. This can be especially useful for labeling axes and adding notes or comments to the picture before it is committed to a hard copy device.

For more details, check G on the HP Reply Card.

Spectrum analysis with 100 or 300 Hz resolution with new option

For high resolution in microwave signal analysis, the HP 8565A Spectrum Analyzer (10 MHz—22 GHz) is offered with 100 Hz and 300 Hz resolution bandwidths as a new option. These are in addition to the instrument's 1 kHz to 3 MHz bandwidths. The 100 Hz resolution performance is specified to 8.5 GHz and usable to 12.9 GHz. Measurements at 22 GHz can be made with 300 Hz resolution.

Higher resolution results in 10 dB more sensitivity, giving the 8565A analyzer an amplitude range of -120 to +30 dBm, 70 dB dynamic range, and internal preselection from 1.7 to 22 GHz. And it's easy to use—most measurements use just three controls, and there are LED displays in the CRT bezel presenting all pertinent control settings.

For technical data, check O on the HP Reply Card.

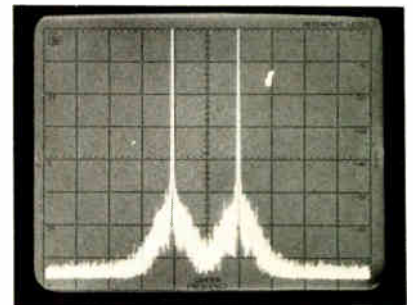

The HP 8565A spectrum analyzer's stability and low noise sidebands ensure full use of 100 Hz resolution, as shown in this two-tone intermodulation test.

New financial calculator evaluates and prints investment alternatives



Whether you're printing amortization and depreciation schedules, or listing all the cash flows in an Internal Rate of Return problem, the HP-92 Investor gives you that indispensable hard copy for instant analysis or later perusal.

The new Hewlett-Packard HP-92 is a briefcase-sized, financial calculator,—with printer and display. It offers time savings with its preprogrammed functions for institutional investors, financial consultants, and other professionals examining investment alternatives.

The HP-92 Investor solves problems involving time and money. Compound interest. Annuities. Balloons. Internal rate of return for 30 uneven cash flows. Net present value. Bonds and notes. Three kinds of depreciation.

The printer on the HP-92 gives you the answers quickly and quietly—with descriptive labels.

The HP-92 will fit into a standard briefcase and can operate from the rechargeable batteries inside its case. Instant financial analyses are available whether you're at your desk, in a boardroom, even traveling across the country.

The HP-92 Investor solves complicated "real world" problems: time and money calculations; discounted cash flow analysis; percent functions; amortization and depreciation schedules; bonds and notes computation; and statistical functions.

For more details, check B on the HP Reply Card.

New remote terminal plotter

(continued from first page)

size, slant and direction, combine to provide flexibility and application throughout the world.

Automatic selection of any four colored pens, through program command or front panel control, permits multi-color plotting which proves extremely useful in applications where traces are hard to distinguish or interpret.

Over forty different instructions, including automatic pen selectability, are built in to simplify programming and increase communications efficiency. Point digitizing, labeling, character sizing, programmable graph limits, rotation, and single command arc and circle plotting are

some of the standard instructions.

PLOT/21 user level software support is available for a number of systems and timeshare services. Interface is RS-232C/CCITT V.24 asynchronous serial ASCII, with eight switch selectable baud rates from 75 to 2400 baud.

Excellent line quality and repeatability is retained at all 36 pen speeds, from 1 to 36 cm/s. This results in precise, easy-to-read graphic plots suitable for reports and presentations as well as your more mundane data and graphic needs.

To see more examples of four-color plots, check M on the HP Reply Card.

GHz pulser system for advanced digital design meets your growing needs

Hewlett-Packard's new 8080 system produces precision 300 ps pulses with repetition rates from dc to 1000 MHz. This flexible system is also a digital data generator, producing 16, 32, or 64-bit serial words at up to 300 megabit rates. The 8080 gives you the stimulus capabilities you need for multi-hundred megahertz research and development—in integrated circuits and digital system development, telecommunications research, and fiber optic design.

The system is modular; you choose just the functions you need from a range of pulse and word generating modules. Should testing requirements change, you can easily expand or reconfigure your system to keep it tailored to your application.

Starting simply, for example, with a repetition rate generator and output amplifier, you have a GHz clocking source for subnanosecond logic systems. 300 ps transition times, ECL pulse levels, external triggering, and synchronous gating guarantee high performance and wide applicability. Later a delay generator/frequency divider and a second output amplifier can be added.

For details on this versatile new stimulus system, check N on the HP Reply Card.

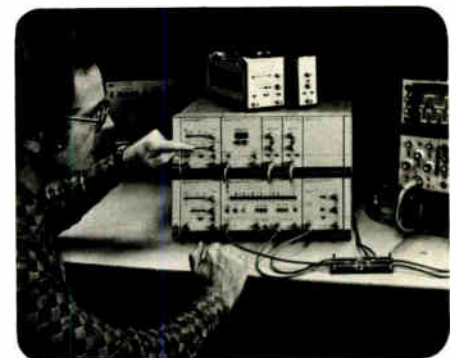

The HP 8080 series is a powerful new 1 GHz pulse and word generator system for subnanosecond rise-time applications. Because of modular capability, you can configure a pulse stimulus system to exactly match your high frequency testing requirements.

"Smart" instrument/computer interface uses HP's new SOS microprocessor

New complete DC power supply catalog from HP

Choosing the right power supply for your application is easy with HP's new *DC Power Supply Catalog*. This 128-page catalog contains product descriptions, photographs, outline drawings, specifications, and prices for HP's complete line of power supplies covering the range from 10 watts to 11 kW. Products include:

- General-purpose lab and system power supplies
- Precision voltage and current sources
- Digitally programmable power sources

Included is a section detailing several methods to control DC power supplies using the HP Interface Bus. In addition, another section covers power supply ac and load connections.

For your free copy, check Q on the HP Reply Card.

HP reduces prices on 2 popular counters

HP's highly popular lower priced counters are now more affordable than ever before with a recent 20% price reduction. The counters are the 8-digit 225 MHz Model 5382A and the 9-digit 520 MHz Model 5383A. Their benefits include:

- Direct counting and direct readout to 1 Hz in 1 sec makes it easy to monitor or adjust frequencies to a precise value much faster than by analog techniques or with a low frequency counter and prescaler.
- High sensitivity (25 to 50 mV)
- Stable time base (aging rate <0.3 ppm/mo.) TCXO optional.
- Three position input attenuator
- Rugged metal case, with rack mounting hardware optional
- In the 5383A, input is fused and switchable (50Ω/1 MΩ).

For more details, check K on the HP Reply Card.

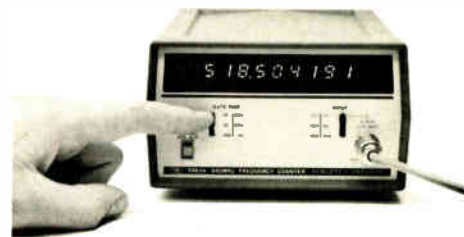

In laboratory testing...

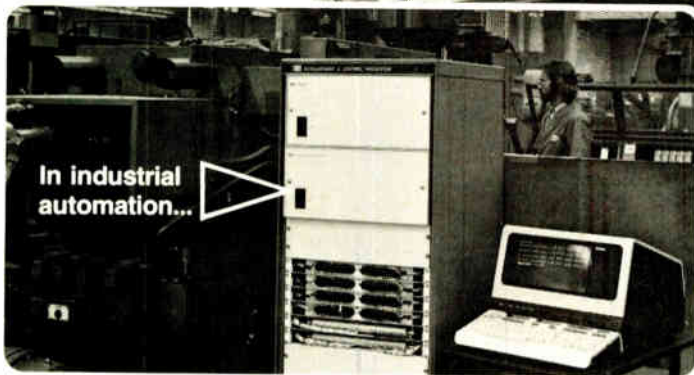

In industrial automation...



New intelligent analog/digital subsystem simplifies product test, monitoring, and control.

Incorporating HP's new silicon-on-sapphire LSI technology, this microprocessor-based analog/digital subsystem is designed to simplify product testing and real-time monitoring and control. Powerful commands are sent to the HP 2240A with simple FORTRAN, BASIC, or HPL programming statements. It performs measurement and control tasks that your computer previously had to handle, freeing it for other uses and reducing program timing constraints.

The HP 2240A in conjunction with the HP Interface Bus (HP-IB) simplifies task communications and programming. It decouples automation tasks from the computer through its microprocessor intelligence: timing, scanning, event synchronizing, formatting, and interrupt tasks can now be delegated to the HP 2240. And an advanced level of self testing allows you to speed your installation and lower your service costs.

The 16-bit silicon-on-sapphire (SOS) microprocessor, tailored for controller applications, operates at the high speed required for real-time applications, and consumes just half the power of comparable systems. This built-in intelligence, and an industry-standard interface (HP-IB), let you implement measurement and

control solutions in three easy steps:

- **Connect to the computer of your choice.** The HP 2240 operates with any HP-IB compatible computer. With the HP 2240, the HP 1000 and 21MX series computers and HP 9800 series desk-top computers become powerful tools for the acquisition of data and the control of physical and electrical processes.
- **Connect to your measurement and control application.** The HP 2240 accepts both analog/digital inputs and outputs, and several interrupt-driven inputs. Simplify interfacing with industrial sensors common in real-time processes.
- **Give simplified instructions to the HP 2240.** The powerful command set of the HP 2240 is easy to use. When you delegate real-time tasks from the computer, the HP 2240 holds the task instructions in memory and executes them in sequence without further computer interaction—freeing the computer for other operations.

For more information on building your own laboratory data acquisition system, check F on the HP Reply Card.

New 70 dB step attenuators for equipment designs to 26.5 GHz

Two new coaxial step attenuators are available for designers of equipment and systems requiring 26.5 GHz operation.

Both models offer 70 dB range in 10 dB steps. Model 33321D is manual and model 33321K is electrically-actuated. The attenuators use the new APC-3.5 connector to achieve operation dc-26.5 GHz, mode-free, and with high repeatability. (Typically 0.05 dB after 1 million steps.) Typical accuracy is 4% of dB reading at 26.5 GHz where SWR is <2.2.

For equipment designs, the small size will be appreciated. Both models fit a 168 x 52 x 43 mm envelope (6.6 x 2.1 x 1.7

inches). For the programmable version, the 24V, 3 watt solenoids are automatically disconnected after a 20 ms switching time. The manual version uses a cam-actuated design that exhibits a low torque action with a particularly smooth "feel", ideal for front panel use on quality instrumentation.

For additional information, check H on the HP Reply Card.

HP 33321D/K attenuators provide 0—70 dB in 10 dB steps to 26.5 GHz.



New systems ROM gives communication capability to 9825A desktop computer



The new System Programming ROM for the HP 9825A desktop computer enhances its capabilities. Among the capabilities provided by the 98224A ROM are the following:

- Read from a busy input buffer.
- Operate the 9825A via a remote keyboard.
- Simplified access to the R4 registers on the 98036A Interface.
- Dynamically store and modify program lines while a program is running.
- Use the 9825A keyboard as an external peripheral using interrupt.

The 98224A ROM will be useful in the following applications:

Terminal Emulation—allows the 9825A to go on-line to a large computer which supports asynchronous data communication.

High Speed Data Logging—in conjunction with the 9885M Flexible Disk Drive, it is possible to log continuous, periodic

data at rates in excess of 1K bytes/sec.

Redefinition of 9825A Keyboard—using the keyboard interrupt routines, the keyboard can be treated as an external device with each key being redefined.

Operation of the 9825A in a Remote Environment—control the 9825A from a remote keyboard, useful if the 9825A is located in a hostile environment.

The 98224A and the Asynchronous Terminal Emulator software package (09825-10040) allows the 9825A to act as terminal to the HP 3000 or other computers that support timesharing via an asynchronous, full duplex line.

For more information, check P on the HP Reply Card.

HP quartz oscillators are available for "do-it-yourself" needs

This family of three, high performance quartz oscillators helps you optimally meet your needs for precise frequency in instrumentation, communication and navigation systems...electrically and physically. The 10544 A/B/C family offers:

AGING RATE is a low 5×10^{-10} /day in all models. These are aged under computer surveillance and are never shipped until that rate is met. So you don't need to age them for months and recalibrate frequently.

SPECTRAL PURITY is excellent, so you can multiply the frequency into the microwave region. Signal to phase noise ratio exceeds 150 dB (for 1 kHz offset) and short term stability is 1×10^{-10} (1 sec. avg. time).

RUGGEDNESS All models are built to withstand field use, and environmental performance is fully specified. One model has shock mount provisions, too.

CONNECTORS Models are available with pc board or feed through connectors.

RELIABILITY We produce these oscillators in large quantity both for systems users and for HP's most accurate electronic counters and frequency synthesizers so we have the large data base necessary for accurate reliability figures. And, they're built to HP's high quality standards, of course.

For more details, check C on the HP Reply Card.



Compactness (72 x 52 x 62 mm), ruggedness, and high performance are key features in this quartz oscillator family.

New logic analyzer traces nested loops to 7 levels with state sequences and 'menu' control

Signature analysis proves effective in HP service programs. Possibly yours too!



The new HP 1610A logic state analyzer is designed to efficiently test digital systems ranging from the simplest logic circuits to microprocessors and computers. Keystroke retrievable testing and display programs offer such test formats as numerical trace listing, data magnitude versus time graphs, and a comparison between current and stored measurements.

The new HP 1610A logic analyzer offers the most extensive triggering available in a logic state analyzer. New measurement capabilities include a greatly expanded trace specification with up to seven levels of sequential state conditions (state values with multiple occurrences); seven choices of trace qualification; and a state count or time interval which can be acquired and displayed in either absolute or relative modes.

With the easy-to-operate 1610A keyboard, the user can trace events in as many as 32 channels at rates up to 10 MHz, selecting only the particular occurrences, coincidences, or logical sequences that are of interest, with results displayed in a well organized format on the CRT screen. A memory 32 bits wide and 64 bits deep can be commanded to capture everything that went on for 63 clock-periods after the trace point of interest, or for 63 periods before; or the trace point may be selected to be in the center of a trace.

A new "menu" concept allows you to select measurement parameters as they are displayed on the screen. Press a key,

and the screen presents one of two specification menus: a **format specification**, which defines the relationship between the input channels and the display, or a **trace specification** which defines the conditions under which the test data will be captured.

With state sequences, you can directly locate branched, looped or nested forms (or sections) of state flow. Since you can specify each state condition to "occur" up to 65,536 times, you can locate the nth pass of a loop, beginning at a given state.

Not only can the instrument trace and display logic states, it can also measure absolute or relative time intervals between events, it can count events, it has a graph mode for an overview of all 64 words in memory and produces documentation.

For hard copy records, the 1610A is compatible with HP 9866 thermal printers.

For additional information, check D on the HP Reply Card.

The HP 5004A Signature Analyzer detects and displays the unique digital "signatures" associated with data nodes in digital products. By comparing actual signatures to correct ones as shown in the appropriate product manual, a technician can backtrace to a faulty node in a malfunctioning product.

By designing Signature Analysis into appropriate new Hewlett-Packard products, we can provide troubleshooting procedures for component-level repair, without dependence on expensive board exchange programs. The results:

- Decreased costs of ownership for end-users.
- Reduced warranty and service support costs.
- Increased confidence in field repair results.

Can Signature Analysis yield these benefits in *your* service operation? HP and over 50 other companies are finding that the answer is "Yes". Some of the digital products currently benefiting from the technique are:

- Computers and peripherals
- Instrumentation
- Communication/navigation equipment
- Industrial and process controls

To learn how signature analysis can make your service operation more efficient, send for the 5004A literature package which includes Application Note 222, *A Designer's Guide to Signature Analysis*. Check J on the HP Reply Card.



Many of HP's new μ P-based instruments and data products utilize the Signature Analysis technique for economical component-level troubleshooting in production and service.

HEWLETT-PACKARD COMPONENT NEWS

First subminiature LED lamps with built-in resistors

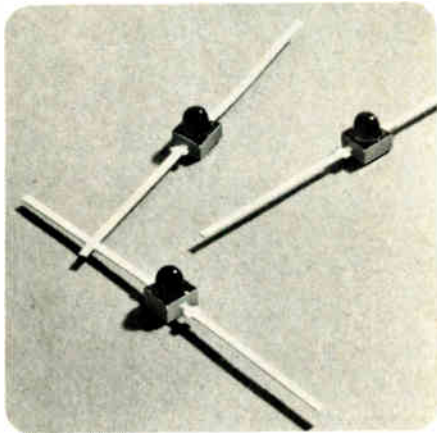

Because of low current requirements and low size, these lamps will be widely used as gate status indicators with DTL, TTL and low power Schottky TTL gates. Manufacturers will also find them an excellent choice as indicator lamps in cameras and portable electronic equipment.

HP offers the first subminiature light-emitting diode lamps with built-in current limiting resistors.

The red 5-volt HLMP-6600/6620 lamps have a current limiting resistor chip built-in with the LED chip, eliminating the need for an external resistor and giving the digital designer a compact package with which to work.

In addition, the lamps contain a reverse protection diode which allows the user to operate the lamp from a 5-volt source without additional biasing components. The diode offers advantages to designers whose circuits may encounter reverse transients and to customers who drive lamps in the pull-up mode.

The lamps may be mounted on .100 inch centers. The nominal forward current for the HLMP-6600 is 10 milliamperes at 5 volts and provides typically 2.4 millicandelas of axial luminous intensity.

Broadband mixer features low loss, high isolation

The new HMXR-5001 is designed for low conversion loss and high isolation across the full 2 to 12.4 GHz RF/LO band, while retaining a wideband IF of 0.01 to 1.0 GHz. Conversion loss is typically 7.5 dB from 1-8 GHz and 8.5 dB from 8-12.4 GHz. LO to RF isolation is typically 30 dB. With only a slight sacrifice in performance the HMXR-5001 can be used up to 18 GHz.

The HMXR-5001 contains hermetically packaged Schottky beam lead quads instead of the chip diodes used in most microwave mixers. For applications where high reliability testing is required, the user can order mixers with screened Schottky diodes. The mixer also uses small semi-rigid cables for transmission lines instead of the stripline configurations found in other mixers.

The combination of sealed diode packages and semi-rigid transmission lines confines the high frequency signal within these components for improved isolation. In addition, this combination allows the use of an epoxy foam to fill the mixer package void and greatly increase mechanical ruggedness.

For more details, check I on the HP Reply Card.



New double balanced mixer is intended for frequency conversion use in electronic surveillance systems, instrumentation and test bench set-ups.

HP lowers price on alphanumeric displays

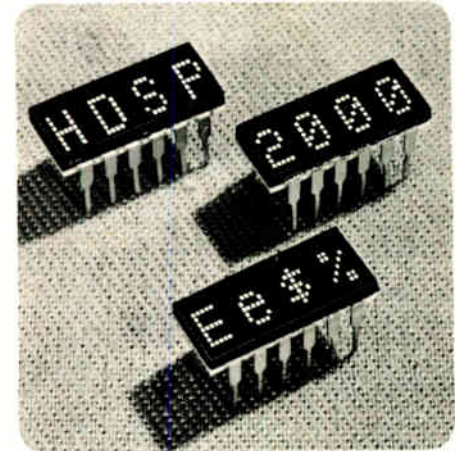

Display the full ASCII character set, upper and lower-case letters, punctuation, mathematical symbols, and numerals with displays now available at reduced prices.

HDSP-2000 alphanumeric, solid-state displays have been decreased in price up to 30%.

The HDSP-2000 is a compact, 5x7 dot matrix display with on-board electronics. By including shift registers and constant-current drivers within the display package, the user can reduce external parts count for a typical 32-character system by a factor of 36 to 1. These low-voltage displays are TTL or CMOS compatible and are readily microprocessor controlled.

Because of their small package size (3.8 mm) and on-board circuitry, HDSP displays are used in applications including interactive point-of-sale devices, hand-held devices, compact mobile communication sets, 'smart' microprocessor-based systems, medical instruments, and portable terminals.

These displays are available immediately through HP's franchised distributors.

For more technical information, check E on the HP Reply Card.

Two new scientific programmables that won't forget. One prints; one doesn't

Both the new HP-19C and HP-29C handheld calculators have Continuous Memory capability so the programs you store are saved, ready for use, until you clear or overwrite them.

As a result, you can program frequently-needed calculations once, and then perform them as often as necessary—hour after hour, day after day—without the bother or lost time caused by reentering your program.

The Continuous Memory not only retains programs, it also retains the data stored in 16 of the 30 addressable registers plus the display register.

You can merge up to four keystrokes in each of the 98 program steps. Thus you can typically store programs of 175 keystrokes or more for those complex calculation problems you face daily.

The high-powered HP-19C and HP-29C easily handle today's sophisticated calculations with advanced programming features including:

- Branching
- Three levels of subroutines
- 8 Conditional tests
- Indirect addressing
- Relative addressing
- Indirect control of data register operations
- Decrement or increment for looping
- Pause function
- Ten labels for programs and subroutines
- And, editing is fast and easy. You can

step through your program a step at a time verifying the listing. Operations can be inserted or deleted and all subsequent steps are automatically "bumped" down or moved upward.

With the HP-19C you have the additional advantage of a quiet thermal printer

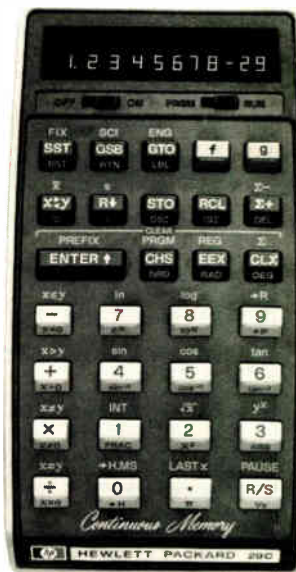

On or off, your programs and data are always ready for instant reuse in two new advanced programmable calculators.

to help you with your editing. You can list your programs or trace executing programs and easily check them for mistakes.

For more information, check A on the HP Reply Card.

- East-4 Choke Cherry Road, Rockville, MD 20850.
Ph. (301) 948-6370.
- South-P.O. Box 10505, Atlanta, GA 30348.
Ph. (404) 434-4000.
- Midwest-5201 Tollview Dr., Rolling Meadows, IL 60008.
Ph. (312) 255-9800.
- West-3939 Lankershim Blvd, North Hollywood, CA 91604. Ph. (213) 877-1282.
- Europe-Central Mailing Depot., P.O. Box 529.
Amstelveen-1134, Netherlands.
Ph. (020) 47 20 21
- Japan-Yokogawa-Hewlett-Packard Ltd., Ohashi Bldg., 1-59-1 Yoyogi, Shibuya-ku, Tokyo 151. Ph. 03-370-2281/92.



MEASUREMENT **COMPUTATION** *news*
product advances from Hewlett-Packard

September/October 1977

New product information from
HEWLETT-PACKARD

Editor: Iona M. Smith

Editorial Offices:
1507 Page Mill Road
Palo Alto, California, 94304 U.S.A.

MIL-SSR UPDATE

Another SSR first from Teledyne!



Experience, design know-how, and advanced solid state relay technology bring you another industry milestone with Teledyne's M640 Series — the first solid state relays to receive QPL approval to MIL-R-28750:

- M28750/5 (Teledyne P/N M640-1W)
- M28750/6 (Teledyne P/N M643-1W)
- M28750/7 (Teledyne P/N M643-2W)

These SSRs have already established a high reliability record that spans a broad spectrum of switching applications for both airborne and ground support equipment. Our M640 Series features all-

solid-state circuitry utilizing hybrid microcircuit techniques in a hermetically sealed TO-5 package. And they're available with bipolar output for AC or DC loads up to 60mA/40V and DC outputs for loads up to 300mA/40VDC or 100mA/250VDC.

For complete specification data, contact your nearest Teledyne Relays sales office listed in EEM, Gold Book or Electronics Buyers' Guide. You'll find we have the experience, products, and technical support to meet all your SSR needs — including a quick reaction capability to design SSRs specifically for your application.

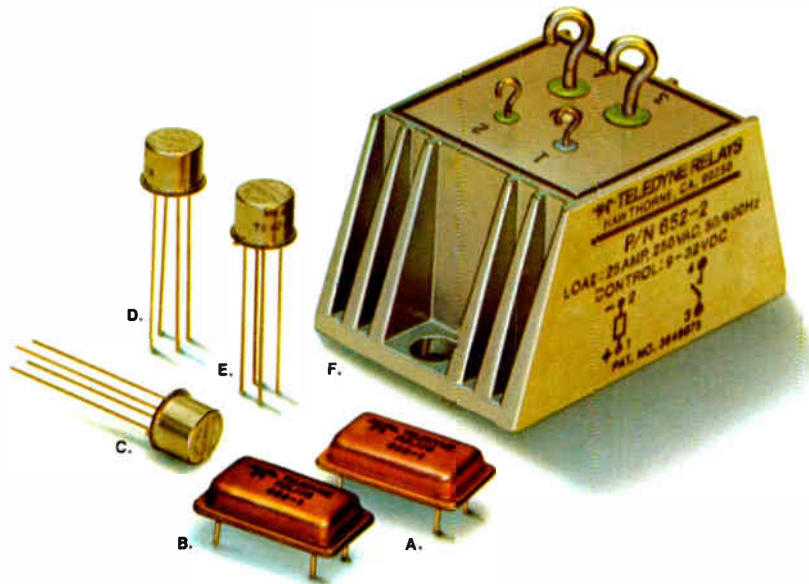

TELEDYNE'S MILITARY SSRs

- A. **P/N 683-1 DC SSR**
DIP package, with output rated at 600mA/50VDC
- B. **P/N 682-1 AC SSR**
DIP package, with output rated at 1A/250VAC
- C. **P/N M640-1W Bi-polar SSR**
Mil P/N M28750/5, TO-5 package, with bi-polar (AC/DC) output rated at 60mA/40V
- D. **P/N M643-1W DC SSR**
Mil P/N M28750/6, TO-5 package, with output rated at 300mA/40VDC
- E. **P/N M643-2W DC SSR**
Mil P/N M28750/7, TO-5 package, with output rated at 100mA/250VDC
- F. **652 Series AC Power SSR**
Output rated at 25A/250VRMS

TELEDYNE RELAYS

3155 West El Segundo Boulevard, Hawthorne, California 90250
Telephone (213) 973-4545

**Now AMP's most versatile
interconnection system
is even more so.**

**We've added a
whole family
of pin
headers.**



Top performance in a tiny space. AMPMODU posts, receptacles and headers make your packaging designs as tight as necessary.

We've also made it easier to place pins on a board. Forget about positioning pins one at a time. Forget costly front-end insertion equipment. Because AMP engineering ability shows up in our recently introduced AMPMODU pin headers.

Pins are fully protected. Headers are polarized and have self-retention locking latches. Headers fit everywhere on a board, including board center.

Ten basic header styles offer several thousand possible variations. You can approach mass termination with AMPMODU headers. Up to 80 positions.

These headers now complement the AMPMODU interconnection system, which features dual cantilever spring beams in the receptacle, five basic contact types and board to board or board to wire versatility. The forgiving nature of the receptacle design also ensures a uniform, positive electrical contact with the mating posts, everytime.

At AMP our application, service and sales engineers are located throughout the world, and are ready to help you with prototyping as well as providing a complete after-sale service.

For more facts about AMPMODU headers, write or call Customer Service. (717) 564-0100. AMP Incorporated, Harrisburg, PA 17105.

AMP has a better way.

AMP
INCORPORATED

SEE US AT
INTERNEPCON, BRIGHTON

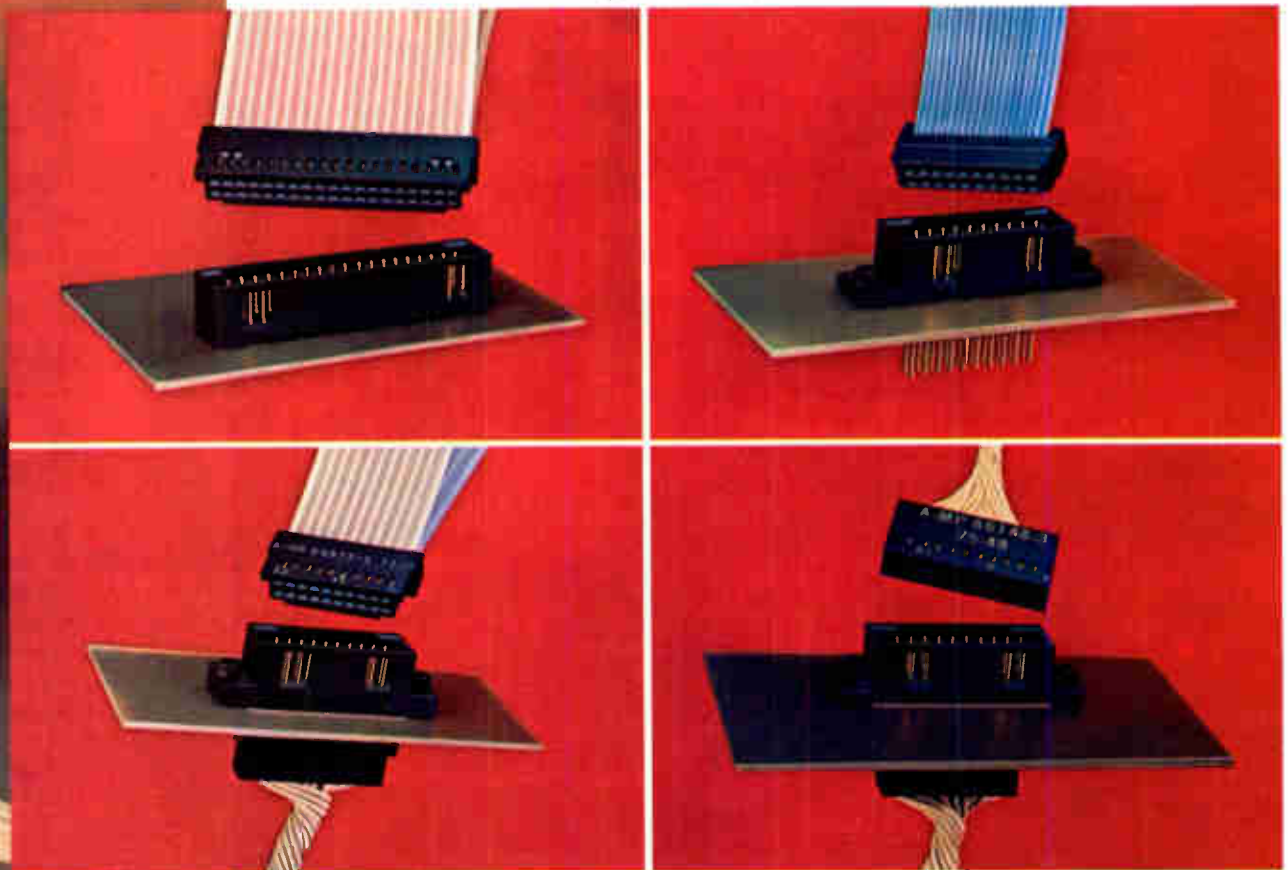

Circle 29 on reader service card

AMP and AMPMODU are trademarks of AMP Incorporated

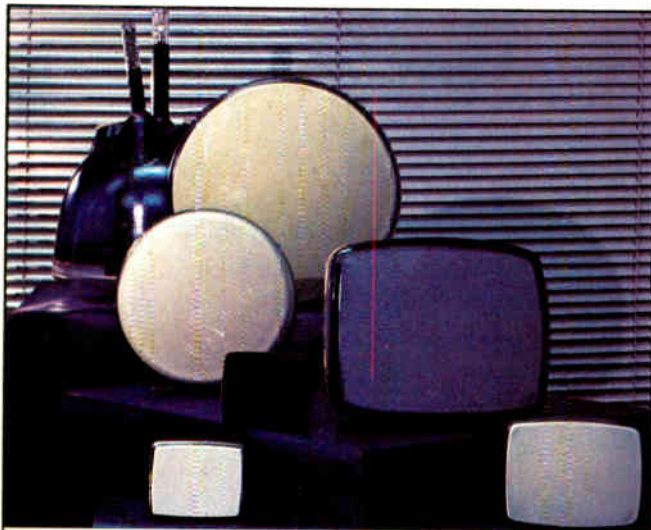

FOR TRULY STATE-OF-ART INDICATOR AND DISPLAY (FULL COLOR) SCREENS —

ELMITRONS

- as bright as 2000 cd/m²
- line width to 0.15 mm
- recording/reproduction rate to 2 mm/μsec
- clearly and distinctly broken-down spectrum from red through intermediate colors to green — for dependable performance even in bright sunlight
- a choice of screens: spherical and flat, round and square, 6 to 20 inches, deflection angles 50° to 100°, afterglow from 0.001 s to 10 s

Available in a comprehensive range:

single- or double-ray (i. e. with one or two beam systems), with rear screens, with screen grids.

Also available in a special vibration — impact — explosion proof make for the most trying conditions and high altitudes.

Exporter:



32/34 Smolenskaya-Sennaya
121200 Moscow
USSR
Tel. 251-39-46, Telex 7586

Meetings

Tenth Annual Connector Symposium, Electronic Connector Study Group Inc. (Camden, N. J.), Hyatt House, Cherry Hill, N. J., Oct. 19 — 20.

Third Workshop on Reliability Technology for Cardiac Pacemakers, National Bureau of Standards, Gaithersburg, Md., Oct. 19 — 20.

1977 Design Automation Workshop, IEEE, Michigan State University, East Lansing, Mich., Oct. 19 — 21.

Nuclear Science and Nuclear Power Systems Symposia, IEEE, Sheraton Palace Hotel, San Francisco, Oct. 19 — 21.

ISHM 77, International Society for Hybrid Microelectronics (Montgomery, Ala.), Baltimore Hilton Hotel and Civic Center, Baltimore, Oct. 24 — 26.

International Conference on Energy Use Management, University of Arizona (Tucson), Marriott Hotel, Tucson, Ariz., Oct. 24 — 28.

1977 Fall Symposium — PC Boards for the 80s, California Circuits Association (Palo Alto, Calif.), Airporter Inn, Irvine, Calif., Oct. 25 — 26.

Electro-Optics/Laser 77, Industrial & Scientific Conference Management Inc. (Chicago), Anaheim Convention Center, Anaheim, Calif., Oct. 25 — 27.

1977 Annual Semiconductor Test Symposium, IEEE, Cherry Hill Hyatt House, Cherry Hill, N. J., Oct. 25 — 27.

Ultrasonics Symposium, IEEE, Del Webb's Town House, Phoenix, Oct. 26 — 28.

Midwest Personal Computing Show, Personal Computing Magazine (Albuquerque, N. M.), O'Hare Holiday Inn, Chicago, Oct. 27 — 29.

1977 SID One-Day Technical Conference, Society for Information Display (Los Angeles), Sheraton Inn-Airport, San Diego, Calif., Oct. 28.



Lower system power with Mostek's Edge-ActivatedTM static RAMs.

Higher density, lower power, and simplified system design are the important advantages of Mostek's new Edge-ActivatedTM series of static RAMs. Implemented with a new Edge-ActivatedTM circuit design concept, the +5V-only family operates at faster speeds than traditional static circuits, but with much lower power dissipation and smaller chip area.

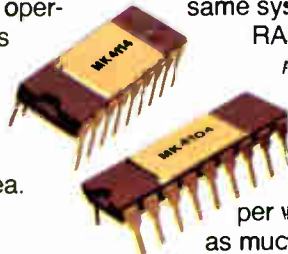

Lower Power Means Lower Costs.

A 16K × 9-bit storage matrix designed with Edge-ActivatedTM 4104's (4K × 1) or 4114's (1K × 4) dissipates less than 1 watt in the memory array. The same system with static-interface RAMs would dissipate *more than 18 watts.*

This means that power sub-system costs, which range from \$1.00 to \$1.50 per watt, can be reduced by as much as \$24.00 in a single storage matrix.

A battery back-up mode, where data retention is maintained at less than 0.3 μW per bit (typ.), offers even greater reduction of standby power.

Mostek High Performance RAMs

MK 4104-3*/ MK 4114-3*

Access Time	200 ns (max)
Cycle Time	310 ns (max)
Standby Power Dissipation	2ε MW
Active Power Dissipation	<120 MW
Power Supply	+5V (± 10% tolerance)
Pin Configuration	Industry Standard 18 Pin

* Available in several speed/power ratings.

MOSTEK

Setting Industry Standards

1215 West Crosby Road • Carrollton, Texas 75006 • (214) 242-0444 • MOSTEK GmbH • West Germany • Telephone: (0711) 701096 • MOSTEK ASIA • Hong Kong • Telex: 85148MKA HX

Intel delivers the 8085, designers just

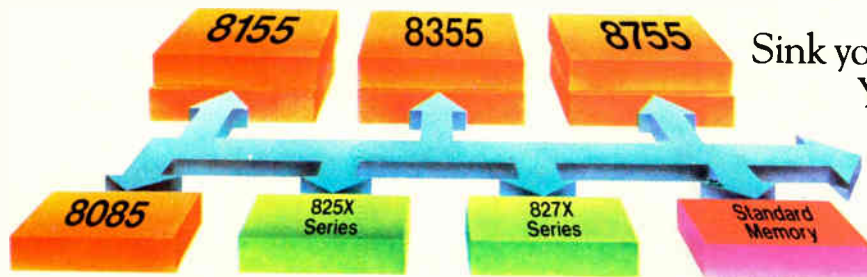

Sink your teeth into Intel's new 8085. You'll find it's the only micro-computer that combines the performance, economic advantages and total support it takes to be recognized as

the new industry standard. So it's no surprise that there are already four announced sources for the 8085. In fact, the deeper you go, the better the 8085 gets.

The 8085, even more than the 8080 it succeeds, is a total design solution, not just a component. It delivers higher performance, for capabilities far beyond the 8080's. It has a higher level of integration, so you can design your products with fewer components, making them more competitive and more profitable. And to help you get those products to market quicker we've given the 8085 the industry's broadest base of system and development support.

Yet the 8085 is fully compatible with the 8080. So your investment in existing designs is protected, and implementing new designs is simplified by the wealth of 8080 software and peripherals at your disposal.

It all adds up to a design solution you won't be able to resist. That's true for a broad range of applications. The 8085 can be designed in as an economical stand-alone three-chip system using the 8085 CPU, the 8155 256-byte RAM with I/O and timer, and the 8755 2K-byte EPROM with I/O or its interchangeable 8355 ROM with I/O.

You can expand this basic system for larger applications using additional RAM, ROM, EPROM and Intel's complete family of first and second generation peripheral controllers, including our four new programmable peripheral controller chips—the 8271* Floppy Disc Controller, 8273* Synchronous Data Link Controller, 8275 CRT Controller and 8279 Keyboard/Display Interface. All these components including 8755 EPROM operate from a single +5V supply.

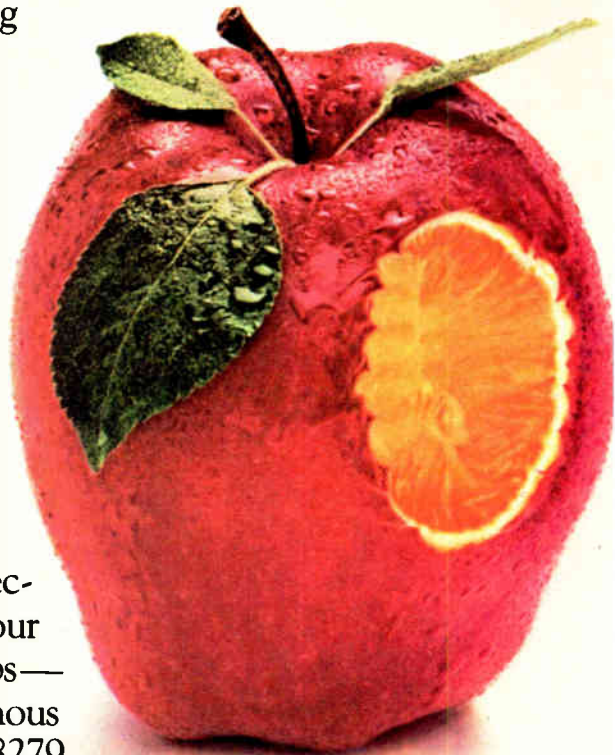

*Available 4th Quarter 1977

the new microcomputer can't resist.

A multiplexed data/address bus permits integration of many auxiliary system functions—such as clock generation, system control and multiple interrupts—onto the 8085 chip while maintaining 8080 compatibility and the same 40-pin package. And forward-thinking engineers will realize that it is also a link to Intel's future generation microcomputer products.

No microcomputer can match the 8085 as a total design solution because no microcomputer can come close to the 8085's support base. Support for the 8085 includes the Intellec[®] microcomputer development system with resident PL/M, the high level programming language that can cut months off your software development time. Intellec is the only development system with ICE-85,[™] providing in-system emulation for faster system development and debugging. Then there's application assistance, training classes and seminars worldwide. And a comprehensive development software library at your disposal.

The quickest way to get a taste of the 8085's power and versatility is with the SDK-85 System Design Kit. It's available now for only \$250. You can order SDK-85 and all MCS-85[™] components directly from your nearest Intel distributor: Almac/Strom, Components Specialties, Cramer, Hamilton/Avnet, Harvey Electronics, Industrial Components, Pioneer, Sheridan, L.A. Varah, Wyle Liberty/Elmar or Zentronics.

Or, for more information on the 8085 and SDK-85, use the reader service card or write: Intel Corporation, 3065 Bowers Avenue, Santa Clara, California 95051. Telephone: (408) 246-7501.

intel[®] delivers.

MCS-85[™] Microcomputer System Components Family

8085 CPU with system bus control, system clock generator, serial I/O and 4-level interrupt control.

8155/8156 RAM, I/O & Timer. 256-byte static RAM, 22 I/O lines, 14-bit programmable interval timer/event counter.

8355 ROM & I/O. 2048-byte masked ROM, 16 I/O lines. Interchangeable with 8755.

8755 Erasable PROM & I/O. 2048-byte UV erasable and electrically reprogrammable EPROM. Interchangeable with 8355.

Compatible MCS-80[™]/MCS-85[™] Peripheral Components

General Purpose

8251 Programmable Communications Interface

8253 Programmable Interval Timer

8255 Programmable Peripheral Interface

8257 Programmable DMA Controller

8259 Programmable Interrupt Controller

8205 High Speed 1 out of 8 Binary Decoder

8212 8-bit Input/Output Port (Latch/Buffer)

8216/8226 4-bit Parallel Bidirectional Bus Driver

Dedicated Function

8271 Programmable Floppy Disk Controller

8273 SDLC Protocol Controller

8275 Programmable CRT Controller

8279 Programmable Keyboard/Display Interface

Performance Matched Standard Memory

Static RAM

2114 1024x4-bit, 450 nsec, 18 pin

2142 1024x4-bit, 450 nsec, 20 pin

8101A-4 256x4-bit, 450 nsec, separate I/O

8102A-4 1024x1-bit, 450 nsec, separate I/O

8111A-4 256x4-bit, 450 nsec, common I/O

ROM/EPROM

2716 2048x8-bit Erasable PROM, 450 nsec

2708 1024x8-bit Erasable PROM, 450 nsec

2316E 2048x8-bit Masked ROM, 450 nsec

8398 1024x8-bit Masked ROM, 450 nsec

A-B quality trimmers for the same price as "B" trimmers.

Accept nothing less than Allen-Bradley quality in trimmers, especially when it doesn't cost you any more. The real decision is whether to use our Type 90 or Type D. Both are cermet, single-turn with a choice of top, side or through-the-board adjustment.

We have what you need; our distributors have it when your need is now. Ask for Publication 5242 (Type 90) and 5240 (Type D).

Type 90

$\frac{1}{8}$ " dia.
\$.55 ea/1000
2 terminal options
0.5 Watts at 70°C
100 ohms to 2 megs

Front or Rear Adjust
with rugged dust cover (Type D),
metal actuator (Type 90).

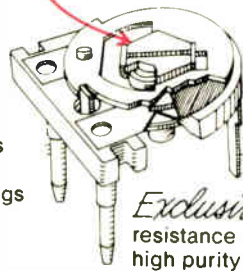

Specially swaged leads offer redundant contact, high strength and excellent solderability.

Exclusive resistance material on high purity alumina for low TCR and CRV. Typical TCR for Type D is less than ± 35 PPM/°C.

Type D

$\frac{3}{8}$ " dia.
\$.37 ea/1000
8 terminal options
0.5 Watts at 70°C
10 ohms to 2.5 megs

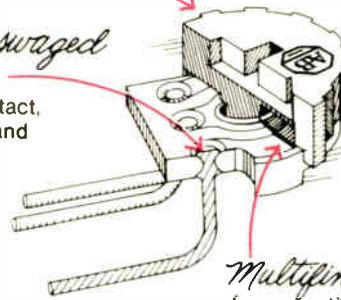

Multifinger contacts for exceptionally low CRV.



Quality in the best tradition.



ALLEN-BRADLEY
Milwaukee, Wisconsin 53204

SOS is used in HP's first medium-speed printer

Hewlett-Packard Co. is using its silicon-on-sapphire technology—17 chips in all—to break into the market for medium-speed printers. Its 2631A, a serial dot-matrix type, has among its SOS chips a microprocessor, random-access and read-only memories, and buffers. The 2631A, from HP's Boise, Idaho, division, will sell for \$3,150 and prints 180 characters a second, but is efficient because its processor controls high-speed slewing and bidirectional printing. It also offers three modes—normal, compressed, and expanded font—in its 128-character ASCII set.

Static RAM cells help overcome faults in ROM

By adding static random-access-memory cells to its electrically-alterable read-only memory, General Instrument Corp. has overcome some of the memory's shortcomings, including the limit on the number of erase/write cycles and of read accesses between write cycles. **The new device will be sampled in a 1,024-bit configuration by year-end.** It is similar to the TMM142C developed by Japan's Toshiba. The electrically alterable ROM cell takes over only when the system is powered down or turned off. Working with NCR Corp., the Hicksville, N. Y., Microelectronics division of GI puts a two-transistor electrically alterable ROM cell, along with two control transistors, into the load circuit is a standard six-transistor static RAM cell. The p-channel device has a cycle time is about 1 microsecond, a dramatic improvement on the electrically alterable ROM's several-millisecond read-erase-write cycle.

Sample-and-hold amp chip designed for 12-bit jobs

Look for Precision Monolithics Inc. to announce soon a monolithic sample-and-hold amplifier with performance that is good enough to meet the accuracy demands of 12-bit applications. **The SMP-81 takes only 3.5 microseconds to acquire a signal and has a droop rate of only 500 microvolts per millisecond,** yet it will be price-competitive with existing monolithic units, selling for about \$3.50. To get the performance, PMI is ion-implanting super-beta transistors at the front end and employing a transconductance amplifier as a supercharger to speed up the charging time of the external hold capacitor.

Cobra Judy radar ready for contract definition

In November, the Air Force will probably select one or more companies for the contract definition phase of its Cobra Judy program. The aim of the program is a shipboard system somewhat similar to the Cobra Dane radar in the Aleutian Islands [*Electronics*, Aug. 7, 1975, p. 44], which monitors the flights of Soviet ballistic missiles. **There could be as many as three contract-definition phase awards,** with Hughes Aircraft Co., General Electric Co.'s Communications division, RCA Corp., and Raytheon Co. rumored as contenders to build the \$50 million radar.

Detector combines GaAs FET, waveguide on one substrate

By combining on a single substrate a microwave gallium-arsenide field-effect transistor and an optical waveguide, researchers at Cornell University's Electrical Engineering department have developed a novel monolithic optical detector. The waveguide consists of a gallium-aluminum-arsenide core sandwiched between two layers of cladding materials that have lower indices of refraction: **One layer is the GaAs material that is part of the FET's gate structure.** Where no gate exists on the substrate, air acts as the cladding material. The FET acts as a light detector, and the light absorbed

under its gate structure, which creates additional charge, modulates the gate potential and gives extra gain.

Deposition system provides hermetic seal for wafers

LFE Corp. has begun to deliver its System 8000, a low-temperature silicon-nitride deposition system for semiconductor wafers that hermetically seals the chips [*Electronics*, March 4, 1976, p. 40]. The system was publicly shown for the first time at the Semicon East show in Boston, close to the Waltham, Mass., headquarters of LFE. Company officials say the automated, microprocessor-controlled passivation system **permits the protected chip to be packaged in plastic**. The System 8000 will sell for about \$75,000, and delivery is 20 weeks.

Zenith may sell off entire research groups

Electronics companies may benefit from layoffs at Zenith Radio Corp.'s now-disbanded research department as the company tries to place intact research groups with other firms, with hopes of retaining first-right-of-refusal for any development that may turn up from the activities it is abandoning. While some teams are being folded into other Zenith departments, insiders report—but Zenith will not confirm—that the cuts may total several hundred engineers, and include flat-panel display and light-emitting-diode efforts. **The firm is resorting to the research cuts to pare costs in the face of declining earnings**; it has also shaved television prices 3% to 5% in an attempt to maintain its market share.

Zenith has developed 2½-inch-thick gas-discharge displays in 35- to 50-in.-diagonal screen sizes. Three-color resolution is reportedly comparable to that of a standard 25-in. TV receiver, and has as many as 100 elements/in. for one-color displays. The firm's LED group is working with zinc-sulfur-selenide systems for greater display efficiency and a broader spectrum of colors.

\$100 body heat detector uses IR to douse lights

Adcom Systems Corp. of New York has developed a passive infrared body-heat detector to turn lights on or off when people enter or leave a room. **The IR optics package, which will sell for under \$100 per detector, fits into a 4-inch octagonal box that looks much like a wall outlet**. The sensor has a field area or pick-up angle of 90°, which Adcom hopes to improve to 130° by the time the detectors become available in November, and a user-programmable adjustable time delay from 30 seconds to 30 minutes to prevent unwanted cyclings.

HP microwave counter uses microprocessor

Hewlett-Packard Co.'s Santa Clara, Calif., division has initiated pilot production on a microwave counter to be priced considerably less than comparable units—among them HP's own \$6,200 model 5340. The basic model 5342A covers the frequencies up to 18 gigahertz, expandable to 23 GHz. The new counters' base price will be about \$4,500. **Unlike the 5340, the 5342A uses one—rather than two—samples to provide its frequency coverage**. To be available late this year or early 1978, the 5342A will use an HP-developed microprocessor for self-test and calibration functions.

**You
like
our
EPROM.**



**You'll
love this
new PROM.**

It's our new MCM2708P, the first inexpensive 2708-type PROM. It's inexpensive because it's the first ever in a plastic package.

Use the one-time programmable MCM2708P. It's exactly plug-in compatible with 2708 EPROMs. Program it just as you would program the EPROM, and save dollars by the handful.

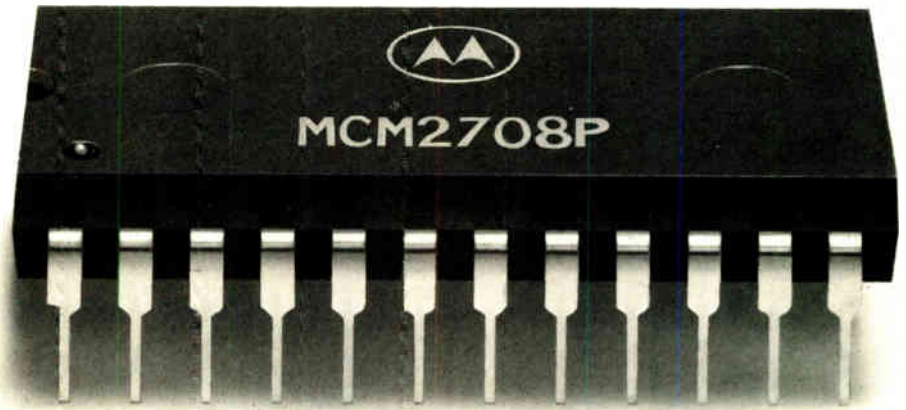

You'll love our new EPROM/PROM prices, too.

Get your MCM2708P data sheet from Motorola Semiconductor Products Inc., P.O. Box 20912, Phoenix, AZ 85036, or circle the reader service number.

Device Number	Function	100-999 Price
MCM2708P	8K PROM	\$14.20*
MCM2708L	8K EPROM	\$21.00

*Under \$10.00 in higher quantity

Contact your authorized Motorola distributor or any Motorola sales office for the MCM2708L and the new MCM2708P.



MOTOROLA Semiconductors
The mind to imagine... the skill to do.

A little knowledge about computers can be expensive. A lot can be free.



1. The inside story on how our full **PRODUCT LINE** makes the difference to you.
Reader Service #201



2. How **Commercial ECLIPSE** Systems answer the diverse demands business makes today on a data system.
Reader Service #202



3. The secret of having computer power where your business needs it. Our book on **CS/40 SMALL BUSINESS SYSTEMS** tells.
Reader Service #203



4. Describes seven important **SUPPORT SERVICES** that get systems up and running, then keep them there.
Reader Service #204



5. Find out how our **Real-Time Disc Operating System SOFTWARE** can get you on-line fast, and keep you there.
Reader Service #205



6. **IT'S SMART BUSINESS** to know how our way of doing business benefits our customers.
Reader Service #206



7. How **OEM's** solve the dilemma of keeping their system costs down with our **NOVA 3 COMPUTER FAMILY**.
Reader Service #207



8. What you need to know about getting everything for a **DATA ACQUISITION and CONTROL** system from one place.
Reader Service #208



9. The last word in microprocessor-based **microNOVA** systems with full 16-bit **NOVA** architecture.
Reader Service #209



10. The amazing story behind our unique heuristic **MULTI-PROGRAMMING** operating system.

Reader Service #210



11. What to do when you need fast, fast access to **MASS STORAGE**.

Reader Service #211



12. **NOVA 3** systems, software and support let you customize a system to your application.

Reader Service #212



13. A wealth of information about how our computers are being used in actual **APPLICATIONS**.

Reader Service #213



14. Wonder what sets the benchmark for big performance computer systems? Wonder no more, it's **ECLIPSE S/230**.

Reader Service #214



15. Is there a sensible way to use computers in **DATA COMMUNICATIONS**? The message comes through clear.

Reader Service #215



16. What's the most you can expect to get from a mid-range mini today? What you get with an **ECLIPSE S/130**—the standard setter.

Reader Service #216

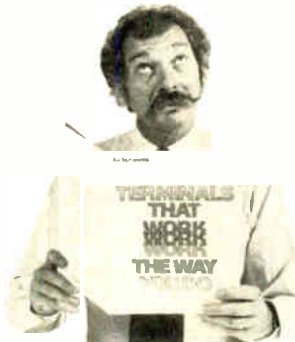

17. You want terminals that work the same way you do? You want the facts on our **DASHER TERMINALS**.

Reader Service #217



18. Our whole **SPARE PARTS** catalog. They're too important to be kept a mystery.

Reader Service #218



19. 1976 was a very good year. Our **ANNUAL REPORT** could be good for you.

Reader Service #219

Mail to: Data General, Westboro, MA 01581

Yes, I'd like to pick your brains. Please send me the brochures I have circled.

I'm in a hurry. Have your sales representative bring in the brochures I have circled.

Brochure numbers: 1 2 3 4 5 6 7 8 9 10 11 12 13 14 15 16 17 18 19

Name _____ Title _____

Company _____

Address _____ Tel. _____

City _____ State _____ Zip _____

Data General, Westboro, MA 01581, (617) 366-8911. Data General (Canada) Ltd., Ontario. Data General, Europe, 15 Rue Le Sueur, Paris 75116, France, 50-006-06. Data General Australia, Melbourne (03) 82-1361.

© Nova and ECLIPSE are registered trademarks of Data General Corp., 1977. DASHER is a trademark of Data General Corporation.

 **Data General**

It's smart business.

EM929

© Data General Corporation, 1977

Bite-sized 8080A systems make big boards hard to swallow.

A one card system (PLS-881)

Our 8080A-based PLS-881 gives you everything you need for simple dedicated control. It includes 1K bytes of RAM, sockets for 4K bytes of PROM program memory, interrupt input, crystal clock, power-on and external reset, three 8-bit output ports, and two 8-bit input ports. It costs only \$165 in 100 piece quantities.

#165

Simple, flexible, standardized Pro-Log 8-bit microprocessor systems a best buy for OEM's.

We sell 8080A and 6800 microprocessor cards two ways; as single and multicard systems, or as individual CPU and support cards so you can build a system of your own.

Our cards are all standard 4.5" by 6.5" with 56 pin edge connectors. They fit into standard card racks. To keep you from being tied to a specific semiconductor manufacturer for parts, delivery and pricing, our 8080A and 6800-based systems use only second-sourced parts.

Buy 250 of any particular card and we throw in free its manufacturing and assembly plans and non-exclusive rights to manufacture it, allowing you to build your own hardware, relying on us as an established and dependable second source.

We've got 4-bit systems, instruments, education and literature, too.

4-bit 4040 and 4004 systems; 4- and 8-bit microprocessor system analyzers; PROM programmers; a half-day economics seminar for decision makers; a three-day hands on design course for engineers; manuals and support documentation.

Call or write for data sheets or a free copy of The Microprocessor User's Guide.

Check our new low prices!

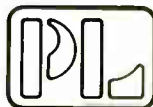

PRO-LOG CORPORATION
2411 Garden Road
Monterey, CA 93940
Telephone (408) 372-4593
TWX 910-360-7082

#160

An expandable plug-in CPU card (8821)

Our "buffered bus" 8821 processor card implements the 8080A as a fully TTL buffered microprocessor. Add one I/O card and it becomes a complete two-card system. Or expand it to use full 8080A memory and I/O capability—it's compatible with all the Pro-Log ROM, RAM and I/O modules shown here plus many more. The 8821 costs only \$160 in 100-piece quantities. We also have equivalent cards implementing the 6800 microprocessor.

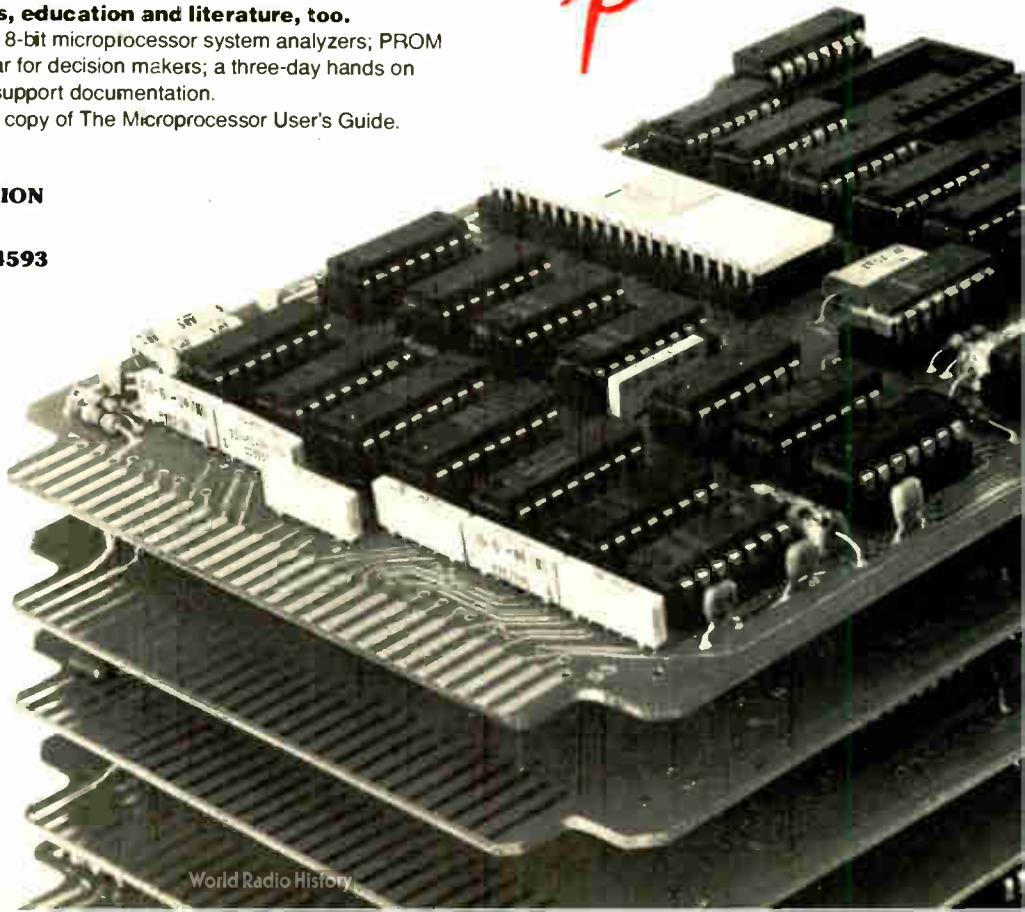

Circle 40 on reader service card

Hologram, LCD are the keys to head-up display

U.S. Air Force OKs development of system using holographic lens plus liquid-crystal chips

The U. S. Air Force has decided that it looks feasible to design a head-up display—which allows a pilot to see critical cockpit instruments while looking straight ahead through the windscreen—with liquid crystals on silicon chips and a holographic lens, components untried for this purpose in an aircraft. Accordingly, the Air Force Avionics Laboratory has given Hughes Aircraft Co. the green light to develop a flyable brassboard by next August. Eventually, the unit might fit into the service's new fighters, such as the F-16, and attack aircraft.

"Though both technologies are state-of-the-art, we have confidence they'll do what we expect of them," says John Coonrod, the project manager at the laboratory at Wright-Patterson Air Force Base, Dayton, Ohio. His confidence comes after seeing mock-ups of the system together with thermal, mechanical, and electrical designs, as well as a display made up of four 1-inch-square liquid-crystal chips, each on its own silicon substrate and butted into an array [*Electronics*, Feb. 19, 1976, p. 29], as well as larger display chips 1.75 in. square. The silicon contains the metal-oxide semiconductor excitation circuitry for the liquid-crystal material and also acts as the display's light reflector.

Hughes' new system will have a larger display than the one reported

earlier—using four of the bigger LCD chips plus a 5-in.-diameter holographic lens. Coonrod points out that the capability of the lens was recently demonstrated on head-up displays configured by Hughes for the Swedish air force's Viggen attack plane.

Better images. Compared with a cathode-ray tube, the new system should have a threefold improvement in symbol brightness and much better contrast—about a 60% improvement when viewed in bright sunlight, says Michael Ernstoff, a Hughes project engineer. In addition, the entire system will be smaller, weigh less, and fit more easily into an aircraft's cramped cockpit than the conventional displays that incorporate bulky optics to focus the CRT's image. Coonrod

estimates, for example, that the new optics should weigh 8 pounds, compared with the 20 lb of optics contained in the F-16 fighter.

Moreover, he notes, "current head-up design stresses the CRT and its circuitry up to and beyond the limits of reliable design, imposing high support costs." To make the CRT image as bright as possible, 20,000-volt power supplies are used. "The development of these supplies to meet environmental specs is often difficult and expensive," Coonrod says. "They're a high-maintenance item." The LCDs should operate in the 10s-of-volts range.

Conventionally, the CRT symbols are reflected off a mirror and through a bulky collimating lens that projects the image onto a partially silvered combining glass. When the

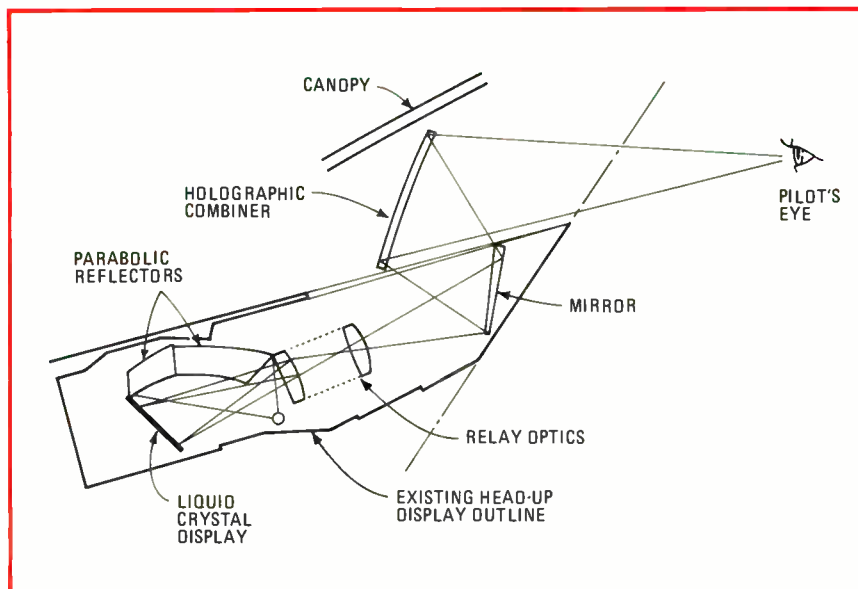

Smaller. Hughes' head-up display, with its holographic lens and flat, liquid-crystal elements, takes up less space than usual CRT approach. Brassboard, to fit into F-16 with a wider field of view than present display, is to be ready by next August.

symbols reach the combining glass, directly in front of the windshield, they appear on the glass as virtual images and are melded with the actual scene before the pilot. The combiner then reflects the collimated image into the pilot's eyes. Thus the pilot can look out of the cockpit at targets and see the CRT's flight and weapon-delivery information without his having to refocus his eyes to see both target and data.

Replacement. The holographic lens takes the place of the bulky collimating optics. It is made by depositing a thin film of dichromated gelatin directly on the glass

combiner and then using laser light to record in the gel a diffraction pattern that depends upon the geometry of the head-up display, including the position of the LCD and the combining glass.

As shown in the drawing, monochromatic light from a thallium-iodide arc lamp shines on the liquid-crystal display, then is reflected onto a mirror, and from there is projected through small relay optics onto the combining glass. The diffraction pattern reacts with the wavefront from the liquid-crystal elements to produce an image that appears to the pilot to be at infinity. □

Audio

Japan readying ultrahigh-fidelity stereo system built around PCM disk

Don't look now, but even as Japanese-designed video-tape recorders start their market climb, the next big-ticket consumer electronics item is already in sight. This time it is for the audiophile—ultrahigh-fidelity digital stereo phonographs.

The systems will use plastic disks of the kind familiar from ordinary sound recording, but the audio signals will be pulse-code-modulated. For playback the Japanese are proposing to use a laser, much as in a video-disk recorder.

In early September, Mitsubishi Electric Corp. in partnership with two other firms demonstrated the first experimental system. Mitsubishi announced that it expects to be able to build a commercial player within perhaps two or three years. Such a system would include pickup of information from the disk, decoding, and the low-level audio output stage; a power amplifier would not be included. The disks are said to be not much harder to stamp out than ordinary phonograph records. One 300 millimeters in diameter, about 12 inches across, would hold a half-hour of music and would sell for \$11 to \$15.

Moreover, since the bandwidth required for this kind of recording is almost 4 megahertz—about the same as for recording television images—the units may be fitted with options to make them convertible to either ultrahigh-fidelity audio or television.

Not to be outdone by Mitsubishi, Sony Corp. soon after announced a similar experimental system that it claims has a potentially longer playing time. But this one-upmanship is largely a bargaining ploy. Sony president Kazuo Iwama says that compatibility between different manufacturers is essential because the product, like the ordinary phonograph, will depend for its success on the availability of prerecorded disks. Iwama contrasted this dependence with the capacity of the video-tape recorder to record its own program material—which makes it a viable product even though there are two basic systems at present.

Hitachi Ltd. has also shown an experimental system. It also points out that in 1972 its subsidiary, Nippon Columbia Co., pioneered Japan's use of PCM for making master tapes, so that by now there is a large supply of the highest-fidelity program material available.



Stereo. Circuits inside audio disk system built by Sony are on breadboards, so that shift to production boards could shrink the cabinet. Laser senses PCM pattern recorded on plastic disk, resulting in frequency response that is flat out to 20,000 hertz.

The fidelity of the PCM systems is all anyone could ask for. A sampling frequency of about 44 kilohertz gives them a frequency response that is flat within a fraction of a decibel from direct current to 20 kHz. Harmonic distortion is typically 0.03%. Wow and flutter are kept below measurable levels. No noise is picked up by the systems, and dynamic range is set by the quantization to more than 85 dB for the Sony system and even higher for Mitsubishi's. (About 66 dB is considered extremely good for an analog system.) Crosstalk between channels is zero—compared with the 20 to 30 dB for an analog system.

Disks resemble those used in video players from Philips and MCA Inc. They have a pitch of 1.6 to 1.7 micrometers between the spiral "tracks" and spin at 1,800 revolutions per minute. The audio pickup is handled by the reflection of a laser beam positioned by a three-axis servo system. Mitsubishi and Sony use helium-neon gas lasers, Hitachi uses the so-called channel substrate planar semiconductor laser.

The systems employ redundancy of about 50% extra bits in PCM coding to correct for errors from dropouts. Where the systems part company is in the method of recording information on the disk. Mitsubishi frequency-shift-modulates individual bits, with two frequencies for 0 and 1 and a third frequency for formatting. Sony employs direct nonreturn-to-zero recording of 0s and 1s in the delay modulation scheme used for computer tapes.

Sony claims that its scheme permits higher recording density, and that by increasing density and slowing down motor speed it can obtain an hour or more of recording time. This longer recording time would not affect the performance of a dual-mode audio-video player, because the direct motor drive of the turntable would derive its frequency from a quartz crystal. An extra divider stage could then provide half frequency for half speed or a phase-locked-loop integrated circuit could allow generation of a frequency of any conceivable ratio. □

Trade

Japanese ICs take larger U. S. share

Is Japan's next target the U. S. integrated-circuit market? At least one Government analyst of electronics thinks so, on the basis of new import statistics showing Japanese first-half IC shipments up 77% from last year.

The \$15.2 million share is not large, a mere 3.3% of the \$463.1 million total most of which was earned by the "valued-added" imports of U. S. producers. Under U. S. Tariff Code sections 806 and 807, American firms can import products previously exported in an unfinished state for completion abroad and pay duty only on the value that was added offshore.

Nevertheless, Japan's share of IC imports is climbing steadily, even though total IC imports are also rising. The first-half imports total, for example, is 25% higher than a year ago, when Japan captured only 2.2% of a \$370 million total. Moreover, when value-added ICs are removed from the import total, the analyst explains, "Japan's share of the true trade [with foreign compa-

nies] is larger than the figures show, particularly when you add the imports from plants Japanese companies have in places like Korea, Taiwan, and Hong Kong."

First-half IC imports from those three countries (which have U. S. producers, too) totaled \$78.5 million, \$40.6 million, and \$18.9 million, respectively. How much of these totals represent value-added production will not be known until breakouts become available in about six months from now. Separating value-added ICs imported from Singapore, Malaysia, and the Philippines is easier. "You can figure about 99% of those shipments are in the value-added category," says a Commerce Department specialist. In the first half, those three countries increased shipments, respectively, to \$11 million, \$108 million, and \$29.9 million, making up more than half the import total.

Other factors. Federal analysts see another element in America's first-half deficit of \$293 million in IC trade, a 35% increase from 1976. Beyond Japan—which for the first time, with 18% of the trade, moved into the lead as largest foreign supplier of all components—the foreign share of work on U. S. products is rising steadily. The value-added

Imports of consumer electronics set record

Import records were also set by audio and video consumer electronics products in 1977's first half, according to figures for imports released by the Commerce Department. Japan is accounting for nearly two thirds of the \$1.8 billion. That total was 23.5% more than last year's first-half figure, which had also set a record.

Imports of color television receivers rose one third to \$246 million. Eighty-five percent of the 1.28 million units brought in came from Japan, whose three-year "orderly marketing agreement" with the U. S. did not take effect until July 1. Under that arrangement, Japan will limit color TV shipments to the U. S. to 1.75 million units per year.

However, industry representatives in Washington are impressed by the doubling of color TV imports from Korea and Taiwan, even though those imports still represent less than 2% of the total. They believe the increase already reflects a shift in production strategy by major importers hoping to offset the constraints on suppliers in Japan.

Two other categories of consumer products also showed significant import increases in the half. Color video cassette recorders, almost exclusively from Japan, soared to nearly 46,000 units—up from the 32,000 brought in during all of 1976. Citizens' band radios, primarily 40-channel units, accounted for nearly 85% of the 9.8 million transceivers imported, reflecting a 14% rise from last year.

percentage "has been going up about 1% a year for some time," an official notes. "Now it averages about 56% of a circuit's value; it will probably reach about 60% before long." Of the seven IC categories tracked by Commerce, imports are led by monolithic bipolar types, with metal-oxide-semiconductor circuits totaling \$170 million in the first half. Transistor-transistor-logic circuits accounted for \$130 million in the same period.

Overall, America's long-standing advantage in components trade of all types appears to be eroding. The first half's trade surplus of \$380.4 million is down 25% from the 1976 level. The nation's trade deficit with Japan was \$100 million in the period as that country increased shipments by 41% to \$164 million, while American exports there fell 5%.

Also causing the trade balance to decline were sharp increases in capacitor and resistor imports, which are producing mounting deficits in these categories. The figures show that capacitor imports, worth \$83 million in the first half, were up a third from last year, increasing the negative trade balance to \$32 million, or 40% more than in 1976. First-half resistor imports of \$52.8 million represented an ever sharper increase in that category's U. S. deficit—some \$19 million, or more than four times the \$4.3 million of the year before. □

Microprocessors

\$4,800 buys 6500 development system

To establish quickly its 6500 microprocessor family which it recently acquired, Rockwell International's Microelectronic Devices is betting on a low-priced microcomputer development system. Called System 65, it relies on a miniature floppy disk that Rockwell says is much simpler to use than present paper-tape storage.

Selling for \$4,800, it is much cheaper than units supplied by Intel

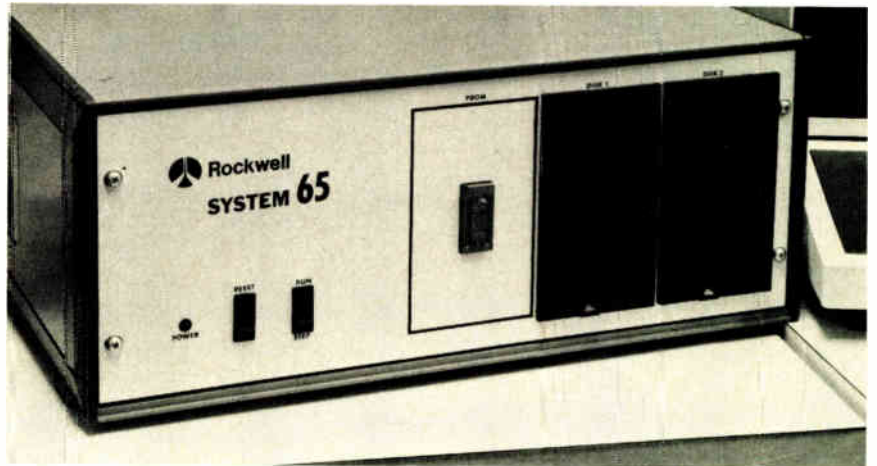

Desk topper. Rockwell microprocessor development system relies for storage on 5 1/4-in.-diameter floppy disks, which plug into the right side of the unit.

Corp. and Motorola Semiconductor. Anticipating possible knocks by competitors that System 65 is a loss leader for the 6500 family or a bare-bones unit that offers less, Rockwell says it expects the system to be profitable itself, as a complete tool for the customer.

The disk-based approach simplifies things because it stores programs under development in 13 kilobytes of resident read-only memory chips, says H. R. Anderson, manager of product planning for the Anaheim, Calif., Rockwell operation. "The big advantage is getting away from the rat's nest of paper tape that has to be loaded and handled to run other systems," he says. About 50 units will be completed by month's end, Anderson estimates, with the unit first demonstrated at the Wescon show in San Francisco.

Among important subprograms that are ROM-encoded and permanently resident are those for assembly, monitoring, text editing, file management, peripherals interface, and debugging. Not having to sort, load, unload, and file paper tape can save up to nine tenths of the time required to write, assemble, and edit a typical program, he estimates. Another improvement claimed for System 65 is that the entire user-oriented memory is dedicated to user programs. Some development systems crib part of user memory for operating routines, he says.

For the \$4,800, a buyer gets a

complete development system, according to Anderson. Included are cabinet, dual 78-kilobyte mini-floppy disk systems and four cards: 6500 central processor unit, input/output controller, 16-kilobyte static random-access memory, and monitor/debug routines. In-circuit emulation, which permits much more precise and extensive debugging, will be an option card available for \$1,000 to \$1,100. Both Intel and Motorola supply in-circuit emulation options at additional cost—\$1,000 to \$2,700 and \$995, respectively.

Comments. Commenting on the Rockwell system, Intel and Motorola officials do not question its ability to perform adequately despite its low price. Both note, however, that the systems are not price-sensitive, at least as yet. "I don't recall anyone yet complaining about price," says the Motorola manager of the firm's Exorcisor, which sells for \$7,665 in a comparable configuration. "A few thousand dollars' difference is not significant for a customer whose development program runs to a quarter million dollars," adds his Intel counterpart. An Intellec with performance similar to System 65 is priced at \$8,275.

Where System 65 might not match the Exorcisor or Intellec, they speculate, is in three areas. The 78-kilobyte mini-floppy disks may not have enough memory capacity, against their 1-million-byte full disks; high-level computer languages

New: The First Monolithic D/A Converter System.

No one else can give you an 8-bit DAC with all peripheral functions on-chip. It's truly microprocessor-compatible and costs \$6.95!

Single-chip D/A converter circuits have been around a long time. But so have the design problems that go along with them when interfacing with microprocessors—selection of op amps, voltage reference, latches and the various other active components you've had to add to use them.

Now, for the first time, you can simplify your system design by using the Signetics 5018 Monolithic D/A Converter System. It combines, on a single chip, the converter circuit and all the required peripheral functions—a voltage reference, input latches, and an output amplifier. It costs, in quantities of 100 and up, only \$6.95. That's one reason why it saves you money.

Reduce Parts Count and Assembly Costs.

The 5018 is a system simplifier and cost reducer. You can forget about the costs associated with all those extra parts. Material control is simpler. Incoming test and inspection costs go down. Component handling and assembly expenses can be reduced as much as 75 percent.

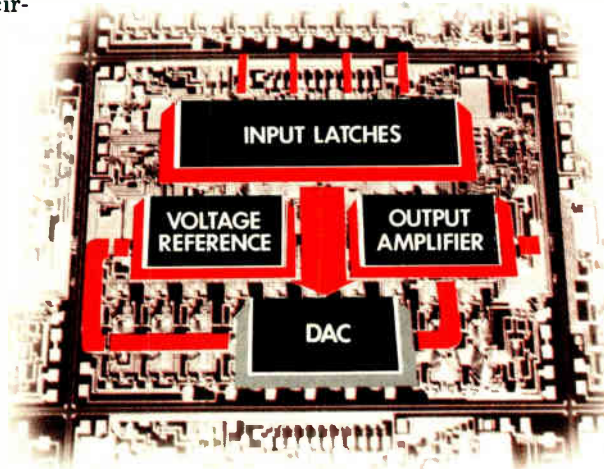

Ideal Architecture for Computer-Based Systems.

The 5018 has built-in latches and extremely low input loading (1/100 TTL load per line). These features make it a good choice for multiple-peripheral, bus-oriented microprocessor or computer-

based systems. The low input loading lets you drive many converters from a single bus.

The latches then permit the bus to service several peripherals at its maximum throughput rate.

Temperature stability is an added plus. The reference voltage can be adjusted for correct full-scale value with minimal temperature effects.

Temperature-related inaccuracies are also minimized because the precision, low-temperature coefficient resistors are on the chip.

Other Signetics DACs.

The 5018 is our newest D/A conversion product. The coupon below will help you learn more about it. If you'd like other data sheets on our other D/A converters listed below, be sure to check the appropriate boxes or call your nearest Signetics distributor.

Signetics

a subsidiary of U.S. Philips Corporation

Signetics Corporation
811 East Arques Avenue
Sunnyvale, California 94086
Telephone 408/739-7700

SIGNETICS D/A CONVERTERS

5018—Monolithic D/A Converter System
5007/5008—8-Bit, High Speed, Multiplying DAC ($\pm 0.19\%$)
5009—8-Bit, High Speed, Multiplying DAC ($\pm 0.1\%$)
MC 1408—8-Bit, Multiplying D/A Converter

To: Signetics Information Services, 811 E. Arques Ave.
P.O. Box 9052, MS 27, Sunnyvale, CA 94086

Please send me information on the 5018 DAC System

I'm also interested in these other D/A conversion products:

5007/5008 5009 MC1408

I have an urgent requirement. Please have a D/A conversion specialist phone me at once: () _____ X _____

Name _____ Title _____

Company _____ Division _____

Address _____ MS _____

City _____ State _____ ZIP _____

EM929

are increasingly demanded; and a system must be expandable to handle more than one processor chip.

Anderson has answers for all three. "The mini-floppy capacity was picked after a survey," he responds. The system initially has a Focal-65 user-developed language, and others can be added. As for expansion, it has space for four or five extra cards, including "personality cards" to allow the system's use for other microprocessors such as Motorola's 6800 family. □

Consumer

Microcomputer tunes and holds frequencies

When Quasar Electronics Co. starts shipping television receivers with what it calls Compu-Matic tuning next month, the firm will be one of the first to offer sets that rely on a frequency synthesizer both to ac-

quire the television channel and to keep that channel tuned to its exact frequency. General Electric Co. has taken a similar approach to the TV-tuning system it has introduced, but other manufacturers that use frequency synthesis revert back to automatic frequency control once the channel has been tuned.

For Quasar, the new models represent a late entry into all-electronic tuning, now commonplace on most manufacturers' top-of-the-line sets. But the firm has not copied other set makers' custom logic implementations; instead, it has put its tuning system under the control of a single-chip microcomputer. Unlike West Germany's Blaupunkt-Werke GmbH, which requires a three-chip processor to handle such extra features as pre-programming [*Electronics*, Sept. 1, p. 36], the Quasar system performs only traditional channel select and tuning chores.

"We considered going the custom route, but when we started optimizing our custom circuit, it began to

look like a microcomputer," says Ted Rzeszewski, manager of advanced development engineering at the Franklin Park, Ill., firm. So Quasar turned to a sister subsidiary of Japan's giant Matsushita Electrical Industrial Co.: Matsushita Electronics Corp.

Microcomputer. The Kyoto subsidiary spun off a special version of its recently introduced MN1400 4-bit microcomputer for the Quasar tuning application. The Japanese component maker also designed and built a custom phase-locked-loop circuit for the Compu-Matic.

Though the microcomputer is necessary for decision making and control, the key to the system's ability to select channels and maintain their stability is the phase-locked-loop chip, shown in the diagram. It develops a precise refer-

Tuner. Quasar's entry into electronic tuning of TV receivers relies on phased-locked loop under 4-bit microcomputer control to select and hold the channel frequencies.

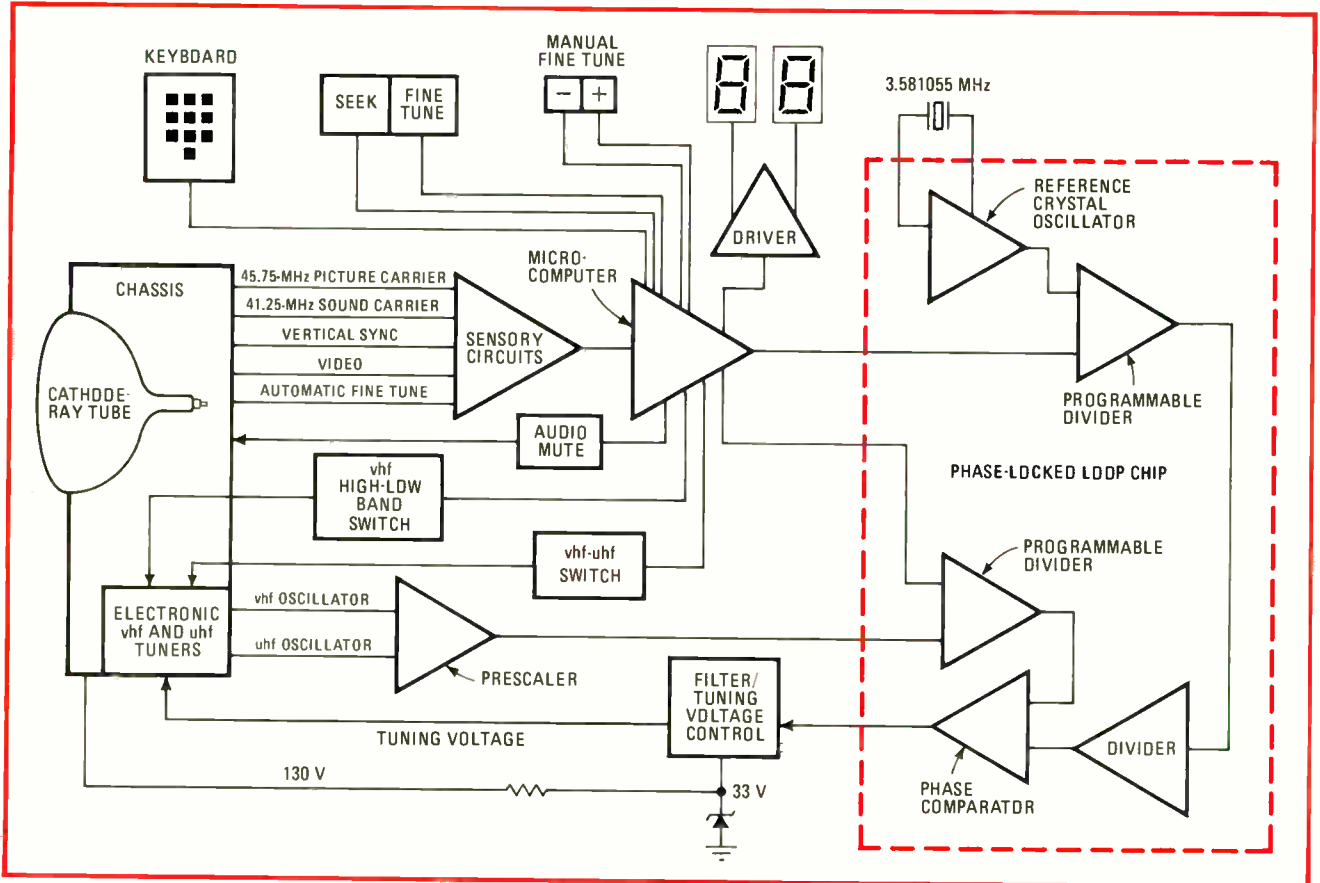

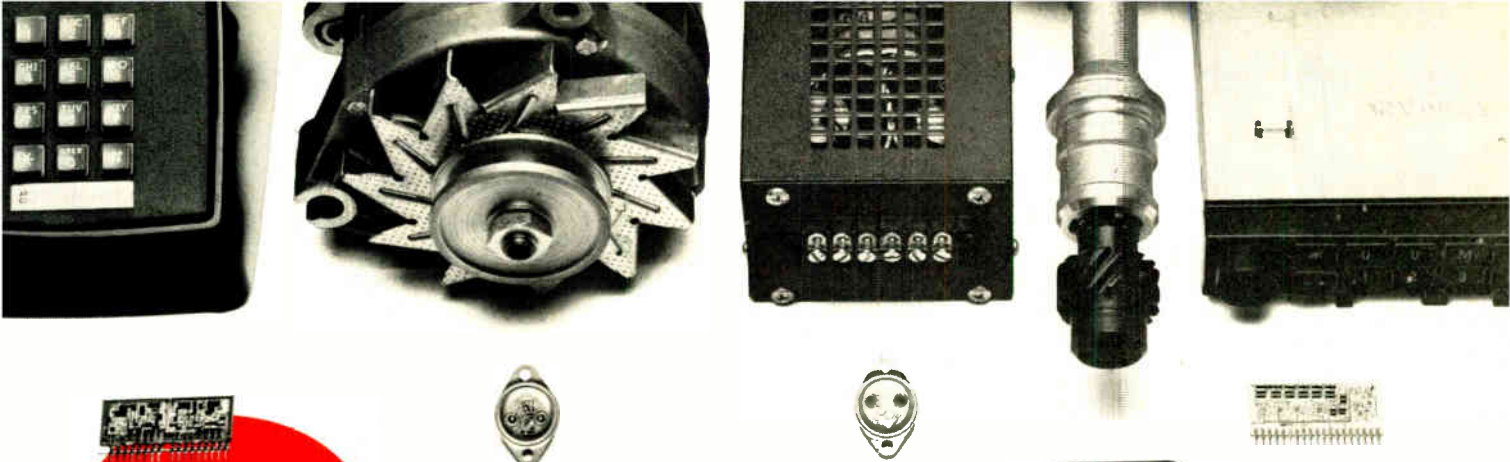

HYBRID

HYBRIDS RUSH IN WHERE MONOLITHICS FEAR TO TREAD.

When you want to mix semiconductor technologies, maintain cost-effectiveness and avoid buying bulky subsystems, the only answer is hybrids. And when your requirements put equal emphasis on small size, high volume, high quality and low cost, Fairchild is the answer.

Although most people know us as one of the component giants of the western world, we also happen to be one of the world's largest suppliers of custom hybrids.

No other manufacturer can match our total hybrid capabilities. We custom-design and volume-produce hybrids for telecommunications, automotive, consumer electronics and industrial control applications. Our facilities in California and Hong Kong can turn out more reliable hybrid products in a day than most hybrid makers can produce in a week.

IF WE'RE SO GOOD, WHY AREN'T WE FAMOUS?

Just about everything we make is custom. For example, we designed and now produce a hybrid ignition module for a major automobile manufacturer. We also make tuner control/station memory units for AM/FM radios and TV, products for telecommunications systems, and voltage regulators for industrial applications.

IT HELPS TO HAVE FRIENDS ON THE INSIDE.

If we're known for anything, it's cost-effectiveness. There are two reasons. First, we're a volume manufacturer. Our ability to turn out hybrids in very large quantities translates into considerable cost savings for our customers. Second, Fairchild is one of the world's leading semiconductor manufacturers. We don't have to depend upon outside suppliers for the delivery, reliability or quality of the components we use. We also work directly with the people who design our components. So custom design time (and cost) is held to a minimum. The result is a better product at a lower cost to our customers.

READ OUR BROCHURE BEFORE YOU SEND US YOUR BREADBOARD.

Get out your company letterhead and write to us about the kind of requirements you might have. We'll send you a comprehensive booklet on the world's most comprehensive hybrid facilities.

Your Fairchild sales office, distributor or representative could also help you get your hands on a copy. The phone number at the bottom of this ad is a direct line to our Hybrid Products people. Fairchild Camera and Instrument Corp., 464 Ellis Street, Mountain View, California 94042. Telephone: (415) 962-3771. TWX: 910-379-6435.

FAIRCHILD

**CALL US ON IT.
(415) 962-3771**

ence frequency from a standard 3.58-megahertz crystal and compares it with the divided-down tuner oscillator signal. If there is a difference in frequency between the two, an output voltage automatically adjusts the tuner oscillator frequency until the comparator inputs coincide.

"The PLL does the job normally done by automatic-frequency-control circuitry, but it does it an order of magnitude better," Rzeszewski says. The frequency-division chain from the tuner oscillator includes a programmable divider on the PLL chip. The microcomputer programs the divider to divide by the oscillator frequency of the channel selected, ensuring a signal that matches the crystal reference.

While forcing crystal-controlled stability onto the tuner oscillators (which are prone to drift), Quasar has also allowed the user a couple of ways to move off the precise tuning frequencies. "We wanted to retain a manual fine-tuning feature so the customer could tune out noise on very weak stations, at the sacrifice of some picture crispness," Rzeszewski says. "Or he may want to deliberately mis-tune to minimize disturbing signals."

So the user can command the microprocessor to change the reference oscillator signal, which it does by continuously changing the number in the reference's programmable divider as long as the fine-tune buttons are depressed. Also, there is an automatic fine-tune mode for use in cable and master-antenna installations where carriers are often offset from the correct frequencies. In such setups, the Quasar system will search for the carrier frequency as far as 2 MHz away from where it is supposed to be.

Station choice. The microcomputer also gives the user a choice of two ways to find the station—either searching for the next active channel higher or lower with seek buttons or tuning directly to the channel by entering two digits on the set's keyboard. Invalid keyboard entries and inactive channel numbers are tuned to the next higher active channel, although the user can defeat the

News briefs

Charles Ferris to head the FCC; Brown also nominated

Charles D. Ferris, counsel to House speaker Thomas P. "Tip" O'Neill, has been named by President Carter to head the Federal Communications Commission, confirming an earlier report [*Electronics*, Sept. 15, p. 55]. Ferris will succeed Richard E. Wiley, who is resigning.

Carter also nominated Washington lawyer Tyrone E. Brown to the FCC's so-called "minority seat," vacant since Benjamin L. Hooks left to become director of the National Association for the Advancement of Colored People. Ferris' term will expire June 30, 1984. Brown will complete Hooks' term and in 1979 is expected to be renominated for a full seven years.

U. S. tactical ground and ship radar outlays seen rising

Tactical ground and shipboard radars will constitute the bulk of an estimated \$10.6 billion U. S. military radar market in the six years ending in 1982, says a study by Frost & Sullivan Inc. of New York. Annual outlays are projected to rise about 5% annually from \$1.6 billion in the Federal fiscal 1977 year just ended to nearly \$1.9 billion in fiscal 1982, with a surge to just over \$2 billion in fiscal 1979. While tactical ground radars and shipboard radars are forecast to account for \$4.5 billion and \$4 billion in outlays over the six years, F&S says spending for large surface-based surveillance systems will remain flat at \$2.1 billion, as more of their functions are taken over by satellite systems. Offsetting this will be increased spending on hostile weapons locators, search radars, and tactical fire control systems.

Tektronix expands its microprocessor development lab

Tektronix is enhancing the general-purpose nature of its model 8001 microprocessor development lab, adding in-circuit emulation of the Z-80, TMS 9900, and 8085 devices, as well as the 8080 and 6800, the two devices covered when the system was first announced [*Electronics*, March 31, p. 122]. The company is the first and only major instrument manufacturer to offer a microprocessor development system.

Distributed network architecture for HP 1000

Hewlett Packard Co. has committed itself to a distributed network architecture that permits HP 1000 and HP 3000 computing systems to be tied together. Comprising software and a read-only-memory subsystem, DS/1000 follows up HP's DS/3000, which initiated a high-level network protocol for the top-end 3000s alone. DS/1000 now goes a step further since it permits both systems to be hooked up, transparent to the operating systems in each. The network can be arranged in any configuration—star, ring, string, or combinations—with the best path set up automatically for high-speed communications between machines.

Perkin-Elmer introduces thermal printer

The Terminals division of Perkin-Elmer Data Systems Inc. has introduced a \$795 thermal printer. The 75-quantity price includes interfacing electronics for RS-232C standard input, making the 100-character-per-second model 650 one of the lowest-priced printers available.

The 650 prints sideways on 8½-by-11-inch dye-impregnated paper, depositing an entire column of dots at one go. A stationary thick-film print head with an array of 288 resistive elements spans the length of the carriage, and the 9-by-12-dot arrangement for each character allows the printer to handle the entire 96-character ASCII set. A 6800 microprocessor controls the 650, which has buffer memory for storing a single page.

seek feature with a switch, allowing inactive channels to be used for such purposes as video games or videotape playback.

"We use five sensors in the chassis

to tell the microcomputer if a valid signal is present and, if so, how accurately it is tuned," Rzeszewski says. A pair of quad comparators look at the five signals—vertical synchroni-

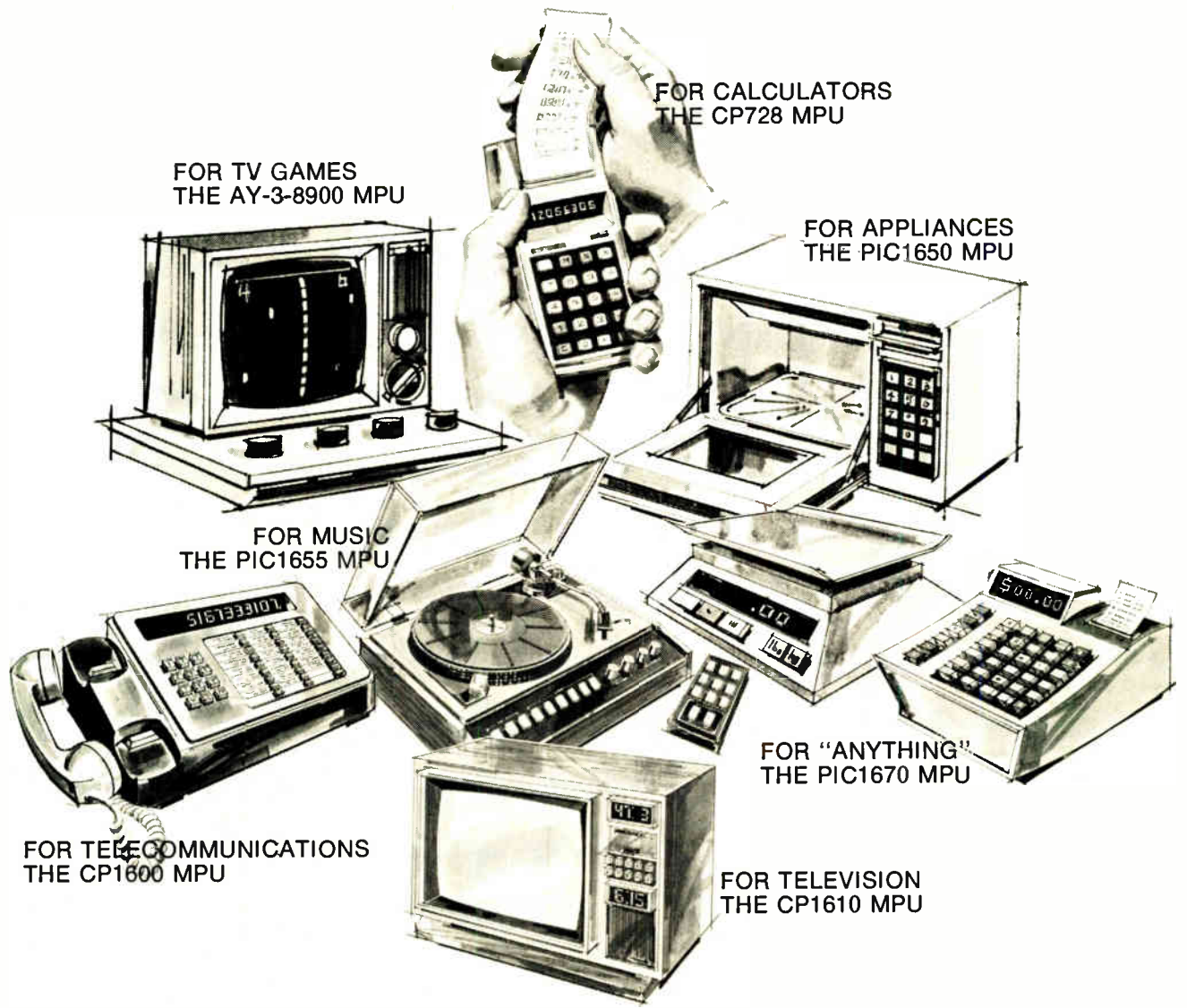

FOR CALCULATORS
THE CP728 MPU

FOR TV GAMES
THE AY-3-8900 MPU

FOR APPLIANCES
THE PIC1650 MPU

FOR MUSIC
THE PIC1655 MPU

FOR TELECOMMUNICATIONS
THE CP1600 MPU

FOR "ANYTHING"
THE PIC1670 MPU

FOR TELEVISION
THE CP1610 MPU

GI MICROPROCESSORS...

"DEDICATED" TO HELP OUR CUSTOMERS COMPETE.

General Instrument standard microprocessors are *optimized* for the application they serve . . . a unique approach that *minimizes* interface circuit requirements and *eliminates* unnecessary costs. For example, the standard microprocessor designed as a numbers cruncher isn't the optimum vehicle for appliance control. It requires too many external circuits to interface it with the appliance and it carries along overhead hardware you simply don't need. In contrast, the GI "dedicated" approach provides the optimum interface LSI to best tailor the standard microprocessor to its application. And GI's "dedicated" solutions are drawn from our broad experience in the consumer and telecommunications markets.

Standard microprocessors... dedicated to help our customers compete.

**GENERAL INSTRUMENT CORPORATION
MICROELECTRONICS**

600 WEST JOHN STREET, HICKSVILLE, NEW YORK 11802



FIXED & VARIABLE Ceramics FROM ERIE

LOOK TO ERIE FIRST FOR

CERAMIC TRIMMERS



ACTUAL SIZE
STYLE 513 STYLE 518 STYLE 538

- 1000 variations
- \$.30 to \$.75 in production quantities
- World's finest quality trimmers
- Other styles available

Write for catalog 500



ERIE

ERIE TECHNOLOGICAL PRODUCTS, INC.
Erie, Pennsylvania 16501
814/453-5611

... AND STILL THE BEST BUY

TUBULAR CERAMIC CAPACITORS



Designed for
Temperature Compensating and
BY-PASS-COUPLING applications
Complete line - High quality

FEED-THRU CERAMIC CAPACITORS



- For filtering and by-pass applications
- \$.05 to \$.30 in production quantities
- MIL Types

Write for catalog 0570



ERIE

ERIE TECHNOLOGICAL PRODUCTS, INC.
Erie, Pennsylvania 16501
814/453-5611

Electronics review

zation, automatic-fine-tuning voltage, composite video, 45.75-MHz picture carrier, and 41.25-MHz sound carrier. The customer can adjust the composite video threshold so that he can skip over weak signals. □

Distributors

Schweber takes on Data General micros

Microcomputers are widely available from semiconductor distributors, so the announcement that Schweber Electronics Corp. has added a new line might normally be greeted with a big yawn. But the fact that it is the microNova line from Data General Corp. should cause a stir in distributor, minicomputer, and semiconductor circles.

The agreement gives Schweber Data General's line of 16-bit microprocessor products—chips, boards, packaged computers, peripheral equipment, and software. It is believed to be the most important such agreement to date between a leading computer manufacturer and a major distributor, and Data General president Edson de Castro says it is just the beginning. The Westboro, Mass., company will be lining up other distributors for the microNova line as well.

"We feel the market for small computers, particularly for microcomputers, is much too broad for us to sell into directly," de Castro says. "Local, off-the-shelf delivery is becoming very important." Schweber, a Westbury, N. Y., based distributor, has 16 U. S. locations, and approximately 100 salesmen. "A distributor salesman can afford to make a call on prospective microcomputer users in conjunction with other component products he sells," de Castro reasons. In addition, Data General field service contracts will be made available to users as part of the agreement.

For his part, Seymour Schweber, president of Schweber, says the agreement will open the doors of more than 500,000 potential custom-

ers "who have been virtually ignored by computer manufacturers. These people have been orphans in a storm, because the computer manufacturer didn't even return their phone calls." Salesmen selling systems at \$100,000 or more did not want to take the time to follow up an inquiry about microcomputers, he says.

Data General's list prices for the microNova line range from \$225 for a chip set to \$1,995 for a boxed system and as much as \$11,000 for a system including a diskette and printer. The full range will be offered by Schweber.

The only other minicomputer manufacturer offering microcomputers through distributors is the Digital Systems division of Texas Instruments Inc. Three distributors offer the TI 990/4 microcomputer and the division's advanced microprocessor prototyping lab. □

Instruments

3 1/2-digit DMM hits low of \$49.95

How low in price can a 3 1/2-digit digital multimeter go? At least to \$49.95, says Sinclair Radionics Ltd., the British firm near Huntingdon, in Cambridgeshire, which pioneered low-priced calculators and claims to be Europe's largest manufacturer of digital multimeters.

For this price, Sinclair does not include the ability to make accurate current measurements. But the model PDM35's accuracy—to within 1% of reading—is better than the 2% of full scale typical of analog multimeters, with their d'Arsonval-type movements. Also, the meter's input impedance is the standard 10 megohms of a DMM, compared with the much lower 20,000 ohms per volt of analog voltohmmeters.

Until now, digital multimeters have been almost twice the price of the new unit, which is aimed directly at the low-cost analog multimeter field. In that field, the familiar Simpson model 260 now sells for about \$75, whereas a miniature

The biggest, fastest little shift registers you can buy.



TRW's new TDC-1006J 256-bit serial shift register is unmatched for speed and power.

When you need a fast, compact shift register, there's nothing around to match the TRW TDC-1006J 256-bit serial shift register. Advanced bipolar construction gives you speeds of 30 MHz. Power consumption is under 500 mW. It's TTL compatible, with complementary outputs. And the 16 pin C DIP configuration lends itself nicely to inexpensive, high density packaging.

Also available is the TDC-1005J Dual 64-bit serial shift register with a speed/power product comparable only to the TDC-1006J. It consumes only 350 mW.

Cost: 256-bit \$55 in 100's—dual 64-bit \$40 in 100's. Contact your nearest TRW Electronic Components field sales office or call us at (213) 535-1831, or send the coupon.

TRW LSI Products

An Electronic Components Division of TRW, Inc.,
One Space Park
Redondo Beach, CA 90278

Please send data sheets on your shift registers.

NAME _____

COMPANY _____

DIV/DEPT _____

MAIL CODE _____

ADDRESS _____

CITY _____

STATE _____

ZIP _____

E-9

TRW LSI PRODUCTS

...from a company called TRW

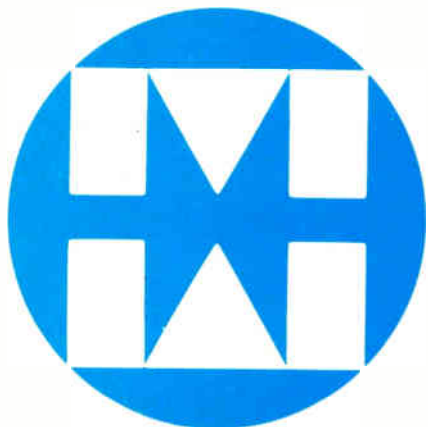

MITEL

Micro-processor Display Drivers

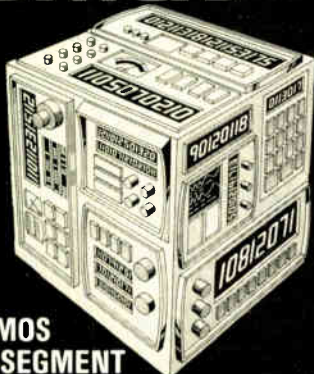

CMOS 7-SEGMENT HEXADECIMAL DECODER/DRIVER/LATCH MD4368B

DRIVES COMMERCIAL AND MILITARY LED, LCD, INCANDESCENT, FLUORESCENT AND GAS DISCHARGE DISPLAYS. THE MD4368B IS PIN-FOR-PIN WITH THE TTL9368 DEVICE, BUT OFFERS THE FOLLOWING ADDED BENEFITS:

- INCREASED RELIABILITY THRU CMOS LOW POWER (25mW TYP.) AND DELETION OF OUTPUT CURRENT LIMITING RESISTORS.
- 3 TO 18 VOLT OPERATION AND OUTPUT CURRENTS OVER 50mA PER SEGMENT.

OTHER MITEL CMOS DISPLAY DRIVERS AVAILABLE INCLUDE:

- MD4311B - 7-SEGMENT HEXADECIMAL DECODER/DRIVER/LATCH
- MD4511B - 7-SEGMENT DECIMAL DECODER/DRIVER/LATCH
- MD4330B - 30-BIT LCD DRIVER/REGISTER
- MD4055B - 7-SEGMENT LCD DECODER/DRIVER
- MD4056B - 7-SEGMENT DECODER/DRIVER/LATCH

For more information write or phone

18 AIRPORT BLVD.
BROMONT, QUEBEC, CANADA
JOE 1L0
(514) 534-2321
TLX 05-267474



MITEL

Semiconductor

Electronics review

VOM, such as the Triplett model 310, now sells for about \$50. Sinclair also says it will introduce a 4½-digit multimeter for \$199 early next year.

Nevertheless, the firm admits there will always remain applications where the moving-needle analog display will be preferred to monitor input changes. And there always will be people who plainly prefer to look at a meter needle.

Market. John T. Nicholls, head of Sinclair's Instrument division, estimates the total world market for analog multimeters at about 1 million units per year, selling for an average price of \$40. Sinclair hopes to sell somewhere between 50,000 and 100,000 PDM35 units the first year, he says. Already, preliminary showings to dealers have resulted in firm orders for about 20,000 units.

The 3½-digit model is packaged in a modified version of a Sinclair calculator case, has a 0.150-inch light-emitting-diode readout, and runs off a standard 9-v transistor battery. It has automatic polarity indication and uses a simple slide switch for range changing.

According to Nicholls, the low price comes from using bipolar field-effect-transistor circuits for the analog input circuits and a digital large-scale integrated circuit for counting



Meter. Sinclair's DMM has accuracy to within 1% of reading, no ac measurements.

pulses and driving the LEDs. The precision input voltage divider employs thick-film technology. The LSI chip is the one in the company's 3½-digit \$99 model DM2 multimeter of which more than 25,000 units have been sold. The chip is built by both General Instrument Corp. in Scotland and by Plessey Co. and comes in a 16-pin low-cost package.

The unit uses a single-slope technique for analog-to-digital conversion. In this technique, a ramp is internally generated, and the count from an internal 10-kilohertz clock is accumulated until a comparator senses coincidence between the ramp and the unknown input signal.

Accuracy. The meter's accuracy depends on the stability of the clock frequency; therefore Sinclair uses a temperature-compensated oscillator. It says the accuracy of within 1% holds over a temperature range of 19°C to 23°C. Although calibration is guaranteed for only three months, Nicholls says it should hold for about a year. As to the absence of an ac-current range, Nicholls points out that the few users who require such capability usually need up to 20 amperes full scale, which would be beyond the capability of a low-cost digital instrument anyway.

The meter measures dc voltages in four ranges with full-scale values from 2 v (actually 1,999 v) to 1,000 v; ac voltage in four ranges from 2 v to 500 v full scale; dc current in six ranges from 200 microamperes to 200 milliamperes full scale; and resistance in five ranges from 20 Ω to 20 MΩ full scale. □

LSI-11 helped plot *Courageous*' course

Engineers at Digital Equipment Corp.'s Components Group joined Skipper Ted Turner's *Courageous* crew—at least in spirit—in celebrating the 12-meter yacht's successful defense of the America's Cup Sept. 18 off Newport, R. I. DEC's LSI-11 helped *Courageous* navigator Bill Jorch (pronounced "george") compute his position and such other critical data as wind speed and direction [*Electronics*, June 23, p. 34] as the U. S. entry swept to four straight wins over Australia. In the system's automatic mode, the boat's instruments were multiplexed to the LSI-11, which computed and displayed data, including distance to marks along the course.

Our first SBC 80 compatible systems for 1977!

4K to 64K RAM Up to 8K EPROM on one board

Now you can have RAM and EPROM on the same board and buy as much or as little memory as you need. And because our memories use 16 pin memory element sockets you can change your memory when you change your mind.

Speaking of changing your mind, when you want to change address locations of either RAM or EPROM, it's done with two, on-board switches—providing 16 possible start locations for each memory.

Compare these features with our much improved read, write and refresh cycle times and you'll choose MSC first.

16K RAM Version

Up to 16K × 8 of RAM and up to 8K × 8 of EPROM on the same board.

RAM expandable in 4K × 8 increments and EPROM expandable in 1K × 8 or 2K × 8 increments.

On-board DIP switches to select any of 16 address start locations for RAM and 16 address start locations for EPROM.

Cycle times:
Read, 350 nsec.
Write, 500 nsec.
Refresh, 500 nsec.

Totally SBC 80 and Intellec MDS hardware and software compatible.

Limited one year warranty on parts and labor.

Delivery 30 days ARO.

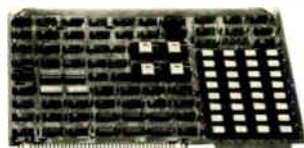

MSC 4502

64K RAM Version

Up to 64K × 8 of RAM and up to 8K × 8 of EPROM on the same board.

RAM expandable in 16K × 8 increments and EPROM expandable in 1K × 8 or 2K × 8 increments.

On-board DIP switches to select any of 16 address start locations for RAM and 16 address start locations for EPROM.

Cycle times:
Read, 350 nsec.
Write, 500 nsec.
Refresh, 500 nsec.

Totally SBC 80 and Intellec MDS hardware and software compatible.

Limited one year warranty on parts and labor.

Delivery 30 days ARO.

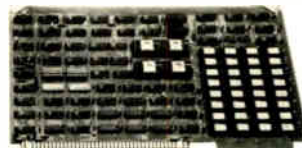

MSC 4602

Beginning firsts

Beginning with compatible memories Monolithic Systems will continue to introduce SBC 80 systems with features which are firsts.

First to take advantage of the latest technology. And first in reliability, value and delivery.

You can be among the first, when you call us for SBC 80 compatible systems.

SBC 80 compatible systems... from the first.



Monolithic
Systems corp.

14 Inverness Drive East
Englewood, CO 80110
303/770-7400

Intellec is a registered trademark of Intel Corporation

© 1977, Monolithic Systems Corp.

Incredible performance... at unbelievable prices!



TRW hybrids shatter the price/performance barrier for RF output power, linearity and dynamic range!

You'll have to see it to believe it! And we're ready to show you proof. Take a look at some of our typical applications. Look at the gain quoted for each.

Then take a look at the price. Now, in your production units, you can get the performance you'd only expect from precision laboratory gear.

TRANSMITTER DRIVERS:

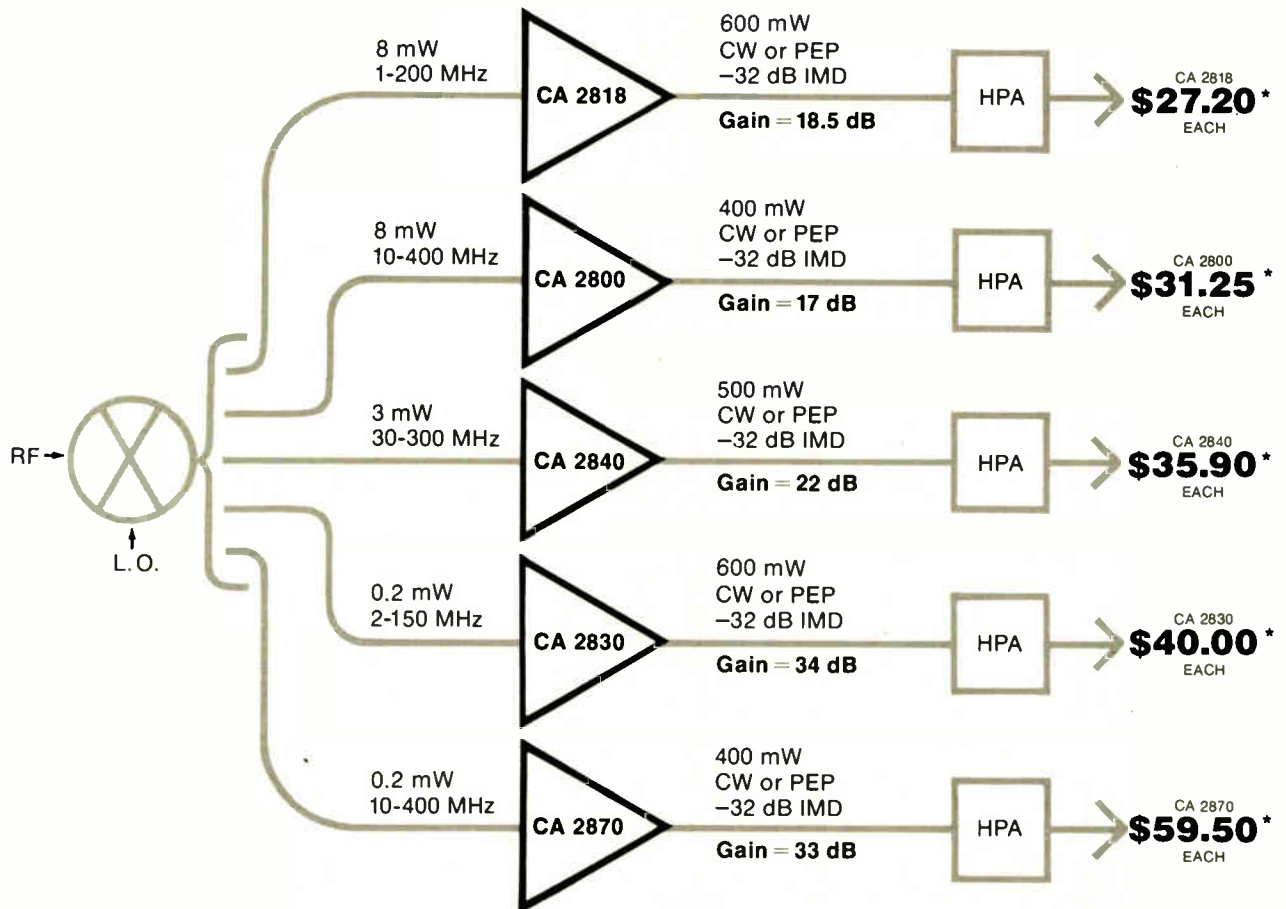

RECEIVER APPLICATIONS:

40 MHz to 100 MHz IF amplifier.

STANDARD IF

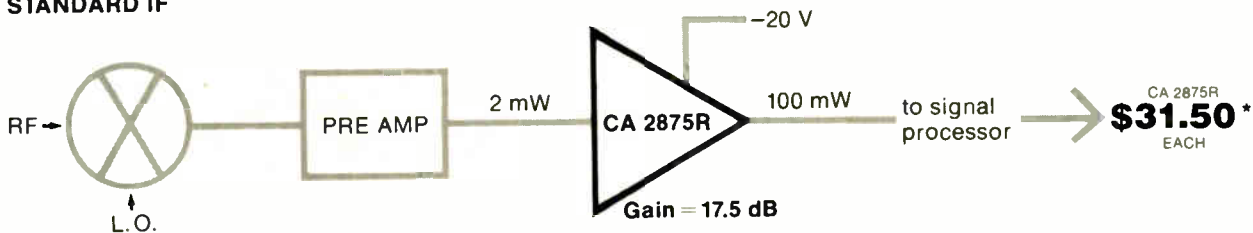

HIGH PERFORMANCE IF

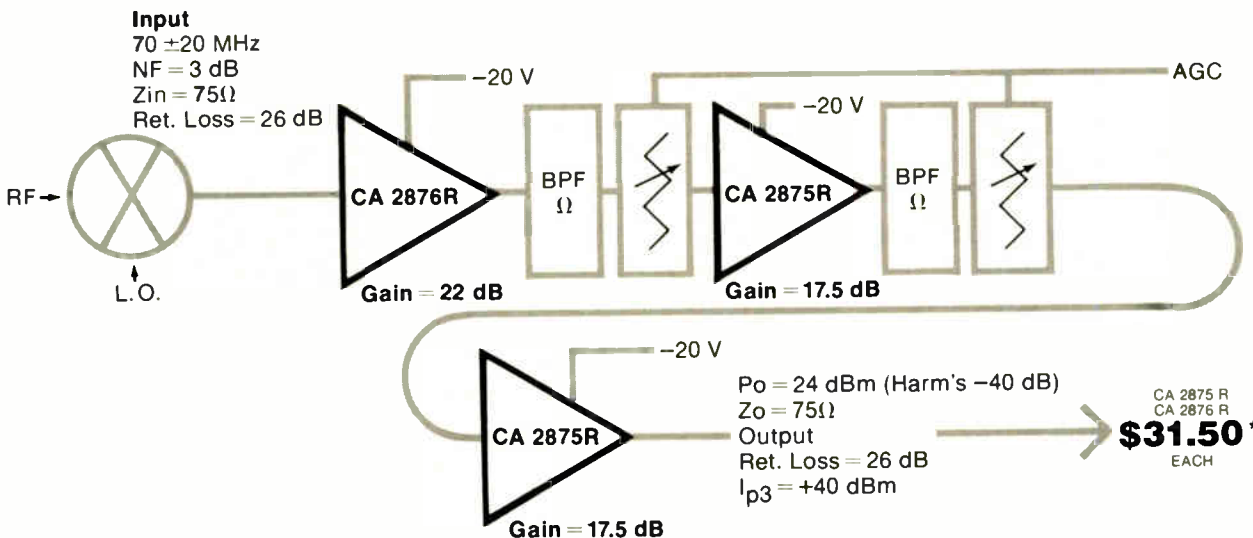

INSTRUMENTATION APPLICATIONS:

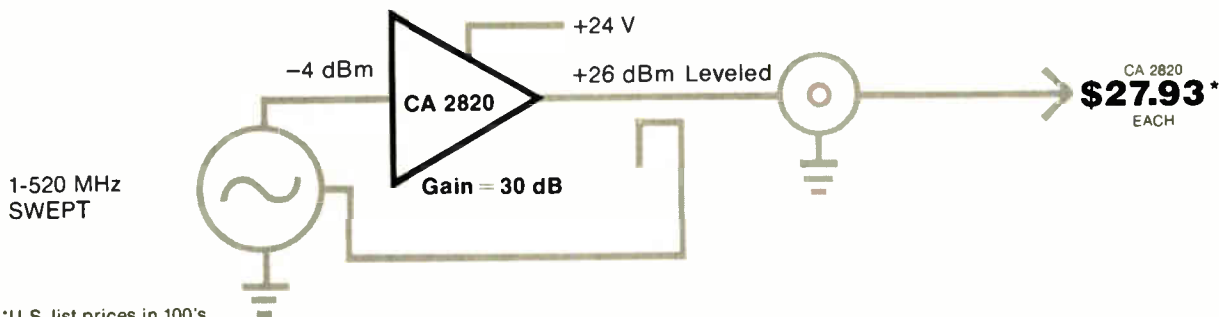

*U.S. list prices in 100's

These applications are only the beginning. TRW RF linear hybrids can revolutionize design after design...with incredible performance at unbelievable prices. Let us prove it. To get complete data sheets, send us the coupon.

To find out how you can get a free sample and test fixture, call Dan Brayton at (213) 679-4561.

TRW RF SEMICONDUCTORS

ANOTHER PRODUCT OF A COMPANY CALLED TRW

TRW RF Semiconductors

An Electronic Components Division of TRW, Inc.
14520 Aviation Boulevard, Lawndale, California 90260

- Please send me your new RF linear catalog.
- Please have an applications engineer contact me.

(Phone) _____

Name _____

Position _____

Company Name _____

Address _____

City _____

State _____

Zip _____

New Sinclair Cambridge Programmable.

An astonishing \$29.95!

How pocket calculators grew up

A couple of years ago, calculators took a step forward. Programmability transformed the slick slide-rule calculator into an advanced scientific machine.

Sadly, it also transformed a cheap little calculating aid into a piece of capital investment.

Now the all-new Sinclair Cambridge Programmable puts programmability where it belongs: in the palm of your hand, for less than \$30.

The features of the Sinclair Cambridge Programmable

The Cambridge Programmable is genuinely pocketable. A mere 4½" x 2", it weighs about 2oz.

Yet there is absolutely no compromise in the package of functions it offers.

Because the Cambridge Programmable is both a scientific calculator with memory, algebraic logic and brackets (which means you enter a calculation exactly as you write it), and a programmable calculator which offers simple, flexible through-the-keyboard program entry and operation.

The Cambridge Programmable has a 36-step program memory, and features conditional and unconditional branch instructions (go to and go if negative).

There is also a step facility, which allows you to step through the program to check that it has been entered correctly. If there is any programming error, the learn key allows you to correct single steps without destroying any of the remainder of the program.

To achieve this, each program key-stroke has an identifying code, or 'check symbol'. (The symbols for the digit keys are the digits themselves, while the symbols for the operator keys are letters printed beside the keys.)

The check symbol for \square , for example, is F. So if, as you step through the program, the display shows

check symbol step number



it means that \square is programmed as step 26. If step 26 should have been \square , all you have to do is press

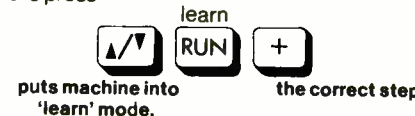

It's as simple as that!

These facilities make the Cambridge Programmable exceptionally powerful, whether it's running programs you devise for yourself or the programs in the Program Library.

Use the 294-program library to tailor the machine to your own specialty

Like a full-size computer – and unlike far more expensive specialist calculators – the Sinclair Cambridge Programmable can be programmed to handle calculations concerned with any specialty.

And of course, whatever it's doing the Programmable is error-free – in fact, once it's programmed, it can even be given to an operator who doesn't understand the program!

To save you time, and to help inexperienced programmers, Sinclair have produced a library of 294 programs ready to be entered straight into the calculator.

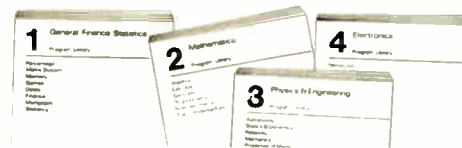

Using these standard programs, the Cambridge Programmable solves problems from quadratic equations (where the program gives both real and imaginary roots) to twin-T filter design, and from linear regression to bond yields. It even plays a lunar landing game! To realise the full power of the Cambridge Programmable, the Program Library is a must.

(The calculator is supplied with 12 sample programs, and full instructions for entering your own program. The four books in the program library are available at \$4 each, or \$10 for the complete set.)

Why the Cambridge Programmable costs so little

The Sinclair Cambridge Programmable uses the Sinclair talent for miniaturisation to the full – as you'd expect from the company that pioneered the truly pocketable pocket calculator, and recently introduced the world's first pocket TV.

Chip and circuitry design are unique to Sinclair, and the Cambridge Programmable is assembled by Sinclair's own staff at their headquarters plant. Shipped direct, and sold to you direct, the Cambridge Programmable accumulates no middleman's profits on the way.

The result is a pocket programmable calculator of advanced design, sold by the manufacturer with the manufacturer's own 1-year comprehensive guarantee, at a price unmatched by any comparable calculator.

10-day no-obligation offer

There's a lot more to this remarkable calculator than a brief written description can cover.

You need to see it and handle it... to program it yourself in a few seconds to save you hours... to check its performance against tables and graphs... to test the full range of programs available... to evaluate, perhaps, its use as an educational aid in developing a student's computer understanding.

So we're offering a 10-day trial. Send your check or money order with the order form below, and you'll receive a calculator direct. Use it for 10 days, and if you don't feel it's the finest \$29.95 you've ever invested, send it back. We'll refund your money without question.

There's nothing to lose, and so much calculating power to gain.

Post your order today.

sinclair

Sinclair Radionics Inc., Galleria,
115 East 57th Street, New York, N.Y. 10022 USA.
Tel: (212) 355 5005.

To: Sinclair Radionics Inc., Galleria, 115 East 57th Street, New York, N.Y. 10022, USA.

E9 S A 9P

Please send me _____ (qty) Sinclair Cambridge Programmable(s) at \$29.95 each, including full instructions, and sample programs. \$ _____

_____ (qty) AC line adaptor(s) at \$4.95 \$ _____

_____ (qty) Program Library Book 1 at \$4 \$ _____
General/Finance/Statistics
(percentage, metric system, memory games, dates, finance, mortgages, statistics)

_____ (qty) Program Library Book 2 at \$4 \$ _____
Mathematics (algebra, calculus, geometry, trigonometry, number theory, transcendental functions)

_____ (qty) Program Library Book 3 at \$4 \$ _____
Physics and Engineering
(astronomy, statics and dynamics, relativity, mechanics, properties of matter, fluids, structures, thermodynamics)

_____ (qty) Program Library Book 4 at \$4 \$ _____
Electronics (networks, circuits, filters, electro-dynamics, radiation and propagation)

_____ (qty) complete set(s) of 4 books at \$10 per set \$ _____

Sales tax (NY residents) \$ _____

Post and packing \$ 2.50

World Radio History Total \$ _____

Enclosed is check/MO payable to Sinclair Radionics Inc.

Name _____

Address _____

City _____

State _____

Zip _____

(PLEASE PRINT)

I understand that you will refund purchase price in full if I return calculator(s) and accessories in saleable condition within 10 days of receipt.

Signature _____

Army names Boeing, Vought to compete for GSRS missile

Development of the General Support Rocket System, a highly mobile, surface-to-surface missile, has been started by the Army with the award of competitive contracts of more than \$34 million each to Boeing Co. of Seattle and Vought Corp. of Dallas. **The 29-month validation program by the Army Missile Research and Development Command, Huntsville, Ala., calls for a competitive shutoff prior to a production decision.** The GSRS, with a range of more than 18 miles, will include six factory-sealed and maintenance-free rockets in a disposable, rectangular launching pod. Modular design, the Army says, will permit interchange of rockets, pods, and launchers with those of U. S. allies.

Telecommunications technology in China gaining, says EIA . . .

Telecommunications technology in the People's Republic of China "is more advanced than anyone thought," says the Electronic Industries Association's John Sodolski, following the return from that country of an EIA delegation of seven member companies [*Electronics*, Aug. 4, p. 49]. The firms' representatives, specializing in satellite communications, were impressed by a Chinese-built, 10-meter earth station and a telecommunications switching center. **"No one knew they had the earth stations, but they said they had a number of them,"** Sodolski said, adding that "the quality of the switching center was impressive—better than anyone anticipated."

. . . But Peking trade potential seen hurt by new study

As a People's Republic of China telecommunications delegation visits European space facilities (see International Newsletter), efforts by U. S. satellite communications companies to cultivate a Chinese market received a severe setback. It came in the form of a Library of Congress study assessing the China space program as almost completely oriented to military uses. The study, which evaluated space programs of 148 nations, says the last five of the seven Chinese satellites orbited since 1970 **appear to have been either reconnaissance or electronic eavesdropping satellites.** The report, made public Sept. 20 by the House Committee on Science and Technology, is regarded by electronics company representatives as offsetting the encouragement they derived earlier in the month from the technology export policy statement by Defense Secretary Harold Brown.

FCC spells out uhf/vhf antenna rules for TV sets

Television receiver makers who want to attach a common ultra- and very-high-frequency antenna to their products have been told by the Federal Communications Commission that they must meet one of two conditions. **Their measurement data must show that the common antenna's uhf reception is comparable to that of the uhf loop antenna now provided, and it must come complete with a description of the test procedures and equipment used to derive the data.** Alternatively, the common antenna request must show that receivers incorporate a built-in splitter circuit to couple uhf signals to the uhf tuner in a way that tests show yields acceptable reception.

The FCC ruling came after set makers sought clarification of an order requiring all receivers produced after July 15, 1978, to have a uhf antenna attached, not merely provided, if the vhf antenna is also attached. "Merely connecting the built-in vhf antenna to the uhf terminals" is not acceptable, the FCC said in response to industry queries.

Promises and problems in ERDA's push for solar electric power

Solar electric power advocates are being told there is "good news" in the Energy Research and Development Administration's plans to accelerate its photovoltaics program [*Electronics*, Aug. 4, p. 33]. The word comes from Henry H. Marvin, ERDA's solar energy division director, who in mid-September detailed the agency's proposals before the House Committee on Science and Technology.

Back from a tour of U.S. industry and Government laboratories involved in photovoltaic development, Marvin found that solar cell prices in the range of \$1 to \$2 per peak watt might be achieved by 1978-79, "two years earlier than ERDA's current projected milestone," and move the market "into a very rapid growth stage in the 1980-85 time frame."

By 1986 this could lead to the development of commercial plants capable of an annual production of 500 megawatts of modules "at a market price of less than 50 cents per peak watt," expanding by the year 2000 to "50 gigawatts of solar array modules at a market price of 10 to 30 cents per peak watt." Should that happen, ERDA believes some 20 gigawatts of electricity—3% of estimated U. S. demand—could be generated by photovoltaic conversion. That figure beats ERDA's previous 1.5% estimate.

Thorns in the roses

Nevertheless, there are some sharp thorns on ERDA's rosebush, as Marvin is quick to point out. "The major factor we see holding back this price reduction is the very large investment in manufacturing facilities required to implement cost-reducing technologies."

To stimulate this investment, ERDA's proposed new plan would accelerate solar cell buys through a series of "pull-through" experiments and applications in load centers of 25-to-500-kilowatt size, contracted for in 8 to 12 solicitation cycles over a 10-year period. Marvin adds that "smaller-scale applications, such as residences, become an option in the early 1980s."

ERDA's draft plan thus represents a switch from its existing program, for it opts to emphasize solar-cell technology and applications instead of pushing the development of equipment for large-scale manufacturing.

A good part of ERDA's decision to stress photovoltaic technology in its new proposal to the Congress is based on what Marvin calls "the very sizable technical problems to be resolved." These range from the need to double the efficiency of solar arrays to 15% to 20% from the present 8% to 10% level to development of a

low-cost, highly transparent, and noncontaminating array encapsulant to replace glass, plus "a very strong need to improve the capability of electric energy storage" derived from arrays.

As with any new technology, ERDA's draft plan has critics as well as advocates. Rep. Mike McCormack (D., Wash.), chairman of the Science and Technology subcommittee on advanced energy technologies, told one reporter, "There is no way to legislate a technology into being." Others who have seen ERDA's draft revisions have more particular criticisms.

Of the 30 responses analyzed by ERDA thus far, Marvin says, "some feel that the goal of \$1 to \$2 per watt in 1980 is too ambitious, particularly for flat-plate silicon." But half of ERDA's fiscal 1977 technology funds are devoted to silicon array cost reductions, and photovoltaic specialists want a better R&D balance between silicon and materials like cadmium sulfide, gallium arsenide, and cadmium telluride.

While there is general agreement in industry with ERDA's concept of a demand-pull strategy to spur the market through larger array buys and experimental applications, the responses also raise the question whether a market that is wholly dependent on Government stimulus can attract the necessary private investment in plant and equipment. "The underlying issue," Marvin contends, "is whether an intermediate market which will be growing and self-sustaining exists as we approach the \$1 to \$2 per peak watt goal." Clearly, industry is uneasy about that prospect.

Persuading Congress

The fact that ERDA's new proposal is generating as much debate as it already has—much of it outside the industry—is encouraging to some industry optimists. "At least there is someone else in church besides the choir," says one. As for those who say ERDA's revised goals are too ambitious, the same person recalls that "no one believed we could meet the timetable for a lunar landing either." He dismisses Congressman McCormack's observations quickly. "He wouldn't be saying that if he hailed from Arizona, Texas, or Utah. Washington is always cloudy—except when it's raining." But McCormack, a sponsor of solar heating and cooling as well as electric vehicles, is widely regarded as a realist and a force to be reckoned with on energy issues. If ERDA is to succeed with its program, it must muster its fellow optimists to convince the Congress that its goals are in fact achievable.

Ray Connolly

Ion implantation... a way of life.

Pioneered by Sprague Electric's Semiconductor Division, the process technique of ion implantation has become an industry standard and is now used by virtually every semiconductor manufacturer. Sprague Electric applies this universally-recognized technology to a broad base of discrete and integrated devices which use both MOS and bipolar processes. Ion implantation has made possible substantial size reductions and tighter process controls, which result in improved device performance.

At Sprague Electric's Semiconductor Division, we have accumulated over 15 years of intensive experience in the manufacture of *innovative* semiconductor devices... devices which have made special contributions to technology... devices which are manufactured under a most exacting QAR pro-

gram... devices which are designed to assure total customer satisfaction.

We have built the kind of operation that is required to produce semiconductors which are compatible with today's as well as tomorrow's requirements.

We proudly invite customers and prospects to tour our plant, the nation's finest semiconductor facility of its type. Here you will see the magnitude of effort that goes into properly designed and manufactured devices. You'll be pleasantly surprised!

Write or call George Tully or Bob Milewski to arrange a visit. You can reach them at the Semiconductor Division, Sprague Electric Co., 115 Northeast Cutoff, Worcester, Mass. 01606. Tel. 617/853-5000.



455 7135

FOR FAST INFORMATION, CALL YOUR NEAREST SPRAGUE SALES OFFICE:

ALABAMA, Sprague Electric Co., 205/983-0520 • ARIZONA, Sprague Electric Co., 602/279-5435 • CALIFORNIA, Sprague Electric Co., 213/649-2600, Wm. J. Purdy Co., 415/347-7701; KCE Corp., 714/278-7640 • COLORADO, Wm. J. Purdy Co., 303/777-1411 • CONNECTICUT, Sprague Electric Co., 203/281-2551 • DIST. OF COLUMBIA, Sprague Electric Co. (Govt. sales only), 202/337-7820 • FLORIDA, Sprague Electric Co., 305/831-3636 • ILLINOIS, Sprague Electric Co., 312/678-2262 • INDIANA, Sprague Electric Co., 317/253-4247 • MASSACHUSETTS, Sprague Electric Co., 617/899-9100; Sprague Electric Co., 413/664-4411 • MICHIGAN, Sprague Electric Co., 517/787-3934 • MINNESOTA, HMR, Inc., 612/920-8200 • MISSOURI, Sprague Electric Co., 314/781-2420 • NEW JERSEY, Sprague Electric Co., 201/696-8200; Sprague Electric Co., 609/795-2299; Trinkle Sales Inc., 609/795-4200 • NEW MEXICO, Wm. J. Purdy Co., 505/266-7959 • NEW YORK, Sprague Electric Co., 516/549-4141; Wm. Rutt, Inc., 914/698-8600; Sprague Electric Co., 315/437-3111; Mar-Com Associates, 315/437-2843 • NORTH CAROLINA, Electronic Marketing Associates, 919/722-5151 • OHIO, Electronic Salesmasters, Inc., 800/362-2616; Sprague Electric Co., 513/778-0781 • PENNSYLVANIA, Sprague Electric Co., 215/467-5252; Trinkle Sales Inc., 215/922-2080 • TEXAS, Sprague Electric Co., 214/235-1256 • VERMONT, Ray Perron & Co., Inc., 617/762-8114 • VIRGINIA, Sprague Electric Co., 703/463-9161 • WASHINGTON, Sprague Electric Co., 206/632-7761 • CANADA (Ontario), Sprague Electric of Canada, Ltd., 416/766-6723 • CANADA (Quebec), Sprague Electric of Canada, Ltd., 514/683-9220





... and you thought we
only make great capacitors.

Check out TI's new 4K static RAMs.

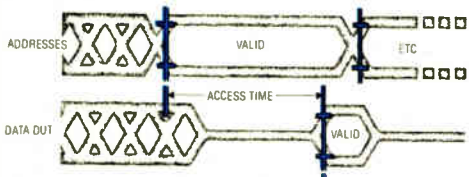
They've got everything you ever liked about the 2102. And more.

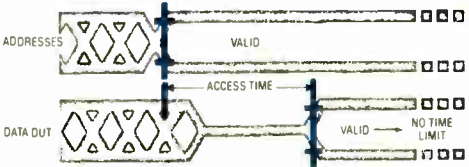
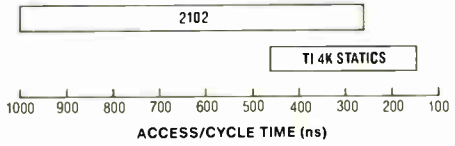
	2102 1K Static RAM	TI's New 4K Static RAMs	
SIMPLE TO USE	✓	✓	Like the popular 2102, TI's new 4K static RAMs are easy to use. Minimize system overhead; no refresh; simple addressing. It's easy!
NO CLOCKS. NO TIMING STROBES. 	✓	✓	No clocking needed for TI's fully static 4K RAMs. No edges. Just present an address to the selected device and data can be read at access time. That's it.

	2102 1K Static RAM	TI's New 4K Static RAMs																			
FULLY STATIC. ACCESS TIME = CYCLE TIME.	✓	✓	Fully static RAMs are totally asynchronous. Require no precharge or recovery time. Access and cycle times are always the same.																		
DATA VALID—NO TIME LIMIT. 	✓	✓	Fully static RAMs offer output data that are valid as long as the address is valid. Makes designing straightforward. No limit on output valid time. No extra circuitry.																		
SINGLE +5 V SUPPLY. FULLY TTL COMPATIBLE.	✓	✓	Just one +5 V supply needed. Full TTL compatibility on all inputs and outputs with full 400 mV guaranteed dc noise immunity.																		
±10% TOLERANCE SUPPLY.		✓	Improved power supply tolerance means less stringent regulation. Less cost.																		
HIGH SPEED.  <table border="1" data-bbox="72 1232 532 1377"> <thead> <tr> <th>Max Access</th> <th>4K x 1</th> <th>1K x 4</th> </tr> </thead> <tbody> <tr> <td>150 ns</td> <td>TMS 4044-15</td> <td>TMS 4045-15</td> </tr> <tr> <td>200 ns</td> <td>TMS 4044-20</td> <td>TMS 4045-20</td> </tr> <tr> <td>250 ns</td> <td>TMS 4044-25</td> <td>TMS 4045-25</td> </tr> <tr> <td>300 ns</td> <td>TMS 4044-30</td> <td>TMS 4045-30</td> </tr> <tr> <td>450 ns</td> <td>TMS 4044-45</td> <td>TMS 4045-45</td> </tr> </tbody> </table>	Max Access	4K x 1	1K x 4	150 ns	TMS 4044-15	TMS 4045-15	200 ns	TMS 4044-20	TMS 4045-20	250 ns	TMS 4044-25	TMS 4045-25	300 ns	TMS 4044-30	TMS 4045-30	450 ns	TMS 4044-45	TMS 4045-45		✓	TI's new 4K static RAMs take up where the 2102 left off. Offering a wide choice of speeds from 150 ns to 450 ns maximum access/minimum cycle. Plenty of performance to match today's and tomorrow's CPUs.
Max Access	4K x 1	1K x 4																			
150 ns	TMS 4044-15	TMS 4045-15																			
200 ns	TMS 4044-20	TMS 4045-20																			
250 ns	TMS 4044-25	TMS 4045-25																			
300 ns	TMS 4044-30	TMS 4045-30																			
450 ns	TMS 4044-45	TMS 4045-45																			
LOW POWER. <table border="1" data-bbox="72 1491 532 1667"> <thead> <tr> <th>Parameter</th> <th>Four Low Power 1K Static RAMs (2102AL-2)</th> <th>One TI 4K Static RAM (TMS 4044-25)</th> </tr> </thead> <tbody> <tr> <td>Max. Access</td> <td>250 ns</td> <td>250 ns</td> </tr> <tr> <td>Min. Cycle</td> <td>1368 mW</td> <td>500 mW</td> </tr> <tr> <td>Operating Power (Max.)</td> <td>4 x 16 pin</td> <td>1 x 18 pin</td> </tr> <tr> <td>Package(s)</td> <td>3.7</td> <td>1.0</td> </tr> <tr> <td>Board Area Ratio</td> <td></td> <td></td> </tr> </tbody> </table>	Parameter	Four Low Power 1K Static RAMs (2102AL-2)	One TI 4K Static RAM (TMS 4044-25)	Max. Access	250 ns	250 ns	Min. Cycle	1368 mW	500 mW	Operating Power (Max.)	4 x 16 pin	1 x 18 pin	Package(s)	3.7	1.0	Board Area Ratio				✓	Compare the power savings of the new 4K statics to the low power 21L02. For equivalent speed, the new TMS 4044 uses 63% less power. For super low standby-power/battery-backup operation, use the pin-compatible 20-pin TMS 4046/47 Series. Data is retained down to 10 mW.
Parameter	Four Low Power 1K Static RAMs (2102AL-2)	One TI 4K Static RAM (TMS 4044-25)																			
Max. Access	250 ns	250 ns																			
Min. Cycle	1368 mW	500 mW																			
Operating Power (Max.)	4 x 16 pin	1 x 18 pin																			
Package(s)	3.7	1.0																			
Board Area Ratio																					
HIGH DENSITY 18-PIN PACKAGE. 		✓	The new 4K statics come in industry-standard, 18-pin packages, plastic or ceramic. A density improvement of almost four-to-one over 2102s.																		

FOR DATA SHEETS, application reports, price and delivery, call your nearest authorized TI distributor or TI field sales office.

TEXAS INSTRUMENTS
INCORPORATED

**Need miniature audio transformers
in most popular configurations
in any of three sizes?**

TRW/UTC has a stock answer.

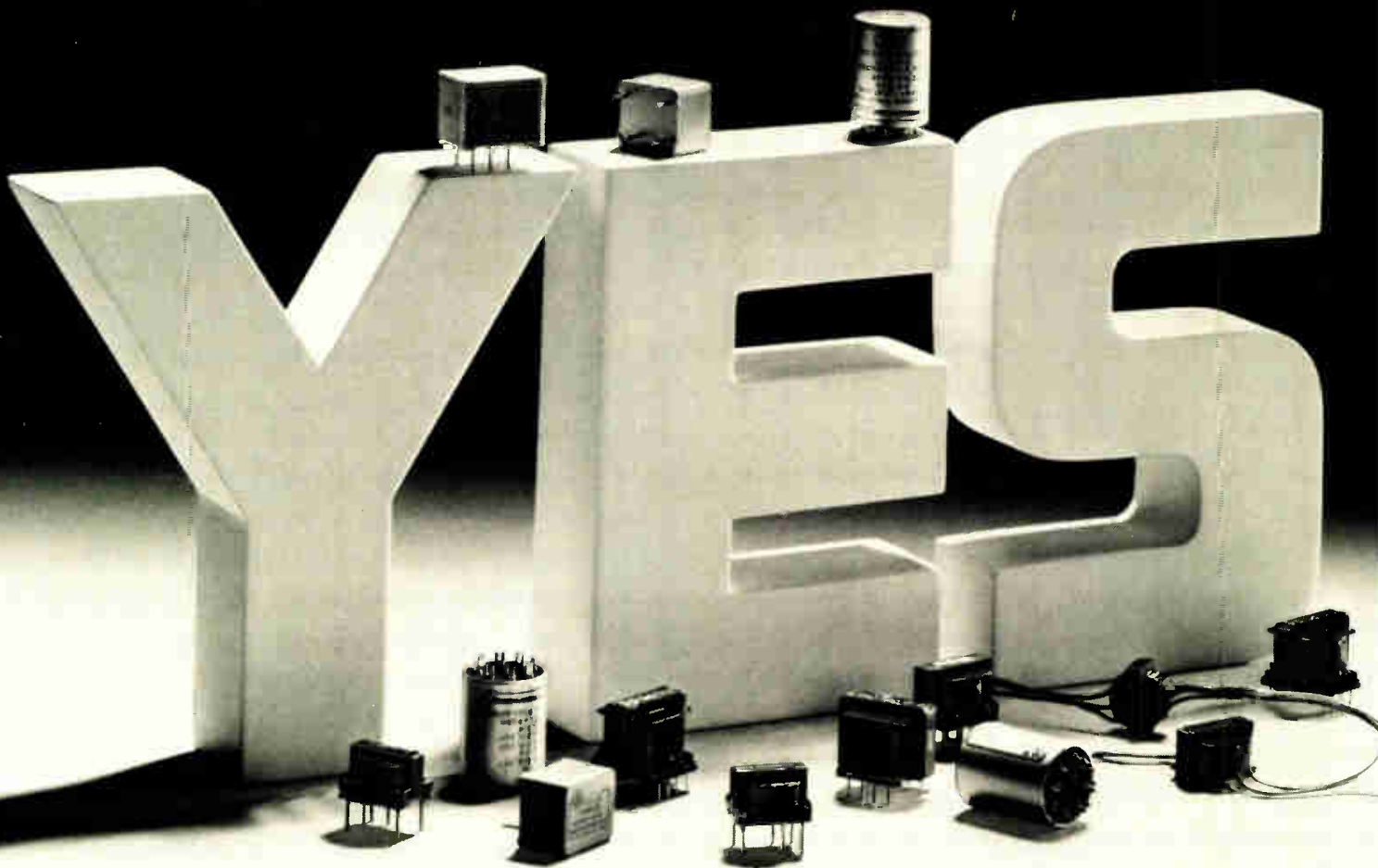

TRW/UTC has a line of miniature industrial audio or signal transformers that come in three wattage ratings. And, they're available in four different configurations.

To find the unit you need, check the table below.

	Ouncer	Subouncer	Sub-Subouncer
P.C. Board Mounting	PC-O Series	PC-SO Series	PC-SSO Series
Flexible Leads		SO Series	SSO Series
Molded		SO#P Series	SSO#P Series
Alarm Housing	O Series		

Because our miniatures come in 4 styles, you have a choice. Now you can design our unit into your circuit in the manner most convenient for you.

For immediate off-the-shelf delivery check your authorized TRW/UTC local distributor. Or for more information on standards that are something special, contact TRW/UTC Transformers, an Operation of TRW Electronic Components, 150 Varick Street, New York, N.Y. 10013. Area Code: 212-255-3500.

TRW UTC TRANSFORMERS

ANOTHER PRODUCT OF A COMPANY CALLED TRW

A third firm shows audio-tape systems based on VTRs

Japanese manufacturers of consumer electronic products are positioning themselves to move into what they see as a promising new market segment: audio-tape ultrahigh-fidelity systems that use pulse-code modulation and are based on video-tape recorders. The latest firm to show possible offerings is Mitsubishi Electric Corp., with two experimental systems based on the video-home-system technology for VTRs. **One is based on an adapter for VTRs, making it similar in concept to systems earlier announced by Sony and Matsushita** [*Electronics*, Sept. 15, p. 64]. The other, for hi-fi buffs, is a special-purpose audio deck built around a VHS tape drive. It has electronic circuits for recording and playback of PCM audio—all video functions have been omitted. Japanese firms are also pushing development of disk-based ultrahi-fi systems (p. 42). The Osaka firm hopes to negotiate a standard format with other VHS makers in order to facilitate sales of prerecorded tapes.

U.S.-Japanese firm plans to join video-disk market

In a move that will step up the competition in the burgeoning market for video-disk players, the U. S. entertainment giant MCA Inc. and the Japanese hi-fi component maker Pioneer Electronic Corp. have formed a joint company. Universal Pioneer Corp. will begin production of industrial data-retrieval systems in October 1978, at a rate of about 1,000 systems a month. **The player will include a microprocessor and will retrieve information from 5,400 individual television frames on a disk.** About a year later, the company expects to start production of consumer units.

Chinese delegation views European Satcom facilities

The People's Republic of China, anxious to expand its satellite telecommunications capabilities (see p. 57), has sent nine specialists to six Western European countries on a six weeks' tour, says the European Space Agency. The delegation from the Chinese Electronics Society, headed by Lei Hung, will conclude its trip on Oct. 20 after visiting national space facilities and companies **for briefings on high-power broadcast satellites, transmission techniques, fixed and mobile earth stations, plus new technological developments and satellite applications.** The visit will cover France, the Federal Republic of Germany, the Netherlands, Italy, the United Kingdom, and Sweden. (See Washington Newsletter, p. 54).

2 British firms target audio cassettes for TV game memories

Believing that cassettes based on programmable read-only memories are too limited for the TV game market, EMI Ltd. and General Instrument Microelectronics of Great Britain plan to introduce early next year hardware for a microprocessor-based game set that uses standard audio-tape cassettes. EMI, the world's largest producer of records and tape cassettes, claims to have developed a high-density recording technique that protects program integrity. **Thus, a standard programmed \$5 cassette can hold 2 megabits of program, including voice and sound effects, versus only 16,000 bits for the typical mute \$20 PROM.** General Instrument is basing its approximately \$150 chip set around a CP 1610 16-bit microprocessor, a standard TV interface chip, a custom-designed n-channel MOS character-generator chip, and various memory circuits. Both firms are talking with U. S. and continental TV makers about building the scheme into sets due in late 1978 because "the add-on market for TV games is dead," surmises a General Instrument executive.

SABRE VII

makes no compromise with quality and performance... Why should you?

No other IRIG tape recorder/reproducer gives you all these capabilities. System prices from less than \$15,000.

- Two electrically switchable tape speed ranges from 120 to 1 1/2 ips or 60 to 15/16 ips
- Direct bandwidths to 2 MHz
- FM bandwidth from DC to 500 kHz
- 10 1/2, 14 and 15-inch reels with 38.4 hours of record time
- IRIG PCM to 600 kb/s serial rate
- HDR to 4 Mb/s serial rate
- 7, 14 or 16 channel capacity
- Low flutter/TBE
- Self-contained power supply
- Both tape shuttle and loop operation available

Now have the full-capability performance you need at the lowest price. All it takes is SABRE VII, the all-band portable recorder/reproducer that handles either 1/2-inch or 1-inch tape . . . records and reproduces Direct, FM, PCM and either serial or parallel high density PCM. Easily switches between IRIG, FM bands by means of a single switch. For even more versatility, you get two bi-directional speed ranges, plus automatically-switched reproduce electronics for up to 7 tape speeds. *You get it all, and SABRE VII actually costs less than comparable systems.*

Amazing? Yes, and because of the same superior engineering, SABRE VII also controls tape speed accuracy to within $\pm 0.10\%$ and extends tape and head life through enhanced tape handling. Options include FM calibrator, remote control, voice, IRIG tape servo, rack mount kit, shuttle, sequential record and/or reproduce and anti-vibration mounts. **SABRE VII doesn't compromise with quality and performance. Why should you!**

For complete details, write or call:

Sangamo Weston, Inc.
Data Recorder Division
P.O. Box 3347
Springfield, IL 62714
TEL: (217) 544-6411

SANGAMO WESTON
Schlumberger

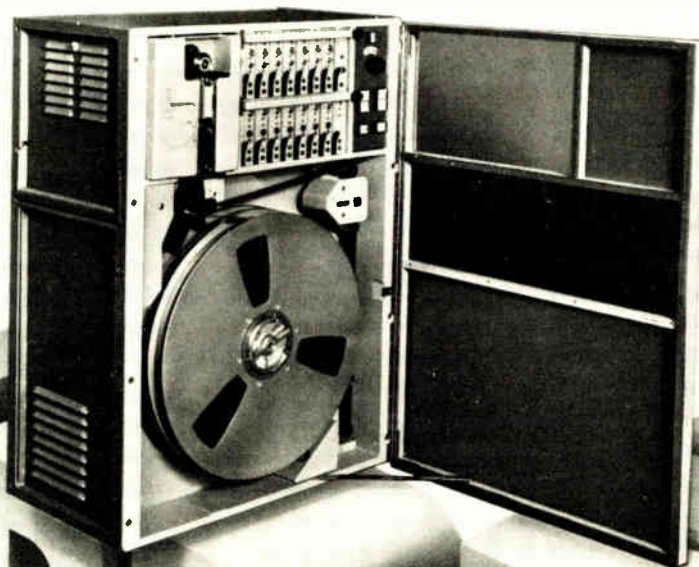

Multilevel bit storage in CCD memory gives higher packing density

If CCD memories are to make it as replacements for disks and tapes in low-cost storage systems, they must be cheap. That means they must be dense—much denser than random-access memories, which have high speed as their selling point. So increased packing density is the goal of Mitsubishi Electric Corp.'s new technique of stacking two levels of storage one on top of the other, thereby packing 2 bits of memory into each storage site.

Using this approach, they have produced an experimental 131,072-bit charge-coupled-device memory that achieves its high packing density with the same geometry as in 65,536-bit CCD chips. Their chip measures 8.9 by 7.9 millimeters, but it has large margins as a precaution. The cell area per bit is 208 square micrometers.

The memory is organized as 256 randomly addressable shift registers of 512 bits each for application as a 131-k-by-1-word device. Each register is composed of four parallel registers, each containing 64 cells that can store levels of zero charge, a third of the full charge, two thirds, and full charge.

Input stage. To store 2 bits in one cell requires two write cycles and an input stage with two input cells, one of which (S in the figure) is twice the size of the other (I in the figure). The first bit is sampled and stored in S as 1 or 0. The second bit is sampled and stored in I, which is electrically separated by M from the bigger input cell.

Next, the two charge packets are mixed by lowering M. If both bits are 0 or 1, then the charge to be transferred to the shift register's first serial storage cell is, respectively, 0 or 1. If the first bit is 0 and the second is 1, then the charge to be transferred is a third of the full charge because I is only a third of the combined input cells; if the first

is 1 and the second is 0, then the charge is two thirds because S makes up two thirds of the combined cells.

For read and refresh operations in each register, an associated high-performance cross-coupled amplifier is used with two reference levels to detect the 2 bits of stored data. In effect, it compares the value of the output signal with values that are midway between the output's possible values.

For the first bit, the sense amp compares the output signal with a half-level signal from a dummy register. If the output signal is zero or one third—less than the half-level signal—the sense amp generates a 0 for the first bit and resets the dummy register's signal at one sixth. If the shift register's output is zero—less than the dummy register's new signal—then the sense amp generates a 0 for the second bit. However, if the shift register's output is one third, the sense amp generates a 1.

If the shift register's output is two thirds or one, compared with the dummy register's half level, then the sense amp generates a 1 for the first bit and resets the dummy at five sixths. Then if the shift register's output is one, the sense amp generates a 1 for the second bit. However, if the shift output is two thirds—less than five sixths—the sense amp generates a 0.

The CCD array employs a double-level polysilicon gate structure that is an extension of the conventional n-channel silicon-gate technology. The

Two for one. Configuration of input stage permits one CCD cell to hold 2 bits.

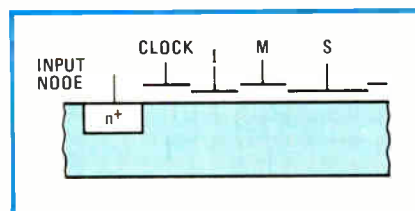

device is compatible with transistor-transistor logic and operates from conventional metal-oxide-semiconductor supplies of 12, 5, and -5 v. The register desired can be selected by address input. Clocks—including data-transfer, read-and-write control, chip-select, and column-address-strobe clocks—are common to all 256 registers.

Researchers at Mitsubishi's laboratory at Kitaitami, near Osaka International Airport, say the transfer efficiency of charges down the serial cell array of their 131-k memory is not 100%. Moreover, a 64-cell length for each register is the maximum possible, given the state of the art in MOS fabrication. In fact, there is some question if the transfer efficiency can be maintained at a high enough value to give good yield in production. A company spokesman says fabrication technology will soon improve sufficiently to make this question academic. □

Great Britain

6800 broadens range of process controller

Much process-control hardware has been tailor-made by systems houses, but standard units suitable for a wide range of jobs can be built with microprocessors. So believes The Solartron Electronic Group Ltd., which is announcing a process-control computer built around a Motorola 6800 8-bit microprocessor. The unit is intended for applications in hydrocarbon processing.

"Thanks to the microprocessor, we're providing an off-the-shelf standard product that does not have to be tailored to accept a variety of inputs from gas or fluid measurements," says John Emmerson, marketing manager for the firm's trans-

ducer group. The 7900/01 is designed for such applications as petrochemical pipelines, where it can monitor a pipeline used to transfer different products, one after the other, he says.

Emmerson forecasts a good market for the \$3,000 unit. "I don't see any major European competition," he says. He expects to ship half his products to the U.S. market to compete against units that measure only gases or only liquids.

Applications. Other uses include monitoring the energy used by the system being controlled and measuring the energy content of oil or gas. The instrument can compute volume, mass, and energy flow from as many as 10 inputs, including density, static and differential pressure, temperature, specific gravity, fluid flow rate, and calorific value.

The Farnborough, Hants., firm chose the 6800 because it has a better instruction set and better backup than its competition, according to Emmerson. For density measurement, the 7900 needs only 4,096 bits of electrically programmable read-only memory and 384 bits of random-access memory, of which 265 bits are provided with a battery backup. The 7901 has an additional computer board so that it can also measure flow.

The portable controller is designed so that "it can be used in the field by a process engineer who is not a software expert," he says. With a simple control-word program based on a table of 100 numbers broken down into groups representing the various parts of a system, the user can enter data from the transducers or other sources. This programmability means that the unit may be moved without having to be taken back to home base for reconfiguration.

Another selling point is that "we've paid more attention to integrity," Emmerson says. By that, he means the firm aimed for a well-thought-out design that yields consistent, highly accurate results. For example, the primary transducer inputs of flow and density are duplexed so that the controller can compare for any mismatch. □

Around the world

Saddle yoke, reuse of flyback energy cut color TV power

Coming on the market next month is a Blaupunkt GmbH 20-inch TV set that dissipates 75 watts, as much as 100 W less than comparable sets. The Hildesheim, West Germany, firm is stressing the improved set life that comes as a result of the low power use. Its new model compares favorably with the most thrifty of the Japanese 20-in. sets and with the Xtended Life line from RCA Corp., which has a 19-in. set (corresponding in viewing area to the foreign 20-in. models) with an 86-W consumption.

The German set combines first-stage developments that reduced power to 95 W with a saddle yoke used for power deflection instead of the usual toroid to achieve the drop to 75 W. With its greater number of windings, the saddle yoke has a higher impedance—thus halving current use, which means less power consumption and less heat.

The chief energy saver is a first-stage development: a vertical deflection circuit that uses the horizontal-flyback pulse energy, which usually goes to waste once it has traced the scan lines for one frame of the TV picture. The circuit includes a modulator that produces a pulse-modulated rectangular signal fed by two synchronously switched low-voltage thyristors to the vertical-deflection stage. The thyristors are configured as a class AB amplifier, which has an efficiency of about 70% when driven with the rectangular signal, compared with about 12% for the more common class B amps. So energy needed for vertical deflection is 7 or 8 W, about 17 W less.

Also helping to drop power to 95 W are special transistors in place of thyristors in the horizontal-deflection stage, and a red-green-blue-driver designed as a push-pull circuit using less power than class A or B amps.

CCD-MOS chip promises high-performing correlator

In the breadboard stage at the University of Edinburgh, Scotland, is an analog correlator that combines MOS devices and CCD circuitry. Researchers at the Wolfson microelectronics liaison unit say the monolithic correlator will practically fit onto one chip while promising significantly better performance than other approaches.

They think the unit will be a cheap way to pluck weak signals from background noise for pulse-compression filters or to build programmable filters for other signal-processing jobs. Moreover, it promises to be an attractive alternative to costly and complex digital hardware and to nonprogrammable analog charge-coupled-device circuits, they say.

So far, their chip combines a 32-stage CCD register that serves as a delay line and a MOS multiplier of 32 matched transistor pairs. Soon to be tested are chips that also include a three-phase CCD clock, a sample-and-hold circuit for storing the reference, and a 32-way array of complementary-MOS switches for clocking in the reference. Off chip will be only five operational amplifiers and a counter. The correlator is programmable because the reference signal may be changed and even refreshed either synchronously or asynchronously with the CCD clock. The prototype operates at 8,000 samples per second, although higher speeds look obtainable.

Audio sales booming in West Germany

Audio-equipment sales in West Germany are expanding vigorously and are running neck and neck with television receiver sales, says Philips GmbH, the Hamburg-based affiliate of the Dutch company. For the first time, the audio market will match the combined sales of color and monochrome TV sets: nearly \$2 billion this year, says the firm.

Because they tend to be highly accurate, Philips' predictions are taken seriously by market watchers. Moreover, the West German economy is considered the pacesetter in Europe. For example, what consumers there snap up now are likely to be the next hot items in other countries.

The segments performing the best are car radios and high-fidelity systems for the home, says the Hamburg firm. Both are expected to do well in coming years; in fact, prospects for audio sales in general through 1980 are bright despite the relatively high penetration figures for some products.

We've lowered the cost of environmentally-qualified terminals.

Interstate Electronics has developed a new family of ruggedized plasma display terminals that cost significantly less than any comparable military terminals.

Because Interstate Electronics—and nobody else—gives you “next generation” plasma display electronics. Through innovative circuit integration, we've reduced terminal size, weight and electrical complexity. As well as price.

The PD Series can be specified for a variety of military environments—sheltered, shipboard and airborne.

Each model offers:

- 4,000 character display capability
- Complete graphics capability

- Extremely fast transfer rates (up to 50K baud)
- Inherent memory and selective write/erase to free computer time
- Extremely long panel life

We also offer a complete selection of options, including:

- Touch panel input
- Special function keys
- Programmable character generator
- Multiple input/output capability
- Software support packages

Interstate can help you select the optimum

terminal configuration for your requirements. Give us an opportunity to discuss your operational environment and performance needs.

Write or call Don Poulos, Products Manager, Computer Products, Interstate Electronics Corporation, 707 E. Vermont Ave., Anaheim, CA 92802. (714) 635-7210 or (714) 772-2811.

**INTERSTATE
ELECTRONICS
CORPORATION**

SUBSIDIARY OF **ATO**

Circle 67 on reader service card

Copyright 1977
Interstate Electronics Corporation



The P400 makes excuses obsolete.

A new product comes on line and the circuit boards start piling up. This is when the excuses begin:

"I can't get near the computer."

"I need more programmers."

"I just got schematics last week."

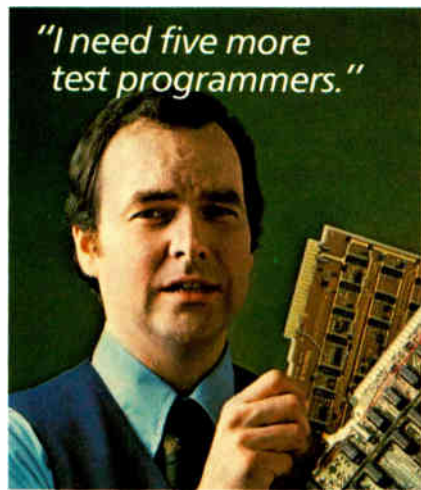

It's a difficult time for a test engineer because the success of an important product can hang in the balance.

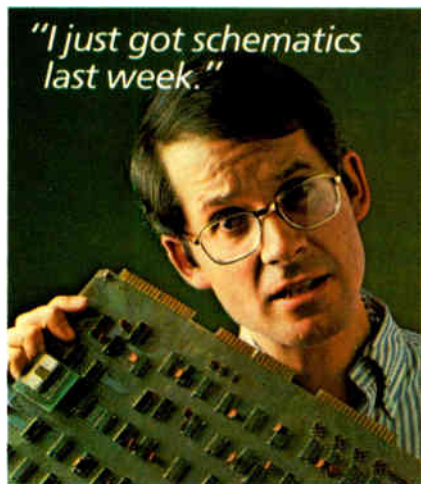

But Teradyne's P400 Automatic Programming System has changed all that. Used with L100 series test systems, the P400 creates the entire test program



automatically. It gives you all input patterns, provides all diagnostic data, and resolves all races. It cuts programming time from weeks to days. And it does it all without tying up the computer on your production tester or increasing your programming staff.

Suddenly, new programs can be ready on time, even in the face of the tightest schedules. And even for the most complex boards.

Just as important, the P400 spares you all the boring work it usually takes to deliver new programs. You get typically better than 95% fault coverage simply by using the telephone to access a large computer containing the P400 software.

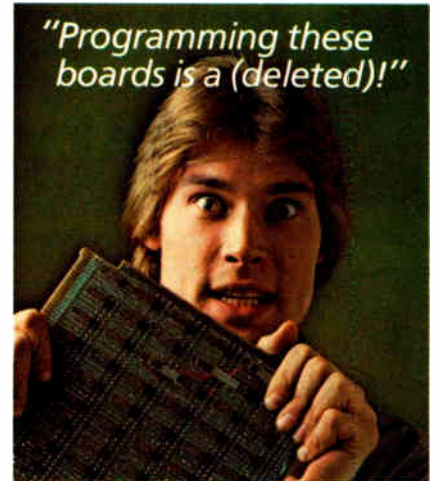

The P400 Automatic Programming System.

Now there's no reason for being late.

And we think that's the way you want it.

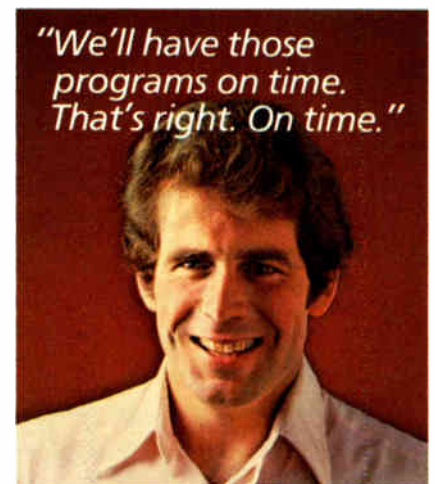

TERADYNE

183 Essex Street, Boston, Mass. 02111

One-chip micros spur new race

Intel, Mostek, and TI are bunched up front; basic question is whether devices should be compatible with multichips

The most volatile segment of the microcomputer market, byte-oriented one-chip devices, has reached flashpoint: three designs introduced during the past year are fighting for supremacy. At stake is a market that should grow to more than \$100 million in the next 12 months.

The microcomputers are:

- Intel Corp.'s 8048, an 8-bit microcomputer that comes with 1,024 bytes of program read-only memory, 64 bytes of scratch-pad random-access memory, and three 8-bit input/output ports. The 8048 family, which includes the 8748, the industry's only user-erasable programmable ROM, is upwardly expandable, with matched ROM I/O and RAM I/O chips for adding the extra memory that more powerful control applications need. It is not, however, software-compatible with the general-purpose 8080/8085 family, but can be used with the peripherals. Other suppliers are Advanced Micro Devices Inc., Signetics Corp., and Nippon Electric Corp.

- Mostek Corp.'s 3870, an 8-bit device that is software-compatible with the multichip F8 and is one of the most powerful one-chippers available. It has 2,048 bytes of program ROM, 64 bytes of RAM, and 32 bits of I/O ports. It is not upwardly expandable in program capacity or I/O capability. Other suppliers are Fairchild Camera and Instrument Corp. and Motorola Semiconductor.

- Texas Instruments Inc.'s 9940, which is software-compatible with TI's family of 9900 16-bit microcomputers. Like the 3870, it has 2,048 bytes of program ROM, but its 128

8-BIT MICROCOMPUTERS						
	Intel	Fairchild	Mostek	Motorola	Rockwell	Texas Instruments
Computer	8048/8748	3859	MK3870	MC6801	unnamed (1-chip 6500)	TMS9940
Technology	n-channel	n-channel	n-channel	n-channel	n-channel	n-channel
ROM size (bytes)	1,024	1,024	2,048	2,048	2,048	2,048
RAM size (bytes)	64	64	64	128	64	128
Instructions	96	70	70	72	53	58
Input/output bits	32	32	32	30	34	32
Power supply (V)	+5	+5	+5	+5	+5	+5
Availability	now	now	now	1978, 2nd quarter	1978, 1st quarter	1978, with EPROM, 1st quarter, with ROM, 2nd quarter
Alternate sources	AMD Signetics	-	Fairchild Motorola	-	MOS Technology Synertek	-

bytes of RAM gives it twice the scratch-pad capacity of the Intel or Mostek entries. Like the 3870, it has 32 general-purpose lines, but like the 8048, it is expandable (to a full 256 bits) and will be supplied in a user-programmable model, the 9940E. Another supplier is American Microsystems Inc.

While there are some differences in the processing power and program size of these chips, the three suppliers diverge sharply on the question of whether to make a single-chip microcomputer compatible with established multichip families of devices.

Intel adopted the view that it was better to surrender the compatibility with 8080 software in order to optimize its design around the most efficient software for one-chip configurations. TI, on the other hand, chose to make its 9940 software-compatible with its more powerful multichip 9900 family, so as to minimize its software investment, but at the expense of a slightly less elegant design. Mostek's philosophy stands somewhere between the two. It was

able to optimize its one-chip 3870 and still make the devices software-compatible with the multichip F8, thanks to the ease with which the original two-chip F8 design proved capable of being redesigned into a one-chip format.

Design concepts. According to George Adams, product marketing manager for low-end microcomputers at Intel, the strategy the Santa Clara, Calif., firm is taking is to build a full family of single-chip devices, all with the same instruction set and the same basic architecture but with different mixes of ROM, RAM and I/O for different price and performance levels.

The software, he says, is used to tailor the particular device in its family of one-chip microcomputers to a specific application. Intel's family of one-chippers is dedicated, in the sense that each is tailored to meet the needs of various segments of the one-chip marketplace.

"Our strategy is to bracket the 8048/8748, above and below," says Adams. At the low end, competitive with 4-bit devices is the 28-pin 8021,

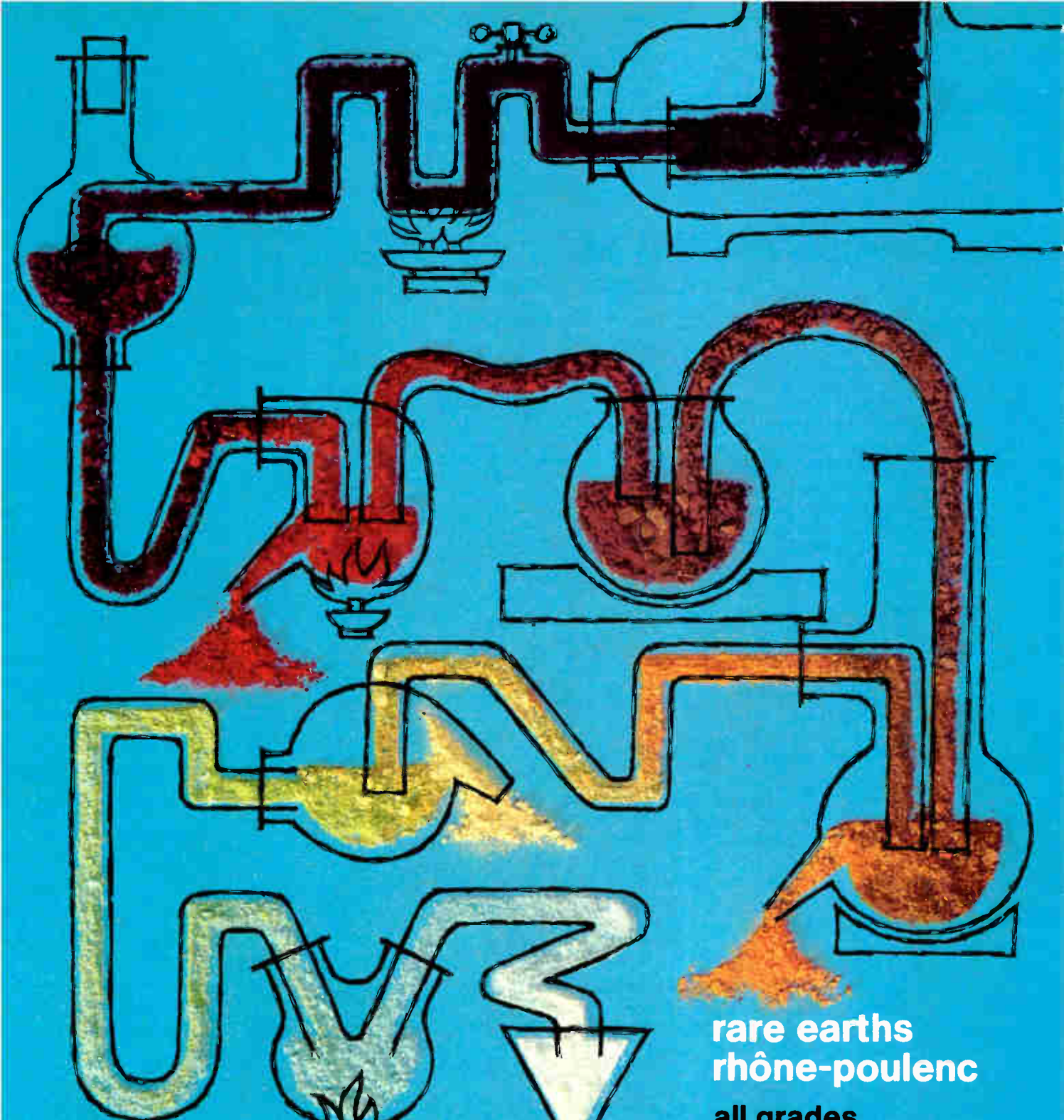

**rare earths
rhône-poulenc**
all grades
ranging
up to

99,9999% purity

La	Gd	Yb
Pr	Er	Lu
Ce	Tb	Tm
Nd	Dy	
Sm	Ho	Th
Y	Eu	

For further information, please send your name and address with the reference : **G.7.30**
for U. S. A.

rhodia inc
Chemicals Division - P.O. Box 125, Monmouth Junction, NEW JERSEY 08852 (USA), Tel. 201-846-7700, Telex 844527
or other countries

rhône-poulenc (CF/PSP) 21, rue J. Goujon, F-75 360 PARIS CEDEX 08, Tel. (1) 256-40 00, Telex 640 100 F
Circle 70 on reader service card

World Radio History



Probing the news

with 1 kilobyte of ROM or erasable PROM, 64 by 8 bits of RAM, 21 I/O lines, and a 10-microsecond instruction cycle time. Above it is the 8049, with 2 kilobytes of ROM or erasable PROM, 128 by 8 bits of RAM, 271 I/O lines, and a 2.5-microsecond instruction execution time.

Again, the software and instruction sets of the one-chip devices are not compatible with those of the higher-performance multichip systems. "That would defeat the whole purpose of the one-chip family," he says. "The idea is a family of microcomputers complete on one chip and with software designed specifically for control applications. If there were a one-chip controller with a multichip microcomputer's instruction set, it would be worse than useless."

Quite the contrary, asserts Edwin S. Huber, marketing manager at TI's microprocessor department in Houston. "By making the 9940 compatible with all 9900 devices, we will allow designers who have been using multichip systems with limited amounts of memory to look at single-chip microcomputers for cost reduction and performance improvement," he says. "In the near term, the emphasis at TI is going to be hardware and software compatibility wherever possible."

Mostek poised its part at the juncture between the 4-bit p-channel microcomputers and other firms' single-chip 8-bit entries, optimizing it as a high-volume, low-cost computer for stand-alone applications. That is why, unlike the TI and Intel approaches, Mostek's MK3870 is not expandable but can address 2,048 bytes of program ROM. Users that require more could turn to multiprocessor systems or to the multichip F8 microprocessor from which the 3870 derives its instruction set. Memory for variable data can also be added.

Because the 3870 lacks any inherent program expandability, software compatibility with the F8 was almost a necessity. "We were concerned that 3870 users might have to re-engineer their software in order to expand," comments Robert F.

Schweitzer, microcomputer marketing manager for the Carrollton, Texas, firm. "And compatibility is important because it provides a scheme for emulating the device in RAM or PROM before the program is committed to on-chip ROM."

The pack. Making a lively situation even livelier are a host of entries from three other manufacturers, some of which will be self-contained families, while others will be subsets of larger series. The latter approach is being taken by Rockwell International Corp. Adding to the wide assortment of one-chip 4-bit devices that make up its PPS/4 series will be a software-compatible, 2-megahertz 8-bit member of Rockwell's newly acquired 6500 multichip family, a system the firm supplies with MOS Technology Inc.

Nowhere is the push toward one-chip parts more evident than at Motorola Semiconductor. Besides getting on Mostek's 3870 bandwagon, the firm's Austin, Texas, MOS operation will also be supplying a device that will be part of and software-compatible with its MC6800 family. The MC6801, due in the second quarter of 1978, will be as powerful as any one-chip model available, with 2 kilowords of ROM, 128 words of RAM, an instruction repertory of 72, and 30 I/O bits.

The firm is also developing single-chip parts that will stand alone. The first is the MC67000, with 2,048 by 10 bits of ROM and 128 by 8 bits of RAM and a serial I/O configuration useful for real-time control applications. The device, in two-chip form, is now sold only to Motorola's Automotive Products division for use on Ford Motor Co. programs. Motorola hopes the experience it gets with the auto part will give it a pricing edge on its standard devices.

Like their counterparts at Intel, the designers at Fairchild, who invented the original F8 microcomputer, are supplying a series of one-chip parts that will be software-compatible with each other and with the original F8 instruction set. The first chip, called the MicroMachine 1, has 1 kilobyte of ROM, 64 bytes of RAM, and 32 I/O lines. Fairchild also will supply the 2-k 3870 Mostek version and will consider offering Motorola's 6801 as well. □

FOUR MOST...

In Sample & Holds

A quartet of feature-packed sample & hold amplifiers offering cost/performance that will amaze you.

A-880 Module: 1 μ s acquisition time to $\pm 0.01\%$, 5ns aperture time, dielectric absorption $< 0.003\%$ over 5 μ sec, small 2x2x0.4" size \$105.00 (1-24)

A-881 Module: 500ns acquisition time to $\pm 0.01\%$, 5ns aperture time with $< .2$ ns jitter, small 2x2x0.5" size \$180.00 (1-24)

A-882 Module: 6 μ s acquisition time to $\pm .0007\%$, 25ns aperture time, droop rate $< 1 \mu$ V/ μ sec, only 16-bit S&H now on the market only \$85.00 (1-24)

A-883 Module: 15ns (25ns) acquisition time to 1% (.2%), aperture jitter 20ps TTL or ECL control option. check the price \$249.00 (1-24)

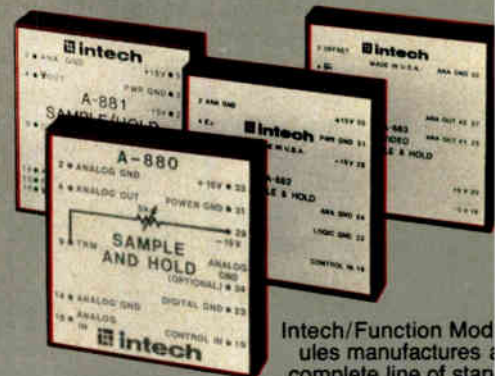

Intech/Function Modules manufactures a complete line of standard signal conditioning

data conversion and non-linear products, as well as custom designs to fit varied applications, both industrial and military.

For further application and ordering information contact:



intech / function modules

282 Brokaw Road, Santa Clara, California 95050
Phone (408) 244-0500 TWX: 910-338-0254

Ask Us When You're Ready To Convert

Circle 71 on reader service card

Communications

New ITT unit has eye on the 1980s

European firm crosses national lines with development of System 12, a PCM system aimed at electronic switching market

by James Smith, McGraw-Hill World News

Electronic switching will open the next billion-dollar telephone equipment market for the public-telephone business. No one is more aware of this than ITT-Europe, which has already leapfrogged over many of its European competitors in nailing down its position in the field. Through a special Europe-wide center for systems design and manufacturing development set up last fall, ITT is currently completing systems development for a pulse-code-modulation exchange that will be its workhorse for the next decade—much the way the semielectronic Metaconta was for the 1970s.

The vehicle for developing System 12, as the new PCM system is called, is the Brussels-based International Telecommunications Center. ITC now has an engineering and marketing staff of about 100 and is scheduled to go to 130 next year. In addition, it draws heavily for inputs on national design centers in Antwerp,

Paris, Stuttgart, and Salerno. An independent company, its stock is held by International Standard Electric Co., the ITT worldwide holding company, and 10 ITT manufacturing affiliates in West Germany, Austria, France, Great Britain, Norway, Spain, Italy, Belgium, the Netherlands, and Switzerland. Officials of the national houses make up the board of directors, with E. A. Van Dyck, senior vice president of ITT-Europe and head of its Telecommunications Group, as chairman and H. O. Nordsieck, vice president of ITT-Europe, managing director.

While Metaconta was the product of a relatively loose cooperation between national houses of ITT, developing the next generation of electronic equipment requires such heavy investment and coordination of production and testing that probably none of ITT's big national manufacturing units could tackle the job alone. System 12, like Meta-

conta, is intended to be ITT's contender for the public switching business of European countries that do not have their own national switching development programs and for export to Third World countries.

To move hard on a standardized PCM system, ITT-Europe officials had to overcome doubts of national houses that feared their participation in ITC might upset delicate relationships with their respective postal and telephone authorities (PTTs). The question was especially sensitive for ITT affiliates already cooperating with national telephone authorities on national development programs.

This was true for ITT's British subsidiary, Standard Telephone Co., which is already engaged in a three-year effort with Plessey Co. and British General Electric Co. to develop System X, a top-secret electronic system for the British Post Office. ITC is required to keep strict separation of technical crews working on System 12 and System X, which is why it has no design center in Britain. The same is true for Switzerland, another country developing its own electronic system. In fact, some of the national systems may eventually compete with System 12 for export business.

Rivals. Despite the problems, ITT seems to have a lead in digital switching over its European competitors. Both L M Ericsson and Philips Gloeilampenfabrieken appear to be concentrating on semielectronic exchanges. France's CIT, probably ITT's most advanced European competitor, has reportedly run into cost problems on its E-10 and is thought to be changing its design concept for the larger E-12 system. But the main

Test run. ITT has installed its PCM exchange in Charleroi, Belgium, for a trial. Called System 12, it is being developed by a newly organized Europe-wide center.



competition is from North America, where technical developments are monitored for ITC by ITT's affiliate, Telecommunications Technical Center, Stamford, Conn. Some of the pressure is coming from smaller U. S. firms such as Vidar Corp. and Stromberg-Carlson Corp.

But ITT has also been carefully watching efforts of Northern Telecom Ltd., a subsidiary of Bell Canada, which has been selling all-electronic systems to independent telephone companies in the U. S. and is making efforts abroad, mainly in the Far East. ITT is also following efforts by the Bell System to set up an international advisory group.

One of the most complicated problems facing ITT's engineers has been to design a system for both low- and high-capacity exchanges so that purchasers will not have to buy two systems. The main drawback for small switchers has been the cost of control computers, but rapid growth of microprocessing techniques points a way over this hurdle. "The microprocessor," says Nordsieck, "is decentralizing switching control—giving greater flexibility for telephone authorities to start with smaller exchanges."

Size is also a key consideration for developing countries, many of which may move directly to electronic systems. Such countries often install equipment first in large population centers, requiring large exchanges. Some, such as Indonesia and Malaysia, have completed installation of initial systems and are expected to shift to smaller equipment.

To reach the Third World market, ITC incorporated national specifications of key European systems—British, French, Swiss, and West German—even though these countries have national programs that may lock System 12 out of their domestic markets. The objective, however, is to reach export markets whose specifications are still based on those of European countries.

ITC is now producing hardware to meet the 1980 deadline for its first PCM exchange in Jutland. This means it needs its prototype by 1979 and models in 1978. It has completed the first round of circuit design and is putting models together for tests. □

Radiometer Electronics Introduces . . .

the specific generator



and

the stereo generator

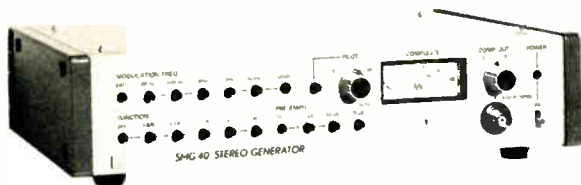

Spectacular quality FM and AM signal services at your fingertips.

An unsurpassed combination for AM, FM, FM Stereo receiver testing and design in R&D, Production, QC, and Service activities.

We believe this combination provides the cleanest FM Stereo with the best separation, lowest distortion and greatest flexibility available today. These are just the highlights . . . like to know more? Contact us for additional information or a demonstration.

RE 101 — RF GENERATOR . . .

Specifically designed for the radio industry.

- Digital display of carrier frequency in FM and AM specific ranges of 86 MHz to 130 MHz and 150 kHz to 30 MHz plus 10.7 MHz.
- Internal or external FM and AM modulation.
- Exceptionally low distortion; 0.05% FM and 0.3% AM.
- Low leakage RF output; continuously variable 0.1μV to 1 V rms.
- Built-in Sweep capabilities.

SMG 40 — STEREO GENERATOR . . .

The ultimate stereo modulation source.

- Full function capability; L&R, L=R, L=-R, L, R.
- L-R Separation; better than 65 dB.
- Low Distortion; less than 0.03%.
- Residual 38 kHz; less than 0.06%.
- Five built-in modulation frequencies.

THE LONDON COMPANY

U.S. Representative for

re Radiometer Electronics

811 Sharon Drive • Cleveland, Ohio 44145 • Telephone (216) 871-8900

Circle 73 on reader service card

1977 Answer Book. It makes your job easier. \$25.

Who makes what? Over 4000 products, more than 5000 manufacturers with their local contracts and distributors, directory of trade names and catalogs, post-paid inquiry cards for 5-second ordering of current catalogs.



Electronics Buyers' Guide
1221 Ave. of the Americas
New York, N.Y. 10020

Yes, send me a copy of The Answer Book. I've enclosed \$25 (USA and Canada only, elsewhere send \$35). Full money back guarantee if returned within 10 days.

Name _____

Company _____

Street _____

City _____

State _____

Zip _____

Military electronics

Navy merges San Diego labs

Electronics center is now part of Naval Ocean Systems Center, the better to develop tactical information systems

by Larry Waller, Los Angeles bureau manager



Narrower goals. Howard L. Blood, technical director of center, says that before it was revamped it was too spread out.

If the electronics industries have heard little of late from the Navy's Electronics Laboratory Center, which normally seeks visibility for its state-of-the-art work, there is a good reason: the San Diego lab no longer exists as a separate entity. Ever since March, it has been part of the new Naval Ocean Systems Center, along with the former Naval Undersea Center.

Why did the Navy submerge its electronics lab into another organization when the lab is renowned for its accomplishments? Since its for-

mation in 1945, its contributions have included the Naval Tactical Data System and, most recently, a worldwide lead position in fiber-optics research.

The official Navy line is: "The consolidation recognizes the increasing importance of tactical information systems integration for the benefit of Naval command." To this end, the new center becomes the principal research arm for the technologies that support this mission and will also develop surveillance and undersea weapons. Furthermore, the elimination of officers' jobs and more than 300 civilian posts is expected to save \$1.33 million a year. As of October, the center will have no more than 3,000 personnel—still enough for it to remain a major facility.

But funding pressure itself evidently is not a major reason for consolidation. The tentative 1978 budget for the new center calls for approximately \$200 million, compared with \$85 million for the former electronics lab and \$100 million for the undersea center in fiscal 1977.

A better focus. With internal shifts still under way, things are confused. But conditions will start improving when results of an outside study surface next month, believes Howard L. Blood, technical director of the center. "We hope to identify specific areas on which to focus our funding and structure [our operation] accordingly," he says.

Blood believes that such a move will help to correct a condition that was becoming apparent before the consolidation. "We were too broadly spread out and simply couldn't do

everything for everybody," he states.

Another goal for the center is to establish a stronger identity in the Navy hierarchy. Most other labs are what Blood calls "platform-oriented," meaning they have a clearly defined mission to serve specific carrier, submarine, or aircraft needs. Instead, "we're inter-platform integrators" whose efforts are somewhat diffused into most Navy programs, Blood says.

Looking ahead. He expects electro-optical technology to be perhaps the most eye-catching part of future electronics work, since up to 150 people are already involved in fiber optics and related jobs. Traditionally strong capabilities in electromagnetic-wave propagation and acoustics, both vital in Navy surface and undersea communications, also are slated for heavy emphasis, Blood predicts. At the same time, the electronics-system content of undersea weaponry has grown to the point that a closer association of the two formerly separate centers can be expected to help future developments. Whatever form the structure takes, management continuity is intact. Blood retains the post in the new center that he had in the undersea operation, and Capt. Robert R. Gavazzi, who was commander of the Naval Electronics Laboratory Center, now directs the entire Naval Ocean Systems Center.

The current estimate of how long it will take for new roles to be defined, further changes to be made, and conditions to be smoothed out is a "realistic 12 to 18 months." In the meantime, the center will keep a low profile, meeting its commitments, but not undertaking new ones. □

FIVE NEW WAYS TO BUILD THEM BETTER.



If you're making LED or LCD meters for your customers or yourself, consider these new A/D converter circuits.

Micro Power's new A/D Converter chips give you five new ways to build DPMs, DVMs and DMMs—fast, simply, and at a minimal expense.

They're standard circuits, ready to ship and ready for you to use. They're new, but they're based on our five-plus years experience making meter chips for a lot of the best-known names in the instrument business.

Study the table for a moment. Take a particularly close look at those specs—especially for the MP7138. You won't find a single-chip CMOS circuit with a better combination of performance specs for 3½-digit meter applications. The price is right, too—only \$6.95 in 100 quantity.

When we say performance, we mean it—outstanding linearity (0.025% of reading, +½ count), true ratiometric dual-slope conversion plus auto zero and auto polarity outputs.

Micro Power's leadership in CMOS processing technology is well-established. And these circuits are products of it. If you'd like your product to benefit too, contact Tarlton Fleming, Standard Products Marketing, at (408) 247-5350.

MICRO POWER CMOS ICs FOR DPMs & MULTIMETERS

END PRODUCT	MPS IC REQUIRED
LED DIGITAL PANEL METER (3½-Digit)	MP-7138 Single CMOS IC; requires few external components. Gives 100-μV resolution, .05% of reading +1 count accuracy; auto zero, auto polarity.
LCD DIGITAL PANEL METER (3½-Digit)	MP-7138 Single CMOS IC with separate LCD decoder/driver (can be mounted on same substrate). MP-7104A Single CMOS IC; requires inexpensive discrete op amps. 1000 quantity price is low (\$5.20).
LED/LCD DIGITAL MULTIMETER	MP-7138 Single CMOS IC; external discrete components required.
LCD DIGITAL MULTIMETER	MP-7104A/MP-5007R Two-chip set, ideal for portable applications. MP-5007R is linear bipolar with AC + OHMS conversion on-chip; MP-7104A is CMOS digital logic chip. Both will operate 1 year on 9V battery.



3100 Alfred Street, Santa Clara, CA 95050

A GOOD LOOK AT A BETTER MODEM made from Exar building blocks.

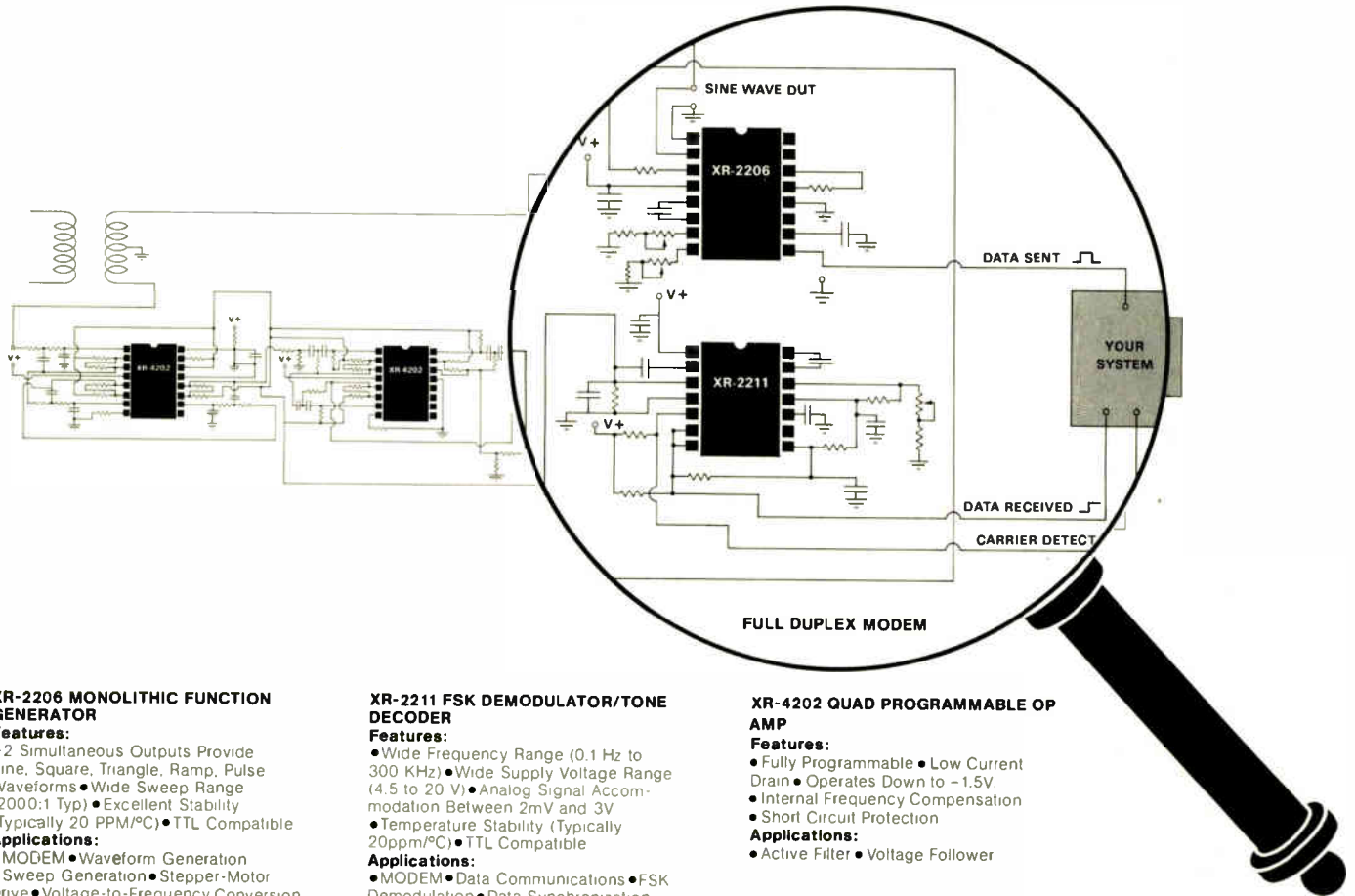

XR-2206 MONOLITHIC FUNCTION GENERATOR

Features:

- 2 Simultaneous Outputs Provide Sine, Square, Triangle, Ramp, Pulse Waveforms
- Wide Sweep Range (2000:1 Typ)
- Excellent Stability (Typically 20 PPM/°C)
- TTL Compatible

Applications:

- MODEM
- Waveform Generation
- Sweep Generation
- Stepper-Motor Drive
- Voltage-to-Frequency Conversion
- Tone Generation
- Precision Phase-Locked Loops
- AM, FM FSK Generation

XR-2211 FSK DEMODULATOR/TONE DECODER

Features:

- Wide Frequency Range (0.1 Hz to 300 KHz)
- Wide Supply Voltage Range (4.5 to 20 V)
- Analog Signal Accommodation Between 2mV and 3V
- Temperature Stability (Typically 20ppm/°C)
- TTL Compatible

Applications:

- MODEM
- Data Communications
- FSK Demodulation
- Data Synchronization
- Tone Decoding
- FM Detection
- Carrier Detection

XR-4202 QUAD PROGRAMMABLE OP AMP

Features:

- Fully Programmable
- Low Current Drain
- Operates Down to -1.5V
- Internal Frequency Compensation
- Short Circuit Protection

Applications:

- Active Filter
- Voltage Follower

Now Exar offers this flexible cost-saving method for meeting many of your difficult data transmission requirements. Here is a basic building-block approach that will give you a full-duplex Modem that will operate up to 100K baud and is readily usable at standard baud rates from 60 to 9600 and up. It can code and decode three waves – sine, square, and triangle. And with our application note, it's a breeze to design.

So if you're presently buying ready-made Modems, you're paying too much; and if you're still making them the old discrete way – Exar's building-block approach will save you time and money by reducing component count and costs.

For multi-channel applications, the XR-4202 Quad Programmable Op Amp used in the full-duplex Modem above is versatile enough to meet most front-end active filtering needs. And for applications with operating frequencies over 300 KHz, Exar also offers the XR-210 and XR-215 FSK MOD/DEMOC circuits.

To find out how Exar products can improve your design and save you money too – send in the coupon now.

- Send the MODEM Application Note featuring the XR-2211 and XR-2206, with the XR-4202
- Send information on XR-210 and XR-215 FSK MOD/DEMOC IC's.
- Send information on your XR-4202 Quad Programmable Op Amp.

Name _____ Title _____

Company Name _____

Company Phone _____

Company Address _____

City _____ State _____ Zip _____

My application is _____

EXAR INTEGRATED SYSTEMS, INC. P.O. Box 62229, Sunnyvale, California 94088 • Phone (408) 732-7970

Electronics abroad

The Soviets struggle to catch up

Most resources are reserved for military programs,
with little fallout allotted for civilian sectors

by Peter Hann, McGraw-Hill World News

In the Soviet Union, the electronics industries are like an iceberg. Under water is the military area: it is much bigger than the civilian sector and gets top priority in both money and manpower. It is never publicly discussed by the Russians and is virtually impenetrable as far as foreign experts or businessmen are concerned.

The smaller, visible tip is the civilian segment: it absorbs much less in the way of resources but is still extremely hard to quantify. This difficulty is largely due to the Soviets' sense of secrecy, but it is partly because some electronics—airport radar and space hardware are examples—obviously have quasi-military significance. One feature of the Soviet system is that scientists, engineers, and other experts, who in the West would move freely between defense and civilian work, never do so in the Soviet Union. This restriction limits cross-fertilization of experience and ideas, and it means that the advantages that the Soviet military programs enjoy do not result in the kind of spin-off that the U. S. space programs, for instance, have brought to U. S. consumer electronics.

The development of electronics is of prime importance to the Russians, who are faced with a labor shortage that demands the introduction of more automation into industry. Electronics is also a key element in the energy field, which is enormously important to the Soviet economy, but trying to pin down Russia's exact intentions is difficult.

The current five-year plan, which runs from 1976 through 1980, offers mainly generalizations. It says, for instance, that the aim is "to increase the output of instruments and means of automation 1.6 to 1.7 times and of computer facilities 1.8 times" during the period. But there are no specific figures to establish exactly what these increases will mean.

The Russians' objectives and progress become clearer, however, from a study of their dealings with some of the Western and Japanese companies trying to do business with them. The general conclusion to be drawn is that the Soviets are well behind the West in almost all areas of electronics. Their research is often as good as that of their Western colleagues, with whose work they are usually familiar. But the equipment used in research is sometimes inferior; more important, when a good idea emerges, it invariably gets bogged down in the production process. The problem of turning ideas into products plagues Soviet industry as a whole but is particularly noticeable in electronics, where technology is moving so fast.

One generation behind. In computers, the Soviets are considered to be from five to seven years behind the West. In hardware terms, this means about one generation and reflects Russian failure to master the technology and manufacture of advanced integrated circuits. Some Western sources estimate Soviet output at less than 1,000 computers a year, so that the Soviets appear to have

Parade. TV tubes made in Lithuania are exported to Italy, France, Finland, Yugoslavia, and other countries.

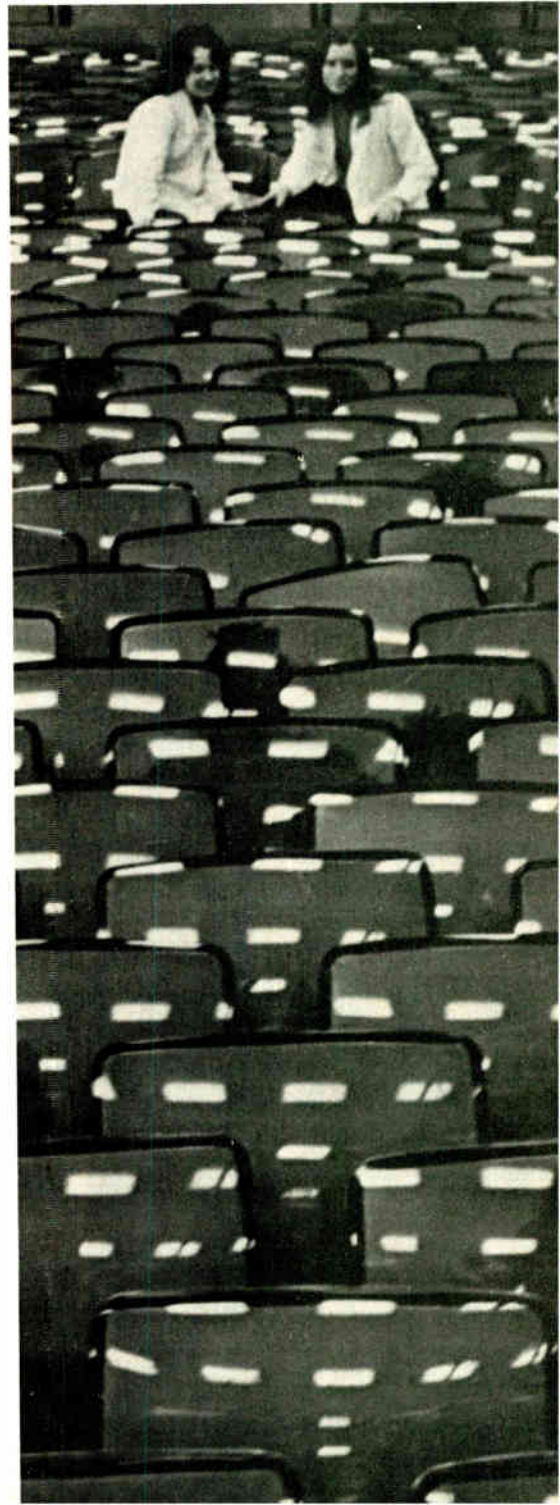

This article is the sixth in a series that examines the electronics industries of the Eastern European Bloc, or Comecon.

Probing the news

Getting the picture. Scientists in Kharkov use graphics terminal to design air- and water-purification systems for the region.



perhaps 5,000 to 7,000 computers at work in the civilian sector today.

Nevertheless, the Russians have a computer industry that is growing. Its main emphasis is cooperation with five other members of the Council for Mutual Economic Cooperation (Comecon), each of which collaborates in making machines or computers under the unified system of Electronic Computers of Socialist Countries (ES for short), previously called the RJAD program.

The smallest are the ES1020, with a speed of 20,000 operations per second, which is made jointly by the Soviet Union and Bulgaria; the ES1021, a 40,000-operation/s machine made in Czechoslovakia that is designed for management and economics work; and the ES1030, a Soviet-made computer capable of 80,000 operations/s.

The group is also producing larger machines. The ES1040, made in East Germany, can handle 300,000 operations/s and is intended for high-level scientific work, according

to Soviet literature. The ES1050, capable of 500,000 operations/s, has just gone into production in the Soviet Union. The Soviets also claim that by November they will have assembled their first fourth-generation machine, the ES1060, which will handle 1.5 million operations/s, with a random-access storage of 256 to 2,048 kilobytes.

To date, the Russians appear to have sold about 400 small- and medium-sized computers, the vast majority to their Comecon partners. This year, the Soviets have also begun to push exports of the ES1033, which they say is 2.5 times faster than the ES1030. Specifications published by Electronorgtehnica, which handles computer exports, say it can solve up to 15 problems simultaneously and has a storage capacity of up to 512 kilobytes. The organization claims to have orders for 40 ES1033s.

Despite this record, the Russians are plainly interested in buying Western computers whenever their

We're showing off for Commonwealth Edison.

Chicago's Commonwealth Edison uses Ramtek color graphic displays for rapid display and status reporting of pipelines, valves, pumps, and other generating station data. A clear, color-coded display is updated every 5.0 seconds, giving near-instantaneous visual scan-log-alarm functions, bar graphs, one-line piping diagrams, flow status, etc.

Before the Ramtek systems were installed, status reporting was by hardwired mimic boards, black and white alphanumeric CRTs and typers.

The Ramtek system not only costs less, it also allows more information to be presented to the operator in a form that is quickly and easily under-

stood. This results in better operator efficiency, and faster alarm reaction time. In Commonwealth Edison's 16,000 Megawatt system, thirty Ramtek color graphics displays will be utilized.

own conditions and those outside permit. The potential size of the Soviet market is hard to pin down. "There are about 6 to 10 big opportunities every year," says Gary Lehr, Moscow representative for Honeywell Inc. He says these are worth anything from \$2 million to \$15 million each, which means a total of perhaps \$100 million a year.

Lightning. In the broad area of communications, the Soviets are making tremendous efforts to span their huge country, which has 11 time zones. They have a well-established network of communications satellites and ground stations that they plan to expand before 1980. The basic system comprises the Molniya (Lightning) satellite, the latest of which, the Molniya-3, has an on-board computer, three complete transceiver systems, and a sun sensor that powers a solar-cell propulsion system. It is being used to relay color TV programs.

The Molnias work in conjunction with a series of approximately 60

comparatively simple ground stations called the Orbita network. By 1980 the network will have 70. Three of the existing installations are outside Soviet borders.

The latest development is the introduction of the Statsionar or Raduga (Rainbow) satellites, which sit in stationary orbit over the equator to give continuous coverage of the country. These satellites relay both TV programs in color and black and white and telephone and telegraph messages, and they are shortly to carry computer data also. At least 10 are to be in use by 1980.

Space wrangling. For the longer term, the Russians want to set up a system called Intersputnik, which would rival the U.S.'s Intelsat. But the radio frequencies and the positions in space over the equator required by the plan have caused an international dispute with France and West Germany, which are collaborating on the Symphonie series, and with Indonesia.

Telephone communications are

also due for a big expansion in the Soviet Union, which is still in the Dark Ages in some respects. Moscow, a city of about 8 million, has only 2 million phones. Breakdowns and interruptions are frequent, and most of the exchanges are about 30 years old. Direct dialing is available to many cities, but the noise level is often high. Britain's Plessey Co. has penetrated this market, having sold two electronic 1,000-line exchanges with multifrequency push-button phones. The company has also been talking about a 7,000-line exchange.

In broadcast equipment, the Soviets are producing both color and black-and-white television sets, but without integrated circuits. In 1975, three out of four Soviet families owned a TV set. Monochrome production will be about 7 million sets this year, and color sets, based on the French Secam system, will total just over 1 million. Earlier this year, Soviet officials were talking about buying the PAL system to produce a two-system set for export. □

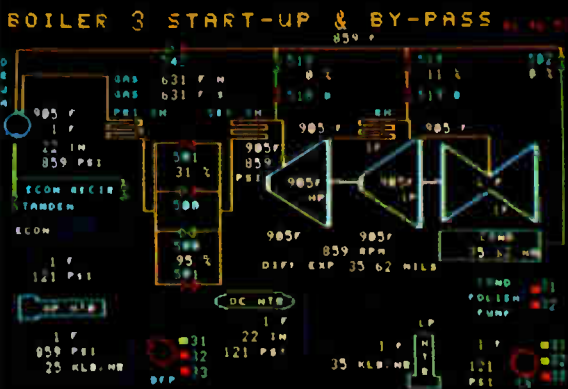

Commonwealth Edison monitors on-off, full-empty, flow status, and other parameters on a Ramtek FS-2400. Color is assigned for steam, water, no-flow, and oil flow to differentiate visually between materials and status. On the RM-9000, resolutions from 240 lines x 320 elements to 512 lines x 640 elements are available.

Commonwealth Edison is but one of a growing number of customers who are finding that Ramtek's raster scan modular graphics and imagery systems are giving them the expandability, flexibility, and increased productivity they need. Besides the basic alphanumeric and imaging capability, Ramtek offers a wide variety of other functions including graphics—vectors, conics, plots, bar charts—pseudocolor, and grey-scale translation.

Ask about our new Ramtek RM-9000 family that is totally controlled by a standard 8080 micro-processor that really makes it easy to develop and download your own control software.

To find out more about how Ramtek can show off for you, call or write: Ramtek Corporation, 585 North Mary Avenue, Sunnyvale, California 94086 (408) 735-8400.

ramtek
Our Experience Shows

Circle 79 on reader service card

Multiwire[®] reliability: 99 percent.

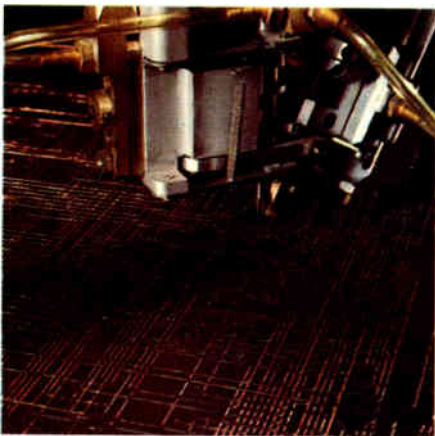
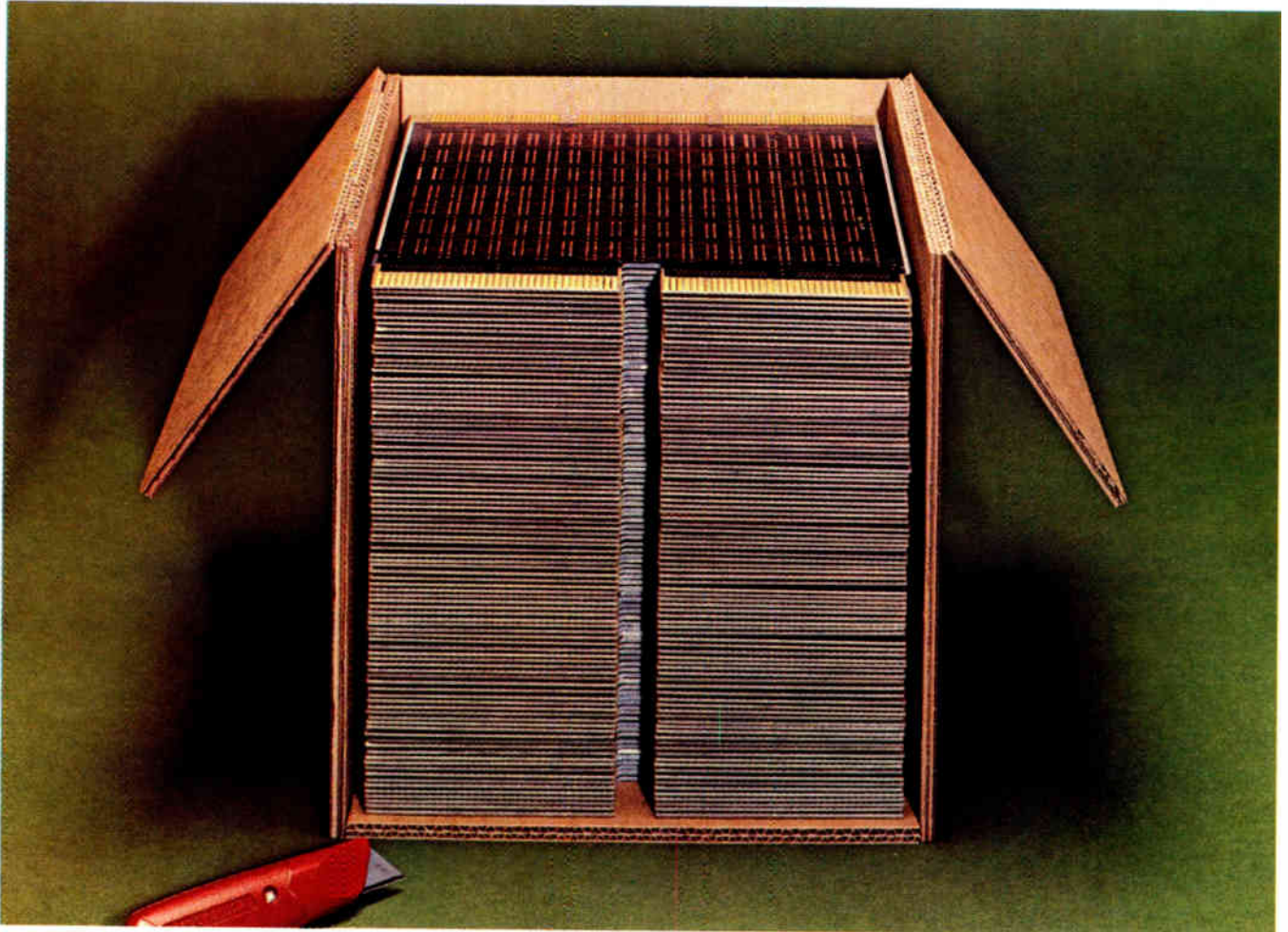

Until recently multilayer boards have been unchallenged in providing highest density interconnection systems. Their disadvantages, including lack of reliability, have been accepted as unavoidable by the user. Now Multiwire boards provide the same high density with several major advantages over multilayer boards. For many the most important is greater reliability.

Here is what one defense program manager says, "... multilayers have a questionable reliability. The interconnections in the middle layers to the

plated-through hole are very suspect when you consider the thousands of such connections in a dense multilayer board... we have not found any failures in the (Multiwire) boards."

After carrying out accelerated life tests on Multiwire, a large computer manufacturer had zero failures.

To avoid assigning perfect performance to Multiwire, they assumed one failure and projected a real life failure rate of 0.01%/1000 hours.

In most military and commercial thermal shock specs a minimum of 36 interconnections are put through 5

Multilayer reliability: _____ percent.

What is your experience?

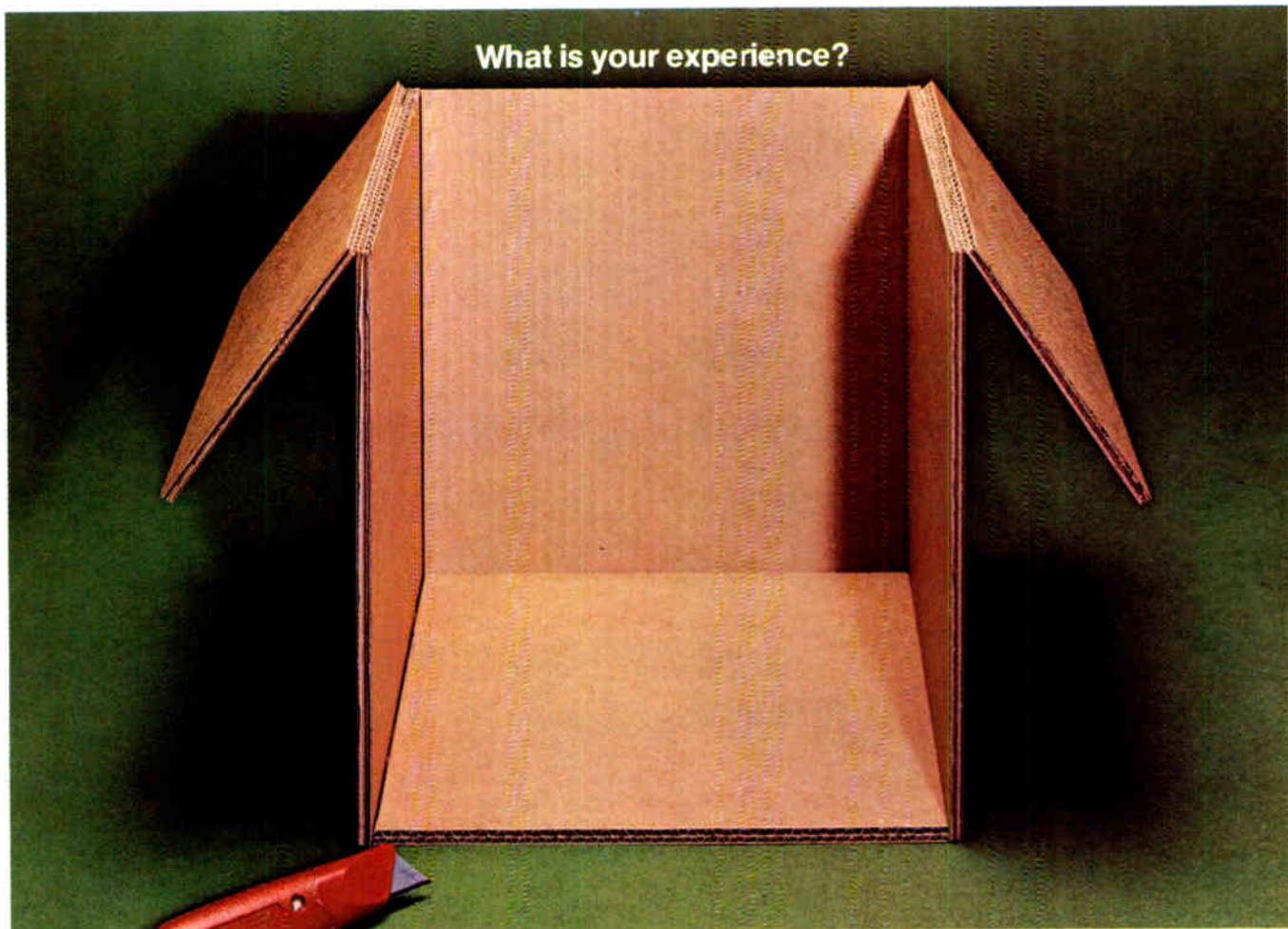

cycles. To find any faults, an independent testing laboratory put 12,240 Multiwire interconnections through 200 cycles. Only one Multiwire connection opened.

Multiwire consists of a high-density grid of insulated wire laid down by numerically-controlled machines. All intersections typically have a 2000-4000-volt breakdown. The wires connect far more reliably to the plated-through holes than do the multilayer connectors, due to the inherent characteristics of the process.

Now consider other advantages of

Multiwire over multilayer: Multiwire offers much shorter lead times. No artwork except for the basic ground planes and connections. From there on, you need supply only an interconnection list . . . and we prepare the input data for our N/C machines. Or, from the software we offer, you can prepare your own input data. Our N/C machines do the rest. Result: Multiwire design and tooling costs are much lower and first-piece delivery is much faster.

Changes on wired or assembled boards? You have much higher

accessibility to connections throughout a Multiwire board.

Multiwire manufacturing automatically produces impedance control that requires sophisticated multilayer design to match.

It's no stroke of luck that 139 Multiwire boards are in one military vehicle already. Design, development, production and reliability advantages are too overwhelming to ignore.

Write Multiwire Marketing Department or call 516-448-1117. In New England, call 603-889-0083. In California, 213-999-1710.

Multiwire[®] from Photocircuits.

Division of Kollmorgen Corporation, Glen Cove, New York 11542

Berg Quickie Connectors are the logical cable interface for Digital minicomputers

Berg Quickie™ Connectors rapidly, reliably terminate multi-lead, flat, round conductor cable—without pre-stripping. Quickie designs allow for visual inspection before and after assembly.

Digital Equipment Corporation likes the Quickie connector's ease of termination and how its askewed tines strip away insulation to assure positive electrical contact. They like the way Quickie Headers latch to maintain connection integrity through vibration and impact. Digital has found it can rely on Berg . . . to supply the products and the application

machines that precisely meet its demanding interconnection needs.

Berg is experienced. We read interconnection needs like Digital computers read data. We have the products, the background, and the back-up to do the job. Your job. Let's work on it, together. Berg Electronics, Division E. I. du Pont de Nemours & Co., New Cumberland, Pa. 17070—Phone (717) 938-6711.



BERG ELECTRONICS

Circle 82 on reader service card

We serve special interests—yours!

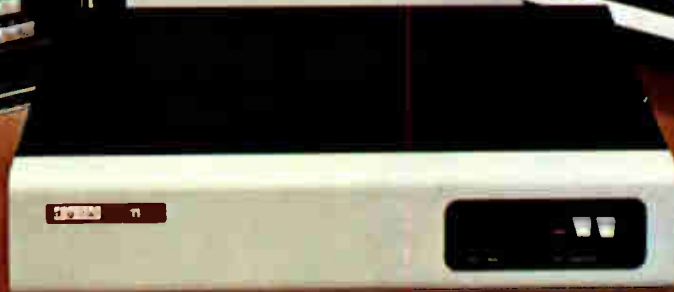
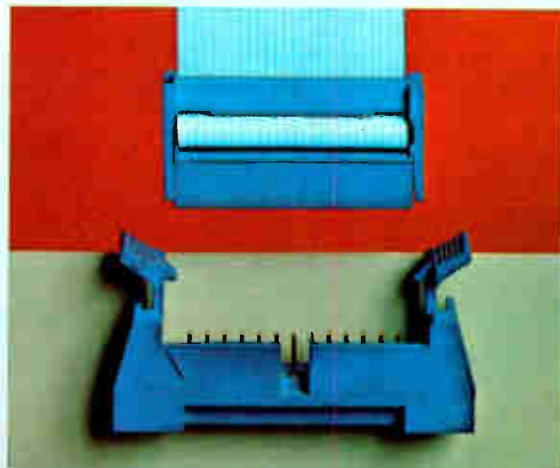

□ Now speeding along after a slow cranking-up period, automotive electronics is bringing the passenger car to a new level of efficiency, convenience, safety—and complexity. The big challenge to the electronics designer these days is that the great traffic cop in Washington, the Federal Government, has mandated both nonpolluting cars and gas-saving engines. As usual, there is much debate over how soon and in what ways its conflicting demands can be met, but on one thing the Big Three are finally agreed—electronic engine controls will be essential.

Adding electronic controls to an engine of itself improves fuel economy and limits polluting emissions. Electronic spark advance and electronic fuel metering, separately or in combination, are the two principal approaches here. Digital controllers seem to be winning out over analog systems for spark advance. But the car makers differ on whether to go with a greatly altered but still recognizable carburetor or whether to swing over to electronic fuel injection, as General Motors has done in its Cadillac system. The availability of low-cost sensors is another concern. But the biggest problem concerns the catalytic conversion of exhaust gas wastes, which for efficiency must work with an electronic engine control but which at the same time prevents it from maximizing fuel economy (see “Fuel economy conflicts with cleanliness,” p. 85). Still, Government pressure makes this the fastest track in automotive electronics.

Moving almost as fast, the car's other electronic subsystems are continuing to evolve. Digital displays are perhaps the liveliest issue here. As for circuitry, voltage regulators and electronic ignition systems, two of the first converts to electronics, have already gone into second generations with increased integration. Yet to be settled is whether controls for headlights, intrusion alarms, windshield wipers, hazard flashers, and so on, should use custom large-scale integrated circuits or general-purpose microprocessors. By now, standard microprocessors have fallen far enough in price to compete with custom LSI, which has a high front-end cost, and if designers opt for them, that could mean the use of six to eight microprocessors per car.

The computerized car

Indeed, car makers are already working toward the day when the automobile's various sensing, control, and display systems can be integrated completely into micro-computer-based systems, though it is not yet clear whether each car will have a central computer or an automotive version of distributed processing. Either way, the automobile of the mid-1980 model years will be a rolling computer center in which multiplexing will have become a necessity.

Still close to the starting line, however, are totally new electronics systems such as radar-controlled braking for increased safety. This effort and others like it (adaptive suspension is an example) are still at the laboratory stage. While they are promising, they face either technical or cost obstacles or both that will delay their

SPECIAL REPORT

Automotive electronics gets the green light

by Gerald M. Walker, *Consumer Editor*



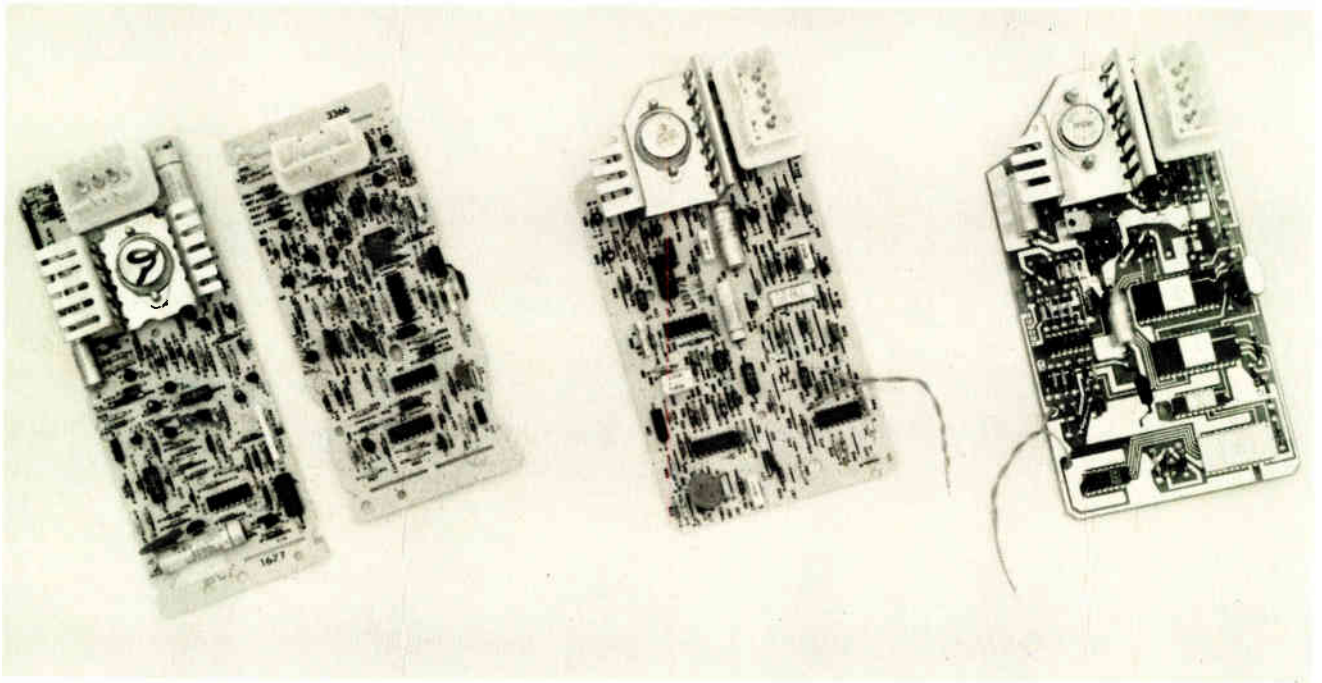

1. Lean-burn generations. Since introducing its lean-burn spark-advance system, Chrysler has continued development. The first was an analog two-circuit-board version (left), the second was cut to one pc board, and the third is a digital microprocessor version.

adoption until well into the 1980s. (Actually, it is safe to say that today virtually every conceivable application of electronics is undergoing development or evaluation somewhere within the highly secret confines of the automobile companies' laboratories.)

Finally, the extent of all these electronic applications raises the specter of maintenance and repair. The average car is already straining the capabilities of the trained mechanic, so for fear of selling a machine too complex to maintain, the automobile firms have stepped up their programs for developing automated test and diagnostic systems for repair shops (see "Testing goes microelectronic, too," p. 90). They are also working on an on-board microprocessor-based diagnostic system that would monitor the operation of the engine, the amount of air in the tires, and other vital functions and alert the driver to any problems. But they are leery of providing him with more information than a warning—the highly sophisticated diagnostic systems will be reserved for the mechanic back in the repair shop.

Focus on engine controls

The engine is what a car is all about, so any system or components that affect its performance are treated by Detroit's designers with the utmost care.

"The most sophisticated large-scale integrated circuits won't impress a motorist much if they cause the car to break down some rainy night in the middle of nowhere," an automotive company electronics development manager points out. "That's why we make sure that every new system has a 'limp home' capability, so that if the electronics fails, the car will run—maybe not very well, but well enough to get the driver home."

Chrysler Corp. was the first in the field, with an electronic lean-burn spark-advance system intended initially for 400-cubic-inch four-barrel engines. An

analog design, it has two printed-circuit boards containing the spark-advance controls and receives four inputs from the throttle position, engine vacuum, and water and inlet air temperature.

Since then, the company has phased in a one-board version for 1978, which uses three custom chips and has reduced component count from 230 to 120. It will go on all V-8s and on the company's new line of four-cylinder subcompacts, the Omni and the Horizon, due to be introduced later in the 1978 model year. Chrysler intends to have the lean-burn system on all its cars and light trucks after 1978, although, because of the carburetor design, the six-cylinder cars will be more difficult to equip with such a system.

The next step—further integration—has already been taken. Chrysler is working on two approaches at present. The first is a digital, microprocessor-based lean-burn system that will undergo a thorough production test run this year (Fig. 1). RCA Corp. is at present supplying the parts—its 40-pin 1801 microcomputer, plus a 1,024-bit read-only memory, a 32-byte random-access memory, and a complementary-metal-oxide-semiconductor input/output device. The second, also a digital, microprocessor-based system, will add electronic fuel metering to the spark-advance computer. RCA Corp. and Texas Instruments Inc. have been signed to compete for its design, which will probably require an extra 1-k ROM and an extra I/O chip. Eventually, either system could be reduced to a single processor and memory chip plus a custom I/O device.

The Misar system

General Motors Corp. also made its entry into electronic engine controls with a spark-advance system, called Misar (for microprocessed sensing and automatic regulation) and designed by its Delco-Remy division for

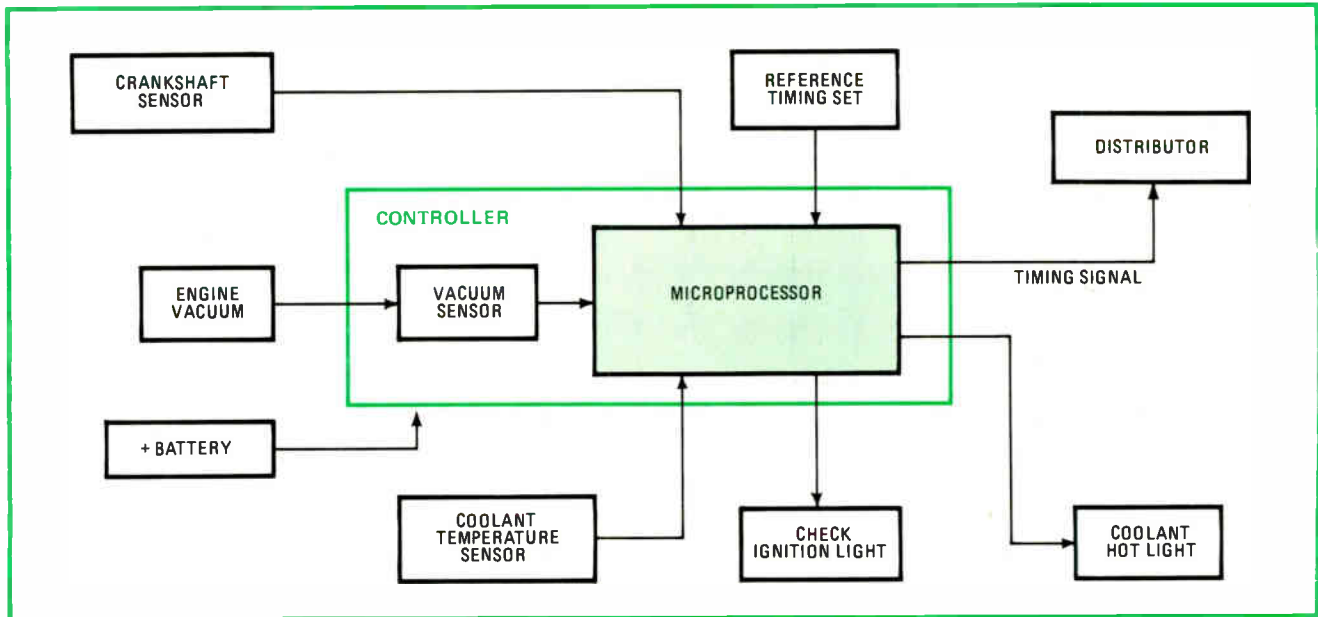

2. Advanced spark advance. The Delco-Remy Misar system funnels four inputs into a 10-bit custom microprocessor developed by Rockwell. It is a spark-advance system programmed with a "map" of the spark timings appropriate to different engine conditions.

the 1977 Oldsmobile Toronado (Fig. 2). The system permits the engine to be tuned to improve fuel economy and drivability and, according to GM, has cut the Toronado's fuel consumption by approximately 10%.

Basically, the Misar system is a "map" of spark-advance settings stored in memory and accessed in the initial design by a custom 10-bit microprocessor from Rockwell International Corp.'s Microelectronics division. Input signals are crankshaft position, manifold vacuum, coolant temperature, and reference timing. Fed with these four inputs, the microprocessor in effect looks up the spark advance required to match the driving conditions and passes the information to the distributor.

The advantage of the microprocessor is that it can be programmed to fit the characteristics of various engines.

In addition, the Misar system can be expanded to take on other engine control functions, such as fuel metering or exhaust-gas recirculation, because of its as-yet unused ROM capacity.

While the 10-bit microprocessor for the Misar program is a custom design, it is not clear yet whether other companies in the GM family will take the same route. The I/O chip will remain a custom design without question, primarily because of the specialized sensors that must be used. For the microprocessor, however, customized versions of the general-purpose machines will

Fuel economy conflicts with cleanliness

An automobile that always burned up all the gas fueling it would be both economical and nonpolluting. No engine attains this goal, but electronic control can bring it very close—if not close enough to satisfy the Government.

For all the gas to burn, it must be mixed with sufficient air, in at least the chemically correct or stoichiometric air-fuel ratio. At moderate speeds, however, a car runs easily off a much leaner mixture, one containing proportionally more air and less fuel, while to start or go really fast, it needs a richer-than-stoichiometric mixture. Otherwise variations in the mix delivered to the various cylinders may cause stalling or knocking and overheating at high speeds. For instance, a lean mixture tends to retard combustion, hence the usefulness of spark-advance systems.

So far, the goal would seem to be to operate the car at all times off the leanest mixture consistent with drivability. An electronic engine control can do this by using inputs from critical variables—notably engine speed, quantity of air intake, and temperature, whether of air or coolant—to fine-tune some aspect of fuel use by, say, spark timing or fuel metering. This fine tuning also keeps polluting emissions low, but the Environmental Protection Agency wants

them kept still lower, causing a design predicament.

The problem is that the only known method of further reducing emission levels—catalytic conversion of exhaust gases into nonpollutants—requires not a lean air-fuel mixture but one controlled precisely at the stoichiometric ratio. It therefore militates against the fuel economy mandated by another set of Federal regulations.

The conflicting requirements are these: on the one hand, the Environmental Protection Agency (as of the time of writing) intends to limit automobile emissions of hydrocarbons, carbon monoxide, and nitrogen oxide to at most 0.41, 3.4, and 0.4 gram per mile, respectively, and it wants these standards met by 1980 (recently moved back from 1978). On the other hand, Public Law 94-163 requires each manufacturer to have a production-weighted average fuel consumption of 18 miles per gallon in 1978, 20 mpg in 1980, and 27.5 mpg in 1985.

Still, any solution involving catalytic conversion has to involve electronic control of the air-fuel ratio. Remember the 1974 model year cars, which limited emissions with the converters alone and as a result suffered from hesitation and slow startup.

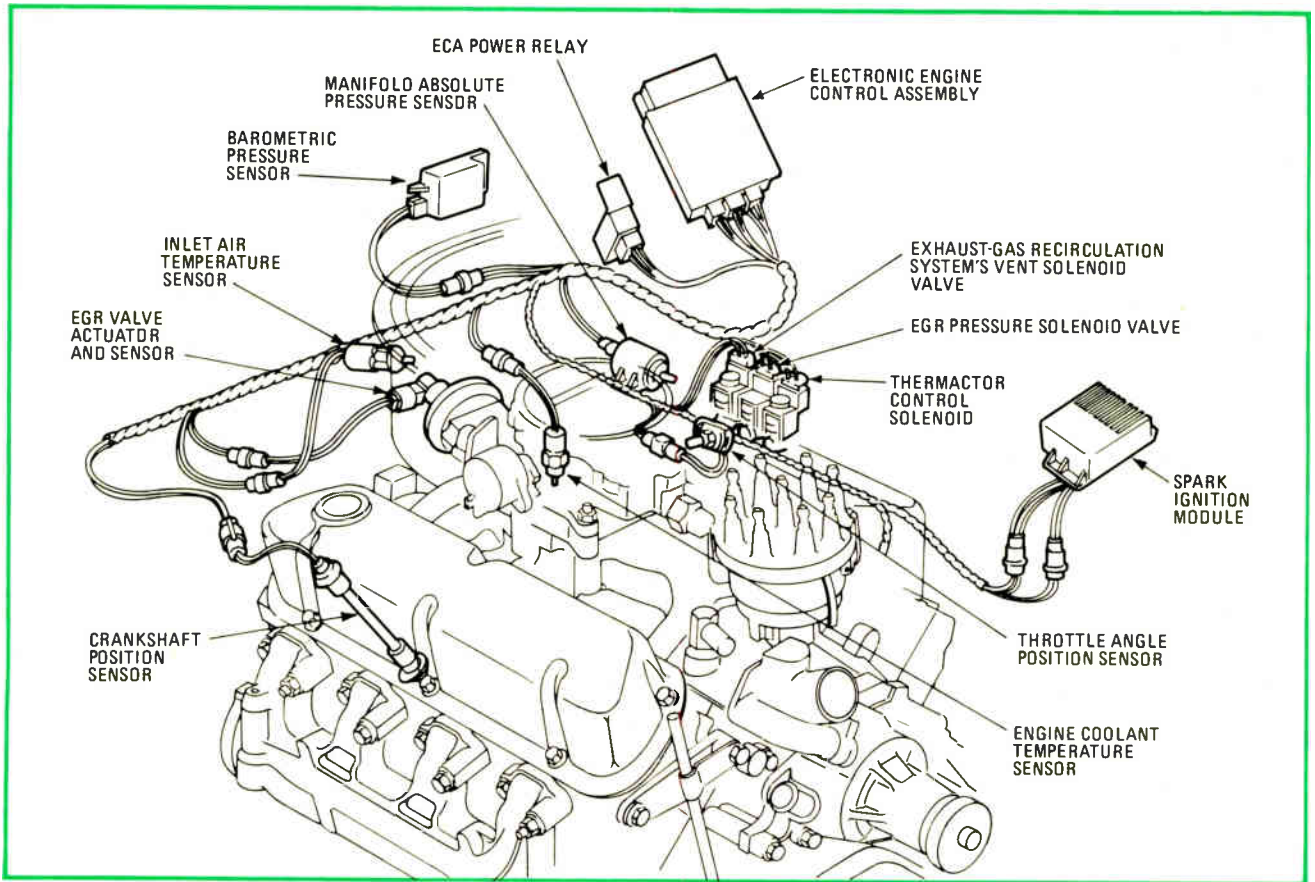

3. Recirculation. The first electronic engine control from Ford puts both spark timing and exhaust-gas recirculation under the control of a 12-bit microprocessor. It uses seven sensors, and its outputs go to two actuators—the spark-ignition module and the EGR valve actuator.

be used, depending on the engine-control application. Motorola Inc.'s Integrated Circuits division has a contract with GM to supply it with microcomputer devices built around its 8-bit n-channel MOS family and also to furnish design and processing technology to GM's Delco Electronics subsidiary.

A building-block approach

Ford Motor Co. has announced three distinct systems for engine control, of which two are aimed at emissions control and one at fuel economy. The idea is eventually to combine all three systems.

The first is a microprocessor-based system combining ignition timing and exhaust-gas recirculation (EGR), designed to meet current emission-control regulations, but also intended as a building block for future model years. As diagrammed in Fig. 3., the 2-bit microprocessor is fed by altogether seven engine-condition sensors and controls two actuators. The seven sensors comprise two pressure, two position, and two temperature, and one exhaust-gas device. One actuator governs the standard ignition module, which produces the high-voltage pulse fed to the appropriate spark plug. The other controls the EGR valve, which diverts unburned fuel from the exhaust back into the intake manifold. The 1978 model version has 12 custom integrated circuits, including a 12-bit microprocessor developed by Tokyo Shibaura Electric Co. (Toshiba) in Japan.

A vital part of the electronic engine-control design is

what Ford calls "default logic." The company has determined that redundancy, the hallmark of the aerospace industry, is not the best way to ensure reliability on an automobile, because of cost and space limitations. Instead, to protect the driver against unnecessary towing, the default logic allows the control to ignore a failure and keep the engine firing. There is an easily recognizable loss in operating efficiency, but the car runs well enough to get to a repair station.

The second major system, also intended to be a building block for future combined electronic engine controls, is a feedback carburetor system (Fig. 4). When mated with a three-way catalytic converter, it will help meet future emissions-control requirements.

Catalytic conversion requirements

The three-way catalyst allows simultaneous conversion of hydrocarbons (HC), carbon monoxide (CO), and oxides of nitrogen (NO_x) into harmless wastes. But for the catalyst to perform satisfactorily, the engine must have a very closely controlled air-fuel ratio. In fact, an offset of 2% from the ideal or stoichiometric air-fuel ratio can result in a 30% reduction in conversion efficiency. A standard carburetor cannot adapt adequately to the variations in engine operation and so will not give the catalyst the quality of input needed.

Instead, a feedback control has been designed for the carburetor (Fig. 5). Whenever the engine is running outside the ideal air-fuel ratio, a sensor placed in the

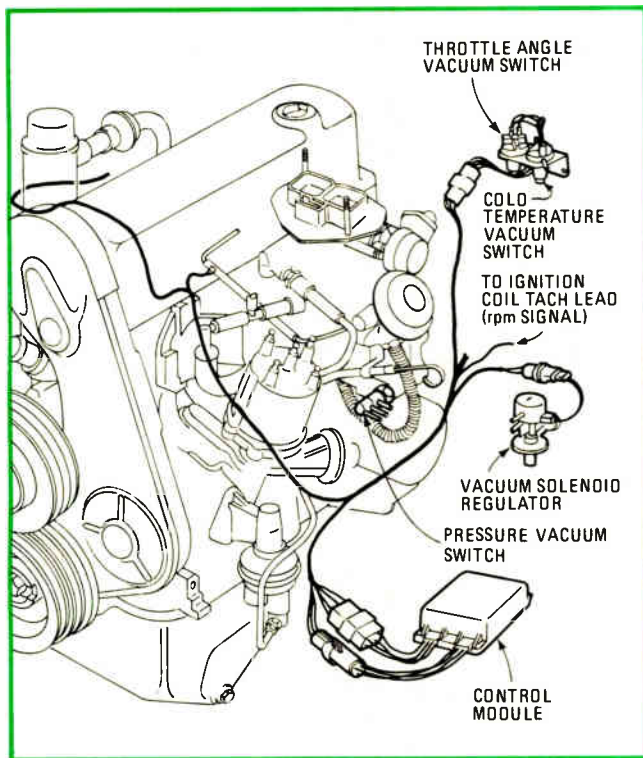

4. Electronic carburetor. Ford's feedback carburetor is designed to work with a three-way catalytic converter to meet emissions control requirements. An exhaust-gas sensor feeds data to the control module, which then adjusts the carburetor's air-fuel ratio.

exhaust manifold sends signals to an electronic module, which then corrects the fuel-metering system, in this case, the carburetor. For example, if the oxygen in the exhaust manifold is running too high, the carburetor is set to a richer air-fuel mixture. To put it another way, the closed-loop system optimizes catalyst performance by keeping the air-fuel ratio in the stoichiometric region.

Besides the exhaust-gas sensor, the system has a couple of special-condition sensors for cutting out the converter when the engine is cold or idling. The only output is the carburetor control.

Probably the most intriguing new control, which Ford will bring out later in the 1978 model year, is the dual-displacement engine (DDE) system, to be introduced as an option on some trucks with 300-cubic-inch, six-cylinder engines. Engines are designed for vehicles to meet peak demand but are not always operated at peak demand, which means a loss in efficiency. In recognition of this, the dual-displacement engine system is designed to tell when the full power of the engine is not needed and turn off three cylinders, thus saving fuel. On the basis of tests covering both city and highway driving, Ford expects its DDE system to increase fuel economy by 10% on average.

In the DDE system (Fig. 6), there are sensors for engine load, temperature—the DDE system will not operate when the engine is cold—throttle position, and engine speed. There is only one output: signals to three solenoids that are directly mounted in the valve train. Energizing these solenoids stops valve motion, sealing off those three cylinders. For the driver's convenience, there

is an indicator light, to tell him when the cylinders have been deactivated, and a toggle switch for overriding the control system and returning the vehicle to six-cylinder operation.

After the 1978 model year, if no major problems arise, Ford will likely extend the DDE concept to eight-cylinder vehicles and passenger cars. At the same time, it plans to mix and match all three control systems.

In fact, it has also taken steps to combine the first two, as evidenced by its recent announcement that Motorola Semiconductor has won the design award for the engine controls to go into the 1980 model cars. Until this point, the spark-timing and EGR system has been supplied by Toshiba, the Essex group of United Technologies Corp., and Ford's own Electrical and Electronics division (EED), which is supplied by Texas Instruments Inc. and Intel Corp. The carburetor controls have come from Motorola's Automotive Products division and EED.

Now spark timing, exhaust-gas recirculation, and fuel management will all be handled by Motorola's two-chip system, which mates an n-channel MOS microprocessor with an injection-logic I/O and analog-to-digital converter chip. The other suppliers will have to copy Motorola's customized approach.

Ford expects to ship just 30,000 cars equipped with the 1978-model-year spark-timing and EGR system. For the 1979 model year, Ford expects to ship some 100,000 to 150,000 of these systems, using a repartitioned module that will reduce the nine custom ICs to six. This module will be used until the two-chip combination system can be phased into production.

Application of sophisticated electronic controls to the engine raises the ticklish problem of where to locate the control modules. So far, the Big Three have split over whether to put the engine controls in the engine compartment or in the passenger compartment.

The best place

The tradeoffs are almost equally balanced. On the one hand, auto designers like to put engine components in the engine compartment, where they are accessible and easy to connect to the portion of the engine they control; but the temperature there reaches 105°C and dictates insulation for electronic modules. On the other hand, the passenger compartment has a more congenial climate for electronics, but requires connective wiring through the fire wall, which auto engineers do not like.

To date, Chrysler has opted to mount the control module in the engine compartment. Comments Earl Meyer, its chief engineer for engine electrical engineering: "We tried heavy insulation of the type used for batteries, but found it too costly. The solution was to mount the spark-advance computer at the air intake point, close to the engine. Mounting it away from the engine, you face wiring and harness problems that probably double the possibilities of failure."

For its electronic engine controls—the Misar spark-advance and also the Cadillac analog electronic fuel-injection system—General Motors has chosen the passenger compartment. John T. Auman, executive engineer of advance products engineering at the General Motors Technical Center, points out that the engine

What about air bags?

Another recent Federal regulation requires passive restraints to be installed in all new automobiles by the 1984 model year. The air bag controls, of course, would be electronic.

The announcement took the auto companies by surprise, since the Government had appeared to be favoring a study period before making a decision. In fact, General Motors Corp. had signed a contract with the Department of Transportation for a Government subsidy to install air bags in 150,000 intermediate-sized cars for the 1980 and 1981 model years and then sell the cars to consumers at no extra cost. The goal was to discover how acceptable air bags would be to the public and to track how they performed.

Now, seemingly regardless of the results of this project, the auto companies will have to install air bags in large

cars from the 1982 model year on, intermediate-sized cars from 1983 on, and small cars from 1984 on. At present, the car makers are "studying" the impact of these installations, so that the actual design work has yet to begin.

Use of air bags is bound to increase the amount of electronics in the automobile, adding acceleration-deceleration sensors, control modules, and on-board recorders that will monitor air bag performance. But neither the auto companies nor their electronics suppliers appear overly enthusiastic about the prospect. They have been down this road before with the seat-belt interlock systems: a year after the belts became mandatory, Congress wiped out the regulation because consumers were complaining about the inconvenience. Now the auto producers all fear they will be forced to gear up for air-bag installation only for the requirement to be eliminated after the fact.

compartment environment may affect the peripheral components more than the microprocessor. Particularly sensitive are driver circuits with high duty cycles operating at high currents and temperatures.

Ford is in both camps. Two of its three engine-control systems are in the engine compartment—the carburetor feedback and the dual-displacement engine modules. The microprocessor-based spark-timing and exhaust-gas recirculation module is in the passenger compartment. "We have no long-term position on location," remarks Robert S. Oswald, manager of electronic engine controls for Ford's engine engineering department. "You can create an 80°C environment in the engine compartment with proper insulation and shielding, but you've got to pay for it. You get that environment automatically when you go into the passenger compartment. But accessibility of components and length of harness both strongly favor the engine compartment.

"If the semiconductor manufacturers can get the technology to a point where temperature capability is available without a significant increase in cost, then there's no decision—it will all be in the engine compartment. The perfect engine control would be mounted on the engine where you can assemble and test the system as an entity," he concludes.

Auto companies in Europe, which have often led Detroit in introducing design innovations, have been somewhat slower in applying microelectronics, particularly microprocessors, to engine controls. The Japanese car makers, Nissan and Toyota, are being even more cautious, apparently waiting to see what the Americans do. Cost of electronics, particularly as it affects the price-sensitive small imports, is the major roadblock for microprocessors overseas.

Overseas producers proceeding with caution

Nevertheless, some companies are working on engine-control systems, realizing that ever-tightening requirements for fuel economy and pollution abatement enforce the use of electronics. As in the U. S., the auto systems suppliers and their semiconductor suppliers are pushing the development of automotive electronics in pace with the auto makers.

For example, at Robert Bosch GmbH, the big German automotive-accessory maker, microprocessors are currently undergoing vehicle tests as controls for two engine functions—ignition and fuel metering. (Later on, processors will also be tested in electronic transmissions and for anti-skid control.)

Microprocessor-based ignition systems with digital spark advance will probably be employed on a broad basis by 1979-1980, according to Bosch. In this area, Bosch is working on two systems. They process the signals differently, use memories differently, and employ different sensors. One system is based on a special-purpose microprocessor chip with on-chip read-only memory. Somewhat like GM's Misar system, the ROM stores spark-timing characteristics in relation to vehicle speed and load.

The other system is also based on a special-purpose microprocessor, but has an external data memory that is also accessible to other digital controls in the car, such as electronic fuel injection, electronic transmission, or anti-skid. This second system is especially suited for the central electronic optimization system (EOS) that Bosch is developing for future centralized computer controls.

Sensors: a sensitive area?

Ever since the development of the first automotive electronic controls, a major problem has been mating the memory and logic portions with the sensing points. It has been tough to find low-cost sensors and transducers that are both sensitive enough and reliable enough.

Most of today's electronic engine-control systems use inputs from atmospheric and/or manifold pressure (vacuum), engine speed and/or throttle position, and coolant and/or air temperature. In addition, fuel metering or carburetor feedback aimed at maintaining precise air-fuel ratios requires exhaust-gas sensors. Bendix Corp. has estimated that there are 55 different sensor configurations for cars that could be used in 8,000 possible system designs.

The manifold-pressure sensor provides an electric signal indicating the intake manifold absolute pressure. The amount of air taken in by a cylinder is directly dependent on the pressure in the manifold, so this sensor

has to be extremely accurate. There are at least four transducer types: LVDT (linear variable differential transformer), piezoelectric, variable capacitor, and strain gage.

To compute engine speed, sensors are placed to measure crankshaft position. The favored sensor for this application has been a variable-reluctance magnetic type that reacts to flux changes produced by holes or gear teeth on the rotating shaft.

As for throttle-position sensors, which provide inputs representing the torque desired by the driver, the primary approach has been with linear potentiometer types. Solutions have been found to problems arising from wear of sliding contacts, so that performance of over a million full cycles is possible.

To cope with sudden changes in air temperature, particularly likely in exhaust-gas recirculation systems, temperature sensors need a very fast response. One coolant temperature sensor consists of 99% pure nickel wire wound on a bobbin inside a brass housing.

There are two exhaust-gas sensors for closed-loop exhaust-gas recirculation systems: zirconium oxygen and the titanium oxygen types. They also are required to respond to abrupt changes. The zirconium oxygen sensor is an electrochemical device that gives an electrical voltage output as a function of engine exhaust condition. Bosch has developed a special lambda sensor for this application. It exhibits a step voltage change at the stoichiometric air-fuel ratio, independent of changes and drifts in the engine (Fig. 7).

Changing displays

Digital displays run into cost obstacles and also present a problem to auto designers raised on analog indicators. So far only clocks and radios have offered openings for electronic digital displays. But the auto makers are planning major changes in dashboard display, in which they want to include digital "message centers" showing drivers pre-programmed reminders or trip computers showing distance traveled, gas mileage, and the like. Another incentive, reports Smiths Industries Ltd. in England, is that a conventional dashboard using analog instrumentation contains more than 400 parts, whereas a solid-state version can be manufactured with only 35 parts.

Chrysler, which has introduced a digital clock with a vacuum fluorescent display, has put light-emitting diodes on its new electronically tuned radios and combination radios and citizens' band transceivers. However, the company will probably go with vacuum fluorescent displays in its new generation of dashboards because of their visibility under all ambient conditions and their appearance. One drawback of LEDs in cars, explains John Webster, manager of electronic product development at Chrysler's Huntsville division, is that they wash out in bright sunlight. Another is their color—red in a car is reserved for important warnings and using yellow and green LEDs imposes a cost premium, he says. As for liquid-crystal displays, Webster says that it is too soon to predict whether they will be successful in an automobile, because of problems at low temperatures and their long response time.

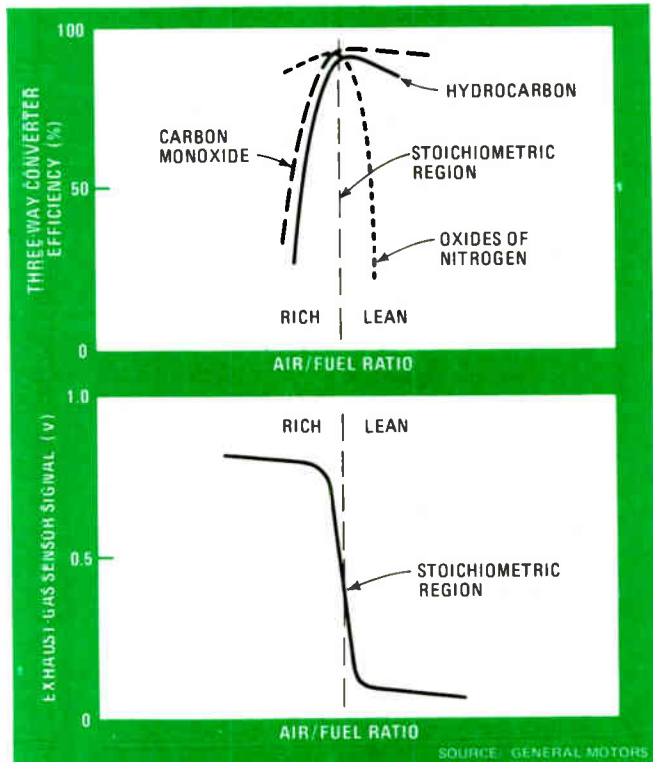

5. Cleaning up. The three-way catalytic converter operates most efficiently when the engine's air intake is just enough for all the fuel to burn. Keeping the air-fuel ratio in this stoichiometric region (top) requires a sensor responsive to any air or fuel excess (bottom).

GM researchers, however, have installed and tested in a 1975 Chevrolet an instrument panel cluster consisting of five twisted nematic liquid-crystal displays. They included warning indicators, a speedometer, fuel gauge, clock-odometer, fuel gauge, and automatic transmission indicator. The warning indicators were tried in four different formats: transmissive, color transmissive, reflective, and color transreflective. The rest operated in the reflective mode only. The reflective and color transreflective warning indicators were deemed the best for clarity under all operating conditions.

Reporting for the Society of Automotive Engineers on the results of the trials, the GM researchers concluded: "LCDs have a number of very positive attributes for automotive use: low voltage and power requirements, excellent visibility in bright sun, flexibility of design, color capability, and reduced bulk. Additional work is still required to increase their temperature range without use of heaters and shorten their response times."

In Great Britain, Smiths Industries has also experimented with dashboards using LCDs as well as dc electroluminescent, gas-discharge panels, LEDs, and electrochromic displays. For cost, appearance, temperature range, and ease of manufacture, Smiths likes the dc electroluminescent type best. Its advantage for vehicle display is visual appeal and the possibility of a wide range of colors (see table). The basic bright-yellow phosphor color may be filtered externally to provide green and red displays, and the viewing angle, also important in a car, is over 160°. The disadvantages are poor brightness and contrast in sunlight and short life expectancy

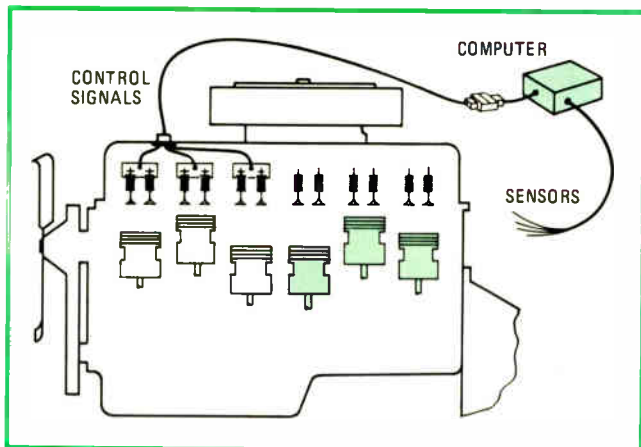

6. 6 - 3 Ford's new dual-displacement engine option will go on six-cylinder engines for light trucks. Sensors measure temperature, transmission gear, engine load and speed, and throttle position, and the control module shuts down three of the six cylinders.

under very bright conditions, according to Smiths.

The size and complexity of the automotive electrical system increases every model year. With more and more electronic control systems in the offing, the amount of wiring to accommodate it all is going to escalate.

According to one General Motors estimate, there are already some 17 electronic subsystems being designed for the automobile, with more to come. A typical American car may be equipped with more than 400 meters of cable, 83 switches, 14 electric motors, and 69 lamps. There may also be up to 27 sensors and 27 fuses and breakers to protect circuits that are tied together with something like 100 connectors.

In addition, copper is going up in cost, making auto

harnesses more expensive. Removing some of it by multiplexing would both cut costs and lighten the load, thus aiding fuel economy. Clearly, the automobile represents a prime target for a multiplexed electrical system, not only to reduce the parts count, but potentially to improve reliability by reducing the number of connections.

The way is clear for multiplexing

Multiplexing in a car would mean replacing the direct copper wire links between switches and motor lights with a system that would convert and transmit commands to activate or deactivate the motors or lights along a single network. These coded signals could be sent along either two or three copper wires or an optical-fiber light pipe. Chances are the first place auto companies would look to multiplex would be the steering column, which now conceals a mass of copper wires. The second place might be in the left front door, which also holds a lot of wire for window, seat, and door-lock controls.

Right now the cost of a multiplexed car is still higher than the copper wire, say auto engineers. However, multiplexing might buy some additional features that would make it worthwhile. For instance, given the right transducers, an on-board diagnostic system would be easier to install with a multiplexed hookup. Alternatively, if fiber optics takes off as predicted, the cost of multiplexing could become competitive even sooner.

All the auto companies are working on multiplexing, but their estimates of when it will be a reality range from a couple of years to 10 years. Whenever it comes, it will certainly increase the use of power transistors, Darlingtons devices, and the new gate turn-off silicon controlled rectifiers, which unlike conventional SCRs can be shut down as well as turned on by having a voltage

Testing goes microelectronic, too

The automobile companies are also applying microelectronics to the test equipment that will keep their dealer repair stations abreast of the new electronic engine controls.

For instance, a Motorola MC6800 microprocessor is basic to the electronic engine performance analyzer to which Chrysler Corp.'s Huntsville division recently put the final touches. When attached to special test points on the engine's electrical system, this unit checks out its starting, primary and secondary ignition, and no-load operation, and diagnoses any problems.

The advantage of the microprocessor is that it eliminates the need to replace the entire tester as new car models come out. Instead, the system can be reprogrammed to handle each new engine electrical system. The variable information, such as the size of the alternator and number of cylinders, is entered via a keyboard.

The unit performs some 70 or 90 tests in four to five minutes, displaying the results on a five-line Burroughs Panaplex gas-discharge display and an optional cathode-ray-tube display. The Burroughs character display presents a statement of the condition or fault found, with results and/or corrective action to be taken. The cathode-ray tube displays ignition and other waveforms.

The tester also makes a cylinder-to-cylinder compres-

sion check, allowing the mechanic to determine which cylinders are contributing to engine power and which are not. In addition, it spot-checks the Chrysler lean-burn spark computer to see if it is functioning. However, if a problem is indicated, the mechanic then makes a more thorough examination using the stand-alone lean-burn test instrument developed earlier by the company.

Down the road, say the Chrysler designers, the service shop diagnostic computer will link up to a diagnostic microprocessor in the car. At this point it will be possible to program the tester very quickly to fit each model car, because the on-board microprocessor will carry a "signature program" for that model.

Ford has taken a different tack. In support of its 1978 program, the company has developed a system consisting of a "core" tester—a digital volt-ohmmeter with some special signal-conditioning circuits and logic—plus an adapter box or boxes with harness. A dealer who is selling only one of Ford's three basic engine-control systems would acquire the core tester and one of the boxes. The core will be constant from year to year, and only the adapter boxes will be changed with the new models.

Eventually, for those dealers who want greater speed and sophistication, Ford plans to introduce a more elaborate, microprocessor-based diagnostic tester.

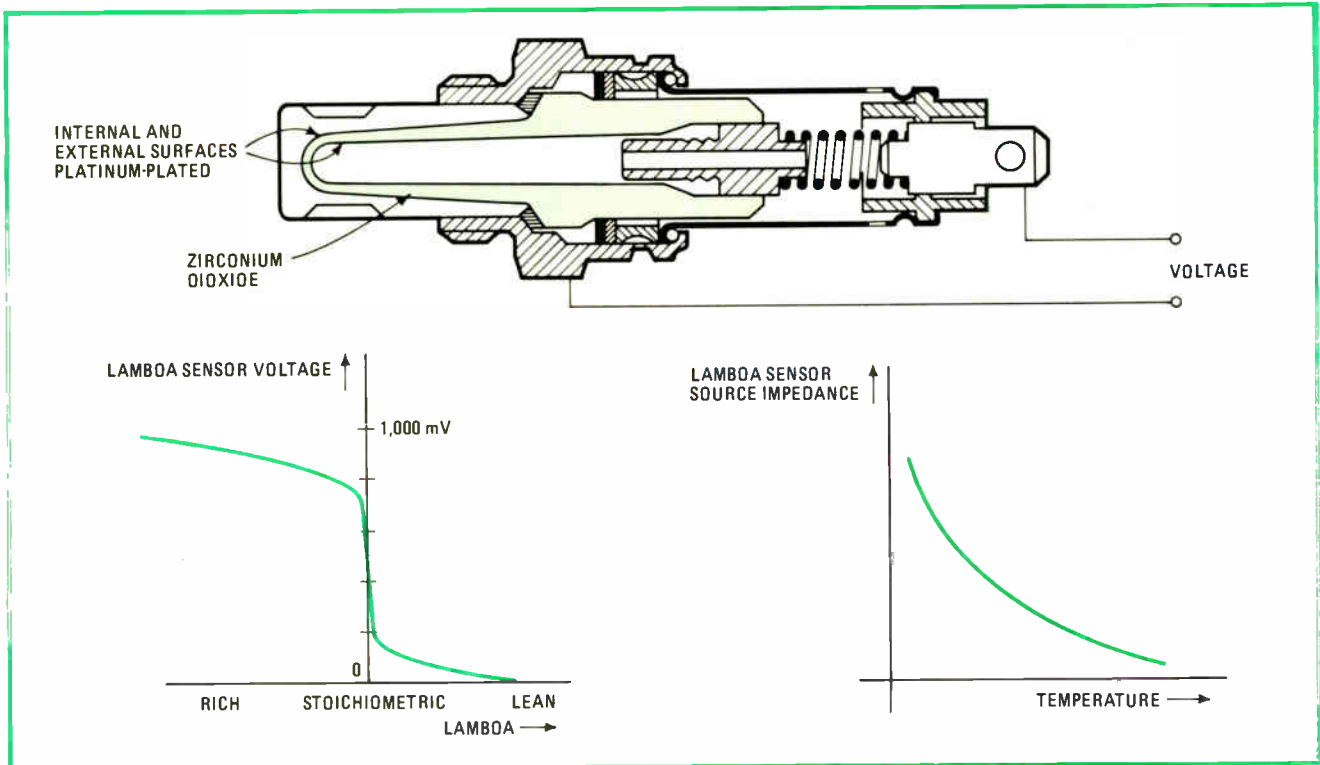

7. Sensored. The zirconium lambda sensor designed by Robert Bosch is meant for use in a closed-loop electronic fuel injection system. The sensor responds to deviations from the stoichiometric air-fuel mix by signaling a control module to adjust the quantity of fuel injected.

applied to the gate. It is predicted that a fully multiplexed automobile could require 20 such devices.

In the U.S., General Motors is probably furthest along in this area. It has developed a multiplexed control system with a single fiber-optic cable to replace the multiwire harness, connectors, and printed-circuit boards required to interconnect steering column switching functions with power actuators and lights.

An encoder module located at the top of the steering column digitally multiplexes switching signals for windshield wipers, turn signals, hazard flashers, key reminder, horn, headlights, and cruise control. It transmits these signals as light pulses through an optical-fiber cable to a decoder module at the base of the steering column. This module decodes the signals and routes them to the appropriate power actuators.

A light-emitting diode on the encoder converts the 32-bit digital words to light pulses to be transmitted down the optical-fiber cable. A photodiode on the receiving end reconverts the light pulses to electrical signals for the decoders to route.

Test results

Installed in a 1975 Buick Electra, this multiplexed system handled signal chores and proved that small switches could replace the larger, high-current switches used at present. One problem this test program underscored was the need for a low-cost solid-state switch capable of taking the low-current signals from the decoder module and converting them into high-current power drive signals.

In Germany, Robert Bosch is developing a number of microprocessor-based multiplexed wiring systems to

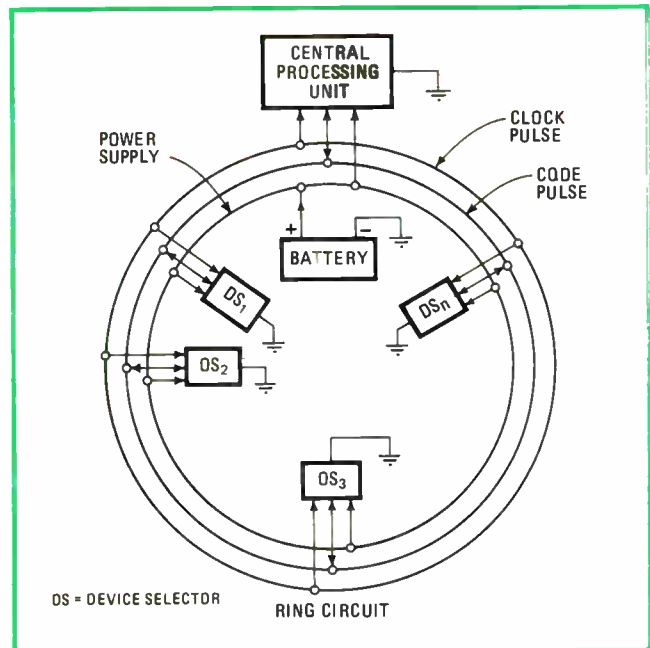

8. Multiplexing. The Bosch three-wire multiplexed system is in the form of a ring, with a microprocessor handling signals. The first wire carries a 150-kHz clock pulse. Coded data words from the processor go along the second. The third supplies battery power.

replace harnesses in trucks and buses. One system can supply, control, and monitor up to 128 loads on the vehicle by way of only three conductors. The loads can be switches, sensors, and all the electrical functions.

The three-conductor multiplexed ring system, as Bosch calls it, uses a 150-kilohertz generator to produce

SOLID-STATE DISPLAY TECHNOLOGIES FOR AUTOMOTIVE USE

Technologies available	Criteria for instrument display			
	Most suitable	Satisfactory	Poor	
<p>Light-emitting diodes (LED): small dots or digits used in calculators and some watches; semiconductor process.</p> <p>Liquid-crystal displays (LCD): electrically controlled liquid; switches from clear to blocking as a shutter.</p> <p>Gas-discharge (plasma) panels (GAS): excited gas in tiny pockets emitting light as a neon tube does.</p> <p>Dc electroluminescence (DCEL): large-area light-emitting phosphor silk-screening type manufacturing process.</p> <p>Electrochromic (EC): reflecting symbols by coloring of electrodes as a reversible electro-coating.</p>	System cost	DCEL	others	
	Appearance	DCEL	LED EC LC GAS	
	Life	LED	DCEL LC GAS	EC
	System reliability	LED	DCEL LC GAS	EC
	Temperature range	DCEL	LED EC GAS	LC
	Overall choice	DCEL	EC LC GAS	LED

SOURCE: SMITHS INDUSTRIES LIMITED

clock pulses carried over one of the three wires as illustrated in Fig. 8. Coded data words selected by the appropriate data switch are generated in the microprocessor and transmitted along the second conductor. The third conductor supplies the battery power. The three conductors link 16 selector substations, which in turn serve 8 loads each for a total of 128 loads.

Coded data words comprise 22 bits in a sequence of binary pulses for synchronization control functions and commands. Pulses at the end of the signal train are sent back to the central processor to confirm the execution of the command or to report a condition such as headlights dimmed, brights on, etc. The two-way data exchange can also be used to monitor operating conditions such as water temperature, oil level, and the like.

A radar car for the future

As a way of making cars safer, air bags may be much in the news (see "What about air bags?" p. 88). But for some years now, auto companies and some of their systems suppliers have been trying a much more radical approach—the development of a cost-effective, radar-controlled braking system that would help prevent accidents caused by inattentive or alcohol-impaired drivers. The technical and cost problems have been so intractable that the projects have not left the laboratory, but the Government's interest continues and could move radar safety systems to the front burner.

The biggest technical obstacle to an automatic radar braking system has been target discrimination—how to distinguish between a nonhazardous object off the road and a hazardous object ahead. Fewer false targets would be picked up if the maximum detection range were restricted and a highly directive antenna were used. A recent study made by the U. S. Department of Transportation of a car with radar-controlled braking developed by Bendix Corp. determined that a detection range of

150 feet and a beam width of 2.5° were acceptable for this 22.125-gigahertz system. The agency also recommended changing to a radar transmitter frequency of 35 to 36 GHz, on the basis of antenna beam width and total size, but found either pulse or duplex-interrupted continuous-wave modulation acceptable. Finally, DOT concluded that transmitter power should be at least 20 milliwatts or better to detect targets right out to maximum operating range.

The use of microprocessors to process the radar signals may hasten a solution to the problem of false alarms. One such system using two microprocessors in an experimental car has been developed by RCA. One microprocessor controls dashboard warning displays. The other operates in conjunction with a forward-pointing frequency-modulated continuous-wave radar.

With the microcomputer program the radar unit can perform three functions. First, during highway driving under cruise control, the radar monitors the lanes ahead, and if the vehicle comes too close to another car, the computer cuts out the cruise control and the radar system automatically maintains a safe distance thereafter. Second, the radar system can be set to sound an audible warning of obstacles or other cars up to 30 meters ahead when there is fog or impaired visibility. Third, the radar system automatically applies the brakes in situations in which the computer deems a serious collision to be unavoidable. The driver can override this last function if necessary.

Although reducing the distance and beam width of the transmission and using a microprocessor to evaluate radar target data have not completely done away with false alarms, the present systems could reduce highway accidents, say some researchers. But that still leaves the cost barrier to be overcome. □

A reprint of this special report is available for \$3. Write to Electronics, Reprint Dept., P. O. Box 669, Hightstown, N. J. 08520. Copyright 1977, Electronics, a McGraw-Hill Publication.

Real-time processing gains ground with fast digital multiplier

Refinements in algorithm and hardware cut speed-power product of one-chip device, promising new applications

by Shlomo Waser, *Monolithic Memories Inc., Sunnyvale, Calif.*,
and Allen Peterson, *Stanford University, Palo Alto, Calif.*

□ In real-time signal processing, analog methods have held sway despite the advances in digital techniques. But now, fast multiplier chips are helping turn the tide. These chips can speed the complex operations needed for digital treatment, which previously could only be carried out off line using large computers. Functions like autocorrelation and fast Fourier transforms necessary for digital filtering and compression, for example, can now be done in real time by the multipliers and the new, fast analog-to-digital converters. As a result, performance in such fields as telephony, television, and sound reproduction will be greatly enhanced, and digital signal processing will assume the dominance in these areas once held by analog techniques.

The single-chip MMI67558 can multiply two 8-bit numbers in 100 nanoseconds, yet it dissipates only 1 watt. These figures represent a significant breakthrough in speed-power product. The combined attributes of high speed, small size, and low power dissipation destine the

67558 for new roles in signal processing. The classic example of a notch filter 1 hertz wide and 100 decibels deep, which would be pointless to design using tuned circuits, now becomes practical with digital techniques. And spectral analysis, the process of breaking down complex signals into their single-frequency components, is done most accurately using the fast Fourier transform which requires extremely fast multiplication.

The reduction in cost and size of complex digital components translates into dramatic savings on the system level. The low-power 67558, besides costing far less than the functionally equivalent hard-wired logic, has a smaller power supply requirement, occupies far less circuit board area, and needs no forced-air cooling or heat sinking. Moreover, the reduction in circuit interconnections means an inherently more reliable design.

The 67558 not only has guaranteed entry into the conventional areas of digital signal processing, such as radar and sonar, but it has clear access to a host of

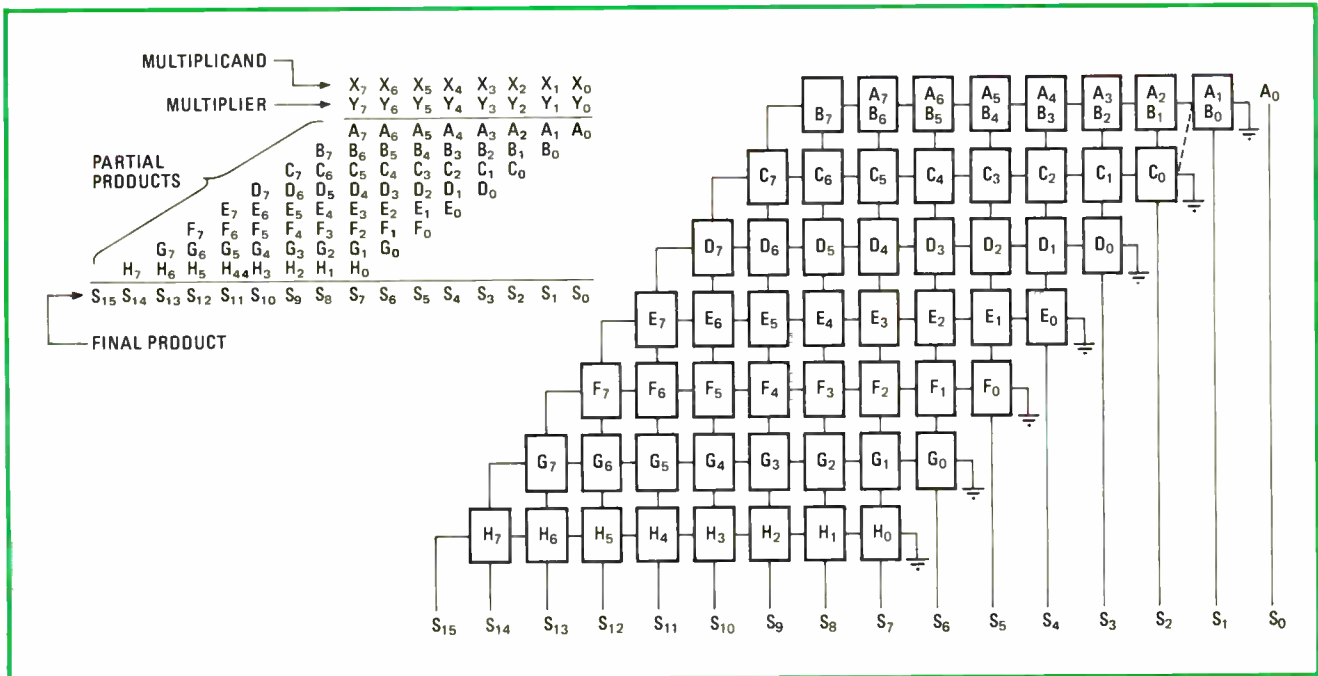

1. Combinatorial multiplier. The double-length product is formed by adding together the eight partial products, each of which is shifted according to the weight of the corresponding multiplier bit. In the scheme at the right, the operation is carried out by 56 binary full adders, and the speed of multiplication is governed by the ripple carry from A_1 through B_7 , and on down to S_{15} .

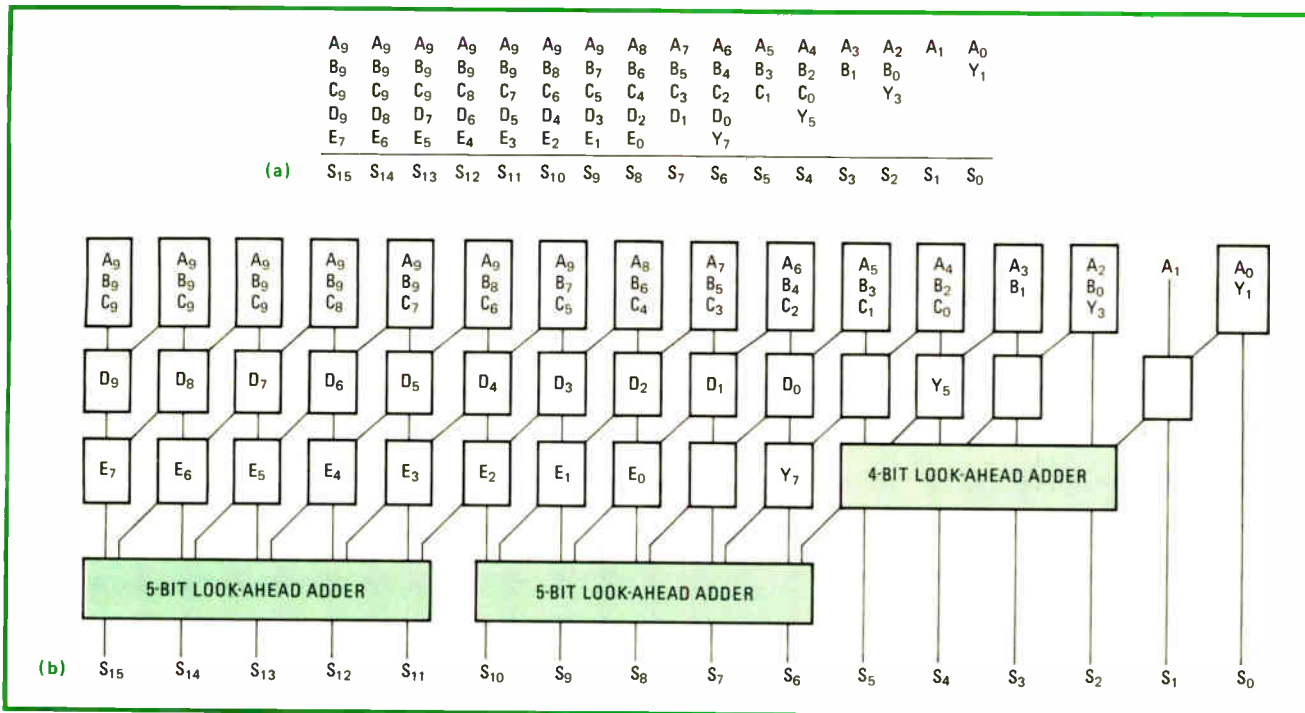

2. Adder array. Modified Booth's algorithm reduces the number of partial products (a), which are sign-extended to accommodate two's-complement operations. The adder array (b) is arranged in a modified Wallace tree, requiring fewer carry-save adders to sum the partials.

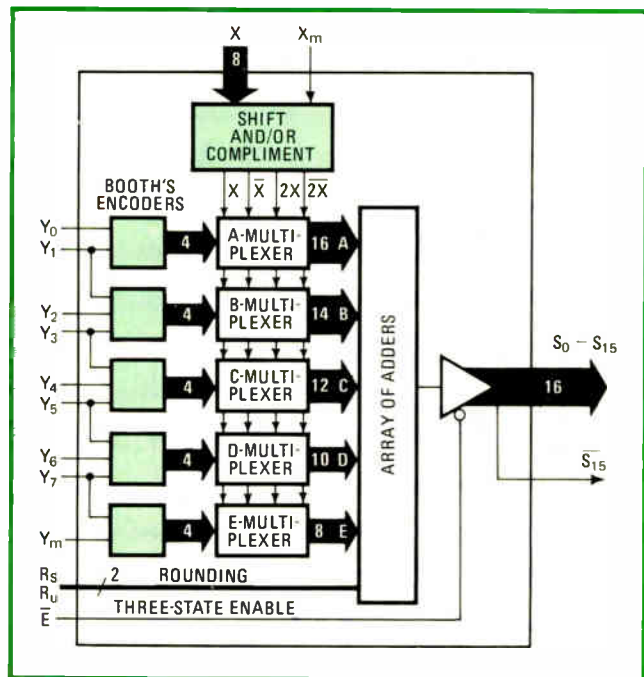

3. Chip design. The MM167558 breaks up the Y operand into five parts, each of which is encoded to four select lines. Only one select line is active at a time; it chooses the value of the partial product to be $\pm X$ or $\pm 2X$. If no select line is active, the partial product is zero.

relatively new areas, such as medical electronics, for electrocardiography and brain and body scanning; sound processing, for voice synthesis or speech scrambling and musical recording applications like compression and expansion; and video enhancement, for facsimile transmission, satellite relay of weather photographs, and compression of digital television signals.

Although it seems like an oversimplification, it is fair to say that the bandwidth in digital signal processing is limited by the speed of multiplication. In the final analysis, all computation reduces to addition and multiplication; and multiplication is traditionally performed by successive addition, such that the calculation of the product of two n -bit numbers requires at least $n - 1$ additions. Thus, if the signal is quantized into 8 bits and a computation consisting of an addition and a multiplication is required, the latter consumes almost 90% of the processing time. If, however, the multiplication speed were to match that of the addition, the bandwidth of the signal processor would be $4\frac{1}{2}$ times larger.

Modified algorithm

Speed enhancement in the 67558 begins with modification of the multiplication algorithm. The add-and-shift algorithm is the simplest way to perform multiplication, the operation being carried out in a manner analogous to the way one multiplies numbers using pencil and paper. For example, in multiplying two binary numbers, each bit of the multiplier requires a corresponding add-and-shift operation:

multiplier	110	(5)
multiplier	$\times 101$	(6)
	<hr/>	
partial products	110	(6×2^0)
	000	(0×2^1)
	<hr/>	
final product	11110	(6×2^2)
		(30)

Even though computers can add and shift in the same instruction cycle, n bits of multiplier require at least n such operations. This method, known as sequential multiplication, is performed with adders and shift regis-

4. Weighting-function filter. Finding the prototype low-pass filter weighting function is the first step in digital bandpass filter bank design. A transversal filter, the analog version of which is shown in (a), does the job. The digital version (b) uses a shift register instead of a tapped delay line. Finally, the system shown in (c) implements the nonrecursive digital transversal filter used as the low-pass prototype weighting-function filter.

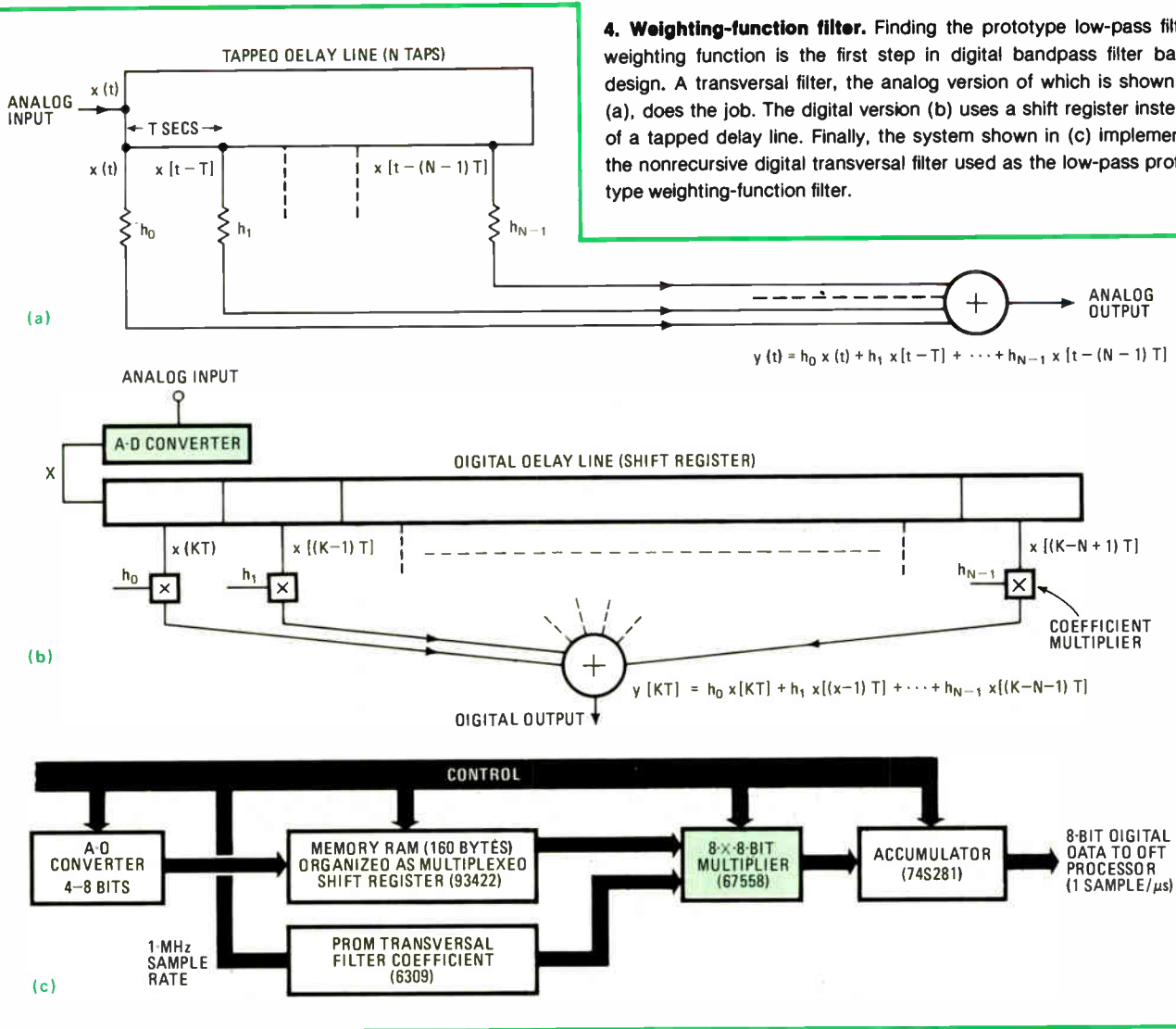

ters and is adequate for low-speed multiplication.

High-speed multiplication calls for a combinatorial approach. In this approach, the partial products are formed simultaneously and then added in one operation. Each successive bit in the partial product is determined by an AND operation of successive multiplicand bits with a single multiplier bit. This procedure is related to the add-and-shift algorithm, since a 0 multiplier produces a zero partial product and a 1 multiplier simply duplicates the multiplicand in the partial product. The actual shifting is performed by the interconnections of the adders used to sum the partials, as shown in Fig. 1.

For the sake of simplicity, the speed of multiplication is best expressed as a function of logic-gate propagation delays, while the power dissipation is directly related to the total number of gates. Referring to Fig. 1, the speed of multiplication is governed by the delays from A_1 to B_7 , to S_{15} . This path consists of 14 adder stages, each of which has 4 gate delays; with another gate delay for the generation of partial products, the total is 57. The gate count results from 64 AND gates that generate the partial products and from the 56 binary adders. Since each adder contains 10 gates, total count for the combinato-

INSTRUCTIONS FOR CARRYING OUT MODIFIED BOOTH'S ALGORITHM			
Bit			Operation
2^1	2^0	2^{-1}	
Y_{i+1}	Y_i	Y_{i-1}	
0	0	0	add zero (no string)
0	0	1	add multiplicand (end of string)
0	1	0	add multiplicand (a string)
0	1	1	add twice the multiplicand (end of string)
1	0	0	subtract twice the multiplicand (beginning of string)
1	0	1	subtract the multiplicand ($-2X$ or $+X$)
1	1	0	subtract the multiplicand (beginning of string)
1	1	1	subtract zero (center of string)

rial multiplier described is $64 + (56 \times 10) = 624$ gates.

The combinatorial multiplier, though significantly faster than the sequential type, has room for improvement. The carry bits that are passed among the adders slow down the operation, and a technique known as carry-look-ahead, which keeps track of carry bits while not adding them, is often used to reduce the carry-

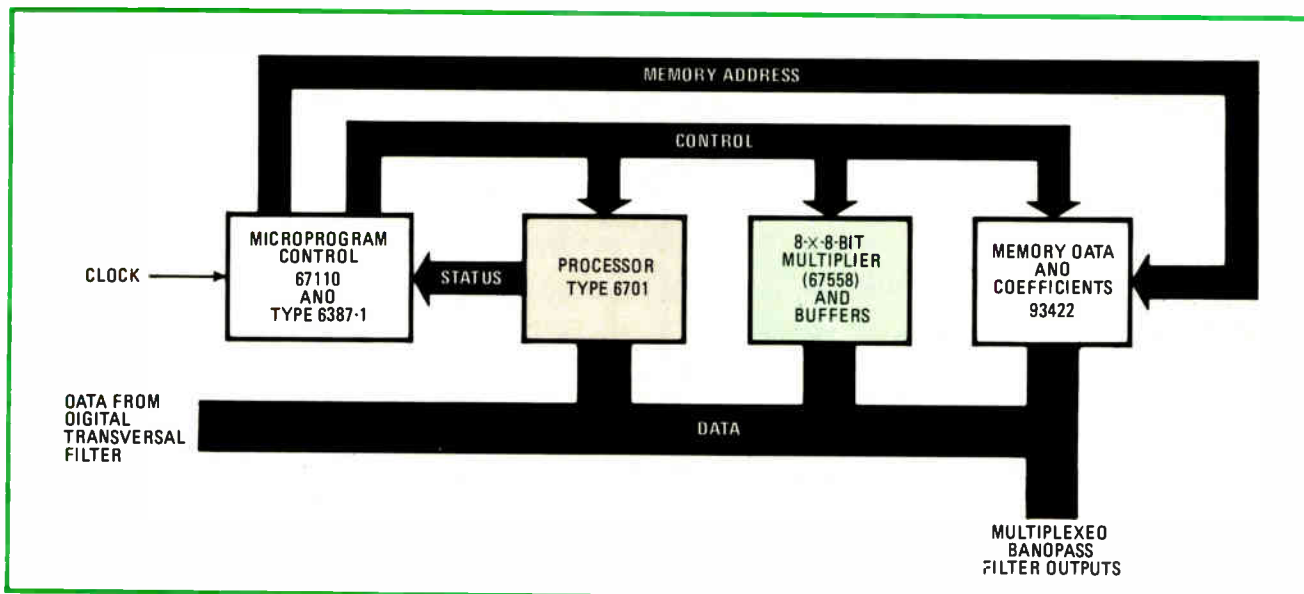

5. Digital bandpass filter system. Once the low-pass weighting-function filter is built, a discrete Fourier transform (DFT) of the weighted data stream is used to transform the prototype filter into a bank of bandpass filters, each with a center frequency that corresponds to one of the DFT components. Transformation is best performed under bit-slice processor control.

propagation delay, but with the penalty of a much higher gate count.

But the 67558, instead of waiting for the carry bit to ripple through, adds them at a later time. Postponement of the addition of carries is applied to all the adder stages except the last one. The carries from the last stage essentially form an n -bit operand to be added to the n -bit sum, and this operation requires look-ahead adders.

Another side benefit of postponing addition of the carries to a later stage is that the first stage can be made up of carry-save adders, each having three inputs, with the result that the total number of adder stages is reduced from seven to six. This entire scheme is a modified Wallace tree.

The tree reduces both the number of gate delays and the gate count. Contributors to the propagation delay include 1 gate that generates partial products, 6 carry-save-adder delays of 4 gates each, and 2 stages of carry-look-ahead with 3 gates each, for a total of 31 gate delays. The gate count is made of $64 + 48$ carry-save adders + 2 carry-look-aheads. Each of the latter has 30 gates, giving a total count of $64 + (48 \times 10) + (2 \times 30) = 604$ gates.

One other technique is used to increase speed. The approach, the modified Booth's algorithm (first used in the IBM 360), reduces the number of partial products by half; consequently, the number of carry-save-adder stages, and hence the gate count, are also reduced. Basically, Booth's algorithm allows the multiplication operation to skip over any contiguous string of all 1s and all 0s, rather than form a partial product for each bit. Skipping a string of 0s is straightforward, but in skipping over a string of 1s, the following property is put to use: a string of 1s can be evaluated by subtracting the weight of the right-most 1 from the modulus. (The modulus of an n -bit word is 2^n , and the weight of any n th bit is 2^{n-1} , counting from the right.) For example, the value of the binary string 11100 computes to $2^5 - 2^2 = 28$.

In the actual hardware implementation of the algorithm, each multiplier is divided into substrings of 3 bits, with adjacent groups sharing a common bit. However, Booth's algorithm works only with two's-complement numbers—the most significant bit of which has a weight of $-(2^{n-1})$ —and requires that the multiplier be padded with a 0 to the right to form four complete groups of 3 bits each. To work with unsigned numbers, the multiplier must also be padded with two 0s to the left, one so that the multiplier will not be treated as a negative number and the second so that the fifth group will be complete. Thus the modified Booth's algorithm is a multiplier-encoding scheme that involves a constant shift of 2 bits at a time while examining 3 multiplier bits, and it produces five partial products rather than eight—the fifth partial product being a consequence of the fact that Booth's algorithm only handles two's-complement numbers. All the possible permutations, as shown in the table, form instructions that prevent unnecessary computation for zero partial products.

The hitch in the modified algorithm is that, as shown in the table, a subtractor is required. The subtraction is implemented by adding the two's complement of the number to be subtracted. In taking the two's complement, the number is first complemented and 1 is then added to the least significant bit.

From the table, it can be seen that the Y_{i+1} can simply be added to the LSB of the partial product. If bit $Y_{i+1} = 0$, no subtraction is called for and adding 0 changes nothing. On the other hand, if bit $Y_{i+1} = 1$, then the proper two's complement is performed by adding 1 to the LSB. Of course, in the two's complement, the sign bit must be extended to the full width of the final result, as shown by the repetitive adders in Fig. 2a.

The scheme of the modified algorithm is shown in Fig. 2b. The gate delay is made up of 2 gates decoding the 3-bit multiplier instruction, 2 gates for selecting shift or double shift, and 2 carry-save-adder stages and 3 stages

of carry-look-ahead, yielding a total of 21 gate delays. The gate count is made up of 5 encoders, 32 multiplexers, 40 carry-save adders, and 3 carry-look-aheads for a total of $(5 \times 5) + (32 \times 5) + (40 \times 10) + (3 \times 30) = 675$ gates. Thus, for a small penalty in gate count, the speed multiplication is improved, and the output data is also available either signed or unsigned.

Hardware implementation

In implementing the multiplication algorithm, several techniques contribute to the reduced power dissipation in the 67558. First, computer-aided circuit design was used to determine noncritical signal paths—those with lower speed requirements—slowing down the gates in these paths lowers the power dissipation.

Second, the number of devices required for AND-OR-invert gates in the multiplexer section of the circuit was minimized: the logical equation $\overline{C} = \overline{A \cdot B}$ is realized by a single transistor, where C is the collector, B is the base, and A is the emitter. With fewer transistors, each multiplexer dissipates less power.

Finally, power is reduced in the implementation of exclusive-OR gates. Although transistor-transistor logic is most suitable for NAND gates, they build an inordinately extensive exclusive-OR circuit. Typically, the problem is circumvented with a circuit that resembles an AND followed by an OR; but this approach produces output voltages that are too high, and level translators must then be used to readjust thresholds. The 67558, however, does not use level translators—instead, the input threshold voltages of subsequent stages are matched to the exclusive-OR outputs. The final design of the 67558 is diagrammed in Fig. 3.

Digital signal processing

In determining the bandwidth limits in the digital processing of analog signals, the first rule is that the sampling rate must be at least twice that of the highest frequency component of the analyzed waveform. In speech processing, for example, since the highest pitch generated by the vocal chords is about 4 kilohertz, a sampling rate of 8 kHz is required. Therefore a sample must be taken at least as often as every 125 microseconds to fulfill the requirement.

A figure for the computational speed of real-time voice processing can be arrived at depending on the operation to be performed. To compute the autocorrelation function for 256 samples of a speech waveform, for example, each sample value is multiplied by 256 other samples. Therefore, in a period of 125 μ s, 256 multiplications are required, and thus each multiplication must be performed in less than 500 ns.

The number of bits of resolution in signal processing is of concern at the time of analog-to-digital conversion and during computations. When an analog signal is converted to a digital word, the signal-to-noise ratio is critical. A poor ratio can result in clipping of the waveform, which, when converted, introduces phantom frequency components. For example, if a waveform at one point has a level of 160 millivolts and each quantizing level is 10 mv, 4-bit resolution is sufficient for the a-d conversion. If the resolution of the system is

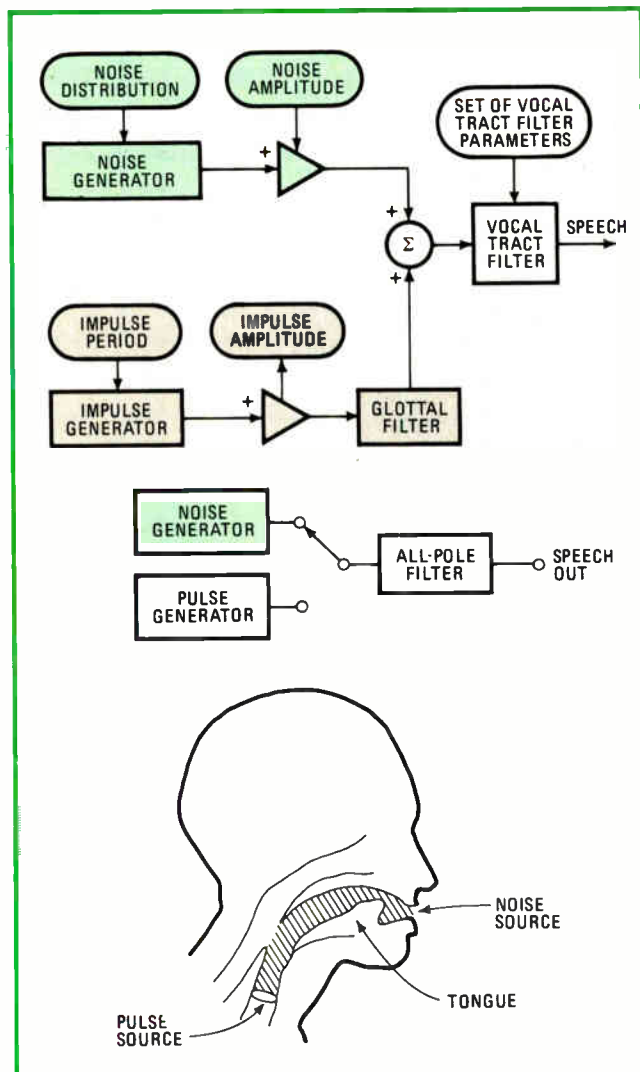

6. Speech mechanism. Understanding the mechanism of speech is key to voice processing. In speech synthesis, the vocal tract becomes a time-varying digital filter excited by pitch impulses (to simulate voiced sounds) or random noise (unvoiced sounds).

extended to 8 bits, a maximum noise level or interfering signal of $2^8 \times 10 \text{ mv} = 2.56$ volts can be tolerated.

The second place that the number of bits is significant is during the computation. In discrete time analysis, infinite precision of the filter coefficients is usually assumed. In carrying out arithmetic operations, however, the number of bits grows as the calculation proceeds—multiplication may double the word length of the operands, and products must therefore be rounded. Using fixed-point arithmetic with real-time hardware requires careful analysis of operations; too many bits adds to expense and may convey a false sense of accuracy, whereas too few bits results in erroneous analysis.

For full precision in multiplication, each time the product is used as an operand, the number of required bits is doubled. Multiplication of two 8-bit numbers requires 16 bits for full precision, and operating on the result requires a 16-bit multiplier, which in turn generates a 32-bit product.

When using fractional numbers, the full precision is

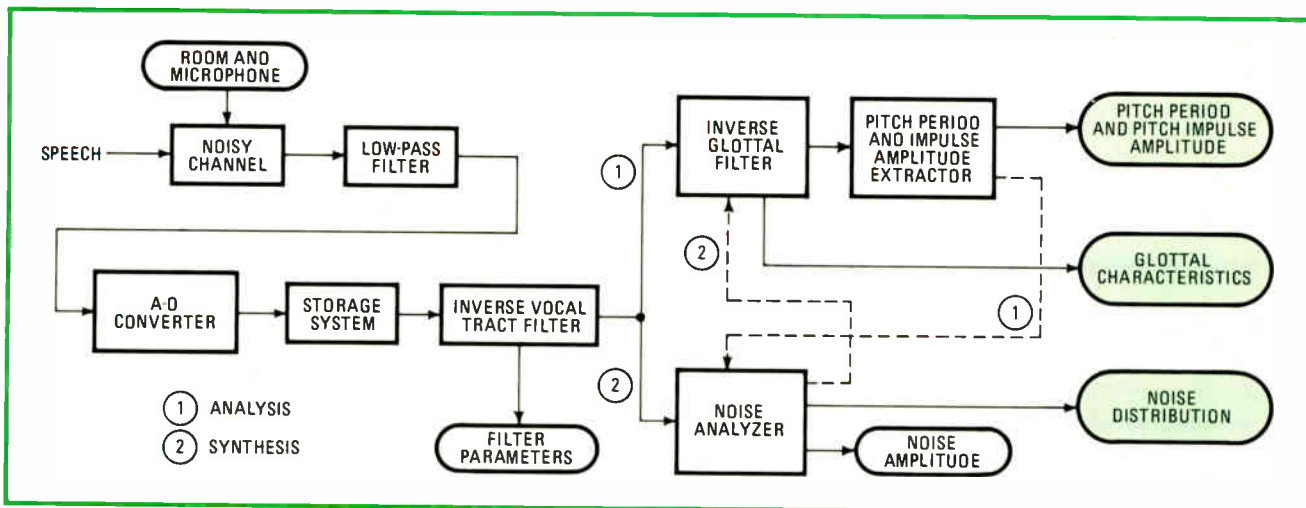

7. Speech analysis model. Speech is digitized and stored, and vocal-tract filter coefficients are then computed. Next, pitch period is determined for voiced signals and noise excitation is determined for unvoiced signals.

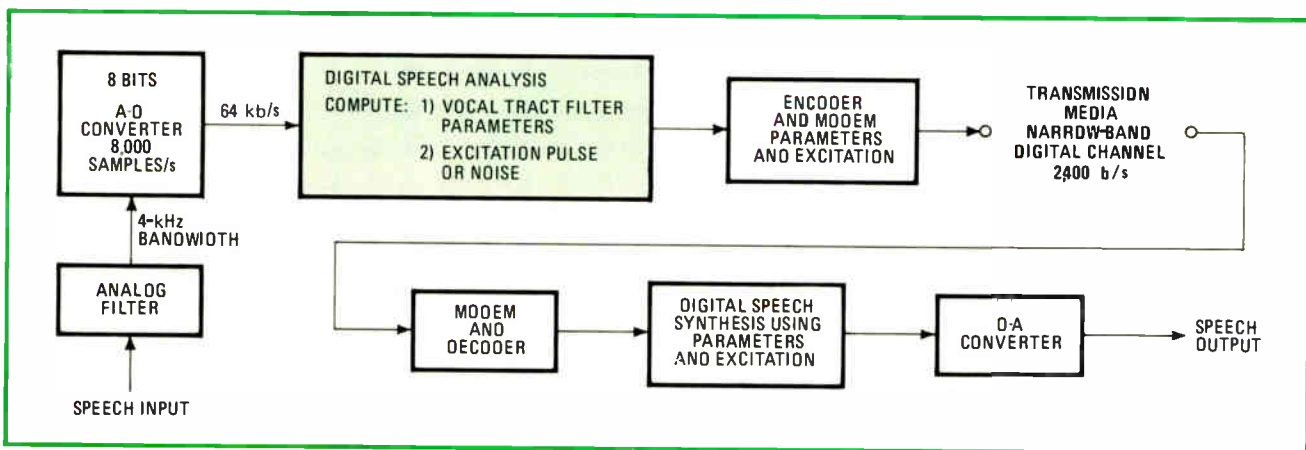

8. Compression. Narrow-band digital voice communication system shows the advantages of digital over analog processing. Digitized speech, converted to a data rate of 64,000 b/s, is compressed to a rate of 2,400 b/s to reduce the cost of transmission.

not always needed. Instead, a rounding scheme provides the best 8-bit fractional number from the full 16-bit product. Rounding in the binary number system is similar to the scheme used with decimal numbers whereby 0.5 is added to the part to be discarded and the number is then truncated.

Bandpass filter

Digital processing techniques can be applied directly to the real-time domain. Bandpass filters, for example, can be assembled efficiently using finite impulse response filters and fast Fourier transform computers. Basically, the design of banks of such filters starts with a low-pass prototype digital filter that derives a weighting function. A discrete Fourier transform of the weighted data stream then transforms the low-pass prototype into a bank of bandpass filters. Each of these filters has a center frequency that corresponds to one of the transform frequency components.

The prototype is a digital version of an analog transversal filter. A standard configuration for the latter consists of a tapped delay line, a set of weighting resistors, and a summer, as shown in Fig. 4a. The output signal is formed by summing the delayed and weighted

input signals, according to the equation shown.

To make a digital version, the input signal is first sampled and quantized into a digital form as shown in Fig. 4b. An n -stage digital delay line—or shift register—holds successive numbers (usually in binary format) generated by the a-d converter and shifts the sequence by one state when a clock pulse is applied every T seconds.

The digital filter is nonrecursive, since each output number depends only on the input sequence. Weighted sums of the output sequences are not involved, as they are in the recursive digital filter. Figure 4c gives a system configuration for the transversal filter operations that yields the low-pass prototype.

To complete the design of the multichannel bandpass filter, the n -point discrete Fourier transform of the digital output samples from the transversal filter must be computed. While this computation can be built up with hard-wired medium-scale integrated building blocks, a more flexible system uses a microprocessor. Only minor changes in architecture need then be made to accompany a different number of channels in the bank. Bipolar 4-bit slices such as the 6701 or 2901, together with program controllers like the 67110 or 2911, work well and are

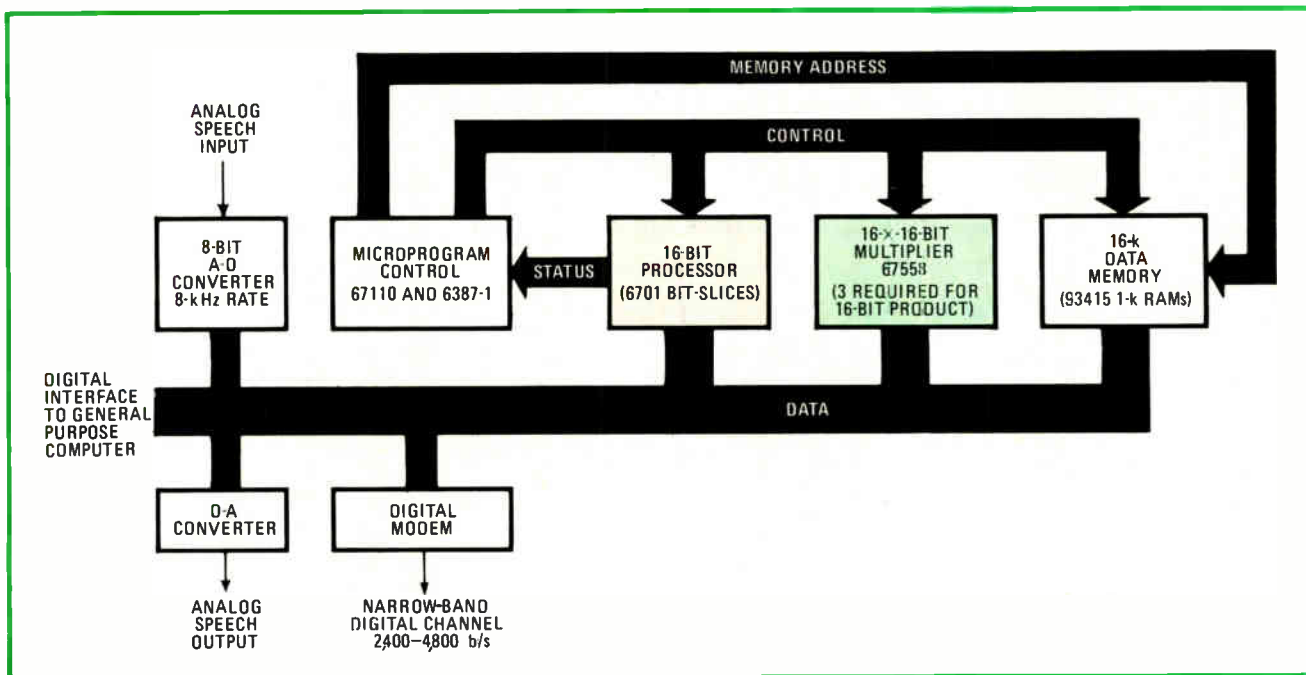

9. Real-time microprogrammed speech processor. Full-blown speech processing is carried out by this system, which uses bit-slice processors, fast RAM, and 67558 multipliers. Analog output, narrow-band digital output, and interface with a computer are provided.

relatively simple to arrange, as shown in Fig. 5.

The filtering and processing techniques thus developed can be applied to the area of speech analysis and synthesis. Research in this area has led to the introduction of voice encoding and other digital techniques into telephone communications, and these techniques can achieve great savings as the cost of digital hardware declines.

Real-time implementation of digital speech analysis and synthesis involves a large number of multiplications and therefore requires a high-speed computational capability. Since the speech model is time-varying, the computations are usually carried out in blocks of about 20 or 30 milliseconds' duration. Speech samples are obtained at rates of 8,000 to 10,000 samples per second, with a typical block length of 256 samples.

While one block of samples is being taken, complicated computations such as autocorrelation and updating of digital-filter coefficients must be carried out. A system is typically limited in its capability by the multiplication rates available, since several million multiplications per second often must be performed.

The speech process

The 67558 multiplier permits the building of a generalized processor that can carry out the necessary calculations. By applying rules of speech generation and digital filtering techniques, specialized hardware such as the 67558, under fast microprocessor control, now makes possible relatively low-cost real-time speech processing.

Analysis of the actual speech process is the key to its synthesis. It is generally accepted that speech is created by a combination of glottal excitation—the rapid opening and closing of the glottis, or vocal chords—and noise excitation of the vocal tract produced by the flow of air out of the lungs. The vocal tract is the portion of the windpipe that begins at the glottis and separates into

two paths, one of which terminates at the lips and the other at the nostrils. The characteristics of the vocal tract are mainly the cross-sectional area and the resonance coefficients.

In speech processing, it is usually assumed that the source of excitation and the vocal tract system are independent. Accordingly, in speech synthesis the vocal tract is treated as a time-varying digital filter that is excited by pitch impulses to simulate voiced sounds or by random noise to simulate unvoiced sounds. The problem of speech analysis reduces to two parts: computing the numbers that characterize the transfer function of the time-varying digital filter, and determining the position in time of the excitation-pitch pulses (or sometimes only the pitch frequency for periodically occurring excitation pulses).

Speech parameters

Whether impulses or noise should be used as the excitation for the speech-synthesis filter is determined by the voicing. Voiced sounds generate pulses, while unvoiced sounds produce only noise. A model of speech generation is shown in Fig. 6.

Figure 7 is a configuration for digital analysis of speech in order to obtain excitation and filter transfer-function parameters appropriate to a given sample of speech. The parameters are then used to recreate speech in a digital analysis-synthesis communication system. One advantage of digital speech processing is clearly shown by Fig. 8, which illustrates the compression of 64,000 bits per second of encoded speech into a bandwidth of only 2,400 b/s.

A generalized digital processor capable of carrying out calculations for real-time analysis and synthesis of speech either for communication or for research is shown in Fig. 9. □

Buffer improves converter's small-signal performance

by Will Ritmanich
Precision Monolithics Inc., Santa Clara, Calif.

If an operational amplifier is placed in the integration and error compensation loop of the popular AD7550 analog-to-digital converter, the converter can measure

microvolt-level signals without errors being introduced by its own or the op amp's offset-voltage drifts. Adding this buffer also increases the impedance of the signal (input) port of the converter, allowing it to be driven from high source impedances.

To understand why an external buffer can improve converter performance, it is necessary to know how the converter processes the input signal. The AD7550 uses the quad-slope integrating method, an improved version of the often-used dual-slope method.

A shortcoming of the dual-slope type is that errors at the input of the integrator due to noise or comparator

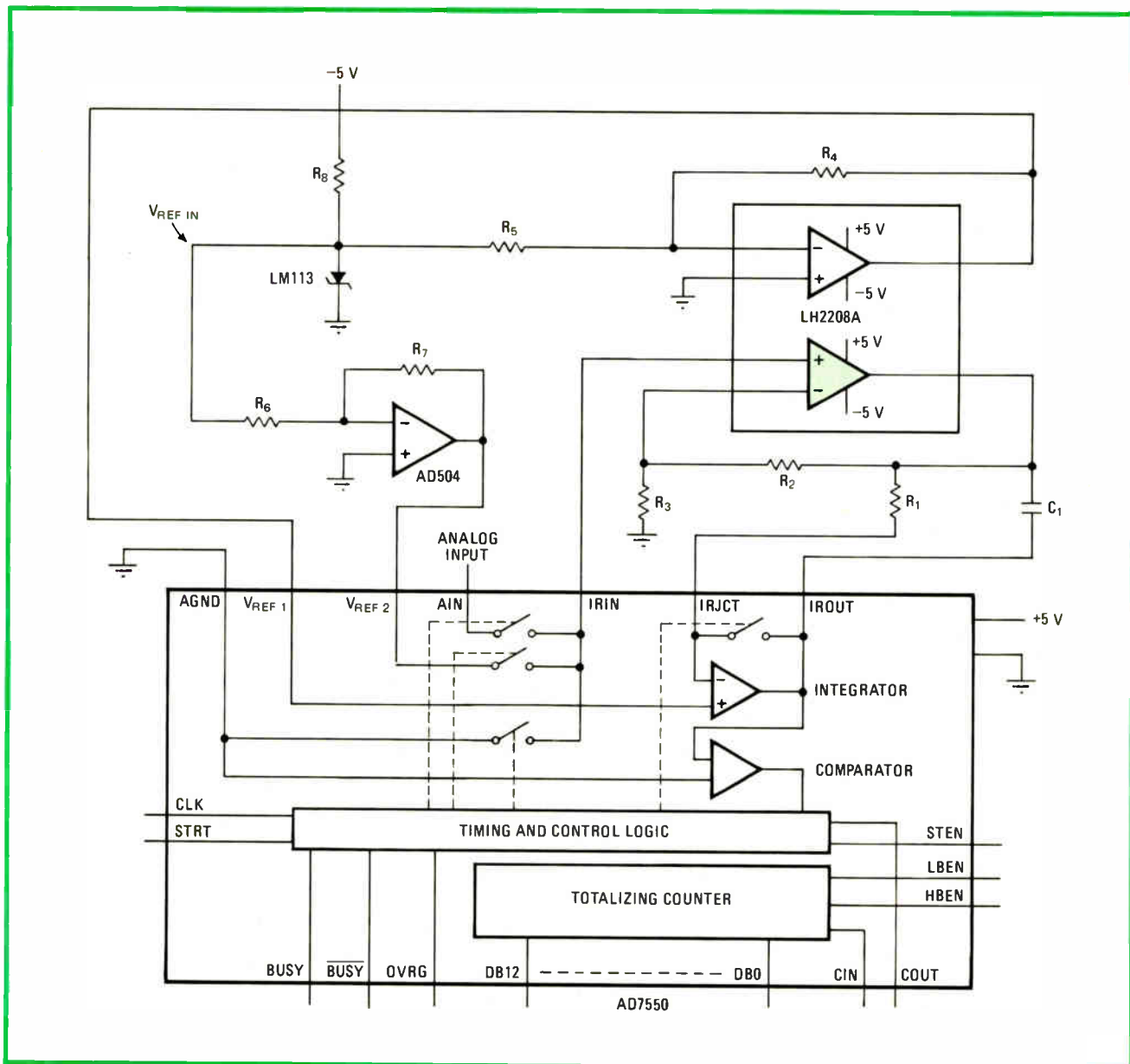

1. Improved performance. AD7550 accurately measures even microvolt-level analog voltages if op-amp buffer is placed in converter's integrator and error compensation loop. Converter views offsets as just another error that has been introduced in integrator loop.

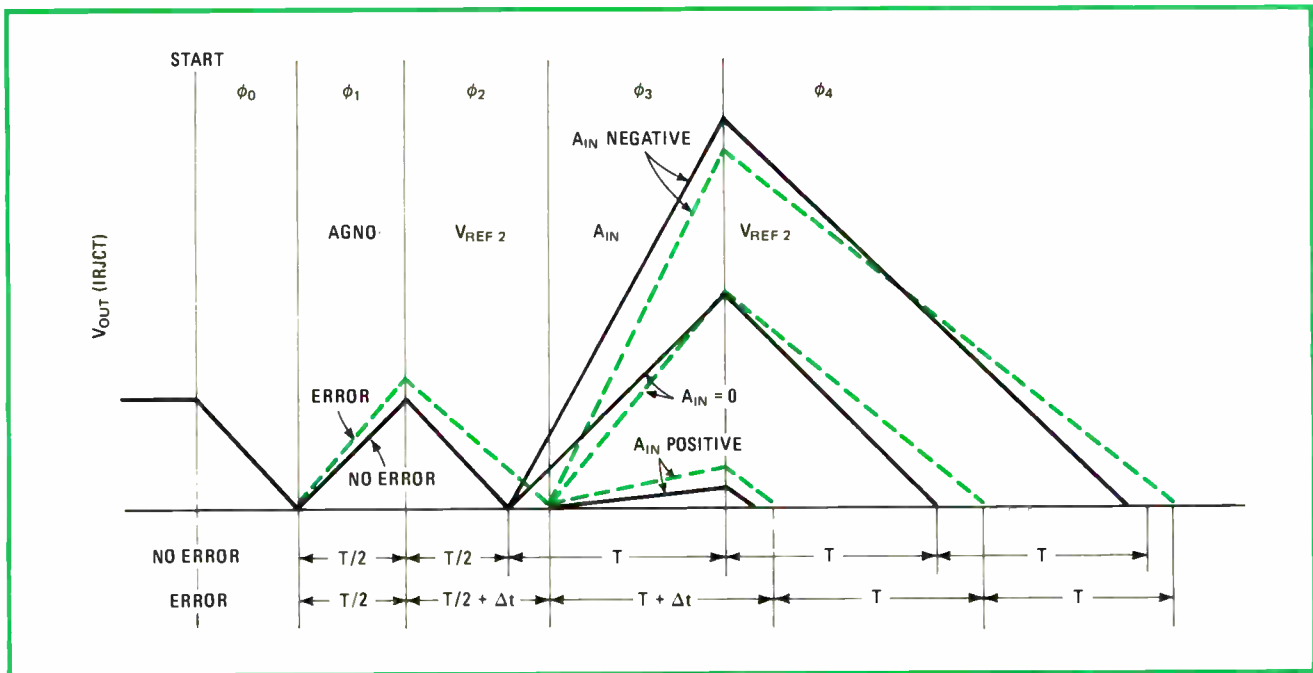

2. Four-phase integration. AD7550 uses quad-slope method to detect most errors, including op-amp offset voltage drifts. This method eliminates error by measuring comparator trip-time delay, Δt , converting Δt to a voltage and subtracting the voltage at end of cycle.

offset drift show up as errors in the digital output word. The quad-slope method detects all AD7550 offset-voltage errors, converts them to a digital equivalent during the integrating cycle, and subtracts them from the final count at the end of the cycle.

Normally, a ground signal, a reference voltage, or an analog input is connected through the converter's integrator input (IRIN) terminal to the integrator junction (IRJCT) port. As shown in Fig. 1, the buffer is connected between the terminal and the port, in series with integrating resistor R_1 . The choice of signal is determined by internal logic-controlled switch settings.

Before a four-phase a-d conversion begins, a reference voltage, $V_{REF 2}$, is applied to the inverting input of the integrator, resulting in a negative-going ramp at the integrator's output port. The ramp resets the output to zero. When the output voltage is equal to the comparator's trip voltage, phase ϕ_1 is initiated.

At this time, a digital counter starts and the integrator is connected to input AGND to determine whether the converter's negative supply voltage is at ground potential. If not, an error voltage is generated that is proportional to the difference.

The output of the integrator rises proportionally to the error voltage until the counter stops counting system clock pulses, at fixed interval $T/2$, (Fig. 2.) Then ϕ_2 is initiated. The accumulated voltage on the integrating capacitor, C_1 , is proportional to $AGND \times T/2$.

During ϕ_2 , the integrator is connected to $V_{REF 2}$ and any error voltage on this signal. The output of the integrator falls at a rate proportional to the error until the comparator trip point is reached. If there are no errors, the counter stops after time T ; otherwise, the trip time is delayed by Δt .

ϕ_3 then begins, starting a second counter that ultimately displays the digital equivalent of the analog input

voltage introduced during the phase. $V_{REF 2}$ is again applied during ϕ_4 , and the counter continues to run until the integrator falls below the comparator trip point. $V_{REF 2}$ is normally equal to $2V_{REF 1}$, and the converter detects any difference.

Because ϕ_1 through ϕ_3 occupy a total period of $2T$ if there are no errors, any errors detected during these phases must show up as a delay in trip time by Δt . Since the charge gained during ϕ_3 by the integrating capacitor is proportional to $A_{IN_{av}} \times T$, and the charge lost will be equal to $V_{REF 2} \times \Delta t$ during ϕ_4 , then the number of counts (N) relative to the normalized (full-count) time is equal to:

$$\Delta t/t = A_{IN_{av}}/V_{REF 2} = N$$

and is displayed directly. Thus any offset error in the buffer will not affect system accuracy, because it will be viewed as an additional (series-introduced) error existing during ϕ_1 through ϕ_4 . At the same time, the amplifier can still be used to boost small-signal input voltages.

The gain of the amplifier may be determined by resistors R_2 and R_3 , and is equal to:

$$G = \frac{(R_2 + R_3)}{R_3}$$

To maintain the proper relationship between $V_{REF 1}$ and $V_{REF 2}$, resistors R_2 through R_7 are employed in the circuit and are determined by the equations:

$$V_{REF 1} = (R_4/R_5)V_{REF in}$$

and:

$$V_{REF 2} = \frac{R_7}{R_6} \frac{R_2 + R_3}{R_3} V_{REF in} = 2V_{REF 1}$$

$V_{REF 1}$ and $V_{REF 2}/2$ should be within 6% of each other at all times. Otherwise, in ϕ_2 and ϕ_4 , during which time



Relax

It's amazing how an easy mind eases your swing.

We're the easy mind people. TRW Capacitors.

You'll never have to worry about reliability, for example. Our X675HV polyester capacitor line is proof of that, it's a true high voltage capacitor with a range from 2,000 v to 16,000 v DC. MTBF (90% lower confidence limit) is better than 260,000 hours at 85° C and full rated voltage.

And can they perform! IR is 30,000 megohms x MFD. DF is less than 1% at 1,000 Hz. Capacitance values are .68 mfd and smaller. For applications such as voltage multi-

pliers and filters in high density, high voltage power supplies, instrumentation, data displays, pulse modulators and copiers. TRW can take a big load off your mind.

Our engineering services and field support will also put your mind at ease. Just give us a call. Or write: TRW Capacitors, An Electronic Components Division of TRW, Inc., 301 W. "O" St., Ogallala, Nebraska 69153 • Tel: (308) 284-3611.



Circle 102 on reader service card

TRW CAPACITORS
ANOTHER PRODUCT OF A COMPANY CALLED TRW

World Radio History

V_{REF1} is compared with V_{REF2} , error voltages will be generated that the converter cannot compensate for.

This conversion technique requires a stable reference

voltage at the V_{REF2} terminal of the AD7550, and therefore the LM113 zener diode is used with the low-offset AD504 op amp for the greatest accuracy. □

Timer and converter generate slow ramp for chart recorders

by David Wingate

London Hospital Medical College, London, England

A long sweep time increases the effectiveness of an X-Y chart recorder in monitoring slow system changes. An astable multivibrator operating at low frequency and a versatile digital-to-analog converter can be used to generate an extremely linear, low-frequency ramp for the X axis, and at low cost, too. Although many good chart-recorder systems have the ability to hold down the distance the pen traverses to 0.02 centimeter per second, this circuit can limit it even further—in the neighborhood of 1 centimeter per hour, if needed.

In this circuit, the rate of increase in the ramp voltage produced by the converter is controlled by the frequency of the timer. As shown in the figure, the clock for the circuit is the Ferranti ZN1034E precision timer, operated in the astable mode. This device is somewhat unusual in that the pulse width of the oscillations produced is controlled by $R_T C_T$ but the frequency of oscillation is controlled by combination $R_T C_T R_{CAL}$. The

second combination is part of the astable network, detecting the fall of the output pulse and retriggering the timer, and thus controlling its basic repetition rate.

R_T and C_T are held constant, with R_{CAL} the variable resistor. The table in the figure shows the relation of R_{CAL} to the pulse frequency. The pulse width is not critical for timebase applications, but it can be varied if required. The width equals $0.6 R_T C_T$ seconds, where R is expressed in kilohms and C is expressed in picofarads.

After passing through a buffer stage, the clock drives the binary counter in the Ferranti ZN425E d-a converter, which is wired to serve as a ramp generator. The rate of increase in the magnitude of the ramp voltage is a function of the clock frequency; since the output rises incrementally, a staircase approximation of a ramp is generated. After passing through a buffer, the ripples in the staircase waveform are smoothed by a standard low-pass filter tuned to the clock frequency.

By increasing the capacity of the converter from an 8- to a 12-bit device, it is possible to generate a ramp voltage having even greater resolution. The circuit has served well in an application involving prolonged recording of biomedical and biological data, but, many other nonmeasurement applications are possible. □

Designer's casebook is a regular feature in *Electronics*. We invite readers to submit original and unpublished circuit ideas and solutions to design problems. Explain briefly but thoroughly the circuit's operating principle and purpose. We'll pay \$50 for each item published.

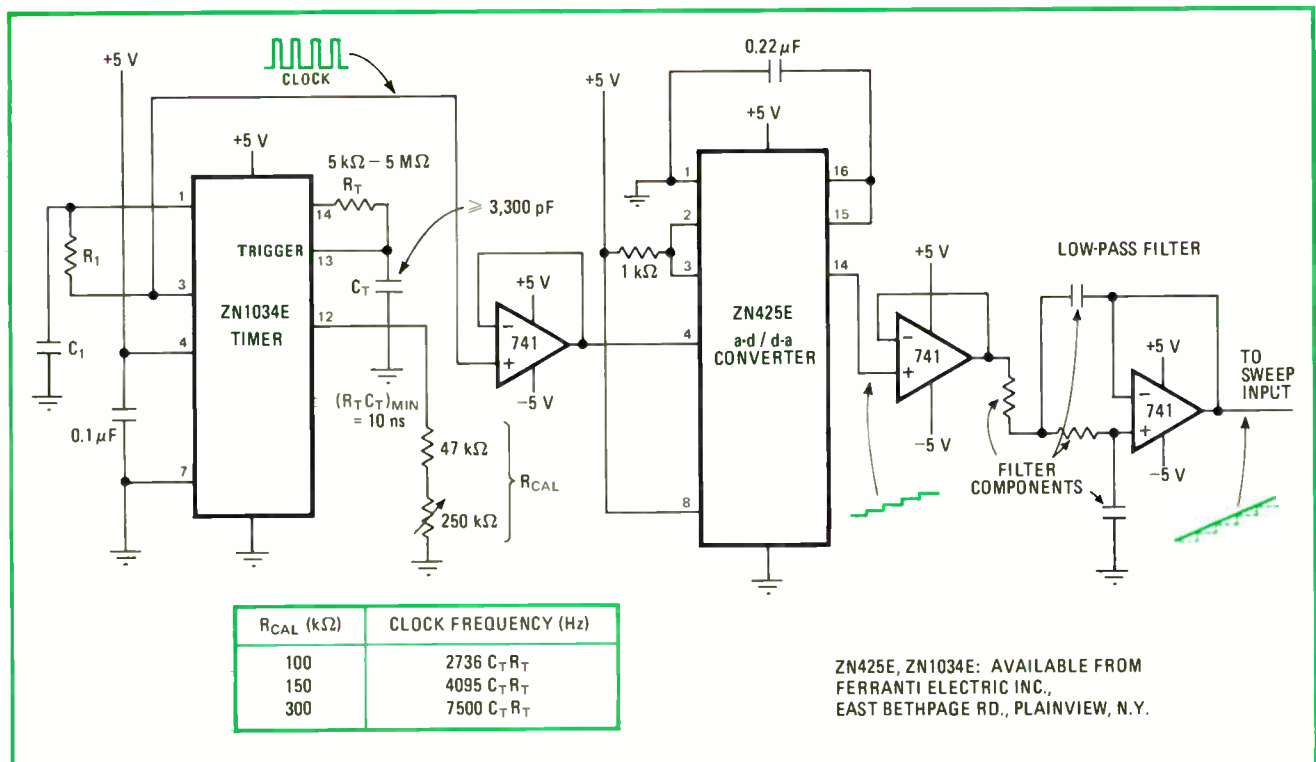

Slow time base. Low ramp frequency for X input of chart recorder, permitting long-period monitoring assignments of various systems, is generated by d-a converter and timer. Slope of ramp voltage with respect to time is determined by clock frequency.

Assembling a complex breadboard can be as easy as 1, 2, 3

An updated version of the bus bar helps make parts layout more orderly and power distribution less noisy

by Bernard J. Carey and Harry Grossman, *Department of Electrical Engineering and Computer Sciences, The University of Connecticut, Storrs*

□ The breadboard for complex digital circuitry often winds up as a system's stumbling block, simply because a designer has failed to account for parts layout and power distribution. Yet a systematic approach to breadboard building, using an updated version of the bus bar known as the power distribution element, can produce easy-to-assemble wire-wrapped breadboards for microcomputer system modules. Moreover, this approach eliminates much of the high-frequency noise generated by the switching action of the high-speed logic of such modules.

This new prototyping method has been used successfully at the University of Connecticut's microprocessor laboratory to construct central processing units and memory and peripheral-interface modules. It is simple enough for untrained workers to complete complex boards quickly and easily.

Of course, the designer must adhere to the guidelines that follow if semiskilled workers are to be able to build microcomputer boards. Breadboards that were built following these guidelines were tested for noise, and the results demonstrate the noise reduction possible with power distribution elements.

The advantages of using the new prototyping method with these bus bars are several:

- The method imposes an orderliness on board layout that facilitates the layout itself and speeds up the process of creating the breadboard (especially when untrained workers do the job).
- It results in electronic assemblies that have a low noise level on power and ground lines because of the inherent noise suppression of the PDES.
- It provides a lower-cost technique of fashioning breadboards by substantially reducing the number of decoupling capacitors required to reduce system noise.
- It eases the transition from breadboard to printed-circuit board, because the layout used in the breadboard is reasonably efficient and logically organized from the outset (especially where the bus bars are incorporated into the production pc board design).

Breadboard to pc

This breadboard procedure was designed to exploit the potential of the mechanical and electrical properties of PDES for realizing a low-noise system. The use of these bars also established an orderly layout.

Students at the University of Connecticut who

constructed prototypes with this method were able to conceptualize the PDE as a black box with an input/output relationship that could be used to advantage in constructing new digital modules. Thus they saw the construction process as the positioning and interconnection of a group of functionally related digital elements (logic devices and PDES).

A close similarity may exist between the layout and signal interconnection of a wire-wrapped prototype and those of the final pc board version of the prototype. This relationship is most evident in the memory matrix of a memory board, but it will also hold true in other boards using random logic, microprocessors, and large-scale integrated devices.

The trend away from random logic to LSI results in a more standard signal interconnection system. That standardization, coupled with the formal organization of the board imposed by PDES, simplifies layout.

Bus power

Before looking at the actual construction of prototype boards, it is best to examine the power distribution element itself. A PDE (Fig. 1) is composed of two copper conductors laminated into an integral unit with an interleaved thin dielectric. The exterior is generally covered with a plastic barrier material to prevent accidental shorting. One conductor is the power bus and the other is

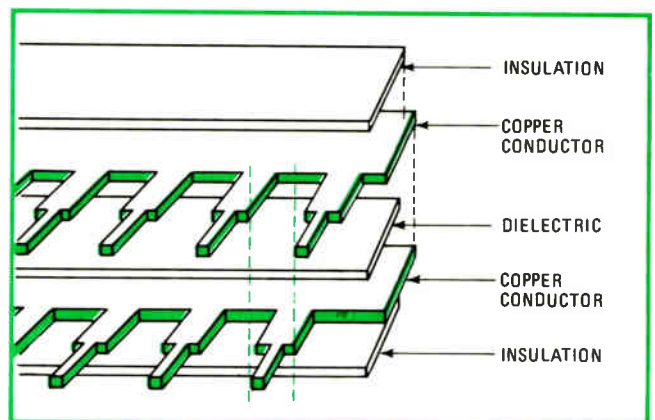

1. **Power distributor.** The power distribution element (PDE) is composed of a two-conductor bus bar interleaved with a dielectric. This exploded view shows the components of a vertically mounted configuration. Other PDES are available in horizontal configurations.

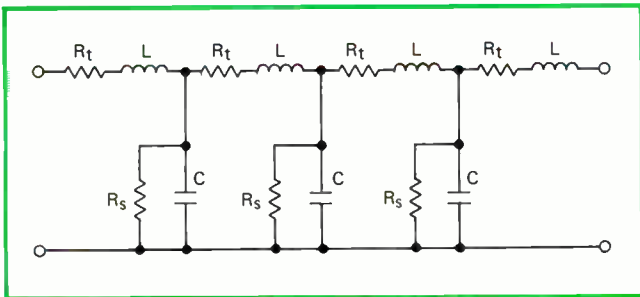

2. Equivalent circuit. The circuit equivalent of a PDE resembles a very lossy transmission line. The buses' low impedance and low inductance make them effective elements for suppressing high-frequency noise on power and ground lines.

a ground return. Pairs of leads from the two conductors are brought out at regularly spaced intervals for insertion into standard pc-board holes. Power and ground for a particular integrated circuit are connected to a pair of leads, while the pair of leads at either end serve as the bus bar's I/O points.

A PDE is equivalent to a very lossy transmission line (Fig. 2) with a low characteristic impedance on the order of several ohms. Because of its low impedance, current transients will produce lower noise voltages than on pc wiring, which has a characteristic impedance as high as 50 ohms. Because a bus bar is quite lossy, it also will attenuate the noise voltage and energy more per unit length than buses printed on the pc board.

A PDE is more efficient at suppressing high-frequency noise than are decoupling capacitors—in spite of the fact

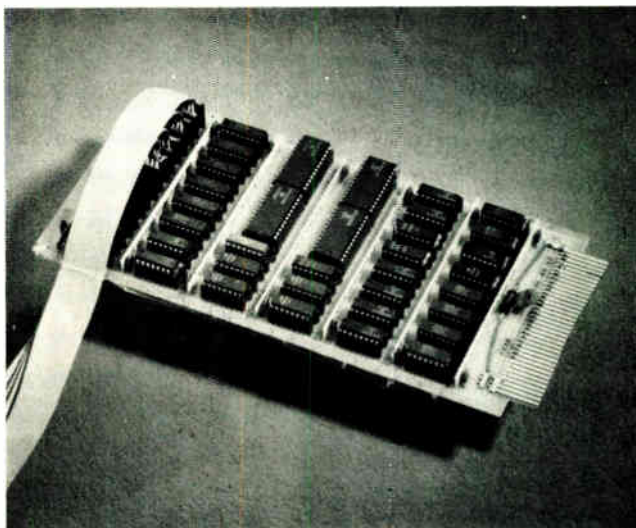

3. Interface breadboard. This 8080 interface card is an illustration of a circuit built with the method described. The thin upright components between the rows of DIPs are PDEs. All system wiring is done on the underside of the board by wire-wrapping.

that commercial bus bars usually have much lower capacitances than typical decoupling capacitors. Above 20 megahertz, the inductance of the leads of most decoupling capacitors renders the capacitance ineffective. While the PDE is limited in capacitance (225 to 1,200 picofarads per square inch), it is an extremely low inductance element at noise frequencies above 20 MHz.

PDEs are available from such firms as Rogers Corp.,

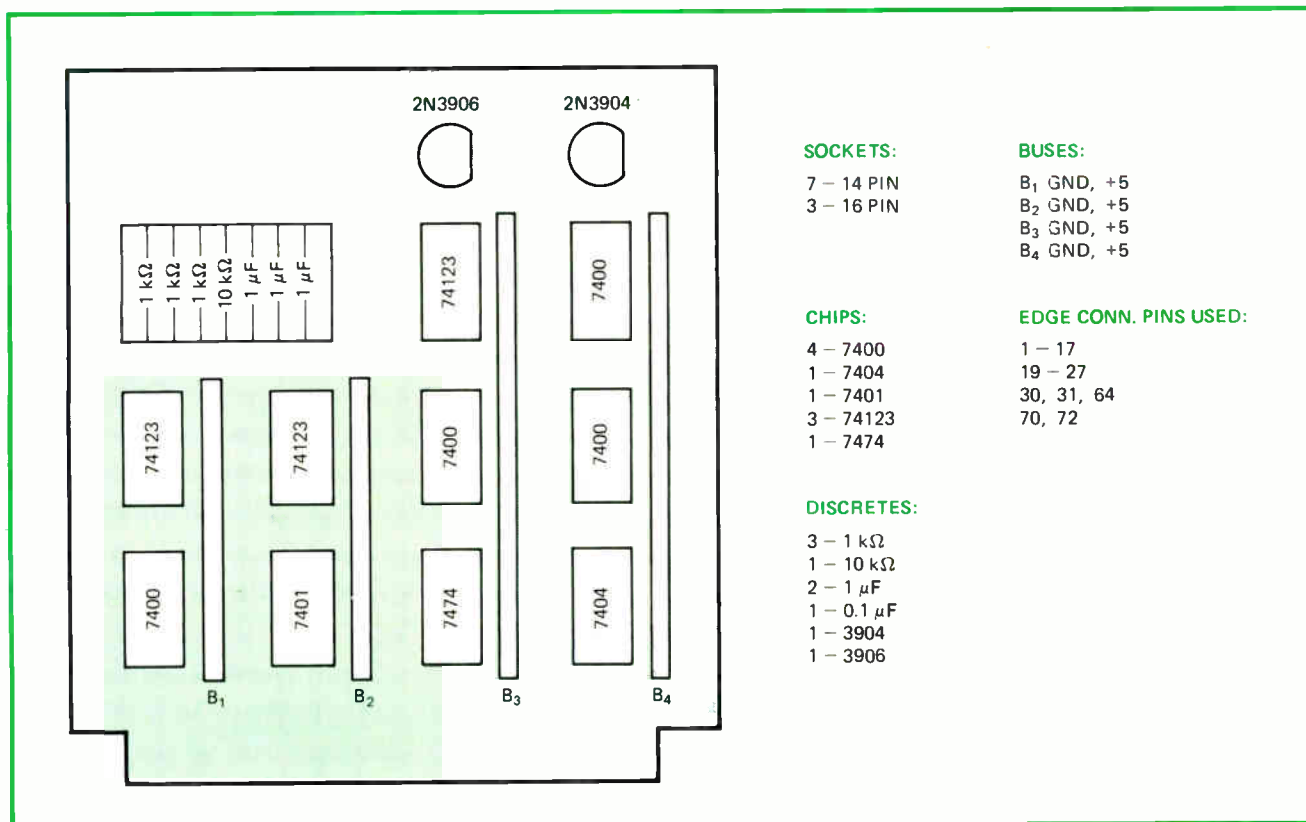

4. Board layout. In this construction method for breadboards, sockets are arranged in rows or columns, with a PDE for each. Every PDE has its own separate ground and power returns to the edge connector's plated-on ground- and power-connector fingers.

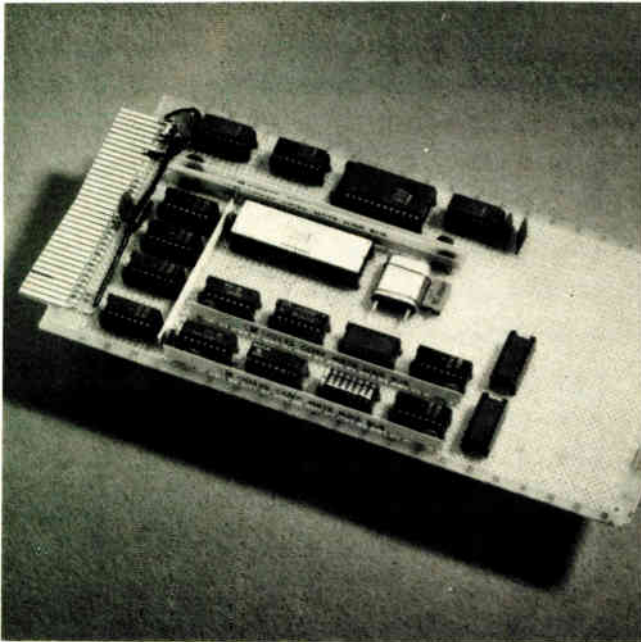

5. Microprocessor. This board (left) has an 8080A CPU plus interface circuitry. It has a mix of TTL and MOS circuitry. Layout (right) must account for three power supplies rather than one as in a memory card, and this prevents a symmetrical layout.

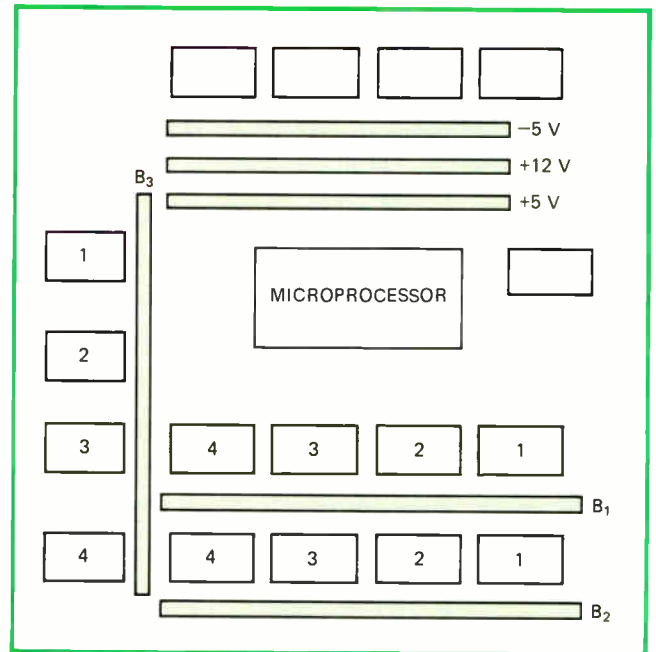

Rogers, Conn.; Eldre Components Inc., Rochester, N. Y., and Bussco Engineering Inc., El Segundo, Calif. The units come in vertical configurations, as in Fig. 1, and horizontal configurations with pins at 90° angles to the edge so that the bar will lie flat on the board. The type in the circuits described in this article is the Rogers M-823, a vertically mounted, two-conductor PDE.

Breadboarding with the PDE

The main component used in the development of the breadboard is a simple glass-epoxy pc board without printed power or ground planes. This inexpensive board has holes predrilled on 0.1-in. centers and 72 edge contacts. It accommodates a mixture of different sizes and families of ICs, in association with discrete components. Standard wire-wrappable sockets ranging in size from 14 to 40 pins are inserted into the board along with standard 9-in.-long PDEs with solder tabs, costing less than \$1 each. When combined with discrete components, the result is a breadboard such as the 8080 interface circuit of Fig. 3.

A specific example can best demonstrate the procedures involved in layout of a typical breadboard. But it should be clear that these procedures apply to any circuit design. The goal is to produce a buildable board that is immediately operable (assuming no engineering design errors) in a minimum amount of time, after minimal effort, and at the least possible expense. There are seven specific layout considerations in this procedure. The breadboard builder should:

1. Generate a complete parts list from the circuit diagram so that every part that must appear on the breadboard is known.
2. Note any relationships between IC functions that might make wiring easier. For example, consolidate gates electrically interconnected on the circuit diagram into as few packages as possible, and then locate the

packages as close to each other as possible.

3. To get a systematic grounding and power-distribution system, arrange sockets in rows or columns, with a separate PDE for each row or column. Segregate all transistor-transistor-logic and metal-oxide-semiconductor devices by family types into these rows and columns.
4. To prevent ground loops, make power and ground connections to each PDE at one end only and as close to the edge contacts as possible.
5. For added filtering, leave room at either end of the bus bars for an hf ceramic disk capacitor with a value of at least 0.01 microfarad.
6. Whenever possible, put discrete components in sockets connected by wire-wrapping terminals. This makes for easier replacement of defective components and keeps the board neater.
7. Keep drivers/receivers as close as possible to the edge contact being serviced, because these devices draw the most current.

With all these precepts in mind, the designer generates a board layout diagram: the means of correlating information on the circuit diagram with the pieces of hardware it describes. The layout diagram (Fig. 4) should be a representative picture of the component side of the board (not necessarily to scale). Essentially, it shows the position of each socket and the type of chip or component in that socket. This information corresponds directly to that recorded on the circuit diagram. Where discrete components are to be mounted, the sockets should also show the position and value of each such component. Moreover, each PDE circuit should be labeled.

A complete parts list should also be shown on the layout diagram to describe everything mounted on the board. This list should include the type and quantity of chips, sockets, and discrete components needed, all PDEs and the voltages they carry, and a list of all edge

6. Memory. The memory board (below) is a 2-k-by-8-bit static memory using 16 Intel 2102 MOS random-access memories and TTL control logic. The board is divided into families of logic types (right) each having its own PDE for distributing +5 V and ground.

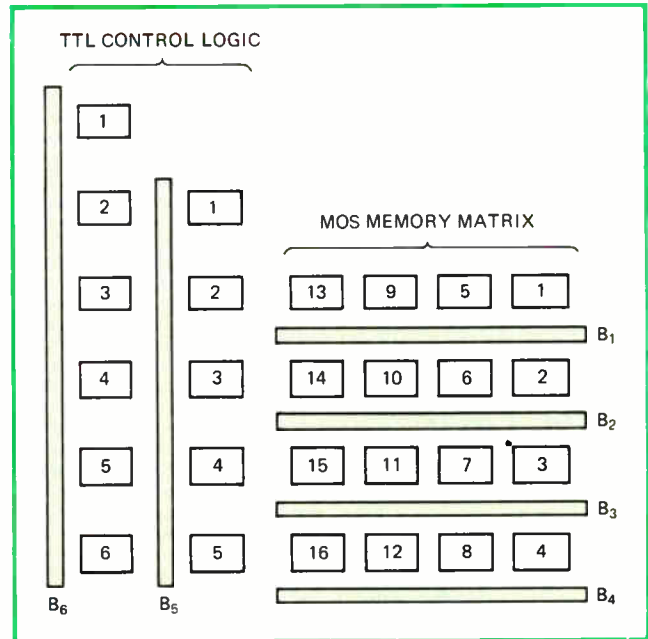
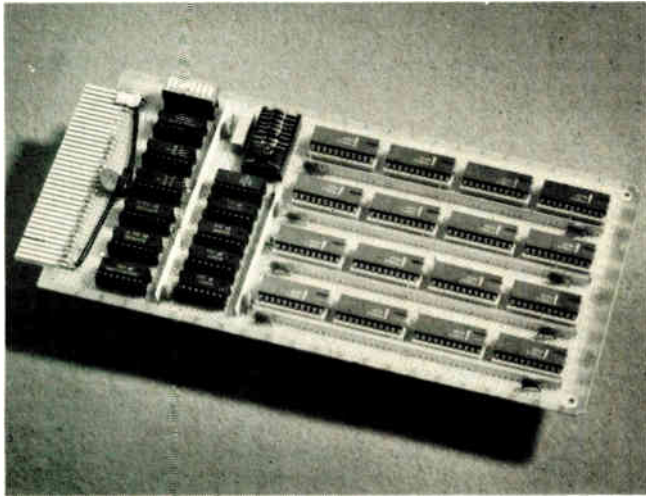

connection pins required. The board layout diagram, together with the circuit schematic, contains all of the information necessary to generate the signal-path wire-wrapping list.

With the board diagram in hand, even an unskilled worker can construct the breadboard. He or she should take the following steps, in order.

First, position all sockets as shown on the layout diagram and secure them to the board with adhesive. Discrete components not in sockets should be attached to the board with a soluble adhesive for easy removal.

Next, solder wire-wrappable pins in place only at those edge contacts that are to be used. Each edge contact carrying the same supply voltage should be positioned and tied together at the edge connector. To bring a good ground to the board, connect three adjacent edge pins and their opposites. All other power supply connections may be made on one edge pin and its opposite connected together.

To cut noise, decouple each power supply voltage brought on to the board edge contacts. In some cases, this is the only decoupling necessary. The recommended decoupling values are 0.1 μF for an hf ceramic-disk capacitor paralleling a tantalum capacitor of 20 to 30 μF .

Then make connections to PDEs. Define one side of the bus bar as ground and the other as a supply voltage. Connect power and ground to the ICs composing the row or column to which the PDE is assigned. Connections are made by soldering a wire to the tabs on the bus bar and by wire-wrapping to appropriate IC sockets. Thirty-gauge wire can be used for wire-wrapped connections. With all the sockets connected to their appropriate bus bars, connect each PDE to its appropriate ground and power supply at the board's input edge contacts.

To avoid couplings between the PDEs, which would increase the noise level, each bus bar should have a separate ground and power connection, with both connected at the same end of and as close to the edge contacts as possible. Minimum wire size for these

connections should be 24-gauge multistranded. Of course, the wire gauge should become heavier as the number of devices hung off the PDE increases.

To illustrate the noise-reduction properties of this construction method, a microcomputer system composed of an 8-bit CPU and a 2,048-word-by-8-bit MOS static memory was built. The cards used a mixture of MOS logic, TTL and Schottky-TTL along with various PDE layout configurations. A special test program was designed so that noise would be injected into the power and ground lines of the two-board microcomputer system. The resulting noise signals were monitored at test points on the various bus bars.

Cutting noise

The microprocessor board (Fig. 5) contains an Intel 8080A CPU, a system clock, and interface circuitry between the processor and other modules in the overall system. A variety of power supplies (+5 volts, -12 v, -5 v) and dual in-line packages (14-, 16-, 22-, and 28-pin) are used, together with a heavy proportion of random logic. Of the 14 packages, 12 are small-scale integration and 2 are LSI. As the source of the control, data, and address variables that activate the memory board, the CPU consists of a mix of MOS and TTL.

The 2-k-by-8 memory board (Fig. 6) has an LSI array of 16 Intel 2102 MOS random-access memories and an address-decoding and control section of SSI 7400 series TTL devices. The memory matrix is a 4-by-4 array and is logically organized so that the lower 2-by-4 array is the first 1,024 8-bit words of system memory, while the upper 2-by-4 array is the next 1-k-by-8-bit portion of system memory.

Each column on the board has its own PDE for distributing +5 v and ground, so switching noise is isolated between columns. In addition, the logic organization of the memory matrix is such that noise behavior for each column is essentially the same. The 8-bit word is distributed across the columns so that exactly two devices per

TABLE: EXPERIMENTAL TEST DATA

Noise in MOS memory matrix				
Instruction	Test point	Decoupling	Noise observed	Explanation and analysis
Read / 18 ms	B ₁ , IC ₁	None	860 mV pk/pk	Case (a). No decoupling. Typical noise levels approximately 860 mV pk/pk.
Halt	B ₁ , IC ₁	None	68 mV pk/pk	Case (a). No decoupling. Only system clock and some support functions operate.
Write / 18 ms	B ₃ , IC ₁₅	0.01 μ F	460 mV pk/pk	Case (b). Noise at decoupled supply node of PDE. Note noise is reduced by approximately 2 : 1 over case (a).
Write / 18 ms	B ₃ , IC ₃	0.01 μ F	520 mV pk/pk	Case (b). Noise at end of the PDE without decoupling. As expected, noise is less (460 mV) at decoupled node.
Write / 18 ms	B ₄ , IC ₁₆	0.1 μ F	440 mV pk/pk	Case (b). Decoupling values were increased from 0.01 μ F to 0.1 μ F. It was concluded that 0.01 μ F decoupling capacitors were adequate in this breadboard condition.
Write / 18 ms	—	0.01 μ F	360 mV pk/pk	Case (c). Decoupling of 0.01 μ F at both ends of the PDE reduced noise level to 360 mV pk/pk.
Noise in TTL memory control logic				
Instruction	Test point	Decoupling	Noise observed	Explanation and analysis
Write / 18 ms	B ₅ , IC ₂	None	1.2 V pk/pk	Case (a). No decoupling. Typical noise levels were 1.2 V pk/pk.
Write / 18 ms	B ₅ , IC ₁	0.01 μ F	440 mV pk/pk	Case (b). Noise at the decoupled supply node of the PDE. Note noise is reduced by about 3 : 1 over case (a).
Write / 18 ms	B ₅ , IC ₅	0.01 μ F	740 mV pk/pk	Case (b). Noise at end of the PDE without decoupling. Again, noise is greater (740 mV) than at the decoupled end of the PDE (440 mV).
Write / 18 ms	B ₅ , IC ₁	0.01 μ F	300 mV pk/pk	Case (c). With decoupling at both ends of PDE, noise is typically reduced by about 4 : 1 over case (a).
Noise in microprocessor				
Instruction	Test point	Decoupling	Noise observed	Explanation and analysis
Write / 18 ms	—	None	940 mV pk/pk	Case (a). No decoupling.
Write / 18 ms	—	0.01 μ F	400 mV pk/pk	Case (c). With decoupling at both ends of the PDE, noise was reduced typically by 2 : 1 over case (a).

column will be active at any given time. A maximum of two devices will be switching and injecting noise into the power- and ground-distribution system at any one time.

The layout of this board (Fig. 6b) is much more orderly than the microprocessor layout (Fig. 5b). However, both boards follow the layout rules enunciated earlier, with resulting low noise characteristics for both. Timing of noise appearing in the system will be a function of two variables: the program being executed and system clock rate, which specifies the rate at which a program is sequenced.

Microcomputer testing

Two instructions, load accumulator and jump, were used in a test program to cause internally generated switching noise to appear on the system's power and ground lines. The program controls the characteristics of the noise to cause generation of worst-case noise. It switches 11 address variables simultaneously, along with almost all of the devices on the memory board—putting maximum hf noise into both power and ground lines of the PDES.

Noise tests on the memory board were divided between the transistor-transistor and MOS logic families, each operating under three power and ground noise-distribution conditions: (a) PDES without decoupling capacitors; (b) PDES with 0.01- μ F decoupling at one end; and (c) PDES with 0.01- μ F decoupling at both ends.

The configuration in (a) provides a basis of comparison for determining the need for and amount of decoupling capacitors. Noise generated in the columns of the matrix and rows of control logic was measured with the CPU exercising the memory through a read/write loop.

With configuration (b), power and ground from the main power supply were individually connected to the bottom of each PDE. Noise flows toward power supply connections where it is dissipated, since this is the lowest-impedance path back to the main supply. For this reason, 0.01- μ F decoupling capacitors were added to the bottom (connection end) of each PDE, and noise measurements were taken as in configuration (a).

Noise may be generated at any point along a bus bar and is initiated at any PDE/IC node. Since the noise power is dissipated as the spike propagates from its point of origin along the PDE in either direction, decoupling at both ends—configuration (c)—should provide some improvement over decoupling at one end. So noise measurements were obtained as in other two cases.

Noise tests on the microprocessor board were carried very much as they were on the memory board. The table shows the test data obtained on the memory board (for both the MOS memory matrix and the TTL control logic) and on the microprocessor. The tests were performed on +5-v and ground lines at points referenced in the table by bus and IC numbers.

As the table shows, decoupling both ends of a PDE proved to be the most effective method of noise reduction for both boards. Noise reduction from 2:1 to 4:1 over the configurations without decoupling were obtained. Decoupling only at the supply end gave some improvement, but not as much as with double decoupling.

Finally, a test was performed to determine the effect

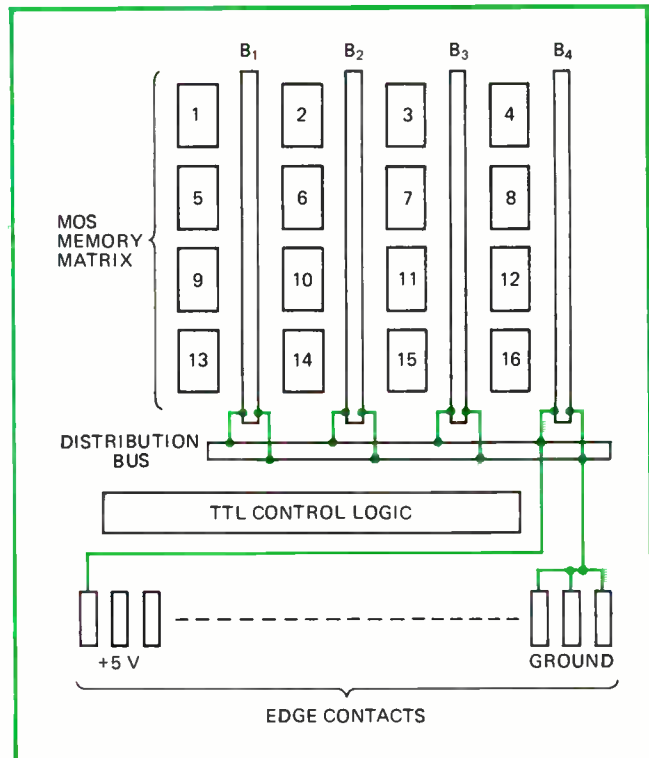

7. Daisy chaining. It is possible to replace all separate PDE ground and power returns with one distribution bus on the memory board of the microcomputer. However, this approach actually increases system noise levels by introducing extra coupling between PDES.

of daisy chaining: replacing the individual power and ground connections to each bus bar with one pair of wires. A memory board was configured with a PDE used as a distribution plane supplying all columns in the matrix (Fig. 7).

As predicted, noise in the matrix is greater than in the configuration without daisy chaining, because the coupling between the bus bars is closer and the impedance at the junctions of the distribution bus and the PDES is higher. A comparison of the measured noise voltages with those in the table shows that daisy chaining the power and ground connections increases noise about 33% at the junctions and 60% at the top of the PDES.

To provide a comparison, a commercial wire-wrapable microcomputer board was tested in the same manner as the microcomputer breadboards. The commercial board's arrangement is such that power and ground are distributed on pc wiring, and a 0.01- μ F decoupling capacitor is used with every chip. Signal interconnections are wire wrapped.

Measured noise voltage at power and ground points on this board range from about 350 millivolts peak to peak to 800 mv pk-pk. Of course, there are 25 decoupling capacitors, compared to the 10 when one PDE per column is used on the breadboards. Even with all these added capacitors, the noise characteristics were worse than with the equivalent breadboard. Wire-wrapped boards with PDES appear to offer clear design and cost advantages over commercial wire-wrapped boards with etched power- and ground-distribution systems and "brute force" decoupling. □

Astable multivibrator measures tolerance of capacitors

by V. Ramprakash
Electronic Systems Research, Madurai, India

Knowing the absolute value of a capacitor is sometimes less important than knowing its tolerance, or deviation from a standard value, especially in batch-measuring applications. This circuit uses an astable multivibrator in a simple bridge-type circuit to directly measure the signed value of capacitor tolerance. Once the meter is calibrated, it can be used over a wide range of reference-capacitor values without adjustment, thus combining accuracy and low cost with convenience.

As shown in the figure, the test and reference capacitors (C_T and C_{ref} , respectively) are used with resistors R and R_1 to control the frequency of oscillation in the astable multivibrator. A center-zero microammeter measures the bidirectional current flowing between the collectors of the transistors during each cycle.

As expected, the duty cycle of the output waveform is normally 50%, occurring when $C_T = C_{ref}$. The magnitude of the current flowing from Q_1 during one half of the cycle is equal to that of Q_2 flowing in the opposite half; since the currents are opposite in magnitude, the average-responding meter reads zero.

If C_T is greater than C_{ref} , then Q_2 will be off for a greater time per cycle than Q_1 , and the meter will show a positive deflection. The deflection is a measure of the difference between C_T and C_{ref} , although the relationship between the deflection and the difference is not linear.

The tolerance is defined as $T = \Delta C / C_{ref}$, where ΔC is equal to $C - C_{ref}$. If $R = R_1$ and we neglect R_C , the

meter current flowing per cycle is:

$$I_{av} = \frac{0.69R\Delta C}{0.69RC_T + 0.69RC_{ref}} \times I_m \quad (1)$$

or:

$$I_{av} = \frac{\Delta C}{C_{ref} + \Delta C + C_{ref}} \times \frac{V_{cc}}{R_m} \quad (2)$$

Dividing the numerator and denominator of the first term by C_{ref} reduces the equation to:

$$I_{av} = \frac{T}{2+T} \times \frac{V_{cc}}{R_m} \quad (3)$$

This equation is used to make a one-time calibration of the instrument for a given full-scale meter deflection, provided the reference capacitor does not change by a factor greater than 10. Let $C_T = C_{ref} = 1$ microfarad in the astable circuit so that R_1 can be adjusted for a zero indication on the meter. Use a $0.2\text{-}\mu\text{F}$ capacitor for C_T so that there is a 20% difference between C_T and C_{ref} and adjust R_m for a full-scale reading of 100 microamperes. Thus equation (3) becomes:

$$100 (10^{-6}) = \frac{0.2}{2+0.2} \times \frac{V_{cc}}{R_m} \quad (4)$$

from which it is determined that $V_{cc}/R_m = 1,100 \mu\text{A}$. Substituting this value in (3) and dividing both the numerator and denominator of the first term by T , the relation of meter deflection (D) to the tolerance for a $100\text{-}\mu\text{A}$ movement becomes:

$$I_{av} = D = (1 + 2/T)^{-1} \times 1,100 \mu\text{A} \quad (5)$$

This equation is easily evaluated in order to calibrate the meter. The results are shown in the table. \square

Engineer's notebook is a regular feature in *Electronics*. We invite readers to submit original design shortcuts, calculation aids, measurement and test techniques, and other ideas for saving engineering time or cost. We'll pay \$50 for each item published.

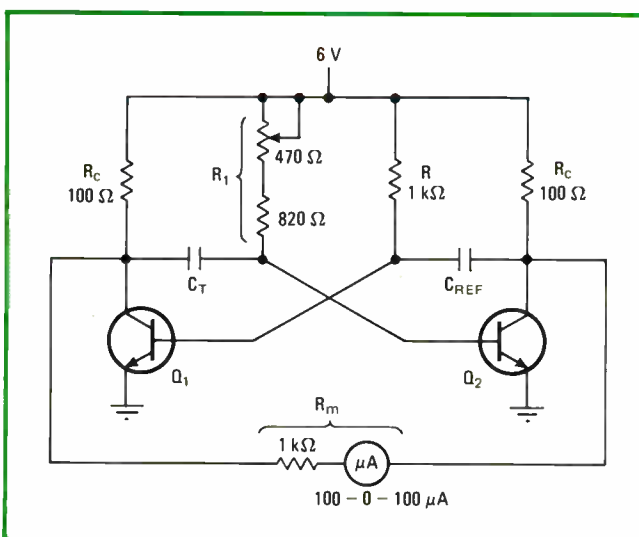

Tolerance meter. Test capacitor C_T and reference capacitor C_{ref} control frequency and duty cycle of astable multivibrator. Tolerance rating of C_T is related to change in duty cycle and is found by measuring arithmetic average of the bidirectional current flowing in the collector circuit. Relation of meter's deviation to tolerance rating of C_T is shown in table.

C_T TOLERANCE (%)	± 20	± 15	± 10	± 5	± 1	0
METER READING	± 99.99	± 76.74	± 52.38	± 26.82	± 5.47	0

SR-52 solves second-order differential equations

by H. E. Lee
Dover Heights, New South Wales, Australia

Transient-analysis or heat-transfer problems often involve a second-order differential equation. But even if the equation is nonlinear, this SR-52 program solves it quickly and accurately. It uses a numerical approximation method based upon the fourth-order Runge-Kutta technique to achieve excellent results.

The program will solve any equation of the form $y'' = f(x,y,y')$, given any set of initial boundary conditions. The second-order equation is reduced to two first-order equations by the program, thus creating a set of 10 linear, interrelated equations that are solved using the well-known method of finite differences.

A simple example demonstrates the usefulness of the program. Consider the resistor-inductor-capacitor circuit shown, where the current is to be found as a function of time. The Kirchoff loop equation may be written:

$$V = L \frac{di}{dt} + Ri + \int \frac{i}{C} dt \quad (1)$$

This is the well-known integrodifferential equation that characterizes a series RLC circuit. Differentiating with respect to t , and noting that V is a constant 5 volts, the equation becomes:

$$\frac{dV}{dt} = 0 = L \frac{d^2i}{dt^2} + R \frac{di}{dt} + \frac{i}{C} \quad (2)$$

$$\text{or: } \frac{d^2i}{dt^2} = -\frac{R}{L} \frac{di}{dt} - \frac{1}{LC} i \quad (3)$$

Substituting for R , L , and C , the equation now becomes:

$$\frac{d^2i}{dt^2} = i'' = -500i' - 0.5(10^6)i \quad (4)$$

This equation is of the desired form for the calculator, where x is the time (t), y is current (i), and y' is i' .

The right side of Eq. 4 is entered into the calculator program beginning at location 166; the table in the figure shows how this is done. First, however, we may store the i' coefficient ($-R/L$) in a spare register, such as R_{19} , the i coefficient ($-1/LC$) in R_{18} , and any constant term in R_{20} , permitting these values to be easily changed without affecting the stored general equation.

The key code shown in (b) will be easily understood if it is recognized that the coefficient of the y term must always be multiplied by the contents of the R_{02} plus R_{05} registers and that the y' coefficient must be multiplied by R_{11} , to ensure that the 10 linear equations are updated properly. If the right side of the equation has an x coefficient, it must always be multiplied by R_{01} . The small table shows the coding needed for the equation $y'' = x^2 + 3x + 4 + 4y' - 7y$ as an additional example so that there will be no confusion in programming any general second-order equation. After the equation has been keyed in, all one need do is enter the initial boundary conditions at R_{01} through R_{03} and specify in R_{04} the increment of time over which the internal linear

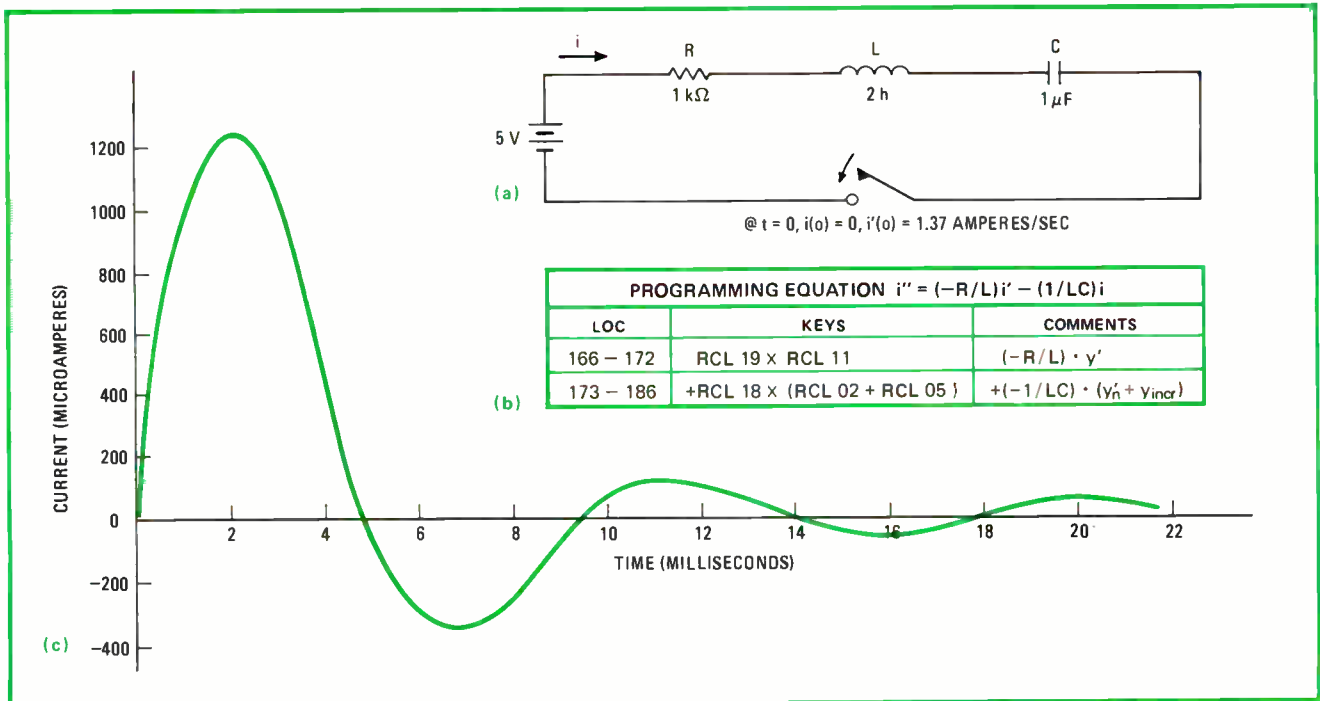

Classical solution SR-52 solves second-order differential equations, linear or nonlinear. Once the general equation for the typical network shown in (a) is known, it may be presented to the calculator for evaluation (b). Plotted results (c) show expected damped oscillation.

REED RELAY REVOLUTION

44¢

In quantities of 25K

STANDEX'S NEW L-SERIES

Never before . . . a superior reed relay combining such rugged construction, high reliability and maximum versatility . . . at so economical a price. Just 44¢ each in quantities of 25K for LG 101-1-5. This is a low profile, highly durable reed relay, with leads that can be bent to any configuration thus eliminating any retrofit problems.

RELAY INFORMATION VDC @ 25°C

Order Info	Rated Coil Voltage (VDC)	Must Operate (VDC)	Must Release (VDC)	Coil Resistance, Ohms (± 10%)	Max Coil Voltage
LG101-1-5	5-12	4.0v	5	500	25
LG101-1-24	24	19.0	2.0	2000	50

DIMENSIONS

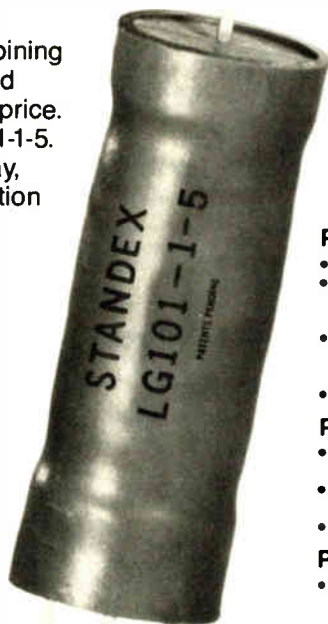
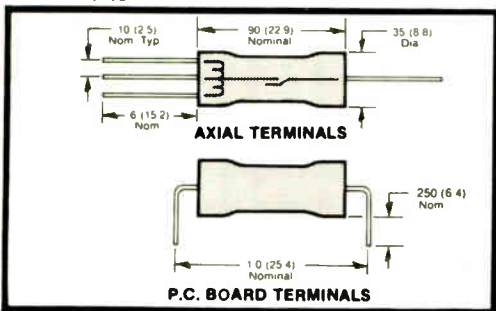

PREMIUM QUALITY SWITCHES

- **Low Contact Resistance** Typically 50 to 90 mΩ
- **Quality Assured** Each switch is extensively tested for internal purity and hermeticity on automated process equipment
- **Wide Range of Contact Ratings** 1000 × 10⁶ operations at low level loads
9 × 10⁶ operations at 1 amp, 10-volt resistive loads
- **Highest strength glass-to-metal seals available**

PREMIUM COIL CHARACTERISTICS

- **Low Power Consumption, High Sensitivity** (TTL Compatible) 50 mw nominal
- **High Overvoltage Capacity** Designed for up to 5 times nominal coil voltage
- **Fast Operation** Operations less than 1 m.s.

PATENTED CONSTRUCTION (Pats. Pend.)

- **Quality Engineering Plastics** High insulation resistance (10¹² Ω typical), high humidity protection, high chemical resistance
- **Rugged** No exposed parts, withstands physical abuse, can be submerged for cleaning
- **Practical** Low profile size and mounting pattern will retrofit most industry standards, terminals accessible for in-circuit testing
- **Integral Switch Terminals** No joints

Standex Electronics

4538 Camberwell Road, Cincinnati, Ohio 45209 • (513) 871-3777
Morley Road, Tonbridge, Kent, England • (732) 358398



SALES REPRESENTATIVES

ANBAK SALES CANADA LTD.
Mississauga, Ont., Canada
(416) 625-1061

CARTER ASSOCIATES, INC.
Scottsdale, Arizona
(602) 947-4355

CONTI-YOUNGER ASSOCIATES
Waltham, Massachusetts
(617) 890-4582

MORRIS CUNNINGHAM & ASSOCIATES
Indianapolis, Indiana
(317) 255-2458

EL-COM, INC.
Los Angeles, California
(213) 223-1351

GALLAGHER & ASSOCIATES
Plantation, Florida
(305) 792-9218

HITE ELECTRONIC SALES CO.
Arlington, Texas
(817) 265-2912

ED JOYNER & COMPANY
Chicago, Illinois
(312) 792-1277

JACK LOGAN & ASSOCIATES
Burlingame, California
(415) 697-6100

WILLIAM K. METZ CO.
Ardmore, Pennsylvania
(215) 649-3966

R. W. MITSCHER COMPANY
Main Office
Buffalo, New York
(716) 622-7970

NEVCO, INC.
Kansas City, Missouri
(816) 421-1751

QUANTUM SALES
Minneapolis, Minnesota
(612) 831-8583

S-J SALES ASSOCIATES
Jamaica, New York
(212) 291-3232

THE PROGRAMMING OF $y'' = 4y' - 7y + x^2 + 3x + 4$

LOC	KEYS	COMMENTS
166 - 170	4 · RCL 11	4y'
171 - 182	-7 · (RCL 02 + RCL 05)	-7y
183 - 188	+RCL 01 · x ²	+x ²
189 - 196	+3 · RCL 01 + 4	+3x + 4

equations are stepped in order to determine the current.

A wise choice for the increment (h) is the smallest value possible: typically, 0.001 second or less. Otherwise, the program has difficulty converging to a solution. (A value of 0.0005 s was used for the example discussed.) Press A to find the current after time $t_0 + h$; thereafter, pressing RUN n times will yield the current flowing after time $t_0 + nh$. □

SR 52 SECOND-ORDER DIFFERENTIAL EQUATION PROGRAM

LOCATIONS	CODES	KEYS	COMMENTS
000 - 001	46 11	*LBL A	
002 - 005	15 43 00 07	E RCL 07	
006 - 011	42 00 09 55 02 95	STO 09 ÷ 2 =	$K_1 = h \times f(x, y, z) = h \times f(t, y, y')$
012 - 017	42 00 05 43 00 08	STO 05 RCL 08	
018 - 023	42 01 00 55 02 95	STO 10 ÷ 2 =	$L_1 = h \times g(x, y, z)$
024 - 028	42 00 06 12 15	STO 06 B E	
029 - 034	43 00 07 65 02 95	RCL 07 X 2 =	$2K_2 = 2h \times f(x + h/2, y + K_1/2, z + L_1/2)$
035 - 040	44 00 09 55 04 95	SUM 09 ÷ 4 =	
041 - 046	42 00 05 43 00 08	STO 05 RCL 08	$2L_2 = 2h \times g(x + h/2, y + K_1/2, z + L_1/2)$
047 - 049	65 02 95	X 2 =	
050 - 055	44 01 00 55 04 95	SUM 10 ÷ 4 =	$2K_3 = 2h \times f(x + h/2, y + K_2/2, z + L_2/2)$
056 - 060	42 00 06 15 12	STO 06 E B	
061 - 066	43 00 07 42 00 05	RCL 07 STO 05	$2L_3 = 2h \times g(x + h/2, y + K_2/2, z + L_2/2)$
067 - 072	65 02 95 44 00 09	X 2 = SUM 09	
073 - 078	43 00 08 42 00 06	RCL 08 STO 06	evaluate differential changes in K and L in test equation, sum in R ₁₀ (L ₄), in R ₀₉ (K ₄)
079 - 084	65 02 95 44 01 00	X 2 = SUM 10	
085 - 088	15 44 01 00	E SUM 10	$y_{n+1} = y_n + (K_1 + 2K_2 + 2K_3 + K_4) / 6$
089 - 094	43 00 07 44 00 09	RCL 07 SUM 09	
095 - 099	43 00 09 55 06	RCL 09 ÷ 6 =	$z_{n+1} = z_n + (L_1 + 2L_2 + 2L_3 + L_4) / 6$
100 - 104	85 43 00 02 95	+ RCL 02 =	
105 - 108	81 42 00 02	HLT STO 02	decrement h
109 - 114	43 01 00 55 06 95	RCL 10 ÷ 6 =	
115 - 118	44 00 03 00	SUM 03 0	$h \times (y_n + y \text{ increment}) = \text{store in } R_{07} = h \times g$
119 - 124	42 00 05 42 00 06	STO 05 STO 06	
125 - 128	41 11 46 12	GTO A *LBL B	$h \times \text{test equation entered} = h \times y'' = \text{store in } R_{08}$
129 - 134	43 00 04 55 02 95	RCL 04 ÷ 2 =	
135 - 138	44 00 01 56	SUM 01 *rtn	
139 - 140	46 15	*LBL E	
141 - 145	43 00 04 65 53	RCL 04 X (
146 - 149	43 00 03 85	RCL 03 +	
150 - 153	43 00 06 54	RCL 06)	
154 - 157	42 01 01 95	STO 11 =	
158 - 160	42 00 07	STO 07	
161 - 217	43 00 04 65 53 . . .	RCL 04 X (.	
218 - 223	54 95 42 00 08 56) = STO 08 *rtn	

INSTRUCTIONS

- Key in program
- Enter differential equation, excluding y'' term, beginning at location 166
Form is $y'' = f(t) + Ay' + By + Cy$. See text.
- Clear all data memories
Press *CMs
- Enter initial values
(y_0), STO 02, (y_0'), STO 03, at (x_0), STO 01
- Enter incremental values of x for which equation steps to find new y (h), STO 04
- Enter equations y, y' and constant coefficients (C), STO 18, (B), STO 19, (A), STO 20
- Press A to find y_1
- Press RUN to find y_2, y_3, \dots, y_n
Calculation time for each is about 12 seconds

REGISTERS

R ₀₀	-
R ₀₁	$x_0 \times n = x_n$
R ₀₂	$y_0 \times n = y_n$
R ₀₃	$y_0' \times n = y_n'$
R ₀₄	$h = \Delta t$
R ₀₅	y increment
R ₀₆	y' increment
R ₀₇	h × g
R ₀₈	h × f
R ₀₉	K _{sum} accumulator
R ₁₀	L _{sum} accumulator
R ₁₁	($y_n' + y'$ increment) temporary store
R ₁₈	y' term coefficient (optional)
R ₁₉	y term coefficient (optional)
R ₂₀	constant term (optional)

High-level languages are tops for microcomputer systems

Most programs for microcomputers are written directly in assembly language, but you can look for far more extensive use of high-level languages now that the necessary program compilers are becoming available. From the programmer's viewpoint, high-level-language programs are easier to write and much more compact than assembly-language programs. **And since the number of program errors is largely a function of the number of lines of code, regardless of the language used, errors certainly will be fewer.** Also, the block structure of high-level languages permits easy program modification, and tightening up an assembled program is simple because the code that the compiler generates may be checked over and tweaked up by hand. You may even sidestep assembly language altogether by storing the compiled program in a programmable read-only memory.

A better way to approximate factorials

Apparently there is a faster and more accurate way of computing an approximation for a factorial than the one given on this page in the Aug. 18 issue. According to F. A. B. Smith of Washington, D. C., it is known as Stirling's equation: $n! = [1 + 1/(12n - 1)](n/e)^n(2\pi n)^{1/2}$. For 13!, **this approximation yields an error on only 0.002%**, dropping to a mere 0.00014% for 50!, notes Smith. What's more, Bob Jewett, who is with Hewlett-Packard in Santa Rosa, Calif., has come up with a streamlined equation: $n! = (2\pi n)^{1/2} \exp[n[\ln(n) - 1] + 1/12n]$, which requires taking a logarithm and only one exponent. With this form, the residual fractional error is approximately $1/360n^3$, Jewett points out. And if integer truncation is used, the worst-case error is still only 0.0003%.

A simple route to bit-oriented Instructions

Microprocessor-based programmable controllers seldom offer **simple bit-oriented instructions, such as set, reset, or test one input/output bit or one flag bit.** But with Texas Instruments' 9900 or 9980 microprocessors, there's a straightforward and inexpensive way to get these instructions without adding logic, notes Horst Huse, who is with Germany's TI Deutschland. You use the three bit instructions (SBO, SBZ, and TB) of the 9900/9980 communications-register-unit interface, along with a 1,024-bit static random-access memory (for 1,024 extra flag bits). Connect the three CRU control lines directly to the RAM (CRUOUT to DATA IN, CRUCLK to R/W, and CRUIN to DATA OUT), the microprocessor's A₅₋₁₄ address lines to the RAM's A₀₋₉ inputs, and the A_{3,4} microprocessor addresses to the RAM's \overline{CE} input through an OR gate. Now, with the proper addresses loaded in WR 12 of the register file, the SBO instruction becomes SET FLAG BIT, SBZ becomes RESET FLAG BIT, and TB becomes TEST FLAG.

Learn to characterize dielectric materials

Measuring the properties of dielectrics like synthetic films, elastomers, fibrous materials, plastics, and laminates is a complex task. To ease the way, GenRad has put together a helpful application note that explains the procedure and even **describes how to prepare a specimen for characterization.** The 16-page booklet, number EID 11, also includes definitions of pertinent terms and a discussion of the various factors affecting the dielectric properties of materials. For your copy, write to: GenRad, 300 Baker Ave., Concord, Mass. 01742.

Lucinda Mattera

Solid State Scientific has over ten years of experience in developing successful custom CMOS circuits. Our track record includes devices for military programs, data processing, automotive applications, instrumentation, telecommunications, consumer products and most other applications using CMOS technology.

The successful development and production of a custom circuit begins with the problem to be solved. Our engineers will work

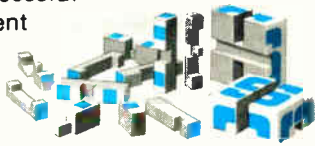

closely with you to define system requirements. We'll review the economy/performance tradeoffs involved in various design decisions and recommend the optimum approach for your application.

The next step is to translate a concept into a practical and reliable integrated circuit. Our advanced chip layout procedures provide a circuit with extremely high yields and what is generally the industry's smallest area. Computer-based mask tooling is produced in

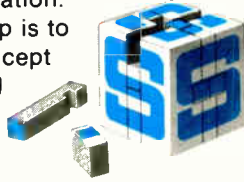

the SSS Image Design Center — the most advanced mask making facility anywhere.

To insure high reliability of your devices, our test engineering staff generate sophisticated procedures which provide full and thorough testing. In addition, prototype wafers are run in our production facility to eliminate any processing variation from prototype to production.

For complete information on our capabilities, write today for our new Custom Circuit Brochure. Solid State Scientific Inc., Montgomeryville, Pa. 18936. (215) 855-8400. TWX: 510-661-7267.



SOLID STATE SCIENTIFIC INC.

All sides of CMOS technology

**Custom
solutions
in CMOS,
a major
side of
SSS**



Circle 115 on reader service card

INTRODUCING DELCO ELECTRONICS' MONOLITHIC OPERATIONAL AMPLIFIER

If you're now using discrete power output transistors, we've got an alternative that gives you design versatility.

It's the DA-101—Delco's Monolithic Operational Amplifier—with all the circuitry you need in one compact package.

The Monolithic Operational Amplifier (MOA) has two separate gain and power stages contained in a modified dual-in-line package.

The DA-101 operates from a 10- to 16-volt DC supply and can be used in an audio bridge configuration with floating speaker output, or as two separate amplifier-speaker systems.

The MOA means weight savings in more ways than one. Besides reducing the total number of components you need, the MOA has a copper mounting surface to assure ample heat transfer to the convactor. The tab negative or ground connection eliminates the need for mica insulation.

In fact, the design of one power megaphone showed a components weight savings of 65 per cent.

Our new MOA means added design application flexibility, too. In automotive and home entertainment systems, two-way communication systems, power megaphones, motor controls, various H switch applications, and more.

Another advantage of our Monolithic Operational Amplifier is its durability. It has integral protective circuitry for not only overvoltage, but

temperature, current conditions and shorted outputs as well.

And it can be mounted by either direct soldering to a printed circuit board or through the use of a suitable socket.

For more information, contact an authorized Delco distributor, your nearest Delco sales office, or return the coupon on the right.

ABSOLUTE MAXIMUM RATINGS

Supply Voltage	24V
Operating Voltage	16V
Peak Current	3A
Storage Temperature	-55°C to 150°C
Power Dissipation	22W

ELECTRICAL CHARACTERISTICS

	TYPICAL
V _{cc} = 14V dc	
I _{in} , P _{out} = 0W	40mA
Differential Input Bias Current	0.80 μA
Open Loop Gain	90dB
Power Out @ 5% Distortion	
4Ω Bridge	6W
4Ω Non-bridge	3.5W

THERMAL CHARACTERISTICS

Thermal Resistance, R _{θjc} (Typical)	4° C/W
--	--------

AUDIO BRIDGE CIRCUIT

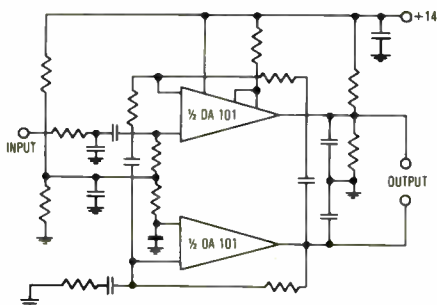

TWO SEPARATE AMPLIFIERS CIRCUIT

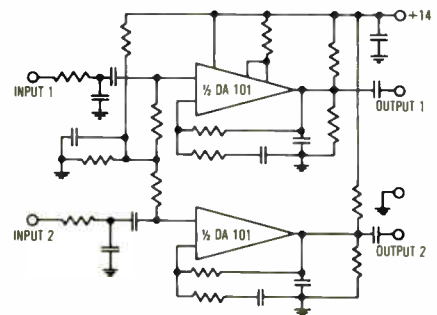

DERATING CURVE

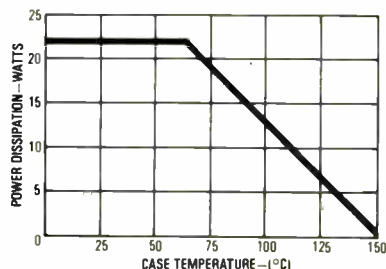

DIMENSIONS AND CONNECTIONS

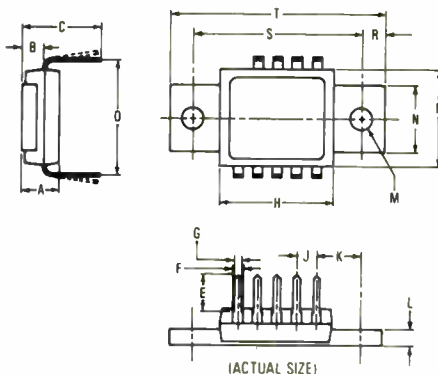

SYMBOL	INCHES		MILLIMETERS	
	MIN.	MAX.	MIN.	MAX.
A		.220		5.59
B	.127	.133	3.22	3.38
C	.423	.443	10.746	11.254
D	.628	.632	15.95	16.05
E	.215	.225	5.463	5.717
F	.044	.048	1.13	1.21
G	.015	.019	0.39	0.47
H	.644	.650	16.37	16.52
J	.095	.105	2.413	2.667
K	.275	.285	6.983	7.237
L	.086	.096	2.183	2.437
M	1.220	1.280	3.100	3.250
N	.369	.379	9.373	9.627
P	.539	.549	13.693	13.947
R	.120	.130	3.053	3.307
S	.955	.965	24.253	24.507
T	1.199	1.219	30.446	30.954

**NOW AVAILABLE FROM THESE DISTRIBUTORS
IN PRODUCTION QUANTITIES.**

ALABAMA

HUNTSVILLE
Powell Electronics
(205) 539-2731

ARIZONA

PHOENIX
Sterling Electronics, Inc.
(602) 258-4531

CALIFORNIA

GARDENA
Bell Industries
Electronics Distributors Div.
(213) 321-5802

GOLETA
R.P.S. Electronics, Inc.
(805) 964-6823

LOS ANGELES
Kierulff Electronics, Inc.
(213) 725-0325

R.P.S. Electronics, Inc.
(213) 748-1271

PALO ALTO
Kierulff Electronics, Inc.
(415) 968-6292

SAN DIEGO
Kierulff Electronics, Inc.
(714) 278-2112

R.P.S. Electronics, Inc.
(714) 292-5611

SUNNYVALE
Bell Industries
(408) 734-8570

COLORADO

DENVER
Kierulff Electronics, Inc.
(303) 371-6500

CONNECTICUT

NORWALK
Harvey Electronics
(203) 853-1515

FLORIDA

CLEARWATER
Diplomat/Southland
(813) 443-4514

MIAMI SPRINGS
Powell Electronics/Florida
(305) 592-3260

ILLINOIS

ELK GROVE VILLAGE
Kierulff Electronics, Inc.
(312) 640-0200

SKOKIE
Bell Industries
Electronics Distributors Div.
(312) 282-5400

INDIANA

INDIANAPOLIS
Graham Electronics
Supply, Inc.
(317) 834-8202

MARYLAND

BALTIMORE
RESCO/Baltimore
(301) 823-0070

MASSACHUSETTS

BILLERICA
Kierulff Electronics, Inc.
(617) 935-5134
(617) 667-8331

NEWTON
The Greene-Shaw Co., Inc.
(617) 969-8900

MICHIGAN

LIVONIA
Pioneer/Michigan
(313) 525-1800

MINNESOTA

MINNEAPOLIS
Stark Electronics Supply Co.
(612) 332-1325

MISSOURI

KANSAS CITY
Walters Radio Supply, Inc.
(816) 531-7015

ST. LOUIS
LCOMP-St. Louis
(314) 291-6200

NEW JERSEY

CINNAMINSON
Wilshire Electronics/
Philadelphia
(609) 786-8990
(215) 627-1920

CLIFTON
Wilshire Electronics/
New Jersey
(201) 340-1900
(212) 244-8930

NEW MEXICO

ALBUQUERQUE
Sterling Electronics
(505) 345-6601

NEW YORK

BINGHAMTON
Harvey Electronics
(607) 748-8211

BUFFALO
Summit Distributors, Inc.
(716) 884-3450

FARMINGDALE
Wilshire Electronics/
Long Island
(516) 293-5775

FREEPORT
Milgray/New York
(516) 546-6000

WOODBURY
Harvey Electronics
(516) 921-8700
(212) 895-9260

OHIO

CINCINNATI
United Radio, Inc.
(513) 761-4030

CLEVELAND

Pattison Supply Co.
Industrial Electronics Div.
(216) 441-3000

DAYTON
Pioneer/Dayton
(513) 236-9900

PENNSYLVANIA

PHILADELPHIA
Almo Electronics
(215) 698-4000

PITTSBURGH
CAM/RPC Electronics
(412) 782-3770

SOUTH CAROLINA

COLUMBIA
Dixie Radio Supply Co., Inc.
(803) 779-5333

TEXAS

DALLAS
Sterling Electronics
(214) 357-9131

HOUSTON
Harrison Equipment
Co., Inc.
(713) 652-4700

Sterling Electronics
(713) 627-9800

WASHINGTON

SEATTLE
Kierulff Electronics, Inc.
(206) 575-4420

IN CANADA:

Zenronics Ltd.
Toronto (416) 635-2822
Ottawa (613) 238-6411
Montreal (514) 735-5361

**OVERSEAS:
EUROPEAN
INQUIRIES:**

European Parts &
Accessories Marketing
Group
General Motors Continental
Plant 2, Noorderlaan,
Postbus 9
B-2030, Antwerp, Belgium

**ALL OTHER
OVERSEAS
INQUIRIES:**

General Motors Overseas
Operations
Parts & Accessories Dept.
767 Fifth Avenue
New York, N.Y. 10022
(212) 486-4412

**DELCO ELECTRONICS
REGIONAL SALES
OFFICES**

Charlotte, North Carolina
28209
4600 Park Road
(704) 371-5160

Van Nuys, California 91404
Box 2968
(213) 988-7550

**GENERAL SALES
OFFICE**

700 E. Firmin, Kokomo,
Ind. 46901
(317) 459-2175



**FOR MORE INFORMATION ABOUT
DELCO'S NEW MONOLITHIC
OPERATIONAL AMPLIFIER, MAIL
THIS COUPON TO:**

**Delco Electronics Division
General Motors Corporation
Marketing Services MS A-213
700 E. Firmin Street
Kokomo, Indiana 46901**

NAME _____

TITLE _____

COMPANY _____

ADDRESS _____

CITY _____ STATE _____ ZIP _____

PHONE _____



11

9/29

Desktop computer challenges minis

Self-contained system leads HP's desktop line in speed, power, and flexibility; easy-to-operate machine uses enhanced Basic

by Raymond P. Capece, Computers Editor

Minicomputers have a tough new competitor in Hewlett-Packard's 9845 desktop computer. With the most powerful central processor and the largest built-in mass-memory storage of any desktop unit, the latest addition to the 9800 desktop line crowds even the minis made by HP's own Data Systems division. The 9845, built by the Calculator Products division, is an easy-to-use, self-contained system—processor,

cathode-ray-tube display, keyboard, thermal printer, and cartridge-tape memory storage are all combined in one unit.

Significant developments in hardware, architecture, and software are scattered throughout the 9845's design, which was begun over two years ago at the division in Loveland, Colo. Advances in both hardware and architecture are found in the computer's processing arrangement,

which comprises two n-type, metal-oxide-semiconductor chips—a 7-megahertz execution interfacing processor and a peripheral processor that primarily manages interfacing and input/output control. The two chips normally operate in serial fashion, but can be commanded into an overlap mode that amplifies the throughput of the computer several times.

The high-speed operation of the computer is also attributable to programming developments. Jack Walden, the product manager and group leader, explains: "The 9845 is pseudo-compiled—the hierarchy of expressions is predetermined and embedded in the program, and keywords have pointers to subroutines and to locations in a symbol table—giving it a speed that's comparable to the faster minicomputers."

Marketing officials at HP now have to consider the overlap of the 9845 with the products of the Data Systems division, HP's minicomputer builder. The desktop computer, being a turnkey type of system, is geared more towards technical communities, such as engineering, statistical, and even financial programmers, rather than towards computer programmers. Frederick Bode, marketing manager at the Calculator Products division, explains that "the 9845 is aimed at vertical market areas—technical users who need a powerful computer that's self-contained and easy to operate." HP promises software packages for many different fields, including medicine, business, and management sciences.

The computer is highly efficient in



the operation of its built-in "peripherals." A separate processor controls the tape drive, which accepts standard microcartridges that each store 210 kilobytes of data. All the computer's peripherals are in a file-by-name arrangement, which does not care whether tape, disk, or any other medium is being addressed.

The 12-inch cathode-ray-tube display combines an alphanumeric mode with optional raster-scan graphics. The alphanumeric mode displays 25 80-character lines in a 720-by-360-dot matrix, whereas the high-resolution graphics are displayed in a 560-by-455-dot matrix. The marriage of the two different arrays avoids the tradeoff in aspect ratio between graphics and alphanumeric data, but requires two scan systems.

Storage in the 9845 is independent—32 kilobytes of random-access memory just for the graphics and 16 kilobytes for user storage, which can be expanded to 64 kilobytes.

The 9845 programs in Basic, actually an enhanced version of the ANSI standard, and any software meeting the standard can be run as is. Enhancements overcome many of the shortcomings of standard Basic. For example, the limit of variable names and labels is increased to 15 characters, which enables programs to be practically self-documenting. The array-handling capability of the computer is also extended, allowing up to six-dimensional arrays of either bit-string or alphanumeric data with up to 32,767 elements. String manipulation accommodates lengths of up to 32,767 bits. Subprogram capability has also been increased.

The computer is priced at \$11,500 for a minimum configuration that includes a single tape transport and 16 kilobytes of random-access memory. The price for a full configuration, with 64 kilobytes of memory, two tape drives, the thermal printer, and graphics, is \$20,000. Delivery time is 8 to 12 weeks, and the machines may be leased.

Hewlett-Packard Co., 1507 Page Mill Rd., Palo Alto, Calif. 94304 [338]

Get hold of the new TO-220 Triac, SCR from Hutson.

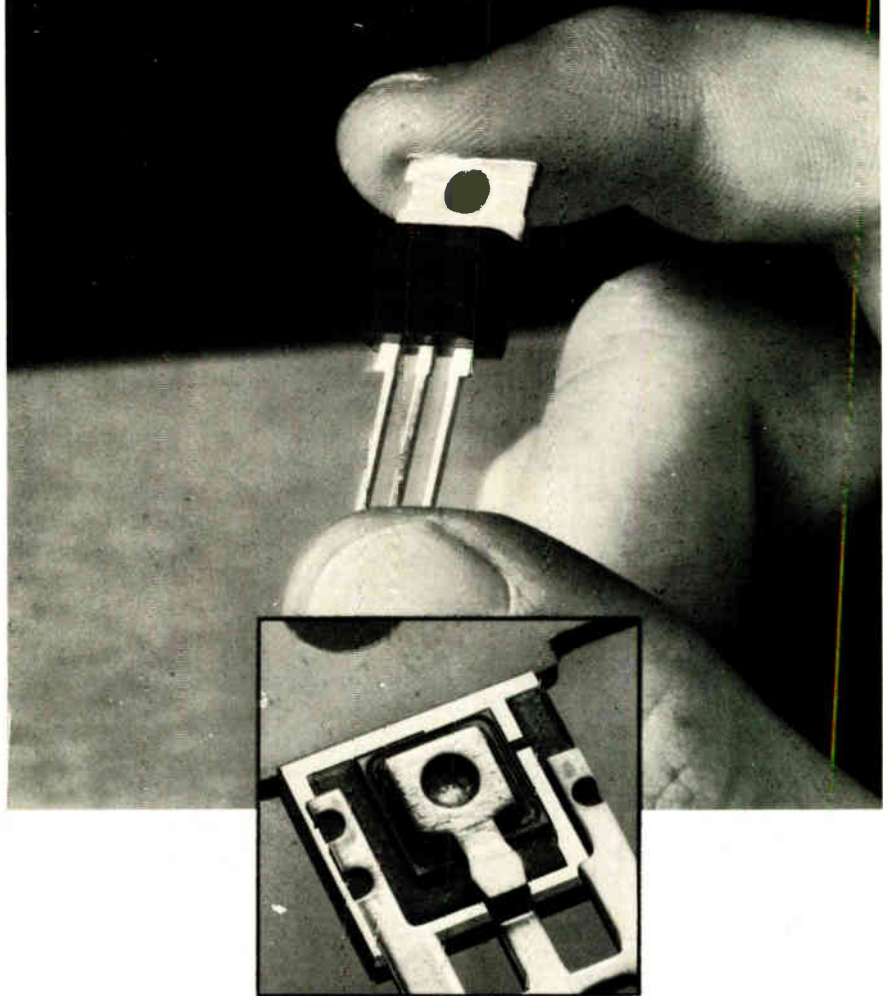

... the first with a face down chip
for high volume production!

Hutson is first with the TO-220 isolated device with face down chip that gives you improved thermal, electrical and mechanical performance. Hutson can produce more devices per day than ever before.

So call Hutson for your needs and remember . . . you got it first from Hutson . . . a leader in thyristor applications technology and one of the largest manufacturers of thyristors!



HUTSON INDUSTRIES

2019 W. VALLEY VIEW LANE
DALLAS, TEXAS 75234 (214) 241-3511
TWX 910-860-5537

EUROPEAN OFFICE: 30 RUE PIERRE SEMARD. YERRES, 91, FRANCE
TEL: Paris 948-8258 TELEX 21311

Dual technique pinpoints digital faults

In-circuit emulation and signature analysis are combined
in test instrument designed for checking microprocessor-based systems

by Stephen E. Scrupski, Instrumentation Editor

By combining two of the latest digital diagnostic techniques, Millennium Systems has developed a test instrument for microprocessor-based systems that it says can be used successfully by service personnel having widely different levels of skill. Designated μ SA, the microsystem analyzer employs the software technique of in-circuit emulation to classify faults and then uses signature analysis [*Electronics*, March 3, p. 89] to pin the faults to the component level.

Moreover, in-circuit emulation can inject signals to generate signatures for analysis at the various nodes. The system designer therefore

need not build the requirements of signature analysis in from the beginning, although, as originally introduced by Hewlett-Packard, the technique required just that.

The new instrument is the first of a family. It is similar to Millennium's Universal-One microcomputer development system [*Electronics*, Sept. 16, 1976, p. 91], which is also the basis for the Tektronix 8001 and 8002 development systems.

The μ SA has two sections. Those features that are related to the operator are controlled by a master central processing unit, and those related to the particular system under test are controlled by a slave

CPU. With this setup, new microprocessors can be handled simply by changing the slave CPU. In its initial form, the system analyzer will handle equipment built around the 8080 or the 6800.

A read-only memory plugged into the front panel allows both go/no-go testing and signature analysis, and test programs also can be stored in the random-access memory. The signature is displayed on a light-emitting-diode display comprising 20 alphanumeric characters. The display is also used for operator prompting. Discrete LEDs indicate various states of the machine.

The system also has a real-time trace option that allows a record of 128 bus states—any combination of address, control data, or auxiliary data conditions. With another option, the analyzer may be connected to an RS-232-compatible modem, so that diagnostic programs can be loaded remotely from a central point. As a result, an on-site technician could dial a diagnostic specialist for help with a problem, since all functions and all status lines can be read remotely.

The system is built in a card cage with seven slots. Only three are required for the basic model, so there is room for future expansion.

Basic price of the instrument, without signature analysis, is \$2,475 in small quantities, but the price drops to below \$2,000 in quantities greater than 50. Low-quantity price of the signature analysis capability is about \$500, with corresponding decreases for large quantities.

Millennium Systems Inc., 19020 Pruneridge Ave., Cupertino, Calif. 95014. Phone (408) 996-9109. [339]





One company can cut keyboard costs. Even when their keyboards cost more.

The most expensive mistake you'll ever make selecting a keyboard could be spending too little. In the long run, that adds up to cutting corners, not costs.

So to make sure you get the keyboard that really meets your needs, MICRO SWITCH uses Value Engineering.

Through Value Engineering, we look at your particular product needs to design a cost-effective solution to your problems. That means designing a keyboard that interfaces with your total system and meets your needs. Precisely.

It also means we can often lower your total system cost. For example, we might be able to incorporate into a keyboard several levels of codes that you had been paying for separately. And at a much higher cost.

Or maybe customize

integrated circuits to provide you more logic for less money.

Besides giving you cost-efficiency, MICRO SWITCH keyboards out-feature practically every other in the industry.

You can choose LED or incandescent lighting. Tactile or linear feel. Sealed versions for military and industrial uses. Alternate or momentary action. Encoding techniques that'll meet any code requirement.

There are also wired-only assemblies or separate modules available. And you can pick from the industry's largest legend library.

Standard, solid state Hall-effect technology throughout the line delivers reliability no mechanical keyboard can offer. Plus, we back up every keyboard we make with a 1% Acceptable Quality Level and a two-year

warranty.

It all adds up to quality you can put your fingers on every time.

For more information, call 815/235-6600.

With MICRO SWITCH, you'll be paying for keyboards instead of mistakes.



MICRO SWITCH

FREEMONT ILLINOIS 61037

A DIVISION OF HONEYWELL

MICRO SWITCH products are available worldwide through Honeywell International.

Circle 121 For Data

World Radio History

Semiconductors

Multiplier built for on-line use

8-bit-by-8-bit device is microprogrammable, includes on-chip accumulator

Until the advent of digital multipliers, as much as one third of a computer's time went on repetitive multiplication. To increase throughput, designers of computer systems have often taken this function away from the central processing unit and assigned it to one or several peripheral boards containing arrays of small-scale and medium-scale integrated multipliers plus associated support circuitry. Now, Advanced Micro Devices Inc. is introducing an 8-bit-by-8-bit microprogrammable multiplier-accumulator that in some applications replaces 30 ICs.

Designated the AM25LS2516, the

low-power Schottky device is aimed at what some consider the fastest-growing portion of the digital multiplier market—real-time multiplication in such microcomputer or mini-computer applications as process control.

Other 8-by-8, 12-by-12 and 16-by-16 large-scale integrated multipliers are already on the market. But John Mick, applications manager for bipolar digital products at AMD points out that they are of the so-called combinatorial type, aimed at high-speed applications and more suitable for the traditional signal-processing jobs. When used for on-line, real-time multiplication in computer systems, Mick adds, these multipliers still require much external circuitry.

The AM25LS2516, on the other hand, he explains, is a serial/parallel device specifically designed for on-line use, as well as for medium-performance signal-processing applications like digital filtering, fast Fourier transforms, and statistical correlation. Even more important for computer system designers is the

fact that the 40-pin device is configured to work with AMD's 4-bit-slice bipolar microprocessor family of computer components.

Key elements in the device are an 8-bit X-input register followed by an 8-bit X latch, an 8-bit Y register, a 4-bit-by-2-bit multiplier, a 2-bit adder, two 8-bit accumulators (high order and low order), a byte-selection multiplexer, and instruction decode logic. These components, equivalent to about 625 gate elements, are fabricated onto a chip measuring about 200 by 205 mils. "The on-chip accumulator is provided to minimize component count and power dissipation in high-density systems," says Mick. "It allows completion of a multiply and add operation in the time normally required for a multiply only."

Using two's-complement carry-save arithmetic, the AM25LS2516 delivers an 8-bit product in four clock cycles and a 16-bit product in eight clock cycles. A single device can, as a result, perform an 8-by-8 multiplication in 400 nanoseconds, drawing only 1.7 watts of power, 600 milliwatts of that in the multiplier array itself. Two devices may be cascaded to achieve a 16-by-16 multiplication in less than 900 nanoseconds. Power required, says Mick, is at least 1/10 to 1/5 that required of boards containing multipliers and surrounding circuitry.

Perhaps the most novel feature of the AM25LS2516 is that it is microprogrammable from an external read-only memory controlled by four instruction lines. "This programming capability is the key to its flexibility," says Mick. "Two cascaded 25LS2516 devices, for example, can be programmed to perform in a number of different multiplication configurations, not only square functions such as 4 by 4, 8 by 8, 12 by 12, and 16 by 16, but rectangular ones in which the multiplicand is different from the multiplier. "Sixteen micro-instructions are provided that can be grouped into three major functions—data move, read, and multiply. A control array is provided on chip to test for overflow during the last add cycle of the operation—that

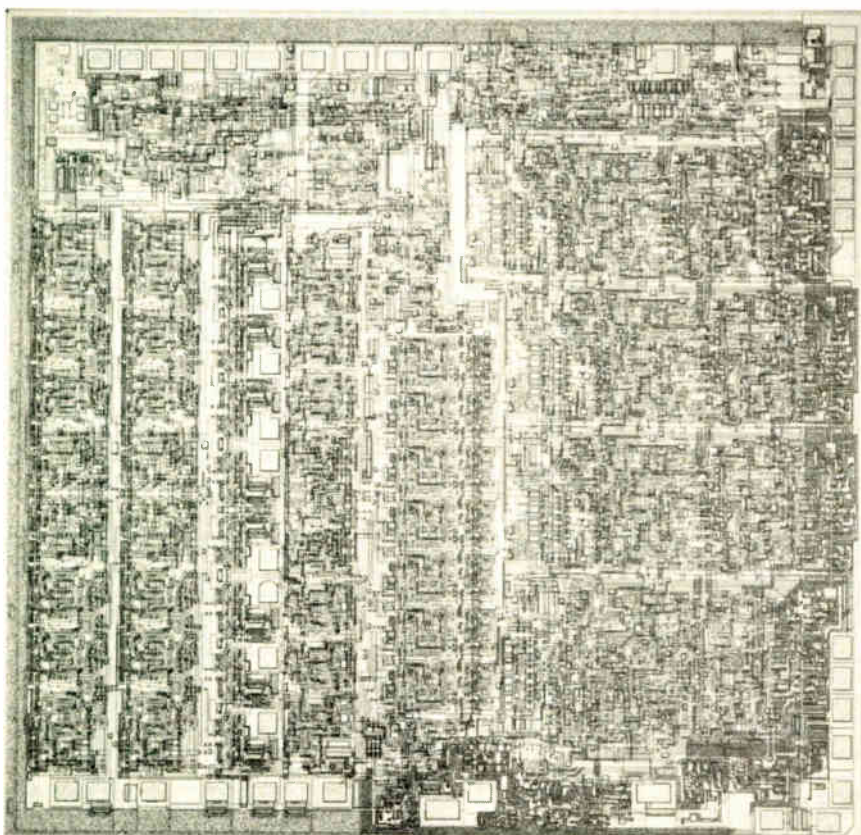

Flat cable connector system ...high reliability in ultra-compact design

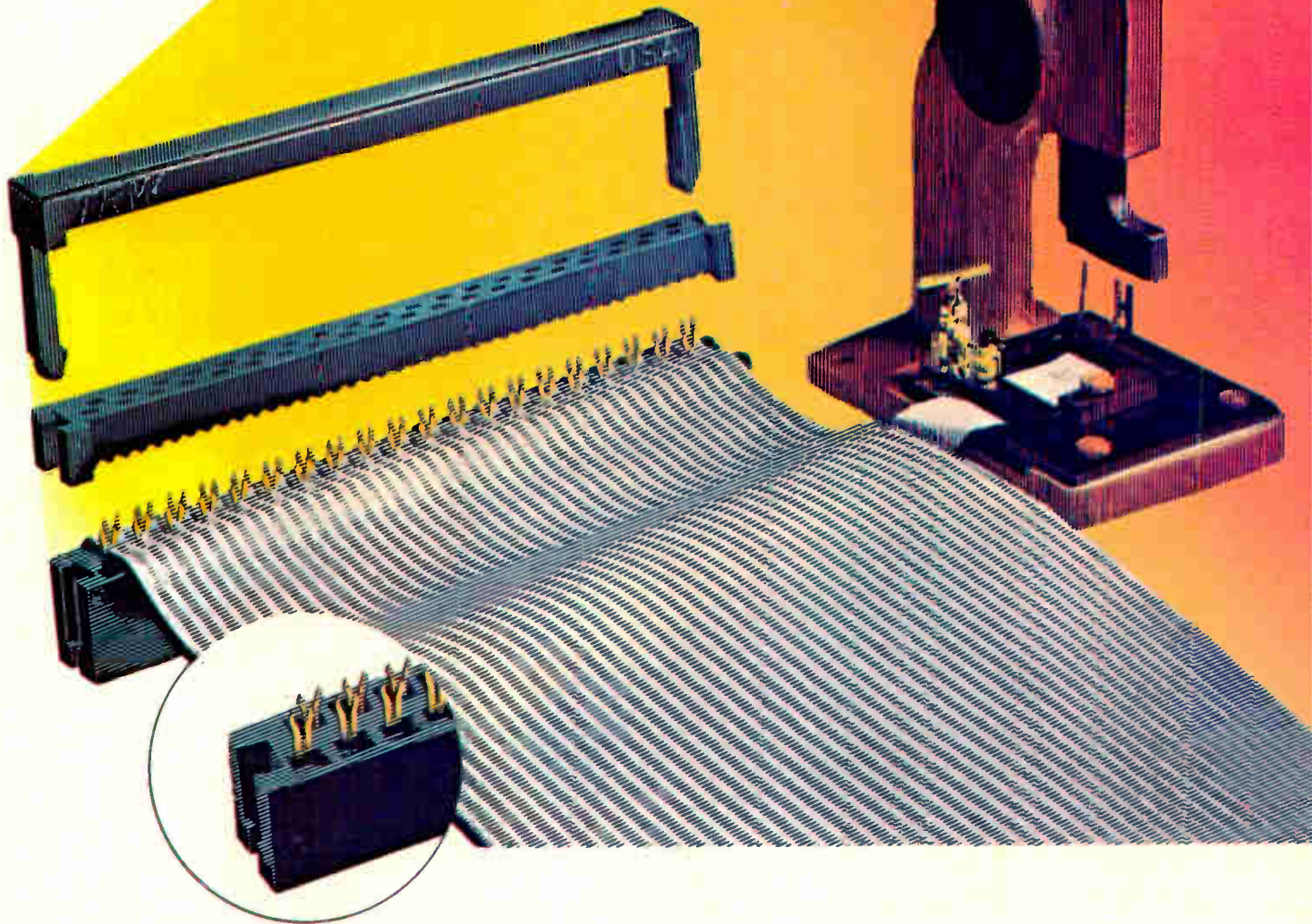

In TRW Cinch flat cable connectors, two gold-plated wire contact points for each conductor assure extra reliability. The socket contact also provides two surfaces for electrical contact when mated with feed-thru pins or headers. Integral molded-in locking tabs on the cover increase cable retention, as does the optional cable strain relief assembly.

The ultra-compact design saves valuable space, and the connectors can be positioned on .250-inch centers on a mother board if required. One contact size accepts 24 gauge solid and 26 gauge solid or stranded wire and another gauges 28 and 30 solid and stranded.

The cable supplied by TRW Holyoke Wire & Cable has conductors positioned on .050" centers. The

connector contacts are positioned on two staggered rows of .100" centers.

Fast, positive cable positioning and registration is assured by molded-in guides in the connector cover. Only one fixture is required to accommodate all six connector sizes—10, 20, 26, 34, 40 and 50 positions.

STOCKED BY DISTRIBUTORS. Off-the-shelf delivery is available from your local TRW Cinch Connectors distributor. For additional information contact your TRW/ECD field sales office or write to TRW Cinch Connectors, an Electronic Components Division of TRW Inc., 1501 Morse Avenue, Elk Grove Village, IL 60007; phone (312) 439-8800. CC-77:8

TRW CINCH CONNECTORS

ANOTHER PRODUCT OF A COMPANY CALLED TRW

World Radio History

Circle 123 on reader service card

New products

is, cycle 8 for 8-bit and cycle 16 for 16-bit operations. The timing and control of this specific cycle is accomplished by the microcode chosen. In contrast, says Mick, most present arrays are fixed; that is, to do a 4-by-4 multiplication, a 4-by-4 array is necessary. "In a typical computer system, performing a number of different types of multiplication," says Mick, "considerable time and space is saved if the same device can do them all." In hundreds, price of the unit is \$68 each.

Advanced Micro Devices Inc., 901 Thompson Pl., Sunnyvale, Calif. 94086 [411]

Voltage regulator offers low temperature coefficient

Expanding its line of monolithic three-terminal adjustable voltage regulators, National Semiconductor Corp. is adding the LM137, a negative-output device. It complements the company's LM117, a positive-output unit that when announced was the industry's first three-

terminal adjustable regulator [*Electronics*, Nov. 27, 1975, p. 133].

"The LM117 introduced the concept of an adjustable voltage regulator that fits into the same slots as its fixed-voltage, three-terminal counterparts," says Robert C. Dobkin, director of advanced linear circuits at National. "The LM137 series—adjustable from -1.2 to -37 volts with two external resistors—extends the concept over the full range of voltages in common use today, positive and negative."

In many systems, there are requirements for variable voltages and nonstandard voltage options. Until the development of the adjustable three-terminal regulator, designers were often forced to maintain a large inventory of fixed-voltage devices over a wide range of voltages and currents. The other option was to redesign circuit boards around one of several nonstandard, multiterminal, adjustable regulators.

The new LM137 series is a 1.5-ampere family featuring internal current limiting, thermal shutdown, and safe-area compensation, making

the devices virtually blowout-proof against overload. Regulation for the unit is within 0.02% for line variations of up to $\pm 10\%$, and load regulation is less than 0.05%.

The addition of a new specification—thermal regulation—fully characterizes the regulation of the LM137 series. According to design engineer Robert Pease, the real significance of the LM137 series is in its tight specification for thermal regulation: output voltage varies no more than 0.004% per watt of power change. "The LM137 is the first IC regulator in the industry to guarantee that the output voltage will shift less than 0.2% when a 10-watt pulse is applied for 10 milliseconds," he says. "All other regulators are specified for regulation for only a few microseconds, before the junction warms up."

When power is dissipated in an IC, explains Dobkin, a temperature gradient occurs across the chip, affecting the individual circuit components. With an IC regulator, this gradient can be especially severe, since power dissipation is large.

a stroke of genius

- **Built-in hybrid optoelectronic circuitry**
- **Light sensitivity is operator adjustable**
- **Features TTL outputs for "light pen hit", and "light pen switch"**

The originator of the solid-state optical switch also has a bright idea in light pens. HEI's new TTL compatible light pen is packed with features and performance capability. An HEI manufactured hybrid optoelectronic circuit senses spot brightness as low as 2 footlamberts, yet rejects high levels of ambient light. Pen sensitivity may be adjusted by the operator over a 3 to 1 scale. An optional "no touch" switch enables the user to activate the pen without CRT faceplate contact.

This rugged new pen is ideal for interactive graphic systems, alphanumeric manipulation, and special symbol picking. You'll find it easy to buy, and easy to use.

HEI has the lowest reject rate in the business, and nearly ten years of optical and hybrid experience. Ask for specifications on the new light pen, and other optoelectronic devices such as encoders, position sensors, card readers, paper sensors and optical switches. In a hurry? Call Roger Young at (612) 448-3510.

Because of its thermal regulation, the LM137 minimizes the effect of these temperature gradients on output voltage. Thermal regulation is independent of line and load regulation, as well as temperature coefficient, Dobkin says, and occurs within 5 to 50 milliseconds after a change in power dissipation.

Regulators in the LM137 series are easy to use, requiring only two external resistors to set the output voltage and one output capacitor to ensure dynamic stability and low output impedance. The series features one on-chip -1.250-v reference voltage, which is stable to within 35 parts per million per $^{\circ}\text{C}$. This low temperature coefficient, says Pease, prevents case temperature changes from degrading accuracy. Other features of the LM137 series are high ripple rejection of 75 decibels and a root-mean-square output noise of 0.003% of the output voltage up to 10 kilohertz.

The units are available now in four standard, low-cost, three-lead transistor packages: the TO-3 (steel), TO-5 (hermetic), and TO-

220 and TO-202 (plastic). Pricing depends on package and temperature range. The LM137, guaranteed over the military temperature range from -55°C to 150°C , sells for \$13.60 each (for 100 to 999) in the steel TO-3 package. The LM337, guaranteed over the commercial temperature range of 0°C to 125°C , is priced at \$3.60 each in the TO-3 package and \$2.80 in the plastic packages.

National Semiconductor Corp., 2900 Semiconductor Dr., Santa Clara, Calif. 95051 [412]

Monolithic v-f-v converter sells for \$3.70 in thousands

A monolithic voltage-to-frequency converter that also functions as a frequency-to-voltage converter interfaces with all logic families and is available in a standard 14-pin dual in-line package sells for only \$3.70 each in thousands. The model 9400 is a mixed-process device fabricated with a combination of bipolar and

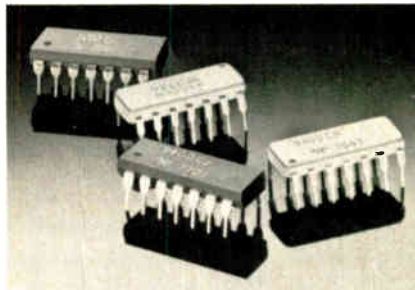

complementary metal-oxide-semiconductor technology. As a v-f converter, it operates from 10 hertz to 100 kilohertz with a typical non-linearity of 0.01% to 10 kHz. In its f-v mode, the 9400 operates from dc to 100 kHz with a typical nonlinearity of 0.1% over the full range.

Typical applications of the converter are in 13-bit analog-to-digital converters, four-digit panel meters, data-acquisition systems, analog data-transmission systems, scales, frequency meters, and voltage-controlled oscillators. The units are available from stock.

Teledyne Semiconductor, 1300 Terra Bella Ave., Mountain View, Calif. 94043. Phone Michael Paiva at (415) 968-9241 [414]

...from HEI!



The Optoelectronic Specialists

HEI

10000 Highway 101, Suite 100, San Diego, CA 92126

New products

Packaging & production

Tester checks all boards

Low-noise integrated system exercises digital, analog, and combinations of circuits

Equipment for production-testing of loaded circuit boards is often a collection of instruments and modules that were never designed to play together in an integrated system. Engineers at GenRad Inc., Concord, Mass., claim their GR 1799 is the first board tester in its price range that was conceived from the outset as an integrated system for production testing of boards with analog or digital—or any combination of both—circuits.

Brendan Davis, product marketing manager in the Electronic Manufacturing Test division, says a typical 1799 system will sell for between \$100,000 and \$110,000. He adds that system noise is lower in an integrated system that is optimized for production board-testing than in the so-called "rack and stack" collection of instruments.

The 1799 measures ac and dc volts, dc current, and dc resistance. In addition, it provides peak and hold measurements on the voltmeter to measure positive and negative

peaks of a waveform; offers frequency period and time measurements; has a tracking mode that allows voltage tracking; and has a low-pass filter mode that Davis says eliminates high-frequency effects to produce true dc measurements.

Sources that come with the system include an ac function generator, programmable pulse generator, and programmable power supplies. The latter, says Davis, were designed for an automatic test system, offering software-programmable voltage, current, and time-period limits. Like the earlier and more expensive GR 1976, the 1799 has a universal scanner that allows each pin, under program control, to be analog or digital, with analog or digital stimuli. Scanner bandwidth is approximately 10 megahertz, as in the 1976, says Davis.

The test system will handle up to 480 pins that are programmable as driver or sensor pins, but Robert Szpila, division marketing manager, points out that most of the GenRad test systems sold recently have averaged 200 pins. The 1799 is software-compatible with all of those models, including the 1796, 1795, and the older 1792D. That includes the capability to run the company's computer-aided programming system (CAPS), a logic simulation package, and automated program generation (APG) for quick preparation of test programs.

With today's circuit board holding an average of about 100 integrated

circuits, many of them large-scale devices, Davis says APG is an especially useful option, leading to fast generation of programs that catch more than 90% of the faults on a board. Deliveries of the GR 1799 will begin in November.

GenRad Inc., 300 Baker St., Concord, Mass. 01742. Phone Brendan Davis at (617) 369-8770. [391]

IC extraction tool won't damage DIP leads

A universal tool for removing integrated circuits from their sockets has a lift-height control that prevents damage to the circuit leads. De-



signed to extract any dual in-line package, the tool's lift height is continuously adjustable from 0.0 to 0.5 inch. It must be applied to each end of the IC before the package can be removed from the socket.

Chuck-A-Chip Inc., P. O. Box 1137, High Point, N. C. 27261. Phone (919) 887-1374 [395]

Screen-imaging system needs no yellow room

A table-top system for coating and imaging screens for thick-film circuits can be operated in ordinary



Need custom LSI? That's easy. Call NITRON: (408) 255-7550.

When you need custom LSI, you need Nitron. For years, we've been meeting hard-nosed designers' demands for industrial, commercial and military LSI applications with just what they need: definition, design assists, and unequalled manufacturing capabilities for MNOS, n and p channel MOS, CMOS, and Ion-implant custom products that are the best in the business.

Stability: it's an advantage

Sized right to give you the flexibility and attention of a high-quality custom house, Nitron has the added advantage of the resources and stability of McDonnell Douglas behind it. And the production versatility of a standard products supplier.

Your one-stop source

Services? Everything from design assistance through manufacturing to packaging. Response? Design cycle times of 20 weeks are not uncommon with us. Special capabilities? A few of immediate

interest to you might be our own in-house mask making facility (utilizing chrome masking, by the way), application of ADS computer aided design to generate masks, and a new cell technology which brings the densities of Nitron's ADS circuits to within 13% of that of expensive, handcrafted layouts.

Custom or off-the-shelf

Name your needs: non-volatile memories (NVMs); mask-programmable ROMs; frequency synthesizers; communications circuits; or something that's never been done before. Tell us. We can work with you on the design if you wish, translate it into a manufactured and packaged product, or you may even discover that it's already on our shelf. Whatever the problem, we're here to help you solve it. Quickly, efficiently, happily. If you want more information, fill out the coupon below and send it to us, or call Nitron Custom Marketing at (408) 255-7550.

NITRON 
A DIVISION OF MCDONNELL DOUGLAS

MAIL TO: Nitron Custom Marketing
10420 Bubb Road, Cupertino, CA 95014

SEND ME THE FACTS!

I'm interested in (check boxes):

- | | |
|--|-------------------------------|
| <input type="checkbox"/> Capabilities Brochure | <input type="checkbox"/> MNOS |
| <input type="checkbox"/> NMOS | <input type="checkbox"/> CMOS |
| <input type="checkbox"/> PMOS | |

DATA SHEETS

- | | |
|---|---|
| <input type="checkbox"/> Non volatile memories (NVMs) | <input type="checkbox"/> Frequency synthesizers |
| <input type="checkbox"/> Data Communications | <input type="checkbox"/> ROMs |
| <input type="checkbox"/> Telecommunications | |

SEND TO:

name & title

company

address

city

state

zip

E-9

EQUAL OPPORTUNITY IN PROFESSIONAL CAREERS SEND RESUME BOX 14526 ST LOUIS, MO 63178

RF Power Amplifiers?

One unit may be all you'll ever need.

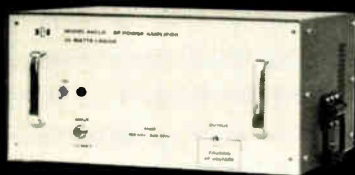

If you have the ENI Model 440LA ultra-wideband solid state power amplifier, all you need is a laboratory signal generator and you've got the ultimate in linear power for such applications as RFI/EMI testing, NMR/ENDOR, RF transmission, ultrasonics and more.

Capable of supplying more than 40 watts of RF power into any load impedance, the 440LA covers the frequency range of 150 kHz to 300 MHz.

We could mention unconditional stability, instantaneous failsafe provisions and absolute protection from overloads and transients, but that's what you expect from any ENI power amplifier, and the 440LA is no exception!

Our catalog contains complete specifications on the 440LA as well as the entire line of ENI amplifiers, and is available without obligation, of course.

For further information or a demonstration, contact ENI, 3000 Winton Road South, Rochester, New York 14623. Call 716-473-6900, or Telex 97-8283 ENI ROC.

ENI

The World's Leader
in Power Amplifiers

New products

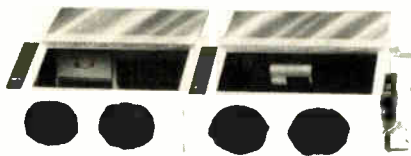

room light without exposing the photosensitive film emulsions. The system consists of two amber-paneled glove boxes and a temperature-controlled tank. From left to right these are a coating-and-drying glove box, an exposure glove box, and a developing tank. Stretched screens enter the left side of the system and move through sliding-panel ports towards the tank. After leaving the tank, the screens can be washed under ordinary room illumination.

A key advantage of the SIS-900 is that it allows screens to be coated and imaged in the same area where the screen printers are working. And the process is fast: starting with a stretched frame, a screen can be produced in less than an hour. Screen sizes up to 8 inches by 10 inches can be accommodated.

Qualco, One First St., Los Altos, Calif. 94022. Phone (415) 964-7666 [393]

Boards interface with standard computer buses

Series CIP4 and CIP4/11 wire-wrappable integrated-circuit boards are designed to plug directly into Digital Equipment Corp. Omnibus and Q-Bus systems. The boards, which can thus be used with the LSI-11 microcomputer and with PDP-8 and PDP-11 minicomputers,

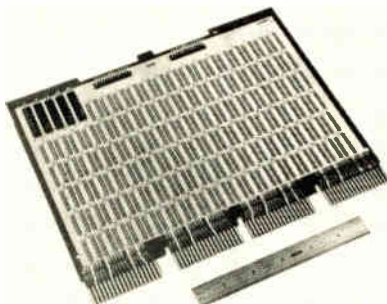

provide 32 columns of 60 low-profile socket terminals per column with alternate rows of committed ground and supply-voltage wire-wrap terminals. The boards will accommodate up to 110 16-pin dual in-line packages or a lesser number of larger packages or mixtures of packages. Available in dual, quad, and hex sizes, the boards range in price from \$1.50 to \$2.00 per IC position.

Garry Manufacturing Co., 1010 Jersey Ave., New Brunswick, N. J. 08902. Phone Harry A. Koppel at (201) 545-2424 [396]

System makes and inserts round and square pins

A pin-terminal insertion system called Autopin actually makes its own pins from a continuous coil of wire and then inserts them into coils, bobbins, printed-circuit boards, etc.

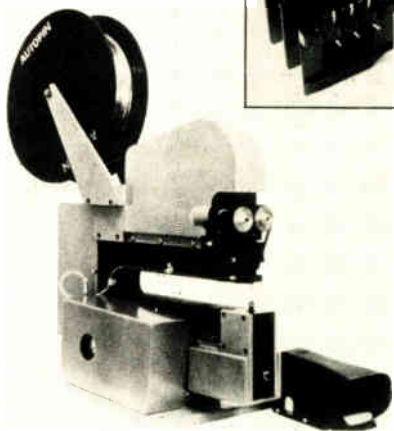

The wire may be either round or square.

In a typical operation the operator positions the work in the machine and steps on a foot pedal. The machine then feeds a length of wire, cuts it with a proper point profile, and inserts it into the work. The point profile is determined by the cut-off tool; it may be square-cut, tapered, or concave.

A major feature of the Autopin system is its provision for easy adjustment of pin length up to 1.125

New products

inches. In addition it can be set for different board or bobbin thicknesses. Standard pin materials include brass, phosphor bronze, and cupro nickel—all with various platings. An operator can insert from 1,500 to 2,500 pins per hour with the system at a cost of \$3 to \$7 per thousand depending upon length and material. The equipment is available both for sale and for lease.

Autosplice Division, General Staple Co., 220 East 23rd St., New York, N. Y. 10010. Phone Irwin Zahn at (212) 674-4369 [394]

Flat-cable connectors handle up to 50 wires

The PS series of insulation-displacement connectors for mass termination of flat cables comes in sizes that can handle from 10 to 50 wires. The two-row connectors are available in seven contact layouts. They require

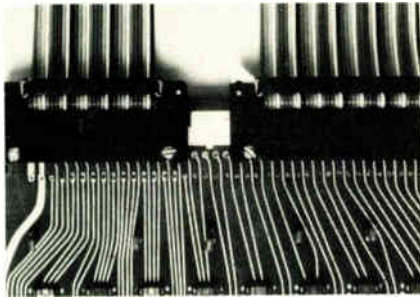

no prestripping of the cable and can be applied at the cable ends or at any point along the cable for daisy-chain applications. In lots of 5,000 pieces, a 10-wire receptacle sells for \$1.07. Delivery time is three to four weeks.

ETC Terminal Products Unit, ITT Cannon Electric, 29000 Aurora Rd., Solon, Ohio 44139. Phone Allen Guth at (216) 248-8800 [397]

Flexible-circuit connectors cost less than 0.7¢/line

The model M-1255 flexible-circuit connector is available with any number of contacts on a single strip. The connectors have a patented circuit-gripping design which needs

NOW measure AC, DC, and AC on DC CURRENT without breaking the circuit



Bell Model 1776 Digital Current Meter with non-contact, clamp-on probe does it!

Current measurements are faster, easier and safer. Utilizing Hall effect probes, the 1776 introduces practically no disturbance into the measured circuit. It can measure currents ranging from DC to 5 kHz.

- 3½-Digit Readout
- Peak—Read—Hold
- Three Current Ranges
1000A, 100A, 10A (Resolution to 10 mA)
- Fully Portable
Operates on 117VAC or rechargeable integral batteries.

Request complete information on this unique instrument for use in troubleshooting, R & D and maintenance.

Fw
A Subsidiary of
The Arnold Engineering Company

BELL INC.
4849 Freeway Drive East
Columbus, Ohio 43229
Phone: (614) 888-7501
TWX: 810-337-2851

SEE US IN BOOTH #507 AT ISA/77 NIAGARA FALLS OCT. 17-20

Circle 129 on reader service card

Hewlett-Packard 9830 Users

You can now dimension, sort and search any array that will fit in your memory.

With Infotek's Fast Basic III ROM the 256 row-column limit no longer exists!!!!

Infotek Systems

1400 N. BAXTER STREET • ANAHEIM, CALIF. 92806
(714) 956-9300 • TWX 910-591-2711

WHETHER YOU'RE COUNTING ONE THING EVERY NOW AND THEN OR FIVE HUNDRED MILLION EVERY SECOND, THIS CHIP CAN HELP YOU DO IT BETTER AND SAVE YOU MONEY, TOO.

It's the LS7031 6 decade MOS up counter with 8 decade latch and multiplexer.

It can count up to 5MHz on its own over its entire range of 4.75V to 15V.

It's the only MOS chip that allows you to attach prescalers and count up to 500 MHz.

But it's also so efficient and inexpensive that you'd do well to consider it when you're counting things that go a lot slower.

And it has power-saving features which make it suitable for portable instruments. Leading zero blanking and leading zero blanking override. Overflow outputs for 6, 7, or 8 decades.

Our customers—including some of the biggest manufacturers of frequency counters in the business—tell us it's the best counter chip they've ever seen.

We think you'll agree. Let us tell you more about it. Contact Ron Colino at (516) 271-0400.

LSI COMPUTER SYSTEMS INC.

1235 Walt Whitman Road
Melville, NY 11746
TWX: 510-226-7833.
Argentina Tel. 46 9549.
Germany Tel. 089/69 65 66/67.
Italy Tel. (02) 688.38.06
Japan Tel. (03) 449-7141/2.
U.K. Tel. 01 995 8495. Mr. Glyn Hall

Circle 130 on reader service card

1977 Answer Book. It makes your job easier. \$25.

Who makes what? Over 4000 products, more than 5000 manufacturers with their local contracts and distributors, directory of trade names and catalogs, post-paid inquiry cards for 5-second ordering of current catalogs.

Electronics Buyers' Guide
1221 Ave. of the Americas
New York, N.Y. 10020

Yes, send me a copy of The Answer Book. I've enclosed \$25 (USA and Canada only, elsewhere send \$35). Full money back guarantee if returned within 10 days.

Name _____
Company _____
Street _____
City _____ State _____ Zip _____



Electronics Buyers' Guide

New products

no solder or hardware to form a sound connection. Priced at less than 0.7 cent per line, the connectors are available in copper-based alloys and with a pre-tinned finish. Contact pins for insertion into printed-circuit boards can be supplied at various angles to accommodate many mounting configurations. The connectors are available from stock.

Precision Concepts Inc., Bohemia, N. Y. Phone Robert J. Nicola at (516) 567-0995 [398]

Computerized unit controls deposition of thin films

A microprocessor-based system that can be linked directly to a process-control computer contains a library of programs for controlling the deposition of thin films. By activating a combination of program elements, the instrument is capable of controlling rise, soak, deposition, and other parameters for as many as 99 film layers.

Designated the MDC 9000, the controller can be programmed manually or by remote automatic equipment. Manual programming is done through an alphanumeric keyboard, which is equipped with an interactive data display that monitors the values being entered into the unit's memory. Remote programming is handled by a teletypewriter or paper-tape reader.

The MDC 9000 is equipped with four crystal sensor inputs and four source-control outputs. A layer-saver circuit prevents the loss of a run in the event of crystal failure by computing the required power and time values and instructing the controller to complete the deposition to the programmed thickness. In high-volume production applications, this feature could save thousands of dollars worth of material.

Supplied complete with a manual programming keyboard and a manual source-control unit, the MDC 9000 sells for \$4,995.

Sloan Technology Corp., 535 East Montecito St., Santa Barbara, Calif. 93103. Phone (805) 963-4431 [399]

All aerosol cleaners are not alike.

What do we mean by this statement? Simply, that not all industrial cleaners have kept pace with the increasing demands for purity in the electronics industry.

For years now, we've recognized industrial cleaning as a vital link in maintaining component and system purity and reliability. And here's what we've done to make sure Miller-Stephenson aerosol cleaners can help achieve the system integrity you need.

PURITY COMES FIRST In laboratory testing, Miller-Stephenson aerosol cleaners have the lowest residual contamination in the industry — some approaching 5-7 parts per million. The general industry range is 50-130 ppm.

We believe the purer *our* product, the better the performance and reliability of *your* product.

ATTENTION — FILTER AT WORK We use only the highest grade certified virgin solvents and propellants (all propellants are nonflammable — TWA 1000ppm — the surest, safest propellants available.)

We *double filter* our Freon solvent and propellant, first with a 5 micron filter, then with a Millipore 0.2 absolute filter. The filtered product goes directly into seamless cans, eliminating any possibility of flux contamination from seamed cans. We have complete quality control, from tanker to customer.

WE'RE FUSSY ABOUT OUR LOADING ENVIRONMENT Our loading room environment is immaculate, controlled by Clean Room conditions. Each loading line is kept exclusive for an individual product. This avoids the danger of contamination often caused when loading lines are used for multiple products.

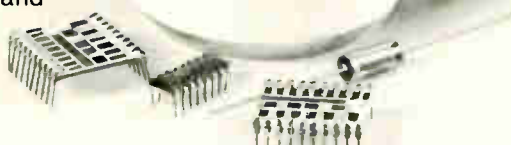

MS CLEANERS CAN BE SHIPPED WITH SAFETY Here's an important bonus! Because of our special formulating most Miller-Stephenson aerosol cleaners can be shipped Air Transport. They are exempt from all the federal regulations listed under the heading, "Restricted Articles".

WHY DO WE TELL YOU ALL THIS? *Because we believe no other aerosol cleaner now on the market meets these purity standards. And we think the rigid standards we demand of our products will help you meet your own high level of safety and reliability.*

But let us send you a can of MS-180 Freon TF Solvent to try for yourself.

"Freon" is DuPont's registered trademark for its fluorocarbon compounds.

miller-stephenson

E-9V

Danbury, Connecticut 06810 (203) 743-4447

- Enclosed is \$2.00, please send trial unit of MS-180 Freon Solvent
- Enclosed is \$5.00, please send trial units of MS-180 and Cobra Brush
- Please send FREE literature and prices on complete line of MS cleaners

Intended Use _____

Name _____ Dept./Title _____

Company _____

Address _____

Since our products are For Industrial Use Only, government labeling regulations prevent our sending these trial units to your home address.

LOS ANGELES · CHICAGO · DANBURY, CT. · TORONTO



Our exclusive Cobra extension brush MS-226 will convert any Miller-Stephenson aerosol cleaner into an efficient metered spray with scrubbing action. Insures maximum cleaning accuracy with minimum solvent waste

MS-180
Freon TF
Solvent



Subassemblies

SCR bridges come in single packages

Two series of power devices handle up to 40 amperes at up to 800 volts

Power thyristor bridges for use in such applications as phase controllers, pulse modulators, and transformer control circuits are rarely available in a single package, and that is precisely the gap for which Unitrode Corp. has designed two new series of silicon phase-control bridges made of silicon controlled rectifiers. The glass-passivated devices are housed in the company's solderable ChipStrate package.

The two series are designated SMA 1250-SMA 8250 and SMA 1400-SMA 8400. The former handles 25 amperes of root-mean-square current at up to 800 volts, and the latter is rated at 40 A rms up to 800 v. Each series has eight different circuit configurations, and each has models handling 200 v, 400 v, 600 v and 800 v. Carl Uretsky, product

marketing manager for thyristors, says the current ratings are conservative because each of the four devices—two SCRs and two rectifiers—in some of the circuits can handle 25 or 40 A at 85° C.

Uretsky adds that the biggest advantage the bridges offer is their one-step assembly by Unitrode, "which means these parts aren't expensive for the power they handle." A representative price in either series would be less than \$9 for the 400-v units in quantities of 1,000. Joseph Pappalardo, applications engineer, adds that the single-package design simplifies mounting for the customer. "Formerly," he says, "circuit designers had to buy large power SCRs and power rectifiers, isolate them from each other, and mount them on large heat sinks."

With the Unitrode bridges, there is a single alumina or beryllia substrate and rugged quick-connect terminals with holes in them so that customers can plug them in or solder them down after wrapping wires around the terminals, if that is required. There are three basic variations in the eight circuit configurations in both series: two SCRs and two rectifiers, four SCRs, and two SCRs and one SCR, with the largest package having an area of approxi-

mately 2 square inches.

The peak one-cycle, nonrepetitive surge current for the 25-A units at 60 hertz is 300 A; for the 40-A devices, it is 600 A. Both series are available with an optional free-wheeling diode for especially inductive loads.

Delivery time is four to six weeks for standard parts, 12 to 14 weeks for custom configurations. Unitrode Corp., 580 Pleasant St., Watertown, Mass. 02172. Phone Carl Uretsky at (617)926-0404 [381]

Opto-isolators boast high gain at low input current

A line of optically coupled isolators with transistor-transistor-logic-compatible outputs and 3,000-volt dc isolation voltages is noteworthy for its high current-transfer ratios at low input currents. The model 6N138, for example, has a minimum CTR of 300% at an input current of 1.6 milliamperes, and the 6N139's is 400% at 0.5 mA. The units are housed in 8-pin dual in-line packages and are pin-for-pin compatible with Hewlett-Packard 5082-4370 (6N138) and 5082-4371 (6N139) isolators. In thousands, the 6N138 sells for \$1.65 each, while the 6N139 carries a price tag of \$2.05 each for the same quantities. Delivery time is 30 days.

Spectronics Inc., 830 East Arapaho Rd., Richardson, Texas 75081. Phone (214) 234-4271 [383]

10-bit d-a converter settles within 20 ns

Designed for summing-point applications where voltage outputs are not required, the DAC-V digital-to-analog converter is well suited for video reconstruction applications, including TV and radar, and for digitally controlled transmitters and displays. The unit combines a resolution of 10 bits and a maximum error of 0.05% of full scale with a settling time of only 20 nanoseconds. This settling time is for a full-scale input

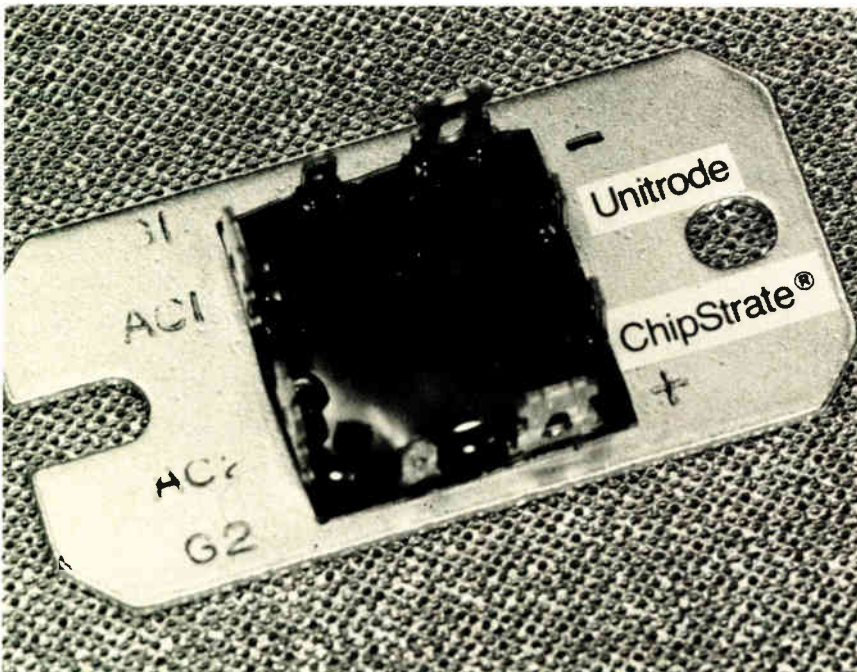

Even in today's digital world, there are hundreds of applications where the infinite resolution and graphic indication of a linear slide control work best.

Duncan Series 400 Slideline™ instrumentation pots are already in use in rapid transit speed controllers, X-ray and blood analysis equipment, petrochemical plant servo-controls, office copiers, solar energy instrumentation and many other unique applications.

Duncan linears can be set instantly and accurately. And reset perhaps 50 million times without significantly changing their characteristics (thanks to our special RESOLON® conductive

plastic element). Even lay people find their operation self-explanatory.

You can order Series 400 Slidelines with single or dual elements, in values from 600 to 250k ohms, with 70 or 108mm stroke lengths and linear, audio, or balance tapers with your choice of tolerance. There's even an exclusive *dual-slider* version that's perfect for setting both upper and lower limits.

So next time you're designing a control system, stop and think about the advantages of going analog. Then grab onto a Slideline and take control! Write us for complete literature.



Series 400 puts you in control.



1. X-ray equipment controller
2. Reproducing machine tone control
3. People mover speed controller
4. Rapid transit system speed/brake controller
5. Medical instrumentation for cardiac diagnostic machine
6. Controller for blood analyzer

Electronics / September 29, 1977

DUNCAN ELECTRONICS
SUBSIDIARY

BYSTRON  **DONNER**

2865 FAIRVIEW ROAD • COSTA MESA, CALIFORNIA 92626
PHONE: (714) 545-8261 TWX 910-595-1128

Circle 133 on reader service card 133

Now from Digital— a low-cost paper tape reader.



The PRSO1, Digital's new low-cost, portable paper tape reader for high performance terminals.

Now you can easily load your programs, bootstraps and diagnostics into any make or model of computer or terminal you currently own through an approved 20 mA interface. Available in 300 baud and 2400 baud versions, the small (12" x 8") and light (3kg) (6.5 lbs.) self-contained unit can go just about anywhere you need an input device. All for a mere \$750.

For complete information on the PRSO1, call your nearest Digital office; or write Digital Equipment Corporation, Traditional Products, 125 Northeastern Boulevard, Nashua, New Hampshire 03060.

digital

Circle 134 on reader service card



- **Fast TurnAround**
25 days from your design to prototype circuits
- **Low Cost**
Save 80% over a fully custom design
- **Reduced Circuit Size**
Multiple saving by reducing circuit size 90%
- **Proven Process**
Standard CMOS assures high reliability and dependable delivery

**INTERNATIONAL
MICROCIRCUITS, INC.**

3004 Lawrence Expwy., Santa Clara, Ca. 95050 (408) 735-9370

Circle 20 on reader service card

World Radio History

New products

change and represents the time required to get within 1 least significant bit of final value. Temperature coefficient is a maximum of 15 parts per million per °C.

Housed in an encapsulated module measuring 2.3 by 2.3 by 0.4 inches, the DAC-V weighs 1.5 ounces. It includes a temperature-compensated voltage reference and is fully protected against short circuits. The unit sells for \$135. A similar converter with 8-bit resolution and a maximum error of 0.2% of full scale has a typical settling time of 15 ns and a price of \$110.

ILC Data Device Corp., Airport International Plaza, Bohemia, N. Y. 11716. Phone Paul Roberts at (516) 567-5600 [384]

8-bit converters are aimed at video applications

Two new video devices, the ADC 820 analog-to-digital converter and the DAC 850 digital-to-analog converter, are 8-bit units that have been optimized for video applications. The ADC 820 is a 20-megahertz board that includes a low-pass anti-aliasing filter right at the input to the quantizer. Its differential phase and gain errors are 0.5° and 1% root mean square, respectively.

The DAC 850 is a 50-MHz unit built on the same size board (6 by 8 by 1 inch) as the ADC 820. It is available with or without an output filter and has maximum differential phase and gain errors of 0.25° and 0.75% rms, respectively. In small quantities, the ADC 820 sells for \$1,650, and the DAC 850 for \$525.

Tektronix Inc., P. O. Box 500, Beaverton, Ore. 97077. Attn: Charles R. Payne at Delivery Station 58-699. Phone (503) 644-0161, Ext. 6597 [385]

F-v converter produces only 0.5 mV of ripple

Intended to be used with voltage-to-frequency converters as part of a communications system for rate information (outputs of tachometers,

flowmeters, etc.), the model 22A frequency-to-voltage converter has as its most outstanding characteristic an essentially ripple-free output. Because its peak-to-peak ripple is less than 0.5 millivolt (0.005% of full scale), the unit's output can be sampled at any time with practically no ripple uncertainty. The result is that the 22A can be inserted between a rate data signal and the input port of a data-acquisition system with no need for averaging filters, counters, or other expensive and time-consuming measures.

The converter covers the four decades from 1 hertz to 10 kilohertz with 12-bit linearity. It is inherently monotonic and features an optically isolated input which greatly reduces the effects of noise and ground loops. Other key specifications of the 22A are a slew rate of 2.5 volts per millisecond, a scale-factor temperature coefficient of 20 ppm/°C, an offset voltage of 1 millivolt, and an offset-voltage temperature coefficient of 20 $\mu\text{V}/^\circ\text{C}$. In small quantities, the 22A sells for \$49; delivery is from stock to two weeks.

D-B-D Developments, 7709 Kilbourne Rd., Rome, N. Y. 13440. Phone Dave Manzolini at (315) 339-1265 [387]

Op amp has gain-bandwidth product of 1.7 gigahertz

The model 3554 operational amplifier is an extremely wideband unit with a gain-bandwidth product of 1.7 gigahertz, a minimum slew rate of 1,000 volts per microsecond, and a maximum settling time (to within 0.05%) of 150 nanoseconds. Prime applications are in digital-to-analog

converters, sampling circuits, multiplexers, integrators, pulse amplifiers, and waveform generators.

The op amp has output ratings of $\pm 10\text{ v}$ at ± 100 milliamperes, making it a good choice for line-driving applications involving fast pulses or wideband signals. It is available in three grades. The 3554AM operates from -25°C to 85°C , has a typical input-offset drift of 20 microvolts/°C, and sells for \$60 in small quantities. The 3554BM operates over the same temperature range, but has a typical drift of only $8\ \mu\text{V}/^\circ\text{C}$. It sells for \$70. For operation from -55°C to 125°C , Burr-Brown offers the 3554SM. This unit has a typical drift of $12\ \mu\text{V}/^\circ\text{C}$ and a small-quantity price of \$75. All three units have a minimum open-loop dc gain of 100 decibels, an input bias current of 50 picoamperes, and a common-mode rejection ratio of 78 db. They are protected against continuous output shorts to ground, but not to the supplies.

Burr-Brown Research Corp., International Airport Industrial Park, Tucson, Ariz. 85734. Phone Dennis Haynes at (602) 294-1431 [386]

TOPICS

Subassemblies

Estatech Inc., Placentia, Calif., is introducing dc-input versions of its series 3A triple-output power supplies. Four standard models are being offered: two take a 28-V dc input, the other two require 48 V dc. The 110-watt units sell for \$485 each in small quantities.

... **Burr-Brown, Tucson, Ariz.**, has cut the price of its model 4341 rms-to-dc converter by as much as 20%. Formerly priced at \$31.50 in singles, the unit now sells for \$26 in lots of 1 to 24, \$20 each in lots of 25 to 99, and \$16.50 apiece in quantities of 100 to 999. ... **Deltron Inc., North Wales, Pa.**, has announced a series of 78 power supplies that are drop-in replacements for ACDC's OEM series units. Prices range from \$40 to \$233 each in small quantities. Typical delivery time is six weeks.



Quad Output Power Sources...

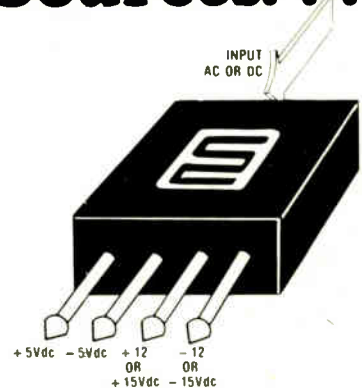

QUADRUPLE YOUR DESIGN POWER DENSITY!!

Now ... Up to FOUR dc outputs from a compact, cool-running package ... AC/DC and DC/DC models for powering μP 's, A/D/A's, DAS's and op amps.

Take Your Choice ...

- OUTPUTS** ...
 - $\pm 5, \pm 12, \pm 15\text{V}$
 - ... To 25 Watts
- INPUTS** ...
 - AC**
 - 105-125Vac
 - 210-250Vac (K2 Option)
 - 50-440Hz (All Models)
 - DC**
 - 4.5-90V
 - INPUT RANGE UP TO 4:1
 - Over/under voltage protection available
- PERFORMANCE** ...
 - Reg. to 0.15%
- RELIABILITY** ...
 - MTBF's > 100,000Hrs.
- PRICE** ...*
 - From \$133.00 (unit)

*LIBERAL OEM DISCOUNTS

To get complete data and our NEW 1977 Catalog, circle the number below. Your No. 1 SOURCE is ready to serve you.



SEMICONDUCTOR CIRCUITS, INC.
POWER SOURCES DIVISION

306 RIVER ST., HAVERHILL, MA 01830
TEL. (617) 373-9104, TWX. 710-347-0269

Microprocessors

Computer serves many users

Fast floppy-disk system and special format maker for efficient timesharing

A quantum jump in the application and use of a microcomputing system, is how Mupro Inc. describes its new timesharing software and disk operating-system package.

The timesharing software, called Mute for multi-user/task executive, provides task-queuing and -scheduling capabilities similar to those of Digital Equipment Corp.'s RSX-11 and file management much like that of Hewlett Packard Co.'s HP-3000 system. The software also supports disk data transfers through direct memory access. This operating system is contained on diskettes in the Mupro 80D system, which operate in conjunction with the Mupro family of microcomputers, development systems, and in-circuit emulators.

According to Larry Gray, manager of system software at Mupro, this multi-user, multi-task disk operating system makes the one-machine, one-operator concept obsolete. The combination of the Mupro 80 and Mute, he says, allows many

users to share the microcomputer and development system, with no noticeable holdups.

The Mute software provides the capability of executing multiple tasks on an event-driven basis. As many as 256 tasks divided into 64 priority levels can be scheduled by a task-queuing algorithm. A combination of linear and circular queues ensures that both task priority and resource sharing are accomplished efficiently. Those system peripherals that critically affect system throughput receive the highest priority, and all devices, including disk drives, printers, terminals, and other peripherals are interrupt-driven with Mute.

File-management routines maintain the file structure of the data stored on the disk and permit applications programs to access peripheral devices.

Proper operation of the Mute is ensured, says Gray, by extensive checks for errors at various stages within the operating system. Error conditions are flagged to the operator by messages on the terminal.

Mupro 80D disk system hardware includes a dual floppy-disk drive, made by Persci Inc., with a voice-coil actuator that reduces track-seek delays by a factor of 7½ compared to conventional drives. Average seek time, according to Gray, is less than 50 milliseconds, and therefore no appreciable delays in operating time are observed.

The IBM 3740-compatible disk system contains a programmable

real-time clock that offers an accurate time reference for system operations. The disk controller, contained on a single circuit card within the Mupro 80 chassis, accommodates up to two dual-drive units, or four single drives. Provision is made for upper- or lower-head selection, which doubles the regular 256-kilobyte capacity of the diskette by permitting it to be recorded on both sides.

The Mupro 80 chassis itself is an 8080-based microcomputer system containing central processing unit, memory, power supply, input/output, and a self-documenting front panel. The display panel lets the user peer into all the workings of the processor, including all registers, storage locations, and flags. Hexadecimal displays provide the information. The microcomputer system contains 64 kilobytes of addressable memory for user programs, data, and I/O. In addition, storage is available for 256 device codes each for input and output.

The Mupro system uses a block-structured assembly language to minimize coding time. Called BSAL-80, the versatile language combines high-level-syntax Algol-like statements with the flexibility, the size, and the speed of assembly language.

The complete Mupro 80D dual-disk system with microcomputer and power supply can be rack-mounted in a space only 5¼ inches high. In single quantities, the complete system with the Mute software is priced at \$9,000. Pricing for original-equipment manufacturers is \$5,800 in single quantities for units shipped without power supply and front panel.

Mupro Inc., 424 Oakmead Parkway, Sunnyvale, Calif. 94086. Phone (408) 737-0500 [362]



Control-oriented computer demands no expertise

For manufacturers and users who cannot afford the learning and development time to build microproces-

Dialight is your second source to C&K for miniature rockers and toggles...



Come to the people who've always been specialists in having more good ways to solve problems: Dialight. What we've done in indicator lights, illuminated switches, readouts and LEDs, we're doing now in miniature rockers and toggles.

This new Dialight family of switches, which comes in a full range of sizes is, we're proud to point out, all-American made.

When you consider all the configurations of styles, sizes, life and safety ratings, colors and mountings, you'll find there are literally hundreds of thousands of design combinations. Such a number of possibilities

can in itself be a problem, except that the new Dialight catalog is specifically designed to prevent confusion and help you quickly and easily find the most advantageous combination of features for your applications.

If you'd like to see what Dialight quality rockers and toggles can do for the looks, durability and economics of your products, contact us today for the Dialight "Meets Your Need" Book. Your free copy will include a list of stocking distributors in the U.S. and Canada.

DIALIGHT
A North American Philips Company

Dialight meets your needs.

Dialight, 203 Harrison Place, Brooklyn, N.Y. 11237 (212) 497-7600

Circle 137 on reader service card

New products

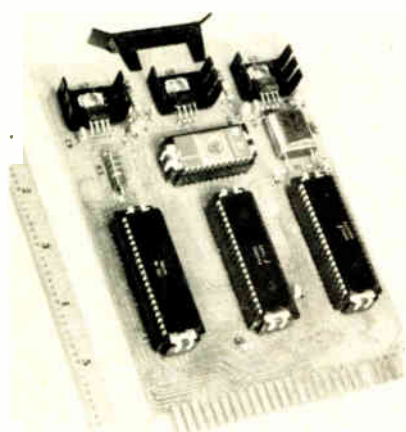

sors into their equipment, a company in Indiana has put together an attractive microcontroller package. The product, offered by Environmental Technology Inc. of South Bend, is a single-board microcomputer. With it, ETI "takes customers by the hand" in helping them to design microcontroller prototypes.

The microcomputer board, called Little Bit, is built around the F8 microprocessor from Fairchild Camera and Instrument Corp. But the board, which sells for \$125 in hundreds, might be upstaged by the service that goes along with it.

"What we're actually selling are the board, service, and software as a cohesive unit," says the company's president, Thad Jones, "and it's not an easy package to market." Jones explains that ETI is aiming at those manufacturers whose production quantities are too limited to warrant heavy investment in controller development.

Little Bit simplifies this development. Specifically, since control applications seldom require much in the way of main and program memory but need a lot of input/output capability, the board carries only 1,024 bytes of programmable read-only memory and 64 bytes of random-access memory but has 32 bidirectional I/O lines.

One of the ways ETI saves customers' money is through the use of a timesharing network for software development. The company charges only \$17 per hour for the service, which includes all computing and

printing charges. The network is Terminet, part of the National Computer Network of Chicago, which has locations in 80 cities across the country.

"Using the timesharing, a customer can get us on the phone to discuss a problem, and we can both look at his program listing simultaneously," says Jones. Terminet also provides services like remote printing of listings and loading of programs onto paper tape. "With timesharing," Jones points out, "the customer can do a lot of development and testing that couldn't be done with a box sitting on his table."

An unusual service offered by ETI is what it calls "dial-a-PROM." Dial-a-PROM lets customers send their microprograms over phone lines by modem and order them to be stored into a PROM. ETI can also access the program from a dataset stored in the Telenet library. Says Jones, "We usually offer next-day service, but a customer in a hurry can have his programmed ROM in a half-hour if need be."

Jones makes the point that the actual operation of the F8 microprocessor, which was chosen because of its orientation towards control applications, need not be completely understood by the user. "We're more dedicated to the niche of control technology—not to the processor itself," he says. "Next year we could change over to the Intel 8085, or some other microprocessor that might be better suited for control, and the users wouldn't feel any effects at all."

Plans for the future include the introduction of Little Bit More, an enhanced version of the controller board, which, to date, has been employed in windmill power-generating systems, motor starters, and heating-system controllers.

The \$125 price of the single-board controller does not include the erasable programmable ROM, which—fully programmed—is an additional \$20. Delivery of the Little Bit is from stock.

Environmental Technology Inc., 2821 West Sample, South Bend, Ind. 46619. Phone (219) 233-1202 [361]

Board interfaces computers with calculator chips

Users of 8080, Z-80, 6800, and other microprocessor systems can now perform mathematical functions not provided for in many Basic interpreters and Fortran compilers if they interface their devices with an inexpensive board to a powerful scientific-calculator chip: MOS Technology's 7529-103.

With the board, calculations can be performed with less than 1 kilobyte of memory. Without it, if they can be done at all, they require from

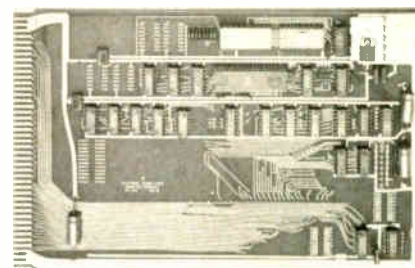

8 kilobytes to 16 kilobytes.

Two versions of the board are available: the RM series, which is compatible with the Motorola Exorcisor bus and a second version that works with the S-100 bus. The RM unit is easily adaptable to Intel SBC 80/10 systems. Software is included for both 8080 and 6800 systems. The board is available in kit form for \$99.95.

Mini Micro Mart, 1618 James St., Syracuse, N. Y. 13204. Phone (315) 422-4467 [365]

Compact DC100A cartridge drive stores 672,000 bytes

An extremely small drive for the 3M Company's DC100A miniature data cartridge weighs about 1 pound and stores up to 672,000 bytes of unformatted data on the cartridge's 140 feet of tape. Designated the model 200 Minidrive, the storage module measures only 3 by 4 by 4.125 inches. In its basic OEM form, the Minidrive includes a tape-transport mechanism and such essential elec-

AVX SkyCaps® They're economically number 1.

AVX SkyCaps give you more for less. Like more consistent life-cycle performance at operating voltage frequency and temperature. More to select from in our broad range of sizes and ratings. And more quality than you're used to for the price.

SkyCaps cost less because at AVX, we make them better.

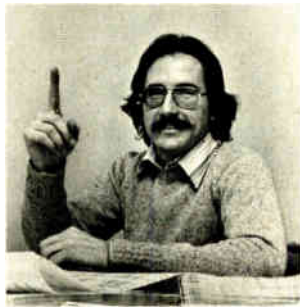

And faster. Which means that SkyCaps are immediately available in volume from your service-oriented AVX distributor.

Call for a quote from the local AVX Representative or Distributor in your area.

He'll show you how easy it is to save with AVX SkyCaps.

AVX Ceramics, P.O. Box 867, Myrtle Beach, SC 29577 (803) 448-3191
TWX: 810-661-2252; Olean, NY 14760
(716) 372-6611 TWX: 510-245-2815
AVX Limited, Aldershot, Hampshire, GU12 4RG England, Tel: Aldershot (0252) 312131 Telex: 858473

AVX: The Insiders



SkyCap dipped monolithics are available in the broadest range of sizes and ratings.

Dimensions

Body: 0.15 square to 0.5 square
Leads: Length 1.25 standard (others available)
Space 0.1 to 0.4 standard (others available)

Capacitance: 4.7pf to 4.7mfd

Voltages: 50, 100VDC

Three temperature characteristics



AVX Distributors: Cramer Electronics / Elmar Electronics / Future Electronics / Jaco Electronics / Liberty Electronics / Texas Instrument Supply Company

New products

tronics circuitry as read and write amplifiers, a motor-drive amplifier, speed-control circuitry, track-selection logic, and so on.

Three capacities are offered: a one-track version stores 168,000 bytes at a density of 800 bits per inch; a two-track version stores 336,000 bytes at the same density;

and the top unit stores 672,000 bytes at a density of 1,600 b/in. Data-transfer rates are 24,000 bits per second for the 800-b/in. units and 48,000 b/s for the high-density drive.

In addition to the basic unit, the drive can be furnished complete with all the interface and control circuitry



needed to make a complete functioning memory.

The basic one-track 200 Minidrive sells for \$250 in unit quantity and \$205 each in hundreds. The no-frills 672,000-byte unit has a one-piece price of \$350. The one-track unit with all the electronics needed to make a functioning recorder sells for \$485 (\$397 each in hundreds). Delivery times for all units are about four weeks.

North Atlantic Industries Inc., Qantex Div.,
200 Terminal Dr., Plainview, N. Y. 11803.
Phone (516) 681-8350 [364]

CABINETS WITH FLAIR

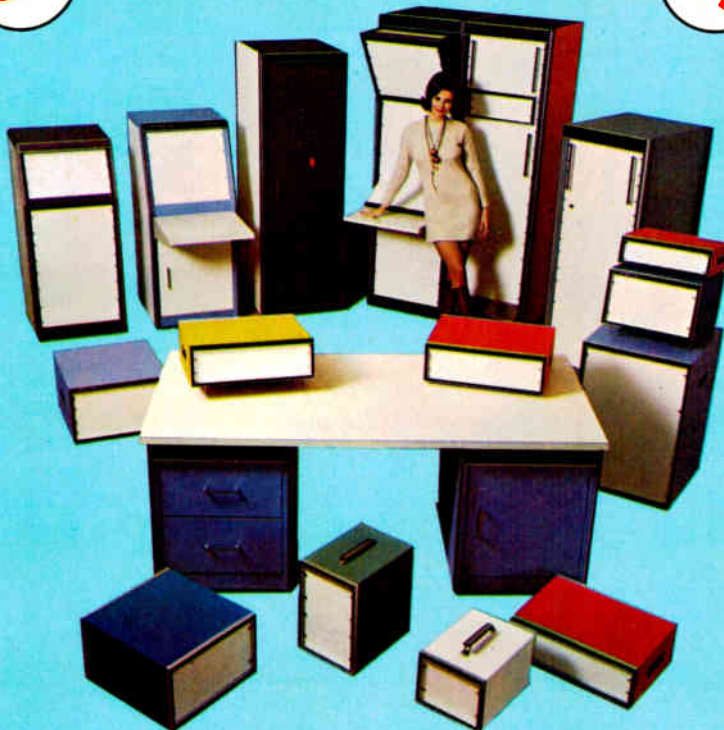

- Elegant Designs** for marketing power...
- Rugged Construction** for practical packaging...
- Many Models and Sizes** for space requirements...
- Accessories** for completion of enclosure needs...
(panels, fans, blowers, slides, outlet strips, shelves, drawers, chassis, hardware, etc.)

You can rely on Premier for quality,
good delivery, and surprisingly low prices.

write for complete catalog and prices



PREMIER METAL PRODUCTS CO.

381 CANAL PLACE, BRONX, N.Y. 10451 (212) 993-9200

Video terminal board uses Mostek 3870 micromputer

Sized to work with S100 systems, an inexpensive video terminal board that needs only a keyboard and TV monitor to form a full-duplex video terminal is built around the Mostek 3870 microcomputer. Called the SCT-100 single-card terminal, the board provides both absolute and relative X-Y cursor control, screen clear, clear to end of line, page mode, and autoscroll features. It has a repertoire of 96 characters.

The SCT-100 is available in three forms. A completely assembled and tested board sells for \$185, a complete kit goes for \$155, while a partial kit that includes the printed-circuit board, the custom-programmed 3870 microcomputer, and the character-generating read-only memory is priced at \$85.

Vectron, P. O. Box 20887, Dallas, Texas
75220. Phone (214) 350-5291 [366]

Who put long-track stability into a ceramic trimmer no larger than this?



CENTRALAB!

Centralab, a leading producer of ceramic-based trimmer resistors, now offers the long-track stability of full-size trimmers with a resistor element measuring .750" in a unit only .475" x .640" . . . and with terminals which meet IEC requirements of 0.100" spacing.

We call it "Series R".

Despite its miniature size, this new trimmer provides set-stability of 0.2% total voltage, thanks to its long-track resistor element which permits 300° mechanical and 260° electrical rotation.

In addition to big-trimmer stability, the new Series R retains all the most-wanted quality features of the Centralab Series S. See the cutaway view and listing of features at right.

Shown above are prices for both series of Centralab trimmer resistors.

For full specifications and complete pricing for the Series R, talk to your Centralab Technical Representative, or call (915) 779-3961.

PRICING

(1,000 lot quantities)

	Series S Vert. Mount	Series S Horz. Mount	Series R
CERBON™	.17	.19	.20
CERMET	.26	.28	.29

Products you need from people who care.



CENTRALAB

Electronics Division
GLOBE-UNION INC.

7158 MERCHANT AVENUE
EL PASO, TEXAS 79915

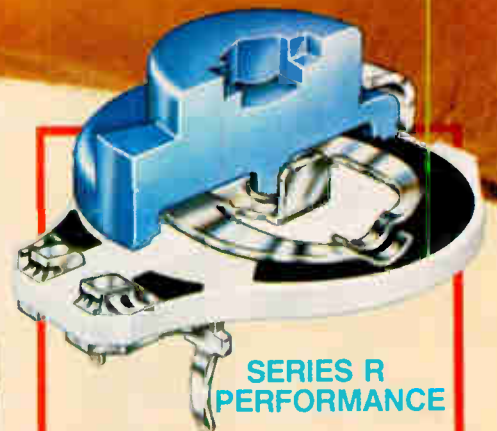

SERIES R PERFORMANCE

Set-stability, Adjustability, Low Noise

- Long-track resistor element.
- Dual tine contacts.
- Mechanical ruggedness.

Reliability

- Ceramic substrate.
- Rigid soldered terminals with hold-in option.
- "Fluxgard" environmental protection.

Flexibility

- CERBON and cermet resistor systems.
- 1-¼ watts cermet, ¾ watts CERBON.
- Hex hole/screwdriver and screwdriver/finger adjust knobs.

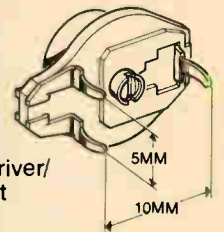

The computer you can call your own.



The System 8813 from PolyMorphic Systems is a complete, powerful problem solver in a walnut cabinet. This microcomputer allows you to quickly formulate and solve sophisticated financial, scientific, and engineering models from the convenience of your office or den.

The English language commands of our disc BASIC programming language permits easy use of our video graphics and disc files. Complete systems are available as low as \$3250. See it at your local PolyMorphic Systems dealer.

**PolyMorphic
Systems**

460 Ward Dr., Santa Barbara, CA 93111 (805) 967-0468

Circle 122 on reader service card

1977 Answer Book. It makes your job easier. \$25.

"WHO MAKES
WHAT?"

"WHAT
COMPANIES
MAKE THE
PRODUCTS
I NEED?"

(See alphabetical
directory of
4000 products)

"WHERE ARE
THEIR NEAREST
SALES OFFICES?"

"WHO
ARE THEIR
DISTRIBUTORS?"



"WHAT ARE THEIR
LOCAL PHONE
NUMBERS?"

(See alphabetical
directory of over
5000 manufacturers)

"HOW CAN I
GET THEIR
CURRENT
CATALOGS
FAST?"

(See directory of
catalogs by product
and by company,
including catalog
inquiry cards for
5-second ordering)

"WHO
MANUFACTURES
THIS TRADE NAME?"

(See directory of
trade names)

Electronics Buyers' Guide
1221 Avenue of the Americas, New York, N.Y. 10020

Yes, send me a copy of Electronics Buyers' Guide. I've enclosed \$25 (USA and Canada only, elsewhere send \$35). Full money back guarantee if returned within 10 days.

Name _____

Company _____

Street _____

City _____

State _____

Zip _____

New products/materials

A polyester-film tape with a thick layer of adhesive is designed to protect printed-circuit patterns during solder stripping and final gold or rhodium plating of finger tabs. Translucent 576 plater's tape consists of 3.1 mils of silicone adhesive on a 1-mil polyester film; its thick adhesive coating provides excellent conformability to circuit lines, eliminating undercutting and leakage. When removed, the tape leaves no adhesive residue.

Finite Industries Inc., 2 S. Commercial Ave., Carlstadt, N. J. 07072. Phone (201) 939-0565 [476]

Void-free rosin-cored solders for manual and automated soldering consist of a central core of solder, an intermediate layer of rosin flux, and an outer layer of solder. Because the outer sleeve of solder is very thin, it melts quickly, resulting in fast flux release and simultaneous flow, chemical action, and wetting. Called Cen-Tri-Core II, the solder is available in 60Sn/40Pb alloy, 32 to 156 mils in diameter, with 2.4% or 3.6% of either a mildly activated or fully activated flux. Other alloys, diameters, and flux percentages can be made on special order. Packaging is in 1-, 5-, and 20-pound spools.

Alpha Metals Inc., Route 440, Jersey City, N. J. 07304. Phone (201) 434-6778 [477]

A high-temperature coating for insulating thermocouples, Cerama-Dip 538 has a high alumina content for good thermal conductivity. The material, which has a dielectric strength of 100 volts per mil at 1,000°F, can



be used up to 3,200°F. It is a thixotropic paste that can be dipped or brushed onto the ends of thermocouples to insulate them. A kit consisting of one quart of Cerama-Dip base and a quart of thinner sells for \$46.20. It is available from stock.

Aremco Products Inc., P. O. Box 429, Ossining, N. Y. 10562. Phone Herbert Schwartz at (914) 762-0685 [478]

The Story of a Routing List Dropout

(as told in the tormented words of the victim)

inter-office memorandum

To: Ruth [REDACTED] Don [REDACTED]
From: [REDACTED] Corp.
Subject: Library, Room C-2 Engineering
42nd fl. 32nd fl.
Routing List

Dear Ruth:

I'm returning the Electronics magazine routing list you sent me.

As you suggested, I contacted everyone on the list to find out who was sitting on the June 9 issue I'm looking for. You may be interested in the results:

1. I found two other people were looking for the same issue.
2. Fred K thought he had it in his briefcase, which he thought he had left in the Palo Alto office.
3. It was finally found in a pile of incoming mail in Bill Johnson's office. Bill, as you may or may not know, retired from the company three months ago.
4. With great anticipation I turned to the article on microprocessors which Mr. Snyder had referred to in a meeting. You remember Mr. Snyder. He is our President and Founder. He asked me to read the article. I turned to the article. The article wasn't there. Somebody had clipped the article out of the magazine.

Ruth, as you probably know, I am not a man to part with money lightly. But I have sent in the subscription card which by some miracle was still intact in the back of the magazine. I am going to have my very own subscription. It is going to my very own house. Therefore it is with undisguised pleasure that I ask you to

DROP ME OFF YOUR ROUTING LIST.

Don

Note to other routing list victims:

Turn to the subscription card in the back of this magazine.

Fill it out. Mail it in. We can't promise you happiness.

But you will remove one frustration from your professional life.

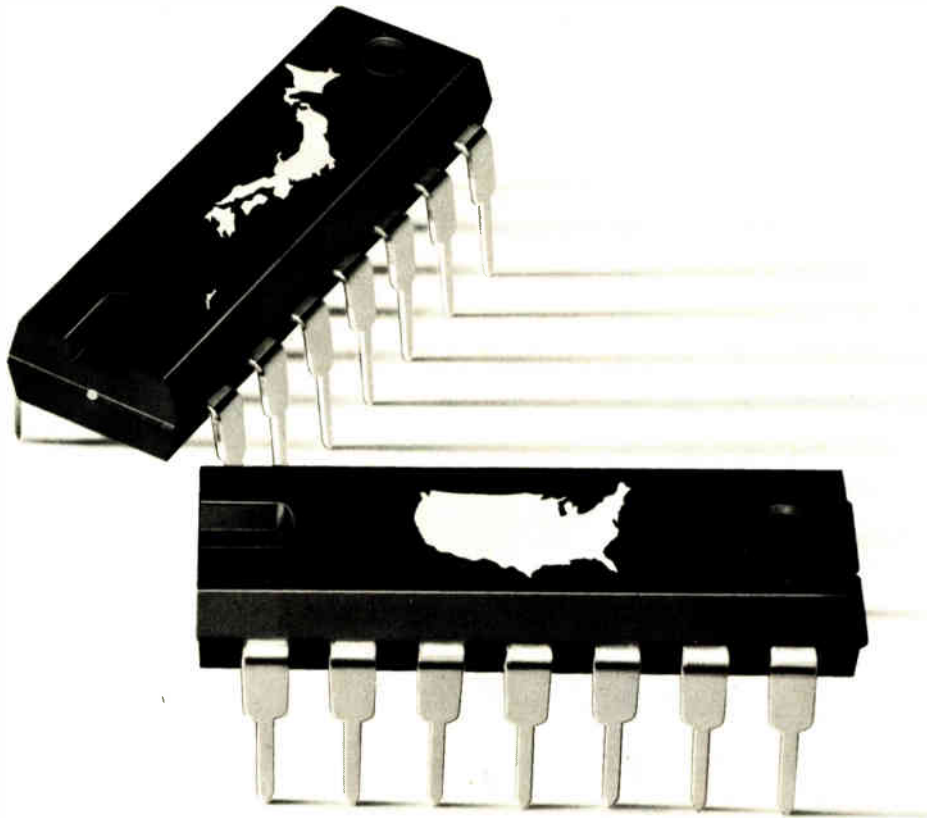

We Know You Need a Special Circuit in Japan.

To many—even the most seasoned businessmen in the electronics field—finding the way to make profitable deals with their Japanese counterparts may seem as much a labyrinthine maze as complicated circuit wirings look to the man in the street who only knows how to plug in and turn on his electrical appliances. It is not really so. Japan is actually engaged in extensive import and export of electronic products, technology and know-how with all nations all over the world. But, whether it is a simple purchase or a complex exchange agreement or tie-up,

it is done differently because the Japanese are different.

We are Japanese and publish Nikkei Electronics, a biweekly magazine in Japanese, and our readers are the people who run the show and have brought Japan to the fore in electronics today.

You can think of Nikkei Electronics as that special circuit design that will deliver the signal you want to the proper terminal, to that profitable deal you are looking for. If you try a short cut you may end up with a short circuit. The failure free way is through Nikkei Electronics.

Japan's foremost electronics publication

Nikkei Electronics

NIKKEI-McGRAW-HILL, INC.
The publisher of Nikkei Electronics
Wataru Makishima, Manager, Advertising,
Nikkei Annex Bldg. 2-1-2, Uchi-Kanda, Chiyoda-ku,
Tokyo, Japan. Telex: J26296 NKMCGRW

Subscriptions: 35,261 (as of May 30th, 1977)
Regularly audited by the Japan ABC

For further information, write to:
H.T. Howland, Marketing Services Manager,
Electronics, McGraw-Hill Publications Co.,
1221 Avenue of the Americas, New York,
N.Y. 10020, U.S.A. Tel: (212) 997-6642

THE ELECTRONICS CONFERENCE ON MANAGING ENGINEERS

sponsored by Electronics,
McGraw-Hill's International Magazine of Electronics Technology

The growing
challenge of
motivating, training,
and utilizing the EE

*If you hire, fire, manage, motivate, train, or educate EEs,
here are some facts that you should know:*

- *74% of 1,300 engineers surveyed this year by Electronics believe that electrical engineers in the next decade will not attain the professional status of physicians or lawyers;*
- *55.4% think that employers practice age discrimination;*
- *51.5% are only moderately satisfied with their engineering careers;*
- *Over 45% said that their companies do not have adequate dual ladder systems for engineers who prefer to stay in technical assignments;*
- *Fewer than half of those responding—45.3%—said that employers usually recognize engineering contributions appropriately;*
- *49.4% feel underutilized in their present positions;*
- *Many engineers believe that promotions are slow in coming.*

These are just a few of the findings from the Electronics survey of engineers' attitudes. Such career-oriented attitudes will be analyzed at the Electronics Conference on Managing Engineers at the Fairmont Hotel in San Francisco on November 8th, and at the McGraw-Hill Corporate Headquarters in New York City on November 15th. You can't afford to miss the opportunity to learn more about the significant role managers must play in successfully handling these emerging EE career problems.

Conference Program:

9:00-9:30 AM Electronics Career View Survey

What are 1,300 electrical engineers' attitudes toward the engineering career, its satisfactions and frustrations? What is the impact of the microprocessor on the way EEs do their jobs? What are the future career trends, both professional and technical?

Gerald M. Walker
Senior Editor
Electronics

10:00-11:00 AM The Thompson-Dalton Study of the Four Stages of Career Development

How do you get a company to recognize the problem of obsolescence—the corporation's and the individual's? What is the relationship between age and performance? How can you educate management to include the EE's career in its planning? How do you convince management that the project engineer is as important as the project?

Gene W. Dalton
Professor of Organizational Behavior
Brigham Young University

Paul H. Thompson
Associate Professor and Chairman
Department of Organizational Behavior
Brigham Young University

11:00-1:00 PM

Coping with the problems of education, motivation, and utilization of the EE

Part I: The academic world: Can engineering schools stay up-to-date with current technologies—especially in the field of microprocessors? Is there too much theory and not enough practical application?

Is it necessary to achieve a graduate degree or is an MBA more valuable? How can universities counter complaints of current graduates—unqualified instructors, inadequate textbooks, etc?

James D. Bruce

Associate Dean
School of Engineering
Massachusetts Institute of Technology

Kenneth S. Down

Assistant Dean and Director,
Stanford Instructional Television Network
School of Engineering
Stanford University

Part II: The Corporate World: How do you deal with the underutilized EE? The problems of shifting technologies? Career anxiety? Career motivation? Is the 'dual ladder' a myth? What should the EE consider when deciding to remain in technology—financial gain, career potential, etc? What in-house programs have corporations developed to keep EEs updated?

William O. Nilsson

Corporate Training & Management
Development Manager
Hewlett-Packard Company

1:00-2:15 PM

Luncheon

2:30-3:30 PM

Is competency assessment the wave of the future?

Is it possible to identify the successful performer? What are the pros and cons? The alternatives?

George Klemp

Director of Research
McBer and Company

Other speakers to be announced

3:30-5:00 PM

Performance Appraisal

Should performance appraisal become an integral part of the career development program? Is forced turnover an effective means of achieving high performance? Is it possible to quantify performance so that the individual who is of most value to the department receives the best salary?

John D. Porter

Organizational Development Consultant
Lawrence Livermore Laboratory

C. R. Wischmeyer

Director of Education
Bell Laboratories

Your registration fee includes the *Electronics* 140-page survey of over 1,300 electrical engineers (the survey will not be sold independently), and the magazine's three-part editorial analysis of the Career View Survey.

NOTE: While the program issues will remain the same in both New York and San Francisco, some of the above speakers will appear in only one city.

Who should attend . . .

- Design and development managers
- Engineering services managers
- Basic research managers
- Manufacturing and production managers
- Training directors
- Personnel directors
- Engineering school deans and professors
- Career counselors and consultants

Send registration form to:

McGraw-Hill Conference & Seminar Group
1221 Avenue of the Americas—Room 3677
New York, New York 10020
(212) 997-4930

THE ELECTRONICS CONFERENCE ON MANAGING ENGINEERS

The growing challenge of motivating, training, and utilizing the EE

___ San Francisco, November 8, 1977, Fairmont Hotel

___ New York, November 15, 1977, McGraw-Hill Corporate Headquarters

Conference fee: \$250 Academic fee: \$150

Name _____
Title _____
Company _____

Company address _____
Company telephone _____
Signature _____

Check one: Payment enclosed Please bill me directly Please bill company

Cancellation policy: Cancellations made less than seven days prior to the conference are subject to a \$25 fee.

You may, if you wish, send a substitute in your place.



E 1234

BUILD YOUR OWN POWER SUPPLIES WITH Δ LAMBDA'S 270 WATT POWER HYBRID VOLTAGE REGULATOR.

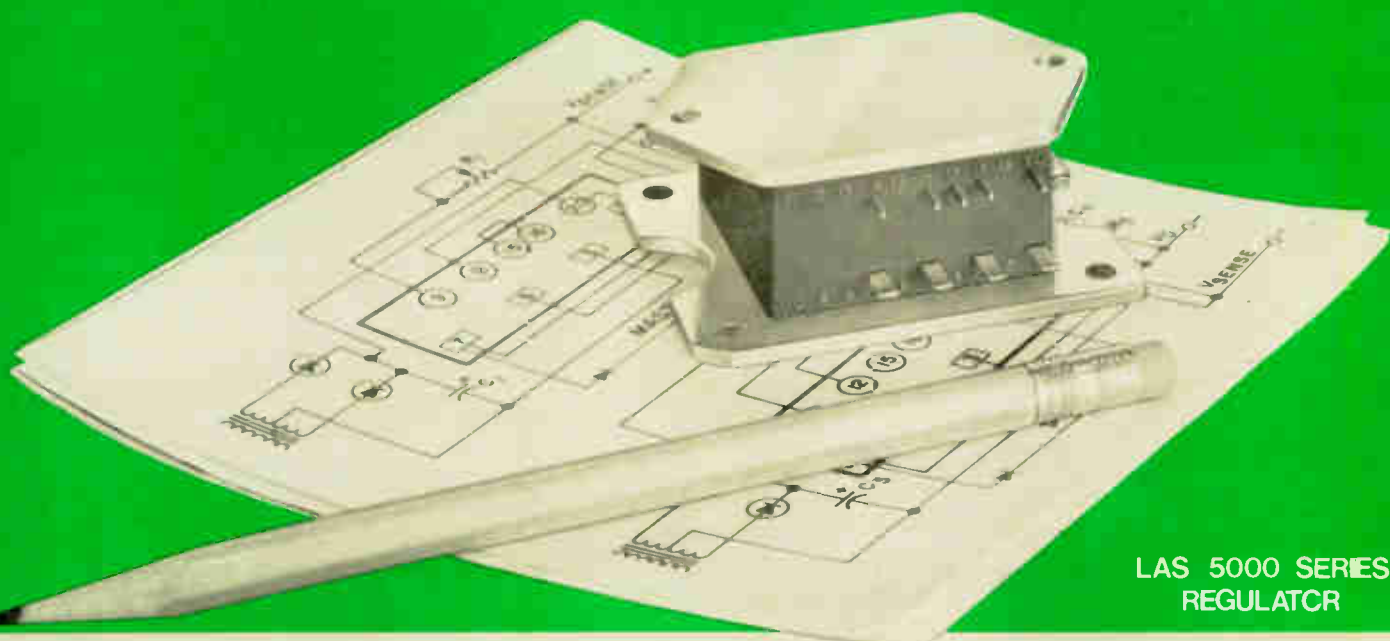

**LAS 5000 SERIES
REGULATOR**

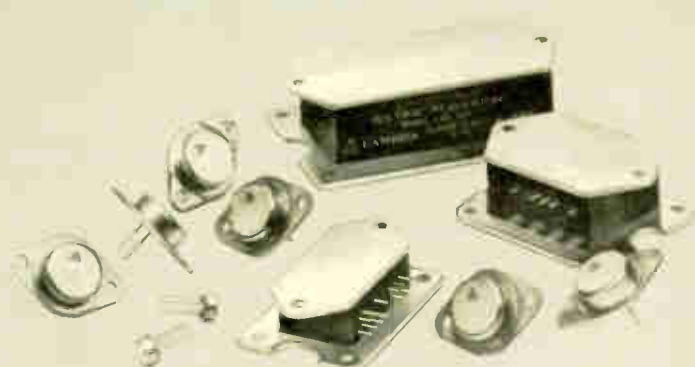

**Up to 28V, up to 20A
0.01% line reg, 0.2% load reg
built-in short circuit and overload protection
replaces up to 40 components for simple circuit design**

LAS 5000 SERIES

Regulator Performance Specifications

20 amp, 270 watt positive regulator

General Description

The LAS 5200 Series of Power Hybrid Voltage Regulators is designed for applications requiring a well regulated output voltage for load current variations up to 20 amperes. A key feature of the LAS series of Power Hybrid Voltage Regulators is its construction. A high degree of thermal isolation between the heat generating power elements and the heat sensitive control and reference elements is achieved by the placing of the power section on the heat-dissipating base of the unit, and the control stage on the heat-dissipating upper surface. This thermal isolation results in extremely low thermal drift characteristics for changes in power levels. In addition, a unique thermal power limiting circuit is built into the power section of the unit for increased operational reliability. This reliability is accentuated by a demonstrated MTBF of 100,000 hrs.

PARAMETER	SYMBOL	CONDITIONS	MIN.	MAX.	UNITS
Input voltage to pin (1) ^(A) (H)	$V_{IN}(1)$		7.25	40.0	volts
Input voltage to pin (20) ^(A) (G)	$V_{IN}(20)$		11.9	40.0	volts
Output voltage	V_O		4.75	29.4	volts
Input-output differential ^(A) (F)	$V_{IN}(1) - V_O$		2.5	28.6	volts
Input-output differential ^(B) (F)	$V_{IN}(20) - V_O$		7.20	28.6	volts
Output current	I_O			20.0	amps
Standby current	$I_Q(1)$			30.0	mA
Standby Current	$I_Q(20)$			7.0	mA
Power dissipation	P_D	Plate #1 @25°C		270	watts
Power dissipation	P_D	Free Air @25°C Amb		11	watts
Thermal resistance junction-Case #1	$\theta_j - C1$			0.65	°C/watt
Thermal resistance junction-free air	$\theta_j - FA$			12.0	°C/watt
Storage temperature	T_S		-55	+125	°C
Power transistor junction temperature	T_j			+200	°C
Regulation line ^(C)				0.014	%/ ΔV_{IN}
Regulation load ^(D)				0.2	%
Programming resistance				1000 nominal	ohm/volt
Programming voltage				one/one	volt/volt
Temperature coefficient				0.015	%/°C
Ripple attenuation ^(E)		$V_{IN}(1)$ minimum 60 I_O maximum			dB

NOTES:

- A. Separate DC input voltages for power circuit (pin 1) and control circuit pin (20).
- B. Common input voltages for power circuit (pin 1) and control pin (20).
- C. I_O constant for entire input voltage range from [$V_{IN}(1)$ & $V_{IN}(20)$ min.] to [$V_{IN}(1)$ (20) max.]
- D. V_{IN} constant for entire range from 0 to full load.
- E. Ripple attenuation is 54 dB min. for 24V and 28V models.
- F. Minimum input-output differential based on $T_j > 25^\circ\text{C}$.
- G. For AC source to Pin 20 with source resistance less than 10 ohms, minimum VAC = 12V rms. For other conditions consult factory.
- H. Maximum input voltage is 30V for LAS 5205 and 5206.

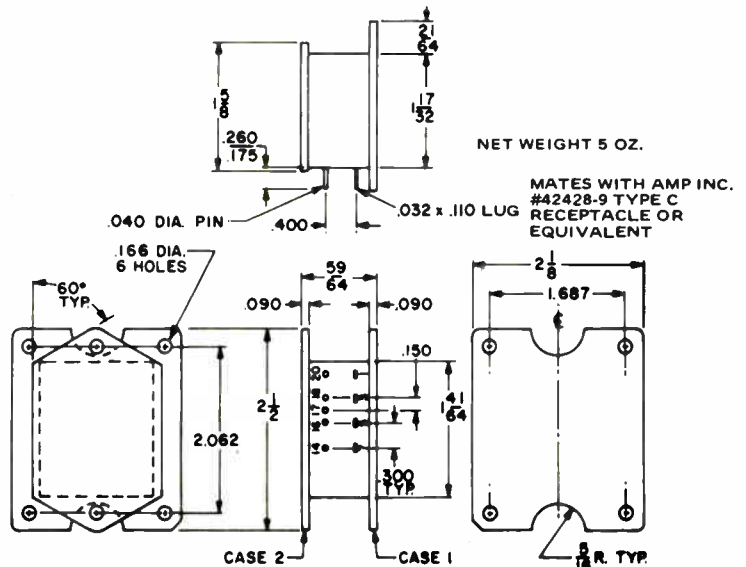

OUTLINE DRAWING, POWER HYBRID VOLTAGE REGULATOR, LAS 5000 SERIES



VTGE VOLTS	MODEL	I_O AMPS	PRICE QTY						
			1-24	25-49	50-99	100-249	250-499	500-999	1000
5±5%	LAS 5205	20	\$80	\$65	\$55	\$46	\$46	\$42	\$38
6±5%	LAS 5206	20	80	65	55	46	46	42	38
12±5%	LAS 5212	15	80	65	55	46	46	42	38
15±5%	LAS 5215	15	80	65	55	46	46	42	38
24±5%	LAS 5224	14	80	65	55	46	46	42	38
28±5%	LAS 5228	13	80	65	55	46	46	42	38

LAS 5000 SERIES

Operational Data

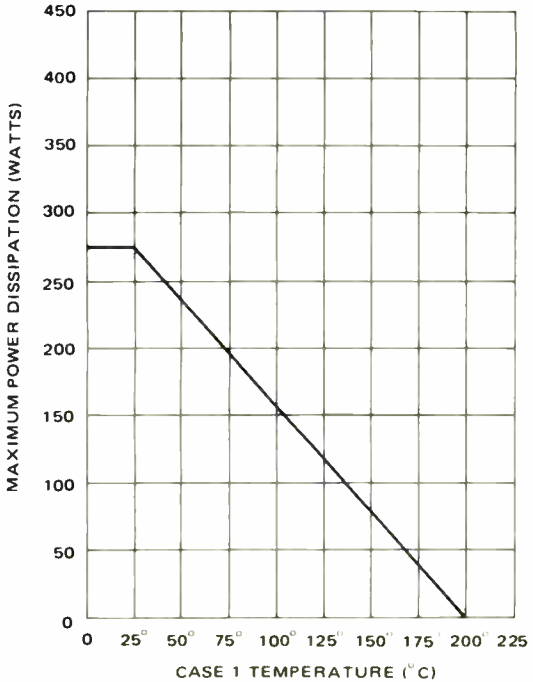

POWER DERATING CURVE AS A FUNCTION OF CASE 1 TEMPERATURE

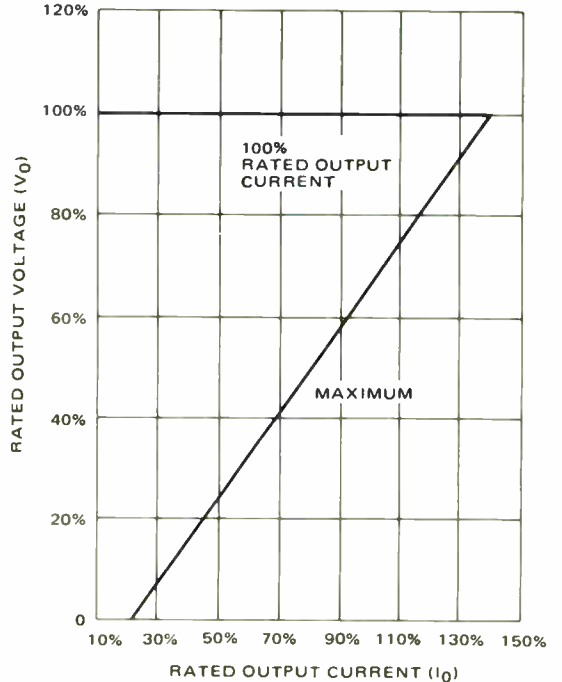

SHORT CIRCUIT PROTECTION CHARACTERISTIC, LAS 5000 SERIES

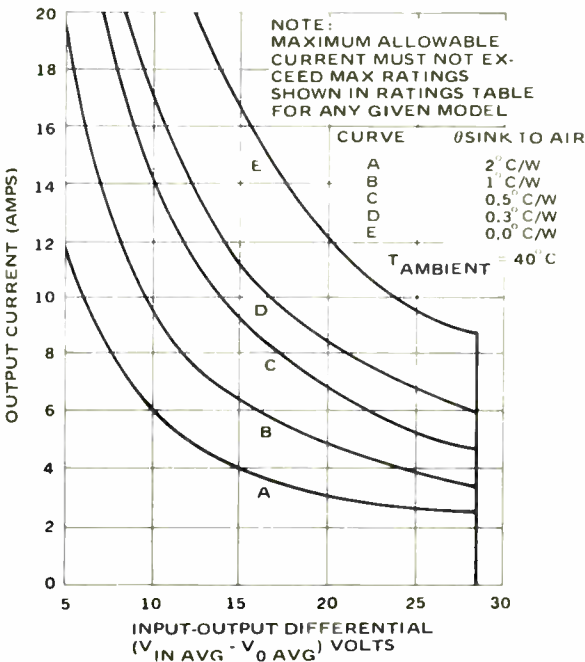

DC SAFE OPERATING AREA AS A FUNCTION OF HEATSINK THERMAL RESISTANCE TO AIR AT 40° AMBIENT TEMPERATURE FOR LAS 5000 SERIES

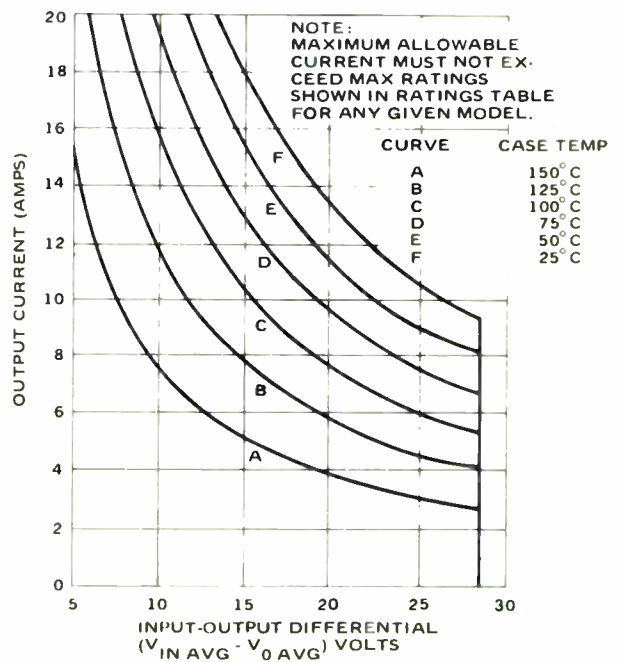

DC SAFE OPERATING AREA AS A FUNCTION OF MODULE CASE TEMPERATURE FOR LAS 5000 SERIES

LAS 5000 SERIES

Connection Diagrams

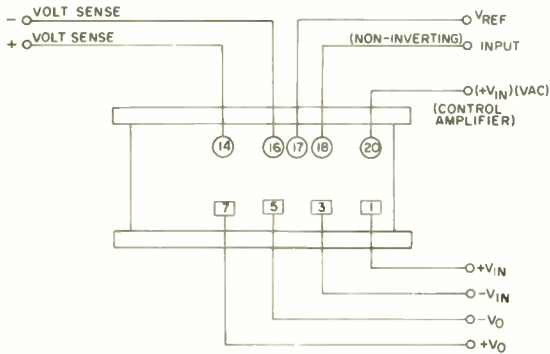

9-PIN POWER HYBRID VOLTAGE REGULATOR

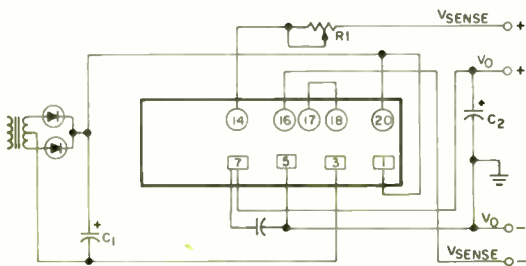

POSITIVE POWER HYBRID VOLTAGE REGULATOR CIRCUIT

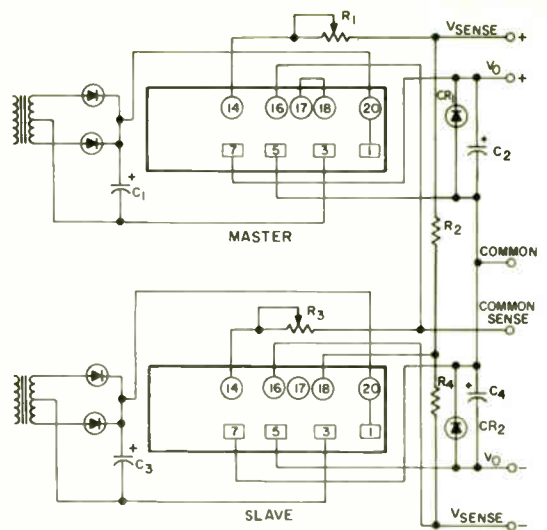

DUAL TRACKING POWER HYBRID VOLTAGE REGULATOR CIRCUIT

NOTES

1. Minimum value of input filter capacitors C1 and C3 is determined by: $C_1, C_3 = I_o$ (1000 mfd/amp) recommended.
2. Minimum value of output capacitors C2 and C4 is determined by: $C_2, C_4 = I_o$ (100 mfd/amp).
3. Minimum value of output voltage adjust resistors R1 and R3 or LAS 5205, ohms. See note 4 to determine value for all other models.
4. Minimum value of output voltage adjust resistors R1 and R3 is determined by: $R_1, R_3 = (0.25V_o \times 1000\Omega/V)$ ohms wirewound. Use next highest standard value.
5. Values of tracking reference voltage divider resistors R2 and R4 for all models are determined by:
 - a) $R_2 = (2000V_o - 2490)$ ohms, $\pm 1\%$, $\frac{1}{2}W$ film
 - b) $R_4 = 2.49K$ ohms, $\pm 1\%$, $\frac{1}{2}W$ film
6. Rectifiers CR1 and CR2 should be rated at peak inverse voltage of 50V and forward current equal at least to maximum rated I_o .

▲ Lambda staffed sales and service offices

1

MID-ATLANTIC REGION
Melville, New York 11746
515 Broad Hollow Road
Tel. 516-694-4200
TWX: 510-224-6484

Long Island, N.Y.; New York, N.Y.;
Northern New Jersey
Tel. 516-694-4200

Delaware; Eastern Pennsylvania;
Southern New Jersey
Tel. 215-279-5644

Maryland; Dist. of Columbia;
Northern Virginia
Tel. 703-451-9340

Southern Virginia;
North & South Carolina;
Alabama; Georgia;
Tennessee; Mississippi
Tel. 704-542-1991

2

NORTH-EASTERN REGION
Lexington, Massachusetts 02173
2 Militia Drive
Tel. 617-861-8585
TWX: 710-326-7558

Rochester, New York
Tel. 716-454-6770

Poughkeepsie, New York
Tel. 914-297-4800

3

SOUTH-WESTERN REGION
Dallas, Texas 75231
6950 Winchester
Tel. 214-341-5130
TWX: 910-861-9048

Houston, Texas
Tel. 713-464-6554

Oklahoma
Tel. Enterprise 2 183

Largo, Florida
Tel. 813-596-5151

4

MID-WESTERN REGION
Arlington Heights, Ill. 60005
2420 East Oakton St., Unit C
Tel. 312-593-2550
TWX: 910-222-2856

Minneapolis, Minnesota
Tel. 612-935-6194

Cleveland, Ohio;
Western Pennsylvania
Tel. 216-585-7808

5

FAR-WESTERN REGION
Carson, Calif. 90746
20601 S. Annalee Ave
Tel. 213-537-8341
TWX: 910-346-7649

Denver, Colorado
Tel. 303-779-9561

6

NORTH-WESTERN REGION
Sunnyvale, California 94066
599 N. Mathilda Ave., Suite 210
Tel. 408-738-2541
TWX: 910-339-9243

INTERNATIONAL

Lambda Electronics Corp., Export Dept
515 Broad Hollow Road
Melville, N.Y. 11746
Tel. 516-694-4200
TWX: 510-224-6484
Cable: Lambdatron, Melville, N.Y.

ENGLAND

Lambda Electronics
Abbey Barn Road, Wycombe Marsh
High Wycombe, Bucks HP 11 1RW
Tel. High Wycombe 36386/7/8
TWX: 837153
Cable: VEELAM HIWYC

CANADA

Veeco Lambda Ltd.
100C Hymus Blvd.
Pointe Claire, Quebec M9R 1E4
Tel. 514-697-6520
TWX: 610-422-3029

Veeco Lambda Ltd.
P.O. Box 501, Postal Station K
Toronto, Ont. M4P 2G9
Tel. 416-486-0794

FRANCE

Lambda Electronique S.A.
Route de Grivery
91 Gometz le Chatel
Address Postale: BP 77 91403 Orsay
Tel. 012 1487

GERMANY

Lambda Netzgerate GmbH
Lindenstrasse 93
D 7590 Achern 15
Tel. 078 41 5527
Telex 752209 Lake D

ISRAEL

IsLAMBDA ELECTRONICS LTD.
85 King Solomon St.
Tel Aviv, Israel
Tel. 240-672
TWX: 03-2470 COIN (IL) LAMBDA

JAPAN

Pan Electron Inc.
1 Higashikata-Machi, Midori Ku
Yokohama, Japan
Tel. 045-471-8811

LAMBDA MANUFACTURING PLANTS

Melville, N.Y.
Plant I: 515 Broad Hollow Rd.
Plant II: 1770 Walt Whitman Rd.
Reynosa, Mexico
Corpus Christi, Texas
121 International Dr.

**POWER SEMICONDUCTORS
DESIGNED, DEVELOPED
AND MANUFACTURED BY**



**LAMBDA
ELECTRONICS**

We know your needs. Electronics Magazine Book Series. Zero-risk trial offer.



1. Microprocessors

What you must know about available microprocessor technology, devices, information, 4th printing. \$8.95

2. Applying Microprocessors

2nd and 3rd generation technology. 26 detailed applications from data networks to video games. \$9.95

3. Large Scale Integration

Covers the basic technology, new LSI devices, LSI testing procedures, plus system design and applications. \$9.95

4. Basics of Data Communications

Includes 47 articles from Data Communications magazine covering more than 11 key areas. \$12.95

5. Circuits for Electronics Engineers

Contains 306 circuits arranged by 51 functions from Amplifiers to Voltage Regulating Circuits. Saves design drudgery. \$15.95

Electronics Book Series

P.O. Box 669, Hightstown, N.J. 08520



1. Send me _____ copies of "Microprocessors" at \$8.95 per copy.
2. Send me _____ copies of "Applying Microprocessors" at \$9.95 per copy.
3. Send me _____ copies of "Large Scale Integration" at \$9.95 per copy.
4. Send me _____ copies of "Basics of Data Communications" at \$12.95 per copy.
5. Send me _____ copies of "Circuits for Electronics Engineers" at \$15.95 per copy.

Discounts of 40% on orders of 10 or more copies.

I must be fully satisfied or you will refund full payment if the book is returned after ten-day trial examination.

Payment enclosed Bill firm Bill me

Charge to my credit card:

- American Express Diners Club
 BankAmericard Master Charge

Acc't No. _____ Date exp. _____

On Master Charge only, first numbers above name _____

Name _____ Title _____

Company _____

Street _____

City _____ State _____ Zip _____

Signature _____

Classified section FOR ENGINEERING/TECHNICAL EMPLOYMENT OPPORTUNITIES

CLASSIFIED SALES REPRESENTATIVES

Atlanta	Joe Lane	404/892-2868	Cleveland	Mac Huestis	216/781-7000	Houston	Mike Taylor	713/659-8381	Pittsburgh	Dean Genge	412/391-1314
Boston	Holt Buchanan	617/262-1160	Dallas	Mike Taylor	214/742-1747	Los Angeles	Stan Kassir	213/487-1160	San Francisco	M.E. Kenny	415/362-4600
Chicago	Bill Higgins	312/751-3733	Denver	Shirley Klotz	303/837-1010	New York	Larry Kelly	212/997-3594	Stamford	Holt Buchanan	203/359-2860
			Detroit	Mac Huestis	313/873-7410	Philadelphia	Dan Ferro	215/568-6161		XEROX 400 TELECOPIER	212/997-6800

These Positions Must Be Filled NOW

They tie into a series of long range programs involving state-of-art technology, and extraordinary opportunity for personal contribution with one of the nation's "Big Ten" electronics manufacturers.

Systems Engineers. We are looking for individuals with knowledge of the definition and solution of complex radar, communications, weapons and fire control systems problems. We seek in-depth experience in system and sub-system synthesis and analysis, computer control and technical direction of major proposals and related technical customer liaison. Individuals should have background in phased array technology, progressive system design knowledge, circuit design and system integration. Individual should be familiar with entire system, its inter-relations and inter-functions with ability to advise customer and to support high level engineering personnel. Hands-on experience in the following areas is desirable: Operations Research, Weapons System (Definition/Analysis/Simulation), Fire Control Systems Design.

Digital Logic Design Engineers. You will need a BSEE or technical degree in a related area plus 3-7 years' experience in GENERAL PURPOSE LOGIC DESIGN using high speed integrated circuit logic devices and familiarity with State-of-the-Art digital devices and computer aided design techniques. You should also have experience in DIGITAL CIRCUIT DESIGN, including A/D and D/A Convertors and Worst Case Design.

Signal Processing Design Engineers. Background should include a BSEE and 8-15 years' experience in Digital Logic Design (emphasis on Signal Processing techniques) and a thorough knowledge of Digital Hardware, Radar Principles, Timing, Coding/Decoding, Formatting, Data Transfer and Control Logic, including Worst Case Analysis.

Microwave Design Engineers. Background should include conceptual definition through design and development of microwave circuits & components necessary in design of antennas (including phase arrays) knowledge of computer applications and a familiarity with RF amplifier design, various type microwave & solid state devices, pulse modulator circuit design, fault sensing logic design.

If you have current experience in one of these areas, forward your resume, including salary history, in complete confidence to: **LRK ASSOCIATES**, 6845 Elm Street (EL-8), McLean, Virginia 22101. Or call us Monday through Friday at (703) 790-8640. **West Coast Division: LRK ASSOCIATES**, 16371 Beach Boulevard, Suite 141 (EL-7), Huntington Beach, California 92647. Call Monday through Friday at (714) 848-8494 or (213) 592-1915.

LRK ASSOCIATES

U.S. CITIZENSHIP
REQUIRED — representing
an equal opportunity employer m/f/h.

PRODUCT DEVELOPMENT ENGINEER (TRANSFORMERS)

A leading, national electro-mechanical manufacturer at a midwest location is seeking a professional engineer to develop a new manufacturing phase of its well established, seventy year old business. The individual we seek must be intricately familiar with transformer technology and manufacturing from the initial development and conceptual stages to final production and have a proven track record in all aspects of the process involved in the development of such a product line. Interested applicants may send resume and salary history in confidence to:

**P-5563
ELECTRONICS
Class. Adv. Dept.
P.O. Box 900
New York, N.Y. 10020**

An Equal Opportunity Employer

We have been placing graduate **ENGINEERS** in **FREE-PAID** positions THROUGHOUT THE U.S. since '59. Over 1,000 client companies. We are graduate engineers working full-time for you. Send resume & salary history today or request confidential application.
ATOMIC PERSONNEL, INC.
Suite L, 1518 Walnut St., Phila., Pa. 19102
An Employment Agency
For All Technical Fields

WHERE DO YOU FIT?

In today's job market, that is. One way to see if you're in demand is to check the employment opportunities contained in ELECTRONICS' Classified Section.

Another way to get a reading on your value is to place a blind (box number) Position Wanted ad there. The cost is low (only \$1.25 per line) and the results are often rewarding.

For more information call or write:

ELECTRONICS

Post Office Box 900
New York, N.Y. 10020
Phone: 212/997-2556

RATES \$46 per advertising inch (1/8"). Commissionable.
SIZES 1/8" to 10" deep in widths of one column (1 1/8"), two (3 3/8"), three (5 1/8"), and four (7").
CLOSING Two weeks prior to mailing.
MAILING One week prior to issue date.
ISSUE DATE Every other Thursday.
AD ORDERS/BOX NUMBER ANSWERS Send to Electronics, Post Office Box 900, New York, N.Y. 10020.

MAJOR NON-IMPACT PRINTER DEVELOPMENT

A growth opportunity for both non-impact and impact printer specialists

Computer Peripherals, Inc., the joint venture company of Control Data Corp., NCR Corp., and ICL, Ltd., has several key openings in a long term high technology program destined to make significant contributions to the state of the art. Impact printer specialists will also have opportunities to extend their expertise into the non-impact area.

NON-IMPACT DEVELOPMENT

MANAGER, INK JET TECHNOLOGY

You will be responsible for ink jet technology development for low speed non-impact printers, including direction of a staff of engineers, technicians, and design and drafting personnel. A BS degree plus a minimum of 10 years' related experience including project management, and low cost design engineering are required.

PRINCIPLE ENGINEERING SCIENTISTS

- Ink Jet Technology Selection, design & development of materials and processes
- Electrostatic Phenomena Extensive research in electrostatic deflection of ink droplets
- Fluid Mechanics Properties, flow, boundary, modeling and analysis of hydrodynamics

SENIOR ENGINEER, EPG

You will be a member of a technology team which will establish and provide design approaches for use in electrophotographic high speed printer products. Two to six years of EPG design and development experience with

specialization in EPG image development and fusing needed. BS degree in engineering or physical science or equivalent experience required.

MANAGER, MECHANICAL DEVELOPMENT

Leading the team responsible for development and application of mechanical aspects of ink jet technology, you will have a substantial annual budget, and a staff of approximately 10 engineers, technicians and support personnel. A BSME, MS preferred, plus a minimum of 10 years' related experience, including accountability for the design of a portion of a manufactured product are required. A background in low cost design and project management is also desirable.

PRINCIPAL SCIENTIST

Electrophotographic printers

Lead a technology development team in establishing design approaches to new products. Ten years' EPG design and development experience with specialization in EPG image development and fusing required. A BS in engineering or physical science is also required.

IMPACT PRINTER DEVELOPMENT

MECHANICAL DEVELOPMENT ENGINEER

You will be responsible for the development of a new generation of band printers utilizing low cost innovative designs, in addition to responsibility for development of band printer paper stacker. Your background must involve the ability to direct a staff of approximately eighteen engineers, technicians and design and drafting personnel. Position requires BSME or the equivalent (MSME desirable) and a minimum of ten years' previous related experience including previous design

accountability for a portion of a manufactured product, experience in project management and low cost design.

MECHANICAL ENGINEERS

Mechanical production design background including mechanical processes as they apply to design, and value engineering techniques. Proven product development experience with expertise in mechanisms, structures, electromagnetics, electronic packaging/cooling, and value engineering. A BSME or the equivalent plus 4-6 years' related design and manufacturing experience.

ELECTRICAL (Electronics) ENGINEERS

A strong background in electronic circuit design including digital logic design, microprocessor design, and programming is required. We are looking for a BSEE or the equivalent with 3 years' design experience and the ability to direct engineering support personnel, design analog and digital circuits, AC power, and servo mechanisms.

These positions, both in the non-impact and impact areas, offer exceptional career potential, competitive salaries and excellent benefits. For confidential consideration, please forward your resume including salary requirements to:

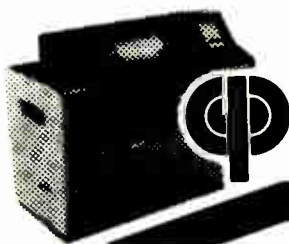

COMPUTER PERIPHERALS, INC.

Mr. Bob Brown
1480 N. Rochester Rd.
Box E-34
Rochester, Michigan 48063
1-313-651-8810

An Affirmative Action Employer



ELECTRONIC ENGINEERING

- In an Advanced Systems Group
- Emphasizing Technical Innovation
- For New Venture Development

These openings will not appeal to everyone. They are strictly for the exceptional EE who thrives on invention, on challenge, on diversity . . . and who also appreciates the career advantages of being in a long-term program of a \$1.5 billion corporation. A prime focus of our Advanced Systems Group is non-impact printing at extremely high speeds, utilizing new electronic and computer techniques. Our Group has already scored a series of breakthroughs, creating openings in these three units:

Technology Laboratories

Advancing state-of-the-art in Photography, Digital Image Processing, and Information handling.

DIGITAL DESIGN ENGINEER —Develop advanced concepts and applications for special purpose digital systems and microprocessors. Requires several years of logic and digital design experience. Exposure to computer design and configuration desirable.

Digital Systems

A leader in the development of Ink Jet Imaging technology.

ELECTRONIC ENGINEERS —Utilize at least 1-2 years or experience in any of these areas:

- Analog/Digital Circuit Design
- Minicomputer Interface
- CMOS, TTL Design • Microprocessor Applications
- Electromechanical Interface

Research & Development

Concerned with state-of-the-art studies, new applications and breakthroughs in Ink Jet Imaging technology.

ELECTRONIC/ELECTRO-OPTICAL ENGINEERS/PHYSICIST —Use strong experimental orientation and research experience in any of the following:

- Analog and Digital Circuit Design and Testing (specifically TTL, CMOS, and other logic families)
- Micro and/or Minicomputer
- Electro-Optical Systems • Acoustics
- Experimental Fluid Mechanics
- High Performance Analog Operational Amplifiers

You will join an outstanding multi-disciplinary team of engineers and scientists. The environment is exceptionally favorable to contributions and career advancement. Your experience and abilities will be evaluated carefully and fully recognized. Dayton offers a refreshing change for those seeking relaxed yet sophisticated living. To explore these opportunities, please send resume detailing pertinent achievements, in confidence to Manager, Professional Employment.

Mead
Advanced Systems Group

World Headquarters • Courthouse Plaza, N.E., Dayton, Ohio 45463
Equal Opportunity Employer M/F

Would you hire an engineer who couldn't understand this magazine?

Of course not. ELECTRONICS is the technical publication for technical people. If they can't understand it, they can't receive it. That's why, when you're looking for qualified engineers, you should consider our Classified Section.

For only \$46.00 per inch your recruitment advertising will reach 46,000 pre-screened engineers—that's just \$1 per thousand!—as they're reading to combat job obsolescence, while they're thinking about their future and bettering themselves.

There's no charge for typesetting and free layout service is provided.

For more information call or write:

ELECTRONICS

Post Office Box 900
New York, N.Y. 10020
Phone: 212/997-2556

A New Frontier for Hardware and Software Designers

Consider the growth potential, and unparalleled creative latitude involved in a technical evolution that encompasses an industry as large as the telephone systems of the U.S. and other countries.

It is underway! and GTE Automatic Electric, a major member of the GTE family, whose research and development expenditures ranked among the top 50 R&D spenders in U.S. Industry in 1976, is leading the way with a major expansion of the engineering, and all related support staffs. Our assignment . . . research and develop the communications systems of the future. Not a single system project, but a continuing evolution of sophisticated high speed, computer-controlled telecommunications systems.

SOFTWARE DESIGN ENGINEER

Responsible for the specification, design and testing of telephone systems support software, network and control software, or maintenance and diagnostics software. Prefer a minimum of 3 years' experience in structured design, coding, testing and documentation of programs; development with large data base on multi-file computers and real-time systems, HIPO design documentation, TSO usage and software simulation techniques. Requires a BS or MS in Computer Science or Electrical Engineering, and specialized study in the use of PL/I Fortran, Assembler, Intel 8080 and PDP-11 programming languages.

HARDWARE DESIGN ENGINEER

Primary responsibilities will cover the specification and design of the Common Control hardware system and development of control processors, memories, peripheral controllers, network, network controllers, and trunks. Prefer a minimum of 3 years' experience in diagnostic software and hardware development in large real-time systems, system architectural planning and digital logic design, and TSO and structural programming techniques. Requires a BS or MS in Electrical Engineering or Computer Science and specialized study in logic design, assembly or computer language programming and fundamentals of sequential design.

MANAGER, PROTOTYPE PRODUCTION . . .

and Prototype Test. You will direct the overall operations of a pilot production facility including scheduling, engineering, and test development related to the manufacturing-design, construction and testing of electronic switching system prototypes prior to their release to commercial production. A minimum of 8 years' experience, including management, plus fundamental knowledge of digital electronics and computer systems, and an engineering degree are required. MBA is preferred.

TELETRAFFIC ENGINEER

Responsible for the analysis of teletraffic probability and queuing problems on digital and analog switching systems and the development of computer programs for switching systems. Prefer a minimum of 3 years' experience in real-time control systems teletraffic problems, systems equipment quantities specification, and exposure to switching system specifications. Requires a BS or MS in Electrical Engineering, Computer Science or Math

and a strong statistical background and experience in PL/I or Fortran programming and model simulation.

ELECTRONIC PACKAGING ENGINEER

Will be engaged in the development and evaluation of electronic system packaging for effectiveness and cost reduction purposes. Includes development of packaging standards and maximizing effectiveness of hardware systems with respect to packaging density, thermal efficiency and I/O constraints at the PWC and file levels. Prefer 3 or more years' experience in electronic system packaging design and development and the functions of PWC generation. Requires a BS in Electrical Engineering, Mechanical Engineering or Applied Sciences and specialized study in packaging mechanics, materials and production processes.

COMPUTER AIDED DESIGN ENGINEER

Responsible for specification, design and implementation of integrated Computer Aided Design/Computer Aided Manufacturing (CAD/CAM) systems. Includes planning and design of information system architecture, data base systems, simulation systems, and the development of interactive user access and PCB Physical Design system. Prefer a minimum of 3 years' experience in software development for CAD or CAM systems, data base systems, data base administration, and interactive graphic systems or computer systems. Requires a BS, MS or PhD in Electrical Engineering, Computer Science, or Math and specialized study in high level programming languages and techniques.

CIRCUIT DESIGN ENGINEER

Will analyze, evaluate and test integrated circuit assemblies, discrete devices and prototype systems; generate specifications, parameter measurements and operational life testing; design test circuits and perform failure analysis on semiconductors. Prefer a minimum of 3 years' experience in integrated circuitry, design of logic systems (digital TTC IC families), failure analysis and assembly processes. Requires a BS or MS in Electrical Engineering or Physics and specialized study in semiconductors, integrated circuits, digital circuits, electrical measurement and programming.

Let's talk about the evolution in telecommunications, and what it can mean to your career. One of our representatives is standing by:

**CALL TOLL FREE
(800) 323-1966**

In Illinois (800) 942-0491

Sunday thru Friday from 8 am to 5 pm cst
If unable to call, please send your resume to:
Paul Jensen or Doug Allen

**GTE AUTOMATIC ELECTRIC
LABORATORIES**

400 N. Wolf Road
Northlake, IL 60164

An Equal Opportunity Employer M/F

**GTE AUTOMATIC ELECTRIC
LABORATORIES**

Opportunities to Challenge Yourself and Your Ideas.

The Environmental Research Institute of Michigan (ERIM), serves as a catalytic agent among government agencies, universities and industries for the application of advanced technology and associated scientific methodology to society's problems.

Formerly Willow Run Laboratories of the University of Michigan, ERIM offers qualified candidates the opportunity to explore the areas of scientific research and development usually found only in the academic world, in the less constricted atmosphere of a private non-profit research organization. The independent environment of ERIM breeds challenges and complexities of opportunity which extend beyond specific job classifications.

Our expanding research and development program has created a number of new, permanent engineering staff positions. If you hold an advanced degree and have experience in the areas of Radar, Remote Sensing, Optics, Data Processing, or Energy Technologies and Applications; we want to hear from you.

The location of ERIM in Ann Arbor, Michigan, adjacent to the University of Michigan, offers cultural, academic, sports and entertainment opportunities of every kind. Salaries are competitive and fringe benefits are above average. All replies strictly confidential.

Send your detailed resume to:

ENVIRONMENTAL RESEARCH INSTITUTE OF MICHIGAN

P.O. Box 618, Ann Arbor, Michigan 48107
Attention: Personnel Administrator
An Equal Opportunity Employer

WESCON INTERVIEWS

Engineers with experience in any of the following:

**Realtime Programming
Inertial Navigation
Microwave Systems
Computer Hardware/Software
Telecommunications
RF Design
Marketing**

Interview with companies from California, Texas, East Coast or Midwest. Make an appointment to attend our confidential employment center at the downtown San Francisco HILTON HOTEL. Send your resume or call Mr. Manny Roo, collect, at (513) 579-1513; or call him at the HILTON at (415) 771-1400.

REGIONAL CONSULTANTS, INC.

213 W. 9th Street, Cincinnati, Ohio 45202
(513) 579-1513

If you are not attending WESCON, we will arrange to meet with you when we are in your city. Regional Consultants, Inc., is a nationwide technical search firm representing a broad base of clients serving the Electronics field.

Our Clients are Equal Opportunity Employers

Power Supply Engineer

An exceptional opportunity for an experienced power supply designer in new product development. The position requires a background in conventional regulators, switching regulators, high voltage circuits, and high efficiency circuits. A keen interest in pursuing the latest technology in power supply concepts is essential.

Tektronix, Inc., develops, manufactures and markets internationally recognized precision electronic measurement instruments, computer peripherals and related electronic instrumentation. Located near Portland, Oregon we are within a two hour drive of the Cascade Mountains and Ocean Beaches. The close-by nature playgrounds and the City of Portland provide a variety of recreational and cultural interests.

Salary is open. Benefits include liberal educational support, insurance and profit sharing programs.

Send resume and complete salary history to Roy Epperson, TEKTRONIX, INC., P.O. Box 500, E45, Beaverton, OR 97077.

An Equal Opportunity
Employer M/F/HC.

Tektronix
COMMITTED TO EXCELLENCE

Job-seekers... be the first to know with McGraw-Hill's Advance Job Listings

By having our weekly ADVANCE JOB LISTINGS sent to your home every Monday you can be the first to know about openings both in and out of your field. AJL will enable you to contact anxious recruitment managers BEFORE their ads appear in upcoming issues of 21 McGraw-Hill publications. To receive a free sample copy, plus information about our low subscription rates, fill out and return the coupon below.

ADVANCE JOB LISTINGS / P.O. BOX 900 / NY 10020
PLEASE SEND A SAMPLE COPY
OF ADVANCE JOB LISTINGS TO

NAME _____ ADDRESS _____
CITY _____ STATE/ZIP _____



**Would
you hire
an engineer
who
couldn't
understand
this
magazine?**

Of course not. **ELECTRONICS** is the technical publication for technical people. If they can't understand it, they can't receive it. That's why, when you're looking for qualified engineers, you should consider our Classified Section.

For only \$46.00 per inch your recruitment advertising will reach 46,000 pre-screened engineers—that's just \$1 per thousand!—as they're reading to combat job obsolescence, while they're thinking about their future and bettering themselves.

There's no charge for typesetting and free layout service is provided.

For more information call or write:

ELECTRONICS

Post Office Box 900
New York, N.Y. 10020
Phone: 212/997-2556

Electronics

Join The Industry Leader

KAISER

On The San Francisco Peninsula

Join the industry leader supplying CRT display systems for the A-6, the B-52, the F-111, the F-14, the A-10, the F-16, the Alpha Jet . . . and now for the F-18. Excellent opportunities currently exist for self-motivated professionals with our dynamic, growth oriented company. The following positions require BS degrees and a minimum of three years' experience in the military avionics field.

Digital Design Engineer

Applicants must have recent experience with digital systems and high speed logic design techniques. Position requires knowledge of contemporary T2L/LS/MOS logic family characteristics and proper application of these devices in circuit designs. Familiarity with the NOVA computer and FORTRAN is desirable.

Software Digital Engineer

Candidates must have microprocessor, minicomputer or special purpose computer experience. Experience with 2901, 8080, FORTRAN and NOVA is highly desirable.

Project Mechanical Engineer

This is a supervisory level position requiring a background in military avionics packaging techniques. Position requires experience in the areas of manpower planning, project scheduling, proposal writing, design analysis and fabrication techniques.

Mechanical Design Engineer

Experience with current electronic packaging and fabrication techniques is necessary as well as familiarity with military specifications and geometric dimensioning. Analytical skills are also required for thermal, vibration and stress analysis. This position will involve the supervision of mechanical designers and draftspersons.

Mechanical Designer

Requires knowledge of current electronic packaging and fabrication techniques with emphasis on producibility. Knowledge of military specification and drawing standards is required. Degree not required.

Analog Engineer

To design resonant recovery linear and power on demand deflection amplifiers, video amplifiers, processing circuitry and LVPS. Specify CRT's, yokes, contrast filters and HVPS.

Reliability Engineer

Candidates must be capable of performing stress analysis to the component level. Applicants must be familiar with parts application analysis, MTBF predictions and FMEA predictions. Responsibilities also include the planning coordination and reporting of reliability testing.

Components Engineer

Applicants must be familiar with military specifications regarding component standardization, component selection and non-standard part qualification. Ability to prepare procurement specifications, test plans and reports is required.

Send your detailed resume (handwritten acceptable) including salary history to, the Personnel Manager, 1681 Page Mill Road, Palo Alto, California 94306. We are an equal opportunity employer male, female, handicapped.

KAISER

ELECTRONICS

RF Communications Division

With a Stroke of a Pen...

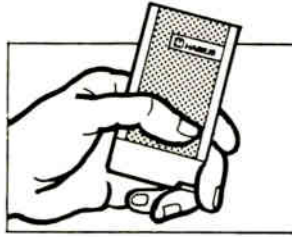

Harris Corporation, RF Communications Division, became one of the leading manufacturers of pocket pagers. We have already taken the lead in the development of high quality radio communication systems and equipment and with the acquisition of another high quality communication company, our product line and mix in the Long Range, Mobile and personal communication devices is reaching every corner of the globe.

To help us continue on our rapid growth path, the following immediate career opportunities exist:

REGIONAL MANAGERS and APPLICATIONS ENGINEERS

(International)

This is an outstanding opportunity to really do something different. You should possess a technical background plus a minimum of 5 years experience in applications engineering or sales support. Knowledge of RF Communications in the UHF, VHF and HF frequency ranges required. Openings exist in Europe, Latin America, Mid East and Far East.

DIRECTOR OF PRODUCT MANAGEMENT

You will report directly to the Product Line Vice President and have the responsibility for the evaluation of competition, R&D Program Assessment, Strategic Planning and all areas of Product Planning. You should possess a knowledge of radio communication products, technical degree desired, MBA preferred and a minimum of 10 years experience in product development and marketing support.

These are high visibility growth positions with excellent salary and benefits in addition to liberal relocation assistance to our scenic upstate New York Headquarters where we enjoy one of the nation's best educational, cultural and recreational areas in the country.

For immediate consideration, please forward resume and salary history to: Mr. Les Michaels, Harris Corporation, RF Communications Division, 1680 University Avenue, Rochester, New York 14610.



HARRIS

COMMUNICATIONS AND
INFORMATION HANDLING

An Equal Opportunity Employer—Male and Female

PROJECT ENGINEER

A nationally-known, highly regarded manufacturer of electrical/mechanical automotive switches is seeking man to build prototype samples of new products and related assignments. Plant located in northern Indiana college and resort town, boating—fishing abundant. Liberal financial and fringe package.

Reply to:

P-5665, Electronics
Class. Adv. Dept., P.O. Box 900
N.Y., N.Y. 10020

Equal Opportunity Employer M/F

TECHNICAL TRANSLATIONS

English/French by professional translator with over 10 years experience in electronic and electrical systems. Call or write:

JEAN LOUIS AVRIL
5ter, rue des Bois
92310 SEVRES FRANCE
Tel: (1) 027.68.99

DESIGN DRAFTSMAN

Well-known, highly regarded national manufacturer of electrical/mechanical automotive switches is seeking an innovative electrical/mechanical design draftsman. Plant located in northern Indiana college and resort town—boating—fishing. Liberal financial and fringe package.

Reply to:

P-5664, Electronics
Class. Adv. Dept., P.O. Box 900
N.Y., N.Y. 10020

Equal Opportunity Employer M/F

MAKE YOUR
NEXT
MOVE A STEP
IN THE
RIGHT
DIRECTION



The road to professional fulfillment can be a real jungle. We can help you find the right path. Our affiliation with

National
Personnel
Associates®

keeps us informed of opportunities in the ELECTRONICS industry from coast to coast as they occur. Together with over 190 associates, we offer our knowledge and expertise at no charge to you. Fees are company paid.

BUTTERFIELD'S EMPLOYMENT SERVICE

161 West Wisconsin Avenue
Suite 269
Milwaukee, Wisconsin
53203
(414) 278-7800

PLACEMENT EXPERTS, INC.

944 Central Bank Building
Huntsville, Alabama 35801
(205) 539-2467

AVAILABILITY, INC.

Engineering Consultants
Suite 285
5401 W. Kennedy Boulevard
Tampa, Florida 33609
(813) 872-2631

BRENTWOOD PERSONNEL ASSOCIATES

Electronics Division
1280 Route 46
Parsippany, New Jersey
07054
(201) 335-8700

PRODUCT ENGINEERS

MAGNETIC MEDIA PRODUCTS DEVELOPMENT

San Francisco Peninsula

INFORMATION TERMINALS, a leader in the development of removable magnetic storage media for the computer industry is seeking several key individuals to complement our Engineering staff.

If you are degreed in EE, ME, Physics or Chemistry, have a demonstrated track record in magnetic media products development, materials and processes evaluation, magnetic recording performance characteristics or peripheral drive tape systems and are interested in joining a winning team, give us a call—we'd like to talk to you.

Exceptional benefits in a young successful, planned-growth firm. Please send resume or contact Phil Boltinghouse, INFORMATION TERMINALS, 323 Soquel Way, Sunnyvale, CA 94086. Phone (408) 245-4400. An equal opportunity employer.



Information
Terminals
Corp.

Project Engineer

Join a recognized leader in the field of high technology power products on the SAN FRANCISCO PENINSULA

Manage the development and coordination of projects for specific applications of our switching regulated power supplies. The individual will work closely with marketing, manufacturing and engineering personnel in coordinating the efforts of a design team. Position requires a BSEE and 3 years of product development experience.

We offer highly competitive salaries, stock option, attractive fringe benefits and the opportunity to develop your career with an industry leader. Please send your resume, including salary history, in complete confidence, to Personnel Manager, BOSCHERT ASSOCIATES, 384 Santa Trinita Ave., Sunnyvale, CA 94086. An equal opportunity employer

boschert

P.O.S. TERMINAL DESIGN ENGINEER

To perform hardware design and some systems work on a next generation hospitality terminal including communications from the terminal to the CPU and peripherals. Some microprocessor architecture knowledge would be helpful.

A degree plus 2 or more years design experience will qualify.

NCR's P.O.S. facility is located in rural east central Ohio.

SYSTEMS ENGINEER

You will perform and/or conduct system evaluation related to performance characteristics of computer based Point-of Sale systems and subsystem elements (terminals, computers, peripherals, etc.)

Candidates must be familiar with micro and minicomputer systems hardware and they should bring 2 or more years experience including exposure to isolating and solving problems related to RFI-EMI.

LOGIC DESIGN ENGINEER

For digital implementation of algorithm required for video signal processing using TTL and/or microprocessor circuits.

NCR's P.O.S. division is located in east central Ohio and offers an inviting work and family living environment.

Robert W. Donovan
Terminal Systems Division
NCR Corporation

Box 728
Cambridge, Ohio 43725

614/439-0293

NCR

An Equal Opportunity Employer

ANALOG/DIGITAL DESIGN ENGINEERS POWER SUPPLY DESIGN ENGINEERS ELECTRONIC PRODUCT ENGINEERS

Wescom has immediate career opportunities available for qualified engineers to join our Engineering Organization.

ANALOG/DIGITAL DESIGNERS

The individuals we seek must have experience in TTL and CMOS technology coupled with an understanding of bipolar logic families. Some knowledge in A to D conversion and PCM multiplying techniques is also desirable.

POWER SUPPLY ENGINEERS

You will be responsible for the design of power supplies to be utilized in telecommunications systems. The individuals we seek must have a B.S.E.E. and a minimum of 3 years relevant experience.

ELECTRONIC PRODUCT ENGINEERS

Responsibilities include coordinating the introduction of new PCM carrier equipment into the manufacturing area and liaison with quality control and purchasing in maintaining system quality.

Requirements: Minimum of 2 years experience in the design of industrial and commercial electronic circuits and equipment, and a B.S.E.E. degree.

Wescom is a leader in the design, development and manufacture of electronic telecommunications equipment. We offer a challenging position with excellent potential for professional growth. Please submit resume, including salary requirements in confidence to:

Christine Rosenbach
Employment Manager



WESCOM
P.O. Box 458
Downers Grove, IL 60515

An Equal Opportunity Employer M/F

MANAGER of Electronic Engineering

We wish to fill this newly created post in our Research Department with a thoroughly qualified person. Experience with the application of computer control to high speed mechanisms essential.

Please Send Resume To The Attention Of The President.



KULICKE and SOFFA
INDUSTRIES, INC.

507 PRUDENTIAL ROAD • HORSHAM PA 19044

Equal Opportunity Employer, M/F

PACIFIC NORTHWEST Field Service Engineers

Must know: analog digital TTL, op-amps, CMOS. Will test, install, maintain, troubleshoot, repair computer controlled laser trimming systems (you receive complete training). Requires up to 40% travel, both domestic and foreign. EE degree or equivalent or 4-7 years related experience. Salary open. Excellent benefits. Long established quality firm now growing rapidly. Mail resume and salary history to:



Tom Allen
Electro Scientific Industries
13900 N.W. Science Park Drive
Portland, Oregon 97229
An Equal Opportunity Employer

STANLEY Help Us Do Things Right

SENIOR PRODUCT ENGINEER-ELECTRONIC

The DOOR OPERATING EQUIPMENT DIVISION of The Stanley Works, headquartered in Farmington, Conn., is seeking an Electronics Engineer. The successful applicant must have proven abilities as project manager on product development programs, and will be responsible for evaluation of field requirements and problems, for product design and development, and for coordination with factory on new design. Must be degreed, with a minimum of five years experience in electronics: solid state devices, logic circuits, and power control of fractional H. P. motors. Knowledge of microwave technology and infra-red devices helpful. Submit your resume, including salary history to:

THE STANLEY WORKS

Corporate Employment, Dept. 929E

P.O. Box 1800, New Britain, Conn. 06050

Local interviews may be arranged at a mutually convenient time.

An Equal Opportunity Affirmative Action Employer

STANLEY

RATES \$46 per advertising inch (1/8"). Commissionable.
SIZES 1/8" to 10" deep in widths of one column (1 3/8"), two (3 3/8"), three (5 1/8"), and four (7").
CLOSING Two weeks prior to mailing.
MAILING One week prior to issue date.
ISSUE DATE Every other Thursday.
AD ORDERS/BOX NUMBER ANSWERS Send to Electronics, Post Office Box 900, New York, N.Y. 10020.



**Would
you hire
an engineer
who
couldn't
understand
this
magazine?**

Of course not. ELECTRONICS is the technical publication for technical people. If they can't understand it, they can't receive it. That's why, when you're looking for qualified engineers, you should consider our Classified Section.

For only \$46.00 per inch your recruitment advertising will reach 46,000 pre-screened engineers—that's just \$1 per thousand!—as they're reading to combat job obsolescence, while they're thinking about their future and bettering themselves.

There's no charge for typesetting and free layout service is provided.

For more information call or write:

ELECTRONICS

Post Office Box 900
New York, N.Y. 10020
Phone: 212/997-2556

MICROPROCESSOR APPLICATIONS MANAGER

ZELTRON, a recently formed electronics engineering company which specializes in designing microprocessor-based systems, is looking for a top-notch electronics engineer to head its Microprocessor Applications Laboratory (about 30 professionals).

The person

We seek an outstanding digital-system designer and technical manager, with extensive experience in designing digital systems, especially microprocessor-based (hardware, software, peripheral devices). This person must be thoroughly familiar with the latest logic and LSI families. A degree from a leading technical university is required. Previous experience in managing highly skilled professional people is desirable. Age is open. English is currently spoken at ZELTRON, so knowledge of Italian is not a prerequisite.

The position

Responsibilities include: definition of specifications; technical excellence in design; timeliness and level of effort; P & L for Laboratory and individual jobs.

The person will report to the General Manager, with whom he will cooperate in defining objectives and in expanding the company.

Salary is open and a function solely of qualification and experience. We can offer either a renewable fixed-length contract or a permanent position with ZELTRON.

The Company

ZELTRON is a totally-owned subsidiary of ZANUSSI, a leading European manufacturer of appliances and electronic consumer goods (consolidated 1976 sales of US \$ 650 million and after-tax profits exceeding US \$ 30 million). The Zanussi Corporation employs 30,000 people and has 35 plants in Italy and divisions in 12 Countries.

ZELTRON has laboratories and offices in Udine and in Milano (Italy). It operates as an electronics engineering company, offering services in the following areas: Microprocessor Applications (development and design of microprocessor-based products); Industrial Systems (development and design of microcomputer-based process control and monitoring systems); Reliability (semiconductor component reliability, failure analysis, test and qualification, both to support ZELTRON's design activities and as a service to third parties).

The location

Work location is Udine, a lovely, small (100,000 people) city in Northern Italy. The city, which was much shaken but not damaged by last year's earthquake, has been developing as a center of trade and light industry because of its favourable geographic position: it is only 80 miles from Venice, very close to Austria and Yugoslavia. The climate is mild and seaside and skiing resorts are at half an hour's drive.

We also seek staff engineers for above-mentioned areas of activity.

Reply to:

ZANUSSI ZELTRON s.p.a.
Istituto Zanussi per l'Elettronica
Via Principe di Udine, 66
33030 Campofornido (UD) Italy (Tel. 0432-69652)



ENGINEERS

McDonnell Douglas Electronics Company, a divisional company of McDonnell Douglas Corporation, located in the St. Louis suburban area, has immediate openings in the following areas in support of Audio Products (Voice Response System), Training Simulators (Vital and A7D), Electronic Warfare Systems, Avionic and Support Systems:

SYSTEMS PROGRAMMERS—BS in Engineering, Computer Science or Math with experience in design and programming of computer software. Use of assembly or higher level language (PDP 11 Systems Programming preferred).

DIGITAL DESIGN ENGINEERS—BSEE with experience in high speed digital logic design in computer I/O also in fast linear circuits and D/A conversions. Experience in design of training simulators desired.

MANUFACTURING TEST ENGINEERS—BSEE with at least 5 years experience in design and checkout of sophisticated electronic test instrumentation. Knowledge of programming requirements for automatic electronic test desirable. Openings include senior level to project level.

PRODUCTION ENGINEER—BSEE of Physics with at least 10 years in electronic/electro-optical assembly, assembly processes and testing. Requires knowledge of state of the art electronics including LSI devices.

FIELD SERVICE ENGINEERS—Experience/knowledge of solid state digital electronics, operation and maintenance of digital computers and associated peripherals. Knowledge of programming highly desirable.

• **SIMULATION EQUIPMENT**—Experience on aircraft simulators and/or CGI Visual Systems also desired. World wide travel involved during installation and integration with aircraft simulators and on service calls.

• **VOICE RESPONSE SYSTEMS**—Experience with telephone service, such as trunk lines, switching networks, touch tone systems required. Will work on automatic telephone — message dispensing equipment. Travel involved.

SECTION MANAGER—PRINTED WIRING BOARD FACILITY—Requires 5 years supervisory experience in the fabrication of printed wiring boards (doublesided, multi-layer and plated thru holes). Prefer a degree in Chemical or Metallurgical Engineering or Physics or equivalent specialized manufacturing production experience. Must be results oriented and capable of planning, developing and implementing a broad range of methods designed to improve quality and quantity of printed wiring boards.

To explore these career opportunities with a technically renowned and stable organization, offering an excellent benefit package, please send resume in confidence to:

L. M. Blase, Supervisor of Employment

MCDONNELL DOUGLAS ELECTRONICS COMPANY

2600 N. Third Street • St. Charles, MO. 63301

An Equal Opportunity Employer

**Would
you hire
an engineer
who
couldn't
understand
this
magazine?**

Of course not. ELECTRONICS is the technical publication for technical people. If they can't understand it, they can't receive it. That's why, when you're looking for qualified engineers, you should consider our Classified Section.

For only \$46.00 per inch your recruitment advertising will reach 46,000 pre-screened engineers—that's just \$1 per thousand!—as they're reading to combat job obsolescence, while they're thinking about their future and bettering themselves.

There's no charge for type-setting and free layout service is provided.

For more information call or write:

ELECTRONICS

Post Office Box 900
New York, N.Y. 10020
Phone: 212/997-2556

Job-seekers... be the first to know with McGraw-Hill's Advance Job Listings

By having our weekly ADVANCE JOB LISTINGS sent to your home every Monday you can be the first to know about openings both in and out of your field. AJL will enable you to contact anxious recruitment managers BEFORE their ads appear in upcoming issues of 21 McGraw-Hill publications. To receive a free sample copy, plus information about our low subscription rates, fill out and return the coupon below.

.....
ADVANCE JOB LISTINGS / P.O. BOX 900 / NY 10020
PLEASE SEND A SAMPLE COPY
OF ADVANCE JOB LISTINGS TO

NAME _____ ADDRESS _____

CITY _____ STATE/ZIP _____

POSITION VACANT

The Department of Electrical Sciences and Engineering at UCLA anticipates a faculty position at the Assistant Professor level in the area of applied electronics. The position requires a Ph.D. or equivalent research experience in areas of electronics, preferably including digital integrated circuits. Teaching and research ability are essential. Interested and qualified applicants should write to the Chairman, Electrical Sciences and Engineering Department, University of California, Los Angeles, 90024. The University of California is an equal opportunity/affirmative action employer.

Electronics Development Engineer
North Carolina firm seeking EDE. Minimum 8 yrs. experience with major machining manufacturer in the development of electronic controls for cigarette making and packing machines. College graduate. Preferably PE. 7½ hour work day. Salary \$18-25. 5K. Minimum travel. Excellent company benefits. Equal Opportunity Employer. Piedmont, North Carolina location. Send resume to Mrs. Beverly Wilson, Job Service, Box 82, Winston-Salem, North Carolina 27102.

BUSINESS OPPORTUNITY

How To Earn Money As A Consultant
(including specimen contracts). Send stamped, self-addressed envelope to: Business Psychology Int'l 890/44 National Press Bldg. Washington, D.C. 20045.

WHERE DO YOU FIT?

In today's job market, that is. One way to see if you're in demand is to check the employment opportunities contained in ELECTRONICS' Classified Section.

Another way to get a reading on your value is to place a blind (box number) Position Wanted ad there. The cost is low (only \$1.25 per line) and the results are often rewarding.

For more information call or write:

ELECTRONICS

Post Office Box 900
New York, N.Y. 10020
Phone: 212/997-2556

MAKE YOUR FUTURE COUNT

JOIN THE LITTON TEAM!

We're the Amecom Division of Litton Systems, and new long-term contracts in Electronic Warfare and Telecommunication means new career opportunity for ambitious engineers who seek tomorrow's future today. If you have the experience in these disciplines, you owe it to yourself and to us to talk:

RF ENGINEERS

- ★ Spread Spectrum Systems Design
- ★ High Sensitivity UHF, VHF, SSB Receivers & Transmitters
- ★ Solid State Microwave
- ★ Circuit Control Design
- ★ TTL/CMOS Logic

TELECOMMUNICATIONS SYSTEM DESIGN ENGINEERS

- ★ Advanced Digital Subsystems including TDM
- ★ RF and Analog Subsystems including Frequency Synthesis and FDM Techniques
- ★ Microprocessors and related Real-Time Operating Systems Software
- ★ Voice and Data Switching Systems
- ★ Hardware/Software Integration

Litton Systems, American Division is located in metropolitan Washington, DC, close to five major universities, libraries, the Congress and the Nation's Capitol. We provide excellent compensation including a benefits package second to none in the industry together with an excellent work environment with seasoned professionals.

Please send your resume in confidence including salary history, or telephone COLLECT:

J. J. FitzGerald

(301) 864-5600



Amecom Division
**LITTON
SYSTEMS, INC.**

5115 Calvert Road
College Park
Md. 20740

An Equal Opportunity
Employer M/F

Wanted: Engineers Seeking Challenging Opportunities Now

POWER CONDITIONING ENGINEERS

Electrical Engineers at all degree levels are required to work on a broad range of problems associated with energy storage, switching and power conditioning systems. Major program areas include laser and magnetic fusion, laser isotope separation, high-current accelerator technology and nuclear explosives R&D. Typical assignments include: design, installation supervision, and checkout of multimega joule capacitive storage systems, design of high average power systems, conceptual design studies for advanced energy storage techniques and development of related power conditioning systems.

ELECTRO-OPTICAL AND INSTRUMENTATION ENGINEERS

Openings exist to work on a variety of assignments associated with electro-optical systems. Typical projects include electro-optical imaging using both solid state and electron tube devices, and sampled data systems, high-speed optical detection systems, optical communication systems, electro-optical control systems for precision-pointing, focusing and centering of high-power lasers, and high-speed optical modulation and pulse shaping systems. Will work on both digital and analog circuits and systems, high-voltage pulsed circuitry, as well as electro-optical devices. B.S. in EE (M.S. degree preferred) with strong background in electro-optical systems and general engineering.

ELECTRONICS ENGINEERS/ COMPUTER SCIENTISTS

Computer Systems Engineering/Hardware and Software. Electronics Engineers/Computer Scientists are needed at all degree levels to work on computer systems for real-time control and data acquisition applications. Positions generally require knowledge of both hardware and software. Also, requires experience with mini and microcomputer systems, with interactive graphics experience desirable. Knowledge of FORTRAN and assembly language required.

Applications Software Engineering. Assignments will involve analytical and computational tasks in code development in the area of systems analysis and simulation, geophysical probing, digital signal processing, and/or electromagnetic wave interactions. A knowledge of FORTRAN, numerical analysis and basic engineering sciences is required. B.S. or M.S. in EE/Computer Science.

Openings also exist in *Digital Systems, *Microwaves, *Numerically controlled machine tools and *Facility Power Systems.

Our National Defense Laboratory in the San Francisco Bay Area is heavily involved in laser fusion, energy research and development, and biomedical and environmental programs. We also house one of the world's largest computer complexes. We invite interested and qualified candidates to send resume to Employment Division, P.O. Box 808, ET-097, Livermore, CA 94550.

U.S. Citizenship
Required



An Equal
Opportunity
Employer

LAWRENCE LIVERMORE LABORATORY



ATARI

The innovative producers of games
that make your life more fun . . .
has immediate openings for

COMPONENT ENGINEER

Positions require 2-5 years experience as a Design Engineer (Electromechanical) with responsibilities for component specification, evaluation and testing. Experience desired with ICs, active and passive components, motors, etc.

You will provide technical support/advice to Engineering, Manufacturing and Purchasing in selection and qualification of components and suppliers. BS/EE, ME or Physics required.

Excellent benefits, exceptional working conditions in a unique, fascinating environment . . . plus excellent compensation! Please send your resume, including salary history, to Personnel Dept CE, ATARI, INC., P.O. Box 9027, 1265 Borregas Ave., Sunnyvale, CA 94086. We are an equal opportunity employer. Individuals only apply. (408) 745-2040.

Application Engineer

You will provide technical leadership for these circuits; A/D, D/A, sample and hold circuits, voltage-to-frequency, frequency-to-voltage, phase locked loops, CCD and others by assisting product design engineers in their use. Other responsibilities will include developing software for automated test systems to assure component quality and reliability and introduce new components and component technology.

Several years of recent experience in analog circuit design with a combination of the above devices is necessary. Experience with high level programming language is desirable. Effective technical communication skills required.

Salary is open. Benefits include liberal insurance, educational support and profit sharing programs.

Send detailed resume and salary history to Roy Epperson, TEKTRONIX, INC., P.O. Box 500, E72, Beaverton, OR 97077.

An Equal Opportunity Employer M/F/H

Tektronix
COMMITTED TO EXCELLENCE

THREATS AND OPPORTUNITIES: HOW TO FACE TODAY'S CHALLENGES

How to cope with the Japanese trade and technology threat.

The potential of microprocessors: What is going to happen?

The economy and the markets: Where are they going?

Two major developments confront the U.S. electronics industries today. One opens up unparalleled business opportunities, while the other, many claim, is already eating into their existing markets. Japanese trade and technology advances are the threat; the advent of the microprocessor is the opportunity.

Fear of the Japanese is widespread, and there are sound reasons for it. The U.S. television industry already has lost much of its market share to Japanese competition, just as radio manufacturers, shipbuilders, and steel makers have in the past. Now the Japanese are taking aim at the U.S. semiconductor and computer industries. They are also advancing rapidly in fiber optics and other high-technology areas. All of this is leading to sharp debate: How serious is the threat to the domestic industry? How should the Government respond? What should the electronics industries be doing to protect their markets?

The questions surrounding microprocessors are different. Virtually everyone agrees that we are in the midst of an explosion in

microprocessor activity. Not only are the chips spawning new businesses, but the availability of cheap computing power enables designers to exploit decision-making capability in ever-widening areas of application. The challenge to users lies in picking the right microprocessor, understanding what it can and cannot do and integrating it properly into their products. The challenge to manufacturers lies in leading users to system solutions. The challenge to makers of other components, sub-assemblies, and measurement equipment lies in anticipating future directions of microprocessors so they can fit in.

The 1977 *Electronics* conference, "Threats and Opportunities: How to Face Today's Challenges," will examine these two developments in depth, providing the information that managers in the electronics industries simply cannot go without. With so many changes taking place so quickly, you and your company cannot afford to miss the 1977 *Electronics* conference, "Threats and Opportunities: How to Face Today's Challenges."

**December 7-8, 1977
The Shoreham Hotel
Washington, D.C.**

**Sponsored by
*Electronics***

McGraw-Hill's
International Magazine
of Electronics Technology



How to cope with the Japanese trade and technology threat.

The gathering wave of Japanese technology: What will the impact be?

Japan's share of the semiconductor market is still small, and its share of the computer market is even smaller. But the Japanese have set their sights on these targets, and their progress in the past couple of years has been so startling that many key executives in the U.S. electronics industries are mapping a counterattack. Other analysts disagree. The two keynote speakers will present each side of the issue.

Wilfred J. Corrigan
Chairman and President
Fairchild Camera and Instrument Corp.

Other speaker to be announced

What must American companies do to keep their technological edge?

In the past the U.S. electronics industries have been the world's unquestioned technological leaders. A serious challenge is developing now in semiconductors, computers, fiber optics, and other areas. In the past couple of years, Japanese research and development programs have begun to close the gap, and it is the Japanese government that is financing much of the R & D. Texas Instruments is one of the most technologically sophisticated companies in the country, and its president, J. Fred Bucy, will give his views about what U.S. companies must do to retain their technological edge.

J. Fred Bucy
President
Texas Instruments Incorporated

The Labor Department's Response to the Japanese Challenge

Several branches of the government are keeping tabs on the increasing threat of the Japanese electronics industries, but none more closely than the Labor Department. The reason: Greater Japanese penetration in the market means fewer jobs for U.S. workers. Howard D. Samuel, Deputy Under Secretary of Labor for International Affairs, has kept abreast of the issues involved and will give the Labor Department's view of the situation as well as its plans for action.

Howard D. Samuel
Deputy Under Secretary for
International Affairs
U.S. Department of Labor
Washington, D.C.

How to succeed in business with the Japanese

As one of the biggest industrial economies in the world, Japan has a market that cannot be ignored by either small or large U.S. electronics firms. Yet doing business there is significantly different from selling in another state or even in a European country. Experts will outline some of the different ways of doing business with the Japanese, listing the advantages and potential pitfalls of each.

Bernard V. Vonderschmitt
Vice President and General Manager
Solid State Division
RCA Corporation

Terry Wong
Director, Business Development
Microelectronic Devices
Rockwell International Corporation

How American electronic companies can win the battle for foreign markets

The Japanese semiconductor industry has about a quarter of the worldwide market and is working to expand that share as fast as possible. Likewise other sectors of the Japanese electronics industries are implementing effective marketing campaigns to increase their sales. Some portions of the Japanese marketing effort—financing terms, for example—are tough to counter, but other tools are available to U.S. companies. ITT senior vice president Richard Hodgson will explain what those tools are and how you can use them.

Richard Hodgson
Senior Vice President
International Telephone and Telegraph Corporation

Japan versus the U.S.: The government response

The key government agency overseeing the entire trade question is the Office of Special Trade Negotiations. Richard Heimlich negotiated the color TV agreement with Japan and has stayed abreast of the entire electronics question. He will discuss the Carter Administration's response to the question of Japanese competition and describe what steps the Office of Special Trade Negotiations is taking.

Richard W. Heimlich
Assistant Special Trade Representative for
Industrial Trade Policy
Office of the Representative for Trade Negotiations
Washington, D.C.

How can domestic electronics firms respond to the Japanese marketing threat in the U.S.?

The Japanese share of the U.S. semiconductor market is still small, but industry observers, fully aware of how the Japanese captured the U.S. color television market, predict it will grow. Simultaneously, Japanese firms are gearing up for an even bigger sales push. Leading experts from the U.S. industries will give their insights into steps U.S. firms can take to cope with the Japanese challenge.

L. J. Sevin
Chairman of the Board
Mostek Corporation

The potential of microprocessors: What is going to happen?

The outlook in microprocessors: Where are they going next?

Microprocessors have made it big already, offering new business opportunities and a new tool to use in your operation. Their development is far from complete, however. One of the leading microprocessor experts will tell you how he sees microprocessors developing.

Leslie L. Vadasz

Vice President and Assistant General Manager
Microcomputer Division
Intel Corporation

The microprocessor universe: What's out there?

Choosing the proper microprocessor for your needs is a crucial task, but also one that requires a good technical understanding of just what is available. What are the advantages of choosing a one-chip microprocessor? What are the advantages and disadvantages of 8-bit and 16-bit systems? What are the cost-performance tradeoffs of chips versus boards? A panel of leading industry experts will answer these questions and more.

Colin Crook

Group Operations Manager, Microproducts
Semiconductor Group
Motorola Inc.

Andrew C. Knowles

Vice President/Group Manager
Digital Equipment Corporation

Malcolm B. Northrup

Vice President
Microelectronic Devices
Electronic Devices Division
Rockwell International Corporation

James Van Tassel

Manager, MOS Microprocessor
Texas Instruments Incorporated

How to get started in microprocessors

Many basic management considerations must go into selection and implementation of a microprocessor. What can a microprocessor do for your company? What will be the likely effect of microprocessors on your industry? Eric Garen, who has taught courses on this subject for top management of several major corporations, will answer these questions and more.

Eric Garen

Vice President
Integrated Computer Systems

The economy and the markets: Where are they going?

Electronics markets in the coming year: A preview

Electronics publisher Dan McMillan and Executive Editor Samuel Weber will give a special preview of the annual *Electronics* market forecast, looking at worldwide market prospects.

Dan McMillan

Publisher
Electronics

Samuel Weber

Executive Editor
Electronics

Where is the economy going and what does it mean for you?

The economy has been on a gradual upswing for the past several months, and now the question is: How long will that upswing last? Will the economy lose steam by mid-1978? What does future economic growth rate mean for the inventory levels electronics firms should maintain?

If capital spending takes off—as many think it will—what should that mean for your business? Noted economist Douglas Greenwald will announce results of some original research he has just completed that is especially pertinent to the electronics industries.

Douglas Greenwald

Vice President—Economics
McGraw-Hill Publications Company

Preliminary Conference Schedule

Wednesday December 7, 1977

- 8:00 — 9:00 AM Registration
9:00 — 9:15 AM Welcome
9:15 — 10:15 AM Economic outlook
10:15 — 10:45 AM Coffee break
10:45 — 11:30 AM The outlook in microprocessors
11:30 — 12:00 PM Intermission
12:00 — 1:30 PM Lunch: Market outlook
1:45 — 3:15 PM The microprocessor universe
3:15 — 4:15 PM How to get started in microprocessors
4:30 — 5:30 PM Cocktail reception to meet speakers

Thursday December 8, 1977

- 9:00 — 10:15 AM Keynote addresses: The impact of Japanese technology
10:15 — 10:45 AM Coffee break
10:45 — 11:45 PM How electronic companies can respond to the Japanese marketing threat
11:45 — 12:30 PM The Labor Department Response to the Japanese Challenge
12:30 — 1:00 PM Intermission
1:00 — 2:15 PM Lunch: Richard Heimlich
2:30 — 3:30 PM How Do You Successfully Do Business With the Japanese?
3:30 — 4:15 PM How Americans can win the battle for markets abroad
4:15 — 5:15 PM How can American companies keep their technological edge?

All registrants will receive copies of *Electronics'* best selling books: "Applying Microprocessors: New hardware, software and applications" and "Microprocessors" edited by senior editor Laurence Altman as well as *Electronics'* reprints on the Japanese threat.

Please register me for Threats and Opportunities: How To Face Today's Challenges, sponsored by **Electronics**.
Conference fee: \$300

Name _____
Company _____ Title _____
Street _____
City _____ State _____ Zip _____
Business Phone _____

Check one:

- Payment enclosed Please bill me directly Please bill company

Applicant's signature _____ Date _____

Hotel reservations: The Shoreham Hotel is holding a block of rooms for this conference. For reservations, contact the Shoreham directly. Be sure to identify the title of the conference.

Cancellation policy: No refunds will be made seven days prior to the Conference. You may, if you wish, send a substitute.

World Radio History

THREATS AND OPPORTUNITIES: HOW TO FACE TODAY'S CHALLENGES

Sponsored by **Electronics**

December 7-8, 1977

The Shoreham Hotel, Washington, D.C.

To register, mail the coupon to:

McGraw-Hill Conference & Seminar Group
1221 Avenue of the Americas (Room 3677)
New York, New York 10020 • 212/997-4930

▪ Abbott Transistor Labs	6	Instrumentation Engineering	13
Advanced Micro Devices	10-11	Intech/Function Modules	71
• AEG Telefunken	23E	Intel-Microcomputer Components	32-33
▪ Allen-Bradley	34	International Microcircuits, Inc.	134
▪ Amp, Inc.	28-29	Interstate Electronics	67
• APEM	12E	▪ Kepco, Inc.	5
AVX Corporation	139	‡ Kollmorgen Corp., Photocircuits Division	80-81
▪ F.W. Bell, Inc.	129	▪ Lambda Electronics	147-152
Berg Electronics Div. of Dupont	82	‡ The London Company	73
Bergquist Company	14	▪ LSI Computer Systems	130
▪ Bourns, Inc.	2nd C.	▪ Matsuo Electric Co., Ltd.	16E
• Cardion Electronics	10E-11E	• MDB Systems	125
• Carlo Erba SA	53	Micro Power Systems	75
▪ Centralab Electronics Division	141	▪ Microswitch, Div. of Honeywell	121
▪ Cherry Electrical Products	1	▪ Miller-Stephenson Chemical Co., Inc.	131
▪ Clairex Electronics	4th c	Mitel Semiconductor, Inc.	52
Conferences on Electronics	145-146, 167-170	‡ Monolithic Systems Corporation	53
▪ Continental Rentals, Div. Cont. Resources	8	Mostek Corp.	31
• C. P. Clare International	9E	▪ Motorola Semiconductor Products	37
▪ Data General Corp.	38-39	Nitron	127
Delco Electronics, Div. Gen. Motors	116-117	• NEOHM SPA	13E
▪ Dialight Corp.	137	Nikkei Electronics	144
Digital TPL	134	• Oscilloquartz	20E
• Ducati Elettrotecnica Microfarad	30E	• Philippe ELA	25E
Duncan Electronics (Systrom-Donner)	133	• Philippe Elcoma	6E
‡ Eastman Kodak Co., Graphic Markets Division	15	• Philippe Elcoma	15E
Electronic Navigation Industries	128	• Philippe Industries	80-81
Elong Electronorgtechica	30	• Philippe TMI	2E-3E
▪ EMI Tech	17E-18E	▪ Polarad	3rd c
▪ Entran Devices, Inc.	2	PolyMorphic Systems	142
▪ Erie Technological Products	50	▪ Precision Monolithics Inc.	7
Exar Integrated Systems Inc.	78	▪ Premier Metal Products	140
Fairchild/Semiconductor Operations Division	47	Pro-Log	40
Figaro Engineering, Inc.	8	• Quest Automation	29E
General Instrument, Microelectronics	49	• Racal Instruments Ltd.	4E-5E
‡ HEI, Inc.	124-125	Ramtek	78-79
▪ Hewlett-Packard, Electronic Products Group	17-26	RCA Solid State	9
Hutson Industries	119	Rhone Poulenc-Chimie Fine	70
A.L.S. Corporation for Infotek	129	• Rohde & Schwarz	1E

CALCULATORS

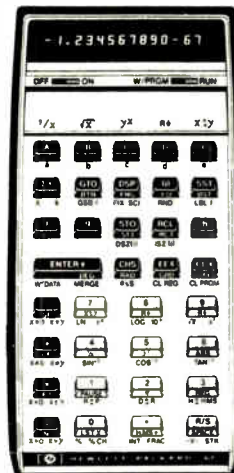

Hewlett-Packard	HP-10	139.95
	HP-10C	275.95
	HP-21	63.95
	HP-22	99.95
	HP-25	99.95
	HP-25C	127.95
	HP-27	139.95
	HP-29C	155.95
	HP-47	359.95
	HP-80	235.95
	HP-81	259.95
	HP-82	499.95
	HP-87	599.95
	67/87 Pace	28.95
	120 Mag. Cards	39.95

Texas Instruments	Bus. Analyst.	29.95
	MBA	69.95
	TI-5015	69.95
	TI-5040	99.95
	TI-5050M	79.95
	TI-5100	42.95
	SR-40	24.95
	SR-51-N	49.95
	TI-57	64.95
	TI-58	99.95
	TI-59	259.95
	PC100A	149.95
	58/59 Modules	29.95
		249.95
		169.95

Smith-Corona 2200—Pica or Elta
Atari Video Computer—Prog. TV Game

For faster delivery use cashier's check or money order. Add shipping: 1% of your order (\$1 min.). East of Miss. Riv. add \$1.00. Calif. Res. add 6% tax. (BA-MC-VISA accepted, 3% surcharge on HP calculators). U.S.A. prices. Subject to availability.

ORDER TOLL-FREE 800-421-8819 OUTSIDE CALIFORNIA



For technical information call (213) 744-1444

TAM'S DEPT. SE
3303 S. Hoover St.
Los Angeles, CA 90007
(213) 744-1444

Circle 171 on reader service card

From Electronics Magazine Book Series. Zero-risk trial offer.

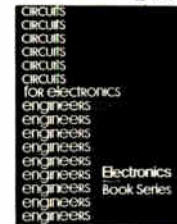

Circuits for Electronics Engineers
Contains 306 circuits arranged by 51 functions from Amplifiers to Voltage Regulating Circuits. Saves design drudgery. \$15.95

Electronics Book Series
P.O. Box 669, Hightstown, N.J. 08520
Send me _____ copies of "Circuits for Electronics Engineers" at \$15.95 per copy.
Discounts of 40% on orders of 10 or more copies.
I must be fully satisfied or you will refund full payment if the book is returned after ten-day trial examination.
 Payment enclosed Bill firm Bill me
Charge to my credit card:
 American Express Diners Club
 BankAmericard Master Charge

Acc't No. _____
Date exp. _____
On Master Charge only, first numbers above name _____
Name _____ Title _____
Company _____
Street _____
City _____ State _____ Zip _____
Signature _____

ELECTRONICS REPRINTS

No. of
copies
wanted

New reprints

- ___ R-718 Display makers strive to refine their technologies 8 pp \$3.00
- ___ R-716 Special report—Japanese wave in semiconductor technology 24 pp \$3.00
- ___ R-714 Special report—active filter technology 6 pp \$3.00
- ___ R-713 Electron-beam lithography draws fine line 10 pp \$3.00
- ___ R-712 Special report—large-scale integration 16 pp \$3.00
- ___ R-710 Personal computers mean business 8 pp \$2.00
- ___ R-708 So you want to be a consultant 6 pp \$2.00

Charts

- ___ R-516 Electronic symbols \$2.00
- ___ R-213 Electromagnetic spectrum (updated 1976) \$3.00
- ___ R-326 Optical spectrum (6-page report and chart) \$3.00

Books

- ___ R-711 Circuits for electronics engineers: 306 circuits in 51 functional groups—Electronics Book Series \$15.95
- ___ R-704 Thermal design in electronics \$5.00
- ___ R-701 Applying microprocessors—Electronics Book Series \$9.95
- ___ R-608 Basics of Data Communications—Electronics Book Series \$12.50
- ___ R-602 Large Scale Integration—Electronics Book Series \$9.95
- ___ R-520 Microprocessors—Electronics Book Series \$8.95
- ___ R-011 Computer-aided Design 135 pp \$4.00
- ___ R-032 Active Filters 88 pp \$4.00

Payment must accompany your order

Make check or money order payable to Electronics Reprints. All orders are shipped prepaid by parcel post. Allow two to three weeks for delivery. For additional information call (609) 448-1700 ext. 5494.

Mail your order to:

Janice Austin
ELECTRONICS REPRINTS
P.O. Box 669
Hightstown, N.J. 08520

Back issues now available:

1960 to 1969, \$5.00 each
1970 to 1973, \$3.00 each
1974 to 1976, \$4.00 each

Sakata Seisakusho	8
Sangamo Data Recorder Division	64
■ Semiconductor Circuits	135
• Sternice	8E
• Siemens AG Munich	62
Signetics Corporation	45
Sinclair Radionics	143
• Sodeco	27E
Solid State Scientific	115
Sprague Electric	59
Standex Electronics	112
Tam's Incorporated	171
■ Tektronix	73
■ Teledyne Relays	27
Teradyne, Inc.	68
Texas Instruments, Components	60-61
• Trio Kenwood Corporation	19E
TRW Capacitors	102
TRW LSI Products	51
TRW RF Semiconductors	54-55
‡ TRW/UTC Transformers	62
TRW/Cinch Connectors	123
• V/O Techmasheexport	28E
■ Wavetek Indiana Inc.	15
Wilhelm Westermann	16

Classified and employment advertising

F. J. Eberle, Manager 212-997-2557	
Atari	166
Atomic Personnel	154
Avril, Jean Louis	180
Boschert	161
Computer Peripherals	155
Douglas, McDonnell Electronics Co.	164
ERIM (Envir. Res. Inst. of Mich.)	158
Electro Scientific Ind.	162
GTE Automatic Electric Laboratories	157
Harris Comm. & Information Handling	160
Information Terminals Inc.	161
Kaiser Electronics	159
Kulicke & Soffa	162
LRK Associates	154
Lawrence Livermore Laboratory	166
Litton Systems, Inc., Amecom Division	165
Meads Advanced Systems	156
NCR	161
National Personnel Inc.	180
Regional Consultants, Inc.	158
Stanley Works	162
Tektronix	158, 166
Weacom	162
Zeitron Spa	163

For more information of complete product line see advertisement in the latest Electronics Buyers Guide
 * Advertisers in Electronics International
 † Advertisers in Electronics domestic edition

Advertising Sales Staff

Advertising sales manager: Paul W. Reiss
1221 Avenue of the Americas, New York, N.Y. 10020
[212] 997-4371

Atlanta, Ga. 30308: Glen N. Dougherty
100 Colony Square, 1175 Peachtree St., N.E.
[404] 892-2868

Boston, Mass. 02118: Frank Mitchell
607 Boylston St.
[617] 262-1160

Chicago, Ill. 60611
645 North Michigan Avenue
Robert W. Bartlett [312] 751-3739
Robert M. Denmead [312] 751-3738

Cleveland, Ohio 44113: William J. Boyle
[716] 586-5040

Dallas, Texas 75201: John J. Uphues
2001 Bryant Tower, Suite 1070
[214] 742-1747

Denver, Colo. 80203: Harry B. Doyle, Jr.
123 Spear Blvd. #400
[303] 837-1010

Detroit, Michigan 48202: Robert W. Bartlett
1400 Fisher Bldg.
[313] 873-7410

Houston, Texas 77002: John J. Uphues
601 Jefferson Street, Dresser Tower
[713] 659-8381

Los Angeles, Calif. 90010: Robert J. Rieley
Bradley K. Jones, 3200 Wilshire Blvd., South Tower
[213] 487-1160

Minneapolis, Minn. 55435: Robert M. Denmead
[312] 751-3738

New York, N.Y. 10020
1221 Avenue of the Americas
Michael J. Stoller [212] 997-3616
Matthew T. Reseska [212] 997-3617

Philadelphia, Pa. 19102: Matthew T. Reseska
Three Parkway
[212] 997-3617

Pittsburgh, Pa. 15222: Matthew T. Reseska
4 Gateway Center
[212] 997-3617

Rochester, N.Y. 14534: William J. Boyle
1175 Pittsford-Victor Rd., Pittsford, N.Y.
[716] 586-5040

San Francisco, Calif. 94111: Don Farris
Robert J. Rieley, 425 Battery Street,
[415] 362-4600

Paris: Patrick Mouillard
17 Rue-Georges Bizet, 75116 Paris, France
Tel: 720-73-01

Geneva:
1 rue du Temple, Geneva, Switzerland
Tel: 32-35-63

United Kingdom & Scandinavia: Robert Ghey
34 Dover Street, London W1
Tel: 01-493-1451

Scandinavia: Andrew Karnig and Assoc.
Kungsholmsgatan 10
112 27 Stockholm, Sweden
Tel: 08 51 68 70 Telex: 179 51

Milan: Luigi Rancati
1 via Baracchini, Italy
Phone 86-90-656

Brussels:
23 Chaussee de Wavre
Brussels 1040, Belgium
Tel: 13-73-95

Frankfurt/Main: Fritz Krusebecker
Liebigstrasse 27c, Germany
Phone 72 01 81

Tokyo: Tatsumi Katagiri, McGraw-Hill
Publications Overseas Corporation,
Kasumigaseki Building 2-5, 3-chome,
Kasumigaseki, Chiyoda-Ku, Tokyo, Japan
[581] 9811

Business Department

Thomas M. Egan
Production Manager [212] 997-3140

Carol Gallagher
Production Manager International
[212] 997-2045

Dorothy Carter
Production Manager Domestic
[212] 997-2908

Diane Ariotta
Production Assistant [212] 997-2044

Frances Vallone
Reader Service Manager
[212] 997-6057

Electronics Buyers' Guide

H.T. Howland, General Manager
[212] 997-6642

Regina Hera, Directory Manager
[212] 997-2544

Diane Ariotta, Production Manager
[212] 997-2044

Frances Vallone, Reader Service Manager
[212] 997-6057

Classified and Employment Advertising
Frank Eberle, Manager
[212] 997-2557

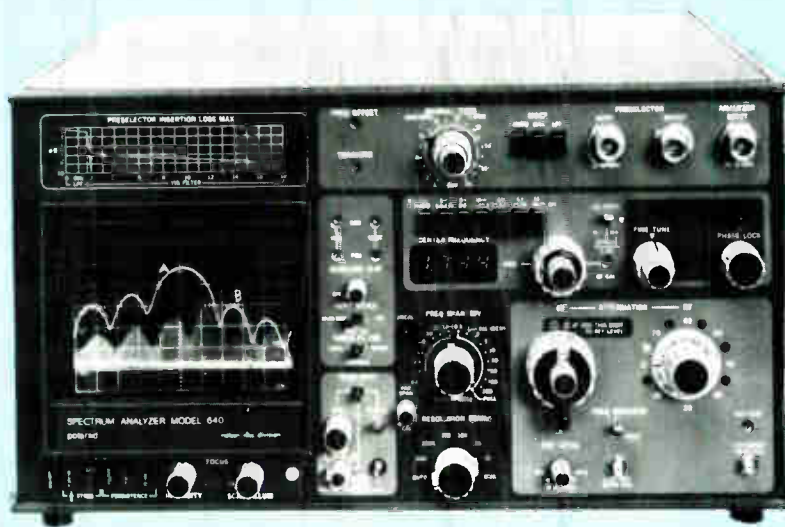

MODEL 640 includes preselector and memory. Display: Split Memory Comparison. "A" is stored reference pulsed spectrum (Peak mode). "B" is incoming pulsed spectrum. Frequency and level differences are easily measured.

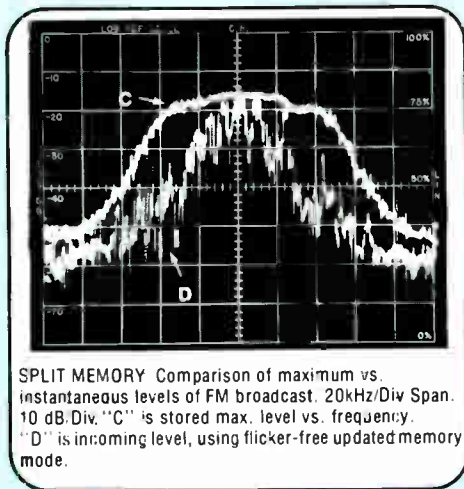

SPLIT MEMORY Comparison of maximum vs. instantaneous levels of FM broadcast. 20kHz/Div Span. 10 dB/Div. "C" is stored max. level vs. frequency. "D" is incoming level, using flicker-free updated memory mode.

Digital Memory & I/O Interface...

New Dimensions in RF/Microwave Spectrum Analyzers

COMPACT N-R 600 SERIES 100 kHz-40 GHz WITH DIGITAL MEMORY

- Eliminate annoying flicker— even when highly selective, slow scans are used.
- Provide precise on-screen comparisons; dual display of stored and incoming signals.
- Plot maximum signal level vs. frequency for any desired time interval.
- Have memory I/O interface for remote storage and recall of standard displays.
- Also used for signal processing; "talker" and "listener" functions. Adaptable to IEEE 488 Bus.

New N-R 600 Series Summary		U.S.A. Prices	
Model		Without Memory	Including Memory
632	100 kHz to 2 GHz	\$ 5,975	\$ 7,075
630	10 MHz to 40 GHz, 7 Bands	\$ 7,750	\$ 8,850
640	630 plus Internal Preselector	\$10,150	\$11,250
631	10 MHz to 40 GHz, 6 Bands	\$ 7,100	\$ 8,200
641	631 plus Internal Preselector	\$ 9,500	\$10,600

N-R 600 SERIES provide the absolute calibrated analysis features needed for today's stringent applications, at very affordable prices. Select among 5 easy-to-use models. Digital Memory (Option 1) is only one of the N-R 600 SERIES' outstanding design features. Some others include:

- LED frequency readout. Absolute level calibrations.
- Calibrated 0-2 GHz frequency spans.
- Resolution: 300Hz (phase-locked) to 1 MHz BW, auto-tracked or selectable.
- -115 dBm sensitivity, Model 632. To -110 dBm, other Models. Sensitivity conservatively rated @ S+N=2N, 1kHz BW.
- Internal tracked preselector (Models 640 & 641).
- 70 dB Log Scale (10 dB/Div.). Also 2 dB/Div and Linear Scales.
- Parallax-free internal CRT graticule. Scale illumination. Std. camera mount.
- Interface for Tracking Generator (Option 2).
- Compact, portable, all solid-state construction. Models 630, 631 & 632 are 7" high; approx. 40 lbs.

Call or write for complete specifications



polarad nelson • ross electronics division

5 Delaware Drive / Lake Success, New York 11040 / 516-328-1100 TWX 510-223-0414

Circle 901 on reader service card

The single source for all your Opto-Electronic needs...CLAIREX

Clairex specializes in Opto-Electronics. It's our only business. Therefore, you can depend on Clairex for the optimum solution to your "light" problems, whether you need photoconductors, phototransistors, photodarlingtons, photodiodes,

opto-isolators, optical switches, or complete arrays.

Give us your problem. We'll develop the solution. Call (914) 664-6602 or write Clairex® 560 South Third Avenue, Mount Vernon, New York 10550.

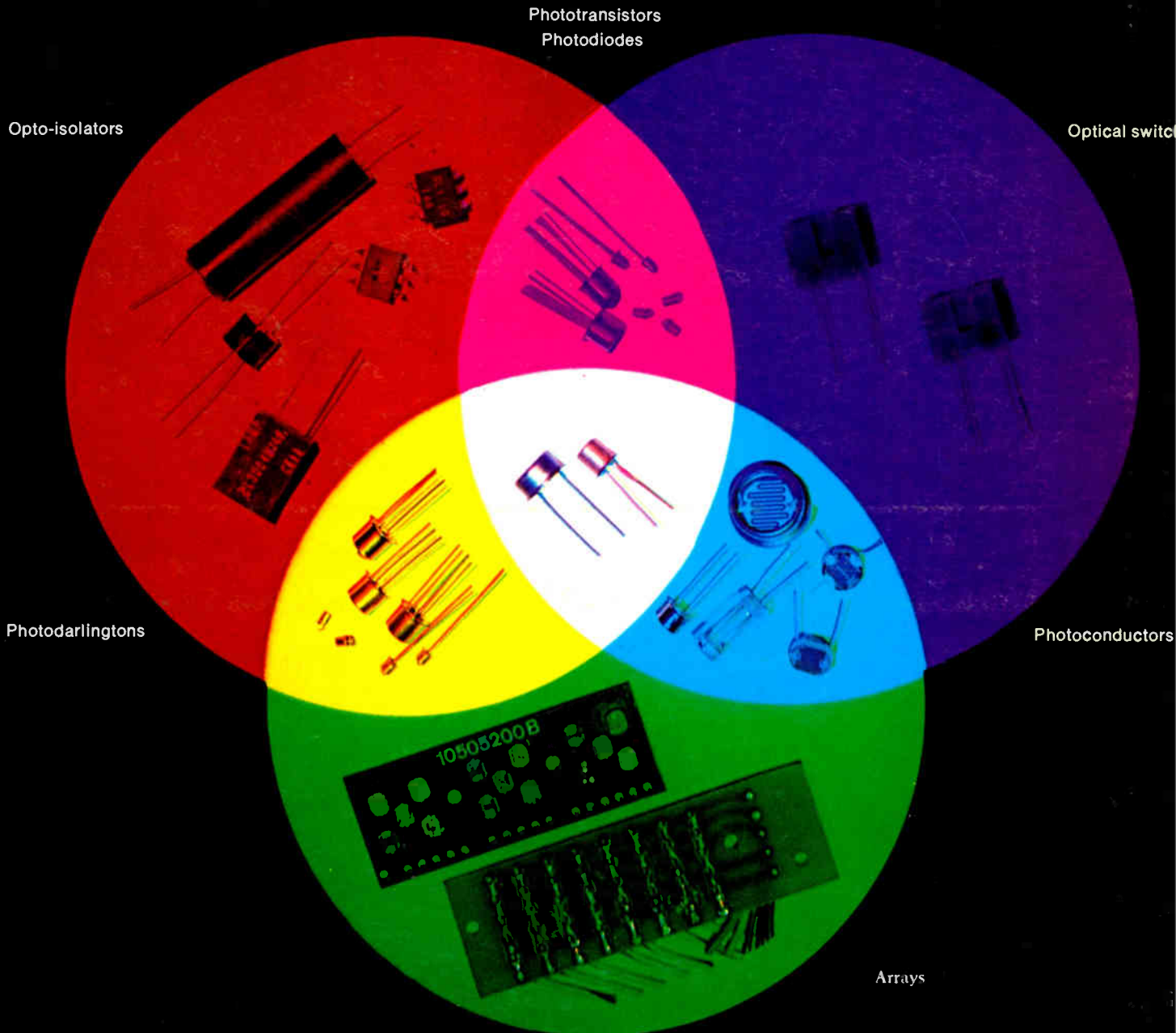

CLAIREX ELECTRONICS

A Division of Clairex Corporation

Circle 902 on Reader Service Card