

SEPTEMBER 15, 1977

**WESCON PREVIEW: MICROPROCESSORS STILL KING AT SESSIONS/97**

Designing with electrically alterable read-only memories/ 107

Development system speeds bit-slice prototype design/ 127

FOUR DOLLARS A MCGRAW-HILL PUBLICATION

# Electronics®

FLEXIBLE CIRCUITS  
Working in inner space

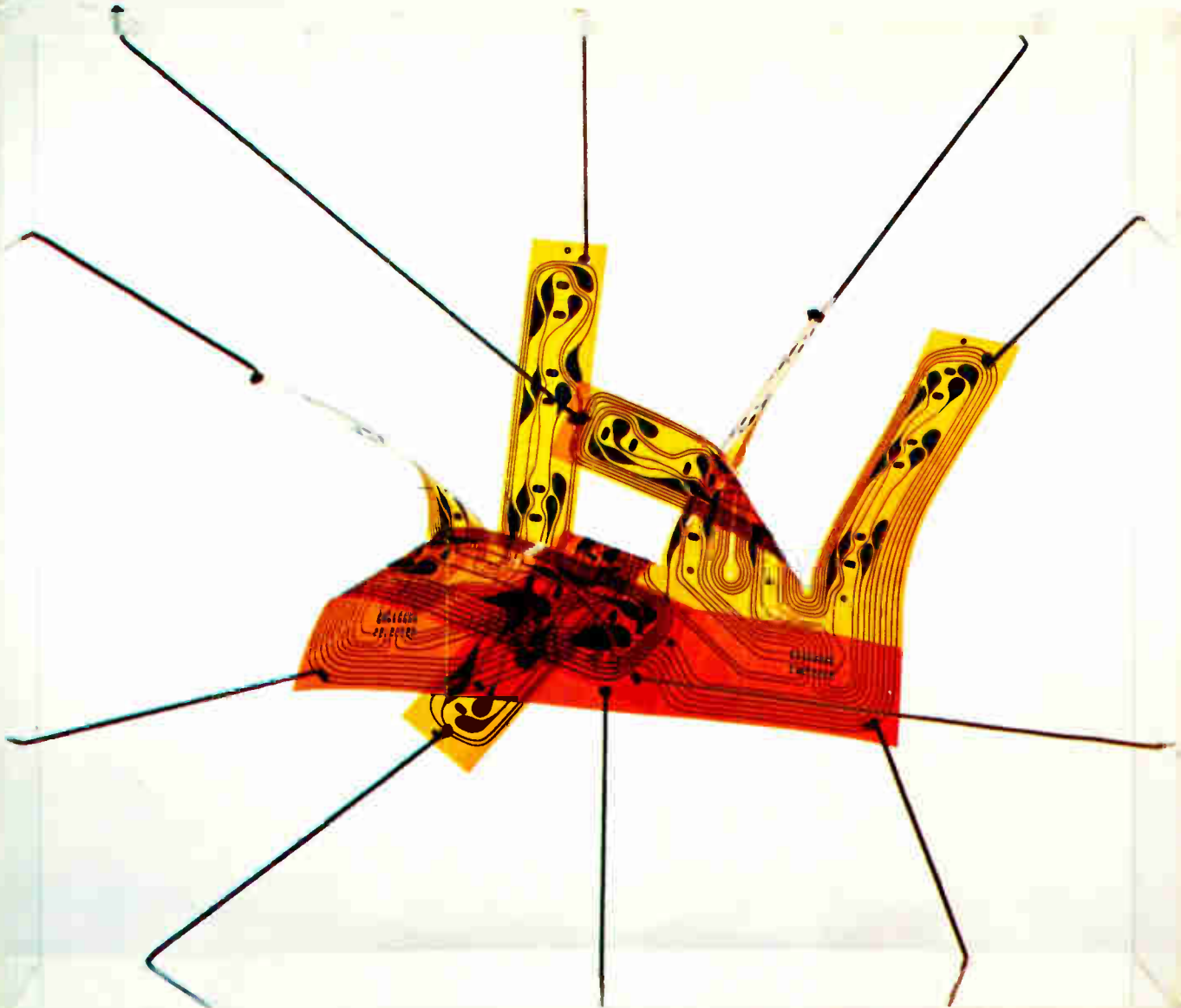

1420 N. 251 CANNON NOV 77  
MATT NEILL  
2516 NE CLACKAMAS  
PORTLAND OR

97232

# Introducing HP's 3466A ...

## The right DMM decision means $1\mu\text{V}$ sensitivity and autoranging in a 4-1/2 digit instrument.

HP's 3466A gives you unusual measurement capability in a 4½-digit DMM. It combines autoranging with  $1\mu\text{V}$  sensitivity... meaningful resistance measurements to 1 milliohm with 2-terminal convenience... true RMS measurements with 100 kHz bandwidth... plus 5-function measurement ease.

**High ohm and DC volt sensitivity.** Now you can make meaningful measurements to  $1\mu\text{VDC}$  or 1 milliohm with this autoranging 4½-digit DMM. And for low value resistance measurements, you no longer need 4 terminals. The 3466A has a front-panel adjustment that lets you null lead and contact resistance for faster, more convenient measurements.

**True RMS Volts and Amps.** In addition to 100 kHz bandwidth with true RMS, the 3466A gives you selective DC coupling to allow DC plus AC true RMS measurements with both current and voltage (two extra functions you normally don't get with a DMM). That means you can make direct true RMS measurements of signals such as digital pulse trains as well as sinusoidal waveforms.

**Battery and probe versatility.** You can operate this DMM from the line or select rechargeable lead-acid batteries for complete portability. And to extend the 3466A's capabilities, choose from HP's wide selection of probe accessories, including RF, high voltage and Touch-Hold probes.

**Diode test.** Another added plus with the 3466A is a diode test function to speed equipment servicing and troubleshooting. You simply select the  $1\text{ k}\Omega$  range and read the forward voltage drop across the diode or transistor junction directly on the digital readout.

**Excellent DMM value.** Five standard and three extra measurement functions, 38 ranges autoranging, high sensitivity, true RMS and more. And the 3466A has survived HP's demanding abuse testing program, so you know it's rugged and reliable. That's a lot of capability for a \$575\* DMM. Or get battery portability for \$650\*. Your HP field engineer has all the details. Contact him today.

\*Domestic U.S.A. price only.

**HP DMM's-  
the right decision**



HEWLETT **hp** PACKARD

1507 Page Mill Road, Palo Alto, California 94304

For assistance call Washington (301) 948-6370, Chicago (312) 255-9800, Atlanta (404) 955-1500, Los Angeles (213) 877-1282

Circle 900 on Reader Service card

# SURPRISE!

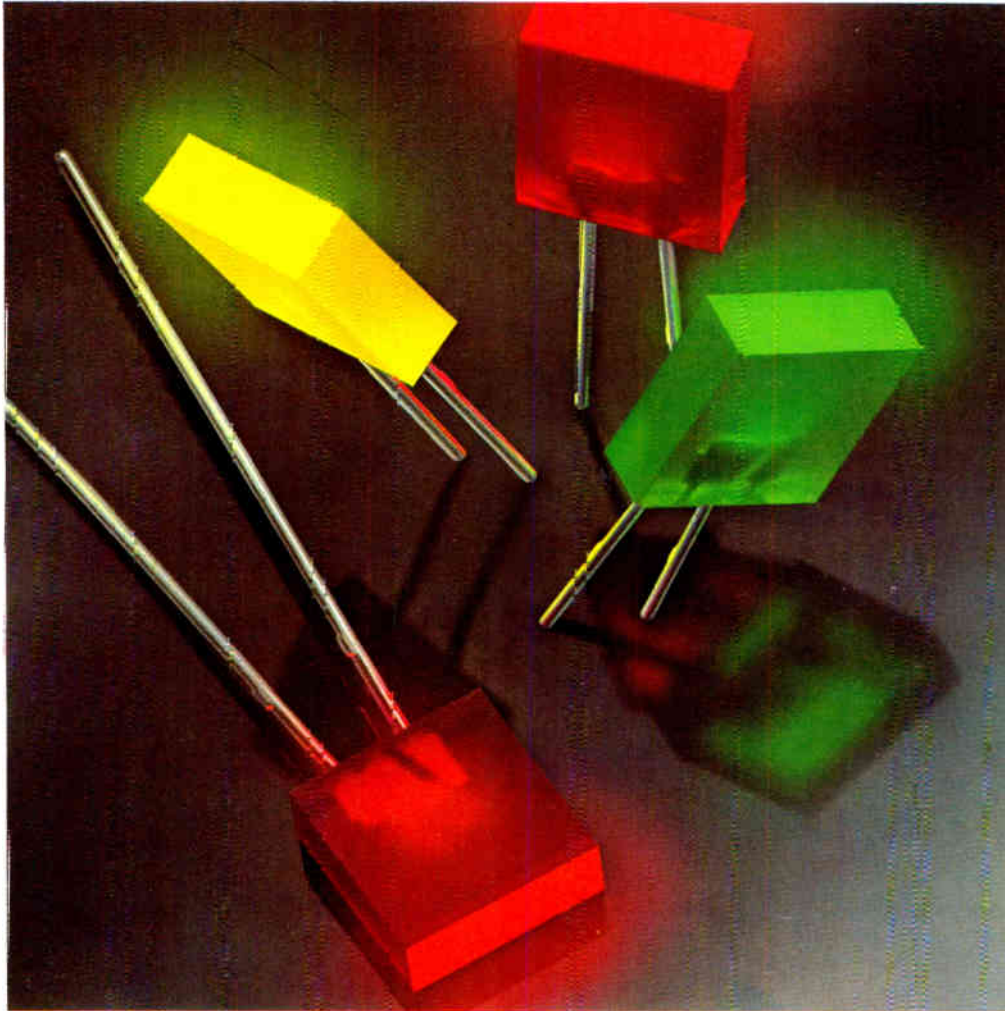

## The World's First Rectangular LED Lamps

For the first time LED's are offered in a rectangular epoxy package. Available in high-efficiency red, yellow and green, they feature a flat, high intensity, light emitting surface.

And, since they're end or side stackable, they're ideal for flush mounted panel indicators, backlighting legends, and linear arrays. Plus you get long life and solid state reliability. And they're in stock right now. Choose our 5082-4570 for yellow, the 5082-4670 for high efficiency red, or the 5082-4970 for green. Priced at \$1.00\* in quantities of 1000. \*U.S. Domestic prices only

In the U.S., contact Hall-Mark, Schweber, Wilshire or the Wyle Distribution Group (Liberty-Elmar) for immediate delivery.  
In Canada, contact Schweber Electronics or Zentronics, Ltd.

**HEWLETT  PACKARD**

Sales and service from 172 offices in 65 countries.

1507 Page M-1 Road, Palo Alto, California 94304

The  
performance  
you  
need.

The  
convenience  
you  
want.

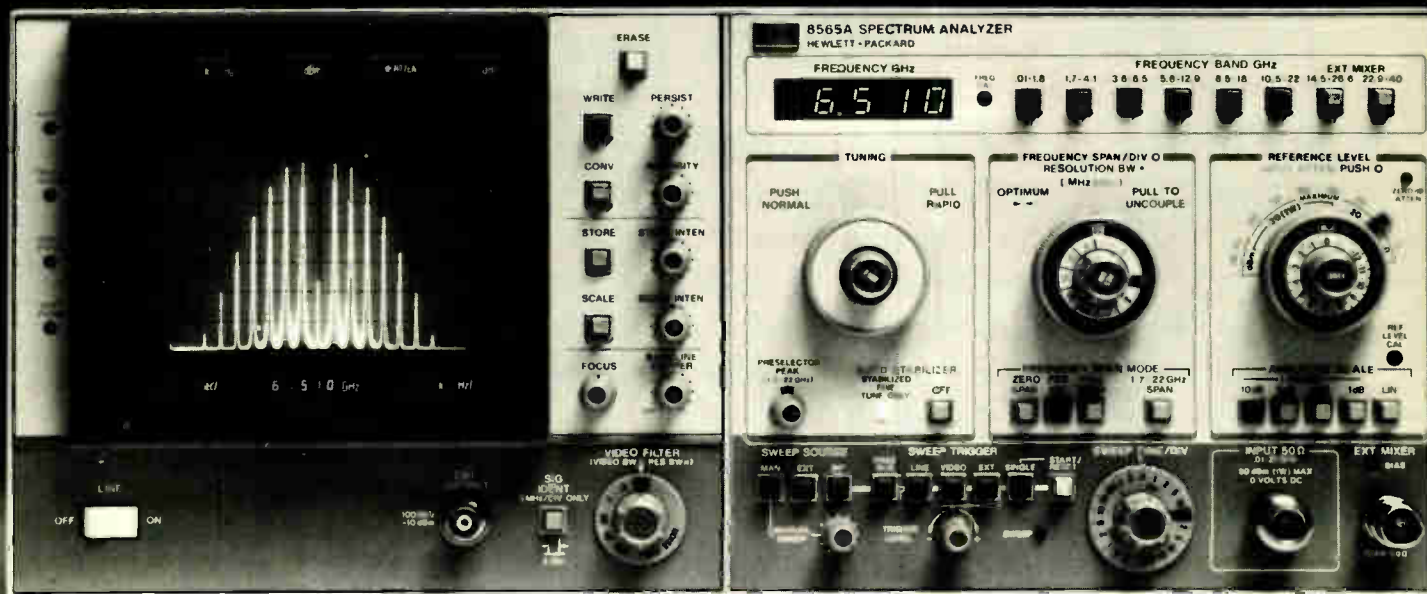

## HP's 8565A Microwave Spectrum Analyzer gives you both.

Here's a combination of fully-calibrated performance, with wide dynamic range from 10 MHz to 22GHz (extendable to 40 GHz), plus operating features that make it extremely easy to use.

Frequency response is within  $\pm 1.2$  dB to 1.8 GHz, and from  $\pm 1.7$  dB at 4 GHz to  $\pm 4.5$  dB at 22 GHz. These figures include all input circuitry effects as well as frequency band gain variations. Internal distortion products are 70 dB down from 10 MHz to 18 GHz; 60 dB, 18 to 22 GHz.

Resolution bandwidths from 1 kHz to 3 MHz are provided, with 100Hz optionally available. The resolution filters are all synchronously tuned to prevent ringing. For frequencies from 1.7 to 22 GHz, an internal preselector provides more than 60 dB rejection, permitting measurements of distortion products as small as 100 dB down.

As for convenience, the 8565A makes most measurements using just three controls: tuning frequency, frequency span and amplitude reference level.

Resolution, video filtering and sweep time are automatically set to the proper values. Bright LED's in the CRT bezel give you all pertinent operating conditions right there with the trace being viewed. And a scope camera records these data along with the CRT trace.

The 8565A Spectrum Analyzer gives you the capability you need and the convenience you'll fast appreciate. Domestic U.S. price is \$17,850 (add \$800 for 100 Hz resolution). Find out more by calling your nearby HP field office, or write.

HEWLETT  PACKARD

1507 Page Mill Road, Palo Alto, California 94304

## 39 Electronics Review

MEMORIES: Japanese 4-k RAM rivals U.S. devices, 39  
DISPLAYS: Package combines optical fibers, lasers, 40  
NAVIGATION: Microprocessor ups missile capabilities, 41  
MICROPROCESSORS: National produces 16-bit, 40-pin chip, 41  
PACKAGING & PRODUCTION: Phillips says yes to resistless boards, 42  
FIBER OPTICS: Hughes fiber shows 0.01 dB/km loss in IR, 44  
RADAR: Moving radar beats detectors, 44  
TESTING: LSI outdistances tester makers, 46  
COMMUNICATIONS: Secure voice link to use CCDs, 48  
NEWS BRIEFS: 48  
MILITARY: Cost savings eyed in modular testing, 50  
CONSUMER: Data link is key to home security system, 52

## 59 Electronics International

SWEDEN: Minicomputer net to serve city's entire administration, 63  
JAPAN: SIT cell may boost RAM performance tenfold, 64

## 73 Probing the News

MEMORIES: Big ROMs begin to make waves, 73  
ABROAD: For Czechs, production gear comes first, 76  
COMMERCIAL: L.A. buses to get monitoring system, 78  
COMPANIES: ITT Semiconductors stakes U. S. claim, 82  
COMPONENTS: Will V-MOS make it in power-transistor market? 84

## 97 Technical Articles

SPECIAL REPORT: Flexible circuits bend to designers' will, 97  
SEMICONDUCTORS: Designing with nitride-type EAROMs, 107  
DESIGNER'S CASEBOOK: 555 protects gear from overvoltage, 116  
Resettable electronic fuse consists of SCR and relay, 117  
Versatile phase detector produces unambiguous output, 117  
CIRCUIT DESIGN: Multivalued logic lessens interconnections, 122  
MICROPROCESSORS: Bit-slice debugging made easier, 127  
ENGINEER'S NOTEBOOK: One-chip meter monitors salt solution, 132  
Gate and counter check phase-locked-loop sensitivity, 133  
It's easy to connect dc supplies in parallel, 135  
WESCON/77: Sessions focus on microprocessors, 141

## 158 New Products

WESCON PRODUCT PREVIEW:  
4 1/2-digit meter sells for \$199, 158  
Rockwell to introduce 32-k static ROM, 160  
DMMs tailored to communications, 162  
Hybrid data system comes in two DIPs, 164  
Multimeter ranges up to 1,000 volts, 164  
Printer interfaces with data sources, 166  
\$195 counter resolves 8 digits, 166  
Loggers handle all detectors, 170  
Pulse generators are programmable, 172  
IN THE SPOTLIGHT: Data system plays triple role, 185  
SEMICONDUCTORS: Reference-diode IC offers wide range, 188  
INDUSTRIAL: Thermistors are interchangeable, 204  
INSTRUMENTS: Logic analyzer and scope are combined, 220  
PACKAGING & PRODUCTION: Probe catches narrow pulses, 246  
COMPONENTS: Air activates button cell, 259  
MATERIALS: 272

## Departments

Publisher's letter, 4	Washington newsletter, 55
Readers' comments, 6	Washington commentary, 56
News update, 8	International newsletter, 59
People, 14	Engineer's newsletter, 138
Editorial, 22	New literature, 279
Meetings, 25	New books, 288
Electronics newsletter, 33	

## Services

Employment opportunities, 294  
Reader service card, 315

## Highlights

### Cover: Ready, set, flex! 97

Bendable printed circuits are coming into their own in all areas of electronics. As this special report details, their flexibility and the savings in weight, unit assembly time, and money are becoming especially important in the computer, industrial, consumer, and automotive areas.

Cover by Robert Strimban.

### Bigger ROMs ready to storm the market, 73

As program sizes grow, microprocessor users are showing that they want big volumes of read-only memories with high bit densities, and the semiconductor houses are anxious to oblige. Marketing of the 32,768-bit ROMs is off to a slow start, but device makers are racing ahead with 65,536-bit designs.

### Nitride EAROMs get into designs, 107

The electrically alterable read-only memory combines nonvolatility with reprogrammability—characteristics that make the nitride-storage device ideal for TV tuners, phone dialers, and point-of-sale terminals, where its relative slowness is no limitation.

### Wescon's 26th gears up, 141

San Francisco is the site of Wescon's 26th annual edition, Sept. 19–21. The exhibits lean strongly toward microprocessor design, while the technical sessions are peppered with advice on what to do and how to do it with the popular little devices, with emphasis on the peripherals. Beginning on page 158 is a preview of products being introduced at the show.

### In the next issue . . .

Automotive electronics get the green light . . . a one-chip multiplier with an amazing speed-power product . . . a better way to build prototype boards.

EDITOR-IN-CHIEF: Kemp Anderson

EXECUTIVE EDITOR: Samuel Weber

MANAGING EDITOR: Arthur Erikson,  
*International*

SENIOR EDITORS: Laurence Altman,  
Ray Connolly, Lawrence Curran,  
John Johnsrud, H. Thomas Maguire,  
Stephen E. Scrupski, Gerald M. Walker

ART DIRECTOR: Fred Sklenar

ASSOCIATE EDITORS: Howard Wolff,  
Alfred Rosenblatt

#### DEPARTMENT EDITORS

*Aerospace/Military*: Ray Connolly  
*Circuit Design*: Vincent Biancomano  
*Communications & Microwave*:  
Richard Gundlach  
*Components*: Lucinda Mattera  
*Computers*: Raymond P. Capece  
*Consumer*: Gerald M. Walker  
*Instrumentation*: Stephen E. Scrupski  
*New Products*: H. Thomas Maguire,  
Michael J. Riezenman  
*Packaging & Production*: Jerry Lyman  
*Solid State*: Laurence Altman

CHIEF COPY EDITOR: Margaret Eastman

COPY EDITORS: Ben Mason, Mike Robinson

ART: Charles D. Ciatto, *Associate Director*  
Paula Piazza, *Assistant Director*

EDITORIAL SECRETARIES: Janet Noto,  
Penny Rothman

EDITORIAL ASSISTANT: Marilyn B. Rosoff

#### FIELD EDITORS

*Boston*: Lawrence Curran (Mgr.)  
*Los Angeles*: Larry Waller (Mgr.)  
*Midwest*: Larry Armstrong (Mgr.)  
*New York*: Bruce LeBoss (Mgr.)  
*San Francisco*: Bernard Cole (Mgr.)  
Judith Curtis  
*Washington*: Ray Connolly (Mgr.)  
*Frankfurt*: John Gosch  
*London*: William F. Arnold  
*Paris*: Arthur Erikson  
*Tokyo*: Charles Cohen

#### McGRAW-HILL WORLD NEWS

*Editor*: Michael Johnson  
*Brussels*: James Smith  
*Milan*: Andrew Heath  
*Moscow*: Peter Hann  
*Paris*: Andrew Lloyd  
*Stockholm*: Robert Skole  
*Tokyo*: Robert E. Lee

PUBLISHER: Dan McMillan

ADVERTISING SALES MANAGER:

Paul W. Reiss

MARKETING ADMINISTRATION MANAGER:

Wallis Clarke

CIRCULATION MANAGER: Karl Peterson

MARKETING SERVICES MANAGER:

Tomlinson Howland

RESEARCH MANAGER: Margery D. Sholes

**C**halk one up for the East. Although the Southwest and the Bay Area around San Francisco have become the hotbed of new semiconductor technology, a development effort on the East Coast gets the credit for pioneering nitride technology for read-only memories. The article starting on page 107, by General Instrument's Brian Cayton, gives details on that effort.

While Cayton has day-to-day responsibility for marketing the growing line of electrically alterable ROMs, it is really his boss, Edgar A. Sack, a senior vice president and worldwide operational director for GI's microelectronic and related products, who brought the nitride technology to commercial fruition. It started in the late 1960s, when Sack was running Westinghouse's military electronics division in Baltimore.

"I saw an internal report from our central research laboratories in Pittsburgh describing a hysteresis phenomenon in the thin-oxide-nitride interface under an MOS gate," recalls Sack. A few days later, while driving to attend the ISSCC, Sack realized that the technique might work for nonvolatile storage. "When I got back to Baltimore and called the research team with my opinion," he continues, "they of course had reached the same conclusion. Patents were filed and the technology was born."

Cooperation in the East did not stop there. Dayton-based NCR was also looking at the nitride process as a candidate for providing nonvolatile storage in reprogrammable terminals. "At that time GI was interested in nitride memories for TV tuners," says Sack, "so in 1973 we formed a

joint program with NCR for developing nitride storage further." GI has the venture's exclusive rights for marketing the alterable ROMs.

"We'll make a believer out of Silicon Valley yet," Sack says. Apparently he is on his way to that goal. The only other commercial supplier of nitride memories in the world is Nitron Corp., and it is in Cupertino, Calif.

**F**lexible circuits, the subject of our cover article this issue, are more than just another wiring method. They are the basic elements in a whole approach to circuit design.

Our packaging and production editor, Jerry Lyman, found in his reporting for the article that flexible-circuit manufacturers, unlike their counterparts in the rigid printed-circuit-board business, are really building complete interconnection systems, not just components.

Says Lyman: "I found flex people busy designing complete system packages for customers or converting existing packages to flex circuitry configurations. Often this work involves assembling flex circuitry, rigid boards, component sockets, and connectors. As an added fillip, flex companies can supply two-sided or multilayer rigid pc boards and, in one case, flat cable."

For a roundup, then, on what is happening in flexible circuits, and what they can do for equipment design, turn to the report that starts on page 97.



September 15, 1977 Volume 50, Number 19 95,272 copies of this issue printed

Published every other Thursday by McGraw-Hill, Inc. Founder: James H. McGraw 1860-1948. Publication office 1221 Avenue of the Americas, N.Y., N.Y. 10020; second class postage paid at New York, N.Y., and additional mailing offices.

Executive, editorial, circulation and advertising addresses: Electronics, McGraw-Hill Building, 1221 Avenue of the Americas, New York, N.Y. 10020. Telephone (212) 997-1221. Teletype 12-7960 TWX 710-581-4879. Cable address: MCGRAW HILL N E W Y O R K.

Subscriptions limited to professional persons with active responsibility in electronics technology. No subscriptions accepted without complete identification of subscriber name, title or job function, company or organization, and product manufactured or services performed. Based on information supplied, the publisher reserves the right to reject non-qualified requests. Subscription rates: in the United States and possessions \$14 one year, \$25 two years, \$35 three years; company address and company libraries \$20 one year, \$36 two years, \$50 three years; APO/FPO addressed \$35 one year only; Canada and Mexico \$16 one year, \$28 two years, \$40 three years; Europe \$40 one year, \$71 two years, \$100 three years; Japan, Israel and Brazil \$65 one year, \$115 two years, \$165 three years; Australia and New Zealand \$90 one year, \$170 two years, \$240 three years, including air freight; all other countries \$45 one year, \$80 two years, \$112 three years. Limited quota of subscriptions available at higher-than-basic rate for persons allied to field served. Check with publisher for these rates. Single copies: \$4.00. Please allow four to eight weeks for shipment.

Officers of McGraw-Hill Publications Company: Gordon L. Jones, President; Paul F. McPherson, Executive Vice-President; Group Vice-President Gene W. Simpson; Senior Vice-Presidents: Russell F. Anderson; James E. Boddorf, Planning & Development; David G. Jensen, Manufacturing; Ralph R. Schulz, Editorial; Vice-Presidents: Denis C. Beran, European Operations; David P. Forsyth, Research; Douglas Greenwald, Economics; James E. Hackett, Controller; Robert L. Leyburn, Circulation; Edward E. Schirmer, Sales.

Officers of the Corporation: Harold W. McGraw, Jr., President, Chief Executive Officer, and Chairman of the Board; Robert N. Landes, Senior Vice President and Secretary; Ralph J. Webb, Treasurer.

Title registered in U.S. Patent Office. Copyright © 1977 by McGraw-Hill, Inc. All rights reserved. The contents of this publication may not be reproduced in whole or in part without the consent of copyright owner.

Subscribers: The publisher, upon written request to our New York office from any subscriber, agrees to refund that part of the subscription price applying to copies not yet mailed. Please send change-of-address notices or complaints to Fulfillment Manager; subscription orders to Circulation Manager, Electronics, at address below. Change-of-address notices should provide old as well as new address, including postal zip code number; if possible, attach address label from recent issue. Allow one month for change to become effective.

Postmaster: Please send form 3579 to Fulfillment Manager, Electronics, P.O. Box 43, Hightstown, N.J. 08520.

# 4 filters in 1

Model 3202 offers two independent low-pass or high-pass channels or single channel band-pass or band-reject from 20 Hz to 2 MHz.

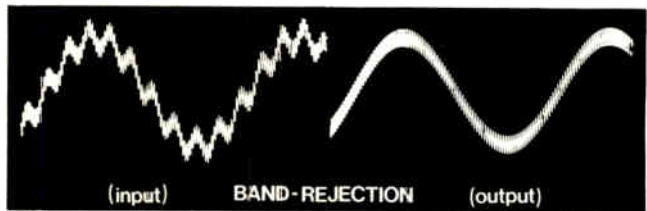
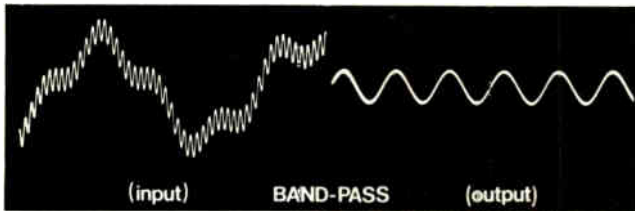
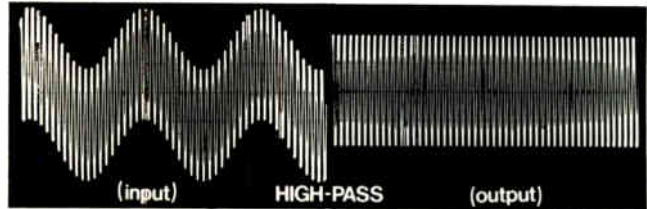
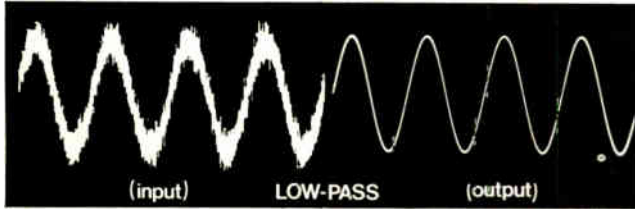

For only \$895, Model 3202 provides the flexibility essential for complex frequency or time domain measurements.

**FUNCTIONS:** Low-pass—direct coupled with low drift.

High-pass—upper 3 dB at 10 MHz. Band-pass—continuously variable. Band-rejection—variable broad band or sharp null.

**TWO RESPONSE CHARACTERISTICS:** (1) Fourth-order Butterworth or (2) simple R-C (transient free).

**ZERO-dB INSERTION LOSS:** All-silicon amplifiers provide unity gain passband response. 24 dB per octave slopes per channel extend to at least 80 dB.

**90-dB DYNAMIC RANGE:** Low hum and noise (less than 100 microvolts) eliminate costly preamplifiers.

For fast action, call: (617) 580-1660

TWX: 710-320-6583, Krohn-Hite Corporation  
Avon Industrial Park, Avon, MA 02322, U.S.A.

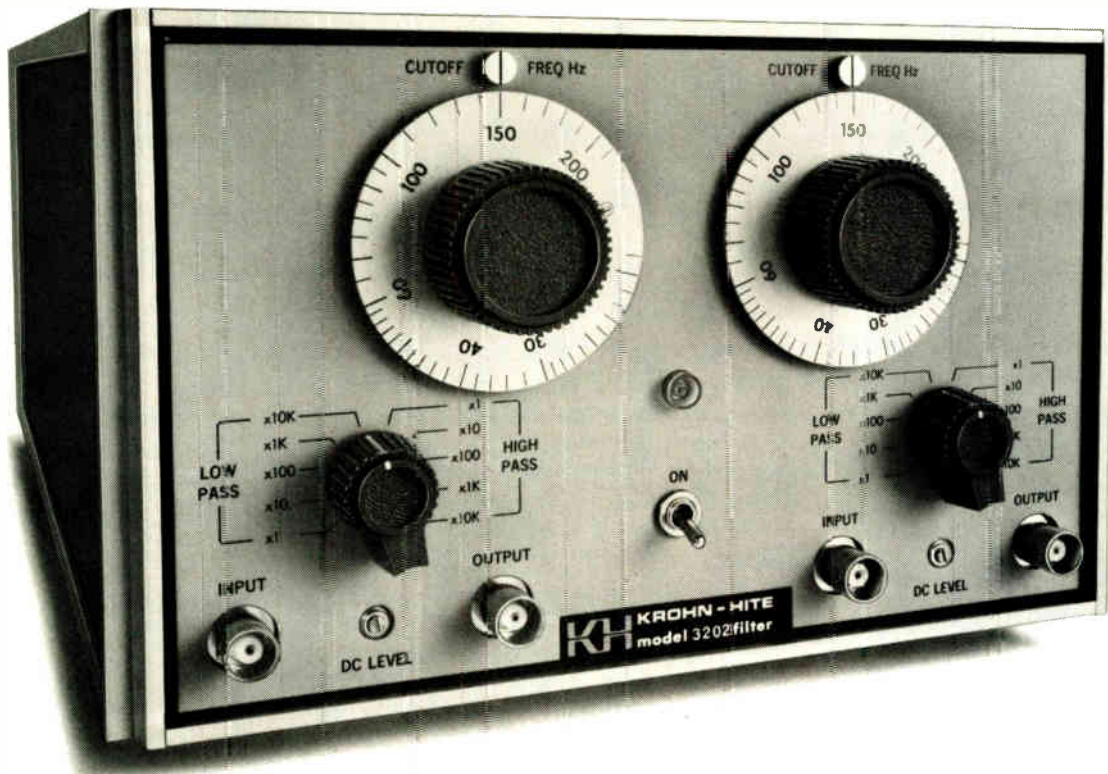

## KH KROHN-HITE CORPORATION

Avon Industrial Park, Avon, MA 02322. (617) 580-1660

SALES OFFICES: ALA., Huntsville (205) 534-9771; ARIZ., Scottsdale (602) 994-5461; CAL., San Jose (408) 292-3220; Inglewood (213) 674-6850; CDL., Denver (303) 773-1213; CONN., W. Hartford (203) 525-7647; FLA., Orlando (305) 894-4401; GA., Atlanta (404) 455-1206; HAWAII, Honolulu (808) 941-1574; ILL., Arlington Hts. (312) 394-3380; IND., Ft. Wayne (219) 485-0845; KS., Overland Park (913) 384-2710; LA., Lafayette (318) 984-3516; MD., Baltimore (301) 321-1411; MASS., Wakefield (617) 245-5940; MI., Southfield (313) 569-4497; MINN., St. Paul (612) 645-5816; MO., St. Louis (314) 731-5400; N.M., Albuquerque (505) 255-2330; N.J., Cherry Hill (609) 482-0059; N.Y., Elmont (516) 488-2190, Rochester (716) 328-2230, Syracuse (315) 437-6666, Vestal (607) 785-9947; N.C., Burlington (919) 227-3639; OHIO, Chesterland (216) 729-2222, Dayton (513) 434-8993; OKLA., Tulsa (918) 299-2636; ORE., Portland (503) 297-2248; TEX., Dallas (214) 661-0400, Houston (713) 688-1431; VA., Falls Church (703) 573-8787; WA., Bellevue (206) 454-3400; CANADA, Montreal, Quebec (514) 341-7630, Ottawa, Ontario (613) 235-5121, Toronto, Ontario (416) 445-9400, Vancouver, British Columbia (604) 253-5555, Halifax, Nova Scotia (902) 454-8321, St. John's, Newfoundland (709) 726-2422.

**Before you specify or buy tantalum capacitors, look at the Tansitor line.**



**MINIATURE SOLIDS**

Types HA/TC; cylindrical, rectangular, polar and non-polar; -55°C to +125°C.

**PuriTan™**

4 case sizes approved to MIL-C-39006/22 (CLR 79).

**CUSTOMIZED PACKAGES**

Rectangular packages: CM type; CL or TE 51-54; CL 55; TE 59; tantalum to glass hermetic seal.

**WET TYPES**

CLR 65, CL 64/65, CL 66/67. Hermetic or elastomer seals. Standard or high cap.

**FOIL TYPES**

Tubular style CLR, CL or TE; Elastomer and hermetic seals.

For more information on TANSITOR capacitors, call your local Tansitor Rep, or contact:



West Road, Bennington, Vermont 05201 U.S.A.  
Phone (802) 442-5473  
TWX (710) 360-1782

Specialists in Tantalum Capacitors

™ Trademark of Tansitor Electronics

**Readers' comments**

**More for your money**

To the Editor: In part 2 of your career series [July 21, p. 100], you quote Paul Groner, circuit design manager at Varian Data Machines, as accusing the Institute of Electrical and Electronics Engineers of inactivity in promoting the EE's health and welfare: "The American Medical Association and the American Bar Association do a good job, whereas the IEEE doesn't do anything." While it is true that the AMA and the ABA have for many years done quite a bit for their members in exchange for several hundred dollars in annual dues, the IEEE has—since an enabling amendment barely five years ago—done a disproportionate amount of promotion of its members' welfare for the initially \$5 and now \$10 annual assessment. A special report by the institute's United States Activities Board, "How USAB Helped Members in 1976," is available from the IEEE's Washington office (2029 K Street N. W., Washington, D. C. 20006).

The USAB will ask IEEE members in a September survey (in The Institute) which professional programs they deem important and how much they are willing to pay for them.

Herbert H. Heller  
USAB, Surveys  
Cleveland Heights, Ohio

**In-house concepts**

To the Editor: As the inventor of pocket electronic games at Mattel, I would like to correct the implication that Mattel relies on outside sources for creative inputs in this area [Aug. 18, p. 71].

The first game was built by me in November 1975, several months before Rockwell entered the scene. It used C-MOS logic and an array of LEDs to simulate motion.

All our game concepts were and are being created within Mattel's preliminary design department.

George Klose  
Mattel Inc.  
Hawthorne, Calif.

■ *There was no suggestion that Mattel relies on outside help in conceiving or designing its electronic games—only that it is supplied by Rockwell.*

**Electronics Magazine Book Series. Zero-risk trial offer.**

**1. Microprocessors**

What you must know about available microprocessor technology, devices, information. 4th printing. \$8.95



**2. Applying Microprocessors**

2nd and 3rd generation technology. 26 detailed applications from data networks to video games. \$9.95

**3. Large Scale Integration**

Covers the basic technology, new LSI devices, LSI testing procedures, plus system design and applications. \$9.95

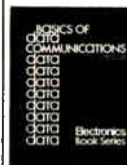

**4. Basics of Data Communications**

Includes 47 articles from Data Communications magazine covering more than 11 key areas. \$12.95.

**5. Circuits for Electronics Engineers**

Contains 306 circuits arranged by 51 functions from Amplifiers to Voltage Regulating Circuits. Saves design drudgery. \$15.95



**Electronics Book Series**

P.O. Box 669, Hightstown, N.J. 08520

1. Send me \_\_\_\_\_ copies of "Microprocessors" at \$8.95 per copy.
2. Send me \_\_\_\_\_ copies of "Applying Microprocessors" at \$9.95 per copy.
3. Send me \_\_\_\_\_ copies of "Large Scale Integration" at \$9.95 per copy.
4. Send me \_\_\_\_\_ copies of "Basics of Data Communications" at \$12.50 per copy.
5. Send me \_\_\_\_\_ copies of "Circuits for Electronics Engineers" at \$15.95 per copy.

Discounts of 40% on orders of 10 or more copies.

I must be fully satisfied or you will refund full payment if the book is returned after ten-day trial examination.

Payment enclosed  Bill firm  Bill me

Charge to my credit card:

American Express  Diners Club  
 BankAmericard  Master Charge

Acc't No. \_\_\_\_\_

Date exp. \_\_\_\_\_

On Master Charge only,

first numbers above name \_\_\_\_\_

Name \_\_\_\_\_ Title \_\_\_\_\_

Company \_\_\_\_\_

Street \_\_\_\_\_

City \_\_\_\_\_ State \_\_\_\_\_ Zip \_\_\_\_\_

Signature \_\_\_\_\_



# The Cube widens the gap...

## In Power-Ferrite EC cores for switching power supply chokes

Now available from Ferroxcube are standardized gapped EC cores in four sizes: 35, 41, 52 and 70 mm. The gap lengths have been optimized to prevent saturation of the core due to a high DC field while simultaneously providing maximum impedance to the AC ripple current.

For worst case DC bias, two gapped cores should be used. Under less stringent conditions, one gapped and one ungapped core in combination may be used. The chart below shows the DC ampere-turns which can be supported for both 2-gapped and gapped/ungapped combinations that will not decrease incremental permeability more than 10%.

EC Core	2 Gapped Cores	1 Gapped + 1 Ungapped Core
35 mm	325 AT	200 AT
41 mm	370 AT	220 AT
52 mm	540 AT	330 AT
70 mm	860 AT	570 AT

For complete specifications on gapped EC cores, bobbins and hardware, call on The Cube.

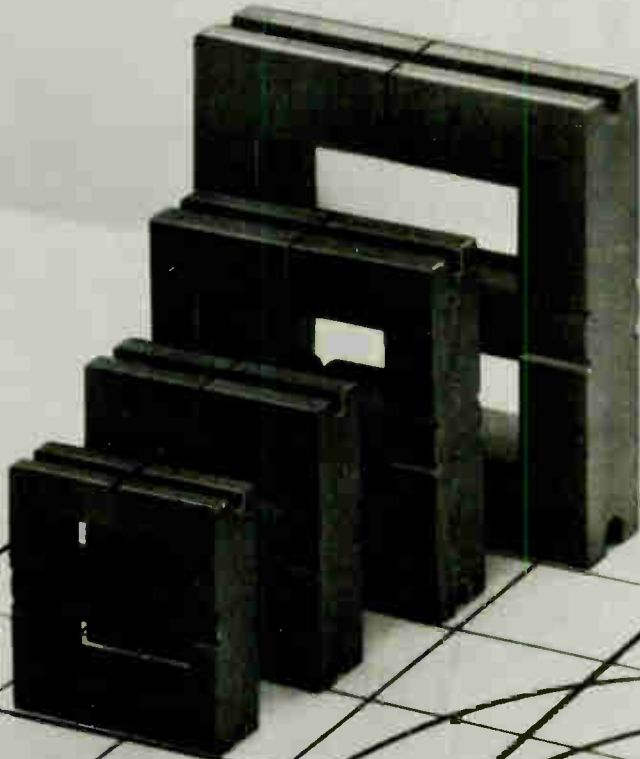

Call  
on the  
cube

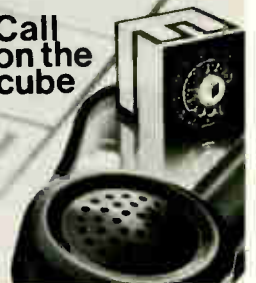

**FERROXCUBE** Division of Ampere Electronic Corporation,  
Saugerties, New York 12477 (914) 246-2811  
A North American Philips Company

# WE'RE #1 IN EQUIPMENT RENTALS



More people  
More plant  
More experience

The Continental concept of sales and service has grown to a team of more than 150 "Professionals" in 10 nation-wide offices.

Rental inventory, offices, service and calibration labs exceed 60,000 square feet of floor space.

In-house service, experienced personnel and four hundred thousand dollars/month in new equipment purchases keep us #1.

## Rent with Confidence

Call  
Continental  
Rentals

Get our  
FREE  
Catalog

Div. Continental Resources, Inc.  
175 Middlesex Turnpike, Bedford,  
MA 01730 (617) 275-0850

FOR IMMEDIATE RESPONSE CALL:  
N.E. (617) 275-0850; L.I. (516) 752-1622;  
NY, NJ (201) 654-6900;

Florida (800) 638-4050;  
Gtr. Phila. (609) 234-5100;  
Wash., D.C. area (301) 948-4310;  
Mid West (312) 439-4700;  
So. Central (800) 323-9656;  
Costa Mesa, CA (714) 540-6566;  
L.A., CA (213) 638-0454;  
Santa Clara, CA (408) 735-8300.

## News update

■ The U. S. Navy's hopes of eventually replacing heavy copper wiring on ships with lighter, interference-free cables are riding high after recent tests at sea of a fiber-optic sonar link. Designated FOSL-1, the 52-channel analog link used plastic-fiber cable from E. I. du Pont de Nemours & Co. of Wilmington, Del.

The Naval Underwater Systems Center in New London, Conn., is believed to have installed FOSL-1 aboard a nuclear submarine [*Electronics*, May 27, 1976, p. 39]. The Navy hoped the tests would demonstrate fiber optics' ability to transmit wideband, low-level signals with very little distortion. Thus, FOSL-1 had to have a system capability of 100 decibels of dynamic range and harmonic distortion of less than 1%. Short-term reliability and maintainability, as well as low cost, were other musts.

"We built a breadboard to establish credibility for the fiber-optics technology, and we did that in spades," states Fred Allard, head of the fiber-optics systems branch at the New London center's Submarine Electro-Optical Systems division. The FOSL-1 link was built with off-the-shelf commercial components, and after 25,000 hours of operation all of its channels were still operative, showing no signs of deterioration, says Allard.

He estimates it would cost about \$91 per channel to purchase the electro-optical components and another \$40 a channel for the fiber-optic parts, so that per-channel costs for a 50-channel system should be on the order of \$130 to \$150. This is much less expensive than other high-quality systems, he claims.

The Navy has made no commitment as yet to an operational system. Nevertheless, "we at the laboratory feel we're onto something that will play a part in our future systems," Allard concludes.

Meanwhile, Du Pont has been doing some environmental testing in support of possible use by the Navy of its PFX plastic cables, says senior marketing specialist C. Ronald Ferguson. The tests include two years of accelerated aging at 90°F and 99%

# Introducing the PMUX

The world's first programmable multiplexer

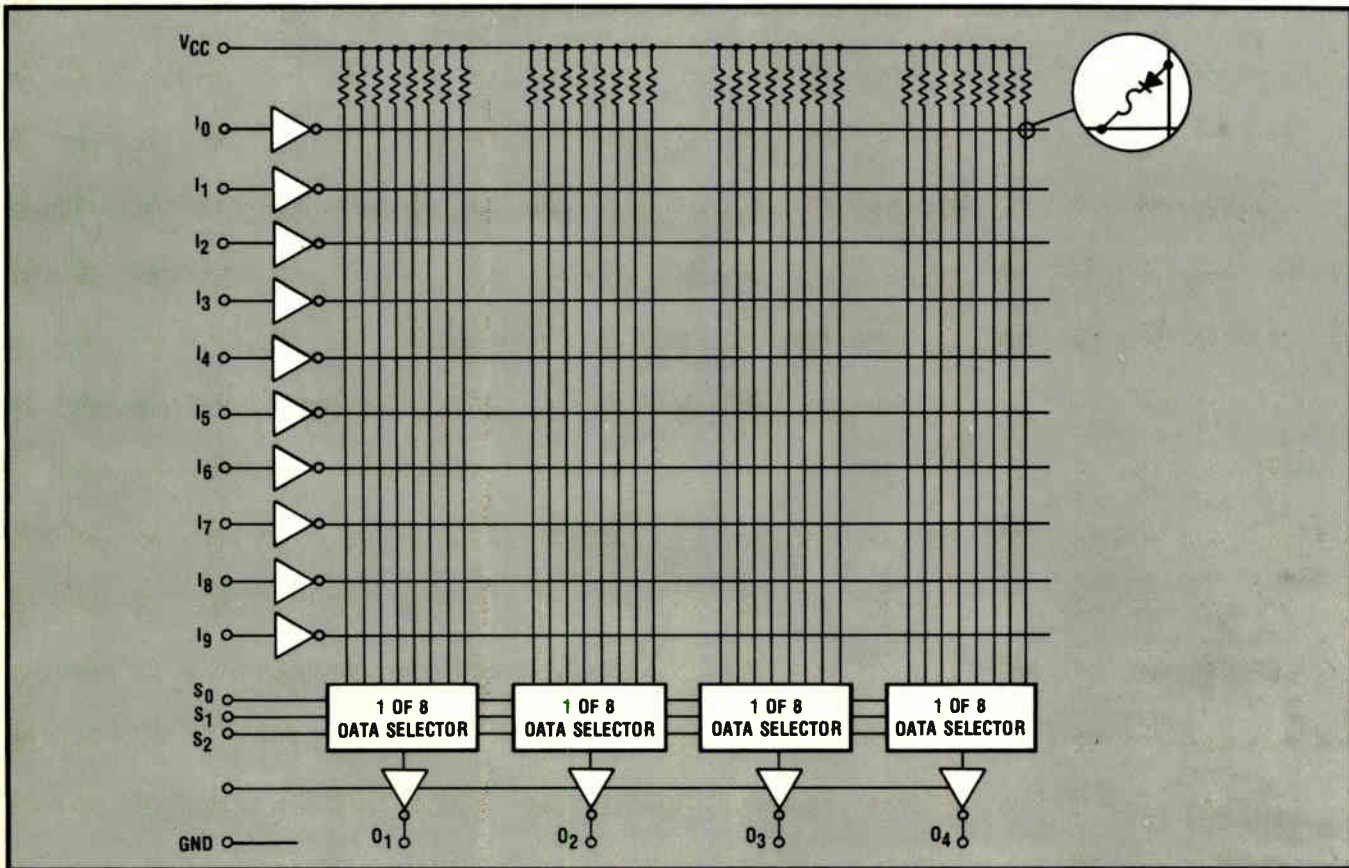

**THE  
29693  
IS:**

- A poor man's FPLA
- A sign extender
- A programmable data flow control
- A buffered programmable diode matrix
- A digital crosspoint array
- Easily programmed
- Fast, only 30nS typical (I<sub>x</sub> to O<sub>N</sub>)
- Economical, only \$4.25 at 100 pieces

Another first from

**“The Specialists in Bipolar Microcomputer Components”**

**Field Sales Offices**  
**California:** Irvine (714) 833-9042, Mountain View (415) 969-3475.  
**Florida:** St. Petersburg (813) 576-2221. **Illinois:** Des Plaines (312) 297-5540. **Massachusetts:** Newton (617) 527-0030.  
**Minnesota:** Minneapolis (612) 920-7935. **New Jersey:** Cherry Hill (609) 663-4066. **New York:** Melville (516) 420-0700.



**SEMICONDUCTOR DIVISION**

**Tell me more . . .**

Full data and applications on your PMUX  
 Your full Semiconductor Selection Guide

Name \_\_\_\_\_  
 Title \_\_\_\_\_  
 Company \_\_\_\_\_  
 Address \_\_\_\_\_  
 City \_\_\_\_\_  
 State \_\_\_\_\_ Zip \_\_\_\_\_  
 My phone number is \_\_\_\_\_

Mail to: Raytheon Company, Semiconductor Division  
 350 Ellis Street, Mt. View, CA 94042

quality  
makes  
the difference  
in...



NORTH ATLANTIC

## Synchro Test Instruments

with 48 hour burn-in

• High Reliability • High Performance

### Simulators and Bridges

- $\pm 2$  second accuracy
- 0.0001° resolution
- Stable-passive circuits
- Wide band — 60 to 10,000 Hz
- Synchro or resolver
- Full rack or DPM style

### Phase Angle Voltmeters

- Digital and analog
- High harmonic rejection
- High accuracy
- Wide bandwidth
- ATE compatible
- Direct reading phase reading

CALL OR WRITE FOR  
COMPLETE SPECIFICATIONS.



NORTH ATLANTIC  
*industries, inc.*

200 TERMINAL DRIVE, PLAINVIEW, NEW YORK 11803  
cable: noatlantic / twx: 510-221-1879 / phone: (516) 681-8600



## News Update

humidity; 25 weeks at 122°F, cable immersed in water; one year ambient environment in a lab at estimated conditions of 60°F to 90°F and humidity of 30% to 85%; and 40 days and nights of salt water immersion at 25°C, both for the fiber and the cable. "In all cases, there were no adverse effects on the transmission characteristics of the plastic cable," Ferguson says.

■ Solid State Scientific Inc. of Montgomeryville, Pa., is delivering samples of its first second-source devices for the CDP 1800 family of C-MOS microprocessor products. The action comes less than six months after the company signed an alternate source agreement with RCA Corp.'s Solid State division, which is in Somerville, N. J. [*Electronics*, July 21, p. 8].

Earlier this month, Solid State Scientific began shipping samples of its 1852, an input/output port that acts as a buffer interface to adapt peripheral devices to RCA's 1802 central processing unit. It is "well into initial production" on its 1802 CPU and will begin sampling that 8-bit part next month, says Jeff Krawitz, manager of microprocessor marketing.

Krawitz, who recently joined the Pennsylvania firm from RCA's microprocessor marketing group, says it expects to have an initial group of six 1800 series products "in volume production by the end of this year. All will be available in samples by late November or early December," he adds. In addition to the 1802 and 1852, the initial devices include the 1824 random-access memory organized as 32 registers of 8-bit words, the 1831 and 1832 mask-programmable 4,096-bit static read-only memories, and the 5101, an equivalent to RCA's 1822 1,024-bit RAM.

"We'll be in volume production by the end of the first quarter of 1978 on virtually all CDP 1800 parts that RCA currently is marketing," Krawitz says. As for his company's option to make a silicon-on-sapphire version of the 1802 CPU, he says, "The decision has not been made."

**Bruce LeBoss**

# MOTOROLA OMNIBUS



Rollin' along the routes to right design'

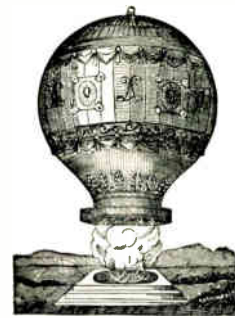

## Raise your SOA with 1500 V horizontal deflection MJ12005

The story's simple—25 times more SOA than the BU208. Correct. 25 Times more. At 400 V, the new MJ12005 offers 20 amps of SOA, 50 $\mu$ s single pulse. The BU208 provides just 0.8 amps.

Where Darlingtons aren't needed, the new unit's ideal. And besides super SOA, you get higher gain, too—all the way out to 5 at 8 A.

The MJ12005 is triple-diffused to attain its high-voltage rating and photo-glass-passivated at collector-base junction for reliability and stability. Operating and storage junction temperature is spec'd from -65°C to +150°C.

Price is only \$3.50, 100-up, or about 35¢ less than the '208.

Super SOA. Super gain. Super price. From the SuperPower, of course. Motorola.

E



Do it at any frequency

## Motorola RF does it better!

**More 900 MHz stuff . . .**  
Rugged radio message here.

Characterized at 870 MHz for the 806-907 FM mobile band, the new MRF840/842 units are 100% tested for load mismatch stress at all phase angles with 20:1 VSWR at 16 V supply and 50% RF overdrive.

We publish that on the data sheet! Not just infer it in private.

Min power gain specs for the 12.5 V units range from 6.5 dB for the 1 W MRF838 common-emitter studless and 838A stud unit to 8 dB for the 20 W CQ-packaged MRF842 . . . pretty super for this frequency. Both the MRF840 and 842 are internally matched for broadband operation.

Here's the lineup:



A

### Speaking of Linear Price/Performance . . .

Here's the only transistor spec'd for 100 to 500 MHz with mounting ease and increased P<sub>D</sub> through emitter-grounding.

The MRF525 TO-39 offers impressive specs for linear aircraft radio/instruments and cable communications. Third order intercept is +35 dB, minimizing those nasty IMD problems in AM and multi-channel.

It's fully characterized for S parameters at 13.6 and 26 V, 10-100 mA, has

min gain of 13 dB and max noise figure of just 4 dB at 225-400 MHz, 26 V.

If you can go \$2.30 each for a hundred or more, contact your authorized distributor. If not, dicker with your OEM man for larger quantity savings. A bargain either way. B

### Now back to rugged VHF

Here's a bunch of splendid 28 V devices complementing a UHF lineup we intro'd a while back, the MRF321-327.

Gold-reliable and thermally-engineered using IR scan techniques for guaranteed ruggedness at 30:1 VSWR, all phase angles, the new MRF314-317s have super wide-band characteristics and are ideal for hi-rel designs. They employ SOE and Controlled Q\* technology, offering up to 10 dB min G<sub>P</sub>E at 150 MHz.

You get stud and studless in 0.380 SOE and 0.5 CQ. P<sub>out</sub> ranges from 30 to 100 W.

Input impedances remain consistent through programmed, computer-controlled wire bonding. You'll surely use them in MIL radio, class A, AB, B and C for AM, FM or FSK application. They're good as gold.

C

### HF RF at LF \$\$ = TO-220

There's a lot of RF in TO-220 around. But none with the low lists of ours—prices approaching that of our also-new but well-accepted LF TO-220. Take the new MRF476. At \$1.09, 500-up. A comparable ceramic SOE stud would run about \$8.50.

Whattaya get for that? The same performance for SSB and CB others offer at higher prices. The 12.5-V '476, for instance, provides 3 W PEP, 15 dB min G<sub>P</sub>E and 40% SSB efficiency at 30 MHz. IMD is typically -35.

The '475 muscles out 12 W at 13.6 V, 10 dB min G<sub>P</sub>E and 50% efficiency (CW) at 30 MHz. IMD is -30 min. It's just \$2.30.

Plus we offer gold-plated headers, gold-tin pre-forms for die attach and high-volume production taken for granted by everyone using plastic devices. Now it's your turn. D

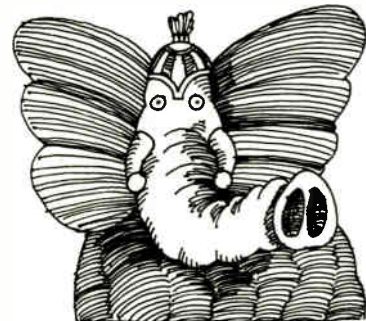

Bigger and Bigger static ROMs.

## This one's 32K.

The MCM68332 is a 32K static ROM with 4096-word by 8-bit organization that makes it prime for high-density fixed memory applications like microprogramming in MPU-based systems. It's a second source for TMS4732 and MK32000.

All inputs and outputs are TTL-compatible. Inputs are directly driven by TTL without external pull-up resistors, and outputs drive TTL without external resistors. Outputs are three-state.

Silicon gate NMOS technology gives this large ROM excellent speed. Max access time is 450 ns, and min cycle time the same. Active P<sub>D</sub> is 450 mW (typ). It operates with a single 5 V supply.

Pin-compatibility with MCM2708, MCM65308 and MCM68316E is another important feature of the MCM6832, available in both plastic and ceramic 24-pin. F



## CMOS ICs

reduce  
smoke detector costs,  
simplify circuitry.

Two new Motorola CMOS ICs clear away the fog of some 30-odd components while reducing costs and improving reliability in battery-operated ionization chamber smoke detectors. Because the units are designed for use with less expensive 9-volt alkaline batteries, the consumer nets additional savings in operating costs.

It's the combination of economical circuitry, battery operation, and ease of wire-free installation that's generating the consumer popularity of this type detector.

The MC14462P incorporates an on-board FET for direct operation with the ion chamber, whereas with the MC14461P the FET is separate. Another key feature of the MC14462 is the active guard on the input, which achieves vast reductions in circuit and package leakage currents. Both units provide the choice of operating the low battery warning circuit in either the static-test or pulse-test mode. On-off pulsing of the horn and protection from pulse-caused transients are exclusive features.

Additional system cost-savings in the smoke detector are realized because both use minimal external capacitance and require a low value of timing capacitance. The circuits also feature on-chip predrivers, voltage reference, and voltage regulator.

Large volume supplies of these smoke detector ICs are assured. They're produced with low-power linear and digital CMOS on the chip using the same process and lines on which we produce the industry's largest volume of CMOS gates, flip-flops, and MSI.

Call us and compare the cost savings obtained by using our smoke detector ICs. **G**

## Sleuthing around for cost-saving?



Try  
**L14H1/MRD160**  
**Photo Detectors**

Plastic is what they're packaged in and tight places are where these new miniature photo transistors go.

Sensitive throughout the visible and near IR spectral range, the TO-92 and Mini-T\* units are ideal for punched card and tape reading, pattern/character recognition, industrial inspection, processing and control, sorters, switching and logic circuits, shaft encoders or any design requiring radiation sensitivity, stable characteristics and high-density mounting. (Whew!)

Easiest to understand is price—just 33¢ for the L14H1 and 50¢ for the MRD160. And that's in published quantities.

The L14H family has a range of sensitivity and voltage for your exact needs. You have a choice of either 30 or 60 V min  $C_{EO}$  and either 0.5 or 2.0 mA collector light current. Dark current is just 100 nA, max. It makes a great companion to the MLED92 IR emitter and, of course, derives from Motorola's "billions-made" TO-92 capability.

The MRD160 complements Motorola's MLED60/90 IREDS. It specs out at 0.20 mA light current sensitivity and 0.10  $\mu$ A max dark current.  $C_{EO}$  is 40 V.

Both offer Annular† passivation for reliability and stability.

Both offer the solution to cost problems. Try 'em and you'll like 'em. **H**

†Annular is a patented Motorola process.

## Big IF for FM Scanners

Big is right. Not in size, for this little linear gem's in standard 16-pin plastic DIP.

What we're talking about in the MC335 is just about the whole bag of function needed for the IF stage in FM scanners. T. wit: oscillator, mixer, limiting amp, quadrature discriminator, active filter, squelch, scan control and mute switch. Not many external to add here.

This Mr. Complete uses a dual conversion system including second crystal oscillator circuit with demodulator for max signal to noise ratio.

You can convert the input frequency (i.e., 10.7 MHz) down to 455 kHz where after external bandpass filtering, most of the amplification is done. Audio is recovered using the quadrature and absence of input signal is indicated by presence of noise above desired frequency. "Noise band" is monitored by the filter and detector and the squelch trigger indicates presence of noise (or tone) by an output which can control scanning. Plus, an internal switch is operated which can be used to mute audio.

At 6  $V_{CC}$ , squelch-on draws a meager 3 mA typ. (others run high as 10 to 20) for low power drain. Sensitivity's excellent—input limiting voltage: (-3 dB) = 5.0  $\mu$ V typ. Recovered audio is 350 mVrms typ, mute off is 0.5 V max and mute on is 5 V min.

What may turn you on most is the low low \$1.75, 100-up. And it's available through authorized distributor or OEM order.

No ifs, ands, or buts. **K**

## Big push on Small SCR nets 600 V technology

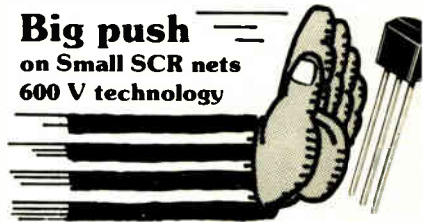

All of the people have some of the stuff. None of the people have all the stuff... except Motorola... leader in 0.5 A to 40 A thyristors. We're talking about the capital and the equipment to do what we've done—come up with the one and only 600 V TO-92 SCR in the industry.

Right. The good ol' MCR100 TO-92 SCR is rated to 600 V, something nobody else but we plastic SCR pioneers seem to have the nuts, bolts, screws, gears, buckles and commitment to build.

You'll be pleased because it offers all the traditional advantages: 200  $\mu$ A max gate triggering, 100  $\mu$ A max reverse and forward blocking, 5 mA max holding current, etc. Not to mention glass passivation that (at las count) has provided second-to-none reliability in TO-220 SCRs of 43 million cycles of 30°C to 125°C  $T_J$  power cycling with just 15 failures!

Use it for bigger jobs in line-power applications like relay and lamp drivers, small motor controls, gate drives for larger thyristors, sensing and detection circuits. And have your P.A. check our pricing. He'll find it's the most aggressive since the beads-for-Manhattan deal... and less than half TO-18 and TO-5s! **L**

## Movin' On with M10800

Motorola in Mountain View?

Could be, for Fairchild's announced intentions of second-sourcing the M10800 prove what we've been telling you all along... the M10800 high-performance processor family will be the standard for next generation, performance-oriented systems.

Motorola and Fairchild. Partners in progress. What more can you ask?

Well, how about our MC10802 timing function for starters. Fast starters. Currently being sampled, the part is designed to provide timing signals for a processor in one LSI circuit. It contains logic to generate 4 clock pulses, simplify system start and stop commands and provide some diagnostic capability. It is not restricted to use in '10800 systems, but can simplify timing requirements in any MECL 10K designs because (how could you forget!?) it's fully compatible with the industry standard 10K family!

Other new sample members are the MC10804 and '10805 bidirectional transceivers that interface MECL logic levels with T<sup>2</sup>L logic levels. Data can be transferred in either direction—MECL to T<sup>2</sup>L or T<sup>2</sup>L to MECL—and an optional gated latch is also provided.



The '10804 is a 4-bit version in 16-pin CERDIP and the '10805 is a 5-bit device in a 20-pin CERDIP.

For MOS memory freaks, the MC10805 is designed to interface MECL systems to MOS main memories. And if you haven't been able to remember all our Fast Freddie on the MECL track, one more time—

MC10800	4-Bit ALU -30°C to +85°C
MC10800M	4-Bit ALU -55°C $T_A$ to +150°C $T_J$
MC10801	Microprogram Control
MC10802	4-Phase Timing
MC10803	Memory Interface
MC10804	4-Bit Bidirectional Translator w/Latch
MC10805	5-Bit Bidirectional Translator w/Latch
MC10806	32 x 9 Dual Access Stack
MC10807	5-Bit MECL Transceiver w/Latch
MC10808	16-Bit Programmable Shifter

Keep on movin' with MECL. **J**

## Motorola PowerBase Silicon Power Breaks

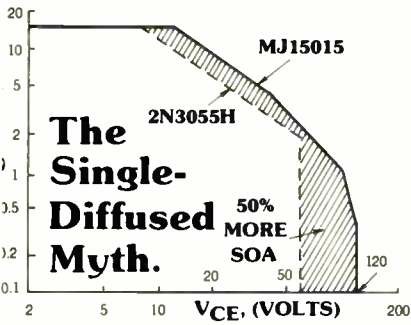

Everybody thinks single-diffused is always better. Everybody thinks single-diffused dice make for increased SOA curves. Everybody's wrong.

Motorola's new PowerBase\* is a high-energy breakthrough in power transistor technology and here's what it does:

Provides rugged SOA previously obtained only with conventional single-diffused.

Allows economy previously possible only with conventional EpiBase\* products.

Closely approximates FT characteristics of single-diffused transistors (there's hardly any difference).

Offers complementary structures eliminating the single-diffused, single-polarity bugaboo.

Take a look at the curve and you'll find 50% more SOA capability with our '15015 than a single-diffused 2N3055H.

We use a patented process on our optimized PowerBase die to achieve superior SOA with greatly improved uniformity and reproducibility over S.D. By improving device thermal efficiency so significantly less silicon is required, we offer you lower cost, simple, right?

What it all comes down to is if you're using a single-diffused RCA 2N3055H, you can obtain 50% more SOA for 19% less bucks with the MJ15015! If you're using a 2N3443 you can get 10% more SOA for 49% less \$. And so on, according to latest available pricing.

Flawless performance at far less cost!

Make your own comparisons today. Our authorized distributor's got off-the-shelf units. Coupon response brings you new PowerBase product data sheets.

Motorola PowerBase is a hit and that's not no myth. **M** \*Trademark of Motorola Inc.

## RAMs multiply like rabbits

### MCM2114 4K static RAM



Static operation means no clocks and no refreshing required for Motorola's new MCM2114, a 1024-word by 4-bit organized silicon-gate plug-in equivalent for the Intel NMOS RAM.

It's fast, with access time as low as 200 ns and cycle times to match. Power dissipation is typically a low 400 mW, and the 2114 operates from a single 5 V power supply. It's directly compatible with TTL and DTL, and has three-state outputs. **N**

### MCM4116 makes the 16K RAM derby a real race.

Those hard to get 16K RAMs will be a lot easier to find now that Motorola has introduced the MCM4116. It's in the industry standard 16-pin package and compatible with common automated test and insertion equipment. It's an easy upgrade from 16-pin 4Ks, and is pin-compatible with other 16Ks now on the RAM market.

Three different speed options are available with access times from 200 ns to 300 ns. All inputs are TTL-compatible as are the three-state outputs. **P**

### New source for the 4096 dynamic 4K.

Maybe you've noticed. Availability of the 4096-type 4K has tightened up. Well, we're loosening things up again with the MCM4096. It's compatible with the other popular 4K standards like the 2104, MK4096, and MCM6604A.

## Eight-Bit Latches

### added to CMOS B Series

The new MC14099B and MC14599B are the first in a series of 8-bit addressable latches being added to Motorola's industry-leading standard CMOS line. These latches are designed to meet JEDEC B-Series specifications. They are excellent in demultiplexing and serial-to-parallel conversion applications, but they have yet another claim to fame. Use MC14599B or MC14099B to provide outputs for our unique new MC14500B single-bit processor called the Industrial Control Unit.

The MC14099B is an alternate source part for the CD4099B. The MC14099B and the MC14599B are similar, with but one significant difference. The MC14599B has a bidirectional input port, which allows data to be placed in a latch, then retrieved through the single port or from the 8 parallel outputs. It's in 18-pin plastic and ceramic packages, and the MC14099B uses 16-pin packages. The two extra pins in the MC14599B are assigned to Chip Enable and Write/Read.

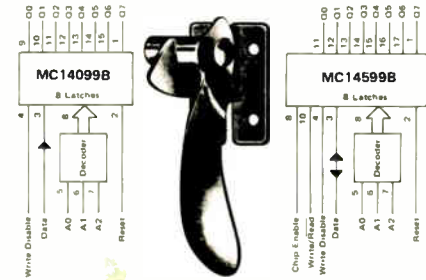

Three additional 8-bit latches are being prepared for introduction. The MC14598B is similar to the MC14099B, but its outputs are three-state, with the capability to drive a bus line and sink one TTL load or four LSTTL loads over temperature. The MC14597B differs from the MC14598B by virtue of an on-board counter at the input, rather than direct address. The third future 8-bit latch is the MC14094B, alternate sourcing the CD4094B. It also has three-state output, with a drive capability of one LSTTL load. The MC14094B has a shift register input contrasted to the decoder input of the MC14598B or the counter input for the MC14597B. Pricing, 100-up, for the introduced parts is \$2.21 for the MC14099B and \$2.81 for the MC14599B. **R**

## All Aboard! Motorola Omnibus • Rollin' along the routes to right design.



### Please Check Only Items You're Interested In:

- |   |  |  |
|---|--|--|
| <input type="checkbox"/> A 900 MHz RF     | <input type="checkbox"/> F MCM68332 ROM      | <input type="checkbox"/> L 600 V Plastic SCR |
| <input type="checkbox"/> B MRF525 RF      | <input type="checkbox"/> G Smoke Detector IC | <input type="checkbox"/> M PowerBase         |
| <input type="checkbox"/> C VHF MRF314-317 | <input type="checkbox"/> H Photodetectors    | <input type="checkbox"/> N 4K Static RAM     |
| <input type="checkbox"/> D TO-220 RF      | <input type="checkbox"/> J M10800 MPU        | <input type="checkbox"/> P 16K RAM           |
| <input type="checkbox"/> E MJ12005 Power  | <input type="checkbox"/> K Linear IF         | <input type="checkbox"/> R 8-bit latches     |

For complete product itineraries, fill in and send to:  
Motorola Semiconductor Products Inc., P.O. Box 20912, Phoenix, Arizona 85036

Please have salesman call ( ) \_\_\_\_\_

Name \_\_\_\_\_ Title \_\_\_\_\_

Company \_\_\_\_\_ Address \_\_\_\_\_

City \_\_\_\_\_ State \_\_\_\_\_ Zip \_\_\_\_\_



## OPTRON OPTICALLY COUPLED ISOLATORS

NEW JAN 4N22A SERIES  
OFFERS  
HIGHEST RELIABILITY

You can't buy a more reliable optically coupled isolator than one of OPTRON's new JAN 4N22A series. The popular JAN 4N22A, 4N23A and 4N24A all feature fully qualified JANTX and JANTXV ratings.

These new OPTRON isolators consist of a high efficiency, solution grown gallium arsenide LED and a silicon N-P-N phototransistor in a hermetically sealed 6-pin TO-5 package. Minimum input-to-output isolation voltage for the series is 1000 volts and minimum current transfer ratios range from 25% for the 4N22A to 100% for the 4N24A.

New "A" version OPTRON isolators are a significant improvement over the older 4N22 series since the case is isolated from the sensor and LED to eliminate the need for an insulating spacer in many applications.

OPTRON also offers a new JEDEC registered series of high reliability isolators in a 4-pin TO-18 package. The 3N243 series includes three devices with the same reliability and similar characteristics as the JAN 4N22A TO-5 series, yet in a smaller package.



3N243

In addition, OPTRON's complete line of optically coupled isolators includes other immediately available standard devices in high-rel metal cans and low cost DIP and other plastic configurations for almost every application.

Detailed technical information on optically coupled isolators and other OPTRON optoelectronic products... chips, discrete components, limit switches, reflective transducers, and interrupter assemblies... is available from your nearest OPTRON sales representative or the factory direct.



**OPTRON, INC.**

1201 Tappan Circle  
Carrollton, Texas 75006, U.S.A.  
TWX-910-860-5958  
214/242-6571

## People

### Hinkelman sees SIA as free-trade vehicle

With the appointment of Thomas Hinkelman, a 30-year veteran of the semiconductor industry, as its first executive director, the newly formed Semiconductor Industry Association has picked a firm believer in the importance of semiconductor technology in today's—and tomorrow's—society.

"Just as steam and steel were the motivating forces that made the industrial society happen," says the 52-year-old executive, "semiconductor technology and the manipulation of the flow of electrons is what motivates our present age." As executive director of the SIA, which was established to provide a public platform for the flourishing \$6 billion U.S. semiconductor industry, he sees one of his jobs as convincing governments and the public of its importance and another as promoting open competition.

"The SIA is really an association of free traders," says Hinkelman, "for it is free trade that has contributed to the spectacular growth of the semiconductor and electronics industries. If it is to continue to grow, free trade must continue."

He is a veteran of the semiconductor industry in every sense of the word. His first job after graduating from Rensselaer Polytechnic Institute in 1947, was with Eckert-Mauchley Computer Corp., the company formed during World War II to build vacuum-tube computers. In 1955 he joined General Electric Co. as product planner for transistors, working on germanium-alloy and grown-junction germanium transistors. He was active at this time in developing the first Jedec specifications on transistors.

He was at Motorola Inc. from 1958 to 1968, serving finally as director of planning. Then he moved to Fairchild Camera and Instrument Corp. with then president Lester Hogan. Since 1973 he has been at Monsanto Co.'s electronics division as director of product planning. Always, he was active in the semi-

conductor group of the Electronics Industries Association, serving as its chairman from 1971 to 1972 and also heading its trade policy committee.

Reflecting on his experience, Hinkelman points out that "the semiconductor industry grew up in a freely competitive environment." However, those conditions are changing. "There is a rise of Government regulation in the U. S. and an increase in competition from other countries with the positive support of their governments," he says. "The U.S. semiconductor industry does not expect to be nurtured, as it is in other countries, notably Japan. But, at the very least, it should not be handicapped."

### For Hybrid Systems' Peacock, reorganizing is key

The problems that Wayne Peacock faced when he became president of Hybrid Systems Corp. in April were the kind you would only wish on your worst enemy. The company, now in Bedford, Mass., makes discrete modules and hybrid thin-film microcircuits used in data-conversion, signal-processing, and measurement products, among other things.

The problems included the move of the thin-film facility from Worcester, its location before the com-

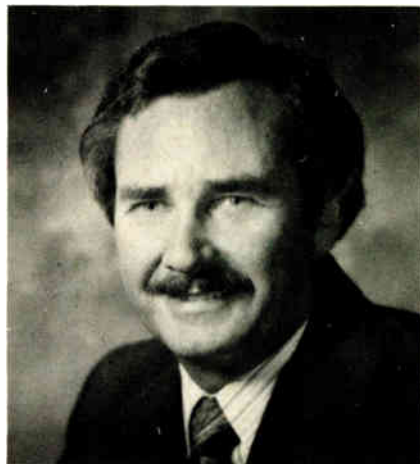

**Taut.** Cutting back, on payroll and business, was Wayne Peacock's move.



# Precision quad op amps.

## Precision.

PMI's new OP-09 and OP-11 are pin-compatible with the un-precision quads now on the market.

The quad op amp has finally come of age. With the introduction of the OP-09 and OP-11, PMI has made it a truly workable reality. Consider:

### Low $V_{OS}$ and other goodies.

Since quads can't be nulled—there aren't enough pins available—the user is at the mercy of whatever input offset voltage ( $V_{OS}$ ) he happens to get. PMI refined the manufacturing process to get  $V_{OS}$  under control. We came up with the lowest  $V_{OS}$  of any quad op amp made today.

At the same time, we gave the OP-09 and OP-11 the highest gain and the lowest drift of any quad op amp. We expanded bandwidth, reduced offset and supply current, and increased the slew rate. Here it is in black and white:

### OP-09/OP-11 Features

	TYP.	MIN./MAX.
• Low $V_{OS}$	0.30 mV	0.5 mV MAX.
• Low offset current	8.0 nA	20 nA MAX.
• Low supply current (Total for all 4)	3.5 mA	6 mA MAX.
• Voltage gain	250K	100K MIN.
• Slew rate	1.0 V/ $\mu$ S	0.7 V/ $\mu$ S MIN.
• Matched positive and negative slew rate for low distortion.		
• Bandwidth		2.0 MHz MIN.

### We make them match.

Another important advantage: we guarantee that all four op amps will match in terms of  $V_{OS}$  and CMRR. Here's how we specify them:

### Matching Characteristics

Parameter	Symbol	OP-09A/E OP-11A/E			OP-09B/F OP-11B/F			Units
		Min	Typ	Max	Min	Typ	Max	
Input Offset Voltage Match	$\Delta V_{OS}$	—	0.5	0.75	—	0.8	2.0	mV
Common Mode Rejection	$\Delta$ CMRR	—	1.0	20	—	1.0	20	$\mu$ V/V
Ratio Match		94	120	—	94	120	—	dB

(Match exists between all four amplifiers)

Circle 15 on reader service card

DUAL INSTRUMENTATION AMPLIFIER 2 OP AMP DESIGN  
(1/2 CIRCUIT SHOWN)

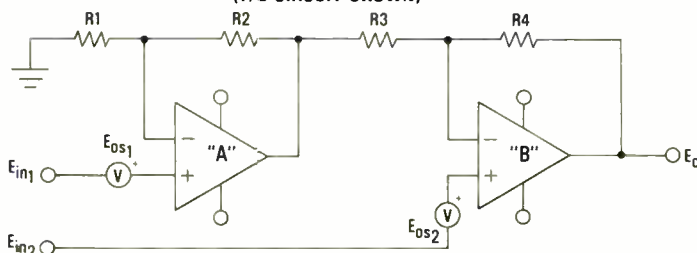

These matching dc characteristics should interest you. They reduce distortion, improve system performance, and simplify your design. But that's not all.

We've given all four op amps symmetrical positive and negative slew rates—an important thing to keep in mind for audio system design.

It's fair to say that the OP-09 and OP-11 are the most accurate, most advanced and the only precision quad op amps on the market. And they are on the market—available now, today.

Like to check one out? Be our guest. Just drop us a line on your company's stationery, telling us if you'd prefer an OP-09 (4136 pinout) or an OP-11 (148/474 pinout). We'll be glad to send literature and a sample.

Precision Monolithics Incorporated  
1500 Space Park Drive  
Santa Clara, California 95050  
(408) 246-9222.  
TWX: 910-338-9222  
Cable MONO.

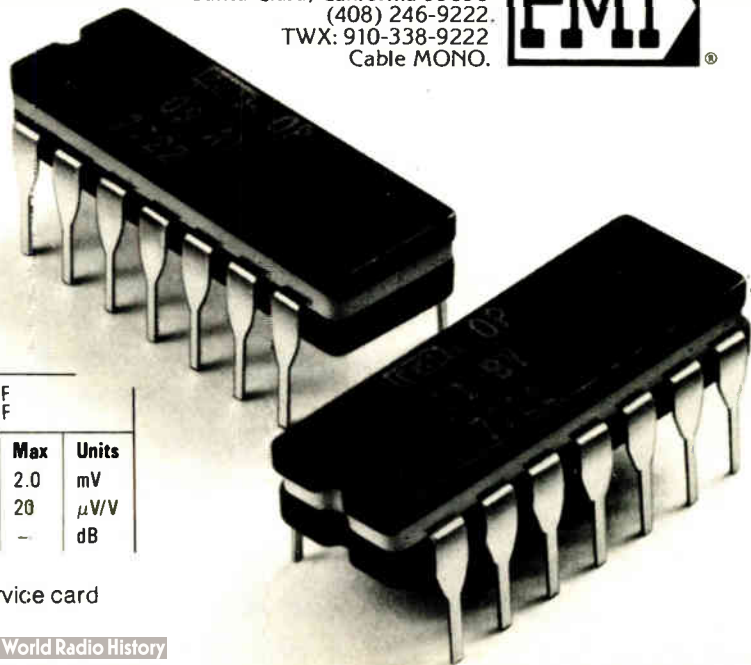

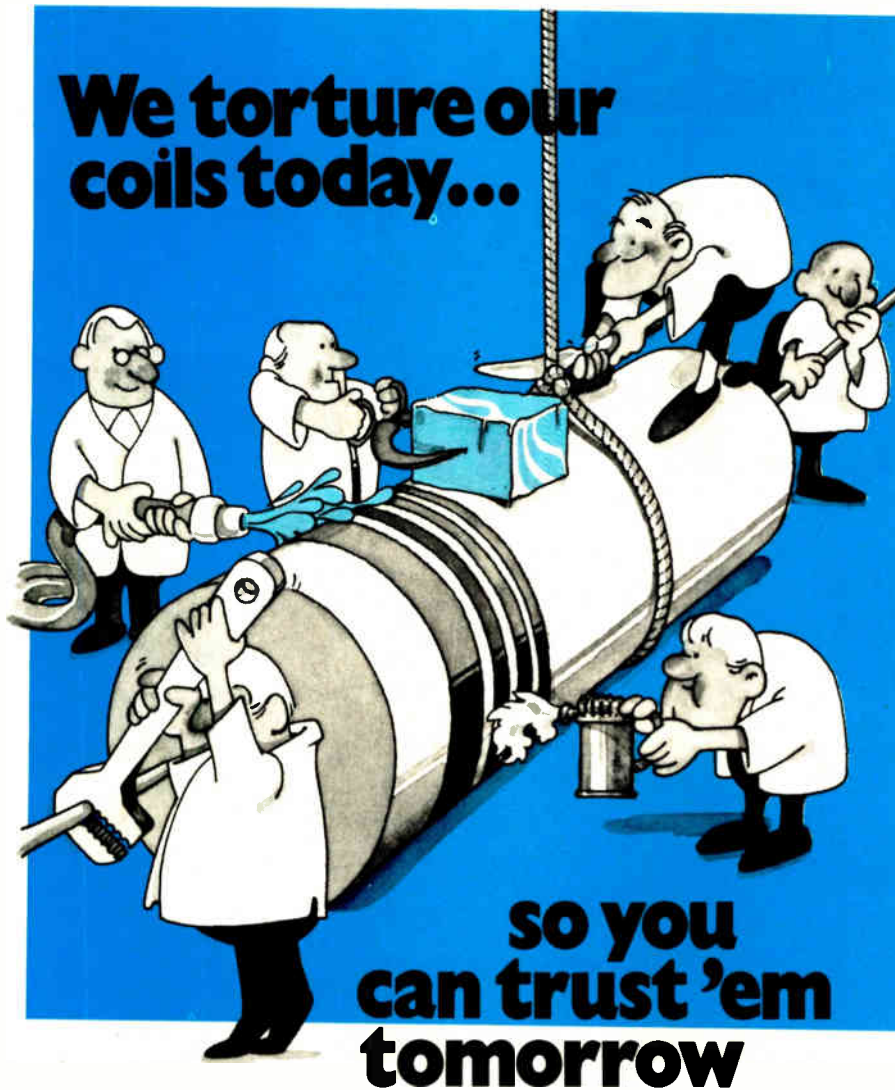

Rugged environment? Routine trips through torture test prove out the reliability of typical inductive components selected at random from production runs. This sample is subjected to a series of high and low temperature extremes with performance characteristics verified for conformance to Military Specification MIL-C-15305. In addition, periodic samples are subjected to other torture tests:  Mechanical Shock — 18 shocks at 100g force  Vibration — 12 hours to 20g force  Humidity — 10 days to 98% R.H.  Terminal Strength — Pull and Twist  Immersion — Cyclic  Load Life — 2000 hours at elevated temperature. Performance characteristics hold the line.

We are proud that we can't make 'em fail. Our failure is your assurance of reliability. Any better reason for specifying Delevan inductors?

Our Environmental Test Laboratory is sanctioned by DESC with electro/mechanical equipment calibrated and certified under MIL-C-45662. This service is available to you.

Ask us about our repair and calibration service of Boonton Q Meters, Model 260.

**INDUCTIVE COMPONENTS — CLUTCH AND BRAKES FOR ELECTRONIC AND AEROSPACE INDUSTRIES**

**Delevan**  **AMERICAN PRECISION INDUSTRIES INC.**  
*Division*

270 QUAKER RD./EAST AURORA, N. Y. 14052  
 TELEPHONE 716/852-3800 TELEEX 091-293

Other Divisions  
 Basco • Dustex • A.P.I. of Tennessee • A.P.I. (U.K.) Ltd.

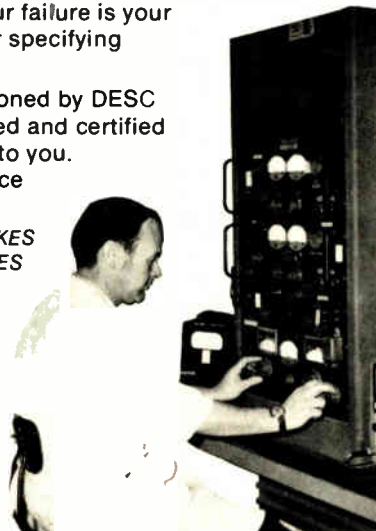

pany bought it from Sprague Electric Co. in October 1973, to Bedford. That move, in late 1975 and early 1976, caused disruptions in production and the loss of experienced assembly workers. There was also a flood that caused a "very large dollar loss," of work in progress and resistor-chip inventory in Worcester, Peacock says. Add to that a cash drain of some \$500,000 to support the mercurial growth of stereo-component subsidiary, Audio Pulse Inc., and the picture begins to fill in.

"What with financing Audio Pulse, the move, and the flood," says the ebullient Peacock, "we didn't even notice the recession that was going on." The 42-year-old president says, however, that he has stopped the down trend. The company's most recently concluded quarter, ending June 25, set records for sales and profits, and he projects sales of \$10 million by fiscal 1980, up from between \$5.5 million and \$6 million last year, which included Audio Pulse's sales.

To start the recovery, Peacock sold most of Audio Pulse's assets and the right to market its products to Hoffman Electronics Corp. in return for royalty income. That cut the payroll by 22. Then, he lopped off another 77 Hybrid Systems employees—a move that reduced the average yearly salary by 20%. The cuts hit management-level people hard, but Peacock felt the company was too top heavy.

On the plus side, training programs for new employees have begun to show results in good thin-film product yields. What's more, Peacock has reorganized the company into three business centers—modules, resistors, and hybrids.

Peacock left Zeltex Inc., Concord, Calif., late last year and spent two months evaluating job opportunities. Despite its recent history, he joined Hybrid Systems as vice president for sales and marketing in January. "When I saw how good the thin-film technology was," he relates, "and the caliber of the technical people, I realized what a nugget this was." He plans to polish that nugget back to a high gloss soon.

# WAFERTRAC. STILL STEAMING AHEAD!

Since GCA introduced the revolutionary WAFERTRAC™ a few months ago—the completely automatic, microprocessor-controlled wafer processing system, 9 out of 10 of the world's largest manufacturers of semiconductors have purchased their WAFERTRAC systems. Why?

WAFERTRAC provides higher yields in less facility space.

WAFERTRAC improves up-time and reliability to higher levels than ever before possible.

WAFERTRAC eliminates traditional 25-wafer group processing limits.

WAFERTRAC lets you design your own specific configuration, according to your firm's unique requirements.

WAFERTRAC.

The first practical application of the microprocessor to semiconductor processing, requiring only a single person in your processing loop ... and *then* only to load and unload carriers.

Don't be the last to get on board. WAFERTRAC's still steaming ahead ... destination: greater profits!

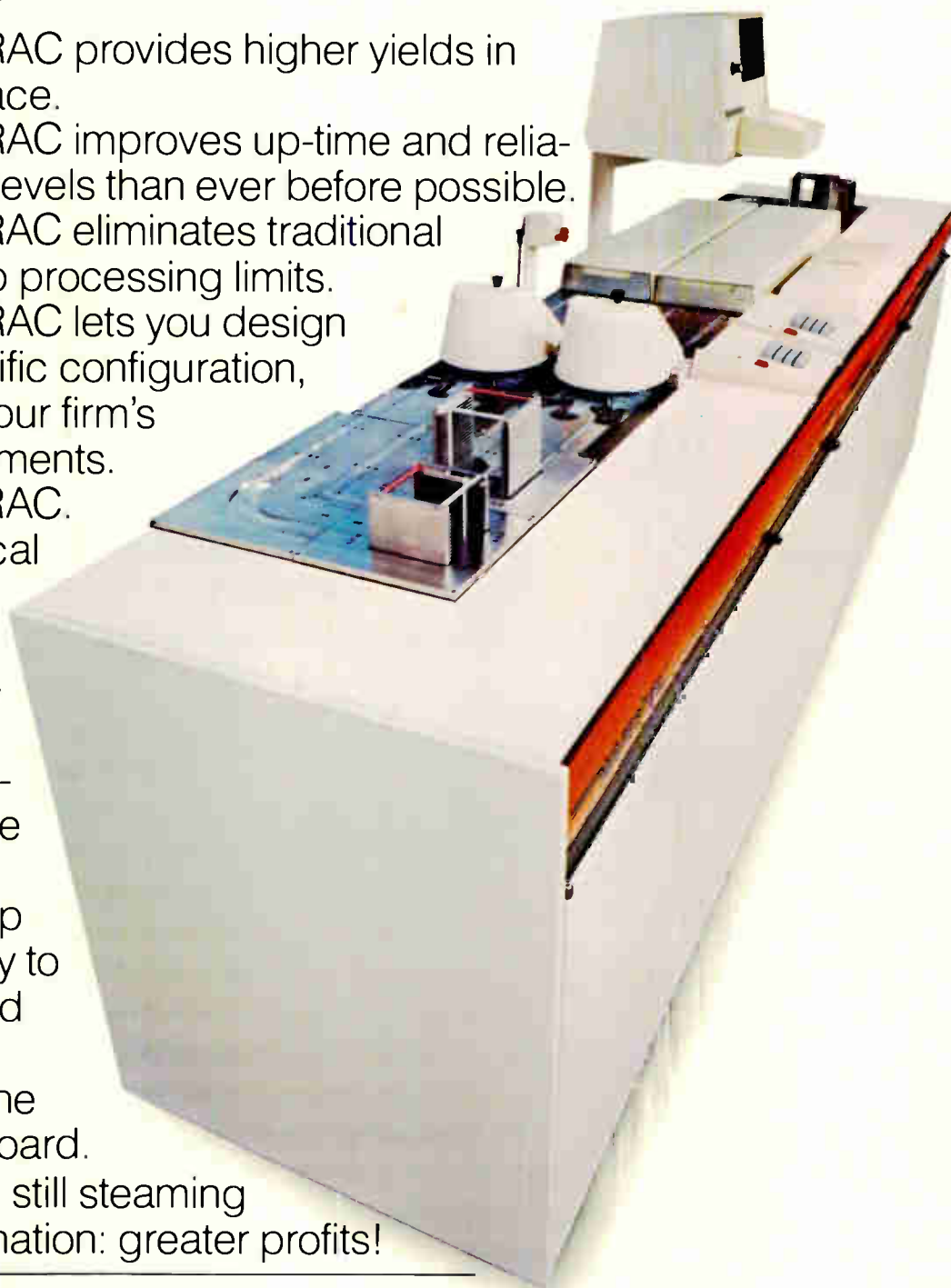

**GCA/SUNNYVALE DIVISION ●●▲**

PART OF THE GCA/IC SYSTEMS GROUP  
1050 Kifer Road, Sunnyvale, Calif. 94068 TWX: 910-339-9211 (408) 732-5330

# Intel delivers the best for today

Industry standards, volume support and cost efficiency are what you've learned to expect from Intel, the company that invented EPROMs and delivers more of them than all other manufacturers combined.

In 1972 we introduced the world's first EPROM, the 2K 1702. Then in 1975 it was the 8K 2708 which quickly became the industry standard. Now we're delivering the 5 volt 2716 EPROM with the performance and economic advantages it takes to be the industry standard 16K EPROM—for today's system upgrades from 8K to 16K and for tomorrow's systems designed with 5 volt microprocessors.

For economy, the 2716 offers a die size 20% smaller than any other 16K EPROM and a price-volume learning curve that will descend even more rapidly than our 1702 and 2708 EPROMs. And the 2716 is the only 16K EPROM with a pin for pin interchangeable 16K ROM, the 2316E.

For performance, the 2716 consumes a maximum of 525 mW in the read mode. That's 50% less power than our 2708 and 25% less than any other 16K EPROM. Intel's unique power-down feature reduces the standby current to 25mA maximum, a 75% savings over active power. And at 450ns there's no penalty in access time.

Programming the 2716 is simpler and twice as fast as any other 16K EPROM. Single-pulse, single-location

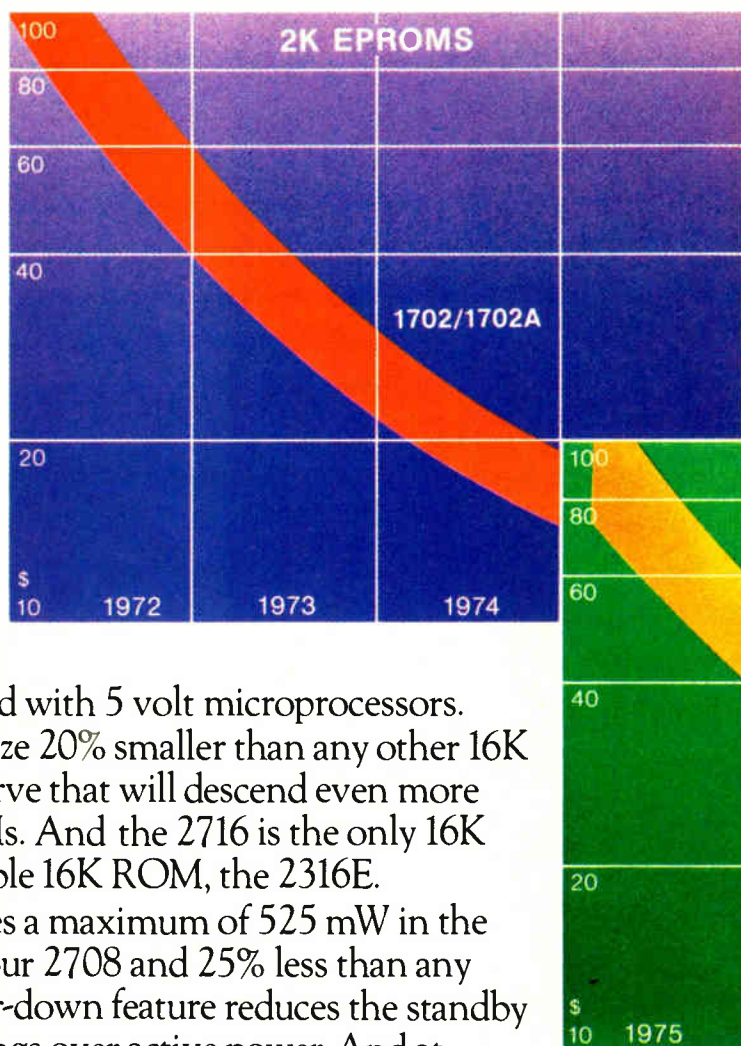

PART NUMBER	SIZE	POWER SUPPLY	MAXIMUM CURRENT		ACCESS TIME (MAX)	COMPATIBLE ROM
			ACTIVE	STANDBY		
1702A	256 x 8	+5V -9V	65 mA	65 mA	1 $\mu$ s	1302
2708	1K x 8	+5V -5V +12V	10 mA 45 mA 65 mA	10 mA 45 mA 65 mA	450 ns	2308
2758	1K x 8	+5V only	100 mA	25 mA	450 ns	2316E
2716	2K x 8	+5V only	100 mA	25 mA	450 ns	2316E



# 8K and 16K EPROMs and tomorrow.

programming and TTL-levels allow programming on-board, even in the field. Use the Intel Universal PROM Programmer or any other commercially available programmer to program any 2716 word location, either individually, sequentially or randomly.

Intel's 2716, along with the compatible 2316EROM, is your best choice for upgrading from 8K to 16K.

For new designs using 5 volt microprocessors, the 2716 and new 5 volt 2758 8K EPROM are the obvious choices.



The 2758 is the lowest power 8K EPROM available. Use it for small systems where 1K bytes is all you need, or for 1K byte modularity. The 2758 has all the cost savings and performance benefits of the 2716. And since the 2758 and 2716 are completely interchangeable, future upgrading from 8K to 16K in 5 volt systems is simplified.

Go with Intel industry standard EPROMs because they give you maximum value in today's system upgrades to 16K and in tomorrow's 5 volt designs. Order the 2716, 2758 and compatible 2316E ROM from your Intel distributor.



For technical information and a copy of "The new 16K EPROM" article reprint (AR-42) write Intel Corporation, 3065 Bowers Avenue, Santa Clara, California 95051. In Europe contact Intel International Brussels, Belgium. Telex 24814. In Japan contact Intel Japan, K. K. Tokyo Telex, 28426.

**intel® delivers.**

# Forget our products.

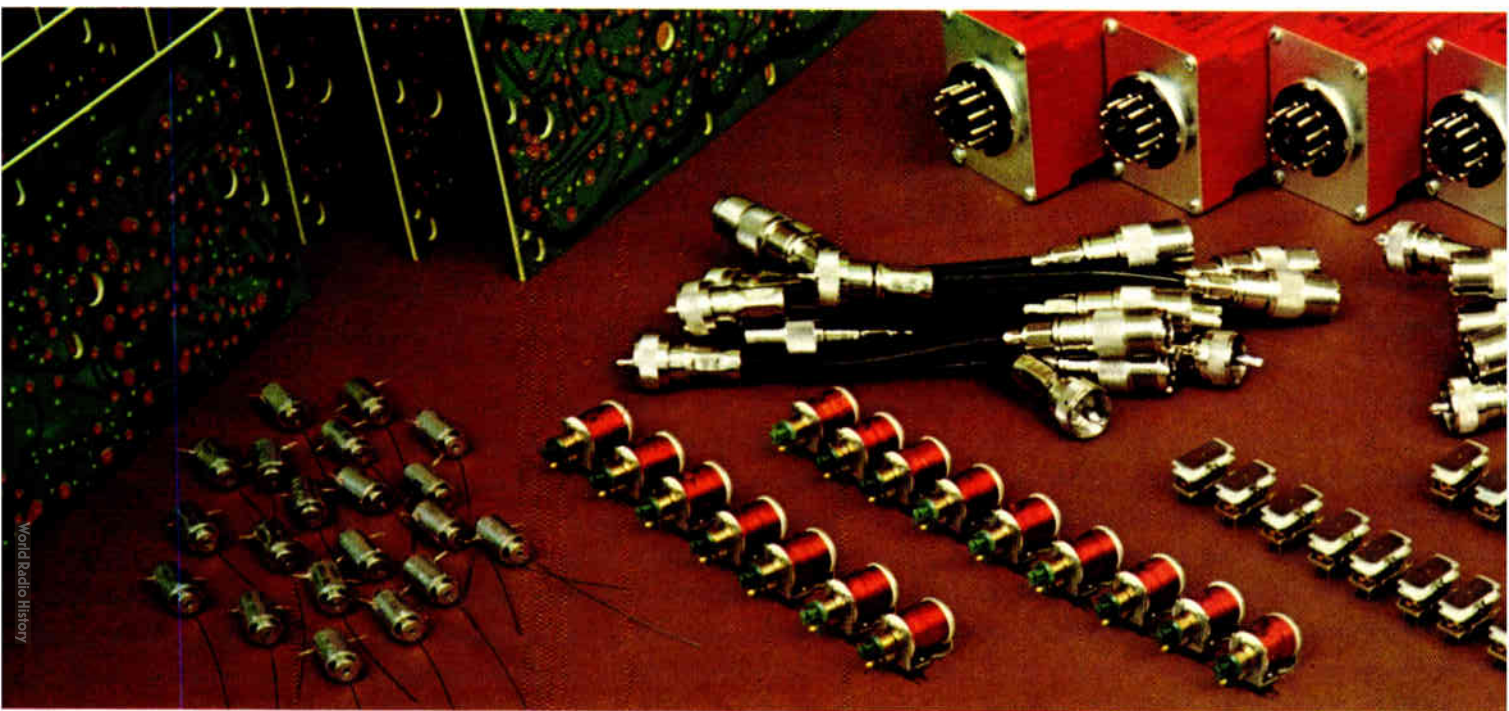

World Radio History

Major manufacturers forget them all the time. Polaroid. DEC. Honeywell. Tandy. Foxboro. Ford. Bendix. Our products are easy to forget. Because, once installed, all of

Hi-G's quality products (transformers, solenoids, timers, printed circuit boards and others) do what they are meant to do. Keep right on working.

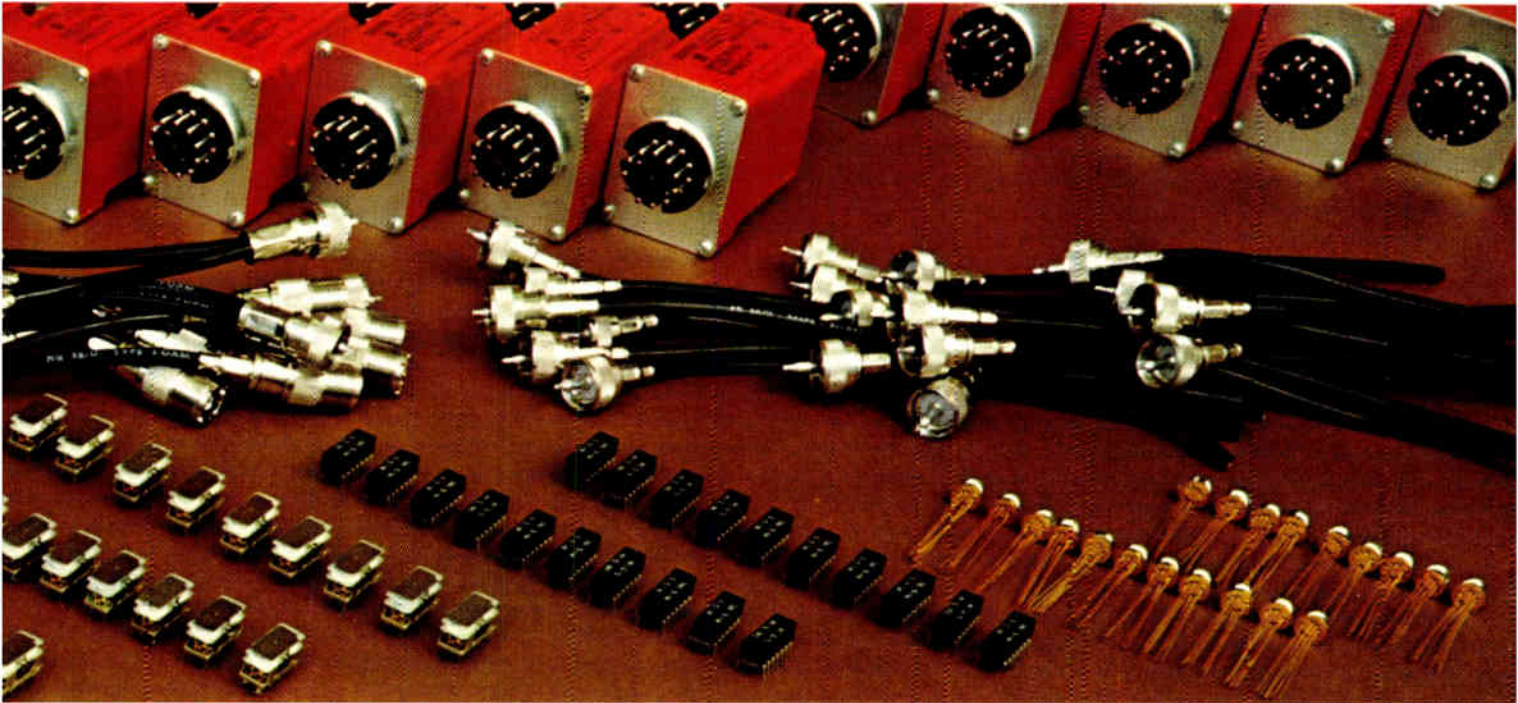

That's why Polaroid selected a Hi-G Magnetec solenoid to actuate the shutter on the SX-70 and the Pronto Land Cameras. Why Raytheon relies on the quality and performance of our Defiance printed circuit boards, counts on our prompt delivery at competitive prices. And why Hi-G commercial relays are on the job in scores of Foxboro control systems.

Our products work. And keep working. So it's fine with us if you forget them. Just remember our name. Hi-G Incorporated, 580 Spring Street, Windsor Locks, CT 06096.



# Remember our name.

## **A new sense of time for Wescon**

As a showplace of the highly innovative electronics industries, Wescon should feel comfortable with innovations. Indeed, the original decision to alternate the annual show between Los Angeles and San Francisco reflects that openness to trying new things. And over the years it has responded to the changing needs of both its exhibitors and its attendees. The success of that response can be measured by the fact that this year's attendance may even exceed the 31,000 people who attended the last San Francisco edition in 1975.

It is heartening, then, that the Wescon management continues to try new ways of making the show a valuable working tool to the engineer, as well as a worthwhile vehicle for electronics companies. This year's show marks the first time that it will span three days instead of the traditional four. The move

was based on the results of an exhibitor survey that was in favor of trying the shorter show as an experiment, and it was natural to make the experiment this year to avoid Yom Kippur, which falls on what would have been the fourth day.

Since the majority of showgoers do not stay the full four days, the three-day run should not prove a great hardship. In fact, with all the activities crammed into a shorter time, most attendees might even get more benefit out of their limited visits. What is more, exhibitors will not have to tie up quite as much time and talent for the same show exposure. Indeed, if even the same number of people come to the show this year, that averages out to some 10,000 a day, up from 7,500 or so in 1975. All in all, going to three days is a sensible idea. It will be interesting to see how it works in practice.

## **IEEE: perils of an active campaign**

The IEEE election campaign is really heating up. The latest major campaign move is the organization of a membership committee that opposes the Good Government Group, which was itself only recently formed by a number of industry officials, former IEEE leaders, and engineering educators. The new committee, called the Electrical and Electronics Engineers' Committee for a Member-Oriented Institute, characterizes itself as a grass-roots response to an "elitist" point of view.

Such groups are the sign of an active campaign, which we are all for, because that is the sure way to generate interest among the apathetic members. The trouble is, in the flurry of public statements, newsletter articles, and mailing pieces, a lot of charges and countercharges are being made. There is,

then, the danger of a damaging polarization of the institute between extremist groups, and the interests of the membership at large may become obscured.

The members' attention should be attracted with serious and constructive debates over the issues—from the professional directions the institute should take to career problems—not by personal attacks, rumor spreading, and other questionable tactics.

Certainly apathy hurts, but, in its way, unstatesmanlike campaigning can do even more damage to a professional organization like the IEEE. It is to be expected, of course, that the campaigners' emotions should run high. But they must take a longer view and make sure that the campaign is based solidly on the issues—not on side issues.





# BENDIX BRISTLE BRUSH BUNCH.

## Opens new horizons for PCB design.

70%-90% Reduction in Mating and Unmating Forces

- simpler board support systems
- fewer damaged boards

### Extended Circuit Count Potential

- up to 400 Bristle Brush contacts per connector



### Extensive Product Line

- mother board, daughter board, input/output, PC receptacle body styles
- 2-, 3-, and 4-row configurations
- 90° and straight PC, solderless wrap, crimp removable, willowy tail terminations

For complete information, contact The Bendix Corporation, Electrical Components Division, Sidney, New York 13838.

**Bendix**

Circle 23 on reader service card



**AMP's CR connectors  
prevent damage to  
pc board traces.**

**They mate with  
Zero Insertion Force.**

AMP 40 position CR connectors assure excellent connections. Because they apply over 150 grams of force to each contact with just a turn of the cam. The wipe backwipe motion of the contacts precleans the surfaces for full electrical continuity. And contact wear is virtually nonexistent for well over 5,000 insertion cycles.

The 40 position CR connector is designed specifically for input/output functions in today's high density pc board applications such as those used in microprocessors. Its modular design means extra economy because it can be loaded with as few or as many contacts as you'll actually use. And it will accept either crimp snap-in or insulation displacement modules.

There are other sizes of AMP CR connectors including the 120 and 156 position types. All have positive lock and keyed housings with contacts on .100" centers. And all come with AMP's assurance of experienced technical aid whenever and wherever you need it.

For more information on CR Series connectors, call Customer Service at (717) 564-0100. Or write AMP Incorporated, Harrisburg, PA 17105.

**AMP has a better way.**

**AMP**  
INCORPORATED

AMP is a trademark of AMP Incorporated

Circle 24 on reader service card

World Radio History

## AMP EUROPE

**Austria** — AMP Austria. Branch of AMP Deutschland GmbH. Markgraf-Ruediger Str. 6-8, 1150 Vienna. Phone: 924191/92

**Belgium** — AMP Belgium. Branch of AMP-Holland B.V., Rue de Brabant 62-66, Brussels. Phone: 322.17.55.17

**Finland** — AMP Finland OY Postilokero 3, 00401 Helsinki 40 Phone: 90/584122

**France** — AMP de France. 29 Chaussée Jules-César. Boite Postale No. 39. 95301 Pontoise France. Phone: 030 82 20, 030 92 30

**Germany** — AMP Deutschland GmbH. Ampèrestrasse 7-11, 607 Langen, 8. FFM., West Germany. Phone: (06103) 7091

**Great Britain** — AMP of Great Britain Limited, Terminal House, Stanmore, Middlesex, England. Phone: 01-954-2356

**Holland** — AMP Holland B.V., Papierstraat 2-4 5223 AW 's-Hertogenbosch, Holland. Phone: (073) 125221

**Italy** — AMP Italia S.p.A., Via Fratelli Cervi 15, 10093 Collegno (Torino), Italy. Phone: 785-656

**Spain** — AMP Española, S.A., Apartado 5294. Pedro IV, 491, 495, Barcelona 5, Spain. Phone: 307-75-50

**Sweden** — AMP Scandinavia AB, Datavägen 5, 17500 Jakobsberg, Sweden, Mailing Address: Fax 5-175 20 JARFALLA 1, Sweden. Phone: 0758/10400

**Switzerland** — AMP AG, Haldenstrasse 11, 6006 Luzern, Switzerland. Phone: (414) 235421, 235422, 235423

## AMP NORTH AMERICA

**Canada** — AMP OF CANADA LTD., 20 Esna Park Drive, Markham, Ontario, Ph: 416-499-1251

**Mexico** — AMP de Mexico, S.A., Apartado Postal 179, Naucalpan de Juarez, Edo. de Mexico, Phone: Mexico City 576-41-55

**Puerto Rico** — AMP OF CANADA LTD., 677 Calé de Diego, Rio Piedras, Puerto Rico 00924, Phone: (809) 766-2346

**United States** — AMP Incorporated, Harrisburg, Pa. 17105, Phone: 717-564-0100

## AMP SOUTH AMERICA

**Argentina** — AMP S.A. Argentina 4 de Febrero, 76 Villa Zagla — SAN MARTIN, Buenos Aires, Argentina, Phone: 752-4612

**Brazil** — AMP do Brasil Ltda., AV Comendador Martinelli 185, Lapa, Sao Paulo, Phone: 262-4353

## AMP PACIFIC

**Australia** — Australian AMP Pty. Limited, 155 Briens Road, Northmead, N.S.W. 2152 Australia, Mailing Address: P.O. Box 194, Baulkham Hills, N.S.W. 2153 Aus. Ph: 630-7377

**Japan** — AMP (Japan), Ltd., No. 15-14, 7-Chome, Roppongi Minato-Ku, Tokyo, Japan, Ph: 404-7171

Products and services for many specialized industries are provided by the AMPLIVERSAL Division. In the United States, this division is known as AMP Special Industries.

For Amp products and services in other countries, write: AMP International Division, Harrisburg, PA 17105, USA.



## Meetings

**Industry Applications Society Annual Meeting**, IEEE, Marriott Hotel, Los Angeles, Oct. 2-4.

**Euromicro—Third Symposium on Microprocessing and Microprogramming**, IEEE *et al.*, Free University, Amsterdam, the Netherlands, Oct. 3-6.

**Nepcon 77 Central, Industrial & Scientific Conference Management Inc.** (Chicago), O'Hare International Trade and Exposition Center, Chicago, Oct. 4-6.

**Gidep—Government-Industry Data Exchange Program Conference**, Gidep (c/o Dennis Starling, Datagraphix Inc., San Diego, Calif.), South Coast Plaza Hotel, Costa Mesa, Calif., Oct. 5-7.

**Interkama 77—International Congress and Exhibition for Instrumentation and Automation**, NOWEA (Düsseldorf, West Germany), Fairgrounds, Düsseldorf, Oct. 6-12.

**Info/Expo 77—International Data Processing Conference and Business Exposition**, Data Processing Management Association (Park Ridge, Ill.), Washington Hilton Hotel; Washington, D. C., Oct. 9-12.

**Electrochemical Society, Electronics Division Symposium**, The Electrochemical Society (Princeton, N. J.), Hyatt Regency Hotel, Atlanta, Ga., Oct. 9-14.

**National Electronics Conference and National Communications Forum**, NEC (Oak Brook, Ill.), O'Hare Hyatt Regency Hotel, Chicago, Oct. 10-12.

**Tenth Convention of Electrical and Electronic Engineers in Israel**, (c/o Daphna Knassim Ltd., New York), Tel Aviv, Oct. 10-13.

**International Symposium on Information Theory**, IEEE, Cornell University, Ithaca, N. Y., Oct. 10-14.

**IntelCom 77—International Telecommunication Exposition**, Horizon House International (Dedham,

Mass.), Georgia World Congress Center, Atlanta, Oct. 10-15.

**Loran-C Comes to the West Coast—Sixth Annual Wild Goose Association Convention**, WGA (c/o Samuel H. Goldstein, Great Neck, N. Y.), Edgewater Inn, Seattle, Wash., Oct. 12-14.

**Minicomputer Applications Conference**, American Institute of Industrial Engineers (Santa Monica, Calif.), Twin Bridges Marriott Hotel, Washington, D. C., Oct. 12-14.

**1977 Canadian Reliability Symposium**, Society of Reliability Engineers, Ottawa Chapter, Talisman Motor Hotel, Ottawa, Ontario, Oct. 13-14.

**ISA-77: Fall Industry-Oriented Conference and Exhibit**, Instrument Society of America (Pittsburgh, Pa.), National Convention Center, Niagara Falls, N. Y., Oct. 16-20.

**Noise-Con 77—National Conference on Noise Control Engineering**, NASA Langley Research Center and Institute of Noise Control Engineering, Sheraton Inn, Hampton, Va., Oct. 17-19.

**Oceans 77**, IEEE, Los Angeles Bonaventure Hotel, Los Angeles, Oct. 17-19.

**Seminar on Time and Frequency Calibration**, National Bureau of Standards, Boulder, Colo., Oct. 17-19.

**Info 77—Information Management Exposition & Conference**, (c/o Banner & Grief Ltd., New York), New York Coliseum, New York, Oct. 17-20.

**Data Management Symposium**, NASA Marshall Space Flight Center and University of Alabama in Huntsville, MSFC, Huntsville, Ala., Oct. 18-19.

**International Telemetry Conference**, International Foundation for Telemetry and Instrument Society of America, Airport Hyatt House

# P.C. JACKS/CONNECTORS

by  
**CONCORD**



With a heart  
of Beryllium copper  
for longer life.

**CONCORD**  
ELECTRONICS CORPORATION

37 GREAT JONES ST., NEW YORK, N.Y. 10012 (212) 777-6571 TWX 710-581-4930

Circle 26 on reader service card

## LAYOUT PC BOARDS IN HOURS PROTOTYPES IN MINUTES

- Layouts
- Silkscreen Art
- Solder Mask Art
- Drilling Drawings
- Ground Planes
- Fabrication Drawings
- Assembly Drawings

THE PC50 SYSTEM HAS CAPABILITIES YOU HAVE BEEN LOOKING FOR... Build double sided or multilayer PCB's on the CRT... Produce high density layouts up to 30x40 inches... Edit layouts quickly... Store designs on magnetic tape or flexible disc... Output camera ready art on plotter...

PC BOARD PROTOTYPES IN A SINGLE DAY... Generate double sided prototypes in minutes... Output layout directly on copper clad PCB stock... Use etch resist ink pens and plotter to prepare your board for etching and drilling.

SIGNIFICANT TIME SAVINGS... PC50 eliminates manual tape-up... Complete layouts in one-third to one-tenth the time spent on manual tape-up... Generate documentation from layout data...

GOOD NEWS... The entire PC50 computer assisted layout system costs less than \$16,000.

## SECOND SOURCE INDUSTRIES

735 ADDISON STREET • BERKELEY, CALIFORNIA 94710 • (415) 848-6600

26 Circle 122 on reader service card

## Meetings

Hotel, Los Angeles, Calif., Oct. 18-20.

**Eighth Korea Electronics Show**, Korea Fine Instruments Center (Seoul), Korea Machinery Permanent Exhibition Hall, Oct. 18-25.

**Tenth Annual Connector Symposium**, Electronic Connector Study Group Inc. (Camden, N. J.), Hyatt House, Cherry Hill, N. J., Oct. 19-20.

**Third Workshop on Reliability Technology for Cardiac Pacemakers**, National Bureau of Standards, Gaithersburg, Md., Oct. 19-20.

**1977 Design Automation Workshop**, IEEE, Michigan State University, East Lansing, Mich., Oct. 19-21.

**Nuclear Science and Nuclear Power Systems Symposia**, IEEE, Sheraton Palace Hotel, San Francisco, Oct. 19-21.

**ISHM 77**, International Society for Hybrid Microelectronics (Montgomery, Ala.), Baltimore Hilton Hotel and Civic Center, Baltimore, Oct. 24-26.

**International Conference on Energy Use Management**, University of Arizona (Tucson), Marriott Hotel, Tucson, Ariz., Oct. 24-28.

**1977 Fall Symposium—PC Boards for the 80s**, California Circuits Association (Palo Alto, Calif.), Airporter Inn, Irvine, Calif., Oct. 25-26.

**Electro-Optics/Laser 77**, Industrial & Scientific Conference Management Inc. (Chicago), Anaheim Convention Center, Anaheim, Calif., Oct. 25-27.

**Machine Tools Industry Technical Conference**, IEEE, Marriott Inn, Cleveland, Oct. 25-27.

**Semiconductor Test Symposium**, IEEE, Hyatt House, Cherry Hill, N. J., Oct. 25-27.

**Radar 77—International Radar Conference**, IEEE *et al.*, London, England, Oct. 25-28.

Electronics/September 15, 1977

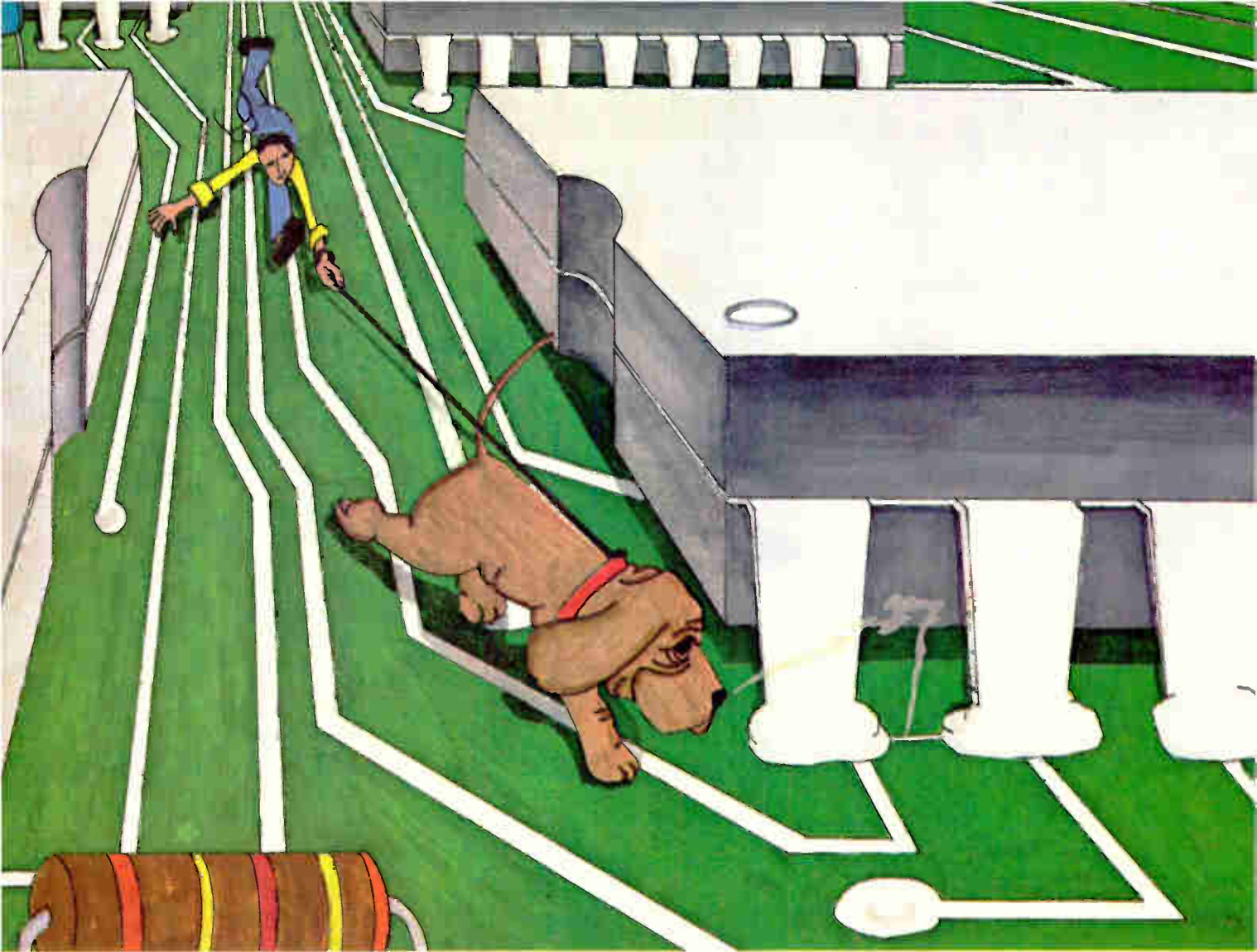

## Track Down Your Faults With A Bug Hound.



The GenRad 2220 Bug Hound will track down your shorts, opens, bad ICs, etc. in a fraction of the time it takes you now, **including those hard-to-find shorts between power and ground.**

Even though your automatic board tester may be giving you good diagnostics, it is still only telling you the **electrical** location of the faults. Finding the **physical** location can still be a time-consuming and expensive task. The GenRad 2220 Bug Hound solves this problem by providing the repair technician with a variety of testing techniques in one self-contained little package.

It has a unique new phase-sensitive current-tracing probe\* which makes it easy to trace the correct track even when many narrow tracks are running very close together. In addition, it has a dc tracing capability, a connectivity tester, an ac current source, and a dc current source.

The GenRad 2220 is easy to use and in most applications will pay for itself in just a couple of weeks.

\*Patent Pending

300 BAKER AVENUE CONCORD, MASSACHUSETTS 01742  
 ATLANTA 404-394-5180 • BOSTON 617-646-0550 • CHICAGO 312-884-6900 • DALLAS 214-234-1357  
 DAYTON 513-294-1500 • LOS ANGELES 714-540-9830 • NEW YORK NY 212-964-2712 (IN NJ 201-991-8990)  
 SAN FRANCISCO 408-985-0602 • WASHINGTON DC 301-948-7071 • TORONTO 416-252-3395 • ZURICH (011-55 24 2)



# GenRad

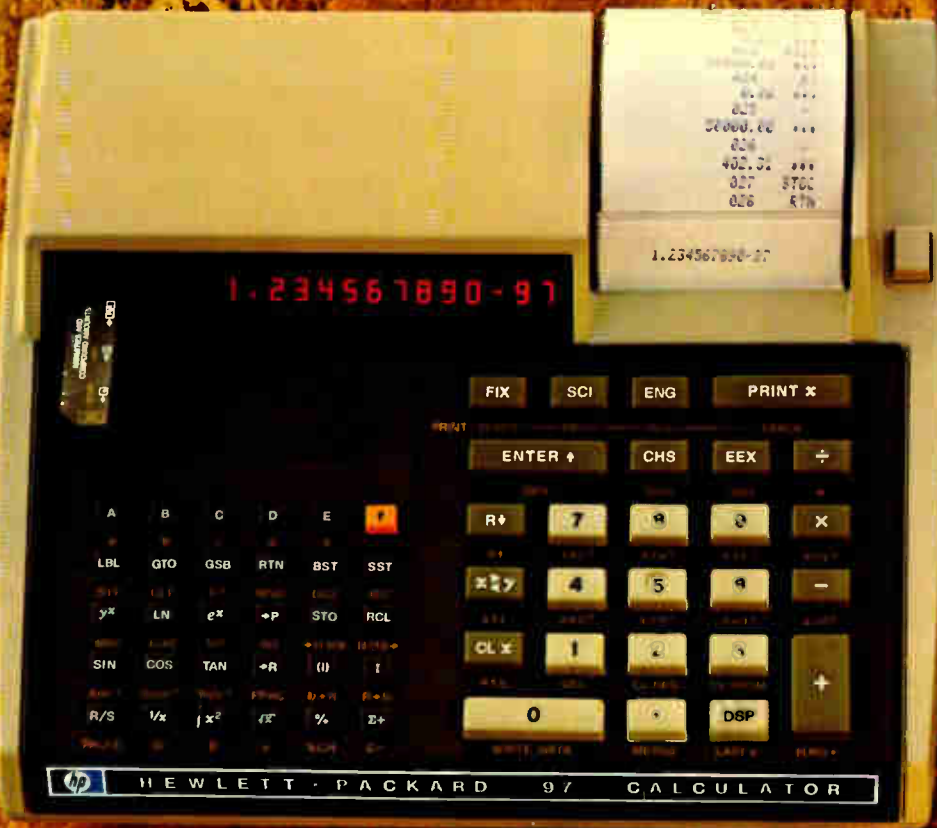

# Hewlett-Packard's first family of programmables. One is dedicated to you.

No matter which of our programmable calculators you choose, you can be sure of one thing: you'll be able to solve your problems—your way. Programming is a personal problem-solving technique, and ours are personal programmables.

There are other benefits as well:  
**Fully merged keycodes.**

All prefix functions and operations merge so one program memory location can hold multi-keystrokes. Programs go in easier, require fewer steps. Capacity goes up. So does flexibility.

## **Our parenthesis-free RPN logic system.**

RPN is straightforward, simple and utterly consistent. You run through all problems the same way. No false starts. No wrong turns. It's comfortable, easy, habit-forming.

## **Human engineering.**

A mainstay of all HP programmables. No hidden keystrokes. All functions are clearly labeled, even shift keys are color coded for ease of use.

## **Solution-oriented software.**

Comprehensive Owner's Manuals, Application Pacs and Books, User's Libraries (HP-67/97), and more. We want HP users to get the most from their calculators, for as long as they use them.

## **Valuable accessories.**

With every HP programmable comes the opportunity to add value and flexibility over time, because the problems you face will grow in complexity over time.

## **First family heritage.**

We built the first advanced pocket calculator in 1972. Since that time, HP calculators have satisfied millions worldwide. Our continuing commitment to quality goes with every calculator we build.

**(800) 648-4711.**

The toll-free number to call for details on our programmables and the name of a dealer near you (unless you're in Nevada, in which case you can call 323-2704 collect). Or send the coupon.

## **Presenting the most complete line of programmables ever offered.**

### **HP-67 Fully Programmable. \$450.00\***

The most powerful pocket calculator we've ever built. 224-step program memory. 26 storage registers. "Smart" card reader records contents of both. Fully merged keycodes increase typical program memory capacity up to 450 keystrokes and beyond. 14 conditional test functions. 10 user definable functions. Three levels of subroutines. Three types of addressing. Superior editing capability. Surprisingly simple to operate.

### **HP-97 Fully Programmable Printing Portable. \$750.00\***

Gives you the same powerful capability as the HP-67, plus a quiet three-mode thermal printer that simplifies programming and editing and provides a permanent record of your calculations. Battery-powered and briefcase portable.

### **HP-29C. Our NEW Programmable with Continuous Memory. \$195.00\***

Its 98-step program memory and 16 of its 30 storage registers stay "on" even when the calculator is "off," so you can store programs and data for as long as you wish. Continuous

Memory plus fully merged keycodes bring typical program memory capacity up to 175 keystrokes and beyond. Insert/delete editing. Conditional and unconditional branching. 10 decision tests. Three levels of subroutines. Exceptional versatility at an exceptional price.

### **HP-19C. Our NEW Printing Programmable with Continuous Memory. \$345.00\***

World's first handheld printing programmable. Offers everything the HP-19C does, plus a quiet three-mode thermal printer. Now you can have the portability of a handheld and the tracing/recording capability of a printer in one programmable calculator.

### **HP-25 Scientific Programmable. New Low Price \$125.00\***

Solves repetitive problems automatically. Enter your formula once; thereafter only variables. Requires no software, no "computer" language. Our lowest priced programmable. Also at a new low price of \$160.00\* our HP-25C, an HP-25 with Continuous Memory that retains programs and data even when turned "off."

Displays are photographed separately to simulate typical appearance



Dept 214L, 1000 N.E. Circle Blvd., Corvallis, Oregon 97330

HEWLETT-PACKARD

Dept. 214L  
1000 N.E. Circle Blvd.  
Corvallis, Oregon 97330

Please send me additional information on the Hewlett-Packard First Family of programmable calculators.

NAME \_\_\_\_\_

ADDRESS \_\_\_\_\_

CITY \_\_\_\_\_

STATE \_\_\_\_\_ ZIP \_\_\_\_\_

\*Suggested retail price, excluding applicable state and local taxes - Continental U.S., Alaska and Hawaii # 616/49

# Allen-Bradley Trimmers:

**We have what  
you need.**

**Our distributors have  
them when your  
need is now.**







## CERMET TRIMMERS

 **Type A:** ¼" diameter, single turn, 10 ohms to 2 megs ±10%, 0.5W at 85°C, immersion sealed, 3 terminal options, Publication 5238. **1000 piece price \$1.12 to 1.68.**

 **Type S:** ⅜" dia., single turn, 50 ohms to 1 meg ±10%, 0.5W at 85°C, immersion sealed, top or side adjust, Publication 5208. **1000 piece price \$1.15 or 1.40.**

 **Type E:** ⅜" square, single turn, 10 ohms to 2 megs ±10%, 0.5W at 70°C, immersion sealed, 13 terminal options, Publication 5219. **1000 piece price \$0.49.**

 **Type D:** ⅜" diameter, single turn, 10 ohms to 2 megs ±20%, 0.5W at 70°C, dust cover, 6 terminal options, Publication 5240. **1000 piece price \$0.42.**

 **Type 90:** Approx. ⅞" square, single turn, 100 ohms to 2 megs ±20%, 0.5W at 70°C, open frame, 2 terminal options, Publication 5242. **1000 piece price \$0.55.**

 **Type MT:** ⅜" square, 20 turn, 10 ohms to 2 megs ±10%, 0.5W at 70°C, immersion sealed, 3 terminal options, Publication 5241. **1000 piece price \$1.18.**

 **Type RT:** ¼" long, 20 turn, 10 ohms to 2 megs ±10%, 0.75W at 70°C, immersion sealed, 3 terminal options, Publication 5237. **1000 piece price \$0.65 or 0.93.**

## CARBON COMPOSITION TRIMMERS

 **Type Y:** ½" dia., single turn, 100 ohms to 5 megs ±10% or 20%, 0.25W at 50°C, dust/splash resistant, 5 styles, non-linear tapers, Pub. 5209. **1000 piece price \$0.90 to 1.59.**

 **Type F:** ½" dia., single turn, 100 ohms to 5 megs ±10% or 20%, 0.25W at 70°C, immersion sealed, 6 styles, non-linear tapers, Pub. 5234. **1000 piece price \$1.00 to 1.62.**

 **Type O:** ½" dia., single turn, 100 ohms to 5 megs ±10% or 20%, 0.40W at 70°C, immersion sealed, 4 styles, non-linear tapers, Pub. 5235. **1000 piece price \$1.20 to 1.58.**

 **Type FD:** ½" dia., 2 sec., 1 turn, 100 ohms to 5 megs ±10% or 20%, 0.25W at 70°C, immersion sealed, 4 styles, 5 tapers, 2 atten. Pub. 5231. **1000 piece price \$2.65 to 4.10.**

 **Type BT:** ½" dia., 2 section, 1 turn, for 75 ohm Bridged-T pad applications, dust/splash resistant, side and top adjust versions. Pub. 5236. **1000 piece price \$2.49.**

 **Type N:** 1¼" long, 25 turn, 100 ohms to 2.5 megs ±10% or 20%, 0.33W at 50°C, immersion sealed, Publication 5206. **1000 piece price \$2.50 or 2.65.**

 **Type R:** 1¼" long, 25 turn, 100 ohms to 2.5 megs ±10% or 20%, 0.25W at 70°C, immersion sealed, bushing mount option, Pub. 5205. **1000 piece price \$2.87 to 3.73.**

# Quality in the best tradition.



**ALLEN-BRADLEY**  
Milwaukee, Wisconsin 53204

EC120

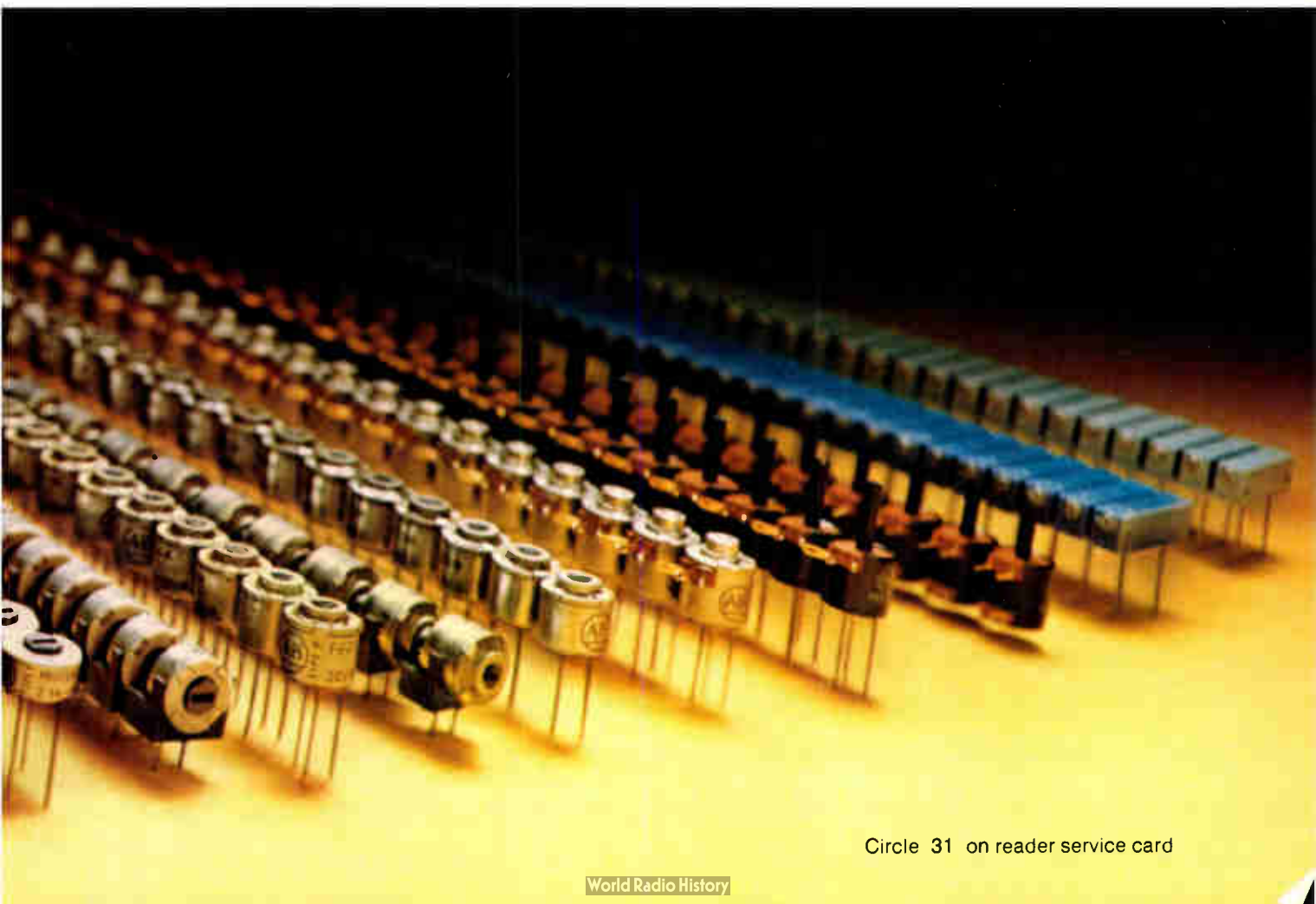

Circle 31 on reader service card

# Why does a little GE Press-Pak SCR handle more current than a big one?

## More pellet power.



The larger the pellet, the greater the current. The basics behind General Electric's new 1/2-inch Press-Pak SCR package are just that simple.

You get all the performance, and more, of a 1-inch Press-Pak SCR . . . plus lower profile, reduced cabinet space, more room for heat-sinking. Lower thermal impedance through a 33% improvement in thermal resistance add up to improved heat transfer for higher reliability.

New GE 1/2-inch Press-Pak SCR's are interchangeable with standard 1/2-inch Press Paks. Thus, you can use them to upgrade equipment without redesign. And higher surge current in the 1/2-inch packages means you're buying a higher margin of safety.

Models include C430 (1200v, 1000A) and C431

(1800v, 1000A) phase controllers; and C435 (800v, 1000A) and C438 (1200v, 850A) inverters.

High current performance in a small SCR package is the kind of innovation you expect from the world's leading manufacturer of power semiconductors. For more information, call your nearby GE electronic components sales engineer, or write General Electric Co., Electronics Park 7-49, Syracuse, NY 13201.

222-03

**There's more  
to GE semiconductors  
than meets the eye**

**GENERAL  ELECTRIC**

## **Nonimpact printers drawing attention and R&D dollars**

Look for some big changes in the high-end printer market as money is diverted from impact-printer work to research on nonimpact models. According to industry sources, the yawning gap between the fastest line-impact printers (2,000 lines per minute for under \$20,000) and the nonimpact types (about 20,000 lines per minute for a few hundred thousand dollars) is begging to be filled, and companies like Dataproducts Corp. and Computer Peripherals Inc. are after the market.

Although electrographic printers like the IBM 3800, Xerox 9700, Honeywell's page-printing system, and others dominate the market, most of the action will be in ink-jet printing, once the technology is worked out. The process has the advantage of printing on any material, and four-color picture-quality prints are not inconceivable.

## **Germans find way to put op amps on LSI chips**

Two researchers at the University of Dortmund in West Germany think they have found a way to put operational amplifiers in otherwise digital large-scale integrated circuits. The technique, which will be discussed at the third European Solid State Circuits Conference in Ulm, West Germany, Sept. 20-22, uses an n-channel enhancement-depletion mode tailored to analog circuit needs. It results in an op amp with a gain of 90 dB, power dissipation of 4 mW, and a unity gain bandwidth greater than 1 MHz. Each op amp occupies only 2.5 square millimeters of the chip.

## **Emulation, signature analysis to be used in service instrument**

Millenium Information Systems, Inc., Cupertino, Calif., the supplier of the Tektronix 8000 series of microcomputer development systems, is about to move into service instruments for microprocessor-based equipment. Millennium is combining the techniques of signature analysis [*Electronics*, March 3, p. 89] and in-circuit emulation to produce an instrument that, it says, can be used by technicians with low skill levels.

## **Evaluation kit is Augat's entry into fiber-optics**

Augat Inc., the large electronic-interconnection firm, has taken the plunge into the fiber-optics field. Its first product, a low-cost kit for engineering evaluation of fiber-optic interconnections, will be shown at Wescon.

The kit comes in two versions. One at \$190 has an infrared emitter assembly with an 880-nanometer spectral peak; a 5-meter-long fiber-optic assembly; a temperature-referenced photodetector assembly matched to the emitter; and preamplifier and emitter driver modules compatible with TTL. A \$99.50 version is available without the two modules.

## **Analog Devices lists nine I/O interfaces for microcomputers**

It has been a while in coming, but Analog Devices Inc. has greatly broadened its plan for going after the burgeoning microcomputer analog input/output interface market. The Norwood, Mass., company will introduce nine new products between October and February to go with microcomputers from Intel, Pro-Log, Motorola, National, and Texas Instruments. The company's first such product was an analog I/O board for Intel SBC-80/10, which bowed last fall [*Electronics*, Nov. 25, 1976, p. 141]. The new round of introductions indicates that Analog Devices will have a broad-based analog I/O board line, with prices ranging from \$235 to approximately \$500.

The lowest-priced unit will be the four-channel output board, with 8-bit accuracy, designed to go with the Pro-Log 4- and 8-bit microcomputers. It

and a 16-channel data-acquisition board for the same machines will be available next month, as will similar boards for the Intel SBC-80 and MDS, and the National BLC-80. Three I/O boards for the Motorola 6800 will reach the market in November and December, with two more for TI's TMS-990/1000 being prepared for next February.

## **Potentiometer line gets two options from Allen-Bradley**

Allen-Bradley Co. has started sending out samples of two new options for its distributor-assembled MOD POT line, and is preparing the devices for production this month. New to the series of interchangeable panel potentiometer modules is a switch for signal-level circuits, tested for currents as low as 15 mA and rated at 5 v. The dry-current switch is designed for such applications as function switching in oscilloscopes. The Milwaukee, Wis., firm is also adding low-torque conductive plastic resistive elements to get the easier-turning pots often needed for miniature equipment. They will be available from 100  $\Omega$  to 1 M $\Omega$  in tolerances of  $\pm 10\%$  and  $\pm 20\%$ , and power ratings of 0.25 and 0.50 w.

## **Intel gets out of watch business, closes Microma**

The anticipated departure of Intel Corp. from the digital watch business [*Electronics*, Aug. 18, p. 74] has been made official with the closing of its Microma subsidiary. Microma will continue to manufacture watch products only until it "fills shipments of products already committed," says Gordon Moore, Intel's president. Intel is charging the \$1.4 million after-tax loss to its earnings in the current quarter. The decision does not affect the parent firm's commercial production of C-MOS watch chips.

## **Motorola, Fairchild to bring out V-MOS power parts**

It looks as though power v-MOS, a young technology for fabricating power MOSFETS, is starting to catch on. Two major semiconductor houses, Fairchild and Motorola, will shortly have devices out in the marketplace, and other traditional leaders in bipolar power now have evaluation programs under way (see "will V-MOS make it in power market," p. 84).

Next month, Fairchild is introducing a pair of power FETs, types 2N6557 and 2N6660, and is now circulating samples of a p-channel device. Additionally, besides second-sourcing the entire line of power MOSFETS now made by Siliconix, which pioneered power v-MOS, Fairchild plans to develop its own rf and high-voltage high-current parts. The latter should be available in the first quarter of next year. In particular, the firm is working toward a general-purpose complementary pair of 140-v, 10-A devices.

Meanwhile, Motorola has been shipping samples of a low-power v-MOS part since the beginning of the year. Intended for vhf applications, the unit develops 1 w at 175 MHz. It is slated for introduction later this year.

## **Leeds & Northrup seeks acquisitions**

Look for Leeds & Northrup Co. of North Wales, Pa., to acquire companies or product lines that complement its own catalogue of process controls and instrumentation. The firm, in various stages of discussions with about a half dozen companies, is most interested in adding test and measuring equipment, such as digital voltmeters, multimeters, counters, and signal sources, to its line of laboratory instruments.



## microNOVA keeps on trackin'.

Southern Railway has a long track record of being one of the most profitable rail systems in the country. To help stay on that track, they decided to increase the speed and flexibility of their online distributed communications network. So Southern Railway is now changing dumb terminals into intelligent ones throughout its rail system, using microNOVA microcomputers.

Southern Railway found that only the Data General microNOVA microcomputers could help them cut costs and keep track of some 75,000 freight cars moving over 10,500 miles of track, and do it the way Southern Railway wanted to. Controlling rolling inventory like that takes a lot of flexibility. And that's the big advantage Data General microNOVA microcompu-

ters bring to any application. Whether in a chip, on a board, or as a packaged system.

With the speed, flexibility and software of a minicomputer and the economies of microprocessor technology, microNOVA microcomputers let you do things your way. That's why they're setting track records in all kinds of applications.

Mail to: Data General, Westboro, MA 01581

- Send microNOVA technical literature.  
 Send literature and have your sales representative call.

Name \_\_\_\_\_  
 Title \_\_\_\_\_  
 Company \_\_\_\_\_  
 Address \_\_\_\_\_ Tel. \_\_\_\_\_  
 City \_\_\_\_\_ State \_\_\_\_\_ Zip \_\_\_\_\_

NOVA is a registered trademark of Data General Corporation  
 ©Data General Corporation, 1977

Data General, Westboro, MA 01581, (617) 366-8911. Data General (Canada) Ltd., Ontario. Data General Europe, 15 Rue Le Sueur, Paris 75116, France, 50-006-06. Data General Australia, Melbourne (03) 82-1361. **EM915**

**Data General**  
 It's smart business.

Circle 35 on reader service card

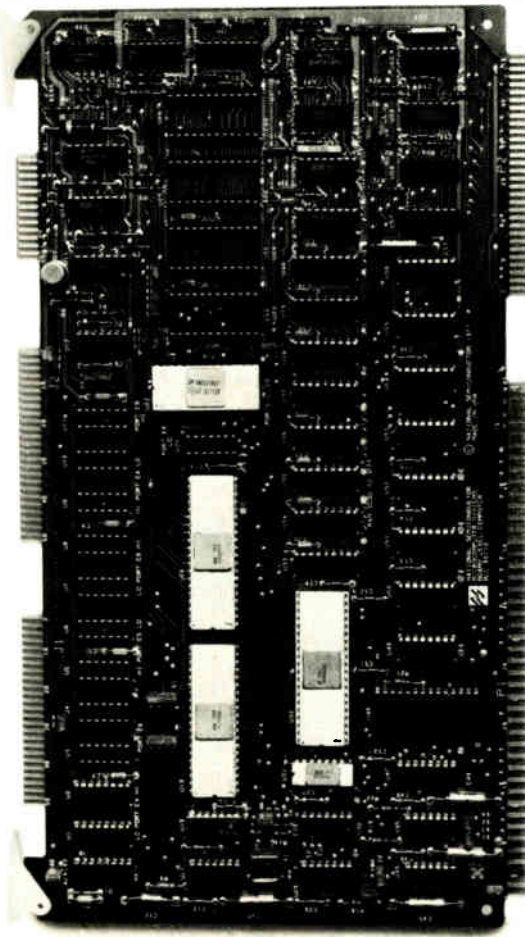

# 10% off.

If your project group is using the Intel SBC 80/10 — and you'd like to save some money — call us at 800-538-1866. In California call 800-672-1811. Because we're second-sourcing the 80/10 at 10% off Intel's prices.

ACTUAL SIZE

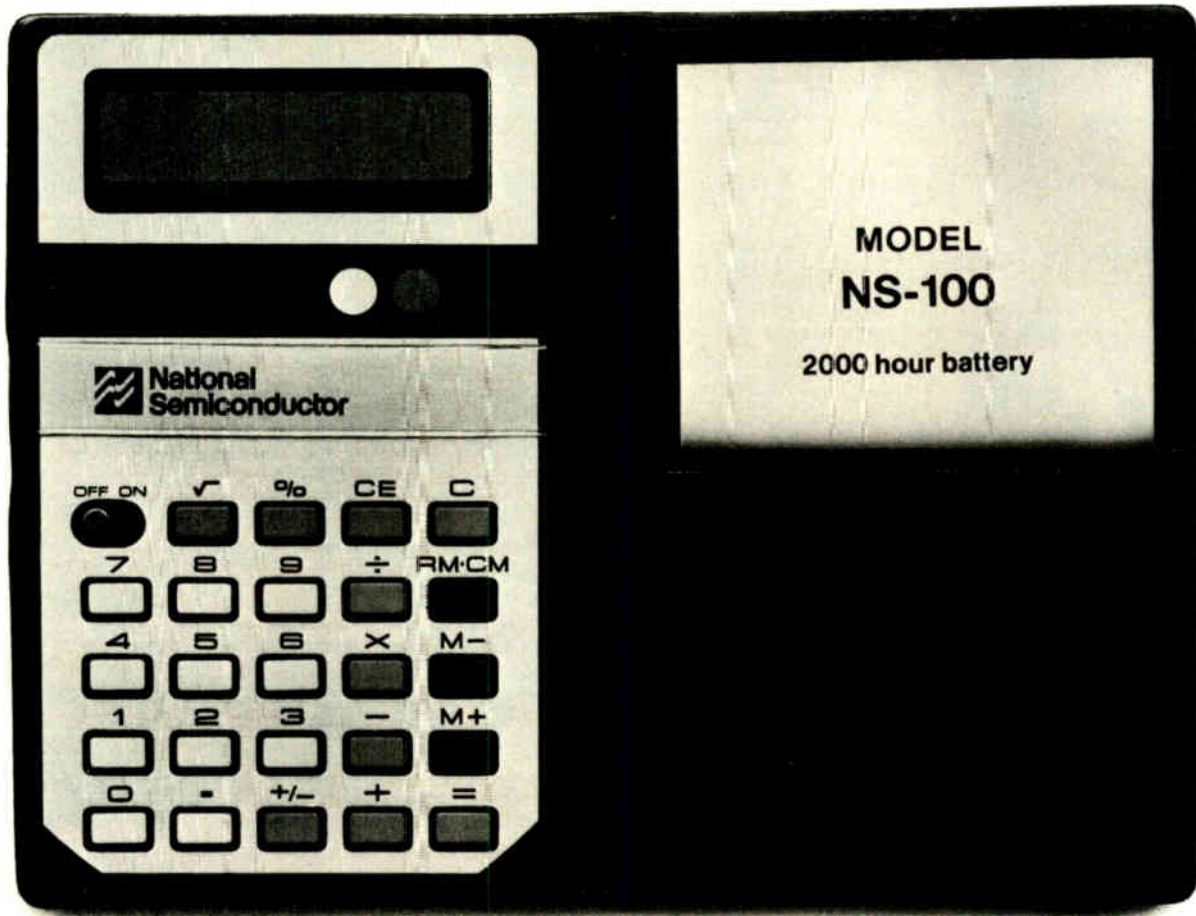

# 100% off.

If your project group is using the Intel SBC 80/10 — and you're the first one in your group to call us at 800-538-1866 (in California, 800-672-1811) — we'll give you this calculator free. Just to find out who you are.

Offer expires October 15.

# The only Double-Balanced Mixers with a 2-YEAR GUARANTEE

featuring Hi-Rel tested diodes-

Introduced in 1971 at \$7.95...

still only

**\$7.95**

(500 pieces)

\$9.95 (1-49)

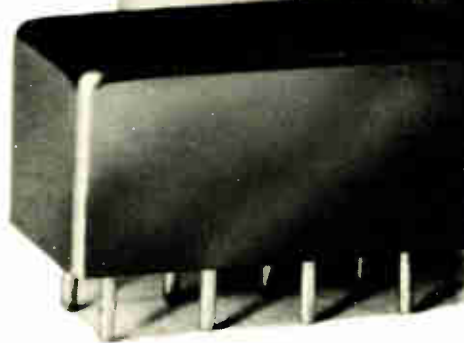

\*including diodes!

Yes, a two-year guarantee for hermetically sealed DBM's is now a reality... made possible by an accelerated life diode screening program adopted at Mini-Circuits.

Each Schottky diode used in Mini-Circuits' SRA-1 mixers is now preconditioned by the HTRB (High Temperature Reverse Bias) technique, previously reserved almost exclusively for semiconductors assigned to space applications. With HTRB testing, each diode is operated for 168 hours at 150°C with one volt reverse bias applied.

To screen out "infant mortality", the diodes are deliberately stressed to accelerate aging and to force time-related failure modes to take their toll. In conventional testing or "baking", the diode does not experience anywhere near the stress encountered with the HTRB program. Hence, the ability at Mini-Circuits' to locate the potentially-unreliable diodes before they are assembled into SRA-1 units. And, with double-balanced mixers, the overall reliability hinges almost entirely on the diodes used.

Yes, the HTRB procedure costs us more and screens out more devices. But our goal is to improve reliability to a level unmatched for off-the-shelf DBM's at no increase in cost to our customers. You — our customers by your overwhelming confidence in our product line have made us the number one supplier of DBM's in the world.

To earn your continuing support, we are now employing HTRB Hi-Rel testing for every diode used in the SRA-1, at no increase in cost to you. So, for the same low price of \$7.95, you can purchase our SRA-1, with a two-year guarantee, including diodes.

To ensure highest system reliability demand highest quality diodes on your source-control drawings and purchase orders. Specify SRA-1 mixers, with HTRB tested diodes from Mini-Circuits... where low price now goes hand-in-hand with unmatched quality.

#### MODEL SRA-1

Freq. range (MHz) LO - 0.5-500, RF 0.5-500, IF dc-500

Conversion loss (dB) **Typ.** **Max.**

One octave from band edge 5.5 7.0

Total range 6.5 8.5

Isolation (dB) **Typ.** **Min.**

Lower band edge to LO-RF 50 45

one decade higher LO-IF 45 35

Mid range LO-RF 45 30

LO-IF 40 25

Upper band edge to LO-RF 35 25

one octave lower LO-IF 30 20

Min. Electronic attenuation (20 mA) 3 dB

Signal, 1 dB compression level + 1 dBm

Impedance all ports 50 ohms



## WE'VE GROWN

Customer acceptance of our products has been so overwhelming, we've been forced to move to larger facilities — THANKS.

**International Representatives:** □ AFRICA: Altra (PTY) Ltd P.O. Box 9813 Johannesburg 2000 S Africa □ AUSTRALIA: General Electronic Services 99 Alexander Street, New South Wales Australia 2065 □ ENGLAND: Dale Electronics Dale House Wharf Road Frimley Green Camberley Surrey □ EASTERN CANADA: B D Hummel 2224 Maynard Avenue Utica, NY 13502 (315) 736-7821. □ FRANCE: S C E - D I M E S 31 Rue George - Sand 91120 Palaiseau France □ GERMANY, AUSTRIA, SWITZERLAND: Industrial Electronics GMBH 6000 Frankfurt Main Klüberstrasse 14 West Germany □ INDIA: Gaekwar Enterprise, Kama Mahal, M L Dananukar Marg, Bombay 400 026 India □ ISRAEL: Vectronics Ltd 69 Gordon Street Tel-Aviv, Israel □ NETHERLANDS, BELGIUM, LUXEMBOURG: Cormex Veldweg 11 Hattem Holland □ NORWAY: Datamatik AS Ostensjoveien 62 Oslo 6, Norway □ SINGAPORE & MALAYSIA: Electronics Trading Co (PTE) Ltd 87 Bukit Timah Road Singapore 9 Malay Peninsula □ SWEDEN: Integerad Elektronik AB, Box 43, S-18251 Djursholm Sweden

**U.S. Distributors:** □ NORTHERN CALIFORNIA: Cain-White Co. Foothill Office Center, 105 Fremont Avenue, Los Altos, CA 94022 (415) 948-6533 □ SOUTHERN CALIFORNIA, ARIZONA: Crown Electronics 11440 Collins Street No Hollywood CA 91601 (213) 877-3550



World's largest supplier of Double-Balanced Mixers

# Mini-Circuits

MINI-CIRCUITS LABORATORY

A Division Scientific Components Corp

2625 EAST 14th STREET  
BROOKLYN, NEW YORK 11235  
(212) 769-0200

OUR NEW ADDRESS  
AND PHONE NO. IS

DOMESTIC TLX 125460 • INTERNATIONAL TELEX 620156



## Japanese 4-k RAM challenges U.S. devices

Fallout from Japanese government's subsidized project, double-diffused static unit can copy many parts

Using a double-diffused MOS process, Nippon Electric Co., under Japanese government sponsorship, has developed a 4,096-bit static random-access memory that rivals the performance of the most advanced static RAMs now in the works at U.S. suppliers. This development supports the American industry fear that Japanese government-sponsored electronic programs will spawn advanced semiconductor components, which when exported will quickly penetrate the American and European digital markets.

The device is a 57-nanosecond 1,024-word-by-4-bit fully static RAM built with a 4-micrometer double-diffused metal-oxide-semiconductor process, which is called diffusion self-aligned MOS in Japan. It was developed as a cache or buffer memory for a high-speed microcomputer in the \$100 million 10-year national project on pattern-information processing. The project, started in 1971, is financed by the Ministry of International Trade and Industry. To export a version of the device, NEC, which manufactures the part for MITI, will apply to the government for a commercial license.

NEC has not disclosed which of the American static memory types it will copy. For new mainframe applications, it could copy the pin-out and power-down configuration of Intel's new 2147 4-k static RAM built with

the 4-micrometer high-performance MOS process, or it could copy the 4-k versions from American Microsystems Inc., built with the double-diffused V-groove MOS process. For cache applications, it could supply the part in 4-k-by-1-bit configurations identical with the industry-standard 95415 bipolar package. For high-speed microprocessor and peripheral static RAMs, it could copy the 1,024-word-by-4-bit or 4-k-by-1-bit MOS configurations of Mostek Corp., Intel Corp., or Semi Inc.

In any case, industry sources close to the development estimate that NEC's part will turn up as samples in some form in the U.S. within six months. In that time frame, only Intel and AMI are expected to have 50-ns 4-k single-5-volt MOS static RAMs on the market.

The current NEC device has a typical access time of 57 ns, typical cycle time of 100 ns, active power dissipation of 520 milliwatts, and standby power dissipation of 375

mw. Cell size is 52 by 64.5  $\mu\text{m}$ , and chip size 4.6 by 6.09 millimeters. It operates off a supply voltage of 5 v,  $\pm 1$  v, and dissipates power in a backup mode of 4.4 mw at 1.1 v.

For commercial export NEC designers will either optimize the specifications on the D-MOS part or switch to a short-channel silicon-gate approach (similar to Intel's) which is also under development. Within six months, the company expects to see samples of 4-k RAMs built with either process, so that NEC may be the only other semiconductor manufacturer in a position to provide an alternate source to Intel for a power-down 2147-type static RAM for sub-100-ns mainframe use.

**How it's built.** The basic configuration of the NEC approach is six transistors per cell. A special configuration of silicon-gate enhancement-depletion inverter including double-diffusion and advanced local-oxidation techniques gives the high speed. The basic mask dimension is about 4

**Inside view.** Basic structure of Nippon Electric Co.'s static random-access memory uses diffusion self-aligned, or D-MOS, driver and conventional n-MOS load.

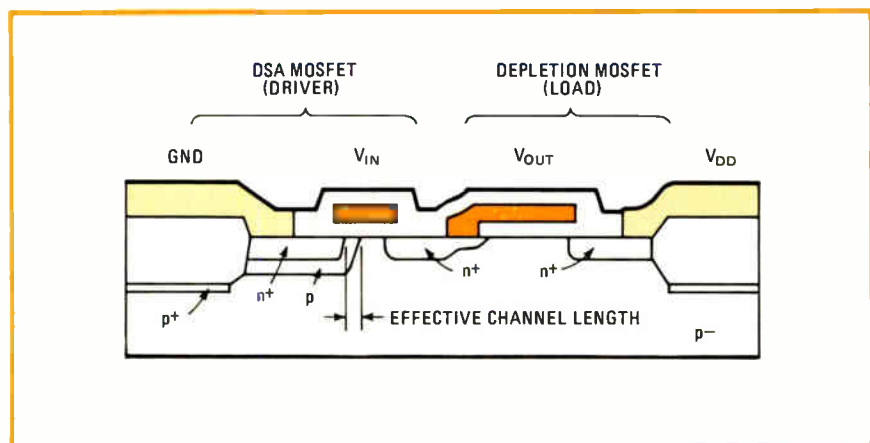

$\mu\text{m}$ , giving source-to-drain separation of less than  $2\ \mu\text{m}$  and source and drain depths of about  $1\ \mu\text{m}$ . The gate oxide is 800 angstrom units thick.

Despite the small dimensions, the double-diffused configuration eliminates punch-through, shifts in threshold voltage, and other short-channel effects. It also allows use of thicker oxide, plus deeper source and drain diffusions than is possible in standard n-channel transistors of similar dimensions.

Two measures were taken to decrease junction capacitance and thus increase operating speed. The  $p^+$  diffused channel stopper under the local oxidation was fabricated by

an advanced technique so that it is vertically separated from the source and drain  $n^+$  regions, and a substrate with the high resistivity of 100 ohm-centimeters was used.

Ion implantation is used for deposition of the boron in the p-diffusion layer of the transistors to precisely set the threshold at  $1\ \text{v}$ ,  $\pm 0.1\ \text{v}$ . Thresholds of the depletion-load transistors are also adjusted by ion implantation—to two different threshold voltages—to meet high-speed—low-power requirements. Threshold voltages for the write driver and decoder and for the decoder buffer and load cell are  $-3\ \text{v}$  and  $0\ \text{v}$ . □

cylindrical lens to efficiently couple as much as some three quarters of the light from the lasers into the larger fiber light guides.

The group realized early on that a silicon substrate was the key to solving all the problems that faced them. Using the same technology as is employed in making v-MOS transistors, they preferentially etched the silicon wafer along the (111) planes to form V grooves with a shape and depth precisely controlled by the crystalline planes. When the (111) faces meet at the bottom of the groove, the etching process is essentially terminated; thus grooves of different depths can be etched into the same substrate in a single fabrication step.

**Silicon benefits.** Precise optical alignment in an inexpensive material with an easily fabricated process was a key consideration, says Eric G. Lean, an IBM researcher who helped formulate the package concept and guided its progress, but the silicon substrate offered other benefits as well.

"It's easy to diffuse an n layer into the p-type silicon substrate to form a diode that is reverse-biased and thus electrically isolates one electrode from all the others," he says. "And these junctions do not affect the heat flow from the laser to the copper heat-spreader." What is more, the

## Displays

### Package combines optical fibers, lasers for liquid-crystal display

The package may be the key to making gallium-aluminum-arsenide laser arrays practical in display, printing, and communications applications. Researchers at IBM Corp.'s Yorktown Heights, N. Y., research center have developed a novel fiber-optic laser array package that goes a long way toward solving the many optical and physical problems associated with such devices.

John D. Crow, one of the developers, says that such a fiber-optic laser array combination, with each laser providing 50 milliwatts in continuous-wave operation, can write characters into a liquid-crystal display by heating sections of it. The feasibility of this approach has already been demonstrated at IBM's San Jose Research Center, he says.

Crow sees other applications as well. Printing hard copy using the laser array to heat volatile dye on a ribbon, similar to a typewriter ribbon, literally blows the ink off the ribbon and onto the paper. "And of course with such an array, parallel data can be sent over fibers in a byte-wide format instead of in bit-serial fashion, when only a single fiber is used," he adds.

The package designed by the

group of IBM researchers from different disciplines contains 13 gallium-aluminum-arsenide double-heterostructure lasers bonded to an inexpensive silicon substrate. The substrate is soldered to a copper heat-spreader, which is attached to a thermoelectric cooler to ensure that the lasers' operating characteristics remain constant for full-array operation. An optical fiber is used as a

**In the groove.** Glass fiber, placed in etched V groove, acts as lens to concentrate light from semiconductor lasers into output fibers, giving 70% transfer efficiency.

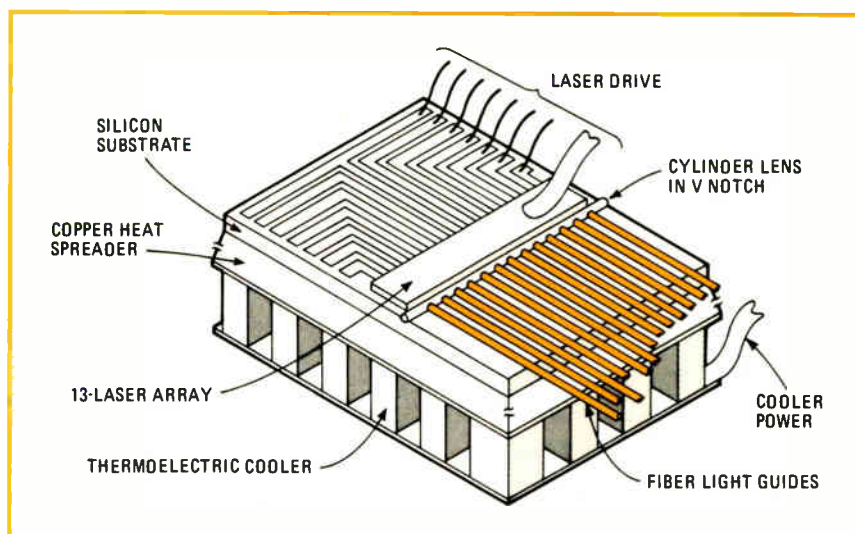

thermal coefficient of expansion of silicon is a better match to GaAs than is copper, putting less stress on the laser and greatly reducing laser degradation.

Lean and Crow agree that future packages will integrate active driver- and control-circuit chips directly onto the same silicon carrier that contains the laser array and the optical components. Then, too, easily fabricated pn junctions used for electrically isolating electrodes for individual addressing can also be used as temperature sensors. Looking ahead, they see no reason why fibers from a number of source packages could not be combined into larger arrays to allow rapid printout of full pages of information onto a liquid crystal display, or carry more data on parallel paths. □

## Navigation

### Microprocessor ups missile capabilities

Microprocessor technology promises to pack more punch into future U. S. Air Force and Navy tactical missiles. Not only will more computing power go into their midcourse inertial guidance systems, but their terminal seeker electronics will be simplified and will be better integrated with the midcourse unit. That is the conviction of engineers at the Precision Products department of Northrop Corp.

Probably the first weapon to benefit from this integration will be the advanced medium-range air-to-air missile, for which requests for proposals are expected to be issued next month by an Air Force-Navy program office at Eglin Air Force Base, Valparaiso, Fla.

Joseph Yamron, vice president and general manager of the Northrop department in Norwood, Mass., says his organization has a good chance to win the midcourse guidance system subcontract because it builds the attitude-reference assembly for the system in the Navy's Harpoon antiship missile. That unit

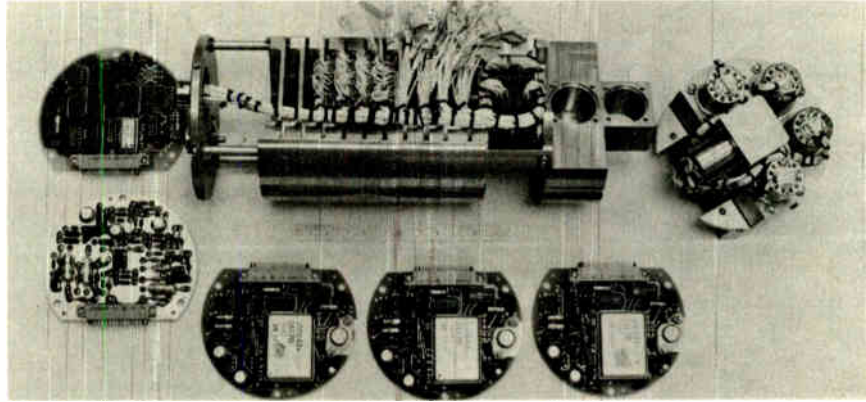

**Inertial guidance.** Advanced version of Northrop Corp.'s attitude-reference assembly, part of midcourse guidance system for Harpoon anti-ship missile, uses microprocessor.

was the first all-digital strapped-down inertial unit to go into production for a missile [*Electronics*, Dec. 23, 1976, p. 26]. An advanced version of the Harpoon attitude-reference assembly has undergone successful bench and sled tests at the Navy's China Lake, Calif., Weapons Testing Center.

For the advanced medium-range air-to-air missile, the Precision Products department will probably propose an even newer generation of midcourse inertial unit than the one tested at China Lake. John McNeil, systems development section manager at the department, says the newest-generation strapped-down unit can use microprocessors such as the Motorola 6800, Texas Instruments 9900 or Advanced Micro Devices 2901 bit-slice device.

**Operation.** The Northrop design incorporates three of the department's rate-integrating gyros and three of its accelerometers. Before launch, the midcourse guidance system would store the coordinates of its launch position and the target coordinates derived by the fire-control system of the launching ship or aircraft.

After launch, the guidance unit puts out error signals indicating how far off course the missile is in relation to the target and in relation to the launch reference coordinates, starting, according to Christopher Reynolds, systems design branch manager, with angular information from the gyros.

The microprocessor, McNeil says,

computes the attitude of the midcourse guidance unit in reference to the missile airframe to which it is strapped. It then takes digital signals from the accelerometers to compute changes in the missile's velocity. Finally, the microprocessor translates the missile coordinate data into the reference coordinates and generates commands to steer the missile.

The digital data is ultimately converted to analog signals that will drive actuators to change the missile's course. The Northrop unit can also provide commands that will aim a terminal seeker that is capable of being steered. In this manner, the time the terminal seeker takes to acquire the target can be shortened, lessening the chance that its radar may be jammed. Then, too, duplication of inertial components in the terminal seeker, midcourse guidance, and autopilot units can be reduced or eliminated. □

## Microprocessors

### National produces 16-bit, 40-pin chip

With their third-generation 8-bit medium-range microcomputers on the market, semiconductor makers are taking aim on the 16-bit marketplace as well. Major microprocessor firms—among them Intel Corp., Zilog Inc. and Motorola—have announced plans to introduce high-throughput 16-bit n-channel metal-

oxide-semiconductor microcomputers during 1978, with speeds as much as 10 times that of present 8-bit machines.

Hoping to blunt the impact of both the advanced 8-bit machines on the market and to steal a march on the projected 16-bit devices, National Semiconductor Corp. has gone into production on a high throughput n-MOS 16-bit microprocessor that it says outperforms most present 8-bit designs. Designated the INS8900, the three-power-supply, 40-pin device is the newest member of the Santa Clara, Calif., firm's Pace family of microprocessors.

**Timing.** Execution times for the most commonly used instructions are equivalent to those on advanced 8-bit designs such as the 8085 and 10% to 30% faster than on older designs, such as the 2-microsecond 8080, according to Howard Raphael, director of microprocessor marketing at National. Most significant is the price in volume on the 8900: only \$10 each in volume.

"Our strategy from here on out is to leapfrog the competition," says Raphael. In the works are single-supply, +5-volt, scaled n-MOS versions of the 8900 with even greater throughput, as well as minimum three-chip systems in which the 8900 or some more advanced version will be coupled with two input/output timer chips, one for read-only and one for random-access memories.

Even in its present configuration, the new microcomputer is impressive. Fabricated with an advanced depletion-load n-MOS process and operating with only a 2-megahertz clock, it has a microinstruction cycle

time for most internal operations—even 16-bit-wide ones—of 2  $\mu$ s. At the macroinstruction level, the 8900 really shines, says Raphael. A bit transpose takes 110  $\mu$ s, a memory-to-memory add about 16  $\mu$ s, and an interrupt I/O about 54  $\mu$ s. Comparable speeds on a 2- $\mu$ s 8080 are 164, 27, and 44  $\mu$ s, respectively.

The 8900 makes use of both 16-bit instruction words and data words and features a powerful and flexible set of 45 instruction types with 337 individual instructions. All instructions use a single 16-bit word, thus reducing memory-access and program-storage requirements.

**Novel.** The device has the ability to operate on both 8- and 16-bit data words. This extends the inherent efficiency and power of a 16-bit processor to 8-bit applications, Raphael says. In addition, the 8900 can add four-digit-per-word binary-coded-decimal data as well as straight data. "This capability eliminates the program storage and execution time usually required for BCD-to-binary conversions in 8-bit designs," Raphael says.

Like other advanced microprocessor designs, the 8900 has an on-chip I/O capability. It has flag output and jump commands that, in addition to giving it flexibility in controlling peripherals, can be used together as a serial I/O port, "eliminating the hardware that would otherwise be required to interface to the data bus and to decode the device address," Raphael says. The device also has a six-level, priority-interrupt structure on the chip, while most 8-bit systems require a separate large-scale integrated device. □

---

## Packaging & production

---

### Philips says yes to resistless, etchless printed-circuit boards

A two-year-old process for delineating printed-circuit board patterns without using resist may be getting a shot in the arm from Philips' Elcoma division. The Dutch group is considering switching much of its subtrac-

tively etched board production to its own version of the American-devised photographic process. Philips intends to license the process, which it calls PD-R.

"The prestige of a giant like

Philips is going to do a lot to legitimize the process in the eyes of potential users," asserts John Dennis-Browne, manager of technology sales and licensing for the Kollmorgen Corp.'s Photocircuits division, Glen Cove, N. Y. His unit introduced the resistless process, called Photoforming, in 1975.

Several companies in the United States and abroad have secured licenses but, according to Dennis-Browne, additional development time was required to adapt the procedure to a manufacturing environment. Photocircuits and its licensees are now at the prototype stage of their operations.

The Philips and Photocircuits processes are very similar. Both use ultraviolet light to project an image onto a printed-circuit board with a chemically treated surface. The surface reacts with the light and the image is then developed using photographic techniques.

What results is a metallic pattern that can be built up to circuit-board thickness using electrolessly plated copper. Gone are the screened-on or film resists used in the conventional additive and subtractive processes and the masks through which the pattern is screened on. Gone, too, is the stripping operation in which the unwanted resist is removed chemically. Unlike the subtractive process, there is no etching away of copper in the resistless method.

**Savings.** All of this adds up to a 30% reduction in cost over Philip's standard subtractive etching of pc boards, according to a company spokesman in Eindhoven. Also, it is also possible to plate conductors and spaces as narrow as 6 mils, compared to 13-mil conductors and 16-mil spaces possible with subtractive etching. Additive-process limits are conductors and spaces about 10 mils wide.

The Elcoma division in Eindhoven is using the PD-R process for prototype telecommunications boards. In its process, Philips first coats a standard FR-4 glass-epoxy board with a layer of titanium oxide. After holes are drilled, the board goes through a swell-and-etch step to ensure a firm

# A high performance spectrum analyzer family?

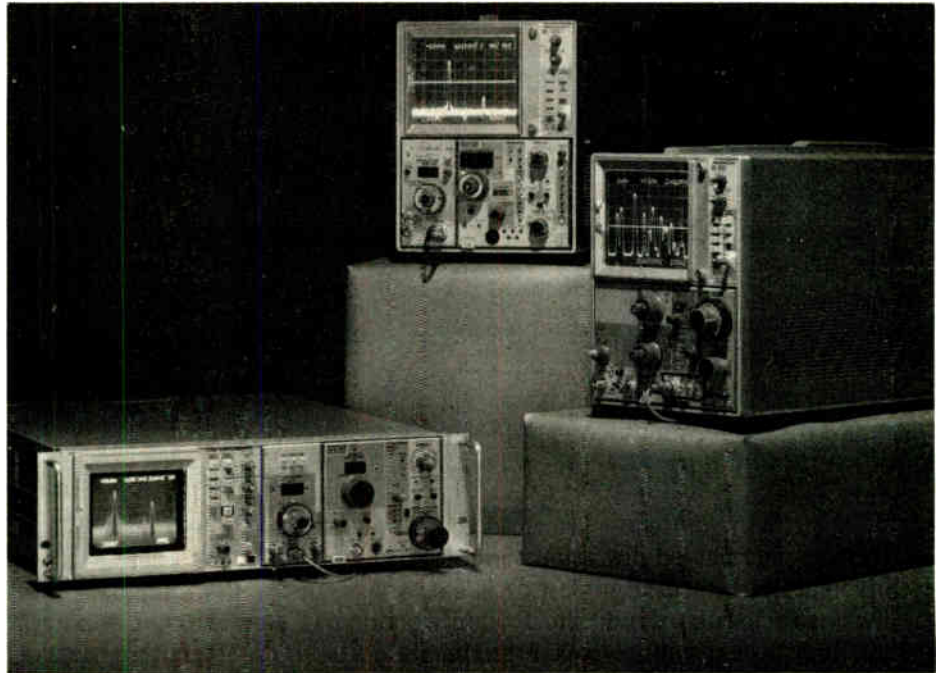
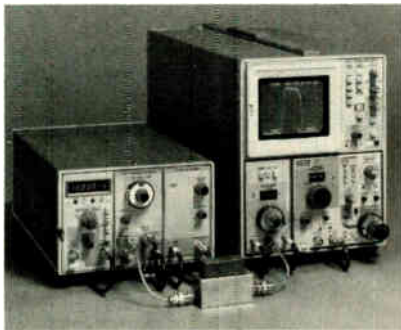

## Yes, and here's why—

### Call it a *family*

because you can work from 20 Hz to 60 GHz with three analyzers in a choice of rackmount and cabinet mainframes with crt readout. You may already have the mainframe.

### Call it *high performance*

because you can work with an operating ease, resolution, stability, and accuracy that is unexpected in transportable analyzers.

### From 60 GHz to 1.5 GHz

The new 7L18 Microwave Spectrum Analyzer offers

- Microprocessor-aided controls for easy operation
- Digital storage display and signal processing
- 30 Hz resolution into X band
- Full internal preselection and amplitude calibration
- $\pm 2.5$  dB absolute amplitude accuracy is usually achieved\*
- Optional waveguide mixers with  $\pm 3$  dB frequency response

### From 1.8 GHz down to 1 KHz

The 7L13 Spectrum Analyzer offers

- Single-knob tuning
- 30 Hz resolution
- $\leq 10$  Hz residual fm
- $-128$  dBm sensitivity
- Full vertical calibration
- Companion tracking generator
- $\pm 2.5$  dB absolute amplitude accuracy is usually achieved\*

### From 5 MHz down to 20 Hz

The 7L5 Spectrum Analyzer offers

- Digital storage display and signal processing
- Reference level control in 1 dB increments
- Synthesizer stability and accuracy with 250 Hz steps
- 80 dB display
- 50  $\Omega$ , 75  $\Omega$ , 600  $\Omega$  and 1 M $\Omega$  input impedance
- Optional tracking generator
- $\pm 1$  dB absolute amplitude accuracy is usually achieved\*

7L18 Spectrum Analyzer . . . \$12,000 plus mainframe and optional waveguide mixers.

7L13 Spectrum Analyzer . . . \$8,650 plus mainframe. Tracking generator optional.

7L5 Spectrum Analyzer . . . \$5,200 plus input module and mainframe. Tracking generator optional.

Prices for appropriate 7000 Series Mainframes begin as low as \$1,995.

U.S. Sales Prices F.O.B. Beaverton, Oregon.

\*Since overall accuracy is a function of measurement technique it includes several interrelated factors.



Find out how to make the high performance spectrum analyzer family work for you. Call your Tektronix Field Office or Representative for more information. Or write to Tektronix, Inc., P.O. Box 500, Beaverton, Oregon 97077.

**Tektronix**  
COMMITTED TO EXCELLENCE

surface for the conductor patterns.

This roughened laminate is then activated by the palladium ions in a solution of palladium chloride. Conductor patterns can then be printed onto the board with ultraviolet light. After exposure, the remaining palladium chloride is merely washed off, leaving a pattern of metallic palladium. Copper can then be plated onto this pattern to a thickness of 25 micrometers.

While PD-R works solely with FR-4 laminate, Photocircuits' Photoforming can be used on a variety of glass-epoxy boards and other materials like paper and phenolics. Moreover, Photoforming does not need a catalytic coating like titanium oxide but relies on an adhesive coating to hold the copper. Finally, Photoforming's light-sensitive material is based on non-noble copper salts rather than palladium. □

---

### Fiber optics

---

## Hughes fiber shows 0.01 dB/km loss in IR

Although fiber-optic technology based on silica materials works in transmitting signals at visible frequencies, there are basic optical limits to its use in infrared ranges. Yet, the IR range offers some promising applications for short-range image relay, power transmission, and long-distance communications.

Now, a team at the Hughes Aircraft Co. Research Laboratories, Malibu, Calif., has demonstrated a polycrystalline core technique that permits fabricating IR fiber-optic waveguides. "We have achieved optical transparency of these fibers extending from approximately 0.6 micrometer in the visible to approximately 35  $\mu\text{m}$  in the infrared," reports Douglas A. Pinnow, assistant manager of the chemical physics department. "Conventional oxidic glass fibers have infrared cutoffs in the range of 3 to 4  $\mu\text{m}$ ."

Hughes produces polycrystalline cores with a prototype extrusion process, using thallium bromide and thallium bromiodide materials. For a waveguide, the cores are inserted into a loose-fitting polymer cladding, which serves as optical confinement as well as mechanical protection, Pinnow explains. Developed for a sensing requirement in a classified military project, the cores are manufactured in low volume in diameters in the range of 100 to 500  $\mu\text{m}$ .

In tests, the new fibers have exhibited low losses in comparison with the best glass materials, Pinnow says. At 4 to 5  $\mu\text{m}$ , for example, the fibers have a 0.01-decibel-per-kilometer loss, against 0.5 dB/km, "probably at the fundamental limits of silica," he observes. Moreover, the polycrystalline fibers have a pliable quality that allows bending them more easily without damage.

**Medical uses.** While this performance shows what is possible with further development in improving low-loss communications links, applications in medicine are imminent, according to Anthony L. Gentile, head of the semiconductor optical materials section. "The best transparencies we've been able to observe is 10% attenuation at 10.6  $\mu\text{m}$  by transmitting a 2-watt continuous carbon-dioxide laser beam," he says.

Its significance to physicians is as a highly selective cauterization instrument, which is particularly useful for internal surgery. Now, such

---

**Burn in.** Showing only a 0.01-decibel loss per kilometer, polymer-clad fiber handles infrared energy hefty enough to burn holes.

lasers are in the visible light range and deeply saturate tissue, he says, whereas the 10.6- $\mu\text{m}$  laser can excise such growths as shallow tumors of one-cell thickness.

While Hughes fibers have the potential of being perhaps three orders of magnitude more transparent than silica, Pinnow concedes the need for a lot more research in two areas. Materials of much higher purity are basic, he says, and production processes must be improved from the "now feeble rate of a few centimeters per minute" in the Hughes laboratory. □

---

### Radar

---

## Highway radar eludes detectors

Police departments now have another weapon to help in enforcing—and motorists another obstacle to beating—the speed limits. The device is a small traffic radar that uses a micro-processor to help in camouflaging itself from the barrage of radar detectors now on the roads.

The radar, which Kustom Signals Inc. started shipping last month, is programmed with a hold feature that suppresses the microwave transmission until a target vehicle is within sight. That way, it is invisible to radar detectors until it is fired, and by the time it is seen, the radar has recorded the target's speed. "It's the same idea as hand-held point-and-shoot radars, but we've applied it to a moving radar," says William D. Goodson, chief engineer for the Chanute, Kansas, firm that supplies most police radars. Kustom has shipped more than 100 units, 85 to state police in Kansas and Minnesota.

**Short bursts.** Moving radars not only look at the Doppler shifts of signals returned from the target vehicle, but also must keep track of patrol car speed by scanning the roadway. Instead of simply turning off the radar, Kustom's KR-11 sends out bursts of pulses shorter than the integration time most radar detec-

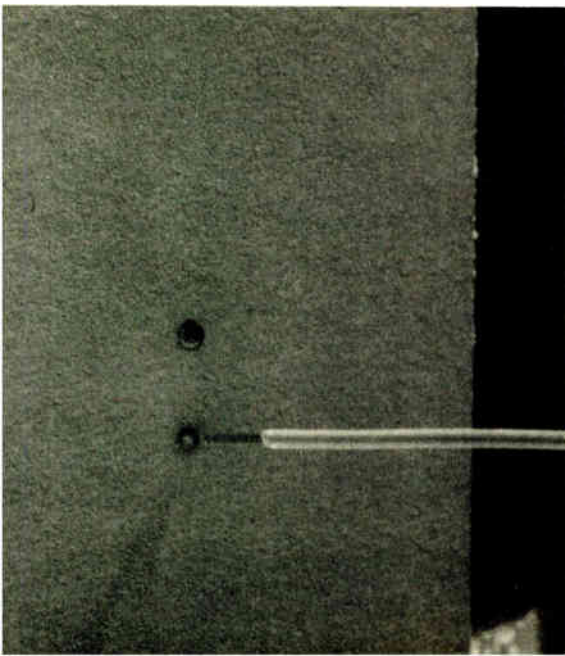

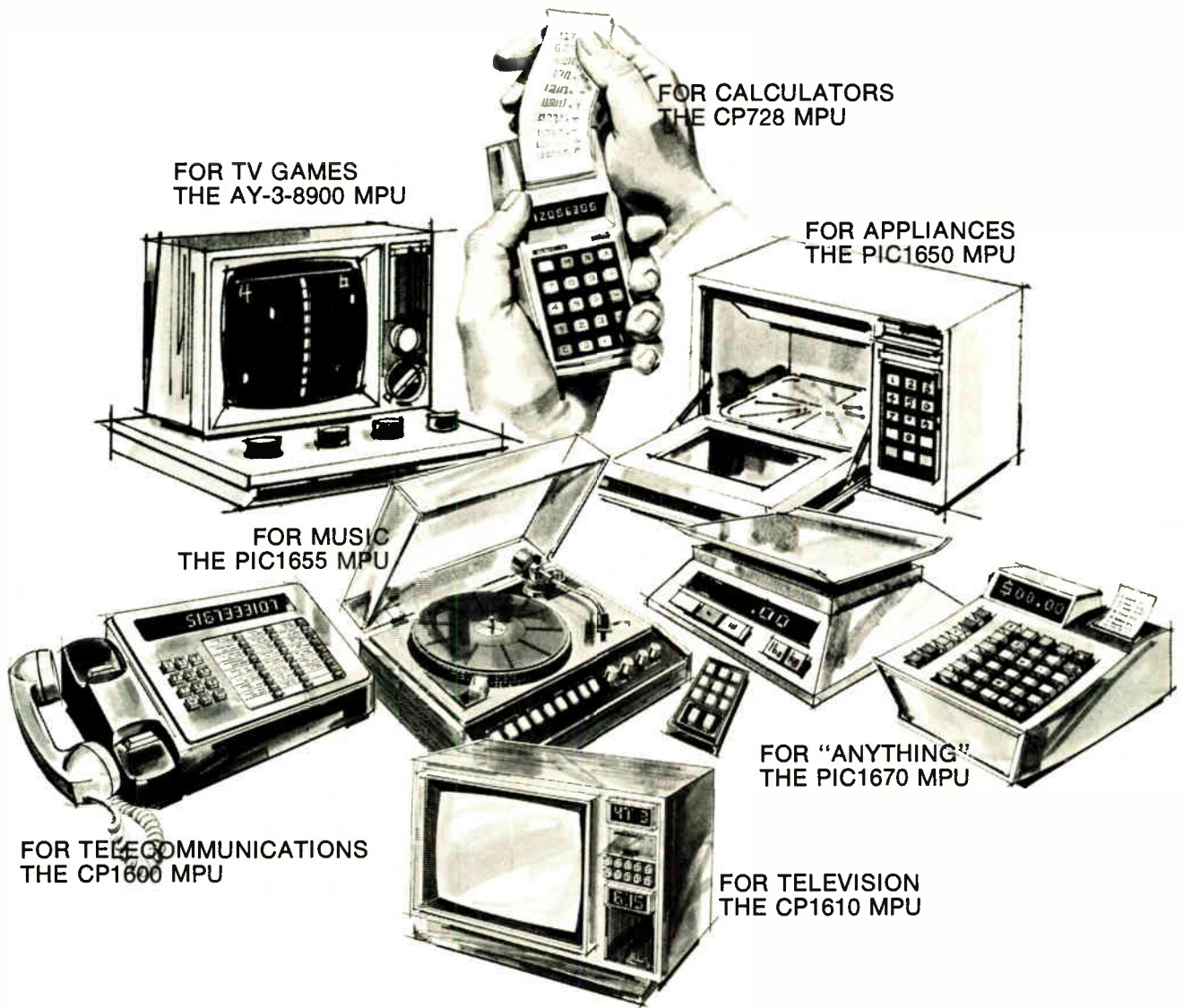

FOR CALCULATORS  
THE CP728 MPU

FOR TV GAMES  
THE AY-3-8900 MPU

FOR APPLIANCES  
THE PIC1650 MPU

FOR MUSIC  
THE PIC1655 MPU

FOR "ANYTHING"  
THE PIC1670 MPU

FOR TELECOMMUNICATIONS  
THE CP1600 MPU

FOR TELEVISION  
THE CP1610 MPU

# GI MICROPROCESSORS...

**"DEDICATED"  
TO HELP OUR  
CUSTOMERS  
COMPETE.**

General Instrument standard microprocessors are *optimized* for the application they serve . . . a unique approach that *minimizes* interface circuit requirements and *eliminates* unnecessary costs. For example, the standard microprocessor designed as a numbers cruncher isn't the optimum vehicle for appliance control. It requires too many external circuits to interface it with the appliance and it carries along overhead hardware you simply don't need. In contrast, the GI "dedicated" approach provides the optimum interface LSI to best tailor the standard microprocessor to its application. And GI's "dedicated" solutions are drawn from our broad experience in the consumer and telecommunications markets.

*Standard microprocessors... dedicated to help our customers compete.*

**GENERAL INSTRUMENT CORPORATION  
MICROELECTRONICS**

600 WEST JOHN STREET, HICKSVILLE, NEW YORK 11802



tors use to minimize false triggering.

"We use a pseudorandom pulse, period- and frequency-randomized by the microprocessor," Goodson explains. "If a detector manufacturer figures out how to detect our radar signature, we can change it by simply changing the software."

The \$300 premium that Kustom is asking for its \$3,000 radar may be justified by its antidetector aspect alone, but the firm is using the microprocessor to load the unit with other features as well. "We had reached a size limit using standard logic," Goodson says, and the microprocessor not only meant a smaller device, but "also allowed us more features at a lower cost than if we had used standard transistor-transistor logic."

Those features include improved range and accuracy and faster target acquisition than earlier radar units. Range, for example, has been roughly doubled to an average of 4,000 feet, and the new radar has spotted cars three miles away under extremely favorable conditions. "With the Motorola MC6800 microprocessor, we can use a more sophisticated algorithm for digging signals out of noise," Goodson explains.

Kustom units previously looked for five additional consecutive readings before locking onto a target. "Now we look not only at the frequency of the signal, but at what it's doing—whether it's increasing or decreasing and by how much." Goodson will not specify what criteria are used, but, he says, "we can

now make intelligent decisions based on what the signal is doing, and we can make them in about a fifth the time, or about 14 milliseconds." In addition, the radar can speed through its calibration sequence so fast that it checks its accuracy with a pair of crystal oscillators each time it locks onto a target.

Conversion factors for kilometers and knots are also written into the device's 2,650 bytes of programable read-only memory, and Kustom has equipped the radar with connections for future peripherals. "By changing the PROMs and adding a peripheral interface adapter, we can give the customer whatever he wants," Goodson says. The first accessory, due next month, is a plug-in camera that captures speeders on film along with time, date, and speed readings. "We can also bring out analog information for a strip-chart recorder, or data for some sort of remote display or for a data-gathering statistical package."

The unit is the first moving radar to operate in the K band, at 25.15 gigahertz, the upper end of the microwave spectrum allocated by the Federal Communications Commission for police radar. Doubling the frequency of the earlier X-band—10.525-GHz—radars means that the antenna's waveguide and microwave assembly can be half the size. Kustom launched K-band hand-held units two years ago, "and there's yet to be a detector developed that works very well against K-band radars," he says. □

---

## Testing

---

### With LSI outdistancing tester makers, chip insides must be guessed at

Even with full cooperation of chip makers, manufacturers of automatic logic test equipment would find it a knotty problem to prepare the software simulation packages necessary to check out computer and memory boards. "But it is even tougher when a definitive internal description of the part is not supplied by the

vendor, which is usually the case," says Ray Turner, senior systems analyst for the industrial products division of Computer Automation Inc., Irvine, Calif., which builds test equipment. Turner discusses this problem, and his solution, at the September 19 Wescon technical session on automatic test techniques for

complex digital assemblies.

Such descriptive data was available in the past, when the Computer Automation division devised logic test packages for simpler small-scale and medium-scale integrated components, in the form of vendor-supplied "gate equivalents"—internal input/output characteristics of such devices as NAND gates, flip-flops, or decoders. Engineers and programmers employed this information to construct mathematical software models that were put together into simulation packages for testing entire boards.

An Intel Corp. official confirms that it does not normally supply internal device specifications to outsiders, but says this decision is dictated largely by economics. "It's not that we don't want to be open," explains James Coe, international marketing manager for microprocessors. Developments are moving so rapidly, and advanced LSI chips becoming so complex, "that we don't have the manpower to do this and our own manufacturing, too."

Although it is in the interests of semiconductor companies to encourage independent test equipment makers, in his view "the burden of keeping up is on the testers."

**Emulation.** In the meantime, faced with customers needing to test more complex logic and memory boards, Turner's division had to find a solution. Their answer is a shortcut technique, called functional emulation. To get around the lack of internal component data, division engineers treat each complex device as a single element, writing a functional mathematical description based on inputs, outputs, and a transfer function relating the two. Put into a high-level computer language, combinations of these descriptions, reflecting specific board configurations, become simulation packages that generate automatic test programs.

The packages generate test programs four times faster than manual methods, Turner says, and are particularly useful in manufacturing environments, where many different circuit boards are used.

Functional modeling will not pin-



# New: The First Monolithic D/A Converter System.

**No one else can give you an 8-bit DAC with all peripheral functions on-chip. It's truly microprocessor-compatible and costs \$6.95!**

Single-chip D/A converter circuits have been around a long time. But so have the design problems that go along with them when interfacing with microprocessors—selection of op amps, voltage reference, latches and the various other active components you've had to add to use them.

Now, for the first time, you can simplify your system design by using the Signetics 5018 Monolithic D/A Converter System. It combines, on a single chip, the converter circuit and all the required peripheral functions—a voltage reference, input latches, and an output amplifier. It costs, in quantities of 100 and up, only \$6.95. That's one reason why it saves you money.

### Reduce Parts Count and Assembly Costs.

The 5018 is a system simplifier and cost reducer. You can forget about the costs associated with all those extra parts. Material control is simpler. Incoming test and inspection costs go down. Component handling and assembly expenses can be reduced as much as 75 percent.

### SIGNETICS D/A CONVERTERS

5018—Monolithic D/A Converter System  
5007/5008—8-Bit, High Speed, Multiplying DAC ( $\pm 0.19\%$ )  
5009—8-Bit, High Speed, Multiplying DAC ( $\pm 0.1\%$ )  
MC 1408—8-Bit, Multiplying D/A Converter

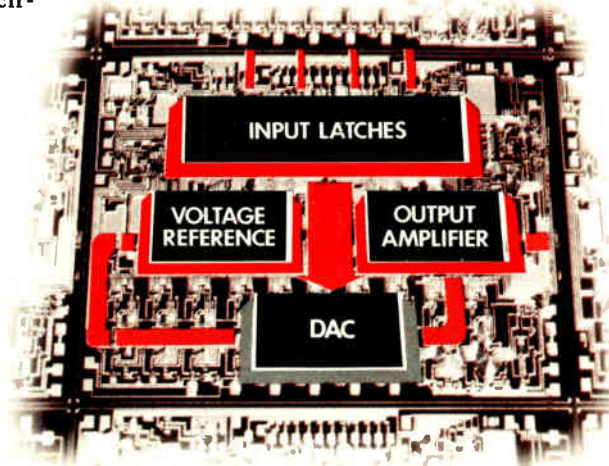

### Ideal Architecture for Computer-Based Systems.

The 5018 has built-in latches and extremely low input loading (1/100 TTL load per line). These features make it a good choice for multiple-peripheral, bus-oriented microprocessor or computer-based systems. The low input loading lets you drive many converters from a single bus. The latches then permit the bus to service several peripherals at its maximum throughput rate.

Temperature stability is an added plus. The reference voltage can be adjusted for correct full-scale value with minimal temperature effects.

Temperature-related inaccuracies are also minimized because the precision, low-temperature coefficient resistors are on the chip.

### Other Signetics DACs.

The 5018 is our newest D/A conversion product. The coupon below will help you learn more about it. If you'd like other data sheets on our other D/A converters listed below, be sure to check the appropriate boxes or call your nearest Signetics distributor.

## signetics

a subsidiary of U.S. Philips Corporation

Signetics Corporation  
811 East Arques Avenue  
Sunnyvale, California 94086  
Telephone 408/739-7700

To: Signetics Information Services, 811 E. Arques Ave.  
P.O. Box 9052, MS 27, Sunnyvale, CA 94086

Please send me information on the 5018 DAC System

I'm also interested in these other D/A conversion products:

5007/5008     5009     MC1408

I have an urgent requirement. Please have a D/A conversion specialist phone me at once: (    ) \_\_\_\_\_ X \_\_\_\_\_

Name \_\_\_\_\_ Title \_\_\_\_\_

Company \_\_\_\_\_ Division \_\_\_\_\_

Address \_\_\_\_\_ MS \_\_\_\_\_

City \_\_\_\_\_ State \_\_\_\_\_ ZIP \_\_\_\_\_

EL915

point internal device faults, he admits. But since many LSI failures "are related to timing, noise, and threshold problems," it still works.

Other tester makers agree that economics blocks needed information transfer. GenRad Inc., Concord, Mass., for example, gets around that by taking a functional-model approach, too. Says Robert Szpila, marketing manager for the Electronic Manufacturing Test division: "You don't care what's inside, but you do need conductivity information—what inputs affect what outputs—so that you can track down faults with a guided probe."

Fred McDonald, product manager for functional card testing at Tera-dyne Inc., Boston, however, says his company has not had any real problems getting NAND-gate models from vendors. "Because we do it with gate descriptions, we can generate test patterns as if these [LSI devices] were SSI or MSI." □

## Communications

### Secure voice link to use CCDs

With digital data communications spreading rapidly, related techniques, like digital voice transmission look ever more attractive. Compared with analog methods, going digital allows voice signals to be easily encoded for security and privacy, noise and interference to be lessened, and economical time-division multiplexing to be used.

One bottleneck, of course, is that voice-processing techniques are complex enough to need a large computing capacity and much equipment. However, developers at TRW's Defense and Systems Group, Redondo Beach, Calif., believe they have a solution to this processing problem. "The only way to get a low parts count and high power appears to be charge-coupled devices," says Thomas A. Zimmerman, charge-transfer department manager.

Building on unique digital processing research [*Electronics*, June

## News briefs

### TI 40-channel CB delayed till next year

Texas Instruments has had to put off application for FCC-type acceptance of its 40-channel combination a-m and single-sideband citizens' band radios. The reason they give: the need to make minor redesign changes to improve the sets' manufacturability. According to a TI spokesman, the firm expects to have sets on the market the first part of next year.

### Amdahl taps Xerox, IBM computer execs

In an apparent bid to deepen its penetration into the mainframe computer market, Amdahl Corp. of Sunnyvale, Calif., has appointed two executives from International Business Machines Corp. and Xerox Corp. to key management and marketing posts. John C. Lewis, former president of Xerox' Data Systems division and most recently president of Xerox' Business Systems group, has been named Amdahl's president and chief operating officer. Lewis succeeds Eugene R. White who becomes deputy chairman for the producer of IBM-compatible mainframe computers. William F. O'Connell also has joined Amdahl as senior vice president, marketing, a new post. He was large systems marketing manager for IBM World Trade Europe/Middle East/Africa Corp.

### Sikorsky tops Boeing Vertol for \$750 million Navy helicopter pact

United Technologies Corp.'s Sikorsky Aircraft division in Stratford, Conn., has been awarded a Naval Air Systems Command contract to produce the Light Airborne Multi-Purpose System, or Lamps, as the anti-submarine warfare helicopter is called. In winning the approximate \$750 million award, Sikorsky beat out the Boeing Co.'s Vertol division in Philadelphia. IBM Corp.'s Federal Systems division in Owego, N. Y., is prime contractor for the Mark-3 avionics system for detecting and tracking submarines. Major electronics subcontractors include Texas Instruments, Sperry Univac, Raytheon, Interstate Electronics, Itek, and Fairchild Space & Electronics Co.

10, 1976, p. 41], the TRW workers are planning fabrication of chips to go into a voice processor. Their program, partially supported by the Navy, will have the CCD devices ready by the second quarter of next year, Zimmerman predicts. The next step is building the voice-processing breadboard module, which could be completed by the end of 1978 if expected funding is obtained.

**Three chips.** As now configured, the processor would require only three CCD chips, one arithmetic unit, and two control units, although these two controllers stand a good chance of being combined into one, Zimmerman notes. All functions, analog-to-digital and d-a converters, amplifiers, and memory, go into only 43 16-pin components, attached to a 5-by-7-inch board, which will fit under a telephone set.

Concerning chip architecture, "there is very little novel or original," he explains, "It is simply a way

of connecting two or three CCD chip types to form a processor." Main elements on the arithmetic chip are a 16-by-16-bit multiplier, already completed, and a nearly developed 32-bit adder/subtractor with multiplexed gates to route data in the desired order. The control chips provide both data and read-only memory shift registers, also with multiplexers to route inputs and outputs.

The Navy program is directed toward providing an advanced secure communications terminal, and one measure of the complexity of voice processing is the 7.4 million operations per second required to implement linear predictive coding. The technique, which achieves good bandwidth compression and best reproduces individual voice nuances, was developed some years ago. "CCD processors should have no problem performing at this speed," Zimmerman notes, based on proved 5-mega-

# Get Smart.

ADDS Regent • Smart for the price of Dumb.

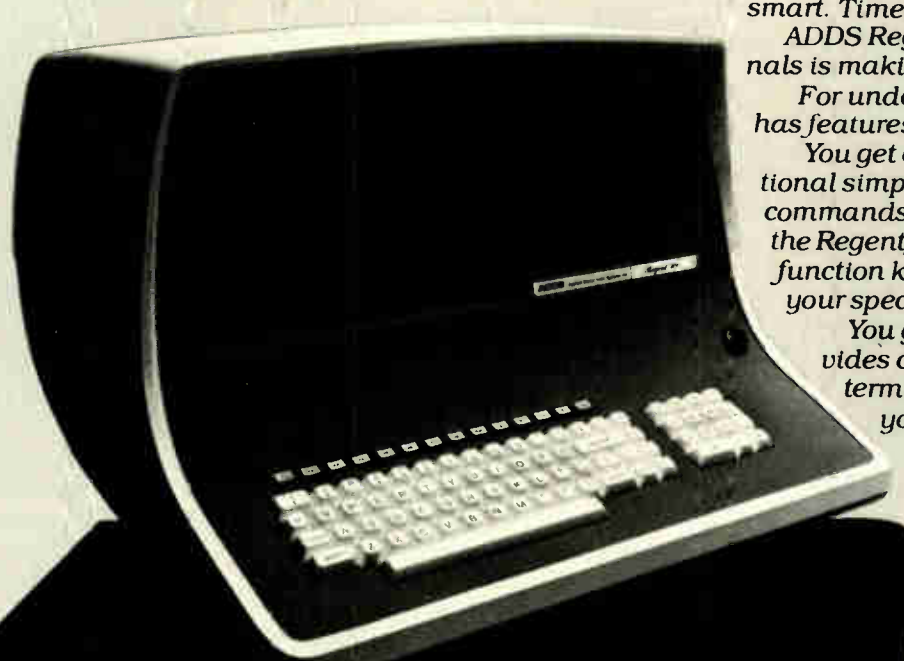

Time was, if a man bought a Dumb terminal, he was considered pretty smart. Times change.

ADDS Regent family of Smart terminals is making Dumb look dumb.

For under \$1000\* our Regent 100 has features no smart man can resist.

You get cursor controls for operational simplicity and extensive remote commands that make it easy to control the Regent from the computer. Optional function keys customize Regent to your specific application.

You get a Status Line that provides current information on the terminal's operating status. And, you get visual highlights such as blinking, zero intensity, half intensity, underline and reverse video.

You also get self diagnostics.

In other words, you get Smart. Or Smarter: Our Regent 200 has everything our 100 has plus buffered transmission, auxiliary port and editing options.

You can't get a whole lot more.

Get Smart. Get ADDS.

**Quality, Reliability and Integrity. It all adds up to ADDS.**

\*In moderate quantity.

**ADDS** Applied Digital  
Data Systems Inc.  
100 Marcus Blvd., Hauppauge,  
New York 11787 516-231-5400

Name \_\_\_\_\_

Firm \_\_\_\_\_

Title \_\_\_\_\_

Address \_\_\_\_\_

City \_\_\_\_\_ State \_\_\_\_\_

Phone \_\_\_\_\_

# Bud has 2700 ways to save you money on special enclosures.

Look at it this way: Bud makes 2700 standard enclosures. We can take any one, modify it, convert it into the special enclosure you need. A modified standard simplifies your life, and by using existing tooling and dies, you save money.

**A second approach.** If a modified standard won't answer your special enclosure needs, we'll help you design, then build a custom-made model.

The point is, Bud's big enough to give you options. That, plus two manufacturing centers, skilled people and on-time delivery, is why firms all over the country call Bud when they need special enclosures.

And why not! We're the Number One designer and manufacturer of enclosures. Standards. And specials!

**You've got our number!** Dial it now, toll free, if you want to talk about special enclosures. (800)321-1764; in Ohio, (800)362-2265.

## An extra "special" offer! Win a trip to the next Super Bowl!

Circle Bud's number on the reader service card and we'll mail you a brochure on our special fabrication service and an entry form for our Super Bowl Sweepstakes!

BUD INDUSTRIES, INC.  
4605 East 355th Street  
Willoughby, Ohio 44094

BUD WEST, INC.  
3838 North 36th Avenue  
Phoenix, Arizona 85019

## Electronics review

hertz clock rate and the capability to advance instructions at 200-nano-second intervals. □

## Military

### Cost savings eyed in modular testing

The U.S. Air Force thinks it has found a way to stop the proliferation of the extremely costly automatic test equipment used to maintain avionics systems. If the service is right—and it is willing to risk from \$50 million to \$100 million to prove it is—the test-equipment industry could be in line for an estimated \$1 billion-plus in new business.

The solution is to develop a modular automatic test equipment, (MATE) system for use with not one but all Air Force aircraft avionics systems at all maintenance levels, says Lt. Col. Kenneth D. Wilkinson, MATE program manager in the Aeronautical Systems division at Wright-Patterson Air Force Base in Ohio. He says it marks the first time the Air Force has sought development of automated test equipment independent of a specific aircraft. Early this month, over 130 companies received the service's request for proposals for MATE hardware development.

**Saving.** He expects the system to save the Air Force in excess of \$100 million a year by the mid-1980s. To date, the service has developed and purchased separate test equipment, from a variety of contractors, for each aircraft at each level of maintenance—field, organizational, and depot. "We spend about \$700 million a year purchasing, maintaining, and operating this equipment," he notes. But under the MATE program, the Air Force would purchase interchangeable, or modular, hardware and software to a single system, he says. The systems would be assembled from the hardware and software modules appropriate to the aircraft and avionics to be tested.

Unlike the Navy's Versatile Avionics Shop Test (VAST) system and other military automatic-test

systems that are procurable from one source and built around specially developed functional building blocks or standard hardware, MATE will be defined by hardware standards, says Wilkinson. Any available hardware that meets the performance and interface standards is a candidate for use in a MATE configuration.

**Bus structure.** Through interface adapters, the various stimuli and measurement modules will be linked to a central data bus, as will be the unit under test, the control module, and any input/output modules, such as a display. Software will be modularized, too, and a hardware module will have an associated software module. "The biggest cost savings will be in software, as well as in test program sets and interface adapters," notes Wilkinson.

The proposals from industry are due back to the Air Force by Oct. 31, with cost data to follow by Nov. 15. Wilkinson expects "about 12 to 20 responses made up of teams from some 70 companies." After considering these proposals, at least two contractors will be chosen for the first and largest phase of the four-step MATE program.

Initial awards, to be made around April of next year, will call for each contractor to build at least four feasibility development models of MATE configurations and to conduct studies on applying the system to future weapons systems. Later phases of the program involve: the development of programming aids, software verification and validation, and technical-services support.

Overall, the advanced development of MATE will take five to six years. Halfway along, notes Wilkinson, one contractor will be selected to continue advanced development and build a first prototype, and "engineering development could start before fiscal 1983."

Thus far, \$53.4 million has been approved for advanced development of MATE, "but I've asked for substantially more, in excess of \$90 million," states Wilkinson. The program's total business potential for industry, though, could be many times larger. "If MATE is used to

# For the infinite repertoire of one-bit tasks Motorola introduces

## the bit fiddler

Our new MC14500B single-bit static CMOS processor is designed expressly for the cost-effective bit fiddling of simple one-bit decision and command oriented tasks. On formal occasions, it's called the Industrial Control Unit, or ICU.

Until now, designers have been forced to use inflexible hardwired logic or wastefully overqualified multi-bit processors to perform the vast repertoire of single-bit jobs that abound in the digital world. Our bit fiddler changes that for good.

The MC14500B is essentially the monolithic equivalent of a programmable logic controller central architecture, with the inherent CMOS qualities of high noise immunity, microwatt power dissipation, adaptability to low-cost, low-current power supplies and a wide 3 to 18 volt operating range. Because the ICU operates over the full voltage and temperature range of JEDEC B-Series CMOS, the entire Motorola CMOS family of more than 100 different functions can supply peripheral components in systems tailored to the application.

Sixteen four-bit instructions perform at the bit level, executing in a single clock period, with clock frequency variable over a wide range. At a frequency of 1.0 MHz, more than 8,300 instructions may be executed in a 60-Hz half-cycle.



Yes, the range of applications for the ICU is nearly unlimited. Just to start you thinking, consider these.

- Low cost programmable logic controller
- Industrial controls
- Traffic controller
- Remote bit-stream controller
- Numerical controller
- Machine controller
- Companion for unloading overburdened microprocessor
- Microprogram control sequencer
- Copier controller
- Automatic test system
- Serial data processor
- Peripheral controller

You can hire the bit fiddler from any Motorola sales office or autho-

rized distributor, or obtain data sheet and ICU description by writing to Motorola Semiconductor Products Inc., P.O. Box 20912, Phoenix, Arizona 85036.

### Complete MC14500B Industrial Control Unit Handbook Available

We offer a handbook that covers the theory, operation, and applications of our B-Series CMOS compatible ICU. The 15-chapter, 106-page volume sells for \$3.00 per copy in small quantities. It's available from authorized Motorola distributors. If it's more convenient, send your order with check or money order to Motorola Semiconductor Products Inc., Literature Center, P. O. Box 20924, Phoenix, Arizona 85036.



**MOTOROLA Semiconductors**  
*The mind to imagine... the skill to do.*

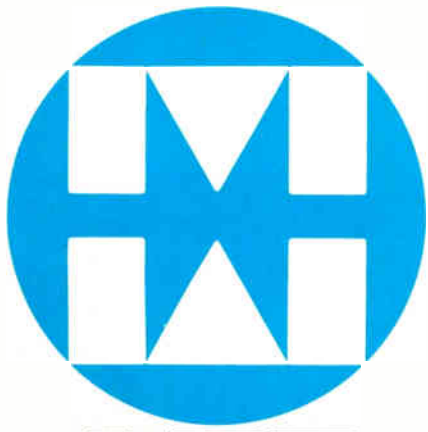

# MITEL

## Micro-processor Display Drivers

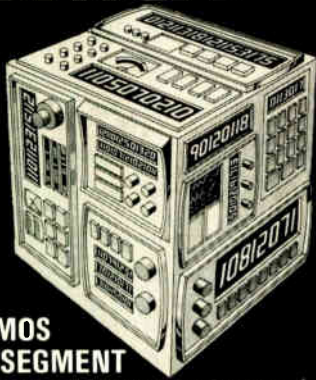

### CMOS 7-SEGMENT HEXADECIMAL DECODER/DRIVER/LATCH MD4368B

DRIVES COMMERCIAL AND MILITARY LED, LCD, INCANDESCENT, FLUORESCENT AND GAS DISCHARGE DISPLAYS. THE MD4368B IS PIN-FOR-PIN WITH THE TTL9368 DEVICE, BUT OFFERS THE FOLLOWING ADDED BENEFITS:

- INCREASED RELIABILITY THRU CMOS LOW POWER (25mW TYP.) AND DELETION OF OUTPUT CURRENT LIMITING RESISTORS
- 3 TO 18 VOLT OPERATION AND OUTPUT CURRENTS OVER 50mA PER SEGMENT

OTHER MITEL CMOS DISPLAY DRIVERS AVAILABLE INCLUDE:

- MD4311B - 7-SEGMENT HEXADECIMAL DECODER/DRIVER/LATCH
- MD4511B - 7-SEGMENT DECIMAL DECODER/DRIVER/LATCH
- MD4330B - 30-BIT LCD DRIVER/REGISTER
- MD4055B - 7-SEGMENT LCD DECODER/DRIVER
- MD4056B - 7-SEGMENT DECODER/DRIVER/LATCH

For more information write or phone

18 AIRPORT BLVD.  
BROMONT, QUEBEC, CANADA  
JOE ILO  
(514) 534-2321  
TLX 05-267474



# MITEL

Semiconductor

## Electronics review

support just two weapons systems at all maintenance levels, then \$1 billion is a conservative estimate of the program's value," he says.

Will it be worth the expense? Wilkinson answers, "If we can make it work on only one aircraft, at all levels of maintenance, we will be making money on it." □

## Consumer

### Communications chip aids home security

A device borrowed from the data communications industry may go a long way toward achieving the "fool-proof" status that is the goal of security systems for the home. At least so thinks Joseph E. Pascente, who is putting a UART in the basement of every house in an expensive subdivision in Oak Brook, Ill.

The plan is for each of 95 homes—selling for \$200,000 and up—to have a home security monitor built around a universal asynchronous receiver/transmitter and tied to a central microcomputer in the subdivision's guard station, explains Pascente, president of Electronic Relays Inc. and Sadeto Inc., the Oak Brook subsidiary he has set up to handle his security business. With the communications chip, "we're monitoring a digital bit stream, instead of looking for the presence or absence of a tone or electrical signal," he says. "That makes the system very difficult to defeat." It also makes the lack of a valid signal an alarm condition.

**Batteries.** The UART, which converts parallel data into a serial bit stream, is a complementary-metal-oxide-semiconductor chip from Intersil Inc. By using C-MOS, the entire network can be powered through leased phone lines by the central computer or its battery backup. Earlier p-channel MOS devices, with their multivoltage and higher power requirements, would have made the system more expensive.

As in most home security systems, more money is spent on installa-

tion—distributing standard sensors throughout the house and wiring them to a central monitor—than on the hardware itself. "A basic system guarding front and back doors, with a smoke detector and emergency button, costs about \$1,000," Pascente says, "but most are going for roughly \$3,000 to \$3,500 per house, and then about \$4 a month to lease the phone lines." The higher price includes a unit that uses reed switches to monitor all windows and doors for break-ins and accepts inputs from fire, smoke, flood, freeze, power-loss, and medical-emergency sensors, and an alarm button. The UART-based system translates the sensors' contact closures into logic levels and is the least expensive way to put the signals into a time-multiplexed format, according to Pascente.

Most other home security systems sound an alarm in the home, alerting only the resident and his neighbors. Residences that are connected to a central station, such as a guard house or local police station, usually rely on automatic telephone dialers to relay taped or digital messages—a technique that can be defeated simply by cutting the telephone lines.

**Scanning.** The guard station computer is a Mike 3 microcomputer—built around Intel Corp.'s 8080 microprocessor—from Martin Research Inc., a Northbrook, Ill., firm that also wrote the multitasking software program that allows the computer to scan houses even as it goes about its other security chores. Those include running the system's keyboard, printer, and video display. The program is stored in 6,144 bytes of 8-bit erasable programmable read-only memory; 98,304 bits of random-access memory contain information about the homes such as owner, address, and phone number.

This information is printed out each time an alarm condition is sensed or removed, along with date, time, and type of alarm. Using the computer's keyboard, the guard must acknowledge the alarm within one minute to forestall a second alarm that automatically alerts the city's police and fire department. □

# MICROCOMPUTER USERS.

## Single Board Real Time Analog I/O Systems

...Widest Selection, Fast Turnaround, Lowest PRICES

Single Board Analog I/O Systems		DEC LSI-11				INTEL SBC-80 Series				COMPUTER AUTOMATION LSI 2 & 3				NATIONAL IMP & PACE		PCS Superpac		ZILOG MCB Series (Z-80)									
		DT1761	DT1762	DT1763	DT1764	DT1765	DT1731	DT1741	DT1742	DT1743	DT1744	DT1735	DT1841	DT1842	DT1843	DT1731	DT1722	DT1733	DT1734	DT1722	DT1723	DT1791	DT1795	DT1781	DT1782	DT1784	DT1785
Analog Inputs	16 channels	•	•	•	•	•	•	•	•	•	•	•	•	•	•	•	•	•	•	•	•	•	•	•	•	•	•
	32 channels	•	•	•	•	•	•	•	•	•	•	•	•	•	•	•	•	•	•	•	•	•	•	•	•	•	•
	64 channels	•	•	•	•	•	•	•	•	•	•	•	•	•	•	•	•	•	•	•	•	•	•	•	•	•	•
	10mV to 10V range	•	•	•	•	•	•	•	•	•	•	•	•	•	•	•	•	•	•	•	•	•	•	•	•	•	•
	0 to 10V, ±10V, ±5V ranges	•	•	•	•	•	•	•	•	•	•	•	•	•	•	•	•	•	•	•	•	•	•	•	•	•	•
Analog Outputs	1 to 5V (4 to 20mA) range	•	•	•	•	•	•	•	•	•	•	•	•	•	•	•	•	•	•	•	•	•	•	•	•	•	•
	8 bit resolution	•	•	•	•	•	•	•	•	•	•	•	•	•	•	•	•	•	•	•	•	•	•	•	•	•	•
	12 bit resolution	•	•	•	•	•	•	•	•	•	•	•	•	•	•	•	•	•	•	•	•	•	•	•	•	•	•
	2 channels	•	•	•	•	•	•	•	•	•	•	•	•	•	•	•	•	•	•	•	•	•	•	•	•	•	•
	4 channels	•	•	•	•	•	•	•	•	•	•	•	•	•	•	•	•	•	•	•	•	•	•	•	•	•	•
Features	8 channels	•	•	•	•	•	•	•	•	•	•	•	•	•	•	•	•	•	•	•	•	•	•	•	•	•	•
	0 to 10V, ±10V, ±5V ranges	•	•	•	•	•	•	•	•	•	•	•	•	•	•	•	•	•	•	•	•	•	•	•	•	•	•
	4 to 20mA range	•	•	•	•	•	•	•	•	•	•	•	•	•	•	•	•	•	•	•	•	•	•	•	•	•	•
	point plotting	•	•	•	•	•	•	•	•	•	•	•	•	•	•	•	•	•	•	•	•	•	•	•	•	•	•
	8 bit resolution	•	•	•	•	•	•	•	•	•	•	•	•	•	•	•	•	•	•	•	•	•	•	•	•	•	•
12 bit resolution	•	•	•	•	•	•	•	•	•	•	•	•	•	•	•	•	•	•	•	•	•	•	•	•	•	•	
programmable gain	•	•	•	•	•	•	•	•	•	•	•	•	•	•	•	•	•	•	•	•	•	•	•	•	•	•	
100KHz throughput	•	•	•	•	•	•	•	•	•	•	•	•	•	•	•	•	•	•	•	•	•	•	•	•	•	•	
program I/O & interrupt	•	•	•	•	•	•	•	•	•	•	•	•	•	•	•	•	•	•	•	•	•	•	•	•	•	•	
DMA interface	•	•	•	•	•	•	•	•	•	•	•	•	•	•	•	•	•	•	•	•	•	•	•	•	•	•	
power required: +5V only	•	•	•	•	•	•	•	•	•	•	•	•	•	•	•	•	•	•	•	•	•	•	•	•	•	•	

These single board systems provide the most cost effective and fastest way to get analog signals into and out of your micro-computer. Just plug in the board and hook-up your analog signals. Get a headstart on solving your system's problems without the headaches of designing an analog front end.



We've got the broadest selection of input and output capability—10mV to 10V or 4-20mA inputs, up to 64 channels on a single board, line amplified buffered D/A outputs, point plotting, or 4-20mA outputs—all at a cost that says you can't afford to do it yourself.

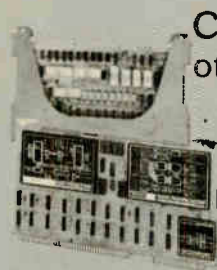

Concentrate on the software and other key system requirements... and let us take care of your analog problems. We've seen them all and solved them in these systems...no mysteries, no tweaking.

Prices are surprisingly low, with 8-bit models starting at \$295 and 12-bit models at \$395 both in OEM quantity.

Send for full technical data or call us.

### DATA TRANSLATION

INC

23 Strathmore Rd., Natick MA 01760  
(617) 655-5300 Telex 94-8474

SALES OFFICES: AZ, Scottsdale 602-994-5400; CA, Cupertino 408-257-5131; CA, Santa Ana 714-540-3245; CO, Denver 303-837-1247; IA, Cedar Rapids 319-362-0503; KS, Prairie Village 913-649-4000; MD, Fulton 301-953-3724; MA, Natick 617-655-5300; MO, St. Louis 314-997-1515; NJ, Parlin 201-727-6454; NM, Albuquerque 505-292-1212; NM, Las Cruces 505-523-0601; NY, Rochester 716-334-2445; UT, Salt Lake City 801-466-6522; VA, Arlington 703-527-3262; WA, Bellevue 206-455-1246.

# Now! 99%-programmable PROMs with 8K EROM compatibility.

The Fujitsu MB 7055 (3-state) and MB 7060 (open-collector) electrically field-programmable bipolar read only memories are the new leaders in quality PROMs for the industry. With these devices, you get the solid economy of the 8K-bit capacity and the sensational 99% typical programmability available thanks to superior Fujitsu processing and exclusive Fujitsu *after-packaging* testing. And these Fujitsu PROMs also offer you the superior diffused aluminum eutectic programming technique designed to provide faster programming (only 10 $\mu$ s/bit) and full immunity against reverse-migration—factors that put Fujitsu PROMs way ahead of “nichrome-fused” PROMs in meeting your memory requirements.

Interested in performance after programming? Well, it's tops. First of all, you get full pin compatibility with industry-standard 8K EROMs, like the Fujitsu MB 8518, for direct mounting on circuit boards used during prototyping. And you can choose from either the 3-state output or open-collector output versions to meet your specific DTL/TTL circuit requirements. You also get solid benefits like fast (150ns, typ.) access time, low (0.04mW/bit, typ.) power dissipation, operation via a single +5V power supply, and two chip select leads for simplified memory expansion.

The sensational new Fujitsu EROM-compatible 8K PROMs are available now. Our comprehensive MB 7055/60 combined data sheet gives all the details, including programming procedures, and is available on request. So write or call right now for more information about the new state-of-the-art in PROM technology—the Fujitsu MB 7055/60 PROMs. Contact Fujitsu America, Inc., IC Division, 2945 Oakmead Village Court, Santa Clara, California 95051, phone: 408-985-2300, telex: 357402, twx: 910-338-0047.



**FUJITSU LIMITED**

*Communications and Electronics*

Circle 54 on reader service card



# Washington newsletter

---

## **Commercial birds board early shuttle flight**

The first commercial use of the space shuttle as a satellite delivery system will be a July 1980 joint mission for Satellite Business Systems and Western Union International. The first SBS satellite, designed for domestic satellite communications on the 12-to-14-GHz frequency, will be launched with the first of a series of data-relay satellites to be owned and operated by Western Union for NASA's deep space missions. **NASA says that it has signed up eight Space Shuttle payloads** from three firms, including WUI, SBS and the Communications Satellite Corp. In addition, several NASA missions and Defense Department projects also are among the 17 shuttle flights currently scheduled.

Meanwhile, SBS says that Hughes, General Electric, and RCA submitted bids on building three satellites, and a contract award will be made by the end of the year [*Electronics*, June 9, p. 49].

## **Ferris to replace Wiley as head of the FCC**

Federal Communications Commission Chairman **Richard E. Wiley will soon submit his resignation to the White House.** Wiley says he wants to be out by very early October. Charles Ferris, general counsel to House Speaker Thomas P. "Tip" O'Neill Jr., will replace Wiley, with the White House expected to send his name to Congress for confirmation any day. Wiley will remain in Washington to practice law upon leaving the FCC.

## **Navy expects approval to put Seafarer in Michigan**

Navy brasshats privately express optimism that the service will get its multimillion-dollar submarine communications facility, Seafarer, located in Michigan. The National Academy of Sciences' final report on the biological and ecological effects of the extremely-low-frequency communications facility states: "A number of concerns raised over the years that Seafarer e-l-f fields might constitute a source of dangerous—even catastrophic—environmental contamination **have been examined and found invalid and unwarranted.**"

The Navy is using the report to squelch objections to the facility. It plans to issue a final environmental impact statement by late November and to make a formal site selection recommendation to the Secretary of Defense by year's end. The admirals hope to get President Carter's official approval early next year to build the facility, possibly over the objections of Michigan officials.

## **No action expected against imports of microwave oven**

The microwave-oven manufacturers' appeal to President Carter for an agreement with Japan to voluntarily restrict exports of ovens to the U. S. will be politely rebuffed. Because of the healthy growth in production and employment in the microwave-oven industry, **U. S. officials are skeptical that the industry can prove injury.** Without such proof, the International Trade Commission cannot propose import restrictions, which would be the foundation for the "orderly marketing agreement" sought by the manufacturers in a Sept. 6 letter to the President. Alternative anti-import strategies also would fail, the officials say, because of the lack of injury to the industry.

Ironically, the microwave-oven industry's Association of House Appliance Manufacturers concedes its healthy growth, declaring, "The industry is one of the fastest-growing in the United States today. Sales in 1976 were estimated at 1.6 million units and are expected to grow to 2.2 million units in 1977."

## The arms export control numbers game

A wide-ranging Treasury Department analysis of the policy and economic impact of U. S. arms export controls proposed by President Carter has been delivered to Congress and is now being assessed by the aerospace and military electronics industries. Since it is designed to support the White House plan, the numbers are far less terrifying than those advanced last month by the Electronic Industries Association [*Electronics*, Aug. 4, p. 50]. Which merely proves once more that a competent statistical analyst can make any point he wishes, depending on his initial assumptions and data selection and weighting. Even so, the Treasury report is the more extensively researched and better-reasoned of the two and is worth reading for insights into the Administration's thinking. Analysts for many corporations—including some EIA members—are now doing just that.

The Treasury's study of arms export economics is based on six assumptions, the first of which is that the existing \$32.8 billion order backlog will not be affected. The hardware portion of that is \$20.4 billion—nearly \$10.4 billion and \$3.8 billion for aircraft and missiles, respectively, \$2.6 billion for ships, \$1.7 billion for vehicles and weapons, \$1 billion for ammunition, and \$849 million in communications. The remainder is for construction, maintenance, supplies, training, and technical assistance.

Other assumptions include: an annual ceiling on new orders of \$8.5 billion, equal to the fiscal 1976 level; achieving a 40% reduction by gradually cutting new commitments 10% each year from the previous year's level or, less probably, invoking the total reduction immediately. The study also assumes that 30% of arms money unspent by the Organization of the Petroleum Exporting Countries would be invested by the Government in the economy, or, alternatively, there would be no such investment and the dollar would be allowed to depreciate.

### Job losses

On this basis, Treasury concludes that 29,000 American jobs would be lost by a 10% annual reduction in new orders from the \$8.5 billion base spread over four years, while 52,000 jobs would be lost by an immediate 40% cutback. The aircraft, communications, and ordnance industries would be most affected, and 25% of the jobs would involve professional, technical, and management posts. However unsettling the figures may be, they are less frightening than EIA's estimate of 100,000 jobs lost.

The Treasury also considered tax losses to the

national economy that the EIA did not. For example, corporate and personal income tax revenues lost in and by fiscal 1983 would be \$300 million. Total revenue lost by that year would be \$1.4 billion if the dollar depreciates. If not, it would be \$2.9 billion. And that does not include the unmeasurable costs of higher unemployment compensation, increased public assistance, or the loss in social security taxes.

The impact of a graduated reduction on the Defense Department budget would also be considerable. Smaller procurements would boost military hardware costs by \$604 million, recoupment of R&D investments made possible by longer production runs for overseas sales would be cut \$192 million, while DOD's overhead savings from foreign sales income would be reduced by \$32 million.

One military electronics company analyst believes the Treasury report "tends to minimize the economic impact" of the Carter proposals. For example, he points out that Treasury failed to consider other elements, however unmeasurable, that could lead to even higher defense costs. These include possible added outlays to maintain the U. S. industrial mobilization base at an effective level and to increase U. S. troop deployments in areas abroad where an ally's capabilities are cut by export restrictions, as well as the possible loss of bases, porting privileges and intelligence-gathering facilities.

### Discounting EIA

Nevertheless, the same analyst discounts the EIA data in a report to his management. "It's hard to work your way through the EIA report because they use all exports, not just defense exports—foreign military sales and commercial defense sales." Indeed, the EIA did use the U. S. Standard Industrial Classification for communications electronics (SIC-36) and transportation equipment (SIC-37) and then estimate their electronics content. "It's not clear," the analyst's report points out, "how defense exports get backed out [of these categories]."

Of the EIA study's state-by-state breakout of the economic impact of reduced arms exports, he concludes it is "rather tortured" in view of its extrapolation of 1972 figures out to 1985. The EIA goal, he believes, is "to stir up state congressional delegations to fight the Administration's new restrictive policy." The assessment is valid. For a frightened Congressman can be a vicious opponent, especially when he remembers that a voter out of work is a voter he has probably lost.

**Ray Connolly**

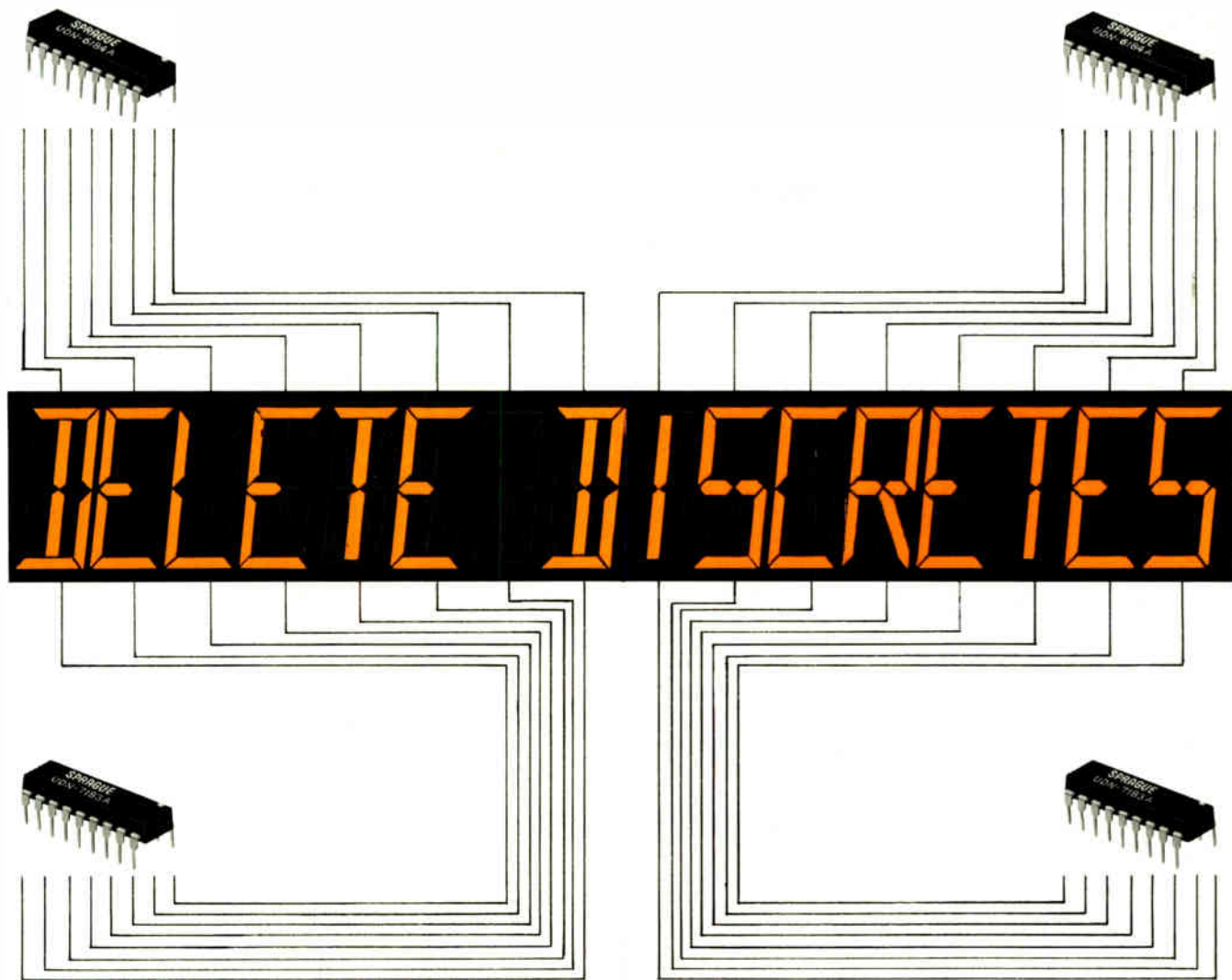

## Now... A Series of Sprague ICs that simplify gas discharge display interface

Sprague Series UDN-6100/7100 Display Drivers offer the systems designer a simplified, low-cost interface with planar gas discharge displays that essentially eliminate the need for discrete components. Designers can now take advantage of the superior aesthetics of gas discharge panels with their low power consumption, relative ease in customizing, and large digit capability without the need to use large quantities of discrete components.

With broad commercial/industrial applications, these unique drivers find wide usage in business calculators, POS systems, cash registers, scales, appliances, clocks, electronic games, instrumentation, computer peripherals, industrial controls, avionics, and a variety of other display products.

Series UDN-6100 Digit (anode) Drivers are rated with a supply voltage of +120 V max. and an output current of 70 mA max.

They are available with 4, 6, or 8 drivers per device, in 14, 16, and 18 pin plastic and hermetic DIP packages, respectively.

Series UDN-7100 Segment (cathode) Drivers operate at a max. supply voltage of -120 V. Circuits are available with nominal output current ratings from 0.6 mA to 14 mA. Each device has 8 drivers and is available in an 18-pin plastic or hermetic DIP package.

For application engineering assistance, write or call George Tully or Paul Emerald, Semiconductor Division, Sprague Electric Company, 115 Northeast Cutoff, Worcester, Mass. 01606. Tel: 617/853-5000.

For Engineering Bulletins 29311 and 29312 as well as WR-172 'Quick Guide to Interface Circuits', write to: Technical Literature Service, Sprague Electric Company, 35 Marshall Street, North Adams, Mass. 01247.

### FOR FAST INFORMATION, CALL YOUR NEAREST SPRAGUE SALES OFFICE:

ALABAMA, Sprague Electric Co. 205/883-0520 • ARIZONA, Sprague Electric Co. 602/279-5435 • CALIFORNIA, Sprague Electric Co. 213/649-2600, Wm. J. Purdy Co. 415/447-7701, KCE Corp., 714/278-7640 • COLORADO, Wm. J. Purdy Co. 303/777-1411 • CONNECTICUT, Sprague Electric Co. 203/261-2551 • DIST. OF COLUMBIA, Sprague Electric Co. (Govt. sales only), 202/337-7820 • FLORIDA, Sprague Electric Co. 305/631-3636 • ILLINOIS, Sprague Electric Co. 312/678-2262 • INDIANA, Sprague Electric Co. 317/253-4247 • MASSACHUSETTS, Sprague Electric Co. 617/899-9100, Sprague Electric Co. 413/664-4411 • MICHIGAN, Sprague Electric Co. 517/787-3934 • MINNESOTA, HMR, Inc. 612/920-8200 • MISSOURI, Sprague Electric Co. 314/781-2420 • NEW JERSEY, Sprague Electric Co. 201/696-8200, Sprague Electric Co. 609/795-2799, Trinkle Sales Inc. 609/795-4200 • NEW MEXICO, Wm. J. Purdy Co. 505/266-7959 • NEW YORK, Sprague Electric Co. 516/549-4141, Wm. Ruit, Inc. 914/698-8600, Sprague Electric Co. 315/437-7311, Mar-Cam Associates, 315/437-2843 • NORTH CAROLINA, Electronic Marketing Associates, 919/722-5151 • OHIO, Electronic Salesmasters, Inc. 800/362-2816, Sprague Electric Co. 513/278-0781 • PENNSYLVANIA, Sprague Electric Co. 215/467-5252, Trinkle Sales Inc. 215/922-2080 • TEXAS, Sprague Electric Co. 214/231-1256 • VERMONT, Ray Peiron & Co., Inc. 617/762-8114 • VIRGINIA, Sprague Electric Co. 703/463-9161 • WASHINGTON, Sprague Electric Co. 206/632-7761 • CANADA (Ontario), Sprague Electric of Canada, Ltd. 416/766-6123 • CANADA (Quebec), Sprague Electric of Canada Ltd. 514/683-9220

4SS-7114R2



... and you thought we only make great capacitors.

# There are two places in Wabash, Indiana with economical, high volume production capability.

Knee's Rabbitry is one. Wabash Transformers is the other. And it's a generally held local opinion that Wabash has got the edge. Not just in sheer numbers—but in variety. While Knee's Rabbitry can produce only two genders of rabbits, Wabash produces literally thousands of different types of transformers.

Not only that—Wabash custom designs their product to precisely suit the application—any type of transformer or high voltage power

supply application. A few where Wabash is a leader are air cleaners, photocopying and VRT equipment.

With their engineering expertise, sophisticated products, automated winding and high volume production capability, Wabash is a standout among the hundreds of transformer manufacturers. But, in turning out sheer numbers, Knee's Rabbitry is pretty stiff competition.

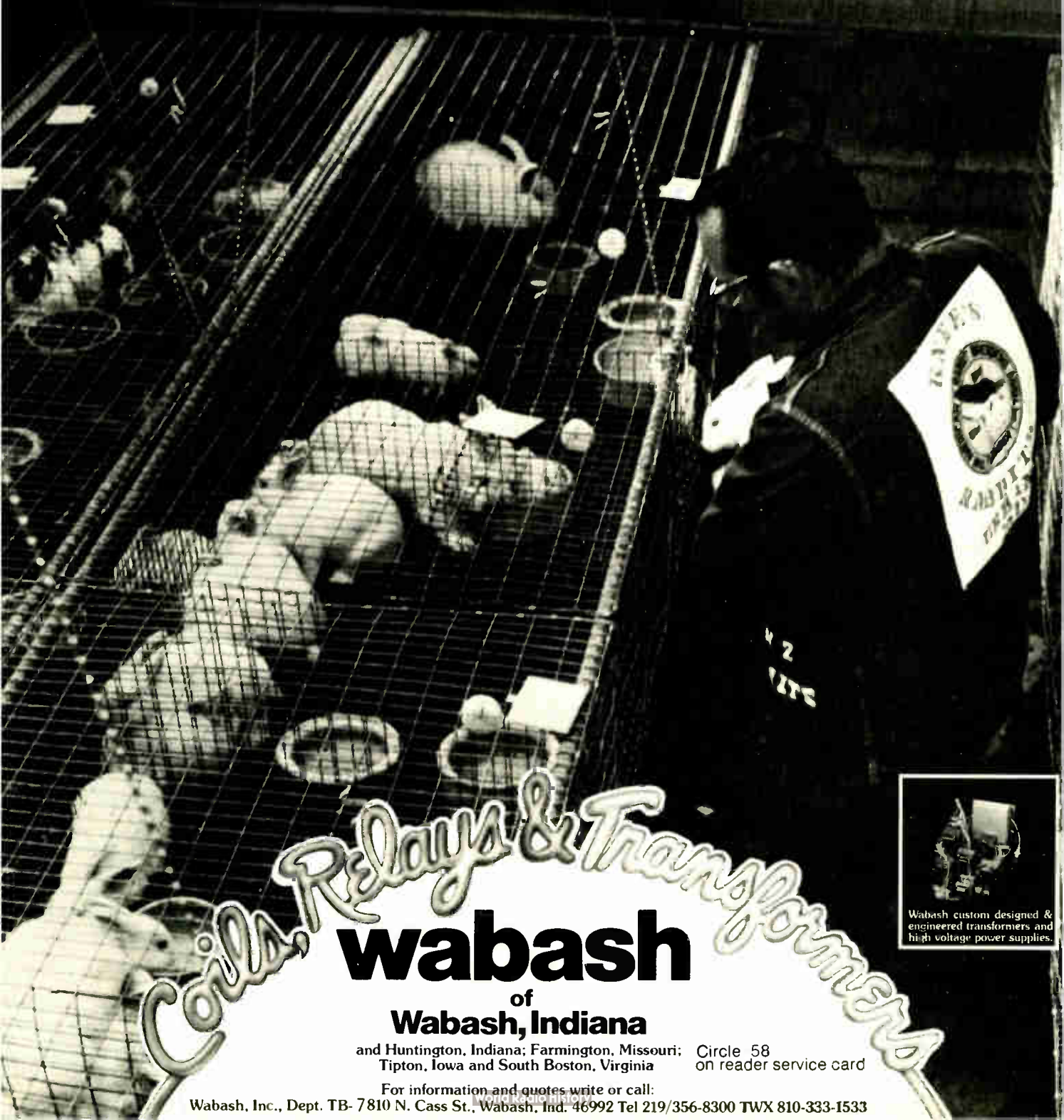

*Coils, Relays & Transformers*  
**wabash**  
of  
**Wabash, Indiana**  
and Huntington, Indiana; Farmington, Missouri; Tipton, Iowa and South Boston, Virginia



Wabash custom designed & engineered transformers and high voltage power supplies.

Circle 58 on reader service card

For information and quotes write or call:

Wabash, Inc., Dept. TB- 7810 N. Cass St., Wabash, Ind. 46992 Tel 219/356-8300 TWX 810-333-1533

## International newsletter \_\_\_\_\_

### **48-fiber optical cable will be linking four Tokyo exchanges**

Within a year, 20 kilometers of fiber-optic cables will be carrying customers' voices and data along a route in Tokyo linking four exchanges of the Nippon Telegraph and Telephone Public Corp. Each pair of fibers will transmit pulse-code-modulation signals at 100 megabits per second: the equivalent of 1,440 telephone channels. **Thus the 48 fibers in the cable will be able to transmit 34,560 telephone channels (24 for each direction in a conversation).** For data, the system will transmit the required bit rate, so there is no true comparison with telephone channels.

There will be eight repeaters along the route, even though experiments show satisfactory transmission for distances of at least 8 km. NNT feels laser communications are practical because lasers operating at a wavelength of 850 nanometers with an extrapolated lifetime of 1 million hours and low-loss multifiber cables are available. Individual graded fibers in the cable will measure 140 micrometers in diameter, and the 48-fiber cable measures 17 millimeters in diameter.

### **IC for cars drives clock and controls warning circuitry**

Intermetall GmbH, the German member of the ITT Semiconductor group, has readied a complementary-MOS integrated circuit that can control a variety of functions in automobile electric systems. Besides supplying the drive signals for dashboard-mounted crystal-controlled clocks, **the device generates the control pulses for the car's directional indicators, for its external warning lights, and for the alarm circuitry** that indicates conditions like abnormal oil and water temperature, excessive vehicle speed, unfastened seat belts, and other hazards. Designated the SAF1055, the 18-pin plastic-encapsulated IC will be introduced at the Sept. 15–25 international automobile show in Frankfurt. It will be available in quantity towards the end of this year.

### **UK doppler system lands plane automatically**

Britain has demonstrated automatic airplane landing using a microwave landing system. The demonstration is an attempt to bolster its doppler candidate against the U. S. time-reference scanning-beam system for selection as the international microwave-landing-system standard. **A twin-engine transport made five consecutive landings at Gatwick International Airport using a doppler system** colocated with an existing conventional instrument landing system for comparison. Britain is trying to amass enough operational experience with its doppler system to overcome an apparent U. S. lead with the International Civil Aviation Organization, which will choose a standard system. At stake besides national prestige is influence over a vast worldwide market.

### **TV-game market in Europe to grow 400% this year**

The European market for TV games will leap to 1.4 million units this year, forecasts Videomaster Ltd., a dominant British maker of the products. The projected total is four times greater than last year's and will equal 15% of the projected 1977 U. S. market. The company sees a total market of 500,000 units in West Germany, 400,000 in the United Kingdom, and 500,000 for the rest of Europe. **By 1980, it estimates, total European sales will reach 3.5 million, nearly 25% of the projected U. S. market.** West Germany will lead with 1.25 million, the UK will follow with 1 million, and the rest of Europe will total 1.25 million.

To keep pace, the fast-growing company is introducing a three-game color unit based on National Semiconductor's SK 1121 decoder and game

## International newsletter

chip set, to which it has exclusive European rights. It also is mounting a substantial export drive to the Middle East and next year plans to introduce cartridge-based games and to invade the vast U. S. market.

### **User can vary playback speed in new VTR**

Several playback speeds are featured in a new video tape recorder from the Victor Co. of Japan. The tape can be played back at twice the normal speed, with the audio processed to restore normal pitch so that it is intelligible—albeit with low fidelity. It can also be played back silently in slow motion or stopped on a single frame. **The HR-3600 is a deluxe version of the company's video-home-system VTR, with provision for speed selection added.** It has the usual two-hour recording and playback capability in a real-time mode. It will go on sale in Japan in December for about \$1,200, or about \$110 more than the standard model. Victor says that about a fifth of its production will be time-selection models. Exports are contemplated, but no schedule has been set.

### **Mideast sales of air-traffic-control gear mount for SEL**

For West Germany's Standard Elektrik Lorenz AG, the Middle East region is turning into a sizable market for its solid-state air-traffic-control and navigational systems—this after SEL is already firmly established on the North African market for such gear. **The latest Middle East orders for the ITT affiliate call for the delivery of a number of systems to both Turkey and Saudi Arabia.** The deal with Turkey involves five very-high-frequency omnidirectional range (VOR) systems, while that with Saudi Arabia is for 16 such systems, plus 6 doppler VORs and 13 instrument landing systems. Oil-rich Saudi Arabia has embarked on a major equipment modernization program that, according to SEL, will make the country the operator of one of the world's most advanced air-traffic-control setups.

### **All-channel alarm lets CB operator get help faster**

A new signaling scheme from Blaupunkt-Werke GmbH will increase the effectiveness of citizens' band radio communications in emergencies. In the West German firm's scheme, implemented with signal-generating circuitry in the transceiver, **an operator in need of help triggers the transmission of beep tones on all CB channels.** This alarm tells others on the air to switch to channel 9—the one set aside for emergency purposes. With many people aware of the call, aid can be given much faster than previously. Blaupunkt plans to introduce CB radios incorporating the beep-producing circuitry some time next year, after it has obtained government approval.

### **Sony PCM unit converts Betamax to stereo recorder**

Bowing Sept. 21 is Sony's pulse-code-modulation adapter that converts the video channel of the Betamax video tape recorder into an ultra-high-fidelity stereo tape recorder. An analog-to-digital converter and coder turn the incoming audio into a 1.762-Mb/s PCM stream, while a decoder and d-a converter turn the code back into the original audio. **At the same time, Matsushita is unveiling a similar prototype.** The Sony unit operates with the new two-hour VTRs—an improvement on the prototype units shown last year. The adapter costs \$1,800 in Japan, with U. S. sales probably starting next year. It features a frequency response flat within 1 dB from 2 Hz to 20 kHz, harmonic distortion of less than 0.03% at all frequencies and levels within its range, and a dynamic range of more than 85 dB.

# CONSIDERING DEC'S LSI-II?

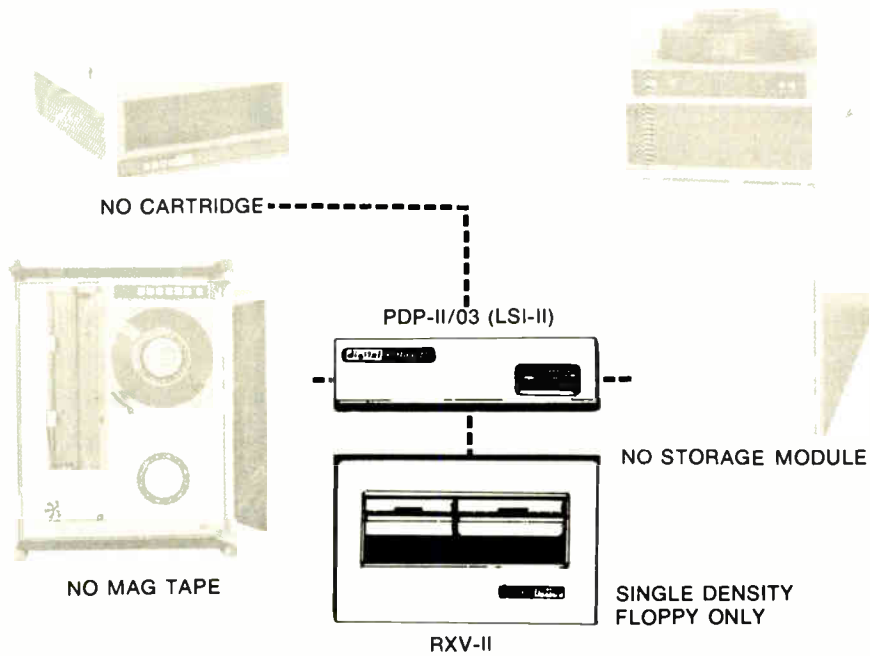

## CONSIDER IT AGAIN WITH A FULL LINE OF PERIPHERALS.

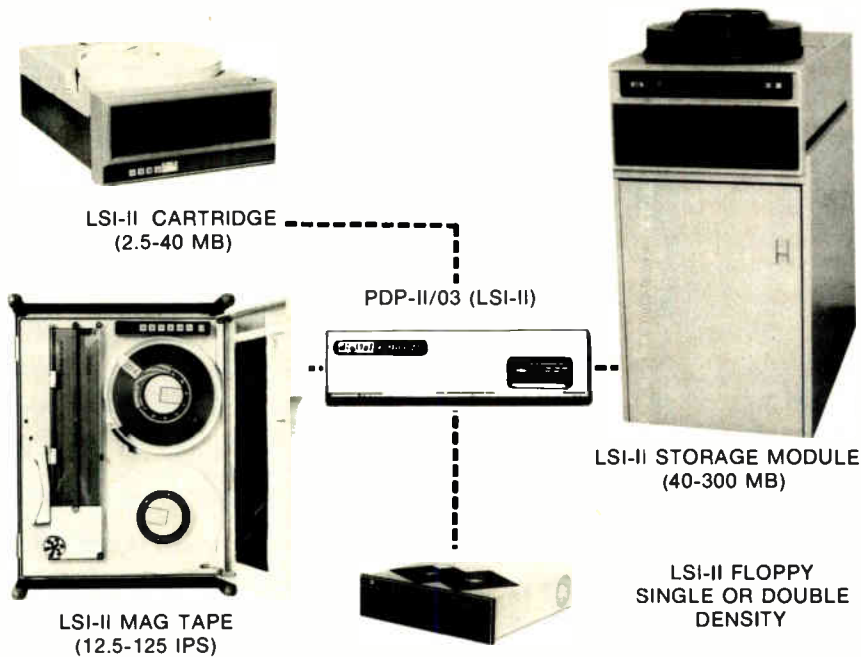

**FROM XEBEC**   
(THE DEC PERIPHERAL SUPPLIER)

2985 KIFER ROAD, SANTA CLARA, CALIFORNIA 95051 • (408) 988-2550 TWX 910-338-0130

# Overprotection can affect a CMOS switch for life.

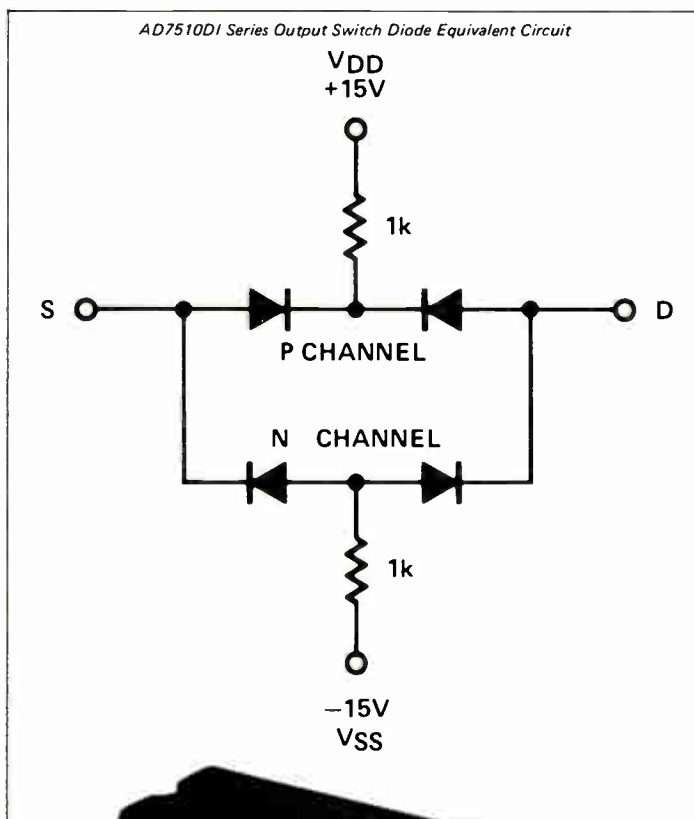

But not Analog Devices' AD7510 family of DI CMOS analog switches. They belong to a whole new generation. With positive overvoltage protection, but without any inhibition on performance.

We accomplished it through a unique design, utilizing "on-chip" resistors in series with the power supply. It provides as much as  $\pm 25V$  overvoltage protection. But the resistors only switch in when an overvoltage condition occurs. So normal performance never suffers. And you get both the main assets of an analog switch: a low "ON" resistance of  $75\Omega$  and a low leakage current of  $400\mu A$ .

The equivalent circuit of the output switch element shows that, indeed, the  $1\text{ k}\Omega$  limiting resistors are in series with the back-gates of the P- and N-channel output devices — not in series with the signal path between the S and D terminals.

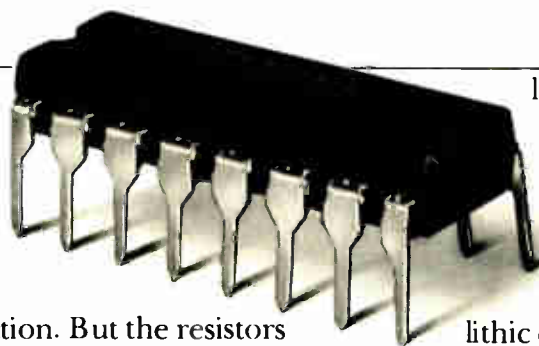

This design, combined with our dielectrically-isolated CMOS fabrication process, prevents

latch-up. And allows TTL/CMOS direct interfacing.

We also included two other measures of security. Silicon nitride passivation to ensure long term stability and monolithic construction for reliability.

Now when it comes to protecting CMOS switches so they can survive in the real world, Analog Devices knows best. Write for our 8-page technical bulletin on the entire family of DI CMOS protected analog switches, to Analog Devices, the real company in precision measurement and control.

 **ANALOG DEVICES**

The real CMOS switch company

Analog Devices, Inc., Box 280, Norwood, Massachusetts 02062. East Coast: (617) 329-4700, Midwest: (312) 894-3300, West Coast: (213) 595-1783, Texas: (214) 231-5094. Belgium: 03 3827 07, Denmark: 97 95 99, England: 01/94 10 466, France: 686-7760, Germany: 089/53 03 19, Japan: 03/26 36 826, Holland: 076-879251, Switzerland: 022/319704 and representatives around the world.



## Minicomputer network to serve Swedish city's entire administration

The Swedish city of Malmö is not alone in discovering more virtues in the minicomputer than the mainframe. But it is unusual in putting all its administrative systems onto a network of minicomputers. The comprehensiveness of this network is uncommon—perhaps unprecedented—since it encompasses so many different types of data.

Until next spring, the network approach is limited to local clusters of minis, typically three, linked by high-capacity channels capable of handling around 1.2 million kilobytes per second. The approach is for each central processing unit to handle a specific function—for example, disk storage or the teletype-compatible display units.

The decision to go for the mini

solution rather than to continue with the mainframe approach was mainly economic. The city's data-processing manager, Nils Dahlberg, says his department calculated that a system handling 130 transactions a second would be required to implement all the planned interactive applications. Such a transaction rate would require 13 IBM 370/148s with 2 megabytes of storage costing about \$1.1 million each. Alternatively, 32 Data General Eclipse S/130s with 250,000 bytes of memory would meet the transaction rate and would cost only \$44,500 each. This gives a hardware outlay of about \$1.45 million for the minicomputers, compared with an IBM cost 10 times that.

Configuration. Apart from two 10-year-old Saab large systems with

programs that are being rewritten to run interactively on the minicomputers, Malmö's current configuration is 14 Data General machines, with about 80 terminals on line, and disk storage totaling 1,900 megabytes. Ten different user groups are running about 25 different applications.

The central administration systems for the city of 250,000 include financial long-range planning, a population register, taxi administration, and program-development systems. Other systems include one for billing and book-keeping for the port and several for health care and the social welfare department. Many more are under development.

Testing is already under way to connect the different centers to each

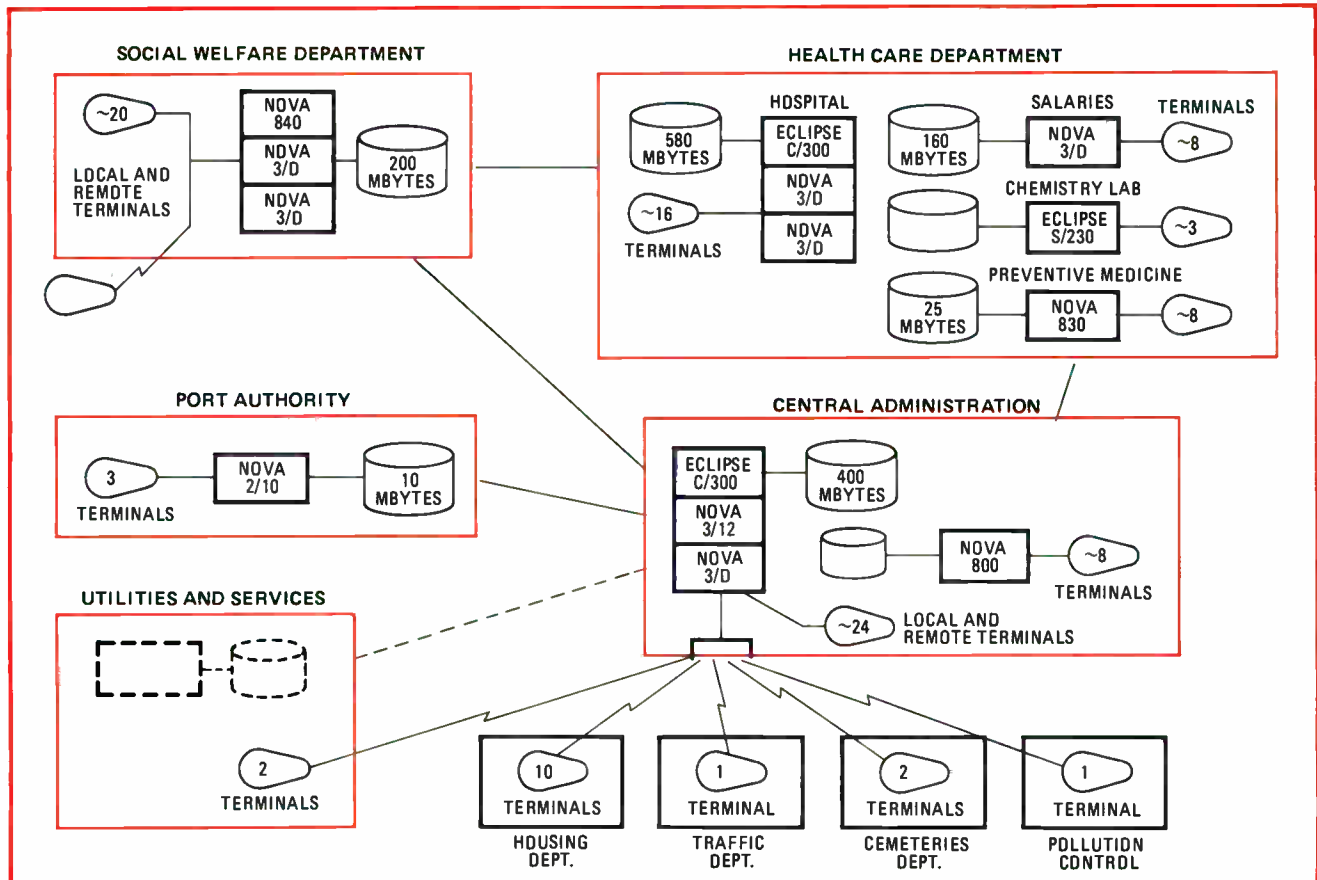

other and to the central administration system. The system will be installed over 9,600-bit-per-s telephone lines, over distances not greater than 3 or 4 kilometers.

Swedish data-protection laws will require extensive security safeguards in the software and protection against unauthorized access to files. One novel safeguard comes in delegating the choice of a key word for an individual data record to the clerk responsible for operating the system. This scheme guards against the hazard of commonly accessible identifiers, which could facilitate easy access to an unlimited number of files. The cross-reference list of these key words and personal identifiers is safeguarded.

The program development has undoubtedly proved less of a stumbling block than is commonly supposed with minis. Dahlberg says that the software for interactive program development is fully comparable with that on bigger machines and is simpler to use. System manager Hans Hallden agrees that large systems are often unwieldy and provide more facilities than can be used. "In addition, there is a big advantage in having the machines close to the programmer," he says. "You can work on one program until it is finished, instead of running several and getting involved in long turnaround times."

**Software.** The Malmö data processing team is using standard Data General real-time disk operating system software. Network protocol is designed along industry standard lines—that is to say, it is similar to IBM's synchronous-data-link-control and the international high-level-data-link-control standards.

For the data-base handling and telecommunications protocol, the Malmö team had to develop extensive routines of their own. One reason is that the city is using more than one type of Data General mini-computer, and the interfaces between the systems are not supplied with the standard software.

The file-handling software, incorporating six access methods, access control, file security, transaction log-

ging, and a variety of other features, has been in existence for around three years. Called Z, this software sits above the Data General operat-

ing-system software and is written so as to interface with any improved version that the Southboro, Mass., firm may bring out. □

---

**Japan**

---

## Static-induction-transistor cell may up RAM performance tenfold

With a device called the static induction transistor—developed as a junction-type vertical field-effect-transistor configuration for high-power applications—a team of researchers at Tohoku University is developing a random-access-memory cell that may offer a very high packing density of 10-micrometer-square cells, operate at subnanosecond switching speeds, and dissipate merely a few femtojoules of power. This performance is easily 10 times better than that contemplated by even the most optimistic metal-oxide-semiconductor and bipolar technologists.

The work, under the direction of Professor Jun-ichi Nishizawa, who jointly holds a basic patent on the SIT configuration, combines the one-transistor double-level configuration of today's 16,384-bit n-channel MOS RAMs with a configuration that, like integrated injection logic, operates with the current flow perpendicular rather than parallel to the surface of the device. This three-dimensional property is responsible for the cell's small size. The high speed comes both from the higher mobility obtainable in the SIT's perpendicular-flow configuration, where carriers travel in the bulk silicon rather than on the surface as in standard MOS devices, and from the faster drift velocity of this bulk-flow operation, compared to the slower diffusion carrier-flow of surface MOS devices.

The RAM array being built at the university is a partially populated device consisting of 10 rows by 3 columns. It contains no peripheral circuitry such as decoding and sense amplifiers. According to Nishizawa, larger arrays and peripheral circuit

development will be undertaken commercially.

The prototype is fabricated in an  $n^-$  or intrinsic epitaxial layer on an  $n^+$  wafer. A shallow  $n^+$  diffusion for the source is sandwiched laterally between two deeper  $p^+$  diffusions that act as the gate. The substrate serves as the drain. The configuration and doping are such that the field from the gate—the natural depletion region—either pinches off the channel or nearly pinches it off with no applied bias.

**Changes.** For memory operation, a silicon-dioxide passivation film is applied directly over the source, and metal word lines that do not connect to the source are run over the oxide. The source forms one plate of the capacitor that stores the state of the cell; the word line forms the other plate. Actually, source diffusion is not required, but it forms a unipotential region and allows storage of a larger charge than if it were omitted.

In the experimental RAM, the source diffusion is rectangular and is surrounded by the rectangular inner periphery of the gate diffusion. The outer periphery of the gate diffusion is also rectangular, and gate diffusions of individual cells are joined to form bit lines perpendicular to the word lines.

In the experimental memories, 1 is written by applying a  $-5$ -v pulse to the word line and holding the bit line at 0 v. Electrons are forced out of the storage cell and flow to the bit plane. The positive charge in the form of holes is stored in the cell maintained by a bit voltage of  $-3$  v and word voltage of 0 v.

For readout, the bit line is raised to 0 v. Electrons flow from the bit plane to the storage cell. □

# Four very small ways to improve on your PC design.

With four types of switches—rockers, pushbuttons, toggles and DIPs—Cutler-Hammer offers one of the industry's broadest and most unique selections of PC subminiatures.

Each of the hundreds of available styles provides the reliability you've come to expect from Cutler-Hammer. With ratings to 6 amps, each conforms to standard circuit board mounting requirements.

PC switches, along with accessories and decorative hardware, are distributor stocked for local availability. And since most are manufactured in the United States, we offer fast reaction time on solder lug and wire wrap terminal variations, as well.

To improve your next design in any number of small ways, contact your Cutler-Hammer Sales Office or Switch Distributor.

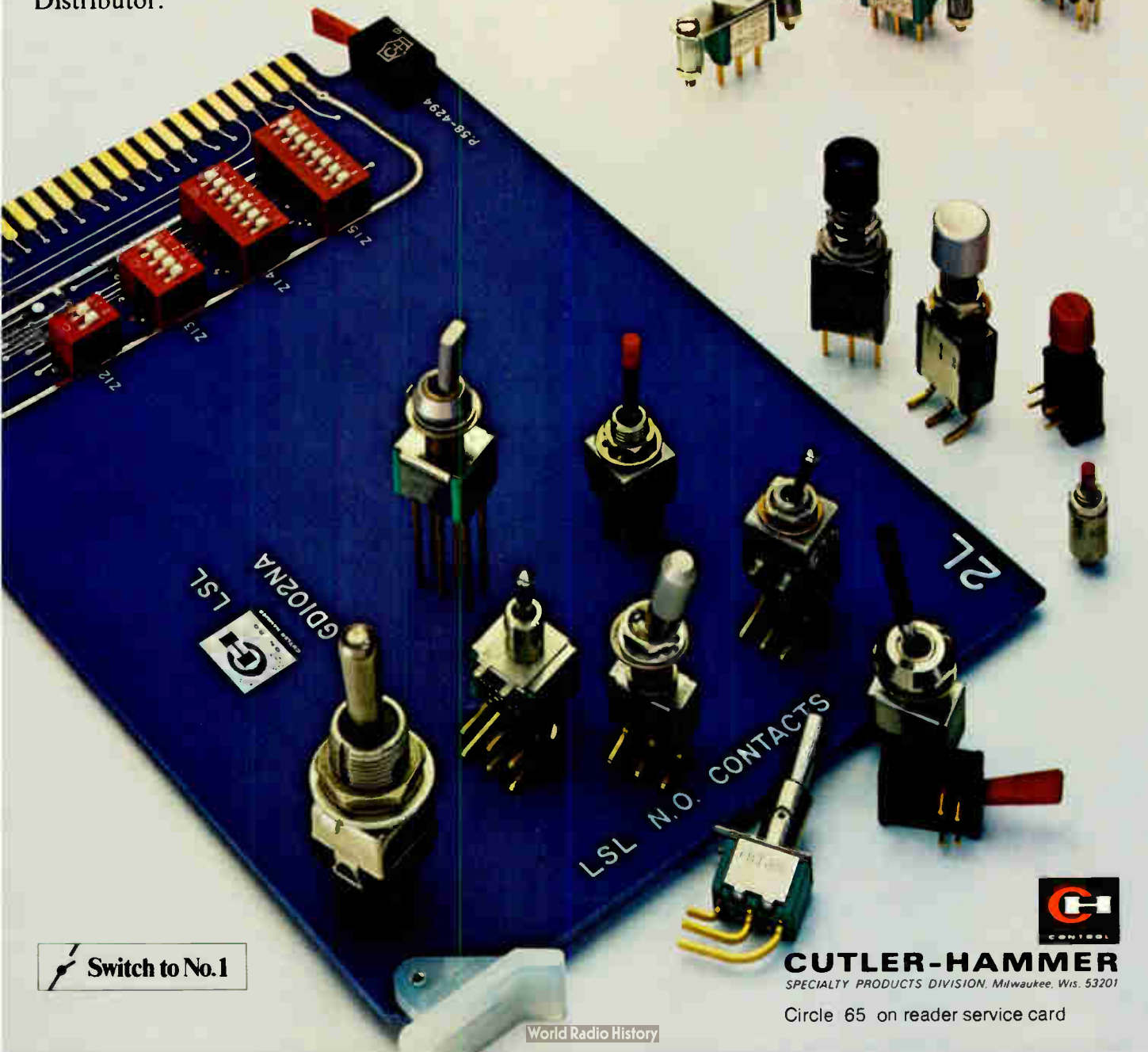

 Switch to No. 1

World Radio History

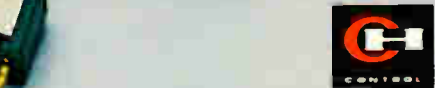

**CUTLER-HAMMER**  
SPECIALTY PRODUCTS DIVISION, Milwaukee, Wis. 53201

Circle 65 on reader service card

# More

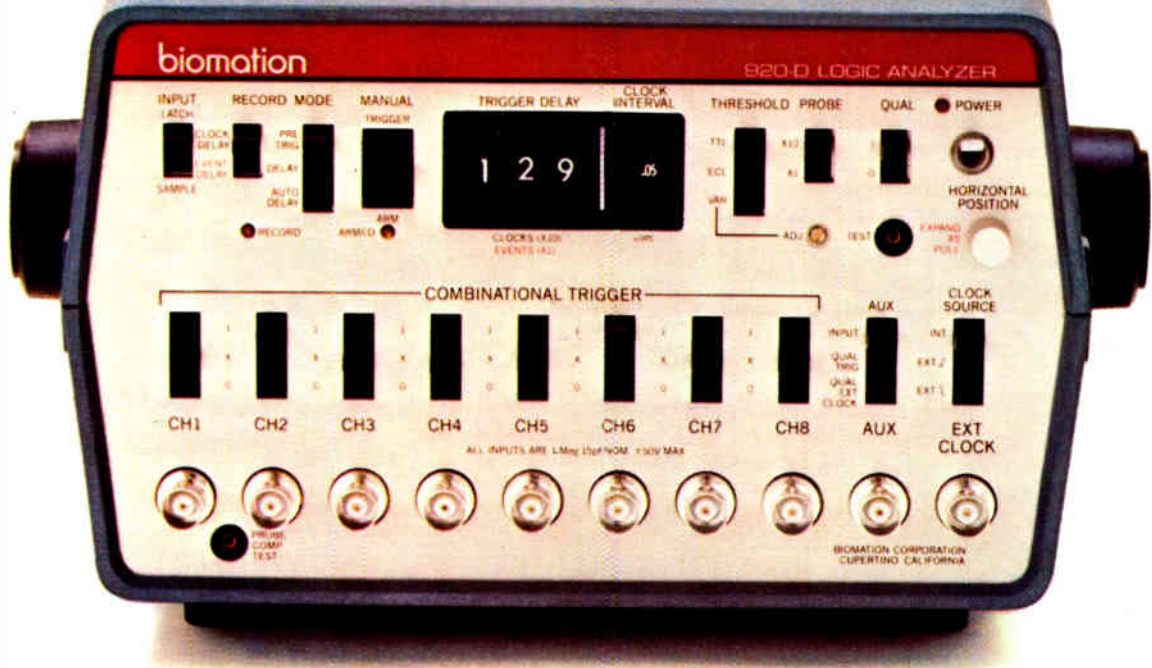

## Introducing the 920-D logic analyzer. Nine channels, 20 MHz and much, much more.

Don't let the low price mislead you. Biomation's new 920-D stands up to logic analyzers costing twice, even three times as much. It includes the functional features design engineers ask for most. And combines them with 9½ pound portability, making the 920-D an ideal field troubleshooting tool.

Nine channels — not just eight — give you added capability for more applications. Use the extra channel for recording data, or to mark a trigger location. And select between trigger or clock qualifier. Attach the optional Biomation 10-TC probe pod and you can select up to a 19-bit combinational trigger word.

The 920-D enables you to set a precise interval between the actual trigger and the start of recording, using either clock periods or number of trigger events. Or the pre-trigger recording mode can be selected to capture data from before the actual trigger. The logic threshold level is selectable — TTL, ECL

or variable. And you can record at rates from DC to 20 MHz.

Captured data, at 256 bits per channel, can then be displayed on any single channel scope or CRT display in timing diagram format.

Compare the 920-D with other logic analyzers, for both price and performance. Then ask yourself if you can afford to settle for less.

Don't let the 920-D's many features and high

performance mislead you. It's priced less — far less — than any comparable logic analyzer.

In fact, the 920-D's \$1295\* price tag makes it practical to put its extensive capabilities to work

wherever you design, debug or troubleshoot TTL logic.

The 920-D is a cost-effective first logic analyzer for most applications. Years of experience providing



# Less



thousands of engineers and technicians with the industry's leading family of logic analyzers has helped us design the 920-D with proven real-world features you can put to good use.

Low price makes the 920-D a great choice for your second... or third or fourth logic analyzer. You won't need to stand in line or share your company's only

logic analyzer when you have a 920-D of your own.

We built the 920-D for lightweight portability. It weighs in at under 10 pounds and connects to

the nearest oscilloscope or CRT. That makes the 920-D the newest tool for field service.

Biomatik has led the way in logic analyzer developments. Today there are seven Biomatik analyzers, offering from 8 to 16 channels, 10 to 200 MHz capture rate, memory lengths from 256 bits to 2048 bits per channel and operating in both time and data domains.

What more can we tell you? Plenty. Ask for the 920-D product sheet. Or give us a call to arrange a demonstration. Ask for Ed Jacklitch (408) 255-9500. Or write Biomatik, 10411 Bubb Road, Cupertino, CA 95014.

## biomatik

\*U.S. price only

# The MOS world



A VMOS transistor, magnified 15,500 times.

# is no longer flat.

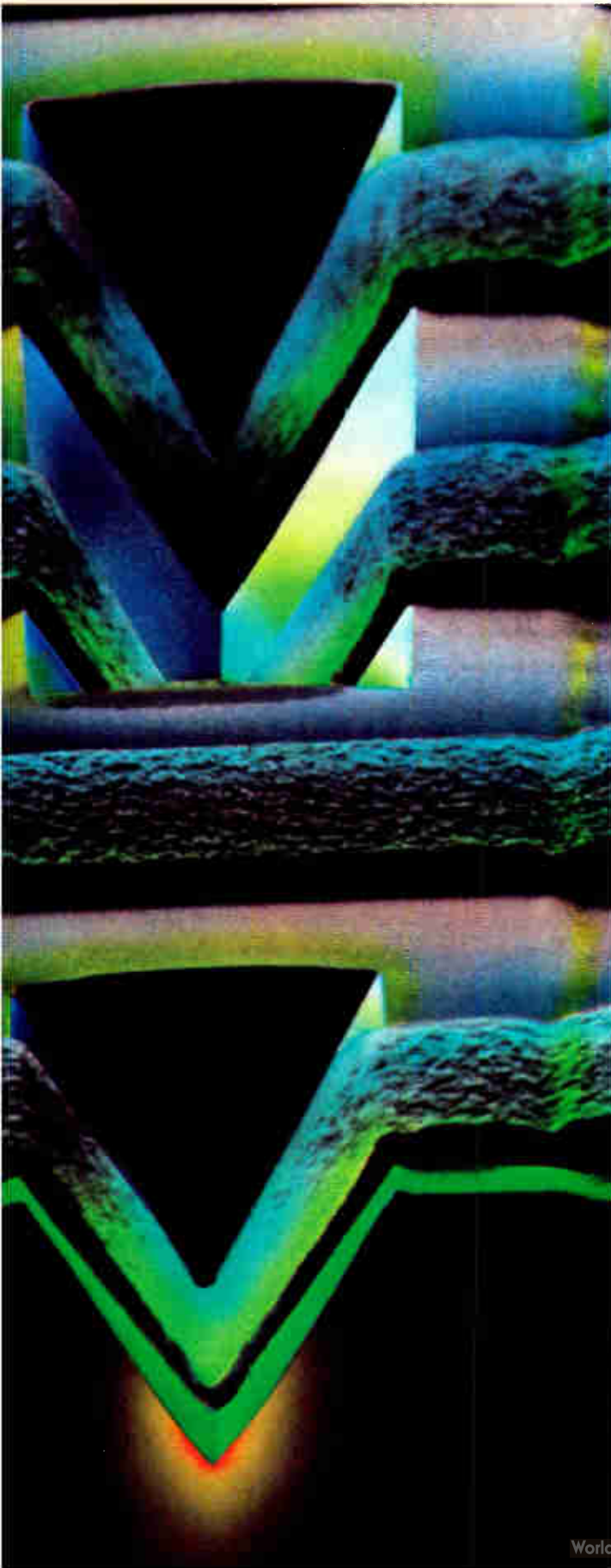

**AMI creates VMOS.** This revolutionary idea revolves around a three-dimensional transistor, etched into the silicon substrate.

The result? A circuit that's extremely fast, dense and inexpensive.

It isn't blue-sky theory. The first VMOS RAM, the 1K S4015-3, is in volume production now. And a reputable second source has committed to manufacture VMOS RAMs in 1978.

Our 35 nanosecond (typical, 45 nanosecond maximum) 1K static memory is pin compatible with the fast 1K NMOS and bipolar RAMs, and leads the way for the large family of VMOS products arriving soon. These will include:

#### NEW VMOS PRODUCTS AND TYPICAL ACCESS TIMES

4K fully static RAM	(1K x 4)	80 ns
4K fully static RAM	(4K x 1)	80 ns
4K fully static low power RAM	(4K x 1)	45 ns
8K fully static RAM	(1K x 8)	125 ns
16K ROM	(2K x 8)	100 ns
64K ROM	(8K x 8)	250 ns
16K EPROM	(2K x 8)	200 ns

The density permitted by vertical short-channel FETs produces VMOS circuits that are much smaller than competitive chips, increasing the speed and lowering the cost. For example, the latest bipolar 1K size is 61% larger, and the new fast NMOS 1K is 87% larger than AMI's S4015-3. And VMOS densities are achieved without stretching feature dimensions at the sacrifice of yields, as is necessary with bipolar and NMOS technologies.

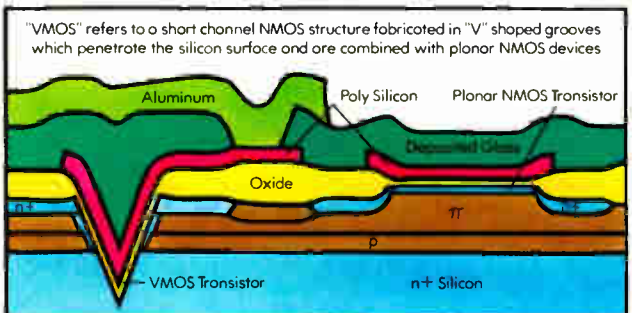

In short, VMOS presents the best of all possible worlds. If you want to stay up to speed at a down-to-earth price, call your nearest AMI distributor or sales office. Or write to AMI Marketing, 3800 Homestead Road, Santa Clara CA 95051. You'll be entering the MOS world of the future.

**VMOS: the  
new technology  
from AMI**  
AMERICAN MICROSYSTEMS, INC.

See VMOS at Wescon, Booth 821  
Circle 69 on reader service card

TIME INTERVAL  
SECONDS

3.4168 - 6

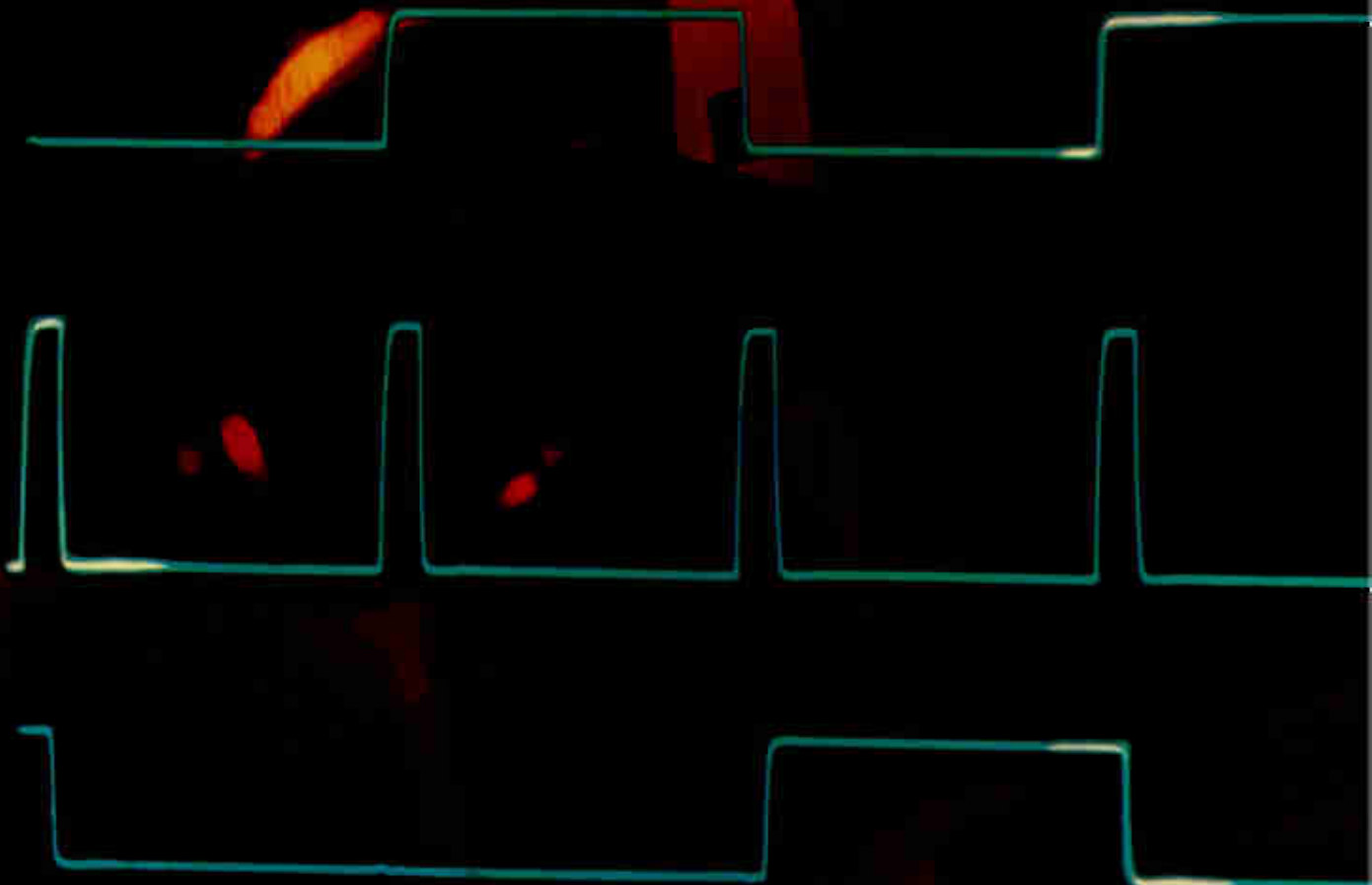



# Announcing a new standard in scope timing measurements.

## For $\Delta$ -time measurements to 0.002% accuracy\* and 100 psec resolution...

### HP's the Answer.

Here's a brand new concept in scopes. HP's revolutionary **1743A**. It has an internal crystal-oscillator time-base reference for high 0.002% accuracy\*... second-generation  $\Delta$ -time capability for added measurement flexibility and convenience...and a 5-digit LED readout for resolution to 1 part in 150,000.

Priced at just \$3300\*\*, this 100 MHz scope provides up to 200 times greater timing accuracy than previous  $\Delta$ -time scopes. And the combination of crystal-oscillator and second-generation  $\Delta$ -time capability means easier timing measurements:

#### **Triggered delay measurements.**

Now,  $\Delta$ -time measurements can be made automatically by positioning markers on the waveform. This means greater speed and convenience in measuring pulse widths and periods. Plus, direct readouts of changing time intervals without touching scope controls.

**Delay functions to zero.** Now you can measure  $\Delta$  time from the first pulse leading edge to any place on screen. That means greater resolution and accuracy, plus easy  $\Delta$ -time measurements with respect to noncyclical pulses such as flags and handshake signals.

**Continuously variable sweep that remains calibrated.** Now you can use the sweep vernier without changing the LED time-display calibration. Make one major division equal to a clock period, compress a long data train to keep it within the display window, or increase readout resolution up to

a factor of three and still read  $\Delta$  time directly and accurately.

**Trigger to channel A and B.** Now you can measure  $\Delta$  time between the trigger signal and events on both channels. This allows you to measure  $\Delta$  time between a flag and the start of a data train, to make phase measurements on dual clocks, or to measure skew between data channels.

And there's much more. Your local HP field engineer has the details.

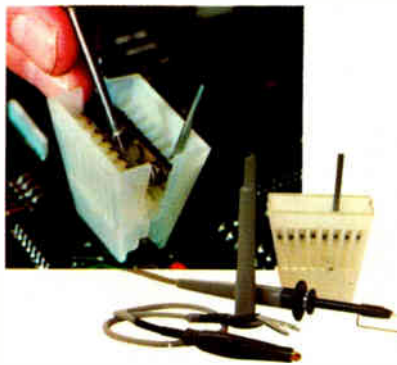

And here's something NEW for scopes. HP's **Easy-IC Probes**. A new idea for probing high-density IC circuits that eliminates shorting hazards, simplifies probe connection to DIP's and generally speeds IC trouble-shooting. Ask your HP field engineer about them.



\* 15°C to 35°C specification.

\*\* Domestic U.S.A. price only.

08/7/10

HEWLETT  PACKARD

1507 Page Mill Road, Palo Alto, California 94304

For assistance call: Washington (301) 948-6370, Chicago (312) 255-9800, Atlanta (404) 955-1500, Los Angeles (213) 877-1282

Circle 71 on reader service card

World Radio History

# Quite frankly, we're going to be #1 in memory testing till the cows come home.

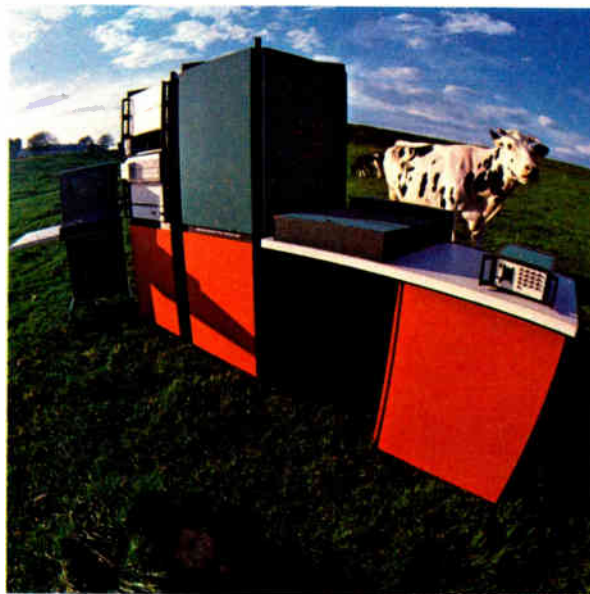

Four years of matching the memory industry breakthrough for breakthrough have made Teradyne the leader in memory testing.

We started back in 1973 with the J384, a dedicated memory test system. It tested RAMs and ROMs efficiently and economically. But things were changing fast.

1974 saw the advent of dynamic devices like the 4k 2107. And we added the M385 microprogrammable pattern

generator to keep pace.

In 1975 our answer to increasingly complex memory technology was a new system, the J387.

In 1976, when 16k and page-mode parts went into production, we responded with the H712 test deck.

Today, Teradyne has an installed base of well over 100 J380-series memory test systems working for more than

20 companies. At probe, at final test, and at incoming inspection. That's a larger dollar base than our two nearest competitors combined.

Four years of experience have made us the most capable source of memory test equipment in the world.

If you test semiconductor memories, call us today. You'll call us eventually. Because no matter where memory technology goes from here, Teradyne will be there.

## TERADYNE

Semiconductor Test Division  
Boston, Mass. - Chatsworth, Calif.

Electronics / September 15, 1977

## Big ROMs begin to make waves

32-k and 65-k devices coming to market in response to need for more storage and use of higher level languages

by Larry Armstrong, Midwest bureau manager

The big ROMs are coming, and they should win untroubled acceptance by users. The new 32,768-bit and 65,536-bit read-only memories are designed to be pin-compatible with their smaller counterparts, easing the expansion of already designed systems. With their increased densities and performance and decreased power and per-bit cost, there is no sacrifice when a user moves up.

The fastest-growing ROM application is program storage for microprocessors, and as the performance of microprocessors and the sophistication of their users increase, so will the amount of program storage. Also driving up ROM sizes is the trend toward higher-level languages for microcomputers. Although less efficient than assembly languages, they are being used to pare the cost of software. Programmers can capitalize on the ROM's falling per-bit price to store extra code.

Nevertheless, the 32-k ROM market got off to a slow start earlier this year: General Instrument Corp. never got beyond the sampling stage with its 850-nanosecond RO-3-9332A. "We decided to pull it back for a redesign so as to come out with a faster part that will be competitive with what the rest of the industry will be offering," explains Robert A. McDonald, memory products general manager for the Hicksville, N. Y., Microelectronics division. Also, Electronics Arrays Inc., Mountain View, Calif., is not yet in full production on the three-supply EA3200 it introduced in May, Mostek Corp. circulated preliminary data sheets on a part that is different from the one it is taking orders on now, and Texas Instruments Inc. has not met with resounding success on its version.

However, a newcomer to the 32-k market may be the first in volume

production. Rockwell International's R2332, a fully static 250-ns part, is intended for program storage in the firm's 6500 microcomputer family. The \$20 silicon-gate unit also could find considerable demand elsewhere.

**Front-runner.** But now, Mostek and American Microsystems Inc. are neck and neck in a race to get the first 65-k parts out next month. Both firms are showing ROMs compatible with the newest generation of microprocessors.

An innovative V-groove metal-oxide-semiconductor process is the key to AMI's extremely fast 65-k ROM [*Electronics*, Aug. 4, p. 40], an effort funded in part by Tektronix Inc., Beaverton, Ore. It is a process that AMI, in Santa Clara, Calif., is counting on to bridge the gap between its reputation as a custom house and its desire to sell standard circuits. The result is a 30,000-square-mil chip, denser than some of

THE BIG MOS READ-ONLY MEMORIES

Vendor	American Microsystems	Electronic Arrays	General Instrument	Mostek	Mostek	Motorola	National Semiconductor	Texas Instruments
Part	S4264	EA3200	RC-3-9332C	MK32000	MK36000	MCM68332	MM5235	TMS4732
Size (kilobits)	65	32	32	32	65	32	65	32
N-channel process	V-groove	metal-gate	metal-gate	silicon-gate	silicon-gate	silicon-gate	metal-gate	silicon-gate
Number of pins	24	28	24	24	24	24	24	24
Chip size (mil <sup>2</sup> )	29,929	41,500	36,000	22,875	34,770	?	?	?
Maximum access time (ns)	350	350	350	300	300	450	800	450
Maximum active power (mW)	725	500	500	200	200	788	1,000	788
Maximum standby power (mW)	*	50	*	50	50	*	*	*
Power supplies (V, tolerance)	+5 (10%)	+12, ±5 (5%)	+5 (10%)	+5 (10%)	+5 (10%)	+5 (5%)	+5 (5%)	+5 (5%)
Input levels (V)	2.0, 0.8	2.4, 0.8	2.4, 0.8	2.0, 0.8	2.0, 0.8	2.0, 0.8	2.2, 0.6	2.0, 0.65
Output levels (V)	2.4, 0.4	4.0, 0.45	2.4, 0.4	2.4, 0.4	2.4, 0.4	2.4, 0.4	2.4, 0.4	2.4, 0.4
Availability	Oct.	now	Jan.	Oct.	Oct.	Oct.	Oct.	now

\*Part is fully static (no clocks), and input/output levels are important for determining TTL compatibility.

the 32-k devices on the market. Access time is typically in the 225- to 300-ns range.

In addition, Mostek has eschewed the fully static designs of its competitors in favor of what it calls edge activation. Though the technique requires a pulse at the chip-enable input to turn the part on and off, it yields a high-performing device that needs very little power. Worst-case access time for the 32-k and 65-k parts is 300 ns; maximum power is less than 200 milliwatts. Clocking the part gives an automatic standby that dissipates less than 50 mW.

National Semiconductor Corp. will start offering samples of its 65-k ROM to outside customers next month also. But it will be next year before other vendors—Electronic Arrays, Intel, GI, Motorola, TI—will have their versions ready.

Intel, at least, plans to deviate from the 24-pin package that AMI and Mostek are using, preferring instead a 28-pin configuration that allows another chip-select input. "We feel that the user needs an output enable on the 65-k devices, as he's had on earlier ROMs, to get the minimum package count in a microprocessor system," says William Reitz, strategic marketing manager for Intel's Components division, Santa Clara, Calif. Others may follow Intel's lead away from the 24-pin package, but in the Mostek design, its clock does it.

**Erasable encroachment.** Microprocessors may be driving ROM sizes up, but they are also nibbling at the lower end of the ROM line: the new one-chip microcomputers—with an on-board ROM—can be expected to start taking over the market for 2,048, 4,096, and 8,192-bit sizes. More dramatic, however, is the competition small ROMs will see from their ultraviolet-erasable and, eventually, electrically alterable brethren, the programmable EPROMs and EAROMs. "In small volumes, our 16-k erasable PROM is already having an impact on masked ROMs," says John Hewkin, strategic marketing manager for MOS memories at TI, Houston. "In 10,000-piece lots, the device costs more, but we find the

## Taking a hard look at software

Makers of read-only memories are keeping an eye on another potentially big market: manufacturer-preprogrammed read-only memories.

Mostek Corp., for one, figures that the cost of generating enough fully debugged software to fill a 65,536-bit ROM is \$48,000—a calculation that assumes that software costs \$10 per line of code, debugged, and that a Z-80 programmer using assembly language averages 1.7 bytes per line of code. "That makes it obvious to us that users are not going to start from scratch on every application program for 65-k ROMs," says Derrell C. Coker, marketing and applications manager for the Carrollton, Texas, firm's memory products department.

An early example of this new software product is the Lawrence Livermore Laboratory version of Basic that Electronic Arrays Inc. has been offering since May. The company packaged it in a pair of 32,768-bit ROMs and used it for samples of the part. "But we've sold a lot of them into the personal computer market, as well," says Michael McCoy, director of memory product development. National Semiconductor Inc. will have an 8080-oriented version of the same Basic on a single chip, along with a hex debugger, when it starts sampling its 65-k ROM next month. A second device will use NIBL, for national industrial basic language, and a third will use two 65-k chips to implement an expanded Basic for the firm's 16-bit Pace microcomputer. Eventually, this will be put on a single 131,072-bit ROM that's now in development at National.

Electronic Arrays' McCoy agrees that the big ROMs are an ideal vehicle for carrying the higher-level languages. "And I think that applications software, such as a small accounting system, will also be sold in ROM. The big advantage for the user is that loading a program in ROM form doesn't take up valuable RAM [random-access memory] space," he says. "Within five years, I believe that just about every terminal will have fixed programs that have been purchased in ROM form."

The microprocessor manufacturer, or software consultant, might also develop libraries of software routines that customers could sift through, selecting several to be put together on a single ROM. "If the manufacturer can guarantee the software, the customer will be more comfortable using ROMs instead of erasable programmable ROMs or random-access memories," says Mostek's Coker.

customer is willing to pay to get instant delivery and the ability to make a change in the program."

The erosion is even more apparent at Motorola, which sells the cheapest erasable PROM on the market, a plastic-packaged version that can be programmed only once. "The majority of industrial accounts will soon be using erasable PROMs instead of masked ROMs because of their flexibility," argues Lyle P. Arends, memory marketing manager.

**Leveling off.** The result is a masked-ROM market that many people think is beginning to level off. "The total dollar volume of the ROM market is going to grow less than 5% a year over the next several years," suggests Thomas L. Humphrey, strategy manager for EDP products at AMI—who pegs this year's market at \$75 million. "But the distribution is going to change dramatically in favor of the larger ROMs, in the 16-k

to 65-k range." Further, the distribution may stay concentrated in that range: "There's a risk beginning with the 65-k, and certainly with the 131-k and 262-k, which are within the range of technical feasibility within the next couple of years," he continues. "The bigger the ROM, the more chance there is of making a mistake in its programming, either in the coding or in the design or the final product. And that mitigates against getting large." Humphrey believes that users prefer to write programs in modules instead.

In a report to be published this month, Dataquest Inc., Menlo Park, Calif., estimates that this year's market for masked ROMs will reach \$103 million, and will grow about 14% per year for the next several years. It feels that the ROMs will average 40 millicents/bit this year, a number that will drop to 9 millicents/bit by 1981. □

# Here's a miniature 3½ digit portable multimeter that delivers extraordinary performance and value for only \$189.



Data Precision proudly presents a 0.1% accuracy multimeter that brings the same high performance and value to 3½ digit portable instruments that our Model 245 brought to 4½ digit multimeters. The same levels of reliability, the same small size, the same great convenience and flexibility. The Model 175 has it all... and more for just \$189.00.\*

## High performance

The Model 175 gives you 32 ranges of measurement capability, six functions, 0.1% DCV accuracy guaranteed for one year, and 100 microvolts resolution. You can measure DCV from ±100 microvolts to ±1000V, ACV from 100 microvolts to 500V with a frequency response of 30Hz to 50kHz, DC Current from ±100 nanoAmps to ±2A, AC Current from 100 nanoAmps to 2A with a frequency response of 30Hz to 50kHz, Resistance from 100 milliohms to 20 Megohms in two excitation voltages.

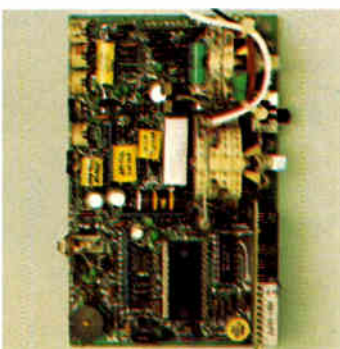

Price U.S.A.

## Real miniature portability

Here is true miniature portability that delivers lab performance wherever you take it. And you can take it anywhere. The 175 operates from AC line, or rechargeable NiCad batteries for 6 hours of in-spec operation. Add this to the remarkably small size 1¾"H x 5½"W x 3½"D, 34 cu. in., weight 22 oz. (4.45 x 13.97 x 8.89cm, 552cc, .63kg.) exceptional operating temperature characteristics, rugged construction... and you can see that this is real portability.



## Right at home in the lab

Connect the 175 to an AC line and you have a great bench instrument. It's always recharging when line connected and ready to go into the field whenever you need it.

## And the Model 175 gives you a lot more.

• **Easy to Read, Big, Bright Display:** 0.43" LED display for easy reading in dim light or bright light.



• **Hi/Lo Resistance Measurement:** Measure resistance in two modes. Hi excitation 2.5V (exceeds semiconductor forward threshold) and Lo excitation 300mV (below silicon junction threshold), for in-circuit resistance measurement without turning on semiconductor junction. No need to unsolder resistor.

- Automatic Zero
- 100% Overrange
- Overload Protected
- Overload Indication
- Recharging Indication
- **A Complete Package:** accessories supplied include: rechargeable NiCad battery module, line cord recharger, test leads carrying case and documentation.

Data Precision Corporation, Audubon Road, Wakefield, MA. 01880, USA  
617 (246) 1600 Telex (0650) 949341.



Actual size, front view.

**DATA PRECISION**  
...years ahead

VISIT US DURING WESCON, BOOTH NUMBERS 1554, 1556, 1558.

For additional information circle 74 Readers Service Card

World Radio History

For demonstration circle 75 Readers Service Card

Electronics abroad

## For Czechs, production gear is first

Tesla, the \$2 billion state company, has neglected consumer goods, but current five-year plan calls for change in that attitude

by John Gosch, Frankfurt bureau manager

Mention Czechoslovakia, and what springs to mind is a land in central Europe known for its fine beer, the "golden city" of Prague, and, possibly, a long industrial tradition.

It is that tradition that has set the course for Czechoslovakia's efforts in electronics: the accent is clearly on systems and devices for industrial applications, especially automated production. So strong is the emphasis that, in the view of many Western observers, the consumer sector has

This article is the fifth in a series that examines the electronics industries of the Eastern European Bloc, or Comecon.

**Homegrown.** Illustrating Czech expertise in industrial electronics is this JPR12 EDP system from Tesla, with 90,000 employees the country's leading electronics combine.

been neglected. Czech officials agree, but they are quick to point out that things are about to change.

A second mainstay is communications. Starting out as a fledgling producer of simple broadcast equipment in the late 1950s, "we now rank among the world's top manufacturers of radio and television transmitters," says one industry official. To support his contention he points to the delivery last year of the 500th transmitter to the Soviet Union. He adds that a large number also have been sold elsewhere, particularly to other Comecon nations and to developing countries in Latin America and the Middle East.

Credit for these achievements goes to Tesla, a state holding company that accounts for 90% to 95% of

Czechoslovakia's electronics production (excluding computers), according to Milos Krejci, director of international business relations. A conglomerate of 21 enterprises, Prague-based Tesla runs some 53 highly specialized manufacturing facilities, with five research centers.

**Selling.** A Tesla-administered business organization with nationwide outlets handles domestic sales. Exports and imports, however, come under the wings of KOVO, a foreign trade organization, also based in Prague. Of Tesla's 90,000 employees, 13,000 work in R&D.

Tesla's production in 1975 came to about \$2.1 billion. That volume, Krejci says, is nearly twice what it was in 1970.

Except for computers, Tesla pro-

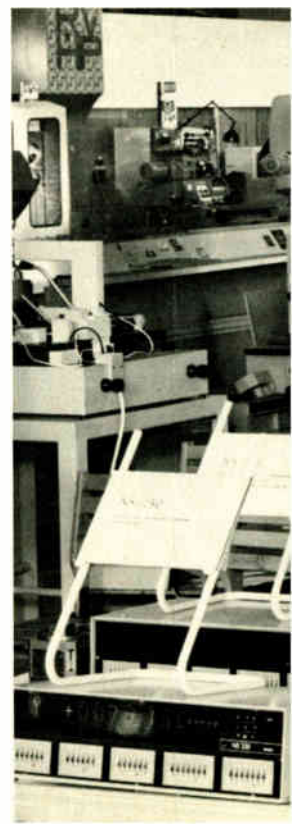
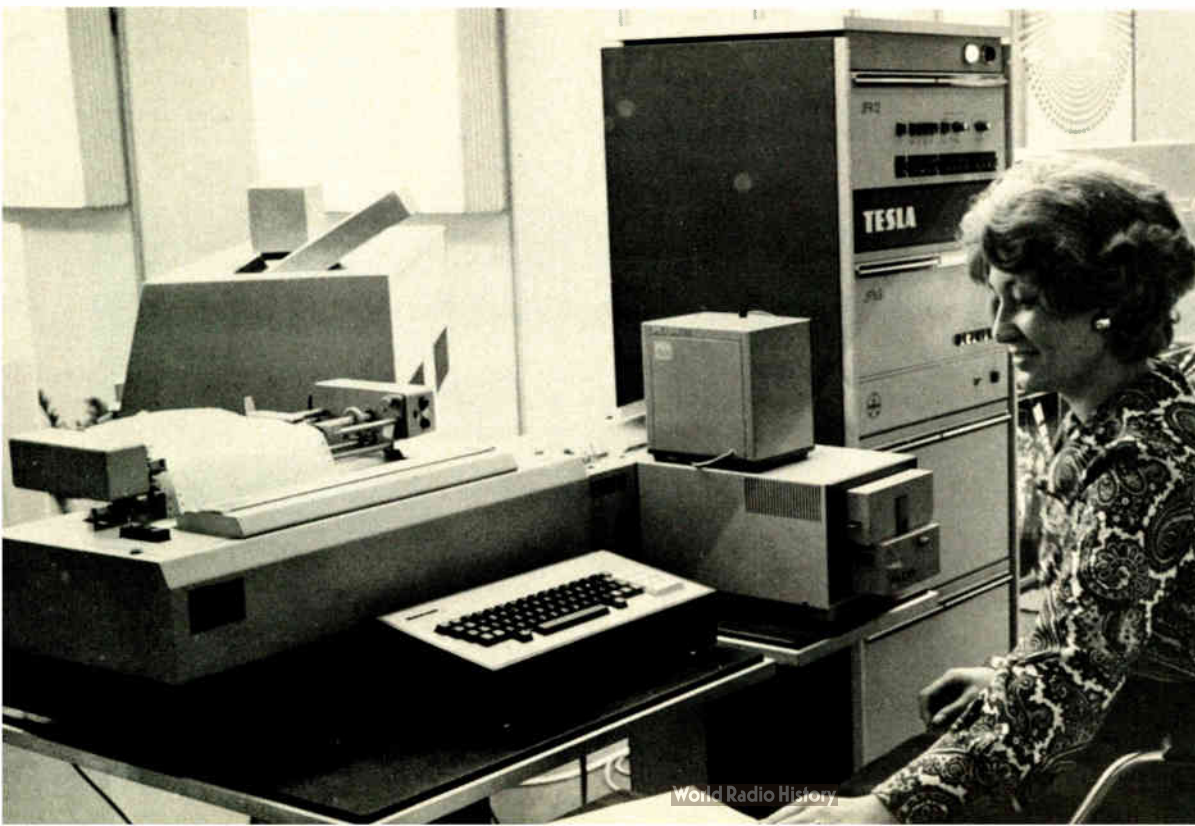

duces just about everything in electronics—from simple passive components and active solid-state devices to consumer goods, studio equipment, industrial control systems, and so on, up to high-powered radio transmitters. The lineup also includes some computer peripherals and automation equipment.

**Computers.** Computers are the domain of ZPA. Employing 35,000 to 40,000 persons, the conglomerate turns out peripherals like tape-punching and -reading equipment, process-control systems, and small to medium-size computers. ZPA's production increases between 15% and 20% a year on average, says Tibor Vasko, who is the director of the computer and automation department in Prague's Ministry for Technology and Investments.

As in other Comecon Bloc countries, economic development in Czechoslovakia proceeds according to five-year plans. The current one, the sixth such plan and running from 1976 through 1980, again gives top priority to electronics. During the five-year period, output of components and equipment in all fields except computers, is to rise 80%—to \$3.5 billion by the end of this decade. Production of computers

during the five-year span is to total nearly \$2 billion, which means doubling production by 1980.

On the qualitative side, the Czechs aim to step up their efforts in readying electronic components for the RJAD line of mutually compatible computer and peripheral systems produced by the Soviet Union, Poland, East Germany, Bulgaria, Hungary, and Czechoslovakia.

Home-grown capability certainly exists in broadcasting equipment, Tesla says. The firm prides itself in being able to produce its own high-power tubes and whatever solid-state components are needed for the radio and TV transmitters it builds, and still have enough for exports.

Such capability also applies to industrial controls, especially to numerical-control systems for machine tools. "While at one time we were dependent on imports from the West, we now produce our own systems," says Jaroslav Hrouda, a Tesla engineering official. The main reason for building up a strong NC capability, Hrouda says, is to keep Czechoslovakia in the forefront of machine-tool technology and exports.

Also commanding considerable attention in Czechoslovakia's electron-

ics efforts is automation. "Putting production lines under computer control is getting top priority," Hrouda says, and the reason is obvious—a shortage of labor. The effort works: Tesla's output doubled during the 1970-to-1975 period with only 6% more employees.

**Solid-state activity.** As for semiconductors, Tesla says it has microprocessors in development, but concedes it lacks the technology and equipment to get them into production soon. So, as one official points out, "it is more economical at present to import the microprocessors we need." They presumably come from the West and are intended for use by Czech research institutes.

When it comes to integrated circuits, though, Tesla clearly has solid know-how, especially in bipolar devices. There is also activity in metal-oxide semiconductors, and much work is said to be going on in research and development of ceramics, plastics, and materials.

Industrialized as Czechoslovakia is, it is only natural for the country to stress computers. R&D in the field, says the technology ministry's Vasko, started in the early 1950s, with first-generation machines coming off Czech production lines during the latter half of that decade. Second-generation versions followed soon thereafter. Typical for this class is the Tesla 200.

**More color TV sets.** For the consumer, production of color TV sets is to be stepped up considerably in an effort to get prices down. Color set production is running at about 50,000 units per year. This is to be doubled by 1980.

Color broadcasting started in Czechoslovakia in 1973. What has hampered its spread is the rather limited color signal coverage of the country, plus the relatively high receiver prices. Black-and-white and color installations total 3.7 million units in the New York State-size country with about 14 million persons. In 1975, about 450,000 receivers of both types came off Czech production lines. Of the monochrome versions, substantial numbers are being exported, including some that are going to West European countries. □

**By the numbers.** Numerical-control system from Tesla is typical of Czech-produced industrial equipment. This system, the NS440, is used to control cutting and forming machines.

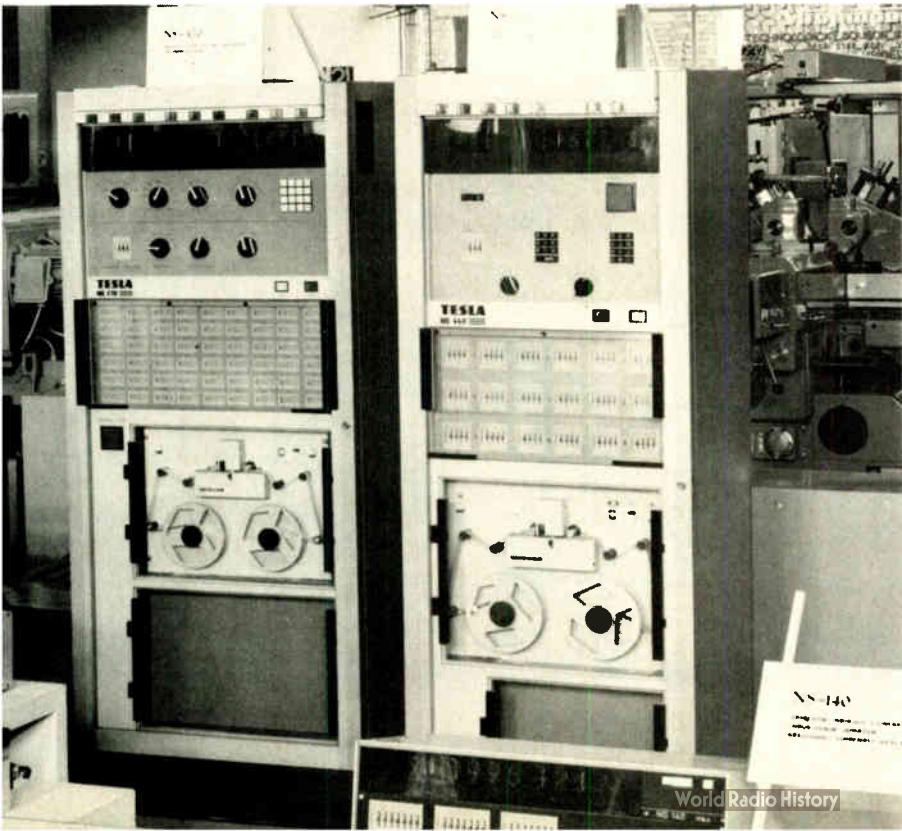

Commercial electronics

# L.A. buses to get monitoring system

---

Hoffman Information wins \$2.7 million Federal contract to install signpost transmitters and vehicle electronics for 200 units

---

by Lawrence Curran, Senior Editor

A minicomputer-based monitor promises bus passengers on seven routes in the Los Angeles area better service in the not-too-distant future. The progress of 200 buses of the Southern California Rapid Transit District will be checked by an automatic vehicle-monitoring system to be installed by 1979 by Hoffman Information Identification Inc., Fort Worth, Texas.

The wholly owned subsidiary of Hoffman Electronics Corp. late last month won a \$2.7 million contract from the Department of Transportation's Urban Mass Transit Administration to design, build, and install its signpost system—winning out over three other bidders [*Electronics*, July 21, p. 26].

The system will be able to pinpoint bus locations to within 300 feet or better and log their time to

---

**Forerunner.** Hoffman bus-monitoring system uses dispatch center similar to this one at Huntington Beach, Calif., police station.

within  $\pm 15$  seconds. Hoffman beat those specifications in tests conducted in Philadelphia during the winter of 1967–77. Those tests were conducted for UMTA by the Federal Transportation Systems Center, Cambridge, Mass.

With the data derived from the system, dispatchers will be able to observe and correct such conditions as buses bunching on a given route. For example, if a crowded bus is closely followed by one carrying far fewer passengers (as determined by an onboard counter), the dispatcher may radio the driver of the crowded bus to skip a stop, or direct the emptier bus to pass the crowded one. In this manner, the transit district plans to maintain schedules as closely as possible, keep uniform headway between buses on the covered routes, and achieve uniform loading of passengers.

Hoffman chose a signpost system similar to one it has installed for the Huntington Beach, Calif., police

department, which monitors 44 police cruisers over their random routes. That system ties into an existing computer-aided dispatch station.

**Signposts.** In the Los Angeles scheme, the signals from two adjacent signposts will be received by the bus simultaneously. The unique digital code from each signpost indicates the bus's direction, and by calculating the signal strength of the two, the minicomputer determines its distance from each of the signposts and hence its location.

The overlapping technique permits use of fewer signposts. Hoffman expects they will be two to three blocks apart in the Los Angeles area, and there will probably be one time-checkpoint signpost every mile. Part of the 16-bit code at those signposts identifies them as time checkpoints, and the data is time-tagged by

---

**Posted.** In Philadelphia test, Hoffman put its signpost-type transmitters on light poles: the black box just below the pole's arm.

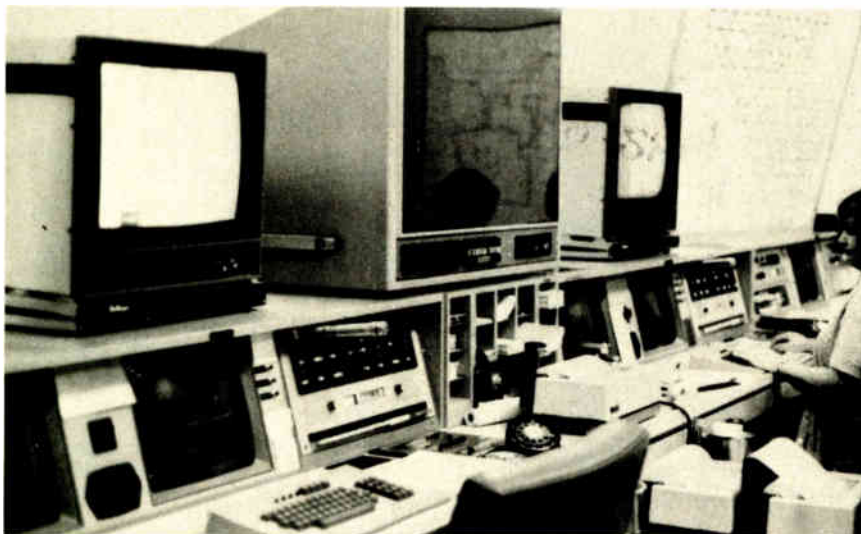



"Every now and again a very special new product is developed . . . like

## the new CURRENT GUN™ from F.W. Bell"

**NOW** you can read both  
**AC** and **DC** currents  
on any voltmeter!

**NOW** you can present a  
true reproduction of the  
current wave form  
on a scope . . . and for  
less than \$200!



The all-new economical Bell clamp-on Current Gun lets you read AC and DC . . . from 0 to 1 kHz and from 0 to 200A . . . accurately, quickly and safely. No need to break a connection. Merely squeeze the trigger and slip the probe over any conductor up to  $\frac{1}{2}$ " dia. The Current Gun is a product of the technology developed and proven in the Bell 1776 current meter . . . a world standard.

The Bell Current Gun has two ranges, 0 to 10A and 0 to 100A. Both have 100% overrange. Accuracy is  $\pm 2\%$ . Only three controls: zero, range selector and press-to-read button for extra long battery life (batteries rated for 30 hours full-time use).

Write today for complete specs on this lightweight, safe-to-use, portable and inexpensive new Current Gun from F. W. Bell, Inc.

**ACCESSORIES AVAILABLE**  
to greatly extend the  
Current Gun's range . . .  
both higher and lower!

*Fw*

*A Subsidiary of The Arnold Engineering Company*

**B**

**BELL INC.**

4949 Freedom Drive East  
Columbus, Ohio 43229  
Phone (614) 866-7501  
TWX 610-337-2851

**See it at WESCON Booths 1460 and 1461**

Circle 79 on reader service card

# Thin-Trim<sup>®</sup> capacitors



Tucked in the corner of this Pulsar Watch is a miniature capacitor which is used to trim the crystal. This Thin-Trim capacitor is one of our 9410 series, has an adjustment range of 7 to 45 pf., and is .200" x .200" x .050" thick. The Thin-Trim concept provides a variable device to replace fixed tuning techniques and cut-and-try methods of adjustment. Thin-Trim capacitors are available in a variety of lead configurations making them very easy to mount.

A smaller version of the 9410 is the 9402 series with a maximum capacitance value of 25 pf. These are perfect for applications in sub-miniature circuits such as ladies electronic wrist watches and phased array MIC's.

Johanson Manufacturing Corporation, Rockaway Valley Road., Boonton, N.J. 07005. Phone (201) 334-2676, TWX 710-987-8367.

MANUFACTURING CORPORATION

80 Circle 80 on reader service card



**Police package.** Vehicle unit for monitoring system is shown in police car's trunk.

means of a real-time clock signal from the base station.

One competitor in the Philadelphia tests also employed a sign-post-based system. Fairchild Space and Electronics Co. of Germantown, Md., used microwave signposts operating at 2.5 gigahertz. Hazeltine Corp. of Greenlawn, N. Y., competed as well, using a pulse-trilateration system at 1,000 megahertz and a network of receivers. Signals received at three of them were used to generate intersecting hyperbolic lines to determine bus location. The final competitor, Teledyne Systems Co. of Northridge, Calif., went with a Loran-C system that converted Loran coordinates into map positions to locate the vehicle.

**Black box.** For the bus system, Hoffman will provide the signpost transmitters; a black box aboard the bus linked to an ultra-high-frequency radio to receive, decode, store, and transmit the coded signpost signals; plus base-station equipment consisting of a fairly large minicomputer and interactive cathode-ray-tube displays to process and present the data to dispatchers.

In addition, George Gruver, program manager for automatic vehicle monitoring systems, says his company will supply some kind of display at four selected bus stops to inform passengers of the schedule status on that route. Finally, Hoffman will also provide a small display in the bus to let the driver know if he is ahead of or behind schedule. Gruver says that could use a light-emitting-diode display.

On the basis of the Philadelphia experience, the signpost transmitters will be powered by lithium batteries with an expected life of seven years

and will operate at 49.5 MHz. Charles Freney, president of Hoffman Information Identification, says each transmitter is turned on about once a second and broadcasts its 16-bit digital code. A receiver that is in the bus's unit picks up the signal, which is decoded there with the aid of a microprocessor.

The vehicle unit stores the time and location data, then transmits it digitally to the base station over a conventional uhf voice radio operating in a band from 465 to 475 MHz. For the Southern California bus system, the base-station computer will poll all 200 buses every 20 seconds, look up the signpost codes in a table, and display each vehicle's location on one of the two CRT displays—which may be color units—for action by the system's dispatchers.

Gruver says the class of minicomputer has not been determined, but its disk-contained data base will be able to store the required signpost codes and other information necessary to cover the 150 miles of Los Angeles County roadways covered by the system.

**Cheap.** Hoffman picked the signpost approach essentially because the company believes it is more economical than other systems. "Most people have known for some time that signposts work," he says, "but it's often thought that so many signposts would be needed that a system would be uneconomical." He maintains, though, that the Hoffman type of signpost transmitter is cheaper than a street light. Combined with the low power and narrow bandwidth required, this means that vehicle electronics can be inexpensive. □

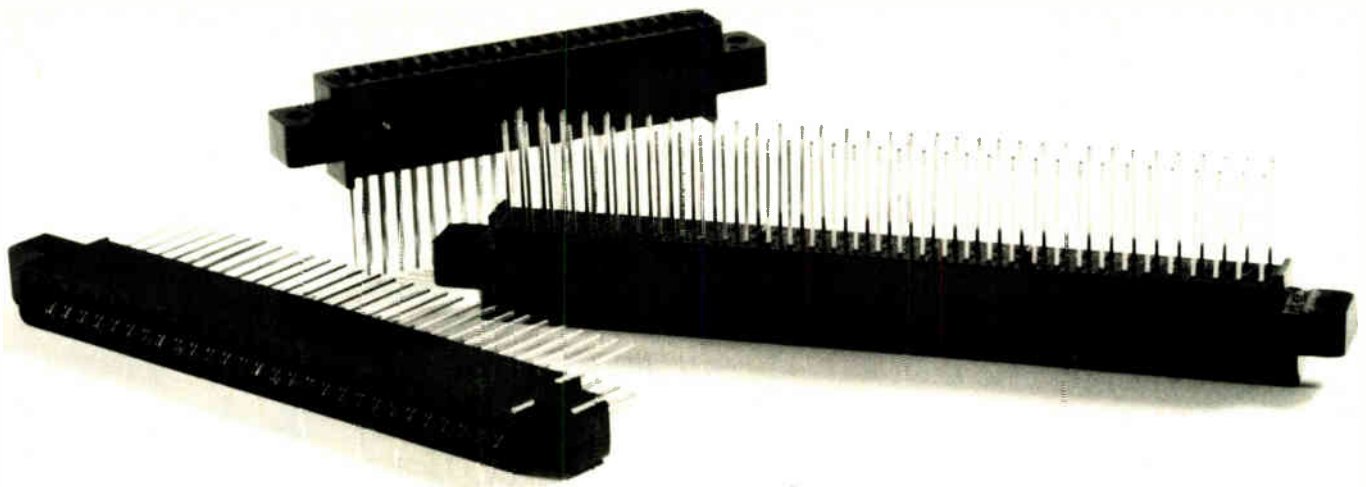

# Presenting our better-mouse-trap line. No frills at all.

When you cut price without cutting quality, soon no one thinks of it as a cut price. That's where our Norsman line of Wire-Wrap\* P/C connectors is headed. Here's why:

The insulator — it's tough, resilient, non-conductive — everything you need in a Wire-Wrap body. And it's made out of low cost phenolic, not the higher cost diallyl phthalate (if you need to meet mil specs, we have that in one of our other lines).

Contacts are semi-bellows and gold-plated — but

plated with our unique AuTac (TM) process. You get .000050" gold plate all along the mating surfaces for a sure, gouge-proof, pop-off-proof contact — but that's it. No wasted gold.

And you can find the size you need — Norsman is a full line from 15/30 to 50/100 contacts, in either .100 or .125 contact centers.

The whole Norsman idea is as simple as it is old: keep performance up and cost down. It works.

Send for details. We haven't told you everything.

\*Wire-Wrap — registered trademark of Gardner-Denver Company.

**Tell me everything.**  Send me detailed literature.

---

Name Title

---

Company Telephone

---

Address

---

City State Zip

---



## Viking

### CONNECTORS

Viking Industries, Inc./21081 Nordhoff St./Chatsworth, Calif. 91311/(213) 341-4330

Companies

# ITT Semiconductors stakes U. S. claim

Miller has a three-year plan for his division based on reinforcement of its role as 'very rapid follower'

by Lawrence Curran, Senior Editor

After a little more than a year as president of the U. S. division of ITT Semiconductors, Norman J. Miller acknowledges the strengths and weaknesses of his organization. He believes the division has established its reputation in certain computer components areas but must do better at penetrating the U. S. semiconductor market, is not a technology leader, and will not be a price leader.

So Miller has taken steps to improve things. He feels he has the right management team in place and has the financial backing of the parent corporation to pursue technology and second-source agreements that are already paying off. He will stake his and the division's reputation on delivering quality parts on time.

"We recognize where we are in the market," Miller says. "We're a follower, and we'll remain a follower for the next three years—but we'll be a very rapid follower" because of alternate-source agreements in the memory and microprocessor lines. Those agreements, combined with the purchase from Standard Microsystems Corp., Hauppauge, N. Y., of its coplanar metal-oxide-semiconductor process [*Electronics*, Aug. 4, p. 72], will allow the division to trade on its reputation as a supplier of transistor-transistor-logic circuits and discrete diodes and rectifiers to the computer market.

Based in Woburn, Mass., the U. S. division bought the SMC coplanar process rights last fall, engineered an exact copy of the Mostek 4027 4,096-bit random-access memory (the ITT 4027), and is offering samples to customers. Using the same process, the division will begin

offering samples of the Mostek 4116 16,384-bit RAM (ITT 4116) to select customers this month.

Miller says the three-year plan is to expand the division's base in the U. S. data-processing market with those RAMs and microprocessors, then take aim at the market for consumer integrated circuits, particularly for television sets, with the proven technology and reputations of ITT Semiconductors in Great Britain and Intermetall GmbH in Germany.

**A dissenting voice.** One Wall Street analyst questions that strategy. Sal Accardo, vice president and electronics analyst at Kidder, Peabody & Co., thinks it would be wiser for the U. S. division to quickly take advantage of the established positions of its British and European counterparts by tackling the consumer and telecommunications circuits business and to avoid the high-risk route of second sourcing in memories and microprocessors. "ITT Semiconductors does such an outstanding job in the consumer market

and secondly the telecommunications equipment market in Europe, they should pursue the same strategy in the U. S.," says Accardo.

"But to be in the 4-k and 16-k RAM business is a very high risk as a second source. That will be a commodity business like TTL, where the U. S. division has had only limited success. There are only three or four companies that can do that job. The rest will lie down and die."

Miller recognizes the commodity nature of the computer market for semiconductors and believes the U. S. division has demonstrated it can take the pressure. He points out that the discrete facility in Lawrence, Mass., has been supplying commodity diodes and rectifiers to the computer market very profitably for years. Gerald Bellis, director of discrete operations in Lawrence, is also getting the facility tooled up to move into the power market—in triacs, transistors, Schottky rectifiers, and power zeners.

The division produces ICs in West

**Talking it over.** Norman J. Miller, left, president of ITT Semiconductors' U. S. division, and Daniel del Frate, vice president and director of marketing, confer at Woburn, Mass., offices.



Palm Beach, Fla., where Miller instituted a yield-improvement program shortly after taking over as president. To date, that effort has led to a 16% improvement in yield, he says. Miller credits that success to Eric Burlefinger, recently named director of IC operations, who retains the title of technical director of U. S. semiconductor operations.

Rounding out the management team responsible for operations and marketing is Daniel del Frate, vice president and director of marketing for the U. S. division. Miller chose del Frate because of his solid experience in semiconductor sales and marketing, especially in the American market, "and especially his understanding of sales representative and distributor organizations," on which his division relies heavily, Miller says.

**Filling some holes.** Over the near term—the next several months—Miller wants to fill out both the discrete and IC product lines. That means continuing the push into power discretes, building volume in 4-k and 16-k RAMs, and implementing a second-source microprocessor agreement reached in July with Monolithic Memories Inc. That agreement covers the MM1 6701 bipolar 4-bit slice and related large-scale integrated parts. It could lead to ITT's second-sourcing the 2901A bipolar microprocessor and provides for a monthly information exchange.

Miller also expects to have a second-source agreement giving ITT an MOS microprocessor family by year's end and by then will have fleshed out the low-power Schottky IC line from 68 circuits in production in July to 108.

Beyond those moves, his goal is to make the division recognized as one that meets its delivery commitments.

His prime goal is to reduce returns and "deliver a minimum of 85% of all line items on the first factory commitment date. We've done that in Lawrence, where the cycle time is inherently less for ICs." Front-end wafer cycle time—production time at that stage—has been cut at West Palm Beach, as well. Now a major program is under way to do the same in assembly. "We'll stake our reputation on service and delivery of commodity products," says Miller. □

# That's Plenco in these AB DE-ION® Circuit Breakers.



## Westinghouse checks off why.

A complete line of circuit breakers from Westinghouse Low Voltage Breaker Division, Beaver, PA. Designed for diversified and demanding use in power distribution applications.

Westinghouse engineers checked off the reasons our Plenco 414 Black phenolic molding compound was selected for the breakers:

- "Plenco 414 has dimensional stability."
- "It meets our heat-resistant requirements."
- "Has good impact resistance."
- "Passes UL 489 tests."
- "Is available as asbestos-free material."

An easy mold, fast cure heat-resistant/electrical compound. Like many of our thermosetting Plenco phenolics, it lends itself to the compression, transfer and screw-injection molding methods.

More than likely we can provide a thermoset to suit your particular application and method. Give us a call and check. (414) 458-2121

**PLENCO**  
THERMOSET PLASTICS

PLASTICS ENGINEERING COMPANY  
Sheboygan, WI 53081

Through Plenco research... a wide range of ready-made or custom-formulated phenolic, melamine-phenolic and alkyd thermoset molding compounds, and industrial resins.

Components

# Will V-MOS make it in power market?

Siliconix expects technology to win price and performance honors against bipolar competitors in \$200 million arena

by Lawrence Altman, Solid State Editor, and Lucinda Mattera, Components Editor

The \$200-million-plus power-transistor market is under attack by an intruder with a new technology. The intruder is Siliconix, a relatively small (\$30 million) California-based specialty manufacturer of field-effect transistors, data converters, and digital stopwatches. The new technology is v-MOS.

How far this Santa Clara firm can take its V-groove metal-oxide-semiconductor power technology in a market dominated by bipolar devices manufactured mostly by large electronics firms is anybody's guess. Art Fury, vice president and marketing manager, makes the case for v-MOS: "We think v-MOS could grab as big a piece of the power market as n-channel MOS is grabbing in the digital market. We'll beat them on performance and we'll beat them on price. We're practically betting our company on it."

**\$1 apiece.** And Siliconix is beginning to deliver, recently introducing three v-MOS 12.5-watt, 2-ampere power transistors in plastic packages for logic-interface applications that will sell for about \$1 in 100-up quantities. That is about the same price as comparable bipolar transistors.

Moreover, the company is readying new, formidable products aimed at the high-voltage, high-current area and the radio-frequency market. Coming in the first quarter of next year are 10-w MOS field-effect transistors for continuous-wave operation at 400 megahertz and 80-w cw devices operating at 100 MHz. For high-power applications, Siliconix is preparing samples of 100-v, 15-A devices, 200-v, 7-to-10-A devices, and 400-v, 4-to-5-A devices.

Thus, Siliconix will challenge bi-

COMPARING V-MOS AND BIPOLAR POWER TRANSISTORS		
Description / use	Bipolar	V-MOS power field-effect transistor
Control mechanism	current	voltage
Bias requirements	normally requires reverse bias	normally off with no bias
Charge carrier technology	minority-carrier injection	controlled by majority-carrier field
Switching speed	100 ns or so	10 ns or so
Rf input impedance	low, limits bandwidth	high, easily matched, permits broadband designs
VSWR range	varies, depending on device	unlimited from short circuit to infinite
Saturation on-resistance	negative temperature coefficient	positive temperature coefficient
Input drive required	< 2 volts, milliampere currents	10 volts, nanoampere currents

SOURCE: SILICONIX INC.

polars in all major areas of the power market. "With this line in full swing," says Fury, "we'll be in a position to range across the whole field. We think we can fill a lot of bipolar sockets, and create a lot of new ones as well."

**The reaction.** But that will not happen if bipolar power-device manufacturers can help it. While many firms are looking into v-MOS technology for power applications, there is considerable skepticism about its virtues and many more reservations about its reach than at Siliconix. In fact, most traditional suppliers see v-MOS FETS as potentially interesting mainly for the high-frequency area.

"Because of its low driving current, v-MOS seems to lend itself to high-frequency applications," notes Donald Watson, director of marketing for power devices at RCA Corp's Solid State division, Somerville, N. J. "On the other hand, the direct cost of manufacturing is high compared to bipolar devices because the process is more complex." RCA is currently evaluating the viability of v-MOS and expects to conclude its investigation in 3 to 6 months.

Further along in its v-MOS effort is Motorola Semiconductor Products Inc., Phoenix, Ariz. Since the beginning of the year, the firm has been sampling a 1-w, 175-MHZ v-MOS power FET, which it expects to introduce officially by year's end. For next year, the company plans to ready a full line of v-MOS FETS for rf applications, says Harry Kosci, product marketing manager for FETS.

"We don't see power FETS as competition to present-day bipolar devices," asserts John Hey, manager of power components at General Electric Co.'s Semiconductor Products department, Auburn, N. Y. The company is presently evaluating the power-FET technology.

**No panacea.** Also looking into various techniques for doing power FETS is National Semiconductor Corp., Santa Clara, Calif. "v-MOS is really not a panacea, and I do not see it as a major competitor of bipolar technology in the next five years," says Mike Turner, product marketing manager for FETS. "It's going to take a major power house and a good second source to make it go." □



# The keyboard switch with a heart of gold

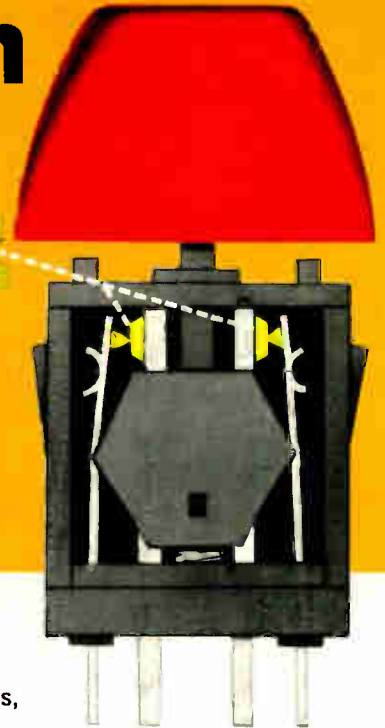

**...keeps your product WORKING year after year... after year.** In your keyboard or ours,

Cherry key switches just don't fail. The knife-edge contact area is so small! (9 millionths of a square inch)... the contact pressure so great (about 5,000 psi)... the gold alloy so pure and film-free... that you are assured of positive contact every time. For 50 million operations and beyond. (Which is probably beyond the life expectancy of your product!)

Cherry "heart of gold" keyboard switches are available individually or with two-shot molded keycaps. Hopefully, you want keycaps. Because, *we have keycaps*... in more legends, sizes, type faces than you're likely to find anywhere else. Sculptured keycaps? We've got 'em. Gloss or matte finish? We've got *both*. Colors? Lighted? Specials? Sure! Some "off the shelf"... all at prices that make it obvious why the *Cherry way* is the *economical way* to put a heart of gold in any keyboard.

See Us At  
Wescon  
San Francisco  
September 19-21  
Booths 1521-27

For free test sample switch and catalog, just  
TWX 910-235-1572...  
or PHONE 312-689-7700



**CHERRY ELECTRICAL PRODUCTS CORP.,** 3608 Sunset Avenue, Waukegan, IL 60085

World Radio History

Cherry switches now available locally from distributors.

Circle 85 on reader service card



Series 401



Series 800



Series 10



Series 600



Series 925



Series 90



Series 440

Series 10, Circle Reader Service No. 269  
Series 90, Circle Reader Service No. 270  
Series 440, Circle Reader Service No. 271  
Series 481, Circle Reader Service No. 272

Series 600, Circle Reader Service No. 273  
Series 800, Circle Reader Service No. 274  
Series 925, Circle Reader Service No. 275



Modern electronics demands switches of all types. Switches capable of withstanding the most rugged working conditions. And giving reliable service that continues throughout the life of the systems they serve.

The same electronic technology demands displays that speak to you clearly. Conveying vital information without confusing the issue.

MSC manufactures a wide range of switches and displays that meet the many applications of today's technology. All have unique characteristics which help to make your system just that little bit more easy to operate and comprehend.

Small wonder that MSC switches and displays are an everyday word in avionics, military and shipboard applications. And in computers, telephone panels and hundreds of other uses which have a daily influence on your life.

Take a look at the variety:

#### **Series 10**

This rugged, versatile four lamp pushbutton switch has become the standard of the industry with many diverse applications in control panels for ships, oil fields and power generating plants, just to name a few. This switch has UL approval, is QPL (MIL-S-22885/9/10) listed and features positive indexing and front panel re-lamping without tools. RF protection, solid state switching, and "high shock" modifications are available as options.

**Series 90**— This two lamp pushbutton switch is cased in stainless steel and is resistant to most environmental extremes. A favorite of designers everywhere because of its overall versatility and the wide variety of terminations available for low cost assembly. Standard features include: UL approval, QPL (MIL-S-22835/58), relamping and legend change from front panel without tools, and a wide choice of switch actions.

**Series 440**— This switch series provides the electronic designer with a microprocessor compatible, touch activated solid state switch. The 440 switch becomes part of the electronic circuitry without the need for interface. Because it is a capacity transducer, the reliability of the switch equals that of any transistor. The compact design eliminates the need for deep panel clearance. The touch face incorporates an optional LED as a visual activation indicator.

**Series 481**— A true solid state electronic "thumbwheel" switch with the same design advantages as the Series 440. Incorporating two series 440 switching functions with an encoder/decoder/driver IC which makes an all solid state lighted thumbwheel switch with true BCD output. The seven segment LED display occupies the center section of the switch plate. The bottom plate advances the count and the top plate resets the switch to zero.

**Series 600**— The Series 600 computer-grade switch is the most versatile switch in its class; unmatched performance is provided by the

sliding wiping action contact design unavailable in any other line of low-cost, computer-grade lighted push button switches. Available in many different mounting configurations, sizes, styles and colors, the 600 also offers a wide choice of switch actions.

**Series 800**— Ideal for matrix mount applications, this four lamp pushbutton switch is available in two display face sizes. A standard 3.4" square and a 3/4" by 1" provide the flexibility needed in panel design. Standard features include positive indexing and front panel relamping without tools. Optional solid state models and electrical interlock holding coils are available. The 800-H has received MIL-S-22885/74/30 approval.

**Series 925**— Designed to meet MIL-R-28803, the 925 offers sunlight readability, required for avionic displays and other control panels used in high ambient light conditions. Utilizing fiber optics, this compact unit can be ordered with 7 or 16-segment displays. Other sizes and character configurations are also available. All MSC fiber optic displays are re-lampable and replaceable from the panel front.

Switch on to MSC today by circling the numbers of the products in which you're interested on the enclosed reader card.

# Switch



# MSC

Worth Switching To  
Master Specialties Company, 1640 Monrovia,  
Costa Mesa, CA 92627, Telephone 714/642-2427

# General Purpose Oscilloscope

New, Quick,  
Accurate,  
Convenient

EXPLORER II is a remarkable new general purpose oscilloscope, a digital oscilloscope. It is for use in exactly the same applications as low frequency analog oscilloscopes. What makes it remarkable is its combination of high precision, versatility, and convenient, hassle-free operation in both ordinary and demanding situations.

Imagine, for example, being able to touch a button to "freeze" the waveform on the screen. If you wish, the live waveforms continue, superimposed, so you can see changes while they are occurring. Then you can zoom-in on any detail of interest, with high magnification, to see changes as small as 0.025%. The stored waveform has almost unbelievable detail. It would take an analog storage 'scope with a screen area 400 times greater than usual to capture the same detail.

It has some long-needed conveniences such as automatic trace centering, with simultaneous numerical display of the voltage and time corresponding to screen center, so you know where you are. It has non-fading storage, which doesn't require adjustments, manual erasure, mode switching or sweep arming. It has automatic perfect persistence. Waveforms stay until replaced by the next to occur, when you wish. It has a numerical display of the true voltage and time corresponding to any selected point — with respect to zero or with respect to any other point.



EXPLORER II

There's a lot more to EXPLORER II. But a simple listing of features doesn't tell the story very well. You really have to see it in action, or better yet, use it. Then, we think you'll agree — It's some 'scope.

Plug-in units include model 204, which has 50 ns rise time; model 205, a single input, 500 ns rise time, high precision unit; model 206, a two channel unit similar to model 205; and model 201, a one millisecond rise-time, 10  $\mu$ v, ultra-stable unit for measuring slowly changing variables. Price \$4400 with model 205 plug-in unit.

**EXPLORER III** is an EXPLORER II with an added module. This module provides two more features: an internal magnetic disk memory, and a digital input/output port to allow interfacing to computers and the fine HP 9825 calculator. The combination of an outstanding digital oscilloscope, the recorder, and the interface to processors or calculator make it possible to handle a wide range of signal acquisition and analysis problems conveniently, and less expensively. These EXPLORERS are new versions of EXPLORER I, now in use in hundreds of laboratories all over the world.

EXPLORERS II & III are identical, except for these two features. An EXPLORER II may be converted to an EXPLORER III by the addition of the third module shown.

The diskette can accept waveforms or recall them for viewing, in two seconds. Recordings may be on manual pushbutton command or in automatic sequence as the signals occur. Disks are removable for filing or for other EXPLORER III's to read.

## There's more you should know about the EXPLORERS.

These are revolutionary new oscilloscopes. It's just not possible in this space to adequately discuss the significance of their extraordinary features and characteristics. We suggest that you write for a brochure, or call Jim Bartosch to arrange for a demonstration at your laboratory. (608) 271-3333.

**NTC** NICOLET  
INSTRUMENT  
CORPORATION

5225 Verona Road  
Madison, Wisconsin 53711  
Telephone: 608/271-3333

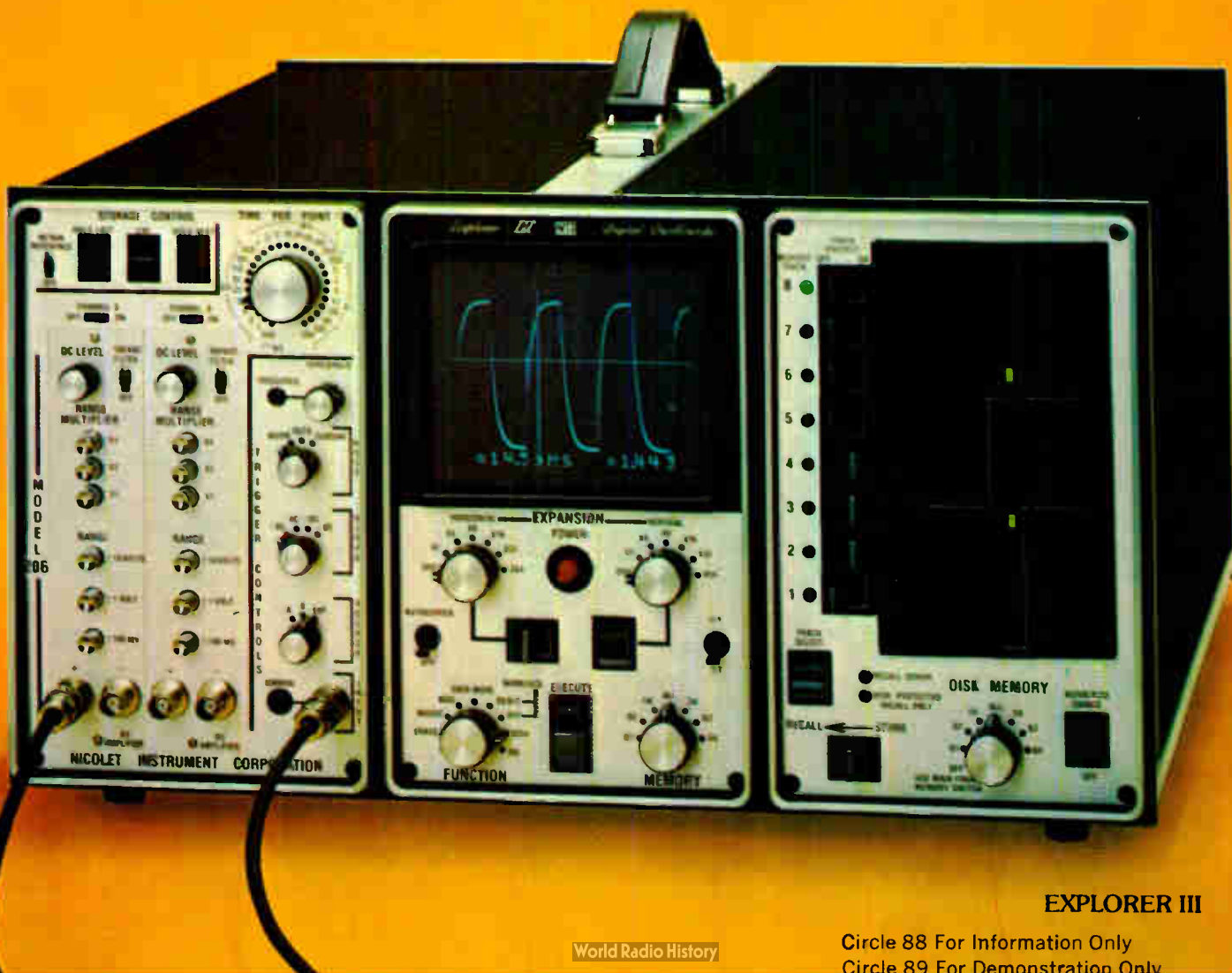

EXPLORER III

# Expand your options with Amphenol® connector systems.

You'll find more ways to get a job done fast and economically. Why settle for less?

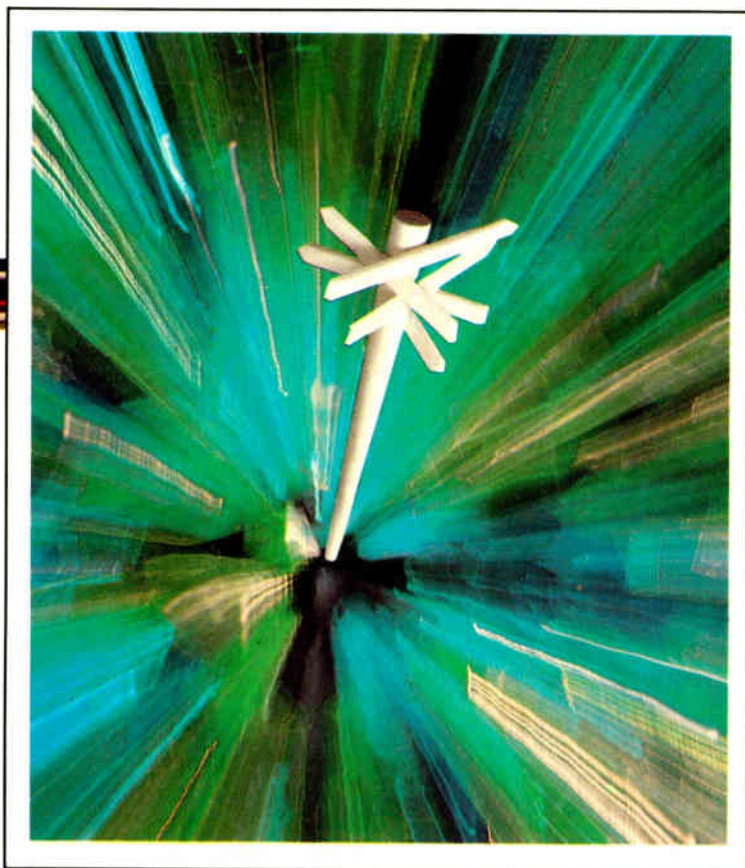

You can get the tried and true in connectors from us. Or you can challenge us to come up with something that's right out of tomorrow's headlines. We're loaded with ideas.

In fact, there are literally thousands of different kinds of Amphenol connector products. Those are pretty good odds, whether you're looking for cost-cutting connectors for business equipment or consumer electronics. Or connectors for data or word processing or telephony. Or a full line of Mil-Spec connectors. Or connectors for aerospace and nuclear applications.

Visit us at  
**WESCON/77**  
Booths 211-214

But we promise you more than an expanding product line. We'll provide proper means of terminating too. There's also our extraordinary quality. Our prompt delivery from our close-to-you distributors. Our personalized technical help. Perhaps what you need now in connectors is shown here. If it isn't, just ask.

Our ideas. Your ideas. They're right for each other. To learn why, just call us at (312) 986-2320 or write to: Amphenol North America Division, Bunker Ramo Corporation, Dept. A97B, 900 Commerce Drive, Oak Brook, Illinois 60521.



Our 32 Series Fire-Plug™ connector lives up to its name. It meets UL 94V-O flammability tests. Mounts on panels without tools. For commercial, industrial and consumer products.



Precision in coax. New subminiature APC-3.5 precision connector ensures mode-free operation through 34 GHz.



Quick change from multi-line to single-line phone service. With our modular adapters. Six-contact jack takes new plug-in cords.

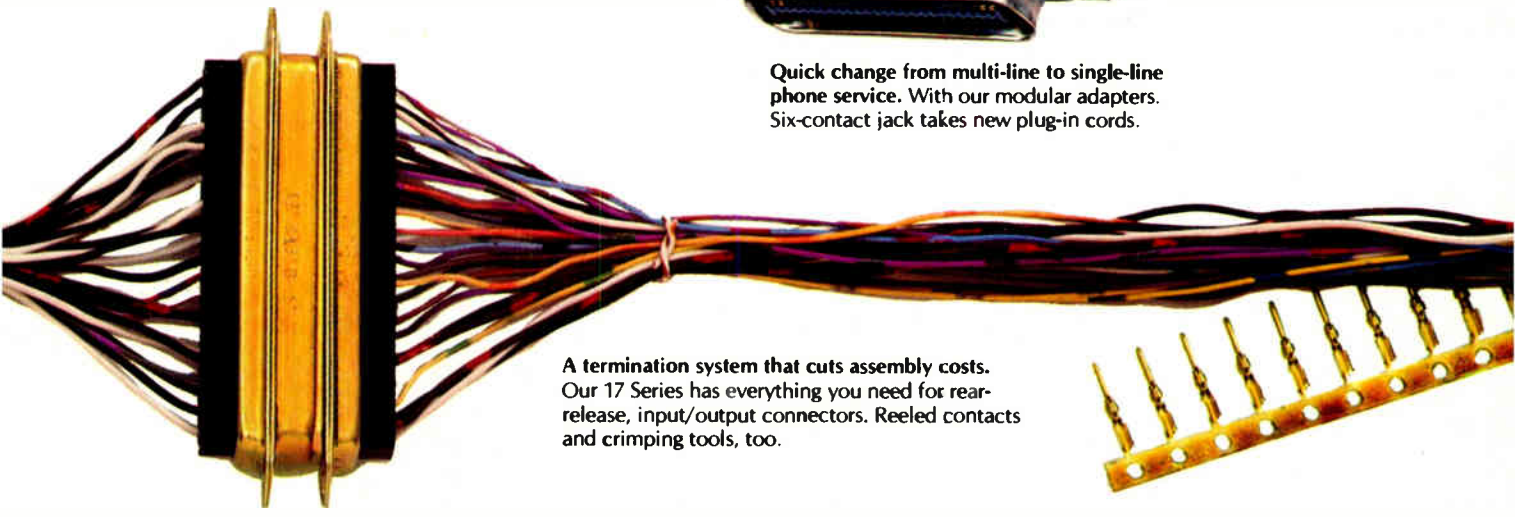

A termination system that cuts assembly costs. Our 17 Series has everything you need for rear-release, input/output connectors. Reeled contacts and crimping tools, too.

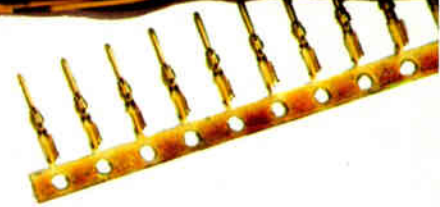

Safety-first power distribution connectors. This 229 Series has integral ground, arc-quenching, and watertight seals.



Circular power connectors. The 97 Series has heavy experience in all kinds of consumer, industrial, and business equipment. It's for rack-and-panel installations and has pre-aligned contacts for quick, easy soldering. Hundreds of configurations for connecting computers, TV's, machine tools, you-name-it.

The right idea  
at the  
right time.

**AMPHENOL**



# TEST DATA

## low profile

**“...TWO contacts are not more reliable than ONE!”**

Surprisingly, a low profile (.150" high) DIP socket is a different breed of cat when it comes to engineering in contact reliability. Most standard DIP sockets have dual contacts. (R-N's dual "side-wipe" contacts are among the most reliable in the industry.) But, when you shorten the contact length to achieve the "low profile" you lose a great deal of contact force and IC retention strength. So, to achieve effective low profile socket reliability you must redesign the contacts and make them out of the strongest contact material available.



Low .150" profile of ICL socket reduces board density by 26%.

AVERAGE  
3.5 oz.  
minimum  
withdrawal  
force

Fat-Skinny **TESTS PROVE\*** that R-N "back fold side-wipe" SINGLE CONTACT design for low profile sockets provides—  
**4 TIMES BETTER IC RETENTION FORCE** than competitive low profile dual-leaf sockets

Minimum withdrawal forces:

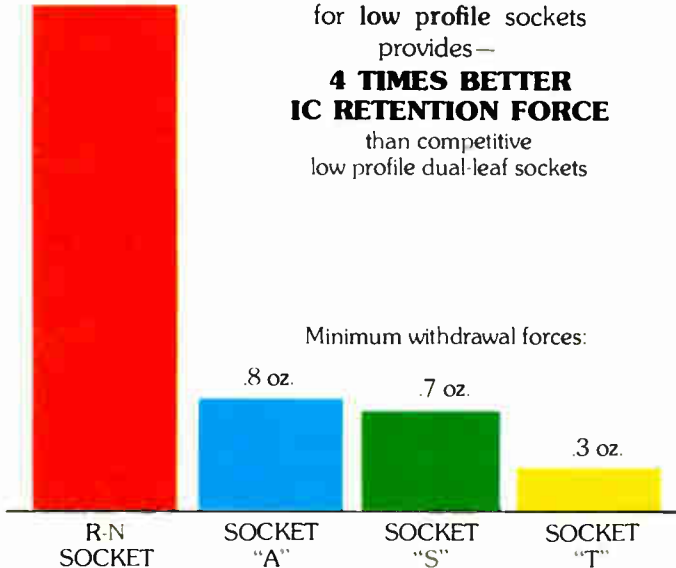

\* In "Fat-Skinny test," withdrawal forces are measured using the smallest size (.008") lead after insertion of largest size (.012") lead.

### Representative NORMAL FORCE Test Scores for 10 R-N ICL low profile sockets

TEST SOCKET	NORMAL FORCE *
1	410 grams
2	465 grams
3	480 grams
4	465 grams
5	395 grams
6	425 grams
7	465 grams
8	395 grams
9	410 grams
10	425 grams

AVERAGE — 430 grams

This force is 4 to 5 times greater than average dual contact socket NORMAL FORCE

\* NORMAL FORCE means force perpendicular or at right angles to IC lead. The single ICL contact exerts this kind of force against the IC lead when inserted into the socket.



High  
reliability  
IC sockets  
... we've got  
'em all!

# DEBUNKS

## DIP socket MYTH



### UNIQUE R-N SINGLE CONTACT DESIGN PROVES SUPERIOR

Tests prove that R-N "back fold side-wipe" single contacts exert up to 4 times greater holding force on your IC leads than competitive low profile dual leaf contacts.

In a tough, 50-G shock test of 25 ICL sockets — not a single IC package came loose from the socket! More convincing proof that vibration problems are ended with R-N's new low profile ICL sockets. Socket density in multi-layer board can now be increased **without** sacrificing reliability.

... and this FULL LINE of low-profile R-N ICL sockets is priced very, very competitively.

Beryllium copper for 36% greater contact strength than other commonly used contact alloys.

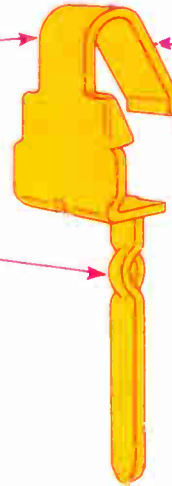

"Back fold" contact design provides longer spring contact for maximum pressure against IC lead.

Self-lock leads hold socket firmly during high speed wave soldering. Also, this "bump" restricts solder flow and prevents solder wicking.

"Side-wipe" design meets flat, smooth side of IC lead for perfect contact.

Check into the low-profile ICL sockets that deliver the high density dependability you need. New R-N catalog contains complete test data on insertion-withdrawal forces. Write today.



# RN ROBINSON NUGENT, INC.

800 East Eighth Street, New Albany, Indiana 47150 • Phone: (812) 945-0211—TWX: 810-540-4082

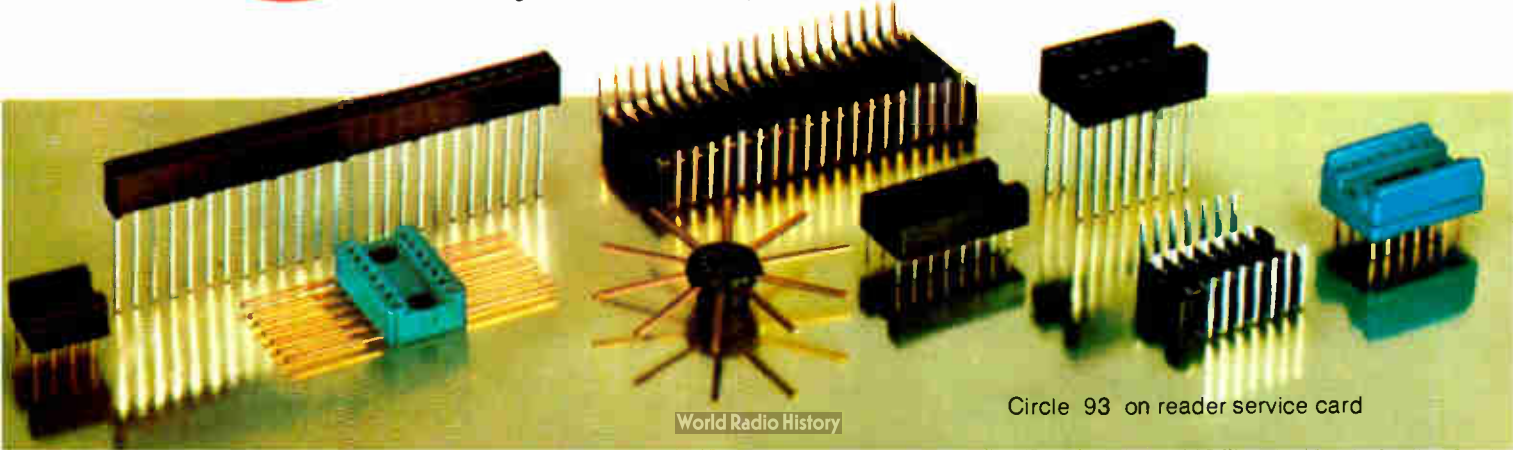

**Before the board meets  
to discuss rising  
service costs,**

**call Tektronix**





## Our new 851 Digital Tester can give you the leverage to control those costs.

Managing a service organization is no bed of roses. It's big business. And it's continually getting more costly. Customer engineers, spare parts inventories, training, designing for serviceability, documentation, and instrumentation all contribute to these spiraling costs. Because service is so important to the success of a company, you need to identify those elements which have the greatest leverage for your service organization.

### Consider instrumentation.

Typically it is less than 5% of your overall service budget. Yet the right test instrument can have a tremendous impact on the other 95%... training, salaries, inventory requirements, travel and backup.



That's why we built the new 851 Digital Tester. It's a synergistic, new service instrument that combines the

functions of many instruments in one portable package.

We know that the task of servicing digital equipment is threatening to outrun existing service resources. Your first-line customer engineers are being required to make more intricate measurements on increasingly complex systems.

With the new 851, your first-line customer engineer will be able to solve more problems in less time on the first call. That's because he can rely on the measurement and interpretation capabilities of the 851 to perform complicated tests in the field. Not only does this save you the expense of calling in the back-up engineer, but it also gives your first-line engineer the satisfaction of solving more problems on the first call.

### A new concept in service instruments.

Your inventory of service instruments probably includes oscilloscopes, DMM's, counters, timers, logic probes, thermometers, and some special purpose test equipment.

A bench full of test equipment is a great resource for your customer engineer to rely on... as long as he doesn't have to travel much.

But imagine a self-contained service instrument that weighs only 13 pounds and makes most of those same measurements.

That's our new 851 Digital Tester.



The power of the 851 lies in the fact that even though this one instrument makes the measurements of a variety of test gear, it is also easy to use.

With just one turn of the knob you can dial 22 different functions to make a wide range of system measurements and tests.

### 851 Functions

MEASUREMENTS	TEMPERATURE	SIGNAL ANALYSIS	SELF TEST
VOLTAGE PEAK (25 ns to 25 ms)	TEMPERATURE TIME (20 ns to 10 s)	LOGIC STATE INDICATORS HI, LO, INVALID, ACTIVE	TEST SIGNAL EXERCISE FUNCTIONS
AC	PERIOD	% DUTY FACTOR	ADJUST PROBE
DC	FREQUENCY	COUNTING	READOUT TEST
POWER LINE	PULSE WIDTH	FREQUENCY RATIO	
INPUT LOGIC	INTERVAL	EVENTS BETWEEN START AND STOP PULSES	
THRESHOLDS	COINCIDENCE	TRANSITIONS BETWEEN START AND STOP PULSES	
RESISTANCE (0.1Ω to 50 MΩ)	TRANSITION	TOTALIZE	

It's easy. Just dial a function, probe the circuit being examined, and read the results directly from the auto-ranging LED display.

### And what about product support? With Tektronix, it's worldwide.

Wherever in the world your service organization goes, Tektronix is with you all the way. Service personnel at 46 Tektronix Service Centers in the U.S. as well as service personnel in 50 other countries back our products.

### Put the 851 to work in your digital service environment.

The measurement capabilities of the 851 make it particularly useful for servicing computer peripherals, small business systems, and industrial control equipment.

We had you in mind when we designed the 851 Digital Tester.

For a demonstration, visit the TEKTRONIX booth at WESCON. Detailed specifications, application notes and a color brochure are also available for your information. Please contact your Tektronix Field Engineer. Or write Tektronix, Inc., P.O. Box 500, Beaverton, OR 97077. In Europe, write Tektronix Limited, P.O. Box 36, St. Peter Port, Guernsey, Channel Islands.

## New concepts in digital service

**Tektronix**  
COMMITTED TO EXCELLENCE

For Technical Data circle 94 on Reader Service Card  
For Demonstration circle 95 on Reader Service Card

If you know signal generators, you know they're typically high-dollar items. You can pay \$6,000 or more for a phase-locked unit, and a programmable with all the goodies can go for \$10K and up. But our Model 3001 is the exception.

First of all, the 3001's base price is just \$2,750. That buys you full frequency programmability, 0.001% accuracy, 1 to 520 MHz frequency range, stability of 0.2 ppm per hour, built-in AM-FM capability, and a front

panel that was actually designed for the user.

Now let's talk options. One lets you lock the 3001 to either an external frequency standard via rear panel BNC input or an internal reference frequency standard with  $5 \times 10^{-7}$  per day stability. And there are others like reverse power protection and auxiliary RF output. But even if you took all these options, you couldn't spend more than \$3,650. Simple arithmetic says

that it's still a lot cheaper to buy two loaded Wavetek 3001s than one Brand X.

At any rate, ask for a Model 3001 demonstration. If the economy alone isn't enough to get you, the performance will. WAVETEK INDIANA, P.O. Box 190, Beech Grove, Indiana 46107, Telephone (317) 783-3221, TWX 810-341-3226.

# WAVETEK®

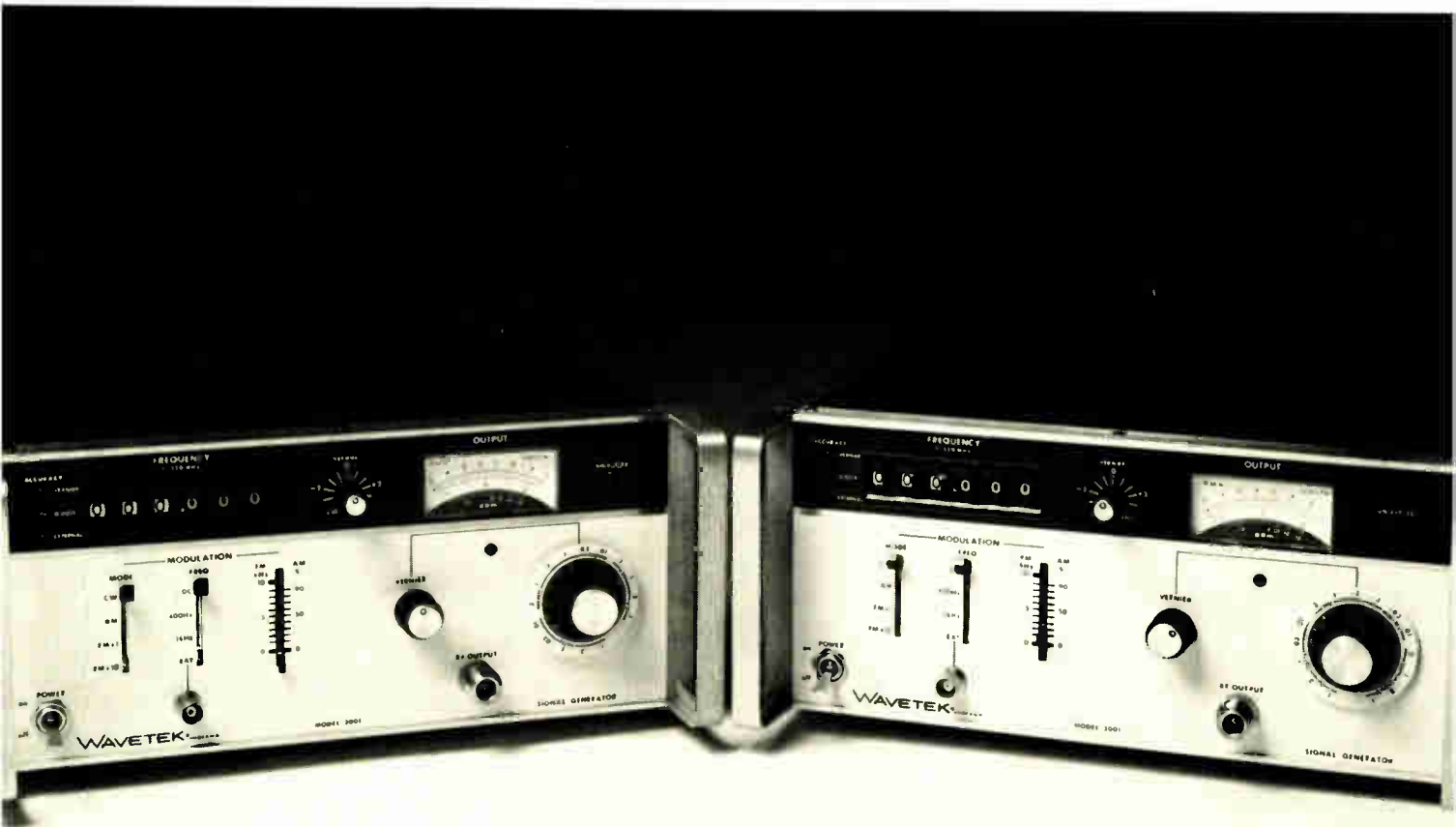

# Get two Wavetek for the price of one Brand X.

Circle 96 on reader service card

World Radio History

# Flexible circuits bend to designers' will

Now competing with rigid boards, flexible printed circuits can form connections in several planes, as well as saving weight, unit assembly time, and money

by Jerry Lyman, *Packaging & Production Editor*

□ After being overshadowed for years by rigid circuitry, flexible printed circuits are moving out of their niche in the military and aerospace industries and into all areas of electronics, especially computer, industrial, consumer goods, and automotive systems. In fact, because of their cost effectiveness as an interconnect technique, it is now mandatory at many firms to try a flexible design first.

The most common manufacturing method starts with a substrate composed of sheets of thin copper, adhesive, and flexible insulating film laminated together. After lamination, circuit patterns are etched on the copper side of the substrate. The resulting device can be used as a harness, a pc board, or a combination of the two. Sanders Associates Inc., Manchester, N. H., originated flexible circuitry in 1952, when it developed this technique for a military application in which space and weight were at a premium.

For example, Fig. 1 shows a military system that has

been converted from rigid boards plus wiring harnesses to a flexible circuit. These photographs illustrate one of the main advantages of flexible circuitry—its ability to be shaped into more than one plane or to conform to an irregular package. Such circuits can also be folded up to save space—say, in a small module—and can branch off in many directions, as shown in Fig 2.

### Flexing the circuit

Another advantage of this kind of circuitry is its ability to be continually flexed from a small folded or rolled-up configuration to its full length. This ability accounts for the popularity of flexible-circuit harnesses in the moving members of plotting boards and magnetic disks.

Flexible circuits are also extremely thin. Their thickness runs from 4 to 11 mils on average, whereas a typical two-sided rigid board is 62 mils thick. And such thinness,

**1. Flexible vs rigid.** A control box from a military system is shown in both its rigid (left) and flexible circuit versions. Note the clean, uncluttered package of the flexible-circuit system. Converting a system of this type to flexible circuitry cuts size, weight, and assembly time.

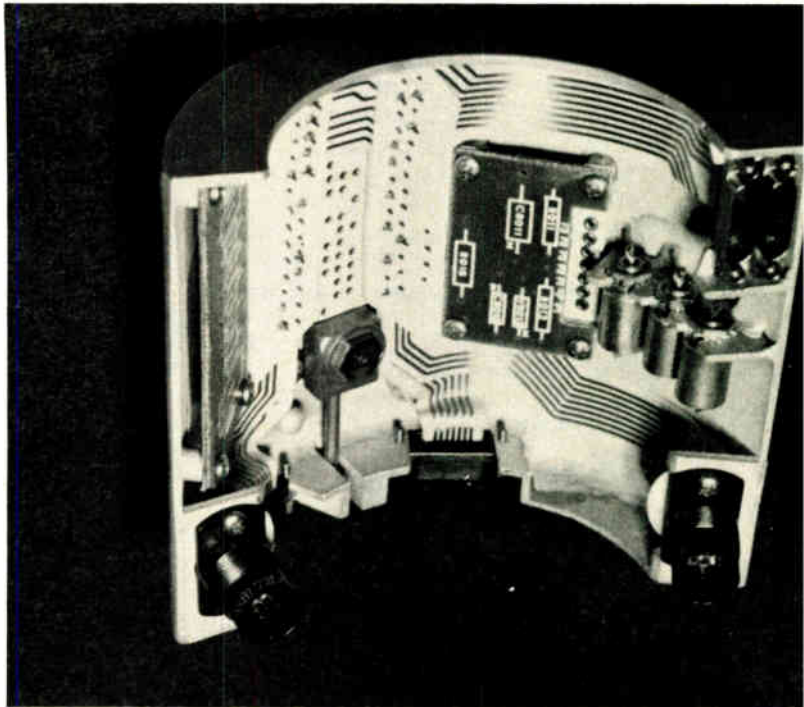
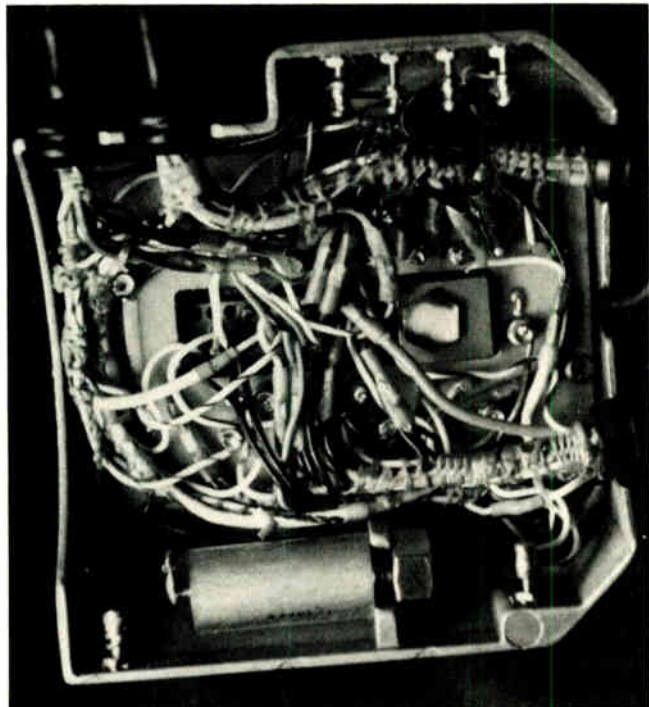

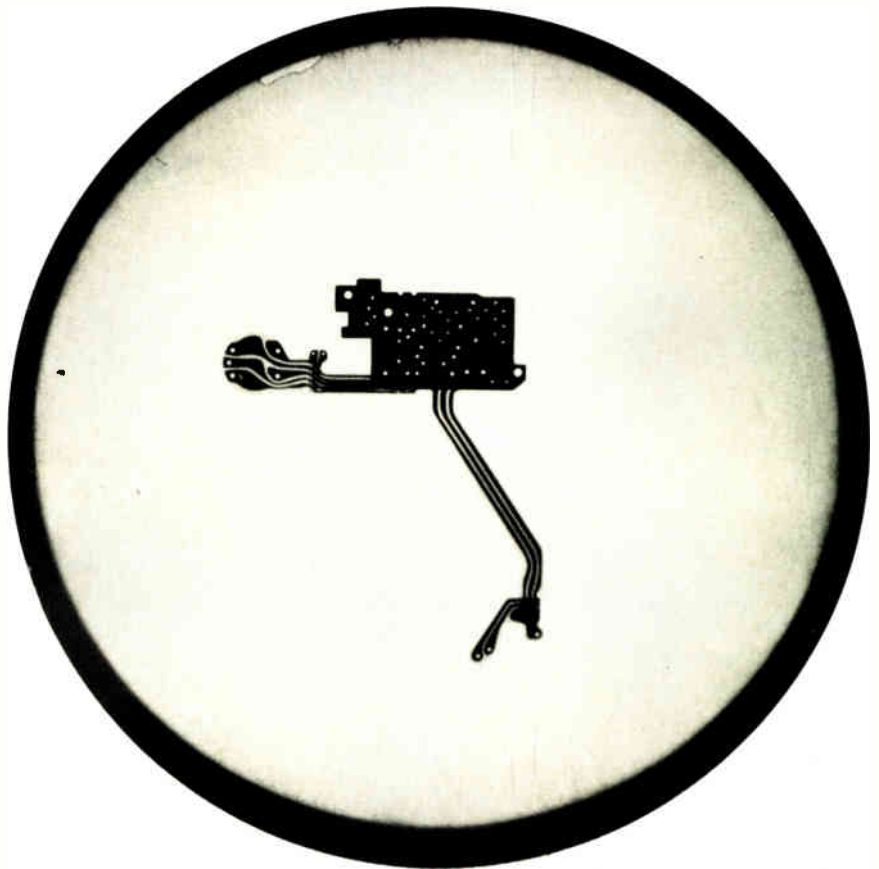

**2. Multiplanar.** Flexible printed circuits can be shoehorned into spaces where rigid circuitry could not possibly fit. This flexible printed circuit is bent into four planes and has two 180° fold-over sections to provide circuit reversal. End use of the board is in a portable movie camera.

plus the lightness of the insulating film, automatically brings with it a drastic reduction in weight.

Nowadays, most flexible circuits are replacing complete interconnection systems rather than individual hardboards. In these cases, in addition to saving space and weight, they eliminate wiring errors and cut testing time, rework, and assembly costs. Vic St. Amand, marketing director of Teledyne Electro-Mechanisms, Nashua, N. H., gives these examples: an avionics black box redesigned by his company's engineers with flexible circuits saved 129 hours per box in assembly time and cut weight 29%. A similar conversion of another military system cut 140 hours off unit assembly time and reduced weight by 50%.

If pins, wires, or plated-through holes are placed at its terminations, flexible circuitry can also eliminate the need for a connector. Still another advantage is shock-resistance. Vibrations and shock that would crack a rigid board have little or no effect on flexible circuits. That is why they appear in such diverse equipment as missile electronics and watch modules.

### Drawbacks

Of course, flexible circuitry does have its disadvantages. One is that for high-frequency work it is difficult to control the characteristic impedance of transmission lines formed by the laminated system used in flexible designs, because of the many variations in the thickness of the layers of copper, adhesive, and film. Also, many users of flexible circuitry claim that it is difficult to use with automatic component-insertion equipment without the addition of hardboard stiffeners. However, Teledyne

Electro-Mechanisms routinely inserts components automatically on unsupported flexible circuits.

What held back the growth of flexible circuitry in spite of its obvious advantages over the rigid-board-plus-harness technique? One factor was problems with materials. Early insulating films were unstable during processing, causing poor yields, a limited capability to hold tight dimensions, and poor solderability. Another problem was a lack of connectors and termination methods to interface flexible printed circuits with other parts of a system.

The introduction of polyimide laminates in 1965 provided the industry with a high-temperature, solderable film that solved the materials problem. Now there are four satisfactory flexible laminates that are available. In addition, many interconnection schemes have been designed for interfacing with flexible circuitry.

Today, the biggest problem flexible-circuit manufacturers face is the resistance of packaging engineers accustomed to designing with hardboards. As Steve Gurley, director of sales and marketing at Sheldahl Inc.'s Electrical Products division, Northfield, Minn., says, "Our biggest problem is educating people to use flexible circuitry. Many companies are just not willing to take a chance on a technique unproven to them."

In spite of the resistance, total sales of flexible-circuit boards will be \$128 million in 1977 and will grow to \$177 million in 1980, according to Steve Grossman, director of interconnection studies for Gnostic Concepts Inc., Menlo Park, Calif. The breakdown of available and captive flexible-circuit production is shown in Fig. 3.

Flexible insulating base materials are literally and

figuratively the backbone of flexible circuitry. In the early years, materials like Vinyl, Kel-F, Teflon, and glass-reinforced Teflon were tried and found lacking. Today, four insulation materials —Kapton, Dacron-epoxy, Nomex, and Mylar—dominate the field (see table). (Kapton, Dacron, Nomex, and Mylar are registered trademarks of E. I. du Pont de Nemours & Co., Wilmington, Del.)

### Base materials

Kapton, a polyimide-based film, is perhaps the most widely used, particularly in military and space projects. It has good dimensional stability, electrical characteristics, and high-temperature properties, and it withstands temperatures produced by wave soldering. However, it is the most costly material of the four.

Dacron-epoxy, used extensively by Western Electric and ITT, consists of nonwoven polyester fibers embedded in an epoxy resin. It has excellent dimensional stability, high moisture and tear resistance, and good electrical characteristics. Wave-solderable and flame-resistant, it has a cost close to that of Kapton.

Nomex, a low-priced nylon-and-paper insulator, is wave-solderable but extremely moisture-absorbent. It is used in commercial applications—especially in cameras and cars—where humidity is not critical.

A low-cost polyester-based film with good electrical properties and good dimensional stability at room temperature, Mylar has poor high-temperature characteristics and limited solderability. It is heavily used for the flexible circuitry of automotive dashboards (mainly as a harness), where soldering is often eliminated.

In addition, a lower-cost insulating film with properties similar to Kapton may soon appear. Exxon Chemical Co. USA, Houston, Texas, has been developing a film made with polyparabonic acid (PPA) for some time [*Electronics*, Dec. 25, 1975, p. 63]. Called Tradlon, it has properties approaching that of Kapton at about 65% to 75% of the price. Tradlon is being evaluated by several manufacturers. However, Exxon is manufacturing it so far only on a pilot basis.

### Manufacturing

Flexible printed circuits, like rigid ones, can be made by either the additive or the subtractive process. In the additive process, electroless copper is selectively plated onto a substrate. The subtractive process selectively

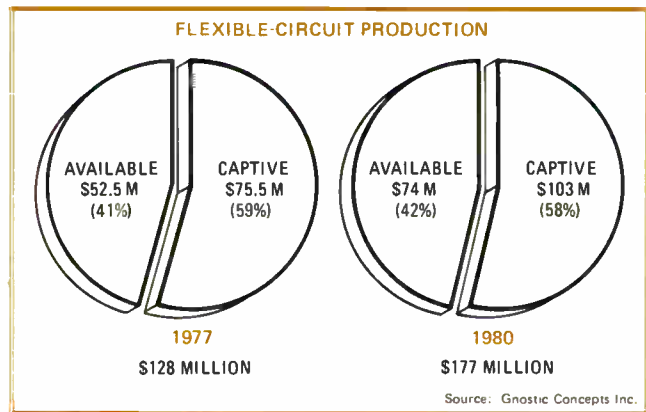

**3. A growing market.** According to Gnostic Concepts, the flexible-printed-circuit market will increase 38.2% by 1980. Captive production will retain the major share of this growing field, particularly in automotive and telecommunications systems.

removes copper by etching a copper-covered substrate. Practically all flexible circuitry is made by the subtractive process, which is shown in Fig. 4a for a simple single-sided board and in Fig. 4b for a two-sided board with plated-through holes.

As the flow chart of Fig. 4a shows, resist (a material that resists etching) can be either screened on through a fine mesh (similar to the process used in thick films) or photographically exposed and developed. Normally, for lines and spaces 10 mils wide or less, most flexible-circuit manufacturers shift from screened-on to photographic resists.

### Fine lines

As with rigid pc boards, the great majority of flexible circuitry is based on 10- to 20-mil lines. However, almost all flexible-circuit manufacturers can supply circuits with 3-mil conductors and spaces; moreover, in an engineering model, Sanders Associates has now achieved 1-mil conductors with subtractive etching. Fine-line (3 mils or less) circuits are of course much more expensive than ones with the normal line work, because processing is more complicated and yields are lower. They are being used to connect to magnetic recording heads or directly to integrated-circuit chips.

At this point, most flexible-circuit manufacturers are just beginning to investigate the use of additive plating. Only Buckbee Mears Co., Nashua, N. H., and Pactel

	Sample thickness (in.)	Tensile strength (psi)	Tear strength (gm/mil)	Folding endurance (cycles)	Ultimate elongation (%)	Moisture absorption (%)	Dielectric constant (1 kHz)	Dielectric strength (V)	Dissipation factor (1 kHz)	Flammability	Service temperature (°C)
Kapton	0.001	23,000	8	10,000	70	3	3.5	7,000	0.003	94V-0	-250 to +250
R/2400 Dacron-epoxy	0.004	5,500	40	50,000	15	1	3.2	3,100	0.015	94V-0	-60 to +150
Nomex	0.002	11,000	49	5,000	10	5	2.0	600	0.007	94V-0	-60 to +120
Mylar	0.001	23,000	15	14,000	100	0.01	3.2	7,000	0.005	burns	-60 to +95

SOURCE: ROGERS CORP.

SINGLE-SIDED

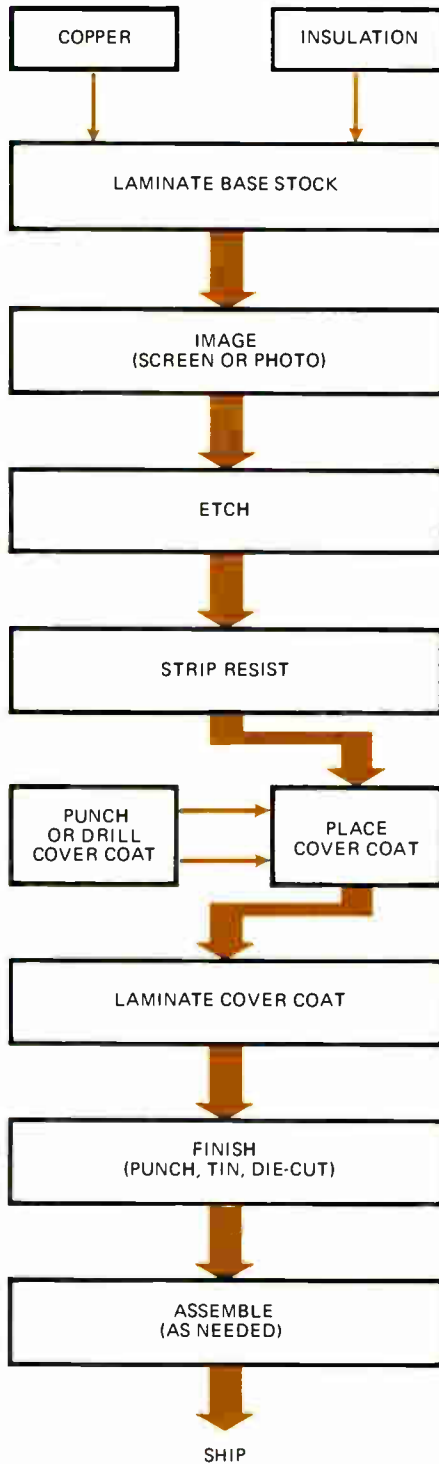

TWO-SIDED WITH PLATED-THROUGH HOLES

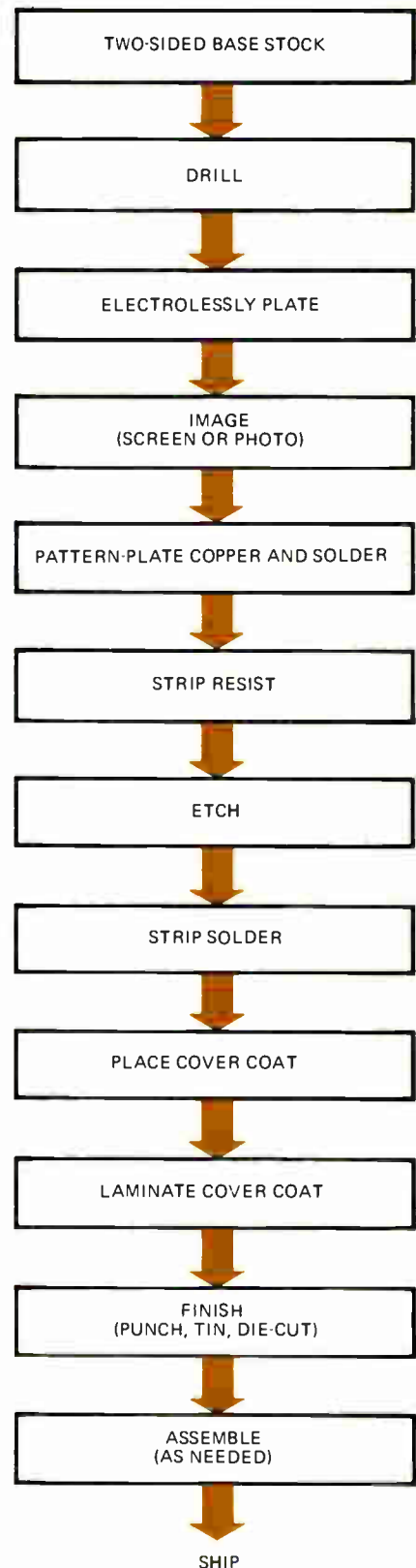

SOURCE: PARLEX CORP.

**4. Film processing.** Both the single-ended flexible-circuit process (a) and the two-sided plated-through-hole process (b) resemble those used in rigid boards. The main differences are the use of a flexible substrate, an overcoat, and special adhesives.

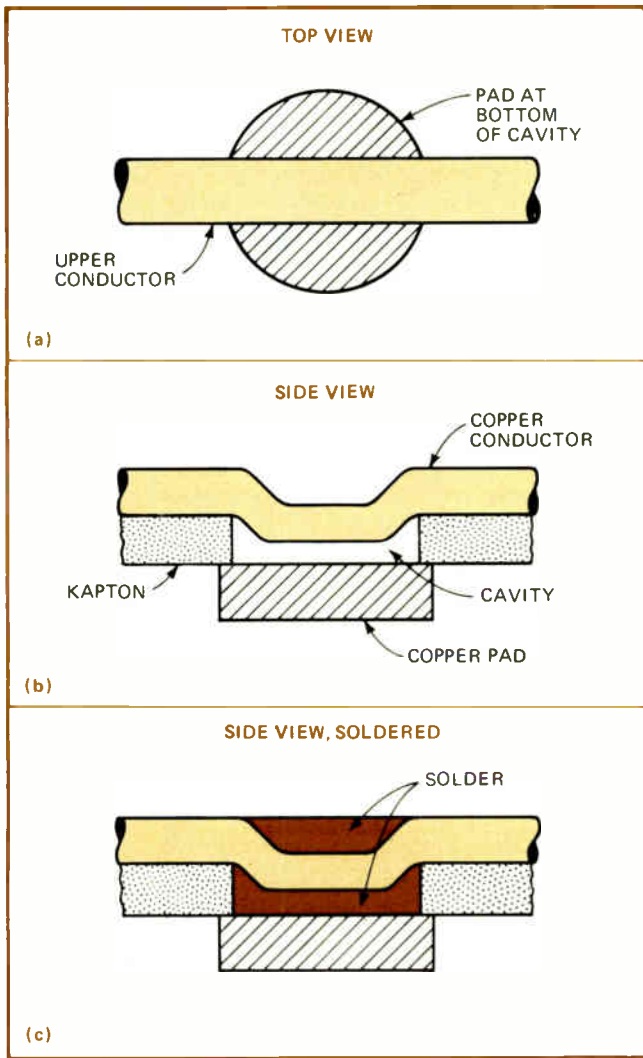

**5. Solder-through.** Teledyne Electro-Mechanisms uses this method as a low-cost alternative to plated-through holes. A cavity (a and b) is created between an upper conductor and a lower pad. During wave soldering, solder fills the cavity (c) making a through connection.

Corp., Westlake Village, Calif., have additive programs, while Flexible Circuits Inc., Warrington, Pa., combines subtractive and additive plating for some special circuits.

Buckbee Mears has a proprietary additive process for putting copper conductors on Kapton that has been used in missile work. Pactel additively plates copper conductors on thin sheets of polyimide [*Electronics*, July 22, 1976, p. 101] and has supplied flexible circuitry 6 mils thick with 5-mil lines and 10-mil spaces for various military and space projects. It has also produced flexible circuits with 1-mil lines on 3-mil centers and expects to be able to make 0.5-mil lines on 1-mil centers. In addition, Pactel uses its additive process to manufacture strips of film carriers (a film carrier—really a series of repeated flexible circuits—is a copper IC interconnect or spider plated onto an insulating film).

Usually, one of the last steps in making flexible circuitry is to protectively coat the subtractively etched copper conductors (see Fig. 4a). The cover coat, or coverlay, is a clear film that is removed at the points where the circuitry patterns must be tinned. For some

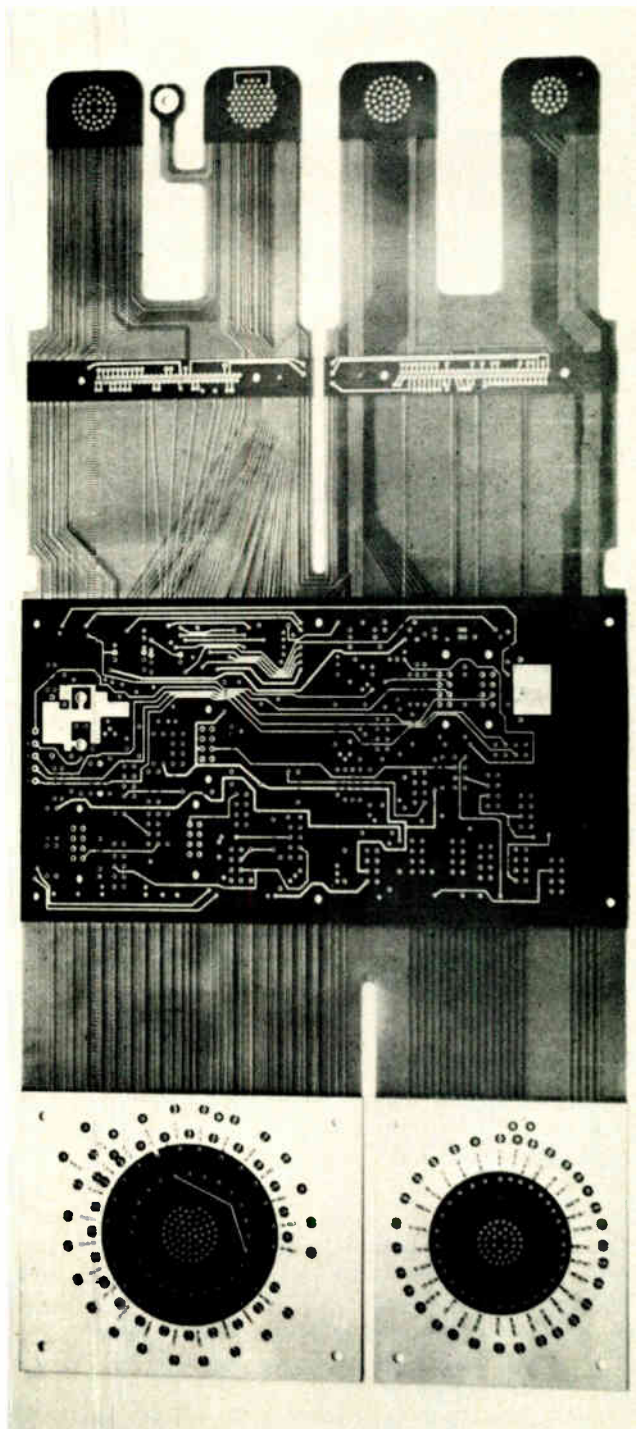

**6. Rigid plus flexible.** The flexible circuit shown has a dual purpose. It ties the nine rigid multilayer printed circuits together and at the same time serves as two conductive layers of interconnect in each multilayer board. Plated holes extend through all the layers.

time, Flexible Circuits has been additively plating ground planes or traces onto the normally bare cover coat, to act as a radio-frequency shield for the circuitry underneath. Ground is carried up through an additively plated hole extending through all the flexible circuit board's layers.

Yet another method of creating conductors on a flexible substrate is screening a low-temperature-curable

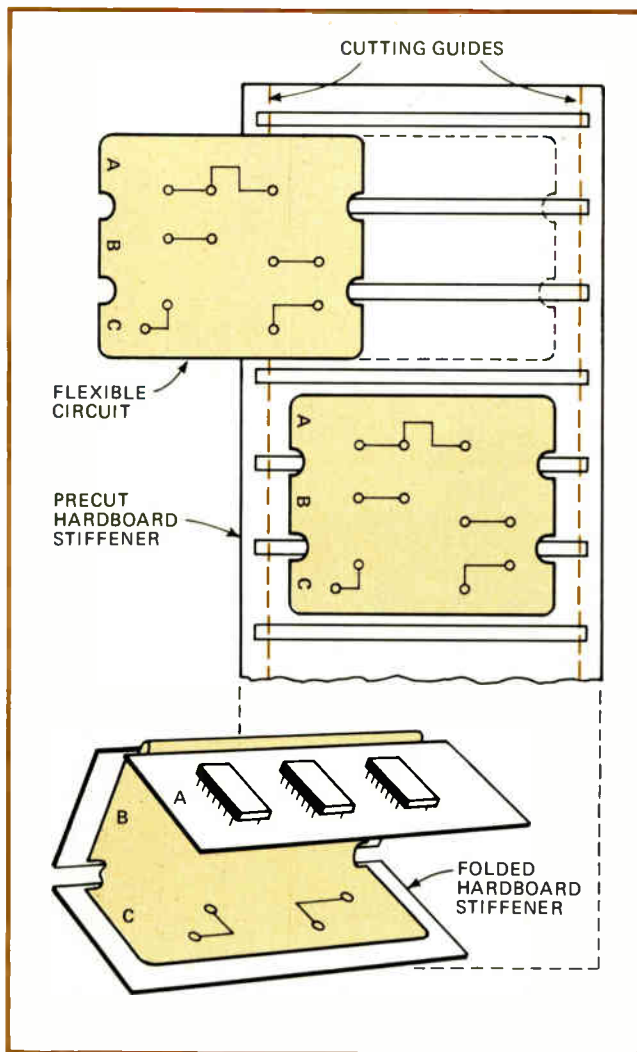

**7. Hardboard center.** Multiple identical flexible circuits can be mounted on a hardboard carrier. The assembly is then loaded with components and wave-soldered. After this step, the individual units are punched out of the carrier and folded into modules.

conductive ink onto a Mylar film. This low-cost technique is now being used by Chomerics Inc., Woburn, Mass., on Touch-Tone telephone keyboards, calculator keyboards [*Electronics*, July 7, 1977 p. 42], and other applications that combine keyboards, circuit boards, and interconnects, and it is ideal for single-sided flexible circuitry in consumer products.

It is also possible to screen resistors onto the film. However, the problem of soldering discrete components to the conductive ink has yet to be solved.

No matter what the etching or plating technique, flexible circuits can appear in three forms—single-sided, two-sided with plated-through holes, and multilayer.

### Bendable boards

Single-sided flexible printed circuits are generally used for the simplest low-cost jobs. The great majority of flexible circuitry made today is two-sided with plated-through holes connecting the patterns on each side. The holes are usually plated through by an additive (electroless) process after the main circuitry has been subtrac-

tively etched (Fig. 4b), although two-sided boards have been made with braised eyelets or pins in the holes.

One company, Teledyne Electro-Mechanisms, has come up with a novel process for electrically connecting layers of a two-sided flexible circuit. Starting point of the proprietary method is a completed two-sided flexible circuit with no connections between the sides. Assume a conductor on one side is to be connected to a circular pad directly underneath it on the other side. A cavity is created under the top conductor and over the bottom pad by removing the insulating film in between (Figs. 5a and 5b). During wave soldering, the cavity is filled with solder connecting the upper conductor to the lower pad (Fig. 5c).

Soldering through costs less than electroless plating of holes. Two other pluses for the process are that the connections are 100% visually inspectable and repairable with standard equipment.

### Flexible multilayer circuits

The most complex flexible circuits made today are multilayer types. The process for making them is similar to that used for making rigid multilayer boards, in which a sandwich of layers is laminated together in a large press under heat and pressure. Flexible boards have been made with as many as 23 layers, but the use of too many layers results in a loss of flexibility. Most manufacturers agree that the limit for a truly flexible multilayer circuit is five to six conductive layers. Flexible multilayer boards are confined mostly to military work but are now finding their way into computers also, because of increasing interconnection and component densities in the new machines.

These multilayer circuits are not simply flexible copies of rigid multilayer boards. Each layer can be extended separately to serve as a wiring harness to connect elsewhere in the system, and the extensions can go off in many planes. This allows points in the overall system to be connected to specific points in a particular layer.

Flexible circuits can be laminated between the layers of several rigid multilayer boards, forming Parlex Corp.'s rigid-flexible multilayer board system in Fig. 6. This entails making plated holes extending through both the rigid and the flexible boards. The flexible printed circuit serves as a preformed, prewired harness for connecting individual rigid boards and the rest of the system. In addition, the flexible circuit adds two conductive layers to each rigid multilayer board.

### Hardboard carrier

This combination in turn has led to a cost-saving variation that is especially popular in the production of small instrument modules. A two-sided flexible pc board composed of multiples of a particular electronic circuit is laminated to a large hardboard base of the type shown in Fig. 7. The rigid board has predrilled holes to accept the components of each flexible circuit and punched-out areas corresponding to the spaces between the circuits on the flexible pc boards.

At the customer's plant, parts are automatically inserted into the assembly and then wave-soldered. If any repairs are needed, they are made on the assembly.



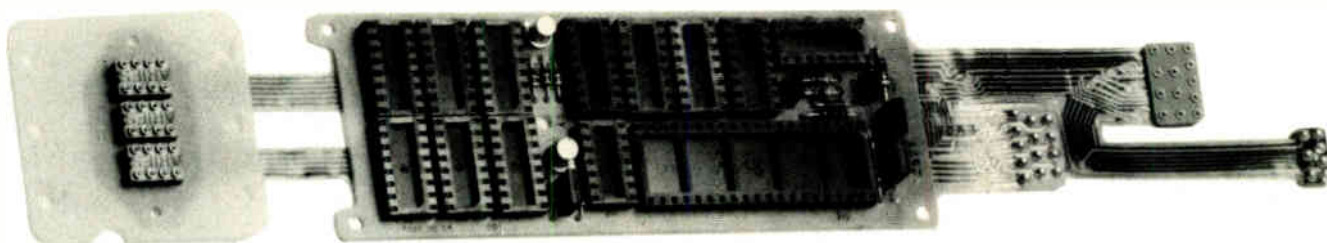

**8. Socketed.** This is a flexible-printed-circuit – hardboard combination used in an airborne fuel gage. To make changing ICs easier, sockets are mounted on the hardboard and soldered to the flexible circuit. The flexible board is both a circuit board and a multitermination harness.

Then the borders of the hardboard are sheared away and the circuits are folded up as at the bottom of Fig. 7 or in any other configuration desired.

In general, components are soldered to flexible circuitry. Soldering can be done with hand tools or by wave, dip, or infrared reflow soldering. In film carrier applications, IC chips have been temperature-compression bonded to copper conductors; however, the conductors require special gold plating.

In general, before soldering it is important to know the temperature limitations of the flexible insulating film and adhesive used. It is also important to keep in mind that a component can be replaced many fewer times on a flexible circuit than on a rigid pc board. For instance, at Gull Airborne Instruments Inc., Smithtown, N. Y., a manufacturer of avionic instruments, a component may only be replaced twice on a flexible circuit as compared with a dozen times on a hardboard. Excessive soldering on a flexible circuit can cause layers to come apart or even cause copper conductors to peel off.

### Pluggable circuit

Gull gets around the problem of component replacement simply. The instrument assembly in Fig. 8 is a combination of flexible circuitry and hardboard stiffeners. Sockets for heat-sensitive ICs and light-emitting-diode displays mounted on the hardboard allow the devices' removal without resort to desoldering.

As was noted before, a user now has many ways to connect his flexible circuitry to the rest of his system. There are numerous types of connectors, including rectangular, cylindrical, edge, crimp-on, insulation-piercing, and pressure-contact, designed specifically for flexible circuits. Also, many manufacturers wave-solder, weld, or braze pins onto the circuitry to eliminate a male connector. In some applications, the ends of the circuits are tinned and soldered directly to the next interface points, such as a rigid or another flexible pc board.

### A DIP connector

A novel approach used at Teledyne Electro-Mechanisms is built around a lead frame that has its outer leads on 0.1-inch centers. Tinned termination leads from a flexible circuit are soldered to the inner leads of the lead frame. Then the outer leads are bent down and placed in a plastic dual in-line package's cavity. The resulting connector, shown in Fig. 9, can be plugged into a rigid printed circuit, a backplane, or a flexible circuit.

Flexible printed circuits found early applications in guided-missile electronics. As more and more circuits

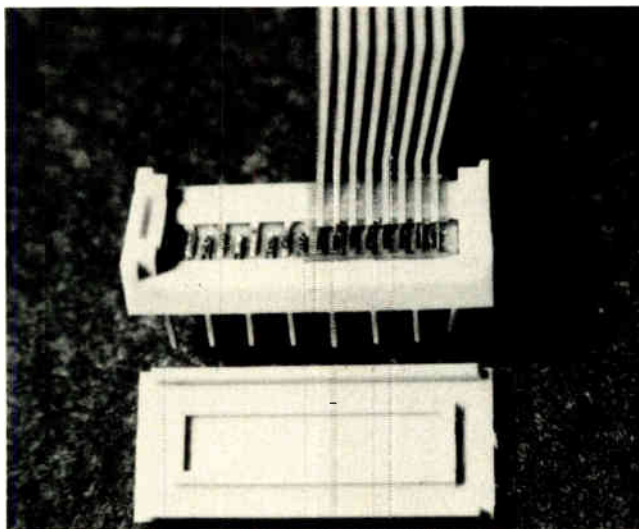

**9. DIP connector.** In this unit, a flexible circuit's tinned ends are soldered to the inner leads of a leadframe having outer leads on 0.1-in. centers. Placing the assembly in a plastic dual in-line body results in a connector that plugs into other rigid or flexible boards.

were crammed into smaller spaces, the density and number of electronic interconnections grew rapidly. General Dynamic Corp.'s Pomona division, Pomona, Calif., which has worked on missile programs for the Navy since 1964, quickly turned to flexible circuitry.

"Our driving force was, first, circuit density and then reliability," recalls Marvin Abrams, chief of advanced technology at GD Pomona. To meet a density requirement that grew from 775 conductors per square inch in 1964 to about 10,500 by 1972, the GD division started out in 1965 with designs that provided 825 conductors per square inch with 50-mil lines and spaces. These were two-sided flexible printed circuits on a Kapton film. Overall size of the flexible boards varied from 5 to 100 mils thick, 4 to 8 in. wide, and 6 to 24 in. long.

Today, GD Pomona, where all circuit fabrication is in-house, is making a six-conductive-layer flexible pc board up to 34 in. long, with lines and spaces of 25 to 10 mils. Used in the preproduction Standard Missile 2, it permitted reduction of a subsystem on the Standard Missile 2 to one quarter of the size of a comparable subsystem on the Standard Missile 1.

The advantages of flexible circuits were also quickly recognized in avionics—another area where space is a major concern. At Grumman Aerospace Corp., Bethpage, N. Y., they are now a way of life: a recent directive specifies that new equipment must be designed with

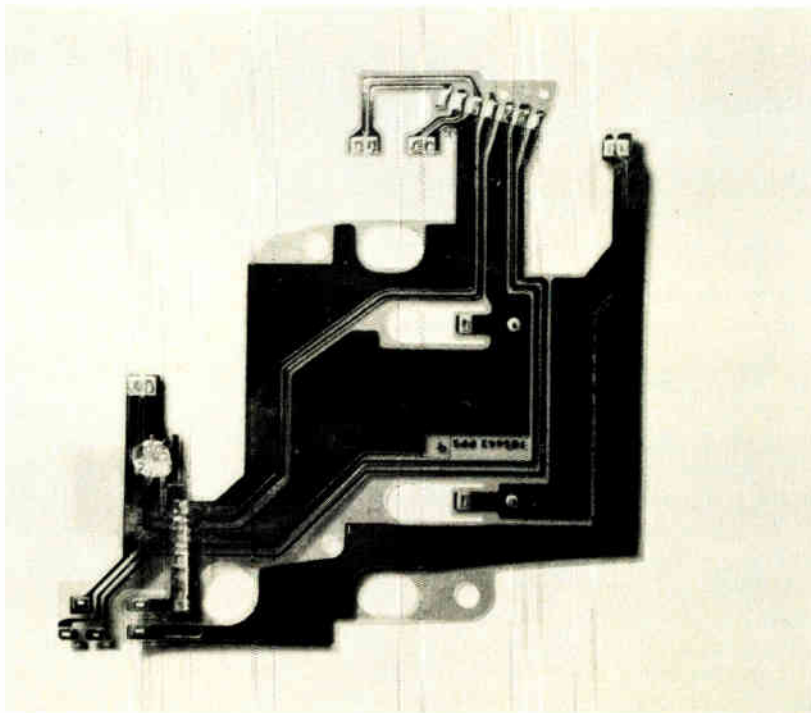

**10. Camera circuit.** An 8-mil-thick flexible circuit, produced by Sheldahl for the Polaroid SX-70 camera, distributes power to electronics, switches, film roller motors, and the shutter solenoid. The part flexes whenever the camera is opened or closed.

flexible circuits if at all possible, and as further evidence of their importance, the company is preparing its own design manual on the subject.

Michael LaTorre, group head of design engineering at Grumman Aerospace, states, "It is obvious to us that this is a superior method of interconnect." As an example, he cites a case in which a system's assembly time was reduced from 45 hours in the hard-wired version to 2 hours with flexible circuits.

### **Saving space**

Telephonics, a division of Instrument Systems Corp., in Huntington, N. Y., has been using flexible circuitry since 1964 on avionic hardware. Telephonics' mechanical designers got their first exposure to these circuits while packaging the multiplexed entertainment system for the Boeing 747 jumbo jet. As a weight-saving measure, flexible pc boards were used instead of discrete harnesses and card-edge connectors to connect system modules. Single-sided Kapton printed circuit were the main substitutes.

As Telephonics' engineers grew more experienced with flexible circuitry, they went to more sophisticated designs, like the electronic packaging for the headset of the Lockheed 1011's cabin galley intercom. Originally, all the electronic circuitry was packed on two rigid pc boards within the set's small volume.

In 1971, new requirements called for many more electronic components and more wiring to be added to the already cramped unit. It was soon evident that more hardboards could not be added to the headset. Therefore, the designers decided to combine all the old and new electronic components and the harness wiring into a two-sided Kapton flexible circuit. The updated version is an example of an electronic package possible only with flexible circuitry.

Now, the firm's engineers are applying the combined

hardboard-carrier-flexible method described earlier to assemble a small modular power controller in which the cut-out boards are folded up and placed in a small cubical package.

Another Long Island avionics firm, Gull Airborne Instruments, uses its flexible-hardboard combination in Fig. 8 to act as both a circuit board and an interconnect for digital fuel metering. The combination has resulted in an overall savings in assembly costs of up to 30% over a straight hardboard package.

Dick Holtz, manager of manufacturing engineering at Gull, has found it cost-effective to apply flexible circuitry to systems that have a production run as small as 25 units and to harnesses with as few as 10 wires. The company converted many units to flexible circuitry two years ago, and the field failure rate has turned out to be less than 1/4%.

### **Consumer products**

The largest area of growth for flexible circuitry in the next few years will be consumer electronics. Already, this interconnect method has found its way into cameras, calculators, watches, citizens' band radios, pocket pagers, video games, and microwave ovens. Within the next few years, it will be found in almost every consumer product that contains electronics.

Polaroid Corp. and Eastman Kodak Co., the two leading U.S. camera makers, both have been using flexible circuitry for some time. Polaroid in particular has applied it to various cameras for two basically different reasons, depending on the camera type.

The Cambridge, Mass., firm's SX-70 is designed to fold up into an extremely compact package. To accomplish this, Polaroid's designers selected a foldable pc board of Kapton to house the electronics in the back of the camera and behind the shutter. The board, which folds and unfolds as the camera opens and closes, is a

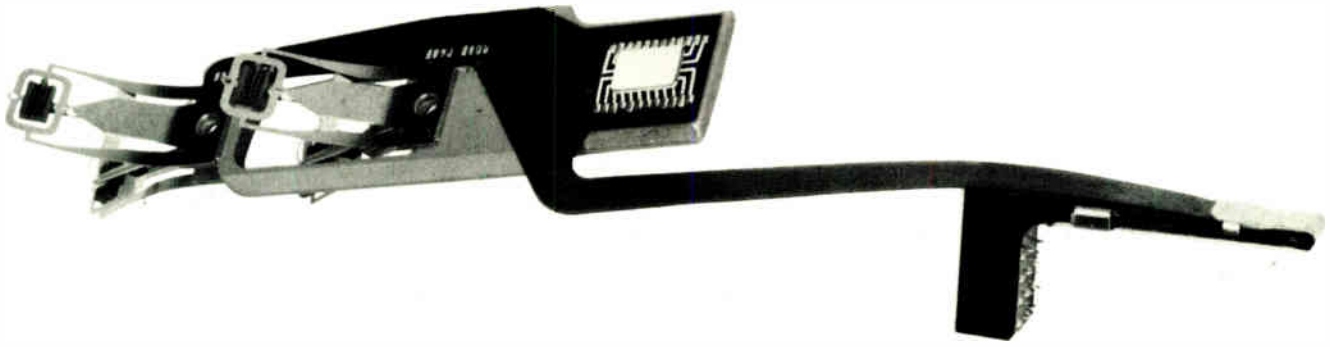

**11. U-shaped.** This circuit interconnects a magnetic head in a disk memory. During normal head motions, the circuit is folded in a U configuration and flexed in excess of 400 million times. Special treatments and processes are used to make this extremely flexible circuit.

single-sided type that is 8 mils thick (Fig. 10).

On Polaroid's Pronto and One-Step instant cameras, which do not fold, flexible circuitry was chosen for its ability to make multiplanar connections. It was used to accommodate camera wiring that turned at right angles and that had to be connected to many different points at different levels.

### Multiple flexures

John Burgarella, director of engineering for product electronics at Polaroid, says that flexible circuitry has proved to be about 25% less expensive than the wiring in early SX-70 designs. He adds that it has also proved extremely trouble-free. The only hitches showed up early in the prototype stage when circuits were sometimes bent too sharply and tore. Modifying the bending radius solved this problem.

In most applications of flexible circuits, the board is bent, shaped or folded only initially. However, in the computer peripheral and rotating memory field, flexible circuitry completely lives up to its name. For instance, a circuit designed by Rogers Corp., Chandler, Ariz., connects signal-processing circuitry to a magnetic head for a disk memory (Fig. 11). Over the course of normal head operation, the circuit may be flexed more than 400 million times. Rogers uses rolled, annealed copper, rather than electro-deposited copper, which work-hardens as it is flexed, resulting in broken conductors; in addition, the company employs special treatments and processes to make the circuit truly flexible.

### Flexible heater

Copper is not the only metallic material that can be laminated to a flexible base. Sheet nichrome can be also. Using this principle, Parlex Corp., Methuen, Mass., among others, is making flexible heaters by selectively etching on a nichrome-covered Kapton base. Like its circuit-bearing counterpart, the flexible heater can be folded and made in unusual shapes and patterns. In addition, the heat at various portions of the circuit can be controlled by varying the conductor pattern and thickness. To prevent heat from being applied in selected sectors, the nichrome can be plated over with copper. Circular flexible heaters are now being used to control the temperature of missile gyro packages.

Another area that thrives on the space savings and reliability of such circuitry is medical instruments. Flexible circuits have been part of pacemakers for some time—and acceptance of any technique or part in a pacemaker is a testimonial to its reliability.

Flexible Circuits manufactures a flexible pc board that is used in another highly reliable medical instrument—a cardiac event recorder. Fairly heavy hybrid modules are mounted unsupported on the 12-mil thick Kapton substrate, which is not usually done with most flexible boards, and the 38-in.-long circuit and a miniature tape recorder are stuffed into a 5-by-2½-by-3-in. package that is hung on a patient's belt; the recorder has a mean time between failures of three years. Only flexible circuitry can supply the tight packaging and reliability needed for this instrument.

### The future

Flexible circuitry is certain to be one of the growth areas in the wiring field. Most of its manufacturers see a 25% growth rate for the next few years. A large part will occur as it spreads into more consumer products areas. In the automotive field, flexible applications will no longer be limited to the present componentless dashboard circuits; instead, new uses will be in the control circuits the industry is developing for ignition control, fully electronic fuel injection, and pollution control—as true flexible pc boards with components soldered on.

In the technology of flexible circuitry, several trends are starting to appear. One, brought on by pressures for even denser circuits and by the use of unhusked ic chips, is a general shift to 3-to-5-mil lines and spaces from the present 10-mil widths.

According to David Cianciulli, marketing manager for Hughes Aircraft Co.'s Connecting Devices division in Irvine, Calif., "There should be a large increase in the use and fabrication of flexible multilayer boards, since manufacturing methods are now fairly well established." Again, demands for increased packaging density can only be met by the density of the multilayer board and the multiplanar feature of the flexible circuit.

Another aspect of flexible circuitry that will increase is the use of combined rigid-flexible boards. The hard-board carrier scheme is becoming more and more popular, while applications that combine a rigid multilayer or two-sided pc board with a layer of flexible circuitry will also become more accepted. □

# The 6852 Year Old Frequency Standard

That's how many operating years are behind  
Hewlett-Packard cesium beam frequency sources.

There's more known and proven about the reliability of HP's cesium beam frequency sources than any others. Not only have they been around longer than any other standard of their type, but a team of highly specialized physicists, engineers and technicians has constantly improved them by applying the knowledge gained from more than 60 million hours of field operation. And because of that they are the most popular choice in frequency/time applications, especially where reliability is most critical: interplanetary and terrestrial navigation, telecommunication systems and in the timekeeping centers of more than 26 countries.

For details of HP's cesium beam frequency sources and some more good reasons that keep these old standards the new ones—for example  $\pm 7 \times 10^{-12}$  absolute accuracy in our Model 5061A option 004, or the extra ruggedness of our 5062C on-line systems model—call or write your nearby HP field sales office.



Photograph of Andromeda Galaxy,  
courtesy of Lick Observatory.  
Photograph has been reversed  
for composition.

HEWLETT  PACKARD

1507 Page Mill Road, Palo Alto, California 94304

# Designing with nitride-type EAROMs

Being nonvolatile and reprogrammable, electrically alterable read-only memories fill the needs of such systems as TV tuners, phone dialers, and point-of-sale terminals

by Brian Cayton, *General Instrument Corp., Microelectronics Division, Hicksville, N. Y.*

□ Attracting the attention of digital-system designers is the electrically alterable read-only memory, or EAROM. First available in volume production about a year ago, the electrically alterable ROM is unique among semiconductor memories in combining nonvolatility with reprogrammability. Like the ordinary ROM, it needs no power to retain data; and like the random-access memory, it is electrically erasable and system-reprogrammable over and over again—in contrast to the 2708-type reprogrammable ROM, which requires ultraviolet light for erasure. In other words, the device operates like an erasable ROM or a nonvolatile RAM.

As such, it fits the needs of a good many electronic systems better than either a RAM or a ROM. For instance, it is perfect for storing channel voltages in inexpensive digital television varactor tuners. In telephone dialing systems, it is the most efficient way of storing and updating phone numbers. It can be designed into point-of-sale terminals for updating inventory and price information or into industrial control equipment for storing process routines or numerical-control data. It can even be built into security systems as part of an electronic lock storing a code the owner can change at will.

Moreover, while not intended for mainframe applications, which require RAMs with access times in the 150-to-300-nanosecond range or for main program storage, which requires ROMs in the 500-ns range, MNOS alterable ROMs are improving dramatically in speed. Access times in new devices are as fast as 750 ns, and erase and write times are in the 10- and 1-millisecond ranges respectively. This makes their performance a perfect fit in systems wherever human input over a keyboard or a dial controls the operation, as in phones, TV sets, or calcula-

tors, and where high speed is not critical, as in some microprocessor-based systems, such as point-of-sale terminals and surveillance gear.

The longest-established way of making semiconductor storage nonvolatile is to put a nitride layer beneath the memory's metal-oxide-semiconductor gate electrode. This method is used in the memories listed in the table below. (Electrically alterable ROMs using an alternative approach—a floating-gate structure—have recently become available and are compared to the MNOS types in "An alternative," p. 110.)

## A lucky chance

Like so many discoveries in electronics, nitride's value as a changeable yet permanent MOS storage mechanism was stumbled upon by accident. It all started with the standard p-channel MOS transistor, which with a negative bias applied to its gate repels negative charges from the substrate into the region forming the channel between the source and gate. At the same time, positive charges (holes) are attracted to the channel, changing it electrically from n- to p-type material and causing conduction between drain and source.

A simple MOS field-effect transistor of this type has an operating threshold voltage of 3 to 4 volts, too high to be driven by the 2-to-3-v signals of standard transistor-transistor logic. The most likely remedy appeared to be the substitution of silicon nitride for the silicon dioxide of the gate dielectric, because the nitride's higher dielectric constant and greater resistance to ion migration were expected to lower threshold voltage.

But to the surprise of the early experimenters, the silicon-nitride transistor exhibited an unstable threshold,

OPERATING TIME OF ELECTRICALLY ALTERABLE READ-ONLY MEMORIES

Part	Size (bits)	Organization	Alterability	Read access time ( $\mu$ s)	Write time (ms)	Erase time (ms)
ER1105	1,024	256 by 4	block	2	10	100
ER1400	1,400	100 by 14	word	—	10	10
ER2050	512	32 by 16	word	6	100	100
ER2401	4,096	1,024 by 4	chip	2	10	100
ER2800	8,192	2,048 by 4	chip	2.6	10	100
ER3401	4,096	1,024 by 4	word	0.95	1	10

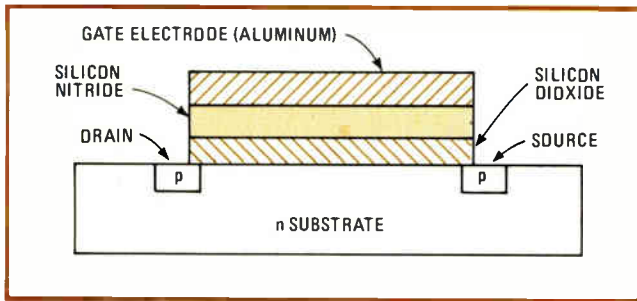

**1. The basic transistor.** To decrease their operating threshold, MOSFETs use a silicon-dioxide – silicon-nitride sandwich as their gate oxide. Without the dioxide, the nitride would store charge—a characteristic exploited in nonvolatile MOS memory design.

one that varied up and down as the device was switched off and on. It turned out that charges were tunneling from the substrate into the nitride and being held there in “trap sites.” So device specialists were quick to abandon this simple nitride structure for one containing a layer of silicon dioxide deposited between the silicon nitride and the silicon substrate (Fig. 1). In this structure, the so-called metal thick-oxide nitride semiconductor device, the oxide was thick enough to prevent charges from tunneling through into the nitride layer, yet thin enough to exploit the superior silicon-nitride characteristics. This MTNS transistor, which was stable and possessed a TTL-compatible threshold, became the basis for today’s mainline MOS device technology.

However, in the late 1960s, researchers found that they could harness the hysteresis effect of the older silicon-nitride devices by reducing the thickness of the silicon dioxide from 500 angstroms to approximately 25 angstroms. Being so thin, the silicon dioxide allows charge to tunnel through it when a high enough voltage (25–30 v) is applied to the gate. This charge is then trapped in the silicon-dioxide – silicon-nitride interface, and since both the oxide and the nitride are high-quality insulators, it remains trapped for a very long time. (Data retention for General Instrument devices is guaranteed for 10 years.) This nitride structure is basic to today’s MNOS memory devices.

A typical MNOS transistor is put (or written) into the low-condition state by the application of –25 to –30 v

to the gate. This drives electrons from the interface region through silicon dioxide into the silicon substrate and leaves the interface region with a net positive charge (Fig. 2a). The charge has the same effect as a positive gate bias, opposing the field produced by normal logic-level, negative signals applied to the gate. The result is a very high threshold, typically –12 v, and this condition serves as the off state of the transistor.

### How it works

To put the cell into a low-threshold (high-conduction) or on state, a positive voltage is applied to the gate (Fig. 2b). This positive voltage attracts electrons into the interface, producing a negative charge that aids negative logic signals applied to the gate.

The memory transistor illustrated is, unfortunately, not quite practical: in the erased state, the threshold may be so far below the transistor’s bias voltage that the device is always on. Additionally, the gate-enhanced source-to-drain junction breakdown is so low as to cause unreliable operation.

Both of these problems are solved by the three-gate structure shown in Fig. 3. In this structure, the high-threshold state is still approximately –12 v. But because the oxide in the noncritical gate region is now at least 10 times thicker than in the thin storage area—400 as against 25 angstroms—the low threshold is pegged by this nonmemory region to approximately –2 v.

Moreover, in this three-gate structure, it is possible to tailor the process parameters to fit the best possible tradeoff between data retention and erase/write or switching time. As the thickness of the silicon dioxide is decreased, the shortened charge-injection path decreases switching time. The thinner oxide, however, also allows easier charge leakage and so decreases data retention. On the other hand, increasing the nitride trap density allows faster writing and erasing, but creates dispersion paths through the nitride, shortening data retention. The decision at General Instrument was to adjust these parameters to obtain a minimum data retention of 10 years and then optimize write/erase time. The ER3401, for instance, has a guaranteed write time of 1 ms and an erase time of 10 ms.

The simplest of the circuits that can write and read

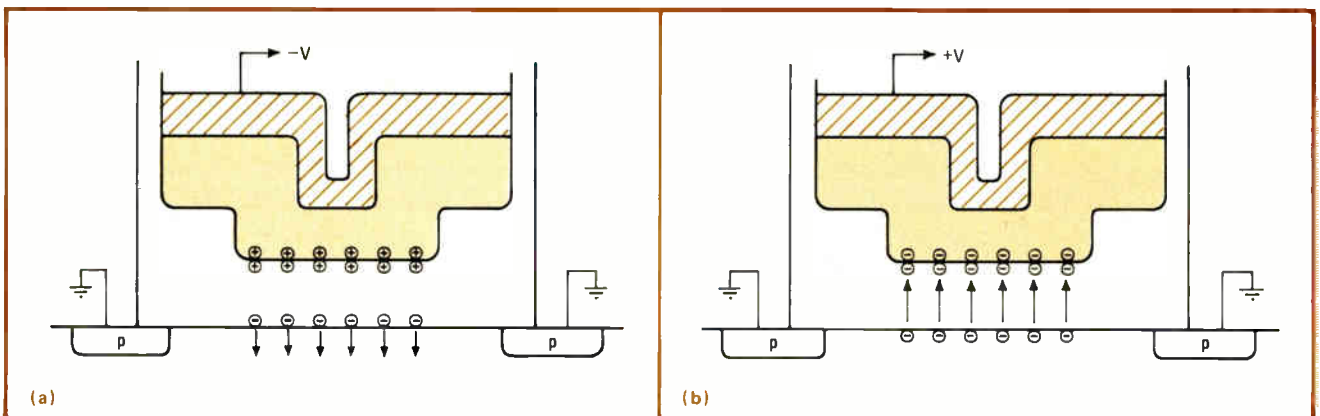

**2. Writing and erasing.** To write into an MNOS memory, a negative voltage is applied to the gate (a), repelling electrons from the nitride trap sites in the silicon-oxide – silicon-nitride interface and setting up a net positive charge. Conversely, erasure of data from the MNOS memory uses a positive voltage (b), which attracts electrons and results in a negative charge at the storage interface.

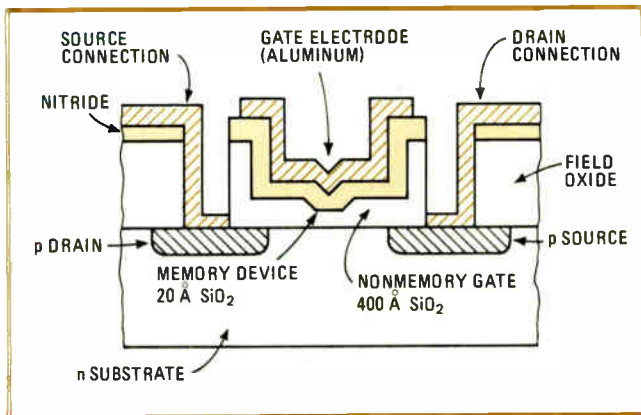

**3. What the three gates do.** This three-gate structure allows the MNOS memory designer the optimum tradeoff between storage-gate thickness and nonstorage-gate thickness. Here a 20-angstrom-thick silicon-dioxide layer in the center of the channel allows charge to tunnel from the memory's substrate to the oxide-nitride interface when a high enough voltage is applied to the gate.

and erase data is the two-transistor structure shown in Fig. 4. (This cell is used in the 512- and 1,024-bit alterable ROMs listed in the table on p. 107.) The flip-flop detects whether an addressed memory location is in the low- or high-threshold state over a range of input voltages. The same circuitry also writes a bit into or erases it from the memory cell.

The cell's operation is unusually simple. Each contains

two transistors. Before writing, both transistors are erased by being put into the low-threshold state.

To write, the gates are then biased with a negative signal, and the flip-flop is switched into the desired state. One memory transistor will then have a high gate-voltage threshold, indicating a bit has been written into it; the other, which still is kept at source potential, continues to have a low threshold. Reading is then simply a matter of using the sense flip-flop to detect the high-threshold transistor. In the erase mode, the drains of memory transistors are placed at a negative potential, as is the memory substrate. The decoder circuitry then positively biases the gates of the memory transistors at the selected address, erasing their contents.

Figure 5a is a simplified schematic of the device in the write mode.  $Q_1$  and  $Q_2$  are biased off, leaving the drains of memory transistors  $Q_3$  and  $Q_4$  floating. In this state the memory gates are biased negatively. Pass transistors  $Q_5$  and  $Q_{10}$  are on, allowing the data signal and the inverted data signal to pass through to transistors  $Q_3$  and  $Q_4$ , respectively. Now, if the data is a logic high (positive),  $Q_3$  will see a negative gate-source potential and will be written.  $Q_4$ , which has its gate source at the same potential, will remain in the erased state.

In the read mode (Fig. 5b),  $Q_1$  and  $Q_2$  are on, providing supply voltage to the memory transistor drains. As the first part of the read sequence, an internal clock sends a preset signal to transistors  $Q_5$  and  $Q_6$ , momentarily shorting the outputs of the sense flip-flop,

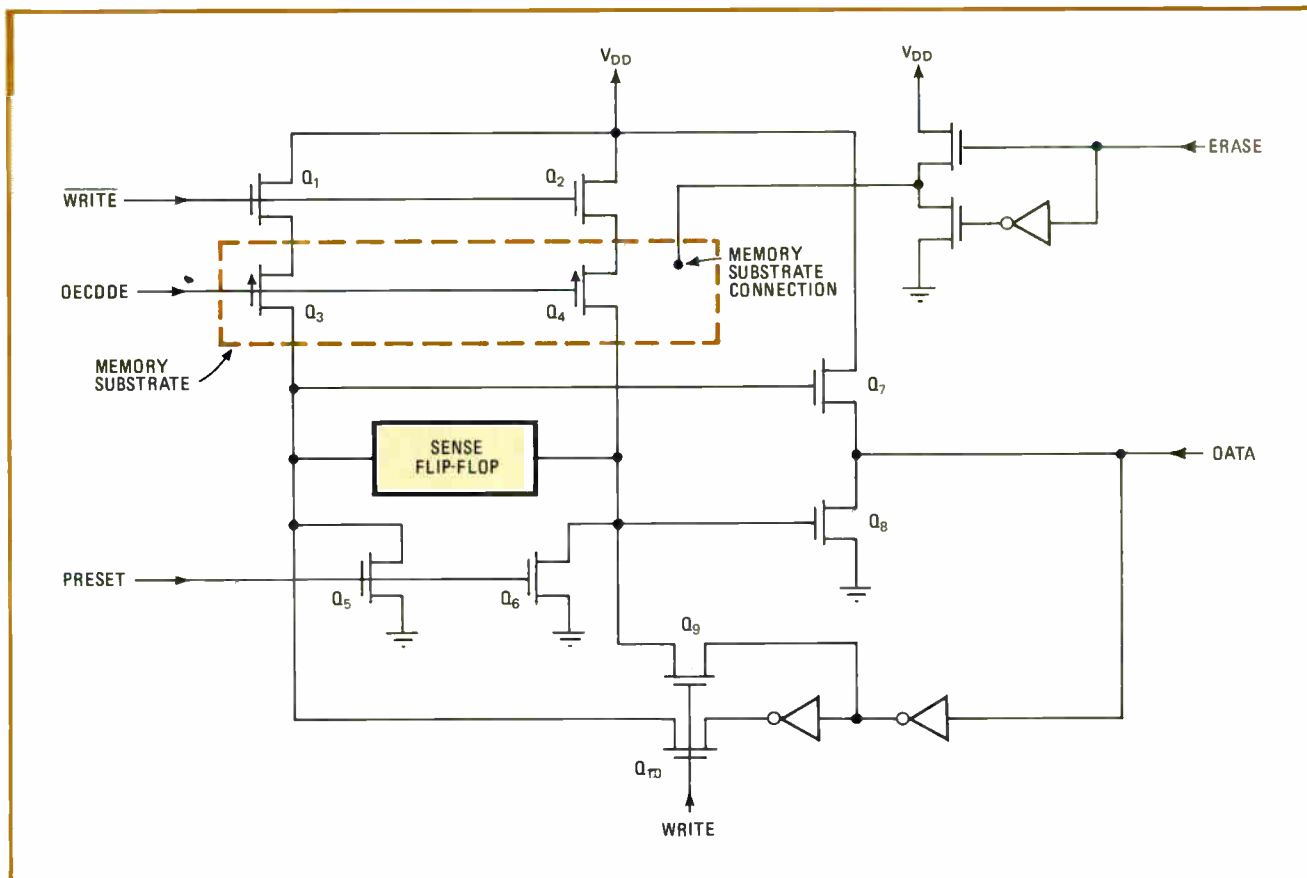

**4. Two transistors.** The flip-flop of this two-transistor cell detects whether an addressed memory location is in the low-threshold or in the high-threshold state over a range of voltages. The same circuitry also writes bits into the memory cell and erases them.

## An alternative

Besides nitride storage, another means of building electrically alterable read-only memories is the floating-gate metal-oxide-semiconductor or Famos technique.

In the Famos process, the need for a thin oxide in the critical gate portion of the device is overcome by the use of two gate layers. One layer is buried in an insulating oxide and kept floating with reference to the substrate's voltage potential, while the other is deposited on top of the oxide and connected to the control circuitry. Data is then stored by charges trapped on the floating gate.

However, no hard connection is made to this floating gate. Also, to isolate it properly from the control gate, the oxide used to separate the two must be at least 1,000 angstroms thick—which is too thick to allow charges to tunnel in and out as in the metal-nitride-oxide-semicon-

ductor structure. Thus writing and erasing are more difficult than with the MNOS device. With Famos cells, the trick is to apply a high enough voltage long enough to break the junction down without destroying it—a definite hazard to reliability, especially as  $-36$  volts and 50 milliamperes are needed to do the job.

This is not the only drawback of the Famos structure. No means of word erasure exists, so the entire device must be erased, and this burns power. For example, erasing a 2,048-bit Famos device requires a supply of 76 V and peak current of 300 mA, or a power rating of over 20 watts. The erase times (60 seconds) are also much longer than for MNOS devices. As for writing, the Famos  $\mu$ PD454, as shown in the accompanying table, needs a supply of 28 V for 100 ms, a lot of power.

COMPARISON OF MNOS AND FAMOS ELECTRICALLY ALTERABLE ROMs

Type	Bits	Write		Read		Erase		Comments
		Voltage (V)	Time	Voltage (V)	Time	Voltage (V)	Time	
$\mu$ PD454	2,048	-2, +26	100 ms	+5, +12	800 ns	+36, -40	60 s	voltage to pins must be switched
ER3401	4,096	+5, -12, -30*	1 ms	+5, -12, -30*	950 ns	+5, -12, -30*	10 ms	word erase or block erase

\*no supply switching necessary

thus sensitizing the flip-flop. Then a reference-level signal is provided to the memory transistors. As the erased or low-threshold transistors will have a lower impedance than the off or written transistor, one side of the flip-flop will see a higher potential; this sets the flip-flop, so that it is ready to drive the output transistors  $Q_7$  and  $Q_8$ , which form a totem-pole output driver pair.

Although this circuit is fine for memory devices not requiring high density (1,024 bits and less), its use of two transistors per memory cell is a drawback. For higher-density, 4,096- and 8,192-bit electrically alterable ROMs, a one-transistor cell is better (Fig. 6). In this configuration, as with the two-transistor cell, erasing is necessary to precondition the cell before writing. This is done by biasing the gate with a potential that is positive with respect to the substrate. The memory cell is then in the low-threshold (logic 0) state. To produce a high-threshold (logic 1) transistor, the gate is pulsed with a negative voltage.

For reading these states, the gate of the memory cell is provided with a reference bias voltage. A threshold lower than the reference holds the cell off; a higher threshold turns the transistor on. A constant current-source is used to overcome any leakage that might occur from the charged cell to the substrate.

Although not apparent from the circuits shown in Figs. 4 and 5, the ability to put a complete memory on a single MNOS chip required innovative processing as well as clever circuit design. Early alterable ROMs were complicated to use because positive gate voltages were required to erase each cell. Since there was no way of

internally switching the high positive voltage required at the memory transistor gates, these gates had to be brought directly out to pins. It then was up to the user to decode the gates with externally generated signals.

### Processing helps, too

Epitaxial wafer processing, a technique developed for bipolar transistors, provided a means of on-chip decoding. By separating the MOS gate from the substrate with an epitaxial layer, a boron diffusion can successfully isolate the gate-memory portion of the circuit from the logic and decoding.

Secondly, because the memory substrate is now isolated from the logic circuitry, the memory cell's input voltage can be made independent of the voltage required for the logic circuitry. If the memory transistor gate is held at ground and the epitaxial layer is biased in the negative direction, a positive gate-substrate potential results that erases the device. The epitaxial layer can alternatively be held at ground, while the gate is negatively biased to allow writing. This makes it possible to design parts that are not only chip-alterable, in which an erase command erases the entire chip, but also word-alterable, in which the user can address and erase one word at a time without disturbing the contents of other memory locations.

Thirdly, once the voltage-switching circuitry has been placed outside the memory substrate on the fixed-potential substrate, all control signals can be made TTL-compatible, while on-chip circuitry can buffer and amplify them to switch supply voltages internally. This



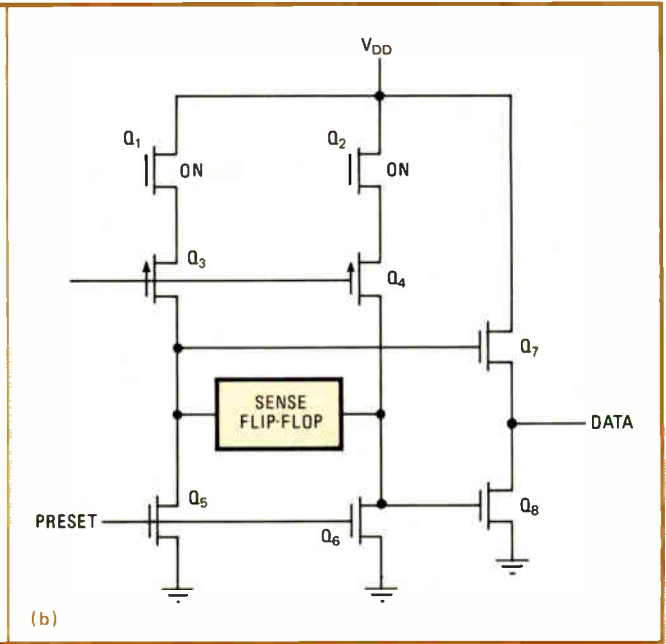
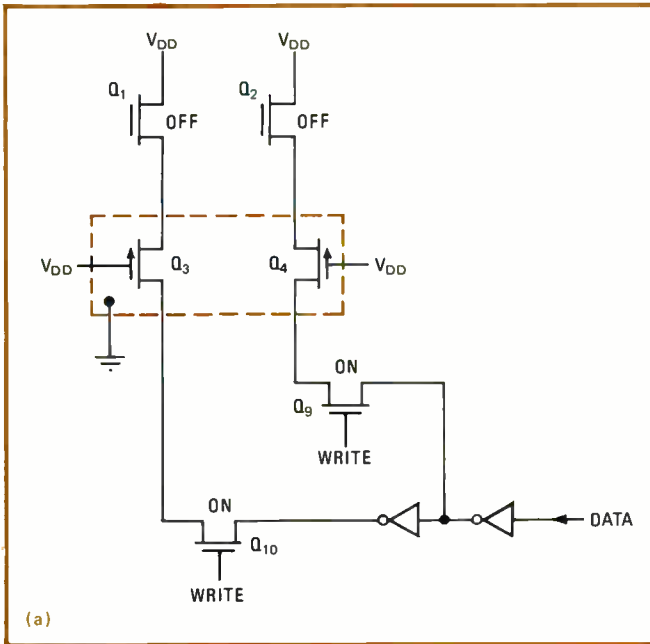

**5. Writing and reading.** In the write mode of an MNOS memory cell (a),  $Q_1$  and  $Q_2$  are biased off, and the drains of memory transistors  $Q_3$  and  $Q_4$  are left floating. With pass transistors  $Q_9$  and  $Q_{10}$  on, the data signal and inverted data signal pass through to  $Q_3$  and write a bit onto the storage transistor. In the read mode (b), the flip-flop transistor pair sends a signal to the output totem pole driver  $Q_7$  and  $Q_8$ .

makes the alterable ROM as easy to use as a RAM.

The use of epitaxy grants yet a fourth benefit, for it permits zener diodes to be fabricated with better characteristics than normal MOS processing can give. Accurate-value low-impedance zener diodes provide excellent static protection, besides serving as on-chip regulated voltage supplies.

**Testing an alterable ROM**

With alterable ROMs, the testing of factory parts is relatively straightforward, consisting of writing and then reversing in checkerboard fashion all 1 and then all 0 test patterns. As is the case with ordinary ROMs, the more sophisticated test patterns used in dynamic RAM are not required, since the relatively static nature of the data storage makes soft failures and pattern sensitivities unlikely.

Tests for data retentivity require plotting the decrease in threshold voltage with time. Fortunately this degradation follows a predictable relationship, requiring just a few points.

As for testing for threshold voltage, since it could vary with individual part types, each type is tested for its

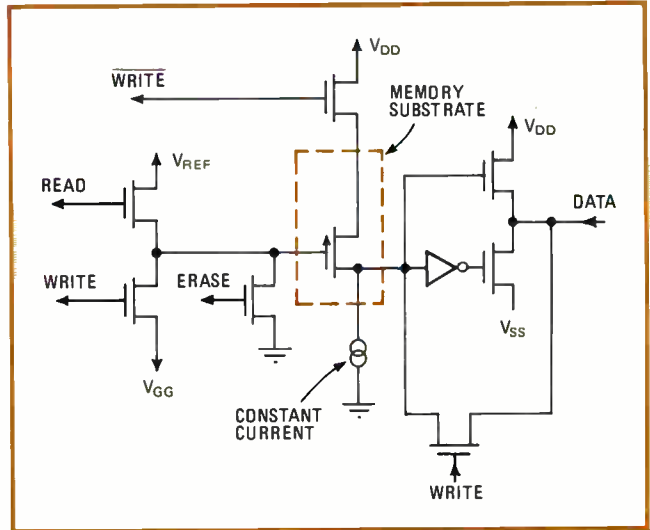

**6. A more compact design.** Intended for use in high-density electrically alterable ROMs, this one-transistor cell is erased by having its gate biased positively and read when the threshold is compared to a reference standard. A constant current source overcomes any leakage from the charged cell to the substrate.

**7. Up to date.** In microcomputer-based systems such as point-of-sale terminals, the electrically alterable ROM can be used as a nonvolatile data store for updating inventory and price information. If the access time is a key factor in the application, a low-cost RAM may be used to receive the alterable ROM's contents on system power-up.

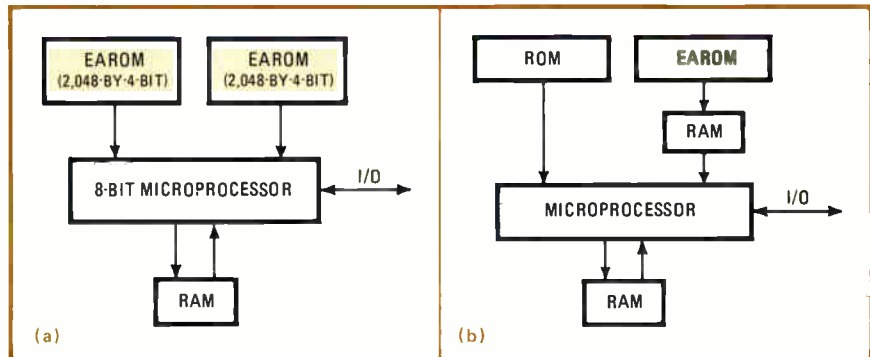

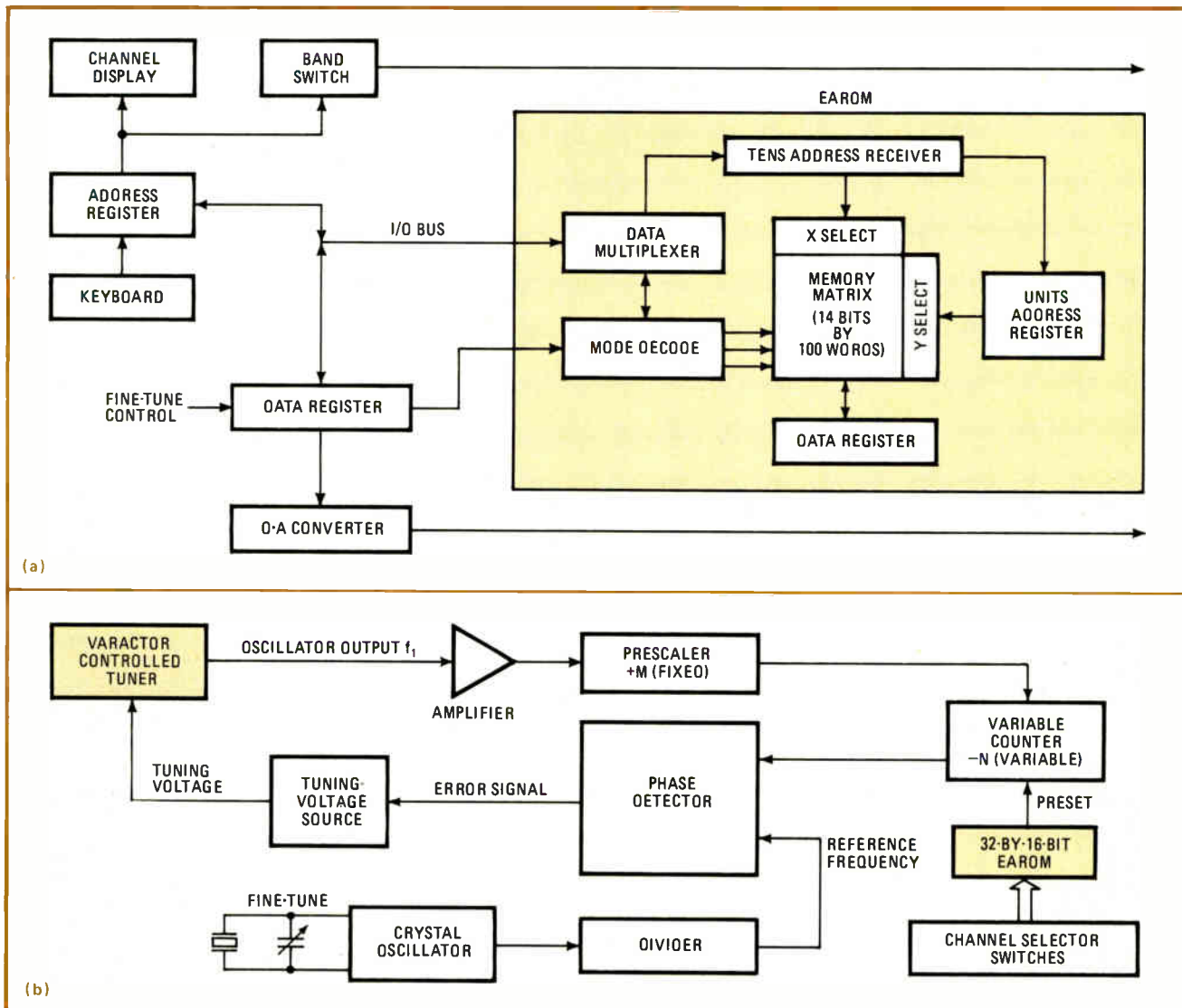

**8. Tuning a television set.** In varactor tuning (a), the electrically alterable ROM stores digital information that goes to a digital-to-analog converter to provide the proper bias to the varactor. In phase-locked-loop systems (b), the alterable ROM stores the proper division information for the various desired channels by controlling the count ratio of the variable counts.

internally generated voltage reference, and the threshold voltage is maintained at sufficiently reliable levels above this reference. This is done by varying the bias voltage until the point is reached at which the output of the memory cell is switched. This adjustment can be done either as wafer mapping, wafer probe, or final die testing. In addition, all devices are "margin tested," a process that consists of measuring the reference voltage,  $V_{ref}$ , and then increasing or decreasing it by an amount determined to be equivalent to the change in threshold over 10 years.

### Applying the alterable ROM

Though the electrically alterable ROM is too new to have accumulated a reservoir of general application information, several basic configurations have already emerged to guide a system designer. Figure 7 shows two microprocessor-based systems that use the device.

In systems in which the microprocessor controls cash registers or other peripheral equipment that uses manual

input, the electrically alterable ROM provides local nonvolatile data storage that can be frequently updated. This is the configuration of Fig. 7a, where the program information handled by the two 2,048-by-4-bit ER2800 alterable ROMs is extensive enough to cope with the inventory of many supermarkets and department stores. The 2-microsecond read times of these devices satisfy the needs of even the fastest cash-register operator.

Other systems, while still requiring some nonvolatile reprogrammable memory, may need part of their data to be immediately accessible to a computer. A credit-card-cash-register point-of-sale terminal is an example. Any data needing fast access would then be programmed into an ordinary ROM while the inventory data would be coded into the alterable ROM. Since the two kinds of ROM are generally compatible in voltage, power, and pinout configurations, the same printed-circuit board can hold both, with standard interface circuits used in reprogramming the alterable ROM.

Another configuration (Fig. 7b) combines an alterable

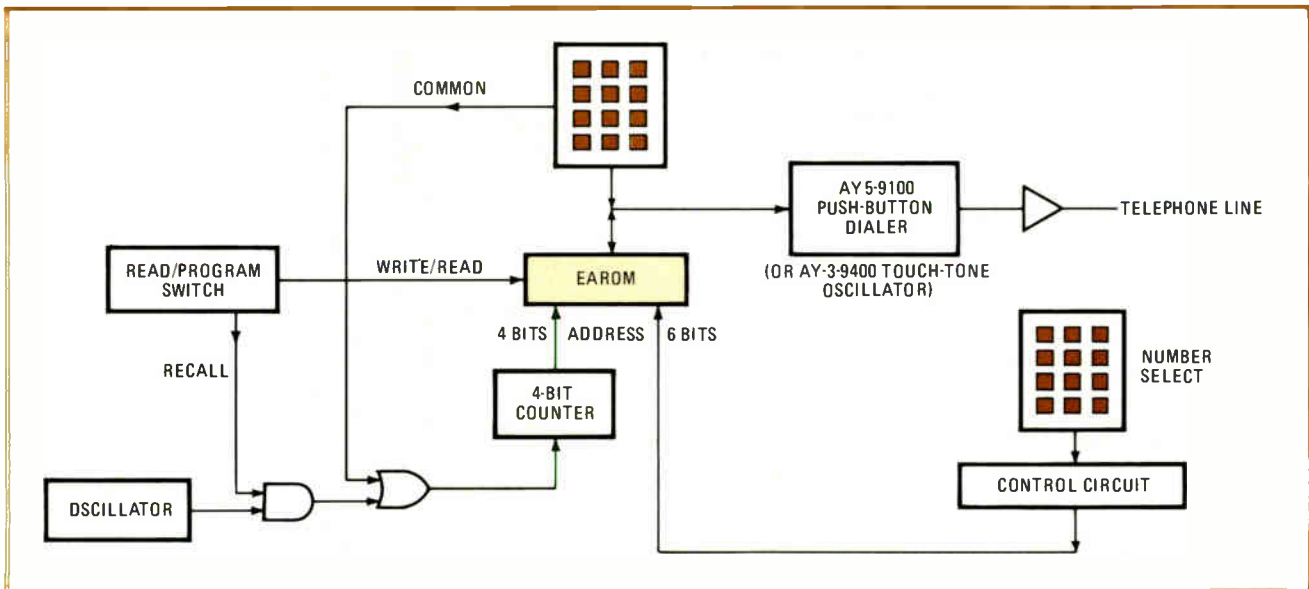

**9. Dialing.** An electrically alterable ROM in a repertory dialing system stores telephone numbers, which are then automatically supplied to the dialing mechanism when requested by the user. This 4,096-bit memory provides enough data to handle 64 16-digit numbers.

ROM with a RAM to handle real-time situations where the system must meet the requirements of many different stores yet also react quickly to an individual store's needs. On these occasions, where faster access times are required than the alterable ROM can provide, the device can automatically dump its contents into an inexpensive RAM on system power-up. The RAM then provides the program information, leaving the alterable ROM free to be updated at leisure. Moreover, although not intended as a scratchpad memory, the alterable ROM can also be used with the RAM to provide data storage off line—a configuration that could be useful for obtaining running totals, say.

Large quantities of alterable ROMs are also being used in digital TV tuners, which exploit both the nonvolatility and the reprogrammability of the devices. In the Omega system developed by General Instrument (Fig. 8a), the alterable ROM stores tuning information needed by the varactor but formerly provided by much more expensive potentiometer banks.

It works like this. The digital tuning information is passed through a digital-to-analog converter to supply the varactor with the proper tuning voltages. But since varactors differ from device to device, these voltages need tweaking, and if this is done with potentiometers during assembly, it is a costly operation. An alterable ROM, however, can be preprogrammed with the digital information that goes to the converter, adjusting for the varactor variations and providing a cheap and very accurate method of obtaining the right voltages (See *Electronics*, April 1, 1976, p. 86, for a full description.)

An alterable ROM can also be used to store the viewer's own fine-tuning settings. Here, after selecting a channel, the viewer fine-tunes the set by incrementing or decrementing the data register with a simple chassis switch. When he or she releases the switch, the data is loaded back into the alterable ROM so that it always contains the most up-to-date information.

Tuning applications are not limited to simple open-

loop tuners. A phase-locked-loop tuning configuration controlled by an alterable ROM is shown in Fig. 8b. In typical phase-locked tuners, channels are selected by varying the counter division ratio, which changes the phase-locked loop frequency. In this circuit, the alterable ROM stores the proper division information for the various desired channels, controlling the count ratio of the variable counts.

In operation, the crystal oscillator frequency is divided down to provide a stable reference. The variable counter, in conjunction with the prescaler, divides the local oscillator to a frequency close to the reference. The two signals are then fed to the phase detector. Any error between the reference and the present frequency is used to adjust the varactor tuning voltage, reducing the error and locking in the desired station.

### In locks and dialers

In an electronic door lock (Fig. 9), the alterable ROM stores the key code, which may be periodically changed by the user against unauthorized entry. To drive the latch that opens the lock, data from a keyboard is compared with the data from the ROM and at the same time fed to a counter. Any error in the data will inhibit the unlatch signal. But if the full string of numbers is entered into the counter without error, the counter overruns, the solenoid is powered, and the door latch opens.

Finally, there is the telephone repertory dialer of Fig. 10. This system uses a 4,096-bit alterable ROM to store 64 16-digit numbers. To select a number, the caller uses either a push-button pad or a thumbwheel switch to enter 6 address bits. In the program mode, the keyboard provides binary-coded-decimal digit data as well as a common signal for incrementing the address counter. As each button is pushed, the digit is fed to the memory, and on completion of the phone number, the counter is incremented. To recall a number, the oscillator pulses the 4-bit counter, scanning through each of the digits of the desired telephone number. □

# RCA devices can new discoveries

New devices. New packages. New parameters. All from the Powerhouse, your source for the widest choice in SCRs and Triacs. These additions to the RCA line offer you the latest ways to improve design, reduce costs and increase performance.

## A new way to heat.

Solid-state induction heating is now entirely feasible, thanks to our new 40A asymmetrical SCR. Along with 40 kHz frequency, the compact RCA S7310 gives you a breakthrough combination of high voltage and current to work with. Plus high  $di/dt$  and  $dv/dt$  capability. When you use the ASCR to generate useful heat, you can also get rid of useless weight by



eliminating bulky 50/60 hertz transformers and related oversize parts.

## A new way to switch.

Now you can design-out some of the problems you've had with big dc relays — such as too much cable bulk in automobiles.

Our new solid-state way to switch up to 15 amps is with the G4000 gate turn-off SCR. Packaged in plastic, this family of SCRs operates with as little as 1V gate trigger voltage — making them well suited to a full range of industrial and computer relay applications.



High frequency thyristor inverters for heating

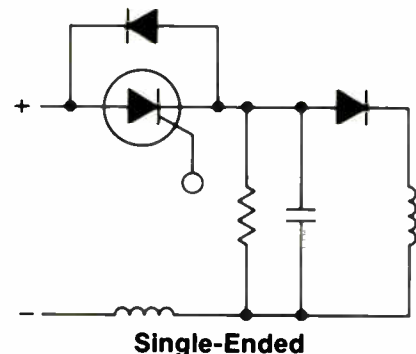
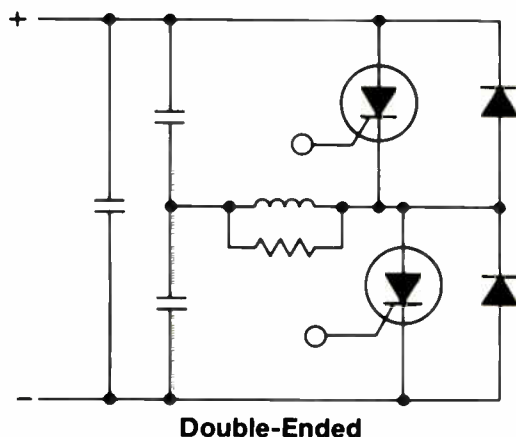

# help you make in power design.

## New design flexibility for you. From RCA.

Family	V <sub>DRM</sub> (V)	I <sub>T</sub> (A)	I <sub>GT</sub> (mA)	Description	Package
S7310	50-600	40	50-100	Fast Asymmetrical SCR	TO-48
G4000	50-400	15	3	Gate Turn-off SCR	TO-220
S860	50-600	100	200	Gen. purpose SCR	½" stud
S5800	100-600	15	25	Fast switching SCR	TO-220
C106	15-600	4.0	0.200	4-amp gen. purp. SCR	TO-202
T2320	50-400	2.5	3-40	Sensitive-gate triac	TO-202
T6000	50-600	15	10-50	Gen. purpose triac	TO-220

### A new source for the C106.

This popular 4A general purpose SCR and corresponding sensitive-gate triac are now available from RCA. Featuring glass-passivated chips for stability. They're in the economical three-lead Versatab



package that facilitates just about any mount-down technique. In a wide range of applications including: appliance motor and speed controls, oil & gas igniters, scoreboards, temperature controllers, solenoid drivers and battery chargers.

### A new source for circuit ideas.

Here is a new designer's guide to the selection of optimum RCA solid-state devices for power circuits. It's arranged by application—over 40 circuits are shown

— with key device requirements and recommended RCA devices included with each circuit. This makes it easy for you to choose the type best suited to the job.

For more information, contact your local RCA Solid State distributor. Or contact RCA Solid State headquarters in Somerville, NJ; Sunbury-on-Thames, Middlesex, England; Quickborn 2085, W. Germany; Ste.-Anne-de-Bellevue, Quebec, Canada; Sao Paulo, Brazil; Tokyo, Japan.



## RCA Power experience is working for you.

# RCA

## 555 timer isolates equipment from excessive line voltage

by R. J. Patel  
Tata Institute of Fundamental Research, Bombay, India

Instruments and appliances can be easily damaged when the line voltages that power them become excessively high or low, but a voltage-sensing circuit using the 555 timer will disconnect the equipment from the power lines if the set limits are exceeded. This circuit offers a better alternative for protecting instruments than a voltage stabilizer circuit, which is usually effective for detection and compensation of short-term variations only.

As shown in the figure, the line voltage is converted to approximately 15 volts by the step-down transformer, whose turns ratio is determined by the magnitude of the incoming voltage at the primary winding. This voltage is rectified, then filtered by capacitor C and applied to a 12-v regulator in order to bias the timer and the 2N2222 sense transistor. The magnitude of the unregulated voltage varies proportionally with the line

voltage, as is to be expected, and this voltage is continually sampled by potentiometers P<sub>1</sub> and P<sub>2</sub>, the upper and lower threshold controls.

The 555 timer is used in the bistable mode, and its state is a direct function of the voltages on its set and reset ports, pins 2 and 4, respectively.

Under normal conditions—that is, when the supply line voltage is within the set limits—the unregulated dc voltage at point A is sufficient to fire zener Z, saturating the transistor. Pin 4 of the timer rises rapidly to 12 v; when this voltage exceeds two thirds of the 12-v bias voltage on the timer, or 8 v, pin 3 moves high and the relay is energized.

If the ac line voltage is below the low set value, the voltage at A is below the value needed to fire the zener, and the relay is de-energized. When the line voltage shoots above the set upper limit and the dc voltage at pin 2 exceeds one third of the 12-v supply voltage, the relay is de-energized as pin 3 moves low.

The upper and lower set limits can be set with an accuracy of  $\pm 5$  v of the true ac line voltage if precision potentiometers are used. There is no set-point hysteresis, because of the avalanche breakdown characteristics of the zener Z. Any transients generated by the power line are rendered harmless by the large filter capacitor C. □

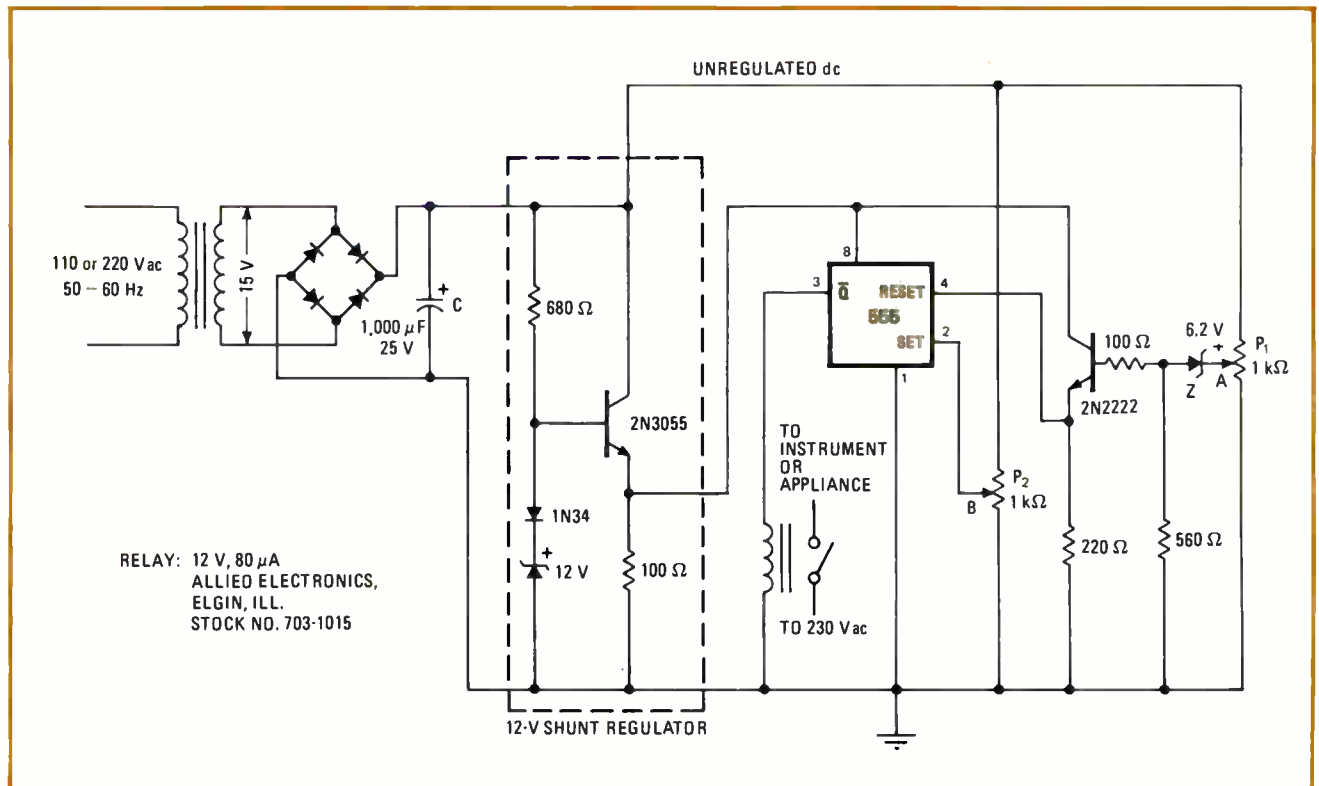

**Line-voltage monitor.** 555 timer circuit senses if ac line voltage is above or below set limits, then de-energizes line relay if necessary, removing power from equipment. Simple circuit uses set-control potentiometers P<sub>1</sub> and P<sub>2</sub> to monitor unregulated dc voltage, whose value is directly proportional to the ac line voltage. Timer and 2N2222 transistor require the regulated power source.

## Resettable electronic fuse consists of SCR and relay

by Russell Quong  
Palos Verdes, Calif.

Most direct-current power supplies rely on a circuit breaker, current-sensing circuit, or fuse for current-overload protection, but this simple resettable-fuse circuit has advantages over all three. Built around a silicon controlled rectifier and a line relay, it is faster than a circuit breaker, less complex than most current-sensing circuits, and never in need of replacement.

How the circuit operates is evident from (a). Momentarily depressing  $S_1$  closes the relay so that current flows from the supply to the load. In normal operation, the

voltage across points PQ will be equal to the nominal supply voltage, and the normal operating voltage will appear across the relay winding. The relay and resistor  $R_2$  are selected according to the dc supply voltage used and the relay's rated coil voltage, respectively.

Excessive current to the load causes a voltage drop across  $R_1$  greater than 0.65 volt and switches on the SCR. The anode-to-cathode voltage of the SCR in the conducting region is approximately 2 v. This voltage, also across the relay coil, is far below the relay's holding voltage. Consequently, the relay opens, disconnecting the load from the supply. The relay may be reset by depressing  $S_1$  again.

If a variable threshold point for SCR switching is desired, the SCR's gate can be connected to  $R_1$  through potentiometer  $R_3$ . Resistor  $R_1$  is calculated as before. □

Designer's casebook is a regular feature in *Electronics*. We invite readers to submit original and unpublished circuit ideas and solutions to design problems. Explain briefly but thoroughly the circuit's operating principle and purpose. We'll pay \$50 for each item published.

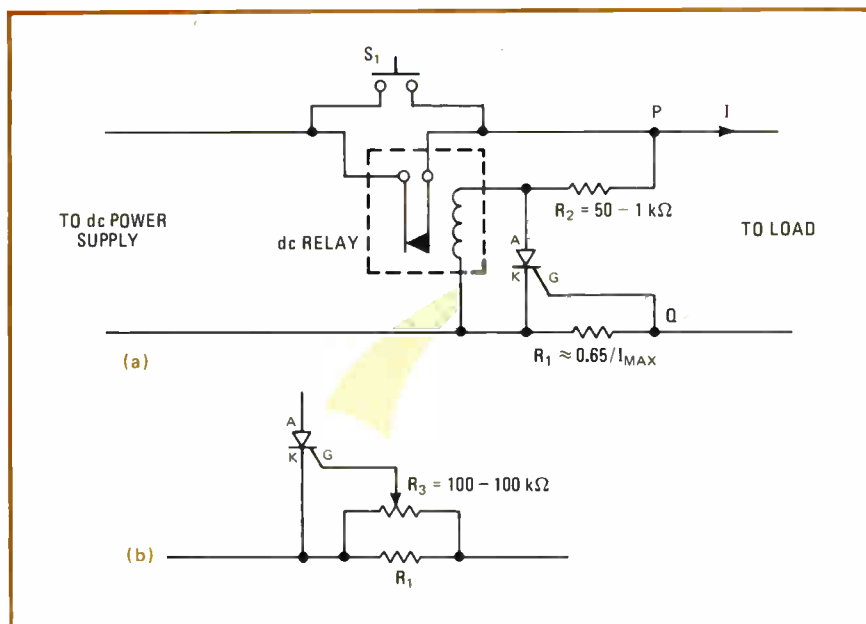

**Electronic fuse.** SCR and relay form resettable fuse for dc power supplies. When  $I_{max}$  is reached, SCR turns on, opening relay and disconnecting power from load. Depressing  $S_1$  reinitializes circuit (a). SCR switching point may be adjusted with  $R_3$  (b).

## Versatile phase detector produces unambiguous output

by L. E. S. Amon and B. Lohrey  
University of Otago, Department of Physics, Dunedin, New Zealand

A dual monostable multivibrator and integrator network forms a detector that not only measures phase difference between two signals throughout the entire  $360^\circ$  range, but also produces an unambiguous output signal for various phase-advance and -retard conditions by generating a voltage and slope output combination that is unique for every angle.

As shown in (a) of the figure, a positive zero crossing of reference signal A triggers the comparator  $C_1$  and

one-shot  $MS_1$  at time  $t_a$ , where  $MS_1$  is one half of the 74123 device. This one-shot, in the retriggerable mode and set so that its pulse width  $\tau_1$  is greater than  $T_a$ , the period of the reference signal, stays on until comparator  $C_2$  and one-shot  $MS_2$  are fired by signal B at time  $t_b$ . The narrow pulse produced by  $MS_2$  resets  $MS_1$ .

The phase of B with respect to A may be related to the duty cycle of the output signal from  $MS_1$ . The duty cycle may be expressed by:

$$W = \frac{t_b - t_a}{T_a}$$

The output signal may be converted to a dc voltage by the integrator network connected to the output of  $MS_1$ . Alternatively, the phase may be measured digitally [see *Electronics*, Dec. 20, 1973, p. 119].

As shown in (b), an increase in the dc output of the integrator occurs when the phase angle of B increases

# Four ways to do 8x8 Multiplication

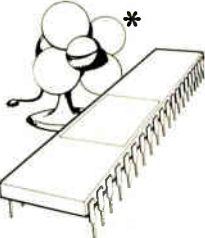
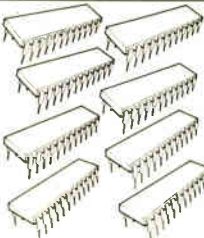
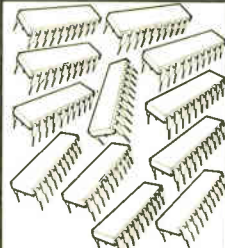
				
<b>DEVICE</b>	MMI 67558	TRW MPY-8	AMD 25S05 (FD 93S43)	TI (MSI) 74S274/5
<b>ORGANIZATION</b>	8 X 8	8 x 8	2 X 4	4 X 4
<b>TYPICAL SPEED</b>	100 NS	130 NS	75 NS	75 NS
<b>POWER</b>	1W	1.8 W	5W	5.4W
<b>PACKAGE</b>	40-PIN	40-PIN	24-PIN	20-PIN
<b>NUMBER OF PACKAGES</b>	1	1	8	12
<b>TECHNIQUE</b>	COMBINATORIAL (BOOTH)	COMBINATORIAL	COMBINATORIAL (BOOTH)	COMBINATORIAL (WALLACE)
<b>ROUNDING</b>	YES	YES	NO	NO
<b>MFG. PROCESS</b>	LS/TTL	TRIPLE DIFFUSION	S/TTL	S/TTL
<b>SECOND SOURCE</b>	YES	NO	YES	NO
<b>DATA REP.</b>	SIGNED and UNSIGNED	SIGNED ONLY	SIGNED ONLY	UNSIGNED ONLY
<b>TOTAL \$</b> <small>At 100 UP quantity</small>	<b>MIL</b>	110	115	210
	<b>COM</b>	64	70 <small>(Fan not included.)</small>	124
				≈140
				68

\*300 fpm cooling required.

#### Europe

Monolithic Memories, GmbH  
8000 Munich 80  
Mauerkircherstr. 4  
West Germany  
Tel: (089) 982601, 02, 03, 04  
Telex: (841) 524385

#### United States

Monolithic Memories, Inc.  
1165 East Arques Avenue  
Sunnyvale, CA 94086  
Tel: (408) 739-3535  
TWX: 910-339-9229

**(Second sourcing from ITT Semiconductor.)**

**For more information, phone, TWX or write.**

#### Far East

MMI Japan KK  
Parkside-Flat Bldg.  
4-2-2, Sendagaya Shibuya-Ku  
Tokyo 151, Japan  
Tel: (3) 403-9061  
Telex: (781) 26364

# Monolithic Memories



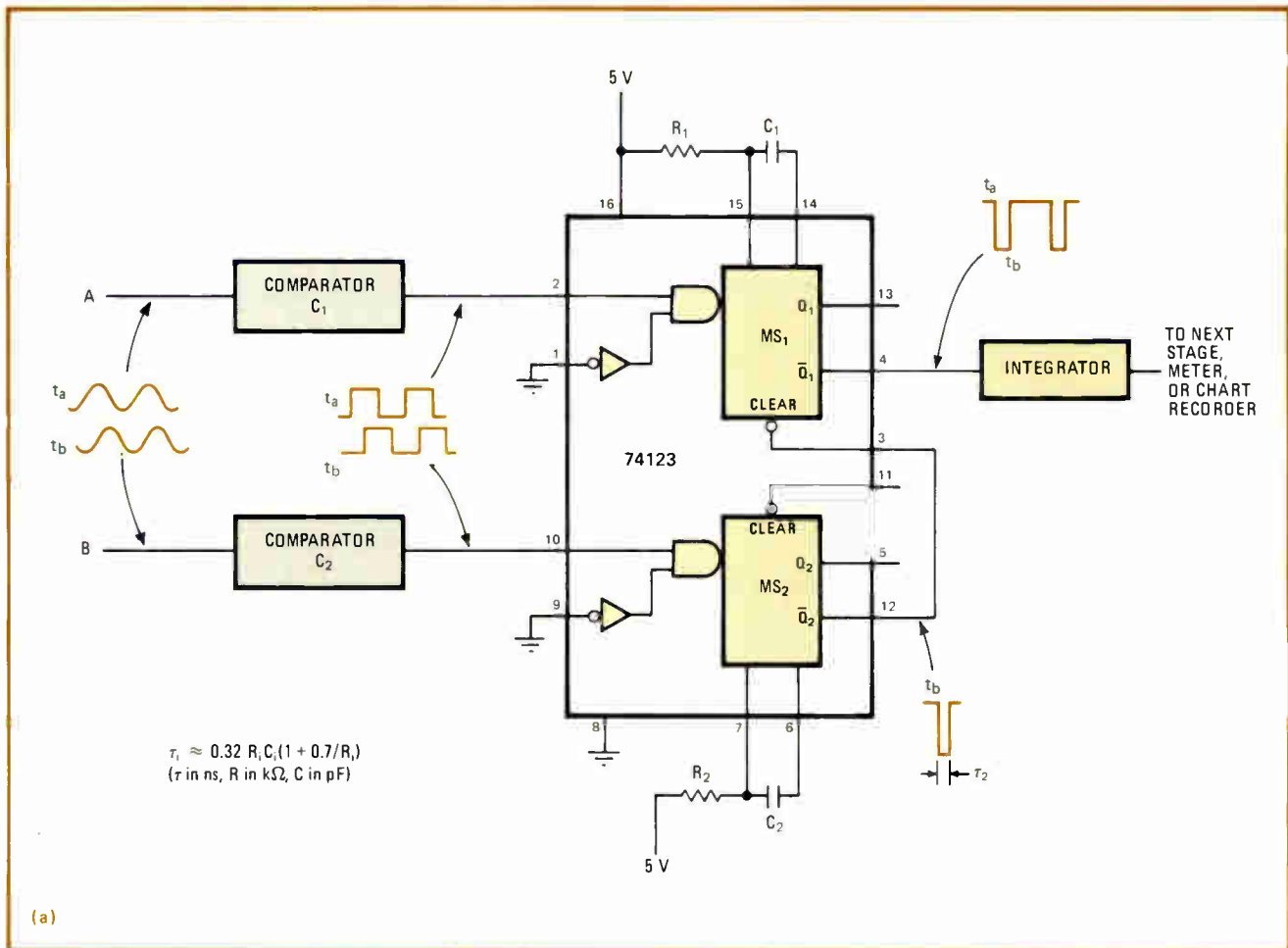

**360° phase detector.** Dual one-shot and integrator yield unambiguous voltage and slope output combination for changing phase-lead or phase-lag angles (a). Output from integrator is maximum at 360° when A leads B, minimum when B leads A (b).

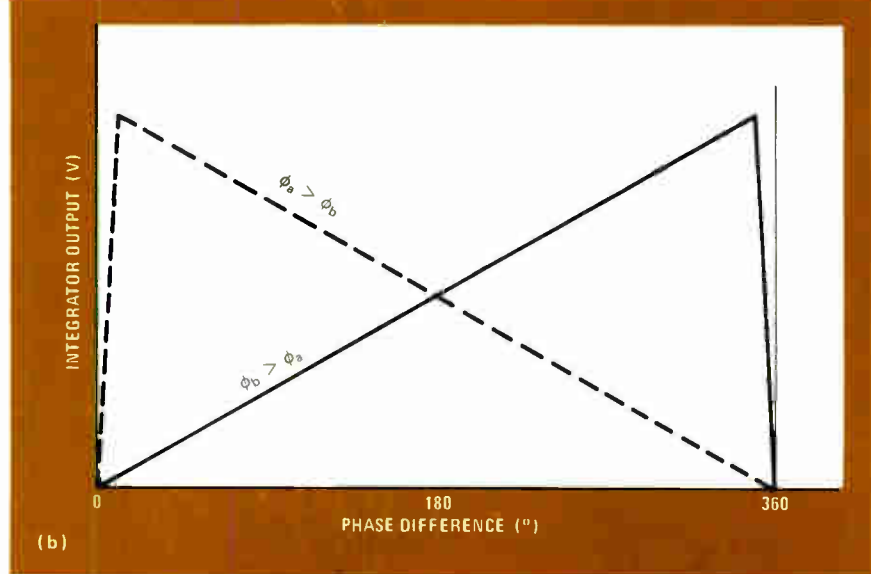

with respect to A. The output decreases when the phase angle of B decreases with respect to A. Thus the frequency relation of B to A may be determined from the slope of the integrator's output if the two signals are of similar but not identical frequency.

When the two signals are not harmonically related, their phase relationship will change with time. The circuit is therefore useful as a phase-modulation detector

for applications in communications receivers.

Further versatility can be achieved by placing frequency dividers at the input ports of the phase detector to achieve a full-scale output at  $N \times 360^\circ$ . The sensitivity can be increased, on the other hand, if both of the input frequencies are multiplied by  $N$ . This reduces the range of phases that yield an identical output voltage to  $360^\circ/N$ . □

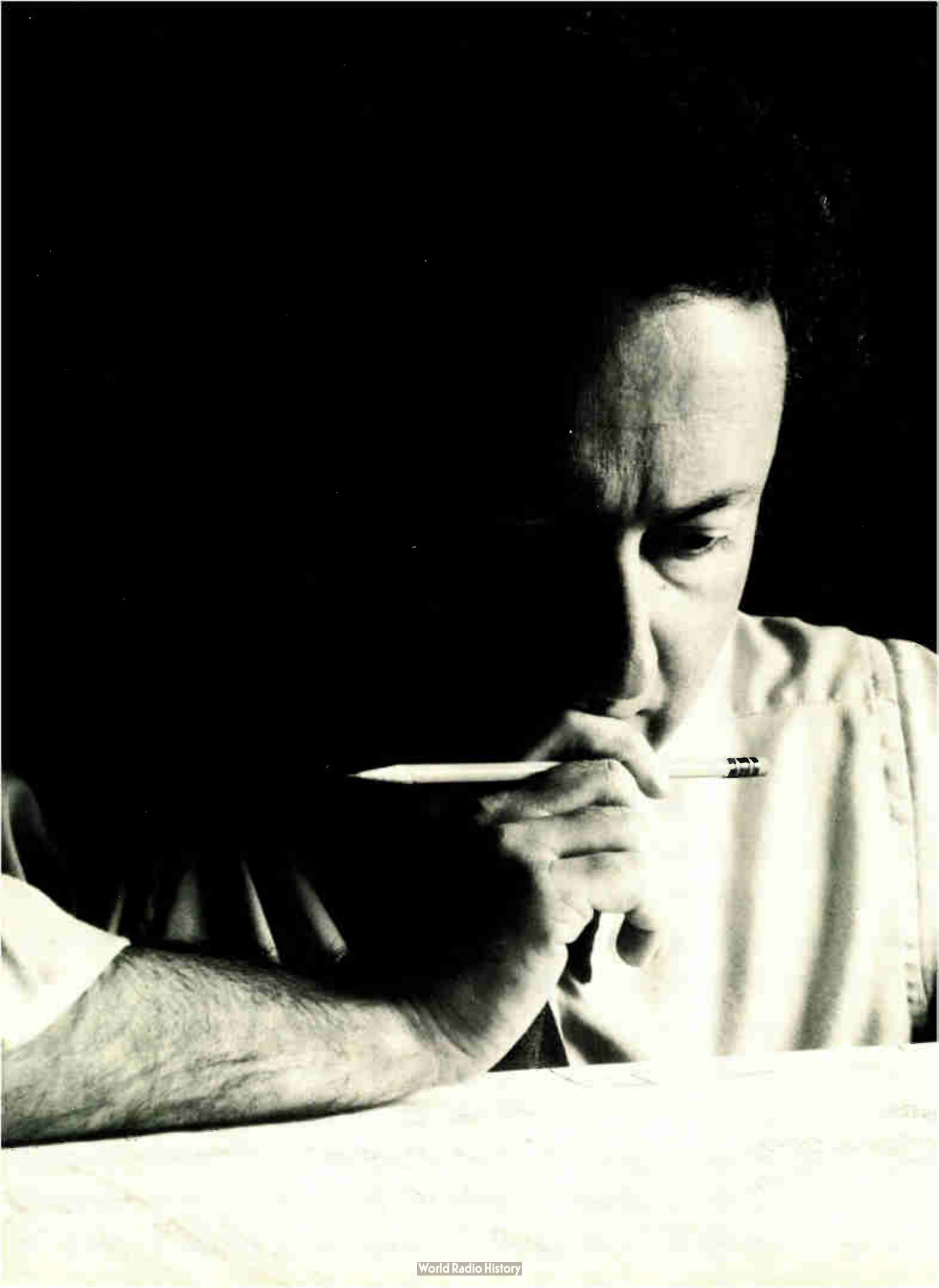

# The best electronic brains are still human.

In the design of new products, too often the latest microelectronic advances create a "technology beats man" mirage.

The truth is, the real difference between competing products still depends on the skillfulness with which the designer can squeeze in electronic functions while squeezing out dollar costs.

And Rockwell offers special ways to help you squeeze.

## When the system solution is microelectronics, the source is Rockwell.

During design, experienced Rockwell applications engineers help you in selecting the cost effective microprocessor system or microelectronic subsystem. You choose from a broad selection of NMOS or PMOS microcomputers with 19 off-the-shelf CPUs (or we'll customize a CPU for you); one-chip or multi-chip systems; LSI MODEMS; RF amplifiers, mixers

and oscillators; mechanical and SAWD bandpass filters; and special telecom circuits.

If you're looking for high reliability packaging and improved production efficiency, you can get the advice of our hybrid or multi-layer board designers on custom packaging or products.

Once you're in production, Rockwell's high volume capabilities keep every order, big or small, moving on schedule to your plant.

Rockwell's commitment to the power of human thinking and to microelectronic squeezing has already associated us with some of the smartest electronic products: cash registers, weighing scales, accounting machines, electronic games, facsimile equipment, avionics, computers, telecom, telemetry and microwave equipment, and many other products.

And for your future, Rockwell is working on advanced devices and processes such as bubble memo-

ries, Very Large Scale Integration (VLSI), CMOS/SOS and other technologies.

Get the best electronic brains and the best human brains together on your new product. Contact C.V. Kovac, Vice President — Business Development, Electronic Devices Division, Rockwell International, P.O. Box 3669, Anaheim, CA 92803 or call (714) 632-2415.

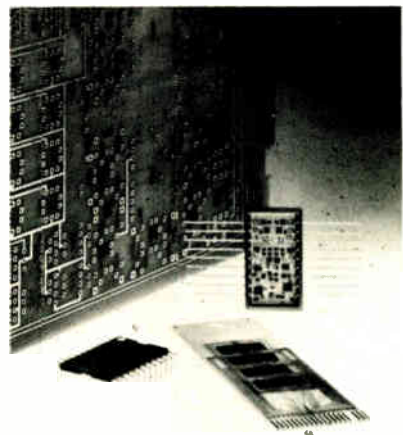

...where science gets down to business

# Reducing system interconnections with multivalued logic

Sending multiple voltage and current levels over a transmission line enhances processing capabilities of otherwise all-binary systems

by Clive W. ROSS, *Plessey Marine, Templecombe, Somerset, England*

□ Even though all present digital integrated circuits work with binary data and control signals, binary logic need not monopolize a digital system. The use of logic based on more than two levels of voltage or current—or, better yet, on multiple values of voltage *and* current—is possible in parts of today's systems. It will greatly expand the amount of information they can process and does not even require the development of new multiple-state devices.

Most efforts in multivalued logic circuits have concentrated on what may be termed a "first order" system, which quantizes either the voltage or the current levels. But greater processing capability can be obtained with a "second order" system, in which both voltage and current levels are used.

Consider a system in which a transmission path links control circuits to other circuits where data is either processed or acquired. Both ends of such a system may work in a binary mode, but if a second-order nonbinary regime is imposed on the transmission path, significantly

fewer interconnection paths are required. It can be done very simply, by using present-day binary devices along with analog-to-digital and digital-to-analog converters to generate the multiple voltage and current levels required. Nor need there be more than, say, three voltage states and two or three current states to gain the promised improvement over strictly binary systems—four to ten times their information processing capability.

## The simplest system

To back up a little, a simple device that can be used in a first-order nonbinary system is the familiar tri-state integrated circuit. Although the tri-state device works in the binary mode, it may actually generate more than two output states. Two of the states in a typical tri-state device are the normal 1 and 0 conditions, while the third is a high-impedance or off state, which permits the device to be controlled by some other source by means of a bus. A bias network can be used at the output of the device to assign an arbitrary voltage value to this third

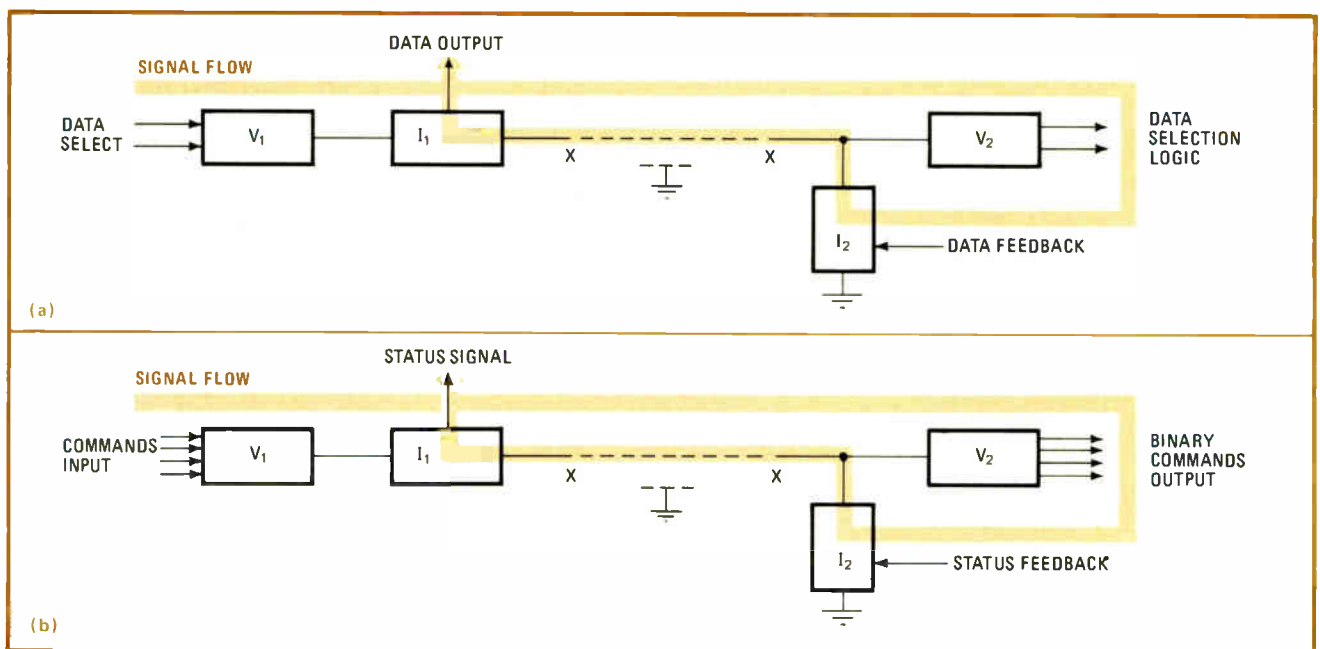

**1. Second-order nonbinary system.** Multiple voltage and current levels are generated for single-wire multiplexing.  $V_1$  converts the binary input signals into several voltage levels, while  $I_1$  detects current flow in  $x-x$  line.  $V_2$  converts the levels back into binary format so logic may pass desired data.  $I_2$  detects data, changing current on line, passing data to output. Digital (a) and process-control systems (b) are similar.

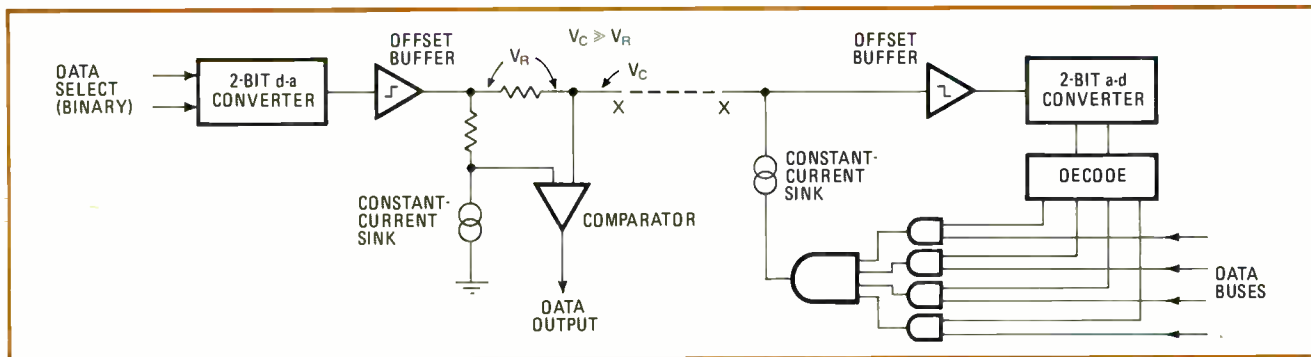

**2. Digital-data application.** Practical nonbinary system may be easily implemented. Two-bit d-a converter assumes duties of  $V_1$  in Fig. 1; a-d converter is  $V_2$ . Logic drives current sink  $I_2$ . Comparator is  $I_1$ . Offset buffers calibrate current sinks.

state. Thus it is shown to be possible for three voltage levels or, alternatively, three current levels to be generated from binary input signals.

A second-order binary system is a more complicated, but easily understood, network. Generally speaking, binary control signals retrieve data from a data source through a bidirectional transmission line and deposit it at a designated point in the operating system. To do so, they must generate several voltage levels on the transmission line. Returning on the line is a multicurrent feedback signal corresponding to the retrieved data.

The basic idea is the same for both a digital data application (Fig. 1a) and a control application (Fig. 1b). Voltage source  $V_1$  converts the binary input signals into one of several voltage levels, while circuit  $I_1$  detects the resulting current flow in the  $x-x$  line. Circuit  $V_2$  detects and translates the voltage levels back into binary format at the receiver end.  $I_2$  detects a data feedback signal, which is a function of the data on the line selected, and changes the line current. Finally the data is transferred to the output.

### Some applications

The relationship of this block diagram to various applications can be easily demonstrated. In many cases, only a single wire and ground will be needed for the data multiplexing.

Figure 2 shows a digital data application—a circuit using two converters, a comparator, and two-state current sinking. Obviously there could be multistate current sinking and the use of multiple comparators, but for simplicity's sake only two current states and four voltage states are considered.

As shown, the 2-bit d-a converter generates four voltage levels and sends these control signals through line  $x-x$ . The offset buffer applies some low potential to the line to allow calibration of the current sink.

At the receiver, the voltage steps are level-shifted by the buffer and fed to a simple analog-to-digital converter, which in turn feeds a decoder and four gates. The gates are enabled by the binary signals from the a-d converter, permitting the data already on particular gates to pass through to the current sink. The constant-current sink switches on or off, depending on the state of the gate array. The data, either a 1 or a 0, is sent back through the line to appear at the output of the comparator. The comparator detects the current changes in the

line by using a reference input voltage derived by a constant-current network. In this case, four lines of data have been interrogated and read out at a remote location, using a single line plus ground.

A control application is also easily implemented. Consider a magnetic-tape recording system having 24 channels and three operating modes (normal playback, playback from record head, record), in which it is desired to detect the magnitude of the bias current flowing through the tape head during a recording period. This information is to be fed to a remote unit containing a number of light-emitting diodes that indicate system status. There are thus five conditions of the system that must be identified: these three voltage states plus two bias-current states. These conditions can be detected with a three-voltage—two-current-state circuit using only a single control line per channel. For example, suppose the system has these voltages and currents:

- Normal playback: 0 volt.
- Playback from head: 10 v.
- Record: 20 v.
- Record bias current, below normal or zero: 0–0.5 milliampere.
- Record bias current, normal or above: 5.0 mA.

### Circuit details

A simple three-voltage—two-current transmitter for this circuit is shown to the left in Fig. 3. A switch selects the mode desired, and a two-level current sensor,  $Q_1$ , determines the relative magnitude of the bias current.

When the switch is in the record mode, a 1-hertz oscillator is connected through diode  $D_1$  to the red lamp, the bias-current indicator. Then if a logic decision made at the receive end indicates normal bias current, the command-line current rises, transistor  $Q_1$  saturates, and the lamp will fully be biased on. Otherwise, the lamp will be controlled by the oscillator and will flash a warning indicating low bias current.

A circuit using simple comparators is needed at the receiving end, to translate the quantized voltages back into binary form. Also needed is a means of applying a binary signal to a current sink that is controlled by some final event, to acknowledge that the chain of command is by then complete.

In Fig. 3, the ratios of resistors  $R_1$  to  $R_2$  and  $R_3$  to  $R_4$  are selected so that  $Q_3$  and  $Q_5$  saturate at control-line potentials of 10 and 20 v respectively. Under certain

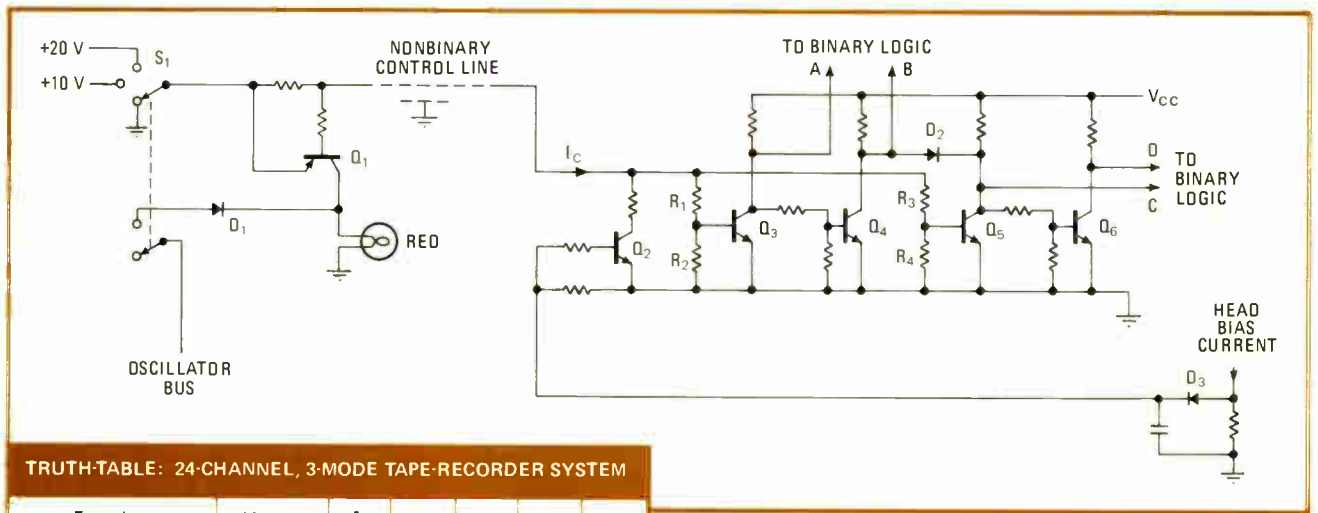

TRUTH-TABLE: 24-CHANNEL, 3-MODE TAPE-RECORDER SYSTEM

Function	$V_{control}$	$I_c$	A	B	C	D
Play (normal)	0	0	1	0	1	0
Play (rec head)	10	0	0	1	1	0
Record (?)	20	0	0	0	0	1
Record (OK)	20	1	0	0	0	1

**3. Process-control application.** Value of head bias current is to be determined during record periods in this magnetic-tape recording system. Receiver detects mode, drives logic circuits so that head current is sampled if system is in required mode.  $D_3$  conducts if current is normal.  $Q_2$  fires, changing current  $I_c$  so as to bias red lamp fully on. Otherwise, lamp is fired by 1-Hz oscillator.

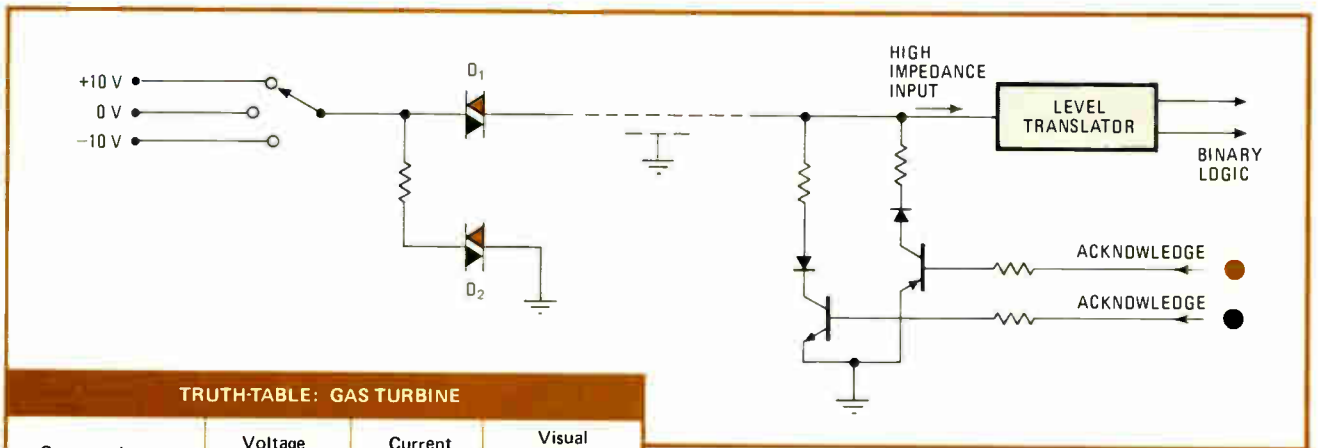

TRUTH-TABLE: GAS TURBINE

Command name	Voltage state	Current state	Visual indication $D_1$ $D_2$	
Standby	$0 \pm 0.5 V$	$0 \pm 100 \mu A$	none	none
Forward propulsion on, velocity low	$+10 V \pm 2 V$	0 to $+500 \mu A$	none	green
Forward propulsion on, velocity normal	$+10 V \pm 2 V$	$+15 mA \pm 20\%$	green	green
Reverse propulsion on, velocity low	$-10 V \pm 2 V$	0 to $+500 \mu A$	none	red
Reverse propulsion on, velocity normal	$-10 V \pm 2 V$	$+15 mA \pm 20\%$	red	red

**4. Modification.** The addition of one current sink and the use of two-color LEDs provide a three-voltage–three current circuit for monitoring a gas turbine system. The output circuit is simplified, because the diodes convert line current changes directly, needing no transistors, comparators, or current sinks.

circumstances  $Q_4$  and  $Q_5$  assume opposite logic states. So diode  $D_2$  has the important function of preventing the condition where they try to force point B to assume two different logic states simultaneously.

When the record command is detected, the logic connected to the binary output points A through D activates the record-head circuits. The bias current is detected by  $D_3$  and turns on  $Q_2$  if the current is greater than 5 mA, and consequently the current on the control line will change.

An interesting transmitter is shown in Fig. 4. Though extremely simple, it produces three voltage states and three current states. Two current sources and red/green LEDs provide more capability than the previous circuit.

Conventional binary-logic circuits are in wide use, and the use of tri-state devices is expanding. It seems certain that nonbinary systems will soon have considerable impact in many areas, particularly as a practical second-order binary system could have 10 times the information capacity of its binary counterpart. □

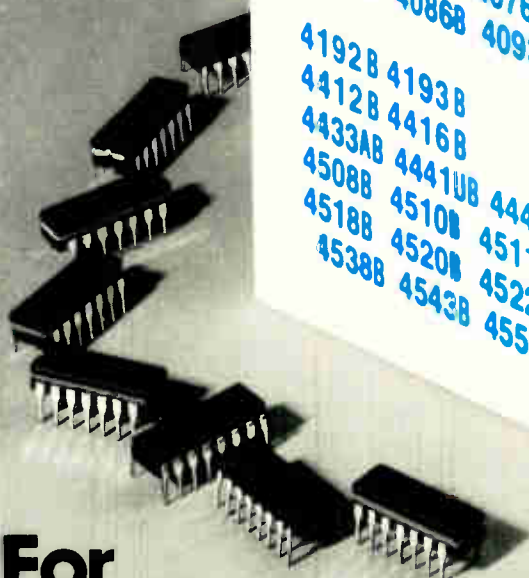
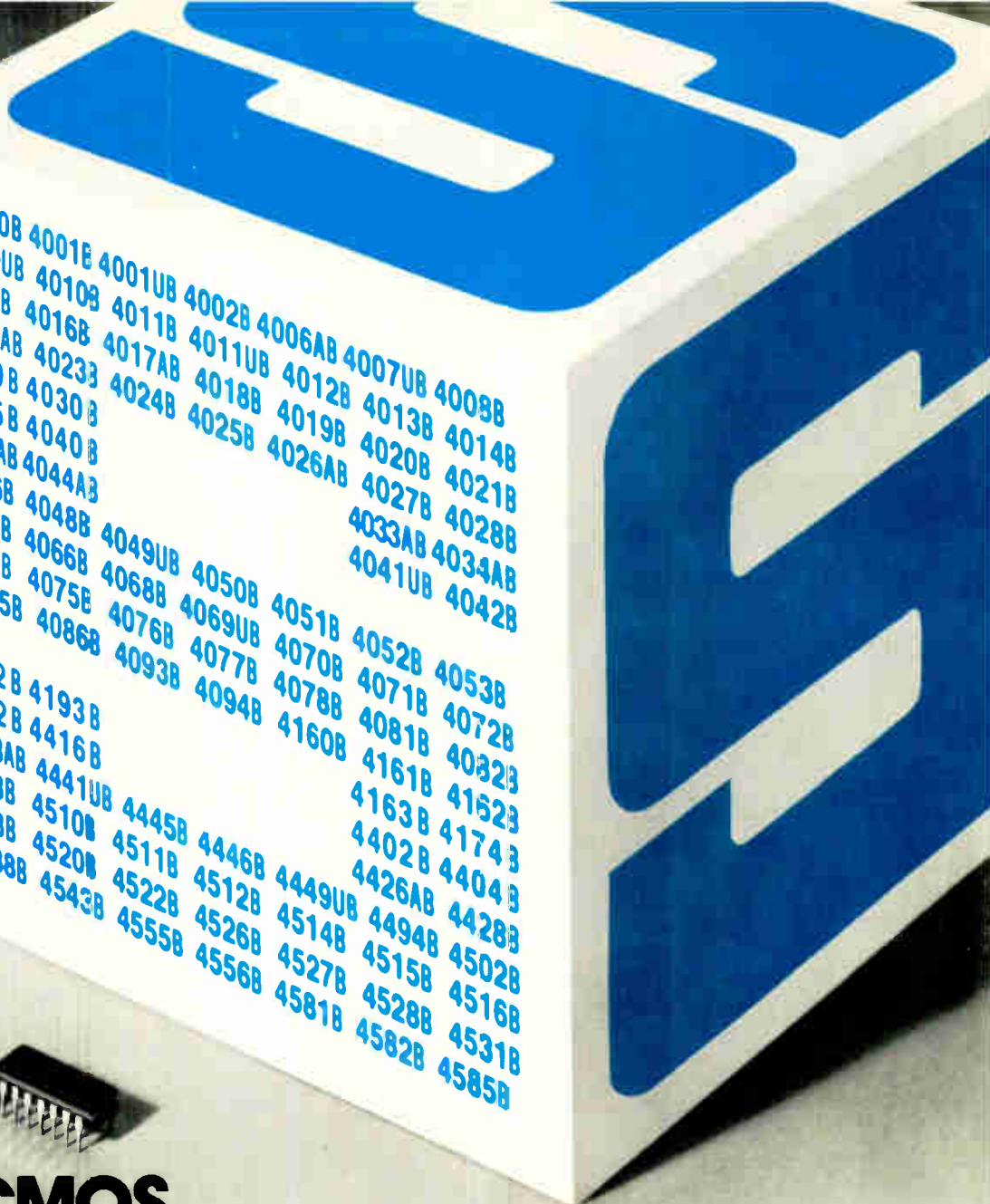

# For B-Series CMOS take sides with the leader

Solid State Scientific has over 100 device types for your standard circuit requirements. We are a major supplier of the 4000, 4100, 4400 and 4500 families and our line includes all popular package configurations. One indication of our commitment to leadership in the B-Series of CMOS circuits is our product development program. Recently, we have upgraded five devices (4016, 4020, 4040, 4060 and 4416) to meet or exceed the full electrical characteristics of the JEDEC Standard Spec-

ification. Five additional types (4006, 4017, 4022, 4043 and 4044) are now being upgraded and samples will be available shortly. In addition, eight new circuits (4048B, 4085B, 4086B, 4094B, 4174B, 4192B, 4193B and 4494B) are available for sampling and will shortly be moving into production. We offer commercial grade devices, 883B Mil-Spec devices and a variety of low cost, industrial high reliability screening programs. Known as Solid Plus, these screening

programs can simplify incoming inspection at your plant and reduce problems caused by infant mortalities. Write today for our new CMOS condensed catalog. In addition to our complete line of B-Series devices, it includes our standard memories and timekeeping circuits, plus details on the Solid Plus program. Solid State Scientific Inc., Montgomeryville, Pa., 18936. Phone: (215) 855-8400. TWX: 510-661-7267.



**SOLID STATE SCIENTIFIC INC.**  
All sides of CMOS technology

Circle 125 on reader service card

# Keep 7,500V isolation between you and trouble with a Motorola coupler. Any Motorola coupler.

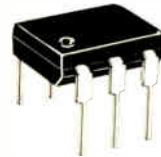

The first source to 4N-register plastic couplers—Motorola—now offers the latest word in isolation capability — 7,500 V!

We test each and every one of our 500 to 5,000 V-rated units to 7.5 KV . . . more than enough to keep trouble out of interfacing and coupling, phase and feedback, relays and switching.

It's spec'd on the data sheet and you don't pay a cent extra for the test or the performance!

Motorola's isolation surge protection doesn't degrade or disappear over time, either.

Our couplers are stable devices using ultra-clean, nitride-passivation and P-enhancement rings in the detector base to eliminate susceptibility to C-E channeling.

Motorola couplers ensure voltage isolation to levels never before attained. Larger light pipe periphery . . . high quality mold compounds . . . matched thermal expansion coefficients and the industry's longest voltage creepage paths combine to form an inherently reliable package.

Keep your logic clean, pure and protected with Motorola optical couplers. Shut down transients and noise before they start between CMOS, MPU, small signal discrete or T'L and ac or dc power circuits for as little as 75¢, 100-up.

See your authorized Motorola distributor or OEM salesman for trouble-shooting demonstrations of our coupler capability.

Motorola Semiconductor Products Inc.,  
P.O. Box 20912, Phoenix, AZ 85036.

<b>A</b>	Transistor Couplers	House/Jedec-Registered Isolation* Voltage (Min.)	Motorola-Tested Isolation* Voltage (Min.)
	4N28	500	7500
	4N26	1500	7500
	4N27	1500	7500
	4N38	1500	7500
	4N25	2500	7500
	4N25A**	2500	7500
	4N38A**	2500	7500
	MOC1005**	5000	7500
	MOC1006**	5000	7500

<b>B</b>	Darlington Couplers	House/Jedec-Registered Isolation* Voltage (Min.)	Motorola-Tested Isolation* Voltage (Min.)
	4N30	1500	7500
	4N31	1500	7500
	4N33	1500	7500
	MOC119	1500	7500
	MOC8030	1500	7500
	MOC8050	1500	7500
	4N29	2500	7500
	4N29A**	2500	7500
	4N32	2500	7500
	4N32A**	2500	7500

\* AC peak voltage — for five seconds.  
\*\* Underwriter Laboratory Recognition.



**MOTOROLA Semiconductors**  
*The mind to imagine... the skill to do.*



# MOS support microprocessor teams with bit-slice prototypes for easier microprogram debugging

by John R. Mick and Robert Schopmeyer,  
*Advanced Micro Devices Inc., Sunnyvale, Calif.*



□ Because of the variety of architectures and instruction formats possible with microprogrammable components, it takes team work of a high order to design high-speed processors with bit-slice devices and to write and debug the programs. A new member of the team that greatly eases these tasks is itself an example of teamwork: it is a prototyping aid called System 29 built with a metal-oxide-semiconductor microprocessor to help in the debugging of bipolar systems.

A designer can actually build a prototype of a microprogrammed processor using the Am2900 bipolar building blocks on special universal cards inside the System 29 chassis. To speed the prototyping, there are several optional cards holding control units that may be used in the final version of the system under design or may stand in for control units yet to be designed. Once the prototype has been fabricated, the designer can check out his microprogram as he debugs the various wiring and design errors and component failures that are sure to occur in the initial stages.

Perhaps the most flexible aspect of the system is part of the software: the disk operating system, called AMDOS/29, gives the rapid access to a large number of programs through a comprehensive file-management package. In addition, it provides all operations necessary to access floppy-disk drives and to interface the system to many standard peripheral devices.

## Two processors

There are actually two separate processor systems in the single package (Fig. 1). One, called the system support processor, is built around a 9080A MOS microprocessor with a dual floppy disk, which holds all operating software, and 32,768 bytes of static random-access memory, which stores the disk operating software. The SSP serves as the user's interface to the second system—the user's prototype—which is built around an Am2900 bipolar bit-slice processor chip set.

The many options on architectures and instruction formats make developing the microprograms generally

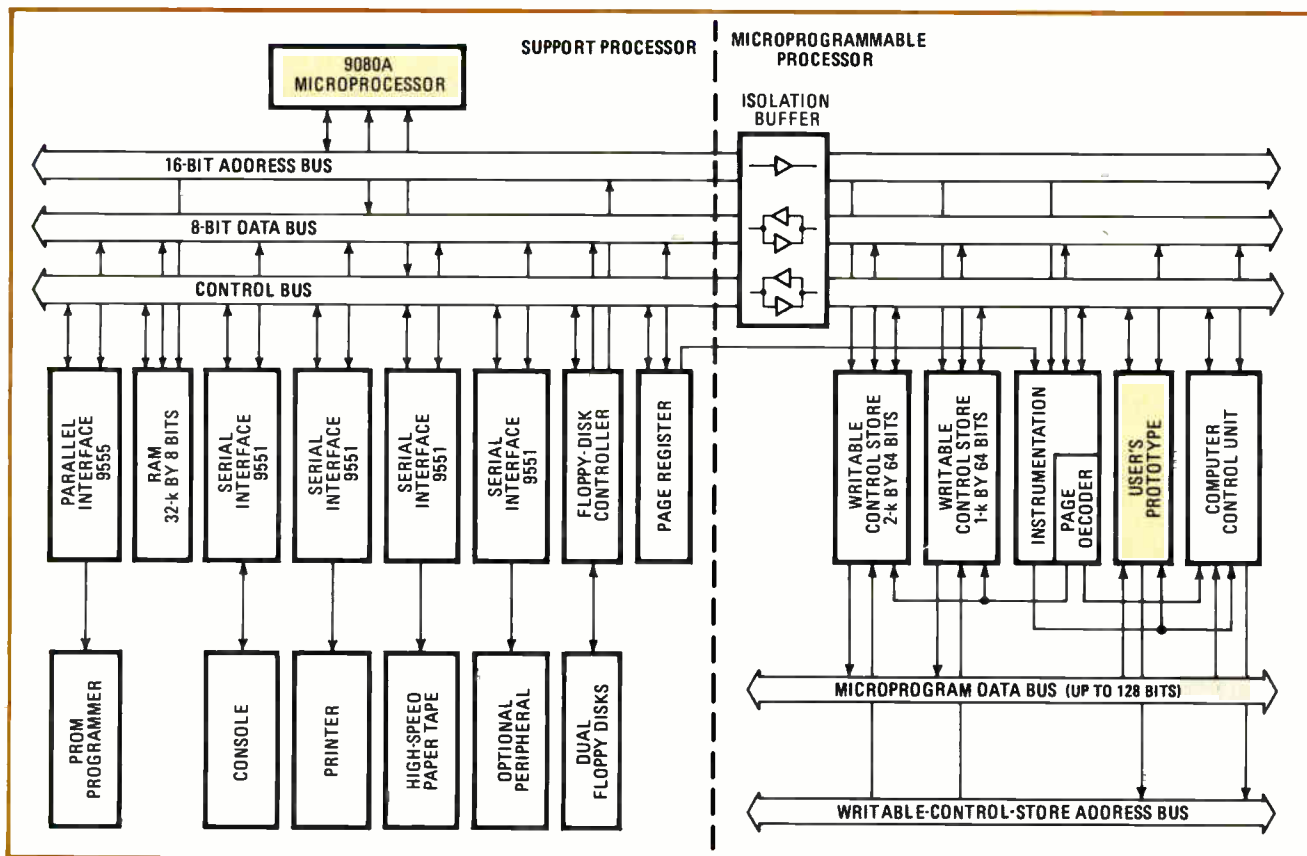

**1. The system.** Built for microprogrammable bit-slice components such as the Am2900 series, the System 29 is run under the direction of a 9080A MOS microprocessor working with dual floppy disks and several peripherals. The bipolar section includes writable control stores, an instrumentation page useful in debugging, and the prototype system that is under development.

more difficult than programming fixed-instruction microprocessors, such as the 9080A. Designers using such devices also have enjoyed a wealth of design and development aids, but the System 29 is the first one for microprogrammable components. Until now the designer using these components had to write the programs and assemble them himself. The new system has a resident assembler, called the AMDASM/29. Moreover, its many controls and peripheral devices eliminate the need to build special test fixtures with switches and displays to give insight into what was happening in the prototype circuitry.

### System hardware

In addition to the 9080A, the floppy disk, and the 32-kilobyte memory board, the support processor has a serial interface for communication to peripheral input and output devices. This interface will provide a current mode or an RS-232C electrical interface. A parallel interface allows communication to a printer and to either a programmer for a read-only memory or a high-speed paper tape producing PROM tapes. Also in the MOS section is the page register that is essential to the memory paging scheme.

Besides the user's prototype microprocessor, the microprogrammable section consists of an instrumentation board, which allows the 9080A to control the bipolar section, and the writable control store, which is a RAM that stands in for the microprogram memory and

mapping PROM of the system under design. The system support processor also has access to this RAM. Another important part of the bipolar section is the optional control unit or units.

The basic configuration of the writable control store is two memory boards with low-cost, 4,096-bit static RAMs. It can provide a microprogram memory space of 32 kilobytes that is either 2,048 words wide by 128 bits deep or 4,096 words by 64 bits. This configuration is intended as a design aid for two types of systems: those using a slow PROM and those that will use a fast PROM but with microprograms that need to be debugged at a reduced system speed.

Alternatively, a 1,024-by-64-bit memory that has 50-nanosecond access time can be substituted. Using 30-ns-access bipolar RAMs, the writable control store lets users simulate as closely as possible the operation of fast PROMs.

One unusual feature of System 29 is the way in which it allows the 9080A to control various functions by memory mapping. Since the processor can address 64 kilobytes of RAM, the system maps various functions into the upper 32 kilobytes of address space, while the lower 32 kilobytes is reserved for the RAM that holds the disk operating system. For example, the system is designed to accept 4 kilowords by 128 bits of writable control storage. This program represents two pages of 32 kilobytes each. Each 32-kilobyte block is mapped into the upper 32-kilobyte address space when needed.

## Extensive software eases development

The software system for the System 29 has four basic parts: the input/output system, the disk operating system, the console command processor, and the transient program area. The disk operating system, AMDOS/29, allows files to be opened, closed, renamed, read, written onto disk, or searched for by name. The console command processor reads inputs from the console and processes these commands to print listings of the file directory and the contents of various files and to control the operations of various other standard programs supplied with the disk operating system. The transient program area holds programs loaded from the disk for execution by the system.

The software package also can load microcode that has been assembled on the Computer Science Corp. time-sharing service. An acoustic coupler can load these programs directly into microprogram memory without punching paper tape. In addition, source files can also be loaded onto the floppy disk in the same way.

The disk operating system also contains a set of commands to display and modify the contents of microprogram memory. Once the microcode has been assembled, the user will probably want to set breakpoints, set trap bits, set comparison values, and so forth so that he may easily test and debug the microcode and its associated hardware. Examples of these commands are:

- Display—Display the contents of memory on the console.
- Move—Move a block of data to one location from another location in memory.
- Locate—Locate a particular character sequence in memory.
- Store—Store hexadecimal data into memory.
- Verify—Compare two blocks of data in memory.
- Set—Set bipolar format table attributes.

- Jump—Transfer control to any memory location in the writable control store.
- Read—Read hex-format paper tape.
- Write—Write hex-format paper tape.
- Page—Select a particular page as the upper 32,768 bytes of the 9080A address space.

Although there are many programs available for the 9080A, some designers will want to provide their own. A number of programs help set up the software to add various control features:

- Assemble—Loads a 9080A assembler and assembles the specified program from the disk.
- Status—Provides statistical information about particular files on the disk.
- Debugger—Loads a debug package from the disk.
- Peripheral interchange—Allows media conversion operations.
- Editor—Loads and executes a 9080A text editor program.
- Batch—Allows batch processing of various disk operating system commands.

On the bipolar side of System 29, a number of microprogram generation aids are available. These include:

- AMDASM/29—A two-pass microprogram assembler used to convert an established set of formats into machine language.
- AMPROM/29—A postprocessing program that allows the user to put out his binary object code in a form that corresponds to the PROM organization.
- AMSCRM/29—A postprocessing program that allows the user to reorganize the columns of microcode for programming in any PROM.
- AMPARITY/29—A postprocessing program that allows the user to generate one or more parity bits on the defined microcode word.

In addition to the pages available for the microcode, a number of other 32-kilobyte pages can be dedicated to provide other features. One page is the instrumentation board, which gives the designer significant firmware-debugging and hardware-checkout capability. It provides the logic necessary for the 9080A to directly control the microprogrammable section. It includes clock control—stop, single step, run, and trap on breakpoint—as well as control of microprogram address trapping and branching. Stop, single step, and run are under control both from the 9080A software and the front panel, while trap on breakpoint is controlled only by the processor's software. A 12-bit breakpoint address is loaded into a register by the software and is compared against the 12-bit address for the writable control store. When there is a match, the microprogrammable processor clock is stopped and an interrupt request is sent to the processor.

Under software control, a branch address can be forced, causing a bipolar sequencer to start executing microcode from there. This feature can be used to provide a starting address or to jump to a diagnostic microroutine when debugging microcode. The instrumentation page also allows the user to examine various buses in his system and determine the correct operation of the prototype.

The paging scheme provides an estimated throughput improvement of 10:1 compared with a system using I/O controls. It owes the improvement to its use of memory instructions, rather than I/O instructions, for access to the bipolar side. It provides 256 individual pages to perform various development system functions. Since only a minimum number of pages are used in the system, the user may add his own circuitry for maximum utilization when developing his designs.

The system can monitor as many as 100 test points in real time. These test points are saved in an additional RAM at the bipolar clock frequency (or some fraction or multiple of this frequency). When the clock is stopped, as from an address compare, then the last 256 states of these test points can be displayed in a user-defined format on the system CRT.

### Using the system

After the basic logic design has been completed, the designer must set up the microcode format, build the microcode source files using the interactive editor, and then assemble the microprogram using the assembler, AMDASM/29 (see "Extensive software eases development"). This assembly produces a binary representation of the microprogram, which can be printed in several

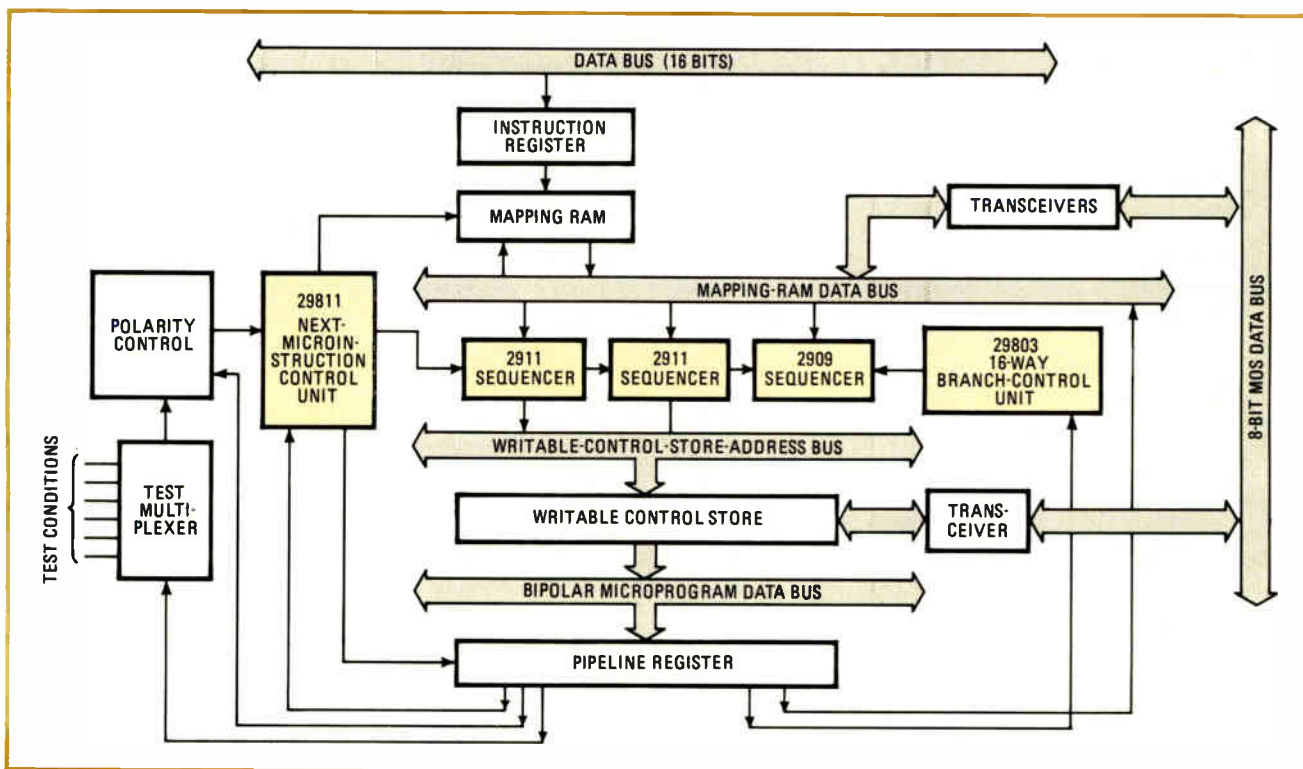

**2. Computer control unit.** A typical example of a 2900-based auxiliary system is this computer control unit, which provides sequencing of a microprogram for a central processing unit. The 2909 and 2911 sequencers are controlled by the 29811 and the 29803.

Am29811 INSTRUCTIONS AND RESULTANT ADDRESSES		
Micro-instruction mnemonic	Micro-instruction bit field	Instruction
JZ	0 0 0 0	jump to address 0.
CJS	0 0 0 1	conditional jump to subroutine with jump address in pipeline register.
JMAP	0 0 1 0	jump to address at mapping-PROM output.
CJP	0 0 1 1	conditional jump to address in pipeline register.
PUSH	0 1 0 0	push stack and conditionally load counter.
JSRP	0 1 0 1	jump to subroutine with starting address conditionally selected from Am2911 R register or pipeline register.
CJV	0 1 1 0	conditional jump to vector address.
JRP	0 1 1 1	jump to address conditionally selected from Am2911 R register or pipeline register.
RFCT	1 0 0 0	repeat loop if counter is not equal to 0.
RPCT	1 0 0 1	repeat pipeline address if counter is not equal to 0.
CRTN	1 0 1 0	conditional return from subroutine.
CJPP	1 0 1 1	conditional jump to pipeline address and pop stack.
LDCT	1 1 0 0	load counter and continue.
LOOP	1 1 0 1	test end of loop.
CONT	1 1 1 0	continue to next address.
JP	1 1 1 1	jump to pipeline register address.

different formats and may also be included in a cross-reference table of symbols.

After assembly, the binary file is routed to floppy-disk storage for further processing. The assembled binary code can be loaded into the writable control store (beginning at a user-defined starting location) for check-out of the microprogram. When microcode check-out has been completed, a utility program, AMPROM/29, is available to punch the microcode on paper tape for use on a given PROM programmer. The output also may be sent to a PROM programmer directly.

Rather than design his own microprogrammed control unit, the user may decide to use the computer control unit (Fig. 2) that is available with System 29. A pipe-

lined microprogram sequencing unit, it will interface directly with the writable control store.

The microprogram sequencing comes from Am2909/11 sequencers, which can select the microprogram address from several sources—the external input, an internal register, the stack, or the microprogram counter register, which holds the last address sent to the microprogram memory incremented by one. The source is determined by the microinstruction, which is fed to the sequencer by the Am29811 next-microinstruction control unit.

The microinstruction can unconditionally select any of these inputs or registers as the address. Or it can select conditionally between two of them for microprogram branches. The table shows the instruction and resultant address as a function of the microinstruction and test condition. The microinstruction also specifies the condition to be tested (which appears as an input through the test multiplexer).

In addition to selecting a particular source for the microprogram address, the sequencer can modify the address using the Am29803 16-way branch-control unit tied to the OR inputs of the Am2909, which is holding the four least significant address bits.

When the external input to the sequencer is selected, the mapping RAM can be selected for the next address. It can change the address bit of an instruction register in order to send it to a new location in the microprogram. The contents of the RAM can be read or written under control of the system software from the support processor. This feature provides a convenient means for users to change the macroinstruction decoding of their design by modifying the contents. □

# PDP-11 users, let the computer experts help you play your hand



DEC\* computers are among the best ever. Everybody knows that. But even with DEC there is room for improvement. We took advantage of that fact and made the best ever even better. In the process, we've given you a chance to supercharge your present PDP-11\* instead of upgrading to the next computer. We've given you more time and improved your cash flow with the most complete line of sophisticated computer enhancements on the market today. They are available off the shelf. They are priced competitively. They install in minutes. They provide immediate results. And, in every instance, they outperform the competition. They should. We are the only *computer* people in the business. We are the only people really qualified to help you play out your hand and win.

Here are all the cards in our present deck: CACHE/34™, CACHE/40™ and CACHE/45™, a series of 2048-byte single-board buffer memories which increase processing speeds as much as 100% in the PDP-11/34, PDP-11/40 and PDP-11/45. SCAT/45™, an add-in memory which installs 128K of high-speed memory on the Fastbus\* of the PDP-11/45, PDP-11/50 and PDP-11/55. QUADRASYNC™, a quad interface board between the PDP-11 Unibus\* and 4 asynchronous serial communication channels which presents only one load to the Unibus. Current loop or EIA/RS-232 versions available. REBUS™, a dual-width board which supplies a repeating function for the Unibus without requiring space for an entire system unit. And UNIVERTER™, an adapter which converts the LSI\* bus to a Unibus structure and gives the LSI-11 access to a megabyte of memory.

There are more cards coming. In fact, we would like to build something especially for you. We'll tell you all about it when you write for details on our present line.

**Able**  
**the computer experts**

Write now. Able Computer Technology, Inc., 1616 South Lyon Street, Santa Ana, California. (714) 547-6236. TWX 910-595-1729.

\*DEC, LSI, UNIBUS, PDP and FASTBUS are registered trademarks of Digital Equipment Corporation.

## One-chip conductivity meter monitors salt concentration

by Michael Ahmon  
The Midlands Center for Neurosurgery, Warley, West Midlands, England

Using a single quad operational amplifier, this inexpensive circuit measures the relative change in the concentration of a solution by checking its conductance. It automatically monitors the long-term variations in the electrical conductance of any ionized fluid—or more precisely, any solution of a salt.

The circuit derives its long-term accuracy by passing an alternating current, rather than a direct current, through the solution, thereby eliminating the electrolysis effect which often causes large errors in measurement. Use of an op amp rather than a bridge circuit eliminates periodic manual adjustments and most nonlinearity. This permits continuous and unattended monitoring at an accuracy acceptable for most industrial applications.

Like metallic conductors, solutions of salts conduct electricity and obey Ohm's law, but a transfer of ions in the fluid, rather than electrons in a solid, takes place between the electrodes. Passing a direct current through the solution causes ions of like charge to cluster around the electrodes (the electrolysis effect), and this often acts to reduce current flow, causing errors when measuring solution concentration. To overcome this, an alternating current is sent through the solution as shown in Fig. 1.

The salt solution may be characterized by a variable resistance. The voltage appearing at point B rises as the salt solution's concentration increases and is amplified and rectified in order to drive a chart recorder or a dc voltmeter.

A Wien bridge oscillator, having  $R_4C_1$  and  $R_2R_3$  as the arms of the bridge, generates a signal of about 1 kilocycle to drive amplifier  $A_2$  through the salt solution. Potentiometer  $P_1$  controls the oscillator's amplitude but has a small effect on oscillator frequency.  $P_2$  adjusts the gain of stage  $A_2$  as required.

The output of  $A_2$  drives a precision rectifier composed of  $A_3$  and  $A_4$ , producing an output voltage equal to the absolute value of the input voltage. The rectified signal is

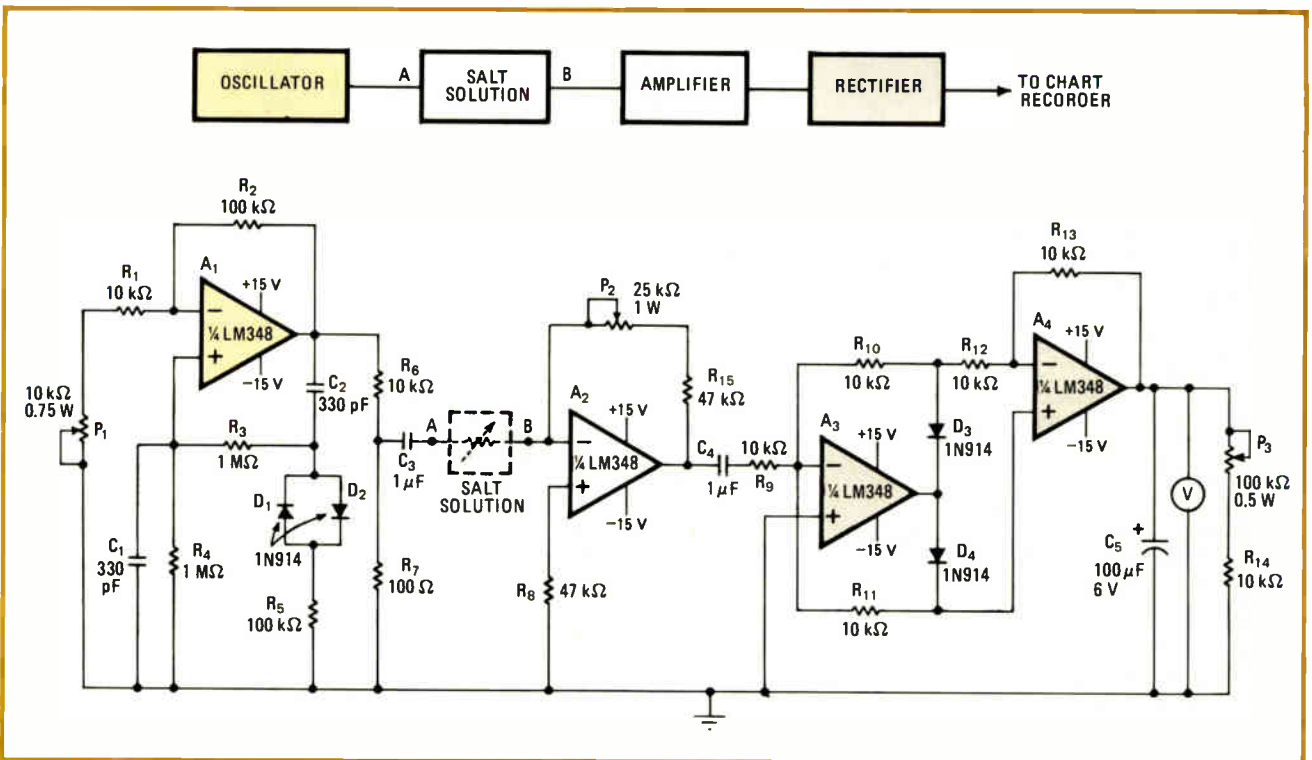

**1. Conductivity checker.** Meter uses one integrated circuit to measure relative change in concentration of salt solution by monitoring its electrical conductivity. It checks solution automatically and has good long-term accuracy, achieved by passing alternating current through solution, in lieu of direct current which causes electrolysis effect and measurement inaccuracies.

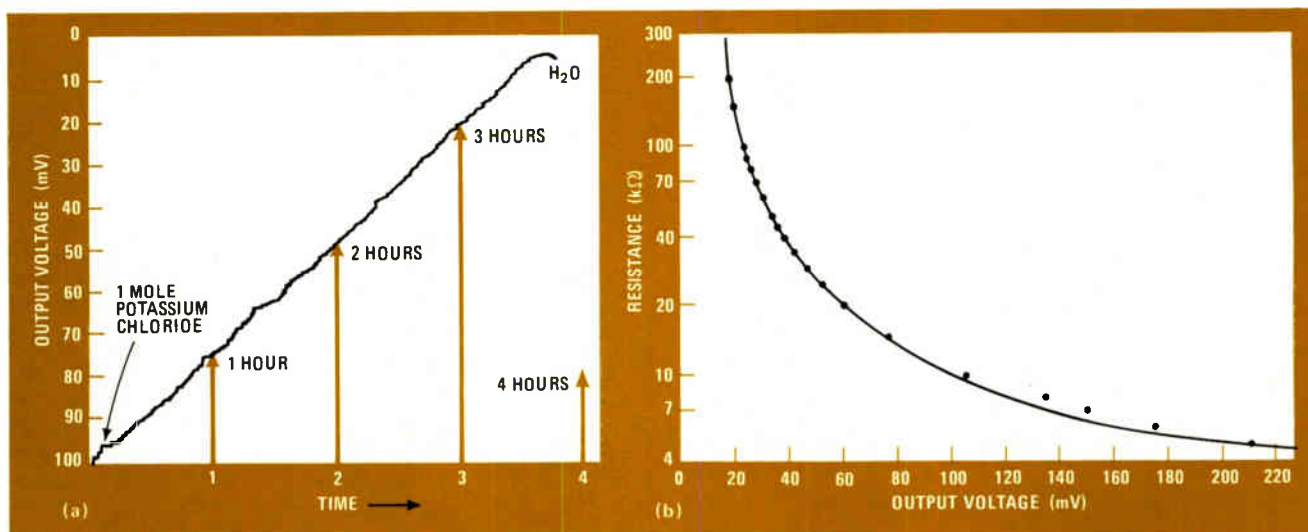

**2. In action.** One mole of potassium chloride is diluted over almost a 4-hour period (a). Output voltage is proportional to the salt concentration; the exact shape of the curve is dependent upon the salt tested. A curve showing relation of output voltage to solution "resistance" may be constructed (b). Alternatively, the ordinate may be calibrated in moles per cubic centimeter.

filtered, or smoothed, by  $C_3$  for the dc instrument.  $P_3$  controls system calibration.

Figure 2a shows a typical test result obtained from the dilution of a solution of 1 mole of potassium chloride over almost a 4-hour period. The output voltage of the circuit is set at 100 millivolts at the start, and the KCl is gradually diluted by water introduced to the solution by gravity feed. The instrument probes are connected to the opposite ends of the beaker holding the salt solution.

Naturally, the shape of the curve depends upon the salt used and the test conditions. It should be noted that it is not unusual to perform tests that may require days to complete.

The instrument is not intended to measure the absolute value of the number of free ions in the solution or even the value of its electrical conductivity. Rather it

uses them only as an indicator of the relative change in fluid concentration. The exact number of free ions is difficult to determine accurately. In addition, determining the "conductivity" or "resistance" of a solution is meaningless in most applications.

If necessary, however, a curve of output voltage vs solution resistance or absolute concentration can be made for special applications, providing a quantitative measurement that is reasonably accurate. Simply substitute a resistance decade box for the salt solution and measure output voltage versus resistance as shown in Fig. 2b. Later, correlate the output voltage of the measured salt curve to resistance. Of course, the vertical scale in Fig. 2b can be calibrated in moles per cubic centimeter, which is the concentration, if the initial concentration of the fluid is known. □

## Gate and counter check phase-locked loop sensitivity

by Marion J. Dudek  
Crookshanks Consultants, Palos Verdes, Calif.

Determining if unwanted feedback from the voltage-controlled oscillator is responsible for poor sensitivity in a phase-locked loop can be difficult, but it can easily be done by measuring the change in system noise that

occurs when the feedback is present. Relatively inexpensive instruments are used to make this usually tough measurement—only an exclusive-OR gate and a frequency counter are needed. VCO feedback problems are often responsible for the loop's poor signal-to-noise ratio, so it is best to perform this test immediately after a system is built—it will cut troubleshooting time greatly.

Unwanted feedback may be due to poor shielding between phase-locked-loop stages, inadequate bypassing of power leads, or a host of other reasons. The signal may enter any point in the system by a back-door route, as shown in (a) of the figure and may be out of phase or in phase with the VCO's normal output. This circuit is



## T-METER™ MEANS TOUGH

This digital thermometer is virtually indestructible... drop proof, shock proof, water proof, chemical proof, you name it. We have hurled it against stone walls, immersed it in boiling water for an hour, and submerged it for a week in a salt water fish tank without harming it. Its electronics are cast in silicon. Its teflon-coated probes and cables resist chemicals. It is so rugged that we confidently offer a 3 Year Full Warranty.

Tough, accurate, and versatile, spanning  $-100^{\circ}\text{C}$  to  $200^{\circ}\text{C}$  and  $-150^{\circ}\text{F}$  to  $400^{\circ}\text{F}$ , the T-Meter (with standard probe) achieves  $\pm 0.5^{\circ}\text{C}$  ( $\pm 0.9^{\circ}\text{F}$ ) accuracy over  $-55^{\circ}\text{C}$  to  $125^{\circ}\text{C}$  ( $-67^{\circ}\text{F}$  to  $257^{\circ}\text{F}$ ). Optional high accuracy probes for special applications achieve  $\pm 0.1^{\circ}\text{C}$  ( $\pm 0.15^{\circ}\text{F}$ ), covering

the MIL range in  $20^{\circ}\text{C}$  increments. You can supplement the standard 3' probe with lengths of 10', 25', and 100'. And you can special order lengths to 3,000'!

Tough as nails and nuisance-free, this fully guaranteed pocket-sized time-saver will cut your costs in a host of practical applications. Our reps stock T-Meters at **\$239**. Standard probe, \$25. General purpose high accuracy probe, \$30. Others available.

ECD CORP.  
196 Broadway  
Cambridge, MA 02139  
(617) 661-4400



SALES OFFICES: AL, Huntsville (205) 533-5896; AZ, Scottsdale (602) 947-7841; CA, Costa Mesa (714) 540-7160; CA, Sunnyvale (408) 733-8690; CO, Denver (303) 750-1222; FL, Winter Haven (813) 294-5815; GA, Chamblee (404) 457-7117; IL, Elk Grove Vill (312) 593-0282; IN, Indianapolis (317) 293-9827; MD, Silver Spring (301) 622-4200; MA, Wakefield (617) 245-5940; MN, Minneapolis (612) 781-1611; MO, Kansas City (816) 358-7272; So. NJ/Philadelphia (215) 674-9600; NM, Albuquerque (505) 299-7658; NY, Great Neck (516) 482-3500, (212) 895-7177, Syracuse (315) 446-0220; NC, Raleigh (919) 787-5818; OH, Centerville (513) 433-8171; TX, Houston (713) 688-9971; TX, Richardson (214) 231-2573.

Circle 134 on reader service card

World Radio History



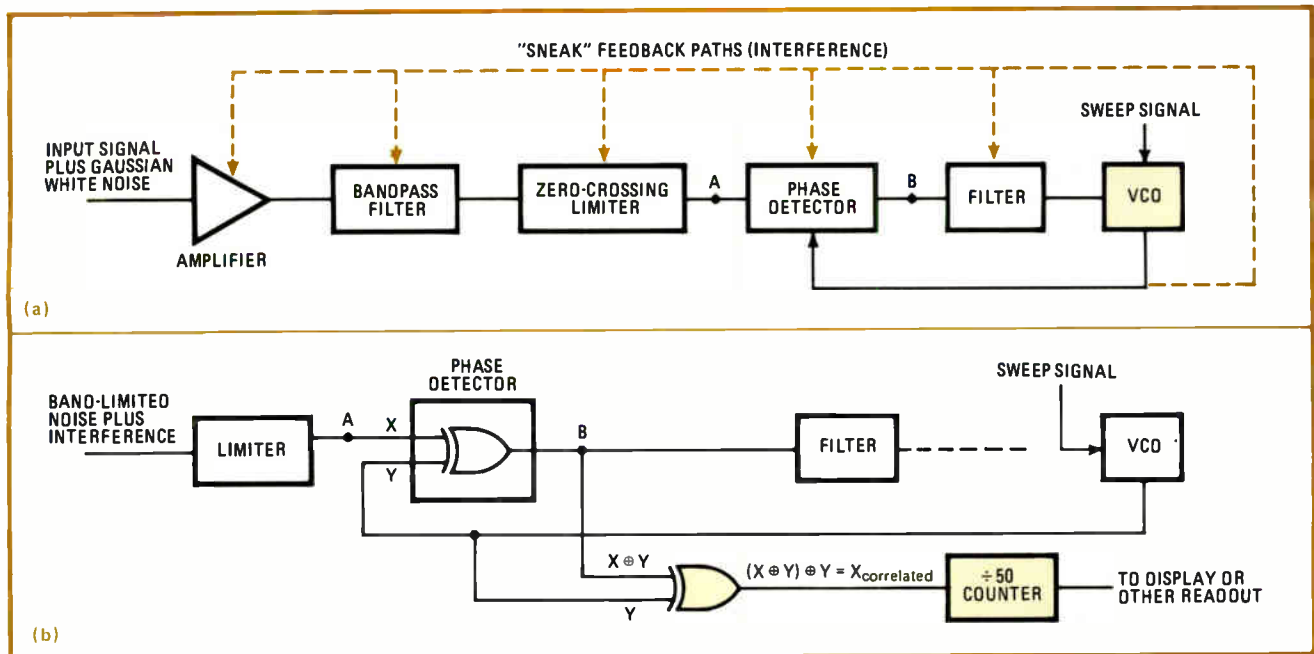

**Signal-to-noise check.** Back-door feedback voltages from VCO often mask input signals, confuse phase detector, and ultimately desensitize system (a). Addition of exclusive-OR gate and counter will determine whether out-of-phase interfering signals emanate from VCO by correlating system's white noise and interfering signals to the prime VCO signal (b). In-phase interference is checked by monitoring point B.

especially useful in detecting the out-of-phase condition.

The signal appearing at point A may be due to the feedback signal, the input signal (which inherently has a certain amount of Gaussian white noise present on it), or both. Thus the feedback signal is a source of interference that ultimately reduces the loop's ability to lock onto the desired signal. If the phase detector is an exclusive-OR circuit, the presence of out-of-phase interfering signals may be detected by adding the second exclusive-OR gate and the frequency counter to the circuit, as shown in (b).

To perform the interference test, it is only necessary to disconnect the input signal from the system and sweep the VCO as shown. The X input of the phase detector is now driven by band-limited noise and, possibly, an interference signal, both which have been converted to pulses by the limiter stage.

In the absence of interference, the output of the phase detector and exclusive-OR gate will switch on and off randomly, triggered by the system's Gaussian white-noise source, and will pulse the counter. The counter then measures the center frequency of the band-limited noise source. Note that the divide-by-50 counter further band-limits the noise, in effect filtering the signal so that the center frequency is more exactly determined and

changes in the frequency are more easily detected. (This point may not be obvious, but may be understood if reviewed in the light of several of the sampled-data axioms that have become the cornerstone of data communications theory.) As the vco is swept through its range, the output should remain constant, of course, because there is no correlation between the noise and the vco signal.

But if out-of-phase interference is present, the counter's display will reflect a change in frequency as the vco is swept, because the output of the phase detector will change state at a different rate. Another way of viewing this is to realize that the exclusive-OR gate has correlated the interfering signal with the vco driving signal, changing the apparent center frequency of the white-noise source.

In-phase interference can be directly and more easily determined without the need for the additional exclusive-OR gate by monitoring point B. If this test proves negative for either type of feedback signal, but the signal-to-noise ratio of the system is subsequently found to be low, the problem lies either in an overall poor design of the system or with an external noise source—but not with interference from the vco. □

## It's easy to connect dc supplies in parallel

by Shri D. Bhanumurthy  
Defense Electronics Research Laboratory, Hyderabad, India

Connecting the outputs of two direct-current power supplies in parallel is not as complicated as one might think. Moreover, the supplies may even have different voltage or current capabilities.

The only criterion for parallel operation is that both sources be current-limited. Any such circuit can provide load currents up to the set limits of one supply. The second unit supplies any needed additional current at its rated output voltage, once it determines that the limits of



## ARE YOU STILL PROGRAMMING MOS PROMS ONE AT A TIME?

Now you can increase production and attain higher yields with Data I/O's new Model 16 MOS Programmer.

The Model 16 programs up to sixteen MOS PROMs in parallel and provides the highest possible production throughput for the new 16K PROMs. The Model 16 also programs smaller PROMs such as 2704 and 2708. And to help you reduce production costs and increase yields the Model 16 gives you three important new benefits:

**Continuity Test.** Insures that the programming circuitry—including cables, connectors, sockets and PROM pins—are properly connected. Also insures that all PROMs are operational prior to programming.

**Checksum.** Guarantees that all data transfers are error-free.

**Calibration.** No extra equipment is required. A calibration mode provides indication that system is operating and in compliance with PROM manufacturers specifications.

**Production throughput never before attainable. We'd like to tell you more.**

This fact filled tabloid gives you valuable information about PROM programming technology. To get your copy, circle reader service number or contact Data I/O Corporation, P.O. Box 308, Issaquah, WA 98027. Phone 206/455-3990.

**HOW TO SELECT THE RIGHT PROM PROGRAMMER FOR YOUR NEEDS.**

# DATA I/O

**THE PROM PROGRAMMER PEOPLE.**



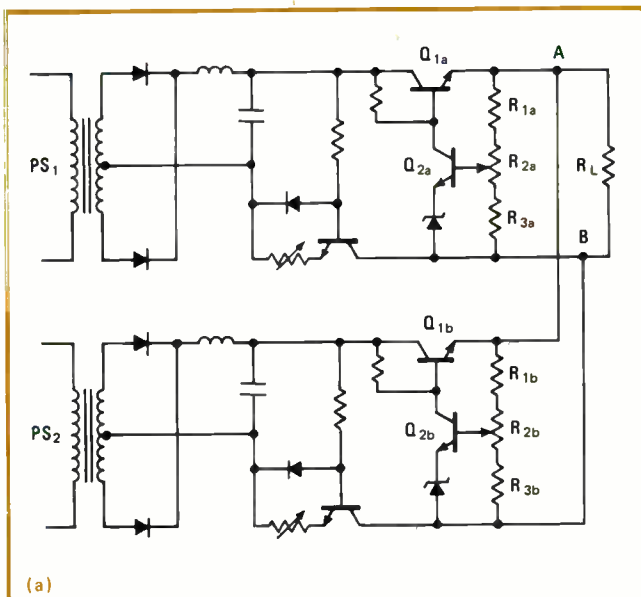

(a)

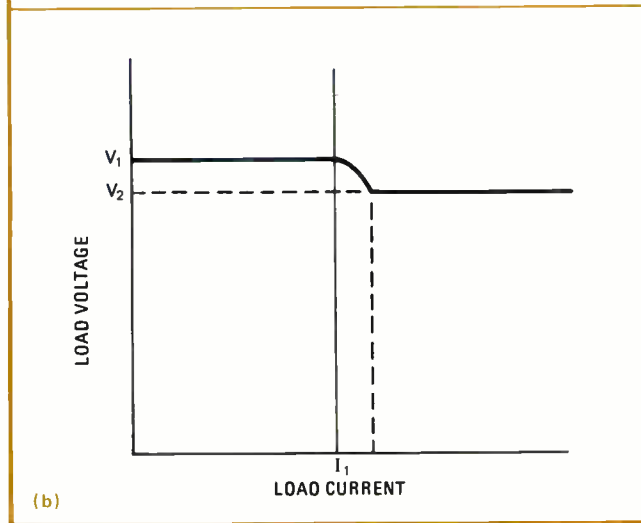

(b)

**1. Current takeover.** Parallel connection of dc supplies for shared current duties is permissible if both have current-limiting networks (a). Current to load is supplied solely by PS<sub>1</sub> until limit  $I_1$  is reached. Then PS<sub>2</sub> supplies additional current needed at voltage  $V_2$ (b).

the first source have been reached.

The outputs of two power sources PS<sub>1</sub> and PS<sub>2</sub> are connected as shown in Fig. 1a. They are set at voltages  $V_1$  and  $V_2$  and current limits  $I_1$  and  $I_2$ , respectively, where  $V_1$  is slightly greater than  $V_2$  at all times.

Under no-load conditions and until the set current limits of PS<sub>1</sub> are reached, the load voltage will be  $V_1$ . This is easily explained. Suppose that because of a power-line voltage increase  $V_2$  temporarily increases. The increase in output voltage will be detected by the current-sensing resistors  $R_{1b}$  through  $R_{3b}$ . Transistor  $Q_{2b}$  will be biased more heavily into the conducting region and will bias  $Q_{1b}$  into the back-biased region. Thus, a greater voltage drop will appear across  $Q_{1b}$  than before. The output voltage will drop slightly, but will still be above  $V_2$ , at  $V_2 + \delta$ . This  $\delta$  voltage is the result of compensation for the increase in input voltage at PS<sub>2</sub>; however, PS<sub>2</sub> will supply very little current to the load.

As long as the current drawn by the load does not

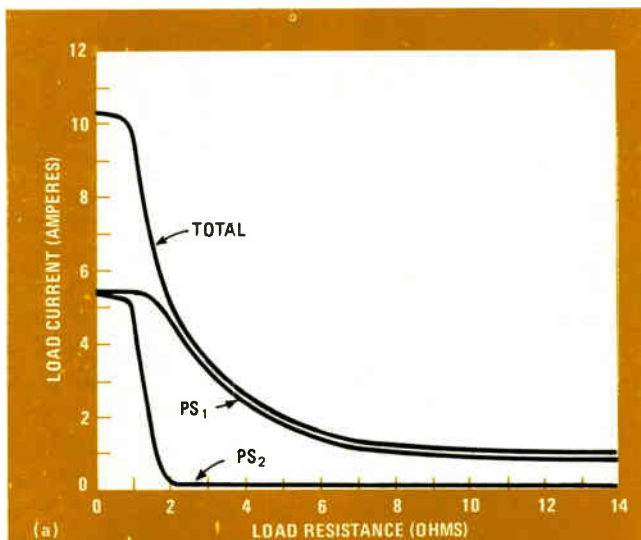

(a)

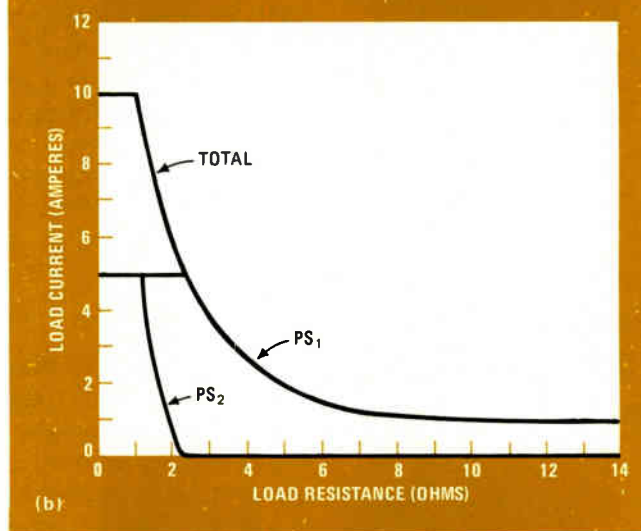

(b)

**2. Supply characteristic.** If two 10-volt, 5-ampere supplies with 0.1% regulation are connected and placed in operation, the curve in (a) results. PS<sub>2</sub> begins heavy turn-on as PS<sub>1</sub> approaches 5 V. Curves of ideal power supplies connected in parallel (b) show that PS<sub>2</sub> turns on at precise moment the current limit of PS<sub>1</sub> has been reached.

exceed  $I_1$ , the voltage across the load will be  $V_1$ , and PS<sub>1</sub> will supply all the current. If the current demanded by the load should exceed  $I_1$ , the voltage will drop to  $V_2$ .  $R_{1b}$  through  $R_{3b}$  will detect this drop, back-biasing  $Q_{2b}$  and forward-biasing  $Q_{1b}$ . Thus PS<sub>2</sub> will contribute the additional current demanded by the load (Fig. 1b).

When two dc supplies conduct in parallel, the result is a system characteristic of the kind shown in Fig. 2a, which is a plot of load resistance to load current. Both supplies can deliver 10 volts at 5 amperes, and each has a regulation of 0.1%. PS<sub>1</sub> is set at 10 v, PS<sub>2</sub> to 9.99 v.

Compare Fig. 2a and Fig. 2b, where a plot of load resistance to load current has been made for two ideal supplies. As one may deduce from these plots, a nonideal PS<sub>2</sub> will begin to contribute current to the load before the PS<sub>1</sub> limits have been reached. □

Engineer's notebook is a regular feature in *Electronics*. We invite readers to submit original design shortcuts, calculation aids, measurement and test techniques, and other ideas for saving engineering time or cost. We'll pay \$50 for each item published.

## **Linear LSI breaks the ice for delta modulation**

Although delta modulation is one of the simplest ways of converting analog into digital data, it has been used in only the most demanding communications chores because of its high cost and the restricted performance of early components. But **now low-cost, high-performance delta-modulator chips are available.** Consumer Microcircuits of America, Motorola, and Harris already have inexpensive chips on the market selling for as little as \$6 in quantities of 100. These linear large-scale integrated devices contain all the active circuitry required for delta modulation and need in addition only a supply voltage, a clock signal, and external resistors and capacitors.

Besides telephony, many other applications are on the horizon for the delta-modulation technique. Digital filters are one, because delta modulation considerably simplifies the circuitry, doing away with the need for costly multipliers and permitting filter characteristics to be changed easily. Another possibility is controlling motor speed remotely by means of a binary signal transmitted over a cable or radio link. Additionally, delta modulation may be used to **realize simple speech-scrambler circuits, to delay audio signals,** to encode photographic profiles of objects for computer processing, and to encode transient signals for storage and delay.

## **Big, fast MOS ROMs deserve checking out**

Systems designers who are automatically specifying bipolar read-only memories for high-speed storage of program and fixed data like look-up tables, should consider the new MOS ROMs now becoming available. Because some semiconductor manufacturers are using the ROM as a vehicle for developing fast MOS technologies, such as V-MOS and H-MOS, **a spate of really big 32,768- and 65,536-bit MOS ROMs is emerging that sport access times typically under 200 nanoseconds.**

While that's not as fast as the sub-100-ns speeds of standard 4,096- and 8,192-bit Schottky parts, it's fast enough for many minicomputer-based real-time data-processing systems. If you can live with their slower speed, the MOS units are a better buy than Schottky devices, being two to three times cheaper per bit, since they pack eight times more memory into a package. Furthermore, they dissipate about half the power.

## **How to make a professional job of prototype pc boards**

If you like to design and etch your own printed-circuit boards for prototype purposes, you have probably found that most industrial suppliers don't sell through distributors and have bought your materials from hobby outfits, even though hobbyist materials don't give professional results. But there is one well-known industrial supplier—Kepro Circuit Systems Inc.—that not only offers a full line of complete kits and materials for making prototype boards but also sells through distributors. Besides high-quality photosensitized boards providing a very uniform coating, the firm has a **room-temperature-immersion tin-plating kit that puts a fine finishing touch on etched boards,** depositing a shiny layer over the etched copper to retard oxidation and increase solderability.

The \$20 kit, part number ITP-801A, plates up to 25 square feet of copper. Kepro's address is: 3630 Scarlet Oak Blvd., St. Louis, Mo. 63122.

**Lucinda Mattera**

# Troubleshoot microprocessor products fast—

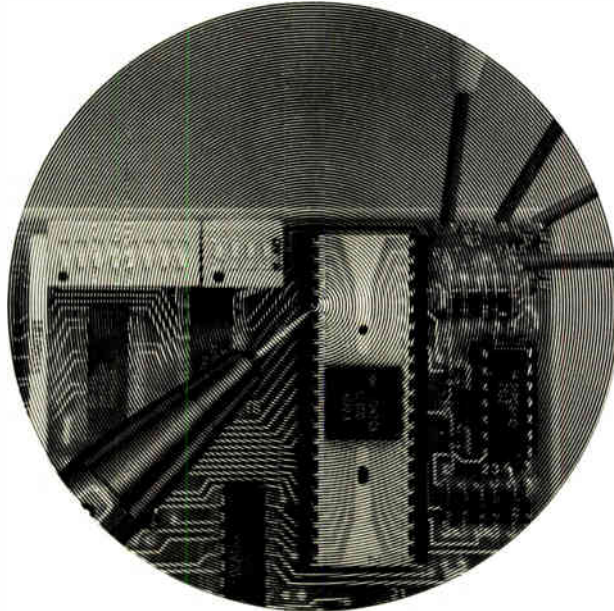

## right down to the component level.

**Here's HP's new Signature Analyzer.** It makes it economical to find the faulty component in a microprocessor-based product both in production and in the field. No longer is it necessary to make a large investment in expensive modules or boards for service. And no longer do you have to troubleshoot by conventional and costly hit-and-miss methods. It could even eliminate the need to partition your product for modular service.

**The concept is simple.** The 5004A Signature Analyzer converts lengthy bit streams at any node in a circuit into short, four-digit, hexadecimal

"signatures." Just activate a digital exercise routine in the circuit under test, and compare the bit stream "signature" at each data node with the known good signatures previously written into your manual. This information lets you backtrace right down to the faulty component. Quickly and confidently.

**The price is low.** Only \$990\*. To help you design your product with all the advantages of digital signature analysis, we've prepared Application Note 222—"A Designers Guide to Signature Analysis." It's yours for the asking, just contact your nearest HP field sales office, or write. \*Domestic U.S. price only.

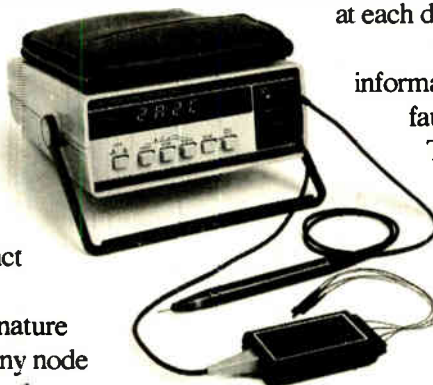

HEWLETT  PACKARD

1507 Page Mill Road, Palo Alto, California 94304

# HP9830A/B and Infotek...



If you use the HP9830A/B, you know that it has great potential.

Now you can extract the full measure of 9830 capabilities with Infotek's Memory, ROMs and Peripherals.

**Memory.** The EM-30, 32,192 byte memory for the '30, pioneered by Infotek, is one of the most significant contributions to increasing the '30's power.

EM-30B, in conjunction with Infotek's Mass Memory II ROM multiplies the speed of the 9880B Mass Memory System by avoiding redundant disc operations. A must for the 9880B user!

**Fast Basic ROMs.** The Fast Basic ROM series provides 54 statements, functions and commands. With these ROMs your '30 acquires versatility and speed superior to any other desk top computer. Here's just a few examples of Fast Basic Power.

- \* Dimension arrays any size you like. Sort or search any array that will fit in your memory!
- Move information in or out at 10K bytes per second . . . fabulous for instrumentation and control applications.
- Interrogate and amend variables without halting the program, just like a live keyboard.

- Suspend any program including mass memory operations to cassette or floppy for future completion.
- Interrupt capability — a peripheral can now demand service, branch or initiate program execution.
- Edit program test and super-secure both program and data files.

If this is the kind of added capability that you can use in your '30 then read on, there's more!

**The FD-30 Series Floppy Discs.** Each of the FD-30s stores 305K bytes. Organize this information any way you like up to 2387 files. Best of all, you can talk to the FD-30s without any software changes because the FD-30 series obeys *every* 9830 cassette instruction.

The series consists of the FD-30A single disc unit, FD-30S slave drive, FD-30M multiple disc drive which contains a master and up to three slave drives, and the FD-30SR slave drive system which will accommodate one to four drives.

 **Infotek  
Systems**

**WE DID IT! THE 256 ARRAY  
SUBSCRIPT LIMIT IS GONE! \***

A single master will support up to seven slaves and only one I/O slot is used.

**Peripherals.** Infotek has applied the same level of ingenuity reflected in the ROMs and floppys to the development of extremely high quality and reliable peripherals tailored to the needs of the 9830A/B. Now available are:

- LP-30, a 200 line per minute matrix printer
- CP-30, a 45 character per second character printer/plotter
- PS-30, a paper tape punch/reader
- TC-30 and RT-30 time clocks
- RS-30, a 9600 BAUD RS 232-C interface with 7 quartz reference rates.
- FI-30, a 10K byte/sec TTL I/O

Contact us now for the name of your local Infotek representative. Discover why more than a thousand 9830 users working with Infotek enhancements believe that the 9830 and Infotek are made for each other. World-wide service and distribution centers back up Infotek's liberal warranty and service commitment.

*At Infotek we're dedicated to making good computers better.*

1400 NORTH BAXTER STREET • ANAHEIM, CALIFORNIA 92806 • (714) 956-9300 • TWX 910-591-2711

The 9830A/B is a product of Hewlett-Packard Company.

140 Circle 140 on reader service card

World Radio History

Electronics / September 15, 1977



# WESCON|77

---

Sessions devoted to one-chip computers, LSI peripherals, and new microprocessor in-circuit design aids show how to lower the cost of more powerful digital systems

---

□ Scratch Wescon/77 and you'll uncover a microprocessor. San Francisco, site of the 26th annual edition and a city that has weathered pirates, earthquake, fire, beatniks, hippies, and tourists only to emerge with its charm intact, will no doubt be able to handle the Sept. 19–21 silicon onslaught. But engineers in town to tune in to some of Wescon's technical sessions and check out the exhibit booths are liable to find themselves thinking they have disturbed a nest of microprocessors.

Moreover, a fast turn through the booths crowded into

several locations will show that the merchants of Wescon have not been outdone in the microprocessor race. Just as the technical sessions are to be heavy in microprocessor talk, so will the exhibit areas.

But while the exhibits set Wescon's pace, the technical sessions set its tone. As it turns out, the two components are well matched—while the exhibition leans strongly toward microprocessor design, the technical sessions are peppered with advice on what to do and how to do it with the ubiquitous device. However, if there is any shift in

emphasis from 1976, then it is toward microprocessor peripherals.

Microprocessors occupy center stage in one of the sessions devoted to communications and also in a pair of discussions on components. There also are two forums on designing with microprocessors and programmable pocket calculators. In all, no fewer than eight of Wescon /77's 32 technical sessions are devoted in whole or in part to the microprocessor. Also, many of the others can be expected to make some mention of the devices in discussions of systems.



## Microcomputers

Reflecting the trend to single-chip microprocessors for low-end byte-oriented controller applications, Dan Hammond of Mostek Corp., Carrollton, Texas, organizer of session 27 on one-chippers, has put together three good applications examples using the most popular device on the market. Included are the TMS 9940 from Texas Instruments Inc. of Dallas, shown designed into a data terminal; an 8048-based keyboard/display module from Intel Corp., Santa Clara, Calif.; and Mostek Corp.'s own 3870 chip, working as an asynchronous data-link controller.

To the user, the three chips offer about the same system capability: plenty of computational power, 1 or 2 kilobytes of program memory, a small but adequate store of data random-access memory, and sufficient input and output ports for accommodating many control applications that till now required more expensive, multichip solutions.

Illustrating how far one-chippers can go in reducing hardware (and software) costs is John Bryant's design of a data terminal, first with an 8080A and then with the TMS 9940. Bryant, who is TI's program manager for the 9940, will show that TI's own model 745 electronic data terminal, first introduced in 1975, needs only two chips with the TMS 9940 device, but it needed all of 17 chips with the 8080A.

Whereas this paper emphasizes simplicity, the Intel 8048 keyboard/display design described by Intel's Larry Goss stresses flexibility. Indeed, the 8048, which can be expanded into fairly complex systems, can be used for terminals having keyboards with up to 128 keys and 16-digit displays of either the seven-segment or dot-matrix format. In the Intel designs, the processor handles debounce, N-key roll-over, first-in, first-out character buffers, and various programmable modes for error indication, automatic repeat, the detection of key depression release, and so on.

While session 27 talks about the lowest-performance one-chip end of microcomputer applications, session 16 treats the highest end: the bipolar bit slices and peripheral large-scale integrated circuits. These are the chips that are the meat of the minicomputer and real-time data-processing applications, where n-channel metal-oxide-semiconductor devices are too slow and too limited

to do the job. Here, instruction-time requirements are in the 100-nanosecond range and data memory capacity in the 32- to 64-kilobyte range.

In these high-speed, complex systems, the industry standard bit-slice family is the AM2900 system pioneered by Advanced Micro Devices Inc., Sunnyvale, Calif., and that's the subject of the paper by Bill Harmon, who describes the capability of the family, including the new sequencer and microprogrammable peripheral chips.

If the AM2900 family was a tough act to follow, the new 4-bit-slice central processing unit described by Harmon—with Vernon Coleman and Michael Economidis—will be even tougher. Designated the AM2903, the 30,000-square-mil, 48-pin device replaces and performs all the functions of the present family's AM2901 4-bit slice, which is 30% smaller. But in addition, it provides a number of enhancements that are especially useful in arithmetic-oriented computer systems. The basic micro-cycle of the AM2903 is about the same as the AM2901's, around 200 to 250 ns. But in a typical system, the increased integration and improvement in circuit architecture obtainable from the new parts will allow at least a 20% to 30% reduction in total throughput, say the authors.

The last few years have seen a remarkable increase in the use of digital signal-processing techniques in medical electronics, speech processing, and music processing, for example. Paralleling this development has been an increase in the level of integration of the bipolar devices used in these systems; in the case of multipliers, it has moved from 1-by-4-bit to 4-by-4-bit, 8-by-1-bit, and, most recently, 8-by-8-bit arrays.

The newest entry in this marketplace is an 8-by-8 combinatorial multiplier, designated the 57558/67558, from Monolithic Memories Inc. in Sunnyvale, Calif. As described by Schlomo Wasser, senior engineer for new product development, the device promises one of the lowest speed-power products on the market. The 5-volt, 40-pin low-power Schottky device, says Wasser, can multiply two 8-bit unsigned or signed 2's complement numbers and generate the 16-bit signed or unsigned product in an average time of about 100 ns, about 25% to 30% faster than combinatorial devices of the same complexity. More remarkable is the power dissipation of the device, only 1 w less than half of that required of similar devices. The 57558/67558 is designed for such high-speed applications as digital filters, fast-Fourier-transform signal processors, and floating-point arithmetic units.

With low and high ends of the microprocessor universe covered, Wescon is not neglecting the midrange devices. Two sessions—2 and 1—are devoted to developments in peripheral devices that will add flexibility to machines in this range.

As Ken McKenzie of Zilog Inc., Los Altos, Calif., points out in session 2, the microcomputer has evolved into the standard tool for solving product design problems. Its inherent flexibility, low cost, and short development cycle have caused the total applications spectrum to explode. But, he predicts in his paper on the role of peripherals, the real impact of the microcomputer has



yet to be felt—and playing key roles in these new developments will be many advanced peripheral circuits.

Some good examples of advanced peripheral support circuits are described by Andrew Allison, of Advanced Micro Devices Inc., Sunnyvale, Calif. To date, says Allison, the development of truly high-performance microcomputer systems has been inhibited by two factors: poor arithmetic capability and limited system throughput. The introduction of sophisticated peripheral controllers, he says, has only worsened these throughput limitations by making it easy to connect high-speed input/output devices to microcomputers.

AMD has designed several products to resolve these problems. Among them are the AM9511, a powerful n-channel depletion-mode MOS floating- and fixed-point processor “slave” with derived function capability; the AM9517, a multimode direct-memory-access controller designed to speed the transfer of information between peripheral devices and system memory without CPU intervention; and the AM9519, a universal priority-interrupt controller that generates up to four fully programmable bytes of response information for each interrupt request input.

But proliferation brings its problems, and with computers one of the big headaches is seeing that important information does not fall into the wrong hands. The National Bureau of Standards has adopted a data-encryption standard for Government and industry to use to allay those fears, and makers of semiconductors and communications equipment, viewing the standard as the source of a major new market, are developing devices and systems to implement it. One, an advanced bipolar large-scale-integration design [*Electronics*, Sept. 1, p. 32], will be described by Krishna Rallipalli, advanced products manager at Fairchild Camera and Instrument Corp., Mountain View, Calif.

In session 7, the focus will be on controllers to interface peripheral devices. Ross Freeman of Zilog will describe his company’s advanced serial interface controller, designed to provide simple interfacing of a Z-80-based system to a broad range of serial devices (such as floppy disks) and communications links. The controller is also flexible enough to work with most 8-bit microcomputers on the market. It combines all of the usual

functions of a universal synchronous/asynchronous receiver/transmitter (Usart) with additional character-oriented protocol capabilities. Under DMA control, Freeman says, data-transfer rates of 500 kilobits per second are possible with a 2.5-megahertz clock and 800-kb/s with a 4-MHz clock. And by taking advantage of the increasing density and yield of LSI processing, says Freeman, it was possible to put dual channels on the device, thus reducing the total number of devices in a typical system.

Jack Kister, microprocessor applications engineer at Motorola’s Integrated Circuits division in Austin, Texas, will describe Motorola’s new cathode-ray-tube controller, an n-channel MOS device that—like other monolithic CRT controllers on the market and in design—strives to replace as much discrete logic as possible between the microprocessor and the raster-scan CRT terminal.

The MC6845 chip is perhaps the most flexible CRT controller yet introduced. Screen and character formatting is fully programmable, Kister explains: instead of giving the terminal designer a number of standard options, the device can put any number of characters on a line and any number of lines on a screen. Included is an important feature that makes the device useful in graphics as well as data terminals. This is an address multiplexer, which switches memory address lines from the microprocessor address bus to the CRT controller address bus after the processor has written into the display memory. This bufferless display-refresh technique frees the microprocessor for more demanding graphics tasks. The controller also includes cursor control and format functions, character-by-character video control, hardware scrolling and paging, and a light-pen detection capability.

Session 3, the only one that concerns microprocessor development, will include some good design hints for cutting development time. For instance, a paper by Dick Woods of Data I/O Corp. of Issaquah, Wash., recommends using random-access memories to emulate the ROMs and programmable ROMs used for program storage, since the RAMs can be instantly modified.

As for microprocessor applications, Wescon has assembled a strong forum, session 24, on communicating with the real world. Microprocessor applications group

---

**W**escon is again a sellout. As the show—in full, the Western Electronic Show and Convention—moves up the California coast to San Francisco for its 26th annual edition, Sept. 19 through 21, officials report they have more applications for exhibit space than they can handle, even using all of Brooks Hall plus all of the adjacent Civic Auditorium including the main auditorium and Polk and Larkin Halls. It will add up to more than 400 exhibitors filling 680 exhibit units, the largest Wescon in San Francisco since 1969.

Moreover, Wescon will try something new this year. With the show running from Monday through Wednesday, it will be the first to be packed into three days instead of four and the first to open on a Monday. The format responds to an exhibitor survey conducted last summer that suggested a three-day Wescon as an experiment, and it also avoids a

conflict with Yom Kippur, which falls on Sept. 22.

However, two events previewing the show are scheduled for Sunday, the day before the official opening. They are the 23rd Wescon Distributor-Manufacturer-Representative Conference and the Wescon Luncheon. Both will take place at the St. Francis Hotel, and the luncheon will feature a keynote address by Bernard M. Oliver, vice president for research and development at Hewlett-Packard Co. and a past president of the Institute of Electrical and Electronics Engineers.

Once the doors open and the show gets under way, show officials won't be surprised to see a record attendance. They predict that more than 30,000 persons will pass through the turnstiles—perhaps even more than the 1975 San Francisco total of about 31,000 during a four-day event.

leader Larry A. Solomon of RCA Corp.'s Solid State division in Somerville, N. J., asks, "Why not do it in software?" when it comes to deciding whether software or a peripheral controller chip is better for performing a particular task.

"When you set out to do microprocessor designs, you should plan on doing everything in software. The only time one should back off and implement in hardware," says Solomon, "is when all the software possibilities have been exhausted." This obviously increases the user's software package. But, he adds, "there's a tradeoff in the amount of read-only memory one needs versus the number of external hardware chips needed."

Since ROMs come in quantum of 512 bits, 1,024 bits, and up, "if you are already a couple of bits into the next quantum, then any additional space is free," says Solomon, "so you might as well use all of it." Unfortunately, one cannot tell ahead of time precisely how many bits will be needed. "But you can guesstimate and come pretty close. For example," he notes, "if you estimate that about 1 kilobit of ROM is needed, then you can buy 1.5 kilobits of ROM."

Another justification for using extra ROM in the system is from the standpoint of testing, says Solomon. "It's a lot easier to test a ROM than it is an intelligent peripheral chip. Incoming inspection is so much simpler for ROMs." What's more, he adds, "by implementing most of the functions in software, one can defer final design decisions to later in the development cycle."

Accessing peripherals through a memory-mapping approach should be used as widely in microcomputers as in minis, in the opinion of Mitchell Gooze of Motorola in Austin. In his paper on addressing peripherals as memory locations, he notes that the flexibility of the procedure is such that the full power of the instruction set is available for input/output manipulation. This not only improves peripheral handling and enhances system throughput, but requires simpler software and less hardware than the isolated input/output technique.

Gooze defines memory-mapping as assigning a peripheral I/O device to an area of memory address space, in effect, treating it as a memory location. It is a "powerful architecture" that can manipulate I/O with the same instructions as those to access memory. This structure was first popularized with the Digital Equipment Corp. PDP-11 minicomputers and was incorporated in the Motorola 6800 microprocessor family, Gooze explains.

The alternate isolated-I/O technique, while communicating directly with the central processor, loses flexibility by being tied to this extremely simple format. The technique is best used in limited I/O requirements or when the entire memory address space is filled.

The concern of Mark Mayes and R. Wade Williams of GenRad Inc. is that electronics designers seldom think of the need for production testing of their finished product when they set out to design it. Williams is a senior development engineer and Mayes an engineer in the Electronic Manufacturing Test division of the Concord, Mass., manufacturer of circuit-board testers and instruments.

In essence, says Mayes, designers of complex digital assemblies go too far when they partition, say, a microcomputer board. They plan for all the components to be soldered down, for example, which means that when production testing is reached, the board may have to be partially disassembled in order to be tested.

"Too often," Mayes continues, "designers are mainly concerned about having a device or module perform the function for which it's intended, and only think of design-verification testing, not production testing." This often leads to a circuit board that becomes a nightmare for the production test engineer. An example Mayes uses to show how the designer can ease the production-testing problem for such a board is the use of a simple address decoder in a 5 cent socket—not soldered down—on the board. "A lot of peripheral devices have to communicate with the microprocessor over the bus," Mayes notes, "and the integrity of the bus must be tested." That can

### Career session hits gut issues

Session 6, "Engineering Career Problems," addresses some of the basic needs of the engineer and should be of interest to all. The idea, says session organizer Jack Kinn, who is staff director of the Institute of Electrical and Electronics Engineers' U. S. Activities Board in Washington, is to identify the area crucial to career planning and present papers dealing with the latest information on these topics.

Thus, the first subject will be job security. Raymond Price of the School of Business Administration at Stanford University will suggest ways in which EEs and employers can overcome worries that engineering is no longer a lifetime career.

Another critical issue is pay. John L. Lipp of Hay Associates in San Francisco, an expert on compensation, will describe how companies arrive at salary scales and how the elements that make up the compensation package are weighted.

A highlight of this gut-issue session will be Donald B. Miller's talk on recognition of contributions. Director of

human resources at International Business Machines Corp.'s General Systems division, San Jose, Calif., Miller has become an expert in developing motivation and reward concepts for engineers.

Capping the session will be a paper describing how management policies can actually work against the career interests of engineers. Describing what he calls "organizational mugging," Peter Graves of the department of business administration, California State College, San Bernardino, Calif., will point out that an organization that rewards managerial behavior having an adverse impact on subordinates' careers may wittingly or unwittingly be guilty of mugging. "Organizations seldom even view the issue of career development as a concern of management at all," he states.

Graves' solutions include, first of all, recognizing that organizations do have a responsibility for the career development of its engineers and, second, rewarding managers who then take steps to advance the careers of their subordinates.

be done before the microprocessor goes onto the board, or the microprocessor can be removed to make sure the bus and peripheral units are working by using the address decoder to exercise them without removing the peripheral units, which would be too expensive. Those peripheral units could consist of RAMS, ROMS, I/O ports, or floppy-disk controllers, for example.

Summing up, Williams adds that he would like to see circuit boards partitioned into small subfunctions with a few sockets provided to accommodate production testing of the finished board.



For those involved with computers, Wescon has two futuristic sessions, one addressing big machines and another covering distributed processing—a hot topic in the minicomputer area.

Session 23, “Transition to distributed processing,” will assess the forthcoming distributed processing evolution (if not revolution) from the business and practical as well as the technological aspects. After a discussion of the meaning of distributed processing, business rationales will be outlined, with one paper disclosing how a major U. S. corporation—Citibank—profited from the decentralization in terms of productivity and accountability. In a more technical vein, planning of distributed-processing structures will be discussed in a talk that covers hardware, software, communications, and the interaction among them. Also, the microcomputer’s impact on distributed processing will get attention.

As for large-scale computers, session 12 attacks the more esoteric reaches of computer technology. Papers by the top engineers from the Institute for Advanced Computation in Sunnyvale, Calif., will emphasize the superscale memories that will support the supercomputers of the future (particularly the Illiac IV now under development).

Included is a paper by R. S. Lim and J. E. Korpi on laser mass storage, which can put upwards of several hundred billion bits on a 4¾-by-31½-inch strip of polyester. But fault-correcting schemes must be developed for these memories since dust and dirt limit their present error rates to about  $10^{-9}$  per bit—and commercial data-processing applications require error rates of at most  $10^{-12}$  per bit. However, when special correction codes are employed in laser mass storage, they often require inordinately long decoding times that stifle system throughput. So speed must be traded off, at this time, for reliability.

Another paper will discuss alternate methods of ensuring data integrity in optical stores, such as a dual-writing approach that duplicates each optical strip. The system, which is employed in Precision Instrument Co.’s Unicon 690 optical archival memory, allows low-error storage in excess of 240 billion bits of data, with access times of less than a 0.25 second worst case.

Perhaps the most futuristic concepts arise in a discussion of optical memories, the paper in this case crystal-balling the potential of optical-disk memory. Simple systems that are optical variants of magnetic-disk designs—a focused laser beam melts bit patterns in evaporated metal film—are already providing storage in the billion-bit range, and Harry G. Heard, who is organizing the session, remarks that advanced systems will surely provide direct access to  $10^{15}$ -bit stores in a single disk drive—the equivalent of hundreds of thousands of today’s magnetic tapes or disks. Moreover, he says, bandwidth limitations, head and media wear, and other problems that befall magnetic technology, are virtually nonexistent in the optical techniques.

Finally, the central memory for the Illiac IV computer is explained by Lim and Heard, who discuss how it achieves its fantastic memory bandwidth—over 1½ gigabits per second. The memory, a 20-port synchronous core-type designed by System Concepts Inc., can store a million 36-bit words, but its organization should be inspirational to today’s memory designers. With a 93-nanosecond clock, the maximum data transfer rate per port would normally be one word every clock cycle; but by using four special switch modules and a minicomputer to keep four parts active concurrently, the maximum data transfer is upped to 144 bits per 93 ns, and the throughput is thus a whopping 1.548 billion b/s.



The growing use of microprocessors to process real-world analog data, especially in automobiles, instrumentation, and industrial process control, is breeding a whole new generation of microprocessor-compatible data-conversion products—units that aim to make the job of interfacing as simple as possible for the user. In recognition of this trend, Wescon will devote two of its technical sessions to the subject: “Analog and Digital Data Acquisition and Distribution with Microprocessors” (session 26) and “Analog Interface in Microprocessor Systems” (session 21).

In his overview for the first session, chairman Robert Morrison of Burr-Brown Research Corp., Tucson, Ariz., examines the individual analog components involved in microcomputer applications and discusses interfacing techniques. The other three papers offer some hard-line applications guidance. For example, Claude Wiatrowski from the University of Colorado in Colorado Springs looks at various architectures for implementing a front-end preprocessor in microcomputers for industrial applications. The proper use of analog conversion products in microcomputer systems is the concern of George Bryant of Datel Systems Inc., Canton, Mass. To make his point, he cites several specific applications examples, among them a test system for computer memories and a system for monitoring a number of hospital patients. Additionally, M. L. Roginski and J. A. Tabb of Lockheed-

Georgia in Marietta, Ga., describe a microcomputer-controlled system for monitoring the flight-by-flight fatigue load of an aircraft.

In the analog-interfacing session, David Fullegar of Intersil Inc., Cupertino, Calif., will lead off by reviewing the characteristics of integrating and successive-approximation analog-to-digital converters and comparing serial and parallel methods of data transfer. David Chung of Umtech Inc., Sunnyvale, Calif., will emphasize cost-effective ways of converting analog data to digital and vice versa, even taking into consideration the type of sensor being used in the application.

Two of the papers in this session reveal details on new microprocessor-compatible data-conversion products. One paper, to be given by Jim Simmons of Signetics Corp., Sunnyvale, Calif., describes the first self-contained 8-bit digital-to-analog converter to be microprocessor-compatible. It is a bipolar chip that contains an 8-bit input latch, an internal voltage reference, binary-scaled current switches, and an output operational amplifier. The second new device, to be described by Russell Apfel and John Conover of Fairchild Camera and Instrument Corp., Mountain View, Calif., is a multi-channel converter subsystem. Depending on a microprocessor for its digital intelligence, this bipolar chip includes a sample-and-hold circuit, multiplexer, and voltage-to-pulse-width converter. It can handle six channels of input, completing an 8-bit conversion in 300 microseconds in a cycle that incorporates both automatic zeroing and full-scale calibration.

Because of the clocking and timing needs of digital watches and microprocessors, quartz crystals have been rediscovered as easy-to-use cost-effective components. And this year, they will have a session (29) of their own at Wescon. Kicking off the session, Richard Nelson of Statek Corp., Orange, Calif., extols the versatility of low-frequency quartz tuning forks, reviewing such applications as Touch-Tone pads, long-period timers, time-of-day clocks, audio standards, and instrument time bases. In another applications-oriented paper, Daryl Kemper and Richard Bush of Tyco Crystal Products Inc., Phoenix, Ariz., discuss applying crystal bandpass filters to communications systems.

In a third paper, Paul Bryan of Colorado Crystal Corp., Loveland, Colo., suggests optimum ways to specify precision quartz crystals for sophisticated frequency-control applications. Finally, for IC and microprocessor applications, John Fisher of Standard Crystal Corp. in El Monte, Calif., explains how to interface a quartz crystal to an oscillator, whether this circuit is built with bipolar or MOS devices.

performance capability for use in digital signal-processing systems. The session underscores the fact that although it is tempting for the designer to look to standard microprocessors with everything on one chip and a fixed instruction set, such MOS devices lack the speed needed for real-time processing chores. The faster bit-slice bipolar microprocessors are better suited for signal-processing applications that demand efficient code in time-critical domain and, in addition, allow the user to tailor his own instruction set.

The session examines the software, hardware, and application problems involved in getting very-high-performance signal-processing systems with bit-slice microprocessors. Howard I. Cohen of GTE Sylvania Inc. in Needham Heights, Mass., the session organizer and chairman, says, "The speakers will focus on some of their design approaches because it's important that the engineer consider his requirements carefully and think about how he might use bit-slice machines."

A paper on software strategies in the use of bit-slice microprocessors for radar signal processing by P. C. Barr of Raytheon Corp., Wayland, Mass., and M. S. Gerhardt of Digital Equipment Corp., Maynard, Mass., emphasizes the fact that an important aspect of the architecture design is the ease with which a design engineer programs the microprocessor to perform the many signal-processing tasks.

A paper cowritten by Cohen will show that it is possible to handle hardware efficiently so that life can be made tolerable for the programmer. "If the hardware design can't be used conveniently by the programmer, then it's a failure," says Cohen.

A different facet of the problem of programming ease is covered by Allen Peterson of Stanford University's Center for Radio Astronomy in Palo Alto, Calif. Peterson will deal with the advantages and limitations of architecture for real-time digital filtering and linear predictive-coding applications.

Satellite systems of the 1980s, the topic of session 5, offers the nonspecialist an up-to-date view of several satellite systems currently under development. All five papers emphasize the novel aspects of spacecraft antenna systems, transponders, and sensors.

The paper on Intelsat V (scheduled for a late 1979 launch) details a dual-polarization scheme for frequency reuse at K-band frequencies, which have never been used before on Intelsat satellites. The authors, F. J. Dietrich and C. F. Holber of Ford Aerospace Corp., Palo Alto, Calif., deal mainly with the new equipment designed for that craft.

A second paper, by P. Walker of TRW Systems Group, Redondo Beach, Calif., discusses the tracking and data relay satellite system that will use two synchronous tracking satellites to relay data between orbiting user satellites and a single ground station located at White Sands, N. M. The two TDRSS satellites will "see" virtually 85% of all satellite orbits and will therefore do away with the need for elaborate ground tracking stations and the dependence on other nations for help in system operation.

A third and fourth share a common theme—electronic beam-steering and beam-shaping techniques. K. Swimm



## Communications

The ubiquitous microprocessor makes its influence felt at Wescon's communications sessions. One in particular, session 20, should interest those looking for high-

of General Electric Co.'s Space division in Philadelphia, will focus on a system designed for the Defense Satellite Communications System that shapes and steers the antenna beam upon command from ground control. S. H. Durrani from NASA-Goddard Space Flight Center, Greenbelt, Md., will discuss an experimental system for doing the same thing automatically with onboard processing.

His paper, cowritten by T. Noji of AIL, Melville, N. Y., and C. Allen of General Electric Co., Valley Forge, Pa., examines the system they are proposing to include with the Space Laboratory experiments that will fly in the shuttle. The ultimate application of their system is to provide communications between small mobile terminals and satellites in stationary orbits.



### Instruments

Test systems are taking wing, borne along by the advent of high-speed digital circuits that can generate pulses in the subnanosecond range, plus other high-speed digital sampling and conversion circuits. These new systems obtain much faster and more accurate results by taking measurements in the time domain and converting to the frequency domain and by using computers to take advantage of the latest Fourier analysis techniques.

In session 10, "Applications of Time Domain Measurement Systems," organizer Norris S. Nahman of the National Bureau of Standards, Boulder, Colo., will describe NBS measurements in the picosecond and nanosecond range, using continuous and sampled data measurements in real and equivalent time. Real time, he points out, means measurements are made on signals that occur only once, whereas equivalent-time methods require multiple occurrences of the signal. He then will explain the NBS automatic pulse measurement system/time-domain automatic network analyzer, which uses a sampling head with a bandwidth from dc to 18 gigahertz, a sampling oscilloscope, 14-bit analog-to-digital and digital-to-analog converters, and a minicomputer to control the system.

Harry M. Cronson of the Sperry Rand Research Center, Sudbury, Mass., will discuss a computer-controlled time-domain system used to obtain properties of both networks and materials between 100 megahertz and 16 GHz. Cronson says it can make such measurements in many cases more directly and with less error than can conventional continuous-wave methods. For example, he will discuss an insertion-loss measurement system based on an impulse generator producing a pulse with a half width of about 60 picoseconds and accuracies of about 0.1 dB in 10 dB. He also will describe measurements of permittivity and permeability of materials such as Teflon and ferrites.

Fred J. Deadrick of the Lawrence Livermore Laboratory, Livermore, Calif., will examine the uses of picosecond pulses for measurements of antenna parameters,

such as input impedance and effective heights, using a 300-ps pulse. By time-windowing, he says, unwanted reflections from walls and ceilings are eliminated so that an anechoic chamber is not needed.

Finally, S. Gottfried of Bell Laboratories in Holmdel, N. J., will describe optoelectronic components such as optical fibers, sources, and photodetectors, and then methods of characterizing the fibers with time-domain measurements. The system uses a sampling and compares the output of an optical attenuator with that of the optical fiber.



### Production

Present practice and the state of the art in automatic test equipment are important enough to rate a session each at Wescon. Indicative of session 4's practical approach, a paper on detecting race conditions with a production environment simulator comes from Paul Accampo of Hewlett-Packard Co.'s Automatic Measurement division, Sunnyvale, Calif. A race condition occurs when two or more signals at a logic circuit's input change simultaneously, and it can be critical if the order of the signals' arrival affects the circuit's output state.

Also in this session, Noel Lyons of Fluke-Trendar Corp., Mountain View, Calif., will take on microprocessor board testing. His paper reviews microprocessor boards and how they differ from conventional logic. In addition, there is an analysis of the pros and cons of various test approaches including cost of implementation, one-time costs, and relative effectiveness.

At the ATE forum on state-of-the-art techniques, vendors and a user will talk about the application of testers to boards bearing microprocessors and other complex LSI circuits. A paper by Thomas Bush of GenRad explores current and upcoming techniques for troubleshooting microprocessor boards after first listing the boards' unique properties—high data rates, bit architectures, and complex failure modes—and analyzing the implications of these for testing. A companion paper by Ed Steinberg and Robert Lecoq of Digital Equipment Corp., Maynard, Mass., will give a black-box approach to testing and isolating manufacturing-type faults in an 8080 chip set.

The tape chip carrier with its suitability to automation could be one of the most exciting things ever to have happened to the hybrid industry. However, says session 15's chairman, Stanley Stulbarg of Hughes Aircraft Co., Newport Beach, Calif., because of practical difficulties, small leadless ceramic and plastic chip carriers have been seized upon as an interim chip packaging approach.

An important paper, by Dan Amey of Sperry Univac Computer Systems, Blue Bell, Pa., reviews the five available forms of the chip carrier and shows how a proposed Jeduc standard has attempted to make them interchangeable when referenced to a standard printed-circuit footprint. □

# PLESSEY DELIVERS PDP-11 AND 8 DISC IMMEDIATELY.

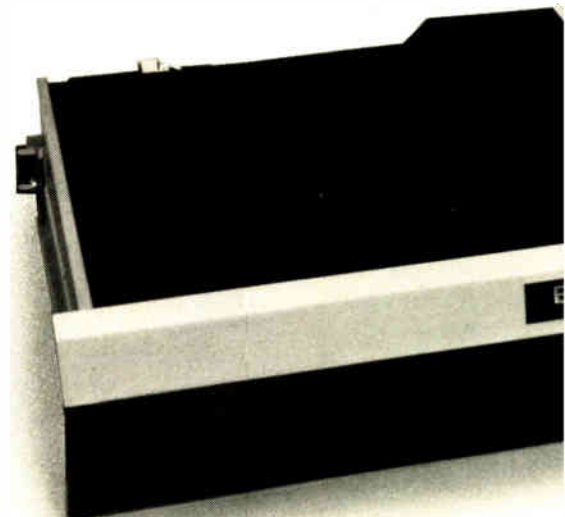

Plessey can save you a bundle of time and money on PDP-11 and 8 disc drives and systems, with no sacrifice of compatibility or reliability. Our drives may be just what you're looking for to expand your mini into time sharing, data base management, and other mass storage applications.

### Complete plug-in compatibility

Plessey disc drives are available in capacities of 2.5, 5 and 10 megabytes, or 1.6, 3.2 and 6.4 megawords. Drives occupy the same space as a single DEC RK05.

They're available with removable cart-ridges for versatility or fixed discs to save

you even more, and they're all fully hardware and software compatible, with media compatibility in our two front-loading versions.

### Mix and match your drives

If you're just starting your expansion, you can't do better than the Plessey Disc Controllers. They are compatible down to the board level so they plug into your PDP-11 or 8 mainframes to control up to 20 megabytes or 6.4 megawords in any combination of DEC RK05 and Plessey Disc Drives.

PLESSEY PM-DS SERIES DISC DRIVE CONFIGURATIONS

DRIVE MODEL: PM-DD		A	B	C	D	E	F
MEDIA	Discs	1-Front Load (2315-type)	1-Front Load (2315-type) 1-Fixed	1-Top Load (5440-type) 1-Fixed	1-Fixed	2-Fixed	2-Fixed
	Compatibility	DEC RK05	DEC RK05	—	—	—	—
CAPACITY	PDP-11 (megabytes)	2.5	5	10	2.5	5	10
	PDP-8 (megawords)	1.6	3.2	6.4	1.6	3.2	6.4

# BIG SAVINGS ON SYSTEMS.



Or if you're already using a disc system, enhance it with any one of our drives. Your computer won't know the difference, but your budget will.

## More for your money, inside and out

Every drive and system we ship includes our advanced electronic and mechanical designs, fail-safe circuitry to protect the heads and discs, a 35 CFM clean air package, and an MTBF of over 5000 hours.

And no matter where your systems are used, you'll find Plessey equipment backed by the resources of a billion dollar corporation.

## Ready to ship now

With all this available now in a disc system that costs less, stores more and performs as well as or better than the one you're waiting for — what are you waiting for?

Contact us and get your orders in today.



## Plessey Microsystems

IRVINE, CA: (714) 540-9945. LOS ANGELES, CA: (213) 473-4581. MOUNTAIN VIEW, CA: (415) 965-1400. SCHILLER PARK, IL: (312) 671-4554.

WHEATON, MD: (301) 949-1664. WALTHAM, MA: (617) 890-2654. MINNEAPOLIS, MN: (612) 881-0190. KANSAS CITY, MO: (816) 444-0166.

SOUTH PLAINFIELD, NJ: (201) 757-2211. ALBUQUERQUE, NM: (505) 294-5790. DALLAS, TX: (214) 387-0229. TORONTO, CANADA: (416) 661-3711.

# BRAND NEW MINICOMPUTERS

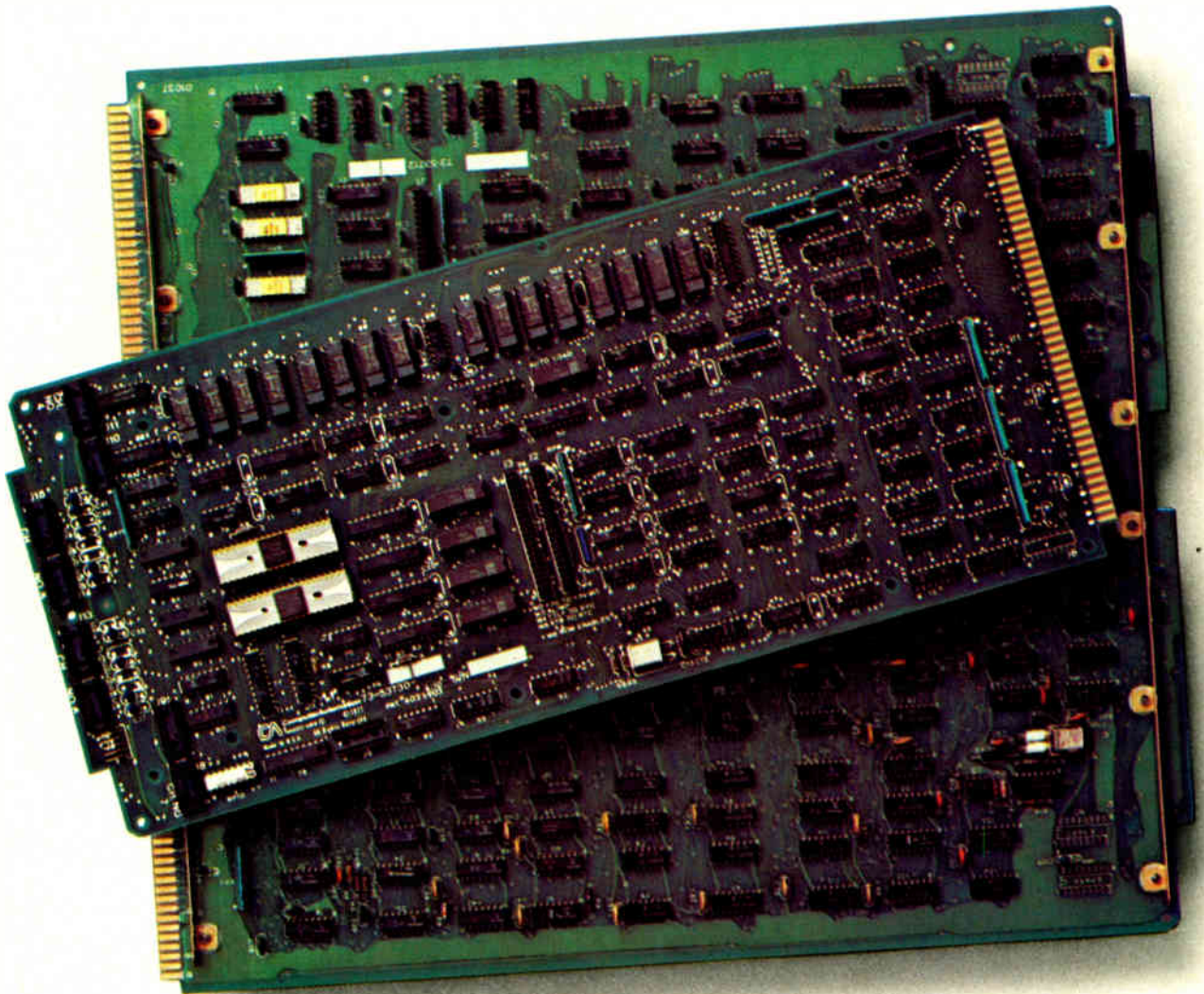



# BRAND NEW BROCHURE



Circle Reader Response No. 190

 **ComputerAutomation**<sup>®</sup>  
NAKED MINI<sup>®</sup> Division  
18651 Von Karman, Irvine, California 92713  
Phone (714) 833-8830

© 1977 Computer Automation, Inc



# FAIRCHILD TAKES

**BACKWARDS.** Hard on the heels of our successful Sentry VII tester (recognized as the most advanced LSI tester in the industry), Fairchild introduces Sentry V: modified for high volume testing and a heck of a lot less expensive.

Like the Sentry VII, the Sentry V will perform complete high-speed functional and parametric testing for both high volume production and incoming inspection. In fact, it will do just about everything the Sentry VII will do except intensive device characterization and data collection. But your investment is protected. The Sentry V can be easily field enhanced to a Sentry VII to meet your expanded testing requirements.

Sentry V can routinely handle microprocessors, peripheral chips, bit slices, RAMs, ROMs, shift

registers, UARTS and digital hybrids in technologies such as NMOS, PMOS, CMOS, SOS, ECL, TTL and I<sup>2</sup> L. It is source program compatible with Sentry VII, 600 and 610 to minimize programing costs and is hardware compatible with Sentry VII to end correlation problems between engineering and production systems. It also provides support to the IEEE-488 bus, which solves the sticky subnanosecond or analog test problems.

To provide lower operating costs, Sentry V offers many features of Sentry VII plus multi-task (foreground/background) software for simultaneous compiling, editing and testing; a *central processor* that provides 50 to 200% faster throughput; a *sequence processor* to handle high complexity devices; a *pattern processor* to tackle the largest memory systems; and, high performance



# A GIANT STEP...

test stations for fast, accurate testing of TTL, ECL and TTL compatible NMOS devices.

Come to think of it, you might call Sentry V an advancement in the state-of-the-art if you're looking for a cost effective production tester. Sometimes you take a giant step forward by simply putting your foot down on costs. FAIRCHILD SYSTEMS TECHNOLOGY, A division of Fairchild Camera and Instrument Corporation, 1725 Technology Drive San Jose, California 95110 (408) 998-0123.

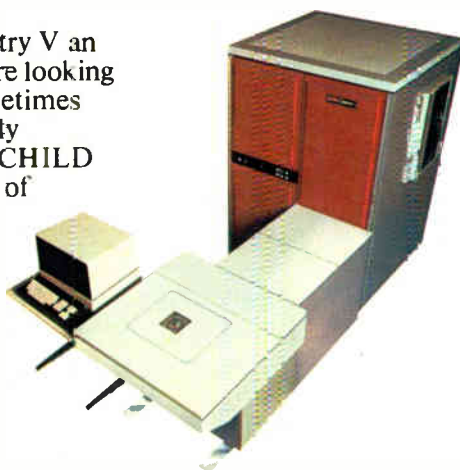

**FAIRCHILD**

# Intel delivers real-time industry's most complete



## It starts with the industry's broadest selection for design flexibility.

Intel's family of cost effective single board microcomputer products is growing to keep pace with a changing world.

We delivered the world's first complete computer on a single board in February 1976. It contained CPU, data and program memory, and both serial and parallel I/O. Today we're delivering five Single Board Computers. For cost-conscious, stand-alone applications there's our new SBC 80/04, under \$100\* in OEM quantities. At the high performance end of the spectrum is our SBC 80/20, with full multimaster system capabilities.

You can expand the capabilities of these SBCs and tailor a system to your specific application, selecting from over 25 memory expansion boards, digital and analog I/O boards, communications interface boards, mass storage systems and a high speed math processor. Or, you can choose one of our packaged System 80s with a customized complement of expansion boards.

INTEL SINGLE BOARD COMPUTERS				
Product	CPU	RAM (bytes)	EPROM (bytes)	Bus interface
SBC 80/20-4	8080A	4K	8K (2716) 4K (2708)	Multimaster
SBC 80/20	8080A	2K	8K (2716) 4K (2708)	Multimaster
SBC 80/10	8080A	1K	4K (2708)	Single master
SBC 80/05	8085	512	4K (2716) 2K (2708)	Multimaster
SBC 80/04	8085	256	4K (2716) 2K (2708)	None

## MULTIBUS™ architecture provides a standard you can live and grow with.

The key to efficient utilization of Intel's SBC family is our Multibus. It's the superior bus architecture designed to maximize system throughput and provide an industry standard you can build on.

Multibus enables you to add processing power to your system in modular increments. It fully supports

multimaster systems with up to 16 parallel processors and ensures efficient single master or multimaster system operation with multi-level vector-ed interrupt capability and bus transfers at up to five million bytes per second.

It's no wonder over 30 other manufacturers have already jumped aboard the Intel Multibus and are now supplying special purpose peripheral boards compatible with it. And, because Multibus is the accepted industry standard architecture, it's your link to future SBC developments.

## RMX /80™ Real-Time Multitasking Executive provides a framework for your application software.

RMX/80 is the most advanced multitasking operating system for any Single Board Computer. For applications that monitor and control a number of interrelated asynchronously occurring events, it can dramatically cut software development time and costs. You develop software only for the individual tasks of your application, and the RMX/80 operating system does the rest providing all intertask communications and

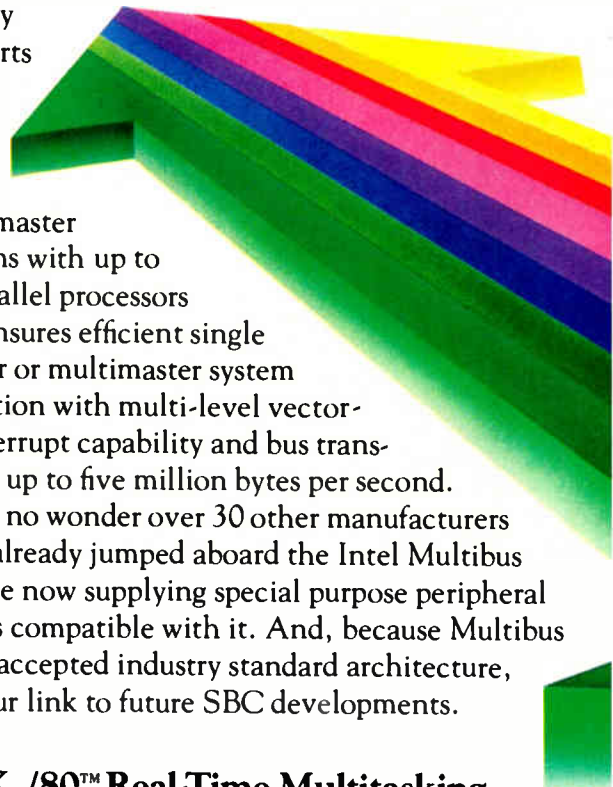

# multitasking software for the Single Board Computer family.

synchronization according to the task priorities you define.

RMX/80 is compact and modular, allowing you to expand and tailor your system software as easily and efficiently as your SBC hardware. The complete RMX/80 executive resides on board in a single 2K byte EPROM chip. Your task programs and the standard RMX/80 I/O drivers you select can reside in additional on-board memory, eliminating the need for bootstrap peripheral devices, or on diskette in modules that are callable by the executive.

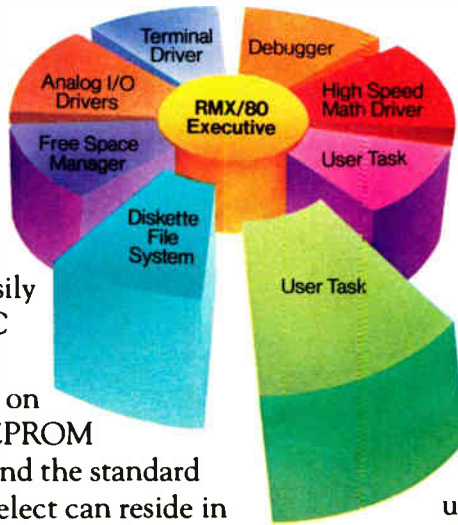

The Intellec® Microcomputer Development System enables you to build programs and debug them in modular form in assembly language or PL/M, our high level system programming language, then link them with standard RMX/80 modules using the Intellec ISIS-II operating system. And, integration of system software with system hardware is simplified by Intel ICE In-Circuit Emulation with symbolic debugging.

Intel gives Single Board Computer users a head start with our comprehensive SBC System Configuration Planning Kit. It's more than a catalog of our SBC products. It contains products, parameters and easy-to-use worksheets—everything you'll need to configure the optimum SBC solution for your application.

For your copy of the planning kit, or for on-site assistance in configuring and pricing your SBC system, contact your local Intel representative or distributor. Or write: Intel Corporation, 3065 Bowers Avenue, Santa Clara, California 95051. Telephone: (408) 246-7501.

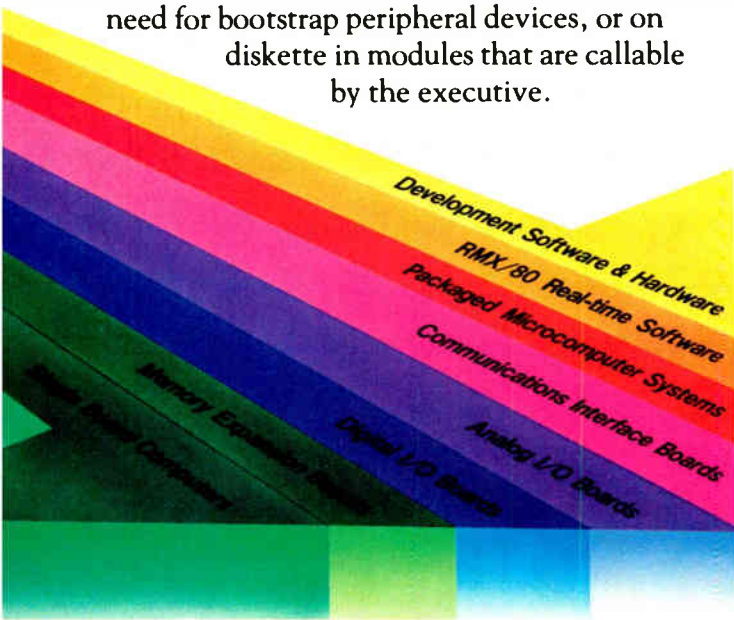

For solutions to real time multitask applications, RMX/80 software makes Intel single board microcomputers the sensible alternative to component-level designs or far more costly mini-computer systems.

## Intel development support gets you to market faster.

Intel stands behind you with development support that makes your job easier and less time consuming.

Electronics / September 15, 1977

# intel® delivers.

\*100 quantity, domestic USA price only. I/O drivers, terminators, EPROMs or ROMs not included.

Circle No. 154 for information

Circle No. 155 for information and demonstration

155



# VERY LARGE SCALE INTEGRATION

for not so everyday  
RF and Digital applications

Back in the early 60's TRW patented the very popular Transistor Transistor Logic (TTL). Since then we have done a lot more than collect royalties. Today, the Microelectronics Center of TRW has four major technologies in development or production. They are now serving some of the most advanced commercial, military and space systems ever conceived.

Very Large Scale Integrated (VLSI) circuits with densities of 50,000 components per square centimeter are now in high volume production. An outstanding example of this VLSI technology is our bipolar triple diffused 16 by 16 bit multiplier. Performing over 5,000,000 multiplications per second, it contains over 18,000 components on a silicon chip that measures only 250 mils square.

For high-speed military applications, we have another bipolar LSI technology designated Oxide Aligned Transistors (OAT). This

exclusive TRW process provides the ultimate in VLSI circuit performance with silicon technology. One result is a family of high-speed analog-to-digital converter circuits that operate at speeds up to 250,000,000 bits per second. Radars and weapons systems have been greatly improved with this precision silicon technology.

Digital processing in space has long been a problem because of hardware size and power. TRW has taken a unique approach to produce very low power, high-density digital circuits. Charge coupled devices are now being developed by TRW into a full family of pipelined digital functions. These CCD digital devices include multipliers, digital signal correlators, adders, and all of the basic logic building blocks formed into sophisticated digital signal processors for voice, TV, and radar signals. Since CCDs use a charge transfer concept, they consume very little power — about 1/10 that of N-channel MOS and CMOS. At the same time, CCDs offer equal performance.

At TRW,

we are developing two RF/LSI technologies that are finding communications applications in the range from 100 MHz to 10 GHz. The first uses the OAT technology and is being used to produce revolutionary receiver monolithic functions such as

phase lock modulators and demodulators that operate in the 100 to 200 MHz range.

The second RF/LSI technology uses Gallium Arsenide instead of silicon and has been advanced by TRW to a point where we now can produce integrated circuits operating in the 5 to 10 GHz range. TRW combines field effect transistors, transferred electron devices, capacitors, resistors, and coplanar transmission lines on these GaAs chips to achieve previously unattainable performance at these frequencies.

These are a few of the LSI microelectronic technologies that TRW is actively pursuing. We are continuing to push forward the frontiers of the amazingly versatile and limitless field of solid state integrated circuits. We didn't stop with TTL — we are moving ahead with the most advanced technologies and products in VLSI, RF/LSI, GaAs, and CCD/LSI. This capability is helping us form the foundation for some of the most advanced systems ever conceived.

If you have a not so everyday application for one of our microelectronic technologies and you would like more information, write on your company letterhead to the TRW Microelectronics Center, Defense and Space Systems Group, E2/9043, One Space Park, Redondo Beach, California 90278.

**Microelectronics**

FROM A COMPANY CALLED

# TRW

## New products

ohms to 20 megohms full scale.

The 179, the true-rms meter, differs in that it performs rms measurements on ac and has one lower range on ac and dc volts, a 200-millivolt full-scale range, which means that the least significant digit corresponds to 10 microvolts. It also adds dc and true-rms current measurements with five ranges from 200 microamperes to 2 amperes full scale. Input frequencies can range between 45 hertz and 20 kilohertz.

The 179 has resistance ranges that are similar to those of the 178, but offers a higher protection voltage—it will stand 450 v rms sustained or a momentary 1 kilovolt dc or peak ac. (The 178 is protected to 250 v rms or dc.) It also adds high- and low-voltage drives on the resistance ranges; the low drive allows in-circuit measurements without turning on semiconductor junctions.

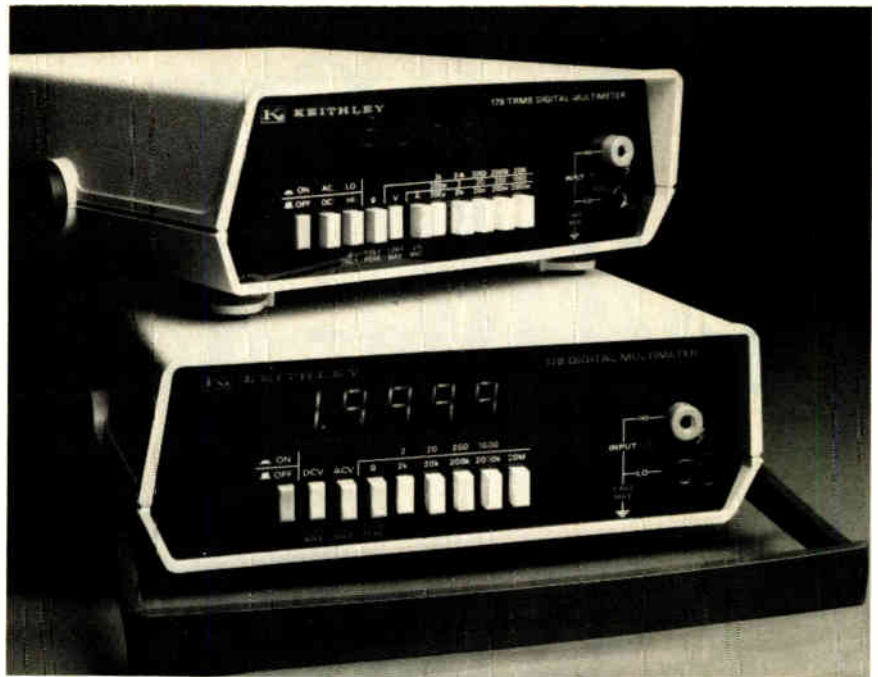

Each model uses 0.5-inch light-emitting-diode displays with automatic polarity indication (but neither model is automatic-ranging). When an overload is applied, the display blinks all zeroes. Each model also is powered from an ac line cord.

An optional rechargeable lead-acid battery, which is priced at \$59, provides the user with up to six hours of operation.

Keithley Instruments Inc., 28775 Aurora Rd., Cleveland, Ohio 44139. Phone (216) 248-0400 [402]

# Rockwell to introduce 32-k static ROM

Spurred on to meet internal deadlines, the Microelectronic Devices group at Rockwell International has pushed development of a 32,768-word static read-only memory to the point where it is ready for the marketplace ahead of competitors.

"We can accept user codes immediately, and deliver eight weeks after receipt," promises H. R. Anderson, manager of product planning for the microelectronic devices operation. What is more, if samples are needed, "we can run a short turnaround." The price of the 24-pin model R2332 ROM comes to about \$20 each in 1,000-piece orders.

Rockwell's development schedule escalated into a crash program in April when the firm opted to go ahead full speed with the System 65, a microcomputer development system. For the System 65, the ROM had to be ready by this month to go along with initial sales of the 6500 microprocessor that Rockwell is starting to turn out in volume under license from MOS Technology Inc. A key element in simplified design for the System 65 is that operating

programs are resident in ROM, rather than fed in by paper tape.

Of course, the R2332 also was needed for other sales along with the

6500 processor family, observes Anderson. A critical specification of the R2332 is the 250-nanosecond access time, required by the 2-megahertz

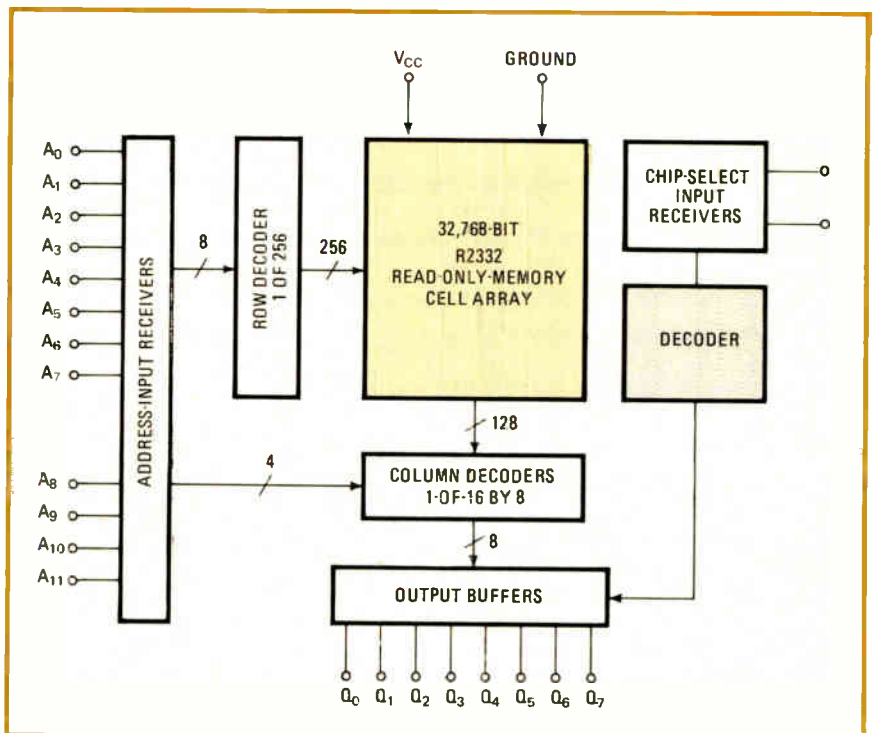



# Profit from sameness.

Kodak micro resist 747 gives you the precise uniformity to help improve your yields.

It's formulated to give excellent adhesion, etch resistance, and resolution for use on semiconductor and metal surfaces common to microelectronics manufacturing.

Our rigid filtering standards mean a consistently low metal-ion content. And the tightly controlled viscosity means

more uniform coating and higher reliability.

747 resist is negative-working and is available in four viscosity grades: 110, 60, 45, and 30 centistokes.

Batch-to-batch consistency—helps build your profits.



For a free packet of information on Kodak products for photofabrication, write Eastman Kodak Company, Dept. P04802, Rochester, N.Y. 14650.



## Kodak micro resist 747

RESULTS COUNT



## New products

speed of the 6500 family.

"We were in the position of not only being under the gun on deadline, but if the R2332 doesn't work in your own system, that's a double failure," says C. W. Padgett, circuit design engineer responsible for the new ROM. "The design is a trade-off between speed/power and chip size," he explains. The 191-by-237-mil chip uses about 375 milliwatts in reaching the 250-ns speed.

In a 4,096-word-by-8-bit organization, the ROM is compatible with all microprocessors, while primarily supporting the 6500 family. The Rockwell device offers transistor-

transistor-logic input and drives at one TTL load, and probably one more as soon as performance characterization is completed, according to Padgett.

Other features include asynchronous operation and no clock input. Two chip-select inputs allow four 32-k ROMs to be OR-tied without external decoding. The chip-select delay parameters typically average 100 ns, with timing reference levels of 1.5 volts for input and 0.8 or 2 v for output. Current required is 70 to 80 milliamperes, and ambient operating temperature is over a 0° to +70° C range.

Although the R2332 ROM is the first n-channel memory produced by Rockwell, the semiconductor house has long built p-channel devices, including a 32-k chip, for its p-channel microprocessors, points out Anderson. Rockwell chose the 32-k market for its entry into n-channel because no design has yet established itself as the standard. In Anderson's view, the industry standard of the 32-k ROM will be the static type, just as at the 16-k level.

Microelectronic Devices, Rockwell International, 3310 Miraloma Ave., P. O. Box 3669, Anaheim, Calif. 92803. (714) 632-2558 [401]

## DMMs tailored to communications

To round out its line of digital multimeters, Systron Donner Corp. is introducing five 4½ digit DMMs—four portable and one rack-mountable—at Wescon this year. The four portable models, designated the models 7141A, 7141B, 7241A, and 7241B, carry prices of \$395, \$450, \$395 and \$450 each. The fifth model, the 7344A, is designed as a systems multimeter for use in calculator-based systems and is priced at \$945.

According to product marketing manager Chuck Bishop, the models plug a gap in Systron Donner's DMM line between its 3½-digit portables and 5½-digit bench and microprocessor-controlled DMMs. The 7141A has a basic dc accuracy of +0.05% of full scale and +0.05% of reading. For those applications requiring

more accuracy, the model 7141B provides a basic dc accuracy of +0.02% of reading and ±0.01% of full scale.

The models, says Bishop, utilize a true-rms ac converter. Its crest factor of 4 at full scale allows the user to make virtually any kind of ac measurement from 45 hertz to 20 kilohertz. In addition, the two models offer five dc current ranges and five ac current ranges. Protection is provided by a resettable circuit, located on the rear, that automatically opens at 2 amperes.

In the models 7241A and 7241B, the current-measuring capability has been replaced with five ranges of dbm, says Bishop. Dynamic range is from -60 dbm to +60 dbm referenced to a 600-ohm balanced line. The frequency range of 20 Hz to

20 kHz satisfies all requirements of the communications and telephone industry for checking tones, he says.

All of the models have an analog meter option. In addition to the light-emitting-diode display, Systron Donner has added an analog meter on the front of the panel. This feature gives the user the ability to make nulling and peaking measurements, which are usually impossible with a rapidly changing digital readout. The meter is connected to the integrator input so it gives a representation of the input regardless of range or function. All instruments have a battery-pack option, giving the user 4 hours of continuous use.

The model 7344A is a low-cost, high-performance, 20,000-count DMM that is IEEE-488 compatible. This instrument handles dc voltage,

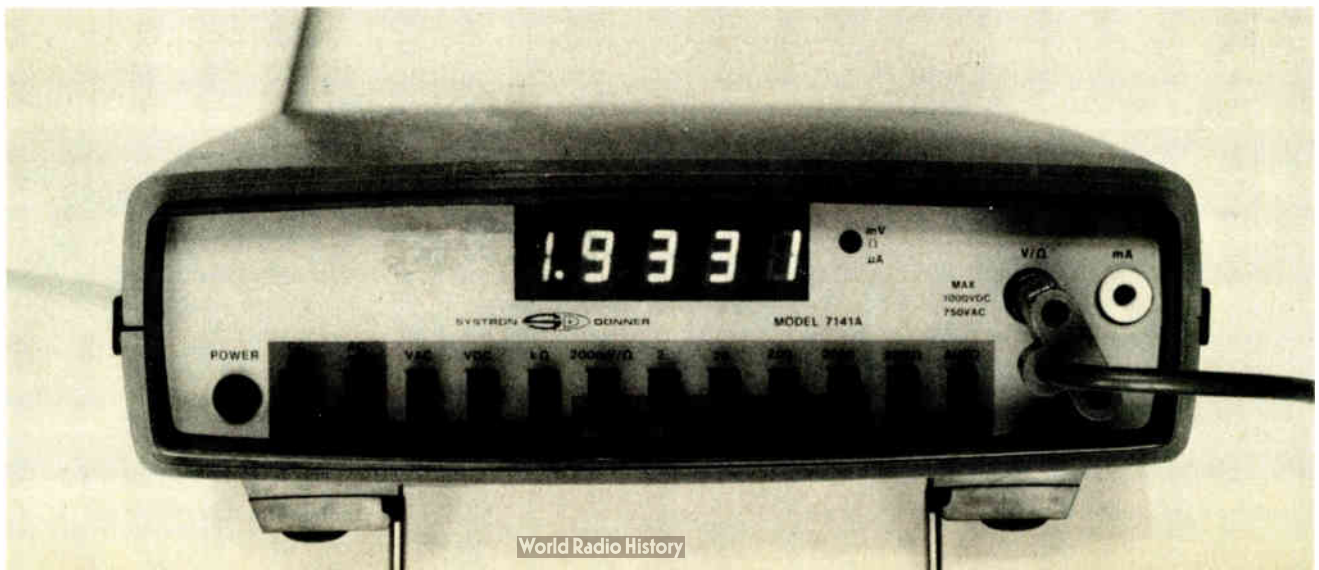

Our severe environment products have been subjected to some pretty rough treatment. From being bounced around miles above the earth to operating thousands of feet beneath the sea, they've handled it all. At EMM, we've been building memories for severe environments longer than anyone else. A lot of companies have been in and out of this hostile market. We've remained committed to it. We know what it takes to design and build rugged, reliable products that withstand corrosive atmospheres, shock, vibration, and temperature extremes. And, we're continually developing new ideas. Like our new industrial mini-computer system available as a complete system or as a card set. It's PDP-11/34\* compatible and built for tough jobs on oil well drilling platforms, in steel mills and paint plants, or wherever the environment is too rough for conventional computers. Another new idea is our high-capacity semiconductor memory for military applications with up to 28.8 million bits. If you need speed, we're working on a 200 nanosecond access, 500 nanosecond cycle core memory. Then there's our airborne data recorder. Compact, 4.0 x 6.0 x 3.0 with 23 million bits of storage and a removable sealed tape cartridge. We know it takes a lot to survive out in the rough, real world of industrial, military or aircraft electronics. So, when you're confronted with operating in a severe environment, we have your solutions. After all, rough is our way of life.

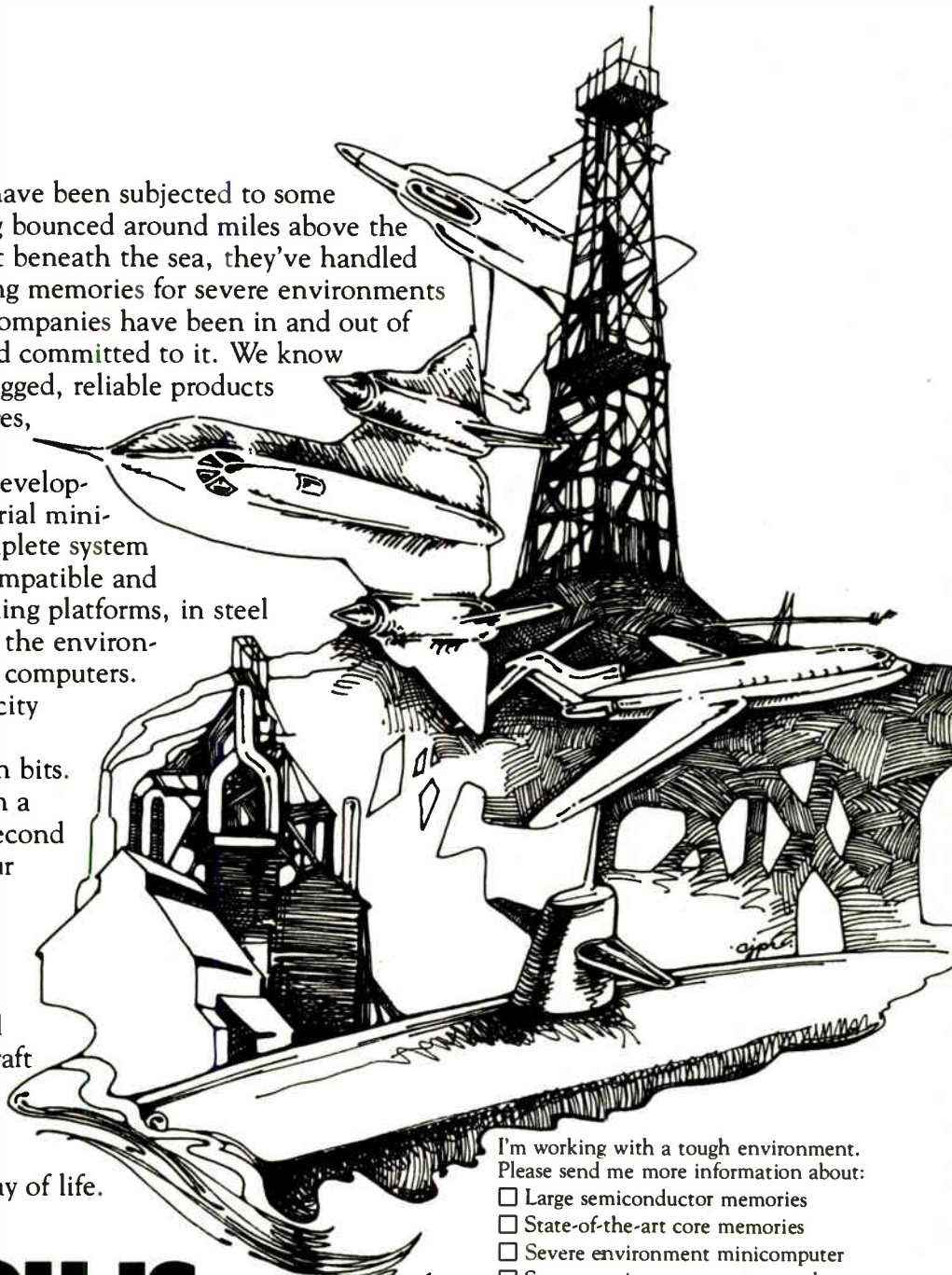

\*PDP-11/34 is a product of Digital Equipment Corporation

I'm working with a tough environment. Please send me more information about:

- Large semiconductor memories
- State-of-the-art core memories
- Severe environment minicomputer
- Severe environment tape recorder

Application \_\_\_\_\_

# ROUGH IS OUR WAY OF LIFE

Name \_\_\_\_\_

Title \_\_\_\_\_

Company \_\_\_\_\_

Address \_\_\_\_\_

City \_\_\_\_\_

State \_\_\_\_\_ Zip \_\_\_\_\_

Telephone \_\_\_\_\_

**EMM SEVERE ENVIRONMENT PRODUCTS**  
 A Division of Electronic Memories & Magnetics Corporation  
 20630 Plummer Street, Chatsworth, CA 91311  
 (213) 998-9090

## New products

true-rms ac voltage, and resistance measurements, works with the IEEE 488 interface, and is rack-mountable. It features a 1¾-inch-high full rack configuration.

It features five dc voltage ranges from  $\pm 10$  microvolts to +1,000 volts with dc accuracy of  $\pm 0.02\%$  of reading and  $\pm 0.01\%$  of full scale. With a true rms converter, the 7344

can measure virtually any kind of wave shape. Its crest factor of 4 at full scale and a dc-coupled input amplifier allow measurements of triangles, pulses, square waves, or distorted sine waves up to 20 kHz. The 7344A has six resistance ranges, allowing measurements down to 0.01 ohm. In addition, a novel circuit protects the ohms circuitry from

overloads up to 350 volts rms. Autoranging is a standard feature, but the range can be selected manually or remotely. All functions, ranges, and sample rates can be controlled in the format specified by the IEEE 488 standard.

Systron Donner Corp., Concord Instruments Division, 10 Systron Dr., Concord, Calif. 94518 [403]

# Hybrid data system comes in two DIPs

Most data-acquisition systems are fairly large modules that consume considerable space on a circuit board. But engineers at Micro Networks Corp., Worcester, Mass., have a hybrid alternative that provides a 12-bit, 16-channel data-acquisition system in two dual in-line packages that requires less than 4 square inches of board space. In addition, at \$137.50 each for orders of 100 or more, the acquisition system is only about two thirds the price of competitive modules, says John Munn, marketing engineer.

The new ingredient in the system is the MN7130, which includes a multiplexer and a sample-and-hold amplifier. The previously available Micro Networks ADC80 analog-to-digital converter completes the two-package system. Together, they offer 16 single-ended or 8 differential input channels that may be addressed with a single digital word.

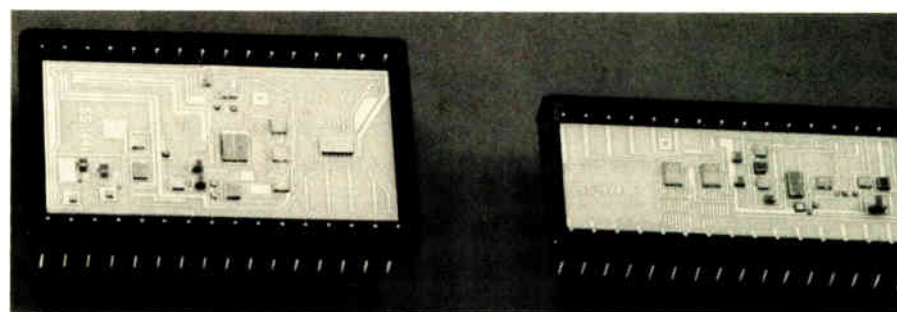

Total throughput rate of the system is 30 kilohertz, including conversion.

Also included in the 32-pin MN7130 is an instrumentation amplifier that provides 250 megohms input impedance and more than 80 decibels of common-mode rejection in the differential-input mode. All the user needs to provide, says Robert Calkins, manager of circuit development, is addressing for the multiplexers and the analog inputs. The analog output goes to the a-d converter and the latter sends an

end-of-conversion pulse to gate the sample-and-hold on and off.

Munn says the user may have to add about \$10 worth of transistor-transistor-logic packages if he needs three-level output gates or address latches. In single units, the MN7130 sells for \$120, and the ADC80 for \$77.50. Those prices drop to \$90 and \$47.50, respectively, in quantities of 100 to 249.

Micro Networks Corp., 324 Clark St., Worcester, Mass. 01606. Phone John Munn at (617) 852-5400 [404]

# Multimeter ranges up to 1,000 volts

A digital multimeter that provides eight input ranges will test instrument and system voltages of up to 1,000 volts. The model 5940, 5½-digit ratiometer has four ranges of ac references and four ranges of ac signal input (1, 10, 100, and 1,000 v) and is useful for checking ac-to-ac ratios on instruments with greater than 10-v outputs. The Dana Laboratories Inc. instrument also features true rms converters and switchable front/rear inputs.

A typical application—and one

impossible with present multimeters, says a company official—would be to test a transformer with, for example, 115-v input and 500-v output. Previously it would have been necessary to attenuate at least one of the voltages to derive the ratio, he says. Similarly, entire guidance systems and their subsystem gyroscopes, servos, and accelerometers may be tested with the new Dana Lab instrument.

The true-rms ac converter feature allows a user to make accurate

measurements of distorted or non-sinusoidal voltages, he adds. Also, by means of a blocking capacitor, either the ac or dc component of a signal may be measured.

For systems applications, the switchable front-rear inputs allow localized troubleshooting without disconnecting the first input. In such an application, the user, for instance, could maintain the rear input signal, while employing the model 5940's voltmeter for front input reference.

In addition to the ac-to-ac ratio

# Smart Hardware for calculator and computer systems

## 53A ASCII Party Line System<sup>®</sup>

You can now plug together automatic data acquisition and control systems without having to build hardware interfaces or write software drivers.

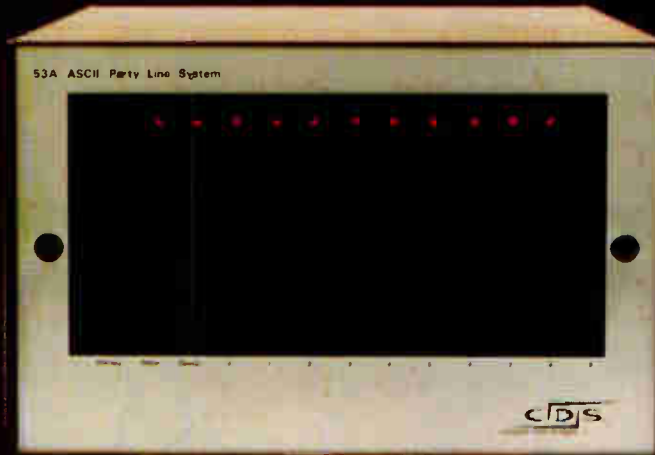

- IEEE-488 Compatible
- Digital Data Coupling
- Analog Measurement and Stimulus
- Switches and Scanners
- Resistance Programming
- Clocks

**CDS**<sup>(i)</sup>

computer data systems

186-58 Homestead  
Morrison, Colorado 80465  
Telephone (303) 697-8014

Circle 165 on reader service card



## New products

capability, the instrument has five dc ranges with accuracies of  $\pm 0.001\%$  of full scale (10 ppm). In this mode, it has eight ranges of resistance and a four-wire—four-quadrant dc ratio. Inputs are protected up to 1,000 v on all ranges.

Another feature is guaranteed one-year specifications on the new instrument, which eliminates the need for frequent calibration, the company says, reducing both this expense and system downtime.

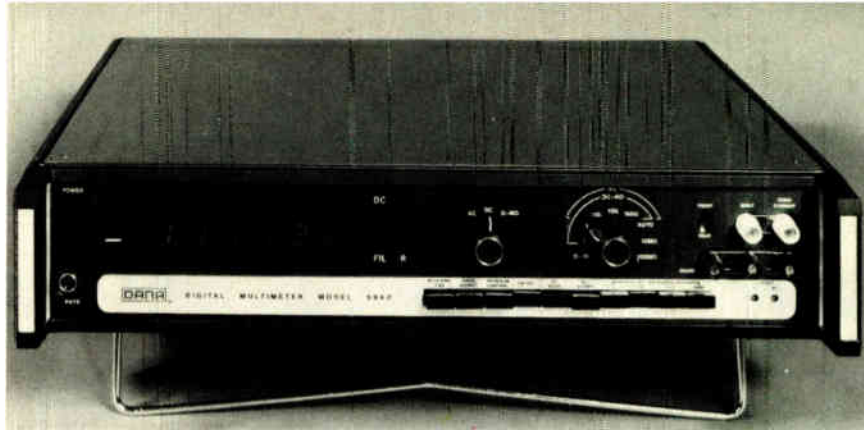

Base price of the model 5940 is \$3,495, termed substantially cheaper than previous comparable models by the Dana official, through incorporation of improved transistor-transistor-

logic and linear circuits. Delivery time is 90 days.

Dana Laboratories Inc., 2410 Campus Dr., P.O. Box C-19541, Irvine, Calif. 92713. Phone (714) 833-1234 [405]

# Printer interfaces with data sources

Printers for industrial and instrumentation applications are often computer peripherals with price tags that are too high for these applications. Engineers at the Measurement and Control Systems division of Gulton Industries Inc. have attacked that problem with two units that will debut at Wescon. They are the AP-20L, an alphanumeric lab printer, and a dedicated numeric printer.

The AP-20L offers the user direct connection to a variety of data sources, including data-communications equipment, microcomputers and minicomputers, teletypewriter and keyboard equipment, and the IEEE standard-488 instrument bus. The 20-column unit prints 2½ lines per second in a 64-character ASCII upper-case font using a 5-by-7-dot matrix.

Any of the following interface options may be included: two versions of bit-serial/character-serial data interfaces, a bit-parallel/character-serial IEEE instrument-bus interface, or a binary-coded-decimal interface. The latter produces four-line BCD data that is bit-parallel/character-serial, is 10 columns

wide, and is programmable over any of the 20 columns.

The AP-20L's interfaces are built as self-contained plug-in modules that come complete with a dedicated input/output connector and whatever controls are needed. They plug into a dedicated opening in the unit's rear panel. The lab printer also provides access to the bit-parallel/character-serial interface offered in an earlier OEM version by a D connector on the back.

Gulton engineers point out that in some instances, this input can be used concurrently with a dedicated interface, each printing on a separate portion of the paper tape. Such a bilingual mode can be especially useful in labeling or identifying BCD data with bit-parallel/character-serial alphanumeric.

The AP-20L also provides space for an optional real-time clock, front-panel light-emitting-diode display, and a selector switch that would allow time-of-day printouts and print-sequence gating. The printer will be offered in panel-mount or self-supporting lab or bench-case versions, and it sells for

\$825 in single quantities.

The dedicated numeric printer, priced at \$875, is a self-contained laboratory instrument that includes a 3½-digit panel meter, the division's NP-7 printer, and related electronics. It can measure voltage, current, and temperature, or, using appropriate transducers, will handle weight, pressure, and flow. The printout includes parameter and channel number at selected time intervals from 1 second to 1 hour. The 7-column printout assigns columns 1 and 2 to printing the channel number of interest, column 3 to a plus/minus sign or blank, and columns 4 through 7 for the parameter value.

Possible future options for the numeric printer include a switch-selected printout-by-exception feature, a real-time clock for printout of the time of an event, and autoscan of 10 channels. Delivery of both the AP-20L and the dedicated numeric printer is 60 to 90 days.

Measurement & Control Systems Division, Gulton Industries Inc., Gulton Industrial Park, East Greenwich, R. I. 02818. Phone (401) 884-6800. [406]

# \$195 counter resolves 8 digits

To measure frequencies below 1 kilohertz to a resolution of 0.01 hertz, an operator must wait 100 seconds if he is using a conventional frequency counter in the "period"

mode. But the same measurement can be made in a second with a new low-cost 80-megahertz counter from Ballantine Laboratories Inc. of Boonton, N. J.

The 8-digit model 5720A achieves this resolution by phase-locking an internal 100-times multiplier oscillator to the input signal and counting the oscillator's 100× multiplied out-

# Metal film with muscle.

Our Metal Glaze™ resistors are rated 2 to 4 times mil spec power, yet retain precision resistor characteristics.

Now, with both strength and precision, you can take advantage of these thick film resistors and standardize on one size. Or benefit from an improved safety factor. For example, our 1/8W 1% device will handle 1/2W @ 70° C, or up to 40W pulse.

What's more, we've added a new 2W standard.

It takes 50% of the board space of the old 2W, yet is rated 3W @ 25° C. We're also in the process of substantially increasing resistance well into the megohms.

TRW metal films with muscle are available from 1/8W to 5W, 200 V to 15 KV, with 1, 2 and 5% tolerance. For standards in all types of resistors, contact your local TRW distributor. Or TRW/IRC Resistors, 401 N. Broad St., Philadelphia, Pa. 19108. (215) 922-8900, Dept. G.

## **TRW** IRC RESISTORS

ANOTHER PRODUCT OF A COMPANY CALLED TRW

™ Metal Glaze is the TRW trademark for its thick metal film resistors.

Circle 167 on reader service card

# PREMIER PLUS FACTORS

- Cabinets
- Consoles
- Cases

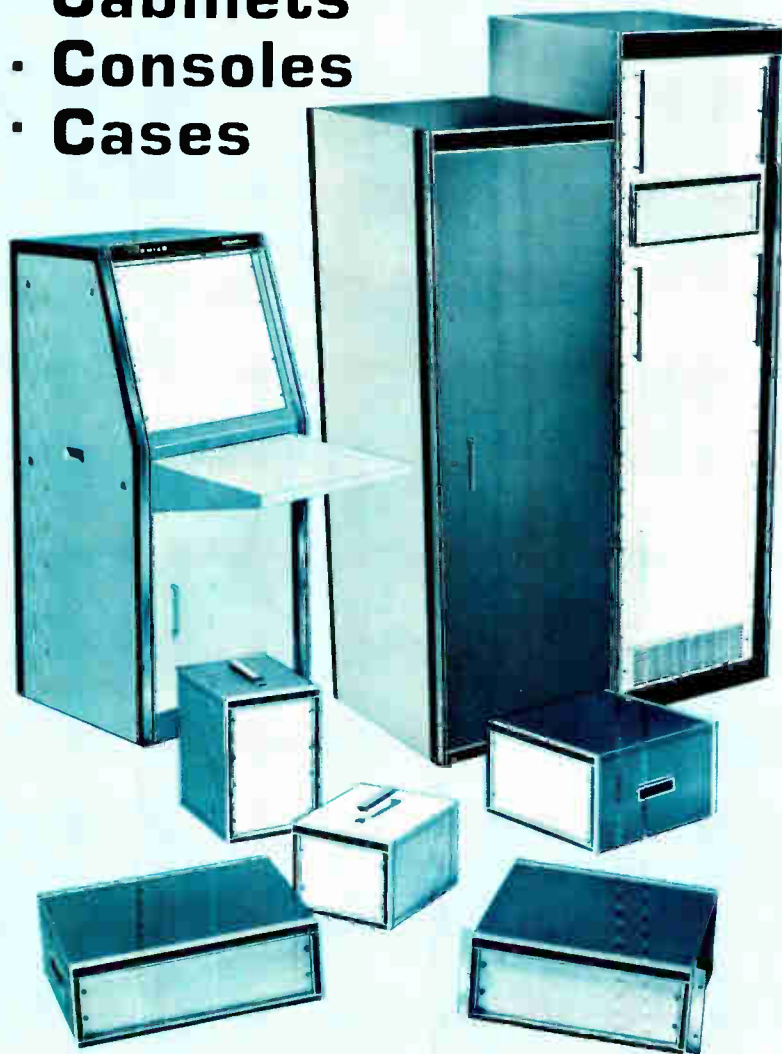

**Standard Models in many sizes**

PLUS

**Modifications for special needs**

PLUS

**Custom Built for complete specials**

PLUS

**Facilities from sheet metal to finishing**

PLUS

**Accessories:** panels, fans, blowers, slides, shelves, drawers, outlet strips, chassis, hardware, etc.

You can rely on Premier for quality, good delivery, and surprisingly low prices.



**PREMIER METAL PRODUCTS CO.**

381 CANAL PLACE, BRONX, N.Y. 10451 (212) 993-9200

## New products



put during a one-gate period. The unit costs \$195.

According to Ballantine president Fred L. Katzmann, this performance is "ideal for calibrating selected-tone communications circuits plus power line frequency, tachometers and other devices which normally use period measurements in more costly instruments." With 8-digit resolution, he continues, "the unit also can serve as a 'digital dial' for precision setting of test oscillators and signal generators."

The model 5720A has a sensitivity of 50 millivolts root-mean-square over its full range of 10 Hz to more than 80 MHz and, using 0.43-inch-high bright orange light-emitting diodes, reads out directly in megahertz, kilohertz, or hertz as selected by a front-panel switch. The same switch automatically positions the decimal point to give resolutions of 1 kHz, 1 Hz, or 0.01 Hz, with gate times of 1 millisecond or 1 s. The display is nonblinking.

The portable counter weighs 2.5 pounds and operates from dc and ac. In the field, the 5720A draws about 600 mA when run on any 9-to-14-volt dc source, such as a car or boat battery, permitting it to be used to certify mobile communications equipment on site. For ac power use, optional wall-mounted ac-to-dc converters are available for 115 and 230 v ac, at a cost of \$30 and \$35, respectively.

The 5720A has a 1-megohm input impedance that is shunted by 25 picofarads. The maximum input to the counter is 250 v rms from 10 Hz to 1 kHz, decreasing to 10 v rms above 10 MHz. A front-panel adjustment provides for continuously variable input sensitivity to accommodate large-amplitude signals and discriminate against noise.

The 5720A's built-in crystal-controlled oscillator has an aging rate of less than 2 parts per million



# Wirewounds that save.

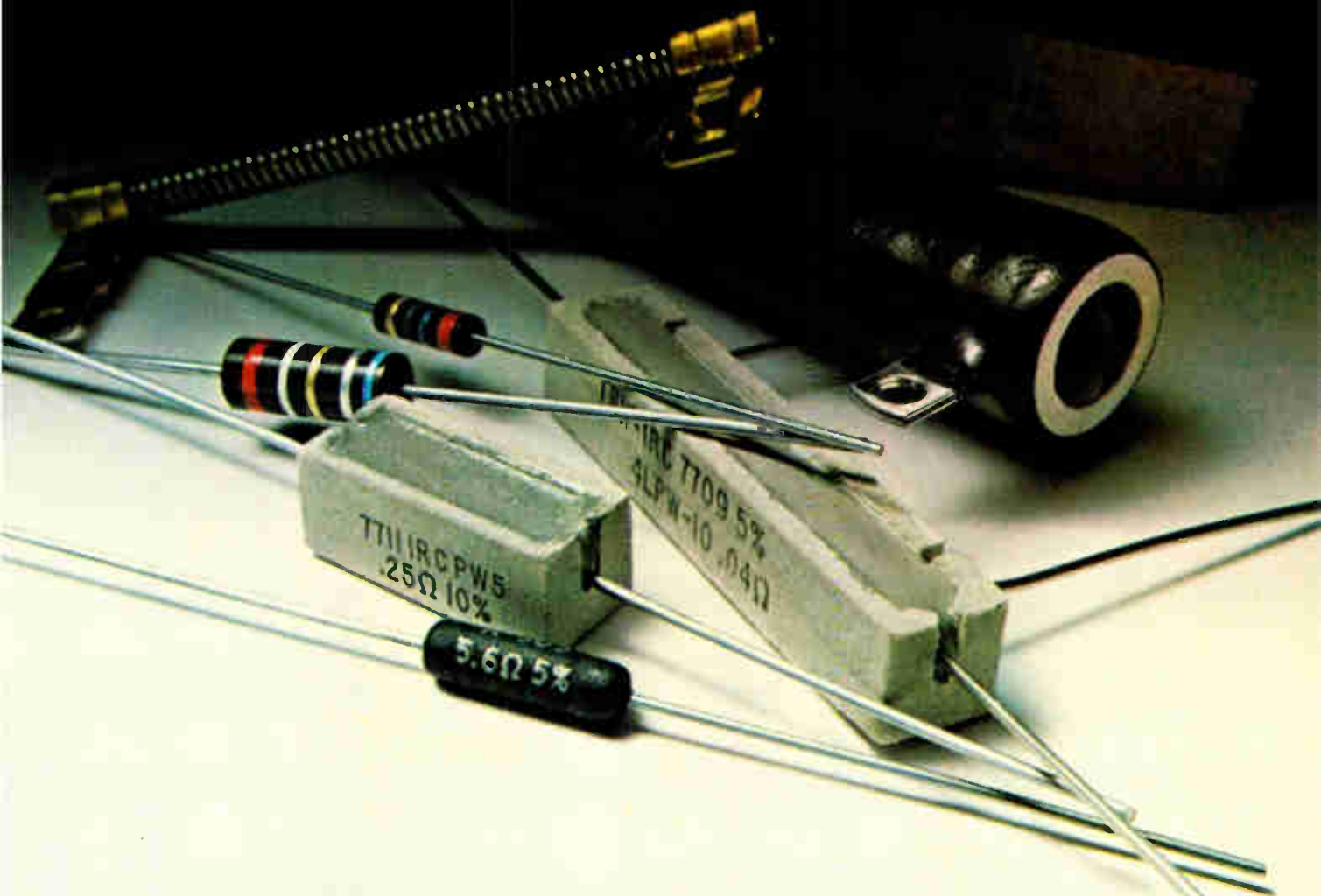

For pennies you can buy circuit protection with our BWF series resistors, perhaps saving your company a bundle later. U.L. approved, they will fail safe under specified overload conditions.

And when it comes to cost and reliability, our molded BW and ceramic PW series are standards for 1-22W general purpose applications.

For higher power we've introduced new PW styles in 30, 40 and 50W ratings. Integral mounting

brackets boost power dissipation up to 30%.

And, if it's good sense you're after, our 4LPW series is designed for current sensing and feedback circuits. Available in 5 ratings from 3 to 15W, with 2 or 4 leads, and resistance values as low as .01Ω.

For standards in all types of resistors, contact your local TRW distributor. Or TRW/IRC Resistors, 401 N. Broad St., Philadelphia, Pa. 19108. (215) 922-8900, Dept. W.

## **TRW** IRC RESISTORS

ANOTHER PRODUCT OF A COMPANY CALLED TRW

# try ours!

If you've been buying keyboards with field replaceable reeds from Spokane, you'll be happy to know that they are also available in Minneapolis! Just ask for the Maxi-Switch 2900 Series.

These keyboards feature rear-mounted reeds, field modifiable switch functions, and optional encoding formats. Modular reed switch construction simplifies assembly of both standard and custom switch and keyboard arrays, and the hermetically sealed contacts are design proven at over 100 million operations, under load.

Maxi-Switch 2900 Series keyboards are already hard at work in process control equipment, data communication systems, computer and data entry terminals, point of sale/electronic cash registers, digital scales, and other demanding applications.

Get your hands on a Maxi-Switch 2900 Series keyboard. Try it out in your environment and under your conditions, and evaluate the specifications in terms of your needs. We know you'll be pleased with the results, and pleasantly surprised at our quantity prices.

You'll find that we work hard at good customer relations, just as we do at keyboard design. If you're looking for a company that tries its best to do business on your schedule, we're both in luck. Call or write the factory, or contact your local Maxi-Switch representative (you'll find him in EEM). We'll put a 2900 Series keyboard in front of you as fast as we can. Try us!

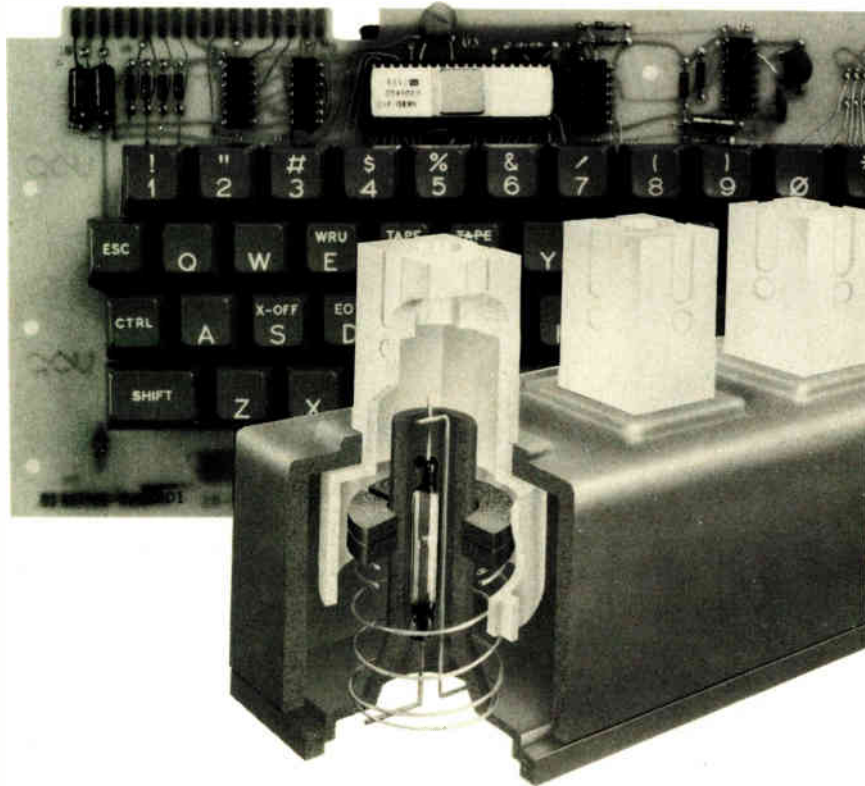

THE **Maxi-SWITCH CO.**

9697 EAST RIVER ROAD • MINNEAPOLIS, MINNESOTA 55433

(612) 755-7660

TWX 910-576-2690



## New products

per month and a temperature-induced drift of less than 5 parts in  $10^7/^\circ\text{C}$  from  $0^\circ\text{C}$  to  $40^\circ\text{C}$ . The temperature operating range of the counter is  $-10^\circ\text{C}$  to  $45^\circ\text{C}$ . Access to the instrument's 1-MHz internal clock is via a rear-panel BNC connector. The same connector, notes Katzmann, also can be used to input any external 1-MHz frequency standard with higher stability or any signal in the range from 1 MHz to 10 Hz for frequency ratio measurements, and to perform a self-test of the digital and input signal analog circuits. "These are features not generally available in instruments of this kind selling below \$300," he adds.

Ballantine Laboratories Inc., P. O. Box 97, Boonton, N. J. 07005 [407]

## Loggers handle all detectors

Since its introduction in late 1975, the Fluke 2240A data logger has dominated the field. Now the firm is expanding its original logger into a full family of "B" instruments with expanded inputs, alarms, and remote programming for process monitoring.

The 2240B (shown in the photograph) includes new input conditioning and scaling to accept any transducer with current, voltage, or digital output and can handle resistance-temperature detectors and virtually any thermocouple.

The full-control mainframe, expandable to 1,000 channels, is \$3,995; minus a printer, it is \$3,595. When remote control only is desired, the mainframe is \$2,700 with a blank panel.

The addressing capabilities of the

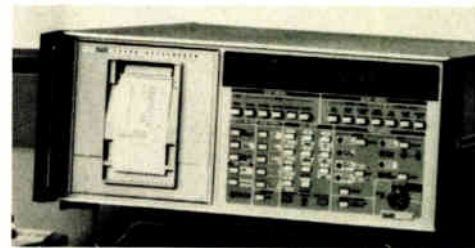

What's TRW up to now?

# Optimizing metal film.



TRW thin film resistors optimize parameters like real estate, accuracy, speed, reliability, and resistance range.

In discrete devices, sets, or networks.

For instance, our ultra-precision MAR series does all of the above with absolute TC's and tolerances to  $\pm 5$  ppm/ $^{\circ}$ C,  $\pm 0.01\%$ . Our smallest discrete uses  $< 0.016$  in $^2$  of PCB space. Complex sets and networks include 16 Bit Binary Ladders, input

attenuators and others up to 28 pins.

In straightforward precision, we have a range of standards in R2R Ladder, MIL-R-83401 flat pack, and RNC resistors with a verified MTBF of  $280 \times 10^6$  unit hours.

Contact TRW/IRC Resistors, 4222 South Staples, Corpus Christi, Texas 78411. (512) 854-4872, Dept. M. For standards in all types of resistors, call your local TRW distributor.

## **TRW** IRC RESISTORS

ANOTHER PRODUCT OF A COMPANY CALLED TRW

Circle 171 on reader service card



## Data General. A la Carte.

Now, you can order our DASHER™ terminals, even if you don't own a Data General computer system. Both our fast impact printer and our user-oriented video display are interface-compatible with any standard computer system.

60 or 30 cps versions of the DASHER printer, with a standard typewriter keyboard, u/l case, 132 columns.

DASHER display features a 1920 character screen, u/l case, detached keyboard, programmable function keys, and a monitor that tilts and swivels.

For more details call your Data General sales office or nearest independent supplier of Data General terminals. Or write. Even a bit of Data General in your computer system is better than none.

DASHER is a trademark of Data General Corporation  
© Data General Corporation, 1977

**Data General**  
It's smart business.

Data General, Westboro, MA 01581, (617) 366-8911. Data General (Canada) Ltd., Ontario.  
Data General Europe, 15 Rue Le Sueur, Paris 75116, France. Data General Australia, Melbourne (03) 82-1361.

Circle 172 on readerservice card

# MAGNETIC SHIELDING

## MATERIAL

- CO-NETIC AA Alloy  
High Permeability  
.002" to .100" thick

### EXCLUSIVE

Perfection Annealed — No further anneal required if severe forming is avoided.

- NETIC S3-6 Alloy — High Saturation Induction.  
.004" to .095" thick
- Immediate Shipment from Stock



## MAGNETIC SHIELD DIV.



PERFECTION MICA CO.  
740 North Thomas Drive  
Bensenville, Ill. 60106, USA  
Phone 312 / 766-7800  
TWX 910-256-4815

SEND FOR NEW MG-4  
Material, Application  
and Fabrication Guide.

*Complimentary Foil  
Samples Included.*

172 Circle 138 on reader service card

## New products

remote-control option permit up to six data loggers to be controlled from a single terminal. Four ASCII characters may be assigned to any one channel for units, control characters, or identifiers. Four alarm-mode choices are possible, all settable from a remote terminal.

The unit measures voltage to 1 microvolt and temperature to 0.1°C. It will scan up to 1,000 points at nearly 15 readings per second with high noise rejection, as often as once a second or as seldom as once every 24 hours. It can be programmed to continuously monitor a single channel, and it will record all the data or only the data that exceeds preselected limits.

The 2240B is key-programmable from the front panel, requiring no special language. Simple front-panel buttons, which are color-coded, allow storage by the internal microprocessor of instructions and exact execution of the measurement routine. Switches are grouped by function, with a minimum use of multiple function keys. If a signal range or function changes, the front-panel programming allows the operator to make most changes without equipment changes, according to the company.

John Fluke Manufacturing Co., P. O. Box 43210, Mountlake Terrace, Wash. 98043 [408]

## Pulse generators are programmable

Three new pulse generators—two programmable units directed at automatic test applications and a third for the laboratory or production line—are being added to EH Research Laboratories Inc.'s line of instruments. The programmable units, called the models 1503 and 1504, are priced at \$5,195 and \$5,145, and the third, the model 136A, carries a \$1,895 price tag.

The model 1503 is aimed at test systems requiring the subnanosecond rise times typical of emitter-coupled logic. The compact 5/8-inch instru-

Electronics / September 15, 1977

# Mini-microcomputer users.

Here are analog and digital  
I/O single board systems  
from the  
company with experience.



DATA GENERAL  
COMPATIBLE

DEC PDP-11  
COMPATIBLE

DEC PDP-8E, F, M AND A  
COMPATIBLE

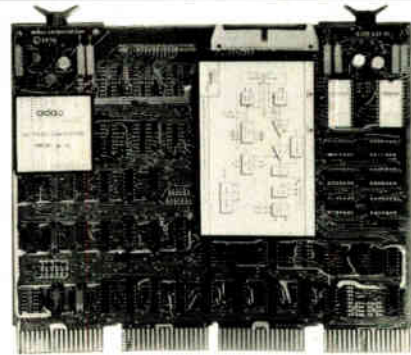

DEC LSI-11 COMPATIBLE

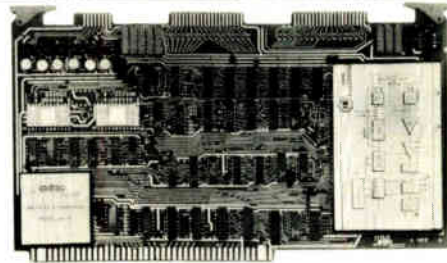

INTEL COMPATIBLE

PRODUCTS COVERED BY GSA SCHEDULE U. OF CALIFORNIA PURCHASE AGREEMENTS

Adac is the first company in the data acquisition field to introduce a wide range of analog and digital I/O single board systems. We can supply you with the solution gained from experience with thousands of installed systems in the most stringent applications from offshore oil data logging to information digitizing on the Viking program.

An extensive library of analog and digital I/O single board systems is available. These include flexible

configurations such as a 16 channel analog input system which features 12 Bit resolution, high speed S & H, voltage or current loop inputs, bus interfacing, RFI and EMI shielding and a system throughput rate of 35KHZ. Single quantity pricing as low as \$495.

When it comes to analog and digital I/O single board systems, Adac can provide the experience, technical knowledge, and application support that will assure your program's success.

#### SALES OFFICES:

##### DOMESTIC:

CA • NV  
213-542-7391  
714-459-3351  
408-245-4392

CANADA  
416-742-8015  
604-526-3312

FL  
305-894-8901  
GA • NC • SC

AL • TN  
404-451-6161

IL  
312-255-4820

IN  
317-846-2591

MD • WV • VA  
DE • DC

301-881-8430

MI  
313-588-2300

MN  
612-425-4455

MO • KA • NE • IA  
816-765-3337

NEW ENGLAND  
617-272-2606

NY • NJ  
212-947-0379

201-652-7055

OH  
216-267-0445  
513-434-7500

PA (WEST)

412-892-2953

TX • OK • LA • AR

713-444-2944

214-361 8584

UPSTATE NY

315-446-0220

WI

414-547-6637

##### INTERNATIONAL:

AUSTRALIA

437-6668

AUSTRIA

22/96 16 65

FRANCE

1-950 22 24

GERMANY

089-594621

HOLLAND & BELGIUM

076-122555

JAPAN

(591) 5241

NEW ZEALAND

9-492-189

SCANDINAVIA

(01) 12 48 03

SPAIN

3-2042099

SWITZERLAND

(022) 31 05 87

UNITED KINGDOM

(0273) 720716

BRIGHTON

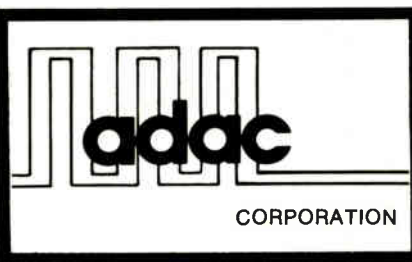

CORPORATION

15 CUMMINGS PARK  
WOBURN/MASSACHUSETTS 01801 USA  
TELEPHONE: (617) 935-6668  
TELEX: 949329

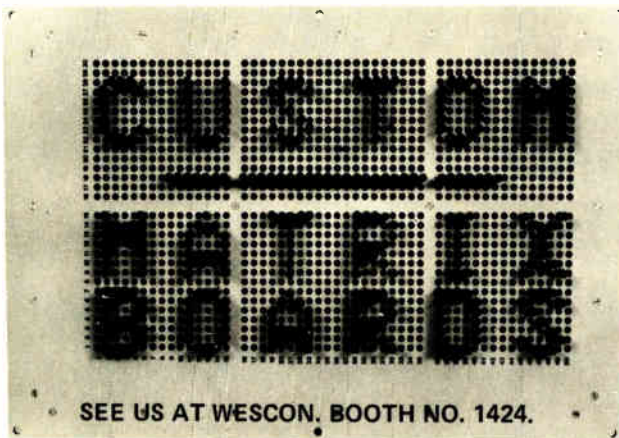

for programming...

**NUMERICAL CONTROL EQUIPMENT  
PROCESS CONTROL EQUIPMENT  
TEST EQUIPMENT**

Spacing between columns = 3mm, 4.5mm, 6mm,  
or multiples thereof—Shorting Pins or Diode Pins  
SEND YOUR REQUIREMENTS TO US OR CALL:

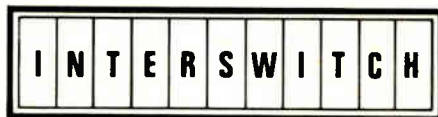

ONE OF THE PURDY GROUP OF COMPANIES  
770 Airport Blvd., Burlingame, CA 94010  
Phone (415) 347-8217 TWX 910-374-2353 TELEX 34-9373  
Circle 97 on reader service card

**SUPER MINIATURE**

**Neon Glow Lamps**

Rated Voltage...AC 100V  
Rated Current...AC 0.3mA  
Total Flux...20mlm MIN.  
Starting Voltage...AC 75V MAX.  
External Resistance...150K $\Omega$



NL-8S

**ULTRA-HIGH BRIGHTNESS**

**Neon Glow Lamps**

Rated Voltage...AC 100V  
Rated Current...AC 5mA  
Total Flux...500 mlm MIN.  
Starting Voltage...AC 85V MAX.  
External Resistance...8.2K $\Omega$

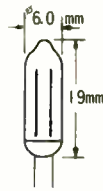

NE-2HU

**CLEAR-GREEN**

**Fluorescent Glow Lamps**

Rated Voltage...AC 100V  
Rated Current...AC 1.5 mA  
Total Flux...90 mlm MIN.  
Starting Voltage...AC 75V MAX.  
External Resistance...27K $\Omega$



NL-21/G

**● MAIN PRODUCT**

NEON GLOW LAMP, XENON FLASH LAMP,  
RARE GAS, DISCHARGE LAMP.  
MINIATURE : BLACK-LIGHT, UV-LIGHT,  
FLUORESCENT COLOR-LIGHT.

**ELEVAM ELECTRONIC TUBE CO., LTD.**

NO. 17-8CHUO 2-CHOME OTA-KU, TOKYO JAPAN  
TELEPHONE : 03(774) 1231~5

EXPORT DIVISION : JAPAN NANOTRONIX CO., LTD.  
OTA-KU TOKYO, TELEPHONE. (03)775-4811 TELEX 246-6583 JNANOX

**New products**

ment provides frequencies from 0.5 hertz to 50 megahertz, fixed rise and fall times of less than 550 picoseconds, and complete programmable control of all pulse parameters.

Capable of driving the fastest digital logic circuits, this instrument offers output amplitudes of 12 volts into 50 ohms with a baseline-offset variable in the range of 1 v. Both positive and negative polarities as well as normal and complement mode are selectable under program control. External trigger and gate inputs plus three trigger outputs provide the flexibility needed to integrate the 1503 into an automatic test system. A wide range of program-bus options are available for the 1503 including the IEEE standard 488-1975 digital interface.

The 1504, on the other hand, is designed for test systems requiring a wide range of pulse-parameter control with amplitudes up to 20 v. The IEEE interface option is also provided on the model 1504, as are the external trigger and gate inputs plus three trigger outputs.

For semiconductor component- and circuit-testing, the 1504 is equipped to handle most device families, with flexible 50-MHZ timing circuits and a fast-rise-time output amplifier ranging from millivolts to 20 v full scale.

The lab model 136A features a pulse repetition frequency of 10 Hz to 60 MHz and pulse amplitude ranges from 140 mv to 120 v. It also offers controllable rise and fall times from 3 nanoseconds to greater than 8 milliseconds up to 10 v in seven common ranges, a variable delay from 10 ns to 50 ms in 10 ranges, width from 10 ns to 50 ms, and offset from 0 to 5 v into 50 ohms.

EH Research Laboratories Inc., Box 1289, Oakland, Calif. 94604 [409]

**Devices handle graphics**

Two new peripheral devices from Wang Laboratories Inc. are being billed by the company as a complete

# MINI STIC



## HIGH VOLTAGE HERMETIC MULTI-JUNCTION RECTIFIERS FOR HIGH DENSITY PACKAGING

New Metoxilite MINI-STIC rectifiers are now available at competitive commercial prices. We have retained the superior technology and premium materials developed for aerospace programs. Stable electrical characteristics are maintained through Semtech's unique internal design. Ideal for high voltage high density packaging, these multi-junction devices are used successfully in single as well as polyphase high voltage rectifier circuits.

### Not epoxy! Our rectifiers are cased in Metoxilite.

To provide rugged minimum sized devices, metal oxides (Metoxilite) are fused directly to the junction pin assembly at high temperatures to form non-cavity hermetically sealed, monolithic rectifiers. Thermal expansion characteristics of Metoxilite are matched with the internal structure allowing

the rectifiers to withstand extreme thermal shock. Designed for use in encapsulated or oil environments.

### Used in CRT Power Supplies.

Our fast recovery multi-chip devices are especially designed for high voltage multipliers used in TV receivers and monitors.



Type: FM50, 75, 100 & 150  
PIV: 5,000, 7,500, 10,000 & 15,000V  
Average Rectified Current @25°C:  
25 & 10mA  
Static Forward Voltage, 10mA @25°C:  
10 & 20V  
Reverse Recovery Time (Max.): 300ns  
Case Size (Max.):  
FM50 & 75; .300"L x .120"D  
FM100 & 150; .400"L x .120"D

### X-Ray Equipment applications.

Our Sub-miniature High Voltage Rectifiers are used in X-Ray equipment. These devices form the building blocks for high voltage sticks such as the "X-WAY STIC" developed by Semtech.



Type: SH75 & SH100  
PIV @25°C: 7500 & 10,000V  
Average Rectified Current @55°C in Oil: 200mA  
Static Forward Voltage, 100mA @25°C: 12V  
D.C. Blocking Voltage @25°C: 7500 & 10,000V  
Case Size (Max.): .450"L x .160"D

1975 NATIONAL SBA SUBCONTRACTOR OF THE YEAR

 **SEMTECH  
CORPORATION**

652 Mitchell Road, Newbury Park, California 91320  
(805) 498-2111 • (213) 628-5392 • TWX: 910-336-1264  
CHICAGO: (312) 352-3227 • DALLAS: (214) 234-6523  
DAYTON: (513) 274-8356 • FLORIDA: (305) 644-5404  
MARYLAND: (301) 937-0070 • NEW JERSEY: (201) 654-4884  
SAN FRANCISCO: (415) 494-0113  
EUROPEAN SALES: Bourns AG Zug, Switzerland (042) 232-242

# This could be the start of something big.

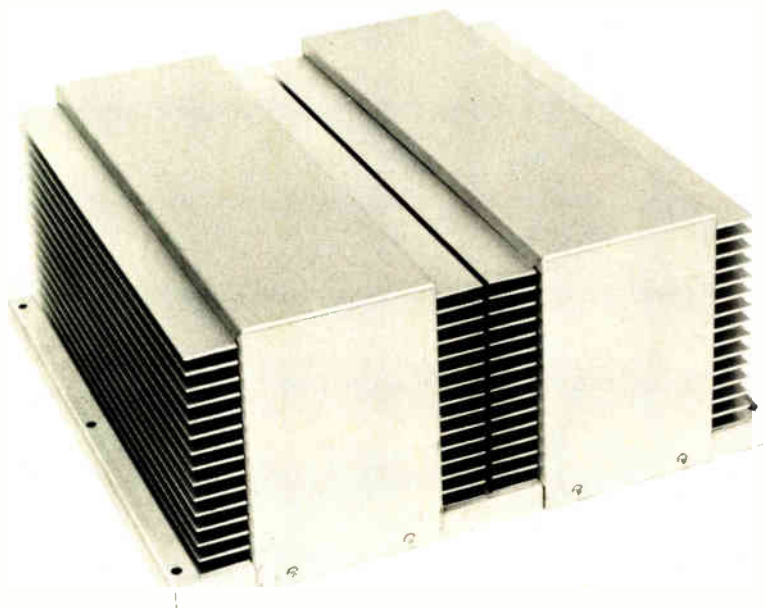

By big, we mean large motors for pumps or air conditioners that need high inrush currents to get going. A need that sometimes occurs where energy availability is limited and efficiency is critical.

Well, that's where Elgar's new DC to AC static inverters come in. They contain patented circuitry that yields 89% conversion efficiency from the two ratings now available—600VA and 1000VA. At these low power levels, losses are about half of those experienced with previously available products.

Elgar inverters are configured for 24VDC or 48VDC inputs and provide 115VAC, 60 Hz output. They're available in two versions—one provides high inrush currents, and the other is for use with sensitive electronic loads. All models are weatherproof, having originally been designed for use with remote Solar Energy Systems and Microwave Repeater Stations.

So if you're looking for a more efficient way to start something big, start with Elgar.

See us at Wescon,  
Booths 1150/52.

**ELGAR**

8225 Mercury Court, San Diego, CA 92111, (714) 565-1155, TWX 910-335-1246

## New products

graphics system suitable for end users. One is the model 2282 graphic cathode-ray tube, and the other is the model 2231W-3 printer/plotter. Together, they provide small business users with both CRT display and hard-copy printouts of alphanumeric and graphical data.

Samuel Gagliano, product manager for small systems in Lowell, Mass., says both peripherals use an 8080 microprocessor controller and both are fully compatible with Wang's 2200 small computer line, some 14,000 of which have been installed. The 2282 is enclosed in a standard CRT console, without a keyboard. It uses scan-refresh technology, with a memory location for each of the 800 horizontal and 512 vertical dots on the screen.

Gagliano says the company initially considered using a storage tube, but its higher cost plus the inability to selectively erase led to the choice of electronic scan refreshing in a conventional CRT.

To make the peripherals work together, Wang uses a printer interface controller for both and regards the CRT as a printer output device. "The controller daisy-chains into the CRT and printer so that we don't need the second interface controller that would normally be used for a line printer or other hard-copy device," Gagliano explains. The printer is a 132-column unit that would normally run at 120 characters per second. Wang, however, has used a new character set to get better resolution, an adaptation that slows the rate to between 100 and 110 characters per second.

Gagliano says most of Wang's existing plotter software can run on the CRT without modification, but a plotter utility software package comes with the system to allow the printer to plot such things as bar and pie charts. That feature, he says, gives the systems the ability to generate business forms.

The 2282 graphic CRT is priced at \$3,600; the 2231W-3 printer/plotter sells for \$3,800.

Wang Laboratories Inc., One Industrial Ave., Lowell, Mass. 01851. Phone Samuel Gagliano at (617) 851-4111 [410]



# You won't find a better family of printers for the price. It's that simple.

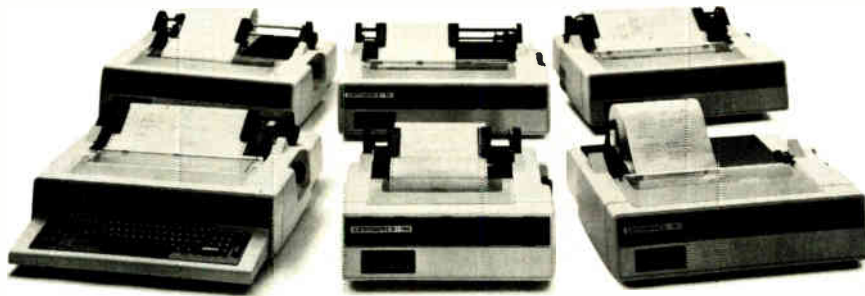

## The New Centronics 700 Series.

Now, the features that make our model 700 the best, lowest-priced serial printer are available in a *family of seven* models: uncomplicated modular construction; the reliability of fewer moving parts; high parts commonality; and low price. All of which means a lower cost of ownership.

The new 700 family covers a full range of serial printer requirements: 80- and 132-column format; 60 to 180 cps speed range; bi-directional and logic-seeking operations; and 110-300 baud KSR and RO teleprinters.

Like all Centronics printers, the 700 family is better because we back them with a wide choice of customizing options and accessories. More than 100 sales and service locations worldwide. Centronics' financial stability, and dependability proven by more than 80,000 printers installed.

Simplicity of design, full range capabilities, and better back-up make our 700 series printers simply better.

Centronics Data Computer Corp., Hudson, N.H. 03051, Tel. (603) 883-0111. Or Centronics Offices in Canada and throughout the world.

**CENTRONICS® PRINTERS**  
**Simply Better**

# Our 8X300 Bipolar Microprocessor handles 4 million operations/second with an optimized fixed-instruction set.

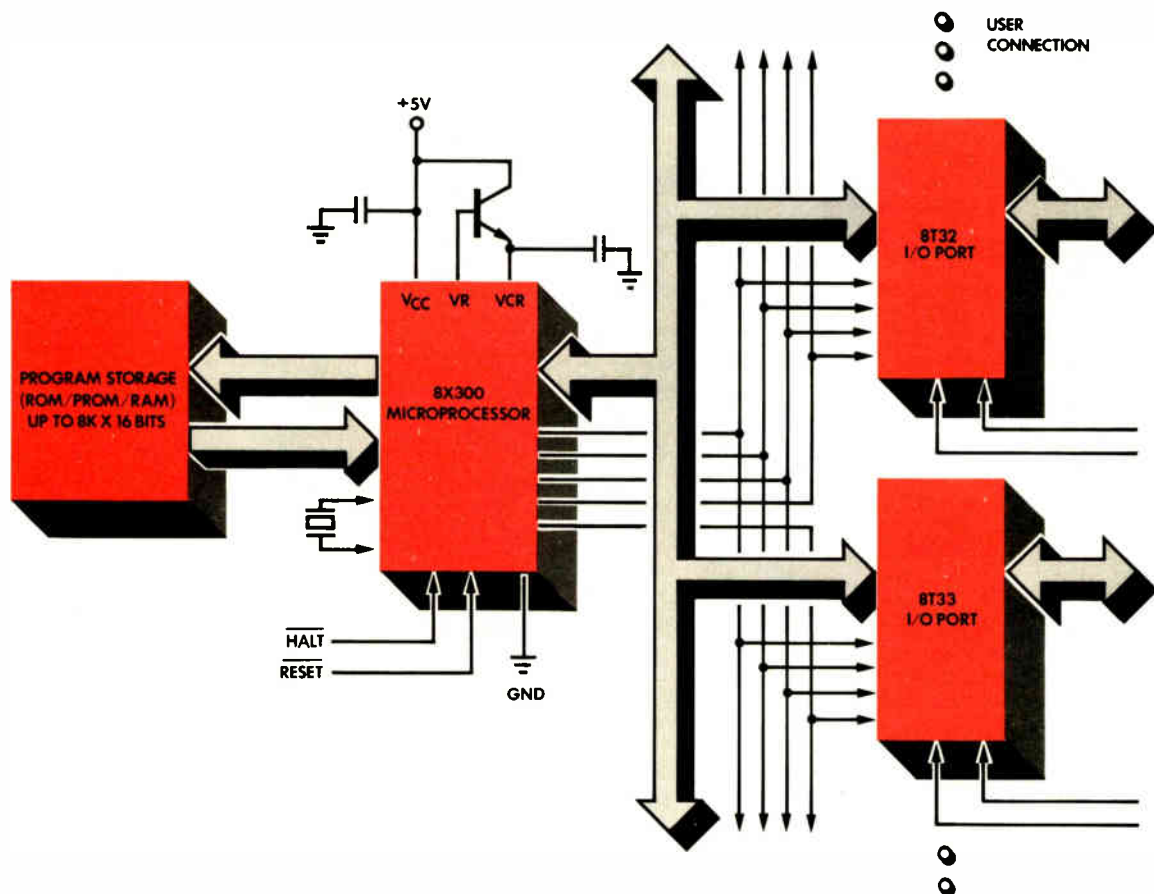

# That kind of speed even makes sense for slow systems because it reduces parts count. This Guide explains why.

Our new Evaluation Guide was written to help you analyze the system design economics of microprocessor speed. It describes how a typical application can be implemented four different ways. Use of the Signetics 8X300 is compared with three other alternatives.

This Guide explains how microprocessor speed can shrink system cost by reducing parts count. You need it if you're sincerely interested in an apples-to-apples comparison of popular design techniques. Chances are, it may also convince you that you need the 8X300.

## Learn the Hidden Economics of Speed.

Regardless of a system's overall speed requirement, microprocessor speed affects the most important selection criteria you can apply—operations/second/dollar.

The 8X300 has the raw speed—4,000,000 operations per second—combined with a surprisingly low price. Speed also buys you much more than high processing throughput and greater I/O capability. You get lower system cost because you can eliminate the extra parts a slower microprocessor might force upon you. And quite often, because of the 8X300's speed, you don't have to hassle with interrupts.

## 8X300 HONOR ROLL:

- First NASA-qualified bipolar microprocessor
- "Product of the Year" Award/*Electronic Products*

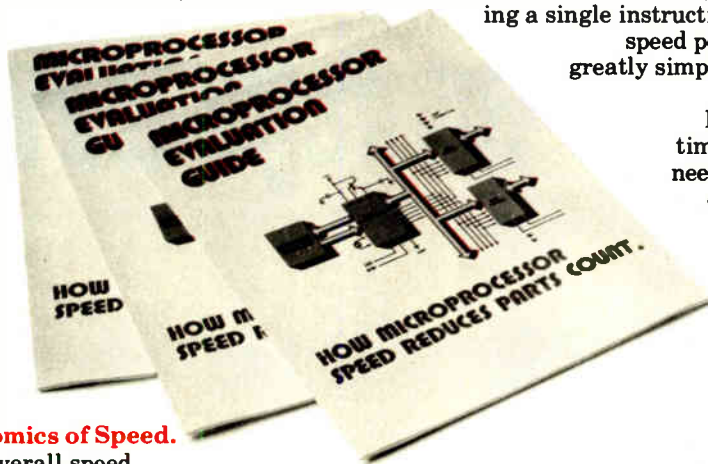

## Fixed Instructions: Optimized for Control.

The 8X300 is the only single-chip bipolar microprocessor available with both a fixed instruction set and a reasonable price. This small, powerful instruction set took more than 3 man-years to develop.

That's work you don't have to do. You have just 8 basic instructions to learn. There are no separate instructions for rotate, merge and mask. Because these operations are integral to the basic instruction set, they're routinely executed during a single instruction cycle. Moreover, the 8X300's speed permits line-by-line control. This greatly simplifies the I/O for handling serial or parallel data.

If you need a microprocessor optimized for high-speed control, you need to know about the 8X300. For convenience. For simplicity. For lower cost. Contact your local Signetics distributor—or use the coupon below to send for your Microprocessor Evaluation Guide today. For peace of mind.

# Signetics

a subsidiary of U.S. Philips Corporation

Signetics Corporation  
811 East Arques Avenue  
Sunnyvale, California 94086  
Telephone 408/739-7700

To: Signetics Information Services, 811 E. Arques Ave.,  
P.O. Box 9052, MS 27, Sunnyvale, CA 94086.

- Please send me your free "Microprocessor Evaluation Guide."
- My needs are urgent. Please have an 8X300 applications specialist phone me at once: ( ) \_\_\_\_\_ X \_\_\_\_\_

Name \_\_\_\_\_ Title \_\_\_\_\_  
Company \_\_\_\_\_ Division \_\_\_\_\_  
Address \_\_\_\_\_ MS \_\_\_\_\_  
City \_\_\_\_\_ State \_\_\_\_\_ ZIP \_\_\_\_\_

EM915

# **Now from NPC, 20 W operational amplifier in**

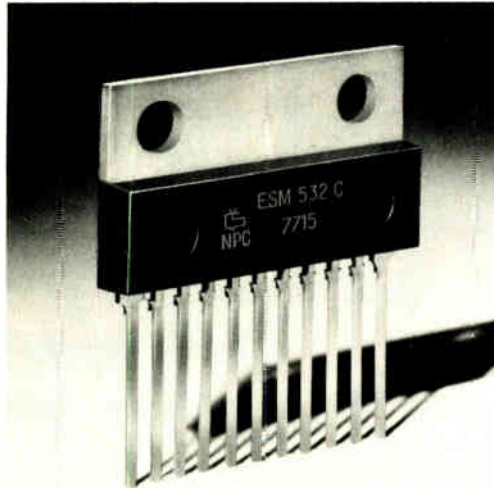

# 11-pin package.

**NPC's new ESM-532C can be used in audio, sweep, motor control and other circuit applications.**

It is a differential input power operational amplifier capable of delivering 20 W RMS sine wave power with a bandwidth up to 140 kHz. A proprietary epitaxial process permits integration of power transistors with 40 V breakdown and 3.5 amp output current. To prevent damage by overheating, a bootstrap shutdown circuit on the chip diverts excess current to ground when the junction temperature exceeds 100°C. The in-line package has a maximum thermal resistance of 3°C/W junction to case.

For information, contact your NPC distributor, representative or the factory.



THOMSON-CSF

**NPC**®

ELECTRONICS

*Where Pricing is as  
Important as Technology*

6660 Variel Avenue  
Canoga Park, California 91303 • (213) 887-1010  
Telex 69-8481 • TWX 910-494-1954  
A Division of DuMont Electronics Corporation

**ARIZONA** G. S. Marshall (602) 966-6181 **CALIFORNIA** Brill Electronics (415) 834-5888; Intermark (714) 540-1322, (714) 279-5200, (408) 738-1111; G. S. Marshall (213) 999-5001, (714) 556-6400; Mouser Electronics (714) 449-2220; Rose Electronics (415) 692-5700; Semiconductor Concepts (213) 884-4560; Zeus Components (714) 990-1911 **COLORADO** Century Electronics (303) 424-1985 **FLORIDA** National Resistor Corp. (305) 792-2600; Zeus Components (305) 942-4312 **ILLINOIS** Advent Electronics (312) 297-6200; Bodelle/R-M Electronics (312) 323-9670; Edmar Electronics (312) 298-8580 **INDIANA** Advent Electronics (317) 297-4910; Ra-Dis-Co. (317) 637-5571 **IOWA** Advent Electronics (319) 363-0221 **MARYLAND** Pytronic Industries (301) 953-9650; Technico, Inc. (301) 461-2200 **MASSACHUSETTS** G. S. Marshall (617) 965-5115; Zeus Components (617) 273-0750 **MICHIGAN** Advent Electronics (313) 477-1650; R-M Electronics (616) 531-9300 **MINNESOTA** Joel Company (612) 545-5669; G. S. Marshall (612) 559-2211 **NEW JERSEY** General Radio Supply (609) 964-8560 **NEW MEXICO** Century Electronics (505) 292-2700 **NEW YORK** Kahgan Components (516) 538-2300; Zeus Components (914) 592-4120 **NORTH CAROLINA** Pytronic Industries (919) 782-6370; Resco (919) 832-2077 **OKLAHOMA** Component Specialties (918) 664-2820 **OREGON** Dunn Electronics (503) 285-0214 **PENNSYLVANIA** General Radio Supply (609) 964-8560; Pytronic Industries (215) 643-2850, (412) 276-6722 **SOUTH CAROLINA** Resco (919) 832-2077 **TEXAS** Component Specialties (512) 459-3307, (214) 357-6511, (713) 771-7237; Quality Components (214) 387-4949, (713) 789-9320 **UTAH** Century Electronics (801) 487-8551 **WASHINGTON** Zepher Electronics (206) 575-0922 **WISCONSIN** Taylor Electric (414) 241-4321

# BREAKT



**HARRIS HOT LINE!**  
**1-800-528-6050, Ext. 455**

Call toll-free for phone number of your nearby Harris sales office, authorized distributor or expedited literature service.

# THROUGH!

## Announcing the first all-digital CVSD.

The only Encoder/  
Decoder available  
in a single IC.

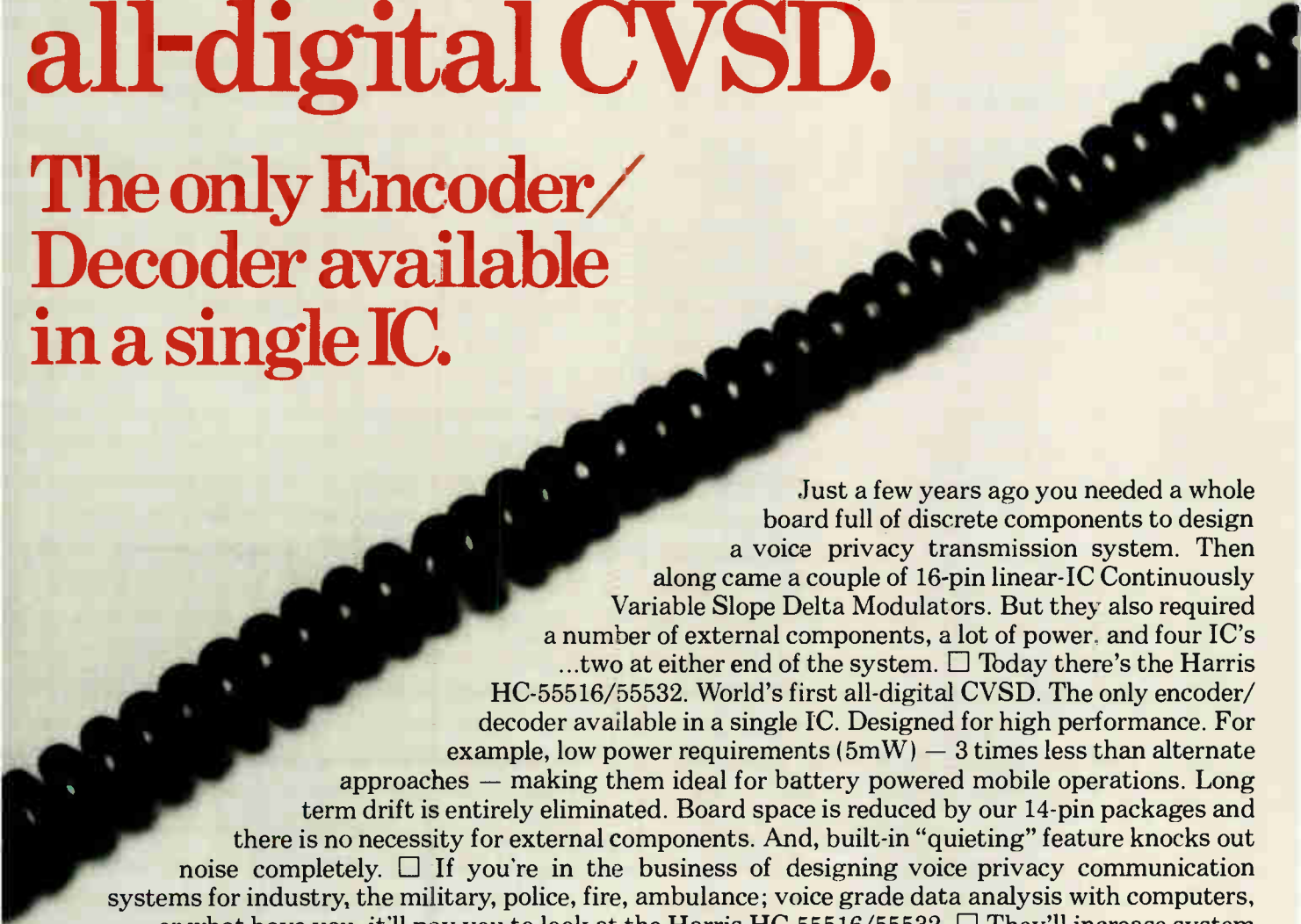

Just a few years ago you needed a whole board full of discrete components to design a voice privacy transmission system. Then along came a couple of 16-pin linear-IC Continuously Variable Slope Delta Modulators. But they also required a number of external components, a lot of power, and four IC's ...two at either end of the system.  Today there's the Harris HC-55516/55532. World's first all-digital CVSD. The only encoder/decoder available in a single IC. Designed for high performance. For example, low power requirements (5mW) — 3 times less than alternate approaches — making them ideal for battery powered mobile operations. Long term drift is entirely eliminated. Board space is reduced by our 14-pin packages and there is no necessity for external components. And, built-in "quieting" feature knocks out noise completely.  If you're in the business of designing voice privacy communication systems for industry, the military, police, fire, ambulance; voice grade data analysis with computers, or what have you, it'll pay you to look at the Harris HC-55516/55532.  They'll increase system performance. They'll save money; cut overall system costs appreciably. They'll provide you with a design flexibility you've never enjoyed before.  They come in a variety of packages, models and temperature ranges: 14-pin DIP or flat pack, or chips. 16K for lower data bandwidth; 32K for improved fidelity. —40°C to +85°C and —55°C to +125°C.  For complete information, call your nearby Harris sales location, or write Harris Semiconductor, P. O. Box 883, Melbourne, FL 32901.



**HARRIS**  
SEMICONDUCTOR  
A DIVISION OF HARRIS CORPORATION

# Rent the Tek 8002 Microprocessor Lab today.

## And get Leasametric's total support package.

### The System

The new Tektronix 8002 Microprocessor Lab is the most advanced microprocessor development system available today. Each system is delivered complete with software support for two microprocessors plus hardware support for one microprocessor—all of your choice.

With the real-time prototype analyzer (including its 8-channel external ability), CRT console and 180 CPS line printer, your design team will enjoy the most productive design tool in existence.

In addition, the 8002's universality enables it to support several microprocessors—the 8080, 6800, Z-80 and 9900 with more to follow—thus freeing the designer to select a microprocessor solely on the basis of capability and cost-effectiveness.

### The Training

With the advent of the microprocessor, your design team now faces a new kind of development process, a process which brings with it an unprecedented opportunity for design flexibility. It also brings a process where proper training on the equipment and hardware/software integration techniques are of vital importance.

As part of Leasametric's total support package, we offer you **Tektronix-qualified** training, consisting of two full days of specialized on-site sessions for up to three members of your design team. There's no need to send your designers across the country to attend costly and time-consuming seminars. Upon completion of the training, you get immediate design productivity since your design team can now concentrate on the design task at hand and not on system operation.

### The Service

In the unlikely event that repairs should be necessary on the development system, Leasametric will initiate either in-house service or a replacement system within 24 hours—at no additional cost.

Leasametric will also make available a special hot line telephone number to assist you in solving any operational problems.

Our 18 fully-stocked Inventory Centers across the U.S. and Canada will provide on-going technical assistance and dedicated service whenever needed.

Call your nearest Leasametric Rental Inventory Center listed below for immediate shipment of the Tek 8002 or further details.

 **Leasametric**

Division of Metric Resources Corporation  
822 Airport Blvd., Burlingame, CA 94010

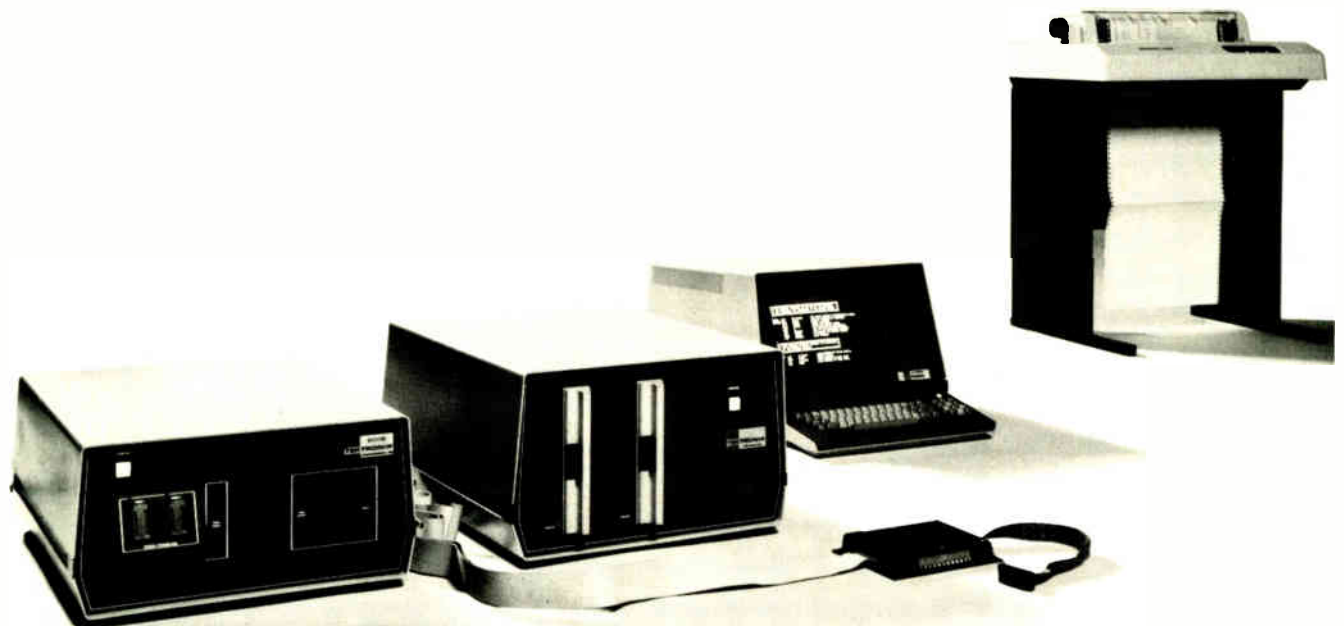

**INVENTORY CENTERS:** San Francisco, CA (415) 342-7111; Los Angeles, CA (213) 768-4200; Anaheim, CA (714) 634-9525; San Diego, CA (714) 565-7475; Houston, TX (713) 477-9911; Chicago, IL (312) 595-2700; Boston, MA (617) 244-9400; Midland Park, NJ (201) 444-0662; Long Island, NY (516) 293-5881; Washington, D.C. (301) 881-6700; Orlando, FL (305) 857-3500; Dayton, OH (513) 898-1707; Philadelphia, PA (215) 583-2000; Denver, CO (303) 429-7900; Minneapolis, MN (612) 854-3426; Dallas, TX (214) 661-9193; Atlanta, GA (404) 491-1155; Toronto, Ontario (416) 676-1897.

**TOLL FREE NUMBERS:** Outside California 800-227-0280; Outside New Jersey 800-631-7030; Outside Maryland 800-638-0838; Outside Illinois 800-323-2513.



# Data system plays triple role

Equipment can be configured as a smart data-acquisition front end, a computer-based system, or a peripheral for a large computer

by Michael J. Riezenman, New Products Editor

The term "data-acquisition system" has come to cover so many types of products—from small hybrid subsystems to dedicated data loggers—that the advent of a true system capable of being configured to perform a variety of tasks is something of a rarity. Such a rarity is Adac's system 1000.

Built around a bus architecture identical to that of Digital Equipment Corp.'s LSI-11 microcomputer, the system 1000 consists of three main components: a card-cage/backplane assembly, a rack drawer, and a power supply. Key to the system's versatility is the card-cage/backplane. This section can accommodate up to 11 8.5-by-10-inch (quad) boards or 22 8.5-by-5-in. (half-quad) boards in any combination. Among the boards that can be plugged into the backplane is the LSI-11 microcomputer itself. Another is a board that interfaces the LSI-11 bus to the DEC Unibus so that any PDP-11 series minicomputer can use the system 1000 as a data-acquisition front end. This capability to be configured as a complete stand-alone computer-based system, as a data-acquisition system with a preprocessor, or as a simple peripheral for a large computer is what makes the unit unique, according to Al Grant, Adac's vice president for marketing.

Adding to the system's versatility is its rack drawer, which has 2 inches of unused space behind its front panel. This makes it easy for users to mount their own switches, indicators, and other components on the panel to customize the system for their individual applications.

To make sure that a backplane full of boards and a front panel full

of extra equipment causes no power-supply problems, the system 1000 is equipped with a really hefty supply. It is rated to deliver 25 amperes at 5 volts dc, 4 A at 12 v dc, and  $\pm 1.5$  A at  $\pm 15$  v dc. Two fans cool the system; one is dedicated to the power supply, the other cools the card cage.

A modular system is no more flexible than the modules it accommodates. In the case of the system 1000 there are 13 modules currently available, with many more on the way. (Announcements on new cards are expected over the next two to three months. Among them, Adac says, will be translators for other minicomputers.) These include boards for acquiring high- and low-level analog data with 12-bit resolution. The high-level boards are available with from 16 to 64 single-ended or

isolated-ground input channels. The low-level units offer 8 or 16 differential inputs. The remaining analog board is an output device that contains from one to four 12-bit digital-to-analog converters.

A series of digital input/output boards [*Electronics*, July 21, p. 140] includes units for detecting transistor-transistor-logic signals, putting out TTL signals, detecting contact closures, and putting out up to 300 milliamperes for driving lamps or relays.

The remaining boards include a programmable crystal clock, a bus-repeater card, the Unibus-to-LSI-11-bus translator, and a serial I/O card for connecting the system to a 20-milliamper current loop or EIA RS-232-C standard interface. The card provides for jumper-selectable

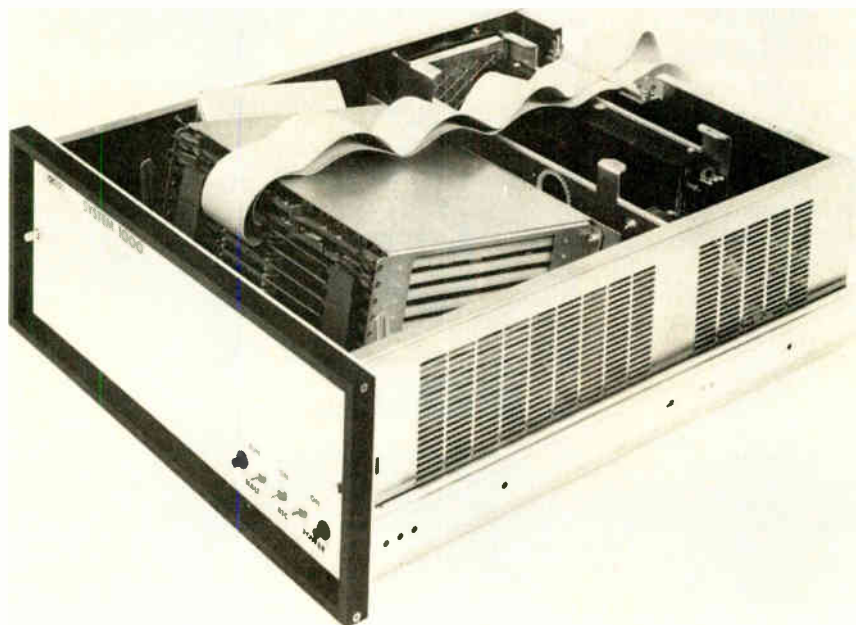

MILITARY APPLICATIONS

# AD CONVERTERS

by

## MSK

- Accuracy
- Speed
- Size
- Repairability
- Military
- Temp. Range  
-55°C to +125°C

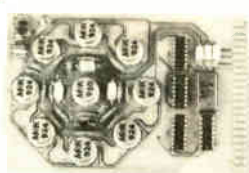

- 4 Bit/50 nSec; Low Cost
- Ideal for Radar Scan Converters
- Holds Absolute Accuracy Over Temperatures
- Tracks a 10 MHz Analog Input



- 9 Bit/ 200 nSec.
- < 2 Bit Drift Over Temperature
- Insensitive to Clock Frequency

For Further Information Call or Write  
**M.S. Kennedy Corp.**  
 Pickard Drive, Syracuse, New York 13211  
 Tel. 315-455-7077

### New products

Semiconductors

## Reference diode offers wide range

Linear integrated circuit has adjustable breakdown voltage and temperature coefficient

Using a novel differential-input-circuit technique, National Semiconductor has built a 2.5-volt band-gap-reference integrated circuit that performs as if it were a zener shunt regulator.

The result is a 2.5-v reference diode that is not only usable as either a positive or negative reference but has an adjustable breakdown voltage and temperature coefficient. The device, which is designated the LM136/236/336, can operate over a wide input-current range, anywhere from 300 microamperes to 10 milliamperes. It can be trimmed to operate with a minimum temperature coefficient. Over the commercial temperature range, for example, the LM336 variation is typically 2.5 millivolts, and it is guaranteed at no more than 6 mv.

Dynamic impedance on the LM136 series is 0.5 ohm maximum, which is 25 to 250 times lower than the resistances of discrete zener devices on the market, says Robert C. Dobkin, director of advance linear circuits.

Like other 2.5-v references, the LM136 is basically a two-terminal device, says Dobkin. An option allows users to trim the device to their particular needs. "The series units, as a result, are much easier devices to use than other 2.5-v references," says Dobkin. "The low impedance and wide operating current range simplify biasing in almost any circuit. Moreover, since either the breakdown voltage or the temperature coefficient can be adjusted, it's easier to optimize any circuit's performance."

To use the LM136 as either a positive or negative reference is a

simple matter of connecting a resistor to either the positive or negative terminals, says Dobkin. Current range is determined by the value of the resistor. To adjust the reverse breakdown voltage, a potentiometer is connected between the adjust pin and the other two terminals without affecting the temperature coefficient of the device. The adjustment range, is usually sufficient for both the initial device tolerance ( $\pm 1\%$ ) and any inaccuracies in buffer circuitry, Dobkin says.

Key to the performance of the LM136 is the fact it is designed to be independent of the current gain of the transistors from which it was fabricated. To achieve this, the input stage to the LM136 reference is configured as a differential amplifier much as in an operational amplifier, says Dobkin, using a pair of transistors with a 10:1 ratio between their emitter stages. "This gives us an offset proportional to the absolute temperature," he adds. "And because it is a differential configuration, many of the secondary errors tend to cancel out."

The LM136 is rated for operation over -55°C to 125°C; the LM236, from -25°C to 85°C. Both are housed in TO-46 metal packages. In 100-up quantities, the price is \$6 each.

The LM336 is rated for operation over the commercial temperature range from 0°C to 70°C and is available in either a three-lead TO-46 metal package or in a TO-92 plastic package for \$2.25 and \$1.20 each, respectively, in 100-up quantities.

National Semiconductor Corp., 2900 Semiconductor Dr., Santa Clara, Calif. 95052 [411]

## Bar-graph driver IC replaces 30 to 50 devices

A bar-graph driver integrated circuit, replacing as many as 30 to 50 discrete devices and other components, has been developed by Signetics Corp. Designated the NE580, the 140-by-140-mil bipolar linear ic is another in a series of large-scale

Liquid Xtal Displays <sup>INC</sup> offers  
**pacesetting  
performance**

**95%**  
HUMIDITY

**40 ON**  
ms

**+80°C**

**70 OFF**  
ms

**-20°C**

- **extended temperature ranges**
- **greater environmental stability**
- **exceptional speed of response**

## Liquid Xtal Displays are setting new standards

LXD's new generation of LCDs is now available with extended operating temperature ranges — up to +176°F (80°C). With response times of 100 ms total (T on plus T off). And with a temperature-humidity specification of 95% relative humidity at 50°C for 30 days.

For night use, we have a new integral Videobrite panel backlight.

Interested? Call us now.



**Liquid Xtal Displays <sup>INC</sup>**

SUBSIDIARY OF DICKEY-john CORPORATION  
24500 HIGHPOINT ROAD • CLEVELAND, OHIO 44122  
TELEPHONE 216/831-8100 • TELEX 98-5442

## New products

linear ICs, under development by the Sunnyvale, Calif., semiconductor firm, that combines linear and digital devices on the same chip.

The NE580 is a dual bar-graph logic circuit designed to provide all the functions necessary to drive a gas-discharge self-scan bar-graph panel. It is configured to drive a 201-element bar graph in either five- or six-phase operation. Phase-number selection is obtained by applying a logic 0 or 1 level to the phase-select pin.

On-chip functions include a clock generator, linear ramp generator, control logic, sample-and-hold circuitry, counter circuitry, phase decoder, two comparators and buffer circuitry. Output functions include two anode control lines, two over-range indication outputs, six cathode phase outputs, and one cathode reset output. The device accepts an analog voltage in the range of 0 to 2.5 volts and requires a digital supply voltage in the range from +5 to +7 volts dc.

A bar-graph display operates in a self-scan mode, in which a neon glow discharge is propagated from one cathode spot to another under one anode. The NE580 has most of the components necessary to interface an analog voltage level to the bar-graph display.

Each column of the display requires an anode control signal and each cathode—usually from four to seven—requires an interlaced logic signal. An on-chip clock generator drives the master counter and cathode phase generator. The clock also gates a constant-current source, which charges the ramp capacitor of the system with a staircase waveform of equal increment steps, corresponding to the cathode segments. At the 200th count, the ramp voltage is compared with the reference voltage and a signal is fed back to the ramp constant-current source.

A minimum of external components is required for the whole conversion and display system. The NE580 can be expanded to handle more analog channels using external comparators. A few external low-cost logic packages can, in addition,



## NEW 101C PULSE GENERATOR WITH 18V OUTPUT

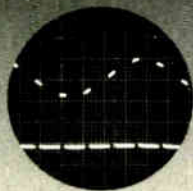

Modulated CMOS output

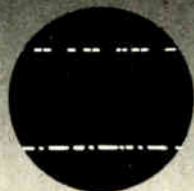

ASCII code simulation

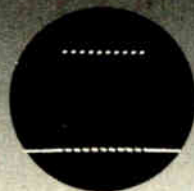

Variable pulse burst

Back in the days of 5V logic, the Datapulse 101 was the pulse generator. Now Systron-Donner brings you Model 101C with these updated features and accessories:

- Main output variable to 18V from 50 ohms
- 20 MHz rep rate
- Two simultaneous front panel outputs:  
(1) for TTL logic level, (2) a CMOS output for driving up to 40V pulses.
- Fixed rise time less than 10 nanoseconds
- Burst Generator accessory (1-999 pulses in length)
- Code Generator accessory (up to 4096 bits long)

Like its famous predecessor, Model 101C is an economical pulser, priced at \$595 (U.S. only). For bench or systems applications, it will serve you faithfully for years. It's a family tradition.

For details, contact Scientific Devices or Systron-Donner at 10 Systron Drive, Concord, CA 94518. Phone (415) 676-5000.

**SYSTRON**  **DONNER**

Circle 142 on reader service card

## 1977 Answer Book. It makes your job easier. \$25.

Who makes what? Over 4000 products, more than 5000 manufacturers with their local contracts and distributors, directory of trade names and catalogs, post-paid inquiry cards for 5-second ordering of current catalogs.

Electronics Buyers' Guide  
1221 Ave. of the Americas  
New York, N.Y. 10020

Yes, send me a copy of The Answer Book. I've enclosed \$25 (USA and Canada only, elsewhere send \$35). Full money back guarantee if returned within 10 days.

Name \_\_\_\_\_

Company \_\_\_\_\_

Street \_\_\_\_\_

City \_\_\_\_\_

State \_\_\_\_\_

Zip \_\_\_\_\_



**If you're  
using these,  
the best you can expect is  
2 % linearity and 100,000 cycle life.**



**For about  
the same price,  
new ECONOPOT  
MK III conductive**



**plastic  
units provide  
1 % linearity and  
5 million cycle life**

Until now, 2 % linearity and 100,000 cycle life was the best you could expect in semi-precision potentiometers selling for about \$2.50 in quantity. Now our new ECONOPOT MK III offers you 1% linearity and 5 million cycle life, plus the infinite resolution and low cost of conductive plastic, and sells for less than

\$3.00 in quantity. Other advantages of ECONOPOT MK III over the best of competition are precious metal contacts, 303 stainless steel shafts, and thermoset plastic terminal supports. All MK III units are single-turn 7/8" diameter bushing mount potentiometers with 1/4" shafts. Send now for details.

**new england instrument company**

KENDALL LANE NATICK, MASS 01760 • TEL: 617-873-9711 • TWX: 710 346-0398  
The leading precision potentiometer manufacturer offering molded conductive plastic, wirewound, conductive film & hybrid technologies.

Circle 191 on reader service card

## New products

provide binary or binary-coded-decimal encoded data to interface with a logic control system. The device is supplied in a 22-pin plastic molded or ceramic dual in-line package and is priced at about \$6 each in a 100-piece quantities.

Signetics Corp., 811 E. Arques Ave., Sunnyvale, Calif. 94086 [412]

## PMI introduces family of bi-FET op amps

Precision Monolithics has introduced a family of three high-performance bi-FET operational amplifiers that combine high speed with

low input offset voltage.

The low-power member of the family is the OP-15, which has a slew rate of 17 volts per microsecond, a maximum input offset voltage of 500 microvolts, and a maximum supply current of 4 milliamperes. A temperature-compensated front end keeps the input bias current low at all temperatures, with a maximum of 9 nanoamperes at 125°C. At 25°C, the current is typically only 18 picoamperes.

The OP-16 is a faster unit with a slew rate of 25 v/μs and a maximum supply current of 7.0 mA. Like the OP-15 it has an 18-pA 25°C bias current, but this can rise to 11 nA at 125°C. Where the OP-15 has a gain-bandwidth product of 6 megahertz, the OP-16 is rated at 8 MHz.

The fastest op amp in the family is the uncompensated OP-17. Its key specifications are a slew rate of 70 v/μs, a gain-bandwidth product of 30 MHz, a typical input bias current of 20 pA (11 nA at 125°C), and a supply current of 8 mA. Like the other units, the OP-17 has a maximum input offset voltage of 500 μV and a drift of 2 μV/°C.

Versions of the op amps that operate from -55°C to 125°C sell for \$18 each in hundreds, while units rated for use from 0°C to 70°C are priced at \$10. Cheaper devices with relaxed input offset voltage specifications are also available. All models in both temperature ranges are available from stock.

Precision Monolithics Inc., 1500 Space Park Dr., Santa Clara, Calif. 95050 [413]

## 4,096-bit static RAMs have 45-ns access time

Built with Intel's high-performance metal-oxide-semiconductor (H-MOS) technology [*Electronics*, August 18, p. 94], the 2147 family of 4,096-bit static random-access memories features a typical access time of 45 nanoseconds (55 ns maximum for the 2147-3 and 70 ns maximum for the 2147) and typical power dissipations of 500 milliwatts (2147) and 600 mw (2147-3). The speeds are



# Call C. P. Clare

and ask them why they charge twice our prices for mercury wetted relays. If you don't like their answers—or their prices—call us at (714) 540-1234.

## Babcock Relays

An Esterline company, 3501 Harbor Blvd., Costa Mesa, CA 92626.

- Dry reed • Mercury wets • Military/aerospace
- Ultra hi-rel • Telephone • General purpose

# A quick memory test.

Feature	Our HP 1000 and 21MX Computers	Your old favorite
Memory	High density 128K byte modules use new 16K bit RAMs — just 5¢ per byte for 595 ns speed. Capacity to 1.8 million bytes with 22-bit Hamming fault control. Cache-speed 350 ns MOS/RAMs available for all memory.	
CPU	Mapped memory addressing for large memories. Standard instruction set includes floating point, integer arithmetic and data communications. Fast FORTRAN processor optional. User microprogramming. Direct memory access rates up to 2M bytes/sec; microprogrammed burst rates to 11.4M bytes/sec. Standardized interfaces for parallel TTL, process I/O. RS232 and IEEE-488 (HP-IB).	
Reliability	Memory parity standard; fault control also available. Automatic microcoded diagnostics. High resistance to shock, vibration and temperature variations. Brown-out proof power supply. Battery backup.	
Cost	16K byte 595 ns memory : \$ 488* 128K byte 595 ns memory : \$4,160* 32K byte 350 ns memory : \$1,365* 21MX M-Series computer with 256K bytes of fault control memory : \$13,910* HP 1000 System with 21MX E-Series computer and 512K bytes of fault control memory, 15M bytes of disc storage, CRT console with dual mini-cartridges, and RTE operating system : \$62,300	
Delivery	3 to 12 weeks ARO.	

*\*Prices shown include 35% OEM quantity discount.  
All other prices U.S. domestic list.*

It's hard to beat that kind of performance at those prices. Especially when you have one of our compatible RTE operating systems to make it all work smoothly. So if your old favorite didn't score very well in this test, maybe you should call your nearest HP sales office listed in the White Pages. Or write to Robert Puette, Hewlett-Packard, 11000 Wolfe Road, Dept. 609, Cupertino CA 95014. The quicker, the better.

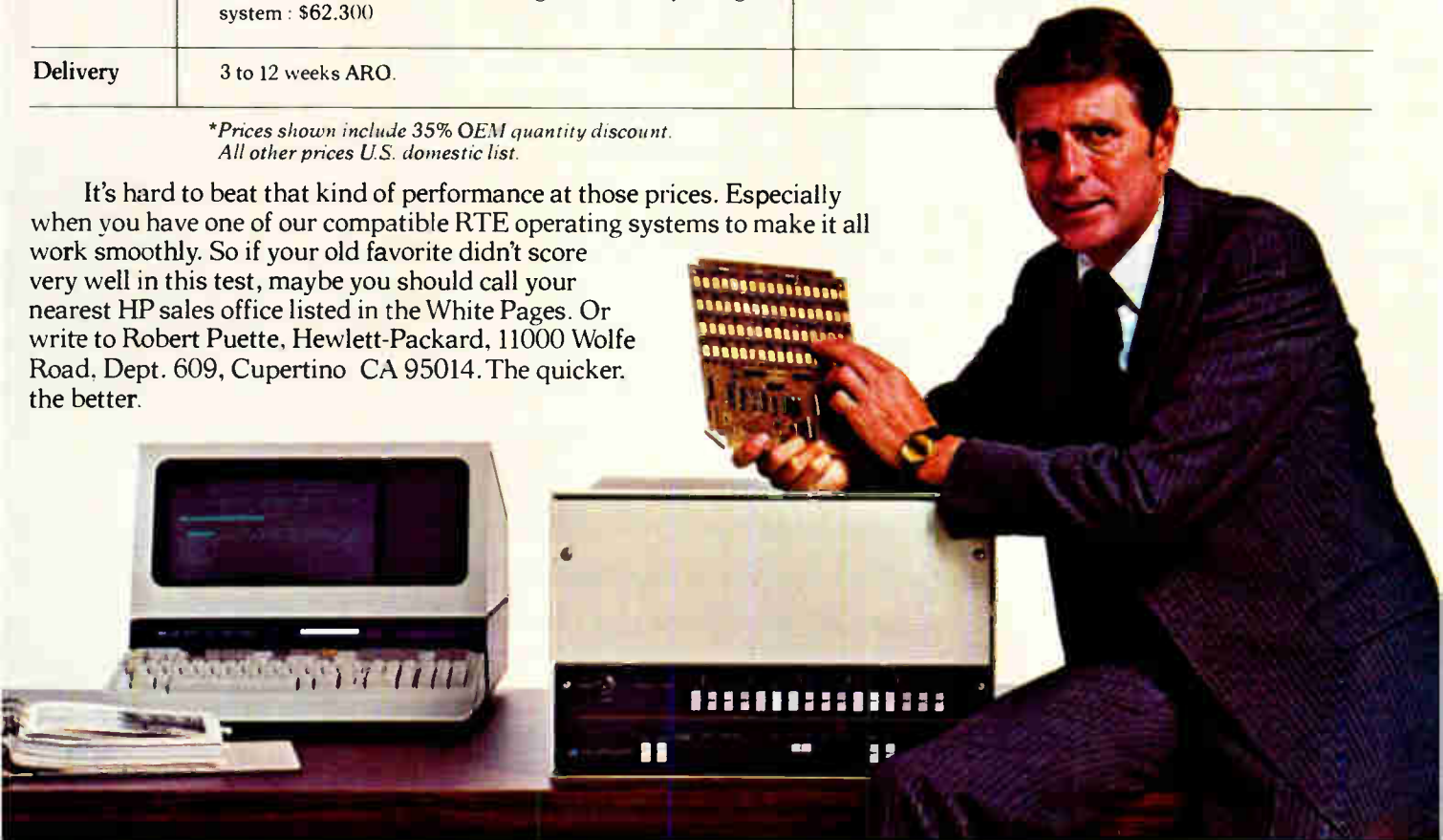

HEWLETT  PACKARD

22702HPDS4

World Radio History

Circle 193 on reader service card

# THE NEW DIT-MCO SERIES 8210 AUTOMATIC WIRE CIRCUIT ANALYSIS SYSTEMS



## A CHOICE... FLEXIBLE, EXPANDABLE, POWERFUL SOFTWARE/HARDWARE TEST SYSTEM PACKAGES

### Obsolete is Obsolete...

The DIT-MCO Series 8210, comprised of systems 8211, 8212, and 8213, offers the most complete package of automatic wire circuit test capabilities available to serve your present and continuing test needs. In fact, Series 8210 obsoletes the word obsolete. You can select the system to fit your current test requirements with certain knowledge that as your needs expand your DIT-MCO system can be upgraded to deliver!

### Powerful Software/Hardware...

Series 8210 are real-time disc operating systems with disc file maintenance in the system.

Series 8210 systems are driven by fully interactive computer systems yet require no specialized operator training. A unique and comprehensive group of programs for testing, maintenance, and diagnostics are standard. Software is the evolutionary culmination of over five years experience and proven field use.

### Eeny, Meeny, Miney...

You get a choice... to fit your budget. To fit your test needs. You get versatility, flexibility, the ability to expand and adapt.

And remember, when you choose DIT-MCO you have chosen Number One.

### Too New to be Copied...

So new you won't find anything like it available anywhere else.

System 8210 incorporates all the "state of the art" advancements with some new wrinkles only DIT-MCO could provide.

So if you are going to look around for a comparison you will just have to compare the systems within the 8210 Series. None of the others come close.

### Hand in Hand...

When you select DIT-MCO equipment you have bought not only the hardware and software you also get the Company... our over 25 years leadership in the field, our just reputation for treating every customer, big or small, with the same respect and dedicated service. With DIT-MCO you get it all!

### Call or Write for Full Information...

A DIT-MCO representative can show you how Series 8210 or any of our complete line of interconnect test systems can accommodate your test requirements. Call or write us for full information.

### DIT-MCO — The Difference in Testing...

## DIT-MCO INTERNATIONAL

5612 Brighton Terrace  
Kansas City, Missouri 64130  
Telephone (816) 444-9700  
Telex Number 42-6149



European Technical  
Representative  
Radix House  
Central Trading Estate  
Staines, Middlesex, TW18-4-XA  
England  
Telephone (0784) 51444  
Telex Number 935023

## New products

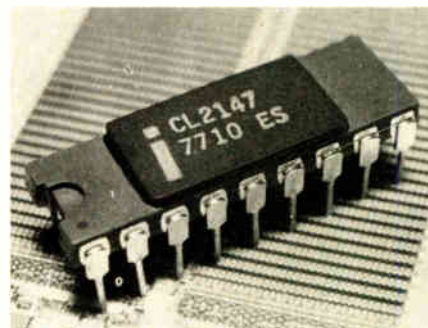

guaranteed for temperatures from 0°C to 70°C and for a power-supply voltage of 5 v dc  $\pm 5\%$ . The RAMs have a standby mode with an eighth the power consumption of the normal operating mode.

Housed in the industry-standard 18-pin package, the RAMs are compatible with transistor-transistor logic on all inputs and outputs. Their three-state outputs typically sink 25 milliamperes and source 15 mA at TTL levels, allowing them to drive a data bus and several TTL loads without difficulty. In hundreds, the 2147 sells for \$37.50 each and the 2147-3 goes for \$45.

Intel Corp., 3065 Bowers Ave., Santa Clara, Calif. 94301. Phone Rob Walker at (408) 246-7501 [414]

## Bipolar PROM includes power-switching circuitry

Called a SPROM, a new memory device is a bipolar programmable read-only memory with built-in circuitry for reducing the average power dissipation of large PROM arrays by switching off the collector supply to all unselected chips. Until the development of the SPROM, this power-switching function had to be performed by external circuitry. The

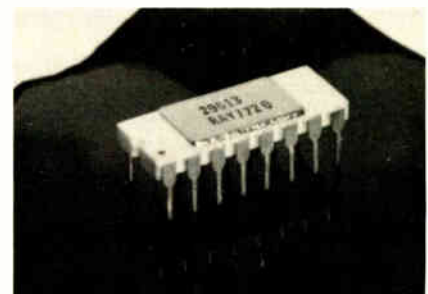



# How fast can you measure rise time, fall time and pulse width?

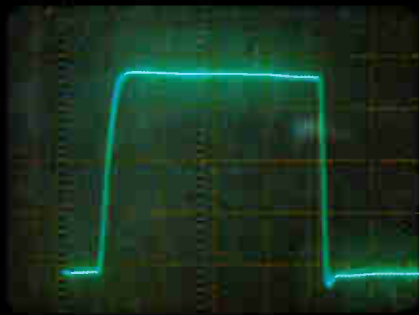

## Your way.

(About 5 minutes.)

1. Connect signal to scope.
2. Adjust trace intensity.
3. Adjust focus.
4. Select VOLTS/DIV range.
5. Select TIME/DIV range.
6. Adjust vertical gain to fill screen for location of 10% & 90% points.
7. Locate 10% point.
8. Locate 90% point.
9. Determine horizontal displacement between 10% & 90% points.
10. Multiply displacement by horizontal scale factor.

That's RISE TIME. Only 9 more steps and you've got PULSE WIDTH and FALL TIME.

See us at Wescon booth number 1059, 1160, 1161.

## Our way.

(About 5 seconds.)

1. Connect signal.
2. Push  button for RISE TIME.
3. Push  button for PULSE WIDTH.
4. Push  button for FALL TIME.

The rest is automatic.

## Your move.

Give us a call and we'll tell you how the Dana 9000 Microprocessing Timer/Counter can solve your measurement problem the easy way.

# DANA<sup>®</sup>

Others measure by us.

Dana Laboratories, Inc., 2401 Campus Drive, Irvine, CA 92715  
Phone: 714/833-1234

Circle 143 for Product Demonstration  
Circle 195 for Literature Only

# here's your answer

## the E-H Model 8200 Integrated Measurement System

it's a: DMM  
COUNTER  
SAMPLING DIGITIZER  
SINGLE-SHOT DIGITIZER  
SHORT TIME INTERVAL METER  
MICROPROCESSOR CONTROLLER  
SYNCHRO-TO-DIGITAL CONVERTER

## IT'S A SYSTEM !

Ready for the next step?

The complete measurement solution: fully integrated, fully programmable, comprehensive, modular, expandable.

Powerful internal micro-computer, mnemonic communication, GPIB.. Distributed processing in ATE is now reality.

Let the 8200 move your system into the Fourth Generation.



515-11th Street  
Oakland, California 94607  
Phone (415) 834-3030



See the 8200 at  
Booth 1149 at  
WESCON.

Circle 196 on  
reader service card

## New products

new device uses industry-standard pinouts and can be plugged into existing designs without any wiring changes. Both the 256-by-4 and the 512-by-4 units are available in a choice of open-collector and three-state configurations.

Address access times are a maximum of 70 nanoseconds for the commercial versions and 80 ns for the memories that operate over the full military temperature range. Because the chip-select inputs activate the power switch, their access times are 10 ns longer than the address access times.

The 1,024-bit memory sells for \$4.25 each in hundreds, in its commercial version and \$7.90 in its military form. The 2,048-bit RAMs have respective prices of \$7.25 and \$14.50. The units are currently available in sample quantities.

Raytheon Semiconductor, 350 Ellis St., Mountain View, Calif. 94040. Phone (415) 968-9211 [415]

## OR/NOR gate switches in 500 picoseconds

A dual four-input OR/NOR gate fabricated in emitter-coupled logic has a gate switching time of just 500 picoseconds. Designated the SP16F60, the device provides simultaneous OR and NOR outputs, drives 50-ohm loads, and is internally compensated so that its threshold point is in the center of the transition region over the temperature range from  $-30^{\circ}\text{C}$  to  $85^{\circ}\text{C}$ . No-load power dissipation is typically 120 milliwatts. Housed in a ceramic dual in-line package, the SP16F60 sells for \$12 each in hundreds.

Plessey Semiconductors, 1641 Kaiser Ave., Irvine, Calif. 92714. Phone (714) 540-9979 [417]

## Bucket-brigade device delays audio signals up to 205 ms

The MN-3005 is a one-chip bucket-brigade device that can delay an audio signal for as long as 205 milli-

# Specialties of the House



For over 30 years, capacitors have topped MuRata's menu of products and made us the largest producer of ceramic capacitors in the world, bar none. Our Georgia manufacturing facility, designed from the ground up with one goal in mind—deliver super-quality capacitors in the most efficient way possible—is a showplace for automated production technology. This experience, production know-how and capability is your guarantee to capacitors that you can count on at competitive prices.

**High Voltage**—The stresses generated by 60 KVDC on a ceramic capacitor rapidly separate the gourmet chef from the short order cook. Our HV capacitors can take it and we've thousands

of customers world-wide, to provide testimony. We've units for almost every HV application—power supplies, TV, microwave ovens—you name it. And, they're available in dozens of configurations and materials.

**Monolithic Ceramics**—We serve them all—chips, conformal-coated radials, conformal-coated axials—in all stand-and TC's, voltages and tolerances. What's more, our deliveries and costs just can't be beat.

**Discs**—From tight tolerance temperature compensating ceramic capacitors to our little low voltage, large capacity Super-Caps™ for automatic or hand insertion, MuRata offers an unequalled

selection of ceramic disc capacitors. If it's not on our menu, it can't be made ... at any cost.

**Trimmers**—Our "axle-less" ceramic trimmers offer true set-and-forget performance by eliminating electro-mechanical stability problems inherent to crimped eyelet, axle-type trimmers. They're smooth, precise, rugged, small, stable and they stay put.

**Aluminum Electrolytics**—From 6.3 to 450 VDC, from 1 to 22,000 $\mu$ F in both radial and axial leads, they're on the MuRata menu. We even have a complete line of low noise 'lytics for that fussy application. We don't charge gourmet food prices either.



1148 Franklin Road, S.E.  
Marietta, Georgia 30067  
Tel: 404-422-9777  
Telex: 54-2329  
TWX: 810-763-4723

# When Clear Displays Count

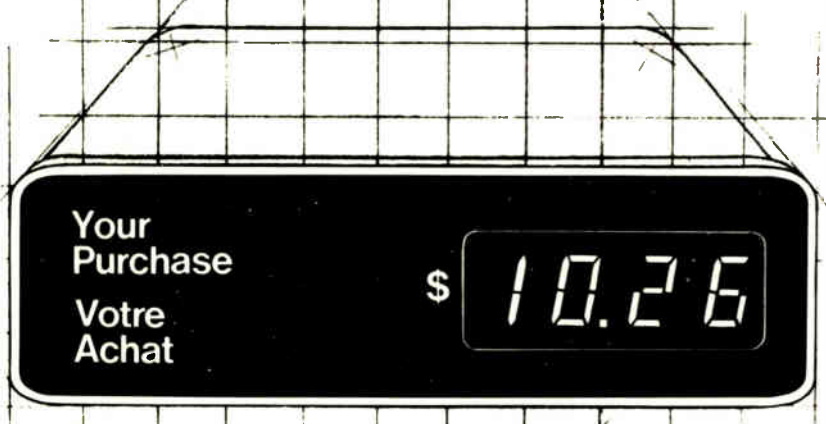
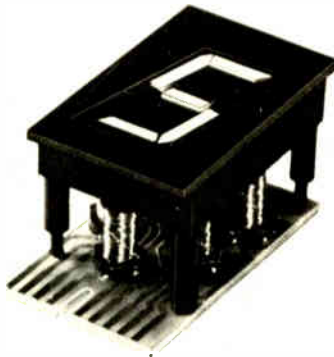

You can count on Ferranti-Packard's electromagnetic 7-Bar display module to give you the electronic compatibility you need plus the reliability and visibility your customers demand.

Only 7 moving parts to each display module — no complex mechanical linkages to wear out, or incandescent lamps and neon tubes to burn out.

Performance-proven for over 5 years, the simple design and construction, backed by Ferranti-Packard research and engineering, gives you the combination of reliability, visibility and flexibility that no other read-out component can match.

When you design an electronic read-out system, Ferranti-Packard display modules will help you do it better. It's clearly the display module you should consider. See the difference for yourself, write or call us and we'll prove it.

**When clear displays count — Specify Ferranti-Packard.**



## Ferranti-Packard Limited

Electronics Division,  
121 Industry Street,  
Toronto, Ontario, M6M 4M3, Canada  
Telephone: (416) 762-3661  
Telex: 06-22007

## New products

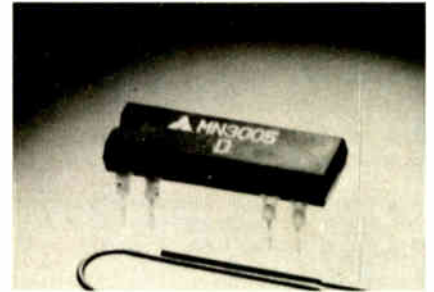

seconds. The 4,096-stage unit has a signal-to-noise ratio of 75 decibels and essentially no insertion loss. Intended primarily for use in high-quality electronic music equipment—echo chambers, organs, and synthesizers—the device can also be used to implement fixed or variable analog delays in a variety of other applications: time compression and voice scrambling in communications systems, for example.

Panasonic Co., Electronic Components Division, 1 Panasonic Way, Secaucus, N. J. 07094. Phone (201) 348-7276 [416]

## 40-watt transistors

operate to 50 MHz

Developed for use in power supplies, regulators, and other switching applications, the 1814 series of power transistors can dissipate 44 watts at 25°C. Maximum turn-on and fall times of 600 nanoseconds allow efficient switching up to 50 megahertz. The npn devices have collector-emitter voltage ratings from 200 v to 375 v with peak collector currents of 10 amperes. They are housed in TO-66 cases and sell for \$10 to \$28.50 each in hundreds.

Solid State Devices Inc., 14830 Valley View Ave., La Mirada, Calif. 90638. Phone (213) 921-9660 [418]

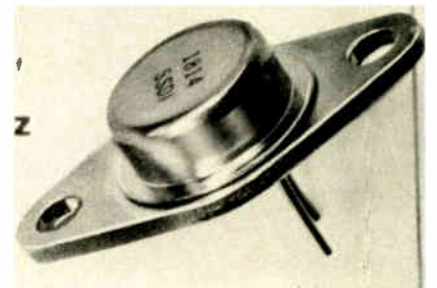



Made like a fine watch

## Inspired design... meticulous craftsmanship in a very low cost, very low profile relay

The Guardian 1475 relay: Engineered to work like clockwork in your most demanding single pole or double pole high density packaging applications. It switches currents from dry circuit right on up to 5 amps that could weld contacts on other small relays and reeds. All because of design features like these (indicated on the above illustration):

(A) Convoluted stationary contacts with built-in wipe because of (B) armature with off-center fulcrum. (C) .031" diameter terminal pins on .1" grid spacing for PC boards are molded into base with reinforced bosses around thick center section of pins. May be deformed without affecting adjustment. (D) Sealed theroset glass-filled polyester housing and cover. (E) Built-in bosses provide air space between board and base for better heat dissipation. Plus U/L recognition... and more:

Sealed to shrug off 650°F wave soldering or immersion in cleaning solvents. Sealed to keep contamination outside—where it can't foul contacts. Fast acting, with typical attract time of 3.5 ms; release time, 2.2 ms at: up to 50 operations per second. With contact bounce of less than 1 ms on N.O. contact. Shock and vibration resistant. Typical mechanical life of 100 million operations.

Each relay's performance and reliability are proven by nine—yes, nine!—individual tests. (Operation at normal, specified pick up and release voltages; time delay limits on attract and release; contact resistance limits; contact gap and pressure; and ground test.) The nine testing sequences are automatic on every relay. A single failure? Automatic rejection. To the scrap pile.

Ask your Guardian Angel for this free 48-page handbook and catalog.

Circle 199 on reader service card



This mark indicates recognition under the component program of Underwriters Laboratories, Inc.



# GUARDIAN®

GUARDIAN ELECTRIC MANUFACTURING CO. • 1566 West Carroll Ave., Chicago, Illinois 60607 • 312/243-1100

World Radio History



# The better counter choice:

Counting is not complicated: unless you've got noise and transients on your measurement signals.

Noise can trigger the input circuitry just like the signal and thereby give a false count. Transients can destroy it.

Therefore Philips high-frequency counters employ unique, PIN-diode circuitry that automatically and continuously attenuates the input signal to a level just above the trigger window. The signal therefore triggers the input circuitry, the noise does not. At the same time the PIN-diode circuitry is fast acting, so transients are caught and attenuated in time.

This way, the operating sensitivity is conditioned to match the signal's amplitude, giving the counter a wide trigger window.

Time interval measurements, on the other hand, have fundamentally different requirements for the input circuitry. Timing demands a narrow trigger window in order to minimise the influence of hysteresis. Therefore error-free, high frequency counting and timing facilities cannot be provided by the same input circuitry without compromising one or both measurement parameters.

Therefore all our instruments have separate input channels, each optimised for either frequency or time interval measurements. With Philips you can thus be sure of a better, as well as a bigger choice: whatever your application.

## Fully automated counters:

80 MHz model PM 6661 (1) 520 MHz model PM 6664 (2) employing the unique HF PIN-diode input.

## Universal counters:

all having 10 mV sensitivity. 80 MHz model PM 6611 (3) 80 MHz counter/timer PM 6612 (4) with 100 ns resolution.

250 MHz model PM 6613 (5) 520 MHz model PM 6614 (6) 1 GHz model PM 6615 (7); last three have separate HF input.

## Compact timer/counters:

80 MHz model PM 6622 (8) with 100 ps resolution and trigger hold-off facility; 520 MHz model PM 6624 (9) and 1 GHz model PM 6625 (10) have same 100 ps resolution plus separate HF counting input.

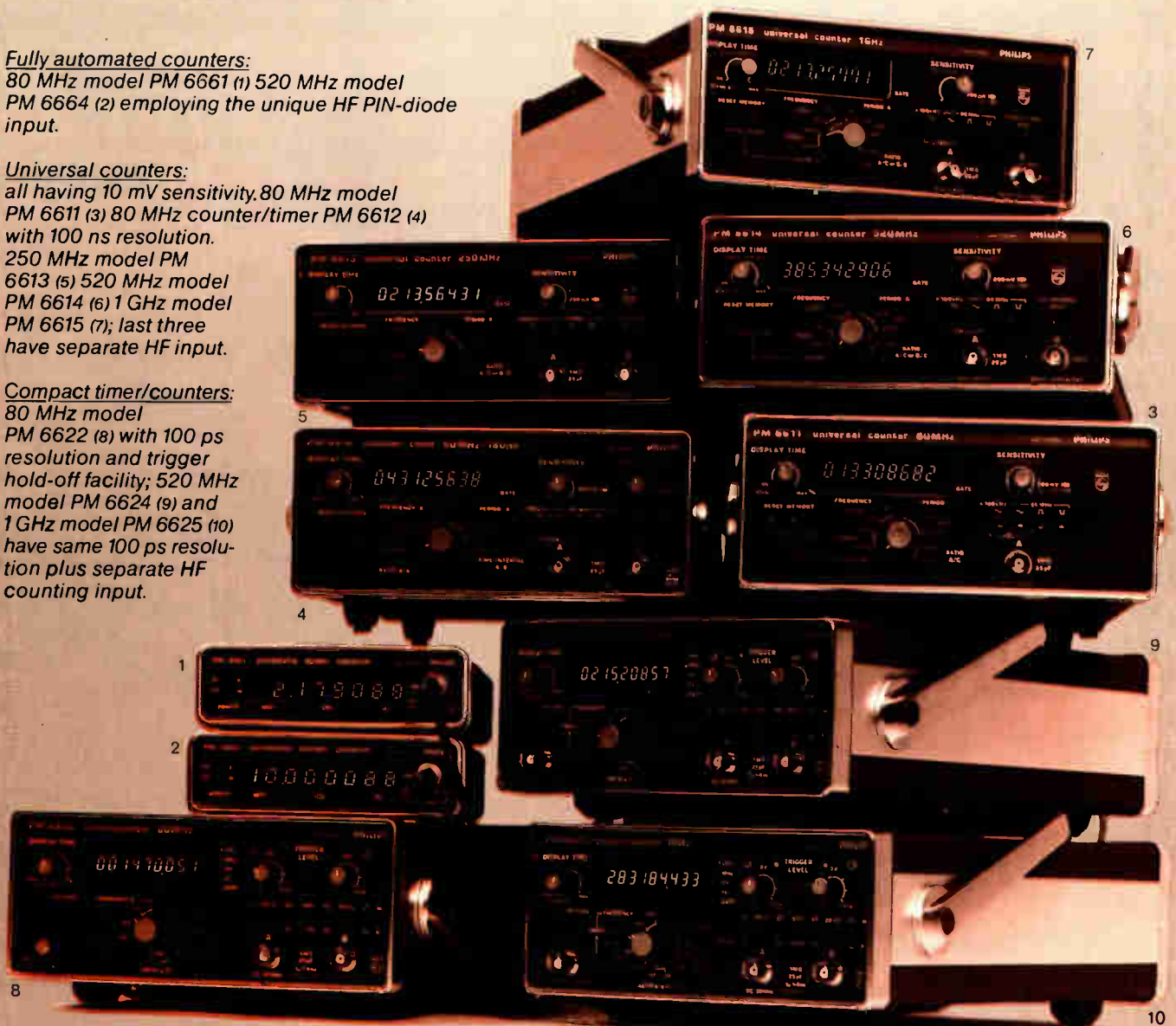

# timer/counters too

## An eleven-model choice of fully automatic counters; universal counters and counter/timers

### Fully automatic counting

Models PM 6661 and PM 6664 are fully automatic and represent the ultimate in easy operation, by having no controls other than the on/off switch. The former counts to 80 MHz, the latter to 520 MHz: both with optimum signal conditioning and high stability time-bases. Dimensions are extremely compact, weight only 1,45 kg and the 8-digit LED display is bright and easy to read.

### Error-free from 80 to 1000 MHz

Four universal counters and one counter/timer cover this frequency range, the VHF and UHF models having the unique Philips PIN-diode circuitry that is proof against noise and that maximises the value of a high 10 mV sensitivity. Moreover, optimum counting accuracy is ensured by a wide choice of high-stability X-tal oscillators, which match your individual needs. This accuracy is extended to the field via the optional built-in battery pack.

The basic 80 MHz instrument is model PM 6611, while the PM 6612 offers basic timing facilities in addition to error-free counting. Models PM 6613, 6614 and 6615

are dedicated counters having frequency ranges of 250 MHz, 520 MHz and 1 GHz.

The high-performance standards of all these instruments can be further extended by plug-in options that provide:

- a BCD output
- a D/A converter that gives an analog "magnifying glass" view of any three digits
- and a serial data output for operation with IEC/IEEE Bus interface systems.

### Compact timer/counters

The timer/counters feature powerful performance in the same compact housing as the previously described frequency counters. Each has specific measurement facilities. All have the following common features:

- 80 MHz direct frequency counting
- high DC-coupled 20 mV sensitivity
- versatile time interval (averaging) measurements down to 1 ns
- and period, ratio and conditioned pulse counting

Depending on your individual needs, you then select the

specific model with either:

- trigger hold-off to extend the timing capability as provided by model PM 6622. This allows spurious signals such as contact bounce to be ignored; enables period measurements to be made on double-pulse signals and permits a specific signal to be "picked-out" from a pulse train, to give just three examples of this instruments timing versatility.
- extended frequency counting, on a separate input, to 520 MHz for model PM 6624 or to 1 GHz for model PM 6625. These two instruments thus offer the same error-free counting facilities as the universal counters, while retaining the 100 ps resolution of the time interval averaging technique.

The timer/counters also offer the same choice of timebase as the universal counters and the same plug-in options and battery operation.

Get the full facts on the bigger, better counter and timer/counter choice. Tick the reader service number, fill in the coupon or contact Philips at the address below.

### A high-speed, high-resolution, systems instrument

Model PM 6650 below is a systems instrument that features accurate, noise- and transient-suppressed counting to 512 MHz on a special frequency channel. And time interval averaging measurements with up to 1 ps resolution on the timing channel. Plug-in modules extend the performance: two increase the frequency range to either 1 GHz or 12.6 GHz; another boosts the basic 50 mV sensitivity to 1 mV. User options are numerous.

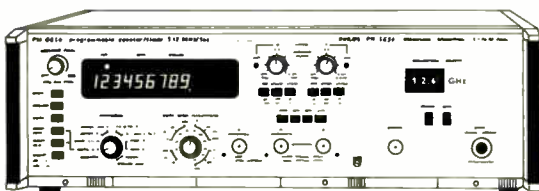

### Please send me full details on:

- Fully automated counters PM 6661 and 6664
- Universal counters PM 6611 to 6615
- Timer/counters PM 6622, 6624 and 6625
- Universal model PM 6650
- All Philips Test and Measuring Instruments

Name .....

Department .....

Company .....

Address .....

City ..... Country .....

For further information call our toll-free HOT LINE number 800 631-7172 or contact: Philips Test & Measuring Inc., 85 McKee Drive, Mahwah, New Jersey 07430 or in Canada: 6 Leswyn Road, Toronto, Ontario, Canada M6A1K2 Tel. (416) 789-7188

Philips Test & Measuring Instruments Inc.  
A NORTH AMERICAN  
PHILIPS COMPANY

# PHILIPS

Circle 201 on reader service card

Send enquiries to Mr. Alridge / Eundhover and Mr. Rauch in Mahwah



# “Hey buddy... wanna buy a connector?”

Lots of people will sell you a connector. But a complete interconnection system, with complex or unusual requirements? That's something else. And that's when you should look to Fabri-Tek's National Connector Division. We're one of the few companies that can handle an interconnection system job from start to finish. Design to your specifications, tool up, manufacture, assemble, and service. And nobody beats us when it comes to quality. That's why we've been doing business successfully with many demanding customers in the computer, communications, and defense industries for 20 years.

Whatever shape, size, or material your interconnection system requires — call us. We can be a **real** buddy.

**FABRI-TEK INC.**  
**NATIONAL CONNECTOR DIVISION**

9210 Science Ctr. Drive • Minneapolis, MN 55428  
 (612) 533-3533

**TELL ME MORE!**

- Fabri-Pak™ backpanel systems
- Flat cable connector systems
- Military
- Send literature
- Molded connectors
- Commercial
- Telephone connectors
- Plate connectors
- Have salesman call

Name and Title

Company

Address

City, State, Zip

Telephone

Circle 146 Fabri-Pak® backpanel system  
 Circle 147 Flat cable connector systems  
 Circle 148 Molded connectors

Circle 150 Plate connectors  
 Circle 151 Telephone connectors

World Radio History



# The Panasonic Plus: you get more power transistor than you pay for.

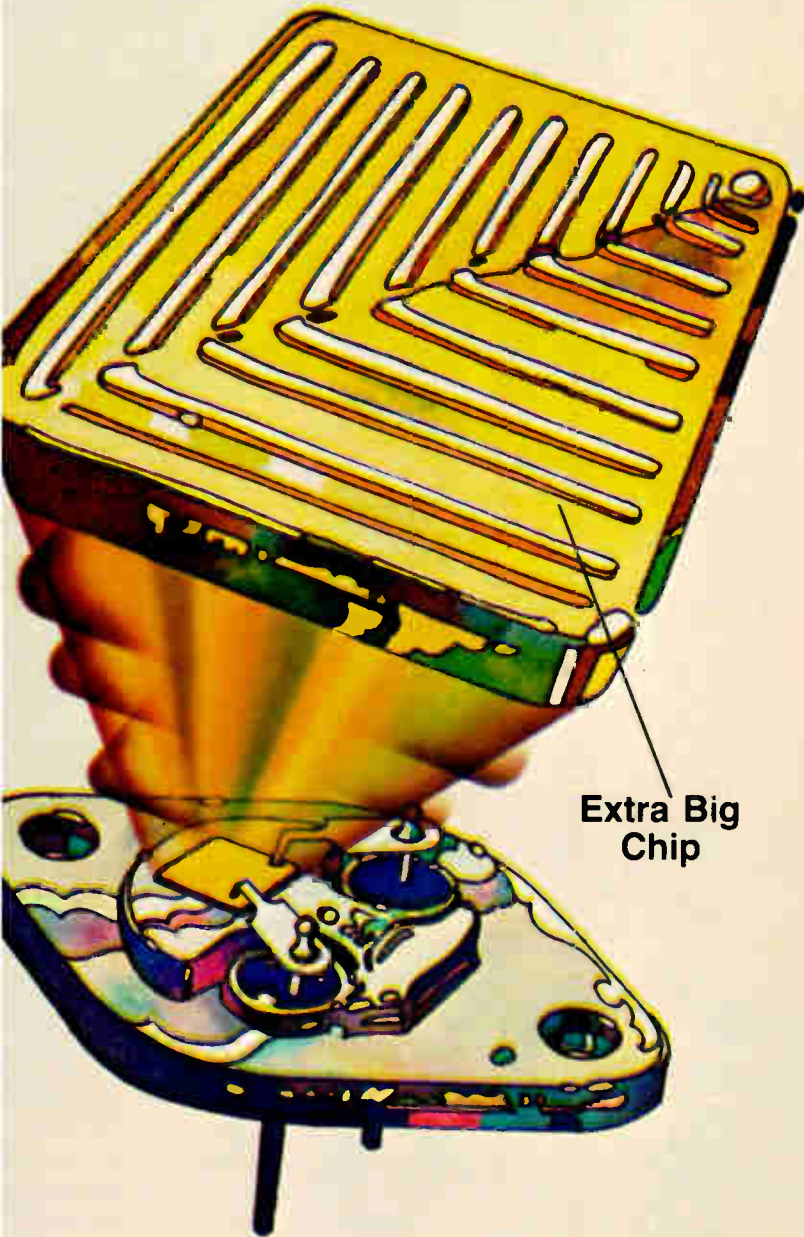

Extra Big Chip

One look at the extra big chip in any Panasonic power transistor makes it obvious—not all transistors are created equal.

Because of our extra big chip and proprietary construction we could rate these devices higher, but we don't. They're always conservatively rated. Which, along with our rigid QC system, is why we have such a low rejection rate.

That's part of the Panasonic Plus...one reason to switch to our power transistors. There's also competitive pricing and broad range.

Many of our power transistors are matched to 2N numbers, and are available in standard TO plastic or metal packages, in a complete range of power, voltage and current ratings. And we also offer a line of small signal transistors, Hall Effect devices, and 4-bit microprocessors. All at prices that are highly competitive with those of other makers of quality semiconductor devices.

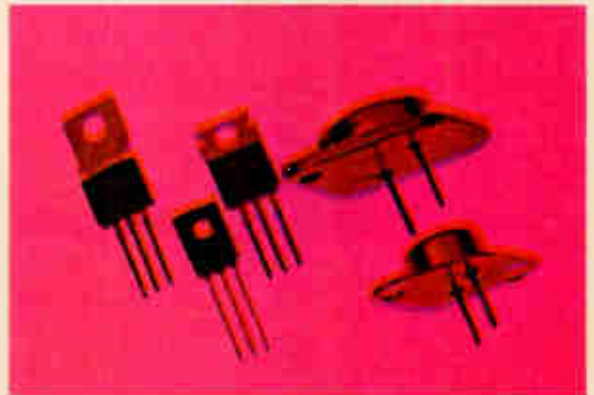

For complete information and prices, write to Panasonic Electronic Components, One Panasonic Way, Secaucus, N.J. 07094; or call (201) 348-7269.

## Specifications

	TO-3	TO-66	TO-126	TO-202 TO-220
V <sub>ceo</sub> (V)	80-1500V	40-300V	18-300V	20-300V
I <sub>c</sub> (A)	100m-6A	100m-2.5A	50m-1.5A	100m-4A

Also available: TO-92 and other semiconductor packages

**Panasonic**<sup>®</sup>  
just slightly ahead of our time

World Radio History

Circle 203 on reader service card

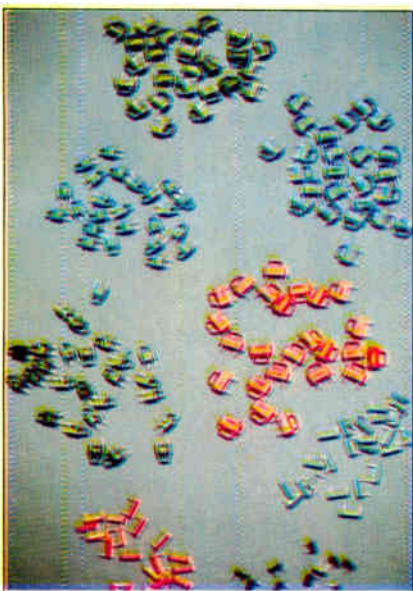

**Uses are jumping for our low cost switches.**



Tiny jumpers mated to spring-loaded receptacles are increasingly popular for use as low-cost highly reliable circuit switches. In longevity tests they easily passed 50,000 insertion/extraction cycles. Color coded and positive position indication adds to their usefulness and application possibilities. To help you put them to use, we offer a catalog, samples or a call from a sales engineer if you wish. Write: Cambridge Thermionic Corporation, 445 Concord Avenue, Cambridge, MA. 02138. Phone: 617-491-5400. In California: 2733 Pacific Coast Hwy., Torrance, CA 90505. Phone: 213-326-7822.

Standardize on

**CAMBION**  
The Guaranteed Electronic Components

## New products

Industrial

### Thermistors are interchangeable

Tight matching makes recalibration unnecessary when sensors are replaced

The Unichip is a single-chip thermistor that has been R-T matched for complete interchangeability to within a maximum error of 0.2°C without recalibration. Designed for operation between 0°C and 70°C, the Unichip is capable of realizing its full 0.2°C accuracy because its manufacturer publishes resistance values for temperature increments of 0.1°C. Other units with similar accuracy, but with published values in only 1.0°C increments, can lead to measurement errors as large as 0.6°C, according to the manufacturer.

Applications for the Unichip include the measurement and control of temperature in heating and ventilating systems, photographic laboratories, and some chemical manufacturing. It is also expected to find many uses in clinical medicine where its short time constant (typically 4 seconds) gives it an edge over competitive devices.

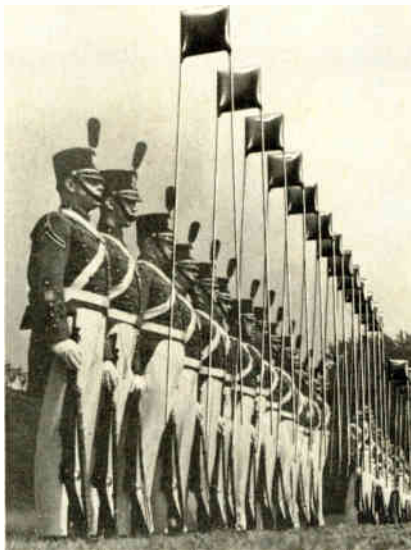

If operated within its specified range, the Unichip is expected to meet its specifications indefinitely. Continuous operation or cycling above 75°C may eventually cause it to drift out of spec. Temperature storage range is -80°C to 120°C.

In addition to the 0.2°C device, the Unichip is offered in a 0.5°C version (with 0.2°C chart) and a 1.0°C version (with a 0.5°C chart). Presently available resistance values are 10,000, 5,000, and 2,500 ohms, all with a 0/50 ratio of 9.3. Additional values and ratios are planned for the future.

Supplied with a polyurethane protective coating, the Unichip has a nominal thickness of 75 mils and a small-quantity price of approximately \$4. It is available from stock. Victory Engineering Corp., Victory Road, Springfield, N. J. 07081. Phone (201) 379-5900 [371]

Rugged transducer measures pressures to 5,000 psia

Actually a pressure-to-frequency converter, the Digiquartz high-pressure transducer is a rugged sensor that can accurately measure abso-



lute pressures as high as 5,000 pounds per square inch. The heart of the unit is a quartz-crystal resonator whose resonant frequency varies with the stress induced by the applied pressure. It is relatively insensitive to most other environmental effects and thus can be used in such hostile environments as oil wells, gas wells, the ocean, and geothermal wells.

The transducer, which includes a miniature hybrid oscillator, is housed in a cylindrical package with

# INK JET WILL TELL YOU WHAT HAPPENED, WHEN IT HAPPENED.

Gould's new Ink Jet annotation device allows you to automatically print time, date and other data parameters alongside your Gould analog traces.

The Ink Jet writing system employs the most advanced technology consisting of ink reservoir and electrostatic charging and deflection plates to print highly legible characters in a 5 x 7 dot matrix at chart speeds of up to 50 mm/sec. Any desired annotation of up to 256 characters may be entered by means of our optional keyboard or from an external ASCII parallel data source.

Designed to complement the Gould 2000 Series pressure ink direct writing recorders, Ink Jet



adds an entirely new dimension to analog data display. Medical, industrial, research and engineering users now have a means of immediately annotating all pertinent information while a study is taking place.

Consider the additional breadth of data display that only Ink Jet applications will bring to you. For a descriptive brochure, contact Gould Inc., Instrument Systems Division, 3631 Perkins Av., 57 rue St. Sauveur, 91160. Ballainvilliers, France. Or call toll free at (800) 325-6400, Ext. 77. In Missouri: (800) 342-6600.

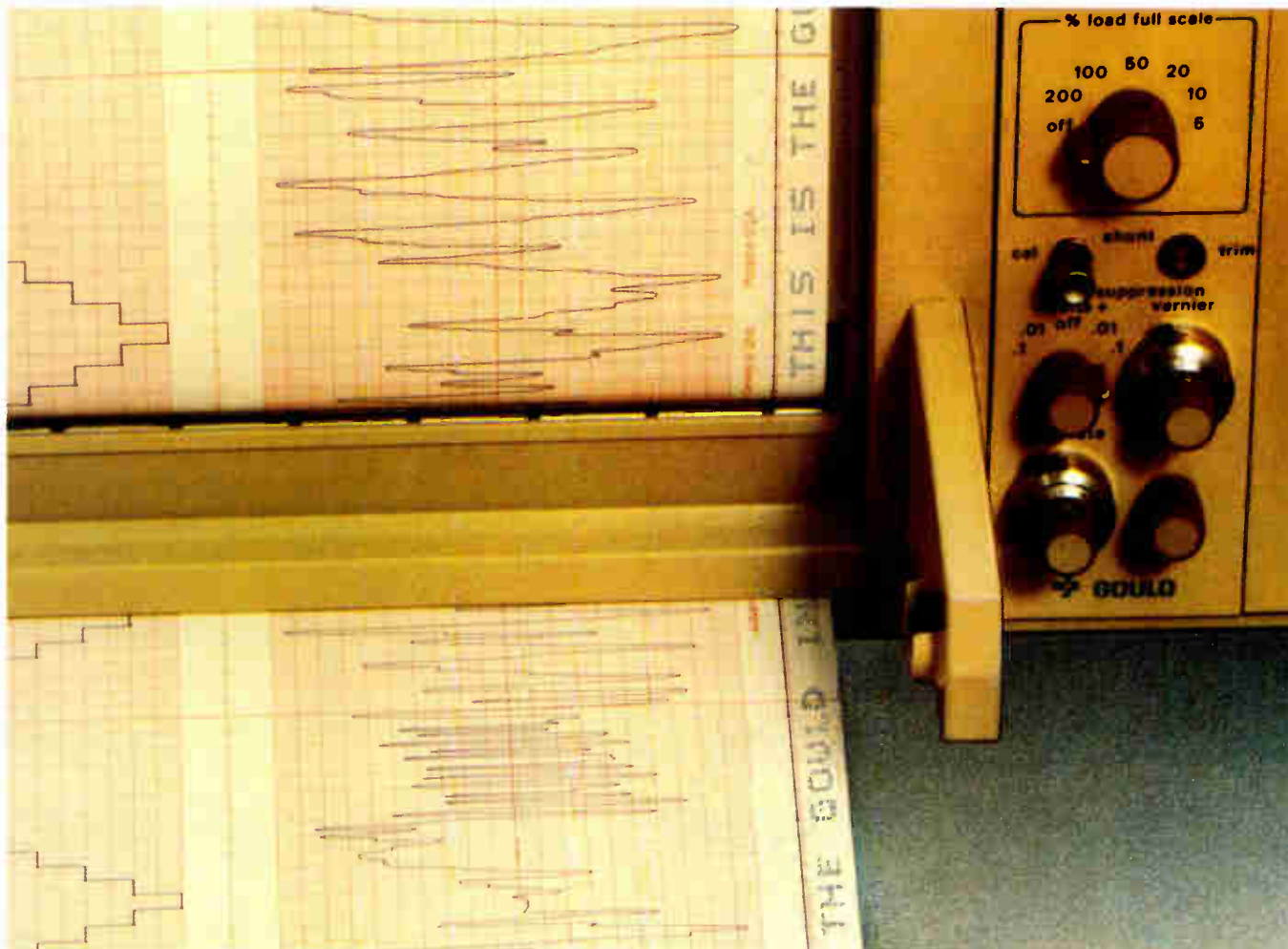

# THE POWER PACKAGE OF THE 80's - AVAILABLE TODAY

Newly developed LITHIUM batteries, with highest cell voltage commercially available (3.4V/cell), are manufactured in standard "AA", "C", and "D" sizes and an array of miniature button sizes. Each cell is hermetically sealed and exhibits the following outstanding features:



- 3.4 volts/cell nominal operating voltage
- highest energy density per weight and volume
- wide operating temperature range (-55°C to +75°C)
- long shelf life - up to four times the shelf life of conventional cells.

Our experienced applications engineers are available to industry and the military in solving specialized battery problems. For information and technical brochure write:

## TADIRAN

3 Hashalom Road, P.O.B. 648 Tel Aviv 61000, Israel, Telex 33537

Circle 206 on reader service card

### New products

a diameter of 1.15 inches and a length of 3.85 in. In small quantities, the transducers sell for \$2,900 each.

Paroscientific Inc., 14827 N.E. 40th St., Redmond, Wash. 98052. Phone (206) 883-8700 [373]

Pressure transducer is easily customized

In an effort to provide users with a virtually custom pressure transducer as a standard item, Bourns Inc. has introduced its model 2900. This transducer system gives the user a wide choice of parameters at no extra charge. Among the choices are one of three electrical connectors, one of four pressure connectors, one of three spans, one of three zero



balances, and one of three temperature coefficients. A choice of ac or dc operation is also provided.

Depending upon application, the model 2900 can measure pressures relative to three different references: vacuum (absolute pressure), ambient pressure (gage pressure), or the standard sea-level pressure of 14.7 psia (sealed pressure). Full-scale ranges from 15 to 5,000 psi are available.

Industrial Products Group, Instrument Division, Bourns Inc., 6135 Magnolia Ave., Riverside, Calif. 92506. Phone (714) 781-5182 [376]

Proximity switches offer three outputs

A series of rugged proximity switches for demanding industrial applications is available with a choice of three outputs: a dc voltage output, a dc current output, and an

### From Electronics Magazine Book Series. Zero-risk trial offer.



**Applying Microprocessors**  
2nd and 3rd generation technology. 26 detailed applications from data networks to video games. \$9.95

#### Electronics Book Series

P.O. Box 669, Hightstown, N.J. 08520

Send me \_\_\_\_\_ copies of "Applying Microprocessors" at \$9.95 per copy.

Discounts of 40% on orders of 10 or more copies.

I must be fully satisfied or you will refund full payment if the book is returned after ten-day trial examination.

Payment enclosed  Bill firm  Bill me

Charge to my credit card:

American Express  Diners Club  
 BankAmericard  Master Charge

Acc't No. \_\_\_\_\_ Date exp. \_\_\_\_\_

Interbank No. \_\_\_\_\_

On Master Charge only,  
first numbers above name \_\_\_\_\_

Name \_\_\_\_\_ Title \_\_\_\_\_

Company \_\_\_\_\_

Street \_\_\_\_\_

City \_\_\_\_\_ State \_\_\_\_\_ Zip \_\_\_\_\_

Signature \_\_\_\_\_



## SEL-REX: An important part in the OMI world of metal finishing.

Sel-Rex has led its industry for more than a generation in advancing the technology of precious metal electroplating. For both decorative and functional plating deposits, Sel-Rex has been the leading innovator, with more processes than any other company in the industry.

The world's first bright gold plating process was an invention of Sel-Rex researchers. Sel-Rex made significant contributions to high-speed gold plating for the electronics industry. Their low-karat, cost-cutting alloy systems are currently changing cost patterns in many markets. And Sel-Rex research led to a complete chemical system for printed circuit board processing, from cleaners and surface conditioners, to electroless copper baths, to final tin/lead and gold coatings uniquely suited to the special requirements of printed circuits.

Sel-Rex refineries on the east and west coasts help platers reclaim and reuse precious metals from scrap and solutions. And Sel-Rex's in-depth knowledge of precious metal electroplating has been applied to enable OMI's Equipment

Division to improve its full range of semi-automatic equipment for high-speed, high-volume plating, as well as cost-saving selective strip, stripe, and spot plating equipment.

Today, Sel-Rex's position of leadership has been further strengthened as an integral member of OMI.

With its components, the Sel-Rex Division; the Udylite Division, leader in base metal plating processes; the Parker Division, industry's major supplier of cleaning, treating, and prefinishing chemicals; Recovery Systems Division, a pioneer in designing and engineering environmental and metals recovery systems; and the Equipment Division; OMI represents the most complete source of processes, equipment, supplies, and services, to the world of metal finishing.

For further information, write to Oxy Metal Industries Corporation, 21441 Hoover Rd., Warren, Mi. 48089.



# OMI

**OXY METAL INDUSTRIES CORPORATION**

World Radio History

Circle 207 on reader service card

## New products

ac output. The voltage-output switch delivers 12 v from a source impedance of 4.7 kilohms. The current-output unit is similar except that a current amplifier is added to boost the output to a maximum of 200 milliamperes at 24 v dc. The ac unit uses a thyristor to switch up to 1 ampere (resistive) over a range of

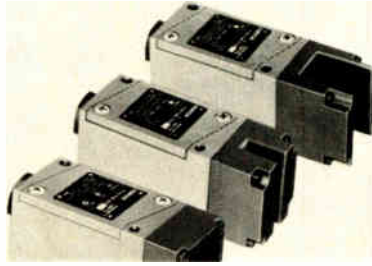

applied voltages from 110 to 220 v.

All three types are made with a variety of sensing-head shapes and are enclosed in drip-and-dust-proof housings. Their die-cast aluminum cases are designed for mounting on 2.36-by-1.18-inch centers in accordance with DIN standards. Water resistance conforms to JIS-C0920 requirements. Prices range from \$77 to \$319.

Omron Electronics Inc., 233 S. Wacker Dr., Chicago, Ill. 60606. Phone Don Papesh at (312) 876-0800 [374]

## Predetermining counter includes presignalling

The MVS16 predetermining counter is a six-digit unit that operates a single-pole, double-throw switch any factory-fixed number of counts before it operates the main switch at the zero count. The presignal can be used, for example, to slow down a machine, refill a low batch, or warn an operator that something is running low or nearing an end.

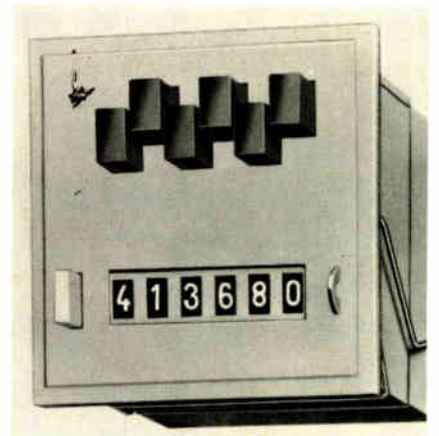

The MVS16 uses large, staggered push buttons to set the predetermined number into the counter. Electrical pulses from the machine or process under control cause the counter to count backwards, activating first the presignal switch and then the main, or zero, switch. The unit can be reset to the same starting number automatically, manually, or by an externally applied electrical signal. The counter sells for about

# 2 $\frac{1}{2}$ Relays Per Inch

The popular Opto 22 P-Series, 3/8 inch-thin SSR is now available with the industry's smallest footprint.

This new unit has the same high quality features you have learned to expect from Opto 22. It switches 120-240 VAC, has T<sup>2</sup>L input with built-in snubber. 3 ampere current rating and up to 4000 Volt photo-isolation.

**opto 22**

The Solid State of the Art in PC Board Relays  
5842 Research Drive, Huntington Beach, California 92649 (714) 892-3313

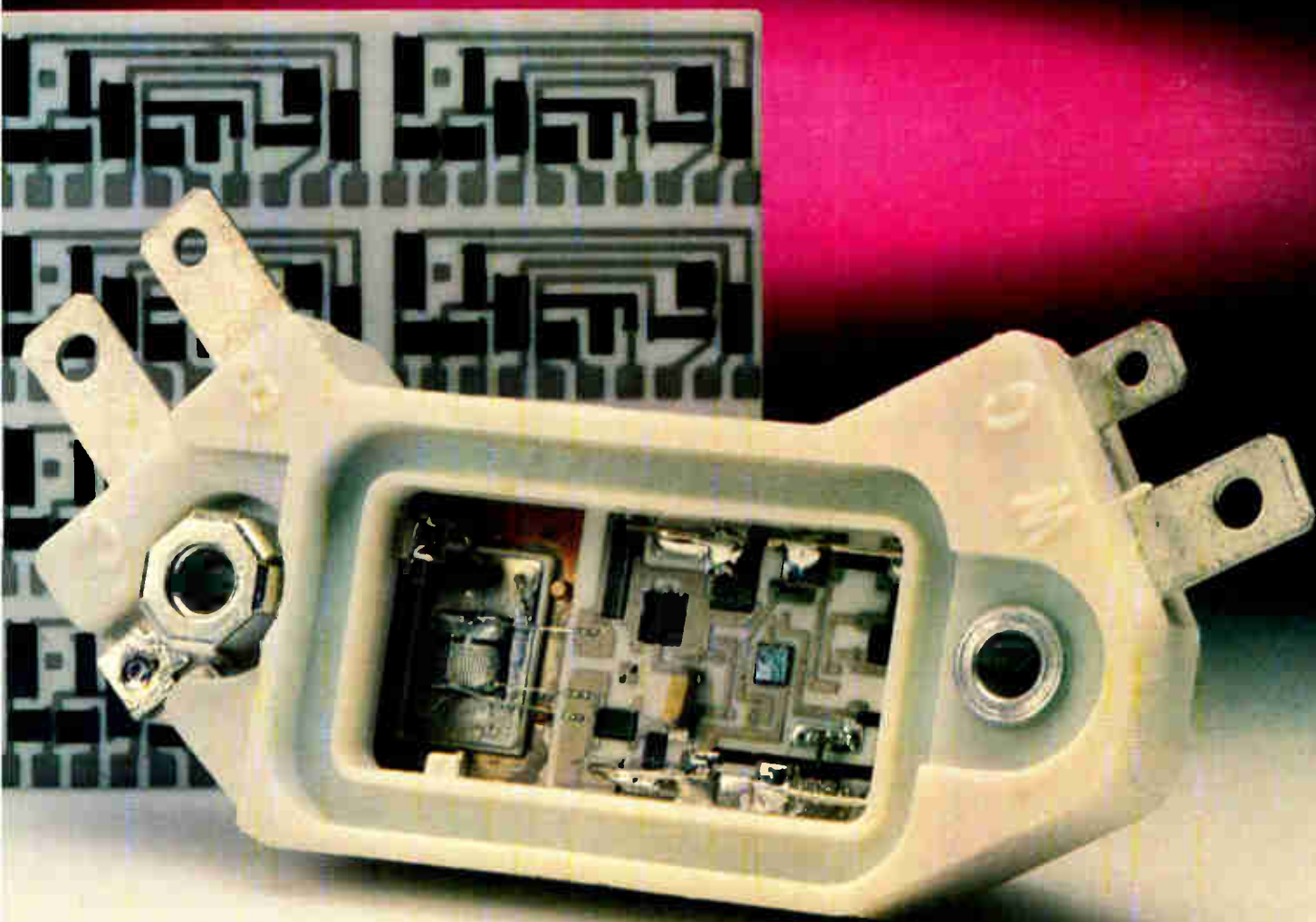

## Lower your costs in high-volume microcircuit applications with Du Pont's new system of thick film materials.

To help cut your costs and raise your yields, Du Pont has developed a new system of cost-effective, compatible resistor and conductor materials for high-volume production.

With the new vehicle technology in our CERTI-FIRED® 4800-Series Resistors, you can get more consistent prints and reproducible resistance values, even with high-speed printers and long production runs. You get the same consistency if you print multiple

circuit patterns on one large substrate.

Our new Palladium/Silver Conductor 9843—compatible with the 4800-Series—uses the same new vehicle technology and offers the same processing advantages.

Altogether, it's a low-cost system that offers more of the quality and performance for which Du Pont is known. Palladium/Silver Conductor 9843 offers high adhesion and excellent soldering. The 4800-Series Resistors

offer tight laser trimming tolerances, excellent stability and TCR's less than 250ppm/°C. Both offer reproducible performance, lot-to-lot and substrate-to-substrate.

If you manufacture circuits or networks for any application, from consumer to military, Du Pont has a cost-effective system of thick film materials for you. Call 800-441-9475 toll-free. Or write Du Pont Company, Rm. 35639, Wilmington, DE 19898.

### Electronic Materials Division



**Electronics**

Circle 209 on reader service card

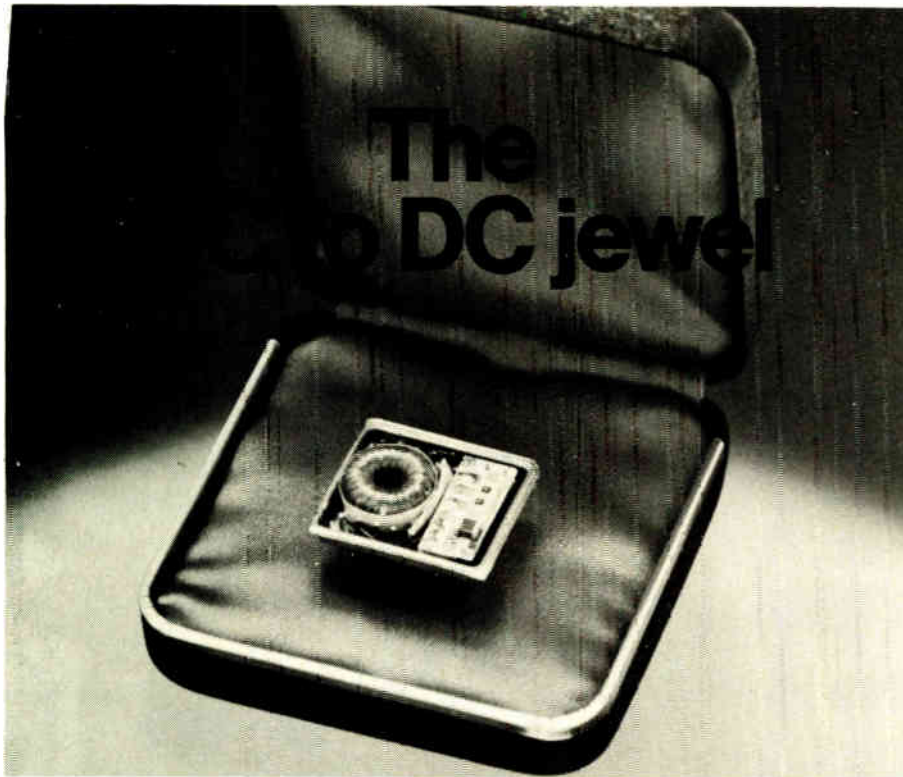

## Now with a narrower input range.

The Tecnetics HC Series unregulated DC to DC power supplies are more of a jewel than ever. We've optimized performance by adding a more efficient core and narrowing the input range. And it still weighs only 0.3 ounces.

Choose from a wide variety of input voltages and single or dual outputs. HC Series power supplies are available in a non-hermetic package for industrial and commercial applications, a her-

metic package for military, space and industrial applications that require protection from severe environmental conditions, and a fully-encapsulated package for use where extreme shock and vibration are expected.

Write for our 26 page catalog that gives full specs and prices on the HC Series and over three hundred other power supplies.

### HC SERIES UNREGULATED ISOLATED DC-DC CONVERTER

INPUT VOLTAGES	5VDC+1V to 28VDC-4V
OUTPUT VOLTAGES	5VDC @ 2 watts to 300VDC @ 3 watts
OPERATING TEMP.	-55° C ambient to 125° C case, without derating
DIMENSIONS	1.05 x 0.94 x 0.32 Inches
EFFICIENCY	65% to 75% typically at full load 55% to 60% typically at half load
PACKAGE OPTIONS	HCN (Non-hermetic) 49.00
AND PRICES	HCH (Hermetic) 59.00 HCE (Encapsulated) 69.00

**tecnetics®**

The Power Conversion Specialists

P.O. Box 910, 1625 Range Street, Boulder, Colorado 80302 (303) 442-3837 TWX 910-940-3246

Circle 210 on reader service card

## 1977 Answer Book. It makes your job easier. \$25.

Who makes what? Over 4000 products, more than 5000 manufacturers with their local contracts and distributors, directory of trade names and catalogs, post-paid inquiry cards for 5-second ordering of current catalogs.

**Electronics Buyers' Guide**  
1221 Ave. of the Americas  
New York, N.Y. 10020

Yes, send me a copy of The Answer Book. I've enclosed \$25 (USA and Canada only, elsewhere send \$35). Full money back guarantee if returned within 10 days.

Name \_\_\_\_\_

Company \_\_\_\_\_

Street \_\_\_\_\_

City \_\_\_\_\_

State \_\_\_\_\_

Zip \_\_\_\_\_



### New products

\$50 and is available from stock.

Kessler-Ellis Products Co., Atlantic Highlands, N. J. 07716. Phone Leslie Gleason, Product Manager toll-free at (800) 631-2165 [375]

### Temperature controllers handle severe load changes

Series 400 three-mode temperature controllers are designed for use in applications where severe and frequent load upsets occur, where there is a time lag between changes in the heat supply and a temperature change at the sensor, where there is heat generated by the process itself, and where the process is fuel-fired and requires continuous control of

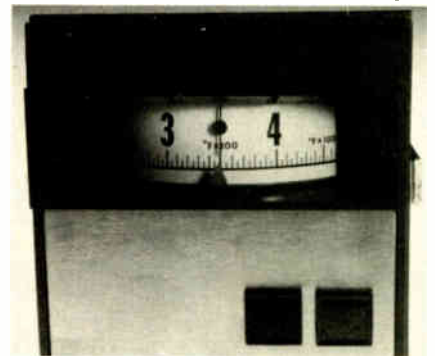

the fuel flow. The proportional controllers include a meter and provide for the adjustment of loop bandwidth and cycle time. Two models offer a choice of one or two set points.

Controllers in the 800 series can also handle time lags, but they are intended for use in situations where temperature changes are small and load changes are infrequent.

Omega Engineering Inc., P. O. Box 4047, Stamford, Conn. 06907. Phone (203) 359-1660 [377]

### Direct-contact thermocouples work on rotating parts

Designed to determine the temperatures of rotating drums, disks, and shafts, a line of direct-contact temperature sensors consists of a spring-



# P/rel™ Bio-Mechanical Interface to the Digital World



**P/Rel . . . Standard Grigsby's programmable rotary encoded logic switch or control is fully programmable to any code.**

When you need design flexibility, Standard Grigsby's P/Rel will do the job. No other programmable rotary switch offers the design engineer as much versatility, with as low a cost, as the P/Rel switch.

You can use the P/Rel as a detented switch for feeding encoded information direct to your digital logic circuit. Or, use it without a detent, as a "digital pot," and eliminate the cost of expensive A-D conversion.

Find out how your product can use the standard or miniature P/Rel. Send for Free literature.



**standard grigsby, inc.**

920 Rathbone Avenue, Aurora, Il. 60507  
Phone: (312) 844-4300

IN EUROPE: W. Gunther GMBH, Virnsberger Strasse 51,  
D 85 Nurnberg 1, West Germany Phone: 0911/65521



Circle 211 on reader service card

# Revolutionary cooling extrusion cuts size and cost in half.

Here is the first in a new series of unique cooling extrusions from Wakefield.

A totally different design concept called "High Fin Density" allows Extrusion 5113 to give the same cooling performance as devices needing nearly twice as much space.

And because of substantial material savings, the 5113 is half the price of the larger units—only \$1.10 per inch.

Until now, the space between fins of an extrusion could be no less than 1/4 the height of the fins. This limited the surface cooling area of the fins for any given size extrusion.

"High Fin Density" has changed all this by reducing the space between fins to as little as 1/10 their height. The result is a tremendous gain in cooling efficiency with 130 sq. in. of cooling surface per linear inch of extrusion.

Knowledgeable people say this is the most significant breakthrough in the history of cooling devices. But then, what would you expect from the leader? Write or call for full details.

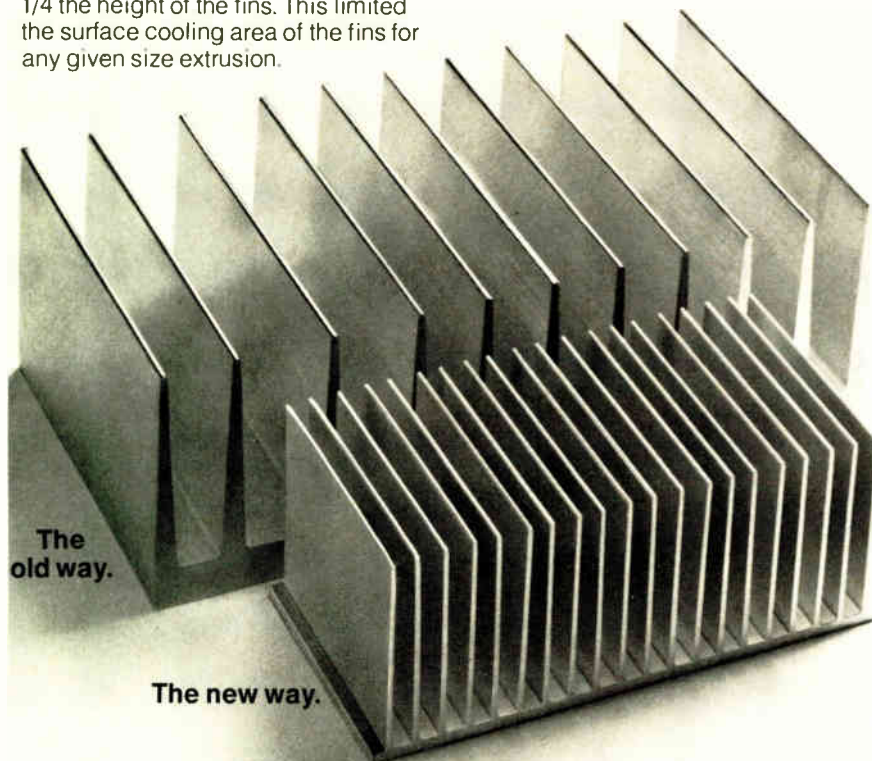

**WAKEFIELD ENGINEERING INC.**

77 AUDUBON ROAD WAKEFIELD, MA 01880 (617) 245-5900  
TWX 710-348-6713 AN **EG&G** COMPANY

Circle 212 on reader service card

## CAREER OPPORTUNITIES

Usually the best opportunity to grow in your field lies within your present company. You have made an investment in them. They have an investment in you.

But occasionally the best opportunity lies somewhere else. No one can decide but you.

Companies looking for good people run their recruitment ads in our Classified Section in the back of this magazine. Perhaps you'll find an opportunity there that's worth following up.

### New products

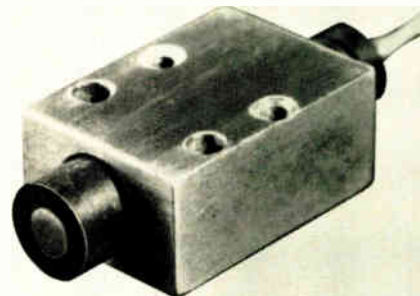

loaded thermocouple sensor mounted in an aluminum block. The thermocouple junction is welded to a soft brass disk attached to a phenolic thermowell. Units are available for use up to 600°F. A complete assembly sells for \$35 with replacement sensing tips priced at \$20 each. Delivery time is two to three weeks.

Nanmac Corp., 9-11 Mayhew St., Framingham Centre, Mass. 01701. Phone (617) 872-4811 [378]

### Plug-in counter/timer uses microprocessor control

The series TC-100 plug-in counter/timer is a microprocessor-based unit with an internal time base and three sets of 10-ampere isolated output contacts. The instrument, which has debounced inputs, is designed to control timing and counting operations at rates to 600 pulses per second. Timing ranges are from 0.01 second to 99.99 hours. Counting ranges, in either a total-



# ELEC-TROL RELAYS

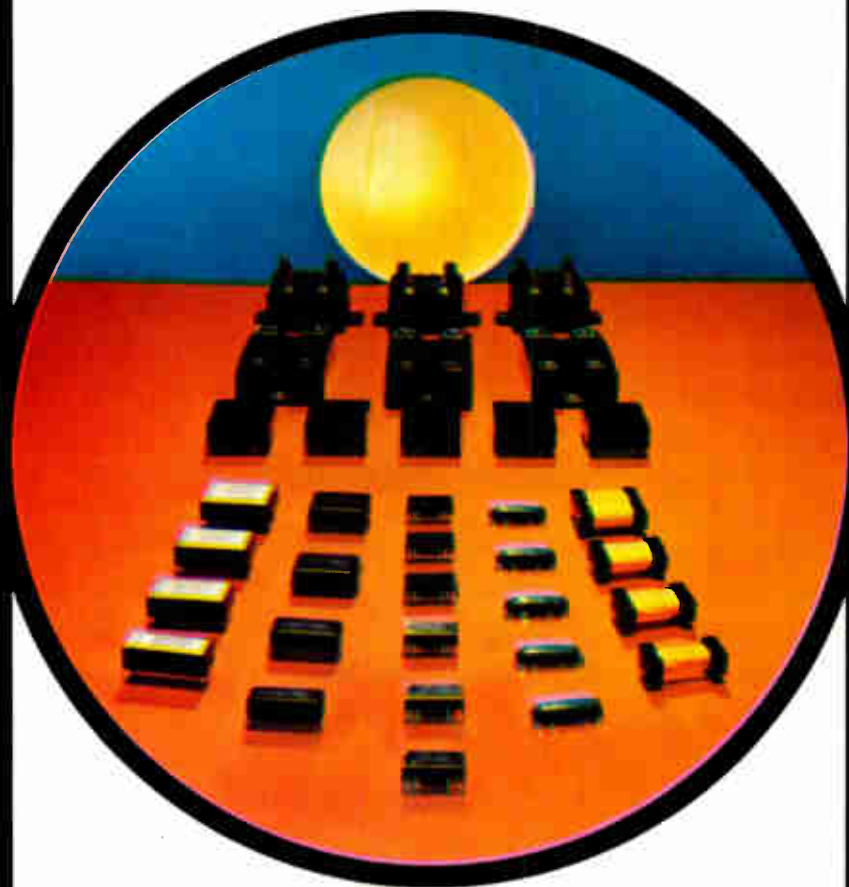

## YOUR BEST BET FOR REED AND SOLID STATE RELAYS

For those of you who haven't used our relays yet - here are two good reasons for making Elec-Trol your first call.

**(1) Reed Relays** We sell more dry reed relays than any other manufacturer in the United States. We offer packaging styles like DIP's, Open Lines, Encased Lines, Molded Lines, and Blue Boys - in a complete range of coil voltages and contact forms. You can get optional features like magnetic shielding, electrostatic shielding, and contact run-ins. Also available - the best in mercury-wetted.

**(2) Solid State Relays** We're coming on strong with printed circuit board and standard high-power-switching models that feature: zero-crossover switching, photo isolation between input and output, positive on/off control, TTL compatibility, long life, immunity to shock and vibration, and competitive pricing.

So the next time you're thinking relays - think Elec-Trol. Send for a quick overview of our products. Ask for our Short Form Catalog.

Elec-Trol, Inc., 26477 N. Golden Valley Road, Saugus, CA 91350, (213) 788-7292, (805) 252-8330. TWX 910-336-1556.

# ELEC-TROL

# ELEC-TROL REED RELAYS



## Now! The Miniature 100 WATT "Powermite"!

Elec-Trol now offers the "Powermite" series of Reed Relays - the industry's first line of miniature dry reed relays capable of switching up to **100 watts**, 1 Amp, and 200 VDC.

These super-space-saver "miniatures" (down to .375" wide by 1.125" long by .350" high) are designed for high-wattage applications such as switching the gates of power-switching thyristors, or handling greater lamp and reactive loads.

Powermites are available in the 1 through 4 pole form A Open Line and the totally sealed Encased Line body styles with both .100" X 1.000" and .150" X 1.000" industry standard terminal spacing. Optional features include magnetic shielding and electrostatic shielding.

For more information, use the reader service card. For immediate action, contact your local distributor, representative, or the factory direct:

Elec-Trol, Inc., 26477 N. Golden Valley Road, Saugus, CA 91350, (213) 788-7292, (805) 252-8330. TWX 910-336-1556.

# ELEC-TROL



# ELORG:

## ELECTRONIC COMPONENTS FROM THE U. S. S. R.

Integrated Circuits · Solid-State Devices  
Electronic Tubes · Various Evacuated Electronic  
Devices and Discharge Tubes

Resistors · Capacitors · Ferrite Articles

### COMPLETE DEPENDABILITY FULLY GUARANTEED.

Because they have been put to severe tests in most diverse instrumentations and circuits.

Because they have been most thoroughly designed and elaborated.

Because they have been manufactured with every technological duty meticulously followed and watched. Because they have been checked up by uncompromising Quality Control.

**ELORG embodies huge industrial and scientific potential of the U. S. S. R. in every field of radio-electronics.**

**ELORG displays electronic components at the International Exhibition "WESCON-77" in San Francisco, September 19-21, 1977, Booth 1062**



32/34 Smolenskaya-Sennaya PI  
121200 Moscow  
USSR  
Tel. 251-39-46, Telex 7586

## New products

izing or predetermining mode, go up to 9,999. Typical applications include injection-molding machines, hot-stamping machines, and materials-handling equipment. The TC-100 sells for \$300 and is subject to Schedule A discounts.

Industrial Timer Corp., U. S. Highway 287, Parsippany, N. J. 07054. Phone (201) 887-2200 [379]

### Solid-state timing relay needs little panel space

Designated the Agastat STA, a new solid-state timing relay requires less than two thirds the front-panel space of conventional units, while its tab-type headers fit most popular sockets. The STA also features two light-emitting-diode indicators that show the status of its input and output circuits and aid in circuit checkout and performance monitoring.

The relay is offered in three operating modes, provides a choice of seven ac and dc operating voltages, and has 12 timing ranges that cover a total span of 0.1 second to 60 minutes. Repeatability is within approximately 0.5% and is enhanced by adjustment dials that are calibrated in time increments. In addition to adjustments mounted directly on the relay, versions are available with remote adjustments (external potentiometer) and with fixed time intervals.

The STA's double-pole, double-throw output relay is rated to switch 10 amperes at 28 v dc or 120 v ac. The unit has a reset time of 30 milliseconds, an operating temperature range of  $-20^{\circ}\text{F}$  to  $149^{\circ}\text{F}$ , and transient protection against up to 3,000 v for 100 microseconds.

Amerace Corp., Control Products Division, 2330 Vauxhall Rd., Union, N. J. 07083. Phone (201) 964-4400 [380]



# NEC JUST MADE INTEL'S 8080A TWICE THE MICROPROCESSOR IT USED TO BE.

Introducing the  $\mu$ PDS080AF.  
From NEC Microcomputers.

Now you can get a microprocessor  
that's absolutely identical to Intel's  
8080A.

And we can prove it.

In three separate tests using  
standard Intel programs, conducted  
by three independent laboratories,  
the  $\mu$ PDS080AF was demonstrated  
to be, both parametrically and func-  
tionally, exactly the same as the  
8080A. (The certified results of the  
tests are available upon request).

Which means that now there's a  
microprocessor that's pin for pin and  
program compatible to the Intel 8080A.  
And available in plastic or ceramic.

Of course, we continue to offer

our original  $\mu$ PDS080A—a microproc-  
essor with enhanced arithmetic capa-  
bility and logical flags.

With either an  $\mu$ PDS080AF or  
 $\mu$ PDS080A comes our complete line  
of standard peripheral chips. Plus  
state-of-the-art support chips like the  
8K Electrically Erasable PROM  
( $\mu$ PD458), a Universal Synchronous  
Receiver Transmitter Data Commu-  
nications Controller ( $\mu$ PD379), a  
450ns 32K ROM ( $\mu$ PD332) and a  
Floppy Disc Controller ( $\mu$ PD372).

that can control up to four IBM 3740-  
compatible drives, and a complete  
line of the most reliable memories  
you can buy.

All backed up by applications sup-  
port available nationwide.

The  $\mu$ PDS080AF from us. And  
the 8080A from them.

Even with a program, you won't  
be able to tell them apart.

NEC Microcomputers, Inc., Five  
Militia Drive, Lexington, MA 02173.  
(617) 862-6410.

**NEC microcomputers, inc.**



REPS East—AD Sales 301-274-4376; Central—617-277-1520; Harry Nash Assoc. 215-657-2711; Rome 516-249-0071; Tech-Mark 607-748-7471; 716-223-1211; 5-612-6239; Techni-Logic 314-466-7300; South—Dorsett Assoc. 305-792-2211; 813-585-4327; 305-775-1118; 20th Century Mktg 305-775-9237; Wallace Sales Serv. Co. 816-781-0184; Midwest—Electronic Indicators #1-800-747-1111; Pat Fraligh 817-640-2101; 817-649-2381; 713-775-1577; Interch 216-826-3400; #1-278-6507; K-MAR Eng. & Sales #16-763-5345; R.C. Nordstrom & Co. 313-559-7373; 616-473-8907; Technology Sales 312-438-1380; West—Carver 714-566-3143; 7-Ampco 303-514-3849; Electronic Component Mktg. 714-879-9450; Summit Sales 619-994-4587; Trident Assoc. 408-734-6300; Tri-Tronics 206-714-4343; 507-267-8409; Canada—RFQ Ltd. 416-625-1445; 314-636-8134.

DISTRIBUTORS: A-1 Electronics (Baltimore); Bell Ind. (Bellevue WA); Century Electronics (Albuquerque, Salt Lake City, Wheatridge CO); Diplomat (Chicago Falls MA, Clearwater FL, Elk Grove Village IL, Farmington MI, Minneapolis MI, Laurel NJ, Ball Lake City, St. Louis, Sunnyvale, Totowa NJ, Woodbury NY); Future Electronics (Montreal, Ottawa, Roxdale Canada); Harvey Electronics (Fairfield); Lexington MA; Norwalk CT; Woodbury NY; Inletmark Electronics (San Diego, Santa Ana, Sunnyvale); G.S. Marshall (Sunnyvale); Micro Electronics (Phoenix); Resco (Raleigh); R.M. Electronics (Kenilwood MI, Madison Hgts MI); Semicon (Costa Mesa CA); Semiconductor Specialists (Burlington MA, Chicago, Dallas, Dayton, Farmington MI, Hazelwood MO, Indiana, Kansas City, Milwaukee, Minneapolis, Oshkosh, Mellen Canada); Sterling Electronics (Albuquerque, Dallas, Houston, New Orleans, Phoenix, San Diego, Seattle, Sun Valley CA, Watertown MA); Summit Distributors (El Paso); Summit Electric (Fitchester); Technico (Columbia MD, Roanoke VA); Western Micro Technology Sales (Sunnyvale); Zeus Components (Elmsford NY).

# From Non-Linear Systems, Inc.

## A Professional 15 MHz Oscilloscope for \$289.

### THE NEW MS-15 MINISCOPE

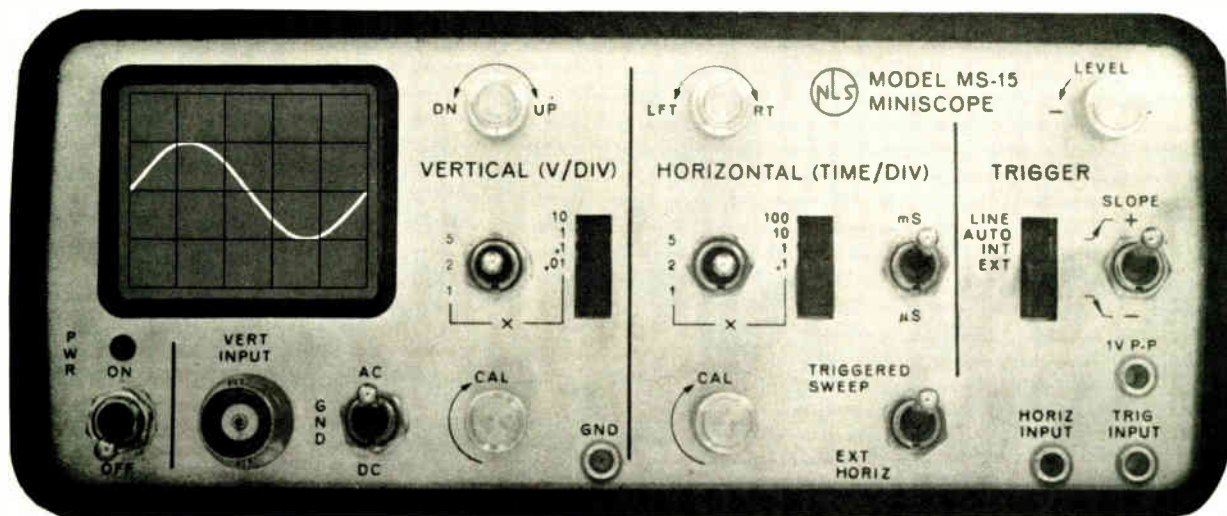

ACTUAL SIZE

The Model MS-15 Miniscope has been designed to provide the basic features associated with more expensive oscilloscopes. Some of these features are: calibrated gain settings, calibrated sweep rates, external synchronization and external horizontal input. A few features of the more expensive 'scopes which we considered to be nonessential were omitted in the interest of economy, portability, reliability and ease of operation.

The MS-15 is the ultimate in state-of-the-art design sophistication and was developed with ruggedness and durability as a matter of prime concern. It is battery or line operated with batteries and charger unit included.

We expect the experienced user to feel comfortable with the MS-15 and to find the instrument capable of performing most of the tasks for which he has used an oscilloscope in the past. We also expect that the inexperienced oscilloscope user will not be intimidated by the multiplicity of controls normally associated with older oscilloscopes and will find it easy to become proficient in using the MS-15.

The Miniscope is a real jewel—try it, you'll like it!

*NLS' 25th Anniversary Year*



**Non-Linear Systems, Inc.**

*Originator of the digital voltmeter.*

Box N, Del Mar, California 92014 Telephone (714) 755-1134 TWX 910-322-1132

Non-glare, high resolution monitor for clarity

THE TELETYPE MODEL 40 PRODUCT LINE OF INTERACTIVE DATA TERMINALS AND LIMITED APPLICATIONS AND WITH ALL YOUR DATA HANDLING SIMPLER, FASTER

THE VERSATILE MODEL 40 IS IDEAL FOR ENTERING, STORING, DISPLAYING AND RECEIVING DATA OVER DIAL-UP SWITCHED POINT PRIVATE LINE FACILITIES.

COMPATIBLE WITH TODAY'S PROTOCOLS, THE MODEL 40 IS HIGHLY ADAPTABLE

Human-engineered typewriter-like keyboard for ease of operation



Perhaps the best printers available in the industry



State-of-the-art CMOS/LSI electronics for outstanding reliability

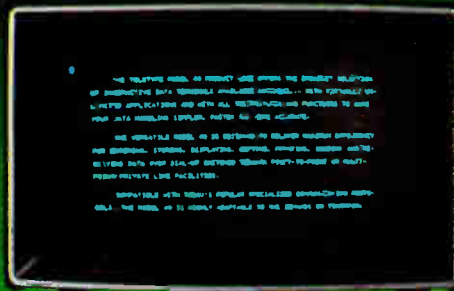
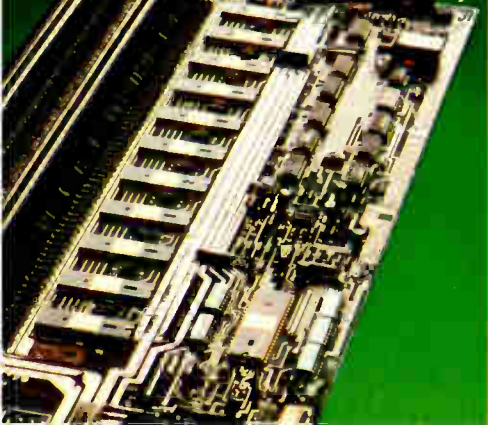

## THE MODEL 40 IS SO GOOD, NOTHING EVEN COMES CLOSE. AND WE CAN PROVE IT, COMPONENT BY COMPONENT.

We're convinced the Teletype® model 40 product line matches—if not exceeds—any data terminal system on the market today. Because on a cost/performance basis, nothing even comes close.

The 40 printer, using a unique design, is incredibly dependable. And its CMOS/LSI drive electronics are so advanced and compact, they fit inside the printer itself on a single circuit card.

Our keyboard is anything but ordinary, too. Naturally, all controls are grouped according to function. But more importantly, the entire unit is human engineered to provide the most in throughput. Not only do the keys impart a typewriter feel, they're also contoured to the shape of the operators' fingers.

We admit we could have cut corners when we designed and built our display tube. But good enough wouldn't have been good enough. So we used a glare reducing screen. Even the display type is specially designed for legibility, with a flicker-free refresh rate of 60 times/second. Character separation and clarity are insured by a large 7 x 9 dot matrix. And the whole unit tilts through 20° for the best viewing angle.

As good as the individual components are, added together they put the model 40 product line in a class by itself. For more information, write or call: Teletype, 5555 Touhy Ave., Skokie, IL 60076. Phone 312/982-2000.



Teletype is a trademark and service mark registered in the United States Patent and Trademark Office.

Circle 217 on reader service card  
World Radio History

# THE STANDARD FOR DOPPLER RADAR NAVIGATION SYSTEMS

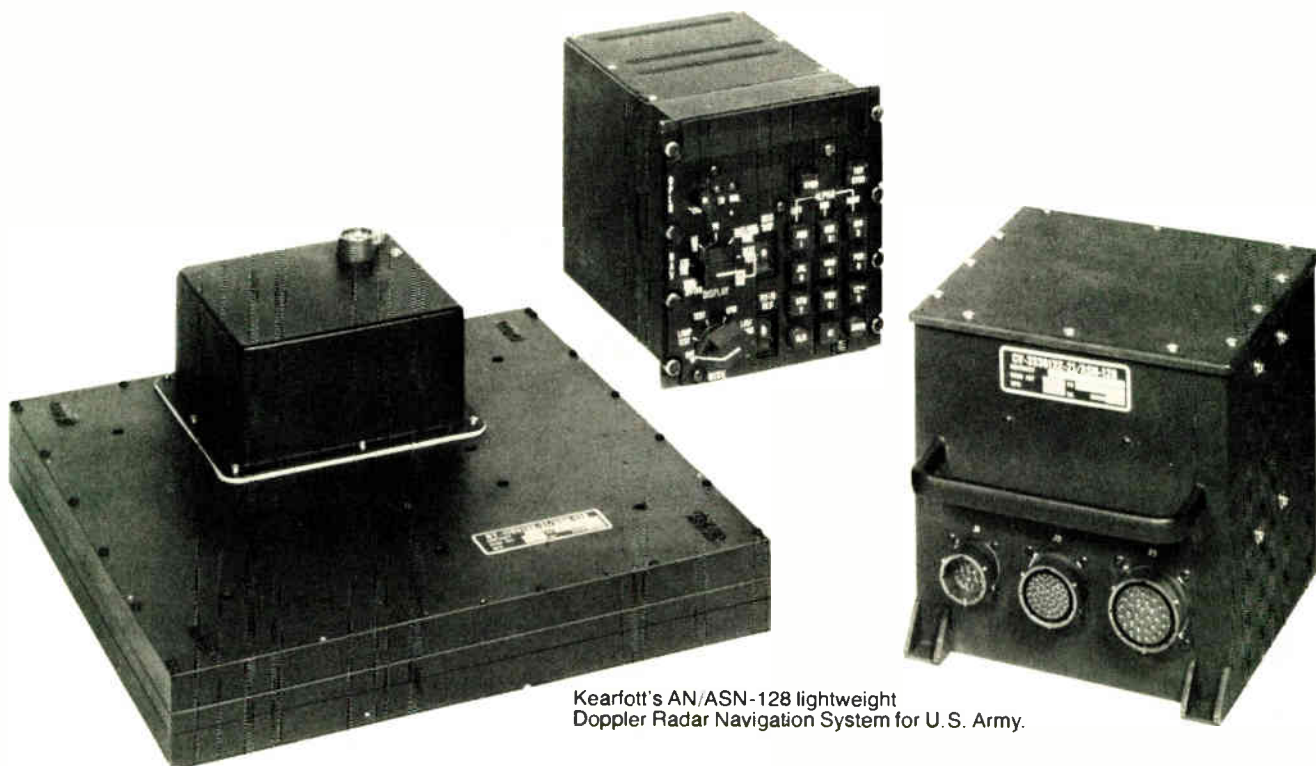

Kearfott's AN/ASN-128 lightweight Doppler Radar Navigation System for U.S. Army.

Kearfott's AN/ASN-128 Lightweight Doppler Navigation System is the U.S. Army's standard airborne doppler navigator.

The Receiver/Transmitter Antenna (RTA) and Signal Data Converter (SDC) constitute the Doppler Radar Velocity Sensor (DRVS), which continuously measures the velocity of the aircraft. The Control Display Unit (CDU) provides control and display functions for the operator, and contains the navigation computer.

With inputs from external heading and vertical references, the ASN-128 system provides accurate aircraft velocity, present position, and steering information. It is completely self-contained and requires no ground based aids.

The DRVS accepts heading, roll, and pitch as synchro inputs and converts them into digital format for transmission to the computer. The DRVS can also be used separately from the ASN-128 to provide velocity inputs to other aircraft equipment.

The CDU accepts beam velocities, heading, roll, pitch and true air speed (in some installations) from the Doppler Radar Velocity Sensor and performs the navigation computations. The front panel includes provisions for entering operator inputs and for displaying system data such as present position, steering information to 10 destinations, and status of the system. The CDU also puts out velocity and navigation data in ARINC digital format.

**The CDU performs three functions for the ASN-128:**

- Provides mode controls, display controls, and keyboard entry of destinations and other data.
- Performs all computations for LDNS including Doppler processing, velocity coordinate transformations, navigation in both UTM and latitude/longitude, steering signals to 10 destinations, and BITE functions.

218 Circle 218 on reader service card

- Displays navigation data on its front panel.
- BITE function identifies and displays failed LRU.
- Provides BCD and binary outputs for external equipment.

### Operational Advantages:

- Weight 28 lb (12.7 kg)
- FM-CW transmission, with Doppler tracking of the J1 sideband providing accurate velocity measurement from ground level, to over 10,000 feet (3,048m).
- Printed-Grid Antenna—"Land-sea" switch eliminated, because of inherent beam shaping.
- Single transmit-receive antenna, utilizing the full aperture for both transmission and reception, minimizing beam width and reducing fluctuation noise.
- Navigation data in both UTM coordinates and Latitude/Longitude.
- Redundant navigation modes for backup.
- Single time-multiplexed signal processor module—only one-fourth the number of components of previous designs.
- Over 2000 hour MTBF for the ASN-128 and over 4500 hour MTBF for the DRVS alone.
- No maintenance adjustments at any maintenance level.
- No special test equipment at the flight line.

For additional information write to: The Singer Company, Kearfott Division, 1150 McBride Ave., Little Falls, N.J. 07424.

## Kearfott

a division of The SINGER Company

Electronics/September 15, 1977



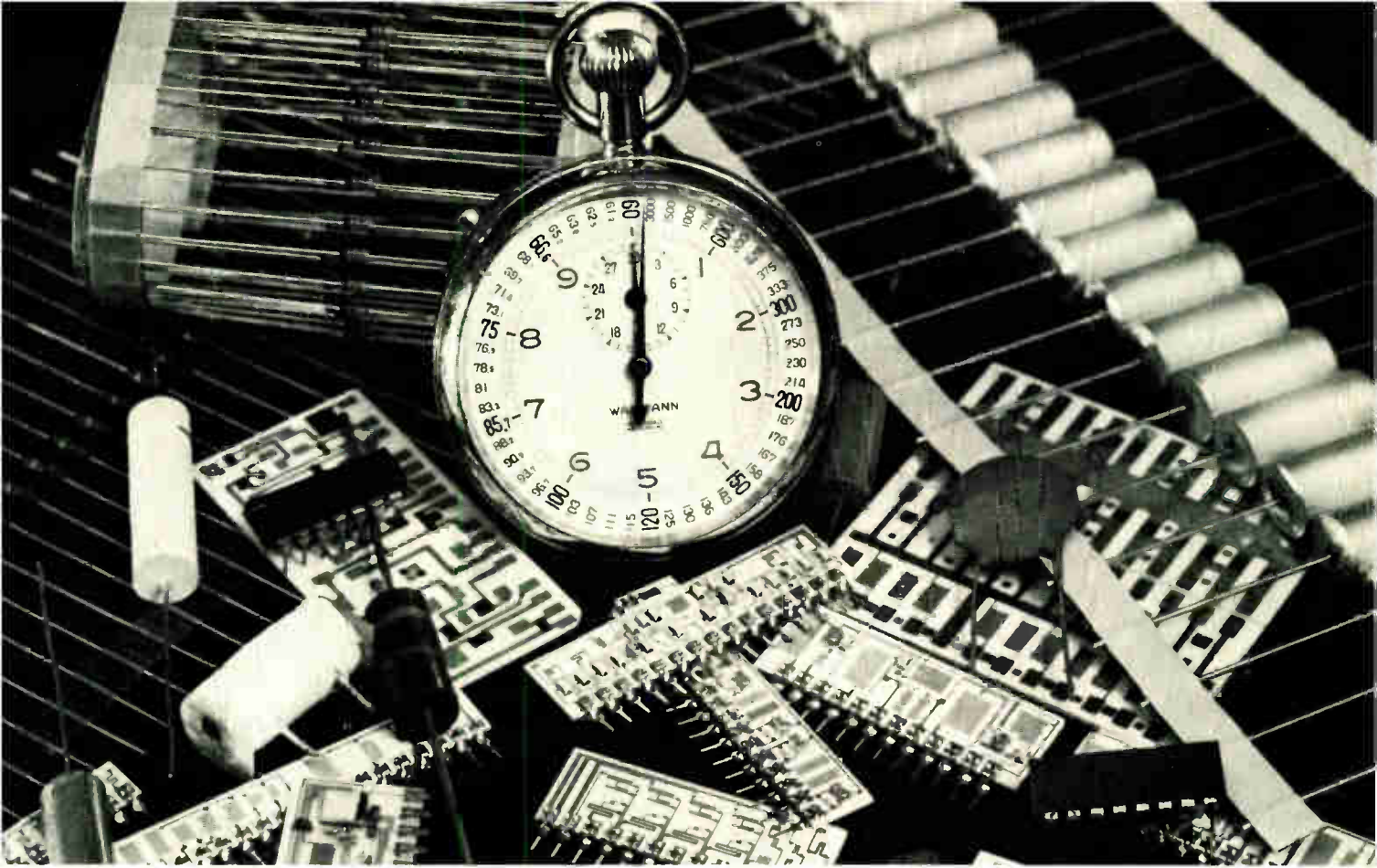

# 80 tests per second with GenRad's 2230

The GR 2230 is the first computer-controlled network and module tester for under \$20,000. This extremely flexible multifunctional circuit tester increases productivity in both manufacturing and incoming inspection areas. It has total programming flexibility and readily interfaces with handlers and other instrumentation.

The 2230 provides:

- mixed R, L, C and dc measurements with individualized test limits
- point to any other point scanning with Kelvin connections
- simple programming with macro-instruction keyboard
- both Go/No-Go and parameter read-out modes of operation
- quick-disconnect device adaptors for various package styles
- data-logging and data-reduction capabilities with hard-copy output
- ease of interface to automatic device handlers
- computer-controlled speed and accuracy at low cost

The 2230 will test:

- thick- and thin-film hybrid circuits
- discrete components on reels
- sequenced components
- diodes and transistors
- small functional modules/circuits
- D/A and A/D converters
- integrated circuits

Contact us now on your specific application requirements.

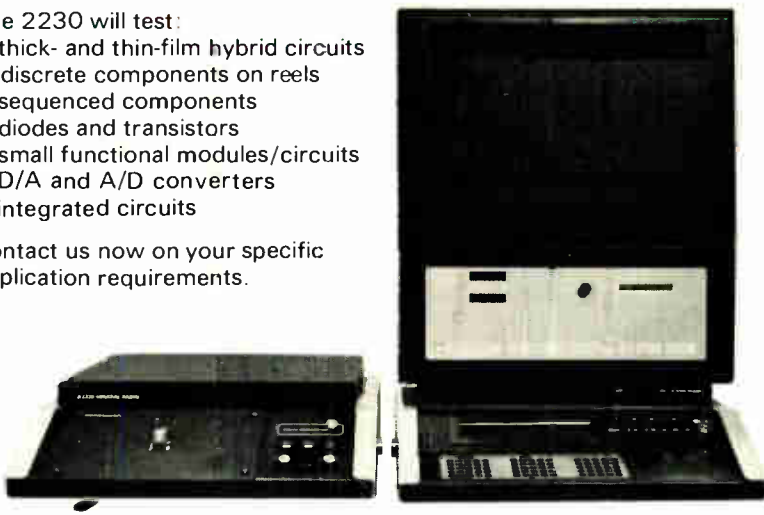

## GenRad

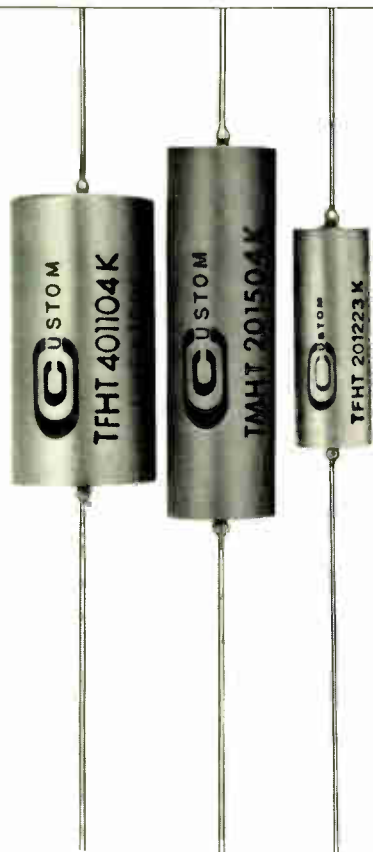

# Precision Film Capacitors

for High Temperature Applications

Standard Series Balco capacitors made of DuPont TEFLON are available in two internal construction styles ideally suited for critical circuits at operating temperatures up to 200°C.

**TFHT** (extended foil) — for use in high power resonant and pulse circuits.

**TMHT** (metallized film) — for resistor coefficient matching and for use in subminiature circuits.

**Performance Features:**

- Insulation Resistance  $10^{10}$  ohms to  $10^{12}$  ohms @ 25°C.
- Dissipation factor to 0.02% @ 25°C
- High Retrace Stability
- Low Dielectric Absorption

For complete specifications, write for FREE Product Bulletin T-1.



CUSTOM ELECTRONICS, INC.  
12 Browne Street, Oneonta, NY 13820  
PH: 607-432-3880 TWX: 510-241-8292

## New products

Instruments

### Logic analyzer, scope combined

Package is designed for troubleshooting microprocessor circuits

Logic analyzers have greatly eased the problem of troubleshooting microprocessor-based circuits, but probably there will always be a need for an oscilloscope to completely check out such circuits. Recognizing this likelihood, Scanoptik Inc., Rockville, Md., has designed a combined logic analyzer-scope unit that is portable and easy to use. It is built in the Tektronix TM-500 series package format.

Called the LC-320 instrument package, it combines a 32-channel-by-64-word logic-state analyzer with a Tektronix type SC-502 15-megahertz dual-trace oscilloscope. Scanoptik slightly modifies the scope and adds interconnecting circuitry to allow simple switching between the logic-analyzer and waveform-display modes.

In the analyzer mode, the user connects 32 leads to his circuitry—16 for the address bus and the other 16 to various data and machine logic-state lines. A 16-bit trigger address can be set on the front panel, and when the state of the address bus corresponds to the trigger address, the analyzer stores the next 64 states of the 32 connection points. It then formats the 64 words into a 64 eight-digit hexadecimal word block for display on the scope. The analyzer will handle microprocessors with clock rates up to 4 MHz.

The scope, which can also be used to display waveforms, can be triggered from the 16-bit address match to show the behavior of various circuit elements and to show timing relationships at a critical point in the program.

Price of the combination is \$4,490. Options are available.

Scanoptik Inc., P. O. Box 1745, Rockville, Md., 20850. Phone (301) 977-9660 [351]

Portable, 4 1/2-digit

DCMM resolves 1 microvolt

Designed for both bench and field use, the 3466A is a five-function 4 1/2-digit multimeter that can resolve 1

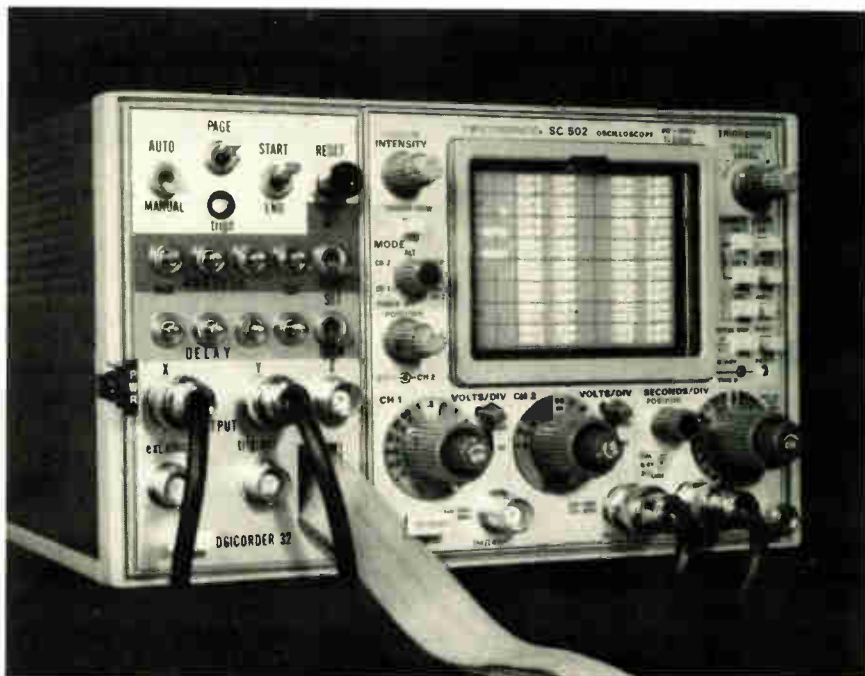

# Did you know that you can save \$1,005 by buying a Fluke 1953A Counter instead?



That's right.

Fluke's 1953A Universal Counter-Timer mainframe plus IEEE Programming option will cost you just \$1,595.\* Instead of the \$2,600 or more you'd pay for comparable models.

And you'll get excellent systems performance plus extras you didn't count on.

Like "clean dropout." If the signal is too small, the 1953A will show zeros. Theirs can give you a wrong reading.

Our frequency range on Channel A is 125 MHz. Theirs is 100 MHz.

Our Z-axis time interval marker is standard. Theirs is optional.

Board access is better on the 1953A. We use one custom I.C. They use many.

Our input capacity on Channels A and B is 30 pF. Theirs is 40 pF. And our Channel B frequency response is 25 MHz. Theirs is 10 MHz.

The 1953A is half the weight, consumes one-fifth the power and makes no noise at all. On theirs you'll hear the fan and switching regulator.

Our switch and control "feel" is as good as theirs, and our front panel labeling is much less confusing.

Where the 1953A shows 9 digits all the time, theirs offers 9 digits only on

Channel C.

And, if you need the option of Parallel BCD for both control and data out, we have it. They don't.

So, if you're in the market for a programmable counter, consider the Fluke 1953A.

And consider how much you'll save.

For data out today, dial our toll-free hotline, 800-426-0361. John Fluke Mfg. Co., Inc., P.O. Box 43210, Mountlake Terrace, WA 98043. Fluke (Nederland) B.V., P.O. Box 5053, Tilburg, The Netherlands. Phone: (013) 673-973. Telex: 52237.

\*U.S. price only

**The 1953A. A programmable counter at a reasonable price.**



For literature only circle 221

# COMPARE THE TOP-RATED 4½-DIGIT DMMs.

Put these three 4½-digit multimeters side-by-side and you'll want the Keithley 172.

The 172 gives you superior accuracy, resolution and convenience with no compromise—at a competitive price.

If you want more evidence, send for our detailed "Comparative Guide to 4½-digit DMMs." The Keithley 172 rates best—not on every factor, but on most.

If you want hands-on proof, put our 172 side-by-side with the Fluke 8600A, HP 3465A, or any other 4½-digit DMM. The Keithley will stand alone.

Check the chart below or make your own comparison, you'll pick the Keithley 172.

**Fluke 8600A**



**HP 3465A**



**Keithley 172**



	Fluke 8600A	HP 3465A	Keithley 172
Functions & Ranging:			
dcV	Auto/Manual	Manual	Auto/Manual
acV	Auto/Manual	Manual	Auto/Manual
dcA	Manual	Manual	Auto/Manual
acA	Manual	Manual	Auto/Manual
ohms	Auto/Manual	Manual	Auto/Manual
Basic Accuracy (dc volts @ 25°C ambient)	±0.02% reading + 1 digit	±0.02% reading + 1 digit	±0.01% reading + 1 digit
Full Range Display (Counts)	19999	19999	29999
HI/LO Ohms	No	No	Yes
Ohms Configuration	2 terminals	2 terminals	2 or 4 terminals
Lighted Function Indicator	No	No	Yes
Price	\$549	\$510	\$525

Comparison based on manufacturers' published specifications. Prices are domestic U.S. for ac line-operated instruments.

It's easy to make your own comparison. Use coupon. Or call (216) 248-0400.

**KEITHLEY INSTRUMENTS**, 28775 Aurora Road, Cleveland, Ohio 44139.  
In Europe: D-8000 München 70, Heighofstrasse 5, West Germany, (089) 7144065.

- Send specs on the Keithley 172. I'll make my own comparison.
- Send "Comparative Guide to 4½-digit DMMs." I need more proof.
- Bring in a Keithley 172 so I can make a side-by-side comparison.

Name \_\_\_\_\_ Title \_\_\_\_\_

Company \_\_\_\_\_

Address \_\_\_\_\_

City \_\_\_\_\_ State \_\_\_\_\_ Zip \_\_\_\_\_

Phone \_\_\_\_\_

**KEITHLEY**  
The measurement engineers.

222 Circle 222 on reader service card

## New products

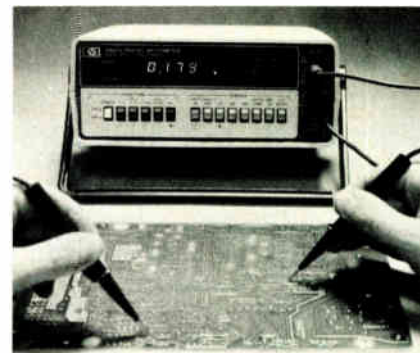

microvolt on its lowest (20-millivolt) dc voltage range. The autoranging instrument makes true-root-mean-square measurements on ac voltages and currents. The operator may select either ac or dc coupling for these measurements, which enables him either to block the dc component or to determine the true-rms value of the combined ac plus dc signal. For dc voltage, maximum midrange error is 0.03% of reading plus 1 count; for ac voltage, it is 0.3% of reading plus 20 counts from 20 hertz to 100 kilohertz.

The 3466A measures ac and dc currents from 200 microamperes full scale to 2 amperes and resistances from 20 ohms full scale to 20 megohms. On its 2-kilohm resistance range, the meter provides a 1-milliampere current source, which can be used to display the forward voltage drop across a diode.

The standard unit sells for \$650 and includes a rechargeable lead-acid battery. A line-only version is priced at \$575. Delivery is from stock.

Hewlett-Packard Co., 1507 Page Mill Rd., Palo Alto, Calif. 94304 [353]

## Function generator offers burst-mode operation

A low-frequency function generator that covers the frequency range from 1 millihertz to 1 megahertz offers single-shot and burst-mode operation as well as normal continuous-wave generation. The model PM5129 produces sine, square, and triangle waveforms that can be varied in amplitude, dc-offset level,

# Your Problem Solvers!



## Special Pots from Spectrol

For more than 20 years, designers with application problems have turned to Spectrol for special pot solutions. They have come to us for • cermet, conductive plastic, and wirewound pots • linears and non-linears • special torque devices • concentric shafts • spring returns • linear motions • pot/switch combinations • element sectors • 1000<sup>o</sup>C pots • Moon pots and Mars pots.

So for help with your tough applications, come to Spectrol. Let us design a "Problem Solver" for you.

**Spectrol**

### SPECTROL ELECTRONICS GROUP

UNITED STATES Spectrol Electronics Corporation 17074 E. Gale Avenue, City of Industry, Calif. 91745, U.S.A. • (213) 964-6565 • TWX (910) 384-7474

UNITED KINGDOM Spectrol Reliance Ltd. Drakes Way, Swindon, Wiltshire, England • Swindon 21351 • TELEX. 44692

ITALY SP Elettronica SpA Via Carlo Pisacane 7, 20016 Pero (Milan) Italy • 35 30 241 • TELEX. 36091

# We cyclo-solder our springs so things get accurately tested out, not thrown out.

A lot of IC's, flexible circuitry and PC boards get tossed away during testing through no fault of their own. The problem lies with test probes that don't provide a low and stable electrical resistance from one end to the other.

The way to make sure you're not throwing away good product is to use Ostby and Barton test probes. You see, our test probes have special cyclo-soldered springs (a proprietary process). This provides one continuous metallurgically bonded unit assuring low and stable electrical resistance throughout their entire length for reliable test results.

Ostby and Barton 1,000,000-cycle guaranteed test probes. Try them once and you'll throw out any others. Mail the coupon for complete data.

## ostby and barton company

487 Jefferson Boulevard, Warwick, RI 02886  
(401) 739-7310 TELEX-927573



Name \_\_\_\_\_  
Position \_\_\_\_\_  
Company \_\_\_\_\_  
Phone \_\_\_\_\_  
Address \_\_\_\_\_

City \_\_\_\_\_ State \_\_\_\_\_ Zip \_\_\_\_\_

Circle 224 on reader service card

# 1977 Answer Book. It makes your job easier. \$25.

Who makes what? Over 4000 products, more than 5000 manufacturers with their local contracts and distributors, directory of trade names and catalogs, post-paid inquiry cards for 5-second ordering of current catalogs.



**Electronics Buyers' Guide**  
1221 Ave. of the Americas  
New York, N.Y. 10020

Yes, send me a copy of The Answer Book. I've enclosed \$25 (USA and Canada only, elsewhere send \$35). Full money back guarantee if returned within 10 days.

Name \_\_\_\_\_  
Company \_\_\_\_\_  
Street \_\_\_\_\_  
City \_\_\_\_\_ State \_\_\_\_\_ Zip \_\_\_\_\_

## New products



frequency, and duty cycle. Its maximum output is 30 volts across 50 ohms; a step attenuator can reduce this figure by up to 68 decibels. The PM5129 sells for \$1,140 and has a delivery time of six weeks.

Philips Test & Measuring Instruments Inc., 85 McKee Dr., Mahwah, N. J. 07430. Phone (201) 529-3800 [354]

## 3 1/2-digit multimeter sells for \$119.95

Shielded against radio-frequency interference, the model 2810 portable 3 1/2-digit multimeter is a five-function instrument that sells for only \$119.95. Among its features are a switch that allows resistance measurements to be made with either a high voltage or a low voltage; the low-voltage position allows in-circuit resistance measurements without biasing semiconductor junctions. All ranges are protected against overloads. The ohms circuitry, for example, can withstand momentary dc or ac-peak overloads of up to 1,000 volts; continuous protection is pro-

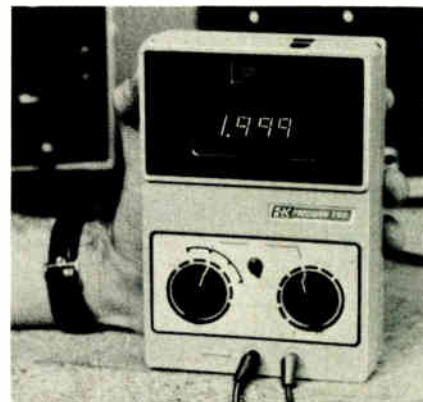

# Here are two ways to measure ceramic capacitor reliability

# 40 15

## Major Hi-Rel Programs

You'll find our ceramic capacitors functioning in some of the toughest environments known to man. Here are just a few of the programs. Space: Surveyor, Mercury, Gemini, Apollo (Command Module, LEM, PLSS). Defense: Minuteman II and III, F-14, F-15 and F-16, Polaris and Poseidon, Sparrow, Hawk and Maverick, F-111 and the B-1 bomber.



## Years of Hi-Rel Experience

Founded in 1960 to supply ceramic capacitors for Hi-Rel programs, we were a technology leader almost from the start. We were the first to develop precious metal alloy electrode systems; the first to automate chip production to meet a proven failure rate level of .001% per 1000 hours; the first to perfect the use of base metals in electrodes. Latest — the totally redundant fail-safe feed-thru capacitor.

Unlike many companies, we do not have separate chip lines for Hi-Rel military and commercial MonoKap products. You get the same high quality in both. And, you can buy MonoKaps right off our distributor's shelves.



**CENTRALAB/USCC**

Electronics • GLOBE-UNION INC.

4561 Colorado Blvd., Los Angeles, CA 90039 (213) 240-4880  
CERAMIC CAPACITORS • FILTERS • THICK FILM CIRCUITS • SWITCHES  
TOUCH SWITCHES • POTENTIOMETERS • TRIMMER RESISTORS

See our complete catalogue in EEM Pages 317-335; and Gold Book Pages 103 to 121 or contact us directly

World Radio History

# How do you resolve two signals spaced 1 Hz apart at 2 MHz?

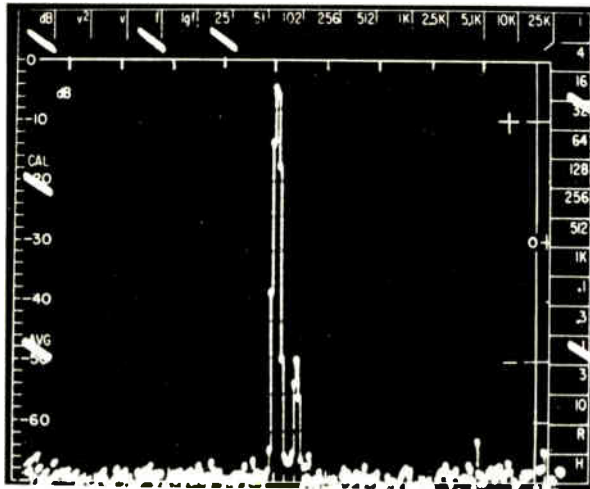

With an EMR Model 1510 Digital Real-Time Spectrum Analyzer and EMR Model 1520 Digital Spectrum Translator. Simply add the optional EMR Model 1521 Range Extension Module to the 1520 Translator, and you have real-time spectrum analysis at frequencies up to 2 MHz!



The CRT photograph illustrates the result. The input signal consisted of two discrete frequencies spaced 1.0 Hz apart, with a 50 dB difference in amplitude. The frequency range covered is 25.6 Hz centered about 1.990000 MHz, and the frequency resolution is 0.1 Hz!

Only EMR offers that much resolution at frequencies up to 2 MHz in real time.

So if you have an analysis problem requiring high-resolution/high-frequency real-time spectrum analysis, contact EMR... we will arrange for a demonstration or detailed information.

Sangamo Weston, EMR Telemetry Division  
P.O. Box 3041, Sarasota, FL 33578  
813-371-0811

**SANGAMO WESTON**  
**Schlumberger**

## New products

vided up to 300 v ac, -450 v dc, and +100 v dc. The meter will operate for more than 40 hours on a set of alkaline batteries. Nickel-cadmium batteries and a charger are available as options. Delivery is immediate from B&K-Precision distributors.

B&K-Precision, Dynascan Corp., 6460 W. Cortland, Chicago, Ill. 60635. Phone Myron Bond at (312) 889-9087 [355]

## Unit generates delays up to 1 ms in 1-ns increments

Capable of generating delays and gate times up to 1 millisecond in 1-nanosecond increments, the model 7065 digital delay generator keeps its jitter below  $\pm 100$  picoseconds. An option extends the maximum range to 1 second. In case the user inadvertently selects a delay time longer than the triggering period, an error-indication lamp will glow as a warning that some of the delay

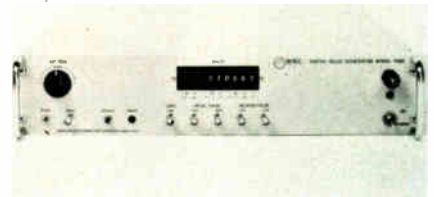

cycles are now being missed.

Standard features of the instrument include input trigger level and slope selection, positive and negative outputs, and output pulse rise times of 3 ns. The 7065 sells for \$2,950 and has a delivery time of four to six weeks.

Berkeley Nucleonics Corp., 1198 Tenth St., Berkeley, Calif. 94710 [356]

## Snap-around ac VOM has 3 1/2-digit display

The latest snap-around ac volt-ohmmeter from A. W. Sperry is a digital unit with a 3 1/2-digit liquid-crystal display. Called the Digisnap, the portable instrument uses its



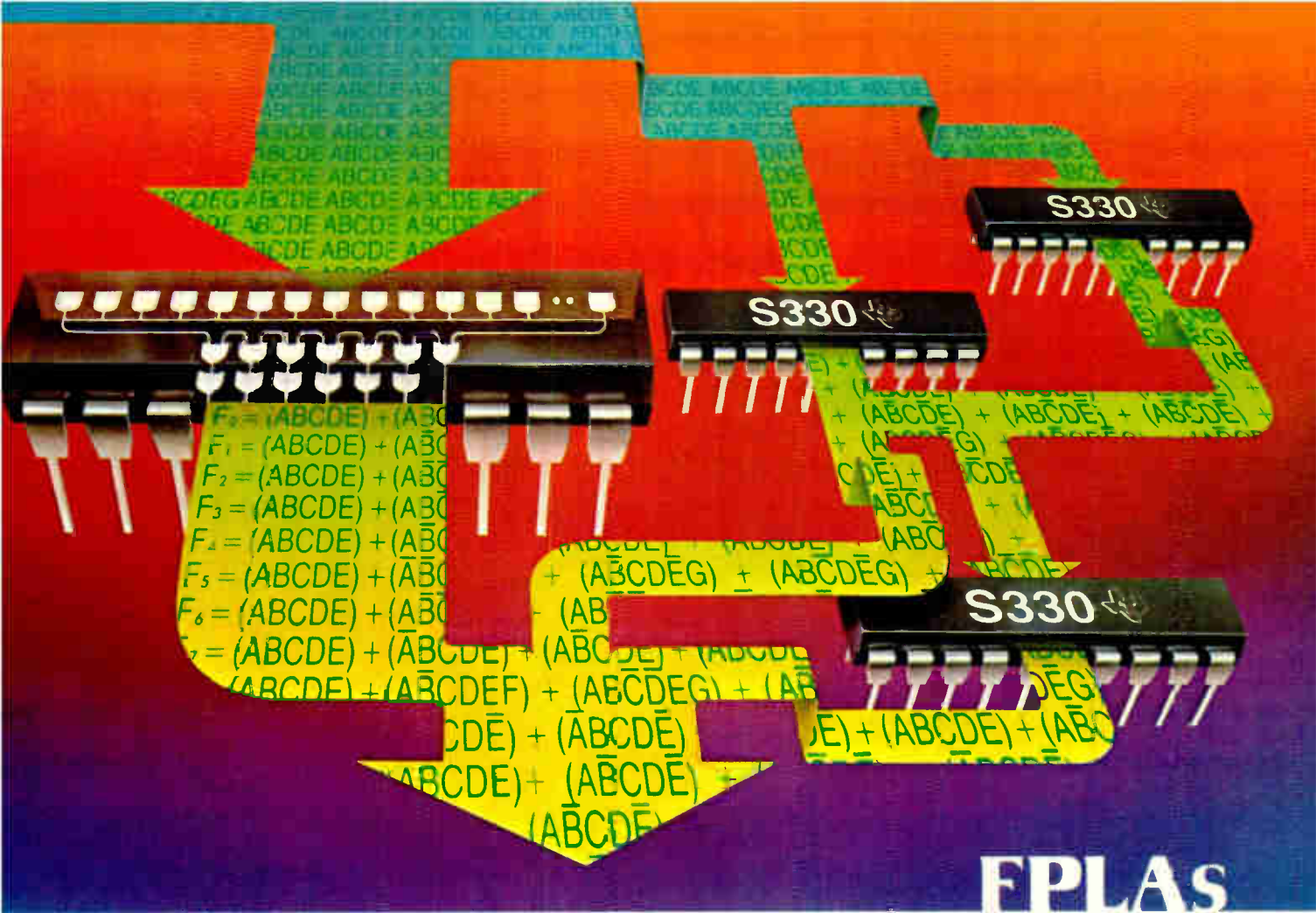

*New dimensions in logic...*

# Field Programmable Logic Arrays. From Texas Instruments.

TI's new S330 and S331 Schottky TTL FPLAs open new dimensions in logic design. They feature a unique built-in capability for multidimensional expansion of the basic 12 input x 50 term x 6 output organization. A flexible means for achieving more efficient designs.

### Automatic enable

A special circuit resides dormant in TI's new FPLAs. Fuse a single link and the FPLA turns "smart". Automatically enabling itself by decoding true product terms. Result: Multidimensional expansion to almost any size array. You expand variables, product terms, and outputs. Without external components, logic or control.

### Efficient, flexible, user programmable

Use these LSI FPLAs to replace standard SSI and MSI logic functions. To implement unique random logic. To supplement PROMs.

They're field programmable. Using proven titanium-tungsten fuse links for fast, low-voltage, reliable programming. You can "wire up" whatever combination of AND, NAND, OR, NOR logic that most precisely fits your design. Reducing design time. Package count. And cost.

### 20-pin Schottky TTL

With the S330 and S331, you get the high performance of TI's

Schottky TTL. Typical delay time: 35ns. Typical enable time: 20ns.

They come in TI's space-saving 20-pin plastic or ceramic packages. For greater board density, greater reliability, lower cost. In both commercial and military applications.

### Useful, economical

The SN54S/74S330 (3-state output) and SN54S/74S331 (2500-ohm passive pullup output) are both available now at \$9.00 for commercial (plastic) versions (100 pieces).

Order today from your TI distributor. Or for more details, write Texas Instruments Incorporated, P.O. Box 5012, M/S 308, Dallas, Texas 75222.



**TEXAS INSTRUMENTS**  
INCORPORATED

# If you want to communicate better by radio,

To: EEV, Chelmsford, Essex, CM1 2QU, England.  
Please send me details of EEV triodes and tetrodes  
for radio transmission.

General information      please tick.  
Or information for equipment type .....

Name \_\_\_\_\_  
Position \_\_\_\_\_  
Company \_\_\_\_\_  
Address \_\_\_\_\_  
\_\_\_\_\_

Telephone \_\_\_\_\_ Telex \_\_\_\_\_

S 5167/EWW

## communicate with EEV.

EEV have an impressive range of triodes and tetrodes for radio transmission.

Made by one of the world's most experienced manufacturers, EEV power tubes have a vast amount of expertise behind them.

And service to match.

The range includes units with glass or ceramic envelopes and powers between 1 kW and 250 kW.

Whether you need tubes for replacement or are designing equipment to take them, remember that one thing is built into every one of our tubes: EEV quality.

If you'd like to know more, please fill in the coupon and send it to us at Chelmsford.

EEV TRIODES AND TETRODES	
BR1161	4CX1000A
BR1162	4CX1500B
BY1161	4CX5000A
C178	4CW10000A
C1108	4CX10000D
C1112	4CX15000A
C1134	4CW25000A
C1136	4CX35000C
CY1170J	
CY1172	

## EEV/M-OV

Members of GEC - turnover £1902 million



ENGLISH ELECTRIC VALVE CO LTD, CHELMSFORD, ESSEX, ENGLAND CM1 2QU. TEL (0245) 61777. TELEX 99103. GRAMS ENELECTICO CHELMSFORD

# When you need LED readout displays or more than LED readout displays...

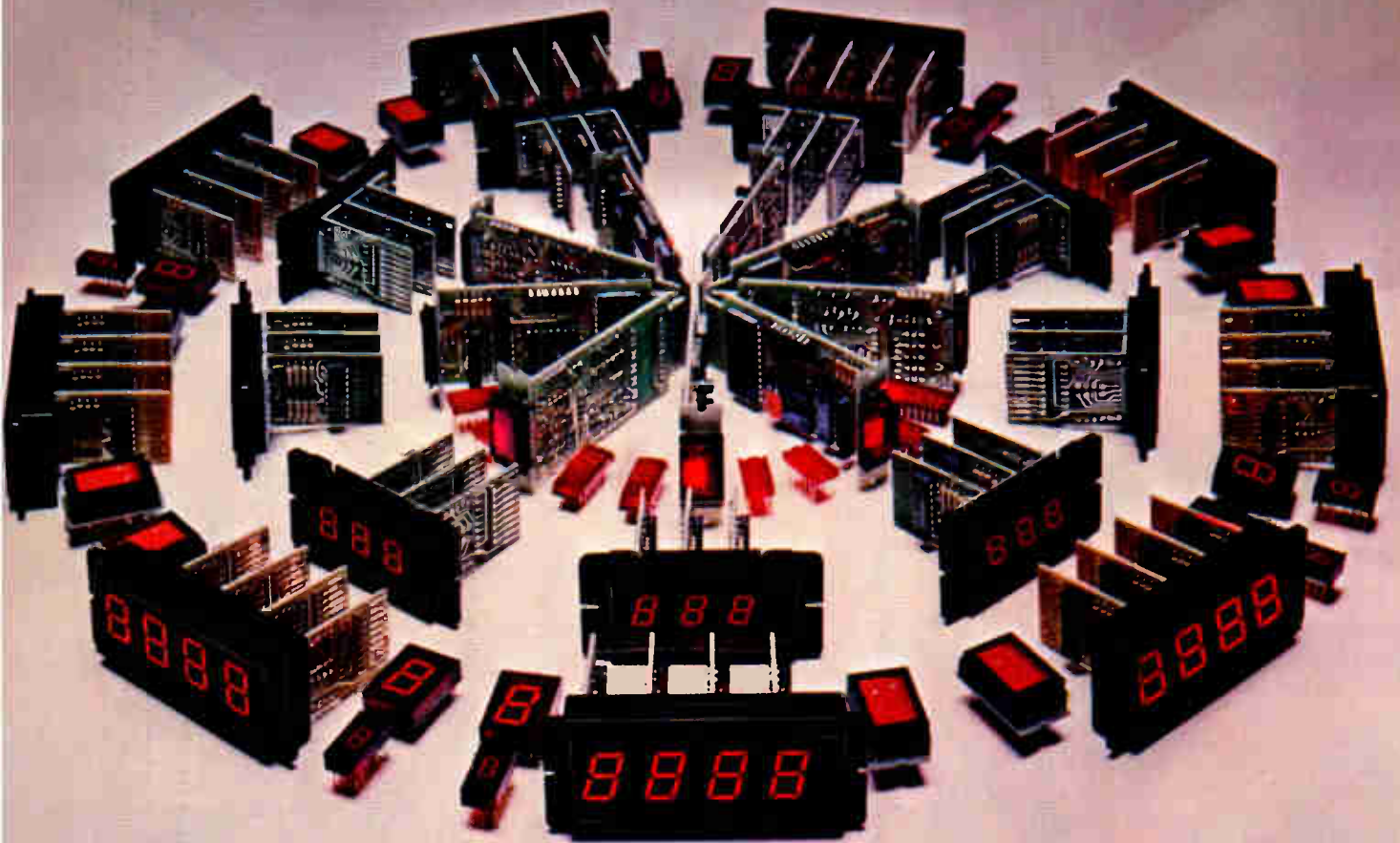

Come to Dialight. For built-in circuitry for example. If that's the type of convenience you're considering, then Dialight's the first place to look . . . because Dialight's the first in value-added LED readout displays.

For many years now we've been offering not only the latest technology, but also the latest in time and labor-saving pre-engineered displays. These can be ordered any way you wish: with or without on-board decoder/driver, with or without code generator, in any

number of digits in an assembly, complete with bezel for instant panel mounting.

We also offer high brightness, low cost design flexibility with a choice of discrete and assembly displays with character heights of .270", .300" and .600".

For your free copy of our new Readout Product Selector Guide, call or write to us at Dialight today.

**DIALIGHT**

A North American Philips Company

## Dialight meets your needs.

Dialight, 203 Harrison Place, Brooklyn, N.Y. 11237 (212) 497-7600

World Radio History

Circle 229 on reader service card

# NO BRIDGE TOO FAR.

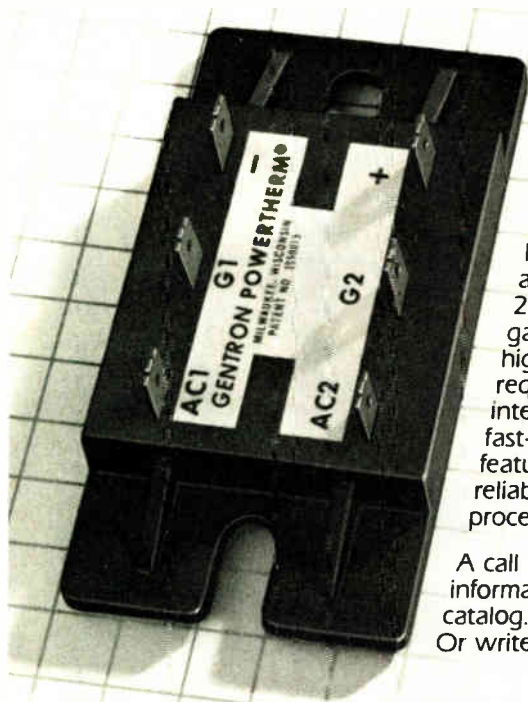

Gentron spans the entire spectrum of SCR bridge circuits

Here's our newest family addition: the 15-amp and 25-amp B series. Bridges the gap where small size, low cost, high thermal efficiencies are required. Choose either interconnect option: wires or fast-on terminals. The B series features the proven and reliable POWERTHERM process.

A call will bring complete information and our new color catalog. Dial (414) 351-1660. Or write us today.

## GENTRON CORPORATION

6667 N. Sidney Place • Milwaukee, Wisconsin USA 53209

Circle 230 on reader service card

## New products



display to indicate overload conditions, low battery voltage, and the type of measurement being made, as well as the numerical value of the parameter.

The meter is powered by a 50,000-hour rechargeable battery pack that will operate the meter for 50 hours on one charge. Accuracy is within 1% of full scale for voltage and resistance readings and 2% of full scale for current measurements. The instrument also has a peak mode of operation for voltage and current in which the maximum error rises to 3% of full scale. A data-lock push button allows the user to freeze the reading for examination in a convenient position. Called the model DSA-1000, the meter is protected against overloads and covers the frequency range from 50 to 400 hertz.

A. W. Sperry Instruments Inc., 245 Marcus Blvd., Hauppauge, N. Y. 11787. Phone (516) 231-7050 [358]

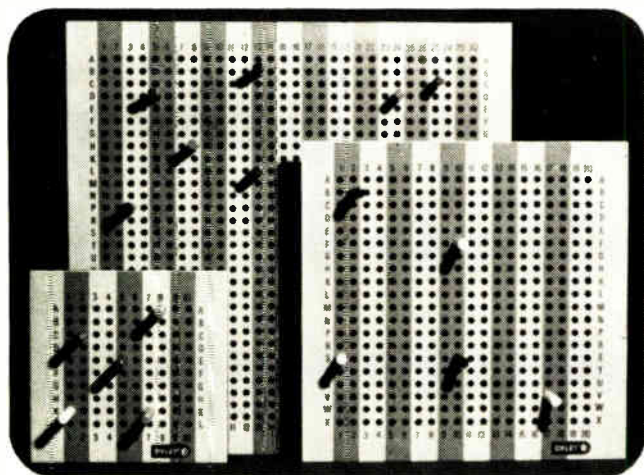

**OXLEY** make complex programmes as simple as A, B, C and 1, 2, 3 ...with **CONTROLOX** logic

CONTROLOX matrix plug board system is in constant world-wide demand because of its versatility. It reduces complex circuit change to simple re-positioning of plugs. The matrix system can have continuous or interrupted spacing. Standard 5mm pitch makes it simple to manipulate without special tools, giving optimum performance with reasonable compromise between small size, ease of handling and high contact quality, whilst also permitting inclusion of diodes in the pins. Up to 10 planes of contact can be supplied. Available with fascia panels designed and coloured to specific requirements.

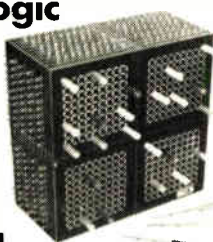

## STAND 1016/8 WESCON

Oxley Incorporated PLAZA SUITE 900, 3250 WILSHIRE BOULEVARD  
LOS ANGELES, CALIFORNIA 90010 PHONE (213) 383 8270 TWX 1 910 321 2903

**OXLEY** Oxley Developments Co. Ltd.

ULVERSTON · CUMBRIA · LA12 9QG · ENGLAND  
CABLES OXLEY ULVERSTON · TELEX 65141 · TELEPHONE 0229 52621

Function generator sweeps across 100,000:1 range

Capable of sweeping over a 100,000:1 frequency range, the mod-

# SORENSEN IS THE SOURCE.

## FOR A COMPLETE LINE OF HIGH QUALITY POWER SUPPLIES

... that are priced right, immediately available, conservatively designed and rated, and covered by Sorensen's full warranties.

Sorensen. For a complete line of modules, lab supplies, assemblies, AC regulators, open frame, encapsulated and D/A programmers.

Sorensen Company,  
676 Island Pond Rd.,  
Manchester, N.H.  
03103.  
(603) 668-4500.

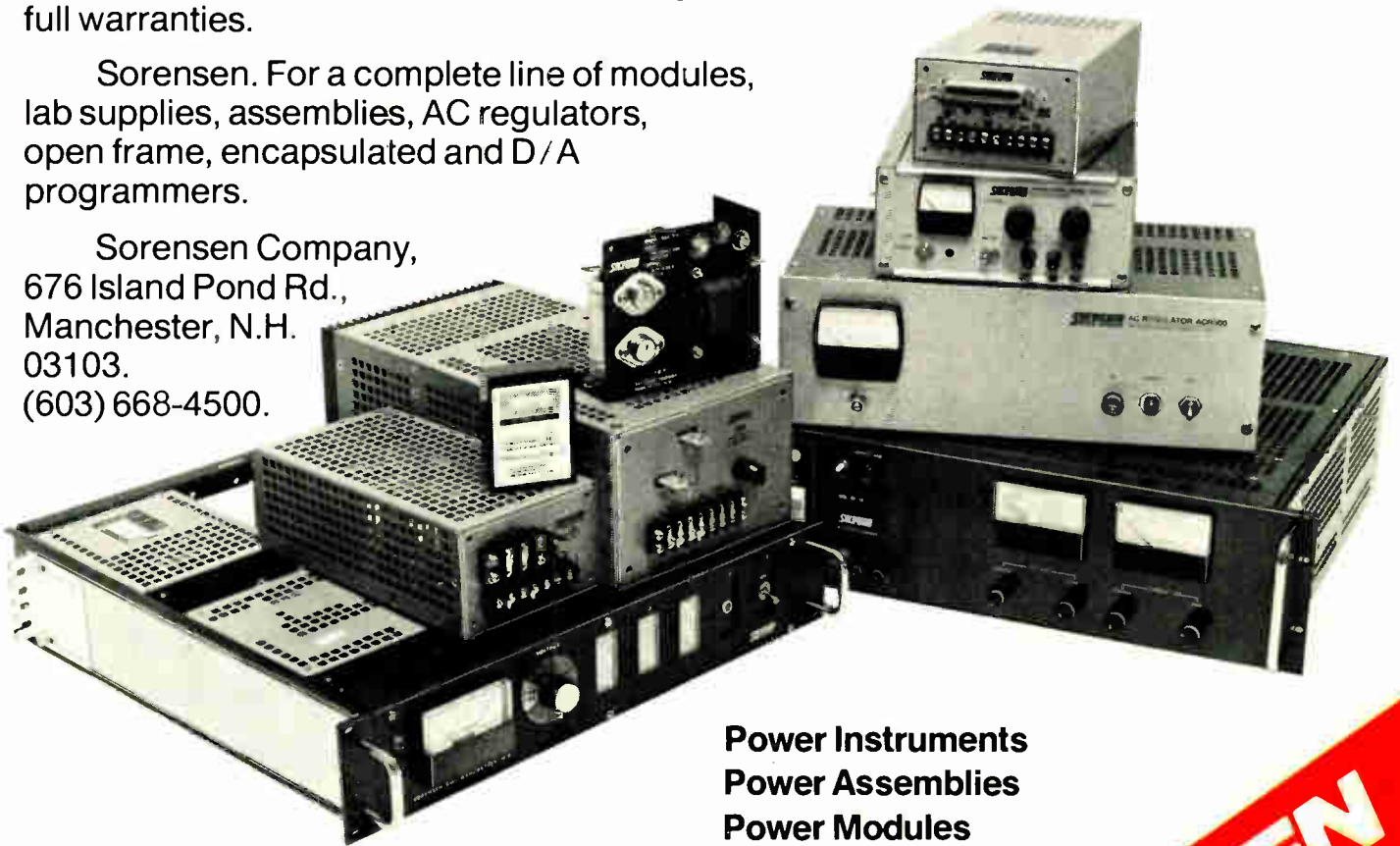

Power Instruments  
Power Assemblies  
Power Modules

See us at Booth  
#1443-1445  
Wescon '77  
San Francisco, Sept. 20-23

**SORENSEN**  
POWER SUPPLIES

A Raytheon Company

**SPRAGUE  
GOODMAN**

# TRIMMER CAPACITORS

Our only business!



## PISTONCAP® Multi-Turn Tubular

- Low-Loss, Glass or Quartz
- High Stability/High Reliability
- Simple, Long-Life Adjust Mechanism
- Professional / Military Applications, MIL Approved

## CERAMIC Single-Turn

- Compact, Conserves Board Space
- Variety of Mounting Configurations
- Low Cost for Commercial/Industrial Applications

## FILMTRIM\* Single-Turn Film

- PTFE, Polypropylene, Polycarbonate
- Most Stable Trimmer for Size
- Very Wide Capacitance Ranges
- Low Cost for Commercial/Industrial Applications

\*Trade Mark

Tired of broken delivery promises and poor quality? Deal with the trimmer capacitor specialist, for quality products delivered on schedule! Call on us for custom designs too, we deliver!

TRIMMER CAPACITORS — OUR ONLY BUSINESS!

## Sprague-Goodman Electronics, Inc.

(An Affiliate of the Sprague Electric Company)

134 FULTON AVE., GARDEN CITY PARK, N.Y. 11040 • 516-746-1385 • TLX: 14-4533

PLEASE VISIT OUR BOOTH 1431 AT WESCON. Circle 232 on reader service card

THE NUMONICS  
**1224**  
INTELLIGENT  
DIGITIZER

PUTS  
GRAPHICS  
ON SPEAKING  
TERMS WITH YOUR  
COMPUTER FOR UNDER  
\$ 4000.

At last. An electronic graphics calculator that adds the program and memory power of a micro-computer and front-end digitizer. One easy-to-operate unit that's both portable and programmable for custom application and on-site use. Input data via the alpha numeric keyboard or the Electronic Digitizer itself. Data goes directly to the micro-processor for calculations, output to a 16-digit display and/or computer interface. And you've a choice of either character serial or EIA-RS232C output formats standard. Data batching, axis rotation, scaling, point-to-point area and length measurements. . .with the Numonics 1224's library of field changeable programs, we can put your computer on speaking terms with graphics. At less than \$4000. May we tailor one for you?

**NUMONICS** 418 Pierce St., Lansdale, Pa. 19446 (215) 362-2766

232 Circle 708 on reader service card

## New products

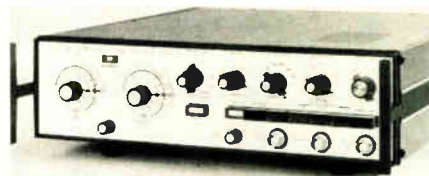

el 508 5-megahertz function generator is really two generators in one. The main unit, which can be frequency-controlled by an external voltage, covers the range from 0.1 millihertz to 5.5 MHz producing sine, square, triangle, pulse, haversine, and havertriangle waveforms. The other generator produces ramps with periods from 10 microseconds to 100 seconds and is used for direct output as well as for sweeping, triggering, and gating the main generator.

When the main generator is swept by the ramp generator, frequency ranges of up to 1,000:1 can be covered linearly. A logarithmic mode allows the 100,000:1 range.

In its pulse-generator mode, the model 508 uses its ramp generator to trigger the main unit to produce pulses of either polarity. In this application, the ramp generator can be free-running, or it can be triggered either manually or by an external signal.

In addition to being operated under control of the ramp generator, the main generator can also be swept manually or by an external voltage. Its start- and stop-frequency dials can be used to provide 10-turn resolution, single-turn resolution with 1,000:1 linear coverage, or single-turn resolution with 100,000:1 logarithmic coverage. Light-emitting diodes, visible through the dials, indicate both the mode of operation and the frequency setting. Improper combinations of control settings cause the LEDs to flash. Priced at \$745, the model 508 has a delivery time of 45 days.

Exact Electronics Inc., P. O. Box 160, Hillsboro, Ore. 97123. Phone (503) 648-6661 [357]

Circle 223 on reader service card →

**Electronics**/September 15, 1977

# MORE **NEW** SEMICONDUCTORS FROM LAMBDA

## **NEW** 30 AMP MONOLITHIC FULL-WAVE, CENTER-TAP RECTIFIERS



Replaces two stud rectifiers

Up to 200V PIV: 30 amps.

Available in common-cathode and common anode arrays in a TO 3 package.  
Designed for and used in Lambda's 5-year guaranteed power supplies.

### BETTER THAN MOTOROLA!

Parameter	Compare these specifications		Units
	Lambda PMR35K200	Motorola 1N1186	
$V_{RRM}$	200	200	Volts
$I_o$ (Avg)	30	35	Amps
$I_{2T}$	600	—	$A_{TMS}^2S$
$I_{SEM}$	400	400	Amps
$V_F$ @ $I_o$	1.4	1.3	Volts
$T_{J-STG}$	-65° to +200°	-65° to +175°	°C
Quantity required for full-wave center-tap bridge	1	2	—
Price quantity 100 for full wave center tap bridge	3.15 ea.	2.24 ea. (2 needed)	—

## **NEW** 2 AMP MONOLITHIC OVERVOLTAGE PROTECTORS No external components needed.



\$1.70 Qty. 1000

# LAMBDA'S MONOLITHIC FULL-WAVE PMR 27, 31, 35, 36 CENTER-TAP RECTIFIERS TO 3 Package Replaces two stud mount rectifiers.

## GENERAL DESCRIPTION

The PMR 27K, PMR 31K series and PMR 35K, PMR 36K series of devices are center tapped Common Cathode, Common Anode rectifiers designed for use in power supplies. They are designed for 15 Amp and 30 Amp average current applications requiring 200V, 100V, or 50V peak inverse voltage. Both devices are Monolithic construction.

## ABSOLUTE MAXIMUM RATINGS

	PMR27K050 PMR31K050	PMR27K100 PMR31K100	PMR27K200 PMR31K200	PMR27K400 PMR31K400	PMR35K050 PMR36K050	PMR35K100 PMR36K100	PMR35K200 PMR36K200	UNITS
$V_{RRM}$ —Maximum Repetitive Peak Reverse Voltage	50	100	200	400	50	100	200	Volts
$I_{R(RMS)}$ —Maximum RMS Reverse Current	35	70	141	282	35	70	141	Volts
$I_{FM}$ —Average Rectified Forward Current	15	15	15	15	30	30	30	Amps
$I_{SM}$ —Peak Non-Repetitive Surge Current (1/2 cycle)	250	250	250	250	400	400	400	Amps
$T_{RAT}$ —Rating—Non-Repetitive for $t_{MS} < 1 < 8.3mS$	240	240	240	240	600	600	600	$A_{RMS}^2 S$
$P_D$ —Power Dissipation Total Package Derate @ 1W/°C above 50°C	150	150	150	150	150	150	150	Watts
$T_{STG}$ —Operating and Storage Temperature			-65 to +200					°C
$\theta_{JC}$ —Thermal Resistance Junction to Case	1.0	1.0	1.0	1.0	0.67	0.67	0.67	°C/W

ELECTRICAL CHARACTERISTIC ( $T_J$  0°C to 200°C)

	MIN	MAX	
$V_f$ (av)—Full Cycle Average Forward Voltage Drop, $I_o = 15A$ (PMR 27/31); $I_o = 30A$ (PMR 35/36)		1.4	Volts
$I_{FM}$ —Maximum Reverse Current at $V_{RRM}$ , each diode		10	mAdc

## ORDERING INFORMATION

COMMON CATHODE	COMMON ANODE	$V_{RRM}$	$I_o$	1	100	PRICE QTY		
						250	1000	2500
PMR 27K 050	PMR 31K 050	50	15	2.08	1.25	1.10	.95	.91
PMR 27K 100	PMR 31K 100	100	15	2.15	1.30	1.15	1.00	.96
PMR 27K 200	PMR 31K 200	200	15	2.25	1.35	1.20	1.05	1.00
PMR 27K 400	PMR 31K 400	400	15	2.75	1.65	1.50	1.27	1.21
PMR 35K 050	PMR 36K 050	50	30	4.75	2.85	2.57	2.18	2.10
PMR 35K 100	PMR 36K 100	100	30	5.00	3.00	2.70	2.30	2.20
PMR 35K 200	PMR 36K 200	200	30	5.25	3.15	2.83	2.42	2.30

Contact the factory for higher quantity prices.  
Device configurations, Specifications, and prices subject to change without notice.

## OUTLINE DRAWINGS

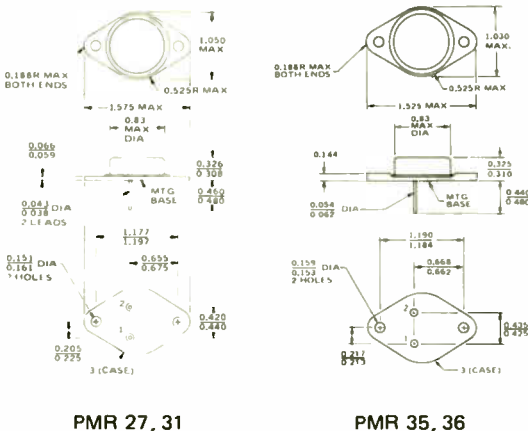

## PIN CONNECTIONS

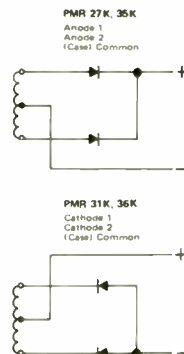

## OPERATION DATA

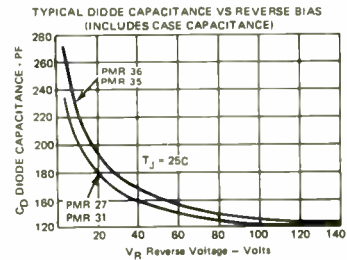

TYPICAL DIODE CAPACITANCE VS REVERSE BIAS (INCLUDES CASE CAPACITANCE)

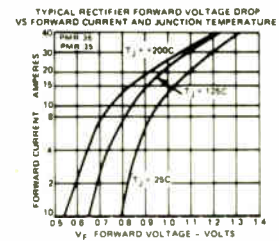

TYPICAL RECTIFIED FORWARD VOLTAGE DROP VS FORWARD CURRENT AND JUNCTION TEMPERATURE: PMR 35,36

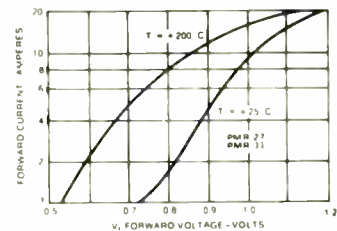

TYPICAL FORWARD VOLTAGE VS CURRENT: PMR 27,31

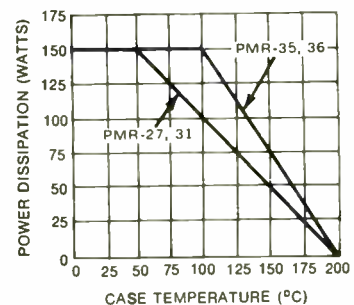

POWER DERATING



# OUTLINE DRAWING

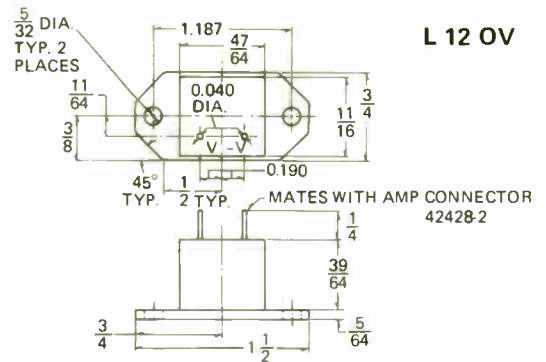
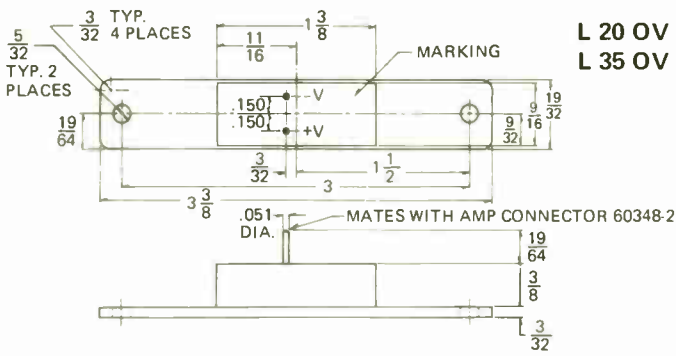

## OUTLINE DRAWING

## HYBRID OVERVOLTAGE PROTECTOR SCHEMATIC DIAGRAM

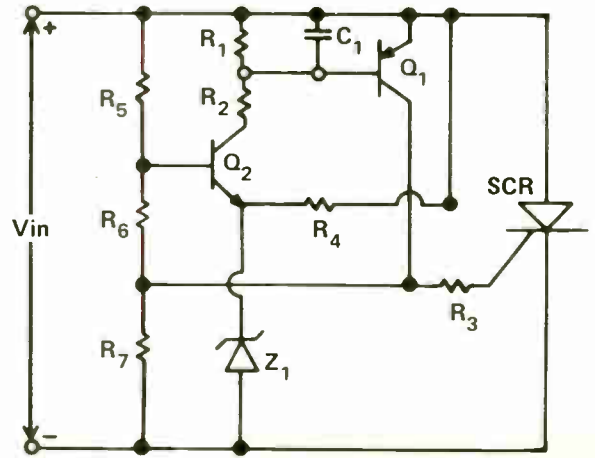
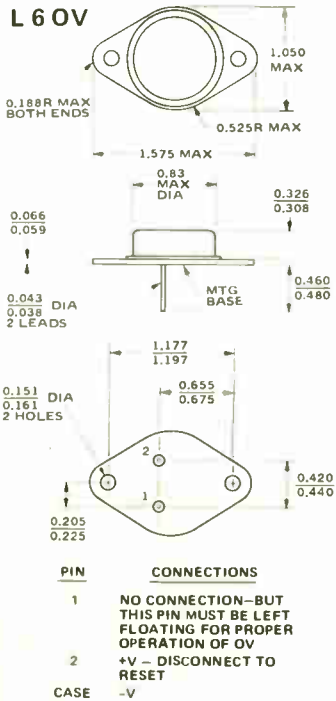
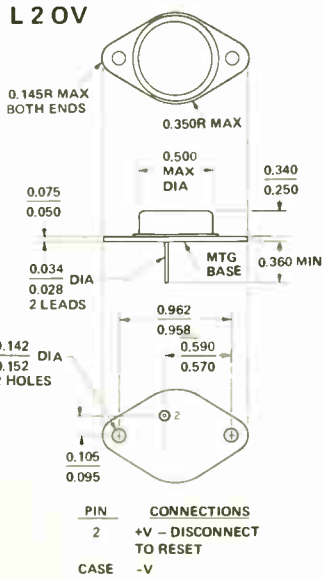

# ▲ Lambda staffed sales and service offices

**1**  
**MID-ATLANTIC REGION**  
 Melville, New York 11746  
 515 Broad Hollow Road  
 Tel. 516-694-4200  
 TWX: 510-224-6484

Long Island, N.Y.; New York, N.Y.;  
 Northern New Jersey  
 Tel. 516-694-4200

Delaware; Eastern Pennsylvania;  
 Southern New Jersey  
 Tel. 215-279-5644

Maryland; Dist. of Columbia;  
 Northern Virginia  
 Tel. 703-451-9340

Southern Virginia;  
 North & South Carolina;  
 Alabama; Georgia;  
 Tennessee; Mississippi  
 Tel. 704-542-1991

**2**  
**NORTH-EASTERN REGION**  
 Lexington, Massachusetts 02173  
 2 Militia Drive  
 Tel. 617-861-8585  
 TWX: 710-326-7558

Rochester, New York  
 Tel. 716-454-6770

Poughkeepsie, New York  
 Tel. 914-297-4800

**3**  
**SOUTH-WESTERN REGION**  
 Dallas, Texas 75231  
 6950 Winchester  
 Tel. 214-341-5130  
 TWX: 910-861-9048

Houston, Texas  
 Tel. 713-464-6554

Oklahoma  
 Tel. Enterprise 2 183

Largo, Florida  
 Tel. 813-596-5151

**4**  
**MID-WESTERN REGION**  
 Arlington Heights, Ill. 60005  
 2420 East Oakton St., Unit D  
 Tel. 312-593-2550  
 TWX: 310-222-2856

Minneapolis, Minnesota  
 Tel. 612-935-6194

Cleveland, Ohio;  
 Western Pennsylvania  
 Tel. 216-585-7808

**5**  
**FAR-WESTERN REGION**  
 Carson, Calif. 90746  
 20601 S. Annalee Ave  
 Tel. 213-537-8341  
 TWX: 910-346-7649

Denver, Colorado  
 Tel. 303-779-9561

**6**  
**NORTH-WESTERN REGION**  
 Sunnyvale, California 94086  
 599 N. Mathilda Ave., Suite 210  
 Tel. 408-738-2541  
 TWX: 910-339-9243

**INTERNATIONAL**  
 Lambda Electronics Corp. Export Dept.  
 515 Broad Hollow Road  
 Melville, N.Y. 11746  
 Tel. 516-694-4200  
 TWX: 510-224-6484  
 Cable: Lambdatron, Melville, N.Y.

**ENGLAND**  
 Lambda Electronics  
 Abbey Barn Road, Wycombe Marsh  
 High Wycombe, Bucks HP 11 1RW  
 Tel. High Wycombe 36386/7/8  
 TWX: B37153  
 Cable: VEELAM HIWYC

**CANADA**  
 Veeco Lambda Ltd.  
 100C Hymus Blvd.  
 Pointe Claire, Quebec H9R 1E4  
 Tel. 514-697-6520  
 TWX: 610-422-3029

Veeco Lambda Ltd.  
 P.O. Box 501, Postal Station K  
 Toronto, Ont., M4P 2G9  
 Tel. 416-486-0794

**FRANCE**  
 Lambda Electronique S.A.  
 Route de Grivery  
 91 Gometz le Chatel  
 Address Postale: BP 77 91403 Orsay  
 Tel. 012 1487

**GERMANY**  
 Lambda Netzgerate GmbH  
 Lindenstrasse 93  
 D 7590 Achern 15  
 Tel. 078 41 5527  
 Telex 752209 Lake D

**ISRAEL**  
 IsLAMBDA ELECTRONICS LTD.  
 85 King Solomon St.  
 Tel Aviv, Israel  
 Tel. 240 672  
 TWX: 03 2470 COIN (IL) LAMBDA

**JAPAN**  
 Pan Electron Inc.  
 1 Higashikata-Machi, Midori-Ku  
 Yokohama, Japan  
 Tel. 045-471-8811

**LAMBDA MANUFACTURING PLANTS**  
 Melville, N.Y.  
 Plant I: 515 Broad Hollow Rd.  
 Plant II: 1770 Walt Whitman Rd.  
**Reynosa, Mexico**  
 Corpus Christi, Texas  
 121 International Dr.

**POWER SEMICONDUCTORS  
 DESIGNED, DEVELOPED  
 AND MANUFACTURED BY**



**▲ LAMBDA  
 ELECTRONICS**

# L 2 OV, L 6 OV, L-12-OV, L-20-OV, L-35-OV SERIES

## Lambda Overvoltage Protectors Monolithic & Hybrid - No external components needed

### GENERAL DESCRIPTION

The Lambda overvoltage protector prevents damage to the load caused by excessive power supply output voltage due to improper adjustment, improper connection, a disconnected sense lead, or failure of the power supply. Load protection is accomplished by effectively short circuiting the output terminals of the power supply when a preset limit voltage has been exceeded. The trip-point limit voltage cannot be adjusted. To reset overvoltage protector, remove AC input to power supply, allow overvoltage protector to cool, and reapply power.

### OVERVOLTAGE PROTECTOR ABSOLUTE MAXIMUM RATING

PARAMETER	SYMBOL	L2 OV SERIES		L6 OV SERIES		L-12-OV SERIES		L-20-OV SERIES		L-35-OV SERIES	
		MIN	MAX	MIN	MAX	MIN	MAX	MIN	MAX	MIN	MAX
In State Current	$I_{DC}$		2A	-	6A	-	12A	-	20A	-	35A
In State Voltage	$V_{DC}$		2.6V	-	2.6V	-	1.3V	-	1.4V	-	1.6V
Non-Repetitive Peak Surge Current*	$I_P$		20A	-	70A	-	200A	-	260A	-	350A
Standby Current	$I_S$		35mA	-	25mA	-	5mA	-	5mA	-	5mA
Operating Temperature (Blocking)**	$T_{CB}$	-40°C	+100°C	-40°C	+100°C	-40°C	+100°C	-40°C	+100°C	-40°C	+100°C
Operating Temperature (Conducting)***	$T_{CC}$	-40°C	+150°C	-40°C	+150°C	-40°C	+140°C	-40°C	+140°C	-40°C	+140°C
Storage Temperature	$T_S$	-40°C	+150°C	-40°C	+150°C	-40°C	+125°C	-40°C	+125°C	-40°C	+125°C
Power Dissipation @ $T_C = 25^\circ C$	$P_D$		30 Watts		150 Watts						
Derate @ 1.5W/°C above 50°C											
Thermal Resistance	$R_{\theta JC}$		5.0°C/W		1.0°C/W						

\*For sinusoidal current duration of 8.3 milliseconds max.

\*\*Case temperature for overvoltage protector in non-conducting or "OFF" state.

\*\*\*Case temperature for overvoltage protector in conducting or "ON" state. Power must be removed and case temperature allowed to drop to 100°C before application of output voltage.

The overvoltage protector requires an external heat sink to maintain case temperature below rated limit. When the overvoltage protector is used with a Lambda power supply, the power supply chassis acts as the heat sink. The L-12-OV, L-20-OV, L-35-OV, overvoltage protector is supplied with mating connectors for pins on overvoltage protector (+V and -V engraved on unit.).

### ORDERING INFORMATION

NOM SUPPLY VOLTAGE (VOLTS)	TRIP POINT VOLTAGE <sup>A</sup> (VOLTS)	2 AMP MODELS	PRICE				6 AMP MODELS	PRICE			
			QTY 1	QTY 100	QTY 250	QTY 1000		QTY 1	QTY 100	QTY 250	QTY 1000
5	6.6 ± .2	L2 OV 5	\$2.50	\$2.00	\$1.90	\$1.70	L6 OV 5	\$5	\$4	\$3.75	\$3.40
6	7.3 ± .2	L2 OV 6	2.50	2.00	1.90	1.70	L6 OV 6	5	4	3.75	3.40
9	10.5 ± .4	L2 OV 9	2.50	2.00	1.90	1.70	L6 OV 9	5	4	3.75	3.40
10	11.0 ± .5						L6 OV 10	5	4	3.75	3.40
12	13.7 ± .4	L2 OV 12	2.50	2.00	1.90	1.70	L6 OV 12	5	4	3.75	3.40
15	17.0 ± .5	L2 OV 15	2.50	2.00	1.90	1.70	L6 OV 15	5	4	3.75	3.40
18	20.5 ± 1.0						L6 OV 18	5	4	3.75	3.40
20	22.8 ± .7	L2 OV 20	2.50	2.00	1.90	1.70	L6 OV 20	5	4	3.75	3.40
24	27.3 ± .8	L2 OV 24	2.50	2.00	1.90	1.70	L6 OV 24	5	4	3.75	3.40
28	31.9 ± 1.0	L2 OV 28	2.50	2.00	1.90	1.70	L6 OV 28	5	4	3.75	3.40

NOM SUPPLY VOLTAGE (VOLTS)	TRIP POINT VOLTAGE <sup>A</sup> (VOLTS)	12 AMP MODELS	PRICE				20 AMP MODELS	PRICE				35 AMP MODELS	PRICE			
			QTY 1	QTY 100	QTY 250	QTY 1000		QTY 1	QTY 100	QTY 250	QTY 1000		QTY 1	QTY 100	QTY 250	QTY 1000
5	6.6 ± .2	L12-OV-5	\$10	\$8	\$7.50	\$6.80	L20-OV-5	\$14	\$11.20	\$10.50	\$9.50	L35-OV-5	\$18	\$14.40	\$13.60	\$12.30
6	7.3 ± .2	L12-OV-6	10	8	7.50	6.80	L20-OV-6	14	11.20	10.50	9.50	L35-OV-6	18	14.40	13.60	12.30
9	10.5 ± .4	L12-OV-9	10	8	7.50	6.80										
12	13.7 ± .4	L12-OV-12	10	8	7.50	6.80	L20-OV-12	14	11.20	10.50	9.50	L35-OV-12	18	14.40	13.60	12.30
15	17.0 ± .5	L12-OV-15	10	8	7.50	6.80	L20-OV-15	14	11.20	10.50	9.50					
20	22.8 ± .7	L12-OV-20	10	8	7.50	6.80	L20-OV-20	14	11.20	10.50	9.50					
24	27.3 ± .8	L12-OV-24	10	8	7.50	6.80	L20-OV-24	14	11.20	10.50	9.50					
28	31.9 ± 1.0	L12-OV-28	10	8	7.50	6.80	L20-OV-28	14	11.20	10.50	9.50					
30	33.5 ± 1.0	L12-OV-30	10	8	7.50	6.80	L20-OV-30	14	11.20	10.50	9.50					

VOLTAGE TOLERANCE MAINTAINED OVER 0-71°C DUE TO POWER DESIGN



Monolithic

L 6 OV



Monolithic  
L 2 OV

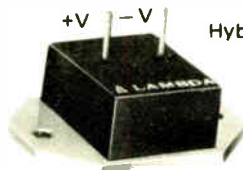

Hybrid

L 12 OV

1-1/2x11/16x3/4 (inches)

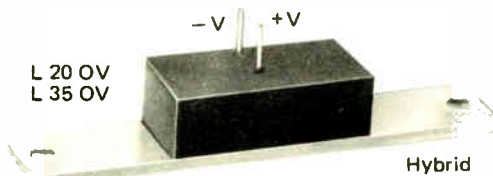

L 20 OV  
L 35 OV

Hybrid

3-3/8x15/32x19/32 (inches)

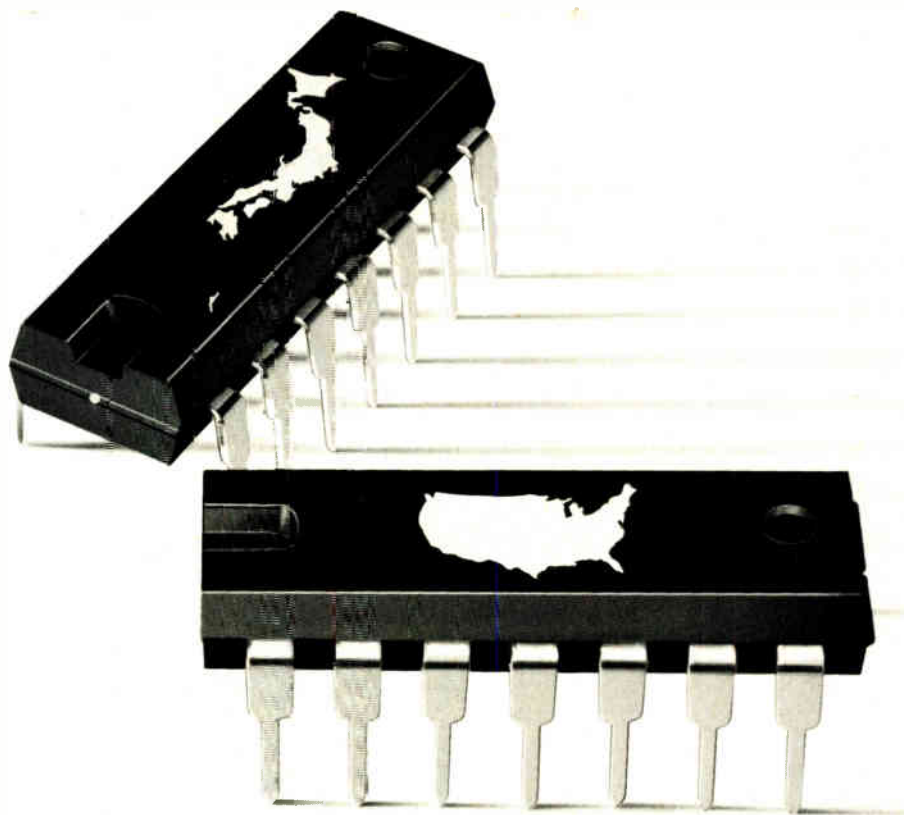

# We Know You Need a Special Circuit in Japan.

To many—even the most seasoned businessmen in the electronics field—finding the way to make profitable deals with their Japanese counterparts may seem as much a labyrinthine maze as complicated circuit wirings look to the man in the street who only knows how to plug in and turn on his electrical appliances. It is not really so. Japan is actually engaged in extensive import and export of electronic products, technology and know-how with all nations all over the world. But, whether it is a simple purchase or a complex exchange agreement or tie-up,

it is done differently because the Japanese are different.

We are Japanese and publish *Nikkei Electronics*, a biweekly magazine in Japanese, and our readers are the people who run the show and have brought Japan to the fore in electronics today.

You can think of *Nikkei Electronics* as that special circuit design that will deliver the signal you want to the proper terminal, to that profitable deal you are looking for. If you try a short cut you may end up with a short circuit. The failure free way is through *Nikkei Electronics*.

Japan's foremost electronics publication

## **Nikkei Electronics**

NIKKEI-McGRAW-HILL, INC.  
The publisher of *Nikkei Electronics*  
Wataru Makishima, Manager, Advertising  
Nikkei Annex Bldg. 2-1-2, Uchi-Kanda, Chiyoda-ku,  
Tokyo, Japan. Telex: J26296 NKMCGRAW

Subscriptions: 35,261 (as of May 30th, 1977)  
Regularly audited by the Japan ABC

For further information, write to:  
H.T. Howland, Marketing Services Manager,  
*Electronics*, McGraw-Hill Publications Co.,  
1221 Avenue of the Americas, New York,  
N.Y. 10020, U.S.A. Tel: (212) 997-6642

# B&K-PRECISION's 30MHz scope has a feature that Tektronix and H-P would love to have...our price! (and immediate delivery, too.)

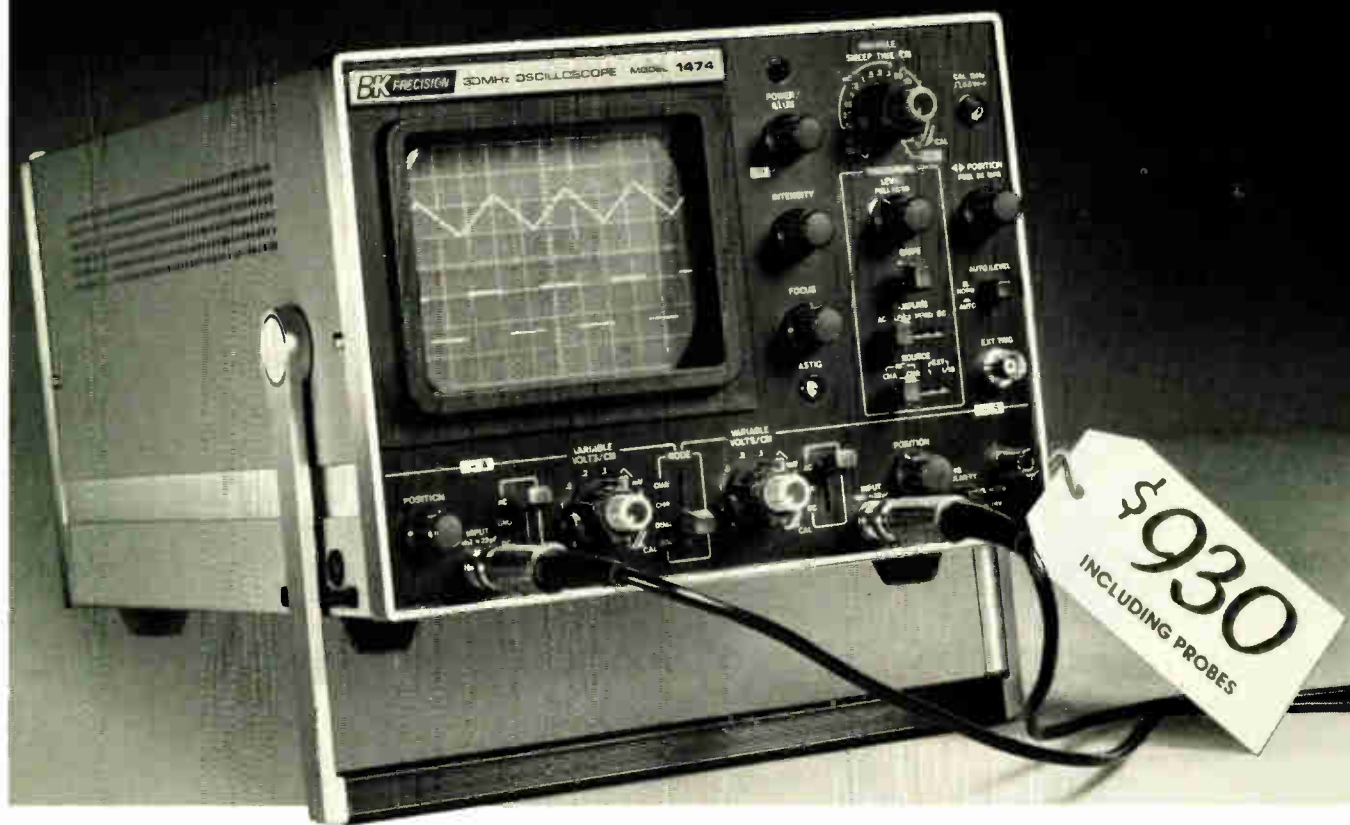

But we don't think they'd complain about the performance or features of our Model 1474 either.

The B&K-PRECISION Model 1474 is the most cost-effective 30 MHz dual-trace scope available. No compromise features include a built-in single delay line, 5mV/cm sensitivity, switchable high- and low-pass triggering filters and a TTL compatible Z-axis input. Vertical response is typically down only -6dB at 49 MHz.

Like other B&K-PRECISION products, the 1474 is designed to fill most user requirements at the lowest

realistic price possible. The 1474 isn't loaded down with expensive features you may never use, but it does have every feature you're likely to need. Don't take our word for it though, prove it to yourself.

We're so sure that the B&K-PRECISION 1474 will fill your needs that we can offer a no obligation ten-day free trial.

Off-the-shelf delivery is another of our features, and it's the one you can take advantage of first. Contact your local B&K-PRECISION distributor for immediate delivery or a demonstration.

Visit our booths 1132 & 1134 at Wescon

**B&K PRECISION** **DYNASCAN CORPORATION**

6460 West Cortland Avenue, Chicago, Illinois 60635 • 312/889-9087

In Canada: Atlas Electronics, Ontario • International Sales: Empire Exporters, Inc., 270 Newtown Road, Plainview, L.I., NY 11803

for further information circle 244

for salesman to call circle 160

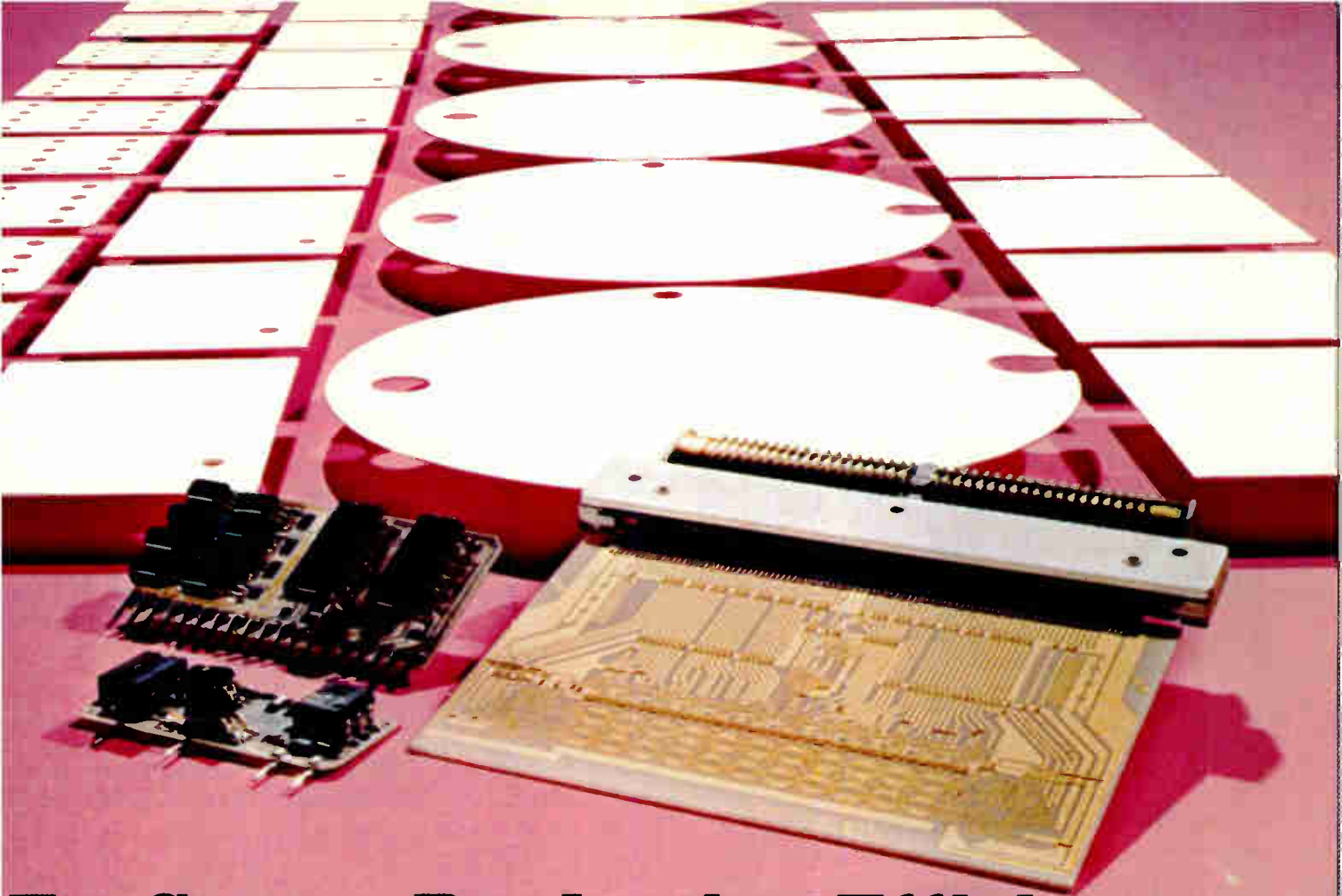

# For Greater Production Efficiency And Higher Yield, Start With a Dependable Base.

To maintain your yields and product quality, you need a dependable foundation for your thick- or thin-film circuits. On your production line and in service, Coors alumina ceramic substrates provide that measure of dependability.

Remarkable mechanical strength enables them to survive the rigors of high-speed, automated processing. Coors quality assurance program constantly monitors composition, dimension, and surface of substrates for greater yield. Our substrates' superior electrical, mechanical and chemical properties provide reliable operation in the field.

A choice of materials, backed with facil-

ities for laser scoring, green scoring and metallizing, means Coors can match a substrate to your circuit specifications and finishing requirements. With tooling on hand for more than 1000 shapes, we can speed your designs and save you tooling charges.

The final elements of Coors dependability are a special substrate service group to give you personal follow-through on your substrate orders, and an additional plant that will provide faster delivery in late summer, 1977.

For complete details on Coors substrates, write for our Electronic Ceramic Handbook, or call your local Coors representative.

**For fast service, call Coors Substrate Hotline: (303) 279-8320.**

**Coors** CERAMICS

**Coors Porcelain Company**

600 Ninth Street/Golden, Colorado 80401  
(303) 279-6565 Telex 45-593

World Radio History

Circle 245 on reader service card

**Hipotronics inc.**

# HIGH VOLTAGE DC POWER SUPPLIES AND POWER PACKS

Standard supplies from 1 kW to 50 kW



1 kW supply provides 120 kV @ 8 mA

## Power Supplies

Complete range of unregulated high voltage dc supplies with voltage outputs from 1 kV to 1000 kV and current outputs from 10 mA to 50 Amps available in standard designs at economical prices. Fully instrumented and protected, these supplies are ideal for:

- Laboratory use
- Capacitor charging
- Laser supplies
- CRT supplies
- Marx generators
- Many more

5, 7.5 & 10 kV @ 5 mA OEM Power Packs



## Power Packs

Miniaturized, oil-filled steel cans for OEM use. Voltages from 2.5 kV to 100 kV at 2, 5 & 10 mA. Low cost, high reliability.

## Metered Power Packs

Same miniature power packs available with simplified or deluxe controls for rack-mounting. Short circuit current limit option makes these ideal for cap charging applications.

Write or call for complete details.

**HIPOTRONICS**

**HIPOTRONICS, INC.**

P O Drawer A, Brewster, NY 10509  
(914) 279-8031 Twx 710-574-2420  
Amex Symbol HIP

## New products

Packaging & production

## Probe catches narrow pulses

Circuit-powered unit tests logic state and pulse symmetry

The digital logic probe, with its price of about 1/100 that of a good memory oscilloscope, has rapidly become the favored troubleshooting tool for production, test, and field engineers. This probe can be used to check all types of digital circuits, such as clocks, gates, registers, counters, arithmetic/logic units, and central processing units.

A new low-cost (\$69.95) probe from Continental Specialities Corp., the LP-3, can test four popular high-speed logic families—transistor-transistor, diode-transistor, high-threshold, and complementary metal-oxide-semiconductor. Drawing its power from the circuit under test, the LP-3 has pulse-detection, pulse-stretching, and latching capabilities. It also gives an instant readout of logic levels, positive and

negative transitions, and pulse symmetry.

The new probe allows detection of pulses as short as 10 nanoseconds. In the pulse mode, a built-in stretcher causes the pulse light-emitting diode to blink at a 10-hertz rate to indicate pulse transitions. Two LEDs—high (logic 1) and low (logic 0)—indicate logic levels present in the circuit. At high frequencies, the LP-3 will also indicate whether signals are symmetrical. Pulse trains with duty cycles of less than 30% will activate the low LED and the pulse LED, while duty cycles of 70% or more will activate the high and pulse LEDs. The probe's 500-kilohm input impedance prevents circuit-loading problems.

The new testing aid, whose dimensions are 5.8 by 1 by 0.7 inches, features a plug-in connector system. The rear of its high-impact plastic housing is equipped with a phono jack that accepts the unit's standard 36-in.-long clip leads or leads of any other desired length, terminated in a phono plug. The front of the probe accommodates plug-in interchangeable tips, including a straight needle probe, alligator clip, and quick-attaching insulated clip, as well as a ground lead.

Another new instrument developed by CSC, the DP-1 pulser, is a



# If you could cut base material cost from \$15 or \$30 down to \$3 per square foot, how much would you save next month?

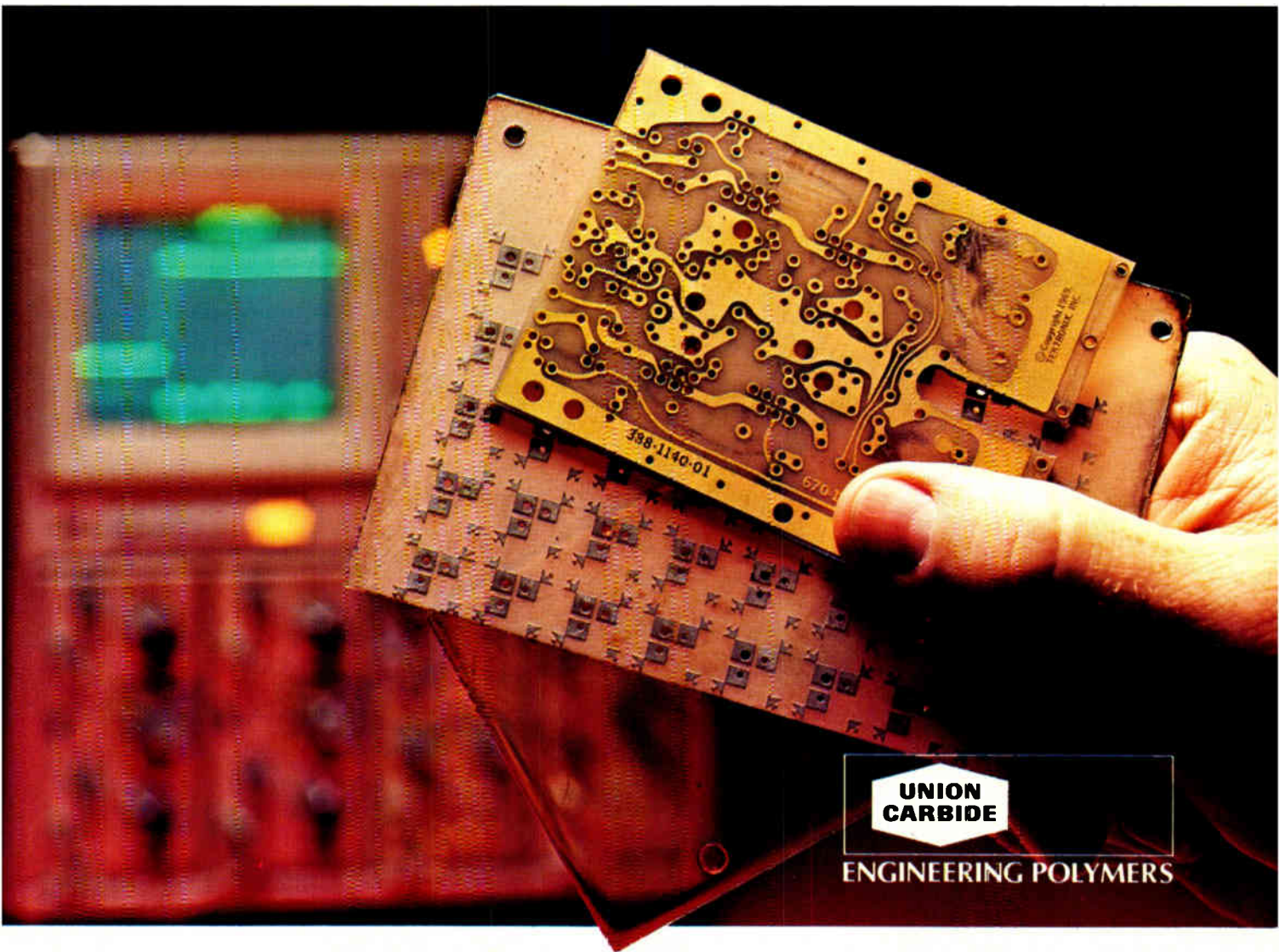

**UNION  
CARBIDE**  
ENGINEERING POLYMERS

Maybe \$10,000 per month? More? Less?

Well, Tektronix, Inc. of Beaverton, Oregon thought the savings impressive enough for their high frequency circuit boards to switch from polyphenylene oxide to an extruded polysulfone (UDEl Polysulfone, of course) just 1/16 of an inch thick.

Their processing costs are about the same as for other base materials with similar electrical properties. Even the quality and yields (c. 80%) are close on. But since they stopped using copper clad polyphenylene oxide they also get a use temperature 100 deg. F. above that material.

Polysulfone outperforms other materials at a lower cost in high frequency applications because of its excellent electricals (see graph) plus all these advantages:

- withstands 500 deg. F. wave solder bath for 5 secs.
- good notched Izod: 1 ft-lb/in.
- impressive chemical resistance
- ink and adhesive baking at 320 deg. F.
- good peel strength
- and polysulfone can be *molded* with stand-offs, holes of all sizes, and any shape, to save machining and finishing time.

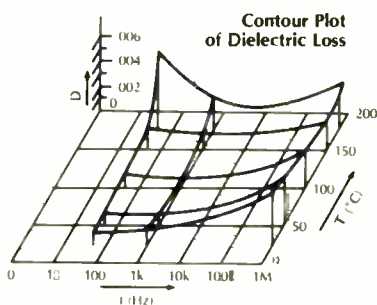

How much more can we tell you here? Write for full data using the coupon below or the reader service card.

-----  
 Maybe I can cut my high frequency circuit boards cost by 90%. Let me look at your data on UDEl Polysulfone

Name \_\_\_\_\_  
 Title \_\_\_\_\_  
 Company \_\_\_\_\_  
 Address \_\_\_\_\_  
 Phone ( ) \_\_\_\_\_  
 City \_\_\_\_\_  
 State \_\_\_\_\_ Zip \_\_\_\_\_  
 Mail to:  
 Union Carbide Engineering Polymers, Dept. PEL 9-2  
 270 Park Avenue, New York, N.Y. 10017.



**Three ways  
to get a  
good CRT yoke**



**Call  
Syntronic  
(312) 543-6444**



**Write  
Syntronic**

**Use  
our Yoke  
Selection Guide**

It shows a simplified way to specify the best yoke for your CRT display. Our engineers have developed a unique concept—the yoke energy constant—as a way to estimate yoke inductance and current. From there, it's an easy step to specify a yoke "by the numbers". Try it. Call or write for your copy.\* See for yourself how Syntronic's years of experience can add up to getting a better yoke for your display.



**syntronic**

Syntronic Instruments, Inc.  
100 Industrial Road, Addison, IL 60101  
(312) 543-6444

\*Or see Pages 405 to 408 in EEM

## New products

useful adjunct to the LP-3. The pulser, powered from the circuit under test, is used to inject signals at key points in TTL or DTL and in C-MOS circuitry. A logic probe can then sense the circuit's state or response.

The short-circuit-proof DP-1 tests either with a single pulse or at a 100 pulse-per-second rate. Pulse width can be selected to accommodate C-MOS, TTL or DTL. The pulser senses the initial state of the circuit under test and produces an input pulse of the opposite polarity.

The DP-1's size is identical to that of the logic probe. Price of the DP-1 is \$74.95.

Continental Specialties Corp., 44 Kendall St., Box 1942, New Haven, Conn. 06509. Phone (203) 624-3103 [391]

System tests power  
supplies automatically

Unlike manual testers, which are subject to human variability and even outright error, the computer-controlled UTS-1900 power-supply tester ensures tight quality control by performing every test in exactly the same way. The unit is also estimated to be some 80% faster than a manual tester although its actual throughput will depend, of course, on the power supply under test and on the tests to be performed.

The system runs on a Basic interpreter that gives full program control of all test functions. This multi-tasking executive makes maximum use of the interrupts of input/output devices to speed test execution by allowing wait periods only when really necessary. Although the 8080-based microcomputer will normally





# Gates introduces the future in energy cells.



There's now a new energy source that's a superb alternative: Rechargeable, sealed lead-acid batteries from Gates.

We call these batteries the future in energy cells. And for good reason.

They have all the product advantages you need plus economic advantages that may well give a new dimension to your product pricing.

Advantages: Gates Energy Cells are as compact as nickel cadmium or gelled type cells. And they are completely sealed, so that no acid vapor can leak out (they also include a self-sealing vent for extra safety). Gates Energy Cells provide low internal impedance for high discharge rates (more than 100 amps from the D cell and 200 amps from our X cell for short periods of time). And can be operated or stored in any position.

Gates Energy Cells offer great packag-

ing flexibility. In fact, our individual cell availability allows you to choose your own specific voltage (in 2-volt increments) and current, as well as configuration.

Just as important as what Gates Energy Cells have to offer is what they don't have to offer. Like outgassing problems. Or cell reversal. Or "memory" problems.

Because Gates Energy Cells are made from low-cost materials that are readily available, they're very high in watt-hr. per dollar value. Which means that if you specify them, you'll probably save your company more than a few dollars. And make yourself into something of a hero in the bargain.

To find out more about the future in energy cells, circle our reader service number or write us. We'll send you *free* literature containing features, application information, ratings and specifications. George Sahl, Gates Energy Products, Inc., 1050 S. Broadway, Denver, CO 80217.

E-9



**Energy Products**

**Where the  
energy future is now**

# WE'VE GOT THE MERCURY REED RELAY YOU WANT...

## No matter how small a package you need.

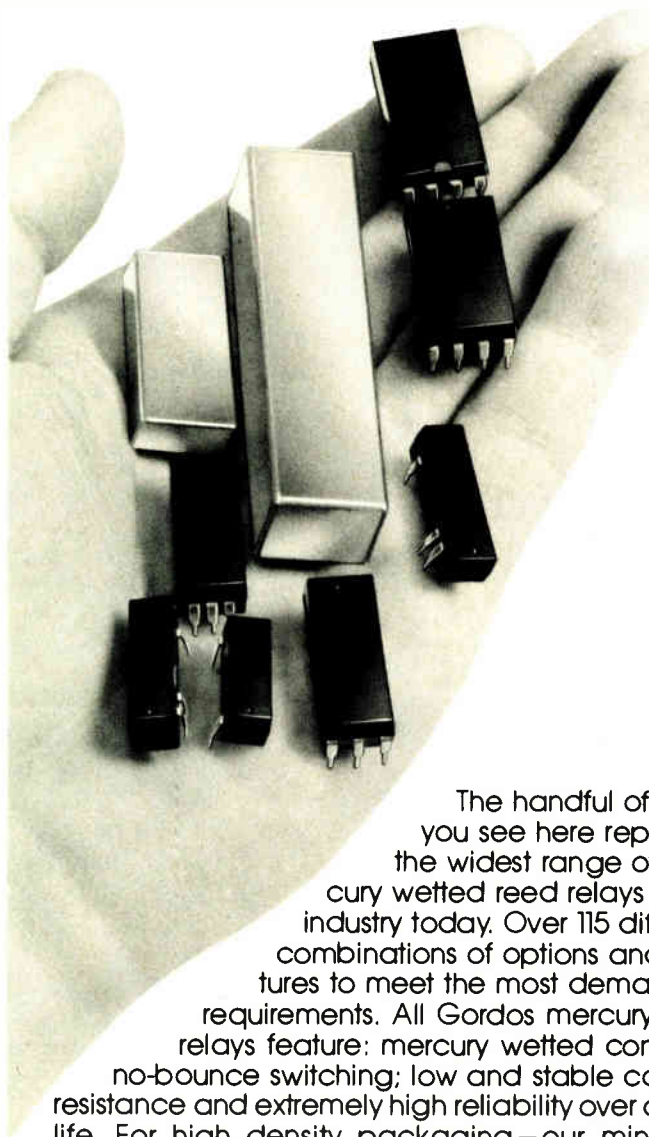

The handful of styles you see here represent the widest range of mercury wetted reed relays in the industry today. Over 115 different combinations of options and features to meet the most demanding requirements. All Gordos mercury reed relays feature: mercury wetted contacts; no-bounce switching; low and stable contact resistance and extremely high reliability over a long life. For high density packaging—our mini PCB models, the smallest in the business.

For complete specs send for free Bulletin RR409. Call or write GORDOS CORPORATION, 250 Glenwood Avenue, Bloomfield, N.J. 07003. Telephone (201) 743-6800  
TWX 710 994-4787.

**GORDOS**  
CORPORATION

### New products

run a complete test in its stored-program mode, it can also step through the program line by line to facilitate power-supply troubleshooting or program debugging.

Maximum load capability is 1,900 watts dc distributed among six electrically isolated loads. Loading accuracy is within 0.5% of full scale. Line input is provided by a feedback-controlled autotransformer capable of supplying 0 to 280 volts root-mean-square at 20 amperes, accurate to within 1 v rms. Two programmable dc supplies are also included for testing dc-to-dc converters. These supplies are rated to deliver 5 A at 0 to 30 v dc.

The measurement system consists of 16 lines, any of which can be connected to a built-in 5½-digit Systron-Donner multimeter, which measures ac and dc voltage and resistance. In addition, a 3½-digit scanning measurement system, capable of 100 conversions per second, continuously monitors load current, line voltage, and line current and displays them on the system's cathode-ray-tube display.

The basic UTS-1900, which includes everything needed to test power supplies, sells for \$44,975. Most users will probably want to add an ASR-33 printer. Other options include a true-rms or peak detector for ripple measurements, data-logging capability, a floppy-disk system, a line-isolation transformer, a 50-hertz line selector, and pulsed-load capability.

Autotest Co., P. O. Box 20264, San Antonio, Texas 78220. Phone Robert W. Cox at (512) 661-8391 or 661-4111 [393]

### Unit programs eight EPROMS in less than three minutes

A gang personality module capable of simultaneously programming as many as eight 2708-type 8,192-bit MOS erasable programmable read-only memories works with both ProLog's series 90 PROM programmer and series 92 PROM programmer/duplicator control units. Called the PM 9051, the module can program,



# acdc explodes a myth!

We've got a mighty short fuse when it comes to the myth about ACDC not being competitive in low-cost open-frame power supplies. And while myths usually aren't worth the powder to blow 'em up, we've taken aim at this one.

We have exploded our production facilities to become one of the industry's largest and most modern - with production lines capable of turning out thousands of open-frame power supplies of the highest quality, yet at much lower cost.

Our inventory is bursting with more than 80 models. Microprocessor power supplies for the popular 8080A, single output power supplies ranging from 2V at 3 amps to 24V at 10 amps plus dual and triple output models. All ready for immediate delivery.

And not one of 'em is a dud. We're so sure that we unconditionally guarantee each unit, even if re-sold as part of your OEM package.

Use the coupon to tell us what types of power supplies you need, the quantities you require, and the prices you'd like to pay. Fire it off to us right away, and by return salvo we'll tell you how quickly we can get them into your arsenal.

If you don't have a requirement yet, but would like full specs on our low-cost power supplies, just circle the reader service number.



## DO IT YOURSELF POWER SUPPLY PRICING

I'd like to help you explode your myth. Listed below are the details of the linear power supplies we'd like to have in our arsenal.

Description	Overvoltage Protection		Quantity	Price I'd Like to Pay
	Yes	No		
1. _____ V@ _____ Amps	( )	( )	_____	_____
2. _____ V@ _____ Amps	( )	( )	_____	_____
3. _____ V@ _____ Amps	( )	( )	_____	_____

Special features, number of outputs, etc. \_\_\_\_\_

Name \_\_\_\_\_ Title \_\_\_\_\_

Company \_\_\_\_\_

Street \_\_\_\_\_

City \_\_\_\_\_ State \_\_\_\_\_ Zip \_\_\_\_\_

## acdc electronics

401 Jones Road, Oceanside, California 92054, (714) 757-1880



## C&K's Pushbutton Switches with Snap-in Bezels make the screwdriver obsolete.

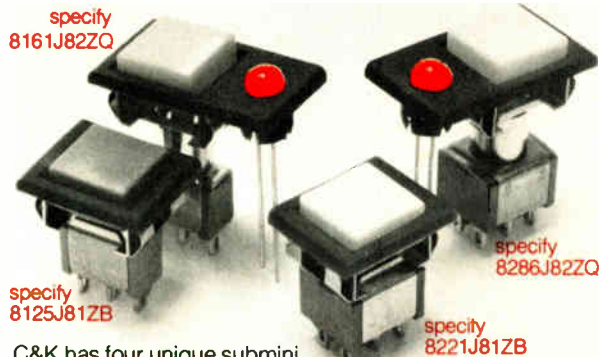

C&K has four unique submini pushbutton switches with snap-in bezels that make a screwdriver unnecessary in panel assembly. These time-and-money saving switches simply snap into a panel hole and a nickel-plated steel mounting spring holds the switch firmly in place. The switches are available in 1-amp and 6-amp models in SPDT and DPDT configurations. Also .4VA for low energy circuits. LED illumination is available on certain models. For specifics, write or call today. With these new switches, the next time you pick up a screwdriver will be in your local tavern.

**C&K Components, Inc.**, 103 Morse Street, Watertown, MA 02172 Tel: (617) 926-0800 TWX: 710-327-0460 TELEX: 92 2546  
Free Engineering Sample on Request.

Visit C&K at Wescon, Booth 1818

Circle 252 on reader service card

## ALCOSWITCH<sup>®</sup>

### HIGHEST QUALITY MINIATURE TOGGLES

Our premium Green Series inherently contain many quality features — all included at no extra cost.

During the past 16 years we've listened to customers. The result is a product that is indisputably the #1 miniature switch line in the industry.

Of importance, our terminals have bonded fine silver contacts which are gold flashed to retard oxidation and facilitate soldering, furthermore, the terminals are Molded-In SE-0 diallyl phthalate cases.

We urge you to call Customer Service at (617) 685-4371. Our sales people would like to tell you why ALCOSWITCH is your best buy.

P.S. Don't forget to ask for our new 76-page catalog and free samples, too!



**ALCO** ELECTRONIC PRODUCTS, INC.  
1551 OSGOOD STREET, NORTH ANDOVER, MA 01845 U.S.A.

Tel: (617) 685-4371 TWX: 711 342-0552

A SUBSIDIARY OF **AUGAT<sup>®</sup> INC.**

## New products

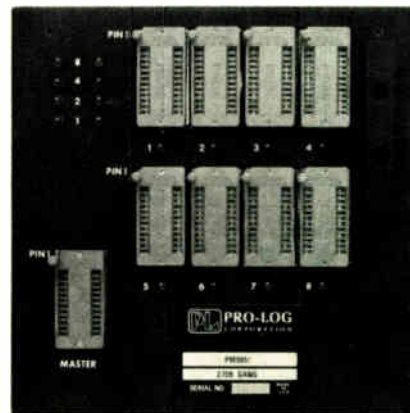

duplicate, list, and verify 2708-type erasable PROMs from Advanced Micro Devices, Electronic Arrays, Intel, Intersil, Motorola, National Semiconductor, Signetics, and Texas Instruments. With the PM 9051 priced at \$895, users can do gang programming with a series 90 for as little as \$2,695 or gang duplicating with a series 92 for as little as \$1,890. The units are available from stock.

Pro-Log Corp., 2411 Garden Rd., Monterey, Calif. 93940. Phone (408) 372-4593 [394]

## Reusable solderless cards have five tie points

Because they have five tie points instead of the four of their predecessors, the latest Unicard solderless breadboards are particularly well suited for use with large-scale integrated circuits. The reusable devices require no special patch cords and plug into standard 5.25-inch racks. Unicard I has 960 tie points (192

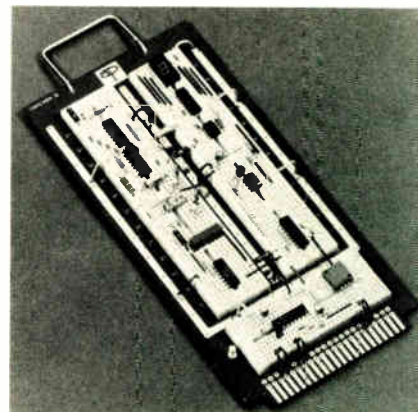

# The Ansley "D" Connector...



Our new series of male and female "D" connectors offer you a cost effective external mass termination cable and connector system second to none. Its uniqueness begins with a one-piece "D" connector package that meets industry standards for size, pin spacing, and contact reliability. With no loose parts to match up, positive cable-to-contact alignment is assured. Conductors are mass terminated in seconds with our standard BLUE MACS™ hand or bench tools. The results? Faster installation, higher reliability.

Contact pins are spaced on .0545" centers — a perfect fit for any standard inter-cabinet "D" type connector application. Our new "D" connectors are designed to mate with standard .050" pitch flat cable as well as our new, improved jacketed cable — the only flexible flat cable engineered specifically for out-of-cabinet use.

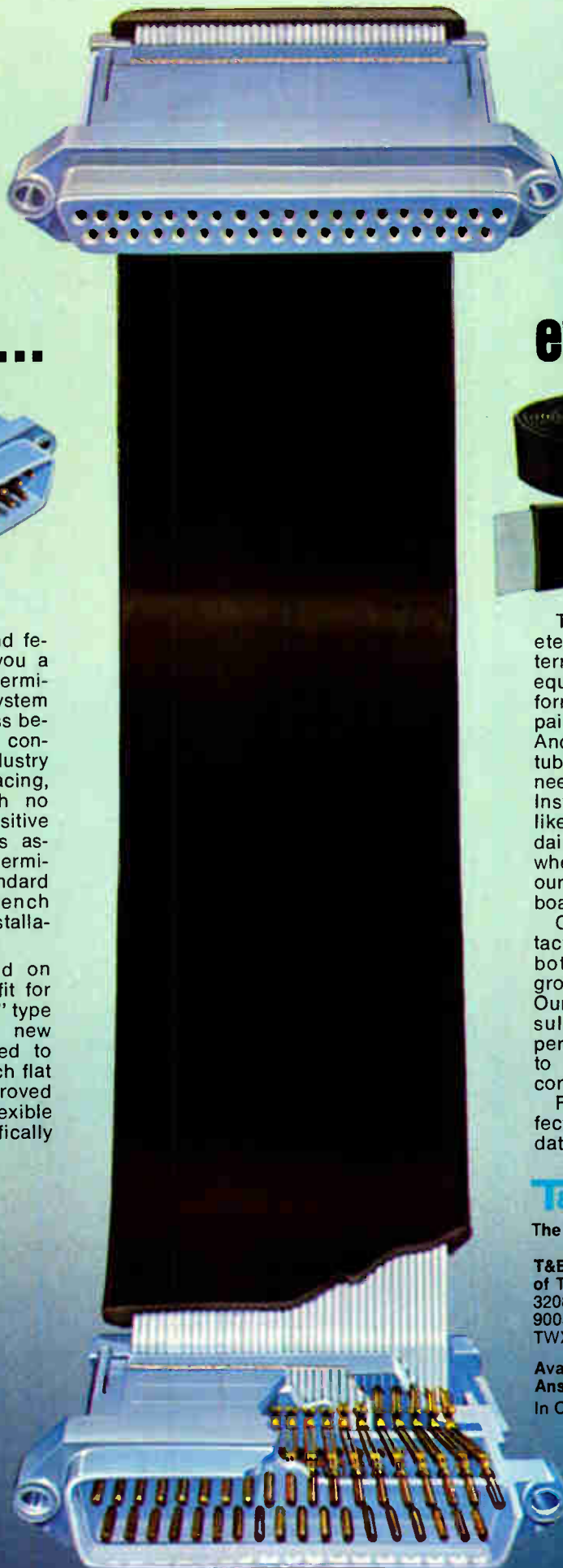

# a new meaning to cost effectiveness.



The Ansley BLUE MACS™ jacketed cable is U.L. listed for external interconnection of electronic equipment. Electrically, it outperforms standard jacketed twisted pairs in typical I/O applications. And there's no special zipper lock tubing required — reducing the need for an extra cable accessory. Installation is faster, easier. And like all Ansley connectors, you can daisy chain our "D" types anywhere in the cable — along with our DIP socket, card edge, or pc board connectors.

Cable alignment and high contact reliability is assured — because both cable and connector are grooved for absolute alignment. Our patented TULIP™ 4-point insulation-displacing contacts are permanently fixed and sealed-in to provide a reliable, gas-tight, corrosion-free mass termination.

For the full reliability/cost effectiveness story and technical data, call or write:

**T&B / Ansley**

The mass termination company.

T&B/Ansley Corporation • Subsidiary  
of Thomas & Betts Corporation  
3208 Humboldt St. • Los Angeles, CA  
90031 • Tel. (213) 223-2331 •  
TWX 910-321-3938

Available through authorized  
Ansley distributors

In Canada: T&B/Ansley, Ltd.  
700 Thomas Ave.,  
Industrial Park  
Iberville, P.Q.

MONOLITHIC  
CRYSTAL FILTERS



**FIVE THINGS TO DO WITH  
VHF MONOLITHIC FILTERS  
ON A RAINY DAY**

- 1) Make a paging receiver or other single-channel receiver, (models 2133F & 4171F).
- 2) Reduce IM and front-end overloading in a VHF mobile or base station receiver, (models 2131-33 VBP and 4131-33 VBB).
- 3) Make an up-conversion HF receiver or exciter (custom models).
- 4) Clean up the spectrum in your frequency synthesizer, (custom models).
- 5) Make a 900 MHz mobile receiver (Models 4371F & 2372F, 45 MHz first IF filters).

If one of these projects turns you on, or if you've got a project of your own, don't wait for a rainy day — turn us on right now. Just call or write. We offer a rain barrel full of monolithic crystal filters — from 5 MHz to 180 MHz, including over 60 stock models at 10.7 and 21.4 MHz.

**NEW KIO ON THE BLOCK ...**

45 MHz is a popular first I-F for the new 900 MHz mobile radio band. We've got the filters for it — two poles (Model 2372F) and four poles (Model 4371F). And they're in stock. Just write or call for data sheets and quantity pricing.



**Piezo Technology Inc.**

2525 Shader Road, Orlando, FL 32804  
(305) 298-2000

The standard in  
monolithic crystal filters.

Circle 254 on reader service card

**New products**

terminals each with five tie points), and Unicard II offers 1,620 tie points (324 terminals). Prices start at \$31.50—the same as for the earlier four-tie-point cards.

A P Products Inc., 72 Corwin Dr., Box 110, Painesville, Ohio 44077. Phone Ken Braund at (216) 354-2101 [396]

Small screw-clamp terminal blocks mount on pc boards

Three series of UL-recognized miniature terminal blocks are designed for mounting on printed-circuit boards. The units, all of which have screw-clamp terminals, differ in the number and spacing of their connecting

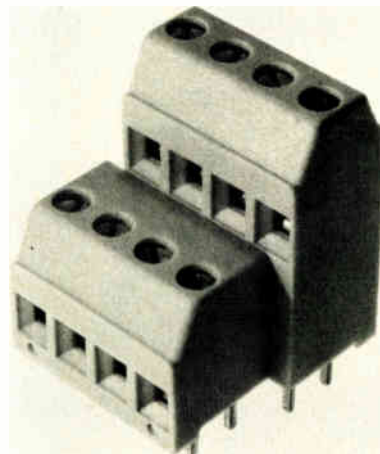

pins. Of particular interest for high-density wiring is the model GSD 5/8, with pins on the widely used 0.1-inch centers.

Weidmuller Terminations Inc., 4326 Eubank Rd., Richmond, Va. 23231. Phone (804) 226-2877 [395]

48-pin socket  
has staggered contacts

Designed to be used with devices like Texas Instruments SN74S481 or SN54S481, a line of 48-pin sockets has its contacts arranged in four 12-pin rows: the outer rows are 0.8 inch apart while the offset inner rows have a 0.6-in. spacing. Spacing between pins within a row is 0.1 in.

**Gas Sensing Semiconductor**

**FIGARO  
TGS  
GAS  
SENSOR**

quickly senses  
even small  
amount  
of gas.

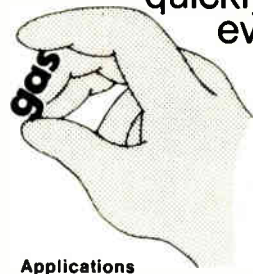

**Applications**

1. Natural Gas-Leak Alarm
2. Propane Gas-Leak Alarm
3. Carbon Monoxide Detector
4. Automatic Fan Control
5. Fire Alarm (Detecting
6. combustible gases contained in smoke)
7. Alcohol Detector (Detector for drunken driver)
8. Air Pollution Monitor

Please contact any of the addresses below directly for catalogs and price/delivery information

**FIGARO ENGINEERING INC.**

●Head Office: 3-7-3 Higashitoyonaka, Toyonaka City, Osaka, 560, JAPAN TELEX 05286155  
FIGARO J. CABLE FIGARO TOYONAKA  
TEL (06) 849-2156

●North America: 3303 Harbor Boulevard, Suite D-8, Costa Mesa, California 92626, U.S.A.  
TELEX 678396 CABLE FIGARENGIN  
COSTAMESA TEL (714) 751-4103

Circle 718 on reader service card

**TEST NTI'S DIGITAL UNI-PATTERN**

- Pattern is generated electrically. No tube is used.
- DRC (Digital Rise time Controller) is employed to produce an image having the same feeling as that of a pick-up camera tube.
- Plug-in unit system by function makes maintenance easy and another resolution can be made.
- Any desired pattern can be produced. Send us your pattern diagram and we will send you an estimate.

**MODEL 525 DIGITAL  
MONOSCOPE SIGNAL GENERATOR**

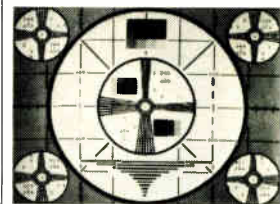

Basic pattern of conventional television signal.

**MODEL 535 COLOR  
MONOSCOPE SIGNAL GENERATOR**

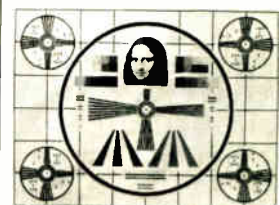

Simple pattern. But perfect color test signal generated. Flying spot face projection is unnecessary.

**NTI America, Inc.**  
1880 North Vine Street LOS ANGELES, California 90028  
Phone 213-462-8945

Circle 719 on reader service card

## One Mallory THF capacitor can replace up to four CSR types in a switching power supply.

These small, solid-tantalum capacitors give you a per-unit substitution factor as high as one for four and can by-pass 4.5 amp rms at 100kHz. So by using these high ripple performance capacitors you save in space, weight and cost.

Specially designed for low equivalent series resistance, at frequencies from 1 kHz through 1 MHz. They're ideal for high frequency power supply switching, for regulator switching, or for bypassing or filtering unwanted ripple currents.

Because ESR is low, power losses are low. With the solid electrolyte and hermetic seal, long life is inherent. Electrical characteristics are very stable over a temperature range of  $-80^{\circ}\text{C}$  through  $125^{\circ}\text{C}$ . Two case sizes: .29 x .69 and .35 x .79 inches.

Mallory THF capacitors are available in a wide range of ratings: 5.6 to  $330\mu\text{F}$ , 6 to 50VDC.

They're the result of Mallory's engineering program that's finding ways to produce high performance type capacitors at less cost to you.

Just ask your Mallory representative. Available direct, or through authorized Mallory Distributors in U.S. or overseas. Or call Help-Force Headquarters at (317) 856-3731. Mallory Capacitor Company, a division of P. R. Mallory & Co. Inc., Box 1284, Indianapolis, IN 46206.

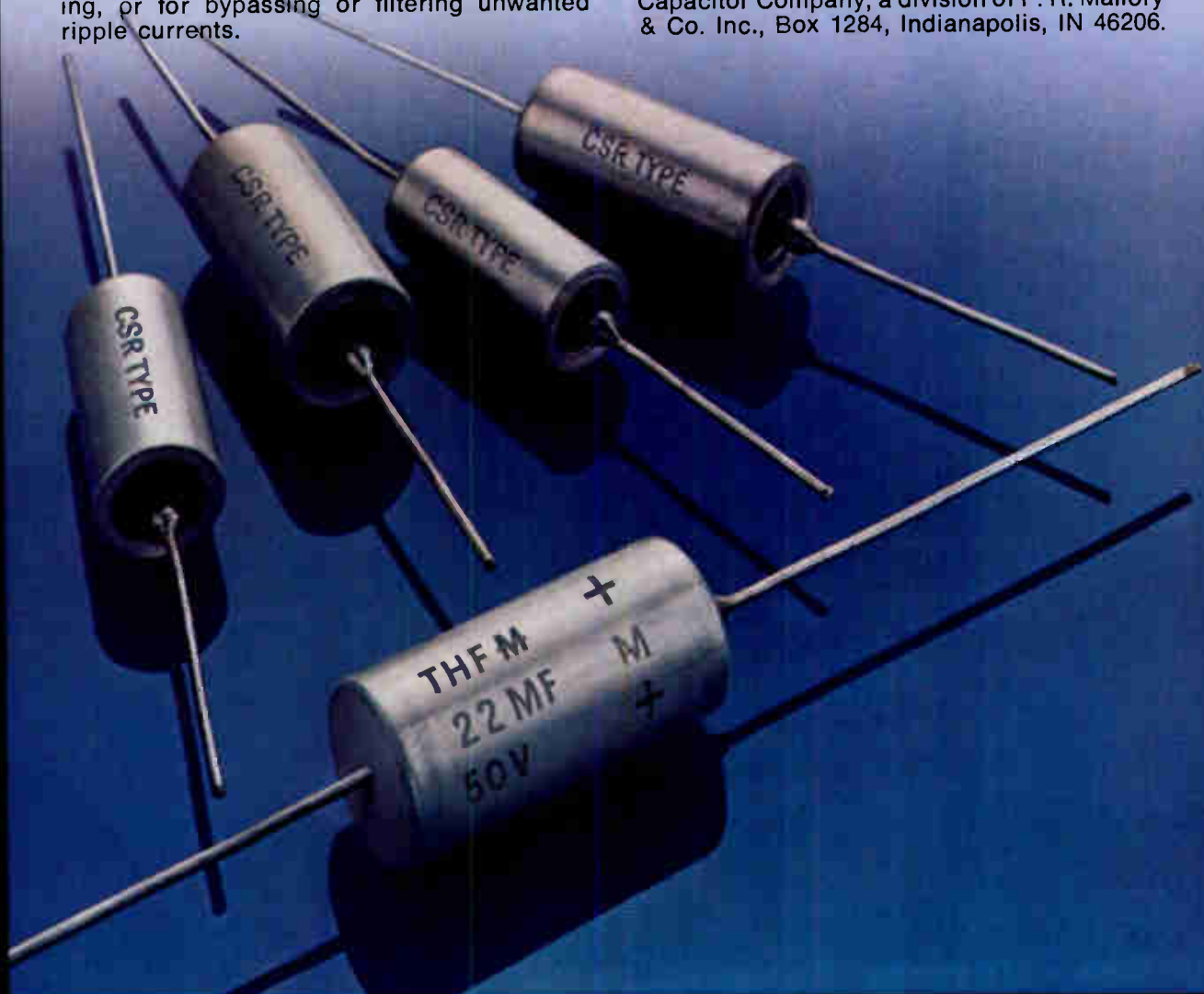

# MALLORY

# We're first on the Buss\* (488)

... with programmable D.C. currents  
and voltages!

Our 501J meets the IEEE 488/1975\* interface specs to let your computer,  $\mu$ p's or programmable calculator call up voltages from  $0.1\mu\text{V}$  to  $200\text{Vdc}$  or current from  $10\text{nA}$  to  $100\text{mAdc}$  at speeds to  $50\mu$  seconds with accuracy to  $\pm 0.005\%$ .

Put these NBS traceable values to work checking A/D converters and other voltage or current sensitive function modules — Prices from \$1595. Contact Bob Ross at (617) 268-9696.



Circa 1982

**Electronic Development Corp.**

11 Hamlin Street, Boston, Mass. 02127  
(617) 268-9696

## New products

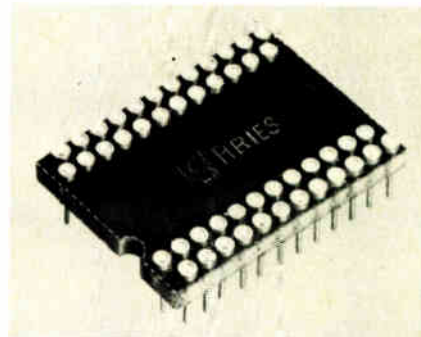

The solder-tail socket, 48-513-10S, sells for \$3.36 each, while the three-level wire-wrap version, 48-503-31S, costs \$3.84. Delivery is from stock.

Aries Electronics Inc., P. O. Box 231, Frenchtown, N. J. 08825. Phone (201) 996-4096 [397]

Clip-on heat sink  
fits TO-92 packages

The model 6024 heat sink clips onto standard TO-92 packages with no need for mounting hardware or adhesives. It can be installed after board assembly is complete (a boon in solving last-minute thermal problems) and takes up very little space.

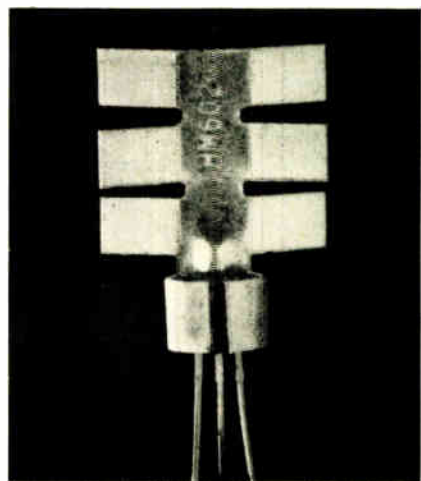

Its thermal performance in natural convection is  $58^{\circ}\text{C}$  per watt. The heat sink is made of phosphor bronze and weighs only 0.6 gram. Typical pricing is 2 cents each in thousands. Availability is from stock.

Thermalloy Inc., Dept. M, 2021 W. Valley View Lane, Dallas, Texas 75234. Phone (214) 243-4321 [398]



# Our R-10 series Relays will switch you 7 ways to Sunday.

Giving you more design options  
than any other relay.

It's about as close as one relay can get to being all things to all designs. The R10 series.

A compact, reliable multi-pole relay, the R10 is specified for a wide variety of critical applications. Business machines, computer peripherals, copiers, communications equipment, precision instruments and more.

Consider these options that are available with the R10. Ratings from dry circuit to 10 amperes. Contact arrangements to 8PDT. Six styles of contacts including bifurcated types. Sockets with solder or printed circuit terminals, including one for mounting the relay parallel to a printed circuit board. All with or without grounding provision.

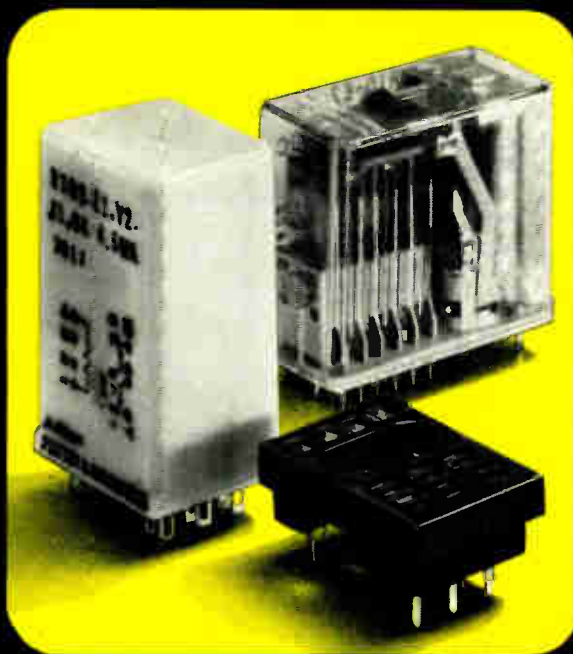

Mechanical life expectancy of the R10 is to 100 million operations—except W contacts, 1 million—and is available with a voltage or current-sensitive coil. It weighs, depending on the number of contacts, from 22 to 40 grams. Pickup ranges from 2.25 to 86 VDC, 5 to 86 VAC, or 0.6 to 45 milliamp with proper power supply.

Design options by the dozen, all from a single relay. The R10. It's in stock now at your distributor. Call your P&B Representative or write to us

direct for a copy of our latest catalog. Potter & Brumfield Division of AMF Incorporated, 200 Richland Creek Drive, Princeton, Indiana 47671. 812/386-1000.

AMF  
Potter & Brumfield

# Potter & Brumfield



## One company can cut keyboard costs. Even when their keyboards cost more.

The most expensive mistake you'll ever make selecting a keyboard could be spending too little. In the long run, that adds up to cutting corners, not costs.

So to make sure you get the keyboard that really meets your needs, MICRO SWITCH uses Value Engineering.

Through Value Engineering, we look at your particular product needs to design a cost-effective solution to your problems. That means designing a keyboard that interfaces with your total system and meets your needs. Precisely.

It also means we can often lower your total system cost. For example, we might be able to incorporate into a keyboard several levels of codes that you had been paying for separately. And at a much higher cost.

Or maybe customize

integrated circuits to provide you more logic for less money.

Besides giving you cost-efficiency, MICRO SWITCH keyboards out-feature practically every other in the industry.

You can choose LED or incandescent lighting. Tactile or linear feel. Sealed versions for military and industrial uses. Alternate or momentary action. Encoding techniques that'll meet any code requirement.

There are also wired-only assemblies or separate modules available. And you can pick from the industry's largest legend library.

Standard, solid state Hall-effect technology throughout the line delivers reliability no mechanical keyboard can offer. Plus, we back up every keyboard we make with a 1% Acceptable Quality Level and a two-year

warranty.

It all adds up to quality you can put your fingers on every time.

For more information, call 815/235-6600.

With MICRO SWITCH, you'll be paying for keyboards instead of mistakes.



### MICRO SWITCH

FREEPORT, ILLINOIS 61032

A DIVISION OF HONEYWELL

MICRO SWITCH products are available worldwide through Honeywell International.

Circle 258 For Data

World Radio History

## New products

### Components

## Air activates button cell

Zinc-air battery designed for consumer applications

Electrochemists have long been aware that oxygen from the air would react chemically with certain metals in the presence of a caustic to produce electrical energy. In the 1930's, rather large, cumbersome zinc-air batteries were developed and applied to low-cost, high-capability power sources for railroad use.

Scientists from Gould Inc.'s portable battery division have now developed a button-sized zinc-air cell, called Activair, which is said to have twice the life of competitive button cells. The new unit's cathode has a membrane of polytetrafluoroethylene only 20 mils thick. The laminated membrane includes separating, conducting, structural, catalytic and wet-proofing layers.

The anode of the new battery is zinc, and the cathode is oxygen from the air. The cells, which will be available in sizes A 675, A 13 and A 41, can be used instead of conven-

tional silver or mercury units.

The capacity for the 1.4-volt A 675, A 13 and A 41 are 400 milli-ampere-hours, 170 MAH and 300 MAH respectively. These capacities are double those provided by competitive button cells now on the market. This increase mainly comes about because no storage space is needed within the cell for cathode reactants. The available space is used for added anode material.

The Activair cells have been specifically designed for hearing aids. Other applications for the new Gould cell are electromechanical watches, and watches and calculators with liquid-crystal displays.

The new zinc-air button cell has an energy density of 125 watt-hours/pound; an operating temperature of  $-10^{\circ}\text{C}$  to  $+55^{\circ}\text{C}$  and excellent shelf life. The cell has a flatter discharge characteristic than competitive button cells along with a low internal impedance.

Gould Inc., Portable Battery Division, 931 North Vandalia St., St. Paul, Minn. 55114. Phone (612) 645-8531 [341]

Metal-film resistors are compact, accurate, and stable

Type FM metal-film resistors are fixed-value components intended for precision applications that require

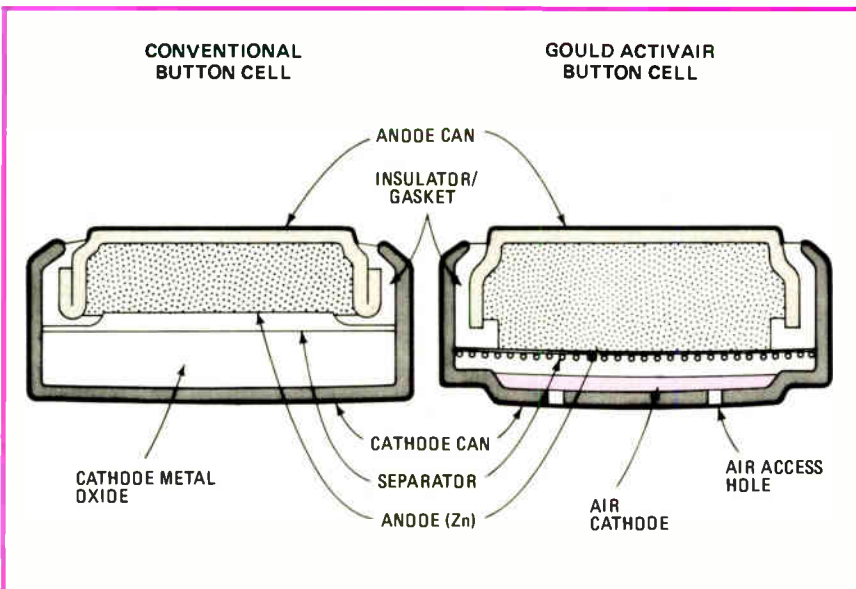

## THE LOW PRICED DC/DC CONVERTERS... that out-perform the higher priced brands

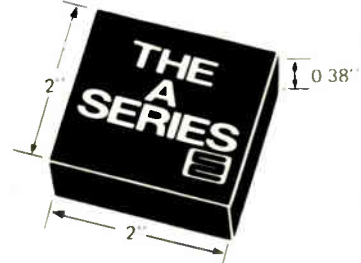

ONE LOW PRICE: \$40.50 (1-249)

THE I/O RATINGS YOU NEED ...

Input Voltage Vdc	Output Vdc @ mA	Model No.
5	$\pm 12\text{V} @ \pm 150\text{mA}$	A5-12D150
12		A12-12D150
5	$\pm 15\text{V} @ \pm 150\text{mA}$	A5-15D150
12		A12-15D150

QUALITY PERFORMANCE...

Regulation: 0.1% Line/Load  
Efficiency: to 55%  
I/O Isolation: 300Vdc Min.  
MTBF: >100,000 Hrs.

Input ...

Reflected Ripple: 1%  $V_{in}$   
Range:  $\pm 5\%$

Output ...

Ripple & Noise: 20mV (typ)  
Short Ckt. Protection: Yes

HERE'S THE PINOUT ...

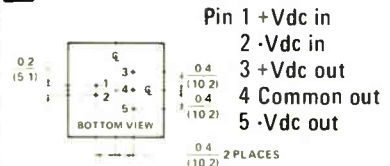

Order your newly designed A Series converters now. We've shaved cost — not quality. That's why SCI is the No. 1 SOURCE

Get Complete Information FAST!  
Circle the number for our new 1977 FREE CATALOG.



**SEMICONDUCTOR CIRCUITS, INC.**  
POWER SOURCES DIVISION

306 RIVER ST., HAVERHILL, MA 01830  
TEL. (617) 373-9104, TWX. 710 347 0269

# STANDARD CUSTOMER ON FOS

- **Fast TurnAround**  
25 days from your design to prototype circuits
- **Low Cost**  
Save 80% over a fully custom design
- **Reduced Circuit Size**  
Multiple saving by reducing circuit size 90%
- **Proven Process**  
Standard CMOS assures high reliability and dependable delivery

## INTERNATIONAL MICROCIRCUITS, INC.

3004 Lawrence Expwy., Santa Clara, Ca. 95050 (408) 735-9370

Circle 11 on reader service card

### New products

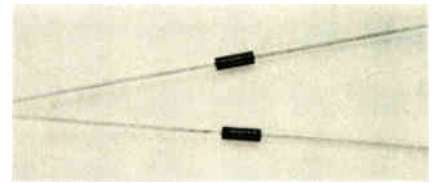

both high initial accuracy and good stability over temperature and time. Rated to dissipate 0.25 watt at an ambient temperature of 70°C and 0.1 w at 125°C, the resistors are available with tolerances of 1%, 0.5%, 0.25%, 0.1%, and 0.05%. A choice of three temperature coefficients of resistance is offered: 25 parts per million per °C, 15 ppm/°C, and 10 ppm/°C.

Units in the FM series have bodies molded to a uniform maximum length of 0.281 inch (7.14 millimeters) and a maximum diameter of 0.098 in. (2.49 mm). Standard resistance values in the nominal range from 20 ohms to 357 kilohms are offered. Type FM is approved to MIL-R-10509F for Style RN55, characteristic E, resistance values 49.9 ohms to 100 kilohms, all tolerances.

Prototype quantities of RN55E with a 1% tolerance and a TCR of 25 ppm/°C are available from stock in popular values. They sell for 25 cents each in thousands with delivery times ranging from 10 to 12 weeks depending upon volume and specifications.

Marketing Dept., Electronics Division, Allen-Bradley Co., 1201 S. Second St., Milwaukee, Wis. 53204 [342]

## The fabulous Phi-Deck<sup>®</sup> family of 5 cassette transports under \$100 in quantities of 10

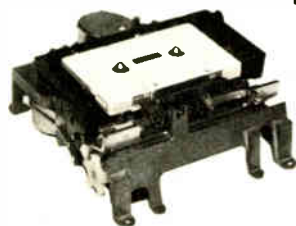

- Featuring:
- Die-cast frames
  - Remote controllable
  - Precise, fast head engage/disengage
  - Quick braking
  - Search FF/rewind 120 ips
  - Speed ranges from .4 to 20 ips

### Electronic packages and mag heads for most applications

For application in:

- |                                   |                                       |
|-----------------------------------|---------------------------------------|
| 1. Micro processing               | 7. Security/automatic warning systems |
| 2. Data recording/logging/storage | 8. Test applications                  |
| 3. Programming                    | 9. Audio visual/education             |
| 4. Instrumentation                | 10. Telephone interconnect            |
| 5. Industrial Control             | 11. Hi-Fi                             |
| 6. RS-232 Data storage            | 12. Point of sale                     |



**Triple I** Incorporated  
4605 N. Stiles P.O. Box 18209  
Oklahoma City, Oklahoma 73118 (405) 521-9000

I am interested in application no. \_\_\_\_\_

Have Representative call     Send application notes

Name \_\_\_\_\_ Title \_\_\_\_\_

Company Name \_\_\_\_\_

Address \_\_\_\_\_

City \_\_\_\_\_ State \_\_\_\_\_ Zip \_\_\_\_\_

Phone Number \_\_\_\_\_

Circle 182 on reader service card

World Radio History

### Low-inductance resistors dissipate up to 15 watts

For applications requiring extremely low inductances, wirewound resistors are outmatched by a new family of metal-film power resistors having a serpentine resistive pattern that keeps both inductance and distributed capacitance at much lower levels than can be achieved by any practical method of noninductive winding. As an example, the 2-watt model 220 N has an inductance of less than 100 nanohenries.

Resistors in the MS family have a

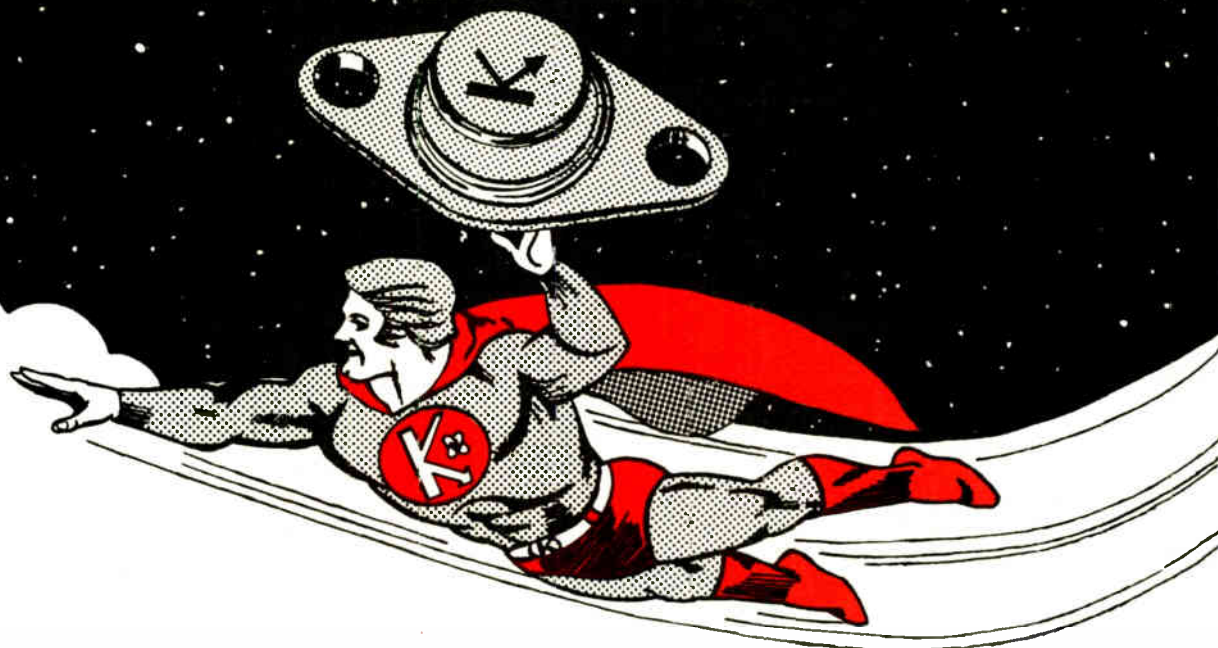

# Power Transistors? We've got em!

## High Voltage

PART #	BVCBO	BVCEO	Ic max	hFE @ Ic	ES/g	Pkg.
2N6542	650	300	5.0A	12-60 2A	180μJ	TO-3
2N6543	850	400	5.0A	12-60 2A	180μJ	TO-3
2N6544	650	300	8.0A	12-60 2A	500μJ	TO-3
2N6545	850	400	8.0A	12-60 2A	500μJ	TO-3
2N6546	650	300	15A	12-60 2A	2.0mJ	TO-3
2N6547	850	400	15A	12-60 2A	2.0mJ	TO-3
2N6249	300	200	10A	10-50 3A	2.5mJ	TO-3
2N6250	375	275	10A	8-50 3A	2.5mJ	TO-3
2N6251	450	350	10A	6-50 3A	2.5mJ	TO-3
2N6306	500	250	16A	15-75 3A	180mJ	TO-3
2N6307	600	300	16A	15-75 3A	180mJ	TO-3
2N6308	700	350	16A	12-60 3A	180mJ	TO-3

## High Current

PART #	BVCBO	Ic max	VCE(sat) @ Ic	VBE(sat) @ Ic	hFE @ Ic	Pkg.
2N5185	60	50A	1.0V 25A	2.0V 25A	15-60 25A	TO-3
2N5186	80	50A	1.0V 25A	2.0V 25A	15-60 25A	TO-3
2N6274	120	100A	1.0V 20A	1.8V 20A	30-120 20A	TO-3
2N6275	140	100A	1.0V 20A	1.8V 20A	30-120 20A	TO-3
2N6276	160	100A	1.0V 20A	1.8V 20A	30-120 20A	TO-3
2N6277	180	100A	1.0V 20A	1.8V 20A	30-120 20A	TO-3

\* .060" pins

## High Speed Fast Switching

PART #	BVCBO	Ic max	hFE @ Ic	t <sub>on</sub> (nS)	t <sub>off</sub> (nS)	Pkg.
KS6038	80	2A	25 1A	50	150	TO-60/I
KS6039	80	2A	10 1A	50	150	TO-60/I
KS6107	60	2A	15 1A	42	105	TO-37
KS6108	40	2A	15 1A	50	135	TO-37
KS6109	80	2A	15 1A	30	120	TO-60/I
KS6110	40	2A	15 1A	30	120	TO-60/I
KS6111	80	2A	15 1A	42	150	TO-60/I
KS6112	40	2A	15 1A	42	150	TO-60/I
KS6113	30	4A	15 2A	20	45	TO-60/GE
KS6114	20	4A	15 2A	25	55	TO-60/GE
KS6115	30	7A	15 5A	35	70	TO-60/GE
KS6116	20	7A	15 5A	35	90	TO-60/GE
KS6117	100	10A	15 5A	37	120	TO-3
KS6118	60	10A	15 5A	45	140	TO-3
KS6119	40	10A	15 5A	70	180	TO-3
KS6120	100	15A	15 5A	37	120	TO-3
KS6121	60	15A	15 5A	45	140	TO-3

## General Purpose

PART #	BVCBO	BVEBO	Ic max	hFE @ Ic	ICEO @ VCE	Pkg.
2N2880	100	8.0	5A	40-120 1A	60V 0.1μA	TO-111
2N3749	100	8.0	5A	40-120 1A	60V 0.1μA	TO-111/I
2N3879	120	7.0	10A	20-80 5A	75V 0.20A	TO-66
2N5000	100	6.0	5A	70-200 1A	40V 50μA	TO-59
2N5001*	100	5.5	5A	70-200 1A	40V 50μA	TO-59
2N5002	100	6.0	10A	30-90 2.5A	40V 50μA	TO-59
2N5003*	100	5.5	10A	30-90 2.5A	40V 50μA	TO-59
2N5004	100	6.0	10A	70-200 2.5A	40V 50μA	TO-59
2N5005*	100	5.5	10A	70-200 2.5A	40V 50μA	TO-59
2N5006	100	6.0	20A	30-90 5A	40V 50μA	TO-60/I
2N5007*	100	5.5	20A	30-90 5A	40V 50μA	TO-60/I
2N5008	100	6.0	20A	70-200 5A	40V 50μA	TO-60/I
2N5009*	100	5.5	20A	70-200 5A	40V 50μA	TO-60/I
2N5660	250	6.0	1A	40-120 0.5A	200V 10mA	TO-66
2N5661	400	6.0	1A	25-75 0.5A	300V 10mA	TO-66
2N5662	250	6.0	1A	40-120 0.5A	200V 10mA	TO-5
2N5663	400	6.0	1A	25-75 0.5A	300V 10mA	TO-5
2N5664	250	6.0	3A	40-120 1A	200V 10mA	TO-66
2N5665	400	6.0	3A	25-75 1.0A	300V 10mA	TO-66
2N5671	120	7.0	30A	20-100 15A	90V 0.20A	TO-3
2N6233	250	6.0	10A	25-125 1A	225V 1.0mA	TO-66
2N6234	300	6.0	10A	25-125 1A	275V 1.0mA	TO-66
2N6235	350	6.0	10A	25-125 1A	325V 1.0mA	TO-66
2N6338	120	6.0	50A	30-120 10A	100V 50mA	TO-3
2N6339	140	6.0	50A	30-120 10A	120V 50mA	TO-3
2N6340	160	6.0	50A	30-120 10A	140V 50mA	TO-3
2N6341	180	6.0	50A	30-120 10A	150V 50mA	TO-3

\* PNP device  
 ⊕ VCE0 (sus)

All Kertron power transistors are manufactured with high reliability construction techniques. Ask Kertron to screen your parts to your environmental and electrical specifications.

For quick dependable delivery call:



# KERTRON INCORPORATED

7516 Central Industrial Dr. Riviera Beach, Fla. 33404 U.S.A.  
 Tel. 305/848-9606 TWX 510/952-7611

## New products

temperature coefficient of 50 parts per million per °C and are available with resistances from 10 ohms to 30 megohms and power dissipations from 0.5 watt to 15 w. Maximum operating temperature is 275°C. Tests run for more than five years indicate that typical long-term drift is less than 0.05% per 1,000 hours.

As an example of pricing for units in the MS family, the MS 310 is rated at 10 w, has a 1% standard tolerance, is available with values from 30 ohms to 20 megohms, and sells for \$1.65 each in thousands.

Caddock Electronics Inc., 3127 Chicago Ave., Riverside, Calif. 92507. Phone Richard Caddock at (714) 683-5361 [343]

## Hospital-grade nylon plug offers 12 assembly angles

An all-nylon angle plug, which can be assembled in any of 12 positions for maximum outlet convenience, gives users the safety of straight-in wiring. Its transparency also allows easy visual verification of proper wire termination, while its hospital-grade designation means it can handle severe abuse of the kind that may occur in hospitals, schools, factories, and some commercial fa-

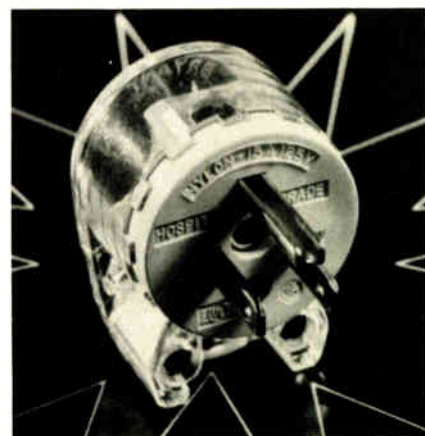

cilities, according to the company. Bryant Division, Westinghouse Electric Corp., Marketing Communications Department, 1421 State St., Bridgeport, Conn. 06602 [345]

## Heavy-duty ac capacitors use a nontoxic impregnant

A series of drawn-case oil capacitors for alternating-current applications use a nontoxic, biodegradable impregnant instead of polychlorinated biphenyl oils, which have been banned by the Environmental Protection Agency. Type 520P Eccol capacitors are intended for use in air-conditioning and refrigeration equipment, in phase-splitting and power-factor-correction applications, for stabilizing transformers, and so on.

Capable of continuous operation at case temperatures up to 70°C, the

# SOLID STATE POWER

Off-The-Shelf Designs...  
Standard Models...  
We've Got 'Em!

Big performance  
plus big savings  
in time, effort  
and dollars

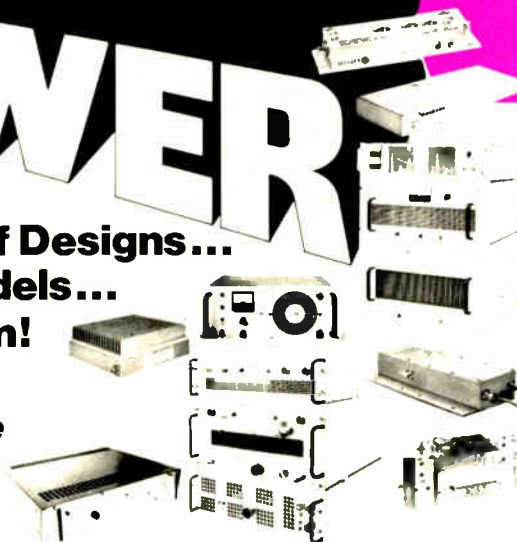

### Solid State Class A Linear Power Amplifiers

Series LWA, power module packages for systems applications. 26 standard models, frequencies from 5MHz to 4.2GHz, power output up to 20 watts. Ideal replacement for TWT amplifiers. Series LAB, instrument version with built-in power supply. Choice of 62 standard models with such features as gain control, leveling, external modulation.

### Solid State Class A/B High Power Linear Amplifiers

Series EWAL, PWAL, PAL deliver up to 1000 watts of A/B linear power. Standard models for frequencies from 2MHz to 500MHz, plus standard designs for frequencies up to 3GHz. Bandwidths up to several octaves. Electronic or circulator protection. Ideal for applications such as ECM/EW jammers, and TV transmitters, add-on AM amplifiers, etc.

### Solid State AM Modulator/Power Amplifiers

Series PAM, operate in VHF, UHF and VHF/UHF transceivers. Up to 1KW peak envelope power; low distortion transmission, <math>\le 5\%</math>. Typical standard model covers 225-400MHz band, for use with up to 7000 channels.

### Solid State High Power TV Transmitter Amplifiers

Series TVA, for CCIR (channels 5-12) and NTSC (channels 7-13) television broadcast applications. Visual and aural power outputs up to 1000 watts. Broadband operation over 174-230MHz frequency range, or narrow band for selected channels. Max. MTBF and min. MTTR.

### Solid State Class C Protected Power Amplifiers

Series EWA, PWA are used in applications requiring high power and maximum bandwidth. 60 standard-design EWA models have electronic protection, frequencies from 1 to 1000MHz, octave/decade bandwidths, power up to 1000 watts. Series PWA is circulator-protected, more than 160 standard models, frequencies from 100 to 4200MHz, power up to 1000 watts.

### Solid State High Level Baseband and Baseband Distribution Amplifiers

Series BBA and BDA, designed for CCIR and Intelsat telecommunication applications requiring low group delay, low VSWR, extremely flat amplitude characteristics. Standard models with single or multiple output, gain up to 30dB, power output greater than +15dBm.

### Solid State Class A Wide Band Linear Multi-Couplers

Series LMC and LLMC, for connection of several receivers to a single antenna. Includes 24 standard models covering frequency range from 2MHz to 2GHz in decade and octave bandwidths. Available with 4 to 16 outputs, power up to +23dBm.

### Solid State IF Amplifiers

Series IFA, ideal for telecommunication applications such as Comsat or Intelsat satellite ground stations. Standard models for center frequencies of 70, 700 or 1100MHz. Features include low group delay, low return loss, rugged construction with up to 250,000 hrs. MTBF.



**MICROWAVE POWER DEVICES, INC.**

Adams Court, Plainview, N.Y. 11803 • Tel. 516-433-1400 • TWX 510-221-1862

# If you have one of these...



## ...you can start automatic testing with one of these



Now you can get into automatic testing equipment (ATE) for well under \$10,000, total cost.

All you need is one of the units pictured, the new SPG-800 Synthesized Programmable Generator, and a little do-it-yourself effort. Just use one of the units pictured to store your test procedure program with simple instructions to command the SPG-800 (and any other programmable instruments you use) and you're off and running.

No more knob spinning. No more hooking up counters and scopes and voltmeters to your signal source. Now automatic testing is within reach of every manufacturer—along with the savings in time and labor it means.

And the Model SPG-800 is a modular instrument. So you can get started with just the basic unit for only \$3195. It is a combination programmable function generator operating in the 0.1Hz to 13MHz range and a programmable DC voltage source.

Now or later, add Interstate's low cost field-installable plug-in cards and you'll have a programmable synthesizer and pulse generator too—four programmable test instruments in one.

Interfacing the SPG-800 is easy, too. Use its basic ASCII interface or one of its (optional) plug-in cards for the IEEE bus, the RS-232C or 20 mil loop or parallel interface.

No matter what configuration you order, you'll find the SPG-800 easy to program and reliable in use. And the optional operator control panel—in English—is easily learned by non-technical personnel, so you can program it directly, the day you get it.

If you didn't think your company could afford ATE, it's time to re-think... write today for more information Or call us at (714) 772-2811 or (800) 854-3825 toll free.

### The new SPG-800.

Please send me full information

Name \_\_\_\_\_ Title \_\_\_\_\_  
 Company \_\_\_\_\_  
 Address \_\_\_\_\_  
 City \_\_\_\_\_ State \_\_\_\_\_ Zip \_\_\_\_\_  
 Telephone Number \_\_\_\_\_

Interstate Electronics Corp.  
 Department 7000  
 P.O. Box 3117, Anaheim, CA 92803

## INTERSTATE ELECTRONICS CORPORATION

SUBSIDIARY OF **ATO**

Circle 16 on reader service card

# Connect with a little help from A.P.

**Intra-Connector**

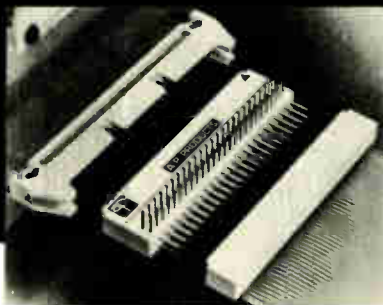

**Intra-Switch**



**Intra-Connector and Intra-Switch do for flat cable systems what our IC Test Clips do for DIPs, which can do a lot for you.**

Intra-Connector mates in-line with standard double row socket connectors. It has one set of female contacts, but two sets of male, at right angles. So it provides instant line-by-line probeability, and, allows for attachment of test probes, components or an additional connector.

Intra-Switch plugs right in line, too. But small, dependable slide switches are built

right in to switch each line, independently. So it's great for diagnostic and quality testing, terrific for programming or selective line inhibiting.

Intra-Connector and Intra-Switch are available in 20, 26, 34, 40 and 50 contact versions at the dealer or distributor in your area who stocks our Faster and Easier Line. You can locate him by calling our toll-free number, 800-321-9668.



**Faster and easier is what we're all about.**



## **A.P. PRODUCTS INCORPORATED**

Box 110 • 72 Corwin Dr., Painesville, OH 44077 • (216) 354-2101 TWX: 810-425-2250

Circle 264 on reader service card

# Productronica 77

Munich, 22-26 November 1977

Processes and Equipment for the Manufacture of Semiconductors, Components and Assemblies in the Electronics Field

International Trade Fair with Demonstrations and Conferences

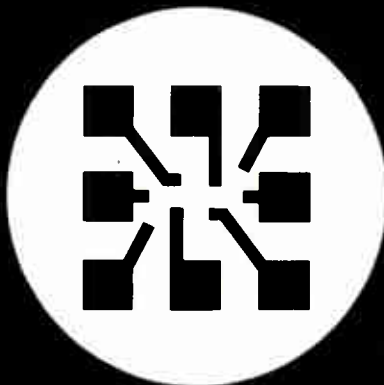

### The Demonstrations

- Yellow Zone: Artwork generation and copying techniques
- Brown Zone: Measuring and testing equipment
- Red Zone: Semiconductor technology
- Green Zone: Equipment and materials for the production of PC-boards and mounting techniques
- Blue Zone: Mounting and connecting techniques, workplace equipment, also hybrid technology
- Violet Zone: Other equipment and means for the production technology within the line of Productronica

### The Conferences

- Assuring dependability and testing quality in electronics
- Programmed measuring and testing in manufacturing
- Materials and control methods for the manufacture of semiconductors
- Modern processes in the manufacture of printed circuits
- Functional galvanizing in electronics

For further information and details on group travel programs: Kallman Associates, U.S. Representative  
30 Journal Square, Jersey City, N.J. 07306 (201) 653-3304

Name \_\_\_\_\_

Address \_\_\_\_\_

Münchener Messe- und Ausstellungsgesellschaft mbH,  
P.O.B. 12 10 09, D-8000 München 12, Tel. (089) 51 07-1

264 Circle 20 on reader service card



## New products

Fujitsu  
Plasma  
Display Units

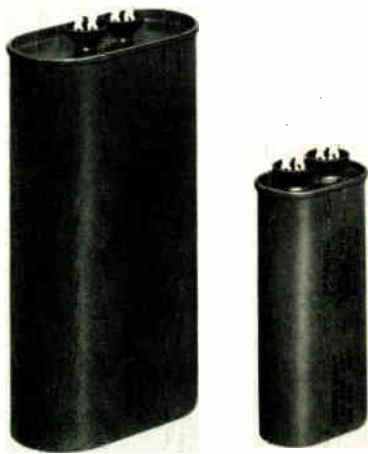

capacitors have an internal pressure-activated switch that will disconnect the capacitor element if excessive pressure develops within the case. Units are available with capacitances from 1.0 microfarad to 50  $\mu$ F and with voltage ratings from 330 volts ac to 660 v ac. Their service life is in excess of 60,000 hours on voltage with 94% survival. First-year survival is designed to be at least 99.5% under rated conditions.

Sprague Electric Co., 35 Marshall St., North Adams, Mass. 01247. Ask for Bulletin 4551 [344]

## Solid-state relay sells for \$12.55

Because it uses a pulse-transformer input circuit instead of an opto-isolator, the model EAX solid-state relay can be sold in small quantities at a list price of only \$12.55. The unit has an input/output isolation resistance of  $10^9$  ohms and a breakdown rating of 1,500 volts rms at 60 hertz.

Input requirements are 8 milliam-



# Now! AC-drive graphic plasma displays with inherent memory from Fujitsu.

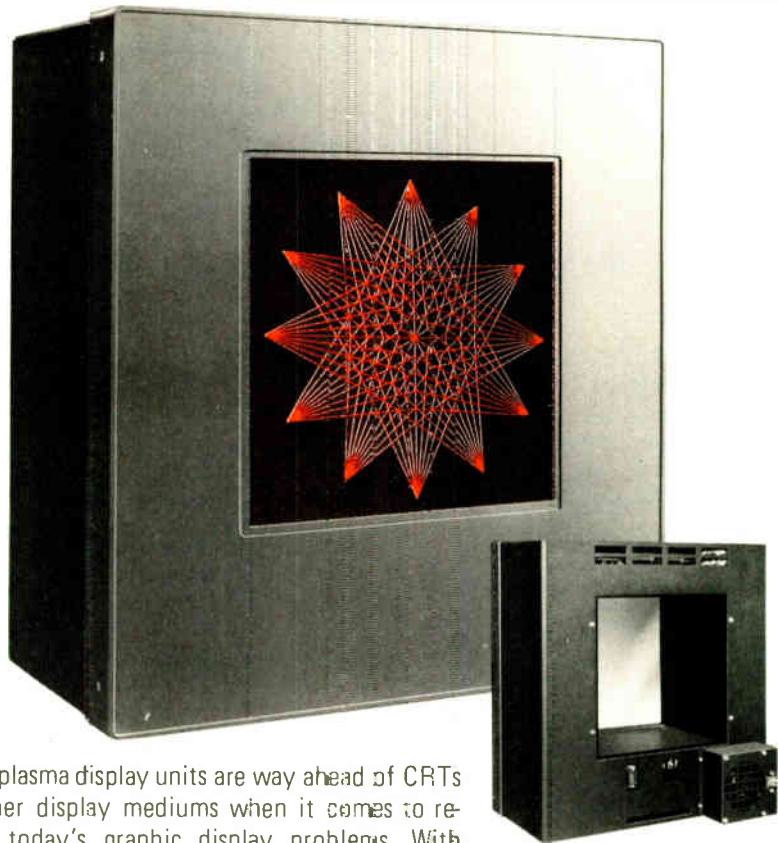

Fujitsu plasma display units are way ahead of CRTs and other display mediums when it comes to resolving today's graphic display problems. With Fujitsu AC-drive graphic plasma displays, you get all the conventional plasma benefits like more compact size, full compatibility with digital operation, suitability for direct replacement of your existing graphic display, high image resolution, long-life operation and more. And Fujitsu also offers you some special pluses. First, you get the largest size available in graphic plasma displays—an expansive 512 x 512 dot field. Then there's our unique AC-drive and inherent memory features which enable Fujitsu plasma displays to retain displayed information *without refresh operation*; thus, operation is easier and size is reduced even further. And, moreover, display is *flicker-free* and *brighter* for improved visualization that eliminates operator eyestrain. Interested in resolving your graphic display problems with the finest display equipment: available today? Write or call now for more information about the total Fujitsu AC-drive plasma display lineup.

### Fujitsu 512 x 512 graphic display (Model PDUG0909R) specifications

Effective display area	8.54" x 8.50"
No. of effective lines	512 x 512 lines
Resolution	60 lines/inch
Serial mode address rate	50K dots/second
Parallel mode address rate	800K dots/second

Fujitsu also offers character display units in five sizes from 16 characters to 480 characters.

Circle 265 on reader service card

**FUJITSU LIMITED**  
Communications and Electronics

Head Office: 6-1, Marunouchi 2-chome, Chiyoda-ku, Tokyo 100, Japan Phone: 03-216-3211 Telex: J22833  
New York Office: 68G Fifth Avenue, New York, N.Y. 10019, U.S.A. Phone: 212-265-5360 Telex: 23 234969

World Radio History

# OPTO-METERS

## two proven performers

Name your most important criteria for a general purpose photometer/radiometer. If you need reliability and an excellent price/performance ratio, we've got it.

**40X ANALOG OPTO-METER**—a high quality, low cost photometer/radiometer. It's a portable instrument with the accuracy, reliability and capability found in higher priced models. Measurement range:  $10^{-2}$  to  $10^{-9}$ W;  $10^4$  to  $10^{-3}$ fc • flat 450 to 950 nm, and CIE response • NBS traceability to  $\pm 2\%$  • no measurable drift • fully calibrated.



**80X DIGITAL OPTO-METER**—one step up from the 40X with an extra decade of measurement ( $10^{-2}$  to  $10^{-10}$ W and  $10^4$  to  $10^{-4}$ fc). The 80X is battery and AC powered for both lab and field use.



These are only two of the UDT Performers—light measurement instrumentation to fill a wide range of requirements. Call or write for applications assistance.

### YEARS AHEAD IN LIGHT detection • measurement • application



**UNITED DETECTOR TECHNOLOGY, INC.**

2644 30th Street, Santa Monica, California 90405  
Telephone: (213) 396-3175 Telex: 65-2413

Circle 266 on reader service card

# HOPE

in a word is what we are.

Project HOPE exists because there are people with hope—people who have given 3.5 million men, women, and children on four continents the chance for happier, more productive lives through improved health care.

Give to

**PROJECT  
HOPE**

Department A  
Washington, D. C. 20007

### New products

peres at 5, 12, or 24 v dc. Output rating is 1.2 A at 120 v ac. The relay has a turn-on time of no more than 0.5 millisecond and a maximum turn-off time of 10 ms (60 Hz) or 12 ms (50 Hz). Expected life is at least 100 million operations at rated load across the temperature range from  $-10^{\circ}\text{C}$  to  $55^{\circ}\text{C}$ . Delivery time is four weeks.

Potter & Brumfield Division of AMF Inc., Princeton, Ind. 47671. Phone Wm. Sidmore at (812) 386-1000 [347]

### Rotating coaxial connector handles 15 A at 2,000 rpm

Ball-bearing construction and mercury sliprings allow the model RTX-2 rotating coaxial connector to carry 15 amperes at 1,500 v rms while rotating at 2,000 revolutions per

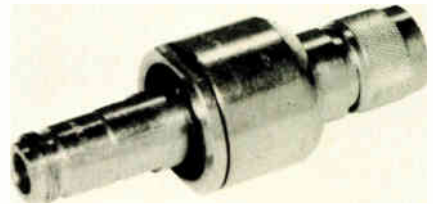

minute. Built in a rugged UG series housing, the connector weighs just 8 ounces.

Meridian Laboratory Inc., 2415 Evergreen Rd., Middleton, Wis. 53562 [346]

### Thin-film thermistors offer high accuracy

A line of thin-film thermistors that cover the range from  $-55^{\circ}\text{C}$  to  $125^{\circ}\text{C}$  are accurate to within  $0.5^{\circ}\text{C}$  over the limited span of  $0^{\circ}\text{C}$  to  $60^{\circ}\text{C}$ . The low-cost, interchangeable thermistors in the TFT304 series have a temperature coefficient of resistance of  $-3\%/^{\circ}\text{C}$  over the full operating range. Priced at \$1.20 each in hundreds, the devices are packaged in a plastic TO-92 style transistor case with an integral metal mounting tab that also pro-

# United Systems' NEW Datalogger 1000

## What does it do?

For only \$1995 your Datalogger 1000 comes complete, ready-to-monitor 10 data points and is easily expandable to 100. Unattended, it watches your test, experiment or process, logs all pertinent information and warns you of potential problems.

It provides continuous display of time, channel and 20,000 counts of measured data for instant visual analysis while the hard-copy printout permanently records the same information for future reference... all standard.

With the Datalogger 1000, you only pay for the capability you require. A minimum initial investment will meet your present measuring needs, while low-cost field-installable modules provide the flexibility to change parameters as required.

Simplicity of front panel controls provides straightforward operation... easy enough for anyone to use without special training.

Compact and portable, the Datalogger 1000 can be used by Research, Engineering or Manufacturing, in the plant or in the field, to provide a quick return on investment.

**At \$1995, there is nothing comparable.**

For additional information contact your United Systems Representative or call the factory (513) 254-6251.

Doesn't make mistakes, take coffee breaks or get sick...  
Doesn't watch the clock (although it has one)...  
Doesn't get premium or overtime pay and never complains...

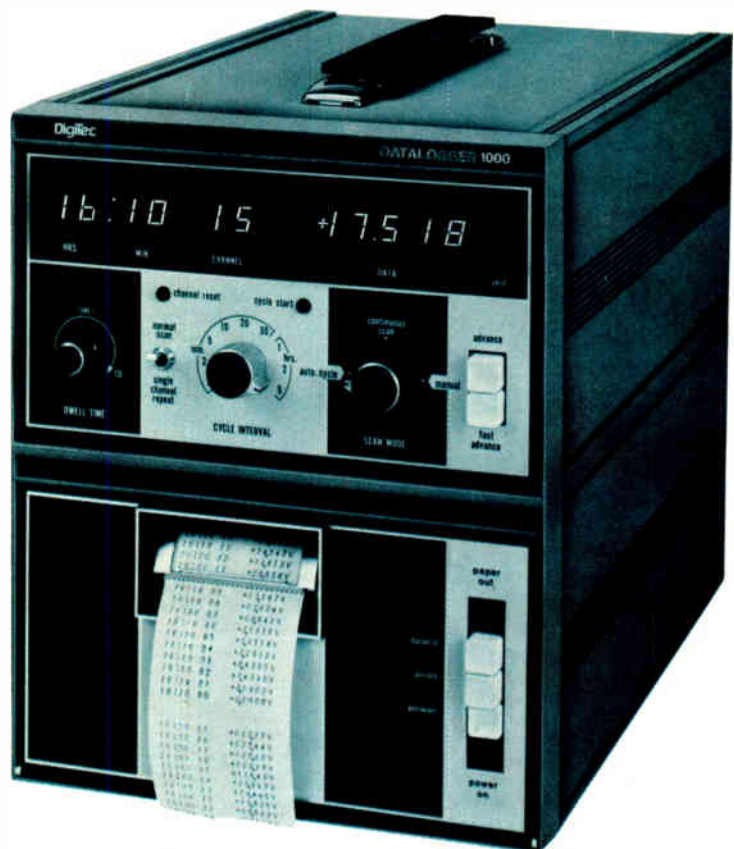

**Digitec** UNITED SYSTEMS CORPORATION

918 Woodley Road, Dayton, Ohio 45403  
(513) 254-6251, TWX (810) 459-1728

*United Systems Corp.:  
Precision measurements to count on*

"Information only" Circle 186

"Demonstration only" Circle 267

## Paying More Than \$295 For Waterproof Load Cells?



**Why?**

Designing electronic weighing, force measuring or test systems for all weather use? You won't find a price this low for any other *waterproof and barometrically insensitive* strain gage load cell—especially one offering an error band of less than  $\pm 0.04\%$ !

Buy a definite competitive edge in price and performance with Sealed Super-Minis that operate in tension or compression—with capacities to 1,000 pounds.

For detailed specifications on 5 pound to 100 ton capacity load cells, call—write Interface, 7401 E. Butherus Dr., Scottsdale, AZ USA 85260. (602) 948-5555, Telex 668-394.



Low Profile



Minibeam



Super-Mini

**interface**  
ADVANCED FORCE MEASUREMENT

Circle 22 on reader service card

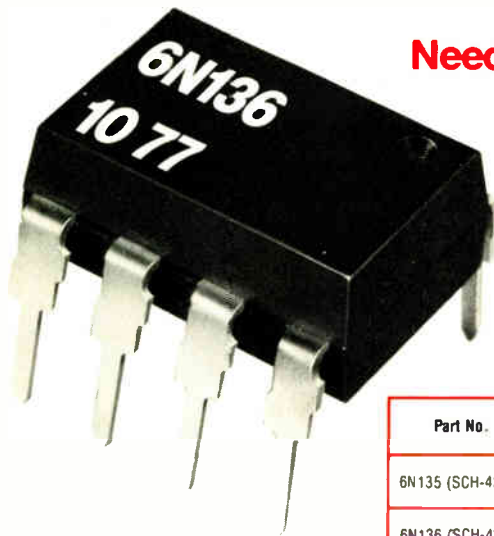

## Need a second source on high-speed optically coupled isolators?

Spectronics 6N135-6N139 are pin-for-pin replacements for respective HP6N135-139 devices.

3000 VDC Isolation!

Part No.	Input Current	Data Rate	CTR
6N135 (SCH-4350)	16 ma	1 Mbit/sec	7% (min)
6N136 (SCH-4351)	16 ma	1 Mbit/sec	19% (min)
6N137 (SCH-4360)	5 ma	10 Mbit/sec	700% (typ)
6N138 (SCH-4370)	1.6 ma	30M Kbit/sec	300% (min)
6N139 (SCH-4371)	0.5 ma	30M Kbit/sec	400% (min)

Now there's a second-source for those hard-to-find high speed optically coupled isolators. Spectronics, Inc., leading manufacturer of quality optoelectronic products, is offering advanced technology optical isolators in 8-pin DIPs. (See chart at right for performance features.)

For more details and delivery information, contact our Corporate Office at 830 E. Arapaho Road, Richardson, Texas 75081, (214) 234-4271.



**Spectronics**  
INCORPORATED

Circle 716 on reader service card

## New products

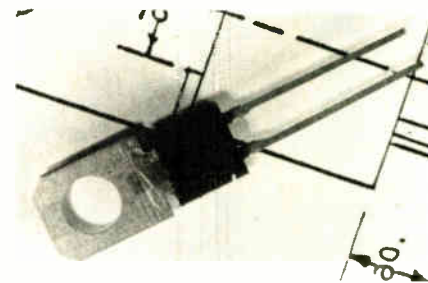

vides high thermal conductivity.

Multi-State Devices Ltd., 2255 Dandurand St., Montreal, Quebec H2G 1Z6, Canada. Phone Goeffrey Geduld at (514) 279-4507 [348]

## One relay provides two time delays

Known as the Double Time, a new time-delay relay makes it possible to obtain two factory-preset time delays from a single device. The double-pole, double-throw thermal device is designed so that both time delays are initiated upon the energization of a common thermal actuator. Upon completion of each preset delay, a separate set of double-pole snap-action contacts is transferred.

Originally developed to help telephone companies determine the source of interrupted service, the Double Time can also be used for stagger starting and other sequencing operations and to detect the loss of voltage or resistance on a line.

Contacts are rated at 3 amperes at 115 volts ac or 28 v dc. Each delay can be adjusted at the factory from 10 to 60 seconds. Standard heater ratings are 6.3, 26.5, and 115 v.

Relay Specialties Inc., 1300 Plaza Rd., Fair Lawn, N. J. 07410 [349]



Electronics/September 15, 1977



Model 252  
Digital Impedance Meter

# L-R-C Gotcha! ...and for only \$695

(U.S.A. only)

## Newest ESI "weeder" does it all - even Dissipation Factor.

At \$695, incoming inspection and evaluation of passive components becomes easily affordable. You not only measure L, R, C and G with high accuracy over wide ranges, but the dissipation factor reads out also. Check these features in this light, compact, easy to transport tester:

- Measures D as well as L, R, C, G, automatically.
- Light weight; tilt stand handle.
- 0.25% basic accuracy.
- Wide ranges.
- 1 kHz test frequency.
- 2 measurements/sec.
- External bias.
- 4-terminal connection.
- Analog outputs.
- Low power design.



- Large 3½-digit display.
- Front panel dust cover (option).
- Input protection.

Measurements are simple, fast and accurate . . . Set the range and connect to unknown. Four-terminal KELVIN KLIPS® are included, and a front panel dust cover is optional. The Model 252 can also be combined with ESI's Model 1412B Limits Comparator for go/no-go testing.

Handy tiltstand handle completes this value buy, along with the assurance of our precision measurement name: Electro Scientific Industries, 13900 NW Science Park Dr., Portland, Ore. 97229. Units will be available in November, so request a demo today. Telephone 503/641-4141.



Circle 18 on reader service card

# Low-leakage current for half the currency.

Replaces expensive tantalum and film capacitors. Our new Low-Leakage Series of Aluminum Electrolytic Capacitors have been specifically designed to meet the most stringent low-leakage design specifications. Yet they cost up to 50% less than tantalum or film-type capacitors. These V Series radial type capacitors offer a maximum leakage of .002 CV or 0.4  $\mu$ A (whichever is greater) with a capacitance range from 0.1  $\mu$ F to 100  $\mu$ F. It's operating temperature range is  $-40^{\circ}\text{C}$  through  $+85^{\circ}\text{C}$ . Low-Leakage Aluminum Electrolytics

are just one example of our continuing emphasis on reliability as the dominant design criterion. We manufacture every type of capacitor including other types of aluminum electrolytics, ceramic discs, film, oil filled—without PCB's, metallized paper and wax paper capacitors for standard or specialized applications.

Send for your free catalog and engineering samples today. Simply write to us on your company letterhead.

You'll hear from us soon.



## nichicon

**The pulse of the industry.**

NICHICON (AMERICA) CORPORATION  
6435 N. Proesel Ave. • Chicago, IL 60645 • (312) 679-6530  
Division of NICHICON CAPACITOR LTD., Kyoto, Japan

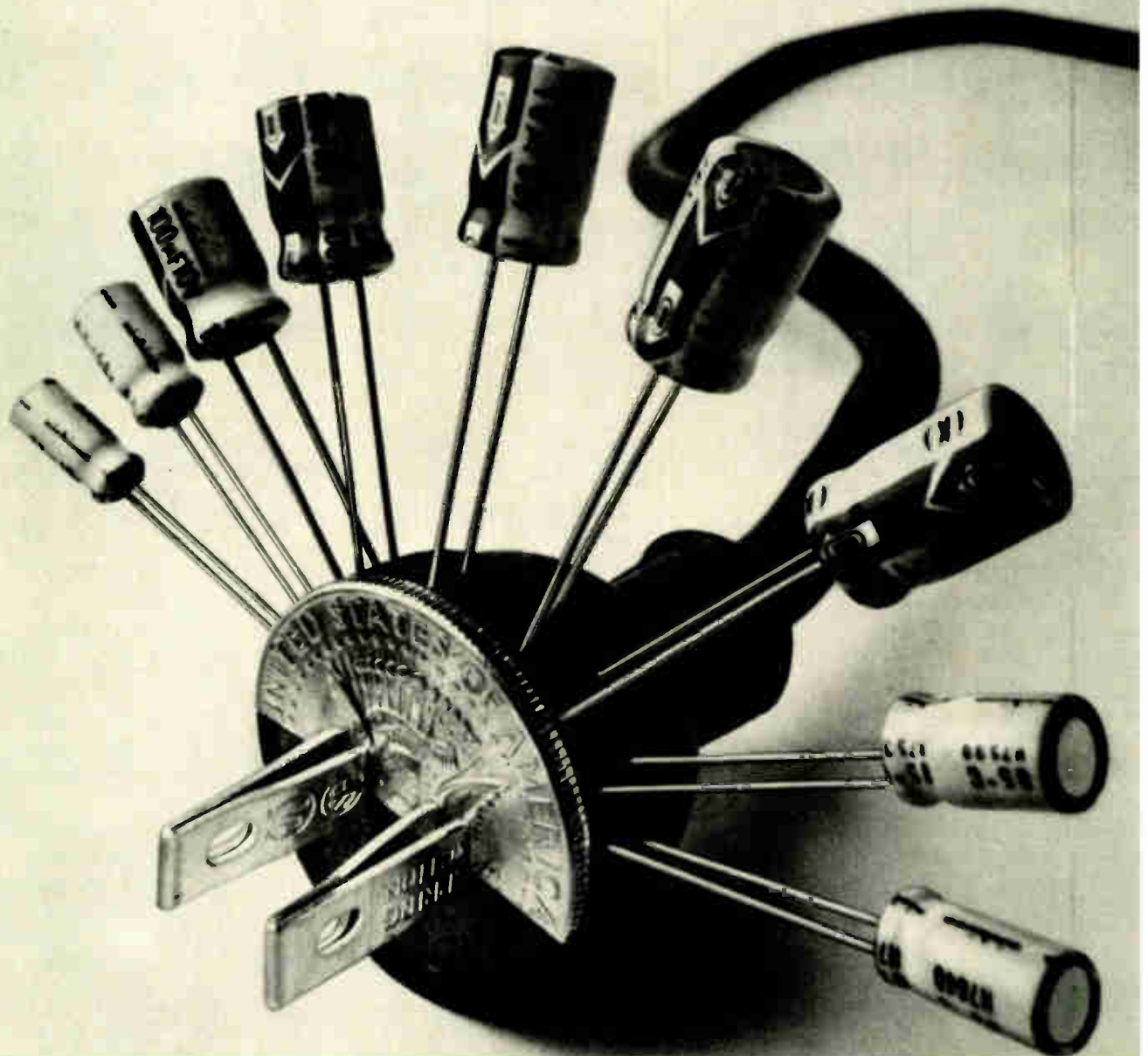

# Versatility is written all over its face.



First thing you probably notice—it's a dual filter. Each of the 24db/octave filters can be used as high pass, or low pass, with selectable gain of 1 or 10.

### Consider the possibilities.

Connect the dual channels in series for bandpass, 48db/octave high pass, and 48db/octave low pass, with selective gain of 1, 10, or 100. Butterworth and Bessel modes are available at

the push of a button. And you can select AC or DC coupling.

### Versatility is not just skin deep.

Switch selectable frequency settings ensure repeatability of settings from 10Hz to 1MHz. And repeatability of settings, combined with only .005% distortion at 20 volts output, means you can predict results—without having to calibrate your tail off.

Look a little deeper and

you'll find 100db outband noise rejection, and a remarkably low 25  $\mu$ volts noise.

### Ask for a demonstration.

Versatility like this should be seen to be believed. And wait till you see the price. \$655. Not bad for all that versatility.

Call or write John Hanson at Ithaco, Box 818, Ithaca, N.Y. 14850. Phone. (607) 272-7640.

**ITHACO**

# STANDARDIZED

## TERMINATED LEADS

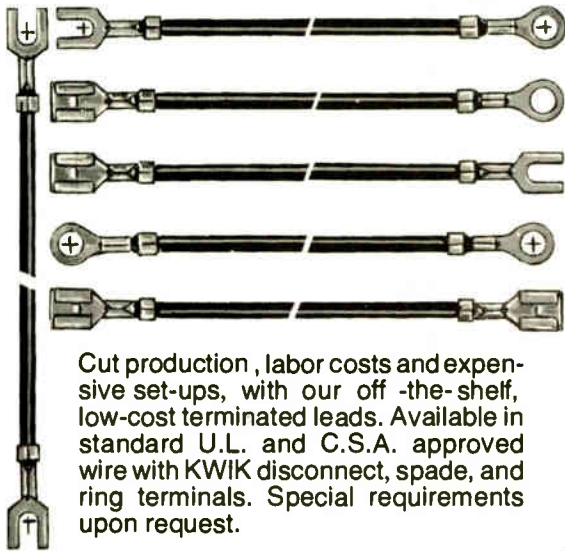

Cut production, labor costs and expensive set-ups, with our off-the-shelf, low-cost terminated leads. Available in standard U.L. and C.S.A. approved wire with KWIK disconnect, spade, and ring terminals. Special requirements upon request.



NEW FREE CATALOG ON REQUEST

### KEYSTONE

ELECTRONICS CORP.

49 BLEECKER STREET, NEW YORK N.Y. 10012 212-475-4600

Circle 28 on reader service card

# digit for digit Gralex DPM's read out best



- Easy-to-read GAS DISCHARGE DISPLAY
- Accurate 3½ DIGIT performance
- Ultra-Reliability
- Low Cost
- NEMA Interchangeability

Send for specifications or see for yourself.  
Send for FREE 30 day evaluation unit.



## GRALEX

INDUSTRIES

155 Marine Street,  
Farmingdale, N.Y. 11735  
Tel: 516-694-3607  
TWX 510-224-6406

Send literature: circle 710  
Send Free evaluation unit: circle 30

World Radio History

### New products/materials

Liquid two-way tape is a pressure-sensitive adhesive that can be applied like ink with a marker pen. The water-based material will adhere to any dry, nonoily surface—even Teflon—where it polymerizes and turns into a tacky, transparent surface in about half an hour at room temperature. In this state, the adhesive may be used for many of the applications in which one usually

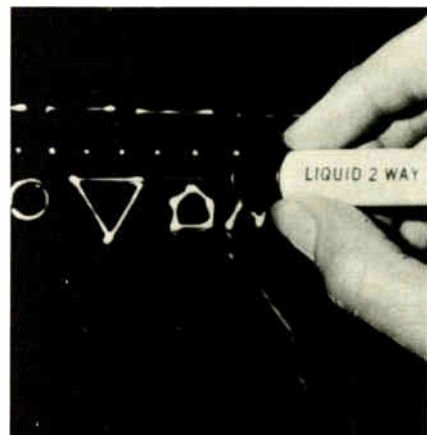

finds double-sided tape: film overlaying, pre-positioning of electronic parts, and flexible bonding in general. If speed is important, the adhesive can be polymerized in five minutes with a hot-air blower. Pens filled with the adhesive sell for \$2.95 each in singles or \$2.65 each in quantities of five or more.

Metron Optics, Box 690, Solana Beach, Calif. 92075. Phone (714) 755-4477 [476]

Experimental indium plating is easy and inexpensive with a kit that includes a liter of indium-sulfamate





# The Simpson DIGITAL MULTIMETER FAMILY KEEPS GROWING!

Here's our latest addition  
For \$130



**New Compact Portable Model 461**  
Complete with nickel-cadmium batteries, AC charger/adapter, test leads and instruction manual

- 8 FULL HOURS continuous battery operation . . . a full day's work without interruption
- 0.25% DC V accuracy
- Large bright 0.3" LED display
- Automatic zero and polarity
- 100 $\mu$ V, 0.1 $\Omega$ , 100 nA sensitivity
- 26 pushbutton selected ranges
- High energy fuse safely contained in case
- Folding bench stand
- Only 2 x 5.6 x 4.6"; 1 1/2 lb.

## ALL SIMPSON DMM'S HAVE

- Reliable overload-protected LSI circuitry
- Easy-to-read 3 1/2 digit red LED displays with automatic polarity
- Performance proven with a 200-hour burn-in, backed up by a one-year guarantee
- Complete line of accessories is available

### For \$210

#### Popular Priced Model 464A

- 0.1% DC V accuracy
- 28 pushbutton ranges including 10A AC/DC
- Bright 0.43" LEDs, automatic zero
- High-impact case with tilt-view adjustable handle
- For AC line operation. Optional AC/rechargeable version available for \$247



### For \$285

#### Deluxe 460-3A

- 0.1% DC V accuracy, custom MOS/LSI circuitry
- 32 ranges including low power resistance ranges and 10A AC/DC current
- Bright 0.43" LEDs, automatic ZERO
- Calibrated auxiliary analog meter
- For AC line operation. Optional AC/rechargeable version available for \$322



### For \$295

#### Autoranging Model 465A

- Automatically selects and displays the proper measuring range
- High 0.1% DC V accuracy, custom MOS/LSI circuitry, 0.43" LEDs
- Measures DC voltage to 1000 V, AC voltage to 600 V, resistance to 20 megohms, low power ohms ranges AC/DC current to 10A
- AC line operation. Optional AC/rechargeable version available for \$332



### For \$257

#### Digital VOM — the 360-2

- AC line and rechargeable operation standard
- 0.25% DC V accuracy exclusive MOS/LSI circuitry, automatic zero
- 29 ranges including low power resistance
- Calibrated zero center analog meter
- Recorder output



CHOOSE THE ONE THAT'S BEST FOR YOU  
AT YOUR LOCAL ELECTRONICS DISTRIBUTOR



#### SIMPSON ELECTRIC COMPANY

853 Dundee Avenue, Elgin, Illinois 60120  
(312) 697-2260 • Cable SIMELCO • Telex 72-2416

KATY INDUSTRIES



# Industry's First Companding A/D In a DIP

- 7 Bits plus sign  
±72 dB dynamic range
- Follows Bell  $\mu$ 255 law
- ±5V input range
- Low Power  
660 mW
- Adjustment free
- Small  
18-pin hermetic DIP

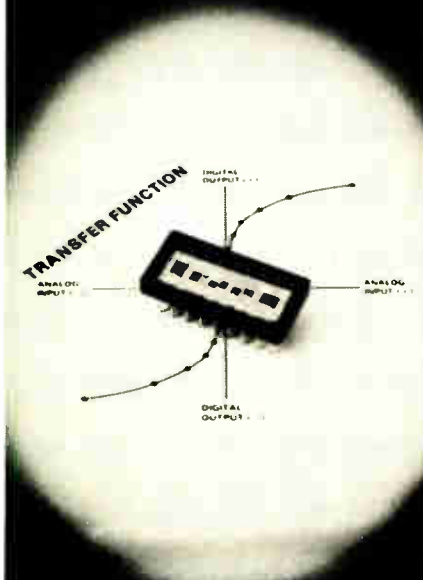

**MN 5110**  
**\$55.00\***

\* in 100 quantity



Micro Networks Corporation  
324 Clark Street, Worcester, MA 01606  
(617) 852-5400 TWX 710-340-0067

Circle 34 on reader service card

## New products/materials

bath, two 99.99% indium anodes, and an instruction manual. The anodes measure 1 by 12 by 0.030 inches. The plating research kit sells for \$95.

The Indium Corp. of America, P. O. Box 269, Utica, N. Y. 13503 [477]

**Conductive natural rubber** combines low cost with high wear resistance, making it suitable as a floor covering in areas in which static electricity can cause problems. Called Stati-Ex, the material is offered in two thicknesses: 1 millimeter and 2 mm. The 2-mm thickness is recommended for floor covering and other heavy-duty applications, while the 1-mm is good for bench tops and other light duties. Standard sizes are 1 meter by 5 m and 10 m by 20 m. Sample squares that measure 1 m on a side sell for \$15 in the 1-mm thickness and \$25 in the 2-mm.

Signalarm Inc., P. O. Box 3128, Springfield, Mass. 01101 [478]

**Interference filter tubing** in the Eccoshield FC family is a plastic extrusion useful for suppressing electromagnetic interference along a wire or cable. A replacement for conventional emi filters and ferrite transmission-line beads, the flexible Eccoshield FC also provides some shielding against radiated energy. Three types are available: a conductive tubing for use above several hundred megahertz where magnetic properties are not required, a magnetically loaded nonconducting tubing for use from 50 MHz to 100 gigahertz, and a ferrite-loaded tubing for use from 30 MHz to 100 GHz. Prices range from \$1.26 to \$3.42 per foot for quantities from 1 to 49 feet.

Emerson & Cuming Inc., Canton, Mass. 02021 [479]

A **substrate material** for microwave integrated circuits, RT/duroid 5870 has a dielectric constant of 2.34 ±0.03% from 1 megahertz to 10 gigahertz. Made of glass-fiber-reinforced polytetrafluoroethylene clad with a conductive layer, the material can be machined and soldered without damage. Samples measuring 5 by 8 inches may be obtained by

**Our Strict Production  
Control System with  
Full Automation Guarantees  
Quality and Uniformity  
of Products.  
This is Our Everlasting Target.**



Miniature lamps: Sub-miniature lamps:  
Various base caps: All other parts for lamps:  
For further information and your problem settlement,  
contact us immediately

**SAKATA MANUFACTURING CO., LTD.**

14-12, 3-Chome, Hatanodai,  
Shinagawa-ku, Tokyo, 142, Japan  
Cable Address: "SAKATABASE" TOKYO.  
Tel: (03) 781-6078

Circle 39 on reader service card



**TOUCH TONE\*  
ENCODERS ARE  
MICROPROCESSOR  
CONTROLLABLE  
MODEL 510 & MODEL 511**

Provide  
true sinewave outputs  
low distortion < 1%  
no external components  
required

Low profile packaging

\*Reg TM of AT & T  
FOI also manufactures  
Active Filters, Sinewave  
Oscillators, Touch Tone\* Detectors  
and other Communications components.

Frequency Devices, Inc.  
25 Locust Street  
Haverhill, Mass. 01830

(617) 374-0761, TWX 710-347-0314

Circle 40 on reader service card

# METSHIELD™ Fabric.

## The first major advance in magnetic shielding in 50 years.



### Now in 40" widths

METSHIELD™ Fabric can help you achieve EMC in field repairs, prototype design, production equipment, and shielded rooms.

Now you have such a shielding. METSHIELD™ magnetic shielding fabric—a wholly new flexible product made from Allied Chemical's METGLAS® amorphous metal alloys.

Because of its exceptional strength and flexibility, METSHIELD fabric retains its full shielding effectiveness during fabrication and use.

This reliability of performance—plus the ease with which METSHIELD fabric can be fabricated—enables you to use magnetic shielding as a preferred method to achieve electromagnetically compatible system designs. And METSHIELD fabric now comes in 40" (1 meter) widths for even greater design flexibility.

Discover how this remarkable material can help meet your shielding needs. Phone John Dismukes at 201-445-4031 or Jack Thorp at 201-455-3306. Or return the coupon.

This is the magnetic shielding product whose time has come.

Increased sales of electronic equipment, a trend toward miniaturization and intensified regulatory considerations have put increased emphasis on EMC.

Consequently, electronics manufacturers need cost-effective magnetic shielding not plagued by fabrication problems and use limitations associated with conventional nickel alloys.

Check boxes for information on METGLAS® alloys and METSHIELD™ fabric.

- Technical data
- Fabrication
- Grounding and contacting
- Other (specify) \_\_\_\_\_
- Send me sample of METSHIELD fabric

Name/Title \_\_\_\_\_

Company \_\_\_\_\_

City/State/Zip \_\_\_\_\_

Mail to: Metglas Products, Allied Chemical Corporation  
7 Vreeland Road, Florham Park, NJ 07932



# KEEP THE HORSE BEFORE THE CART!

You've probably known design engineers who are half-way through a project before they realize the power supply that could have come from a standard line must all of a sudden be a customized design. And you also know what that means in the way of extra costs. It's the old cart before the horse theory.

Call us when you are in the embryonic stages of your design and we'll work with you in your primary important stages. And not only will you like the fact that our standard lines will both fit your supply and keep you in budget. . . you'll like the idea of our already field-tested dependability.

Our power supplies are available for OEM computer, point of sale, EDP, bank telling and telecommunications use:

- Switching regulator and linear designs • 11 models — single/multi-output • Voltage ranges, from 2 to 30V • 50 current levels from .01 to 225 amps • Overcurrent/overvoltage protection • Filtering to meet world-wide EMI requirements • Designed and built to UL, CSA and European safety requirements.

*Dependability.* That's a word we define as quality and reliability. It's also what design engineers define as our reputation!

# NCR

NCR POWER SYSTEMS DIVISION

formerly Scott Electronics  
584 S. Lake Emma Road, P.O. Box 898  
Lake Mary, Florida 32746

Telephone (305) 323-9250

Circle 44 on reader service card

## New products/materials

letterhead request.

Rogers Corp., Chandler, Ariz., 85224, Attn: Barbara Boss [480]

**Oxide-free solder cream**, resulting from a new processing technique, eliminates solder balls, contamination of joints, and dewetting. At the same time, the performance and shelf-life of the solder cream are improved, according to the manufacturer, Multicore Solders. Because of the new manufacturing method, the company says, the cream requires shorter dwell time and lower soldering temperatures. The flux residue is light and clear in color, which makes it easier to inspect joints. Wetting properties are improved since flux activity is not expended in removing oxides from the metal powder during heating, but rather can be concentrated on the surfaces to be soldered. Multicore solder is available in a variety of tin-lead as well as silver-bearing alloys with either an active or a mildly active rosin-base flux. Purity, mesh size and flux properties conform to QQ-S-571. Under normal circumstances, stirring before use is not required. The tacky consistency of the material enables it to be used as a temporary adhesive to hold components in place before and during application of heat. Depending on alloy and quantity, prices average about 10 cents per gram. Multicore Solders, Westbury, N. Y. 11590 [362]

**High-temperature conductive coating**, Electro-Chem 100, provides continuous service at 800°F and higher. The material consists of conductive carbon suspended in a solution of highly polymerized silicone resin. In its final form, as shipped, the highly viscous solution is diluted with xylol to form a 50% solids solution that is easy to apply to the inside of cathode-ray tubes and other surfaces. Electro-Chem 100 bonds readily to glass and ceramic. It can be sprayed, brushed on, or be applied by dipping.

Delta Electro-Chemical Products Co., Division of Brunswick Chemical Corp., 49 Brunswick Rd., Montclair, N. J. 07042. Phone (201) 744-8117 [363]

## GAINESVILLE IS READY FOR ELECTRONICS

Gainesville is quickly becoming the medical research center of the south. Electronics and medicine have joined forces. Today more than ever before these two industries support each other. The University of Florida's Electronic Research Laboratories (directly assisting Florida's industries), the accessibility of Gainesville to the southeastern markets, available sites and existing buildings, low taxes, and adequate area labor population make Gainesville very attractive. Add to these a mean temperature of 69.9, the Atlantic Ocean, the Gulf of Mexico, year round recreation, and major sport attractions and you can come to only one conclusion: Gainesville is READY for Electronics.

GAINESVILLE  
AREA CHAMBER OF COMMERCE  
GAINESVILLE  
FLORIDA 32602  
Dept. D / P.O. Box 1187 / (904) 372-4771

In cooperation with the Division of Economic Development, Florida Dept. of Commerce.

Circle 45 on reader service card

## PINPOINT HEAT

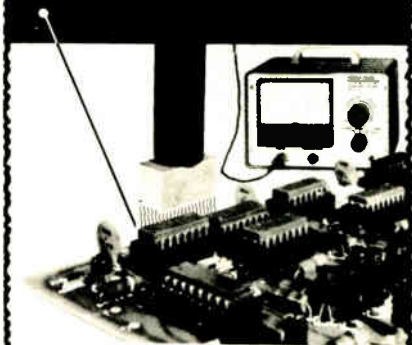

Heat any integrated circuit or electronic component to its rated temperature with a heat probe. Accuracy  $\pm 3^{\circ}\text{C}$  or better. Or check the component's temperature with a thermo-couple probe. Model 810 Thermo-Probe does both. Reads out directly in  $^{\circ}\text{C}$  and  $^{\circ}\text{F}$  on a large  $4\frac{1}{2}$ -inch meter.

Models with other temperature ranges available. For details write to:

**MTI** MICRO-TECHNICAL INDUSTRIES

P.O. Box 287 South Laguna, CA 92677  
(714) 545-3734 • TWX910 596-1325 MOCROTEC LBEH

Circle 46 on reader service card

# PROVEN PERFORMANCE CRYSTAL CLOCK OSCILLATORS



Motorola's K1100A leads the industry with a crystal clock oscillator that has a proven track record of more than two million units. That's right... over two million oscillators are in use by satisfied, repeat customers.

How versatile is the K1100A? With over 1200 frequencies already designed, and same-day shipment for standard stock frequencies of 4, 4.9152, 5, 10, and 20 MHz, you make the decision.

Oscillators are available from 250 kHz to 70 MHz,  $\pm 0.01\%$  stability from  $0^{\circ}\text{C}$  to  $70^{\circ}\text{C}$ , TTL-compatible, and standard +5V dc input.

For full specifications and prices on the oscillator that design engineers trust, write Motorola, Component Products Department, 2553 N. Edginton, Franklin Park, Illinois 60131.  
Or call (312) 451-1000, ext. 4183.

**It's simple!**  
**Motorola wants to be**  
**your clock company.**



**MOTOROLA**  
Communications and Electronics Inc.

# DIGITAL SWITCHES BY EECO

## THUMBWHEEL SWITCHES

### NEW . . . 8mm WIDE 1800 SERIES

Slim—only .315" (8mm) wide with large .234" high characters. Assemblies snap into panels; no tools or screw holes required. All popular codes. P.C. Board Termination. Front mount.

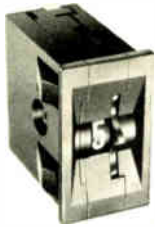

### 1776 and 1976 SERIES

1776 series, miniature .500" wide thumbwheel switches offers a selection of over 50 codes, and plastic window dust seal protection. 1976 is a slimmer .350" wide switch with the same advantages. Options include Fast-Mount Hardware, lighting, RFI shielding, stops to limit rotation and notched terminals for direct P.C. Board mounting.

## PRINTED CIRCUIT BOARD SWITCHES

### MICRO-DIP

Binary coded dip switch. Solder directly to circuit boards or plug into one-half of a 14-pin socket. 10 and 16-positions, screwdriver setting.



**NEW**

### MINI-DIP

Positive wiping SPST gold contacts give tear-proof reliability. Dust-free design, improved legibility and rocker-locking device. 2-10 stations.



### STRIPSWITCHES

Series 21 and 2500 stripswitches mount directly on printed circuit boards. Available in BCD, decimal and other popular 10 and 16-position codes. Screwdriver, thumbwheel and extended knob setting models are available.

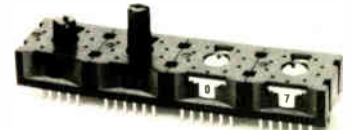

One Year Warranty!

**EECO**

\* FREE

8-Page Full Color Product Guide

1441 East Chestnut Avenue • Santa Ana, California 92701 • Phone: (714) 835-6000 • TWX 910-595-1550 • Telex 67-8420  
Distributed in U.S. by Marshall Industries, Hall-Mark and Schweber. In Canada by R.A.E and Penryn. Agents Throughout The World.

Circle 107 on reader service card

# At +125°C you can burn your fingers on some DAC's our 4058 stays cool



Because this new, hybrid 12 bit DAC was specifically designed for the temperature range -55 to +125°C.

It is not merely a top-end selection of commercial DAC's, where you don't know today what tomorrow's yield will be.

Your application may not need the full temperature range nor the hermetically sealed metal DIP. But for a lot of industrial applications these and other features of the new DAC offer you vital safety factors.

For example, it is produced to MIL Std 883 giving extremely high reliability. It has a very low temperature drift of 5 ppm/°C gain, 10 ppm/°C max. offset.

And if you want to fly with it, the 4058 is shock, vibration and acceleration tested - its already being used in the new MRCA.

 **TELEDYNE PHILBRICK**

Allied Drive at Route 128  
Dedham, Massachusetts 02026  
Tel: (617) 329-1600

TWX: (710) 348-6726  
Telex: 92-4439  
Cable: TELEPHIL

# Pay less, get more.

## New literature

**Indium-tin-oxide films.** Application note CAN-4 explains the procedure for depositing indium-tin-oxide films into a diffusion pump vacuum system with a magnetron S-Gun. The productivity of the 3120-H S-gun sputtering system for ITO films is briefly discussed, along with some of the characteristics of ITO films deposited with the S-gun source. Varian Palo Alto Vacuum Division, 611 Hansen Way, Palo Alto, Calif. 94303. Circle reader service number 421.

**Pincushion distortion.** Application note 1, entitled "Pincushion Distortion, a Significant Factor in CRT Displays," is being offered by Syntronic Instruments Inc., 100 Industrial Rd., Addison, Ill. 60101 [422]

**Benchmarking ADP systems.** Methods that can be applied by Federal agencies to validate hardware and software performance are contained in the pamphlet "Guidelines for Benchmarking ADP Systems in the Competitive Procurement Environment." Included are an overview of the process, ways to reduce problems, and recommended procedures. Copies can be obtained at \$4.00 each using order number NBS-FIPS-PUB-42-1. Microfiche copies can be ordered at \$3.00 each. National Technical Information Service, U. S. Department of Commerce, Springfield, Va. 22161.

**Converters.** A large variety of design engineering problems can be solved by using voltage-to-frequency and frequency-to-voltage converters. Application note 32 gives information on how to optimize uses of these converters for improving response time, for tailoring performance to specific input/output requirements and for maximizing usefulness. Tele-dyne Philbrick, Allied Drive at Route 128, Dedham, Mass. 02026 [424]

**Integrated circuits.** Seventeen types of display-driver integrated circuits are discussed in a 71-page data book. Metal-oxide semiconductors drive light-emitting diodes, thermal print-



Lots more. In fact, the new 8020A digital multimeter has more features and capability than any other DMM at any price.

Once again, it pays to think small. Costing only \$169,\* the 8020A is big on features and value.

You get unbelievable field versatility with the 8020A, and it's sized to slip easily into your pocket or service kit. Compact, with big features—like 0.25% dc accuracy and 26 ranges. Conductance ranges for measuring leakage to 10,000 M $\Omega$ , or transistor beta. Ten megohm input resistance, ac and dc. Battery powered, with a large liquid crystal display.

For reliability, we've shrunk the number of total parts to only 47, including the world's first custom LSI CMOS multimeter chip.

On-the-job reliability you can't be without. A full-year guarantee. Worldwide parts and service. And more, including the traditional Fluke quality you depend on.

Call (800) 426-0361, toll free. Give us your chargecard number and we'll put an 8020A in your hand immediately. (Or a ten-pack of 8020As for only \$1521\*.) Call now for the location of the closest Fluke office or distributor.

\*U.S. price only.

**Fluke 8020A DMM for Field Service: \$169.**

1807-7006



For literature only circle 72

279

Electronics/September 15, 1977

**Active filter products.** A 36-page catalog, "Active Filter Products," is designed to help an engineer select

Electronics/September 15, 1977

For literature only circle 76

281

# FREQ. OUT.

## MATSUO CAPACITORS. NOW! 5 TYPES, 22 CASE SIZES, 348 STANDARD RATINGS.

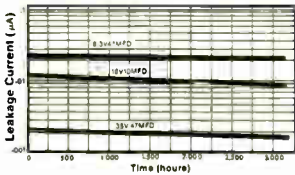

Matsuo developed the world's first resin dipped tantalum capacitor in 1960. Today, Matsuo delivers a broad range of capacitors to meet your needs. 5 types, 22 case sizes, 348 ratings. And one standard of excellence.

That's why Matsuo capacitors perform better. We build them better. And because we do, we can talk about things like failure rates and leakage current when no other manufacturer does. Here are some highlights.

### DIPPED TANTALUM WITH LEAD FRAMES.

Type 221. 7 case sizes, 188 standard ratings. We not only build them better, we pretest longer—48 hours at full voltage. That's why we offer the lowest failure rate—less than 2% per 1,000 hours—60% confidence level. Selected units at 1% FR. Better DC leakage control—.01XCV. Selected units at .001XCV. Fixed lead spacing. Square leads that "bite" corners so Dip stands upright even during soldering.

### NEW! MICRODIPS

Type 203. 3 subminiature case sizes for high component density. From .110" to .126" diameter; .177" to .236" high. 31 standard ratings. Color coded. Solid tantalum, wire leads. Matsuo  $\mu$  Dips exhibit superior electrical characteristics. Better DC leakage control—.01XCV.

Shown actual size.

### NEW! DIPPED TANTALUM WITH WIRE LEADS.

Type 202. 7 case sizes, 55 standard ratings. Flexible wire leads for point to point wiring. High reliability. Better DC leakage control—.01XCV. Designed for superior performance where minimum cost is required.

### NEW! MOLDED TANTALUM.

Type 242. 1 case size, 38 standard ratings. Pretested for 48 hours at full voltage. Lowest failure rate—less than 1% per 1,000 hours. Better DC leakage control—.01XCV. Uniform lead location.

### TANCHIPS. THE CHIPS ON STILTS.

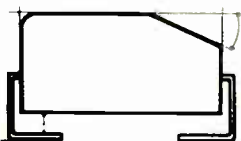

Type 262. Now, 4 case sizes instead of 3. Each size now available in 3 lead styles. 36 standard ratings. Stilt-like leads keep capacitor away from hot solder, preventing heat transfer. Also, facilitates

cleaning of solder flux, allows visual check of connection, eliminates moisture entrapment. Pretested 48 hours at full voltage. Lowest failure rate and better DC leakage control (.01XCV).

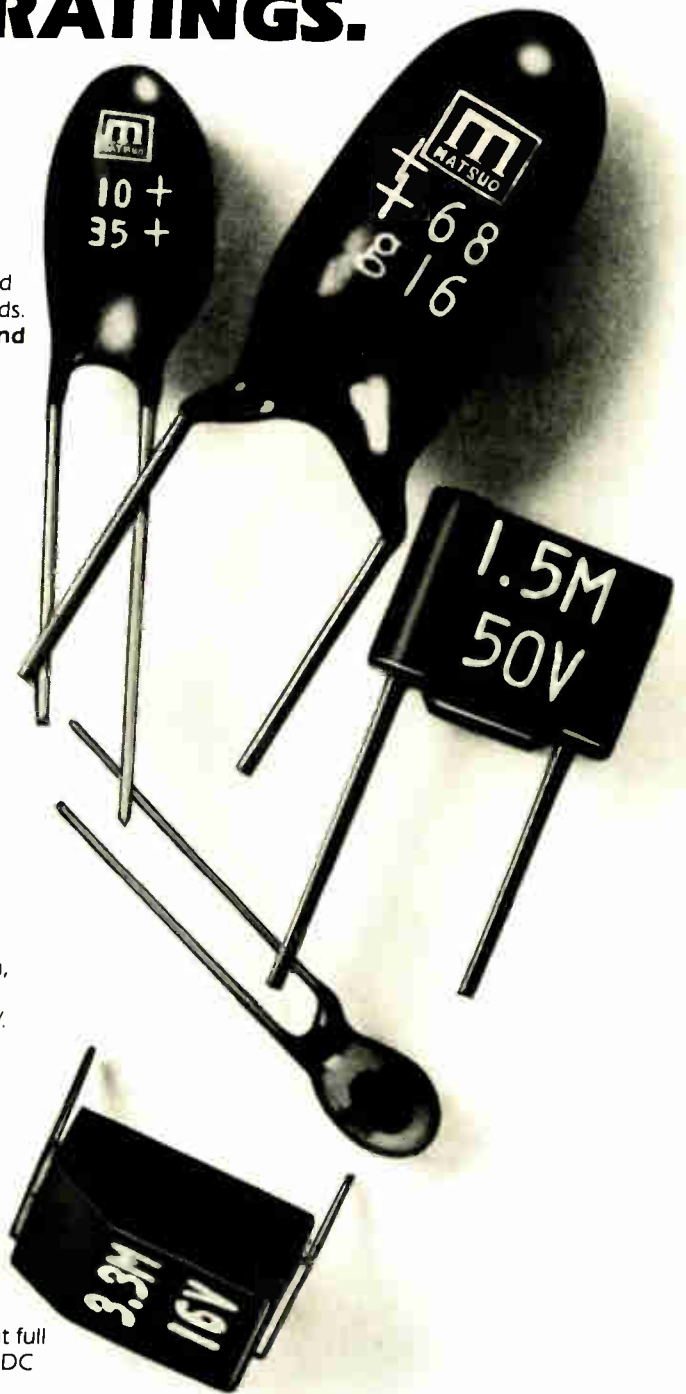

You should also know: Most orders are filled from stock. And Matsuo prices are competitive and then some. For more information, engineering samples, prices, just write or call.

## MATSUO ELECTRONICS

831 S. Douglas St., El Segundo, CA 90245 • (213) 679-0379

Electronics/September 15, 1977



## New literature

the correct filter for a specific application. Selection guides are given for high-pass, low-pass, bandpass, and band-reject filter types. Information on the four filter types includes the range of center or cutoff frequencies, number of poles, transfer characteristics, frequency tuning, and case dimension drawing number. Frequency Devices Inc., 25 Locust St., Haverhill, Mass. 01830 [428]

**Line drivers and receivers.** A 206-page publication, "The Line Driver and Line Receiver Data Book for Design Engineers," discusses over 70 types of line-driver and receiver integrated circuits. Detailed technical information is given for dual line drivers, differential line and quad-bus transceivers, and triple and quad line receivers. The book also provides selection guides for each device. Texas Instruments Inc., Inquiry Answering Service, P. O. Box 5012, M/S 308 (Attn: LCC 4290) Dallas, Texas 75222 [429]

**Switching relays.** A 28-page catalog describes cable-coaxial relays, integral-connector coaxial relays, and radio-frequency switching relays. Specifications, charts and drawings

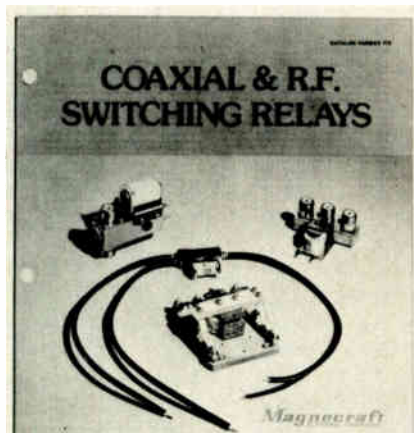

are provided for each type, as well as shipping instructions for special orders. Magnecraft Electric Co., 5575 North Lynch Ave., Chicago, Ill. 60630 [433]

**Industrial electronic equipment.** Over 100 items used in the manufacture, repair, and service of industrial

# You have your own calculator. Why not a DMM?



Finally, a digital multimeter that's yours, just like your pocket calculator, and more useful. Only \$169.\*

You pack only 13 ozs. in your pocket or service kit, but size is deceptive. The 8020A has more useful features than any other multimeter available—at any price! Features like 26 ranges and seven functions, including *conductance*. 2000-count resolution. Hi/lo power ohms.

And it's rugged. The high-impact case protects a minimum number of component parts (47 in all), and they're all readily available from any of the worldwide Fluke service centers. Your 8020A is factory calibrated by NBS traceable equipment. And we guaran-

tee it'll live up to published specs for a full year.

The 8020A is a true field instrument, designed with a highly readable LCD display, and inexpensive 9V transistor battery power for continuous use up to 200 hours. Reliability, quality and value: *that's* Fluke tradition.

To get your hands on one, call (800) 426-0361, toll free. Give us your charge-card number and we'll ship an 8020A the same day. Or, we'll tell you the location of the closest Fluke office or distributor (where you can save by buying a ten-pack of 8020As for only \$1521\*).

\*U.S. price only.

## Fluke 8020A DMM for Field Service: \$169.

1807-7004



For literature only circle 78

283

# TOTAL FREQUENCY CONTROL

## FROM ERIE

### HIGH FREQUENCY AT CRYSTALS



Erie AT Crystals are used over the frequency spectrum from 950 kHz to 200 MHz. Low temperature coefficient, extremely high Q, economical. Used in TCXO and VCXO oscillators, temperature controlled and, non-controlled oscillators, and filter applications. All size cans.

### LOW FREQUENCY CRYSTALS

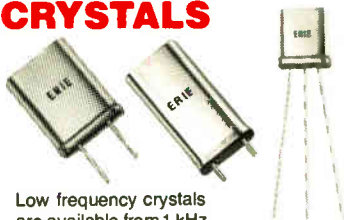

Low frequency crystals are available from 1 kHz to 1MHz in a broad variety of crystal holders and mounting configurations. Erie is a leading source for all types of high quality, Low Frequency Crystals.

### CRYSTAL OSCILLATORS



Erie offers a broad range of economical as well as highly sophisticated Crystal Oscillators. These small size oscillators are available in a wide range of frequencies. Hermetically sealed crystals assure long term stability. Design assistance available.

### CRYSTAL FILTERS

Erie quartz crystal filters are specified for use in communications receivers as well as for radar, sonar and space applications.



Write for brochure describing Erie Crystals, Filters, Oscillators and Ovens.

# ERIE

ERIE FREQUENCY CONTROL DIV. OF  
ERIE TECHNOLOGICAL PRODUCTS  
Carlisle, Pa. 17013  
717/249-2232

Circle 82 on reader service card

### New literature

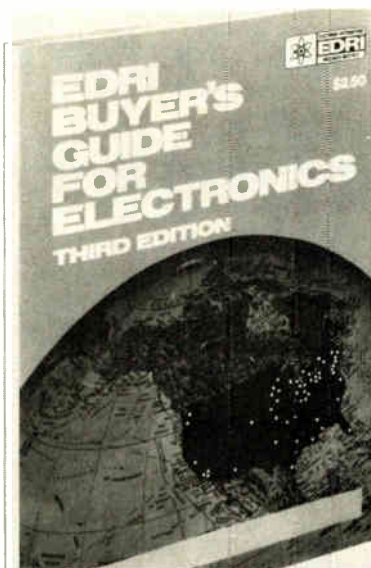

equipment are listed in a 280-page buyer's guide. In addition, replacement and substitution data are provided for each item, along with ordering information. EDRI Buyers Guide, P. O. Box 23875, Fort Lauderdale, Fla. 33307 [430]

Metric precision components. A compilation of over 25,000 standardized metric precision mechanical components and assemblies is being offered in a 208-page booklet,

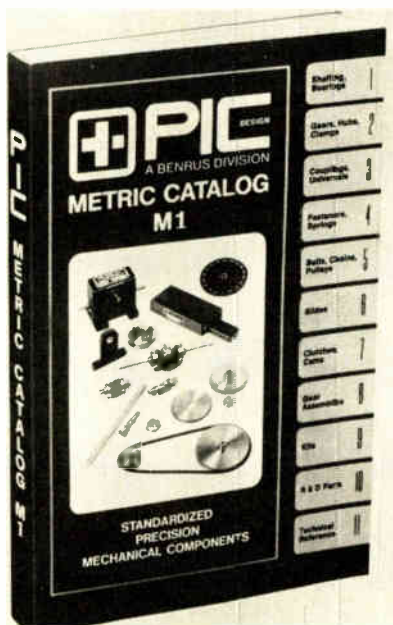

which also gives design information and specifies production material. PIC Design Division, Bensus Corp.,

## PROFESSIONAL DISCOUNTS

### Texas Instruments electronic calculator

TI-1750 LCD	\$19.95	SR-40	\$24.95
TI-2550 III	24.95	SR-51-II	49.95
Little Prof	12.95	TI-57 NEW	64.95
Dalman NEW	22.50	TI-58 NEW	99.95
TI-5100	44.95	TI-59 NEW	249.95
TI-5015 NEW	65.00	PC-100A	147.00
TI-5050 M	84.95	Money Mgr	17.95
TI-5040 PD	95.00	Bus Analyst	29.95
TI-30 SP	17.95	All Libraries Available	



### HEWLETT PACKARD

We are franchised H-P dealer. All accessories at discount.

HP-10 NEW	\$139.00	HP-27	\$140.00
HP-19C NEW	299.00	HP-29C NEW	159.00
HP-21	64.00	HP-80	235.00
HP-22	100.00	HP-67	360.00
HP-25	100.00	HP-91	275.00
HP-25C	128.00	HP-92	\$15.00
		HP-97	599.00

Also SCM, Olivetti, National Semiconductor, Casio, Canon, Corvus, APF, Sharp, Craig, Sanyo, Record-A-Call and more. ALL AT GREAT PRICES!

### FAIRCHILD

Programmable Video Game \$135.00

(2000 games possible)

Cartridges 17.95

Also Fairchild Watches!

WE WILL BEAT OR MEET ANY COMPETITORS' PRICE IF HE HAS MERCHANDISE ON HAND. All units shipped in original factory cartons with accessories according to manufacturers' specifications. In Calif call (213) 370-5795 or CALL (800) 421-0367 (other than CA). Above prices are for cash only. Credit card prices differ. BankAmericard/Visa & Master Charge accepted. Send money order. Pers. ck (2 wks to clear). In CA add 6% sales tax. Add \$3.50 min. shipping charges. WE SHIP AIR on request. Subject to availability. Send mail orders to DEPT. EM-H

2 locations in So California  
**tkenterprises**  
ENTERPRISE BUSINESS PRODUCTS

16611 Hawthorne Blvd., Lawndale, Ca. 90260  
(213) 370-5795 (800) 421-0367

Circle 84 on reader service card

# The 1977 Answer Book. It makes your job easier. \$25.



- Over 4000 products.
- More than 5000 manufacturers with local sales offices, reps/and distributors.
- Directory of Catalogs with postpaid inquiry cards for 5-second ordering of current catalogs.

Electronics Buyers' Guide  
1221 Ave. of the Americas  
New York, N. Y. 10020

Yes, send me a copy of The Answer Book. I've enclosed \$25 (USA and Canada only, elsewhere send \$35). Full money back guarantee if returned within 10 days.

Name \_\_\_\_\_  
Company \_\_\_\_\_  
Street \_\_\_\_\_  
City \_\_\_\_\_ State \_\_\_\_\_ Zip \_\_\_\_\_

Electronics / September 15, 1977

# Introducing the 0.38" DIP relay

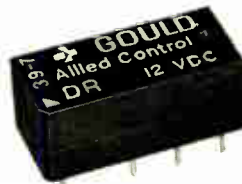

**The most sensitive  
DPDT relay  
costs less than  
two SPDT  
equivalent reeds!**

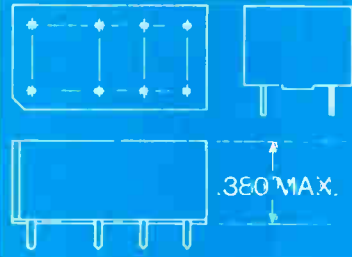

**Consider these parameters for  
your next PC board:**

Lowest profile—fits well within  
0.5" spacings when mounted  
directly on PC board.

Adaptability—fits standard 16-pin

I.C. sockets; footprints are interchangeable with similar-but-higher e/m DIP relays.

Sensitivity—200 mw max. at pull-in, with 1 amp 28 vdc  
switching and 5 amp carrying capacity.

2 form C configuration.

Life expectancy—10,000,000 cycles low level or mechanical.

Gould/Allied Control has just packaged a lot more performance into a lot lower relay!

The new miniature Dual-in-line Relay combines the compactness of reed relays with the low cost and high switching capabilities of electromechanical units.

It's particularly suited to telecommunications and medical electronic equipment, but it is already finding widespread usage in other areas as well.

Call your Gould/Allied Control distributor for full details or write us at Gould Inc., Control and Systems Division, Allied Control Operation, 100 Relay Road, Plantsville, Conn. 06479

**GOULD ALLIED CONTROL**

Circle 86 on reader service card



## No Property Tax For Five Years!!

And here are some of the other reasons why it is worth your time to investigate locating or expanding in Rochester, New York:

- Progressive schedule of tax abatement for five more years
- Corporate franchise tax credits for ten years
- Total sales tax exemption for materials and equipment purchased during construction
- 100% financing possible through Industrial Development Agency bonds
- Technical assistance from the City of Rochester Bureau of Economic Development, including:

Helping applicant firms to qualify for abatements, tax credits and financing

Accommodating relocation and expansion requirements

Coordinating services and procedures with City, County, and State agencies.

**A move to Rochester could prove profitable for growth-oriented companies. We're ready to help... and able.**

**For further information contact:**

**John Stockton, Director  
Bureau of  
Economic Development  
150 State Street  
Rochester, N.Y. 14614  
(716) 428-6965**



**City of Rochester**

## New literature

P. O. Box 335, Benrus Center, Ridgefield, Conn. 06877 [432]

**Lasers.** "Lexel Argon and Krypton Ion Lasers" is a 28-page brochure that clarifies how to purchase the correct laser for a particular need. Every feature of each laser model is discussed, including the laser head, optical resonator, plasma tube, and power supply. Diagrams and charts help to further explain laser capabilities. Lexel Corp., 928 Meadow Drive, Palo Alto, Calif. 94303 [434]

**Power supplies.** Test procedures and recommendations for users of both line-operated and dc-dc converter power supplies are presented in a 40-page application and selection guide. It gives electrical and mechanical

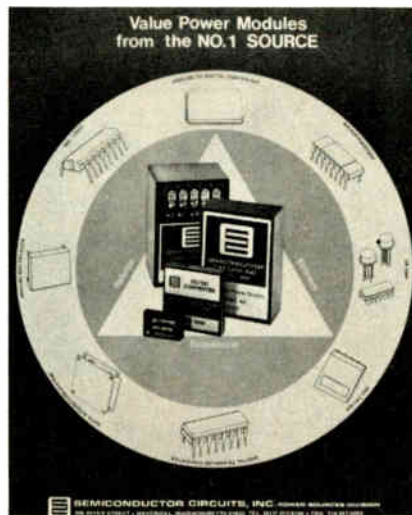

specifications for both power supply types and describes sockets according to the power supply with which they will mate. Semiconductor Circuits Inc., 306 River St., Haverhill, Mass. 01830 [435]

**Varactors.** Detailed information on silicon- and gallium-arsenide varactors and silicon switching diodes is given in a 72-page booklet. A special section explains how to reliably test the diodes and components, and a section on microwave control devices covers switch modules, switches, and diode limiters and modules. GHZ Devices Inc., 16 Maple Rd., Chelmsford, Mass. 01824 [436]

## Electronics Magazine Book Series. Zero-risk trial offer.

### 1. Microprocessors

What you must know about available microprocessor technology, devices, information. 4th printing. \$8.95

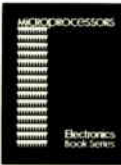

### 2. Applying Microprocessors

2nd and 3rd generation technology. 26 detailed applications from data networks to video games. \$9.95

**3. Large Scale Integration**  
Covers the basic technology, new LSI devices, LSI testing procedures, plus system design and applications. \$9.95

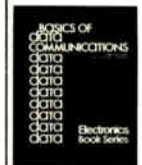

### 4. Basics of Data Communications

Includes 47 articles from Data Communications magazine covering more than 11 key areas. \$12.95.

### 5. Circuits for Electronics Engineers

Contains 306 circuits arranged by 51 functions from Amplifiers to Voltage Regulating Circuits. Saves design drudgery. \$15.95



### Electronics Book Series

P.O. Box 669, Hightstown, N.J. 08520

1. Send me \_\_\_\_\_ copies of "Microprocessors" at \$8.95 per copy.
2. Send me \_\_\_\_\_ copies of "Applying Microprocessors" at \$9.95 per copy.
3. Send me \_\_\_\_\_ copies of "Large Scale Integration" at \$9.95 per copy.
4. Send me \_\_\_\_\_ copies of "Basics of Data Communications" at \$12.50 per copy.
5. Send me \_\_\_\_\_ copies of "Circuits for Electronics Engineers" at \$15.95 per copy.

Discounts of 40% on orders of 10 or more copies. I must be fully satisfied or you will refund full payment if the book is returned after ten-day trial examination.

Payment enclosed  Bill firm  Bill me  
Charge to my credit card:  
 American Express  Diners Club  
 BankAmericard  Master Charge

Acc't No. \_\_\_\_\_ Date exp. \_\_\_\_\_

Interbank No. \_\_\_\_\_

On Master Charge only,  
first numbers above name \_\_\_\_\_

Name \_\_\_\_\_ Title \_\_\_\_\_

Company \_\_\_\_\_

Street \_\_\_\_\_

City \_\_\_\_\_ State \_\_\_\_\_ Zip \_\_\_\_\_

Signature \_\_\_\_\_

# Until now, you had good reasons for shying away from foam-in-place packaging.

## Until Tri-Wall Containers introduced SolidiFoam<sup>T.M.</sup>

Ideally there are many benefits you can get from a foam-in-place system. Outstanding protection because your product is completely encapsulated. Space savings because you produce foam only as you need it, eliminating storage of bulky packaging materials like air pillows, corrugated inserts and excelsior. Lower shipping costs because urethane foam is light, reducing tare weight. And more.

But until now, you couldn't be sure of getting all these benefits. You couldn't be sure you had the proper chemical mix, so inferior foam was often produced. You couldn't be sure the dispenser gun wouldn't clog. You were only supplied with small quantities of chemicals. And you even had to wait each morning for the chemicals to heat up.

With SolidiFoam, at last you can be sure of producing high quality urethane foam economically and in foam densities to fit your requirements.

**SolidiFoam Means Consistent Foam Every Time.** With SolidiFoam, you always have the proper mixture of isocyanate and polyol resin. Positive rationing is insured through the use of rotary proportioning pumps (not the aerosol type piston pumps found in many other systems) and by a common mechanical drive that locks the pumps together.

Internal hose heaters in each line guarantee positive heat control. This feature, combined with the proper mix ratio, makes certain the urethane foam will never be out of balance. So you won't waste chemicals.

Additional quality control is provided by an automatic interlock that shuts down the system when there is an insufficient amount of pressure or the chemical supply is depleted.

**The SolidiFoam System is Easy to Operate.** Four switches control everything. And the SolidiFoam system is completely adaptable to a timer to control metering of each shot and for use in automated operations.

The dispenser gun has a mechanical purge that automatically cleans the chamber after each use, eliminating the need for solvents.

With all these automatic features, learning to operate a SolidiFoam system is uncomplicated and can be mastered quickly. To make your opera-

tion totally self-sufficient, Tri-Wall trains your operator in your plant and offers a comprehensive mechanic maintenance training program.

**Tri-Wall Stands Behind You All the Way.** The Tri-Wall network is your single source for equipment, chemicals and service nationwide. Conveniently located packaging specialists throughout North America stand ready to back up every system. And you can purchase or lease.

Find out more about SolidiFoam by calling Bruce Geiger at (516) 364-2800 or send in the coupon below. We'll prove to you that SolidiFoam is the one foam-in-place system that can consistently deliver outstanding product protection.



## SolidiFoam.

From the Foam Packaging Division of Tri-Wall Containers.  
An Indian Head Company  
100 Crossways Park West, Woodbury, New York 11797

I want to know more about SolidiFoam, the one foam-in-place system you say I can't afford to be without. We ship these products \_\_\_\_\_.

Send me a brochure and complete specifications.

Call me to arrange an appointment. Telephone \_\_\_\_\_

(area code)

E-9

Name \_\_\_\_\_

Company \_\_\_\_\_

Division \_\_\_\_\_

Job Title \_\_\_\_\_

Address \_\_\_\_\_

City \_\_\_\_\_

State \_\_\_\_\_

Zip Code \_\_\_\_\_

# HIGH & LOW

Anritsu's Spectrum Analyzer offers you high performance at low power consumption.

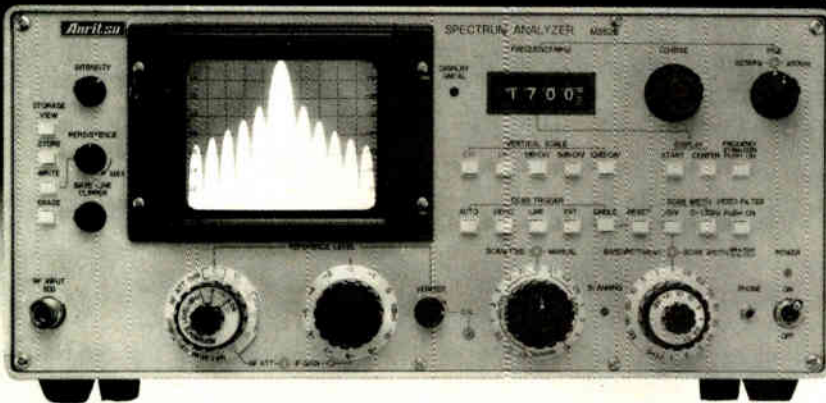

MS62B

- Only 55watts power consumption (capable of battery operation), the lowest in the world
- High sensitivity of  $-122\text{dBm}$  (MS62A/B),  $-9\text{dB}\mu\text{V}$  (MS62A3/B3)
- Wide 70dB dynamic range even with  $-30\text{dBm}$  input signal  
Covers 100kHz-1700MHz frequency range
- All-around measurements include pulse signal, CW signal, mixer/demodulator spurious signal, transmitter spurious radiation, AM signal, FM signal, pulsed AM, field strength, etc.
- Compact construction for space-saving installation
- Virtually maintenance-free
- CRT: Normal persistence type P7 phosphor (MS62A/A3) and half-tone storage type (MS62B/B3)
- The field strength direct reading dial is attached to the MS62A3/B3, so the field strength can be measured in conjunction with the calibrated antenna (option) by the unit of dB/m on the level reference dials of the MS62A3/B3.

## ANRITSU

**ANRITSU ELECTRIC CO., LTD.**  
MEASURING INSTRUMENTS DIVISION  
SALES DEPARTMENT:

12-20, Minamiazabu 4-chome, Minato-ku, Tokyo 106, JAPAN  
Phone: (03) 446-1111/Telex: 0-242-2353  
Cable: ANRITDENKI TOKYO

U.S.A. Tau-Tron Inc. Tel: (617) 667-3874 • West Germany Knott Elektronik GmbH Tel: (08178) 4085 • England Dymar Electronics Limited Tel: Watford 37321 • France Tekelec Airtronic Tel: (1) 946-96-48 • Italy Vianello S.p.A. Tel: 544041 • Sweden Tejeinstrument AB Tel: 08-38 03 70 • Singapore O'Connor's (Pte) Ltd. Tel: 637944 • Malaysia O'Connor's SDN. BHD. Tel: 51563/5 • Australia NEC Australia Pty. Ltd. Tel: Melbourne 560-5233

288 Circle 98 on reader service card

## New books

**Electronic Designers' Handbook**, 2nd ed., L. J. Giacoletto, ed., McGraw-Hill, 2,344 pp., \$47.50.

Engineers with 1950s-vintage bachelors degrees may remember the first edition of this book, edited by Robert W. Landee, Donovan C. Davis, and Albert P. Albrecht and published in 1957. For its time, it was a valuable handbook. But the editors, in the mid 1950s when the book was in preparation, could not have foreseen the tremendous impact that integrated circuits would have on the electronics engineer. This second edition remedies that situation and more, just about doubling the size of the first edition.

First of all, to dispose of the major criticism that could be made against the book—it makes no mention of microprocessors, in terms either of hardware or software. But that field is moving so rapidly that any handbook intended to be useful for more than a couple of years would quickly become obsolete with respect to microprocessors anyway. And there are already plenty of books available on the devices.

What this book has to offer is solid design information on all types of electronic hardware as well as the mathematics of signal and circuit analysis. In its 2,344 pages, it covers filters, attenuators and equalizers, and transmission lines in three chapters, active and passive components, power supplies, various types of amplifiers, signal sources, wave-shaping and -generating circuits, digital logic design, computer-aided design, and various aspects of communications, including modulation, transmitters and receivers, and radar systems. It closes with chapters on information theory and on system reliability.

As with all handbooks, the specialist in any particular area will probably find the chapter related to his own area to be rather basic, but it is in the other chapters that the book's usefulness lies. For example, few engineers specialize today in power supplies, yet this book gives a good 64 pages of information that would start any engineer off on the

# THE ELECTRONICS CONFERENCE ON MANAGING ENGINEERS

sponsored by Electronics,  
McGraw-Hill's International Magazine of Electronics Technology

The growing  
challenge of  
motivating, training,  
and utilizing the EE

*If you hire, fire, manage, motivate, train, or educate EEs,  
here are some facts that you should know:*

- *74% of 1,300 engineers surveyed this year by Electronics believe that electrical engineers in the next decade will not attain the professional status of physicians or lawyers;*
- *55.4% think that employers practice age discrimination;*
- *51.5% are only moderately satisfied with their engineering careers;*
- *Over 45% said that their companies do not have adequate dual ladder systems for engineers who prefer to stay in technical assignments;*
- *Fewer than half of those responding—45.3%—said that employers usually recognize engineering contributions appropriately;*
- *49.4% feel underutilized in their present positions;*
- *Many engineers believe that promotions are slow in coming.*

---

*These are just a few of the findings from the Electronics survey of engineers' attitudes. Such career-oriented attitudes will be analyzed at the Electronics Conference on Managing Engineers at the Fairmont Hotel in San Francisco on November 8th, and at the McGraw-Hill Corporate Headquarters in New York City on November 15th. You can't afford to miss the opportunity to learn more about the significant role managers must play in successfully handling these emerging EE career problems.*

---

## Conference Program:

### 9:00-9:30 AM Electronics Career View Survey

What are 1,300 electrical engineers' attitudes toward the engineering career, its satisfactions and frustrations? What is the impact of the microprocessor on the way EEs do their jobs? What are the future career trends, both professional and technical?

**Gerald M. Walker**  
Senior Editor  
Electronics

---

### 10:00-11:00 AM The Thompson-Dalton Study of the Four Stages of Career Development

How do you get a company to recognize the problem of obsolescence—the corporation's and the individual's? What is the relationship between age and performance? How can you educate management to include the EE's career in its planning? How do you convince management that the project engineer is as important as the project?

**Gene W. Dalton**  
Professor of Organizational Behavior  
Brigham Young University

**Paul H. Thompson**  
Associate Professor and Chairman  
Department of Organizational Behavior  
Brigham Young University

11:00-1:00 PM

**Coping with the problems of education, motivation, and utilization of the EE**

Part I: The academic world: Can engineering schools stay up-to-date with current technologies—especially in the field of microprocessors? Is there too much theory and not enough practical application?

Is it necessary to achieve a graduate degree or is an MBA more valuable? How can universities counter complaints of current graduates—unqualified instructors, inadequate textbooks, etc?

**James D. Bruce**  
Associate Dean  
School of Engineering  
Massachusetts Institute of Technology

**Kenneth S. Down**  
Assistant Dean and Director,  
Stanford Instructional Television Network  
School of Engineering  
Stanford University

Part II: The Corporate World: How do you deal with the underutilized EE? The problems of shifting technologies? Career anxiety? Career motivation? Is the 'dual ladder' a myth? What should the EE consider when deciding to remain in technology—financial gain, career potential, etc? What in-house programs have corporations developed to keep EEs updated?

**William O. Nilsson**  
Corporate Training & Management  
Development Manager  
Hewlett-Packard Company

1:00-2:15 PM

**Luncheon**

2:30-3:30 PM

**Is competency assessment the wave of the future?**

Is it possible to identify the successful performer? What are the pros and cons? The alternatives?

**George Klemp**  
Director of Research  
McBer and Company

*Other speakers to be announced*

3:30-5:00 PM

**Performance Appraisal**

Should performance appraisal become an integral part of the career development program? Is forced turnover an effective means of achieving high performance? Is it possible to quantify performance so that the individual who is of most value to the department receives the best salary?

**John D. Porter**  
Organizational Development Consultant  
Lawrence Livermore Laboratory

**C. R. Wischmeyer**  
Director of Education  
Bell Laboratories

Your registration fee includes the *Electronics* 140-page survey of over 1,300 electrical engineers (the survey will not be sold independently), and the magazine's three-part editorial analysis of the Career View Survey.

**NOTE:** While the program issues will remain the same in both New York and San Francisco, some of the above speakers will appear in only one city.

**Who should attend . . .**

- Design and development managers
- Engineering services managers
- Basic research managers
- Manufacturing and production managers
- Training directors
- Personnel directors
- Engineering school deans and professors
- Career counselors and consultants

Send registration form to:  
McGraw-Hill Conference & Seminar Group  
1221 Avenue of the Americas—Room 3677  
New York, New York 10020  
(212) 997-4930

**THE ELECTRONICS CONFERENCE ON MANAGING ENGINEERS**  
The growing challenge of motivating, training, and utilizing the EE  
\_\_\_\_ San Francisco, November 8, 1977, Fairmont Hotel  
\_\_\_\_ New York, November 15, 1977, McGraw-Hill Corporate Headquarters  
Conference fee: \$250      Academic fee: \$150

Name \_\_\_\_\_  
Title \_\_\_\_\_  
Company \_\_\_\_\_

Company address \_\_\_\_\_  
Company telephone \_\_\_\_\_  
Signature \_\_\_\_\_

Check one:  Payment enclosed       Please bill me directly       Please bill company

Cancellation policy: Cancellations made less than seven days prior to the conference are subject to a \$25 fee.  
You may, if you wish, send a substitute in your place.



E 12345



# EDP books you can't afford to be without



any one  
of these great  
professional books  
for only **\$1.89**  
values up to  
**\$28.50**

## TECHNOLOGY MATHEMATICS HANDBOOK

by J. J. Tuma  
654/31X Pub. Pr., \$18.95 Club Pr., \$12.95

## MICROPROCESSOR APPLICATIONS MANUAL

by Motorola, Inc.  
435/278 Pub. Pr., \$28.50 Club Pr., \$19.95

## MICROPROCESSOR/MICROPROGRAMMING HANDBOOK

by B. Ward  
768/749 Pub. Pr., \$9.95 Club Pr., \$8.45

## GAMES & PROGRAMS Mathematics for Modeling

by R. R. Singleton & W. Tyndall  
767/815 Pub. Pr., \$13.00 Club Pr., \$10.75

## WRITTEN COMMUNICATION FOR DATA PROCESSING

by R. S. Smith  
769/77X Pub. Pr., \$12.95 Club Pr., \$9.75

## MODERN GUIDE TO DIGITAL LOGIC: Processors, Memories & Interfaces

by United Technical Publications, Inc.  
769/419 Pub. Pr., \$9.95 Club Pr., \$8.45

## DIGITAL SYSTEM DESIGN AUTOMATION Languages, Simulation & Data Base

by M. A. Breuer  
768/498 Pub. Pr., \$18.95 Club Pr., \$15.95

## THE DESIGN OF AN OPTIMIZING COMPILER

by W. Wulf, R. K. Johnson, C. B. Weinstock,  
S. O. Hobbs & C. M. Geschke  
768/773 Pub. Pr., \$13.50 Club Pr., \$10.95

## ELECTRONIC CIRCUITS & APPLICATIONS

by S. D. Senturia & B. D. Wedlock  
772/517 Pub. Pr., \$20.75 Club Pr., \$12.95

## HIGH LEVEL COBOL PROGRAMMING

by G. Weinberg, S. Wright, R. Kaufmann  
& M. Goetz  
768/595 Pub. Pr., \$16.95 Club Pr., \$13.95

## APPLYING DATA STRUCTURES

by T. G. Lewis & M. Z. Smith  
768/714 Pub. Pr., \$16.50 Club Pr., \$12.25

## SYSTEMS ANALYSIS & DESIGN USING NETWORK TECHNIQUES

by G. E. Whitehouse  
767/300 Pub. Pr., \$21.95 Club Pr., \$17.50

## PRINCIPLES OF DIGITAL COMPUTER DESIGN

by A. M. Abd-alla & A. C. Meltzer  
769/869 Pub. Pr., \$19.50 Club Pr., \$16.25

## ALGORITHMS + DATA STRUCTURES = PROGRAMS

by N. Wirth  
769/664 Pub. Pr., \$18.00 Club Pr., \$13.75

## SOFTWARE RELIABILITY Principles & Practices

by G. J. Myers  
769/885 Pub. Pr., \$19.95 Club Pr., \$15.75

## THE THINKING COMPUTER Mind Inside Matter

by B. Raphael  
769/893 Pub. Pr., \$12.95 Club Pr., \$10.25

## Introductory offer to new members of the Computer Professionals' Book Club

Special \$1.89 bonus book comes to you with your first club selection

**T**HIS new professional club is designed to meet your day-to-day on-the-job needs by providing practical books in your field on a regular basis at below publisher prices. If you're missing out on important technical literature—if today's high cost of reading curbs the growth of your library—here's the solution to your problem.

The Computer Professionals' Book Club was organized for you, to provide an economical reading program that cannot fail to be of value. Administered by the McGraw-Hill Book Company, all books are chosen by qualified editors and consultants. Their understanding of the standards and values of the literature in your field guarantees the appropriateness of the selections.

How the Club operates: Every month you receive free of charge *The Computer Professionals' Book Club Bulletin*. This announces and describes the Club's featured book of the month as well as alternate selections available at special members' prices. If you want to examine the Club's feature of the month, you do nothing. If you prefer one of the alternate selections—or if you want no book at all—you notify the club by returning the card enclosed with each *Bulletin*.

As a Club Member, you agree only to the purchase of four books (including your first selection) over a two-year period. Considering the many books published annually, there will surely be at least four you would want to own anyway. By joining the club, you save both money and the trouble of searching for the best books.



VALUES UP TO \$30.00 WITH MAJOR DISCOUNTS ON ALL OTHER CLUB SELECTIONS. Your bonus books come with the first selection, and you may choose both of them from the books described in this special introductory offer.

EXTRA SAVINGS: Remit in full with your order, plus any local and state tax, and McGraw-Hill will pay all regular postage and handling charges.

### NO RISK GUARANTEE:

If not completely satisfied return selections for full refund and membership cancellation.

### MAIL THIS COUPON TODAY

COMPUTER PROFESSIONALS/Book Club P.O. Box 582 Princeton Road, Hightstown, New Jersey 08520

Please enroll me as a member and send me the two books indicated. I am to receive the bonus book at the introductory price of \$1.89 plus my first selection, plus tax, postage, and handling. If not completely satisfied, I may return the books within 10 days and request that my membership be cancelled. If I keep the books, I agree to take a minimum of three additional books during the next two years at special Club prices (guaranteed 15% discount, often more). I will receive the Club Bulletin 12 times a year. If I want to examine the featured selection, I need take no action. It will be shipped automatically. If, however, I want an alternate selection—or no book at all—I simply notify the Club by returning the convenient card always enclosed. I will always have a minimum of 10 days in which to return the card and you will credit my account fully, including postage, if this is not the case. Membership in the club is continuous but cancellable by me at any time after the four-book purchase requirement has been filled. This order subject to acceptance by McGraw-Hill. Orders from outside the continental U.S. must be prepaid. Company, business, or

Institutional tax exemption status is not applicable to purchases made through individual Club memberships. All prices subject to change without notice. Offer good for new members only.

Write Code # of \$1.89 bonus  
book selection here

Write code # of  
first selection here

NAME

ADDRESS

CITY

STATE  ZIP

P39251

# Electronics Magazine Book Series.

## Zero-risk trial offer.



**1. Microprocessors**  
What you must know about available microprocessor technology, devices, information, 4th printing. \$8.95

**2. Applying Microprocessors**  
2nd and 3rd generation technology. 26 detailed applications from data networks to video games. \$9.95

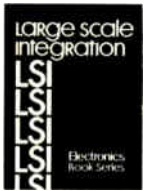

**3. Large Scale Integration**  
Covers the basic technology, new LSI devices, LSI testing procedures, plus system design and applications. \$9.95

**4. Basics of Data Communications**  
Includes 47 articles from Data Communications magazine covering more than 11 key areas. \$12.95

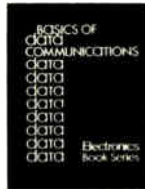

**5. Circuits for Electronics Engineers**  
Contains 306 circuits arranged by 51 functions from Amplifiers to Voltage Regulating Circuits. Saves design drudgery. \$15.95

**Electronics Book Series**  
P.O. Box 669, Hightstown, N.J. 08520



1. Send me \_\_\_\_\_ copies of "Microprocessors" at \$8.95 per copy.
2. Send me \_\_\_\_\_ copies of "Applying Microprocessors" at \$9.95 per copy.
3. Send me \_\_\_\_\_ copies of "Large Scale Integration" at \$9.95 per copy.
4. Send me \_\_\_\_\_ copies of "Basics of Data Communications" at \$12.95 per copy.
5. Send me \_\_\_\_\_ copies of "Circuits for Electronics Engineers" at \$15.95 per copy.

Discounts of 40% on orders of 10 or more copies.

I must be fully satisfied or you will refund full payment if the book is returned after ten-day trial examination.

Payment enclosed       Bill firm       Bill me

Charge to my credit card;       BankAmericard

American Express    Diners Club    Master Charge

Acc't No. \_\_\_\_\_ Date exp. \_\_\_\_\_ Interbank No. \_\_\_\_\_

On Master Charge only,  
first numbers above name \_\_\_\_\_

Name \_\_\_\_\_ Title \_\_\_\_\_

Company \_\_\_\_\_

Street \_\_\_\_\_

City \_\_\_\_\_ State \_\_\_\_\_ Zip \_\_\_\_\_

Signature \_\_\_\_\_

## New books

right foot toward designing a supply. Similarly, as the microprocessor extends its realm into nearly every type of electronic equipment, even a microprocessor specialist will have to brush up on the techniques involved in each kind of equipment, and this book could well serve as his starting point.

At \$47.50, it's a high-ticket item. And, weighing in at 4½ pounds, that comes to about \$10 per pound. More expensive than coffee at present, but decidedly a lot more useful.

**The Design of Active Filters with Experiments**, Howard M. Berlin, E&L Instruments Inc. (Derby, Conn.), 285 pp., \$8.50 (paper).

**The Data Processing Security Game**, Robert S. Becker, Pergamon, 103 pp., \$5.95.

**Turning Points in American Electrical History**, James E. Brittain, ed. IEEE Press, 397 pp., \$29.95 (hardcover—\$19.45 for IEEE members), \$12.95 (paper—only to IEEE members for educational purposes).

**Solid State Design for the Radio Amateur**, Wes Hayward and Doug DeMaw, American Radio Relay League (Newington, Conn.), 256 pp., \$7 (paper).

**Servomechanisms—Devices and Fundamentals**, Richard W. Miller, Reston, 260 pp., \$14.95.

**Microcomputer-Based Design**, John B. Peatman, McGraw-Hill, 540 pp., \$21.

**Display Electronics**, Ken Tracton, Tab Books, 252 pp., \$8.95 (hardcover), \$5.95 (paper).

**The Complete Handbook of Slow-Scan TV**, Dave Ingram, Tab Books, 304 pp., \$14.95 (hardcover), \$9.95 (paper).

**Programming Microprocessors**, M. W. McMurrin, Tab Books, 280 pp., \$9.95 (hardcover), \$6.95 (paper).

# POLYIMIDE VS. EPOXY

**Kerimid®601**

**Epoxy**

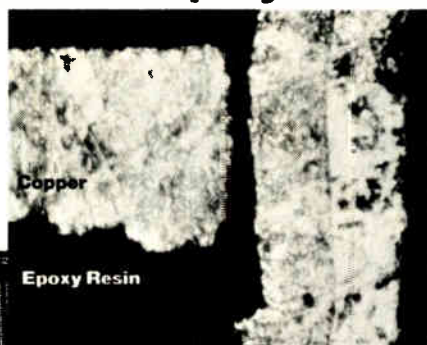
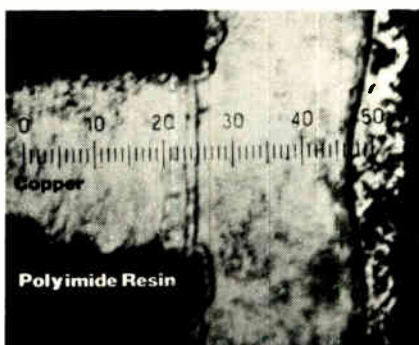

After drilling and soldering extreme magnification shows no resin smear or delamination interrupting circuitry.

After drilling and soldering extreme magnification shows smear and delamination causing circuit malfunction.



## Now approved for military use.\*

Kerimid 601 can significantly improve production yields by dramatically reducing smear and delamination. Which, when you consider the defective rate of epoxy boards, more than pays for the higher cost of Kerimid 601. Not to mention the gain it offers to your reputation for reliability in meeting promised delivery dates and in ultimate in-use functioning. In fact, one customer of ours hasn't rejected one circuit board due to smear or delamination in three years.

Kerimid 601 makes all this possible because it brings to circuit packaging the twin advantages of high heat resistance (4-500°F) and epoxy processability (355°F/200Psi). Additionally, void-free laminates offer improved characteristics over epoxies in z-dimensional stability and moisture resistance.

We think the combination of production and performance advantages offered by Kerimid 601 makes it well worth your investigation.

For more information, direct inquiries to: Rhodia Inc. Specialty Plastics Department, P.O. Box 125, Monmouth Junction, New Jersey 08852 (201) 846-7700. Rhone-Poulenc, 22 Av. Montaigne, Paris-8e, France 256-4000.

**KERIMID® 601**   
A SUBSIDIARY OF RHÔNE-POULENC

\* MIL P-13949/10 Amendment 2; MIL P-55617 revision B; MIL G-55636 revision B.

# Classified section FOR ENGINEERING/TECHNICAL EMPLOYMENT OPPORTUNITIES

## CLASSIFIED SALES REPRESENTATIVES

Atlanta . . . Joe Lane . . . 404/892-2868  
 Boston . . . Holt Buchanan . . . 617/262-1160  
 Chicago . . . Bill Higgins . . . 312/751-3733

Cleveland . . . Mac Huestis . . . 216/781-7000  
 Dallas . . . Mike Taylor . . . 214/742-1747  
 Denver . . . Shirley Klotz . . . 303/837-1010  
 Detroit . . . Mac Huestis . . . 313/873-7410

Houston . . . Mike Taylor . . . 713/659-8381  
 Los Angeles . . . Stan Kassir . . . 213/487-1160  
 New York . . . Larry Kelly . . . 212/997-3594  
 Philadelphia . . . Dan Ferro . . . 215/568-6161

Pittsburgh . . . Dean Genge . . . 412/391-1314  
 San Francisco . . . M.E. Kenny . . . 415/362-4600  
 Stamford . . . Holt Buchanan . . . 203/359-2860  
 XEROX 400 TELECOPIER . . . 212/997-6800

# These Positions Must Be Filled NOW

They tie into a series of long range programs involving state-of-art technology, and extraordinary opportunity for personal contribution with one of the nation's "Big Ten" electronics manufacturers.

**Systems Engineers.** We are looking for individuals with knowledge of the definition and solution of complex radar, communications, weapons and fire control systems problems. We seek in-depth experience in system and sub-system synthesis and analysis, computer control and technical direction of major proposals and related technical customer liaison. Individuals should have background in phased array technology, progressive system design knowledge, circuit design and system integration. Individual should be familiar with entire system, its inter-relations and inter-functions with ability to advise customer and to support high level engineering personnel. Hands-on experience in the following areas is desirable: Operations Research, Weapons System (Definition/Analysis/Simulation), Fire Control Systems Design.

**Digital Logic Design Engineers.** You will need a BSEE or technical degree in a related area plus 3-7 years' experience in GENERAL PURPOSE LOGIC DESIGN using high speed integrated circuit logic devices and familiarity with State-of-the-Art digital devices and computer aided design techniques. You should also have experience in DIGITAL CIRCUIT DESIGN, including A/D and D/A Convertors and Worst Case Design.

**Signal Processing Design Engineers.** Background should include a BSEE and 8-15 years' experience in Digital Logic Design (emphasis on Signal Processing techniques) and a thorough knowledge of Digital Hardware, Radar Principles, Timing, Coding/Decoding, Formatting, Data Transfer and Control Logic, including Worst Case Analysis.

**Microwave Design Engineers.** Background should include conceptual definition through design and development of microwave circuits & components necessary in design of antennas (including phase arrays) knowledge of computer applications and a familiarity with RF amplifier design, various type microwave & solid state devices, pulse modulator circuit design, fault sensing logic design.

If you have current experience in one of these areas, forward your resume, including salary history, in complete confidence to: **LRK ASSOCIATES**, 6845 Elm Street (EL-7), McLean, Virginia 22101. Or call us Monday through Friday at (703) 790-8640. **West Coast Division: LRK ASSOCIATES**, 16371 Beach Boulevard, Suite 141 (EL-7), Huntington Beach, California 92647. Call Monday through Friday at (714) 848-8494 or (213) 592-1915.

# LRK ASSOCIATES

U.S. CITIZENSHIP  
REQUIRED — representing  
an equal opportunity employer m/f/h.

**RATES** \$46 per advertising inch (1/8"). Commissionable.  
**SIZES** 1/8" to 10" deep in widths of one column (1 3/8"), two (3 3/8"), three (5 1/8"), and four (7").  
**CLOSING** Two weeks prior to mailing.  
**MAILING** One week prior to issue date.  
**ISSUE DATE** Every other Thursday.  
**AD ORDERS/BOX NUMBER ANSWERS** Send to Electronics, Post Office Box 900, New York, N.Y. 10020.

## PRODUCT DEVELOPMENT ENGINEER (TRANSFORMERS)

A leading, national electro-mechanical manufacturer at a midwest location is seeking a professional engineer to develop a new manufacturing phase of its well established, seventy year old business. The individual we seek must be intricately familiar with transformer technology and manufacturing from the initial development and conceptual stages to final production and have a proven track record in all aspects of the process involved in the development of such a product line. Interested applicants may send resume and salary history in confidence to:

**P-5563  
ELECTRONICS  
Class. Adv. Dept.  
P.O. Box 900  
New York, N.Y. 10020**  
*An Equal Opportunity Employer*

We have been placing graduate **ENGINEERS** in **FEE-PAID** positions **THROUGHOUT THE U.S.** since '59. Over 1,000 client companies. We are graduate engineers working full-time for you. Send resume & salary history today or request confidential application.  
**ATOMIC PERSONNEL, INC.**  
 Suite L, 1518 Walnut St., Phila., Pa. 19102  
 An Employment Agency  
 For All Technical Fields

## POSITION VACANT

The Department of Electrical Sciences and Engineering at UCLA anticipates a faculty position at the Assistant Professor level in the area of applied electronics. The position requires a Ph.D. or equivalent research experience in areas of electronics, preferably including digital integrated circuits. Teaching and research ability are essential. Interested and qualified applicants should write to the Chairman, Electrical Sciences and Engineering Department, University of California, Los Angeles, 90024. The University of California is an equal opportunity/affirmative action employer.

## BUSINESS OPPORTUNITY

**How To Earn Money As A Consultant** (including specimen contracts). Send stamped, self-addressed envelope to: Business Psychology Int'l 890/44 National Press Bldg. Washington, D.C. 20045.

**THIS SPACE  
AVAILABLE  
FOR  
\$46.00**

# Wanted: Engineers Seeking Challenging Opportunities Now

## POWER CONDITIONING ENGINEERS

Electrical Engineers at all degree levels are required to work on a broad range of problems associated with energy storage, switching and power conditioning systems. Major program areas include laser and magnetic fusion, laser isotope separation, high-current accelerator technology and nuclear explosives R&D. Typical assignments include: design, installation supervision, and checkout of multimega joule capacitive storage systems, design of high average power systems, conceptual design studies for advanced energy storage techniques and development of related power conditioning systems.

## ELECTRO-OPTICAL AND INSTRUMENTATION ENGINEERS

Openings exist to work on a variety of assignments associated with electro-optical systems. Typical projects include electro-optical imaging using both solid state and electron tube devices, and sampled data systems, high-speed optical detection systems, optical communication systems, electro-optical control systems for precision-pointing, focusing and centering of high-power lasers, and high-speed optical modulation and pulse shaping systems. Will work on both digital and analog circuits and systems, high-voltage pulsed circuitry, as well as electro-optical devices. B.S. in EE (M.S. degree preferred) with strong background in electro-optical systems and general engineering.

## ELECTRONICS ENGINEERS/ COMPUTER SCIENTISTS

Computer Systems Engineering/Hardware and Software. Electronics Engineers/Computer Scientists are needed at all degree levels to work on computer systems for real-time control and data acquisition applications. Positions generally require knowledge of both hardware and software. Also, requires experience with mini and microcomputer systems, with interactive graphics experience desirable. Knowledge of FORTRAN and assembly language required.

**Applications Software Engineering.** Assignments will involve analytical and computational tasks in code development in the area of systems analysis and simulation, geophysical probing, digital signal processing, and/or electromagnetic wave interactions. A knowledge of FORTRAN, numerical analysis and basic engineering sciences is required. B.S. or M.S. in EE/Computer Science.

**Openings also exist in \*Digital Systems, \*Microwaves, \*Numerically controlled machine tools and \*Facility Power Systems.**

Our National Defense Laboratory in the San Francisco Bay Area is heavily involved in laser fusion, energy research and development, and biomedical and environmental programs. We also house one of the world's largest computer complexes. We invite interested and qualified candidates to send resume to Employment Division, P.O. Box 808, ET-097, Livermore, CA 94550.

U.S. Citizenship  
Required



An Equal  
Opportunity  
Employer

LAWRENCE LIVERMORE LABORATORY

## WHERE DO YOU FIT?



In today's job market, that is. One way to see if you're in demand is to check the employment opportunities contained in ELECTRONICS' Classified Section.

Another way to get a reading is to place a blind (box number) Position Wanted ad there. The cost is low (only \$1.25 per line) and the results are often rewarding.

For more information call or write:

## ELECTRONICS

Post Office Box 900  
New York, N.Y. 10020  
Phone: 212/997-2556

## NOTICE TO EMPLOYERS:

### Why we can recommend our readers for the top jobs

The subscribers to this magazine have qualified professionally to receive it. They are also paid subscribers—interested enough in the technological content to have paid a minimum of \$14 for a subscription.

As subscribers to ELECTRONICS, our readers have told you several things about themselves. They are ambitious. They are interested in expanding their knowledge in specific areas of the technology. And they are sophisticated in their need for and use of business and technology information.

Our readers are now in senior engineering or engineering management, or they are on the road toward those levels. In either case, they are prime applicants for the top jobs in almost any area.

If you are interested in recruiting the best people in electronics, these pages are open to you for your recruitment advertising.

Our readers are not "job-hoppers". To interest them you will have to combine present reward with challenge and opportunity for future career advancement.

The cost of recruitment advertising on these pages is \$46 per advertising inch. For information call or write:

## Electronics

Post Office Box 900, New York, NY 10020  
Phone 212/997-2556

## MAKE YOUR FUTURE COUNT

### JOIN THE LITTON TEAM!

We're the Amecom Division of Litton Systems, and new long-term contracts in Electronic Warfare and Telecommunication means new career opportunity for ambitious engineers who seek tomorrow's future today. If you have the experience in these disciplines, you owe it to yourself and to us to talk:

#### RF ENGINEERS

- ★ Spread Spectrum Systems Design
- ★ High Sensitivity UHF, VHF, SSB Receivers & Transmitters
- ★ Solid State Microwave
- ★ Circuit Control Design
- ★ TTL/CMOS Logic

#### TELECOMMUNICATIONS SYSTEM DESIGN ENGINEERS

- ★ Advanced Digital Subsystems including TDM
- ★ RF and Analog Subsystems including Frequency Synthesis and FDM Techniques
- ★ Microprocessors and related Real-Time Operating Systems Software
- ★ Voice and Data Switching Systems
- ★ Hardware/Software Integration

Litton Systems, American Division is located in metropolitan Washington, DC, close to five major universities, libraries, the Congress and the Nation's Capitol. We provide excellent compensation including a benefits package second to none in the industry together with an excellent work environment with seasoned professionals.

Please send your resume in confidence including salary history, or telephone COLLECT:

J. J. FitzGerald

**(301) 864-5600**



**Litton**

Amecom Division  
**LITTON  
SYSTEMS, INC.**

5115 Calvert Road  
College Park  
Md. 20740

An Equal Opportunity  
Employer M/F.

## RF Engineering Opportunity Senior RF Design Engineer

Growing midwest corporation with a solid reputation as an innovative technological leader is currently seeking a Senior Technical Project Engineer to assume immediate supervisory responsibilities in RF design. An up-to-date familiarity with RF design in the "L" band range and strong problem solving capabilities are essential. If you're a strong believer in the "hands-on" approach to supervision and would enjoy receiving an earnings and benefits package that reflects your standing as a professional and your specialized knowledge of RF design, please give me a confidential (collect) call or drop a resume to me:

**Robert L. Davis Co.**  
Management Consultants  
17000 W. Ten Mile Road  
Southfield, MI 48075  
(313) 557-1115

Local Interviews  
Will Be Arranged

## Manufacturers Representatives in EUROPE

are looking for additional lines in the fields of Telecommunications, Computer Peripherals and Microelectronic Production Equipment.

Handling Direct Sales to End-Users and OEM's, establishing of Dealer/Distributor Network, all Promotional Activity, assistance in setting up European Operation for U.S. Manufacturers.

**George R. Furrer**  
33, Ch. Grange-Canal  
CH-1208 GENEVA  
SWITZERLAND

## TECHNICAL TRANSLATIONS

English/French by professional translator with over 10 years experience in electronic and electrical systems. Call or write:

**JEAN LOUIS AVRIL**  
5ter, rue des Bois  
92310 SEVRES FRANCE  
Tel: (1) 027.68.99

# MAJOR NON-IMPACT PRINTER DEVELOPMENT

## A growth opportunity for both non-impact and impact printer specialists

Computer Peripherals, Inc., the joint venture company of Control Data Corp., NCR Corp., and ICL Ltd., has several key openings in a long term high technology program destined to make significant contributions to the state of the art. Impact printer specialists will also have opportunities to extend their expertise into the non-impact area.

### NON-IMPACT DEVELOPMENT

#### MANAGER, INK JET TECHNOLOGY

You will be responsible for ink jet technology development for low speed non-impact printers, including direction of a staff of engineers, technicians, and design and drafting personnel. A BS degree plus a minimum of 10 years' related experience including project management, and low cost design engineering are required.

#### PRINCIPLE ENGINEERING SCIENTISTS

- Ink Jet Technology Selection, design & development of materials and processes
- Electrostatic Phenomena Extensive research in electrostatic deflection of ink droplets
- Fluid Mechanics Properties, flow, boundary, modeling and analysis of hydrodynamics

#### SENIOR ENGINEER, EPG

You will be a member of a technology team which will establish and provide design approaches for use in electrophotographic high speed printer products. Two to six years of EPG design and development experience with

specialization in EPG image development and fusing needed. BS degree in engineering or physical science or equivalent experience required.

#### MANAGER, MECHANICAL DEVELOPMENT

Leading the team responsible for development and application of mechanical aspects of ink jet technology, you will have a substantial annual budget, and a staff of approximately 10 engineers, technicians and support personnel. A BSME, MS preferred, plus a minimum of 10 years' related experience, including accountability for the design of a portion of a manufactured product are required. A background in low cost design and project management is also desirable.

#### PRINCIPAL SCIENTIST

##### Electrophotographic printers

Lead a technology development team in establishing design approaches to new products. Ten years' EPG design and development experience with specialization in EPG image development and fusing required. A BS in engineering or physical science is also required.

### IMPACT PRINTER DEVELOPMENT

#### MECHANICAL DEVELOPMENT ENGINEER

You will be responsible for the development of a new generation of band printers utilizing low cost innovative designs, in addition to responsibility for development of band printer paper stacker. Your background must involve the ability to direct a staff of approximately eighteen engineers, technicians and design and drafting personnel. Position requires BSME or the equivalent (MSME desirable) and a minimum of ten years' previous related experience including previous design

accountability for a portion of a manufactured product, experience in project management and low cost design.

#### MECHANICAL ENGINEERS

Mechanical production design background including mechanical processes as they apply to design, and value engineering techniques. Proven product development experience with expertise in mechanisms, structures, electromagnetics, electronic packaging/cooling, and value engineering. A BSME or the equivalent plus 4-6 years' related design and manufacturing experience.

#### ELECTRICAL (Electronics) ENGINEERS

A strong background in electronic circuit design including digital logic design, microprocessor design, and programming is required. We are looking for a BSEE or the equivalent with 3 years' design experience and the ability to direct engineering support personnel, design analog and digital circuits, AC power, and service mechanisms.

These positions, both in the non-impact and impact areas, offer exceptional career potential, competitive salaries and excellent benefits. For confidential consideration, please forward your resume including salary requirements to:

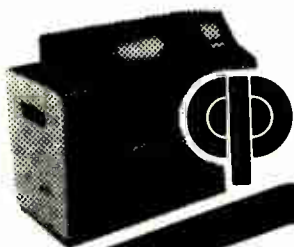

## COMPUTER PERIPHERALS, INC.

Mr. Bob Brown  
1480 N. Rochester Rd.  
Box E-34  
Rochester, Michigan 48063  
1-313-651-8810

An Affirmative Action Employer

# **ANALOG/DIGITAL DESIGN ENGINEERS POWER SUPPLY DESIGN ENGINEERS ELECTRONIC PRODUCT ENGINEERS**

Wescom has immediate career opportunities available for qualified engineers to join our Engineering Organization.

## **ANALOG/DIGITAL DESIGNERS**

The individuals we seek must have experience in TTL and CMOS technology coupled with an understanding of bipolar logic families. Some knowledge in A to D conversion and PCM multiplying techniques is also desirable.

## **POWER SUPPLY ENGINEERS**

You will be responsible for the design of power supplies to be utilized in telecommunications systems. The individuals we seek must have a B.S.E.E. and a minimum of 3 years relevant experience.

## **ELECTRONIC PRODUCT ENGINEERS**

Responsibilities include coordinating the introduction of new PCM carrier equipment into the manufacturing area and liaison with quality control and purchasing in maintaining system quality.

Requirements: Minimum of 2 years experience in the design of industrial and commercial electronic circuits and equipment, and a B.S.E.E. degree.

Wescom is a leader in the design, development and manufacture of electronic telecommunications equipment. We offer a challenging position with excellent potential for professional growth. Please submit resume, including salary requirements in confidence to:

**Christine Rosenbach  
Employment Manager**



**WESCOM**

**P.O. Box 458  
Downers Grove, IL 60515**

*An Equal Opportunity Employer M/F*

# **Power Supply Engineer**

An exceptional opportunity for an experienced power supply designer in new product development. The position requires a background in conventional regulators, switching regulators, high voltage circuits, and high efficiency circuits. A keen interest in pursuing the latest technology in power supply concepts is essential.

Tektronix, Inc., develops, manufactures and markets internationally recognized precision electronic measurement instruments, computer peripherals and related electronic instrumentation. Located near Portland, Oregon we are within a two hour drive of the Cascade Mountains and Ocean Beaches. The close-by nature playgrounds and the City of Portland provide a variety of recreational and cultural interests.

Salary is open. Benefits include liberal educational support, insurance and profit sharing programs.

Send resume and complete salary history to Roy Epperson, TEKTRONIX, INC., P.O. Box 500, E45, Beaverton, OR 97077.

An Equal Opportunity  
Employer M/F/HC.

**Tektronix**  
COMMITTED TO EXCELLENCE

# **Job-seekers... be the first to know with McGraw-Hill's Advance Job Listings**

By having our weekly ADVANCE JOB LISTINGS sent to your home every Monday you can be the first to know about openings both in and out of your field. AJL will enable you to contact anxious recruitment managers BEFORE their ads appear in upcoming issues of 21 McGraw-Hill publications. To receive a free sample copy, plus information about our low subscription rates, fill out and return the coupon below.

ADVANCE JOB LISTINGS / P.O. BOX 900 / NY 10020  
PLEASE SEND A SAMPLE COPY  
OF ADVANCE JOB LISTINGS TO

NAME \_\_\_\_\_

ADDRESS \_\_\_\_\_

CITY \_\_\_\_\_

STATE/ZIP \_\_\_\_\_



# A New Frontier for Hardware and Software Designers

**Consider the growth potential, and unparalleled creative latitude involved in a technical evolution that encompasses an industry as large as the telephone systems of the U.S. and other countries.**

It is underway! and GTE Automatic Electric, a major member of the GTE family, whose research and development expenditures ranked among the top 50 R&D spenders in U.S. Industry in 1976, is leading the way with a major expansion of the engineering, and all related support staffs. Our assignment . . . research and develop the communications systems of the future. Not a single system project, but a continuing evolution of sophisticated high speed, computer-controlled telecommunications systems.

## SOFTWARE DESIGN ENGINEER

Responsible for the specification, design and testing of telephone systems support software, network and control software, or maintenance and diagnostics software. Prefer a minimum of 3 years' experience in structured design, coding, testing and documentation of programs; development with large data base on multi-file computers and real-time systems, HIPO design documentation, TSO usage and software simulation techniques. Requires a BS or MS in Computer Science or Electrical Engineering, and specialized study in the use of PL/I Fortran, Assembler, Intel 8080 and PDP-11 programming languages.

## HARDWARE DESIGN ENGINEER

Primary responsibilities will cover the specification and design of the Common Control hardware system and development of control processors, memories, peripheral controllers, network, network controllers, and trunks. Prefer a minimum of 3 years' experience in diagnostic software and hardware development in large real-time systems, system architectural planning and digital logic design, and TSO and structural programming techniques. Requires a BS or MS in Electrical Engineering or Computer Science and specialized study in logic design, assembly or computer language programming and fundamentals of sequential design.

## MANAGER, PROTOTYPE PRODUCTION . . .

and Prototype Test. You will direct the overall operations of a pilot production facility including scheduling, engineering, and test development related to the manufacturing-design, construction and testing of electronic switching system prototypes prior to their release to commercial production. A minimum of 8 years' experience, including management, plus fundamental knowledge of digital electronics and computer systems, and an engineering degree are required. MBA is preferred.

## TELETRAFFIC ENGINEER

Responsible for the analysis of teletraffic probability and queuing problems on digital and analog switching systems and the development of computer programs for switching systems. Prefer a minimum of 3 years' experience in real-time control systems teletraffic problems, systems equipment quantities specification, and exposure to switching system specifications. Requires a BS or MS in Electrical Engineering, Computer Science or Math

and a strong statistical background and experience in PL/I or Fortran programming and model simulation.

## ELECTRONIC PACKAGING ENGINEER

Will be engaged in the development and evaluation of electronic system packaging for effectiveness and cost reduction purposes. Includes development of packaging standards and maximizing effectiveness of hardware systems with respect to packaging density, thermal efficiency and I/O constraints at the PWC and file levels. Prefer 3 or more years' experience in electronic system packaging design and development and the functions of PWC generation. Requires a BS in Electrical Engineering, Mechanical Engineering or Applied Sciences and specialized study in packaging mechanics, materials and production processes.

## COMPUTER AIDED DESIGN ENGINEER

Responsible for specification, design and implementation of integrated Computer Aided Design/Computer Aided Manufacturing (CAD/CAM) systems. Includes planning and design of information system architecture, data base systems, simulation systems, and the development of interactive user access and PCB Physical Design system. Prefer a minimum of 3 years' experience in software development for CAD or CAM systems, data base systems, data base administration, and interactive graphic systems or computer systems. Requires a BS, MS or PhD in Electrical Engineering, Computer Science, or Math and specialized study in high level programming languages and techniques.

## CIRCUIT DESIGN ENGINEER

Will analyze, evaluate and test integrated circuit assemblies, discrete devices and prototype systems; generate specifications, parameter measurements and operational life testing; design test circuits and perform failure analysis on semiconductors. Prefer a minimum of 3 years' experience in integrated circuitry, design of logic systems (digital TTC IC families), failure analysis and assembly processes. Requires a BS or MS in Electrical Engineering or Physics and specialized study in semiconductors, integrated circuits, digital circuits, electrical measurement and programming.

Let's talk about the evolution in telecommunications, and what it can mean to your career. One of our representatives is standing by:

**CALL TOLL FREE  
(800) 323-1966**

In Illinois (800) 942-0491  
Sunday thru Friday from 8 am to 5 pm cst  
If unable to call, please send your resume to:  
Paul Jensen or Doug Allen

**GTE AUTOMATIC ELECTRIC  
LABORATORIES**  
400 N. Wolf Road  
Northlake, IL 60164

An Equal Opportunity Employer M/F

**GTE AUTOMATIC ELECTRIC  
LABORATORIES**

# ENGINEERING LAB MANAGER

## Computer Science Research

Advanced digital design responsibilities with one of the nation's leading university hardware faculties

Manage hardware activities including long range planning, design, construction and maintenance of state-of-the-art computing systems. Research is presently underway in systems architecture, multiprocessors, highly specialized processors, custom LSI and large scale systems to support programming and artificial intelligence projects.

Candidates should be experienced in both hardware design and construction. An M.S. degree in Electrical Engineering or Physics is preferred. A minimum of five (5) years experience is required including some at the supervisory or management level.

The Pittsburgh district's educational, cultural and recreational opportunities combined with its comparatively low costs of real estate and living make it an ideal location. The University offers a comprehensive benefits program. Salary will be commensurate with education and experience. For consideration, please send a resume with salary history/requirements in strict confidence to: Director of Research Facilities,

Carnegie-Mellon University  
Computer Science Department  
Schenley Park  
Pittsburgh, Pennsylvania 15213  
An equal opportunity employer, M/F



**STANLEY** Help Us Do Things Right

### SENIOR PRODUCT ENGINEER-ELECTRONIC

The DOOR OPERATING EQUIPMENT DIVISION of The Stanley Works, headquartered in Farmington, Conn., is seeking an Electronics Engineer. The successful applicant must have proven abilities as project manager on product development programs, and will be responsible for evaluation of field requirements and problems, for product design and development, and for coordination with factory on new design. Must be degreed, with a minimum of five years experience in electronics; solid state devices, logic circuits, and power control of fractional H. P. motors. Knowledge of microwave technology and infra-red devices helpful. Submit your resume, including salary history to:

**THE STANLEY WORKS**  
Corporate Employment, Dept. 901E  
P.O. Box 1800, New Britain, Conn. 06050  
Local interviews may be arranged at a mutually convenient time.  
An Equal Opportunity/Affirmative Action Employer

**STANLEY**

# ELECTRICAL ENGINEER

MS or PhD required with 3-10 years achievement in performing analog circuit design for key assignments at B&W's Lynchburg R&D facility. Familiarity with DEC PDP-11 minicomputer and INTEL 8080 a strong plus. Most suitable background includes experience on medium to large scale projects, exposure to areas such as budget control, estimating, scheduling, technical monitoring on electromechanical projects.

Will design analog circuits and multiplexers, feedback control; also electromechanical and computer-based systems. Excellent salary/benefits package. Attractive location in the foothills of the Blue Ridge Mountains. Send resume/salary history: L. B. Comp,

**Babcock & Wilcox**  
Research and Development Division  
P.O. Box 1260  
Lynchburg, Va. 24505  
Equal Opportunity Employer M/F

## NOTICE TO EMPLOYERS:

**Why  
we can recommend  
our readers  
for the top jobs**

The subscribers to this magazine have qualified professionally to receive it. They are also paid subscribers—interested enough in the technological content to have paid a minimum of \$14 for a subscription.

As subscribers to ELECTRONICS, our readers have told you several things about themselves. They are ambitious. They are interested in expanding their knowledge in specific areas of the technology. And they are sophisticated in their need for and use of business and technology information.

Our readers are now in senior engineering or engineering management, or they are on the road toward those levels. In either case, they are prime applicants for the top jobs in almost any area.

If you are interested in recruiting the best people in electronics, these pages are open to you for your recruitment advertising.

Our readers are not "job-hoppers". To interest them you will have to combine present reward with challenge and opportunity for future career advancement.

The cost of recruitment advertising on these pages is \$46 per advertising inch. For information call or write:

# Electronics

Post Office Box 900, New York, NY 10020  
Phone 212/997-2556



**Would  
you hire  
an engineer  
who  
couldn't  
understand  
this  
magazine?**

Of course not. ELECTRONICS is the technical publication for technical people. If they can't understand it, they can't receive it. That's why, when you're looking for qualified engineers, you should consider our Classified Section.

For only \$46.00 per inch your recruitment advertising will reach 46,000 pre-screened engineers—that's just \$1 per thousand!—as they're reading to combat job obsolescence, while they're thinking about their future and bettering themselves.

There's no charge for typesetting and free layout service is provided.

For more information call or write:

**ELECTRONICS**

Post Office Box 900  
New York, N.Y. 10020  
Phone: 212/997-2556

Electronics

**Join The Industry Leader**

**KAISER**

**On The San Francisco Peninsula**

Join the industry leader supplying CRT display systems for the A-6, the B-52, the F-111, the F-14, the A-10, the F-16, the Alpha Jet . . . and now for the F-18. Excellent opportunities currently exist for self-motivated professionals with our dynamic, growth oriented company. The following positions require BS degrees and a minimum of three years' experience in the military avionics field.

**Digital Design Engineer**

Applicants must have recent experience with digital systems and high speed logic design techniques. Position requires knowledge of contemporary T2L/LS/MOS logic family characteristics and proper application of these devices in circuit designs. Familiarity with the NOVA computer and FORTRAN is desirable.

**Software Digital Engineer**

Candidates must have microprocessor, minicomputer or special purpose computer experience. Experience with 2901, 8080, FORTRAN and NOVA is highly desirable.

**Project Mechanical Engineer**

This is a supervisory level position requiring a background in military avionics packaging techniques. Position requires experience in the areas of manpower planning, project scheduling, proposal writing, design analysis and fabrication techniques.

**Mechanical Design Engineer**

Experience with current electronic packaging and fabrication techniques is necessary as well as familiarity with military specifications and geometric dimensioning. Analytical skills are also required for thermal, vibration and stress analysis. This position will involve the supervision of mechanical designers and draftspersons.

**Mechanical Designer**

Requires knowledge of current electronic packaging and fabrication techniques with emphasis on producibility. Knowledge of military specification and drawing standards is required. Degree not required.

**Analog Engineer**

To design resonant recovery linear and power on demand deflection amplifiers, video amplifiers, processing circuitry and LVPS. Specify CRT's, yokes, contrast filters and HVPS.

**Reliability Engineer**

Candidates must be capable of performing stress analysis to the component level. Applicants must be familiar with parts application analysis, MTBF predictions and FMEA predictions. Responsibilities also include the planning coordination and reporting of reliability testing.

**Components Engineer**

Applicants must be familiar with military specifications regarding component standardization, component selection and non-standard part qualification. Ability to prepare procurement specifications, test plans and reports is required.

Send your detailed resume (handwritten acceptable) including salary history to, the Personnel Manager, 1681 Page Mill Road, Palo Alto, California 94306. We are an equal opportunity employer male, female, handicapped.

**KAISER**

**ELECTRONICS**

RF Communications Division

# With a Stroke of a Pen...

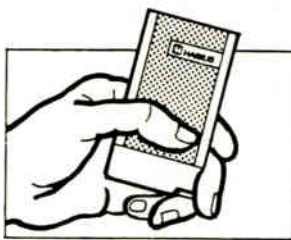

Harris Corporation, RF Communications Division, became one of the leading manufacturers of pocket pagers. We have already taken the lead in the development of high quality radio communication systems and equipment and with the acquisition of another high quality communication company, our product line and mix in the Long Range, Mobile and personal communication devices is reaching every corner of the globe.

To help us continue on our rapid growth path, the following immediate career opportunities exist:

## REGIONAL MANAGERS and APPLICATIONS ENGINEERS

(International)

This is an outstanding opportunity to really do something different. You should possess a technical background plus a minimum of 5 years experience in applications engineering or sales support. Knowledge of RF Communications in the UHF, VHF and HF frequency ranges required. Openings exist in Europe, Latin America, Mid East and Far East.

## DIRECTOR OF PRODUCT MANAGEMENT

You will report directly to the Product Line Vice President and have the responsibility for the evaluation of competition, R&D Program Assessment, Strategic Planning and all areas of Product Planning. You should possess a knowledge of radio communication products, technical degree desired, MBA preferred and a minimum of 10 years experience in product development and marketing support.

These are high visibility growth positions with excellent salary and benefits in addition to liberal relocation assistance to our scenic upstate New York Headquarters where we enjoy one of the nation's best educational, cultural and recreational areas in the country.

For immediate consideration, please forward resume and salary history to: Mr. Les Michaels, Harris Corporation, RF Communications Division, 1680 University Avenue, Rochester, New York 14610.



**HARRIS**  
COMMUNICATIONS AND  
INFORMATION HANDLING

An Equal Opportunity Employer—Male and Female

## Would you hire an engineer who couldn't understand this magazine?

Of course not. ELECTRONICS is the technical publication for technical people. If they can't understand it, they can't receive it. That's why, when you're looking for qualified engineers, you should consider our Classified Section.

For only \$46.00 per inch your recruitment advertising will reach

90,000 pre-screened engineers and managers as they're reading to combat job obsolescence, while they're thinking about their future and bettering themselves.

There's no charge for typesetting and free layout service is provided. For more information, contact the nearest McGraw-Hill regional office, or write:

**ELECTRONICS**

Post Office Box 900  
New York, N.Y. 10020 • Phone: 212/997-2556

MAKE YOUR  
NEXT  
MOVE A STEP  
IN THE  
RIGHT  
DIRECTION



The road to professional fulfillment can be a real jungle. We can help you find the right path. Our affiliation with



keeps us informed of opportunities in the ELECTRONICS industry from coast to coast as they occur. Together with over 190 associates, we offer our knowledge and expertise at no charge to you. Fees are company paid.

**BUTTERFIELD'S EMPLOYMENT SERVICE**  
161 West Wisconsin Avenue  
Suite 269  
Milwaukee, Wisconsin  
53203  
(414) 278-7800

**PLACEMENT EXPERTS, INC.**  
944 Central Bank Building  
Huntsville, Alabama 35801  
(205) 539-2467

**AVAILABILITY, INC.**  
Engineering Consultants  
Suite 285  
5401 W. Kennedy Boulevard  
Tampa, Florida 33609  
(813) 872-2631

**BRENTWOOD PERSONNEL ASSOCIATES**  
Electronics Division  
1280 Route 46  
Parsippany, New Jersey  
07054  
(201) 335-2700



**Would  
you hire  
an engineer  
who  
couldn't  
understand  
this  
magazine?**

Of course not. ELECTRONICS is the technical publication for technical people. If they can't understand it, they can't receive it. That's why, when you're looking for qualified engineers, you should consider our Classified Section.

For only \$46.00 per inch your recruitment advertising will reach 46,000 pre-screened engineers—that's just \$1 per thousand!—as they're reading to combat job obsolescence, while they're thinking about their future and bettering themselves.

There's no charge for type-setting and free layout service is provided.

For more information call or write:

## **ELECTRONICS**

Post Office Box 900  
New York, N.Y. 10020  
Phone: 212/997-2556

# **ELECTRONIC ENGINEERING**

- In an Advanced Systems Group
- Emphasizing Technical Innovation
- For New Venture Development

These openings will not appeal to everyone. They are strictly for the exceptional EE who thrives on invention, on challenge, on diversity . . . and who also appreciates the career advantages of being in a long-term program of a \$1.5 billion corporation. A prime focus of our Advanced Systems Group is non-impact printing at extremely high speeds, utilizing new electronic and computer techniques. Our Group has already scored a series of breakthroughs, creating openings in these three units:

## **Technology Laboratories**

Advancing state-of-the-art in Photography, Digital Image Processing, and Information handling,

**DIGITAL DESIGN ENGINEER** —Develop advanced concepts and applications for special purpose digital systems and microprocessors. Requires several years of logic and digital design experience. Exposure to computer design and configuration desirable.

## **Digital Systems**

A leader in the development of Ink Jet Imaging technology.

**ELECTRONIC ENGINEERS** —Utilize at least 1-2 years of experience in any of these areas:

- Analog/Digital Circuit Design
- Minicomputer Interface
- CMOS, TTL Design • Microprocessor Applications
- Electromechanical Interface

## **Research & Development**

Concerned with state-of-the-art studies, new applications and breakthroughs in Ink Jet Imaging technology.

**ELECTRONIC/ELECTRO-OPTICAL ENGINEERS/PHYSICIST** —Use strong experimental orientation and research experience in any of the following:

- Analog and Digital Circuit Design and Testing (specifically TTL, CMOS, and other logic families).
- Micro and/or Minicomputer
- Electro-Optical Systems • Acoustics
- Experimental Fluid Mechanics
- High Performance Analog Operational Amplifiers

You will join an outstanding multi-disciplinary team of engineers and scientists. The environment is exceptionally favorable to contributions and career advancement. Your experience and abilities will be evaluated carefully and fully recognized. Dayton offers a refreshing change for those seeking relaxed yet sophisticated living. To explore these opportunities, please send resume detailing pertinent achievements, in confidence to Manager, Professional Employment.

**Mead**  
**Advanced Systems Group**

World Headquarters • Courthouse Plaza, N.E., Dayton, Ohio 45463  
Equal Opportunity Employer M/F

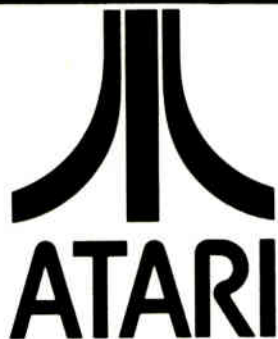

The innovative producers of games  
that make your life more fun . . .  
has immediate openings for

## COMPONENT ENGINEER

Positions require 2-5 years experience as a Design Engineer (Electromechanical) with responsibilities for component specification, evaluation and testing. Experience desired with ICs, active and passive components, motors, etc.

You will provide technical support/advice to Engineering, Manufacturing and Purchasing in selection and qualification of components and suppliers. BS/EE, ME or Physics required.

Excellent benefits, exceptional working conditions in a unique, fascinating environment . . . plus excellent compensation! Please send your resume, including salary history, to Personnel Dept CE, ATARI, INC., P.O. Box 9027, 1265 Borregas Ave., Sunnyvale, CA 94086. We are an equal opportunity employer. Individuals only apply. (408) 745-2040.

## Project Engineer

*Join a recognized leader in the field of high  
technology power products on the SAN  
FRANCISCO PENINSULA*

Manage the development and coordination of projects for specific applications of our switching regulated power supplies. The individual will work closely with marketing, manufacturing and engineering personnel in coordinating the efforts of a design team. Position requires a BSEE and 3 years of product development experience.

We offer highly competitive salaries, stock option, attractive fringe benefits and the opportunity to develop your career with an industry leader. Please send your resume, including salary history, in complete confidence, to Personnel Manager, BOSCHERT ASSOCIATES, 384 Santa Trinita Ave., Sunnyvale, CA 94086. An equal opportunity employer

# boschert

## WESCON INTERVIEWS

Engineers with experience in any of the following:

**Realtime Programming  
Inertial Navigation  
Microwave Systems  
Computer Hardware/Software  
Telecommunications  
RF Design  
Marketing**

Interview with companies from California, Texas, East Coast or Midwest. Make an appointment to attend our confidential employment center at the downtown San Francisco HILTON HOTEL. Send your resume or call Mr. Manny Roo, collect, at (513) 579-1513; or call him at the HILTON at (415) 771-1400.

### REGIONAL CONSULTANTS, INC.

213 W. 9th Street, Cincinnati, Ohio 45202  
(513) 579-1513

If you are not attending WESCON, we will arrange to meet with you when we are in your city. Regional Consultants, Inc., is a nationwide technical search firm representing a broad base of clients serving the Electronics field.

*Our Clients are Equal Opportunity Employers*

### NOTICE TO EMPLOYERS:

**Why  
we can recommend  
our readers  
for the top jobs**

The subscribers to this magazine have qualified professionally to receive it. They are also paid subscribers—interested enough in the technological content to have paid a minimum of \$14 for a subscription.

As subscribers to ELECTRONICS, our readers have told you several things about themselves. They are ambitious. They are interested in expanding their knowledge in specific areas of the technology. And they are sophisticated in their need for and use of business and technology information.

Our readers are now in senior engineering or engineering management, or they are on the road toward those levels. In either case, they are prime applicants for the top jobs in almost any area.

If you are interested in recruiting the best people in electronics, these pages are open to you for your recruitment advertising.

Our readers are not "job-hoppers". To interest them you will have to combine present reward with challenge and opportunity for future career advancement.

The cost of recruitment advertising on these pages is \$46 per advertising inch. For information call or write:

# Electronics

Post Office Box 900, New York, NY 10020  
Phone 212/997-2556

# Engineers... are you pigeonholed?

We won't keep you pigeonholed in the same old assignment, year after year. After all, variety is the spice of a life's work. And we have a commitment to it. We make our living selling variety: command and control systems, complete air defense systems, radar systems, sonar systems, computer systems and much more. We're part of a company of 36,000 people, active in more than 550 major product areas in 80 technologies. Plenty of room for developing interests, plenty of room for growth.

Our Systems Division engineers enjoy technical diversity because of our program variety, and growth opportunities that we're steadily expanding. They benefit from the technically oriented management which put us on our strong growth curve. And they enjoy a good professional environment, where many of our people wear 10, 15, and 20 year service pins.

**Any more good news? Well, yes. We're hiring now.**

**For quick action, reach for your phone instead of your resume...** call M. F. Duggins collect (714) 871-4080, Ext. 5410 between 8 A.M. and 4 P.M. Monday through Friday. Or send your resume to: Professional Employment—Ground Systems Group E, 1901 W. Malvern, Fullerton, CA 92634.

U.S. citizenship required • Equal opportunity M/F/HC employer

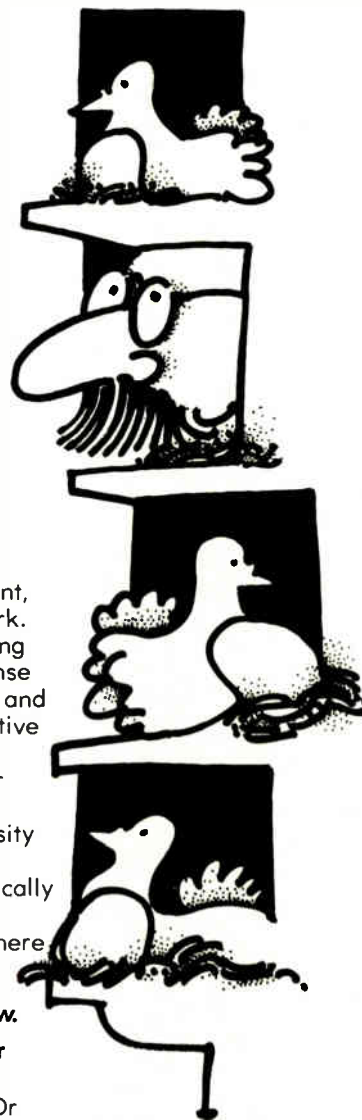

**Communications System Engineers.** Must understand hardware/software interaction, signal processing, spread spectrum.

**Senior Systems Engineers.** Tactical, strategic system application of radar, sonar communications, electro-optical software, data processing and command and control technologies.

**Communication Analysts.** Lead/direct application of systems theory, applied math, estimation, probability to communication system problems.

**Data Processing and Software Analysts.** System level data processing architecture analysis, design, performance evaluation for multisensor systems.

**Display System Engineers.** Long term opportunity to lead display product definition/selection for military C&C Systems.

**Radar Systems Engineers.** Lead/direct radar system conceptual design/analysis. Integration of radar, weapon, command and control systems.

**Senior Air Defense Engineers.** BSEE, Math or Physics, project management experience in real-time hardware software systems.

**Hardware System Engineers.** Large scale data processing, peripheral, display systems design, specification, integration checkout.

**Systems Analysts.** Systems Theory, applied math background. Variety of problems requiring modern analysis techniques.



# ENGINEERS

McDonnell Douglas Electronics Company, a divisional company of McDonnell Douglas Corporation, located in the St. Louis suburban area, has immediate openings in the following areas in support of Audio Products (Voice Response System), Training Simulators (Vital and A7D), Electronic Warfare Systems, Avionic and Support Systems:

**SYSTEMS PROGRAMMERS**—BS in Engineering, Computer Science or Math with experience in design and programming of computer software. Use of assembly or higher level language (PDP 11 Systems Programming preferred).

**DIGITAL DESIGN ENGINEERS**—BSEE with experience in high speed digital logic design in computer I/O also in fast linear circuits and D/A conversions. Experience in design of training simulators desired.

**MANUFACTURING TEST ENGINEERS**—BSEE with at least 5 years experience in design and checkout of sophisticated electronic test instrumentation. Knowledge of programming requirements for automatic electronic test desirable. Openings include senior level to project level.

**PRODUCTION ENGINEER**—BSEE of Physics with at least 10 years in electronic/electro-optical assembly, assembly processes and testing. Requires knowledge of state of the art electronics including LSI devices.

**FIELD SERVICE ENGINEERS**—Experience/knowledge of solid state digital electronics, operation and maintenance of digital computers and associated peripherals. Knowledge of programming highly desirable.

- **SIMULATION EQUIPMENT**—Experience on aircraft simulators and/or CGI Visual Systems also desired. World wide travel involved during installation and integration with aircraft simulators and on service calls.

- **VOICE RESPONSE SYSTEMS**—Experience with telephone service, such as trunk lines, switching networks, touch tone systems required. Will work on automatic telephone — message dispensing equipment. Travel involved.

**SECTION MANAGER—PRINTED WIRING BOARD FACILITY**—Requires 5 years supervisory experience in the fabrication of printed wiring boards (doublesided, multi-layer and plated thru holes). Prefer a degree in Chemical or Metallurgical Engineering or Physics or equivalent specialized manufacturing production experience. Must be results oriented and capable of planning, developing and implementing a broad range of methods designed to improve quality and quantity of printed wiring boards.

To explore these career opportunities with a technically renowned and stable organization, offering an excellent benefit package, please send resume in confidence to:

L. M. Blase, Supervisor of Employment

## **MCDONNELL DOUGLAS ELECTRONICS COMPANY**

2600 N. Third Street • St. Charles, MO. 63301

An Equal Opportunity Employer

## **Job-seekers... be the first to know with McGraw-Hill's Advance Job Listings**

By having our weekly ADVANCE JOB LISTINGS sent to your home every Monday you can be the first to know about openings both in and out of your field. AJL will enable you to contact anxious recruitment managers BEFORE their ads appear in upcoming issues of 21 McGraw-Hill publications. To receive a free sample copy, plus information about our low subscription rates, fill out and return the coupon below.

**ADVANCE JOB LISTINGS / P.O. BOX 900 / NY 10020**  
PLEASE SEND A SAMPLE COPY  
OF ADVANCE JOB LISTINGS TO

NAME \_\_\_\_\_ ADDRESS \_\_\_\_\_  
CITY \_\_\_\_\_ STATE / ZIP \_\_\_\_\_

# Would you hire an engineer who couldn't understand this magazine?

Of course not. ELECTRONICS is the technical publication for technical people. If they can't understand it, they can't receive it. That's why, when you're looking for qualified engineers, you should consider our Classified Section.

For only \$46.00 per inch your recruitment advertising will reach 46,000 pre-screened engineers—that's just \$1 per thousand!—as they're reading to combat job obsolescence, while they're thinking about their future and bettering themselves.

There's no charge for type-setting and free layout service is provided.

For more information call or write:

## **ELECTRONICS**

Post Office Box 900  
New York, N.Y. 10020  
Phone: 212/997-2556



# We know your needs. Electronics Magazine Book Series. Zero-risk trial offer.

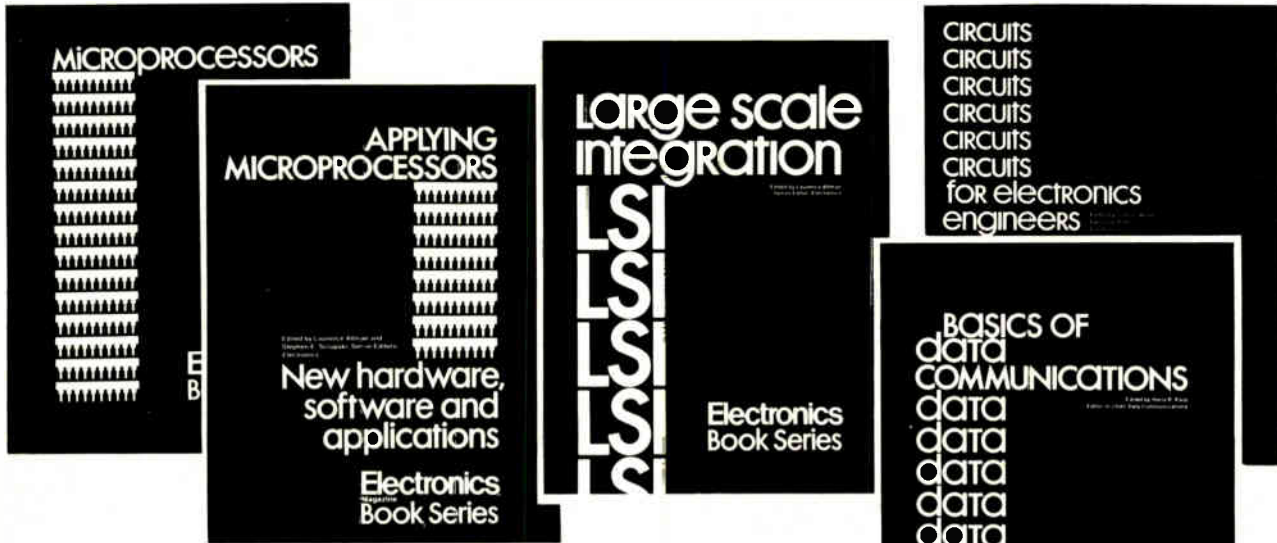

## 1. Microprocessors

What you must know about available microprocessor technology, devices, information, 4th printing. \$8.95

## 2. Applying Microprocessors

2nd and 3rd generation technology. 26 detailed applications from data networks to video games. \$9.95

## 3. Large Scale Integration

Covers the basic technology, new LSI devices, LSI testing procedures, plus system design and applications. \$9.95

## 4. Basics of Data Communications

Includes 47 articles from Data Communications magazine covering more than 11 key areas. \$12.95

## 5. Circuits for Electronics Engineers

Contains 306 circuits arranged by 51 functions from Amplifiers to Voltage Regulating Circuits. Saves design drudgery. \$15.95

### Electronics Book Series

McGraw-Hill Publications Company, Shoppenhangers Rd., Maidenhead, Berkshire SL62QL, England.



1. Send me \_\_\_\_\_ copies of "Microprocessors" at \$8.95 per copy.
2. Send me \_\_\_\_\_ copies of "Applying Microprocessors" at \$9.95 per copy.
3. Send me \_\_\_\_\_ copies of "Large Scale Integration" at \$9.95 per copy.
4. Send me \_\_\_\_\_ copies of "Basics of Data Communications" at \$12.95 per copy.
5. Send me \_\_\_\_\_ copies of "Circuits for Electronics Engineers" at \$15.95 per copy.

Discounts of 40% on orders of 10 or more copies.

I must be fully satisfied or you will refund full payment if the book is returned after ten-day trial examination.

Payment enclosed       Bill firm       Bill me

Charge to my credit card:

- American Express       Diners Club  
 BankAmericard       Master Charge

Acc't No. \_\_\_\_\_ Date exp. \_\_\_\_\_ Interbank No. \_\_\_\_\_

On Master Charge only, first numbers above name \_\_\_\_\_

Name \_\_\_\_\_ Title \_\_\_\_\_

Company \_\_\_\_\_

Street \_\_\_\_\_

City \_\_\_\_\_ State \_\_\_\_\_ Zip \_\_\_\_\_

Signature \_\_\_\_\_

# the inside man...

"I'm ok in the normal chamber, Fahrenheitwise. But these Reliability burn-in chambers, like the CRITERIA IV, are a bit much. 200° C and such.

"But it's the only way I can be sure your production quantities of IC's, RAMS, ROMS,  $\mu$ PS and other devices will receive the precise heat, power and dynamics they need and deserve in this age of exactness.

Just look at these facts:

- Dynamic Burn-in to 200° C
- Up to 11,000 RAMS at one time
- "Exsert Connection" provides for external drivers and long connector life
- 10 billion hours of device time logged by Reliability Inc. in our burn-in facility in Houston — nation's largest
- CRITERIA units now in operation in many major manufacturers of solid state devices

"Let me demonstrate our cost effectiveness for your plant... for small lot or production quantities."

Call Bob Burton, (713) 666-3261.



**Reliability, Inc.**

P. O. Box 37409/Houston, Texas 77036  
713/666 3261/TWX: 910 881 1739



Circle 101 on reader service card

## MDB SYSTEMS presents... The LSI-11 Connection

**GP Logic Modules · Peripheral Controllers · Communications Interfaces · Special Purpose Modules · Accessory Hardware**  
**Plus: DEC's own LSI-11 Microprocessor Module.**

Here are some MDB Systems connections to LSI-11 microprocessors:

- General Purpose Interfaces:  
Parallel for programmed I/O and DMA.  
Do-it-yourself dual and quad wire wrap for any DIP design.
- Device Controllers for most major manufacturer's  
Printers  
Card equipment  
Paper tape equipment  
Plotters
- Communications/Terminal Modules  
Asynchronous Serial Line  
Synchronous Serial Line

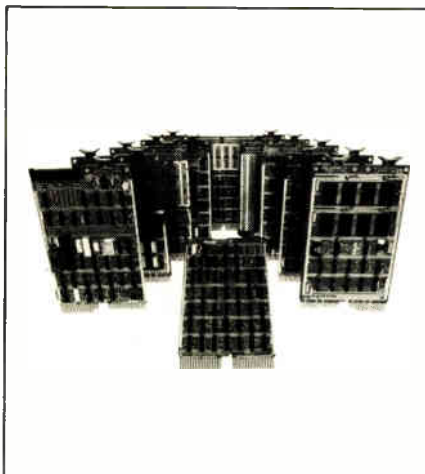

- MDB Backplane/Card Guide Assembly (8 Quad slots)  
Rack mount chassis 5 1/4" front panel.
- Special Purpose Modules and Accessories  
System monitoring unit provides front panel switch addressing, power on/off sequencing, line frequency clock.

- Bus extenders/terminators.  
E-PROM and PROM modules.  
Bus connectors for backplane assemblies.

MDB Systems products always equal and usually exceed the host manufacturer's specifications and performance for a similar interface. MDB interfaces are software and diagnostic transparent to the host computer. MDB products are competitively priced; delivery is usually within 14 days ARO or sooner.

MDB also supplies interface modules for DEC PDP\*11 Data General NOVA\* and Interdata minicomputers.

**MDB**

MDB SYSTEMS, INC.

1995 N. Batavia St., Orange, California 92665  
714/998-6900 TWX: 910-593-1339

\*TMs Digital Equipment Corp. & Data General Corp.

**CIRCLE NO. 102 FOR LSI-11; FOR PDP-11; 103 FOR NOVA; 104 FOR INTERDATA 105**

Able Computer Technology	131	■ Dana Labs	195	GCA Sunnyvale	17
■ ACDC Electronics	251	Data General Corp.	35,172	• GEM M-O Valve	54
AGPOL (Unira)	313	Data I/O Corporation	136	General Electric, A&Sp Operation	32
■ ADAC	173	■ Data Precision	75	■ General Instrument, Microelectronics	45
■ Aloo Electronic Products	252	■ Data Translation	53	General Magnetics	314
■ Allen-Bradley	30-31	■ Delevan Div., American Precision Ind.	18	■ GenRad	27,231
Allied Chemical Co., Metglas Products	275	■ Dialight Corp.	229	Gentron Corporation	230
American Microsystems Inc.	68-69	Digital TPL	312	■ Gordos Corp.	250
AMF Potter & Brumfield	257	• Digitronics	215	Gould, Inc., Allied Control Div.	285
■ Amp, Inc.	24-25	DH-MCO	194	■ Gould, Inc./Instrument Systems Div./T & M	205
Amphenol North America Div., Bunker Ramo Corporation	90-91	E. I. DuPont De Nemours & Co., Inc.	209	■ Gralex Industries	272
Analog Devices	82	‡ Eastman Kodak Company, Graphics Markets Div.	181	‡ Guardian Electric Mfg. Co.	199
Anritsu Electric Co. Ltd.	288	■ ECD Corporation	134	• Hamlin Inc.	313
Analey (Thomas & Betts)	253	• Edelektron srl	17E	Harris Semiconductor	182-183
■ A P Products, Incorporated	284	EBCO	278	Hewlett-Packard	2nd c, 1,2,28,29,70,71 108,139,188,187,193
Applied Digital Data Systems	49	■ E-H Research Labs	196	• HI-G d'Italia	20E
Babcock Relays, Div. Esterline Electronics	192	■ Electronic Applications Co.	313	■ HI-G Incorporated	20-21
■ F.W. Bell, Inc.	79	■ Elec-Trol, Inc.	213	■ Hipotronics, Inc.	248
The Bendix Corporation, Electrical Comp. Div.	23	■ Electronic Development Corp.	256	Infotek	140
Biomation	66-67	Electronic Memories & Magnetics	183	Intel Memory Systems	18-19
■ B&K Precision, Div. Dynason Corp.	244	Electronic Navigation Industries	3rd c.	Intel-Microcomputer Components	154-155
‡ Bud Industries, Inc.	50	■ Electro Scientific Industries	269	■ Interface	288
• Burr Brown	85	Elevam Electronic Tube Co., Ltd	174	International Microcircuits Inc.	260
■ Cambridge Thermionic Corp.	204	■ Elgar Corporation	178	Interstate Electronics Corp.	283
• Carlo Erba SA	171	Elong Electronorgtecnica	214	Interswitch	174
Centronics	177	• EMI Tech	21-22E	• Italtel/Siemens SIT	185,189
■ Cherry Electrical Products	85	EMR-Telemetry	228	■ Itasco, Inc.	271
City of Rochester	286	English Electric Valve Co.	228	■ Johanson Manufacturing Corp.	60
■ C & K Components	252	■ Erie Technological Products	284	Kethley Instruments	222
• Communication Associates Inc.	7	Fairchild Systems Technology	152-153	■ M.S. Kennedy Corp.	188
Computer Automation, Inc., Naked Mini Div.	150-151	• FEME	12E	Kertron	261
‡ Computer Data Systems	185	■ Ferranti-Packard Ltd.	198	Keystone Electronics	272
Computer Professionals' Book Club	291-292,290A-290B	Ferrocube Corp., Div. of No. Amer. Philips	7	■ Krohn-Hite Corp.	5
■ Concord Electronics	28	Figaro Engineering, Inc.	254	■ Lambda Electronics	233-242
Conference on Electronics	289-290	‡ First Computer Corporation	311	‡ Leesametric Div., Metric Resources Corp.	184
Continental Rentals, Div. Continental Resources	8	■ John Fluke Mfg. Co., Inc.	221,281,279,283	LXD Liquid Crystals	189
■ Continental Specialties	208	• Fort Electronique	19E	■ Magnetic Shield Division, Perfection Mica Co.	172
Coors Porcelain	245	■ Frequency Devices, Inc.	274	• Magneti Marelli	197
■ Custom Electronics	220	‡ Fujitsu Limited	54,285	Mallory Capacitor Company	255
‡ Cutler-Hammer, Specialty Products Division	85	Gainesville Area Chamber of Commerce	278	Master Specialties	88-87
		Gatec Energy Products, Inc.	249	• Matsuo Electric Co., Ltd.	215

■ Matsuo Electronics of America	282	• Philips Elooma	2E-3E	‡ Tektronix	43, 94-95
• Matsushita Electric Trading Company	161	■ Piezo Technology	254	Teledyne Philbrick	278
‡ Maxi-Switch Co.	170	Plastics Engineering Company	83	Teletype	217
McGraw-Hill Book Co.	290A, 290B, 291	Plessey Microcomputer Products	14B-149	Texas Instruments, Components	227
MDS Systems	308	• Plessey Semiconductor	14E-15E	Teradyne, Inc.	72
Micro Networks	274	Precision Monolithics Inc.	15	• Thomeon CSF Division D.T.E.	58
■ Microswitch, Div. of Honeywell	258	■ Premier Metal Products	168	TK Enterprises	284
■ Micro Technical Industries	278	• Procond S.P.A.	13E	• Trio Kenwood Corporation	81
■ Microwave Power Devices	282	• Racal Thermionic Ltd.	4E-5E	Triple I	260
■ Mini-Circuits Laboratory	38	Raytheon Company	9	Tri Wall Containers	287
Mitel Semiconductor, Inc.	52	RCA Solid State	114-115	‡ TRW /IRC Resistors	187, 189, 171
■ Motion Motor & Coil	312	Reliability, Inc.	308	‡ TRW Systems Group	156-157
Monolithic Memories	118	Rhone Poulenc - Chimie Fine	293	• TRW /UTC Transformer	199
Motorola Communications & Electronics	277	• Riken Denki Co., Ltd.	20E	■ TRW /LSI Products	159
■ Motorola Semiconductor Products	11, 12, 13, 51, 128	■ Robinson Nugent, Inc.	92-93	■ Union Carbide Corp., Parylene	247
Munich Fair Authority	264	Rockwell Microelectronic Device Division	120-121	United Detector Technology	288
‡ Murata Corporation of America	197	• Rohde & Schwarz	1E	United Systems Corp., Sub. Monsanto	287
• Murata Mfg. Co., Ltd.	170	Sakata Seisakusho	274	Centralab /USCC	225
‡ National Connector	202	Second Source Industries	28	Viking Industries	81
‡ National Semiconductor Corp.	36-37	■ Semiconductor Circuits	254	• V/O Techmashezport	9E
‡ NEC Microcomputers	215	Semtech Corporation	175	‡ Wabash Electronics	58
New England Instrument Company	191	• SEPA S.p.A.	36	Wakefield Engineering	212
Nichicon America Corporation	270	• SGS ATE8	8E	■ Wavetek Indiana	96
NCR Power Systems Division	278	• Shell International Chemical	10E-11E	• Weston Instruments	187
■ Nicolet Instrument Corp., Oscilloscope Div.	88-89	Signetics Corporation	47, 178-179	• Weston Schlumberger	19E
Nikkel Electronics	243	■ Simpeon Electric	273	‡ XEBEC Systems Inc.	81
■ Non-Linear Systems, Inc.	218	Singer Kearfott	218	• Yokogawa Electric Works	185
• North American Philips	8E	Solid State Scientific	125		
■ North Atlantic Industries	10	Sorensen, Div. of Raytheon	219		
NTI America, Inc.	254	■ Spectrol Electronics	223		
Nucleonic Products, Inc.	180-181	• SPI ITT	43		
Numonics	232	Sprague Electric	57		
■ Opto 22	208	■ Sprague Goodman Electronics	232		
Optron, Inc.	14	Standard Grigsby	211		
• Oculloquartz	60	Spectronics, Inc.	268		
Ostby & Barton	224	Syntronic Instruments, Inc.	248		
Oxley Development Ltd.	230	Syston-Donner, Concord	190		
Oxy Metals Industries	207	Tadiran Ltd.	206		
‡ Panasonic, Industrial Div.	203	■ Tansitor Electronics	6		
‡ Panduit Corp.	313	• Teac Corporation	37		
• Perdec Pad	158-157	■ Teconics	210		

### Classified and employment advertising

F. J. Eberle, Manager 212-997-2557  
Send advertisements and box number replies to:  
Electronics, P.O. Box 900, New York, N.Y. 10020

Atari Inc.	304
Atomic Personnel	294
Avril Jean-Louis	296
Babcock & Wilcox	300
Bosherl	304
Carnegie-Mellon University	300
Computer Peripherals	297
Davis, Robert	296
Douglas, McDonnell	306
Furrer, George R.	296
GTE Automatic Electric Engrs.	299
Harris Corp.	302
Hughes Aircraft	305
Kaiser Electronics	301
LAK Associates	294
Lawrence Livermore Lab.	295
Litton Systems, Inc., Amecoom Div.	296
Meade Corp.	303
Personnel National	302
Regional Consultants Inc.	304
Stanley Works	300
Tektronix	298
Wescam	298

■ For more information of complete product line see advertisement in the latest Electronics Buyers Guide  
• Advertisers in Electronics International  
‡ Advertisers in Electronics domestic edition

# WHY ARE MORE LEADING COMPANIES AND UNIVERSITIES BUYING DEC® FROM FIRST COMPUTER?

## 1. DISCOUNTS

Everyone can qualify for discounts, which range up to 20%. Special discount plans for qualified educational and OEM organizations are available.

## 2. DELIVERY

Prompt delivery of factory-fresh DEC® components and products is provided off-the-shelf. Plus, we also stock DEC 11V03®, DECLAB® equivalent, and 11/03 Computing Systems, and can rapidly deliver both standard and customized systems.

## 3. SERVICE

Each customer and order is handled on a personalized basis. We can help you configure your system or select the proper component. Expedited delivery, rapid replies to information requests, and courteous treatment are assured.

## 4. CUSTOM CONFIGURATIONS

We will custom build systems to your specific requirements, with no resulting delays in delivery. We can package your system in a functional yet attractive desk, and provide additional memory, interfaces, terminals, and peripherals.

## 5. ADDED VALUE

Valuable software enhancements for each DEC 11V03®, DECLAB® equivalent, or 11/03 Computing System delivered by First Computer are provided from our continually growing software library. Custom configurations are built to order, fully integrated, and tested prior to shipment.

## 6. WORLD-WIDE FIELD SERVICE

Because all of our systems are thoroughbred DEC®, we can provide for on-site field service by DEC's own factory trained technicians world-wide.

## 7. WARRANTY

We provide the same warranty as DEC®, plus, ask us about our priority exchange plan.

## 8. RENTAL/LEASING

We offer short-term rental or long-term leasing of complete systems. Ask about how these programs can help you meet your system acquisition and budget requirements.

## WHAT THIS MEANS TO YOU

### COMPLETE SYSTEMS

Standard or custom DEC 11V03®, DECLAB® equivalent, or 11/03 Computing Systems with a \$1,000 savings and shipment in 30 to 60 days.

### COMPONENTS

A complete stock of LSI-11® and 11/03® products for immediate delivery—at ATTRACTIVE DISCOUNTS.

**FIRST COMPUTER CORPORATION**  
764 BURR OAK DRIVE WESTMONT, ILLINOIS 60559

Call **FIRST** *first*

Call **FIRST** *first* to find out how much money and time you can save. Call Don Berteau at (312) 920-1050.



11/03 Computing Systems

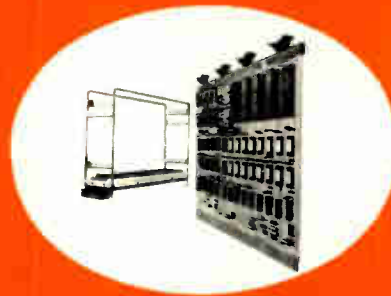

LSI-11® Components



DEC 11V03® Systems

® Registered trademark of Digital Equip. Corp. Maynard, Mass

World Radio History

Circle 70 on reader service card

## Now from Digital— a low-cost paper tape reader.

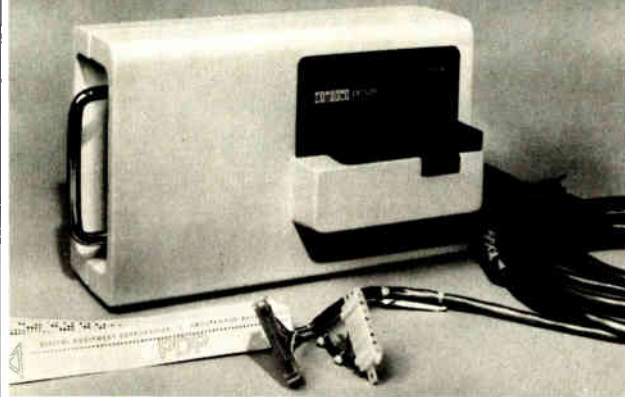

The PRSO1, Digital's new low-cost, portable paper tape reader for high performance terminals.

Now you can easily load your programs, bootstraps and diagnostics into any make or model of computer or terminal you currently own through an approved 20 mA interface. Available in 300 baud and 2400 baud versions, the small (12" x 8") and light (3kg) (6.5 lbs.) self-contained unit can go just about anywhere you need an input device. All for a mere \$750.

For complete information on the PRSO1, call your nearest Digital office; or write Digital Equipment Corporation, Traditional Products, 125 Northeastern Boulevard, Nashua, New Hampshire 03060.

**digital**

Circle 108 on reader service card

## Design engineers lower costs begin here . . .

At Molon, we design our motors to meet your exact needs and budget requirements. And it's this design function that enables us to offer you total quality and total dependability . . . all at the right price. From Gearmotors to Synchronous Motors to Stepper Motors, Contact MOLON . . . the innovators in Rotary Electric Motors.



**MOLON**

3737 INDUSTRIAL AVE., ROLLING MEADOWS, ILL. 60008 312/259-3750  
Designers and Manufacturers of F.H.P. motors and Gearmotors  
from 1/500 H.P. to 1/10 H.P.

312 Circle 110 on reader service card

### Advertising Sales Staff

**Advertising sales manager:** Paul W. Reiss

1221 Avenue of the Americas, New York, N.Y. 10020  
[212] 997-4371

**Atlanta, Ga. 30308:** Glen N. Dougherty  
100 Colony Square, 1175 Peachtree St., N.E.  
[404] 892-2868

**Boston, Mass. 02118:** Frank Mitchell  
607 Boylston St.  
[617] 262-1160

**Chicago, Ill. 60611**  
645 North Michigan Avenue  
Robert W. Bartlett [312] 751-3739

Robert M. Denmead [312] 751-3738  
**Cleveland, Ohio 44113:** William J. Boyle

[716] 586-5040  
**Dallas, Texas 75201:** John J. Uphues  
2001 Bryant Tower, Suite 1070

[214] 742-1747  
**Denver, Colo. 80203:** Harry B. Doyle, Jr.  
123 Speer Blvd. #400

[303] 837-1010  
**Detroit, Michigan 48202:** Robert W. Bartlett  
1400 Fisher Bldg.

[313] 873-7410  
**Houston, Texas 77002:** John J. Uphues  
601 Jefferson Street, Dresser Tower

[713] 659-8381  
**Los Angeles, Calif. 90010:** Robert J. Rielly  
Bradley K. Jones, 3200 Wilshire Blvd., South Tower

[213] 487-1160  
**Minneapolis, Minn. 55435:** Robert M. Denmead  
4015 W. 65th St.

[312] 751-3738  
**New York, N.Y. 10020**

1221 Avenue of the Americas  
Michael J. Stoller [212] 997-3616  
Matthew T. Reseska [212] 997-3617

**Philadelphia, Pa. 19102:** Matthew T. Reseska  
Three Parkway  
[212] 997-3617

**Pittsburgh, Pa. 15222:** Matthew T. Reseska  
4 Gateway Center  
[212] 997-3617

**Rochester, N.Y. 14534:** William J. Boyle  
1175 Pittsford-Victor Rd., Pittsford, N.Y.  
[716] 586-5040

**San Francisco, Calif. 94111:** Don Harris  
Robert J. Rielly, 425 Battery Street,  
[415] 362-4600

**Paris:**  
17 Rue-Georges Bizet, 75116 Paris, France  
Tel: 720-73-01

**Geneva:**  
1 rue du Temple, Geneva, Switzerland  
Tel: 32-35-63

**United Kingdom & Scandinavia:** Robert Ghey  
34 Dover Street, London W1  
Tel: 01-493-1451

**Scandinavia:** Andrew Karnig and Assoc.  
Kungsholmsgatan 10  
112 27 Stockholm, Sweden

Tel: 08 51 88 70 Telex: 179 51  
**Milan:** Luigi Rancati

1 via Baracchini, Italy  
Phone 86-90-656

**Brussels:** Alain Offergeid  
23 Chaussee de Wavre  
Brussels 1040, Belgium

Tel: 13-73-95  
**Frankfurt/Main:** Fritz Krusebecker  
Liebigstrasse 27c, Germany

Phone 72 01 81  
**Tokyo:** Tatsumi Katagiri, McGraw-Hill  
Publications Overseas Corporation,

Kasumigaseki Building 2-5, 3-chome,  
Kasumigaseki, Chiyoda-Ku, Tokyo, Japan  
[581] 9811

### Business Department

**Thomas M. Egan**  
Production Manager [212] 997-3140

**Carol Gallagher**  
Production Manager International  
[212] 997-2045

**Dorothy Carter**  
Production Manager Domestic  
[212] 997-2908

**Diane Arlotta**  
Production Assistant [212] 997-2044

**Frances Vallone**  
Reader Service Manager  
[212] 997-6057

**Electronics Buyers' Guide**  
H.T. Howland, General Manager  
[212] 997-6642

**Regina Hera,** Directory Manager  
[212] 997-2544

**Diane Arlotta,** Production Manager  
[212] 997-2044

**Frances Vallone,** Reader Service Manager  
[212] 997-6057

**Classified and Employment Advertising**  
Frank Eberle, Manager  
[212] 997-2557

# PANDUIT® mounts reduce your installed wiring costs

## METAL MOUNTS

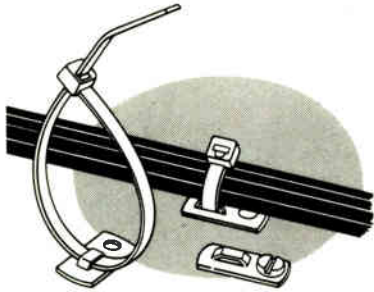

**Secure wire bundles at low cost** with solvent-activated adhesive or screw-applied aluminum mounting base ■ Excellent for mounting to flat metal or other non-porous surfaces ■ Strong, space-saving system includes ½" × 1" mount, solvent and PANDUIT® cable tie  
Circle 111 on reader service card

## ADHESIVE BACKED MOUNTS

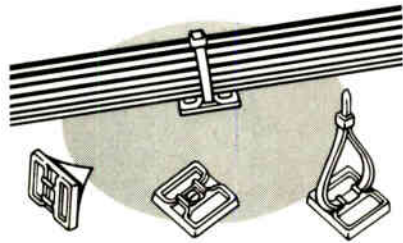

**Fast, easy mounting to any clean, smooth surface** ■ Pressure sensitive adhesive backing with peel-off paper ■ Countersunk hole for screw-mounting where extra strength is required ■ Several types available; also mounts used with commercial adhesives (supplied by user)  
Circle 112 on reader service card

## FLAT CABLE MOUNTS

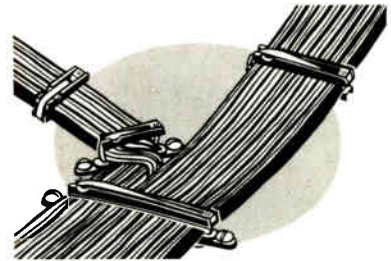

**Economical, versatile method of mounting or bundling flat cable** ■ Use with PAN-TY® cable ties to secure folds, breakouts and stacked cables up to 5" high—widths to 3" ■ Mount to any surface using screws or commercial adhesive ■ Strong, 100% nylon  
Circle 113 on reader service card

**Complete line of PANDUIT® Wiring Components sold through Authorized Panduit Distributors**

# PANDUIT

CORP.

Tinley Park, Ill. 60477 / Phone: (312) 532-1800 • In Canada: Panduit (Canada) Limited

FREE SAMPLES

Visit PANDUIT at Wescon, Booth No. 1221-1223

# UNITRA

Offers...

- Radio and TV consumer goods
- Professional TV and radio equipment
- Active and passive electronic components
- Lighting technique products
- Electronic receiving tubes
- Special technological installations for the electronic industry
- Special raw materials for the electronic industry
- Complete plants for the electronic industry
- Technical expertise, technical documentation, and technical training

You are cordially invited to visit our display in booth number 37, WESCON Western Electronic Show, Civic Auditorium, San Francisco, California, September 19-21, 1977.

Our representative in the USA:

**UNITRONEX CORPORATION**

3158 Des Plaines Avenue, Des Plaines, Illinois 60018

Tel: 312-298-1155

# UNITRA

FOREIGN TRADE ENTERPRISE

A1. Jerozolimskie 44, 00-024 Warszawa, Poland  
POB 66, Cable: Eluni pl • Telex: Eluni 813-827

# 50 Million operations

With TTL loads, our new reed relay offers maximum contact resistance of 0.12 ohms, after more than 50 million operations. And a contact resistance delta



of 0.01 ohms, maximum. Sticking and missed operations are essentially eliminated.

Call or write for information on the RX-1.



# EAC

Electronic Applications Company

4918 Santa Anita Ave., El Monte, CA 91734  
213/442-3212 TWX 910/587-3351

Circle 116 on reader service card

Circle 117 on reader service card 313

# SOLID STATE 3 WIRE SYNCHRO TO LINEAR D.C. CONVERTER



## RESPONSE CURVE

MAC 1422-1  
MAC 1449-1  
MAC 1458-1  
MAC 1459-1

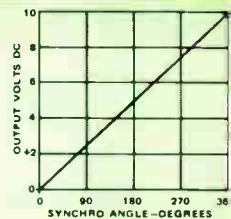
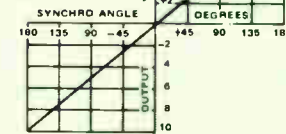

## RESPONSE CURVE

MAC 1460-1  
MAC 1461-1

## FEATURES:

- Develops a DC output voltage linearly proportional to a synchro angle over a  $\pm 180^\circ$  range.
- Completely solid state with all of the inherent advantages over a mechanical system such as:
  - High reliability (since there are no moving parts)
  - Light weight—6 ozs.
  - Small size
  - All units hermetically sealed

- Wide temperature range operation
- Output short circuit protected
- Three wire inputs isolated from ground
- Package size may be altered at no extra cost
- Units can be altered to accept different line to line voltages or different operating frequencies at no extra cost
- Not affected by reference voltage or power supply variations.

UNIT	MAC 1422-1	MAC 1449-1	MAC 1458-1	MAC 1459-1	MAC 1460-1	MAC 1461-1
TRANSFER EQUATION	$\pm 1V/18^\circ$	$\pm 1V/18^\circ$	$\pm 1V/18^\circ$	$\pm 1V/18^\circ$	$+1V/36^\circ$	$+1V/36^\circ$
ACCURACY (+25°C)	1/2%	1/2%	1/2%	1/2%	1/2%	1/2%
ACCURACY (-25°C+85°C)	1%	1%	1%	1%	1%	1%
L-L SYNCHRO INPUT (VRMS)	11.8	90	11.8	90	11.8	90
FREQUENCY (Hz)	400	400	60	60	400	400
FULL SCALE OUTPUT	$\pm 10V$	$\pm 10V$	$\pm 10V$	$\pm 10V$	$+10V$	$+10V$
OUTPUT IMPEADANCE	$<1\Omega$	$<1\Omega$	$<1\Omega$	$<1\Omega$	$<1\Omega$	$<1\Omega$
L-L INPUT IMPEDANCE	$>10K$	$>30K$	$>2K$	$>10K$	$>10K$	$>30K$
REFERENCE VOLTAGE (VRMS)	26	115	26	115	26	115
OPERATING TEMP. °C	-25 +85	-25 +85	-25 +85	-25 +85	-25 +85	-25 +85
D.C. SUPPLY	$\pm 15V$	$\pm 15V$	$\pm 15V$	$\pm 15V$	$\pm 15V$	$\pm 15V$
D.C. SUPPLY CURRENT	$\pm 75MA$	$\pm 75MA$	$\pm 75MA$	$\pm 75MA$	$\pm 75MA$	$\pm 75MA$
BANDWIDTH	10Hz	10Hz	OPT.	OPT.	10Hz	10Hz
WEIGHT	6 oz.	6 oz.	6 oz.	8 oz.	6 oz.	6 oz.
SIZE	3.6x2.5x0.6	3.6x2.5x0.6	3.6x3.0x0.6	3.6x3.0x1.0	3.6x2.5x0.6	3.6x2.5x0.6

## A.C. LINE REGULATION

A new method has been developed which allows us to provide a low distortion highly regulated AC waveform without using tuned circuits or solid state active filters of any kind.

The result is a frequency independent AC output regulated to 0.1% for line and load with greater than 20% line variations over a wide temperature range.

## FEATURES:

- 0.1% total line and load regulation
- Independent of  $\pm 20\%$  frequency fluctuation
- 1 watt output
- Extremely small size
- Isolation between input and output can be provided

Specifications: Model MLR 1476-1  
AC Line Voltage:  $26V \pm 20\%$  @  
400Hz  $\pm 20\%$

Output:  $26V \pm 1\%$  for set point

Load: 0 to 40ma

Total Regulation: +0.1%

Distortion: 0.5% maximum rms

Temperature Range:  $-55^\circ C$  to  
 $+125^\circ C$

Size: 2.0" x 1.8" x 0.5"

Other units are available at different power and voltage levels as well as wider temperature ranges. Information will be furnished upon request.

## High Precision Analog Multipliers

PRODUCT ACCURACY (MCM 1519-1)  $\pm 1\%$  OF ALL THEORETICAL OUTPUT VALUES OVER FULL MILITARY TEMPERATURE RANGE OF  $-55^\circ C$  TO  $+125^\circ C$ . ZERO POINT ERROR FOR ANY INPUT COMBINATION IS  $\pm 2MVRMS$



## Features:

- No external trims required
- Distortion free AC output over entire dynamic range
- Linearity, product accuracy and zero point virtually unaffected by temperature
- All units are hermetically sealed and are not affected by external fields
- High analog product accuracy and wave quality allows dual multiplier assemblies to be matched with 1% of point over the specified temperature range
- Full four quadrant operation
- Package size, power supply requirements and other specs. may be altered to your exact requirements at no extra cost.

## Specifications:

- Transfer equation:  $E_o = XY/10$
- X & Y input signal ranges: 0 to  $\pm 10V$  PK
- Maximum zero point error ( $X=0$ ;  $Y=0$  or  $X=\pm 10$ ;  $Y=0$  or  $X=0$ ;  $Y=\pm 10$ ):  $2MVRMS$
- Input impedance: Both inputs 20K min.
- Full scale output:  $\pm 10V$  peak
- Minimum load resistance for full scale output:  $2K\Omega$
- Output impedance:  $1\Omega$
- Short circuit duration: 5 sec.
- Frequency response characteristics (both inputs) 1% amplitude error: DC to 1200 Hz (min.) 0.5 DB Amplitude error: DC to 3500 Hz min. 3 DB point: Approx. 10K Hz Roll off rate: 18 DB/octave
- Noise Level: 5MV PK-PK @ 100K Hz approx.
- Operating temp. range: See chart
- Storage temperature range:  $-55^\circ C$  to  $+125^\circ C$
- DC Power:  $\pm 15V \pm 1\%$  @ 30MA
- Dimensions: 2" x 1.5" x .6"

Type No.	Product Accuracy	Operating Temperature Range
MCM 1519-1	± 0.5%	-55 C - +125 C
MCM 1519-2	± 0.5%	-25 C - +85 C
MCM 1519-3	± 0.5%	0 C - +70 C
MCM 1520-1	± 1.0%	-55 C - +125 C
MCM 1520-2	± 1.0%	-25 C - +85 C
MCM 1520-3	± 1.0%	0 C - +70 C

There is No Substitute for Reliability



# GENERAL MAGNETICS • INC

211 Grove St., Bloomfield, New Jersey 07003 - Tel. (201) 743-2700

World Circle 19 on reader service card



**PLEASE ENTER MY SUBSCRIPTION TO ELECTRONICS FOR:**

1.  ONE YEAR AT \$14  
 THREE YEARS AT \$35

- Payment Enclosed  
 Bill My Company  
 Bill Me

CHARGE MY SUBSCRIPTION TO

<input type="checkbox"/> AMERICAN EXPRESS	<input type="checkbox"/> MASTER CHARGE
<input type="checkbox"/> DINERS CLUB	<input type="checkbox"/> BANKAMERICARD
ACCT. NO. _____	
DATE CARD EXPIRES _____	
INTERBANK NO. _____	1st No's. above name on MasterCard only.

53180

NAME \_\_\_\_\_ TITLE \_\_\_\_\_  
 COMPANY \_\_\_\_\_ DIV or DEPT \_\_\_\_\_  
 COMPANY ADDRESS \_\_\_\_\_  
 CITY \_\_\_\_\_ STATE \_\_\_\_\_ ZIP \_\_\_\_\_  
 Check here if you wish publication to be sent to home address. STREET \_\_\_\_\_ CITY \_\_\_\_\_ STATE \_\_\_\_\_ ZIP \_\_\_\_\_

Qualification for above rates is based on answers to all questions listed below. Those not qualifying may pay higher than basic price of \$25 one year or \$62.50 for three years.

Signature \_\_\_\_\_

2.  1 PLANT  2 DEPARTMENT

Indicate the primary product manufactured or service performed at your plant (Box 1) and in your department (Box 2). Be sure to indicate applicable letter in each of the two boxes even if they are the same letter.

- A. Large computers
- B. Mini-computers
- C. Computer peripheral equipment
- D. Data Processing Systems (systems integration)
- E. Office and business machines
- F. Test and measuring equipment
- G. Communications systems and equipment
- H. Navigation and guidance or control systems
- I. Consumer entertainment electronic equipment
- J. Other consumer electronic equip. (appliances, autos, hand tools)

- K. Industrial controls, systems and equipment
- L. Sub-assemblies
- M. Passive electronic components
- N. Active electronic components
- O. Materials and Hardware
- P. Aircraft, Missiles, space and ground support equipment
- Q. Oceanography and support equipment
- R. Medical electronics
- S. Industrial equipment containing electronic components or products
- T. Independent R&D laboratory and consultant

- U. Research and development organizations which are a part of an educational institution
- V. Government Agency and military
- W. Industrial companies using and/or incorporating electronic products in their mfg., research or development activities
- X. Utilities
- Y. Broadcasting, sound and motion pictures and recording studios
- Z. Commercial users of electronic equipment (railroads, pipelines, police, airlines)
- 9. College, University

3.  Indicate your principal job function (place applicable number in box. If numbers 9, 10, or 11 are used, fill in name of college or university)

- 1. General and corporate management
  - 2. Design and development engineering
  - 3. Engineering services (evaluation, quality control, reliability, standards, test)
  - 4. Basic research
  - 5. Manufacturing and production
  - 6. Engineering support (lab assistant, technician)
  - 7. Purchasing and procurement
  - 8. Marketing and sales
  - 9. Professor at \_\_\_\_\_
  - 10. Senior student at \_\_\_\_\_
  - 11. Graduate student at \_\_\_\_\_
- Senior and graduate students are eligible for professional rate for one year subscription only.

4.  Indicate your principal job responsibility (place applicable number in box)

- 1. Management
- 2. Engineering

5.  Your design function: (Insert each letter that applies)

- A. I do electronic design or development engineering work
- B. I supervise electronic design or development engineering work
- C. I set standards for, or evaluate electronic components, systems and materials

6. Estimated number of employees at this location. (check one)

- 1 to 49  50 to 249  250 to 999  over 1,000

First Class  
Permit No. 42  
Hightstown, N.J.

**BUSINESS REPLY MAIL**

No postage stamp necessary if Mailed in the United States

POSTAGE WILL BE PAID BY

**Electronics**

**McGRAW-HILL, INC.  
SUBSCRIPTION DEPT.  
P.O. BOX 514  
HIGHTSTOWN, N.J. 08520**

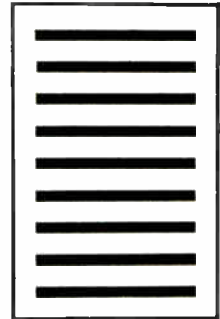

# Electronics Reader Service

For additional information on products advertised, new products or new literature, use these business reply cards.

Complete entire card.  
Please print or type.

Circle the number on the Reader Service postcard that corresponds to the number at the bottom of the advertisement, new product item, or new literature in which you are interested.

To aid the manufacturer in filling your request, please answer the three questions.

All inquiries from outside the U.S. that cannot reach Electronics before the expiration date noted on the Reader Service postcard must be mailed directly to the manufacturer. The manufacturer assumes all responsibilities for responding to inquiries.

### Subscriptions & Renewals

Fill in the subscription card adjoining this card. Electronics will bill you at the address indicated on the card.

## Electronics September 15, 1977 This reader service card expires December 15, 1977

NAME \_\_\_\_\_ TITLE \_\_\_\_\_  
 PHONE ( \_\_\_\_\_ ) \_\_\_\_\_ COMPANY \_\_\_\_\_  
 STREET ADDRESS (Company  or home  check one) \_\_\_\_\_  
 CITY \_\_\_\_\_ STATE \_\_\_\_\_ ZIP \_\_\_\_\_

Was This Magazine Personally Addressed to You?  Yes  No

### Industry classification (check one):

- a  Computer & Related Equipment  
 b  Communications Equipment & Systems  
 c  Navigation, Guidance or Control Systems  
 d  Aerospace, Underseas Ground Support  
 e  Test & Measuring Equipment  
 f  Consumer Products  
 g  Industrial Controls & Equipment  
 h  Components & Subassemblies  
 j  Independent R&D Organizations  
 k  Government

### Your design function (check each letter that applies):

- x  I do electronic design or development engineering work.  
 y  I supervise electronic design or development engineering work.  
 z  I set standards for, or evaluate electronic components, systems and materials.

### Your principal job responsibility (check one)

- t  Management  
 v  Engineering

Estimate number of employees (at this location): 1.  under 20 2.  20-99 3.  100-999 4.  over 1000

1 16 31 46	61 76 91 106	121 136 151 166	181 196 211 226	241 256 271 348	363 378 393 408	423 438 453 468	483 498 703 718
2 17 32 47	62 77 92 107	122 137 152 167	182 197 212 227	242 257 272 349	364 379 394 409	424 439 454 469	484 499 704 719
3 18 33 48	63 78 93 108	123 138 153 168	183 198 213 228	243 258 273 350	365 380 395 410	425 440 455 470	485 500 705 720
4 19 34 49	64 79 94 109	124 139 154 169	184 199 214 229	244 259 274 351	366 381 396 411	426 441 456 471	486 501 706 900
5 20 35 50	65 80 95 110	125 140 155 170	185 200 215 230	245 260 275 352	367 382 397 412	427 442 457 472	487 502 707 901
6 21 36 51	66 81 96 111	126 141 156 171	186 201 216 231	246 261 338 353	368 383 398 413	428 443 458 473	488 503 708 902
7 22 37 52	67 82 97 112	127 142 157 172	187 202 217 232	247 262 339 354	369 384 399 414	429 444 459 474	489 504 709 951
8 23 38 53	68 83 98 113	128 143 158 173	188 203 218 233	248 263 340 355	370 385 400 415	430 445 460 475	490 505 710 952
9 24 39 54	69 84 99 114	129 144 159 174	189 204 219 234	249 264 341 356	371 386 401 416	431 446 461 476	491 506 711 953
10 25 40 55	70 85 100 115	130 145 160 175	190 205 220 235	250 265 342 357	372 387 402 417	432 447 462 477	492 507 712 954
11 26 41 56	71 86 101 116	131 146 161 176	191 206 221 236	251 266 343 358	373 388 403 418	433 448 463 478	493 508 713 956
12 27 42 57	72 87 102 117	132 147 162 177	192 207 222 237	252 267 344 359	374 389 404 419	434 449 464 479	494 509 714 957
13 28 43 58	73 88 103 118	133 148 163 178	193 208 223 238	253 268 345 360	375 390 405 420	435 450 465 480	495 510 715 958
14 29 44 59	74 89 104 119	134 149 164 179	194 209 224 239	254 269 346 361	376 391 406 421	436 451 466 481	496 701 716 959
15 30 45 60	75 90 105 120	135 150 165 180	195 210 225 240	255 270 347 362	377 392 407 422	437 452 467 482	497 702 717 960

## Electronics September 15, 1977 This reader service card expires December 15, 1977

NAME \_\_\_\_\_ TITLE \_\_\_\_\_  
 PHONE ( \_\_\_\_\_ ) \_\_\_\_\_ COMPANY \_\_\_\_\_  
 STREET ADDRESS (Company  or home  check one) \_\_\_\_\_  
 CITY \_\_\_\_\_ STATE \_\_\_\_\_ ZIP \_\_\_\_\_

Was This Magazine Personally Addressed to You?  Yes  No

### Industry classification (check one):

- a  Computer & Related Equipment  
 b  Communications Equipment & Systems  
 c  Navigation, Guidance or Control Systems  
 d  Aerospace, Underseas Ground Support  
 e  Test & Measuring Equipment  
 f  Consumer Products  
 g  Industrial Controls & Equipment  
 h  Components & Subassemblies  
 j  Independent R&D Organizations  
 k  Government

### Your design function (check each letter that applies):

- x  I do electronic design or development engineering work.  
 y  I supervise electronic design or development engineering work.  
 z  I set standards for, or evaluate electronic components, systems and materials.

### Your principal job responsibility (check one)

- t  Management  
 v  Engineering

Estimate number of employees (at this location): 1.  under 20 2.  20-99 3.  100-999 4.  over 1000

1 16 31 46	61 76 91 106	121 136 151 166	181 196 211 226	241 256 271 348	363 378 393 408	423 438 453 468	483 498 703 718
2 17 32 47	62 77 92 107	122 137 152 167	182 197 212 227	242 257 272 349	364 379 394 409	424 439 454 469	484 499 704 719
3 18 33 48	63 78 93 108	123 138 153 168	183 198 213 228	243 258 273 350	365 380 395 410	425 440 455 470	485 500 705 720
4 19 34 49	64 79 94 109	124 139 154 169	184 199 214 229	244 259 274 351	366 381 396 411	426 441 456 471	486 501 706 900
5 20 35 50	65 80 95 110	125 140 155 170	185 200 215 230	245 260 275 352	367 382 397 412	427 442 457 472	487 502 707 901
6 21 36 51	66 81 96 111	126 141 156 171	186 201 216 231	246 261 338 353	368 383 398 413	428 443 458 473	488 503 708 902
7 22 37 52	67 82 97 112	127 142 157 172	187 202 217 232	247 262 339 354	369 384 399 414	429 444 459 474	489 504 709 951
8 23 38 53	68 83 98 113	128 143 158 173	188 203 218 233	248 263 340 355	370 385 400 415	430 445 460 475	490 505 710 952
9 24 39 54	69 84 99 114	129 144 159 174	189 204 219 234	249 264 341 356	371 386 401 416	431 446 461 476	491 506 711 953
10 25 40 55	70 85 100 115	130 145 160 175	190 205 220 235	250 265 342 357	372 387 402 417	432 447 462 477	492 507 712 954
11 26 41 56	71 86 101 116	131 146 161 176	191 206 221 236	251 266 343 358	373 388 403 418	433 448 463 478	493 508 713 956
12 27 42 57	72 87 102 117	132 147 162 177	192 207 222 237	252 267 344 359	374 389 404 419	434 449 464 479	494 509 714 957
13 28 43 58	73 88 103 118	133 148 163 178	193 208 223 238	253 268 345 360	375 390 405 420	435 450 465 480	495 510 715 958
14 29 44 59	74 89 104 119	134 149 164 179	194 209 224 239	254 269 346 361	376 391 406 421	436 451 466 481	496 701 716 959
15 30 45 60	75 90 105 120	135 150 165 180	195 210 225 240	255 270 347 362	377 392 407 422	437 452 467 482	497 702 717 960

# Electronics Reader Service

If the cards below have already been used,  
you may obtain the needed information  
by writing directly to the manufacturer,  
or by sending your name and address,  
plus the Reader Service number and issue date,  
to Electronics Reader Service Department,  
P.O. Box No. 2530, Clinton, Iowa 52732.

Affix  
Postage  
Here

## Electronics

P.O. Box No. 2530  
Clinton, Iowa 52732

Affix  
Postage  
Here

## Electronics

P.O. Box No. 2530  
Clinton, Iowa 52732

*Tomorrow ideas today.*



Using solid-state technology to replace bulky tube-type equipment ENI's broadband amplifiers are tomorrow ideas available today.

ENI's Class A power amplifiers already cover the frequency spectrum of 10 kHz to 1 GHz, with power outputs ranging from 300 milliwatts to over 4000 watts. And we're still climbing. Driven by any signal generator, frequency synthesizer or sweeper, ENI's compact portable amplifiers are completely broadband and untuned. Amplifying inputs of AM, FM, SSB, TV and pulse modulations with minimum distortion, these rugged units are

versatile power sources for general laboratory work, RFI/EMI testing, signal distribution, RF transmission, laser modulation, data transmission, NMR, ultrasonics and more.

Designed to be unconditionally stable and failsafe (impervious to severe load conditions including open or short circuit loads), ENI power amplifiers will deliver their rated power to any load, regardless of match.

For information write: ENI, 3000 Winton Rd. So., Rochester, New York 14623. Call 716-473-6900. TELEX 97-8283 ENI ROC.

**ENI**

*World's Leader in Solid State Power Amplifiers*

Circle 901 on reader service card

World Radio History

# A New Dial Design...

... beautiful  
from any angle.

Any way you look at it, there's beauty and reliability at a low cost in our new Model H-1400 turns-counting dial. From the smooth, high impact tapered plastic design . . . to the big, bold legible numbers . . . this dial will add to the aesthetics of any control panel.

But, with beauty being only skin deep, we've put durable long-lasting metal inside where it counts — including the gears and set-screw thread insert. And, the price is just as attractive — only \$4.26\* in production quantities!

Send today for complete technical data and discover a beautiful new angle in turns-counting dials — from Bourns, naturally! Direct or through your local distributor.

TRIMPOT PRODUCTS DIVISION, BOURNS, INC. 1200 Columbia Ave.,  
Riverside, CA 92507 Phone: 714 781-5123. TWX: 910 332-1252

\*Domestic U.S.A. price only, H1411, without brake



International Marketing Offices: European Headquarters — Tel: +44 (0) 1223 822118 • France 01/2039633 • Germany 0711/24 29 36 • Italy 02/12 55 88 • Netherlands 71 67 44 01 • United Kingdom 01/2039633 • Norway 2/71 18 72 • Sweden 764/20 110 • Japan 075/92 9111 • Australia 92 45 0411 • U.S.A. 714/781-5123 • Israel 37 24 88/57

For immediate Application — Circle 129  
or for Future Application — Circle 629