

NOVEMBER 27, 1975

**LSI ADVANCES DOMINATE AT ELECTRON DEVICES MEETING/97**

Data acquisition with high speed and resolution, part 2/115

Why applications should govern IC testing/108

FOUR DOLLARS A MCGRAW-HILL PUBLICATION

# Electronics®

1420 HRR305 JCJAO MAY/6  
JB HARRIS  
HARRIS ELECTRONIC SVC  
5051 W JACKSON BLVD  
CHICAGO IL  
60644

# SOFTWARE WARE

**TESTING'S  
HIDDEN  
COST**

# WHY BRAND-REX SAYS, "YES WE CAN" WHEN OTHERS SAY, "MAYBE."

We've been growing. In directions that we think you'll find valuable. In years past you may have known us as a producer of wire and cable. Today the scope of Brand-Rex has expanded in many dimensions and directions. We've increased our technical knowledge and manufacturing capability, and we have the experience that comes from finding new applications for Brand-Rex products in all kinds of markets. Today we're solving problems from a broader viewpoint than ever.

To gauge our growth — look at our sales. From \$38 million in 1969 to \$128 million in 1974. Then look at the products we can now supply:



**Electronic and Industrial Cable Division,** Willimantic, Conn. Wire, cable and electrical insulating tubing and sleeving for industrial, business machine and computer, commercial, and aerospace and defense applications.

**Telecommunications Cable Division,** Willimantic, Conn. Wire and cable for the telecommunications industry.

**Teltronics, Inc.,** Lakeland, Fla. Telecommunications products and systems.

**Nonotuck Manufacturing Co.,** South Hadley, Mass. Uninsulated copper and copper alloy wire.

**Abbott & Co.,** Prospect, Ohio. Electrical harnesses for industry.

**Pyle-National Co.,** Chicago, Ill. Electrical and electronic connectors and electrical construction materials.

**Brand-Rex Ltd.,** Glenhroes, Fife, Scotland. Wire and cable for the European market.

Each Brand-Rex division has its own sales, marketing, product engineering and quality control departments — the decentralization that allows each to respond to your needs in a personalized "small company" way while offering "big company" advantages.

Brand-Rex is a part of Akzona Incorporated, a Fortune 500 company. Akzona gives us the ability to grow, diversify and respond to your problems with a "Yes we can."

Take advantage of our capability. Call us whenever you feel we can help to solve one of your problems.

Brand-Rex Company, Willimantic, CT. 06226, 203/423-7771.

## BRAND-REX

# Value Packed Spectrum Analyzers

**Communications**  
10Hz - 43MHz  
(or 400MHz)

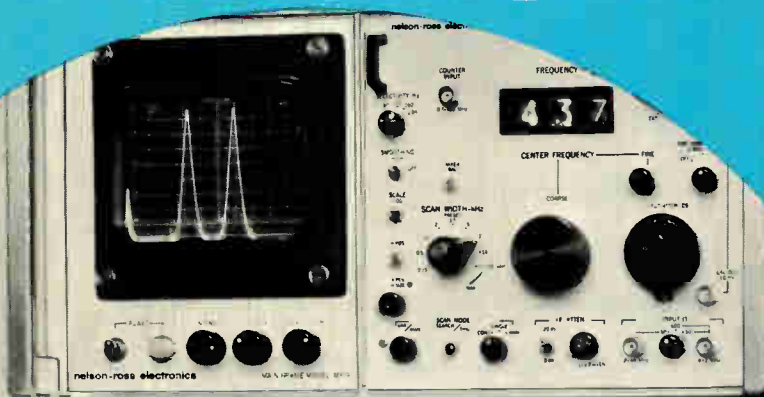

**Broadband**  
100Hz - 25MHz

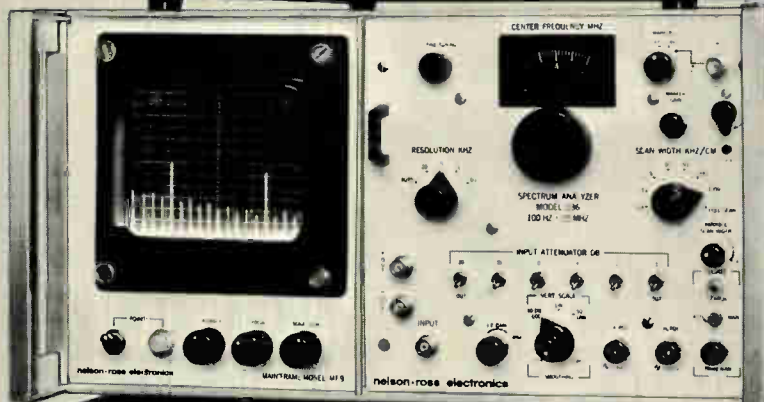

**Microwave**  
10MHz - 6.5GHz

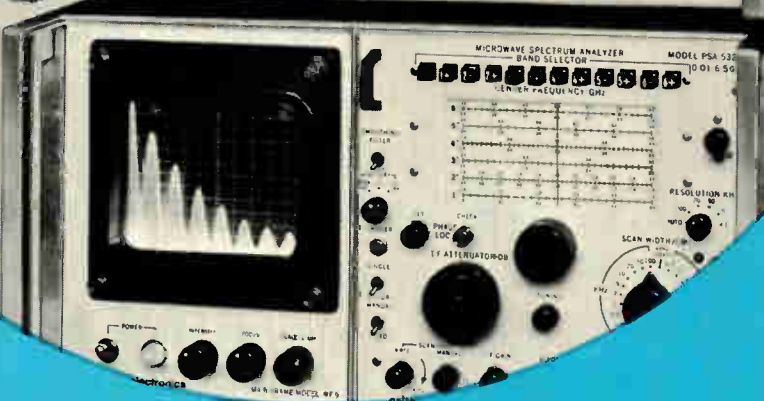

**Sub-Audio thru Microwave 0.5Hz to 6.5GHz  
Self-Contained Analyzers or Plug-Ins for hp & Tek Scopes**

Nelson Ross, the "SPECIALIST" in Spectrum Analyzers, offers you the most comprehensive selection of reliable, easy-to-use instruments — and backed by 15 years of spectrum analysis leadership.

Select from more than 30 models: Sub-Audio, Audio, Ultrasonic, Broadband, Telemetry, RF/SSB, RF/UHF, TV, Microwave . . . all at lowest cost.

Ask for your new NR SPECTRUM ANALYZER CATALOG with specifications and prices. Chances are that we have the right Spectrum Analyzer for you.

**nelson • ross electronics**

*A Division of Polarad Electronics Corp.*

5 Delaware Drive / Lake Success, New York 11040 / 516-328-1100 / TWX 510-223-0414

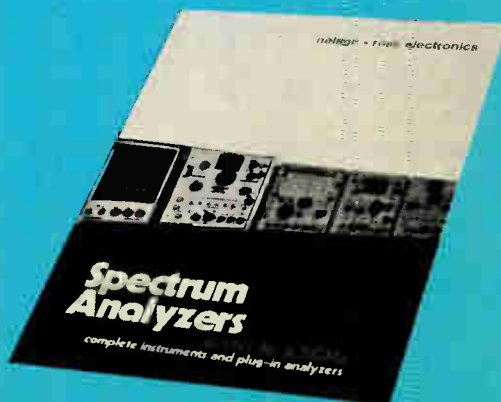

Circle 1 on reader service card



# SUPERECTIFIER™



## WINNING PRICE

**1N5059GP 7¢\***

## WINNING PACKAGE

Everything about the 1N5059GP SUPERECTIFIER is super, including its DO-15 package. As the comparison table below demonstrates, there's really no comparison between General Instrument's 1N5059GP SUPERECTIFIER and General Electric's 1N5059.

FEATURES	GI's 1N5059GP	GE's 1N5059
Uniform JEDEC DO-15 package for more efficient handling both manually and with automatic insertion equipment	X	
Exclusive UL recognized flame-retardant epoxy molding compound rated 94V-0, the highest available	X	
Uniform cylindrical body with smooth surface for excellent marking clarity	X	
Marking surface that accommodates up to 20 digits plus cathode band	X	
Hermetically sealed construction	X	X
Electrical characteristics not adversely affected by light	X	
Patented glass passivation	X	X
Brazed at greater than 600°C at both leads and cell (Pat. Pend.)	X	
Reliability proved equal to military requirements	X	X
At super low prices	X	
And a Super Girl T-shirt, if you want one†	X	

SUPERECTIFIER'S combination of features makes it truly deserving of the title . . . SUPERECTIFIER, because that's what it is, a super rectifier.

If you want to know more, call us at 516-733-3355 or write; General Instrument Corporation, Semiconductor Components Division, 600 W. John St., Hicksville, N.Y. 11802.

\*1N5059GP Rating: 1A @ 200 PRV. Minimum Order Quantity: 50,000 units scheduled within 60 days.

†If you have a Super Girl around, we have a Super Girl T-shirt for her. To find out how to get yours, contact your local General Instrument distributor, listed below.

**GENERAL INSTRUMENT CORPORATION  
SEMICONDUCTOR COMPONENTS**



ADVENT ELECTRONICS • ALTA ELECTRONICS • CENTURY ELECTRONICS • COMPONENT SPECIALTIES • CRAMER ELECTRONICS • DIPLOMAT ELECTRONICS • GREENE-SHAW CO. • HALL-MARK • INTEGRATED ELECTRONICS • INTERMARK • K. A. ELECTRONICS SALES • OLIVE ELECTRONICS • PHILADELPHIA ELECTRONICS • PIONEER ELECTRONICS • PYTRONIC INDUSTRIES • ROSYL ELECTRONICS • SEMICOMP SALES • SEMICONDUCTOR CONCEPTS • SEMICONDUCTOR SPECIALISTS



## 39 Electronics Review

CONSUMER: Calculators for blind provide audible, braille output, 39  
COMMUNICATIONS: Competition could ease Bell capital needs, 40  
CONSUMER: Flexible circuit turns watch on/off, 41  
GOVERNMENT: Advanced avionics to track smugglers, 41  
COMPUTERS: CDC shows off Ryad computer, 42  
INSTRUMENTATION: NBS speeds calibration of standard cells, 42  
INDUSTRIAL: Process control gets stand-alone items, 44  
SOLID STATE: Home TV chip plays any of six games, 46  
NEWS BRIEFS: 46  
PACKAGING & PRODUCTION: Boards wired fast without wrapping, 48

## 63 Electronics International

JAPAN: Chip automatically tunes TV set to preset channels, 63  
AROUND THE WORLD: 63

## 77 Probing the News

CONSUMER: Japanese clamor for short wave, 77  
COMMERCIAL: EFTS to chalk up a first in 1976, 80  
CONSUMER: Video games adopt the family, 82  
COMPUTERS: Hobbyists create an industry, 86  
MATERIALS: Four-inch wafers grow in popularity, 88

## 91 Technical Articles

PACKAGING & PRODUCTION: Weighing the cost of a board tester, 91  
SPECIAL REPORT: Bipolar, MOS LSI vie for meeting spotlight, 97  
DESIGNER'S CASEBOOK: Speeding m-sequence generation, 104  
Memory, peripherals share microprocessor address range, 105  
COMPONENTS: User's tests assure IC performance, 108  
INDUSTRIAL: Part 2, Getting speed in data-acquisition systems, 115  
ENGINEER'S NOTEBOOK: Optical circuit shows phone-line status, 120  
Weigh-counting technique is faster than binary, 121

## 133 New Products

IN THE SPOTLIGHT: IC voltage regulator is adjustable, 133  
COMPONENTS: Potentiometer is a 10-millimeter cube, 135  
INSTRUMENTS: LSI cuts cost of angle indicator, 145  
DATA HANDLING: Processor increases computer's throughput, 151  
SUBASSEMBLIES: Low-priced a-d converter works to 125°C, 156  
PACKAGING & PRODUCTION: Board tester is versatile, 160  
MATERIALS: 165

## Departments

Publisher's letter, 4  
Readers' comments, 6  
News update, 8  
Editorial, 10  
People, 14  
Meetings, 30  
Electronics newsletter, 35  
Washington newsletter, 59  
Washington commentary, 60  
International newsletter, 65  
Engineer's newsletter, 124  
New literature, 167

## Highlights

### Cover: Why automatic testers cost so much, 91

Developing the software for a sophisticated automatic circuit-board tester is what makes it so expensive. An analysis of the process reveals that it's generally wiser to buy such a system than to attempt to build it in-house.

### Video games are set to invade the home, 82

With visions of a \$300 million market, semiconductor manufacturers and other electronic-games makers will be pushing video games hard this Christmas and even harder in the New Year.

### Characterizing LSI devices is user's job, 108

Large-scale integrated circuits are so complex that no vendor's data sheet can fully describe their electrical behavior. Instead, the user must develop his own test program in relation to the needs of his particular application.

### Putting a data-acquisition system together, 115

If the first step is to understand each component fully, the second step in designing a data-acquisition system is to find the best fit among the components. The need to eliminate sources of error must be traded off against the costs involved, as the second and final part of this article explains.

### And in the next issue . . .

Special report on the telephone . . . cost factors to remember in designing with semiconductor RAMs . . . the case for ac parametric testing.

EDITOR-IN-CHIEF: Kemp Anderson

EXECUTIVE EDITOR: Samuel Weber

MANAGING EDITORS: Lawrence Curran, *News*;  
Arthur Erikson, *International*

SENIOR EDITORS: John Johnsrud,  
H. Thomas Maguire, Laurence Altman,  
Ray Connolly, Stephen E. Scrupski

ART DIRECTOR: Fred Skienar

ASSOCIATE EDITORS: Howard Wolff,  
Gerald M. Walker, Alfred Rosenblatt

DEPARTMENT EDITORS  
*Aerospace/Military*: Ray Connolly  
*Circuit Design*: Don Blattner  
*Communications & Microwave*:  
Richard Gundlach  
*Components*: Lucinda Mattera  
*Computers*: Stephen E. Scrupski  
*Consumer*: Gerald M. Walker  
*Industrial*: Margaret A. Maas  
*Instrumentation*: Andy Santoni  
*New Products*: H. Thomas Maguire  
Michael J. Riezenman  
*Packaging & Production*: Jerry Lyman  
*Solid State*: Laurence Altman

CHIEF COPY EDITOR: Margaret Eastman

COPY EDITORS: Everett C. Terry, Bill Dunne

ART: Charles D. Ciatto, *Associate Director*  
Patricia Cybulski, *Assistant Director*

EDITORIAL SECRETARIES: Janet Noto,  
Julie Gorgogione, Penny Roberts

#### FIELD EDITORS

*Boston*: Gail Farrell (Mgr.), Pamela Leven  
*Los Angeles*: Larry Waller (Mgr.)  
*Midwest*: Larry Armstrong (Mgr.)  
*New York*: Ron Schneiderman (Mgr.)  
*San Francisco*: Bernard Cole (Mgr.)  
Judith Curtis  
*Washington*: Ray Connolly (Mgr.)  
Larry Marion  
*Frankfurt*: John Gosch  
*London*: William F. Arnold  
*Paris*: Arthur Erikson  
*Tokyo*: Charles Cohen

#### McGraw-Hill World News

*Director*: Ralph R. Schulz  
*Bonn*: Robert Ingersoll  
*Brussels*: James Smith  
*London*: James Trotter  
*Madrid*: Dom Curcio  
*Milan*: Andrew Heath  
*Moscow*: Peter Gall  
*Paris*: Michael Johnson, Richard Shepherd  
*Stockholm*: Robert Skole  
*Tokyo*: Mike Mealey

PUBLISHER: Dan McMillan

DIRECTOR OF MARKETING: Pierre J. Braudé

ADVERTISING SALES SERVICE MANAGER:  
Wallis Clarke

BUSINESS MANAGER: Stephen R. Weiss

CIRCULATION MANAGER: Nancy L. Merritt

MARKETING SERVICES MANAGER:  
Tomlinson Howland

RESEARCH MANAGER: Margery D. Sholes

### The International Electron Devices

Meeting stands out in the yearly roster of technical gatherings as one of the two big leading-edge-of-technology conferences. As we do every year, we've put together a round-up of the major technological trends that are reflected in this year's conference sessions. You'll find our wide-ranging six-page preview on page 97.

Topping the list of developments is the scaling up of the battle between bipolar and metal-oxide-semiconductor approaches to circuit design, as work in the microworld of large-scale integration builds up. And, as we point out in the round-up, even transistor-transistor logic is in the LSI running with the advent of heavy gold diffusion.

Then, there are solid advances in microwave and power semiconductors, thanks to ion implantation and polysilicon techniques. In optical devices, too, there is heartening progress in such areas as thin-film transistors in fairly large displays and lead-tin-telluride lasers. And, at several new IEDM sections, solar cell researchers report steady progress in raising efficiency and lowering cost.

A lot has been happening in device development in the past few months, and a lot will surface in the next few. So, to see where the action is, read the conference preview that starts on page 97.

Consumers have been voracious buyers of electronic wares ever since the days of crystal radios. While electronics technology has taken some astounding twists and turns since then, the consumer is rarely far behind.

Take computers, for example. You might not be aware that low-cost computers based on microprocessors are selling like electronic hotcakes in what can only be described as a hobbyist market. They are not cheap, to be sure, but priced at less than a garden tractor or a small pleasure boat, they are attracting the dollars of numerous private citizens. For the full story on where to get your hands on some of this low-cost computer power, turn to the Probing the News story on page 86.

Another growing area of consumer interest is in television games, which have been called the hottest new consumer electronics market since calculators and digital watches. The number and variety of games is climbing and the games themselves are becoming more complex. Behind the games, however, is an even more interesting story—the chips that make all the on-screen action possible. So, just in time for Christmas reading, we've wrapped up where things stand in video games. You'll find that story on page 82.

Yet another consumer area that is booming—in Japan at least—is shortwave receivers. There, in a market that is very youth-oriented, the shortwave listening that was an international hobby decades ago is making a strong come-back. For a look at the world-wide chances for a resurgence of that hobby, turn to the story on page 77.



November 27, 1975 Volume 48 Number 24  
96,006 copies of this issue printed

Published every other Thursday by McGraw-Hill, Inc. Founder: James H. McGraw 1860-1948. Publication office 1221 Avenue of the Americas, N.Y., N.Y. 10020; second class postage paid at New York, N.Y. and additional mailing offices.  
Executive, editorial, circulation and advertising addresses: Electronics, McGraw-Hill Building, 1221 Avenue of the Americas, New York, N.Y. 10020. Telephone (212) 997-1221. Teletype 12-7960 TWX 710-581-4879. Cable address: MCGRAW HILL NEW YORK.

Subscriptions limited to professional persons with active responsibilities in electronics technology. Publisher reserves the right to reject non-qualified requests. No subscriptions accepted without complete identification of subscriber by name, title and job function, company or organization, and product manufactured or services performed. Subscription rates: in the United States and possessions \$12.00 one year, \$30.00 three years; Canada and Mexico \$14.00 one year, \$32.00 three years; Europe \$35.00 one year, \$87.50 three years; Japan, Israel and Brazil, \$60.00 per year, Australia and New Zealand \$80.00 per year, including air freight; all other countries \$40.00 per year. Limited quota subscriptions available at higher-than-basic rate for persons outside of field served, as follows: U.S. and possessions and Canada, \$25.00 per year, Europe \$40.00; Japan, Israel and Brazil \$85.00; all other countries \$50.00. Single copies: \$4.00.

Officers of the McGraw-Hill Publications Company: John R. Emery, President; J. Elton Tuohig, Executive Vice President-Administration; Gene W. Simpson, Group Publisher-Vice President; Senior Vice Presidents: Ralph Blackburn, Circulation; Walter A. Stanbury, Editorial; John D. Hoglund, Controller; David G. Jensen, Manufacturing; Gordon L. Jones, Marketing; Jerome D. Luntz, Planning & Development.  
Officers of the Corporation: Shelton Fisher, Chairman of the Board; Harold W. McGraw, Jr., President and Chief Executive Officer; Robert N. Landes, Senior Vice President and Secretary; Ralph J. Webb, Treasurer.

Title registered in U.S. Patent Office; Copyright ©1975 by McGraw-Hill, Inc. All rights reserved. The contents of this publication may not be reproduced in whole or in part without the consent of copyright owner.  
Subscribers: The publisher, upon written request to our New York office from any subscriber, agrees to refund that part of the subscription price applying to copies not yet mailed. Please send change of address notices or complaints to Fulfillment Manager; subscription orders to Circulation Manager, Electronics, at address below. Change of address notices should provide old as well as new address, including postal zip code number. If possible, attach address label from recent issue. Allow one month for change to become effective.  
Postmaster: Please send form 3579 to Fulfillment Manager, Electronics, P.O. Box 430, Hightstown, N.J. 08520.

# five important reasons to specify the **KEPCO JQE** power supply

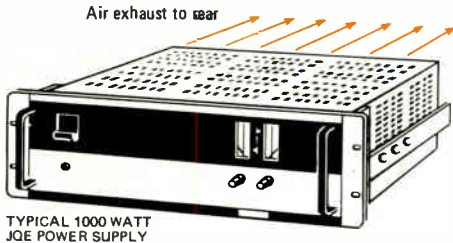

TYPICAL 1000 WATT JQE POWER SUPPLY

- **JQE deliver their rated output right up to +71°C** without any derating whatever. Moreover, they run cool! Internal blowers actually help circulate the air in your system to keep hot spots from developing.

**YOUR MECHANICAL PEOPLE WILL APPRECIATE THIS.**

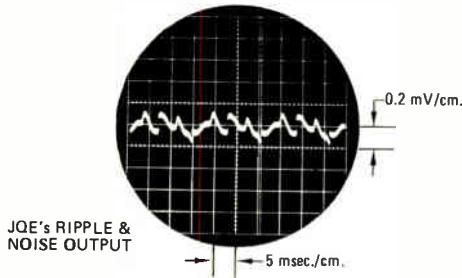

JQE'S RIPPLE & NOISE OUTPUT

- **JQE produce clean d-c**, less than 0.2 mV rms ripple and noise (1.0 mV p-p including spikes up to 10 mHz). The output varies less than 0.0005% for the worst sort of line variation, and long-term drift is less than 0.01%.

**YOUR LOAD WILL APPRECIATE THIS.**

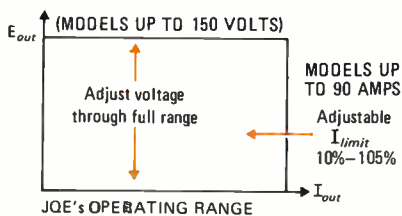

JQE'S OPERATING RANGE

- **JQE are wide-range instruments.** Every JQE can be set from zero to its rated output. What's more, they all have one additional volt capacity so that wire drops do not subtract from the voltage available to your load. Buy a 0-15V model to cover the 5V, 6V, 8V, 10V, 12V and 15V loads. A 0-36V model to take care of 18, 24, 28, 32 and 36V jobs.

**YOUR BUDGET WILL APPRECIATE THIS.**

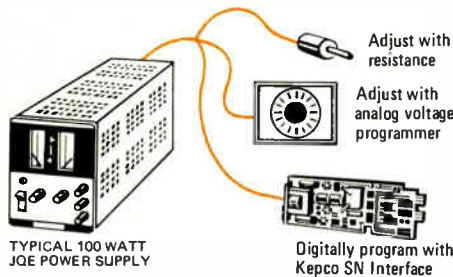

TYPICAL 100 WATT JQE POWER SUPPLY

Digitally program with Kepco SN Interface

- **JQE are fully programmable**—by resistance (1000Ω/volt) or by voltage (any gain ratio you choose) or by parallel binary or BCD logic. That means you can easily interface your JQE with a computer control bus. (Use the Kepco SN Programmer)

**YOUR SYSTEM WILL APPRECIATE THIS.**

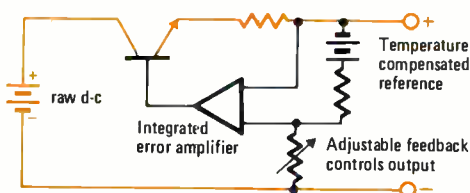

JQE IS AN OPERATIONAL POWER SUPPLY THAT BEHAVES LIKE A LARGE LINEAR AMPLIFIER

- **JQE are linear voltage stabilizers**—which means that JQE are a lot simpler and more reliable than switching machines. (You get a 5-year warranty.) A linear JQE will respond in microseconds to a load shift; will maintain its low output impedance into high frequency pulsed loads; produces no RFI/EMI and doesn't hack up the power line like SCR types.

**YOUR NEIGHBORS WILL APPRECIATE THAT.**

## JQE

is a premium quality voltage stabilizer for the no-compromise job

Write Dept. V-14 for the new Kepco Catalog and Handbook.

**KEPCO**®

131-38 SANFORD AVENUE • FLUSHING, N.Y. 11352  
(212) 461-7000 • TWX #710-582-2631



**New  
Lower  
Prices**



# Start Getting Your Money's Worth Out of Power Modules

Now, you can really start getting your money's worth out of power modules with Abbott's new LOW COST series. Designed to give you 100,000 hours of trouble-free operation (that's 11½ years), these reliable units meet the needs of OEM engineers. Their purchase price is about \$7 per year of service. The model LC series feature:

- 47-420 Hz Input Frequency
- 0.1% Regulation
- +60°C. Ambient Operation
- Single and Dual Outputs
- 1 Day Stock Delivery

These units provide more quality per dollar compared to similar items on the market. See table below for prices on some of our LC models. Many other LC models are listed in our catalog.

If analyzing the many similar power supplies on the market is confusing; if you are concerned about the long-term reliability of those units, then decide on an Abbott power supply for your system. Your best buy in OEM power modules is ABBOTT.

Abbott also manufactures 3,000 other models of power supplies with output voltages from 5 to 740 VDC and with output currents from 2 milliamps to 20 amps. They are all listed with prices in the new Abbott Catalog with various inputs:

- 60 to DC
- 400 to DC
- 28 VDC to DC
- 28 VDC to 400
- 12-38 VDC to 60

5V @ 6 Amps	5V @ 10 Amps	12V @ 10 Amps	15V @ 4 Amps	28V @ 1 Amp	±12V @ 1.2 Amps	±15V @ 4 Amps
LC5T6	LC5T10	LC12T10	LC15T4	LC28T1	LLC12T1.2	LLC15T4
\$62	\$73	\$99	\$73	\$62	\$87	\$119.00

Please see pages 1054-1056 Volume 1 of your 1975-76 EEM (ELECTRONIC ENGINEERS MASTER Catalog) or pages 612-613 and 620 Volume 2 of your 1975-76 GOLD BOOK for complete information on Abbott Modules.

Send for our new 60 page FREE catalog.



**INDUSTRIAL PRODUCTS DIVISION**

general offices

eastern office

5176 W. Jefferson Blvd./Los Angeles 90016  
(213) 930-1040 Telex: 69-1398

1224 Anderson Ave./Fort Lee, N.J. 07024  
(201) 224-6900 Telex: 13-5332

## Readers' comments

### Tomorrow, trivial

**To the Editor:** I noted with interest the debate concerning "back-door" entry into the electrical engineering profession [Sept. 18, p. 77 and Oct. 30, p. 6]. As an outsider who has recently watched the passing scene in electronics, it is my opinion that "back-door" entry into the "profession" will be much easier in the future than it has been in the past. The ease of entry may well be related to the number of wire connections required for a given circuit. For example, the design and construction of a minicomputer from available IC chips would have been very difficult for a non-EE in 1965. Today, it is not difficult provided that one would be willing to settle for a microcomputer. Tomorrow, the task will be trivial.

I have heard somewhere that the object of any profession should be to obsolete itself. EEs can be congratulated on their efforts to make such a goal a reality.

Peter R. Rony  
Virginia Polytechnic Institute  
& State University

### Sine wave counting

**To the Editor:** In the Designer's casebook article, "Digital pulses synthesize audio sine waves," by P. L. McGuire, [Oct. 2, pp. 104-105], a stepped approximation to a sine wave is obtained, using a counter and a multiplexer. The spectrum of the generated wave is seen to contain all harmonics, with the 15th and 17th dominant over the others.

The author has not chosen the steps in his approximation to greatest advantage: His wave contains four steps per quarter-cycle—if these steps are of magnitude 19.89, 56.65, 84.78 and 100% (with no dwell on the horizontal axis) then, ideally, all harmonics up to the 15th and 17th are zero. (The 16th harmonic is zero.) Also the 15th harmonic is of magnitude 1/15th of the fundamental, and so on. The next harmonics in the spectrum would be the 31st and 33rd, and so on.

R. Kitai  
McMaster University  
Hamilton, Ontario

# What Every Designer or Specifier Should Know About RESISTOR NETWORKS!

A wise man once said, "A chain is only as strong as its weakest link".

That phrase says as much for electronic circuitry today . . . as it originally did for the value of the individual quality of man. For example, the failure of a single tiny printed conductor path in a resistor network can cause the failure of an entire circuit . . . or system.

Bourns doesn't want that to happen to one of your circuits. For that reason, we want to share some "inside" information about the design and manufacture of thick-film networks . . . so that you can be a more knowledgeable and more selective specifier.

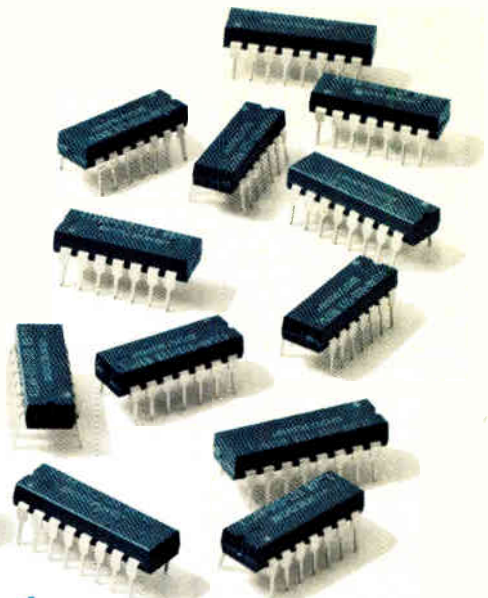

## 1. Lead Termination Failure

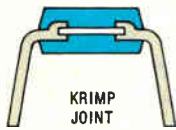

During Bourns initial design program, customer interviews indicated that commonly used "lap joint" and "butt joint" lead termination designs were subject to failure due to weakening of the solder termination during PC board wave soldering operations, and in-circuit heat cycling and vibration. These design-types depend heavily on solder alone for both mechanical and electrical bonding of leads to the substrate.

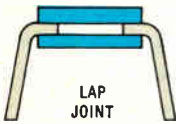

With this in mind, Bourns engineers developed the "Krimp-Joint™" lead frame termination design to protect customers from this hazard.

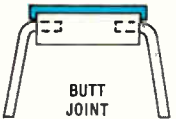

Bourns Krimp-Joint leads are firmly crimped onto the network element, much like a vise grasps a piece of lumber. To "cinch" the electrical connection, a special high temperature, reflow resistant solder is also used.

## 3. The Packaging

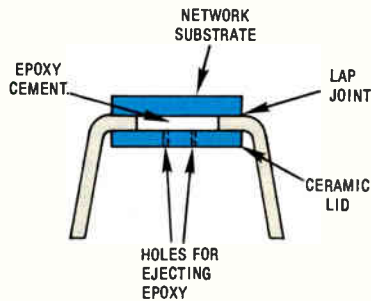

Various types of DIP packaging are utilized of which the molded and "sandwich" types seem most common. One problem that frequently occurs with the sandwich types is delaminating. This happens when air in tiny voids remaining in the epoxy filler (bonds the substrate to the sandwich "lid") expands in hot operating environments to the extent that the package comes apart and fails.

Bourns Krimp-Joint networks are encased in a homogenous molded thermoset plastic package, which is highly heat resistant. Both 14- and 16-pin DIP models are machine insertable, and are available in handy cartridge packages.

## 4. Power

Bourns uses a high-copper alloy lead material to enhance power dissipation capacity. Other materials — ferrous and brass alloys — do not have comparable performance. Furthermore, there is potential for rust with the ferrous alloy material. The high-copper alloy costs us more . . . but we think your satisfaction is worth it.

## 5. A Good Coat Is Important

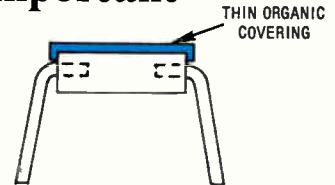

Our little network package must "weather" the homo sapien as well as the electrical environment. Example? Some users report that marking the top of thinly coated networks actually changed internal resistor values. With the tight board spacing found in most equipment cabinets, components occasionally get scraped when boards are inserted and/or removed. Customers report that some thinly protected networks have shorted-out or opened under these conditions. Bourns networks wear a heavy coat of molded plastic to weather the homo sapien climate.

## 2. Krimp-Joint Eliminates "Edge-Arounds"

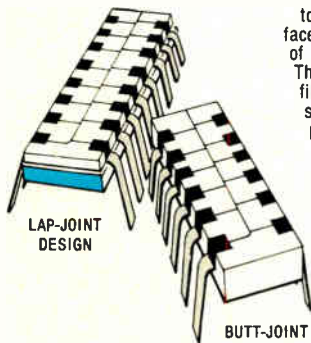

"Edge-around" thick-film printing techniques are required by some designs to electrically connect the network circuit — printed on the horizontal surface of the substrate — to pin leads which are always "buted" to the edge of the substrate, or are "lap-jointed" to the opposite side of the substrate. The latter condition exists with lap-joint designs when more complex thick film circuits are executed which require printing on both sides of the substrate (such as resistor/capacitor networks, dual terminators, special application circuits, etc.). Edge-around printing leaves a natural conductor path weakness on the fine edges of the substrate, resulting in the possibility of a very "tenuous" connection. Such connections are subject to failure after exposure to heat cycling, shock, vibration, etc., and can result in an open circuit condition. Sometimes an intermittent condition results, which makes fault diagnosis more difficult.

Since most packages are not tested at full rated power during manufacturing QC, weak edge-arounds sometimes pass final tests . . . and then burn-out (like a fuse), when subjected to full power in an operating circuit.

Bourns Krimp-Joint mechanically contacts both top and bottom surfaces of the resistor network substrate, resulting in a strong, positive connection between pin lead and both sides of a network circuit. No edge-around paths are required.

EDGE-AROUND CONDUCTOR PATHS

## FREE SAMPLES

Try the Bourns "Krimp-Joint" Resistor Network Design. Write to us on your company letterhead telling us

1. current manufacturer's part number you are now using,
2. what resistance values you need . . .

and we will send samples for your evaluation. We'll also include a complete data packet, with a handy cross-reference guide.





# BETTER COMMUTATING CAPACITORS FOR SCRs

(and other non-sine wave voltage applications)



## THE CAPACITORS:

Type 355P and 356P, newest members of the proven Sprague Clorinol® Capacitor family . . . paper and paper/polypropylene film dielectrics with non-flammable synthetic askarel impregnant.

## THE APPLICATIONS:

Chopper circuits such as those in d-c motor control, inverter circuits for induction heating, high frequency lighting, high frequency power supplies, ultrasonic cleaners.

## THE ADVANTAGES:

Volt-ampere ratings as much as 250% higher than those of older designs. Deliver large peak currents with lowest possible inductance and dissipation factor.

For complete technical data, write for Engineering Bulletin 4701 to Technical Literature Service, Sprague Electric Co., 35 Marshall St., North Adams, Mass. 01247.



THE BROAD-LINE PRODUCER OF ELECTRONIC PARTS

## News update

■ Rolm Corp. has new software programs that broaden the capabilities of its computer-stored-program private branch exchange [May 29, p. 38]. One of the most attractive aspects of such PBXs is their resistance to obsolescence: new features may be added simply by on-site programming instead of hard-wired physical additions. Rolm's new software package, called Release II, contains 26 no-charge user features and two one-time chargeable options. The last two are direct inward dialing, which allows incoming calls to bypass the attendant, and direct inward system access, which allows authorized callers from outside the exchange to use the system's major features.

■ The pick-proof lock containing a C-MOS shift register designed last year by Arthur D. Little Inc. for Eastern Co. [Aug. 8, 1974, p. 42], is still in the prototype stage. C.H. Lambert, Eastern's executive vice president, says the Naugatuck, Conn., company won't manufacture the lock itself, but is still seeking U.S. and foreign patents. Eastern then would either sell rights or release the patent to another manufacturer. Two companies have indicated interest, says Lambert.

■ Calspan Technology Products of Buffalo, N.Y., has received orders for six of its Fingerscan fingerprint units [July 25, 1974, p. 44], according to the office of marketing manager Frank G. Woods. Of those six, three have been installed at "top secret" Government installations. But there has been one change in the system since it came out: the price has gone up to the \$30,000-to-\$40,000 range, depending on the number of Fingerscan terminals in the completed installation. The original price was set by Calspan as \$20,000 to \$30,000. The system is designed to limit access to secure installations to authorized personnel only. Its accuracy is rated as one incorrect access in 1,000 attempts.



# INTRODUCING TWO IC PRECISION OP AMPS TO IMPROVE YOUR SYSTEM. AND YOUR BOTTOM LINE.

**The AD510. At \$5.95 in 100's, the lowest cost, laser trimmed precision IC op amp you can buy.**

There are other super op amps that approach the AD510's high performance. Not one that can deliver it at the AD510's low price.

It has 25 $\mu$ V max. offset voltage. It's laser trimmed so you never have to adjust it. Drift of 0.5 $\mu$ V/ $^{\circ}$ C, max. And bias currents of 10nA, max.

And it's 741/725-pin compatible, so even if you haven't been using precision op

amps before, you can upgrade economically and easily, right now.

If ultra low bias current is what you're after, we've also got the AD515.

**AD515. At \$9.90 in 100's, the lowest cost ultra low bias current IC op amp ever offered.**

The AD515's  $I_b$  is as low as 75fA, max., warmed up. The AD515 also gives you a combination of features never before available in an ultra low bias current circuit.

Like a low 1.5mA power requirement for portable instrumentation.

Offset voltage laser trimmed to 1.0mV. Drift of 15 $\mu$ V/ $^{\circ}$ C. And low noise of 4 $\mu$ Vp-p. All max.

So take your pick. The AD510. Unbelievable performance at the price. Or AD515. Unbelievable performance at any price.

Analog Devices Semiconductor. Components for test and measurement instrumentation and control systems. Norwood, Mass. 02062.

East Coast: 617-329-4700.

Midwest: 312-894-3300.

West Coast: 213-595-1783.

Texas: 214-231-5094.



Circle 9 on reader service card



## Reading the IEEE election results

Now that the campaign for president of IEEE is over and the “new administration” prepares to take office, the institute’s leaders may interpret this past election in two ways.

IEEE officials may see the victory of Joseph K. Dillard, the candidate selected by the board of directors, over Irwin Feerst, self-styled institute reformer, as a confirmation of present policies. This view would indicate business as usual—the majority has spoken.

Another and broader interpretation of this vote is that a sizable minority of voters has expressed dissatisfaction with the status quo and wants changes, particularly with regard to professional or career activities. No doubt a good number of votes for Feerst were cast by members not thoroughly in favor of this candidate’s positions, but mainly to “shake up” the IEEE establishment.

Often in American politics, dissident candidates or third-party candidates for President, although they have not won the election, have influenced the two major parties enough to change policies. Many of the great social and diplomatic changes eventually adopted by the Government were originally

proposed by the “losers.”

The one blockbuster issue out of all the barrage that Feerst has fired is the mid-career crisis and its many ramifications. The ramifications involve not just what the IEEE can contribute in continuing education (perhaps a mid-career academy) but what it can do to combat age discrimination in hiring, firing, or job assignments.

Most explosive of all the ramifications, however, is the opening of the question about what IEEE should do in controlling the supply and quality of EEs entering the job market. Feerst did not invent this issue, but he did say it should be a major item of business for the IEEE, and apparently a good number of members agree.

Perhaps the institute is not up to the task of dealing with these problems, much less satisfying everyone with viable solutions. Maybe that’s why we have begun to hear more and more talk among engineers about unions. Therefore, it behooves the IEEE hierarchy to find out what the dissident members are thinking—to put aside questioning who Feerst is and examine what he has been saying.

## Can we afford to outwait risks?

Just ten years ago, *Electronics* carried a story that came as a surprise to many readers. A major American TV-set maker, despite the then widely held opinion that integrated circuits for consumer applications were five to ten years down the road, revealed that its upcoming line of color sets would be the first to use ICs. Thus was triggered the first round of consumer IC development.

The launching of consumer ICs was clearly a case of technology being ready to take on a job, while most companies were not ready to take on the risks of trying something new. And that kind of entrepreneurial timidity is with us again in today’s industrial climate.

The position of ICs ten years ago is

analogous to the status today of solar cells and the use of electronics for tapping solar power. Experts are saying that extracting significant amounts of energy from the sun will be economically feasible by the turn of the century—but only if the Government kicks in enough research and development funding between now and then.

One wonders when the more imaginative companies will reject the risk-free Government contract approach to profits and start the ball rolling by declaring what has become clear to many: that no technological breakthroughs are really needed—just a plain old-fashioned running of the risks in the marketplace.



# New Honeywell portable packs 28 channels, meter monitoring and solid ferrite heads all into one small, superb unit.



If you've been waiting for better features and more capability in a portable tape recorder — you've got it. The Model 5600E from Honeywell!

Our new portable gives you up to 28 tracks, 7 speeds, field-convertible intermediate or wideband, solid ferrite wideband heads and 10 1/2-inch reel capacity. There's also a variety of rack and shock mount configurations and an integral dc power supply option.

Our meter monitoring isn't typical either. Not with simultaneous monitoring of record input and reproduce output on any channel, plus track monitoring with rms or peak ac or dc meter coupling, and there's more . . .

Like electronics and parts commonality with other Honeywell portables; a 3,000-hour ferrite head warranty and a proven transport all in a lightweight compact package.

Get complete technical specifications by calling Darrell Petersen, (303) 771-4700, or write Honeywell Test Instruments Division, P. O. Box 5227E, Denver, Colorado 80217.

# Honeywell



# Intel is the way memory drivers and

Intel industry standard 2104, 16 pin and 2107B, 22 pin, 4K dynamic MOS RAMs help you keep system costs low. Now you can save even more with our new family of quad memory drivers and refresh controllers.

The new bipolar 3245 TTL to MOS driver is the first quad driver that does not require an extra 15 volt supply or an external transistor to generate and maintain the MOS clock level. The 3245 is a plug-in replacement for our 3235 and other MOS clock drivers. For ECL logic systems, choose the bipolar 3246 driver.

For CMOS and TTL logic systems where low power, battery back-up operation is required, use our new CMOS low power 5234 and 5235 drivers.

To make our 22 pin RAMs even easier to use and further reduce cost, all our new drivers feature individual address, as well as common refresh, clock and enable inputs. And all four drivers operate without the extra 15 volt supply or external transistor which was required with previous designs.

This simplifies system design and reduces cost even more.

We're also announcing two new refresh support circuits. The 3222 is used with Intel's 2107B and other 22 pin 4K dynamic

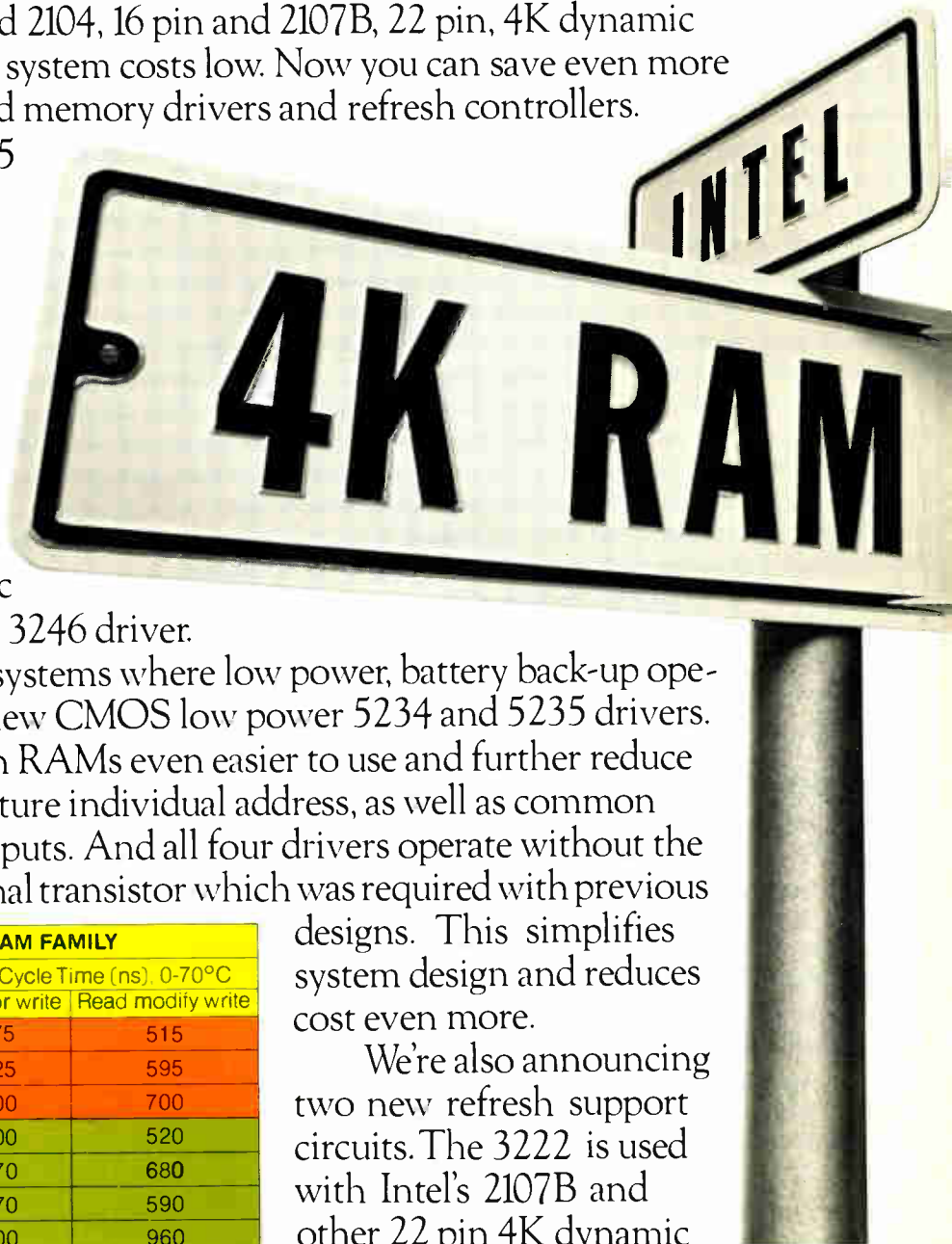

INTEL'S STANDARD 4K RAM FAMILY				
Part Number	Pins	Max. Access Time (ns), 0-70°C	Min. Cycle Time (ns), 0-70°C	
			Read or write	Read modify write
D2104-2	16	250	375	515
D2104-4	16	300	425	595
D2104	16	350	500	700
2107B	22	200	400	520
2107B-2	22	220	470	680
2107B-4	22	270	470	590
2107B-6	22	350	800	960

# to go for 4K RAMs, refresh controllers.

RAMs, while the 3232 is designed for Intel's 2104 and other industry standard 16 pin 4K dynamic RAMs. Both of these new circuits operate from a single +5 volt supply, help you simplify system design, reduce power and reduce the number of discrete packages required.

Intel 16 pin and 22 pin 4K MOS RAMs are helping engineers

cut system design costs. Now our new quad drivers and refresh controllers make Intel 4K RAMs even easier to use. Save dollars, save space, and eliminate extra power supplies and discrete components. Start saving now. To order contact our franchised distributors: Almac/Stroum, Component Specialties, Cramer, Elmar, Hamilton/Avnet, Industrial Components, Liberty, Pioneer, Sheridan or L.A. Varah.

For data sheets on the new drivers and refresh controllers write: Intel Corporation, 3065 Bowers Avenue, Santa Clara, California 95051. For \$5.00 we'll send you our new 288 page "Memory Design Handbook." This handbook contains applications notes and useful design information on our line of RAMs, ROMs, PROMs and support circuits.

16 PIN QUAD MOS DRIVERS FOR INTEL 2107B 22 PIN 4K RAMs					
Note: Intel 16 pin 2104 4K RAMs are TTL compatible					
Part Number	Technology	Input Levels	Worse Case Delay & Rise Time 0-75°C	Power Supplies	Power Dissipation Channel
D3245	Schottky Bipolar	TTL	32ns	+5, +12V	75mW
D3246	Schottky Bipolar	ECL	30ns	-5.2, +5, +12V	110mW
D5234	CMOS	CMOS	100ns	+12V	3mW @ 0Hz, 39mW @ 1MHz
D5235	CMOS	TTL	125ns	+12V	
D5235-1	CMOS	TTL	95ns	+12V	

REFRESH CONTROLLERS FOR INTEL 16 & 22 PIN 4K RAMs				
Part Number	Pins	Maximum Address Input to Output Delay 0-75°C	Power Supply	Used With
D3222	22	12ns	+5V	2107B
D3232*	24	8ns	+5V	2104

\* Available 1st quarter 1976.

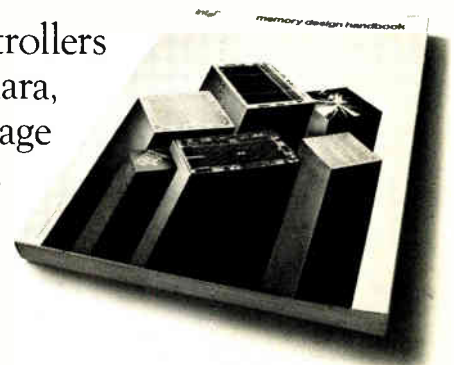

**intel® delivers.**

**FREE/NEW**

'76 Edition

**RCL'S**

**Electromagnetic  
Delay Line  
Engineering  
Handbook**

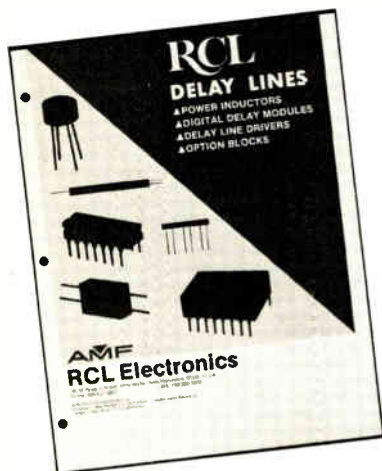

- △ DIP Delay Lines
- △ Power Inductors
- △ Low Priced Commercial DIPs
- △ Delay Line Drivers
- △ Digital Delay Modules
- △ Option Blocks

Terms . . . Test Methods . . .  
Engineering Definitions . . .  
Characteristics . . . Specifications

*Send For Your FREE  
Handbook Today!*



**RCL Electronics**

**195 McGregor Street  
Manchester, N.H. 03102  
(609) 627-3831**

## People

Morris pushes Marisat  
at Comsat General

The banana business tied him down, so Fred W. Morris grabbed an opportunity in October to discard the title of president of TRT Telecommunications Inc. and become vice president for corporate development at Comsat General Corp., the new-ventures subsidiary of the Communications Satellite Corp., Washington, D.C.

"At Comsat," Morris says, "opportunities for growth are not restrained by other businesses." By contrast, he notes that TRT, a communications common carrier between Latin America and the U.S., was one of the few profitable subsidiaries of United Brands, the troubled conglomerate that grew from the profits of Central American fruit exports. TRT couldn't grow as Morris wished because that might have drained cash from the parent.

In the new Comsat General post, Morris' first priority is to find more users for Marisat, a series of satellites and ground stations dedicated to worldwide communications service between land and ocean-going vessels. He expects the 200 terminals ordered from Scientific Atlanta Inc. [*Electronics*, Nov. 14, 1974, p. 38] to be leased to shippers after the satellites are operational. This will happen next spring after a six-month delay caused partly by construction problems at Hughes Aircraft Co., the manufacturer of the satellites, and partly by NASA's clogged launch schedule at Cape Canaveral, according to Morris.

**Not stopping.** Morris doesn't intend to stop at 200 leased terminals. "We're going to pull the shipping industry out of the 19th century. It has been dependent on [high-frequency] communications, and they don't realize what they don't have," the ebullient executive contends. He expects to order additional terminals next year, with features such as higher data speeds.

Twenty-two terminals have already been leased, he says, but "there'll be a big burst of marketing



**Priority.** Fred Morris' aim is to interest ship owners in satellite communications.

when the system comes into being."

Morris will concentrate on Marisat and "two new opportunities we are analyzing in depth." He refuses to identify them before their announcement in six months.

For Morris, the new position comes at an ideal time. "We have the wherewithal to apply an essential technology, but we have to find the users. They must recognize what can be done with this 20th century service," he says.

Developing managers  
satisfies Beckman's Teeter

G. Howard Teeter regards himself as a developer of managers, and apparently he's been rather successful at it. He was recently named executive vice president at Beckman Instruments Inc., Fullerton, Calif.—the No. 3 spot in the company behind chairman Arnold O. Beckman and president William Ballhaus. His promotion after Beckman's 17 consecutive quarters of steadily improving financial results, tallied even through the recession, speak well for Teeter's earlier shaping of worldwide manufacturing and sales organizations for Beckman's four key groups: medical equipment, analytical instruments, electronic components, and chemicals.

But it's been his shaping of man-



# How to get more production out of your drafting room.

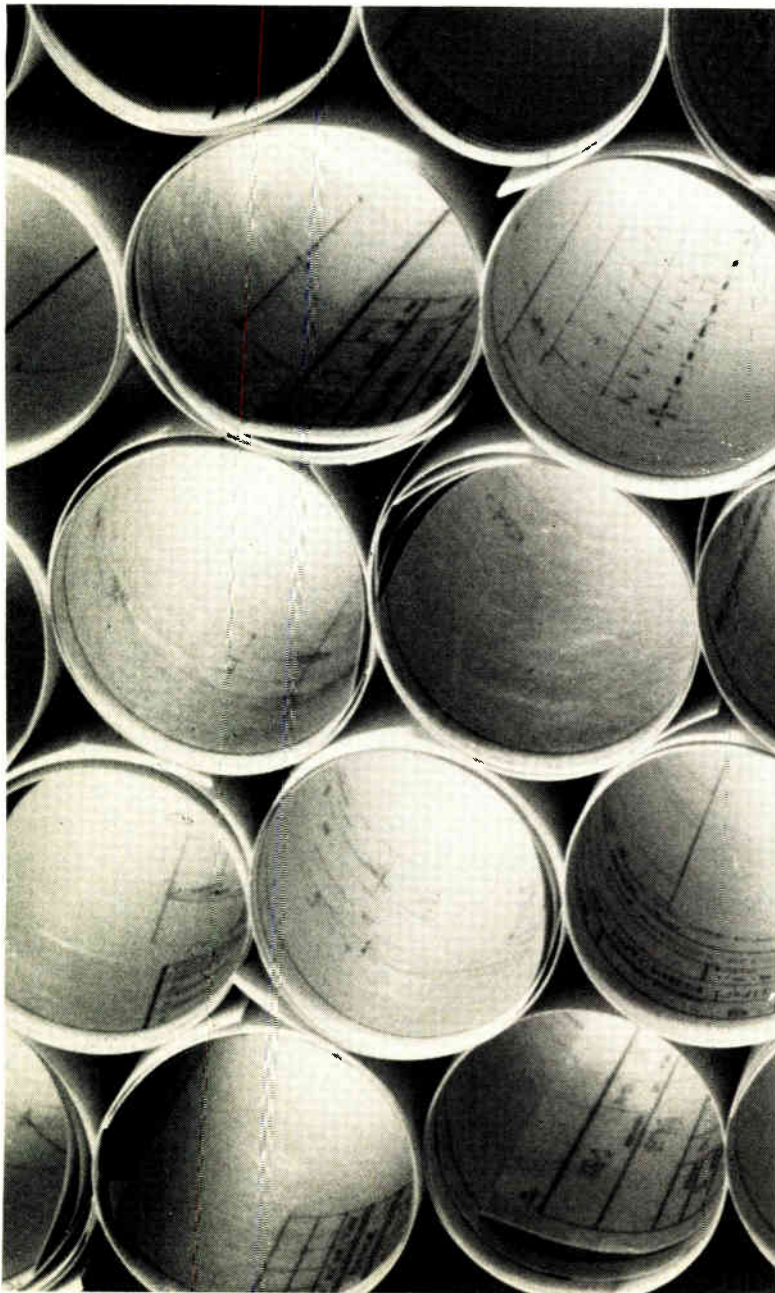

We don't mean your draftsmen aren't working hard. Certainly they are! But what exactly are they doing? Probably a lot of their work involves revisions, repetitive elements, maybe even restorations. Much of which could be done in minutes instead of hours—photographically.

We can explain how Kodagraph films and papers and modern photo-reproduction techniques can cut redrawing time to a minimum...give you more design time...and probably make your drafting budget go further, too.

And we can show you how to get reproductions back to your draftsmen faster, with a Kodak Supermatic-Star processor. This automated unit processes both wash-off and conventional films, quickly and with outstanding uniformity.

For more information, write: Eastman Kodak Company, Graphics Markets Division, Dept. R5774, Rochester, N.Y. 14650.

## Kodak products for drawing reproduction.



# Subminiature capacitors with small mounting areas for printed circuit boards

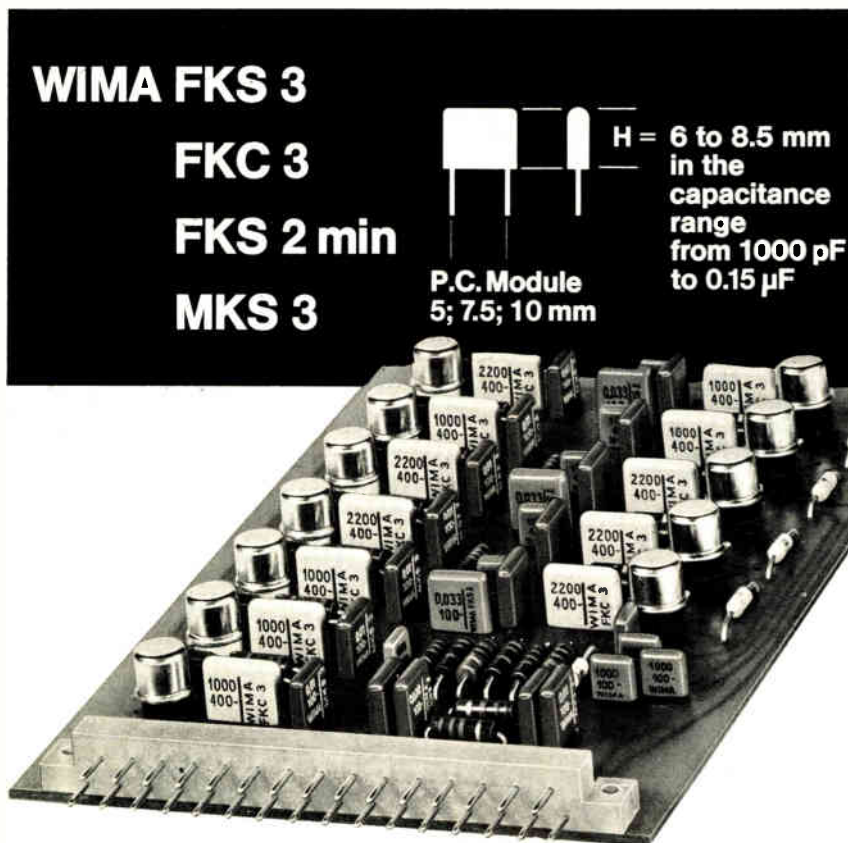

## Characteristics:

The design has made better use of the vertical area in order to reduce the mounting area requirement for the capacitor. This facilitates greater packing density and easier mounting on printed boards.

The termination wires are compatible with the standard printed board grid to allow simple insertion. Equally important, the height of the capacitors is compatible with transistors.

**These new cast-moulded capacitors are so small that they offer advantages hitherto not obtainable when used on printed circuit boards.**



**WILHELM WESTERMANN**  
 Spezialvertrieb elektronischer Bauelemente  
 D-68 Mannheim · Fed. Rep. of Germany  
 P.O. Box 2345 · Tel.: (0621) 40 8012

## People



**Growth.** G. Howard Teeter calls biomedical instrumentation "a natural" for Beckman.

agers to run Beckman's more than 25 profit centers that Teeter regards as his major accomplishment. In striving to motivate people, he preaches that "a man is not limited by his own capabilities, but by how he works through the strengths of others." And in measuring a manager by his output, Teeter stresses that he doesn't give up on a person easily.

**Medical.** In explaining Beckman's growth record, Teeter zeros in on medical-instrumentation, "a natural for (a company) with three decades of experience in biomedical instrumentation," he says. More than \$103 million, or 45%, of fiscal 1975's \$229 million in sales came from this field, double the level of only four years before. Teeter says Beckman will concentrate on segments within this market, and predicts a 20% growth rate or better. Exotic-sounding, but practical new products, such as a series of systems for the radioimmunoassay field, are on the market, and more are coming. Radioimmunoassay is a nuclear technique for measuring constituent body fluids as precisely as one part per billion.

Teeter believes the best is ahead. He even thinks Beckman has a chance to come up with its own "flashy product" like the calculator or digital watch to catch the public eye. "We have the potential" he observes, but declines to say more.





# MEASUREMENT COMPUTATION

innovations from Hewlett-Packard

# NEWS

DECEMBER 1975

## in this issue

Third channel  
trigger view with  
new data domain scope

Microprocessor controlled  
SLMS for FDM systems

New low-profile LED

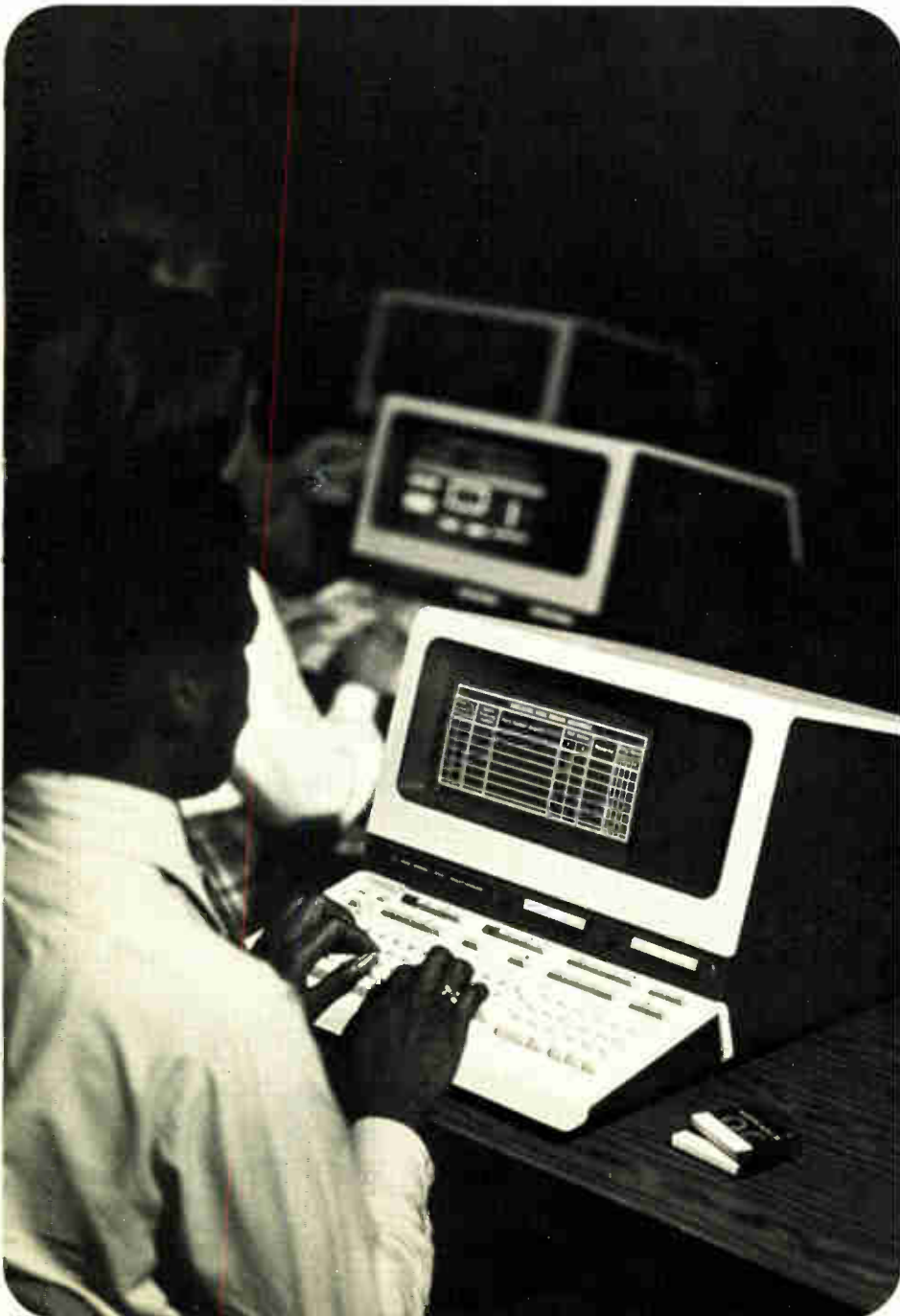

### New On-line/Off-line Mini DataStation saves computer time and data transmission costs

Program preparation, editing, tape copying, and tape-to-printer operations are now the domain of an off-line CRT terminal. HP's newest microprocessor-controlled 2644A Mini DataStation allows you to perform these and myriads of other operations normally requiring costly and often inconvenient connection to a computer.

220,000 bytes of local mass data storage has transformed the powerful HP 2640A CRT terminal into a new kind of terminal. The key to data storage is in the two fully-integrated cartridge tape transports using the newly developed shirt-pocket size version of the 3M data cartridge. The advantages over cassettes include reliability, assured inter-

*(continued on third page)*



# HP-9815A: Big calculator features in a new small package

The new 9815 calculator combines keystroke calculating convenience, dedicated problem solving and an optional two-channel I/O to give you versatility and power in solving problems from the simple to the sophisticated.



A new AUTO-START capability and high-speed dual-track data cartridge capable of storing 96,384 bytes of data and programs are features that make the 9815A calculator a viable and easily customized choice for virtually any lab. Add the optional interface capabilities and you can easily extend powerful 9815 desk-top computing capabilities.

The 13-pound (5.9 kg) calculator features the Hewlett-Packard stack-oriented logic system simplifying keystroke calculations and giving you answers you can trust. The buffered keyboard contains 24 preprogrammed functions, 4 arithmetic keys plus keys for memory-stack manipulation.

The thermal printer prints up to 16 characters per line at 2.8 lines per second. In addition, there is an easy-to-read numeric display.

With the addition of the optional two-channel I/O structure, you can add 9800 Series peripheral devices, including the new 9871 printer/plotter, (see

right column), 9862 plotter, tape readers or tape punches, or a digitizer.

The 9815 also mates with BCD instruments and devices with 8-bit parallel interfaces. The 9815 accommodates the Hewlett-Packard Interface Bus, (HP-IB) allowing you to control, gather, and process data from as many as 14 different HP-IB compatible test and measurement instruments.

The 9815 contains computer language functions for programming power and performance. The standard 9815 has 472 steps of program memory and 10 data storage registers. An option is available to expand the calculator's internal memory to 2,008 program steps.

Many standard problem solutions are available from the extensive library of pre-recorded programs in statistics, engineering, science and surveying.

*For more information, check P on the HP Reply Card.*

## Prepare charts, graphs and text easily under program control with new printer

The new HP 9871A printer extends the output characteristics of the 9800 series desk-top programmable calculators including the new HP 9815A (see story on this page).

This new impact printer is a full-character, fixed carriage peripheral that can be used to fill out forms, create reports, draw charts and plot graphs using the bi-directional platen and carrier. It also features programmable horizontal and vertical tabulation.

In addition to the standard 96-character, upper/lower case print wheel, optional interchangeable wheels are available for ASCII character sets and European character sets.

The 9871 is a versatile printer, accommodating paper up to 15 inches (38 cm) wide and prints up to 132 columns at 10 characters per inch. Average printing speed is 30 cps. Six-part paper in single-sheet or continuous-feed form may also be used.

*For more information on interfacing this new printer/plotter to your 9800 series calculator, check Q on the HP Reply Card.*

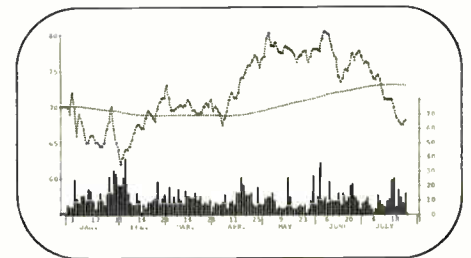

*Interchangeable printwheels are shown with new rugged 9871 output printer.*

## New On-line/Off-line Mini DataStation saves computer time and data transmission costs

(continued from first page)

changeability, and lower error rates. One cartridge contains the equivalent of 1000 feet of paper tape—enough for many hours of off-line work.

Here are some of the operations you can perform on the 2644:

- Enter data from the keyboard and view the data instantly on a high-resolution 7×9 dot enhanced display. Up to 4 different 128-character sets may be in the 2644.
- Store data on tape. Many hours of work at the keyboard can be stored on a single cartridge by pushing a single button—and selectively retrieved in seconds.
- If data entry requires a form, call any of up to 255 variable-length files stored on tape and retrieve the form you want at 60 ips search speed, usually within 10 seconds—with pushbutton ease.
- Edit the data, using the 2644's full editing capabilities, including character and line insert and delete, cursor sensing and positioning, and programmable protected fields.
- Batch-transmit stored data to the computer directly from the cartridge, at transfer rates up to 2400 baud.
- Move data among the 2644's functional units by pushbutton—between tapes, semiconductor memory, optional printer, and data communications interface.
- Expand terminal applications by using the 2644's dual tape unit so that one cartridge provides a write-protected input while the other provides a separate output.

The 2644 not only conserves computer resources and reduces communications line charges, it also improves the efficiency of data entry and provides a valuable backup during computer down-time.

To receive your copy of detailed specifications and performance information, check C on the HP Reply Card.

## More markers, more sweeps, with new sweeper mainframe

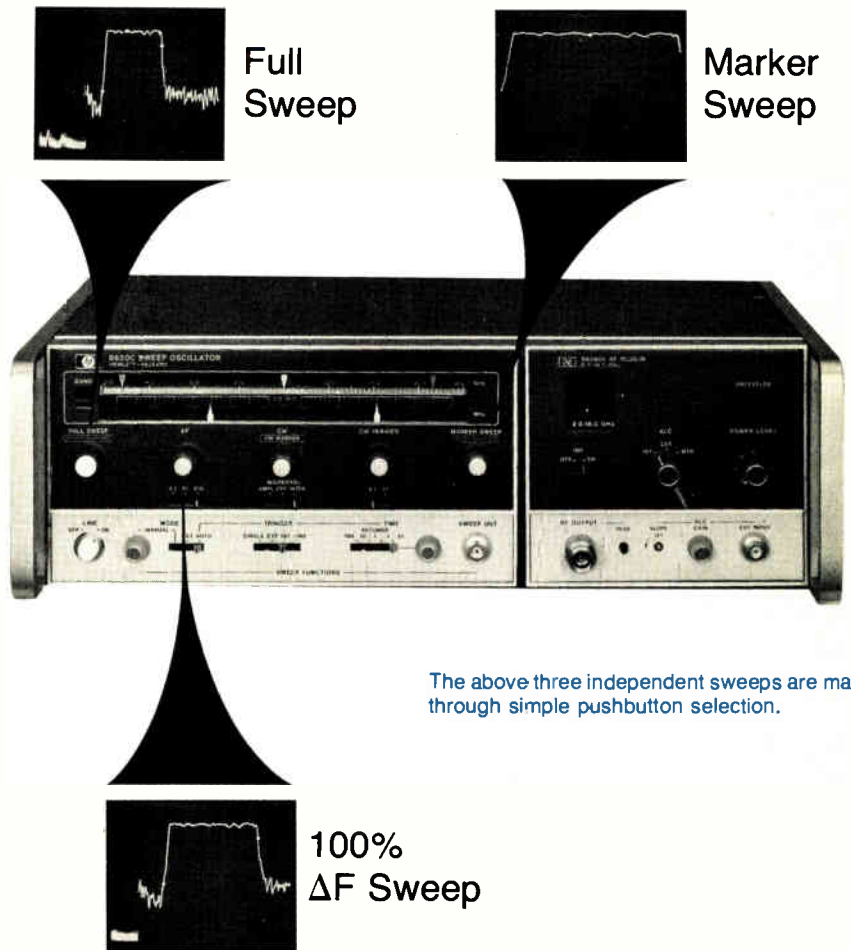

The above three independent sweeps are made through simple pushbutton selection.

The new HP 8620C mainframe for HP's solid-state sweep oscillators offers highly useful new sweep modes plus up to three frequency markers for additional operating flexibility. Start with the FULL SWEEP mode: Just press the button and the RF plug-in's full band is swept. You have three frequency markers (select either "amplitude" or "intensity" markers) available to bracket and pinpoint portions of the full-band sweep. Then press the MARKER SWEEP button and the sweep now covers from the START marker to the STOP marker. In this mode, the CW marker is still available. Press the CW and  $\Delta F$  buttons and you now have another independent sweep (in which the START and STOP markers can be used). The  $\Delta F$  sweep, symmetrical around the CW frequency, can be as wide as 100% of the full band. This is 10 times greater than could be swept with

the 8620C's predecessor (HP 8620A). Yet the 8620C still retains the narrow band  $\Delta F$  and "CW Vernier" capabilities that permit very high frequency resolution and settability.

The 8620C mainframe offers two forms of frequency programming as options: BCD programming (Option 001) or through the HP Interface Bus (Option 011). Either form permits selection of 10,000 frequency points per band. RF plug-ins covering from 3 MHz to 18 GHz are available for the 8620C, including ultra wideband units spanning 10 to 2400 MHz and 2 to 18 GHz.

For more data, check N on the HP Reply Card.



## New portable DMM has five full functions and $1 \mu\text{V}$ dc/ $10 \mu\text{V}$ ac sensitivity

HP's new 3465A digital multimeter lets you measure low-level voltage with 1 microvolt dc resolution and sensitivity. AC voltage resolution and sensitivity of 10 microvolts is provided on the 100 MV range. Your choice of ac lines or battery power make it attractive for use as a lightweight portable service tool, while serving your lab needs.

Full functional capability with high sensitivity make it a preferred measurement tool for troubleshooting in the lab or in the field. Its ease of use, low cost and unambiguous display, plus input protection, makes the HP 3465A especially attractive.

This new DMM gives you dc voltage accuracy of  $\pm .02\%$  of reading  $\pm .01\%$  of range on most often used ranges. The ac voltage accuracy is  $\pm .15\%$  of reading  $\pm .05\%$  of range for midband frequencies over the audio range. Ohms are measured from 10 milliohm sensitivity to 20 megohms with an accuracy of  $\pm .02\%$  of reading  $\pm .01\%$  of range for most ranges. Both ac and dc current measurements range from 10 mA sensitivity on the 100  $\mu\text{A}$  to 2 A on the highest range. The dc current accuracy is typically  $\pm .11\%$  of reading  $\pm .01\%$  of range, and the ac accuracy at midband is  $\pm .25\%$  of reading  $\pm .05\%$  of range. There is a front panel 2A fuse for input protection.

The standard 3465A has rechargeable batteries. Option 001 is for AC operation only, Option 002 uses 4 Type D batteries.

*For additional details, check D on the HP Reply Card.*

Look at the front panel and you see what the 3465A can do for you. Look inside and you will see the latest technology with only seven adjustments for routine maintenance. Low cost to buy, and low cost to own were design considerations.

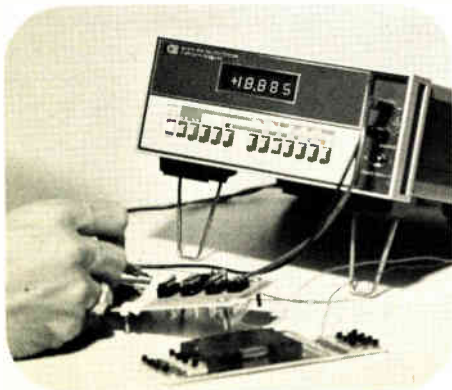

## New synchronizer/counter improves usefulness of low cost signal generator



Now you can phase-lock the 8654A/B signal generator with the new HP 8655A synchronizer/counter for very low drift and 500 Hz resolution.

Tuned-circuit-type signal generators such as the HP 8654B are hard to beat for good spectral purity and non-harmonic signals more than 100 dB below the carrier. But they tend to exhibit turn-on drift and have only moderate frequency accuracy.

Now a new HP 8655A Synchronizer/Counter phase-locks the HP 8654A/B Generator to bring drift down to 0.1 ppm per hour. It can be locked to 500 Hz points across its 10-520 MHz range.

In the phase-locked mode, the excellent spectral purity of the generator is preserved as well as the FM capability (up to 100 kHz deviation). Operation is simple; after tuning to the desired frequency as indicated on the 6-digit LED display, a push of the LOCK button establishes phase lock to the displayed frequency.

The 8655A also serves as a versatile counter with excellent RFI performance, a very important consideration when used next to microvolt test signals. Less than  $1.5 \mu\text{V}$  leakage is induced in a 2 turn-1 inch diameter loop at a 1 inch distance.

In the external count mode, frequencies from 1 kHz to 520 MHz may be measured to a sensitivity of 100 mV into 50 ohms. An internal crystal oscillator provides better than  $\pm 2$  ppm accuracy within 3 months and over  $15^\circ$  to  $35^\circ\text{C}$ .

Provision is made to mechanically couple the synchronizer to the 8654A/B generator for excellent portability. The combination weighs 14 kg (31 lbs.) and is small in size.

*To learn more, check O on the HP Reply Card.*

## Automate your process with a calculator-based multi-programmer

Process engineers can now plug together and program their own automatic test and process control system quickly and economically. It's all made possible with a calculator-based HP Interface Bus (HP-IB) Multiprogrammer System designed for ease in communicating bi-directionally with your process instrumentation.

A basic system includes the controller, a desk-top programmable calculator (HP Models 9830, 9821, or 9820), connected via the HP-IB to a multiprogrammer interface unit, a 6940B multiprogrammer, and from 1 to 15 randomly-addressable I/O cards that plug into the 6940B mainframe.

Up to 15 extender mainframes, each holding 15 plug-in cards, can be combined permitting system expansion up to 240 I/O channels controlled by a single calculator.

Several different types of multiprogrammer input and output cards are available to interface with your process instruments. Input card functions include current monitoring, voltage monitoring, digital input, counting, and event sensing. Output functions cover stimulus and control including voltage, current, resistance, relay contacts, digital bit patterns, stepping motor control, time and frequency references. Cards may be added or changed as the functions of a real-time test and control system change.

*To learn more, check J on the HP Reply Card.*



HP-IB Multiprogrammer building-block components (center modules above), bring the power, economy, and ease of programming of HP desk-top programmable calculators to your automation job.





## Application Note describes dynamic measurement of microwave VCO's

The new Application Note 173-1, "Dynamic Measurement of Microwave VCO's with the 5345A Electronic Counter," describes a simple technique for determining the frequency-vs-time characteristics of fast-tuning VCO's to 18 GHz. This technique, centered about the 5345A Electronic Counter and its microwave plug-ins, is ideal for measuring VCO ringing and overshoot characteristics, risetime, settling time, and post-tuning drift.

Using the set-up described in AN 173-1, measurement resolution of microwave frequencies is better than 1 MHz, while resolution on the time axis is as fine as 5 nanoseconds. These values far exceed the capabilities of discriminators now used to make these measurements.

Of course, the technique is also applicable to sub-microwave VCO's. An accompanying application note AN 173, "Recent Advances in Pulsed RF and Microwave Frequency Measurements," discusses in detail the theory, techniques, and set-up considerations for this class of measurements.

For your copy of both of these Application Notes, check T on the HP Reply Card.

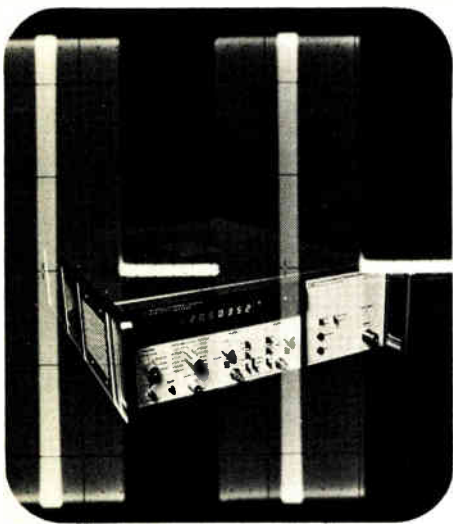

Several unique features of the 5345A Electronic Counter—external gating, frequency averaging, and the ability to accept plug-in microwave down-converters—are exploited to achieve an exciting new class of high-speed frequency measurements.

## Display the external trigger as a *third* trace on new data domain oscilloscope

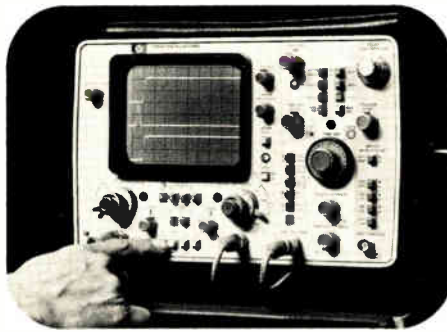

A new scope ideally suited for data-domain analysis and general purpose measurements including low-level signals of read/write heads, power supplies, electro-mechanical transducer outputs.

Special characteristics of the new Hewlett-Packard 1740A 100-MHz oscilloscope make it a logical first choice as companion instrumentation for today's data-domain analysis.

With the new third channel trigger, you can have a simultaneous display of the trigger waveform *plus* channel A and B traces. You can make accurate time measurements from the trigger signal to events on either or both channels.

In the data domain, you can combine the 1740A with HP's 1607A logic state analyzer offering a solution to digital troubleshooting with the combination of logic state and electrical analysis. Option 101 to the 1740A adds rear-panel inputs with internal switching circuits for convenient single push-button switching between the standard front panel inputs and the rear panel state display inputs without changing any cables. This single pushbutton switching capability is very useful when digital word-flow errors require analysis of electrical parameters to determine correcting measures.

5 mV/division at 100 MHz provides the detail needed to study ECL and other fast, low-level signals. A vertical magnifier provides 1 mV sensitivity on both channels to 40 MHz for measuring low-level signals without cascading problems. And, for maximum measuring flexibility, the 1740A has switch selectable 1 megohm or 50 $\Omega$  inputs.

This scope with its new ideas simplifies both real-time and data-domain measurements.

For your copy of a technical data sheet, check B on the HP Reply Card.

## 8580B Component Test System and new application program for more effective stimulus-response testing

The HP 8580B Automatic Spectrum Analyzer is now available with a new component test option (Option 300) that makes major contributions to stimulus-response testing. These contributions include the capability for swept IM measurements for amplifiers and mixers, conversion loss for mixers, and for high dynamic range (120 dB) measurements. These measurements are difficult, if not impossible, to make manually.

The 8580B Option 300 adds to the base system an additional source control unit which can multiplex up to three sources plus CTEST, a microwave application program that provides powerful and flexible measurement capabilities.

Difficult test measurements can be made quickly and easily using CTEST, or programs can be easily generated by the customer in high level BASIC or FORTRAN with the TODS-II Disc Operating System.

The HP 8580B with Option 300 is capable of making the following measurements:

- VSWR
- Return Loss
- Frequency
- Power
- Isolation
- Conversion Loss/Gain
- Gain/Loss at equal frequencies
- IM and Harmonic Distortion
- Unwanted Mixing Products

The system is flexible enough to test a variety of devices such as active and passive components, subsystem modules and systems.

The Component Test System provides a practical solution to production testing needs. Its accuracy, speed, ease of operation and measurement versatility will provide an attractive return on investment through lower test costs, higher yield, and improved productivity.

For more information on the HP 8580B with Option 300, check M on the HP Reply Card.



# Add a new dimension to your plotted graphics with a time-share plotter

Using a highly efficient data transfer format, the HP 7203A high speed X-Y plotter can plot up to seven vectors per second in any direction.

Each data coordinate is expressed with a binary number and represented by the bit pattern of two successive ASCII characters. Thus, only 4 characters are required to define any move. ASCII characters are accepted at 10 or 30 cps through a standard RS232C compatible interface.

Operating in parallel with data communications terminals, graphs can be

plotted on any size paper up to 27.9 × 43.2 cm (11 × 17 in).

Paper is held by an electrostatic paper holdown. Front panel controls allow adjustment of graph limits to fit a plot to any preprinted grid. Four colors of ink are available in disposable pens. Pens are changed quickly and easily so that plots may be superimposed in color for comparison.

For more information, check K on the HP Reply Card.



Add a fast digital X-Y plotter to your communications terminal and display your data in easy-to-understand charts and graphs.

## HEWLETT-PACKARD COMPONENT NEWS

### New low-profile lamps in three colors

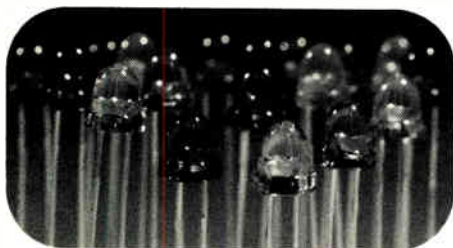

New low profile LEDs in three colors, narrow or wide beam, ideal for compact applications.

HP introduces a new low-profile configuration of solid state lamps: 5.8 mm (0.23 in) nominal. These high-efficiency red, yellow and green LED lamps are packaged in a T-1 3/4 outline and are available in diffused and non-diffused types providing you with the choice of wide or narrow viewing angles.

These lamps are high intensity, IC compatible, have general purpose leads and operate at low current levels.

Models available are as follows:

Color	Viewing Angle	
	Wide	Narrow
Yellow	5082-4590/92	5082-4595/97
Hi-Efficiency Red	5082-4690/93	5082-4694/95
Red	5082-4790/91	—
Green	5082-4990/92	5082-4995/97

For more information, check R on the HP Reply Card.

### New microwave high Q varactor offers maximum stability even in harsh environments

Hewlett-Packard 5082-1300 series tuning varactors are manufactured using a diffused junction mesa structure. Low surface leakage is insured in that the diode is passivated with silicon nitride and silicon dioxide.

These varactors are optimized for high Q with high tuning ratio. Various package styles, as well as chips are available.

Designed for applications requiring a high Q with high tuning ratio, the devices are also suitable for use with transistor, Gunn or IMPATT oscillators.

For a technical data sheet with specifications, check H on the HP Reply Card.

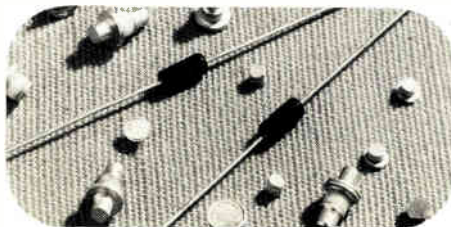

Applications for these new varactors include tunable filters, voltage tuned oscillators and AFC loops.

### New high power, high efficiency silicon double drift IMPATT diodes for CW power sources

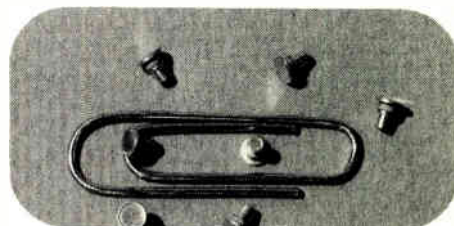

New IMPATT diodes have the reliability to exceed the requirements of MIL-S-19500.

Two new double drift silicon IMPATT (Impact Ionization Avalanche Transit Time) diodes are now available with output of 3W from 5.9 to 8.4 GHz.

Double drift IMPATT diodes offer advantages of higher power and efficiency, lower junction capacitance per unit area, and lower fm noise, as compared to single drift IMPATT diodes.

Because of their high output power, efficiency, and reliability, these devices are ideally suited for use as the active element in C-band oscillators and amplifiers in point-to-point telecommunications links.

For details, check G on the HP Reply Card.



# New selective level measuring set for faster, more accurate management of Frequency Division Multiplex system

HP introduces a new concept in selective level measuring sets, the 3745A/B. It is a powerful new tool specifically designed for surveillance, maintenance and commissioning of Frequency Division Multiplex (FDM) Carrier Systems. Ability to tune in terms of an FDM Plan numbering scheme and make highly-accurate measurements using dedicated filters, distinguishes the 3745A/B from a traditional SLMS.

Measurement capability includes a frequency range from 1 kHz to 25 MHz and true rms measurements from +15 dBm to -125 dBm, depending upon the filter selected. A resolution of 0.01 dB and purpose-designed, flat-topped filters give accurate measurements of channel powers, group powers and pilot levels. The narrow-band pilot filter can be used for other single-tone measurements.

A micro-processor controls all instrument functions, including receiver tuning via a synthesized local oscillator. The SLMS can be operated from the keyboard or remotely, using a suitable calculator or computer, via the Hewlett-Packard Interface Bus (HP-IB).

New selective level measuring set for attended or unattended FDM system surveillance.



There are two versions of SLMS, the 3745A and 3745B. The 3745A contains information on CCITT Recommended FDM Plans, and the 3745B contains information on BELL FDM Plans.

*For a data sheet on the 3745A (CCITT), check E on the HP Reply Card. For information on the 3745B (BELL), check F on the HP Reply Card.*

**HEWLETT**  **PACKARD**

East-4 Choke Cherry Road, Rockville, MD 20850  
Ph. (301) 948-6370.  
South-P.O. Box 28234, Atlanta, GA 30328,  
Ph. (404) 434-4000.  
Midwest-5500 Howard Street, Skokie, IL 60076,  
Ph. (312) 677-0400.  
West-3939 Lankershim Blvd, North Hollywood, CA  
91604, Ph. (213) 877-1282.  
Europe-P.O. Box 349, CH-1217 Meyrin 1, Geneva,  
Switzerland, Ph. (022) 41 54 00.  
Canada-6877 Goreway Drive, Mississauga, Ontario,  
L4V 1L9, Ph. (416) 678-9430.  
Japan-Yokogawa-Hewlett-Packard Ltd., Ohashi  
Bldg., 59-1 Yoyogi, 1-chome, Shibuya-ku,  
Tokyo 151. Ph. 03-370-2281/92.

**hp MEASUREMENT COMPUTATION NEWS**  
 innovations from Hewlett-Packard

- A. HP-25 programmable pocket calculator
- B. 1740A 100-MHz oscilloscope
- C. 2644A CRT terminal
- D. 3465A digital multimeter
- E. 3745A CCITT selective level measuring set
- F. 3745B BELL selective level measuring set
- G. 5082-0607 IMPATT diodes
- H. 5082-1300 microwave varactors
- I. 5082-4590 low-profile LED lamps
- J. 6940A multiprogrammer system
- K. 7203A time-share plotter
- M. 8580B/Opt 300 automatic spectrum analyzer
- N. 8620C sweep oscillator mainframe
- O. 8655A synchronizer/counter
- P. 9815A programmable desk-top calculator
- Q. 9871A impact printer
- R. Coaxial and Waveguide Catalog
- S. Power Supply Catalog
- T. AN 173-1 Dynamic Measurement of Microwave VCO's...

If you wish to receive 26A literature only, check

If you wish to be contacted, check

PLEASE PRINT and include zip code

Name \_\_\_\_\_  
 Title \_\_\_\_\_  
 Department, Building, Mail Station, Etc. \_\_\_\_\_  
 Company \_\_\_\_\_  
 Post Office Box or Street No. \_\_\_\_\_  
 City \_\_\_\_\_ State \_\_\_\_\_ Zip \_\_\_\_\_  
 Phone (Area Code) Number \_\_\_\_\_

**hp MEASUREMENT COMPUTATION NEWS**  
 innovations from Hewlett-Packard

- A. HP-25 programmable pocket calculator
- B. 1740A 100-MHz oscilloscope
- C. 2644A CRT terminal
- D. 3465A digital multimeter
- E. 3745A CCITT selective level measuring set
- F. 3745B BELL selective level measuring set
- G. 5082-0607 IMPATT diodes
- H. 5082-1300 microwave varactors
- I. 5082-4590 low-profile LED lamps
- J. 6940A multiprogrammer system
- K. 7203A time-share plotter
- M. 8580B/Opt 300 automatic spectrum analyzer
- N. 8620C sweep oscillator mainframe
- O. 8655A synchronizer/counter
- P. 9815A programmable desk-top calculator
- Q. 9871A impact printer
- R. Coaxial and Waveguide Catalog
- S. Power Supply Catalog
- T. AN 173-1 Dynamic Measurement of Microwave VCO's...

If you wish to receive 26A literature only, check

If you wish to be contacted, check

PLEASE PRINT and include zip code

Name \_\_\_\_\_  
 Title \_\_\_\_\_  
 Department, Building, Mail Station, Etc. \_\_\_\_\_  
 Company \_\_\_\_\_  
 Post Office Box or Street No. \_\_\_\_\_  
 City \_\_\_\_\_ State \_\_\_\_\_ Zip \_\_\_\_\_  
 Phone (Area Code) Number \_\_\_\_\_

**PRICES**

The following are U.S.A. domestic prices only:

HP-25 .....	\$195	5082-4500 .....	
1740A .....	\$1995	(Qty of 100).37 to \$.85	
2644A .....		6940A .....	\$10,000
(Qty of 6) .....	\$4400	7203A .....	\$3945
3465A Standard .....		8620C .....	\$1950
.....	\$500	Opt 001, add .....	\$650
3465 Opt 001 .....	\$480	Opt 011, add .....	\$950
3465 Opt 002 .....	\$425	8655A .....	\$2000
3745A .....	\$23,625	9815A .....	\$2900
5082-0607 .....	\$150	9871A .....	\$3400
5082-0608 .....	\$250		
5082-1300 .....			
(Qty of 100) .....	\$16.50		

**DIRECT RESPONSE SYSTEM**

For fast response, use the above reply cards. Please note that you can choose two types of HP response:

- Literature (You will receive more information on a product.)
- Please contact me. (You will receive product information and a follow-up call by an HP field engineer.)

If both reply cards on this page have been used, contact your nearest HP field office or one of the regional offices listed on the preceding page. Or write directly to the Hewlett-Packard Company, 1820 Embarcadero Road, Palo Alto, California 94303.

No Postage Necessary if Mailed in the United States

**BUSINESS REPLY MAIL**

Postage will be paid by

**HEWLETT-PACKARD**  
1820 Embarcadero Road  
Palo Alto, California 94303

First Class  
Permit No. 201  
Palo Alto  
California

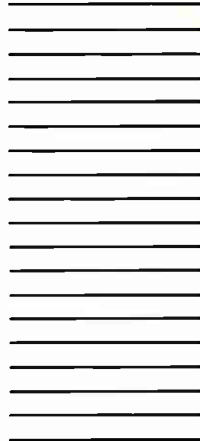

No Postage Necessary if Mailed in the United States

**BUSINESS REPLY MAIL**

Postage will be paid by

**HEWLETT-PACKARD**  
1820 Embarcadero Road  
Palo Alto, California 94303

First Class  
Permit No. 201  
Palo Alto  
California

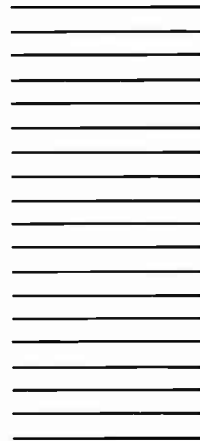



There are  
many quality  
FHP MOTOR  
builders,  
but...



When  
you say  
“Jump”  
Howard  
says,  
“How high?”

We all build tough, dependable FHP MOTORS. But HOWARD tries harder to make **your** job as easy as possible—with pleasant, personalized service. No “take-it-or-leave-it” attitudes, no “our-design-is-best” reaction to your particular product problem.

HOWARD engineers know that our FHP MOTORS can be adapted or modified to eliminate **your** design problems—not create new ones for you. That’s why more and more major companies are selecting HOWARD as another prime source—where custom engineering, reliable performance, delivery-as-promised and fair prices—are standard procedure.

After all, some of the most successful (and demanding) firms in the nation—companies like IBM, XEROX, A.B. DICK, 3M and CONTROL DATA—have found HOWARD’s personalized service suits them just fine.



Why don’t you write today for the newest HOWARD FHP MOTOR/GEARMOTOR catalog—and start making **your** job easier than ever before?

# HOWARD

**HOWARD INDUSTRIES**, Division of MSL Industries, Inc.  
One North Dixie Highway, Milford, Illinois 60953,  
Phone: (815) 889-4105

Circle 27 on reader service card

# THE NEW 3403A. OUTPERFORMS ALL QUAD OP AMPS. FASTER SLEW RATE. DISTORTION FREE.

Raytheon Semiconductor's new 3403A Quad Op Amp gives you a faster slew rate and absolutely no output distortion, plus other improved AC and DC characteristics. The 3403A is significantly better than either the standard MC3403 or LM324. And it's pin compatible too. Our 3403A is simply the best quad op amp

from the leader in linear quads.

For complete details and your own Quad/Dual brochure, contact Raytheon Semiconductor or your local distributor. For your *free sample*, write Raytheon Semiconductor on your company letterhead.



## RAYTHEON SEMICONDUCTOR

Dept. 3403A, 350 Ellis Street, Mountain View, CA 94042

## Meetings

**Magnetism and Magnetic Materials Conference**, IEEE, Benjamin Franklin Hotel, Philadelphia, Dec. 9-12.

**Third Annual Symposium on Computer Architecture**, IEEE, Fort Harrison Jack Tar Hotel, Clearwater, Fla., Jan. 19-21.

**On-Line Systems, 1976-1986**, American Institute of Industrial Engineers, Quality Inn-Pentagon City, Washington, D.C., Jan. 19-21.

**Reliability and Maintainability Symposium**, IEEE et al., MGM Grand Hotel, Las Vegas, Jan. 20-22.

**Design and Finishing of Printed Wiring and Hybrid Circuits Symposium**, American Electroplaters' Society (East Orange, N.J.), Fort Worth Hilton Inn, Fort Worth, Texas, Jan. 21-22.

**Data Base Systems**, American Institute of Industrial Engineers, Quality Inn-Pentagon City, Washington, D.C., Jan. 21-23.

**Power Engineering Society Winter Meeting**, IEEE, Statler Hilton Hotel, New York, Jan. 25-30.

**Twelfth Modulator Symposium**, IEEE, Statler Hilton Hotel, New York, Feb. 4-5.

**ISSCC-76, International Solid State Circuits Conference**, IEEE, Sheraton Hotel, Philadelphia, Feb. 18-20.

**Comcon Spring**, IEEE, Jack Tar Hotel, San Francisco, Feb. 24-26.

**Federal DP Expo '76 (Data Processing in the Federal Government)**, Instrumentation Fair Inc. (Beltsville, Md.), Sheraton Park Hotel, Washington, D.C., March 2-3.

**Programing Micro/Minicomputers**, ACM, Delta Towers Hotel, New Orleans, March 4-6.

**Ninth Annual Simulation Symposium**, ACM, IEEE, et al., Sheraton-Tampa Motor Hotel, Tampa, Fla., March 17-19.



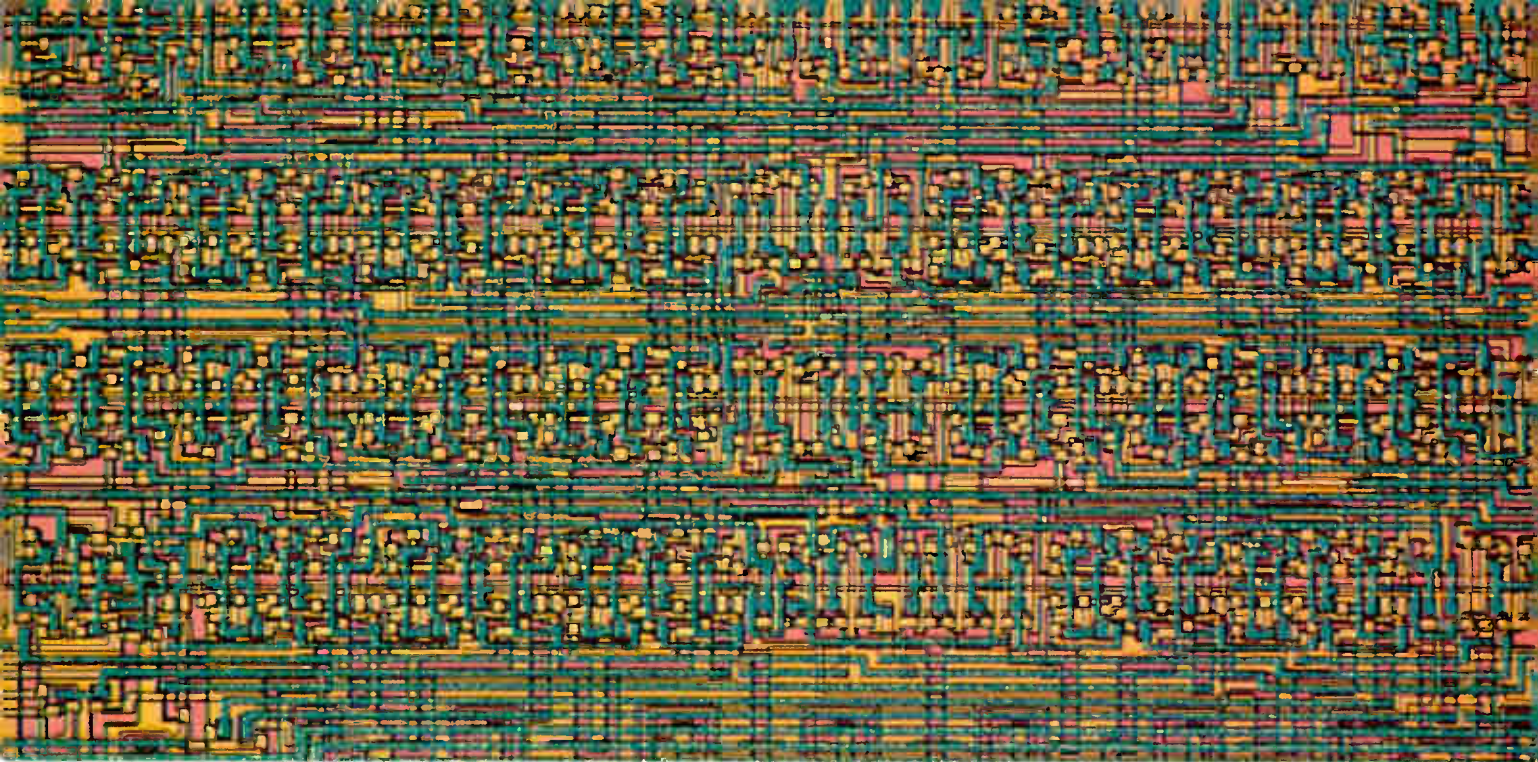

# LAST YEAR THIS PROPRIETARY LSI CIRCUIT WAS ONLY AN IDEA. This year it made a good idea into an outstanding product.

Our business is helping original equipment manufacturers exploit the advanced semiconductor technologies to improve performance and reduce costs. We do it by developing proprietary LSI circuits for our customers' exclusive use. Maybe we should be doing it for you.



If you're trying to stay competitive with a new product—or by improving an existing product—now is the time to consider a custom development program. We can help you fully understand the very significant benefits of custom LSI.

**Performance Bonuses That Cost You Nothing!** The real beauty of LSI is the way it gives you product design options. Once you've made the decision to develop a custom circuit,

there's usually plenty of silicon real estate to use in new and different ways. You can add performance features to the product at virtually no incremental cost. In short, your product can be much better than a competitor's non-LSI equivalent.

**High Yields Mean Lower Costs.** Our LSI processes are production-proven. We get high yields. Which means you get lower chip costs. Plus, LSI reduces product assembly costs. Your product should have a competitive edge in price.

**Low Power Consumption.** LSI circuits conserve power. Their low current requirements often permit portability which would otherwise not be possible. Energy conservation in itself is a product advantage these days.

**Small Size is Only Part of the Story.** Product miniaturization is the most obvious advantage of LSI. Even if small size seems unnecessary for your application, don't overlook the numerous other benefits that we've been talking about.



Our knowledge of the custom LSI approach can help you to evaluate these potential benefits in your own terms. LSI may be exactly what you need. If it isn't, we'll be the first to tell you.

Contact us today for some of the answers. We'll be happy to send you some fact-filled material that describes actual ways we've helped other companies prosper through the use of custom LSI. If you'd like to talk specifics, call Dan Hauer or Rich Koury at (408) 247-5350.

We sell more than circuits, We sell solutions.



3100 Alfred Street, Santa Clara, CA 95050  
Telephone: (408) 247-5350  
Cable: Micropower  
Telex: 910-338-0154 MICROPWR SNTA



# What our bottom-of-the-line

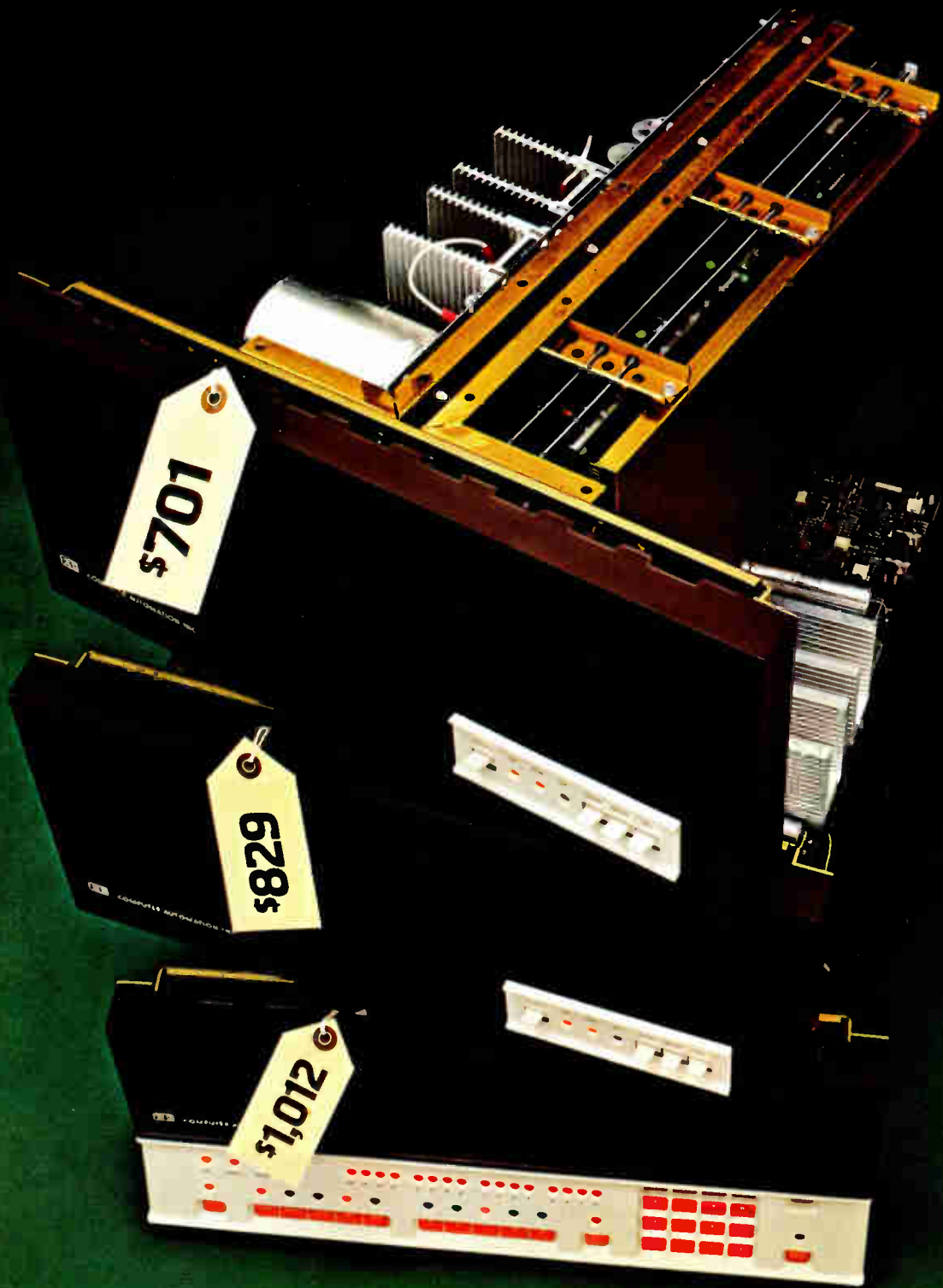

## The New ALPHA™ LSI-3/05

Introducing the lowest priced, 16-bit, full-scale, fully compatible, packaged computers in the world.

# can do for your bottom line.

Stack the new ALPHA LSI-3/05 millicomputer up against any other low-end computer.

Preferably while you're sitting down, because on price alone, you're bound to be astounded.

Ready? \$701 total packaged price. And that's complete with 256 words of MOS RAM, and a CPU that offers a really powerful instruction set, Power Fail Restart, Real-Time Clock and Autoload capability.

Try to buy an equivalent computer at twice the price.

## Have it your way.

You also get the capability to configure your computer pretty well the way you want it. A choice of packaging, of course, that includes either the Operator's or the Programmer's Console, power supplies and so on.

A choice of two standard I/O options.

And a choice of optional memory configurations that

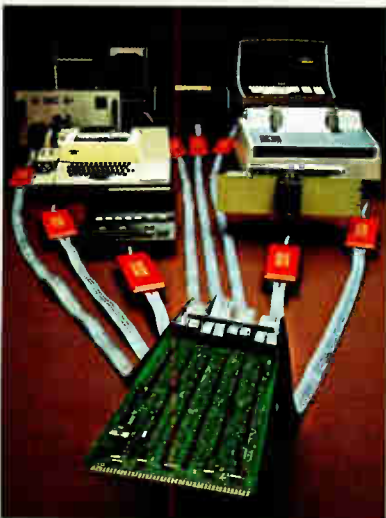

Maxi-Bus compatible ALPHA LSI-3/05 achieves unprecedented cost-effectiveness with ComputerAutomation's new Distributed I/O System.

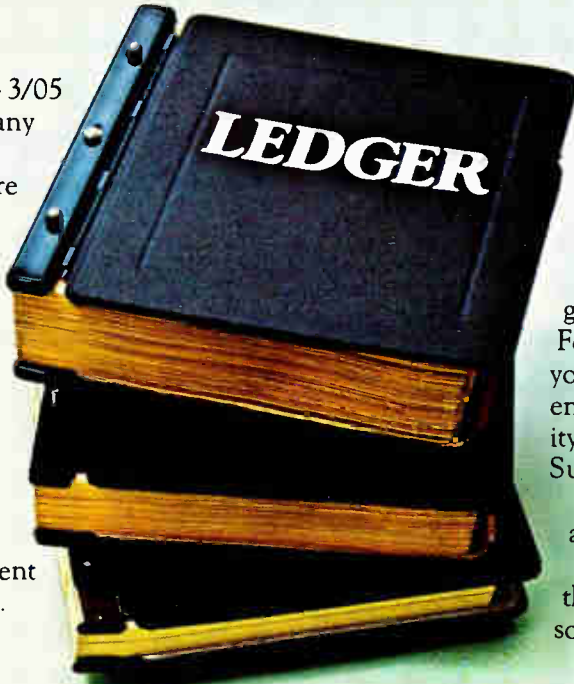

include RAM/ROM, RAM/EPROM and RAM-only in sizes from 256 words all the way up to 32K words. Totally addressable.

## Family connections save you still more money.

So far, what we've been talking about could easily add another five or six figures to the bottom line of your ledger.

But there's more. Really big savings on off-the-shelf software, peripheral controllers and I/O interfaces.

The reason is that the ALPHA LSI-3/05 millicomputer is a full-fledged member of ComputerAutomation's LSI Family... Maxi-Bus compatibility and the whole works. So, every piece of Family hardware we've ever developed will work like it was made for the ALPHA LSI-3/05. Including ComputerAutomation's exclusive new Distributed I/O System... just like you see it in the picture.

With this versatile interface system, you can interface virtually any kind or combination of peripherals. Parallel or serial. Just by plugging them in.

Your cost? Probably less than \$200 per interface.

## The pros know.

Computer-wise OEM's will tell you that product requirements sooner or later get ahead of the hardware. For instance, the computer you buy today may not have enough I/O or memory capacity for tomorrow's Mark II Super Widget.

Then you'll have to scrap all your software and your interface designs, because they're not about to work on some other machine.

You lose.

Of course, with our LSI Family of compatible computers you don't.

You can switch to a different CPU or a different memory anytime. Faster, slower, bigger, smaller. The electrical interface will still be the same; the original programming will still work.

You win.

## From the people who brought you the NAKED MINI®

And the NAKED™ MILLI. And the Distributed I/O System. And the PICOPROCESSOR.

And now the ALPHA LSI-3/05 millicomputer.

One cost breakthrough after another. Breakthroughs that didn't just happen... a lot of profits got plowed back into R&D.

But then, that's the price of leadership.

 **ComputerAutomation**  
NAKED MINI Division

U.S.A. 18651 Von Karman, Irvine, CA 92664  
(714) 833-8830

EUROPE 31/35 Clarendon Road, Watford,  
Hertfordshire, WD1. 1JA England (0923) 39627

Circle 33 on reader service card



# INTRODUCING THE NEW 3000 SERIES LOGIC TESTERS.



On-line editing is standard.  
Program debugging is simple.



Whenever a pin number is entered, the sequence assignment is displayed. Sequences can be changed simply by depressing the appropriate pushbutton.

There are no assemblers or compilers to fuss with. Highly comprehensive programs are completed in hours, not days or weeks.

#### "CREDIT CARD" STORAGE

Once a complete program has been entered into memory, you can record it easily on a handy little magnetic card that looks exactly like all those credit cards in your wallet.

Our little card also records the correct output count signature for GO/NO-GO testing.



**A MATCHED PAIR FOR FACTORY AND FIELD.** The new 3020A LOGICTESTER is a feature-packed console for production applications. It offers 4 million tests per second, test sequences to 40

million words, programmable logic levels and much, much more. Its 128 comparators, displays, and stop-on-fail circuitry immediately detect and display any functional failure. IC clips and probes speed precise isolation of the board fault.

The new 3010A compact is a fully program-compatible unit which is ideal for field service as well as low volume production.

Circle 34 on reader service card

Let's face it. Modern circuit boards are fast becoming beyond the ken of mortal man. That's why we've decided to abolish manual labor when it comes to automatic logic testing.

#### **PUSHBUTTON PROGRAMMING**

With our new 3000 Series, test program pin assignments are made with the flick of a forefinger on an innovative pushbutton program panel.

A mind-boggling array of over 700 different test sequences, initialization signals and bi-directional bus assignments can all be conveniently keyed in

**FLUKE** TRENDAR  
a subsidiary of John Fluke Mfg. Co., Inc.

500 Clyde Avenue, Mountain View, CA 94043, (415) 965-0350, TWX 910-379-6573. Europe, Fluke (Nederland) B.V., P.O. Box 5053, Tilburg, Netherlands, Tel. 013-673973, Telex 52273. U.K., Fluke International Corp., Garnett Close, Watford, WD2 4TT, Tel. Watford (0923) 33066, Telex 934583. Fluke (Deutschland) GmbH, Imhofstrasse 3, 8 Munchen 40, Tel. 09-4989369086, Telex 5216087. Fluke (Deutschland) GmbH, Meineckestrasse 53, 4-Dusseldorf, Tel. 09-49211450831, Telex 8585576



# Electronics newsletter

---

## C-MOS standard market stabilizing

The C-MOS marketplace is apparently beginning to firm after a disastrous 18 months that saw volume dip and prices cut practically in half. Both RCA's Solid State division, which has about 45% of the market, and Motorola Semiconductor agree that things are getting better.

At RCA, C-MOS marketing manager Peter Jones says, "**Price stability has crept back in and there is significant new design activity.** And lead time is going out from paperwork time to four to six weeks." His opposite number at Motorola, Wolf Loescher, points out that "booking" levels are now three to five times higher than they were a year ago. There may even be shortages cropping up here and there as demand builds." Jones and Loescher also note that prices are rising from a low of 9 cents per gate to about 12 or 13 cents.

## Interdata, Varian drop prices on new minis

While mainframe manufacturers such as IBM and Sperry Univac have been raising prices, a pair of minicomputer manufacturers have created a stir by doing the opposite. Interdata Inc. of Oceanport, N.J., has a new 16-bit mini, Model 6/16, that is **priced below Digital Equipment's PDP-11/04 and Data General's Nova 3** [*Electronics*, Oct. 16, p. 32]. The 6/16, with 4 kilowords of MOS memory, is priced at \$1,364 in quantities of 100, or \$2,200 in quantities of one. The 11/04 costs \$1,621 and \$2,495; the Nova 3, \$1,612 and \$2,600. And, demonstrating how much the MOS memory can reduce costs, the 6/16 with 4 kilowords of core memory is priced at \$1,736 and \$2,800, respectively, in similar quantities.

Varian Data Machines, Irvine, Calif., is making an even bigger point out of the price reductions possible with semiconductor memory. The company's new V76 computer system with 128 kilowords of semiconductor memory is priced at \$28,450, **which the company says is a whopping \$45,550 less than an earlier computer with the same amount of memory in core.** "Memory is the key," the company says, because it can put 64 kilowords of 16-pin, 4,096-bit MOS RAM devices on a single printed-circuit board at a cost per bit of only 0.85 cent.

## U.S. may ease export restrictions on some items

A major program is underway to permit the export of more electronics products to the Soviet Union and other Eastern Bloc countries. Betsy Ancker Johnson, assistant secretary of Commerce for science and technology, says the Department of Defense Science Board **hopes to cut several items now considered "strategic"** from its embargo list.

"This list is just too long," she observes. As a result, she adds, the joint committee made up of representatives of the Commerce, Defense, and State Departments, which administer U.S. export controls, is facing a growing backlog of applications from U.S. electronics firms wishing to export high-technology products to Eastern Bloc countries.

## HP divides calculator division, hints at changes

Hewlett-Packard Co. has split its Calculator Products division in two and is **hinting at more dramatic changes over the next few months.** The Calculator Products division will be responsible for the development, manufacture, and marketing of major calculator mainframes. The new and as yet unnamed division will initially handle the manufacture of "certain peripheral products." The Advanced Products division is unaffected.

Robert E. Watson, former engineering manager of the old division, will

be the general manager of the unnamed division. Thomas Kelley will continue as general manager of the restructured Calculator Products division. Reason for the split, according to George Swann Jr., general manager of the calculator products group, is a need "to accommodate the increasing growth and diversity of our desk-top programable product line."

## **Hallicrafters sold, to re-enter the CB market**

Once a leader in the citizens' band radio business, Hallicrafters will be back in the market next spring with five new models, including a base station and single-sideband unit. The firm dropped its CB line in the late 1960s, when Northrop Corp. acquired it, **but was sold this month to 11-month-old Breaker Corp.**, an Arlington, Texas, manufacturer of CB antennas and accessories that expects to see 1975 sales top \$8 million.

Early models will be assembled at Hallicrafters' Kansas City plant on Japanese chassis, but the firm will manufacture the entire line domestically by late summer, says Darrell Fletcher, the former Radio Shack official who founded Breaker. Hallicrafters' amateur radio gear also will be reintroduced next summer, and the firm will continue to build paramilitary communications equipment for international markets.

## **Rockwell seeking I<sup>2</sup>L designers**

The Microelectronic Device division of Rockwell International Corp., **signaling the start of its effort in integrated injection logic**, is looking for circuit designers and process engineers. This confirms a prediction made earlier this year [*Electronics*, Aug. 7, p. 18] by vice president and general manager Charles V. Kovac that the Anaheim, Calif., division would enter the bipolar product area.

At the same time, RCA Corp. is actively pursuing I<sup>2</sup>L development work at its Solid State division in Somerville, N.J. While Richard A. Santilli, division vice president for bipolar and special products, and Richard L. Sanquini, director of bipolar ICs, would not discuss the work in detail, Sanquini gives some hint about the direction the work is taking when he says: **"The one area I'm excited about is the linear/digital concept.** The all-digital I<sup>2</sup>L process requires continued heavy development in both metal interconnect and the high-frequency performance of the inverted npn transistor to make it a viable production process. The winners in I<sup>2</sup>L will be determined by how well they execute the various solutions to this problem."

## **Four-Phase Systems using 16-k MOS RAMs in new computer**

Four-Phase Systems Inc. of Cupertino, Calif., says it is making the industry's first computer using 16-k RAMs. The n-channel silicon-gate MOS devices measure about 220 mils on a side and are in a 16-pin DIP. The device is being used in the company's NP/80 16-bit computer with up to 256 kilobytes, including error correction, on a single printed-circuit board. **Initial deliveries of the machine are scheduled for the first quarter of 1976.** The chips are designed and made by Four-Phase.

The NP/80 processor is being aimed at hierarchical network structures in which up to 84 local display terminals can access an NP/80 data base of up to 270 megabytes of disk storage. Monthly rental for a system with 256 kilobytes of memory, 67 megabytes of disk storage, and support for one wideband communications line is \$1,419 on a 42-month lease.

What's new in solid state...

# Join the SOS Revolution. Just \$17.76.

## RCA fires it up with a 150 ns, 4 mW static RAM.

We're ready if you are! RCA is making good on the speed/power promise of silicon-on-sapphire: we've got the production, the product, the price. In fact, for a limited time, RCA offers its 1024 x 1-bit SOS RAM for a revolutionary price of \$17.76. The MWS5001 gives you 150 ns with only 4 mW of operating power.

Key to 5001 performance is our SOS structure with a self-aligned silicon gate. It virtually eliminates overlap of the gate onto source and drain areas. Which greatly reduces interelectrode capacitances compared to aluminum gate SOS.

### Cost effectiveness

Our revolutionary low introductory price of \$17.76 is only part of the cost story. When all factors are considered —

Type	Technology	Voltage	Access from address	Power @ 1 MHz
RCA MWS5001	SOS/CMOS	5 V	150 ns	4 mW
Compet. 6508	Bulk CMOS	5 V	400 ns	8 mW

including capability, power and parts-count savings — overall system savings can turn out to be even more dramatic. Since it's static, the 5001 saves on parts by requiring no memory refreshing, no clock, no pulsing. And it has a 3-state output, which allows power savings from common busing.

### Design flexibility

CMOS on sapphire gives the 5001 wide usefulness, with its  $-20^{\circ}\text{C}$  to  $+85^{\circ}\text{C}$  temperature range and  $+4.5\text{ V}$  to  $+6\text{ V}$  voltage range. Bear in mind, too, this is only an early shot in the SOS revolution. Following the 1024 x 1-bit RAM, RCA will announce one with 256 x 4-bit organization. Then, higher performance versions of both, providing even faster access

time. To less than 100 ns. With very little increase in power. You'll also have a choice of open drain or 3-state output.

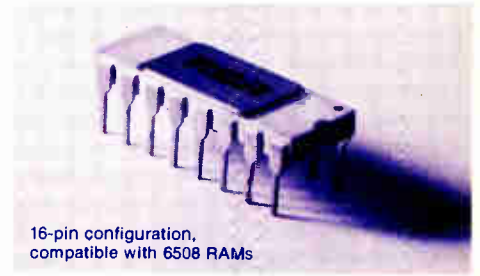

16-pin configuration,  
compatible with 6508 RAMs

For more information and your \$17.76 samples, use the coupon below.

# RCA

## JOIN THE REVOLUTION NOW!

To purchase sample(s) of the MWS5001 for \$17.76 each, send this coupon to RCA, Box 3200, Somerville, N.J. 08876; or check your local distributor. In Europe, mail the equivalent of \$17.76 each to: RCA Solid State, Sunbury-on-Thames, England TW16 7HW.

This coupon good for up to 10 RCA MWS5001 Random Access Memories. Offer good until January 31, 1976.

Please send me \_\_\_\_\_ of your MWS5001 for \$17.76 each. Enclosed is my  check  money order for \$\_\_\_\_\_  Please send me more information only.

Name \_\_\_\_\_ Title \_\_\_\_\_

Firm \_\_\_\_\_

Address \_\_\_\_\_

City, State, ZIP \_\_\_\_\_

Distributor \_\_\_\_\_

E 1127

## RCA. First house in CMOS adds SOS.

Circle 37 on reader service card



# LFE

## FIRST IS OUR MIDDLE NAME



### FIRST UL RECOGNIZED DIGITAL PANEL METER FIRST SEVEN-SEGMENT DPM DISPLAY FIRST DIGITAL CONTROL METER

In 1968, LFE introduced the first DPM with a seven-segment planar display—our Model 4304. Ever since, we've been first with major benefits for DPM users. Not gimmicky, small details, or clever made-up words but substantial improvements to meet real needs, like these:

**UL-RECOGNIZED**—The LFE Model 4360, 2½ digits, is the first DPM to qualify as a component in the UL category Electrical and Electronic Metering and Testing Equipment. For certifiable safety in commercial, industrial, and medical applications.

**DIGITAL CONTROL METER**—The LFE Model 4354-K has 2 push-to-set continuously variable control points for 0.2% resolution in alarm or control of voltage, current, resistance, temperature and most other real world variables.

**DUAL CONTROL COMPARATOR**—The LFE Model 4355 provides full four digit HI/LO comparison with BCD input from any DPM,

counter, or other parallel-output device. Relay and logic output, front-panel LED indicators, AC or DC powered and latching options.

**FIRST IN RELIABILITY**—A lengthy elevated-temperature burn-in and exhaustive computer controlled checkout guarantee the most reliable DPM products available anywhere.

Our nationwide network of representatives, distributors, and modification centers stands ready to serve you. For leadership in value and quality in digital instruments, look to LFE . . . **FIRST**. For information contact LFE Corporation, 1601 Trapelo Road, Waltham, MA, 02154, (617) 890-2000

**LFE**  
CORPORATION

Process Control Division

## Calculators supply answers audibly or in braille

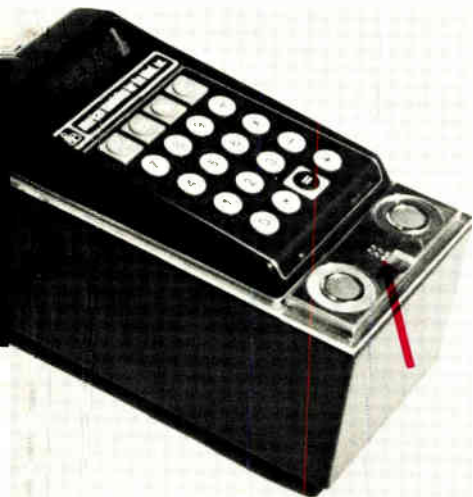

Foundation for Blind also offering light detector that can differentiate between paper-money values

Electronic versions of the human eye are still in the future [*Electronics*, Jan 24, 1974, p. 81], but less ambitious electronic devices can help the blind today. In that belief, the American Foundation for the Blind has developed two electronic calculators—one with a braille output and the other with a voice output—plus a paper-money identifier to aid some

of the 1.7 million or more visually handicapped U.S. students and workers.

To produce the braille calculator, the foundation's engineering division took a standard portable five-function calculator with a floating decimal point and equipped it with a single braille cell. Within the cell is a two-by-three array of six solenoids underlying a similar array of small pins. Energizing the solenoids forces the pins above the cell surface in various patterns that represent the decimal point and the numerals 0 to 9 in braille.

To activate the cell, the blind person simply presses a read button on the front of the calculator. This action starts transferring the contents of the visual readout, one decimal place at a time, to the braille cell. If a number is repeated on the visual display, the set of pins representing it momentarily submerges, before reappearing as the next number in the sequence.

**Speed control.** A control feature enables the user to regulate the speed at which the braille digits follow each other. The adjustment allows anything from a half to four seconds per digit. "Some 10% of the blind people in the U.S. read braille," says Loyal Eugene Apple, executive director of the foundation, "and some read faster than others, so we thought the speed control would be appropriate."

The battery-operated, rechargeable braille calculator is available from the foundation for \$345. Apple says the foundation will "make an effort" to offer the calculator worldwide.

The audible calculator, called



**Touch or sound.** Calculators for the blind are designed to activate either a basic six-dot braille matrix, arrow, top, or, in the model below, a recorded 24-word vocabulary.



Speech Plus, was developed for the foundation by Telesensory Systems Inc. of Palo Alto, Calif. Priced at \$395, the unit has a 24-word vocabulary built into a speech-generating read-only memory custom IC that announces every entry and result. It has six basic functions, including square root and per cent, accumulating memory, automatic constant, a change of sign key, a floating decimal point, and an eight-digit visual display.

**Instant replay.** The speech key can be pressed repeatedly to announce what is on display without initiating further calculations. Apple says the audible calculator will be available from the foundation next February.

The pocket-size paper-money identifier uses an infrared sensor to

detect the dark and light areas of a bill of any denomination and emits a low-pitched tone for dark areas and a higher-pitched tone for light areas. An instructional tape recording is supplied with the device to teach the operator to identify the tone pattern that indicates the value of a particular bill.

Originally produced with the support of NASA's biomedical-application program, the unit is now manufactured by EMR Ltd., Los Angeles. A switch converts the paper-money identifier into a light detector. Operated in this mode, the unit is sensitive enough—according to Apple—to detect the lights that blink on multiple-button phones, for example, or determine whether or not a coffee pot's ready light is on. It is priced at \$125. □

---

## Communications

---

### Telephone group claims interconnect competition will ease Bell capital needs

Open competition in the U.S. telecommunications terminal market could lead to a 50% penetration in 1980 by equipment makers not affiliated with the Bell System, said rival vendors of terminal equipment to the Federal Communications Commission recently. They maintain that this competition could go far toward resolving American Telephone & Telegraph Co.'s "financial crisis," cutting its capital costs by \$600 million to \$800 million annually over the next five years.

That argument by the North American Telephone Association, whose members represent vendors of terminal equipment, was filed in mid-November as part of FCC Docket 20003 examining the economic impact of telecommunications competition and was cited by NATA president Richard Long in later testimony before the House Interstate and Foreign Commerce Committee's communications subcommittee. The new argument proved "intriguing" and "worth more examination" to staffers of the

subcommittee and the FCC Common Carrier Bureau after preliminary review.

In its detailed financial analysis, NATA asserts that nearly one fourth of AT&T's capital spending goes for terminal equipment and related facilities. "Prudent Bell management would dictate steering away from an objective to serve every . . . requirement in the telephone system," NATA contends. Moreover, the NATA study declares that the Bell System's terminal-hardware business isn't profitable because of "disproportionately heavy expenses in maintenance, marketing, installation, moves, and other areas."

**Reverse.** The long-standing AT&T contention that loss of terminal business will cause higher telephone charges is wrong, says NATA. "If the present policies of Bell management are followed to their logical conclusion: (a) rate payers will be drowned in a record-breaking flood of rate increases . . . through 1980; and (b) capital markets will be cannibalized by AT&T's hunger for new financ-

ing," the study says.

Asked to comment on the NATA charges, an AT&T spokesman in Washington says company policy precludes public comment on ongoing FCC inquiries before filing a response with the commission.

The NATA study is one more weapon for advocates of open competition in the market for terminal equipment and its deregulation by the FCC. Most of the proponents, as well as a heavyweight roster of AT&T representatives, addressed the issues of competition, interconnection and deregulation at six days of hearings in November on Federal telecommunications policy before the House Communications subcommittee, chaired by Massachusetts Democrat Torbert Macdonald.

The Macdonald hearings were ostensibly held to consider H.R. 7047, a bill introduced last May to amend the Communications Act of 1934, which created the FCC, so that the commission could suspend the implementation of tariffs for a year instead of the present five months. AT&T and other telephone companies oppose the bill, saying it would extend rather than diminish the lag in FCC rulings.

Congressional advocates argue that the bill would prevent predatory pricing by telephone companies by permitting new lower tariffs from taking effect automatically before an FCC decision is made.

**Competing.** Calling the hearings "something of a crucible for common-carrier-competition policy," John Eger, acting director of the White House Office of Telecommunications Policy, hit FCC decisions favoring competition as halfway measures that have produced "regulated competition, which is another way of describing a Government-imposed allocation of the market." Eger urges deregulation "of all terminal equipment."

AT&T's hearings presentation by senior vice president Edward B. Crosland criticized the FCC's plan for interconnection of certified equipment without an AT&T protective module as one that "will require substantial regulatory supervision,



at significant expense to both taxpayers and consumers, and could well delay, rather than expedite," introduction of new equipment. □

## Consumer

### Flexible circuit turns watch on/off

It may not be surprising that Sinclair Radionics Ltd., having established a solid reputation in packaging pocket calculators, would apply the same production principles to its new Black Watch now going on sale for about \$49.95 in the U.S. and United Kingdom. But the three-function watch, built around an integrated-injection-logic chip inside a black plastic case, employs a novel application of flexible circuitry to optimize use of the space inside the tiny case and minimize production steps.

"We think we have a unique approach," states Mike Pye, R&D chief at Sinclair's plant in St. Ives, Cambridgeshire, England. "No watch that we know of adopts the same principles."

Basically, the flexible circuitry is the switch that activates the light-emitting-diode display and provides the battery contacts and interconnections from the battery to the watch module itself. And, unlike many watches, the batteries can be placed alongside the watch module to get a slim styling, Pye says.

**Wraparound.** Most watches employ somewhat cumbersome switches connected to external knobs. But in the Black Watch, the flexible circuitry wraps around the watch module much like a sideways letter C, as shown in the photo, top, right. The two straps with the switch contacts rest on the dual in-line I<sup>2</sup>L package, which acts as a structural support, Pye explains. Pressing the appropriate area on the top of the case, which has a thin nickel conductive layer, closes a narrow gap and simply shorts the contacts to light up the red light-emitting diodes.

Simplifying the circuitry reduces the production steps so that semi-skilled workers with soldering irons can assemble the watches after a few days of training. Fewer soldering steps than for comparable watches are needed to join chip, trimmer, crystal, and tantalum capacitor to the module and to the flexible circuitry, Pye says. By January, 5,000 watches are expected to be turned out each week.

Also, using I<sup>2</sup>L technology by ITT Semiconductors, Foothill, Kent, offers less complexity and smaller geometry than a complementary-metal-oxide semiconductor chip. And "you have a direct digital drive for the LEDs without any penalty in the chip area," points out company president Clive Sinclair.

**Optimism.** Overall, Sinclair optimistically predicts he'll capture 30% of the digital watch market in the UK, which he estimates at 750,000 units in 1976. And claiming his calculator sales are rising, Sinclair expects calculators and watches to be equal income producers for his \$15 million-a-year operation.

But will Sinclair come a cropper with his plastic watch introduced too late for large Christmas sales? "It's too early to tell," he chuckles. So far, the reactions have been to the contrary, he says, mentioning a trial order from Macy's and an unprecedented response to a mail-order ad offering a kit for \$29.95.

Despite his optimism, however, many think his black plastic watch

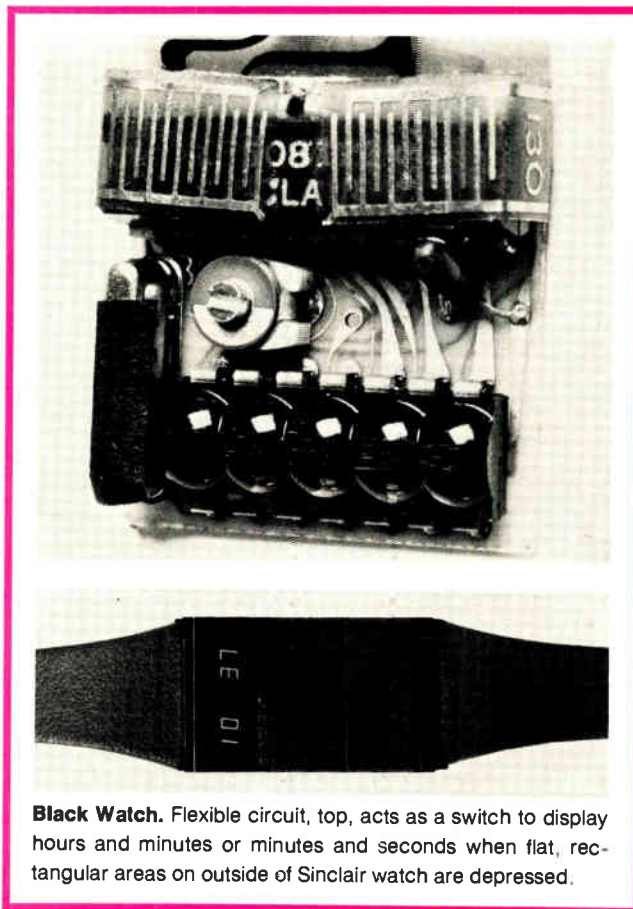

**Black Watch.** Flexible circuit, top, acts as a switch to display hours and minutes or minutes and seconds when flat, rectangular areas on outside of Sinclair watch are depressed. □

looks, in a style-conscious market, like a kid's toy. "We have the right watch; others have the wrong one," asserts Sinclair. "People buy for the excitement of them. They find out later that it's a better way to tell time." □

## Government

### Advanced avionics to track smugglers

Narcotics smugglers along the southern U.S. border will run into fiercer opposition from U.S. Customs Service officers next year if the service's plans to deploy new airborne electronics work out. A key element in the plans is Project Linebacker, a \$5 million program that uses air and ground sensors to detect, track, and intercept smugglers.

Linebacker's principal mission since its 1974 beginning has been in

the development of a new, faster and better-equipped light plane for Customs Service air support pilots. The first of these, a twin-engine Cessna 500 Citation turbojet, is scheduled to go into operation by mid-April of next year, according to Treasury Department officials. "If we can get the money from Congress, we would like to have a whole fleet of them," says one officer.

**Military avionics.** Linebacker officials see its success resting in good part on the \$2 million worth of military avionics it will carry. This includes a modified Hughes Aircraft AN/APS-123 search radar used by the Navy aboard its early S-2D anti-submarine warfare planes.

The \$1 million radar will be linked to a Texas Instruments forward-looking infrared sensor. Costing about \$250,000 and originally developed for antisubmarine warfare, the unit will enable pilots to spot smugglers' ships or planes up to a mile away, day or night.

The Linebacker system will be the first specifically designed for Customs' task using modified military avionics and commercial aircraft. Until now, officials reluctantly acknowledge, the Treasury Department program has been obliged to use a broad mix of castoff equipment picked up from the military surplus inventory.

**Analyst.** Working with Customs on the engineering side of the Linebacker program has been the Naval Air Development Center, Warminster, Pa. NADC has been analyzing systems and tactics and helping to develop requirements for the airborne equipment. It has also tested modifications of various acoustic, magnetic, and seismic ground sensors originally developed for use along the northern border of South Viet Nam.

The need for Linebacker, however, is still not as clear to the Congress as it is to the Customs Service or even to organized crime. Sighs one Customs official, "The syndicate operates with good aircraft and top-of-the-line avionics because they are bringing in hard stuff like heroin where the profits are very big." □

---

## Computers

---

### CDC urges trade with East Europe

The United States will get no share of the projected \$1.8 billion computer equipment market in the Soviet Union and Eastern Europe over the next two years unless it changes its "confused and over-restrictive" export policies on high technology.

That is the judgment of Control Data Corp. chairman William C. Norris, who brought an IBM-compatible East German computer to Washington in November so U.S. officials could "kick the tires and see for yourself that those countries do have significant computer technology." Norris also proposed a new five-year cooperative effort by American government and industry to foster détente with the Soviet Union through a \$25 billion program of technology exchange.

According to CDC, officials from the departments of Commerce, Defense and various intelligence agencies were impressed by the Ryad-series ES-1040 system [*Elec-*

*tronics*, Sept. 25, 1972, p. 72], imported from its German Democratic Republic manufacturer, Veb Robotron-Elektronik of Dresden. Robotron director Fritz Wokurka says 20 of the medium-to-large systems are in operation in Czechoslovakia and estimates annual production at 50 systems.

In comparing the system design and operation to U.S. counterparts, CDC's R.A. Koenig, manager of systems engineering for the Peripheral Subsystems division, ticked off the following points:

- The ES-1040, "quite modern by U.S. standards," is built with integrated transistor-transistor logic, is faster than the IBM 370/145, and executes the IBM/360 instruction set.
- The core memory, having an access time of 450 nanoseconds, is somewhat slower than the processor.
- The peripheral equipment "shows a general lag" behind U.S. products.
- Testing showed the equipment to be "generally very reliable."

**The system.** The first ES-1040 was completed in late 1972, three to four years after a similar machine could have been built in the U.S. with then-available ICs, according to CDC. The system being shown by CDC consists of:

- A central processor with 256 kilobytes of core memory, one-byte multiplexer channel, one selector channel, and a console.
- Disk subsystem, consisting of a controller and two disk drives, made in Bulgaria, each with a capacity of 7.25 megabytes.
- Tape subsystem, consisting of a controller and two nine-track, 800-bit-per-inch tape units with a speed of 75 inches per second.
- Card reader that operates at 500 cards per minute, and a card punch that operates at 120 cards per minute. Both were made in the USSR.
- Line printer with a speed of 900 lines per minute.

The CPU, which includes 16 general-purpose 32-bit registers, four floating-point 64-bit arithmetic registers, and a read-only memory, has an instruction-look-ahead capability that allows processor functions to be

### Calibrating cells

The National Bureau of Standards in Washington has developed a calculator-based system that promises to reduce the cost and turnaround time for calibrating standard dc voltage cells. Such cells are routinely sent to NBS by metrology laboratories.

The 16 measurements required to characterize standard cells, along with statistical calculations and a printout of a report, take about 12 minutes with the new system, compared with 18 to 20 minutes just to make the measurements alone by the previous, manual methods. Robert E. Kleimann, an electrical engineer at NBS' Electricity division, predicts a reduction of 20% to 25% in the present 2-week to 2-month turnaround times.

# Announcing..... A New Portable from Tektronix

## The TEKTRONIX 455

- 50 MHz bandwidth. ● Dual trace. ● Delayed sweep. ● Sweep rates to 50 ns/div with 2% accuracy (5 ns/div with 3% accuracy.)
- Vertical deflection factors to 5 mV/div with 3% accuracy.
- Large 8 x 10 cm CRT display ● \$1695.

And that's not all. The 455 offers this performance combined with more convenience features to speed measurements and reduce human error. All at a budget-conscious price. Measurements are made easier and faster with trigger view; trigger hold-off; lighted deflection factor indicators; and a functionally laid out, easily understood control panel.

Servicing the 455 is faster and less expensive. Although monolithic in design, the instrument contains easily removable vertical amplifier and time-base modules for ready access to all components. That means quicker repairs and less down time. And the entire unit is housed in a shock-resistant, reinforced plastic case to withstand rough handling in factory or field environments.

Optional battery pack provides operation at remote sites and eliminates noise due to line transients. The 455 will operate up to 4 hours without a battery recharge. When AC power is available, the battery pack can be detached to reduce weight.

For specialized applications, the 455 can be equipped with emi protection or tv sync separator.

The 455 is the latest entry in the Tektronix 400 Series of Portable Oscilloscopes. Other dual channel delayed sweep units offer:

- 5 mV/div sensitivity at 100 MHz (the 465)
- 2 mV/div sensitivity at 200 MHz (the 475)
- 5 mV/div sensitivity at 350 MHz with simultaneous displays of intensified and delayed waveforms (the 485)
- Unique single-shot storage to 100 MHz (the 466)

**For complete information on how the 455 Portable Oscilloscope delivers the performance, versatility, and cost-saving effectiveness you need, contact your local Tektronix Field Engineer. Or write: Tektronix, Inc., Beaverton, Oregon 97077, for the new 455 applications and specifications brochure. In Europe, write Tektronix Limited, P.O. Box 36, St. Peter Port, Guernsey, Channel Islands.**

U.S. Sales Price FOB Beaverton, Oregon



**TEKTRONIX®**

committed to  
technical excellence

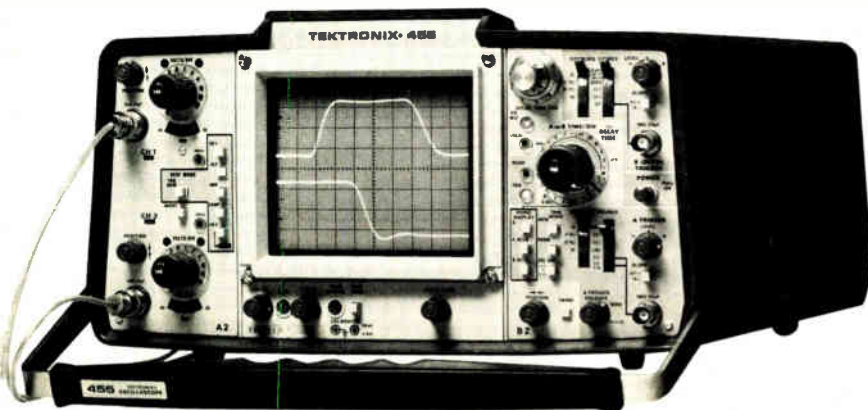



overlapped if so desired.

CDC's Norris says tests of the ES-1040—which can run IBM software and accept CDC plug-in peripherals—show it to be “three to four times faster than the IBM 370/145 in solving scientific problems” and equal in commercial applications. He therefore contends that Soviet military capabilities could not be enhanced by shipping equivalent U.S. computer hardware to East Germany or the Soviet Union. Yet a U.S. export license to do so takes six months to obtain, he observes ironically—a delay he and other CDC officials attribute to the Federal bureaucracy's ignorance of East European computer technology and the resultant excessive caution in the Pentagon about high-technology exports (see p. 60). □

### Industrial

## Process control gets stand-alone items

The announcement by Honeywell Inc. of microprocessor-based controllers and cathode-ray-tube terminals brings to the designer of process-control systems a long-awaited tool [*Electronics*, Nov. 13, p. 25]. This is, namely, the ability to distribute relatively low-cost stand-alone process controllers and display stations throughout a plant and tie them into a hierarchy of more costly computers.

Although digital electronics and hierarchal systems have, until now, been available, they have been generally offered separately, not as a complete package. Thus, for example, the Bristol division of Acco, Waterbury, Conn., earlier this year introduced a stand-alone microprocessor-based controller, but not as part of a computer-based system.

Meanwhile, the giants of the process control field, like Foxboro Co., Taylor Instrument Process Control, Fisher Controls Co., and Leeds & Northrup Co., offer either supervisory control systems in which a central computer monitors analog



**New look.** Honeywell's new TDC 2000 process-control system connects microprocessor-based controllers and stand-alone CRT terminals to central computers via coaxial cable.

controllers and adjusts their set points, or systems using direct digital control from a central computer of such process devices as valves and solenoids.

**Modular.** Honeywell's new off-the-shelf TDC 2000 links controllers and display stations via coaxial cable to one another or to a central process computer.

“The microprocessor adds advanced control to a lower level in the system than ever before,” says W. Edward Williamson, manager of systems development at Honeywell in Ft. Washington, Pa. Such a system of controllers can function without a central computer. But even if a central computer is installed and should fail, operations out in the plant need not be affected. And with distributed control, a failure in one part of the system does not cause the entire system to shut down; each loop continues to function independently. Distributed control also frees the computer for management information tasks such as the extensive data logging necessary to implement government pollution-control requirements imposed on many of the process industries.

Moreover, the system can be designed without the traditional central instrument panel; instead parameters may be called up as needed and displayed on the CRT terminals where an operator may also adjust set points and change modes of operation.

According to Williamson, the

Honeywell system can be configured into everything from a simple eight-loop process controller up to a sophisticated computer-based system for a large process plant. In the latter case, the system uses either the HS 716 or HS 4400, process computers acquired by Honeywell from General Electric Co. in 1974.

When Honeywell decided in 1972 to add microprocessors to implement stand-alone capability in the controllers and CRT stations, the amount of control that was needed called for a 16-bit machine. But at that time, there were no 16-bit microprocessors on the market. So Honeywell began a development program with the Microelectronics Group of General Instrument Corp., Hicksville, N.Y. which led to GI's announcement last February of CP 1600, an n-channel metal-oxide-semiconductor chip. The device processes data in two serial 8-bit bytes, in order to use the silicon area efficiently, but has a 16-bit address and data exchange with external devices [*Electronics*, Feb. 20, p. 25].

**Algorithms.** A special feature of the controller is the 28 control algorithms that are stored in core memory and which can be selected at any time, on-line, merely by entering a code through the controller keyboard. The operator-selectable algorithms will permit changes in control strategy that previously called for new hardware.

“Honeywell's major thrust will be in the chemical, petroleum and pe-

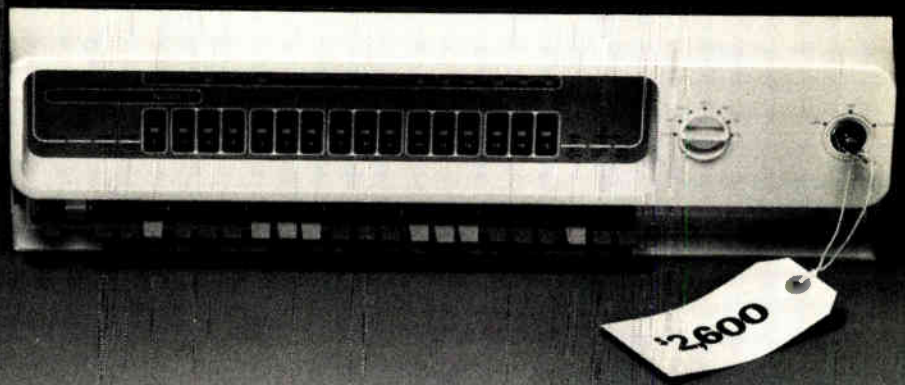

## Has your \$500 micro ended up costing more than our \$2,600 mini?

If you've had to spend a lot of money on a low priced micro, you may be in a position to appreciate the cost advantages of a higher priced computer.

Our \$2600 Nova 3.\*

When you buy a Nova 3, you don't have to put as much into it to get it to do your job.

You don't have to create your own operating systems. Nova 3 is software compatible with our other Novas. So you get to use all the existing Nova operating systems, language processors and utilities.

And you don't have to worry about performance. Nova 3 executes instructions in 700 nanoseconds using MOS memory. And its sophisticated architecture lets you use up to 128K Words with the optional Memory Management Unit.

You don't have to buy more

computer than you need. Nova 3 has the broadest range of compatible configurations you can get in an OEM minicomputer line. There's a 4 slot Nova 3. A 12 slot Nova 3. (It has an optional expansion chassis that gives you 12 more slots of I/O.) And you can configure multiple processor Nova 3 systems.

You don't have to worry about Nova 3 availability. We're manufacturing virtually every part of the Nova 3. Including the silicon gate N-channel MOS RAM memories. (They're coming from our Sunnyvale, California facility.)

And you don't have to go it alone. Because when you buy a Nova 3, you can get all the support Data General offers an OEM.

Write or call for the Nova 3 brochure. It may persuade you to buy more and spend less. \*\$2600 is the single unit price for a 4K MOS memory Nova 3. Before the OEM and quantity discounts get figured in.

# Data General

## Nova 3: The biggest thing to ever hit the OEM market.

• Data General, Dept. L1, Route 9, Southboro, Mass. 01772 (617) 485-9100. Data General (Canada) Ltd., Ontario. Data General Europe, 15 Rue Le Sueur, Paris 75116, France. Data General Australia, Melbourne (03) 82-1361/Sydney (02) 908-1366.



trochemical industries," states Robert L. Patton, vice president for marketing, "but the system will also have a significant market in the metals and electric utility fields." □

---

### Solid state

---

## Home TV game chip plays six games

The availability of a low-cost semiconductor chip for video games should fan the competitive fire in that growing market (see "Video games adopt the family," p. 82). Using n-channel ion implantation of a metal-oxide semiconductor, General Instrument Corp. is offering a chip for \$5 to \$6 that can operate six different games, says Richard C. Norwood, manager for industrial products at GI's Microelectronics Group, Hicksville, N.Y.

"No one comes close to that price in the microprocessor area," Norwood declares. He reports, perhaps somewhat hopefully, that 1.25 million chips already have been "verbally sold" in the U.S. pending approval of production units by the potential customers. And chips have already been sold to an undisclosed European manufacturer of TV games and sets.

**Low-price possibility.** A rule of thumb is that the integrated-circuit chip represents 20% of the cost of a video game. This indicates that the GI device could lead to a complete system costing between \$25 and \$30. With the manufacturer's markup taken into account, this could yield a game retailing for less than the \$65 to \$75 of today's lowest-priced games. These other units rely on a range of semiconductor technologies, including MOS logic and microprocessor chips, medium-scale integrated transistor-transistor logic, and discrete devices.

Designed and built at General Instrument Microelectronics Ltd. (GIM), Glenrothes, Scotland, the chip, designated the AY-5-8500, can program one-player and two-player squash, tennis, soccer (which could

## News briefs

### Government wants delay in bus antilock brakes

Buses will not be required to have antilock braking systems until 1977 if a mid-November proposal of the National Highway Traffic Safety Administration goes into effect. Reason for the proposed delay is that the system, of which 10,000 were delivered by Rockwell International Inc.'s Automotive Operations division, Troy, Mich., has malfunctioned repeatedly and drawn the ire of bus drivers and system operators [*Electronics*, Nov. 13, p. 29]. The safety agency has asked for industry comments on its proposal, but, in this case the request is a mere formality and the delay should take effect next January 1.

### National settles on secrets, hiring injunction

To avoid a court trial in the Martin J. Alter trade secrets case, National Semiconductor Corp. and Fairchild Camera & Instrument Corp. have reached an out-of-court agreement that has led to a court-approved permanent injunction barring National from using any proprietary information on Fairchild's patented Isoplanar technology, and forbidding the Santa Clara, Calif., semiconductor manufacturer from hiring any personnel from Fairchild's bipolar and emitter-coupled-logic divisions until Aug. 1, 1976. Says National counsel Jack Orlove, "All we're agreeing to do is obey the law." The injunction also allows for the appointment of a special officer to oversee National's development of a high-density bipolar memory.

### Digital Computer Controls barred from Nova 1200

A Delaware court has granted Data General Corp., Southboro, Mass., an injunction barring Digital Computer Controls Inc., Fairfield, N.J., from further use of Nova 1200 or D-116 logic drawings for manufacturing the D-116—a procedure that Data General says violates its trade secrets. The Nova 1200, a 16-bit minicomputer, was designed by Data General in the late 1960s and introduced in 1970, while DCC introduced its D-116 in 1971. Data General claims that DCC obtained the logic drawings for the Nova 1200 through a third party, Minicomputer Systems Inc., Scarsdale, N.Y., and subsequently built the D-116 as a copy of the 1200. DCC admits to "losing a battle, but not the war," since it says the Delaware Supreme Court has agreed to hear the appeal.

### Tube, component orders turn up in September

Dollar value of new orders received by U.S. distributors of tubes and passive and other components (exclusive of semiconductors) rose 28.7% in September, according to the Electronic Industries Association, pushing total orders for the first nine months up 1.8% from the same 1974 period. The dollar values, which were not disclosed by EIA, are not adjusted for inflation. Although distributor orders for tubes of all types rose 19.9% in September from a year ago, orders for the first nine months remain 4.7% under 1974. Orders for passive components—capacitors, resistors, coils, circuit breakers, transformers, and filters—increased only 0.6% in September, with the nine-months total 30.2% below that of a year ago. Orders for all other components, excluding semiconductors, showed the biggest gains, rising 47.8% in September from the 1974 level and putting that category ahead 23.8% for the first nine months.

### Fairchild forms new Microsystems division

Changes at Fairchild Camera & Instrument Corp. have strengthened the hand of James Bowen, vice president and general manager of the Systems Technology group. A new Microsystems division, responsible for everything related to microprocessors, bipolar and integrated-injection logic, and MOS has been formed under David L. Hahn, former general manager of the defunct Communications Equipment unit and placed in Bowen's group. In addition, a memory systems unit has been formed under Chester A. Burns, formerly director of advanced systems development for the IC Group.



# NON-TDI NON-MOCA BASED

POLYURETHANE POTTING, ENCAPSULATING  
AND CASTING COMPOUNDS

FROM  
**CONAP**

**CONATHANE® SYSTEMS** combine unique advantages, easier handling and lower costs in urethanes that cure without voids. Series 2500 Systems are offered in a variety of filled and unfilled formulations to meet virtually any requirement for the potting or encapsulating of modules, strain-sensitive components, coils, transformers, and similar devices. The two liquid components of the Conathane Systems mix readily and change to solids with very low exotherm. Working life is excellent and vapor pressure low. Cure is at room or elevated temperatures. And the resulting solid polymers vary from soft elastomers with a Shore A hardness of 70 to tough and rigid plastics.

#### CHECK THESE OUTSTANDING PROPERTIES

- Non-MOCA\* curing systems
- Non-TDI prepolymers — for minimum health hazard to personnel
- Low stress buildup on sensitive embedded components
- Superior thermal shock resistance
- Excellent dielectric properties
- Reversion resistance
- Low water absorption
- Low shrinkage
- Excellent hydrolytic stability
- Dimensional and heat stability.

**FOR FLAME RESISTANCE** choose the Conathane EN-2540 Series, a new family of filled polyurethane resins specially formulated for general purpose electrical/electronic potting, casting and encapsulating. Provides flame resistance ratings of SE-0 to SE-II when tested in accordance with UL-492. Because of fast gelation and cure at low temperatures, is ideal for high volume production.

**GET MORE FACTS.** Write for Selector Bulletin P-133 on Conathane 2500 Series, or Bulletin P-137 on flame resistant Conathane EN-2540 Series.

\* DuPont Trademark

# CONAP

CONAP, INC. / OLEAN, N.Y. 14760 / 716-372-9650

CONAP (CANADA) LTD.

5200 Dixie Rd. North — Unit 41 / Aerowood Industrial Plaza / Mississauga, Ont.

also be made into hockey), and two rifle-shooting games that use a photocell rifle. Included are such features as automatic scoring on the TV screen, automatic or manual ball service, and "amateur" or "professional" status for bat size, ball angles, and ball speed.

The chip is partially based on the company's experience with a TV-channel display circuit it originally developed for Salora Oy in Finland and also built for Telefunken GmbH and Loewe-Opta GmbH in West Germany and Vanguard S.A. in Spain. Andrew McDonald, GIM's product manager for industrial and consumer products, says the approach in that circuit was "straight-forward," but the trick was "how to make a small chip and retain [layout and design] flexibility."

**Special-purpose logic.** A micro-processor would be too big and too slow for the 2-megahertz clock rate required, McDonald explains. Instead, the 160-mil-square chip is a special-purpose logic system with the equivalent of about 60 flip-flops, more than 520 MOS NOR gates, and 500 bits of read-only memory, he explains. The n-channel chip draws only 20 to 30 milliamperes from a 9-volt power source. A rechargeable-battery-powered game as a separate plug-in box is one possibility, he says, although one prospective customer is considering incorporating a chip-based system in his top-of-the-line TV sets.

Some of the game characteristics are mask-programable, but the scores and players are positioned by the ROMs and the games themselves come from a mixture of the ROMs and hard-wired logic. The ROMs also allow GIM to match the chip with the quality of the TV set and type of broadcasting system used, he adds.

The tennis, soccer, and squash games operate much like the electronic games familiar at bars. For these games, "the minimum to get the chip going would be a 2-megahertz oscillator, two variable resistors, two fixed capacitors, and some interface with the TV circuitry," McDonald says. □

## Packaging & production

### Boards wired fast without wrapping

A new quick-connect method for breadboarding integrated-circuit packages in digital systems could replace the wire-wrapping that's often used. Developed at Bell Laboratories, Holmdel, N.J., the method relies on snapping, or pushing, connecting wire into narrow, U-shaped terminals that have edges sharp enough to pierce the insulation and make connections.

**Faster operation.** The method is much faster than wire-wrapping because stripping and wrapping operations with a special wrapping gun are eliminated, points out Charles Von Roesgen, supervisor of optical-transmitter systems at Holmdel. In addition, the new quick-connect board is more easily repaired and modified than the wire-wrapped one.

Von Roesgen says the quick-connect breadboard method has been used for the past year and a half at Bell Laboratories facilities at Holmdel and Merrimack Valley, Mass. Samples of boards using the method have passed extensive MIL-type environmental tests, he says, and are being used with Schottky transistor-transistor- and emitter-coupled-logic families. Eventually, Bell may seek to license the wiring system to other manufacturers, Von Roesgen says.

"On wrapped boards, repairs or wiring changes at pins with two or three layers of

wires often occur on the lowest layer, resulting in extensive unwrapping and rewiring," says Von Roesgen. "On a quick-connect board, circuit changes are made simply by pulling a wire out of a terminal, then either reinserting it or adding a different wire."

The starting point for the new wiring approach is the usual drilled and plated copper-clad glass-epoxy laminate board with its rows of pin sockets on 100-mil centers that accept dual in-line integrated-circuit packages. Von Roesgen's group uses Minisert socket pins on Kapton strips from Berg Electronics division of Du Pont, New Cumberland, Pa.

One side of the conventional pc board contains half-inch-high pins around which the wire is wrapped. Instead, Bell inserts plastic strips containing the insulation-piercing terminals. Von Roesgen declines to name the manufacturer of these terminals, but points out the pins are similar to those used to terminate flat, or tape, cable.

The pins are high enough to permit two levels of connections with #30-gauge insulated wire. This is fed into the terminal and cut by a special, pencil-sized tool. □

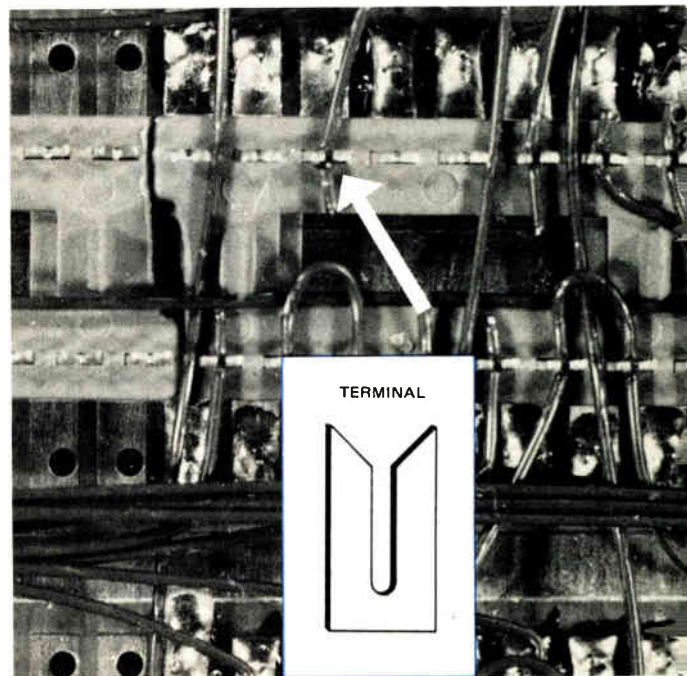

**Cutthroat.** Sharp, narrow edges of quick-connect terminal makes electrical contact on breadboards by piercing wire insulation.



# The Ten Most WANTED INSTRUMENTS



Brush Oscillograph 260

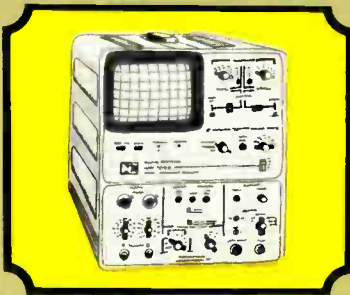

Nicolet  
Digital Storage Oscilloscope



Hewlett-Packard 5302 A



Data Research  
Transient Voltage Recorder

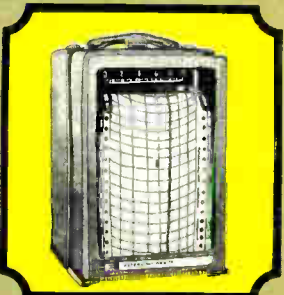

Esterline Angus Chart Recorder

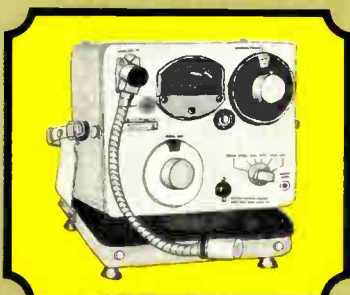

General Radio  
Sound Level Analyzer

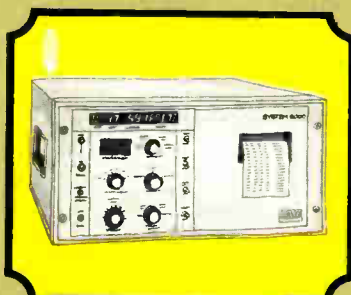

Kaye Data Acquisition System



Tektronix Oscilloscope



GE Chart Recorder

**RENT'EM  
FROM GE**



Texas Instruments  
Temperature Recorder

What's at the top of your Most Wanted List? Quick • rental instruments has rounded up over 5,000 different instruments from all the manufacturers. Our 100 Sales/Service Centers are major-city located, coast-to-coast. And we'll ship

your instruments on the day you call, calibrated to the manufacturer's specs.

Short or long term rentals...money-savers when you want instruments. Want more information? Call 518-372-9900 collect.

**Quick•rental\***  
**instruments**

GENERAL  ELECTRIC

\*Trademark General Electric



# MICROPROCESSING MADE A 16-BIT EASIER

**WITH  
GENERAL INSTRUMENT'S  
SERIES 1600 MICROCOMPUTER**

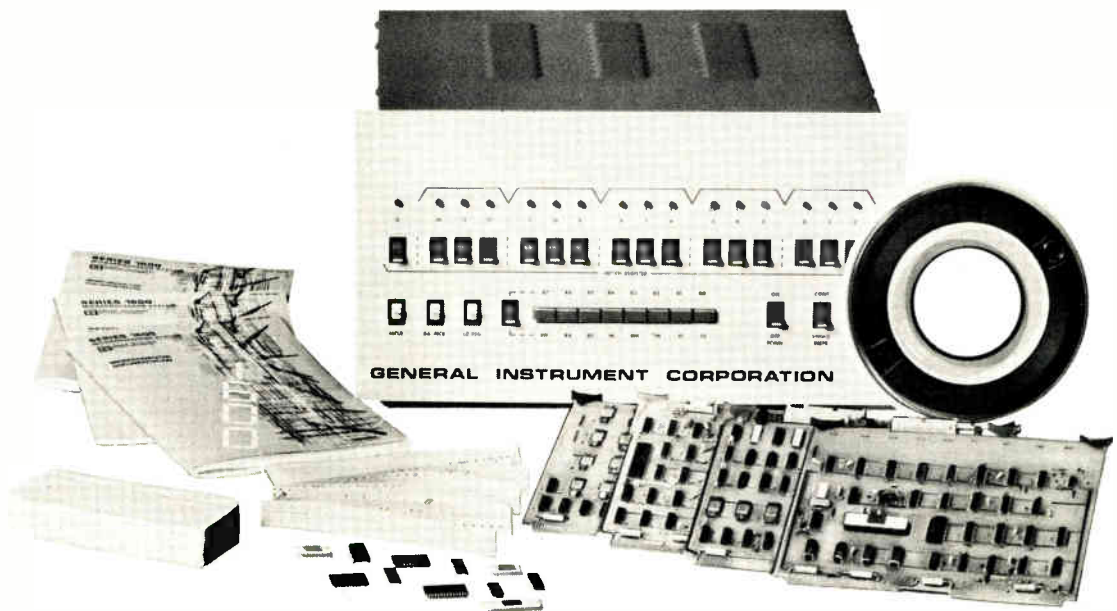

## GENERAL INSTRUMENT'S 16-BIT CP 1600, THE WORLD'S MOST POWERFUL SINGLE-CHIP MICROPROCESSOR

CP 1600 is the first single-chip 16-bit microprocessor with third generation minicomputer architecture. The only one. And, together with its powerful and continually growing support package, provides a new level of microprocessor system capability.

Let's start with the chip. It uses eight high-speed, general purpose 16-bit registers. Twice as many as the competition's 16-bit unit.

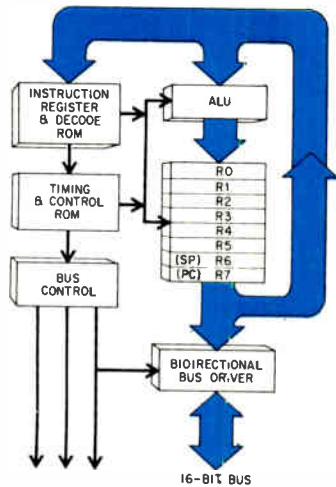

And it's twice as fast. Register to register operations take only 3.6  $\mu$ s. Memory to register and Input/Output operations, only 4.8  $\mu$ s. But speed is only one of the CP 1600's outstanding features. 16-bit word length and four addressing modes permit efficient access to 64K of memory—in any combination of program, data storage, or peripheral devices. So, I/O data can be manipulated just like memory. By all 87 instructions.

## AND ALL THE SUPPORT THAT GOES WITH IT

With a chip like the CP 1600, it's only right to maximize its support. So, we have a complete family of processor

### COMPARISON OF SINGLE-CHIP, 16-BIT MICROPROCESSORS

PARAMETER	NATIONAL'S PACE	GI's CP 1600
# of Stack Levels	10	UNLIMITED
# of Interrupt Levels	6	UNLIMITED
# of General Purpose Registers	4	8
Output Drive Capability	Low Current	1 TTL Load
Direct Address Capability	256	65,536
$\mu$ Cycle Time	2.0 $\mu$ s	0.6 $\mu$ s
REG to REG 16-Bit Add	8.5 $\mu$ s	3.6 $\mu$ s
MEM to REG 16-Bit Add	8.5 $\mu$ s	4.8 $\mu$ s
Input Instruction	8.5 $\mu$ s	4.8 $\mu$ s
Output Instruction	8.5 $\mu$ s	5.4 $\mu$ s
Range of Instruction Times	8.0/14.0 $\mu$ s	2.4/7.2 $\mu$ s

and memory products. ROMs from 4K to 16K. All fully static. All with a single 5 volt power supply. Plus static RAMs from 1K to 4K bits. And there's a continually growing family, including the Programmable Interface Controller chip, coming in early '76.

### Development Hardware

The Series 1600 MicroComputer System (GIMINI™) will simplify your design cycle. It will provide you with a test bed for interfaces and related hardware, as well as full program preparation facility with resident on-line hardware and software debug aids. Peripheral interfaces include TTY, high-speed paper tape equipment and serial line printer. And all card level modules of the Series 1600 system, ranging from the microcomputer module to the memory and I/O modules, are available on an OEM basis for further system integration.

### Complete Software Support, Too

Among the Series 1600's sophisticated program preparation tools are extensive resident software and a fully compatible Cross Software package for popular minicomputers. There's the powerful, easy-to-use, resident On-Line Debug program to aid in check-out. The Text Editor. The Assembler. The Relocating Linking Loader. And coming up . . . the Super Assembler



Language package that allows programs to be coded using high level, procedure-oriented statements. An expanding library of application sub-routines and complete documentation are, of course, available. As are strategically located Test Centers and applications assistance.

The kind of support you'd expect for the world's most powerful microprocessor system. And the kind of support you'll get.

Please send further information on your Series 1600 Microprocessor System

Name \_\_\_\_\_

Title \_\_\_\_\_

Company \_\_\_\_\_

Dept./MS \_\_\_\_\_

Address \_\_\_\_\_

City \_\_\_\_\_

State \_\_\_\_\_ Zip \_\_\_\_\_

Mail to: General Instrument Corp.,  
Microelectronics, Dept. M22,  
600 W. John St., Hicksville, N.Y. 11802

**GENERAL INSTRUMENT CORPORATION  
MICROELECTRONICS**



# DELCO'S NEW FAS HIGH-GAIN TRANSIS

## MAJOR PARAMETER LIMITS

TYPE	$h_{FE}$ @ 10A	$V_{CBO}$	$V_{CEO}$ (sus)	$V_{CE}$ (sat) @ 7A	tf (typical @ 5A)
DTS 515	3.5	300V	250V	5.0V	0.25 $\mu$ sec
DTS 516	4	400V	250V	1.9V	0.25 $\mu$ sec
DTS 517	5	500V	250V	1.6V	0.25 $\mu$ sec
DTS 518	5	600V	275V	1.4V	0.25 $\mu$ sec
DTS 519	5	700V	300V	1.4V	0.25 $\mu$ sec
2N6573	5	500V	250V	1.6V	0.25 $\mu$ sec
2N6574	5	600V	275V	1.4V	0.25 $\mu$ sec
2N6575	5	700V	300V	1.4V	0.25 $\mu$ sec

NPN triple diffused silicon transistors. Packaged in solid copper cases conforming to JEDEC TO-3 outline dimensions.



Our newest high-energy silicon power transistors have increased capabilities over our earlier types in current ratings, gain and switching speeds. These improvements were achieved without sacrificing the useful peak power handling capacity that is characteristic of Delco's transistors.

Full time of these transistors is typically 0.25 microseconds. Their biggest advantage, however, is their high current gain as shown on the accompanying beta curves.

A new characterization feature offered with the DTS-515 series is a graph of capabilities for reverse bias clamped inductive switching. Parameter variables, dealt with in the graph, are voltage, collector current, temperature, and forward and reverse base current. As can be seen in the

" $V_{BE}(\text{reverse}) \geq 5V$ " notation, emitter diode avalanche is recommended under certain conditions.

And, of course, these high-energy silicon power transistors come in Delco's solid copper TO-3 packages to ensure low thermal resistance.

The accompanying curves, charts and circuits tell part of the story. Prices, applications literature and electrical data from your nearest Delco sales office or Delco distributor can supply another part.

But the most important part of the story is how well these new transistors function in your applications.

You can order them today; they're in stock at your Delco distributor's.

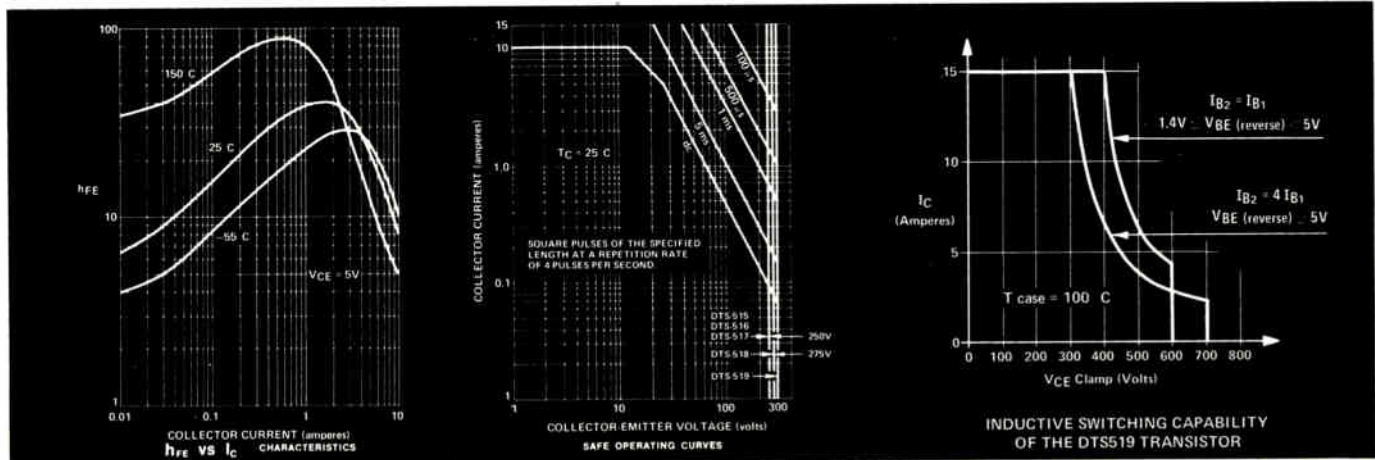



# TER SWITCHING, TORS NOW IN STOCK.

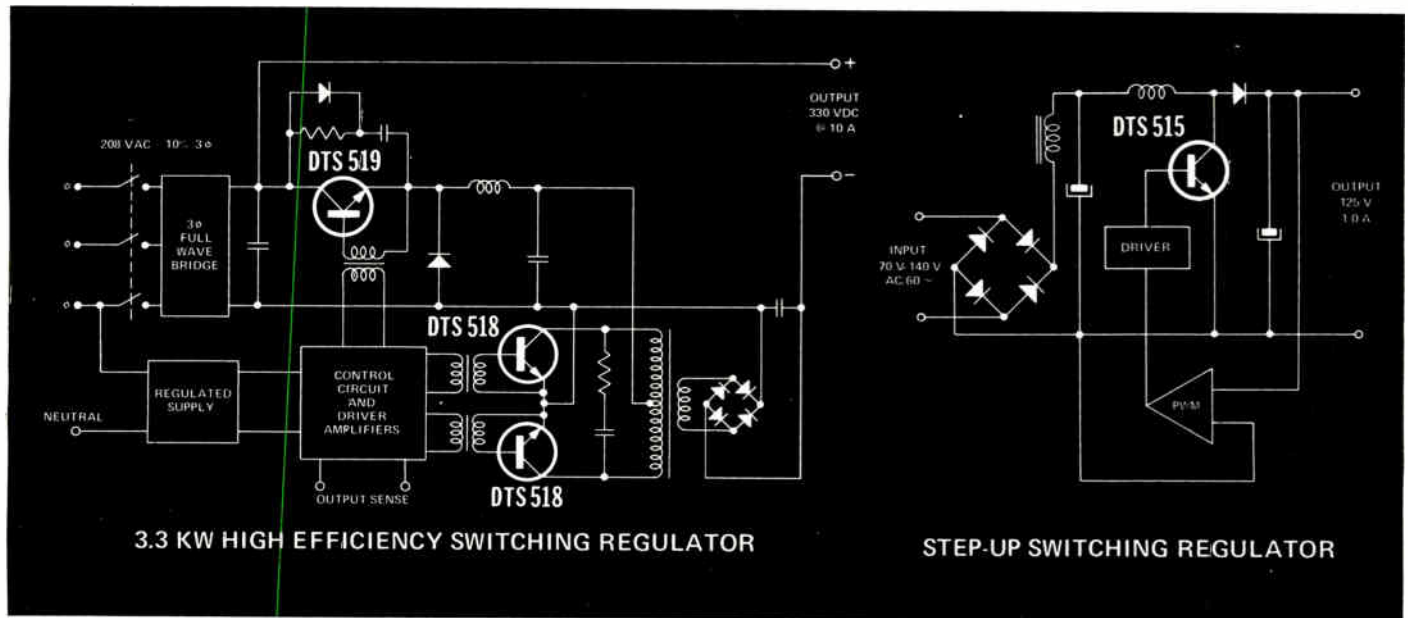

NOW AVAILABLE FROM THESE DISTRIBUTORS IN PRODUCTION QUANTITIES.

**ALABAMA, Birmingham**  
Forbes Distributing Co., Inc.  
(205) 251-4104

**ALABAMA, Huntsville**  
Powell Electronics  
(205) 539-2731

**ARIZONA, Phoenix**  
Sterling Electronics, Inc.  
(602) 258-4531

**CALIFORNIA, Gardena**  
Bell Industries  
Electronics Distributors Div.  
(213) 321-5802

**CALIFORNIA, Goleta**  
R.P.S. Electronics, Inc.  
(805) 964-6823

**CALIFORNIA, Los Angeles**  
Kierulff Electronics, Inc.  
(213) 685-5511

**CALIFORNIA, Los Angeles**  
R.P.S. Electronics, Inc.  
(213) 748-1271

**CALIFORNIA, Palo Alto**  
Kierulff Electronics, Inc.  
(415) 968-6292

**CALIFORNIA, San Diego**  
Kierulff Electronics, Inc.  
(714) 278-2112

**CALIFORNIA, San Diego**  
R.P.S. Electronics, Inc.  
(714) 292-5611

**CALIFORNIA, Sunnyvale**  
Bell Industries  
(408) 734-8570

**COLORADO, Denver**  
Kierulff Electronics, Inc.  
(303) 371-6500

**CONNECTICUT, Norwalk**  
Harvey Electronics  
(203) 853-1515

**FLORIDA, Clearwater**  
Diplomat/Southland  
(813) 443-4514

**FLORIDA, Miami Springs**  
Powell Electronics/Florida  
(305) 592-3260

**ILLINOIS, Elk Grove Village**  
Kierulff Electronics, Inc.  
(312) 640-0200

**ILLINOIS, Skokie**  
Bell Industries  
Electronics Distributors Div.  
(312) 282-5400

**INDIANA, Indianapolis**  
Graham Electronics Supply, Inc.  
(317) 634-8202

**MARYLAND, Baltimore**  
Radio Electric Service Co.  
(301) 823-0070

**MASSACHUSETTS, Billerica**  
Kierulff Electronics, Inc.  
(617) 935-5134  
(617) 667-8331

**MASSACHUSETTS, Newton**  
The Greene-Shaw Co., Inc.  
(617) 969-8900

**MICHIGAN, Livonia**  
Pioneer/Michigan  
(313) 525-1800

**MINNESOTA, Minneapolis**  
Stark Electronics Supply Co.  
(612) 332-1325

**MISSOURI, Kansas City**  
Walters Radio Supply, Inc.  
(816) 531-7015

**MISSOURI, St. Louis**  
LCOMP-St. Louis  
(314) 647-5505

**NEW JERSEY, Cinnaminson**  
Wilshire Electronics/Philadelphia  
(609) 786-8990 (215) 627-1920

**NEW JERSEY, Clifton**  
Wilshire Electronics/New Jersey  
(201) 365-2600 (212) 244-8930

**NEW MEXICO, Albuquerque**  
Sterling Electronics  
(505) 345-6601

**NEW YORK, Binghamton**  
Harvey Electronics  
(607) 748-8211

**NEW YORK, Buffalo**  
Summit Distributors, Inc.  
(716) 884-3450

**NEW YORK, Farmingdale**  
Wilshire Electronics/Long Island  
(516) 293-5775

**NEW YORK, Woodbury**  
Harvey Electronics  
(516) 921-8700 (212) 895-9260

**OHIO, Cincinnati**  
United Radio, Inc.  
(513) 761-4030

**OHIO, Cleveland**  
Pattison Supply Co.  
Industrial Electronics Division  
(216) 441-3000

**OHIO, Dayton**  
Pioneer/Dayton  
(513) 236-9900

**PENNSYLVANIA, Philadelphia**  
Almo Electronics  
(215) 698-4000

**PENNSYLVANIA, Pittsburgh**  
Cameradio Electronics  
(412) 288-2600

**SOUTH CAROLINA, Columbia**  
Dixie Radio Supply Co., Inc.  
(803) 253-5333

**TEXAS, Dallas**  
Sterling Electronics  
(214) 357-9131

**TEXAS, Houston**  
Harrison Equipment Co., Inc.  
(713) 652-4700

**TEXAS, Houston**  
Sterling Electronics  
(713) 627-9800

**WASHINGTON, Seattle**  
Kierulff Electronics, Inc.  
(206) 763-1550

**IN CANADA: ONTARIO, Scarborough**  
Lake Engineering Co., Ltd.  
(416) 751-5980

**OVERSEAS: EUROPEAN INQUIRIES:**  
European Parts & Accessories  
Marketing Group  
General Motors Continental  
Plant 2, Noorderlaan, Postbus 9  
B-2030 Antwerp, Belgium

**ALL OTHER OVERSEAS INQUIRIES:**  
General Motors Overseas  
Operations  
Plant & Accessories Dept.  
767 Fifth Avenue  
New York, N.Y. 10022  
(212) 486-4412

**Delco Electronics Regional Sales Offices**  
Union, New Jersey 07083  
Box 1018 Chestnut Station  
(201) 687-3770  
Van Nuys, California 91404  
Box 2968  
(213) 988-7550  
**General Sales Office**  
700 E. Firmin, Kokomo, Ind. 46901  
(317) 459-2175

## Delco Electronics



Division of General Motors

# The health of the system depends on the condition of the heart

We make sound hearts for systems – power supplies that are also twice as efficient, more than twice as compact, and price competitive with conventional series-pass types.

The 40 models in the Sorensen STM family are modular switching power supplies designed for OEM systems, 3.0 to 56 Vdc. Despite their compactness and efficiency, they retain all of the advantages inherent in the series-pass design.

The physical fitness of your system begins with a good look at our catalog. Simply circle the inquiry number. Sorensen Company, a unit of Raytheon, 676 Island Pond Road, Manchester, N.H. 03103. (603) 668-4500.

**Sorensen**  
POWER SUPPLIES

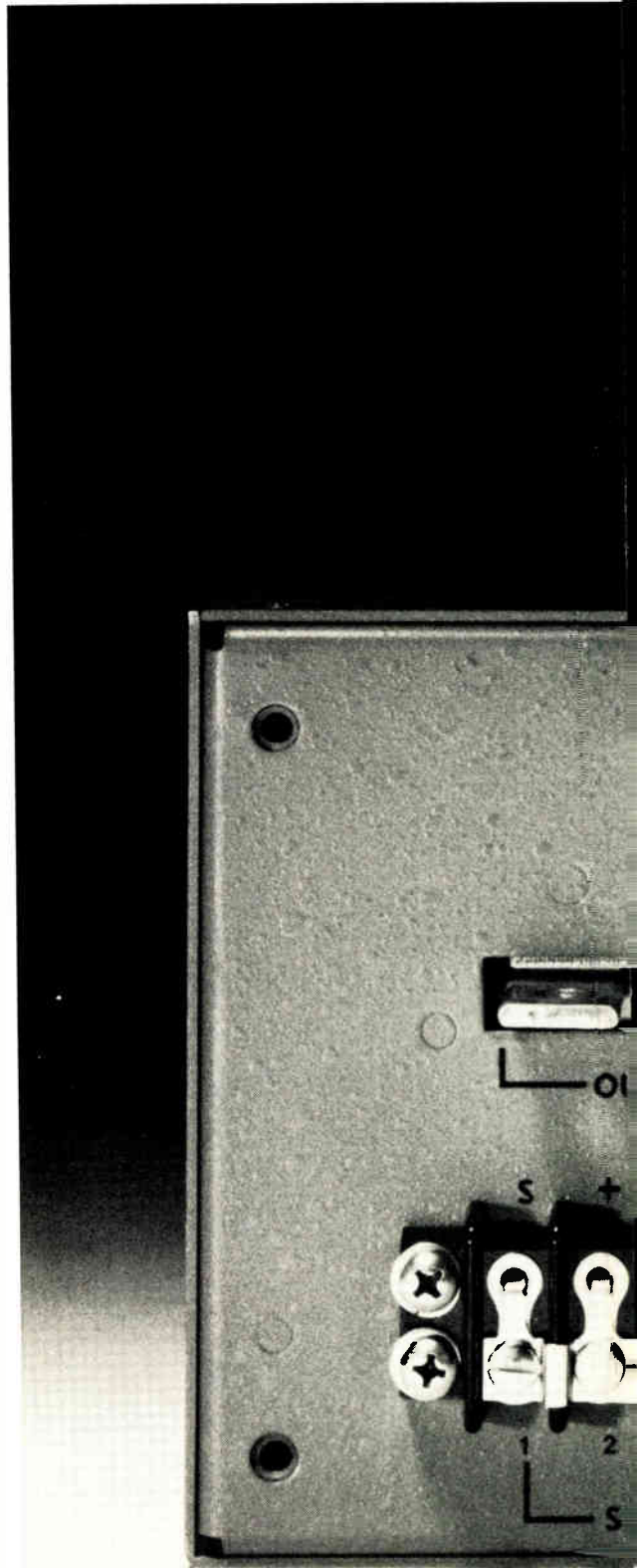

**Sorensen**  
POWER SUPPLIES

**STM**

5-60



OVP  
VOLT

S GND INPUT

A terminal block with four screw terminals and two screws. The terminals are labeled "S", "GND", and "INPUT". The screws are labeled "4", "5", "6", and "7".

4 5 6 7



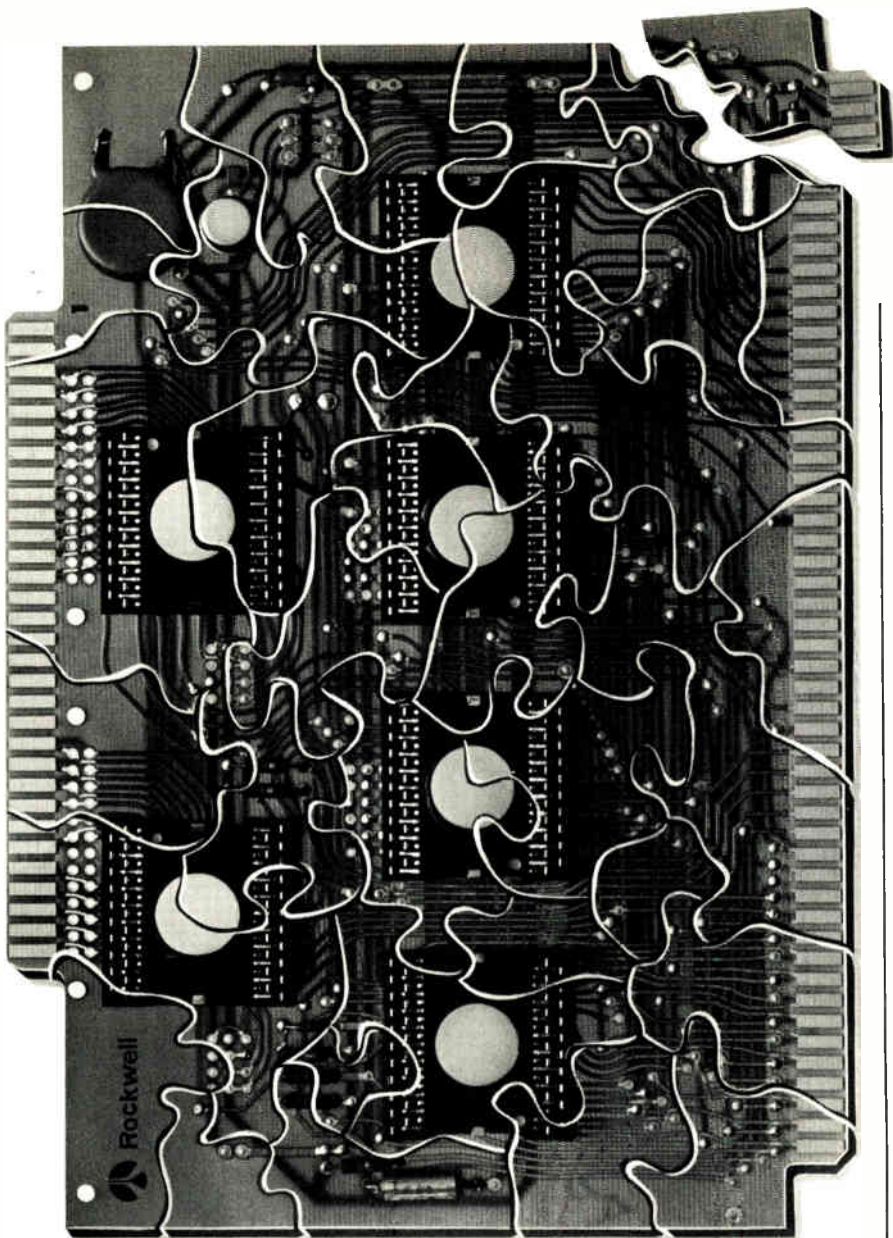

## Intelligent I/O's do the CPU's busywork.

We've identified many common tasks performed by micro-processing systems and designed intelligent LSI I/O's to control them — independent of the CPU. The CPU is thus able to delegate mundane chores such as running the peripherals, while concentrating on the serious thinking it does best.

The spreading of intelligence among the I/O's also reduces the amount and cost of program memory in your system. And because the CPU is no longer responsible for monitoring a multiplicity of functions all over the lot, programming becomes simpler, faster, and more flexible. You simply plug in or remove a chip with minor, not total, software changes to add or subtract functions.

# Rockwell a system.

**BEFORE  
PPS**



**AFTER**



## DMAC:

**Another burden  
lifted from the CPU.**

Our 8 channel Direct Memory Access Control (DMAC) gives priority to data flow between the I/O's and the system's memory. Once again, the CPU is freed from a routine, time-consuming chore.

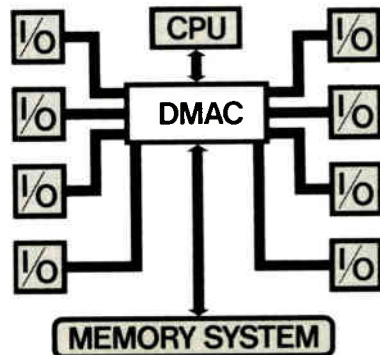

# is there with approach to microprocessing.

## PARALLEL PROCESSING: HIGH SPEED RESULTS FROM LOW COST TECHNOLOGY

With so much independent intelligence spread through our system, many tasks can be executed at virtually the same time. With our parallel processing system (PPS) you can now perform tasks with MOS micro-processing that would otherwise require higher cost technologies.

## A THRILLING CASE HISTORY

A fellow designed a new cash register whose I/O's sprawled over three PC boards and cost about \$250. He felt there was a better way and went to a large microprocessing house, but one which sold chips, rather than systems. They reduced him to one large and two small PC boards, with a cost of about \$160. Finally, he came to Rockwell, where we applied

our LSI system approach to his problem. He walked out with his entire system in LSI on one PC board at a cost of about \$85.



## MILLIONS OF DOLLARS SAY WE'RE SERIOUS ABOUT ALL THIS

We've spent millions of dollars to develop more than 40 LSI microprocessor circuits to offer you LSI options for most of

your electronic needs. As well as a worldwide sales and field service organization. Add to that a production capacity of tens of millions of circuits per year and you get the picture: giant Rockwell is very serious about tiny micro-processors. Don't let anyone tell you otherwise.

**Help is never more than  
ten digits away:**

# 714• 632•3729

Just call us at any hour and tap into a wealth of Rockwell customer support: detailed literature, software libraries, assembler - simulators and other design aids. Programming and board development assistance. And training programs at our facilities or yours. Some of this help is free; some costs. Take as much or as little as you need. What's important is that it's there. Right now.

Stop trying to solve micro-processor problems by bits and pieces. Instead, see how Rockwell's LSI system approach can help you. Call Bill Roland at (714) 632-3729 or write to:  
Department 2 B 1127  
Microelectronic Device Div.  
Rockwell International  
P.O. Box 3669  
Anaheim, California 92803



## Rockwell International

...where science gets down to business



# The Model 186 art gallery.

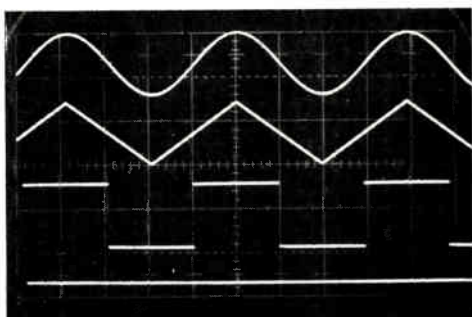

Sine, square, triangle and dc

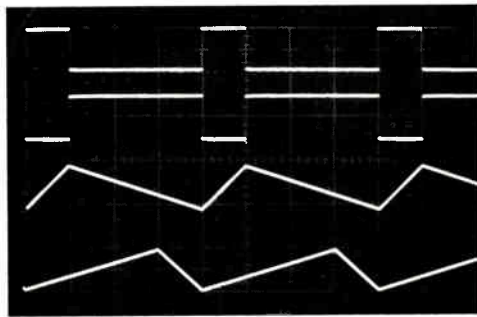

Pulse and ramp

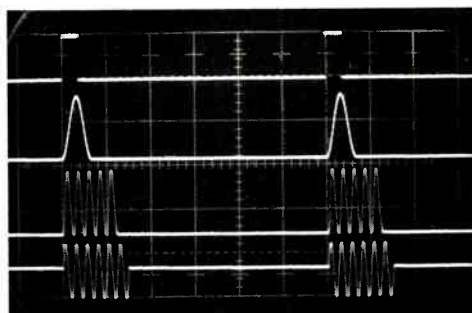

Trigger and gate

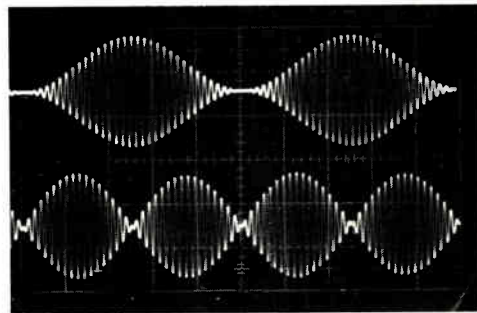

Amplitude Modulation

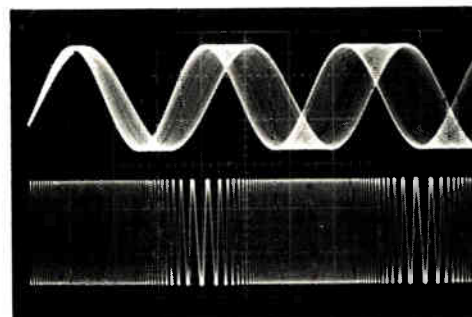

Frequency Modulation

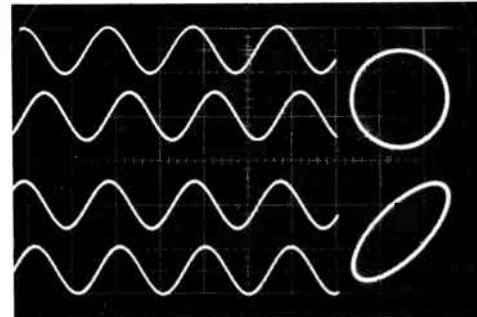

Phase lock.

There's a whole lot more to the Model 186 than just pretty pictures. Like its calibrated phase lock and built-in oscillator for 1 kHz AM/FM capabilities. It also has 30 v p-p output plus continuous, triggered and gated modes. And it's the only generator that gives you the combination of AM and phase lock.

Circle 58 on reader service card

The Model 186 has a frequency range of 0.0001 Hz to 5 MHz and sells for just \$795. Just circle our bingo number and we'll send you the complete picture.

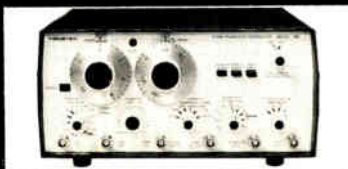

## WAVETEK®

P.O. BOX 651, SAN DIEGO, CALIFORNIA 92112  
TELEPHONE (714) 279-2200, TWX 910-335-2007



# Washington newsletter

## Approval seen for \$5 million EDP sale to China

Federal approval of the first major U.S. computer sale to the Peoples Republic of China is expected by Control Data Corp. before Dec. 1. Actual shipment of the two Cyber 172 models, worth approximately \$5 million with peripherals, to Machimpax—the China Machinery Import and Export Corp.—could come “early next year,” says Hugh P. Donaghue, assistant to Control Data chairman and chief executive William C. Norris. Though the exact specifications of the two systems for Peking were not disclosed, a Control Data official said the 172 represents the low end of the company’s Cyber line, having a 500-600 nanosecond cycle time and a maximum memory capacity of 131,000 words of 50 bits each.

The two Cyber 172s will be used by a seismic institution outside Peking to analyze data gathered in the Chinese search for offshore oil reserves, according to Donaghue. The sale faces one more U.S. hurdle, says Donaghue: **“We may be faced with conditions on the sale such as a requirement that periodic U.S. inspections be permitted to make sure the equipment is being used for its intended purpose. Then we would have to negotiate the acceptability of such points with the Chinese.”**

## New AF office formed to cut maintenance costs

In a new move to hold down life-cycle costs of its aircraft and avionics systems, the Air Force has created a new system program office called PRAM. “It stands for producibility, reliability, availability, and maintainability,” explained Gen. George S. Brown, chairman of the Joint Chiefs of Staff, at a mid-November hearing of the Senate Budget Committee’s Defense task force. **PRAM is soliciting the views of commercial airline operators and equipment makers, as well as defense airframe and avionics contractors and user commands** to collect “ideas and insights” in a drive to “have our equipment break less frequently so that we can employ less people” in maintenance operations.

At the same time, Brown disclosed that the Air Force contemplates cutting maintenance costs in fiscal 1977 on its B-52 and upcoming B-1 bomber fleets by centralizing major maintenance functions at one base. The results, he said, will be reduced purchases of electronic test and maintenance equipment as well as fewer maintenance personnel and lower training costs. An estimate of the savings is still undetermined.

## Reed looks good for AF Secretary

Watch for Thomas C. Reed, director of telecommunications for the Pentagon, to get the White House nod for Secretary of the Air Force, replacing John L. McLucas who is moving over to head the Federal Aviation Administration. Reason for the Ford in-house search for a new service Secretary: **“Tom Reed’s bright and well-liked, but,”** says one DOD insider, **“Ford’s election is still questionable, and no one of any stature outside DOD wanted a job that may not be good for more than a year.”**

## \$30 million a-m radio advisory net seen for N.Y.

A \$30 million computerized traffic, weather and tourist-information advisory system on Long Island for broadcast to a-m car radios may get the go-ahead next June. **A \$624,000 feasibility study by Sperry Rand in Great Neck, N.Y. is under way.**

Sperry will design the system if New York State and local governments give their approval. Bids for the hardware would be requested in late 1977 or 1978, backed by up to 90% Federal funding.

## The Norris plan for improving East-West trade

*Electronics details on page 42 why Control Data Corp. imported an ES-1040 Robotron computer from the German Democratic Republic to show the Washington bureaucracy that technologically the Soviet Bloc is not as far behind the U.S. as it would like to believe. At that same November 18 presentation, CDC chairman and chief executive William C. Norris challenged the Government to alter its export policies on high technology by, among other things, letting some light from the real world into the cobwebbed cubicles of its bureaucracy. Significant excerpts from Mr. Norris's novel and straightforward presentation follow. Ray Connolly*

Our main purpose today is to provide an opportunity to increase awareness of the status of computer technology in the Socialist countries. In the absence of this knowledge, many persons in Washington assume that the Socialist countries are far behind the U.S. in computer technology; hence, they say, Soviet military capabilities would be significantly increased if the U.S. sold them computers.

This lack of information is seriously impeding the export of computer equipment to the Socialist countries. It is also hindering the expansion of exports of other products and the realization of other business opportunities for co-production and technology exchange.

### Policy confusion

Continued confused and over-restrictive U.S. policies on computer equipment exports will lose U.S. manufacturers the peripheral equipment opportunity, just as it caused the loss of [much] of the mainframe market.

In the three and a half years that have passed since the U.S./USSR agreement to establish scientific and technical cooperation on many fronts, it has not produced an extensive exchange of technology. The reason is restrictions on trade imposed by Congress. These restrictions have arisen primarily because of misconceptions of the status of advanced technology in the USSR, from unsubstantiated fears that U.S. state-of-the-art commercial computer technology will somehow substantially enhance USSR military capabilities, and from fears that American business will sell its technology too cheaply.

The United States needs a better defined and more aggressive program to develop business opportunities with Russia and the other Socialist countries. Here are my suggestions for such a program:

- Establish a continuing program for collecting and disseminating information on the status of technology available in Socialist countries and the business opportunities presented by the needs of the United States for such technology.
- Change the present adversarial relationship between U.S. Government and business into a partnership.
- Establish a definitive and aggressive blanket program with the USSR for technology exchange.

### Basic problems

The average person in and out of the Government is still under the illusion that the United States can solve any problem and has such a commanding lead over the Socialist countries that technology exchange is only a one-way street. If it were widely understood that we need their technology as much as they need ours and that there is no basic addition to USSR military capability involved, the climate for East/West trade could improve and the present legislative curbs be removed.

The root cause is our bureaucracy's lack of information. The status of technology in Socialist countries is not well understood in the U.S. Government, nor is there much information on the technology needs of the United States. Consequently there is no Government leadership in identifying opportunities, and there is little help offered in qualifying export applications.

The French, British, Germans and Japanese all approach export business in a mode of partnership between business and government. However, the U.S. procedure is for our Government to hold separate meetings with [other governments] with no involvement by U.S. business.

But this could be changed in simple and straightforward manner by a U.S. Government decision to assume leadership in expanding business with the Socialist countries and by joining with business in a partnership attitude.

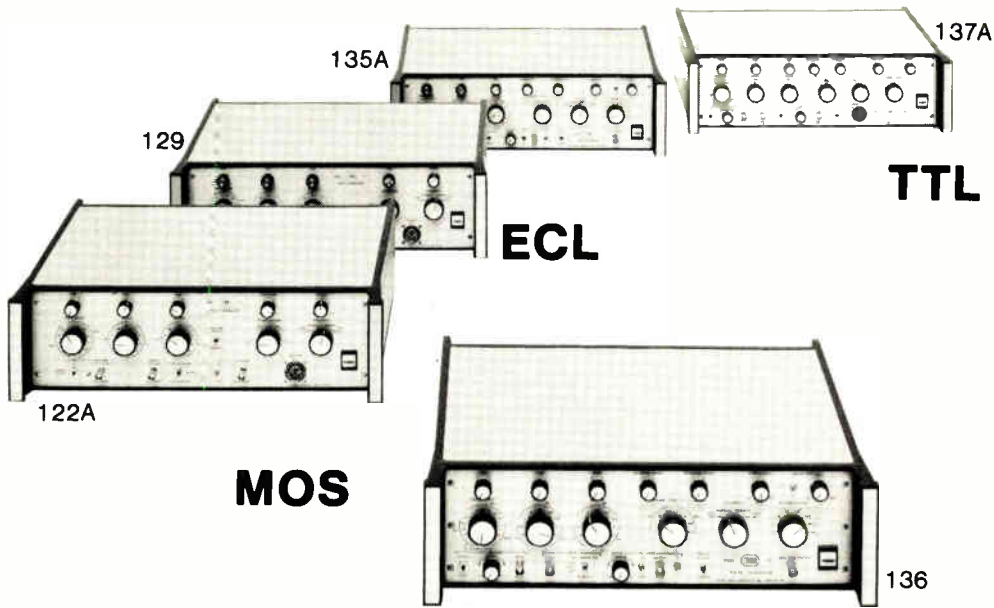

# THE PULSE GENERATOR FAMILY

## Provides Quality and Performance

Clean pulse waveforms, timing stability, reliability and state-of-the-art performance has built E-H's reputation as the leader in Pulse Technology.

Look over our FAMILY; you will find a pulse generator to match your testing needs:

Detailed technical information on these units plus ten other specialized pulse generators are yours free when you circle the inquiry number or address us directly.

MODEL	FREQUENCY	AMPLITUDE	RISETIME
122A	250 MHz	± 5 Volts	< 1ns
125A	1 MHz	-10 Volts	< 300ps
129	500 MHz	± 2 Volts	< 500ps
135A	50 MHz	±10 Volts	< 3ns-8ns
136	60 MHz	±20 Volts	< 3ns-8ns
137A	125 MHz	± 5 Volts	< 2ns-160μs

 research laboratories, inc.

515 11th Street □ Box 1289, Oakland, California 94604 □ (415)834-3030 □ TWX 910-366-7258

In Europe: E-H Research Laboratories (Ned) B.V., Box 1018, Eindhoven, The Netherlands □ Telex 51116

In Japan: E-H International - Tokyo Branch, 1-5, 3-Chome, Naka-cho, Musashino-shi, Tokyo, Japan □ 0422-54-9261



## HERMES LOOP ANTENNA

THREE SAMPLE SITES  
ON THE NORTH AMERICAN  
CONTINENT —

DIFFERENT LATITUDES  
DIFFERENT CLIMATE



64°N



42.5°N

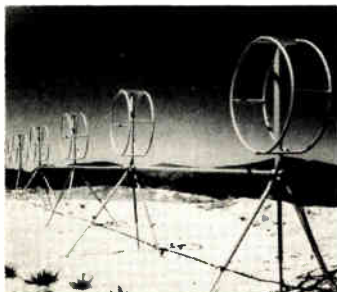

32.5°N



# Good Listeners maintain a low profile

Even in the solitude of the forest depths, from rooftops, arctic tundra, swamps to sweltering tropics, 'neath snow, sand or ice,

the Hermes Loop antenna keeps an ear to the sky.

The amazing aperiodic antenna does away with vast log periodic and rhombic arrays - those towering antenna farms.

In rosette configuration, the Hermes loop antenna provides an omnidirectional broadband receiving array in space merely 1/100th that of the traditional antenna farm.

More than 53 government agencies around the world have pressed the loop antenna into service.

A new, even more compact version is available.

Only Hermes Electronics makes it.

**2-32MHz  
BROADBAND**



**ASK US** Send for our Brochure

Hermes Electronics Limited

Suite 315

2020 F Street NW

Washington, DC 20006 USA

202-296 2978

TWX 710 822 1106

## Chip tunes Toshiba color-TV set to preset channels at desired times

A single large-scale integrated circuit enables the viewer of a new 22-inch color-television set to preselect the channels he will want to see at different times. Toshiba, the developer, will start selling the \$1,333 set in Japan in February. Because of the size and weight of the set, it and its wooden cabinet are shipped separately and assembled at the purchaser's residence.

The chip automatically switches the varactor-tuned TV set at times preset in five-minute increments to both uhf and vhf channels. To make his selections, the would-be viewer presses various of the 12 push buttons mounted in a circle on the front of the set. One of these buttons, when pressed, displays the preselected channels on the TV screen along with the desired viewing times, which are in blue for a. m. and red for p. m. Another button restores the program to the screen.

The chip's 16 registers can store a maximum of 16 instructions, each of which may be a combination of an on time and a channel number or an off time. Eight of these choices are temporary and are automatically erased as they are used. The other eight remain in memory until they are changed. One of the push buttons steps through the registers in sequence until an empty register or one with an unwanted program is reached. Another button can erase the unwanted contents of a register.

**Clocked C-MOS.** The clocked complementary-MOS chip, which contains about 8,200 transistors, measures 5.11 by 5.73 millimeters and is packaged in a 42-pin dual in-line package. Circuits on the chip include a digital clock for keeping track of the time, the program memory, a time comparator, channel-selection circuits, and a character generator. Clocked C-MOS differs from conventional C-MOS in using an inverter and two series switches, rather than an inverter and a trans-

mission gate. This arrangement greatly reduces cell size.

Toshiba was able to cram all the circuits on one chip at reasonable cost because most of them work at low frequency, although some go as high as 4.5 megahertz. To conserve transistors, the memory registers are built as shift registers, rather than static registers. The digital-clock and memory circuits operate on 4.5 volts.

The power is supplied by an ac line when the set is in operation and in a preheat mode, but it is provided by three dry cells to keep the clock

running and retain contents of the memory when the set is completely off or when the power fails.

Two kinds of clock pulses drive the dynamic circuitry. One kind is derived from the internal oscillator, and the other comes from the receiver. The chip contains an inverter for a crystal oscillator operating at 4.1943 MHz to provide accurate time-keeping, and the 16 15-bit registers and matrix gates are driven by two-phase clock pulses at about 32 kilohertz, counted down from the output of the crystal oscillator. □

### Around the world

#### French ultrasonic scanners show vital organs

Nearly harmless ultrasonic techniques—thanks to new electronic signal-processing advances—are now offering doctors real-time television-like displays of organs inside the body. Two hospital research teams in France are experimentally using variations of radar techniques to provide visual presentations of vital organs, particularly the heart. The Study Center for Surgical Techniques at the Hospital Broussais in Paris has built a system that uses a 16-unit array to give 78 pictures a second on a 46-line display. At a Tours University clinic, another team has built a system around a scanning-beam device that produces 40 frames a second.

The Paris-built system, designed mainly for cardiac analysis, combines a doppler system that measures the speed of blood flow and a fast-imaging unit that dynamically displays the heart in cross section. By using techniques based on experience with military radar moving-target-indicator systems, the laboratory has achieved real-time visualization of signals from 64 points on each line. The useful doppler signal is separated from unwanted fixed-object echoes and background noise by digital signal analysis that combines sampling techniques and reference signals.

#### Philips TV set offers colorful tuning

A 26-inch color-television receiver being readied by Philips N. V. of the Netherlands for Christmas shoppers in West Germany, Holland, and Belgium offers a colorful display as it is being tuned in. Receiver settings are indicated by colored bars displayed horizontally on the screen, and a small matrix indicates the station being received. Station tuning is indicated by a red bar, and the settings for volume, brightness, and color-saturation are shown by three green bars.

A complementary-MOS-memory circuit stores the tuning voltages for the channel selector and thus takes over the function of the potentiometer normally used for storing tuning voltages. A p-channel MOS memory contains the voltages required for setting the volume, brightness, and saturation at optimum values previously selected by the viewer. Both chips were custom-designed for Philips by American Microsystems Inc., of Santa Clara, Calif. The tuning voltages for the channel selector are stored in the C-MOS memory. The voltage corresponding to the selected station is read out, converted into an analog value, and applied to the channel selector.



# WE MAKE THESE ELECTROSTATIC PRINTER/PLOTTERS EASIER TO READ.

## Test it yourself with a free sample roll.

Graphic Controls electrostatic paper reads easier than conventional types. Because it's obviously whiter...giving a sharper, blacker look to letters, numbers, dots and lines.

We should be able to produce a better paper. Making specialty papers is our ONLY business. We produce both report and translucent grades that fit all **Gould, Varian and Versatec** electrostatic printer/plotters in both roll and fanfold form.

In the wider roll sizes we offer the unique feature of rolls

cross-perforated every 11 inches for easy fanfold stacking.

As a standard feature, we sequentially page number all of our fanfold packs for increased operating efficiency and ease of information retrieval. For your specialized applications, roll and fanfold paper is available with preprinted formats in your choice of color. **All this and...priced significantly below your present supplier.**

For more information—or a free sample to make your own reading test—use the coupon. Or call Ray Newstead, Manager of Marketing. Phone: (716) 853-7500, Ext. 352.

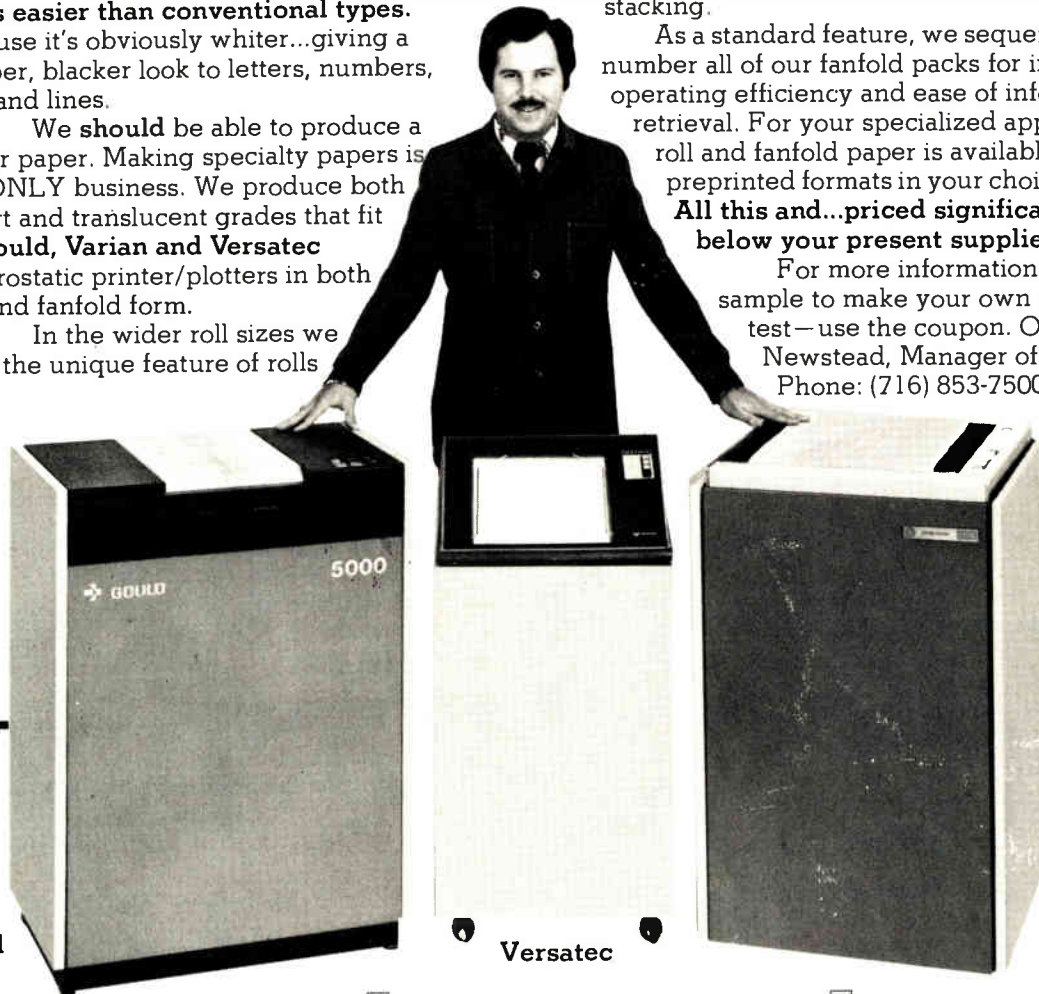

Gould

Versatec

Varian

Send me more information on your electrostatic paper, including prices. Estimated annual usage: \_\_\_\_\_ rolls.

I'd like a free sample to make my own reading test on my \_\_\_\_\_ machine. Chart No. \_\_\_\_\_.

Have your representative call.

Name \_\_\_\_\_

Company \_\_\_\_\_

Address \_\_\_\_\_

City \_\_\_\_\_ State \_\_\_\_\_ Zip \_\_\_\_\_



COATED PRODUCTS DIVISION  
**GRAPHIC CONTROLS CORPORATION**  
189 VAN RENSSELAER STREET, BUFFALO, NEW YORK 14210



# International newsletter

---

## French encourage telecommunications to aid IC makers

In the hope of developing new semiconductor technology to compete with U.S. and other European MOS makers, French government and industry planners have switched their emphasis from computer development to telecommunications, especially electronic switching. However, the manufacturers are already warning that unless the government provides more funding for research and more protection from foreign competitors, **the new effort will be as unsuccessful as the earlier drive to stimulate semiconductor development by encouraging advances in computer technology.**

## Plastic replaces carbon granules in microphone . . .

A plastic diaphragm replaces the carbon granules in a new telephone mouthpiece under development by the British Post Office to make the microphone smaller and lighter than conventional ones. The work is being performed at the BPO research laboratories at Martlesham Heath, Suffolk. **In operation, the thin polyvinyl-fluoride diaphragm, which contains a permanent electrical charge, is moved by speech vibrations to produce corresponding electrical signals that can be boosted by a tiny transistor-type amplifier.**

## . . . as BPO tests helical waveguide for transmissions

The British Post Office is beginning field trials of a helix-waveguide system 50 millimeters in diameter that transmits for 112 kilometers near the BPO research laboratories at Martlesham Heath, Suffolk. The waveguide, which contains a precision 50-millimeter helix of fine copper wire set within a lossy resin-impregnated glass-fiber tube impregnated with dry nitrogen, has solid-state digital repeaters every 14 km. **An operational waveguide that exploited the waveguide's capabilities to 90 gigahertz would transmit 24 gigabits per second each way, or the equivalent of more than 300,000 two-way telephone circuits, the BPO says.** The capacity, if needed, would be even higher above 90 GHz.

## Siemens sells electronic data switch to Austria

The fifth major foreign customer for the electronic data-switching system made by Siemens AG is the Austrian Postal Administration. **The system, to begin operation in 1977 in Vienna, will initially handle about 8,000 lines.** The other customers are the postal administrations of Italy, Denmark, and Finland plus the private communications company Italcable.

## British slump cuts color-TV-set sales total in Europe

A 25% slump in sales of color-television sets in Great Britain will knock total European sales 5% below the 1974 level, predict Philips market researchers, well known for the accuracy of their market forecasts. **However, if the poor record in the UK is disregarded, sales in Europe will show a 5% gain.** In contrast, Philips is experiencing in Australia a boom in color-TV sales to 700,000 sets from last year's level of 80,000.

## Mitsubishi builds 1-k dynamic memory with 50-ns access

A prototype 1-kilobit dynamic memory built by the diffusion self-alignment process has an access time of 50 nanoseconds and consumes 230 milliwatts. **This gives the MOS memory bipolar speed with lower power consumption.** The memory, developed in the semiconductor laboratory of the Kitaitami works of the Mitsubishi Electric Corp., has one transistor

## International newsletter

---

per bit. This design would provide high packing density for large-scale memory systems. The diffusion-self-alignment process, also known as D-MOS, reduces the number of masking steps needed and avoids masking problems in making the short channels needed for high speed. However, production is still a year or two in the future.

**All dopants are deposited in the prototype by ion-implantation on p<sup>-</sup> silicon substrate.** An n<sup>-</sup> channel of depletion-type load transistors is implanted before the polysilicon gates. After the gates are fabricated, n<sup>+</sup> source and drain regions, as well as p<sup>+</sup> channels of the memory-cell and peripheral-inverter transistors, are implanted. The p<sup>+</sup> channels are within the n<sup>+</sup> implantations, but a later thermal diffusion pushes the p<sup>+</sup> dopant forward laterally under the gates to form extremely short p<sup>+</sup> channels.

### **Settlement causes Plessey to quit making phone ICs**

Plessey Co. and its subsidiary LSI (Electronic Systems) Ltd. in the UK will stop making and marketing three MOS telephone circuits that General Instrument Microelectronics claimed in a court action were copied. They are a push-button telephone dialer, repertory dialer, and a receiver/transmitter circuit announced by GIM and later introduced by Plessey. Under the High Court agreement, Plessey will turn over all materials relating to these chips, publicly advertise that it is withdrawing the circuits because of the settlement, specifically reference GIM's chips, and pay the costs of the court action.

### **Toshiba uses LSI to build mini on single board**

Large-scale integration of the arithmetic-control unit and bus-control unit has enabled Toshiba to cram the mainframe of its new Tosbac 40L minicomputer onto a single printed-circuit board. Delivery is to begin next July for the 16-bit machine, priced at about \$16,660 with a cabinet and 8 kilobytes of memory. **Like other Tosbac 40s, the 40L has a memory capacity of 64 kilobytes, 117 instructions, and 16 general-purpose registers.**

The clock rate is 300 nanoseconds, and, when used with semiconductor memory, cycle time is 600 ns. N-channel silicon-gate enhancement-depletion MOS is used for both the 3,800-gate arithmetic-control unit and the 700-gate bus-control unit. In 42-pin packages, both are compatible with transistor-transistor logic.

### **Sinclair to add consumer lines next year**

Next spring Sinclair Radionics Ltd. of the UK plans to step up its as-yet miniscule assault on the low-end consumer-electronics market dominated by Far Eastern suppliers. **The first products announced are a watch with five or six functions and a new line of calculators with programable capabilities for the mass market.** The long-heralded 2-inch Tiny Telly television set is planned for sale later in the year.

Sinclair hopes that the watches, to have such functions as date, day of week, and possibly the month, as well as hours, minutes, and seconds, will protect its market as the price of its new Black Watch (see p. 41), made with integrated injection logic, is driven down by competition. Sinclair predicts that the Tiny Telly will dominate the company's electronics sales by 1978. **Being considered as options for the Tiny Telly are color and the capability to receive text broadcast as "magazine of the air" by British TV networks.**

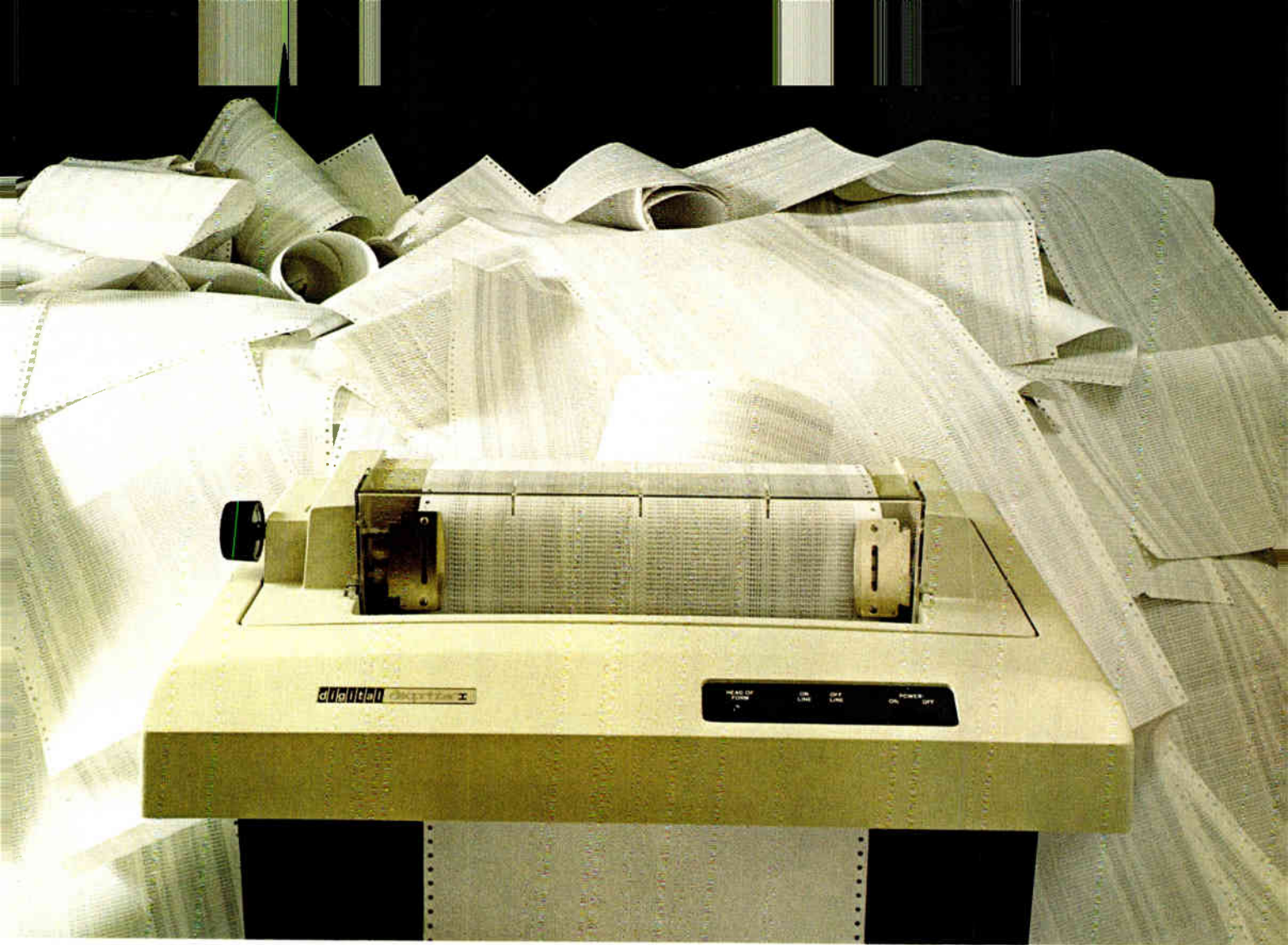

## Our new LA180. You get more out of it because we put less into it.

Introducing the LA180 180-cps line printer.

What you get out of it is more work.

Because what we've put into it are fewer moving parts. To make it the most reliable 180-cps line printer you can buy.

With the LA180, we've replaced all possible mechanics with electronics and put everything onto just four subassemblies to make servicing a snap. It's the same design concept that's been proven

on our LA36—the keyboard printer that sold over 20,000 units its first year. And to further insure reliability, we've designed the machine to run only when it's printing.

The LA180 also gives you: top of form, paper out, paper out override, self-test, upper and lower case, back space (an exclusive), ASCII delete command, adjustable tractors on both sides, and incredible quietness. All for just \$1975 in 100's.

At the same time, we've made

all these goodies available in a lower-priced 30-cps machine—our new LA35.

For details, call 800-225-9480 (Mass. 617-481-7400, ext. 6078). LA180. LA35.

Both simply reliable.

Components Group, Digital Equipment Corp., One Iron Way, Marlborough, Ma. 01752. Canada: Digital Equipment of Canada, Ltd. Europe: 81 Route de l'Aire, 1211 Geneva 26, Tel. 42 79 50.

Prices apply to USA only.

**digital**  
**COMPONENTS**  
**GROUP**



# This is what the public will see.

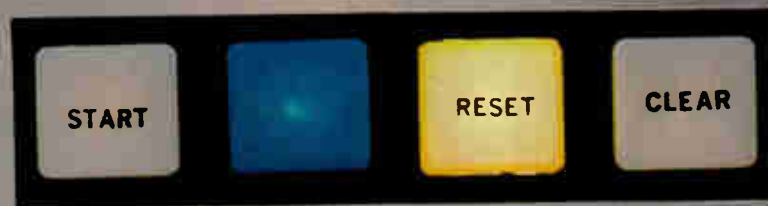

# This is what the designer sees.

## A REPLACEABLE LAMP LIGHTED PUSH BUTTON SWITCH

10400/10410  
10420 Series

### DESCRIPTION

Molex has introduced a new U.L. listed replaceable bulb/lens lighted push button switch family. The buttons may be molded in an assortment of colors and shapes to enhance the appearance of your assembled unit. Switch actions include SPST, SPDT, DPST, and DPDT with momentary or alternate action. Applications include office machines, appliances, computers and the home entertainment field.

### FEATURES

50,000 minimum life cycle. In addition to the 10.1 AMP rating, the entire series offers reliable switching action at low levels (100 milli-amps at 30 volts), and a replaceable T 1 3/4 bulb in all but the 125 Neon version.

Molex offers a wide variety of button colors, bezels, and legends as

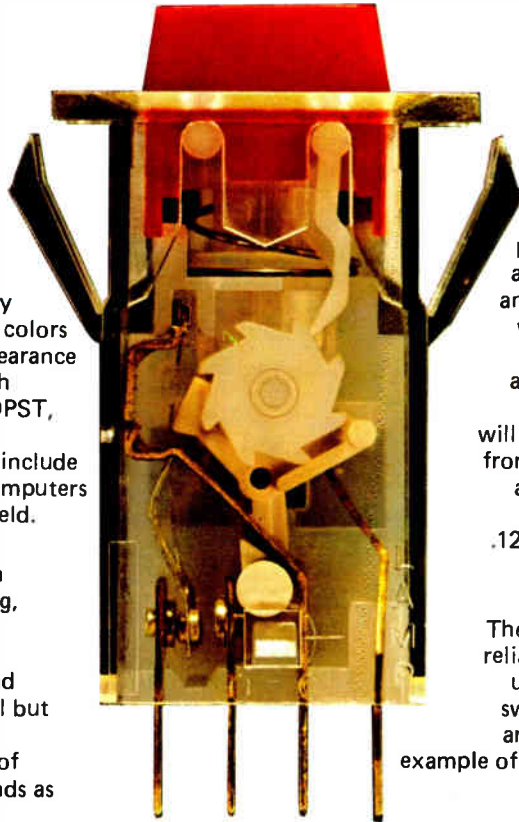

well as a square or pyramidal shaped lens. Recommended panel cutout dimensions include an .875 x .875 (10410 and 10420) and .875 x 1.050 (10400 versions) which are compatible with most comparable switches presently available today. The 10400 with integrally molded mounting ears will accommodate a panel thickness from .030 to .093, while the 10410 and 10420 versions offer a front removable feature from .030 to .125 thick panels. Spade terminals are .02 x .19 x .30 length.

### FOR "UNDER A BUCK"

The Molex product is designed as a reliable, low cost unit with features usually found only on expensive switches. In 5M quantities SPST are 99¢ each (including bulb). An example of Molex "affordable technology".

**10400** Rectangular bezel w/molded mounting ears

**10410** Rectangular bezel w/spring clip mounting

**10420** Square bezel w/spring clip mounting

Patent Pending

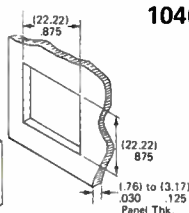
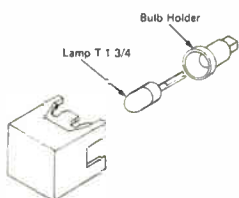

10400

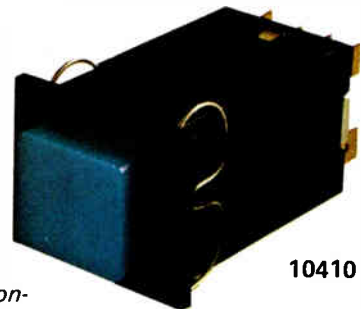

10410

### MOLEX SERVICE

Molex has a nationwide network of representatives and authorized distributors to handle your off-the-shelf and large quantity orders. Field engineers are at your service to solve your tooling problems.

### LITERATURE

For your FREE 16-page Switch Catalog including photos, line drawings and specifications of the Molex line, call (312) 969-4550; or write Molex Incorporated, 2222 Wellington Court, Lisle, IL 60532.



... Affordable Technology

# HIGH RELIABILITY

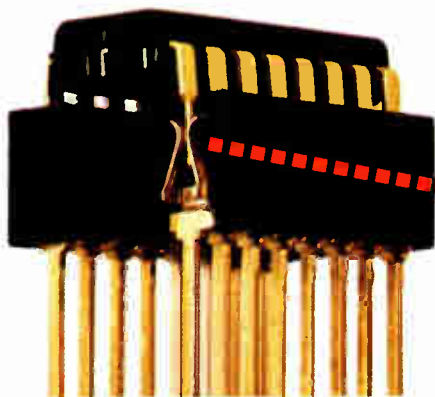

Get the **high reliability** that eliminates trouble. RN DIP sockets make contact with the wide, flat sides of your IC leads. This provides **100% greater surface contact** for positive electrical connection.

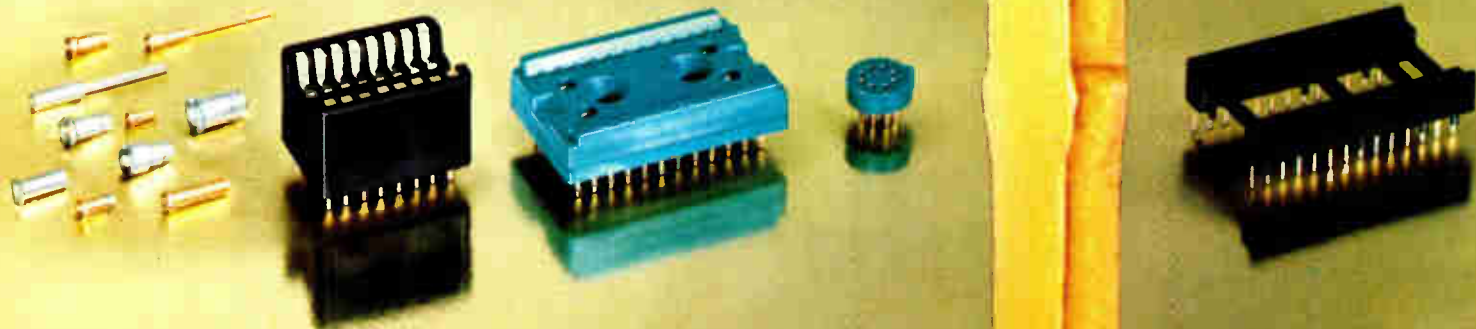



# DIP SOCKETS **for the price you're paying for junk!**

**Robinson Nugent "side-wipe" DIP sockets make 100% greater contact than any edge-bearing socket on the market.**

This 100% greater contact with the wide, flat surface of your IC leads is your guarantee of unmatched reliability. This RN "side-wipe" contact provides constant low contact resistance. No edge-bearing contact can possibly deliver this long term dependability. This designed-in reliability of RN DIP sockets is your assurance of trouble-free IC interconnects—yet they cost no more than ordinary sockets.

**Put an end to troublesome junk sockets!** Write today for catalog and informative book "What to Look for in IC Interconnects." It's free from RN—the people who make more kinds of high reliability IC sockets than anyone.

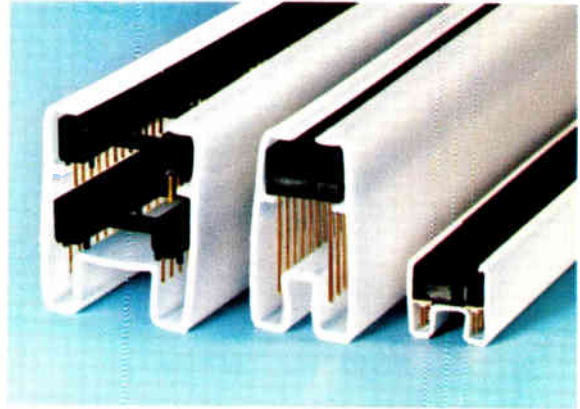

**They're even packaged for high reliability.**

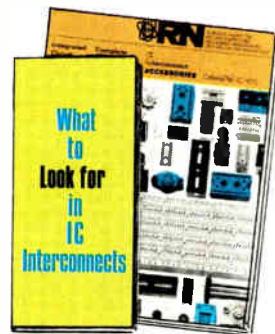

"Protecto-pak"® packaging delivers consistently perfect RN sockets to your production line—for automated or manual assembly.

# **RN ROBINSON NUGENT, INC.**

800 East Eighth Street • New Albany, Indiana 47150 • Phone: (812) 945-0211



**High reliability IC sockets . . . we've got 'em all!**

Circle 71 on reader service card

# Pick a Plug-in Scope For

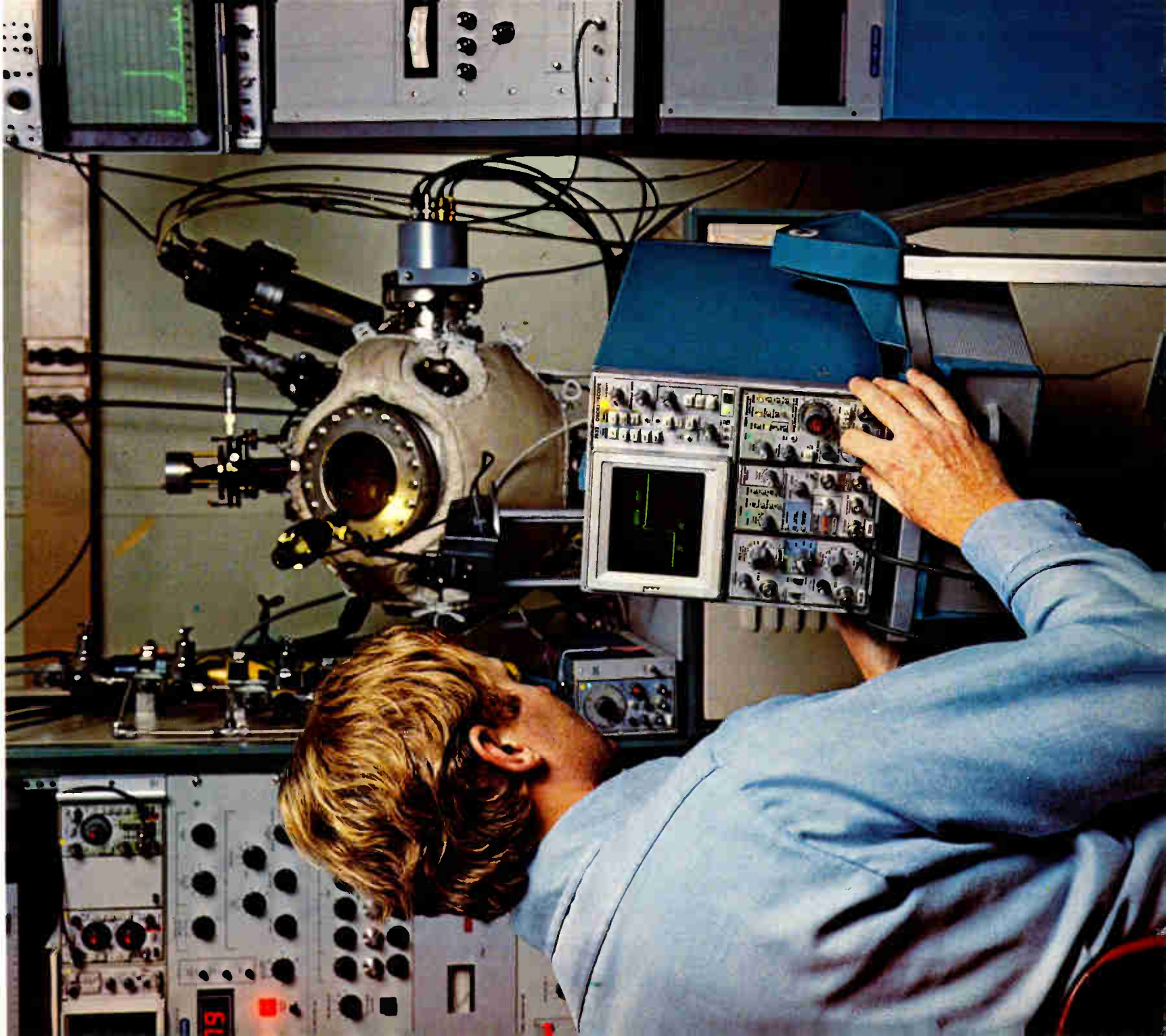



# Superior Performance

TEKTRONIX plug-in oscilloscopes define the state of the art today. With the 7000 Series, you can make the most complex measurements technology permits. The 7000 Series features:

The 7904, with the widest bandwidth available in any real-time oscilloscope. (Dc to 500 MHz with signal amplification, 1 GHz with your signal applied directly to the crt.)

The 7633, with three storage modes at the fastest usable writing speeds in one instrument. (1000 cm/ $\mu$ s captures a 100-MHz sine wave or a 3.5-ns rise time.)

The 7D11, 7D12, 7D13, 7D14, and 7D15, with interactive analog-digital measurements. (Digital ease and accuracy for voltage and timing measurements between selected points on complex waveforms.)

The 7844, with dual beam at 400 MHz. (Two electronically independent electron beam and deflection systems within one crt.)

The 7A22, with maximum differential capability. (10  $\mu$ V/div input sensitivity; 100,000:1 common-mode rejection ratio.)

The 7L13 spectrum analyzer. (0 to 1.8 GHz frequency domain displays with 30-Hz resolution bandwidth.)

The 7J20 rapid-scan spectrometer. (400 nm scanned in 4ms.) (Available in U.S. only.)

The 7S11 sampling unit. (Displays repetitive signals up to 14-GHz equivalent bandwidth.)

In the application shown, an engineer evaluates the circuit he's designing with a 7633 multimode storage, 100-MHz bandwidth mainframe, a 7A26 dual-trace amplifier, a 7D11 digital delay unit, and a 7B53A dual time base. In the FAST transfer variable persistence storage mode, he can capture and display the 3.5-ns rise time of a single-shot event for detailed analysis.

At the push of a button, he has the option of normal (nonstored) operation or a choice between variable persistence and bistable storage, each with or without FAST mesh transfer. The fastest writing speed is obtained by selecting a reduced crt scan.

ferent traces—by using the 7D11 in a digital delay-by-time mode.

This configuration is only one of countless combinations of superior performance mainframes and plug-ins from Tektronix' 7000-Series.

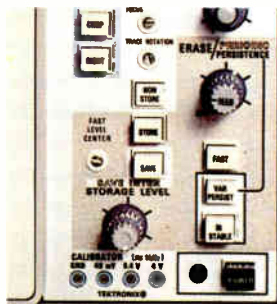
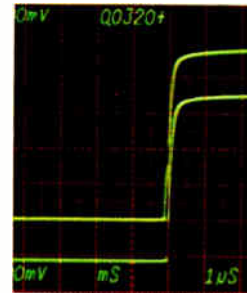

High frequency, storage, sampling, dual beam, differential, analog-digital synergism, rapid scanning spectroscopy—whatever the state of your art, turn to a plug-in oscilloscope from Tektronix to measure it.

For a catalog of 7000-Series plug-in instruments, write Tektronix, Inc., P.O. Box 500, Beaverton, Oregon 97077. In Europe, write Tektronix Limited, P.O. Box 36, St. Peter Port, Guernsey, Channel Islands.

## The 7000 Series more than an oscilloscope



He can also make digitally accurate timing measurements — between points on the same trace or on dif-



**TEKTRONIX®**

committed to  
technical excellence





La Salle National Bank &

FEDERAL BANK OF CHICAGO

# We think our data terminal system is so good nothing even comes close.

In fact, we believe the Teletype® model 40 system is so good it'll change the way business looks at data. We're that sure it's that good.

Here's why:

It's a complete, versatile, reliable terminal system delivering maximum efficiency in a wide range of applications. From message communications to computer input/output on switched network or private-line systems. Right now, the model 40 system is being used by airlines, news services, brokerage firms, manufacturers, law enforcement agencies and time-sharing services.

Significant features of the system are speed, ease of data preparation and editing, compactness and extremely low maintenance. And since the model 40 is completely modular, you can forget about obsolescence.

It's designed to grow as your needs grow.

Data is presented with extreme clarity on the big, 13-inch screen. Characters are 35 percent larger than standard print size and are formed on a 7 x 9 dot matrix. Screen capacity is 24 lines of 80 characters each for a total of 1,920.

Teletype's exclusive solid-state design makes the model 40's fast (up to 2400 wpm), heavy-duty impact printer the most cost-effective unit on the market. Its simplicity of design makes it one of the most reliable printers we've ever made. And after more than 60 years experience building printers that set the standards for reliability, that's saying something.

It took a total corporate commitment to come up with something as good as the model 40. For example, we had to develop and manufacture our own MOS. It didn't come easy, but we think it's worth it. Because the solid-state components throughout the system deliver exceptionally high reliability. And the self-diagnostic circuitry and design modularity significantly reduce downtime and maintenance costs.

Operator comfort and efficiency are increased by human-engineering efforts like a brightness control and screen tilt, plus a glare-reducing display tube and an easy to operate keyboard.

The Teletype model 40 data terminal system.

It's every bit as good as you've heard. And probably even better.

For complete technical data, please contact our Sales Headquarters at

5555 Touhy Avenue, Skokie, Illinois 60076.

Or call TERMINAL CENTRAL at (312) 982-2000.

Teletype is a trademark registered in the United States Patent Office



## The Teletype model 40 system.

Circle 75 on reader service card



# New tape readers for numerically controlled machines.

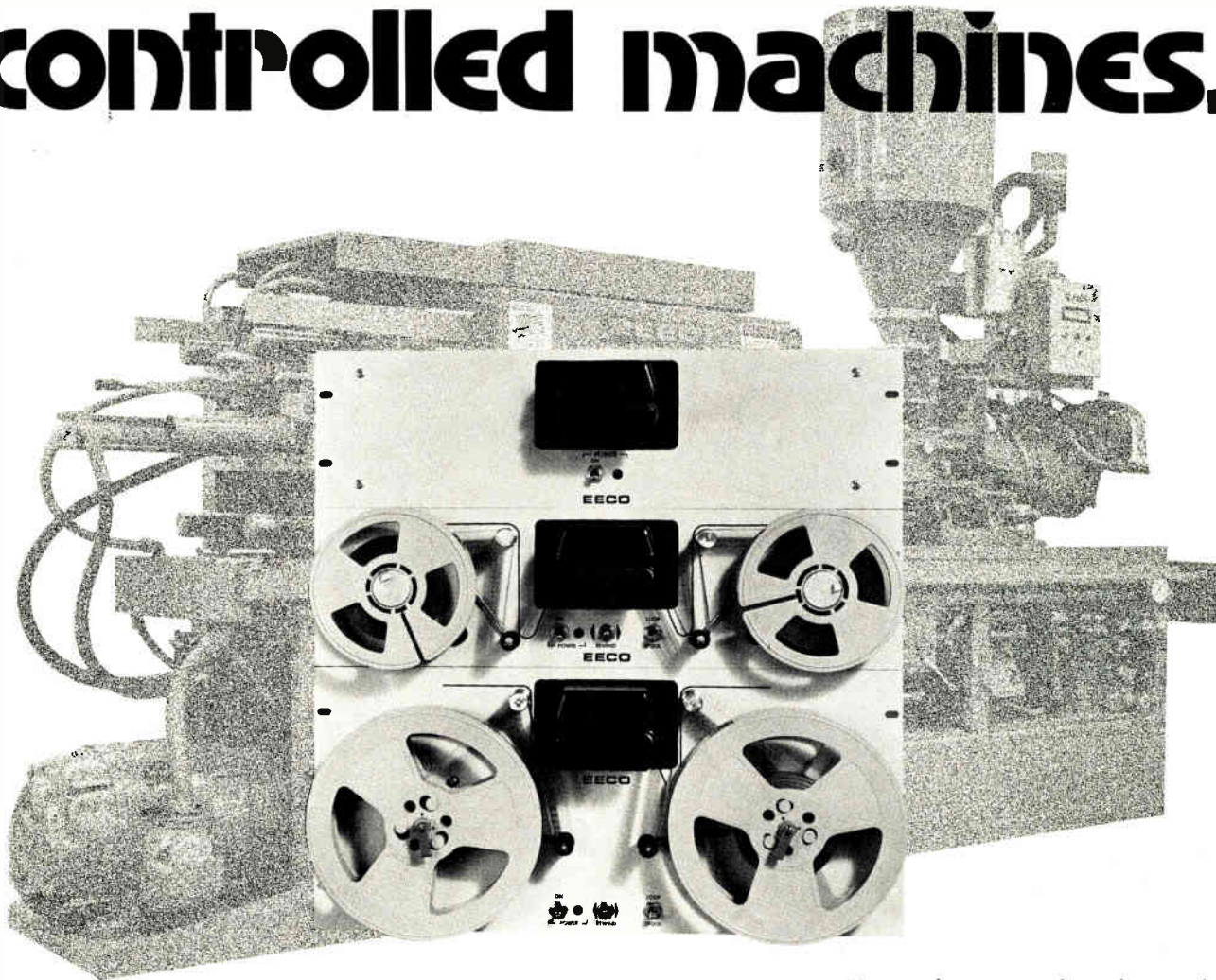

We are pleased to announce our new Series 9200 Tape Readers, an event that will be of little interest to everyone outside the numerical control field. That suits us, because these readers have been designed specifically for NC people.

By specifically we mean that they combine performance, simplicity, ruggedness, availability, service, and low price all at the same time.

*The basic reader operates at a fixed 200 characters per second, includes its own power supply (115 vac) and sells for \$640.*

*That reader equipped with 5 1/4-inch reels (for 500 feet of tape) sells for \$945.*

*Make those reels 7 1/2 inches (for 1000 feet of tape) and it goes for \$1045.*



Now, they may be cheap, but they're not *cheap*. They are driven by a genuine stepping motor (no solenoid). The tape is firmly and gently handled by a full-width barrel sprocket. The light sources are LEDs (not filament bulbs). The read sensors are phototransistors (no errors). The read head is self-cleaning and opens for easy loading. And it handles all standard tapes.

They are made to be compatible with most major types of NC machines. And we can deliver units to your door within 30 days.

So don't just sit there, write a P.O. Or... well, write. Either way, we'll answer. Fast.

## EECO FOR READERS



## Japanese clamor for short wave

As market for receivers booms, innovative design gives Sony the early edge in million-unit-a-year market

by Charles L. Cohen, Tokyo bureau manager

Sales of short-wave receivers are booming in Japan, and innovative design has given Sony Corp. the early lead in a market that will absorb a million radios this year. It's a youth-oriented market, where price and performance are equally important. Competitors concede that the edge in Sony's design comes chiefly from a bandspread dial and reuse of the fm intermediate-frequency amplifier.

What those and other features give the customer buying Sony's latest popular-priced model for less than \$100 is a receiver with performance equal to that of far more expensive two-way communications radios. Sony's engineers, in using existing components to hold down price and give that kind of performance, have probably opened a new era in Japanese radio design.

Designers at competing companies, while pointing to some disadvantages of the Sony instrument—they say the dial could be a bit difficult for a teen-ager to handle—and insisting that they could have done the same thing, admit that Sony is clearly the one out front in the short-wave receiver business.

Sony and Matsushita Electric Industrial Co. had been running neck and neck in sales. However, one Matsushita engineer, working to design a better radio than Sony's, says that beating Sony's design and price would not be easy. And a

spokesman at Toshiba, whose sales rank a distant third, agrees that Sony's radio is an excellent one for the price.

The new Sony radio, which went on sale last month, covers the broadcast band, three short-wave bands to 28 megahertz, and the fm broadcast band. The receiver's bandspread dial enables the listener to set the receiver frequency within 2 or 3 kilohertz on all short-wave bands so that there's no need to search for a station. In addition to other communications-receiver fea-

**Leading the field.** This is the top seller in a relatively new Japanese market that is the latest youth craze: short-wave receivers. The Sony radio sells for less than \$100.



tures, the bass and treble tone controls provide the quality of home radio. Still further innovative engineering not only makes it possible to build the short-wave receiver from standard consumer-radio components, but it can be built on the same production line.

**Tuning.** Perhaps the outstanding characteristic of the radio is its bandspread-tuning dial, which tunes at a constant rate through all short-wave bands. The scale is divided into 10-kHz increments over a  $\pm 150$ -kHz band segment adjusted against a built-in crystal marker oscillator for high precision. Less apparent is its use of double-superheterodyne circuits, a common practice for excellent image rejection on high-frequency bands of communications receivers. The radio also has a beat-frequency oscillator to permit reception of Morse code or single-sideband traffic, and an attenuator labeled DX-local at the input prevents overloading by extremely strong signals.

The circuit arrangement for both medium-wave and fm-broadcast bands is essentially standard. In the double-superheterodyne configuration, the 10.7-MHz first fm intermediate-frequency amplifier-stage is used as the first i-f stage for short-wave reception. The 455-kHz broadcast i-f stage is used as the second i-f stage. Thus, the high first i-f stage assures that, even on the 28-MHz band, the image frequency is far enough away from the desired frequency to be eas-

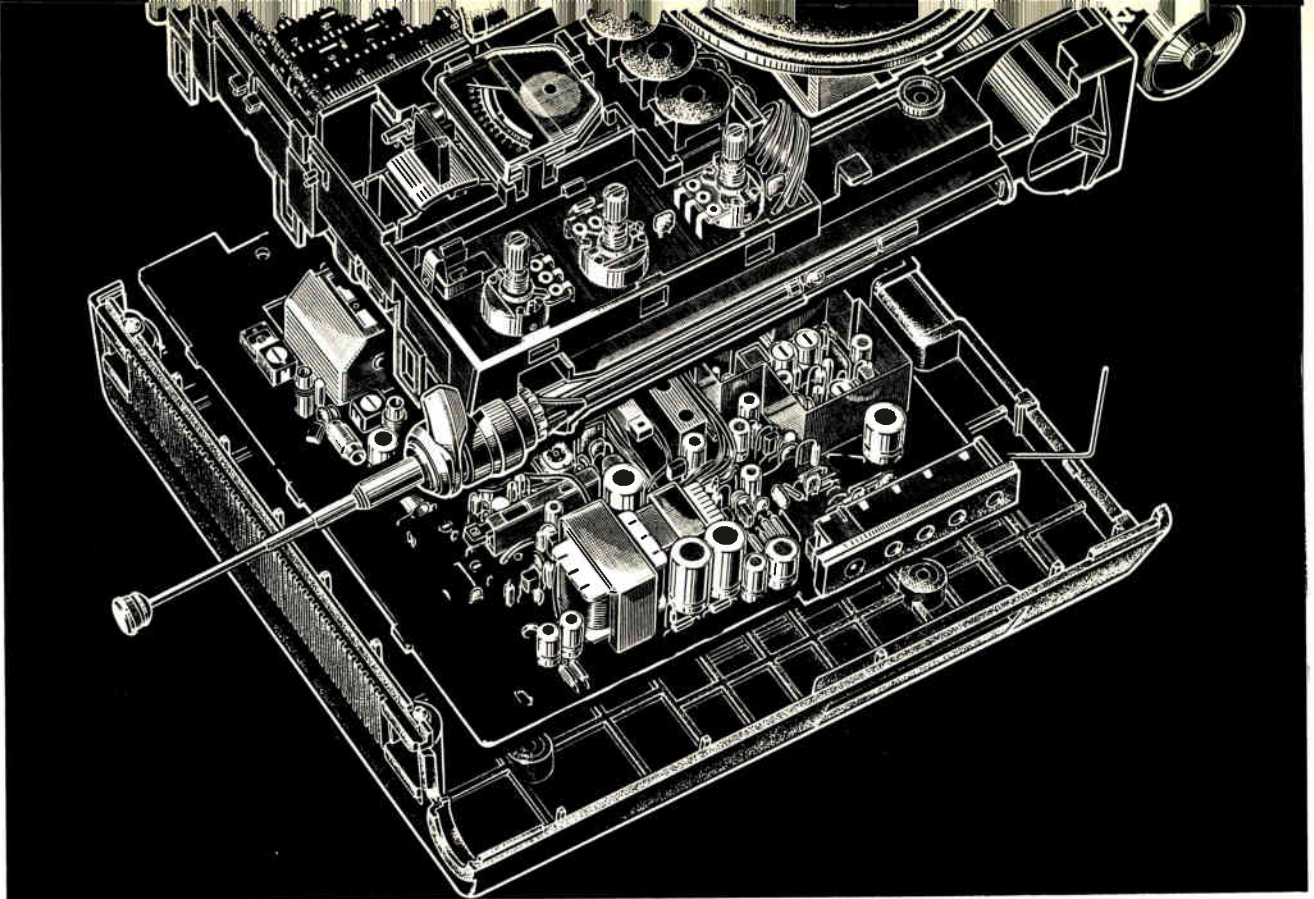

**Inside Job.** Sony has used clever design and included features like a bandspread dial and re-use of the fm i-f amplifier to keep the price of its radio low while maintaining a high standard of performance.

ily rejected. The low second i-f stage makes it easier to achieve desired gain and bandpass characteristics—its bandwidth determines receiver selectivity.

The choice of the fm i-f stage as the first i-f stage kills several birds with one stone. The frequency is high enough for good image-rejection, and its use doesn't cost anything. The 300-kHz bandwidth is large enough to obtain the desired bandspread characteristics without the complication of multiple ganged-tuning circuits.

**Bandspread.** The bandspread dial varies the second local oscillator, used for frequency conversion between the first and second i-f frequencies by  $\pm 150$  kHz from its center frequency. This gives bandspread tuning at a constant tuning rate on all of the receiver's short-wave bands.

The dial is marked in 10-kHz increments with almost equal spacing between marks. Because of the flat-bandpass characteristics of the fm i-f tuned circuits and the broad tuning of the rf tuned circuits, the sensi-

tivity of the radio is almost constant throughout this range.

To provide direct reading of the bandspread dial, a crystal-marker oscillator is built into the radio. It consists of 0.5-MHz oscillator and a single frequency-divider stage to give marker signals at 0.25-MHz intervals throughout the tuning range of the radio.

**Zero beat.** All the operator has to do is adjust the main tuning dial for a zero beat against the marker to the 0.25-MHz frequency multiple nearest to the desired frequency and then tune the bandspread dial to the precise frequency desired.

As with most other short-wave radios, the scale length of the main tuning dial (in centimeters per megahertz) is much too short to find the desired station directly on the higher-frequency bands. But the resolution is much more than adequate to read the nearest 0.25-MHz frequency without ambiguity. And backlash has been eliminated to permit easy adjustment to the zero beat. Although it may be necessary to tweak the dial in Sony's radio for the test reception, it can be set to the correct frequency without listening, in contrast to other receivers, which require searching for the station desired.

Sony engineers eliminated the potential danger of stations near the first i-f riding directly through by using a double balanced mixer in the first mixer stage. This mixer, which is not used in consumer products, also operates as an up-converter on the low-frequency short-wave band. Another technique not commonly used in consumer receivers is the use of a product detector when the beat-frequency oscillator is used for reception of Morse code or single-sideband signals. This arrangement keeps the oscillator-injection voltage out of the automatic-gain-control circuits and prevents loss in sensitivity while using the oscillator.

Although Sony is ready to export its radios to the U.S., such a market is unlikely to develop because of the popularity of citizens'-band radio in this country, a type that Japan doesn't have. And there is no market in Europe because those countries are so close together that short wave isn't needed to pick up foreign broadcasts; what's more, European youngsters generally don't have the money to spare for short-wave receivers. Still, judging from Sony's production of 25,000 units a month, its domestic prospects are bright enough. □



# Who's who in high performance linear I.C.'s? We are.

Teledyne Philbrick. The ones who started it all some 29 years ago. Today we have the best line of bipolar and FET input high performance linear I.C.'s. Some 17 different I.C. families in all... general purpose, wideband, high speed/fast settling and ultra-low drift bipolar I.C.'s. General purpose, low cost, high accuracy, ultra-low bias current, ultra-fast and wideband/fast settling FET I.C.'s.

Linear I.C.'s that give you low-cost, high reliability and high performance without any of the usual trade-offs. So you get all the performance you need at competitive prices that will surprise you. Dependable I.C.'s with the experience to back them up.

We've got a wideband bipolar I.C., our 1321, that boasts a settling time of 500 nsec. to 0.1%, better than any competition and sells for \$6 in 100's.

Or we'll give you the same specs in a FET input I.C., our 1433, for \$9.50 in 100's.

How about our 1340, an ultra-low drift bipolar I.C. with  $0.2 \mu\text{V}/^\circ\text{C}$   $E_{osTC}$  and  $5 \mu\text{V}/\text{year}$  long-term stability that sells for \$25 in 100's.

Or the fastest FET I.C. op amp on the market, our 1430, that gives you a settling time of 200 nsec. to 0.01%, max. and 10 V @ 50 mA output.

We could go on and on. But you get the idea. If you want the best high performance linear I.C.'s check us first.

Write for our new Linear/ Nonlinear Catalog. Or "DIAL" (our Direct Information Access Line) 617-329-1600.

Teledyne Philbrick, Dedham, MA 02026. In Europe, Telephone 673.99.88, Telex: 25881. Or write 181 Chaussee De La Hulpe, 1170 Brussels.

 **TELEDYNE  
PHILBRICK**

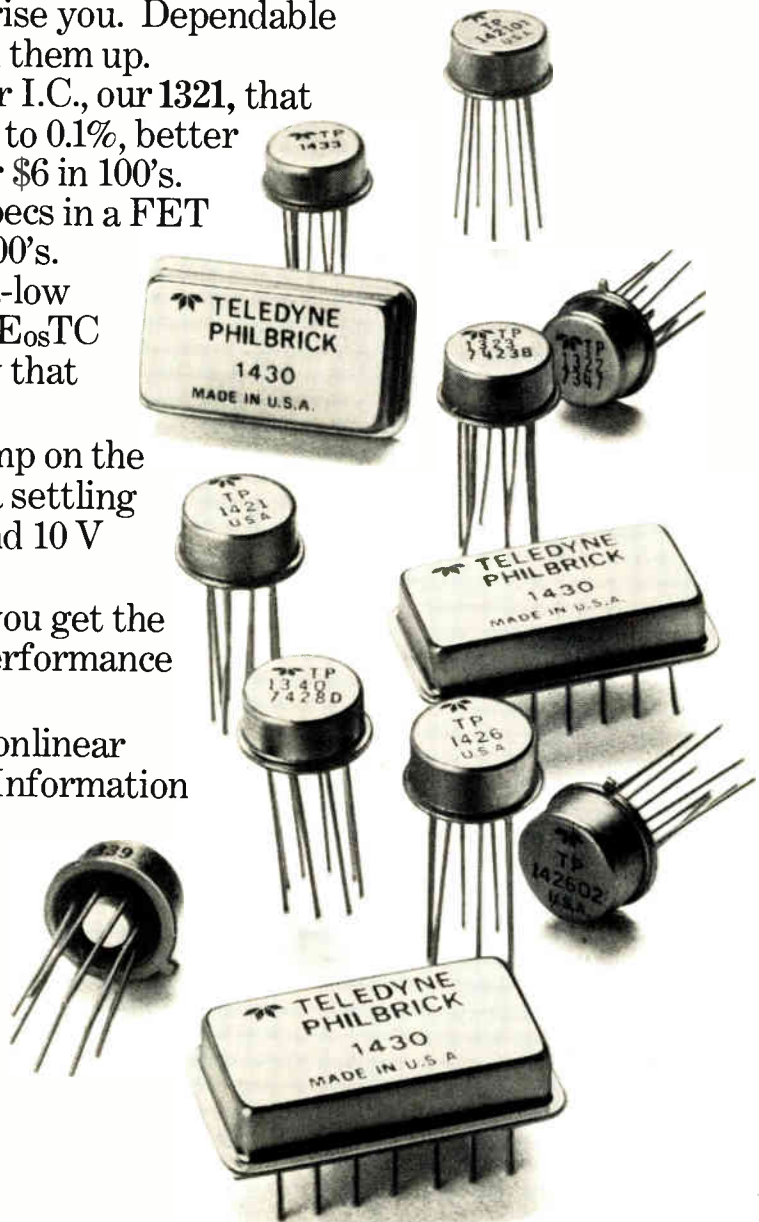



Commercial

# EFTS to chalk up a 1976 first

Closed-circuit, multibank funds-transfer network to start operating in Missouri; hardware purchases to reach \$20 million

by Larry Marion, Washington bureau

Historians of the cashless society will record 1976 as the year that a closed-circuit multibank electronic-funds-transfer network went into commercial operation. That network won't be in the traditional commercial centers such as Los Angeles, Chicago, or New York, but in Missouri.

Through the efforts of the Mid-American Automated Clearinghouse Association of Kansas City and the forthcoming network of the Financial Communications Services Corp. of St. Louis, an employee of a participating corporation in Missouri will be able to have his salary deposited automatically in his bank account through the clearinghouse. And he will be able to make retail transactions on the FCSC network within seconds. This service, company officials predict, will begin late in 1976.

William S. Anderson, chairman and president of the NCR Corp., estimates that "tens of billions of dollars of potential deposits" are at stake in the coming rush to buy EFTS equipment.

**Inside track.** More than \$20 million in hardware, including 6,500 point-of-sale terminals and 150 automated stand-alone teller machines, will be ordered "within the next two weeks" to link FCSC-member banks, notes a company official. In July, that company released seven requests for quotation to 61 companies for a master switch and processing center (computer, processors, and communications modems), regional data concentrators, terminals, and operator's console to monitor the network and data scrambler for security.

The entire transaction, from employer deposit to merchant-funds transfer may be made on International Business Machines Corp. equipment. The FCSC official says "IBM has the inside track for the unique \$1.5-million switching center" purchase because of FCSC's eight years' experience with three IBM System/7 machines already switching computer-to-computer transfers among its founding institutions, the Mastercharge banks in the St. Louis area. The switch will be the first in the U.S. to route messages from point-of-sale terminals at various retailers' to a variety of banks.

Many banks, such as Bank of America in San Francisco and First National City Bank in New York, have linked merchants to its bank computer for credit authorization or account crediting and debiting, without including other banks in their systems. "FCSC is the nation's only third-party electronic-funds-transfer system," an official says, and the American Bankers Association agrees.

IBM also supplied the 370-class computer used by the Federal Reserve Bank of Kansas City, which is used by the regional clearinghouse to process magnetic-tape salary records of five companies and ship

**Handling money.** This is a typical configuration for an electronic funds-transfer switch system, suggested by IBM. Computers are linked via microwave or land lines.

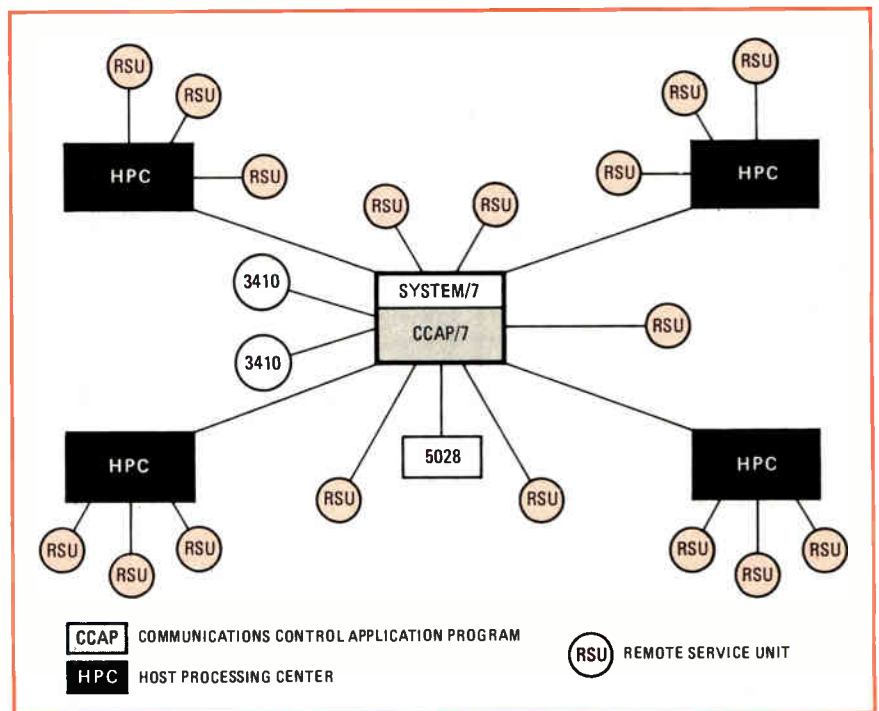

payroll information to 1,000 area banks that credit the accounts of hundreds of employee depositors. More companies are expected to join after the FCSC becomes operational next year. Indicative of industry interest were the 2,600 bankers who crowded the first FCSC system briefing, held in Kansas City earlier in November.

Officials of IBM's Data Processing division and its General Systems division are making proposals to bank groups around the country, but the competition is keen. IBM's General Systems people have developed computer-to-computer switch proposals for banks. Price tags start at about \$225,000 for the switch, built around the System/7, together with numerous peripherals such as processors, multiple input/output modules, and other devices [*Electronics*, Nov. 13, p. 38]. For the St. Louis system, though, nothing less than a \$1.1 million System/370-155 can do the job, says FCSC. The company predicts about 85 million transactions a year within five years, and that the 370-155 won't be adequate if the network attracts additional users. "And we're betting that it will," says an FCSC official.

**Competition.** Competing with IBM for the St. Louis switch, off-the-shelf peripheral, and terminal business are industry giants such as Burroughs Corp. of Detroit and NCR Corp. of Dayton, Ohio. Each has extensive banking-industry experience, although industry officials say Burroughs is the only real competition to IBM for the switch because half of the 16 automated clearing houses in operation use Burroughs equipment, and IBM hardware is in the others. More than 300 computers and 16,000 terminals from Burroughs are installed in banks, it says.

NCR, which entered the competition late, has begun a marketing effort to break the IBM-Burroughs hold on automated-clearing-house business, an official says. Although Burroughs hasn't said so publicly, it is believed that its big switch proposal would include one of its 4700-series medium-size computers with at least 150 kilobytes of memory, multiple communications processors with 32 kilobytes each, at least four

disk drives, and other peripherals.

In a recent competitive evaluation of switch hardware, a \$1.2 million Burroughs proposal, including a 3700 and those peripherals, had the highest price of the industry leaders, according to the Federal Home Loan Bank Board. The board reviewed the proposals as a service to its 13 regional bank boards, which service savings and loan associations. A recent Justice Department decision has stalled switch-buying plans of banks.

NCR officials are confident that hardware sales will continue, despite rulings by the Justice Department and other government agencies. "Our proposal to the St. Louis project includes a mix of minicomputers and large processors," notes an official. The NCR proposal is based on a module approach, with building blocks of magnetic-tape drives and memory.

For the FHLBB, NCR proposed an NCR-605 series microprocessor and Century 151 computer. The microprocessor would be used as a regional message switch, while the 151 would be used to forward messages to bank computers and credit and debit bank accounts.

NCR is offering complete software services, the FHLBB says, and is also offering to link FHLBBs to the regional Federal Reserve banks and the automated clearinghouses, forbidden by present statute. NCR declined to submit detailed cost estimates to the FHLBB, but it indicated that the hardware costs would be at least \$455,000.

NCR's strategy is to provide the total capability within a single unit, notes the FHLBB review. Current projects include:

- The Chase Manhattan Bank, New York, and NCR next year will test a new unreleased NCR terminal called the Model 910. It is loaded with undisclosed options, FHLBB says, to be considered for the next generation of NCR terminals capable of providing EFT functions.
- Hoping to sign up savings and loan associations, NCR has sold 12 POS terminals to a group of Milwaukee, Wis., sales offices. The units will be installed in supermarkets with a regional Burroughs processor.

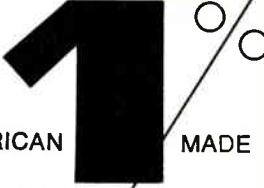

AMERICAN MADE

# Tolerance

# SCHAUER

## 1-Watt

# ZENERS

### Immediate Shipment

### Low Prices

ANY voltage from 2.0 to 16.0

Quantity	Price each
1-99	\$1.07
100-499	.97
500-999	.91
1000-4999	.86
5000 up	.82



All welded and brazed assembly

No fragile nail heads

Gold plated leads

Write for complete rating data and other tolerance prices.

## Buy the kit-

## Save a lot



Kit contains a 51-piece assortment of SCHAUER 1% tolerance 1-watt zeners covering the voltage range of 2.7 to 16.0. Three diodes of each voltage packaged in reusable poly bags. Stored in a handy file box. Contact your distributor or order direct.

A \$54.57 value for  
**ONLY \$24.50**

Semiconductor Division  
**SCHAUER**  
 Manufacturing Corp.

4514 Alpine Ave. Cincinnati, Ohio 45242  
 Telephone: 513/791-3030





**Fun and games.** Atari Inc., which started the arcade-game fever with its "Pong" electronic table-tennis game, is selling this version for the home for less than \$100.

## Video games adopt the family in big way

by Bernard Cole, San Francisco bureau manager

Now that you've wowed the kids with your digital watch and calculator, the kids may have a chance to dazzle their friends with what some view as the next hot consumer electronics item: home video games.

Priced now at \$100 to \$150, the games represent a two-pronged opportunity for semiconductor companies. They can supply components and also follow the calculator and watch route by making the entire game. The biggest effort will be made by National Semiconductor's Novus division, which plans to move into a dominant position in toys and games. At the summer Consumer Electronics Show in June, it will probably make its first move, with a \$75 to \$100 unit with three game options. "The company that will dominate the business will be

the one that combines low cost and a wide range of game options," says National's product manager for games and toys, Stephen W. Fields. So, further down the line, the strategy includes introduction of eight to 10 plug-in modules with new options each year.

Charles Sporck, National's president, estimates that by 1980 the market could amount to 10 million units a year at an average retail price of \$29.95. Despite the fact that the semiconductor content of the games will be only 20% or so, he says that will still amount to \$60 million a year. "Although not quite as attractive as calculators and digital watches," says Sporck, it will nonetheless be a significant market.

But the threat from vertically integrated semiconductor makers is

discounted by the traditional games maker. At Atari Inc. of Los Gatos, Calif., which started the electronic arcade-game craze three years ago with "Pong," president Nolan Bushnell says, "The electronic-game business is a game business, not an electronics business. You must understand the consumer and the game psychology better than the electronics."

Still, the big semiconductor houses are waiting in the wings. Fairchild Camera & Instrument Co. of Mountain View, Calif., hoping not to be caught flat-footed as it was with watches and calculators, is supplying parts and also seeking a way to use its F8 microprocessor in a game. As one Fairchild engineer puts it: "If you get the cost down, video games are a great way to sell microprocessors."

What has opened the door to this new industry is the low cost of MSI and LSI circuits. The technologies run the gamut from discretes to medium- and large-scale integrated circuits using both bipolar transistor-transistor-logic and p-channel and n-channel metal-oxide-semiconductor technology.

**Shopping list.** One games maker, Executive Games Inc. of Boston, uses a set of 23 standard MSI TTL chips. Universal Research Labs of Elk Grove Village, Ill., employs a read-only memory as controller, again in MSI. The original Odyssey game from Magnavox was basically an analog approach using discrete resistors, capacitors, and linear components, but the newer versions use off-the-shelf operational amplifiers and a custom-designed set of seven TTL chips. Atari replaces a hard-wired collection of MSI flip-flops, hex inverters, gates, binary counters, and multiplexers with a 200-by-200-mil n-channel MOS chip containing random logic and read-only memory. National's first efforts will be somewhat similar to Atari's, except that its LSI chip will be metal-gate p-channel MOS.

And if prices continue to drop, a number of these game makers hint that 1977 will see microprocessor-driven versions with plug-in software games. Already being used to cut costs of arcade games [*Electronics*, Oct. 30, 1975, p. 32], this would



mark, they say, the microcomputer's first significant play for a place in the home.

Semiconductor makers supplying parts include National of Santa Clara, Calif., Synertek, Electronic Arrays Inc. of Mountain View, and Texas Instruments Inc. of Dallas. Also interested are TV makers like Admiral, GTE Sylvania, Quasar, RCA, and Zenith.

**Christmas presents.** A hint of what is to come in the New Year is supplied by the games now on the market for this Christmas season. Atari Inc. is marketing an "under \$100" Pong table-tennis game through its own distributors and through Sears, Roebuck's "Tele-games" line. Magnavox is selling its original "Odyssey" for \$99.95 through its own 2,500 dealers and also through the Montgomery Ward stores and Star Case Inc., of New York, N.Y., a distributor with 26 reps.

Universal Research Labs has "Video Action" in two versions, one for about \$300 and the other for \$150, featuring basketball, football, tennis, and handball. They are selling through 300 to 400 department stores in California, Texas, and Ohio. National Computer Systems' combination TV-set-and-video-game provides table tennis and soccer for two players and sells in four models for \$290 to \$590. But the least costly home video game on the market—\$65 retail—is "Television Tennis" from Executive Games.

It is next year, however, that the games will really begin to proliferate. Universal Research Labs will be coming out with a \$99 version of its game in time for the January Toy Show in New York City. Magnavox will finally be in production with updated Odyssey 100 and 200 games, with sound and scoring, for \$89.98 and \$119.95, respectively. Atari will announce a whole family of \$99 home video games that will draw on the library of video skill games it has already developed for its arcade units. National Computer Systems is planning to introduce a \$100 home version of its games from which the TV set has been eliminated. And Executive Games intends to expand the number of game options in its \$65 unit. □

# 1024 Element Analog Delay 75 DB S/N

RETICON's SAD-1024 Serial Analog Delay is the most recent in our line of analog signal processing devices. It is designed for variable or fixed delay of analog signals including various audio applications (e.g., reverberation, echo and chorus effects in electronic organs and musical instruments, speech compression, voice scrambling, etc.) It is packaged in a 16 lead DIP and is priced at less than 1¢/bit in OEM quantities.

Other units offer up to 12 MHz sampling frequency, independent read-in/read-out, and can be used to perform analog storage, digital filtering, convolution, correlation, real time Fourier transforms and many other functions.

There are over 70 salesmen and 16 distributors to serve you worldwide.



**RETICON®**  
910 Benicia Avenue  
Sunnyvale, Ca. 94086  
(408) 738-4266  
TWX: 910-339-9343

# S6800: The whole Kit.

## Smart Terminal.

Complete program editing through CRT and keyboard. Also includes Modem communication to remote computers. (Avail. Feb.)

## Magnetic Tape.

Cross product software— assembler, loader, simulator. (Avail. Now)

## S6800 Family.

It's all here: MPU, RAM, ROM, PIA, ACIA, PROM, USRT and Modem. By test, the best. (Avail. Now)

## Evaluation Board.

Includes everything you need to evaluate parts, program PROMs and, connected with a peripheral, run programs. (Avail. Jan.)

## Dual Floppy Disk.

Storage for resident software— assembler, editor, etc. (Avail. Feb.)

## Disk Program Storage.

500K bytes for program development and on-line data storage. Cuts out the paper tape! (Avail. Feb.)

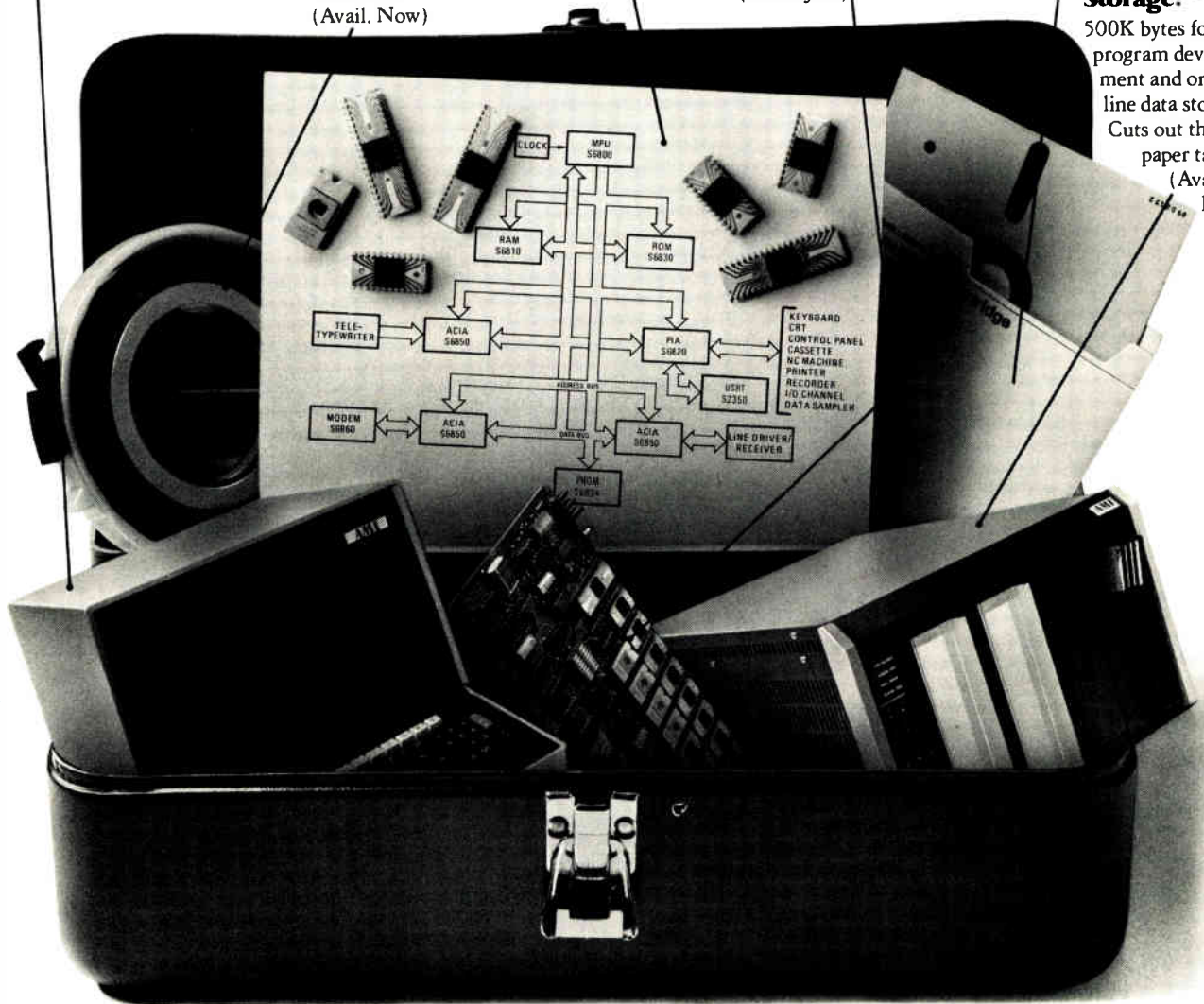

Our S6800 Kit is a big step forward in simplifying your design, evaluation and test programs. For example, our intelligent CRT is simple to operate with either resident or remote software. It really is smart, because it contains an S6800! And it's planned to have an in-circuit emulator added later.

Our dual disk is extremely useful for developing programs, and saves you hours of paper tape shuffling. And our Evaluation Board is loaded with

all the parts you need to get your product on the market on time.

Now for the Caboodle. The dictionary calls it a "package." You'll call it the neatest set of instructions for any kit you've ever bought.

Now why don't you call your nearest AMI sales office or distributor, and ask them for the whole Kit and Caboodle. Or write AMI, 3800 Homestead Road, Santa Clara CA 95051. What could be easier?

## Here's where you pick up your Kit.

**SALES OFFICES**  
 Manhattan Beach CA • (213) 379-2452  
 San Jose CA • (408) 249-4550  
 Altamonte Springs FL • (305) 830-8889  
 Elk Grove Village IL • (312) 437-6496  
 Norwood MA • (617) 762-0726  
 Livonia MI • (313) 478-9339  
 Minneapolis MN • (612) 559-9004  
 Monsey NY • (914) 352-5333  
 Cleveland OH • (216) 292-8850  
 Ambler PA • (215) 843-0217  
 Richardson TX • (214) 231-5721



# And Caboodle.

## Software Brochure.

A rundown on AMI software products including assembler, loader and simulator.  
(Avail. Now)

## \$6800 Brochure.

List of goodies. All you want to know about the \$6800 family.  
(Avail. Now)

## Evaluation Board Application Notes.

The why and wherefore of our Prototyping System, and how to make the most of it!  
(Avail. Jan.)

## NCSS Users Manual.

All the magic necessary to work with National CSS time-sharing network.  
(Avail. Now)

## Assembly Language Programming Manual.

Describes the instruction set and how to use the AMI Assembler and Simulator.  
(Avail. Now)

## AMI Guide to Standard Products.

All the MOS you might need in addition to microprocessors.  
(Avail. Now)

## Hardware Reference Manual.

A detailed description of each component in the system, and how to make them work!  
(Avail. Jan.)



### DISTRIBUTORS

ALTA ELECTRONICS:  
Utah—Salt Lake City (801) 486-7227

ARROW ELECTRONICS:  
Minnesota—Bloomington  
(612) 888-5522

CENTURY ELECTRONICS:  
New Mexico—Albuquerque  
(505) 292-2700

Utah—Salt Lake City (801) 487-8551  
INTERMARK ELECTRONICS:  
Washington—Seattle (206) 767-3160

SCHWEBER ELECTRONICS:  
California—Costa Mesa (714) 924-5594  
and (714) 556-3880  
Connecticut—Danbury (203) 792-5500

Florida—Hollywood (305) 927-0511  
Georgia—Atlanta (404) 449-9170  
Illinois—Eik Grove Village  
(312) 593-2740

Iowa—Cedar Rapids "Lorenz Sales"  
(319) 393-0100  
Maryland—Rockville (301) 881-3300

Massachusetts—Waltham  
(617) 890-8484  
Michigan—Troy (313) 583-9242

Minnesota—Edina (612) 941-5280  
New Jersey—Somerset  
(201) 469-8008  
New York—Rochester (716) 461-4000

Westbury (516) 334-7474  
Ohio—Beachwood (216) 464-2970  
Texas—Austin (512) 837-2890  
Dallas (214) 661-5010  
Houston (713) 784-3600

Canada—Mississauga, Ont.  
(416) 878-9050

SEMICOMP CORP:  
California—Newport Beach  
(714) 971-5253 and  
(714) 833-3070

STERLING ELECTRONICS:  
Arizona—Phoenix (602) 258-4531  
Louisiana—Metairie  
(504) 887-7810

Massachusetts—Watertown  
(617) 926-9720

New Jersey—Perth Amboy  
(201) 442-8000

New Mexico—Albuquerque  
(505) 345-6601  
Texas—Dallas (214) 357-9131  
Houston (713) 827-9800

Virginia—Richmond "Meridian"  
(804) 335-6521

R.V. WEATHERFORD CO.:  
Arizona—Phoenix (602) 272-7144  
California—Anaheim (714) 547-0881  
Glendale (213) 849-3451  
Palo Alto (415) 493-5373  
Pomona (714) 823-1261  
San Diego  
(714) 278-7400

Colorado—Englewood  
(303) 761-5432

New Mexico—Albuquerque  
(505) 842-0868

Texas—Dallas (214) 243-1571  
Houston (713) 688-7406

Washington—Seattle  
(206) 243-6340

it's  
standard  
at AMI.  
AMERICAN MICROSYSTEMS, INC.



Computers

# Hobbyists create a new industry

Microprocessor-based computers in packages and kits sell for up to \$1,000; makers have sold 8,000 in past year

by Andy Santoni, Instrumentation Editor

**Chalk up** another market for the microprocessor. And this time, the simplicity and low cost of developing microprocessor-based equipment has spawned a new industry: hobby computers.

With useful systems—generally in kit form—costing up to \$1,000, it still takes a well-heeled aficionado to buy one. But the hobby has attracted a mixture of people using the devices to operate systems ranging from stage lights to model railroads, or to gain hands-on experience with microprocessors. Many of the customers are inveterate kit builders who have worked their way through digital clocks, oscilloscopes, and color television sets, and now relish the challenge of building a computer.

A half-dozen companies are in the business, and well-known kit maker Heath Co. of Benton Harbor, Mich., is taking a look at it. Although it's hard to get a fix on sales, about half the buyers are hobbyists, and the rest are industrial customers who like the low price of the kits—they're less expensive than wired systems and save the expense of design and development.

The industry, barely a year old, has begun to look like the well-established computer industry, and manufacturers are offering plug-compatible peripherals. And at least one users' group has sprung up and scheduled a meeting.

And like the large-computer business, the hobby-computer market so far is dominated by one firm: MITS of Albuquerque, N.M. Along with the ubiquitous Altair 8800, MITS

sells a type-6800 microprocessor-based computer, the Altair 680, and a line of peripherals, all available as kits or assembled units.

**Dropping some.** Since the beginning of the year, when MITS entered the computer business, its employment has grown from about 25 to almost 100, says president Ed Roberts. In fact, computer business has been so good that MITS plans to drop its older products—calculators and test equipment in kit or wired form.

This year, more than 8,000 Altair products have been sold in kit or assembled form and either ready-to-use or in the form of separate CPU, memory, and interface boards. While this includes sales to industrial users, MITS estimates that half is to hobbyists.

MITS is not alone. Southwest Technical Products Corp., San Antonio, Texas, has introduced a 6800-based computer while it continues to market its test equipment and other hobby kits. Sphere Corp. of Bountiful, Utah, has been putting together low-cost computer systems since it was founded in March. Radio Shack, a division of the Tandy Corp. in Fort Worth, Texas, is investigating a computer designed around National Semiconductor's PACE microprocessor system for consumer use, and Heath is making a preliminary study.

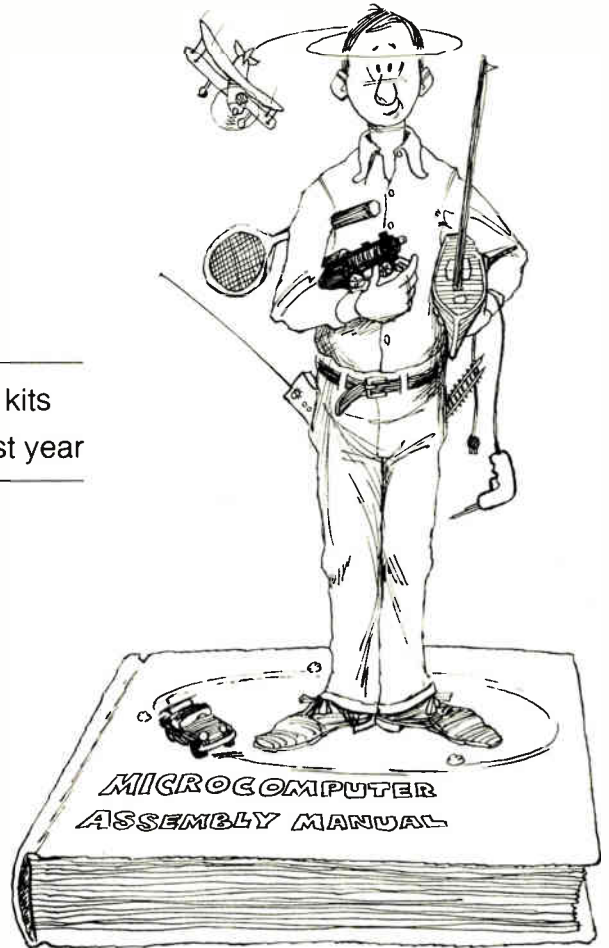

**All customers.** Along with packaged systems, there are microcomputer kits that consist of printed-circuit boards and the necessary components to build programmable devices, but there are no finishing touches like cabinets or enclosures. Along with microprocessor vendors like Intel and Motorola, independent suppliers such as Microcomputer Associates Inc., Los Altos, Calif., a microcomputer consultant, are selling board sets to both industrial and hobby customers. It is in this area that the major price declines are already taking place; Microcomputer Associates' CPU board, which includes an MOS Technology 6502 microprocessor, was priced at \$249 when it was introduced last month, and is now selling for \$159. The firm's 4,096-bit random-access memory board has likewise dropped in price, from \$265 to \$199. And MITS has cut its price for a 4,096-bit RAM card from \$264 to \$195.

While these cards are selling to hobbyists, they are more specifically designed for OEM customers that

"don't want the worry of processor designs," says Ray Holt, executive vice president of Microcomputer Associates. Most of his firm's sales are to small companies that build systems and don't want the overhead expense and time to build their own microprocessor boards.

The Altair series started out as an OEM product, too, says MITS's Roberts, and they have been applied in accounting systems for small businesses; in medical equipment for laboratory analyses, patient monitoring, and machine controls; and in some industrial applications.

**Playing games.** As for enthusiasts' computer applications, "Everyone's standing around not knowing what to do," says Ted Nelson, lecturer at the University of Illinois at Chicago and author of "Computer Lib," a book advocating computer language and terms comprehensible to the layman. So far, the major use for hobby computers has been playing games, though some owners are applying them to model railroads, photographic timers, and burglar alarm systems.

The real breakthrough in sales won't come until better input/output and mass-storage devices come along at reasonable prices, says Nelson. There are already some relatively low-cost peripherals on the market, but they still increase the price of a computer system beyond most consumers' budgets. For example, the MITS Altair 8800 is priced at \$439 in kit form, and the Altair 680 kit is \$293. But a floppy-disk kit is \$1,480, a small terminal kit is \$780, and a high-speed printer kit is \$1,750. For a user satisfied with programing in octal, MITS offers a model VLCT for \$129 in kit form.

Software support is also a problem. Microprocessor suppliers are not geared to handle requests from individual customers, and the computer makers do not yet have the staff to efficiently handle all queries. The problem is somewhat eased, though, by supplying the microprocessor makers' literature with each kit. Basic-language software is also becoming available as an alternative to binary machine-language entry to make programing easier. □

# Price/ Performance Breakthrough

Actual Size



**8 bit A/D's  
now only  
\$59<sup>00</sup>**

Micro Networks MN5120 Series of successive approximation 8 Bit A/D converters is now less than half the cost of the previously available Dip A/D converters.

The outstanding features include:

- Completely Adjustment Free...no external components or trim pots required, just plug in.
- Linearity... $\pm\frac{1}{2}$  LSB from 0 to 70C, no TC specs needed.
- High Speed...6  $\mu$ sec conversion time.
- Low Power...680mw typical—a savings of 30 to 50% over modular units.
- Hermetic Sealed Dip...for long term stability.

The MN5120 Series of A/D converters with its high performance and low cost makes it ideal for commercial and industrial applications, typical of which are: medical instrumentation, process control, computer peripherals, and interface circuits. All units are 100% electrically tested at 0, 25, and 70C for linearity and accuracy.

For complete data write or call—  
Jerry Flynn: Tel: 617 852-5400.



**MICRO NETWORKS**  
CORPORATION

324 Clark Street, Worcester, MA. 01606

Materials

# Four-inch wafers seen as standard in five years

by Judy Curtis, San Francisco bureau

Now that many semiconductor makers are just completing the change to 3-inch silicon wafers, they're beginning to look at the 4-in. size. In fact, some pilot lines are already using the larger size.

The advantages is in yield—almost double in some cases. And most handling equipment purchased in the last two years for 3-in. wafers is easily adaptable to 4-in. However, some semiconductor houses are going slowly on conversion for technical reasons or because their existing lines aren't being used to capacity as it is.

The key to conversion is the availability of material in the new size. At Monsanto Co.'s Palo Alto, Calif., Electronic division, Paul F. Golden, electronic-materials product manager, says the company is in the final stages of expanding one of its silicon plants to handle the larger wafers. By 1977, he says, 15% to 20% of Monsanto's production will be 4-in. wafers. He believes that in five years most of the industry will have converted.

David Brooks, national sales manager for Wacker Chemical Corp.'s Santa Clara, Calif., division, estimates that 25% of his business will be in 4-in. sizes by late 1976 "with a greater influx in 1977."

Neither Golden nor Brooks foresees a materials shortage "if custom-

ers order what they really need," adds Brooks, "and they don't panic and triple-order."

Charles S. Isherwood, senior manufacturing vice president at American Microsystems Inc., thinks the larger size is worth demanding from materials makers. For one thing there's the 50% increase in capacity the wafers allow, as well as reduced numbers of partial dice. "For the same overhead and labor," says Isherwood, "you get twice as many dice out." Wilfred J. Corrigan, president and chief executive officer at Fairchild Camera & Instrument, estimates that 12 months after the 4-in. wafer becomes standard, cost of the individual chip will decrease by 20%.

Another plus resulting from use of the 4-in. slices, says Jack Harris, sales vice president at Cobilt division of Computervision Corp., which makes wafer-handling equipment, is improved yield. "The larger the batch," he says, "the more identical the devices are." Harris estimates yields could be a minimum of 10% and up to 30%, depending on the device and process.

Companies already utilizing 4-in. wafers in pilot quantities include AMI in Santa Clara, Calif., which has been producing the 1103 for six months and plans to convert its p- and n-channel lines by the

middle of 1976; Advanced Memory Systems Inc. of Sunnyvale, Calif., which expects to have the "entire factory on all processes" producing 4-inchers by June 1976; and General Instrument Corp.'s Microelectronics group in Hicksville, N.Y.

Because of the uncertainties companies like Intersil, Intel, Advanced Micro Devices, and Mostek are not committing themselves to 4-in. production, which takes nine months to set up. An AMD spokesman says his company is operating at only 50% capacity, and Mostek says it sees no trend to 4-in. wafers and will not go in that direction.

Intel is holding back for several reasons, says Robert T. Jenkins, manager of die production. For instance, he says, "there's only one company that makes an ion-implantation machine that easily processes 4-inch." In addition, there is no 4-in. projection printer available, says Jenkins. He also notes that bipolar devices are the most difficult to make in 4-in. sizes because of the high temperatures required and the resulting warping. He says that larger wafers decrease capacity because they have to be placed flat. However, Jenkins says, Intel is "beginning to investigate how to oxidize 4-in. wafers" and will set up some test runs besides its 3-in. lines. □

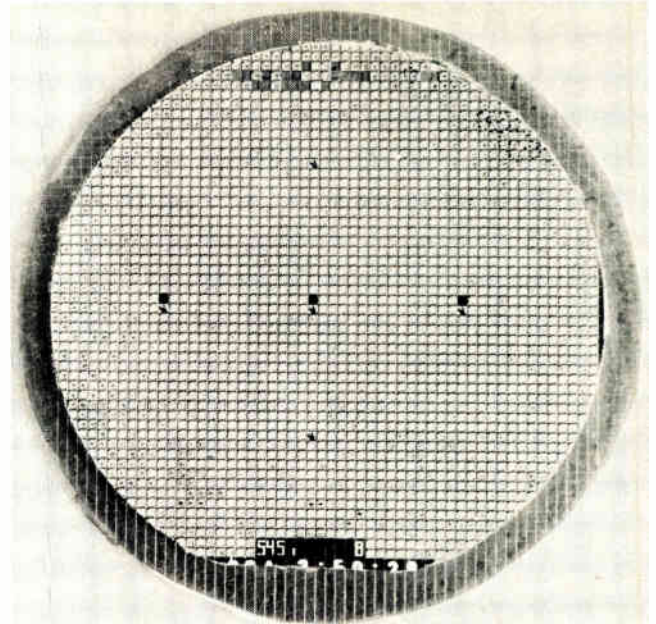

**What size?** Materials availability is the key to changing from a 3-in. to a 4-in. silicon wafer, and materials makers foresee no problems.



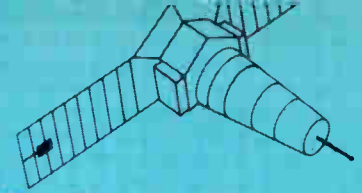
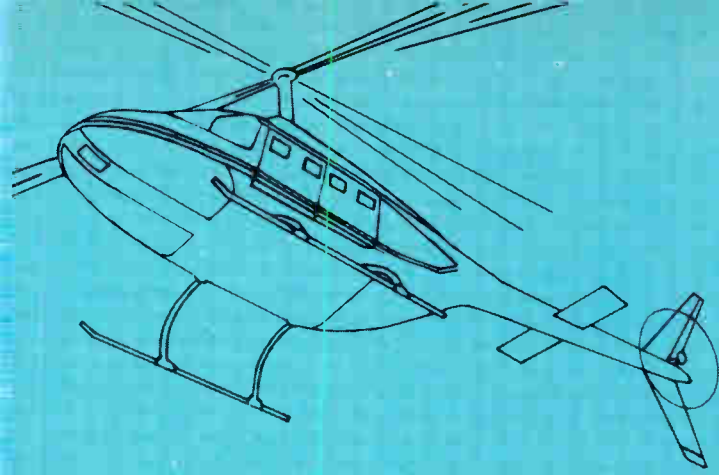

# LogiMetrics.

## In RF subsystems and test equipment the word gets around.

The fact is, LogiMetrics manufactures a greater variety of RF signal generators and TWT amplifiers for the communications market than any other U.S. company. And our new frequency synthesizers are making a tremendous impact, too.

The reasons are clear. We've developed some of the most dramatic techniques in the industry. Like direct digital calibration for unprecedented accuracy, resolution and reliability in our signal generators.

What's more, all of our products are specifically designed for the systems application in which they're used. So there's no need to settle for the wrong size equipment or less than the right specs, even if cost is a consideration. And our standard designs offer additional cost advantages, too.

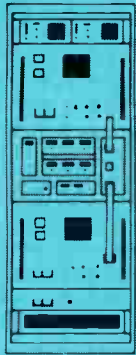

Consider, too, that we're very responsive. Our worldwide organization knows the RF communications and test equipment field so well that we can probably help you solve most problems. We'll help you before you buy to make sure you get exactly what you need. And we're ready to help after you take delivery, too. So, if you decide what RF subsystems and test equipment to buy, don't do it without calling LogiMetrics.

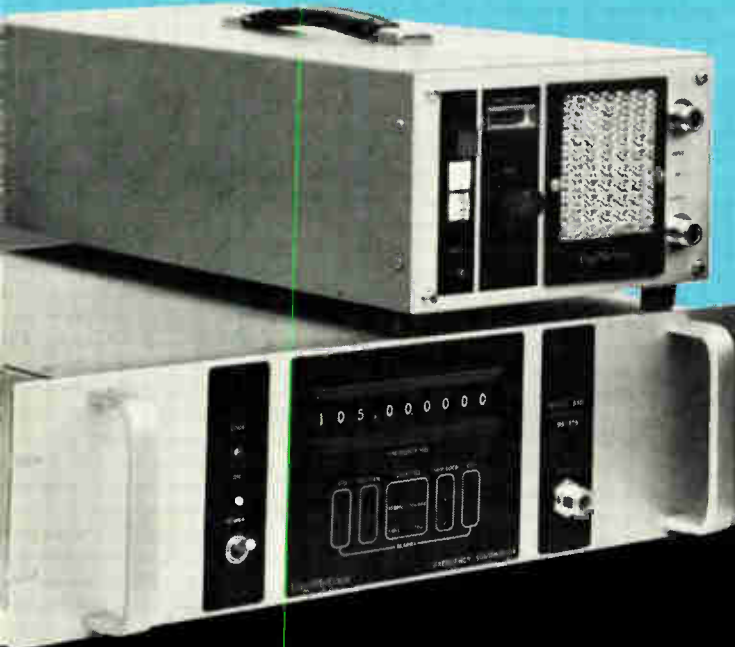
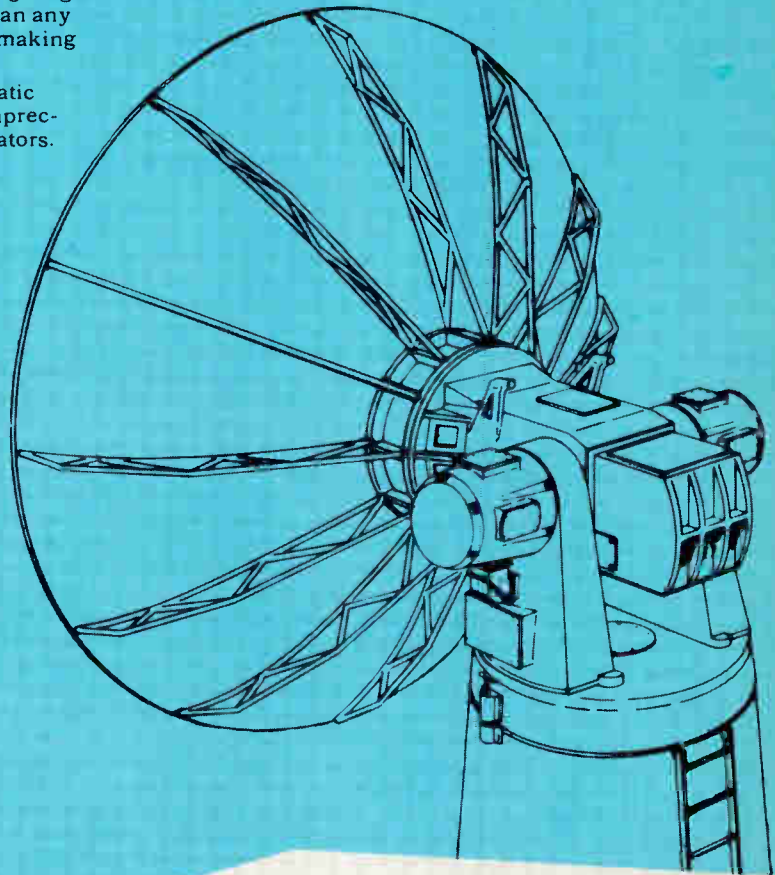

# LogiMetrics

Circle 89 on reader service card

121-03 Dupont Street, Plainview, New York, 11803. (516) 681-4700

RF Signal Generators, Frequency Synthesizers, Traveling Wave Tube Amplifiers

# welcome addition to the family

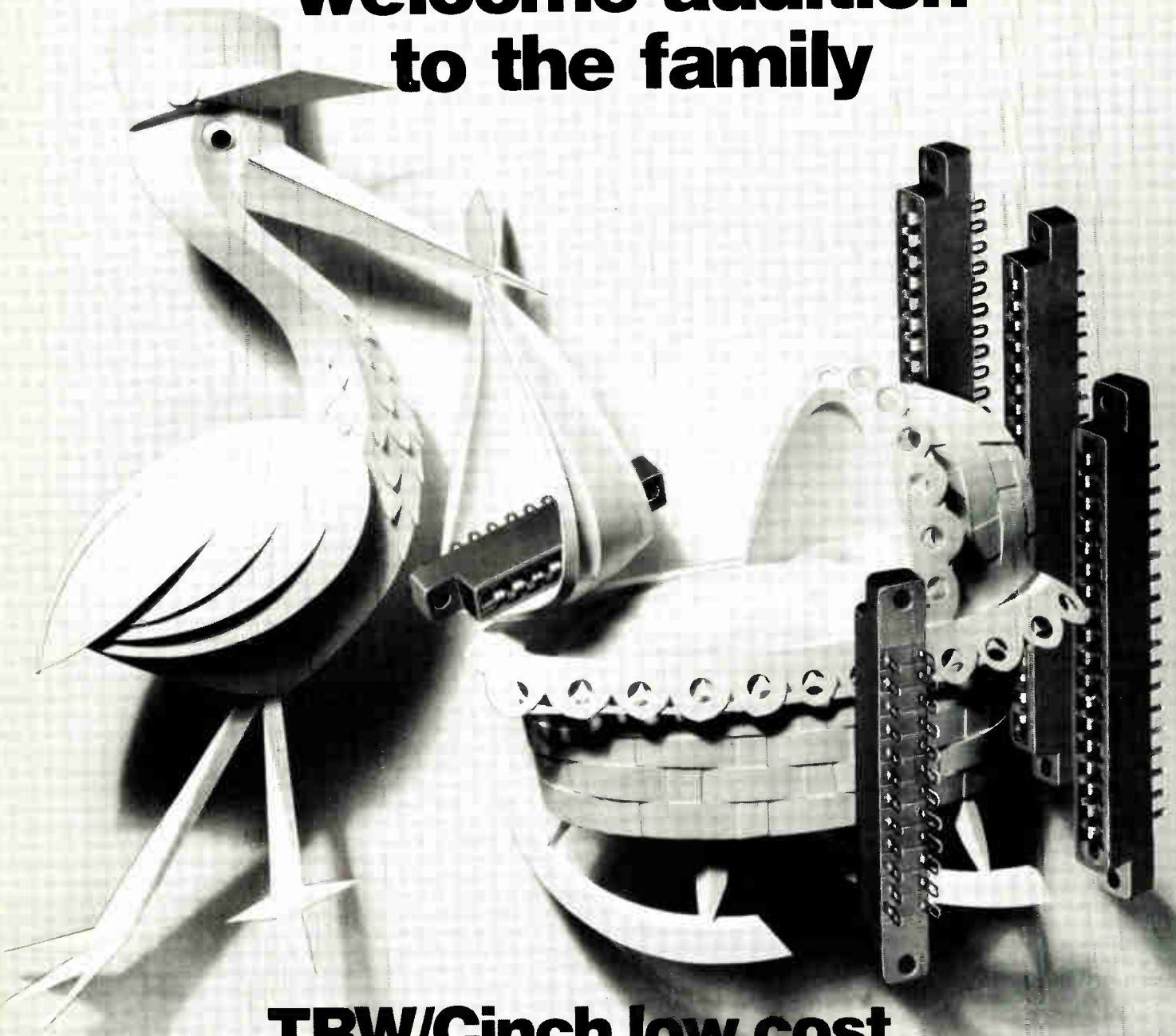

## **TRW/Cinch low cost Series 90 P.C. edge connectors**

These TRW/Cinch Edge Connectors were created to beat rising material costs while maintaining product performance. Designed with 20 micro-inches of gold—at the contact areas only, over 30 microinches of nickel underplate—with high capability, glass-filled polyester insulators, they cost about 20% less than our standard commercial units, 50% less than our military types. The use of nickel, an effective barrier to base metal migration, rather than copper underplate, provides a longer wearing, more stable gold layer.

CC-7508

As with other members of TRW/Cinch Edge Connector family, you have a choice of seven sizes from 6 to 25 positions, in both dip solder and solder tab terminations—and delivery is when you expect it, from TRW/Cinch Connectors or its distributors.

For more information call your nearest sales office or distributor (listed in EEM)—or contact TRW/Cinch Connectors, An Electronic Components Division of TRW, Inc., 1501 Morse Avenue, Elk Grove Village, Illinois 60007, (312) 439-8800.

**TRW<sup>®</sup> CINCH CONNECTORS**



# Weighing the real cost of a board tester

by Robert E. Anderson, *Cmnnicomp Inc., Phoenix, Ariz.*

□ Many manufacturers of electronic equipment are finding it economically advantageous to buy or build automated testers to check their printed-circuit boards—often at every level of the manufacturing cycle. In fact, automated testing has been so widely adopted that sales of logic-test systems alone are expected to exceed \$50 million this year. These systems can often be justified by their automatic operation, speed of testing, diagnostic capability, and generation of management information.

Building a tester appears to be easy. All that's required is to connect peripherals and driver/sensor electronics to a minicomputer. In contrast, the high prices of commercial systems appear to be difficult to justify. The difference is the cost of developing the software, which many companies have discovered to their chagrin is as costly as the hardware—much more if the system has simulation and fault-isolation software. Of course, the final cost depends upon the complexity of the software.

Test-system vendors can reduce the development costs of complete sophisticated automated test systems because they can amortize these heavy expenses through sales of a large number of systems. As a result, many manufacturers that had built their own testers are switching to more sophisticated commercial testers.

Although consultants and handbooks are available to expedite accurate prediction of system costs before the buyer makes his decision, it is useful for him to know the major factors involved in selecting a software package for his particular tasks. And before he buys a system, he should at least try to program it and test a few boards on it to make sure it meets his needs.

However, it is quite difficult to evaluate the cost-effectiveness of developing software for an in-house test system. Unless the design group is experienced in test-system development, simulators, and diagnostic software, many of the cost-performance trade-offs won't be encountered until the development program is well under way. But whether the decision is to build or buy,

emphasizing software performance instead of hardware specifications will help immensely to evaluate the eventual cost-effectiveness of a circuit-board test system.

### Considering computer languages

A computer consists of a base machine and an emulator (Fig. 1). The base machine is the circuitry that performs the basic logical, or micro-operations, such as moving data from one processor register to another and setting a bus-signal level high.

The emulator decodes the bit patterns of the computer instructions, often called macro-instructions, and causes the base machine to execute several micro-operations to perform each macro-instruction. In that way, the emulator circuitry determines the instruction set, or machine language, of the computer. The emulator can consist of hard-wired logic circuits especially designed to run a specific instruction set, or it can be designed to use a programmed sequence of steps, called micro-instructions, which are stored in a control memory. Since memory elements are decreasing in price more rapidly than hard-wired logic, a growing percentage of computers being designed today are microprogrammed.

Often the computer manufacturer writes the microprograms and thereby determines the instruction set of the computer. However, some computer companies now let their customers write their own microprograms. Microprograms are usually stored in read-only memories, although sometimes they are stored in random-access memories, which are called writable control stores.

If the user can write his own microprograms, he can create his own instructions, which will probably be more suitable for his application than the general-purpose instructions supplied by the computer manufacturer. However, changes in the instruction set would not be supported by the manufacturer's software, and changes would be required throughout the system.

Desired test-system operations are usually specified



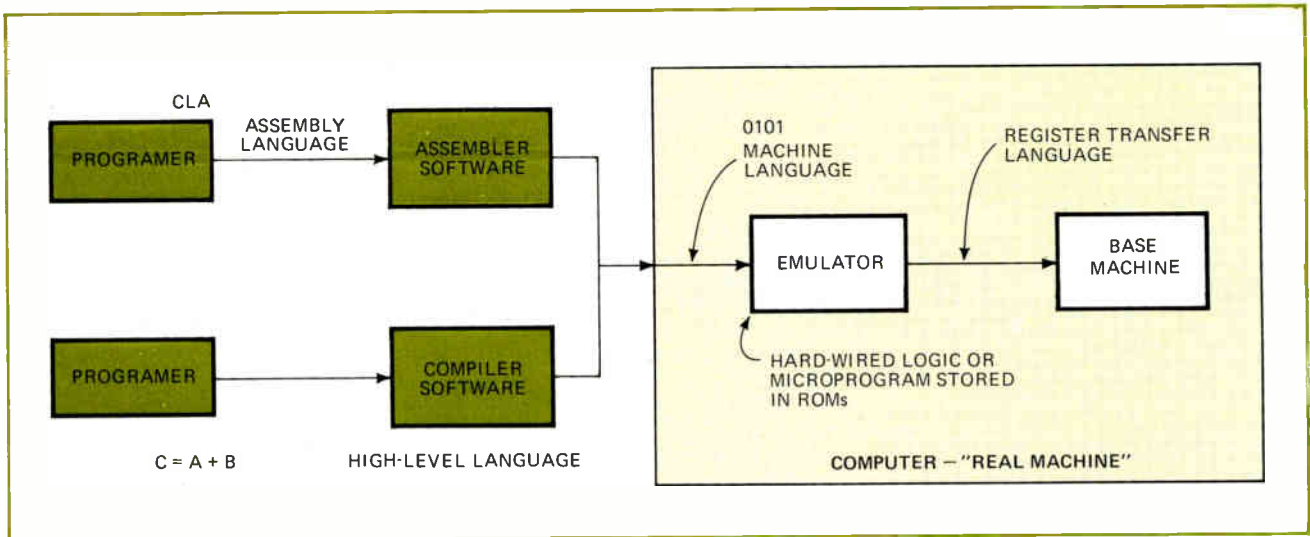

**1. Software.** Compilers and translators are used to convert test programs into the format needed within the processor and to execute the test programs. This involves conversion from high-level or assembly language to a machine language that is decoded by the emulator.

by test programs written in a language that is unique to the computer that controls a particular test system. Languages for computer-programing and testing are both classified as low-level or high-level, depending upon their orientation toward the computer and system hardware or toward the programmer and his task.

Machine language is the lowest-level language used in computer programing. The computer-instruction set, written in machine language, consists of bit patterns in memory. Programing in machine language is possible, but tedious, because the bit patterns have little meaning to the programmer, since they are closely oriented to the computer and not to the problem being solved.

The second level is known as assembly language in which a mnemonic symbol is used for each machine-language instruction and address. These simpler instructions make it easier for the programmer to specify what he wants through an instruction such as CLA for clear accumulator.

Assembly language is still considered low-level for test-programing because the programmer must write many instructions to control each test function, a time-consuming and tedious task. He must spend most of his time specifying the way the system is to function, rather than specifying the type of tests to be made. A high-level language enables a programmer to use terms that are related to the way in which he thinks about the task to be performed. High-level languages are oriented toward specific applications.

### Defining test languages

A low-level test language requires a programmer to divide his task into many small steps and to express it in terms oriented toward the test computer or controller. A high-level test language enables the programmer to express his task in terms oriented toward the stimulus and measurement requirements of the board or component to be tested. Since high-level languages are oriented toward specific types of applications, a language like Fortran can be high-level in one application such as programing mathematical formulas and low-level in a

test-programing application.

The advantage of a low-level test language is to minimize the cost of system design, since simpler support software is required. The disadvantage is higher board-test programing costs because the language is more difficult to learn, write, and debug.

Some commercial tape-controlled and low-cost computer-controlled systems have used ASCII symbols as a programing language. Codes such as these are used to control the test system hardware:

001F, G321, D110, K312

002F, D210, G330, L321

where 001F and 002F are test-step numbers and the other symbols are instructions to instrumentation.

Logic-circuit testing requires hundreds of test statements that can affect hundreds of input and output pins of the board under test. Most commercial logic testers use test languages in which short mnemonics of various kinds specify each pin as high (H) or low (L), input (I) or output (O), and monitored (M) or neglected (N).

In addition, most commercial languages oriented to logic-circuit testing are incremental so that each test statement need only specify the changes from the state of the previous test, as illustrated below:

100; H23, 37, L55, 92, X

110; L23, H92, X

which means in step 100, ICs 23 and 37 are high, ICs 55 and 92 are low, and "execute."

This capability alone requires many fewer man-days of programing effort than a test language that requires that every pin be specified for every test. Incremental programs are easier to write, edit, and debug. Other differences, even among several application-oriented digital test languages, include the capability to repeat portions of the program as loops and subroutines and to

### Closing the loop

*The author will answer questions on this article by mail or phone. He may be reached at from 9 a.m. to 5 p.m. Mountain Standard Time. Omnicomp, Suite 253, 5150 North 16th St., Phoenix, Ariz. 80516, telephone (602) 264-2475.*

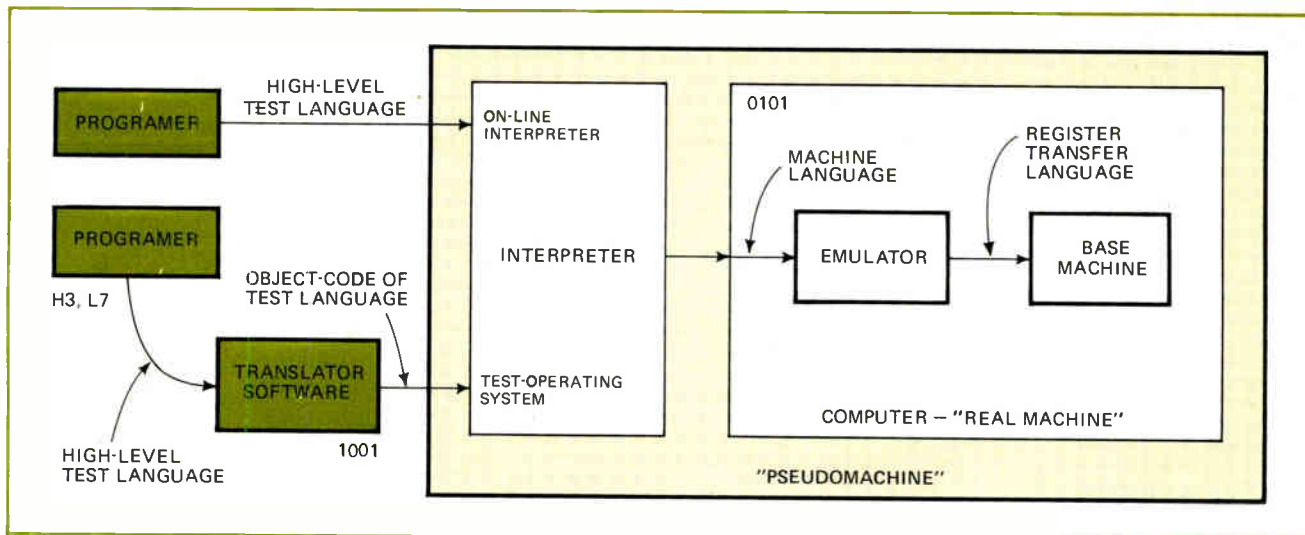

2. High level. Special interpreter software can be used to convert a computer into a "pseudo-machine" with a test-oriented language. The machine language for the pseudo-machine is called the object code or interpretive code of the application program.

branch conditionally according to measurement results. Although there may be significant differences in the ease of using various high-level test-programming languages, in general, the more dedicated a test language is to a specific type of testing, the easier it is to learn and use. And the more versatile the test system's capabilities, the more general the language must be. This trait usually means it is more difficult to learn.

As the capabilities of the test system are broadened, the test language must be expanded to control these capabilities. The relative advantages of the various test languages then become a function of the particular type of testing that will require the majority of the programming effort. If calculations are required for transforming test measurements into data, the test language must have convenient statements for calculations.

If reports are to be generated, the test language should enable convenient specification of data formats. If measurements must be compared to accuracy limits, the test language should enable these limits to be specified in the test statements, rather than requiring the programmer to generate routines to calculate the accuracy of each measurement. The movement toward standardization of test languages is discussed in "Seeking standardization."

### Compiling programs

A software program that converts the high-level language program into a machine-language program is called a compiler. Compiling is slow and difficult, particularly if the compiler optimizes the machine-language program to a great extent. Each program is compiled once, and the resulting program can be stored and run each time the application is needed.

But, rather than compiling the high-level language into machine-language directly, a pseudo-machine (see Fig. 2) can be created to run the high-level language as if it were its machine language. The language is converted by a software program called an interpreter, which reads each instruction directly. Although an interpreter eliminates the problem of compiling the high-

level language into machine language, it usually runs much more slowly because the computer must execute many more instructions in running the interpreter program than it would in a compiled program.

Test systems frequently use intermediate levels between compiling and interpreting so that the high-level language statements are translated into an intermediate instruction format or interpretive code selected for the application. This interpretive format is then executed by the pseudo-machine, consisting of the computer with an interpreter program, to get the best compromise be-

### Seeking standardization

Several attempts have been made to develop standard test languages that can be interpreted by men and machines with equal ease. The best example is Atlas (abbreviated test language for avionics systems), developed for Arinc, the aircraft industry's communications organization, and widely used in airline and military avionics test applications. The Atlas language is oriented entirely toward the unit under test, and it enables the specification of test procedures independently of any particular test system.

This wide acceptance makes Atlas a viable means of communicating test-procedure information among various organizations. However, since implementation of Atlas requires the allocation of stimulus and measurement equipment for particular test-system configurations, virtually all present Atlas compilers implement a subset, an adaptation, or a dialect of Atlas. For that reason, there is little possibility of transferring test programs between several different test systems that use the Atlas language.

But the use of Atlas is expected to be greatly expanded because of recent progress in the formal definition of the language, in the techniques of allocating test-system resources, and in language improvements. In addition, other language-standardization efforts, such as OPAL (operational performance-analysis language) are under way, and this movement toward standardization is expected to continue.



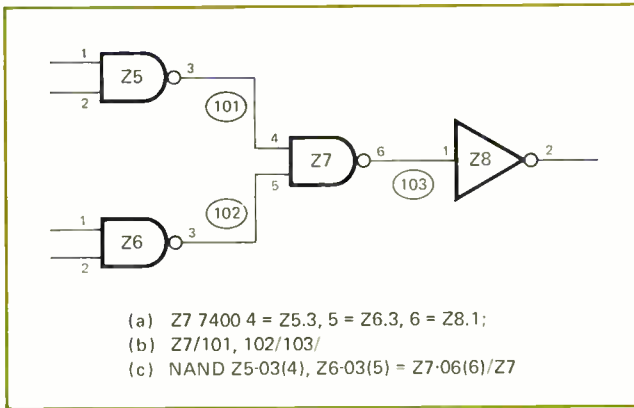

**3. Encoding.** The programmer must describe the logic circuit to be modeled for simulation software. Several formats list logic elements.

tween memory-space requirements and execution speed. In this way, the high-level language can be optimized to the user's testing requirements, the intermediate code format can be optimized for minimum length of the translated test programs, and execution speed can be consistent with the test system's stimulus and measuring equipment.

Most computer-controlled test systems require three types of software, although two or all three may be combined in one executive-software package.

- An editor simplifies program preparation by enabling changes or additions to a test program stored in the computer memory. A line editor assigns a number to each line of the test program text. A programmer edits the information on a particular line by specifying the desired line number along with a command to delete or change that line. Page editors are used in several test systems. The editor program transfers a page of text to the cathode-ray-tube terminal's control, and the programmer uses editing keys to insert, delete, or modify characters or lines of text. The editor then replaces the original version of the page in memory with the corrected version from the terminal.

- A translator converts the high-level source language in which the test program is written into an object code, consisting of binary 1s and 0s; that is, it makes a more concise version of the test program. A variety of object-code formats are used (see "Choosing a storage format"). Most translators also check for syntax errors within the test program and flag them with messages to the programmer to indicate the error type and location.

- A test-operating system interprets the object-code version of the test program and executes the specified system-hardware functions. The operating system contains the software routines that accept interrupt and data signals from the control panel and peripheral equipment. These routines execute the program by sending signals to the tester drivers, receive signals from the tester sensors, and, in some systems, compare the sensor responses with the responses stored in memory.

### Aiding the programmer

The test-operating-system software determines what modes of operation are available in the tester. Typical modes such as stop-on-fail, single-step, loop-on-fail, and

## Choosing a storage format

There are significant differences in the efficiency with which different formats, or object codes, store the same test program, a factor that is seldom recognized in the evaluation of a tester. The chosen code is manipulated by the interpreter. For example, the following test statement specifies pin numbers to be set high, set low, expected high, and expected low.

SH(1,3,7) SL(9,11) EH(2,4,6) EL(8,10)

Such a statement could be stored directly and executed by the tester. It requires 34 ASCII characters, or 17 16-bit words of memory.

Another format for storing this information in object code is a table of the desired states for every pin at each test. A board with 160 pins would require 10 16-bit words of memory for the pin states plus perhaps two command words. The following example shows only the pin states determined by the example statement (previous statements would have determined the other pin states):

	....	....	....	....	(command)
	....	....	....	....	(command)
(pin 1)	1111	.110	000.	....	(pin 16)
(pin 17)	....	....	....	....	(pin 32)
and so on to					
(pin 145)	....	....	....	....	(pin 160)

Another possible format for storing this information in object code is a table consisting of 8-bit bytes that contain only the pin numbers of those pins that change at each test, plus several one-byte commands. In this example, 10 bytes of pin numbers and four bytes of commands would require seven 16-bit words of memory.

....	....	(command: "Set high")
0000	0001	(pin 1)
0000	0011	(pin 3)
0000	0111	(pin 7)
....	....	(command: "Set low")
0000	1001	(pin 9)
0000	1010	(pin 10)

In this type of test program, the relative memory advantage of the different formats depends upon how many pins change state at each test:

Format	16-bit words required
ASCII characters	17
Table of states	12
List of pin changes	7

In the examples, the third format is more efficient if fewer than 20 pins change state at each test or if there are a significant number of other pin-reference statements such as input/output definitions and monitor/neglect (ignore) statements.

generate-sync-pulse-at-test-n are valuable for troubleshooting defective boards, especially if more automatic diagnostic software is not provided.

Typical operating-system software packages for circuit-board testers require 4,000 to 16,000 12-bit or 16-bit words of computer memory. Since this software must be in the computer memory during program execution, the system must contain enough memory for this software, as well as the longest program to be executed.

One of the most significant test-programming aids is

circuit simulation, in which the operation of a circuit is modeled in software. Advances in simulator design and minicomputer technology have started a significant trend toward minicomputer-based circuit simulators, whereas early simulators required long runs on large computers. Complete fault-simulation systems with automatic fault-dictionary look-up and guided probing are often priced from \$25,000 to \$125,000. Although circuit simulators have been developed for both analog and digital circuits, their use as test-programming aids has been primarily for digital circuits.

One important use of a circuit simulator is the verification that the circuit operates as expected before an actual board is assembled. With this software, design errors or testing problems can be detected while corrections can still be made conveniently and inexpensively.

As a programming aid, a digital simulator can determine the effects of each test pattern throughout the circuit to simplify the task of generating additional patterns. The simulator can warn the programmer when race or other indeterminate conditions exist within the board and can evaluate the comprehensiveness of the test program by determining how many of the modeled faults it will detect. The feedback of the effectiveness of the programmer's efforts and the logic-state information at each node improve the efficiency with which he can generate additional input patterns.

Another programming aid, usually used with a digital simulator, is an automatic-pattern-generation software package. Various algorithmic and empirical techniques have been developed to create input patterns directly from encoded logic-circuit descriptions. Most of these techniques require manual intervention to initialize (place memory element in correct states) each circuit, to specify how to work around problem areas, and to improve the test comprehensiveness to a satisfactory level. In addition, most of this software still requires expensive computer time. Nevertheless, it is expected that use of this type of programming aid will increase as more pattern-generation capability is added to minicomputer-based programming stations.

#### Using a digital simulator

Digital simulators require two types of input data. The first is an encoded description of the digital circuit to be modeled (see Fig. 3), and the second is a set of input-test patterns. Preparation of the circuit description can be a clerical function, which consists of listing each of the logic elements on the board and its interconnection with the other elements. These elements may be the basic gates of the circuit or they may be complete small-scale, medium-scale, or even large-scale integrated circuits.

A preprocessor software package usually checks the network description for correctness and consistency between the information provided and the previously stored information about the logic elements. Typical information provided by such preprocessors includes a list of unused elements within ICs, unused inputs of logic elements, and overloaded output pins. The test programmer also provides an initial set of input-test patterns, either through manual analysis of the circuit or by using

pattern-generation software to develop the routines.

Since the memory elements on a board can assume any of their states when power is applied, the input patterns must first initialize the board by putting it into a known state. The input patterns must next exercise the board thoroughly while providing adequate "visibility" of each node from the output pins. Many simulators are used interactively, enabling the programmer to evaluate the results of applying each set of input patterns and to modify them accordingly.

The simulation of the correctly functioning circuit determines what logic states will exist at each node of the board for each test pattern. Most simulators also indicate when indeterminate conditions exist, and when pulses occur. The simulator should accurately model the sequence in which the tester applies patterns to the board so that the simulated and actual results will agree.

A digital fault-simulator models the effect of each of several classes of faults by creating a new model of the circuit containing each specific fault. A fault is detected when the test program indicates a response from the modeled good circuit that differs from the reaction of a modeled faulty circuit.

#### Isolating faults

The resulting output response can be stored to generate a dictionary of faults to aid in fault-isolation. If the simulated response is the same from both the good circuit and the faulty circuit, that fault will not be detected by that test program. Fault-simulation software usually provides a list of undetected faults and statistics about the comprehensiveness of the program.

Several types of software packages provide automatic or semiautomatic fault-isolation on circuit boards. The

**4. Guided probe.** A display of this Teradyne L 125 circuit-board tester tells the operator which points to probe. The system is displaying PROBE 7F8, which tells the operator to probe pin B of IC No. 7.





BOARD: M8091.TP TEST PROG: M8091.TP  
DIAGNOSIS FROM: AUTOMATIC - INITIAL

DATE: 1/31/75  
FAILING TEST # 51

#### CONNECTIONS

E52.8 (7430) NODE STUCK LOW E64.3(74S04) E63.1(7437)  
E64.3 (74S04) BAD CONNECTION E52.8(7430)  
4 NODE STUCK HIGH E48.13(7408) E48.4(7408) E48.1(7408)

**5. Finding fault.** A fault dictionary consists of a list of possible error messages displayed by a tester when a defective board is tested. The dictionary may be stored in the test system for automatic lookup, or it may be printed for an operator's manual lookup.

data base required for this software can be generated by simulation software, or it can be learned from a known-good board. Simulation is used primarily with digital-circuit boards, but the known-good-board approach may be used with both digital and analog boards.

A widely used fault-isolation technique guides the operator in probing a series of nodes on the board according to commands displayed by the system. This technique uses a "guided-probe" software package that records the results at each node in a path from an incorrect output pin and tells the operator which node to probe next. Guided-probe systems without simulators, such as the one in Fig. 4, sell for \$25,000 to \$75,000.

The data base required by the guided-probe software is a circuit description and a table of the correct responses at all nodes. The correct responses may be recorded from a known-good board or generated by a software simulator. The nodal responses for digital circuits usually are the logic states at each test, those for analog circuits include voltages and impedances.

During fault-isolation of digital circuits (Fig. 5), the software directs the operator to probe the next IC in the path leading back from a pin with an incorrect output. The test program is executed again, and the measured result at the input of that IC is compared to the expected response. If the response at an input pin of the IC is incorrect, the procedure is repeated for each of the next ICs in the path until an IC is reached that has correct inputs. The incorrect output of that IC is assumed to be the fault location.

#### Allowing for probe errors

A guided-probe software package must accommodate operator misprobing, including both probing the wrong node and intermittent probe contact with the correct node. The software also should distinguish when the circuit is in a feedback loop and when oscillations or other dynamic problems are present.

The structure of a digital circuit and the fact that the effects of most faults are catastrophic failures, rather than marginal failures, enable use of a fault dictionary to predict the fault location from the output-pin states in a failure test. The table of the possible-error messages that a digital tester may provide when a defective board is tested is generated either by physical fault-insertion on a known-good board or by fault-simulation.

Either way, software records the error messages or "fault signatures" that result from each fault and re-arranges these signatures in the order in which they may appear at the tester. Most fault dictionaries are arranged in order of increasing test numbers, and within each test number, the entries are arranged in order of board-pin numbers. A complete system that uses a fault dictionary based on a known good board typically sells for \$40,000 to \$60,000. Those based on fault-simulation range from \$70,000 to \$125,000.

During fault-isolation, the diagnostic software records the error message from the tester and searches the dictionary to find an identical signature. If one is found, the probable faults listed under that signature are displayed to the operator. The fault-isolation procedure is rapid and automatic, but since several faults in a typical circuit may give the same signature, this method may only locate the fault to one of several ICs. Usually, some additional probing of the circuit is required to isolate further the fault to a single IC.

A trend has developed recently in fault-isolation of digital circuits to combine the fault-dictionary and guided-probe software. This combination speeds up fault-isolation because the fault dictionary can predict the several possible fault causes that should be probed. This reduces the number of probing steps that would be required if the probing procedure had to be started at an incorrect output pin of the board.

Before deciding upon an automated testing system, it is useful to calculate the optimum level for programing and fault-isolation that is economically feasible for the specific application. Although the actual cost calculations are beyond the scope of this article, consultants and vendors can provide precise figures and formulas for each of the many types of testing systems. In general, programing costs escalate rapidly as the comprehensiveness of tests is increased. The cost to increase test comprehensiveness beyond a certain point—say, 90%—may be more than the gain in comprehensiveness is worth. The costs of testing at the system level and in the field must be included in this calculation.

The costs of programing and fault-isolation can vary by more than 20 to one, depending upon the relative complexity of the circuit boards, the comprehensiveness of the tests, and the wide differences in the types and capabilities of the various test systems available. □

# Bipolar, MOS large-scale integration vie for spotlight as device designers meet

by Electronics staff

The International Electron Devices Meeting will also hear of advances in power semiconductors, solar cells

□ System and equipment designers can confidently expect the performance levels of active components to go on rising while price levels continue to drop. As reports to the International Electron Devices Meeting will reveal in Washington next week, steady progress was made last year in almost every area, from semiconductor digital devices to solar cells.

Bipolar large-scale integration, a relatively recent arrival, is being further refined with cheaper device-isolation methods and the use of vertical instead of lateral integration in injection logic. Even transistor-transistor logic becomes an LSI candidate when heavily diffused with gold. Fighting back, workers in metal-oxide-semiconductor LSI will report on improved silicon-gate and n-channel processes that boost MOS density and speed.

In microwave and power semiconductors, specialists

have found that ion implantation and polysilicon techniques dramatically improve device ratings, while maintaining gigahertz cutoff frequencies and pushing breakdown voltages and power levels to all-time highs. One group has even built a new type of thyristor that rivals existing switching devices for high-speed medium-power applications.

As for optical devices, the technology of thin-film transistors is being applied with more success to displays as large as 6 by 6 inches and including as many as 350 characters. Moreover, the efficiency of lead-tin-telluride lasers is now high enough to make these solid-state devices more practical for integrated optical communications and pollution-control systems.

Finally, reflecting the widening interest in solar cells, IEDM is devoting several new sections to the devices. Slowly, but surely, they appear to be becoming more efficient and economical.

## The next steps in bipolar LSI

Now that integrated injection logic has launched bipolar large-scale integration into the commercial world, designers have begun improving it by adding

**Speeding up MOS.** New gate-oxidation method for 1-k static RAMs from Toshiba shortens their access time and increases their density.

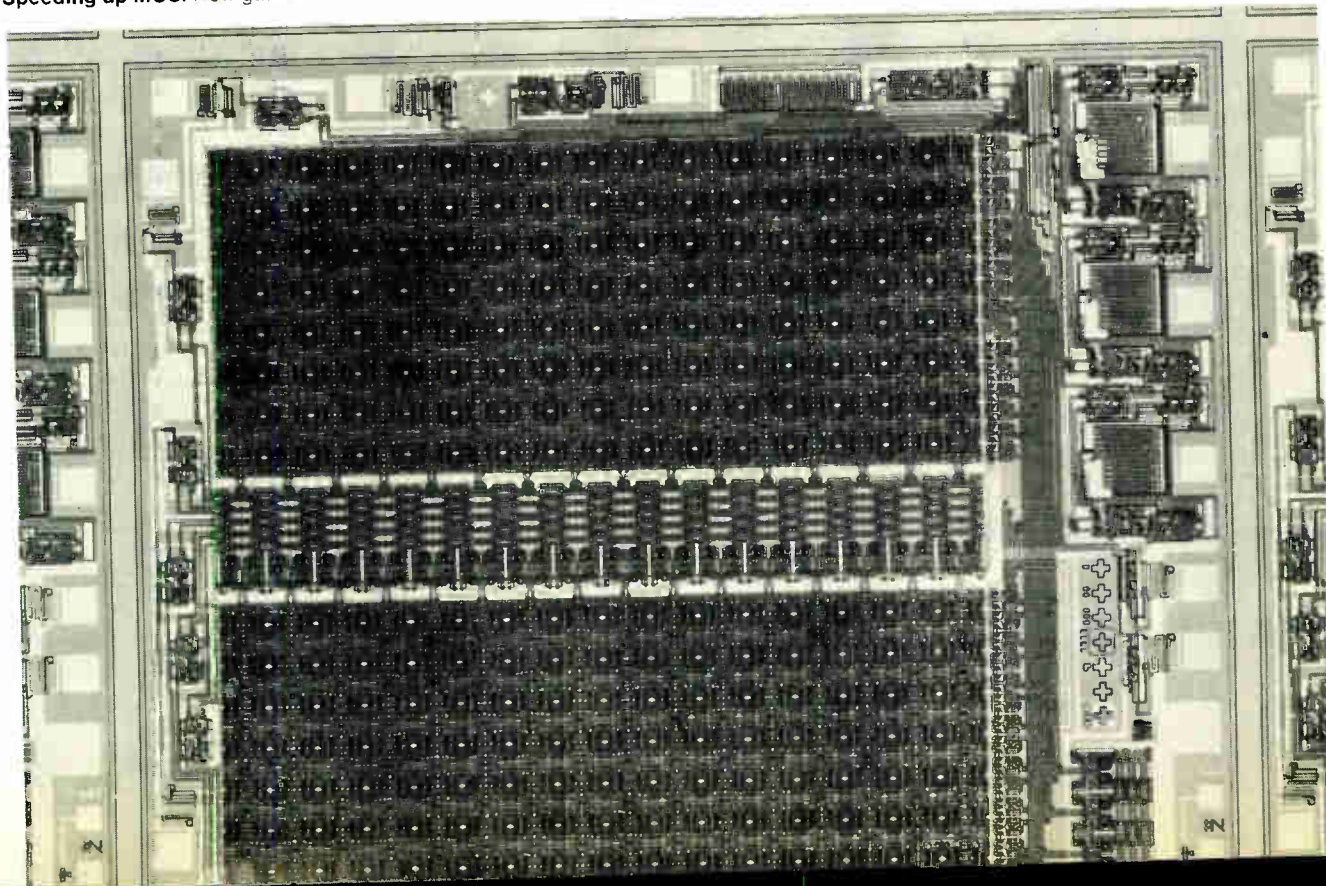



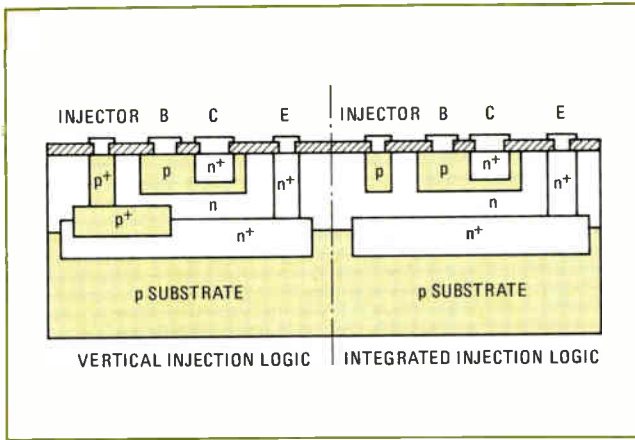

ELECTRICAL CHARACTERISTICS						
	pnp		npn		Speed per gate (ns)	Power-delay product (pJ)
	Inverse gain ( $\alpha$ )	$V_{CEO}$ (breakdown) (V)	Forward gain ( $\beta$ )	$V_{CEO}$ (breakdown) (V)		
Integrated injection logic	0.4	30	5 - 15	5	37.0	0.30
Vertical injection logic	0.9	30	5 - 15	5	8.8	0.07

**1. Vertical is better?** That's the opinion of Mitsubishi engineers who've built vertically integrated I<sup>2</sup>L structures for high gain and fast operation. Compared to lateral I<sup>2</sup>L configurations, gain is more than doubled, and gate speed is more than four times higher.

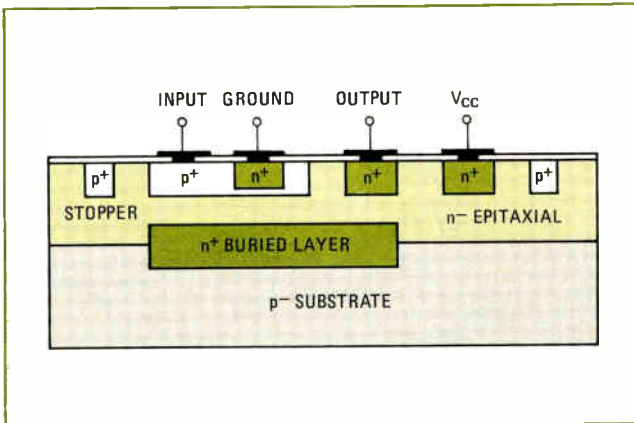

GOLD TRANSISTOR LOGIC AND INTEGRATED INJECTION LOGIC COMPARED		
Parameter	GTL	I <sup>2</sup> L
Packing density (gates/mm <sup>2</sup> )	100 - 200	120 - 200
Propagation delay (ns/gate)	5 - 50	25 - 250
Speed-power product (pJ/gate)	0.5 - 20	0.5 - 10
Logic swing (V)	0.4 - 0.6	0.4 - 0.6
Supply voltage (V)	1.5 - 6.0	1.0 - 15
Photoresist steps	6	4

**2. It's precious.** A new gold process comes from Nippon, where workers have found that a single heavy gold diffusion provides both the isolation and high resistivities needed for dense LSI circuits. The resulting gold-transistor-logic devices are five times faster than I<sup>2</sup>L.

such process refinements as ion implantation and passive isolation. Two groups adopted more radical approaches, however, and will report on them at IEDM.

At ITT Semiconductors, West Palm Beach, Calif., workers under the direction of Suhael Ahmed have developed a method of anodizing silicon that enables them to isolate the active elements on bipolar and MOS chips alike but that works particularly well on I<sup>2</sup>L devices [*Electronics*, Nov. 13, p. 101]. Basically, the low-temperature process creates dielectric walls out of anodized silicon, the thickness and depth of which are easily controlled by varying a few process parameters. Applied to I<sup>2</sup>L, it doubles chip density, more than doubles speed, and, by eliminating one or more mask steps, could cut wafer costs by 25%.

Using standard processing, on the other hand, Japan's Mitsubishi Electric Corp. gets better I<sup>2</sup>L performance by fabricating the pnp injector transistor vertically instead of laterally. This device, which merges with a multicollector npn transistor to form the basic I<sup>2</sup>L gate, needs a narrow base for high gain, but this same narrow base also results in poor breakdown voltages, high leakage currents, and other degrading electrical characteristics. When stood on end, however, the now vertical base can be as narrow as need be, and electrical performance will not be affected.

Compared with conventional I<sup>2</sup>L, vertical injection logic (VIL) has more than double the gain (0.9, as against 0.4), four times the gate speed (8.8 nanoseconds per gate, as against an average 37 ns), and a much lower power dissipation. Its power-delay product of 0.07 picojoule is the lowest reported to date for any I<sup>2</sup>L structure. The table in Fig. 1 compares other parameters.

As for the future, Mitsubishi engineers predict that VIL will prove capable of 1-ns gate delays and contend that this performance will give them an edge in memory and LSI logic. In fact, VIL versions of 4,096-bit and 16,384-bit random-access memories and 8- and 16-bit microprocessors are already in development, along with watch chips and linear-to-digital and digital-to-linear interface circuits.

#### A different use for gold

Another approach to bipolar LSI, also from Japan, comes from Nippon Electric Co. where workers are employing a single heavy gold diffusion for IC fabrication. Very light diffusions of gold into the substrate are normal in TTL circuits, to quench minority carrier lifetimes and increase speed. In the Nippon approach, a much heavier gold diffusion increases the resistivity of the n-type silicon substrate beyond its intrinsic value, forcing it to become distinctly p-type. Thus, with one gold diffusion step, it's possible to get both the device isolation and the high values (100 kilohm to 1 megohm) of buried-layer resistivities that are needed in dense LSI circuits. Also, it's possible to grade and tailor the diffusion to almost any degree of resistivity or isolation.

The outcome is a new LSI family (Fig. 2), called gold transistor logic (GTL), that sports a packing density, and speed-power product as sensational as those of today's I<sup>2</sup>L and in addition operates five times faster. Moreover, GTL can be fabricated in a variety of configurations—

TTL, DTL, ECL and so on—and can therefore, unlike  $I^2L$ , interface on chip with other bipolar circuit forms. However, GTL does need six photoresist masking steps as opposed to four for basic  $I^2L$ .

Nippon reports it is already applying GTL to memories and microprocessors. An example is a 4-bit arithmetic-logic unit with speed-power operation two orders of magnitude better than similar TTL designs.

**MOS hits back**

Aware of the threat from bipolar LSI, MOS specialists are mounting two major counterattacks. They are wringing the last drop of performance from the silicon-gate process, and they are adopting more complex fabricating methods.

Unfortunately, some of the best of the high-density silicon-gate work, like the folded-gate concept borrowed from charge-coupled devices [*Electronics*, Oct. 8, p. 78] will not be presented at IEDM—it's being used by U.S. manufacturers for their 16-kilobit RAMs, and they want no publicity. However, a Japanese technique is being disclosed that increases silicon-gate density and performance without resorting to new structures.

Toshiba calls it the gate oxidation method, though in truth it's a different gate oxidation method. The basic change is the use of a wet oxidation process at 900°C instead of a dry one at 1,500°C. Needing one mask step instead of the conventional two, the method automatically self-aligns the MOS transistor by keeping the impurity concentration in the field region high enough to prevent unwanted field inversions. (In conventional gate oxidation, this requires a separate boron implant.)

Using this method, Toshiba has already built a 1,024-bit static n-channel RAM with an access time of 250 ns—about twice as fast as today's best production static RAMs. It's also built a single-chip LSI processor (Fig. 3) that contains the full measure of 16-bit logic, memory, and input/output capability needed for some minicomputer designs.

A big improvement in n-channel performance comes from Bell Laboratories, which has not till now been in the forefront of MOS technology. Apparently, it has developed a silicon-gate process with high yields and used it in a 4,096-bit RAM vehicle having a 50-ns access time—four or five times faster than today's 4-k products. Bell does it rather conventionally, with a boron implant for field isolation and a shallow gate diffusion only 750 angstroms deep. The self-aligned structures have good electrical properties, including adjustable thresholds and four times the gain of p-channel MOS.

A more complex version of MOS that's gaining in popularity for LSI purposes is the double-diffused process. Its strength is that it can extract gate delays of less than 10 ns from standard-sized MOS devices based on 10-micrometer-long channels. (To supply the same speeds with the single-diffused MOS process, much smaller devices built around 1- $\mu$ m channels would be necessary.)

Indeed, by combining a 10- $\mu$ m D-MOS device with a depletion-mode load device (Fig. 4), a trio of researchers from Westinghouse, Maryland University, and NASA (in Hampton, Va.), have achieved 4-ns propagation delays and 2-pJ power-delay products at a low 1.3-V oper-

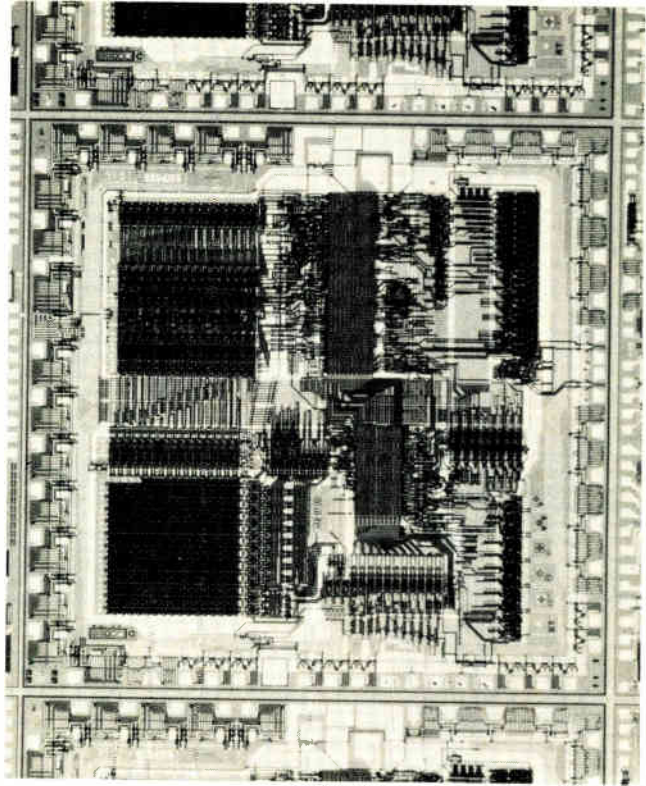

3. **New gates on MOS RAMs.** This 1,024-bit static RAM from Toshiba is built with a different gate oxidation method that results in very fast MOS operation. Access time is only 250 nanoseconds, which is about twice as fast as the best production devices available today.

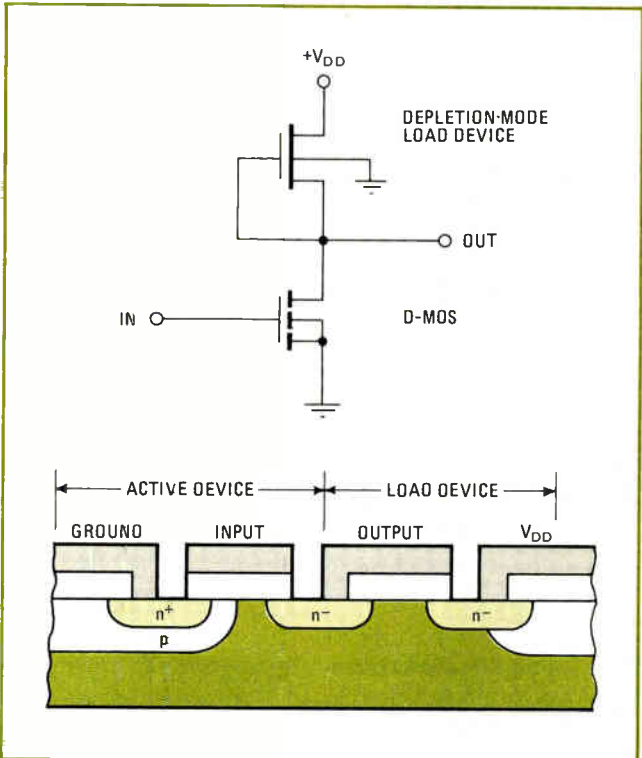

4. **Double diffusion.** One way to increase MOS performance is to diffuse twice under the gate and use depletion load outputs. This D-MOS gate, developed by Westinghouse and NASA, has a 4-ns propagation delay and a 2-pJ power-delay product.



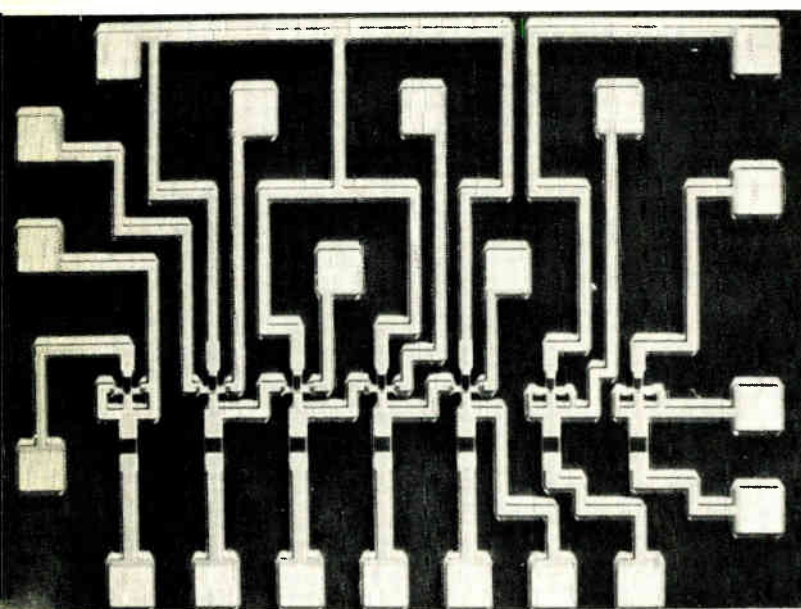

**5. Looking ahead.** For future high-frequency logic applications, designers may be able to turn to Gunn-effect devices. This experimental two-stage Gunn shift register is built by Fujitsu with gallium-arsenide technology. It can move data at gigahertz rates.

ation. Such performance is clearly as good as PL.

A big advantage in this process is the self-alignment achieved for both the D-MOS device and the depletion load by the use of a polysilicon gate in combination with selective nitride masking. (Ordinarily, D-MOS processes are not self-aligning.) The gate's dielectric polysilicon and the silicon nitride are sequentially deposited on the substrate. Then windows for the D-MOS transistor's source and drain diffusions are cut into the nitride, and the remaining nitride is left as a mask for later removal of the polysilicon and gate oxide.

Finally, for the future, researchers at Fujitsu Laboratories in Japan are reporting on a monolithic Gunn-effect shift register that operates at 1.6 GHz. Built with gallium-arsenide technology, the two-stage laboratory device heralds the time when semiconductor devices will routinely handle gigabit data rates for optical and other high-speed logic and memory applications.

The integrated form of the two-stage shift register (Fig. 5) incorporates seven Gunn devices with serially connected load resistors. In operation, two Gunns are triggered by alternating sine waves, and the resulting domain pulses are used as the clock pulse to the other Gunn devices. The chip is mounted in a copper heat sink and set to a 50-ohm strip-line test circuit.

### Microwave, power devices get newer look

By putting relatively new technology to still newer uses, manufacturers are improving the performance of microwave bipolar power and transistors. GE goes further—it will tell IEDM about a completely new power device, a field-controlled thyristor.

Ion implantation, to start with the familiar, helped Tektronix Inc. of Beaverton, Ore., to boost the breakdown voltage of the transistor used for the output stage of a common-based direct-coupled linear amplifier.

(The amplifier is used in drivers for cathode-ray tubes in instruments.) The normal diffused guard ring can cause so much collector-base capacitance as to degrade performance, so instead, Tektronix ion-implants a shallow lightly doped ring. This creates a device with a breakdown voltage 40% to 50% higher and a collector-base capacitance 25% to 30% lower than in a diffused-ring unit.

Elsewhere, by consolidating the fabrication steps for an isolated microwave bipolar transistor, Stanford University's Electronics Laboratory, Calif., has practically done away with the misalignments that often entail device breakdown problems and low current gains. Both emitter and base are fabricated in one temperature step, rather than in the usual sequence of such steps. Stanford's reward was to obtain, in a device only 250 by 140  $\mu\text{m}$  in area, a common-emitter static forward-current transfer ratio of 1,000 and a transition frequency of 1.3 GHz at a collector-emitter voltage of 5 v and with a collector current of 20 milliamperes.

In power semiconductors, many workers are exploring polycrystalline-silicon techniques to boost device ratings without increasing chip size. For instance, the Central Research Laboratory of Hitachi Ltd., Kokubunji, Tokyo, Japan, has fabricated a power metal-oxide-semiconductor field-effect transistor that can handle 20 amperes of current, has a breakdown voltage of 85 v, yet is merely 5 by 5 millimeters in size.

As Fig. 6 shows, the MOSFET has a vertical drain electrode and an ion-implanted meshed-gate structure. Its source and drain areas are arranged in checkerboard fashion on the top chip surface, which also contains the polysilicon-gate electrodes. The drain region at the bottom is connected to a highly doped  $\text{p}^+$  substrate through an epitaxial  $\text{n}$  layer, while the source electrodes at the top are connected to the  $\text{p}^+$  source regions through contact holes. The device provides a transconductance of 3,000 millimhos, exhibits a cutoff frequency of 1.5 megahertz, and can operate stably at ambient temperatures as high as 180°C.

The same polysilicon-gate technology has been applied to power JFETs by Toshiba's Research and Development Center, Komukai, Kawasaki, Japan. The new junction FET (Fig. 7) is a 4-by-4-mm chip intended for audio applications—it can deliver 50 watts to an 8-ohm load when operated as a push-pull amplifier. It is a p-channel device, fabricated with heavily doped polysilicon source contacts and having a diffused-gate vertical-channel structure. Location of the source contacts exactly midway between the gate regions maximizes the device's source-gate breakdown voltage—the actual figure is 60 v. The JFET exhibits a voltage gain of five and a drain-gate breakdown of 200 v.

Meanwhile, bipolar power transistors are by no means standing still. The Atsugi facility of Japan's Sony Corp. is using semi-insulating polysilicon films to triple-passivate both npn and pnp planar devices. The three layers consist of an oxygen-doped polysilicon film that stabilizes the silicon interface, a nitrogen-doped polysilicon film that prevents water or sodium ions from reaching the silicon surface, and a silicon-dioxide film that guards against dielectric breakdown.

Sony fabricates the devices with multiple field-limiting rings. The triple passivation not only makes possible breakdown voltages of up to 10 kilovolts, but also results in devices that are suitable for inexpensive miniature molded packages.

The completely new device, developed by General Electric's Corporate Research and Development Center, Schenectady, N.Y., is a field-controlled thyristor. The FCT (Fig. 8) is a medium-power switching element, rated at 650 V and 20 A, for fairly high-speed applications, like 15 to 30 kHz.

Since the FCT is not a regenerative device, it is not fired into the on state as conventional thyristors are. Instead, it is turned on by simply removing the bias from its grid terminal. Once on, it operates as a p-i-n rectifier—it has a low forward voltage drop and does not require any driving current to maintain it in the on state.

GE feels that this new component offers a viable alternative to existing switching power semiconductors, including transistors, silicon-controlled rectifiers, and gate-turn-off units. For a given voltage rating, says GE, the FCT can handle higher currents, with lower forward voltage drops, than a transistor having the same base area. Turn-on and turn-off times are shorter than those of a comparable SCR or gate-turn-off unit and, like a transistor, the FCT is immune to static  $dv/dt$ . Additionally, the new device can be operated at higher temperatures than any of these other devices, claims GE.

Finally, in high-frequency signal processing, surface acoustic-wave devices are setting the pace for military secure communications systems. For example, Motorola researchers have developed a monolithic surface acoustic-wave filter capable of generating and detecting programmable waveforms. The device combines zinc oxide transducers (to generate acoustic signals) with piezoelectric p-channel MOSFETs (to detect and process the signals) and achieves programability through a read-only memory on the same chip.

Meanwhile, scientists at IBM's Research Center and at the University of Glasgow, Scotland, will report on the acousto-optical interaction between surface acoustic and guided optical waves and how it can be used in a high-resolution electronically controlled light-beam deflector. Their present device uses a beam 3 mm wide and a 150-MHz 3-decibel acousto-optic bandwidth capable of resolving 129 spots. By increasing the beamwidth to 10 mm, the scientists claim they could resolve 600 spots with the same power.

### Optical technologies progress

For several years, a group of Westinghouse scientists at their Pittsburgh Research Laboratories has doggedly pursued thin-film-transistor technology with the aim of producing a flat, message-display screen [*Electronics*, Oct. 31, 1974, p. 32]. Their work is backed by the U.S. Army Electronics Command, which likes the potential ruggedness, reliability, low power and low cost of such displays. Meanwhile, General Motors has decided it wants a lead-tin-telluride laser.

This year the Westinghouse team, led by T.P. Brody, will describe a 6-by-6-inch display of 350 characters with a resolution of 30 lines per inch, an improvement

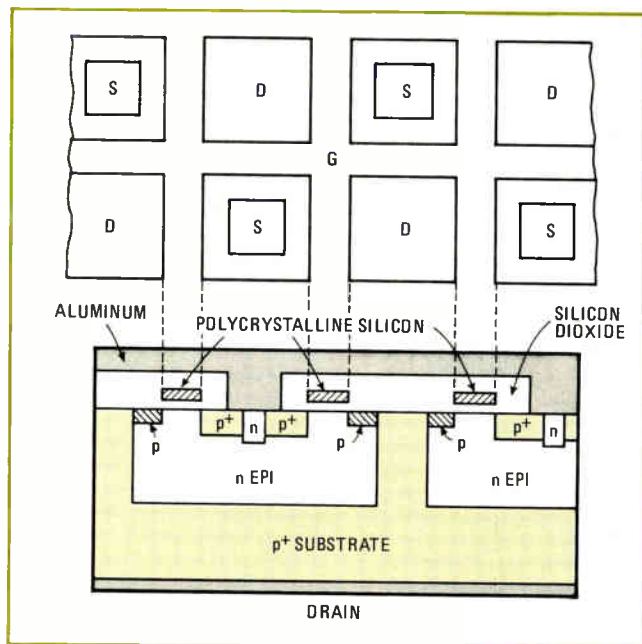

6. **Hefty MOSFET.** Polysilicon-gate technology is making a difference for high-frequency power devices. This microwave MOSFET made by Hitachi can handle 20 A, yet its breakdown voltage is 85 V. The device has an ion-implanted meshed-gate structure.

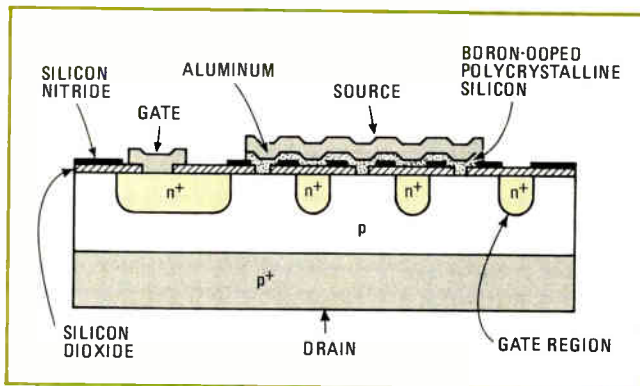

7. **Power for audio.** In a push-pull configuration, p-channel J-FET from Toshiba can deliver 50 watts to an 8-ohm load. It has heavily doped polysilicon source contacts. Breakdown voltages are high—60 volts source to gate, 200 volts drain to gate.

of 50% over what it reported a year ago. The basic display element in the thin-film array is a pair of transistors, formed by evaporating cadmium selenide on a glass substrate, plus an associated storage capacitor. These elements are arranged in an X-Y matrix, and when addressed, activate oblong areas of an overlying electroluminescent phosphor. Different sets of oblongs produce different alphanumeric characters. The 350-character panel needs a matrix of 170 by 170, or approximately 28,000, individual addressable elements.

What's more, the group has extended the thin-film-transistor-array concept to optical signal processing, by incorporating photoconductors in an array that performs logic optically in image-processing applications. Similar structures proposed before for such applications have been handicapped by the lack of both gain and speed in any one photoconductor. But here the density



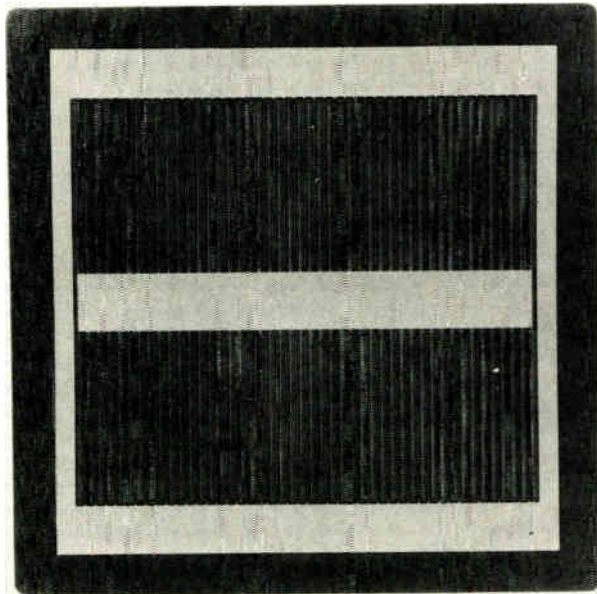

**8. New thyristor.** Field-controlled thyristor developed by General Electric is intended for high-speed medium-power applications. Rated at 650 V and 20 A, the device operates as a p-i-n rectifier after it is turned on (by simply removing the bias from its grid terminal).

of the array permits high-speed low-gain photoconducting materials to be used.

To demonstrate this, Brody's group has built for NASA Goddard Space Flight Center a 1-square-inch, 128-by-128-element array called an image negator. It has a photoconductor surface that converts incoming digitized optical signals into electrical signals, plus a logic thin-film-transistor surface that performs the Boolean NOT function simultaneously at every picture point. It also amplifies the light signal for data fanout and to drive an electroluminescent display surface.

Brody and his team say the circuit can be modified to perform AND and OR operations without increased complexity. Furthermore, their experiments show that megabit data rates are achievable with amplification.

As for optical source devices, lead-tin-telluride lasers built by Massachusetts Institute of Technology's Lincoln Laboratories have been used experimentally to monitor air pollution, and General Motors sees the device as having potential for analyzing exhaust gas. By now, a team at GM's research laboratories in Warren, Mich., has pushed the output power of its version of the MIT laser up to about 1 milliwatt. GM is using a diffused junction, doped with cadmium. Earlier diffused-junction lead-tin-telluride lasers, made by Texas Instruments with an antimony dopant, exhibited an output power of only 10 to 100 microwatts.

While the GM lasers are not the most powerful at the moment—Lincoln Labs claims 1 to 6 mW for its annealed-junction lead-tin-telluride lasers—the impurity-diffusion approach works with a wider range of lead-tin-telluride mixtures, discloses Wayne Lo, associate senior research physicist at GM. And the composition of the lead-tin-telluride determines the frequency of the laser's output. A disadvantage of the impurity-diffusion

process, however, is that it may generate defects and precipitate impurities that will degrade junction properties and output power.

GM attributes the improved power output to:

- A new low-temperature (450°C) diffusion technique for cadmium that yields a better junction and less damage (TI's antimony diffusions were done at 700°C).
- A better contact-formation process, giving a low contact resistance of  $10^{-5}$  ohm-centimeters squared (GM plates platinum on the p-side and overcoats it with indium but uses indium alone on the n-type side.)
- A new method of growing the lead-tin-telluride, which GM calls ingot nucleation (to be described in January's *Journal of Applied Physics*). "We grow the crystal nucleus right on the ingot rather than on the growth ampule," Lo says. "That lowers the dislocation density by three orders of magnitude."

### Solar-cell prospects brighten

The intense activity being reported in photovoltaic devices at this year's meeting is gradually lowering their construction costs and raising their efficiency.

Aiming to lower costs, Ting Chu of Southern Methodist University, Dallas, starts with a very cheap, metallurgical-grade silicon substrate and deposits on it a 30-to-40- $\mu$ m layer of polycrystalline silicon of controlled (1 ppm) purity. He's achieved a conversion efficiency of only 4-4.5%. "We'll never be able to match the efficiencies (12-14%) of single crystalline cells," he states. "But we can probably get it up to 8% in a few years by growing larger crystals at higher temperatures during crystallization. Nevertheless, if present production technology were applied to our process, assuming 8% conversion efficiency, our silicon-on-silicon solar cells could be made for less than \$1 per watt." Single-crystal silicon cells presently cost about \$15 per watt.

At RCA Laboratories, Princeton, N.J., R.V. D'Aiello, P.H. Robinson, and H. Kresel have been working to improve silicon-cell efficiency. The researchers compared cells fabricated from grown epitaxial junctions with those formed by direct diffusion into edge-fed ribbons. The former's efficiency of 10% is much the higher and results mainly from lower saturation-current density at the epitaxial junction.

Higher efficiency is also the reason why researchers at the Tokyo Institute of Technology, NASA's Langley Research Center, and the Science Center of Rockwell International are studying graded band gaps in gallium-arsenide solar cells. J.A. Hutchby at Langley and R. Sahai and J.S. Harris at Rockwell, in working with  $Al_xGa_{1-x}As$ -GaAs cells, found a substantial increase in power conversion efficiency with increasing aluminum gradient. In addition, the graded-band-gap cell responded better than the abrupt-heterojunction cell to blue-ultraviolet photons.

At the Tokyo Institute of Technology, working with a  $pGa_{1-x}Al_xAs$ - $pGaAs$ -GaAs structure, M. Konagai and K. Takahashi determined that an aluminum concentration of only  $x = .25$  to  $.30$  would reduce the surface recombination effect and produce a collection efficiency twice that of the abrupt-heterojunction gallium-arsenide cells. □

# SMPU: Radiotelephones measured automatically

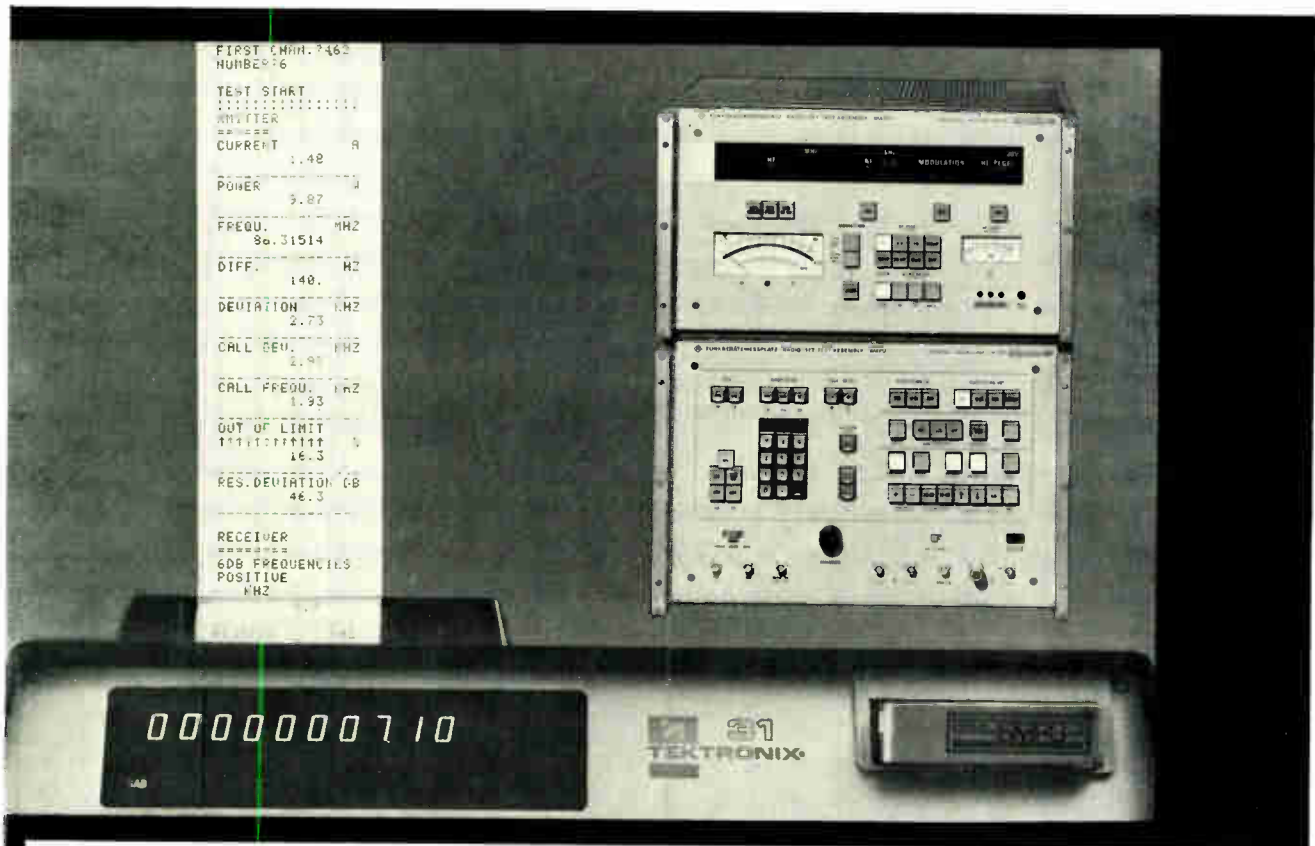

## "Intelligent" Test Assembly with IEC bus rationalizes production and servicing

The Radio-Set Test Assembly SMPU with its built-in microcomputer enables automatic measurements without external control equipment. Operation is extremely simple and easy to understand.

The accuracy of the built-in measuring instruments provides for testing of RT equipment in accordance with **CEPT standards**. And all incorporated measuring instruments are separately accessible so that module testing is also possible.

Programming is performed in line with the **IEC-bus** standard. Thus system extension by additional test and control equipment is easy and adaptable to immediate needs. With the **Card Reader PCL**, for instance, settings and data can be entered using program cards. Combination with the **desk-top Calculator**

**Tektronix TEK 31** (or any other calculator compatible with the IEC bus) offers all the advantages of a fully automatic computer-controlled test system:

- No restriction to fixed programs
- High "intelligence" for program execution and data logging, including **error diagnosis** and **dialogue** with the calculator
- Extreme ease of program modification and possibility of linking peripherals, such as plotter, display and high-speed printer.

The SMPU's "intelligence" considerably simplifies the preparation of programs, which are set up by merely calling the individual measurements. No special programming language has to be learnt for operating the assembly.

**Ask Rohde & Schwarz** for the detailed SMPU brochure.

**Rohde & Schwarz**  
Postfach 80 14 69  
D-8000 München 80  
Bundesrepublik Deutschland  
(Fed. Rep. of Germany)  
Telex 5 23 703 (rus d)

Electronic Measurements  
and Telecommunications:  
Development, manufacture,  
sales and service, known  
for "electronic precision"

Independent concern  
(established 1933),  
represented in 80 countries



# ROHDE & SCHWARZ



## Delay line in shift register speeds m-sequence generation

by J.T. Harvey  
Amalgamated Wireless (Australasia) Ltd., North Ryde, Australia

The clock rate of a shift-register generator of maximal-length pulse sequences is significantly increased when a delay line replaces one or more of the register's stages. High-speed m-sequences, as maximal-length pulse sequences are called, are needed for testing data links, for generating repeatable pseudo-noise, and in spread-spectrum techniques [*Electronics*, May 29, p. 127].

Repetitive sequences of pulses can be generated by connecting the output of a shift register back to the input in some way, setting in some initial condition that is not all zeroes, and turning on the clock. In this situation, the length of the repeating pulse sequence that emerges from the register depends upon the feedback arrangement and perhaps upon the initial condition—if the register has  $N$  stages, the sequence may repeat after only two,  $N$ , or some other number of pulses.

However, the m-sequence is independent of the starting condition. This follows from two facts. First, its length is  $2^N - 1$  pulses (the all-zero condition never appears in the register). Second, its generation involves every possible combination of 1s and 0s in the shift register except for the all-zero combination.

A typical m-sequence generator is shown in Fig. 1. The feedback signal in the four-stage device is obtained by taking the exclusive-OR (XOR) of the outputs from the last and next-to-last flip-flop stages. The resulting sequence repeats after  $(2^4 - 1)$  bits, i.e., 15 bits. It goes 1, 1, 0, 0, 1, 0, 0, 1, 1, 0, 1, 0, 1, 1, and then repeats. Various feedback combinations must be used to achieve the maximum-length pulse sequence from registers with various numbers of stages, but it is of interest to note

that generators having 2, 3, 4, 6, 7, or 15 stages can operate by feeding back the XOR of the outputs from the last and next-to-last stages.

The limit to high-speed operation of this device occurs when the interval between clock pulses is less than the combined effective propagation delay in a shift-register stage and the XOR gate. For a given family of logic, the propagation time of the XOR is typically slightly less than that of a shift-register stage. Thus, the clock rate at which an m-sequence generator can operate is typically 0.5 to 0.7 of the rate at which the shift register can operate alone.

Provided that operation is required over a limited range of clock frequency (most are operated at a fixed clock rate), then the first stage of the shift register can be removed and a delay line substituted. This arrangement is shown in Fig. 2. The optimum delay is the interval between clock pulses less the exclusive-OR-gate propagation delay. The gate and delay line thus simulate a delay-free gate and one shift-register-stage delay. The maximum frequency of operation is then the maximum shifting rate of the flip-flops.

To demonstrate this idea, some experiments were conducted with MECL III logic, for which 270-megahertz flip-flop clock rate and 2.7-nanosecond gate propagation time worst-case figures are claimed. A pair of MC1670L D-type flip-flops were connected in a ring counter, which was observed to operate to 310 MHz. The same shift-register was used in a two-stage m-sequence generator with the addition of an MC1672L XOR gate, one section of which was used as an output buffer. At this point, the maximum clock rate was found to be only 215 MHz. Then this generator was converted to a three-stage device by the addition of a 20-cm length of 50-ohm coaxial cable, and satisfactory operation was observed in the range from 220 to 310 MHz, giving a speed improvement of up to 44%.

The susceptibility of the circuit to noise will be greatest near these speed limits. When a 90-cm length of cable was used, four-stage operation was observed in

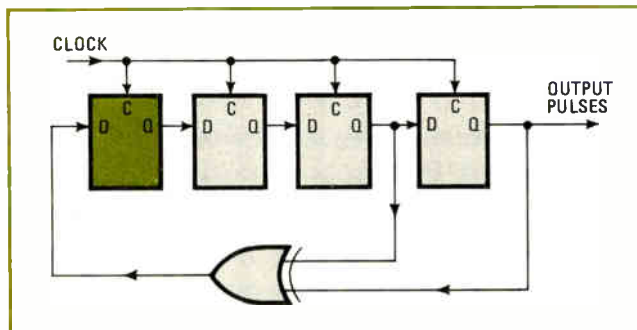

**1. Maximizes.** Four-stage shift register with feedback arrangement cycles through all possible states except the all-zero condition, producing an output sequence of  $2^4 - 1$  pulses. This is the maximum-length sequence (m-sequence) from a four-stage register. Speed of the m-sequence is limited by the propagation delay in the XOR gate.

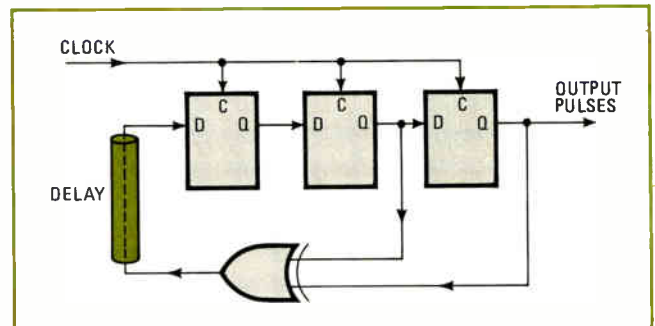

**2. Faster.** In modified m-sequence generator a delay line simulates one stage of the shift register, so the output pulse sequence is the same as for the circuit of Fig. 1. The delay line is designed so it, plus the XOR gate, offers the same propagation delay as one register stage, permitting a 44% increase in clock rate for the m-sequence.

the range from 245 to 310 MHz, and a 220-cm length gave six-stage operation (63-bit sequence) at frequencies from 265 to 310 MHz. Similarly, 260 cm of coaxial cable yielded a seven-stage 127-bit sequence for clocks from 275 to 310 MHz.

For a given number of stages, an increase in the ex-

ternal delay decreases the upper and lower clocks in roughly the same ratio, while an increase in the number of simulated stages decreases the range in the clock rate. At least one shift-register stage must be used in front of the first feedback tap to eliminate the possibility of spurious oscillation. □

## Memory, peripherals share microprocessor address range

by James A. Kuzdrall  
Candia, N.H.

Designers find that the direct addressing mode of the M6800 microprocessor and similar devices cannot be beaten for convenience and efficiency. This mode allows the user to directly address the lowest 256 bytes in the machine—the bytes in locations 0 through 255.

Instructions that use the mode consist of one byte to designate the operation to be performed, plus a second byte to designate the address of the operand. By contrast, other addressing modes have to supply one bit for each of the 16 lines of the memory bus and therefore require a two-byte address for the operand. Thus the direct-addressing mode saves one byte, or 33% of program memory space, in each instruction.

Usually the designer sets aside a portion of the RAM for the easily accessed locations 0–255. However, it is also convenient to assign some of these locations to the peripheral-interface adapter chips that interface the microprocessor to peripheral equipment. The reason is that, in applications requiring a large amount of data input and output, the addresses of the PIA chips may be as active as the RAM addresses.

The circuit arrangement shown in the accompanying diagram allows the direct addressing range of memory locations to be used for both random-access memory and peripheral interface adaptors with a minimum of hardware. It provides control for RAM in locations 0–239, PIAs in locations 240–255, and ROM in locations 1,024–4,095. Although the decoding is not complete because address lines  $A_8$ ,  $A_9$ ,  $A_{12}$ – $A_{15}$  are not fully decoded, the decoding does prevent two devices from being active on the data bus simultaneously.

In the circuit, decoding an address to reach RAM or a PIA requires only two integrated circuits—a 74LS10 triple NAND gate and a 74LS139 dual decoder.

Gate  $U_{1B}$  enables the decoder when valid memory-address data is present and the data is stable ( $\phi_2$  from clock  $U_{10}$  is high). Then address lines  $A_{10}$  and  $A_{11}$  of the central processing unit are decoded to make one of the 2Y outputs low. Decoder outputs 2Y1, 2Y2, and 2Y3

each select a 1-kilobyte section of ROM, i.e. ROM-1, ROM-2, or ROM-3. If both  $A_{10}$  and  $A_{11}$  are low, however, so that 2Y0 is low, the RAM and interface adapters are enabled. RAM-1,  $U_4$ , is selected if the address is below 128 ( $A_7$  low).  $U_5$  is enabled for addresses between 128 and 255 ( $A_7$  high), but inhibited by gate  $U_{1A}$  for addresses 240–255.

To activate the interface adapters ( $U_6$ – $U_9$ ) for these unused addresses, the inhibit signal is inverted by  $U_{1C}$ . The decoder outputs 1Y0–1Y3 of  $U_2$  provide the final selection among the interface adapters. The decoding meets all worst-case timing and loading requirements.

The table shows the contents of the microprocessor address locations for this circuit arrangement. The selection of devices addressed is shown only as an example. For instance, more RAM can easily be added in memory locations 256–511 using the enable inputs of the MCM6810L-1 devices. Unneeded ROM chips, RAM

CONTENTS OF MICROPROCESSOR ADDRESS LOCATIONS

Starting address	Finishing address	Chip	Contents
0	127	$U_4$	RAM-1 Random-access memory
128	239	$U_5$	RAM-2 Random-access memory
240	—	$U_6$	PIA-1 Data register A
241	—	$U_6$	PIA-1 Data register B
242	—	$U_6$	PIA-1 Control register A
243	—	$U_6$	PIA-1 Control register B
244	—	$U_7$	PIA-2 Data register A
245	—	$U_7$	PIA-2 Data register B
246	—	$U_7$	PIA-2 Control register A
247	—	$U_7$	PIA-2 Control register B
248	—	$U_8$	PIA-3 Data register A
249	—	$U_8$	PIA-3 Data register B
250	—	$U_8$	PIA-3 Control register A
251	—	$U_8$	PIA-3 Control register B
252	—	$U_9$	PIA-4 Data register A
253	—	$U_9$	PIA-4 Data register B
254	—	$U_9$	PIA-4 Control register A
255	—	$U_9$	PIA-4 Control register B
1024	2047	$U_{11}$	ROM-1 Read-only memory, program
2048	3071	$U_{12}$	ROM-2 Read-only memory, program
3072	4087	$U_{13}$	ROM-3 Read-only memory, program
4088	4095	$U_{13}$	ROM-3 Restart and interrupt vectors

Have you used a microprocessor to replace either hard-wired or mechanical logic in a circuit or made some other use of these versatile devices? Engineers who are just starting to design with microprocessors would be interested in learning about your experiences. We'll pay \$50 for each microprocessor: item published, as we do for all published Designer's Casebook ideas. Please send them to our Circuit Design Editor, summarizing the problem and how a microprocessor provides a novel solution.



**If it weren't for its frequency response  
of 30 Hz at 100 mm,  
its 99.65% linearity,  
its pressure-ink writing,  
its highest quality traces,  
its full range of plug-in conditioners,  
its 12 chart speeds, and  
its wide channels,  
the GOULD/Brush 2400 would be like  
most any other direct writing recorder.**

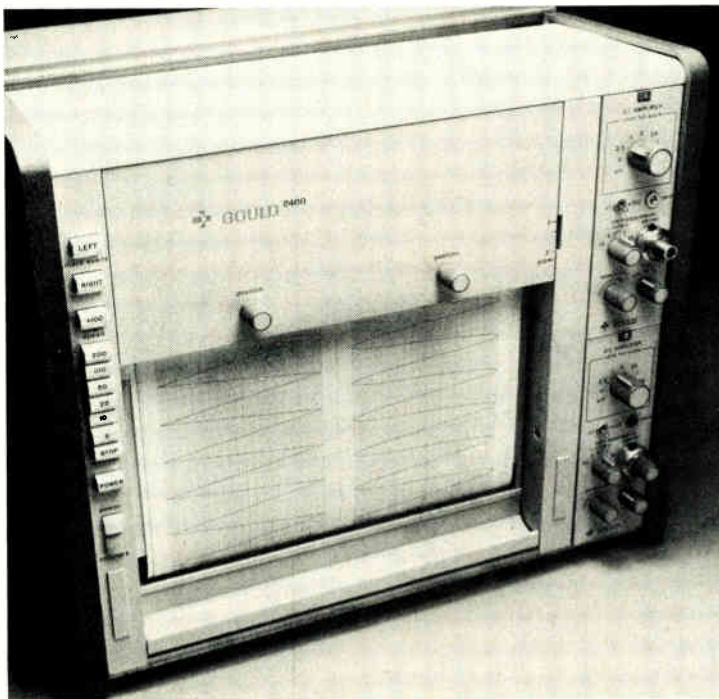

But because of all this, it's the best performing direct writing recorder on the market today. When you see it, you'll believe it. So call your nearest Gould Sales Engineer today for a demonstration. Or, for more details, write Gould Inc., Instrument Systems Division, 3631 Perkins Avenue, Cleveland, Ohio 44114. Or Gould Allco S.A., 57 rue St. Sauveur, 91160 Ballainvilliers, France.

 **GOULD**

**PHONE TOLL FREE TODAY FOR TECHNICAL BROCHURE (800) 648-4990.**

chips, and PIA chips can be deleted, of course. When using the configuration as shown, the programmer should initialize the stack pointer to location 239 and locate the restart vector and interrupt vectors in the last addresses of ROM-3 (U<sub>13</sub>). □

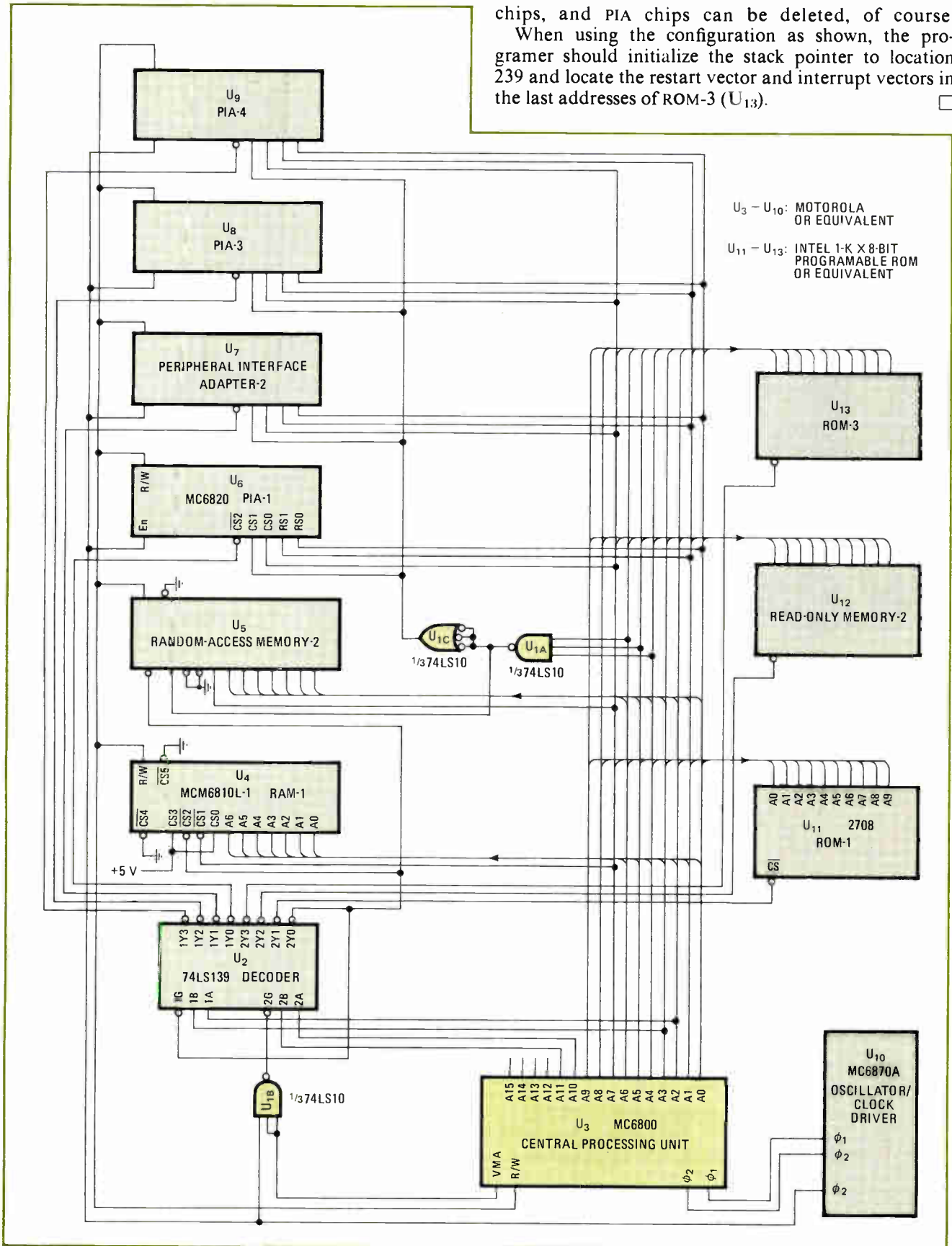

**Versatile.** This circuit arrangement allows both random-access memory and peripheral interface adapters to be addressed in direct-addressing-mode locations of M6800 microprocessor. This is convenient in operations with lots of data input and output. Logic gates enable the decoder for valid stable addresses and enable or disable the RAM and PIA sections. Lines A<sub>2</sub> and A<sub>3</sub> are decoded for final selection of PIA.





## User's tests, not data sheets, assure IC performance

by Eugene R. Hnatek, DCA Reliability Laboratory, Mountain View, Calif.

---

System designers using LSI devices should not rely on vendors' data alone but do their own characterization

---

□ The complexity of today's large-scale integrated circuits is making their electrical characterization a must, rather than a luxury. Properly done, the tests give a vendor the understanding of a part's personality he needs to write a viable data sheet, and they provide a user with the graphic descriptions of parameter variation he needs to design his system properly.

However, the characterization testing that satisfies a vendor's needs is usually engineering-oriented and far from adequate from a user's viewpoint. To define how a given type of LSI device will work in a particular system and what design safety margin it offers there, if any, the user needs an independent test program, designed for

that particular application. Such a program should be undertaken whenever the user is about to design a new generic part into a system. It is also the key to successful screening and inspection testing.

In electrical characterization, a sample of a given device type is subjected to all practical combinations of supply voltages, temperatures, timing conditions, and parametric variations. The goal is to discover how the part responds under these conditions and within what limits it remains functional.

The tests include stringent functional stressing by means of patterns or truth tables, as well as timing and parametric variations under temperature extremes. Worst-case patterns with supply and timing variations are applied to the device to expose as many of its failure modes as practical and to determine its performance under the most severe conditions.

To the user of an LSI device, the most important form of electrical characterization is one based on his actual system constraints. In this case, the test program is de-

signed around his particular system's supply voltages, timing conditions, and operating temperatures. During the testing, one option is to hold all except one parameter constant at the system levels and to vary or iterate that parameter until the device fails. The last valid operating point is then noted, and testing of another variable is begun. This process is repeated until all parameters are tested to failure for the entire sample.

Since the number of tests in such a program can run into the millions, test times can be quite long, and test data quite voluminous. So the data, to be comprehensible, must be translated into visual terms, perhaps curves or histograms. These show the operating profile of the part and also reveal whether its design margin matches or falls short of the vendor's specified limit.

The testing of an LSI device may be performed by the user himself, but, because the equipment is expensive, it is more usually done for him by the vendor or an independent test laboratory. Sometimes he may have it done only after failures have occurred, in which case it's generally called backdoor characterization. The principal differences between characterization testing and incoming inspection testing are summarized in the table at right.

### What the vendor does differently

Of course, the vendor, before releasing the device as a new product, will have performed a general, engineering-oriented characterization for the purpose of establishing data sheet limits. But he cannot thoroughly test a part himself for all possible failure modes and generally does not characterize it from an individual system viewpoint. Moreover, the vendor usually characterizes a new product after he has completed a few successful prototype runs and at that point feels confident that the part's design is final.

But once the product is handed over to production, changes are often made in the process in order to increase yields. These changes may affect the part so that it no longer performs exactly as stated in the data sheets set up by the earlier characterization. And in some cases, the differences in the product, particularly if it is a complex one, can be significant.

After all, a vendor's main interest is to remain competitive in the marketplace, so he will institute the simplest test patterns to yield the lowest-cost test. With this approach, he assumes no problems exist until shown otherwise. Only when users begin to have problems will the vendor reevaluate the types of tests performed at his facility, as well as the test patterns used.

Traditionally, too, the solutions have not been arrived at through a complete analysis but through an evolutionary trial-and-error process. For instance, when the major users of the 1103-type 1,024-bit random-access memory discovered its pattern sensitivity and shortcomings in critical timing parameters, the problems were eventually solved by redesigning the part. This same evolutionary process, though somewhat modified, is taking place with present-day 4-kilobit RAMs and microprocessors.

The user can spare himself much of the grief of this trial-and-error approach by adopting a carefully

### CHARACTERIZATION VS INCOMING INSPECTION: A COMPARISON

Characterization	Incoming inspection
Sample of parts tested	Large volume of parts tested
Exhaustive and complex test sequence	Simple testing
Long test duration	Short test time; throughput is the key
High engineering content	Low or no engineering content
Requires ancillary data storage equipment: line printers, hardcopy printouts, special routines, mass-storage media	Requires automatic handlers
Vast amounts of data collected	No data required, strictly go/no-go testing
High cost	Low cost
Sophisticated flexible test system	Dedicated test system
Can provide process stability analysis and indicate parametric distribution	Generally no data is provided, except attrition summary
Normally done one time or as problems occur	Performed continuously

planned cost-effective electrical-characterization program, tailored to his system's needs. It's just not enough for a user to test a part in accordance with its data sheet, despite the fact that he's bought it because of what the data sheet promised. For even if the part matches up to its specifications, it may still fail when installed in his system. Often the cause is a unique parameter that is incompletely specified, or design flaws may exist to which the system is unforeseeably sensitive.

### Making the data understandable

Electrical characterization can provide much valuable information, but only if the characterization program is well planned. Much data exists at well-intentioned vendors' and users' facilities that is incomplete, unclear, or retrieved too late, making it so difficult to interpret that no meaningful conclusions can be reached. Or, all too often, vital data must be discarded because there is no reasonable means of processing the voluminous amount generated.

In this situation, an effective technique is to reduce the data to graphic displays. Histograms, data-sheet curves, Schmoop plots, and probability distributions all make it easy to grasp the precise effects of temperature, supply voltage, or timing conditions on any of the part's key parameters.

Users can utilize reduced data to design a better system. Through electrical characterization, the user tailors the vendor's dc and ac parametric tests to fit the design margin, variations, and performance of the LSI part within his system. Incoming inspection, therefore, can



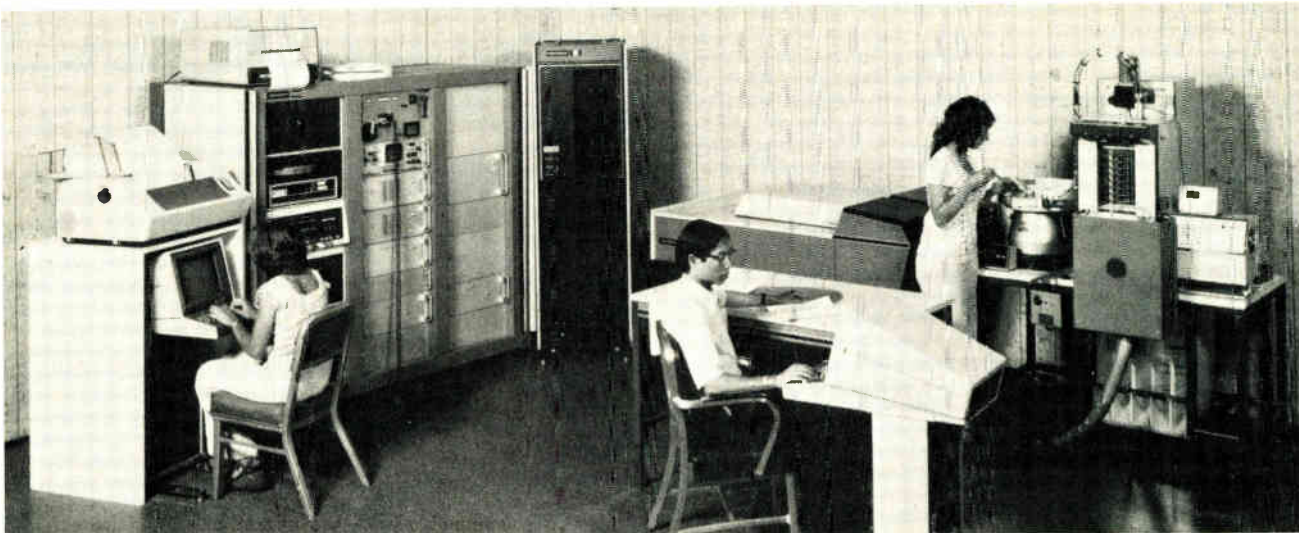

1. **Typical LSI test system.** To do electrical characterization properly, the test equipment must be sophisticated, like this Tektronix S3260 system intended for LSI devices. Because voluminous data is generated, the test system should be capable of on-line data reduction.

also be made practical, economical, and constrained only to the specifications necessary to detect proven failure mechanisms.

Vendors can use reduced characterization data on a one-time basis, during prototype development. They can also use it later, on a continual basis, to monitor production since the data can set boundaries for critical process-sensitive parameters. For example, when daily sample testing shows a preponderance of units approaching, equaling, or exceeding a certain boundary (parameter shift), the product's process and/or design should then be reevaluated. If this is done, the process will not get out of hand, and any deficiencies can be corrected rapidly.

### Expensive but worthwhile

Relative to conventional volume production testing, characterization is expensive, and so is the kind of equipment (shown in Fig. 1) needed to do the job properly. For example, a test system used to characterize LSI devices should incorporate: computer control; 16 to 48 kilobits of disk storage, plus magnetic-tape capability; a hardware pattern generator and a high-speed local memory with nesting capability, as well as foreground/background terminals and capabilities, a graphics terminal, and a high-speed line printer. It also needs a fast data rate of 10 to 20 megahertz, functional dc and ac test capability, and software flexibility. Only equipment of this complexity can store the data accumulated and do meaningful data reduction on-line—off-line data reduction is slow and incapable of manipulating the data freely enough.

Most users cannot afford an in-house characterization test system. Rather, they pay either the part's manufacturer or a test laboratory to do the testing for them.

What they will be charged depends on the specific part, as well as the complexity of the test pattern, and is directly related to the amount of engineering time required for pattern generation, test-program generation, and devising a testing philosophy. In fact, planning time for a program is generally several times longer

than the actual testing time, which is quite lengthy itself—as long as 5 to 15 minutes a device.

All this costs a dollar to tens of dollars per device tested, whereas production testing generally costs under a dollar a device. The expense of characterization can even rise exponentially if the device is changed, say, from a 64-bit memory to a 16-kilobit one. Since a sample should contain at least 30 to 50 units, the total cost is at least several thousand dollars—it ranges from \$4,000 to \$50,000, depending on the complexity of the part and what the user wishes to accomplish.

Incidentally, the sample population should be put together over a period of several months so that the devices have different date codes. In that way, they will be representative of the manufacturer's continuing process, rather than skewed by a single date code.

### Characterizing a NAND gate

An examination of some typical reduced data will demonstrate the value of a meaningful characterization program. Figure 2 shows some of the possible ways to represent massive amounts of data accumulated on a low-power Schottky-TTL quad two-input NAND gate.

The two plots of propagation delay ( $t_{PLH}$ ) shown in Fig. 2 indicate the maximum, minimum, and mean values of  $t_{PLH}$  for load capacitances of 20 picofarads (a) and 100 pF (b). Figures 2 (c) and 2 (d) are histograms of the distributions of the input supply currents ( $I_{CCL1}$  and  $I_{CCL2}$ ) when the outputs are low, while Fig. 2 (e) represents plots of  $I_{CCL}$  versus supply voltage ( $V_{CC}$ ). The transfer characteristic of Fig. 2 (f) shows output voltage ( $V_{OUT}$ ) as a function of input voltage ( $V_{IN}$ ).

These graphs represent only some of the data gathered for the characterization program. Every gate parameter was measured at a number of different temperatures for various stepped power-supply voltages and currents, so that 200 parts produced about 3.5 million data readings. If this data had been simply logged on a line printer, the printout would have been a stack 42 feet thick—much too much to assimilate. But an on-line graphic capability reduced the data to meaningful

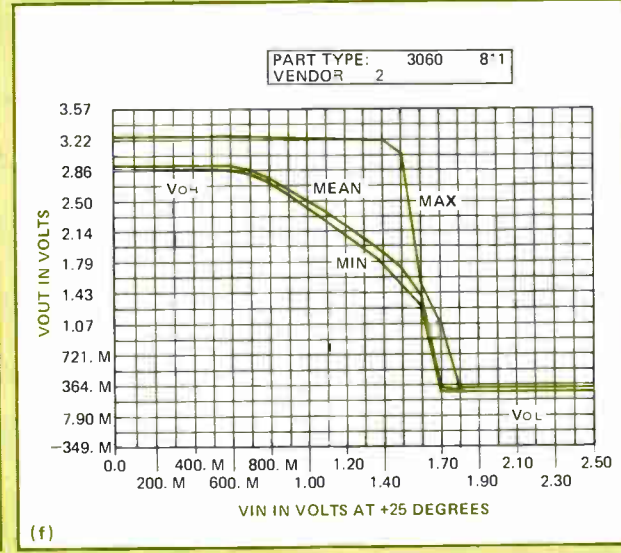
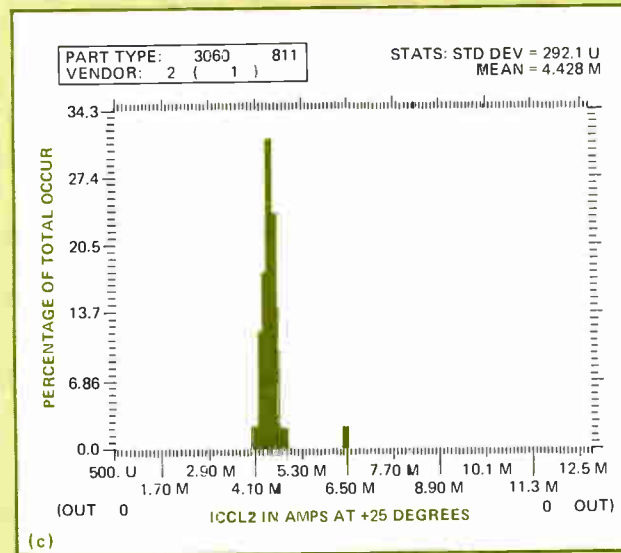
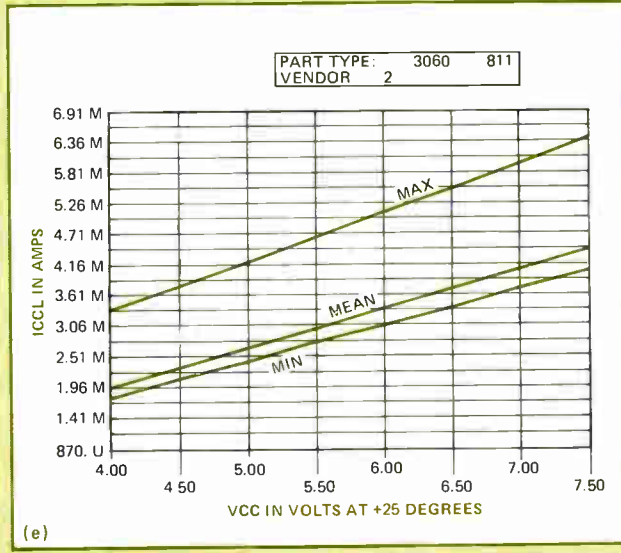
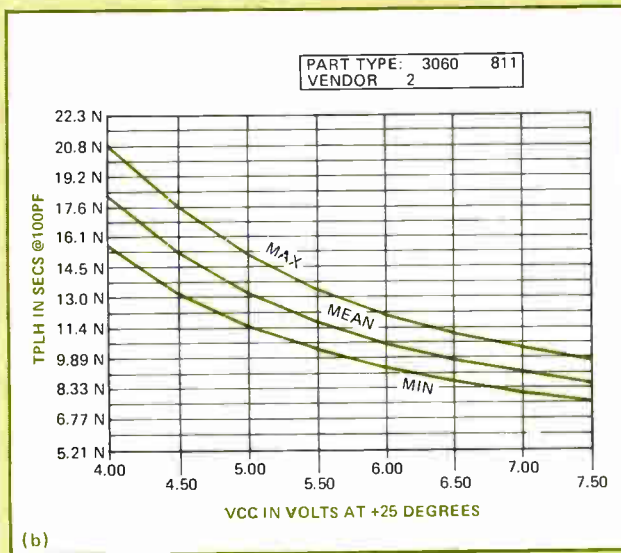
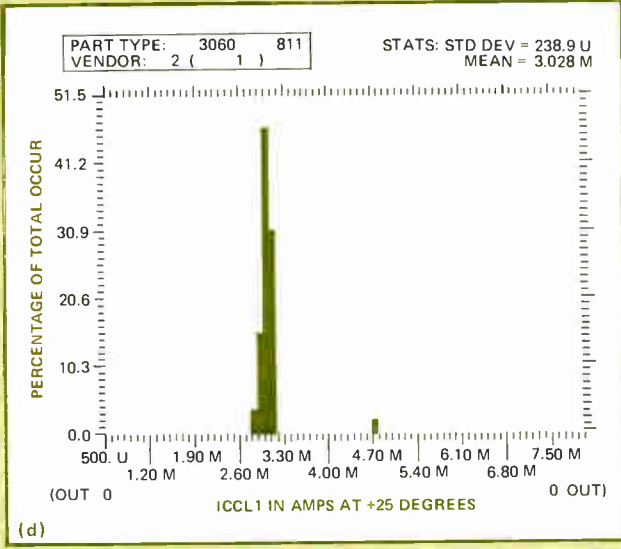
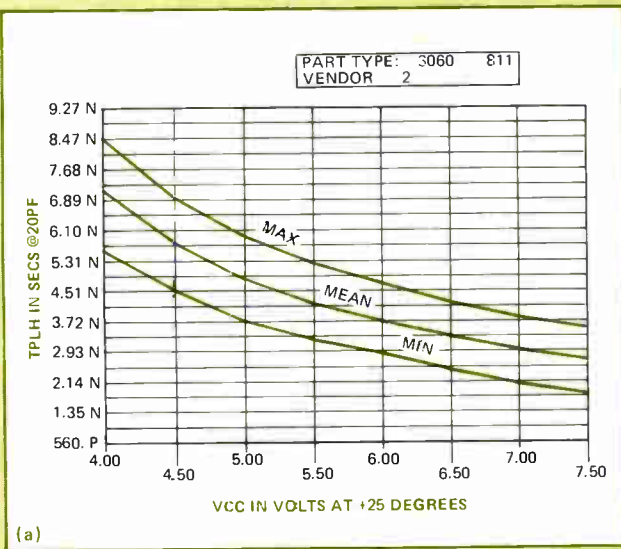

2. Meaningful reduced data. Graphs for Schottky-TTL NAND gate illustrate the sort of helpful design information obtained with characterization. These plots show delay vs supply voltage (a, b), variations of input supply current (c, d, e), and voltage transfer characteristic (f).



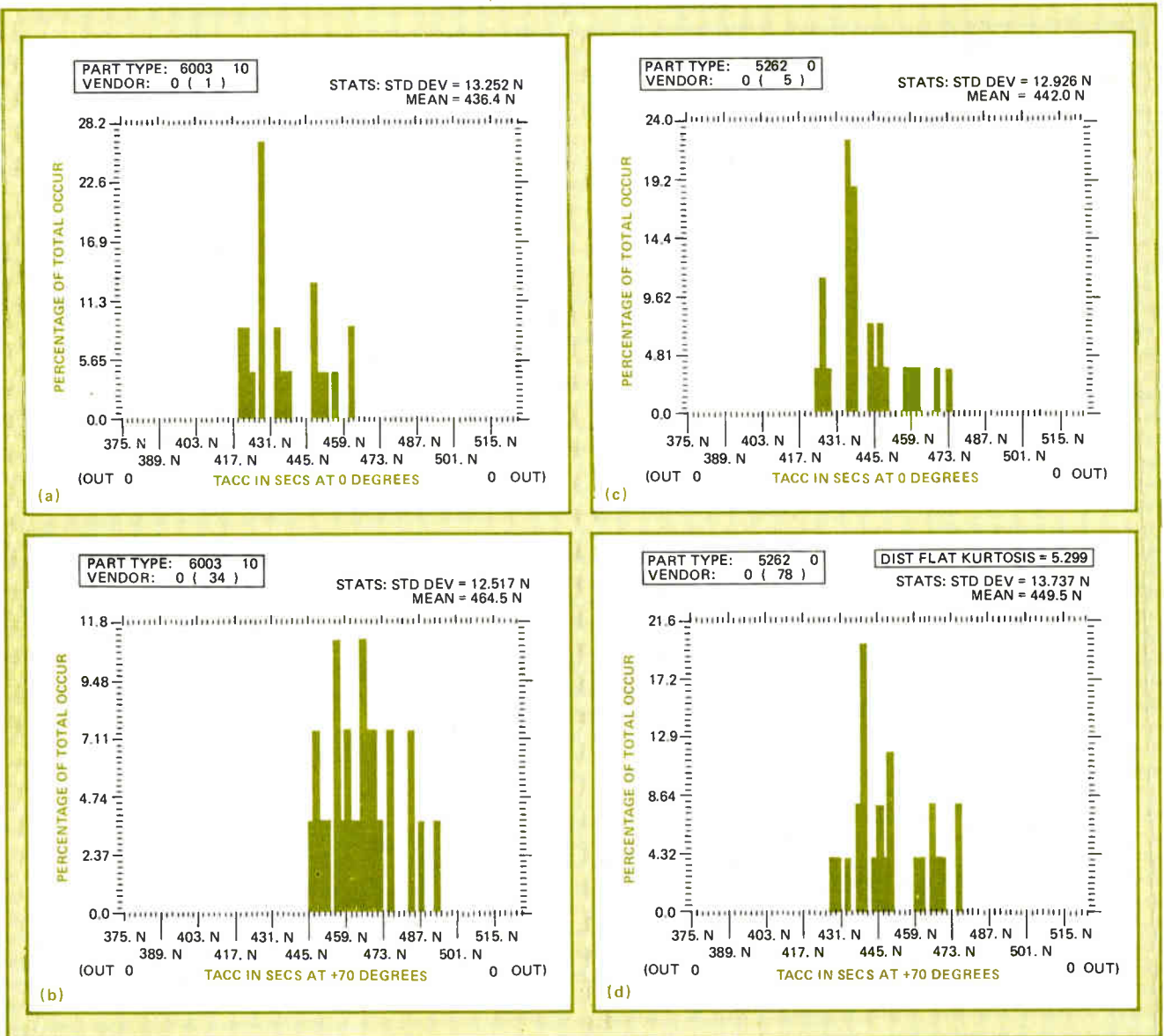

**3. RAM comparison.** Histograms depict variation of access time for a pair of RAMs (the AMS6003 and the MM5262) at 0°C and 70°C. Access time changes only slightly for both devices, with that of the 6003 (a, b) varying somewhat less than that of the 5262 (c, d).

graphic displays within a reasonable length of time.

A more complex example will illustrate more vividly the need for characterization. Two popular 2,048-bit MOS p-channel RAMs—the AMS6003 from Advanced Memory Systems and the MM5262 from National Semiconductor—were characterized to determine their sensitivity to supply voltage, as well as timing conditions, and to compare the two against each other.<sup>1</sup>

### Comparing a pair of RAMs

The testing was performed at three temperatures—0°C, 25°C, and 70°C—on a 30-piece sample population of each RAM. Forty-two parameters were measured, 24 of which were iterated by means of a recursive binary search technique. First the system voltage was held constant and the timing varied, and then the timing was held constant at the system levels and the supply voltages varied.<sup>2,3</sup> The vast amount of read and record data generated in this fashion was condensed into only 124

histograms, depicting the spread and fluctuation of the 42 parameters with variations in the supply voltages, timing conditions, and temperature. Figures 3 and 4 present the more salient results.

The histograms of Fig. 3 show how access time varies with temperature for both the RAMs. Access time, or the delay between addressing the memory and reading data from it, is one of the most critical parameters of an LSI RAM. The histograms depict the normal distribution of access time at two of the test temperatures—0°C and 70°C—and the mean value can be related to the vendor's typical specification value. (Remember that the values shown are those at which the test parts became nonfunctional.)

As can be seen, access time varies only slightly with temperature, though the variation for the 5262-type device is somewhat greater than that for the 6003-type device. Both RAMs exhibit similar normal distributions that are centered within 15 nanoseconds of each other

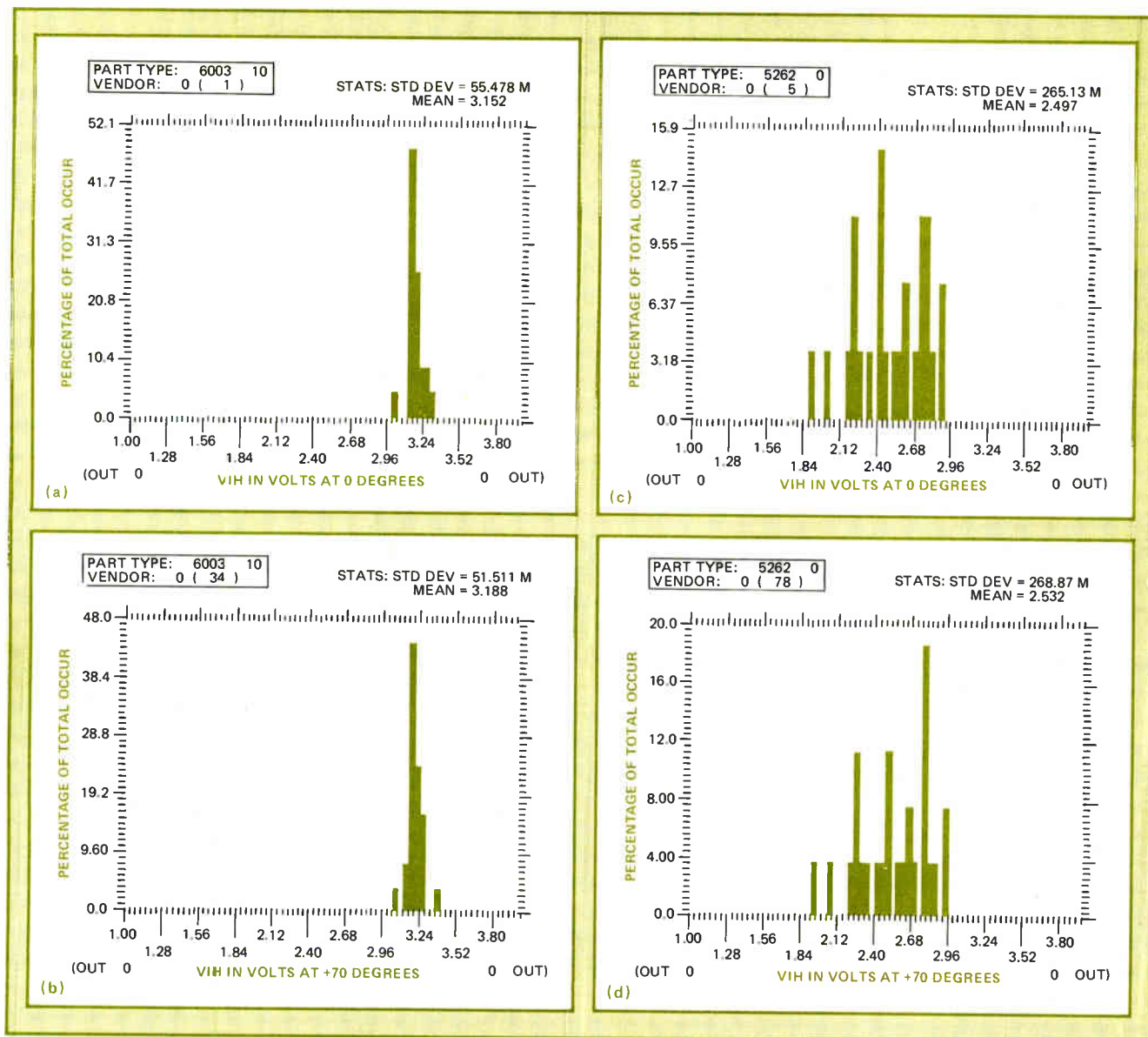

4. More RAM data. Tight distribution of high-level input logic voltage ( $V_{IH}$ ) for the 6003 at 0° (a) and 70°C (b) indicates that the part's process is quite stable. The more dispersed distributions of  $V_{IH}$  for the 5262 (c, d) points out a potential noise-immunity problem.

at the worst-case temperature condition of 70°C. Figure 4 consists of histograms of the distribution of the high-level input logic voltage ( $V_{IH}$ ) measured at 0°C and 70°C for both RAMs. The plots for the 6003 are centered about 3.24 volts at both temperatures, indicating that this device must be driven with a logic 1 level higher than that of standard TTL. Since the distribution is very tight, the part's process seems to be quite stable.

On the other hand, the histograms for the 5262 are centered about 2.5 v at both temperatures and have a more dispersed distribution that indicates a potential noise-immunity problem. This device may possibly be driven with standard TTL devices, but a noise problem can easily develop. All the histograms show that both RAMs exhibit excellent stability over the temperature range of 0°C to 70°C, with a positive temperature coefficient of 0.5 millivolt/°C.

This RAM characterization program not only proved that the two RAMs were indeed interchangeable in the

user's system—it brought out some other useful points. For both devices, the specified variations in power-supply voltage are extremely conservative. Also, all timing parameters are significantly below their data-sheet limits, with those of the 5262 being lower (faster) than those of the 6003. Finally, the measured switching parameters of both RAMs are one half the minimum specifications (twice as fast) given on their data sheets.

This kind of information is vital to the systems designer. Besides assuring him that system design margins exist and that the device chosen is a proper one, characterization testing tells him any shortcomings of the part, and helps in developing meaningful incoming-inspection tests. □

#### REFERENCES

1. Eugene R. Hnatek and Robert G. Schmitt, "2,048-bit RAM Characterization Program," 1975 IEEE Semiconductor Test Symposium Digest of Papers, pp. 23-29.
2. Eugene R. Hnatek, "4-kilobit Memories Present a Challenge to Testing," Computer Design, May 1975, pp. 117-125.
3. R. Nevala and A. Pelletier, "Testing of Bipolar RAMs," 1974 IEEE Semiconductor Test Symposium Digest of Papers, pp. 72-86.



# Now ready!

**A new line of VHF tetrodes with PYROBLOC® grids...  
for super-reliable FM-radio transmitters**

- 3 kW to 30 kW of output power.
- Only one power tetrode needed.
- Direct solid-state drive for the output stage.

With a big extra plus: THOMSON-CSF's own RF line-circuit designs for optimum overall amplifier performance and reliability!

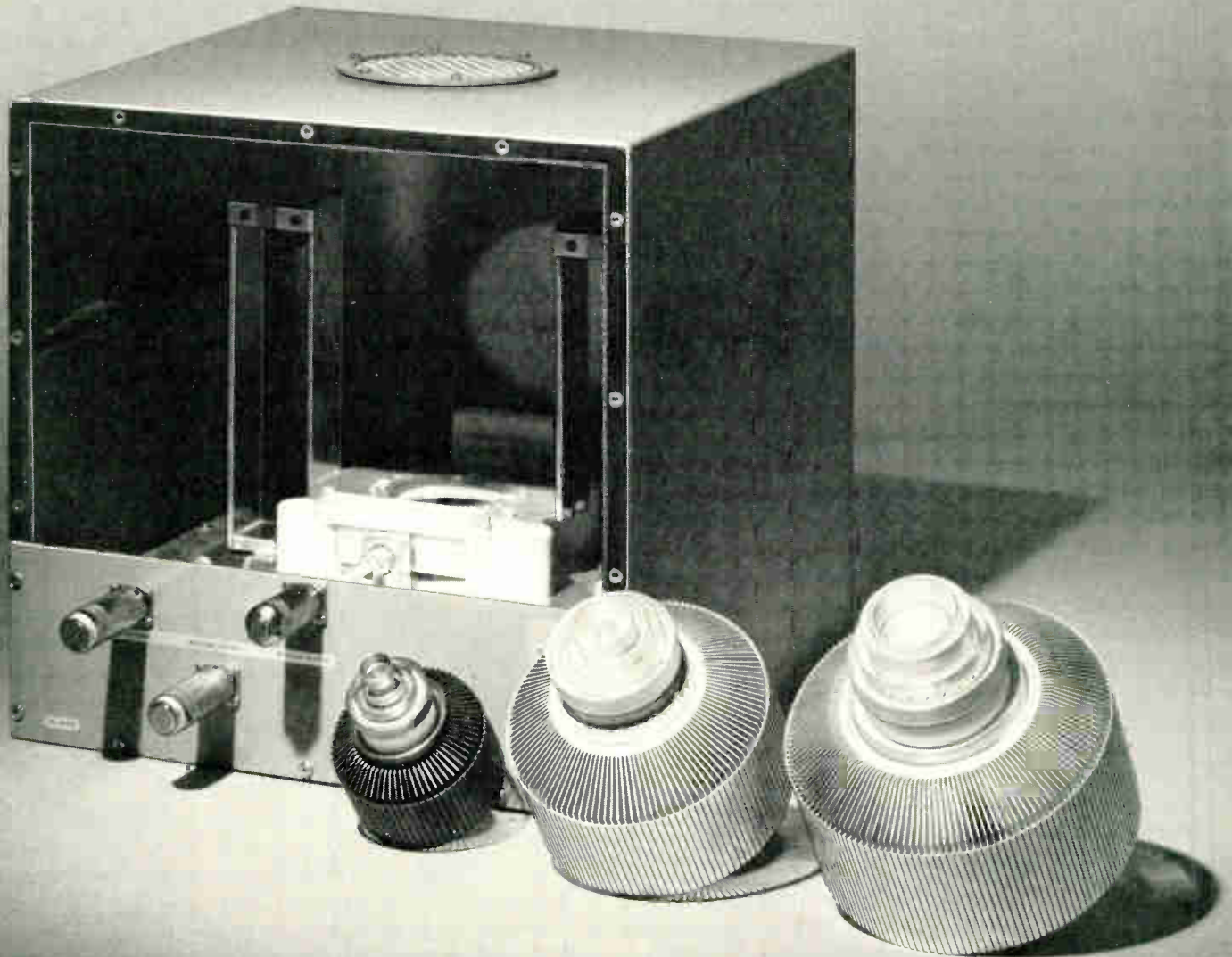

**THOMSON-CSF**

THOMSON-CSF ELECTRON TUBES / 750 BLOOMFIELD AVENUE CLIFTON NJ 07015 / TEL. : (201) 779 1004 / TWX : 710 989 7149

France - THOMSON-CSF Division Tubes Electroniques / 38 rue Vauthier 92100 BOULOGNE-BILLANCOURT / Tel. : (1) 604.81.75

Germany - THOMSON-CSF Elektronenröhren GmbH / 6 FRANKFURT/MAIN / Am Leonhardsbrunn 10 / Tel. : (0611) 70 20 99

Italy - THOMSON-CSF Tubi Elettronici SRL / Viale degli Ammiragli 71 / I - 00136 ROMA / Tel. : (6) 638 14 58

Japan - THOMSON-CSF Japan K.K. / Kyōsho Building / 1.9.3, Hirakawa-cho / Chiyoda-ku / TOKYO / 〒 102 / Tel. : (03) 264 63.41

Spain - THOMSON-CSF Tubos Electronicos S.A. / Alcalá 87 / 7º Doha / MADRID 9 / Tel. : (1) 226 76.09

Sweden - THOMSON-CSF Elektronrör AB / Box 27080 / S 10251 STOCKHOLM 27 / Tel. : (08) 22 58 15

United Kingdom - THOMSON-CSF Electronic Tubes Ltd / Ringway House / Bell Road / Daneshill / BASINGSTOKE RG24 0QG / Tel. : (0256) 29155 / Telex : 858865

# Maneuvering for top speed and high accuracy in data acquisition

Part two of two-part article focuses on matching system parts for faster error-free operation

by Dennis Santucci, *Teledyne Philbrick, Dedham, Mass.*

□ To avoid the errors or even the lost data that can occur in some data-acquisition systems, a designer must have a thorough understanding of the over-all interaction among system components. As Part 1 of this article emphasized [Nov. 13, p. 114], performance is likely to suffer if the various parts of a system—basically the sample-and-hold, the multiplexer, and the analog-to-digital converter—are not selected and matched with utmost deliberation.

Part 1 discussed the sample-and-hold and the multiplexer in detail. Now the a-d converter will be considered, and then the over-all system—its sources of error and the factors influencing throughput.

## The a-d converter

Conversion of the analog signals to digital words can be accomplished in several ways, including integration, counting, successive approximation and parallel conversion. While each technique has its advantages, successive approximation by far is the most widely used because of its speed performance in relation to cost.

In the successive-approximation process, the analog input voltage is compared to a reference voltage equal to precisely half the full-scale rated input of the a-d. If the input exceeds half the rated value, the first bit in the digital word is one. If less than half, it is zero. This first bit is referred to as the most significant bit.

Next the rated input is halved again. If the first bit is one, this new value is added to the previous comparison value. In other words the second step compares the input voltage with a number equal to half the rated input plus  $\frac{1}{4}$  the rated input. Whenever the actual value exceeds the comparison value, that bit becomes a one. Each successive comparison adds  $\frac{1}{2}$  the previously added value ( $\frac{1}{8}$ ,  $\frac{1}{16}$ ,  $\frac{1}{32}$ , etc.) to the preceding total, provided the preceding bit is a one. If at anytime the actual value is less than the comparison value, that bit becomes a zero and the last value added to the comparison value is omitted from the next comparison. In other words, if the first two bits were 11, then the third comparison value would be  $\frac{1}{2} + \frac{1}{4} + \frac{1}{8}$ . But if they were 10, then the third comparison value would be  $\frac{1}{2} +$

$\frac{1}{8}$ . This process is continued  $n$  times for an  $n$ -bit converter, essentially approaching the number by taking smaller and smaller approximations. For a 12-bit device, the rated input voltage is divided into  $2^n = 2^{12} = 4,096$  parts; that is, the smallest comparison value is  $1/4,096$  of the full-rated voltage. This number of parts also defines the resolution. A 12-bit converter has 12 bits of resolution or 4,096 possible outputs.

Absolute accuracy, on the other hand, is the degree to which the actual input-output relationship matches the calculated relationship. If a device has 12 bits resolution but  $\pm 2$  LSB nonlinearity error, then it is only accurate to within  $\pm 0.04\%$  or 10 bits. However, a converter with offset error and gain error can still have perfect relative accuracy, that is, no nonlinearity error. The converter still follows the ideal transfer relationship from one end point (zero scale) to the other end point (full scale).

When dividing a continuous signal into a finite number of discrete steps (quantizing), there is an inherent error equal to half the smallest quantized value (the least significant bit, or LSB), known as quantization error. This is because the digital word is, in effect, rounded off to the LSB and its exact value may be any value within a range of analog values covering one LSB. Therefore the digital word precisely equals the analog value only when the analog signal is at the mid-point of the possible range of values represented by the digital word. So, a  $\pm \frac{1}{2}$  LSB error is possible. The weight of the LSB for an  $n$ -bit converter is listed in Table 1. The value of the analog input can be calculated by adding the weights of all the "1" bits in the digital word and multiplying the sum by the rated input (full-scale value.) If the rated input were 10 v and the digital word for a 12-bit converter were 101101111111, its analog value, calculated from the values in Table 1, would be 7.185.

In most successive approximation a-d converters, the serial data output is transmitted sequentially with no demarcation between bits or words. This is referred to as a non-return to zero format. The only way the system can tell which bit or word it is looking at is by counting

TABLE 1: CONVERTER BIT WEIGHTS

Number of bits (n)	Value of bits ( $1/2^n$ )	Resolution of converter (rounded)
1	0.5	50%
2	0.25	25%
3	0.125	12.5%
4	0.0625	6.25%
5	0.03125	3.12%
6	0.015625	1.56%
7	0.0078125	0.78%
8	0.00390625	0.39%
9	0.001953125	0.2%
10	0.0009765625	0.1%
11	0.00048828125	0.05%
12	0.000244140625	0.024%



**1. Timing the a-d.** Serial data is not valid for the  $n$ th bit until the  $n + 1$  clock pulse. Take bit 3. The leading edge of the ON portion of the bit matches the leading edge of the third clock pulse. But the decision to turn the bit OFF doesn't occur until the leading edge of the fourth clock pulse.

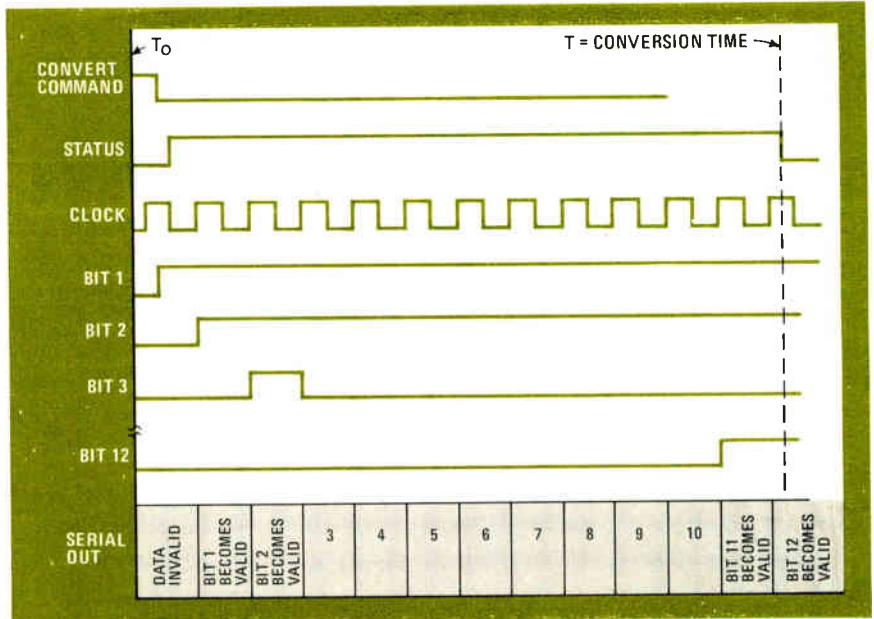

clock pulses. But the system must wait until the leading edge of the  $x + 1$  clock pulse before it can tell the value of the  $x$  bit—that is, whether the bit is a 1 or 0.

Take, for example, the timing diagram (Fig. 1) for a 12-bit converter whose output is the digital word 110000000001. Bits 1, 2 and 12 are “on” bits, while 3 through 11 are “off” bits. In the successive-approximation method, the value of each bit is determined by comparing the analog input with a comparison value, whose derivation was described above.

Prior to comparison, the bit being determined is turned on; the comparison is made, and if the analog value exceeds the comparison value, that bit is left on (1). If it is less than the comparison value, it is turned off (0). But the decision as to whether the  $x$  bit remains on or is turned off is not made until the leading edge of the  $x + 1$  clock pulse. In Fig. 1, the third bit is turned on at the leading edge of clock pulse 3, but is not turned off until the leading edge of clock pulse 4.

With zero volts input, the a-d converter should generate the code appropriate for zero input, be it all 0s for natural binary, all 1s for complementary binary, or whatever is appropriate for the coding used.

In actual practice, analog zero may not generate a code zero. The amount by which the input must be changed from analog zero to obtain a zero code output is known as the zero-offset voltage. This value, which is approximately a few millivolts, can be nulled using an external potentiometer.

Likewise, an input equal to the full-scale or rated output should produce only digital 1s from the converter. The difference between the actual analog value which generates all 1s and the full-scale value is the full-scale gain error or absolute accuracy. This error, trimmed by the factory to the neighborhood of  $\pm 0.01\%$ , can also be nulled using an external potentiometer.

Ideally, the digital word 0 will represent the analog input of zero volts. The quantization error of  $\frac{1}{2}$  LSB will fall to either side of true zero. In other words, digital zero will represent the analog value of zero volts  $\pm \frac{1}{2}$

LSB. Because of the difficulty in measuring the center of a quantization level, the transition points are used for reference.

Precisely at the  $\frac{1}{2}$  LSB input, the output of the a-d converter should move from one digital word to the next. Ideally these transitions should take place at equal (1 LSB) increments of analog inputs, but actually there is an error band, called the differential nonlinearity error, around the transition step. This error can accumulate, but only within the restrictions of total nonlinearity error. Total nonlinearity error defines an error band on either side of the ideal transition path (Fig. 2) that extends over the entire range of the converter. The width of this band is one of the factors that determine the accuracy of the system. At no point can the differential nonlinearity be permitted to accumulate to a value that exceeds the width of this band. If it were to exceed this band, the a-d converter could miss a code entirely. This may not be important in some systems but it can have dire results in systems that are using this information to operate servos; continuous oscillations can result.

Fig. 2 illustrates the transfer function of a 4-bit a-d that reaches the error limits of  $\pm \frac{1}{4}$  LSB differential nonlinearity and  $\pm 1$  LSB total nonlinearity after being trimmed for zero offset and zero-gain error.

### Getting it together

Once carefully matched with each other, the a-d converter, the sample-and-hold, and the multiplexer will constitute a solid framework for efficient data acquisition. But of course there is more to it than that. They must also harmonize with the rest of the system, namely the transducer network.

Transducers are considered “soft” signal sources in that they cannot withstand much load before becoming load dependent. And the transducer output must often be amplified as part of the signal conditioning. In systems where loading is critical, such as pH control, operational amplifiers are available with bias current inputs as low as the femtoampere range ( $10^{-15}$ ). The output of

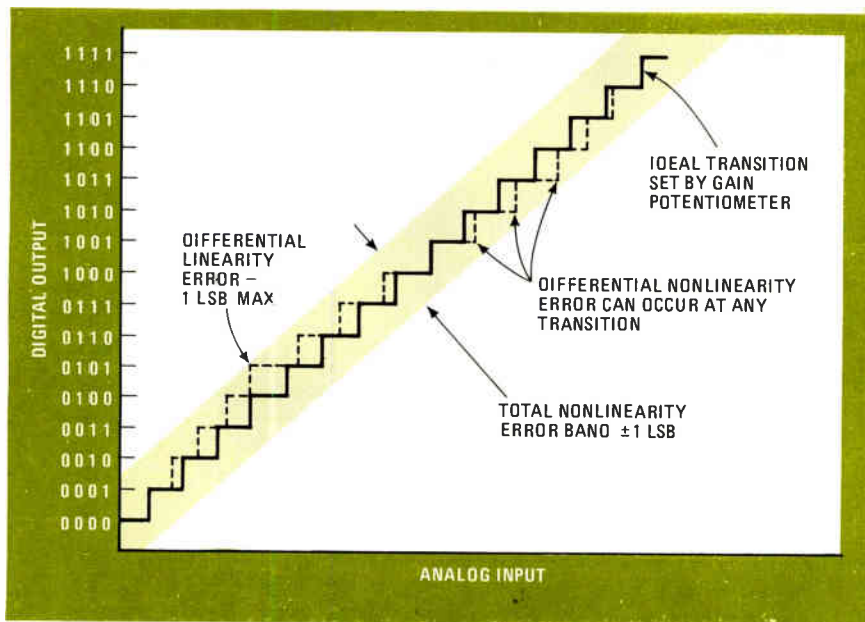

**2. Errors.** The solid line marks the ideal response of an a-d converter to a step change in analog input. The dotted lines show the possible variations from ideal due to the differential nonlinearity error. In this 12-bit a-d the total nonlinearity is  $\pm 1$  LSB and the differential nonlinearity error is  $\pm \frac{1}{4}$  LSB, so the differential nonlinearity can accumulate up to 1 LSB, but no more than that.

these amplifiers is sufficient to feed devices whose input impedances would overload the transducer.

In general, the transducer signal should reach a low-impedance signal conditioner as soon as possible in order to minimize both the noise problem and the possibility that stray capacitances will create poor response times. Outputs of the signal conditioners must be able to drive the input of the sample-and-hold through the transmission lines separating them with sufficient bandwidth to satisfy system parameters, including the bandwidth limitations of each device. Most sample-and-hold outputs have built-in operational amplifiers with outputs that can drive relatively high-impedance a-d converters. But the impedance of the sample-and-hold must be very low and non-capacitive in order to avoid errors. This is necessary because any unbuffered a-d converter will kick back current, particularly at major transitions (when many bits change simultaneously).

The best sample-and-holds use feedforward output circuitry to minimize the effects of a dynamically switching load. The circuitry features low output impedance, fast response, and low feedthrough from the input. When a multiplexer is placed between the sample-and-holds and the a-d, the sample-and-holds, which are usually "stiff sources," can drive the multiplexer and the a-d. A buffered multiplexer may be required if it is located at any distance from the a-d.

Still another area that requires careful matching is the logic. The interfaces between the system programmer and the sample-and-hold and a-d converter are usually compatible with transistor-transistor logic. But for highest speed, Schottky logic should be used. With some slower sample-and-holds, however, the fast rise time of Schottky logic may cause large sample-to-hold transients and large hold-jump voltages. The transients are spikes produced by parasitic capacitances, while the hold-jump voltage refers to the constant voltage added to the output by the charge that is transferred to the holding capacitor when the device switches from sample to hold.

Electrical and physical isolation of signals is another factor that must be considered, both within the component and within the system. Careful techniques of shielding and grounding should be observed. To avoid ground loops and noise, components should be mounted on a common ground plane. In a high-speed sample-and-hold and in high speed, high accuracy a-d converters, the analog and digital grounds are not connected internally, but are physically and electrically separated to keep switching spikes out of the analog signal. In properly constructed sample-and-holds and a-d converters, this physical separation is readily indicated by the pinout.

To avoid ground loops and noise, components should be mounted on a common ground plane. To reduce noise still further, leads to potentiometers (used for offset and jump trim in the sample-and-hold, and zero and gain trim in the a-d converter) should be kept as short as possible. Leads in a multiplexed system can be a problem because the multiplexer is often located some distance from the transducers. For maximum signal-to-noise ratio, signals should be processed at the source as much as possible. The resulting high-level signals can then be transmitted over any long distances.

Power supplies should be regulated and should have sufficient capability and tight enough specifications (especially with respect to ripple) so they do not add appreciable error to the analog signals. Both the plus and minus 15-v power leads should be bypassed to common through a hefty capacitor—on the order of 40-50 microfarads—and located as close to the sample-and-hold as possible. Otherwise settling time may be greatly extended.

### Maximizing throughput

In a multiplexed system, the throughput rate is calculated by combining the operation time of each component. Take the example of a system with a buffered multiplexer, an ultra-fast sample-and-hold and an ultra-fast, 12-bit a-d converter. The maximum specifica-



**3. Stealing time.** If sample-and-hold feedthrough is low, the multiplexer can switch channels and begin settling while the sample-and-hold is still holding the previous value. In addition, the a-d requires a preparation time in which to clear the registers before beginning the next conversion. This period, during which it is not really operating on the input, can be used as part of the settling period. By advancing the a-d conversion command, the beginning of the conversion can be timed to start with the end of the sample-and-hold settling period.

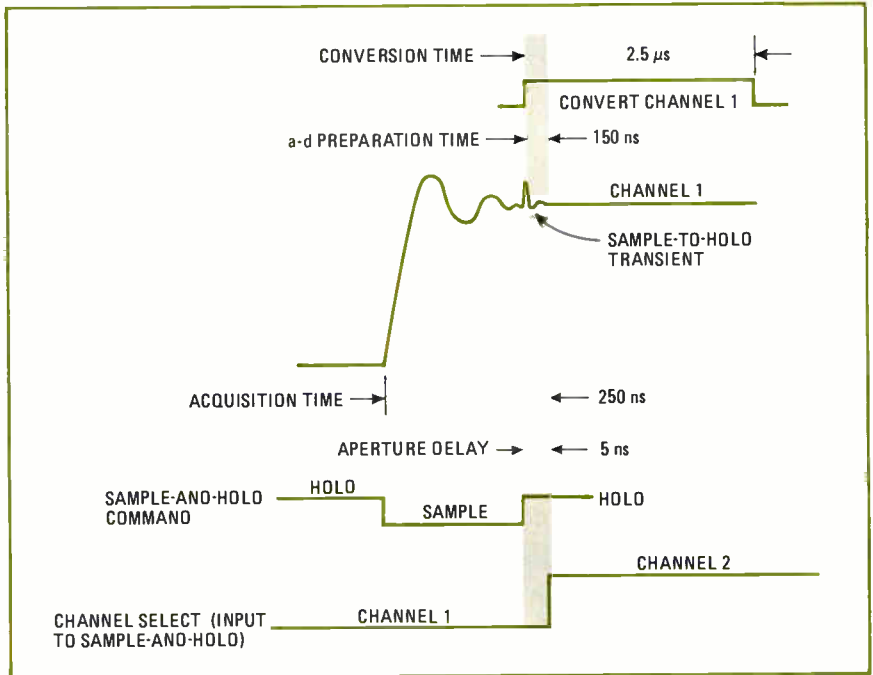

tions listed by the manufacturer might read:

	Multiplexer	Sample-and-hold	A-D
Settling time	2.5 μs	100 ns	
Aperture delay		5 ns	
Acquisition time		400 ns	
Conversion time			2.5 μs

Based on these specifications, a timing analysis can be performed: first the multiplexer switches channels and settles before the sample-and-hold is commanded to acquire another signal. Then, after receiving a command, the sample-and-hold is allowed to settle before the a-d converter is commanded to convert. Thus the throughput time of one cycle would comprise:

- 2.5 μs multiplexer settling (to within 0.01% accuracy)
- 0.4 μs sample-and-hold acquisition time (to within 0.01% accuracy)
- 0.1 μs sample-and-hold settling time (to within 0.01% accuracy)
- 2.5 μs a-d conversion time
- 5.5 μs total, or throughput time

The throughput rate, therefore, would be 181.8 kHz. Note, however, that the above addition omits aperture-delay time. This was left out because it can be compensated for by advancing the sample-to-hold command, as was explained in Part 1 of this article.

There is also another factor that, if it can be ignored, will significantly increase the allowable system throughput rate. This is the sample-and-hold feedthrough, or the amount of signal that can squeeze into a sample-and-hold after it has supposedly finished storing a transducer value. This occurs in many cases—usually where the output of a transducer continues to change as the transducer continues monitoring the process, and so there is a certain amount of feedthrough to the storage capacitor. But it is usually quite small, typically 1 mV peak to peak per 20 V peak to peak, 1 MHz input. If it is

so small that it will not introduce any significant error, it can be safely ignored. And if so, the multiplexer can be permitted to seek and settle on another channel while the sample-and-hold is in the hold mode. Thus—and assuming that the settling time of the multiplexer is equal to or less than the a-d conversion time—all the multiplexer switching and settling times can be eliminated from the throughput calculation.

Based on the data listed above, therefore, the multiplexer settling time of 2.5 μs is ignored and the throughput period becomes 3.0 μs instead of 5.5 μs, yielding a throughput rate of 333.3 kHz instead of 181.8 kHz.

There are other ways, too, of obtaining higher throughput. One is by making use of the little-known fact that the successive-approximation a-d converter must clear all registers before it begins a new conversion. In the fastest converters, this housekeeping time, which is included in most conversion time specifications, runs between 150 and 350 nanoseconds. Thus the convert command may be given 150 to 350 nanoseconds before the sample-and-hold settles, because it takes that long before the converter can begin operating on the new input. At 150 ns, the timing of 2.85 μs, as shown in Fig. 3, produces a throughput rate of 350.9 kHz. This system then would satisfy the conditions of a maximum input frequency of 35.1 kHz, an aperture time of 1 nanosecond, and rule-of-thumb sampling at 10 times the maximum frequency to compensate for non-ideal filters and noise. Thus a 12-bit a-d with a 2.5-μs conversion time and a sample-and-hold with a 1 nanosecond aperture time are an ideal combination for many high-speed, high-resolution digitizing jobs.

Under certain conditions even more delays can be eliminated from the system. If, for example, the acquisition time of a sample-and-hold is 400 nanoseconds, this means the unit can swing from one end of its rating to the other and settle, say +10 v to -10 v, in 400 nanoseconds. But when the largest voltage difference that

TABLE 2: SOURCES OF SYSTEM ERRORS

SYSTEM NOISE	PARAMETERS	CURES
Common mode	Transducer, environment, transmission media	Use high common-mode-rejection-ratio devices, shield and guard
Normal mode	Environment, transmission media	Filter, shield and guard
<b>MULTIPLEXER</b>		
Leakage current	Voltage, temperature	Use low-leakage devices, stabilize temperature, minimize excessive heating
Crosstalk	Frequency, voltage	Filter, guard and shield
Error caused by ripple or other power-supply changes	Inherent	Use low-ripple power supply, low-drift device
<b>SAMPLE AND HOLD</b>		
Gain error	Inherent	Trim to zero
Gain temperature coefficient	Temperature	Stabilize temperature, use low-temperature-coefficient device
Sample-offset voltage	Inherent	Trim to zero
Sample-offset-voltage temperature coefficient	Temperature	Stabilize temperature, use low-temperature-coefficient device
Hold-jump voltage	Inherent	Trim to zero
Feedthrough	Inherent	Use low-feedthrough device, filter
Errors caused by ripple or other power-supply changes	Inherent	Use low-ripple power supply, low-drift device
Long-term stability	Inherent	Use highly stable device
<b>A/D CONVERTER</b>		
Total nonlinearity	Inherent	Use device with good linearity
Zero-offset voltage	Inherent	Trim to zero
Zero-offset temperature coefficient	Temperature	Stabilize temperature, use low-temperature-coefficient device
Full-scale error	Inherent	Trim to zero
Full-scale-error temperature coefficient	Temperature	Stabilize temperature, use low-temperature-coefficient device
Errors caused by ripple or other power-supply changes	Inherent	Use low-ripple power supply, low-drift device

will be applied to the sample-and-hold is less than full swing, then the slewing time will be correspondingly lower, giving a reduction of throughput time. To facilitate such matters for the engineer, manufacturers will often list different acquisition times on a data sheet, so a typical data sheet might read as follows:

- 10-v step accurate to 0.01% 300 ns max, 250 ns typ.
- 10-v step accurate to 0.1% 120 ns
- 20-v step accurate to 0.01% 400 ns max, 350 ns typ.
- 20-v step accurate to 0.1% 180 ns.

In the example of Fig. 3, a sample-and-hold that must slew only 10 v instead of 20 v (to within 0.01% accuracy) can cut 100 ns off the throughput time, reducing 2.85  $\mu$ s to 2.75  $\mu$ s. As a result, the throughput rate jumps to 363.6 kHz.

Depending on the accuracy demands placed on the system, the allowable throughput rate can be increased even further. For example, an RMS sum of the difference between typical and maximum specifications will increase the permissible throughput rate, but will lower the probability of achieving 100% accuracy. In addition, some channels in a multiplexed system require accuracy to within 0.01%, while others do not. Operation of those that do not need as much accuracy can be calculated based on the shorter settling times for accuracy to 0.1%.

But being able to take advantage of this variation among channels requires a very accurate, extremely flexible and customized system programmer.

### Sources of error

It becomes clear from all this that a careful study of error sources can reveal where emphasis must be placed to develop a workable and economical system. Table 2 is a first-order checklist of possible errors and solutions.

Many error sources are inherent in the design of the device and are not dependent on external parameters. Several of these inherent sources, such as gain and offset errors, are trimmable to zero using external potentiometers. The cost of the potentiometers and the cost of calibration must be weighed against the importance of the error to the application.

Cost is also a tradeoff when dealing with common-mode and normal-mode noise. These can be filtered out and shielded against to a degree, but the cost must be weighed against the error.

Some error sources are temperature dependent and can be significant if large temperature variations occur. Devices with very low temperature coefficients can be very expensive, and temperature stabilization may be a cheaper alternative, especially if the components are grouped together. □



# Engineer's notebook

## Optical isolator circuit shows phone-line status

by Matthew L. Fichtenbaum  
General Radio Co., Concord, Mass.

The status of a telephone line can be indicated at a remote location, such as the key unit on a secretary's desk, by a light-emitting diode connected in the circuit shown here. The LED is dark if the phone line is not in use, flashes on and off once every second if the phone is ringing, and stays on if the phone is off the hook.

The circuit includes an oscillator that operates continuously, some logic elements, and an optical coupler that senses the voltage on the phone line. If this voltage is ac, the logic circuit connects the oscillator to the LED, producing the flashing light. Low dc voltages, either steady

OPERATION OF PHONE-STATUS-DISPLAY-CIRCUIT			
Phone condition	Line voltage (V)	Isolator output level	LED condition
On hook	50 dc	Low	Off
Ringing	100 ac	Pulses	Flashing
Off hook	6 - 8 dc	High	On
Dialing	6 - 50 dc	Pulses	On

or pulsed, hold the LED on, and high dc voltages leave it off. The table summarizes circuit performance.

As can be seen from the schematic diagram, the isolator output signal is applied to two RC networks—an integrator and a differentiator. The integrator filters out the ring and dial pulses, giving an output dependent on the steady state of the phone line. The differentiator extracts the pulses.

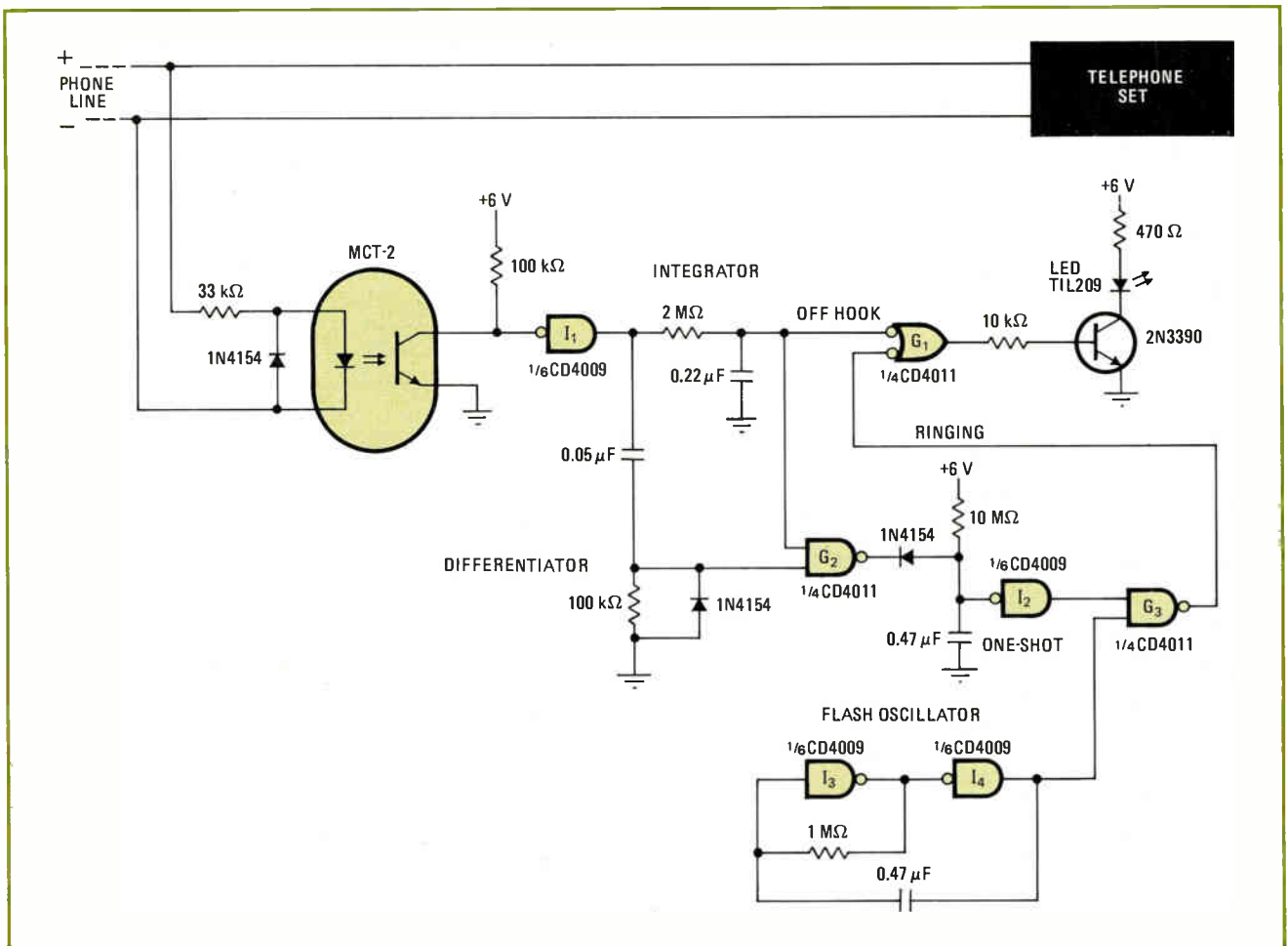

**Secretary's helper.** LED indicates status of a remote telephone. Light is off if phone is hung up, shines steadily if phone is off hook, and flashes on and off while phone rings and for 5 seconds after ringing stops. The flashing oscillator operates continuously, but can drive LED only when a ringing signal discharges the one-shot capacitor to enable NAND gate G<sub>3</sub>. Thus, one oscillator handles several phone lines.

When the phone is on the hook, so that inverter  $I_1$  has low input and high output,  $G_1$  is deactivated and cannot turn the transistor or LED on.

When the phone rings, the high dc from  $I_1$  and the high output from the differentiator combine to activate  $G_2$ , allowing the one-shot capacitor to discharge and enable  $G_3$ . Thus the output from the flash oscillator is applied to  $G_1$ , flashing the LED. Flashing continues during the slow charge-up of the 0.47-microfarad one-shot capacitor between rings and after ringing stops.

When the phone is off the hook,  $I_1$  has high input and low output, so  $G_1$  is able to turn on the transistor and let the LED light. The momentary high-voltage pulses that occur during dialing are suppressed by the integrator, so  $G_2$  is not enabled.

The 100-v ac ringing signal might apply excessive reverse voltage to the light-emitting diode in the optical coupler. Therefore, the coupler input is shunted by a protecting 1N4154 diode.

Because the flash oscillator operates continuously, it can be connected to the NAND gates  $G_3$  associated with a number of different phone lines and LEDs. In the author's office, one oscillator is used for 10 phones.

This circuit uses ordinary C-MOS ICs and operates from a noncritical supply voltage between 5 and 10 volts. The ac adapter from a pocket calculator is a convenient source. A single power supply can handle all of the phone lines.

The signals that are developed at the integrator and differentiator outputs can be used for other purposes than lighting a LED. Other areas of application include playing a recorded message when a phone rings, or running a timer while a phone is in use.

This circuit does not draw appreciable current from the phone line, feed back to the line, or reference any voltages to the line because the coupling is optical. Nonetheless, the telephone company should be consulted before the circuit is installed.  $\square$

## Weigh-counting technique is faster than binary

by Patrick F. Howden  
Sydney University, Sydney, Australia

A system of counting that is more condensed and much faster than binary can easily be implemented with tri-state integrated circuits. It is based on the fact that all

rational numbers can be represented through a series such as . . . 243, 81, 27, 9, 3, 1,  $1/3$ ,  $1/9$ ,  $1/27$ , . . . , assuming any of these "weights" can be put on either "pan" of a "scale." This weigh-counting scheme is not related to tertiary counting, though it uses the same number of digits as does tertiary with a sign bit.

A weight digit is designated by a plus sign in a circle if it is in the pan opposite the number to be measured, and by a minus sign in a circle if it is in the same pan. Then the integers 1 through 15 can be represented as shown in the table.

As can be seen, n digits of weigh-counting reach

### WEIGH-DIGIT FORMAT AND COUNTING RULES

	27	9	3	1		
1				⊕	<b>RULES</b> $\circ + \circ = \circ$ $\ominus + \circ = \ominus$ $\oplus + \circ = \oplus$ $\oplus + \ominus = \circ$ $\ominus + \ominus = \oplus$ AND CARRY $\ominus$ $\oplus + \oplus = \ominus$ AND CARRY $\oplus$	<b>ADDITION</b> <b>EXAMPLE</b> $\oplus \ominus \ominus = 5$ $+ \oplus \ominus \circ = +6$ <hr/> $\oplus \oplus \ominus = 11$
2			⊕	⊖		
3			⊕	∘		
4			⊕	⊕		
5		⊕	⊖	⊖		
6		⊕	⊖	∘		
7		⊕	⊖	⊕		
8		⊕	∘	⊖	<b>MULTIPLICATION</b> <b>RULES</b> $\circ \times \circ = \circ$ $\ominus \times \circ = \circ$ $\oplus \times \circ = \circ$ $\oplus \times \ominus = \ominus$ $\ominus \times \ominus = \oplus$ $\oplus \times \oplus = \oplus$	<b>EXAMPLE</b> $\oplus \ominus \ominus = 5$ $\times \oplus \ominus \circ = \times 6$ <hr/> $\ominus \oplus \oplus$ $\oplus \ominus \ominus$ <hr/> $\circ \oplus \circ \oplus \circ = 30$
9		⊕	∘	∘		
10		⊕	∘	⊕		
11		⊕	⊕	⊖		
12		⊕	⊕	∘		
13		⊕	⊕	⊕		
14	⊕	⊖	⊖	⊖		
15	⊕	⊖	⊖	∘		





# power hybrid voltage regulators

For your high reliability applications, Solitron's new Series Voltage Regulators feature planar construction, silicon eutectic die mounting and ultrasonic aluminum wire bonding. Thermal cycling capability is enhanced by the complete absence of any soft solder. All of these regulators are competitively priced and available now from Solitron.

## POWER VOLTAGE REGULATOR PRODUCT SELECTION GUIDE

TYPE	OUTPUT VOLTAGE	PEAK CURRENT	REGULATION LINE & LOAD (-55°C to +125°C)	POWER DISSIPATION	INPUT VOLTAGE		INPUT-OUTPUT VOLTAGE DIFFERENTIAL	
					MIN	MAX	MIN	MAX
<b>VARIABLE OUTPUT (8 PIN TO-3 PKG)</b>								
CJCA 001*	+ 8 to + 56	5A	Dependent On External Circuitry (Refer to Data Sheets)	50W	10V	60V	2V	50V
CJCA 002*	- 8 to - 56	5A		50W	10V	60V	2V	50V
CJCA 007#	+ 8 to + 56	5A		50W	12V	60V	4V	50V
CJCA 008#	- 8 to - 56	5A		50W	12V	60V	4V	50V
<b>FIXED OUTPUT** (2 PIN TO-3 PKG)</b>								
CJSE 001	+ 15V	3A	± 3%	90W	20V	50V	5V	—
CJSE 002	- 15V	3A	± 3%	90W	20V	50V	5V	—
CJSE 003	+ 15V	3A	± 2%	90W	20V	50V	5V	—
CJSE 004	- 15V	3A	± 2%	90W	20V	50V	5V	—
CJSE 005	+ 15V	3A	± 1%	90W	20V	50V	5V	—
CJSE 006	- 15V	3A	± 1%	90W	20V	50V	5V	—
CJSE 009	+ 20V	3A	± 3%	90W	25V	50V	5V	—
CJSE 010	- 20V	3A	± 3%	90W	25V	50V	5V	—
CJSE 011	+ 20V	3A	± 2%	90W	25V	50V	5V	—
CJSE 012	- 20V	3A	± 2%	90W	25V	50V	5V	—
CJSE 013	+ 20V	3A	± 1%	90W	25V	50V	5V	—
CJSE 014	- 20V	3A	± 1%	90W	25V	50V	5V	—
CJSE 017	+ 6V	3A	± 3%	90W	11V	40V	5V	—
CJSE 018	- 6V	3A	± 3%	90W	11V	40V	5V	—
CJSE 019	+ 6V	3A	± 2%	90W	11V	40V	5V	—
CJSE 020	- 6V	3A	± 2%	90W	11V	40V	5V	—
CJSE 021	+ 6V	3A	± 1%	90W	11V	40V	5V	—
CJSE 022	- 6V	3A	± 1%	90W	11V	40V	5V	—

\*CJCA 001 and CJCA 002 ARE BASIC REGULATORS #CJCA 007 and CJCA 008 HAVE A CONSTANT CURRENT SOURCE AND PROVIDE CURRENT LIMITING AND SHORT CIRCUIT PROTECTION \*\*FIXED OUTPUT REGULATORS FEATURE FOLDBACK CURRENT LIMITING AND SHORT CIRCUIT PROTECTION. OUTPUT VOLTAGE CAN BE SUPPLIED FROM 4 to 30 VOLTS TO MEET SPECIFIC REQUIREMENTS

1177 Blue Heron Boulevard  
Riviera Beach, Florida 33404  
Tel: (305) 848-4311  
TWX: (510) 952-7610

**Solitron**  
DEVICES, INC.

PLANTS IN: CALIFORNIA • FLORIDA • NEW YORK • ENGLAND • HONG KONG • MEXICO



# Engineer's newsletter

## Calculator can serve as stopwatch . . .

The HP-45 calculator can be used as a 12-hour digital stopwatch if you press the right keys, says Jim Trulove, Phoenix, Ariz. It seems you simply turn the power on, press RCL, and then simultaneously press three keys: R↓, STO, and CHS. The display then will change to **four ordered pairs of zeros, representing, from left to right, hours, minutes, seconds, and hundredths of a second.** It may require several tries before you hit the keys exactly at the same time, he says, but it can be done. And be sure to press the RCL key before each try, he warns.

Once in the stopwatch mode, pressing CHS starts and stops the timer, while EEX turns off the digits displaying hundredths of a second.  $\Sigma +$ , since it's in the lower right-hand corner, may be a more convenient key to stop the timer. To return from the timing mode, press ENTER↑. However, note that the HP-45, unlike the HP-55, does not have a crystal-controlled time base, and the timer function may not be accurate, although it can be calibrated, says Trulove.

## . . . in two ways at least

Speaking of simultaneity, *Electronics* received three letters describing the calculator/stopwatch within the space of two weeks. Burl Buchanan, Fountain Valley, Calif., and R. J. Eikelberger, of Licon, Chicago, Ill., also suggested the idea (Trulove's letter arrived first). However, Buchanan and Eikelberger both said **the timing function can be obtained by pressing CHS, 7, and 8 simultaneously after the RCL key.**

## Who needs precision meters to measure microwaves?

You can determine the complex impedance and reflection coefficients as well as other parameters of a microwave transmission line without precise instruments. You need only **a six-port measuring circuit and a combination of four wattmeter readings**, claimed Cletus Hoer, physicist at the National Bureau of Standards, Boulder, Colo., last year. [*Electronics*, Dec. 26, 1974, p. 28].

Now Hoer is backing up his claim with a 29-page technical note, "Using six-port and eight-port junctions to measure active and passive circuit parameters," that details the mathematics behind his theory. NBS Technical Note 673 is available from the Superintendent of Documents, U.S. Government Printing Office, Washington, D.C. 20402, as SD Cat. No. C13.46:673. Price is 80 cents.

## Videotape shows how laser scanners aid semi production

Meanwhile, in another lab of the NBS, in Gaithersburg, Md., researchers David E. Sawyer and David W. Berning have been busy in front of TV cameras recording a videotape called "Laser scanning of active semiconductor devices." The tape shows how **the scanner can reveal the inner workings of semiconductor devices, mapping dc and high-frequency transistor gains, nonlinear operations, and temperature distributions.** A 55-minute presentation, the tape is available on loan from NBS (call Elaine C. Cohen at (301) 921-3625). And if you have further questions once you've seen the tape, Sawyer and Berning say they will be available for telephone conference calls at (301) 921-3541. Their hope, they say, is that the semiconductor community will be stimulated to construct and use similar scanner systems. —**Stephen E. Scrupski**

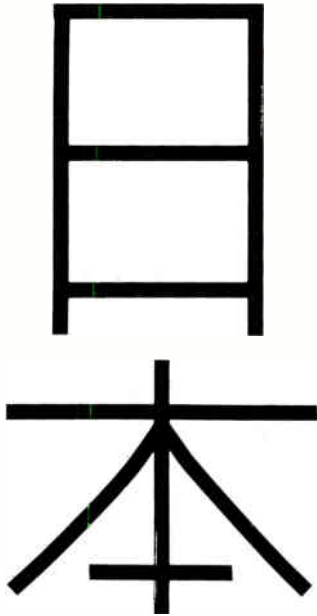

The Japanese economy in general and the electronics industries in particular have begun to recover from the unsettling effects of the recession that has hit all of the industrialized nations. This recovery, however, is too slow for the Japanese who are accustomed to sharp rebounds rather than gradual improvement.

As a result, despite better sales and somewhat better profits, managers for the major Japanese electronics firms remain rather subdued. More experienced at managing during periods of rapid growth of 20% or more per year, these executives are far from satisfied with 6% to 10% growth rates.

Overall, total electronic-equipment consumption in Japan in 1975 should be about 5% above 1974, according to a survey of electronics firms conducted by Electronics magazine. Total components consumption—semiconductors, passive devices, tubes, and electromechanical parts—will decline slightly in 1975, down approximately 4%.

But these totals are somewhat misleading, for there are pockets of prosperity as well as continuing declines

among certain specific segments in both the equipment and components markets. For example, hi-fi components in the consumer group, electronic switching equipment in the communications sector, and medium-sized and large computers in the data-processing market have recorded very good gains. On the other hand, sales of virtually all industrial electronics equipment and some test equipment have lost ground or else remained flat.

Within the semiconductor group, discrete devices chalked up lower figures in 1975 compared to 1974, the survey indicates, while integrated circuits, especially MOS logic devices, have gained in sales dollars. Passive and electromechanical components did less well this year than last. Sales in these categories reflect the ups and downs of equipment production—good for data processing, poor for industrial, and flat for most consumer products.

Japanese companies are somewhat optimistic about the coming year, however. Every product category indicates dollar gains for 1976, the Electronics magazine survey forecasts. As encouraging as this view may be, for many electronics markets the 1976 "recovery" will mean simply a return to the sales levels achieved prior to the recession. Consequently, the Japanese continue to be impatient for a return to solid expansion at home and

hopeful for a rapid recovery in America, their favorite overseas market.

In past recessions, exports have helped pull up electronics companies. But this situation may not be as easy to repeat as before, in the view of Shigeo Kurebayashi, chief economist for the Fuji Bank Ltd. in Tokyo. He points out that the Japanese may not enjoy a price advantage because of domestic "stagflation," and demand from overseas markets is also recovering slowly. Profits have suffered even after the turnaround partly because of a decline in productivity caused by idle or partially idle workers carried by many Japanese companies, Kurebayashi adds.

Even now, according to an estimate by the Electronics Industries Association of Japan, the electronics industries are running at around 80% of capacity. And some manufacturers, notably components makers, have hesitated to return to 100% capacity for fear of running into another slowdown that would once again force layoffs and cutbacks.

Yet there is one strong indicator in the fact that the Japanese electronics companies have continued to support research and development, maintaining their commitment to new products and new markets. As a result, when the general economy recovers fully, the Japanese electronics industries will be in the forefront of renewed growth.

## JAPAN'S RECOVERY



# The heart of the matter

DIP Latching Reed Relay

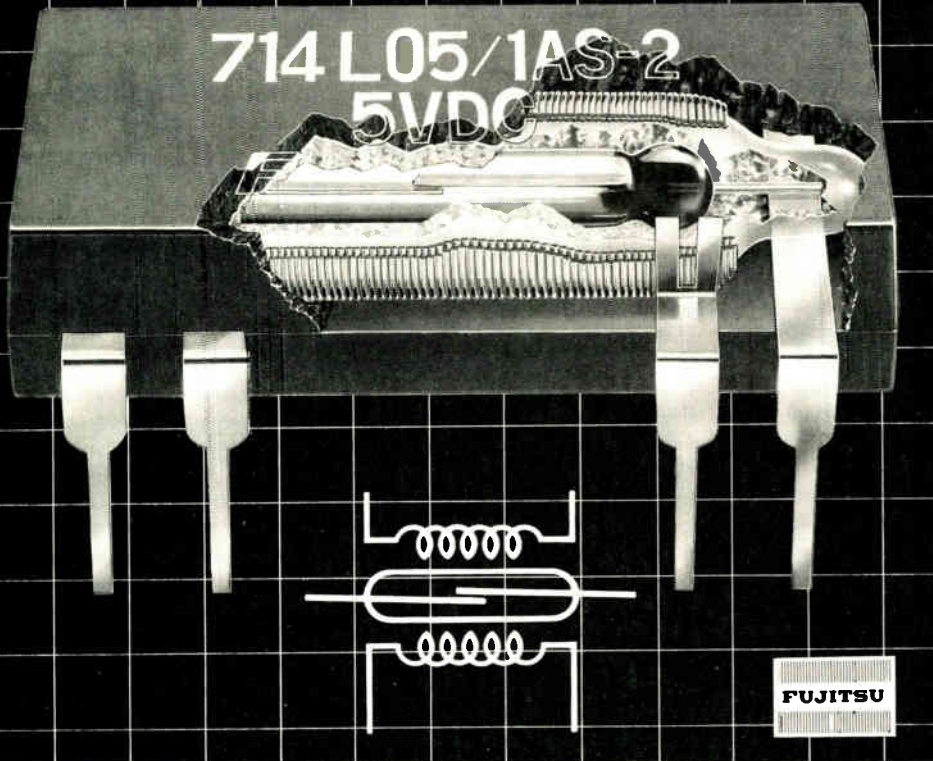

If you're wondering what makes the Fujitsu DIP Latching Reed Relay so special, take a look. Within this standard package unit is a hermetically-sealed, magnetically self-latching dry reed switch, similar in design to the now-famous Fujitsu Memoreed® Latching Reed Switch. This unique construction lets you beat the energy pinch because the switch remains latched (once pulsed) without the need for a holding current being applied to the coil. And this same construction offers longer service life with stable contact resistance, further increasing the benefits to you.

No matter how you look at it, there's more to Fujitsu DIP Latching Reed Relays than meets the eye. Come take a look for yourself!

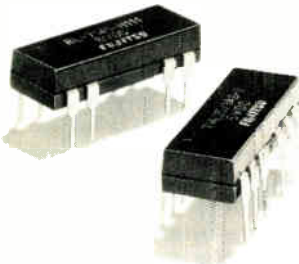

## FUJITSU LIMITED

Communications and Electronics  
Marunouchi, Tokyo, Japan

For further information please contact:

**Components Division:** Syuwa Gararimon Bldg., 1-1, Shinbashi 6-chome, Minato-ku, Tokyo 105, Japan  
**(Head Office)** Phone: Tokyo (03) 437-2111 Cable: FUJITSU LIMITED TOKYO Telex: 2422808 FT SIN J  
**New York Office:** 680 Fifth Avenue, New York, N.Y. 10019, U.S.A. Phone: (212) 265-5360  
**Fujitsu California, Inc.:** 1135 East Janis Street, Carson, California 90746, U.S.A. Phone: (213) 636-085E, (213) 537-893J  
**London Office:** Norman House, 105/109 Strand, London, W.C. 2 England Phone: 240-0461/0462 Telex: 51-22305

**MAIN PRODUCTS** Telephone Exchange Equipment □ Carrier Transmissions Equipment □ Radio Communication Equipment □ Space Electronics Systems □ Electronic Computers & Peripheral Equipment (FACOM) □ Telegraph & Data Communication Equipment □ Remote Control & Telemetry Equipment □ Electronic Components

Advertisement

## The new look in Fujitsu's Plasma Display Panels

The display functions essential to its mainstay lines of communications and computer products have led Fujitsu into the pursuit of advanced display systems. The results of this in-depth research are now available from the Components Division in the form of small to medium-size capacity Plasma Display Panels (PDPs) for direct installation in the customers' equipment.

Although similar to conventional gas discharge type units, Fujitsu PDPs feature an original construction technique which increases the service life, thus providing more economical operation for the user. During fabrication of Fujitsu PDPs, the electrode pattern is screened onto the glass plates that form the front and rear surfaces of the display. Next, a special insulating glass layer is applied directly over the electrode pattern, with an additional protective layer applied on top of the insulating glass. As a result, Fujitsu PDPs exhibit a higher degree of electrode stability for longer life and more stable operation. Fujitsu PDPs are available in special models to meet customer requirements.

### Numeric Type

Fujitsu Numeric Type PDPs are available in models with up to 9 digits, each featuring conventional seven-segment (plus decimal) multiple digit layout. For all models, typical firing voltage is 115V, with a typical driving voltage of 150V. Power consumption is low (as small as 0.35W/digit) for added savings. Also, brightness is high (60 fL/digit at 12.5kHz), with an excellent contrast ratio, for maximum visibility. These competitively priced units are ideal for use in clocks, meters, measuring equipment, and other devices requiring numeric-only display.

### Matrix Type

Matrix PDPs are available in character-only and graphic models. Fujitsu character type PDPs offer either a 5 x 7 or 7 x 9 dot matrix composition for high character legibility. Graphic type PDPs offer free composition of up to 512 x 512 elements. These panels are constructed in a space-saving thin-line package, thus providing ease of installation. Specific features of the matrix PDPs include: high contact stability for even and continuous illumination; high display stability for ease of viewing; a fully built-in memory function to eliminate the need for storage of information being displayed; elimination of the requirement for refreshing (as with CRTs); and the capability for super-imposition (from the rear) of film recorded data for comparison with displayed data. Fujitsu matrix models are available with a neon orange display color, and offer brightness levels of approximately 50 fL.

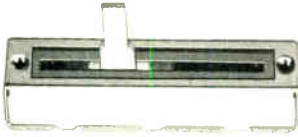
**NOBLE****"NOBLE" makes quality.****● VJ308-45N**

Slide potentiometers, 30, 45, 60mm stroke, are available.

**● ET-T 11S (with switch)**

Potentiometer for varicap tuner.

**● TM282HT**

Thick-film high voltage potentiometers using 94V-O material  
UL Approved File NO. E58390.

**● V24L5S (U80DM-U)**

24mm dia. potentiometers, single unit, with NON-Burning switch DPST UL-TV5.  
UL Approved File NO. E35961.

**TEIKOKU TSUSHIN KOGYO CO., LTD.**

HEAD OFFICE 335, KARIYADO, NAKAHARA-KU, KAWASAKI 211, JAPAN  
PHONE KAWASAKI(044)422-3171. TELEX 3842-155 TEITSU J. CABLE TEITSU

Established in 1944, Teikoku Tsushin Kogyo Co., Ltd. is a leading manufacturer in the field of Electronic Components in Japan, having 12 subsidiaries in Japan and 3 factories overseas.

Year by year the sales amount has been increasing steadily and is expected to reach in amount of 40 million US dollars by the end of fiscal year '75.

Especially, potentiometers, switches, fixed resistors and capacitors under the brand of "NOBLE" are very famous and highly reputed worldwide for their quality and reliability. "NOBLE" is a name of highly reliable electronic components, produced by long established technologies and experiences under the integrated quality control from design to production with a goal of defective rate per million less than 20 ppm.

"NOBLE" will continue to do its best to make higher performance parts and make ready at any time what the users want.

100 engineers and 3,500 employees of "NOBLE" have been and will be keeping in mind a motto of "Reliability makes tomorrow".

Circle 127 on reader service card

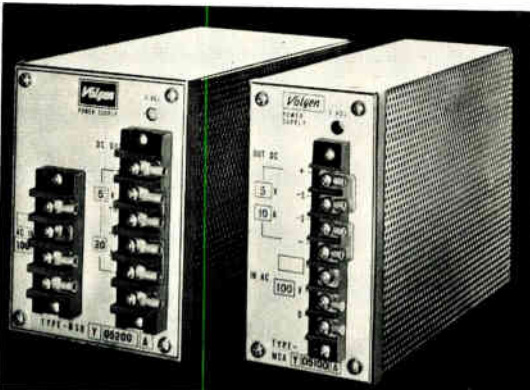
**Volgen's Mag Amp Switchers MS Series**

- High Reliability
- Low Cost
- High Efficiency
- AC input Type and DC input Type
- Outputs from 5V to 24V, from 2.5A to 50A. (Input 117 VAC)
- 20 KHz Switching.

■ Pulse Width Control by Mag Amp (Fast response Type)

Model	MSAY05100B-117	MSAY0560C-24
Input	117VAC ± 10%	24VDC ± 10%
Output	5V 10A	5V 6A
Line regulation	± (0.05% + 5mV)	± (0.05% + 5mV)
Load regulation	0.5% (0 ≧ 100%)	0.5% (0 ≧ 100%)
Ripple and Noise	60mV P-P	60mV P-P
Recovery time	1 m sec (30% ≧ 100%)	1 m sec (30% ≧ 100%)
Efficiency	70%	60%
Ambient OP Temperature	-10°C ~ +50°C	-10°C ~ +50°C
Size (W x H x D)	60 x 120 x 190	60 x 120 x 190

**Volgen Electric Co., Ltd.**

Head Office: 4-12-5 Meguro Meguro-ku,  
Tokyo, Japan.

Factory: Meguro (Tokyo) and Niigata

Tel: 03-715-3125

**Volgen Electric Co., Ltd.**

We have been making positive manufacture and sales of power supply built into electric and electronic equipments since 1972 and have already supplied many products to many industries.

First we developed module type by molding dicast frame case and circuit with silicon resin and then manufactured the one with compressed air cooling system fan built-in.

Further, we are now producing almost 1,000 kinds of power supply based on compact and high performance switching regulator system.

In order to have our customers use these products for OEM without any anxiety, we have placed most importance on the environmental test, rationalization of production and expansion of production equipments. The present capital is 55 million yen.

The switching regulator of magnetic amplification system which we recently announced as forerunner in this industry has the lowest failure rate of which we are very much proud.

This switching regulator will undoubtedly be accepted by many of our customers in wide range of industries.



**FUJI****CORE  
MEMORIES****STATIC/LOW COST-RAM**

**NON-ROTATING PARTS·HIGH RELIABILITY  
NON-VOLATILITY·RANDOM ACCESS  
HIGH DATA TRANSFER·COMPACTNESS**

- 262K BYTES MODULE
- 524K BYTES MODULE
- 16K BYTES MODULE

FOR MINI DRUM



**APPLICATIONS**  
**DRUM REPLACEMENT**  
**FIXED HEAD DISK FILE REPLACEMENT**  
**LARGE CAPACITY AUXILIARY MEMORY**  
**BLOCK ORIENTED RAM**  
**BACK UP MEMORY FOR ON-LINE COMPUTER**  
**LARGE CAPACITY INTERNAL MAIN FRAME**

The four outstanding features of (1) low cost, low drive current, and a temperature-independent core (TIN core) made by the tape stamping process, (2) development of automatic stringing technology, (3) rationalization of peripheral circuitry, and (4) the use of a switching-regulated power supply have realized successful development of a low-cost (3 to 4 bits per penny), static, large-capacity, random access memory system and made possible the direct replacement of a fixed-head drum memory and disc-file memory. Since this system has no rotating parts, no maintenance fees are required and expected to use as a highly reliable data bank system utilizing the non-volatility. Endowed with an access time 1000 times faster than that of a drum and disc-file memory and with a data transfer which rates a high 6 to 10 megabits/second, the opening of new fields is anticipated regarding application to a block-oriented random access memory (BORAM), and or auxiliary RAM. This system is designed to demonstrate an extremely high MTBF reliability of more than 10,000 hours. A standard 19-inch rack mounting type is designed for use as a stand-alone system. Memory system cards possessing storage capacities of 16K bytes and 65K bytes have been standardized for mini-drum replacement use as a sister product. In addition to standard products, special interfaces and other OEM products are available for immediate delivery.

	MODEL	CAPACITY	SPEED		POWER	DIMENSION		NOTE
			CYCLE TIME	ACCESS TIME				
SYSTEM CARD	CMS2163	16KW-8B	3 $\mu$ s	1 $\mu$ s	+5V only	10" x 8" x 1"		MINI DRUM REPLACEMENT
	CMS2804 (QD)	32KW-18B	1.2 $\mu$ s	0.4 $\mu$ s	+5V, -15V	18.9" x 12.2" x 1"		PLUG COMPATIBLE WITH CMS2651
	CMS2651	65KW-18B	3 $\mu$ s	1.5 $\mu$ s	+5V, -15V	18.9" x 12.2" x 1.4"		CARD FOR MB2200 MB2300
FULL SYSTEM	MB2200	131KW-18B	3 $\mu$ s	1.5 $\mu$ s	AC 100/115V 50/60Hz	19" RACK	9" HEIGHT	TEMP. RANGE 0°C to +50°C HUMIDITY 95% RH max. INPUT VARIATION $\pm$ 15%
		262KW-18B						
	MB2300	262KW-36B					12" HEIGHT	
		524KW-36B					16" HEIGHT	

**FUJI ELECTROCHEMICAL CO., LTD.**

Head Office: No.36-11, 5-chome, Shinbashi, Minato-ku, Tokyo, Japan Tel: 03-434-1271

New York Office: 261, Madison Avenue, RM.1102, New York, N.Y. 10016, U.S.A. Tel: 212-532-5630

Los Angeles Office: c/o Kanematsu-Gosho, (U.S.A.) Inc.

333 S. Hope St., Suite 2800, Los Angeles, Calif. 90017, U.S.A. Tel: 213-626-1123

Düsseldorf Office: c/o Kanematsu-Gosho GmbH

4, Düsseldorf, Karl-Rudolf Strasse 178, West Germany Tel: 211-38811

**COMPANY PROFILE**

The Fuji Electrochemical Co., established in 1950, is a manufacturer of ferrite cores, memory products, switching regulated power supplies, hybrid circuits, magnetic heads, stepper motors, piezoelectric components, DC-DC, DA-AD converters, and various other electronics components.

FUJI is attaining stable growth as a consolidated manufacturer supplying core memories and plated wire-memories in fields which demand reliability and stored information non-volatility, in addition to semiconductor memories for main frame application which stress speed and economy. Especially a low-cost, static, non-volatile, large-capacity memory system, realized through rationalization of the peripheral circuitry through adopting FUJI's automatic stringing know-how, is expected to open new fields as a replacement of fixed-head drum, disc-file memory as a block-oriented, random access memory (BORAM) from the standpoint of its pre-eminent performance and price.

Further, so-called mixed memory, a small capacity memory for one-chip CPU micro-processor, has been developed utilizing non-volatility which is the feature of core memory and can be used in conjunction with PROM and RAM, now opening new field of application that focus on it as a versatile low-cost, high reliable memory. FUJI has developed a new ferrite core for power electronics. It is highlighted by its low power loss and high flux density characteristics; through utilizing it as an applied product, tremendous advances have been made in the field of switching-regulated power supply. Also being developed is a stepper motor adopting a ferrite magnetic having magnetic anisotropy in the radial direction, a magnetic head for VTR, audio and duplicator application incorporating ferrite single-crystal.

FUJI intends to continue exerting efforts to forge ahead, helping to build a better life through better technology. That's the part FUJI plays as an important manufacturer in the modern electronics industry.

**PRODUCTS****MEMORIES**

FOR MICRO-PROCESSOR  
 FOR COMPUTER MAIN FRAME  
 FOR MILITARY APPLICATION  
 EAROM·SEMI-CONDUCTOR MEMORIES

**POWER SUPPLIES**

STANDARD MODULES·LOCAL POWER SUPPLIES  
 OEM POWER SUPPLIES  
 DC-DC CONVERTERS·INVERTERS  
 NOISE FILTERS

**ELECTRONIC COMPONENTS**

HYBRID IC·CHIP CAPACITORS  
 D/A, A/D CONVERTERS  
 MICROWAVE COMPONENTS  
 PIEZO ELECTRONIC CERAMICS  
 DELAY LINE MODULES  
 PULSE TRANSFORMER  
 MAGNETIC HEAD ASS'Y·STEPPER MOTORS

**FERRITE CORES**

FOR POWER ELECTRONICS  
 FOR TELECOMMUNICATIONS  
 FOR CONSUMER ELECTRONICS  
 PERMANENT MAGNETS  
 SINGLE CRYSTAL FERRITES



At Systek more than 70% of total products are electronic calculators. Major portion of them have been exported into overseas markets.

Demand for electronic calculators is still strong. By month by month, export volume has been increased; on the other hand, prices have been steadily dropping. To withstand such dilemma, we have to accomplish new technologies in making calculators since such price declining trend requires us total changes in concept of calculator production method. Means of labor saving will come to limit in this industry sooner or later as long as conventional production system lasts. 1976 will be a very important year for us.

Systek's R & D group have been challenging to innovate new technologies to overcome such dilemma imposed over the industry by automating production line with use of own developed computerized system. Research activity for materials has been accelerated. New mechanical devices to add value on products will be introduced in earlier part of 1976. Several scientific calculators will be debut around that time. Upon accomplishment of such technologies, we believe we can perfect our motto, "To supply most reliable and most competitive priced products to our customers at fastest period of time". At the same time such technologies will limitlessly contribute to improvement on our other products such as micro-computers, programmable calculators, etc.

Those machines will be processed in the same pattern in production and marketing like calculator industry was followed for past. They would be required to make smaller in size and more economical in cost. Portability and usability for those machines will be required by users. It is time for Systek. Our knowledges accumulated through calculators development and manufacturing will be fully utilized to realize more economical and easy operative systematic machines which each different industry looks for.

Coming year's economy will slowly grow though it will be more flexible in many aspects comparing to 1975. Systek is group of young and aggressive staff members. We believe we can meet constantly changings made from market needs as management policy intends to be flexible at all time.



H. Kikuchi, President

# SYSTEK RESPOND YOU

INSTANTANEOUSLY

AT ANY TIME & AT ANY PLACE



**Systek**

DEVELOP, MANUFACTURE AND MARKET:

MICRO-COMPUTERS, WORD PROCESSORS,  
BILLING AND INVENTORY MACHINES,  
TYPE SETTING CALCULATORS, NAVICOM  
PROGRAMMABLE CALCULATORS,  
POCKETABLE SCIENTIFIC CALCULATORS  
PRINTING CALCULATORS, ETC.

**Systek**

**Systek Corporation**

HEAD OFFICE: SHINJUKU SUMITOMO BLDG. 36F, 2-6-1

NISHI-SHINJUKU, SHIJUKU-KU, TOKYO, JAPAN

TEL: 344-2451 TELEX: 2323308

U.S.A. OFFICE: 1695 EAST DEL AMO BLVD CARSON, CALIF. 90746

TEL: 213-638-8721 TELEX: 673574

# REPLACING TANTALUM MARKET?

## NEW "GT SERIES"....

EXTREMELY WIDE TEMPERATURE RANGE:  $-70^{\circ}\text{C} \sim +150^{\circ}\text{C}$   
 EXTREMELY LONG LIFE: 100,000 HOURS AT  $+85^{\circ}\text{C}$   
 EXTREMELY LOW LEAKAGE CURRENT: LESS THAN 0.002CV  
 AND/OR 2 MICRO AMPERES  
 MIL-C-39018 PRODUCTS RANGE: 5WV~50WV  
 12MFD~1,000MFD

### SHOULDN'T YOU KNOW THAT THESE ARE ALUMINUM LYTICS???

ALUMINUM  
 ELECTROLYTIC CAPACITORS  
 TANTALUM SOLID  
 ELECTROLYTIC CAPACITORS  
 TANTALUM FOIL  
 ELECTROLYTIC CAPACITORS  
 OP/MP CAPACITORS  
 CONDENSER MICROPHONES  
 MACHINERIES & MATERIALS  
 FOR CAPACITOR PRODUCTION

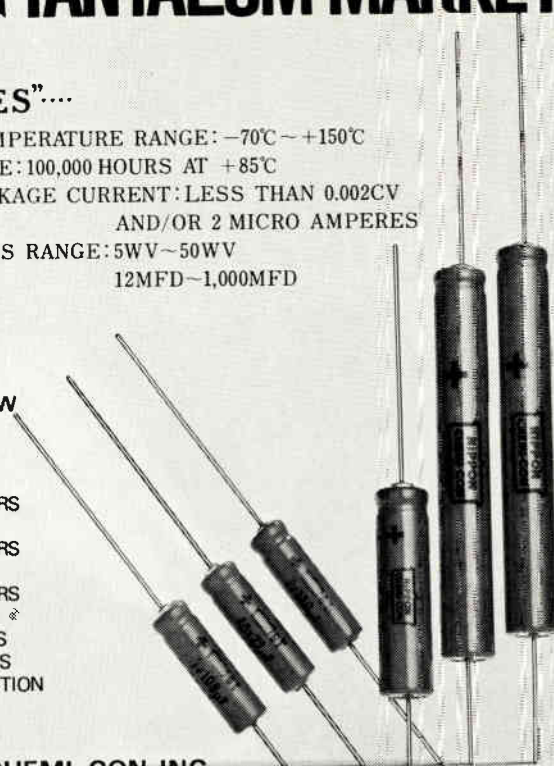

**UNITED CHEMI-CON, INC.**

731 James St., Syracuse, N.Y. 13203 U.S.A. Tel: 315-474-6451. Tlx: 937439



**NIPPON CHEMICAL CONDENSER CO., LTD.**

7-8, 2-chome, Shinagawa-ku, Tokyo, Japan. Tel: 03-785-1256. Tlx: J24618

Nippon Chemical Condenser Co., Ltd. is one of the largest manufacturers in the world for the miniature aluminum electrolytic capacitors having the production capacity of over 85 million pieces per month.

The Chemi-Con's production lines have been fully automated where every one of the 85 million pieces being produced each month has been carefully checked by the machines before the shipments, thus the one can depend on the high quality and performance.

Chemi-Con is only the company in the world who has the 100% self-supplied aluminum foil for both anode and cathode where the one can take his advantage of the stable pricing, stable quality and stable volume supply in long run.

This particular "GT SERIES" has been newly developed under the joint program with United Chemi-Con R&D Laboratory in Massachusetts USA in order to take some of the tantalum market for the high grades requirements in the industrial fields such as computers, telecommunication, automotive, etc.

It is the breath-taking event which shall entirely break the traditional concept of the aluminum electrolytics in the industry.

Circle 130 on reader service card

## Primo

**Primo's perfect communications handset  
 ...for your particular application.**



Using the basic 500 styling with new long life leaf switches, Primo provides your choice of 2 leaf or 5 leaf switching. New Primo dynamic cartridges with intricate moisture barriers are standard. Primo also offers the latest integrated transistorized dynamic cartridges with moisture barriers. Whether your application is marine, professional two-way, mobile telephone, or CB, Primo's new communications handset will fulfill your needs exactly and at a most competitive price.

• For further information write or call us today.

**PRIMO MICROPHONE INC.**

2468 DELTA LANE, ELK GROVE VILLAGE, ILLINOIS 60007  
 PHONE: 312-595-1022

**PRIMO COMPANY LTD. TOKYO, JAPAN**



The DM-1525 is omnidirectional microphone having performances corresponding to Top Class. Equipped with popping noise, handling noise prevention countermeasures professional use audio connector and shock absorber which protects the unit.

#### SPECIFICATIONS:

- Directionality: Unidirectional
- Frequency Response: 40~15,000Hz
- Output Impedance: 200Ω balanced
- Output Level:  $-76\text{dB}/\mu\text{bar}$

Ever since our founding in 1951 PRIMO has been contributing to the industrial world as microphone specialists. The spread of the microphone applied field to tape recorders, communications apparatus, PA systems, Hi-Fi recording, hearing aids, broadcast stations, and other businesses has been especially extensive and the demanded quantity in each field has become extremely large in recent years.

Consequently, new product development and specialization including software have become a necessity. We have added condenser and Electret microphones to our existing dynamic type and are exerting efforts toward making these suitable products for each applied field. This year we successfully produce a miniature speaker through the utilization of our microphone production techniques.

Today we are pouring all our efforts into the development of sophisticated technology to meet the general demand and in product planning and development to lead the new age.

#### Main Products:

- Condenser Microphone
- Electret Condenser Microphone
- Ceramic Microphone
- Dynamic Microphone
- Microphone Cartridges

130 Circle 182 on reader service card



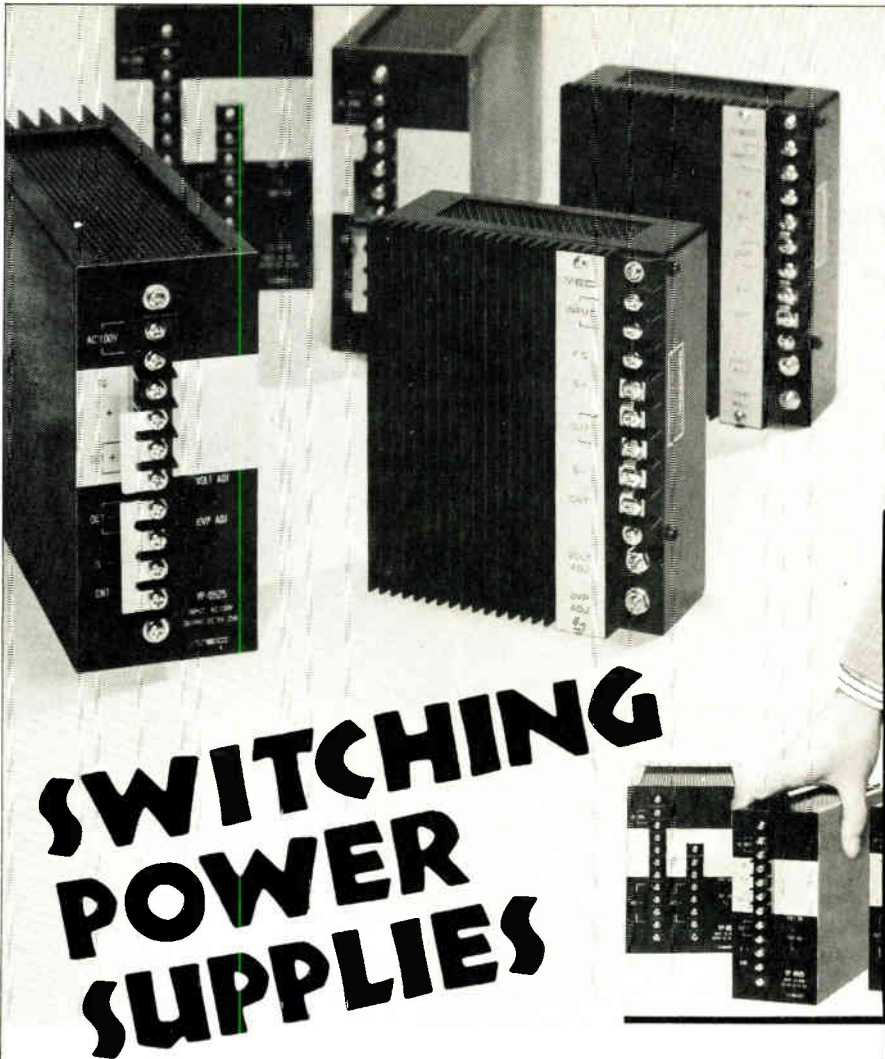

# SWITCHING POWER SUPPLIES

**COMPACT AND LIGHTWEIGHT!  
LOWER PRICE WITH HIGHER RELIABILITY!  
SIMPLER CIRCUITS BUT HIGHER EFFICIENCY!**

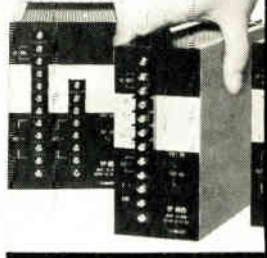

## Switchers Are Better, But Not Best! Consider with...

Since company's inauguration in May 1946, YUTAKA ELECTRIC MFG., CO., LTD. (YEC) has always been maintained a leading position in the field of DC/AC power supplies for the electronics equipment, power conversion equipment and regulating transformers, actualized by applying new technology and accumulated experimental developments, also manufacturing them on a commercial scale based on "seek for the economical-utilization for the users".

More than 70% of annual sales achievement 11 million U.S. dollars in 1974 was consisted of the constant voltage transformers (CVT) themselves, CVT type DC power supplies, droppers and switching power supplies, and others are consisted of the solid-state frequency converters and AC line conditioners. So far as the DC power supplies with respect to the OEM market, a conspicuous tendency shown in the latest 2/3 years is the users' will to put their unique characteristics of CVT and switching types respectively to practical use in effective ways. Although the CVT is, in point of its size, weight and electrical performances, slightly inferior to the other systems, its reliability and cost concern are unsurpassable and by these advantages, its demand as a system power supplies in mass production is rapidly increasing. In view of this, YUTAKA is designing a CVT which will regulate all fluctuation includes load and frequency within 3% in a specific condition, also YUTAKA is keenly aware of a point that many users should realize ..... not to require regulation more than needs on the TTL, motors and other all powers and should rather pay particular attention to its reliability and economization!! On the other hand, to improve reliability and economization of the switchers, concentrative effort has been taken to actualize circuit simplification and reached to the competitive level with the conventional droppers and, moreover, it will be reached to a comparable level with the CVT type DC powers. The power supply for the mass production items such as the peripheral devices cannot set limit to the specific form, otherwise, its resultant loss will become larger. Please check with your actual needed regulation at terminals of load components again, and inquire the general power supply manufacturer, like as YUTAKA, for the most reliable and economical process.

### SPECIFICATIONS:

#### INPUT SPECIFICATION

Input voltage.....115V + 10%  
Frequency.....47-430Hz Single phase

#### OUTPUT SPECIFICATION

Volt. regulation for input volt.....Less  $\pm 0.2\%$   
Volt. regulation for load range.....Less 0.5%  
Ripple voltage.....Less 50mVp-p  
Temperature coefficient.....Less  $\pm 0.03\% / ^\circ\text{C}$   
Transient: response-sudden load change 50/100% vice versa  
Transient voltage.....Less  $\pm 5\%$ , Recovery time.....Less 1ms  
Holding time.....More than 10ms, Rising time.....Less 50ms

#### PROTECTION

Overvoltage: Output short by thyristor & stops inverter concurrently  
Overload.....Current-limit characteristics  
Remote sensing.....Capable, Remote control.....Capable

OPERATING TEMPERATURE RANGE..... $10^\circ\text{C} - +50^\circ\text{C}$

EFFICIENCY.....Higher 70%

#### INSULATION

Dielectric strength.....AC 1500V 1 minute btwn case & input  
Resistance.....10-megohms or higher  $\approx$  DC 500V btwn input, output & case

MODEL NO.	OUTPUT VOLTAGE (V)	OUTPUT CURRENT (A)
YP-0510A	5	10
YP-0525A		25
YP-0550A		50
YP-1204A	12	4
YP-1210A		10
YP-1220A		20
YP-1504A	15	4
YP-1510A		10
YP-1520A		20
YP-2402A	24	2
YP-2405A		5
YP-2410A		10
YP-3002A	30	2
YP-3005A		5
YP-3010A		10

## YUTAKA ELECTRIC MFG. CO., LTD.

No. 228 KARIYADO NAKAHARA-KU, KAWASAKI CITY  
KANAGAWA PREF-211 JAPAN  
TELEX: J22890  
CABLE: TLX-J22890 YUTACO JAPAN



# ALPS;

## Japan's Top Producer of Electronic Parts

*With 27 years of experience in the field of electronics, Alps has always continued to maintain its position as a leader in technological innovation and production capacity in the rapidly expanding field of electronics. With the news media becoming more and more complicated and diversified, there has been increasing demand for more sophisticated electronic parts. To satisfy this increased demand, the company continues to concentrate on developing the highest level of technology, becoming an integrated electronic parts maker capable of supplying highly functional electronic part units rather than just individual parts.*

*Alps also designs and manufactures its own products, producing six major lines: switches, variable condensers, volume controls, tuners, magnetic heads and tape decks.*

*This in turn, has gained Alps the reputation internationally of being a top maker of electronic parts.*

*Accompanying this rapid advance, Alps has become an international enterprise, not only as an exporter of electronic parts, but also for its technological assistance and joint ventures abroad. For example, several years ago Alps signed a contract to supply technological assistance to two companies in the U.S. Alps also has established a joint venture with a U.S. company to supply technology on a reciprocal basis. In India, Alps formed a joint venture with one company and signed a contract for technological assistance with another company.*

*Alps also established joint ventures in Taiwan and Korea. To expand and develop new applications for integrated circuits, Alps formed Alps do Brazil, a joint venture company in Brazil and Alps Motorola Semiconductors Inc., a joint venture with Motorola of the U.S. Progress in chemistry and technology continues at a rapid pace. As a result, electronic parts have come to play an extremely important role in today's information-oriented society.*

*Alps continues to stress specialization in each of its divisions as well as place special emphasis on research development at its central research institute and its engineering center, which has enabled the company to produce the highest quality products through an integrated production system.*

*The future of the electronics industry promises many new and exciting developments and Alps will continue to play a significant role as Japan's top producer of electronic parts.*

# Alps Electronics Parts

## the active driving force behind the electronics industry

Alps Electric is Japan's top broad-line electronic components maker, and a leader in both consumer and industrial fields. It applies specialized technological expertise to meet the requirements of the industry, and its products have built up a reputation for quality and supply stability.

Alps produces switches, variable resistors, TV tuners, variable capacitors, FM tuners, magnetic heads, tape decks and keyboard switches, among others.

### Push switches SUE

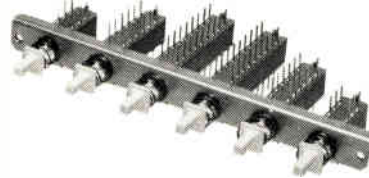

The double-faced contact design upgrades both the electrical and mechanical characteristics. The rich selection of key pitches, terminal shapes and mounting heights above the printed board, meet the requirements of any finished products.



### Keyboard switches AKC8 (for TV tuning)

The special leaf spring ensures a consistent contact action irrespective of the force used to actuate the key. The key-top is compact and features a tactile feedback mechanism specially designed according to the principles of human factors engineering.



### Multi-turn potentiometers LFQ4R (with band-change switch)



With excellent resolving power and with voltage drift kept to the absolute minimum, this unit is the ultimate in cost/performance. Also available is a variety of rectangular multi-turn potentiometers, which provide a wide degree of freedom in the design of consumer products such as electronic TV tuners.

# ALPS

## ALPS ELECTRIC CO., LTD.

145 HEAD OFFICE: 1-7, YUKIGAYAOTSUKA-CHO,  
OHTA-KU, TOKYO, JAPAN.  
NEW YORK OFFICE: 77 NORTH CENTER AVENUE  
ROCKVILLE CENTRE, N.Y. 11570 U.S.A.  
DÜSSELDORF OFFICE: 178, KARL-RUDOLFSTRASSE,  
DÜSSELDORF, WEST GERMANY.



# IC voltage regulator is adjustable

Three-terminal monolithic device fits in same card slots as fixed type; first in series is variable from 1.2 to 37 volts, has 0.1% load regulation

by Bernard Cole, San Francisco bureau manager

National Semiconductor Corp. will soon be in production with what may become the pacesetter in three-terminal monolithic voltage regulator design—an adjustable voltage device that fits into the same slots as its fixed-output counterparts.

Three-terminal, fixed-output voltage regulators, such as National's own LM109 devices or Fairchild Semiconductor's 7800 series, have revolutionized power-supply design since they were introduced five years ago by making on-card voltage regulation practical and cost effective. But despite the advantages such monolithic devices offer in terms of high performance, reliability, cost effectiveness, and ease of use, there have been disadvantages.

In many systems there are requirements for variable voltages and non-standard voltage options. To meet these the designer is often forced to maintain a large inventory of devices over a wide range of voltages and currents. His other option is to redesign his circuit board around one of the several non-standard four-terminal adjustable regulators available.

**First in family.** To fill the need for adjustable voltage regulators in standard three-terminal packages, National is introducing the first in a family of such devices—the LM117—a 1.5 ampere positive-voltage regulator adjustable from 1.2 to 37 volts with short-circuit protection. Furthermore, since the device is essentially a floating regulator, supplies of several hundred volts can be regulated as long as the input-to-output differential of 40 volts is not exceeded.

In addition, says Robert C. Dob-

kin, National's director of advanced linear circuit development, the LM117 has a line regulation of about 0.01% per volt and a load regulation of about 0.1%/V typically. Normally, he says, no capacitors are needed unless the device is situated far from the input filter capacitors. When an input bypass is needed, an optional output capaci-

justed to the needed voltage. By shorting the adjustment terminal to ground, the output will drop to 1.2 V, where most loads draw very little power. A 1-kilohm resistor between the terminals then would result in a 6.2-v regulator; and, by using a potentiometer, the designer of an ECL circuit, for example, could tweak his system for the highest possible speed.

To achieve the three-terminal design in an adjustable device, says Dobkin, the ground terminal that is usually needed to handle the quiescent current developed internally was eliminated. Quiescent current to run the device is instead dumped into the output, says Dobkin. "This means that the device needs a minimum load of 5 milliamperes to operate. But this isn't a problem because even ordinary three-terminal fixed regulators are specified for reliability at 5 mA. So the LM117 is no different than anything else out there," he says.

**Samples ready.** In the standard 30-watt TO-3 package, the 80-by-100 mil monolithic device, in 100 to 999 quantities, is priced at \$11 each over the  $-55^{\circ}\text{C}$  to  $150^{\circ}\text{C}$  range; \$7.50 each over the  $-25^{\circ}\text{C}$  to  $150^{\circ}\text{C}$  range; and \$3 each over the 0-to- $125^{\circ}\text{C}$  range. In the  $7\frac{1}{2}$ -watt TO-202 plastic power package, the LM117 is \$1.30 each in 100 to 999 quantities over the 0-to- $125^{\circ}\text{C}$  range. Other package sizes include the 15-watt TO-220 and 2-watt TO-5. Samples are available now and National will begin stocking distributor shelves in volume quantities in December.

National Semiconductor Corp., 2900 Semiconductor Drive, Santa Clara, Calif. 95051 [338]

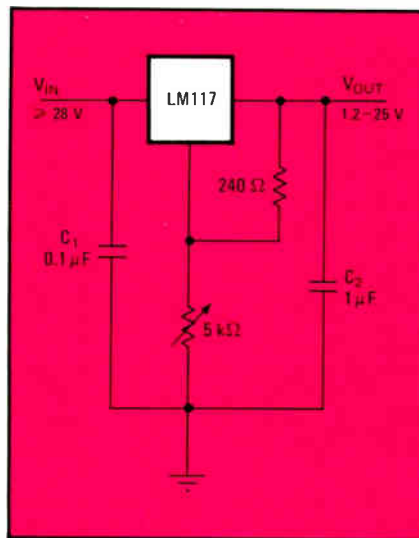

**Typical application.** In this configuration, capacitor  $C_1$  is needed if the device is far from filter capacitors;  $C_2$ , which is optional, improves transient response

tor can be added to improve transient response. Also, the adjustment terminal can be bypassed to achieve very high ripple-rejection ratios, especially at higher output voltages.

To make the LM117 programmable, National engineers have set the minimum voltage level between the output and adjustment terminals at 1.2 v. By switching in various resistances between the two, says Dobkin, the regulator can be ad-

# Why do more than half the people in the world who buy solid state relays choose Crydom?



Maybe it's because Crydom pioneered, perfected and patented electro-optical isolation and zero-voltage switching. Or because we use efficient back-to-back SCR's. Possibly it's because we offer more standard models. Could be our encapsulation process, our broad distribution, our extensive applications experience, or the fact that you can specify a Crydom relay in the U.S. and order the same part number anywhere in the world.



Back-to-back SCR's are superior to triacs in many applications.

## Technically Speaking . . .

All Crydom Solid State Relays use inverse parallel SCR's which are superior to triacs in many applications. Back-to-back SCR's have much higher critical dv/dt ratings and greatly improved performance with inductive loads . . . minimal need for "snubbers" or softening devices.

Crydom was the first to use transfer-mold encapsulation, applied under pressure, to fully protect circuitry from humidity, shock & vibration. Many

merely "pour fill"—a process that can leave troublesome voids or bubbles within the relay.

Two more firsts. Crydom's patented photo-isolation & zero-voltage switching! The optical isolator, which never wears out, provides complete input isolation without transformers or reed relays. The zero-voltage switching feature minimizes current surges & RFI noise caused by arcing contacts.

Every Crydom relay is 100% solid state. There are no moving parts to malfunction or wear out. This means infinite life, silent operation & no maintenance. Also, Crydom's SSR's are digital logic IC compatible. UL & CSA approved too.



Cutaway photo shows complete encapsulation of components.

## A Single Minded Company . . .

Crydom produces *only one* product. Our total resources, including the manufacture of many internal com-

ponents, are dedicated toward refining and improving this product. This is why we've become the pace setters in the SSR technology. And why the name Crydom means ultimate quality in the field of solid state relays.

## World-wide Distribution . . .

Crydom has a network of distributors throughout the world, with manufacturing facilities in Holland & Japan. Over 60 distributors service the U.S. alone. Each is fully stocked to provide immediate delivery on Crydom standard models.



Crydom has over 50 standard models from 1 to 200 amperes.

## More Models Than Anyone . . .

Crydom has over 50 standard catalog models (including a complete line of 400 Hz relays) with current ratings from 1 to 200 amperes. We also react fast to the toughest OEM custom designs.

**So contact Crydom today. Or send for our SSR catalog and list of authorized distributors.**

To receive Crydom catalog promptly, attach coupon to letter head and mail to:  
**1521 Grand Avenue,  
 El Segundo, Ca. 90245**

Name \_\_\_\_\_

INTERNATIONAL RECTIFIER



1521 Grand Avenue, El Segundo, California 90245  
 (213) 322-4987

Circle 134 on reader service card



## New products

Components

### Potentiometer is a 10-mm cube

Tiny component is believed first of kind in U.S. with 'hard metric' dimensions

Measuring 10 millimeters on a side, a cube-shaped potentiometer introduced by Allen-Bradley's Electronics division is configured as a dual variable resistor or as a pot-and-switch combination. It's said to be

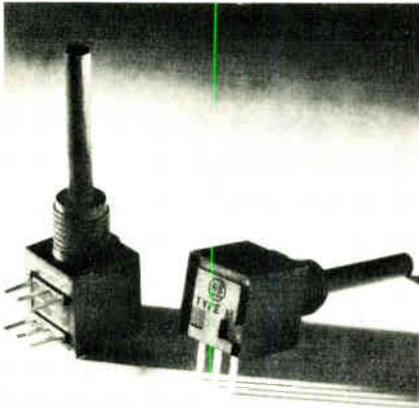

the smallest available to makers of portable electronic equipment.

Since its dimensions are metric, the Type M Mini-metric pot is aimed at new U.S. designs, says John Stanley, manager of variable-resistor sales at Allen-Bradley. "Manufacturers of instruments and medical electronics are both going heavily toward portable devices, and of course we'll also find applications in communications equipment, such as pagers and two-way radios," he adds.

Besides being the first "hard-metric" pot being in the U.S.—the case is a 10-millimeter cube with 7-mm bushing diameter and 3-mm shaft diameters—the device conforms to International Electrotechnical Commission resistance-value standards, ranging from 100 ohms to 1 megohm.

Case, bushing, and shaft of the Type M pot are built from a flame-retardant (SE-O) glass-filled polyester. When coupled with a plastic knob, the pot gives two levels of electrical isolation for protection of the user. For the resistive elements, Allen-Bradley designed a new conductive plastic system, integrally molded to the plastic substrate.

The device is rated at 0.1 watt on the panel section and 0.05 w at the rear section at a maximum working voltage of 90 volts rms or dc. Standard total resistance tolerance is  $\pm 20\%$ , while independent linearity is specified with a maximum deviation of 5%. Variation in contact resistance, or adjustability, is less than 2%, or 3 ohms, whichever is greater.

Resistive elements are available in three standard tapers—one linear and two audio—and switch sections can have a detent at either end of rotation, clockwise or counterclockwise.

Delivery time for Type M pots with one or two resistor sections, or with a resistor section and a rotary switch, is six to eight weeks. In quantities from 500 to 1,000, prices range from \$2 to \$2.50 each, depending on options. The pot will cost much less in large volumes.

Allen-Bradley Electronics Division, 1201 South Second St., Milwaukee, Wis. 53204 [341]

### 4-ampere solid-state relay occupies only 1 cubic inch

Requiring no external heat sinking, and able to switch loads from 0.1 ampere to 4 A, the Grayhill Power

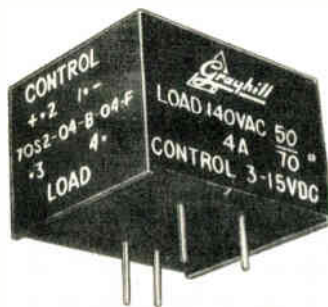

## Dynatrac<sup>®</sup> 3 lock-in analyzer can measure noisy signals up to 200 kHz.

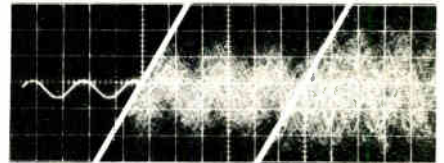

This unique new tool measures amplitude, phase, and frequency of signals obscured by noise, from picovolts to volts at frequencies from .1 Hz to 200 kHz and selectable bandwidths from .001 Hz to 100 Hz.

And, unlike conventional lock-in amplifiers, no phase adjustments are required.

There are many applications (with new ones turning up all the time) in which Dynatrac 3 picks up where the performance of vector voltmeters, phase meters, lock-in amplifiers, wave analyzers, transfer function analyzers, bridge balance null detectors, and noise meters leave off.

To get the complete Dynatrac 3 story (and to tell us about your measurement problems), contact Ithaco, Box 818-EIR, Ithaca, N.Y. 14850. Or call (607) 272-7640, TWX 510-255-9307.

**ITHACO**

## New products

Cube is a solid-state relay that measures 1.0 by 1.2 by 0.85 inches. Its control input is compatible with logic circuitry operating on 3 to 15 or 14 to 30 v dc, and its output can handle line voltages of 120 or 240 v ac. Optically isolated, and including zero-voltage turn-on as a standard feature, the unit has a dv/dt rating of 3,000 v per microsecond. It sells for \$12.60 each in hundreds. Prototype quantities are available from stock; production quantities require about four weeks.

Grayhill Inc., 561 Hillgrove Ave., La Grange, Ill. 60525. Fred Stevens (312) 354-1040 [344]

Ceramic trimmers are only 0.134 inch in diameter

Measuring only 0.134 inch (3.4 millimeters) in diameter, a line of ceramic trimmer capacitors from Panasonic consists of five general-purpose devices that are particularly well suited for use in small electronic watches. The five devices have capacitance ranges of 2.5 to 5 picofarads, 4 to 10 pF, 4.5 to 25 pF, and 5.5 to 35 pF. They meet the shock and vibration specifications of MIL-STD-202D. Nonstandard lead configurations and capacitance ranges are available on a custom basis.

Matsushita Electric Corp. of America, One Panasonic Way, Secaucus, N.J. 07094. Steve M. Fried (201) 348-7284 [343]

Modular potentiometer is factory-assembled

The model 80 series modular potentiometer is a building-block line of components assembled in the factory to a customer's specifications, so that they combine the versatility of modular construction with the reliability of factory assembly. The 5/8-inch-square building blocks have both cermet and conductive-plastic resistance elements, and both types may be combined in an assemblage of up to four sections. Power dissipation

**Will your next frequency counter have all these features?**

- **Frequency Range:** 20 Hz to 512 MHz
- **Input Protection:** 45 Watts instantaneous, 2 Watt continuous
- **Metered Input:** Visual indication of high/low signal strength
- **Tone Measurement:** Example: measure 1020.001 Hz automatically in 1 sec.
- **Price:** All of the above standard features on Model 6252 for only \$895
- **Options:** Tailor your counter with two TCXO's or three oven oscillators, internal battery pack, external DC operation, carry case, etc.

**Meet the whole family:**

5 MHz Frequency Counter	\$430
50 MHz Frequency Counter	\$595
50 MHz Universal Counter	\$695
180 MHz Frequency Counter	\$795
512 MHz Frequency Counter	\$895

For more details, contact Scientific Devices or Systron-Donner at 10 Systron Drive, Concord, California 94518. Phone (415) 676-5000.

**SYSTRON  DONNER**

Circle 136 on reader service card

## Need a current catalog?

Use your EBG to order the catalogs you need. Last year, 80,000 requests for catalogs were generated through the use of EBG Catalog Inquiry Cards. Put EBG to work for you—and your company.



**Electronics Buyers' Guide**

THE **ACTION** BOOK





# Compare all three.

Some digital systems fabrication methods fool you. They seem to offer a new way of doing things, but a closer look could save you a lot of grief.

**Real economy** It's simple. Others may do a lot of shouting about economy hoping you won't notice the bottom line. But ICC's Abacus is different — we start there.

After all isn't that the best way to look at a project?

As a result our customers are more productive and more secure in the fact that ICC services and support are tantamount to on-time delivery of their logic systems.

**We mean it** And we're realistic when it comes to delivery dates. When we tell

you your pre-designed finished product will be totally packaged, completely debugged, entirely documented and ready in 5 weeks, we mean it.

**Control cost/no shortcuts** You'll have our secret — flexible pre-designed and prefabricated logic designs the size of your business card. No quick, risky shortcuts and hidden costs. Operate just as our customers — many of the world's biggest corporations — total control all the way.

**Compare today** But to really appreciate the difference you have to send for our free "Compare" book. Or call us now. ABACUS DIVISION, INFORMATION CONTROL CORPORATION. (213) 641-8520

**FREE. Compare all three.**

Yes. I want to know all about my alternatives. Rush me my "Compare" book.

Name

Company/Phone

Address

City/State/Zip

Information Control Corp.  
9610 Bellanca Avenue  
Los Angeles, CA 90045



Circle 137 on reader service card

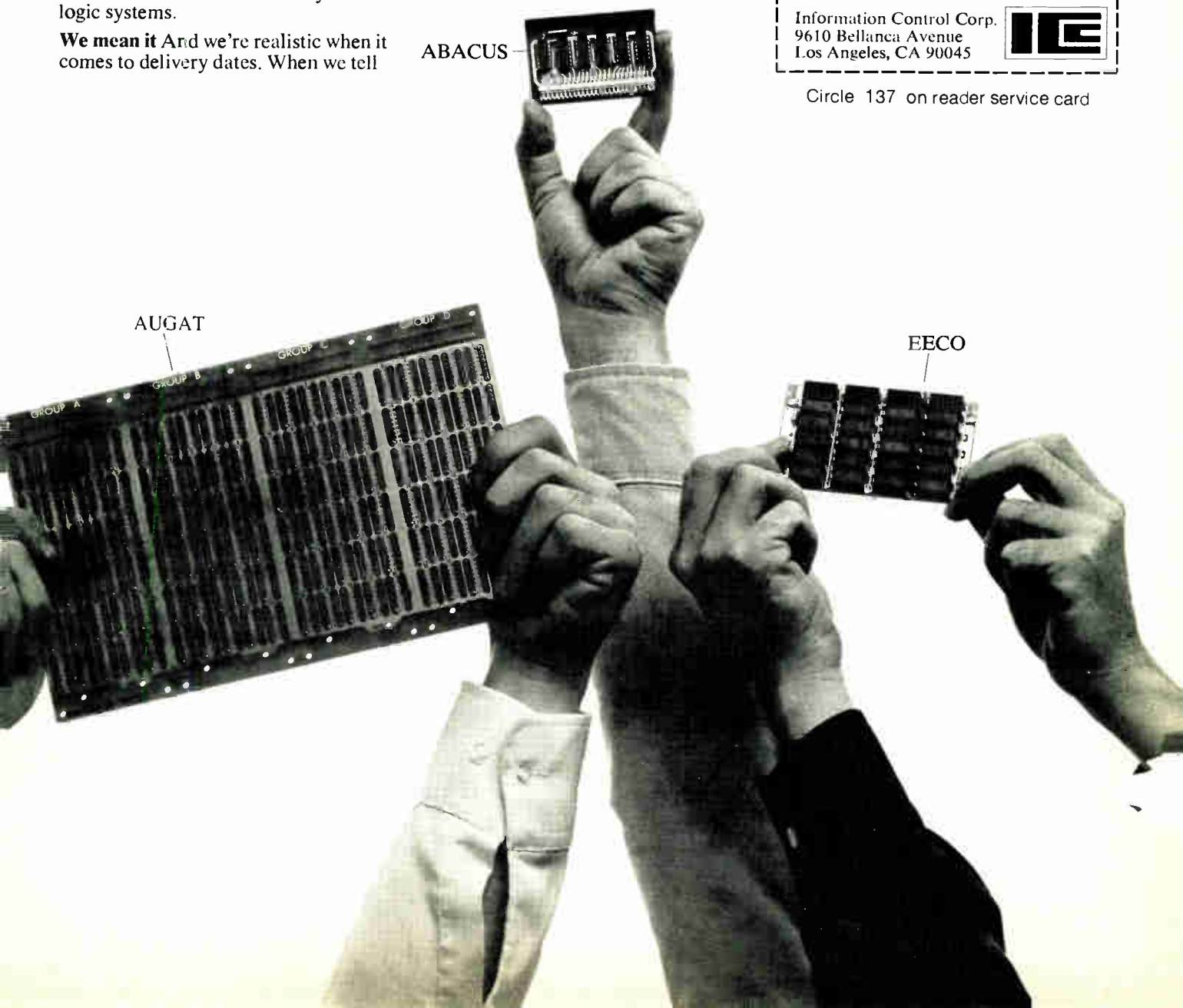

# Where can you find a remote controlled cassette tape transport for under \$100?

## For Applications In:

1. Micro Processors
2. Data recording/logging/storage
3. Programming
4. Instrumentation
5. Industrial Controls
6. Data duplicating
7. Security/automatic warning systems
8. Test applications
9. Audio Visual/Education
10. Others

## With Features Of:

- 4 motor reliability
- Quick head engage
- Completely programmable-Logic
- No tape coasting
- Low power—AC or battery

**HERE!**

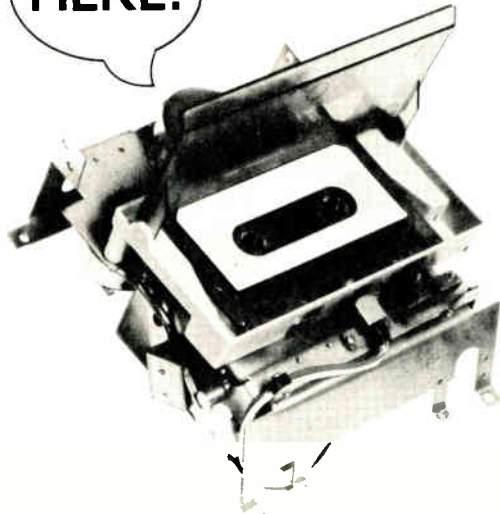

## PHI-DECK

*The Economy Co., III Division  
Oklahoma City, Oklahoma 73125*

The Phi-Deck is the first American-made tape transport with remote control capabilities and features including standard and nonstandard functions — selling for under \$100 in quantities of one.

**The Economy Co., III Division**  
1901 North Walnut  
Oklahoma City, Oklahoma 73105  
(405) 528-8444 Ext. 71

- I am interested in application no. \_\_\_\_\_
- Have Representative call
- Send application notes

Name \_\_\_\_\_ Title \_\_\_\_\_

Company Name \_\_\_\_\_

Address \_\_\_\_\_

City \_\_\_\_\_ State \_\_\_\_\_ Zip \_\_\_\_\_

Phone Number \_\_\_\_\_

## New products

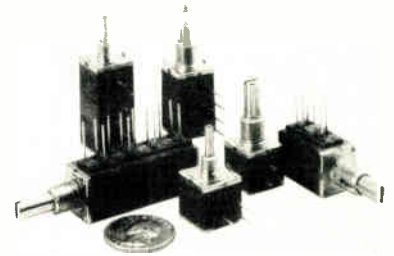

patation at 70°C is 2 watts for a single section and 1 w per section for multi-section assemblies. Prices vary widely with the configuration, but one example is \$1 each for a single-unit cermet unit in 1,000-piece quantities.

Bourns Inc. 1200 Columbia Ave., Riverside, Calif. 92507. Phone (714) 684-1700 [345]

Tiny directional couplers span 2 to 500 megahertz

Measuring only 0.125 by 0.375 by 0.5 inch, the CRF-A series of four-port directional couplers from Merrimac includes 10- and 20-dB units that cover the frequency range from 2 to 500 megahertz. The CRF-20A-250 spans the frequency range from 10 to 400 MHz with a directivity of 20 dB, a frequency sensitivity of less than 0.5 dB, and a VSWR of 1.3. A version that covers the full frequency range has a directivity of 18 dB, a frequency sensitivity of 0.75 dB, and a VSWR of 1.5. The units, which are designed to be mounted onto printed-circuit boards, can be used for signal sampling, leveling generator outputs, injecting test signals, etc. The units meet or exceed the conditions on humidity, barometric pressure, moisture resistance,

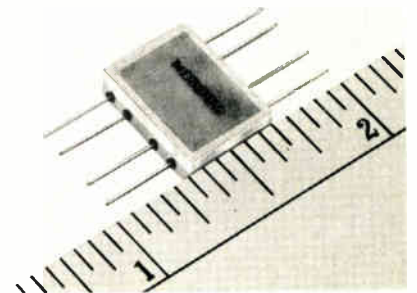



# Monsanto creates a 'counter' revolution...



## Introducing two new revolutionary 'counter' features!

**1.** OPTI-RANGING; exclusive display technique. This unique process is a better kind of autoranging that organizes your data and displays it only in units most easily understood by you.

All our Opti-ranging counters are augmented by a standard LED display of 9 full digits that shows your complete measurement.

**2.** INPUT SHUTDOWN; our exclusive guarantee. Based on the standard input sensitivity of 10mV RMS, this technique shuts down the display if the input signal drops below a reliable measuring level, preventing erroneous readings. Additional measurement confidence is provided by AGC circuitry and an oven controlled crystal oscillator which is standard on these instruments.

### COMPARE BEFORE YOU BUY!

These counters are not partial-function. All our UNIVERSAL COUNTERS feature two separate channels for complete time interval measurements. Each channel has a separate set of input controls, including slope, waveform and attenuators for extra precision.

Every counter is housed in a rugged diecast and extruded aluminum case for lightweight convenience and total protection.

### 8500 Series Universal Counter/Timers

consist of 4 models for measurements from 5Hz thru 1GHz

Start at **\$725.**

### 8700 Series Frequency Counters

consist of 3 models for measurements from 5Hz thru 1GHz

Start at **\$625.**

We also offer 15 other counters from which to choose.

Call your nearest United Systems representative for complete specifications.

UNITED SYSTEMS CORPORATION

a subsidiary of **Monsanto**

918 Woodley Road • Dayton, Ohio 45403 • Ph: (513) 254-6251 • TWX: (810) 459-1728

These instruments available under GSA Contract GS-OOS-27741

# NEW '76 POWER SUPPLY CATALOG

More new products...

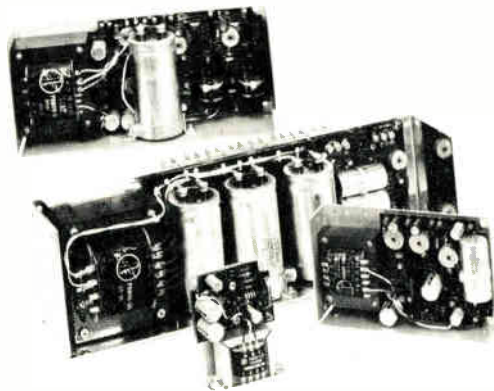

...same low prices!

Send for your copy today. For immediate product information, contact Power-One or your local factory representative.

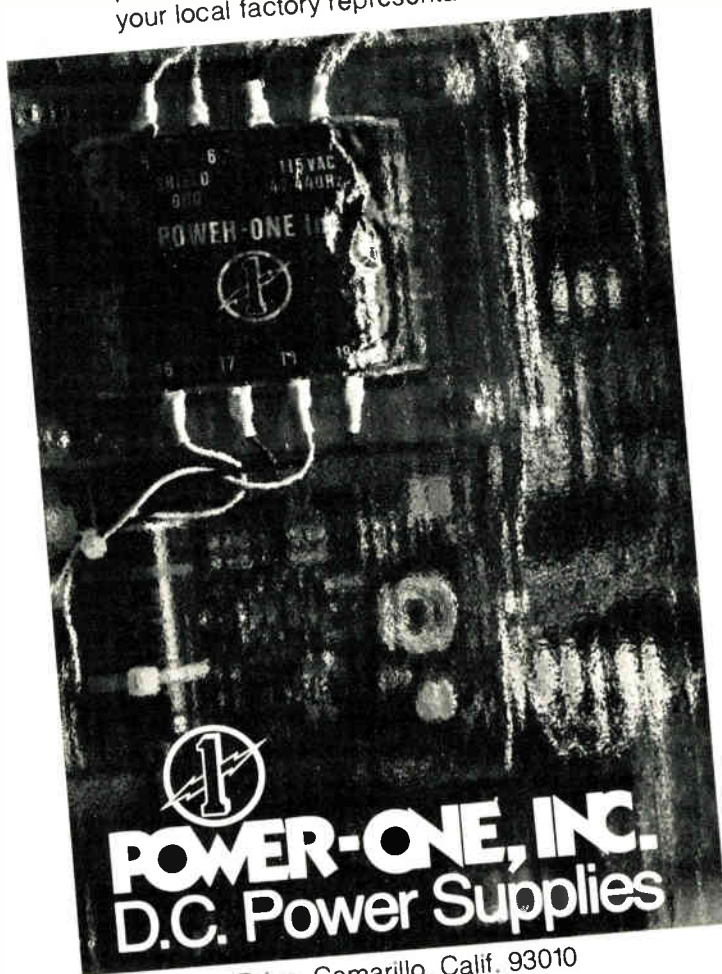

POWER-ONE, INC.  
D.C. Power Supplies  
531 Dawson Drive, Camarillo, Calif. 93010  
(805) 484-2806 TWX: 910-336-1297

## New products

thermal shock, vibration, and solderability presented in MIL-STD-202. Priced at \$45 in small quantities, the couplers have a delivery time of 30 days.

Merrimac Industries Inc., 41 Fairfield Pl., West Caldwell, N. J. 07006. Frank Weber (201) 228-3890 [346]

Wire-wound precision resistors are noninductive

Series G noninductive precision wire-wound resistors are instrument-quality devices with tolerances as close as 0.005% available. Standard temperature coefficient is 10 ppm/°C, but 1 ppm/°C is also offered. Many physical sizes and

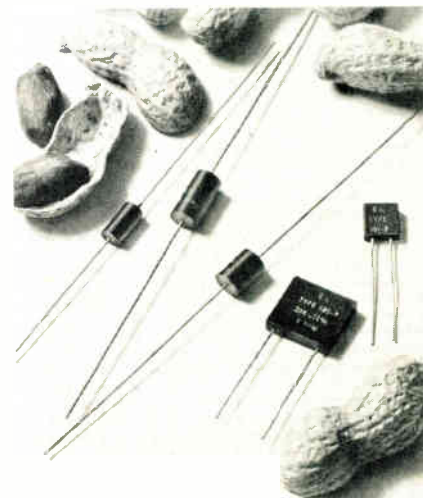

power ratings are available. All resistances and tolerances are made to order; there is no minimum charge for small quantities.

Elliott Industries, 23961 Craftsman Rd., Calabasas, Calif. 91302. Ken Martin (213) 888-1774 [347]

Plug-in ceramic capacitors are compact and hermetic

A family of molded plug-in monolithic ceramic capacitors are miniature devices hermetically sealed for resistance to hostile environments. Offered with NPO, SL, BX, AX, AE, and AF temperature characteristics, the



# On January 8, 1976, Electronics magazine will introduce an exclusive world-wide analysis and forecast of the electronics technology market.

If you are not a subscriber to Electronics, or if you are a subscriber wishing extra copies of the world markets section of the January 8 issue, you may reserve them before December 10 at the pre-publication price of \$1.00 per copy. After December 10, the price will be increased to \$5 per copy to cover the cost of reprinting and handling individual orders.

Since 1958, Electronics' reports on world markets have been an indispensable planning tool for electronics companies. You have probably used them yourself.

Compilation of these forecasts is a major undertaking. Market research questionnaires are answered by major electronics companies all over the world. Key electronics executives are interviewed. Trade associations and government bureaus are called upon. Information is exchanged with private market research firms.

The result is the only public, worldwide markets analysis and forecast of the electronics industries.

#### Advertising managers, please note this change.

The World Markets Forecast, which previously was published in three separate issues of Electronics, will now be combined into one issue, January 8, 1976. The issue will close for advertising on December 18.

You will recognize this extra-special issue as a unique advertising opportunity. It will be used throughout the year by your customers' most influential management, resulting in frequent and high-level exposure to your advertising.

Electronics is the only electronics publication with readership throughout the world. The most economic way to find your customers in these worldwide markets is to let them find you, in the advertising pages of Electronics. This advertising generates more inquiries than any other publication in the field.

Reserve your copies of the World Markets Forecast today at special pre-publication price of \$1.00. After December 10, the reprint price will be \$5.00. Closing date of advertising is December 18, 1975.

**Electronics**   
**THE SOURCE.**

1221 Avenue of the Americas  
New York, N.Y. 10020

I would like to reserve \_\_\_\_\_ copies of the January 8, Electronics World Markets Forecast at the pre-publication price of \$1.00 each.

- I enclose a check for \$\_\_\_\_\_ with this reservation.
- Please bill my company.
- I'd like more information about advertising in this Special Issue. Please have your local salesman call me.

Name \_\_\_\_\_

Title \_\_\_\_\_

Company \_\_\_\_\_

Street \_\_\_\_\_

City \_\_\_\_\_ State \_\_\_\_\_ Zip \_\_\_\_\_

Signature \_\_\_\_\_

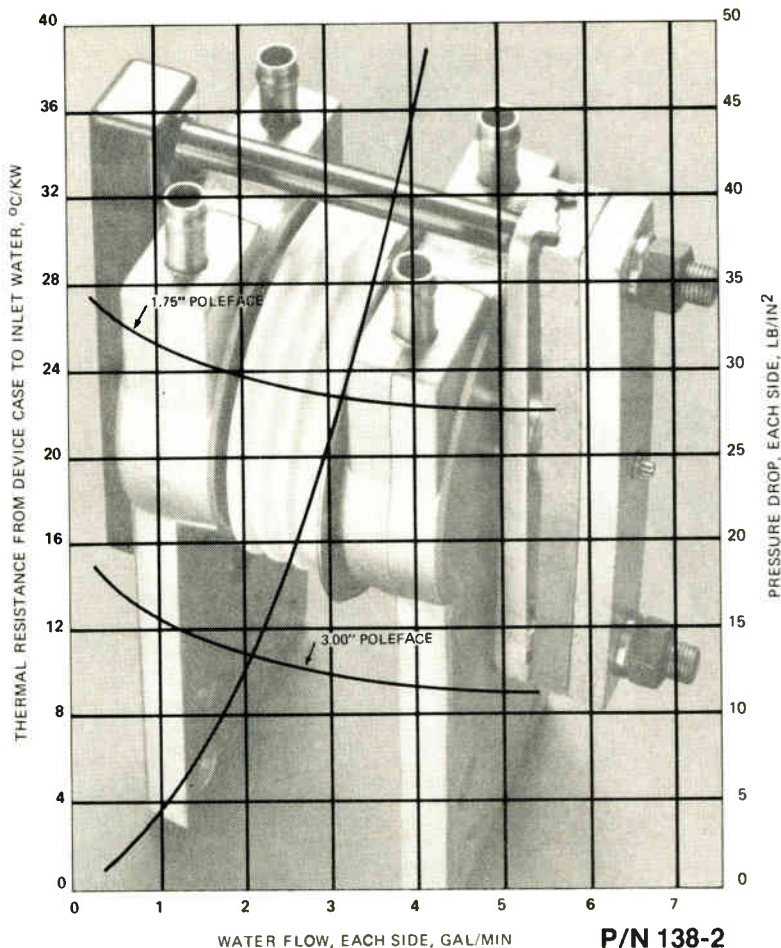

# The Best Way to Cool Compression Type SCR's and Diodes

Wakefield's new Series 138 is a super efficient liquid-cooled bus block for use with up to 3 inch diameter compression type SCR's and diodes. Its unique design allows dissipation of 1 KW with less than 10° C temperature rise—performance unmatched by anything else available.

Accommodating Wakefield clamp #144 (6,000 lbs.) or #145 (10,000 lbs.), the Series 138 features low thermal resistance, low water flow and a massive area for mounting to a bus bar. The units are cast aluminum around copper tubes, combining the economy of aluminum with the compatibility of water and copper.

Call or write for full details on the latest of Wakefield's semiconductor coolers.



**WAKEFIELD ENGINEERING INC.**

AN **EG&G** COMPANY

77 AUDUBON ROAD, WAKEFIELD, MA 01880 (617) 245-5900. TWX 710-348-6713

## New products

types MG-1, -2, and -3 capacitors come with working-voltage ratings of 25, 50, 100, and 200 v dc. Standard tolerances are 10% and 20%. However, tolerance ranges such as +80%, -20% for AE characteristic are also available. The capacitors are completely encapsulated by a flash-free molding process, and have tinned copper leads. Prices range from \$5.24 to \$0.18 each depending upon specifications and quantity. Delivery time is from stock to eight weeks. Their molded cases range in size from 0.197 by 0.236 by 0.102 to 0.413 by 0.236 by 0.118 inches.

American Components Inc., Eighth Ave. at Harry St., Conshohocken, Pa. 19428. John R. Brignoli (215) 825-6200 [348]

## Components topics

Mica capacitors made by the **Capacitor Division, Sangamo Electric Co., Pickens, S. C.**, have been granted R-level approval, based on Established Reliability Specification MIL-C-39001A. This level of approval means that Sangamo can now offer CMR03 through CMR08 mica capacitors at failure-rate levels L, M, P, and R. . . . The half-size crystal-can rf relays marketed by **General Electric's Data Communication Products Dept., Waynesboro, Va.**, are now qualified to MIL-R-39016/33A. . . . **Singer's Librascope Division, Glendale, Calif.**, has announced a magnetic shaft-angle encoder that can operate at temperatures up to 400°F. Designated model 878-23-042, the encoder conforms to MIL-STD-202D, Method 107B, Test Condition C. . . . "Li'l Earsplitter" is a miniature solid-state buzzer that measures 1 by 5/8 by 5/16 inch. The device, which is made by **Kolin Industries, Bronxville, N. Y.**, sells for \$1.99. . . . A pair of box-frame, pull-on-operate solenoids have been added to the line of relays, switches, and circuit breakers manufactured by **Potter & Brumfield Division, AMF Inc., Princeton, Ind.**



Amphenol's **MERLIN™**  
 is lighter, shorter, and  
 more reliable than most  
 other MIL-C-26482/0026482/83723  
 connectors.

That takes guts:

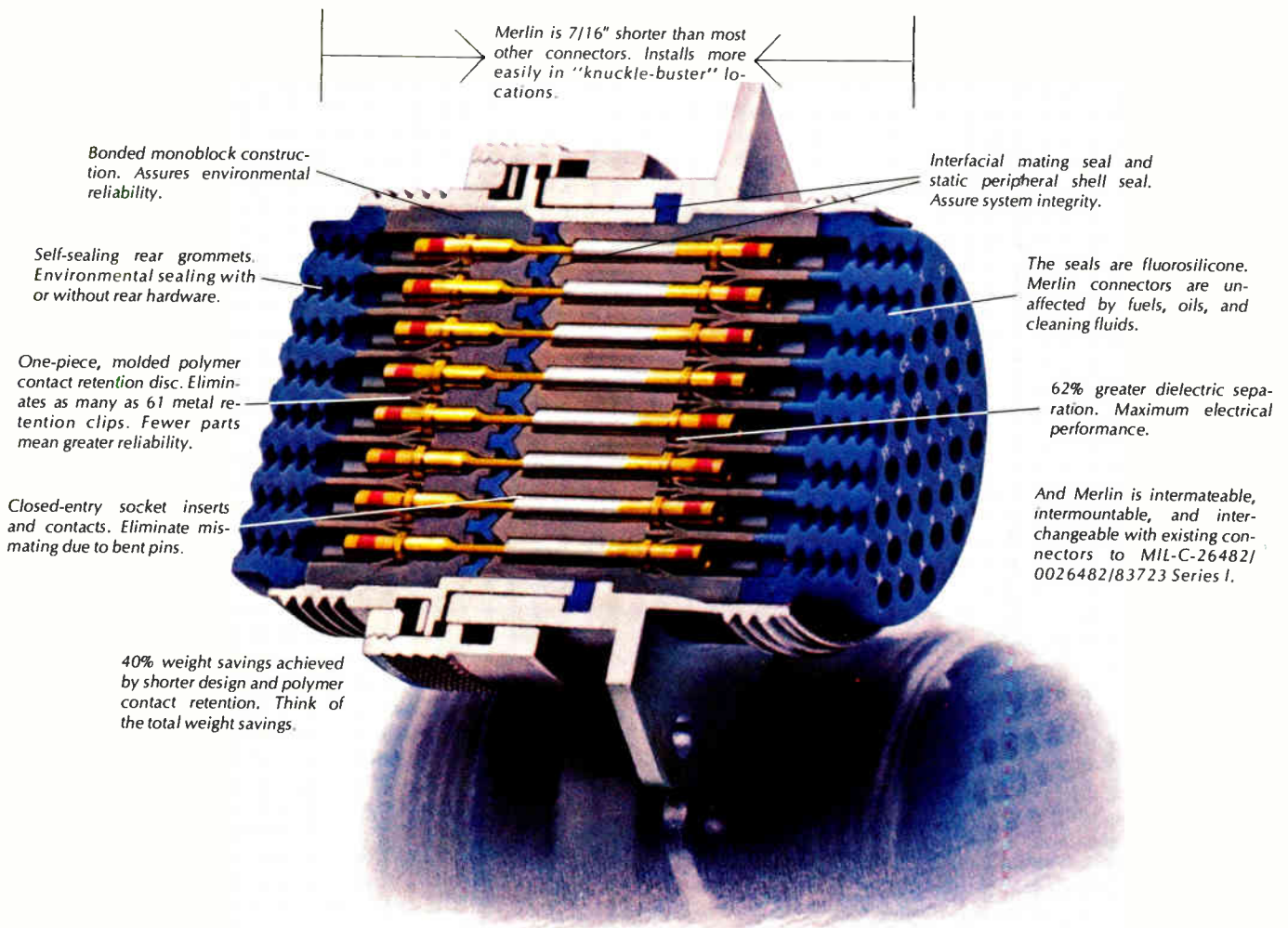

Merlin is 7/16" shorter than most other connectors. Installs more easily in "knuckle-buster" locations.

Bonded monoblock construction. Assures environmental reliability.

Interfacial mating seal and static peripheral shell seal. Assure system integrity.

Self-sealing rear grommets. Environmental sealing with or without rear hardware.

The seals are fluorosilicone. Merlin connectors are unaffected by fuels, oils, and cleaning fluids.

One-piece, molded polymer contact retention disc. Eliminates as many as 61 metal retention clips. Fewer parts mean greater reliability.

62% greater dielectric separation. Maximum electrical performance.

Closed-entry socket inserts and contacts. Eliminate mismatching due to bent pins.

And Merlin is intermateable, intermountable, and interchangeable with existing connectors to MIL-C-26482/0026482/83723 Series I.

40% weight savings achieved by shorter design and polymer contact retention. Think of the total weight savings.

**Merlin — a quality connector you can connect and forget.** At a competitive price.

Ask for a quotation. Most sizes and styles are available, off-the-shelf, from your Amphenol Industrial Distributor. Or call or write:  
 Wayne Zimmerman, Amphenol Connector Division, 2801 South 25th Avenue, Broadview, Illinois 60153. Phone: (312) 345-9000.



*When you can connect it  
 and forget it...that's quality.*

**AMPHENOL**

Circle 143 on reader service card

# They're good... no matter how bad!

**TW MEETS MIL-S-89731.**  
OFFERS SWITCHING VERSATILITY OF LARGER TOGGLES WITH ADVANTAGE OF SMALL SIZE, PANEL SEALING. IDEAL FOR APPLICATIONS LIKE ON/OFF SWITCH IN THIS MANPACK EQUIPMENT.

**SERIES 1 ROUND LIGHTED PUSHBUTTONS** OFFER FLUSH MOUNTING, PANEL SEALING AND VERSATILE SWITCH CIRCUITRY; INCLUDING SOLID STATE. MIL SPEC QUALITY (MIL-S-22885) AT COMMERCIAL PRICES FOR CONTROL CONSOLES.

**DS SERIES PUSHBUTTONS.** COMPACT .75 INCH SQUARE DESIGN OFFERS PLUG-IN DESIGN AND 4 LAMP DISPLAY. RFI ATTENUATION. MIL-S-22885.

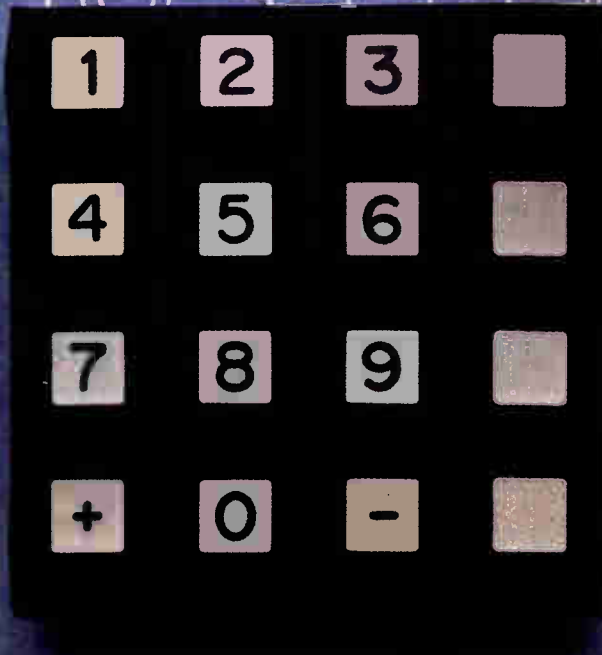
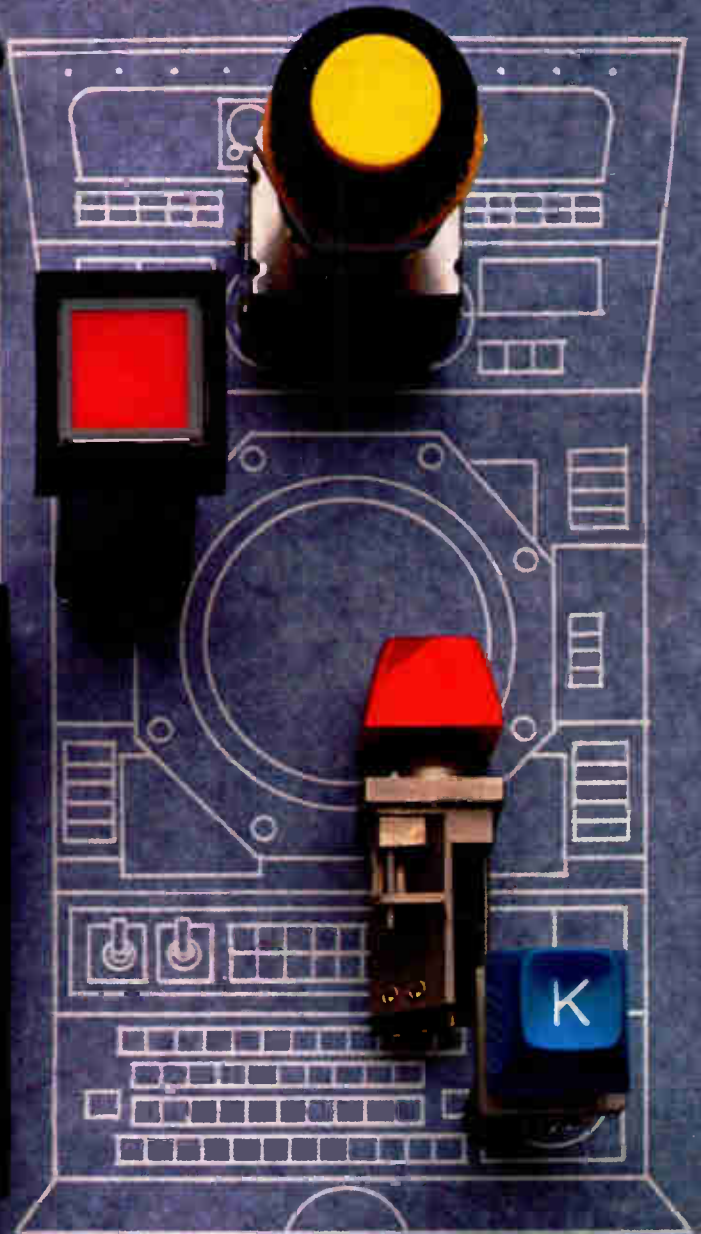
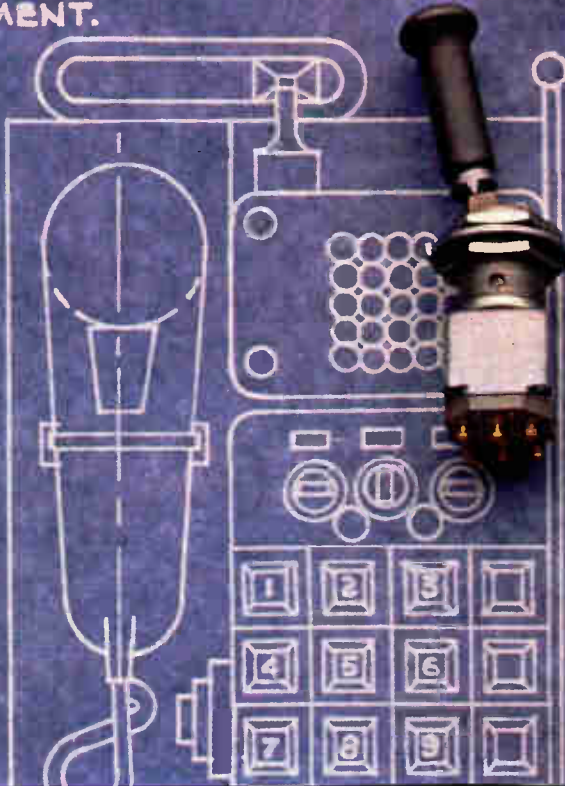

**PX KEYBOARDS.** TOTALLY SEALED WHEN MOUNTED, WITH ZERO DEPTH BEHIND PANEL, PX IS A NATURAL CHOICE FOR MANPACK EQUIPMENT SWITCH MATRICES.

**PANEL SEALED KS KEY SWITCHES.** USE OF SPDT SNAP-ACTION SWITCHES (MIL-S-8805) AND FRONT-OF-PANEL REPLACEMENT, MAKE KS IDEAL FOR RUGGEDIZED CONTROL PANEL KEYBOARD APPLICATIONS.



# Things get.

The five switches you see here have all been designed to operate reliably under extremely rugged environmental conditions. Exactly the kinds of environments where Command, Communications & Control Systems are required to work.

But if these switches aren't exactly what you need, you're not out of luck.

Because they're only a sampling of literally thousands of MICRO SWITCH listings available to fill your needs. Including toggle switches. Lighted pushbuttons. Unlighted pushbuttons. Key switches. Sealed keyboards. Plus hermetically and environmentally sealed limit, proximity and basic switches.

All of them available almost anywhere in the world, through over 500 MICRO SWITCH Authorized Distributors and Branch Offices.

And if that still isn't enough, our Application Engineers will work with you to modify an existing MICRO SWITCH product to your needs. Or come up with a new one, through our field and factory engineering staff.

If you'd like more information on the devices you see here, or more information on how we can help, write or call your nearest MICRO SWITCH Branch Office or Authorized Distributor.

## MICRO SWITCH

FREEMONT, ILLINOIS 61032

A DIVISION OF HONEYWELL

MICRO SWITCH products are available through Honeywell International.

Circle 144 for Data

Circle 145 for Salesman Call

## New products

Instruments

### LSI cuts cost of angle indicator

Synchro- or resolver-to-digital converter uses processor for flexibility

Angle-position indicators (APIs) are useful in many control and mechanical-testing applications, but have usually been limited by the need to tailor each unit at the factory for the mode, frequency, and line-to-line



voltage of the application. This meant that users with a variety of systems required a stock of APIs, each uniquely configured.

The model 8300 from North Atlantic Industries, though, is designed for greater flexibility in the field. It can accept either synchro or resolver inputs on either of two channels at line-to-line voltages of 11.8, 26, or 90 volts, at any frequency from 47 to 440 hertz, and at reference levels that can range from 26 to 115 v. All of these variations are programmable at a rear-panel connector by terminal selection or jumpers so that one API can be moved from application to application.

Two other options do require factory modification, however. The display can read out in either degrees and minutes or degrees and hundredths of a degree, and can range either from 0° to 360° or ±180°, the company says.

The 8300 employs Type II servo techniques and yields accuracies within 3 minutes at dynamic speeds to 1,800° per second. A single large-scale integrated circuit is used as a trigonometric and logic processor to reduce the number of printed-circuit

boards from four in the older 8525-series API to one in the 8300. Price has also been reduced, by about half, to \$1,000.

Additional features of the 8300 include an indicator to warn that fast-changing data is causing one or more digits to appear as an 8. The numerics themselves are Beckman gas-discharge devices.

North Atlantic Industries Inc., 200 Terminal Drive, Plainview, N.Y. 11803. Phone Peter G. Wittenberg (516) 681-8600 [351]

### Network analyzer spans 500 kHz to 1.3 GHz

The model 8505A network analyzer is a digitally controlled wideband (500 kilohertz to 1.3 gigahertz) instrument, each of whose three channels has a displayed dynamic range of 100 decibels without switching. The analyzer determines both the magnitude and phase of transmission and reflection functions and displays them in either rectilinear or polar form. Group delay and deviation from linear phase can also be displayed. Digital readouts can resolve magnitude to 0.01 dB, phase angle to 0.1°, and group delay to 0.1 nanosecond. In addition to its swept signal source, the 8505A contains five independently settable frequency markers; a built-in frequency counter displays the marker frequencies to within an accuracy of ±(0.01% + 2 counts).

A built-in electronic line stretcher is adjustable up to almost five wavelengths (equivalent to as much as 1.5 kilometers of cable for a 1-MHz sweep width) for linearization of the phase characteristic of the device under test. The 8505A network analyzer is priced at \$22,500. An accessory transmis-

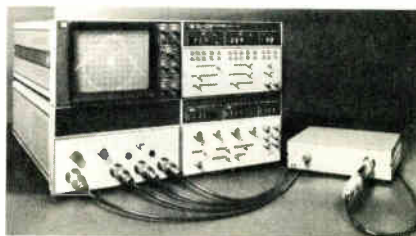

## New products

sion/reflection bridge adds \$1,850, and an S-parameter test set adds \$3,700. An automatic version of the 8505A, called the 8507A, consists of the analyzer, a 9830A programable calculator, the S-parameter test set, an operating desk, a set of measurement and verification programs, and all necessary interfacing gear. It sells for \$48,225. Deliveries of the new analyzers will begin in February.

Inquiries Manager, Hewlett-Packard Co., 1501 Page Mill Rd., Palo Alto, Calif. 94304 [354]

## 6,000-count DMM is rms-responding

The model 31 digital multimeter from Data Technology is a 6,000-count instrument with a true-rms detector for ac voltage and current measurements. The meter also measures dc voltage and current resistance. As a voltmeter, the model 31 has five ac and dc ranges from 600 millivolts full scale to 1,000 volts full scale. Corresponding current ranges are 600 microamperes to 3 amperes. There are six resistance ranges, from 600 ohms to 60 megohms full scale. Basic dc voltage accuracy is within  $\pm(0.04\%$  of reading + 1 count). The true-rms converter used for the ac measurements can handle a maximum crest factor of 5. A special model will also measure ac waveforms with dc offsets. Capable of operating from either line or battery power, the DMM sells for \$395 in unit quantities. Delivery is from stock.

Data Technology Corp., 2700 South Fairview Road, Santa Ana, Calif. 92704. Phone (714) 546-7160 [355]

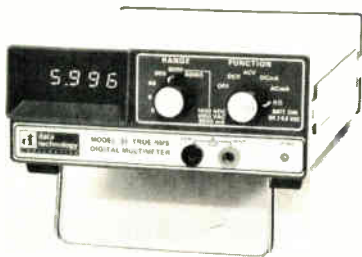

## DPM displays get bigger as prices get smaller

Analog Devices' second-generation of digital panel meters takes advantages of large-scale integration and improved (larger, more efficient) light-emitting-diode displays to offer larger readouts, lower power consumption, and lower prices than previous instruments. Three second-generation meters have been introduced so far: the AD2021 logic-powered (5-volt)  $3\frac{1}{2}$ -digit meter, the AD2027 logic-powered  $4\frac{1}{2}$ -digit meter, and the AD2024 line-powered  $4\frac{1}{2}$ -digit device. The AD2021 uses Fairchild half-inch LED displays and the Siliconix p-MOS chip set to keep its small-quantity price down to \$128 and its power consumption down to 1.45 watts. The  $4\frac{1}{2}$ -digit units use Hewlett-Packard 0.43-inch displays: they make it easier to pack  $4\frac{1}{2}$  digits into a tight space. The AD2027 dissipates 3.75 w and sells for \$197; the line-powered AD2024 dissipates only 4 w (it uses high-efficiency readouts) and is priced at \$207. As for the  $3\frac{1}{2}$ -digit meter, the prices are for one to nine pieces. All three meters are available from stock, and four additional instruments are expected to be added to the line within the next few months.

Analog Devices Inc., P. O. Box 280, Norwood, Mass. 02062. Lowell Wickersham (617) 329-4700 [353]

## Low-cost 10-MHz scope has TTL-compatible Z axis

A dual-trace, 10-megahertz oscilloscope, priced at only \$495, has a TTL-compatible intensity-modulation (Z-axis) input that makes it easy to display characters directly from logic-level inputs. The model 1471 has a maximum sensitivity of 10 millivolts per centimeter, a rise time of 35 nanoseconds, and a maximum sweep speed of 1 microsecond per centimeter. The scope weighs 19.6 pounds and consumes about 20 watts. Use of the scope requires two

## For off-the-shelf delivery, contact your closest Dialight Distributor:

**Arizona**  
Moltronics (602) 272-7951  
**California**  
Richey Elect. (213) 875-2862;  
Westates Elect. (213) 341-4411;  
Western Electromotive/Shepherd  
(213) 820-3777;  
Bell Indust. (408) 734-8570;  
Fisher/Brownell (408) 244-6182  
**Colorado**  
Meter Master Inst. (303) 722-5766  
**Connecticut**  
Suburban Supply (203) 757-1251  
**Florida**  
Peerless Radio (305) 566-5966  
**Georgia**  
Lykes Electronics Corp. (404) 355-2223  
**Illinois**  
Newark Elect. (312) 638-4411  
**Indiana**  
Radio Dist. (219) 287-2911;  
Graham Dist. (317) 634-8486  
**Kentucky**  
P. I. Burks (502) 589-3960  
**Louisiana**  
Ralph's of Lafayette (318) 234-4507  
**Maryland**  
Cramer/EW Wash (301) 948-0110  
**Massachusetts**  
Cramer Elect. (617) 969-7700;  
Gerber Elect. (617) 329-2400;  
Sager Elect. (617) 542-2281  
**Michigan**  
RS Elect. (313) 491-1000  
**Minnesota**  
Gopher Elect. (612) 645-0241  
**Missouri**  
Walters Radio (816) 531-7015;  
LCOMP-St. Louis (314) 647-5505  
**Nebraska**  
Scott Elect. (402) 464-8308  
**New Jersey**  
Federated Elect. (201) 376-8900;  
Gordon/Horne Inc. (201) 835-7400  
State Elect. (201) 887-2550  
**New York**  
Rome Elect. (315) 337-5400;  
Summit Dist. (716) 884-3450  
**Metro NY**  
Arrow Elect. (516) 694-6800;  
Harrison Elect. (516) 293-7990;  
Harvey Elect. (516) 921-8700;  
Peerless Radio (516) 593-2121;  
Ancar Elect. (914) 592-7100  
**North Carolina**  
Hammond Elect. (919) 275-6391  
**Ohio**  
Pioneer/Cleveland (216) 587-3600;  
Hughes-Peters (513) 351-2000;  
Stofts-Friedman (513) 224-1111;  
Hughes-Peters (614) 294-5351  
**Oklahoma**  
Radio, Inc. (918) 587-9123  
**Oregon**  
Almac/Stroum (503) 292-3534  
**Pennsylvania**  
Almo Elect. (215) 698-4000;  
Barbey Elect. (215) 376-7451;  
Phila. Elect. (215) 568-7400;  
Pyttronic Indust. (215) 643-2850  
**Rhode Island**  
Wm. Dandreta & Co. (401) 861-2800  
**Tennessee**  
Radio Elect. Supply (615) 247-8111  
**Texas**  
Texas Instruments Supply (214) 238-6821;  
Harrison Equip. (713) 652-4700  
**Virginia**  
Meridian Elect. (804) 355-6521  
**Washington**  
Almac/Stroum (206) 763-2300  
**Wisconsin**  
Parts Mart (414) 276-4160  
**Canada**  
Saynor Elect. (416) 445-2340;  
Zentronics (416) 789-5111;  
L. A. Varah (604) 873-3211;  
Wackid Radio (613) 728-1821

# DIALIGHT

Dialight, A North American Philips Company  
203 Harrison Place, Brooklyn, N. Y. 11237  
(212) 497-7600



# Dialight sees a need:

Need: A new computer-grade switch at a price you can afford.

LOW COST • COMPUTER GRADE QUALITY • DESIGN FLEXIBILITY • GOLD OR SILVER CONTACTS • CHOICE OF TERMINALS • MOMENTARY OR ALTERNATE SWITCHING ACTIONS • SPDT, DPDT • DESIGNED TO MEET UL SPECIFICATIONS • UNIFORM FRONT PANEL APPEARANCE AND REAR PROJECTION • MATCHING INDICATOR LIGHT • FRONT MOUNTING SNAP-IN BEZELS—4 SIZES/SHAPES TO CHOOSE FROM • REAR MOUNTING SWITCH WITH ANTI-ROTATION FEATURE • CHOICE OF OVER 200 CAP SHAPES, SIZES AND COLORS • CHOICE OF ENGRAVED, HOT STAMPED OR REPLACEABLE LEGENDS.

Dialight's low cost 554 series switches are available in a wide selection of rear panel and front bezel mounting types. Switches are available with silver or gold contacts for wide range of applications; operating life is 250,000 operations.

Fingertip grips permit easy cap removal . . . lamp replacement is from front of panel . . . no special tools needed.

Caps are available with or without underlying color filter in

$\frac{5}{8}$ " and  $\frac{3}{4}$ " square,  $\frac{5}{8}$ " x  $\frac{3}{4}$ " and  $\frac{3}{4}$ " x 1" rectangles. At Dialight it's your choice because we see your need.

## DIALIGHT

Dialight, A North American Philips Company  
203 Harrison Place, Brooklyn, N.Y. 11237  
(212) 497-7600

Circle 147 on reader service card



**\$1.65**  
EA

P/N 554-1121  
(1K PRICING)

**See  
Dialight.**

# ONE UVOLT STABILITY & 5-YR WARRANTY ONLY FROM NLS

AVAILABLE THROUGH —



**G.S. Marshall Products**  
**MARSHALL INDUSTRIES**

9674 Telstar Ave., El Monte, CA 91731  
213-686-1500/TWX: 910-587-1565

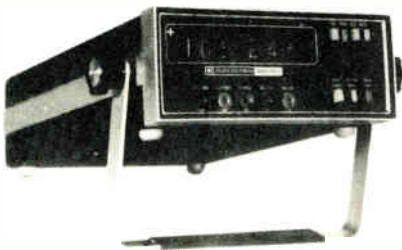

The

**MX-1**. The biggest bargain in the industry becomes an almost incredible buy. Our base price now includes AC, DC and ohms. And we do it without sacrificing NLS quality on any feature. Price includes five voltage ranges from .100000 volt full scale (1 microvolt sensitivity), to 1000.00 volts full scale; plus autoranging and wide-range ratio. Five full digits (with a sixth for 20% over-ranging). Options include BCD outputs and ratio to + 100 VDC reference

OR



The

**LX-2**. There is no competitive instrument that can match the LX-2's quality. The standard model comes with four full digits—plus a fifth for over-ranging; and measures DC volts, AC volts, resistance, and multi-function ratios—automatic ranging included. Automatic polarity and range selection. Options permit BCD outputs and battery operation. The LX-2 is our fastest selling four plus digit multimeter.



**Non-Linear Systems, Inc.**  
Originator of the digital voltmeter  
Box N, Del Mar, California 92014  
Telephone (714) 755-1134 TWX 910 322 1132

## New products

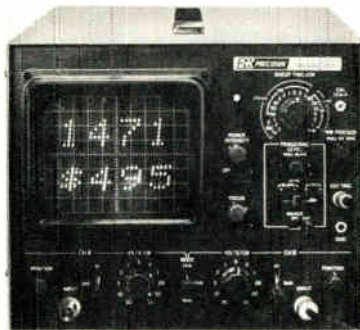

PR-20B probes which are not supplied. They sell for \$24.

B&K Precision, a division of Dynascan Corp., 1801 W. Belle Plaine Ave., Chicago, Ill. 60613. Phone (312) 525-3992 [356]

Quartz frequency standard is extremely stable

Boasting a short-term frequency drift of less than 1 part in  $10^{12}$ , the model 2200 quartz frequency standard is a laboratory instrument containing an ultra-stable 5-megahertz



oscillator, a universal power supply with a standby battery, and an optional clock module with a built-in time comparator. The oscillator, which is made in Switzerland by Oscilloquartz, S.A., has outputs at 1, 5, and 10 MHz.

Frequency & Time Systems Inc., 182 Conant St., Danvers, Mass. 01923. Lloyd F. Lyons (617) 777-1255 [358]

Tiny DMM occupies less than 21 cubic inches

Measuring only 1.9 inches high by 2.7 in. wide by 4.0 in. deep, the LM-

3.5 Volksmeter Plus is a 3½-digit instrument that measures ac and dc voltage and resistance. The voltage ranges are 2, 20, 200, and 1,000 volts full scale dc and peak ac, and there are five resistance ranges from 2 kilohms to 20 megohms full scale. The battery-operated meter sells for \$147 including rechargeable batteries, input leads, a battery charger, and a set of current shunts.

Non-Linear Systems Inc., P. O. Box N, Del Mar, Calif. 92014. Phone (714) 755-1134 [357]



## Instrument topics

A 14-channel amplifier housing, model 1870, is available from **Honeywell's Test Instruments Division, Denver, Colo.**, to increase the recording capacity of the company's 1858 Visicorder oscillograph to 32 data channels. The housing sells for \$2,470.

**United Systems Corp., Dayton, Ohio**, announces the expansion of its line of DigiTec data loggers to include six new models. Three are temperature-measuring instruments—one each for thermistors, platinum resistance thermometers, and thermocouples. The remaining three measure microvolts, current, and resistance. . . . A redesign of the model 4200 selective voltmeter, the model 4200B by **Harmon Electronics, Grain Valley, Mo.**, is a battery-operated portable voltmeter with a liquid-crystal display. The unit includes a heater for the display so that it can operate under conditions as low as  $-10^{\circ}\text{F}$ .





# EMI FILTER CAPITAL OF THE WORLD

**FROM CERAMIC POWDER TO MIL-APPROVED TEST LAB...  
ERIE HAS IT ALL, UNDER ONE ROOF**

Only one company can deliver your total EMI Ceramic Filter needs... ERIE. We've been applying sophisticated ceramic and related technologies to developing superior filters for 35 years. Today ERIE has, by far, the broadest line of subminiature EMI Filters in the world. From tiny high frequency filters to broad band filters to custom filter assemblies, ERIE offers the ultimate in quality. And you get single-source responsibility too, for we build the complete filter in a plant devoted exclusively to the design and manufacture of EMI Filters. So come to ERIE for your filter needs. We'll put a team to work on your particular application. Aerospace. Communications. Avionics. Industrial Equipment. Whatever the market, we can help eliminate electromagnetic "noise" and emissions. In the meantime, write for our complete catalog... EMI Filters or call 613/392-2581.

**ERIE TECHNOLOGICAL PRODUCTS, INC.**  
Erie, Pennsylvania 16512  
Circle 149 on reader service card



**ERIE**



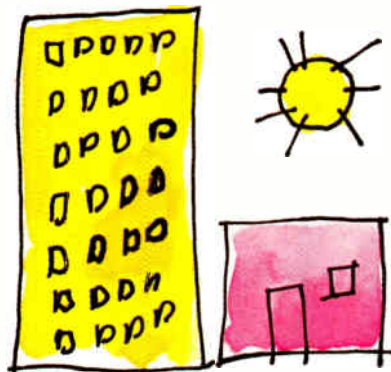

## THE IMPORTANCE OF BEING LARGE AND SMALL

Large companies have the resources. Financial stability. Purchasing clout. Product depth. Optimum inventories. Blanket distribution. Close technical help. Engineering reserve. After sale service. And the luxury to chase far-flung ideas back to reality. Superior Electric is a large company.

Small companies have the flexibility. Quick customer response. Working one-on-one. Opening early, staying late. The motivation to meet emergency deadlines. Turning off-the-shelf standards into one-of-a-kind specials. The absence of bureaucracy. And the tenacity of entrepreneurs. Superior Electric is a small company.

Superior Electric. Controlling the motions in manufacturing with *SLO-SYN*<sup>®</sup> numerical controls. From

economical 2-axis to contouring 4-axis models. Open or closed loop.

Program storage, memory files, tool length and diameter compensation — you choose the options. And with *SLO-SYN* motors and drives. The entire range of *SLO-SYN* synchronous and stepping motors. Matched translator and preset indexer drives. Rotary and positioning tables.

For information on Superior motion systems, write the large and small company:  
The Superior Electric Company, 383 Middle Street, Bristol, Connecticut 06010.  
Or call 203/582-9561.

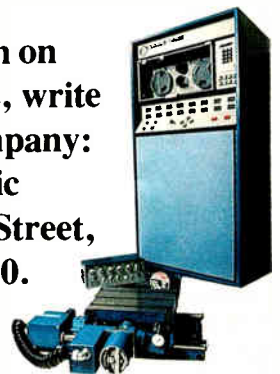

**Superior Electric**

We live up to our name.



---

## New products

---

Data handling

### Processor adds to throughput

Floating-point device for DEC's PDP-11/70 doubles speed of earlier unit

When Digital Equipment Corp. introduced its PDP-11/70 computer last winter (*Electronics*, Feb. 20, p. 31) it became the high end of the PDP-11 line, balancing speeds in buses, processor, and memory for increased throughput. But one thing that remained the same was the optional floating-point processor, the FP-11B, which was originally developed for the PDP-11/45. Now DEC is introducing a new floating-point processor, the \$5900 FP-11C, designed specifically for the 11/70, twice as fast as the earlier one and still software compatible.

DEC notes that "the 11/70 had two goals, throughput and reliability, and this is one more step in increasing throughput." The new FP-11C can crunch numbers 2 to 2.5 times as fast as the older FP-11B, providing a balance between the I/O bandwidth of 5.8 megabytes and the floating-point processor.

The FP-11C has a set of six 64-bit floating-point accumulators. Any of four accumulators can do arithmetic operations, with two additional internal registers for storing temporary results.

Whereas the older FP-11B shifted only one bit at a time, the 11C has 8-bit shifters, giving a wider range of shifting. The unit is binary normalized, with a basic accuracy of  $\pm\frac{1}{2}$  LSB. In the longer floating-point instructions such as double precision divide, as much as 100% of the floating point execution time may be overlapped with CPU operation. Calculations can be either single precision (32 bits) or double precision (64 bits). DEC has eliminated much of the handshaking between the CPU and the FP-11C, thereby increasing

the number of operations that can run in parallel and also increasing speed.

The average execution time for a single precision load is 1.5 microseconds in the register-to-register mode and 1.95  $\mu$ s in the memory-to-register mode; single precision add time is 1.65  $\mu$ s in R-R and 1.95  $\mu$ s in M-R; single precision multiply time is 3.47  $\mu$ s in R-R and 3.87  $\mu$ s in M-R; and single precision division time is 4.29  $\mu$ s in R-R and 4.89  $\mu$ s in M-R. These times assume a 100% hit rate in the 11/70 cache memory, but they would be almost exactly the same for a 90% hit rate. In addition, instructions also include floating-point clear, negate, make-absolute, test, compare, convert, and others, for a total of 46 hardwired instructions.

Cost of the FP-11C is \$5,900, and it will be available starting in December.

Digital Equipment Corp., 146 Main St., Maynard, Mass. 01754 [361]

---

Disk-storage systems offer up to 1.2 billion bytes

Two additions to System Industries' line of disk-storage systems offer minicomputer users up to 1.2 billion bytes of memory at an average access time of 30 milliseconds. Applications include sales-order entry—up to 15 CRT terminals can instantaneously access more than 500,000 items (16-bit words) on file. To implement the billion-byte storage system, four storage-module drives made by Control Data Corp. are connected to a special controller, which matches the performance of slow processors to the 1.2-megabyte transfer rate of the drives. The controller also handles many software routines in hardware. The two new disk memories are the models 9500-64 and 9500-66. In single quantity, the billion-byte system (9500-66) is priced at less than \$60,000, complete with controller, power supply, minicomputer interface, and cable.

System Industries, 535 Del Rey Ave., Sunnyvale, Calif. 94086 [363]

---

Portable analyzer checks out Intel 8080

A portable microcomputer-analyzer system for checking the Intel 8080 microprocessor is connected to the user's system by a cable plug that inserts into the 40-pin socket that usually contains the 8080 circuit. The analyzer, designated the MAS-80, can be used in production test to monitor the state of the 8080 signals prior to inserting a known-good

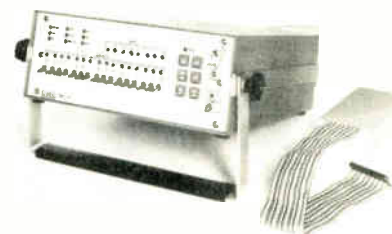

8080 IC on an untested board. The MAS-80 module contains its own 8080 that is protected against damage by buffer circuits. The control panel enables the user to monitor and control his system without developing special modules or test devices. The MAS-80 is priced at \$850. California Micro Computer, 9323 Warbler Ave., Fountain Valley, Calif. 92708. Phone David Mayotte (714) 963-5050 [364]

---

Serial impact printers run at 340 lines/minute

Two high-speed serial impact printers can operate as fast as 340 lines per minute. Models 103 and 503 include electronics that permit bidirectional printing and the ability to seek through logic the fastest path

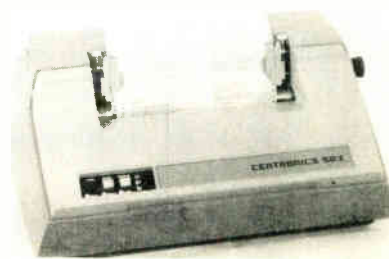

# AN INTRODUCTION TO MICROCOMPUTERS

From the authors of  
"THE VALUE OF POWER"

**Here is a book that is easy to read. It takes you by the hand, from elementary logic and simple binary arithmetic, through the concepts which are shared by all microcomputers. It tells you how to take an idea that may need a microcomputer, and create a product that uses one.**

This book is complete — every aspect of microcomputers is covered: the logic devices that constitute a microcomputer system; communicating with external logic via interrupts, direct memory access and serial or parallel I/O; microprogramming and macroprogramming; assemblers and assembler directives; linking and relocation — everything you need to know if you are going to select or use a microcomputer.

These microcomputers are described in detail: The Intel 8080, the Rockwell PPS-8, the Fairchild F8, the National Semiconductor PACE and SC/MP, the Motorola M6800 and the Signetics 2650.

Copies of the book are available for \$7.50, plus sales tax where applicable. Discounts are available on orders for 100 books or more.

Order from:  
Adam Osborne & Associates, Inc.  
2950 - 7th Street  
Berkeley, California 94710

(415) 548-2805



OSBORNE & ASSOCIATES INC.

BankAmericard and Master Charge telephone orders accepted.  
Dealer and distribution inquiries welcome.

## New products

to the next print line. This eliminates the need for time-wasting, inefficient carriage returns. The result is faster printing—70 to 340 lines per minute, depending on demands of the application. In addition to higher throughput, the 103/503 offer an optional six to eight lines per selectable switch, which can reduce paper costs by increasing page density by 33%. On an 11-inch form, the operator can print as many as 88 lines instead of the standard 66 lines. The end-user price for the 103 is \$4,340; for the 503, \$3,565.

Centronics Data Computer Corp., Hudson, N.H. 03051. Phone Pauline A. Uzzle (603) 883-0111 [365]

Microprocessor module  
includes 2-k memory

A 4-bit microprocessor module fits a widely used card cage—the Cambion bin. The module contains an Intel 4040, a memory of 2,048 words by 8 bits, and a crystal clock, as well as provisions for 1,024 by 8 bits of RAM, a 1,024-by-8-bit PROM, and an 80-word-by-4-bit RAM. Also included is a test programable ROM, which checks out all system input/outputs. The module provides separate input and output data buses, as well as three latched designate-command lines (DCL), and the entire input/output structure is TTL-compatible. Power requirements are +5 and -12 v dc. A terminal control board, front-panel monitor, and a wire bin with power supplies are also available. Price of the module is \$395, and delivery time is 30 days.

International Microsystems Inc., 122 Hutton St., Gaithersburg, Md. 20760 [367]

Terminal system built for  
remote data processing

A complete system of matched terminal units, called the Transdata 810, includes a video data terminal, a printer station, and two multiple-control units, all of which can be



# Outsiders on the inside in a big way in the Japanese electronics market advertise in Nikkei Electronics



International firms like RCA, Texas Instruments, Burr-Brown, and others who really know the Japanese electronics market, know the value of Japan's No. 1 electronics media. Nikkei Electronics.

And if the Japanese market is your next world market, it not only wise to get to know Nikkei Electronics but profitable, too.

We specialize in lots more than simply carrying your sales messages direct to 60% of Japan's top engineers and firms. Our back-up service gives you full merchandising support.

Nikkei Electronics research helps you grasp the real market situation . . . research on production goods procurement procedure, on procured production goods, and on important product preference covering measuring instruments and semiconductors, electronic parts, component parts, and peripheral and terminal equipment.

No other media in Japan offers you such valuable assistance. Much less for free. Simply because no other media is more media in electronics.

*We help make the foreign familiar.*

## NIKKEI ELECTRONICS



For more information, please contact McGraw-Hill's Electronics sales office or Advertising Dept.

**NIKKEI-McGRAW-HILL INC.,**

Nikkei Annex Bldg., 2-1-2, Uchikanda, Chiyodaku, Tokyo, Japan.

# TWO NEW TITLES FROM McGRAW-HILL ON TODAY'S NOW TOPIC—MICROPROCESSORS



## MICROPROCESSOR APPLICATIONS MANUAL

By Motorola Semiconductor Products Inc.  
716 pages, 8½" x 11", illus., \$25.00

General purpose Microprocessing Units (MPUs), architecturally descended from the minicomputer and implemented as integrated circuit semiconductor products, are an exciting reality for today's electronics business. This book provides detailed applications information for a representative general purpose microprocessing unit. In addition to system considerations, such topics as architecture, instruction set, addressing modes, interrupt structure, etc. are thoroughly covered.

While the Motorola MC 6800 and its family of associated parts are used as a model, the system design considerations and hardware/software discussions are applicable to designs based on other MPUs.

Written for practicing system/circuit designers, this "hands on" manual includes programming examples and individual control routines for a variety of peripheral devices that can be used to fit the design requirements.

## MICROPROCESSORS

ELECTRONICS BOOK SERIES

Edited by Laurence Altman  
160 pages, 8½" x 11", illus., \$13.50

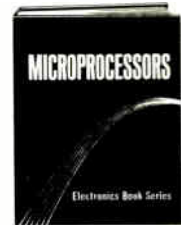

Based on articles from Electronics, this book contains practical and up to date information on available microprocessor devices, technology and applications—ranging from the simplest 4-bit p-channel MOS system . . . through the second-generation n-MOS 8-bit processor chips . . . to the new injection logic and Schottky TTL bipolar processor families needed for today's computer-based control applications.

As a fundamental departure from the familiar hard-wired logic techniques, microprocessor technology has already produced a host of devices competing for the designer's attention. This book cuts through the confusion, presenting the potential of this exciting technology for the design engineer who needs to know *how to use* microprocessors, and for the system analyst who must assess the *tradeoffs* between microprocessors and other techniques to accomplish system goals.

### Forthcoming Titles of Special Interest

#### SEMICONDUCTOR MEASUREMENTS AND INSTRUMENTATION

A comprehensive, up-to-date guide for the working engineer and technician to use in solving everyday semiconductor measurement and evaluation problems. The only reference devoted solely to semiconductor measurements, it covers the latest techniques, including many never before published. Provides detailed, specific, how-to steps on testing. Topics include crystal orientation, crystallographic defects and their observation, resistivity and carrier-concentration measurements, lifetime, mobility, Hall, and type measurements, thickness measurements, preparation of samples for microscopic examination, microscopy and photography, and the electron microscope and other analytical instruments. Comprehensive index includes nearly 800 entries.

By Walter R. Runyan, Texas Instruments Co.  
320 pp., 7" x 10", illus., \$19.95

**JUST PUBLISHED—UPDATED EDITIONS OF 2 "CLASSICS" devoted exclusively to helping you prepare for—and pass—your P. E. exams. Here you will find the answers to virtually any question you will face.**

#### ELECTRICAL ENGINEERING FOR PROFESSIONAL ENGINEERS' EXAMINATIONS, 3rd edition. By John D. Constance.

A thorough revision of a best-seller used by both electrical and other engineers for the PE exam. Topics covered are: Electrical units and Ohm's law; battery circuits; units of area and resistance; temperature coefficient of resistance; power, energy, and thermal units; wire sizing; measurement of direct current machinery; direct current transmission; magnetism and the magnetic circuit; direct-current machinery; direct-current motors; condensers; alternating current; alternating current motors; power circuits; transformers; a-c transmission lines; lighting; electronic tubes and circuits.  
544 pp., 5½" x 8", \$17.00

#### ENGINEERING ECONOMICS FOR PROFESSIONAL ENGINEERS' EXAMINATIONS, 2nd Edition. By Max Kurtz

A completely updated edition of the popular reference on the economics portion of the PE exam. Covers mathematical review; the mechanics of investment; money as a function of time; sinking funds and annuities, amortization of debt; valuation of bonds; depreciation and depletion; cost comparison of alternative methods; analysis of business operations; the continuous compounding of interest; analysis of random variables; probability. 288 pages, 5½" x 8", \$14.95

**AVAILABLE AT YOUR BOOKSELLER OR USE THIS 10-DAY FREE EXAMINATION COUPON**

#### PRINCIPLES OF UNDERWATER SOUND

The new edition of a classic on underwater acoustics, completely updated to cover the many new findings and techniques in the active, developing field of underwater acoustics.

Offers a complete treatment of all aspects of underwater sound, based on the "sonar equations."

With emphasis on practical applications, it presents new material on such subjects as nonlinear (parametric) sonars . . . synthetic aperture arrays . . . techniques for reducing target strength and flow noise . . . the effect on detectability of signal fluctuations and multiple targets . . . and much more!

Updated graphical material plus the use of the new American acoustical standard of **one micropascal** make this volume an invaluable working tool for practicing engineers.

By Robert J. Urick, 248 pages, \$22.50

### McGraw-Hill Book Company

1221 Avenue of the Americas  
New York, N.Y. 10020



Please send me the books checked for 10 days' FREE EXAMINATION. At the end of that time I will either pay the purchase price plus local tax, postage and handling or return the books and owe nothing.

Remit in full with order, plus local tax, and McGraw-Hill pays postage and handling. 10-day return privileges still apply.

- \_\_\_ (043527-8) Motorola: Microprocessor Applications Manual, \$25.00
- \_\_\_ (019171-9) Electronics: Microprocessors, \$13.50
- \_\_\_ (054273-2) Runyan: Semiconductor Measurements and Instrumentation, \$19.95
- \_\_\_ (066086-7) Urick: Principles of Underwater Sound, \$22.50
- \_\_\_ (012448-5) Constance: Electrical Engineering for Professional Engineers' Examinations, \$17.00
- \_\_\_ (035675-0) Kurtz: Engineering Economics for Professional Engineers' Examination, \$14.95

NAME \_\_\_\_\_

ADDRESS \_\_\_\_\_

CITY \_\_\_\_\_ STATE \_\_\_\_\_ ZIP \_\_\_\_\_

This offer good only in U.S. and subject to approval by McGraw-Hill.

23-A789-4018-3



## New products

connected to systems belonging to the Unidata 7000 series and the Siemens System 4004. Up to 1,920 characters can be displayed on the screen of the video data terminal. A noteworthy feature is the possibility of having cursive, dimmed, or flashing displays. The appropriate sections of the text are marked by a light pen. The 8121 printer belonging to the system can write up to 180 characters per second and it can be directly connected to the video terminal.

Siemens AG, D-8520 Erlangen 2, Postfach 3240, West Germany [366]

## Data handling topics

Prices on six **Hewlett-Packard** multiprogrammer cards have been cut by as much as 45%. Also, the price of option J99, which enables HP digitally controlled power sources to be integrated into instrument systems interfaced with the HP Interface Bus, has been cut by 57.5% . . . The model CO:7350, a standard feature on the CO:77 display subsystem of **Computer Optics Inc., Bethel, Conn.**, is now available for OEM-quantity sales . . .

**Storage Technology Corp., Louisville, Colo.**, is increasing monthly lease charges about 4% for its model 3400 tape subsystems. Also, all maintenance charges will go up about 9%. The increases are effective Jan. 1 . . . In the second quarter of 1976, **Documation Inc., Melbourne, Fla.**, will start delivering its DOC 2250 impact line printer, capable of handling 2,250 lines a minute, single-spaced, using a 48-character set . . .

**Pelam Inc., Schiller Park, Ill.**, has developed what it calls the PSL/2 programming tool kit. It's a collection of subroutines for use with Fortran IV on Data General computers . . .

**Warner & Swasey Co., Solon, Ohio**, has signed an agreement with Réalisations Etudes Electroniques of Paris to manufacture and market the Micral minicomputer line in the U.S. and Canada.

# COMPACTMATRIX

An all new low cost programming device

The Compactmatrix is specifically designed for PCB mounting and is the answer to your economical miniature programming requirements. This 10 x 10 matrix is available in 5 colors and can be mounted side-by-side without gaps, allowing a limitless variety of configurations. Matrix boards and programming pins are available from stock.

Call or write for complete information.



ONE OF THE PURDY GROUP OF COMPANIES

770 Airport Boulevard  
Burlingame, CA 94010

(415) 347-8217 • TWX 910-374-2353

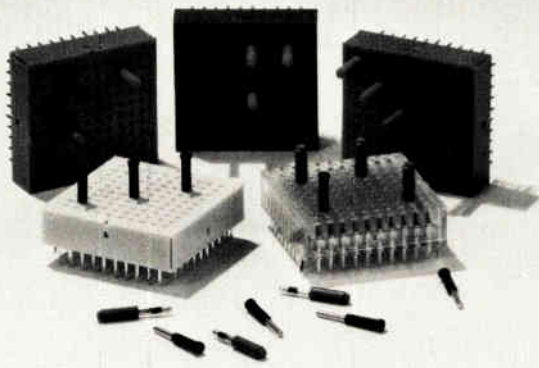

Circle 155 on reader service card

MEMORY SERIES NO. 13

## PICK ANY 48 WORDS FROM A 65,538 POOL

IN THE FIELD, WITH JUST ONE FPLA. And edit your program at will. In our Field Programmable Logic Arrays with 16 inputs to the decoder, product terms can be added (up to 48) or removed—or delete input variables from your terms. And outputs programmed active-high are reprogrammable to active-low.

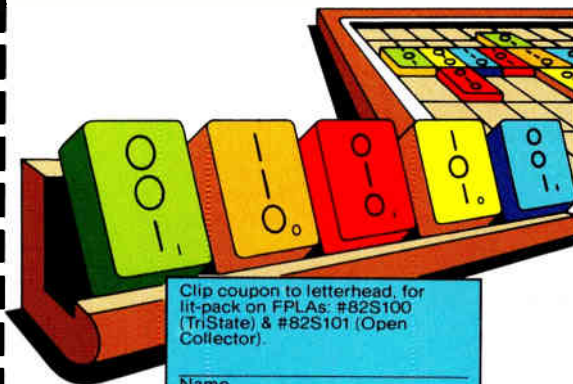

Clip coupon to letterhead, for lift-pack on FPLAs: #82S100 (TriState) & #82S101 (Open Collector).

Name \_\_\_\_\_

Tel. \_\_\_\_\_

Ext \_\_\_\_\_

Call me with sample part quote.

THINK

# Signetics

811 E. ARQUES, SUNNYVALE, CALIF. 94086

---

## New products

---

### Subassemblies

# Low-cost a-d unit works to 125° C

---

12-bit hybrid converter is linear within 0.04% over full military range

---

Using thin-film resistor networks, which it produces in volume, Hybrid Systems has developed what it describes as a military-quality analog-to-digital converter in hybrid form at commercial prices. The ADC 580 is a low-drift, successive-approximation 12-bit a-d converter that is housed in a 24-pin hermetic dual-in-line metal package. It is priced at \$150 each in quantities of 1 to 24.

The converter maintains linearity within 0.04% of full scale over the full military temperature range of -55° to +125° C. Over the typical commercial range of 0 to 70° C, the ADC 580 has a linearity within better than 0.01%. Hybrid Systems says that most commercial a-d converters hold a linearity within 0.01% over a much smaller range, typically +15 to +40° C. Temperature coefficient of the ADC 580 is 2 ppm/° C.

Conversion time is 50 microseconds, and the unit requires a single 4-microsecond pulse to start. The company points out that the conversion time is of necessity slower than units with commercial specifications so that the accuracy is maintained over the whole temperature range. The basic device would convert in 5 or 10  $\mu$ s if it only had to hold its accuracy at room temperature, the company adds.

Digital coding is selectable through pin interconnection. The options are complementary binary (unipolar), complementary-offset binary (bipolar), and two's complement (bipolar). Input ranges are  $\pm 5$  v and 0 to +10 v. The ADC 580 operates from  $\pm 15$ -v and +5-v power supplies and uses less than 1 watt. The hybrid converters are compat-

ible with DTL and TTL levels.

Logic, clocks, and precision reference are all built into the converters so they require no external components for operation. Hybrid Systems says the converter, at 1.37 by 0.80 by 0.19 inches, is one of the smallest units available.

The ADC 580 is particularly suited for applications where the operating environment is harsh, as in oceanographic systems, or where instrument accuracy and dependability are crucial, as in electronic medical equipment.

Hybrid systems says that the ADC 580's low price is possible because the company fabricates its own resistors in large volume and is able to pass the savings along. A-d accuracy and performance are functions of the thin-film resistors, the company points out.

Price is \$150 in quantities of 1 to 24. Delivery is stock to four weeks.

Hybrid Systems Corp., 22 Third Ave., Burlington, Mass. 01803 Phone (617) 275-1570 or (617) 272-1522 [381]

---

### Nonvolatile analog memory stores peak voltages

Able to store positive and negative voltage peaks for over a year with less than 5% decay, an analog memory module (AMM) needs no "keep-alive" power supply while in its storage mode. The acquisition time of the AMM may be programed from a minimum of 100 microseconds to a maximum of 50 seconds. Three versions are offered: the AMM-1 has a maximum input-voltage rating of 20 volts and can put out up to 14 v at 10 milliamperes; the AMM-2 can handle input voltages as high as 200 v and can put out up to 18 v at 9 mA; the AMM-3 is rated at 15 v on the input and 15 v at 9 mA on its output. All three units have an output impedance of 1 kilohm. Expected applications of the modules will be in peak-reading instrumentation, tuning circuits, dimming controls, medical electronics, process control, and data processing. Delivery time for the analog

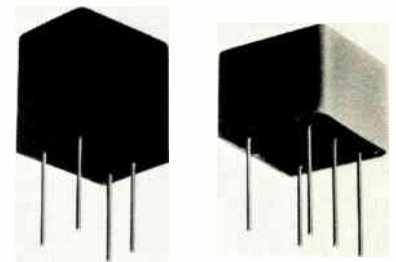

memories is approximately eight weeks.

Matsushita Electric Corp. of America, One Panasonic Way, Secaucus, N. J. 07094. Alex Jordan (201) 348-7270 [383]

---

### Price and size of 12-bit a-d converter are halved

A 12-bit analog-to-digital converter from Analog Devices is half the size, half the price, and just as fast as its predecessor—the ADC-12QM. The new module, designated the ADC-1133, is housed in a 2-by-2-in.-by-0.4-inch package and sells for \$159 in small quantities. It has a max-



imum conversion time of 25 microseconds, a maximum linearity error of half a least significant bit, and a gain temperature coefficient of 7.5 ppm/°C. The ADC-1133 provides both parallel and serial outputs. Delivery is from stock.

Analog Devices Inc., P.O. Box 280, Norwood, Mass. 02062. Lowell Wickersham (617) 329-4700 [387]

---

### Dc-dc converter has high efficiency under light loads

The series 1265 dc-to-dc converters are 420-watt devices that have a no-



# If you need a few custom ICs and can't afford them, call us.

When others quote you high prices for a few custom ICs, it's because they treat them as a sideline. At Silicon Systems, custom ICs are our bread and butter. Especially low quantity orders — even under 5000. Priced to compete with catalogue ICs.

One reason for our low prices is our proprietary design system. Developed in our own computer lab, this system helps us solve design problems in any technology — TTL, Schottky, ECL, Linear, PMOS, NMOS, CMOS, I<sup>2</sup>L — whatever is best for you. Designs that are fully protected because they can't be copied.

Over the years, we've become expert at satisfying all kinds of special design requirements. With ICs that replace entire groups of catalogue ICs, saving you board area, power, cooling, testing, spares — money and grief.

So when you think you can't afford custom ICs, write us. Silicon Systems, Inc., 2913 Daimler Street, Santa Ana, CA 92705. Better yet, call:

**(714) 979-0941**

**Silicon Systems  
The One-of-a-Kind IC Company**

Circle 157 on reader service card

## OAK SUBMINIATURE TOGGLE SWITCHES



The same Oak quality and dependability you expect and get in rotary and pushbutton switches is now available to you in these Oak toggle switches.

- Single to 4 pole double throw switching
- Three basic lever styles
- Solder tab or PC terminals
- 6 amp rating at 125 VAC
- Silver or Gold plated contacts
- Competitively priced

Stocked for immediate delivery by Oak distributors. Call toll free 800-435-6106 for the name and phone number of your nearest distributor, or write for a catalog.

**OAK Industries Inc.**  
SWITCH DIVISION / CRYSTAL LAKE, ILLINOIS 60014

Circle 186 on reader service card

MEMORY SERIES No. 6

## 8192 BITS- NO EXTRA PIECES NEEDED.



**8K MOS ROM #2608.**  
Use this big fast memory (1024x8 at 650ns) without costly supportive parts. TTL compatible: no interface required. Static logic: no clocks. Single +5V means no extra power supplies. Volume stock now.

Rush coupon on letterhead, for specs on #2608 8K MOS ROM.

Name

Tel.  Ext.

**THINK  
Signetics**

811 E. ARQUES, SUNNYVALE, CALIF. 94086

Circle 187 on reader service card 157

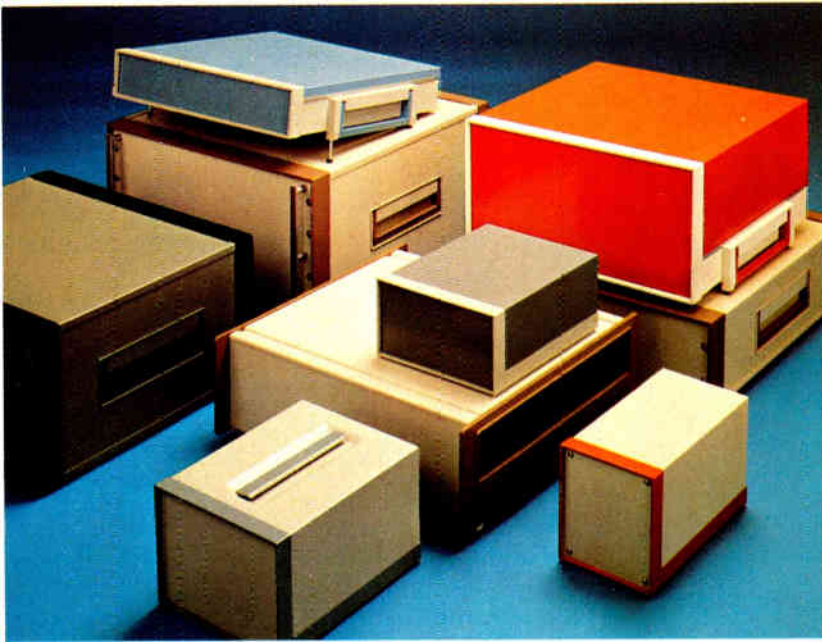

# Freedom of choice

That's what's important to us at Optima. And that's why Optima cabinets and cases come in more sizes and colors than any other kind you can buy. With Optima you get 11 different colors to choose from, in fact. And hundreds of different models and sizes. Not to mention a great long list of optional features like rack adapters and perforated panels and tiltstands and spring-loaded handles.

In other words, you can have any enclosure, the way you want it. That's what freedom of choice means. And that's what Optima means, too.

# OPTIMA

Optima® Enclosures, a division of Scientific-Atlanta, Inc.  
2166 Mountain Industrial Blvd., Tucker, Georgia 30084

SA-87512

Circle 158 on reader service card

## Cost Cutter

NEW Electronics Buyers' Guide ...

Easy-to-use, single volume source for:

- Data on over 4,000 products
- Over 6,000 company listings and phone numbers.
- **EBG EXCLUSIVE:** quick access to over 1000 catalogs through a Direct Inquiry Service. The international world of electronics at your fingertips. Find suppliers ... fast... accurately ... and locally! For your copy send \$20.00 (USA and Canada only; elsewhere send \$30.00) to address shown below.

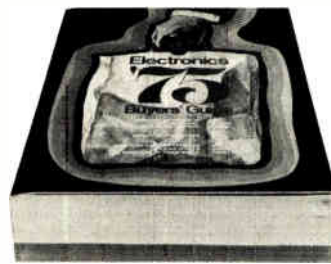

## Electronics Buyers' Guide

A McGraw-Hill Publication  
1221 Ave. of the Americas, New York, N.Y. 10020

158

## New products

load power requirement of only 5 w. Thus, they are highly efficient even when lightly loaded and are well suited for applications requiring extended periods of standby operation. Communications transmitters, signaling and alarm equipment, and many control systems are characterized by considerable idle time and can benefit from



such a power supply—especially if they are battery-operated. The series 1265 has an efficiency in excess of 80% over most of its output-power range and is internally protected against overloads, short circuits, and reversal of input polarity. Models are available for input voltages of 48 v dc  $\pm 20\%$  and 24 v dc  $\pm 20\%$ . Output voltage is adjustable from 12 to 14 v dc for currents from 0 to 30 A. Series 1265 converters sell for \$470 and have a delivery time of stock to 30 days.

Wilmore Electronics Co., Inc., P.O. Box 2973, Durham, N.C. 27705. J. L. Harris (919) 489-3318 [384]

Analog divider maintains accuracy at low input levels

Most transconductance-type analog multipliers with a specified accuracy of X% have an error of  $(10X/D)\%$  in the divide mode, where D is the denominator. Thus a multiplier with an accuracy specification of within 0.5% can produce errors as large as 50% if the denominator goes down to 100 millivolts. However, the model 4291 analog divider is a module that has a maximum error of 0.25% at a 100-mv denominator voltage. And with the addition of several external trimming resistors, the unit can reduce the error to 0.1% at a denominator voltage of 10 mv. The divider has a full-power fre-



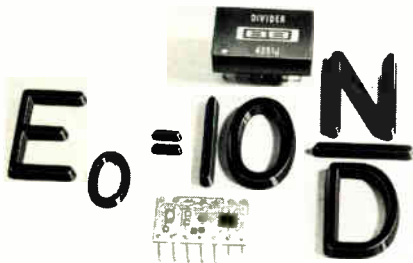

quency response out to 20 kilohertz and a small-signal response to 400 kHz.

Housed in a 14-pin DIP, the 4291K sells for \$53 each in small quantities. The 4291J, with a maximum-error specification of 0.5% sells for \$42, and the 4291H, at 1.0%, is priced at \$34.

Burr-Brown, Box 11400, Tucson, Ariz. 85734. Joe Santen (602) 294-1431 [386]

## Subassemblies topics

**Deltron Inc., North Wales, Pa.**, has announced the completion of a system whereby custom power supplies can be designed almost completely by computer program. Bulletin 1-72 describes the company's custom-design capability. . . . A 400-Hz resolver standard from **Magnetics Inc., Holtsville, N. Y.**, operates from 26 volts at 400 Hz and provides isolated outputs of 11.8 V rms in 15-degree increments to a precision of 10 arc seconds. . . . The SSD series of switching power supplies from **Sorensen Co., Manchester, N. H.**, covers the voltage range from 1.8 V to 56 V dc with 10 models. The line is efficient (the 5-V unit has an efficiency of 76%) and sells for about \$295 each. . . . The model 6270 three-dimensional image-display module made by **Optical Electronics Inc., Tucson, Ariz.**, is a universal device containing a quadrature oscillator, two function generators, three four-quadrant analog multipliers, and an operational amplifier. The unit has a single-quantity price of \$428.

# VERSATESTER I™



## What is it? A labstrument\*

**VERSATESTER I**  **Generates** Pulses, Sine waves and Square waves to 20MHz  **Supplies** dc power at +5v, +15v, -15v, ±30v  **Digitally Measures** frequency from 20Hz to 20MHz, with autoranging; DC and AC volts, 0-500v; Resistance to 5 Megohms.  **Complete for only \$1,650!**  **Contact your nearest Scientific Devices Office for specs or demo or Systron-Donner at 10 Systron Drive, Concord, CA 94518. Phone (415) 682-6161.**

\***lab-stru-ment** \ˈlab-strə-mənt \ n 1: a complete test lab in one lightweight, portable, 3½" panel height Systron-Donner instrument.

SYSTRON  DONNER

Circle 159 on reader service card

MEMORY SERIES No. 3

## SUPER GIVEAWAY: 6 YEARS OF PROM RESEARCH



FREE for the asking: our PROM reliability report. The kind of hard-nosed data you need on nichrome fusing, and the critical conditions governing rel maximization. A strong evaluation of our PROM research, further supporting RADIC findings.

FREE COPY of Signetics PROM Reliability summary: attach coupon to letterhead.

Name \_\_\_\_\_

Tel. \_\_\_\_\_

Ext. \_\_\_\_\_

THINK

# Signetics

811 E. ARQUES, SUNNYVALE, CALIF. 94086



**RELIABILITY** walks in  
with

**ELORG**

## PHOTOMULTIPLIER TUBES

**THE WIDE SPECTRUM.** From near-infrared to X-rays.

**THE BROAD FIELD OF USES.** B & W and color TV — broadcasting, applied, closed-circuit, small-frame; phototelegraph; infrared TV; photometry; spectrometry (infrared included); scintillation equipment for monitoring lasers.

**THE TWENTY-PLUS TYPES.** Including:

**FEU-82** — particularly suited for scintillation equipment. The light response linear (by anode current) in pulsing mode, up to 800 mA.

**FEU-57** — ideal for ultraviolet region research. The photocathode offers  $5 \times 10^{-3}$  A/W response, anode — 2000 A/W (at 230 nm wavelength).

**FEU-96** — the one for measuring threshold light fluxes. The cathode dia. mere 3 mm. Dark current  $3 \times 10^{-10}$  A. Response threshold  $5 \times 10^{-13}$  lumen/Hz<sup>2</sup>.

**FEU-113** — specifically developed for infrared research. Oper. range from 300 to 1060 nm. Cathode response at 1060 nm wavelength —  $6.5 \times 10^{-4}$  A/W. Response by anode current 300 A/W.

**FEU-114** — THE RUGGEDNESS IS UNMATCHED. Withstands vibration to 20 g, 1 Hz to 3000 Hz, linear acceleration up to 500 g and single impacts as strong as 1000 g. Operative within 250 nm to 850 nm range.

The louvres dynode system in the FEU Photo Multiplier Tubes ensures a broad linear range of light response, stable anode (plate) current, independence of external magnetic fields.

**V/O ELECTRONORTECHNIKA**



32/34 Smolenskaya-  
Sennaya  
Moscow 121200  
USSR  
Telex 7586

## New products

### Packaging & production **Pc card tester is versatile**

Minicomputer-controlled  
system performs in-circuit  
plus functional checks

By adding a minicomputer to its FF101 line of in-circuit test systems, Faultfinders Inc. of Latham, N.Y., is now offering both analog and limited digital functional and in-circuit testing in its new FF101B and a modified FF101A. The minicomputer also makes it possible for the user to employ a cathode-ray-tube terminal so that both diagnostic messages and operator instructions may be displayed in plain English statements. Furthermore, the recently introduced Faults 1 in-circuit test-program-generator software package may be run on line, the company points out.

A functional test system connects a group of digitally programable supplies, generators, and measuring instruments to a circuit board to test it for normal circuit operation. An in-circuit test system, on the other hand, employs a fixture to contact each solder node on the bottom of a printed-wiring assembly and tests each component one at a time [*Electronics*, Sept. 4, p. 98]. The success of the in-circuit system comes from its capability to identify defective components and workmanship errors such as missing or reversed components and solder shorts.

"We have watched several trends in printed-circuit-board design develop over the past year. Consequently, we have expanded our FF101 line to meet the test and fault-diagnostic requirements of the latest printed-wiring assemblies," says Faultfinders president Melvin E. Stanford. "First, boards are becoming larger, and the growing number of orders over the past several months for FF101As with its 900-point capacity bears that out.



"Secondly, a number of our customers want to do both functional and in-circuit testing on small boards. Our new FF101B will serve that market well because it offers both in-circuit and functional testing in a single package," adds Stanford.

Faultfinders' new FF101B is a compact, minicomputer-controlled in-circuit test system that lets a customer choose the programable functional instruments that suit his needs and incorporate them into the system.

The FF101 line offers engineers three basic system options: the FF101B, and controller-based and minicomputer-based versions of the FF101A. The controller-based FF101A may be configured as a dual-test-station system and can run different test programs on the two stations, either from ASCII punched-paper tape or from a 10-program core memory.

The FF101A is also offered with a minicomputer replacing the controller shown in the photo. A larger minicomputer makes this system more versatile. Like the FF101B, users may add programable functional instruments to this version of the FF101A. On-line program generation of Faults 1 [*Electronics*, Sept. 18, p. 122] may be included as an option. Thus in-circuit test programs may be generated by an operator unskilled in programming. The operator merely enters the component specifications from a parts list and pin assignments from a marked schematic into a terminal.

Additional options include floppy disks for mass storage of programs



# HOW CAN YOU PRINT 23 COLUMNS WITH ONLY ONE MAGNET???

with **INZADI S23**

a most reliable DIGITAL PRINTER suitable for many electronic applications:.....

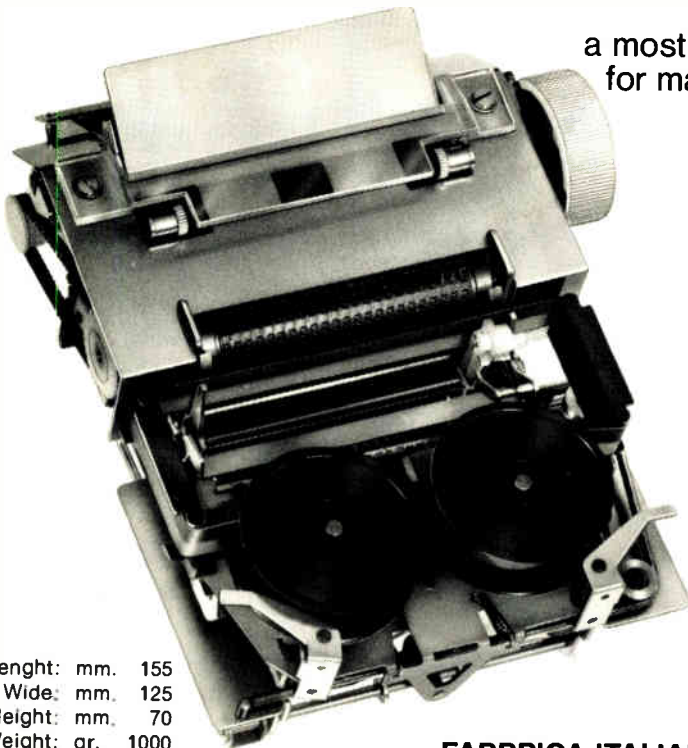

Length: mm. 155  
 Wide: mm. 125  
 Height: mm. 70  
 Weight: gr. 1000

- ELECTRONIC SCALES
- CASH REGISTERS
- INSTRUMENTATION
- CALCULATION INSTRUMENTS
- NUMERICAL TELEPRINTERS

high capacity serial flying printer • two-colour printing • large and easily readable figures • standard paper roll and ribbon • noiseless: motor runs only if printing-patented sturdy construction-highly compact

**FABBRICA ITALIANA CALCOLATORI**  
 Via S. Tecla 4 - Milano Italy - Tel. 861037 - 871803



Circle 161 on reader service card

## IC troubles? try these high-performance **Super-Grip™ IC Test Clips**

for fast,  
 non-shorting access  
 to all leads on dual-in-line  
**IC packages**

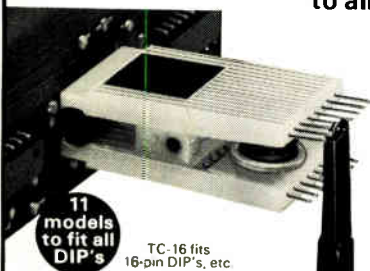

No more shorting across DIP leads... just quickly clip on an IC TEST CLIP to bring DIP leads out for safe attachment of scope probes and other leads. Ideal for signal input, tracing, troubleshooting, etc. Patented precision, "contact comb" design guarantees no shorting between DIP leads. Probes can hang "no-hands" free on Test Clip terminals in card racks (unique - see photo). Engineered Mechanical clamping plus gold-plated phosphor bronze terminals provide superior electrical contact. *Also unequaled as a DIP removal tool.*

Model	Row-To-Row Dim.	Part Number	Price
TC-8	.3 IN.	923695	\$7.35
TC-14	.3 IN.	923698	4.50
TC-16	.3 IN.	923700	4.75
TC-16 LSI	.5/ .6 IN.	923702	8.95
TC-18	.3 IN.	923703	10.00
TC-20	.3 IN.	923704	11.55
TC-22	.4 IN.	923705	11.55
TC-24	.5/ .6 IN.	923714	13.85
TC-28	.5/ .6 IN.	923718	15.25
TC-36	.5/ .6 IN.	923720	19.95
TC-40	.5/ .6 IN.	923722	21.00

Quick phone service — call distributor number nearest you:  
 201/381-5700 215/698-4000 313/525-1800 415/969-9240 714/279-5281  
 206/682-5025 216/587-3600 314/863-7800 513/236-9900 714/549-8611  
 213/971-3721 303/761-7870 412/782-2300 617/879-0860 914/664-0088

If no distributor in your area — call the factory  
 All products guaranteed to meet or exceed published specifications



**A P PRODUCTS INCORPORATED**  
 Box 110-E • Painesville, OH 44077 • 216/354-2101

Circle 189 on reader service card

ANALOG SERIES No. 1

## USE DMOS FETS FOR CLEANEST ANALOG SWITCHING.

DMOS, the key to transient-free switching. DMOS analog switches boost state-of-the-art performance with lowest parasitic capacitances, low on-resistance (30Ω) and high speed (1.5ns). SD210 series for singles; SD5000 for quads.

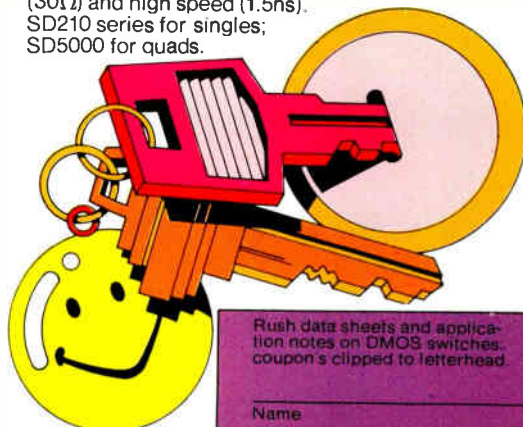

Rush data sheets and application notes on DMOS switches. coupon's clipped to letterhead.

Name \_\_\_\_\_

Tel. \_\_\_\_\_

Ext. \_\_\_\_\_

THINK  
**Signetics**  
 811 E. ARQUES, SUNNYVALE, CALIF 94086

Circle 190 on reader service card 161

MEMORY SERIES No. 5

# WE MAKE ONE FAST RAM DO THE JOB OF NINE

Why string up nine 64-bit RAMs, when a single 64x9 package does the same job—at 45ns. Savings? Obvious: less parts to buy, less power to burn. Quantity stock available now. Ask for high-speed #82S09.

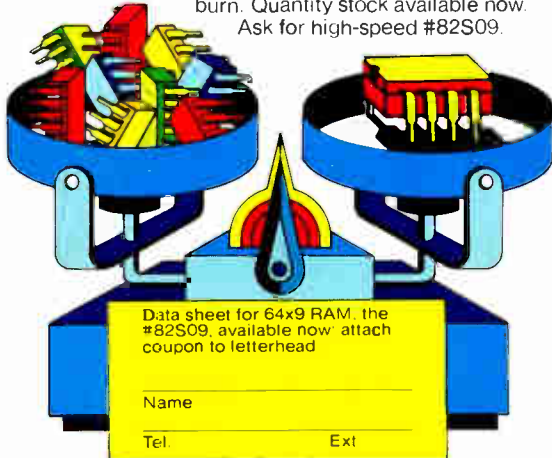

Data sheet for 64x9 RAM, the #82S09, available now attach coupon to letterhead

Name \_\_\_\_\_

Tel. \_\_\_\_\_

Ext \_\_\_\_\_

# THINK Signetics

811 E. AROQUES SUNNYVALE, CALIF. 94086

Circle 162 on reader service card

# PRECISION LOAD CELLS FOR TESTING, WEIGHING, FORCE MEASUREMENT



Specify Interface... offering industry the most innovative and comprehensive selection of superior load cells available.

Industry standards for accuracy, stability, versatility and cost have been established by Interface... providing a complete line of load cells for electronic weighing, testing or force measurement applications—in any industry! With standard ranges from 5 pounds to 100 tons, these load cells combine extremely high accuracy with low installed cost.

# Interface

7401 East Butherus Drive/Scottsdale, Arizona, USA 85260  
Telex: 668-394 Telephone: (602) 948-5555

Circle 191 on reader service card

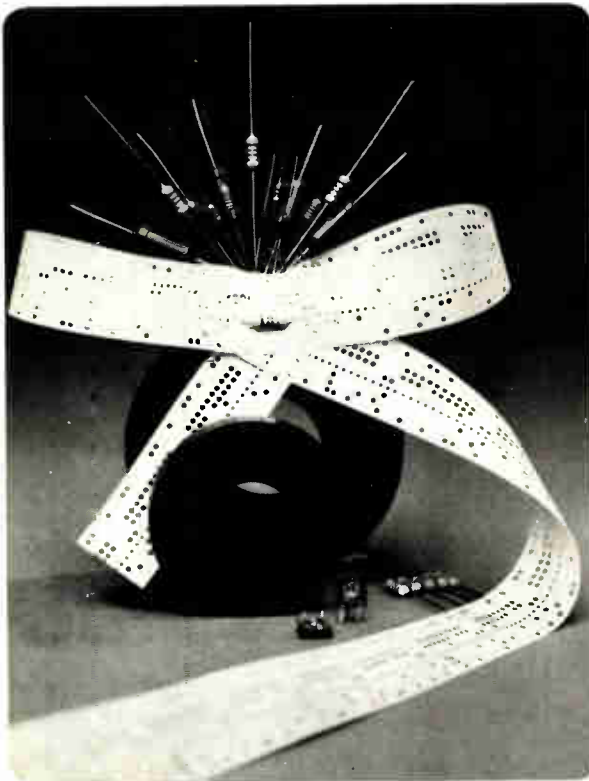

# RELIABLE CAPACITORS

## from the USSR for Mini and Micro Circuits

- "K10-7V" low voltage ceramic capacitors
- "K10-31" ceramic disc capacitors

For any current—direct, alternate, or pulsing  
—also for pulsing mode of operation.

TYPE:	K10-7V	K10-31
Capacitance range, pF	22-47,000	1-4,700
Nom. voltage, V	50	500
Length, mm	5.0-13.0	—
Height, mm	5.0-13.0	4.0-16.0*
Thickness, mm	3.5	0.4-0.6
Mass, g	1.0-2.5	0.3-2.5

\*diameter indicated instead of height

Select the right capacitor for your specific circuits from the broad range supplied by: V/O Electronorgtechnica, 32/34 Smolenskaya Sennaya, Moscow 121200, USSR. Telex: 7586

Our agents in the U.S. are:

**AMTORG Trading Corporation**

355 Lexington Avenue, New York, New York 10017  
212-682-7404



162 Circle 192 on reader service card

Electronics/November 27, 1975



## New products

and a choice of input/output devices, including a teletypewriter, a CRT display or a magnetic-tape terminal. Dual test stations are available on both versions of the FF101A. The FF101B, with 100 test points, wired and tested for 300 points and with a Teletype I/O, is priced at \$39,350.

The FF101A—controller version—with 300 points, expandable to 900 points—is priced at \$41,500. Delivery time is 60 to 90 days.

Faultfinders, 15 Avis Dr., Latham, N.Y. 12110 [391]

### Interactive graphics system does several jobs at once

By using two computers (a Nova 2 and an Eclipse) to run a system for the design and layout of printed-circuit boards, the designers at Calma have come up with an interactive system that can perform such func-



tions as net listing, remote job entry, artwork verification, and parts listing while the design and layout work are going on. Calma's graphic data system (GDS) is thus faster than others in which some of the steps must be performed sequentially.

Calma Corp., 707 Kifer Rd., Sunnyvale, Calif. 94086. Phone (408) 245-7522 [394]

### Logic-board system performs analog and in-circuit tests

The 1024H circuit-board tester is a computer-controlled system that can perform analog and digital checks in addition to the in-circuit analysis of individual components. Designed



for the high-speed functional testing and troubleshooting of printed-circuit boards during prototype design, production, and in the repair depot, the system uses a guided-probe technique to rapidly identify such common failures as open runs, shorts, and faulty integrated circuits. It supports the Hughes Digital Fault Analysis (DFA) simulation system which generates models of large sequential networks. Priced between \$150,000 and \$225,000 depending upon options, the 1024H has a 90-day delivery time.

Hughes Industrial Products Div., 2020 Oceanside Blvd., Oceanside, Calif. 92054 [393]

### Laser-based process generates 0.8-mil lines

A laser-based process for the generation of evaporated-metal patterns and designs on a wide variety of substrates, Vacu-Mask can achieve line widths as small as 0.8 mil (20 micrometers). The process consists of coating the substrate with Vacu-Mask material, exposing the coated substrate to the beam from a CO<sub>2</sub>

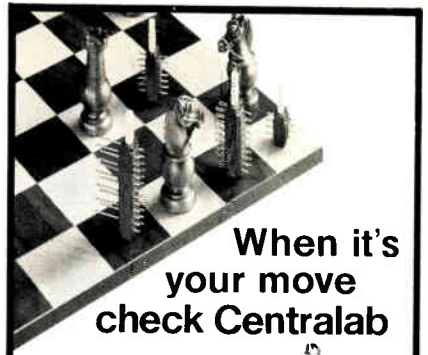
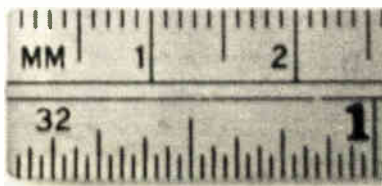

When it's  
your move  
check Centralab

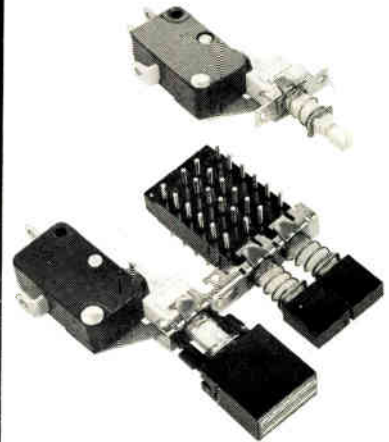

## 5 amp pushbutton switch

You'll meet even the most stringent requirements with this new line switch. It's UL listed for TV-5 rating (120V, 5A, 78A peak in-rush current).

Other features include:

- Furnished as a single station or for left or right mounting on any Centralab pushbutton switch assembly.
- Three circuit options—SPDT, SPST, normally open and SPST, normally closed.
- Button options include lighted, non-lighted or status indicator button (shown above).

See your Centralab Pushbutton Distributor or send inquiry card for complete specifications.

Isostat Licensed



**CENTRALAB**

Electronics Division

GLOBE-UNION INC.

P.O. BOX 858

FORT DOOGIE, IOWA 50501

# NEW!

## Design unusual circuits fast . . . with built-in, regulated, metered POWER!

Now you can build/test electronic circuits WITHOUT SOLDER . . . using solid #22 AWG wire to interconnect discrete components . . . resistors, transistors, linear/digital ICs in TO5 or DIP packages (8-40 pins), and more. Plus, you get 5-15 VDC up to 600ma (9 watts) of variable regulated power, with a built-in 0-15V voltmeter to monitor internal power and/or external circuits. Compact (6.75" L x 7.5" W x 3.25" H), lightweight (only 2 lbs.), and priced very low. Order your DM-1 off-the-shelf from your local distributor or direct from CSC on Master Charge, BankAmericard, Amer. Express. Prices subject to change. Patent #235,554.



CONTINENTAL SPECIALTIES CORPORATION  
Box 1942, New Haven, CT 06509 • 203/624-3103  
W. Coast: Box 7809, S. Francisco, CA 94119  
415/421-8872  
Canada: Len Finkler Ltd., Ontario  
© Copyright Continental Specialties Corp. 1975

# DESIGN MATE 1



Circle 164 on reader service card

## New Value For The Cost- Conscious Buyer \$1050 includes:

- 10 MHz at 10 mV/div •Dual Trace
- Compact Size (4" X 9" X 11") •Probes and Batteries

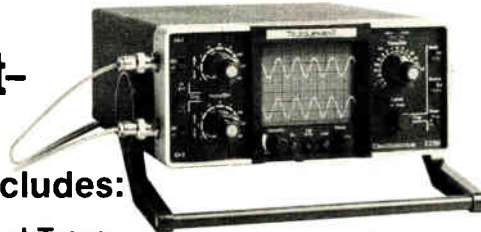

If your requirement dictates a portable oscilloscope with dual trace and 10 MHz at 10 mV/div sensitivity, but your budget demands frugality, then you should consider the new TELEQUIPMENT D32. It offers 10 mV/div to 5 V/div in 9 calibrated steps, automatic selection of chopped or alternate mode, depending on sweep speed setting, plus automatic selection of tv line or frame display. It also offers a choice of battery or ac line operation . . . with up to 4 hours continuous operation from 6 rechargeable, 'D' cell batteries. The batteries, two probes, and a molded front-panel protective cover are all included as **standard equipment**.

We feel the D32, at only 10 lbs., is

well suited as a servicing tool. Especially for industrial manufacturing, computer peripherals, and voice communication equipment. And it should be considered for servicing the rapidly increasing number of consumer electronic products.

If you agree and would like a demonstration at your convenience and in your environment, or simply additional information, contact your local Tektronix Field Office or write: Tektronix, Inc., P.O. Box 500, Beaverton, Oregon, 97077.

U.S. Sales Price FOB Beaverton, Oregon



**TEKTRONIX**  
committed to  
technical excellence

## New products

laser, and then evaporating the desired metal onto the substrate to which it will stick only where the laser has burned away the Vacu-Mask. The process is much simpler than conventional methods, the company says, and is readily adaptable to automated pattern generation. The patented process is available for licensing. Yosemite Laboratory will also manufacture custom systems to order.

Yosemite Laboratory, 2405 Fourth St., Berkeley, Calif. 94710. Ed Darling (415) 548-2995 [395]

## Production topics

A dicing service for extremely hard materials, such as sapphire, alumina, and quartz is offered by **Aremco Products Inc., Ossining, N. Y.** Quantities from one to 1,000 can be handled. . . . A set of four test-circuit patterns for the evaluation or ongoing monitoring of MOS/LSI processes are available from **MosFet \* Micro \* Labs Inc., Quakertown, Pa.** The test patterns are supplied in colored layers ready for the mask maker to cut rubies. . . . The WHO (wire-holding object) clip made by **Gudebrod Bros. Silk Co., Inc., Philadelphia** is now produced with holes at both ends for improved stability. . . . A hot-rail accessory for the company's model 202 IC handler has been introduced by **Ramsey Engineering Co., St. Paul, Minn.** The device is intended to preheat ICs for testing. . . . **Continental Specialties Corp., New Haven, Conn.**, is marketing a 24-pin test clip called the Proto-Clip 24. Similar to their earlier 14- and 16-pin models, the device makes it easy to get access to the leads of 24-pin DIPs mounted on high-density boards. . . . New rf cable assembly facilities opened by **Seaelectro Corp., Mamaronck, N.Y.**, will reduce costs of coaxial cable assemblies for the user. Operations include flexible and semi-rigid cable assembly work.



**ELECTROLUMINESCENT  
LAMPS  
SEALED PLASTIC  
CONSTRUCTION**

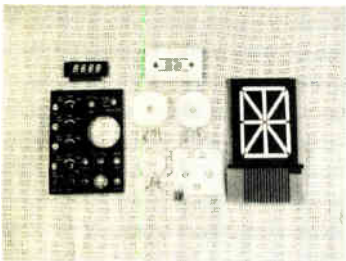

**WE MAKE:**

- Working el prototypes from your drawings in a few days
- Plastic lamps to replace metal ceramic lamps
- Customized el displays, read-outs, dot matrices
- El instrument and control panel lamps

**TLR**

T. L. Robinson Co., Inc.  
P.O. Box D, East Aurora, N.Y. 14052  
Telephone: (716) 652-2111

Circle 165 on reader service card

**Exclusive Economic  
and Industry Studies**

**For Financial Analysts,  
Corporate Planners,  
Business Economists,  
Marketing Executives**

Geared directly to the future, our Department of Economics offers more than 40 forecasting tools to help project the general economy and industrial growth over the short and long run.

**EXAMPLES:** Do you know that the current operating rate for the chemical industry is 86%? For synthetic materials, the utilization rate is 93%? That construction and mining machinery new orders are expected to be 8% higher in 1974 than in '73? That steel expects a 3% decline in physical volume of sales in 1974? That consumer income after taxes will increase 8% in 1975?

At a modest cost, our various services covering most industrial segments of the economy are available to you.

For more information write for our booklet, "Exclusive Economic Studies," or phone Douglas Greenwald, Chief Economist, (212) 997-2216.

**Department of Economics**  
McGraw-Hill Publications Company  
1221 Avenue of the Americas  
New York, N.Y. 10020



Electronics/November 27, 1975

**New products/materials**

**Vitreous solder glass** Corning Code 7555 is a low-temperature material that seals at 450°C. Because this temperature is below the annealing and strain points of the front- and back-plate glasses commonly used in liquid-crystal displays, these displays can be hermetically sealed with the solder glass with a minimum of display distortion and induced stress. Also, the relatively low sealing temperature minimizes changes in the resistivity of conductive coatings applied to the front and back plates. Supplied as a fine powder for screening onto LCD face plates, the material softens at 410°C. Electronic Materials Dept., Product Engineering, Corning Glass Works, Corning, N. Y. 14830 [476]

**Inorganic potting material** Eccoceram CS is a two-component system which, after curing at 150°C, can be used over the temperature range from -57°C to 815°C. Intended for the potting and bonding of electrical components and circuits, the cementing of metal and ceramic parts for high-temperature service, and as a sealant for wiring that will be exposed to high temperatures, Eccoceram CS is non-flammable both before and after curing. When cured, its physical properties are similar to those of ceramics. The material sells for \$5.05 per pound in 8-pound lots. Emerson & Cuming Inc., Canton, Mass. 02021 [477]

**A desiccant material** that serves as a structural part as well as a moisture-adsorbing agent, Natrasorb 900 will adsorb water equal to 18% of its own weight over a period of 10 to 100 hours. Supplied in molded blanks 2 inches in diameter by 1 in. thick, the material can be machined like nylon or aluminum. For high-volume applications, Natrasorb 900 can be supplied in custom shapes. The material can be reactivated by heating, and is particularly well suited for applications in which weight or space limitations militate against the use of a single-purpose desiccant.

Multiform Desiccant Products Inc., 1418 Niagara St., Buffalo, N. Y. 14213 [478]

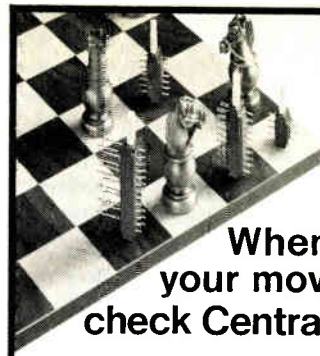

**When it's  
your move  
check Centralab**

**NEW!**

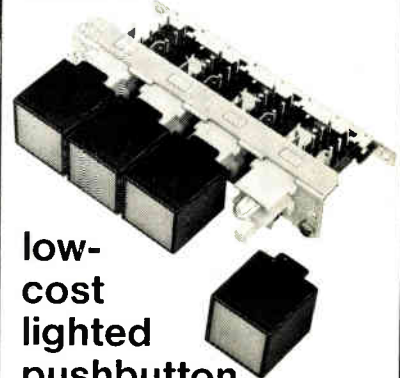

**low-  
cost  
lighted  
pushbutton  
switch**

Centralab reliability, low cost and new design freedom can be yours in this new lighted switch. Its T1-3/4 wedge base lamp brings the price way down\*. Its many options make it easier than ever to achieve an aesthetically harmonized panel. You get features like these:

- Flat, concave or recessed lenses with uniform light diffusion.
- Eight lens colors.
- PC terminated independent lamp circuit.
- 15mm, 17.5mm or 20mm. spacing options.
- Ganged assemblies through 16 stations.

See your Centralab Pushbutton Distributor or send inquiry card for complete specifications.

\* Per station cost at 1000 pieces, \$1.36  
2 PDT switch includes bulb.

Isostat Licensed



**CENTRALAB**

Electronics Division

GLOBE-UNION INC.

P.O. BOX 858

FORT OGDGE, IOWA 50501

Circle 193 on reader service card

# No design engineer should be without this book.

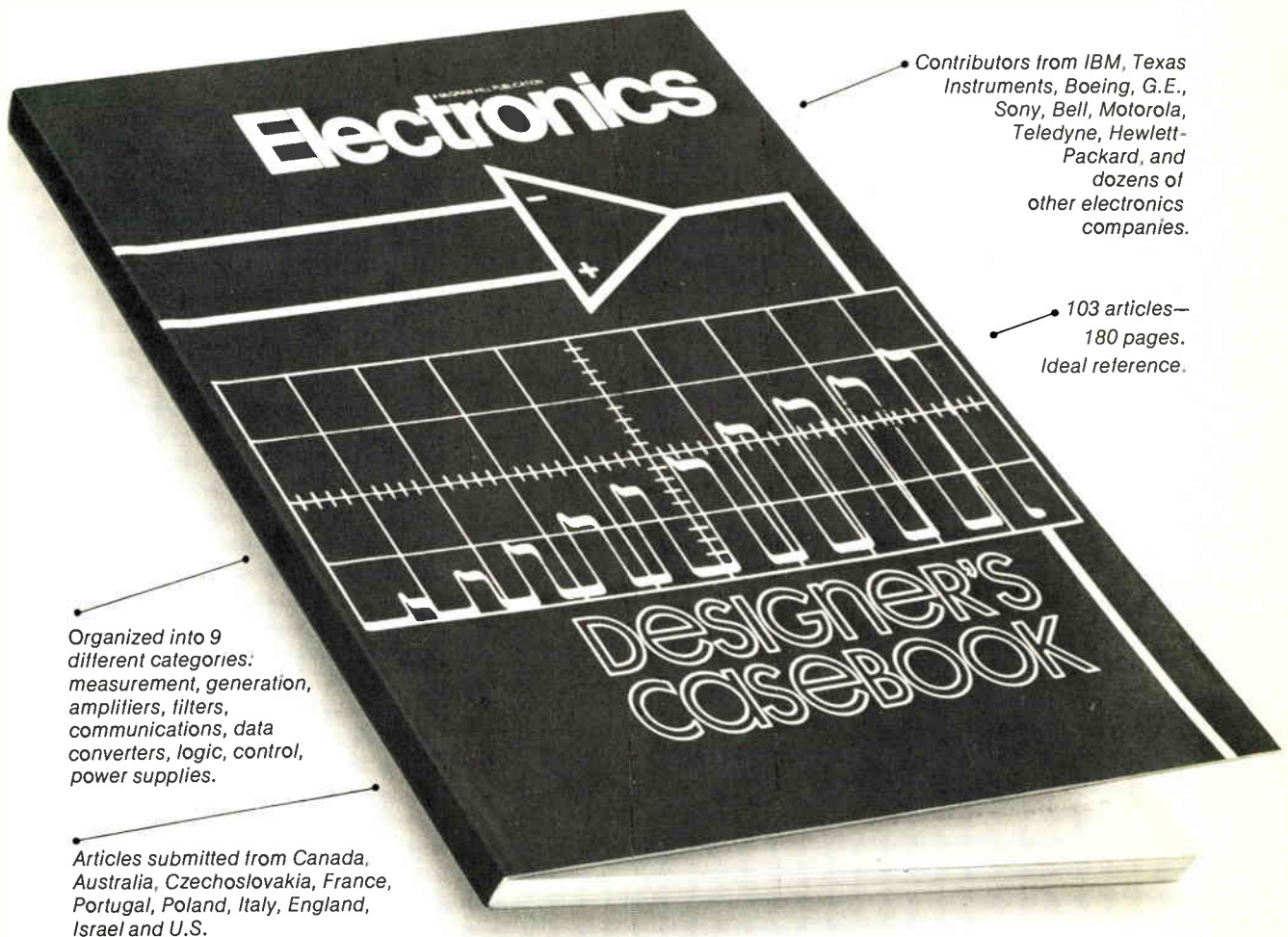

Contributors from IBM, Texas Instruments, Boeing, G.E., Sony, Bell, Motorola, Teledyne, Hewlett-Packard, and dozens of other electronics companies.

103 articles—180 pages. Ideal reference.

Organized into 9 different categories: measurement, generation, amplifiers, filters, communications, data converters, logic, control, power supplies.

Articles submitted from Canada, Australia, Czechoslovakia, France, Portugal, Poland, Italy, England, Israel and U.S.

The Designer's Casebook is indispensable. We're offering it to you *free* with your one-year introductory subscription to Electronics. To current subscribers, it is offered free with the first renewal notice.

We know we don't have to convince you of the value of Electronics. You're reading it now.

But, if you don't have your own subscription, we want to prove the great advantages of getting your own personal copy. That's why we're offering you this valuable Casebook free.

We can point out benefits like reading Electronics' current information, receiving your copy at home, reading a fresh, complete

copy instead of a dog-eared mess—but the real proof will only come with your own subscription.

Once you subscribe, we know you'll never go back to reading someone else's copy. There's a limit to togetherness.

Do it now. Fill out and mail the postpaid subscription card in the back of this issue. And get your Designer's Casebook free.

**Electronics**   
**THE SOURCE.**



## Thin Film Center Tapped Chip Resistors

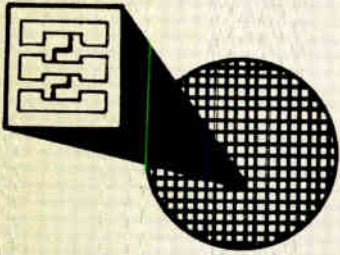

### STANDARD SPECIFICATIONS:

- 4.7 ohms to 560K ohms
- 0.03 x 0.03 x .007 Silicon
- 0.005 inch x 0.005 inch, Bonding Pad Aluminum.
- $\pm .1, 1, 5, 10$  and 20% standard. Custom tolerances from 0.01%.
- TCR,  $\pm 50$  ppm/ $^{\circ}\text{C}$ , from  $-55^{\circ}\text{C}$  to  $+150^{\circ}\text{C}$ . Custom  $\pm 10$  ppm/ $^{\circ}\text{C}$ .
- 250 mw.

For additional information  
write or call:



1001 Digital Drive, Hudson, N.H. 03051  
Tel. 603-883-9351 TWX 710-228-1377

Circle 194 on reader service card

## Gas Sensing Semiconductor

# FIGARO GAS SENSOR

**TGS** quickly senses  
even small  
amount  
of gas.

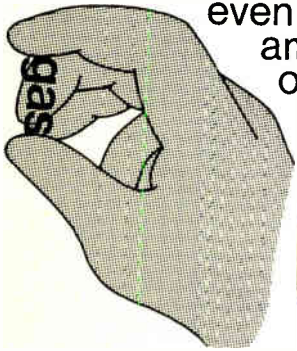

'75 New Models,  
some with highly sensitive  
CO sensor, now on the market.

Please contact the address below directly for  
catalogs and price/delivery information.

## FIGARO ENGINEERING INC.

3-7-3, Higashitoyonaka, Toyonaka City, Osaka 560,  
Japan/Tel (06) 849-2156

Cable: FIGARO TOYONAKA/Telex: 05286155 FIGARO J  
Circle 195 on reader service card

## New literature

**Power-supply testing.** "How to Avoid Common Pitfalls in Checking Power Supply Performance" is the title of a four-page bulletin written by Aaron Anton, secretary of committee SC22E on stabilized power supplies of the International Electrotechnical Commission. The bulletin covers metering techniques, line sources, thermal considerations, and the accurate measurement of load regulation by using Kelvin four-terminal connections along with proper grounding techniques. Bulletin 123A is available from Deltron Inc., Wissahickon Ave., North Wales, Pa. 19454. Circle reader service number 421.

**Selecting semiconductor fuses.** The determination of available fault current is the chief problem faced by designers who have to choose an appropriate protective device for a piece of electronic equipment. A discussion and a set of 33 curves for the computation of various short-circuit parameters are contained in a 10-page application note (AN-804) which can be obtained from International Rectifier Corp., Semiconductor Div., 233 Kansas St., El Segundo, Calif. 90245 [422]

**Power transistors.** An updated and expanded edition of the RCA Power Transistor Directory, PTD-187E, is offered by the RCA Solid State Division, Box 3200, Somerville, N. J. 08876. The 44-page catalog lists currently available power transistors and power hybrid circuits, along with applications information and a list of transistors which may be used as complementary pairs. [423]

**Impedance measurement.** A 40-page catalog of impedance-measuring instruments has been released by General Radio, 300 Baker Ave., Concord, Mass. 01742. The catalog is divided into four sections: impedance bridges, capacitance bridges, resistance bridges, and inductance bridges. Each section is introduced by a brief discussion of pertinent measurement theory and techniques. The catalog includes specifications for 25 instruments. [428]

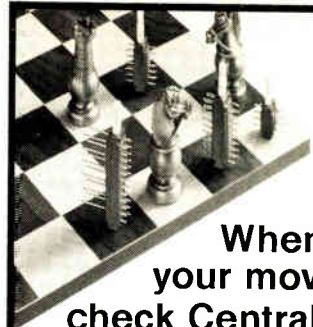

When it's  
your move  
check Centralab

## Visual display

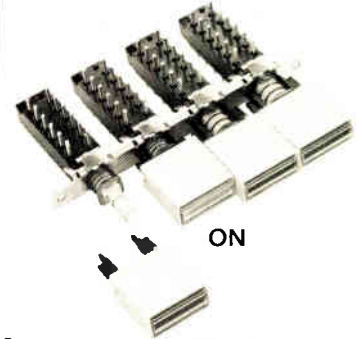

## in a non-lighted pushbutton switch

Now you can add visual display to Centralab non-lighted pushbutton switches. Our new status indicator button with a unique fluorescent reflective surface operates with ambient light to indicate switch status when activated. No power is required. There are no lamps to burn out.

Other features include:

- Choice of 6 display colors, 3 lens options and 5 button colors.
- Available with push-push or interlocking action.
- 140° peripheral viewing angle.
- Vertical or horizontal button mounting.

See your Centralab Pushbutton Distributor or send inquiry card for complete specifications.

Isostat Licensed



**CENTRALAB**

Electronics Division

GLOBE-UNION INC

P.O. BOX 858

FORT DODGE, IOWA 50501

Circle 167 on reader service card

# Electronics advertisers

November 27, 1975

■ Abbott Transistor Labs Inc.	6	■ Hewlett-Packard (Electronics Products Group)	17-26	* Riken Denahi Co. Ltd.	18E
Adam Osborne Associates	152	■ Honeywell Test Instrument Division	11	T. L. Robinson Company Inc.	165
* Alltech	24E	‡ Howard Industries	27	Roblnson Nugent, Inc.	70,71
Alps Electric Co., Ltd.	132	Individualized Instructions, Inc.	138	Rockwell International Electronics Group	56,57
American Microsystems, Inc.	84,85	Information Control Corporation	137	Rohde & Schwarz	103
Amphenol Connectors Division, Bunker Ramo Corporation	143	Intel Corporation	12,13	Schauer Manufacturing Corporation	81
■ Analog Devices, Inc.	9	* International Devices Inc.	67	■ Scientific Atlanta/Optima Division	158
* Anritsu Electric Co., Ltd.	9E	■ Interface Inc.	162	* S. E. Labs. (EMI) Ltd.	17E
■ AP Products Incorporated	161	Interswitch	155	* Sternica	20E
* Bayer AG	1E	Inzadi S.p.A.	161	* SGS Ates	23E
‡ Bourns, Inc.	7	■ Ithaco, Inc.	135	Signetics Corporation	28,29,155,157,159,161,162
Brand-Rex	2nd Cover	* ITT Cannon	34	Silicon Systems	157
■ Centralab Electronics Division Globe-Union, Inc.	163,165,167	■ Kepco, Inc.	5	* Sodeco	13E
* Cerne	22E	* L.E.A.	21E	Solitron Devices, Inc., Transistor Division	123
■ Clalrex Corporation	4th Cover	LFE Corporation, Process Control Division	38	■ Sorenson	54,55
Computer Automation	32,33	Logimetrics	89	Sprague Electric Company	8
■ Conap, Inc.	47	LRC Inc. Microelectronics	167	* STS SpA	27
■ Continental Specialties Corporation	164	McGraw-Hill Book Company	154	■ Superior Electric Company	150
Crydom	134	Micro Power Systems	31	Systek Corporation	129
Data General Corporation	45	Micro Switch Division of Honeywell	144,145	■ Systron Donner Concord Instruments	136,159
‡ Deico Electronics Division, General Motors Corp.	52,53	Micro Networks Corporation	87	Teikoku Tsushin Kogyo Company, Limited	127
■ Dialight Corporation	146,147	Molex, Incorporated	68,69	■ Tektronix, Inc.	43,72,73,164
‡ Digital Equipment Corp.—OEM	67	■ Nelson Ross Electronics, Division Polarad Electronics	1	Teledyne Philbrick	79
‡ Eastman Kodak Co. Graphics Markets Division—Engineering	15	Nikkel—Electronics	153	Teletype	74,75
EECO	76	■ Nippon Chemical Condenser Co. Ltd.	130	Thermalloy	170
E-H Research Laboratories, Inc.	61	Non-Linear Systems	148	Thomson CSF	114
■ Erie Technological Products, Co., Inc.	149	* Nuovo Pignone Divisione "Valvole & Strumenti"	11E	■ TRW, Cinch Connectors	90
Figaro Engineering Inc.	167	Oak Industries, Inc. Switch Division	157	United Systems Corp. A sub. of Monsanto Co.	139
‡ Fluke Trendar	34	* Orega-CC	12E	Vneshtorgreklama (Electronorgtehnika)	162
Fuji Electrochemical Company, Limited	128	* Oscilloquartz	4E	V/O Electronorgtehnika	160
Fujitsu Limited	126	* Philips Industries	52,53	Volgen Electric Co. Ltd.	127
General Electric—Instrument Rental Division	49	* Philips N.V. PIR/T&M Division	64,2E-3E	Wakfield Engineering	142
■ General Instrument Corporation, Semi. Comp. Division	2	* Phillips Eicoma	19E	Wavetek San Diego	58
General Instrument Corporation, Microelectronics, Division	50,51	Power One, Inc.	140	Wima, Westermann	16
General Magnetics	3rd Cover	Practical Automation, Inc.	169	* Yokogawa Electric Works Ltd.	14E
* General Semiconductor Industries, Inc.	15	Primo Co., Ltd.	130	Yutaka Electric Co., Ltd.	131
■ Gould Inc./Instrument Systems Division	106	* R 2 E	7E		
‡ Graphic Controls Corp.	64	Raytheon Semiconductor	30		
Hermes Electronics, Limited	62	* RCA Electro-Optics and Devices	7		
		RCA Electro-optics and Devices	170		
		RCA—Solid State Division	37		
		■ RCL Electronics, Inc.	14		
		Reticon Corporation	83		

■ For more information on complete product line see advertisement in the latest Electronics Buyer's Guide  
\* Advertisers in Electronics International  
‡ Advertisers in Electronics domestic edition



# What you must know about Microprocessors

Using articles from the pages of Electronics, this book contains practical and up-to-date information on available microprocessor devices, technology and applications—ranging from the simplest 4-bit p-channel MOS system to the second-generation n-MOS 8-bit processor chips, and the new injection logic and Schottky TTL bipolar processor families needed for the toughest computer-based control applications.

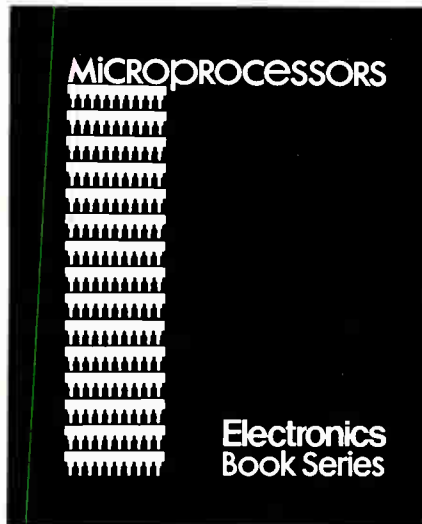

## Electronics Book Series

P.O. Box 669  
Hightstown, N.J. 08520



Send me \_\_\_\_\_ copies of "Microprocessors" at \$8.95 per copy.

I must be fully satisfied or you will refund full payment if the book is returned after 10 days free trial examination.

Payment enclosed     Bill firm  
 Bill me

### Credit Cards Charge My Book To:

American Express     Master Charge  
 Diners Club         BankAmericard

Acct. No. \_\_\_\_\_

Date Card Expires \_\_\_\_\_

Interbank No. \_\_\_\_\_

(1st No's. above name on Master Charge only.)

Name \_\_\_\_\_

Title \_\_\_\_\_

Company \_\_\_\_\_

Street \_\_\_\_\_

City \_\_\_\_\_

State \_\_\_\_\_ Zip \_\_\_\_\_

Signature \_\_\_\_\_

# One good turn...

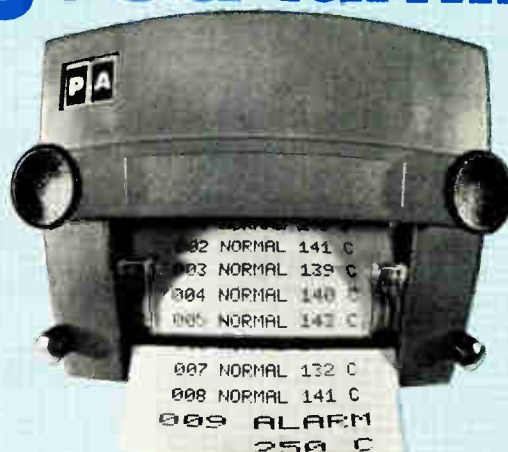

# deserves another.



You flipped over our Matri-Dot alphanumeric mini for "first line down" data printing; now we've flipped our design to give you "first line up" text print format, too. So you're ahead, whatever your point of view. Because no one else makes printers as small as 3"H x 3½"W x 7"D. No one else sells them as low as \$140 (in quantities of 100). And no one else offers our features. Instead of a drum, our unique print head purrs along at 138 lines per minute for 18 data columns, even faster for fewer columns. Instead of messy ribbons, our exclusive drop-in ink platen lasts for 75,000 lines and replaces from the front panel. And instead of engraved drum limitations, our 7 x 5 dot matrix characters provide full alphanumeric with a complete ASCII 63 character set. Enhanced characters are also available... 8, 10, 12, or 14 characters per inch. All this, plus multiple-copying capabilities and plug-in panel mounting. No matter how you look at Matri-Dot, it's a turn for the better.



Trap Falls Road ■ Shelton, Connecticut 06484

Tel: (203) 929-5381

Circle 169 on reader service card

**8204 Series**

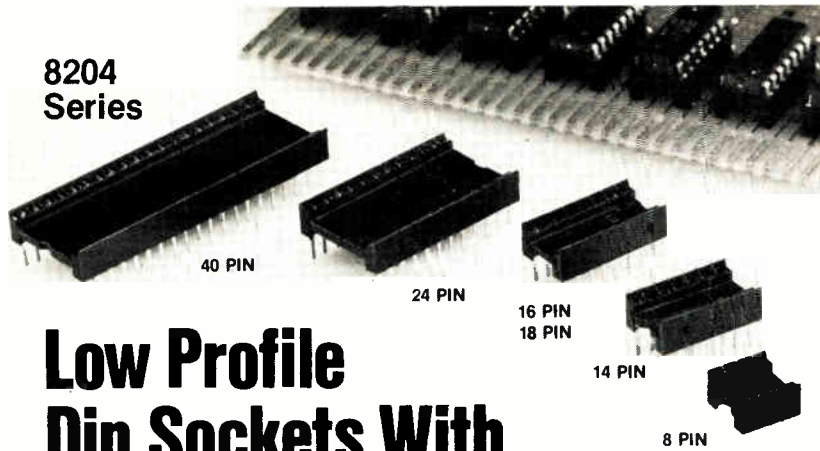

# Low Profile Dip Sockets With A Price to Match

New from Thermalloy, Inc. . . . A superb family of low cost DIP sockets for your IC applications.

The 8204 series insures electrical integrity with high force, redundant phosphor bronze contacts that exceed EIA specifications. Solder tails fit tight in the housing for positive anti-wicking.

The 8204 series saves insertion time by means of the wide angle lead-in housing.

The 8204 series "low" profile DIP sockets with a price to match . . . an unbeatable combination from Thermalloy, Inc.



**Thermalloy, Inc.**  
Post Office Box 34829 • 2021 West Valley View Lane  
Dallas, TX. 75234 • (214) 243-4321 • TWX: 910-860-5542

**NUMBER ONE IN SEMICONDUCTOR ACCESSORIES**

U.S.A.: 17 Sandy Lane, Farnborough Hants GU14 9AR, England, Tel: 0275-31179, Tlx: 856424  
Europe: 30 rue Roemischli, 1202 Geneva, Switzerland, Tel: (41) (22) 31 81 80, Tlx: (45) 222 88

For more details see eem p. 1880.

Write Dept. M for free samples.

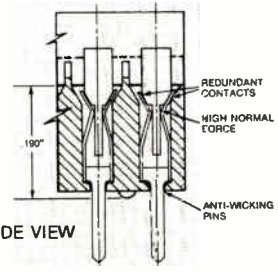

Circle 170 on reader service card

**Advertising Sales Staff**

**Pierre J. Braudé** New York [212] 997-3468  
Paris Tel: 720-73-01  
Director of Marketing

**Atlanta, Ga. 30309:**  
100 Colony Square, 1175 Peachtree St., N.E.  
[404] 892-2868

**Boston, Mass. 02116:** James R. Pierce  
607 Boylston St. [617] 262-1160

**Chicago, Ill. 60611:**  
645 North Michigan Avenue  
Robert W. Bartlett (312) 751-3739  
Paul L. Reiss (312) 751-3738

**Cleveland, Ohio 44113:** William J. Boyle  
[716] 586-5040

**Dallas, Texas 75201:**  
2001 Bryant Tower, Suite 1070  
[214] 742-1747

**Denver, Colo. 80203:** Harry B. Doyle, Jr.  
123 Speer Blvd. # 400  
[303] 837-1010

**Detroit, Michigan 48202:** Robert W. Bartlett  
1400 Fisher Bldg.  
[313] 873-7410

**Houston, Texas 77002:**  
2270 Humble Bldg [713] CA 4-8381

**Los Angeles, Calif. 90010:** Robert J. Rielly  
Bradley K. Jones, 3200 Wilshire Blvd., South Tower  
[213] 487-1160

**New York, N.Y. 10020**  
1221 Avenue of the Americas  
Warren H. Gardner [212] 997-3617  
Michael J. Stoller [212] 997-3616

**Philadelphia, Pa. 19102:** Warren H. Gardner  
Three Parkway,  
[212] 997-3617

**Pittsburgh, Pa. 15222:** Warren H. Gardner  
4 Gateway Center, [212] 997-3617

**Rochester, N.Y. 14534:** William J. Boyle  
9 Greylock Ridge, Pittsford, N.Y.  
[716] 586-5040

**San Francisco, Calif. 94111:** Don Francis  
Robert J. Rielly, 425 Battery Street,  
[415] 362-4600

**Paris:** Alain Offergeld  
17 Rue-Georges Bizet, 75 Paris 16, France  
Tel. 720-73-01

**Geneva:** Alain Offergeld  
1 rue du Temple, Geneva, Switzerland  
Tel. 32-35-63

**United Kingdom & Scandinavia:** Keith Mantle  
Tel: 01-493-1451, 34 Dover Street, London W1

**Milan:** Luigi Rancati  
1 via Baracchini, Italy Phone 87-90-656

**Brussels:** Alain Offergeld  
23 Chaussee de Wavre  
Brussels 1040, Belgium  
Tel: 13-73-95

**Frankfurt/Main:** Fritz Krusebecker  
Liebigstrasse 27c, Germany  
Phone 72 01 81

**Tokyo:** Tatsumi Katagiri, McGraw-Hill  
Publications Overseas Corporation,  
Kasumigaseki Building 2-5, 3-chome,  
Kasumigaseki, Chiyoda-Ku, Tokyo, Japan  
(581) 9811

**Australasia:** Warren E. Ball, IPO Box 5106,  
Tokyo, Japan

**Business Department**

**Thomas M. Egan,**  
Production Manager [212] 997-3140

**Carol Gallagher**  
Production Manager International [212]  
997-2045

**Dorothy Carter,** Production Manager Do-  
mestic  
[212] 997-2908

**Frances Vallone,** Reader Service Manager  
[212] 997-6057

**Electronics Buyers' Guide**

**George F. Werner,** Associate Publisher  
[212] 997-3139

**Regina Hera,** Directory Manager  
[212] 997-2544

# There's no RF energy crisis with RCA power tubes.

RCA's combined families of regular and large power tubes not only comprise the broadest line of such tubes in the industry, but they range in power all the way up to 250 kW . . . and in frequency to 1450 MHz.

Covering almost every major power tube application area, the RCA line also includes a comprehensive array of cavities and circuits. These cavities and circuits are specifically designed to enhance the advantages of RCA's power tubes. Together they achieve a total power package unmatched for reliable high performance.

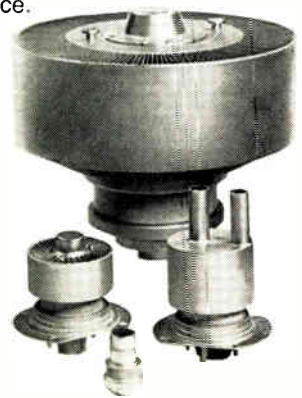

For more information on the entire RCA power tube line, call your RCA Representative or RCA Industrial Tube Distributor, or complete and return the coupon.

## RCA Lancaster — where people and technology make the difference.

Manager, Power Tube Marketing  
RCA, New Holland Avenue, Bldg. 100  
Lancaster, Pa. 17604

\_\_\_\_ Please send me the RCA Power, Frequency and Application Chart.  
\_\_\_\_ Please have an RCA Representative call me. Telephone \_\_\_\_\_

— This is your mailing label. Please print. —

\_\_\_\_ Name \_\_\_\_\_  
\_\_\_\_ Company \_\_\_\_\_  
\_\_\_\_ Street \_\_\_\_\_  
\_\_\_\_ City \_\_\_\_\_  
\_\_\_\_ State \_\_\_\_\_ Zip \_\_\_\_\_



170 Circle 171 on reader service card



# Electronics

PLEASE ENTER MY SUBSCRIPTION TO ELECTRONICS FOR:

1.  ONE YEAR AT \$12  
 THREE YEARS AT \$30

- Payment Enclosed  
 Bill My Company  
 Bill Me

CHARGE MY SUBSCRIPTION TO

<input type="checkbox"/> AMERICAN EXPRESS	<input type="checkbox"/> MASTER CHARGE
<input type="checkbox"/> DINERS CLUB	<input type="checkbox"/> BANKAMERICARD
ACCT. NO. _____	
DATE CARD EXPIRES _____	
INTERBANK NO. _____ 1st No.'s. above name on Mastercharge only.	

52700

NAME \_\_\_\_\_ TITLE \_\_\_\_\_

COMPANY \_\_\_\_\_ DIV. or DEPT \_\_\_\_\_

COMPANY ADDRESS \_\_\_\_\_

CITY \_\_\_\_\_ STATE \_\_\_\_\_ ZIP \_\_\_\_\_

Check here if you wish publication to be sent to home address STREET \_\_\_\_\_ CITY \_\_\_\_\_ STATE \_\_\_\_\_ ZIP \_\_\_\_\_

Above rates apply only to those who answer all questions listed below. All others pay higher than basic price of \$25.00 per year.

Signature \_\_\_\_\_

2.  1 PLANT  2 DEPARTMENT

Indicate the primary product manufactured or service performed at your plant (Box 1) and in your department (Box 2). Be sure to indicate applicable letter in each of the two boxes even if they are the same letter.

- A. Large computers  
 B. Mini-computers  
 C. Computer peripheral equipment  
 D. Data Processing Systems (systems integration)  
 E. Office and business machines  
 F. Test and measuring equipment  
 G. Communications systems and equipment  
 H. Navigation and guidance or control systems  
 I. Consumer entertainment electronic equipment  
 J. Other consumer electronic equip. (appliances, autos, hand tools)

- K. Industrial controls, systems and equipment  
 L. Sub-assemblies  
 M. Passive electronic components  
 N. Active electronic components  
 O. Materials and Hardware  
 P. Aircraft, Missiles, space and ground support equipment  
 Q. Oceanography and support equipment  
 R. Medical electronics  
 S. Industrial equipment containing electronic components or products  
 T. Independent R&D laboratory and consultant

- U. Research and development organizations which are a part of an educational institution  
 V. Government Agency and military  
 W. Industrial companies using and/or incorporating electronic products in their mfg., research or development activities  
 X. Utilities  
 Y. Broadcasting, sound and motion pictures and recording studios  
 Z. Commercial users of electronic equipment (railroads, pipelines, police, airlines)  
 9. College, University

3.  Indicate your principal job function (place applicable number in box. If numbers 9, 10, or 11 are used, fill in name of college or university)

- General and corporate management
- Design and development engineering
- Engineering services (evaluation, quality control, reliability, standards, test)
- Basic research
- Manufacturing and production
- Engineering support (lab assistant, technician)
- Purchasing and procurement
- Marketing and sales
- Professor at \_\_\_\_\_
- Senior student at \_\_\_\_\_
- Graduate student at \_\_\_\_\_  
 Senior and graduate students are eligible for professional rate for one year subscription only.

4.  Indicate your principal job responsibility (place applicable number in box)  
 1. Management 2. Engineering

5. Are you engaged in or do you supervise the design or redesign of electronic components or equipment? (check one)

YES  NO

6.  Your design function: (insert each letter that applies)

- A. I do electronic design or development engineering work  
 B. I supervise electronic design or development engineering work  
 C. I set standards for, or evaluate electronic design components, systems and materials

7. Estimated number of employees at this location. (check one)

1 to 49  50 to 249  250 to 999  over 1,000

First Class  
Permit No. 42  
Hightstown, N.J.

**BUSINESS REPLY MAIL**

No postage stamp necessary if Mailed in the United States

POSTAGE WILL BE PAID BY

**Electronics**

**McGRAW-HILL, INC.  
SUBSCRIPTION DEPT.  
P.O. BOX 514  
HIGHTSTOWN, N.J. 08520**

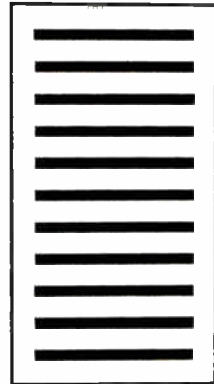



For additional information on products advertised, new products or new literature, use the adjacent business reply cards.

Complete entire card. Please print or type.

Circle the number on the Reader Service postcard that corresponds to the number at the bottom of the advertisement, new product item, or new literature in which you are interested.

To aid the manufacturer in filling your request, please check the appropriate industry classification box.

All inquiries from outside the U.S. that cannot reach Electronics before the expiration dates noted on the Reader Service postcard must be mailed directly to the manufacturer. The manufacturer assumes all responsibilities for responding to inquiries.

**Subscriptions & Renewals**  
 Fill in the subscription card adjoining this card. Electronics will bill you at the address indicated on the card.

**ELECTRONICS** November 27, 1975 Card expires February 13, 1976

NAME \_\_\_\_\_ TITLE \_\_\_\_\_  
 PHONE \_\_\_\_\_ COMPANY \_\_\_\_\_  
 STREET \_\_\_\_\_  
 CITY \_\_\_\_\_ STATE \_\_\_\_\_ ZIP \_\_\_\_\_

**Industry Classification (check one)**

- a Computer & Related Equip.
- b Communications Equip. & Systems
- c Navigation, Guidance or Control Systems
- d Aerospace, Underseas Ground Support
- e Test & Measuring Equip.
- f Consumer Products
- g Industrial Controls & Equip.
- h Components & Subassemblies
- j Independent R&D Organizations
- k Government

1	21	41	61	81	101	121	141	161	181	201	221	241	261	343	363	383	403	423	443	463	483	503	713
2	22	42	62	82	102	122	142	162	182	202	222	242	262	344	364	384	404	424	444	464	484	504	714
3	23	43	63	83	103	123	143	163	183	203	223	243	263	345	365	385	405	425	445	465	485	505	715
4	24	44	64	84	104	124	144	164	184	204	224	244	264	346	366	386	406	426	446	466	486	506	716
5	25	45	65	85	105	125	145	165	185	205	225	245	265	347	367	387	407	427	447	467	487	507	717
6	26	46	66	86	106	126	146	166	186	206	226	246	266	348	368	388	408	428	448	468	488	508	718
7	27	47	67	87	107	127	147	167	187	207	227	247	267	349	369	389	409	429	449	469	489	509	719
8	28	48	68	88	108	128	148	168	188	208	228	248	268	350	370	390	410	430	450	470	490	510	720
9	29	49	69	89	109	129	149	169	189	209	229	249	269	351	371	391	411	431	451	471	491	701	900
10	30	50	70	90	110	130	150	170	190	210	230	250	270	352	372	392	412	432	452	472	492	702	901
11	31	51	71	91	111	131	151	171	191	211	231	251	271	353	373	393	413	433	453	473	493	703	902
12	32	52	72	92	112	132	152	172	192	212	232	252	272	354	374	394	414	434	454	474	494	704	901
13	33	53	73	93	113	133	153	173	193	213	233	253	273	355	375	395	415	435	455	475	495	705	952
14	34	54	74	94	114	134	154	174	194	214	234	254	274	356	376	396	416	436	456	476	496	706	953
15	35	55	75	95	115	135	155	175	195	215	235	255	284	357	377	397	417	437	457	477	497	707	954
16	36	56	76	96	116	136	156	176	196	216	236	256	338	358	378	398	418	438	458	478	498	708	956
17	37	57	77	97	117	137	157	177	197	217	237	257	339	359	379	399	419	439	459	479	499	709	957
18	38	58	78	98	118	138	158	178	198	218	238	258	340	360	380	400	420	440	460	480	500	710	958
19	39	59	79	99	119	139	159	179	199	219	239	259	341	361	381	401	421	441	461	481	501	711	959
20	40	60	80	100	120	140	160	180	200	220	240	260	342	362	382	402	422	442	462	482	502	712	960

**ELECTRONICS** November 27, 1975 Card expires February 13, 1976

NAME \_\_\_\_\_ TITLE \_\_\_\_\_  
 PHONE \_\_\_\_\_ COMPANY \_\_\_\_\_  
 STREET \_\_\_\_\_  
 CITY \_\_\_\_\_ STATE \_\_\_\_\_ ZIP \_\_\_\_\_

**Industry Classification (check one)**

- a Computer & Related Equip.
- b Communications Equip. & Systems
- c Navigation, Guidance or Control Systems
- d Aerospace, Underseas Ground Support
- e Test & Measuring Equip.
- f Consumer Products
- g Industrial Controls & Equip.
- h Components & Subassemblies
- j Independent R&D Organizations
- k Government

1	21	41	61	81	101	121	141	161	181	201	221	241	261	343	363	383	403	423	443	463	483	503	713
2	22	42	62	82	102	122	142	162	182	202	222	242	262	344	364	384	404	424	444	464	484	504	714
3	23	43	63	83	103	123	143	163	183	203	223	243	263	345	365	385	405	425	445	465	485	505	715
4	24	44	64	84	104	124	144	164	184	204	224	244	264	346	366	386	406	426	446	466	486	506	716
5	25	45	65	85	105	125	145	165	185	205	225	245	265	347	367	387	407	427	447	467	487	507	717
6	26	46	66	86	106	126	146	166	186	206	226	246	266	348	368	388	408	428	448	468	488	508	718
7	27	47	67	87	107	127	147	167	187	207	227	247	267	349	369	389	409	429	449	469	489	509	719
8	28	48	68	88	108	128	148	168	188	208	228	248	268	350	370	390	410	430	450	470	490	510	720
9	29	49	69	89	109	129	149	169	189	209	229	249	269	351	371	391	411	431	451	471	491	701	900
10	30	50	70	90	110	130	150	170	190	210	230	250	270	352	372	392	412	432	452	472	492	702	901
11	31	51	71	91	111	131	151	171	191	211	231	251	271	353	373	393	413	433	453	473	493	703	902
12	32	52	72	92	112	132	152	172	192	212	232	252	272	354	374	394	414	434	454	474	494	704	901
13	33	53	73	93	113	133	153	173	193	213	233	253	273	355	375	395	415	435	455	475	495	705	952
14	34	54	74	94	114	134	154	174	194	214	234	254	274	356	376	396	416	436	456	476	496	706	953
15	35	55	75	95	115	135	155	175	195	215	235	255	284	357	377	397	417	437	457	477	497	707	954
16	36	56	76	96	116	136	156	176	196	216	236	256	338	358	378	398	418	438	458	478	498	708	956
17	37	57	77	97	117	137	157	177	197	217	237	257	339	359	379	399	419	439	459	479	499	709	957
18	38	58	78	98	118	138	158	178	198	218	238	258	340	360	380	400	420	440	460	480	500	710	958
19	39	59	79	99	119	139	159	179	199	219	239	259	341	361	381	401	421	441	461	481	501	711	959
20	40	60	80	100	120	140	160	180	200	220	240	260	342	362	382	402	422	442	462	482	502	712	960

If the cards below have already been used, you may obtain the needed information by writing directly to the manufacturer, or by sending your name and address, plus the Reader Service number, to Electronics Reader Service Department, Box 2530, Clinton, Iowa 52732.

# Electronics

P.O. Box No. 2530  
Clinton, Iowa 52732

Affix  
Postage here

# Electronics

P.O. Box No. 2530  
Clinton, Iowa 52732

Affix  
Postage here

## Electronics Reprint Service

Bulk reprints of editorial matter can be ordered from current or past issues. The minimum quantity is 500 copies. Prices quoted on request: call 609-448-1700 Ext. 5494, or write to address below.

**Bringing Sight to the Blind**  
8 pages \$2.00  
Key no. R-408

**Logic's New Design Tools**  
16 pages \$3.00  
Key R-406

**U.S. Market Report**  
28 pages \$2.00  
Key R-404

**European Market Report 1974**  
24 pages \$2.00  
Key R-402

**Japan Market Report 1974**  
18 pages \$2.00  
Key R-400

**The Pervasiveness of Electronics**  
Complete issue 284 pages \$2.00  
Key no. R-328

**The Optical Spectrum**  
\$2.00 Key no. R-326

**Semiconductor Memory Systems**  
16 pages \$3.00 Key no. R-324

**New Electronic Displays**  
10 pages \$2.00 Key no. R-322

**Planar Interconnection Techniques**  
13 pages \$3.00 Key no. R-320

**Automotive Electronics**  
16 pages \$3.00 Key no. R-318

**Hybrid Circuit Technology**  
16 pages \$3.00 Key no. R-316

**Leadless, Pluggable IC Packages Reduce Costs** 7 pages \$2.00  
Key no. R-312

**Penetration Color Tubes are Enhancing Information Displays** 6 pages \$2.00  
Key no. R-310

**Program for Transition from Non Linear to Linear Transistor Model**  
6 pages \$2.00 Key no. R-308

**Charge Coupling Improves Its Image**  
8 pages \$2.00 Key no. R-306

**Electromagnetic Spectrum Chart**  
Key no. R-213 \$2.00

**Electromagnetic Spectrum Report**  
16 pages plus Wall Chart \$4.00  
Key no. R-211

**Active Filters**  
96 pages \$4.00 Key no. R-032

**Circuit Designer's Casebook**  
182 pages \$5.50 Key no. R-031

To order reprints or for further information, please write to:

**Electronics Reprint Department**  
P.O. Box 669  
Hightstown, N.J. 08520

Only orders with cash, check, or money order will be accepted. No invoicing will be done.



# SOLID STATE 3 WIRE SYNCHRO TO LINEAR D.C. CONVERTER



RESPONSE CURVE

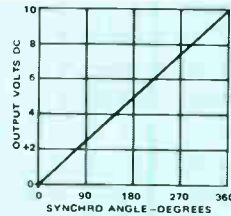
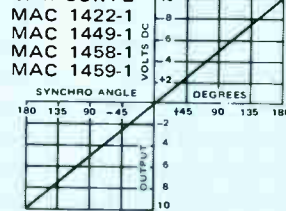

RESPONSE CURVE

MAC 1460-1  
MAC 1461-1

## FEATURES:

- Develops a DC output voltage linearly proportional to a synchro angle over a  $\pm 180^\circ$  range.
- Completely solid state with all of the inherent advantages over a mechanical system such as:
  - High reliability (since there are no moving parts)
  - Light weight—6 ozs.
  - Small size
  - All units hermetically sealed

- Wide temperature range operation
- Output short circuit protected
- Three wire inputs isolated from ground
- Package size may be altered at no extra cost
- Units can be altered to accept different line to line voltages or different operating frequencies at no extra cost
- Not affected by reference voltage or power supply variations.

UNIT	MAC 1422-1	MAC 1449-1	MAC 1458-1	MAC 1459-1	MAC 1460-1	MAC 1461-1
TRANSFER EQUATION	$\pm 1V/18^\circ$	$\pm 1V/18^\circ$	$\pm 1V/18^\circ$	$\pm 1V/18^\circ$	$+1V/36^\circ$	$+1V/36^\circ$
ACCURACY (+25°C)	½%	½%	½%	½%	½%	½%
ACCURACY (-25°C+85°C)	1%	1%	1%	1%	1%	1%
L - L SYNCHRO INPUT (VRMS)	11.8	90	11.8	90	11.8	90
FREQUENCY (Hz)	400	400	60	60	400	400
FULL SCALE OUTPUT	$\pm 10V$	$\pm 10V$	$\pm 10V$	$\pm 10V$	+10V	+10V
OUTPUT IMPEDANCE	$<1\Omega$	$<1\Omega$	$<1\Omega$	$<1\Omega$	$<1\Omega$	$<1\Omega$
L - L INPUT IMPEDANCE	$>10K$	$>30K$	$>2K$	$>10K$	$>10K$	$>30K$
REFERENCE VOLTAGE (VRMS)	26	115	26	115	26	115
OPERATING TEMP. °C	-25 - +85	-25 - +85	-25 - +85	-25 - +85	-25 - +85	-25 - +85
D.C. SUPPLY	$\pm 15V$	$\pm 15V$	$\pm 15V$	$\pm 15V$	$\pm 15V$	$\pm 15V$
D.C. SUPPLY CURRENT	$\pm 75MA$	$\pm 75MA$	$\pm 75MA$	$\pm 75MA$	$\pm 75MA$	$\pm 75MA$
BANDWIDTH	10Hz	10Hz	OPT.	OPT.	10Hz	10Hz
WEIGHT	6 oz.	6 oz.	6 oz.	8 oz.	6 oz.	6 oz.
SIZE	3.6x2.5x0.6	3.6x2.5x0.6	3.6x3.0x0.6	3.6x3.0x1.0	3.6x2.5x0.6	3.6x2.5x0.6

## A.C. LINE REGULATION

A new method has been developed which allows us to provide a low distortion highly regulated AC waveform without using tuned circuits or solid state active filters of any kind.

The result is a frequency independent AC output regulated to 0.1% for line and load with greater than 20% line variations over a wide temperature range.

### FEATURES:

- 0.1% total line and load regulation
- Independent of  $\pm 20\%$  frequency fluctuation
- 1 watt output
- Extremely small size
- Isolation between input and output can be provided

Specifications: Model MLR 1476-1

AC Line Voltage: 26V  $\pm 20\%$  @ 400Hz  $\pm 20\%$

Output: 26V  $\pm 1\%$  for set point

Load: 0 to 40ma

Total Regulation: +0.1%

Distortion: 0.5% maximum rms

Temperature Range:  $-55^\circ C$  to  $+125^\circ C$

Size: 2.0" x 1.8" x 0.5"

Other units are available at different power and voltage levels as well as wider temperature ranges. Information will be furnished upon request.

## SOLID-STATE SINE-COSINE SYNCHRO CONVERTER - NON VARIANT

This new encapsulated circuit converts a 3 wire synchro input to a pair of dc outputs proportional to the sine and cosine of the synchro angle independent of a-c line fluctuations.

- Complete solid state construction
- Operates over a wide temperature range
- Independent of reference line fluctuations
- Conversion accuracy—6 minutes
- Reference and synchro inputs isolated from ground

Specifications Model DMD 1508-2

Accuracy: Overall conversion accuracy 6 minutes. Absolute value of sine and cosine outputs accurate to  $\pm 30MV$

Temperature Range: Operating  $-40^\circ C$  to  $+85^\circ C$ , Storage  $-55^\circ C$  to  $+125^\circ C$

Synchro Input: 90V RMS  $\pm 5\%LL$  400Hz  $\pm 5\%$

DC Power:  $\pm 15V DC \pm 10\%$  @ 50MA

Reference: 115VRMS  $\pm 5\%$  400Hz  $\pm 5\%$

Output: 10V DC full scale output on either channel @ 5ma load

Temperature coefficient of accuracy:  $\pm 15$  seconds/ $^\circ C$  avg. on conversion accuracy  $\pm 1 MV/^\circ C$  on absolute output voltages

Size: 2.0" x 1.5" x 2.5"

Units are available with wider temperature ranges and 11.8V LL, 26V reference synchro inputs. Information will be supplied upon request.

There is No Substitute for Reliability



# GENERAL MAGNETICS • INC

135 Bloomfield Ave., Bloomfield, New Jersey 07003 - Tel. (201) 743-2700

Circle 901 on reader service card

# Optical switches tailored to fit.



## Clairex offers a choice of standard and custom switches with hermetically sealed components.

Don't make your design to fit an optical switch. Let Clairex® make the optical switch to fit your design.

You can get two standard sizes with gap widths of .100 in. or .250 in. Or we'll make them to any width or size you specify.

We seal both the LED and phototransistor in hermetic cases for long life in the harshest environments. Then pretest each switch to make sure it works. The lenses or windows are glass, not plastic, to reduce dust pickup. (Lenses position the light beam more accurately, preventing false signals from stray light.) Outputs are compatible with T<sup>2</sup>L inputs.

Sensors are either phototransistors or photodarlingtons.

You can forget about friction wear, switching "noise", and contact bounce. The two switch heads are completely isolated. Switching time can be as short as 5 microseconds — impossible with mechanical switches.

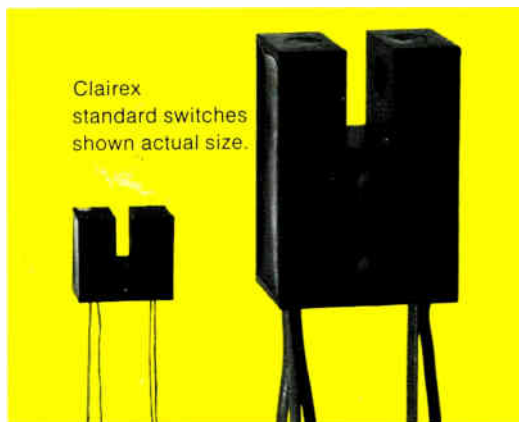

Tell us what you need. We'll develop the solution. With Clairex, you get the best in opto-electronic components — photodarlingtons, phototransistors, photoconductors, opto-isolators. Write Clairex Electronics at 560 South Third Avenue, Mount Vernon, New York 10550. Or phone (914) 664-6602.



**CLAIREX ELECTRONICS**

Circle 902 on reader service card