

JUNE 26, 1975

TV MAKERS TURNING TO DIGITAL TUNERS/65

Understanding digital correlation techniques/98

The lambda diode: a versatile negative-resistance device/105

FOUR DOLLARS A MCGRAW-HILL PUBLICATION **International**
Electronics®

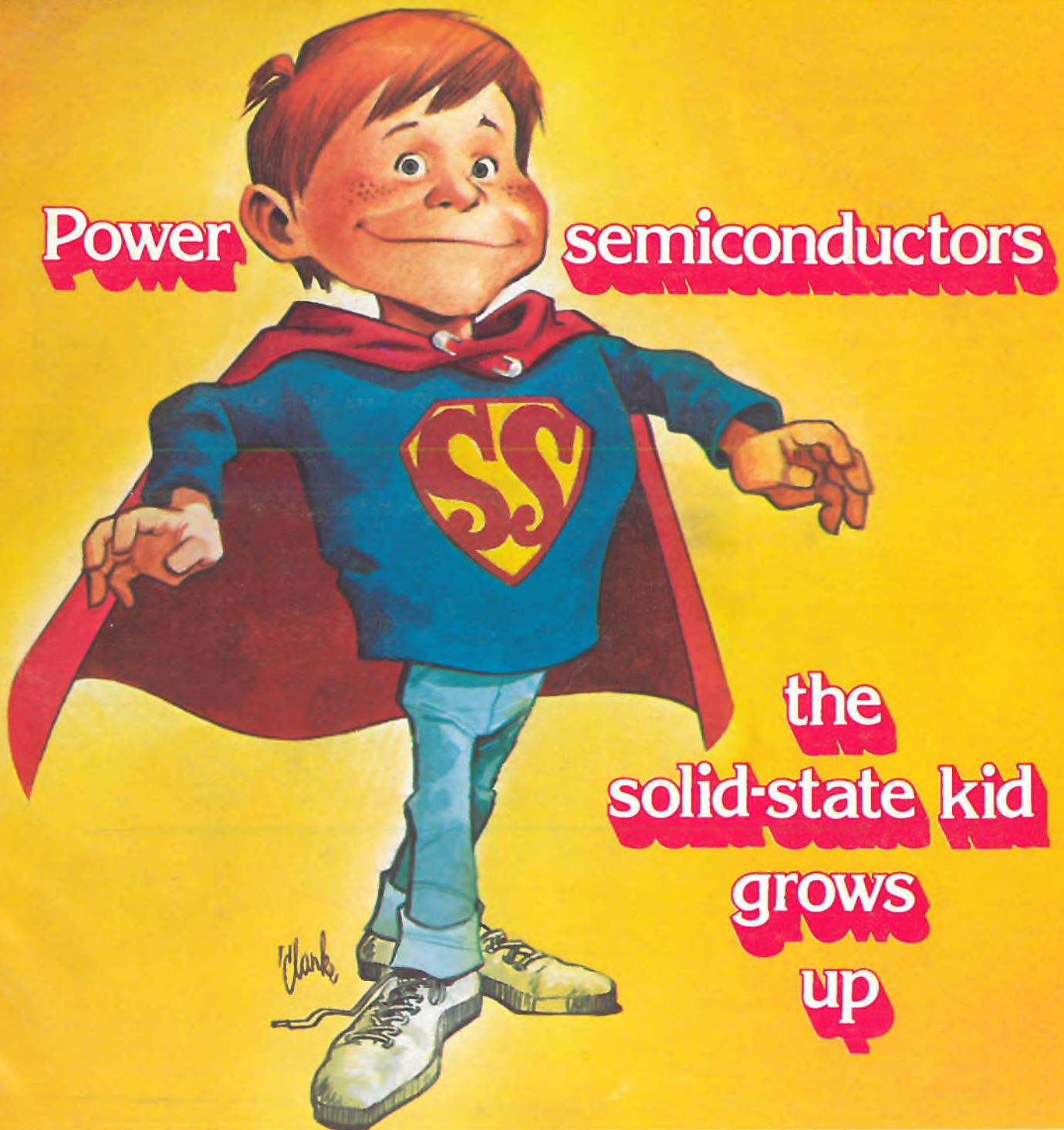

He just completed half a day's testing before his morning coffee break.

The secret? His new 3312A Function Generator—the new-generation source that's actually two function generators in one box. It took the hassle out of his input-signal set-ups. He simply pushed a few buttons and had the functions he needed. No custom equipment... or a kludge of instruments to get a complex waveform.

Because the 3312A has a main generator that can be triggered by a built-in modulation generator, it let him select sweep or gated functions, AM, FM, FSK, or tone bursts with pushbutton ease... plus dozens of other functions he never thought he could get. He got better performance too. Like square waves that didn't become sine waves at 10 MHz. And all for only \$900*.

So enjoy your morning coffee break. But have the satisfaction of some valuable testing under your belt first. Your local HP field engineer can give you all the details on this new-generation instrument. He'll also be happy to tell you about the other members of our source family. From our low-cost, general-purpose function generator to our automatic synthesizers. Give him a call today.



3330B Automatic Synthesizer

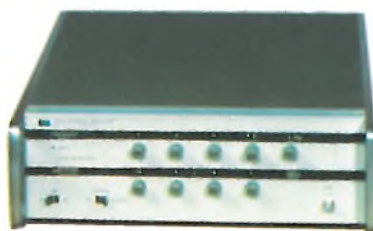

3320B Frequency Synthesizer



3311A Function Generator

3310A Function Generator

HEWLETT  PACKARD

Sales and service from 172 offices in 65 countries
1501 Page Mill Road, Palo Alto, California 94304

*Domestic USA price only.

Circle 900 on reader service card

09648

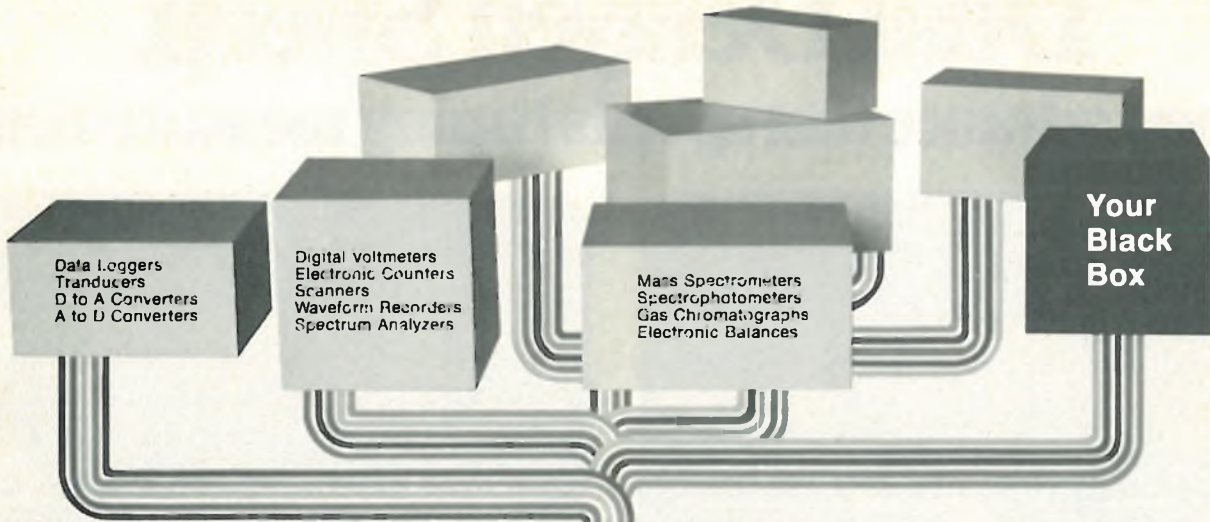

Your Instruments. Our Calculator.

Here's the connection: HP interface cards.

What's so special about them? The amount of time and money they save you. By simply connecting one end to your instrument or black box and the other end to our computing calculator you have an automatic instrumentation system. Then the calculator controls all those things that take up so much of your valuable time—adjusting controls, making measurements, and extracting meaningful answers from masses of data. It frees you from serving as the interface.

Put your connector on the end of the cable and, for all practical purposes, you have a computer-controlled system that can be easily tailored to the job at hand. And you don't have to replace your present instruments or redesign your black boxes if they have any of the common

interfaces. Binary, BCD, ASCII data codes (parallel or serial)—HP has interface cards that handle just about any problem that may arise.

But how about stand-alone use of your instruments or calculator? No problem. You can go from automatic to manual in just about three seconds, as fast as you can unplug the interface card.

If you'd like the complete story on interfacing, use the coupon to request order information for our 77-page manual, "Selecting an HP Calculator Interface." It's a detailed discussion of everything from the calculator and hardware interface to programming and the HP Interface Bus. We also invite you to use the coupon—or call your local HP Sales Office—for free information on ways in which our computing calculators can help you do more with your instruments and electronic devices.

*Domestic USA price only.



HEWLETT  PACKARD

Sales and service from 172 offices in 65 countries.
P.O. Box 301, Loveland, Colorado 80537

- Tell me more about your computing calculators and interface cards.
- Send me order information for your 77-page, \$5.00* interface manual.
 - Send me your free calculator interface material.
 - Please call.

I plan to use your calculator for: _____
 Name _____
 Title _____
 Address _____
 City/State _____
 Zip _____ Phone _____

HP Calc. Inq., P.O. Box 301, Loveland, Colorado 80537

816M

Dual-Delayed Sweep.

A new advance that speeds timing measurements

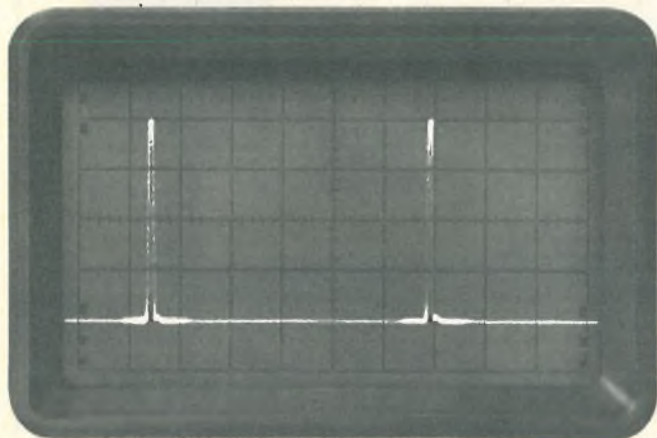

Main-Sweep Mode

Set start point/Set stop point
Read the time interval between
dots directly.

2.735 -6

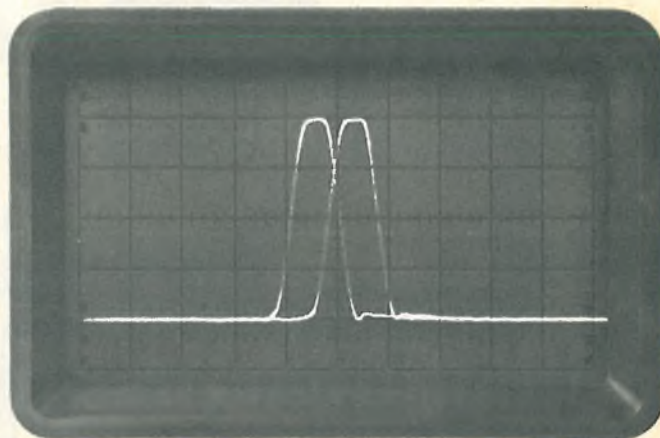

Delayed-Sweep Mode

Start point/Stop point
Start and stop events viewed together
—overlap them for maximum accuracy.

2.735 -6

HP's Dual-Delayed Sweep makes timing measurements just this simple: set two markers on your scope trace and read the time interval between them on a built-in LED display or a separate DVM.

Testing is faster because your setup is easier...there's no graticule counting...no mental calculations either. Accuracy is improved because drift, nonlinearities, and many sources of human error are eliminated.

In the Main Sweep Mode, you simply set the start point with one marker (first dot) and the stop point with the second marker. HP's 1722A oscilloscope with microprocessor automatically gives you a direct time-interval readout on the built-in LED display. With our 1712A oscilloscope, you get direct readings by connecting a DVM to the Time-Interval output. For increased resolution and accuracy, the Dual-Delayed Sweep lets you overlap (null) two traces using the scope controls and again gives you a direct time-interval reading.

If you've had to give up the 1% accuracy achievable with single delayed sweep because you couldn't afford the test time, Dual-Delayed Sweep could be the answer. Since it lets you see both start and stop events simultaneously, you can follow adjustments in your system—even if they're interactive—until you're right on. This can give you as much as a factor of 4 reduction in adjustment time.

Repeatability—so important in critical timing adjustments—is improved as much as 10 times compared to conventional scopes without digital readout.

Whether you're doing single-trace measurements—such as risetimes, pulse durations, and periods—or dual trace measurements—such as propagation delays, dual-clock phasing, and other measurements from one waveform to another—Dual-Delayed Sweep lets you work to new standards of speed and accuracy.

At HP, we made comparative tests using a conventional (single-delay) scope, a single-delay scope with digital readout, and a scope with Dual-Delayed Sweep (DDS). Twelve people made one time-interval measurement each. Based on these tests, we at HP found that Dual-Delayed Sweep (DDS) is about three times faster than a single-delay scope with a turns-counting dial and about the same as a single-delay scope with digital readout. In repeatability, DDS is about five times more repeatable than a conventional scope with digital readout and ten times more repeatable than a conventional scope with a turns-counting dial.

With the 1722A, you can also measure frequency, voltage, and percent with the same ease...and have a direct 4-digit readout on the built-in LED display.

Dual-Delayed Sweep is a standard feature in HP's 1712A 200 MHz scope (time-interval via external DVM—\$3100) and in our 275 MHz 1722A (with LED's built-in—\$4750). Contact your local HP field engineer and find out how Dual-Delayed Sweep can speed your timing measurements while improving their accuracy.



HEWLETT  PACKARD

Sales and service from 172 offices in 65 countries.
1501 Page Mill Road, Palo Alto, California 94304

for Technical Information circle 2 on reader service card

for Immediate Applications Assistance circle 145 on reader service card

29 Electronics Review

MILITARY: Tri-service program aims at standard electronic modules, 29
COMMUNICATIONS: Selecting the best path improves hf links, 30
CONSUMER: Digital chronograph uses diode, liquid-crystal displays, 31
Color-TV filter built on a single chip, 32
TV-sales decline seen to be slowing, 32
COMPONENTS: Mechanical dial-switch gets optical replacement, 34
INDEX OF ACTIVITY: 34
FIBER OPTICS: Optical-fiber link transmits 6.3 megabits/second, 36
AVIONICS: Aviation electronics to increase sales, 38
NEWS BRIEFS: 38
AUTOMATIC TEST: Tester checks out boards at 4 MHz, 40

53 Electronics International

JAPAN: Polysilicon layer improves devices, 5E
FRANCE: TV camera tracks low-flying planes, 6E
WEST GERMANY: 150 grams actuate 'motionless' switch, 8E
JAPAN: Ink-jet printer can vary matrix, 8E
SOUTH AFRICA: TV arrives, but it's expensive, 10E
NEW PRODUCTS INTERNATIONAL: 17E

65 Probing the News

CONSUMER ELECTRONICS: For TV tuners, a digital touch, 65
MEMORIES: Is bubble technology nearing the market? 68
COMPANIES: Yankees put down roots in Quebec, 70
COMPONENTS: The hi-re! business stays good, 74
COMPUTERS: Gearing up for microcomputers, 78

81 Technical Articles

SPECIAL REPORT: Solid-state power reaches new highs, 81
Moderate-power devices flourish, 83
Power devices handle industrial jobs, 88
Devices improve for communications, 90
DESIGNER'S CASEBOOK: Microphone cable brings preamp power, 94
Converter changes 7-segment output to decimal or BCD, 95
Capacitive transducer senses tension in muscle fibers, 97
INSTRUMENTS: Fast Fourier transform simplifies correlation, 98
COMPONENTS: The lambda diode: a versatile device, 105
ENGINEER'S NOTEBOOK: LEDs replace CRT in solid-state scope, 110
Chart recorder plots total of loads in several circuits, 111
Mixed dielectrics improve capacitor stability, 112

117 New Products

IN THE SPOTLIGHT: IC compresses, expands analog signals, 117
Baud-rate generator provides dual output, 118
COMPONENTS: Relays use novel magnetic circuit, 120
INSTRUMENTS: Pulse generator is priced at \$79.95, 126
PACKAGING & PRODUCTION: In-circuit tester checks 900 points, 131
INDUSTRIAL: Battery-run data logger lasts more than a year, 137

Departments

Publishers letter, 4
Readers comment, 6
News update, 8
Editorial, 10
People, 14
Meetings, 20
Electronics newsletter, 25
Washington newsletter, 49
International newsletter, 55
Engineer's newsletter, 114

Highlights

The cover: Power semiconductors take off, 81

Highly refined technologies are producing power semiconductors that can handle megawatts of power at microsecond speeds with great reliability. And high yields have pushed prices down to bargain levels.

Cover is by internationally known cartoonist Bob Clarke.

TV-set makers are turning to electronic tuners, 65

Technically improved and cheaper varactor tuners will soon find their way into the popular 25- and 19-inch television sets. An FCC regulation virtually mandates their use, and set manufacturers also hope to woo customers with the novelty.

How the FFT simplifies correlation, 98

By speeding up the calculations involved, the fast Fourier transform makes it practicable to retrieve signals from a noisy transmission by correlating it with the signals expected. But some pitfalls in the use of the FFT must be avoided.

Negative-resistance device is highly versatile, 105

The lambda diode has an unprecedentedly wide range of characteristics—and applications. It can be used as a fuse, a battery-voltage monitor, in oscillators and dc-to-ac converters, and in static memories.

And in the next issue . . .

Special report on large-scale integration . . . the Wiegand magnetic effect and its many uses . . . timing specifications worth watching in designing with MOS memories.

EDITOR-IN-CHIEF: Kemp Anderson

EXECUTIVE EDITOR: Samuel Weber

MANAGING EDITORS: Lawrence Curran, *News*;
Arthur Erikson, *International*

SENIOR EDITORS: John Johnsrud,
H. Thomas Maguire, Laurence Altman,
Ray Connolly, Stephen E. Scrupski

ART DIRECTOR: Fred Sklenar

ASSOCIATE EDITORS: Howard Wolff,
Gerald M. Walker, Alfred Rosenblatt

DEPARTMENT EDITORS
Aerospace/Military: Ray Connolly
Circuit Design: Don Blattner
Communications & Microwave:
Richard Gundlach
Components: Lucinda Mattera
Computers: Stephen E. Scrupski
Consumer: Gerald M. Walker
Industrial: Margaret A. Maas
Instrumentation: Andy Santoni
New Products: H. Thomas Maguire,
Michael J. Riezenman
Packaging & Production: Jerry Lyman
Solid State: Laurence Altman
COPY EDITORS: Margaret Eastman,
Everett C. Terry, Bill Dunne

ART: Charles D. Clatto, *Associate Director*
Patricia Cybulski, *Assistant Director*

PRODUCTION EDITOR: Arthur C. Miller

EDITORIAL SECRETARIES: Janet Noto,
Julie Gorgoglione, Penny Roberts

FIELD EDITORS

Boston: Gall Farrell (Mgr.), Pamela Leven
Los Angeles: Paul Franson (Mgr.)
Judy Phelps
Midwest: Larry Armstrong (Mgr.)
New York: Ron Schneideman (Mgr.)
San Francisco: Bernard Cole (Mgr.)
Judith Curtis
Washington: Ray Connolly (Mgr.)
Larry Marion
Frankfurt: John Gosch
London: William F. Arnold
Paris: Arthur Erikson
Tokyo: Charles Cohen

McGRAW-HILL WORLD NEWS

Director: Ralph R. Schulz
Bonn: Robert Ingersoll
Brussels: James Smith
London: James Trotter
Madrid: Dom Curcio
Milan: Andrew Heath
Moscow: Peter Gall
Paris: Michael Johnson, Richard Shepherd
Stockholm: Robert Skole
Tokyo: Mike Mealey

PUBLISHER: Dan McMillan

DIRECTOR OF MARKETING: Pierre J. Braucé

ADVERTISING SALES SERVICE MANAGER:
Wallis Clarke

BUSINESS MANAGER: Stephen R. Weiss

CIRCULATION MANAGER: Nancy L. Merritt

MARKETING SERVICES MANAGER:
Tomlinson Howland

RESEARCH MANAGER: Margery D. Sholes

There once was a time—and it was not so long ago at that—when a transistor that could handle 10 watts of power was considered pretty hot stuff. Now the leading edge of technology has pushed transistor power ratings up into the kilowatt range. What's more, other semiconductor devices now carry megawatt ratings. And switching speeds are going up, too.

Says components editor Lucinda Mattera, in our special report on power semiconductors (see p. 81): "Incredibly, a 1,200-V silicon-controlled rectifier with a current rating of 850 A root-mean-square can now turn off in less than 18 microseconds."

You'll find a host of useful device descriptions and specifications, as well as details about marketing and application trends, in the 12-page power semiconductor report. For convenience, the report is divided into three parts: low- and medium-power devices for commercial, industrial, and military applications; high-power devices for industry; and low- and medium-power devices for communications.

"Power is relative," says Lucinda, "it can mean milliwatts up in the microwave region, megawatts down close to dc, or intermediate levels in between. A mere half-dozen years ago, many different technologies were being used to produce devices with poor reliability, and low yields kept prices high.

"But today, production practices have been narrowed to several highly refined techniques to produce reliable power devices that are often downright cheap. The performance of currently available

power semiconductors is already impressive, and yet the state of the art will be pushed to even higher levels within the next six months."

Electronics technology seems finally to be successfully invading another stronghold of the mechanical approach to design. And, since it is over how to design the tuner for television sets, the scene for this battle of technologies could hardly be more fitting.

On page 65, you'll find a round-up of just where electronic tuning stands as manufacturers weigh cost and redesign factors against operating convenience, adaptability to remote control, compatibility to digital circuitry, and the need to offer new features to consumers.

Says consumer editor Jerry Walker: "According to most estimates, fewer than 10% of U.S.-made color-TV sets today have electronic tuners, as against nearly 100% of the color receivers made and sold in Europe. In previous years, picture tubes and picture control circuits have received most attention—remember "the brightness race" and later the emphasis on "one-button" control for color, tint, brightness, and contrast.

"But it now appears that the tuner's time has come, thanks in part to the conclusion by set makers that as long as the uhf channels have to be tuned as conveniently as the vhf, the whole thing might as well be done with a single electronic tuner.



June 26, 1975 Volume 48, Number 13
96,844 copies of this issue printed

Published every other Thursday by McGraw-Hill, Inc. Founder: James H. McGraw '80-'84B. Publication office: 1221 Avenue of the Americas, N.Y., N.Y. 10020; second class postage paid at New York, N.Y., and additional mailing offices.

Executive, editorial, circulation and advertising addresses: Electronics, McGraw-Hill Building, 1221 Avenue of the Americas, New York, N.Y. 10020. Telephone (212) 997-1221. Teletype TWX N.Y. 710-581-5234. Cable address: MCGRAW HILL L.N.Y.

Subscriptions limited to persons with active, professional, functional responsibility in electronics technology. Publisher reserves the right to reject non-qualified requests. No subscriptions accepted without complete identification of subscriber name, title, or job function, company or organization, including product manufactured or services performed. Subscription rates: qualified subscribers in the United States and possessions, Canada, and Mexico \$12.00 one year, \$24.00 three years; all other countries \$25.00 per year, except Japan and Israel \$50.00 per year, Brazil \$40.00 per year, Australia and New Zealand \$60.00 per year, including air freight. Limited quota of subscriptions available at higher-than-basic rate for persons outside of field served, as follows: U.S. and possessions and Canada, \$25.00 one year; all other countries \$50.00. Single copies: \$4.00.

Officers of the McGraw-Hill Publications Company: John R. Emery, President; J. Elton Tuohy, Executive Vice President-Administration; Gene W. Simpson, Group Publisher-Vice President; Senior Vice Presidents: Ralph Blackburn, Circulation; Walter A. Starbury, Editorial; John D. Heiland, Controller; David G. Jensen, Manufacturing; Gordon L. Jones, Marketing; Jerome D. Luntz, Planning & Development.

Officers of the Corporation: Shelton Fisher, Chairman of the Board and Chief Executive Officer; Harold W. McGraw, Jr., President and Chief Operating Officer; Wallace F. Trendly, Group President, McGraw-Hill Publications Company and McGraw-Hill Information Systems Company; Robert N. Landes, Senior Vice President and Secretary; Reich J. Webb, Treasurer.

Title registered in U.S. Patent Office; Copyright ©1975 by McGraw-Hill, Inc. All rights reserved. The contents of this publication may not be reproduced in whole or in part without the consent of copyright owner.

Subscribers: The publisher, upon written request to our New York office from any subscriber, agrees to refund that part of the subscription price applying to copies not yet mailed. Please send change of address notices or complaints to Fulfillment Manager, subscription orders to Circulation Manager, Electronics, at address below. Change of address notices should provide old as well as new address, including postal zip code number. If possible, attach address label from recent issue. Allow one month for change to become effective. Postmaster: Please send form 3579 to Fulfillment Manager, Electronics, P.O. Box 430, Hightstown, N.J. 08520.

The small economy size function generator,

\$295.



Sine, square and triangle waveforms from 0.002Hz to 2MHz at a price you can handle.

If you're in the market for a low-cost, versatile function generator, we've got the unit for you. Model 5700 is the little big man of our 5000 series, with multifunctions, balanced output and a general versatility unmatched at the price. It features a 1000:1 tuning dial, covering the whole audio spectrum on one frequency range. The 50 ohm single ended output and 600 ohm balanced output

are controlled by a common attenuator. An auxiliary square wave output enables synchronization, gating and blanking. Model 5700 is the ideal choice for a broad range of electronic applications from research to calibration. With this performance at a bargain price why shop around?

For fast action, call (617) 580-1660, or contact your local KH representative listed below.

**KH KROHN-HITE
CORPORATION**

Avon Industrial Park, Avon, Mass. 02332 • (617) 580-1660

OVERSEAS SALES OFFICES: ARGENTINA: Coasin, S.A. AUSTRIA: Universal Elektronik Impari. AUSTRALIA: Warburton Franki Limited. BELGIUM: C.N. Rood S.A. DENMARK: SC Metric A/S. ENGLAND: Keithley Instruments, Ltd. FINLAND: Into O/Y. FRANCE: M.B. Electronique. GERMANY: Nucletron Vertriebs GMBH. HOLLAND: C.N. Rood n.v. INDIA: Bait International Agencies. ISRAEL: R.D.T. Electronics Engineering, Ltd. ITALY: Vianelli SPA. JAPAN: Shoshin Seiji Kaisha, Ltd. NEW ZEALAND: Warburton Franki, Ltd. NORWAY: Telemetrisystem A.B. PORTUGAL: Magnetron. SINGAPORE: O'Connor's Ltd. SOUTH AFRICA: Protea Physical. SPAIN: Rema Lino Haag, S.A. SWEDEN: Telemetrisystem A.B. SWITZERLAND: Megex Zurich GMBH.

Circle 146 on reader service card

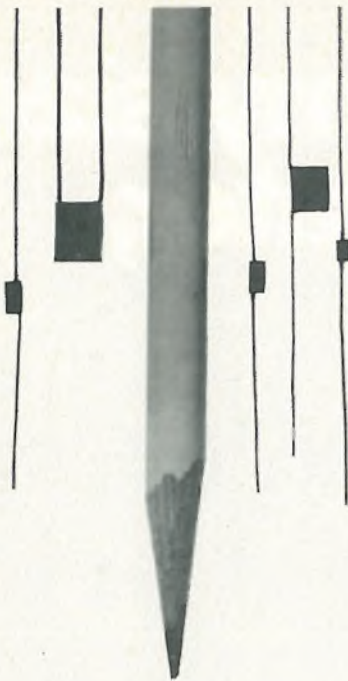

**Tansitor
Miniature solids...
designed to
meet your
tantalum
capacitor
needs... 3 ways.**

in performance. These tantalum HA (cylindrical) and TC (rectangular) deliver a capacitance range from .01 to 68 uf and .01 to 470 uf. Both carry a 2-50VDC and an operating range of - 55°F to 85°C with voltage derating to 125°C. Our polar and non-polar miniatures are encased in plastic with epoxy seals and offer a choice of radial or axial leads. With 24 case sizes one of our standards will meet your needs... perfectly.

in price. Ask for a quote. You'll find us extremely competitive. That's why we're a leading manufacturer of tantalum mini-solids.

and in delivery. At Tansitor, we're different. Our delivery schedule is tailored to your needs. Need we say more? For more information or spec sheets, call your Tansitor representative or write:

Tansitor
ELECTRONICS
DIVISION OF AEROTRON, INC

West Rd. • Bennington, VT 05201
Phone: 802/442-5473 TWX: 710/360-1782

Readers comment

Controlling air traffic

To the Editor: As stated in your air-traffic control article [May 1, p. 34], our 12,000 non-tower airports do have about twice as many collisions as the 500 tower fields, but that makes the tower collision "rate" (your word) 12 times (not your 1/2) the nontower "rate." What's more, non-tower collisions increased less (55%) than the plane-population (57%), while collisions at tower fields went up 250%. Tower clearances had been optional for pilots before 1961, but were mandated that year by rule changes, eroding pilot responsibility and alertness.

We grass-roots pilots can be uneasy: you quote DOT program manager Paul Abramson planning "ultra-high" frequency channels we don't carry, and, worse, saying that his system would get its input from the airport's "radar beacon system" which none of our airports have.

Allen W. Hayes
Chartair Inc.
Ithaca, N.Y.

Paul Abramson replies: The relevant statistic to use in judging the safety of an airport is accidents per operation, not accidents per airport as Mr. Hayes suggests. To take just one example: according to a recent FAA-sponsored report, during 1971, 19 collisions occurred at the 5,000 uncontrolled airports that had more than 5,000 operations that year. These airports generated 77 million operations, yielding a collision rate of 2.4×10^{-7} accidents/operation. For that same year, the 327 airports with towers produced about 52 million operations with seven collisions, yielding a collision rate of 1.3×10^{-7} .

These automated systems under consideration are being designed for higher-density non-towered airports. The intent is to provide the FAA with a lower-cost alternative to a tower. Such a system is to be an automated advisory system, not an automated control system. As such, it will not infringe upon pilot responsibility or the alertness of traffic in the airport area.

The system will employ very-

high-frequency voice communications, not ultra-high-frequency communications. This was an error in the article.

We share Mr. Hayes' belief that providing dedicated voice channels would enhance safety and efficiency of operations at non-towered airports. However, we must keep in mind the serious channel-allocation problem that such a concept would encounter, especially in light of the fact that many aircraft operating at low-to-medium-density airports may not have 50-kHz channel-spacing capability. However, the FAA is seriously studying this approach for a near-term improvement in operations at non-towered airports.

Misstatement cited

To the Editor: Your article entitled, "Theft of secrets: headache continues" [May 15, p. 63], contains a material misstatement of fact regarding the complaint filed by American Microsystems Inc. against Synertek in February of 1974.

This case was never heard on its merits and was, in fact, settled out of court. As part of the settlement, Synertek agreed to refrain from soliciting certain categories of AMI technical employees for two years and to refrain from hiring for one year. A court order was issued as a result of the settlement agreement and the only thing the judge "agreed" to was the settlement itself. As part of the settlement, the AMI suit against American Telecommunications Corp., General Automation Inc., and Victor Comptometer Corp. was dismissed with prejudice.

Robert J. Schreiner
Synertek
Santa Clara, Calif.

Error found

To the Editor: In my article "Multiplying factors correct power for ac waveforms" [March 20, p. 133], constant E in the list of constants at the end of the table, should read:

$$E = (\theta/180) - [(sin 2\theta)/2\pi]$$

William D. Kraengel Jr.
Valley Stream, N.Y.

HiNIL Interface

Keeping the bugs out of microprocessor systems with high noise immunity logic.

An MOS microprocessor system can be troubled by disastrous bugs unless it is protected against noise transients generated by switches, electromechanical peripherals and other nearby noise sources, such as lamps and machinery. But filters and shielding, the traditional cures, are often difficult to add to a microprocessor because of size and cost constraints.

These problems can be avoided by substituting HiNIL interface devices for conventional I/O logic. HiNIL—Teledyne's bipolar High Noise Immunity Logic—has a guaranteed DC noise immunity about 10 times that of TTL, for example (3.5 vs. 0.4V). Also, HiNIL blocks AC transients large enough to cause TTL malfunctions. Two additional advantages are superior output drive and, in low power systems, protection of CMOS memory and random logic inputs.

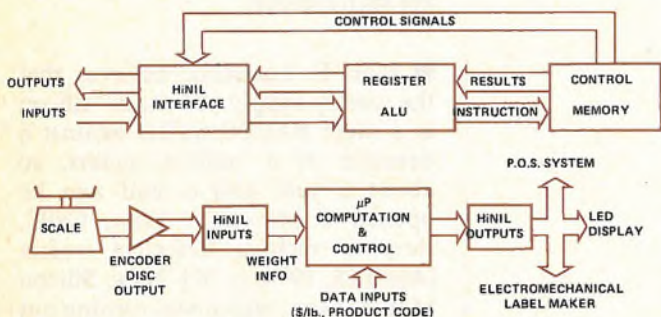

Figure 1. Use of HiNIL interfaces in POS systems with electronic scale. Top diagram shows basic microprocessor configuration.

One manufacturer of microprocessor-controlled electronic scales decided to use the configuration in Figure 1 because he was concerned about the consequences of incorrect weights and prices. The probability of errors resulting from noise transients was high because the scale would be used in a supermarket POS system, where the environment includes refrigerators, fluorescent lamps, meat grinders and electromechanical label makers.

In the system, the microprocessor receives weight codes from an encoder disc in the scale and operates a cash register interface, LED display, and relays of a receipt printer or label maker. The system designers put HiNIL interface logic on the microprocessor board to handle the I/O functions, suppress noise transients picked up along the transmission lines, and drive the peripheral devices. HiNIL output interfaces can drive long lines, relays, displays and lamps without additional components since they sink up to

65 mA and source up to 12 mA. (The new 390 buffer series will sink up to 250 mA.)

Manufacturers of systems requiring random logic are finding that HiNIL and CMOS are an ideal combination. They maximize system noise immunity and assure an excellent system function/power product. HiNIL and 54C/74C CMOS interface directly at V_{CC} voltages from 10 to 16 volts, the power supply range of HiNIL. Moreover, HiNIL protects CMOS inputs from destruction by static electricity and from harmful DC input levels that can exist before CMOS circuits are powered up.

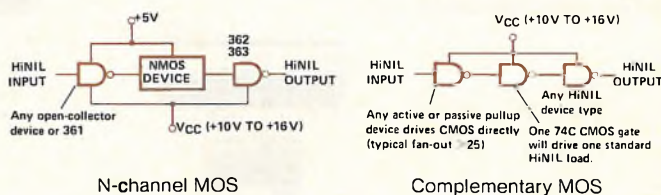

Figure 2. Typical HiNIL/MOS and HiNIL/CMOS interfaces

The rules for using HiNIL with MOS or with CMOS operating at lower voltages are simple. The pullup resistor of an open collector HiNIL device is connected to the desired high logic level voltage (see Figure 2). To use HiNIL with other bipolar logic, just plug in a Teledyne dual or quad interface circuit (see table). HiNIL is also compatible with most analog devices.

Examples of HiNIL Interface Devices

301 Dual 5-Input Power Gate	65mA relay or lamp driver
302 Quad Power NAND Gate (OC)	
323 Quad NAND Gate (OC)	Input noise protection plus open-collector pullup to other logic levels
332 Hex Inverter (OC)	
334 Strobed Hex Inverter (OC)	
350 8-Bit Multiplexer	Drive longer lines than TTL with 10X noise immunity ($I_{OH} = 12mA$)
351 Dual 4-Bit Multiplexer	
361 Dual Input Interface	361 directly connects HiNIL to DTL/RTL/TTL
362 Dual Output Interface	362 and 363 connect DTL/RTL/TTL to HiNIL
363 Quad Output Interface	
367 Quad Schmitt Trigger	Suppress 100V/1µs spikes, protect CMOS, decode switches, etc.
368 Quad Schmitt Trigger (OC)	
380 BCD to Decade Decoder	
381 BCD to Decade Decoder (OC)	Provide decode/drive for lamps, LEDs, gas discharge displays, etc.
382 BCD to Decade Decoder	
383 BCD to 7-Segment Decoder	
390 Interface Buffer Series	250mA HiNIL driver series will be available soon

If you need a simple, inexpensive solution to a difficult noise problem, write or call Teledyne Semiconductor for a copy of application notes and specifications on Teledyne's High Noise Immunity Logic family.

TELEDYNE SEMICONDUCTOR

1300 Terra Bella Avenue, Mountain View, California 94043 Tel: (415) 968-9241 TWX: 910-379-6494 Telex: 34-8416

ENGLAND: Heathrow House, Cranford, Hounslow, Middlesex, Tel: (44) 01-897-2503 Telex: 851-935008

FRANCE: 90, Avenue Des Champs Elysees, 75008 Paris, Tel: 2563069 Telex: 842-29642

WEST GERMANY: Albert Gebhardtstrasse 32, 7897 Tiengen, Tel: 7741-5066 Telex: 841-792-1462

JAPAN: Nihon Seimei-Akasaka Bldg. (3F), 1-19, Akasaka 8-chome, Minato-ku, Tokyo 107, Tel: 03-405-5738 TWX: 781-2424241

Additional offices in West Germany, Hong Kong and the United States. Representatives and distributors worldwide.

...a wide range of power and precision wirewound resistors?

● You need a wide range of power and precision wirewound resistors?

- Yes, but I primarily need stable resistors with a low temperature coefficient.

● In calling Sprague you did the right thing! We make resistors up to 50W, with tolerances down to $\pm 0.1\%$, temperature coefficients of less than ± 20 ppm, and a resistive change below 1×10^{-4} after 10000 hours.

- Really?

● Yes indeed, and this is due to our control of raw materials, supervision of the manufacturing process, and selection of the core material and resistance wire. Attention is also paid both to the quality of the end caps and the welding of the

resistance elements, and the wire is space wound to eliminate hot spots.

- That sounds good, but this technology must be expensive.

● Not at all if you consider the CPS factor.
- CPS?

● Yes. The factor cost \times power dissipated \times stability, the only true measure of the price of a resistor.

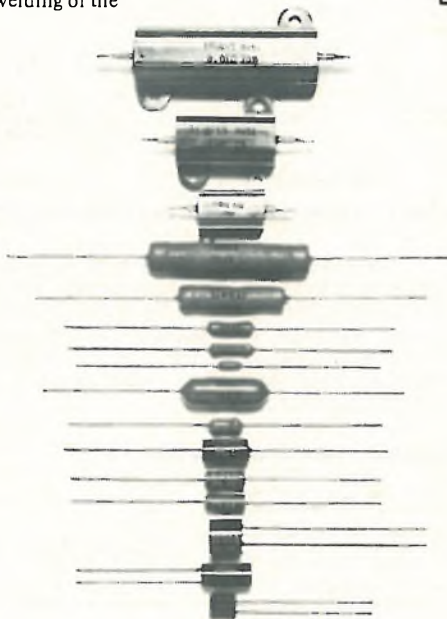

News update

■ The \$500 tracker appears to have been left at the starting line. Conceived by a rock hound and map maker, and developed by Fundamental Products of North Hollywood, Calif., the vehicle-tracking system was said to do much the same job—though with less accuracy and reliability—as million-dollar military units [April 18, 1974, p. 32]. “We had lots of interest,” says Bob Phillips, president of Fundamental Products, “and demonstrated the system to many organizations, but afterwards, they just all went their way. It’s a keen little device, and still the only tracker that I know of (except ones with inertial-guidance systems) that works. But it’s dormant now.” Phillips points out that his company is only a small development firm not equipped to market such systems.

■ John E. Lawrence believes that the weekly supply of “virgin” silicon is a mere 800,000 wafers against a demand of a million wafers, so about a year and a half ago he opened a Mountain View, Calif., shop to reclaim defective wafers [April 18, 1974, p. 32]. Now, Silicon Material Inc., which was turning out 5,000 wafers a week at the outset, is doing 12,000 for its 74 customers. What’s more, says Lawrence, he’s going after a new market: reclamation of test wafers, which he figures are 25% of all wafers used. He expects that business to add 10,000 wafers per week at \$1.35 apiece.

■ Here’s Chapter 3 in the saga of the Cyberlites [June 21, 1973, p. 27 and May 30, 1974, p. 18], the flashing yellow lights designed to be mounted on cars to reduce rear-end collisions by a claimed 60%. They’ve finally been approved by the California Highway Patrol and are now being sold by two Sears Roebuck stores in northern California. The \$49.95 lights also can be purchased through the mail, reports inventor John Voevodsky, who adds that they are also legal in all other states unless a legislature prohibits their use. —Howard Wolff

Sprague World Trade Corporation

Chemin François-Lehmann 19, 1218, Geneva, Grand Saconnex, Switzerland
Tel. 98 40 21/44, Telex 27 494

Sprague Benelux, Bruneellaan 47, 9600 Ronse, Belgium, Tel. 055-215302

Sprague France S.à.r.l., 2, av. Aristide-Briand, 92220 Bagneux, France, Tel. 655-19.19

Sprague GmbH, Friedberger Anlage 24, 6 Frankfurt am Main, W. Germany, Tel. 0611-439407

Sprague Italiana S.p.A., Via G.G. Winckelmann 1, 20146 Milano, Italy, Tel. 02-479121

Sprague Electric (UK) Ltd., 159 High Street, Yiewsley, W. Drayton, Middx, England, Tel. W. Drayton 44627

interface- ability

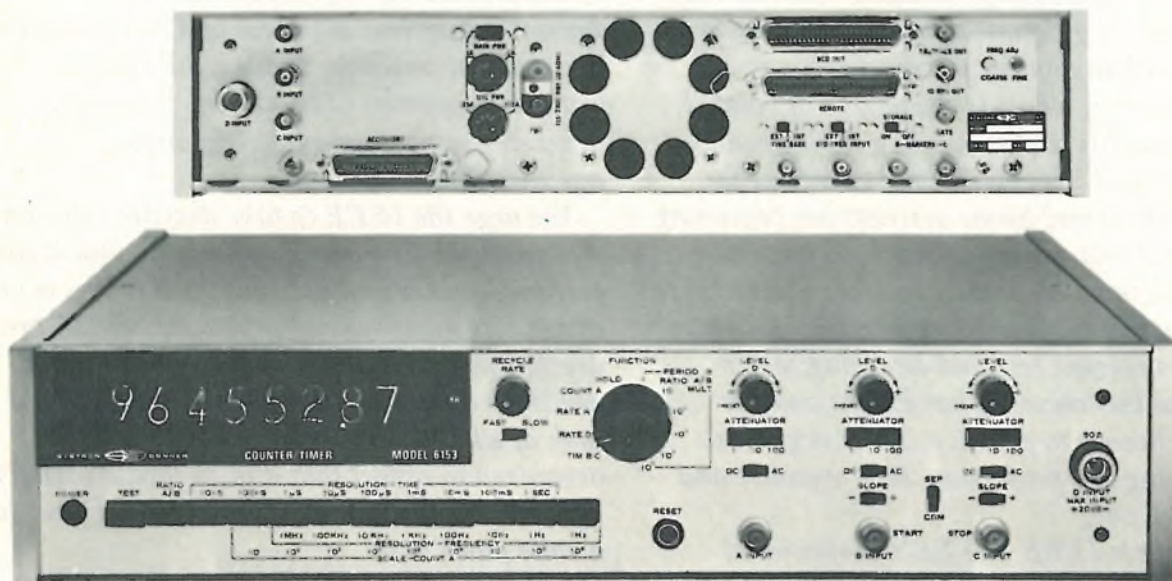

Or why **systems people** buy more S-D counters

- 6 remote **programming** options
- 4 **BCD** outputs (low and high level)
- Special codes, formats, logic levels
- Universal counter/timer functions
- 50, 200, 512 MHz, 3 GHz

For details or a demo on series 6150 counters, call your Scientific Devices sales and service office (listed below). Or contact Concord Instruments Division, 10 Systron Drive, Concord, CA 94518. Phone (415) 682-6161. In **Europe**: Systron-Donner GmbH, Munich, W. Germany; Systron-Donner Ltd., Leamington Spa, U.K.; Systron-Donner S.A. Paris (Le Port Marly) France. **Australia**: Systron-Donner Pty. Ltd., Melbourne.

SYSTRON  DONNER

Albuquerque, (505) 268-6729; Baltimore, (301) 788-6611; Boston, (617) 894-5637; Burlington, NC (919) 228-6279; Chicago, (312) 297-5240; Cleveland, (216) 261-2000; Denver, (303) 573-9466; Dayton, (513) 298-9904; Dallas, (214) 231-8106; Detroit, (313) 363-2282; Ft. Lauderdale, (305) 721-4260; Hamden CT (203) 248-9361; Huntsville, AL (205) 536-1969; Houston, (713) 623-4250; Indianapolis, (317) 783-2111; Kansas City, KS (913) 631-3818; Los Angeles, (213) 641-4800; Minneapolis, (612) 544-1616; New York City area (201) 871-3916; Norfolk, (703) 499-8133; Orlando, (305) 424-7932; Philadelphia, (215) 825-9515; Phoenix, (602) 834-1682; Rochester, NY (716) 334-2445; San Antonio, (512) 694-6251; San Diego, (714) 249-6642; San Francisco area (415) 964-4230; Seattle, (206) 454-0900; St. Louis, (314) 842-2535; Syracuse, (315) 457-7420; Washington, DC area (703) 451-6500.

For literature circle 148 on reader service card.

For demonstration circle 9 on reader service card.

IEEE and age discrimination

Age discrimination—the subtle yet apparently real bias against the over-40 EE—raises some serious challenges to the professional status of electronics engineering.

For one thing, how can electronics engineering be recommended as a career to high-school and college students when all they can expect on graduation is a 15- to 20-year span of viability on the job market?

For another, where is the degree of control over the quality and suitability of electronics engineers that is so commonly exercised for other professions? Some activists are beginning to demand that a quota system—to open and close a valve on incoming students—be instituted to help preserve jobs for veteran EEs. Other talk of some stringent test-and-licensing set-up similar to the lawyers's bar exams and the doctors' license to practice. Their argument: engineering is a profession, let's organize and run it like one.

So what is IEEE, the EE's professional

*society, doing about the problem of ensuring the viability, let alone enhancing the value, of the older engineer? Its Manpower Committee, certainly, has made a good start in delineating the problem and documenting its dimensions in its recent report, *The EE at Mid-Career*. And others associated with the IEEE have demonstrated their alertness and determination to act on the problem. Indeed, the IEEE leadership appears to be moving forward in preparing a position paper regarding age discrimination.*

We urge the IEEE to take decisive steps on this problem. One important service that it can perform—and is uniquely qualified to do—is to expand its manpower efforts to include an in-depth, continuing study of the nation's actual needs for electronics engineers. And it should look at whether engineering could be better organized to reflect that it is, in fact, a socially vital profession—and that the older engineer has a valid place in it.

Pacemakers and responsibility

Electronic pacemakers, which have extended the life of thousands of heart-disease victims, have their failings. They have, in fact, failed enough times that the Food and Drug Administration has had to issue a number of recalls.

The trouble is, the FDA all too often stumbles onto a recall situation during its plant inspections and only seldom because a manufacturer alerts it to a malfunction. Thus, the FDA is pushing hard for a reshaping of safety responsibilities. We feel the matter is of importance, and we present here some recent comments by FDA's commissioner, Alexander M. Schmidt.

"In too many cases a great deal of time elapses between the company's finding a problem and the FDA's awareness that it exists. . . . The FDA is expected to assure that these devices are safe and effective and yet does not

have the authority to go with this responsibility. The after-the-fact authority the agency now has . . . is not giving the American public the protection it deserves. The burden of safety is on the Government instead of on the manufacturer where it belongs.

"Presently there are two bills in Congress which would correct this situation. . . . Both would require a classification process whereby certain devices would require pre-market testing; others would require conformance to formal standards of manufacture and performance. Both bills would enable FDA to require any firm with knowledge that a product on the market is defective or has a potential health hazard to notify the agency immediately."

It's too bad there has to be legislation to define the responsibility of electronics manufacturers for reliability and safety. But we agree that is where the responsibility belongs.

Special price on the best 256-bit RAM you can buy.

Free.

Try the Am27LS00 and sell yourself.

Only one catch. Write us on your letterhead. (Tell us whether you want military or commercial grade and what package you want.) Last time we offered free samples we heard from 7 Cub Scouts, 6 competitors and 5 garden clubs.

So, please. No letterhead, no freebie.

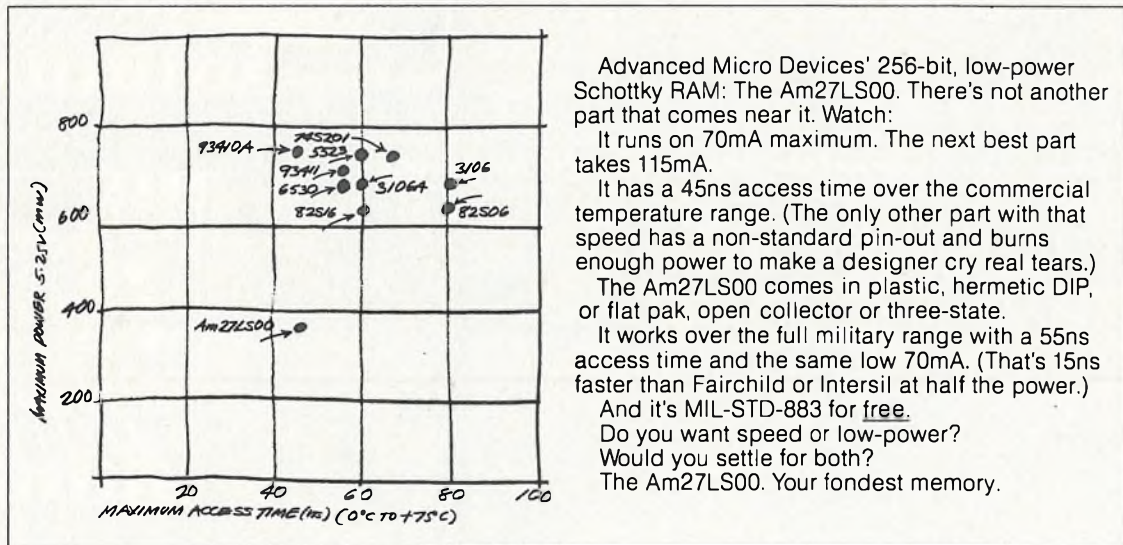

Advanced Micro Devices' 256-bit, low-power Schottky RAM: The Am27LS00. There's not another part that comes near it. Watch:

It runs on 70mA maximum. The next best part takes 115mA.

It has a 45ns access time over the commercial temperature range. (The only other part with that speed has a non-standard pin-out and burns enough power to make a designer cry real tears.)

The Am27LS00 comes in plastic, hermetic DIP, or flat pak, open collector or three-state.

It works over the full military range with a 55ns access time and the same low 70mA. (That's 15ns faster than Fairchild or Intersil at half the power.)

And it's MIL-STD-883 for free.

Do you want speed or low-power?

Would you settle for both?

The Am27LS00. Your fondest memory.

Advanced Bipolar Memory



Let's hear it for 1" high LEDs!

Digital clock readout

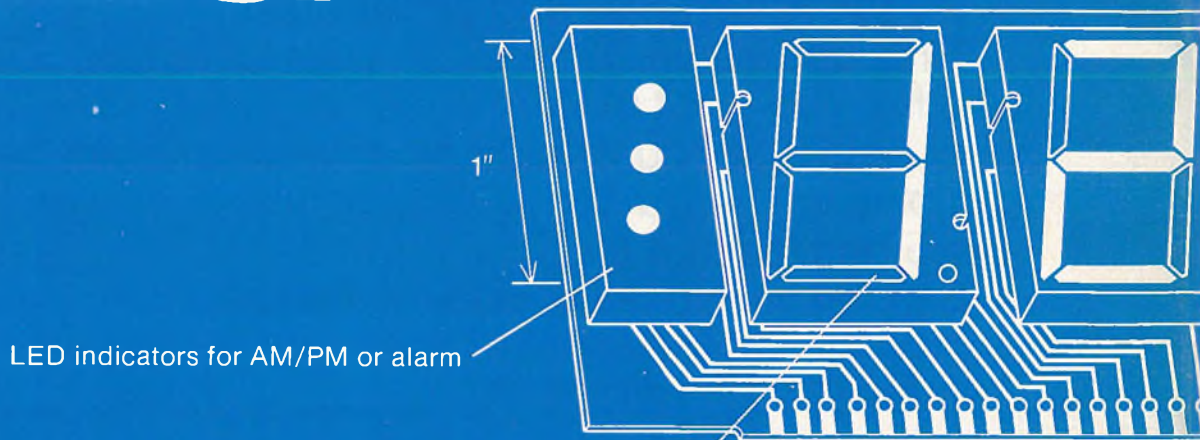

White-walled cavity reflects and directs light

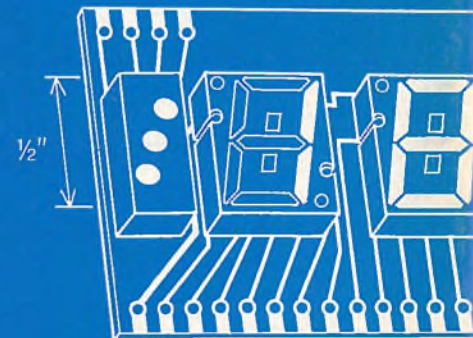

The first ever.

See?

Good things are worth waiting for.

Litronix (who else?) is pleased to announce the industry's first 1-inch high LEDs—big, beautiful, and bright. You can easily read them from 60 feet away without squinting.

That's nice news for manufacturers of digital clocks and panel meters.

But that's not all the news.

These 1-inch digits (as well as our new ½-inch digits) use a new technology to reduce costs. This means a price saving to you of more than 10%. For example, our ½-inch reflective

model costs less than 90¢ per digit vs. about \$1.00 per digit for our ½-inch light-pipe model. Nice?

Here's the clincher. You can get an entire array of 2 to 8 digits already mounted on a single PC board—with colon, AM/PM sign, or ± sign, and over-range "1" as required. All this reduces your assembly costs. Makes the production easier. And simplifies testing and inventory.

If you've been looking at the super reliability of LEDs (average MTBF of 50,000 hours), our 1" LEDs should make your eyes light up.

Get details today from the innovative people who did it first. Contact Litronix, Inc., 19000 Homestead Road, Cupertino, Calif. 95014. Phone (408) 257-7910.

**No wonder
we're No.1
in LEDs**

litronix

a little A-300 goes a long way.

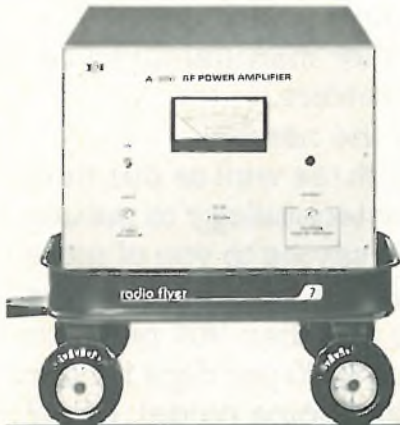

In high frequency transmission. RF power generation for industrial and research processes. RFI/EMI and general laboratory applications, too.

The Model A-300 is a totally solid state power amplifier, covering the frequency range of 0.3 to 35MHz with a gain of 55dB. Capable of delivering 300 watts of linear Class A power and up to 500 watts in the CW and pulse mode, the A-300 is the ultimate in reliability.

Although the unit is perfectly matched to a 50 ohm load, it will deliver its full output power to any load (from an open to a short circuit) without oscillation or damage.

Complete with power supply, RF output meter and rack mount, the A-300 weighs a mere 89 pounds and operates from ordinary single phase power.

High power portability goes a long way for \$5350.

For further information or a demonstration, contact ENI, 3000 Winton Road South, Rochester, New York 14623. Call 716-473-6900 or TELEX 97-8283 E N I ROC

ENI

The World's Leader
in Solid State
Power Amplifiers

People

Simpson of Electronic Arrays opts for n-MOS

To 40-year-old, red-haired David Simpson, the new vice president of engineering at Electronic Arrays Inc., Mountain View, Calif., the most critical period for any semiconductor company—large or



No trivia. The future for David Simpson and Electronic Arrays is in high-end n-MOS.

small—occurs during the transition of a new technology from the laboratory to production.

And if there is anything that his 16 years at Texas Instruments Inc. has taught him, it is that "I seem to have a talent for helping an organization make this transition."

To do this, the six-foot three-inch Texan, a graduate of Rice and Southern Methodist universities, operates by one simple rule: "Concentrate on the essentials and ignore the trivia."

Simpson is concentrating on bringing Electronic Arrays' relatively new and untried n-channel MOS process to fruition in several fast-growing products. In random-access-memories this means, he says, 16- and 22-pin 4,096-bit RAMs. In microprocessors it means a proprietary 8-bit n-channel silicon-gate device on the market by the third quarter of this year, followed by either a second-source Intel 8080 or Motorola 6800. In read-only memo-

ries, it means high speed 16- and 32-kilobit devices.

Interesting as complementary MOS and integrated injection logic are as technologies and markets, for Simpson's company these fall in the category of trivia. "Both are important technologies, but n-MOS has still a lot of surprises left in it, both in terms of low power and high speed," he says. Simpson is leaving to others the low-cost high-volume n-MOS market. "Our niche in the immediate future will be high-performance n-MOS," he says.

The "school" in which Simpson learned to ignore the non-essential was TI's Solid State Group, formed the day he started work in 1959. His first project: applications engineering on one of the first true integrated circuits, the SN500 series. By 1963, he was project manager for the 54/74 series and shepherded it "from design to production," until 1971, when he moved as chief engineer into another relatively new technology, n-channel metal-oxide semiconductors. In 1974 he was named to manage TI's MOS memory effort.

"Challenging as it all was, at a large company like TI there is always a little room for slack, for human error," Simpson says. "At a little company like EA, there's no cushion. It's all or nothing. I like that."

Tom Hyltin expects to move Micro Display to the top 10

From a standing start two years ago, Tom M. Hyltin is guiding Micro Display Systems Inc., Dallas, to where he claims it will be among the "top 10 digital watch makers" in the world by year-end. Although he's not saying just what the privately held company's sales will be, he points out that it will be fighting for a share of a market that in 1975 should reach 2.5 million units, or \$125 million. And for next year, he expects this figure to grow by 40%.

But the 44-year-old Micro Display Systems president is not intimi-

A powerful new idea in ferrites



**NEW FROM
SAUGERTIES, N.Y.**

It's the new Power E core . . . the first ferrite core specifically designed for switched mode power supplies.

Because of its unique shape, it has the power to . . . reduce size, weight, and cost . . . reduce component count for greater assembly ease and higher reliability . . . increase overall equipment efficiency.

Virtually a pot core with the two sides removed—or an E core with a round center leg—the new Series EC core provides an external magnetic field that is a compromise between these other two core types. Because it has a circular cross section for the center leg, turn length of windings is minimized, reducing copper losses. The more compact winding reduces leakage inductance. And the

open side design provides for maximum ease of winding and termination.

Accessories available, too. A complete line of standard bobbins has been designed and tooled to accept the new core. And specially designed mounting hardware helps make for easiest possible assembly.

If you're not yet using ferrites for power converters, you're not yet on to a good thing. And if you haven't investigated this newest and most powerful idea in ferrites yet, perhaps you'd better.

For further information, or quantities from stock, write or phone Ferroxcube or any of the offices listed below.



FERROXCUBE CORPORATION, SAUGERTIES, N.Y. 12477 □ 914-246-2811
A NORTH AMERICAN PHILIPS COMPANY

Distributed through North American Philips Electronic Components Corp.—warehouses in Boston, 617-899-7103; New York, 516-538-2300; Saugerties, 914-246-5861; Philadelphia, 215-836-1618; Chicago, 312-593-8220; San Diego, 714-453-5440; Toronto, 416-425-5161

Circle 15 on reader service card

18172



Plenco 300 Phenolic. Oster uses it to go to your head.

Hair professionals know Oster as producer of quality-crafted barber and beauty products. So do fastidious home tonsorialists. Family pets too are kept in trim with their own special smooth-running clippers for small animals.

Oster Corporation, Milwaukee, selected our Plenco 300, a general-purpose phenolic compound, for molding the textured, firm-grip housings of some clippers, the switch caps of others.

A two-stage compound, it offers ease of molding either by com-

pression or transfer method. It is formulated for good finish with well-balanced physical and electrical properties, and is available in black, brown, maroon and red.

Before your next molding problem grows on you, get a little help from Plenco.

PLENCO
THERMOSET PLASTICS

PLASTICS ENGINEERING COMPANY
Sheboygan, Wis. 53081

Through Plenco research . . . a wide range of ready-made or custom-formulated phenolic, melamine-phenolic and alkyd thermoset molding compounds, and industrial resins.

dated by the size of his competitors in the liquid-crystal-display end of the business, even though they include the giant Timex Corp. and Intel Corp.'s Microma division.

"Industry leadership is a state of mind," Hyltin says. "We've got to convince our customers that we are in the business to stay."

A giant of a man himself, being just a little over six and a half feet tall, the soft-spoken Hyltin is proud of his firm's liquid-crystal watches. Since the first were shipped in May, 1974, some 14 months after he helped start the company, not one has failed, he asserts. The key is the use of curved instead of flat glass, says Hyltin. The liquid crystal rests in its own "pocket" between the glass surfaces instead of being squeezed flat. A much more reliable seal results, Hyltin says.

This and the fact that his company makes its own glass and liquid-crystal materials add up to a product that is relatively expensive.

"If other display manufacturers solve their problems at their lower costs, we will be only marginally competitive," points out Hyltin. "But if, as we think, a low-cost process cannot yield a quality display, then our direction is right."

Watch man. A former employee of Texas Instruments Inc., where he managed the first solid-state phased-array-radar program and new noncalculator consumer products, Hyltin was part of the engineering effort that produced the first digital electronic watch. When TI didn't move on watches as fast as he wished, he decided to leave. The digital watch "was something I wanted to be part of," he recalls.

The watches made by Micro Display Systems are sold under several private labels, as well as two brand names—the premium Sensor models and the economy Eltek models, which retail for \$150 and \$49.95, respectively. This summer, the company will introduce a new line of men's watches, with ladies' versions to follow by the fall. They will have lighted displays that show time, as well as date, and will include automatic calendar correction.

Not New...Just the Best



ERIE RED CAP

Miniature Ceramic Capacitors

WIDEST SELECTION OF MINIATURIZED CERAMIC CAPACITORS IN THE INDUSTRY!

Erie is in the Red Cap winner's circle because of a well engineered component that's backed by a unique process control system. Combine this with talented, motivated people and you have Erie as the leader in its field. These tiny high quality capacitors are not new... but they are the best. Our customers attest to it. Our test laboratories prove it.

Red Cap dielectrics are manufactured by Erie's exclusive Monobloc Process[®]... a modern, time-proven ceramic film technology. And tough environmental extremes routinely are endured by our own Jet-Seal, a hard, bright red polymeric protective coating. (The superior aesthetic appearance of Jet-Seal comes to you at no charge.)

Erie Red Caps have it all. 21 temperature characteristics. 1pF to 10uF capacitance range. Ratings from 25 to 500 Vdc. You name the application... we've got a Red Cap for the job. All this is due to Erie's total in-house capability... from exclusive ceramic formulations to unique packaging. So on your very next buy of ceramic capacitors, do it the easy way... specify Erie Red Caps.

Write TODAY for Red Cap brochure 8000... or call our nearby factory representative.

CAPACITANCE RANGE
1pF to 10uF

21 TEMPERATURE Characteristics

Voltage Range
25 to 500 Vdc

Encapsulated by "JET SEAL"

Meet or Exceed Requirements of MIL C 20 MIL C 11015 As applicable

ERIE TECHNOLOGICAL PRODUCTS, INC.
Erie, Pennsylvania 16512

ERIE

Circle 17 on reader service card

How to buy a m

Which comes first—the hardware or the software? You need both, of course, to create new products with microcomputers. The tougher question is: How do you assure product profitability? That gets you into questions of hardware availability, software support, design assistance and confidence in your supplier. When an electronics publication recently asked readers to rank their micro-computer buying criteria, it came as no surprise to Intel that availability, software support and supplier reputation topped the list.

Intel can supply you today with five general-purpose CPUs, supported by numerous peripheral, I/O and memory components, software packages and development manuals, and the industry's largest library of users' applications programs. Our five microcomputers span a 1000:1 performance range and include the lowest cost, highest performance and most popular designs available today. Their applications are

equally broad, from electronic games to high speed controllers and processors. We want to make sure that our customers don't begin designing with pieces of the hardware/software puzzle missing. To minimize development and assembly cost, each CPU is backed up by more than a score of performance-matched system components—advanced programmable I/O

INTEL MICROCOMPUTER SYSTEM FAMILIES					
MICROCOMPUTER SYSTEM	MCS™4	MCS™40	MCS™8	MCS™80	Series 3000
CENTRAL PROCESSOR	4004	4040	8008	8080	3001, 3002, 3003
Technology	PMOS	PMOS	PMOS	NMOS	Schottky Bipolar
Parallel Bits	4	4	8	8	2 per 3002 CPE
Instruction Cycle	10.8μS	10.8μS	12.5μS	2μS	100nS
SUPPORT COMPONENTS					
RAMS (including CMOS)	4	4	5	5	8
PROMS	3	3	3	4	7
ROMS	4	4	3	3	6
*Peripheral Interfaces	6	6	6	6	8
Interrupt Unit			1	1	1
Clock Generator	1	1	1	1	TTL
*I/O Units	5	5	3	3	3
Total Component Choices	23	23	22	23	33
SYSTEMS SUPPORT					
Software Packages					
Microassembler					1
Assemblers	2	2	2	2	
Compiler			1	1	
Monitor	1	1	1	1	
Simulator	1	1	1	1	
Text Editor			1	1	
Manuals	6	6	5	6	1
User's Library	Yes	Yes	Yes	Yes	Yes
Intellec® Development System	Yes	Yes	Yes	Yes	In development

* Five additional I/O and peripheral devices will be available in 2nd half of 1975.

microcomputer.

subsystems, peripheral interfaces, clock generators, priority interrupt and other control units, and the broadest selection of erasable and bipolar PROMs, compatible metal mask ROMs, CMOS and NMOS RAMs.

Moreover, Intel software packages include resident monitors, assemblers and text editors available on Inteltec® microcomputer development systems. Assemblers, simulators and compilers

are also available as cross products on magnetic tape or on leading time share networks. With these aids programs can be written and debugged in a fraction of the time required a few years ago.

You may need design assistance before the meter starts running in the research and development lab. Intel has the industry's most experienced microcomputer field applications engineering group. If your staff needs help to get started, we have regional training centers, workshops, seminars and on-site training courses available.

With Intel, there's no shell game about hardware or software delivery, no guessing whether the supplier can handle all your production commitments. Intel has been

delivering microcomputers in volume since 1971. Our reputation speaks for itself. We've already delivered more general-purpose microcomputers than the rest of the industry combined.

If you have tough questions about which microcomputer will make your new products most profitable, call or write Intel for our solutions. Intel Corporation, 216 Avenue Louise, B 1050, Brussels, Belgium. Phone: (02) 649-2003. Telex: 24814.

intel® Microcomputers. First from the beginning.

Dialight sees a need:

(Need: The widest choice for your every application.)



513 SERIES With bezel for snap-in panel mounting. Alternate, momentary and snap-action contacts with ratings to 5 amps. N.O., N.C. and two circuit (one N.O., one N.C.). Low level switches also available. Round, square and rectangular bezels in four colors; caps from 1/2" to 1 1/2" in more than 12 colors. Illuminated caps with or without legends. UL listed.



PUSH BUTTON CAPS Round, square and rectangular shapes in wide variety of sizes and colors. With hot stamped, engraved or film legends.



Dialight, the company with the widest choice in switches, LEDs, indicator lights and readouts, looks for needs . . . your needs . . . and then they develop solutions for your every application. No other company offers you one-stop shopping in all these product areas. And no other company has more experience in the visual display field. Dialight helps you do more with these products than any other company in the business, because we are specialists that have done more with them. Talk to the specialists at Dialight first. You won't have to talk to anyone else. Send for your free new copy of Dialight's current catalog.

DIALIGHT

Dialight, A North American Philips Company
203 Harrison Place, Brooklyn, N. Y. 11237
(212) 497-7600

See Dialight.

Meetings

Nuclear and Space Radiation Effects Conference, IEEE, Humboldt State, Arcata, Calif., July 14-17.

Summer Computer Simulation Conference, ISA et al, St. Francis Hotel, San Francisco, Calif., July 21-23.

Dielectric Materials, Measurements, and Applications, IEEE, Churchill College, Cambridge, England, July 21-25.

1975 Gordon Research Conference on Solid State Studies in Ceramics, Brewster Academy, Wolfeboro, N.H., Aug. 4-8.

Associated Public-Safety Communications Officers National Conference, APCO, Washington Hilton Hotel, Washington, D.C., Aug. 11-14.

Symposium on the Simulation of Computer Systems, NBS and ACM, Boulder, Colo., Aug. 12-14.

10th Intersociety Energy Conversion Engineering Conference, IEEE, University of Delaware, Newark, Del., Aug. 17-22.

19th Annual SPIE Technical Symposium: Developments in Optical and Electro-Optical Engineering, Past and Future, Society of Photo-Optical Instrumentation Engineers, Town & Country Hotel, San Diego, Calif., Aug. 18-22.

Active Semiconductor Devices for Microwave and Integrated Optics, IEEE and Cornell University, Ithaca, N.Y., Aug. 19-21.

IFAC/75: International Federation of Automatic Control's Sixth Triennial World Congress, IFAC, Massachusetts Institute of Technology, Cambridge, Mass., Aug. 24-30.

17th Conference on Electronic Materials: Preparation and Properties of Electronic Materials, AIME, Princeton University, Princeton, N.J., Aug. 25-27.

NBS Seminar on Frequency Standards and Clocks: Characterization, Usage, and Problem Areas, NBS, Boulder, Colo., Aug. 25-27.

SURPRISE!

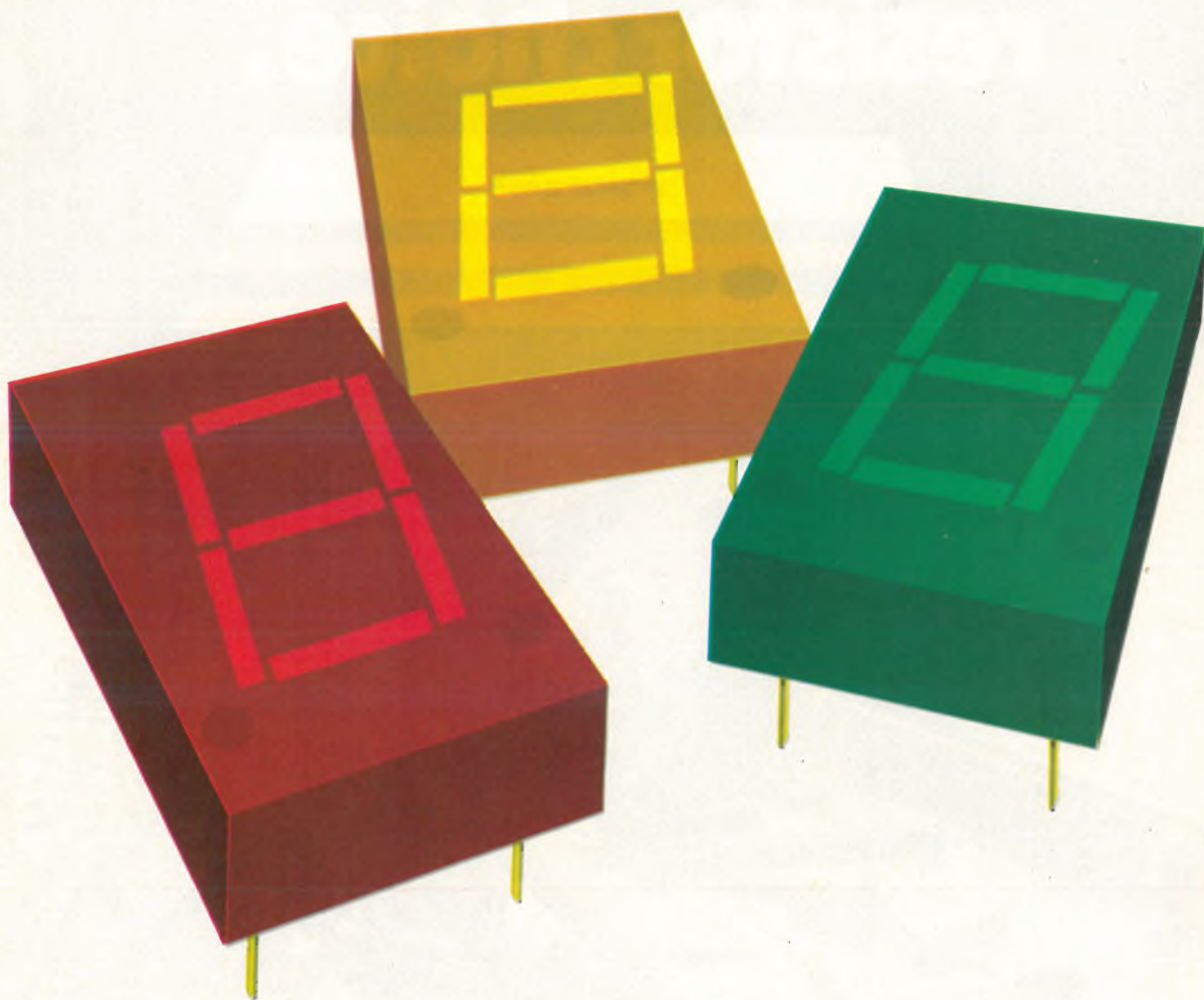

HP's 5 times brighter display!

At 20mA our new High-Efficiency red display is 5 times brighter than our standard red displays. Just 3mA per segment gives you all the brightness you need and makes it ideal for battery powered applications. These large .43" displays are offered in High Efficiency Red, Yellow, or Green and are readable up to 20 feet. The 5082-7650 (High-Efficiency Red), -7660 (Yellow),

-7670 (Green) are available in standard DIP packages with left-hand d.p. and common anode configuration. Just \$3.95* each in quantities of 100.

Contact Hall-Mark, Schweber, Wilshire or the Wyle Distribution Group (Liberty/Elmar) for immediate delivery, or write us for more information and our new application note on contrast enhancement.

01503

*Domestic USA price only.

HEWLETT  PACKARD

Sales and service from 172 offices in 65 countries.
1501 Page Mill Road, Palo Alto, California 94304

**Only TRW/IRC
offers you complete
resistor choice.**



You get exactly the resistor you need for your application.

No compromises. No "favorites." Just quality.



Carbon comp.

Billions used in consumer, industrial, military applications. TRW/IRC carbon comp. capability ranges from standard commercial types through established reliability RCR's, to ultra-high range (10^{11} ohms). Where you're using carbon comp.'s in automated assembly, TRW/IRC packaging options can help cut the cost of interfacing with your machines. Card packs, lead tape reels, cut and formed leads... we'll be glad to explore the potential economies with you.

the popular RN's. You can also look at alloy films offering high-temperature and high-voltage capability at low cost.



Resistive Networks

Advanced resistor technology here. These IC compatible, precision tantalum-film circuits provide inherent low noise, excellent stability, and hermetic performance without hermetic cost. Tolerances from 5% to 0.05% available in custom designs. TRW/IRC also offers the industry's most complete line of discrete fixed resistors.

for appliance/automotive use... to precision subminiatures offering high power density... to low cost fusible, flameproof units for consumer and industrial applications... to tubular and flat power wirewounds with ratings to 250 W.



Metal Glaze™

This is TRW/IRC's thick-film technology—for all types of low power resistor applications. Metal Glaze is widely accepted for its built-in power handling reliability, resistance range, and cost effectiveness. Numerous standard and special designs—precision, semi-precision, flameproof, high-rel, high-voltage.

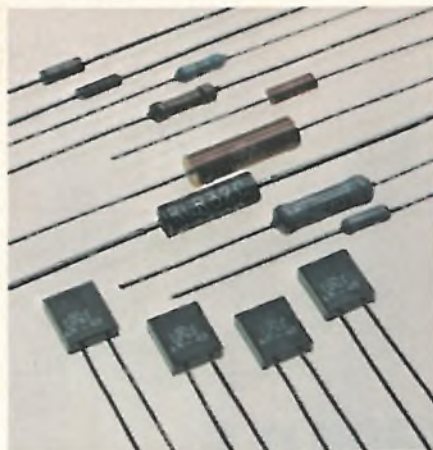

Metal Film

TRW/IRC has brought the state of the art in thin-film to a performance level equaling high-stability wirewounds. Capabilities include resistors with tolerances to $\pm 0.01\%$ and ± 3 PPM T.C. ...high-rel units... precision subminiatures...and, of course



Wirewound

The line starts with molded wirewound resistors—"space-savers" that bridge the cost-performance gap between composition resistors and precision wirewounds. It proceeds to standard, non-insulated types

All types...all technologies... one source

To wrap it up, TRW/IRC offers you the most complete line of fixed resistors in the business, with many of the popular types available from one source—your local TRW/IRC distributor. Having a direct pipeline to each of our plants, he can give you fast delivery.

Contact your local TRW sales office for application assistance, custom designs, and special engineering help when you need it. TRW/IRC Resistors, an Electronic Components Division of TRW, Inc. Plants at Boone, N.C., Burlington, Iowa, and Philadelphia, Pa. Write TRW/IRC Resistors, 401 N. Broad St., Philadelphia, Pa. 19108. Or call (215) 923-8230.

TRW® IRC RESISTORS

Circle 23 on reader service card



CANNON'S CONNECTOR CAPABILITY

Today Cannon and connectors stand for new and exciting ideas. For example, this low-cost modular interconnection system. Connections can be made in multiple directions including thru-board plugging. Crimp contacts are used with tin or gold finishes. Connectors can also be supplied with coding keys and lead-in guides.

Take another look at our spring-contact DIP sockets or the new 'Spectra-Strip' line of flexible

cables shown above. Just a few of our many new interconnection ideas and a very small part of our total interconnection capability.

For more details write to Cannon Headquarters or contact your local organisation or franchised distributor of which there are over 30 in Europe.

ITT Industries Belgium S.A., Cannon Electric Division, 11, Blvd. de l'Empereur, B-1000 Brussels.

Circle 149 on reader service card

ITT **CANNON**

Centralized Television Measurements

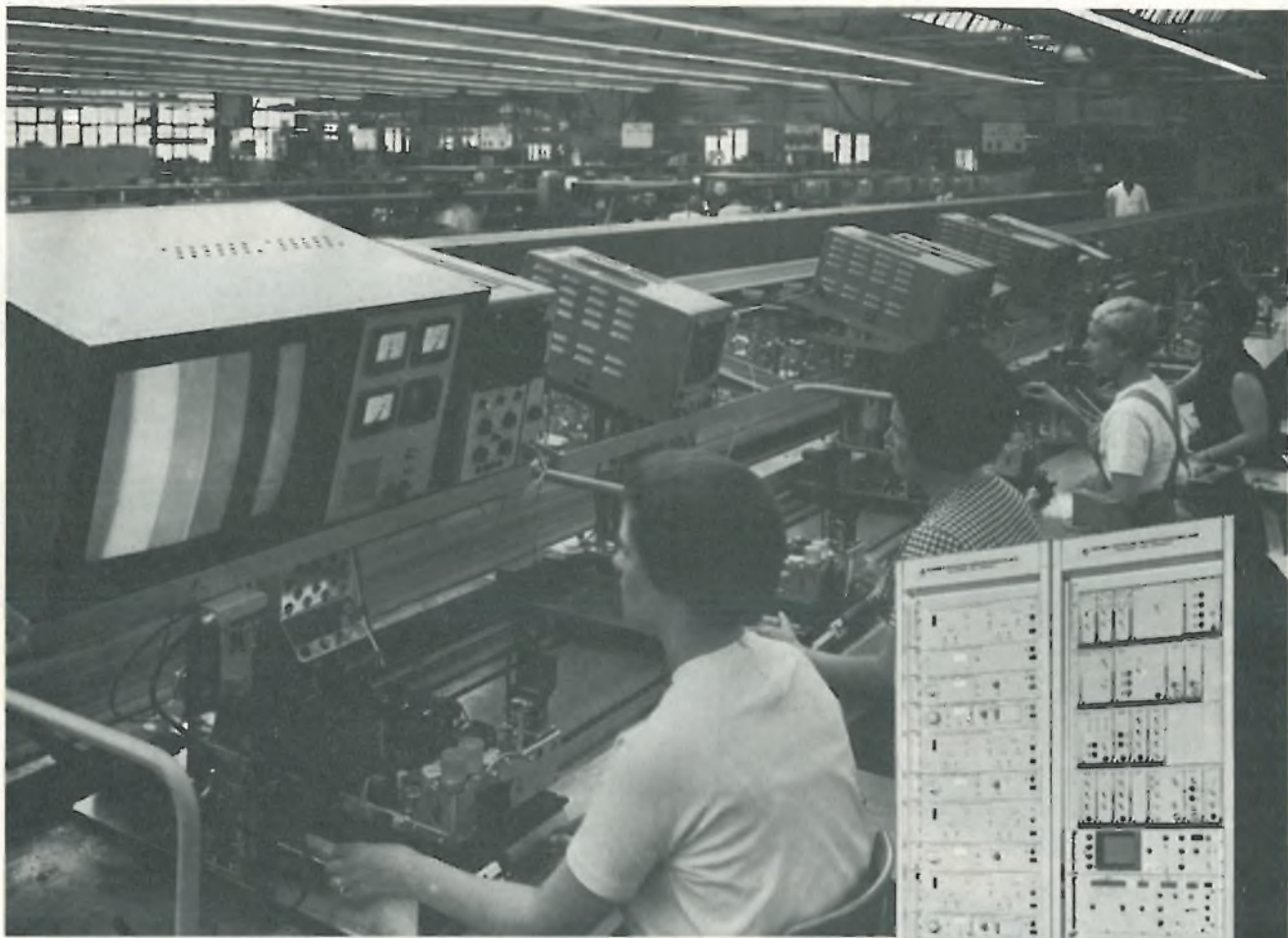

During their manufacture these TV-receiver chassis are aligned using RF signals generated by a Rohde & Schwarz test assembly located in a central transmitting room. The signals are distributed over cable networks to the antenna sockets on the production line. No intermediate amplifiers are used to ensure that work does not have to be interrupted for maintenance. The distribution networks are broadband and cover all frequencies of TV Bands I through V.

For each channel that is used, the test system has a **TV Channel Signal Generator SBTF** made up of a vision/sound modulator and a transmitter unit. The set can handle Standards B, G, D, I, K, K1, L or M, all transmission parameters come up to national and

international specifications, and the equipment is suitable for NTSC, PAL or SECAM colour TV. The normal transmitter power of 0.5 W can be increased in Bands I/III and IV/V by adding amplifiers. Modulation of the standard IF's with VF and AF signals in the vision/sound modulator and conversion to the selected channel in the transmitter unit are performed with crystal accuracy; the channel can be altered by exchanging the oscillator crystal and tuning the selective circuits.

Besides laboratory and production applications, the SBTF can be used for the actual **transmission of TV programs** in mobile stations (outside broadcasting, traffic monitoring).

Rohde & Schwarz has on hand a complete line of equipment for VIT

techniques and TV broadcasting in accordance with ITU, EBU, CCIR, OIRT, ARD and FTZ specifications.

Ask Rohde & Schwarz
for the brochure
>TV Test Equipment



ROHDE & SCHWARZ

8000 München 80
Mühlhofstraße 15
West Germany
Tel. (089) *4129-1
Telex 523703

Distributors in: Argentina, Australia, Austria, Belgium, Brazil, Canada, Chile, Columbia, CSSR, Cyprus, Denmark, Ecuador, Ethiopia, Finland, France, Ghana, Greece, Hongkong, Hungary, Iceland, India, Indonesia, Iran, Ireland, Italy, Japan, Kenya, Mexico, Netherlands, New Zealand, Norway, Pakistan, Peru, Portugal, South Africa, Spain, Sweden, Switzerland, Thailand, Turkey, United Kingdom, Uruguay, U.S.A., Venezuela a.o.

Circle 180 on reader service card

Painless

In the medical school of the University of Utrecht dental students work on sets of teeth fixed into the mouth cavities of plastic heads. Beside each chair are a T.V. screen and earphone.

The professor - who is in what amounts to a small T.V. studio - works on an identical set of teeth. A small T.V. camera photographs him, and the picture, along with his verbal

instructions, is transmitted to the T.V. screens and earphones beside the chairs. Consequently each student has a clear view of what the professor is doing and can practise it himself immediately. Since the camera has a 200 mm lens the professor can show either the whole mouth and the position of his hands, or an extreme close-up of, say, the point of the drill.

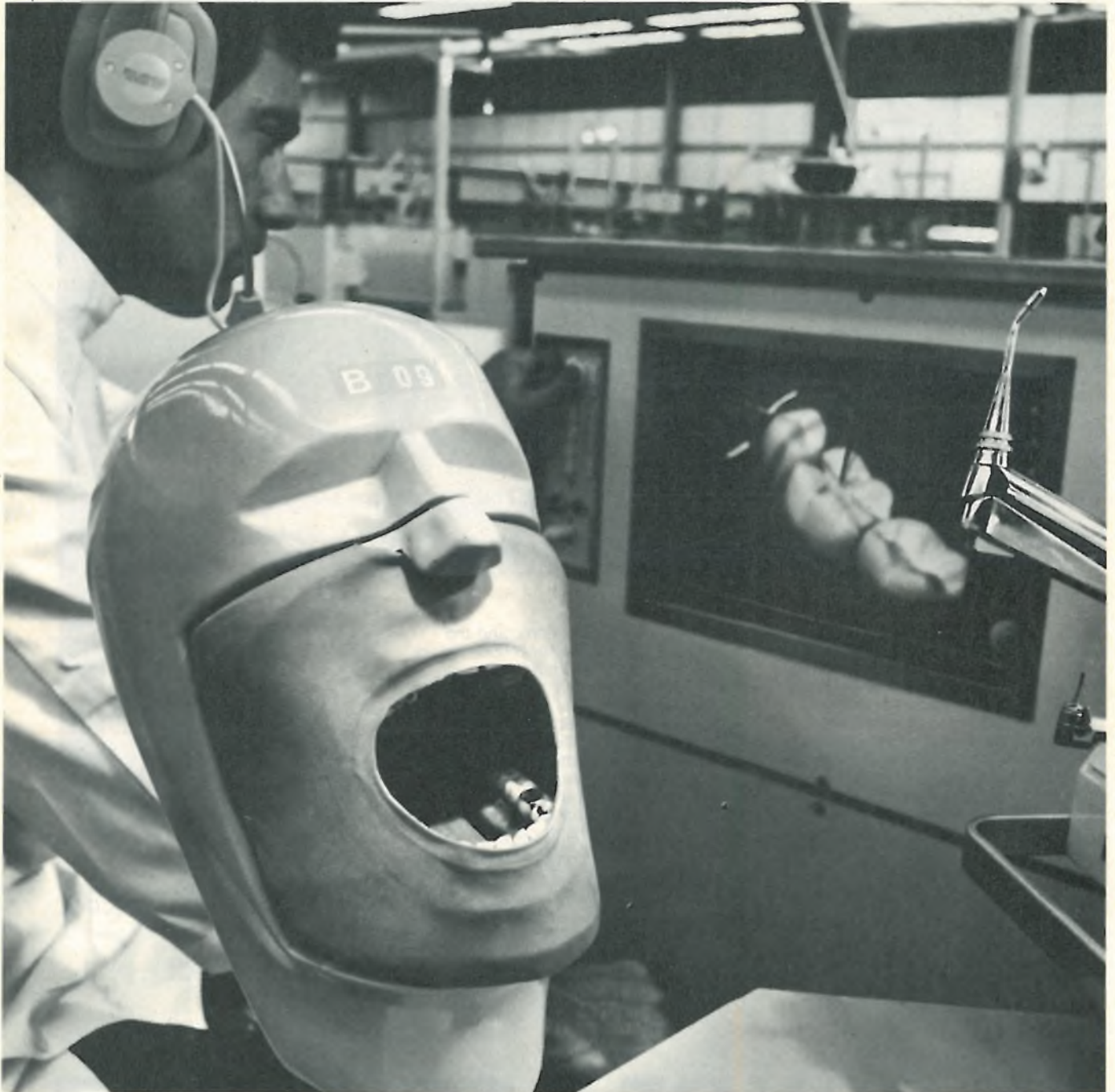

With the large classes common today, this system has the enormous advantage that any number of students can see exactly what the professor is doing. Formerly, students crowded round the professor so that only a few could get a clear view. Those who could went away and tried to remember what they had seen and do the same. Working on a plastic head, the student is free from anxiety

about causing pain or doing damage and not troubled by such things as accumulation of saliva or a tongue that keeps on obscuring his view of the teeth. He can learn his technique painlessly. We designed the entire system.



1 The PIP system (Programmed Individual Presentation) enables a student or trainee to learn at his or her own speed. In fact a PIP teaching programme is a 30-minute sound movie viewed on a projector (Cassettescope) that any student can learn to play forward and back in a few minutes. The programmes are in cassettes so there is no threading.

2 The diagrams in a Practonics textbook work. The student builds up the circuits by plugging capacitors, resistors, etc. into a transparent circuit board laid over the page. A power supply and multimeter enable him to measure the parameters discussed in the text.

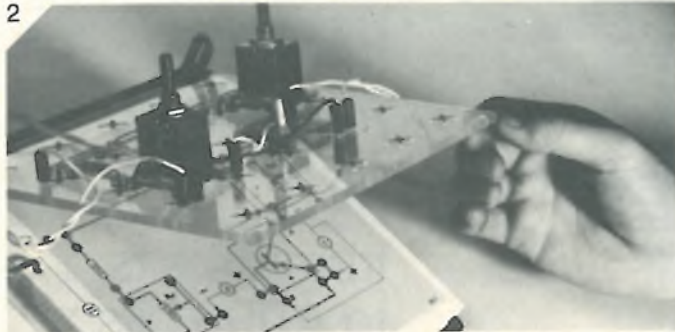

3 Microwaves To understand microwaves students must work with them. For this highly specialised teaching Philips makes two microwave measuring benches for ten basic microwave experiments. Brochures, supplied with the benches, describe the experimental setups in detail.



4 The Video 10 system is a two-camera mini-studio aimed primarily at schools and industrial training centres, enabling students to produce their own TV programmes. It comprises the TV cameras with accessories, control monitors, video mixer, control unit and audio mixer, microphone and head sets as well as power supply units, tripod and cables. A video cassette recorder can also be used so that complex teaching programmes can be prepared and recorded in advance.



If you would like to know more about us, mail the coupon, or write to Philips, GAD-EMB-2/room 16, Eindhoven, Holland.

Please send me the brochure "Components for education and training"

Specific interest:

Name:

Position:

Country/city:

Address:

Post to: Philips, GAD-EMB-2/room 16, Eindhoven, Holland.

PLEASE WRITE IN CAPITALS.

23-14

PHILIPS

working in education



Circle 181 on reader service card

FROM MICRO-PROGRAMMATION TO MICROPROCESSORS

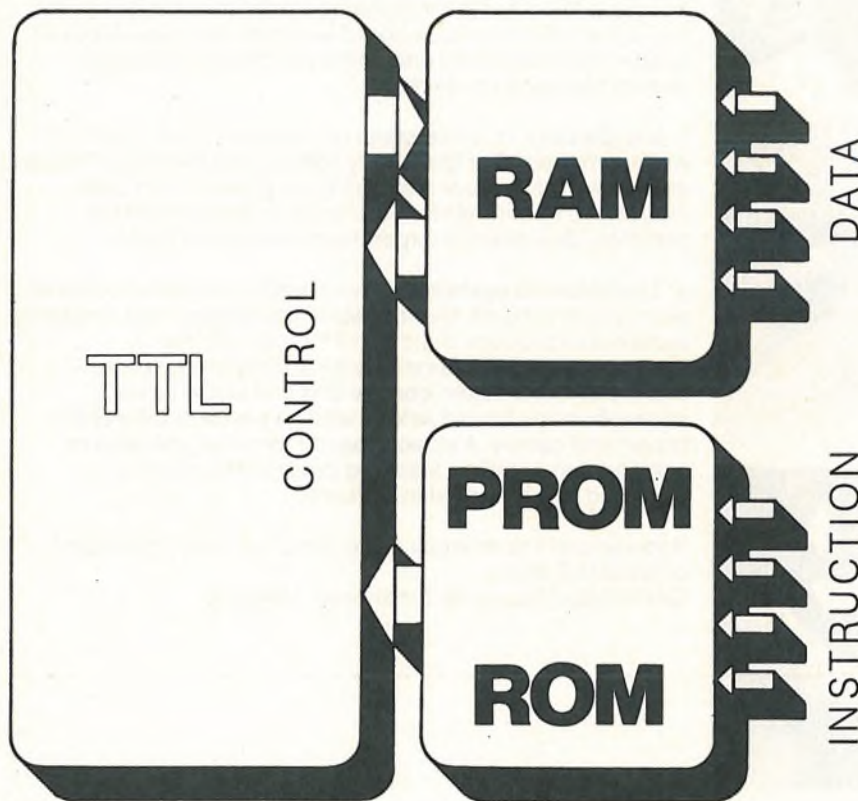

More than
20 devices

RAM

PROM

ROM

from 64 bits
to 4 096 bits

Perez-Publicité 107A



THOMSON-CSF

SEMICONDUCTOR DIVISION
50, rue Jean-Pierre-Timbaud / B.P. 120 / 92403 Courbevoie / France
Téléphone 788 50 01 Télex Sescom 61 560 F

SALES REPRESENTATIVES

BELGIQUE - Bruxelles - Thomson S.A. Tel. 648.64.85 Twx : 23.113 — **BRD - München** - Thomson - CSF GmbH Tel. (089) 76.75.1 Twx : 5.22.916 — **DANMARK - København** - Scansupply Tel Aegir 5090 Twx : 19037 — **ESPAÑA - San Juan Despl (Barcelona)** - Componentes Electronicos S.A. Tel. 319.46.50 Twx : 53.077 — **FINLAND - Helsinki** - OY Suflra AB Tel. 49.01.37 Tig : Pierrejoly Helsinki — **GREAT BRITAIN - London** - Thomson CSF UK Ltd Tel. (01) 579.55.11 Twx : 25.659 — **ITALIA - Milano** - Sescossem Italiana Tel. 68.84.141 Twx : 31.042 & **ROMA** Tel. 31.27.22/35.30.05 Twx : 61.173 Telonde — **NEDERLAND - La Haye** - Compagnie Générale d'Electricité Tel. 60.88.10 Twx : 31.045 — **NORGE - Oslo** - J.M. Feiring A/S Tel. 02.68.63.60 Twx : 16.435 — **OSTERREICH - Wien** - Transalpina Tel. (0222) 56.15.71 Twx : Austand 12.717 — **PORTUGAL - Lisboa 2** - Sd. Com. Rualdo Tig : Rualdo Lisboa Tel. PPC 33 725 — **SUISSE - Berne** - Modulator S.A. Tel. 232.142/43 Twx : 32.431 — **SVERIGE - Solna** - Elektroholm AB Tel. 08/82.02.80 Twx : 19.389 — **U.S.A. - N.P.C. Electronics** - P.O. BOX 1454, Canoga Park, California 91304 - Tel. (213) 887.10.10 - Twx : 910.494.1954 - Telex 651.479 - Cable Nucleonic - 6660 Varie! Avenue, Canoga Park, California 91303.

Polysilicon layer doped with oxygen improves devices

Sony's substitute for planar silicon-dioxide process neutralizes surface charges on wide range of components

A polysilicon layer doped with oxygen is being used by Sony Corp. as a replacement for the conventional silicon-dioxide passivation layer in a wide spectrum of new devices. The products range from bipolar power devices operating at kilovolt levels to low-power complementary-MOS devices. What's more, the same technique is also being used to produce a combination passivation and antireflection layer on high-efficiency silicon photodiodes.

Sony is using the process to produce npn and pnp transistors rated at 800 V and 2,500 v. Because of the protection afforded by the passivation layer, the transistors can be packaged in low-cost molded epoxy as well as metal cans. The 800-v epoxy npn transistor is now in use as color-TV horizontal driver in Sony set. However, because Sony's policy is to use gate-turn-off switches, a type of thyristor, in the horizontal-output stage, the company probably won't use the process for a transistor, even though it can build suitable devices.

Where a high-voltage rating but not a high-dissipation rating is required, these devices can even use dip-coating. An obvious use would be in facsimile scanning where 100 or so transistors are arranged as switches to control one scan line.

Sony workers have also used the new passivation in an experimental

planar transistor with multiple guard bands operating at up to 10 kilovolts, and have found that operation is stable.

In MOS and C-MOS devices, the new method leads to smaller geometries because it eliminates the need for channel stoppers. In integrated circuits, though, vertical leakage between wiring and underlying devices can be a problem. However, it is easily solved by growing silicon dioxide on top of the polycrystalline silicon. This change merely requires adjustment of gas-flow rates and addition of oxygen when the polycrystalline silicon has reached the desired thickness.

The combination layer for photodiodes is applied to a substrate with p diffusion. A metallized ohmic contact near the edge of the diffusion is the positive electrode, while the negative electrode is an ohmic contact on the rear of the substrate. The thickness of the polycrystalline layer is adjusted to form an antireflecting coating similar to those used on lenses. Sony claims to have achieved conversion efficiencies of up to 15% in this configuration.

Shortcomings. The excellent insulating characteristics of conventional silicon-dioxide planar passivation, claim Sony engineers, is also one of its major shortcomings. Electronic charges or ions, which tend to accumulate on its outer surface, act as one plate of a capacitor, and the semiconductor under the layer acts as the other plate. The surface charge induces an opposite-polarity charge near the semiconductor surface and modulates its conductivity. An electronic charge near the surface of the semiconductor can also

be induced by dipole polarization of the epoxy resin used for encapsulation.

Another problem is that a positive charge appears to be locked into the silicon-dioxide layer near its interface with the underlying silicon, tending to cause an inversion layer in p-channel silicon and a resulting difficulty in producing high-voltage pnp transistors. It also causes problems in n-channel MOS, and the presence of the charge usually necessitates the use of channel stoppers, which increase device area.

Neutrality. Polycrystalline silicon, which prevents these problems because it won't support a charge, is intrinsically neutral. Surface charges caused by ions are neutralized by opposite-polarity charges induced near the semiconductor surface. These charges drift into the passivation layer and get stuck in "traps," shielding the semiconductor from ion charges. Surface electrons tend to leak away. The polycrystalline layer is also impervious to penetration by water or sodium ions.

The method, developed by Sony engineers, requires no difficult or exotic processes. A typical bipolar device would be fabricated by standard planar procedures. However, instead of opening windows for the ohmic-contact metalization, the entire silicon-dioxide layer on the surface of the device is etched away. A polycrystalline silicon layer is then grown by chemical-vapor deposition at about 650°C, using a mixture of silane, nitrous oxide, and nitrogen.

Films are grown with an oxygen doping of 15% to 25%, which is controlled by varying the ratio of silane

to nitrous oxide. Undoped films grow at a rate of 50 nanometers per minute, and the growth rate falls as the oxygen percentage is increased. Films have resistivity ranging from 10^8 to 10^{10} ohm-centimeters, compared with about 10^6 ohm-centimeters for undoped films. Since polycrystalline grains have diameters 30 to 100 times those of silicon atoms, they show some crystalline properties, even though the film appears to be almost amorphous.

Passivation. Polycrystalline-silicon films can be used to passivate both planar and mesa devices. Planar devices become, if anything, more planar because the passivating material is put in a single layer instead of a split level. Mesa devices show improved characteristics because the passivating layer is applied to the top and sides of the mesa. In fact, Sony engineers say, the passivating layer reaches its full depth at the corner between the top and sides of the mesa, where many deposited materials break.

Windows for ohmic contacts are made by using a resist mask and a plasma etch. The etch extends slightly into the silicon device, but this depth gives no problem in most devices. It can be eliminated, for devices with shallow junctions. □

France

TV camera tracks low-flying planes

It's difficult enough to follow supersonic aircraft acrobatics with the naked eye, but to keep track of the action with a television camera during a 10-day air show is harder still. Yet the action was followed diligently at this month's Paris show by a new Franco-Swedish television tracker developed for the military fire-control market.

Until now, most fire-control systems have depended almost exclusively on radar for tracking operations. But radar's accuracy and dependability have been inadequate to cope with low-level attacks, so-



On the track. French video tracking system was given a practical task to demonstrate its lock-on abilities: following the planes at the Paris Air Show.

phisticated jamming, and identifying the strike capability of raiding aircraft.

However, these obstacles can be overcome by automatic TV trackers, which are much harder to jam and which enable defense forces to recognize attackers, even at altitudes so low that ground echo would clutter a radar screen. The designers claim their tracker can also track approaching aircraft more accurately than radar can.

Adaptation. The equipment that filmed the antics of the world's aircraft in Paris is a French-developed version of hardware manufactured by Sere Bézu under license from Sweden's SAAB-Scania. The French claim to have improved the main aspects of performance of the system, the TVT-300. The effective operating range has been stretched to about 12 kilometers from the previous 3 or 4 kilometers. In addition, the camera can now track not only the aircraft, but it can zoom in on a vital section, such as weapons or navigation bay. In effect, the vulnerable portion of any enemy aircraft becomes the target of the TV camera.

Sere Bézu engineers are reluctant to discuss how the equipment processes the video signals or how the aiming window is regulated, but performance claims suggest some of the technology. One good reason for the reluctance to disclose details is that the French Navy is evaluating the system. Sere Bézu figures the TV camera—it can be any silicon vidi-

con instrument suited to twilight conditions—can lock on its target that has a minimum contrast of only 5% or 10% when it extends 0.3 milliradian or 80% on one measuring 0.1 milliradian.

The company also claims that the equipment can handle maximum target acceleration of 50 meters per second for distances beyond 500 meters. As one Sere Bézu engineer expresses it, the camera can stay with a supersonic plane passing less than half a mile away. To complete the package, Sere Bézu is planning to sell the equipment with optional laser and infrared trackers to optimize performance and enable operation under conditions of poor visibility.

Operation. The camera clings to its target by reacting to the smallest variation in video signals registered by each of four panels in a window set in the center of the image. Like the cross hairs of a rifle sight, the window is aimed manually at the target by the operator. From then on, the tracking system takes over. Video signals in each panel are compared with one another in sequence so that any change in contrast immediately warns the remote-control system that the target is moving out of the line of sight.

By adding a microprocessor from Intel Corp., Santa Clara, Calif., Sere Bézu has sharpened up the tracking performance so that a lock can be maintained on a specific part of the aircraft or target. The French engineers have also devised a system for

The perfect all-round signal generator 15 Hz to 1.05 GHz

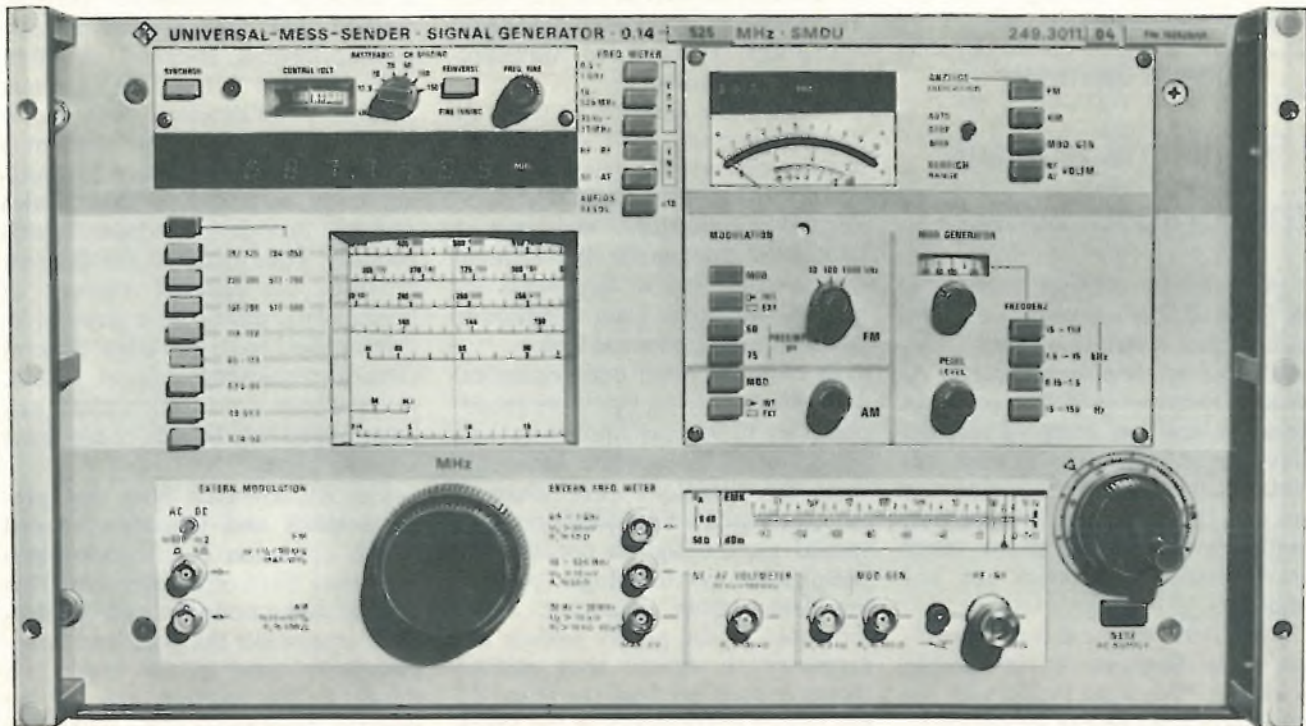

Precise electrical performance
Economical thanks to available options
Versatile in application
Ease of operation for rapid measurements

The general-purpose Signal Generator SMDU is superior to all previous instruments of its kind on the market. It fulfills the most stringent requirements as to frequency constancy and spectral purity as well as accuracy, versatility, ease of operation and cost effectiveness.

Its area of application extends beyond laboratory use to cover all measurements according to international standard specifications on commercial receivers, including aeronautical radiocommunication receivers, and mono and stereo broadcast receivers, plus active and passive components. Economical: With its wide frequency range from 0.14 to

525 MHz (1.05-GHz option), the SMDU replaces several RF generators. Moreover, it contains an AF generator (15 Hz to 150 kHz) and an AF voltmeter – forming an AF level measuring assembly – and a digital frequency meter for AF and RF. Perfect RF engineering: **High frequency constancy** and resolution; **low modulation distortion** (FM <0.1%, also with stereo-multiplex signals); high-precision crystal oscillator for control of digital frequency meter; **high signal-to-noise ratio** and wide level range (EMF 0.03 μ V to 2 V). Suitable for use as interfering-signal source in multi-signal measurements. Crystal control with synchronizer option.

Easy to operate: **Speedy frequency selection** by pushbuttons; combined analog and digital frequency readout; unambiguous level adjustment with **single-range attenuator**; frequency selection with selectable channel spacing using synchronizer. **Autoranging** for modulation, AF level and AF generator voltage setting; overload protection.

You can choose between the standard version and the universal version, not forgetting the four options.

Ask Rohde & Schwarz
 for the data sheet
 ›Signal Generator SMDU‹



ROHDE & SCHWARZ

8000 München 80
 Mühlhofstraße 15
 West Germany
 Tel. (089) *4129-1
 Telex 523 703

Distributors in: Argentina, Australia, Austria, Belgium, Brazil, Canada, Chile, Columbia, CSSR, Cyprus, Denmark, Ecuador, Ethiopia, Finland, France, Ghana, Greece, Hongkong, Hungary, Iceland, India, Indonesia, Iran, Ireland, Italy, Japan, Kenya, Mexico, Netherlands, New Zealand, Norway, Pakistan, Peru, Portugal, South Africa, Spain, Sweden, Switzerland, Thailand, Turkey, United Kingdom, Uruguay, U.S.A., Venezuela a.o.

regulating the window according to the characteristics of the target. A slow, low-flying helicopter would require a different setting from one for a fast interceptor aircraft. □

West Germany

150 grams actuate 'motionless' switch

A piezoelectric ceramic element is the heart of a new pressure-sensitive push-button switch that offers an alternative to touch-sensitive or proximity-type switches used in elevators and on many European television sets. Because of such advantages as insensitivity to moisture and dirt, the element can be used in rough environments where other nonmechanical switches are not suitable.

The B39910 element is now available from Siemens AG in sample quantities. "We want to first wait for the market echo before we decide to what extent the mass-production stage will be entered," says a Siemens marketing official. In quantity, the element will sell for 40 to 50 pfennigs—equivalent to 17 to 21 U.S. cents.

The new element operates on the well-known piezoelectric phenomenon of converting an applied pressure into an electrical signal. The Siemens transducer generates about 0.8 volt under a pressure of only 150 grams—about twice the pressure it takes to operate a typewriter key. And since the element deformation is less than 0.5 micrometer under this 150-gram pressure, Siemens bills its new device as a motionless switch.

Rugged. Neither moisture nor dirt can alter the switching characteristics of the element, and inadvertently touching it does not cause unintentional operation because the element must be actuated by a well defined minimum pressure. Furthermore, shock and vibrations cannot trigger switch operation because of a resistor-capacitor low-pass filter integrated into the element.

These features, Siemens says, suit the element for use in such rough environments as factory halls and workshops, as well as stoves, washing machines, and other household appliances exposed to moisture-laden atmospheres.

Because the B39910 requires no standby current, it is suitable for battery-operated portable radios and television sets. In addition to industrial applications and use in household appliances, the element can also be used in keyboards for medical electronic gear, telephones, and computers, Siemens says.

By contrast, other nonmechanical motionless switches like those sensor plates on TV sets are limited in their applications. To operate those devices, the operator's finger changes the touch area's conductivity, and a special plate design is needed, lest perspiration on the finger prevent the device from operating. Small serrations in the plate's surface are necessary to ensure that minute moisture particles from the finger do not reduce conductivity in the touch plate. And those motionless elevator-control switches normally use a finger-induced change in capaci-

tance to detune a small oscillator circuit.

Installation. The B39910 element is made of a ferroelectric ceramic material like that used in sound-pick-up devices. It comes as a thin slab of about 9 by 20 millimeters that is 3 millimeters thick. In a switching application, the element is installed upright within a supporting body arranged so that guides prevent the element from lateral bending. Thus installed, the element provides the greatest amount of piezoelectric power for a given pressure applied to its top edge. Several element-containing support bodies, covered with a protective plate, can be arranged side by side to construct a switch panel.

The RC low-pass filter that prevents shock and vibration-induced switch operation is integrated into the upper third of the element. This portion is the nonpolarized "protective" area, while the polarized ferroelectric material in the lower two thirds of the element acts as the pressure transducer. The B39910 is compatible with transistor-transistor and low-speed logic, as well as complementary-MOS devices. □

Japan

Ink-jet printer can vary matrix resolution and size

High printing speed and print-out clarity are qualities that can seldom be combined in a printer. But they are two of the features of an ink-jet printer developed jointly by the Musashino Electrical Communication Laboratory of the Nippon Telegraph and Telephone Public Corp. and Sharp Corp. Multiple matrix sizes and variable character height are added innovations.

Sharp expects to market a commercial model next spring for something like \$6,800. NTT's plans are not firm yet, but development of this printer puts it in position to supply high-speed data terminals when the demand for them develops.

The printer uses a five-by-seven-

dot format to print 128 characters at an output rate of 500 characters a minute. Each dot is approximately 200 micrometers in diameter (including spreading of ink in the paper), and positioning accuracy of each dot in ± 20 micrometers, making for very clear printing. The machine can be used with transmission-line speeds of 1,200, 2,400 and even 4,800 bits per second. The non-impact ink jet keeps noise level down to a quiet 53 decibels.

For the Japanese katakana syllabary, though, a finer matrix is desired. Rather than switching to a seven-by-nine matrix, a multiple matrix was developed. This method uses a supplementary four-by-six

PUT A MICRAL IN YOUR SYSTEM

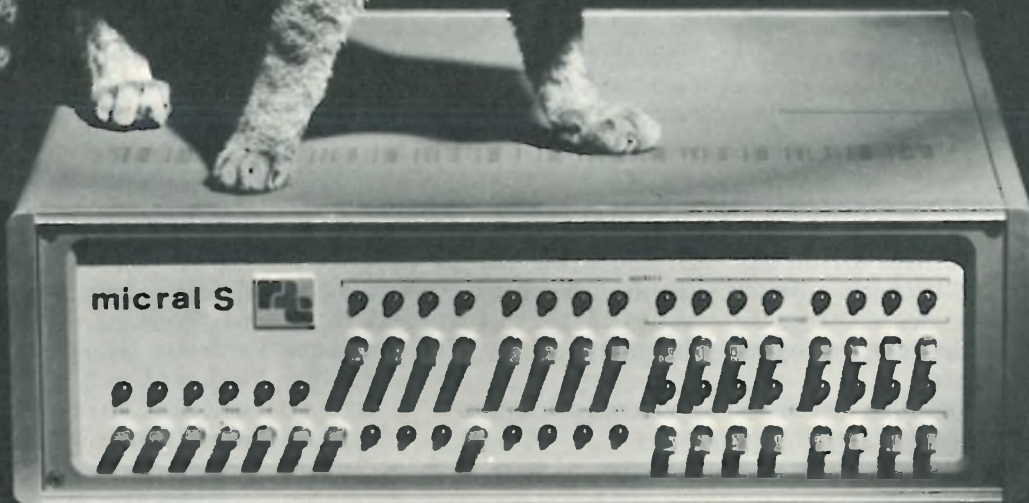

MICRAL is a family of three compatible micro-computers designed to cover a wide range of applications at the lowest-cost.

MICRAL has proved its reliability in a large number of process-control applications over the past two years.

MICRAL's modularity, its range of 23 controllers for industrial and business oriented peripherals, its ease of interfacing, and its field-proven software make it the outstanding micro-computer. Save time, save money : put a MICRAL in your system.

MICRAL S : the most powerful of the MICRAL range

- microprocessor	8080
- memory format	8 bits
- memory capacity	from 256 bytes to 64 K bytes
- time of execution for one base instruction	2 μ S
- number of hardware interrupt levels	8
- push-down stack	unlimited
- high speed buffered i/o channels (1 M bytes/s)	8
- time for processing an interrupt	31 μ S
- software programmable real time clock	yes

SAGHA



Z. A. de Courtabœuf. bp 73 - 91403 Orsay (France). ☎ 907.47.77. Télex R2E 24014 F

matrix between the dots in the main matrix. In the multiple-matrix mode, speed is reduced to 300 characters a second.

The read-only memory requires seven by seven bits for each character. The extra two by seven bits provide spacing between characters. A supplementary memory with four by six bits per character is used to provide the multiple-matrix option.

Another innovation in this printer is the ability to print characters ranging from 1 to 5 millimeters in height, although normally it is adjusted at about the midpoint of the range. Size of the smallest characters is limited by resolution obtainable with a fixed ink-dot size, while the size of the largest characters is limited by the spaces that open up between ink dots. Adjustments are provided for carriage speed and line spacing to match character width and height.

The actual printing mechanism is a refinement of earlier designs. Mounted on a carriage are the ink jet, including 50-kilohertz vibrator and nozzle, electrodes to charge the ink jet, sensing electrode, and upper deflection electrode.

The lower deflection electrode

and ink-return baffle plate are fixed structures that extend across the entire width of the carriage run. The fixed electrode is connected to the positive side of a 5,000-volt supply, and the upper deflection electrode on the carriage is grounded.

Droplets of ink measuring about 100 micrometers in diameter emerge from the nozzle with a spacing of 500 micrometers and pass through the charging electrode. It has a voltage of zero where the paper is to remain white and seven steps between -150 and -300 v—corresponding to the seven dot positions—where printing is desired.

The droplets pass the sensing electrode and then pass between upper and lower deflecting electrodes. Uncharged droplets strike the return baffle while charged droplets are deflected proportionally to their charge.

The charge acquired by a droplet is to some extent affected by the charge on the preceding droplet. Therefore, the sensing electrode is provided to control a dynamic correction voltage that is applied to the charging electrode. This technique is the key to the ± 20 -micrometer positioning accuracy. □

South Africa

Television finally arrives, but it's expensive

South Africa inaugurated the world's most expensive television service when it began test transmissions in the Johannesburg area this spring. The eight-month test period is intended to serve a dual purpose: to iron out minor technical snags in the system before full-scale transmission on one channel is started Jan. 1 and to spur the lagging sales of television sets.

One-hour test programs are now being broadcast twice daily, and test transmissions are to be aired in Durban and Cape Town in July. When regular broadcasting comes on stream, there will be daily programs from 6 to 11 p.m. Because South Af-

rica is bilingual country, half the programs will be in English and half in Afrikaans, the nation's two official languages.

Officials of South Africa's broadcasting system claim that television has met their rigid technical specifications. Piet Meyer, chairman of the system, says, "From a technical point of view—and I have seen television throughout the world—South Africa's TV compares with the best." Even outsiders are impressed. The general manager of Britain's Weekend TV network, Vic Gardiner, acclaims South Africa's system as the Rolls Royce of television.

Indeed, for the South Africans,

television did not come cheap. By next January, about \$156 million will have been invested in the country's system. The total includes a \$60 million broadcasting center in Johannesburg, \$15 million for local television productions, and \$750,000 for the purchase of American and European programs.

At the outset, South African television will be subsidized by the government at an estimated cost of \$65 million per year. Commercial television is scheduled to begin in 1978, but, until that time, the system will operate at a substantial loss. The only income to be received by the state-run system is from an annual \$53 license fee to be levied on each set.

Technical expertise aside, television has not yet taken off in the consumer marketplace. Although the public acknowledges the novelty of TV, buyers are not queuing up to purchase sets. The reason: television sets are inordinately expensive, and the nation's electronics industry is having trouble justifying the cost of the receivers, which use West German PAL technology. A color-TV set with a 26-inch screen, for example, sells at \$1,550 to \$1,620, and even a monthly rental fee of \$53 seems too much for recession-hit pocketbooks.

Expensive. The prime reason for such high prices is the cost of manufacturing sets locally with short production runs. To complicate matters, the government has banned imports because it fears a substantial outflow of foreign exchange would result, and it is attempting to stimulate local manufacturing to provide employment for South Africans.

"Anyone waiting for prices to come down before buying his television receiver is, I'm afraid, in for a rude shock," says Derek Cooper, chairman of the South African Television Manufacturers Association. The government has limited the number of TV-receiver manufacturers to six—Tedelex, Fuchs, Electra, Southern Cross Television Consortium, Philips of South Africa, and Barlows—on grounds that smaller manufacturers would not

Nuovo Pignone at Smederevo

We shall soon put into operation at Smederevo in Yugoslavia the remote control system of the local distribution network, and the number of our P6006 remote control stations installed in Italy and abroad will thus reach the figure of 224.

Not a bad achievement, considering that the advanced P6006 equipment has been produced only since early 1974.

However the experience in electrical applications of our automation systems division is by no means so shortlived.

We started 8 years ago in Vicenza - when we already had to our credit remarkable achievements in other fields - with the remote control systems for the municipal distribution network.

Then, while on the one hand we contin-

Also for the automation of electric net works Nuovo Pignone offers advanced equipment and sound experience.

ued our activity in the distribution field, on the other hand we carried out computerized systems for the acquisition of data in thermo-electric power plants. In these days of energy restraint we feel particularly engaged to analyse the problems of automation, together with electricity authorities, and to thus contribute with our equipment towards a safer and economically convenient production and distribution of the electric energy.

Naturally, our activity in the automation

field is not restricted to the electrical sector and we can offer, particularly to municipal authorities, our experience in other remote control applications such as gas and water systems. Complete automation systems can also be supplied for numerous other sectors.

All these systems are based on advanced equipment such as our P3010 and P4010 process computers, a vast range of terminals (among which the P2656 colour video units) and the already mentioned P6006 remote control stations, all entirely designed in our laboratories and incorporating particular functional and technological features.

To these must be added, as an essential component of the Pignone systems, the expert work of our team of system analysis and application software specialists.

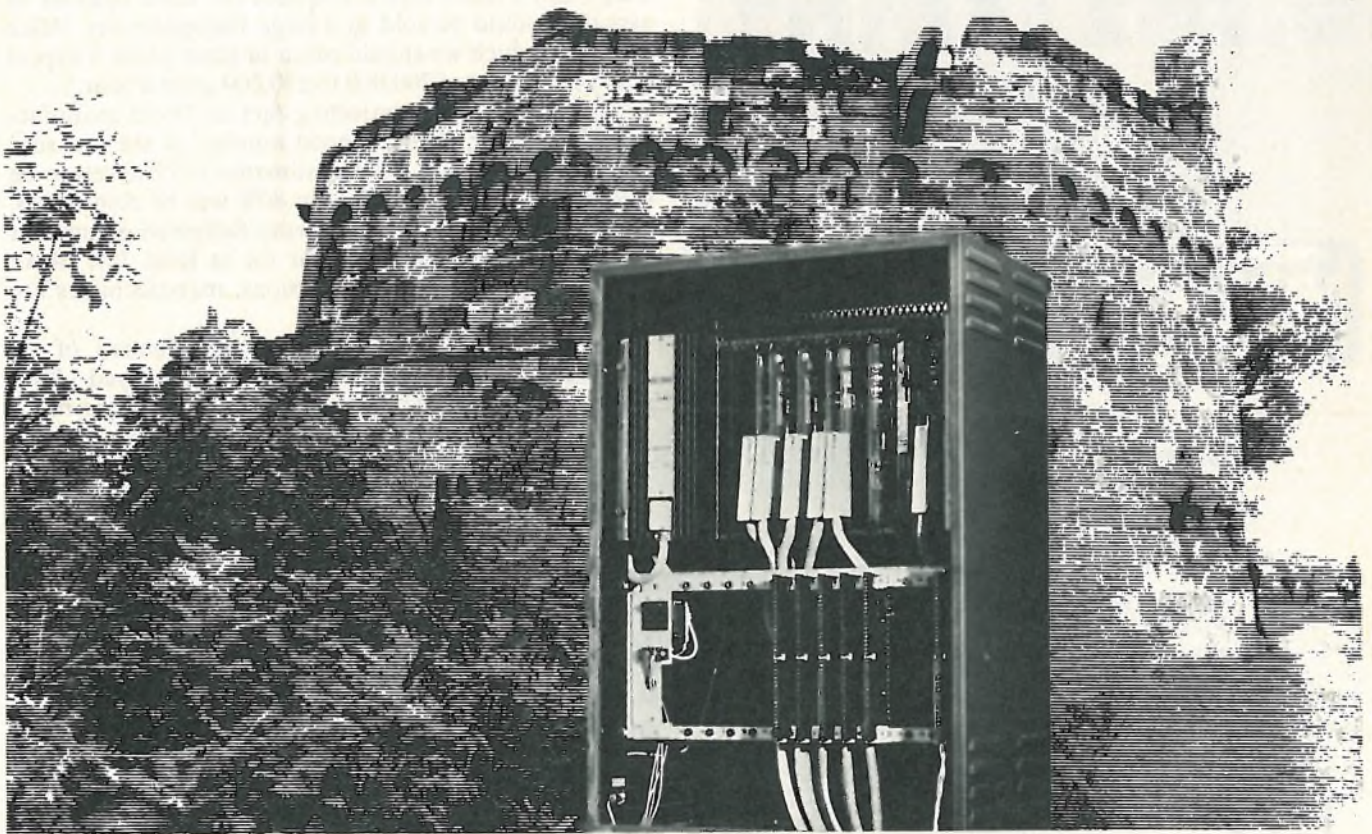

NuovoPignone

DIVISIONE SISTEMI AUTOMAZIONE - Via Casilina, 1674 (Km. 15) - 00133 ROMA - Telefono 06/6154141 - Telex 61250

Adret has your requirements
at
its fingertips



the
Adret 201 SB
generator

0.1 Hz / 2 MHz
resolution : 0.1 Hz

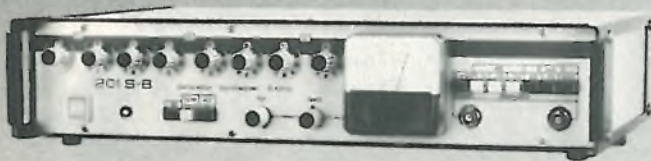

OUTPUT LEVEL

- regulated to ± 0.02 dB (0.2 %).
- adjustable from 1 mV to 3 Vrms (digital attenuator + vernier).

OUTPUT IMPEDANCES :

- 0.50, 75 and 600 Ω

Very low harmonic distortion
(54 dB down).

Frequency programming.

Auxiliary 2 MHz to 3.5 MHz output
(optional).



12, avenue Vladimir Komarov
78190 Trappes - France
Tél. 051.29.72

psycho 340 . es

Electronics international

maintain the high specifications and level of servicing required by the nation's bureau of standards.

Tedex will manufacture and market Blaupunkt and Sony Triniton sets; Fuchs will manufacture German Grundig units; Electra will assemble German AEG-Telefunken sets; Southern Cross will market under the Supersonic label; Barlows will work in conjunction with Britain's Rediffusion; and Philips will assemble and sell its own label. Each firm has been allocated a specific portion of the market ranging from 20,000 to 100,000 units per year.

Market limited. A Johannesburg manufacturer says: "You must not forget that the market here is very small. We estimate total demand will be about 300,000 sets per year, and with this scale of production, we simply cannot sell units at a low cost."

At first, TV will be beamed to only one tenth of the country. This includes Johannesburg, Durban, Cape Town, and Port Elizabeth, where the majority of South Africa's 4 million whites reside. Program director Pieter de Bruyn says that in 1979 there will be a second channel for the country's 20 million non-whites, but until that time, manufacturers will be forced to concentrate on the relatively small white market.

John Poot, chairman of Philips of South Africa, says that "we're distributing—in a country the size of Germany and France together—about the same number of sets that would be sold in a large European city. After the peak, which we should reach in three years, I expect a steady market of 200,000 to 250,000 units a year."

Color sales. One comforting fact to TV-set manufacturers, however, is that a good number of the sets sold will be color models. Of the estimated 175,000 sets to be sold this year, Poot says about 80% will be color units. Electra's managing director Henry Seligman insists that color-TV receivers will account for at least 75% of all sales. But, despite sales projections, manufacturers are playing it by ear.

There are various reasons the introduction of TV broadcasting in South Africa has been delayed [*Electronics*, May 24, 1971]. Albert Hertzog, one-time minister of posts and telegraphs, claims TV will create moral and spiritual decay in a country dominated by Calvinist religious thought. Television, Hertzog says, will force South African children to grow up in the presence of degradation and evil. Other detractors point out that the system will be uneconomical because license fees simply cannot cover the operating costs, let alone allow the transmission to pay for itself.

However, the system says that programing, like the technical standards, will be of high quality. Comments its director general, Jan Swanepoel: "We are not dictated to by the government, and we have never been asked by the government to do a specific program on a particular topic. Our programing will include everything from news to sports to soap operas." But, says one critic, "They'd have to show academy-award winning films every night before I'd even consider paying the amount they're asking for a set." □



there's a
take-away
contact
in our
0.150" connector...



UECL Series 1680 is a standard 0.150" (3.81mm) pitch connector with a difference—it has removable contacts. Contacts that can be removed and replaced from the board slot face. So that, if a contact is your problem, it is quickly replaced with the connector in situ. Series 1680 is a connoisseur's choice when it comes to versatility—that's why UECL sales companies and distributors keep close contact with industry throughout the world.

The UECL patented "Bellows" contact can be fitted or removed with a simple tool. Unsolder one lead, replace one contact, and the problem is solved. Positive location is assured.

UECL

IN CLOSE CONTACT

**Ultra Electronics
(Components) Limited**

Fassetts Road, Loudwater, Bucks., England
Telephone: High Wycombe (0494) 26233
Telex: 83173

Ultra Electronique (France) S.A.R.L.
23 Bd. Berthier 75017 Paris Cédex 17, France
Tel: 754 23 64

Ultra Electronics (Components) G.m.b.H.
52 Sieburg bei Bonn, Zeithstrasse 17, W. Germany
Tel: (02241) 6 39 62

Ultra Electronics Sweden A.B.
Box 350, 17203 Sundbyberg 3 Sweden
Tel: (08) 29 02 55

Agents in all major countries throughout the world



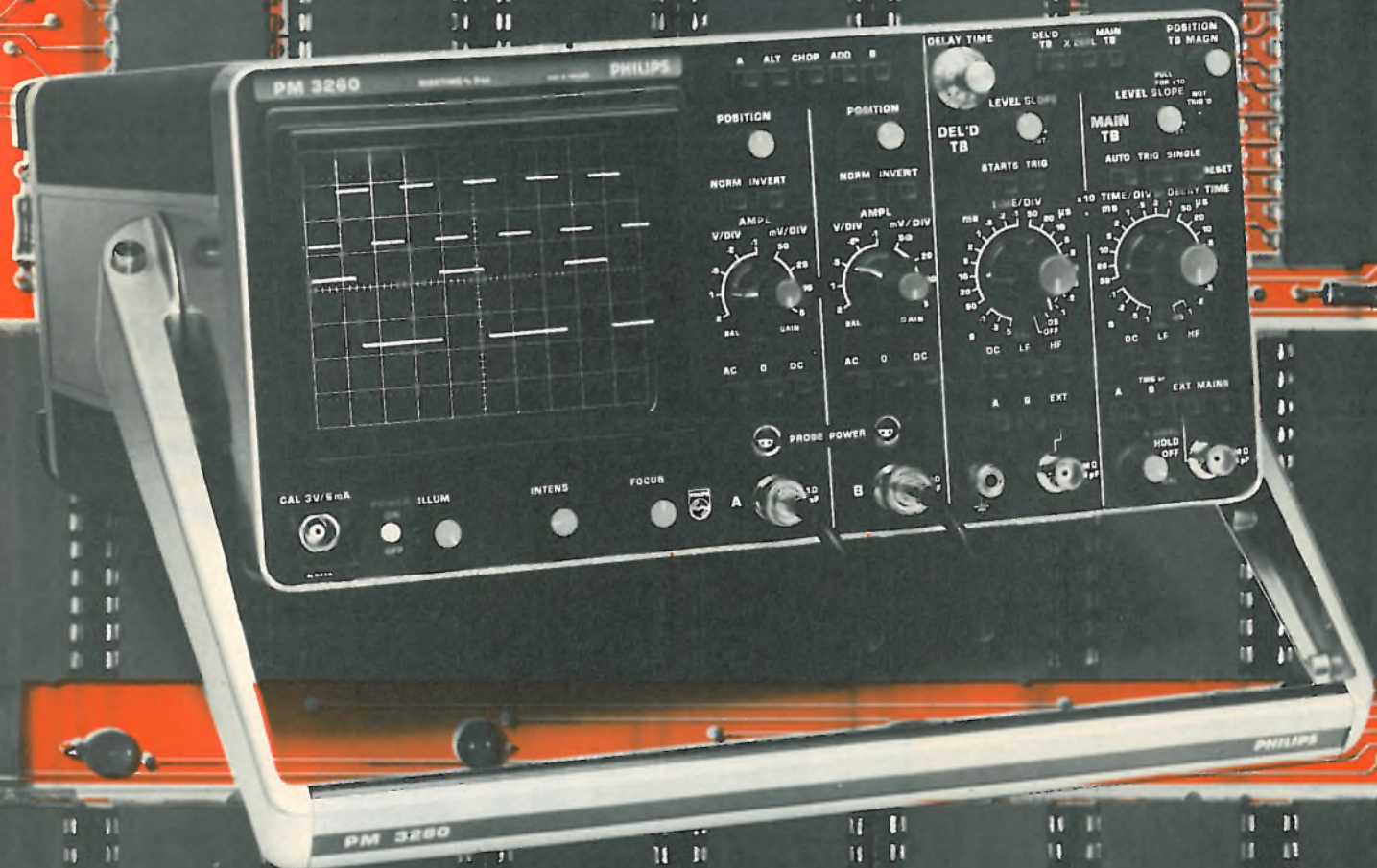

The logical choice for logic circuitry

Compact performance at 50, 120 and 150 MHz

Just as circuits and systems get smaller and faster, so too do our oscilloscopes.

The 50 MHz model PM 3240, for example, weighs in at a mere 8.4 kg. And because it's used as much outside the laboratory as in, we've given it a logical front panel layout where every control falls naturally to hand. The PM 3240 has also been designed to operate from almost any supply, including DC, to have a bright 8 x 10 cm display and good circuit access for short service down-times on the oscilloscope itself.

Moving up to 120 MHz

For higher bandwidth applications the 120 MHz model PM 3260 is available. This 9 kg light instrument therefore keeps you well ahead of Schottky TTL speeds and at the same time goes on triggering to over 200 MHz to meet the great majority of ECL applications.

Like the 50 MHz model, the PM 3260 includes layout features

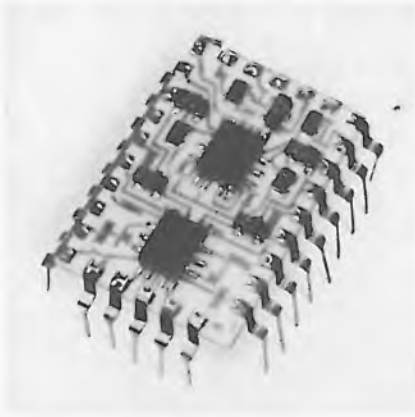

All three oscilloscopes make wide use of monolithic IC's in order to reduce weight and the number of adjustment points.

such as clear separation of the main and delayed time bases as well as operation from DC plus 100 to 240 V supplies having frequencies from 46 to 440 Hz.

Multiplying at 100 MHz

The PM 3265 extends all the previous benefits to a bandwidth of 150 MHz and also adds the unique, built-in 100 MHz analog multiplying facility. Only with this instrument can you therefore make transient power and dynamic phase measurements on high-speed components and circuitry. Moreover this facility, like the rest of the instrument, is extremely easy to use. You simply push the 'A x B' button to obtain the product which can also be displayed together with the B input signal.

A family of compacts

These three compact instruments thus meet the needs of designers and users - at 50, 120 and 150 MHz - and meet them with a number of significant and unique benefits.

Find out more by writing to :

Philips Industries, Test and Measuring Instruments Department, Eindhoven, The Netherlands.

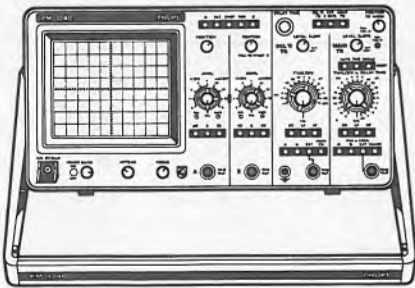

PM 3240 : 50 MHz/5 mV; 8.4 kg; bright 8 x 10 cm display.

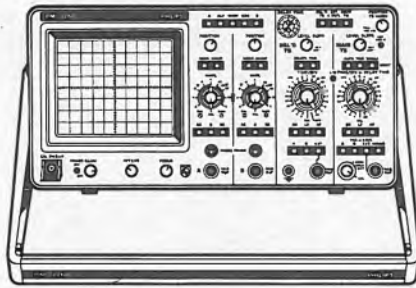

PM 3260 : 120 MHz/5 mV; 9.0 kg; ergonomic layout*; wide choice of line supplies*.

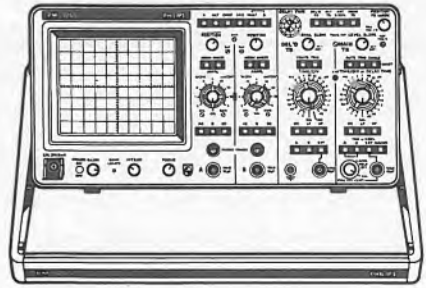

PM 3265 : 150 MHz/5 mV; unique 100 MHz analog multiplier; 9.5 kg.

(* features common to all models)



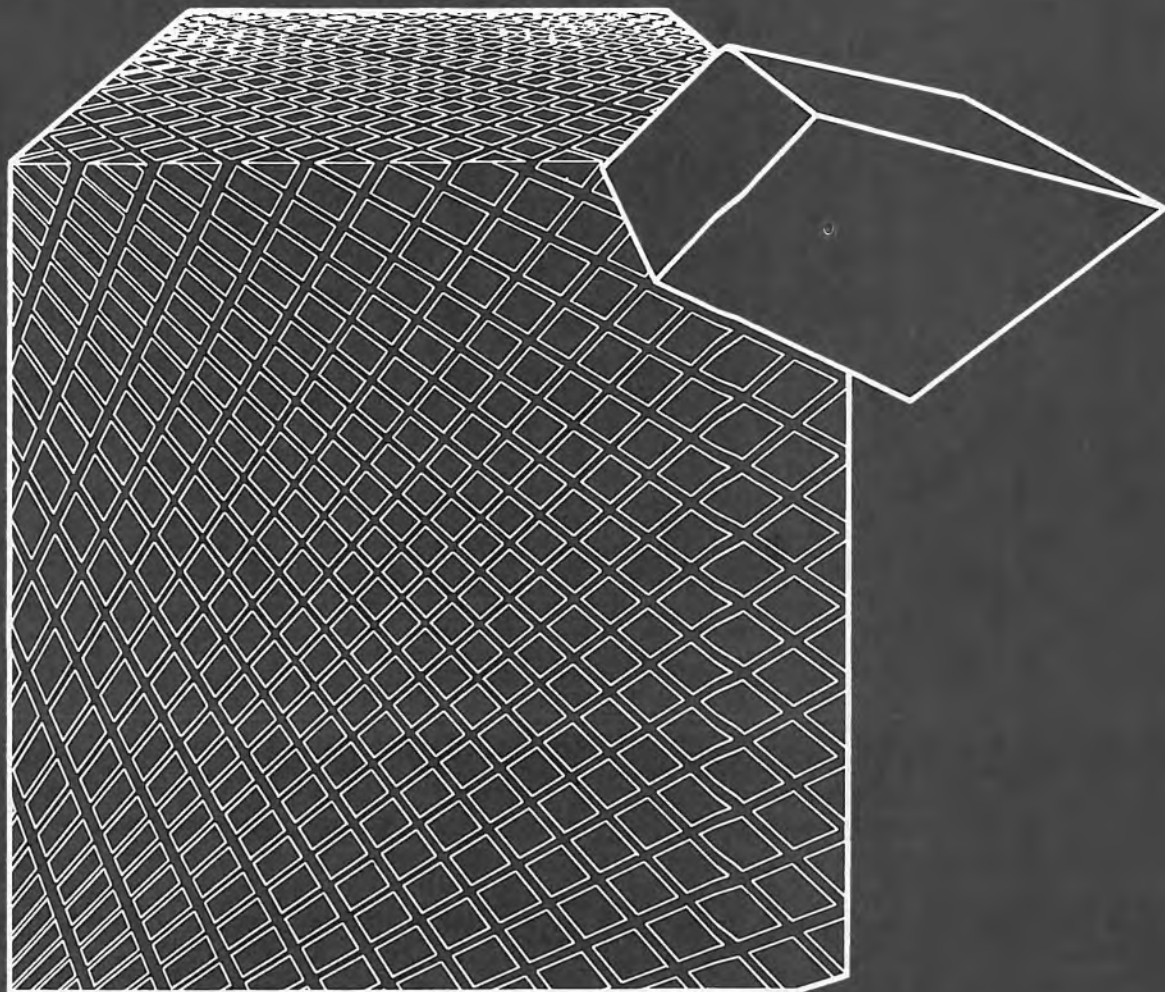

ENJOY SERVICE

With  components

QUALITY, TECHNOLOGY, SERVICE, RANGE, VOLUME, APPLICATION
are our trademarks.

We make components for a wide range of consumer, industrial
and professional applications.

- Thick film carbon resistors
- Wirewound precision trimmers
- Metal glaze resistors
- Cermet precision trimmers
- Metal film resistors
- Carbon composition potentiometers
- Wirewound resistors
- Wirewound potentiometers

Circle 189 on reader service card



ARE OUR EXPORT AGENTS



SEIMART COMPONENTI

Via Torino 177 - 10040 LEINI' (TORINO) Italy - Tel. (011) 9989553 - Telex: 37597

© Trademark of SEIMART s.p.a.

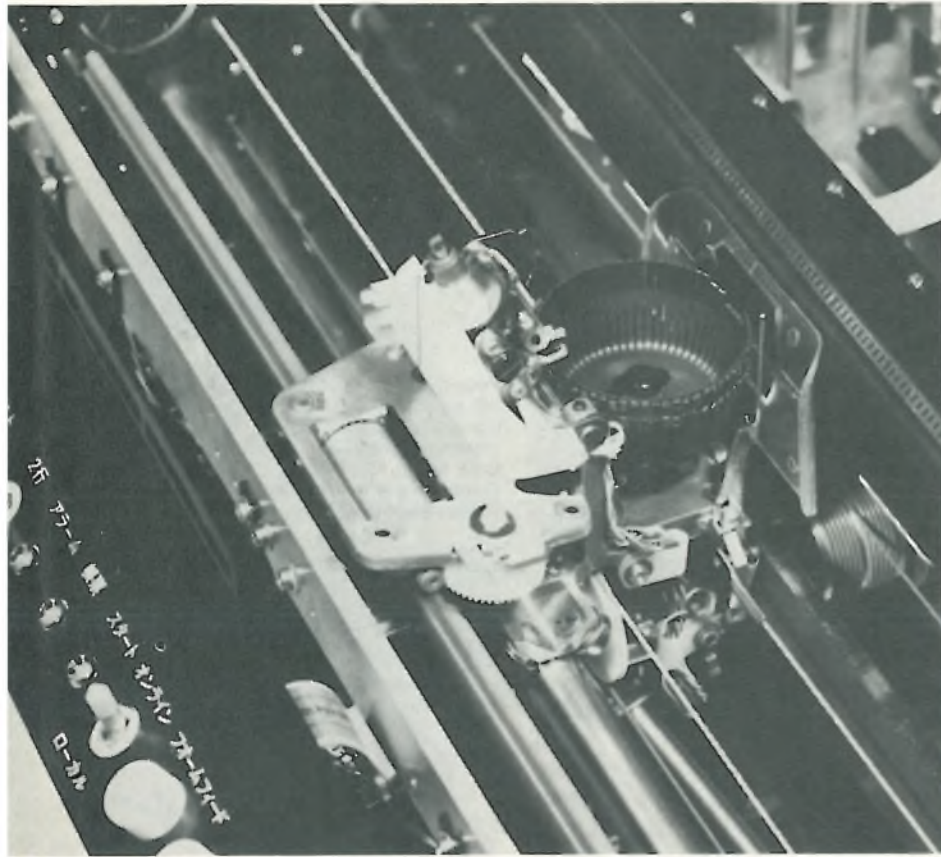

Impact printers have built-in microprocessors

by Charles Cohen, Tokyo bureau manager

One model with crown-type print head operates at 40 characters a second; noise level is 60 dB

In a new family of intelligent impact printers developed by Nippon Electric Co., mechanical components have been replaced by electronic components for increased flexibility, decreased maintenance, and de-

creased noise level—about 10 decibels less than conventional machines, the company says. A built-in 8-bit microprocessor provides a variety of intelligent functions that are more sophisticated than those of conventional low-end printers and overlap those of intelligent terminals at the high end.

The most versatile model now available employs a novel user-replaceable crown-type printing mechanism with 128 characters. Other types use dot matrixes, and

Fast and quiet. Badminton printer, shown with head mounted but without ribbon cassette, operates at 40 characters a second with noise level of 60 dB.

also have 128 characters. In all models, the printer, which is about 80% electronic, contains only about 10% as many parts as mechanical printers.

Nippon Electric calls the machine with the crown-type printing head, which can print an original and four copies, a Badminton printer because the head resembles a badminton shuttlecock with two characters on each feather. Although the head has 128 characters, the printing rate is 40 characters a second. The noise level is only 60 dB, Nippon says.

Character visible. The small plastic head has a small angular moment of inertia, and motion is simple. Rotation is controlled by one dc servo, and elevation is controlled by another. Impact is provided by a solenoid-actuated hammer mounted inside the head. The head, which has several truncated feathers, can be programmed to return to the position in which the truncated feather allows the operator to inspect the character after typing it.

The insides of the Badminton printer look almost empty, compared with the usual electromechanical printer, because there are only about 350 mechanical parts and 290 electronic parts—including the microprocessor. The mean time between failure, the company says, is about an order of magnitude greater than it is for electromechanical designs—about 15 million characters. Even the operator-replaceable ribbon cartridge has been simplified by using a continuous ribbon, which eliminates need for a reversing mechanism. Dc servos are used for print-head rotation, vertical selection, and carriage feed. A stepper motor to feed the paper eliminates ratchet-and-pawl and other wear-prone mechanisms.

The Badminton printer, designed for asynchronous use with the RS-232 modem interface in either serial

New products international

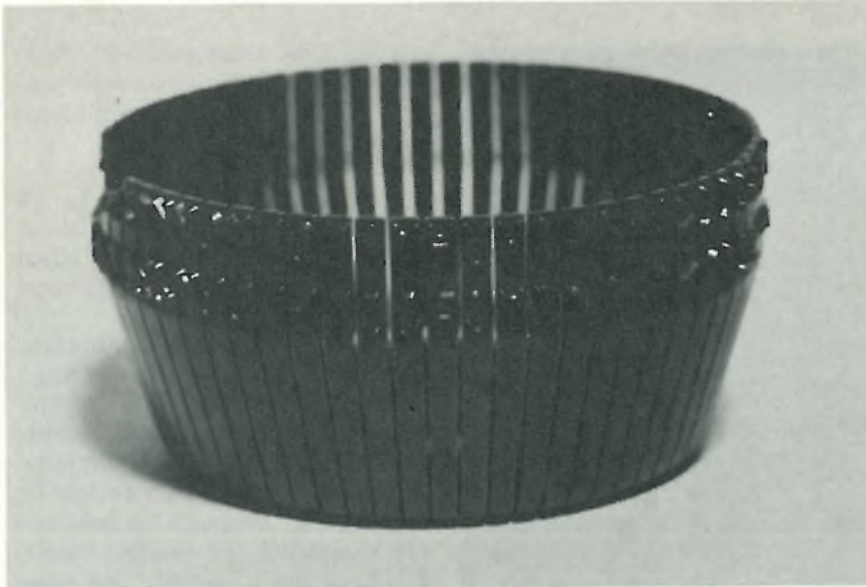

System crown. Print head for Badminton machine has 128 characters. Rotation is controlled by one dc servo and elevation by another. Impact hammer is inside head.

or parallel mode, is normally supplied with about 3 kilobytes of memory, including a core memory that controls the mechanism. The microprocessor, which permits code conversion, also provides test and diagnostic capabilities. It further enables graphic or format control, as well as both-way printing if desired. (A buffer memory enables the machine to print one line forward and the next line backward, eliminating loss of time for carriage return.) For complex control, a magnetic-tape cassette, floppy disk or paper-tape reader can be added.

Variations in the Badminton printer include a split platen and a second tractor. When the machine is used as a data terminal for bank tellers, a pocket for bank books replaces part of the platen, and the remaining part can print a journal or other form—all under control of microprocessor firmware. The printer is available without keyboard for receive-only use, and in naked configuration for OEM applications. Price starts at 1.3 million yen, or about \$4,450.

Nippon Electric has also developed two types of matrix printers that also feature wide-scale replacement of mechanical parts by electronic components. Mechanical and electronic parts counts are again

small. Paper and carriage feed both have stepper motors, to get rid of the usual pawl-and-ratchet or rack-and-pinion drives. In their usual configuration, these printers employ wired logic, rather than microprocessors, although enhanced versions with a microprocessor option are available.

Matrix printers are typically used for synchronous operation on five- or eight-level teletypewriter interfaces. The level is changed by substitution of a printed-circuit board. Alphanumeric characters are printed as a matrix seven high by five wide, seven by seven, or seven high by nine wide. Any alphabet can be programmed merely by changing the character generator.

Fast. The company calls its high-speed version the High printer. It reaches a top speed of 180 characters per second on the seven-by-seven or seven-by-nine matrix and can produce four copies plus the original. This high speed is not needed on a keyboard unit, so the High printer is normally available as an output-only unit. Noise is kept below 50 dB. Price starts at 2.1 million yen, or close to \$7,200.

Nippon Electric Co. Ltd., Terminal Systems Department, EDP Products Planning Division, 5-33-1 Shiba, Minato-ku, Tokyo 108, Japan [441]



Four-quadrant multiplier model 435 has a 3-dB small-signal bandwidth of 300 kHz, a maximum untrimmed error of 0.1%, and a maximum noise level of 250 μ V rms over the 5-Hz-to-10-kHz band. Klaasing-Reuvers Electronics B.V., Tramsingel 74, Breda, The Netherlands [448]



The CQY65, CQY66 and CQY67 are red, green, and yellow light-emitting diodes that can be driven directly by ICs and feature low power requirements and insensitivity to shock and vibration. They come in a 3-millimeter-diameter package. Internettal GmbH, 78 Freiburg, West Germany [449]



BRY 55 S planar thyristor in plastic package has a recovery time of less than 6 μ s. Intended for switching power supplies and similar applications, the device has a voltage rating of 22 V and a current rise rating of 100 A/ μ s. Sescosem, 50 rue J.P. Timbaud, 92400 Courbevoie, France [450]

Starting now, the function generator market does a 180.

This is where Wavetek turns it around again. With three new high-performance, low-cost generators.

The Model 180 Sweep/ Function Generator \$275

Believe it or not, this is a full sweeper—from 0.01 Hz to 2 MHz—with internal 1000 to 1 sweep. The 180 has sine, square and triangle wave outputs (20v output p-p), plus dc voltage, dc offset, and a separate TTL output. It also has a full attenuator which means you get super-clean signals down to -50dB. If you measure price vs. performance, no other instrument even comes close.

The Model 184 Sweep Generator \$495

The 184 has all of the above, plus some other features that you wouldn't expect for the price. First of all, the 184 goes all the way up to 5 MHz, and provides continuous, triggered and gated operation. For precise adjustment of continuous sweep, there's a control to individually set start and stop points. There's also a variable symmetry control and another

The new 180 Series from Wavetek.

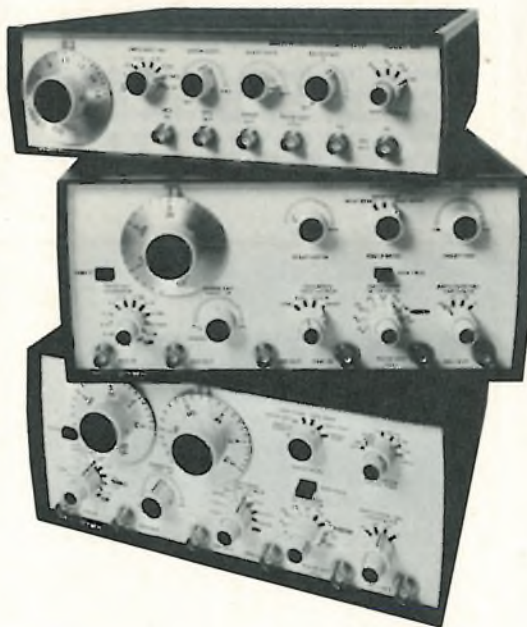

for amplitude—down to -60 dB. Like the rest of the instruments in this series, the 184 comes in a tough, light-weight package.

The Model 185 Lin/Log Sweep Generator \$595

As you can see, the 185 has two frequency dials, which give you the ultimate in precise sweep start/stop settability. Now you can sweep up or down the frequency range, which goes from 100 μ Hz to 5 MHz with continuous and triggered ramps or discrete steps. Like the 184, this model has continuous, triggered and gated operation. Of course, there are both linear and logarithmic modes, and log sweep width is an incredible 100,000 to 1.

We haven't told you everything.

There's a lot more to the 180 series than the three instruments described here. But that's another story.

When we let that out, the market may just do a 360.

For more information, contact Wavetek, P.O. Box 651, San Diego, California 92112. Phone (714) 279-2200. TWX 910-335-2007.

WAVETEK®

Cermet potentiometers



P13V

P130

P13T

MIL-R-94/3 G
RV6 DIMENSIONS
WITH IMPROVED
PERFORMANCE

Sternice series P 13 potentiometers meet the requirements of CCTU 05-01 and MIL-R-94. The excellent performance characteristics of this series are due to unique mechanical design and the use of a cermet resistance element especially developed for potentiometer applications. The main features of series P13 potentiometers are:

- HIGH POWER RATING : 1.5 W at 70°C
- HIGH STABILITY :
 ΔR_T 2% (25 000 cycles)
- LOW TEMPERATURE COEFFICIENT :
 $\pm 50 \times 10^{-6}/^\circ\text{C}$ for $R_n \geq 100 \Omega$
- HERMETIC SEALING
- ROBUST CONSTRUCTION

P 13T and P 13V are fully qualified to CCTU 05-01 A, styles PC 32 and PC 33 respectively

STERNICE

115-121, Bd de la Madeleine
B.P. 17 - 06021 NICE CEDEX
Tel. (93) 87.56.90 + Tx 47251

J.H.F. 149 US

New products international



A digital panel meter, the 18-36, offers 3½ digits and uses a light-emitting-diode read-out. Selectable input ranges are 200 mV, 2 V, 20 V, and 200 V full scale. Overrange is indicated by blinking of the digits. Salford Electrical Instruments Ltd., Eccles, Manchester, England [451]

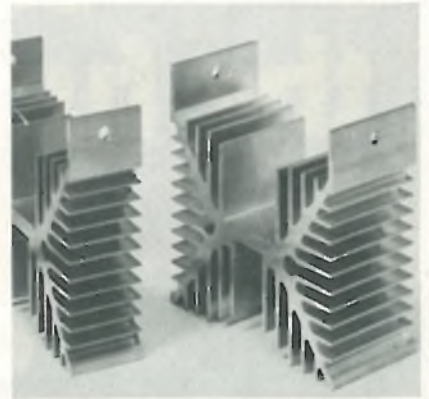

Series BX heat sinks for medium-power semiconductors are made of extruded aluminum and have a heat path that is X-shaped in cross section. They can be assembled into various types of stacks. Mitsubishi Electric Corp., 4-1 Mizuhara, Itami-shi, Hyogo 664, Japan [454]

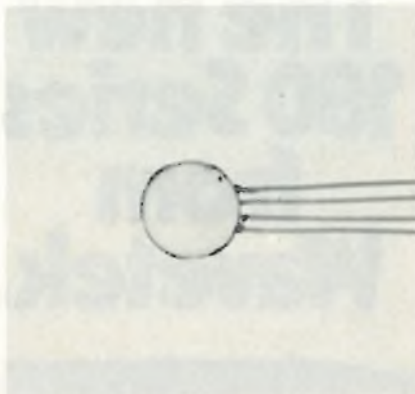

Exhibiting high linearity, an n-type gallium-arsenide Hall-effect probe is designed for measurements at cryogenic temperatures or in strong magnetic fields. Error is guaranteed to be less than 0.1%. Copal Co. Ltd., 2-16-20 Shimura, Itabashi-ku, Tokyo 174, Japan [452]



The Moduload, model 324, is a modular load simulator that can be used as a constant-current source and with which networks can be statistically and dynamically tested. The instrument is also good for testing dc voltage generators. Electronics Corp. of Israel Ltd., P.O. Box 9045, Tel Aviv, Israel [455]



Five-digit green fluorescent display, type 5-LT-03, is designed for instruments. Filament voltage is 3 V and current, 50 mA. Brightness of the display is 200 foot-lamberts typically. Futaba Electronic Industries Ltd., 1-11-5 Sotokanda, Chiyoda-ku, Tokyo 101, Japan [453]



Power-supply units, series BN2095, come in three versions with these voltage and current ratings: 0-8 V/20 A, 0-30 V/10 A, and 0-60 V/4 A. Current and voltage values are adjustable. Dimensions are 111 by 210 by 375 millimeters. Bentron GmbH, 8 Munich 2, Karlstr. 57, West Germany [456]

Data analysis. The last step.

We make it easier with our C-120/F-120 Data Analyzer System. Priced far below other systems, the combination of our high-speed, high-performance, multipurpose correlator and our advanced spectrum analyzer belongs in your lab.

All calculations can be performed on an on-line real time basis. The frequency analytical range can be selected in 25 different ways corresponding to the input data with sampling times of 0.5 μ sec. to 50 sec. And the system offers the widest measuring frequency band in its class: from 0.0001 Hz. (almost DC) to 1 MHz.

TEAC is famous for building a highly sophisticated line of data recorders and magnetic tape transports. Recording technology is our specialty. And now we also offer you the means to analyze your data as well.

To explain all the options the TEAC C-120/F-120 system offers you in terms of computation, interpretation and display of data would take a book. So we've printed one. In a few pages it will explain the many ways in which our equipment can help you in your work. It's free from your TEAC representative. And we think you should read it.

The eight primary functions of the system are:

Auto-Correlation Function

Cross-Correlation Function

Probability Density Function (Histogram)

Probability Distribution Function

Signal Recovery

Transient Record

Power Density Spectrum

Cross Spectrum



TEAC

TEAC CORPORATION: 3-7-3, Naka-cho, Musashino, Tokyo, Japan

Think TEAC Talk with one of these representatives:

AUSTRALIA: JACOBY MITCHELL LTD., 215 North Rocks, North Rocks, N.S.W. Tel: 6307400 **DENMARK:** DANBIT, Plantagevej 21, 2680 Solrød Strand Tel: (03) 14 15 15
ENGLAND: MARUBENI LONDON BRANCH, Moor House, London Wall, London E.C. 2Y 5HT Tel: 01 639 0841 **FRANCE:** TEKELEC AIRTRONIC S.A., Cité des Bruvères, Rue Carle-Vernet, 92 Sewres Tel: (626) 0235, (626) 2438 (Paris) **GERMANY:** nbn Elektronik Starnberg, 813 Starnberg Max Emanuel Str. 8 Deutschland 1 Tel: (08151) 13036, 12158
NORWAY: RODLAND & RELLSMO A.S., Enebakkveien 230, Oslo 11 Tel: (09) 3080 **SWEDEN:** SAVEN A.B., Strandgatan: 3, S-185 00 Vaxholm Tel: 0764/315 80
SWITZERLAND: WENGER DATENTECHNIK, Bruderholz str. 45, 4055 Basel

Circle 192 on reader service card

*Adret has your requirements
at
its fingertips*



THE 600 MHz



This new 600 MHz plug-in unit fits in any of the 6000 series main frames, and covers the range from 400 kHz to 600 MHz by 1 Hz steps.

- One frequency range only, from 400 kHz to 600 MHz
- AM - FM - PM modulation
- Programmable frequency and output level

psycho 320 E.S.T



12, av. Vladimir Komarov
78190 Trappes - France
tel. 051 29 72

New products international

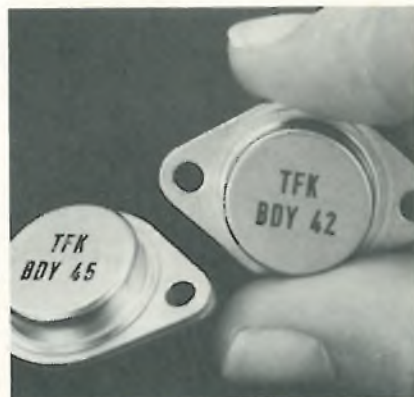

Power transistors BDY42, BDY43, BDY44, and BDY45 are npn versions intended for voltage regulators, inverters, and clocked power supplies. Housed in TO-3 packages, the transistors have short switching times. AEG-Telefunken, 6 Frankfurt 70, AEG-Hochhaus, West Germany [457]

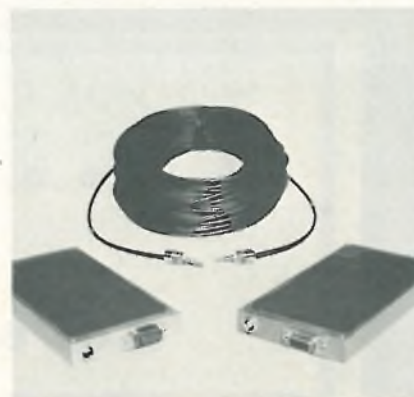

Fiber-optic data transmission system consists of a 16-bit basic unit which includes a light emitter, a light guide, and a receiver. The system transmits a 16-bit digital word or one analog signal with 12-bit accuracy. Triskelion AG, Leimattli, 6317-Oberwil/ZG, Switzerland [458]

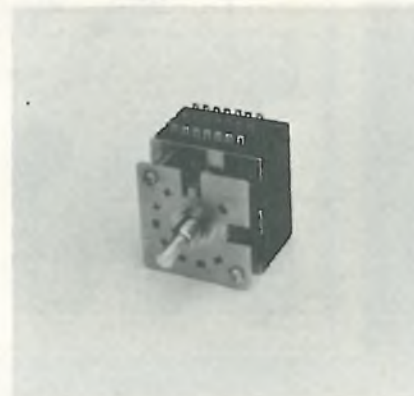

Step-type divider, model AD40, permits setting of precise voltage ratio to within 0.1 dB of nominal value. It can also be used as an attenuator or rotary switch in measuring instruments or stereo receivers. Tokyo Cosmos Electric Co. Ltd., 2-268 Sobudai, Kanagawa 28, Japan [459]

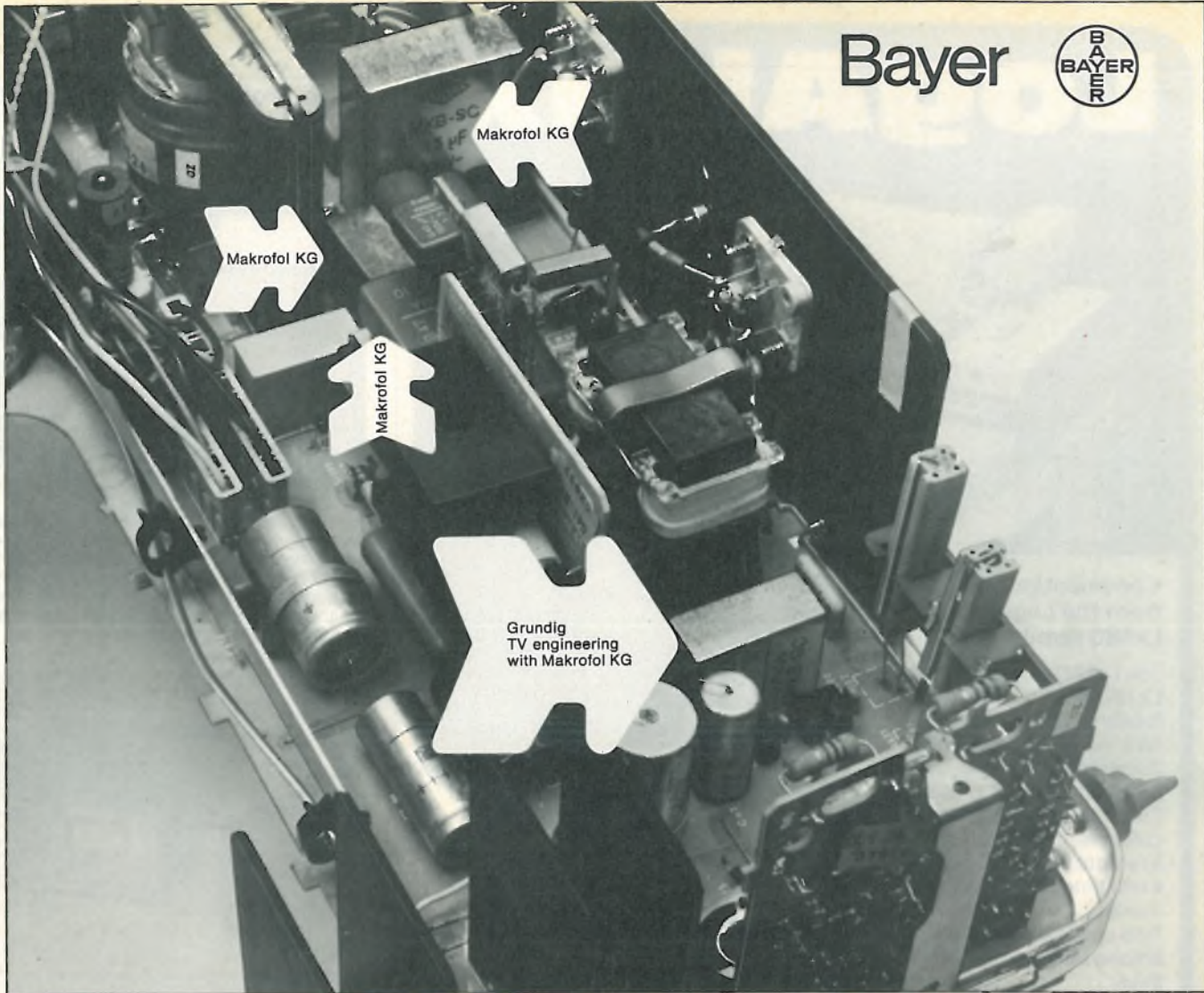

At the critical points: maximum operational safety through Makrofol KG

The substitution of electron tubes by semi-conductors has resulted in an improvement of the operational safety of TV sets by reducing the heat build-up – apart from the fact that the diodes, transistors and thyristors last much longer than tubes. The most significant change, compared with earlier sets, occurred in the line deflection stage.



Grundig employ a 12 μF storage capacitor for the thyristor line deflection stage, which is made of metallized [®]Makrofol KG by WIMA-Westermann. The outstanding thermal properties of Makrofol KG, and in particular the low shrinkage in the transverse direction, are the basic requirements to ensure a satisfactory and reliable contact for the capacitor, which in this case has to withstand a power load of up to 18 amp peak-peak. The low $\tan \delta$ of Makrofol KG ensures a slight intrinsic temperature rise of the capacitor, in spite of the prevailing impulse circuitry.

The following demands present no problem for Makrofol KG:

1. Safe contacting under high power load as is usual with television sets fitted completely with semi-conductors.
2. Low $\tan \delta$.
3. Good capacity constancy, even at varying temperatures.

These properties are demanded of capacitors which are used to adapt the pulse

shape of the line deflection voltage to the curvature of the tube, also known as the "S correction".

Capacitors made of metallized Makrofol KG by Wilhelm Westermann meet these requirements and have already proved successful in practice.

Bayer informs

Please forward the Makrofol leaflet to us.

Please give us technical advice on the following problem:

Please attach this coupon to your company's letterhead and send to

Bayer, WM Information Service
D-567 Opladen/West Germany
Postfach 1144
511.6/75

LogAbax



Conversational terminals from the Logabax Lx 180 family

The Lx 180/KSR and the Lx 180/57 models form a family of high quality terminals adapted to the development of tele-processing applications. These terminals are particularly suited for:-

- remote batch processing;
- real time conversational mode.

Two specific applications among numerous possibilities:

- Lx 180/KSR: conversational printing terminal, AVIS V 24 CCITT compatible;
 - Lx 180/57: conversational terminal, 2740/2 compatible.
- Lx 180: a family of terminals able to transmit from 0 to 180 car/sec. and to receive a large volume of information silently and reliably.

The leading French manufacturer of computer peripherals

Statistics speak for themselves. With 10,000 installations in 20 countries, 1,800 employees in Europe and 3 world manufacturing licenses, we are today's leader in the field of small data processing business machines, and one of the foremost European suppliers of peripherals and terminals for systems made by large manufacturers.

Active research and study, a technological lead, wide industrial possibilities: Logabax, the French force serving European data processing.

 **LogAbax**
OEM

New products international



Built for detection of corrosion in light alloys, an eddy-current instrument called Alco-probe has an infinitely variable oscillator, enabling the user to select any frequency between 100 Hz and 1 MHz. Inspection Instruments (NDT) Ltd., 32 Duncan Terrace, London N1 8BR, England [460]



Intended for facsimile and other recording applications, helium-cadmium laser model LD2186 can put out 15 mW at 442 nanometers or 2 mW at 325 nm with one fifth the noise of earlier RCA units. Electronic Components Div., RCA Ltd., Lincoln Way, Sunbury-on-Thames, Middlesex, England [461]



A special crystal cut and a transistor heater keep consumption of THI series crystal oscillators particularly low, anywhere from 0.5 W to 2 W, depending on the model. Stability is within one part in 10^{-8} from -40°C to 70°C . Quartz et Electronique, 1 rue d'Anjou, 92602 Asnières, France [462]



SELEMO incorporates a selective level meter and a beat-type oscillator all housed in one frame. Frequency-ganging between the selective level meter section and the oscillator section is accomplished by using the heterodyne principle, thus double tuning of the selective level meter and oscillator is eliminated. SELEMO can be used as a general selective level meter or beat-type oscillator independently.



MS13A

Consequently, with SELEMO you get more than just the convenience of two measuring instruments in one. A universal instrument for measuring transmission characteristics (gain and loss), SELEMO allows you to complete the job with speed and accuracy, avoiding any unnecessary and costly manhours. Everyone on the job is able to work faster and smoother thanks to the efficient, versatile service of SELEMO.

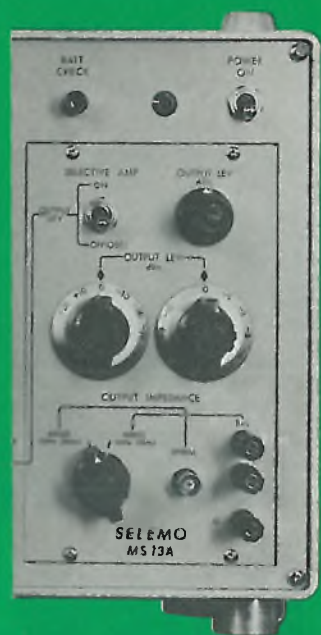

Specifications

Frequency Range:
 MS13A 20Hz to 20kHz
 MS23A 200Hz to 200kHz
 MS38B 800Hz to 2MHz

Impedance:
 MS13A 600Ω
 MS23A 75Ω, 600Ω
 MS38B 75Ω, 150Ω, 600Ω

In addition, SELEMO gives you the following:

●Oscillator section:

Output Level:
 -50 to +20dBm, w/1 dB step variable.

Frequency Characteristics:
 less than 0.3dB.

Level Stability:
 ±0.05dB, nominal AC line voltage change ±10 percent.

●Selective Level Meter section:

Level Measuring Range:
 -115 to +31dBm

Accuracy:
 ±0.5dB.

IF Bandwidth:
 4Hz (MS13A),
 50Hz (MS23A), 150Hz (MS38B)

Anritsu
 Anritsu Electric Co., Ltd.
 MEASURING INSTRUMENTS DIVISION
 SALES DEPARTMENT: 4-12-20, Minami-
 azabu, Minatoku, Tokyo 106, JAPAN
 Phone: (03) 446-1111/Telex: 0-242 2353/
 Cable: ANRITDENKI TOKYO

Circle 196 on reader service card



— Pat. pending in major countries

THE SNAPISTOR

A new way to trim your circuits

Trim your circuit by breaking off pieces of a resistor!

The snapistor is a stable and reliable trimmable resistor without moving parts.

The snapistor is a thick film resistor giving 20% increase in resistance each time a part of the substrate is snapped off.

The snapistor offers a handy alternative to trim your circuits in production and breadboarding.

The snapistor is a thick film resistor network on a 6 mm x 14.5 mm snappable ceramic substrate. The resistance value can be increased in 9 steps of 20% each, up to five times its initial value. Initial resistance values available from 100 ohms to 100 kohms.

Try it! Write for complete information or order a snapistor kit (only \$ 49,50) containing 25 each of 4 different snapistors with values 100/520 ohms, 1 k/5,2 kohms, 10 k/52 kohms and 47 k/240 kohms, together with a handy snapping tool.



ASPOGROUP

PARAMIC

Aspo-talo
Hitsaajankatu 12, 00810 Helsinki 81, Finland
Tel. 782 611, telex 12803

New products international

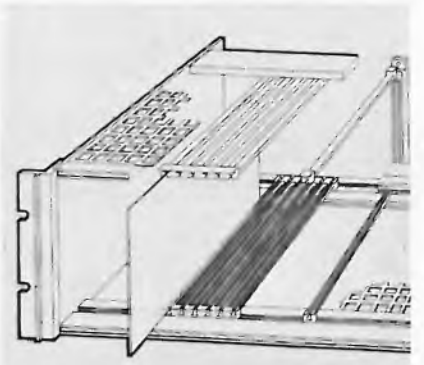

Rack for printed-circuit boards handles American (114 by 165 mm) or European (100 by 160 mm) formats. There is a choice of six card spacings and adapters for any common type of connector. The enclosure is anodized aluminum. S.E.E.M., 19 rue Jean Bluezen, 92170 Vanves, France [463]



Color TV tubes come with scanning coils and beam-bender units permanently fixed to the neck. All static and dynamic convergence and purity adjustments are precision-set at the factory. Thorn Colour Tubes Ltd., Brimsdown, Enfield, Middlesex, England [464]



Slotted line, type 2%, is one of a series of 17 that covers the range from 1.72 to 140 GHz. Residual VSWR of the series varies from 1.007 to 1.02. Enclosed unit has a tunable probe and crystal detector. Flann Microwave Instruments Ltd., Bodmin, Cornwall, England [465]

Fairchild develops first 4-k RAM to use I²L . . .

Those who have been saying that I²L isn't a high-performance technique had better take another look. In a significant development, Fairchild Semiconductor has applied its oxide-isolated Isoplanar technology to an injection-logic configuration. **The result: the industry's first 4,096-bit I²L random-access memory.** The part has a nominal access time of 100 nanoseconds, making it more than twice as fast as today's n-MOS 4-kilobit dynamic RAMs. The device will be ready for selective prototyping late this summer.

Thomas Longo, vice president and general manager of the integrated circuits group, credits Fairchild's proprietary process, which the company calls I³L (for Isoplanar integrated injection logic), with shrinking the memory circuits while retaining high bipolar levels of performance. And although Longo isn't saying so, the Fairchild process **could be applied to microprocessor circuits as well**—with equally dramatic results.

. . . as TI process pushes I²L to TTL speed

A new I²L process is also blooming at TI. Although the company has disclosed no details, industry sources indicate that Texas Instruments has developed an advanced I²L process of its own that **boosts injection logic speed into the TTL range at potentially much lower cost.** By fully implanting the inverted transistors, the sources say, TI designers can operate I²L circuits with gate propagation delays in the 10-to-20-nanosecond range at only 100 microamperes. This is about five times faster than first-generation I²L gates.

Clearly, the advanced process, when applied to TI's recently introduced 4-bit I²L microprocessor chip, the SBP 0400, could result in microinstruction execution times about as fast as most Schottky-TTL processor slices that are now on the market.

N.Y. firm, DEC in synchronous data-link pact

SMC Microsystems Corp. in Hauppauge, N.Y., is moving into the new synchronous data-link control by completing designs of its receiver-transmitter chip with SDLC functions. **Digital Equipment Corp. is funding SMC's SDLC—device—development program;** SMC marketing vice president Gerald Gollub says he expects initial deliveries to DEC late this year.

Developed by IBM, SDLC improves control of data links in computer-based communications systems. The SMC/DEC device will have a fixed 8-bit data character, although Gollub says nothing in its protocol rules out a 6-bit or 7-bit arrangement. SMC plans to publish a spec sheet in late summer for industry comment. Gollub adds that DEC is requiring SMC to withhold data on pinouts of its SDLC device only until after delivery of the first 500 parts to the Maynard, Mass., minicomputer maker.

Microprocessor designed into speech system

Threshold Technology Inc. has redesigned its automatic speech-recognition system around an 8-bit microprocessor, bringing the price for the system down to about \$10,000—**just over half the cost of its predecessor.** To be unveiled at the National Postal Forum in Washington,

D.C., this September, the new unit is designed as a replacement for conventional terminals, but features direct voice input and a 16-character alphanumeric display.

The Cinnaminson, N.J., firm has already pocketed its first order for the smart terminal. Though the customer refuses to be identified, it's known that well over \$500,000 worth of the speech-recognition gear will go into a multiterminal sorting system. Threshold's earlier unit, built around a Data General Nova 1200 mini, **has been used primarily for warehouse sorting and baggage handling.** Customers include United Parcel Service, S.S. Kresge, and several airlines.

The terminal's microprocessor handles time normalization and classification of the speech, as well as the algorithms and reference patterns necessary to recognize individual operators. A hard-wired pre-processor extracts significant speech features and digitizes them for input into the microcomputer.

Pitney Bowes awaits word on Soviet deal

Pitney-Bowes Inc. may finally get a sale out of its year-long discussions with the USSR's Ministry of Post and Telecommunications on how to improve the Soviet mail system. The Soviets earlier this month asked the Stamford, Conn., firm to put together a proposal for an **electronically controlled stamped-mail canceling system that also turns envelopes face up.** Although ministry officials set no deadline for filling the proposal, a Pitney-Bowes spokesman says it will probably be ready by September, when the company will be in Moscow to take part in an international business-equipment exposition.

GI completes calculator deal with USSR

General Instrument Corp. has signed a multimillion-dollar contract to supply the Soviet Union with calculator components some 17 months after it began negotiations with the USSR's Ministry of Electronic Industry [*Electronics*, March 20, p. 25]. "To our knowledge," says Frank G. Hickey, GI president and chief executive, "this is **the first contract between the USSR and a U. S. semiconductor manufacturer.**" The entire project, spread over the next two years, is divided into three phases, the first of which is valued in excess of \$7 million.

Edgar Messing, GI's vice president for consumer electronic components, says in the first phase, covering the next 17 months, GI will deliver 250,000 calculator-component kits that the Soviets will assemble into five-function calculators. The second and third phases of the contract call for delivery of 750,000 additional kits of components—250,000 during the second half of 1976, and the remaining 500,000 during the first half of 1977. Messing says **the Soviets will export some of these calculators,** probably to Western Europe. The calculators are to be assembled at a new facility outside Moscow at the rate of a million units per year on a single shift basis.

Meet the 1500W zener.

The zener with the specs of a surge suppressor.

If you're using power zeners as surge suppressors, you need to know whether the zener will protect your circuit. And the usual specs aren't much help.

Here's the zener you've been waiting for. It's designed and spec'd as a suppressor, with 1500W peak pulse power capability — higher than any

conventional zener. And it's available at a very reasonable price — about a third of what you'd pay for a 50W zener.

Circle our number on the reader service card — we'll send you the whole story on our 1N5629A-1N5650A series of power

zeners. And you'll never have to guess about surge suppression again.

Unitrode Corporation,
580 Pleasant
Street, Watertown,
Massachusetts 02172.

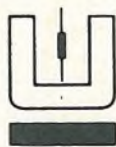
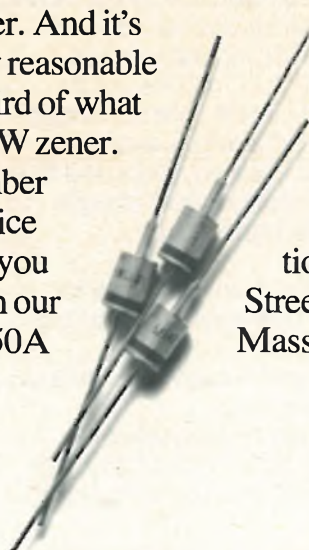

UNITRODE

Available from: EBV Elektronik GmbH, Frankfurt 0611-72-04-16; Munich 0811-64-40-55;
Walmore Electronics Ltd., London 01-836-1228; Spetelec (Paris) 686-56-65; Comprel s.r.l. Milan 64.38.519



THE PEOPLE WHO WROTE THE BOOK ON AUTOMATIC TEST EQUIPMENT JUST WROTE THE CATALOG.

Teradyne has just published a new general catalog covering the broadest range of automatic test equipment offered by any manufacturer.

Here you'll find automatic test systems and instruments for ICs of all types, from ECL to CMOS, from memories to calculator chips.

As well as for transistors, diodes, zener diodes, FETs, unloaded circuit boards, loaded circuit boards (digital and analog), automatic electronic modules, backplanes, thick and thin film resistors (trim and test), hybrid circuits (trim and test), resistors, capacitors, RC networks, and relays.

All of it designed and manufactured for reliable industrial use. This means no calibration adjustments, no forced air cooling, modular construction, and Teradyne's unique 10-year circuit-board warranty.

It also means a highly refined 24-hour telephone troubleshooting service and worldwide applications support and parts stocking centers.

In short, we provide every service necessary to ensure that our customers receive total economic value from their Teradyne test systems.

If you produce electronic components or equipment, or if you use electronic components in moderate or high volume, Teradyne test systems could be saving you money right now.

First, by pinpointing bad parts before you add value to them.

Second, by increasing your yield of good parts reaching final test.

And third, by increasing your end-product quality while decreasing test time and scrap.

Teradyne thinks yield.



Teradyne, Inc.
183 Essex Street,
Boston, Massachusetts 02111

Sold. Please send me a copy of your new full-line catalog.

Name _____

Firm _____

Street _____

City _____ State _____ Zip _____

CHICAGO (312) 233-8110 DALLAS (214) 231-5384 NEW ENGLAND (617) 458-1256/NEW YORK (201) 334-9770
SUNNYVALE (415) 732-8770 LONDON (0932) 51431 PARIS 265 72 62 ROME 59 47 62 MUNICH (089) 33 50 61 TOKYO (03) 406-4021

TERADYNE

Tri-service program to develop standard electronic modules

Military aims at holding down life-cycle costs with sets of modules for ground, air, and space applications

Put commonality at the level of electronic modules rather than complete weapons systems, and the Air Force and Navy will at least talk to each other. And they will even include the Army. The three services are planning to develop by year's end a tri-service program for standard electronic modules. Goals of the program, known as SEM, are expected to be disclosed to industry in a fall briefing, says the Naval Electronic Systems Command's SEM program chief John Wyatt.

Though the Navy has long led service standardization efforts, ever since it inaugurated its Standard Hardware Program at Navelex in the late 1960s, this first tri-service program is being put together under the guidance of the Defense Material Specifications and Standards Board. Navelex will represent the Navy. The Air Force will be represented by the Aeronautical Systems division at Wright-Patterson AFB, Dayton, Ohio, and the Army by the Electronics Command, Fort Monmouth, N.J. In addition, a parallel study on the logistics of SEM and its economies is being directed by the Defense Electronics Supply Center.

Cost drive. The services were brought together by increasing Pentagon emphasis on holding down life-cycle cost of military hardware. Moreover, in its shipboard experience using 125 standard and 50 spe-

cial modules in 60 different systems, the Navy cut "engineering, production and logistics support costs by as much as 50%," points out Merrill De Merit of the Avionics Engineering Directorate at Wright-Patterson. The Air Force's need for avionics standardization is evident from De Merit's observation that "in one recent weapons system, there are over 20 different computers built by 10 companies with individual company-designed electronic modules."

The avionics-standardization effort for the Air Force is already under way. ASD staffer Larry Porter will deliver by Sept. 1 a final plan that he hopes will lead to three stan-

dard electronic-module families of printed-circuit boards for standard functions applicable to future ground, air, and space avionics systems. The plan emphasizes standardization by "form, fit, and function," as Porter puts it, rather than specific hardware designs. It draws on the approach that Aeronautical Radio Inc. employed in developing modules for its commercial-airlines customers.

But despite the advantages, says the Air Force's De Merit, the Arinc approach "may never work effectively unless the U.S. Government changes its procurement policies." Inherent to the Arinc approach, he

Circuit boards of 50 square inches?

How might the services begin on a family of standard modular electronic-circuit boards? For Air Force airborne data processors, for example, "something on the order of 50 square inches with 150 input-output pins is about what's needed to do the job," suggests Texas Instruments' Henry N. Peterson of Dallas. Peterson's view drew support from Rockwell International's Jack Jurison of the company's Autonetics group at Anaheim, Calif. Both were panelists during a technical session this month on integrated avionics at the National Aerospace and Electronics Conference at Dayton, Ohio.

"Fifty square inches is the minimum size," says Jurison, who points out that a limitation of the Navy's standard-module program is that "the modules are too small"—a long-standing industry criticism of the project [*Electronics*, June 7, 1971, p. 95]. Reflecting some of the industry's impatience with prolonged studies of standardization before a firm start is made, Peterson told Air Force representatives discussing circuit-board specifications, "If you standardize on it, industry can live with it."

Past standardization programs have failed because the military "tried to push technology ahead at the same time" in the view of Autonetics' Jurison. "Military standardization," adds TI's Peterson, "should have some commercial basis." His estimate of a 50-square-inch circuit board with 150 pins was derived from cost competition in the commercial market that has pushed computer equipment manufacturers to larger board sizes. But Peterson notes that military requirements "are not the same." The military "supports its own hardware" and could therefore find appeal in a smaller board "because reliability goes up with fewer pins."

points out, "is the responsibility of equipment suppliers to guarantee under the original pricing agreement the reliable functioning of their equipment. Government procurement policies normally don't support this." But De Merit says the AN/ARC-164 ultra-high-frequency transceiver contract, with its incentives and penalties based on life-cycle costs, is "a major step in the right direction" and "an excellent example for future procurements."

Convincer. As the Army's Charles Lascaro points out at Fort Monmouth, "lower life-cycle costs need to be supported by hard data" to persuade reluctant program managers to accept standard modules and their inherent tradeoffs among parameters like performance, reliability, design, weight, and volume. To get these numbers and sell the

module concept, the services need demonstration programs, he points out.

The SEM program in each service proposes to select for standardization a number of pieces of hardware that have multisystem applications and then test them extensively. In addition, the USAF group will undertake preliminary partitioning of systems into the optimum number of modules for broad use and build prototypes.

Moreover, industry must accept the approach, although, as Lascaro notes, "everyone wants standardization as long as it conforms with his own ideas." Beyond that, he points out, there is the inherent conflict in the concept that users want standard modules "to be good for 10 years [but still] use the latest technologies." □

with incoming data signals.

To increase the reliability of hf data communications, the BR Communications division of Barry Research Corp., Sunnyvale, Calif., has developed two sets of equipment that allow an operator to select the communications path that has the least interference. One piece of gear, a tactical frequency-management system, shows which frequency channels are carrying the strongest signals at the receiver. The other product, a time-diversity modem, repetitiously sends the same data to guard against circuit drop-outs and noise bursts.

The Air Force, which tested the equipment earlier this year, is quite pleased with the results, reports Capt. Terry Woodhouse, a systems engineer in the tactical communications area of the Air Force Communications Service, Langley Air Force Base, Va. The service plans to buy "several systems," he says, although the exact funding has not been decided.

Frequencies. The frequency-management system consists of what BR calls a Chirpsounder-transmitter, a sounder-receiver, and a spectrum monitor. The sounder-transmitter puts out a 1-watt linear signal that in about five minutes sweeps the hf band. This signal, repeated every 15 minutes, is then added to the data signal and transmitted.

Communications

Selecting the propagation path improves data communications over hf links

Because it can provide data links for distances up to 2,500 miles, high-frequency radio has been widely used for tactical communications. But the problems with this 2- to 30-megahertz band, which relies for its long range on reflection from the

variable layers of the ionosphere, have given it a reputation for unreliability. Signals may fade because of changes in propagation characteristics of the communications path, while random noise impulses and interference can play havoc

Better hf. Tactical frequency-management system (below) from BR Communications shows which high-frequency channels are receiving strongest signals (upper bar-graph-like part of display) and which are coming in via single and multiple paths (lower part).

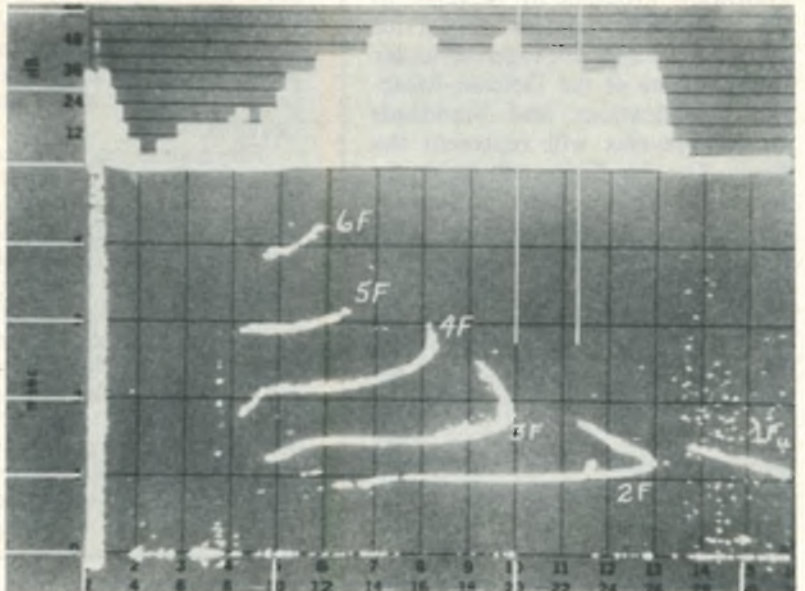
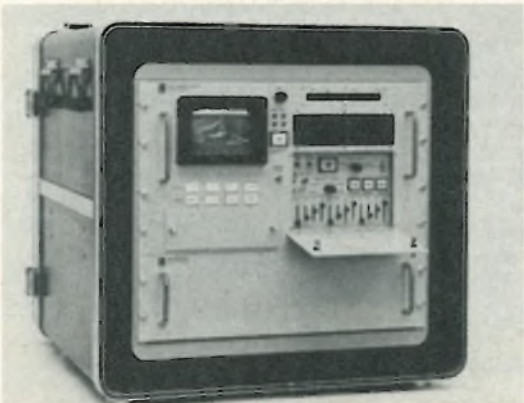

The sounder-receiver contains a cathode-ray-tube display that presents two sets of data. One is a bar-graph display that plots received signal intensity at the various frequencies to show which signals are strongest. Just below is the other, which plots the time that each frequency is received. Some signals, reflected off different layers of the ionosphere, are actually received more than once. These so-called multipath signals are caused partially by the propagation vagaries of the ionospheric layers. But the display enables the operator to choose those frequencies that send signals on a single, more reliable path.

In selecting the transmission path, the operator must also consider frequencies already being used. BR's spectrum monitor helps by displaying the amplitudes of received frequencies that exceed preset levels. The displayed spectrum, which can be either 500 or 100 kilohertz wide, is set at the center frequency. In final selection, the channel width is usually narrowed to 100 kHz. The entire process takes 30 seconds.

Compensation. Unfortunately, short-term fading and bursts of static still interrupt communications. However, to compensate for these lapses, Barry developed the time-diversity modem. Essentially, the modem makes seven replicas of each data channel with 1 second of delay between them. These redundant bit streams are transmitted as a tone packet, and a similar modem on the receiving end realigns them in time, polls each of the channels, and then takes a "vote." For example, if more 1 bits than 0 bits are present, the modem decides the transmitted bit was a 1.

Capt. Woodhouse claims that on a recent field operation where the BR equipment was operating continuously for several days, not a single character of transmitted data was missed. "This is just unheard of in hf," he says. "We got three orders of magnitude improvement in hf performance and four orders of magnitude improvement with troposcatter equipment." One of the systems being considered by the Air Force

consists of six sounder-transmitters, two sounder-receivers, a spectrum monitor, and several diversity modems to be used on priority record-communications links.

"By spreading the sounder-transmitters along the points of the compass, we could manage the entire hf environment from a central hub," Capt. Woodhouse points out. Depending on features, the modems are priced from about \$5,000 to \$9,000 each. A sounder-transmitter-receiver system costs \$100,000. □

Consumer

Timepiece uses diode, LC displays

In the controversy over which digital watch display is better, a U.S. subsidiary of a Swiss watchmaker has decided to sit on the fence. Heuer Time & Electronics Corp. of Springfield, N.J., which is wholly owned by Heuer-Leonidas SA, has put both liquid-crystals and light-emitting-diodes on a single watch.

Shown above, right, the Chronosplit may be the world's first digital wrist chronograph—a combination watch and stopwatch—although Intersil Inc., Cupertino, Calif. sells a digital stopwatch which also serves as a desktop digital clock.

The liquid-crystal portion of the display indicates the date and the time of day in hours, minutes, and seconds. The LED display shows elapsed time up to 9 hours, 59 minutes, and 59.9 seconds in tenth-of-a-second increments. LCDs are used for the watch to provide an "always on" display of hours and minutes. LEDs are used for the stopwatch because of the larger number of digits.

Developer. Although Heuer is assembling the watch and will market it, much of the technology was developed by Integrated Display Systems Inc. in Montgomeryville, Pa. I. Thomas Saldi, IDSI's president, explains that the Chronosplit uses two complementary-metal-oxide-semiconductor devices, one to control each display. "To make every-



Double time. Combination watch and stopwatch from Heuer Time & Electronics and Integrated Display Systems has both liquid-crystal and light-emitting-diode displays.

thing fit," says Saldi, "we had to reduce the size of the LCD module by a factor of eight to one, and we reduced the LED [module] by 30 to one. To get the 30-to-1 reduction, we had to reposition, repack and further miniaturize the stopwatch components." When this was done, Saldi says the two display modules didn't fit together, so that a new interface board had to be fashioned.

"The best way to count for normal digital timepieces is by two's [in binary]. But a stopwatch works best with a decimal system, so the interface board had to bring these two methods into alignment. I'll just say that we developed conversion circuits to generate a 10-hertz signal for the stopwatch from a 32,768-Hz quartz oscillator."

Also, says Saldi, IDSI developed a proprietary light bulb, "about the size of a grain of wheat," to backlight the LCD module. IDSI also plans to produce a line of test instruments to troubleshoot and repair the Chronosplit, which has an over-all thickness of 13.0 millimeters. The watch uses two silver oxide

batteries. Heuer expects to have the Chronosplit on the market in time for the Christmas season, priced from \$395 to \$495. □

Color-TV filter built on one chip

Integrated circuits are about to invade another part of color-television sets if Mullard Research Laboratories in Great Britain has its way. Researchers there have developed a prototype TV filter on a single chip that can separate intermediate-frequency signals for luminance, chrominance, and sound in the receiver.

Although some small kinks need to be ironed out, a production device would replace about five inductance coils, 10 capacitors, and some transistors and resistors now needed to separate the incoming signals. Kenneth W. Moulding, principal engineer, points out that using a single-chip filter would save TV-set makers space, time, and cost. But he adds that no decision has been made yet by the parent Philips company to mass-produce the device.

"The refinement of [bipolar] integrated-circuit technology makes the device possible," Moulding says. A conventional circuit uses a coil to provide inductance, which with capacitance, constitutes a tuned circuit to pick out and separate the luminance, chrominance, and sound information from the incoming signals and pass them along to the set's circuitry for processing.

Gyrator. Instead, Mullard chose the gyrator circuit for simulating inductance with capacitance and coupled it to capacitors to achieve the basic tuned circuit. There are five gyrators in all—two for the sound bandpass, one for chrominance bandpass, and one trap circuit (or stop filter) each for chrominance and sound. The trap circuits discriminate so that only the desired frequencies go through.

Sample performance includes a Q factor as high as 30 and signal rejection of more than 40 decibels,



Filter chip. Gyrator circuits on integrated-circuit chip provide sharply tuned filtering (shown on the display) for color-TV sets.

Moulding says. These performance figures aren't better than ordinary inductance circuits, but they are adequate for TV sets and excellent for gyrator circuits, Moulding says.

One advantage of the integrated-circuit technique, Moulding notes, is that the single-chip filter could be adjusted only once at the factory instead of the five separate tuning adjustments needed in conventional receivers. The single tuning is made possible by the close matching of components on an IC chip. Batches of ICs may vary widely in performance, but on any individual chip, the components match closely, he explains. "If the frequencies are wrong, they're all wrong together," he says. "They can be corrected at one stroke" by a production-line worker using a potentiometer to adjust the dc-bias voltage.

Repeatability. A production concern would be to ensure that the Q factor would be repeatable on every device. Mullard is reluctant to comment on the careful design necessary to ensure that performance, but Moulding comments that "using negative feedback in the gyrator is one of the key points."

Another problem for chip makers may be the device's size. Since each

resonator, which uses 15 transistors, occupies about 1 square millimeter, the whole device would measure from 5 to 10 mm². This size may be commercially unwieldy, but, Moulding says that the space, cost, and time advantages should prevail for set makers if the device can match the \$1.80 unit price for conventional devices. Among the problems to be solved for the research device is the temperature performance, which "isn't buttoned up yet," he adds. □

TV-sales decline seen slowing

The decline in television-receiver sales to dealers appears to be slowing, although the consumer-radio market remains depressed, according to May figures compiled by the Electronic Industries Association. "May has been the best month for TV sales so far this year, even though it is usually flat with summer beginning and the networks starting program reruns," explains Eugene J. Koschella of EIA.

May color-TV sales of 441,800 units were off 11.1% from a year ago, while sales of 339,369 monochrome sets reflected an 8.5% decline from May 1974. The 10% drop in the total TV-receiver market for May was lower than in any prior month. For the first five months of the year, color-TV sales of 2.2 million sets were off 25.1% from the 1974 level, while sales of 1.7 million monochrome sets were 19.6% below last year's level. The entire TV-receiver market was off 22.8% in the January-May period.

Auto-radio sales of 651,592 units in May were down 17% from last year, EIA reports, although the decline was slightly less than that for prior months in 1975. Sales of 3.3 million car radios in the first five months were 19.4% under the 1974 level. Sales of a-m/fm radios, however, were still depressed. The May figure of 1.2 million sets was down 35.3% from that of May last year. The 6.4 million units sold in the first

A new spectrum analyzer— you set center frequency with 6-digit resolution—and it stays there.

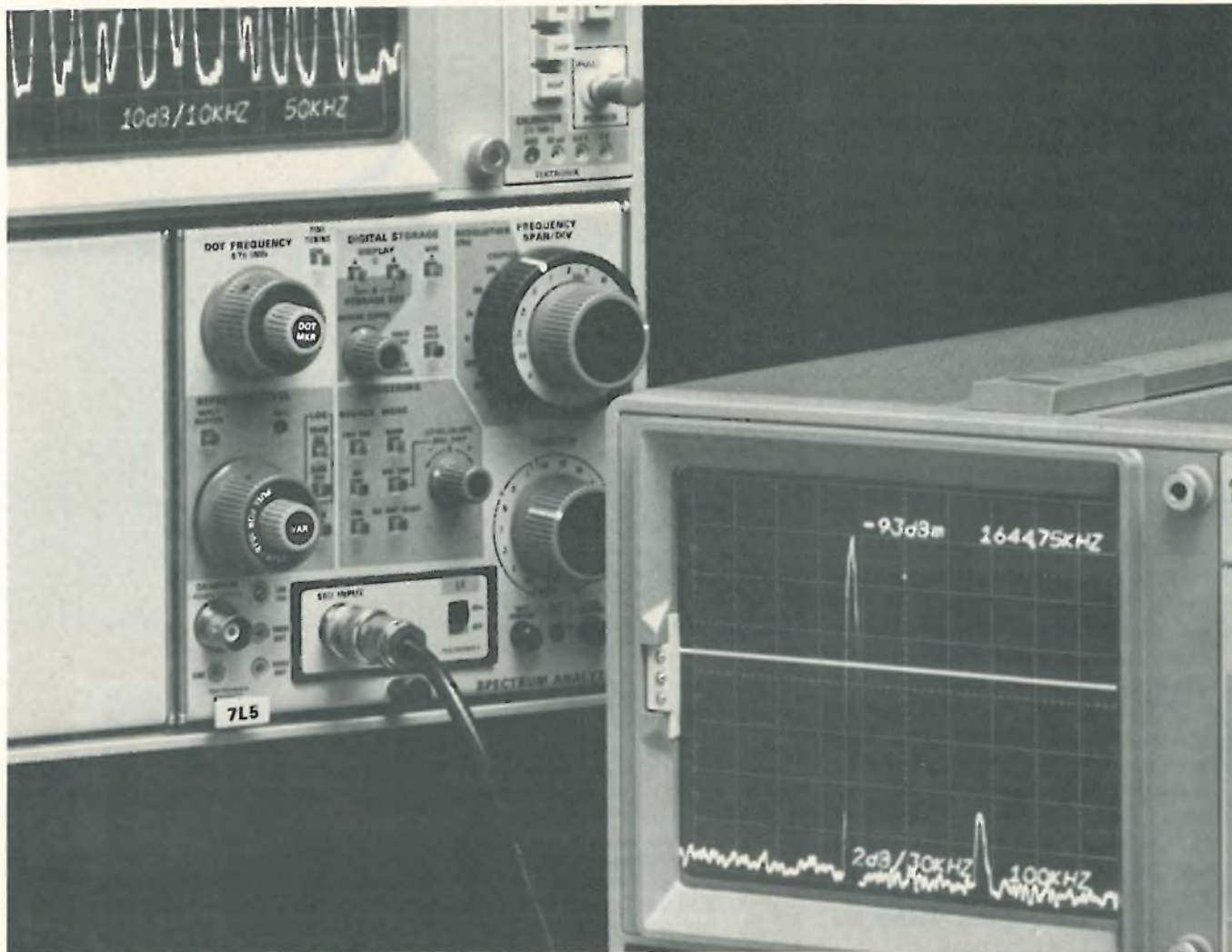

The new 7L5 5-MHz spectrum analyzer has exceptional frequency accuracy, stability, and 6-digit resolution thanks to a combination of synthesizer and digital technology.

Operation is easy with crt readout of display parameters and with sweep time and resolution automatically optimized for each span position.

7L5 performance characteristics include: 80-dB on-screen dynamic range, 10-Hz resolution, and absolute calibration in dBm, dBV, or volts. The reference level is set and read out in 1-dB steps over the range of -128 dBm to +21 dBm (with L1 50Ω plug-in module).

7L5 digital storage provides clean, easy-to-see, easy-to-photograph displays with any 7000-Series crt readout mainframe.

Choose from these display and storage modes:

- Display peak or average of signal with continuously variable threshold shown by crt cursor.
- Store maximum levels of time varying signals.
- Split memory into A and B sections for comparing signals.
- Bypass digital storage for conventional display.

7L5 Spectrum Analyzer (requires plug-in module)	\$4,200
L1 Plug-in Module (50Ω)	300
L2 Plug-in Module (75Ω)	300
7603 Oscilloscope (suggested mainframe)	1,700

Ask for a demonstration or more information. Write: Tektronix, Inc., Box 500A, Beaverton, Oregon 97077. In Europe, write: Tektronix Limited, P.O. Box 36, St. Peter Port, Guernsey, Channel Islands.

U. S. Sales Price FOB Beaverton, Oregon



TEKTRONIX®

committed to
technical excellence

five months were 26.1% below the 1974 level.

Sales of phonographs, however, continued to show sharp gains, led by portable, table, audio-compact, and component systems, according to EIA. Although the console-phonograph market was down, small-system sales of 239,089 units in May were up 51.6% from last year, putting that market segment up 25.9% in the January-May period with sales of 1.1 million non-console phonograph systems. □

Components

Dial switch gets optical replacement

The ordinary switch is one electro-mechanical product not yet impacted by solid-state devices. Yet the typical switch is awkward to disassemble and service, and it requires relatively bulky wiring.

Now, however, engineers at Tektronix Inc., Beaverton, Ore., have developed a solid-state opto-electronic switch they hope will do away with many of these problems. One of the first instruments to use it is the company's new 7L5 5-megahertz spectrum analyzer, although Tektronix won't reveal where the switch might be used next.

According to Carlos Beeck, one of the engineers on the project, the entire switch was designed to fit into a 1-inch diameter, 0.75-inch-long knob mounted on the outside of the instrument case. It's connected to the internal circuitry through seven plug-in leads.

Two sections. The switch, Beeck says, is in two sections. One section has five series-connected light-emitting-diode chips on a lead frame and is transfer-molded in transparent epoxy with integrally molded focusing lenses. The LEDs are fitted onto a carrier disk and soldered into place permanently. In the other section, five Darlington phototransistor chips, also mounted on a lead frame, but wired in parallel, are similarly encapsulated.

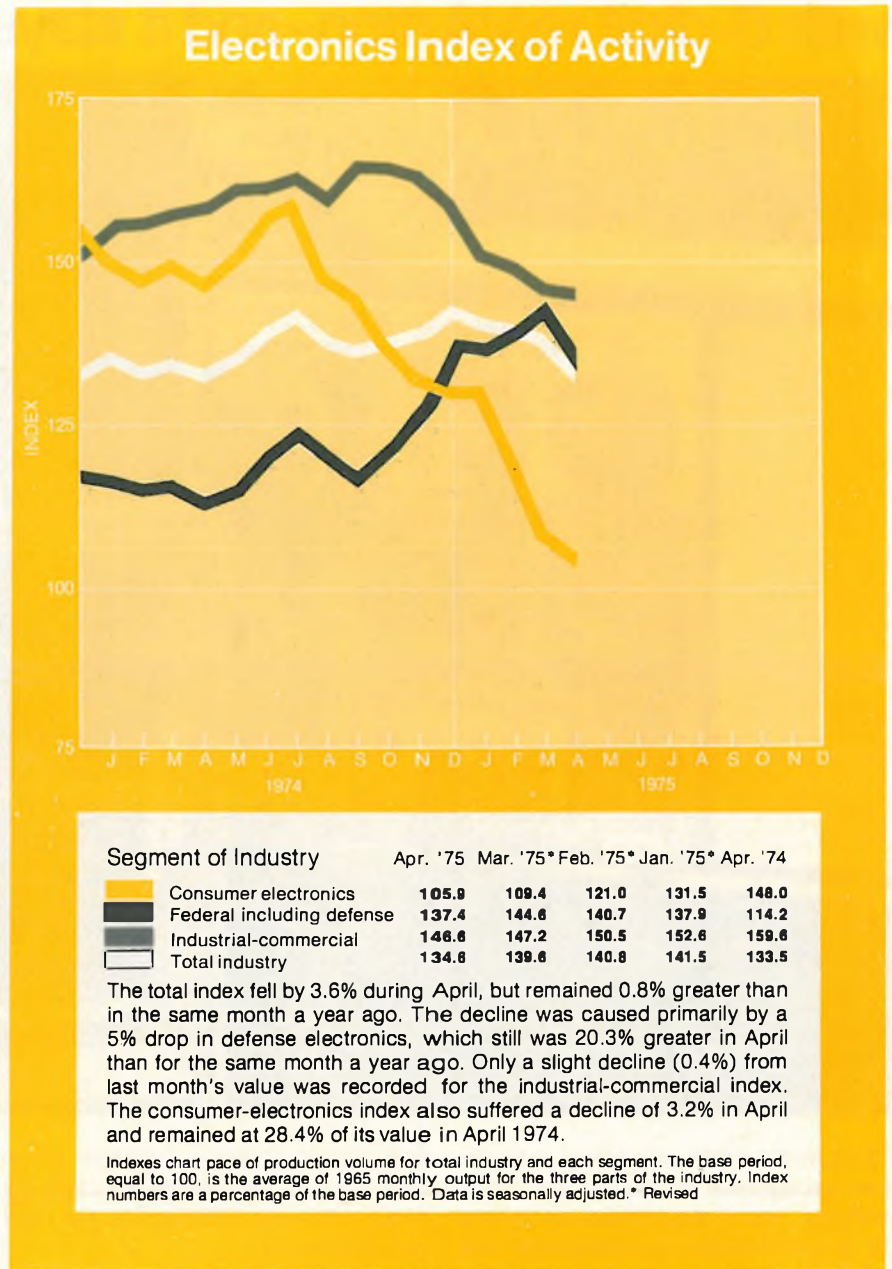

Studs are mounted in a dual in-line configuration on one side so that the knob assembly can be plugged into circuit-board sockets. A shutter wheel between the two arrays, as shown in the figure on page 36, selectively passes light to different combinations of phototransistors. Turning the knob rotates the shutter wheel through 32 possible code positions. Crosstalk between the phototransistor chips is kept below a ratio of 10:1, Beeck says, with the chemically milled shutter win-

dows on 0.045-inch centers. The windows are 0.030 inch wide.

An illuminated phototransistor has a large collector current, producing low output voltages, while a dark phototransistor has only a small leakage current, and its collector voltage will be high. Beeck says that, since the switch was intended to interface directly with complementary-metal-oxide-semiconductor logic, the high-output state is roughly equal to the supply voltage of 5 v. The low-output state is 1.1 v,

At \$1650, You've Never Seen a Portable, 50 MHz Oscilloscope with More Capability and Convenience

New TEKTRONIX 455

- 50 MHz bandwidth • Dual trace • Delayed sweep • Sweep rates to 40 ns/div with 2% accuracy (5 ns/div with 3% accuracy)
- Vertical deflection factors to 5 mV/div with 3% accuracy
- Large 8 x 10 cm CRT display

And that's not all. The 455 offers this performance combined with more convenience features to speed measurements and reduce human error. All at a budget-conscious price. Measurements are made easier and faster with trigger view, trigger hold-off, highest deflection factor indicators, and a functionally laid out, easily understood control panel.

Servicing the 455 is fast, and less expensive. Although monolithic in design, the instrument contains easily removable vertical amplifier and time-base modules for ready access to all components. That means quick repairs and less down time. And the entire unit is housed in a shock-resistant, reinforced plastic case to withstand rough handling in factory or field environments.

Optional battery pack provides operation at remote sites and eliminates noise due to line transients. The 455 will operate up to 5 hours without a battery recharge. When AC power is available, the battery pack can be detached to reduce weight.

For specialized applications, the 455 can be equipped with an option of an N sync separator.

The 455 is the latest entry in the Tektronix 400 Series of Portable Oscilloscopes. Other dual channel delayed sweep units are:

- 5 mV/div sensitivity at 100 MHz (the 465)
- 2 mV/div sensitivity at 200 MHz (the 475)
- 5 mV/div sensitivity at 550 MHz with simultaneous displays of internal and delayed waveforms (the 485)
- Unique single-shot storage to 100 MHz (the 460)

For complete information on how the 455 Portable Oscilloscope delivers the performance, versatility, and cost-saving effectiveness you need, contact your local Tektronix Field Engineer. Or write: Tektronix, Inc., Beaverton, Oregon 97077, for the new 455 applications and specifications brochure. In Europe, write Tektronix Limited, P.O. Box 36, St. Paul's Cray, Gurrney, Chesham Islands.

U.S. Sales Office: 2075 Massachusetts Avenue



TEKTRONIX

Manufactured by Tektronix, Inc.

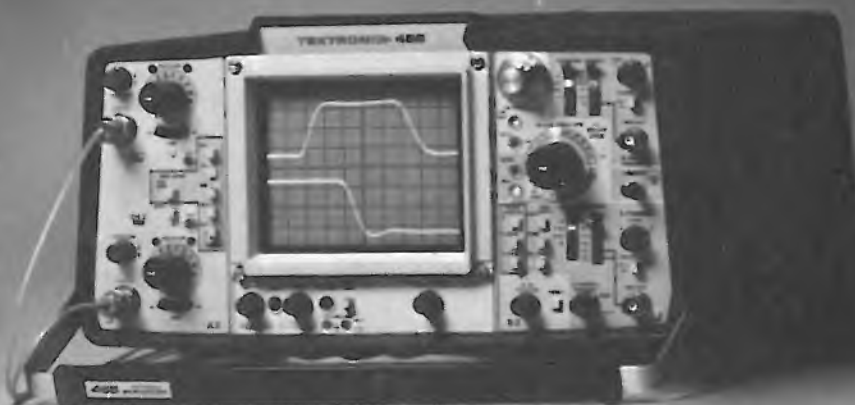

For demonstration circle 34 on reader service card.

Circle 35 on reader service card

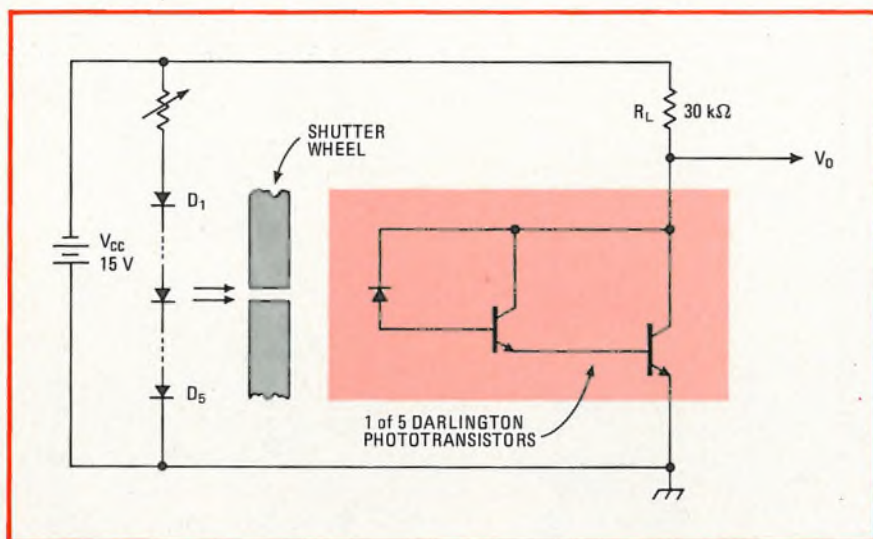

Light dial. Combinations of light-emitting diodes and phototransistors do the job of an electromechanical dial selector on new spectrum analyzer from Tektronix Inc.

about one diode drop higher than normal collector-emitter saturation voltage because of the Darlington configuration.

Interface with transistor-transistor logic can be accomplished, Beeck says, by operating the phototransistors between +5 and -5 V as long as the TTL is protected against the negative-going inputs.

In the present application, a 5-v supply voltage and a load resistance of 100 kilohms are required, necessitating a minimum of 50 microamperes of photo-generated collector current, according to Beeck. The necessary illumination is obtained by biasing the LEDs at 16 mA. □

Fiber optics

Optical fiber link transmits 6.3 Mb/s

As a communications medium, fiber optics is obviously superior to copper cable in immunity to electromagnetic interference, large bandwidth, and potentially lower cost. And now its high attenuation and other shortcomings are being steadily overcome, as evidenced by recent work at GTE Laboratories in Waltham, Mass.

Last week, Samuel M. Stone, a member of the technical staff there,

described the experimental fiber-optic telecommunications system he helped build to an audience at the International Conference on Communications in San Francisco.

Called a pulse-code-modulated optical guided-wave communication system, the equipment transmits telephone, picture telephone, and bit-error signals at a rate of 6.3 megabits per second. This is the telephone company's T2 transmission rate, and Stone sees applications in links between high-density exchanges where cable conduits are now full. Here, fiber optics, with a bandwidth capability of up to a gigahertz, has a great advantage over the 4-kilohertz channel now used by T2, and it can save as much as a factor of 100 in space.

Focus. GTE focussed its efforts on developing the electro-optical components that make up the system. One is a small-area, double-heterojunction aluminum-gallium-arsenide light-emitting diode that provides a high-radiance optical signal for the system. (This type of diode was first built by Bell Laboratories with an optical fiber inserted into a well etched out of the material.) The LED is enclosed in a module, also developed by GTE, with electrical input through a BNC connector at one end and an optical fiber coupled to the LED at the other end.

"We are trying to see how far we

can go with LED's as far as bandwidth and length of the fiber links are concerned," says Stone. "The advantage of the LED is that it is fairly inexpensive, but to fully exploit fiber optics we would probably need to use a diode laser." Currently, the LED has a bandwidth of 40 megabits per second. GTE would like to increase this to 90 Mb/s.

200 meters. At the receiving end of the fiber-optic link, the signal from the LED is picked up by a silicon avalanche photodetector module, modified by removing the window and adding a coupler terminal containing a fiber. The entire link is 200 meters long, with a repeater station consisting of a photodetector and light-diode module in the middle.

To maximize signal output, fiber diameters at the module and optical link termination must align as closely as possible. To do this, GTE designed its own coupling system. According to Stone, the group simplified principles reported by Telefunken AG in Germany. Each fiber is mounted at the center of a cylindrical termination which, when rotated, nevertheless turns the fiber in a slight circle. Two terminations are placed end to end and rotated until the two circles align so that coupling is maximal. GTE claims coupling efficiency in excess of 95% and a loss of only 1 to 2 decibels. The two connectors are held together in a V-block mount. Stone says, "In the field we would probably use something simpler that would handle more than one fiber at a time."

Currently GTE is using Selfoc fiber from Nippon Sheet Glass Co., which is 150 micrometers in diameter, can handle peak emission wavelengths ranging from 770 to 870 nanometers, and has an attenuation of 50 dB per kilometer. GTE is also looking at Corguide, a new multi-channel fiber from Corning Glass Works [*Electronics*, May 15, p. 33] with attenuation of 20 dB/km.

At either end of this communications link GTE uses six telephones, video phone, pulse-code modulators, and multiplexer/demultiplexers. A pseudo-random word



Hughes image memory systems are used by more people, for more applications, than any other image memories in the world.

A lot of people must be happy with Hughes image memories. Because they're used in many ways, by thousands of people every day—helping them do their jobs better and quicker.

Like doctors, commercial airline pilots, blood analysts, production inspectors, baggage

inspectors, quality control technicians, teachers, ship-board fire controllers, medical technicians (ultrasound, x-ray, thermography), aircraft radarmen, records management personnel,

and many, many more.

If you'd like literature or application assistance, call (714) 729-9191. Or write: 6855 El Camino Real, Carlsbad, California 92008.



Creative Image Processing.

Circle 37 on reader service card

**For bonding
metal-
to-metal-
to-glass-
to-glass-to-
plastics-
to-plastics-
to-rubber-to-
rubber-to-
metal-to-etc-
to-etc.**

One drop goes a long way in fasten- ing almost anything to almost anything.

Eastman 910[®] adhesive bonds fast, too. Almost instantane- ously. With only contact pressure.

Tensile strength? Up to 5000 psi at room temper- ature.

New Eastman 910 MHT and THT/Grades hold when the heat's on. Even over 400° F.

For further data and technical literature, write: Eastman Chemical Products, Inc., Kingsport, Tennessee 37662.



Electronics review

generator at one terminal and a bit-error test set with error counter at the other test for errors. GTE developed a mode-selector switch, which tone-encodes the signals that select the operating mode.

In the experimental system GTE has run 10^{11} bits without an error; a typical error rate using wire cables is in the order of 1 in 10^8 bits. □

Avionics

Aviation electronics to increase sales

Airport expansion and construction, heightened concern for safety, and a healthy market for general aviation

News briefs

F-16 NATO agreement for \$2.168 billion will buy 348 planes

The United States and four NATO member countries have signed preliminary bilateral contracts to share production of 348 F-16 air-combat fighters. Unit price of the NATO aircraft will be \$6.09 million in January 1975 dollars, for a total \$2.168 billion exclusive of ground equipment, documentation, training, spares, support, or inflation. Under the agreements, Belgium will pay \$721.2 million for 116 planes; the Netherlands, \$636.7 million for 102; Norway, \$448.5 million for 72, and Denmark, \$361.6 million for 58 planes. The contracts require that there be spent in the four countries 40% of the value of the 348 aircraft, plus 10% of the value of F-16s bought by the U.S., including the 650 ordered by the Air Force, plus 15% of sales to any other countries.

IBM, Comsat to unvell new Domsat plan by mid-August

IBM Corp. and Comsat General Corp. are negotiating for "an additional partner or partners" to reconstruct CML Satellite Corp. They expect "to present a comprehensive proposal" to the Federal Communications Commission by mid-August, according to attorneys for the two companies. The proposal will be in the form of applications by CML to establish and operate a domestic satellite system. The plan is expected to be compatible with the FCC's February ruling, which provided the two companies with the option of finding one or more partners so that no one company would have less than a 10% ownership interest or more than a 49% ownership or would otherwise be able "to exercise *de facto* control" [*Electronics*, Feb. 6, p. 40].

Ozone sensor to study effects of pollutants

A sensor to investigate the ozone levels in the atmosphere will be aboard RCA Corp.'s third Atmosphere Explorer satellite, to be launched in November into an orbit within 85 miles of earth. Called a backscatter ultraviolet spectrophotometer, the sensor will sound the ozone region to determine its density and vertical profile by measuring the reflectance of sunlight. Some scientists believe that fluorocarbons like freon may be destroying the ozone layer that protects the earth against ultraviolet radiation.

Microprocessor checks out Chrysler spark advance

Chrysler Corp. is using a Motorola M6800 microprocessor to control a portable diagnostic tester that it will start selling to its auto dealers this fall. Designed for servicing cars equipped with the Chrysler "lean burn" electronic spark advance system [*Electronics*, April 3, p. 38], the analyzer checks out the system's response to transducers on the car, the condition of the ignition coil and distributor pickups, and voltages on the vehicle's bus.

Floppy disk offered by Data General

Data General Corp. has joined the growing number of computer makers who are offering floppy disks as a fast, inexpensive method of data storage. The Southboro, Mass., company's entry, called the diskette subsystem, can be used with all Nova and Eclipse computers and is provided with Data General's Argos real-time disk-operating system. A single-drive, 350-kilobyte subsystem costs \$2,900, a dual-drive, 630-kilobyte unit, \$3,900.

the Fluke 8800A has:

resolution/accuracy/portability/economy

That's what it's all about!

Look the whole field over. You won't find a better value in 5½ digit DMM bench boxes than the Fluke 8800A. And it's a comfortable buy too. Put it on your bench. There'll be no raised eyebrows or wrinkled forehead from the boss.

After all, it is far and away the widest seller in the field.

Here's what you get for only \$985

AC input voltage. Measures 10 μ Volts to 1200 volts in four ranges. Other 5½ digit DMM's are limited to 700 V maximum, some to 500 V.

DC input voltage. Measures ± 1 μ volt to ± 1200 volts in five ranges.

True 4-wire resistance measurements on all ranges. Measure low value resistance without lead resistance error.

Measures 1 milliohm to 20 megohms in six ranges.

Accuracy and resolution. For 90 days over a temperature span of 18°C to 28°C... 1 microvolt resolution with 0.01% accuracy on dc... 10 microvolt resolution with 0.1% accuracy on ac... 1 milliohm resolution with 0.01% accuracy on resistance.

High DC input impedance. 1000 megohms through the 20 volt range.

Offset current. Less than 15 pA on all ranges.

Maximum open circuit ohms voltage, 3.3V. Most DMM's fall into the 9 to 18 volt range. That's not good enough for measuring IC's.

Overload protection. It's the best overall protection in the industry.

Mean Time Between Failure. 10,000 hours calculated and demonstrated.

Unusually low power consumption. Just 8 watts. One reason why the 8800A is so reliable.

Wide range of accessories. Includes high frequency probes, high voltage probe, clamp-on AC current probe.

Size. One of the lightest and smallest 5½ digit multimeters around.

Price. \$985 (U.S.A. only).

For data out today dial our toll-free number, 800-426-0361.



John Fluke Mfg. Co., Inc.
P.O. Box 43210
Mountlake Terrace, WA 98043

For a demo circle 39 For literature only circle 202
For information on the rest of the Fluke line, see our ad in EEM or the Gold Book.



Grayhill brings all PC terminals out one side

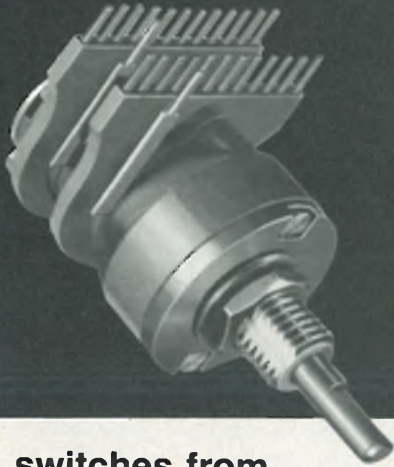

switches from logic levels up to 1/4 amp

- 1/2 inch switches with 10 or 12 positions—1 or 2 poles per deck—1 to 12 decks.
- Designed for wave-soldering process—resists flux contamination
- Enclosed construction at price levels as low as or lower than open wafer switches.

Here's a new Grayhill miniature switch specifically designed for the small loads—and the specialized mounting techniques—of low voltage circuitry. Probably the smallest switch you can find with all PC terminals in the same plane, the switch is surprisingly small in the price dimension too... for enclosed construction and Grayhill quality. For more information on this new member of the Grayhill Series 71 family, write for Bulletin #236... and consult EEM for information on other Grayhill switches.



661 Hillgrove Avenue • LaGrange, Illinois 60525
(312) 354-1040

Electronics review

AVIATION ELECTRONICS — GLOBAL MARKET PROJECTIONS (IN MILLIONS OF DOLLARS)

	GROUND		AIRBORNE	
	1974	1978	1974	1978
Australia	\$ 15.1	\$ 19.9	\$ 7.3	\$ 11.1
France	29.7	44.3	115.5	172.5
Germany	284.0	394.0	16.8	24.8
Italy	45.0	68.0	29.0	42.0
Japan	75.3	128.2	25.0	41.8
United Kingdom	73.9	76.8	103.2	120.0
Nine others	24.0	10.8	24.2	32.8
Total	\$547.0	\$742.0	\$321.0	\$445.0
Percentage of increase		36%		38%

aircraft will spur civilian aviation-electronics sales to increase 37% by 1978 from the estimated \$868 million in sales in 15 "primary" international markets in 1974. These are the key conclusions of a new market-opportunities study (above) by the U.S. Department of Commerce.

"American producers of aviation electronics continue to face excellent sales prospects abroad," the Commerce Department says, while noting that American companies "accounted for nearly 70%" of the \$321 million of airborne electronics and 40% of the \$547 million in equipment sales in the 15 countries in 1974. Included in the survey are the American firms' biggest customers, the United Kingdom, Japan and France, in addition to Australia, Brazil, Germany, and Italy.

Markets. Approximately three quarters of the \$60 million worth of avionics equipment imported into the United Kingdom in 1974 came from the U.S. However, imported ground equipment is only a low 7% of total sales because of an official "preference" for UK manufacturers. Overall, Commerce predicts a near-static 3% to 4% growth rate.

Japan will be the fastest-growing market for American avionics manufacturers. "Air transportation is growing more rapidly in Japan than in any other industrially developed nation," Commerce proclaims. American companies will account for more than 90% of the airborne electronics, worth about \$20 million in current dollars, imported in 1978.

But most ground equipment will be built in Japan.

With more than 65% of both the airborne and ground markets, American firms are the leading foreign suppliers of avionics gear in France. U.S. aviation electronics sales in France in 1978 are estimated at more than \$36 million. □

Automatic test

Tester checks out boards at 4 MHz

The ideal but also expensive way to test printed-circuit boards containing microprocessors is at the real speeds at which they'll be operating. However, given the large number of boards needed by NCR Corp. for its microprocessor-based banking terminals, expense is not such a stumbling block, and NCR has ordered a \$300,000 test system developed by Instrumentation Engineering Co., Franklin Lakes, N.J.

The functional tester not only handles boards at speeds up to 4 megahertz but also guides an operator through a troubleshooting program that isolates faults on "bad" boards down to the component level. This combination of speed and diagnostics is not available elsewhere, says an NCR spokesman.

At the core of the system is a digital word generator/receiver, which can feed data bits to a unit under test at rates up to 20 MHz for 32-bit-

When it comes to 2MFD capacitors, AVX offers an inside advantage.

Because AVX fits that 2MFD's of capacitance into a CKR08 design. Allowing you to put more capacitance into your designs.

Our 2MFD unit gives you big performance. Layer after layer of ultra thin ceramic builds up the required capaci-

tance. And it does it in an economy of space. In the small package size required to meet MIL-C-39014-20.

In addition to more performance in less space, you can get volume delivery. Directly from AVX or from a nearby service-oriented AVX distrib-

utor. And, if you don't require 2MFD's of capacitance, you can get our CKR08's in 1.25 and 1.50MFD values.

If you need greater capacitance in a mil-spec design, put AVX inside your plans. We're the fitting choice.

AVX: The Insiders

AVX Ceramics, P.O. Box 867, Myrtle Beach, SC 29577 (803) 448-3191 TWX: 810-661-2252
Olean, NY (716) 372-6611 TWX: 510-245-2815

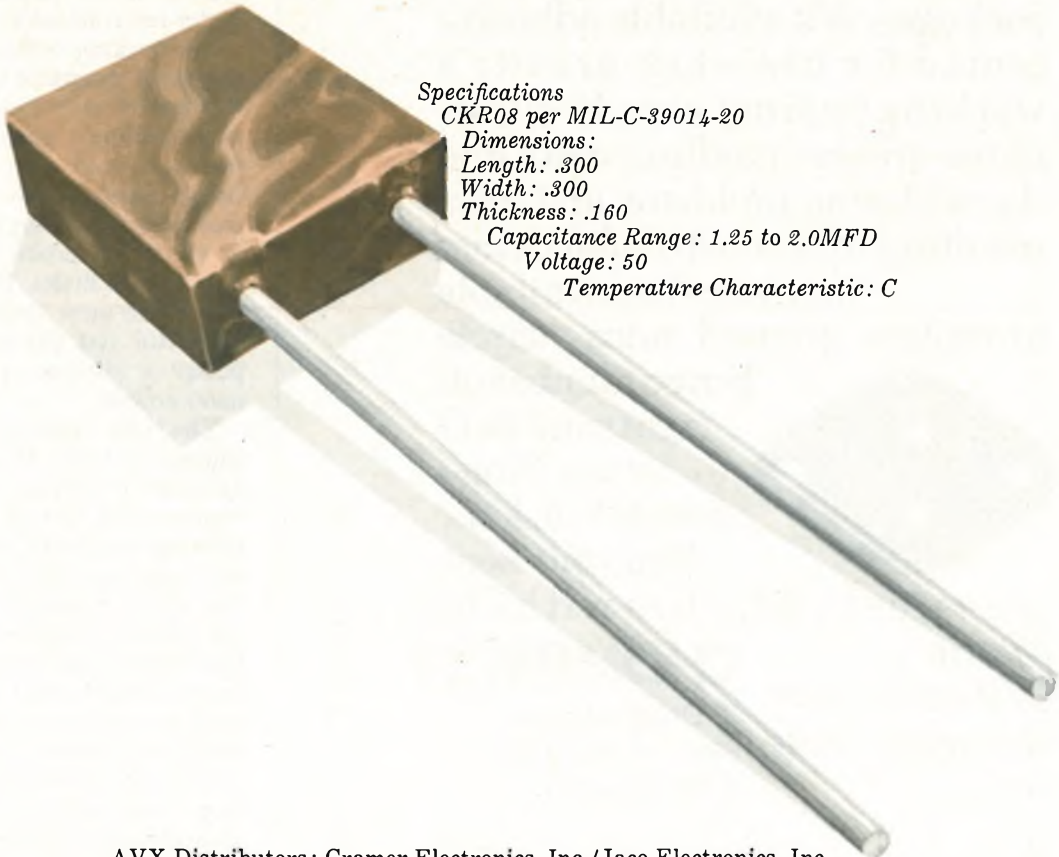

Specifications

CKR08 per MIL-C-39014-20

Dimensions:

Length: .300

Width: .300

Thickness: .160

Capacitance Range: 1.25 to 2.0MFD

Voltage: 50

Temperature Characteristic: C

AVX Distributors: Cramer Electronics, Inc./Jaco Electronics, Inc.
Liberty-Elmar Electronics/Newark Electronics/Texas Instrument Supply

HEATSINK DE-GREASERS

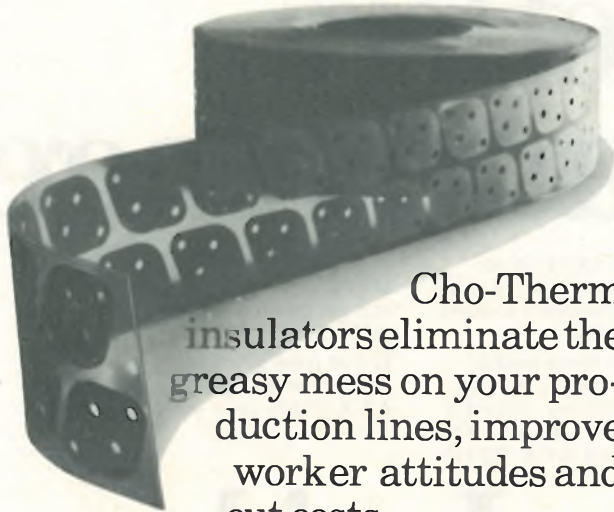

Cho-Therm insulators eliminate the greasy mess on your production lines, improve worker attitudes and cut costs.

Cho-Therm comes in convenient rolls for dispensing ease, pre-cut to fit your power packages. It's available adhesive coated for use when gravity's working against you. It eliminates grease handling costs and the soldering problems and costs resulting from sloppy application.

Grades are available to replace greased mica (circle Bingo number on right) and BeO (circle Bingo number on left).

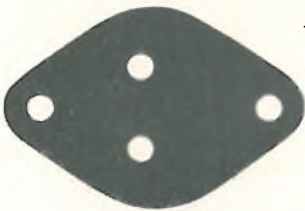

End your heat transfer headaches with Cho-Therm.

(It'll make your QA group smile too!)

CHOMERICS

77 Dragon Court
Woburn, Ma. 01801
(617) 935-4850

I'm
replacing
BeO
42

I'm
replacing
greased mica
210

Electronics review

long words and 4 MHz for the 4,096-bit-long words required by NCR. Located near the connector to the unit under test, the generator section of this device consists basically of shift registers, one for each pin of the connector. Each register is as long as the test word.

For example, when a 160-pin unit under test is to be exercised through 4,096 bits in succession at high speed, program control assembles a 4,096-by-160-bit matrix with the desired bit patterns in the word generator's shift registers. These words are strobed into the unit under test and the subsequent outputs from the unit are stored in the receiver.

No random-access. According to Philip Jackson, engineering vice president at Instrumentation Engineering, this method is much faster than other test systems, which assemble test patterns in some kind of random-access memory. As a test is conducted, these patterns must first be retrieved from the memory, and the computer must usually make many trips to the memory to assemble the bit pattern at the unit-under-test connector.

For tracking down faults, the digital word generator/receiver in the test system may also be connected to a hand-held probe with 40 pins that is clipped onto an integrated-circuit package. The system's display console tells the operator where to place the probe, then logically tracks down faults. The probe operates at the same speed as the edge-connector test jig and can detect pulses or glitches as narrow as 40 nanoseconds.

The test station will soon be shipped to NCR's Financial Systems division in Dayton, Ohio, to test boards used in walk-up self-service banking terminals, teller terminals, and savings-and-loan terminals. The station is actually a variation of the system 390 automatic tester that Instrumentation Engineering introduced several years ago. This is a modular design, allowing a customer to choose components—test stimuli, measurement devices, fixtures, even cabinet configurations—to meet specific requirements. □

Don't waste your time!

**Only THOMSON-CSF has the most complete line of
UHF/VHF TV-translator tetrodes.**

One or five kilowatts in VHF, 200 watts up to two kilowatts in UHF,
in common video and sound-carrier amplification.

An added plus: the possibility of using **all solid-state** drivers.

Optimized tube/coaxial-cavity RF circuit combinations for excellent linearity,
high gain and unexcelled reliability
all with the lowest capital and operating costs!



THOMSON-CSF

THOMSON-CSF ELECTRON TUBES, INC / 750 BLOOMFIELD AVENUE CLIFTON NJ 07015 / TEL. (201) 779 1004 / TWX. 710 989 7149

France - THOMSON-CSF Division Tubes Electroniques / 38 rue Vauthier / 92100 BOULOGNE-BILLANCOURT / Tel. (1) 604 61 75

Germany - THOMSON-CSF Elektronenrohren GmbH / 6 FRANKFURT / MAIN / Am Leonhardsbrunn 10 / Tel. (0611) 70 20 99

Italy - THOMSON-CSF Tubi Elettronici SRL / Viale degli Ammiragli 71 / ROMA / Tel. (6) 638 14 58

Japan - THOMSON-CSF Japan K.K. / Kyoshe Building / 1-9-3 Hiraakawa-cho / Chiyoda-ku / TOKYO / T 102 / Tel. (03) 264 6341

Spain - THOMSON-CSF Tubos Electronicos SA / Alcalá 87 / 7º Dcha / MADRID 9 / Tel. (1) 226 76 09

Sweden - THOMSON-CSF Elektronrör AB / Box 27080 / S 10251 STOCKHOLM 27 / Tel. (09) 22 58 15

United Kingdom - THOMSON-CSF Electronic Tubes Ltd. / Ringway House / Bell Road / Daneshill / BASINGSTOKE RG24 0QG / Tel. (0256) 29155 / Telex 84 9171

Circle 43 on reader service card

Play the Model 1858 numbers game.

18 wins!

You get up to 18 channels in this completely self-contained data acquisition system.

8¾ wins!

The Model 1858 is an unbelievably short 8¾ inches high, including plug-in signal conditioning and internal paper take-up.

65 wins!

The 65-pound-light 1858 is easy to take anywhere, can be used in a rack, on a table, on the seat of a car or plane.

7 wins!

You get up to 7-inch trace amplitude for all channels that allow common baseline recording . . . the most useful and accurate record available.

5,000 wins!

Each channel has dc to 5,000 Hz response, (15 kHz squarewaves) and without amplitude restrictions for superior transient recording capability.

42 & 120 win!

You get 42 discrete paper speeds, from 0.1 to 120 inch/sec.

±0.1 wins!

Precision time lines, accurate to ±0.1% across record width each 0.001, 0.01, 0.1, 1.0 or 10 seconds, each tenth line accentuated and selected interval coded.

1870 wins!

New 14-channel 1870 housing permits up to 32-channel capacity, but adds only 5¼ inches to height. That's only ½-inch per channel!

1887 wins!

This new plug-in signal conditioning module (one of 7) provides simultaneous input signal conditioning for magnetic tape recording and the 1858 for parallel recording or serial record and playback from tape to the Model 1858.



And the 1858 wins in dozens of other ways you can't put a number on. Like constant trace width at all writing and chart speeds, yet without adjustment. And the elimination of overshoot and distortion of

wave pulses and other transient data.

For complete technical specifications, call or write Lloyd Moyer, Honeywell Test Instruments Division, P.O. Box 5227, Denver, CO 80217 (303) 771-4700.

Honeywell Model 1858 Data Acquisition System



**TEST
INSTRUMENTS
DIVISION**

Honeywell

And win with these seven plug-in modules.



Model 1881-HGD
High-Gain Differential Amplifier



Model 1882-LGD
Low-Gain Differential Amplifier



Model 1883-MPD
Medium-Gain Differential



Model 1884-IFM
Interface



Model 1885-SGC
Strain Gage Control and Amplifier



Model 1886-TCU
Thermocouple/Control and Microvolt Amplifier



Model 1887-TCD
Tape-Compatible Differential Amplifier

1881-HGD — A high-gain, floating and guarded dc amplifier. Accepts low-level input signals of from ± 1 mV to ± 1 V/div at common mode voltages up to ± 300 V.

1882-LGD — A low-gain, floating and guarded dc amplifier. Accepts input signals of from $+ 100$ mV to ± 100 V/div to a maximum of 300V, and at common mode voltages to ± 300 V.

1883-MPD — A medium-gain, differential dc amplifier. Sensitivity is from ± 50 mV to ± 1 V/div.

1884-IFM — Adapts to inputs from existing or unique signal conditioning units to the 1858 system. Module is single-ended to ground and consists only of a voltage-to-time converter to convert the analog signal to the PDM format required by the Model 1858.

1885-SGC — For strain gage signal conditioning. In addition to signal amplification, provides for gage excitation and balance as well as "dial-in" voltage substitution

calibration and suppression of the input signals. Sensitivity is from $+ 1$ mV to ± 100 mV/div. Calibration and suppression range is $+$ and $- 1$ to 100 mV.

1886-TCU — For thermocouples or other low-level signals. High sensitivity range of from 100μ V to 50 mV/div, dial-in voltage substitution calibration and suppression are provided. Thermocouple compensation units for standard thermocouple types are available as accessories.

1887-TCD — A high-sensitivity, wide-gain range differential amplifier designed to simultaneously provide input signal conditioning for the 1858 and instrumentation-type magnetic tape recorders. Convenient front-panel switch selection allows parallel recording on the 1858 and the tape recorder, or serial playback recording from the tape recorder to the 1858. Recordings to 100 kHz, beyond the 5 kHz frequency capability of the 1858, can be recorded at high tape speed and played back at a lower speed.

For Literature Circle 45 on reader service card.

For Demonstration Circle 150 on reader service card.

We're taking over Do like we say and



We'll start our takeover with three memory products that'll blow your socks off they're so terrific.

Here's just a taste of what's in store for you.

We'll beat the pants off 1K RAMs with our 4K RAMs.

We didn't do it first (another guy has an 18-pin 4K RAM). We just did it better.

You get the advantages of 22-pin, and darned near the density of 16-pin ...price advantage over those sissy little 1K RAMs...a bunch of goodies that TI doesn't have ...and significantly lower dissipation than Intel's 22-pin.

And it's TTL compatible for ease of use, MM5270 is

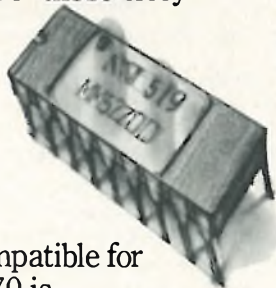

the number.

Try it, it couldn't hurt.

We're also second-sourcing TI's and Intel's 22-pin RAMs. (Look, a buck's a buck.) Our number: MM5280.

We'll slash your programming time with our 4K PROM.

The industry's first 4K PROM. (MM5204.)

Programs twice as much info in 1/3 the time (10-15 seconds). So you slash your programming time in half (one insertion instead of two).

You won't get hurt money-wise because if you're using eight 2K PROMs, for example, you could do the same job with

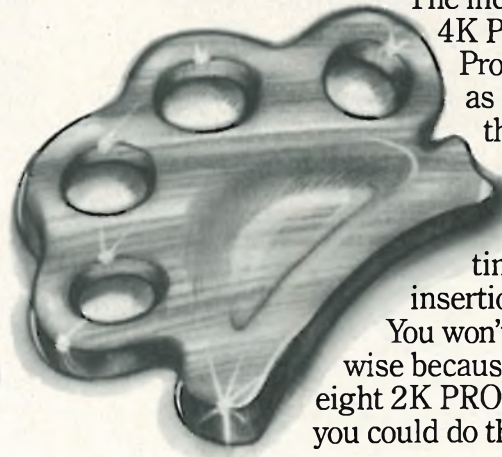

the memory market. nobody'll get hurt.

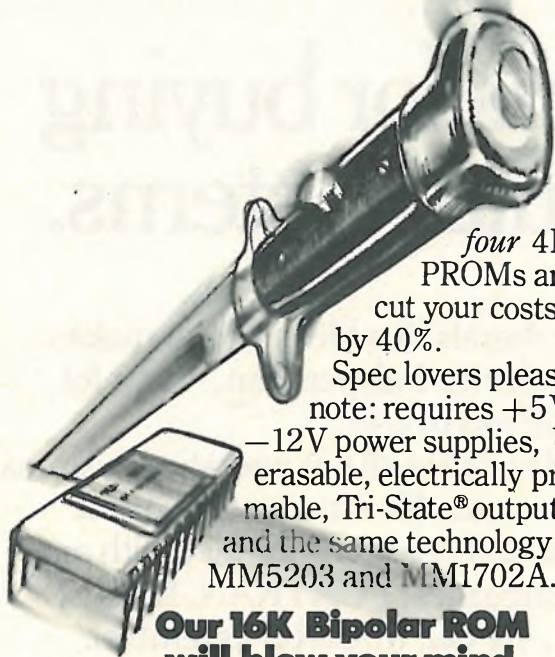

four 4K PROMs and cut your costs by 40%.
Spec lovers please note: requires +5V and -12V power supplies, U.V. erasable, electrically programmable, Tri-State® outputs, and the same technology as MM5203 and MM1702A.

Our 16K Bipolar ROM will blow your mind.

Another first the gang at National has come up with.

A 16K Bipolar ROM.

It'll blow your mind instead of your fuse, because it operates with a single 5 volt power supply and has a typical power dissipation of 575mW.

And you won't get hurt in the speed department 'cause it's faster than any MOS part on two legs. Typical access time is 300 ns.

Detail freaks will be interested to learn that it's organized 2048 x 8 or 1024 x 16, has latched inputs and Tri-State outputs, and series 54/74 specifications compatibility.

Ask for it by name wherever bipolar ROMs are sold: DM8531 or DM8581.

A couple other things before we let you go...

We have all the circuits that go around a 4K RAM...for a total system approach.

And if you don't want to bother building your own memory systems, we sell 'em all ready to go.

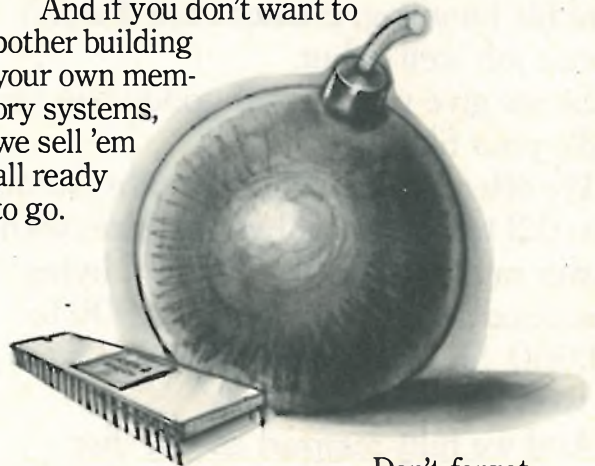

Don't forget.
We mean business.

E626

Fill out this coupon, or else.

Please send me more information on your

16K Bipolar ROM 4K PROM

4K RAM Memory Systems

Name _____

Company _____

Address _____

City _____ State _____ Zip _____

Mail to: National Semiconductor GmbH,
8080 Fuerstenfeldbruck, Industriestrasse 10,
West Germany, Telephone 01841 1484.

National



Six of the best reasons for buying Data General computer systems.

If a computer system can't do a good job of file handling, chances are it won't do your job well either.

So we give you a lot of good ways to handle your files.

We offer six different disc subsystems. From 0.3 to 360 megabytes in size; with transfer rates from 30K to 800K bytes per second; and prices from \$2,900 to \$110,000. So you can pick out the ones that work the way you work.

And we fully support all our disc drives with our systems software. With RDOS and MRDOS for example, you can keep your high-use data on fast access discs, and data you need less on slower discs. With INFOS, you can logically partition a file across different physical media to get the most efficient use of your system peripherals.

All our operating systems treat all

our peripherals like files. Which makes our files device independent. And a lot easier for you to use.

And because all our operating systems share the same file structure, you can maintain and operate your files with any of our languages: FORTRAN, BASIC, ALGOL, RPGII, MACRO assembler.

And you can use any combination of disc drives. So you can manage files from one to one billion bytes and match your file handling to your application.

Yet with all the flexibility we give you, we don't demand a lot in return. You can get an Eclipse S/200 system with 64K bytes of core and a 10 megabyte disc file for under \$30,000. (quantity one, list price.)

Write for more information.

You may end up buying our computer systems because of the way we handle your files.

Data General

Data General, Route 9, Southboro, Mass. 01772 (617) 485-9100. Data General (Canada) Ltd., Ontario, Data General Europe, 15 Rue Le Sueur, Paris 75116, France. Data General Australia, Melbourne (03) 82-1361/Sydney (02) 908-1366.

Pentagon to review Airborne Command Post; funds are cut back

A meeting of the Defense Systems Acquisition Review Council, set for Aug. 28, is expected to result in an order for "significant changes, including some cutbacks" in the electronics proposed for the E-4A Advanced Airborne National Command Post, according to program officials. The high-level meeting between officials of the Pentagon, the Air Force, and prime contractor Boeing Co. is designed to control soaring cost problems [*Electronics*, Apr. 17, p. 36].

Boeing subcontractors, meanwhile, have been notified of a hold on Command Post funds until a review council decision is reached on how to restructure the program, and some have stopped work. The order came after the Air Force put a \$90-million ceiling on Boeing outlays through September 1976. Boeing earlier advised the Air Force it would cost nearly \$142 million this year to continue and implement all the changes proposed by the Strategic Air Command and Joint Chiefs of Staff. A longer range estimate indicated this would have pushed the program's cost to completion up more than 35 per cent, to \$770 million. The Air Force ceiling on program outlays confirms an April report that DOD would drop the \$185.8 million proposed for the last three of six Command Post planes in the special July-September 1976 budget covering the transition between the end of fiscal 1976 and beginning of a new fiscal year. A \$50 million budget for Command Post RDT&E, including the upgraded Block II electronics package, is not expected to be seriously altered by the review council.

Hazeltine, Burroughs lead DABS contest; Bendix out, TI shaky

Hazeltine Corp. of Greenlawn, N.Y., and Burroughs Federal and Special Systems Group of Paoli, Pa., are the leading candidates for a \$15 million contract from the Federal Aviation Administration to build three prototype discrete-address-beacon systems for aviation communications. **This, after the surprise knockout of the Communications division of Bendix Corp., a leader in advanced digital aviation communications research.** Technical details are highly proprietary as the bidding process is still very secret. It is known, however, that while three of the four competitors were advised of where their proposals fell short, Bendix was told flatly that its proposal was "technically uncorrectable." The fourth company in the running, Texas Instruments, is seen as a distant third because of "unique" system architecture, and it may join Bendix as an also ran.

Bendix officials have declined comment, but a member of the TI team concedes that, "TI made some mistakes and there was a lack of communications with the FAA." Meanwhile a senior FAA official says, "We set some pretty high standards and kept them. All the bidding contractors blew it, to one extent or another." For one thing, the FAA wants the system to be able to monitor 700 planes at one time. And the specified mean time between failure for the prototype is 20,000 hours. A contract award is expected in October.

RCA, Western Union set for satellite design contest

In August, NASA will sign two \$1.8 million competitive-design contracts for its \$600 million Tracking and Data Relay Satellite System with teams led by RCA Corp. and Western Union. **NASA says it will negotiate with the winner for a 10-year lease for services beginning in late 1979 or early 1980.** Envisioned is a three-satellite system that will track

and relay information from manned and unmanned space vehicles, beginning in 1980. Teamed with RCA are General Electric, for spacecraft, and Philco-Ford, for ground stations. Western Union's satellites would be supplied by TRW Systems Group. Last March, a consortium led by IBM and including Hughes Satellite and Comsat General Corp. dropped out. [*Electronics*, Feb. 20, p. 50, and March 20, p. 49].

75-kW solar-cell buy set for July

The Energy Research and Development Administration's low-cost solar-cell project will be getting into the hardware phase any day now with the issuance—through NASA—of requests for proposals for production of 75-kilowatts worth of solar-cell arrays. ERDA wants to take its first deliveries by next January. Robert Forney of NASA's Jet Propulsion Laboratory, which is managing the project for ERDA, says **three to five production contracts worth a total of \$1.5 million will be signed by the end of July, and he expects as many as 20 companies to be bidding.** Multiple contracts are planned because no single company is believed capable of producing such a large number of solar cells in so short a time. (Seventy-five kW is equal to three-quarters of the entire U.S. production of terrestrial solar cells during 1974.) NASA will do tests and evaluations for ERDA, which will act as advisor to other government agencies on solar-cell technology.

Also to be signed by JPL in July are contracts for research into improving solar-cell production and materials technology [*Electronics*, March 6, p. 29]. Forney says JPL received proposals from more than 80 companies when RFPs were issued earlier this year and that "two thirds are still in the running."

More competition in communications eyed for U. S.

In an effort to bring more competition to the domestic market for government telecommunications services and equipment, the White House Office of Telecommunications Policy (OTP) has awarded a \$154,000 contract for an eight-month study to Arthur D. Little, Inc., Cambridge, Mass.

The study will look at voice and data services, including the equipment and facilities available from common and specialized carriers, value-added service suppliers and interconnect-equipment makers. **The possible cost benefits of fragmenting services to separately procure equipment, and of partial services or facilities will be examined, as will the impact of bulk-pricing arrangements.** The study will be completed by mid-February, 1976.

FCC is finding no takers for Inmarsat deal

The U.S. communications industry is not inclined to make any commitments by July 15 as to which corporate entity might represent the U.S. in the planned international maritime satellite communications system (Inmarsat), according to industry sources. The Federal Communications Commission, in Docket 20281, has invited such commitments by that date. But, as one senior vice president at a major company says, **"It is premature at this time to expect companies to commit stockholders to something that has not been tested."** He predicts it will take at least a year for international agreement on a maritime satellite organization [*Electronics*, Dec. 26, p. 29] for merchant shipping.

Think Large. Think Small. Think Ise

Think our three jolly green giants for desk-top electronics. Our two pint-size pigmies for carry-in-the-pocket display designs. But don't stop there. Think low operating voltages, low power consumption, glass encapsulation all around, and wafer-thin thickness and dip clip pins for fast efficient mounting.

itron[®]

FG-159A2

ec = eb = 35Vp-p
ic = 4.5mA-p-p
ib = 3.5mA-p-p

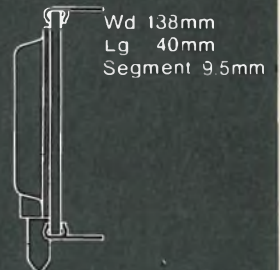

FG-139A2

ec = eb = 30Vp-p
ic = 3.6mA-p-p
ib = 2.8mA-p-p

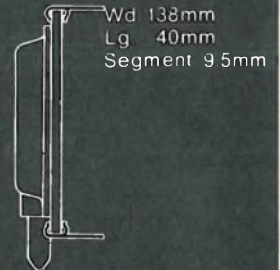
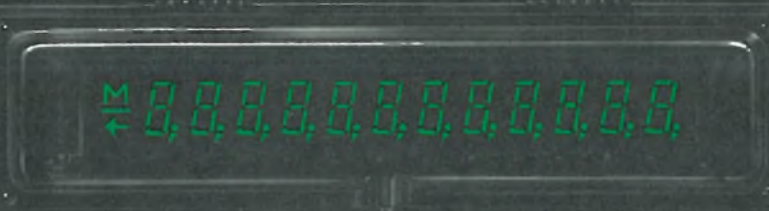

Our jolly
green giants

FG-99A2

ec = eb = 24Vp-p
ic = 3.5mA-p-p
ib = 2.5mA-p-p

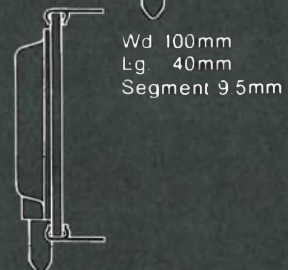

FG-125A2

ec = eb = 24Vp-p
ic = 2.0mA-p-p
ib = 2.0mA-p-p

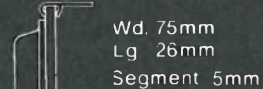

Our pint-size
pigmies

FG-95A

ec = eb = 24Vp-p
ic = 2.0mA-p-p
ib = 1.5mA-p-p

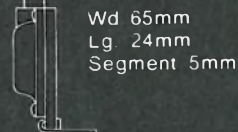

Something else to think about

Think Ise for digital readouts for instruments, clocks and other products, too.

The Brighter Side of Electronics

ISE ELECTRONICS CORP.

Main Office:

P.O. Box 46 Ise City, Mie Pref. Japan
Tel: (05963) 5 2121 to 4 Telex 4969523

Tokyo Office:

2-7-7 Shigashi Shinbashi, Minato-ku, Tokyo, Japan
Tel: (03) 433 6616 to 9 Telex J26546

Noritake Electronics Office:

22410 Hawthorne Blvd. Torrance California 90505 U.S.A.
Tel: (213) 373 6704. Telex 230674910

SIEMENS

Indispensable capacitors For EWS telephone sophistication, for example



The new electronic telephone switching system EWS will widen the scope of the telephone. A 12-button panel will replace the dial plate. Via this panel the telephone subscriber will have access to the wake-up service and will be able to switch his telephone to "do-not-disturb" and to inform the automatic absent subscriber service when he will again be available. He can store the call numbers he uses most and call

down any of them with two digits, he can intercept and identify malicious callers... etc. etc. etc.... Many special services which previously entailed a high labor content can now be automated — with the assistance of a multi-frequency technology using filters equipped with STYROFLEX® and polypropylene capacitors. In addition to the advantage of particularly low losses, these capa-

capitors are specially suitable for filter and resonant circuit applications in conjunction with SIFERRIT® cores, as the capacitor and ferrite temperature coefficients ideally compensate for each other. Hence there is practically no alternative component for high-grade AF filters in the professional sector, and the name STYROFLEX sounds good to hifi technicians who appreciate high standards.

For the present and the future Capacitors from Siemens

Circle 53 on reader service card

Electronics

June 26, 1975

International

Polysilicon in Japanese devices
replaces silicon dioxide: page 5E

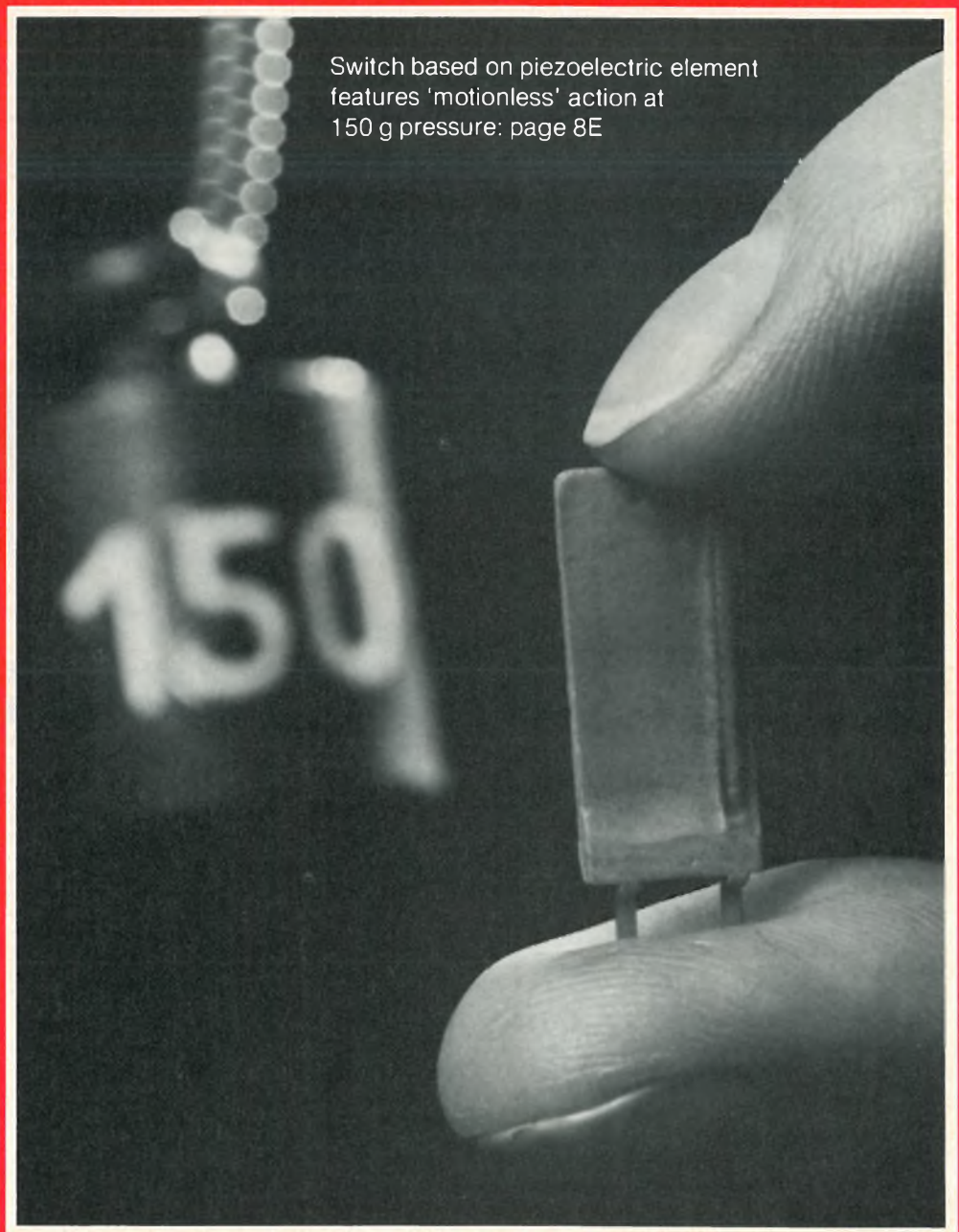

News from Philips

electronic components and materials

COMPONENTS FOR COLOUR TV

SMALL CHROMINANCE DELAY LINE

Our new DL60 delay line for PAL system colour television receivers occupies only about 50% of the print board area that is needed with the existing DL50, and is 20% lower in height. Specially designed for economy and compactness, the DL60 has a nominal frequency of 4,433619 MHz and a phase delay time of 63,943 μ s.



Delay line DL60

A thin slice of zero temperature coefficient glass provided with two transducers is mounted in a shock-proof housing that complies with the UL492 and IEC TC50 specifications for self-extinguishing and non-dripping properties. Four pins enable the delay line to be soldered directly into a printed wiring board.

In combination with the new generation of integrated circuits for television announced last year, the DL60 delay line offers the possibility of constructing an attractive compact colour decoder so contributing to the trend of modular chassis design.

CIRCLE 701 ON READER SERVICE CARD

DIODE-SPLIT EHT TRANSFORMER

The new diode-split transformer promises more economical and more reliable EHT generation for the TV receiver. The rectifier diodes are now incorporated in the device, and the capacitance needed for the voltage multiplier is obtained by means of a special winding technique which produces the

required amount of self-capacitance, so obviating the need for external capacitors.

Transformers have been designed to provide the required scanning amplitude for 110° colour picture tubes up to 66 cm (26 inch) with a neck diameter of 36,5 mm in receivers for 625 lines/50 frames per second and 525 lines/60 frames per second systems. Maximum EHT voltage is 25 kV and the current 1,5 mA; supply voltage is 150 V (for transistor equipped systems) with a consumption of 780 mA at maximum output current. Numerous auxiliary windings are provided.

The magnetic circuit of the transformer comprises two Ferroxcube U-cores screwed together. The primary and secondary windings are mounted separately on each leg and are impregnated in flame retardant polyester which meets the self-extinguishing requirements of IEC65 and UL492. The transformer is provided with pin connections which may be soldered directly to a printed wiring board.

High reliability is an important feature of the new transformer which has undergone extensive testing. It is expected that production devices will have a MTBF at least equal to the best of present designs of line output transformers only, so that the overall reliability of the EHT supply will be higher than before. The diode-split transformer is patented in England, France and the USA. Patents are pending in Germany and many other countries.

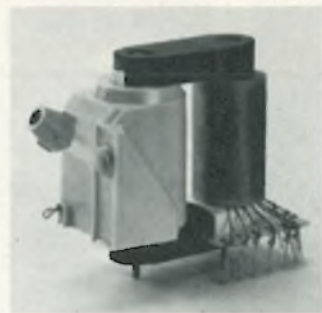

Diode-split transformer

CIRCLE 702 ON READER SERVICE CARD

HIGH SENSITIVITY HALL EFFECT INTEGRATED CIRCUIT

A new monolithic integrated circuit for magnetic field detection, type TCA450A, incorporates a Hall element in which a differential voltage is generated by applying a magnetic field. This voltage is amplified in a differential amplifier of which the output stages are a long-tailed pair.

The voltage generated by the Hall element depends on the density and polarity of the magnetic flux to be detected. The maximum available output current of the differential amplifiers is 50 mA at saturation which can be determined by an external resistor or a current source. The Hall element of the TCA450A has a high sensitivity of 0,4 V/T (40 μ V/gauss) and an offset flux density of only 7,5 mT (75 gauss). The supply voltage may be from 4 to 16 V and the operating temperature range is -55 to +125 °C. The TCA450A is encapsulated in an attrac-

tive 14-pin low-profile package only 1,5 mm high and measures 4 x 5 mm. There are 9 connections which offer circuit designers considerable flexibility for applications.

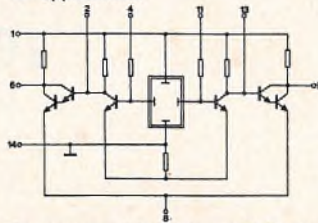

On account of its high sensitivity, the TCA450A can be used in many consumer and professional applications as a magnetic sensor, such as speed and position detectors, tachogenerators, commutation in brushless motors, measuring probes, magnetic pick-ups in precision tape drives, gyroscopes and navigation systems. It can be used almost anywhere magnetic information has to be translated into an electrical voltage or current.

CIRCLE 703 ON READER SERVICE CARD

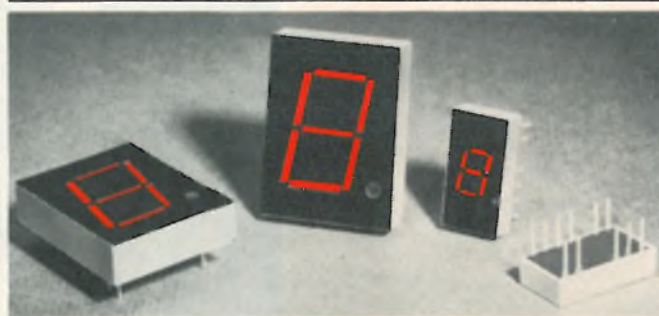

SEVEN-SEGMENT LED DISPLAYS WITH 19MM CHARACTERS

The CQY81 and CQY84 are seven-segment numerical readout displays with right hand decimal point. Using only a single LED per segment for economy, these seven-segment displays are ideal for both measuring equipment and consumer applications.

The CQY81 and the CQY84 are the first types of a new series to be announced. The character sizes are 7,6 x 5,2 mm for the CQY81, and 19,6 x 12 mm for the CQY84. A luminous intensity of 0,2 mcd is given at a forward current of 20 mA for both types, and the power dissipations are 400 mW and 600 mW, respectively.

The new devices are made in the so-called "stretched-segment" technology by which a small LED source is transformed into a line segment. This technology combined with a lead frame as chip carrier is optimized for mass production. Due to the simple construction, any conventional driver-decoder circuit can be used.

CIRCLE 704 ON READER SERVICE CARD

Philips Industries
Electronic Components and
Materials Division
Eindhoven - The Netherlands



Electronic
Components
and Materials

Flat-panel display can store images

A thin-film alternating-current-drive electroluminescent panel that features inherent memory properties and is no bigger than an 8-inch cathode-ray-tube screen has been developed by Sharp Corp. Peripheral circuits for the demonstration panel display 24 lines of 54 characters, which are generated in a five-by-seven matrix. The panel's 240 horizontal and 320 vertical electrodes give a resolution of two lines per millimeter. **Because of the panel's inherent memory properties, logic operates only when displayed information is changed.** Life is predicted to be 15,000 hours, although an earlier 3-inch panel is still going strong after displaying TV images for 20,000 hours.

UK's ITT launches fiber-optic gear in Europe drive

The British ITT Components Group is launching a major push into the European market for fiber-optic communications components June 24 to 27 at the Laser '75 show in Munich, West Germany. On display are an optical video-data link, a prototype solid-state gallium aluminum-arsenide continuous-wave laser, and a prototype portable test instrument to measure the attenuation and continuity of optical fibers.

ITT will also market electronic terminal-conditioning modules and, eventually, integrated optics. Work by The Fiber Optical and Modules division in Leeds, England, is being coordinated with its sister Standard Telecommunications Laboratories. North American sales will be handled by the Electro-Optics division in Roanoke, Va. ITT claims two European firsts—the cw laser, already tested more than 6,000 hours, as well as its extensive package of modules.

Japanese harness microprocessors for industrial use

Both Toshiba and Yokogawa Electric Works are gearing up to push microprocessor-based industrial controls in Japan. **Toshiba's series uses the company's 12-bit microprocessor,** which includes features not found on other microprocessors of less than 16 bits, such as eight-level interrupt and multiply and divide instructions.

The most interesting product is a direct-digital controller that can handle up to eight loop stations, which normally would require eight analog stations, with more flexibility and options than an analog system. Control can be extended to any practical size in increments of eight stations, and failure of a single processor would disable at most only eight loops.

Yokogawa's industrial-control system is built around Nippon Electric's microprocessors. Each 16-bit microprocessor will be able to control up to 32 loops. A feature of its system is a cathode-ray-tube display as the main interface between control system and operator. Thus, both information readout by operator and setting methods will differ from previous industrial-control systems using a separate analog station for each loop.

Poland sells IBM \$2.5 million worth of piezo crystals

Poland, usually the receiver of state-of-the-art electronics technology, occasionally supplies components and equipment to Western countries. The 26-manufacturer electronics combine, Unitra, has already shipped the first batch of two piezoelectric crystals to International Business

Machines Corp. in the U.S. under a \$2.5 million five-year contract.

The devices, designated Q166 and Q167, were developed by the combine especially for IBM computer operations. Unitra claims its piezoelectric products and high-precision resistors are already well established in French and Belgian markets. The export department is now seeking to expand in the United Kingdom, as well.

French ready terminal that speaks English

With the French-speaking **Icophone V terminal ready for market**, under the auspices of the French government's patent-licensing agency Anvar, its developers are turning their attention to an **English-speaking version**. Researchers at the Laboratoire d'Informatique pour la Mécanique et les Sciences de l'Ingénieur of the University of Paris expect to have the prototype working by year-end.

Icophone terminals synthesize speech by means of 44 sine-wave oscillators ranging from 100 to 4,400 hertz, three noise generators, a mixer, and an amplifier. A program of 4,096 16-bit words controls the system, and another 4,096 words of memory converts French fed in by keyboard into codes for 627 phonemes. Along with a retouched conversion program, the **English-speaking Icophone will have four digitally controlled filters to supply the necessary intonations.**

Egypt and Iran pick UK weapons in \$1 billion buys

Britain has won two heats in the **European weapons derby** [*Electronics*, May 29, p. 78]. It has signed a large package deal with Egypt worth \$1.2 billion. What's more, Iran has rejected the much more expensive West German Leopard in favor of the British Chieftan medium tank in an agreement believed to total 800 tanks worth \$1 billion. Included in the Egyptian package are Hawker-Siddeley Hawk trainers, Westland Lynx helicopters, British Aircraft Corp. Swingfire missiles, telecommunications, and radar gear, as well as assorted battlefield vehicles. **Egypt also is talking with France about a similar package.**

AEG picked to build ESA's satellite station in Italy

AEG-Telefunken, West Germany's No. 2 electronics producer, has been picked by Italy's Telespazio to build the European Space Agency's satellite ground station at Fucino, near Rome. ESA considers Telespazio the prime contractor for this station. The \$9 million project, in which firms from five European countries are participating, calls for using the station in transmission and propagation tests in conjunction with the Orbital Test Satellite. OTS is the forerunner of the European Communications Satellite, intended for future telephone and television communications. **The up-link operates at 14 gigahertz and the down-link at 11 gigahertz. Some of the OTS tests will involve the double utilization of frequencies, to be achieved by orthogonal polarization.**

Stansaab edges Univac to build Soviet ATC gear

Sperry Rand's Univac division has given up hope of getting an estimated \$75 million contract from the Soviet Union for air-traffic-control equipment. Sweden's Stansaab, Univac's competitor in the hard-fought bid, is expected to get the contract this summer for the terminal equipment [*Electronics*, Nov. 14, 1974, p. 55]. **The Soviets bought a Stansaab en-route ATC system last spring at an estimated cost of \$100 million.**

First we developed MYCRO-1. Then we expanded it with a floppy disc controller.

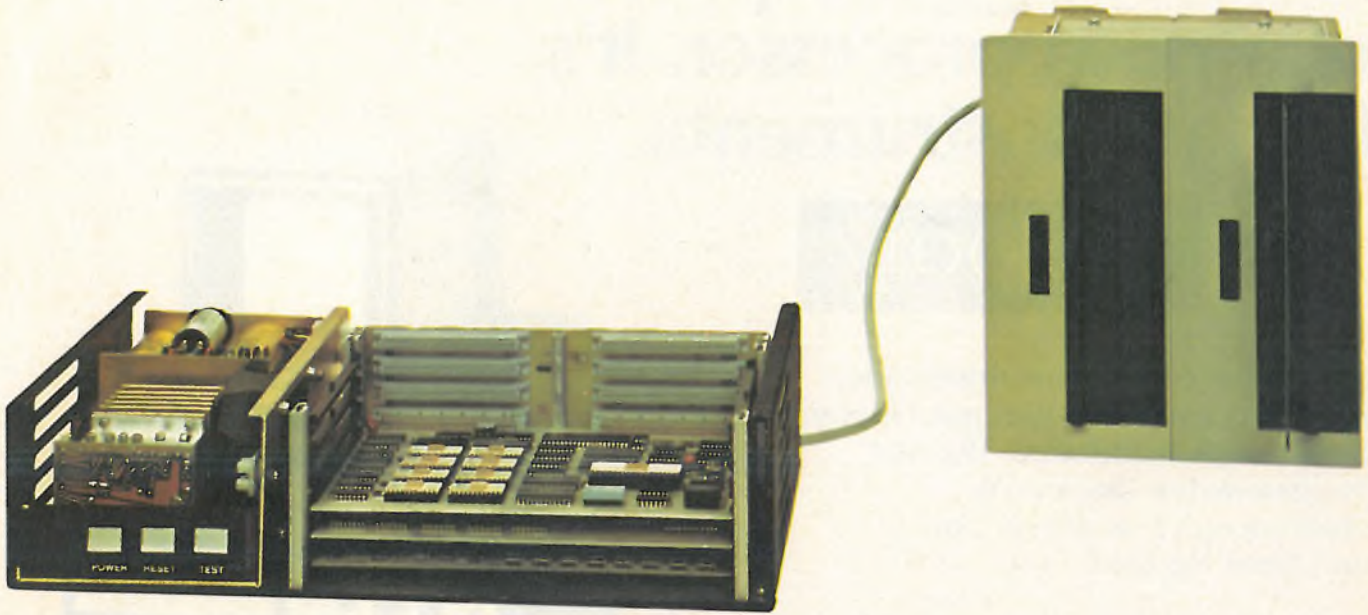

The MYCRO-1 is a truly complete computer on a single printed circuit board; DIM 1001 CPU board (Double Europe standard) with 2 μ sec. cycle time, a 16-bit address bus and an 8-bit bidirectional data bus (8080). On the same board there is also a TTY/Display Interface, space for 2kByte of PROM, 2kByte of RAM and 2kByte of ROM. **BALANCED.**

For more and less expensive memory there is now available from MYCRON a 16kByte RAM (dynamic, DIM 1013) board or you may choose

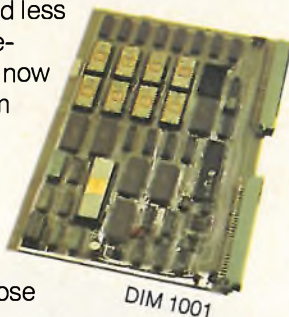

a 4kByte EPROM (1702A) or 4k-Byte RAM (static). You may pick any combination of RAM or PROM modules up to 64k. **FLEXIBILITY.**

To make this an even more powerful system, we developed a disc controller, the DIM 1030, that allows you to control up to 8 floppy discs of 1/4mByte each. You may use any IBM compatible floppy disc drive. The basic driver routines for read/write to file is available in EPROM, and further software support is being developed rapidly. **CAPACITY.**

With the MYCRO-1 system software you can develop your own programs easier than before, since we have both a one-pass assembler and a debugging monitor. **EASE.**

You may buy a complete MYCRO-1 system or modules. Competitive OEM prices and quantity discounts available. **MODULARITY.**

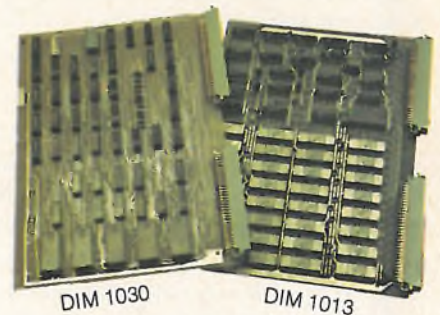

If you are interested in MYCRO-1, our new developments or other MYCRO-1 modules, just write to: A/S MYCRON, P.O. Box 6199 Et, Ensjøveien 20, OSLO 6, Norway, or call NORWAY (472) 67 51 93.

D MYCRON

Meet the all-purpose instrument. It's a digital oscilloscope. It's programmable. It calculates. It utilizes all the power of a microprocessor. It's Norland Instruments

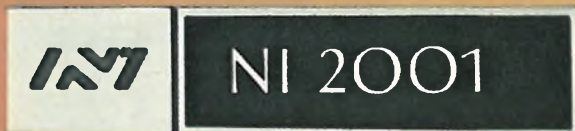

All the function and instrumentation capability you'll probably need is yours in this single mainframe. The first Programmable Calculating Oscilloscope is available now — only from Norland.

Here is the ultimate instrument for the acquisition, processing and manipulation of electrical data. It completely eliminates the need to compromise your requirements with a jumbled array of separate instruments. The NI 2001 combines all the capabilities of a digital oscilloscope and a microprocessor in a single mainframe. It brings you flexibility, convenience, accuracy and reliability you won't find anywhere else.

This — the first Programmable Calculating Oscilloscope — is the product of many years of technological research and instrumentation engineering. With the advent of microprocessor technology, Norland Instruments engineers were quick to recognize the power available to the instrument designer and first applied a microprocessor to the Norland line of medical instruments. That experience ultimately led to the use of microprocessor technology in the development of the NI 2001 — the first truly new generation of test and measurement instrumentation for the industrial and scientific user.





Useful data the easy way

Picture yourself at the keyboard. You control the DISPLAY of both waveforms and alphanumeric. You can use all, halves or quadrants of the data memory to display one to four independent signals and even do X-Y displays. You have the most convenient means for storing waveform data and recalling it from memory for manipulation and display. You've never experienced the versatility and performance that the NI 2001 now puts at your fingertips.

Calculating Power Without Interfacing. The calculating power available in this new instrument eliminates the need for a separate calculating unit. It operates on entire arrays of data as well as individual numbers. Not only can you perform common arithmetic functions, you can also quickly and accurately convert data into required units. Voltage levels can be instantly converted to current, power, energy, acceleration, velocity, displacement, torsion, temperature or other units.

You'll particularly appreciate the way the NI 2001 simplifies complex calculations required in your analysis. Eighteen of the most common engineering and scientific calculations are controlled by fixed-function OPERATORS, pre-programmed at the factory. There's no easier

way to calculate differentials, definite and indefinite integrals, peak areas, N-point averaging, coordinates and delta-coordinates, rise time, peak-to-peak measurements and true RMS values.

Easily Programmable. Repetitive and lengthy data acquisition and manipulation sequences are both simplified and automated because of the ability to program the NI 2001. It requires no computer background — is as simple to program as a programmable calculator and allows easy editing of any program. You can store up to 200 keystrokes. And — the NI 2001's conditional branching ability puts an almost unlimited number of decision-making procedures at your disposal without interfacing with a computer or other peripheral equipment.

Sensibly Priced. With all its versatility, convenience and reliability, the NI 2001 is also sensibly and surprisingly priced. The mainframe is just \$8,500. The instrument shown, with monitor and two single-channel plug-ins can be yours for \$13,400!

Why wait? For a demonstration and complete information send the reader service card or write Norland Instruments, Dept. C-1.



NORLAND INSTRUMENTS
A Subsidiary of Cordis Corporation

For more information circle 58 on reader service card.

Norland Drive
Fort Atkinson, Wisconsin 53538
Tel. (414) 563-8456 U.S.A.

For demonstration circle 59 on reader service card.

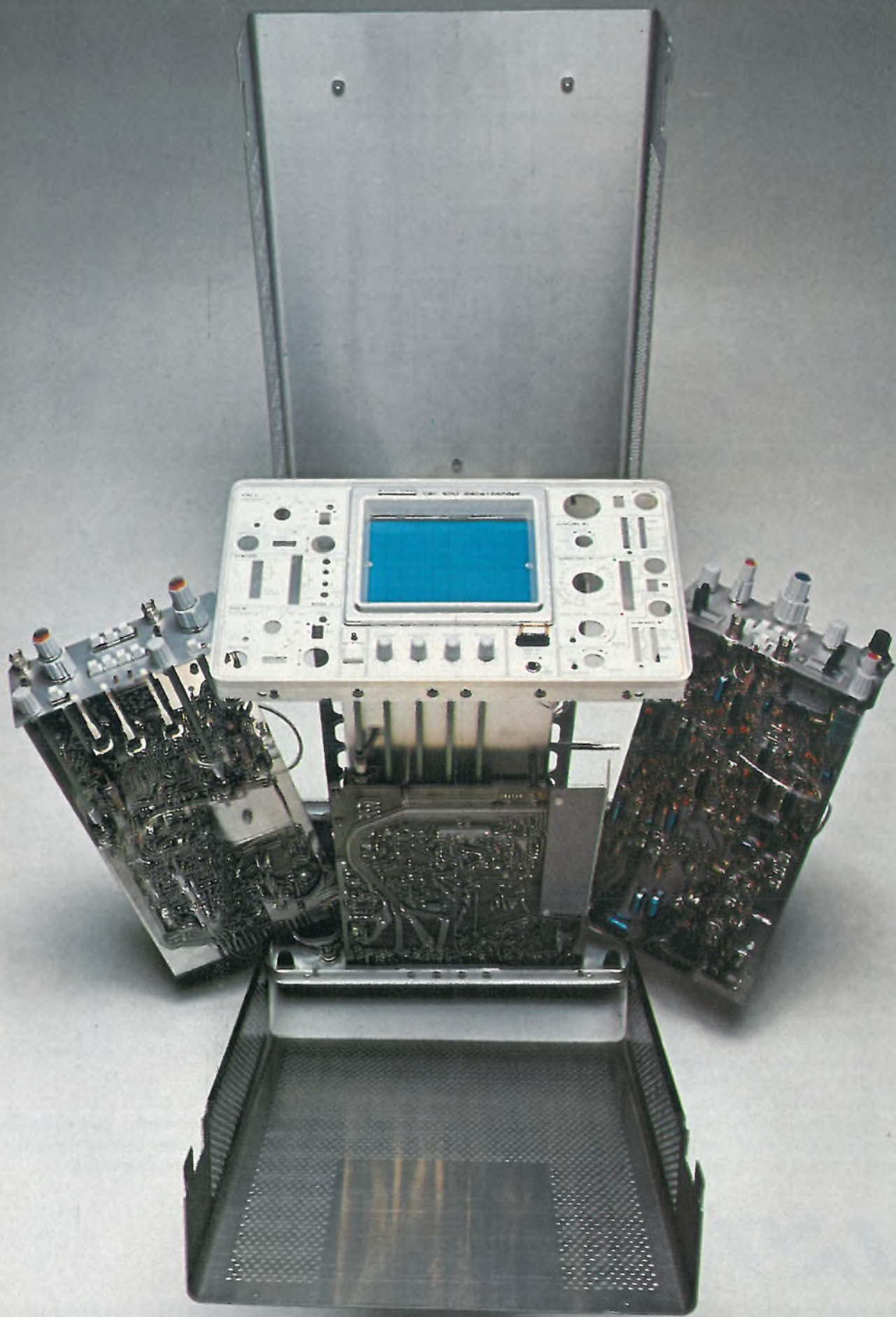

5212

QUADRUPOLEAR CRT CUSTOM DESIGNED ICs

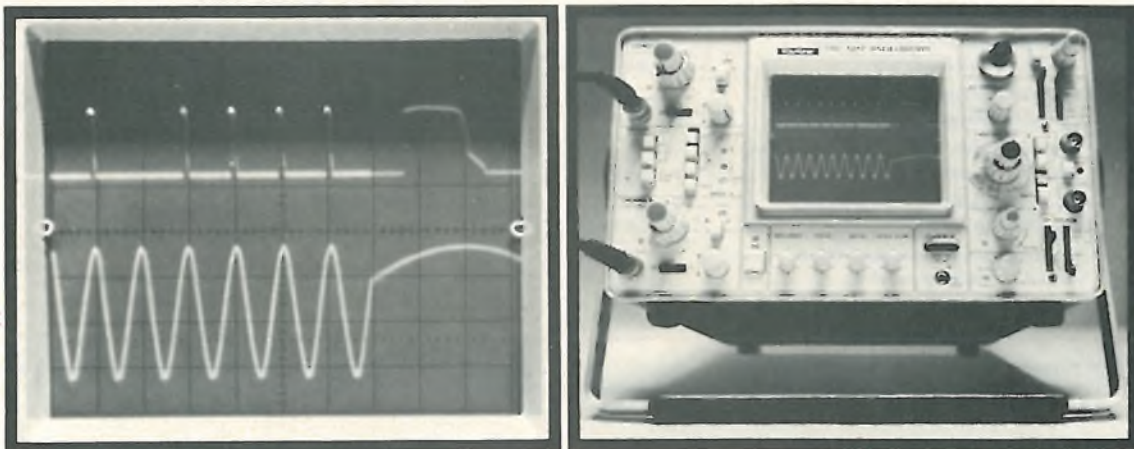

Amplifiers 85MHz. Both Channels: dc to 85MHz 5mV/cm.

Or, instantly, by x 5 button: Channel A: dc to 20MHz 1mV/cm. Channel B: dc to 85MHz 5mV/cm.
Push-button display of trigger signal.

Dual timebase 10ns/cm. 1s/cm to 100ns/cm plus x 10 expansion. Trigger up to 100MHz, separate control for each timebase. Adjustable hold-off.

CRT 8 x 10cm. Specially developed for this 'scope'. Rectangular 8 x 10cm display has unparalleled brilliance and definition due to the new quadrupolar electrostatic lenses.

Indicators. Show when amplifiers or timebase are off-cal; when timebase is not sync; when single-shot is not primed; the direction beams are off-tube.

Schlumberger

SCHLUMBERGER INSTRUMENTS-ET SYSTÈMES
ETABLISSEMENT DE SAINT-ÉTIENNE - 5, RUE DAGUERRE - 42030 SAINT-ÉTIENNE

FEATURE ARTICLES FROM ELECTRONICS MAGAZINE ARE NOW AVAILABLE IN REPRINT FORM!

Valuable additions to your electronics library are now available thru this exclusive reprint service. Just check the articles you wish to order and enclose check or money order for prompt service.

No. of Copies Wanted		No. of Copies Wanted	
_____	R- 11 Computer-Aided Design	_____	R-310 Penetration Color Tubes are Enhancing Information Displays
_____	R- 15 Special Report on LSI Packaging	_____	R-312 Leadless, Pluggable IC Packages Reduce Costs..
_____	R-016 Special Report on The Transistor: Two Decades of Progress	_____	R-316 Hybrid Circuit Technology Solves Tough Design Problems
_____	R- 18 Reshaping the EE for the Seventies	_____	R-318 Buckling Up for the Bumpy Road to Detroit....
_____	R-023 Special Report: Tomorrow's Communications....	_____	R-320 Planar Interconnection Techniques (Designer Must Plan Early for Flat Cable)
_____	R-027 Consumer Hazards: Why They Happen, How They Can Be Fixed	_____	R-322 Special Report: The New Displays Complement the Old
_____	R-031 Circuit Designer's Casebook (U.S. Only)	_____	R-324 Semiconductor Memories Are Taking Over Data-Storage Applications
_____	R-032 Active Filters	_____	R-326 Optical Spectrum Report and Optical Spectrum Chart
_____	Infra-Red Detector Chart	_____	R-328 Pervasiveness of Electronics Entire Issue of Electronics
_____	R-101 Special Report: The Right Numeric Readout, a Critical Choice for Designers	_____	R-500 Japanese Forecast 1975
_____	R-104 The New Concept for Memory and Imaging: Charge Coupling	_____	R-502 European Forecast 1975
_____	R-107 Wanted for the '70s: Easier-to-Program Computers	_____	R-504 U.S. Forecast 1975
_____	R-110 Automation for Survival and Profit	_____	R-406 Logics New Design Tools
_____	R-113 Optoelectronics Makes It At Last (3 part series).	_____	R-408 Bringing Sight to the Blind
_____	R-203 East Europe Market Report	_____	R-410 Passive Components
_____	R-205 Bridging the Analog & Digital Worlds with Linear ICs	_____	R-412 Liquid Cooling Semiconductors
_____	R-207 Technology Gap Starts to Close for Computer Peripherals	_____	R-414 Simplified n-Channel Process
_____	R-209 Semiconductor RAMs Land Computer Mainframe Jobs	_____	R-416 Optical Waveguides Look Brighter
_____	R-211 Electromagnetic Spectrum Report and Foldout Chart	_____	R-418 Computer Analyses of RF Circuits
_____	R-213 Electromagnetic Spectrum Chart (rolled in mailing tube)	_____	R-420 Computerized Text-Editing and Typesetting
_____	R-306 Charge Coupling Improves Its Image, Challenging Video Camera	_____	R-422 A Microprogramable Minicomputer
_____	R-308 Program for Transition from NonLinear to Linear Transistor Model	_____	R-424 Microprocessor Applications
		_____	R-426 Special Issue—Technology Update—1974

3 FOR
\$7.50

Payment must accompany your order... USE THIS PAGE AS YOUR ORDER FORM

Make check or money order payable to Electronics Reprints. All orders shipped prepaid via parcel post. Allow two to three weeks for delivery.

Back Issues Now Available. 1960 to 1969 \$5.00 each. 1970 to 1973 \$3.00 each.

Mail Your Order To
Janice Austin
ELECTRONICS REPRINTS
P.O. Box 669
Hightstown, N.J. 08520

Amount of Order	\$ _____
Plus 10% Handling Charge	\$ _____
TOTAL AMOUNT ENCLOSED	\$ _____

SEND REPRINTS TO

Name _____
Company _____ Dept. _____
Street _____
City _____ State _____ Zip _____



PROFIT

...a few ways Belden can help you protect your bottom line.

Wire and cable usually cost less to buy than install. And poor performance can cut into profitability deeper than potential penny-per-foot savings on an initial buy.

Here's how Belden can help protect your bottom line performance.

BROAD LINE: We can help you meet toughest environmental and application requirements from an exceptionally broad line of standard wire and cable configurations, or design a special for you if stock answers won't work.

UNIQUE PUT-UP CAPABILITY: Ask about Belden's UNREEL™ packaging concept. A dispensing system that eliminates the reel. And time robbing snarls, backlash, and tangle problems. We have a number of ways to put-up wire that can save you production time and money.

ENGINEERING HELP: There's a Belden Electronic cable specialist near you. He's backed by factory engineering specialists and a Technical Research Center. You won't find a better source for solving cable problems.

HOT-LINE ASSISTANCE: Need a "right now" answer to a cable requirement. Call 317-966-6681. It's a direct-line to Belden's cable engineering facility. A way to get immediate assistance on problems that won't wait.

DESIGN KIT: If you're looking for design help, we have a kit that covers most of the nitty-gritty aspects of performance characteristics, costs, and material capabilities. Send for your kit, today.

GREAT DELIVERY: Belden has increased production capabilities and offers shorter lead times on most cable configurations. Check it out.

Profit protection is part of the Belden cable package. But, find out for yourself: Write: Belden Corporation, Electronic Division, P.O. Box 1327, Richmond, Indiana 47374.

...new ideas for moving electrical energy

BELDEN 

Circle 63 on reader service card



Total cost effectiveness. TO-5 relays from Teledyne.



Whether you design commercial aircraft equipment, or MIL avionics, control and communications devices – the tough parameters are the same. High packing density, low power consumption and heat dissipation, utter reliability and always – cost effectiveness.

TO-5 relays from Teledyne are the unqualified answer. High density, PC board pinout, **half** the size and coil power of comparable multi-pole

switching devices. And they are **more reliable** and **less expensive** than semiconductor arrays for multi-switching functions.

Teledyne has the greatest choice of TO-5 relays available to you – ultra-sensitive types, maglatches, internal suppression diodes, internal drive transistors and many contact arrangements. All – welded and hermetically sealed; all fully qualified to MIL-R 39016 B, level “L” and “M” reliability. Specify them for your most exacting designs. Teledyne TO-5 relays – the totally cost effective switching solution. There’s an economical Commercial/Industrial line, too – and they’re in stock near you. Call your nearest Teledyne Relays office for location of your local representative or distributor.

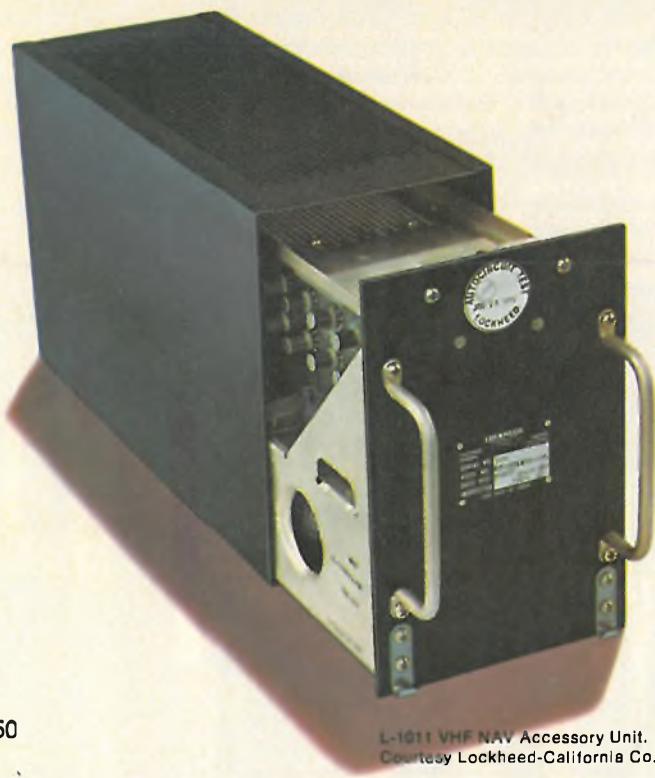

L-1011 VHF NAV Accessory Unit.
Courtesy Lockheed-California Co.

TELEDYNE RELAYS

3155 West El Segundo Boulevard, Hawthorne, California 90250
Telephone (213) 973-4545

Burgstrasse 6-8, 62 Wiesbaden, West Germany
Telephone: 06121-302031/2 Telex: 04-186851 (Trel-D)

Heathrow House, Bath Road, Cranford, Hounslow, Middlesex, U.K.
Telephone: 01-8972501 Telex: 935008

Probing the news

Analysis of technology and business developments

For TV tuners, a digital look

Designers of color receivers are starting a switch to new types of electronic tuners featuring digital addressing systems and displays

by Gerald Walker, Consumer Electronics Editor

American television-receiver makers now find themselves with three good reasons for designing electronic tuners not only into the big-screen, high-priced consoles but into the ubiquitous 19-inch table models, too. First, the price is just about right; second, some of the design problems associated with use of varactor tuners have been solved with the advent of new digital ICs; and third, even though the TV industry is struggling through a year best described as a bummer, new features to attract consumers are, if anything, more necessary than ever before.

Designers in the U.S. have been flirting with electronic tuning for a long time. The need for accurate tuning of more than 12 channels has been especially pressing since the FCC a few years ago issued a regulation requiring parity between vhf and uhf tuners. But with the costs of the electronic varactor tuners relatively high and the reliability of the electromechanical detent versions quite satisfactory, the rate of conversion has been slow.

According to most estimates, fewer than 10% of U.S.-made color TV sets today have electronic tuners, as against nearly 100% of the color receivers made and sold in Europe. In previous years picture tubes and picture control circuits have received most attention—remember “the brightness race” and later the emphasis on “one-button” control for color, tint, brightness, and con-

trast? In Japan, too, the proportion of electronic-tuner-equipped TVs is 10%, but the emphasis this year is on 90° deflection tubes, not on digital tuners.

In Europe, West German set makers are showing growing interest in infrared sound transmission from set to headphones, which is not as susceptible to reflections as ultrasound. At last year's Electronics Show in Munich, Siemens demonstrated an infrared concept; at April's Hannover Fair, one German set maker, Loewe-Opta, followed suit. Now, at the radio and TV exhibition coming up in August in Berlin, more set makers are expected to have the IR feature in their sets. IR could be adapted for remote tuning, but ultrasound is more reliable.

The French set makers' trade association says a “large majority” of the receivers sold in that country

have touch tuners. The feeling is that sets with rotary channel selectors will vanish from showrooms in the next year or so.

Might as well. But for the U.S., it now appears that the tuner's time has come, thanks in part to the conclusion by set makers that as long as the uhf channels have to be tuned as conveniently as the vhf, the whole thing might as well be done with a single electronic tuner. Indeed, the new model lines announced this spring are already reflecting this renewed interest.

For example, Zenith Radio Corp. of Chicago, first in the nation in color-set sales, has incorporated two basic electronic tuning packages in 34 different sets, or over 70% of its new line. Magnavox Co. of Fort Wayne, Ind., which a year ago introduced the “Star” (for selective tuning at random) remote-control

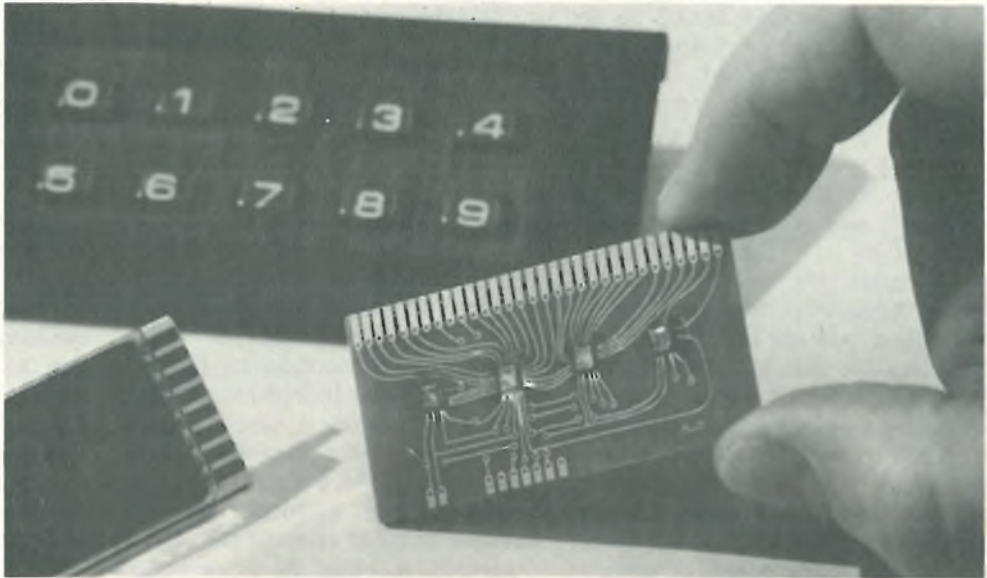

Polished. Digital tuner from F. W. Sickles is said by its manufacturer, a division of General Instrument, to be inexpensive enough for eventual use in all color receivers. It's based on MNOS memory.

Probing the news

tuning, has now expanded the sets using it to include some 25-inch and 19-in. models. GTE-Sylvania, Batavia, N.Y., an early proponent of varactor push-button tuners, has put 20-channel systems in 10 of its new 25-in. receivers.

Next year promises even more announcements of electronic tuners, as design efforts now under way begin to bear fruit. And digital is the way of the future for the address and control systems linked to the varactor tuning circuits. In fact, the development of low-cost digital ICs for electronic-tuning address systems has been a key factor in solving some of the shortcomings of previous varactor tuners' lack of flexibility and additional manufacturing costs.

There are two ways to go in address systems— analog, in which a variable dc voltage is applied across the varactor diodes, or frequency synthesis, in which a local oscillator countdown circuit provides a channel-selection signal through a prescaler.

Price difference. A digital address system requires three to six chips, depending on the degree of integration, plus a channel-number display driver if the set maker wants to use a light-emitting diode or liquid-crystal display for channel number. It's also possible to get on-screen channel display using a character generator. Naturally, semiconductor manufacturers are anxious to develop this market and have begun to offer systems in the \$15 to \$18 range. But the TV manufacturers want to pay less than \$10.

Thus, a competitive battle is shaping up because although there may be seven million to nine million sets produced in the U.S. each year, depending on the state of the economy, there is only a handful of producers and of these only a few are manufacturers in a big way. The IC suppliers, such as Motorola, RCA, Fairchild, National, Plessey, and Texas Instruments, find themselves talking digital electronics to analog-oriented customers. However, they have a good argument: digital addressing is undoubtedly more accu-

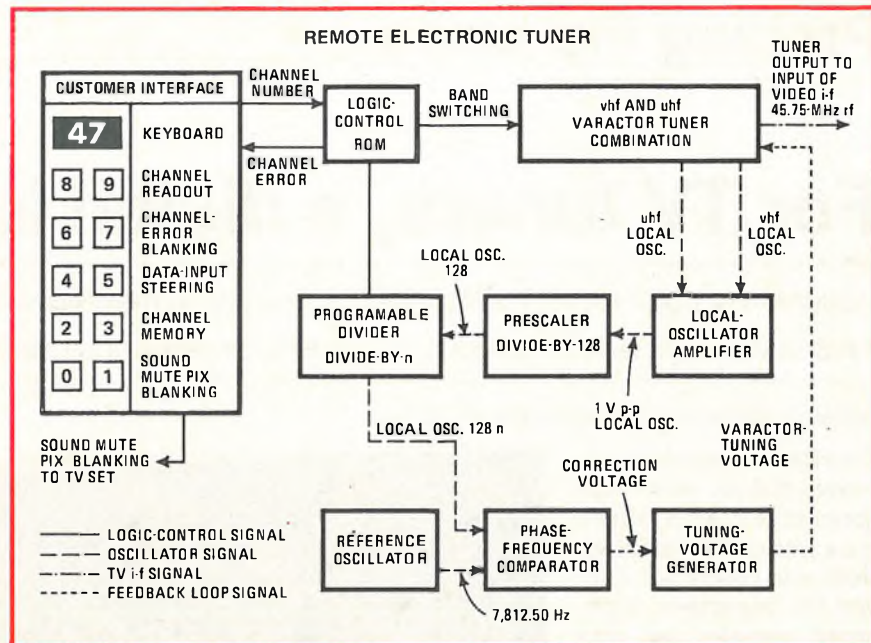

Big gun. Motorola 75 is a phase-locked-loop system. Basic kit contains MECL dividers, MOS control chip, bipolar tuning voltage generator, and a bipolar band switch chip.

rate and stable than the potentiometer-select method.

Motorola Semiconductor has developed a phase-locked-loop tuning system that uses a direct digital countdown of the varactor tuner's local oscillator to obtain the proper local oscillator frequency for the channel number selected (see block diagram). A basic kit is available with two emitter-coupled-logic (MECL) dividers, an MOS control chip, a bipolar tuning voltage generator, and a bipolar band switch chip. Using a similar approach, National Semiconductor in a joint effort with Plessey Semiconductors has developed a digital tuning system with built-in clock and channel display. It incorporates a digital phase-locked loop and digitally controlled frequency synthesizer in a network that will eventually be integrated into a monolithic circuit. Included in the design are an on-screen channel display using a display generator IC and an on-screen time display from a digital clock IC. Both of these ICs are complementary-MOS devices.

A point stressed by the semiconductor companies is flexibility. The devices allow set makers to use different types of channel select methods, including calculator keyboards, and different types of channel displays, such as the on-screen charac-

ter generator. Another entry in the electronic tuning competition certain to score points with the set makers comes from F. W. Sickles division of General Instrument Corp., Chicopee, Mass. The company has announced a complete digital address system based on a nonvolatile nitride-doped MOS (NMOS) memory capable of storing at least 82 channels of vhf and uhf information [*Electronics*, May 15, p. 40]. Sickles expects to market the system with a digital display from GI's Signalite division and a 10-numeral keyboard from GI's Claire division, but the user can adapt it to any channel select and display scheme.

Broad-based conversion to electronics is not going to happen overnight, counters Kevin Joyce, head of sales for Sarkes Tarzian Inc., Bloomington, Ind., which is a leading supplier of electromechanical detent tuners. Digital tuning to date has been a novelty, he says, adding that the remote control units may be the best opening for digital addressing systems because it's difficult to build convenient motor-driven remotes with vhf/uhf detent tuners. Still, Sarkes Tarzian has designed and updated its own digital electronic address system for a varactor tuner in the belief that conversion from electromechanical versions will take place eventually. □

What's new in solid state...

Power Darlington from RCA. For greater cost effectiveness.

In certain high-gain applications, nothing beats a Darlington. And you gain even more when you specify RCA Darlington.

Wide selection, for instance. RCA has added 13 new types, bringing to 29 our wide choice within the popular 40-V to 120-V range. At low prices ranging from \$0.85 to \$1.60 at 1K.

All these Darlington have the ruggedness and performance you'd expect from RCA. Monolithic-chip reliability. Rugged clip-lead construction. Real-time process controls. Plus RCA power transistor experience. The kind that comes from serving volume customers in the auto, TV, computer and power supply industries. So we know how to keep costs down and quality up.

From audio to autos

Right now, our customers are using RCA Darlington transistors to:

1. Cut audio costs at least 30%—each Darlington output replaces 5

2. Simplify and shrink voltage regulators.
3. Control motors, using low IC currents as drive.
4. Drive computer printers with current-saving 120 V Darlington.
5. Switch high current in auto ignitions, where IC drive, thermal resistance and ruggedness are important advantages.



These are just some examples.

Discover how you can use RCA Darlington to improve cost effectiveness. Write and we'll send details on the above applications plus a reply card for ordering a free RCA Darlington of your choice. Please give your name and address in the form of a self-addressed label.

For more information, contact your local RCA Solid State distributor. Or RCA.

Write: RCA Solid State, Box 3200, Somerville, New Jersey 08876; Ste. Anne de Bellevue 810, Canada; Sunbury-on-Thames, U.K.; Fuji Bldg., Tokyo, Japan.

RCA

Type	Beta	Vceo
 RCA8350/50A/50B 2N6383/84/85 2N6055/56 RCA1B07/08	1000 @ 5A	40/60/80
	1000 @ 5A	40/60/80
	750 @ 4A	60/80
	1000 @ 5A	80
 RCA8203/3A*/3B* 2N6386/87*/88* 2N6530/32/33* 2N6531 RCA120/21/22 RCA125/126	1000 @ 3A/ 1000 @ 5A*	40/60/80
	1000 @ 3A/ 1000 @ 5A*	40/60/80
	1000 @ 5A/ 1000 @ 3A*	80/100/120
	500 @ 3A	100
	1000 @ 3A	60/80/100
	1000 @ 3A	60/80
 2N6534/36/37* 2N6535	1000 @ 5A/ 1000 @ 3A*	80/100/120
	500 @ 3A	100

RCA. Powerhouse in Transistors.

Circle 67 on reader service card

Memories

Bubbles are in the air

Decade-old technology appears to be knocking at the door
as Rockwell predicts commercial memories in 1976

Magnetic-bubble memories have been a promising technology for the last decade. But now that they are finding their way into experimental and prototype systems, many in the industry are wondering whether the idea has at last made it into the real world.

Some large semiconductor and system houses are working hard on bubble mass-storage memories—Rockwell International, Texas Instruments, Bell Laboratories, IBM. They believe that the density, non-volatility, low power demand, and low prices will make bubbles an attractive alternative to drum and disk mass memories. In the last year, Rockwell has developed a 61,440-bit memory that it sees as a building block on the way to memories of up to 100 million bits for spacecraft recorders [*Electronics*, May 16, 1974, p. 30]; Bell Labs has built a working prototype that stores 460,544 bits [*Electronics*, May 16, 1974, p. 29]; and TI will begin pilot production this year of a 256,000-bit bubble memory [*Electronics*, May 29, p. 130].

A viable technology. Bell's Paul C. Michaelis, engineering physicist in the subsystem group who coordinated the bubble design, said when the development was announced, "We're at the point now where bubble memories have proved to be a viable technology. They should have a design life of 20 years. Also, there are no mechanical failures or periodic maintenance to worry about." Bell still won't say whether it has decided to produce the memories, though two system prototypes are being evaluated by Bell switching system engineers.

At Rockwell, at least, researchers are bullish about the commercial prospects for bubbles, though interest up to now has been limited largely to space and military roles. William Mavity, staff scientist at the Electronic Research division of Rockwell's Autonetics Group, says bubble analogs of floppy disk and cassette systems will reach production in 1976. And, he says, such systems will coexist easily with existing systems.

"The memory business is great," says Mavity. "That's because no one wants to forget anything—they just keep adding capacity." So Mavity reasons that the appearance of bubble systems won't generate changes in what's already designed in, but will simply create new market opportunities. For example, he says, there is the diminutive bubble

system's potential as a portable memory. "And with its low power demand, if the user wants only, say, 8 bits, he just has to power up that much," points out Mavity.

Manufacturing is relatively simple, say scientists working in the area. Bubbles need only two masks and one alignment, with no semiconductor junctions. And Rockwell talks of yields exceeding 10%, while Bell Labs says it recorded a 15% yield on wafers processed in the lab. And NASA has run a so-called ideal pilot program designed to make certain that bubble production is repeatable. Yield is ahead of where it should be, according to the program's computer model. What's needed now, says George Pulliam, director of physical sciences at the Autonetics Electronic Research division, is photolithography advances that would get bubble sizes smaller than the present 4 micrometers.

But bubbles face a formidable opponent in the mass-memory arena in another new technology—charge-coupled devices. CCDs have the advantage of being a silicon technology, something with which the commercial semiconductor manufacturers feel much more at home.

Bubble backers point to the non-volatility of their memories, and also to the power advantage. Rockwell's Mavity says that for CCDs, power is constant. However, for bubbles, even a million-bit system requires only 9 watts peak if it's doing everything it can do, and it can be "stopped on a bit—read or write sections can be powered up as they are needed." Larger systems, up to 10^8 bits, will still be using only 30 W of power, adds Mavity. □

Just waiting

Commercial semiconductor houses are, for the most part, less than wild about bubble memory technology. Bubbles can compete with CCDs "if they can do what they set out to do," says Les Vadasz, engineering vice president at Intel Corp. of Santa Clara, Calif., but he adds that he has yet to see evidence of that. Intel isn't working on bubbles, says Vadasz, because "we have to feel that development would result in something practical. And the accomplishments have not been spectacular." When can those accomplishments be expected? "That," acknowledges Vadasz, "is the \$64,000 question."

What's new in solid state...

RCA "Gold CHIP" LICs. Hermeticity in plastic at plastic prices.

Plastic LICs may have caused you some worries about field failures, actual or potential. But you didn't want to pay the price of ceramic or frit seal. Or, maybe the expensive hermetic packages you did use were damaged during insertion.

Now, the solution. RCA "Gold CHIP" linear integrated circuits. With gold metalization plus Chip Hermeticity in Plastic (CHIP). For reliability *plus* the economy and ruggedness of plastic.

Gold CHIP LICs have noncorroding gold metalization and leads. No aluminum with its potential problems. We make the chip itself hermetic. And put it in our advanced plastic package

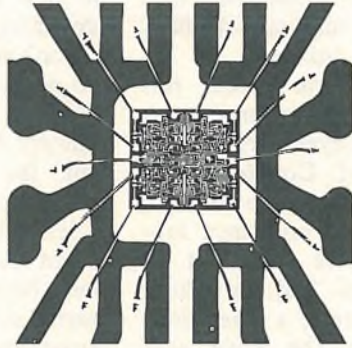

with proven outstanding reliability. Result: truly cost-effective hermetic LICs at the price of standard plastic LICs.

How reliable are they? We experienced zero failures in the following tests (data available): Temperature/Humidity/Bias, Operating Life, Thermal Fatigue, Pressure Cooker, Thermal Shock, Temperature Cycle.

Free Gold CHIP Sample

Evaluate them yourself! We'll send you one of the 6 off-the-shelf "G" standards listed here, free: CA741CG op amp; CA747G dual op amp; CA324G quad op amp; CA339G quad voltage comparator; CA3724G high voltage transistor array; CA3725G high voltage transistor array. Just specify which one, on a self-addressed label.

To find out more, contact your local RCA Solid State distributor. Or RCA.

Write: RCA Solid State, Box 3200, Somerville, New Jersey 08876; Ste. Anne de Bellevue 810, Canada; Sunbury-on-Thames, U.K.; Fuji Bldg., Tokyo, Japan.

RCA

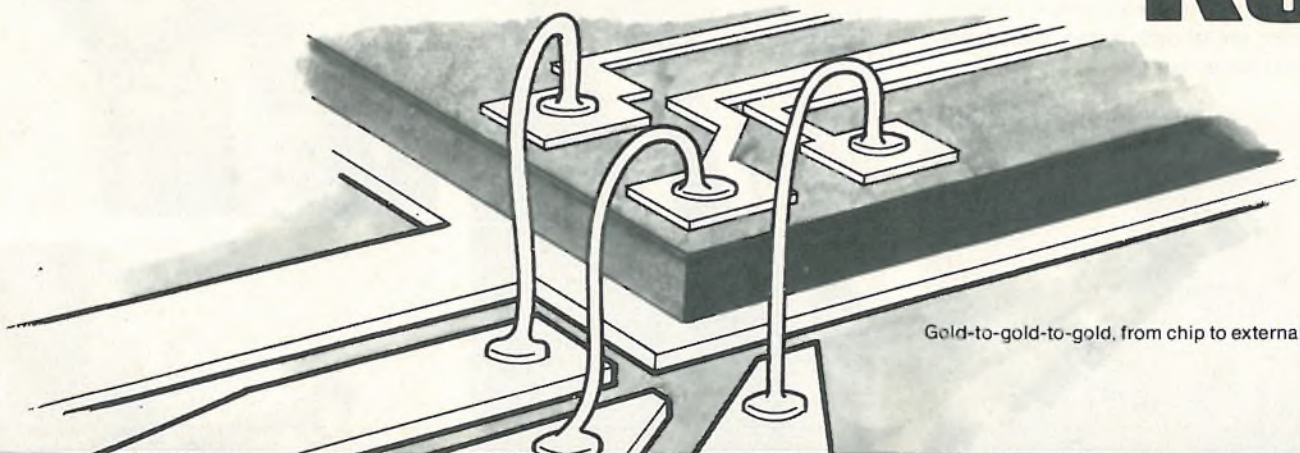

Gold-to-gold-to-gold, from chip to external world.

RCA. Full house in Linear ICs.

Circle 69 on reader service card

Companies

Siltek gets a northern toehold

American founders of Canadian C-MOS maker hope to parlay high specs and aggressive marketing into \$5 million to \$10 million company

by Ron Schneiderman, New York bureau manager

Three winters with eight to 12 feet of accumulated snow apparently haven't chilled the entrepreneurial spirit of the Americans who moved up to Bromont, Ont. near Montreal, in 1972 to establish Siltek International Ltd. and design and manufacture high-reliability C-MOS devices. "We're a very gutsy company," says Robert J. Lesniewski, vice president and director of engineering. "We sample all over the place and challenge everyone to top our specs."

But by its own admission, the privately owned company will need more than courage to weather the highly competitive C-MOS market. Despite having shipped more than 4 million devices its first year of production and a whirlwind schedule of seminars held in major world markets, Siltek is still undergoing "the slow, exacting process of gaining a reputation," concedes cofounder Lesniewski.

Quebec connection. Siltek executives are, below, executive vice president Robert J. Cook; right, president Leslie K. Sellmeyer; far right, top, marketing director Ralph A. Bennett; and far right, bottom, vice president Robert Lesniewski.

Along with Robert J. Cook and Thomas M. Stavish, Lesniewski founded Siltek with the financial backing of the Quebec Industrial Research Center, a government agency, and several Quebec banks and private investors. Siltek also has a Canadian-government grant, based on a formula that takes into account projected sales and employment of Canadian citizens.

Management. Cook earlier this month relinquished the presidency to Leslie K. Sellmeyer, former general manager of Control Data Corp.'s aerospace operations in Minneapolis, Minn., and since January executive vice president of Central Dynamics Ltd. in Point Clair, near Montreal, a television-equipment maker. The move, says Cook, who will now serve as execu-

tive vice president for new projects, is designed to bring someone with a strong operations background into the firm at what he considers to be a critical stage in its development.

Sellmeyer, who acknowledges making "a few phone calls" before joining the company, takes a realistic view of its potential. With current sales levels "nominal," he says, "I don't think we can afford to make too many mistakes." He would like Siltek to concentrate first on U.S. military business and, to some extent, the Canadian military electronics market.

Sensitive to the stir caused by the recent demise of its former neighbor, Northern Electric Co.'s ill-starred subsidiary, Microsystems International Ltd., Siltek is solving its own growing pains with new-prod-



RIGHT ON TARGET AGAIN

SGS  ATEC

Shift to our shifter

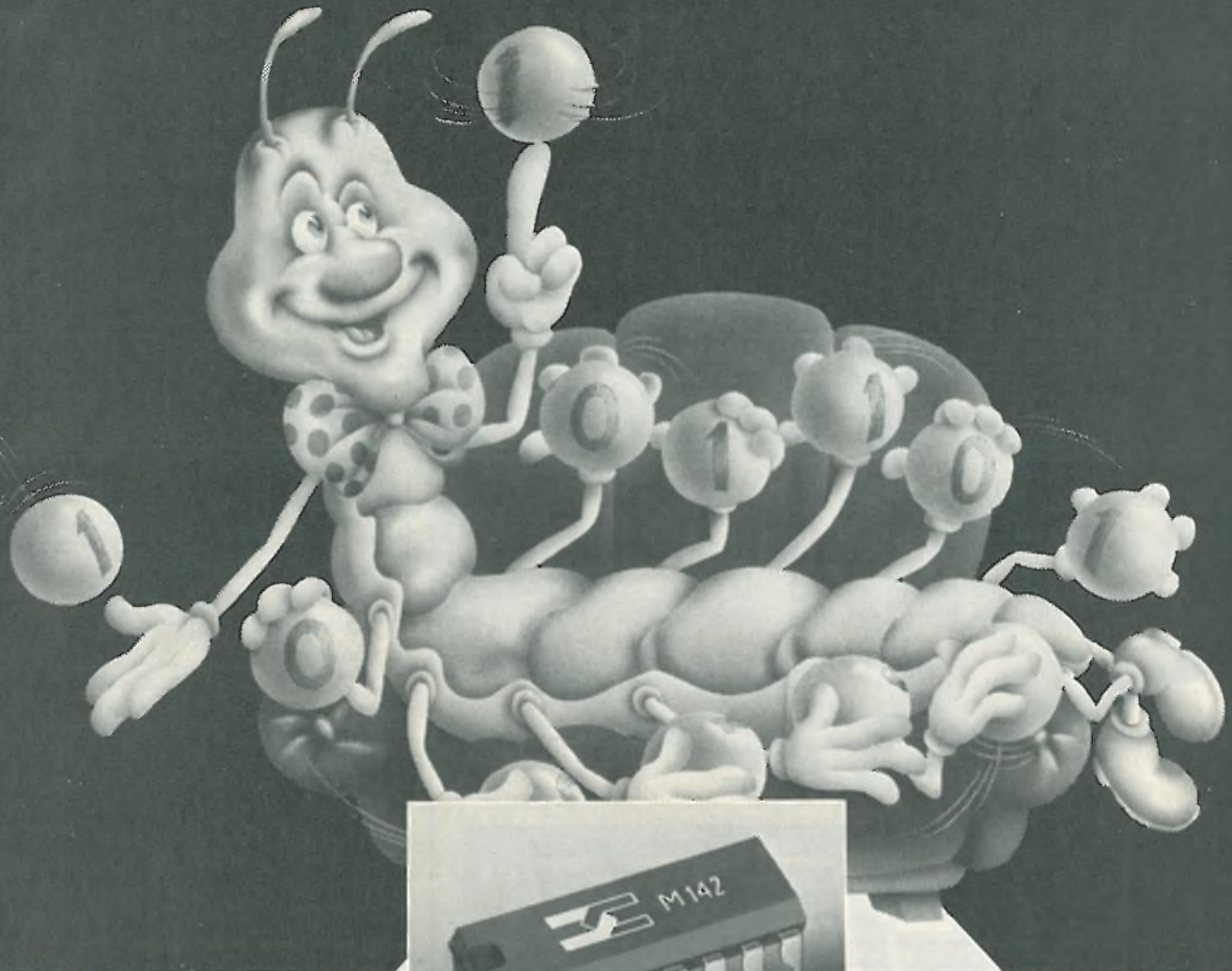

M 142-5V supply-fully DC-4 x 80-bit S-R

The M142 is a monolithic S-R in low-threshold N-channel silicon gate MOS, organized in four 80-bit registers with a common clock line.

It will find application as storage for CRT displays, computer peripherals and in digital signal processing.

The M142 is available in a 16-lead dual in-line plastic or ceramic package and features:

- Single voltage supply ($5V \pm 5\%$)
- Completely TTL compatible
- Fully DC operation, guaranteed to 3MHz
- Pin-to-pin replacement for MK 1007P - TMS 3409 - 2532 - 3347.

Circle 156 on reader service card

Probing the news

uct-development programs plus new engineering and executive talent. The engineers are among the top graduates of Canadian universities.

Growth. Siltek was launched with more than 45 standard circuit types in its catalog—most from the RCA 4000A series.

It has almost doubled that line,

and, in addition, claims a fast-turnaround capability for the design and production of custom C-MOS devices, its main business target. From the beginning, it was decided to produce and test all of Siltek's output as specified under MIL-M-38510 and MIL-STD-883.

Siltek uses five offshore contract assemblers for about 95% of its output. Within the next week or two, the company will begin sampling its

first C-MOS memory. "We can produce 1,000 memory devices per week," says Lesniewski, "and we hope to double that every month hereafter. That's the capability we're shooting for. We'll sample the first three months, then inventory to market."

Together. As in most new companies, the founders worked together at one point in their careers. Cook was MOS department manager at Solid State Scientific Inc. in Montgomeryville, Pa., where he established the MOS operation and pioneered the firm's move into C-MOS processing. Stavish, Solid State Scientific's processing manager for four years, is now Siltek's director of operations.

Before joining Solid State Scientific as technical program manager, Lesniewski was with NASA's Goddard Space Flight Center where he worked in C-MOS development programs. He spent a year at Mostek Corp. as a senior design engineer before rejoining Cook and Stavish to form Siltek. Another key member of the staff is Ralph A. Bennett, director of marketing, and former marketing manager with ITT Semiconductors.

"The foundation has been laid," says Cook. "What we're looking at now are new products and new technologies. We're going to continue with our policy of not making any noise about anything until we are ready to go with it. We are pushing the custom business. Sometimes big companies like to go with small suppliers because they get more attention and a better response. We think we've got a good shot at more of that kind of business." Sellmeyer adds, "We can be successful making \$5 million to \$10 million a year. It's a modest goal, and it can be reached in perhaps three years."

But some observers are not overly impressed. Says one, "They're not making any contribution to the technology; they're just second-sourcing. They have done some custom jobs, but nothing exciting." And a competitor adds, "They're a small company when it's a tough time to be a small company in this industry. But I guess they're not so far behind where we were not so many years ago." □

DO YOU NEED
**LARGE
DIGITS?**



Look at PLASMAC™ Displays

- ★ 3" to 6" character height. ★ Low cost.
- ★ High brightness. ★ Variety of formats.

NATIONAL ELECTRONICS

a varian division

geneva, illinois 60134 (312) 232-4300



the work best, cost less trimmer pots from Piher



Quality, reliability and low price. When you're after those things in a trimmer potentiometer, all at once, remember just one name: Piher. Because Piher innovation is here, on-shore, right now. Bringing you today's most advanced carbon trimmer potentiometers. Bringing them to you immediately, available off-the-shelf, coast-to-coast . . . and in quantity at low price.

Piher's unique PT10 Miniature Trimmers (3/8") and PT15 Trimmers (5/8") are reliability designed. For high signal-to-noise ratio. Circuit integrity. Minimum contact resistance, low noise and design adaptability. Available in resistances from 100 ohms to 10 megohms, plus horizontal or vertical self-supporting configurations that snap-in to PC boards with electromechanical precision, Piher carbon trimmers seal out and shrug off solder flux, humidity, adverse atmospheres and soldering temperatures as high as 320°C. What's more, adjustment types to suit your need best include: screwdriver, thumbwheel, hex slot or spindle shaft.

Whatever your application, get the work best, cost less trimmer pots from Piher. The unique PT10 and PT15 Series. Contact the Piher Distributor near you.

Advanced Design Features

- Patented* fully-enclosed Zytel housing. Protects carbon track against dust, dirt, solder flux.
- Accepts conventional compounds for conformal coating of PC boards and potted modules.
- Adjustment types to suit your needs best. Screwdriver, thumbwheel, hex slot and spindle shaft.
- Pin-for-pin interchangeable with competitive trimmers.
- Zytel housing withstands soldering temperatures as high as 320°C.
- Carbon resistance track sealed away from solder residues. No cleaning needed before initial trimming adjustments.
- Spring-loaded wiper for precise, full electrical contact.
- Advanced wiper design cuts contact resistance, electrical noise to less than 1%.

*U.S. Pat. No. 3,662,314

Advanced quality for the least cost . . . by design.



PIHER Corporation

Electronic Components

399 Washington St. (On Rte. 128), Woburn, Mass. 01801
(617) 935-8750 Telex 94-9382

USA Corporate Headquarters and Manufacturing Facilities

Distributors

Acacia Sales, Inc.
384 San Aleso Avenue
Sunnyvale, California 94088
Telephone: (408) 735-0100
TWX: (910) 339-5268

Acacia Sales, Inc.
11111 West 8th Avenue
Lakewood, Colorado 80215
Telephone: (303) 232-2882
TWX: (910) 937-0731

Piher Offices

Western Region
143A Shaker Road
East Longmeadow, Mass. 01028
Telephone: (413) 525-4741

District Office
1239 Rand Road
Des Plaines, Illinois 60016
Telephone: (312) 297-1560
Telex: 28-2514

Baldwin Component Center
2 E. Sawwood
Deer Park, L.I., New York 11729
Telephone: (516) 586-2230

Components Center, Inc.
1240 "E" Logan Avenue
Costa Mesa, California 92626
Telephone: (714) 978-0433

Edmar Electronics
1275 Rand Road
Des Plaines, Illinois 60018
Telephone: (312) 298-8580

Electra-Distributing Co.
1914 West End Avenue
Nashville, Tennessee 37203
Telephone: (615) 329-3971

Future Electronics Corp.
225 Worcester Road
Framingham, Mass. 01701
Telephone: (617) 878-0860

Kirkman Electronics
Drawer K - Salem Station
901 West 2nd Street
Winston-Salem, N. C. 27108
Telephone: (919) 724-0541

Mastline Electronics
511 S. Clinton Avenue
Rochester, New York 14607
Telephone: (716) 546-5373

Newark
P. O. Box 4217
Inglewood, California 90307
Telephone: (213) 878-0441

Norvell
10210 Monroe Drive
Dallas, Texas 75220
Telephone: (214) 350-6771

OHM Electronics
648 Vermont Avenue
Palatine, Illinois 60067
Telephone: (312) 359-5500

Park Electronics
2206 Edgewood Ave. South
St. Louis Park, Minnesota 55426
Telephone: (612) 925-3118

Powell Electronics
411 Fairchild Drive
Mountain View, California 94040
Telephone: (415) 964-0820

OAR Industries
621 S. Columbus Avenue
Mt. Vernon, New York 10550
Telephone: (914) 699-2224
SC011 Electronic Supply Corp.
P. O. Box 4467
Lincoln, Nebraska 68504
Telephone: (402) 464-8308

Semad Electronics Limited
265 Marshall Avenue, Suite 2
Dorval, Quebec, Canada H9P 1E1
Telephone: 514-636-4614
TWX: 610-422-3048

Semad Electronics Limited
170 Leburner Avenue, West, Suite 902
Ottawa, Ontario, Canada K1P 5V5
Telephone: 613-233-4053

Semad Electronics Limited
2910 Renfrew Avenue, Suite 201
Vancouver, British Columbia,
Canada V5M 3K6
Telephone: 604-434-2622

Semad Electronics Ltd.
1111 Finch Avenue, West
Suite #102
Downsview, Ontario, Canada
Telephone: (416) 635-9880
Sheridan Associates, Inc.
P. O. Box 37826
Cincinnati, Ohio 45222
Telephone: (513) 761-5432

State Electronics
36 Route 10
Hanover, New Jersey 07936
Telephone: (201) 887-2550

Taylor Electric Co.
P. O. Drawer 11N
Milwaukee, Wisconsin 53201
Telephone: (414) 241-4321

Wilshire Electronics/Connecticut
2554 State Street
Hamden, Connecticut 06517
Telephone: (203) 281-1166

Wilshire Electronics/New England
One Wilshire Road
Burlington, Massachusetts 01803
Telephone: (617) 272-8200

Wilshire Electronics/Philadelphia
855 Industrial Highway (Unit 5)
Cinnaminson, New Jersey 08077
Telephone: (215) 627-1920
(609) 786-8990

Wilshire Electronics/Sales
647 Industry Drive
Seattle, Washington 98166
Telephone: (206) 242-2517

Components

Hi-rel business bucks cycles

Depressed state of semiconductor industry has little effect on sales of ICs for military and space programs

by Bernard Cole, San Francisco bureau manager

Amid an economy that's still depressed and a semiconductor industry that hasn't yet shaken its sluggishness, the continued strong demand for high-reliability integrated circuits from the military/aerospace marketplace has been a buoy helping a good number of semiconductor makers ride out the bad times.

While the hi-rel business has been relatively flat over the past year in terms of total dollar volume, the unit volume, according to John Shea, director of hi-rel at Intersil Inc., has increased 10% to 15% across the board in all product lines. This ranges from field-effect transistors, linears, flip-flops, and memories to field-programable logic arrays and microprocessors and includes all technologies—bipolar (Schottky and low-power Schottky), nitride-passivated MOS, p-MOS, and C-MOS.

For the companies with a large stake in the hi-rel business—RCA, Harris, National Semiconductor, Raytheon, Advanced Micro Devices, Signetics, and Motorola—it has cushioned the downturn and led to a significant broadening of their hi-rel product lines into a number of new areas. For companies such as Intersil Inc., which in the past invested only modestly in hi-rel, it represents a significant new market area with spectacular growth opportunities.

According to James Dykes, Harris Semiconductor's operations vice president in Melbourne, Fla., some 30% of the company's standard products business falls into the hi-rel area, an increase of about 10% in a year. He would like to keep the share at about 20%, explaining that "We don't want to turn away any of

this business, but we want to keep our standard products at a high market level, too." Harris' director of special products, Lamar Clark, expects 70% growth in the company's business in radiation-hardened circuits and C-MOS LSI over the next 12 months. The reason for this, he says, is that the military is now funding a lot of new programs and

that Harris has made a long-term investment in the development of many of the products that would fit into these programs. "There is more proposal activity here now than I have ever seen," says Clark.

Although defense spending for fiscal 1976 is expected to total a record \$92.8 billion, about 10% more than last year, much of this in-



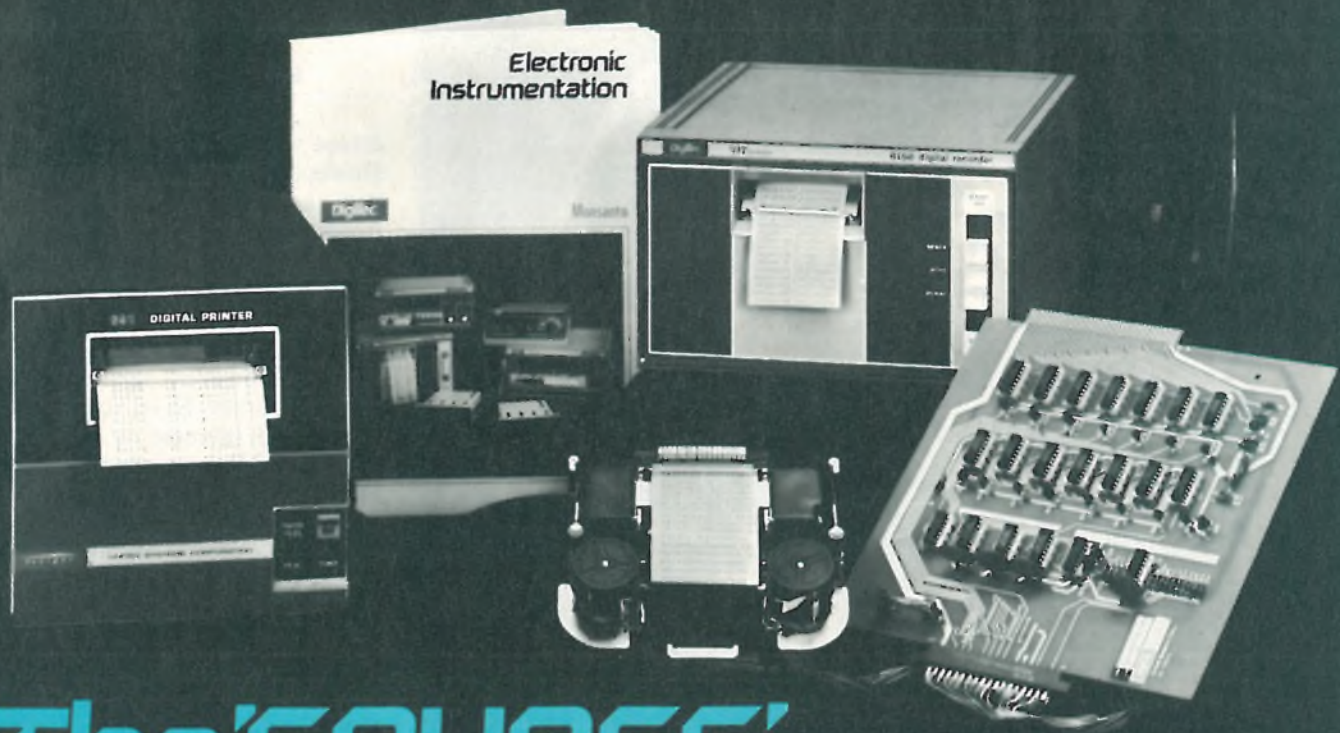

The 'SOURCE'... for Digital Instrument Printers

Need a hard copy printer that is readable, reliable, flexible and maintainable?

With DigiTec's instrument printers you get a model to fulfill your exact specifications.

Want a printer that lasts with use and is easily repaired after abuse?

DigiTec's instrument printers have rugged, high-styled enclosures and state-of-the-art circuitry with plug-in components for serviceability.

Require integral clock for time recording, batch or event counting, up to 21 data columns, red or black print out, TTL or RTL interface, and integration into an existing product or system?

Selected DigiTec models offer these features in combination with many others.

Look first to the "SOURCE" for your digital instrument printers and ask about our generous OEM quantity discounts!

Contact your nearest United Systems representative for complete specifications on all DigiTec instrument printers.

6100 Series
digital printers for production, laboratory and OEM applications.

Starts at
\$549.

Model 6214
custom, modular printer adds hard copy capabilities to your product. Quantity prices starts at

\$350.

Model 691
systems printer for maximum flexibility in data acquisition systems.

Starts at
\$725.

DigiTec

UNITED SYSTEMS CORPORATION

a subsidiary of

Monsanto

918 Woodley Road • Dayton, Ohio 45403 • Ph (513) 254 6251 • TWX (810) 459 1728

"Information Only" circle 75 on reader service card

"Demonstration Only" circle 74 on reader service card

Telonic re-invents the Sweep Generator.

Our new Model 1210 is capable of sweeping a full 1 to 1000 MHz without manual band switching. It's done internally, electronically by a patented circuit. Now you can see a continuous frequency sweep as wide as 1000 MHz or as narrow as 200 kHz, with no interruptions. This solid-state, modular instrument is one of our Series 1200 sweepers covering 2 kHz to 1.5 GHz. They're an investment in dependable instrumentation. And when your equipment dollars are hard to come by, you'd better make the right buy. Right?

The Series 1200 Sweep Generator catalog is free. Write us.



TelonicAltair

2825 Laguna Canyon Rd. - Box 277 - Laguna Beach, California 92652
Tel: 714 494-9401 - TWX: 910 596-1320 - Cable: TELENG

The No. 1 name in Sweep Generators



Circle 76 on reader service card

IC checker champ

the AP test clip



new lower pricing

TC-14 \$ 5.25 ea.
TC-16 5.75 ea.
TC-24 13.85 ea.

All products are guaranteed to meet or exceed published specifications

●
A P TEST CLIPS
provide full access to DIP leads

●
11 models
available to fit all DIP sizes



A P PRODUCTS INCORPORATED
Box 110 E. Painesville, Ohio 44077
(216) 354-2101 • Twx 810-425-2250

76 Circle 157 on reader service card

Probing the news

crease will be eaten up by inflation. However, Jim Feldt, director of military/aerospace marketing at National, estimates that the military market for semiconductors, taking inflation into account, will increase by at least 5% to 7% in dollar volume to about \$400 million to \$500 million. However, says Ron Stephens, Signetics' hi-rel director, unit volume will increase by 10% to 20%. And, he adds that even though total Federal spending for defense may flatten out to about \$100 billion a year, the military electronics marketplace will continue to expand as new R&D programs come on line and as the newer technologies make themselves felt.

Intersil of Cupertino, Calif., which until recently has not had a very broad-based hi-rel program. It was limited mostly to precision analog devices, analog FETs, and some memory, mostly bipolar and n-channel MOS. And where in 1974 this represented only 12% of Intersil's total business, hi-rel this year accounted for 33% of the company's sales, according to Shea. In terms of function, most of this increase was in memory; in terms of technology, the increases were in C-MOS.

"We're betting that a lot of our long-term growth will come from hi-rel, particularly in C-MOS," says Shea. "We are especially optimistic about our C-MOS microprocessor and memory effort, which we expect to account for a lot of our growth." The company is so sure of itself that it has invested more than \$500,000 in its hi-rel program and has 75,000 square feet devoted to hi-rel bipolar, C-MOS, and linear products.

At Signetics Corp. of Sunnyvale, Calif., the hi-rel military business turned 1974-75 from a catastrophic to an only slightly disastrous year. According to Stephens, unit volume for the year in hi-rel is up 20% to 25%. Where most of this previously was in standard transistor-transistor logic, the company expects to do an increasing amount of business in analog devices, low-power Schottky bipolar logic and memory, and n-MOS memories and microprocessors. Particularly big sellers for the com-

Electronics/June 26, 1975

pany are 1,024-bit bipolar RAMs and 2,048-bit and 4,096-bit bipolar PROMs. Some of the developing military programs to which Signetics expects to contribute significantly, he says, are the F-15 fighter, the Navstar global positioning satellite, and the Space Shuttle. "One particularly exciting development in the military market we are looking forward to is the increased interest by the Pentagon in microprocessors," says Stephens.

"Military system planners are already designing them in. Within six to nine months you can expect to see some serious bidding and small-volume buys."

Both Advanced Micro Devices of Sunnyvale and National Semiconductor of Santa Clara, Calif., have been long-term heavy suppliers of hi-rel devices to the military. In the case of AMD this accounts for about 30% to 40% of its business; for National, 10% to 20%. Where both previously supplied standard TTL, AMD is doing an increasing amount of business in linears and LSI bipolar and MOS memory devices, and National is adding volume in C-MOS logic, low-power Schottky, and memories, generally.

One of the main motivations for this increased interest in the hi-rel military market is the high profit margins on the devices compared to their commercial versions. But this may be changing. Currently, says Stephens of Signetics, devices specified to military standards can have an average selling price two to 10 times that of their commercial versions. But as devices and systems for the military get more complex, the price advantage may be only 50% to 75%. "But that's still a pretty healthy incentive to get in the business," he says.

In fact, one supplier of high-rel devices reports that a part it sells for \$5 commercially brings \$19 in its military version, representing a good profit margin.

And there is one great advantage to the high-reliability business, says Feldt of National, that no other segment of the semiconductor market has. "It's constant, it's stable, it's always there," he says. "And in this cyclic business it becomes a terrific asset." □

A BARGAIN IN SOLID-STATE IMAGING:

WHAT YOU GET:

You get a 3"x 3" circuit card which contains RETICON's RL-64P image sensor and *all* of the associated drive and video processing circuitry. A standard ribbon cable connects the unit to your power supply (+5V, -10V) and also carries the 0 to 2V video output. The RL-64P has 64 sensing elements on 2 mil centers in a standard ceramic DIP sealed with an optical quality quartz window. The device has an integrated on-chip driver and portions of the video processing circuitry. The RL-64P is a proven device in production for over three years.

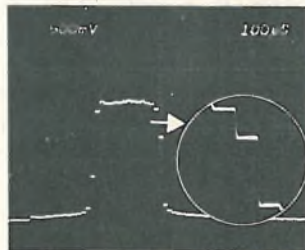
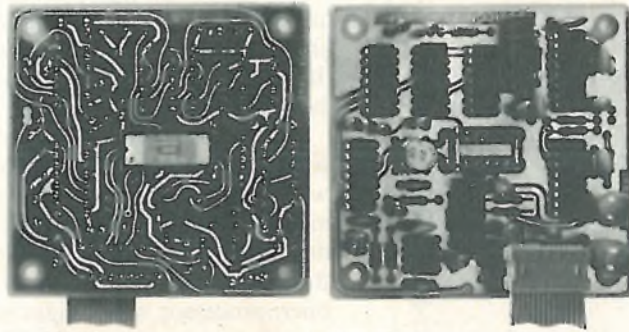

WHAT YOU SEE:

You see over 200:1 dynamic range (peak signal to peak noise) at 250 KHz. The photo shown is the actual output of a 30 mil front illuminated band imaged onto the array using 1:1 optics. The "box-car" type sampled-and-held output can be easily thresholded or A/D converted into multiple grey levels.

Applications in OCR, point-of-sale, industrial non-contact measurement and control are a natural for this unit.

Evaluate our technology with this complete imaging system. If you need higher resolution, we have an extensive line of image sensors with up to 1872 elements. We have over four years of experience in solid state image sensor and related circuit development. And there are over 70 salesmen and 15 distributors to serve you worldwide.

RETICON®

910 Benicia Avenue
Sunnyvale, California 94086
(408) 738-4266 • TWX: 910-339-9343

SWITCHING POWER SUPPLY



HR0510

High Efficiency

Compact and Lightweight

Competitive Price



ELECTRICAL CHARACTERISTICS HR0510

Output	5V10A
Efficiency	74%
AC Input voltage	117V±10% 220V±10%
Line Regulation	±0.2% or less
Load Regulation	±0.2% or less
Ripple & noise (max)	40mV (p-p)
Overload protection	Current Limit Type
Overload protection	Signal Inhibit Type
Output on/off control level	TTL
Withstand voltage	1.5KV AC for one minute
Isolation resistance	100MΩ or more at 500V DC
Temperature rise	30°C or less
Ambient temperature range (operating)	0-50°C
Temperature coefficient	0.02%/°C
Weight	1.7 Pounds
Size (WxHxD)	1.77" x 4.72" x 7.87"

HR0510 · HR0520 · HR0530 · HR0905
5V 10A 5V 20A 5V 30A 9V 5A

HR1204 · HR1506 · HR2406
12V 4A 15V 6A 24V 6A

Corporations interested in acquiring the right to manufacture our products introduced above, please contact:

NEMIC
Nippon Electronic Memory Industry Co., Ltd.

1-20-1, Sendagaya, Shibuya-ku, Tokyo 151, Japan
Tel: (03) 478-3935
Telex: NEMIC J

Probing the news

Computers

Distributors welcome microprocessors

Agree that selling devices and peripherals is hard work, but differ on how much support to offer customers

by Larry Armstrong, Midwest bureau manager

Distributors are agreed that microprocessors are the biggest thing that's happened to their business in 10 years. But they don't agree on the best way to sell them.

It's not an easy job. "I can go out to sell a transistor and come back with an order tomorrow," says Richard K. Dahlem, senior vice president of Chicago-based Semiconductor Specialists Inc. "But a microprocessor sale might take six months to a year. And it's much more of a technical sell—no more free turkeys or free steaks."

The reward, of course, comes with the purchase order. Profit margins are high on the relatively expensive microprocessor chips, and higher still on completed boards. Some distributors are even hungrily eyeing the markup on hardware and software development systems.

Couple those margins with the dozen or so memory and interface devices it takes to implement a system and with the value-added dollars to be gained by programming read-only memories and selling seminars, and it's easy to see why distributors are putting an extraordinary effort—and an extraordinary amount of capital—into gearing up to sell microprocessors.

Guidance. Semispecs, for example, makes hardware and software support available for every manufacturer's microprocessor it sells. "We're not consultants; we won't design a customer's system,"

Dahlem says. "But we'll be experts at guiding a customer to the right microprocessor for his application." In the case of the Motorola M6800, Semiconductor Specialists provides the customer with literature, and he writes his own program. "Then he comes in and uses our terminal and password—at \$40 an hour—to access the Motorola cross-assembler and simulator on the GE-Tymshare network."

Hardware testing and debugging is usually done in the customer's plant. The distributor has purchased a Motorola EXORciser which it rents out for \$5 an hour, or \$50 per day.

"Service and support have become 90% of the game in selling microprocessors," says Ronald R. Smith, president of Century Electronics Inc., Albuquerque, N.M. And in some instances, Smith has provided more than his suppliers: "We've found that people just don't want to use timeshare or an extra computer for cross-assembling, so we're building our own prototyping systems for the Intersil and Fairchild processors." Smith has loaded all his microprocessor gear, including a Fairchild IMP system, Teletype and CRT terminals, and a line

Big business. Microprocessor chip could be foundation of distributor bonanza.

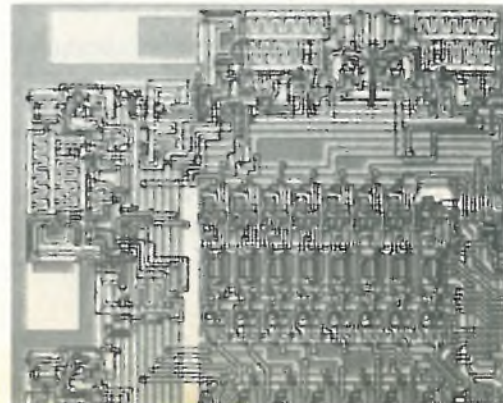

printer, into a Winnebago van. He calls it a roving benchmark center—it allows his customers to compare seven microprocessors.

Other distributors want no part of the equipment rental or lease business. Liberty Electronics, El Segundo, Calif., and Elmar Electronics, Mountain View, Calif., have set up technology centers to demonstrate manufacturer's hardware to their customers. "Our goal is to sell the prototyping system," comments Charles G. Schouw, semiconductor marketing manager at Liberty.

Arrow Electronics, Farmingdale, N.Y. is taking another approach. Gene Higgins semiconductor products manager, says Arrow has hired eight systems engineers to deal directly with potential customers. And it is planning seminars, with the first expected to draw 350 EES.

Newsletter. Other distributors are providing information services—for sale—as well. Cramer Electronics, Newton, Mass., will soon begin an 11-city tour to present three-day seminars on the design and use of microprocessors and microcomputers and has started selling a monthly newsletter, "New Logic Notebook," at \$95 a year.

However, Seymour Schweber, president of Schweber Electronics, Westbury, N.Y., is afraid that distributors may be trying to solve a customer's problem when they really aren't qualified to. Even though he's sent a dozen staffers to Motorola Semiconductor for a microprogramming course, at a cost to Schweber of about \$12,000, he's looking outside his house for expertise. When a potential customer comes to Schweber for microprocessors, he's usually turned over to one of a number of local consultants—moonlighting engineers or small, new garage operations—with systems engineering and programming backgrounds. □

NEW Continental Specialties
Logic monitor
FASTER THAN A SCOPE!
SAFER THAN A VOLTMETER!
BRINGS ICs TO LIFE!

Made in USA

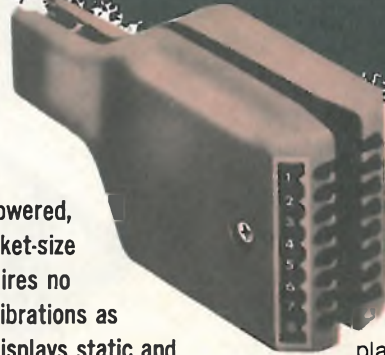

* Patent Pending

The amazing self-powered, self-contained, pocket-size Logic Monitor requires no adjustments or calibrations as it simultaneously displays static and dynamic logic states of DTL, TTL, HTL or CMOS DIP ICs. Now you can watch your signals work their way through counters, shift registers, timers, adders, flip-flops, decoders, even entire systems! High intensity LEDs turn on when lead voltages exceed the threshold (2V). **No power supply is needed!** The power-seeking gate network locates DIP supply leads and feeds them into the Logic Monitor. Forget about grounds, pin counting or sync polarity.

Simply clip the Logic Monitor to any DIP IC up to 16 pins. Precision plastic guides and a flexible plastic web* insure positive connections between non-corrosive nickel/silver contacts and the IC leads. Logic levels appear instantly on 16 large (.125" dia.) high intensity LEDs. Logic "1" (high voltage)-LED ON. Logic "0" (low voltage or open circuit)-LED OFF. Yes, now you can see your designs come alive. Order your fast, versatile, accurate, indispensable Logic Monitor today!

ORDER TODAY! 84⁹⁵

Add \$2.50 postage/handling.
 Foreign orders add 15%.
 Prices subject to change.



Continental Specialties Corporation

Box 1942, New Haven, CT 06509 • 203/624-3103

W. Coast Off.: Box 7809, S. Fran., CA 94119 • 415/383-4207 Canada: Available thru Len Finkler Ltd., Ontario

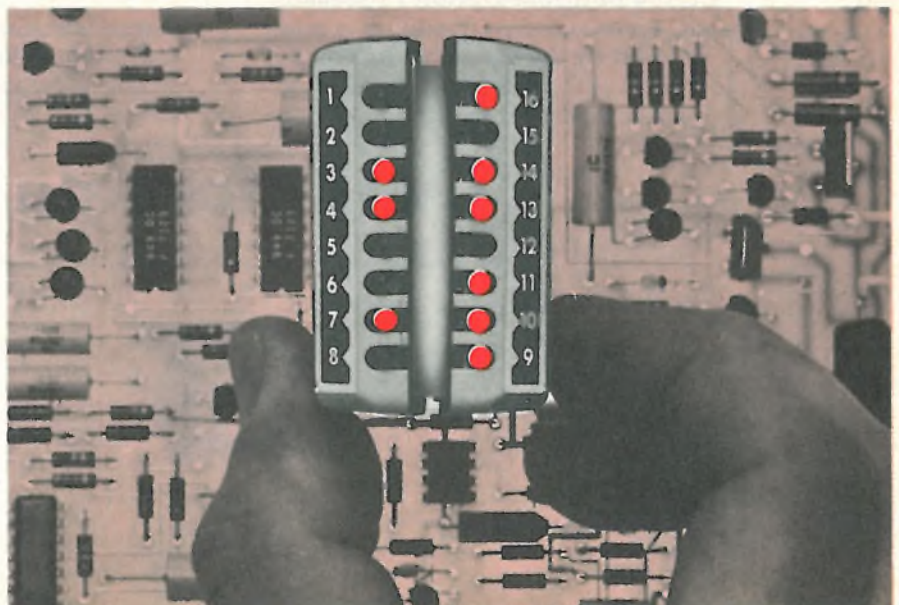

A Price-Performance Benchmark!

3½ Digit A/D Converter

Siliconix state-of-the-art concept in 2-chip 3½-digit A/D converters has established new industry standards. Consider these outstanding device characteristics:

LD110/LD111

Price and performance are two of the many good reasons why the LD110/LD111 3½-digit A/D converter has become an industry benchmark for data display (DPMs and DVMs), data acquisition and logging systems. Exceptional performance and stability is achieved by a unique conversion technique which uses a single full-scale adjustment to produce a highly-accurate 3½-digit output of up to 3100 counts plus sign. The system characteristics include:

Specifications

- Accuracy of 0.05% of reading, ± 1 count.
- $Z_{IN} > 1000 \text{ M}\Omega$.
- 4 pA typical input bias current (25°C).
- 100 μV resolution (200.0 mV range).
- 40 dB NMRR @ 60 Hz.

Features

- Auto-zero minimizes effect of offset, drift and temperature.
- Auto-polarity.
- Sampling rates to 20 samples/sec.
- Two voltage ranges: 2.000V and 200.0 mV.
- TTL-compatible outputs.
- \$19.60 per set (100-unit price).

LD114 Multiple-Option Processor

Greater system design flexibility is now offered by the recently-introduced LD114 digital processor. The LD114, combined with the LD111 analog

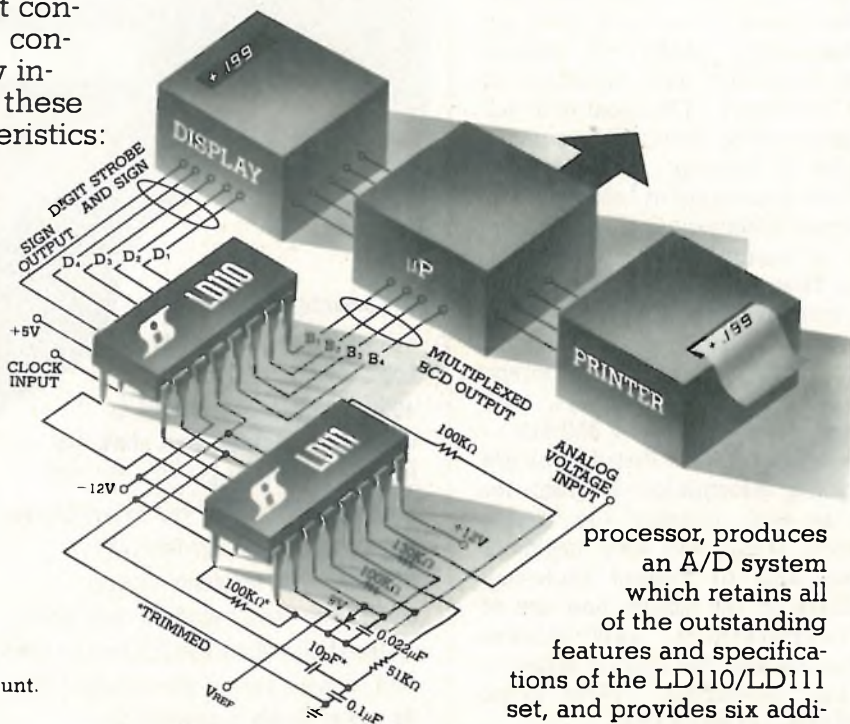

processor, produces an A/D system which retains all of the outstanding features and specifications of the LD110/LD111 set, and provides six additional features which reduce interface problems in many data acquisition applications.

LD111/LD114 Features

- External latch inhibit control ("Hold" feature).
- Multiplexed parallel or serial BCD output.
- Active high or active low digit strobe outputs.
- Active high or active low data bit outputs.
- Sequential or interlaced digit scan.
- ± 512 output available for phase locked loop clock.
- \$25.85 per set (100-unit price).

These features are offered as user-programmable options, with independent selection by means of separate pins on the 28-pin DIP LD114 package.

For further information:

write for data



Siliconix S.A.R.L.

70-72 Avenue du General de Gaulle
Echat 559
94020 Creteil Cedex
France

Siliconix Limited

30A High Street
Thatcham, Newbury
Berks RG13 4JG
United Kingdom

Siliconix GmbH

7024 Bernhausen
Postfach 1340
Johannestrasse 27
West Germany

At megawatts and microwaves, solid-state power reaches new highs

Voltage ratings for power semiconductors are getting larger, current capabilities bigger, and operating speeds faster, while device reliability is improving and prices are declining

by Lucinda Mattera, *Components Editor*

□ Within the last decade, power semiconductors have made the arduous transition from black art to science. A mere half-dozen years ago, many different technologies were being used to produce devices with poor reliability, and low yields kept prices high. But today, production practices have been narrowed to several highly refined techniques to produce reliable power devices that are often downright cheap. The performance of currently available power semiconductors is already impressive, and yet the state of the art will be pushed to even higher levels within the next six months.

Power is relative—it can mean milliwatts up in the microwave region, megawatts down close to dc, or intermediate levels in between. Probably the best way to partition power semiconductors is according to power range and market area. There are low- and medium-power devices for commercial, industrial, and military applications; high-power devices for industry; and low- and medium-power devices for commercial and military communications.

In the first and largest category, the voltage and current ratings of power transistors are increasing, while switching speeds are getting faster. A single high-speed switching transistor can now handle as much as 750 volts at several amperes with a turn-off time of around 1 microsecond, and Darlington pairs are beginning to provide performance that is almost as good. Ratings for high-voltage transistors already range from 1,000 v at 12 A up to 3,000 v at 5 A.

The forward-voltage drop of rectifier diodes is getting smaller and recovery time faster. Today, a fast-recovery diode can switch 600 v at 100 A, and recovery time is only 75 nanoseconds. More thyristors are being put in plastic packages, and there are even some new types of devices from which to choose. Monolithic audio amplifiers can now deliver up to 20 watts to a 4-ohm load.

The second category—power for industry—covers high-current transistors, rectifiers, and thyristors. For these types of devices, voltage ratings and operating

Power semiconductors in motion. Conveyors carry power Darlington on the production line at TRW. These devices make excellent general-purpose power transistors because of their high current gain, high voltage ratings, and reasonably fast switching speeds.



speeds are being increased without sacrificing current-handling capability. Today's power rectifiers and power thyristors are able to control megawatts of power because of their ability to cope with several kilovolts at one or more kiloamperes. Incredibly, a 1,200-v silicon-controlled rectifier with a current rating of 850 A root-mean-square can now turn off less than 18 μ s.

Except for Solid State Devices Inc. of Santa Fe Springs, Calif., which is fabricating power semiconductors by means of ion-implantation (see "A new way to power," at right), manufacturers have concentrated on refining established processing techniques. Also, glass passivation is being widely utilized—a hard glass is used to cover the active junction, or in some cases, the entire chip face. The glass increases yields, reliability, and thermal stability.

In communications, as in the other two power categories, power levels are on the increase, while power efficiency and broadband performance are being improved. Nowadays, rf bipolar transistors are capable of supplying as much as 150 W of peak power at 28 megahertz, and microwave bipolar transistors will soon be delivering up to 10 W at frequencies of 3 gigahertz. Millimeter-wave semiconductor diodes, because of their bigger power outputs and better efficiencies, are resulting in oscillator assemblies that are a fraction of the size of tube-based designs. And microwave FETs capable of producing several hundred milliwatts at X band are emerging from the development stage.

Solid-state power is on the move

The market for power is healthy and growing. What's more, new applications are coming on stream every year. By 1980, worldwide sales for diodes, transistors, and thyristors handling more than 1 ampere may well exceed \$1 billion.

Television designs and stereo amplifiers will continue to change and become more compact as power-semiconductor technology evolves. In the near future, controls for home appliances such as toasters, blenders, washing machines, ovens, and ranges, will be completely solid-state. Automobile-ignition systems and voltage regulators now contain one or more power semiconductors, but there are many other probable applications for solid-state controls on a car, including windshield wipers, dashboard displays, fuel meters, antiskid controls, and fuel-injection systems.

Switching-regulated power supplies, which are smaller, lighter, and more efficient than the older series-regulated types, represent an enormous growth area for today's high-speed diodes, transistors, and thyristors. Moreover, uninterruptible power supplies are being widely used in computers, hospitals, radio stations, and air-traffic-control systems. The power-supply market in the U.S. alone is expected to double and to reach nearly \$4 billion by 1980 (Fig. 1).

Although commercial markets represent many millions of dollars in sales each year, another \$200 million a year is spent on power semiconductors by industry throughout the world. Four major segments make up this industrial market—power generation and distribution, transportation, motor control, and processing

A new way to power

Ion implantation is a relatively new method of introducing impurities into the crystal structure of a semiconductor material to make devices. Until now, this process has mostly been applied to MOS ICs and varactor diodes. But Solid State Devices Inc. of Santa Fe Springs, Calif., is currently using ion implantation to build high-voltage fast-recovery diodes and high-speed switching transistors.

A major advantage of ion implantation is the uniformity it provides. It permits the maximum impurity concentration to be placed accurately just below the crystal surface in a thin junction layer that is unable to store many carriers, as the thick layer in a conventional diffused device does.

With ion implantation, doping is done at a low temperature. Dopants can be placed in the crystal lattice with virtually no lateral migration. This provides low surface-spreading resistance for high pulse current capability and fast forward recovery. Further high-speed characteristics are achieved without requiring gold doping or other forms of crystal degradation and without affecting radiation resistance.

equipment. The last category includes such systems as welding, plating, heat-treating, induction-heating, hardening, and melting equipment. Transportation, of course, involves railroads, subways, and electric cars, while motor control covers machine-tool controls, elevators, cranes, hoists, and forklifts.

Prices for power devices in the first category have been steadily declining and will continue to do so for some years to come. As indicated in Fig. 2, further mechanization of production lines and improved yields, as well as a larger number of elements on a single chip, will all contribute to price reduction. Many manufacturers are now working with 3-inch wafers and will be changing over to 4- or 5-in. wafers in the near future. The bigger wafers will provide more chips per wafer and, therefore, higher yields. Or, instead of getting a greater number of chips per wafer, manufacturers will have the capability to build bigger chips that have higher ratings.

The categories into which power semiconductors are divided for this report can be found on the following pages:

Low- and medium-power devices	83
Transistors	83
Diodes	86
Thyristors	87
Power linears	87
High-power devices	88
Transistors	88
Rectifiers and thyristors	88
Communications devices	90
Bipolar transistors	90
Diodes	92
Field-effect transistors	92

Moderate-power devices flourish

There is probably more activity in power transistors than in any other type of power semiconductor. Manufacturers are concentrating on transistors for switching power supplies, horizontal-deflection circuits for television receivers, and automobile ignitions, as well as Darlington configurations.

The new Switchmode transistor family from Motorola Semiconductor Products Inc., Phoenix, Ariz., will soon be able to handle up to 400 v at 15 A at speeds of 20 kilohertz. Next month, TRW Semiconductors, Lawndale, Calif., will announce two new transistor families that have voltage ratings of 350 to 450 v and a current rating of 5 or 7 A. Quantity pricing will range from \$3 to \$6 each. Near the end of the year, TRW will add 3- and 12-A families covering the same 350- to 450-v range. A fairly new series of switching transistors from Delco Electronics division of General Motors Corp., Kokomo, Ind., has ratings as high as 700 v at 10 A, and they can turn off a 7-A current in less than 0.5 μ s.

In the U.S., impressive switching speeds are provided by the Epitran transistor family now available from Solid State Devices Inc., La Mirada, Calif. This company recently acquired the Westinghouse Electric Corp. epitaxial-transistor line, which includes parts rated from 10 to 90 A at voltages up to 375 v. Switching times range from 200 to 300 nanoseconds, and unity-gain crossover frequencies go out to between 50 and 60 megahertz. These transistors, therefore, can operate at speeds of 50 to 60 kHz, rather than the usual 20 to 25

kHz. The company is planning to introduce ion-implanted versions within three to six months. Voltage ratings for the upcoming devices will be higher, switching speeds will be two to three times faster, and the safe operating area will be larger because of more uniform junctions.

Activity in switching transistors is also high elsewhere. As a matter of fact, the devices made in Japan and Europe are generally more advanced than those made by U. S. companies. Voltage and current ratings tend to be higher, and switching speeds faster. Breakdown voltages are often large enough for the transistors to be used in TV-deflection circuits and even to operate directly from the ac line voltage, which is 220 to 240 v in Europe.

For example, RTC LaRadiotechnique-Compelec, the major components-producing subsidiary in France for the Philips group, has a pair of switching transistors with a rating of 750 v. Both offer a fall time on the order of 0.5 μ s and are priced at roughly \$3.75 each in quantities of 1,000. One device is rated at 35 A, the other at 5 A. Versions having an 800-v breakdown are well along in development. Another French company, Sescosem, which is the semiconductor division of France's largest electronics company, Thomson-CSF, will have switching transistors rated between 1,500 and 2,000 v at up to 5 A by the end of the year. Fall time will be about 1 μ s. Currently available devices have ratings up to 750 v.

Philips in the Netherlands now has four new switch-

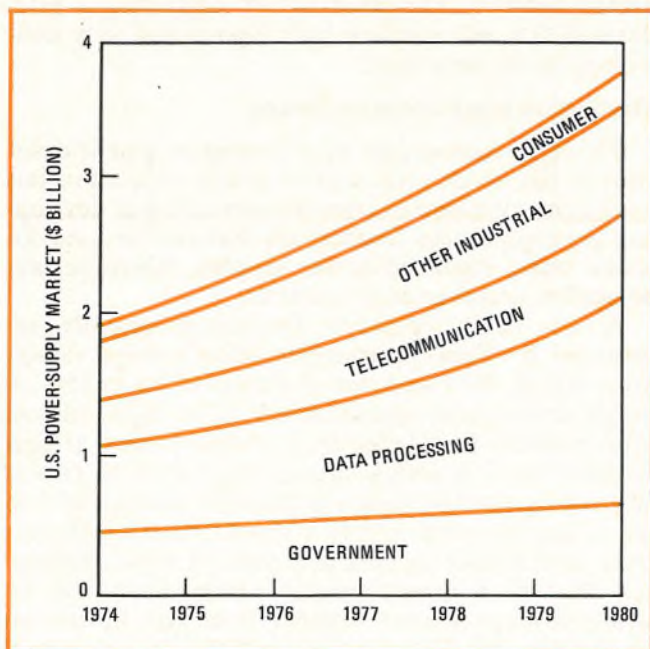

1. Power supplies are big business. Within the next five years, the power-supply market in the U.S. will reach almost \$4 billion, according to study made by Darling & Alsobrook of Los Angeles. The commercial and industrial segments will account for most of the growth.

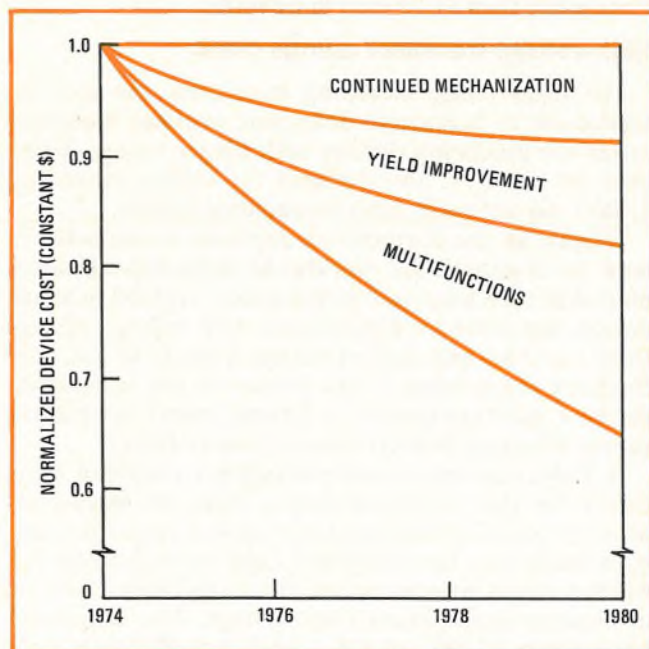

2. Power prices declining. Three factors will influence the price of low- and medium-power semiconductors in the next five years—additional mechanization, better yields, and, most important, more elements on a single chip, predicts RCA Corp.

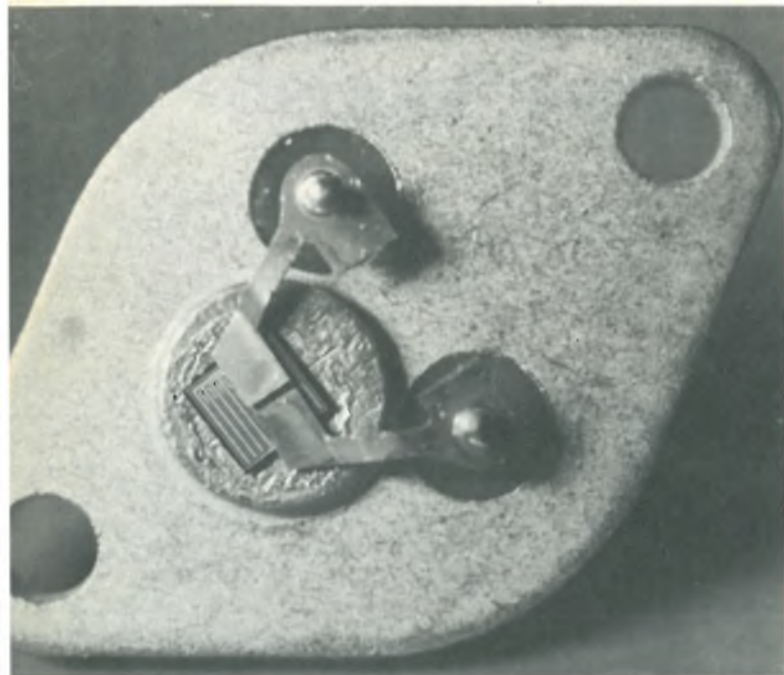

3. For wide-angle television. High-voltage transistor from Texas Instruments Ltd. is intended for color-television sets that employ newer 110° to replace the 90° deflection angle. The wider angle permits the picture tube to be shorter and the yoke less efficient.

ing transistors available in sample quantities and slated to go into volume production later this year. At 40°C, the units offer power ratings of 100, 70, 55, or 25 w. They are all rated at 800 v and provide a switching speed of 0.8 μ s. Texas Instruments Ltd. of Bedford, England, also offers a noteworthy switching transistor rated at 800 v and 10 A for 20- to 30-kHz operation. Price is less than \$1.50 each in quantity.

High-voltage-transistor ratings climb

For high-voltage switching transistors, the sort intended for TV horizontal deflection, overseas manufacturers are producing devices with bigger ratings. However, in the U.S., the demand for ratings exceeding 1,400 v has not really been outstanding to date.

Despite all the competition, Japanese manufacturers tend to dominate the worldwide deflection-transistor market in both sales and performance. Toshiba now has devices for color-TV applications with voltage ratings from 1 to 3 kv and current ratings from 12 to 5 A. The company is exporting 1.7-kv devices to the U.S., while the 3-kv units are needed in Europe, where the power-supply voltage is derived directly from ac lines.

In Italy, SGS-Ates is now producing a couple of transistors for the horizontal-output stage of black-and-white TV receivers. The units are the first production devices made with the company's biplanar technology, in which a step is introduced into the chip's oxide structure to increase device-breakdown voltage. The transistors have ratings of 400 and 330 v, and turn-off time is only 0.75 μ s.

At both Motorola and Delco, the top-of-the-line deflection transistor is a 1,400-v device capable of carrying 5 A. Maximum fall time for the Delco unit is 1 μ s. Texas

Instruments, Dallas, has recently introduced several devices housed in its plastic high-power package, which is capable of dissipating 65 w at 100°C. Ratings range from 1,200 to 1,400 v at currents of 7.5 A; prices are under \$1.75 each in volume. Some of the units include an on-chip damper diode that eliminates the radiation effects that can occur when a damper diode is external.

Texas Instruments Ltd. in England offers a 2,200-v 2-A deflection transistor intended for black-and-white sets. It now sells for \$12 in 100-piece quantities, but the company is planning to halve this price in the next month or so. A few months ago, the firm released transistors (Fig. 3) intended for the newer wide-deflection-angle color-TV sets. Rather than the usual 90° deflection angle, these sets employ a 110° angle, permitting the picture tube to be shorter. The wide-angle tube makes possible a wall-mountable set that can use an inexpensive low-efficiency yoke. The transistors, which have ratings of 1,400 v at 10 A and 1,000 v at 12 A, sell for approximately \$2.25 each in quantity.

Another large application for a single power transistor is the output stage of an automobile ignition. High-voltage devices for ignitions are typically rated at about 400 v at a current of 5 to 7.5 A. However, both silicon-controlled rectifiers and Darlingtons are challenging the single transistors, and Darlingtons are pulling ahead. A Darlington pair offers the distinct advantage of housing both the output transistor and its driver transistor under the same roof, so to speak.

Because a Darlington is actually an integrated power circuit, with its on-chip diode and stabilizing resistors, chances are it will evolve into a complete monolithic ignition system (Fig. 4). By 1980, the RCA Corp. Semiconductor division, Somerville, N.J., expects this monolithic ignition network to be either a transistor or thyristor switch function. The latter circuit, containing a gate-turn-off SCR, will combine both bipolar and MOS technology on the same chip.

Darlington pairs come on strong

The large current gain of a Darlington pair is desirable in just about every type of power circuit. For this reason, many manufacturers are now selling or developing general-purpose Darlingtons that can be used for audio work, regulated power supplies, television, automobiles, and even motor controls.

A new family of plastic Darlingtons recently announced by Texas Instruments offers voltage ratings from 300 to 400 v and current ratings of 7.5 to 15 A. A single device costs approximately \$2 in high volume. Also available from Delco are Darlingtons rated as high as 600 v at 15 A, with a turn-off time of 2.5 μ s. TRW is developing two Darlington families for currents of 5 to 10 A. Devices rated at 800 v should be available this year, and 1,600-v devices next year. A triple Darlington—that is, a three-transistor configuration—will be available in evaluation samples from RCA before the end of this year. The device is an 800-v 10-A unit having a current gain of 400 to 500 and a turn-off time of less than 1.5 μ s.

France's RTC has some noteworthy Darlingtons, too. One family provides current gains as high as 3,000 at

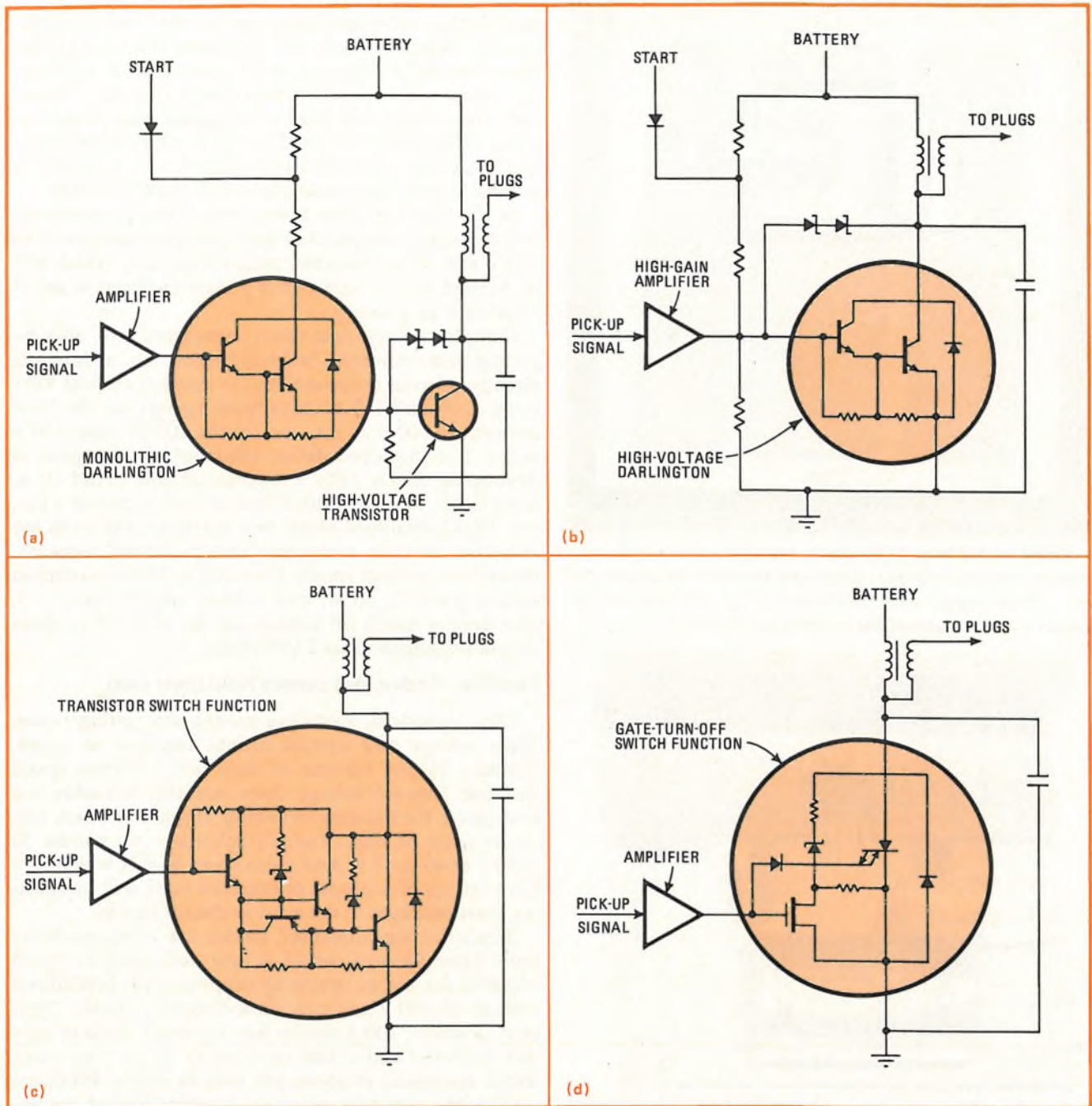

4. Auto-ignition evolution. Present ignition (a) employs two transistors. In the next generation (b), a Darlington will incorporate both transistors. By 1980, projects RCA, the ignition will be almost entirely monolithic, either a transistor (c) or thyristor (d) switch function.

outputs from 1.5 to 10 A. Both npn and pnp pairs are available, and the price is on the order of \$2.50 each in quantities of 1,000. Storage and fall times for the devices are around 1 μ s each, and voltage rating is 60, 80, or 100 v. Another French company, Silec-Semi-Conducteurs, makes a pair of fully glass-passivated Darlington transistors. One is rated at 15 A in versions up to 600 V and the other at 25 A at up to 500 v.

Darlington pairs are also being made by Power Monolithics Inc, Corpus Christi, Texas, a subsidiary of Veeco Instruments Inc. These devices are optimally designed for steady-state, rather than pulsed, operation in series-regulated dc power supplies, as well as low-fre-

quency audio and servo amplifiers. The units, which are fully glass-passivated and packaged in TO-3 metal cans, are rated at 225 w and can operate at a junction temperature of 200°C with a collector-cutoff current (I_{CER}) of only 5 mA. Both pnp and npn pairs are available in voltage ratings of 40, 60, and 80 v at a continuous-duty true dc output of 10 A.

Interestingly, Sanken Electric Co. in Japan sells a line of superbeta transistors that provide a gain approaching that of Darlington pairs, but have the saturation voltage of a single transistor, rather than the sum of two transistors. Current gain is in the range of 500 to 2,000, while voltage ratings go up to between 400 and 600 v. Appli-

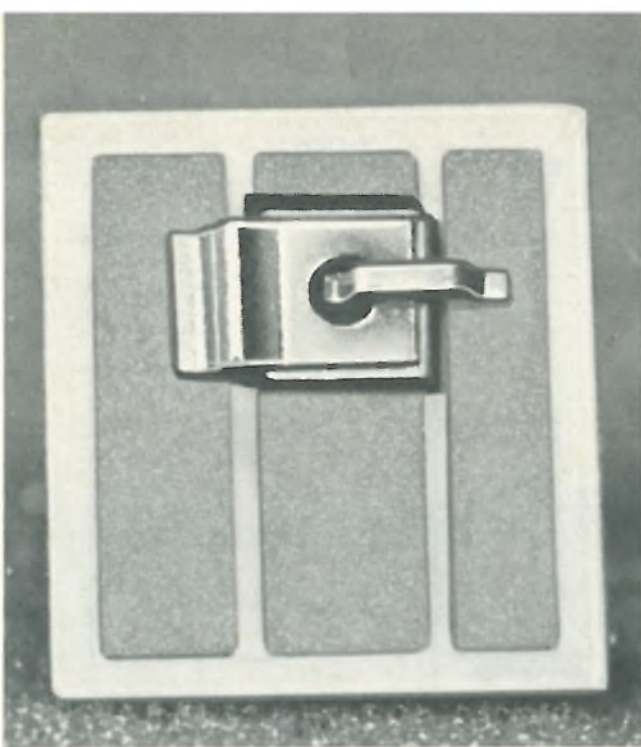

5. Power in chip form. SCRs, triacs, and diodes are available from Unitorde Corp. as fully glass-passivated devices in solderable chip form. Voltage ratings for this ChipStrate family go up to 600 V at currents of 1 to 55 A. General Electric offers a similar line.

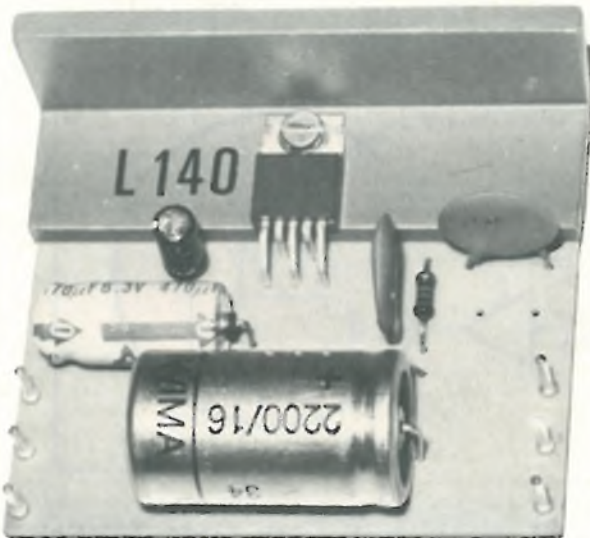

6. Sound amplifier. Monolithic audio amplifier made by SGS-Ates is housed in five-pin plastic package called Pentawatt. The unit, which is aimed at the U.S. car-radio market, is built ruggedly and is able to develop 8 watts of output into a 2-ohm load.

cations include voltage regulators for color-TV sets, as well as solenoid and relay drivers.

Another unusual product is the monolithic quasi-complementary dual Darlington recently introduced by Italy's SGS-Ates. The unit is intended as a power booster for an operational amplifier being used in industrial motor-driver applications. It can deliver a peak current of 3.5 A and operates from a supply voltage of 44 V. The quasi-complementary circuit consists of four npn transistors, but two of these are connected so that they perform as though they were pnp devices.

There is also some activity in discrete, as well as

monolithic, complementary pairs for audio applications. N-type devices still dominate the market, but the selection of p-type ones is growing. This summer, for instance, Fairchild Semiconductor division, Mountain View, Calif., will have a high-speed pnp switch capable of handling 400 V at 2 to 3 A. It is a multiple-emitter device that turns off in less than 1.5 μ s. Fairchild is hoping to price the unit at around \$5 in lots of 5,000.

In the fourth quarter of this year, Texas Instruments will introduce a single-chip npn/pnp pair rated at 60 to 100 V and 30 A. Tentative price of the unit, which will be housed in TI's high-power plastic package, is set at \$2.60 each in quantity.

Complementary field-effect transistors will also be getting more powerful. Nippon Electric Co. of Japan is already offering n-channel and p-channel vertical FETs rated at 50 and 100 W. Maximum ratings for the 50-W devices are 100 V at 3 A, and for the 100-W units, 150 V at 6 A. For improved device efficiency, the company is developing 200-W FETs to operate at 200 V and 10 A. Sony Corp. of Japan has a line of vertical power FETs, too. First introduced about two years ago, the units are available in both n-channel and p-channel versions. Breakdown voltage ranges from 200 to 300 V, maximum output power is 30 W, and voltage amplification is 5. The devices' pinch-off voltage can be 10 to 25 V, while output resistance spans 2 to 6 ohms.

Rectifier diodes and zeners hold their own

Like transistors, switching diodes are getting faster, while voltage and current ratings continue to climb. Schottky diodes, because of their fast operating speed and low forward-voltage drop, are still probably the best choice for building switching supplies in which efficiency must be high. Today's Schottkys can handle 50 to 60 A at 40 to 45 V. And more zener diodes, which now have ratings of a couple of hundred volts, will be sporting glass packages in the not-too-distant future.

Super-fast ion-implanted diodes are being made by Solid State Devices, which is now delivering its Epion rectifiers for use in switching supplies, with breakdown voltages to 700 V and nanosecond recovery times. Typically, a 600-V, 100-A device has a forward drop of only 900 millivolts and a fast recovery of 75 ns. The parts, which are priced at about \$10 each in lots of 1,000, are also highly radiation resistant. Another line of ion-implanted diodes from this company has a lower current rating—only 1 A maximum—but these devices, which can handle up to 150 V, have a threshold of 300 mV and recovery time of 6 ns. They are intended for high-current clamping applications.

In Europe, France's Sescosem deals in some fast switching diodes for power supplies, motor controls, inverters, and choppers. Current ratings range from 4 to 60 A, and switching times vary from 100 ns for a 400-V device to 500 ns for a 1,000-V device.

In the U.S., Semtech Corp. of Newbury Park, Calif., is using neither ion-implantation nor Schottky barriers for its fast-recovery rectifiers, which consist of many individual silicon junctions stacked together and then fused. A 6,000-V device is less than a quarter of an inch long, and recovery time is only 300 ns. Larger stacks are

available, and ratings go as high as 200 kilovolts. In between, there's even a 50-kV stack having a recovery time of merely 150 ns.

In Japan, Sanken Electric Co. has a line of fast-recovery switching-diode stacks intended primarily for high-voltage rectification in color-TV power supplies. Voltage ratings range from 10 to 25 kv. Typically, the average forward current is 10 milliamperes, and reverse recovery time is 300 ns.

The big potential market for zener-type diodes is surge suppression. Motorola already has some hefty devices for use as surge suppressors. They are available in voltages as high as 200 v and can suppress up to a 1,500-w surge in a millisecond time frame. Both Motorola and Fairchild foresee glass as the future package for most zeners. At Fairchild, the biggest zeners are currently 1-w devices, but the company is working to boost ratings between 3 and 5 w within a year or so.

Semtech is introducing miniature bidirectional transient suppressors for protection against ac, as well as dc, surges. They can handle 500 w peak, 1.5 w continuous, and have voltage ratings from 10 to 110 v. Devices for 1,500-w peak power are in development. Semtech also has a line of regulator-type zeners with ratings of 6.8 to 120 v for 1-, 3-, and 5-w applications.

From Mullard, a Philips company in England, there's a series of zener-type diodes intended for clamping applications in low-level dc circuits—they are used to restore dc levels after transients have passed. Voltage ratings range from 5 to 80 v, and power ratings (for up to 100- μ s pulses) range from 3 to 60 kilowatts. The devices can withstand current surges of thousands of amperes.

SCRs and other thyristors are changing form

Despite the challenge of transistors in some key applications, thyristors are still the designer's choice when a true power switch is needed.

The emphasis at Texas Instruments is on high-power plastic. As a result, the company has a full line of plastic-packaged SCRs and triacs, and the biggest devices are now rated at 600 v and 25 A, with 40-A units coming along sometime next year. Plastic is favored overseas, too. The Philips Elcoma division in the Netherlands is now coming out with a 30-A triac, a high-reliability plastic device for household appliances and industrial applications. Rated at 400, 500, or 600 v, this fully glass-passivated unit triggers at a low 100 mA, permitting it to be fired by a simple diac or an IC.

Less than two years ago, RCA brought out its integrated thyristor rectifier, a monolithic composite structure in which an SCR and a diode are connected in parallel with reverse polarity. The device, which is now available in ratings as high as 10 A at 600 v, is used in TV horizontal-deflection circuits and switching inverters. At the end of last year, RCA quietly released a gate-turn-off SCR rated at a maximum of 5 A and 800 v that can be turned off by applying a negative voltage to its gate. Intended for use as a high-voltage dc switch, the unit can handle kilowatts of power and high peak currents. RCA is about ready to announce another new type of thyristor called an asymmetrical SCR. In this device, the reverse blocking capability of the SCR is eliminated,

permitting it to operate at speeds of 20 kHz or so. It is aimed at dc-switching jobs in fluorescent ballasts and high-speed inverters for cool-top cooking ranges.

An unusual concept in thyristors is currently being marketed by Unitrode Corp. of Watertown, Mass. The company's line of ChipStrate thyristors (Fig. 5) are fully glass-passivated, hermetically sealed devices supplied as unpackaged solderable chips. As a result, they can cost 35% to 50% less than packaged units. Medium-power SCRs and triacs are available, with ratings of 1 to 55 A and up to 600 v, in addition to diacs, high-voltage (800 v) diodes, and photosensitive, fast-switching, and sensitive-gate SCRs. In quantities of 1,000, unit price ranges from \$0.90 to \$6.75.

Similarly, the Semiconductor Products department of General Electric Co., Auburn, N.Y., has its Subcrete family of thyristors and rectifier diodes. The devices are supplied as solderable fully glass-passivated chips with lead frames. At present, all the units are rated at 600 v, with current ratings of 10 to 35 A for the SCRs, 6 to 25 A for the triacs, and 10 or 20 A for the diodes.

Fully glass-passivated unpackaged thyristor chips are available from Hutson Industries in Dallas. Both SCRs and triacs can be supplied with ratings of 30 to 800 v and 0.8 to 60 A.

Wattage ratings rise for power linears

Power integration is already well established in both audio amplifiers and television circuits. Italy's SGS-Ates, one of the world's leading suppliers of power ICs, covers virtually all audio applications with its line of monolithic linear amplifiers. At the low end of this array, there's a device intended for portable radios. It is rated at 1.2 w for an 8-ohm load, and minimum supply voltage is only 3 v. At the other end, for high-fidelity applications, there's a unit that can deliver 20 w into 4 ohms with a harmonic distortion of only 1%.

The latest power IC from SGS is a complete audio amplifier (Fig. 6) in a new five-pin plastic package, which the manufacturer calls Pentawatt. This recently released unit typically provides an 8-w output into 2 ohms. It is intended for car radios, particularly in the U.S., where demands are the most exacting. Besides thermal and short-circuit protection, the device has a number of fail-safe limits, guarding it against alternator spikes, reverse polarity, and continuous high voltages.

For television, SGS already has a complete monolithic sound channel, which includes a dc volume control, as well as intermediate-frequency and frequency-modulation circuitry. This device will be part of a kit of seven circuits for color-TV sets that the Italian company and Germany's AEG-Telefunken will market together. The full kit will probably be ready by next year.

Today's three-terminal IC voltage regulators can also be regarded as power devices. They are readily available with both positive and negative output voltages from 5 to 28 v at an output current of 1.5 A. And there is even a selection of devices developing a positive or negative 5-v output at a current of 3 to 4 A. The regulators are generally supplied in a plastic package.

Besides a full line of IC regulators, National Semiconductor Corp. of Santa Clara, Calif., has a pair of inter-

esting power linears. One is an IC that functions like an npn power transistor. The unit, which develops an output of 40 v at 1.5 A, requires less than 5 microamperes to turn on. It can dissipate up to 30 w and includes current, as well as thermal, limiting. Presently, the device is supplied in a TO-3 metal can, but will be available in a

lower-cost plastic version later this year. Price is now \$3 each in 100-unit lots. The other power linear from National is a monolithic stereo audio amplifier that can supply 6 w rms per channel to an 8-ohm load. The unit develops more than 1 A of output current and is protected against both overloads and short circuits.

Power devices handle industrial jobs

In high-power devices for industrial applications, wafer size for a single SCR or rectifier will be going to a 3-in. diameter in the near future. Moreover, different approaches to gate geometry for SCRs are improving both the operating efficiency and the switching speed of these devices.

Although present transistor ratings don't really compete with the monster-like specs of today's power rectifiers and thyristors, transistors are beginning to move into some industrial applications. Transistors, of course, don't need commutation circuits to turn them off, as thyristors do, and at high power levels, commutation circuits can be rather bulky.

Within two to three months, International Rectifier's Semiconductor division in El Segundo, Calif., will have a Darlington transistor rated at 600 to 700 v and 40 to 50 A. Priced at approximately \$20 in volume, this triple-diffused mesa device is aimed at machine-tool controls, large power supplies, and forklift drives. Like all other semiconductors made by International Rectifier, it will be fully glass-passivated.

Another company, RPM Industries of Los Angeles, makes the Darlington transistors it uses in its own controllers for electric vehicles, such as golf carts, fork lifts, and motorcycles. A 100-v device can handle 200 A, with a forced beta of 400, typical saturation voltage of only 1.2 v, and a turn-off time of 120 ns. RPM is not now pushing its transistors, which sell for about \$115 each in 100-unit lots, but rather its complete controllers, which are \$128 each in the same quantities.

Sescosem in France expects next year to have 100-A or possibly even 150-A transistors for low-voltage—up to 48 v—applications like electric vehicles. Fall times should be fairly fast—around 0.5 μ s. The company is now offering a 50-A device rated at 125 v. Japan's Mitsubishi also makes a jumbo transistor aimed at the electric-vehicle market. It's a 500-v unit with a maximum current rating of 200 A and a unity-gain crossover frequency of about 5 MHz. Another Japanese firm, Nippon Electric Co., now has a double-diffused mesa transistor able to handle 400 v at 200 A and is developing devices rated at 400 v and 400 A, as well as 800 v and 50 A, that will operate at speeds up to 100 kHz.

A third Japanese manufacturer, Toshiba, is concentrating on transistors for motor controls, again for electric vehicles. The company now makes 100- and 400-v devices rated from 75 to 100 A. When connected in parallel, these transistors can control motors with power ratings up to 10 kw. In the future, Toshiba wants to use

transistors for controlling 20-kw motors. This company already has a 100-A Darlington and is developing a 400-A 400-v unit.

Power rectifiers and thyristors—the mighty ones

The four-digit voltage and current ratings of today's power rectifiers and power SCRs are enough to boggle the mind. International Rectifier, one of the leading worldwide suppliers of both rectifiers and SCRs, already is working with wafers that are approximately 2½ inches in diameter—and that's for a single device. When made into a rectifier, a wafer of this size will carry an average of 3,000 A at frequencies of 60 to 400 Hz. Peak reverse voltage ranges from 3,000 to 4,000 v. As an SCR,

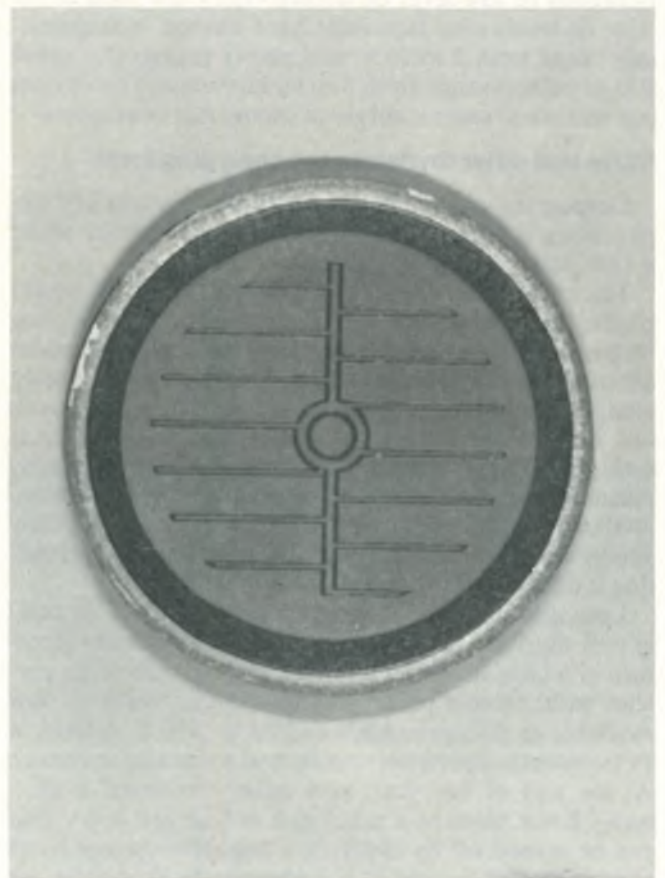

7. Fancy gate geometry for speed. Fast-switching divergence-gate SCR is intended for switching supplies operating at 5 kHz. The device, which is manufactured by International Rectifier, is rated at 1,200 V and 785 A rms. Its turn-off time is only 30 μ s.

such a wafer will handle an average of 1,600 A at 3,500 V, again at speeds of 60 to 400 Hz.

For 5-kHz switching supplies, International Rectifier has a new fast-switching divergence-gate SCR (Fig. 7) rated at 758 A rms. It is a 1,200-v device having a turn-off time of only 30 μ s. There's also a new 50-A triac rated at 400 to 1,200 v that requires only 200 to 500 mA of gate current for firing.

Another U.S. firm that specializes in industrial power, Westinghouse Electric Corp., Semiconductor division, Youngwood, Pa., has a pair of new devices. One is a gate-turn-off SCR with a 200-A rating and a turn-off time of only 1.5 to 2 μ s. The other is called a reverse-blocking diode thyristor. It's a two-terminal device intended for use in series high-voltage stacks to eliminate the need for matched SCRs and the danger of a single SCR carrying the full load. Blocking voltage is 1,000 v maximum, and peak pulse current 5,000 A.

Westinghouse's product line now includes both rectifiers and thyristors housed in either disk-type or stud-mounted packages (Fig. 8). The biggest devices are built with 50-mm wafers. Top-of-the-line SCRs include a 3,000-v unit capable of carrying an average current of 600 A and handling a surge current of 13 kA. In high-power rectifiers, there is a 2,000-v device that is rated at 2,400 A average with a surge capability of 30 kA.

General Electric offers several noteworthy SCR prod-

ucts, too. For phase-control applications at operating speeds of 60 to 400 Hz, there is a high-current unit rated at 2,000 v and 1,900 A rms, a high-voltage unit rated at 2,800 v and 900 A rms, and a high-power unit rated at 2,400 v and 1,500 A rms. In fast inverter-type SCRs, the company has several similarly impressive devices—a high-speed unit rated at 600 v and 700 A rms for 10-kHz operation, a high-voltage unit rated at 1,800-v and 750 A rms for 1-kHz operation, and a high-power unit rated at 1,400 v and 1,250 A rms for 3-kHz operation. All of these inverter SCRs employ an involute-gate design (a multi-arm spiral-shaped gate) that maximizes conduction area without sacrificing operating speed.

Several new thyristors are also being readied worldwide. By the end of this year, Alstom in France expects to have a reverse-conduction SCR (a reverse-polarity parallel connection of an SCR and a diode) made with a 600-A thyristor and a 200-A diode. This company already is selling an SCR with a current rating of 850 A rms at voltages up to 1,200 v and a turn-off time of less than 18 μ s.

Japan's Toshiba, which now supplies SCRs that can handle 2,500 v at 1,500 A for dc-power-transmission applications, anticipates developing higher-voltage types at the present high current level. The company also offers reverse-conduction SCRs rated at 600 to 1,300 v and 300 to 400 A that have operating speeds of 1 to 3 kHz. There's even a 1,200-v 300-A triac for induction-motor control.

West Germany's largest electrical/electronic producer, Siemens AG, has a new SCR for dc-power distribution. The device is rated at 3,200 v, with a continuous current capability of 800 A and a surge capability of 13.4 kiloamperes. Siemens makes the device on a wafer only 50 millimeters in diameter, employing neutron radiation to dope the silicon and obtain the homogeneous dopant distribution necessary for such a high-power thyristor.

Two noteworthy SCRs are currently available from England's AEI Semiconductor. One device, which is built on a 2-in. wafer, can handle 4,000 v at 800 A average. The other is a 1,200-v 400-A thyristor having a turn-off time of only 15 μ s. And France's Silec has triacs

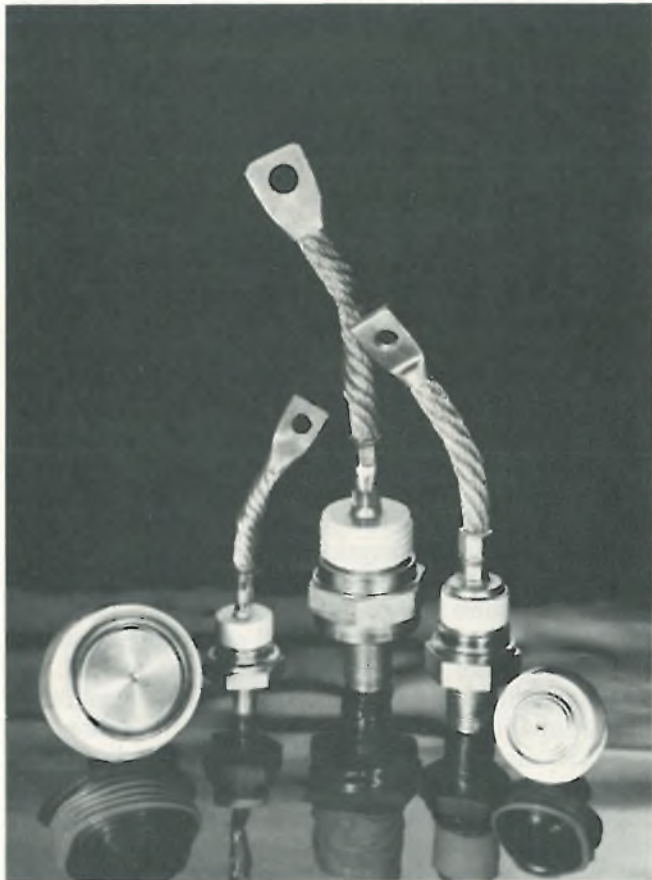

8. High-power rectifiers. Family portrait of power rectifiers from Westinghouse shows both disk-type and stud-mounted packages. The devices (from left to right) have ratings of 1,200, 150, 550, 300, and 500 A—and even bigger rectifiers are available.

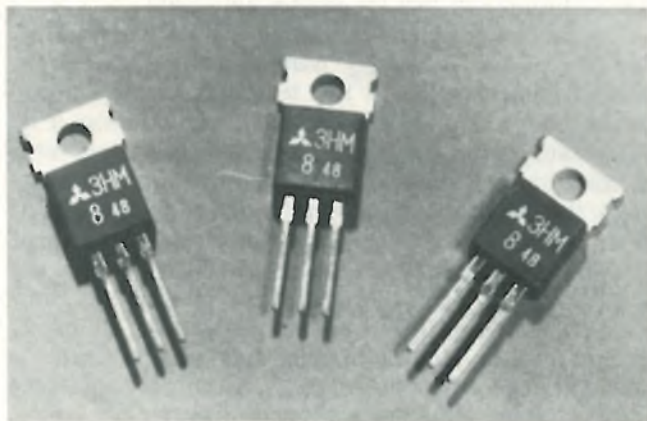

9. Plastic for high current. SCR rated at 400 V and 180 A is packaged in plastic for electronic photoflash applications. Made by Mitsubishi, the device has such a small charge storage that it can be turned off by an auxiliary commutation circuit in a mere 6 μ s.

with current ratings of 60, 100, and 200 A. They are amplified-gate units that can withstand reverse voltages of up to 1,200 v.

Japan's Mitsubishi, like Toshiba, also sells a 1,200-v 300-A triac, and it's constructed to prevent commutation failure. Last year, this company started marketing a

plastic SCR (Fig. 9) rated at 400 v and 180 A maximum for electronic photoflash units. Charge-storage is so small that the device can be turned off by an auxiliary commutation circuit in only 6 μ s. In this application, a metal package can be a shock hazard, but plastic makes a fine insulator.

Devices improve for communications

Like their low-frequency counterparts, bipolar transistors for rf and microwave-communications applications are dependable state-of-the-art power devices. They are fabricated as interdigitated structures that are in effect many small-signal transistors in parallel. As a result, device geometries are so fine that current densities can become enormous, and it's no easy matter to maintain a uniform thermal distribution across the entire chip area. Moreover, a communications transistor is expected to deliver a hefty power output at a sizable power gain over an operating band that may be as wide as 300 MHz—and all of this must be done at a decent level of efficiency without any power slump.

The new generation of transistors meets these demanding requirements. Today, an rf device for 28-MHz service can provide a peak power output of 100 w at around 14 decibels of gain, while a microwave device is capable of delivering 5 to 10 w at 3 GHz with a gain of about 5 dB and an efficiency of approximately 30%. Electrical ruggedness is also important, and state-of-the-art units have the ability to withstand an infinite voltage-standing-wave ratio—that is, they are not damaged if the transmitter output is opened or shorted.

To eliminate the hot spots that can be created under infinite VSWR, manufacturers place a ballast resistor in series with each emitter finger so that current flow is distributed uniformly. Some manufacturers are diffusing these emitter-ballast resistors and, in the process, obtaining zener diodes that help protect the transistors against overvoltages. Other manufacturers deposit thin-film nichrome resistors for emitter ballasting.

The problem of metal migration is also being tackled. Because of the extremely narrow device geometries, current density—even in the metalization structures—can become so high that the metal is carried away (Fig. 10), creating an open circuit and causing the transistor to fail. Although metal migration cannot be stopped entirely, the rate of migration can be slowed so that a transistor has a reasonable lifetime. Manufacturers disagree on what is the best metalization system to use. For example, TRW RF Semiconductors, Lawndale, Calif., employs a titanium-tungsten-gold system for all of its products, while Communications Transistor Corp., a subsidiary of Varian Associates, San Carlos, Calif., uses a silicon-copper-aluminum alloy.

Many transistors now contain integral input-matching networks for reliable broadband performance. These networks are made of MOS capacitors, with the chip's wire bonds serving as inductors.

Packages are changing, too. The conventional round type of stripline housing has limited chip size, and the ribbon stripline leads have often broken off with only minimal flexing. More rugged rectangular packages, which are also simpler assemblies, are being used nowadays, permitting chip size to be bigger, and power outputs consequently can be higher. All of these advantages are adding up to lower costs per watt.

There's quite a bit of new product activity in rf power throughout the world. In the U.S., TRW will shortly have a 3-GHz microwave transistor capable of delivering 10 w at a supply voltage of 28 v. Also imminent is a low-cost 300-w (peak) device for Tacan (tactical aid to navigation) systems operating between 960 and 1,215 MHz. TRW hopes to sell the unit for \$50 to \$60 in quantity. This same product effort will also yield devices intended for L-band phased-array radar and capable of providing more than 100 w of pulsed power over 15% to 20% bandwidths. Within the next six months or so, the company expects to double the power levels for about half of its existing line by building bigger chips and possibly changing device configurations.

Communications Transistor Corp., San Carlos, Calif., has two new transistors for land-mobile applications—one with a peak envelope power (PEP) of 100 w at 30 MHz, and the other rated at 80 w and 175 MHz. In volume, prices are around \$22 and \$27, respectively. For military applications, there's a new 74-w 1-GHz device priced at approximately \$175 in small quantities. Another noteworthy transistor is a 28-v single-sideband unit rated at 150 w PEP and 30 MHz. Within the next year or two, CTC hopes to reduce the price of its bigger devices from \$20/w down to \$2/w. Figure 11 shows a variety of stripline packages it now uses.

Recently, Motorola announced an rf transistor for 50-v single-sideband service that develops 150 w PEP at 30 MHz. It has a VSWR of 30:1 at all phase angles, and a minimum gain of 13 dB at rated output. By the fall, the company will have an 80-w 400-MHz unit for military-aircraft applications, and a 100-w unit is to follow before the year is out. The HPA division of Hewlett-Packard Corp., Palo Alto, Calif., already has a transistor capable of producing 0.5 w continuous-wave in class-A operation at 2 GHz with a small-signal gain of around 8 dB. What's more, the division is anticipating raising power outputs to 1 w at frequencies as high as 4 GHz in the near future.

About two years ago, Philips in the Netherlands introduced an rf transistor for industrial and military ap-

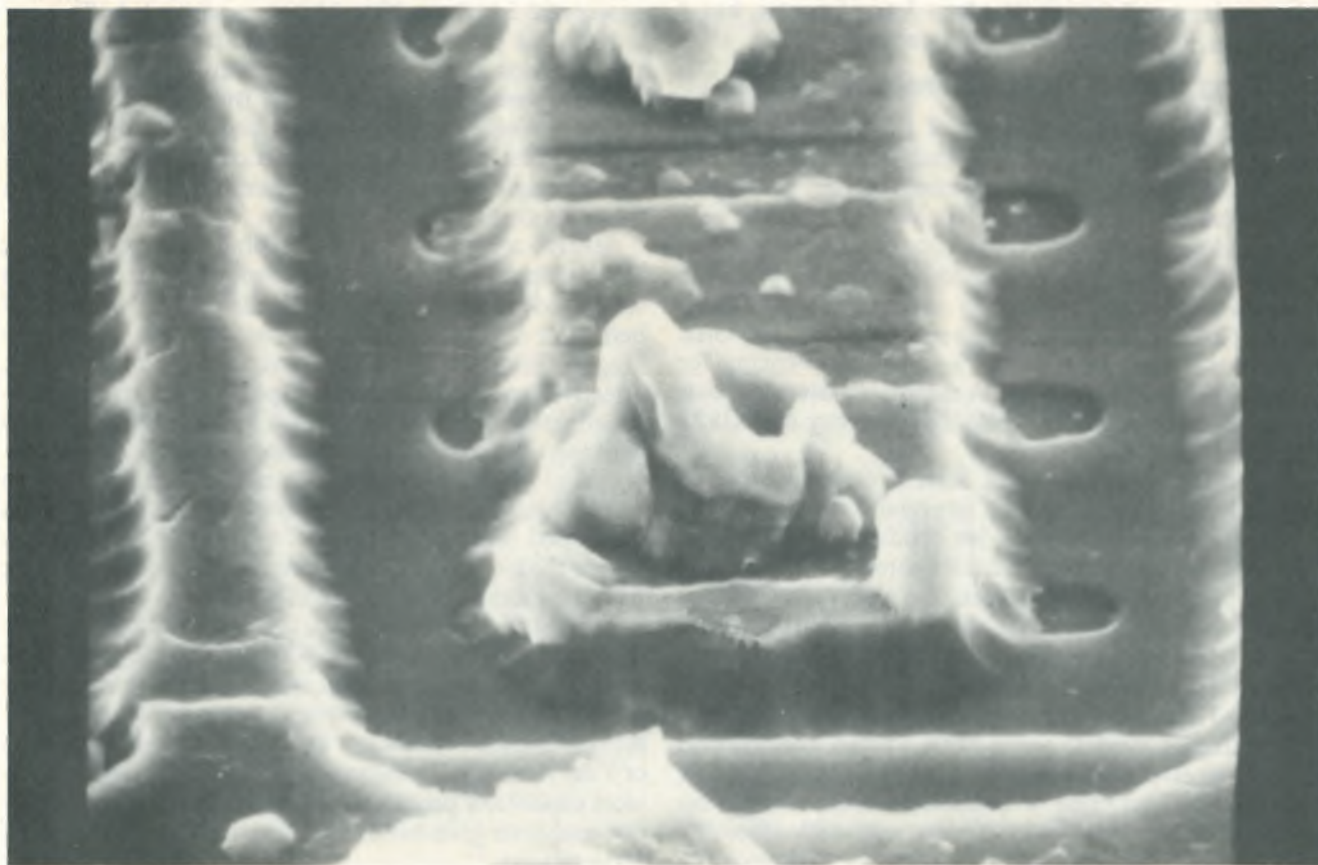
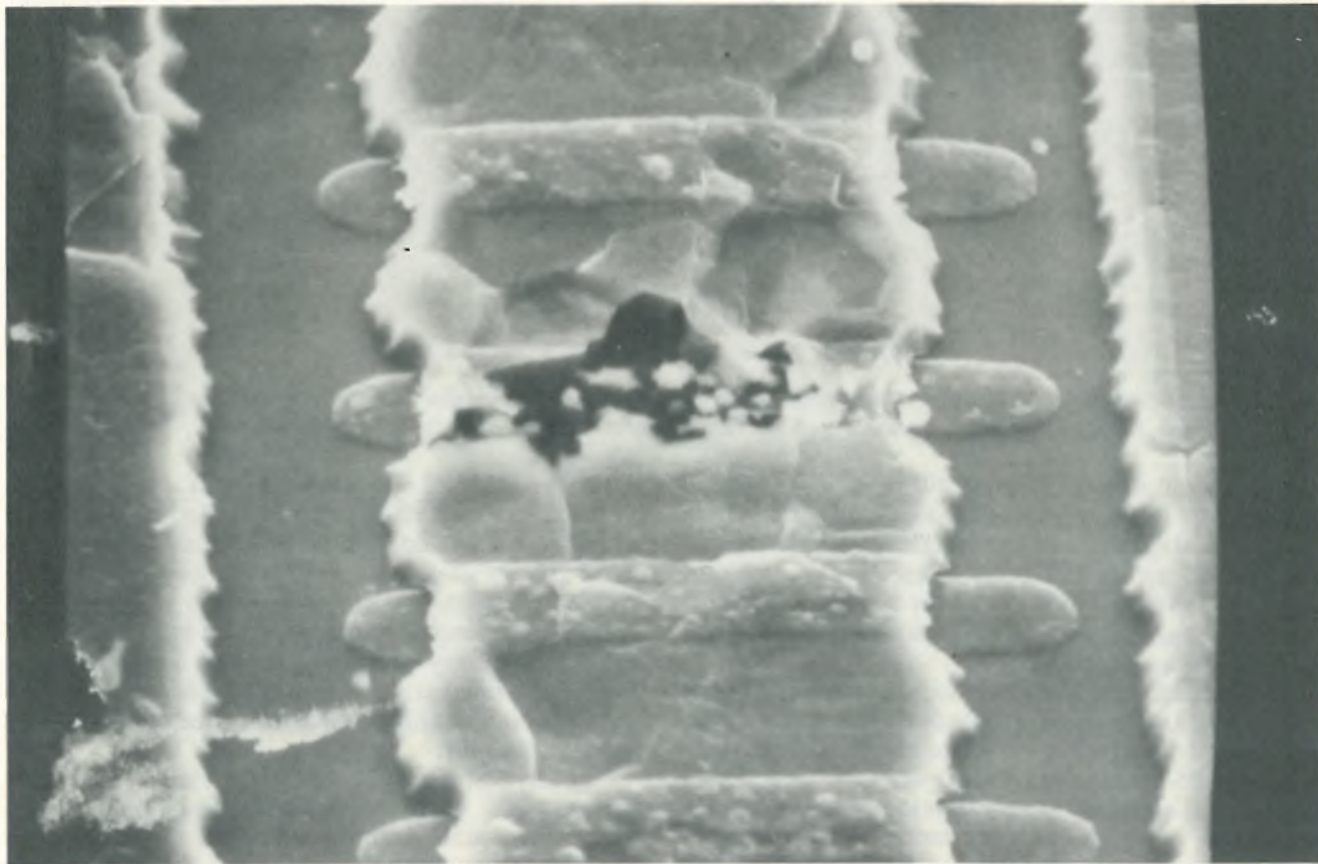

10. Close-up view of metal migration. Because geometries are very fine in rf and microwave transistors, current density can become so high that the metalization structures are damaged. Microscope photos from TRW show void formation (top) and aluminum pile-up (bottom).

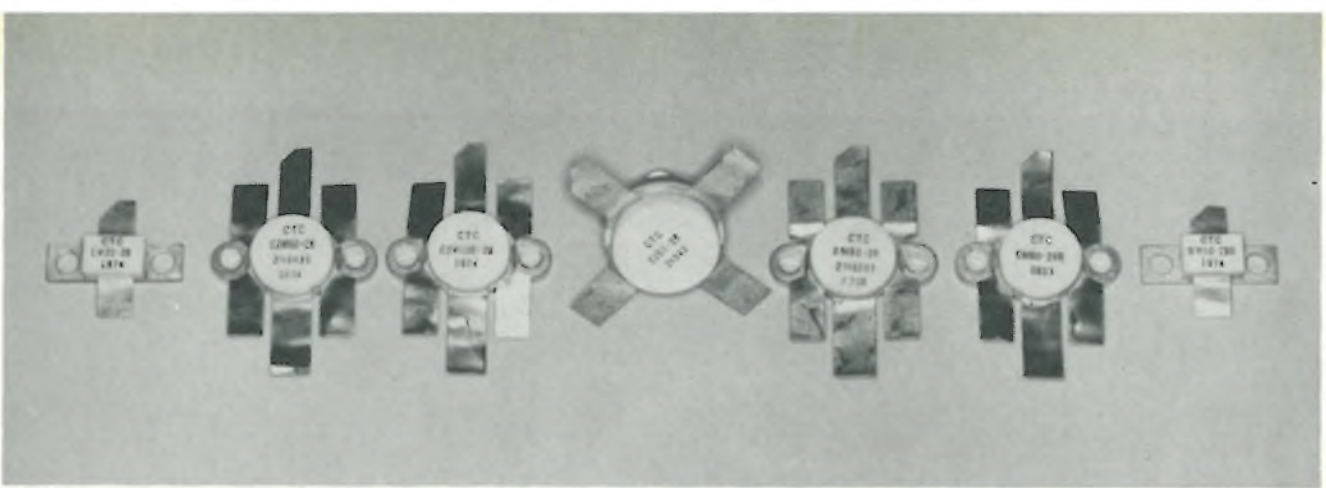

11. Communications lineup. Rf and microwave bipolar transistors made by Communications Transistor Corp. are available in a variety of stripline packages, including the newer rectangular ones that can accommodate bigger chips for higher power outputs.

plications, and its performance still looks impressive. It can develop 150 W PEP in single-sideband service from 1.6 to 28 MHz and 150 W continuous-wave at frequencies of up to 108 MHz. France's Thomson-CSF, which also offers a 150-w device for 30-MHz single-sideband transmitters, now has rf transistors in development that go up to 500 W.

In Japan, Mitsubishi already supplies devices rated at 30- or 60-w at 220 MHz for 28-v operation and is developing a 100-w unit. For vhf mobile applications, Toshiba has a 25-w transistor that operates from a 13.5-v supply. The company is now developing a 100-w part, which can run from 48 v or more, for fixed-station work. For microwave applications, a device for phased-array radar applications develops 5 w of power, has 4 dB of gain, and runs from an 18-v supply.

Operating at super-high frequencies and above

The most widely used types of two-terminal microwave devices are Gunn diodes and Impatt diodes. For both types, output power is getting higher, and operating efficiency is improving, too. Within the next year or so, indium-phosphide Gunn diodes capable of operating at 100 GHz or above should be emerging from the development stage. Presently available gallium-arsenide Gunns are limited to operation below 100 GHz. In Impatt diodes, state of the art is still advancing for both silicon and GaAs types. A silicon Impatt offers better thermal conductivity, while the efficiency of a GaAs device is higher.

In the U.S., Varian's Solid State West division, Palo Alto, Calif., offers a line of impressive Gunn diodes, ranging from a 25-GHz device producing 375 mW at 5.5% efficiency to a 94-GHz device rated at 40 to 50 mW and 0.7% efficiency. Elsewhere, the apparent leader is Japan's Central Research Laboratory of Hitachi Ltd., which is developing devices ranging from a 7.8-GHz unit rated at 2.5 w and close to 10% efficiency to a 57-GHz unit rated at 67 mW and 3% efficiency.

For Impatt diodes, again both Varian and Hitachi have state-of-the-art units. Varian has grown-junction GaAs units, including a continuous-wave device capable of producing 4 w at 10 GHz with 18% efficiency and a pulsed device rated at 14.8 w at 9 GHz and 25% efficiency. Within a year, Varian hopes to boost power levels to 5 w for continuous-wave operation at 13 GHz

and 30 W for pulsed operation at 13 GHz.

Hitachi makes both silicon and GaAs Impatts. In the lab now are single-drift silicon devices capable of developing 530 mW at 48 GHz and 7.8% efficiency, as well as double-drift silicon devices putting out 1.13 w at 53 GHz with 12% efficiency. The company also has a pair of impressive laboratory GaAs Impatts—one is a double-drift 21-GHz unit rated at 1.2 w and 15.6% efficiency, and the other is a single-drift 53-GHz unit producing 420 mW with 5% efficiency.

Another U.S. company, the HPA division of Hewlett-Packard Co., Palo Alto, Calif., also offers some noteworthy double-drift silicon Impatts. An X-band device has a guaranteed minimum continuous-wave power of 2.5 w from 10 to 14 GHz, and typical efficiency is 10%. For pulsed operation, there is a pair of units—one develops a peak output of 12 w from 8 to 13 GHz at 11% efficiency and the other 9 w from 13 to 18 GHz at the same efficiency level. In the next three to six months, HPA plans to introduce a continuous-wave Impatt having a guaranteed minimum power of 3 w from 5.9 to 8.4 GHz with 10% efficiency.

Several companies are developing microwave GaAs FETs, which are free of the isolation problems associated with diode sources and which offer the advantage of being low-noise broadband devices. In the lab stage, the Hughes Electron Dynamics division, Torrance, Calif., already has an X-band FET capable of producing approximately 1 w. Hewlett-Packard's HPA division is also working on X-band units and hopes to have power levels up to 200 mW within six to nine months and up to 1 w within 12 to 15 months. Germany's Siemens AG has developed devices that can operate at frequencies higher than 40 GHz and provide a gain of 5 dB at 8 GHz with a minimum noise figure of 4 dB.

From Japan's Fujitsu Ltd., there's a microwave FET that can produce more than 600 mW at 6 GHz with 35% efficiency; small-signal gain is 7.5 dB. Nippon Electric Co. is developing high-power FETs having an output of several hundred milliwatts at 10 GHz and a power gain of 7 dB. Another Japanese company, Mitsubishi, has devices capable of producing a low-noise output of 5 to 10 mW and their gain-bandwidth product is on the order of 30 to 40 GHz. □

Reprints are available for \$3 from Electronics Reprint Dept., P.O. Box 669, Hightstown, N. J. 08520. Copyright 1975, Electronics, a McGraw-Hill publication.

FAT is a money saver. ACD FAT is a precision money saver.

Fully Additive Technology is today's most economical board for the large volume user. If you don't require military documentation, or extremely complex boards, FAT can be your answer to cost reduction.

What about precision? And quality? ACD FAT guarantees both!

Fully Additive Technology uses both the drilled and pierced method to get the required holes in the boards. ACD has been perfecting the pierced method for years -- and are masters at the drilled technique. Plus, we exceed all specifications for adhesion per square inch. This gives our FAT boards an extra solderability. And with ACD FAT boards, you get no slivering or undercut characteristics that can cause unreliable circuitry.

If you're a volume house and want to look at cost savings (who doesn't today) our FAT board may be your answer.

Call us for a quote.



ADVANCED CIRCUITRY

4811 West Kearney Street, Springfield, MO 65803 • (417) 862-0751

Circle 93 on reader service card



Microphone preamp gets power through signal cable

by Don Jones
Harris Semiconductor, Melbourne, Fla.

When a high-impedance microphone is at the end of more than 20 or 30 feet of cable, a preamplifier powered by batteries is often placed at the microphone to prevent high-frequency loss and to enhance the signal-to-noise ratio. But a preamp can be made much more compact if instead of using batteries it is powered remotely over the shielded or twisted-pair audio cable.

The hookup shown here is an unconventional application of an operational amplifier, but the performance will please any broadcaster or audio enthusiast. Performance is definitely high fidelity. Frequency response is better than ± 1 decibel from 20 hertz to 20 kilohertz, and equivalent input noise is about 3 microvolts rms over this band.

The diagram shows the circuit arrangement. In the

quiescent state, the output terminal (pin 6) of operational amplifier A_1 is biased by R_1 , R_2 , and R_3 to about half the power supply voltage, with negative feedback through R_4 . However, the audio-output signal is not taken from pin 6; instead, the audio output comes from pin 7, the V^+ terminal of the op amp. This output signal is inverted with respect to the normal amplifier output, so even though the audio-input signal from the microphone is fed into the inverting op-amp input terminal, the amplifier is actually noninverting. The gain (about 100) is determined by the ratio of R_1 and R_2 , which form the feedback network from the V^+ (audio-output) pin. The HA-911 op amp is used because its noise level ($8 \text{ nV}/\text{Hz}^{1/2}$, $0.35 \text{ pA}/\text{Hz}^{1/2}$) and gain-bandwidth product (8 MHz) are many times better than those of general-purpose op amps.

In the power module, op amp A_2 supplies about 12 V dc at 7 milliamperes through a 600-ohm termination to the cable; the dc power for the module can probably be obtained from the main amplifier. Instead of using the power module, the power for the preamp could be supplied to the cable through a passive choke in series with a dc supply, but 150 henrys would be required to obtain the same noise isolation from the dc line. \square

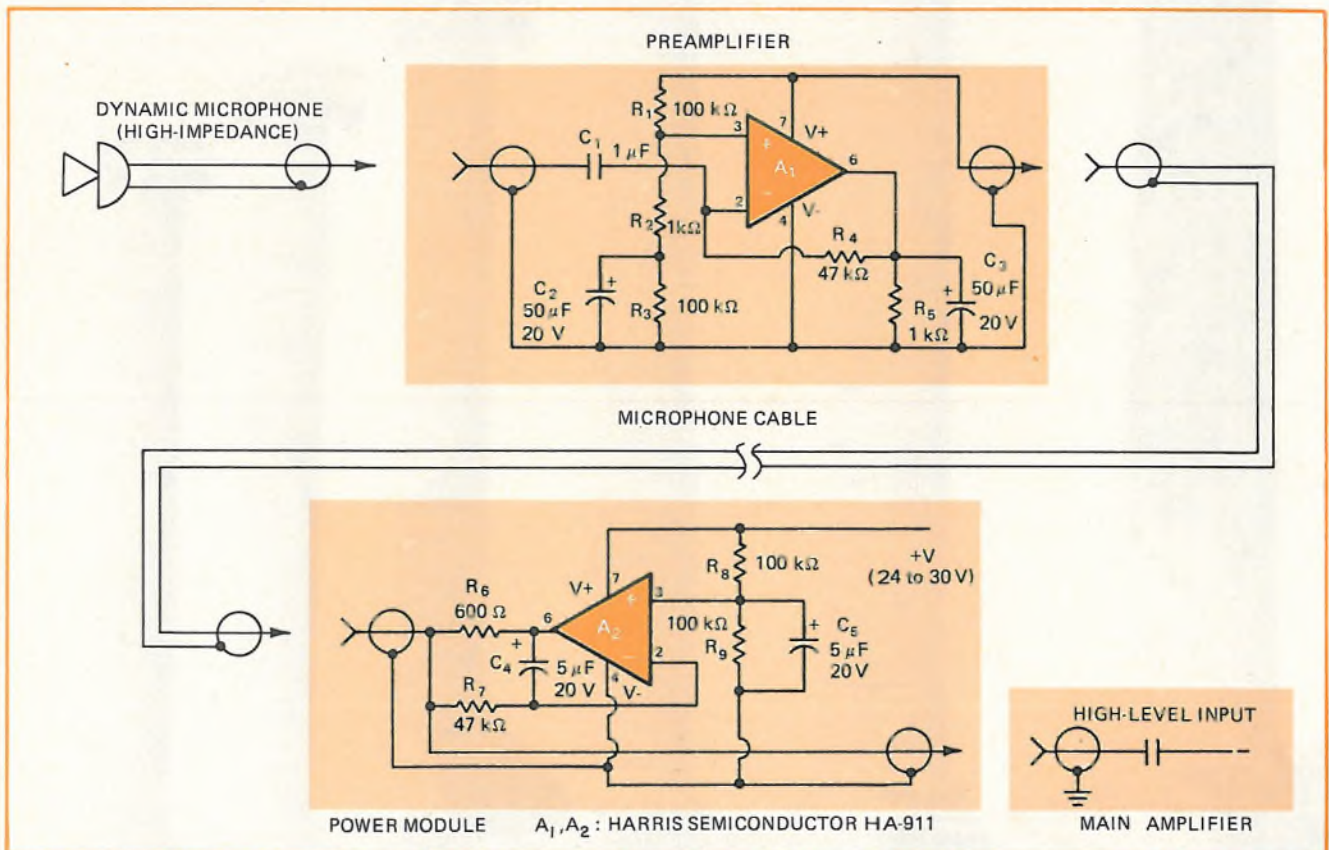

Two-way cable. Microphone cable carries power up to preamplifier and carries amplified signal down to main amplifier. Preamp, mounted at high-impedance microphone before long cable to preserve fidelity and suppress noise, is light and compact because its power is supplied through the cable, eliminating batteries. Although op amps are used in unconventional arrangements, performance is excellent.

Converter changes 7-segment output to decimal or BCD

by Prentice L. Orswell
National Oceanic and Atmospheric Administration, Boulder, Colo.

Calculator chips and other LSI circuits with outputs coded to drive seven-segment displays can have more varied applications if the seven-segment outputs are converted to decimal or binary-coded decimal. The converter described here accepts seven-segment MOS signals directly at voltages up to +15 volts and provides decimal and/or BCD outputs with blanking. It uses only four packages, at a component cost of less than \$5. (For a seven-segment-to-decimal converter that used discrete transistors, gates, and an expensive demultiplexer, see *Electronics*, August 8, 1974, p. 105.)

Only six of the segment outputs are required for this circuit. Four of them—b, e, f, and g—are applied to the input terminals of an MC14028 IC; a and c are applied

to an MC14555, along with two signals from the MC14028. These two packages have a combined total of 10 output terminals, one of which goes high to represent a numeral (0 through 9) when the complements of the numeral's seven-segment voltages are applied at the input; most LSI circuits provide complementary outputs. The 10 terminals are the decimal outputs. (Another output, corresponding to either 1 or 7, is discussed below.)

If BCD outputs are desired, the decimal outputs are connected to the input terminals of a CD4071B and a CD4075B. These units provide a total of four output terminals, which go high to represent the four BCD bits.

In the seven-segment-to-decimal portion of the circuit, the MC14028 (which is a BCD-to-decimal decoder) uniquely determines six of the decimal outputs. The complements of b, e, f, and g segment voltages for both 1 and 7 decode to output Q7, and digits 4 and 9 both decode to Q1. To separate these in the MC14555 (which is a dual binary-to-1-of-4 decoder), the complement of a is used as an additional input. Full blanking is assured by applying the complement of c at the enable inputs.

Conversion to BCD from the decimal code could be accomplished in several ways. An ideal one-package so-

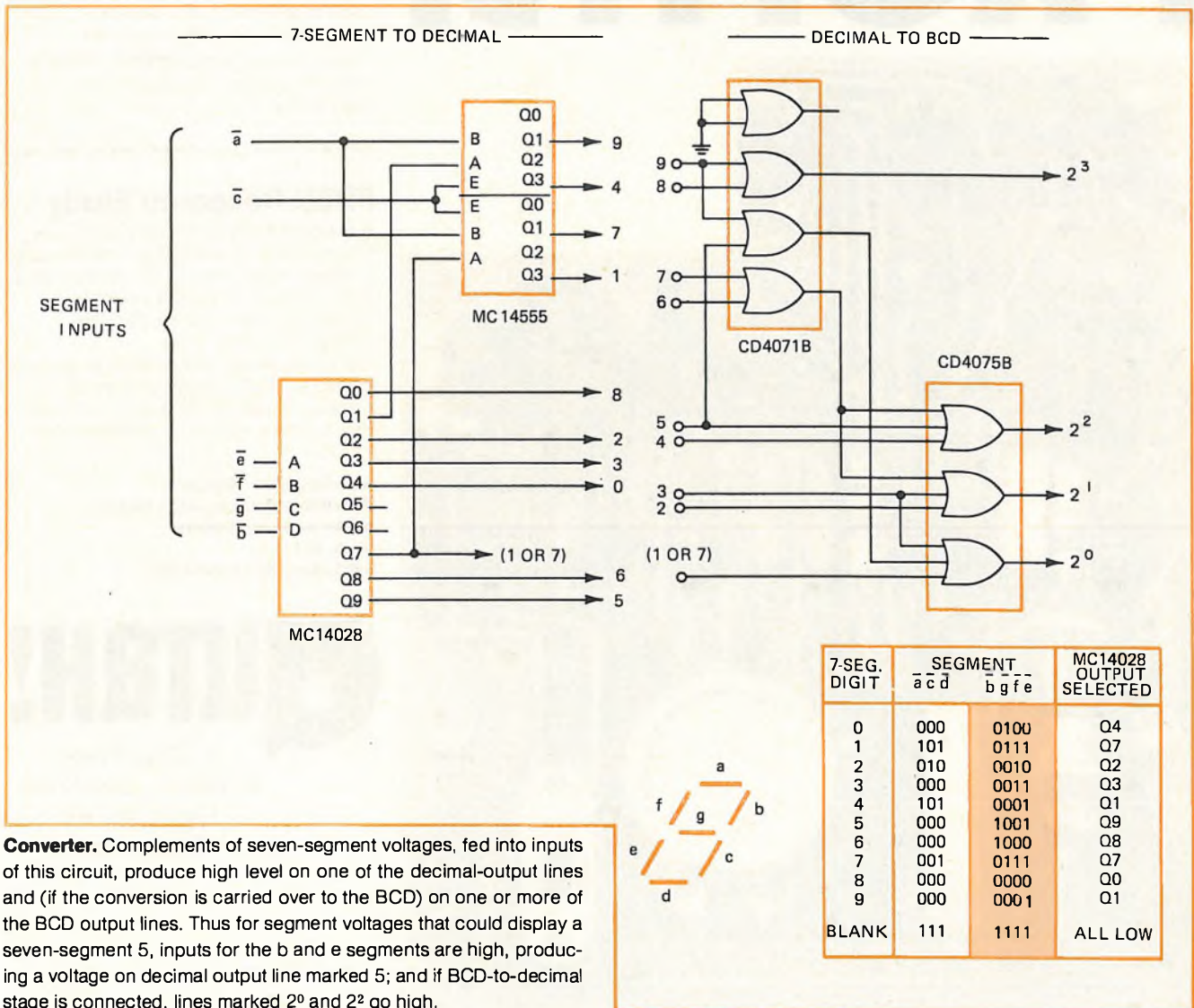

Converter. Complements of seven-segment voltages, fed into inputs of this circuit, produce high level on one of the decimal-output lines and (if the conversion is carried over to the BCD) on one or more of the BCD output lines. Thus for segment voltages that could display a seven-segment 5, inputs for the b and e segments are high, producing a voltage on decimal output line marked 5; and if BCD-to-decimal stage is connected, lines marked 2^0 and 2^2 go high.

Electronics Firms Choose Utah for... **ENERGY, PEOPLE & PROFITS.**

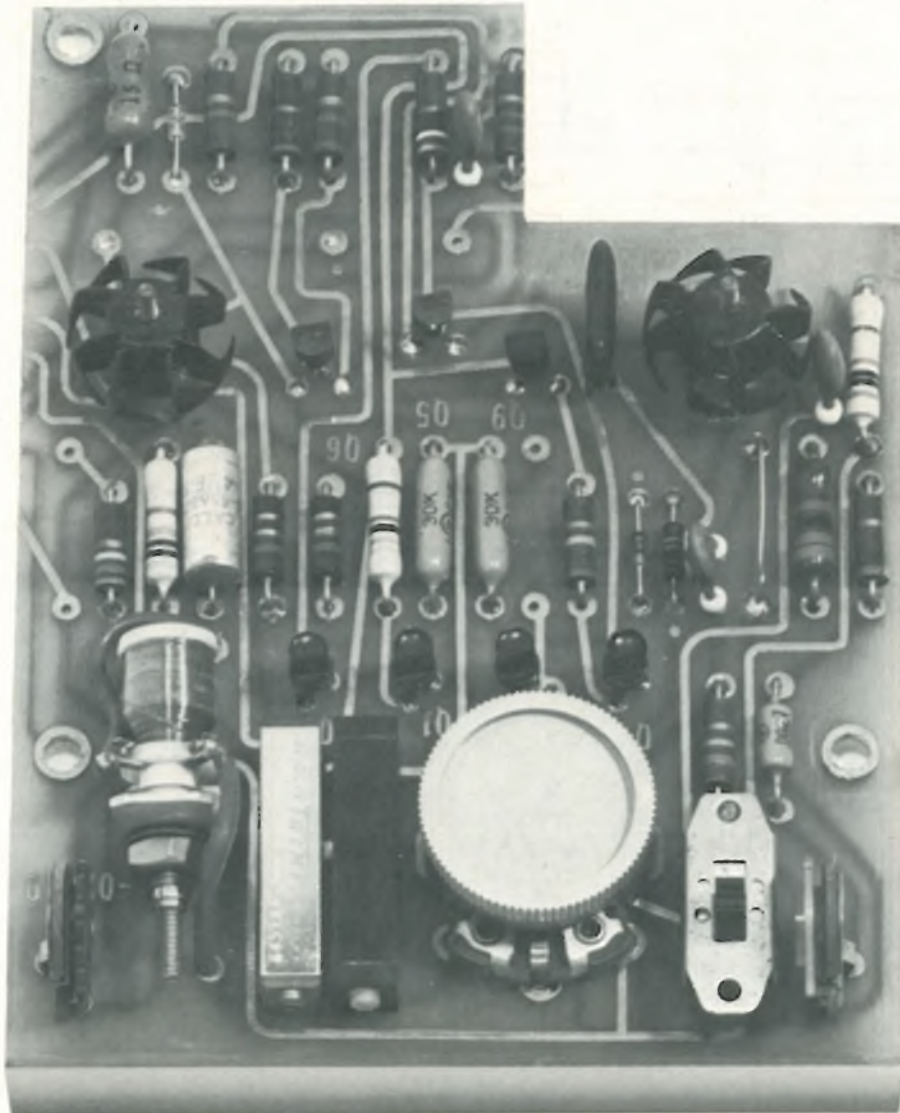

Electronics manufacturers are finding special advantages in locating new plants in Utah. For example:

Utah is Key Energy Center

The most recent major firm to choose Utah came for "energy" reasons. There are no critical energy problems in Utah now, and probably no area has more going for it in the future. Utah is destined to play a vital role in solving the country's energy needs with its vast coal, oil, oil shale, gas, and uranium resources as well as its hydroelectric power and promising geothermal testing. Utah is a key energy source for all America.

Utah People Are Productive

Companies that have plants in Utah and other locations have proved the productivity of Utah's labor force by comparative tests. Maybe it's a tradition from the staunch pioneer stock that settled the State. Maybe it's because Utah is still unspoiled industrially. At any rate, Utahns believe in an honest day's work, and they are well educated and easy to train. What's more, Utah has the facilities to train them.

FREE Research Study

A research study of critical cost factors of a hypothetical electronics manufacturer in eleven major cities of the United States, coast to coast, showed a potential 10% higher profit in Utah than the average of all the others.

The survey results are outlined in an easy-to-read 24-page executive summary, available to you for the asking. Just drop your business card in an envelope and mail to:

**John Rencher, Director
Utah Industrial Promotion Division
#2 Arrow Press Square
Dept. E-1
Salt Lake City, Utah 84101**



*A Great Place
to Work...and LIVE!
Especially for
Electronics!*

Fast Fourier transform makes correlation simpler

Digital techniques eliminate tedious hand calculations, making correlation a more-easily implemented concept, but some pitfalls must be understood and considered

by Robert Ramirez, Tektronix Inc., Beaverton, Ore.

□ Correlation functions offer a direct approach to solving a number of complex problems involving either analog or digital signals. Some of the difficulties that have already been neutralized by correlation are retrieving signals known to exist in noisy transmissions, determining the transfer function of a network, and measuring the time delay between two signal paths.

In a radar system with a long transmission path, for example, the signal is often contaminated by large amounts of noise as it traverses the path. When it is received, however, the desired signal can be detected by cross-correlating the noisy signal with a version of the original signal that has not been transmitted and is therefore free from noise.

Careful analysis shows that in a linear system driven by wideband noise, the cross-correlation of its input and its output is proportional to the system's impulse response, a function that must often be determined. And in a multichannel system, such as the telephone-transmission network, two versions of the same signal, resulting from its transmission over different paths, can be correlated to determine the time-delay difference between the two paths. This difference can then be kept

small to minimize the effect of switching transmission paths during operation.

Correlation is often described in a simplified way as a measure of how similar two signals are. In view of the general applicability of the concept, the range of applications employing the technique seems rather narrow. Narrow it is, largely because of the complex and time-consuming mathematics involved. However, the correlation concept is becoming increasingly attractive since the emergence of the fast Fourier transform (FFT), which allows the tedious arithmetic of converting from the time to the frequency domain to be performed efficiently by computers, and the decreasing cost of applying computers to real-time calculations. In fact, correlation functions can be displayed graphically on a digital-processing oscilloscope (DPO).

But to get best results, it is necessary to understand the FFT algorithm and how to correct for possible ambiguities and errors. The greatest trap facing users of FFT-correlation techniques is thinking only in terms of the analog time-domain signal that is being sampled and digitized in preparation for conversion to the frequency domain by digital techniques. Sidestepping this pitfall

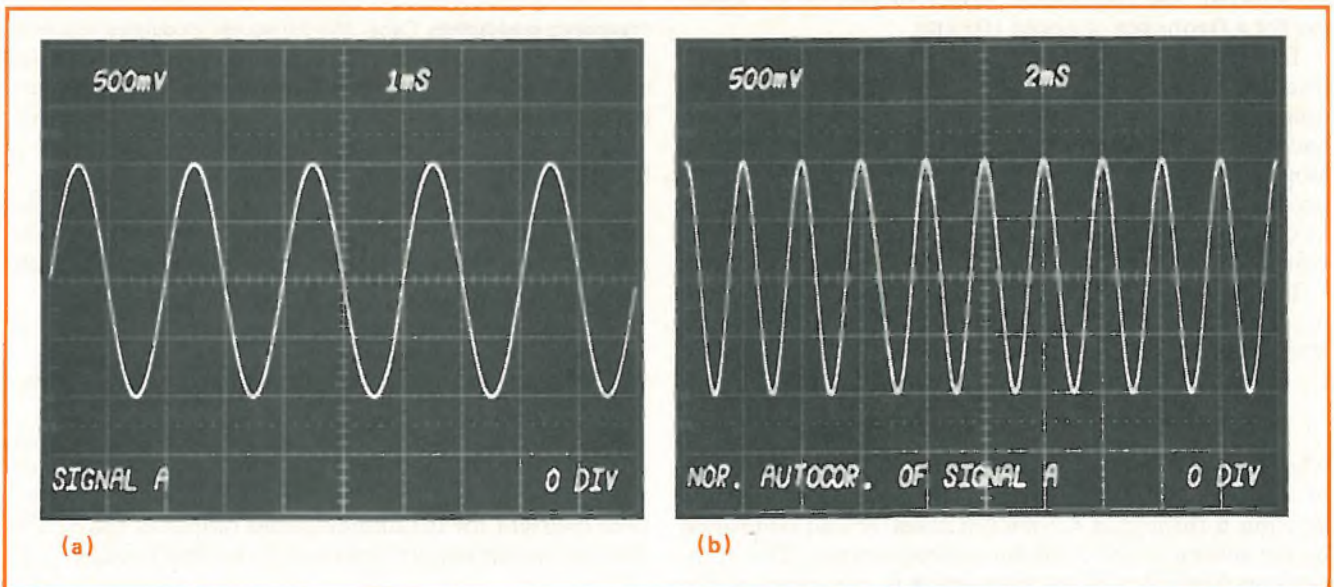

1. Correlation. Information about the similarity between two signals can be obtained by correlation. When a sine wave (a) is correlated with itself, and the result is normalized by dividing by the squares of the rms values of the original signal, an autocorrelation curve (b) results.

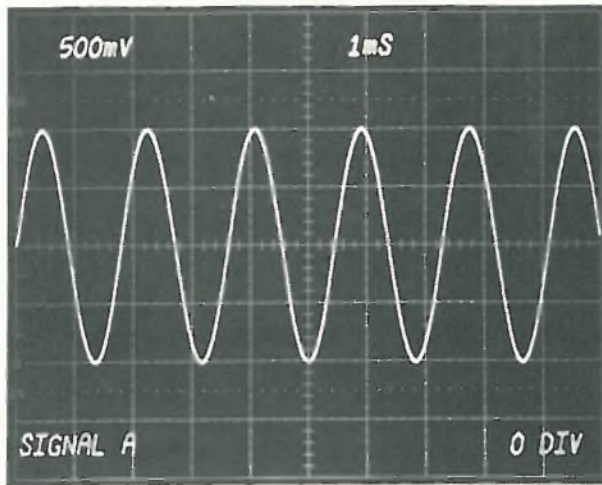

(a)

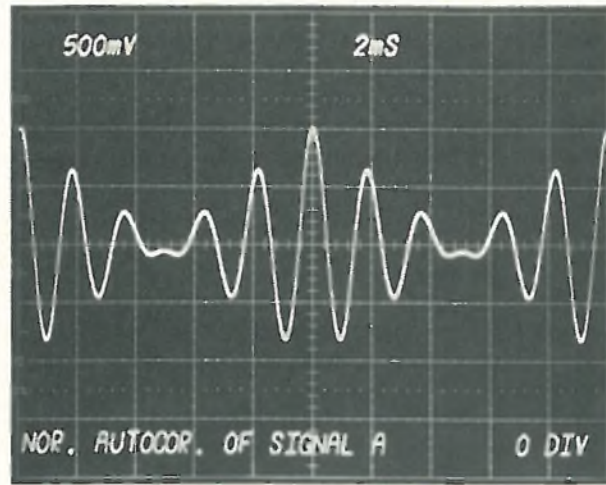

(b)

2. **Cyclic.** When a sine wave has a non-integer number of cycles in the sampling window (a), the autocorrelation function is cyclic (b).

requires thinking in terms of the sampled and digitized version, too. In short, thinking digitally helps explain FFT-correlation results.

Defining correlation

In the most general form, correlation is defined by:

$$r(\tau) = \lim_{T \rightarrow \infty} \frac{1}{2T} \int_{-T}^T x(t)y(t + \tau)dt$$

where $r(\tau)$ is the correlation function formed by summing the lagged products of $x(t)$ and $y(t)$ and τ is the time lag between $x(t)$ and $y(t)$. For practical finite-time measurements, correlation can be expressed as

$$r(\tau) = \frac{1}{T} \int_0^T x(t)y(t + \tau)dt.$$

And when the digital computer is brought to bear,

$$r(k) = \frac{1}{n} \sum_{t=0}^{n-1} x(t)y(t+k) \text{ for } k = 0, 1, \dots, n-1$$

becomes the acceptable expression. Another form uses 0 and $T - \tau$ for the limits of integration and $n - k - 1$ for the summation index. These latter limits state more explicitly the assumption that $x(t)$ and $y(t)$ are zero outside of 0 to T . In either case, the discrete summation assumes that $x(t)$ and $y(t)$ are sampled n times within a finite-time window of length T so that $t = 0, 1, \dots, n - 1$. The value of k is the time lag.

Computer evaluation of this discrete approximation runs into the same time-cost considerations that are met in solving the Fourier integral. Fortunately, however,

correlation corresponds to a simple mathematical operation in the frequency domain. Briefly stated, correlation in the time domain is equivalent to complex conjugate multiplication in the frequency domain. And this is where the economies of the FFT come in.

To correlate $x(t)$ with $y(t)$ via the FFT, the FFT algorithm is used to transform the functions to the complex frequency domain. Then either $X(f)$ or $Y(f)$ is conjugated. Following this, their complex product is formed, giving $R(f) = X(f)Y^*(f) = (X^*(f)Y(f))^*$. (In this equation, * denotes conjugation of the complex expression.) $R(f)$ is then inverse-transformed back to the

How to read the CRT photos

The photographs in this article were taken from the cathode-ray-tube display of the Tektronix digital processing oscilloscope. The CRT has eight vertical and 10 horizontal divisions. The scale factors, giving quantity and units per division, appear at the top of the display. The vertical scale factor is on the left, and the horizontal is on the right.

The zero-reference location for vertical information is displayed in the bottom right-hand corner. The term 0 DIV indicates that the horizontal graticule line at the center of the screen is the zero reference position, and -3 DIV indicates a reference three divisions below the center.

Computer-generated text appearing in the lower left of the display labels the waveforms to be correlated as SIGNAL A and SIGNAL B. The correlation functions are labeled by function type. In presenting the signals to be correlated, zero time is at the left edge of the graticule, and positive time proceeds to the right in accordance with the displayed horizontal scale factor. In depicting correlation functions, zero lag or time shift is at the center of the display. Negative lag proceeds, according to the horizontal scale factor, from center to the left, and positive lag proceeds from center to the right.

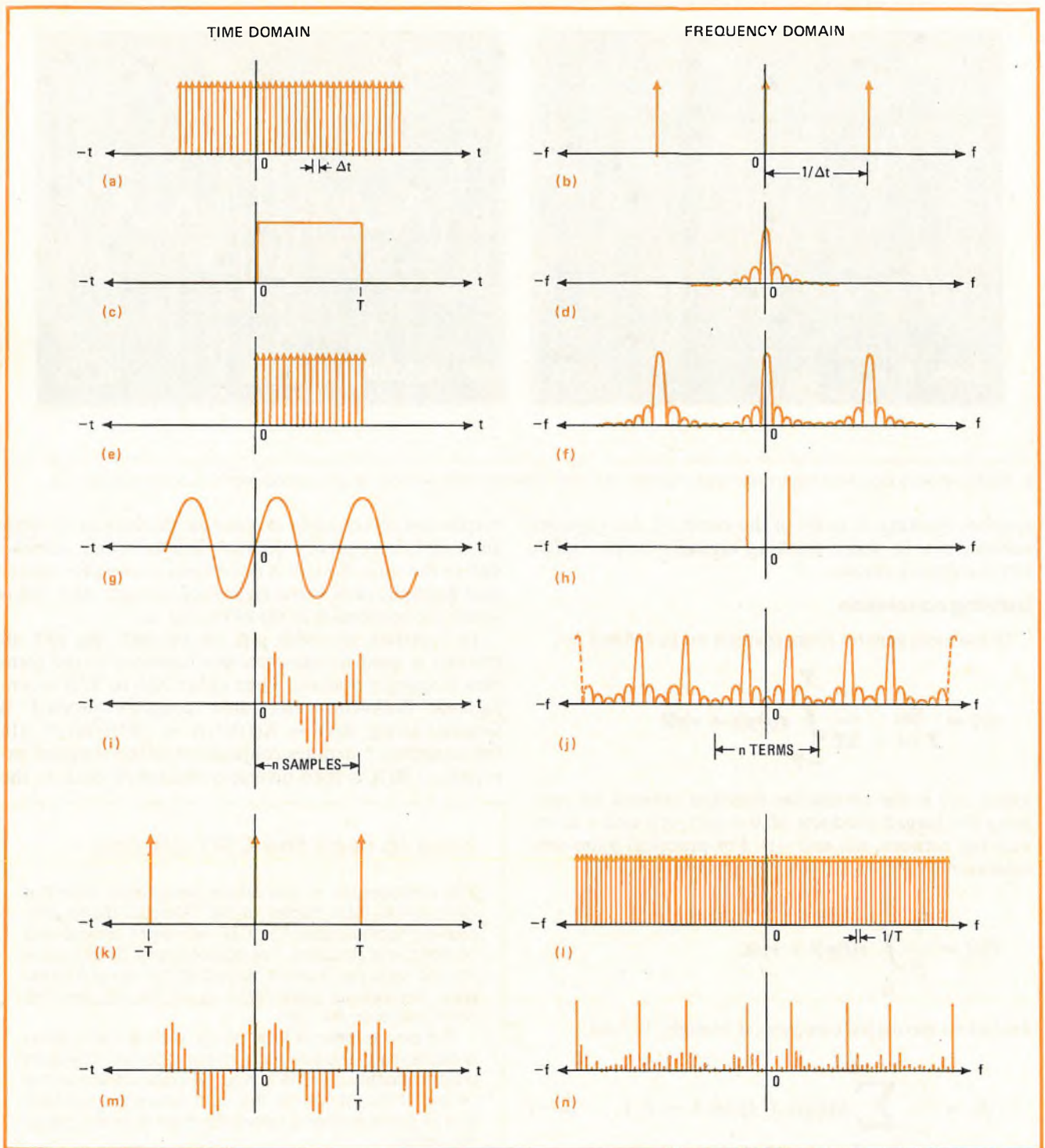

3. Waveform sampling. Digitizing a waveform may be thought of as multiplying the signal by a train of unity-value impulses separated in time by the sampling period, Δt (a). A sampled and windowed sine wave looks like (i), but when the period of the sine wave is not an integral multiple of the window width, convolving this signal with the time-domain impulses of (k) yields the odd-looking curve of (m). Such errors are the result of the unexpected way the FFT assumes periodicity—by windows rather than cycles—but they can be corrected by compensation.

time domain by the same FFT algorithm to give the correlation function $r(\tau)$.

The inherent simplicity of this approach is appealing, especially to those who have labored over the integral solution. Although, for the uninitiated, this simple approach is not without pitfalls, these pitfalls can be avoided when they are understood. Primarily, the peri-

odicity assumed by the FFT must be dealt with, or cyclic correlation will result.

A periodic signal like the sine wave of Fig. 1(a) is a good starting point for considering cyclic correlation. The sine wave is synthesized from 512 amplitude samples generated by a digital-processing oscilloscope. The samples are stored in memory, and the sine wave repre-

sented by this data is transformed to the complex frequency domain using the FFT algorithm of DPO TEK Basic, the programming language for the DPO.

After the frequency-domain signal is conjugated and complex multiplication is performed, the result is inverse-transformed to the time domain. In the resulting autocorrelation function (correlation of the sine wave with itself), positive time lag is at the right of the screen's center, and negative lag is at the left (Fig. 1b).

The autocorrelation function obtained in this way agrees with theory; that is, when the sine wave is exactly overlaid by itself (zero time lag) and multiplied in the time domain, the product has maximum area. This result is indicated by the peak at center screen in Fig. 1(b). As the sine wave is multiplied by slightly time-shifted versions of itself, the area of the product decreases. When the shift or lag is 25% of the sine-wave period ($T/4$ or 90° phase shift), the product has equal positive and negative areas, or zero total area. As the lag increases, the product area grows negatively to a peak at $T/2$, or 180° phase shift. The product area reaches a positive peak again at T .

Coping with unexpected results

If the frequency of the sine wave in Fig. 1(a) is increased to the value shown in Fig. 2(a), and the FFT-correlation process is applied again, the normalized autocorrelation function of Fig. 2(b) results. This curve looks different from the expected shape—a curve similar to that of Fig. 1(b). What happened can be explained by Figs. 3 and 4.

In Fig. 3, the process of sampling a waveform and the effects of this sampling are shown. Sampling may be thought of as a train of unity impulses separated in time by Δt (Fig. 3a). In the frequency domain, as shown in Fig. 3(b), the impulses become separated by $1/\Delta t$. The time interval, or window, over which sampling is done is represented by a square pulse like that of Fig. 3(c). The window's magnitude in the frequency domain is a $|\sin x/x|$ function as in Fig. 3(d).

The sampling interval in the time domain, Fig. 3(e), is the product of the impulse train and the square pulse. This operation corresponds to convolving the curves of Fig. 3(b) and 3(d) in the frequency domain to get Fig. 3(f). A sine wave (Fig. 3g) becomes two weighted impulses in the frequency domain, as in Fig. 3(h). The sine wave is sampled by multiplying the functions of Figs. 3(e) and 3(g), yielding the curve of Fig. 3(i). This operation corresponds to convolving the functions of Fig. 3(f) and 3(h), resulting in the curve in Fig. 3(j).

Frequency-domain sampling, as in Fig. 3(l), corresponds to the time-domain impulses shown in Fig. 3(k). Frequency-domain multiplication of the functions shown in Fig. 3(j) and 3(l) results in the FFT coefficients of Fig. 3(n). This multiplication corresponds to convolving the curves of Fig. 3(i) and 3(k) in the time domain, which yields the curve of Fig. 3(m).

Explaining cyclicity

The periodicity assumed by the FFT algorithm is best demonstrated by Fig. 3(j). Practically speaking, the two spikes nearest zero in this figure are sufficient to fully

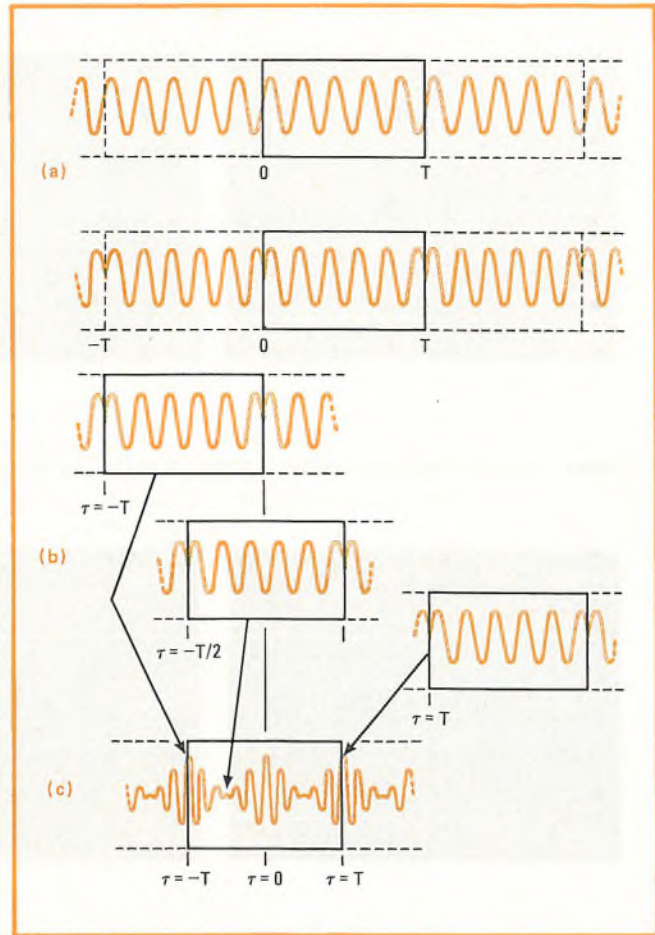

4. Periodicity. The fast Fourier transform assumes the sampled signal is periodic, but not in an obvious way. If the sampled waveform contains an integral number of cycles in the window (a), this assumed periodicity works as expected. But for a non-integer number of cycles in the window (b), a different curve is produced because of the assumption that the period is as long as the window. Autocorrelating this function yields a cyclic autocorrelation curve (c).

describe the sine wave's frequency-domain behavior. The paired spikes extending symmetrically beyond these first two are simply redundant information. Since all of the needed information is in the first two spikes, the FFT algorithm is generally restricted to mapping the n samples of Fig. 3(i) into n Fourier coefficients over the area indicated in Fig. 3(j).

The Fourier coefficients computed by the FFT are shown in Fig. 3(n). Unfortunately, the time-domain curve corresponding to this figure, as shown in Fig. 3(m), is not simply a sampled continuous sine wave. Because the FFT assumes a period T , the result shown in Fig. 3(m) has a period T that bears no relationship to the period of the sine wave. The periodicity assumed by the FFT is not based on the period of individual waveform cycles, but rather on sampling windows that contain chunks of the waveform to be transformed.

The result of assumed periodicity shown in Fig. 2 can be explained further by Fig. 4. Even when looking at a periodic function through a narrow window, as in Fig. 4(a), it is usually assumed the curve continues smoothly, with no discontinuity, in both directions. The FFT sees

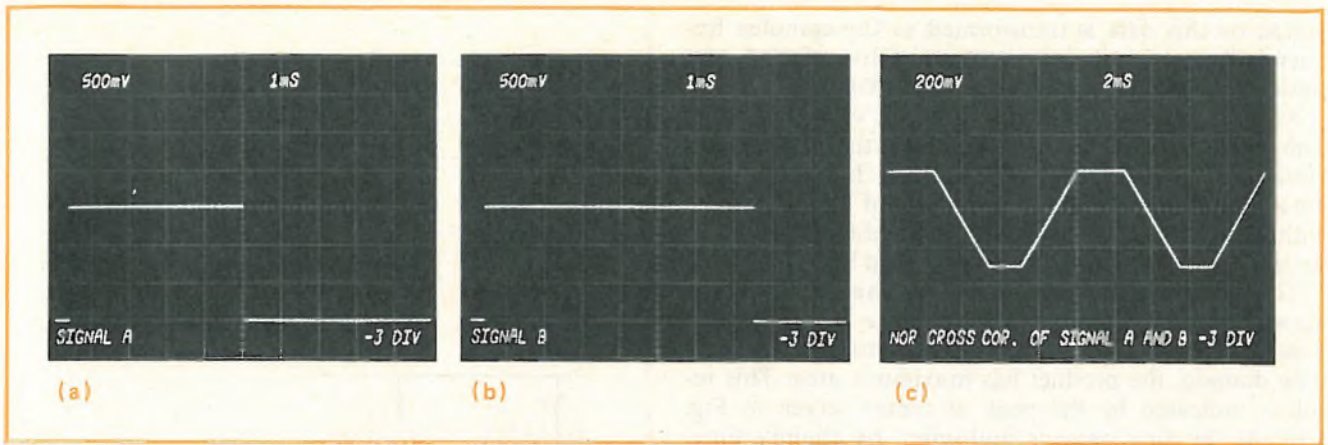

5. **Pulses.** Cross-correlating two pulses (a and b) by the FFT can produce a cyclic cross-correlation function.

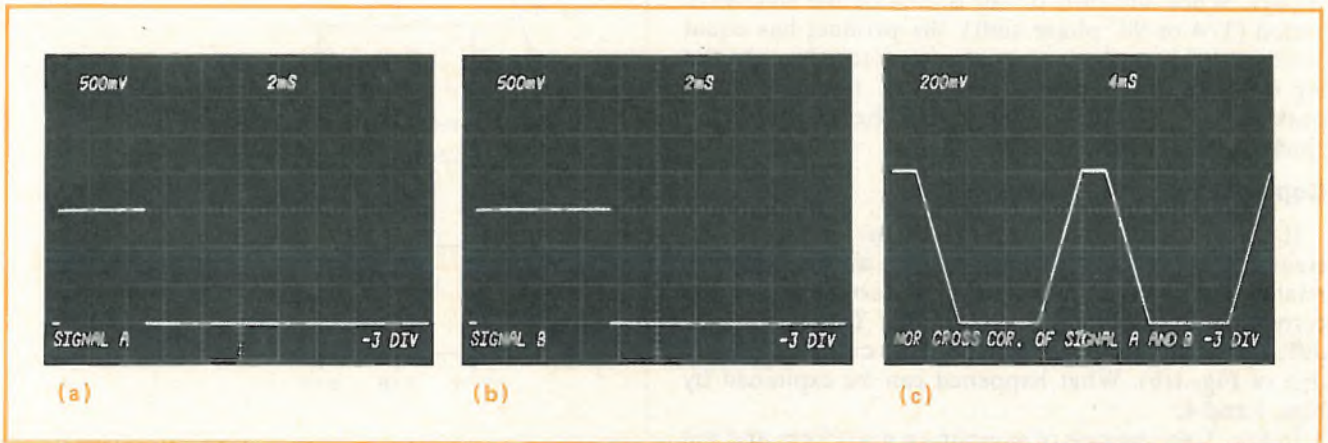

6. **Extending the window.** When the pulses in Fig. 5 are reacquired in windows of twice the length of the previous example (a and b), the period of the cyclic correlation function is increased (c), but the cyclic portion always stays in the window.

the sine wave of Fig. 1(a) in this manner.

The sine wave of Fig. 2(a) brings up a different view, however. This curve is not completing a cycle as it reaches the right-hand edge of the window—there is a non-integer number of cycles of the waveform in the window, as shown in Fig. 4(b). In Fig. 4(a), this periodicity has no effect because the window begins and ends at the same relative points on the sine wave. The situation is different in Fig. 4(b), where the window ends on a fractional portion of a sine-wave cycle.

In autocorrelating the waveform in Fig. 4(b), the resulting function can only be a maximum—the best waveform match—when the windows are lined up, and a minimum—a poor match—when the lag is half a window length. The autocorrelation function of Fig. 4(c), therefore, repeats with period T —cyclic correlation—and the same thing appears in the autocorrelation-by-FFT results in Fig. 2(b).

Cross-correlating pulses

The cross-correlation function of two square pulses should be a trapezoid-like curve. It is disturbing to autocorrelate a sine wave, expecting a curve like that of Fig. 1(b), only to come up with one like Fig. 2(b). It is no less disturbing to cross-correlate two square pulses and get a result like that of Fig. 5.

However, there is a hint of rescue in this result. The

unwanted duplicate portions of the correlation function of Fig. 5 may be pushed tighter against the window edges by including more zero-level samples in the pulse data. This can be accomplished by extending the windows to include more time and then adjusting the sampling rate to keep the total number of samples constant. The results for an attempt at this are shown in Fig. 6.

Including more zero-level samples with the pulses causes the unwanted portions of the cross-correlation function to shrink, but the desired portion at the center of the display shrinks by the same amount. Resolution is lost, and the function remains cyclic in the data window as long as there are pulse samples to correlate.

Trying a successful technique

If the number of zero-level samples before and after each pulse is equal to or more than the number of samples in a single window, a complete correlation function is displayed. However, the cost, in terms of resolution, is spending half the available samples on zeroes.

Fortunately, if the zero-level samples are added in a different manner, this price doesn't have to be paid. After the two pulses are sampled and stored in 512-element arrays, a 512-element array of zeroes is appended to each pulse array. After the two double-length arrays are formed, they are transformed to the frequency domain by a 1,024-point FFT. Complex conjugate multipli-

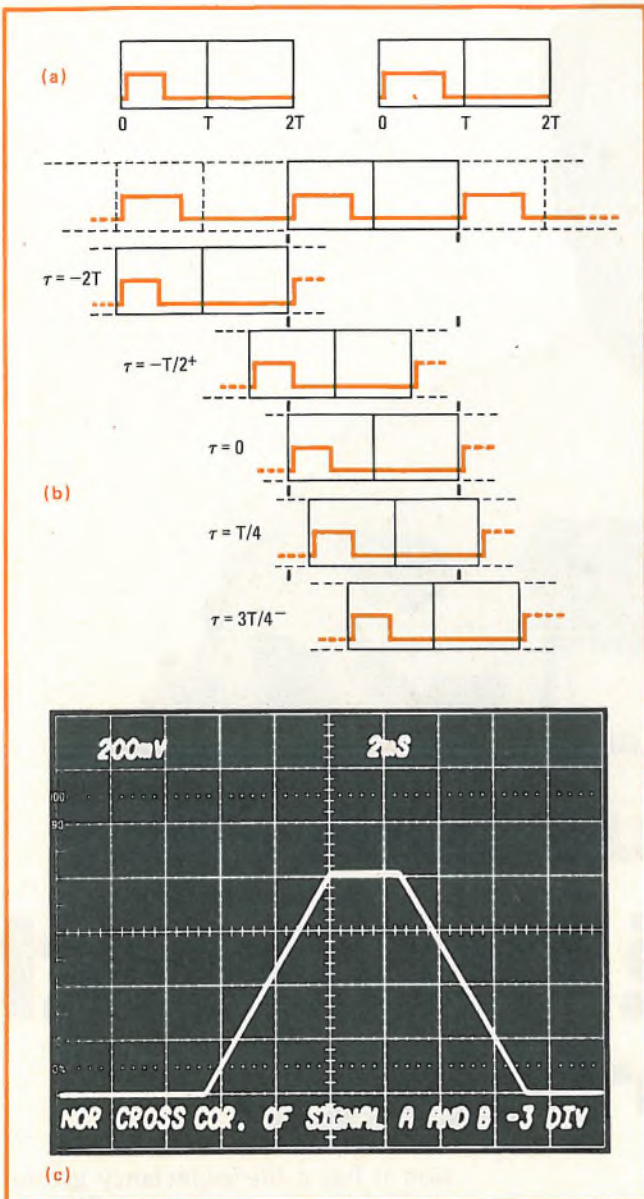

7. Noncyclic. When arrays of zeroes are appended to the pulse arrays before they are correlated by a double-length FFT, a noncyclic correlation function results.

cation is performed, and the result is transformed back to the time domain.

The resulting correlation function is contained in a double-length array, and the desired portions can be reconstructed in single-length arrays of the original 512-point length. As shown in the time-domain process displayed in Fig. 7, the single-length results are noncyclic in their entirety within the $-T$ to $+T$ window. The cross-correlation function determined by FFT correlation is shown in Fig. 7(c), and it matches theoretical results. In general, the method works for an n -element array by appending an n -element array of zeroes and transforming by a $2n$ -point FFT.

Adjusting for continuous functions

If the technique of appending zeroes is applied to autocorrelating the sine wave of Fig. 2(a) with the FFT, the results are as shown in Fig. 8(a). This result is certainly noncyclic in the window, but it is still not what is expected for a continuous sine wave.

Again, the signal that was autocorrelated was not an infinite-extent sine wave. First, it was windowed and sampled, then appending zeroes turned it into a pulsed sine wave. The autocorrelation of such a function does indeed give the function shown in Fig. 8(a).

For waveforms other than pulses, such as sine and square waves that are not zero outside the data window, the correlation function appears to be a triangularly windowed version of what the continuous-correlation integral produces. The FFT results can, however, be made to simulate the correlation-integral results by multiplying them with the inverse of a triangular function, the $n/(n - \tau)$ function shown in Fig. 8(b). The product of Fig. 8(a) and Fig. 8(b) is shown in Fig. 8(c). This result, which is still only an approximation, shows errors, especially at large lags, but it is certainly an improvement over earlier efforts.

For waveforms that are fully contained within the window, windowing and appending zeroes does not change the waveform. Therefore, FFT-correlation produces results identical to those obtained by evaluating the correlation integral. For infinite-extent signals, multiplying the FFT-correlation result by $n/(n - \tau)$ yields accurate results. □

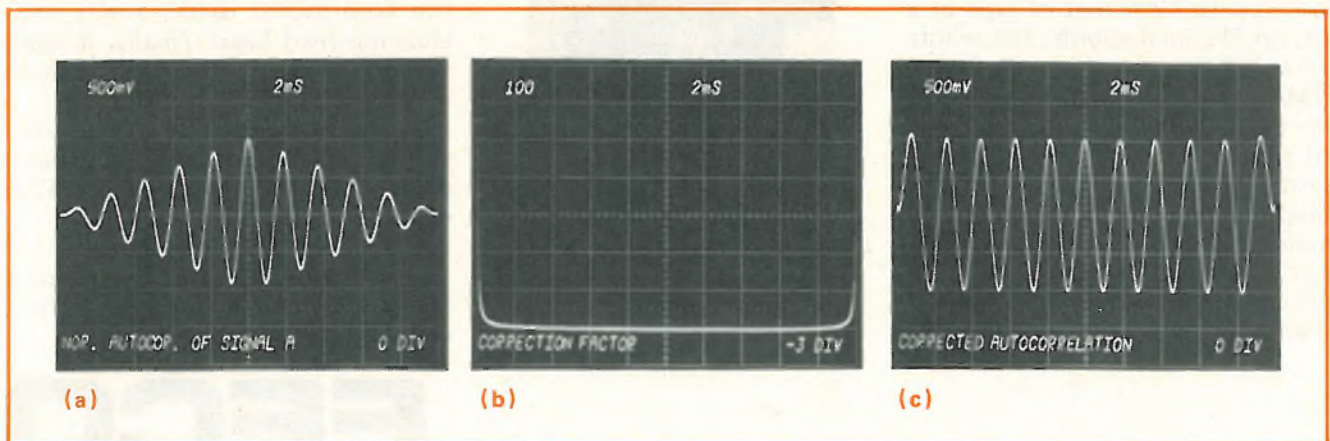

8. Correction. For continuous signals, appending zeroes causes a triangular-shaped correlation function (a). The correct result can be simulated by multiplying with the $(n/n - \tau)$ function (b). The product is correct except for small errors at the window edges.



Introducing 1200 feet of Step-Mate.

This is an ad about an unusual tape reader: Step-Mate. And about what makes it even more unusual than it already is: our new spooler.

With the spooler, Step-Mate can handle up to 1200 feet of tape at a time, on 7½-inch spools. The whole unit, only 8¾ inches high, fits in any RETMA rack. And, with a choice of three different connector types (edge card, ribbon, or subminiature 25-pin), it's exceptionally easy to interface.

Step-Mate, if you don't mind our reminding you, is our reader which reads one character per command pulse. And it does this at speeds up to 150 characters per second. In addition



tion it has a life expectancy greater (probably) than yours, with LEDs for never-fail light sources, error-free phototransistor read sensors, a gentle-on-the-tape barrel sprocket, a genuine step-motor drive, and a self-cleaning read head. Finally, it reads virtually all 5, 6, 7, and 8-level tapes without adjustment.

So there you are, a new tape reader without equal, at a price also without equal, \$905 with power supply, \$795 without.

Our brochure will tell you more. Write for it. Or, for instant action, call collect.

EECO

FOR READERS

1441 East Chestnut Avenue, Santa Ana, California 92701
Phone 714/835-6000

The lambda diode: a versatile negative-resistance device

Two-terminal unit with bistable switching characteristic can easily be integrated on same chip with other devices; potential applications include protection, switching, oscillator, and digital memory circuits

by Gota Kano, Hitoo Iwasa, Hiromitsu Takagi, and Iwao Teramoto, *Matsushita Electronics Corp., Takatsuki, Osaka, Japan*

□ Applications for negative-resistance devices like the unijunction transistor and silicon-controlled rectifier have in the past been limited to pulse and switching circuits. However, a new monolithic negative-resistance device, the lambda diode, demonstrates a remarkable range of versatility in new applications and also simplifies the design of many conventional circuits.

Despite its exotic name, the lambda diode is actually a simple two-terminal device, consisting of a pair of complementary depletion-mode junction-field-effect transistors. A valuable feature of the diode, which can be fabricated more easily than conventional negative-resistance devices, is that it can be integrated on a single chip or with bipolar and MOS devices on the same chip. What's more, unlike tunnel diodes, which are limited to a narrow negative-resistance range, lambda diodes can be produced with a wide range of characteristics.

The lambda device permits switching, memory, oscillator, and amplifier circuits to be fabricated in fairly simple forms. Four versions of the diode, the series MEL 4880 device, packed in a hermetic TO-18 metal can, are available at \$1.75 each in single quantities. Since the diode has a bistable switching characteristic that exhibits a virtual off state at fairly high voltages, it has many potential applications as an electronic fuse.

And because the device requires negligible standby

power in its off state, it can be an automatic battery-voltage monitor in such products as cameras, tape recorders, portable television receivers, and automobiles. For battery-checking circuits, a special device, the MEL 4881S, is supplied in an axial-lead plastic package at about 35 cents each in production quantities.

Two other possible applications are in oscillator circuits and dc-to-ac power-conversion circuits. For these uses, the lambda diode provides high efficiency and good temperature stability, as well as a high-level constant-amplitude output. Because a lambda diode corresponds to a single flip-flop circuit, a sine-wave oscillator can be obtained merely by connecting an LC tank circuit to the device.

But of all the potential applications for the lambda diode, digital integrated circuits may well offer the most promising future. Not only can lambda devices be configured in diode arrays, but they can also become part of the unit-cell structure in a static MOS memory.

Examining the lambda diode

The name for the device (Fig. 1a) is derived from its lambda-shaped I-V characteristic curve (Fig. 1b), and the symbol for graphic representation is indicated in Fig. 1(c). When a positive voltage is applied to the anode of the diode, the current through the device in-

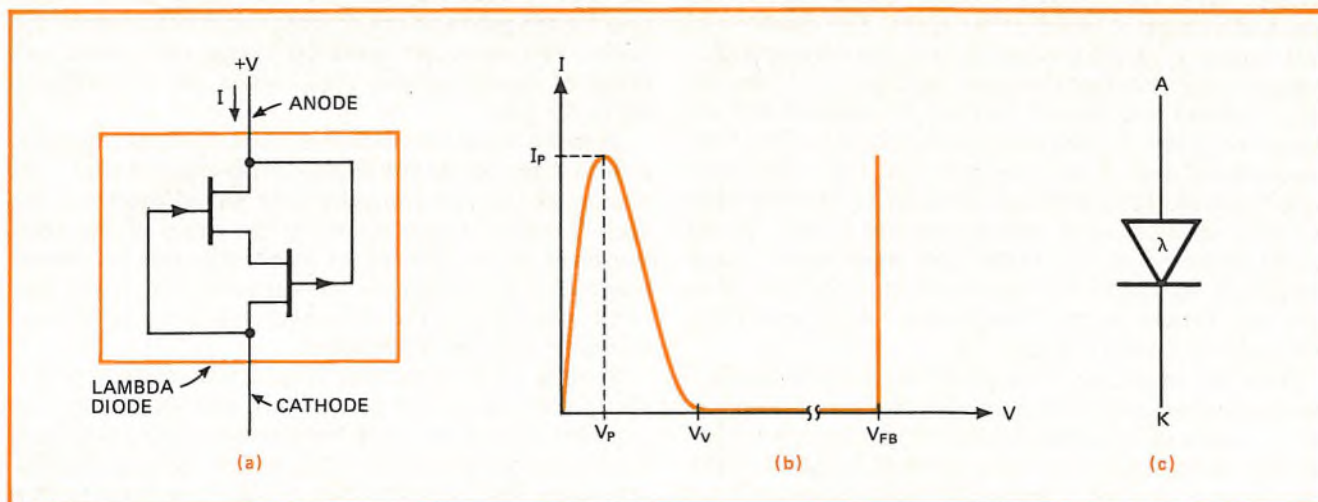

1. Introducing the lambda diode. Complementary JFETs are integrated on the same substrate and interconnected as shown in (a), forming a new monolithic device, called a lambda diode because of its lambda-shaped characteristic (b). Its graphic symbol is shown in (c).

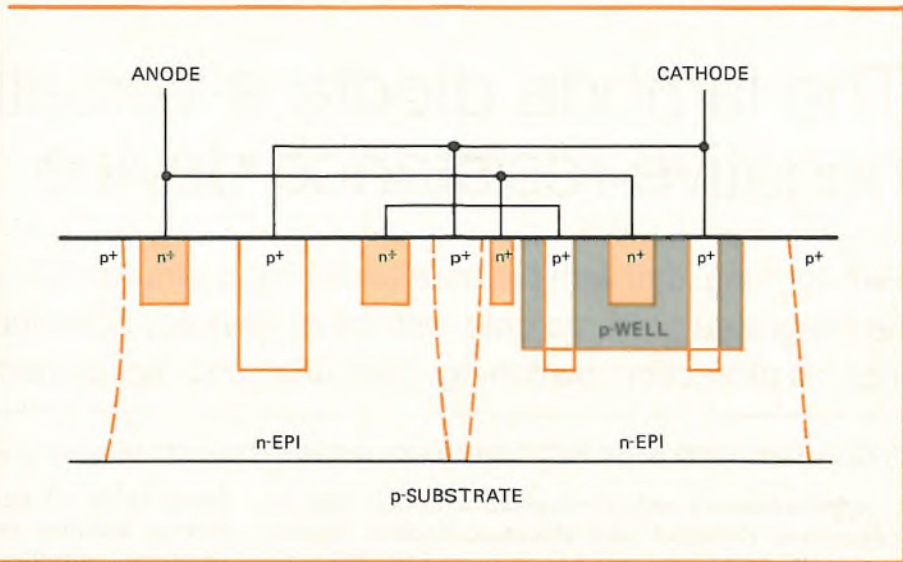
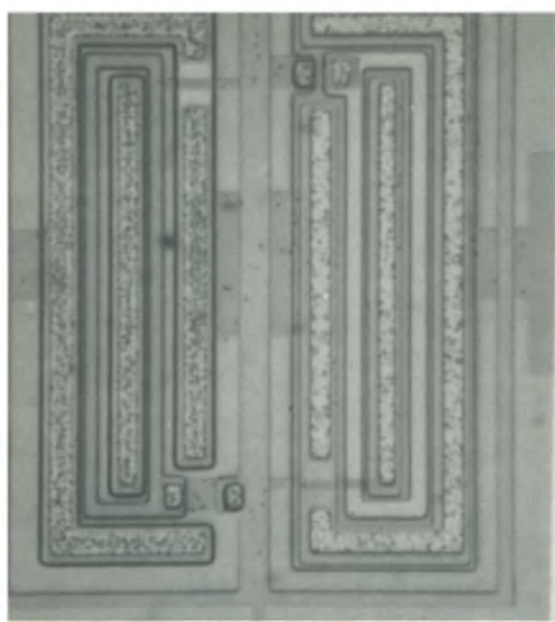

2. Substrate structure. Since the lambda diode is fabricated essentially with only three diffusion steps, its structure is simple, enabling it to be easily integrated with other devices on the same substrate. In the photo, the n-channel JFET is on the left, the p-channel JFET on the right.

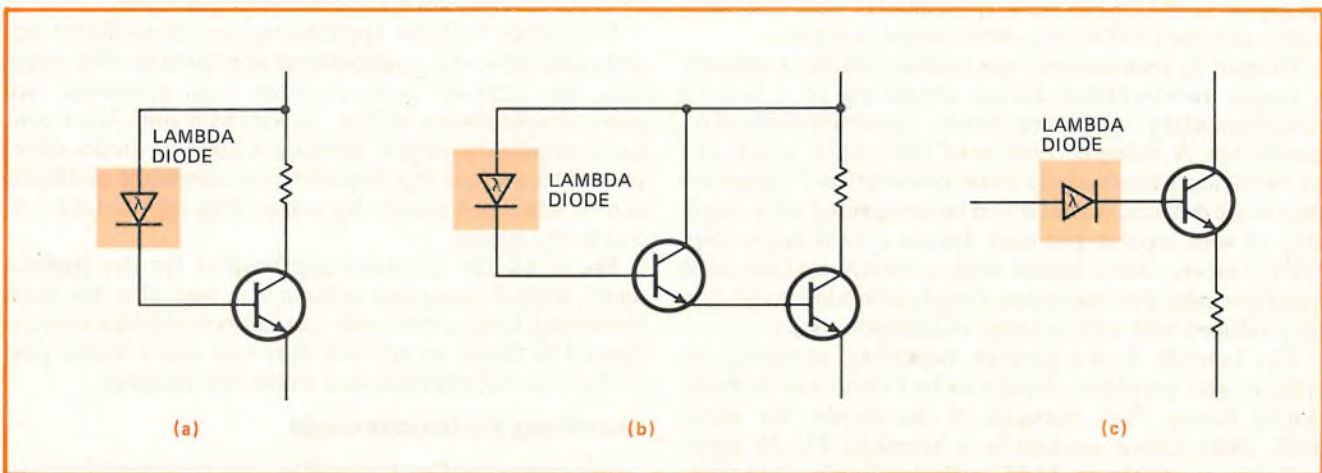

3. As a fuse. The lambda diode is an ideal protection device, because it exhibits a virtual off state at voltage levels on the order of 20 V. In (a), an overvoltage or overcurrent condition causes the diode to cut off, reducing transistor current practically to zero. The diode can even be operated well above its rated current or voltage levels, as indicated in (b) and (c), respectively.

creases until the applied voltage nearly equals the pinchoff voltage of either of the JFETs. The diode's current is now at its peak value, I_P , and the corresponding voltage level is called the peak voltage, V_P . If the applied voltage is increased further, the current will decrease until the applied voltage equals the sum of the pinchoff voltages of the two JFETs. At this valley voltage, V_V , both of the JFETs are in cutoff, so that the diode is in its off state, and leakage current is only in the nanoampere range. No matter how much more voltage is applied, the diode will remain off until the gate of either JFET breaks down. This ultimate voltage level is the forward breakdown voltage, V_{FB} .

Since the operating principle of the lambda diode is based on a functional integration of two complementary JFETs, rather than exotic physics, the device can be fabricated more easily than conventional negative-resistance devices. Figure 2 shows the basic structure of the lambda diode, which is fabricated in two epitaxial n-type isolation regions in p-type material. The n-channel

JFET is obtained with two diffusions—the p^+ diffusion for the gate and the n^+ diffusion for the source and drain. The same p^+ diffusion forms the source and drain of the p-channel JFET, while the n^+ diffusion forms the gate.

Between these two diffusion steps, there is a p diffusion to form the p-type well of the p-channel JFET. The sources of the two transistors are joined together, and each transistor's gate is tied to the drain of the other transistor by an aluminum interconnection. A photograph of a chip surface is also shown in Fig. 2. The left-hand transistor is the n-channel JFET, the right-hand transistor is the p-channel JFET.

Because of its structure, the lambda diode is particularly suitable for integration with bipolar circuits. For instance, an npn or a pnp transistor, or both, can easily be fabricated on the same chip without any extra diffusion steps. With the structure of Fig. 2, an extra vertical pnp transistor can be obtained by putting an n-channel JFET on a different island.

Similarly, a p-channel JFET on a different island produces an extra vertical npn transistor. The only additional process required, other than the standard bipolar-type diffusions, is the formation of the p-type well layer for the p-channel JFET. This diffusion must be as low as 2×10^{16} atoms per cubic centimeter in impurity concentration and as thin as 0.8 micrometer in layer thickness to obtain a practical pinchoff voltage for the p-channel JFET.

In the four versions of the series MEL 4880 lambda diode available commercially, forward breakdown voltage is either 15 or 20 v maximum, depending on the model, while reverse voltage is 2 v maximum for all the units. The different versions (A, B, C, and D) are obtained by controlling the diffusion depth for the gate region of the p-channel JFET.

Typically, the peak current ranges from 0.06 to 0.7 milliamperes, while valley or leakage current is in the order of a few nanoamperes. The result is that the peak-to-valley current ratio is around 10^5 or so. Values for the peak voltage range from 0.5 to 4 v, and for the valley voltage from 2.5 to 12 v.

Many potential applications are suggested for the lambda diode because it maintains a virtual off state at

a fairly high voltage. For example, it can serve as a two-terminal voltage-controlled electronic fuse that blocks current effectively. Compared to its counterpart, the thermal fuse, the lambda diode offers the attractive features of nondestructive operation, fast switching, and low-current protection.

Using the lambda diode

Three basic fuse-type applications are illustrated in Fig. 3. When the diode is connected as indicated in Fig. 3(a), an overload current will cause voltage across the device to increase until its cutoff state is reached, reducing the main line current through the power transistor practically to zero. Overvoltages in the main line will also produce the same result. Darlington configurations (Fig. 3b) enable the diode to work at currents of at least an ampere or so. To operate at voltages higher than the forward breakdown of the device, its anode terminal can be used as a sensing electrode (Fig. 3c).

The diode also provides a bistable switching function with almost zero standby power, enabling it to check voltage automatically. In Fig. 4(a), for instance, the device is the heart of an automatic battery monitor. When the battery voltage drops below the desired level, the

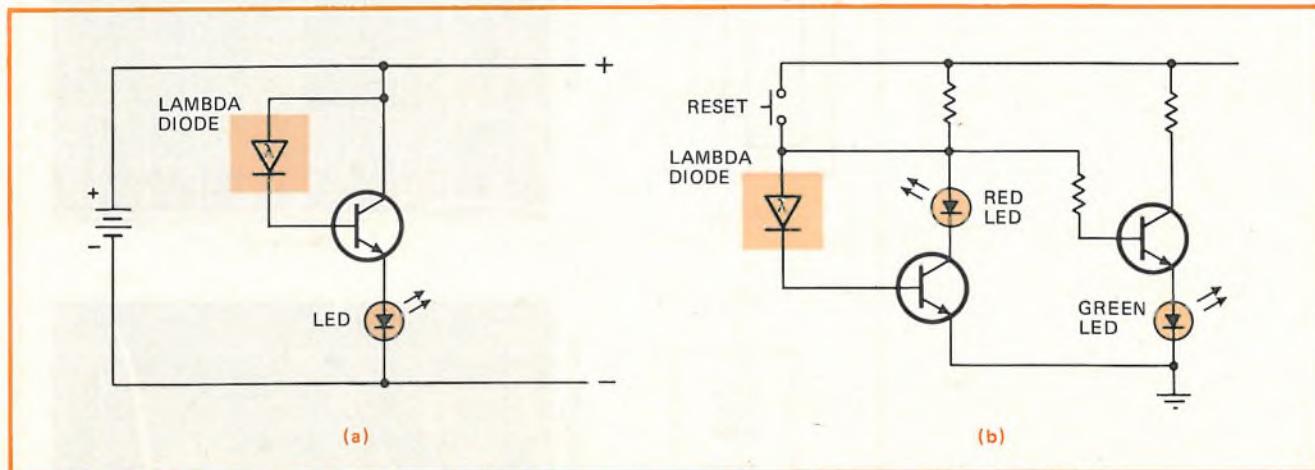

4. As a monitor. Automatic voltage and power-monitoring are also applications for the lambda diode, which offers a bistable characteristic and requires negligible standby power. Here, the device is the key component in a battery checker (a) and a power-failure indicator (b).

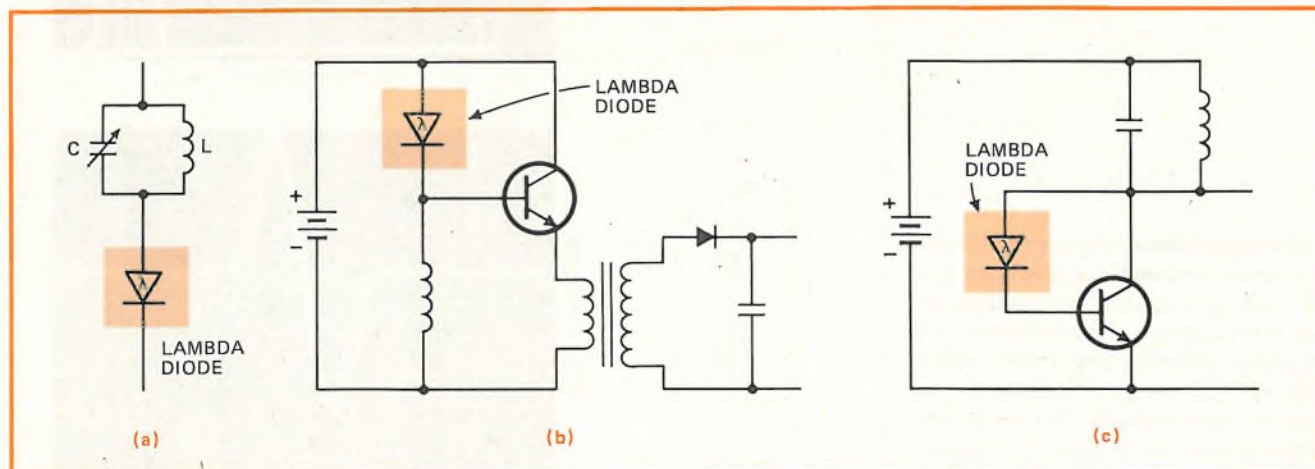

5. As an oscillator. Building a sine-wave oscillator (a) is easy with the lambda diode—it is merely connected in series with an LC tank circuit. Similarly, the device can be used for a voltage-step-up circuit (b) or for a blocking oscillator (c).

6. Other possibilities. Different circuit functions can be obtained by combining the lambda diode with a conventional integrated device on the same chip. An npn transistor (a) will amplify the diode's peak current. With a third JFET (b), low peak currents can be controlled more precisely. Two series-connected diodes will provide two current peaks, either separated (c) when polarity orientation is the same, or symmetrical (d) when polarity orientation is opposing.

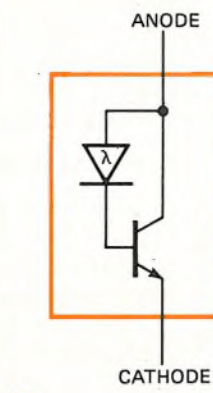

(a)

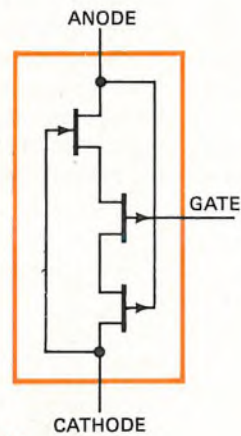
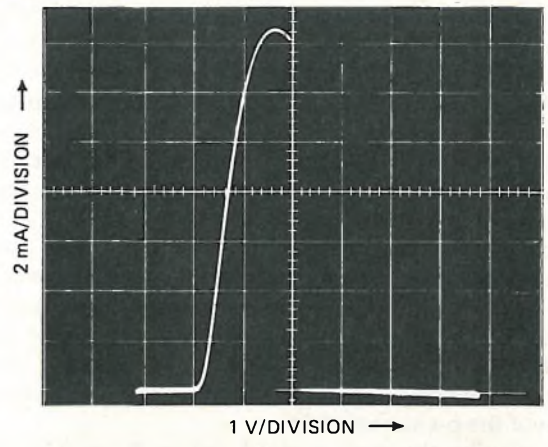

(b)

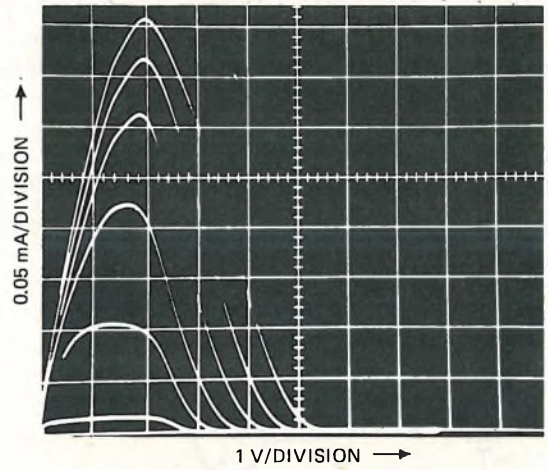

(c)

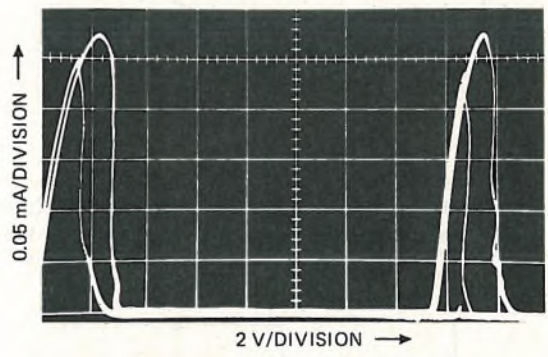

(d)

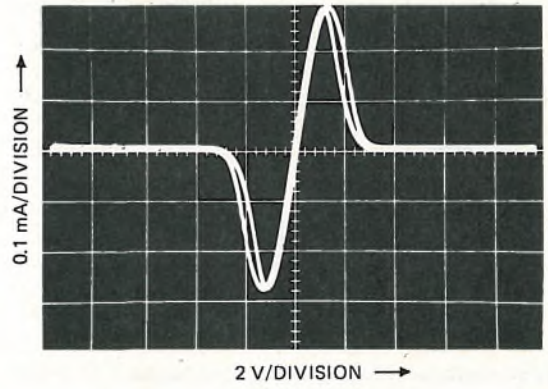

lambda diode automatically turns on, causing the light-emitting diode to become bright. As long as the battery voltage remains within its normal range, the monitoring circuit will not draw any power at all because of the virtual off state of the lambda diode.

The model MEL 4881S device, which is the plastic version intended for commercial battery-checking applications, provides maximum forward and reverse voltage ratings of 20 and 2 v, respectively. It has a maximum peak voltage of 2 v, a maximum valley voltage of 4.5 v, a maximum peak current of 0.5 mA, and a maximum valley current of 50 nA.

Again, because of its bistable characteristic and zero standby power, the lambda diode is also useful in power-failure indicator circuits (Fig. 4b). Normally, the lambda diode is off, and the green LED is on. If a power failure occurs, the lambda diode turns on, causing the red LED to indicate. The red light will remain on until the reset switch is pushed. This sort of power-failure indicator will find application in such equipment as clock radios, computer systems, and security systems for the chemical industry.

To build a sinusoidal oscillator with the lambda diode, all that's needed is a simple LC tank circuit, as shown in Fig. 5(a). When the diode is biased in its negative-resistance region, the output of this circuit is a well-defined sine-wave oscillation occurring at a frequency of $1/[2\pi(LC)^{1/2}]$.

The output amplitude will always be twice the applied voltage because the oscillation energy released to the diode from the resonant tank circuit will hardly be lost, since the diode sustains an almost infinite impedance in its valley region. The output amplitude, therefore, will remain constant even when the capacitance is varied to change the oscillation frequency. The applied dc bias can be used to control the amplitude level. Additionally, the temperature stability of the oscillation is excellent because of the diode's inherently small temperature coefficient of negative resistance.

For these very reasons, the lambda diode performs well for dc-to-ac conversion, or for dc-voltage step-up circuits, such as the one illustrated in Fig. 5(b). A blocking oscillator (Fig. 5c) can also be realized with the lambda diode. In contrast to conventional transistor circuits, this oscillator does not require inductive coupling, permitting fast rise and fall times to be achieved.

Integrating it with other devices

As indicated earlier, the lambda diode can be fabricated with other integrated devices on the same substrate. This integration capability opens up a number of interesting possibilities. For example, when a lambda diode is connected between the collector and base of an npn transistor, as shown in Fig. 6(a), the peak current of the diode is multiplied by the current-amplification factor of the transistor. A typical I-V characteristic of this amplified lambda diode is also shown in the figure. In this example, the peak current reaches 15 mA, a valuable level for applications requiring a high current, such as driving a LED directly.

A third JFET, connected as indicated in Fig. 6(b), results in a novel three-terminal device—the lambda tran-

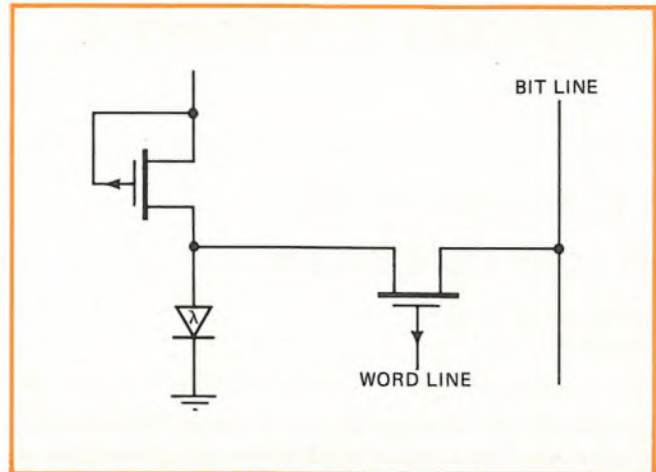

7. As a memory cell. If the lambda diode is fabricated with complementary-MOSFETs, a complete unit cell for a static C-MOS memory can be built with only four transistors, rather than the six normally required for the conventional C-MOS memory cell. The size of a memory chip, therefore, can be reduced by about two thirds.

sistor. As indicated in the I-V curves, the gate terminal of the middle JFET determines the value of the peak current. This configuration permits more control over the lower values of peak current than the lambda diode alone allows.

Two lambda diodes connected in series with the same polarity (Fig. 6c) produce two current peaks at two voltages greater than zero. The voltage of the second peak is a function of the breakdown of the gate of the upper diode plus the peak voltage of the lower diode. On the other hand, two connected in series with reverse polarity (Fig. 6d) give two voltage peaks, symmetrically located on either side of zero.

Designing memories

In fabricating digital ICs, not only can lambda devices be configured in diode arrays, they also can be part of the unit-cell structure for a static MOS memory. Their properties make possible high memory densities.

Since the lambda diode operates as a flip-flop, which is a cascade connection of two depletion-mode FETs, only one bit line is needed to activate the memory cell. Two bit lines, however, are generally required for a conventional flip-flop, since it is a parallel connection of two transistors.

What's more, if the lambda diode is fabricated as a complementary pair of depletion-mode MOSFETs, a new C-MOS static memory cell (Fig. 7) can be made with only four transistors, in contrast to the six transistors needed for the conventional C-MOS memory cell. This possibility means that the chip size of a C-MOS static memory may be reduced by roughly two thirds.

The switching speed of the lambda diode is predominantly determined by device capacitance. To increase the speed, the geometry of the complementary JFETs must be reduced. Even with minimal device geometry, the highest-speed performance probably achievable will be several tens of megahertz for oscillation applications and several tens of nanoseconds for switching applications. □

LEDs replace CRT in solid-state scope

by Forrest M. Mims, III
Albuquerque, N. M.

Thanks to the availability of low-cost light-emitting diodes, an all-solid-state oscilloscope can now be assembled. Figure 1 is the circuit diagram for a prototype that replaces the conventional CRT with a 10-by-10 array of GaAsP red LEDs. Although resolution of the 100-element screen is poor, pulses, square waves, triangle waves, and ramps are easily identifiable.

Input signals to the scope are ac- or dc-coupled to a 536 FET-input operational amplifier. The op amp is connected directly to 10 vertical columns of LEDs in series. The LEDs in each column are paired with individual resistors connected in series to form a voltage divider. The result is that each column of LEDs is a voltage sensor with a bar-graph-style readout.

The 10 LED columns are sequentially scanned by a sweep circuit composed of a 555 clock, a 7490 decade counter, and a 7441 one-of-10 decoder. A single NAND gate provides an optional automatic trigger feature for synchronizing the sweep with incoming waveforms from the op amp.

A pocket-sized version of the scope, measuring 4 by 6 by 13 centimeters, has front-panel controls that include vertical voltage sensitivity, horizontal time sweep, trigger, ac-dc, and power. The voltage sensitivity is adjustable from 0.01 volt per division to 1.0 v/division, where each LED is a division. The sweep is adjustable from 20 microseconds/division to 1.0 second/division. The amplifier and sweep circuits consume a maximum of 54 milliwatts, and the display consumes a maximum of 308 mW when all of the LEDs are on.

Figure 2 is a photograph of the scope's LED screen. The prototype scope shows only half of a bipolar waveform, and the input connections must be reversed to view the other half. □

Engineer's Notebook is a regular feature in Electronics. We invite readers to submit original design shortcuts, calculation aids, measurement and test techniques, and other ideas for saving engineering time or cost. We'll pay \$50 for each item published.

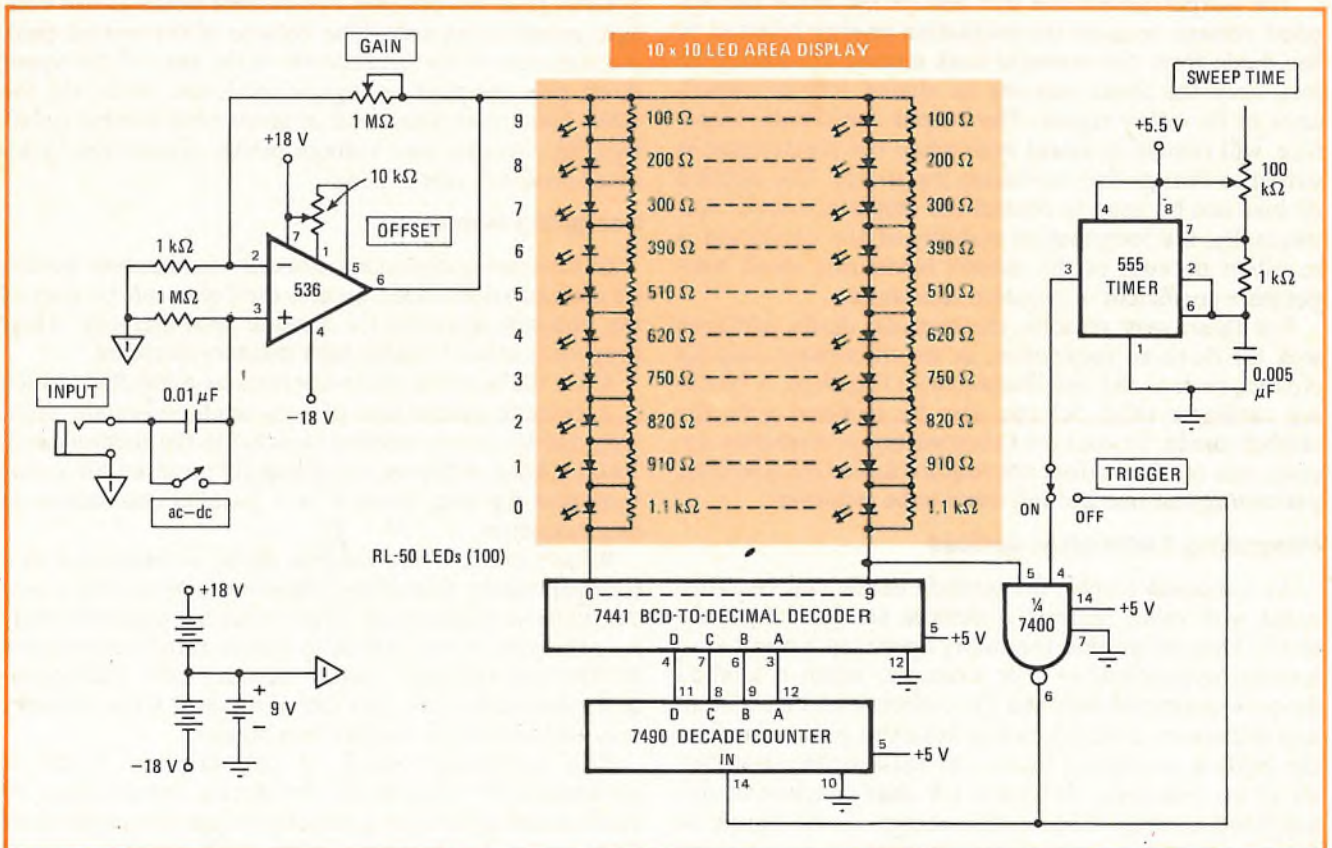

1. Solid-state scope. Waveforms are displayed on 10-by-10 array of LEDs in this scope. Incoming signal is amplified and applied to all 10 columns of LEDs, and decoder completes circuit through each column in sequence to provide scanning. Display shows only the positive half of an ac waveform. The pattern is like a bar graph in that all lights below top of waveform are lighted; thus in a ramp, the bottom two LEDs might be lit in the first column, the bottom three LEDs in the second column, the bottom four in the next column, and so forth.

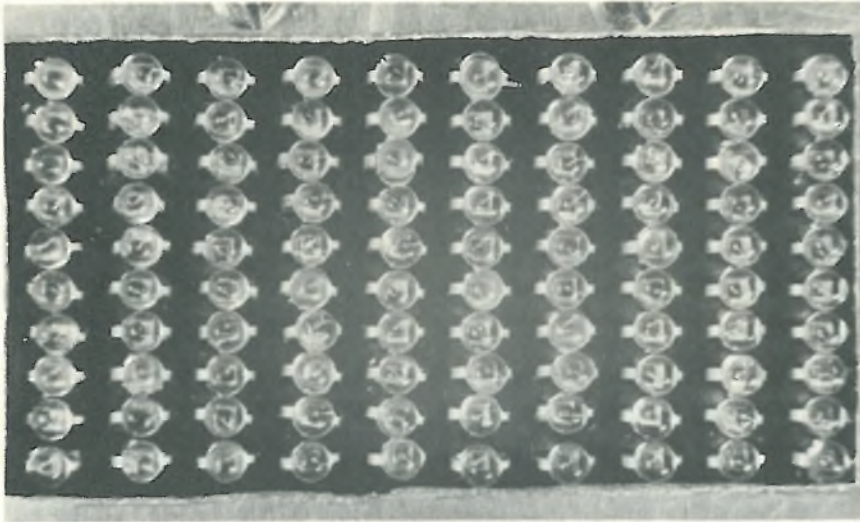

2. LED array. Light-emitting diodes are mounted on perforated board painted black to provide good contrast. Holes in board are 0.1 inch apart, so 10-by-10 array occupies area of approximately 1 by 2 in. Resistors for voltage divider are mounted right behind the LEDs, allowing compact packaging. A second board of similar size, stacked behind the LED board, holds the amplifier and scanning circuitry. Entire scope, including batteries, is about the size of a pocket calculator. Author built prototype for less than \$40.

Chart recorder plots total of loads in several circuits

by L.W. Herring
LWHA, Dallas, Texas

Occasionally it is desirable to record the load requirements of an electrical distribution system or the total usage of a number of communications channels during some period of time. In determining ac distribution loads, a recording wattmeter can log the data, but plotting the total power consumption for several pieces of equipment fed from separate power mains or the traffic through a number of communications channels is more

difficult. Still, if supervisory signals like pilot-light voltages are used to generate current in field-effect transistors, it is easy to develop a signal that can be plotted with any available chart recorder.

As shown in the figure, the currents from FETs used as constant-current sources are summed in a fixed resistor to obtain a voltage signal that indicates total usage rate. To provide equal weighting for each input, the current sources can be equal, or they can be set to various values to provide a scaling effect on the output voltage. Since the FETs are used as current sources, the input signals can be any convenient ac or dc voltages between 5 and 25 volts. The input signals are fed to the FETs through diodes that rectify ac and also protect against negative dc.

As an example, it might be desirable to plot the daily demand curve for five heat-treating furnaces. Two of

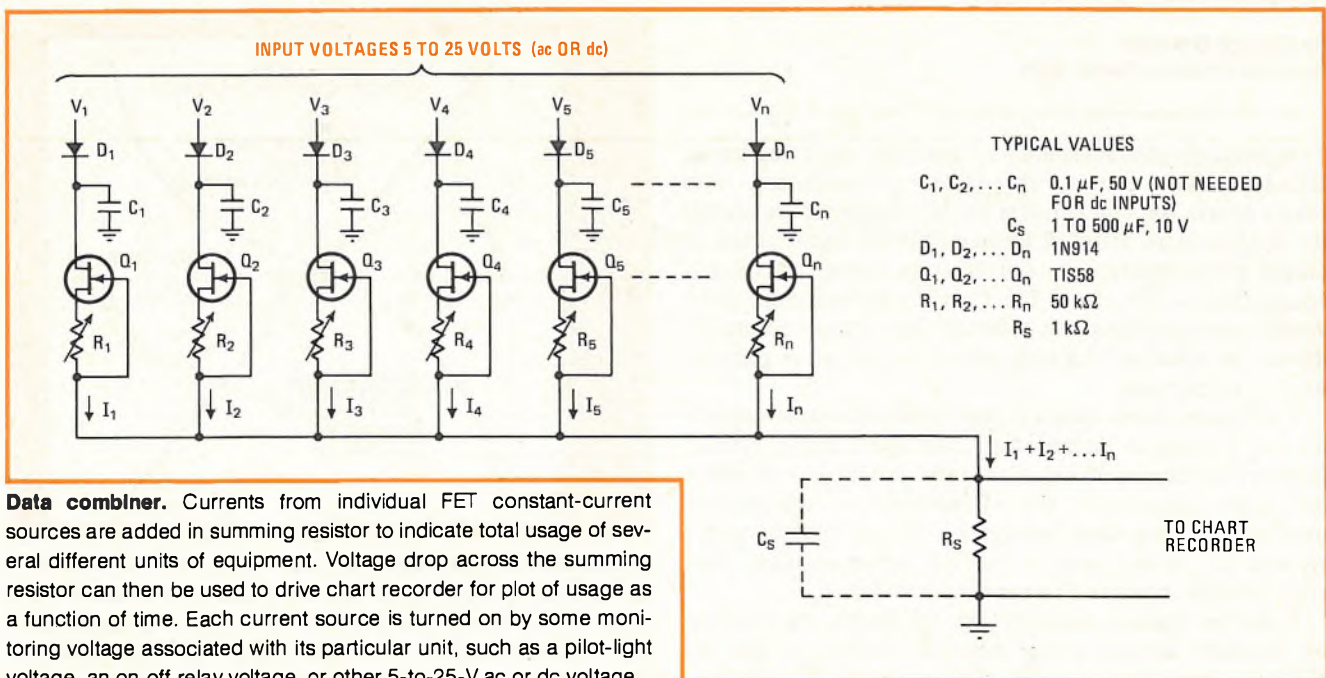

the furnaces are 100-kilowatt/three-phase units, one is 50-kw/single-phase, and the remaining two are 25-kw/single-phase. All of the furnaces have 24-v dc indicator lamps that light on a control console when the furnaces are operating. The lamp voltages can excite FET constant-current sources that are proportional to the power ratings of their respective furnaces. The sum of these currents, passing through a common fixed resistor, produces a voltage that indicates the total power to the furnaces. This voltage drives the pen on the chart recorder.

The first FET, Q_1 , is connected to the 24-v pilot light voltage for the first 25-kw furnace. Resistor R_1 is adjusted so that Q_1 delivers 100 microamperes to resistor R_S . The second 25-kw furnace pilot voltage is connected to FET Q_2 , and R_2 is also adjusted for 100 μA into R_S . A resulting voltage of 0.1 v is produced across summing resistor R_S when either one of the 25-kw furnaces is on, and 0.2 v is produced when both are on.

The 50-kw pilot lead excites FET Q_3 , which is set by means of R_3 to deliver 200 μA to R_S . Operation of the 50-kw furnace produces twice the voltage drop across R_S that either 25-kw unit does. Finally, the two 100-kw furnaces are connected to FETs Q_4 and Q_5 , each adjusted to source 400 μA .

Each 25 kw of furnace load is represented by a constant current of 100 μA , which produces 0.1 v across summing resistor R_S . If the total current is 700 μA , the voltage is 0.7 v, indicating a 175-kw load, and this load can be recorded on any voltage-sensitive chart recorder.

This technique can also be used to plot the number of

telephone lines in use at any time in an office or plant to determine whether or not a business is making effective use of its telephone service. In this example, the 10-v ac voltages that light line-button lamps are the input signals. The ac voltages are rectified by diodes D_1 , D_2 , and so forth before reaching the FETs. Each current source is adjusted for 100 μA so that whenever a line is in use, the voltage across the 1-kilohm summing resistor R_S increases by 0.1 v.

Any general-purpose depletion-mode junction FET with I_{DSS} of 1 to 15 milliamperes can be used for the FETs; the TIS58 has yielded excellent results. Dissipation and voltages are not critical if the input levels are kept under 30 v. A 1-kilohm value of R_S was used for convenience, but its resistance can be scaled along with the current sources to provide any desired output voltages. The maximum output voltage should not exceed 50% of the lowest input voltage. For example, if the inputs are 5, 5, 12, and 24 v, respectively, the maximum output voltage should not exceed 2.5 v. The standard input voltage for many chart recorders is 1 v, so that level is a desirable maximum output from this circuit.

Since the input voltages do not have to all be alike, 24-v dc relay levels, 5-v TTL levels, and 12-v ac signals can all be used as inputs in the same circuit. The input capacitors C_1 - C_8 are required only for ac inputs, but diodes D_1 - D_8 should be used with both ac and dc inputs to protect the FETs. On plots requiring long time periods with inputs that change rapidly, a capacitor C_S may be connected across summing resistor R_S to smooth the graph. □

Mixed dielectrics improve capacitor stability

by George Breindel
Ross Laboratories Inc., Seattle, Wash.

Temperature characteristics of circuits like integrators, RC-dependent timers, free-running oscillators, and many others depend directly on the temperature stability of capacitors. It's well known that the capacitance of either polycarbonate or polystyrene capacitors over a range from $-55^\circ C$ to $+125^\circ C$ often varies more than system specifications can tolerate. But improved stability can be achieved if a polycarbonate is used in parallel with a polystyrene.

The figure shows that a typical polycarbonate capacitor has a positive temperature coefficient and a typical polystyrene capacitor has a negative coefficient of about the same magnitude. If a 1-microfarad capacitor is needed in a long-term integrator, then a $0.47\text{-}\mu F$ polystyrene in parallel with a $0.47\text{-}\mu F$ polycarbonate provides greatly improved temperature stability.

A further gain in stability can sometimes be realized by carefully matching the capacitor values to the respective temperature curves. For example, if a particu-

lar polystyrene capacitor has twice the stability of a particular polycarbonate, a $0.68\text{-}\mu F$ polystyrene can be used in parallel with a $0.33\text{-}\mu F$ polycarbonate to get 1 μF with a flatter temperature curve. □

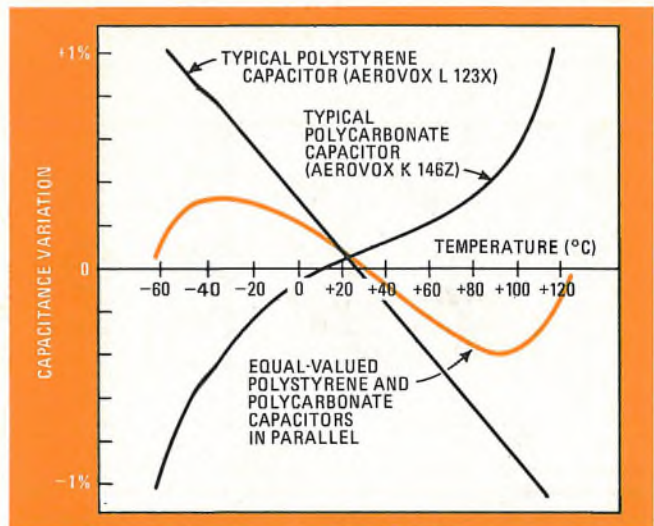

Temperature compensation. Because a polycarbonate capacitor's temperature coefficient is positive and a polystyrene capacitor's is negative, the two in parallel do better than either one alone at providing temperature stability in capacitance-dependent circuits such as RC tuners, oscillators, and integrators.

Introducing a memory system so small it'll shake the memory market to its very core.

Presenting the world's smallest OEM memory system.
3.93 x 6.3 x .5 inches.

MOS RAM 410 static memory system.

Static means easy to use too...and it's available
right now.

4k by 8, 9, 10 bits, and a voltage input of +5v only.

If you can't use it without some customizing, we can
handle that, too.

And we can make a custom system for you from scratch
to fit your specs.

For a fact-packed pitch
write Memory Systems Divi-
sion, National Semiconductor
Corp. 8080 Fuerstenfeldbruck,
Industriestrasse 10, West
Germany.



National
memory systems

TTL signals can make a pretty scope display

Often, a TTL signal is brought out to a BNC-type jack or test point for display on an oscilloscope. But when you do it, **beware of connecting the bare output of the TTL gate or inverter directly to the test jack**—the displayed waveform is truly horrible to behold, says Robert A. Dougherty of RAD Technical Consulting in Dunedin, Fla. The low-impedance output of the TTL device simply can't be used to drive the high-impedance input of the scope without dire consequences, including a high mortality rate for the TTL driver. A quick and effective solution is to insert a back-matching resistor of 80 to 100 ohms in series with and close to the output of the TTL device.

Take the trouble out of testing varied items

Sometimes you have to **alter ranges and modes on all of the instruments in a test system each time the unit under test is changed**. To defend against that contingency, Rohde & Schwarz, Fairfield, N.J., has produced the model PCL card reader. In calibration and repair departments or final inspection stations, for example, this \$1,900 instrument offers a low-cost alternative to programable calculators in systems of up to 10 instruments. And it works on the IEEE standard interface bus. Up to 32 8-bit commands can be stored on each program punch-card.

What's good about I²L for digital circuits . . .

If you've been wondering **why all the shouting about that new bipolar circuit technique called integrated injection logic**, just look at the dozens of different I²L programs that the semiconductor industry is into. The list is longer than your arm, and it includes both pure digital and mixed digital/linear combinations.

In the digital area, of course, there are microprocessors of all varieties—from single-chip, low-power cheapies to high-performance, bit-slice computer circuits. Next there are both very fast and not-so-fast 1,024-bit and 4,096-bit I²L memories, plus watches, counters, timers, and all sorts of random control logic (like telephone switching in central offices and tone generators in users' handsets), plus circuits for organs, clocks, pinball machines, electronic games, and electric toys. Then come the strictly digital TV chips, such as remote tuners, frame grabbers, delay-line video circuits for remote picture display, on-screen numerical display decoders and drivers, I²L video tape control and buffer circuits, and **finally there are the high-speed calculator chips and computer interface circuits**, like bus drivers, managers, decoders, and any number of input/output interface circuits.

. . . and for digital/linear chips, too

In the digital/linear I²L developments, there are all those automobile circuits: I²L microprocessors for controlling I²L anti-skid modules, engine monitors, electronic spark controls, fuel injection circuits, speed and cruise controls, odometer logic and display modules, even digital dashboards and window-power circuits.

Then there are I²L versions of the logic for digital-to-analog and analog-to-digital converters, **digital voltmeter circuits, appliance timers and controls, all kinds of audio and video linears**, like I²L i-f tuners, video deflection circuits, chroma separation circuits, amplifiers, FET-input fm detectors, and so on and on.

—Laurence Altman

Optimized Performance



The ALMA 760 is the only moderately priced,* full capability RAM tester.

It completely tests MOS, TTL and ECL RAM's. The only thing you change are low cost limit and adaptor boards.

Features: A powerful pattern generator, device clock timing generators, device bias supplies, high performance drivers, comparators, programmable reference level supplies . . . and, because of its versatile test deck, the ALMA 760 readily interfaces with automatic handlers and probers. Plug-in options include a DC parametric test unit, a variable program panel, and a classification unit for device sorting.

Production testing. Easy to use, low-cost, plug-in program boards contain all set up values for production testing. The 760 can be operated by non-technical personnel with a minimum of training. A classification unit option provides convenient multi-limit testing and RAM device sorting. And rapid changeover from one type of device to another is made possible by a plug-in device fixture board.

Engineering evaluation. The 760's built-in flexibility includes programmable MOS, TTL or ECL peaking, to achieve maximum pulse fidelity for all types of RAM's. The variable program panel option permits adjustable control of all timing and voltage parameters . . . a convenient and powerful diagnostic tool.

Optimized cost and performance. The ALMA 760 has been carefully designed to solve your memory test problems with the optimum trade-off between low cost and high performance. Circle the number below and let us send you our Model 760 brochure. *Under \$25,000! (U.S. price only)

If it tests IC's, we probably make it. The ALMA 550 tests both standard and complex linear IC's. The ALMA 480B tests most digital IC's, with 700 free test programs. The ALMA 380C is our low-cost, dedicated digital IC tester.

ALMA

Division of Develco, Inc.
530 Loggie Ave.
Mountain View, CA 94043
(415) 919-3903

Circle 115 on reader service card

What Is The Fastest 4K MOS RAM Access Time You've Ever Heard of?

At NEC, we've got it down to

From NEC, Japan's largest manufacturer of semi-conductors, comes a new series of 4K-bit MOS RAMs with access times as fast as an unheard-of 150ns. To help you design the next generation of micro, mini, medium as well as large scale hardware.

Your access to these super fast access RAMs is equally fast: they're available from stock. Now. But fast access and avail-

150
ns.

ability are just part of the story. A product bearing the NEC name comes

from Japan's trusted manufacturer with production and inspection standards much tougher than are usual in the industry. Plus: you get a choice of equally trustworthy bipolar memories also available from stock, and a 1K-bit MOS RAM scheduled for late '75 delivery.

Spend a few nanoseconds to get full information on NEC memories.

4096 x 1 dynamic NMOS RAM family*				
Model No.	Max. Access Time (ns)	Min. Read or Write Cycle (ns)	Min. RMW Cycle (ns)	Refresh Time (ms)
μ PD411D-3	150	380	470	2
μ PD411D-2	200	400	520	2
μ PD411D-1	250	470	640	2
μ PD411D	300	470	650	2
μ PD411D-E	350	800	960	1

1024 x 1 high speed static NMOS RAM** (Tentative data)			
Model No.	Max. Access Time (ns)	Min. Read or Write Cycle (ns)	Min. RMW Cycle (ns)
μ PD405D	85	190	270

Bipolar memories and associated products				
Model No.	Family	Word x Bit	Output	Compatible with
μ PB2089D	TTL RAM	16 x 4	Open collector	SN7489
μ PB2289D	"	"	"	3101A
μ PB2200D	"	256 x 1	Three-state	SN74S200
μ PB2202D	"	"	"	SN74S201
μ PB2206D	"	"	Open collector	SN74S206
μ PB10142D	ECL RAM	64 x 1	ECL	MC10142
μ PB10148D	"	"	"	MC10148
μ PB10144D	"	256 x 1	"	MC10144
μ PB403D	TTL PROM	256 x 4	Open collector	IM5603
μ PB246D	Quad driver for MOS memory			SN75365

*Completely compatible with the 2107B series.
**Completely compatible with the 2105 series.

NEC
Nippon Electric Co., Ltd.
Tokyo, Japan

[Europe]

NEC Electronics (Europe) GmbH
4000 Düsseldorf, Immermannstrasse 22
Tel. Düsseldorf 357088, 357089, 357080
Telex: NECD 8587419

[Japan]

Nippon Electric Company, Limited
33-1, Shiba-Gochome, Minato-ku, Tokyo 108, Japan
Tel. Tokyo 454-1111 Telex: NECTOK A J22686
Cable: "MICROPHONE TOKYO"

[U.S.A.]

NEC Microcomputers Inc.
5 Militia Drive Lexington, Ma. 02173
Tel. 617-862-6410

IC compresses, expands analog signals

Bipolar linear chip replaces discrete components as communications compandor; includes reference voltage, converters, high-gain op amp

by Bernard Cole, San Francisco bureau manager

It usually takes 20 to 30 transistors, as many capacitors, and about 100 resistors to build a compandor system, which compresses or expands the analog signals used in telecommunications trunk lines.

A monolithic equivalent of such a system has been developed by Exar Integrated Systems Inc. The bipolar linear IC, designated the XR-2216, is intended to compress or expand the dynamic range of speech or other kinds of analog signals—and it costs about three to five times less than a discrete system.

In a speech transmission system, the dynamic range of the input signal is first compressed at the transmitting end; then transmitted through the system; and finally expanded back to the original amplitude at the receiving end. Thus, the compressor and the expander sections of a compandor system have reciprocal functions. In a bidirectional transmission system, there is a compandor at each end of the line: one compresses the outgoing signal, and the other expands the incoming signal.

Costs less. What Exar has done, says vice president Alan B. Grebene, is replace all the discrete circuits with one 105-by-88-mil monolithic chip, which will cost \$1 to \$1.25 each in 100,000 quantities instead of the \$3 to \$5 that a system of discrete components would cost. Price of the XR-2216 for 100-lots is \$4.80 each; for 25-99, \$5.60; and for 1-24, \$6.40.

The monolithic circuit consists of four basic blocks: an internal voltage reference; an ac/dc converter which transforms an ac signal input into a dc current level; an imped-

ance converter whose level is a function of a dc control signal; and a high-gain operational amplifier.

When the XR-2216 is connected as a compressor, its output change is 1 decibel for every 2-dB change in input amplitude. However, the output range can be adjusted to -37 to -7 dBm for input signals of 60-dB dynamic range.

As an expander, the input signals of -37 to -7 dBm are expanded to a 60-dB output range up to 0-dBm power-matched output into a 600-ohm load.

Grebene says the XR-2216 is designed to accommodate a wide range of system configurations. It can be operated with positive or negative single-supply systems, or with balanced power supplies, over a supply range of 6 to 20 volts.

Other key features include excellent transfer-function tracking (at a

reference of -14-dB input, output is -4 dB); low power supply drain (3 milliamperes maximum); controlled attack and release times (5 milliseconds to 90% of final value and 10% of final value, respectively); low noise—30 dBmnc (decibels referred to the standard reference noise level of 10^{-12} watts at 1 kHz) as a compressor and 5 dBmnc as an expander; and low distortion (3% total harmonic distortion measured at -4 dB across a 600-ohm load at 1 kHz). Over a frequency range of 300 to 500 hertz, gain change over frequency tolerances is ± 1 dB.

Packaged in a dual in-line 18-pin configuration, the unit has a power dissipation in ceramic of 750 milliwatts with a 6-mW/ $^{\circ}$ C derating above 25 $^{\circ}$ C. In the plastic package, it is 625 mW with a 5-mW derating.

Exar Integrated Systems Inc., 750 Palomar Ave., Sunnyvale, Calif. 94086 [338]

User's choice. Schematic shows equivalent circuit of XR-2216 compandor. The device can be connected as either a compressor or expander, depending on external circuitry.

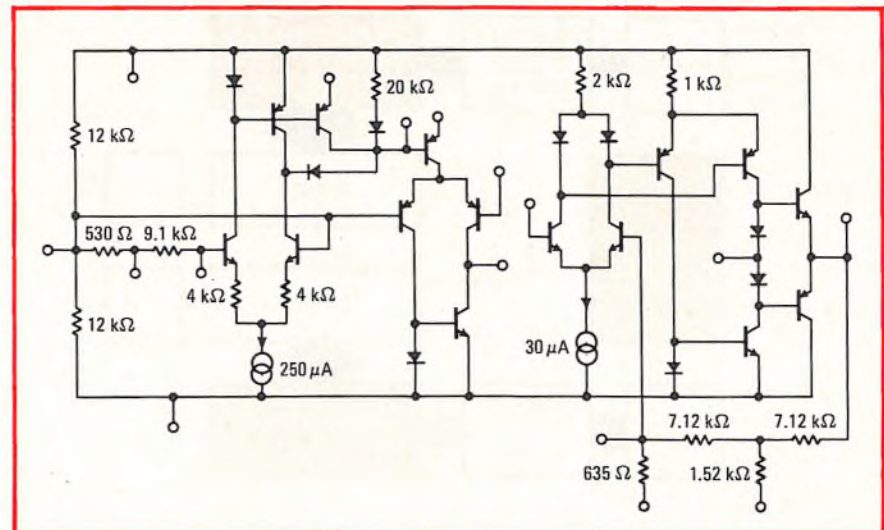

Baud rate generator gives dual output

On-chip crystal oscillator provides asynchronous clock for communications; any of 16 frequencies can be externally selected for each output

by Richard Gundlach, Communications and Microwave Editor

To provide clock rates for asynchronous devices in data communications, it is usually necessary to divide down the output of a high-frequency oscillator. This involves using several stages of counters to generate the necessary frequencies, then passing these frequencies through a multiplexer chip and providing frequency selection.

Virtually all of this is taken care of within a single chip developed by SMC Microsystems Corp. Designed specifically to provide universal asynchronous receiver/transmitters (UARTs) with an asynchronous clock, the dual baud rate generator/programmable divider, designated the COM 5016, can replace as many as 15 medium-scale-integration chips.

The new device eliminates the need for a timing chain (it's on the chip) and for a multiplexer because it, too, is essentially there. Besides

the chip, all that's needed is an inexpensive crystal—costing about \$2 in reasonable quantities.

The 5016—part of a family of COM devices being developed by SMC—can generate separate and independent receive and transmit frequencies simultaneously so that full-duplex operation is possible with the single chip.

The device also offers: 16 asynchronous/synchronous baud rates; direct UART/USRT compatibility; reprogrammable ROMs for generating other frequencies; TTL and MOS compatibility; on-chip input pullup resistors; accuracy to within 0.01%; and a 50% duty cycle.

The chip is a silicon-gate n-channel MOS LSI device made by SMC's Coplamos process. With the addition of a crystal, it provides a dual output of any of 16 externally selectable frequencies that cover just about the full spectrum of asynchro-

nous/synchronous data communications. The reprogrammable frequency-select ROMs, however, can be programmed to generate other frequencies from other crystal or external-input frequencies. Two independent dividers are externally programmed by a 4-bit address to produce the desired frequencies. For example, a crystal frequency of 5.0688 MHz can provide 16 separate baud rates ranging from 50 to 19,200.

The COM 5016 has applications in receive terminals as well as the computer-send end. It allows the user to dc-tie the inputs or to clock-strobe them. For a programmable interface, clock loading the latches in the chip, then putting the correct binary address on the transmit/receive lines will provide the desired frequency. At the terminal end, as the switch is changed different leads are simply tied high and low to provide programing of the correct output frequency. And it's easier to get additional lines by stacking up the SMC chip when interfacing to a computer that handles multiple asynchronous lines.

The 18-pin ceramic DIP device operates from 0° to 70°C, and storage temperatures are from -55°C to 150°C. It typically draws 28 milliamperes at 5 volts and 10 mA at 12 v. The COM 5016 can be driven from an external TTL logic level input, or by an external crystal; another model, the COM 5016T, can be driven only from TTL-level inputs. In single quantities, the 5016 costs \$12; the 100-piece price drops to \$8. The 5016T is 30 cents less.

SMC Microsystems Corp., 35 Marcus Blvd., Hauppauge, N.Y. 11787 [339]

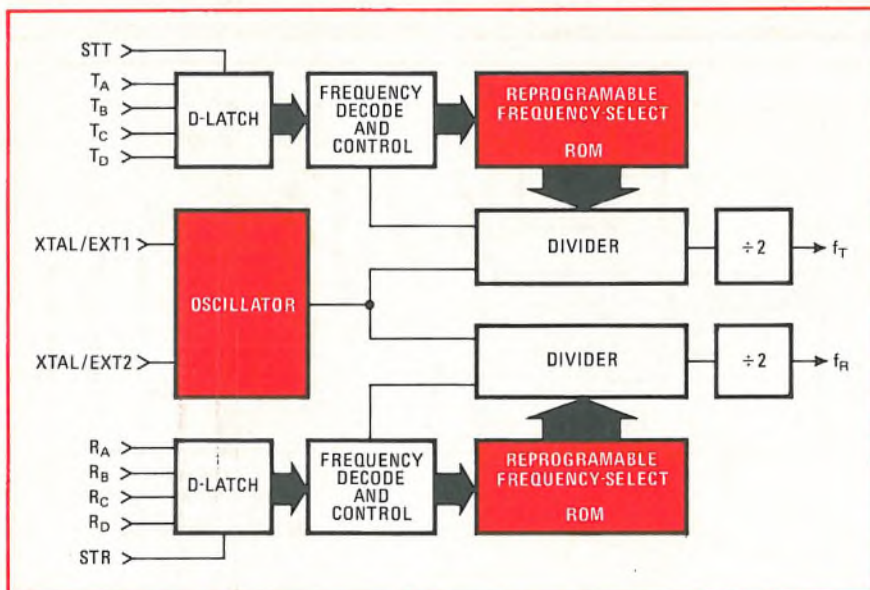

GR's new 1792-D was DESIGNED to test boards with both digital and analog circuitry

GR's new 1792-D was DESIGNED to test boards with both digital and analog circuitry

GR's new 1792-D was DESIGNED to test boards with both digital and analog circuitry

GR's new 1792-D was DESIGNED to test boards with both digital and analog circuitry

GR's new 1792-D was DESIGNED to test boards with both digital and analog circuitry

GR's new 1792-D was DESIGNED to test boards with both digital and analog circuitry



We know we are repeating ourselves, but . . .

. . . we are trying to make an important point. Most hybrid-board testers have been designed with afterthought — not forethought. Either they were digital testers with analog capability added as an afterthought or vice versa. Such tag-along design doesn't result in an efficient and cost-effective test system. The 1792-D, on the other hand, was conceived with the idea of designing the most efficient and cost-effective system for testing and troubleshooting hybrid circuits (containing both analog and digital). And when you include the new CAPS VII Software Package, the 1792-D provides you with computer-aided test generation and powerful diagnostics. . . a hardware/software combination that is hard to beat.

For the complete story, request a copy of our new brochure describing GR's 1792-D Digital/Analog Test System.



General Radio

390 BAKER AVENUE, CONCORD, MASSACHUSETTS 01742
 NEW YORK 914 212-964-2792 • INDIANAPOLIS 317 791-8996
 BOSTON 617 646-8880 • DAYTON 513 294-1506
 CHICAGO 312 998-0900 • WASHINGTON, D. C. 301 948-7177
 ATLANTA 404 394 5780 • DALLAS 214 234-3351
 LOS ANGELES 714 340-9830 • SAN FRANCISCO 415 948-8333
 TORONTO 416 252-3395 • ZURICH 011 55 54 20

GR COMPANIES • Graph Studies • Time Data

Components**Relays use novel magnetic circuit**

Electromechanical units for high-density boards are compatible with TTL, DTL

Both electrical and dimensional compatibility with TTL and DTL integrated circuits have been achieved in a family of electromechanical relays that is built around a new magnetic circuit developed by Electrodyne Inc.

Designated the series 18 and series 28, the relays are low-cost, micro-miniature, environmentally sealed devices designed for high-density electronic packaging. They measure 0.4 by 0.63 by 0.63 inch and 0.4 by 0.95 by 0.63 in. and weigh 5 and 7 grams respectively.

According to A. E. Sprando, Electrodyne president, although the relays are not identical with conventional IC dual in-line packages, their pins are arranged on 0.1-in. centers in two lines 0.3 in. apart. As a result, the devices can be plugged into standard DIP sockets or soldered into the 100-mil-hole grid of a printed-circuit board. Naturally, adds Sprando, they've also been designed to withstand flow-soldering temperatures and circuit-board cleaning materials.

"The balanced rotary armature in these relays is mechanically interlocked and can rotate clockwise or counterclockwise depending on which coil is energized," says Sprando. The 18-series units incorporate two coils and two single-pole, double-throw (spdt) contacts. Each coil operates one spdt contact set independently of the other. "If both coils are actuated at exactly the same time," he says, "no contact change of state takes place. If one pulse leads the other by 5 milliseconds or more, the coil in which the leading pulse is applied will transfer its contact set."

What this gives the user, Sprando says, is low contact capacitance, as well as a device for high-isolation switching and rf applications.

Coil-drive power required to transfer a contact set in these relays is 50 milliwatts maximum, 5 volts dc, at 9.6 milliamperes. The contacts are rated from dry circuit to 1 ampere and can switch 350 v dc or 30 VA maximum. Capacitance between normally closed and normally open contacts is 0.3 picofarad. The minimum insulation resistance is 10,000 megohms at 25°C. Dielectric strength is 750 v dc minimum.

The four contact sets cannot all be operated at the same time, thereby providing a three-position or an OR-function switching arrangement. This is accomplished without the use of polarizing magnets. Relays will be supplied with two different values of coil resistance; and, by application of proper biasing currents to each coil, a differential sensing feature is possible. Other versions include a nonpolarized sensitive and polarized magnetic latch series. One- through four-pole, double-throw configurations are available. In quantities of 1,000, the series 18 relays are \$5.75 each; and the series 28, \$7 each.

Electrodyne Inc., 2126 Adams St., Milwaukie, Ore. 97222 [341]

Brushless dc motors use Hall-effect element

Aeroflex Laboratories Inc.'s Motor Products division is expanding its line of brushless dc motors, previously sold only for military and aerospace applications, with a new

series of commercial solid-state types. The new motors have a lower-cost Hall-effect element for commutation, replacing the resolvers that the firm had used in most of its brushless motors.

John H. Lewis, marketing manager, says the electronic Hall-element is purely resistive in nature and not affected by extraneous fields. Only two wires are needed for motor operation.

Among the advantages of the Hall element, adds Lewis, is reduced power loss in the stator because the power applied to each winding is controlled more precisely in both phase and duration. This adds to the motor's efficiency of operation and coolness, which in any case are already enhanced by the elimination of brush drag. The brushlessness also means there is no sparking, so that the motors can be used in hostile environments or in explosive or corrosive environments.

The new brushless motors have the high starting torque and linear speed/torque characteristics of conventional permanent-magnet dc motors. They have rated torques of 0.1 to 25.0 ounce-inch with proportional power ratings and are available with speed regulation to $\pm 1\%$ for variations in load torque and supply voltage.

Aeroflex is offering the new motors in five frame sizes—8, 11, 15, 25 and 33.

Lewis says that Aeroflex is offering solid-state commutation circuitry with integral speed regulation to meet custom requirements and that existing dc motor-speed controllers can be either used or eliminated. Motors will be supplied for operation from a fixed-polarity volt-

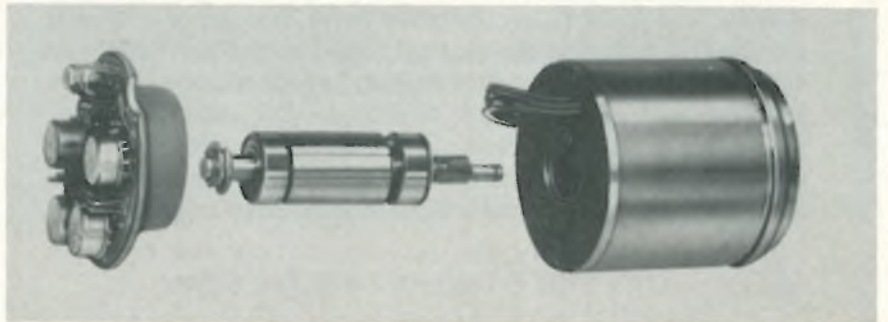

Our Super Switcher is three years old.

Should we call it new?

We're not sure. We noticed our competitors are calling their switching regulated power supplies "new". And why shouldn't they? After all, switching technology itself is new, isn't it?

Or is it?

To them, maybe. Not to Powertec.

Ours have been around about 3 years now. Over 2500 of them. You might even call them *field proven* (now, there's a phrase the other boys have studiously avoided. We wonder why.) Still, we've got to admit that with 24 new models, up to 24V, up to 200A output, our 9N Series *is new*. *All new*.

Only there's a difference.

Our *new* is based on experience, unique design innovations, and the best craftsmanship in the industry. Their "new"? Well, their new is just plain old new.

So take a look. Here are just a few 9N features.

OUTPUT RATING CHART

MODEL ^{*)}	DC OUTPUT		PRICE
	VOLTAGE NOMINAL	CURRENT @ +40°C	
9N2-200	2.0V	200A	\$695
9N5-150	5.0V	150A	\$695
9N5-120	5.0V	120A	\$625
9N12-50	12.0V	50A	\$625
9N15-50	15.0V	50A	\$625
9N17-42	17.0V	42A	\$625
9N20-40	20.0V	40A	\$625
9N24-33	24.0V	33A	\$625

- Up to 80% efficiency
- 24 hour elevated temperature "burn-in" with cyclic testing
- Logic inhibit
- Programmable
- Most second-sourced package
- Modular construction by function for maximum reliability
- "Motherboard" design eliminates internal cabling
- Master/slave adapter for paralleling up to 4 units (equal load sharing)
- 30 ms energy storage
- Long-life fan and dust screen
- Immediate delivery

*Add dash number for desired input:
115VAC, -01; 208VAC, -03; 220VAC, -04

Call us for an evaluation unit. Or, if you're still not convinced, we'll send you a Switcher Evaluation Guide.

POWERTEC

Powertec, Inc. • 9168 DeSoto Avenue, Chatsworth, Calif. 91311 • (213) 882-0004 • TWX (910) 494-2092

Circle 121 on reader service card

**We've
got
them
all...**



- Flatpacks
- Dual In-lines
- Plug-ins
- Microelectronic Headers
- Power Packages
- Microwave Modules

They're all from Isotronics... the widest assortment of microelectronic packages you can find anywhere. And they're all manufactured with uncompromising care to meet your high standards of quality. For engineering ability and product reliability in microcircuit packaging, call Isotronics.

VISIT US AT ISHM

the microcircuit
packaging specialists

Isotronics

Isotronics, Inc.
12 Coffin Ave.
New Bedford, Mass. 02746
(617) 997-4575 TWX 710 344 1961
Cable—ISOTRONICS

New products

age with rotation in either direction; or with the direction of rotation reversing with reverse polarity voltage; or with stop and reverse controlled by a low-power "command signal."

Under certain conditions, Lewis indicates, the motors can be used as replacements for ac motors—where their high starting torques can eliminate the power drains created by ac motors and where high rotational speeds are required.

Price ranges from \$50 to \$300.

Aeroflex Laboratories Inc., Motor Products Division, South Service Road, Plainview, N. Y. 11803 [342]

Film resistors go up to 20 kilovolts and 20 gigohms

Rated at 5 watts, the EI series of film resistors is offered in models with working voltages as high as 20 kilovolts and resistances as high as

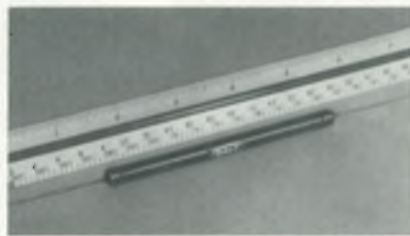

20 gigohms. Consisting of either a metal or metal-oxide film on a ceramic core, the resistors are protected and insulated by a double sleeving of flame-retardant irradiated polyolefin. A typical resistor with a tolerance of 10% and a value of 1 gigohm is priced at \$3.66 each in quantities of 1,000.

Dale Electronics Inc., P. O. Box 74, Norfolk, Neb. 68701 [347]

Ac/dc solid-state relay has 200-ns response time

Capable of handling peak currents of 80 millamperes at 50 volts, the series 234 ac/dc solid-state relay has a response time of 200 nanoseconds. The unit, which has a DTL/TTL-com-

**SPEEDS
to
100 MHz!**

**NEW
A/D CONVERTER**
accurate to $\pm 1.5\% \pm \frac{1}{2} \text{LSB}$



New model ADC 1105-100 is a compact, fully-assembled, tested and calibrated unit only 8x8x2".

Phoenix Data's new very-high-speed analog to digital converter is designed to digitize ultra-high-speed analog input signals — including high-speed display and radar signal input — with exceptional accuracy . . . $\pm 1.5\% \pm \frac{1}{2} \text{LSB}$.

Model ADC 1105-100 also has a resolution of 5-bit binary or 2's complement, with a ± 2 volt input range. The ADC 1105-100 is a "system-ready" compact, totally self-contained module incorporating all functions necessary to perform 5-bit binary conversions at speeds up to 100 million per second, except for power supply.

For complete information, contact Ron Brunnemer, marketing manager, at Phoenix Data, **now!**



PHOENIX DATA, INC.

3384 W. Osborn Rd. Phoenix, AZ 85017
Ph. (602) 278-8528, TWX 910-951-1364

New products



patible input range of 3.8 to 10 v dc, is designed for use in multiplexers, scanners, and other input devices, and as a line driver to interface computers with their peripherals. The relay has a dielectric-withstanding voltage rating of 1,500 v ac, and an insulation resistance of 10^9 ohms. The Series 234 is packaged in an epoxy case that measures 0.165 inch high by 0.75 in. long by 0.25 in. wide, with a standard DIP footprint. It sells for \$10. Delivery is from stock.

C. P. Clare & Co., 3101 W. Pratt Ave., Chicago, Ill. 60645 [343]

DIP switches include solid-state indicators

Housed in a dual in-line package 1 inch by 0.38 in. by 0.44 in., a line of push-button switches comes complete with red-light-emitting-diode indicator lamps. Three configurations are available: one switch and four LEDs (shown), five switches and four LEDs (shown), and four LEDs only. The switches are normally open single-pole, single-throw devices, while the LEDs are miniature T-1-

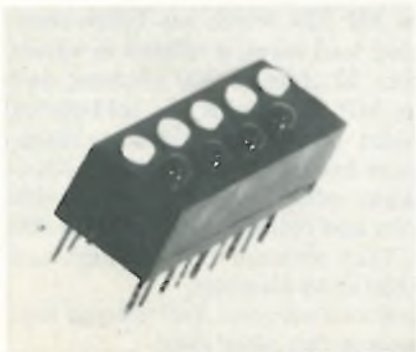

For systems DVM's,

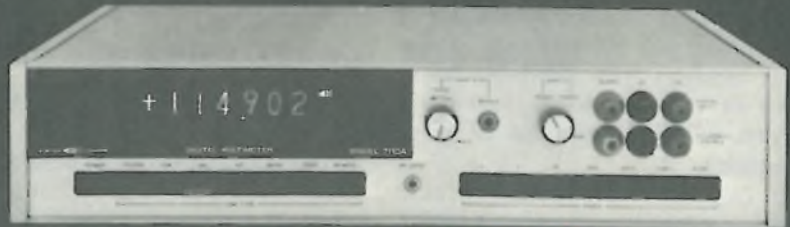

see a specialist

Systron-Donner's programmable Model 7110A DVM is really intended for systems use, although many demanding DVM users won't settle for less for their benches.

Key features: **Speed and accuracy.** Model 7110A makes 30 readings/second (not 5 or 6) with 60 dB of normal mode noise rejection **without** using filters.

- Many systems interfaces. Minimizes compatibility problems.
- True RMS or averaging AC.
- Fully Isolated buffered BCD output and remote programming.
- DC accuracy typically $\pm 0.005\%$.
- DC voltage resolution to ± 1 micro-volt.
- 1,000 volt overload protection.
- True 4-wire ohms and DC ratio

Price is \$2,195 for the basic unit, consisting of 5 ranges each of DC volts and DC ratio, or \$3,400 fully-loaded. For details, contact your Scientific Devices office or S-D at 1 Systron Drive, Concord, CA 94518. Phone (415) 676-5000.

SYSTRON DONNER

Circle 123 on reader service card

PLUG-IN WIRE BUILD TEST MODIFY

without soldering
for as little as

\$ **3**

Continental Specialties' QT (Quick Test) Sockets and Bus Strips expand breadboarding without shorts or burnt fingers. Just Snap/Lock together as many QTs as you need and test ICs, transistors, resistors, capacitors and more. Plug-in and connect with #22 AWG solid hook-up wire without soldering or patch cords. QTs are totally reusable. 10 different sizes. Order today off-the-shelf from CSC or local distributor. Charge: BAC, MC, AX. Write for free catalog. Free English/Metric Slide Rule with each order. Dealer inquiries invited.

UNIQUE NEW SNAP/LOCK DESIGN

Made in USA

Item No.	IC Capacity in 14 pin DIPs	Unit Price (US only)
QT-59S	8	\$12.50
QT-59B	-	2.50
QT-47S	6	10.00
QT-47B	-	2.25
QT-35S	5	8.50
QT-35B	-	2.00
QT-18S	2	4.75
QT-12S	1	3.75
QT- 8S	1	3.25
QT- 7S	1	3.00

Add \$1.50 shipping/handling. Foreign orders add 15%.

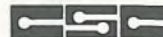

CONTINENTAL SPECIALTIES CORPORATION

Box 1942, New Haven, CT 06509. phone 203/624-3103 TWX: 710/465-1227

Prices subject to change

W. Coast Office: Box 7809, S. Francisco, CA 94119 415/383-4207

Canada: Available thru Len Finkler Ltd., Ontario

© CONTINENTAL SPECIALTIES CORP., 1975

New products

size lamps. Production quantities of the devices will be available in August; samples are available now. Price of the five-switch four-lamp version will be about \$4 in large quantities.

Licon Div., Illinois Tool Works Inc., 6615 West Irving Park Rd., Chicago, Ill. 60634 [345]

Ceramic slabs enable users to make custom capacitors

A line of high-voltage ceramic-capacitor slabs with palladium-silver or silver terminations may be custom-cut by the user into exactly the

size and shape needed for a particular application. With these slabs, according to the manufacturer, the user can overcome the problems of short supplies, slow deliveries, and limited choice of sizes in high-voltage capacitors by keeping a supply of slabs on hand. A diamond saw or laser is also needed to do the cutting. Slabs from 0.6-inch square to 1.8-in. square with voltage ratings from 2,000 volts to 20,000 v are available. Capacitors up to 23,000 picofarads can be produced from them.

Semtech Corp., 652 Mitchell Rd., Newbury Park, Calif. 91320 [344]

Instant Data Acquisition Systems

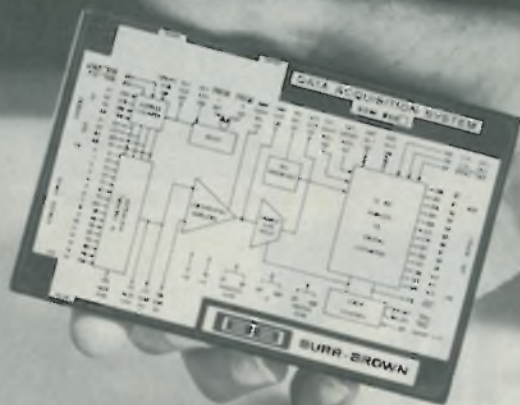

Yours for just \$595

Now you can buy just one single part, plug it in, and have a complete, high performance, 12-bit analog data acquisition system. It's ours, and by using it, you can eliminate the hassle and cost of designing your own, purchasing the parts, putting them together, and then the cost of all the testing you have to go through. We give you a choice of models, too. Our SDM850 accepts 16 single-ended data channels, while the SDM851 accepts 8 differential channels. And, they can be expanded to accept up to 256 single-ended, or 128 differential analog signals.

Each module contains its own Burr-Brown performance-matched multiplexer, differential amplifier, sample/hold, A/D converter, and programming sequencer and logic. Each will multiplex and convert up to ± 10 volt analog data signals into 12-bit digital samples. Accuracies of $\pm 0.025\%$ are guaranteed at throughput sampling rates of up to 50kHz samples per second without the use of external components. Throughput sampling rates of up to 100kHz are possible in an "overlap" mode. Housed in a compact 0.375"H x 4.6"W x 3.0"L steel case, each module is 100% tested for every channel and burned in for 168 hours.

Unit quantity price for either model is just \$595. And, when you see our OEM pricing, we're convinced you'll think that our instant approach is the best. Burr-Brown, International Airport Industrial Park, Tucson, Arizona 85734. Telephone (602) 294-1431.



Film resistors dissipate up to 30 watts

A high-stability power resistor, the type MP, can dissipate up to 30 watts through its low-profile circular case. Consisting of a Micronox film fired onto a ceramic substrate, the MP resistors also contain an aluminum base which conducts heat from the resistor element to the chassis to which they have been bolted. The



resistor is available in two versions: the MP 329, which has Teflon-insulated lead wires, is offered in values from 50 ohms to 200 kilohms; and the MP 330, which has gold-plated solder lugs, is offered with resistances from 10 to 200 kilohms. Maximum voltage rating of both is 450 volts and dielectric strength is 1,000 v. They measure 0.250 in. high and 0.850 in. in diameter.

Caddock Electronics, 3127 Chicago Ave., Riverside, Calif. 92507 [348]

Get up to speed on high frequency power switching for just 10¢



A 10¢ stamp gets you the basics on what you need to know about using high-power, fast-switching Darlington transistors to reduce the size, weight and costs of switching regulated power supplies and motor controls.

Want to know how the Darlington figures in Buck, Boost or Buck-Boost Regulators, Full Bridge, Half Bridge, or Push-Pull Regulator Converter circuits?

Want to replace SCR's and associated commutation circuitry in inverter circuits below 30kva?

TRW has put down the facts for quick study in a free brochure. All you have to do is fill out the coupon and mail it in. If you want the facts faster, call John Power (213) 679-4561 at TRW Power Semiconductors, an Electronic Components Division of TRW, Inc., 14520 Aviation Blvd., Lawndale, California 90260.

TRW POWER SEMICONDUCTORS

TRW Power Semiconductors

14520 Aviation Boulevard, Lawndale, California 90260

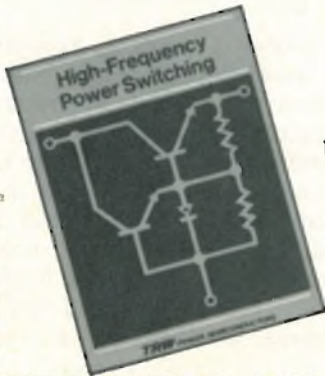

**Please rush
me your
free brochure
on high
frequency
power
switching.**

NAME _____

POSITION _____

FIRM NAME _____

ADDRESS _____

CITY _____

STATE _____

ZIP _____

THE NEW DIGITAL VOLKSMETER

World's lowest priced digital multimeter. Designed to be a more accurate and rugged replacement of delicate pointer meters.



LM-3



\$125.00

With rechargeable batteries and charger unit

Now a multimeter with truly outstanding features.

- **Super Rugged:** Ideal for field service use - you don't have to recalibrate or replace if dropped.
- **High Input Impedance:** 10 megohms on all ranges; no more circuit loading.
- **Auto Polarity:** No more test lead reversing or switching - keep the same ground reference for "+" or "-" voltages.
- **Auto Zero:** No more adjustment of the zero when you change range, function or position; no more full scale ohms adjust - just read the correct value in a linear not hyperbolic scale.
- **Digital:** Full three digits without parallax or required interpolation - easy to read with 0.33" high LED display; a true 1% meter.
- **13 Ranges:** 4 vdc, 4 vac and 5 ohms. Optional external shunts available for current measurement.
- **Resolution:** One millivolt and one ohm.
- **Measurements:** Up to 500V dc or ac and up to 10 megohms.
- **Small Size:** 1.9" H x 2.7" W x 3.9" D. - about the size of two packages of cigarettes.
- **Versatile:** Operates from standard 115V outlets or on self-contained batteries - batteries recharge automatically when meter is connected to outlet (220V charger available).
- **Fully Protected:** No damage from overload on volts and ohms measurement.

Optional Features:

- **Leather Case:** For attaching to belt or with neck strap - \$16.
- **High Voltage Probe:** For measuring voltages up to 30 KV - reading is directly in kilovolts - \$30.
- **Current Shunts:** For measuring current with 1% accuracy from 1 μ A to 1 A - \$6 each.

See your local distributor!

Distributor inquiries invited.



Non-Linear Systems, Inc.

Originator of the digital voltmeter.

Box N, Del Mar, California 92014

Telephone (714) 755-1134 TWX 910-322-1132

New products

Instruments

Pulse generator priced at \$79.95

'No-frills' unit offers range from 5 Hz to 5 MHz, accuracy within $\pm 5\%$

Low-priced instrumentation is one way of ensuring there'll always be enough test equipment around the laboratory for all the engineers that may need it at any given time. For example, the model 20 pulse generator from Advanced Electronics Corp., while lacking the frills normally associated with such instruments, is priced low enough—\$79.95—to justify having many of them available in the shop.

Along with its low price, the

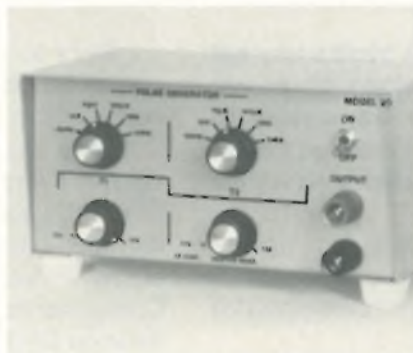

model 20 also features an unusual method for selecting signal characteristics. Instead of choosing repetition rate and pulse width, as with many pulse generators, the operator of a model 20 selects an on-time and an off-time for the output. Each of these periods is set by coarse and fine adjustments which, aside from the power switch, are the only four controls on the model 20's front panel. A graphic representation of a pulse waveform is silk-screened on the panel to clearly delineate which pair of knobs controls which period.

The output of the model 20, through five-way binding posts, is compatible with transistor-transistor-logic levels and can drive 10 TTL

loads. Frequency range is 5 hertz to 5 MHz, set to an accuracy within $\pm 5\%$.

Pulse widths are from 100 nanoseconds to 0.1 second for both the on and off states. Rise and fall times for the pulses are less than 20 ns on all ranges.

The model 20 operates from 105- to 125-volt, 60-hertz ac lines, and draws up to 5 watts. Operating temperature range is 0 to 50°C.

Housed in a 6-by-4-by-3-inch cabinet, the model 20 weighs 1 pound. Delivery is from stock to two weeks.

Advanced Electronics Corp., P. O. Box 63, Newton Highlands, Mass. 02161 [351]

Low-voltage power supplies put out up to 300 amperes

A series of precision dc power supplies intended for powering and protecting critical and sensitive integrated circuits comes in five voltage/current ranges: 5 v/300 A, 12 v/200 A, 15 v/200 A, 24 v/100 A, and 28 v/100 A. All models have a line regulation of 0.02% and an adjustable fold-back current-protection system to prevent damage to the supplies' series-pass regulator should an overload condition occur. All units in this VPL series are priced at \$1,195 and are available from stock to 30 days.

Trygon Electronics, subsidiary of Systron-Donner Corp., 1200 Shames Dr., Westbury, N. Y. 11590 [355]

Analyzer measures peak sound and impact levels

The IMP-103 impact analyzer, when used in conjunction with a Columbia or similar sound-level meter, has the capability to measure and hold the peak level of an impact or the maximum rms level of short but continuous bursts of sound. Intended for measuring the noises produced by punch presses, forging hammers, pile drivers, and similar equipment, the IMP-103 can form



part of a program to protect personnel from hearing losses. It comes with an interconnecting cable that plugs into the basic sound-level meter, sells for \$250, and has a delivery time of three weeks.

Columbia Research Laboratories Inc., Woodlyn, Pa. 19094 [356]

Strip-chart recorder prints alphanumeric and traces

A strip-chart recorder-logger that records one or two traces by means of thermal styli can annotate its records by printing alphanumeric characters over the middle 8.75 inches of its 10-inch-wide chart paper. The TI-Graphic 200 is a single-speed machine that employs a stationary solid-state print head to produce its set of 64 standard characters. The annotation section of the instrument uses TTL levels in a 6-bit ASCII code. The analog traces are produced by one or two self-balancing potentiometric servo systems designed to accept a wide range of voltage-input signals. The styli have a full-scale response time of 0.25



The EPC 2200. A hard copy recorder for spectrum analysis.

The new EPC Model 2200 is the first truly fine quality, low cost, hard copy recorder.

When matched with a spectrum analyzer or processor, the Model 2200 prints spectral data on a continuous dry paper display 19.2" wide. This hard copy history-plot presents 2,048 clearly defined data points per scan, revealing spectrum lines buried as much as 6db below the noise level.

The Model 2200 interfaces with digital and analog equipment, accepts a variable dump rate and permits flexible expansion or contractions of scale. It sweeps at speeds between 1/10 second and 8 seconds, and is mechanically virtually jitter-free.

The EPC Model 2200 is currently built in four modified formats. Further customization is possible. Write for information and a quote.

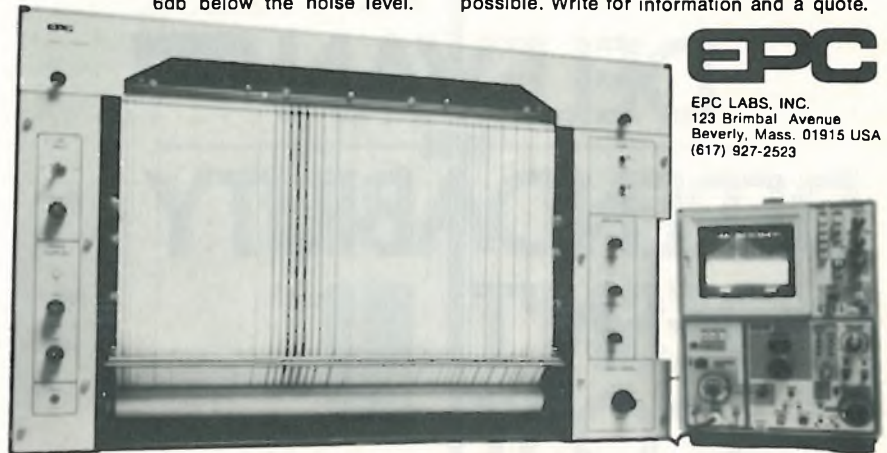

EPC

EPC LABS, INC.
123 Brimbal Avenue
Beverly, Mass. 01915 USA
(617) 927-2523

Circle 127 on reader service card

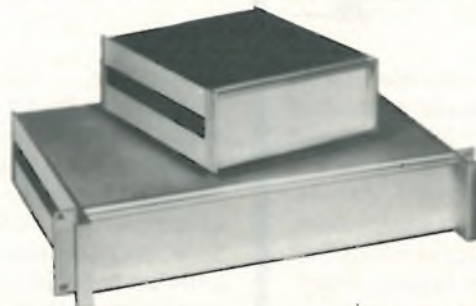

BUCKEYE CASES

Buckeye bord-pak cases are made of aluminum extrusions and available in 1/3, 1/2, 2/3 and full rack widths. Full fabricating capabilities and complete electronic packaging needs from Buckeye include: colorful cabinets, 4 sizes of adjustable P.C.B. Racks, patented card guide modules; retractable tilt-stands with feet, and a complete line of matching instrument knobs.

Write today for free colorful literature!

the **BUCKEYE** stamping co.

555 Marion Rd., Columbus, Ohio 43207

"QUALITY PRODUCTS SINCE 1902"



GUIDES • CABINETS • KNOBS • RACKS



DELEVAN

DEPENDABILITY

DOESN'T COST

There's a lot more than meets the eye in Delevan's lineup of miniature RF inductors and transformers. Like the unmatched dependability built into each component. Thanks to a lot of things that go on at the factory. Hard-nosed quality controls . . . complete material analysis . . . advanced in-plant environmental testing . . . automated techniques for winding, soldering and molding . . . and conscientious people who take pride in true "no-fault" production. And of course, the dependable delivery and service you always get from Delevan.

IT PAYS

Remember . . . the proven reliability of these superior made-in-U.S.A. inductive devices means greater reliability for the products and assemblies *made from them*. Sure, you can save a few pennies by using cheaper components. But this could be expensive in terms of premature failure of the finished product. When your company's reputation is on the line, you can't afford *not to use* Delevan components. Their premium performance more than justifies their use . . . because Delevan dependability pays for itself. Why not prove it to *yourself!*

Delevan  **AMERICAN PRECISION INDUSTRIES INC.**
Division

270 QUAKER RD./EAST AURORA, N.Y. 14052
 TELEPHONE 716/652-3600 TELEEX 091-293
 OTHER DIVISIONS OF AMERICAN PRECISION INDUSTRIES INC.:
 BASCO • DUSTEX

New products

second and a maximum total error of 0.5%. The machine's single speed is set at the factory to any preselected value from 1.5 in. per hour to 6.0 in. per minute. Price of the recorder-logger will be less than \$3,000.

Texas Instruments Inc., P. O. Box 1444, M/S 784, Houston, Texas 77001 [353]

In-circuit stimulator

handles five logic families

The model HL-583 logic pulser can be used with RTL, DTL, HTL, TTL, and C-MOS logic circuitry. It puts out pulses with a nominal duration of 1 microsecond and sufficient energy to



pull existing high states low, and existing low states high. The \$96 instrument can operate in either a single-shot mode or in a continuous mode at a repetition rate of approximately 5 hertz.

Kurz-Kasch Inc., 2876 Culver Ave., Dayton, Ohio 45401 [354]

Digital-signal generator

is highly flexible

Most word generators are periodic devices that put out many pulses per period. The pulse widths and spacings are integral multiples of an input-clock period. The model RS-648 timing simulator/word generator is also a periodic device capable of multiple pulses per period; however,

New products



the width of each pulse and space is independently controlled by a programmed memory word. The time intervals, which are generated by an internal crystal oscillator, can vary from 50 nanoseconds to 999 milliseconds. In its standard form, the RS-648 memory contains 16 words, but is expandable to 64. Output-driver options are offered to provide compatibility with various logic families, and digital-to-analog converter options are available for converting the unit's 8-bit digital output to an analog signal. A read-only memory is also available at extra cost for quickly setting up frequently needed memory words. The basic price of the RS-648 word generator is \$2,495.

Interface Technology, 627 Fremont Ave., P. O. Box 338, S. Pasadena, Calif. 91030 [358]

Synthesized signal generator spans 1 to 2,600 megahertz

The latest addition to Hewlett-Packard's line of synthesized signal generators, the model 8660C, offers two capabilities not previously available: frequency coverage to 2.6 gigahertz (compared with 1.3 GHz in earlier models) and calibrated phase modulation (earlier models had a-m and fm only). The instrument's added capabilities qualify it for testing satellite-communications systems and similar phase-modulated



microwave links, H-P points out.

The generator spans from 1 megahertz to 2.6 GHz in steps as small as 2 hertz. Its output level can be set from a maximum of +7 dBm to as little as -136 dBm. The output can be phase-modulated at rates as high as 10 MHz to peak deviations of 0 to 100° or 0 to 200°. Price of the

instrument varies with the exact plug-ins that are chosen, but the typical price for a 2.6-GHz unit with phase-modulation capability is \$19,600. Delivery time is 12 to 16 weeks.

Inquiries Manager, Hewlett-Packard Co., 1501 Page Mill Rd., Palo Alto, Calif. 94304 [357]

It's all over.

Surprisingly enough, the best kept secret in town was patented over eight years ago. That's right. ICC is the largest and oldest independent manufacturer of light pens in the world. So we can offer performance at the right price — right off-the-shelf.

Our fast-response pens work well with vector and alphanumeric computer graphics, radar displays, automated signs, IC mask or schematic designs, and even color graphics.

So if you're looking for light pens, your search is over.

Information Control Corporation, (213) 641-8520.



FREE. Go for it.

Send us this coupon now. We'll send you our "Understanding Light Pens" book.

Name _____ Date _____

Company _____ Phone _____

Address _____

City/State/Zip _____

ICC, 9610 Bellanca Avenue, Los Angeles, California 90045

If you're worrying about Gallium, you haven't heard the news.

A large stable supply of gallium is now available.

From Alcoa's new plant in Bauxite, Arkansas.

It's already processing Alcoa's own gallium-rich Arkansas bauxite in significant quantities.

So don't worry. Long term availability is here. Enough for major applications . . . from stock . . . as close as your nearest airport.

Keep thinking about electroluminescence, optocoupling, photovoltaic conversion, magnetic bubble memories and other uses of gallium.

Because gallium from Alcoa will stay available.

Gallium is found in bauxite. And Alcoa has extensive reserves of bauxite in Arkansas. So Alcoa will be extracting gallium from Arkansas bauxite for a long time to come.

That's the news.

For more information, contact Alcoa International, Inc., 61 Avenue d'Ouchy, Lausanne, Switzerland. Phone 27-61-61

Change for the better with
Alcoa[®] Gallium



New products

Packaging & production

Dense boards get in-circuit tests

900-point capacity plus multiprogram core memory permit fast checkout

In-circuit testing has taken hold as a proven technique for checking out loaded printed-circuit boards. Such testers check conductors, conductor pairs, and components one at a time. But with the influx of extremely high-density pc boards, systems often lack the test-point capacity to handle them.

For that reason, Faultfinders, a Latham, N.Y., firm, has developed the FF101A, an in-circuit tester with up to 900 test points (its earlier tester, the FF101, has 600 points). "We found that customers were putting more components on larger boards," says Melvin Stanford, president of Faultfinders. "We responded by enlarging our switching section so that we can now place as many as 900 points on the bottom of

a board. We also added a line of companion fixtures which can handle the larger boards and place test points on a region up to 17½ by 25½ inches."

Instead of the two-program storage capability of the FF101, the FF101A may be bought with a new multi-program core memory which enables the operator to select any of 10 programs at the flip of a switch.

The system may also be run from an ASCII-coded paper tape. In this mode, the FF101A tests at twice the speed of the earlier system. The higher test speed is made possible by redesigned reader electronics incorporating a new serial first-in, first-out (FIFO) buffer register. The tape reader loads continuously into the buffer register, which transfers data asynchronously to the program registers at the rate required for the testing. In the earlier system, the tape reader loaded the program register directly. This slowed testing because of the start/stop cycle of the tape reader.

The earlier FF101 had programming capability that enabled the operator to choose the tolerance for the good/bad decision on a component. But it displayed and printed out only the value of a measure-



NEW BROADBAND ELECTRONIC ATTENUATOR



- Frequency range 2 MHz to 200 MHz
- Flat response
- Low distortion
- Custom versions available

The new Model ARE-1 electronic attenuator is designed for broadband signal level control applications in the frequency ranges from HF through VHF. Attenuation range 0 to 20 db with flatness ± 0.5 db. Other key specs include: maximum insertion loss 1.3 db, VSWR 1.6:1, 50 ohms impedance, switching time 50 microseconds, operating temperature range -20°C to $+85^{\circ}\text{C}$, and weight 4 ounces.

Contact Merrimac today for more details on the Model ARE-1 attenuator, including modifications to meet your specific requirements.

MERRIMAC INDUSTRIES INCORPORATED

41 FAIRFIELD PLACE WEST CALDWELL, N. J. 07006
(201) 228-3890 TWX 710-731-4314

U.S. EXPORT REPRESENTATIVE:

Dage Corporation, 203 324 3123

INTERNATIONAL SALES REPRESENTATIVES:

Brussels, Belgium — Eletron, S.p.r.l., tel: 513 7384, tlx: 0225437 Montreal, Canada — Mitec Electronics, Ltd., tel: 514 334 9140, twx: 610 421 3572 London, England — C. T. London Electronics Ltd., tel: 01 527 5641/3, tlx: 851 897488 Paris, France — Datron, tel: 808 02 60, tlx: 842 68135 Munich, Germany — Selectron, GmbH, tel: 089 591 053, tlx: 0524506 Tel-Aviv, Israel — Dage Israel Ltd., tel: 03 415645/410988, tlx: 92232377 Breda, Netherlands — Datron, B.V., tel: 1600/41152, tlx: 844 54512 Stockholm, Sweden — Ajjers Electronic AB, tel: 08 88 03 20, tlx: 854 10526 Zurich, Switzerland — Invertag, SA, tel: 01 65 56 30, tlx: 55670

Fast talk

Here they are at last — high-speed communications interfaces on a single chip.

Our new S2350 Universal Synchronous Receiver/Transmitter and S6850 Asynchronous Communications Interface Adapter make it easy to link your word-oriented controller or microprocessor with a serial transmission line. They're both N-Channel, use single 5-volt power supplies, need no TTL, and are bus compatible.

And they're fast. The USRT transmits and receives at a rate of 500 KHz. The ACIA at 800 KHz (making it the fastest Asynchronous R/T going).

Both circuits will fit right into most synchronous or asynchronous communications systems. But they're especially valuable as part of a system using the AMI S6800 microprocessor family.

They both have interrupt logic and they're both double buffered. This lets the MPU operate much more efficiently, because it's not a slave to its family.

These two chips are the latest additions to our growing list of communications circuits. It now includes the S1757 UART (CMOS compatible), the S1883 UART, the S9544 CRC and the S6860 Modem.

Features of the S2350 USRT

- 500 KHz data rates.
- Internal sync detection.
- Fill character register.
- Double buffered input/output.
- Bus oriented outputs.
- 5-8 bit characters.
- Odd/even or no parity.
- Error status flags.
- Single power supply (+5v).
- Input/output TTL compatible.

Features of the S6850 ACIA

- 8 bit bidirectional data bus for communication with MPU.
- False start bit deletion.
- Peripheral/modem control functions.
- Double buffered receiver and transmitter.
- One or two stop bit operation.
- 7 or 8 bit characters with odd, even or no parity.
- Parity, overrun and framing error checking.
- Programmable control register.
- Optional + 1, + 16, and + 64 clock modes.
- Up to 800,000 bps transmission.

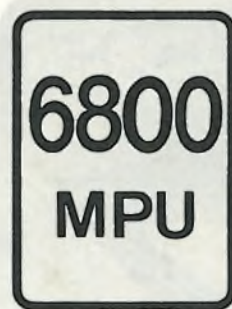

So make communicating a lot easier. Talk to your nearest AMI sales office. Or call our distributor.

AMI, 3800 Homestead Road, Santa Clara, CA 95051. Phone (408) 246-0330.

it's
standard
at AMI.
AMERICAN MICROSYSTEMS, INC.

Here's AMI:

INTERNATIONAL SALES OFFICES

England—Swindon, Wiltshire—Swindon 31345
 France—Vincennes—374 00 90
 Italy—Milan—29 37 45
 Japan—Tokyo—(501) 2241
 West Germany—Munich—48 30 81

REGIONAL DISTRIBUTORS AND REPRESENTATIVES

ARGENTINA:
 Ing Arturo E. Vercesi
 Lamadrid 3140
 Olavarría, F. C. N. G. R.
 Prov. de B. Aires
 284-2876

AUSTRALIA:
 CEMA Distributors Pty Ltd.
 G. P. O. Box 578
 Crows Nest, N. S. W. 2065
 439-4655

BELGIUM:
 United Continental
 Associates
 Avenue Louise, 244
 B-1050 Brussels
 649-0721

BRAZIL:
 LABO—Indústria de
 Equipamentos
 Eletrônicos Ltda.
 Rua Maderia, 28
 Canindé—São Paulo—
 CEP 03033
 228-0224

DENMARK:
 GDS-Henckel ApS
 Fyrrevangen 4
 DK-4622 Havdrup
 38 57 16

ENGLAND:
 Adrian Electronics Ltd.
 28 High Street
 Winslow, Buckinghamshire
 MK18 9HF
 Winslow 3535

GDS (Sales) Limited
 Michaelmas House
 Salt Hill, Bath Road
 Slough, Buckinghamshire
 Slough 30211

FINLAND:
 Atomica AB
 P. O. Box 125
 SF-00121 Helsinki 12
 66 17 99

FRANCE:
 Electronique MS
 89-93, Rue des Alpes
 Cidex L 190
 F-94533 Rungis
 686-7425

PEP-Produits
 Electroniques
 Professionnels S. A. R. L.
 2, rue Barthelemy
 F-92120 Montrouge
 735 33 20

HONG KONG:
 Shanklin Co. Ltd.
 Rm. 503-5 KAM
 Chung Bldg.
 54, Jaffe Road
 (05) 281 521-3

INDIA:
 Radiosound
 42, Canady Bridge
 Bombay 4
 353997

ISRAEL:
 Tadiran Electronics
 P. O. Box 648
 Tel Aviv
 857121

ITALY:
 Celdis Italiana S. p. A.
 via Luigi Barzoni 20
 I-20125, Milano
 68 06 81

KOREA:
 Peninsula Industrial Co. Ltd.
 Room 803, Sam Yoon Bldg.
 63-2, 2-ka chungMu-Ro,
 chung-Ku
 Seoul
 (28) 8486, (23) 0311-8,
 ext. 38

MEXICO:
 Semiconductores Calif.
 S. A.
 Pasaje Reforma #90-Altos
 Mexicani, Baja California
 2-5701-03

NETHERLANDS:
 RITRO Electronics N.V.
 Prins Hendrikweg 19
 Barneveld
 50 41

NEW ZEALAND:
 Professional Electronics
 Ltd.
 P. O. Box 3335
 Auckland
 469450

NORWAY:
 GDS-Henckel A. p. S.
 Heerlökka 14
 N-1440 Drøbak
 93 15 97

**REPUBLIC OF
SINGAPORE:**
 General Engineers Corp.
 Pte. Ltd.
 173-B, Cecil Street
 Singapore 1
 71042, 75995, 913871

**REPUBLIC OF SOUTH
AFRICA:**
 Radiokom (1969) (Pty) Ltd.
 P. O. Box 56310
 Pinegowrie 2123
 48-5712

SPAIN:
 Atajo Ingenieros S. A.
 Enrique Larreta, 10 y 12
 Madrid 16
 215-35 43

SWEDEN:
 AB Rifa
 Fack
 S-161 11 Bromma 11
 826-2600

SWITZERLAND:
 GDS (Sales) S. A.
 8 rue de l'Aubépine
 CH-12H Genève 9
 21 59 77

TAIWAN:
 General Industries
 8th Floor, Tahwa Bldg
 75-1 Song-Chiang Road
 Taipei
 525584

THAILAND:
 SRI Thai Electronic Far
 East Ltd.
 22 Pibulwatana Villa,
 Sam Sen
 Bangkok 4
 70743

WEST GERMANY:
 Omni-Ray GmbH
 D-4054 Nettetal 1-Breyell
 Ritzbruch 41
 (Postfach 3175)
 4548

New products

ment—not how far out of tolerance the part was. A percent-deviation-from-nominal-value capability has been added to the FF101A. Now, if a user is measuring a nominal 10-ohm resistor and its measured value is 11 ohms, he can program the system so that it will display and print out either 11 ohms or +10% by flipping a switch.

The FF101A is priced at about \$40,000, depending on options selected. Delivery is eight to 10 weeks. Faultfinders Inc., 15 Avis Dr., Latham, N.Y. [391]

Low-cost, one-station system laser-trims film resistors

Designed for the medium-volume user, a computer-operated laser trim system developed by Teradyne Inc. provides a single station for trimming and testing thick- and thin-film resistors deposited on silicon, ceramic, sapphire, or glass substrates.

Designated the W211, the system is priced at \$68,400. This includes self-teaching software, which, the company points out, can save the user the cost of program training for an operator.

By omitting a built-in multiplexing capability for multiple stations,

the Boston company has kept the price of the system well below the usual \$100,000. However, the W211 may be converted in the field into Teradyne's full W311 Laser Adjust System, with multiplexing capability and multiple stations, at a price only slightly higher than that of the W311.

Programing is simple. The software supplied with the W211 displays questions on a CRT terminal and uses the answers to generate a program. Typical questions are the number of resistors to be trimmed, their values, pin connections, and type of cut desired. Pre-test results, final test results, and job-summary sheets are also displayed on the CRT terminal.

The laser system functionally trims devices for voltage, current, and frequency, as well as specific resistances. Trim limits can be programmed to a resolution of 0.1% of range, and ranges are 20 ohms to 20 megohms full scale in decade steps.

The W211 includes a control group, a measurement group, and an in-line handler. The control group has a computing controller, a data terminal, and a magnetic-tape unit. The trim station features a YAG laser, high-speed galvanometer beam positioner, and laser station control. A rotary or step-and-repeat handler and viewing optics are



New products

available to the user as options.

Delivery time for the W211 is 12 to 16 weeks.

Teradyne Inc., 183 Essex St., Boston, Mass. 02111 [392]

System approach cuts cost of ceramic IC packages

Two new total-system approaches for assembling ceramic IC packages promise to provide the desirable qualities of ceramic packaging—including hermeticity—at prices competitive with cerdip, pre-molded plastic, and other limited-application systems. One system, MetCerDip, employs a low-temperature frit glass seal supplied as a glaze on the package's preformed ceramic lid. The other system, known as PoxyPak, utilizes a die-cut preform of frozen epoxy either with or without a fiberglass backing. Other than the differences in the sealing technique employed, the two systems are essentially identical: each provides a basic alumina package body or substrate, metalized or spot-gold-plated wire-bond and die-attach areas, side-brazed leads, a final dielectric layer, and a ceramic lid. Pricing runs about 40 to 50% below that of conventional ceramic packaging systems with gold-plated metal lids and gold-tin preforms.

MetCeram, Huntingdon Industrial Park, Providence, R. I. 02907 [393]

Clear molding compounds available in four colors

The MG-18 family of clear molding compounds, which was developed especially for the encapsulation of optoelectronic devices, is now offered in four standard colors: red, yellow, green, and water-white. All four colors are available in clear and diffused versions. The compounds are expected to see wide use in the color coding of light-emitting-diode displays and lamps.

Hysol Div., Dept. OE, 15051 E. Don Julian Rd., Industry, Calif. 91749 [394]

the Champ

problem solver



Bausch & Lomb StereoZoom 7 Microscope with Coaxial Illuminator is the answer to your need for full field, full aperture illumination; full color, high contrast imaging and better resolution.

This unique form of incident illumination eliminates surface glare from highly reflective surfaces and also effectively illuminates low contrast objects.

You zoom over a magnification range of 15X through 280X. Field diameter ranges from 0.55 in. through 0.03 in. Working distance is 3.0 in.—0.56 in.

Send today for our catalog 31-15 and our FREE DEMONSTRATION offer.

BAUSCH & LOMB

SCIENTIFIC OPTICAL
PRODUCTS DIVISION

StereoZoom. Reg. T.M.
Bausch & Lomb

62318 Bausch Street, Rochester, N. Y. 14602

Circle 134 on reader service card

Own your own holder to hold your own!

Hold your own copies of Electronics in specially designed slipcase holders. They'll keep your Electronics library neat and handy—a permanent information file, issue by issue.

Just complete the coupon and mail to Jesse Jones. He'll process your order upon receipt, postpaid.



ELECTRONICS BOXER
Jesse Jones Box Corporation
2250 E. Butler St., Philadelphia, Pa. 19137

Please send me: boxes @ \$4.25 each; 3 boxes @ \$12.00; 6 boxes @ \$22.00.
My check or money order is enclosed.

Name: _____

Address: _____

City: _____ State: _____ Zip: _____

PRESENTING OUR SECOND FULL LINE OF DPMs.



Our full line of AC meters.

We've just completed our first full line of AC DPMs. To go with our original full line of 5V DPMs.

So now, no matter what kind of DPM you need — 5V or AC — all you have to remember are two words: Analog Devices.

Our newest AC DPM is the AD2009 — a 3½-digit unit with Beckman displays that fits the standard panel cut-out. It's a lower-priced, functionally superior replacement for units in the same class.

Then there's the

AD2008 — a 4½-digit AC unit with Beckman displays designed for high performance in adverse electrical environments.

And the AD2011 — the world's first true RMS DPM.

And finally the AD2006 — a high performance 3½-digit Beckman unit with its own power outputs for external circuitry.

Add to these our 5V line of 2½- to 4½-digit DPMs, and you've just run out of excuses to go to anyone else but us.

Send for our free Designer's Guide to Digital Panel Meters.

Analog Devices, Inc.
Electronic components for test and measurement instruments and control systems. Norwood, Mass. 02062. U.S.A.



Circle 163 on reader service card



AUSTRALIA Parameters, Crow's Nest, N.S.W. 2065, Tel: 43 65 77 / BELGIUM Klaasing Benelux, 2020 Antwerpen, Tel: 03 38 37 07 / DENMARK 2750 Ballerup, Tel: 1-97 95 99 / FRANCE 94533 Rungis, CIDEX L 204, Tel: 686-79 05 / GERMANY Munich, Tel: 089/53 03 19 / ISRAEL STG Int'l., Tel Aviv, Tel: 53 45 9 / ITALY DeMico, Milan, Tel: 65 31 31 / JAPAN Tokyo, Tel: 03/26 36 82 6 / NETHERLANDS Klaasing Reuvers, Breda, Tel: 01600/48 45 7 / SWEDEN Komponentbolaget NAX AB, Bromma, Tel: 08/37 29 45 / SWITZERLAND Megex, 8902 Urdorf-Zurich, Tel: 01/98 41 71 / Consult Analog Devices U.S.A. for additional representatives.



Standard & Custom Electronic Cabinetry

- CONSOLES
- VERTICAL CABINETS
- SLOPED PANEL CABINETS
- INSTRUMENT CASES
- DESK CABINETS
- CHASSIS BOXES

Full line of Accessory Fans, Blowers, Slides, Drawers, Writing Shelves, Hardware, etc., complete facilities through finishing.

over 1300 standard items

write for complete catalog and prices

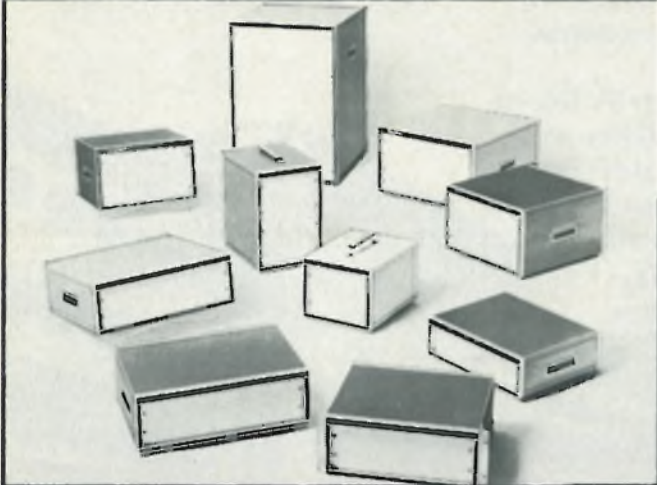

PREMIER METAL PRODUCTS CO.



337 Manida Street, Bronx, New York 10474

Phone: (212) 991-6600

Circle 136 on reader service card

Countdown Free!

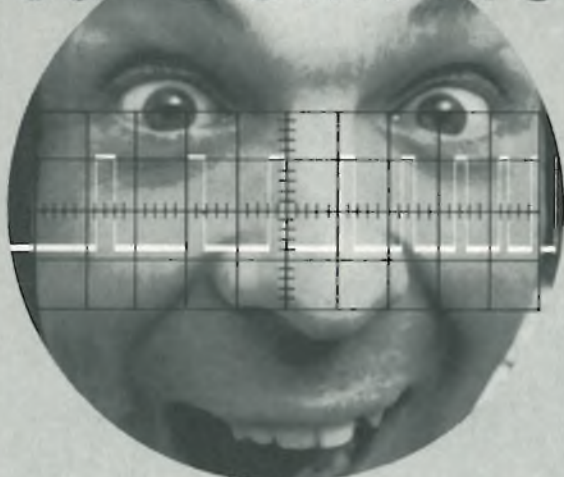

Interstate Pulse Generators have Constant Duty Cycle

Interstate's exclusive Constant Duty Cycle mode automatically controls pulse width as a percentage of the period, so when you're varying the rep rate, the generator can't possibly skip a pulse or two and give you an invalid output.

Constant Duty Cycle is only one of many innovative Series 20 features you've never seen in a pulse generator before. Call John Curry collect and he'll send you the new Interstate Series 20 Pulse Generator catalog—it's free, too!

Phone (714) 549-8282



IEC INTERSTATE ELECTRONICS CORPORATION
Subsidiary of ATO Inc.

Dept. 7000, Box 3117, Anaheim, California 92803
TWX U.S.A. 910-891-1197 TELEX U.S.A. 655443 & 655419

Circle 164 on reader service card

EVEN AN OIL BATH WON'T STOP THIS FLATPACK.

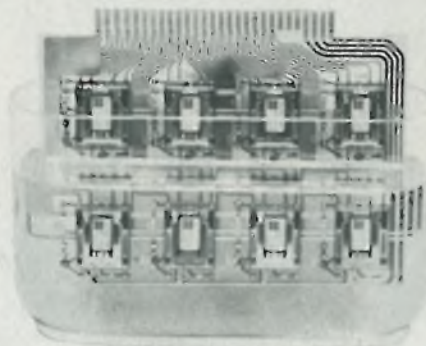

This NFE relay will mechanically switch 10^8 times under the worst operating conditions and live for 5×10^6 at 1 A, 30 VDC resistive and 10^6 at 2 A, 30 VDC. Life expectancies that double those of standard flatpacks used under hostile conditions. NFE relays come in 2 Form C and 4 Form C types with coil voltages of 6, 12, 24, 48, or 60 V. They measure .425" H x .772" (2C) or .953" (4C) W x 1.165" L. Great for dense P/C board mounting. Operate power: 300 mW for the 2C; 480 mW for the 4C. That's half the power needed for comparable flatpacks. There are no other flatpacks like them. Send for full NFE relay specs.

Relays for advanced technology.



Arrow-M Corp. 250 Sheffield St., Mountainside, N.J. 07092 U.S.A.
Telephone: 201 232 4260

Circle 165 on reader service card

New products

Industrial

Unit logs data for over a year

Battery-operated digital system records up to 64 analog input channels

Packaged in a rugged, weatherproof aluminum housing, the Data Logger 2 from Datal Systems is a 64-channel data-acquisition system that can operate for more than a year on a single set of five lithium D cells. Power consumption is kept low by using complementary-MOS circuitry for all logic and timing functions, and a stepper motor for driving the digital-tape cassette.

In its normal mode of unattended operation, the Data Logger 2 completely scans all selected analog input channels at preset intervals of one second to 30 hours. With every scan, the day of the year and the time of day are automatically encoded on the tape along with the 12-bit codes for each of the analog inputs. A full scan of all 64 input channels takes about 11 seconds, but less time is required if all of the channels are not being used. While taking data, the logger consumes about 1.2 watts, but between scans, the power consumption drops to about 6 milliwatts because only the crystal-controlled clock and scan-interval decoding circuitry are running.

The period of time for which the logger can be left unattended depends, of course, on the number of channels being recorded and on the scanning rate. A single Philips-type digital cassette will hold 2,000 scans of 64 channels per scan plus dates and times. Approximately six hours are required to fill a cassette at the maximum data rate. One set of lithium batteries provides enough power to fill about 13 cassettes.

The Data Logger 2 can handle both high-level (± 5 -volt) and low-level (± 5 -millivolt) signals. Since the



input channels are sold in blocks of 32, the buyer may choose 32 or 64 high-level channels, 32 or 64 low-level channels, or 32 of each. The single-quantity price varies from \$3,995 for a system with 32 high-level channels, to \$4,995 for a system with 64 low-level channels.

Since a recording data logger does not have any display or playback provision, the user can never be certain that his system is working properly. However, to overcome this obstacle, a portable battery-operated calibrator/tester has been developed. This auxiliary instrument, complete with its 12-bit digital-to-analog converter for calibration, sells for \$3,995. In addition to testing the Data Logger 2, the DL-2T tester also tests itself.

Datal Systems Inc., 1020 Turnpike St., Canton, Mass. 02021 [371]

Voice-operated system generates NC tapes

A voice-programming system for numerical-control machines produces fully verified punched paper tapes for automatic machine tools when the programmer simply speaks into a microphone using normal English words. A display in the system shows each command to the programmer as he speaks so that he can

CONNECTORS/
P.C.
**JACKS &
PINS**
BERYLLIUM
COPPER
CAGES

CONCORD ELECTRONICS CORPORATION
37 GREAT JONES STREET NEW YORK, N.Y. 10012 (212) 777-6571 • TWX 710-581-4930

and
**TEFLON*
AND SOLDER
TERMINALS**
*DUPONT T.M.

SEND FOR CATALOG

Circle 137 on reader service card

GAS SENSING SEMI-CONDUCTOR



FIGARO GAS SENSOR

'75 New Models, some with highly sensitive CO sensor, now on the market.

Please contact the address below directly for catalogs and price/delivery information.

**FIGARO
ENGINEERING INC.**
3-7-3, Higashitoyonaka, Toyonaka City,
Osaka 560, Japan/Phone: (06) 849-2156
Cable: FIGARO TOYONAKA
Telex: 05286155 FIGARO J

Different hopes for different folks.



People want different things from a college education.

But they all agree on one thing. It takes more than brains to get a diploma.

Why not make the burden a little easier? Start buying U.S. Savings Bonds now.

Bonds are a dependable way to build a college fund for your children. And an easy way to start saving them is by joining the Payroll Savings Plan.

Start a college fund

now with U.S. Savings Bonds. They just might let your kids spend more time studying and less time working to stay in school—whatever they hope to be.



Take stock in America.

Buy U. S. Savings Bonds



The U. S. Government does not pay for this advertisement. It is presented as a public service in cooperation with The Department of the Treasury and The Advertising Council.

New products



verify, and if necessary correct, each command as he goes along. The display also tells the programmer what piece of information it requires next, so that it in effect guides inexperienced personnel through the programming sequence. The VNC-100 system, complete with software, a standard post-processor package, and documentation sells for \$20,300. Discounts are available for multiple-unit orders, and leasing terms are also offered.

Threshold Technology Inc., Route 130 & Union Landing Rd., Cinnaminson, N. J. 08077 [378]

Camless rotary limit switch has a resolution of 0.1°

A solid-state, camless limit switch continuously monitors the rotation of a machine shaft and provides a control output when the shaft angle exceeds a preset limit. The limit can be changed, even while the machine is operating, to a resolution of 0.1°. The limit switch consists of a miniature rotary transducer and an elec-

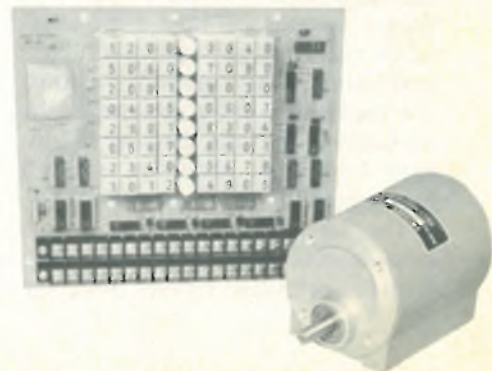

Top Quality MAGNETIC HEADS

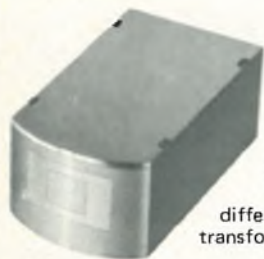

model
SM-SIS
differential
transformer type

ultra high sensitivity magnetic head for paper money exchanger, etc.

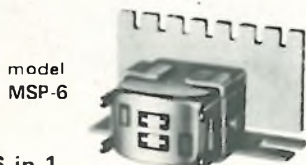

model
MSP-6

- 6 in 1 cassette stereo head for auto reverse play / record / erase

SAN-E SAN-E DENKI CO., LTD.

110-1, Minami Kawahori, Tennoji-ku,
OSAKA, JAPAN
PHONES: OSAKA (06) 779-1591
CABLE: SANMAGNETICS OSAKA

Circle 139 on reader service card

Exclusive Economic and Industry Studies

**For Financial Analysts,
Corporate Planners,
Business Economists,
Marketing Executives**

Geared directly to the future, our Department of Economics offers more than 40 forecasting tools to help project the general economy and industrial growth over the short and long run.

EXAMPLES: Do you know that the current operating rate for the chemical industry is 86%? For synthetic materials, the utilization rate is 93%? That construction and mining machinery new orders are expected to be 8% higher in 1974 than in '73? That steel expects a 3% decline in physical volume of sales in 1974? That consumer income after taxes will increase 8% in 1975?

At a modest cost, our various services covering most industrial segments of the economy are available to you.

For more information write for our booklet, "Exclusive Economic Studies," or phone Douglas Greenwald, Chief Economist, (212) 997-2216.

Department of Economics
McGraw-Hill Publications Company
1221 Avenue of the Americas
New York, N.Y. 10020



New products

tronics package. The latter need not be located at the machine.

Astrosystems Inc., 6 Nevada Dr., Lake Success, N. Y. [375]

Kit aids in testing and installation of transducers

A portable, battery-operated kit contains a set of all the instruments needed to install or service strain gages, strain-gage transducers, and instrumentation systems that contain them. The BLH model 3562 in-



cludes a transducer indicator for checking the output and balance of strain-gage transducers, a precision calibrator, an uncalibrated vernier module, a multimeter, and a set of cables with Bendix connectors. The entire kit is packaged in a rugged carrying case for field use.

BLH Electronics Inc., 42 Fourth Ave., Waltham, Mass. 02154 [376]

Pressure transducer has 0.125-inch diameter

A series of flush diaphragm miniature pressure transducers designed for direct mounting in a variety of pressure fittings has an over-all diameter of only 0.125-inch. The units are hermetically sealed for operation in corrosive fluids or gases and can be provided in pressure

DIELECTRIC MATERIALS CHARTS



Charts in full color contain data on all important materials used by electrical and electronic engineers.

Circle 138 on reader service card

ADHESIVES, RESINS & COATINGS HELP KEEP COMPONENTS COOL



Electrically insulating, thermally conductive . . . for bonding, encapsulating, coating or sealing heat sinks, components or cryogenic devices where rapid heat transfer is desired. New four-page folder describes materials and applications.

Circle 167 on reader service card

NEW -- FREE -- DATA PLASTIC/CERAMIC FOAMS



ECCOFOAM[®] is the broadest line of plastic and ceramic foams for electronics. Foam-in-place; sheet stock; pourable syntactic; artificial dielectrics all described and properties tabulated in new booklet. Send for copy.

Circle 168 on reader service card

Emerson & Cuming, Inc.



CANTON, MASS.
GARDENA, CALIF.
NORTHBROOK, ILL.
Sales Offices
in Principal Cities

EMERSON & CUMING EUROPE N.V., Devel, Belgium



UP goes
the
productivity,

DOWN (by 70%)
go the costs

when the

**»KORUND«
LASER UNIT**

Drills · Watch · Jewels

materials drilled	rubies, corundum, ceramics, ferrite
bore diameters	0.03 mm to 0.15 mm
bore depth	from 0.5 mm to 0.8 mm
bore diameter accuracy	not below ± 0.01 mm
thickness of material drilled	to 1.0 mm
productivity	one bore per second

Exporter:

V/O TECHMASHEXPORT

35, Mosfilmovskaya
Moscow V-330 · USSR
Telex: 7568



SSSR MOSKVA

TECHMASHEXPORT



New products

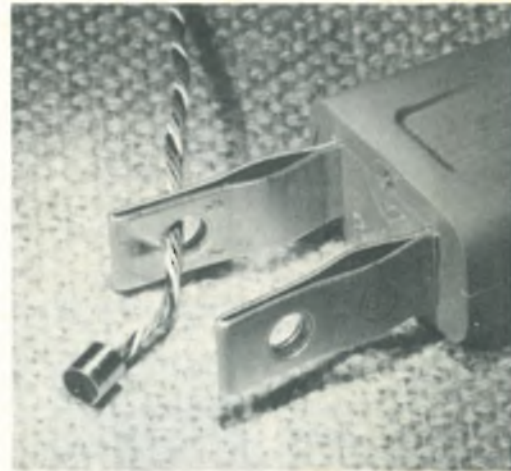

ranges from 5 to 12,000 psi. The transducers are offered with resonant frequencies as high as 200 kilohertz and with both bonded-foil and semiconductor sensing elements. Basic accuracies of the units are within 0.5% of full scale.

Sensotec Inc., 1400 Holly Ave., Columbus, Ohio 43212 [374]

**42-channel tape reader
handles up to 1,600 bits/s**

The model 42 photoelectric tape reader is an all-solid-state unit with a maximum read rate of 1,600 bits per second. Driven by a stepper motor with direct sprocket drive, the model 42 can be interchanged with existing mechanical readers. Op-

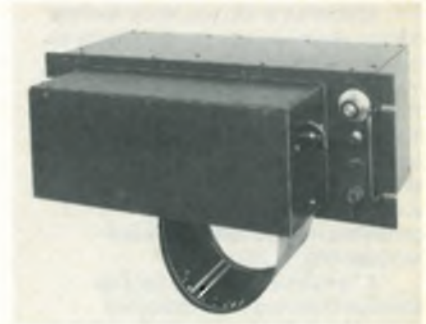

tions include C-MOS logic outputs and ac outputs for relay logic systems. The reader sells for from \$550 to \$1,250 and is available from stock.

Electronic Services, 16 East Franklin St., Danbury, Conn. 06810 [379]

THE FASTEST, MOST DEPENDABLE, MOST VERSATILE STRIP CHART RECORDER ANYWHERE.

It's the new GOULD/Brush 110 with a thermal pen unmatched in the quality of its easy-to-read blue traces.

It produces clear, crisp, dry traces at all speeds. With no smudges, no smears, no skips, no puddles.

The pen tip warms up in just milliseconds. So it can produce accurate traces even during a series of short movements. And response time is exceptional. Full-scale response time is 250 milliseconds, which enables it to record fast-changing signals more faithfully than most other strip charts.

When it comes to reliability, we back up our promise with a lifetime pen guarantee. One reason we can make such a strong guarantee is that the special ceramic pen tip is virtually wear-free. No frequent, costly pen replacements. And although other pens are sometimes damaged by excessive off-scale input signals, ours is not because we use hard-electronic limiters and soft mechanical stops.

Then take versatility. The 110 has features that let you tailor it to your exact application. For example, you can choose from ten

chart speeds. A selection of plug-in signal conditioners accommodate a wide range of input signals. Charts may be pulse-driven by an external device. And an optional solid state electronic chart integrator follows positive and negative signals up to 4 times full scale on the analog channel.

We don't believe there's another strip chart recorder in the market that is as fast, dependable and versatile. But don't take our word for it. We'll be happy to give you a demonstration anytime, anywhere. Once you see it, we think you'll believe it too.

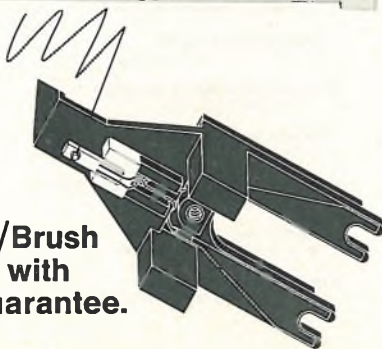
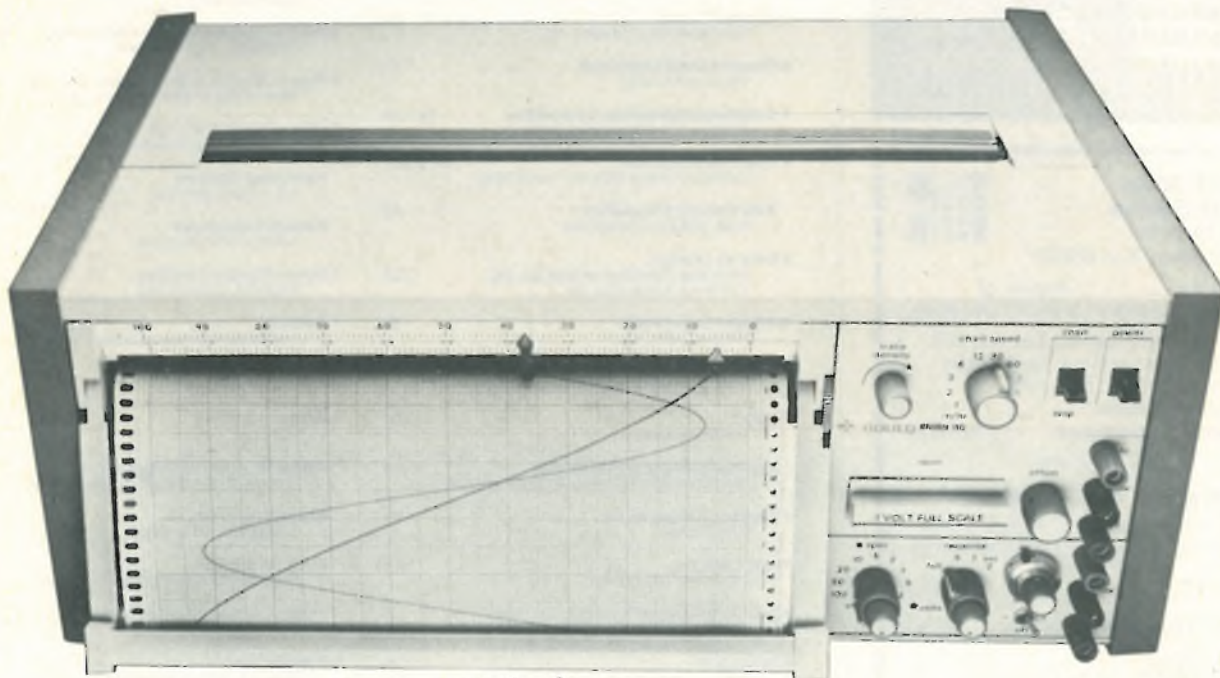

**The GOULD/Brush
thermal pen with
a lifetime guarantee.**

Call your nearest Gould Sales Engineer for a demonstration. Or write Gould, Inc., Instrument Systems Division, 3631 Perkins Avenue, Cleveland, Ohio 44114. Or Kouterveldstraat 13, B 1920 Diegem, Belgium.

 **GOULD**

What you must know about Microprocessors

Using articles from the pages of Electronics, this book contains practical and up-to-date information on available microprocessor devices, technology and applications—ranging from the simplest 4-bit p-channel MOS system to the second-generation n-MOS 8-bit processor chips, and the new injection logic and Schottky TTL bipolar processor families needed for the toughest computer-based control applications.

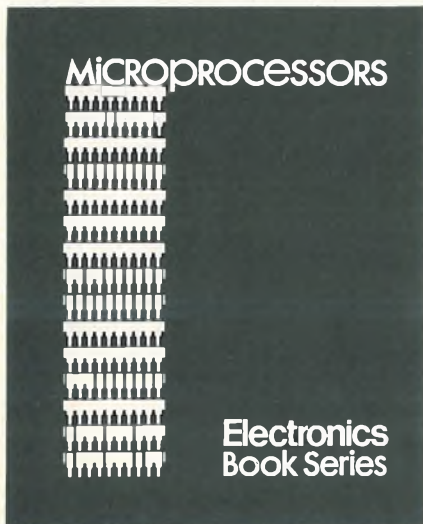

Electronics Book Series

P.O. Box 669
Hightstown, N.J. 08520



Send me _____ copies of "Microprocessors" at \$8.95 per copy.

I must be fully satisfied or you will refund full payment if the book is returned after 10 days free trial examination.

Payment enclosed Bill firm
 Bill me

Credit Cards Charge My Book To:

American Express Master Charge
 Diners Club BankAmericard

Acct. No. _____

Date Card Expires _____

Interbank No. _____

(1st No's. above name on Master Charge only.)

Name _____

Title _____

Company _____

Street _____

City _____

State _____ Zip _____

Signature _____

Electronics advertisers

June 26, 1975

• Adrel Electronics Psycho Publicite	12E, 22E	■ Hewlett Packard Talland/Yates Advertising, Inc.	2
Advanced Micro Devices Keye Donna Pearlstein	11	■ Hewlett Packard Talland/Yates Advertising, Inc.	2nd Cover
‡ Allen Bradley Company Hoffman, York, Baker & Johnson, Inc.	24	■ Hewlett Packard Talland/Yates Advertising, Inc.	1
Alma/Division of Develco Moorhead Marketing	115	■ Honeywell Test Instrument Division Campbell-Mithun, Inc.	44-45
Aluminum Company of America-Chemicals Ketchum, MacLeod & Grove, Inc.	130	Hughes Aircraft Company Foote, Cone & Belding/Honig	37
American Microsystems, Inc. Wilton Coombs & Colnett Inc. Advertising	132	Information Controls Corporation	129
■ Analog Devices, Inc. Schneider Parker, Inc.	135	Intel Corporation Regis McKenna, Inc.	18-19
• Anrlau Electric Co., Ltd. Diamond Advertising Agency Co., Ltd.	25E	‡ Interdesign, Inc. Bonfield Associates	54
■ AP Products Incorporated Marketing Communications Associates	76	■ Interstate Electronics Corporation Chris Art Studio Inc.	136
Arrow-M Corporation Halloff & Caine Associates	136	Ise Electronics Corporation Shinwa International, Inc.	51
AVX Ceramics TCI Advertising, Inc.	41	Isofonics Southeastern Advertising Agency, Inc.	122
Bausch & Lomb, Inc. Wolf Assoc., Inc.	134	ITT Cannon	24
• Bayer AG Werbeagentur	23E	Krohn-Hite Corporation Impact Advertising, Inc.	5
Belden Corporation Fensholt Incorporated	63	Litronix, Inc. Bonfield Associates	12-13
■ Buckeye Stamping Company, The Wheeler, Kight & Gainey, Inc.	127	Liton Industries—ACD Bryan Donald, Inc. Advertising	93
Burr-Brown Research Corp. N.A. Winter Advertising Agency	124	• Logabex	24E
■ Chicago Dynamic Industries Burton Browne Advertising	144	Merrimac Industries Fletcher-Walker-Gessell, Inc.	131
Chomerics, Inc. The Brightman Company, Inc.	42	Mycron	57
■ Concord Electronics Corp. Sound Advertising	137	National Electronics Lea Advertising	72
■ Continental Specialties Corporation Robert A. Paul Advertising Agency	79, 123	■ National Semiconductor Corporation Chiat/Day, Inc. Advertising	46-47, 113
■ Dale Electronics Inc. Swanson, Sinky, Ellis, Inc. Advertising	4th Cover	■ Nippon Electronic Memory Ind. Co., Ltd. Nihon Keizaisha Advertising, Ltd.	78
Data General Corporation Scali, McCabe, Sloves, Inc.	48	■ Nippon Electric Co., Ltd. Hakuhodo Incorporated	116
■ Delevan Division, American Precision Industries, Inc. Comstock Advertising, Inc.	128	Non-Linear Systems A & J Associates, Inc.	126
■ Dialight Corporation Michel-Cather, Inc.	20	Norland Instruments Action Communicators	58-59
Eastman Chemical Products, Inc. Martin Landey, Arlow Advertising Inc.	38	• Nuovo Pignone Divisione Studio Dr. Giuliano Blei	11E
EECO The Greer Agency	104	• Paramic Mainostoimisto As Luotonen OY	26E
Electronic Navigation Industries Hart/Conway Advertising—Public Relations	14	• Phillips Elcoma Intermarco Nederland	54
■ Emerson & Cuming, Inc. Edwin F. Hall	139	• Phillips Industries Vaz Dias	2E-3E
■ EPC Labs, Inc. Superfine Productions	127	• Phillips N. V. Pli/T&M Division Brookies Communications Systems SA	14E-15E
■ Erie Technological Products, Co., Inc. Altman Hall Associates Advertising	17	Phoenix Data, Inc. Craig Miller Advertising	122
■ Ferroxcube Black-Russell-Morris	15	Pihar Corporation Renaccio Advertising & Marketing, Inc.	73
Figaro Engineering Inc. Standard Advertising, Inc.	137	Plastics Engineering Company Kuttner & Kuttner, Inc.	16
■ Fluke Manufacturing Co., John Bonfield Associates	39	■ Powerlec, Inc. Warren C. Wilson & Associates	121
General Radio Company Grad Associates	119	■ Premier Metal Products Corporation Commercial Press, Inc.	136
■ Gould Inc./Instrument Systems Division Carr Liggett Advertising, Inc.	141	• R 2 E Sagha	9E
■ Grayhill, Inc. Stral Advertising Company, Inc.	40	• RCA Industrial Tube Products Al Paul Lefton Company, Inc.	27E
■ Hewlett-Packard Richardson, Seigle, Rolfs & McCoy, Inc.	21	RCA—Solid State Division Marsteller, Inc.	67-69
		‡ Rental Electronics, Inc. Humphrey Browning MacDougall, Inc.	52
		Relcon Corporation The House Agency	77

■ Rockland Systems Roll Johnson, Inc.	143
• Rhode & Schwarz	1E, 7E
San-a Denki Company Limited	139
• Schlumberger Delpire Acvico	60-61
• Schneider Electronique Intermedia	28E
• Salmart CPM Studio	16E
• Sescosem Bazaine Publicite	4E
• Stemica Jean Haechler Publicite	20E
SGS-ATES International McCann-Erickson	71
• Siemens A.G. Munich Linder Presse Union GMBH	52
‡ Siemens Corporation Stietel-Raymond Advertising Inc.	60-61
Siliconix Robertson West, Inc.	80
■ Spectrol Electronica Corp. JMR Inc.	3rd Cover
Sprague Electric Company Harry P. Bridge Company	8
■ Systron Donner Concord Instruments Fred Schott & Associates	9, 123
■ Tanalor Electronics Devey, Thompson & Vignola Advertising, Inc.	6
• TEAC Corp. Dentsu Advertising Ltd.	21E
■ Tektronix, Inc. Tektronix Advertising	33, 35
■ Teledyne Relays S. Michelson Advertising	64
Teledyne Semiconductor Regis McKenna, Inc.	7
Telonic Altair Jansen Associates, Inc., Marketing Services	76
Teradyne, Inc. Quinn & Johnson, Inc.	28
Thomson CSF Bazaine Publicite	43
■ TRW/IRC Resistors Gray & Rogers, Inc.	22-23
■ TRW Semiconductors The Bowes Company	125
• Ultra Electronics Components Ltd. Dennis Dolling Limited	13E
United Systems Corp., A sub. of Monsanto Co. Advertising & Merchandising, Inc.	75
■ Unirode Corporation Schneider Parker, Inc.	27
Utah State Industrial Board David W. Evans, Inc.	96
V/O Techmasheport Vneshtorgreklama	140
• Wavetek San Diego, Inc.	19E

Classified & Employment Advertising
F. J. Eberle, Manager 212-997-2557

EQUIPMENT (Used or Surplus New) For Sale

NCR Corporation138

■ For more information on complete product line see advertisement in the latest Electronics Buyer's Guide
* Advertisers in Electronics International
‡ Advertisers in Electronics domestic-only edition

Still only \$2795



BEST

FREQUENCY SYNTHESIZER

- **DC to 2 MHz Range**
- **0.001 Hz Resolution**
- **Full Programmability** BINARY OR BCD
- **No Switching Transients**
- **Direct Digital Techniques**
NO MIXING OR PHASE LOCKING
- **High Spectral Purity** —70dB SPURIOUS
—55dB HARMONIC
- **High Stability** ±2 X 10⁻⁸/°C STANDARD
±2 X 10⁻¹⁰/°C OPTIONAL
- **Precision Attenuator**
0 TO 85dB IN 1dB STEPS PLUS CONTINUOUS CONTROL
(PROGRAMMABLE ATTENUATION OPTIONAL)
- **High Output Voltage**
10 VOLTS P-P, 50-OHM SOURCE IMPEDANCE

ROCKLAND

Rockland Systems Corporation 230 W. Nyack Road, West Nyack, N.Y. 10994
(914) 623-6666 • TWX 710-575-2631

Circle 143 on reader service card

Need a current catalog?

Use your EBG to order the catalogs you need. Last year, 80,000 requests for catalogs were generated through the use of EBG Catalog Inquiry Cards. Put EBG to work for you—and your company.



**Electronics
Buyers'
Guide**

THE **ACTION** BOOK



No down-time in rotary switches



Unique 5-second water replacement obsoletes other switches. Simply lift out old wafer, slip in new wafer. No unsoldering . . . no disassembling . . . no wire removing.

CDI patented switches with dust covers are available in sizes 2" x 2", 3" x 3", and 4" x 4" with lengths to accommodate up to 36 wafers. Switches can be customized to your specifications.

Operation may be manual, motor or solenoid for use in any rotary selector switch application. Now supplied for numerous military and commercial applications.

Mfd. under Tabet U. S. Patents 2,841,660, 2,971,066, 3,015,000, 2,956,131, 2,988,607.

CHICAGO DYNAMIC INDUSTRIES, INC.



PRECISION PRODUCTS DIVISION

1725 Diversey Blvd., Chicago, Ill. 60614. Phone 312, WE 5-4600

Circle 144 on reader service card

Presenting in your corner: THE ELECTRONICS BOXER!

Why mess around when you can have the ELECTRONICS BOXER clean up your copies—keep them in top condition.

And, it's easy and inexpensive to keep the ELECTRONICS BOXER in your corner. Just complete the coupon and mail. Your order will be processed immediately, postpaid.



ELECTRONICS BOXER

Jesse Jones Box Corporation

2250 E. Butler St., Philadelphia, Pa. 19137

Please send me: boxes @ \$4.25 each;
 3 boxes @ \$12.00; 6 boxes @ \$22.00

My check or money order is enclosed.

Name _____

Address _____

City _____ State _____ Zip _____

Advertising Sales Staff

Pierre J. Braudé New York [212] 997-3468
Paris Tel. 720-73-01
Director of Marketing

Atlanta, Ga. 30309: Warren H. Gardner
100 Colony Square, 1175 Peachtree St., N.E.
[212] 997-3617

Boston, Mass. 02116: James R. Pierce
607 Boylston St. [617] 262-1160

Chicago, Ill. 60611:
645 North Michigan Avenue
Robert W. Bartlett (312) 751-3739
Paul L. Reiss (312) 751-3738

Cleveland, Ohio 44113: William J. Boyle
[716] 586-5040

Dallas, Texas 75201: Charles G. Hubbard
2001 Bryant Tower, Suite 1070
[214] 742-1747

Denver, Colo. 80202: Harry B. Doyle, Jr.

Detroit, Michigan 48202: Robert W. Bartlett
1400 Fisher Bldg
[313] 873-7410

Houston, Texas 77002: Charles G. Hubbard
375 Dresser Tower, 601 Jefferson St. [713] CA 4-8381

Los Angeles, Calif. 90010: Robert J. Rielly
Bradley K. Jones, 3200 Wilshire Blvd., South Tower
[213] 487-1160

New York, N.Y. 10020
1221 Avenue of the Americas
Warren H. Gardner [212] 997-3617
Michael J. Stoller [212] 997-3616

Philadelphia, Pa. 19102: Warren H. Gardner
Three Parkway,
[212] 997-3617

Pittsburgh, Pa. 15222: Warren H. Gardner

Rochester, N.Y. 14534: William J. Boyle
9 Greylock Ridge, Pittsford, N.Y.
[716] 586-5040

San Francisco, Calif. 94111: Don Farris
Robert J. Rielly, 425 Battery Street.
[415] 362-4600

Paris: Alain Offergeld
17 Rue-Georges Bizet, 75 Paris 16, France
Tel: 720-73-01

Geneva: Alain Offergeld
1 rue du Temple, Geneva, Switzerland
Tel: 32-35-63

United Kingdom & Scandinavia: Keith Mantle
Tel: 01-493-1451, 34 Dover Street, London W1

Milan: Luigi Rancati
Robert Saidel (Middle East)
1 via Baracchini, Italy Phone 86-90-656

Brussels: Alain Offergeld
23 Chaussee de Wavre
Brussels 1040, Belgium
Tel: 13-73-95

Frankfurt/Main: Fritz Krusebecker
Dieter Rothenbach (East European Countries)
Liebigstrasse 27c, Germany
Phone 72 01 81

Tokyo: Tatsumi Katagiri, McGraw-Hill
Publications Overseas Corporation,
Kasumigaseki Building 2-5, 3-chome,
Kasumigaseki, Chiyoda-Ku, Tokyo, Japan
[581] 9811

Australasia: Warren E. Ball, IPO Box 5106,
Tokyo, Japan 100-31
Tel: (03) 667-7397

Business Department

Stephen R. Weiss, Manager
[212] 997-2044

Thomas M. Egan,
Assistant Business Manager [212] 997-3140

Carol Gallagher
Production Manager International [212] 997-2045

Dorothy Carter, Production Manager Domestic
[212] 997-2908

Frances Vallone, Reader Service Manager
[212] 997-6057

Lisa Hoenig, Secretary
[212] 997-6481

Electronics Buyers' Guide

George F. Werner, Associate Publisher
[212] 997-3139

Regina Hera, Directory Manager
[212] 997-2544

Don't cheat yourself on trimmer performance.

Compare element size
and see why Dale gives
you better value!

Low profile doesn't have to mean low performance. The larger cermet element in Dale Low Profile Trimmers gives you extra value for your money. Extra assurance of trouble-free performance. You get: **More Power** 1 watt at 70°C lets you derate for assured long-term stability. **Better Adjustability** — $\pm 0.10\%$ output resistance, $\pm 0.05\%$ output voltage ratio. **Low Noise** 1% Contact Resistance Variation standard. **Low T.C.** ± 100 PPM standard.

Immediate delivery
from stock...

Cermet Models
(781, 783, 784)

Wirewound Models
(721, 723, 724)

Phone 402-564-3131
today for complete details.

DALE ELECTRONICS, INC., 1300 28th Ave., Columbus, Nebr. 68601
In Canada Dale Electronics Canada Ltd.
In Europe Dale Electronics GmbH
8 Munchen 60, Falkweg 51, West Germany
A subsidiary of The Lionel Corporation



DALE
780
Low
Profile



Brand H



Brand B



Brand I



Brand E

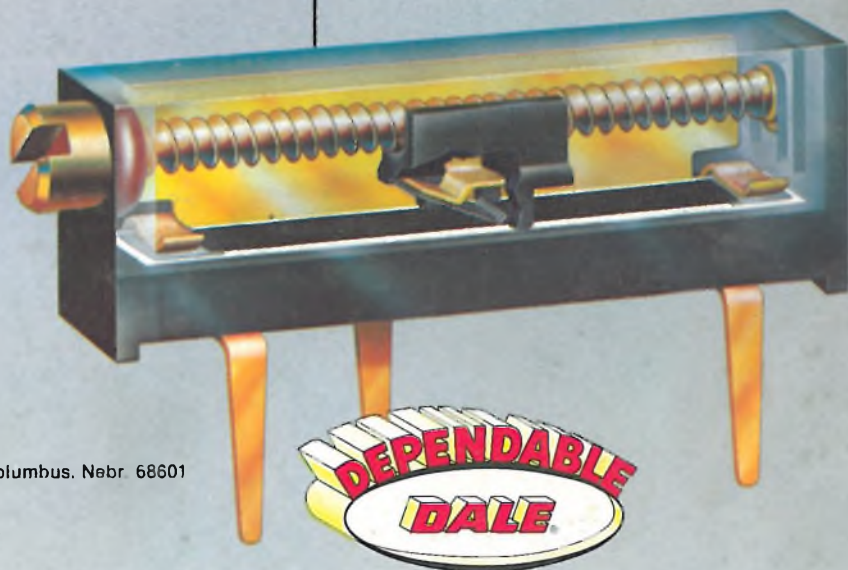

Circle 902 on reader service card

Finally! A unique low-cost multi-turn cermet that speaks for itself!

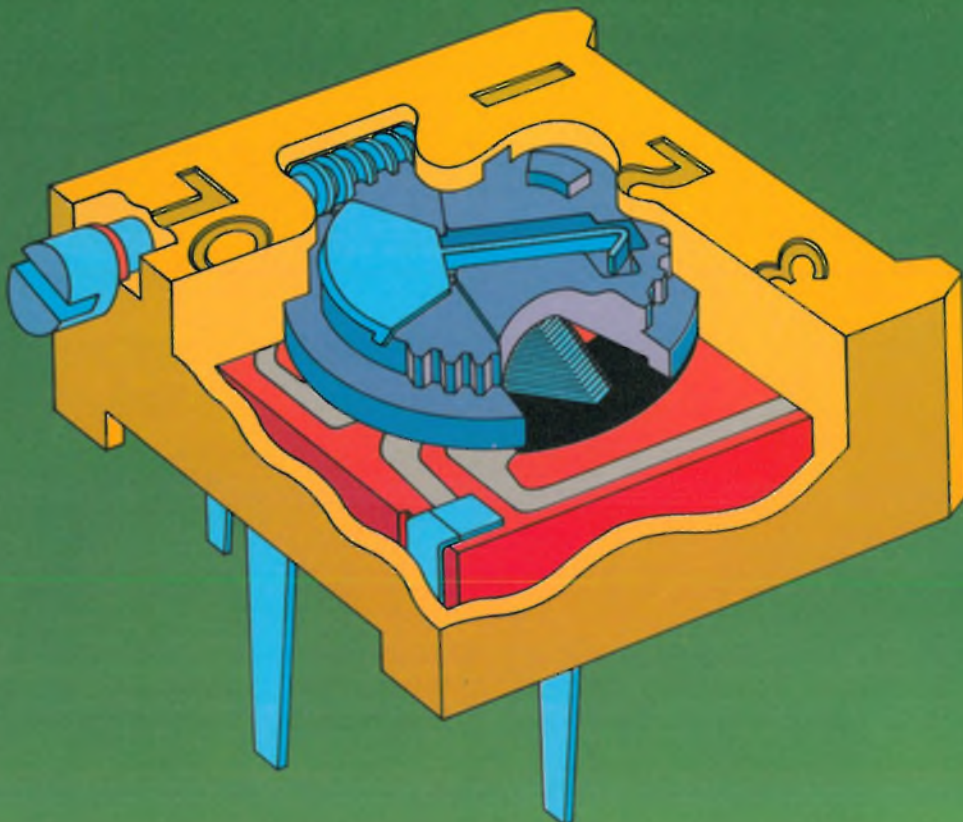

The New Spectrol 3/8-inch Model 64

Unique mechanical design of rotor, clutching assembly, and housing provides superior setability and stability with virtually no backlash . . . 28-fingered brush contact for low CRV . . . compact 3/8-inch square sealed unit . . . top-adjust or side adjust with 6 configurations . . . directly replaces the models 3299 and 66. Available now from the factory and 75 distributor outlets.



Spectrol

SPECTROL ELECTRONICS GROUP

UNITED STATES Spectrol Electronics Corporation 17070 E. Gale Avenue, City of Industry, Calif. 91745, U.S.A. • (213) 964-6565 • TWX (910) 584-1314

UNITED KINGDOM Spectrol Reliance Ltd. Drakes Way, Swindon, Wiltshire, England • Swindon 21351 • TELEX: 44692

ITALY SP Elettronica spa Via Carlo Pisacane 7, 20016 Pero (Milan) Italy • 35 30 241 • TELEX: 36091

Circle 901 on reader service card