

FEBRUARY 6, 1975

Industrial hazards call for intrinsically safe designs/91
Microprocessor design with standard logic, part 2/102
Integrating calculator elements on a glass substrate/109

FOUR DOLLARS A MCGRAW-HILL PUBLICATION

Electronics®

A NEW DIRECTION FOR BIPOLAR LSI

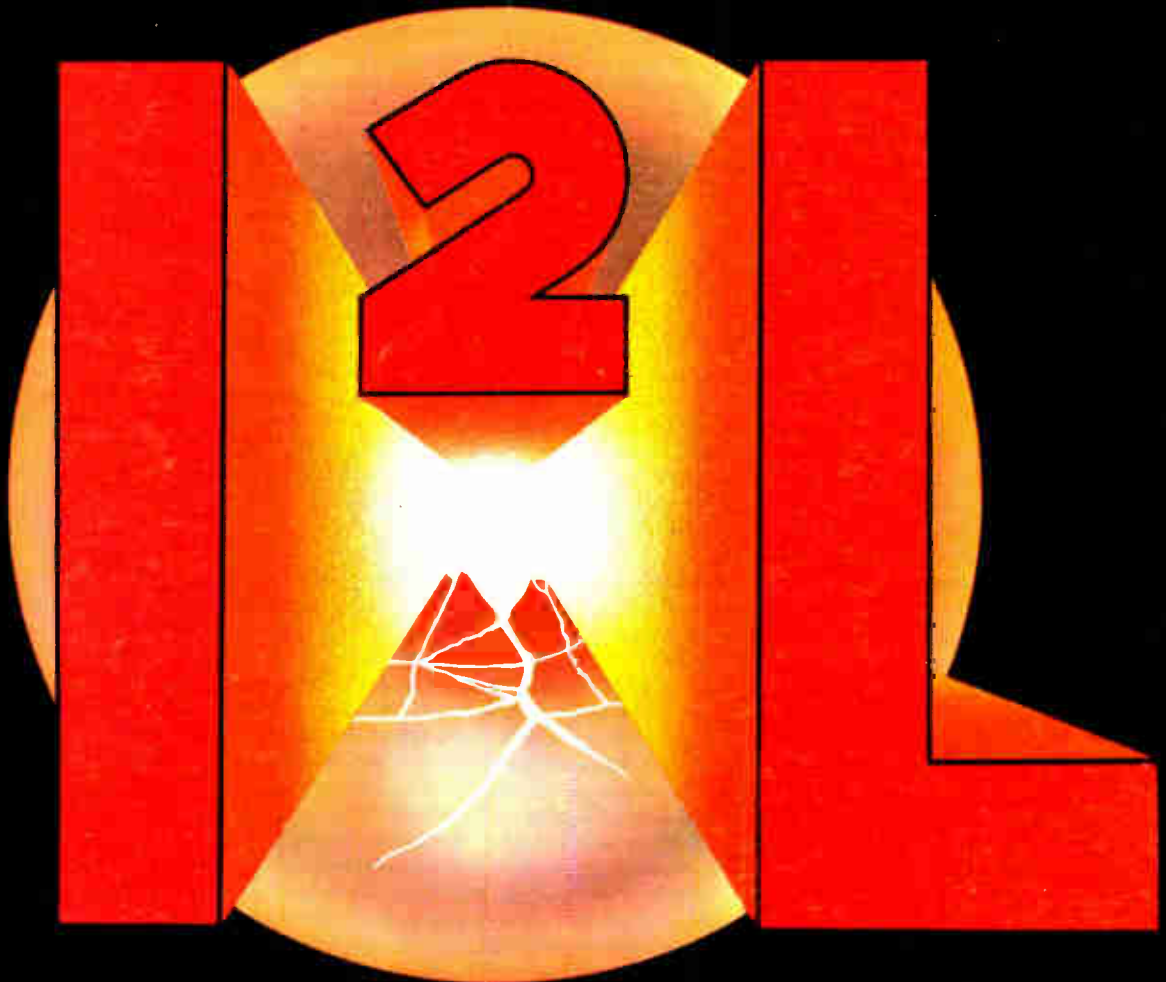

upshur

1420 Hillside Blvd. Ste. 100
Waco, TX 76798
97232
1022 NE 55th Ave
Portland, OR



For the Engineer who needs the best Measuring Instruments...

6 new ideas

■ NEW INSTRUMENTS

- Spectrum Analyzers
- Impedance Plotters
- Sweep Test Systems
- Power Signal Generators
- Frequency Synthesizers
- Selective Microvoltmeters
- Programmable Attenuators
- TV Broadcast Test Equipment
- Semiconductor Test Equipment

■ NEW FACILITY

devoted to Engineering, Manufacturing, Quality Control, Sales and Service.

■ NEW CATALOG

286 pages describing over 1,500 instruments.

■ NEW EXTENDED WARRANTY

up to 3 years on all R&S equipment.

■ NEW DIRECT LEASE PLAN

lease any instrument from R&S.

■ NEW QUICK DELIVERY PLAN

from stock.

Send for your new catalog today and see all our ideas.

World Leader in Test Inst. & Communications for Over 40 Years



ROHDE & SCHWARZ

14 Gloria Lane, Fairfield, N.J. 07006 ■ (201) 575-0750 ■ Telex 133310

Circle 900 on reader service card

World Radio History

KIND HEARTS, BUT NO CORNETS.

**No tubas, no trombones,
no clarinets, no oboes, or flutes,
no drums, no bass fiddles, or bassoons,
nor guitars, nor pianos,
nor anything on John Philip Sousa's list.**

We haven't a thing that makes music.
Unless you count ticking, buzzing and
whirring...the sounds of science!

We are U. S. Instrument Rentals...

...that's oscilloscopes, counters,
analyzers, amplifiers, recorders, meters, and
state of the art test instrumentation, you name it.

What is special about us is not so much
kind hearts, but a commitment to tune out some
of the sour notes of renting.

Sour Note Ever forget to return a piece of equipment
and then get stuck for the payments?

Sweet Note Only we send you an automatic
reminder when the rental period is up.

Sour Note Ever get the telephone runaround
when you're trying to locate equipment?

Sweet Note Only we have IDIOM, a real time
computer capability for instant
inventory commitment.

Sour Note Ever have service turnaround problems?

Sweet Note Only we will pay you a 25% penalty
in dollars if we can't speed a
replacement to you within 48 hours.

With US, service is an essential refrain.

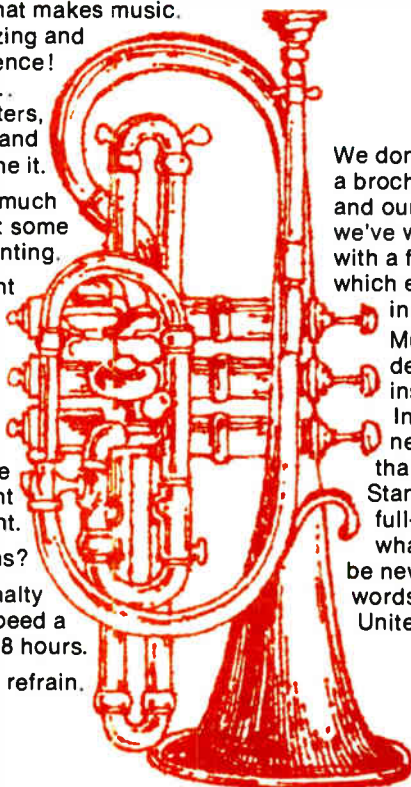

We don't have room to write
a brochure about ourselves
and our services here. Besides,
we've written one already...
with a fat catalog included
which explains the foregoing
in detail and much more.

Much more includes a full
description of the rental
instruments we have.

In fact, we probably have more
new equipment on the shelf
than any other rental company.

Stands to reason: We were born
full-grown just months ago—
what you get from US is bound to
be newer! And now, our catalog,
words and music by
United States Instrument Rentals

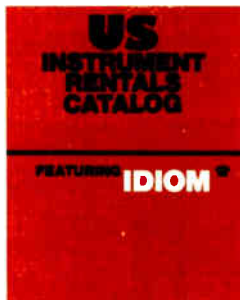

Gentlemen:

I understand you have the only Instrument Rental Catalog in the world
that doesn't read like a telephone directory. Please

- Send it to me without cost or obligation.
- Just send me a copy of pages 6 & 7 which chart the breakeven
relationship between rental cost, ownership cost and utilization.

NAME _____

COMPANY _____

ADDRESS _____

CITY _____ ZIP _____

PHONE _____

951 Industrial Road, San Carlos, CA 94070

IDIOM Inventory and Delivery
Information in
One Minute



(213) 849-5861 (301) 340-1353 (214) 234-3392
(415) 592-9230 (201) 381-3500 (713) 462-6803



TRY 'EM...YOU'LL LIKE 'EM

Instant relief for design congestion: Cherry Subminiature snap-action switches.

When your design is afflicted with circuit congestion brought on by acute lack of space, here's the prescribed cure: Cherry 5 and 10 amp subminiature switches! Compact, easy-to-take size . . . refreshingly dependable coil spring action . . . plus long overtravel to combat assembly line headaches. You get Speedy snap-action relief in the dosage you prescribe: Either individual switches or space-saving multiple switch modules. Consultation available if design distress persists . . . Cherry diagnoses proven in over 160 million cases.

Try 'em: Send for free sample switch.
You'll like it.



E61-00A
Standard Force Basic 10 amp.
Circle Reader Service No. 166

E63-00A

"Goldie" Low Energy 0.1 amp.
Circle Reader Service No. 167



E62-50K

Roller Actuator 10 amp.
Circle Reader Service No. 165



CHERRY



TWX 910-235-1572... or PHONE (312) 689-7600... or WRITE:

CHERRY ELECTRICAL PRODUCTS CORP.
3600 Sunset Avenue, Waukegan, Illinois 60085



Cherry affiliates worldwide • Hirose Cherry Precision Co., Ltd., Tokyo • G W. Engineering Pty Ltd., Svdney
Cherry Electrical Products (U.K.) Ltd., St. Albans, Herts • Cherry Mikroschalter GmbH, Bayreuth, Germany

39 Electronics Review

SOLID STATE: RCA close to commercial CCD cameras, arrays, 39
Three-inch rectifier handles 10 megawatts, 40
COMMUNICATIONS: IBM ponders court action on domsat ruling, 40
COMMERCIAL: Recorder detects counterfeit currency, 41
Funds-transfer systems may have to share single net, 42
PACKAGING & PRODUCTION: Junction plug-ins make own contacts, 42
COMMUNICATIONS: Chip lasers ready for optical systems, 44
DOD wants standardized fiber-optic systems by 1980, 44
NEWS BRIEFS: 46
MANAGEMENT: New Fairchild chairman promises expanded markets, 48
MATERIALS: Chemicals are key to liquid-crystal-display watches, 48
INDUSTRIAL: Optical gear finds water pollutants, 51

62 Electronics International

FRANCE: Portable X-ray machine measures metal stress, 62
WEST GERMANY: Intermetall to sell novelty IC light switch, 62
AROUND THE WORLD: 63

69 Probing the News

NAVIGATION: Air Force gets aboard Omega, 69
SOLID STATE: ISSCC has news for LSI users, 72
AVIONICS: DAIS takes center stage, 76
ELECTRONICS ABROAD: Europe heads for pollution standards, 78
COMPANIES: Signetics digs out, 80

83 Technical Articles

SOLID STATE: I²L boosts bipolar-microprocessor integration, 83
INDUSTRIAL ELECTRONICS: Intrinsic safety foils explosions, 91
DESIGNER'S CASEBOOK: Smoothing 555-timer capacitance levels, 96
Generating overlapped clock phases for CCD array, 97
Overvoltage indicator can be added to C-MOS IC tester, 99
CIRCUIT DESIGN: Part 2, Standard logic in microprocessors, 102
Calculator's parts integrated on a single glass substrate, 109
ENGINEER'S NOTEBOOK: Increasing an instruction set, 114
Low-cost field-strength unit uses simple buffer, 115

123 New Products

IN THE SPOTLIGHT: Scope is combined with multimeter, 123
Plastic telephone-type relays are hermetically sealed, 127
INSTRUMENTS: Digital panel meters have 0.5-inch LEDs, 128
COMPONENTS: LEDs offer high efficiency, 136
SEMICONDUCTORS: Schottky RAM draws only 275 milliwatts, 142
DATA HANDLING: Cartridge drive is built for field use, 149
PACKAGING & PRODUCTION: Large screen aids wafer inspection, 153

Departments

Publishers letter, 4
Readers comment, 6
News update, 8
People, 14
Meetings, 30
Electronics newsletter, 35
Washington newsletter, 59
Washington commentary, 60
International newsletter, 65
Engineer's newsletter, 118
New literature, 157

Highlights

The cover: I²L blazes new bipolar path, 83

A non-isolated gate structure boosts the density of the latest integrated-injection-logic chip, which also has five times the speed of a comparable 4-bit n-MOS microprocessor. The next I²L generation is expected to be even faster and should at last make the full benefits of bipolar LSI available to computer designers. Cover is by illustrator Tom Upshur.

Conference announces LSI advances, 72

Visitors to the International Solid State Circuits Conference in Philadelphia this month will learn about: denser-than-ever bipolar chips; faster-than-ever MOS memories; gallium-arsenide FET oscillators that set new power-frequency records; and charge-coupled devices that are revolutionizing analog signal processing.

How to build an intrinsically safe system, 91

The sparking that always occurs in electronic equipment is often powerful enough to trigger explosions in volatile atmospheres. This danger can be eliminated if the circuitry in the hazardous areas operates with low enough voltage, current, capacitance, and inductance values.

Using high-speed logic for microprocessors, 102

The parts count can be reduced when an application requires less than the utmost performance from a processor built from high-speed logic. This is the second half of a two-part article on the design of standard-logic processors that are faster than MOS chips and use fewer devices than random-logic systems.

And in the next issue . . .

An economical two-way pay-TV system . . . eight ways to improve radio receiver design . . . overcoming the deficiencies of zener diodes as voltage reference sources.

EDITOR-IN-CHIEF: Kemp Anderson

EXECUTIVE EDITOR: Samuel Weber

MANAGING EDITORS: Lawrence Curran, *News*;
Arthur Erikson, *International*

SENIOR EDITORS: John Johnsrud,
H. Thomas Maguire, Laurence Altman,
Ray Connolly, Stephen E. Scrupski

ART DIRECTOR: Fred Sklenar

ASSOCIATE EDITORS: Howard Wolff,
Gerald M. Walker, Alfred Rosenblatt

DEPARTMENT EDITORS

Aerospace/Military: Ray Connolly

Circuit Design: D. J. Blattner

Components: Lucinda Mattera

Computers: Stephen E. Scrupski

Consumer: Gerald M. Walker

Industrial: Margaret A. Maas

Instrumentation: Andy Santoni

New Products: H. Thomas Maguire,

Michael J. Riezenman

Packaging & Production: Jerry Lyman

Solid State: Laurence Altman

COPY EDITORS: Margaret Eastman,

Everett C. Terry, Bill Dunne

ART: Charles D. Ciatto, *Associate Director*

Patricia Cybulski, *Assistant Director*

PRODUCTION EDITOR: Arthur C. Miller

EDITORIAL SECRETARIES: Janet Noto,

Julie Gorgoglione, Penny Roberts

FIELD EDITORS

Boston: Gail Farrell (Mgr.), Pamela Leven

Los Angeles: Paul Franson (Mgr.)

Judy Phelps

Midwest: Larry Armstrong (Mgr.)

New York: Ron Schneiderman (Mgr.)

San Francisco: Bernard Cole (Mgr.)

Judith Curtis

Washington: Ray Connolly (Mgr.)

Larry Marion

Frankfurt: John Gosch

London: William F. Arnold

Paris: Arthur Erikson

Tokyo: Charles Cohen

McGRAW-HILL WORLD NEWS

Director: Ralph R. Schulz

Bonn: Robert Ingersoll

Brussels: James Smith

London: Marvin Petal

Madrid: Dom Curcio

Milan: Peter Hoffmann, Andrew Heath

Moscow: Peter Gall

Paris: Michael Johnson, Richard Shepherd

Stockholm: Robert Skole

Tokyo: Mike Mealey

PUBLISHER: Dan McMillan

DIRECTOR OF MARKETING: Pierre J. Braudé

ADVERTISING SALES SERVICE MANAGER:

Wallis Clarke

BUSINESS MANAGER: Stephen R. Weiss

CIRCULATION MANAGER: Nancy L. Merritt

MARKETING SERVICES MANAGER:

Tomlinson Howland

RESEARCH MANAGER: Margery D. Sholes

The pace of electronics progress is nowhere more breathtaking than in solid state developments. Our cover story this issue, for example, details a technique for fabricating extremely compact integrated injection-logic gates that, since they require no space-consuming pn junctions for isolation, are comparable in size to a single transistor. What's more, power demands are low. The result: digital ^{12L} structures with thousands of gates on a single bipolar chip. Read all about it on page 83.

The instrument-bedecked cockpit of today's Air Force plane may become a far less crowded place as the trend toward using digital methods in jobs that were once solely analog gains momentum. In place of the maze of "black boxes," a time-shared computer-based CRT display is being tried out at Wright-Patterson AFB. With it, a streamlined console could give the pilot even more data than he has available today—and do it with far more efficient use of space. You'll find our story about the program, called DAIS, on page 76.

Larry Armstrong, our Midwest bureau manager, wrote the story after interviewing the project officers at the Air Force Avionics Laboratory and going for a "trial run" of the prototype cockpit simulator that they have developed. In fact, the "trainee" in the photograph on page 76 is none other than our man Armstrong getting a hands-on demonstration of the DAIS hot bench.

Avionics, incidentally, is something of a hot field just now, as shown by the fact that we have two

Probing the News articles on avionics in this issue: the DAIS story and one on the Air Force's ambitious plans for the next decade's worldwide air navigation system (see page 69).

That story, put together by our Washington bureau chief, Ray Connolly, details the steps that the Air Force is taking to replace the geographically limited Loran network with a global-reach Omega net. The prize for the winning contractor will be about \$22 million for just the electronics on board some 1,000 transports. Development, spares, training, and maintenance are extra.

Having decided to switch to Omega—and its eight worldwide stations—the Air Force, in the words of one officer, has "dismissed the Newtonian navigators" with their high-cost inertial systems and is continuing, albeit in an upgraded form, with "the Maxwellian approach." But, as we point out in the story, Omega is not the last word in navigation. The Air Force is already working on the next generation—a satellite-based navigation system to go into operation about 1987. Maybe that will be called the Copernican approach.

The annual index of articles published in *Electronics* is now available, and a copy will be mailed to any reader who requests it. Just circle number 340 on the reader service card, which you will find inside the back cover.



February 6, 1975 Volume 48, Number 3
94,153 copies of this issue printed

Published every other Thursday by McGraw-Hill, Inc. Founder James H. McGraw 1860-1948. Publication office 1221 Avenue of the Americas, N.Y., N.Y. 10020; second class postage paid at New York, N.Y. and additional mailing offices.

Executive, editorial, circulation and advertising addresses: Electronics, McGraw-Hill Building, 1221 Avenue of the Americas, New York, N.Y. 10020. Telephone (212) 997-1221. Teletype TWX N.Y. 710-581-5234. Cable address MCGRAWHILLN.Y.

Subscriptions limited to persons with active, professional, functional responsibility in electronics technology. Publisher reserves the right to reject non-qualified requests. No subscriptions accepted without complete identification of subscriber name, title, or job function, company or organization, including product manufactured or services performed. Subscription rates: qualified subscribers in the United States and possessions, Canada, and Mexico \$12.00 one year, \$24.00 three years, all other countries \$25.00 per year, except Japan and Israel \$50.00 per year, Brazil \$40.00 per year, Australia and New Zealand \$60.00 per year, including air freight. Limited quota of subscriptions available at higher-than-basic rate for persons outside of field served, as follows: U.S. and possessions and Canada, \$25.00 one year, all other countries \$50.00. Single copies \$4.00.

Officers of the McGraw-Hill Publications Company: John R. Emery, President; J. Elton Tushig, Executive Vice President-Administration; Gene W. Simpson, Group Publisher-Vice President, Senior Vice Presidents: Ralph Blackburn, Circulation, Walter A. Stanbury, Editorial; John D. Hoglund, Controller, David G. Jensen, Manufacturing, Gordon L. Jones, Marketing; Jerome D. Luntz, Planning & Development.

Officers of the Corporation: Shelton Fisher, Chairman of the Board and Chief Executive Officer; Harold W. McGraw, Jr., President and Chief Operating Officer; Wallace F. Trendly, Group President, McGraw-Hill Publications Company and McGraw-Hill Information Systems Company; Robert N. Landes, Senior Vice President and Secretary; Ralph J. Webb, Treasurer.

Title registered in U.S. Patent Office. Copyright © 1975 by McGraw-Hill, Inc. All rights reserved. The contents of this publication may not be reproduced in whole or in part without the consent of copyright owner.

Subscribers: The publisher, upon written request to our New York office from any subscriber, agrees to refund that part of the subscription price applying to copies not yet mailed. Please send change of address notices or complaints to Fulfillment Manager, subscription orders to Circulation Manager, Electronics, at address below. Change of address notices should provide old as well as new address, including postal zip code number if possible, attach address label from recent issue. Allow one month for change to become effective.

Postmaster: Please send form 3579 to Fulfillment Manager, Electronics, P.O. Box 430, Hightstown, N.J. 08520.

For \$395

how many functions should a Function Generator generate?

Fifteen. That's the number of waveforms you can get with Krohn-Hite's Model 5100A. How? A unique Symmetry Control that allows pulse rep rate to be set independently of pulse width and also provides independently adjustable triangle slopes. You can skew any of the basic sine, square, triangle and ramp waveforms by as much as 99% to produce 10 additional functions. Frequency range of 0.002 Hz to 3 MHz can be manually tuned or externally controlled for VC of 1000:1. When you compare the 5100A with the rest, there's quite a generation gap. For fast action, call The Wavemakers at (617) 491-3211, TWX 710-320-6583 Krohn-Hite Corporation, 580 Mass. Ave., Cambridge, Mass. 02139.



KH KROHN-HITE CORPORATION

SALES OFFICES: ALA, Huntsville (205) 534-9771; ARIZ, Scottsdale (602) 947-7841; CAL, San Jose (408) 292-3220, Inglewood (213) 674-6850; COLO, Denver (303) 934-5505; CONN, Glastonbury (203) 633-0777; FLA, Orlando (305) 894-4401; HAWAII, Honolulu (808) 941-1574; ILL, Oes Plaines (312) 298-3600; IND, Indianapolis (317) 244-2456; MASS, Lexington (617) 861-8620; MICH, Detroit (313) 426-8800; MINN, Minneapolis (612) 884-4336; MO, St. Louis (314) 423-1234; N.C., Burlington (919) 227-3639; N.J., Haddonfield (609) 795-1700; N.M., Albuquerque (505) 299-7658; N.Y., E. Syracuse (315) 437-6666; Rochester (716) 328-2230, Vestal (607) 785-9947, Elmont (516) 488-2100; OHIO, Cleveland (216) 261-5440, Dayton (513) 426-5551; PA, Pittsburgh (412) 371-9449; TEX, Houston (713) 688-9971, Richardson (214) 231-2573; VA, Alexandria (703) 354-1222; WASH., Seattle (206) 624-9020; CANADA, Montreal, Quebec (514) 636-0525, Toronto, Ontario (416) 444-9111, Stittsville, Ontario (613) 836-4411, Vancouver, British Columbia (604) 688-2619.



Tansitor

Specialists in
Tantalum Capacitors

FOIL TYPES



Tubular Style
CL, CLR or TE
Elastomer or
Hermetic Seals



Rectangular Packages
CL or TE 51, 52, 53, 54
Tantalum to Glass
Hermetic Seal



Special Designs
WF, TES, THS
Volumetrically efficient
Filter Capacitors



Custom Modules
Wide range of ratings
designed to meet
your requirements

WET TYPES



CL 65, CL 67, CLR65
Elastomer or
Hermetic Seals
Standard or High Cap



Rectangular Packages
CL or TE 55
Hermetic Seal
High Cap Values



Miniature Wets
Most Volumetrically
efficient Capacitor
Low DC Leakage

MINIATURE SOLIDS



Type HA Cylindrical
Type TC Rectangular
Axial or Radial Leads
Subminiature size

For more information on TANSITOR
capacitors, call your local
Tansitor Representative, or contact:



Tansitor
ELECTRONICS
DIVISION OF AEROTRON, INC.

West Road, Bennington, Vermont 05201
Phone: (802) 442-5473 TWX: (710) 360-1782

Readers comment

Unfoiled indicator

To the Editor: The very useful lock indicator of the phase-locked loop devised by J. A. Connelly and G. E. Prescott [*Electronics*, Sept. 5, 1974, p. 112] has the undesirable capability of displaying the lock condition when no input signal is applied, or if the input is grounded. The outputs of the wave shaper (HA-2311) and the phase comparator (7400-7406) remain at ground, as they do in the true lock condition.

This can be overcome by exchanging the inputs of the 2311 wave shaper—connecting the input to the inverting lead and the ground to the noninverting lead—and replacing the 7400 and 7406 in the phase comparator with a second exclusive-OR. This exclusive-OR is already available on the chip of the 7486 90° phase shifter.

This modified circuit has the same properties of that published by Connelly and Prescott, but does not signal "lock" when no input signal is applied.

Gunther Kuerbitz
Aalen, Germany

Information source

To the Editor: Your readers may be interested in knowing the source of the market data for the bar graph you published on p. 87 of your Jan. 9 issue concerning the size of the markets for timesharing and remote computing services. The source of the information was a major market study undertaken by International Resource Development Inc. and published in November 1974. The figures were derived from a business analysis of the major suppliers of remote computing services.

Kenneth G. Bosomworth
International Resource
Development, Inc.
New Canaan, Conn.

Correction

The statement that Fujitsu Ltd. claims infringements of its patents by Digital Equipment Corp.'s Unibus (Jan. 9, p. 26) is erroneous. Fujitsu claims that other elements of DEC's PDP-11 infringe on two of its patents.

HIGH PURITY ELEMENTS

We offer
more than
anyone else.

- Antimony
- Arsenic
- Bismuth
- Cadmium
- Copper
- Gold
- Indium
- Lead
- Selenium
- Silver
- Sulphur
- Tellurium
- Thallium
- Zinc

Asarco has the broadest selection of high purity elements in the business. All 99.999+ % pure. All ready for prompt delivery. For semiconductors, electronics, metallurgy, research, and other applications.

Our high-purity elements are also available in commercial quantities.

For more information on Asarco's array of high purity elements, write our By-Products Department at 120 Broadway, New York, N.Y. 10005.

75 Years of Progress in Metals

ASARCO⁷⁵
American Smelting and Refining Company

After all the noise, the quiet logic of HiNIL and 74C CMOS keeps you on the right track.



May 10, 1869. Promontory, Utah. The rumble of wheels, the hiss of escaping steam, the shouts of the celebrating crowd filled the skies with a deafening roar when they drove the golden spike that joined the Central Pacific and Union Pacific Railroads.

But today, when you link Teledyne's high noise immunity logic, HiNIL, and our 74C CMOS together in your digital or analog/digital control designs, you'll no longer have to worry about spikes or noise. Teledyne invented HiNIL to meet the need for high noise immunity found in practically all digital systems. The success of this large and still growing family has made Teledyne a leading supplier of logic for high noise applications.

Just put HiNIL on input-output lines to block heavy noise transients and drive high current peripheral devices. And use CMOS in the middle to minimize power dissipation and increase speed and circuit density. The combination of HiNIL's guaranteed 3.5V noise margin and 74C's low power dissipation lets them quiet a most any kind of system with high noise problems.

Our two logics interface directly, too. Standard 74C drives HiNIL directly and HiNIL drives more than 50 CMOS loads. Simply connect both to an inexpensive 12 or 15V ±1V power supply. You can even connect linear circuits to the same supply for extra savings.

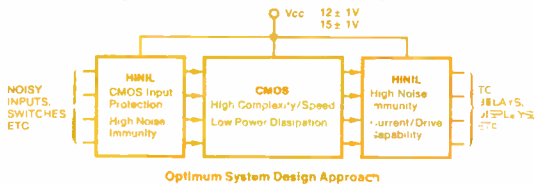

HiNIL eliminates the need for drivers because it sources up to 15mA and sinks up to 65mA. That's ample capability for display tubes, LEDs, lamps and relays.

And with HiNIL you save on filter capacitors, get the extra flexibility and economies of diode-expandable inputs, and have a choice of active or passive pull-up and open collector outputs. There's plenty of board-shrinking MSI in both families, too.

So write or call Teledyne today to find out about our HiNIL and 74C CMOS lines. We'll show you how easy it is to block out all the noise and stay on the right track.

TELEDYNE SEMICONDUCTOR

1300 Terra Bella Avenue, Mountain View, California 94043 Tel: (415) 968-9241 TWX: 910-379-6494 Telex: 34-8416

ENGLAND: Heathrow House, Cranford, Hounslow, Middlesex, Tel: (44) 01-897-2503 Telex: 851-935008

FRANCE: 90, Avenue Des Champs Elysees, 75008 Paris, Tel: 2563069 Telex: 842-29642

WEST GERMANY: Albert Gebhardtstrasse 32 7897 Tiengen Tel: 7741-5066 Telex: 841-792-1462

JAPAN: Nihon Seimei-Akasaka Bldg. (3F), 1-19, Akasaka 8-chome, Minato-ku, Tokyo 107, Tel: 03-405-5738 TWX: 781-2424241

Additional offices in West Germany, Hong Kong and the United States. Representatives and distributors worldwide.

Sprague Delivers!

YOU DON'T HAVE TO TAKE A SUBSTITUTE.



THE CAPACITOR:

Sprague's Type 192P Pacer[®] ...
The Dependable Low-Cost
Miniature Polyester Film Capacitor.

THE DELIVERY CYCLE:

Large Production Quantities
4 - 8 Weeks ARO on All Popular
Ratings. Off-the-Shelf Delivery from
your Sprague Industrial Distributor.

THE CATCH:

None.
Sprague Delivers Film Capacitors.

Call your nearest Sprague district office or
sales representative for complete information.

Sprague Electric Company,
North Adams, Mass. 01247
Tel. 413/664-4411

THE BROAD-LINE PRODUCER OF ELECTRONIC PARTS



8 Circle 8 on reader service card

News update

■ The recession has muddled many a marketing plan, including that of Bernard T. Marren, president of American Microsystems Inc. A year ago, Marren said he was going to change the Santa Clara, Calif., semiconductor maker's product mix from about 90% custom to a third each custom, standard, and memory [Jan. 10, 1974, p. 14]. Marren, then the newly named vice president and chief operating officer of AMI, said he expected to have the changes completed by 1976. Since then, the recession and inflation have hit hard; despite it all, though, AMI is now selling 51% custom circuits, 33% memory, and 16% standard. "Standard didn't grow as we would have liked," says Marren, partly because some of the companies AMI was counting on as customers have had to go out of business—while some of the more successful ones have integrated vertically. Not to be outdone, AMI itself is vertically integrating by making its own C-MOS circuits, light-emitting diodes, and liquid crystals.

■ Remember the gasoline crisis of early 1974? William Smith remembers it well. He's the president of Sunrise Electro-Service Corp. of Farmingdale, N.Y., which developed a digital display terminal for taxicabs and was to have outfitted 250 New York City cabs [Feb. 7, 1974, p. 39]. A few were delivered, the price of fuel began to soar, and that was the end of that—those few were returned, and a \$350,000 order came up all zeroes. But all is not lost. An improved version of the system is about to be delivered to a new customer—City Transfer Co., an affiliate of Allied Van Lines based in Anaheim, Calif. City Transfer plans to use basically the same terminal designed for the taxis, except that the it now operates at 4,800 baud rather than the original 3,125 baud.

■ The IPT Corp. of Sunnyvale, Calif., last year introduced a machine that made it possible to test

Electronics/February 6, 1975

For microwave measurements, see a specialist.



Systron-Donner's newest automatic counter offers more...

Systron-Donner, pioneer of automatic microwave counters, has done it again. S-D's completely new Model 6054A counter offers more of everything that's vital in frequency measurement.

... **Coverage:** Complete microwave coverage from 0.02 to 18 GHz in one band with one connector input.

... **Dynamic Range:** No dead zone! Operative over the complete range up to +30 dBm (1 Watt).

... **Protection:** Unlike other counters offered to date, the Model 6054A provides early warning of pending overload conditions via flashing LED's.

... **FM Tolerance:** Full channel loading and heavily modulated signals with rates up to 10 MHz are measured easily with S-D's new FLACTO™ technique.

... **Speed:** Fast acquisition and 1 Hz resolution in one second are provided over the entire frequency range.

... **Display:** Standard 11-digit LED readout gives you fully displayed readings up to 18 GHz.

... **Information:** In the U.S., call or write Systron-Donner at 1 Systron Drive, Concord, CA 94518. Phone (415) 676-5000. Or contact your nearest Scientific Devices office. Abroad, contact Systron-Donner GmbH, Munich; Systron-Donner Ltd., Leamington Spa, U.K.; Systron-Donner S.A., Paris (Le Port Marly); Systron-Donner Pty. Ltd., Melbourne.

SYSTRON  **DONNER**
CORPORATION

For literature circle 168 on reader service card.

For demonstration circle 9 on reader service card.

Choose your bandwidth.... TAKE YOUR CHOICE!

120 MHz/5 mV

- Dual trace/Delaying sweep
- Lightweight: 19.5 lbs
- Bright 20 KV 8 x 10 cm display
- Low 45 Watt power consumption
- X - Y capability
- Easy to use delayed sweep

PM3260E \$ 1850.00

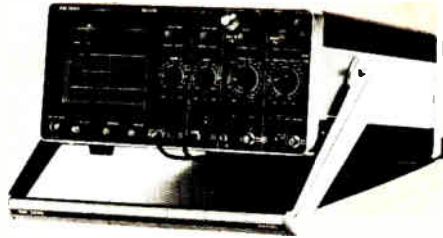

50 MHz/ 5 mV

- Dual trace/Delaying sweep
- Lightweight: 18.5 lbs.
- Bright 10 KV 8 x 10 cm display
- Low 23 Watt power consumption
- X - Y capability
- Easy to use delayed sweep

PM3240 \$ 1470.00

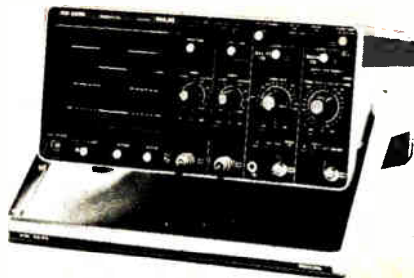

10 MHz/2 mV

- Dual beam to avoid chop/alternate problems
- Brilliant 10 KV 8 x 10 cm display
- Lightweight: 21 lbs.
- TV sync
- X - Y capability

PM3232 \$ 875.00

PM3233 \$ 925.00

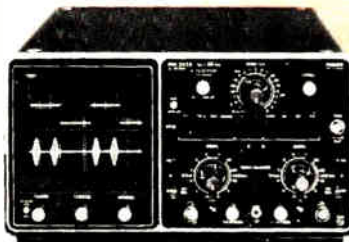

FREE DIGITAL INSTRUMENT COURSE

In-depth information on digital circuits and the mathematical theory behind them. Number theory, Boolean algebra. The course progresses through digital block, data communication and control. This digital instrument course is yours **FREE**, if you allow one of our Sales Engineers to demonstrate Philips equipment to you. Ask our Field Engineer about your complimentary gift during your demonstration.

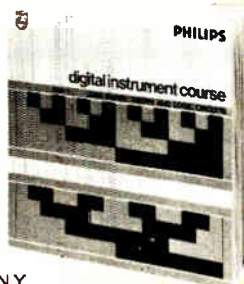

For further information, contact:

Philips Test & Measuring Instruments, Inc.
A NORTH AMERICAN PHILIPS COMPANY

400 Crossways Park Drive Woodbury, New York 11797
Telephone: (516) 921-8880 Twx: 510 221 2120

SPECIAL APPLICATIONS INFORMATION 'HOT LINE'
DIAL TOLL FREE NUMBER (800) 645-3043 NEW YORK
STATE, CALL COLLECT (516) 921-8880

PHILIPS

Circle 240 on reader service card for either a salesman to call or for a demonstration.

News update

ICs dynamically for only a fraction of a cent more than room-temperature tests cost. The machine was developed mainly for computer makers concerned that guard-band tests wouldn't do the job well enough with MOS dynamic RAMs operating in high-density memory systems, where hot spots may occur during system operation [Jan. 10, 1974, p. 29]. IPT says it has sold its tester to some of the major manufacturers—and users—of ICs, including a major foreign-car manufacturer. And the company's vice president for sales, Arthur Rock, says he expects the IC tester market will get better because "there is more mil spec business now." However, he would offer no figures.

■ At the height of last winter's energy crunch, the Lindberg division of Sola Basic Industries came out with a diffusion-furnace controller that allowed semiconductor makers to flip a switch and lower process temperatures to 900°C from 1,200° during idle weekends [Jan. 10, 1974, p. 29]. There was only one problem, as it turned out: as the energy crisis eased, so did sales of the Lindberg controller. But the device has found a new niche for itself, and product manager William D. McEntire estimates that half the furnaces sold today are equipped with it. "In some new processes," he says "especially those using 3-inch wafers, the controller is being used as a secondary set point device that allows ramping for the furnace." Typically, slices are loaded at 900°, the furnace ramps to 1,200°, and then drops to 900° for unloading.

■ When the Surface Transportation Act of 1974 died as Congress adjourned without acting on it, perishing with it was a plan to spend \$35 million on a computerized inventory system for the nation's railroad freight cars [Jan. 24, 1974, p. 36]. Don't look for a fast revival, because the recession has not only meant tighter budgets, but less rail shipping.

—Howard Wolff

Our 2K dynamic shift register is just like theirs. Only better.

Price. Very comfortable.

About the same price as two 1K devices, so you get the board savings free.

Delivery. Now.

Pedigree. Our proven P-channel, silicon gate MOS process. And, of course, every one is built to MIL-STD-883. (That's the only way we make them.)

You'll never know until you try. Call us.

Am2825/5025 —
Dual 1024-Bit Dynamic
Recirculating Shift
Register: Common Clock.

Am2826/5026 —
Dual 1024-Bit Dynamic
Shift Register: Separate
Clocks.

Am2827/5027 —
2048-Bit Dynamic
Recirculating Shift
Register.

Note: All devices operate at 6MHz data rate and are available in hermetic and plastic packages guaranteed to meet military and commercial temperature ranges.

Advanced Micro Devices

Corporate offices are at 901 Thompson Place, Sunnyvale, California 94086. Telephone (408) 732-2400 or toll free from outside California (800) 538-7904/Southern California: Beverly Hills (213) 278-9700/Mid-America: Oak Brook, Illinois (312) 323-9600/Edina, Minnesota (612) 835-4445/Dallas, Texas (214) 423-1502/Eastern United States: Roslyn Heights, New York (516) 484-4990/E. Syracuse, New York (315) 437-7546/Baltimore, Maryland (301) 744-8233/Wellesley, Massachusetts (617) 237-2774/Britain: Advanced Micro Devices, Telephone 01-730-0855/West Germany: Advanced Micro Devices, Munich. Telephone (089) 53 95 88. Southern Europe: Advanced Micro Devices, S.A. Neuilly, France, Telephone 747-4194. Distributed nationally by Hamilton/Avret, Cramer and Schweber Electronics.

Circle 251 on reader service card

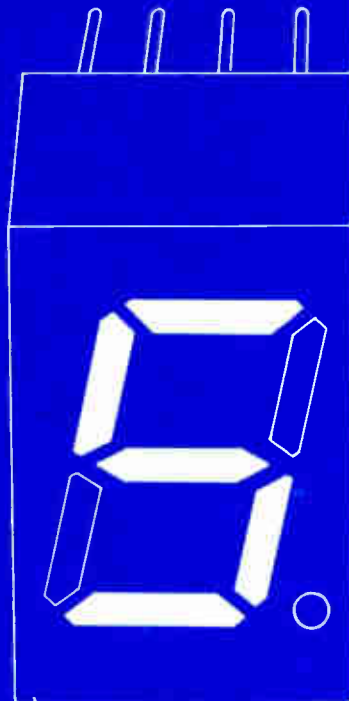
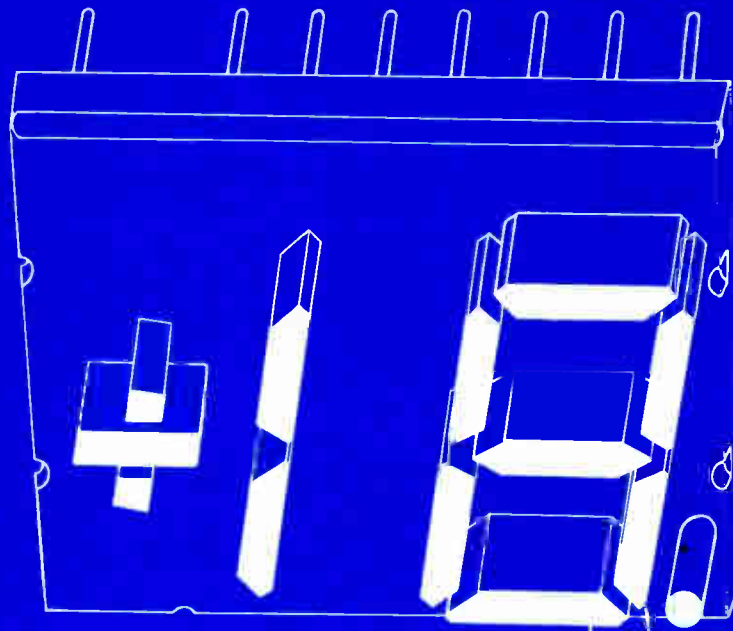

One DIP
handles
two digits

Mitered corners
increase
eye appeal

Light pipes spread
illumination evenly
over broad segments

Announcing the first 0.5" multi-digit LEDs



Here we go again. It's another first from Litronix: multi-digit 0.5"-high LEDs.

These two-in-one packages are tailor made for anyone who wants to save money in lower production costs. They require only half the inventory. Half the handling. Half as many components to assemble and test.

Makers of digital time pieces will find them ideal, as will those who manufacture point-of-sale terminals. FM digital readout tuning systems. TV channel tuners, and instrumentation.

The modules are end-stackable to produce any combination of 0.5" digits on 0.5" centers. The DL-727 is a two-digit module that's ideal for clocks. And our DL-721 module offers a \pm sign and a "1" for polarity and over-range indications on instruments.

Each module has the same drive requirements. Power required is only 30 to 40 mW per segment from standard logic voltage supplies. Modules are packaged in standard DIPs.

Naturally, you enjoy all the solid state advantages of LEDs. They're compatible with today's IC circuits. Rugged. Easy to multiplex. And offer fast response.

In any business lower costs make a difference. Our dual 0.5"-high digits help your products keep a competitive edge.

Our data sheets tell all. Contact Litronix, 19000 Homestead Road, Cupertino, Calif. 95014. Phone (408) 257-7910.

**No wonder
we're No.1
in LEDs**

litronix

MORE POWER MORE BANDWIDTH

Our Model 503L is an ultra-wideband RF power amplifier whose wide range of frequency coverage and power output provides the user with the ultimate in flexibility and versatility in a laboratory instrument. Easily mated with any signal generator, this completely solid state unit amplifies AM, FM, SSB, TV, pulse and other complex modulations with minimum distortion.

Constant forward power is continuously available regardless of the output load impedance match, making the 503L ideal for driving highly reactive loads.

Unconditional stability and instantaneous failsafe provisions in the unit provide absolute protection from damage due to transients and overloads.

This low cost instrument, covers the frequency range of 1.6 to 540 MHz with a linear power output of 3 watts . . . and there's no tuning. Priced at \$995.*

Applications include:

- Laboratory instrumentation
- Communication systems
- Laser modulation
- RFI/EMI testing
- Spectroscopy

*USA and Canada



For further information or a demonstration contact

ENI, 3000 Winton Road South,
Rochester, New York, 14623.
Call 716-473-6900.
Or TELEX 97-8283 ENI ROC.

ENI

The world's leader
in solid-state power amplifiers.

People

Boucher insisted Microma get serious about watches

Forty-seven-year-old Richard Boucher almost turned down the chance to be president of Microma Inc., the digital watchmaking subsidiary of Intel Corp. Rumors had it that Intel was disappointed with Microma's performance and was looking around for buyers. "The first question I asked them was, were they bringing me on just to arrange for the selling of the company?" recalls Boucher, who at the time was assistant president at Electronic Arrays Inc. "They convinced me they weren't. They were serious about making Microma a dominant force in the digital-watch market. So I accepted."

But to persuade the world that Intel was indeed serious about Microma, Boucher—who says he's after 25% of the digital-watch business—insisted that a "high-power corporate staff" be brought in. Intel agreed, even though it meant giving up two of its own key executives.

Boucher had already enticed Irving Cooper, vice president of marketing at Litronix, to a comparable position at Microma. "His experience in the digital-watch market is about the same as mine—next to nil—but he was instrumental in getting that company [Litronix] established in the consumer electronic calculator market," Boucher says. "And that is the way it's going to be in the digital-watch business. It's no longer a technology game. It's a marketing game, with the consumer as the prize."

Boucher next asked for Intel's Keith Thompson, director of operations, responsible for assembly, manufacturing, and purchasing, and Desmond Fitzgerald, director of quality assurance. He wanted them as Microma's vice presidents of manufacturing and engineering, respectively.

Already supplying watches with liquid-crystal displays, Microma, which concentrates on the expensive \$250-and-up end of the watch line, is now introducing light-emitting



New game. Marketing, not technology, is the digital-watch key, says Boucher.

diode displays and new smaller designs with lots of features. The next generation of LCD watches at Microma uses a 0.26-inch-thick, 3-volt module with continuous hours and minutes, as well as seconds, date, and backlighting on demand. That's 0.1 inch thinner than its predecessor.

The company's LED units will be 0.24-inch-thick, 3-volt modules, in two configurations: one with hours, minutes, seconds, day of the week, and the date, and the other, called the Chronograph, with all these plus a stop-watch feature.

Microwave ovens turn Blaha on

Bucking the dismal trend currently afflicting consumer electronics and appliances, sales of microwave ovens are expected to jump a healthy 25% this year, exceeding 900,000 units, according to a January estimate by Litton Industries' Microwave Cooking Products subsidiary. This makes for busy times at the Minneapolis organization, and probably no one there is busier than Verle Blaha, the informal and

Tasty. With microwave-oven sales climbing, Blaha's homework never looked better.

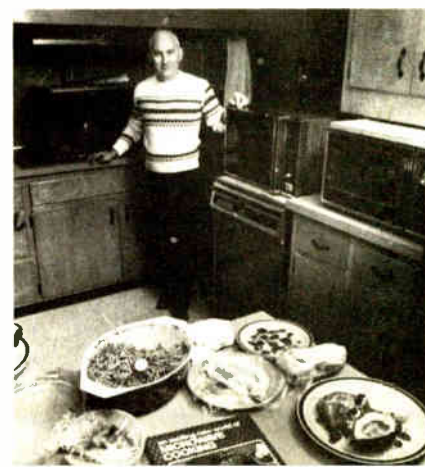

If your counter looks this good...

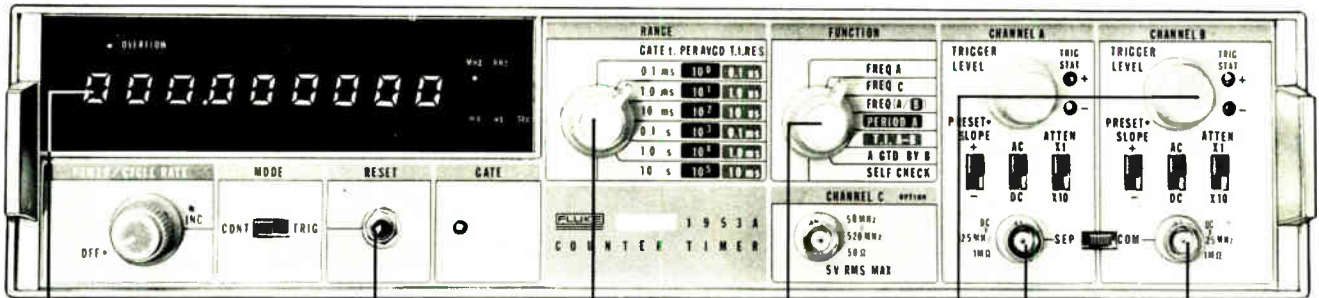

EASY TO READ
9-digit LED display
Large 7-segment characters
Full leading zero suppression
Automatic annunciation and overflow

DISPLAY CHECK
Pressing reset button when counter is in self check mode lights all digit segments

WIDE RANGING
Six choices of:
• Gate times
• Period averages
• Time interval resolution

VERSATILE
Measures:
• Frequencies
• Frequency ratios
• Period and period averages
• Time intervals
• Gateable totals
• Self check

FULL TRIGGERING CONTROL
Preset or variable trigger level controls with status indicators
Slope, coupling, and attenuation switches

TWO INPUT CHANNELS
Direct coupled amplifiers with 30 mV sensitivity

and gives you these options...

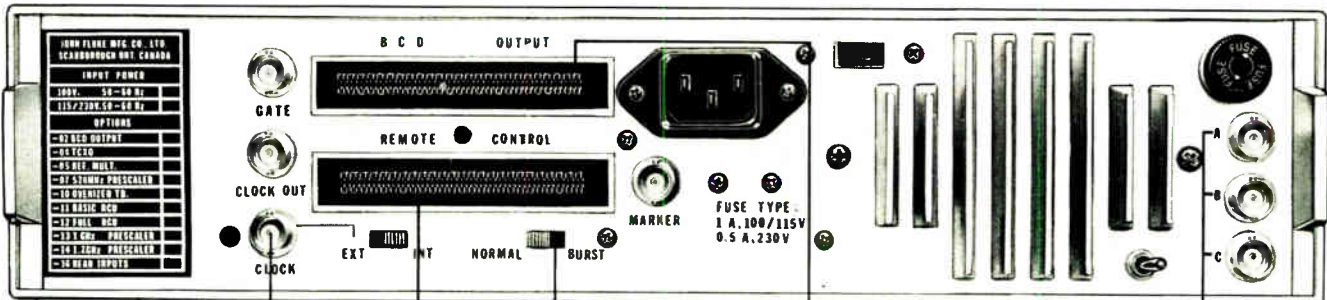

HIGHER ACCURACY
Higher stability timebase
Options 04 and 10

PRESCALERS
520 MHz prescaler. Option 07
1000 MHz prescaler. Option 13
1250 MHz prescaler. Option 14

TIMEBASE MULTIPLIER
For operation from 1 or 5 MHz in addition to standard 10 MHz external reference clock.
Option 05.

REMOTE PROGRAMMING
Basic remote programming. Option 11.
Full remote programming. Option 12.

BURST MEASUREMENTS
Select normal or burst measurements. Burst measurements made on Freq A or Freq C modes.
Option 05.

DIGITAL OUTPUT
Parallel BCD output. Option 02

REAR INPUTS
Three rear panel mounted BNC jacks for A, B and C input channels. A and B are in parallel with front panel inputs.
Option 16

it must be a Fluke
1953A Programmable Universal Counter/Timer
\$849.00*

*U.S. price F.O.B. Buffalo, N.Y.
Remote programming and other options extra.

FLUKE

COUNTER DIVISION

John Fluke Mfg. Co. Ltd.

Counter Division

P.O. Box 1094 Station D Buffalo, N.Y. 14210, Phone (716) 842-0311, TWX 610-492-3214

For a demonstration circle 169 on reader service card.

For more information circle 15 on reader service card.

MAG TAPE FOR HP2100

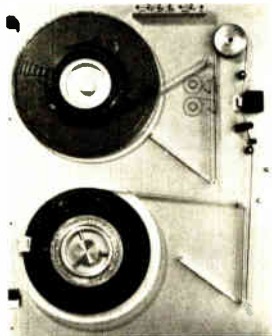

SEE THE REEL EXPERTS FOR YOUR MAG TAPE NEEDS NOW.

A great minicomputer deserves a great mag tape transport! Don't hang second-rate peripherals on your top-notch HP2100. Digi-Data offers you the finest quality tape-handling equipment available anywhere at any cost.

Phase-encoded, NRZI, or both together, and tape speeds to 45 ips. Prices start at \$5,750 for complete systems which are thoroughly checked-out on our own HP2100's and supplied with diagnostic software.

Digi-Data also manufactures mag tape systems for D.E.C.'s PDP-11 and Data General's NOVA series.

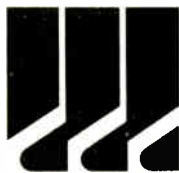

DIGI-DATA CORPORATION

8580 Dorsey Run Road, Jessup, Md. 20794 (301) 498-0200

Digi-Data Europe

Fluestrasse 632 5313 Klingnau Switzerland TELEX: 845-58555

Circle 16 on reader service card

CUSTOM ELECTRONICS' MICA CAPACITORS: short on DELIVERY long on RELIABILITY

That describes our CMR type capacitor, ideal for "potted-in" applications where minimum size and low per-unit cost are important. All our dielectric is screened before production to avoid failure in the field.

Installation No.	TYPICAL UNITS:			L x W x T Max.	1 to 10 Qty. Price
	Cap.	WVDC			
CMRIA102104K	0.1 μ f	1,000		2.062" x 1.425" x 0.200"	\$8.05
CMRIA302104K	0.1 μ f	3,000		2.562" x 1.620" x 0.270"	9.25
CMRIA103103K	0.01 μ f	10,000		2.562" x 1.800" x 0.350"	8.80

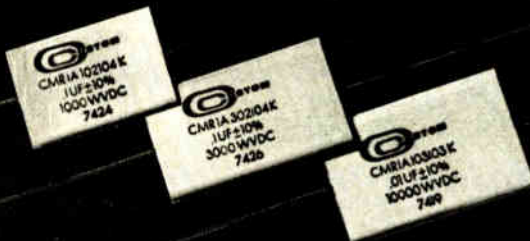

FREE: Descriptive TechniTip,
includes Mica Sample. Write:



CUSTOM ELECTRONICS, Inc.

12 Browne St., Oneonta, N.Y. 13820
PH: (607) 432-3880 TWX: 510-241-8292

People

friendly vice president of engineering.

"We're looking at 45 different tasks," he says, "as we try to add new features to the ovens, as well as improve their reliability and manufacturability."

One feature added last fall, for example, was the ability to vary the magnetron-produced power level beamed into the cooking space. Previously, microwave ovens operated with full magnetron power only. Blaha's engineers accomplished this by varying the duty cycle of the magnetron. Not a very complicated arrangement, he concedes, but one that just had not been applied to microwave ovens before.

Warranty. Perhaps the most important on-going program within Blaha's group was the production of the failure-analysis studies that, coupled with design improvements, have increased the reliability of the magnetrons. Less than 0.5% fail during the two-year warranty period, says Blaha. When the first microwave oven was introduced in 1966, the figure was 15%.

The result of all this engineering effort is that at a time when many engineering staffs are being cut back, Blaha's is expanding. Ten people were added during the last half of 1974, bringing the total to 72.

For the ebullient Blaha, there is obvious excitement in applying microwaves to cooking. And for Litton, it has meant a considerable market. Litton claims about 30% of 1975 consumer microwave oven sales that may reach \$360 million.

Of his job, the 44-year-old Blaha avows, "I love it." Most of the more than 20 years of his engineering life—18 of it with Litton—has been spent on missile and other military projects "so classified I couldn't talk about them with my family, or so dull I didn't want to talk about them."

The situation is different now. "Most of the time there are five ovens in our kitchen at home, often new models we're still developing," he says. "One weekend we made 35 chocolate cakes to evaluate energy distribution."

FEBRUARY, 1975

in this issue

New programmable pocket calculator with timer

Intelligent CRT—low price, high performance

New triple-output bench supply

New smart oscilloscope with built-in microprocessor gives you answers

HP has combined a high-performance 275 MHz scope, a microprocessor, and LED display to put an end to graticule counting, mental calculations, and most conventional scope errors. The new 1722A gives you a quantum leap in measurement accuracy and convenience. It's a working lab partner that speeds measurements of time intervals, frequency, instantaneous or dc voltage levels, and relative amplitude expressed in percentage. And, instead of conventional reading errors, the 1722A gives you a 3½-digit LED reading of your measurements...in seconds, Hz, volts, or percent.

The microprocessor takes over several tasks you used to perform. It keeps track of dial settings, automatically

(continued on page 3)

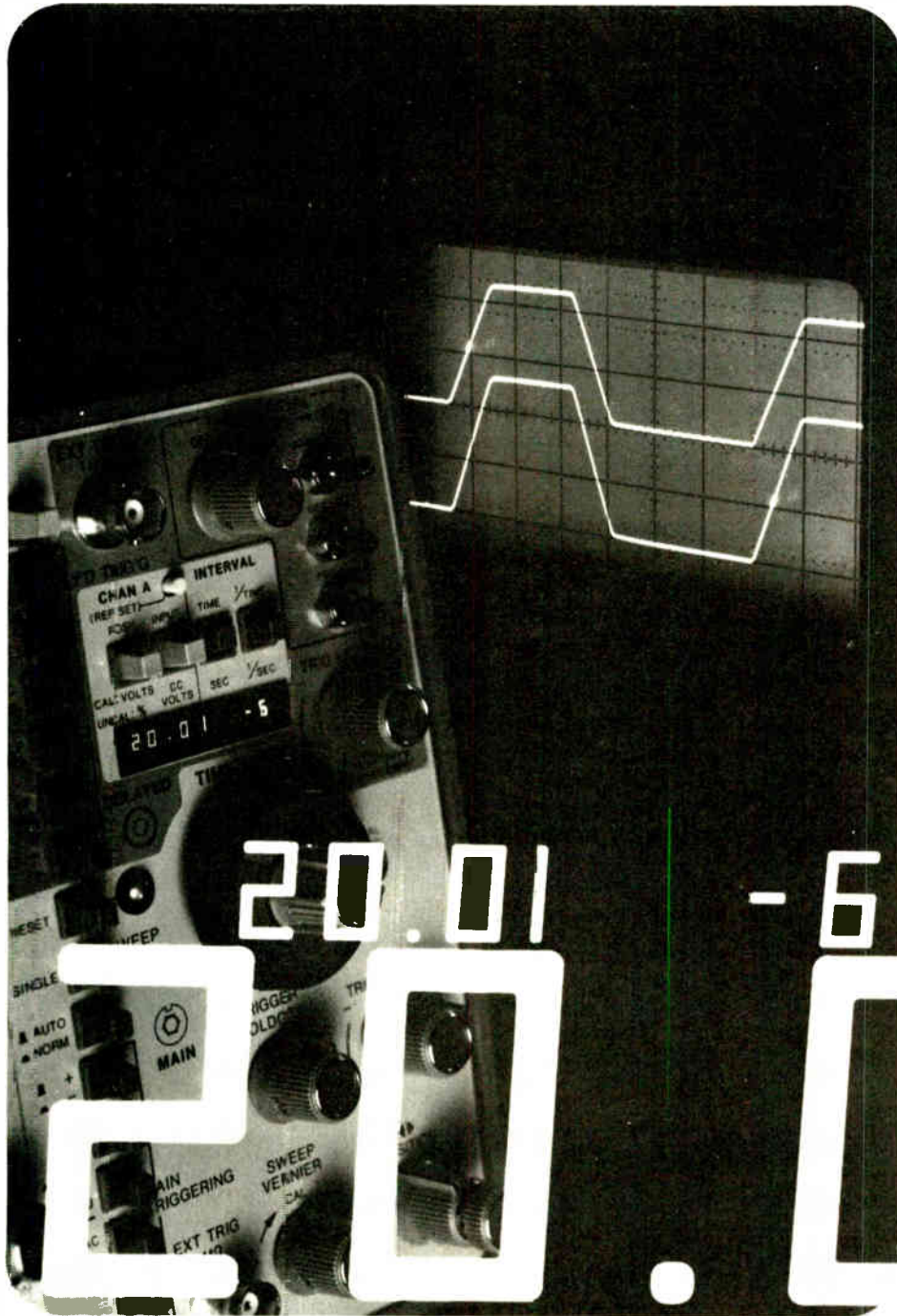

Measure wideband microwave networks— in one sweep

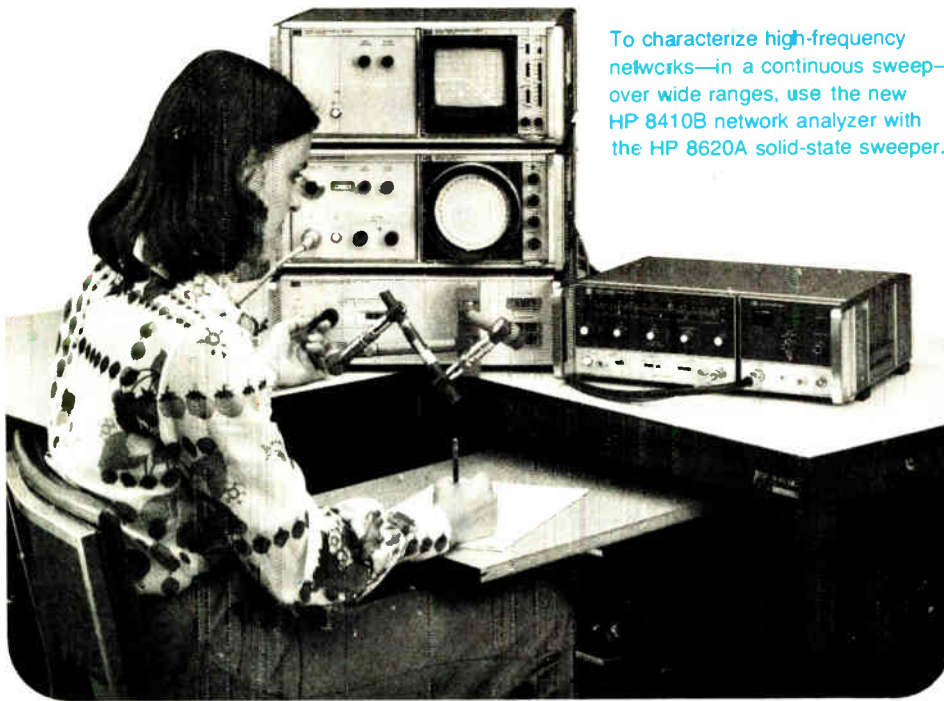

To characterize high-frequency networks—in a continuous sweep—over wide ranges, use the new HP 8410B network analyzer with the HP 8620A solid-state sweeper.

Two dramatic examples of continuous-sweep multi-octave measurements made with the new HP 8410B network analyzer:

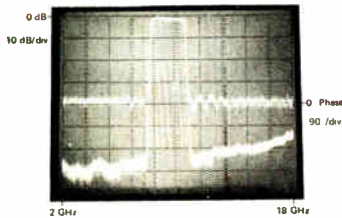

Transmission characteristics (magnitude and phase) of 8-10 GHz bandpass filter, shown over 2 to 18 GHz range. Note that insertion Loss Trace (10 dB/div) is free from harmonic responses.

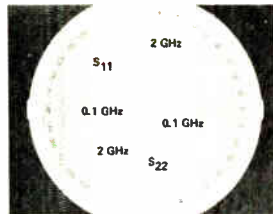

Polar plots of transistor s-parameters from 100 MHz to 2 GHz.

Frequency band switching is a thing of the past when multi-octave range networks are measured with the new HP 8410B network analyzer. The 8410B, successor to the popular HP 8410A* (which was limited to octave-wide sweeps), measures both the magnitude and phase of network parameters, vital data for microwave designers. Test configurations covering from 100 MHz to 40 GHz are offered.

Multi-octave measurements in one continuous sweep are possible when the 8410B is used with the HP 8620A sweep oscillator. For example, with the new HP 86290A sweeper plug-in, you can sweep test from 2 to 18 GHz. Or the HP 86320A RF plug-in and the

8410B cover from 100 MHz to 2 GHz, more than four octaves.

The 8410B network analyzer is a frequency-selective system that tracks the sweeper, resulting in a full 60 dB spurious-free dynamic range. Other multi-octave measurement schemes using broadband detection are typically limited to 20 or 30 dB range because of source harmonics.

*Existing 8410's can be retrofitted for automatic tuning.

For your copy of the Data Sheet, check L on the HP Reply Card.

Up to 24 Millicandelas from new high-efficiency RED, YELLOW, and GREEN LEDs

A new series of high-intensity, solid-state LED 'illuminators' are now available from HP. The new high-efficiency Red LEDs have an intensity of 24 mcd at a forward current of 10 mA.

Packaged in the T-1 $\frac{3}{4}$ outline, the lamps come in both wide and narrow beam types; the wide beam lamps using a diffused lens and the narrow beam lamps with a clear lens. These lamps have long general purpose leads to facilitate all types of mounting.

Four lamps of each color are being introduced, two light output categories for each beam angle. High intensity is obtained using a new HP technology employing a transparent gallium phosphide substrate and adding a reflector in the package. Higher Intensity is possible under "pulsing" conditions (or up to 20 mA dc) as these LEDs do not saturate. These lamps are rugged and are ideal for use in high ambient light conditions. The narrow beam, high output models are used as pushbutton switch illuminators and "Dead Front" panel annunciators. The wide beam models are used for low power panel indicators or backlighting.

For more information, check F on the HP Reply Card.



Red (5082-4650), Yellow (5082-4550) and Green (5082-4950) LED lamps.

NEW high-efficiency step recovery diodes



Special introductory price.

Our new high-efficiency step recovery diodes maximize cutoff frequency while maintaining a fast transition time. Thus, they provide excellent performance in low or high order multipliers and in comb generators.

The new 5082-0800 series diodes are passivated with a thermal oxide for maximum stability. You can buy them in chip form, in low-cost glass packaging, or in hermetically sealed metal-ceramic packages. Test data is supplied with each ceramic packaged device.

As an introductory offer, these devices are available in prototype quantity at the 100 piece price (offer good until April 30, 1975).

For more information, check *E* on the HP Reply Card.

(continued from page one)

New scope with microprocessor

computes time intervals and voltage levels, converts time measurements to frequency, and calculates percent. It even signals if you make an erroneous setting.

HP's dual delayed sweep gives you two adjustable intensified markers for displaying the start and stop points of a time interval. The microprocessor automatically computes and displays the time interval between the markers. This speeds digital timing measurements, reduces errors, and simplifies the adjustment of circuits to meet a timing spec.

The 1722A makes waveform measurements faster, more accurately, and more completely than conventional scopes costing up to twice as much.

For details on HP's microprocessor oscilloscope, check *B* on the HP Reply Card.

NEW HP-55 scientific pocket calculator offers 86 keyboard functions, programmability and built-in timer

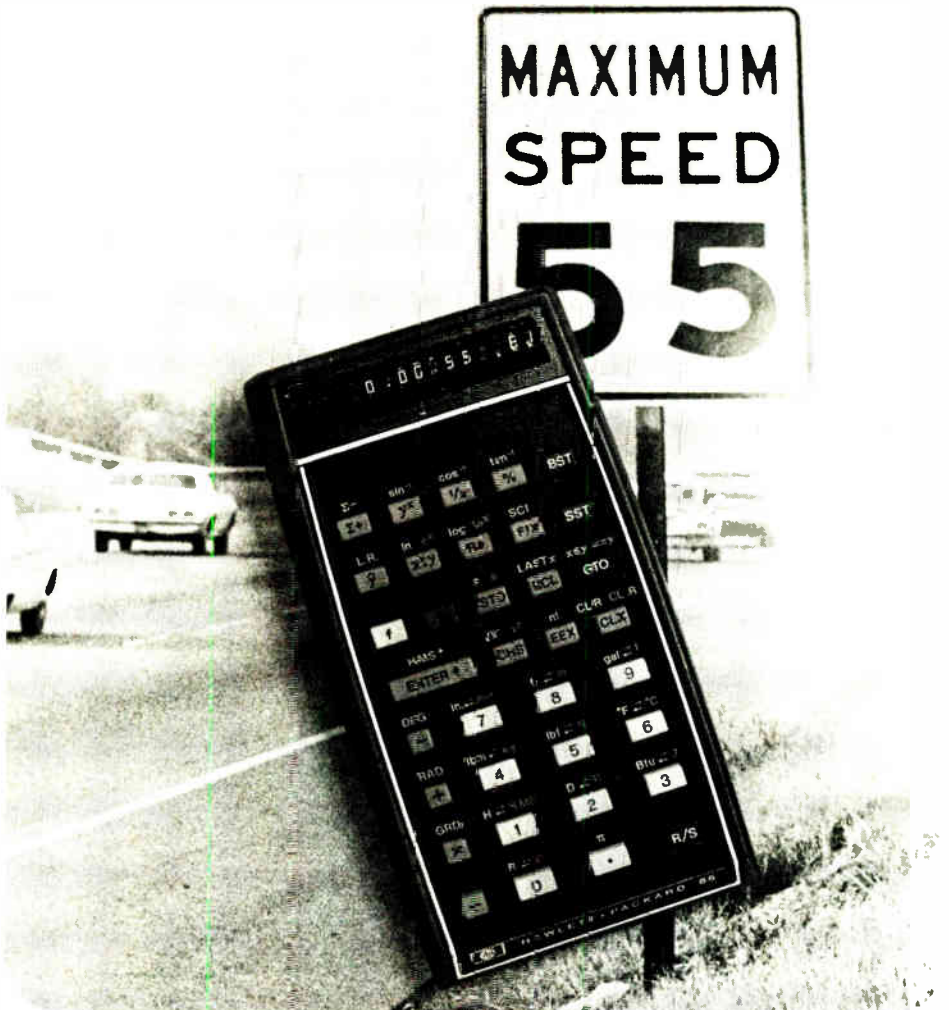

HP introduces an extraordinary new programmable scientific pocket calculator. With all of the pre-programmed functions and operations of our popular HP-45, plus 38 new ones including statistical functions.

You can perform circular trigonometry in degrees, radians or grads and convert among any of them. Also, compute two-variable mean and standard deviation, linear regression, linear estimate, curve plotting and four simultaneous linear equations with four unknowns.

The HP-55 has 20 addressable storage registers—more than twice as many as any other scientific pocket calculator on the market.

And, the HP-55 is the only pocket calculator in the world with a built-in digital electronic timer with 100-hour

capacity—a stopwatch that times and stores up to 10 events within the same experiment, accurate to 0.01%.

Whenever you wish to write a program to solve your particular calculations, just set the program switch, enter a program of up to 49 steps, then run it... as often as you wish. Meanwhile, you still have access to all 86 keyboard functions plus the 20 register memory.

And, with the HP four-register stack, enter the most complicated equations without having to keep track of the parentheses and brackets.

To learn more about the amazing new HP-55, check *A* on the HP Reply Card.

Faster graphs with new high-speed time-share plotter



Fast digital X-Y plotter accepts bit-serial ASCII at 10 or 30 characters per second.

Now you can plot up to seven vectors per second in any direction using the new 7203A high-speed graphic plotter.

Vectors of any length are plotted in any direction and the resulting graph appears as a smooth line, in contrast to the staircase often drawn by incremental plotters.

Check numerical control tapes, display statistical data, quickly analyze engineering designs or use this plotter for any application you have that requires fast graphics.

Four colors of ink are available in disposable pens. Pens are changed quickly and easily so that plots may

be superimposed in color for comparison.

Each plot coordinate is expressed with a Binary number represented by the bit pattern of two successive ASCII characters. Thus, only 4 characters are required to define any move.

The 7203A operates in parallel with data communication terminals. Easy to use software subroutines are available for many time-share systems.

Plots are front panel scalable from 0 × 0 up to 10 × 15 in. (25 × 38 cm) using paper up to 11 × 17 in. (28 × 43 cm).

Check 1 on the HP Reply Card.

NEW HP display terminal offers an intelligent addition to your computer

HP's new 2640A display terminal with built-in microprocessor is the intelligent, cost-effective answer to your data entry and information handling needs.

The 2640A operates either on-line or in stand-alone mode, with full editing capability. You can write 24 lines with 80 characters per line on the 5 by 10 in. (127 by 254 cm) rectangular display. High resolution ensures clear, precise character definition. You can also plug in three additional character sets, such as a line drawing set or a math set, and use them concurrently with the standard character set.

The 2640's dynamically allocated memory lets you store 8 to 50 lines or add optional memory modules and store over 400 lines depending upon line length. Memory protection is standard on all 2640A terminals.

Should the modular 2640A need repair, just lift up the top and replace the necessary printed circuit cards. And, thanks to a universal interface, the 2640A works with a wide variety of computers.

For more information or a demo, check C on the HP Reply Card.

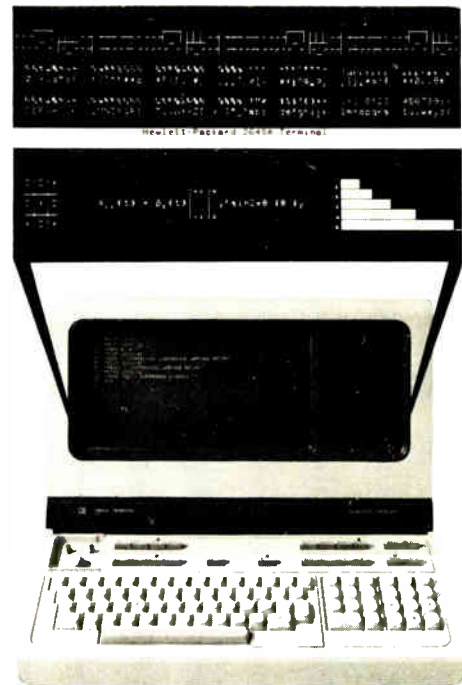

New Hewlett-Packard Model 2640A CRT Terminal is microprocessor controlled. Model 9866A Line Printer (left) is optional.

21MX computer with new Dynamic Mapping System plug-in gives you million word addressing space

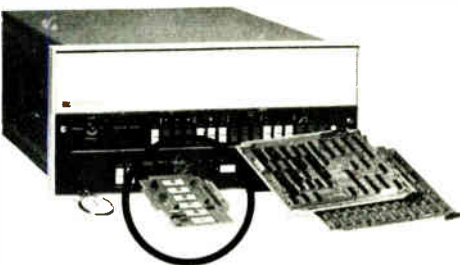

Programmable DMS for 21MX computer expands address space.

A new Dynamic Mapping System (DMS) devised by HP for its 21MX series user-microprogrammable 4K RAM semiconductor memory minicomputer allows access to four independent memory spaces.

The 12976A DMS expands the memory address size to 20 bits, thereby providing a maximum main memory addressing space of 1,048,576 16-bit words. It does this without adding to the 650-nanosecond cycle time.

Accounting for the compactness and low prices of the new large-memory models, HP cites features common to the whole 21MX line. For example, all 38 of the new instructions are contained in a single 265 word module of microcode. Also included is read and or write protection on an individual 1K-page basis. All these instructions are on half of a single small circuit board. These new capabilities are plug-in installable.

The HP Dynamic Mapping System functions with main memory somewhat as "virtual memory" schemes function with disc memory.

The 38 new microcoded instructions in DMS firmware, including cross map moves and block transfers, give extensive control over memory allocation and protection. In addition to these 38 supplied by HP, the user can generate his own unique memory management and protection instructions using the standard microcode capability.

For more info on this new Dynamic Mapping System, check O on the HP Reply Card.

HP interface bus enhances signal generator

Joining the growing list of HP-IB compatible instruments is the HP 8660A/B synthesized signal generator. It's a fully programmable signal generator with .01 to 1300 MHz frequency coverage, 3×10^{-8} /day frequency stability (3×10^{-9} /day optional), +13 to -146 dBm output level, and AM, FM and pulse modulation capabilities.

When installed, the HP interface bus allows programming of:

- Frequency, in 1 Hz steps over the entire 1300 MHz range.
- Output level, in 1 dB steps over the entire 160 dB range.
- Modulation mode, either AM or FM.
- Modulation source, either internal 400 or 1000 Hz tone or external source.
- AM depth, in 1% steps from 0 to 99%.
- FM deviation, in 3 overlapping ranges, either 50 or 100 steps per range, from 0 to 1 MHz.

The HP-IB interface is available as option 005 on new instruments or as a field-installable kit 08660-60189 for instruments already equipped with the standard BCD interface.

To learn more, check M on the HP Reply Card.



Now, you can run a precision signal generator under calculator control.

Helpful techniques for using VHF signal generator



New application information available for 8640A/B.

Three new application notes show you how to extend the usefulness and accuracy of HP's 8640A/B VHF signal generator (450 kHz to 1100 MHz).

AN 170-1 explains how to improve the specified output level accuracy over narrower frequency limits—i.e., how to operate the generator for optimum accuracy. Also, special calibration can be used to minimize effects of frequency response, temperature, detector and meter linearity, and vernier error.

AN 171-1 describes a method for improving crystal filter measurements when using an HP vector voltmeter and the 8640A/B. This technique optimizes frequency tuning sensitivity by using a feedback signal from the phase meter to the generator external FM input.

AN 171-2 describes how to build a simple heterodyne circuit that extends the frequency down range to dc-450 kHz. The circuit mixes the rear-panel fixed 5 MHz crystal output with the tuned output signal and provides a stable frequency that can be read directly on the digital readout.

For your copies, check P on the HP Reply Card.

New capabilities, more options for HP-5300 measuring system

Now there is a high resolution 8-digit display mainframe (Model 5300B) with temperature-compensated crystal option in the HP-5300 series of electronic counters and digital multimeters.

New snap-ons for the system include an 1100-MHz counter and a bus interface.

In the 5300 system, a complete instrument consists of two halves that snap together in about 15 seconds. The width of these units is a very compact 6¼ inch (160 mm). The upper half, or mainframe, contains the readout and associated circuitry. The instrument's measurement functions are determined by the lower half, or "snap-on", of which there are now 7 models for measuring frequency, time interval, ac and dc volts and ohms. The new 5312A ASCII "snap-between" module allows all of the 5300 functions to interface with data acquisition systems via the HP Interface Bus.

With the new 5305A 1100-MHz frequency counter snap-on, you get a sensitivity of 10 mV to 500 MHz and better than 25 mV to 1100 MHz, automatic gain control and manual attenuator to measure noisy or modulated signals, plus a front panel accessible input fuse to prevent costly front end damage.

With the new 5312A ASCII "snap-between" module you can mate other instruments and controllers to the 5300 series via the HP Interface Bus.

For more information, just check H on the HP Reply Card.



HP 5300 Measurement System adds 5300B 8-digit module, 5305A 1100-MHz counter, and 5312A ASCII interface to HP Interface Bus.

Now debug your control system design before you build it

New software for design engineers using 9830A calculator in BASIC language.



With HP's powerful 9830A programmable calculator and state-variables software, you now can know exactly how your control system will perform long before you've committed time, materials, and manpower to an expensive prototype.

The new state-variable software provides a complete transient response solution for control systems, whether for mechanical, electronic, hydraulic, optical, or hybrid systems. It's a carefully developed set of programs that will assure you a stable system in a minimum amount of time. There's no hassle with computer programming and interfacing. You just key in the values directly from your block diagram, and the 9830A does the rest automatically.

In 10 minutes or less, you get a high resolution plot of transient response and printed list of system parameters. If you want to adjust your design, you simply key in different values. Thus, you can explore alternatives—right at your desk—to find a better design or solution.

An extensive library of engineering and design programs are available from HP.

To learn more, check N on the HP Reply Card.

Low frequency spectrum analyzer offers unmatched resolution

Up until now, the biggest problem analyzing low frequency signals has been the display. Now, you can get a clear picture of mechanical vibrations, audio filters, or data communication channels with HP's 3580A spectrum analyzer, covering 5 Hz to 50 kHz. The trace appears on a CRT with 1 Hz bandwidth—that's the best resolution of any low-frequency spectrum analyzer on the market.

You can also store your trace in the CRT's digital storage. In fact, store two traces, and compare them on the CRT. You can study and interpret spectral information easily and quickly.

Dynamic range is 80 dB. HP offers unique adaptive sweep that speeds up your measurements and reduces analysis time. The 3580A weighs just 35 lbs (16 kg) and operates on batteries, as well as line power.

For more information, check D on the HP Reply Card.

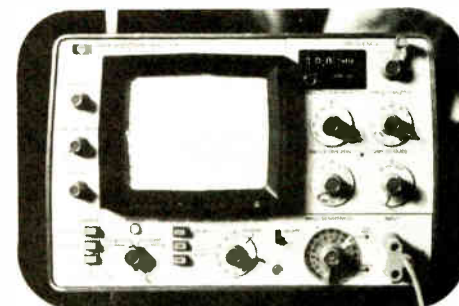

There are many variables in a sound system; thus, instrumentation is needed to track down problems. HP's 3580A Spectrum Analyzer has the range and visual display necessary to analyze audio problems. With this unique instrument, distortion hum, equalization and reverberation can be quantified far better than even the best ear.

For versatility, ease of operation and wide applications, 50 MHz pulse generators

A 20 column low-cost printer that really is quiet



What every Logic laboratory needs: versatile, easy to operate 50 MHz generator.

The 8012B and 8013B pulse generators are ideally suited to the requirements of a general digital logic laboratory where ease of operation and wide range of applications are essential.

Their 10V outputs and fast transition times (3.5 ns on the 8013B and 5 ns on the 8012B) enable you to dynamically test TTL, ECL and even the latest CMOS logic. You can simulate noise patterns and, in double pulse mode, test device recovery times and make noise immunity measurements. You can also use them as amplifiers when generating worst case data patterns.

These instruments not only enable you to set up pulses more easily, but also much more quickly. One big time-saving feature is the unique front panel layout; the slider controls provide a simple, straightforward design that enables

you to set up your pulses very quickly and with a minimum risk of incompatible pulse settings. They also greatly improve the readability of the pulse parameters. Another time-saver is the square wave mode which enables you to set up pulses very rapidly without having to worry about pulse width or delay.

In addition, the variable transition times of the 8012B enable you to generate any triangular or trapezoidal waveforms, and the two independent outputs of the 8013B enable you to test circuits designed with bipolar supplies.

For more information on these extremely flexible pulse generators, check K on the HP Reply Card.

At last: a quiet printer that's really quiet. The new 5150A thermal printer prints faster than 3 lines per second, without any noisy impact mechanisms. It accepts data from BCD or ASCII sources and can list 20 columns of alphanumeric information, yet the price is extremely reasonable.

The 5150A uses heat-sensitive paper and a thermal print head, so you don't have to bother with ink spills or refills. Don't let simple design or light weight fool you—the 5150A is a high technology peripheral that can interface with minicomputers, any Interface Bus (HP-IB) instrument system or other digital data sources having acceptable codes and voltage levels. Available options include clock, BCD or ASCII interface and scanner—whereupon it can serve as an HP-IB controller.

For more information, check G on the HP Reply Card.



The 5150A printer is available in several different configurations to fit your system; here, it logs data from a 5345A Electronic Counter.

New triple-output bench supply for IC test and development

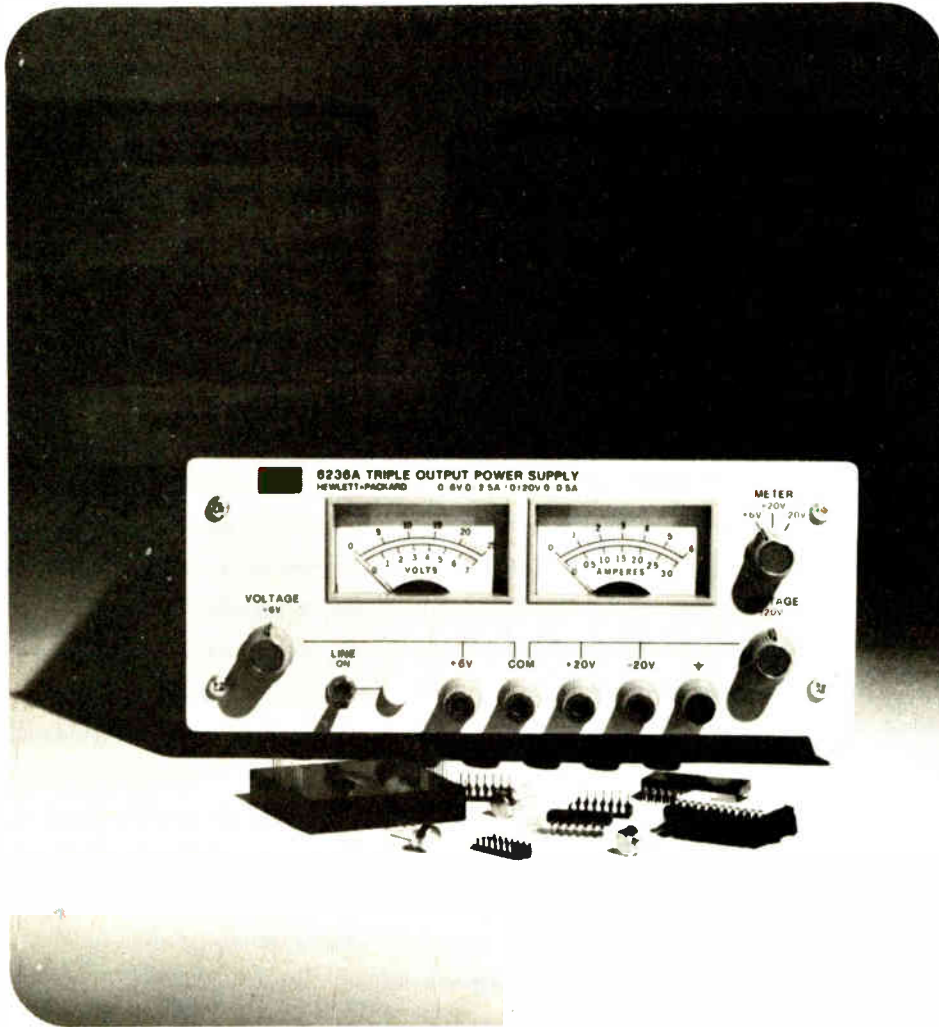

Separate voltage controls adjust the 0 to 6V and 0 to $\pm 20V$ outputs, while the meter switch selects the desired V and I range for display on the panel meters.

Low cost, small size, and outstanding performance, make this new three-in-one lab supply a valuable aid to anyone designing or testing equipment using integrated circuits. Model 6236A delivers three outputs: 0 to 6V, up to 2.5A; and dual-tracking 0 to $\pm 20V$, 0 to 0.5A. The 0 to +20V and 0 to -20V outputs track one another within 1% to supply the symmetrical voltages needed by op amps and similar balanced-voltage-source applications. A single 0 to 40V @ 0.5A output can also be obtained by connecting across the -20 and +20V terminals.

All outputs are regulated to 0.01% +2mV, with ripple and noise of 0.35mV rms/1.5mV p-p. The dc outputs have smooth turn-on and turn-off characteristics so that no output voltage overshoot is produced when the ac line switch is operated. Both the 6V and $\pm 20V$ outputs are protected from overloads by fixed current limiting circuits.

Model 6236A can be powered from a nominal 100V, 120V, 220V, or 240V, 47-63 Hz ac input. The supply weighs only 9½ lbs. (4.3 kg) and is 3½ in. high (8.9 cm), 8½ in. wide (21.6 cm), and 12½ in. deep (31.8 cm). Single and dual-unit rack-mounting kits are available.

For more information on the three-in-one power supply, check 1 on the HP Reply Card.

HEWLETT  PACKARD

East-20010 Century Blvd., Germantown, MD 20767, Ph. (301) 428-0700.
South-P.O. Box 2834, Atlanta, Ga. 30328, Ph. (404) 436-6181.
Midwest-5500 Howard Street, Skokie, Ill. 60076, Ph. (312) 677-0400.
West-3939 Lankershim Boulevard, North Hollywood, Calif. 91604, Ph. (213) 877-1282.
Europe-Post Office Box 85, CH-1217 Meyrin 2, Geneva, Switzerland, Ph. (022) 41 54 00.
Canada-6877 Goreway Drive, Mississauga, Toronto, L4V 1L9, Ph. (416) 678-9430.
Japan-Yokogawa-Hewlett-Packard, 1-59-1, Yoyogi, Shibuya-ku, Tokyo, 151.

CAUTION: 50,000 VOLTS



LET ERIE DESIGN and BUILD YOUR HIGH VOLTAGE POWER SUPPLIES and VOLTAGE MULTIPLIERS

When you talk about designing and packaging miniature, low current High Voltage Power Supplies and Voltage Multipliers, the name ERIE should come to mind first. Why? *No other manufacturer of these sophisticated devices has its own capacitor and rectifier technology in-house.* Only ERIE does it all. Our many years experience in producing State of the Art high voltage capacitors and high voltage silicon rectifiers — plus an unsurpassed technology in circuit designing, packaging and encapsulation, makes ERIE an ideal source for your high voltage component needs. From very low input voltages, ERIE can produce output voltages up to 50,000 volts. Application for these compact high reliability devices includes night-vision image intensification systems, Apollo TV cameras, CRT displays, Avionics systems exposed to rugged environments, Industrial, commercial and military equipments . . . an almost infinite variety of applications. So bring ERIE in early. Let us design and build *your* High Voltage Power Supplies and Voltage Multipliers. We're equipped to handle large or small volume orders . . . in-house.

Write for our 32 page catalog . . .
High Voltage Components and
Devices . . . or for technical
assistance, call

613/392-2581

ERIE TECHNOLOGICAL PRODUCTS, INC.

Erie, Pennsylvania 16512

Circle 27 on reader service card

ERIE

FLAT INTERCONNECTS YOUR COMPLETE SOURCE

Ribbon Cable / IC Interconnects / Custom Harnesses

You're sold on flat cable, now buy it at its best. Precise, compact cable packages to fit your specifications perfectly, computer-loomed for unmatched versatility by Woven Electronics.

Handling ease of independent non-bonded leads speeds production, cuts cost, while technical characteristics outrank other flat cable forms.

Make Woven your source for jumpers, continuous rolls, special harnesses, all your interconnect needs.

WOVEN ELECTRONICS

P.O. Box 189 Mauldin, South Carolina 29622
803/963-5131



Meetings

Nepcon '75 West and International Microelectronics Exhibition, Industrial Scientific Conference Management Inc. (Chicago, Ill.), Anaheim Convention Center, Anaheim, Calif., Feb. 11-13.

CAD/CAM III, Computer-Aided Design and Computer-Aided Manufacturing, Society of Manufacturing Engineers, Hyatt Regency O'Hare Hotel, Chicago, Ill., Feb. 11-13.

International Solid State Circuits Conference, IEEE, Marriott Hotel, Philadelphia, Pa., Feb. 12-14.

Comcon Spring Computer Conference, IEEE, Jack Tar Hotel, San Francisco, Calif., Feb. 25-27.

Industrial Applications of Microprocessors, IEEE, Sheraton Hotel, Philadelphia, Pa., March 11-12.

Reliability Physics Symposium, IEEE, MGM Grand Hotel, Las Vegas, Nev., April 1-3.

Paris Components Show, (*Salon des Composants Electroniques*), Porte de Versailles, Paris, April 2-8.

Southeastcon '75, IEEE, Sheraton Center, Charlotte, N.C., April 6-9.

Intercon-IEEE International Convention, Coliseum and Americana Hotel, New York, N.Y., April 8-10.

Electronics Production and Test Equipment Exposition, U.S. Department of Commerce, Stockholm, Sweden, April 7-11; London, April 15-18.

Society for Information Display International Symposium, SID, Shoreham Americana Hotel, Washington, D.C., April 22-24.

International Optical Computing Symposium, IEEE, Mayflower Hotel, Washington, D.C., April 23-25.

National Relay Conference, NARM and Oklahoma State University, Stillwater, Okla., April 30-May 1.

THE TRIMLINE SERIES

DISTINCTIVE ELECTRONIC ENCLOSURES



PREMIER METAL PRODUCTS COMPANY

337 MANHATTAN STREET, BRONX, N. Y. 10474 (212) 991-6600



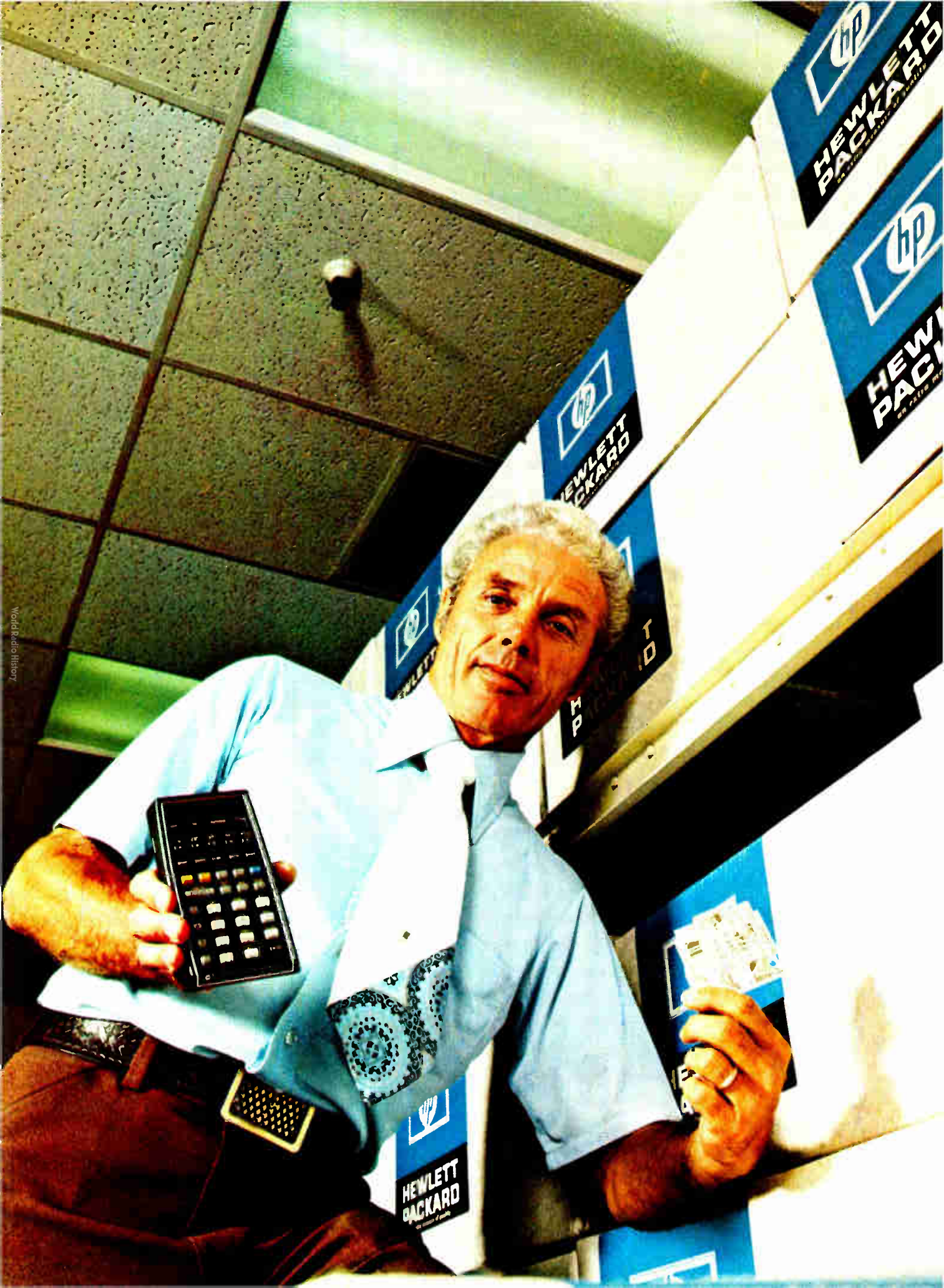

World Radio History

“My records prove it. Photocircuits shipped us over 1/2 million PCBs for calculators. Less than 1% were rejected.”

Tom Miller, Production Control Supervisor, Hewlett-Packard

“I supervised in-house production of printed circuitry for Hewlett-Packard. When the demand for our pocket-sized calculators taxed our own capacity for making printed circuit boards, I had to look outside the company.

“The scientific and business calculators Hewlett-Packard makes have infinitely more functions than the typical ‘house-wife’ variety. And we have sold over one-half million of them. So we needed large volumes of quality boards for logic and battery charger applications.

“Photocircuits’ reputation for quality was confirmed by my first visit.

“I’ve been in this business since 1955, so I knew of Photocircuits even before we made a facilities check. What I had heard proved to be true. Their overall efficiency was evident and everyone seemed to know what they were doing.

“We had no qualms about dealing with an East Coast house either. They were only a short 5 hours away by plane. And seconds away by WATS line. In fact, when we asked for price quotes, they got back to us within ten days. And that

included mailing time.

“Their price was lower and they delivered what they promised.

“Long Island labor costs are comparable to the West Coast, but Photocircuits still managed to beat local prices. To me, that’s another indication of over-all efficiency.

“And even though we hit them at the same time as everyone else, Photocircuits guaranteed they would deliver a certain number of boards every week. They kept that promise.

“Quality-wise, they were the best boards I’ve seen in twenty years.

“We have some very stringent standards at Hewlett-Packard. Not only do we expect operational quality, but esthetics as well. If a customer tears the cover off one of our products, we want our components to look good.

“In both cases, performance and looks, Photocircuits was outstanding. Over half a million boards have been delivered. Less than 1% have been rejected for any reason whatsoever.

“What more is there to say?”

Photocircuits

Division of Kollmorgen Corporation, Glen Cove, New York 11542 (516) 448-1000

Printed circuitry for mass-produced electronics

FEBRUARY 6, 1975

Industrial hazards call for intrinsically safe designs/91
Microprocessor design with standard logic, part 2/102
Integrating calculator elements on a glass substrate/109

FOUR DOLLARS A MCGRAW-HILL PUBLICATION

Electronics®

A NEW DIRECTION FOR BIPOLAR LSI

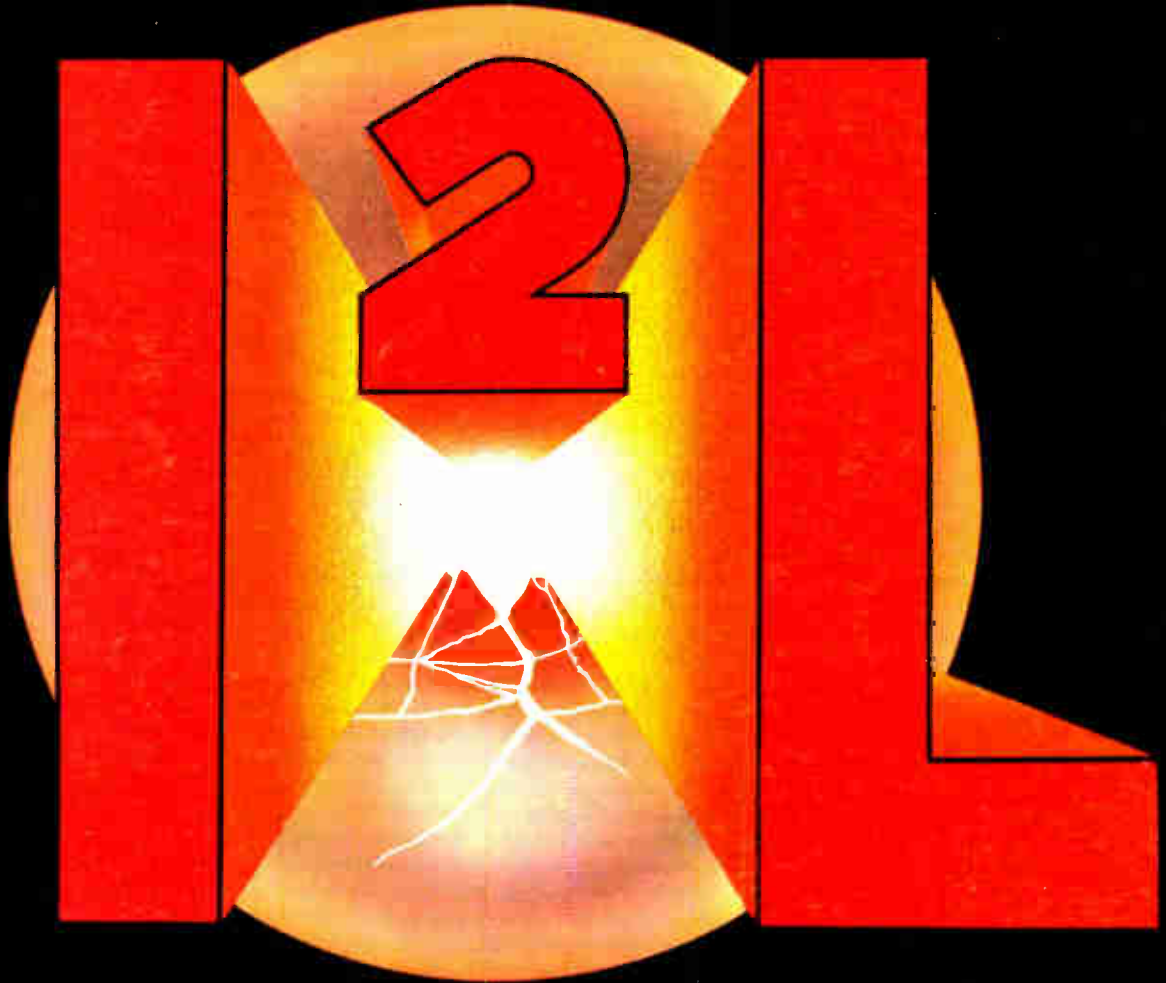

upshur

1420 Hillside Blvd. #100
Hillside, Ill. 60462
97232
1022 NE 55th Ave
Portland, OR



For the Engineer who needs the best Measuring Instruments...

6 new ideas

■ NEW INSTRUMENTS

- Spectrum Analyzers
- Impedance Plotters
- Sweep Test Systems
- Power Signal Generators
- Frequency Synthesizers
- Selective Microvoltmeters
- Programmable Attenuators
- TV Broadcast Test Equipment
- Semiconductor Test Equipment

■ NEW FACILITY

devoted to Engineering, Manufacturing, Quality Control, Sales and Service.

■ NEW CATALOG

286 pages describing over 1,500 instruments.

■ NEW EXTENDED WARRANTY

up to 3 years on all R&S equipment.

■ NEW DIRECT LEASE PLAN

lease any instrument from R&S.

■ NEW QUICK DELIVERY PLAN

from stock.

Send for your new catalog today and see all our ideas.

World Leader in Test Inst. & Communications for Over 40 Years



ROHDE & SCHWARZ

14 Gloria Lane, Fairfield, N.J. 07006 ■ (201) 575-0750 ■ Telex 133310

Circle 900 on reader service card
World Radio History

KIND HEARTS, BUT NO CORNETS.

**No tubas, no trombones,
no clarinets, no oboes, or flutes,
no drums, no bass fiddles, or bassoons,
nor guitars, nor pianos,
nor anything on John Philip Sousa's list.**

We haven't a thing that makes music.
Unless you count ticking, buzzing and
whirring...the sounds of science!

We are U. S. Instrument Rentals...

...that's oscilloscopes, counters,
analyzers, amplifiers, recorders, meters, and
state of the art test instrumentation, you name it.

What is special about us is not so much
kind hearts, but a commitment to tune out some
of the sour notes of renting.

Sour Note Ever forget to return a piece of equipment
and then get stuck for the payments?

Sweet Note Only we send you an automatic
reminder when the rental period is up.

Sour Note Ever get the telephone runaround
when you're trying to locate equipment?

Sweet Note Only we have IDIOM, a real time
computer capability for instant
inventory commitment.

Sour Note Ever have service turnaround problems?

Sweet Note Only we will pay you a 25% penalty
in dollars if we can't speed a
replacement to you within 48 hours.

With US, service is an essential refrain.

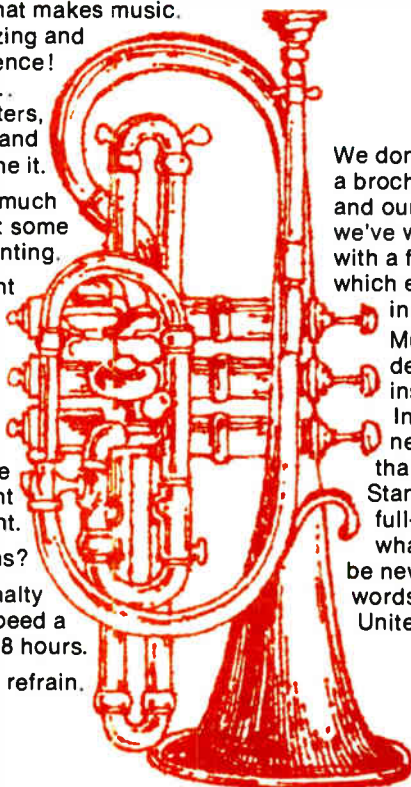

We don't have room to write
a brochure about ourselves
and our services here. Besides,
we've written one already...
with a fat catalog included
which explains the foregoing
in detail and much more.

Much more includes a full
description of the rental
instruments we have.

In fact, we probably have more
new equipment on the shelf
than any other rental company.

Stands to reason: We were born
full-grown just months ago—
what you get from US is bound to
be newer! And now, our catalog,
words and music by
United States Instrument Rentals

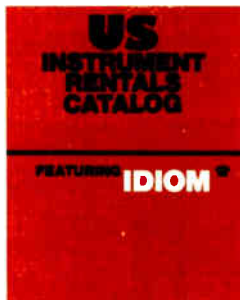

Gentlemen:

I understand you have the only Instrument Rental Catalog in the world
that doesn't read like a telephone directory. Please

- Send it to me without cost or obligation.
- Just send me a copy of pages 6 & 7 which chart the breakeven
relationship between rental cost, ownership cost and utilization.

NAME _____

COMPANY _____

ADDRESS _____

CITY _____ ZIP _____

PHONE _____

951 Industrial Road, San Carlos, CA 94070

IDIOM Inventory and Delivery
Information in
One Minute



(213) 849-5861 (301) 340-1353 (214) 234-3392
(415) 592-9230 (201) 381-3500 (713) 462-6803



TRY 'EM...YOU'LL LIKE 'EM

Instant relief for design congestion: **Cherry Subminiature snap-action switches.**

When your design is afflicted with circuit congestion brought on by acute lack of space, here's the prescribed cure: Cherry 5 and 10 amp subminiature switches! Compact, easy-to-take size . . . refreshingly dependable coil spring action . . . plus long overtravel to combat assembly line headaches. You get Speedy snap-action relief in the dosage you prescribe: Either individual switches or space-saving multiple switch modules. Consultation available if design distress persists . . . Cherry diagnoses proven in over 160 million cases.

Try 'em: Send for free sample switch.
You'll like it.



E61-00A
Standard Force Basic 10 amp.
Circle Reader Service No. 166

E63-00A

"Goldie" Low Energy 0.1 amp.
Circle Reader Service No. 167



E62-50K

Roller Actuator 10 amp.
Circle Reader Service No. 165



CHERRY



TWX 910-235-1572... or PHONE (312) 689-7600... or WRITE:

CHERRY ELECTRICAL PRODUCTS CORP.
3600 Sunset Avenue, Waukegan, Illinois 60085



Cherry affiliates worldwide • Hirose Cherry Precision Co., Ltd., Tokyo • G W. Engineering Pty Ltd., Svdney
Cherry Electrical Products (U.K.) Ltd., St. Albans, Herts • Cherry Mikroschalter GmbH, Bayreuth, Germany

39 Electronics Review

SOLID STATE: RCA close to commercial CCD cameras, arrays, 39
Three-inch rectifier handles 10 megawatts, 40
COMMUNICATIONS: IBM ponders court action on domsat ruling, 40
COMMERCIAL: Recorder detects counterfeit currency, 41
Funds-transfer systems may have to share single net, 42
PACKAGING & PRODUCTION: Junction plug-ins make own contacts, 42
COMMUNICATIONS: Chip lasers ready for optical systems, 44
DOD wants standardized fiber-optic systems by 1980, 44
NEWS BRIEFS: 46
MANAGEMENT: New Fairchild chairman promises expanded markets, 48
MATERIALS: Chemicals are key to liquid-crystal-display watches, 48
INDUSTRIAL: Optical gear finds water pollutants, 51

62 Electronics International

FRANCE: Portable X-ray machine measures metal stress, 62
WEST GERMANY: Intermetall to sell novelty IC light switch, 62
AROUND THE WORLD: 63

69 Probing the News

NAVIGATION: Air Force gets aboard Omega, 69
SOLID STATE: ISSCC has news for LSI users, 72
AVIONICS: DAIS takes center stage, 76
ELECTRONICS ABROAD: Europe heads for pollution standards, 78
COMPANIES: Signetics digs out, 80

83 Technical Articles

SOLID STATE: I²L boosts bipolar-microprocessor integration, 83
INDUSTRIAL ELECTRONICS: Intrinsic safety foils explosions, 91
DESIGNER'S CASEBOOK: Smoothing 555-timer capacitance levels, 96
Generating overlapped clock phases for CCD array, 97
Overvoltage indicator can be added to C-MOS IC tester, 99
CIRCUIT DESIGN: Part 2, Standard logic in microprocessors, 102
Calculator's parts integrated on a single glass substrate, 109
ENGINEER'S NOTEBOOK: Increasing an instruction set, 114
Low-cost field-strength unit uses simple buffer, 115

123 New Products

IN THE SPOTLIGHT: Scope is combined with multimeter, 123
Plastic telephone-type relays are hermetically sealed, 127
INSTRUMENTS: Digital panel meters have 0.5-inch LEDs, 128
COMPONENTS: LEDs offer high efficiency, 136
SEMICONDUCTORS: Schottky RAM draws only 275 milliwatts, 142
DATA HANDLING: Cartridge drive is built for field use, 149
PACKAGING & PRODUCTION: Large screen aids wafer inspection, 153

Departments

Publishers letter, 4
Readers comment, 6
News update, 8
People, 14
Meetings, 30
Electronics newsletter, 35
Washington newsletter, 59
Washington commentary, 60
International newsletter, 65
Engineer's newsletter, 118
New literature, 157

Highlights

The cover: I²L blazes new bipolar path, 83

A non-isolated gate structure boosts the density of the latest integrated-injection-logic chip, which also has five times the speed of a comparable 4-bit n-MOS microprocessor. The next I²L generation is expected to be even faster and should at last make the full benefits of bipolar LSI available to computer designers. Cover is by illustrator Tom Upshur.

Conference announces LSI advances, 72

Visitors to the International Solid State Circuits Conference in Philadelphia this month will learn about: denser-than-ever bipolar chips; faster-than-ever MOS memories; gallium-arsenide FET oscillators that set new power-frequency records; and charge-coupled devices that are revolutionizing analog signal processing.

How to build an intrinsically safe system, 91

The sparking that always occurs in electronic equipment is often powerful enough to trigger explosions in volatile atmospheres. This danger can be eliminated if the circuitry in the hazardous areas operates with low enough voltage, current, capacitance, and inductance values.

Using high-speed logic for microprocessors, 102

The parts count can be reduced when an application requires less than the utmost performance from a processor built from high-speed logic. This is the second half of a two-part article on the design of standard-logic processors that are faster than MOS chips and use fewer devices than random-logic systems.

And in the next issue . . .

An economical two-way pay-TV system . . . eight ways to improve radio receiver design . . . overcoming the deficiencies of zener diodes as voltage reference sources.

EDITOR-IN-CHIEF: Kemp Anderson

EXECUTIVE EDITOR: Samuel Weber

MANAGING EDITORS: Lawrence Curran, *News*;
Arthur Erikson, *International*

SENIOR EDITORS: John Johnsrud,
H. Thomas Maguire, Laurence Altman,
Ray Connolly, Stephen E. Scrupski

ART DIRECTOR: Fred Sklenar

ASSOCIATE EDITORS: Howard Wolff,
Gerald M. Walker, Alfred Rosenblatt

DEPARTMENT EDITORS

Aerospace/Military: Ray Connolly

Circuit Design: D. J. Blattner

Components: Lucinda Mattera

Computers: Stephen E. Scrupski

Consumer: Gerald M. Walker

Industrial: Margaret A. Maas

Instrumentation: Andy Santoni

New Products: H. Thomas Maguire,

Michael J. Riezenman

Packaging & Production: Jerry Lyman

Solid State: Laurence Altman

COPY EDITORS: Margaret Eastman,

Everett C. Terry, Bill Dunne

ART: Charles D. Ciatto, *Associate Director*

Patricia Cybulski, *Assistant Director*

PRODUCTION EDITOR: Arthur C. Miller

EDITORIAL SECRETARIES: Janet Noto,

Julie Gorgoglione, Penny Roberts

FIELD EDITORS

Boston: Gail Farrell (Mgr.), Pamela Leven

Los Angeles: Paul Franson (Mgr.)

Judy Phelps

Midwest: Larry Armstrong (Mgr.)

New York: Ron Schneiderman (Mgr.)

San Francisco: Bernard Cole (Mgr.)

Judith Curtis

Washington: Ray Connolly (Mgr.)

Larry Marion

Frankfurt: John Gosch

London: William F. Arnold

Paris: Arthur Erikson

Tokyo: Charles Cohen

McGRAW-HILL WORLD NEWS

Director: Ralph R. Schulz

Bonn: Robert Ingersoll

Brussels: James Smith

London: Marvin Petal

Madrid: Dom Curcio

Milan: Peter Hoffmann, Andrew Heath

Moscow: Peter Gall

Paris: Michael Johnson, Richard Shepherd

Stockholm: Robert Skole

Tokyo: Mike Mealey

PUBLISHER: Dan McMillan

DIRECTOR OF MARKETING: Pierre J. Braudé

ADVERTISING SALES SERVICE MANAGER:

Wallis Clarke

BUSINESS MANAGER: Stephen R. Weiss

CIRCULATION MANAGER: Nancy L. Merritt

MARKETING SERVICES MANAGER:

Tomlinson Howland

RESEARCH MANAGER: Margery D. Sholes

The pace of electronics progress is nowhere more breathtaking than in solid state developments. Our cover story this issue, for example, details a technique for fabricating extremely compact integrated injection-logic gates that, since they require no space-consuming pn junctions for isolation, are comparable in size to a single transistor. What's more, power demands are low. The result: digital ^{12L} structures with thousands of gates on a single bipolar chip. Read all about it on page 83.

The instrument-bedecked cockpit of today's Air Force plane may become a far less crowded place as the trend toward using digital methods in jobs that were once solely analog gains momentum. In place of the maze of "black boxes," a time-shared computer-based CRT display is being tried out at Wright-Patterson AFB. With it, a streamlined console could give the pilot even more data than he has available today—and do it with far more efficient use of space. You'll find our story about the program, called DAIS, on page 76.

Larry Armstrong, our Midwest bureau manager, wrote the story after interviewing the project officers at the Air Force Avionics Laboratory and going for a "trial run" of the prototype cockpit simulator that they have developed. In fact, the "trainee" in the photograph on page 76 is none other than our man Armstrong getting a hands-on demonstration of the DAIS hot bench.

Avionics, incidentally, is something of a hot field just now, as shown by the fact that we have two

Probing the News articles on avionics in this issue: the DAIS story and one on the Air Force's ambitious plans for the next decade's worldwide air navigation system (see page 69).

That story, put together by our Washington bureau chief, Ray Connolly, details the steps that the Air Force is taking to replace the geographically limited Loran network with a global-reach Omega net. The prize for the winning contractor will be about \$22 million for just the electronics on board some 1,000 transports. Development, spares, training, and maintenance are extra.

Having decided to switch to Omega—and its eight worldwide stations—the Air Force, in the words of one officer, has "dismissed the Newtonian navigators" with their high-cost inertial systems and is continuing, albeit in an upgraded form, with "the Maxwellian approach." But, as we point out in the story, Omega is not the last word in navigation. The Air Force is already working on the next generation—a satellite-based navigation system to go into operation about 1987. Maybe that will be called the Copernican approach.

The annual index of articles published in *Electronics* is now available, and a copy will be mailed to any reader who requests it. Just circle number 340 on the reader service card, which you will find inside the back cover.



February 6, 1975 Volume 48, Number 3
94,153 copies of this issue printed

Published every other Thursday by McGraw-Hill, Inc. Founder James H. McGraw 1860-1948. Publication office 1221 Avenue of the Americas, N.Y., N.Y. 10020; second class postage paid at New York, N.Y. and additional mailing offices.

Executive, editorial, circulation and advertising addresses: Electronics, McGraw-Hill Building, 1221 Avenue of the Americas, New York, N.Y. 10020. Telephone (212) 997-1221. Teletype TWX N.Y. 710-581-5234. Cable address MCGRAWHILLN.Y.

Subscriptions limited to persons with active, professional, functional responsibility in electronics technology. Publisher reserves the right to reject non-qualified requests. No subscriptions accepted without complete identification of subscriber name, title, or job function, company or organization, including product manufactured or services performed. Subscription rates: qualified subscribers in the United States and possessions, Canada, and Mexico \$12.00 one year, \$24.00 three years, all other countries \$25.00 per year, except Japan and Israel \$50.00 per year, Brazil \$40.00 per year, Australia and New Zealand \$60.00 per year, including air freight. Limited quota of subscriptions available at higher-than-basic rate for persons outside of field served, as follows: U.S. and possessions and Canada, \$25.00 one year, all other countries \$50.00. Single copies \$4.00.

Officers of the McGraw-Hill Publications Company: John R. Emery, President; J. Elton Tushig, Executive Vice President-Administration; Gene W. Simpson, Group Publisher-Vice President, Senior Vice Presidents: Ralph Blackburn, Circulation, Walter A. Stanbury, Editorial; John D. Hoglund, Controller, David G. Jensen, Manufacturing, Gordon L. Jones, Marketing; Jerome D. Luntz, Planning & Development.

Officers of the Corporation: Shelton Fisher, Chairman of the Board and Chief Executive Officer; Harold W. McGraw, Jr., President and Chief Operating Officer; Wallace F. Trendly, Group President, McGraw-Hill Publications Company and McGraw-Hill Information Systems Company; Robert N. Landes, Senior Vice President and Secretary; Ralph J. Webb, Treasurer.

Title registered in U.S. Patent Office. Copyright © 1975 by McGraw-Hill, Inc. All rights reserved. The contents of this publication may not be reproduced in whole or in part without the consent of copyright owner.

Subscribers: The publisher, upon written request to our New York office from any subscriber, agrees to refund that part of the subscription price applying to copies not yet mailed. Please send change of address notices or complaints to Fulfillment Manager, subscription orders to Circulation Manager, Electronics, at address below. Change of address notices should provide old as well as new address, including postal zip code number if possible, attach address label from recent issue. Allow one month for change to become effective.

Postmaster: Please send form 3579 to Fulfillment Manager, Electronics, P.O. Box 430, Hightstown, N.J. 08520.

For \$395

how many functions should a Function Generator generate?

Fifteen. That's the number of waveforms you can get with Krohn-Hite's Model 5100A. How? A unique Symmetry Control that allows pulse rep rate to be set independently of pulse width and also provides independently adjustable triangle slopes. You can skew any of the basic sine, square, triangle and ramp waveforms by as much as 99% to produce 10 additional functions. Frequency range of 0.002 Hz to 3 MHz can be manually tuned or externally controlled for VC of 1000:1. When you compare the 5100A with the rest, there's quite a generation gap. For fast action, call The Wavemakers at (617) 491-3211, TWX 710-320-6583 Krohn-Hite Corporation, 580 Mass. Ave., Cambridge, Mass. 02139.



SALES OFFICES: ALA, Huntsville (205) 534-9771; ARIZ, Scottsdale (602) 947-7841; CAL, San Jose (408) 292-3220, Inglewood (213) 674-6850; COLO, Denver (303) 934-5505; CONN, Glastonbury (203) 633-0777; FLA, Orlando (305) 894-4401; HAWAII, Honolulu (808) 941-1574; ILL, Oes Plaines (312) 298-3600; IND, Indianapolis (317) 244-2456; MASS, Lexington (617) 861-8620; MICH, Detroit (313) 426-8800; MINN, Minneapolis (612) 884-4336; MO, St. Louis (314) 423-1234; N.C., Burlington (919) 227-3639; N.J., Haddonfield (609) 795-1700; N.M., Albuquerque (505) 299-7658; N.Y., E. Syracuse (315) 437-6666, Rochester (716) 328-2230, Vestal (607) 785-9947, Elmont (516) 488-2100; OHIO, Cleveland (216) 261-5440, Dayton (513) 426-5551; PA, Pittsburgh (412) 371-9449; TEX, Houston (713) 688-9971, Richardson (214) 231-2573; VA, Alexandria (703) 354-1222; WASH., Seattle (206) 624-9020; CANADA, Montreal, Quebec (514) 636-0525, Toronto, Ontario (416) 444-9111, Stittsville, Ontario (613) 836-4411, Vancouver, British Columbia (604) 688-2619.



Tansitor

Specialists in
Tantalum Capacitors

FOIL TYPES



Tubular Style
CL, CLR or TE
Elastomer or
Hermetic Seals



Rectangular Packages
CL or TE 51, 52, 53, 54
Tantalum to Glass
Hermetic Seal



Special Designs
WF, TES, THS
Volumetrically efficient
Filter Capacitors



Custom Modules
Wide range of ratings
designed to meet
your requirements

WET TYPES



CL 65, CL 67, CLR65
Elastomer or
Hermetic Seals
Standard or High Cap



Rectangular Packages
CL or TE 55
Hermetic Seal
High Cap Values



Miniature Wets
Most Volumetrically
efficient Capacitor
Low DC Leakage

MINIATURE SOLIDS



Type HA Cylindrical
Type TC Rectangular
Axial or Radial Leads
Subminiature size

For more information on TANSITOR
capacitors, call your local
Tansitor Representative, or contact:



Tansitor
ELECTRONICS
DIVISION OF AEROTRON, INC.

West Road, Bennington, Vermont 05201
Phone: (802) 442-5473 TWX: (710) 360-1782

Readers comment

Unfoiled indicator

To the Editor: The very useful lock indicator of the phase-locked loop devised by J. A. Connelly and G. E. Prescott [*Electronics*, Sept. 5, 1974, p. 112] has the undesirable capability of displaying the lock condition when no input signal is applied, or if the input is grounded. The outputs of the wave shaper (HA-2311) and the phase comparator (7400-7406) remain at ground, as they do in the true lock condition.

This can be overcome by exchanging the inputs of the 2311 wave shaper—connecting the input to the inverting lead and the ground to the noninverting lead—and replacing the 7400 and 7406 in the phase comparator with a second exclusive-OR. This exclusive-OR is already available on the chip of the 7486 90° phase shifter.

This modified circuit has the same properties of that published by Connelly and Prescott, but does not signal "lock" when no input signal is applied.

Gunther Kuerbitz
Aalen, Germany

Information source

To the Editor: Your readers may be interested in knowing the source of the market data for the bar graph you published on p. 87 of your Jan. 9 issue concerning the size of the markets for timesharing and remote computing services. The source of the information was a major market study undertaken by International Resource Development Inc. and published in November 1974. The figures were derived from a business analysis of the major suppliers of remote computing services.

Kenneth G. Bosomworth
International Resource
Development, Inc.
New Canaan, Conn.

Correction

The statement that Fujitsu Ltd. claims infringements of its patents by Digital Equipment Corp.'s Unibus (Jan. 9, p. 26) is erroneous. Fujitsu claims that other elements of DEC's PDP-11 infringe on two of its patents.

HIGH PURITY ELEMENTS

We offer more than anyone else.

- Antimony
- Arsenic
- Bismuth
- Cadmium
- Copper
- Gold
- Indium
- Lead
- Selenium
- Silver
- Sulphur
- Tellurium
- Thallium
- Zinc

Asarco has the broadest selection of high purity elements in the business. All 99.999+ % pure. All ready for prompt delivery. For semiconductors, electronics, metallurgy, research, and other applications.

Our high-purity elements are also available in commercial quantities.

For more information on Asarco's array of high purity elements, write our By-Products Department at 120 Broadway, New York, N.Y. 10005.

75 Years of Progress in Metals

ASARCO⁷⁵

American Smelting and Refining Company

After all the noise, the quiet logic of HiNIL and 74C CMOS keeps you on the right track.



May 10, 1869. Promontory, Utah. The rumble of wheels, the hiss of escaping steam, the shouts of the celebrating crowd filled the skies with a deafening roar when they drove the golden spike that joined the Central Pacific and Union Pacific Railroads.

But today, when you link Teledyne's high noise immunity logic, HiNIL, and our 74C CMOS together in your digital or analog/digital control designs, you'll no longer have to worry about spikes or noise. Teledyne invented HiNIL to meet the need for high noise immunity found in practically all digital systems. The success of this large and still growing family has made Teledyne a leading supplier of logic for high noise applications.

Just put HiNIL on input-output lines to block heavy noise transients and drive high current peripheral devices. And use CMOS in the middle to minimize power dissipation and increase speed and circuit density. The combination of HiNIL's guaranteed 3.5V noise margin and 74C's low power dissipation lets them quiet a most any kind of system with high noise problems.

Our two logics interface directly, too. Standard 74C drives HiNIL directly and HiNIL drives more than 50 CMOS loads. Simply connect both to an inexpensive 12 or 15V ±1V power supply. You can even connect linear circuits to the same supply for extra savings.

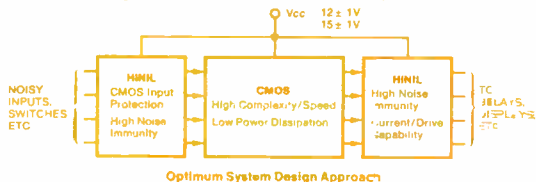

HiNIL eliminates the need for drivers because it sources up to 15mA and sinks up to 65mA. That's ample capability for display tubes, LEDs, lamps and relays.

And with HiNIL you save on filter capacitors, get the extra flexibility and economies of diode-expandable inputs, and have a choice of active or passive pull-up and open collector outputs. There's plenty of board-shrinking MSI in both families, too.

So write or call Teledyne today to find out about our HiNIL and 74C CMOS lines. We'll show you how easy it is to block out all the noise and stay on the right track.

TELEDYNE SEMICONDUCTOR

1300 Terra Bella Avenue, Mountain View, California 94043 Tel: (415) 968-9241 TWX: 910-379-6494 Telex: 34-8416

ENGLAND: Heathrow House, Cranford, Hounslow, Middlesex, Tel: (44) 01-897-2503 Telex: 851-935008

FRANCE: 90, Avenue Des Champs Elysees, 75008 Paris, Tel: 2563069 Telex: 842-29642

WEST GERMANY: Albert Gebhardtstrasse 32 7897 Tiengen Tel: 7741-5066 Telex: 841-792-1462

JAPAN: Nihon Seimei-Akasaka Bldg. (3F), 1-19, Akasaka 8-chome, Minato-ku, Tokyo 107, Tel: 03-405-5738 TWX: 781-2424241

Additional offices in West Germany, Hong Kong and the United States. Representatives and distributors worldwide.

Sprague Delivers!

YOU DON'T HAVE TO TAKE A SUBSTITUTE.



THE CAPACITOR:

Sprague's Type 192P Pacer[®] ...
The Dependable Low-Cost
Miniature Polyester Film Capacitor.

THE DELIVERY CYCLE:

Large Production Quantities
4 - 8 Weeks ARO on All Popular
Ratings. Off-the-Shelf Delivery from
your Sprague Industrial Distributor.

THE CATCH:

None.
Sprague Delivers Film Capacitors.

Call your nearest Sprague district office or
sales representative for complete information.

Sprague Electric Company,
North Adams, Mass. 01247
Tel. 413/664-4411

THE BROAD-LINE PRODUCER OF ELECTRONIC PARTS



News update

■ The recession has muddled many a marketing plan, including that of Bernard T. Marren, president of American Microsystems Inc. A year ago, Marren said he was going to change the Santa Clara, Calif., semiconductor maker's product mix from about 90% custom to a third each custom, standard, and memory [Jan. 10, 1974, p. 14]. Marren, then the newly named vice president and chief operating officer of AMI, said he expected to have the changes completed by 1976. Since then, the recession and inflation have hit hard; despite it all, though, AMI is now selling 51% custom circuits, 33% memory, and 16% standard. "Standard didn't grow as we would have liked," says Marren, partly because some of the companies AMI was counting on as customers have had to go out of business—while some of the more successful ones have integrated vertically. Not to be outdone, AMI itself is vertically integrating by making its own C-MOS circuits, light-emitting diodes, and liquid crystals.

■ Remember the gasoline crisis of early 1974? William Smith remembers it well. He's the president of Sunrise Electro-Service Corp. of Farmingdale, N.Y., which developed a digital display terminal for taxicabs and was to have outfitted 250 New York City cabs [Feb. 7, 1974, p. 39]. A few were delivered, the price of fuel began to soar, and that was the end of that—those few were returned, and a \$350,000 order came up all zeroes. But all is not lost. An improved version of the system is about to be delivered to a new customer—City Transfer Co., an affiliate of Allied Van Lines based in Anaheim, Calif. City Transfer plans to use basically the same terminal designed for the taxis, except that the it now operates at 4,800 baud rather than the original 3,125 baud.

■ The IPT Corp. of Sunnyvale, Calif., last year introduced a machine that made it possible to test

For microwave measurements, see a specialist.



Systron-Donner's newest automatic counter offers more...

Systron-Donner, pioneer of automatic microwave counters, has done it again. S-D's completely new Model 6054A counter offers more of everything that's vital in frequency measurement.

... **Coverage:** Complete microwave coverage from 0.02 to 18 GHz in one band with one connector input.

... **Dynamic Range:** No dead zone! Operative over the complete range up to +30 dBm (1 Watt).

... **Protection:** Unlike other counters offered to date, the Model 6054A provides early warning of pending overload conditions via flashing LED's.

... **FM Tolerance:** Full channel loading and heavily modulated signals with rates up to 10 MHz are measured easily with S-D's new FLACTO™ technique.

... **Speed:** Fast acquisition and 1 Hz resolution in one second are provided over the entire frequency range.

... **Display:** Standard 11-digit LED readout gives you fully displayed readings up to 18 GHz.

... **Information:** In the U.S., call or write Systron-Donner at 1 Systron Drive, Concord, CA 94518. Phone (415) 676-5000. Or contact your nearest Scientific Devices office. Abroad, contact Systron-Donner GmbH, Munich; Systron-Donner Ltd., Leamington Spa, U.K.; Systron-Donner S.A., Paris (Le Port Marly); Systron-Donner Pty. Ltd., Melbourne.

SYSTRON  **DONNER**
CORPORATION

For literature circle 168 on reader service card.

For demonstration circle 9 on reader service card.

Choose your bandwidth.... TAKE YOUR CHOICE!

120 MHz/5 mV

- Dual trace/Delaying sweep
- Lightweight: 19.5 lbs
- Bright 20 KV 8 x 10 cm display
- Low 45 Watt power consumption
- X - Y capability
- Easy to use delayed sweep

PM3260E \$ 1850.00

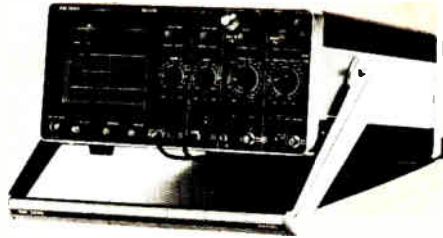

50 MHz/ 5 mV

- Dual trace/Delaying sweep
- Lightweight: 18.5 lbs.
- Bright 10 KV 8 x 10 cm display
- Low 23 Watt power consumption
- X - Y capability
- Easy to use delayed sweep

PM3240 \$ 1470.00

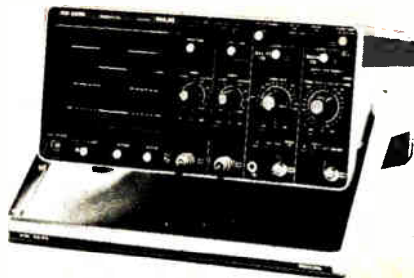

10 MHz/2 mV

- Dual beam to avoid chop/alternate problems
- Brilliant 10 KV 8 x 10 cm display
- Lightweight: 21 lbs.
- TV sync
- X - Y capability

PM3232 \$ 875.00

PM3233 \$ 925.00

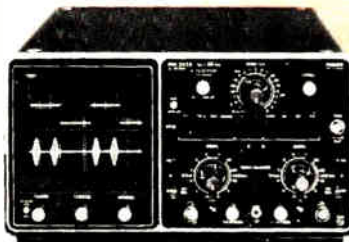

FREE DIGITAL INSTRUMENT COURSE

In-depth information on digital circuits and the mathematical theory behind them. Number theory, Boolean algebra. The course progresses through digital block, data communication and control. This digital instrument course is yours **FREE**, if you allow one of our Sales Engineers to demonstrate Philips equipment to you. Ask our Field Engineer about your complimentary gift during your demonstration.

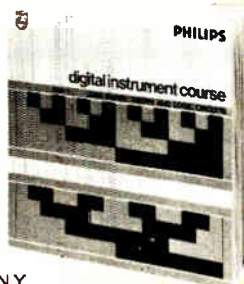

For further information, contact:

Philips Test & Measuring Instruments, Inc.
A NORTH AMERICAN PHILIPS COMPANY

400 Crossways Park Drive Woodbury, New York 11797
Telephone: (516) 921-8880 Twx: 510 221 2120

SPECIAL APPLICATIONS INFORMATION 'HOT LINE'
DIAL TOLL FREE NUMBER (800) 645-3043 NEW YORK
STATE, CALL COLLECT (516) 921-8880

PHILIPS

Circle 240 on reader service card for either a salesman to call or for a demonstration.

News update

ICs dynamically for only a fraction of a cent more than room-temperature tests cost. The machine was developed mainly for computer makers concerned that guard-band tests wouldn't do the job well enough with MOS dynamic RAMs operating in high-density memory systems, where hot spots may occur during system operation [Jan. 10, 1974, p. 29]. IPT says it has sold its tester to some of the major manufacturers—and users—of ICs, including a major foreign-car manufacturer. And the company's vice president for sales, Arthur Rock, says he expects the IC tester market will get better because "there is more mil spec business now." However, he would offer no figures.

■ At the height of last winter's energy crunch, the Lindberg division of Sola Basic Industries came out with a diffusion-furnace controller that allowed semiconductor makers to flip a switch and lower process temperatures to 900°C from 1,200° during idle weekends [Jan. 10, 1974, p. 29]. There was only one problem, as it turned out: as the energy crisis eased, so did sales of the Lindberg controller. But the device has found a new niche for itself, and product manager William D. McEntire estimates that half the furnaces sold today are equipped with it. "In some new processes," he says "especially those using 3-inch wafers, the controller is being used as a secondary set point device that allows ramping for the furnace." Typically, slices are loaded at 900°, the furnace ramps to 1,200°, and then drops to 900° for unloading.

■ When the Surface Transportation Act of 1974 died as Congress adjourned without acting on it, perishing with it was a plan to spend \$35 million on a computerized inventory system for the nation's railroad freight cars [Jan. 24, 1974, p. 36]. Don't look for a fast revival, because the recession has not only meant tighter budgets, but less rail shipping.

—Howard Wolff

Our 2K dynamic shift register is just like theirs. Only better.

Price. Very comfortable.

About the same price as two 1K devices, so you get the board savings free.

Delivery. Now.

Pedigree. Our proven P-channel, silicon gate MOS process. And, of course, every one is built to MIL-STD-883. (That's the only way we make them.)

You'll never know until you try. Call us.

Am2825/5025 —
Dual 1024-Bit Dynamic Recirculating Shift Register: Common Clock.

Am2826/5026 —
Dual 1024-Bit Dynamic Shift Register: Separate Clocks.

Am2827/5027 —
2048-Bit Dynamic Recirculating Shift Register.

Note: All devices operate at 6MHz data rate and are available in hermetic and plastic packages guaranteed to meet military and commercial temperature ranges.

Advanced Micro Devices

Corporate offices are at 901 Thompson Place, Sunnyvale, California 94086. Telephone (408) 732-2400 or toll free from outside California (800) 538-7904/Southern California: Beverly Hills (213) 278-9700/Mid-America: Oak Brook, Illinois (312) 323-9600/Edina, Minnesota (612) 835-4445/Dallas, Texas (214) 423-1502/Eastern United States: Roslyn Heights, New York (516) 484-4990/E. Syracuse, New York (315) 437-7546/Baltimore, Maryland (301) 744-8233/Wellesley, Massachusetts (617) 237-2774/Britain: Advanced Micro Devices, Telephone 01-730-0855/West Germany: Advanced Micro Devices, Munich. Telephone (089) 53 95 88. Southern Europe: Advanced Micro Devices, S.A. Neuilly, France, Telephone 747-4194. Distributed nationally by Hamilton/Avret, Cramer and Schweber Electronics.

Circle 251 on reader service card

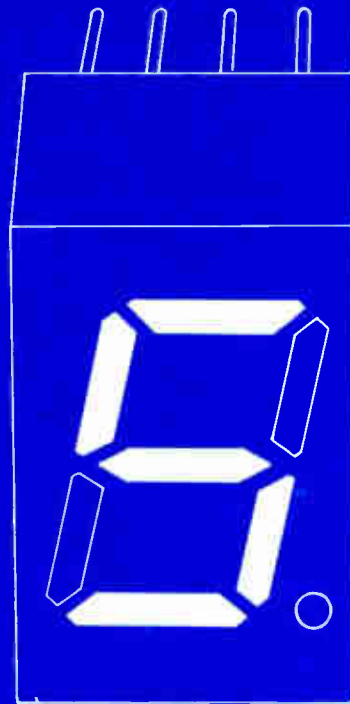
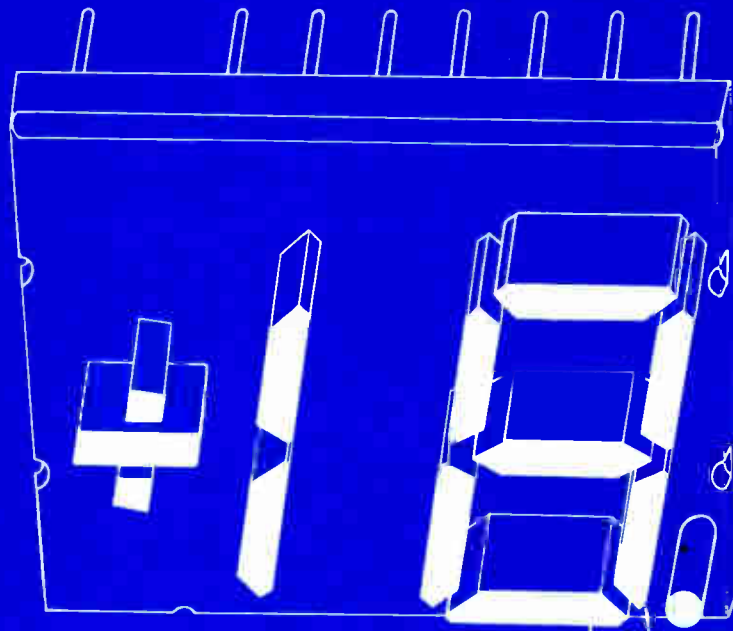

One DIP handles two digits

Mitered corners increase eye appeal

Light pipes spread illumination evenly over broad segments

Announcing the first 0.5" multi-digit LEDs



Here we go again. It's another first from Litronix: multi-digit 0.5"-high LEDs.

These two-in-one packages are tailor made for anyone who wants to save money in lower production costs. They require only half the inventory. Half the handling. Half as many components to assemble and test.

Makers of digital time pieces will find them ideal, as will those who manufacture point-of-sale terminals. FM digital readout tuning systems. TV channel tuners, and instrumentation.

The modules are end-stackable to produce any combination of 0.5" digits on 0.5" centers. The DL-727 is a two-digit module that's ideal for clocks. And our DL-721 module offers a \pm sign and a "1" for polarity and over-range indications on instruments.

Each module has the same drive requirements. Power required is only 30 to 40 mW per segment from standard logic voltage supplies. Modules are packaged in standard DIPs.

Naturally, you enjoy all the solid state advantages of LEDs. They're compatible with today's IC circuits. Rugged. Easy to multiplex. And offer fast response.

In any business lower costs make a difference. Our dual 0.5"-high digits help your products keep a competitive edge.

Our data sheets tell all. Contact Litronix, 19000 Homestead Road, Cupertino, Calif. 95014. Phone (408) 257-7910.

**No wonder
we're No.1
in LEDs**

litronix

MORE POWER MORE BANDWIDTH

Our Model 503L is an ultra-wideband RF power amplifier whose wide range of frequency coverage and power output provides the user with the ultimate in flexibility and versatility in a laboratory instrument. Easily mated with any signal generator, this completely solid state unit amplifies AM, FM, SSB, TV, pulse and other complex modulations with minimum distortion.

Constant forward power is continuously available regardless of the output load impedance match, making the 503L ideal for driving highly reactive loads.

Unconditional stability and instantaneous failsafe provisions in the unit provide absolute protection from damage due to transients and overloads.

This low cost instrument, covers the frequency range of 1.6 to 540 MHz with a linear power output of 3 watts . . . and there's no tuning. Priced at \$995.*

Applications include:

- Laboratory instrumentation
- Communication systems
- Laser modulation
- RFI/EMI testing
- Spectroscopy

*USA and Canada



For further information or a demonstration contact

ENI, 3000 Winton Road South,
Rochester, New York, 14623.
Call 716-473-6900.
Or TELEX 97-8283 ENI ROC.

ENI

The world's leader
in solid-state power amplifiers.

People

Boucher insisted Microma get serious about watches

Forty-seven-year-old Richard Boucher almost turned down the chance to be president of Microma Inc., the digital watchmaking subsidiary of Intel Corp. Rumors had it that Intel was disappointed with Microma's performance and was looking around for buyers. "The first question I asked them was, were they bringing me on just to arrange for the selling of the company?" recalls Boucher, who at the time was assistant president at Electronic Arrays Inc. "They convinced me they weren't. They were serious about making Microma a dominant force in the digital-watch market. So I accepted."

But to persuade the world that Intel was indeed serious about Microma, Boucher—who says he's after 25% of the digital-watch business—insisted that a "high-power corporate staff" be brought in. Intel agreed, even though it meant giving up two of its own key executives.

Boucher had already enticed Irving Cooper, vice president of marketing at Litronix, to a comparable position at Microma. "His experience in the digital-watch market is about the same as mine—next to nil—but he was instrumental in getting that company [Litronix] established in the consumer electronic calculator market," Boucher says. "And that is the way it's going to be in the digital-watch business. It's no longer a technology game. It's a marketing game, with the consumer as the prize."

Boucher next asked for Intel's Keith Thompson, director of operations, responsible for assembly, manufacturing, and purchasing, and Desmond Fitzgerald, director of quality assurance. He wanted them as Microma's vice presidents of manufacturing and engineering, respectively.

Already supplying watches with liquid-crystal displays, Microma, which concentrates on the expensive \$250-and-up end of the watch line, is now introducing light-emitting



New game. Marketing, not technology, is the digital-watch key, says Boucher.

diode displays and new smaller designs with lots of features. The next generation of LCD watches at Microma uses a 0.26-inch-thick, 3-volt module with continuous hours and minutes, as well as seconds, date, and backlighting on demand. That's 0.1 inch thinner than its predecessor.

The company's LED units will be 0.24-inch-thick, 3-volt modules, in two configurations: one with hours, minutes, seconds, day of the week, and the date, and the other, called the Chronograph, with all these plus a stop-watch feature.

Microwave ovens turn Blaha on

Bucking the dismal trend currently afflicting consumer electronics and appliances, sales of microwave ovens are expected to jump a healthy 25% this year, exceeding 900,000 units, according to a January estimate by Litton Industries' Microwave Cooking Products subsidiary. This makes for busy times at the Minneapolis organization, and probably no one there is busier than Verle Blaha, the informal and

Tasty. With microwave-oven sales climbing, Blaha's homework never looked better.

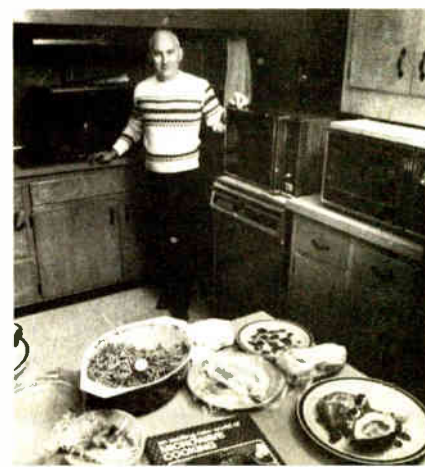

If your counter looks this good...

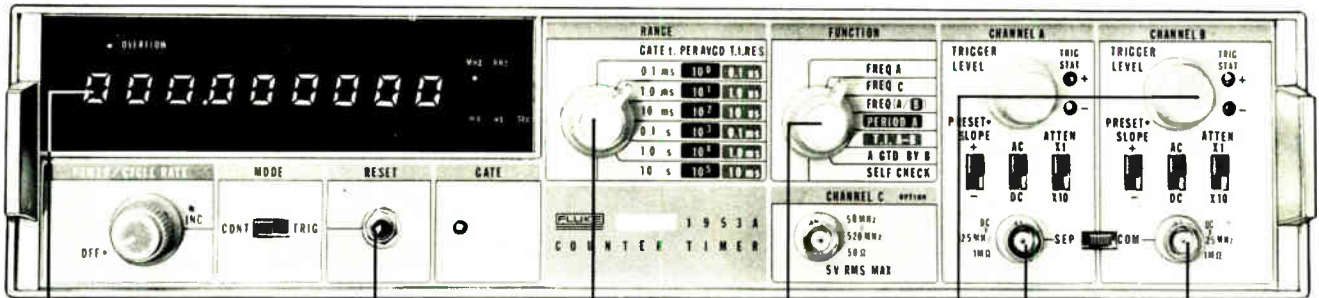

EASY TO READ
9-digit LED display
Large 7-segment characters
Full leading zero suppression
Automatic annunciation and overflow

DISPLAY CHECK
Pressing reset button when counter is in self check mode lights all digit segments

WIDE RANGING
Six choices of:
• Gate times
• Period averages
• Time interval resolution

VERSATILE
Measures:
• Frequencies
• Frequency ratios
• Period and period averages
• Time intervals
• Gateable totals
• Self check

FULL TRIGGERING CONTROL
Preset or variable trigger level controls with status indicators
Slope, coupling, and attenuation switches

TWO INPUT CHANNELS
Direct coupled amplifiers with 30 mV sensitivity

and gives you these options...

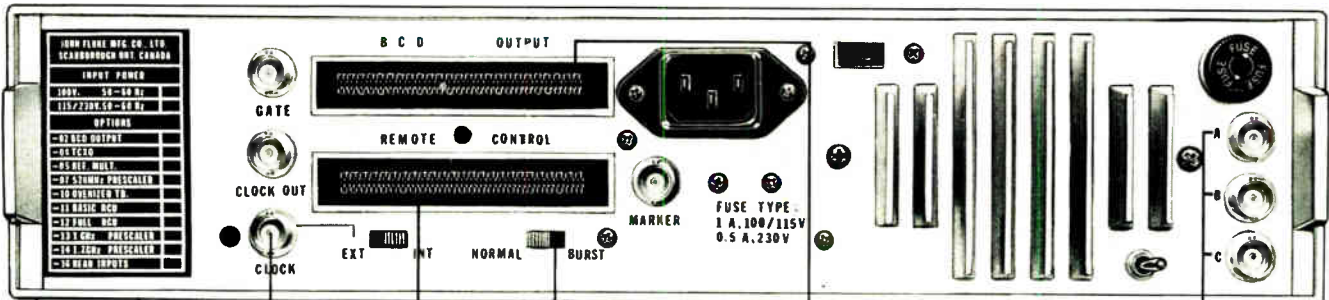

HIGHER ACCURACY
Higher stability timebase
Options 04 and 10

PRESCALERS
520 MHz prescaler. Option 07
1000 MHz prescaler. Option 13
1250 MHz prescaler. Option 14

TIMEBASE MULTIPLIER
For operation from 1 or 5 MHz in addition to standard 10 MHz external reference clock.
Option 05.

REMOTE PROGRAMMING
Basic remote programming. Option 11.
Full remote programming. Option 12.

BURST MEASUREMENTS
Select normal or burst measurements. Burst measurements made on Freq A or Freq C modes.
Option 05.

DIGITAL OUTPUT
Parallel BCD output. Option 02

REAR INPUTS
Three rear panel mounted BNC jacks for A, B and C input channels. A and B are in parallel with front panel inputs.
Option 16

it must be a Fluke
1953A Programmable Universal Counter/Timer
\$849.00*

*U.S. price F.O.B. Buffalo, N.Y.
Remote programming and other options extra.

FLUKE

COUNTER DIVISION

John Fluke Mfg. Co. Ltd.

Counter Division

P.O. Box 1094 Station D Buffalo, N.Y. 14210, Phone (716) 842-0311, TWX 610-492-3214

For a demonstration circle 169 on reader service card.

For more information circle 15 on reader service card.

MAG TAPE FOR HP2100

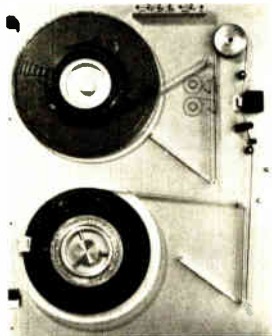

SEE THE REEL EXPERTS FOR YOUR MAG TAPE NEEDS NOW.

A great minicomputer deserves a great mag tape transport! Don't hang second-rate peripherals on your top-notch HP2100. Digi-Data offers you the finest quality tape-handling equipment available anywhere at any cost.

Phase-encoded, NRZI, or both together, and tape speeds to 45 ips. Prices start at \$5,750 for complete systems which are thoroughly checked-out on our own HP2100's and supplied with diagnostic software.

Digi-Data also manufactures mag tape systems for D.E.C.'s PDP-11 and Data General's NOVA series.

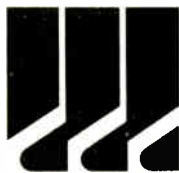

DIGI-DATA CORPORATION

8580 Dorsey Run Road, Jessup, Md. 20794 (301) 498-0200

Digi-Data Europe

Fluestrasse 632 5313 Klingnau Switzerland TELEX: 845-58555

Circle 16 on reader service card

CUSTOM ELECTRONICS' MICA CAPACITORS: short on DELIVERY long on RELIABILITY

That describes our CMR type capacitor, ideal for "potted-in" applications where minimum size and low per-unit cost are important. All our dielectric is screened before production to avoid failure in the field.

Installation No.	TYPICAL UNITS:			L x W x T Max.	1 to 10 Qty. Price
	Cap.	WVDC			
CMRIA102104K	0.1 μ f	1,000		2.062" x 1.425" x 0.200"	\$8.05
CMRIA302104K	0.1 μ f	3,000		2.562" x 1.620" x 0.270"	9.25
CMRIA103103K	0.01 μ f	10,000		2.562" x 1.800" x 0.350"	8.80

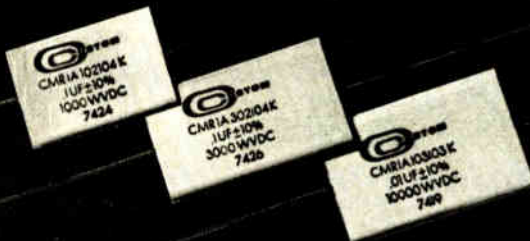

FREE: Descriptive TechniTip,
includes Mica Sample. Write:



CUSTOM ELECTRONICS, Inc.

12 Browne St., Oneonta, N.Y. 13820
PH: (607) 432-3880 TWX: 510-241-8292

People

friendly vice president of engineering.

"We're looking at 45 different tasks," he says, "as we try to add new features to the ovens, as well as improve their reliability and manufacturability."

One feature added last fall, for example, was the ability to vary the magnetron-produced power level beamed into the cooking space. Previously, microwave ovens operated with full magnetron power only. Blaha's engineers accomplished this by varying the duty cycle of the magnetron. Not a very complicated arrangement, he concedes, but one that just had not been applied to microwave ovens before.

Warranty. Perhaps the most important on-going program within Blaha's group was the production of the failure-analysis studies that, coupled with design improvements, have increased the reliability of the magnetrons. Less than 0.5% fail during the two-year warranty period, says Blaha. When the first microwave oven was introduced in 1966, the figure was 15%.

The result of all this engineering effort is that at a time when many engineering staffs are being cut back, Blaha's is expanding. Ten people were added during the last half of 1974, bringing the total to 72.

For the ebullient Blaha, there is obvious excitement in applying microwaves to cooking. And for Litton, it has meant a considerable market. Litton claims about 30% of 1975 consumer microwave oven sales that may reach \$360 million.

Of his job, the 44-year-old Blaha avows, "I love it." Most of the more than 20 years of his engineering life—18 of it with Litton—has been spent on missile and other military projects "so classified I couldn't talk about them with my family, or so dull I didn't want to talk about them."

The situation is different now. "Most of the time there are five ovens in our kitchen at home, often new models we're still developing," he says. "One weekend we made 35 chocolate cakes to evaluate energy distribution."

FEBRUARY, 1975

in this issue

New programmable pocket calculator with timer

Intelligent CRT—low price, high performance

New triple-output bench supply

New smart oscilloscope with built-in microprocessor gives you answers

HP has combined a high-performance 275 MHz scope, a microprocessor, and LED display to put an end to graticule counting, mental calculations, and most conventional scope errors. The new 1722A gives you a quantum leap in measurement accuracy and convenience. It's a working lab partner that speeds measurements of time intervals, frequency, instantaneous or dc voltage levels, and relative amplitude expressed in percentage. And, instead of conventional reading errors, the 1722A gives you a 3½-digit LED reading of your measurements...in seconds, Hz, volts, or percent.

The microprocessor takes over several tasks you used to perform. It keeps track of dial settings, automatically

(continued on page 3)

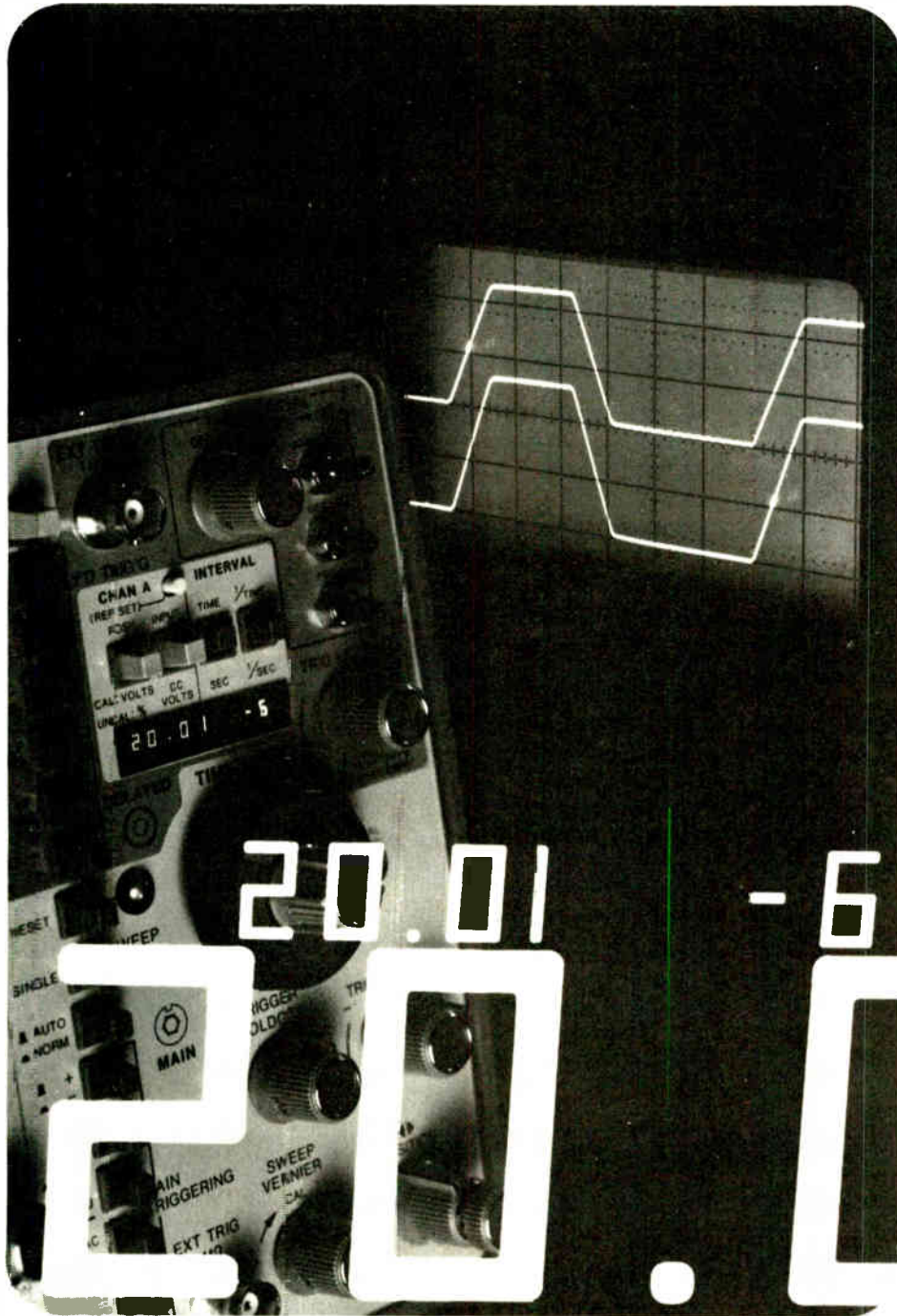

Measure wideband microwave networks— in one sweep

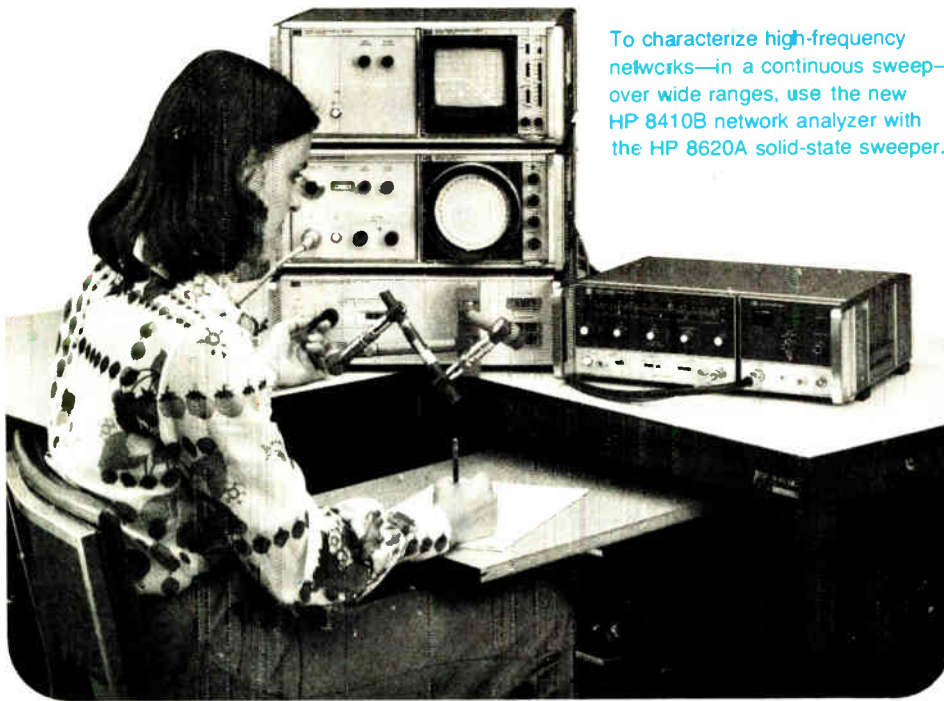

To characterize high-frequency networks—in a continuous sweep—over wide ranges, use the new HP 8410B network analyzer with the HP 8620A solid-state sweeper.

Two dramatic examples of continuous-sweep multi-octave measurements made with the new HP 8410B network analyzer:

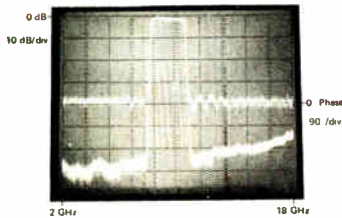

Transmission characteristics (magnitude and phase) of 8-10 GHz bandpass filter, shown over 2 to 18 GHz range. Note that insertion Loss Trace (10 dB/div) is free from harmonic responses.

Frequency band switching is a thing of the past when multi-octave range networks are measured with the new HP 8410B network analyzer. The 8410B, successor to the popular HP 8410A* (which was limited to octave-wide sweeps), measures both the magnitude and phase of network parameters, vital data for microwave designers. Test configurations covering from 100 MHz to 40 GHz are offered.

Multi-octave measurements in one continuous sweep are possible when the 8410B is used with the HP 8620A sweep oscillator. For example, with the new HP 86290A sweeper plug-in, you can sweep test from 2 to 18 GHz. Or the HP 86320A RF plug-in and the

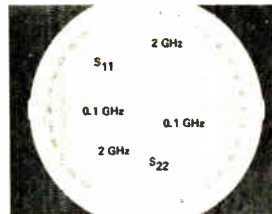

Polar plots of transistor s-parameters from 100 MHz to 2 GHz.

8410B cover from 100 MHz to 2 GHz, more than four octaves.

The 8410B network analyzer is a frequency-selective system that tracks the sweeper, resulting in a full 60 dB spurious-free dynamic range. Other multi-octave measurement schemes using broadband detection are typically limited to 20 or 30 dB range because of source harmonics.

*Existing 8410's can be retrofitted for automatic tuning.

For your copy of the Data Sheet, check L on the HP Reply Card.

Up to 24 Millicandelas from new high-efficiency RED, YELLOW, and GREEN LEDs

A new series of high-intensity, solid-state LED 'illuminators' are now available from HP. The new high-efficiency Red LEDs have an intensity of 24 mcd at a forward current of 10 mA.

Packaged in the T-1 $\frac{3}{4}$ outline, the lamps come in both wide and narrow beam types; the wide beam lamps using a diffused lens and the narrow beam lamps with a clear lens. These lamps have long general purpose leads to facilitate all types of mounting.

Four lamps of each color are being introduced, two light output categories for each beam angle. High intensity is obtained using a new HP technology employing a transparent gallium phosphide substrate and adding a reflector in the package. Higher Intensity is possible under "pulsing" conditions (or up to 20 mA dc) as these LEDs do not saturate. These lamps are rugged and are ideal for use in high ambient light conditions. The narrow beam, high output models are used as pushbutton switch illuminators and "Dead Front" panel annunciators. The wide beam models are used for low power panel indicators or backlighting.

For more information, check F on the HP Reply Card.



Red (5082-4650), Yellow (5082-4550) and Green (5082-4950) LED lamps.

NEW high-efficiency step recovery diodes



Special introductory price.

Our new high-efficiency step recovery diodes maximize cutoff frequency while maintaining a fast transition time. Thus, they provide excellent performance in low or high order multipliers and in comb generators.

The new 5082-0800 series diodes are passivated with a thermal oxide for maximum stability. You can buy them in chip form, in low-cost glass packaging, or in hermetically sealed metal-ceramic packages. Test data is supplied with each ceramic packaged device.

As an introductory offer, these devices are available in prototype quantity at the 100 piece price (offer good until April 30, 1975).

For more information, check *E* on the HP Reply Card.

(continued from page one)

New scope with microprocessor

computes time intervals and voltage levels, converts time measurements to frequency, and calculates percent. It even signals if you make an erroneous setting.

HP's dual delayed sweep gives you two adjustable intensified markers for displaying the start and stop points of a time interval. The microprocessor automatically computes and displays the time interval between the markers. This speeds digital timing measurements, reduces errors, and simplifies the adjustment of circuits to meet a timing spec.

The 1722A makes waveform measurements faster, more accurately, and more completely than conventional scopes costing up to twice as much.

For details on HP's microprocessor oscilloscope, check *B* on the HP Reply Card.

NEW HP-55 scientific pocket calculator offers 86 keyboard functions, programmability and built-in timer

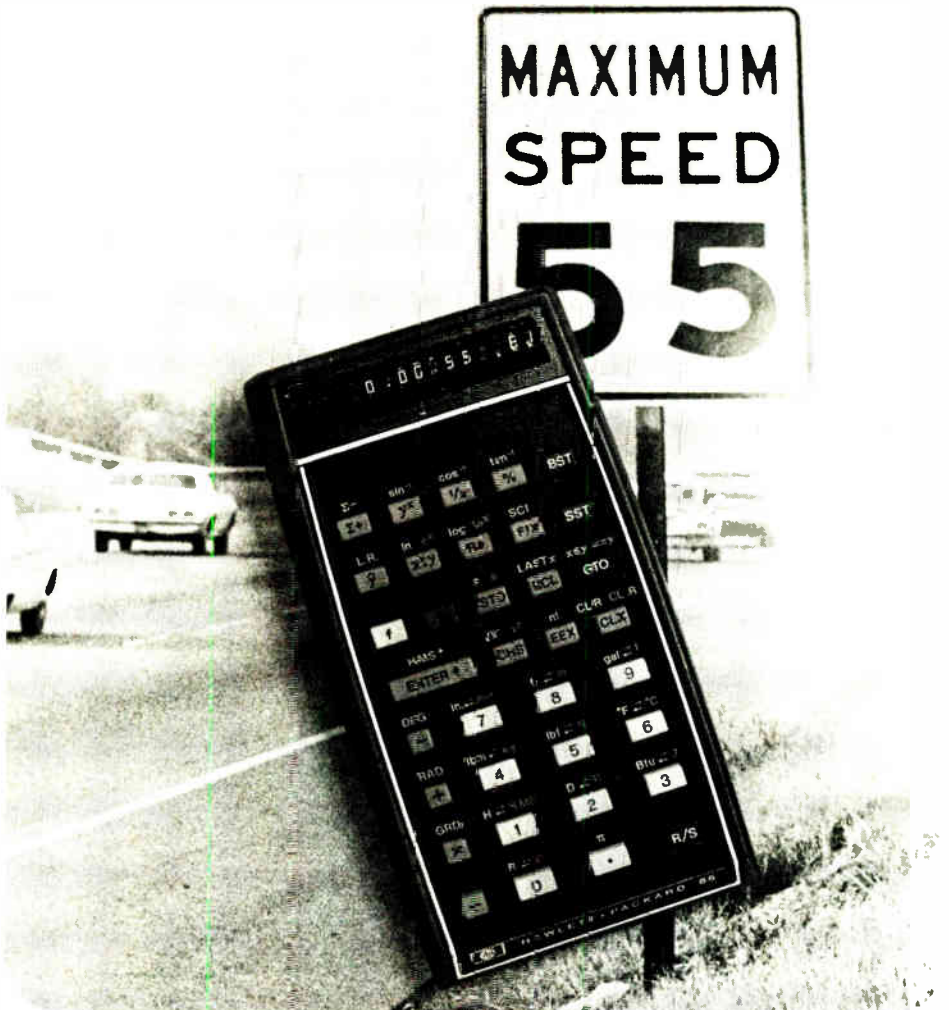

HP introduces an extraordinary new programmable scientific pocket calculator. With all of the pre-programmed functions and operations of our popular HP-45, plus 38 new ones including statistical functions.

You can perform circular trigonometry in degrees, radians or grads and convert among any of them. Also, compute two-variable mean and standard deviation, linear regression, linear estimate, curve plotting and four simultaneous linear equations with four unknowns.

The HP-55 has 20 addressable storage registers—more than twice as many as any other scientific pocket calculator on the market.

And, the HP-55 is the only pocket calculator in the world with a built-in digital electronic timer with 100-hour

capacity—a stopwatch that times and stores up to 10 events within the same experiment, accurate to 0.01%.

Whenever you wish to write a program to solve your particular calculations, just set the program switch, enter a program of up to 49 steps, then run it... as often as you wish. Meanwhile, you still have access to all 86 keyboard functions plus the 20 register memory.

And, with the HP four-register stack, enter the most complicated equations without having to keep track of the parentheses and brackets.

To learn more about the amazing new HP-55, check *A* on the HP Reply Card.

Faster graphs with new high-speed time-share plotter



Fast digital X-Y plotter accepts bit-serial ASCII at 10 or 30 characters per second.

Now you can plot up to seven vectors per second in any direction using the new 7203A high-speed graphic plotter.

Vectors of any length are plotted in any direction and the resulting graph appears as a smooth line, in contrast to the staircase often drawn by incremental plotters.

Check numerical control tapes, display statistical data, quickly analyze engineering designs or use this plotter for any application you have that requires fast graphics.

Four colors of ink are available in disposable pens. Pens are changed quickly and easily so that plots may

be superimposed in color for comparison.

Each plot coordinate is expressed with a Binary number represented by the bit pattern of two successive ASCII characters. Thus, only 4 characters are required to define any move.

The 7203A operates in parallel with data communication terminals. Easy to use software subroutines are available for many time-share systems.

Plots are front panel scalable from 0 × 0 up to 10 × 15 in. (25 × 38 cm) using paper up to 11 × 17 in. (28 × 43 cm).

Check 1 on the HP Reply Card.

NEW HP display terminal offers an intelligent addition to your computer

HP's new 2640A display terminal with built-in microprocessor is the intelligent, cost-effective answer to your data entry and information handling needs.

The 2640A operates either on-line or in stand-alone mode, with full editing capability. You can write 24 lines with 80 characters per line on the 5 by 10 in. (127 by 254 cm) rectangular display. High resolution ensures clear, precise character definition. You can also plug in three additional character sets, such as a line drawing set or a math set, and use them concurrently with the standard character set.

The 2640's dynamically allocated memory lets you store 8 to 50 lines or add optional memory modules and store over 400 lines depending upon line length. Memory protection is standard on all 2640A terminals.

Should the modular 2640A need repair, just lift up the top and replace the necessary printed circuit cards. And, thanks to a universal interface, the 2640A works with a wide variety of computers.

For more information or a demo, check C on the HP Reply Card.

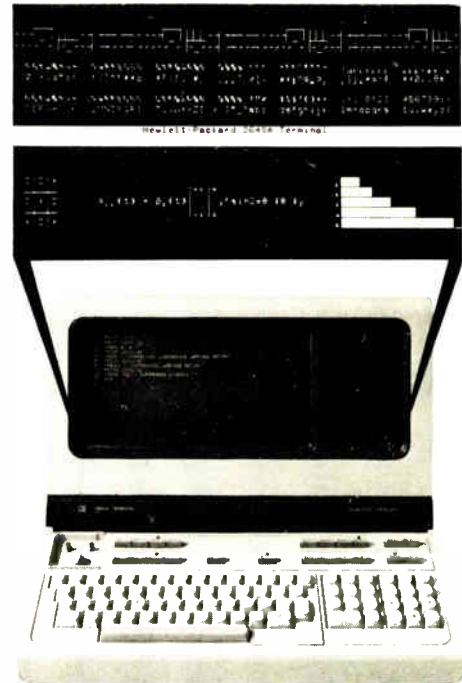

New Hewlett-Packard Model 2640A CRT Terminal is microprocessor controlled. Model 9866A Line Printer (left) is optional.

21MX computer with new Dynamic Mapping System plug-in gives you million word addressing space

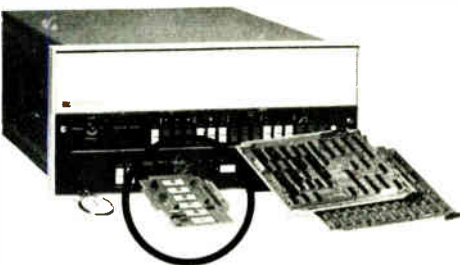

Programmable DMS for 21MX computer expands address space.

A new Dynamic Mapping System (DMS) devised by HP for its 21MX series user-microprogrammable 4K RAM semiconductor memory minicomputer allows access to four independent memory spaces.

The 12976A DMS expands the memory address size to 20 bits, thereby providing a maximum main memory addressing space of 1,048,576 16-bit words. It does this without adding to the 650-nanosecond cycle time.

Accounting for the compactness and low prices of the new large-memory models, HP cites features common to the whole 21MX line. For example, all 38 of the new instructions are contained in a single 265 word module of microcode. Also included is read and or write protection on an individual 1K-page basis. All these instructions are on half of a single small circuit board. These new capabilities are plug-in installable.

The HP Dynamic Mapping System functions with main memory somewhat as "virtual memory" schemes function with disc memory.

The 38 new microcoded instructions in DMS firmware, including cross map moves and block transfers, give extensive control over memory allocation and protection. In addition to these 38 supplied by HP, the user can generate his own unique memory management and protection instructions using the standard microcode capability.

For more info on this new Dynamic Mapping System, check O on the HP Reply Card.

HP interface bus enhances signal generator

Joining the growing list of HP-IB compatible instruments is the HP 8660A/B synthesized signal generator. It's a fully programmable signal generator with .01 to 1300 MHz frequency coverage, 3×10^{-8} /day frequency stability (3×10^{-9} /day optional), +13 to -146 dBm output level, and AM, FM and pulse modulation capabilities.

When installed, the HP interface bus allows programming of:

- Frequency, in 1 Hz steps over the entire 1300 MHz range.
- Output level, in 1 dB steps over the entire 160 dB range.
- Modulation mode, either AM or FM.
- Modulation source, either internal 400 or 1000 Hz tone or external source.
- AM depth, in 1% steps from 0 to 99%.
- FM deviation, in 3 overlapping ranges, either 50 or 100 steps per range, from 0 to 1 MHz.

The HP-IB interface is available as option 005 on new instruments or as a field-installable kit 08660-60189 for instruments already equipped with the standard BCD interface.

To learn more, check M on the HP Reply Card.



Now, you can run a precision signal generator under calculator control.

Helpful techniques for using VHF signal generator



New application information available for 8640A/B.

Three new application notes show you how to extend the usefulness and accuracy of HP's 8640A/B VHF signal generator (450 kHz to 1100 MHz).

AN 170-1 explains how to improve the specified output level accuracy over narrower frequency limits—i.e., how to operate the generator for optimum accuracy. Also, special calibration can be used to minimize effects of frequency response, temperature, detector and meter linearity, and vernier error.

AN 171-1 describes a method for improving crystal filter measurements when using an HP vector voltmeter and the 8640A/B. This technique optimizes frequency tuning sensitivity by using a feedback signal from the phase meter to the generator external FM input.

AN 171-2 describes how to build a simple heterodyne circuit that extends the frequency down range to dc-450 kHz. The circuit mixes the rear-panel fixed 5 MHz crystal output with the tuned output signal and provides a stable frequency that can be read directly on the digital readout.

For your copies, check P on the HP Reply Card.

New capabilities, more options for HP-5300 measuring system

Now there is a high resolution 8-digit display mainframe (Model 5300B) with temperature-compensated crystal option in the HP-5300 series of electronic counters and digital multimeters.

New snap-ons for the system include an 1100-MHz counter and a bus interface.

In the 5300 system, a complete instrument consists of two halves that snap together in about 15 seconds. The width of these units is a very compact 6¼ inch (160 mm). The upper half, or mainframe, contains the readout and associated circuitry. The instrument's measurement functions are determined by the lower half, or "snap-on", of which there are now 7 models for measuring frequency, time interval, ac and dc volts and ohms. The new 5312A ASCII "snap-between" module allows all of the 5300 functions to interface with data acquisition systems via the HP Interface Bus.

With the new 5305A 1100-MHz frequency counter snap-on, you get a sensitivity of 10 mV to 500 MHz and better than 25 mV to 1100 MHz, automatic gain control and manual attenuator to measure noisy or modulated signals, plus a front panel accessible input fuse to prevent costly front end damage.

With the new 5312A ASCII "snap-between" module you can mate other instruments and controllers to the 5300 series via the HP Interface Bus.

For more information, just check H on the HP Reply Card.



HP 5300 Measurement System adds 5300B 8-digit module, 5305A 1100-MHz counter, and 5312A ASCII interface to HP Interface Bus.

Now debug your control system design before you build it

New software for design engineers using 9830A calculator in BASIC language.



With HP's powerful 9830A programable calculator and state-variables software, you now can know exactly how your control system will perform long before you've committed time, materials, and manpower to an expensive prototype.

The new state-variable software provides a complete transient response solution for control systems, whether for mechanical, electronic, hydraulic, optical, or hybrid systems. It's a carefully developed set of programs that will assure you a stable system in a minimum amount of time. There's no hassle with computer programming and interfacing. You just key in the values directly from your block diagram, and the 9830A does the rest automatically.

In 10 minutes or less, you get a high resolution plot of transient response and printed list of system parameters. If you want to adjust your design, you simply key in different values. Thus, you can explore alternatives—right at your desk—to find a better design or solution.

An extensive library of engineering and design programs are available from HP.

To learn more, check N on the HP Reply Card.

Low frequency spectrum analyzer offers unmatched resolution

Up until now, the biggest problem analyzing low frequency signals has been the display. Now, you can get a clear picture of mechanical vibrations, audio filters, or data communication channels with HP's 3580A spectrum analyzer, covering 5 Hz to 50 kHz. The trace appears on a CRT with 1 Hz bandwidth—that's the best resolution of any low-frequency spectrum analyzer on the market.

You can also store your trace in the CRT's digital storage. In fact, store two traces, and compare them on the CRT. You can study and interpret spectral information easily and quickly.

Dynamic range is 80 dB. HP offers unique adaptive sweep that speeds up your measurements and reduces analysis time. The 3580A weighs just 35 lbs (16 kg) and operates on batteries, as well as line power.

For more information, check D on the HP Reply Card.

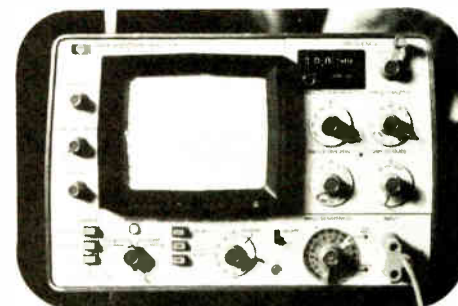

There are many variables in a sound system; thus, instrumentation is needed to track down problems. HP's 3580A Spectrum Analyzer has the range and visual display necessary to analyze audio problems. With this unique instrument, distortion hum, equalization and reverberation can be quantified far better than even the best ear.

For versatility, ease of operation and wide applications, 50 MHz pulse generators

A 20 column low-cost printer that really is quiet



What every Logic laboratory needs: versatile, easy to operate 50 MHz generator.

The 8012B and 8013B pulse generators are ideally suited to the requirements of a general digital logic laboratory where ease of operation and wide range of applications are essential.

Their 10V outputs and fast transition times (3.5 ns on the 8013B and 5 ns on the 8012B) enable you to dynamically test TTL, ECL and even the latest CMOS logic. You can simulate noise patterns and, in double pulse mode, test device recovery times and make noise immunity measurements. You can also use them as amplifiers when generating worst case data patterns.

These instruments not only enable you to set up pulses more easily, but also much more quickly. One big time-saving feature is the unique front panel layout; the slider controls provide a simple, straightforward design that enables

you to set up your pulses very quickly and with a minimum risk of incompatible pulse settings. They also greatly improve the readability of the pulse parameters. Another time-saver is the square wave mode which enables you to set up pulses very rapidly without having to worry about pulse width or delay.

In addition, the variable transition times of the 8012B enable you to generate any triangular or trapezoidal waveforms, and the two independent outputs of the 8013B enable you to test circuits designed with bipolar supplies.

For more information on these extremely flexible pulse generators, check K on the HP Reply Card.

At last: a quiet printer that's really quiet. The new 5150A thermal printer prints faster than 3 lines per second, without any noisy impact mechanisms. It accepts data from BCD or ASCII sources and can list 20 columns of alphanumeric information, yet the price is extremely reasonable.

The 5150A uses heat-sensitive paper and a thermal print head, so you don't have to bother with ink spills or refills. Don't let simple design or light weight fool you—the 5150A is a high technology peripheral that can interface with minicomputers, any Interface Bus (HP-IB) instrument system or other digital data sources having acceptable codes and voltage levels. Available options include clock, BCD or ASCII interface and scanner—whereupon it can serve as an HP-IB controller.

For more information, check G on the HP Reply Card.



The 5150A printer is available in several different configurations to fit your system; here, it logs data from a 5345A Electronic Counter.

New triple-output bench supply for IC test and development

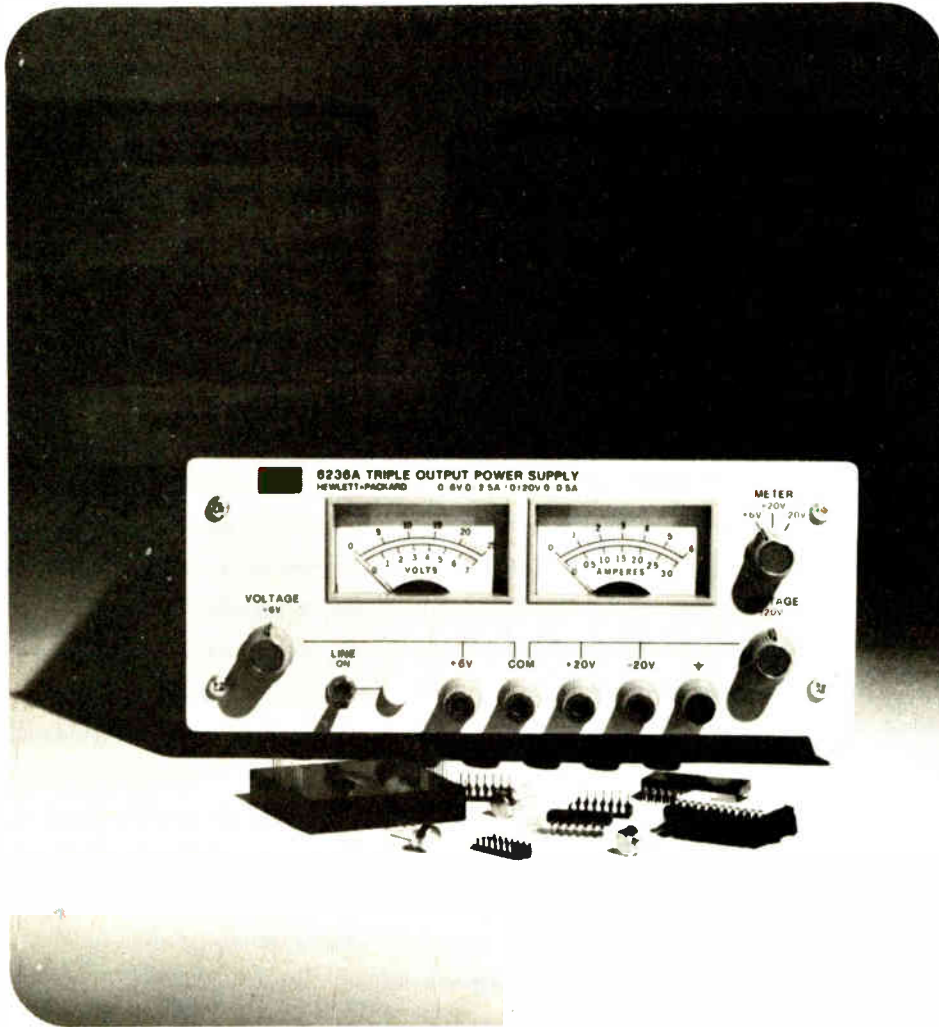

Separate voltage controls adjust the 0 to 6V and 0 to $\pm 20V$ outputs, while the meter switch selects the desired V and I range for display on the panel meters.

Low cost, small size, and outstanding performance, make this new three-in-one lab supply a valuable aid to anyone designing or testing equipment using integrated circuits. Model 6236A delivers three outputs: 0 to 6V, up to 2.5A; and dual-tracking 0 to $\pm 20V$, 0 to 0.5A. The 0 to +20V and 0 to -20V outputs track one another within 1% to supply the symmetrical voltages needed by op amps and similar balanced-voltage-source applications. A single 0 to 40V @ 0.5A output can also be obtained by connecting across the -20 and +20V terminals.

All outputs are regulated to 0.01% +2mV, with ripple and noise of 0.35mV rms/1.5mV p-p. The dc outputs have smooth turn-on and turn-off characteristics so that no output voltage overshoot is produced when the ac line switch is operated. Both the 6V and $\pm 20V$ outputs are protected from overloads by fixed current limiting circuits.

Model 6236A can be powered from a nominal 100V, 120V, 220V, or 240V, 47-63 Hz ac input. The supply weighs only 9½ lbs. (4.3 kg) and is 3½ in. high (8.9 cm), 8½ in. wide (21.6 cm), and 12½ in. deep (31.8 cm). Single and dual-unit rack-mounting kits are available.

For more information on the three-in-one power supply, check 1 on the HP Reply Card.

HEWLETT  PACKARD

East-20010 Century Blvd., Germantown, MD 20767, Ph. (301) 428-0700.
South-P.O. Box 2834, Atlanta, Ga. 30328, Ph. (404) 436-6181.
Midwest-5500 Howard Street, Skokie, Ill. 60076, Ph. (312) 677-0400.
West-3939 Lankershim Boulevard, North Hollywood, Calif. 91604, Ph. (213) 877-1282.
Europe-Post Office Box 85, CH-1217 Meyrin 2, Geneva, Switzerland, Ph. (022) 41 54 00.
Canada-6877 Goreway Drive, Mississauga, Toronto, L4V 1L9, Ph. (416) 678-9430.
Japan-Yokogawa-Hewlett-Packard, 1-59-1, Yoyogi, Shibuya-ku, Tokyo, 151.

CAUTION: 50,000 VOLTS



LET ERIE DESIGN and BUILD YOUR HIGH VOLTAGE POWER SUPPLIES and VOLTAGE MULTIPLIERS

When you talk about designing and packaging miniature, low current High Voltage Power Supplies and Voltage Multipliers, the name ERIE should come to mind first. Why? *No other manufacturer of these sophisticated devices has its own capacitor and rectifier technology in-house.* Only ERIE does it all. Our many years experience in producing State of the Art high voltage capacitors and high voltage silicon rectifiers — plus an unsurpassed technology in circuit designing, packaging and encapsulation, makes ERIE an ideal source for your high voltage component needs. From very low input voltages, ERIE can produce output voltages up to 50,000 volts. Application for these compact high reliability devices includes night-vision image intensification systems, Apollo TV cameras, CRT displays, Avionics systems exposed to rugged environments, Industrial, commercial and military equipments . . . an almost infinite variety of applications. So bring ERIE in early. Let us design and build *your* High Voltage Power Supplies and Voltage Multipliers. We're equipped to handle large or small volume orders . . . in-house.

Write for our 32 page catalog . . .
High Voltage Components and
Devices . . . or for technical
assistance, call

613/392-2581

ERIE TECHNOLOGICAL PRODUCTS, INC.

Erie, Pennsylvania 16512

Circle 27 on reader service card

ERIE

FLAT INTERCONNECTS YOUR COMPLETE SOURCE

Ribbon Cable / IC Interconnects / Custom Harnesses

You're sold on flat cable, now buy it at its best. Precise, compact cable packages to fit your specifications perfectly, computer-loomed for unmatched versatility by Woven Electronics.

Handling ease of independent non-bonded leads speeds production, cuts cost, while technical characteristics outrank other flat cable forms.

Make Woven your source for jumpers, continuous rolls, special harnesses, all your interconnect needs.

WOVEN ELECTRONICS

P.O. Box 189 Mauldin, South Carolina 29622
803/963-5131



Meetings

Nepcon '75 West and International Microelectronics Exhibition, Industrial Scientific Conference Management Inc. (Chicago, Ill.), Anaheim Convention Center, Anaheim, Calif., Feb. 11-13.

CAD/CAM III, Computer-Aided Design and Computer-Aided Manufacturing, Society of Manufacturing Engineers, Hyatt Regency O'Hare Hotel, Chicago, Ill., Feb. 11-13.

International Solid State Circuits Conference, IEEE, Marriott Hotel, Philadelphia, Pa., Feb. 12-14.

Comcon Spring Computer Conference, IEEE, Jack Tar Hotel, San Francisco, Calif., Feb. 25-27.

Industrial Applications of Microprocessors, IEEE, Sheraton Hotel, Philadelphia, Pa., March 11-12.

Reliability Physics Symposium, IEEE, MGM Grand Hotel, Las Vegas, Nev., April 1-3.

Paris Components Show, (*Salon des Composants Electroniques*), Porte de Versailles, Paris, April 2-8.

Southeastcon '75, IEEE, Sheraton Center, Charlotte, N.C., April 6-9.

Intercon-IEEE International Convention, Coliseum and Americana Hotel, New York, N.Y., April 8-10.

Electronics Production and Test Equipment Exposition, U.S. Department of Commerce, Stockholm, Sweden, April 7-11; London, April 15-18.

Society for Information Display International Symposium, SID, Shoreham Americana Hotel, Washington, D.C., April 22-24.

International Optical Computing Symposium, IEEE, Mayflower Hotel, Washington, D.C., April 23-25.

National Relay Conference, NARM and Oklahoma State University, Stillwater, Okla., April 30-May 1.

THE TRIMLINE SERIES

DISTINCTIVE ELECTRONIC ENCLOSURES



PREMIER METAL PRODUCTS COMPANY

337 MANHATTAN STREET, BRONX, N. Y. 10474 (212) 991-6600



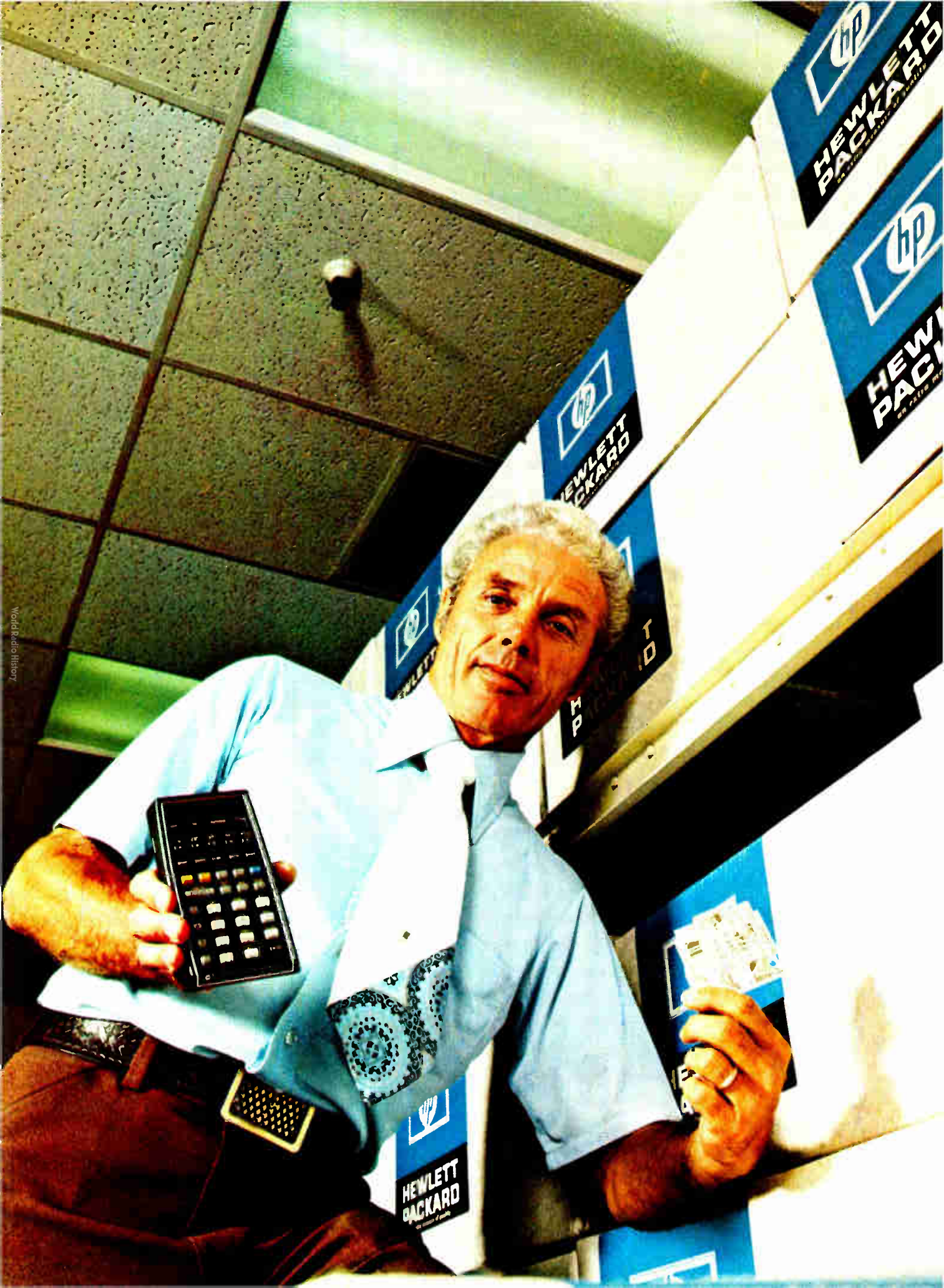

World Radio History

"My records prove it. Photocircuits shipped us over 1/2 million PCBs for calculators. Less than 1% were rejected."

Tom Miller, Production Control Supervisor, Hewlett-Packard

"I supervised in-house production of printed circuitry for Hewlett-Packard. When the demand for our pocket-sized calculators taxed our own capacity for making printed circuit boards, I had to look outside the company.

"The scientific and business calculators Hewlett-Packard makes have infinitely more functions than the typical 'house-wife' variety. And we have sold over one-half million of them. So we needed large volumes of quality boards for logic and battery charger applications.

"Photocircuits' reputation for quality was confirmed by my first visit.

"I've been in this business since 1955, so I knew of Photocircuits even before we made a facilities check. What I had heard proved to be true. Their overall efficiency was evident and everyone seemed to know what they were doing.

"We had no qualms about dealing with an East Coast house either. They were only a short 5 hours away by plane. And seconds away by WATS line. In fact, when we asked for price quotes, they got back to us within ten days. And that

included mailing time.

"Their price was lower and they delivered what they promised.

"Long Island labor costs are comparable to the West Coast, but Photocircuits still managed to beat local prices. To me, that's another indication of over-all efficiency.

"And even though we hit them at the same time as everyone else, Photocircuits guaranteed they would deliver a certain number of boards every week. They kept that promise.

"Quality-wise, they were the best boards I've seen in twenty years.

"We have some very stringent standards at Hewlett-Packard. Not only do we expect operational quality, but esthetics as well. If a customer tears the cover off one of our products, we want our components to look good.

"In both cases, performance and looks, Photocircuits was outstanding. Over half a million boards have been delivered. Less than 1% have been rejected for any reason whatsoever.

"What more is there to say?"

Photocircuits

Division of Kollmorgen Corporation, Glen Cove, New York 11542 (516) 448-1000

Printed circuitry for mass-produced electronics

Introducing the ALC-5.



The hardworking connector that's easy on your pocket.

Now you can truly reduce your cost of interconnecting by designing in the new ALC-5.* It represents a new concept in subminiature coaxial connector design that will yield the best cost-to-performance ratio of any connector available today.

Unshielded hookups can be risky.

The ALC-5 economically provides RF shielding in computer applications where high speed or close proximity prevent the use of unshielded, single conductor interconnects. Where the new FCC 900 MHz reallocations have put higher frequency demands on vehicle monitoring and communications systems, the ALC-5's hard working VSWR virtue shines (1.1:1 at 1GHz, 1.2:1 at 4GHz, 1.4:1 at 6GHz with RG-58 C/U cable).

Crimp-crimp assemblies assure the repeatable performance required for navigational equipment, biomedical monitoring systems and professional

broadcast and recording gear. Everything from marine radar systems to microwave ovens can use these tiny, low-cost, reliable RF connections. And crimp-crimp assembly also keeps your production costs low.

A fresh, new answer for today's interconnection needs.

The ALC-5 is a contemporary line designed around today's demands for lower price, better performance, smaller size and faster delivery and assembly. Rather than a revamp of one of yesterday's solutions, we've invented something totally new. We've taken the first bold step. Why don't you take the next. Specify ALC-5. Amphenol RF Division, Bunker Ramo Corporation, 33 E. Franklin Street, Danbury, Connecticut 06810, (203) 743-9272. *U.S. Patent No. 3,282,303

**BUNKER
RAMO**

AMPHENOL

Circle 34 on reader service card

Showdown looms between U.S. and UK MLS finalists

A possibly bitter global showdown between the United States and the United Kingdom looms in June before the International Civil Aviation Organization over the choice between the U.S. scanning beam and the UK's doppler-scanning system, developed by Plessey, as the "universal" microwave landing system. The winner will have a head start on a multibillion-dollar market in new equipment. UK representatives, irate over what they call "political skullduggery" in a U.S. Federal Aviation Administration committee's recommendation of the "paper" scanning beam, rather than the "proven" doppler system, indicate they may marshal Third-World countries to outvote the scanning-beam system if it remains the U.S. choice.

UK officials charge that the FAA assessment committee changed evaluation and selection procedures to favor scanning beam when technical evaluation began to favor doppler scanning. They also say that they feel double-crossed because they trusted the FAA's selection procedures. A UK delegation has already protested to the FAA. In the balance may be an agreement between the two countries for cooperative development of the discrete-address-beacon system.

However, a suit filed in the U.S. by the Hazeltine Corp., which had also proposed a doppler system, may put a crimp in the FAA decision. Hazeltine is trying to halt the FAA plan until completion of a two-month study by the General Accounting Office on the choice. A delay would increase the odds for the UK entry, which would be able to build up its data base and the persuasiveness of its argument for the ICAO. "The only winner out of this litigation will be the UK," says an FAA source, and the other U.S. loser, ITT Gilfillan, agrees.

Fairchild offers Schottky TTL processor family

In a major move into high-performance LSI logic, Fairchild Semiconductor is supplying a 4-bit, bipolar LSI processor built on five chips with low-power Schottky TTL technology. Tom Longo, vice president and group general manager, says that because this family has a microcycle time under 100 nanoseconds, it is aimed at minicomputer central-processor functions. This contrasts with n-channel MOS processors, which are aimed primarily at the controller market. Equally important, Fairchild is making this LSI processor family pin-compatible with its Isoplanar complementary-MOS line.

The five chips of the processor element are: an arithmetic/logic register (9405); a last-in, first-out shift register laid out in 16 4-bit words (9406); a data-access register (9407); a random-access memory of 16 4-bit words (9410); and a data-path switch (9404). Included in the family are two 1,024-bit RAMs, 2-kilobit and 4-kilobit programable read-only memories, an 8-kilobit ROM, a cyclic redundancy-check generator (9401), and a serial/parallel first-in, first-out buffer memory (9403).

The 9401 generator/checker, the 1-kilobit RAM, and the 2-kilobit PROM are available now, Longo says, and the remaining devices will be available during the first half of this year. The pin-compatible C-MOS versions will be available in sample quantities in March or April.

Intersil to introduce first field PLA . . .

Foreshadowing a trend in logic design is Intersil Inc.'s TTL programable logic array, the industry's first PLA that can be electrically programmed in the field. The device, called IM-5200, has 14 inputs, eight

outputs, and a total of 48 product terms. It is pin-compatible with National Semiconductor's 7576, a mask programmable PLA with twice the capacity of the IM-5200. The Intersil device, which will be sampled next month, has the complexity of more than 480 four-input gates. Like all Intersil programmable products, the 5200 is programmed by an avalanche-induced-migration method that involves blowing out a diode in the transistor structure. Typical propagation delay is only 65 nanoseconds, and a single 5-volt supply provides power.

. . . as it offers one-chip circuit for LED watches

What is probably the first truly one-chip light-emitting-diode watch circuit has been developed by Intersil Inc. **Up to now, most LED watches required separate chips for both the segment and digit drivers—even** Mostek Corp.'s so-called one-chip circuit requires a separate bipolar segment-driver chip.

Not only does Intersil's new 7200 family have all its electronics—oscillator, divider, decoder, and segment and digit drivers—integrated onto one chip, **but it can drive a nine-digit alphanumeric display** as well as the standard seven-digit numeric display. The only external components, says Murray Siegal, director of special products and systems, are two silver-oxide batteries, a quartz crystal, a trimming oscillator, and two switches. To get the 125-square-mil chip, says Siegal, Intersil depended on its **standard low-voltage metal-gate C-MOS process**. The seven-digit model, ICM 7202, is now in volume production; the nine-digit version, ICM 7200, is being sampled and is due for volume production in July.

RFQs increase for linear ICs

In what could be the dawn of a brightening market for semiconductor products, linear-circuit marketing managers report a sudden dramatic **increase in the last few weeks in requests for quotations**. Categories, which pertain to both military and commercial data-acquisition systems, precision operational amplifiers (not commodity types), converters, sample-and-hold devices, and analog switches.

As one manager puts it, "Whereas, in November and December, you could spend all week on one RFQ, now we're staying up nights answering them. And, while RFQs aren't bookings, **at least it means someone out there is thinking of buying something.**" On the other hand, there is no reported increase in quoting activity for digital components.

General Automation enters semiconductor equipment field

General Automation Inc. has applied its Adapt-a-Path numerical-control system, used up to now on massive machine tools, to the other end of the spectrum. **The company has developed a computer-controlled automatic wire-bonder control for integrated circuits**. The \$12,000 system, which can be added to commercially available bonders, includes both a computer and a special X-Y table for the ICs.

The company developed the equipment for an automated production line making high-density multichip memory boards. GA claims the L101 controller **increases throughput by 270% to 2,500 wires per hour**, and a single operator can control as many as six machines. The equipment is adaptively programmed simply by stepping through the bonds, rather than a read-only memory or paper-tape program.

If you could cut your switching loss by 80%, how would you celebrate?

By eliminating a heat sink, maybe? Saving a bit of board space? Improving your circuit's operating characteristics?

Do it with our power darlington. Unlike other darlington, ours offer access to the output transistor base, and have no internal resistors. So they'll give you greater design flexibility, higher temperature stability, and faster switching time.

Because you can vary the bias on the output transistor, you can speed up your switching time or slow it down, give your circuit more gain, less gain, whatever you want.

Using our darlington, you can cut heat loss to one-third or one-fifth, and cut the size of your heat sink proportionately. Most heat dissipation occurs during fall time, so when you speed up

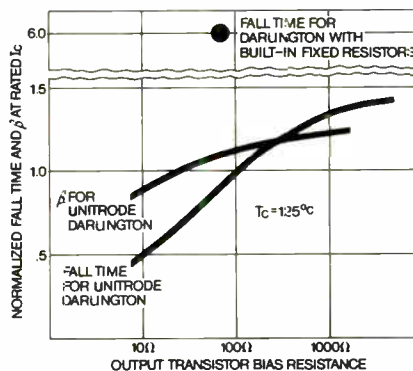

your switching time, you automatically reduce dissipation. And thanks to external resistors, our darlington are much less sensitive to temperature than ordinary darlington.

Send for our free designer's guide. It's the industry's only reference document on darlington, and it'll tell you all about them — what they are, how they work, where to use them. And it includes a dozen application examples for our special darlington.

To get your copy, just circle our number on the reader service card.

Our darlington are available in currents up to 10A and voltages up to 400V.

Unitrode Corporation, 580 Pleasant Street, Watertown, Mass. 02172.

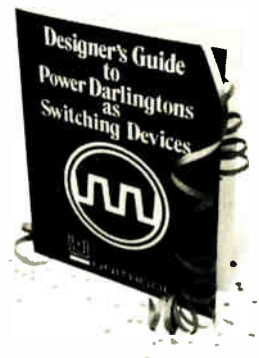

2 GREAT MONOLITHIC D/A'S- COMPLETE WITH REFERENCE & AMP!

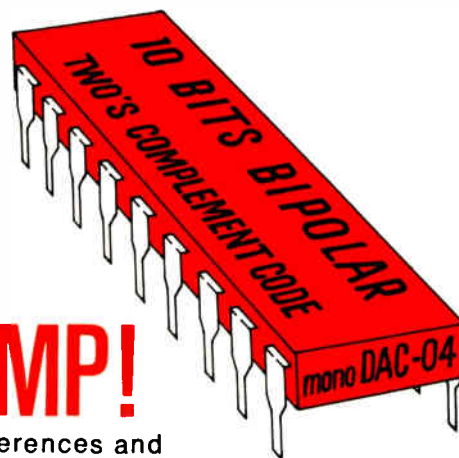
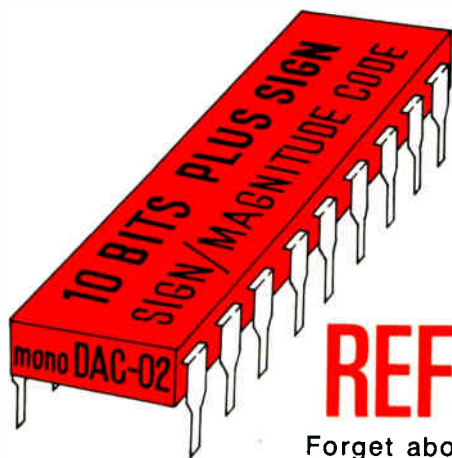

Forget about complex external voltage references and expensive high speed op amps — they're right on the chip! Precision Monolithics monoDAC-02's unique sign/magnitude code or monoDAC-04's handy two's complement code allow a perfect match to any application. These DAC's are 100% tested for monotonicity over the entire 0/70°C temperature range. The other specs are just as impressive — tight 60ppm/°C max tempco, fast 1.5 μsec settling time, low 225 mw power consumption @ ±15V, .015%/V power supply rejection — these DAC's are true performers! Don't let the low cost fool you — these easy-to-use converters are 100% burned-in at +125°C for assured reliability. And they're available. Get 'em from your Precision Monolithics distributor today.

MONOTONICITY	INPUT CODE		PRICE
	SIGN/MAGNITUDE (10 BITS PLUS SIGN)	TWO'S COMPLEMENT (BIPOLAR — 10 BITS)	
GUARANTEED, 0/+70°C			@ 100 PCS.
7 BITS	monoDAC-02DDU1(U2)*	monoDAC-04DDU2*	\$15.00
8 BITS	monoDAC-02CCU1(U2)	monoDAC-04CCU2	\$20.00
9 BITS	monoDAC-02BCU1(U2)	monoDAC-04BCU2	\$30.00
10 BITS	monoDAC-02ACU1(U2)	monoDAC-04ACU2	\$60.00

* ±10 VOLT OUTPUT — U1 SUFFIX . . . ±5 VOLT OUTPUT — U2 SUFFIX

AUTHORIZED DISTRIBUTORS:

NEW YORK METROPOLITAN AREA Harvey Radio, Westbury, N.Y.: (516) 921-8700 • NEW ENGLAND AREA Gerber Electronics, Dedham, Mass.: (617) 329-2400 • UPSTATE NEW YORK Harvey Federal Electronics, Binghamton, N.Y.: (607) 748-8211 • NORTHEAST Newark Electronics, Woburn, Mass.: (617) 935-8350 • BALTIMORE-WASHINGTON Whitney Distributors, Baltimore, Md.: (301) 944-8080 • PENNSYLVANIA Hallmark Electronics, Huntingdon Valley, Pa.: (215) 355-7300 • Pioneer/Pittsburgh: (412) 391-4846 • MICHIGAN RS Electronics, Detroit, Mich.: (313) 491-1000 • SOUTHEAST Kirkman Electronics, Winston-Salem, N.C.: (919) 724-0541 • EAST CENTRAL Pioneer/Cleveland, Cleveland, Ohio: (216) 587-3600 • Pioneer/Indianapolis, Indianapolis, Indiana: (317) 849-7300 • Pioneer/Dayton, Dayton, Ohio: (513) 236-9900 • CENTRAL Hallmark Electronics, Elk Grove Village, Ill.: (312) 437-8800 • Minneapolis, Minn.: (612) 884-9056 • St. Louis, Mo.: (314) 291-5350 • TEXAS-OKLAHOMA Sterling Electronics, Houston, Texas: (713) 627-9800 • Dallas, Texas: (214) 357-9131 • SOUTHWEST Sterling Electronics, Albuquerque, N.M.: (505) 345-6601 • Phoenix, Ariz.: (602) 258-4531 • WEST Westates Electronics Corp., Chatsworth, Calif.: (213) 341-4411 • Sunnyvale, Calif.: (408) 733-8383 • Intermark Electronics, Sunnyvale, Calif.: (408) 738-1111 • Denver, Colo.: (303) 936-8284 • San Diego, Calif.: (714) 279-5200 • Santa Ana, Calif.: (714) 540-1322 • Almac-Stroum, Seattle, Wash.: (206) 763-2300 • Portland, Ore.: (503) 292-3534 • CANADA Intek Electronics, Vancouver, B.C.: (604) 324-6831.



1500 SPACE PARK DRIVE, SANTA CLARA, CALIF. 95050
TEL. (408) 246-9222 • TWX 910-338-0528 • CABLE MONO

RCA is close to commercial CCD cameras, arrays

Image sensor of 512 by 320 elements being readied for black-and-white TV cameras; sensors to be marketed also

RCA Corp. moved a step closer to the charge-coupled-device marketplace last week when it demonstrated a commercial camera that uses its 512-by-320-element silicon imaging sensor [*Electronics*, March 7, 1974, p. 67]. The arrays will be marketed separately in April, along with two black-and-white CCD television cameras. The two cameras, which differ primarily in their criteria for screen blemishes, are priced at \$3,800 and \$3,000.

Meanwhile, CCD-imaging technology is advancing on other fronts. General Electric Co.'s injection-type metal-oxide-semiconductor camera, introduced early last year, has been boosted to 244 by 188 elements and is being shipped to potential customers for evaluation as an optical sensor in tracking and guidance systems, remotely piloted vehicles, and point-of-sale terminals. The GE camera was preceded by Fairchild Camera & Instrument Corp.'s CCD imager with 100 by 100 elements, which was first demonstrated about 18 months ago [*Electronics*, Aug. 30, 1973, p.36]. And at Bell Labs, where work continues on CCDs for imaging and high-density facsimile, as well as other applications, a spokesman hints that substantial improvements in resolution have recently been made over the 256-by-228-element imager demonstrated a year ago.

The RCA arrays are priced ini-

tially at \$2,300 and \$1,500 each, depending on quality. They use the same frame-transfer system as the one the firm described very briefly in 1973. The system consists of three sections.

Two of the sections are partitioned into vertical channels by means of diffused channel stops. Horizontal electrodes that pass across the entire device allow charge to be transferred vertically, with all channels transferring simultaneously.

A third region of the device is a single CCD line. Here, charge can be transferred horizontally to an output amplifier built on the chip.

In effect, says Ralph E. Simon, manager of electro-optics operations at RCA Electronic Components group's Industrial division, Lancaster, Pa., the imager is a large array of closely spaced MOS capacitors. "Charge, which is injected by light, is collected under the electrodes and then passed from electrode to electrode to an output diffusion where the charge is detected. The advantage of the CCD principle is that it permits information to be handled in a relatively small, simple structure."

According to Simon, this attribute is vital in the imager application, where a large number of resolution elements is required. It is also particularly essential in memory applications, he points out, where a high density of storage sites is needed.

Simon also says that the RCA sili-



con imaging device, with its 512 vertical picture elements and 320 horizontal elements, has the resolution required for broadcast television. RCA officials, however, don't believe the company's CCD cameras will be used in broadcast applications for at least another two to three years, and then probably only for special "spot" news coverage. There are other technical problems that have yet to be solved.

Blemish. A problem, for instance, is the loss of half a dozen or more elements in the picture produced by most CCD devices. This appears as a large white dot or blemish on the television screen.

Further, RCA is completing development of a custom C-MOS integrated circuit to generate complete vertical clocking waveforms. The device will be used in both CCD cameras, although RCA says it plans to offer the device as a separate product in the future.

Despite the long list of appli-

Tubeless. Rectangular charge-coupled device is the sensor for TV camera to be manufactured by RCA Electronic Components.

cations for solid-state imaging devices, and their low-cost potential, most suppliers believe vidicon tubes will be around for a long time. RCA says image sensors should be selling in the \$30 region by the early 1980s. But as John Rado, Reticon president, points out: "You can buy a vidicon tube right now for \$25 and get 500-by-500 resolution." □

Solid state

Three-inch rectifier handles 10 MW

A 3-inch-diameter rectifier—a third larger than any commercially available wafer—is being developed by Westinghouse Electric Corp.'s Semiconductor division. And there is the promise that a thyristor of comparable size will follow.

According to Derrick J. Page, manager of semiconductor develop-

Powerful. Three-inch-diameter silicon disk held by Westinghouse's Prosenjit Rai-Choudhury goes into 10-megawatt rectifier.

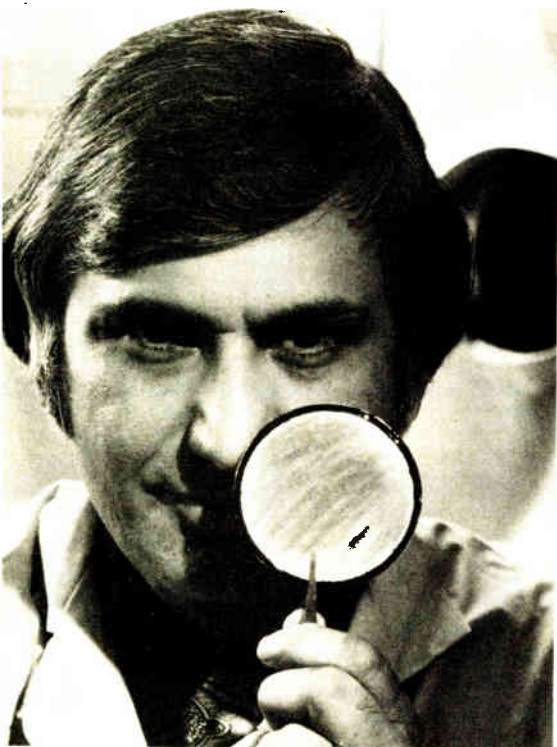

ment at Westinghouse's Research Laboratories in Pittsburgh, the new rectifier will allow electrical-control suppliers to get around the need to use more of the presently available 2-inch devices in parallel, thus reducing system costs and complexity and improving reliability. Westinghouse expects to introduce the rectifier as an off-the-shelf item next year. The 3-inch thyristor is just entering the testing stage.

The rectifier, says Page, can handle 10 megawatts of power. The most powerful commercially available solid-state device is a 5-MW solid-state rectifier.

"The first application of the 3-inch rectifier," says Page, "is likely to be in aluminum processing and fabrication, which demands high current." He also finds obvious applications in fusion reactors and electrochemical platers, because of their high energy requirements, and in welding, where power is stored and then dumped in high current increments.

Prototype. Although the device has been tested at 10 MW, Page believes it can handle 12 MW. "Continued development may raise its ratings even higher," he says. The prototype can handle 2,500 volts at an average current of 4,000 amperes. It has withstood a surge of 26,000 A under test, and members of Page's development team, including Prosenjit Rai-Choudhury and P. F. Pittman, believe it is capable of withstanding 40,000 A. The rectifier's developers say that, as a rule of thumb, the device carries 100 A per square centimeter, it measures nearly 40 cm² in area, and surge ratings generally run about 10 times the normal ampere rating.

The 2-inch rectifiers currently available can handle 2,000 v at 2,000 A, but Westinghouse researchers believe the performance of these devices is limited by the quality of the silicon and nonuniformities of resistivity.

Also, lower voltages are possible with thinner wafers, and Westinghouse initially is interested in low-voltage devices. Page says that 12 mils is about the thinnest silicon

slice commercially available. This can be lapped on one side to 8 mils. However, the Westinghouse development team believes that the 40,000 A peak necessary for welding applications is possible with a 3-inch device of 10 mils thickness.

Properties. According to Page, the high-current capability built into the new rectifier was achieved partly through uniformity of both the silicon crystal structure and dope-element diffusion over the larger surface area, and partly from the extremely low thermal impedance of the device.

The rectifier, basically, is a slice of silicon and a molybdenum backing plate separated by an extremely thin layer of aluminum foil. But, according to Joseph E. Johnson, manager of design and engineering within the Semiconductor division's operations department, much of the device's "uniqueness" comes from the production process, plus its ability to dissipate heat.

One of the major problems that confronted the designers, for instance, was that in bonding, the molybdenum expands faster than silicon, producing cracks near the edge of the silicon. This problem was solved by alloying molybdenum to silicon in a hydrogen atmosphere and by using "certain wetting agents" during the production process.

"This is something we worked at very hard, and it succeeded where graphite compaction failed," says Johnson.

Johnson says he hopes to have a rectifier in the 500-600-v range this year, with an average current rating of 5,500 A. □

Communications

IBM ponders court action on domsat

International Business Machines Corp. is reportedly weighing court action against the Federal Communications Commission ruling that

treats the company's proposed entry into the domestic satellite business as a special case. The FCC, in a 5-to-1 ruling in late January, warned that any IBM entry into satellite communications would come under "special policy conditions" to "minimize the adverse public-interest effects that might potentially arise." This special-treatment provision is seen as a solid legal ground on which IBM might challenge the commission, citing the principle of equality before the law.

The FCC action resulted from the joint petition of IBM and Comsat General Corp. to restructure CML Satellite Corp. [*Electronics*, July 11, 1974, p. 26]. IBM proposed to establish a subsidiary that would acquire 55% control in CML, and Comsat General was to increase its share to 45% on the withdrawal of MCI Communications Inc., and Lockheed Aircraft Corp. from the triumvirate in which each partner owns one third. The FCC modified this plan adding safeguards to prevent IBM from eventually dominating the domestic satellite field.

"If IBM goes to court," says the Washington counsel for one competitor, "it will give us a clear sign of how badly they want in on the domestic satellite business—and just how important it is to their future long-range plans." Lawyers for several IBM competitors believe the court option is being considered within IBM.

However, an IBM official declined comment on the possibility of a suit. He says the company will withhold comment until the full text of the FCC ruling becomes available, which FCC officials estimate will be mid-February.

Speculation that IBM will go to court has risen sharply with the news that it has won its appeal to overturn the 1973 antitrust judgment that ordered IBM to pay \$259 million in damages to Telex Corp., the Tulsa, Okla., peripheral-equipment maker (see related story, p. 46). "They are 'hot' now—winners—and could easily decide to press their case," the counsel explains.

Apart from the extreme of court

action, IBM has three other domsat options open to it as a result of the FCC ruling.

- IBM and Comsat General may find another partner and restructure CML, provided that no one company has "less than a 10% ownership interest or more than a 49% ownership, or otherwise be in a position . . . to exercise *de facto* control."

- Comsat General could arrange to lease satellite bandwidth to IBM, much as Comsat General has arranged to do with American Telephone & Telegraph Co. However, to do this, Comsat General would be obliged to choose between providing satellite channels on contract or public common-carrier services.

- IBM and Comsat General may each choose to enter independently of the other.

Reasonable. Whatever IBM does, says the FCC, the company must do more than set up a separate satellite subsidiary. IBM must also "permit reasonable and nondiscriminatory interconnection of customer-provided communications systems and/or terminal equipment."

At first glance, the FCC decision appears to have favored the arguments of IBM's opponents in the proceeding, including the Department of Justice and the Federal Trade Commission. Both opposed the application. But for those who, like the Computer Industry Association, visualize IBM's new goal as selling time on centrally located processors that can be dialed up directly through the customer's own rooftop antenna, the threat of an IBM-dominated communications monopoly remains [*Electronics*, Nov. 14, 1974, p. 67]. □

Commercial electronics

Recorder detects counterfeit bills

It may not play a tune, but a magnetic-recorder-based device for detecting counterfeit currency will flash a light when exposed to true paper money.



Recorder. Hand-held validator detects counterfeit U.S. currency by impressing magnetic signal on the printing inks.

The currency validator was developed by Arthur A. Burube, a consultant in automated traffic control systems who recently formed a company, Currency Validators Inc., in Lawrence, Mass., to produce a hand-held counterfeit-detection device. He's aiming it at both Government agencies and commercial organizations handling large amounts of currency.

In operation, the validator, which weighs less than 8 ounces, is rubbed over the portrait area of a bill. If the bill is valid, a light on the unit flickers. If counterfeit, there is no flicker.

Signals. Burube says the magnetic read/write head of the validator impresses a magnetic signal on the ferrous oxides used in the ink in all U.S. currency, much like the way data is encoded on magnetic tape containing the same material. Then, explains Burube, the validator head detects the residual magnetic effect on the bill, and by measuring the spacing between engraving lines, the unit can detect whether the engraving resolution is correct. This spacing, as well as the presence of the ferrous material, is sufficient to differentiate between real and fake money.

The first 100 units off the production line have already been deliv-

ered to Chase Manhattan International banking offices in Panama. Burube has also shown the validator to U.S. Secret Service officials and to the Federal Reserve Board. Edward Butler, head of counterfeit investigations at the Federal Reserve's Boston Office, would only say of the device: "We've seen it, and it worked."

Burube is now establishing a network of distributors for the validator initially in the East. The units will range in price from \$89.95 to \$129.95 each, depending on the quantity ordered.

Burube has applied for four patents on the magnetic head and the electronics in the validator, which runs on a single 9-volt battery. The next step will be to develop a model that emits a different sound for each currency denomination. □

Funds transfer to share one net?

Successful operation of a nationwide electronic funds-transfer system (EFTS) will require a shift from the individually controlled communications networks now being set up by separate groups to a shared data-communications utility. This is one of the conclusions of management consultant Booz, Allen & Hamilton Inc., in a report prepared for mutual savings banks.

To share a single utility, the commercial and savings banks must all use the same type of communications, which means that the only differences in the ways these institutions operate their EFT equipment will be in the services offered to consumers. In short, the consulting firm states, EFT is a tool, not a product.

Optimistic. To hardware manufacturers—suppliers of automated tellers, remote deposit terminals, and/or cash dispensers—the report offers the optimistic view that "EFT won't go away, but is a new and important resource to consumer financial services."

To the mutual savings banks, the

smallest of the institutions in terms of total deposits and number of branches, Booz, Allen & Hamilton holds out the hopeful advice that electronic on-line terminals located in shopping centers or supermarkets could help make up their difference in size. This could give the mutuals a competitive lever to use against their larger commercial-bank competitors. At stake in the electronic funds-transfer system of the future are consumer savings accounts, which now represent the major growth business for banks.

Lead. Despite their smallness, the mutual savings banks took the lead in EFTS three years ago, when they formed the Mutual Institutions National Transfer System Inc. (Mints) to aid them in planning the new services. Now Mints, which has more than 300 members, has initiated another new service, called Cashmate. This system is based on a plastic debit card that is compatible with other bank cards in circulation.

Consumers will be able to use the Cashmate card to withdraw or deposit money from savings accounts without using passbooks. It's designed specifically for use with remote on-line teller terminals being set up by more and more banks. Mints executive vice president C. Bickford Henchey says the Cashmate card system will be licensed to Mints members for about 2 cents per card. □

Packaging & Production

Junction plug-ins make own contacts

Call it a junction, distribution block, commoning block, or what have you, its function is to allow different circuits to branch off from a single main line.

Molex Inc. is calling it a connector, and the company's new design for this old function promises a flexibility that it hopes will win the device a bussing role for power and signal circuitry in office equipment,

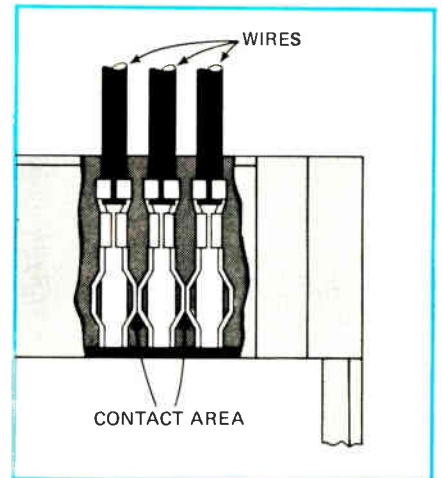

Distributor. Common contacts are made from one terminal to the next as each is plugged into Molex connector. Connectors can also be stacked together, and linked with jumper cables as shown in the photo.

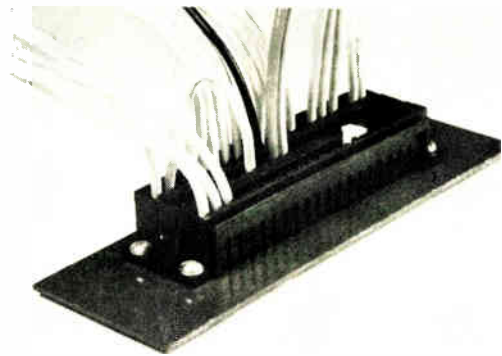

appliances, and consumer electronics gear.

Instead of requiring separate male and female contacts fastened together in some way, the Lisle, Ill., connector manufacturer uses a single, U-shaped metal terminal with bowed flexible sides (see the drawing at the top of this page). The terminal, to which the wire is crimped, slips into a holding channel within a thermoplastic housing. The housing itself contains no conducting wires or busses for making contacts. Instead, contact from one terminal to the next is made as the bowed legs of adjacent terminals in their holding channels press up against each other.

"As the user puts the terminals into the housing, he shorts them out, one to the next," explains Robert V.

Seizure of Nominal Value Deviations – considering previous events

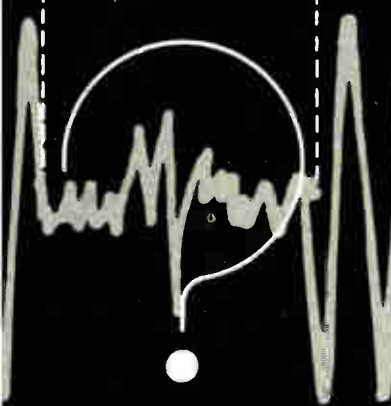

253.17.56.21

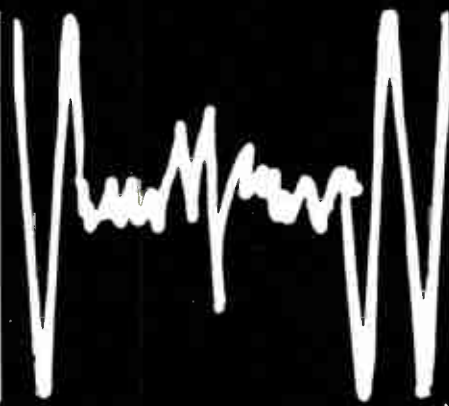
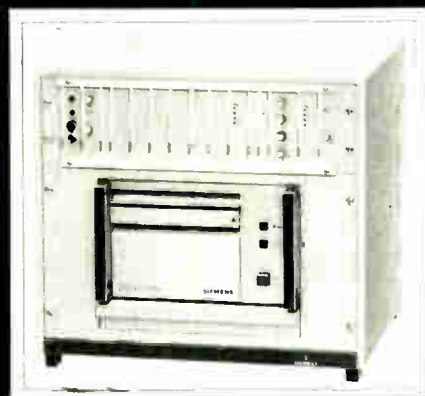

253.17.56.21

What caused the anomaly? Which variable quantities are effected? How long does the nominal value deviation last? What eliminated it eventually? – Questions, needing answers to make an exact fault analysis possible. OSCILLOSTORE® helps you to answer such questions. Because OSCILLOSTORE can monitor continuous processes which can be represented through electrical signals up to 10 kHz. OSCILLOSTORE simultaneously registers, depending on task, up to 32 measurement values for milliseconds or minutes.

OSCILLOSTORE reacts as soon as the monitored measurement value exceeds its limits: A connected recording device is switched on to record the delayed measurement value – a few undisturbed periods, then the process of the entire disturbed measurement value and finally the recurrence of the nominal value.

Would you like to know more about OSCILLOSTORE? Where this modular system has been applied successfully in electrical power stations or processing systems?

Please write to:
Siemens Aktiengesellschaft,
ZVW 133,
7500 Karlsruhe 21,
Postfach 21 1080.

in USA to:
Siemens Corporation,
186 Wood Avenue South, Iselin,
New Jersey 08830

in Canada to:
Siemens Canada Limited,
7300 Trans-Canada-Highway,
Point Claire 730, Québec

with the OSCILLOSTORE by Siemens

Circle 43 on reader service card

Sebastian, manager of applications engineering.

In addition, the Molex housing sports a molded-in lip that allows rows of connectors to be stacked, as shown in the photograph in the middle of page 42. One row is linked to the next with a short jumper cable that plugs into the housing like any other terminal.

In contrast, the most popular terminal block system that Molex hopes to replace is more complex. It consists of a network of metal spades or tabs, wired to make them electrically common, and fastened to an insulating block with rivets. Using wires terminated with slip-on or quick-disconnect female contacts, the input is brought to the block, and two or more outputs distribute the power to other circuits. In some cases, an insulating sleeve is added to the female terminal for safety.

Housing. The first product in the new Molex family, to be launched this month, will be a 20-circuit housing with terminals that are suited for 250-volt, 20- to 25-ampere operation. A plastic detent rib molded within the housing provides a terminal insertion force of 2 pounds; withdrawal force is 10 pounds. Later, 5-, 10-, and 15-circuit blocks will be tooled, depending on how the demand in the marketplace develops, Sebastian says.

"Our next variation on the same theme will be a much smaller version, miniaturized for signal circuits," he adds. While the obvious advantages of the system are reduced cost and simplicity of use, the overriding selling point will be reduction of inventory, he notes.

Usually, terminal blocks are configured to the customers' needs, he says, with the separate contact junctions fastened to a single phenolic block. A different version may be stocked for each type of equipment. But because the Molex housings are of inexpensive plastic, Sebastian continues, a single standard assembly serves a range of applications. And, often, two or more sets of separate electrical junctions can be contained within the same thermoplastic housing. □

Communications

Chip lasers ready for optical systems

Tests of both long- and short-range fiber-optic data-communications systems are under way in New Jersey at RCA's David Sarnoff Laboratory, Princeton, and Bell Telephone Laboratories Inc., Murray Hill, following the development of solid-state injection lasers promising continuous operation of 100,000 hours

at room temperature.

The long-life diode lasers with outputs of between one and 20 milliwatts were disclosed at the Optic Fiber Transmission Conference at Williamsburg, Va., in January.

RCA and Bell researchers and their counterparts in Japan, Germany and elsewhere have been seeking an efficient, low-cost light source for fiber-optic communications. Bell officials say they are now working on laser-pumped fiber-optic communications systems and expect to disclose a major system development in early 1976.

Researchers at Nippon Electric

DOD wants standardized fiber-optic systems by 1980

The military is aiming for standardized, fiber-optic point-to-point communications systems by 1980, and these systems will use what by then will be off-the-shelf components. To achieve this goal, DOD will fund dozens of fiber-optic applications this year. As much as \$30 million could be made available [*Electronics*, Jan. 23, p. 49].

"There are areas where fiber optics can be used for communications right now, and we don't want to wait for further industrial development," says Parviz (Harvey) Soltan, chairman of a tri-service committee set up within the Department of Defense's Directorate of Defense Research & Engineering to review fiber-optic applications. He is also chief technician at the Naval Electronics Laboratory Center, San Diego, Calif.

Committees. To review proposed fiber-optic programs, the tri-service committee has set up five subcommittees, dealing with communications security, standardization of components, radiation environments, source and detector, and cable requirements. Fiber-optic systems offer important military advantages over hard-wired and radio-frequency equipment—notably immunity to radio-frequency and electromagnetic interference, and almost total immunity to wire-tap-

ping by hostile forces.

Possible applications include everything from data buses in the B-1 bomber to cable for a proposed field-radar unit for the Marines, according to Don L. Albares of the Naval Electronics Laboratory. At the recent Optic Fiber Transmission Conference in Williamsburg, Va., Albares listed the following possibilities as being currently under review by the DOD:

- Aircraft wiring systems for the proposed Navy close-support fighter and the antisubmarine fighter, where the attraction is the light weight of fiber optics to replace heavy copper cables.

- Fiber-optic cables linking undersea sonar boxes to surface buoys and cables for towed sensor arrays.

- The Army's field-communications needs, such as a data-bus links between field communications and data-processing systems [*Electronics*, Jan. 9, p. 29].

DOD funding of various systems applications will aim at selecting the most efficient industrial designs by 1980, Soltan explains. Since corporate research and development funds would not be invested in the applications, Soltan expects companies to be willing to abandon an in-house approach in favor of another company's DOD-funded technology. □

NEED A 1/4" x 1-1/4" TIME-DELAY FUSE OR QUICK-ACTING FUSE?

BUSS HAS IT!

Time-current characteristics of FUSETRON® dual-element time-delay fuses

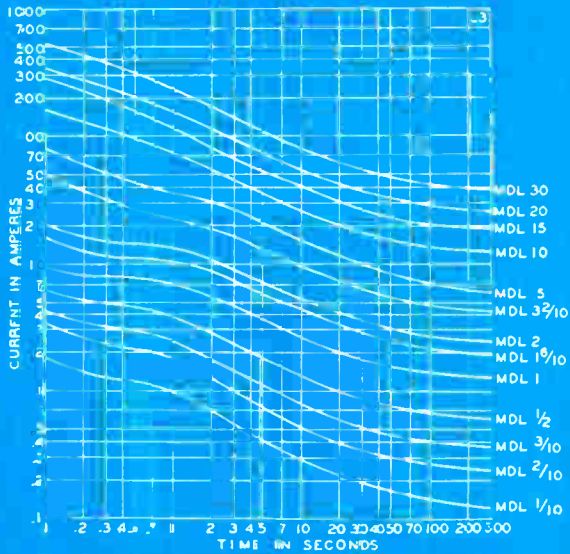

Time-current characteristics of BUSS® fast-acting fuses

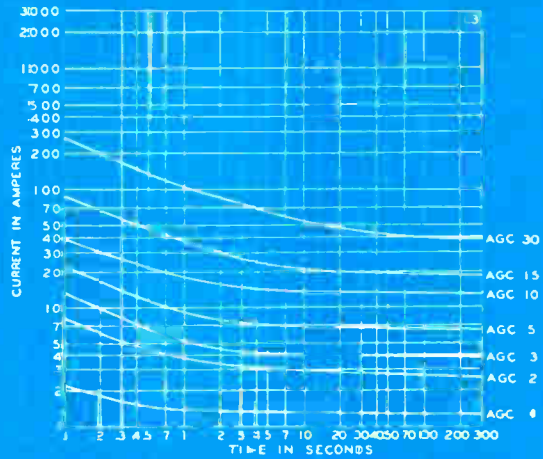

FUSETRON® dual-element fuses

Time-delay characteristics avoid nuisance openings from starting currents or surges—yet, give full protection from short-circuits or dangerous overloads.

Voltage	Symbol	Amperes
250 or less	MDL	1/100, 1/32, 1/16, 1/10, 1/8, 15/100, 175/1000, 3/16, 2/10, 1/4, 3/10, 3/8, 4/10, 1/2, 6/10, 7/10, 3/4, 8/10 or 1
250 or less	MDX	1-1/4, 1-1/2, 1-6/10, 1-8/10 or 2
125 or less	MDL	1-2/10, 1-1/4, 1-1/2, 1-6/10, 2, 2-1/2, or 2-8/10
125 or less	MDX	3, 3-2/10, 4, 5, 6-1/4 or 7
32 or less	MDL	3, 3-2/10, 4, 5, 6-1/4, 8, 10, 15, 20, 25 or 30



BUSS® fast-acting fuses

Fast-acting characteristics provide the instantaneous high speed opening necessary to protect sensitive instruments or delicate apparatus.

Voltage	Symbol	Amperes
250 or less	AGC	1/500, 1/200, 1/100, 1/32, 1/16, 1/10, 1/8, 15/100, 175/1000, 3/16, 2/10, 1/4, 3/10, 3/8, 45/100, 1/2, 5/10, 3/4, 1, 1-1/4, 1-1/2, 1-6/10, 2
250 or less	MGB	1/16 or 1/8 MBW & MBB fuses now called AGC.
250 or less	AGC	2-1/2, 3
250 or less	MTH	4, 5 or 6
For 250 volt fuses above 6 amperes—See ABC fuses.		
125 or less	GLH	7, 8 or 10
32 or less	AGC	4, 5, 6, 7, 7-1/2, 8, 10, 15, 20, 25 or 30

For a complete selection of BUSS fuses and fuseholders ask for bulletin SFB.



BUSS® In-Line Fuseholders

HKF Fuseholder

B-JSS Panel Mounted Fuseholders Lamp Indicating

BUSS HGB-C Fuseholder Military Type FHL11U

BUSS Space Saver Panel Mounted Fuseholders

BUSS WMR Shielded Panel Mounted Fuseholders

BUSS Snap-Lock Rear Panel Mounted Fuseholders

BUSS Panel Mounted Fuseholder

Fuse Blocks For 1/4 x 1 1/4 Inch Fuses No. 4408 2 pole



EUSMANN MANUFACTURING
a McGraw-Edison Company Division
St. Louis, Missouri 63107



Co., Kawasaki, Japan, recently disclosed preliminary data from an experimental fiber-optic data system, but they lack the ability to fabricate laser chips with lifetimes of 100,000

hours. At the optics conference, they claimed lifetimes of only "several thousand hours."

Long-life laser chips are considered vital for successful fiber-optic

communications systems because of their relatively high power output—at least five to 10 times the output of light-emitting diodes. The lower power output of LEDs would require

News briefs

McGraw-Hill is gloomy on GNP

The United States is faced with two consecutive years of downturn in the real gross national product for the first time since immediately after World War II. That's the conclusion of Douglas Greenwald, chief economist in McGraw-Hill Publications Co.'s economics department. Greenwald forecasts that, after adjustment for inflation, the 1975 GNP will be 2.3% lower than in 1974. And 1974's real GNP slipped 2.1% below the 1973 level, according to McGraw-Hill. "The last time we had two consecutive shrink years," says Greenwald, "was 1946-47." On the brighter side, though, he predicts a 1976 growth rate of more than 5%.

Ground-proximity-warning contract goes to Litton

Litton Industries Inc.'s Aero Products division in Woodland Hills, Calif., has won a \$3 million contract to supply American Airlines' aircraft with ground-proximity warning systems. Delivery of the approximately 300 systems begins in June at a rate of about 40 units per week to meet the Federal Aviation Administration's deadline for installation of the systems by Dec. 1, 1975 [*Electronics*, Jan. 9, p. 49]. Pan Am and Braniff have installed systems made by Sundstrand Data Control Inc., another of eight suppliers of the units.

GE-designed microcomputer coming to market

General Electric Co. and Solid State Scientific Inc., Montgomeryville, Pa., have signed a technology-transfer agreement calling for Solid State Scientific to develop and market a GE-designed high-speed microcomputer. The central processing unit of GE's CRD-8 microcomputer will be converted from a TTL MSI circuit board into a single complementary-MOS-on-sapphire chip. Solid State Scientific will then manufacture and market the chips as well as complete microcomputer systems, including random-access memories and GE-designed read-only control memories.

Board of Inquiry looking into BART crash

The San Francisco Bay Area Rapid Transit District's first fatal accident, which occurred last month, is being investigated by a special board of inquiry that includes representatives of other U.S. transit systems. The fatality occurred when a BART train crashed into a maintenance vehicle, killing the vehicle's driver. One question to be answered is why the accident was not prevented by the Westinghouse-built system that's designed to prevent more than one vehicle from occupying the same track space at once.

Telex to appeal reversal of IBM decision

Telex Corp. of Tulsa, Okla., plans to appeal to the U. S. Supreme Court the reversal by the Federal Court of Ap-

peals in Denver of its antitrust award against IBM Corp. The appeals court swept away all findings of a trial court in Tulsa in September 1973 that ordered the computer colossus to pay \$259.5 million to Telex. The appellate decision, however, upheld the lower court's judgment against Telex, and the peripherals manufacturer still must pay reduced compensatory damages of \$17.5 million plus \$1 million in punitive damages to IBM. Payments were based on the finding that Telex had misappropriated and pirated IBM trade secrets.

More layoffs at Motorola, Xerox, Teradyne

The Semiconductor Products division, Motorola Inc., last month laid off about 1,200 employees worldwide. The cutback in production and administrative personnel brings to about 6,800 the number of employees cut by the Phoenix, Ariz., semiconductor manufacturer since Nov. 1, when its worldwide employment stood at 30,000. Continued softness in consumer and automotive electronic products was the reason cited. Xerox Corp. is laying off 1,200 workers, mostly around Rochester, N.Y., where employment has dropped from 17,000 to 15,000. And Boston's Teradyne Inc. laid off 200 of its 1,200 workers because of reduced sales of test equipment.

Inselek enters Chapter XI

Inselek Corp., Princeton, N.J., has filed a Chapter XI petition in the Federal court in Trenton, N.J., apparently stymied by the slow growth of silicon-on-sapphire technology in which it specializes.

Honeywell and U.S. Steel unite on process control

Honeywell Inc. and U.S. Steel Corp. are in the final stages of negotiating an arrangement whereby computer-control systems that combine Honeywell controls and U.S. Steel's software will be marketed to the metals industry by Honeywell. The models cover such important systems as basic oxygen-furnace control, continuous casting, and galvanizing, line operations.

Data General plans to counter-sue Keronix

Data General Corp., the Southboro, Mass., minicomputer maker, plans a counter-suit against Keronix Inc., the Santa Monica, Calif., memory manufacturer that is suing Data General. Keronix charges Data General with arson, wiretapping, and theft. Data General president Edson deCastro has told stockholders the charges "are preposterous, the allegations are without substance, and the lawsuit is totally without merit. We deny all of the acts referred to in the complaint [which asks for \$150 million in damages], and we will vigorously defend ourselves through every available legal process." Data General officials say they have "very substantial" claims against Keronix and will assert them in their suit.

Two new adjustable 4-terminal voltage regulators.

Fairchild's unique new *adjustable* 0.5 A voltage regulators are available either way you want them:

Positive (78MG Series).
Or, *negative* (79MG Series).

They both come in our unique power mini-DIP with integral heat sinks.

And talk about versatile. These adjustable devices are ideal for applications requiring:

1. Continuously adjustable output.
2. Constant output with 4% (worst case) tolerances.

3. Output levels unavailable from standard fixed devices.

Of course, adjustable or fixed, no one gives you a selection of voltage regulators like Fairchild with our broad line of 100mA-to-5A positive 7800 Series fixed devices.

Plus, our new negative 7900 Series for complementary applications.

Five extra reasons Fairchild 7800/7900 Series Voltage Regulators can be a lot easier to use.

No matter which Fairchild device you choose, remember:

1. They're *all* there. Variable or fixed—one resource for every application.
2. They're *complete*. Self-contained. One chip in one package. So you can use them where you want them—with no expensive design time.
3. They're *reliable*. Featuring thermal shutdown, short circuit protection, safe area compensation and automatic recovery when the fault condition's relieved.
4. They're *inexpensive*. Because low-labor,

single-unit installation simply costs a lot less.

5. And of course, they're *in stock* now.

For samples and data sheets complete with application information, call your Fairchild Distributor or Sales Office today.

Semiconductor Components Group,
Fairchild Camera & Instrument Corp.,
464 Ellis St., Mountain View, CA 94040.
Tel. (415) 962-5011. TWX: 910-379-6435.

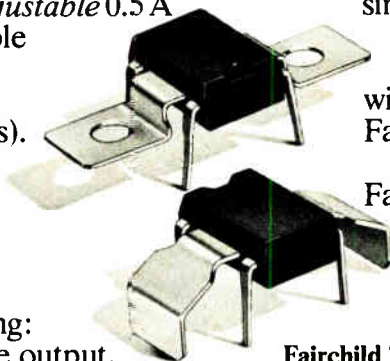

Fairchild 7800/7900 Series Voltage Regulators

OUTPUT VOLTAGE	FIXED				ADJUSTABLE
	5A TO-3 & TO-220	1A TO-39 & TO-220	500 mA TO-39 & TO-220	100 mA TO-92 & TO-39	
P O S I T I V E	2.5			78L02	NEW 78MG POS 500 mA
	5	78H05	7805	78M05 78L05	
	6		7806	78M06 78L06 (6.2V)	
	8		7808	78M08 78L08	
	12		7812	78M12 78L12	
	15		7815	78M15 78L15	
	18		7818		
	20			78M20	
N E G A T I V E	24		7824	78M24	NEW 79MG NEG 500 mA
	5			79M05	
	6			79M06	
	8			79M08	
	12			79M12	
	15			79M15	
	18				
	20			79M20	
24			79M24		

Note: μ A723 is also available in positive or negative.

**MADE IN
FAIRCHILD**

signal repeaters to boost signal-to-noise ratios.

GaAs crystals. Bell's Bernard C. DeLoach and Robert L. Hartman say the key to the long-life laser is "materials perfection," developed step by step since the first gallium-arsenide lasers were produced in 1970. "The first one burned up in minutes," Hartman recalls. Biggest part of the job was to grow the GaAs laser crystals without internal flaws or surface damage by means of a proprietary liquid-epitaxy process.

The addition of phosphorus during the fabrication reduced heat-producing stress, improving chip life to "several thousand hours," Hartman reports. Changing from hard-solder to soft-solder techniques to bond the chip to the header link also increased life. The Bell chips emit five to 10 mw of light at about 9,000 angstroms from a power input of about 0.2 w, Hartman says.

RCA's aluminum-gallium-arsenide lasers emit 20 mw from 0.5-w input at 8,000 Å. Its chips, 0.012 centimeter wide by 0.04 cm long by 0.007 cm high, have been rated by industry sources at 50,000 hours to 100,000 hours of continuous operation at room temperature. However, RCA researchers are reluctant to claim life of longer than 10,000 hours, which was announced at the conference. RCA attributed the increase in lifetime to two developments—recent improvements in techniques for etching chip faces, and a new high in material purity, attained in 1973. □

Management

Fairchild chairman: liquidity is vital

"Our first priority is to maintain our liquidity, despite declining sales." That is the assessment by board chairman-designate of Fairchild Camera & Instrument Corp., Roswell L. Gilpatric. Since 1967, he has been a director of Fairchild, Moun-



Gilpatric: Looking at new end markets.

tain View, Calif., which last year grossed \$385 million, 80% in semiconductors. He is presiding partner of the New York law firm Cravath, Swaine & Moore. "We want to take advantage of our technological base and our manufacturing technology to broaden our product lines and take a look at more new end markets," he says. "We're going to work very hard to broaden our customer base, both here and abroad."

Gilpatric is scheduled to succeed Walter Burke as chairman after the firm's annual meeting on May 2. He says, "there is no basis for the belief" among some Wall Street analysts that Fairchild is being restructured for acquisition—possibly by a major foreign electronics firm. "I think we'd rather do the acquiring.

"We're going to be very careful to avoid errors of the past," adds Gilpatric. "I think we stayed in defense products too long, for example. Our eggs have been in too many baskets; we were too spread out for a company our size." Fairchild will stick close to what it knows best—semiconductors—he says, "We'll broaden the things we're doing in the auto field, and we're moving ahead with our digital-watch and microprocessor programs."

Gilpatric actually began his association with Fairchild in 1932. "Sherman Fairchild was looking for a big, prestigious law firm, but he didn't want to spend a lot of money at the time," recalled Gilpatric as he sat in his 57th floor office over-

looking New York's financial district. "I was quite new to the firm—just out of Yale Law School—when I met Sherman. He was the first client I brought to the firm."

Cravath, Swaine & Moore has served as Fairchild's outside counsel ever since, although Gilpatric has served several tours outside the firm. He was Deputy Secretary of Defense from 1961 to 1964. Previously he had been Assistant Secretary of the Air Force and thereafter, Under Secretary of the Air Force. □

Materials

Chemicals key to LCD watches

Like weight-watchers, digital watchmakers like to slim things down. They know they've got to make models less bulky.

One company that's pushing hard to do this with advanced liquid-crystal formulations for its displays is American Microsystems Inc., where the goal this year is to bring drive requirements down so that a single 1.5-volt battery can drive the display, timing circuitry and an incandescent lamp for backlighting.

The Santa Clara, Calif., company, a leader in LCD watch manufacturing, wants to cut its watch module down to a 200-mil thickness, which is a little more than half the size of AMI's module introduced more than a year ago. That unit was 370 mils thick and required two batteries delivering 6 volts and 12 microamperes for its timing circuits and displays. A 200-mil-thick module would also be a considerable improvement over AMI's latest units, which are 275 mils thick [*Electronics*, Oct. 17, 1974, p. 32].

Boil and bubble. But AMI's success will not depend on sophisticated electronics alone. The critical element may well be the "witch's brew" of LCD formulations. Most of the work at AMI—and indeed by most LCD watch makers—has centered around three organic chem-

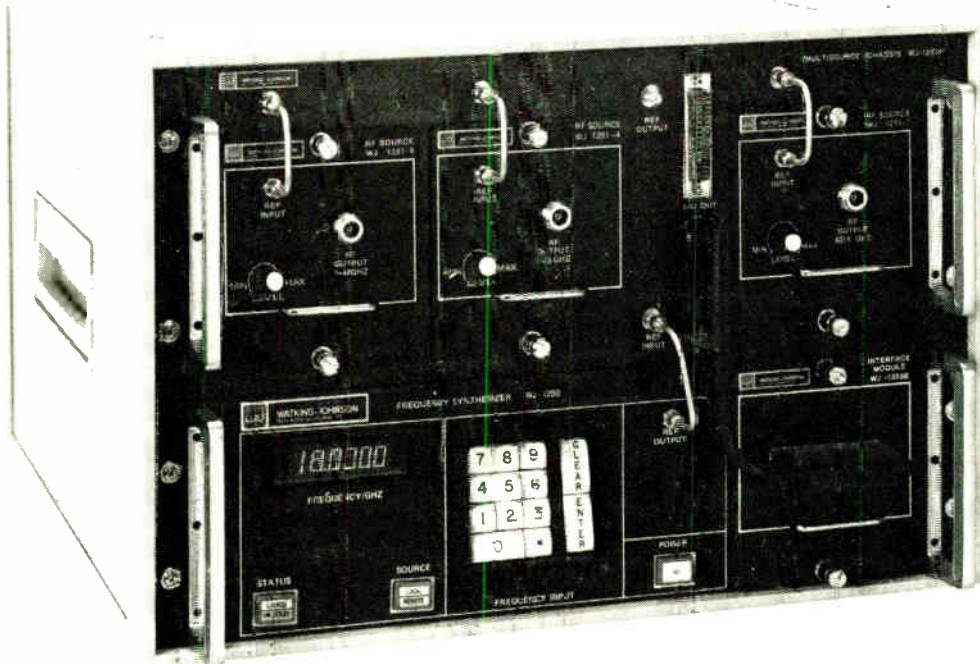

The WJ-1250 Modular Synthesizer System

1 to 18 GHz Coverage Provided in a 13 inch high configuration

The WJ-1250 Modular Synthesizer System pictured above provides a minimum of 5 mW across the full 1 to 18 GHz frequency range. The desired frequency may be commanded via the front panel keyboard or the rear panel BCD input connector, and the synthesized frequency is provided at the appropriate RF Source port.

By employing other available units, a minimum of 10 mW can be supplied across the full 0.5 to 18 GHz range in a

20 inch high configuration and still have room to accommodate a future 18–26 GHz RF Source. Lesser frequency coverage may of course be provided using fewer modular units, while programmable attenuation, modulation, single-port output, etc. can be accomplished through additional units.

With the output signal achieved directly from YIG-tuned oscillators, maximum power and spectral purity are maintained over the full range. Maximum full range

switching time is 100 msec, and long-term stability is ± 3 pp 10^9 /day or that of an external reference.

For specifications on the WJ-1250 Modular Synthesizer System, its component modules, and other related products, contact the Watkins-Johnson Field Sales Office in your area or Systems Applications Engineering at the Palo Alto address and phone number below.



Watkins-Johnson—U.S.A.: 3333 Hillview Ave., Palo Alto, CA 94304 • (415) 491-4141 • TWX: 910-373-1253 • Telex: 34-8415 • Cable: WJPLA • 700 Quince Orchard Rd., Gaithersburg, MD 20760 • (301) 948-7550 • TWX: 710-828-0546 • Telex: 89-8402 • Cable: WJCEI • **United Kingdom:** Shirley Ave., Windsor, Berkshire SL4 5JU. England • Tel: Windsor 69241 • Cable: WJUKW-WINDSOR • Telex: 847578 • **West Germany:** 8033 Panegg, Muenchenerstr. 17 • Tel: (089) 859-9441 • Cable: WJDBM-Muenchen • Telex: 529401 • **Italy:** Piazza G. Marconi, 25 00144 Roma-ELR • Tel: 59 45 54 • Cable: WJROM-RDMA • Telex: 60117

SCIENCE/SCOPE

A new ultra-lightweight radio for tactical field operations, developed by Hughes, employs micro-miniaturized circuits including LSI (Large Scale Integration) to provide high reliability, plug-in modules for easy maintenance, and an AM mode for compatibility with current military systems. Called the HC-191 Manpack, it is a version of the AN/PRC-104 single-side-band transceiver Hughes is building for the U.S. Marine Corps. It has a frequency range of 2 to 30 MHz and 280,000 channels to make enemy jamming difficult. Another significant combat advantage is its completely silent automatic electronic tuning.

The complete Manpack radio weighs only 12½ pounds including a battery pack that gives 16 hours of service before recharging. With its built-in 8-foot whip antenna, the HC-191 has a range of up to 30 miles in the most difficult jungle or mountain terrain. For a copy of the HC-191 brochure, write: Marketing Department, Hughes Aircraft Company, Bldg. 600/C231, P.O. Box 3310, Fullerton, Calif. 92634.

Telephone users in the United Kingdom will benefit from the computer-controlled FACT-II wiring analyzer system recently delivered to Standard Telephones and Cables, Ltd., of International Telephone and Telegraph in Northern Ireland. The 68,000-lb. system can test 34 different products in any of over 5,000 electrical configurations. A special connector developed by Hughes makes it possible to simultaneously access 25,600 circuit terminations in less than 15 seconds.

FACT-II is an adaptation of the system Hughes originally developed to pinpoint and troubleshoot electrical problems in aircraft fire-control systems. Hughes has built 11 FACT systems for European users and scores more for North America, the Middle East, and Japan.

Laser rangefinders for the U.S. Army's M-1 battle tank are being developed by Hughes for prototypes by both Chrysler Corp. and General Motors Corp. Following a competitive evaluation in mid-1976, the Army is expected to select a single contractor. Hughes currently produces laser rangefinders for the Army's M60A2 tank and M551 Sheridan vehicle and is developing a full-solution laser fire control system for an improved version of the M60A1. A tank with a laser rangefinder can fire far more quickly and with a much higher first-round hit probability.

Hughes Ground Systems Group needs Senior Systems Programmer/Analysts and Communication Systems Development Engineers to join the technical staff due to growth of current research and development programs. Applicants must have a BS or MS in electrical engineering or computer science and U.S. citizenship. Qualified applicants should write or send resume to: M. F. Duggins, Hughes Aircraft Company, P.O. Box 3310, Fullerton, CA 92634. An equal opportunity M/F employer.

A solid-state watch module for ladies-size digital watches -- now in production at Hughes -- contains the equivalent of more than 1,500 transistors. It overcomes the size limitations of ladies' watches with a unique time-readout that flashes the hour for about a second, then gives the minutes. The new module supplements the men's watch modules now made for leading name-brand manufacturers by Hughes, one of the largest producers for the watch industry.

Creating a new world with electronics



icals: Schiff compounds, esters and biphenyls. All are long complex chains of carbon, oxygen, hydrogen, with what are called alkyl radicals attached to the ends. But for lowest-voltage displays, AMI is looking at pure biphenyls.

According to Robert Young, senior scientist at the company's Display Systems division, all of the materials exhibit a phenomenon that makes them especially useful in LCDs—the twisted nematic field effect, which, in essence, is the ability to change the direction of polarization of linearly polarized light. Under normal non-energized conditions, an LCD cell appears clear when viewed between crossed polarizers. However, when an electric field is applied between electrode surfaces of the LCD, the molecules tend to align with the field, and the crossed polarizers make the energized portion appear dark.

"The problem has been," says Young, "that although all [of the chemicals] demonstrate the effect, they do it to varying degrees."

Biphenyls, for example, have the advantage of being the most stable compounds in the trio. Thus they are most resistant to environmental changes and impurities. Also, they have the best voltage turn-on and turn-off times (the speed with which the crystal orients with the field). At 1.5 volts, turn-on and turn-off times are 120 and 140 milliseconds respectively, adequate for digital watches. "But biphenyls are the hardest LCDs to make because of their very complexity," Young says.

By contrast, the Schiff compounds (with which AMI built its first LCDs) are probably the least complex of the three molecular structures, and as a result are easy to make and have high yields. Their main drawbacks are a sensitivity to epoxy and a relatively high driving voltage. To get the same turn-on and turn-off times as the biphenyls, a Schiff display requires 6 v.

Esters, the third compound, have not even been considered on their own by AMI, even though they have perhaps the lowest driving voltage of all, between 0.9 and 1.2 v. "Their

big drawback is turn-on/turn-off times half the speed of either Schiff or biphenyl compounds—on the order of 600 to 700 milliseconds—clearly unsuitable for LCDs, especially when multiplexing is involved," he says.

However, for AMI's second-generation 3-v modules, Young and his co-workers have used a Schiff-ester hybrid LCD that has turn-on and turn-off times of 100 and 140 ms at 32 hertz. "We've looked at other Schiff-ester combinations looking for a viable 1.5-v LCD," he says.

"But to get any lower, our only option, difficult as it is, is a pure biphenyl LCD. But we've learned enough from the other two approaches, so that it is safe to say that within a year we'll have a 1.5-v LCD watch module in production." □

Industrial electronics

Optical gear finds water pollutants

Detecting dissolved pollutants in a municipal water system by means of conventional "wet-chemical" methods, which measure biochemical oxygen demand, can take several hours or even days. Now pollutants can be detected in seconds, according to Britain's H. Tinsley and Co., developer of a continuous monitor that uses ultraviolet light and differential sampling circuitry.

Besides saving time, the monitor also saves money. It is priced at about \$2,400, compared with other equipment, which ranges between \$9,600 and \$12,000 and requires a skilled operator, states technical manager Gordon F. Hodges. What's more, the company says that, when properly calibrated, the new instrument has an accuracy within 1% to 2% of wet-chemical equipment.

No ventilation is needed in the unit, and power consumption is 20 watts. The first production models are coming off the line for use in municipal water systems and in process-control applications for making

CABLES, CIRCUITS, CONNECTORS — ONLY HUGHES PUTS IT ALL TOGETHER.

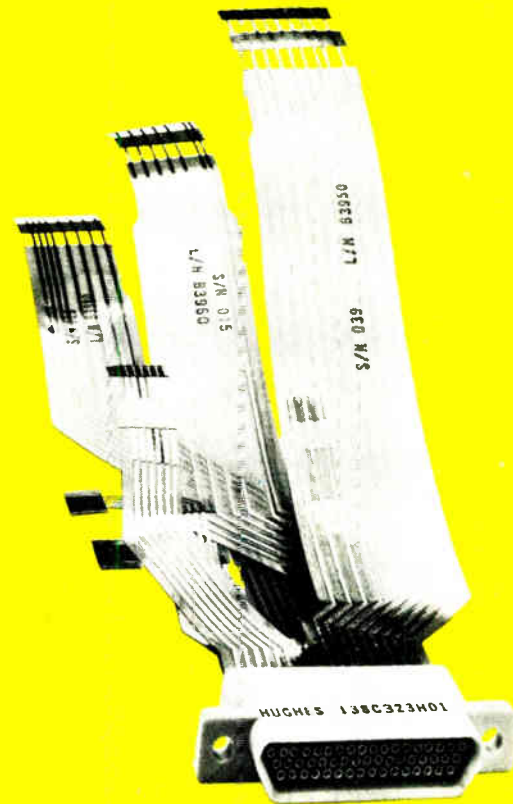

As far as we know, we're the only company that has total interconnection capability—in flat cable, flex circuits and connectors. And we've had more experience designing them for high technology applications.

But we do more than design them to work together—we also put them together for you in special assemblies.

So call the people you can count on. Call us. (714) 548-0671, Ext. 526. Or write: 500 Superior Ave., Newport Beach, CA. 92663



We crack the tough ones.

THE LID'S OFF

THE AIRPAX PARKERMETER SERIES ER-35 CONTROL METER

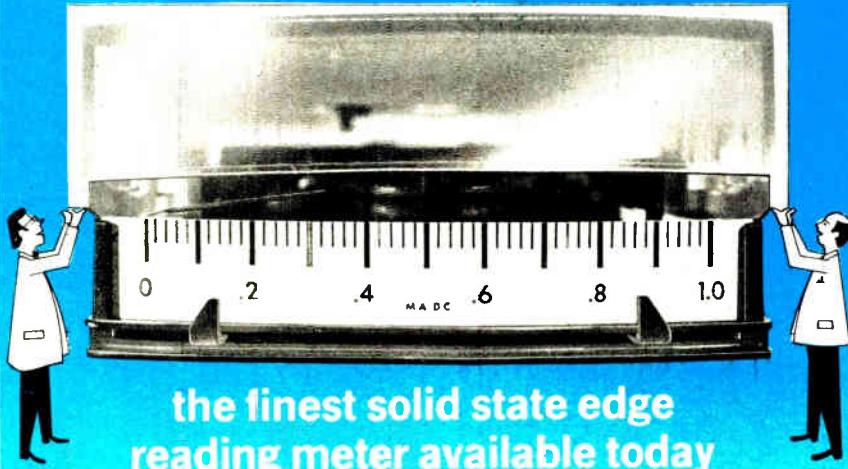

the finest solid state edge
reading meter available today

FEATURING

- Unique Design ● Improved Switching
- Rugged precision molded case
- More reliable meter movement
- State of the art manufacturing throughout
 - Horizontal or vertical displays
- Only 7/8" thick (can be stacked in any quantity)
- Available with one or two setpoints providing four control switching configurations

MORE QUESTIONS?

Write for Bulletin 8515C-674. It tells all about the SERIES ER-35 EDGE READING CONTROL METER . . . truly the most modern and dependable of all.

AIRPAX Controls Division P.O. Box 8488
Fort Lauderdale, Florida 33310 Phone: 305/587-1100

AIRPAX™

such products as plastics and soap.

The instrument "isn't a new idea, but what is new is a practical instrument that does the job automatically," Hodges comments. The organic-pollution monitor is based on the principle that the degree of absorption of ultraviolet light by a fluid can be used to spot the presence of a pollutant in seconds, although the instrument cannot determine what the pollutant is.

The Tinsley instrument operates by electronically comparing the absorption of the ultraviolet light to that of visible light. A mercury-vapor quartz lamp is pulsed through the water at 1 megahertz so that ambient light cannot affect the results. The light is split by a dichroic mirror into ultraviolet and visible components, and circuitry containing a dual-log amplifier connected to a scaled subtractor compares the two beams. Fluids containing suspended solids or air bubbles won't affect the absorption readings, a Tinsley spokesman says, because both the visible and ultraviolet ranges are affected equally.

Construction. The monitor is supplied in two units—the optical section with its quartz lamp, and the electronic unit with the comparator circuitry, the controls, a 40-division absorption panel meter, and an outlet for an alarm or recorder hookup. The optical unit measures about 4 by 5.5 by 8 inches; the other, about 4 by 10 by 12 inches. In the optical unit, a tube 20 millimeters in diameter handles three gallons per minute of the fluid to be tested. On either side of the tube are transparent quartz windows through which the light from the lamp passes.

In operation, an oscillator drives the mercury lamp. The dichroic mirror on the receiving end divides the light into ultraviolet and visible components, which travel through parallel circuits, each consisting of a detector, preamplifier, electronic switch, and a low-pass filter. These circuits feed into the dual log amplifier, and then into a scaled subtractor. The result goes into a gain-and-zero-set unit for display on the panel meter. □

MATSUSHITA LAUNCHES ARROW-M.

NOW YOU CAN BE CHOOSIER ABOUT THE RELAYS YOU BUY AND MANY YOU COULDN'T BUY.

Be choosier.

Yesterday when you needed a large selection of relays to choose from, you could only go to two places. Today Matsushita's Arrow-M Corporation gives you a third source for a broad base of relays. But quantity isn't the whole story. At Arrow-M you find more than currently available relay types. You find quality relays built to electrical and physical specs unmatched by other firms. Relays you just can't buy elsewhere. Relays that shrink a product while expanding its performance and reliability.

Switch to excellence.

Engineered by Matsushita, Arrow-M relays are in use in diverse products the world over. The number of trouble-free field hours for these relays is unestimable. So design them into your product with absolute confidence. You can't buy relays with more integrity.

Always available.

Who isn't worried about availability in today's market? Availability now. Next month. Next year. Don't worry. Because all critical materials and components used in the manufacture of Arrow-M relays are internally controlled, you can count on relays being available from stock whenever you need them.

Read all about it.

Send for our general relay catalog. It contains full specs on reed, miniature and power relays. We'll also send along advanced data on newly-designed, state-of-the-art relays. Call or write now.

ARROW-M CORPORATION
250 Sheffield Street
Mountainside,
New Jersey 07092
201 - 232-4260

Relays for advanced technology.



Arrow-M

Seven cermet trimmers that

How?

- Through design versatility
- Fast delivery
- Excellent quality

Necessary Decisions:

1. Single vs. multiturn
2. Sealed vs. not sealed
3. Size
4. Resistance
5. Pin spacing
6. All-important, PRICE

Take a close look before you select your next trimmer. Call your local Beckman Helipot distributor for free evaluation samples.

To get his phone number, or immediate technical literature, call toll-free (800) 437-4677.

Beckman
HELIPOT DIVISION

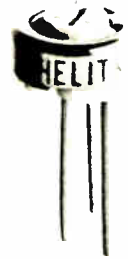
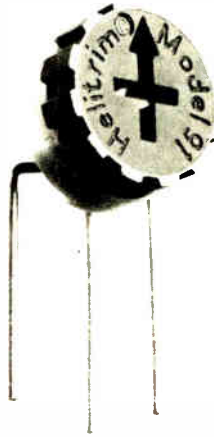

Single-turn

Model 91

- High quality – low price
- Unique brush contact
- Excellent setability
- 100% inspected
- Protective dust cover
- Top or side adjust
- Screwdriver or hand adjust
- Standoffs prevent rotor binding and permit board washing
- Small $\frac{3}{8}$ " dia. size
- 12 pin configurations
- Wide resistance range: 10Ω to $2\text{ meg}\Omega$

Price: \$0.42*



Model 72

- Sealed for board washing
- Available in VALOX 420-SEO housing
- Top or side adjust
- Brush contact
- Excellent setability
- Only 2 ohms of end resistance
- $\frac{3}{8}$ " square
- 100% inspected
- 8 pin configurations
- 19 resistance values

Price: \$0.54*



Model 82

- Lowest profile trimmer in industry
- $\frac{1}{4}$ " dia. by 0.150 " max. height
- Sealed for board washing
- Flame-retardant design
- 82P – top adjust
- 82PA – side adjust
- 100% inspected
- Brush contact provides excellent setability
- A cermet benefit that wirewound can't approach: resistance range 10Ω to $1\text{ meg}\Omega$

Price: \$1.12*



handle 95% of your applications.

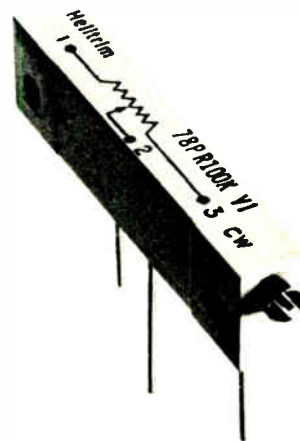
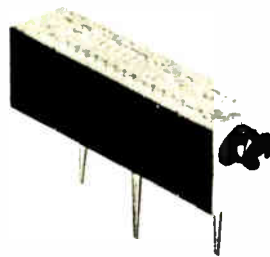
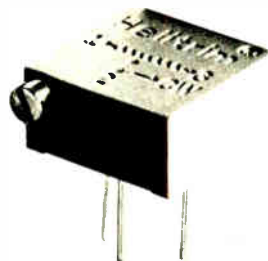

Multiterm

Model 64

- Miniature, sealed trimmer
- 22 turns of adjustment
- Operates with 0.25 watt at 85°C derating to zero watts at 150°C
- 100% inspected
- 18 resistance values: 10Ω to 1 megΩ
- ¼" square size is excellent for P.C. board packaging
- Uses Beckman's unique brush contact design
- Adjustability – voltage ratio within 0.01%

Price: \$4.20*



Model 66

- Low-cost, multiterm with benefits of more costly trimmers
- Sealed for board washing
- 20 turns for adjustment accuracy
- Compact ⅜" square housing
- Brush contact
- 3 pin styles for efficient space utilization
- Broad resistance range: 10Ω to 2 megΩ
- Operates with ½ watt at 25°C
- 100% inspected

Price: \$2.70*

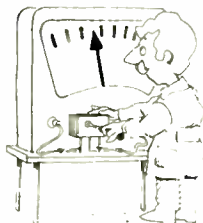

Model 89

- Our lowest cost multiterm
- Sealed for board washing
- ¾" rectangular trimmer just 0.250" high
- Needs no O-ring because of our unique ultrasonic sealing technique
- Only 2 ohms of end resistance
- 15 turns for accurate and quick adjustment
- 3 pin styles for mounting versatility
- Panel mount available
- 100 ppm/°C tempco
- 19 resistance values available
- 100% inspected

Price: \$1.05*



Model 78

- Military performance at industrial prices
- 1¼" rectangular only 0.195" wide
- Sealed
- 3 terminal styles: Flex leads Printed circuit pins Solder lugs
- Panel mount available
- Power rating 0.75 watt at 70°C
- 100% inspected
- 22 turns of adjustment
- Resistance range: 10Ω to 2 megΩ
- 100 ppm/°C tempco

Price: \$2.28*



*1,000-piece price

Electronics/February 6, 1975

Circle 55 on reader service card 55

WHICH WAY IS BEST FOR YOU?

The data acquisition problem is as simple as getting from point A to point B. Just take the analog signals from your sensors and convert them to digital signals for your computer to process.

The solution is not so simple. There are a lot of different ways to go. A lot of potential pitfalls to be avoided. A lot of trade-offs to be judged. Which way is best for your particular needs?

Amplifier-per-channel vs. low-level multiplexers.

If you're not seriously concerned with performance, if the lowest possible price is your only criterion, low-level multiplexers make sense for you. If you're willing to invest a little more money, however, an amplifier-per-channel system offers significant performance advantages. A few of the benefits are signal isolation, lower noise, faster throughput, greater accuracy, continuous analog output, less crosstalk, overload protection, and low pass filtering.

Amplifier-per-channel vs. instrumentation amplifiers.

If you have a real need to maintain constant manual control, and if price is no object, then instrumentation amplifiers are the way to go. On the other hand, if you're geared for computer-control and don't mind saving a great deal of money, an amplifier-per-channel system is the only reasonable choice.

The Neff 620 amplifier-per-channel data acquisition system vs. building your own.

If your engineers are analog-oriented and have a great deal of time on their hands, you might try to build your own system. Lots of luck. If such is not the case, the Neff 620 analog signal processor was designed and built especially for you.

The Neff 620 is a compact box that contains differential amplifiers (Neff invented the original one 18 years ago!), low pass active filters, high level FET multiplexer, programmable gain amplifier, analog-to-digital converter, and control logic. In short, everything you need to get from point A to point B.

The Neff 620 is expandable all the way up to 2048 channels, popular minicomputer interfaces are designed and available, and the unit will not cost you more than about \$200 per channel.

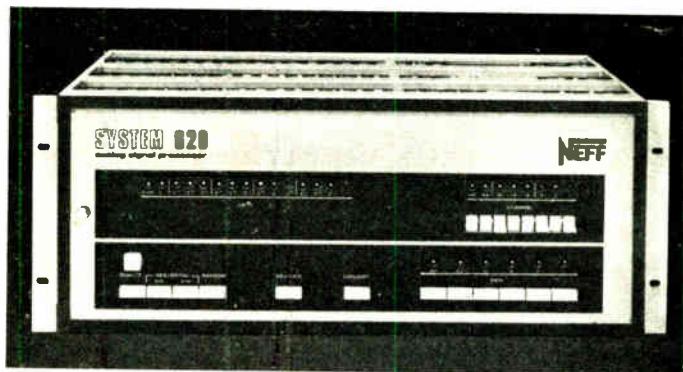

Your next step.

If you're still with us, you're beginning to get a pretty good idea of the way you should go. Your next step is easy. Give us a call. Or write. Ask for our thoroughly informative brochure on the Neff 620 amplifier-per-channel data acquisition system.

You win.

NEFF

Instrument Corporation
1038 East Hamilton Road
Duarte, California 91010
(213) 357-2281

**Eliminate
messy design
and start-up
problems with
the MP12
microprocessor.**

**The clean
machine**

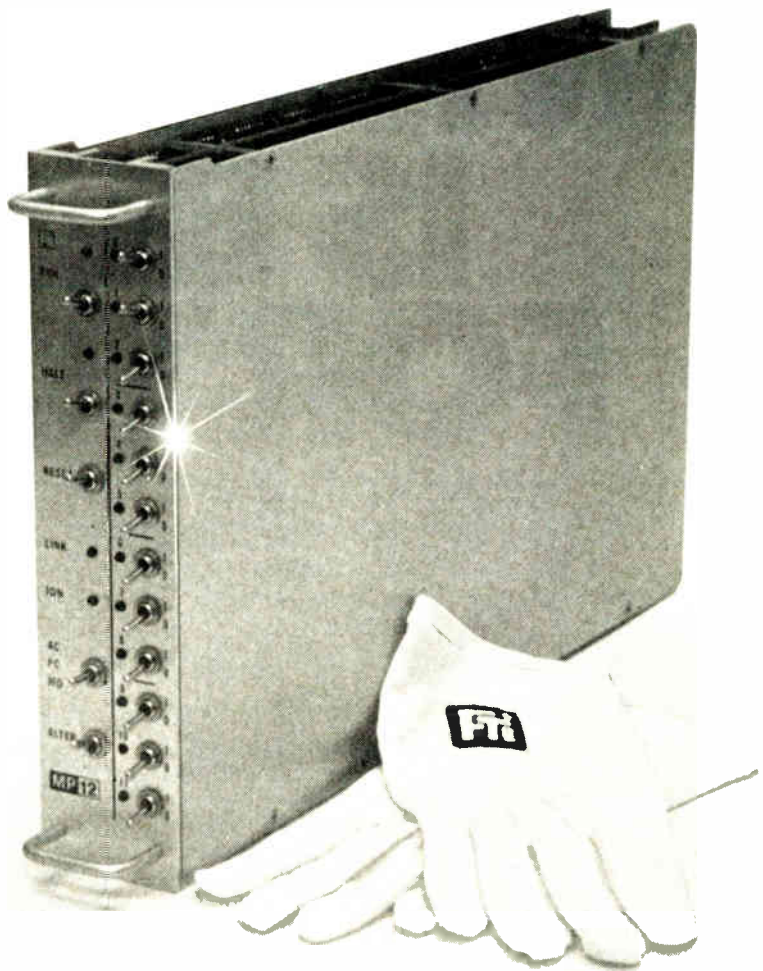

If you think getting a microprocessor on-line means a lot of electronic design and interconnection problems, take a look at the MP12. The cleanest, simplest, most straightforward microprocessor ever made. It can get your system up and running in less time than you ever thought possible.

All Together. When you buy a so-called "computer-on-a-chip", you wind up buying a lot more hardware in order to get a functional unit, and you're faced with a time-consuming design effort. When you buy an MP12, you get a complete computer, with 4K core memory, ready to plug in and run. No messy logic design. No tangle of backpanel wiring.

Easy Interfacing. The MP12 is easy to interface to almost any peripheral—up to 64 devices. It has a 22-line interface which includes the direct mem-

ory access and programmed input/output channel. As an option, we'll supply I/O cards that make it simple to wire wrap your own custom interface electronics. Or you can use our cards to attach to standard peripherals. The whole system plugs into a standard rack containing no wires.

Software Support. Software development can be a real problem with other microprocessors. Not with the MP12. It comes with complete supporting software assembler, diagnostics, loader, utilities, debug, 360/370 cross-assembler. Cuts your application software development time drastically. As a bonus, your PDP-8 programmers already know how to program the MP12 because the machines are software compatible.

Getting on-line can be easy, with the clean machine. Only \$990 in quantities of 100. Write or call for a demonstration.



FABRI-TEK[®] INC.
COMPUTER SYSTEMS

5901 South County Road 18 • Minneapolis, MN 55436 (612) 935-8811



HOME OF MP12

**SALES
OFFICES IN:**

Boston
(617) 969-5077
Chicago
(312) 437-4116

Dallas
(214) 661-3155
Denver
(303) 753-0631

Detroit
(313) 487-5940
Long Beach
(213) 420-2493

New Jersey
(201) 964-4770
Orlando
(305) 857-1050

Phoenix
(602) 266-4448
Sunnyvale
(408) 739-4780

Hong Kong
K-331383
Munich
089-755-8298

Tokyo
(03) 432-6901
United Kingdom
Maidenhead 37321-4

EDP outlook dims as deadline nears on file security

In view of a September deadline for compliance with the Privacy Act of 1974, the possibility looms that some Federal agency chiefs will simply shut down data banks containing personal information on citizens if such information is in duplicate elsewhere; this, rather than pay for the new peripherals needed to make computer files secure from unauthorized access. It would mean a reduced Federal market for electronic data processing—not as lucrative as what was originally expected by the data-processing industry. What the bureaucracy is worried about is the forecast from the Office of Management and Budget that security measures would cost \$1 billion over the next five years, \$100 million of that for electronic security, additional memory and additional transmission costs.

If OMB pushes enforcement only nominally, which is deemed possible by sources in the General Services Administration and the Congress, few systems may be shut down. On the other hand—as one source estimates—“dozens of EDP systems, maybe 100 or more” of the 7,800 operated by the Government, could be returned to inventory by agencies unwilling or unable to pay for strict security.

Limbo possible in data-processing sales to banks

There could be a two-year dry season ahead for data-processing companies wishing to sell electronic funds-transfer systems (EFTS) to nationally chartered savings and loan associations and commercial banks. Rep. Fernand J. St. Germain (D., R.I.) and Sen. William Proxmire (D., Wis.) have proposed a two-year moratorium on EFTS installations to await recommendations concerning data-processing standards before Federal regulators are allowed to authorize new EFTS [*Electronics*, Nov. 28, 1974, p. 75]. A still-to-be-named national commission on EFTS is expected to come up with recommendations by the middle of next year. (For related story, see p. 42.)

Moratorium fever was sparked last Dec. 12 when the U.S. Comptroller of the Currency, James E. Smith, proposed allowing national banks to install on-line terminals in point-of-sale locations. A hearing on the Smith proposal is set for April 2. In the meantime, EDP companies have been lobbying on Capitol Hill, arguing that the comptroller would not let big banks offer services unmatched by local banks, and that the moratorium is therefore unnecessary.

Bidding is near on cockpit warning systems

Bids are due by the end of February to outfit the United Air Lines and Eastern Air Lines jet fleets with ground-proximity warning systems, according to industry sources. At stake is \$5 million to \$6 million in orders for the \$3,500 system. Sundstrand Data Controls, Bendix Avionics, the Aero division of Litton Industries and the Edo Corp. are some of the companies trying to get a large part of the FAA-mandated market in cockpit warning systems. Litton has already won a \$3 million contract to equip the American Airlines fleet (see p. 46).

Bendix has begun product presentations to European airlines, and also to the U.S. Air Force, eyeing the thousands of military transport planes as a lucrative market after commercial fleets are outfitted. There is a December 1975 deadline for the commercial outfitting.

The reliability challenge

Caught in the crunch between the soaring costs of weapons and personnel and a Congress increasingly critical of military spending, the Pentagon is leaning hard on contractors to improve system reliability and maintainability as a cost-cutting device. DOD's approach to its R&M problems was detailed at the end of January in Washington by Jacques S. Gansler, deputy assistant secretary for materiel acquisition. The key points from his remarks to the 1975 R&M symposium follow.

—Ray Connolly

The average cost of a soldier has doubled in the last five years, while the total military force has been reduced by 1.2 million, or about one third. In addition, equipment costs for new weapon systems have shown a fourfold increase over the past decade, excluding the effects of inflation.

The vicious cycle

To keep up the force levels, the DOD must continue to use old systems. Many of these old systems are wearing out and therefore they generally have lower reliability, thus they cost more to operate and maintain. This, then, calls for more use of the increasingly very expensive manpower—a vicious cycle!

The defense account which has been increasing the most rapidly over the past few years is the cost of equipment operation and maintenance. This is the area in which you here can have the greatest impact—if you are able to reverse the trend of rising costs.

Unless these trends are reversed, in only a few years all of our defense dollars will be spent to cover manpower, and operating and maintenance costs, with none left for procurement of new systems or modernization of existing equipment.

What DOD is doing

Now, what can be done?

First, in the area of reducing equipment costs, a critical step is "design to cost." To get the quantities of equipment we need requires designing equipment to an affordable cost; secondly, more test and evaluation; thirdly, more competitive prototypes.

Other steps currently under way which will also reduce our equipment costs include:

- More advanced-technology demonstrations before incorporating new technology into a weapon system. When the state of the art is pushed in new systems, our costs go up dramatically. However, we have found that when the

technology was first fully demonstrated and then applied as a product improvement, our costs were almost half.

- Through feasibility demonstration of new components and new technology, we will develop more options for our weapon systems. But we will do less full-scale development.

- We are planning far more standardization, especially of subsystems. The defense standards board has been set up to do this; and through its panels, we are moving with selected success.

In addition, we have recently established a joint industry/Government group looking at better application of military specifications and standards to see where we can provide guidance to allow more flexibility in their use. Also we have just set up a second industry/Government group looking at broader use of commercial equipment.

An area of particular concern to me is the need to be realistic in specifying our reliability, availability, and maintainability requirements. You need to help us to do this. On the other hand, the DOD also looks to you to realistically demonstrate that these requirements have been met in the field, not the laboratory environment. We ask you to take a great leap forward in field demonstration methodology so as to permit prediction and evaluation of true field reliability.

The changed environment

In the "cold war" era, maximum performance was king, and we were willing to pay whatever it cost. In times of conflict, as in Korea and Vietnam, minimum delivery time was required, and again we accepted the higher costs for maximum performance at the earliest possible date. But in today's environment—of inflation, shortages, and an all-volunteer service—cost has succeeded to the throne.

You in the R&M area have responsibility for correcting the single biggest cost area. For years, you have been talking about the need to do some of these things. But now you have to start coming up with specific suggestions to make them work.

Some of you have been responding to this challenge. Others of you have gone on the defensive and are trying to protect your own institutions, rather than aggressively moving in a direction that will help all of us. If we are not successful in reducing equipment costs and support costs, we will no longer have a credible defense deterrent. The choice is yours; but to achieve anything it has to be done now!

The new EPC 2200 XYZ recorder for spectrum analysis. Low Cost. Lightweight. Precise.

The new EPC Model 2200 is the first truly fine quality, lightweight, low cost XYZ recorder ever made.

When matched with a spectrum analyzer, the Model 2200 prints spectral data on continuous, dry-paper hard copy over a 19.2" display. A hard copy history-plot of spectral data not only permits data comparison, but reveals spectrum lines buried as much as 6 db below the noise level. And the 19.2" display presents in excess of 3,000 data points with each sweep. Information that is subtle and transient on a scope becomes clear and permanent on an XYZ recorder.

The Model 2200 interfaces with either digital or analog equipment. It sweeps at speeds between 1/10 second and 8 seconds.

The EPC Model 2200 is currently built in four modified formats. Further customization is possible to meet specific customer requirements.

EPC

EPC LABS, INC.
123 Brimbal Avenue
Beverly, Mass. 01915 USA
(617) 927-2523

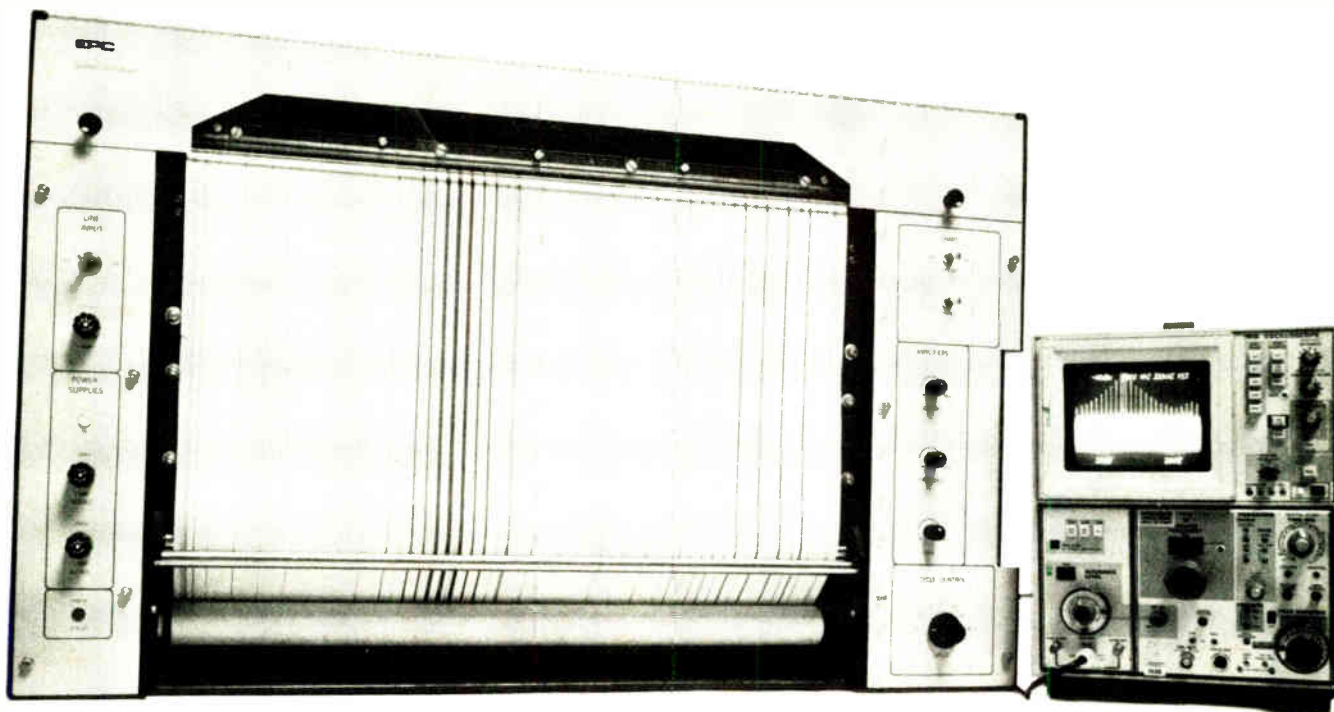

Two linear detectors in portable X-ray machine measure metal stress

One sure way to get a precise reading of surface stresses in metal structures is to measure the crystal deformations by X-ray diffraction. Trouble is, this method traditionally requires a precision goniometer working under laboratory conditions to pick up diffraction peaks. That rules out on-the-spot inspections of such structures as pressure vessels, ships' hulls, and beams.

The precision goniometer is dispensed with, however, in a new set of stress-checking gear that Compagnie Générale de Radiologie (CGR) has readied for the market. Instead of the usual point-detector/goniometer combination, the CGR gear employs a pair of linear detectors that cover the whole diffraction field.

The measuring head—X-ray

source, detectors, and a mounting frame, complete with magnets to hold it on steel plates—weighs only 18 kilograms. "You can bring our machine right out to the structure," says Georges Dodement, who heads the nonmedical activities of CGR. The company, part of the Thomson-Brandt group, has set a rough price of \$55,000 for the equipment and plans to start deliveries this spring.

Time-saver. Along with its *in situ* advantage, the instrument cuts dramatically the time it takes to make stress readings, Dodement points out. Ordinarily, about eight hours must be spent to do the job manually—painstakingly setting up the goniometer at different angles to spot diffraction peaks with a point detector and then calculating the stress. With the CGR gear, a reading

takes only about 15 minutes.

CGR has paired its light-weight measuring head with a mini-computer programed to handle the calculations and print out the stress in hectobars, with accuracy to 3 units. The computer is packaged with the electronics in a portable cabinet that weighs 200 kilograms.

Crucial to the stress-measuring set, Dodement points out, are its linear detectors. The basic idea was first conceived by a researcher working at a U.S. Atomic Energy Commission facility, and now CGR has commercialized the invention, under license from the agency. The detector operates at high voltage and utilizes a carbon-covered quartz fiber inside a gas-filled chamber, fronted by a metalized Mylar window 5 centimeters long.

When an X-ray photon diffracted back from the surface being checked passes through the window and ionizes the gas, an avalanche of electrons is set up at the point where the photon is absorbed. They collect at the corresponding spot on the quartz fiber, which functions as the anode of the detector, and propagate along it toward both ends.

Measurement. The exact spot where the electrons hit the fiber is measured electronically, but not by trying to measure the difference in time it takes them to reach the ends. Instead, the circuitry compares the difference in the time between the pulses at each end of the fiber. Processing that information results in a pair of uniform pulses whose spacing reflects the position along the fiber where the electrons first hit.

Because the linear detectors cover a wide field with their 5-centimeter windows, they pick up the diffraction peaks directly. As a result, operation of the equipment is straightforward. First, the Young's modulus, the Poisson coefficient, and the Bragg angle for the material

Portable. The head for precision measurement of metal-surface stresses, including X-ray source, detectors, and mounting frame, are attached to steel structure by magnets.

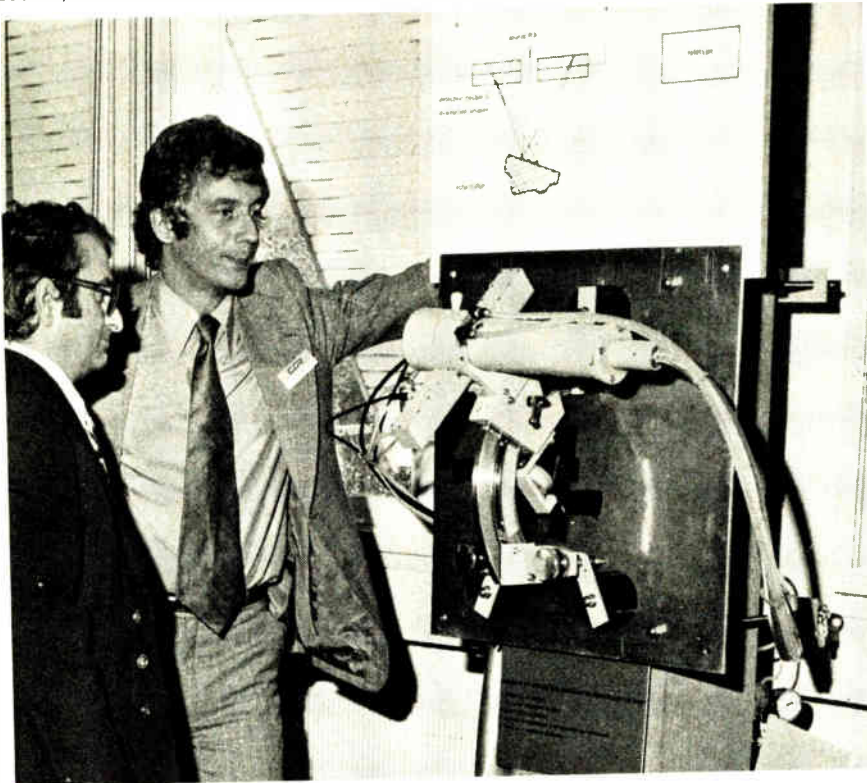

under test are fed into the computer, along with the Bragg angle, for a calibration of the material. Then no-stress peaks are measured by taking readings on gold or iron powder sprinkled on the test area. Next, readings are taken on the structure—first with the X rays hitting it head-on and then at an angle of 45°. The computer then figures out the stress in the structure. □

West Germany

Skin touch actuates IC light switch

A West German component maker is relying on the homeowner's fascination with novelties to induce him to buy a new light switch based on an integrated circuit and operated at a touch. Intermetall GmbH, an ITT subsidiary, will produce the IC, but it won't sell the switch itself.

First samples of the UAA 1001 IC, a bipolar device that comes in a dual in-line minidip plastic package, will soon be delivered to switch manufacturers. Intermetall will also market the external semiconductor components—a triac, a diac, and several diodes per switch—which are made by other ITT affiliates. The switch can operate on the 110 volts ac used in the U.S., as well as the 220 v ac used in Europe.

Expensive. Intermetall says that the finished switch, including a dimmer, will cost 10% to 20% more than conventional dimmer-type switches. However, observers estimate that the new switch will sell for five times as much as conventional household switches without dimmers. A key market target is expensive new homes whose owners won't mind paying a few extra dollars for the novelty, convenience, and reliability.

However, the switch can be installed in existing homes without the need for rewiring, as would be required for the touch-type elevator switch, which the product resembles. And unlike an elevator switch,

the IC switch operates by the conduction of the slight amount of electricity in the body of the person touching it.

When a person touches the switch plate, his body resistance is in series with two input resistors, which typically have a value of 4.7 megohms. The current that flows through the body to ground is so negligible it is harmless. A 500-kilohm potentiometer in the external circuitry can control light brightness by means of a small shaft protruding through the switch plate. If the dimmer is not desired, the switch manufacturer short-circuits the potentiometer. The switch also has a remote-control input that allows it to be operated in parallel with similar switches or electromechanical ones.

Circuitry. The UAA 1001 has three circuits—a highly sensitive input circuit with a Schmitt trigger, an on/off-status memory, and an output stage, which controls the ignition circuit of the external triac. Controlled by the Schmitt trigger, the status memory feeds a signal to the output stage, which consists basically of two thyristors.

These thyristors are connected so that they are blocked when the switch is on, allowing the external triac to be ignited. When the switch is off, each of the thyristors is conducting during one half cycle, which prevents triac ignition. A capacitor/resistor network supplies the voltage for the IC's logic, and a coil/capacitor circuit at the switch output suppresses static. □

Around the world

Gold-diffusion isolation increases IC density

A process of gold-diffusion isolation being developed by Nippon Electric Co. may lead to bipolar ICs that perform better than present ones, yet save dramatically on chip real estate. The key is not to waste space on isolation regions. The other advantages are simplified processing and somewhat higher operating speed, which reduces switching time. What's more, increasing the density level, which can lower costs below those of present bipolar circuits, may make bipolar more attractive than MOS technology in situations where the main attraction of MOS now is higher density. An experimental hex inverter gate measures 0.8 by 0.96 millimeter, an area that NEC engineers say is about half the amount required by conventional techniques.

Modular TV camera can be upgraded

A high-reliability television camera for industrial applications has been built in modular form by Marconi-Elliott Avionic Systems Ltd. so that it can be tailored to the job and expanded. Extended tests predict a mean time between failures of 8,000 hours for everything but the camera tube. For the European market, the camera scans 625 lines at 50 fields per second or for the U.S. market, 525 lines at 60 fields per second. Price in its simplest form without the camera tube is \$1,500, but various options can boost the price to more than \$2,400. The system consists of two units—the camera itself and the camera-control unit. Modularity is attained by means of printed-circuit boards, each of which contains a complete functional circuit.

Analog indicator uses ICs and LEDs

An integrated circuit that drives a line of light-emitting diodes has been designed by Siemens AG to serve an analog indicator similar to a column of liquid in a thermometer. The West German firm will begin next month to sample the bipolar IC, the UAA180, which selectively switches the row of LEDs on and off. A chain of 12 different amplifiers—one for each LED—converts the analog information to be indicated into voltages that control the LEDs. These voltages switch the LEDs on and off successively so that a light band moves back and forth across the scale. Reference voltages mark both ends.

Nowadays, you can't buy immediate delivery.

But you can rent it.

When you order electronic test equipment, you could wait weeks or even months for delivery.

Or, you could rent from REI, and have what you want within hours. With the largest inventory in the business, it's a safe bet that your local REI Instant Inventory Center has exactly what you need. And it's just a phone call away.

Immediate delivery is just one reason for renting from REI. Saving money is another. You pay only for the period you have your instruments, and you can return them anytime . . . so you get more mileage from your equipment budget.

REI stocks 8,137 fully checked-out test instruments. And they're ready whenever you are. For the full story on renting, as well as prices, send in the coupon for prompt delivery of our free illustrated catalog. Or, call us now for your immediate requirements.

Burlington, MA (617) 273-2770 • Gaithersburg, MD (301) 948-0620 • Oakland, NJ (201) 337-3757 • Ft. Lauderdale, FL (305) 771-3500 • Des Plaines, IL (312) 827-6670 • Dallas, TX (214) 661-8082 • Mountain View, CA (415) 968-8845 • Anaheim, CA (714) 879-0561 • Rexdale, Ontario (PLC Leasing Ltd.) (416) 677-7513

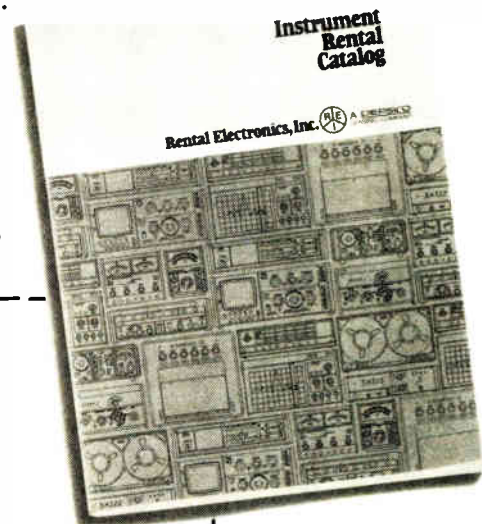

Rental Electronics, Inc.
99 Hartwell Avenue, Lexington, Mass. 02173
Please send me your free, 78-page rental
equipment catalog:

Name _____ Title _____
Company _____
Address _____
City _____ State _____ Zip _____

Rental Electronics, Inc.

A PEPSICO LEASING COMPANY



Europeans fear Cramer moves may portend U.S. grab

If Cramer electronics, the second biggest broad-line components distributor in the U.S., is entering the UK market, can Hamilton and other large U.S. companies be far behind? That's the reaction by some observers to Cramer's announcement that it will begin doing business in the UK on March 1, and it intends to open up shop in France and West Germany in 1976.

Some observers worry that entrance of companies the size of Cramer—\$152 million in sales in 1974—could mean a U.S. takeover of most of the UK and European markets. **One executive comments that it would become easy for U.S. companies to “dump” products in Europe that aren't selling well in the U.S.,** although getting franchises and market penetration will take a while. Cramer's two-and-a-half-year-old Italian operation now has sales of more than \$5 million annually. The UK's largest distributor, ITT Electronics Services, sells about \$17 million a year.

French firm sees spurt in sales of radiation detectors

Le Matériel Téléphonique, a French ITT affiliate best known for its telephone exchanges, flight simulators, and navigation hardware, predicts a spurt this year in sales of its lesser known radiation-detection gear. The company has signed a contract with the nine-nation nuclear-energy community, Euratom, to market a nondestructive tester that checks plutonium levels in radioactive wastes and spent-fuel rods from nuclear-power plants. LMT officials foresee a potential market of 20 or so of the \$35,000 testers in Europe within the next three years. LMT also expects to score this year with a wide-angle multidetector for neutrons. **Intended for in-reactor diffraction experiments, the 130° version of the apparatus covers a sector that would otherwise require 650 individual detectors.**

Germany attracts new investments, despite downturn

West Germany, despite the slowdown of its economy, continues to be one of the preferred countries for investments by foreign electrical-electronics firms. **During the first six months of last year, foreign investments were increased 14.9% or \$185 million. Most came from American, Dutch, Swiss, and French companies.** This upward trend, says an official at the Electrical Industries Association in Frankfurt, continued during the second half of 1974 and is likely to hold up this year. The reason for it is the good long-term prospects of West Germany's electrical-electronics markets.

At the same time, foreign investments by German firms also went up by 7.2%, or more than \$100 million, during the first half of last year. The preferred countries for German investors were Great Britain, Switzerland, Spain, and Brazil.

Executives fear UK vote against Common Market tie

Some electronics executives in the United Kingdom fear that voters will turn down Britain's continued membership in the Common Market in the upcoming referendum engineered by the Labour government. **If the UK withdraws, electronics companies may face higher tariffs, which will put them in a noncompetitive position in selling their**

goods on the Continent. One distribution executive worries that higher tariffs may force him to tackle the tough, expensive U.S. market. Even if the UK could negotiate a special trading position after it leaves the market, years might pass before settlement of the issue. **Some executives are talking about organizing pro-Market advertising campaigns through their trade associations.**

Japanese to sell own faster 8080 microprocessor

A pin-compatible version of the Intel 8080 8-bit n-channel microprocessor has been boosted to a new performance level by the joint effort of two Japanese companies subsidized by the Ministry of International Trade and Industry. **Mitsubishi Electric Corp. and Oki Electric Industry Co. will both sell the chip and use it in their own equipment in a grab at a piece of Japan's microprocessor market.** That market is said to total more than \$3 million a month, including central-processing units, peripheral chips, and memories.

Improvements include interface current high enough to directly drive transistor-transistor logic and operation at the clock frequency of 2.5 megahertz, 25% faster than the 8080. Samples will be available in March and production quantities in July. Other devices available, and to become available by summer, include a static n-channel random-access memory of 1,024 bits by one word, a dynamic n-channel 4,096-bit RAM, an n-channel read-only memory with a capacity of 8 kilobits, an 8-bit input/output port, and a 4-bit bidirectional bus driver.

Customer types gasoline order, computer bills him

A computer-controlled self-service gasoline station is undergoing long-term tests in Braunschweig, West Germany. At the station, operated by Deutsche BP AG, a subsidiary of British Petroleum, the conventional gasoline pumps are replaced by special dispensers with keyboards. **The customer taps the keyboard to select regular, high-test, or a mixture of gasolines, as well as the number of liters, the money value he wants, or a "full tank."**

The operation is controlled by a small MOS-based computer located in the attendant's office. The computer is made by the Scheidt und Bachmann GmbH, a manufacturer of special-purpose electromechanical and electronic equipment. **If the six-month tests go well, BP says, it will install more such stations to streamline operations at big stations.**

Addenda

Kyoto Ceramic Co., a leading Japanese manufacturer of ceramic packages and substrates, will deliver a ceramic-production plant to V/O Technopromimport, the Soviet Union's industrial import agency. The \$17 million package includes \$4.4 million for technology. The integrated plant, to be delivered in June 1976, handles the mixing of raw materials and turns out completed products, including hybrid circuits and substrates for variable resistors. . . . **The 11 West Germans caught providing information on the operation of IBM Corp. computers to the intelligence agency of "an Eastern power," will be tried for violation of embargo regulations.** Nine of the 11, one of whom is an IBM maintenance technician, are still being detained. No trial date has been announced.



THE END OF THE ARGUMENT... THE CHOICE IS YOURS!



ALGEBRA

or

RPN*



- Algebraic Entry
- Two Parenthesis Levels

- *Reverse Polish Notation
- 4 High Operational Stack

Both With

- Full Scientific Functions • Full Scientific Notations • Full Feature Memory • Twelve Digit Display

HEADQUARTERS—
Product Mgr., Mr. Julius Hertzog; MOS Technology, Inc.,
950 Rittenhouse Rd., Norristown, Pa. 19401 (215) 666-7950
EASTERN REGION—
Mr. William Whitehead, Suite 307—88 Sunnyside Blvd.,
Plainville, N.Y. 11903 (516) 822-4240
WESTERN REGION—
MOS Technology, Inc., 2172 DuPont Dr., Suite 221
Patio Bldg., Newport Beach, Calif. 92660 (714) 833-1900



MOS TECHNOLOGY, INC.
VALLEY FORGE CORPORATE CENTER, NORRISTOWN, PA. 19401 (215) 666-7950

Probing the news

been determined yet," although he believes "we can get down to the microprocessor level."

What the computer must do sounds relatively simple. The specification calls for aircraft position in latitude and longitude, ground speed, track, and range. But as Beran, a career navigator, explains: "The problem is this: the propagation corrections are probably the biggest difficulty of converting the signals received into useful information. The corrections involve the speed at which the airplane is traveling over the ground; the time of day; the date; whether it is traveling over ground, or water, or ice; and the relative position of the airplane to the transmitter. All that information has to be either stored, or you are going to have to work out a very, very clever program."

Moreover, the processor will have to "be able to dead-reckon during periods when there is signal outage, or when the signal-to-noise condition degrades to the point where the system is not usable. We want this set to be able to do the same thing the human navigator does."

In July 1976, the third and final phase of production is scheduled to begin after a single winning contractor has been named. That timetable is designed to permit the Air Force to start installing its first operational system in April 1977—eight months before the beginning of the phaseout of the Loran A network that Omega is designed to replace. But it will be the second preproduction phase in which the Air Force will learn if it can meet the design-to-cost target it is aiming for.

One cost key will be the development of a specification by Aeronautical Radio Inc. for the Omega hardware, Beran notes. The control-and-display unit will be the first to get one. "We have a hard spec now," he says, "and the kind of standardization that permits is going to drive the cost of the equipment down" by calling for commercially available parts wherever possible.

The Aeronautical Systems division at Wright-Patterson Air Force Base arrived at its price target rather



Omega boss. Lt. Col. John F. Beran, career Air Force navigator, runs Omega project office. His project could mean \$22 million sale in on-board electronics for winning contractor.

simply, aided by the fact that Omega's vlf technology has been around for more than a decade now. "Commercially available Omega receivers without processors range in price from \$3,000 to \$8,000," observes the division's Brig. Gen. R.A. Foster, deputy for reconnaissance/strike/electronic warfare and Col. Beran's boss. "Processor costs of existing avionics equipments are estimated to be in the \$5,000 to \$15,000 range. The airborne Omega target price is consistent with these component prices."

First-generation airborne, automatic Omega units now cost between \$30,000 and \$50,000 apiece, but Foster notes that present Air Force plans call for "a more austere" system than existing automatic sets. That constraint plus "the combination of progress along the learning curve, new technology, and competition can bring about significant reductions in price," he argues, and make the \$15,000-per-plane figure achievable.

Warranties. A somewhat trickier goal in holding down Air Force Omega life-cycle costs will be its attempt to develop a contractor warranty system to maintain the equipment—another innovation with its

roots in Arinc, the company owned by the nation's commercial airlines and operator of their communications net. "The reliability improvement warranty, or RIW concept, has evolved as a means to resolve the continuing problem of acquiring equipment and finding that field reliability is considerably below that called for in the procurement specification," explained Gen. Foster. The Omega contract will call for an initial RIW period of five years with two renewal options.

Under the plan, a manufacturer will get a fixed price to repair all equipment failures in that time frame. By improving equipment reliability in the manufacturing phase and thus cutting down on field repairs in the warranty period, a manufacturer can maximize profits. That's the incentive that the Air Force hopes it can sell industry to the point where it will become a standard procurement practice on awards where the state of the technological art is not being pushed. The advantage to the Air Force, of course, is the economy it expects to realize in reduced training outlays for technicians and smaller inventories of spare parts at its depots throughout the world. □

High Rel COS/MOS is winning over T²L logic users.

The chart below is merely a partial representation of the broad variety of military and aerospace programs where RCA High-Rel COS/MOS circuits are being used, instead of T²L and other logic. It shows both wide acceptance and confidence. Not only in RCA technology. But in the COS/MOS devices that technology has produced.

If your digital system can be improved by taking advantage of the performance characteristics of CMOS, you can now start incorporating RCA COS/MOS with confidence. All RCA COS/MOS circuits are available in High-Rel Mil-38510/883 specs from a Mil-M-38510 approved production facility in Findlay, Ohio. And all are available through your local RCA distributor. The fact is,

we already have a most comprehensive line of High-Rel COS/MOS ICs and, as new RCA COS/MOS products are developed, they'll become available in High-Rel versions soon after commercial announcement.

To order your High-Rel COS/MOS devices and the free High-Reliability Integrated Circuit brochure, contact your local RCA Solid State distributor. Or RCA.

Write: RCA Solid State, Box 3200, Somerville, New Jersey 08876; Ste. Anne de Bellevue 810, Canada; Sunbury-on-Thames, U.K.; Fuji Bldg., Tokyo, Japan.



PROGRAMS USING HIGH REL COS/MOS

GENERAL GOVERNMENT

- TOW COBRA
- S 3A AIRCRAFT
- LANS PROGRAM
- D-106S COMMUNICATIONS
- AIRS
- ARC-150
- ARC-164
- PRC-85
- STINGER
- AN/ALE 139
- DMD/PLARS
- AFSCS
- FAA VOICE SWITCH
- MULTI ROLE COMBAT AIRCRAFT (EUROPE)
- AN-TPN-19
- AN-ASQ-119
- ARTIC
- AWA

- MK 46
- CAPTOR
- MANPACK
- SKIRU
- NYVC
- BISS

ARMING DEVICES

- XM-56
- SM-70
- ADAM
- FMU-27
- FMI

SATELLITES, AEROSPACE

- ATMOSPHERIC EXPLORER
- HEAO
- SPACE SHUTTLE
- ITOS
- B-SAT
- SAT COM
- NIMBUS
- HELIOS
- OSCAR-6
- PIONEER F
- ATS
- IMP SATELLITES
- MJS-77
- (MARINER, PIONEER-SATURN)
- CTS
- VELA

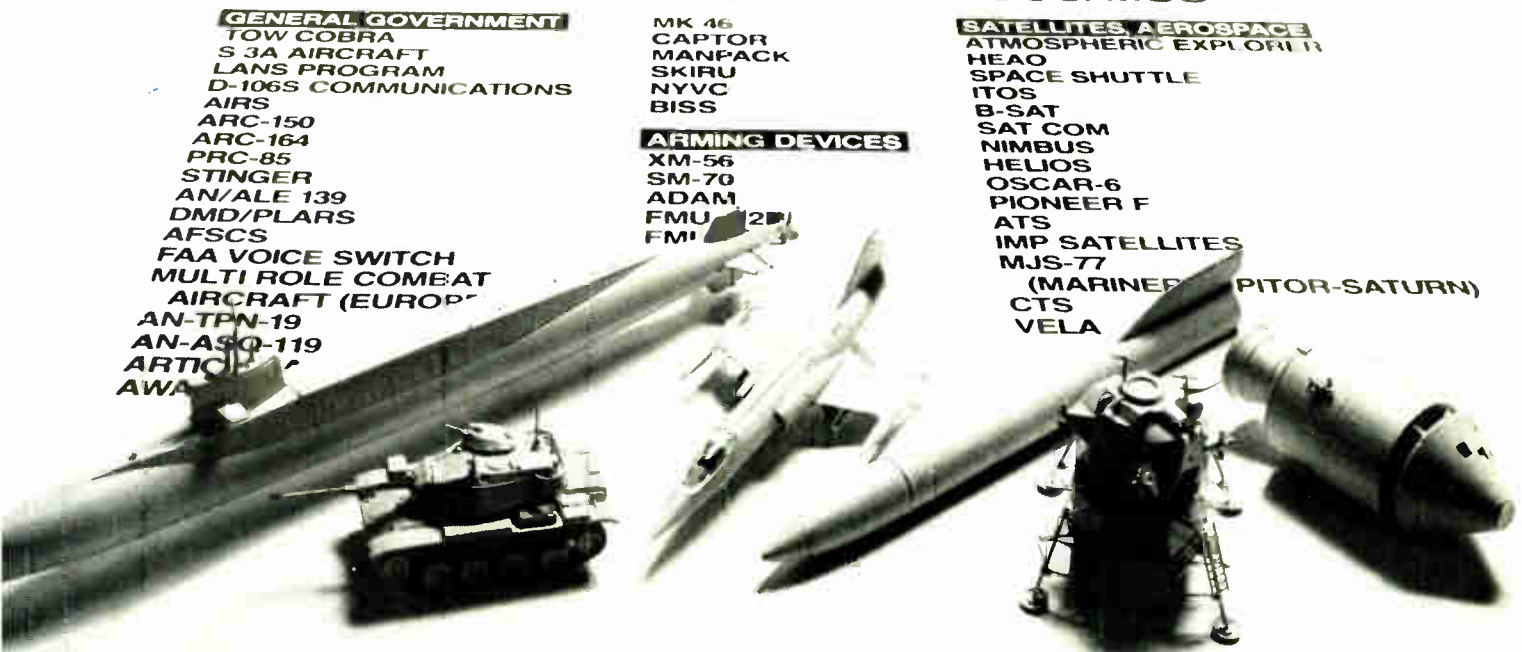

RCA. The first house in CMOS.

Circle 71 on reader service card

Solid state

ISSCC has news for LSI users

Preview of Feb. 12 meeting in Philadelphia uncovers developments in instrumentation, communications, data processing, computerized control

by Laurence Altman, Solid State Editor

The bell is about to sound for the next round of LSI technology as designers take the wraps off new circuits aimed at the next generation of instrumentation, communications, data-processing, and computerized control equipment. That will be the message from Philadelphia and the International Solid State Circuits Conference, where the annual revelations of just what is forming on the leading edge of IC technology will be made Feb. 12 through 14.

Here's what's going to be discussed:

- In digital circuits, bipolar LSI techniques have matured. Now, micropower circuit elements designed with single-transistor logic gates or single-transistor memory cells can be put onto chips containing either tens of thousands of gates of logic or thousands of bits of random-access memory. Meanwhile, improved n-channel and complementary designs are speeding up MOS memory access times to less than 100 nanoseconds, while retaining the MOS hallmarks: low power and high density. These fast MOS RAMs will compete briskly with bipolar units for buffer and cache-memory systems.

- In industrial analog devices, IC digital-to-analog converters are being built with linear techniques that pair dedicated LSI chips in single converter packages. The result is 12- and 14-bit d/a converters. Moreover, the harder-to-design single-chip 12-bit analog-to-digital converter is close to reality, now that MOS and bipolar linear elements are being combined in a compact design. Here, linear versions of injection logic structures could provide the needed digital functions on the

converter chip. Finally, in analog communications, improved switching is available from a mixed junction-field-effect-transistor and bipolar chip design that results in eight channels of analog multiplexing with a switching time better than 1 microsecond.

- In microwave, power-frequency records are being set by gallium-arsenide FET oscillators operating at 5 to 10 milliwatts in X band. Also, high-power GaAs FETs, using interdigitized designs, are achieving 1-watt outputs and 6-decibel gains at 6 gigahertz.

- Finally, in analog-signal processing, complex filtering and bandwidth-delay problems are being solved with single-chip charge-coupled devices. These circuits by themselves are revolutionizing signal processing in new military and commercial communications systems. For example, a 500-point

Fourier-transform CCD chip that has been built for secure military systems can handle a transformation that ordinarily would take almost a bank of discrete analog components or an expensive digital computer. Using another CCD method, researchers have developed a 10-channel multiplexed analog delay line for bandwidth compression.

Digital stars. A closer look at the developments reveals that the new

Superstar. That's Intel 4-k RAM, right, introduced two years ago. Analog Devices' DAC, below, will be unveiled this year.

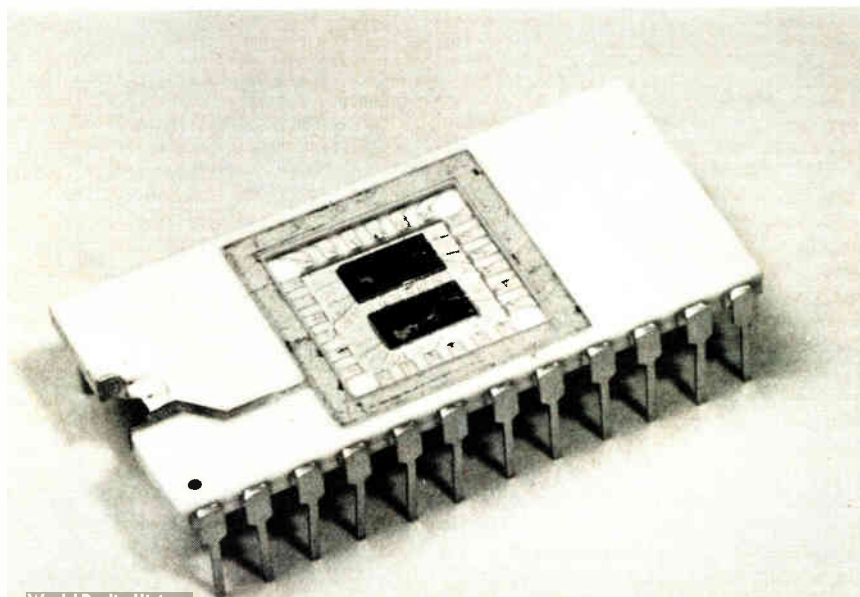
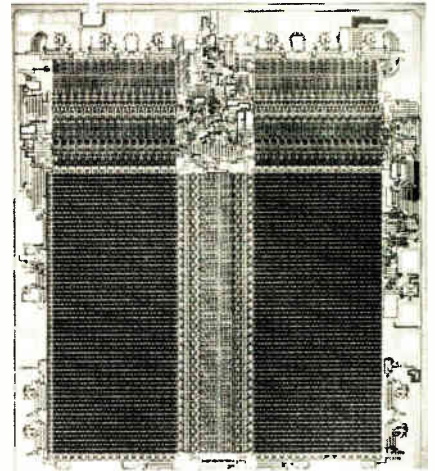

What's new in MOS...

RCA announces the 7001I memory in volume.

What is the company who created CMOS doing in NMOS memories? Putting all of its knowledge in "P" and "N" MOS technologies and its experience in high volume manufacture to work to become an important new source to you.

You told us that although there is already a long list of memory makers you could use another major supplier. One from whom you could expect a steady flow of product in volume. For as long as you need it. Without having to stop to worry about quality problems.

When we decided to enter the field and make memories an important part of the broad RCA semiconductor line, we chose the 7001I 1024-Bit RAM as our starting point. Less than six months after that decision we can accept orders for quantities as high as you can use. And by the time you need 4K memories, we expect to be ready to make the same high volume-high quality offer.

In speed, cycle time, TTL compatibility, package, and every other way the RCA MW7001ID is

interchangeable with any industry standard 7001I. So when the need is there, RCA is ready. We're anxious to set up a program to help you evaluate our product and our production capability.

If you prefer to check out the MW7001ID on your own, you can purchase evaluation quantities through your RCA Solid State distributor. If you really have no immediate need for a new high quality source for the 7001I, watch for the NMOS announcements forthcoming from RCA. When it comes to memories, we're planning to be able to help you in more ways than one.

Write: RCA Solid State, Box 3200, Somerville, New Jersey 08876; Ste. Anne de Bellevue 810, Canada; Sunbury-on-Thames, U.K.; Fuji Bldg., Tokyo, Japan.

RCA

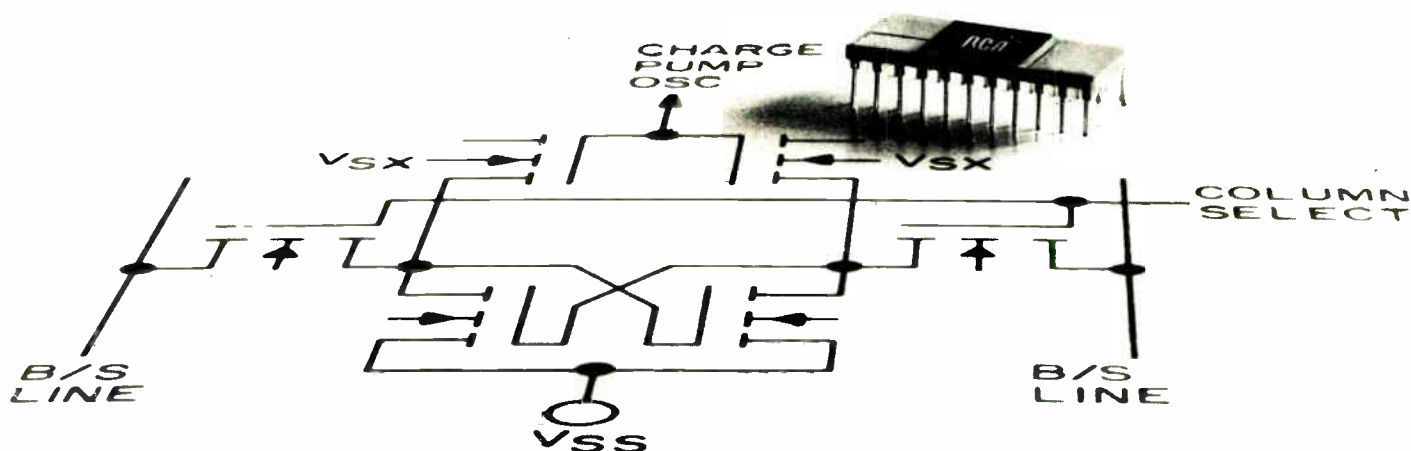

RCA. The first house in CMOS moves into memories

Probing the news

digital LSI circuits are varied and wide-ranging. The highlight in memory design is Intel Corp.'s 4,096-bit random-access memory, which breaks the 100-nanosecond speed barrier [*Electronics*, Jan. 23, p. 25]. The RAM has an access time of less than 80 ns. Moreover, by vir-

tue of its compatibility with emitter-coupled logic at both the inputs and outputs, this n-channel device is not only suited for buffer memories driven by ECL controllers but also is potentially useful as fast ECL-controlled main memory. Clearly, if these high laboratory speeds can be transferred to production devices, this design could weaken the appeal of 1,024-bit fast n-MOS RAMs.

A bipolar memory design that bears watching is the 1,024-bit programmable read-only memory from Siemens AG researchers, who have built the device with ECL structures that use conventional nichrome fusible links for field programming. This PROM, which has the popular 256-word by 4-bit programmable processor organization, can be accessed in 15 ns—fast enough to work with today's bipolar processor designs.

Two trends are evident in the new logic designs: subnanosecond standard logic, and low-power, single-transistor-gate LSI structures. In the high-speed area, researchers at Nippon Electric Co. in Japan are reporting an ECL-type logic family that, with a speed-power product of 8 picojoules, achieves a 400-pJ propagation delay per gate and a 2-GHz toggle frequency. These results, which were obtained on 50-ohm transmission-line systems, earmark the family for data-telecommunications applications, where high-speed controls are required to handle the wide-bandwidth capacity of the new networks.

Another high-speed device is Hewlett-Packard's 1.8-GHz logic circuit. It uses a junction-isolated ECL process, as opposed to the passive or dielectric type of isolation that's become popular with subnanosecond designs but which is more difficult to build, and it achieves cut-off frequencies of 6 GHz that boost the performance of today's emitter-coupled circuits well into the subnanosecond range.

In the single-transistor-gate designs, two developments stand out: International Business Machines Corp.'s new Schottky-transistor logic design developed in West Germany, and Motorola's new complementary-constant-current logic, or C³L, which also uses low-threshold Schottky diodes in single transistor cells.

In the Motorola approach, [*Electronics*, Dec. 12, 1974, p. 36], pnp current-source/load devices make up the entire gate structure, providing a dense and fast LSI design. Its density is 60 to 120 gates per square millimeter; its speed-power product is 2 pJ, and its gate propagation delays are well into the 2-ns ECL range. □

PLASMAC™

A *New* DISPLAY OPPORTUNITY



Custom Design Capability Allows Significant Cost Reductions

- Unlimited combinations of fixed messages, numeric and alphanumeric characters in a single panel.
- Minimized drive requirements with internal bussing and multiplexing.
- Large panels with Large Characters.
- High Brightness with Uniformity.
- Superior Readability.
- Low Power Consumption.

Call or write for full details



NATIONAL ELECTRONICS

a varian division

geneva, illinois 60134 (312) 232-4300

What makes Gallium from Arkansas so special?

It's available . . . in quantity . . . now!
Availability you can depend on for a long time . . . from stock, and as close as your nearest airport.

The reason: Alcoa has just completed a new plant in Bauxite, Arkansas. The plant is in full operation . . . processing large quantities of gallium from our own gallium-rich reserves of Arkansas bauxite.

All of it pure. And the known consistency of our domestic source promises no unexpected trace elements.

That kind of gallium will be coming out of Arkansas for a long time.

Alcoa® gallium.

So there's now an ample supply of gallium for optocouplers, LEDS, injection lasers, magnetic bubble memories or anything else. So don't hesitate in designing with, specifying and purchasing devices utilizing gallium.

Alcoa can now supply the gallium needs for today and tomorrow . . . in million-gram quantities if required.

Send us your questions about gallium. Just write Aluminum Company of America, 850B Alcoa Building, Pittsburgh, PA 15219.

Change for the better with
Alcoa Gallium



Avionics

DAIS takes center stage

Air Force program seeks to time-share instruments and displays in cockpit; first R&D version is already prepared to 'fly'

by Larry Armstrong, Midwest bureau manager

Military avionics gear has traditionally evolved in the form of "black boxes." Newer digital systems have been built one at a time and shoehorned into already crowded cockpits. As military aircraft and their missions have become more and more complex, cockpits have become more crowded and "busy."

To reduce avionics costs and increase pilot efficiency, the Air Force Avionics Laboratory at Wright-Patterson Air Force Base has come up with a flexible cockpit simulator that leans heavily toward displays and controls that are time-shared to

reduce cockpit and panel space they require. They will be incorporated into what the Air Force calls a hot bench—actually, a test bed for avionics systems—now scheduled for September 1977 demonstration, that will link all the elements of the far-reaching DAIS (for Digital Avionics Information System).

Requests for proposals on all major hot-bench procurements—mission software, multiplex system, processors, and a technical-support team—are out now, with the single exception of the controls and displays package. RFPs for that hardware are expected later this month. The hot bench was designed and will be managed in-house, although procurement specs were written by Boeing and Texas Instruments.

To figure out what hot-bench controls and displays are needed and to help debug the software for the facility that will support the hot bench, the avionics lab is using a flexible, general-purpose cockpit simulator that resembles the cockpit that will be used eventually as the DAIS hot bench. Although the hot-bench cockpit will be a one-seater that's laid out for primary DAIS aircraft—the A-7, A-10, and F-16—the prototype in the lab now sports pilot and copilot seats.

The existing R&D cockpit also serves as a tool to get pilots involved before the DAIS hot bench is built, points out Nicholas A. Kopchick, DAIS controls and displays project engineer at Wright-Patterson, near Dayton, Ohio. To that end, A-7D pilots will begin "flying" the general-purpose simulator before the end of the month.

Hardware in the DAIS hot-bench

cockpit will be small and packaged as part of an avionics system; the existing cockpit simulator was patched together with commercially available components, though it looks pretty much like the eventual DAIS cockpit.

When it's all put together in the hot bench, though, it will look like and fly like a DAIS-equipped A-7 or F-16. Principal displays will include a head-up display; a 9-inch vertical-situation display on a color cathode-ray tube containing horizon line and pitch and roll indexes, as well as altitude, air speed, and heading presented digitally; and a 9-in. horizontal situation display in color superimposing navigation information on a map. Flanking the horizontal situation monitor will be two 5-in. monochrome CRTs. All status functions, such as weapons management, communications and navigation data, and engine instrumentation are divided between these two multipurpose displays, and can be called up when the mission demands them. In addition, the DAIS hot bench will be fitted with dedicated analog displays for backup purposes.

Some traditional controls in the DAIS cockpit will be dedicated, such as stick and throttle, volume controls for communications, and buttons for weapons activation. But most control functions will be organized into four levels, Kopchick says. The first level will be dedicated controls for the major areas the pilot has to manage in the cockpit: communications, navigation, sensors, aircraft, and weapons. Second and third levels will incorporate 196 active DAIS functions into the software



On the ground. This simulated cockpit is being used for R&D on the forthcoming avionics test bed for DAIS, a program for time-shared displays and controls.

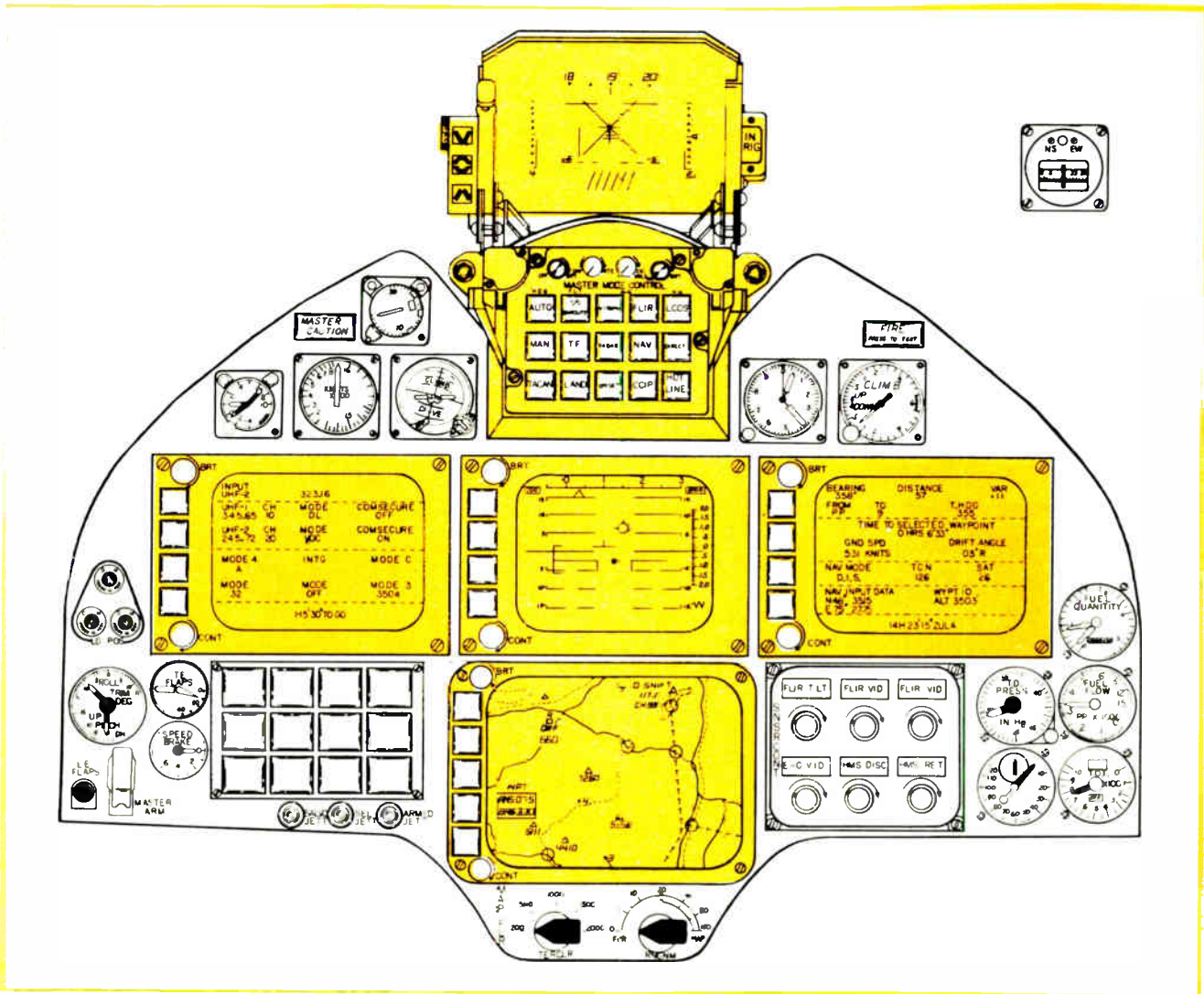

Over-all picture. DAIS cockpit will include head-up display, 9-inch color CRT for vertical situation display, 9-in. CRT for horizontal situation display, and a pair of 5-in. monochrome CRT displays.

for presentation on multifunction keyboards, and the fourth level will be digital entry on a dedicated touchpad.

Most control functions, such as communications, will be split between two primary multifunction keyboards: a 16-button legend-projection keyboard, with 12 possible legends per button, and one of the 5-in. multifunction CRTs, which will have 12 bezel-mounted switches. The third multifunction keyboard, a green plasma panel with 12 bezel-mounted switches, is redundant, and will be on the pilot's right.

To get into the communications mode, for example, the pilot would press the communications button on

the dedicated function-select panel. The system will respond by changing the backlight for that button from white to green, but present the communications-status format on one of the multipurpose displays. The aircraft's various radio sets will be controlled through a keyboard.

Using the keyboard, the pilot will select his radio, such as uhf; the legends on the keyboard will immediately change to tell him what he can do with the radio, such as select frequencies or channels. He will then enter, say, frequency digits on the dedicated digit-entry pad, and check them visually on the communications-status display. Frequency will be selected, and the display updated, with an "enter" key.

The facility that will support the fully integrated DAIS hot bench is also going on stream now—it's built around a Digital Equipment Corp.

DECsystem 10 with 256,000 words of 26-bit memory, a dual-processor system, six tape drives, and eight 10-million word disks interfaced to DEC PDP-11/20s and 11/45s to simulate major subsystems.

The DAIS concept itself, instead of merely replacing analog black boxes with digital ones, proposes a distributed array of minicomputers for processing, multiplexed signal distribution, shared controls and displays, and modular software.

DAIS will first be demonstrated in the laboratory in 1977 with the hot bench. While the concept is applicable to any airframe, the base line design chosen for the DAIS hot-bench demonstration was based on two mission profiles: close air support at night and in adverse weather, as flown by A-7s and A-10s, and night air superiority by the F-16. □

Electronics abroad

Europe heads for pollution standards

Common Market decision on drinking water and installation of systems to monitor air may bring order out of chaos for equipment makers

by James Smith, McGraw-Hill World News

For the makers of pollution-detection and control equipment, Europe is a nightmare. Not only do national and, in some countries, provincial regulatory agencies present a crazy-quilt pattern of rules but pollution meanders back and forth over national boundaries. However, a recent Common Market move bodes well for equipment makers.

Last November, Common Market governments agreed on minimum standards for surface water destined for drinking. It was a small act, on the face of it, but it should simplify matters because it transcends national boundaries. Now the European Economic Community is beginning to attack air pollution, and the first proposal calls for channeling of national measurement data to a central authority.

The move came as the U.S. started a model pollution-detection study in St. Louis designed to come up with a standard system [*Electronics*, Dec. 26, 1974, p. 62].

If nothing else will get governments to agree to comprehensive Common Market standards for air and water, the pollution across national frontiers may eventually force them to face facts. Some reasons:

- Norway has some of the highest carbon-dioxide readings in Europe, even though the country is one of the most rural.
- Pollution of the Rhine River, from which Holland draws much of its drinking water, has been a sore point among all countries through which the river passes.
- Cross-border air and water flows have caused conflict between the Dutch and Belgians.

Still, it will be a while before in-

dustry feels less frustrated by the varying and changing national rules. A.B. Bok says, "So far, industry itself has had to move beyond legislation and the government." Bok, marketing manager for pollution-measuring equipment at Philips Gloeilampenfabrieken in Eindhoven, the Netherlands, says 30 to 40 computerized automatic remote monitoring systems for air pollution are in operation or are being set up in West European countries. Experimental work is moving ahead on remotely controlled continuous water-monitoring equipment, and at least two governments are studying the possibility of setting up national systems to monitor surface water.

Bok estimates the value of ambient systems—as opposed to those that measure at the source—now operating or being installed is \$30 million to \$40 million. Free-standing air-monitoring units, often with in-station analog or digital recorders, will account for another \$25 million to \$30 million a year until 1980, when it may become largely a replacement market. However, source-monitoring systems, most of them private, could increase the potential to perhaps \$50 million a year.

National systems. So far, the Dutch national air-monitoring system is more extensive than any other. The network includes 275 sulphur-dioxide monitoring units interlinked in regional nets and tied to a central computer in Bilthoven, headquarters of the Dutch meteorological service. This year, several stations will be expanded to handle other air pollutants, and later, it will monitor dust and hydrocarbons.

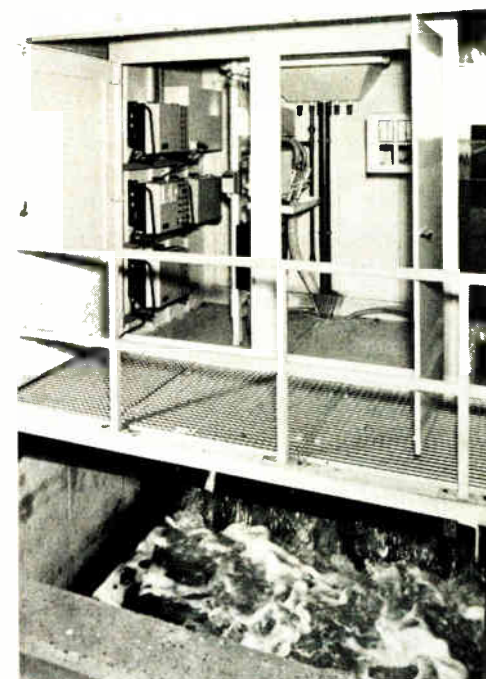

Air and water. Top photo shows Rynmond area of Holland, whose air is monitored by a Philips system. Same company's equipment monitors water at a sewage plant in Dordrecht, Holland, shown in bottom photo.

Not to be outdone, the Belgian government plans in October to start its own national air system, engineered by the Belgian firm CEI and using mainly equipment designed in the U.S. The system includes 68 carbon-dioxide monitors located mainly in urban areas. In addition, the Belgians will monitor other pollutants and dust. Telephone lines will link five local process computers from Varian Data Machines in the various cities to each other and to a central data bank and control system in Brussels. Bids for the central data bank have not been requested yet, but without it, the system costs about \$8 million.

In Germany, where control of air pollution is the responsibility of the seven state governments, there are two air-monitoring systems—one, a Siemens-engineered system in Baden-Württemberg, and the other, in Bavaria, contracted by Dornier Systems GmbH, integrated by Rohde & Schwarz, instrumented by various suppliers of Camac (computer-aided measurement and controls) equipment, and controlled by Digital Equipment Corp. PDP-11s.

Emerging. Still in the infant stage is an emerging market for monitors of surface water, effluent, and drinking water, which Bok thinks will be "far larger than the air business." Technology to cope with this problem has not yet been proved in operation. Philips last year introduced a line of monitoring units capable of measuring the so-called conventional parameters of surface water, and it now claims 40 to 50 units are being tested experimentally in Europe and the U.S.

There are no complete systems yet for automatic surface-water monitoring, although Philips and the Dutch government are jointly developing equipment and a plan for a national linkup. And Belgian authorities have drawn up specifications for a 100-station surface-water system. It will probably be tied to an existing Siemens network that monitors water levels in the country's canal and river system. Experimental stations from Siemens and Philips are being tested by some government agencies, which plan also to order equipment from other producers. □

Free

A P Test Clip



TC-16
for
16-pin
DIPS

with purchase
of each
**A P
Super-
strip**

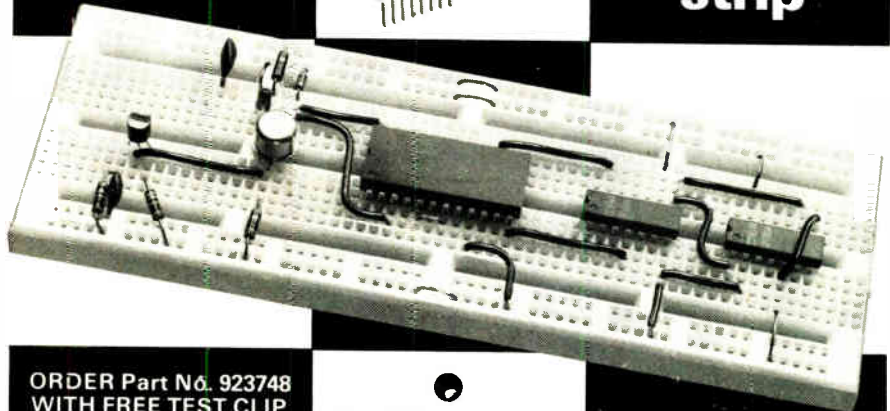

ORDER Part No. 923748
WITH FREE TEST CLIP
\$18.90

Add sales tax if resident of
Ohio or California.

F. O. B. PAINESVILLE, OH.
(Shipped post-paid if
payment is with order.)

OFFER EXPIRES
MARCH 31, 1975

Has 840 solderless
plug-in tie-points
on universal matrix

For all DIP sizes and
discretes with leads
.010" to .031" dia.



A P PRODUCTS INCORPORATED
Box 110-E, Painesville, Ohio 44077

Circle 79 on reader service card

Information that is industry's life blood

- Advertising novelties
- Assembly and work handling
- Building material and components, prefabricated and system building
- CeBIT-Office and data technology
- Chemicals, rubber and plastics
- Electrical energy, plant and equipment
- Electrical materials, wiring and domestic services, leisure electronics
- Electrical engineering — special fields of application machining and processing methods
- Electric and electronic instrumentation and automation
- Electronic components
- Fittings and valves
- Gas and water supply
- Iron and Steel, non-ferrous metals, foundry products, industrial plants
- Lamps, lighting
- Mechanical handling
- Oil hydraulics and pneumatics
- Refuse removal, disposal and utilization
- Scales and balances
- Storage
- Telecommunications
- Testing machines
- Tools
- Transport engineering
- Welding, cutting and jointing

A week earlier



Hanover Fair '75

April 16-24,

"For information apply to
Schenkers Int'l Forw. Inc.
One World Trade Center, S. 1867
Telephone (212) 432 3071"

Companies

Signetics making comeback

Corning subsidiary, severely wounded by reliance on TTL, has changed product mix to include quantities of MOS

by Bernard Cole, San Francisco bureau manager

As Mark Twain once said about stories of his death, the stories that Signetics Corp. is in dire financial straits are "greatly exaggerated," according to company officials.

The semiconductor-manufacturing subsidiary of Corning Glass Works has worried Wall Street analysts for some time. In general they view Signetics as a weak link in the semiconductor industry because of its high dependence on transistor-transistor logic, which has undergone precipitous price erosion, especially in the last six months.

Even so, according to John Halter, Signetics marketing vice president, the Sunnyvale, Calif.-based company, if not exactly well, is recuperating. As for rumors that Signetics was to be sold, he says, Corning has received no purchase offers and is seeking none.

Signetics' fourth-quarter loss in 1974 totaled \$5,148,000. With sales

of \$120,836,000, the company closed the year with a loss of \$3,876,000. And its work force was cut drastically, from 11,000 to 6,000.

How does Signetics plan to come back? "First, of course, is our need to reduce our dependence on TTL," Halter says. "This is something we have recognized for several years and have been hard at work on."

The result has been that from 90% TTL two years ago, Signetics now has only about 50% in that area with the rest in linears and MOS. And some of the TTL is in the newer bipolar memory market rather than in flip-flops. The bipolar memory products include a 1,024-bit emitter-coupled random-access memory, a 4,096-bit read-only memory, and a 4-kilobit PROM.

The company is banking heavily on MOS products by mid-1975, first with a 4-k, 22-pin RAM it is second-sourcing to the Intel-Texas Instru-

ments configuration [*Electronics*, Jan. 9, p. 25], then a 1-k n-channel static RAM, and an 8-k ROM. Several complementary-MOS products are also planned, he says. But making an impact with those products won't be easy. Signetics isn't regarded as a strong MOS competitor, nor is it recognized as a leader in microprocessors, where another of its 1975 product pushes will come.

The company is now sampling its 2650 PIP (programable integrated processor), an n-channel silicon-gate ion-implanted 8-bit MOS device on one chip. Priced at about \$200 each in quantities of 100 and up, it is aimed at both the low-cost and high-speed ends of the market [*Electronics*, Sept. 5, 1974, p. 133].

Signetics is also at work on a bipolar microprocessor, probably something like the one recently introduced by its sister Corning subsidiary, Scientific MicroSystems.

Now that it has more clearly identified its targets, Signetics has quietly revamped its entire marketing structure. Where product marketing functions for C-MOS, ECL, and TTL were once split among three divisions, they have now been melded into a new Logic division with Charles Wheatly, formerly head of the company's TTL division, as general manager. David Laws, former marketing manager at Litronix, is marketing manager. A separate marketing and processing organization has been set up under Larry Liktler, former manager of PROMs and ROMs, to handle military products. And a division has been created under Jerry Crowley, former sales vice president, to put Signetics into new businesses. □

The view from outside

The view of Signetics by competitors and industry analysts is mixed. Semiconductor industry analyst James R. Berdell of the San Francisco securities firm of Shuman, Agnew & Co. says, "If they turn around it will be more a function of the economy." Signetics' problem, he agrees, is product mix: too much TTL. "To grow as fast as, say, an Intel," says Berdell, "they will have to change their product mix and put more emphasis on MOS."

While Signetics is attempting to do that, the company's emphasis on distributor sales could be vital. "It's obvious why they made that move," says an executive at Fairchild Semiconductor. "It was an effort to gain market share. And if the market had continued to grow for another couple of quarters, it might have worked. As it was, the bottom dropped out, and Signetics barely managed to hold on."

But David Parks, president of Gnostic Concepts Inc., a Menlo Park, Calif., consulting firm, thinks this distributor emphasis actually might work in Signetics' favor over the next three quarters. His reasoning: a lot of companies that bought OEM last year, including the large computer makers, are going to buy from distributors in 1975 because they will be willing to settle for smaller purchases rather than buy six months' supplies for inventory.

SHORTFINDER FF202



Faultfinders now make a self-programming system to test loaded PC boards. Called the Shortfinder FF202, it is micro-processor-controlled to test between nodal points, automatically isolate circuit defects during the test cycle and supply printed data for circuit repair. By reducing testing, troubleshooting and repair time, the FF202 increases product yield and lowers manufacturing costs.

The versatile Shortfinder can also be used to test the integrity of the PC boards before components are inserted, testing for shorts, continuity, opens and leakage between circuit paths. With suitable adaptors it may also be used to test cables, wiring harnesses and backplanes.

Any standard fixture for a 600 point plugboard receiver may be used on the Shortfinder. With op-

tional receivers the Shortfinder can provide 2000 connections to the board under test. Additional memory is also an option and will provide dual test program capability, permitting the loading of one board while another is being tested.

Ideal for manufacturers with many different types of circuits, the self-programming FF202 virtually eliminates programming time. A typical 600 point board can be automatically programmed in about 6 minutes and tested in 6 seconds. Only 400 ms is required for each test failure printout. The mag tape cassette may be used for permanent storage of the test program.

See the new Shortfinder at NEPCON West in Booth 869 or call any Faultfinder office for more information.

WE HELP MANUFACTURERS MAKE BETTER ELECTRONIC PRODUCTS

IRVINE, CA (714) 549-4901 SUNNYVALE, CA (408) 732-9020
PARK RIDGE, IL (312) 696-0335 CICERO, IN (317) 984-3494
WALTHAM, MA (617) 890-4717 ALEXANDRIA, VA (703) 451-5558
FRANKFURT, GERMANY (0611) 59 05 03

A1297507



FAULTFINDERS Inc.

15 AVIS DRIVE, LATHAM, NY 12110 (518) 783-7786

New Old Faithful

MICROMEMORY 3000QD...32K x 20

Old Faithful. That's what you've been calling the whole MICRO-MEMORY 3000 family. Fast. Trouble-free. Dependable. Flexible — easy to build on or design around. Either core or NMOS.

Now we have a new Old Faithful to add to the line . . . the MICRO-MEMORY 3000QD. 32K x 16, 18, or 20 (alterable to 64K x 8, 9, or 10). A 3-wire, 3D core system with the same fast 300 nanosecond access. Same single card convenience. Same building block flexibility. Same day-in, day-out dependability. And it's form, fit, and functionally compatible with all core or NMOS MICRO-MEMORY 3000 systems.

Now more than ever MICRO-MEMORY 3000 makes an ideal transition between core and NMOS systems. You can design for all core, mix core and NMOS in the same chassis, or go completely NMOS — whatever suits your needs — without costly equipment modifications. You

can build from an 8K single card memory up to high density mass storage (up to 512K in a single standard chassis).

Let us show you how MICRO-MEMORY 3000 can meet your memory needs whatever they are. Call or write your local EMM office today.

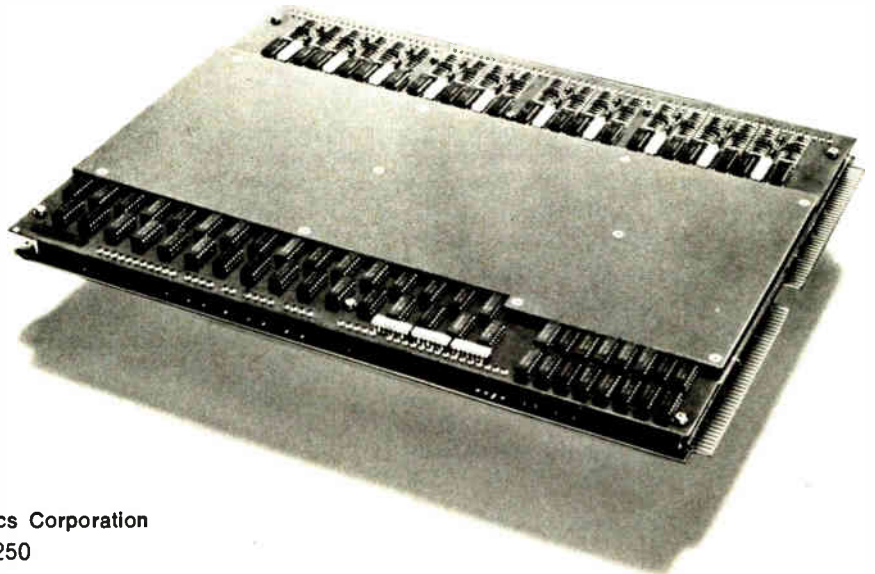

EMM ELECTRONIC
MEMORIES
COMMERCIAL MEMORY PRODUCTS

A Division of Electronic Memories & Magnetics Corporation
12621 Chadron Ave., Hawthorne, Calif. 90250

EMM OFFICES: WESTERN REGION, Regional Office, San Francisco (408) 247-9711, Los Angeles Area (213) 644-9881, Orange County Area (714) 639-5811, Minneapolis Area (612) 941-2404, Phoenix Area (602) 968-2492, Dallas Area (214) 231-7207, EASTERN REGION, Regional Office, Boston (617) 861-9650, Chicago Area (312) 297-7090, Washington, D.C. Area (703) 941-2100, New York Area (516) 423-5800, Akron Area (216) 867-5435, INTERNATIONAL OFFICES, European Headquarters, Belgium (031) 76.69.75, United Kingdom (01) 751-1213, West Germany (089) 714.30.40, Far East Headquarters, Japan (03) 404-8520.

REPRESENTATIVES: Gentry Associates; Orlando (305) 894-4401, Huntsville (205) 534-9771, Burlington, N.C. (919) 227-3639. In Canada: Megatronix, Ltd.: Toronto (416) 742-8015, Montreal (514) 488-0404, Ottawa (613) 729-4004, Burnaby (604) 526-3312.

I²L takes bipolar integration a significant step forward

Extraordinary compactness is achieved in new microprocessor while speed is increased up to five-fold over n-channel devices; 4-bit controllers to 16-bit minicomputers can be simulated

by Richard L. Horton, Jesse Englade, and Gerald McGee, *Texas Instruments, Dallas, Texas*

□ For specialty applications such as watch circuits and linear control elements, integrated injection-logic circuits are already in production. But only with the development of purely digital techniques can system designers realize the full impact of this new bipolar structure. To this end, an extremely compact I²L gate has been devised that does not require isolation between elements within the gate—in contrast to I²L linear types that rely on conventional, space-consuming pn junctions to separate their devices. In the new, non-isolated I²L form, gates shrink to the size of a single transistor, so that, together with their low power capabilities, digital I²L structures may contain thousands of gates on a single high-performing bipolar chip.

With these non-isolated gate structures, a 4-bit bipolar microprocessor chip (Fig. 1) has been built that operates up to five times faster than today's n-channel devices. At the same time, this I²L processor element, which is directly compatible with existing bipolar interface circuits, provides greater instruction capability than n-channel designs. And because the 4-bit device is expandable to larger systems with simple interconnections, this circuit element can handle a wide range of computer functions—from simple 4-bit controller jobs to full 16-bit minicomputer process control functions.

True, the processor speeds achievable with these first-generation I²L gates—propagation delays of 20 to 50 nanoseconds—are not as fast as with today's TTL technologies. But techniques to boost I²L speeds toward the TTL level while still maintaining a compact low-power LSI format are

known to be on the way. These integrated-injection logic chips will, for the first time, provide process control and computer system designers with the full benefit of highly efficient bipolar LSI circuits.

Part 1: Fundamental structure.

All the size and low-power advantages of integrated injection logic come directly from shrinking the old direct-coupled transistor logic (DCTL) into a single complementary transistor equivalent. In this scheme (Fig. 2) the resistor in the DCTL gate is replaced by an active current source; the emitter-grounded output transistor pair is replaced by a single multicollector transistor, and a simple pnp transistor is added to serve as the current injector source.

Thus the six transistors of a three-input DCTL gate are reduced to a single I²L transistor pair. The vertical npn transistor Q_1 , with the multiple collectors C_1 and C_2 , operates as an inverter, and the lateral pnp transistor Q_2 serves as both the current source and active load. No large ohmic resistors are required for either the source or load function. What is perhaps most ingenious, the base of the multi-collector npn transistor is made common with the collector of the lateral pnp current source, while the base of the current source is made common with the emitter of the multi-collector npn. Because of the elements in common (see panel p. 85), the entire I²L gate, when it is configured on silicon, only takes up the room of a single multi-emitter transistor.

Again, the basic I²L

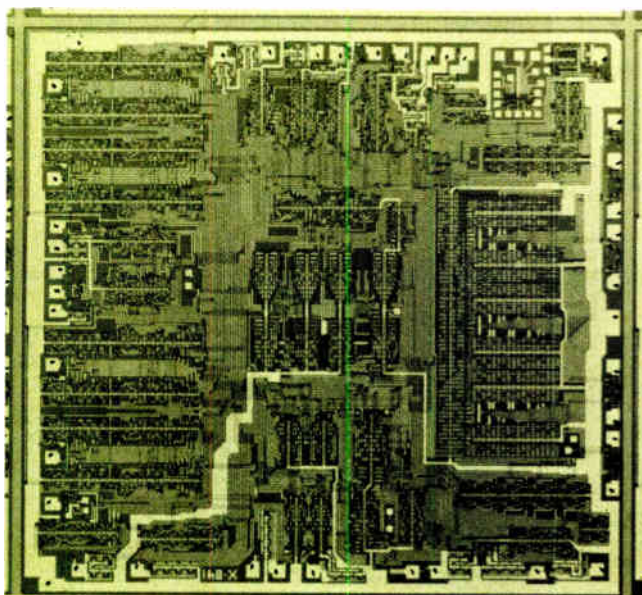

1. **The first.** Entering the picture is the industries first standard-product microprocessor built with the integrated injection logic bipolar technique. This 4-bit-slice device, SBP0400, bridges performance gap between today's n-channel and Schottky devices.

2. Structure. Digital form of I²L has vertical npn transistor Q₁ with multiple collectors C₁ and C₂ operating as inverter; and lateral pnp transistor Q₂ as current-source and load.

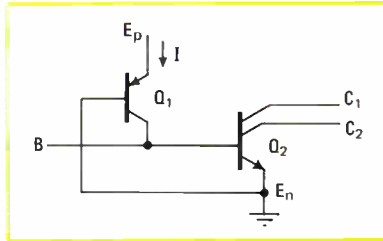

structure can take two forms: isolated or non-isolated. The isolated form, which so far has received more public attention [*Electronics*, Oct. 3, 1974, p. 111-118], makes use of a conventional reverse-biased pn junction for component isolation. Since this form of isolation completely separates adjacent devices, it is the isolated I²L structures that are used in circuits containing mixed-component functions.

Fabricated with a 6-mask bipolar process, isolated I²L allows all other standard bipolar and MOS design techniques (Schottky TTL, ECL gates and memories, and n-channel MOS devices, including linear functions) to be combined directly with the I²L gates. This means that along with I²L digital sections, a single low cost monolithic chip can hold such linear and special buffer functions as LED drivers, memory decoders, current regulators, op amps, comparators, oscillators, and very-fast digital TTL or ECL logic.

Indeed, the I²L watch, entertainment and other commercial LSI circuits already in production are made with this technique. This isolated form of I²L can also be combined with Schottky and ECL memory structure to provide fast low-cost bipolar memory designs. Here the I²L-type gates would form the internal array of the memory, while the TTL or ECL transistors would form the peripheral interface elements. RAMs with I²L-type arrays (74S209) have already been built, pointing to a new low-cost bipolar approach to medium-performance (100 ns) memories.

The boss LSI technology

Even as isolated forms of I²L have endless possibilities for combining linear and digital functions into heretofore-unattainable degrees of circuit integration, it is non-isolated I²L that results in the most dense and efficient form of bipolar logic yet devised for the fabrica-

tion of very complex digital ICs. Utilizing the single transistor switch with the common ground planes shown in Fig. 2, this logic form capitalizes on the high carrier mobility inherent in bulk silicon structures. It need not be isolated, nor does it require ground metalization, because in this single-transistor gate the output of one gate serves as the input of the next.

Nevertheless, these I²L gates are capable of operating at nanosecond speeds and microwatt power dissipation (Table 1), with a component density 10 times that of conventional bipolar circuits, and twice that of p-MOS. Furthermore, non-isolated I²L circuits can be built with a 4-mask, two-diffusion bipolar process, at high yields—an essential requirement of any LSI process where thousands of gates per circuit must be fabricated on a wafer of complex circuits.

The advantages of the I²L process are shown in Fig. 3, which compares the process complexity and gate-size relationships of the various digital technologies in use today. In process complexity, I²L is simpler than all other techniques except low-performing p-MOS, which requires the same number of mask steps but needs one less diffusion step. And, compared to I²L, the newly-evolved depletion-load MOS technology, being relied on so heavily in today's n-channel memories and microprocessors, requires an additional mask step. It also requires two ion implementation steps as opposed to none for I²L although depletion-load MOS does use one less diffusion. In any case, compared to TTL's 7 masks and 4 diffusions, and C-MOS's 6 masks and 3 diffusions, the I²L process is simplicity itself.

Even so, this process results in the smallest component size of any technology in operation—as Fig. 3 shows, the product is less than one tenth the area of either a conventional TTL or C-MOS gate. Even the newest LSI forms of TTL occupy four times as much space.

Speed-power comparisons (Fig. 4) show still another advantage of I²L gates; they have the lowest speed power product of any technology in use today, approaching a theoretical limit of 0.001 picojoule. Even non-optimized I²L test bars have operated with 100 ns propagation delays while dissipating 100nW of power per gate—surpassing today's best C-MOS circuits.

Constant speed-power

Yet, unlike C-MOS, whose power dissipation rises dramatically at higher speeds, I²L gates can be pushed to speeds of 10 to 20 ns while maintaining a virtually constant speed-power product. Indeed, an I²L gate optimized around a high-speed 50-ns format is the one used in the current 4-bit microprocessor circuit design.

Finally, Fig. 5 shows where I²L processor circuits fit into the spectrum of computer applications. I²L microprocessors can potentially handle all the jobs now being performed by today's MOS systems—from non-real time processing, to calculator jobs requiring millisecond add times, to the 50-ns real-time processing of some main-frame controller systems. Second and third generation I²L designs are expected to significantly extend this capability into higher performance applications (Fig. 6).

Taking the simplest case, one in which a single npn grounded-emitter transistor forms the basic I²L gate,

TABLE 1: COMPARISON OF I²L AND TTL PROPERTIES

Parameter	I ² L	TTL
Packing density (7- μ m mask details)	120 – 200 gates/mm ²	20 gates/mm ²
Speed-power product	4 – 0.2 pJ/gate	100 pJ/gate
Gate delay	25 – 250 ns	10 ns
Power dissipation	6 nW – 70 μ W	10 mW
Supply voltage	1 – 15 V	3 – 73 V
Logic voltage swing	0.6 V	5 V
Current range (per gate)	1 nA – 1 mA	2 mA
Interconnect	Single-level	Double-level

How it's built

Designers at Texas Instruments are evaluating a number of I²L fabrication techniques. The one used to build their first microprocessor was chosen for its compatibility with existing TTL production facilities.

An I²L circuit's high packing density is due mainly to the simplicity of designing with a single transistor gate. In the accompanying illustration, for example—working from the bottom up in the cross-section of an I²L gate—the n⁺ substrate serves not only as the structural base for fabrication, but also as a common ground plane to interconnect all the grounded-emitter transistor gates. This eliminates the need for any surface metallization for ground interconnections. Likewise, the thick n-type epitaxial layer, grown on top of the n⁺ substrate, serves not only as the grounded-emitter region of the vertical npn switch, but also as the grounded-base region of the lateral pnp injector.

Continuing upward in the cross-section, the first of the two diffusions serves as the p-base region of the vertical npn, and also as the p-collector region of the lateral pnp injector. The second diffusion completes the I²L gate by providing the multiple-collector n⁺ regions of the vertical npn.

Metallization is then deposited and etched to provide interconnection between various I²L transistor gates. Note that the lateral pnp is integrated into the vertical npn structure and therefore does not exist as a discrete com-

ponent. Furthermore, a single lateral pnp can be utilized as a current injector for multiple npn gates as long as symmetry in the layout is maintained to avoid current-hogging. Density is enhanced by the simplicity of a single-transistor gate requiring no component isolation.

The similarity existing between I²L and TTL circuits is worth noting. This, essentially, is in the similarity between the basic multi-collector I²L transistor and the common multi-emitter TTL transistor. The I²L multi-collector regions correspond to TTL's multi-emitters, the I²L and TTL bases occupy similar regions, while the I²L emitter and TTL collector reside in the deepest n regions. An I²L multi-collector transistor is, in essence, a TTL multi-emitter transistor operated upside down. Transistor logic in I²L structures is implemented by controlling inverse beta, while in TTL structures the forward beta is controlled.

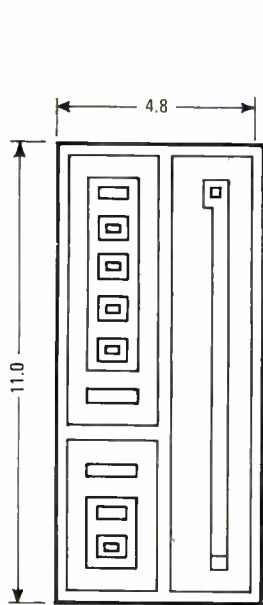
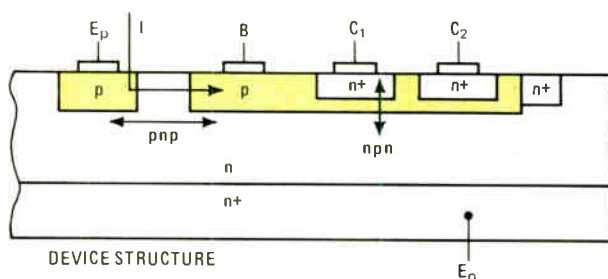

STD TTL MSI

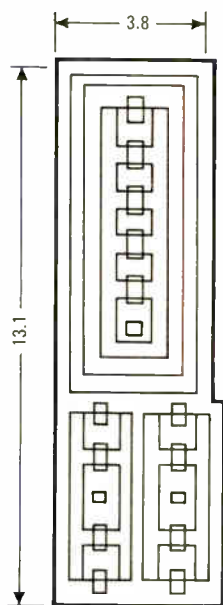

C-MOS

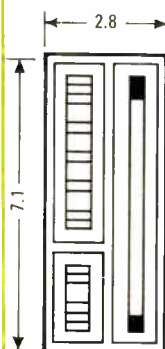

TTL LSI

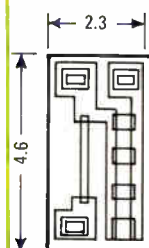

P-MOS

ALL STRUCTURES
4-WIDE GATES
ALL DIMENSIONS
IN MILS

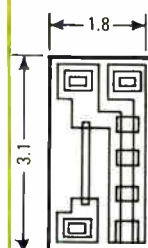

SG-NMOS



I²L

GATE AREA (50 MILS)	52.8
NUMBER OF COMPONENTS	3
MASK STEPS	7
NUMBER OF DIFFUSIONS	4

GATE AREA (50 MILS)	49.8
NUMBER OF COMPONENTS	3
MASK STEPS	6
NUMBER OF DIFFUSIONS	3

GATE AREA (50 MILS)	19.9
NUMBER OF COMPONENTS	3
MASK STEPS	7
NUMBER OF DIFFUSIONS	4

GATE AREA (50 MILS)	10.6
NUMBER OF COMPONENTS	2
MASK STEPS	4
NUMBER OF DIFFUSIONS	1

GATE AREA (50 MILS)	5.6
NUMBER OF COMPONENTS	2
MASK STEPS	7
NUMBER OF DIFFUSIONS	3

GATE AREA (50 MILS)	4.8
NUMBER OF COMPONENTS	1
MASK STEPS	4
NUMBER OF DIFFUSIONS	2

3. Shaping up. An I²L gate fabricated with non-isolated elements saves space and is simple to build, compared to other techniques. It's simpler than all but p-MOS gates and its 5 square mil area makes it the smallest. All structures shown are 4-wide gates.

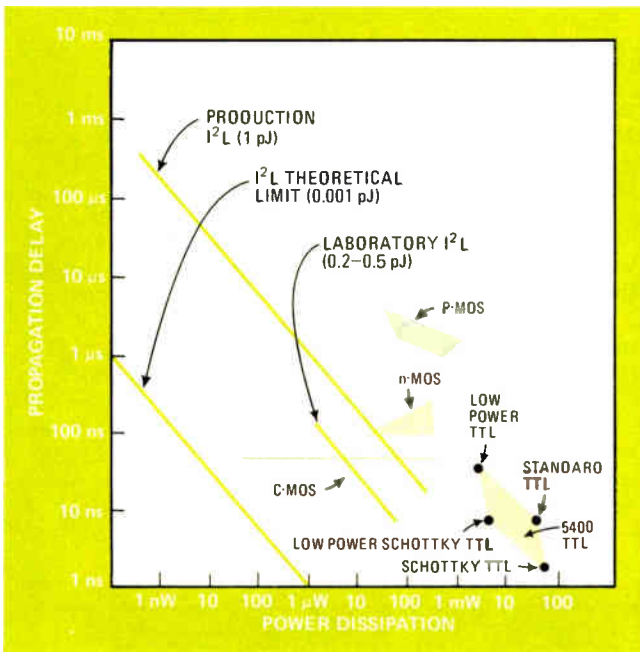

4. Speed/power. The beauty of an I²L gate is its ability to operate at very low power levels while running at respectably fast gate speeds. The same is not true, generally, of today's C-MOS circuits, whose low power properties are sacrificed at high frequencies.

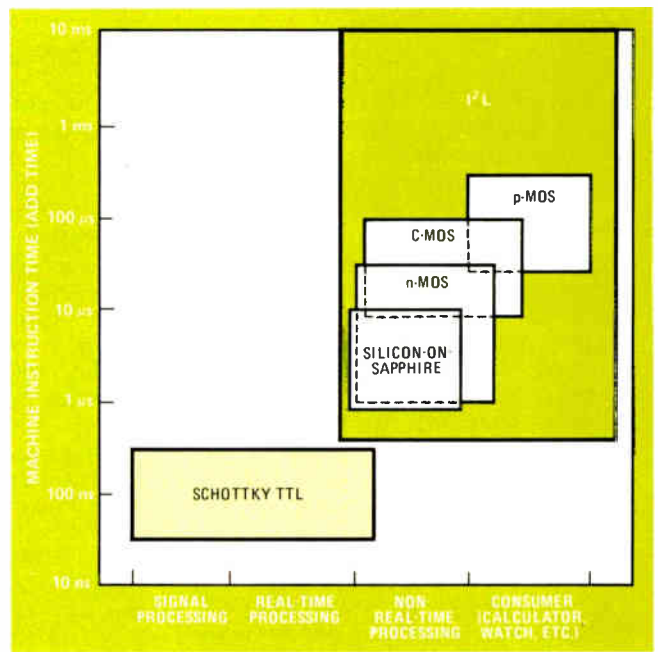

5. Tomorrow. An I²L microprocessor potentially can take over all jobs now being done by MOS units. This includes non-real-time and consumer-type applications. What's more, I²L does overlap into real-time—processing jobs now being handled by TTL products.

positive NAND logic is implemented through the use of a multiple-collector npn switch functioning as an inverter. Here the logical isolation required to perform NAND logic is accomplished by utilizing the multiple-collector outputs to function as isolated ANDing inputs to the stages that follow. Positive NOR logic can also be readily implemented by wire-ORing the I²L gate outputs (Fig. 7). Now, when the I²L npn transistor is normally biased on

(low output) by a lateral pnp current-injector transistor, which is connected between the base of the npn and an external current source, switching action is accomplished by the steering of this injector current.

This is done by adjusting the base-to-emitter gate input voltage V_{BE} . A low input voltage of less than one V_{BE} (750 mV) pulls injector current out of the input through the on (low) output of the driving gate. Robbed of its base drive in this manner, an I²L transistor gate will turn off with its open-collector output rising to a high logic level.

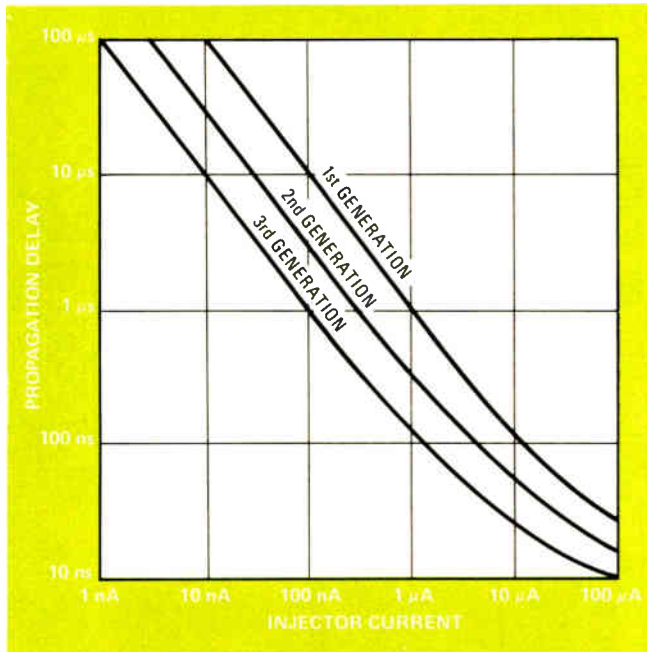

6. Only starting. Impressive as today's production I²L devices are, faster ones are coming. This year's second generation devices and next year's third generation will show steady improvements. Ten-microsecond to 20-nanosecond devices are foreseeable.

Steering the current

This voltage level, as with any open-collector logic, is determined by the load circuit, or pull-up, utilized. In a typical I²L circuit design this is simply the clamp level at the input of the next stage—one V_{BE} (750 mV) above ground.

A high input logic level is achieved, essentially by default, when a low-impedance path of less than one V_{BE} potential is absent from the input. Deprived of a ground path of less than one V_{BE} potential, the injector current will forward bias the I²L transistor gate into the on state and produce an output low-logic level equal to one V_{sat} above ground, or typically 50 mV. It is therefore possible to achieve, by simple steering of the injector current on the npn switch, typical I²L internal logic swings of 700 mV—this from a V_{sat} of +50 mV to a V_{BE} of +750 mV.

Figure 8 shows how I²L transistor gates are interconnected to perform a basic logic function. The NAND gate logic is that of a common TTL D-type flip-flop. The schematic directly below it shows the same D-type flip-flop in I²L NAND/NOR logic at a component count of one transistor per gate. Directly below the I²L schematic is a

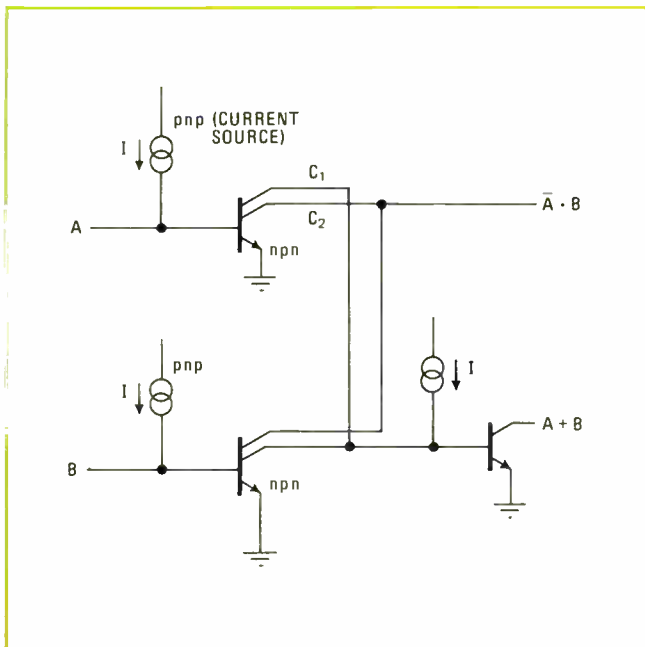

7. Sound logic. NAND functions use the multiple-collector npn switch as an inverter, where logical isolation is obtained by making the collector outputs function as isolated ANDing inputs of the next stages. NOR logic results from WIRE-ORing gate outputs.

scaled topographical drawing of the I²L D-flop. The p-injector used to power the flop is indicated along the drawing's horizontal axis. Note that an entire I²L static flip flop, which would require six 4 by 4 mil bonding pads interfaced to the outside world, would virtually fit under one of those bonding pads. It is this compact geometry that accounts for the high component density of the I²L LSI processor designs currently in production.

All told, practical I²L gates can handle a range of 6 magnitudes or more of injector current—from picoamps to microamps—at speeds ranging from hundreds of microseconds to tens of nanoseconds. They can be powered up for maximum speed, then powered down by a magnitude of 100 to 10,000 without losing functions or data (if they're memories). They do not display increased power dissipation with frequency nor produce the switching noise transients common in standard push-pull logic built with C-MOS or TTL. They require neither gold doping nor Schottky clamping, as does conventional logic in which transistors are easily saturated.

I²L logic is fully static, requiring no multiphase clocks, and temperature stability is superior, with circuits capable of military temperature range operation from -55°C to 125°C.

Designing I²L digital circuits

With the basic gate layouts of Figs. 7 and 8, a designer can use a variety of input/output circuits (Fig. 9). In the I²L microprocessor chip described in this article, input/output characteristics were selected with one objective in mind: full TTL compatibility. The input circuit, shown in Fig. 9(a), is actually an RTL configuration modified for TTL compatibility. An input threshold of nominally +1.5 volts is achieved with two 10-kilohm

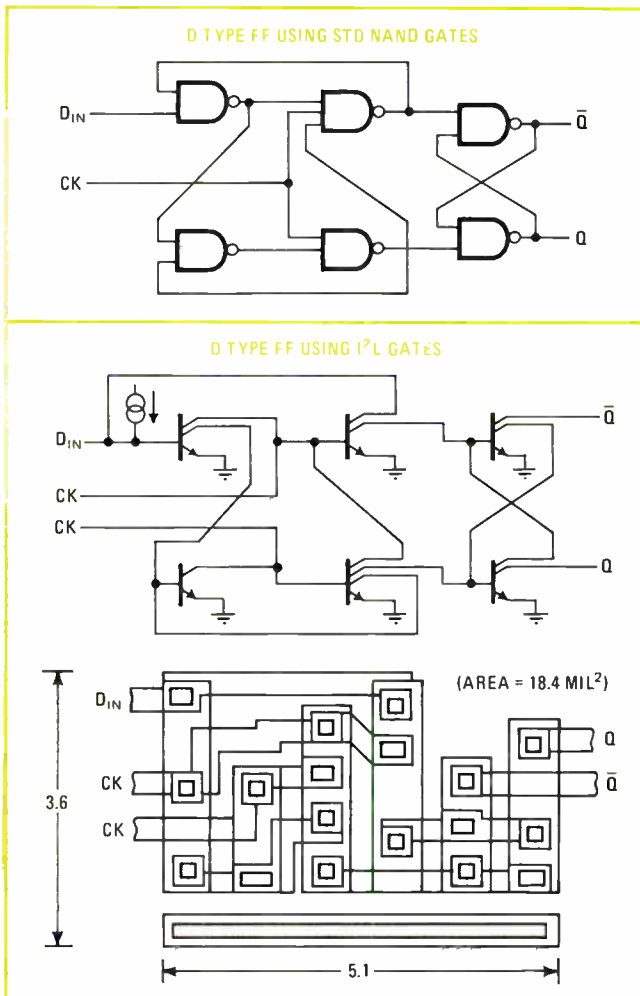

8. Easy fit. Basic to the high packing density of I²L digital circuits is its one-transistor-gate structure. Here a standard D-type flip-flop built with I²L gates takes up less than 20 square mils; it is so small it could fit under a single bonding pad.

resistors functioning as a voltage divider, which boosts the one V_{BE} threshold of the input transistor to 1.5 v.

The input electrical characteristics, plotted in Fig. 10(a) as input current vs. input voltage, show the 10 kilohm load line and the threshold knee at +1.5 v. These high-impedance, high-threshold characteristics were chosen to reduce input loading and to increase the input noise margin over a standard TTL input, yet they retain full compatibility with all 5-v logic families. The I²L inputs also utilize an input-clamping diode to limit negative excursions, or ringing, on the receiving end of a transmission line.

The output schematic and its characteristics, as shown in Figs. 9(b) and 10(b), are virtually identical to TTL or DTL open collector outputs. When turned on, an I²L open collector output will rapidly fall towards ground potential, producing a low logic level.

Standard design practice for I²L is again patterned after TTL in that I²L outputs are generally over-designed by 100%. While a typical I²L output will sink 40 mA without pulling out of saturation, the outputs of I²L logic circuits are guaranteed to sink 20 mA (10 Schottky TTL loads) at 400 mV maximum under worst-case condi-

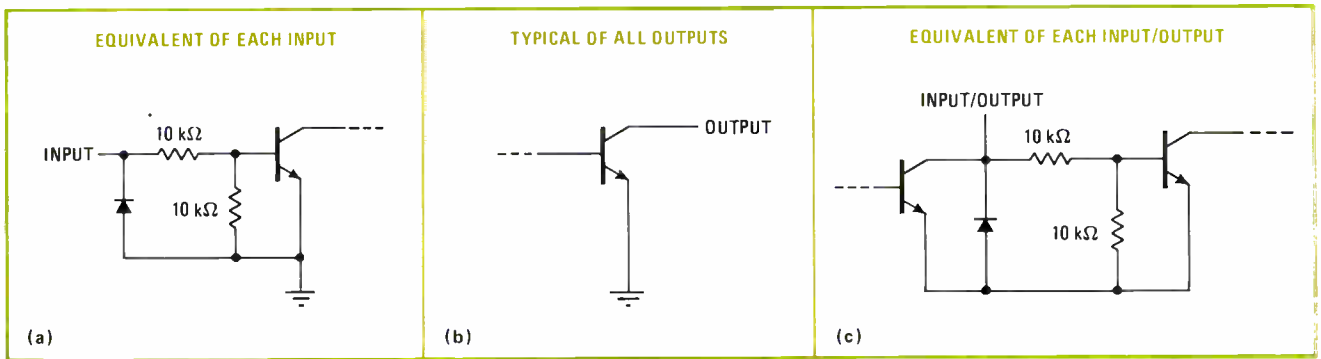

9. Compatible. These input and output sketches show how easy I²L gates can be made compatible with TTL gates. The input in (a) is actually a modified RTL structure, while outputs (b) and (c) are virtually identical with TTL or DTL open-collector outputs.

tions. The high-logic output level, output rise times, and input-noise immunity are determined by a discrete pull-up resistor.

Common I/O configurations, as in Fig. 9(c), can also be utilized for improved functional performance and higher packing densities. This schematic is recognizable as an integration of the separate I/O schematics and electrical characteristics already described.

Powering an I²L circuit

I²L gates, which are current-injected-logic when placed across a curve tracer, resemble a silicon switching diode, a fact that enables a designer to use any voltage or current source capable of supplying the desired current at a voltage of 850 mV or greater. No tricky impedance matching or feedback is required. Perfectly acceptable would be a dry-cell battery, a 5-V TTL supply, a programmable current supply for power-up and power-down operation—practically whatever power source is convenient.

If a 5-V TTL power supply were to be used, for example, a series dropping resistor would be connected between the 5-V supply and the injector pins of a typical

I²L microprocessor device for selecting the desired operating current. The resistor value in this case would be:

$$R = E/I, \text{ or } R_{\text{drop}} = (V_{\text{supply}} - 0.85 \text{ V})/150 \text{ mA}$$

$$R = (5.0 \text{ V} - 0.85 \text{ V})/0.15 \text{ A} = 28 \text{ ohms}$$

Part II: The I²L microprocessor

The first LSI digital circuit built with non-isolated I²L logic is a microprocessor chip slice designated SBP 0400, which stands for “semiconductor bipolar processor,” 400 series. It is a 40-pin, 4-bit microprogrammable binary processor element containing more than 1,450 gates—easily the most complex standard product bipolar logic chip built to date.

Containing all the functions required for 4-bit parallel processing (except for sequencing controls), the features of the SBP0400, as shown in the block diagram of Fig. 11, could only be duplicated by using 30 to 40 small and medium-scale TTL integrated circuits.

The chip contains:

- A 16-function symmetrical arithmetic logic unit (ALU) that has full-carry look-ahead logic.

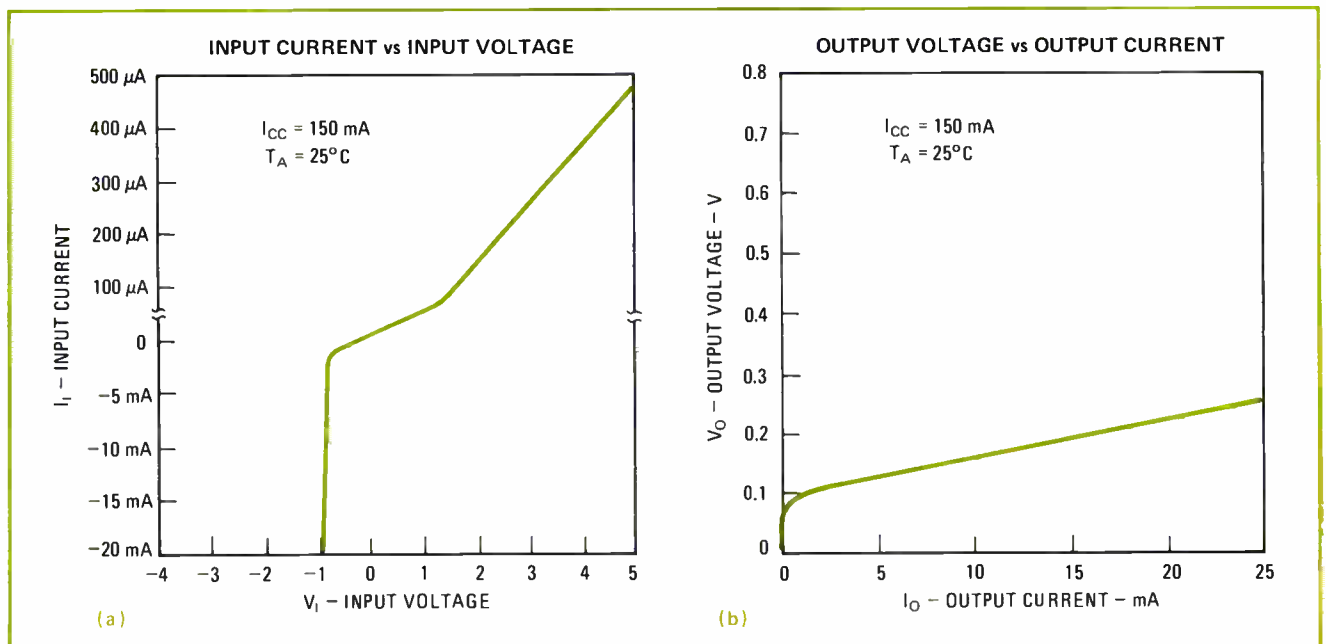

10. Plotting It. Input and output current-voltage characteristics makes designing with I²L a pleasure. The input shows a 10 kilohm load line.

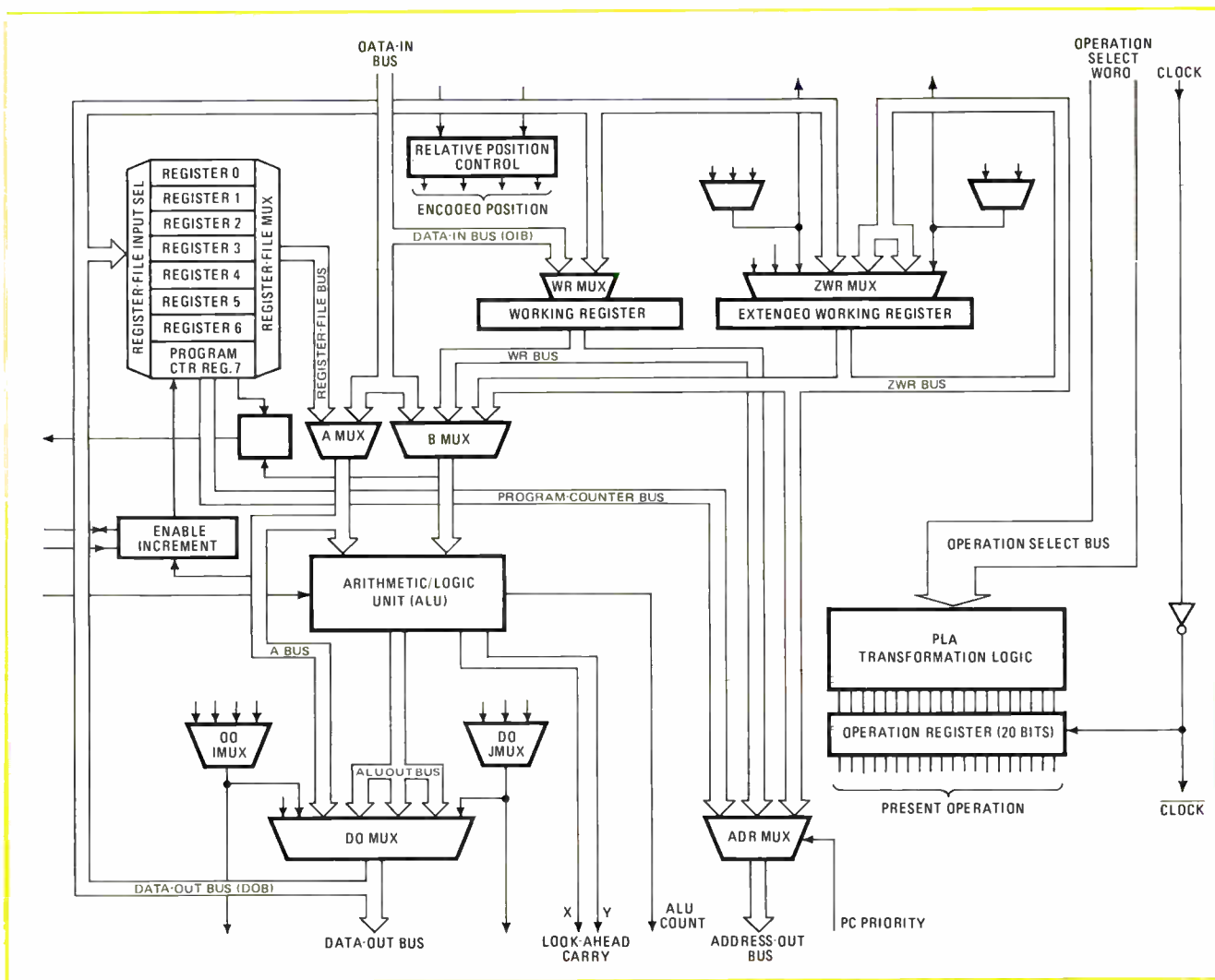

11. Organized. Among the principal blocks of the SPB0400 chip are the 16-function arithmetic logic unit (ALU), and the factory programmable logic array (PLA), which provides 512 standard one-clock operations.

- An 8-word general register file that includes a program counter and incrementor.
- Two 4-bit working registers that can handle both single- and double-length operations.
- Scaled-shifting multiplexers enabling the chip to handle a wide variety of interface conditions.
- Finally—and perhaps the most innovative feature—a factory programmable logic array (PLA) instead of the usual fixed-size control ROM. The 512 standard operations programmed into this on-chip logic array provides a greater degree of instruction capability than is achievable by any other standard bipolar or MOS LSI processor.

This basic 4-bit I²L processor slice is directly expandable in 4 bit multiples—Fig. 12 shows the configuration for a 16-bit system. Like the single 4-bit chip, larger multichip systems provide full-carry look-ahead logic and parallel access to all control, data, and address I/O functions. It is this parallel access, together with the high bipolar speeds (typical propagation time of 110 to 530 ns at power dissipation of 128 mW), that's responsible for the device's short cycle time capability.

Thanks to the program flexibility offered by the PLA

and standard micro-programming techniques, this single 4-bit slice offers a designer a repertoire of 512 one-clock operations, from which a wide range of instruction can be implemented. This compares with a fixed instruction capability of less than 80 for today's second generation n-channel microprocessors, and less than 125 basic operations today's TTL bit-slice systems. This large one-clock operation capability means that a wide range of existing designs can be emulated without loss of software compatibility or increased software investment.

Indeed, virtually any set of instructions is available. In a single one-microsecond clock cycle, for example, any one of 459 non-redundant operations can be selected, including such complicated tasks as transferring data from the processor's register to the external memory, or from memory to register, or from register to register; modifications of the operand or combinations of modifications by means of the 8 arithmetic or 8 boolean functions residing in the ALU; single or double precision arithmetic shifts, with protection of single- or double-signed binary words; single or double precision logical shifts, and so on.

Again, the key to the processor's high flexibility is the

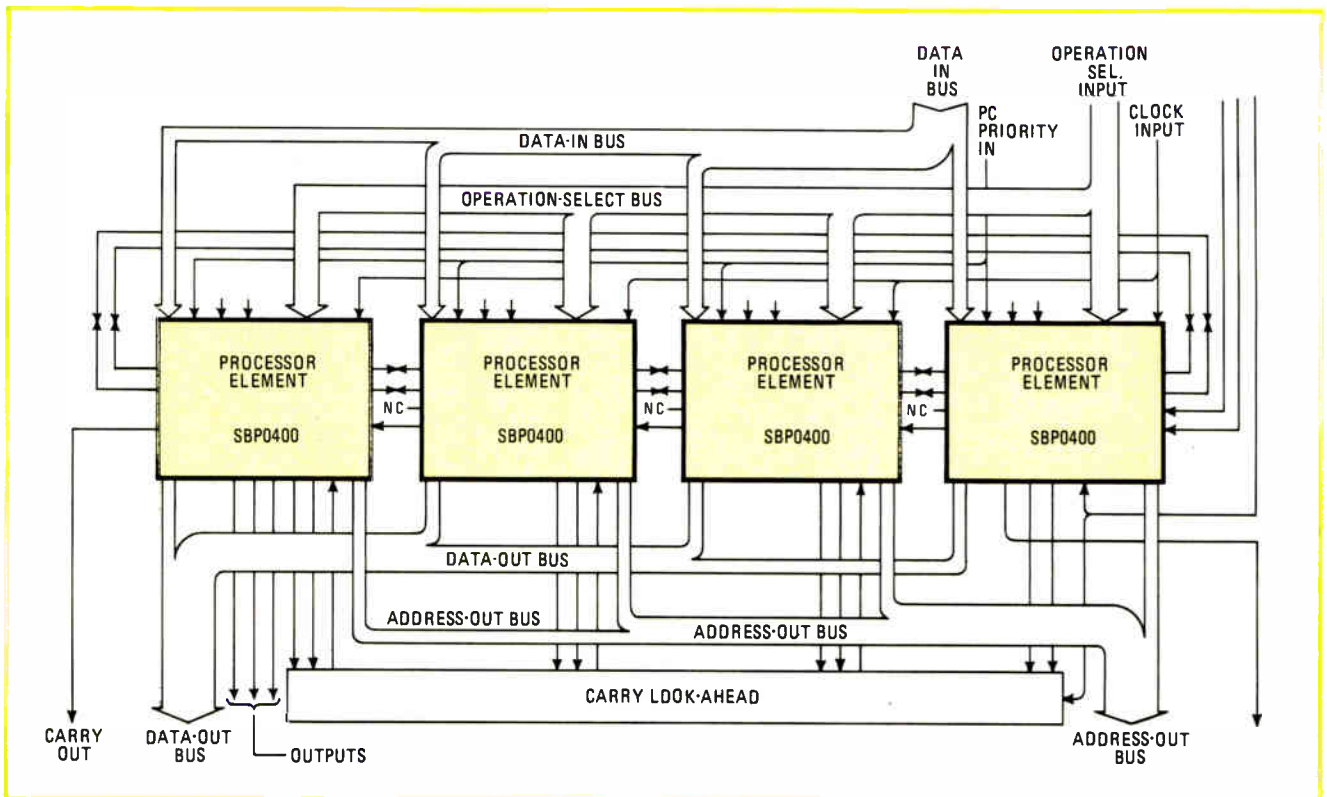

12. Expanded. Four SBP 0400 chips form the heart of a 16-bit parallel machine that has full-carry look-ahead operation. This system can efficiently emulate many low-end minicomputer applications.

programmable logic array. As a factory-programmable block of combinational logic that forms the operation transformation control center, the PLA decodes the 9-bit operation-select word input lines and generates a 20-bit internal control word. This control word is stored in the operations register and contains the appropriate logical operation—functional-block, bus-enable, and/or bus-select, for execution of the decoded instruction.

Using the processor

The operations register is composed of 20 D-type edge-triggered flip-flops. Upon each positive transition at the clock terminal, the operation register loads the preset PLA output. Loaded, the operations register continuously enables the various functional blocks for execution of the ongoing operation, while the PLA can be receiving the instructions for the next operation.

The 4-bit, parallel, symmetrical binary arithmetic logic unit (ALU) meanwhile provides the arithmetic/boolean, operand combination/modification mechanism. The ALU, as directed by the operations register, performs one of eight arithmetic operations, or one of eight boolean operations, on either or both of two operands. The two operands are bused, one to the A input port of the ALU (Fig. 11) via the A bus, and one to the B input port of the ALU via the B bus. The A input port has access to the register-file bus and data-in bus. The B input port has access to the data-in, working-register and extend-working-register buses.

The SBP0400 has accommodations for ALU ripple carry-in and ALU ripple carry-out. To facilitate look-ahead generation across larger word sizes (over 8-bit

lengths) each SBP0400 has output accommodations for both ALU carry-generate (Y) and ALU carry-propagate (X) which are compatible for use with a standard TTL look-ahead generator.

Register file

This 8-word, 4-bit set of D-type general registers is controlled by the operations register. The registers can be used as temporary storage for source data needed in existing processor routines.

An additional register file (location seven) has the added capability of performing as a program counter. Accessed in the same manner as the other files, RF7 is not only presettable but it can also be controlled externally for incrementation by one or two on the next clock transition. This capability is available at the program-counter-carry-in input and the increment-by-one-or-two input.

In addition to the integral operation (pipelining) register, implementation of overlapping instruction fetch and execute commands is further simplified as the content of the program counter is directly available at the address-out bus (AOB). Regardless of the conditions established by the present instruction, a PC priority input overrides and routes the PC data on the AOB input terminal.

For cascading purposes, the most significant output bit at intermediate and least significant package positions is available at the PCCOUT terminal. Depending on the significance of the SBP0400's relative position, these functions are under the control of the POSO and PSOI inputs. □

Intrinsic safety foils explosive situations

Commercially available safety barriers are simplifying the design of circuits that must operate in dangerous environments, and they offer a practical alternative to purging or spark-proof housings

by Robert J. Redding, *Design Automation (London) Ltd., Maidenhead, England*
and Alan Krigman, *ICON/Information Concepts, Inc., Philadelphia, Pa.*

□ All that's needed to trigger an explosion at a refinery or some other location having a flammable environment is a tiny spark from an electronic measurement or control system. Yet if control electronics contain energy-storage elements, and if contacts are made or broken, sparking is virtually impossible to prevent. Sparks will occur when contacts are closed in a capacitive circuit or opened in an inductive circuit.

To get around the problem, the electronics engineer has three choices: explosion-proofing, purging, or intrinsic safety. An explosion-proof circuit is enclosed in an Underwriter's Laboratory, Factory Mutual, or other approved housing that is capable of withstanding an internal explosion without transmitting the flame to the external environment. If the circuit is purged, the components are enclosed in a conventional housing, and the housing is continually flushed with air or an inert gas. The object is to dilute the hazardous atmosphere near the circuits so it cannot explode.

But explosion-proofing and purging are usually costly to implement and inconvenient to operate and maintain. The flanges on an explosion-proof housing must not be scratched, for example, because an explosion may propagate along the scratch to the outside world. Another problem can exist when the enclosure is opened for maintenance. If it is not resealed properly, sparks can escape through the flanges. These dangers are more serious in large installations where maintenance needs are great, or under extremely harsh conditions, such as marine or offshore environments. The third option, intrinsic safety, is therefore attracting increasing interest among electronics engineers.

Simply enough, intrinsically safe equipment is incapable of releasing sufficient electrical or thermal energy, even under abnormal conditions, to cause ignition of a hazardous atmosphere. The concept is not new, but it has taken recent advances in solid-state electronics to make the approach especially practical and economical.

In practice, intrinsic safety is achieved by limiting the voltage and current available in the hazardous area, and by protecting or snubbing any capacitance or inductance so that stored energy can be dissipated without creating dangerous sparks. These conditions must be met, regardless of any faults that may occur.

To design an intrinsically safe circuit, the engineer

must first determine the allowable circuit conditions for the most easily ignited mixture of air and the particular volatile gases and/or vapors involved. This information is found on the ignition curves for various gases published in the National Fire Protection Association Standard 493-1969, or the Instrument Society of America Recommended Practice RP 12.2. Similar data for European standards is found in R.J. Redding's "Intrinsic Safety," published by McGraw-Hill in 1971.

While the curves differ slightly from standard to stan-

Designed for intrinsic safety. Leeds & Northrup developed its Century line of process control instruments to be used in loops protected by energy-limiting barriers. Such instruments particularly interest the safety-conscious chemical and petroleum industries.



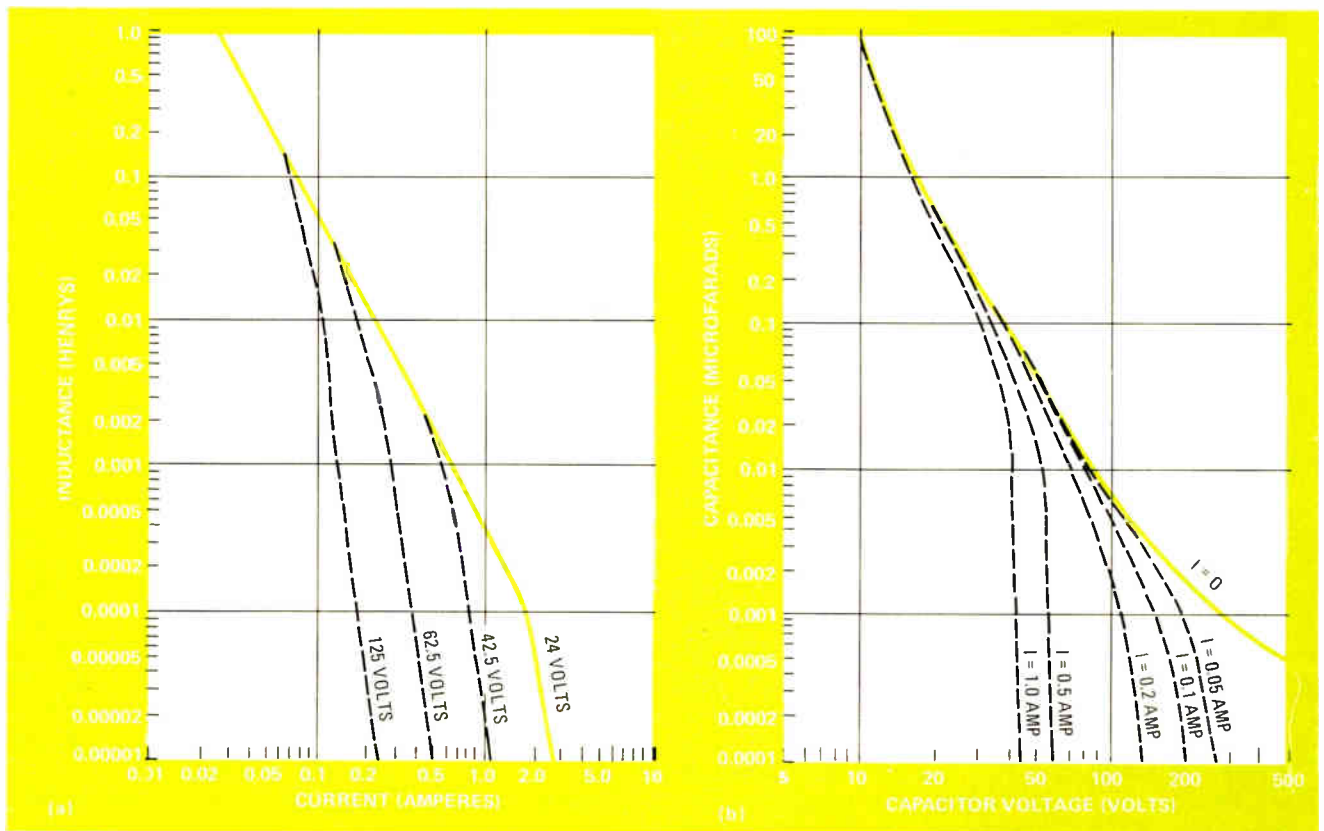

1. Hydrogen and air. Curves show actual ignition limits for the most easily ignited mixture of hydrogen and air. In practice, a safety factor of four must be applied for normal conditions. Curve (a) indicates the series inductance that will not result in ignition for a particular current and voltage, while curve (b) depicts the shunt capacitance that will not result in ignition.

standard, a factor of safety is applied to each standard, so in the end, the values are pretty much the same.

The curves in Fig. 1 show the minimum ignition current and voltage for hydrogen in inductive and capacitive circuits. If the voltage available in the hazardous area is limited and the circuit resistance is known, the maximum current can be calculated. Then, from the appropriate ignition curves, the allowable inductance and capacitance for that voltage and current level can be determined. An intrinsically safe circuit can be designed for any specific gaseous environment, but for optimum safety, it is best to design for hydrogen. Hydrogen is the most easily ignited gas; if a circuit is safe in hydrogen, it will be safe in any volatile atmosphere.

Once safe current and voltage levels have been determined, the engineer must ensure that they will not exceed these levels. A simple way to do this is to select an approved intrinsic safety barrier. The barrier consists of a commercially available network of zener diodes and resistors, including a fuse, that limits the voltage and current delivered to the hazardous area. The barrier will not allow the hazardous-area circuit to be energized beyond a predetermined degree, even if the full main voltage is applied directly to the input (safe-side) terminals of the barrier. (See Fig. 2)

Barriers simplify design

As a result, the circuit on the safe side becomes irrelevant to the question of safety, and it can be changed at will without affecting official approval. In addition, bar-

riers simplify initial approval, because the inspector can forget about the circuit on the hazardous side and only worry about the safe side.

The components in the barrier are not replaceable. Since field replacement of parts might compromise the intrinsic safety of the system, the unit is encapsulated. If a component fails, the entire barrier must be replaced.

A barrier is inserted between each device, transmitter, or transducer in the hazardous area and its associated control-room instrument or controller. All signals must pass through the barrier before entering the hazardous area. Physically, the barrier is usually located at some point in the structure separating the unsafe area (plant) from the safe area (control room).

Safety, a system consideration

After the barrier is selected, the engineer must check the reactance of the hazardous-area circuit, including the cables, to make sure it is sufficiently below the limits set by the voltage and current from the barrier. For purposes of inspection and insurance, components that are certified as intrinsically safe should normally be used. Using certified components doesn't automatically make the system intrinsically safe, however; the total hazardous-area system must still be evaluated.

Wiring can present a problem in this evaluation, since cable inductance may exceed allowable limits. Unless resistance is also high, the distributed nature of the inductance makes snubbing impossible. The problem can generally be overcome by minimizing cable

lengths and selecting aluminum rather than copper conductors.

In cases where circuit inductance and capacitance must exceed the levels allowed for apparent maximum voltage and current, it is sometimes possible to insert resistance into the circuit. Physically, this has the effect of increasing the charge- or discharge-time constant, thereby lowering the energy dissipation rate. A more satisfactory alternative in many applications is to use diodes rather than resistors to decrease the power-release rate in a spark. The advantage here is that normal circuit operation is relatively unimpeded, while a large resistance is inserted to minimize spark-discharge effects. All energy storage and snubbing circuitry must be potted as one integral module having terminal reactance below the established limits. Once the unit is encapsulated to prevent exposure of unsafe points to the hazardous atmosphere, the internal module elements become irrelevant. The potting material will prevent individuals from tampering with the circuit and it will also protect the circuit from physical and environmental damage.

Problems other than design

While the design may, on paper, be intrinsically safe, improper installation can change that. For example, a wireman may take a whole reel of cable, unwind what he needs, but never cut the cable. So a circuit designed to have 100 feet of cable between a transducer and the control room may actually have 1,000 feet, with 900 feet wrapped around a spool somewhere. The unwrapped cable introduces a large inductance into the circuit.

Careless maintenance can also thwart safety efforts. A maintenance man might replace a transmitter with one that performs the same job but isn't quite the same electrically. Fortunately, it is possible to check the reactance connected to the terminal of the hazardous-area side. This can even be done through the barrier. In fact, it's a good idea to do so in order that the test apparatus itself does not cause an explosion. An impedance meter would normally be used for the test, but this can produce an erroneous reading because instrumentation circuitry often contains a moving-coil galvanometer or other variable inductor.

It is better to use an energy storage measuring device, such as that described by R.J. Redding in "Intrinsic Safety." Basically this unit is a battery-powered, high-impedance voltmeter containing some switching circuits and a measuring capacitor. When attached to the input terminals of the barrier, the battery energizes the hazardous-area circuit while the measuring capacitor is disconnected. Throwing a switch removes the battery from the circuit and allows the circuit to discharge into the measuring capacitor. The readout, though not quantitative, will give some indication of the energy stored and dissipated.

Next, the tester is connected to a capacitor that is equivalent to the maximum capacitance allowable in the hazardous-area circuit, and the procedure is repeated. If the reading is higher than that produced by the hazardous-area test, the hazardous area is still within spec. The same test is also performed with an in-

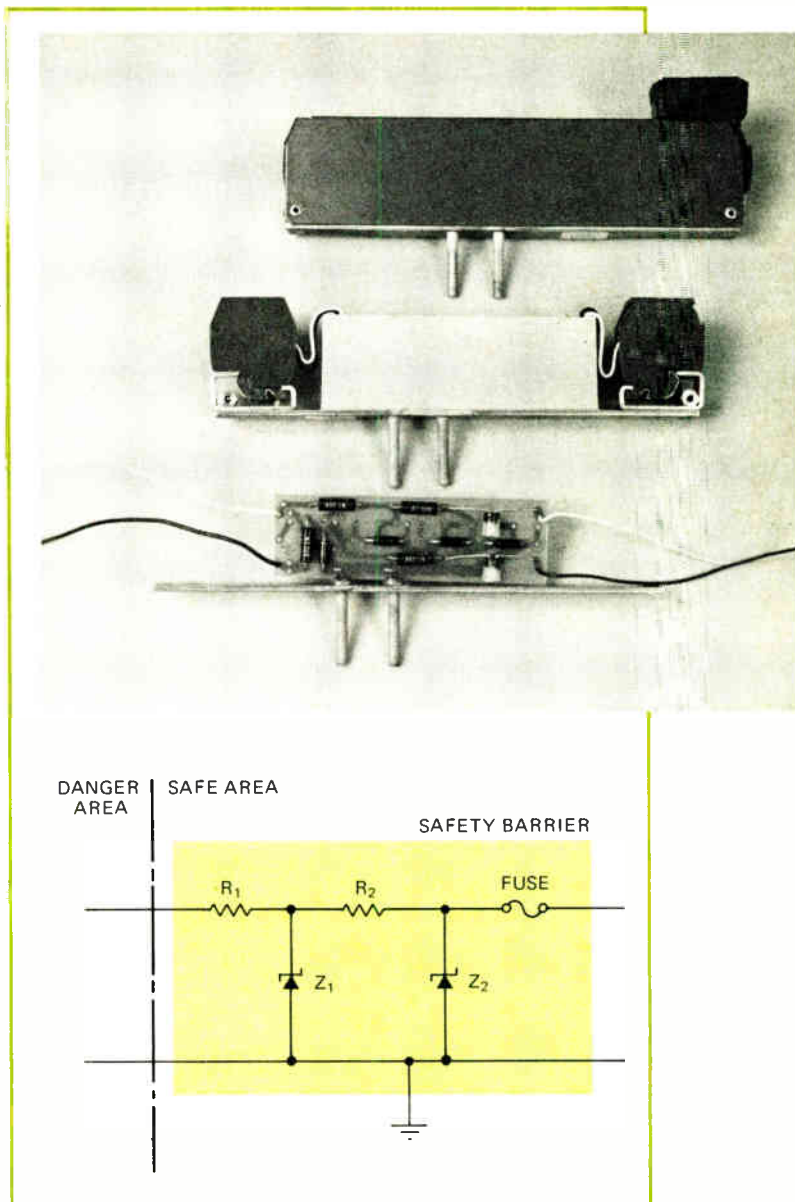

2. Barrier. External fuse mounted on upstream (safe) side of assembled safety device (top of photo) is set to blow at a lower current than the encapsulated fuse as a cost-saving precaution. Circuit board at the bottom is a double-barrier configuration, while the schematic illustrates the basic barrier configuration.

ductor that is equal to the allowable inductance.

In some instances, a traditional design can be modified to lower its operating-power requirements, making it intrinsically safe.

For example, solenoid devices normally operate at several watts. But the energy needed to start the armature moving is considerably greater than that needed to hold it in position. So if a solenoid device has a low enough holding current, it can be operated from an intrinsically safe source provided there is a means to trigger the switching action with a low-energy pulse. One possible technique is to use a permanent magnet as the latch to hold the armature in position.

Figure 3 shows a practical means of operating a magnetically latched solenoid valve from a barrier. In it,

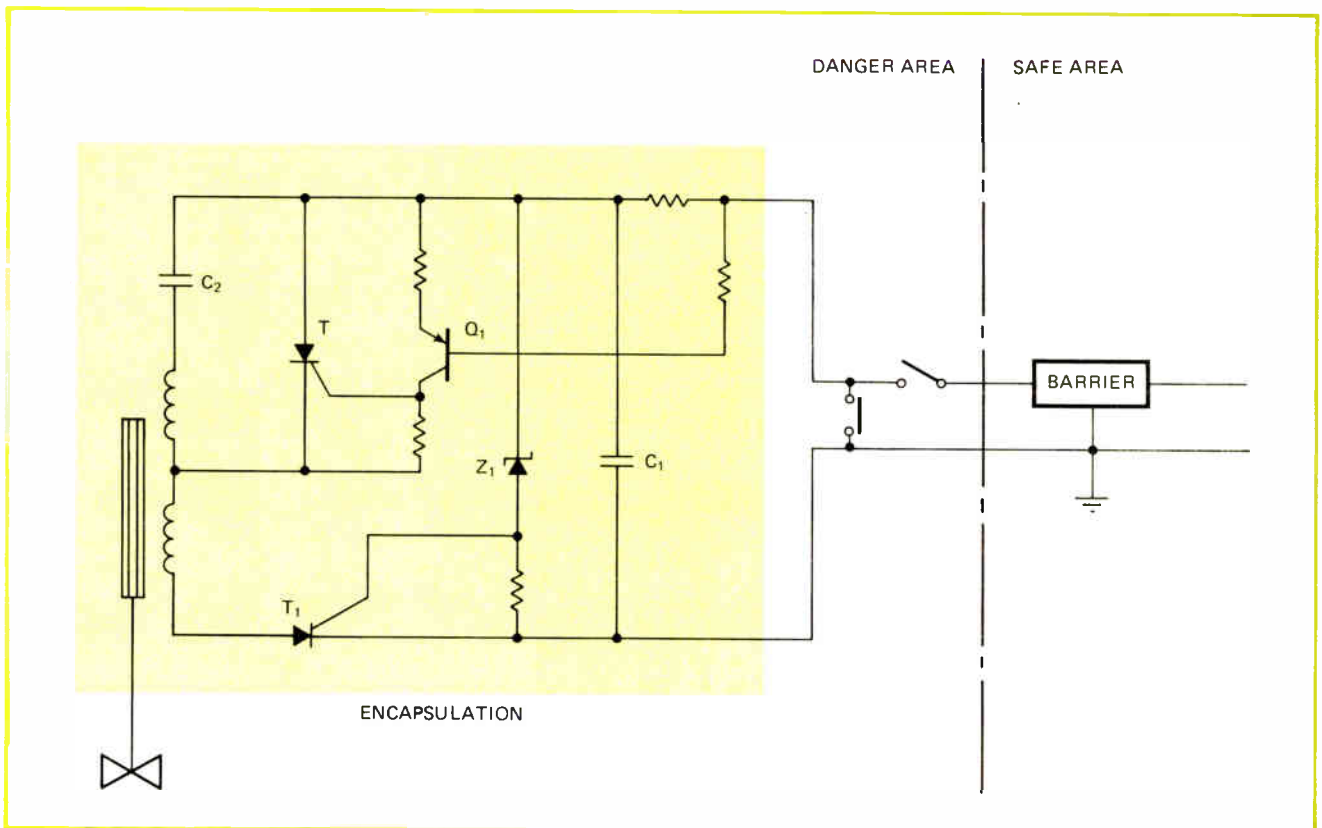

3. Low-level solenoid operator. Intrinsic safety may demand change in component design. This encapsulated circuit will operate a magnetically latched solenoid valve from a low-level signal.

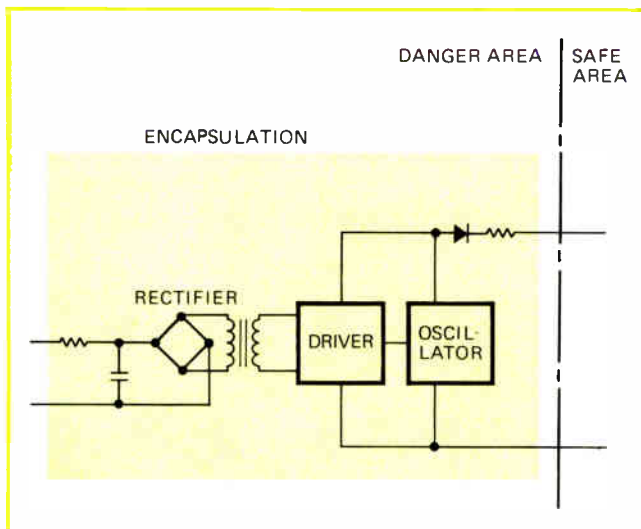

4. High-voltage operation. Encapsulated inverter circuit produces high voltages at intrinsically safe power levels to operate devices such as ionization detectors.

capacitor C_1 charges to the voltage limit of the barrier. Zener diode Z_1 then causes thyristor R_1 to discharge the capacitor through the coil. The resulting surge moves the valve to the on position, where it is latched by a permanent magnet. The discharge of C_1 also charges capacitor C_2 in series with the coil. When the solenoid valve control lines are short-circuited, transistor Q_1 is turned on. Thyristor T_2 then causes capacitor C_2 to discharge through the coil, opposing the latching magnet

and causing the valve to switch back to the off position under spring action.

This configuration is especially useful when the valve must remain on if power fails. The power supplied to the unit only determines the frequency of operation, and this particular valve design has been operated from solar cells.

High voltages or currents

In other cases, it is unavoidable that certain measuring devices used in hazardous environments have high voltages or currents. For example, smoke, fire, and radiation detectors working on the ionization principle require high-voltage supplies. If connecting wires are more than a few hundred yards long, cable capacitance would hold sufficient energy to produce an explosive spark.

One solution is to transmit energy through the cable at low voltages, and obtain high voltage at the sensor by means of an inverter. The unit shown in Fig. 4 operates in this manner. The inverter is designed to fit into the base of a smoke-detector so that the high-voltage leads are only a few inches long. When the sensor is exposed to smoke, its resistance decreases and the current from the barrier rises. At the same time, the current drawn at the safe side of the barrier increases and will activate an alarm that is electrically isolated from the hazardous area. A similar principle comes into play where high current is required at low voltage, as in a hot-wire gas detector. The main difference in implementation is the ratio of the transformer windings. □

The 70-lb. Sabre VI: It's a giant leap beyond any other small, high performance IRIG analog tape recorder/reproducer. Records at 8 electrically selectable speeds: 120 ips through 15/16 ips; reproduces at any 3 electrically selectable speeds; records from 15.3 minutes at the highest speed to 32.8 hours at the slowest on 14" reels. Remote speed selection and LED footage counter. LED bar data monitor. Let us give you full details.

SANGAMO RECORDERS

THE INNOVATORS IN TAPE INSTRUMENTATION

Sangamo Electric Company

Data Systems

P.O. Box 3347 • Springfield, Illinois 62714

(217) 544-6411

Introducing the carry-in recorder reproducer that will carry-on for 32.8 hours!

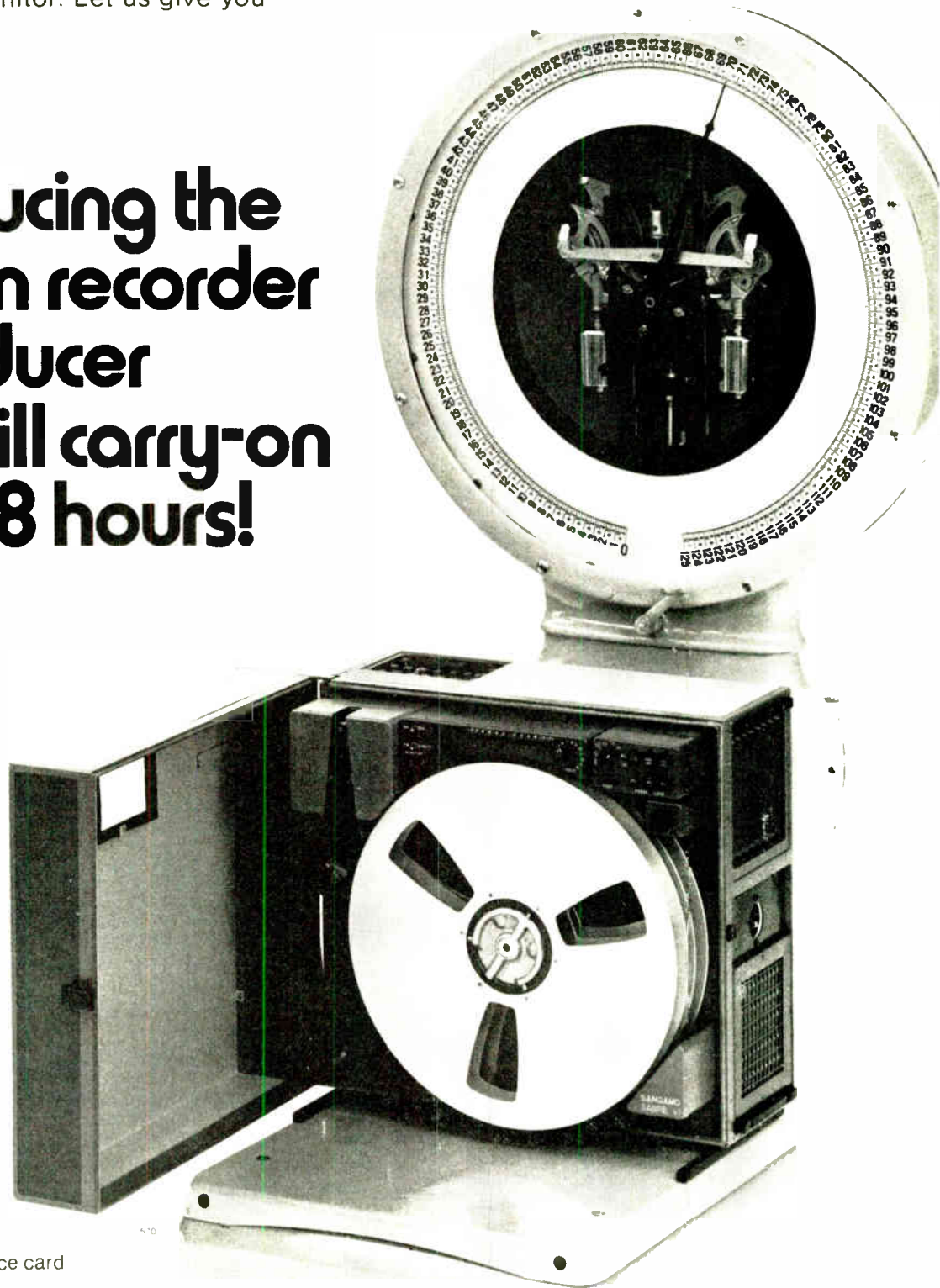

Circle 95 on reader service card

Compensating the 555 timer for capacitance variations

by Kenneth Lickel
Philips Medical Systems Inc., Shelton, Conn.

With the 555 timer, any error in the value of the external timing capacitor causes a corresponding error in the duration of the output pulse. If several fixed timing resistors are used to permit selection of various output pulse widths, it may be desirable to compensate for the capacitor variation instead of changing each timing resistor. The circuit below allows correction for capacitor tolerance variations up to $\pm 12.5\%$ by adjustment of a single variable resistor.

The output pulse width, t , is given by the time required for the timing capacitor to rise to the value of the control voltage, V_{CON} . That relationship can be shown by the equation:

Timer. External variable resistance alters control voltage of 555 timer to compensate for variations in timing capacitor.

$$V_{CON} = V_{CC}(1 - e^{-t/RC})$$

or

$$t = -RC \ln(1 - V_{CON}/V_{CC})$$

This equation shows that the pulse duration depends on the ratio of V_{CON} to supply voltage V_{CC} for given values of timing resistor R and timing capacitor C .

In the technique used to compensate for error in the timing-capacitor value, the ratio V_{CON}/V_{CC} is varied with an external resistance that shunts the 10-kilohm resistance inside the timer. As the circuit diagram shows, this external resistance consists of a 200-kilohm variable resistor R_A in series with a 17.8-kilohm fixed resistor R_B . The ratio V_{CON}/V_{CC} determined by the voltage-dividing network is:

$$V_{CON}/V_{CC} = R_p/(R_p + 5 \text{ k}\Omega)$$

where

$$R_p = (10 \text{ k}\Omega)(R_A + R_B)/(10 \text{ k}\Omega + R_A + R_B)$$

If R_A is set at its minimum value (zero):

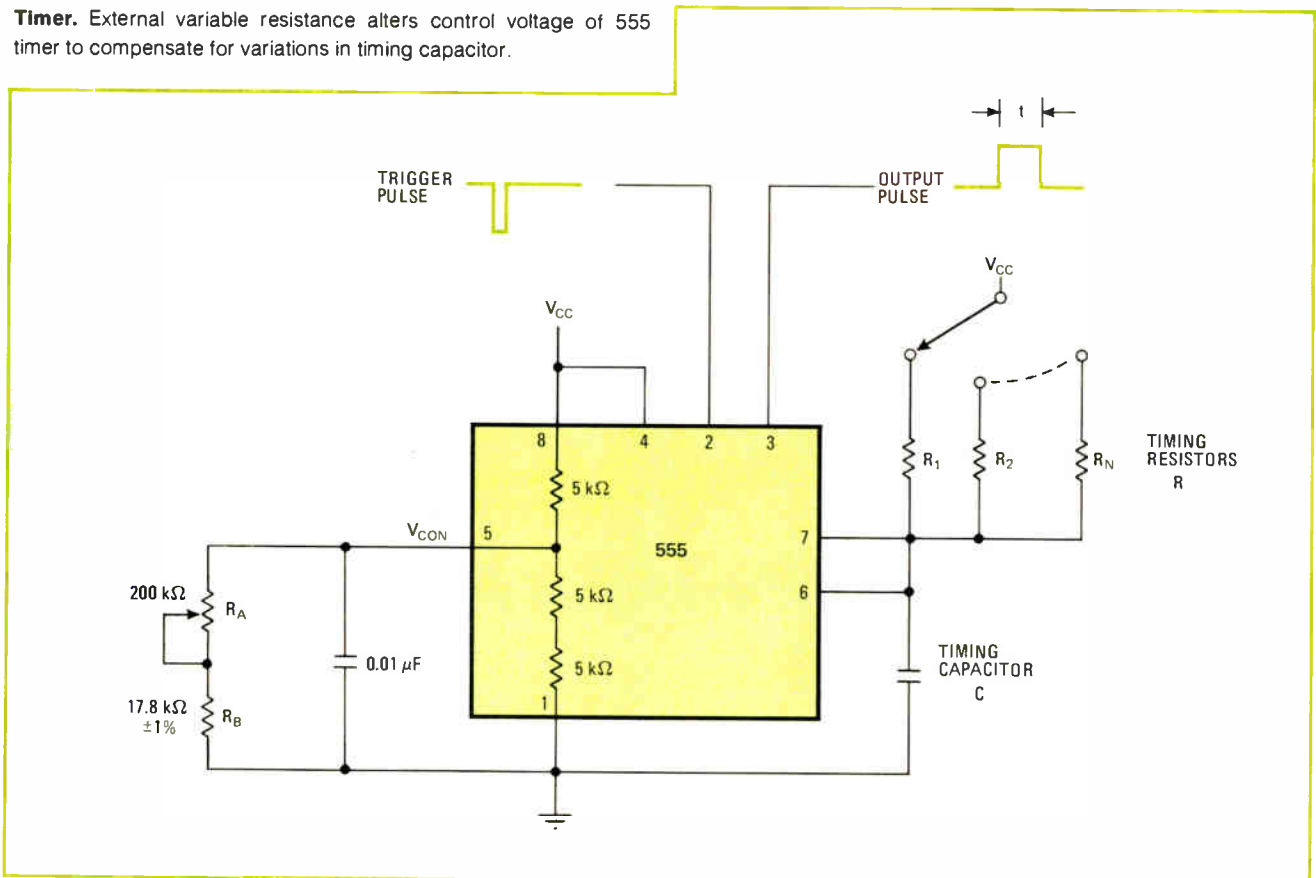

Be serene in your logic.



Attain flexibility with TRW/Cinch logic boards.

You can be master of logic changes. Total flexibility in the interconnection of integrated circuits is the soul of I.C. logic boards from TRW/Cinch Connectors.

For prototyping and short production runs, TRW/Cinch has assembled a line that gives you these features and options:

- High density DIP boards in 14 and 16-pin patterns (in 30-pattern multiples up to 180) or universal boards that accept 8 to 40-lead IC's.
- Socket terminals accept rectangular or round pins. Have two or three-level wire wrap* terminals.
- FR-4 epoxy glass 1/8" boards, with power and ground planes on opposite sides.
- Complete line of interconnection accessories.

Since we believe in flexibility, our application engineers are available to assist in the development of custom board designs.

Fast, off-the-shelf delivery is available through these distributors and their branches in all major market areas:

• **Pioneer-Standard Electronics** • **Rampart Components** • **RESCO Electronics** • **Sterling Electronics** • **Wilshire Electronics**

Dial toll-free (800) 645-9201 for the name and phone of your nearest source. Write or call your local TRW/Cinch logic board distributor or TRW/Cinch Connectors, an Electronic Components Division of TRW Inc., 1501 Morse Avenue, Elk Grove Village, Illinois 60007; phone (312) 439-8800.

© T.M. Gardner-Denver

CC-7501

Circle 98 on reader service card

TRW ® **CINCH CONNECTORS**

the fall of the master clock's pulse clears FF₁ via the CLR input of FF₁.

This approach—setting the output of each flip-flop high with the J input, provided the preceding flip-flop is already on, and setting it low with the clear input when the following flip-flop is on—is used for each of the three flip-flops. The width of the overlap is approximately equal to the width of the master clock's pulse, and the frequency of each waveform is one third that of the master clock's pulse. The circuit is self-correcting and also self-starting.

The same idea can also be used in driving the phase voltages for a two-phase CCD. □

3. Pulse timing. As the three flip-flops turn on and off (second, third, and fourth traces from top), their outputs overlap by the width of the clock pulse, minus circuit delays. The frequency of each waveform is one third that of the master clock's pulse.

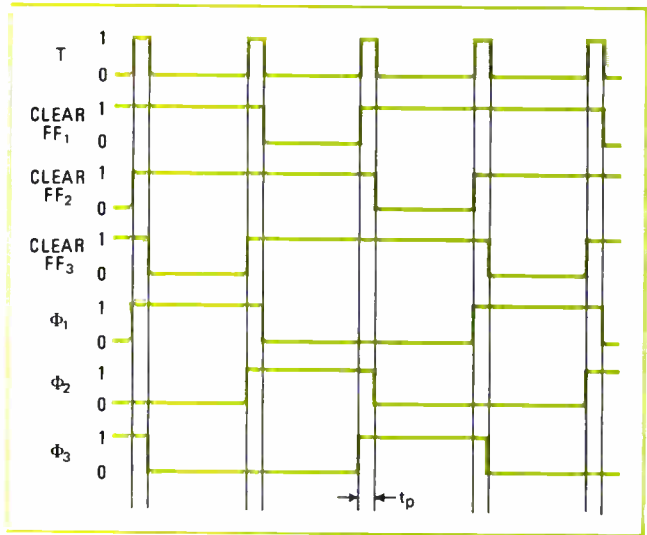

Overvoltage indicator can be added to C-MOS IC tester

by Rajni B. Shah

Rohde & Schwarz, Fairfield, N.J.

A warning light that signals the presence of an overvoltage can be added to the features described in "In-circuit IC tester checks TTL and C-MOS" [*Electronics*, May 30, 1974, p. 120]. A light-emitting diode glows if the IC under test has any pin voltage greater than 18 v. The warning circuit, like the rest of the test circuit,

Indicator. Overvoltage warning LED D₁ lights if the IC under test has any pin at a voltage greater than 18 V. Indicator D₁ and its associated components are shown connected to an in-circuit IC tester. The test circuitry derives its power from the device being checked.

draws its power from the IC being checked. As described here, it can operate at overvoltages as high as 30 v.

The indicator circuitry, shown below, is connected to the tester described previously. Warning LED D₁ is shunted by Q₁, which is normally held in conduction by the potential applied to its base through R₂. Q₂ is normally inhibited by the base connection through R₃. If the voltage at any IC pin exceeds 18 v, however, zener diode D₂ breaks down, and Q₂ starts to conduct. Conduction in Q₂ pulls the base of Q₁ up to turn off Q₁. The voltage drop across Q₁ then is sufficient to light up LED D₁, indicating the overvoltage. □

Designer's casebook is a regular feature in *Electronics*. We invite readers to submit original and unpublished circuit ideas and solutions to design problems. Explain briefly but thoroughly the circuit's operating principle and purpose. We'll pay \$50 for each item published.

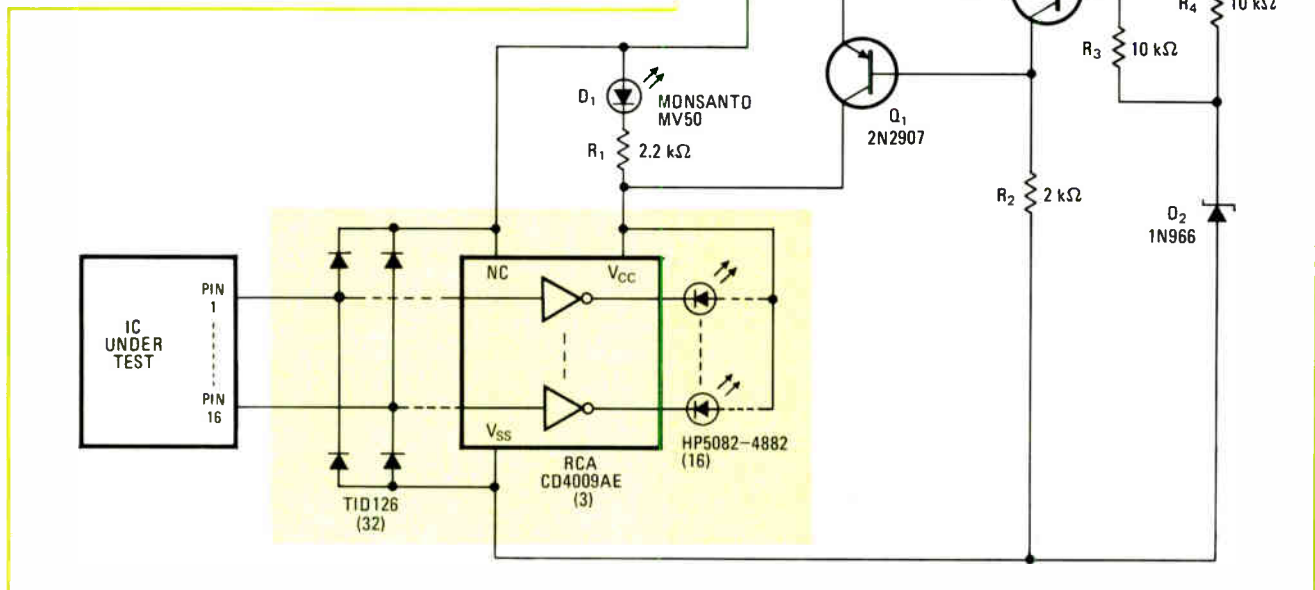

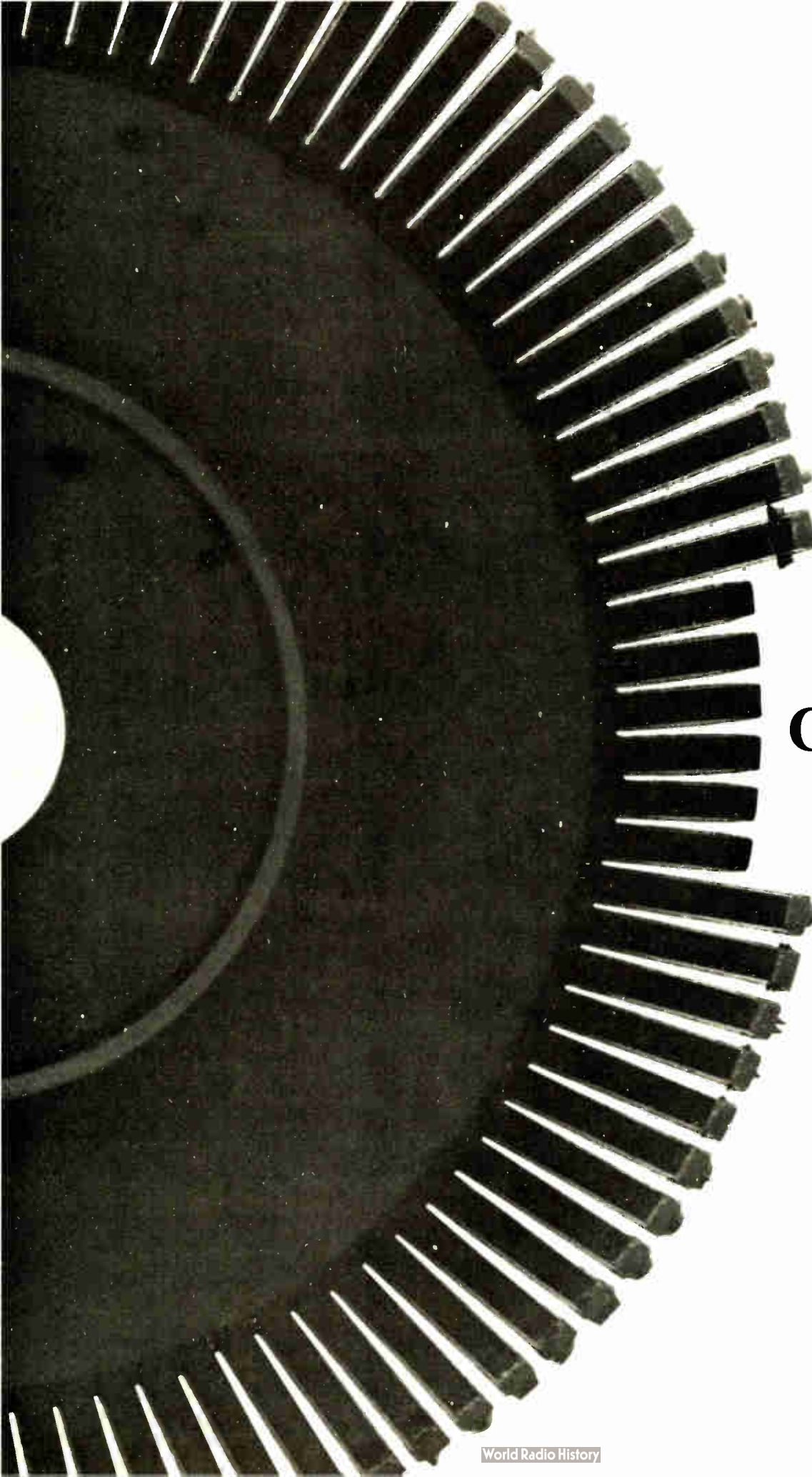

Carousel:

the first impact printer with print quality that rivals Selectric.*



We're introducing a high-performance 30 CPS, serial impact printer with a big difference. Print quality. It's so good you can't tell a Carousel printout from a Selectric printout.

The print quality is the result of the Carousel's rugged interchangeable print cup. And it's available in a variety of type fonts. A print cup with up to 100 character capacity.

But Carousel quality doesn't stop there. It also has a microprocessor built into its print mechanism.

What this means to you as a systems builder is high-quality print capability together with maximum system versatility.

Both of which you get at low cost.

It also means that whether you're developing a word processor, special purpose terminal, data station, or even a teletype replacement, the Carousel printer makes your job easier.

Carousel has a lot of other quality features, too. Just send in the coupon. And we'll send you all the facts about what makes our new Carousel go 'round.

Interdata, Inc., Terminal Products Group
Oceanport, N.J. 07757

Gentlemen:

- Please send me more information about the Carousel Printer.
- Have a sales representative call on me.

Name _____

Title _____

Company _____

Address _____

City _____ State _____

Zip _____ Telephone _____

INTERDATA[®]

A subsidiary of The Perkin-Elmer Corporation

Terminal Products Group

Oceanport, N.J. 07757 (201) 229-4040

Designing microprocessors with standard-logic devices, Part 2

In comparison with TTL random-logic systems, many fewer devices are needed to build high-speed standard-logic processors; but even fewer are necessary when the particular application requires less than optimum performance

by Robert Jaeger, *Signetics Corp., Sunnyvale, Calif.**

□ Processors built with standard high-speed logic take a middle course between MOS microprocessors and random-logic TTL designs—they're faster and more flexible than MOS chips and use many fewer ICs than the random-logic systems. For different applications, they can be optimized in several different ways, as Part 2 of this two-part article describes. (Part 1, which appeared in the last issue, discussed their basic elements: a register/arithmetic/logic unit or RALU, a control memory, and input/output circuitry.)

Generally, the number of devices needed to build a standard-logic processor can be reduced whenever the acceptable level of performance is less than the highest attainable. When speed is not crucial, for instance, the microinstruction format can be modified to reduce the number of read-only memories or programable ROMs required by the control memory. Different types of

memory branching can also be used sometimes to reduce memory size and/or program length. The flexibility of the approach will be illustrated by two standard-logic processor designs.

The role of the microinstruction

A single microinstruction from the control memory may cause the RALU to perform one operation (called monophase) or more than one (polyphase), and the designer should choose carefully which best suits his system. Figure 1 shows four different kinds of RALU operations, which require one, two, or three phases.

The advantage of polyphase RALU operations is that complex microinstructions, such as "read-modify-write," are executed by the RALU in the shortest possible time. Once the microinstruction has been accessed, the RALU needs no further reference to the control memory. Execution time is limited only by the propagation delays of the RALU logic elements.

* Now with MSI Data Corp., Santa Ana, Calif.

1. Monophase or polyphase. RALU operations typically require one or more steps to complete after a single microinstruction is received. More complex microinstructions can be executed faster with polyphase operation, but this often dictates additional decoding logic and more control inputs than with monophase.

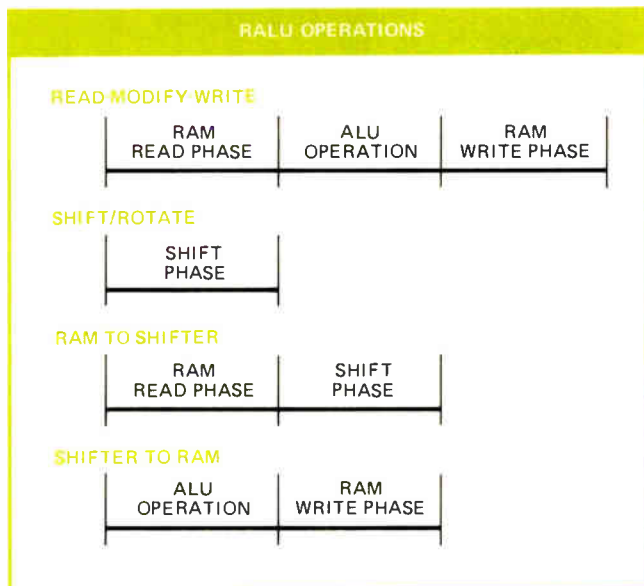
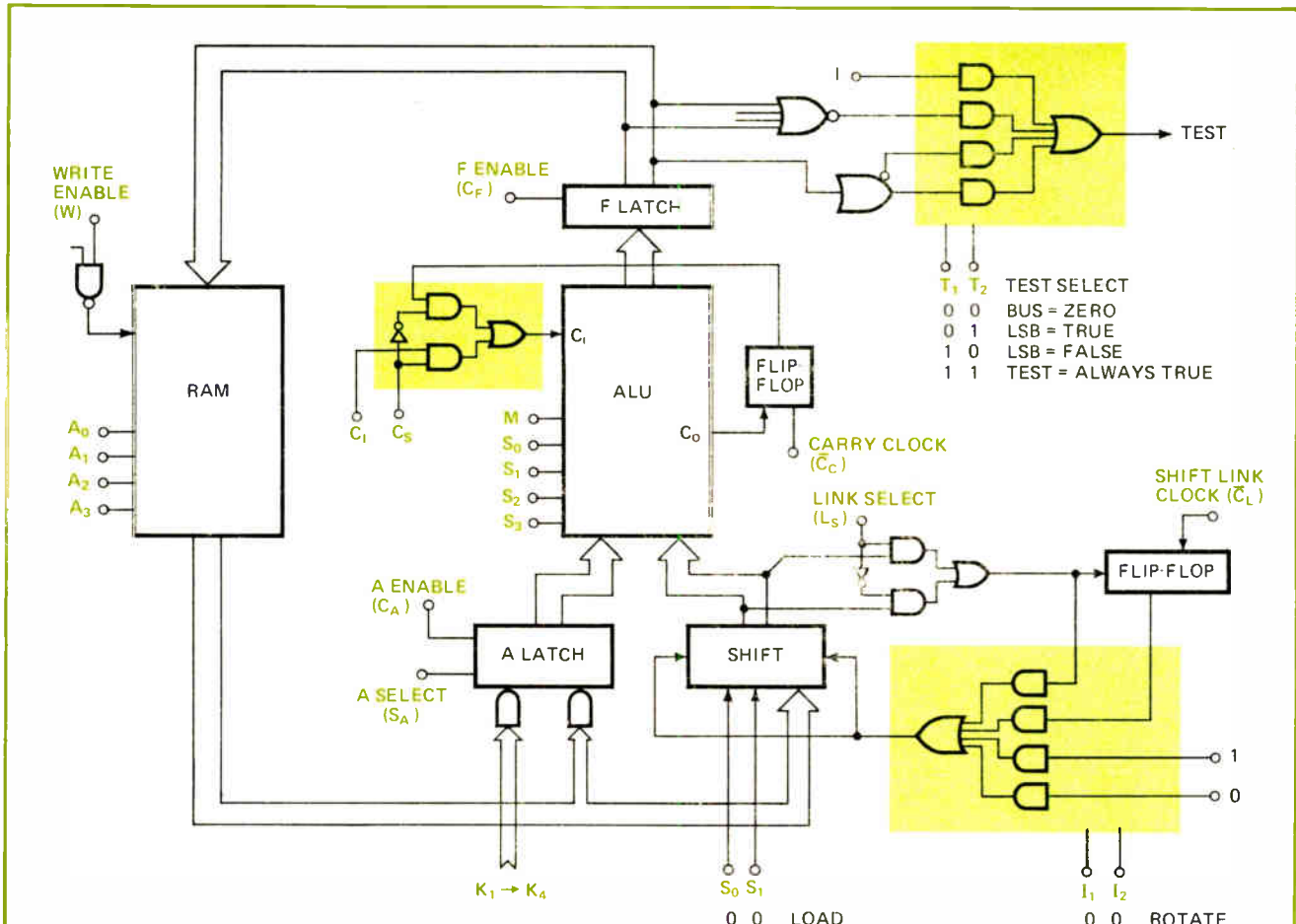

TABLE 1: POLYPHASE VERSUS MONOPHASE CONTROL INPUTS

	Number of RALU control inputs used
Polyphase microinstructions	
Increment RAM word	17
Branch if K is equal to contents of shifter	17
Rotate shifter and branch if LSB = 0	18
Rotate shifter and load result into RAM	21
Monophase microinstructions	
Transfer RAM word to A latch	7
Transfer RAM word to shifter	7
ALU operation (A, B to F latch)	10
Shifter operation	6
Test and branch	7
Load 4-bit K input to A latch	6



2. Better control. More elaborate RALU designs with special features such as linking, testing and additional latches and shifters can boost the number of required control inputs to 28.

0 0	LOAD	0 0	ROTATE
0 1	SHIFT RIGHT	0 1	INSERT LINK
1 0	SHIFT LEFT	1 0	INSERT 0
1 1	HOLD	1 1	INSERT 1

Another advantage is that a sequence of RALU operations can be specified by a single microinstruction. This provides a kind of instruction encoding, which reduces the number of instructions needed in the control memory to perform a given system function.

There are several disadvantages, however, which argue against the use of polyphase operations, unless the system needs the speed. First, if a fixed-phase sequence is used for each microinstruction, the simpler ones will take as long to execute as the more complex ones. If a variable-phase technique is employed, additional decoding logic is required to select the phases to be used in executing each microinstruction. Second, a wide microinstruction is required from the control memory to provide control signals to all the RALU control inputs. This precludes the possibility of encoding the microinstruction to reduce its width, and also increases the required size of the control memory.

Table 1 shows some possible monophase and polyphase microinstructions, together with the number of RALU control inputs that must be specified in order to execute them. The RALU in Fig. 2 has 28 control inputs and a highly flexible 38-bit microinstruction format. However, most microinstructions, particularly if they specify a monophase RALU operation, would not require all 38 bits for every operation, and restricting mi-

croinstruction capabilities can yield significant savings in the size of the control memory, and therefore its total cost.

Table 2 shows five types of operations that can be performed on the RALU and the number of bits in the microinstruction required for each. Some of the control signals must have a defined logic state for every microinstruction, since it is important to ensure that the performance of a microinstruction on part of the RALU does not affect other logic states in the RALU. That is, a shift operation should not disturb the contents, either of the A latch or the ALU's output latch, and a memory operation should not disturb the contents of the link flip-flops. For this reason, some of the control signals must have a defined logic state for every microinstruction. The logic state of the remainder of the signals, however, is significant only when performing an operation on that part of the RALU affected by a specific microinstruction.

Consequently, of the 38 control signals shown in Table 2, only eight must have defined logic states for all microinstructions. Of the remaining 30 control signals, no more than 10 are needed for any specific type of operation. By restricting the number of RALU operations that can be performed in response to a single microinstruction from the control memory, the micro-

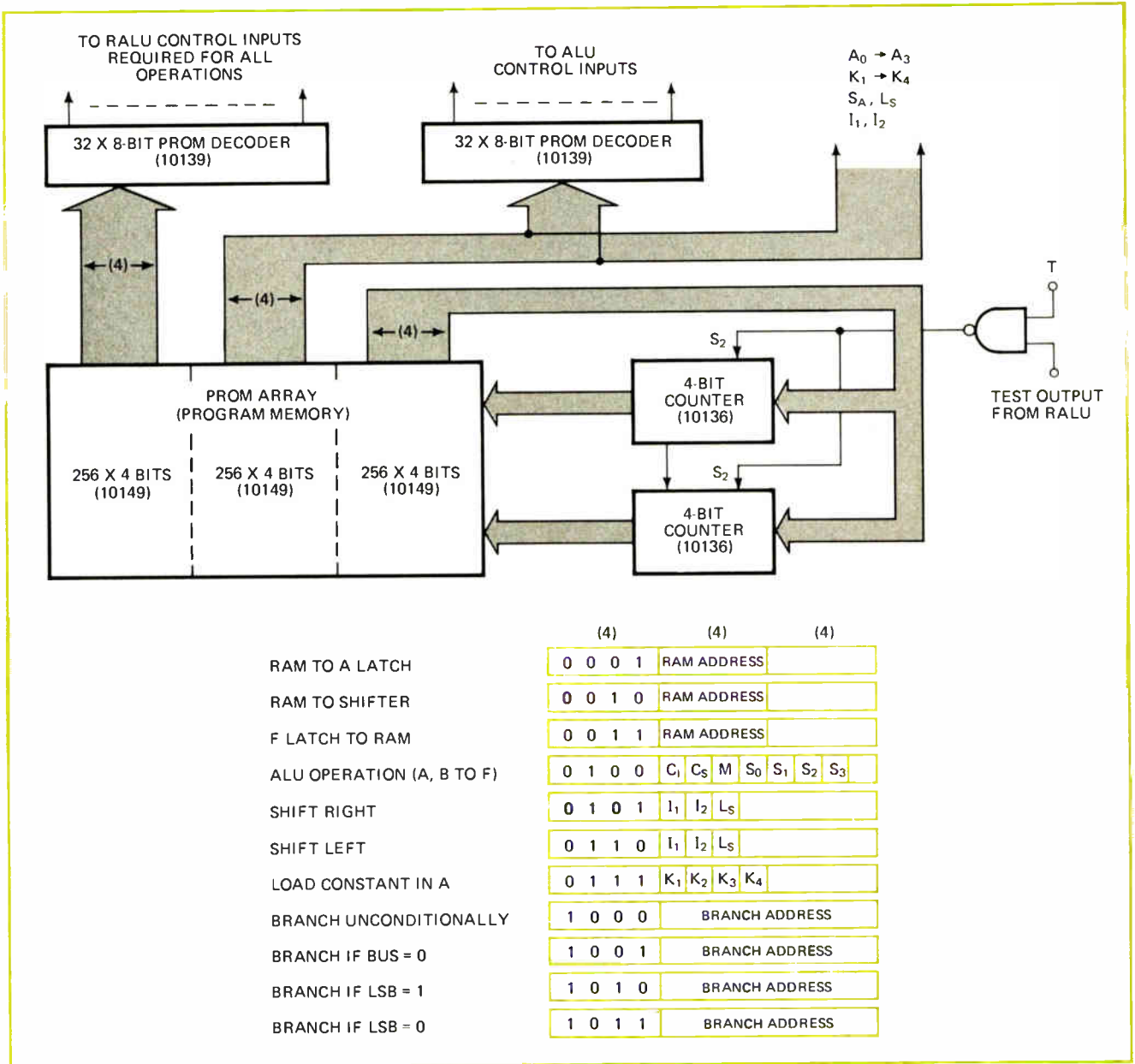

3. Encoding. Microinstructions can be arranged in such a way as to minimize size of program memory. This control memory, which was built with ECL 10K components, uses microinstructions with 12-bit word lengths, examples of which are shown at right.

instructions need never be wider than 18 bits—and the number of ROMs or PROMs needed to store those microinstructions can be reduced.

Further reductions in the width of the microinstructions can be achieved by encoding the bits they contain. Basically, the control memory provides the RALU with control signals that specify an operation, and with a sequence of microinstructions that tell the RALU to perform a more complex, system-level function.

Encoded microinstructions

These two functions can be separated, with one part of the control memory providing the microinstruction-decoding function, and the other part providing the sequencing function. The bit positions in the “sequence” or “program” memory, then, do not have to bear any direct relationship to a specific RALU control input,

since this function is left to the instruction decoder. The microinstructions to be used in the processor can be designed to minimize the size of the program memory and provide the most efficient utilization of the memory bits.

Figure 3 shows a control memory that has a 12-bit microinstruction. The 10139 is a 32-by-8-bit ECL PROM, used for decoding the microinstructions, and the 10149, organized 256 by 4 bits, is used as the program memory. A list of possible microinstructions that might be used with this design is also shown.

It's possible to encode a microinstruction in only 8 bits, but it is then extremely difficult to define instructions that reference memory (branching) or those that contain data or constants. Such instruction sets are possible, though, and one is being used in one of the newer MOS microprocessors. Writing useful programs with these instructions, however, is a tedious and time-con-

suming task. One solution is to use “double-byte” instructions, but that requires additional instruction-decoding logic and therefore adds to the device count. (A double-byte instruction consists of two successive 8-bit words, each of which is half of a 16-bit instruction. The additional logic required is an 8-bit buffer register on the output of the memory for temporary storage of the first byte of the instruction, and a single flip-flop to hold the execution phase of the processor during more than one control-memory cycle. When 8 bits will be enough, a single-byte instruction is used.)

Memory branching

A key feature of a processor is the ability to modify its current sequence of instructions by branching to a different sequence of instructions in another part of the memory. The branching range and kinds of branches that can be performed will influence the ease of programming, size of the memory, and response time of the processor to external inputs.

Branch instructions can be either conditional or unconditional, and either direct (when the instruction contains the address of the next instruction) or indirect (when the instruction contains the address of a location in memory whose contents specify the address of the next instruction). Another kind of branch is an indexed branch. In this case, the address in the branch instruction is modified by adding to or subtracting from it the contents of one of the registers in the RALU. Branch instructions may contain any or all of these features.

Another kind of branch instruction is used for temporarily branching to another part of the memory. The current address is stored temporarily in a register or set of registers. Return to the current-instruction sequence is accomplished by another kind of instruction, which transfers the contents of the temporary register back to the memory-address register. This pair of instructions is useful for reducing the size of a program, since a common subroutine can be used by different parts of the program without having to be repeated.

A subroutine might also contain a branch-and-store instruction within it, which would require a second temporary storage register for saving the second return address. This set of temporary registers constitutes a return-address stack, which may be implemented either by using registers in the RALU or by storing the address in an external memory.

The usefulness of a return-address stack depends heavily on the particular processor application. A stack reduces memory size the most when the program repeatedly uses the same subroutines. But it also increases the program’s execution time, since the branching instructions have to be added to the program to reduce the memory requirements.

Central-processing units

The central-processing unit in a computer system is a special application. The function of the CPU is to provide an interface to the main memory, which, by implication, is larger and slower than the processor’s control memory. The processor receives instructions from the main memory and transfers data to and from it. The

Steps in designing a processor

The design of a processor consists of two parts: the hardware or logic design, and the programming or software design. But before either can be started, the system’s operating requirements must be established.

The best way to do this is with a flowchart, which must be accurate and include every operation that will be required of the system. This flowchart describes the system’s sequential operations (in this case in terms of system-level operations rather than individual microinstructions) and the decision points (which in this case represent branch instructions). The chart should also include some provision for system initialization and take into account system failure modes.

The next step is to establish the critical timing paths in the flowchart—that is, to define those functions, or groups of functions, that must be completed within some maximum allowable period of time. This is important not only for the selection of a logic family but also to establish whether monophasic or specialized polyphase instructions will be required. The flowchart will also show those places, particularly in I/O operations, where a specialized instruction could be used to reduce the control memory’s requirements.

At this point an instruction set can be defined that will allow the processor to meet the system’s performance requirements and make efficient use of the bits in the control memory. Once the instruction set is defined, the hardware and software can be designed simultaneously.

The hardware design consists of implementing, not the required system functions as in the case of random-logic designs, but the logic necessary for the processor to execute those instructions in the defined instruction set in the time allotted. The required system-level functions are designed in the software or control-memory program. Software design consists of using the defined instruction set to implement the operations specified by the system flowchart.

TABLE 2: MICROINSTRUCTION BITS REQUIRED FOR CONTROL

RALU control inputs		Number of bits used per microinstruction					
		All	RAM	ALU	Test and branch	Shift	K ₁ → K ₄ to A latch
RAM	W A ₀ , A ₁ , A ₂ , A ₃	1	4				
A latch	C _A S _A	1	1				1
Shift	S ₀ , S ₁ I ₁ , I ₂	2				2	
	L _S C _L	1				1	
ALU	C ₁ , C _S , M, S ₀ , S ₁ , S ₂ , S ₃			7			
	C ₀ C _F	1					
	T ₁ , T ₂ Branch address				2		
	K ₁ , K ₂ , K ₃ , K ₄ Test enable	1			8		4
Total		8	5	7	10	3	5

number of instructions can be quite large—usually more than 100—and they specify operations to be performed on data in the registers, as well as data transfers between the memory and peripheral devices. In this situation, the main memory can be treated as another external interface.

The processor sets up the main-memory address either by incrementing a number used as the program counter or by specifying the address of a main-memory location for a data transfer. The main-memory address

may be formed by adding or subtracting the contents of a register from memory data (indexed addressing), by using memory data as address pointers (indirect addressing), or by using memory data directly as the next memory address (immediate addressing). It is the function of the processor to interpret the instructions from the main memory and to perform the sequence of operations on the RALU and interfaces specified by it. As the first step in the processing of a main-memory instruction, the processor may sense the state of an input line

4. Little leaguer. This 4-bit emitter-coupled-logic processor requires only 13 devices over and above a read-only-memory/programmable ROM array. Multiple-byte instruction capability can be added with more logic.

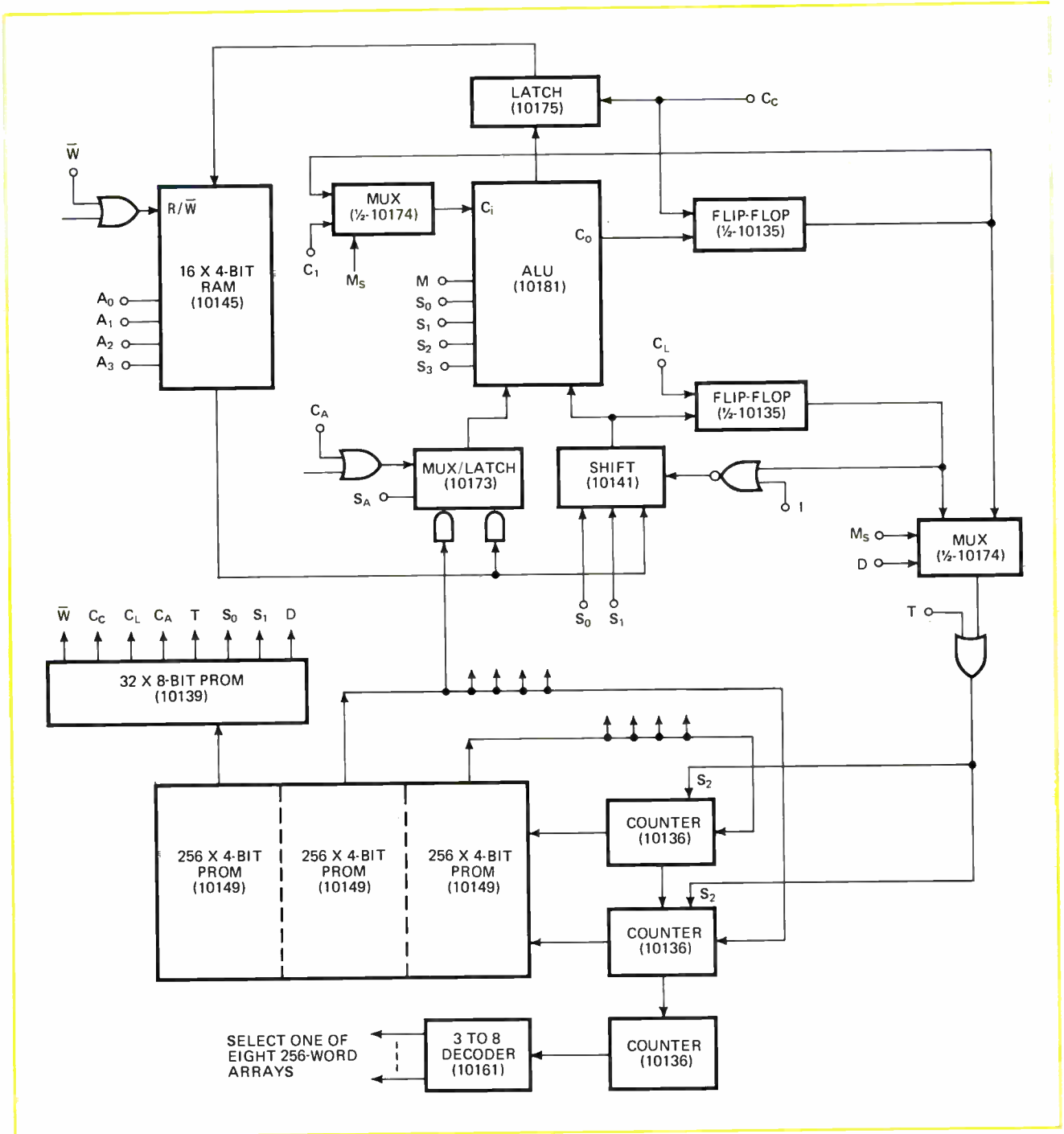

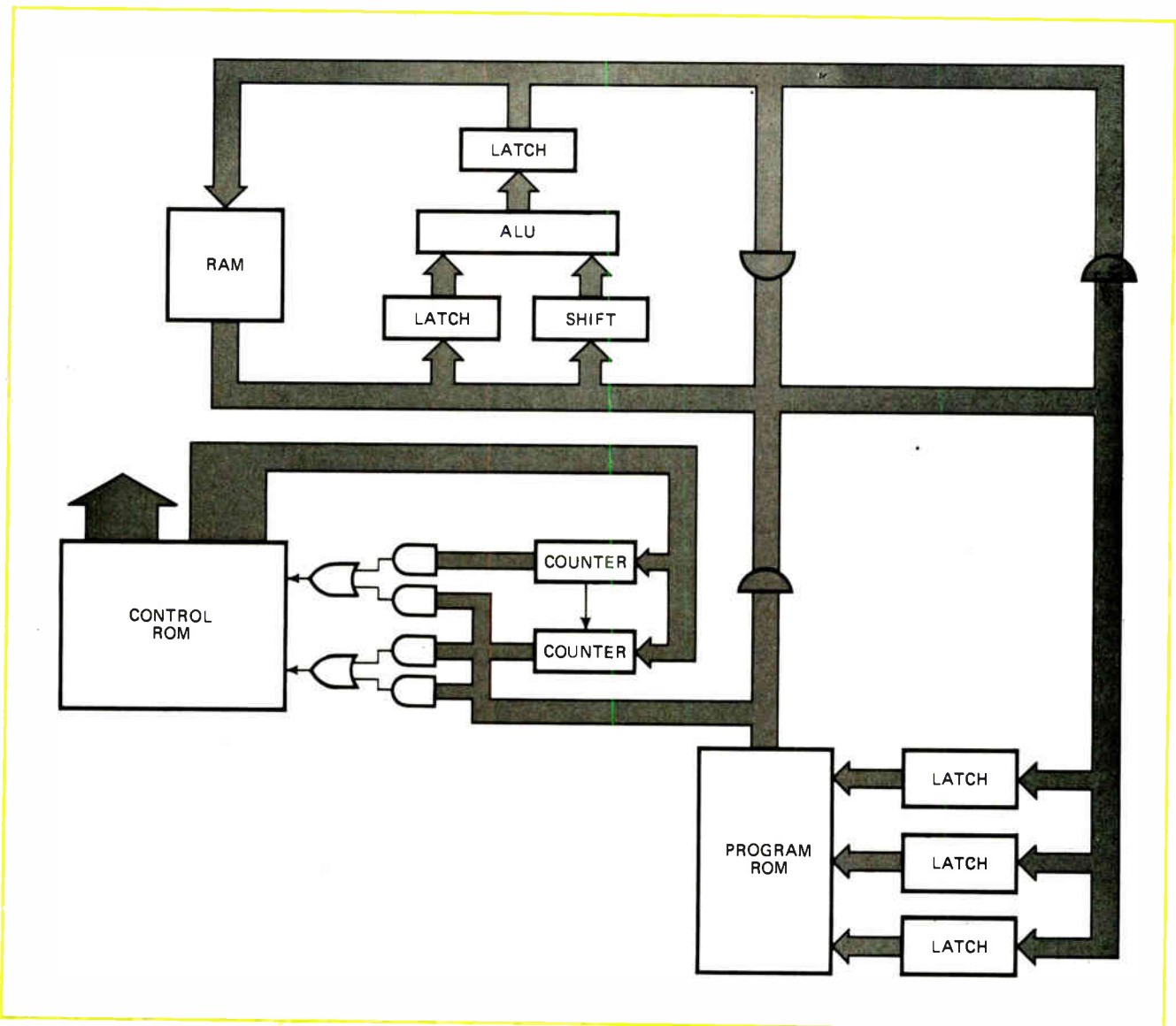

5. Big leaguer. More complex design forms a central processing unit in which the control memory performs a sequence of microinstructions in response to an instruction from the program ROM. This feature can be used to emulate another computer or an MOS microprocessor.

to determine if another operation should be performed first. This is the "interrupt" feature that is found in most computers.

Examples

Figure 4 shows a small 4-bit ECL processor that uses only 13 devices plus an array of 256-by-4-bit ROMs or PROMs. Either the Motorola 10150 or the Signetics 10149 can be used for the ROM/PROM array. The 12-bit memory-address counter adds only five devices to the RALU. In either design, additional features may be added—more test functions, return-address registers, or multiple-byte-instruction capability—by using additional logic. For large ROM/PROM arrays, it may be advantageous to use one of the 4,096-bit TTL ROMs or PROMs, such as the Signetics 8205 or 82S115. ECL interface devices like the 10124 and 10125 will convert the TTL-logic levels to the ECL levels and vice versa.

An 8-bit design with all the features of a CPU is shown in Fig. 5. Here, an 8-bit instruction required on the in-

put points to a memory location in the ROM/PROM array. This location contains a branch instruction, which presets the 8-bit address counter to the starting address of a subroutine, which processes the instruction. The 16-bit memory address register can be loaded from the outputs of the RAM, ALU, control memory or main memory. An arbitrary set of instructions may be provided in the control-memory program.

This results in a flexible design that could be used either to process specialized instructions or to emulate another computer (or MOS microprocessor). Not only are the individual bits in the instruction divorced from the RALU control inputs, but the RALU RAM locations themselves, selected by the control-memory program, are transparent to the main-memory instructions. Another interesting feature of this design is that a 4-bit RALU could be used, yet, to the main memory, the processor could appear to be an 8-, 16-, or 32-bit device. The design can also accommodate multiple-byte instructions of any desired length. □

The Prime Computer User Plan Fights Inflation:

One Prime 300 system gives each of 15 users a completely independent virtual computer. Each with a 128k byte virtual memory and disk operating system. Each for less than \$7,400!

A Complete Virtual Computer for Every User.

Think about it. For less than \$7,400, each user has access to a complete system that if purchased separately would cost over \$60,000. The Prime 300's virtual memory disk operating system automatically and transparently allocates all real system resources among the users of the virtual machines. By applying virtual machine techniques to the handling of I/O operations, each user terminal has direct on-line communication with any peripheral device in the system. Disk back-up can be handled on-line, data can be read directly from cards, tape or disk, and output can be transferred directly from a terminal to cards, tape, disk or printer.

A File Management System supervises the Prime 300's memory hierarchy and provides each user with a variety of direct and sequential file access methods.

A Multilingual System.

Each user is free to write programs in FORTRAN, BASIC, Macro Assembler and Micro Assembler languages. So they can fit the language to the problem instead of the other way around. In fact, problems can be divided into subtasks and each written in the language best suited to the task. For added convenience, programs written in one language can call subroutines written in other languages. And to wrap everything up, all Prime programming languages used the same file system so that any program, written in any language can access any data base without any modification or reprogramming.

A Multifunction System.

A virtual memory Prime 300 is like having up to 15 separate computers in one box. So there's a lot of computing muscle available to tackle just about any mix of applications. Users can develop real-time application software, execute batch command files, use the system as a sophisticated calculator via immediate-mode BASIC, handle data base management, even develop microprograms for the Prime 300's writeable control store or other microprogrammable devices.

Three Systems to Get You Started.

Prime has put together three starter systems, each with a different price/performance balance. If you buy them as packaged, you get a system complete with all necessary system software, one year maintenance policy and an attractive packaged system discount.

You can select a small system for up to four users built around a 300 with 64K byte main memory and 6M byte moving head disk for \$44,000. Or a system for up to eight users we call "The Personal Archive System," that features four diskette units for loading and unloading individual user files, a 12M byte work disk and 300 processor with 128K byte memory, for only \$68,000. For 15 users you can get a system with 256K byte main memory, 60M byte moving head disk, and 16-line asynchronous multiline controller for \$110,000.

Virtually Unlimited Expansion.

Any of these starter systems can be easily and economically expanded. You can add main memory up to 512K bytes. Attach a total of eight 60 million byte disks, four 12 million byte disks and eight diskettes. Add multiple printers and tape drives. Mix terminal types and speeds. And support it all with exactly the same operating systems and language processors you started with.

Try it Before You Buy It.

Find out how a Prime 300 virtual memory system can help you fight inflation. Attend a Try It Before You Buy It seminar at the Computer Caravan. In every caravan city, Prime will conduct seminars to help you test and evaluate the Prime 300. Complete details are available from any Prime sales office or by writing to Prime Computer, Inc., 145 Pennsylvania Avenue, Framingham, MA 01701.

145 Pennsylvania Avenue / Framingham, MA 01701

Calculator's parts are integrated on a single glass substrate

Thin-film methods are used to deposit electrodes on the substrate for a liquid-crystal display; thin-film wiring interconnects components, forms keyboard contacts; the chip is soldered on

by Atsushi Asada, *Business Machine division, Sharp Corp., Nara, Japan*

□ Over the past few years, costs of manufacturing electronic calculators have been drastically reduced by technological improvements in design. Low-cost manufacture has brought calculator prices within range of large numbers of consumers, creating a mass market. And calculator makers are still finding ways to lower manufacturing costs even further.

Perhaps the greatest reductions in manufacturing costs have resulted from integration of the calculator functions on a single chip. This has led to a simple, low-cost assembly procedure: piecing together four major components—keyboard, integrated-circuit logic, power-supply unit, and display or printer.

However, little value is added by a manufacturer that simply assembles these parts. The maximum value is added by making and integrating all the necessary components in the same factory. The ultimate in cost-cutting could be achieved by building the calculator from raw materials as a single part in a single assembly process.

The calculator on a substrate (COS) developed by Sharp Corp. is a giant step toward complete system in-

tegration. A soda-glass substrate (Fig. 1) that replaces the conventional printed-circuit board not only holds the calculator chip, but also contains the keyboard contacts and serves as the front half of the glass package for the liquid-crystal display.

Logic circuits and a few discrete components are mounted on the substrate, and a power-supply subassembly is wired to it. The COS system eliminates as many intermediary components as possible. It also minimizes the amount of labor necessary for assembly, making the process engineering- and equipment-intensive.

To accomplish this, a thin-film process was developed for coating the electrodes of the liquid-crystal display onto the glass substrate, a method was devised for depositing the thick-film wiring that serves as keyswitch contacts and interconnection circuitry, and an effective method was found for bonding the LSI calculator chip to the glass substrate.

A liquid-crystal display that operates in the dynamic-scattering mode was chosen for its low power dissipation. This display had to be designed, not only for ef-

1. Calculator on a substrate. A soda-glass substrate carries keyswitch contacts and the front half of a liquid-crystal-display package on one side (a). The other side contains the rear half of the display and the interconnecting calculator circuitry (b).

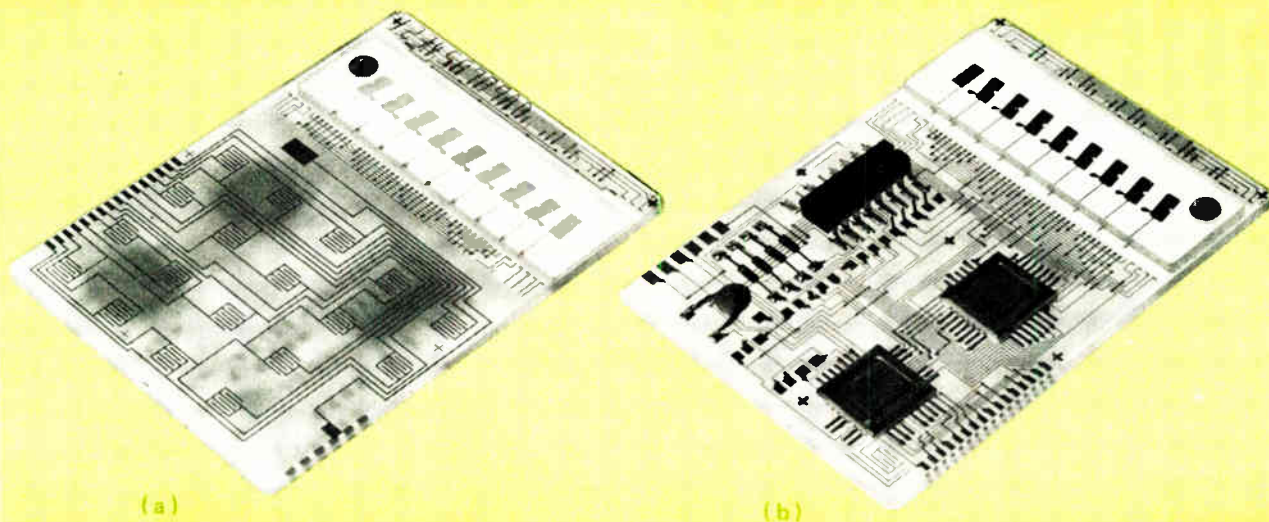

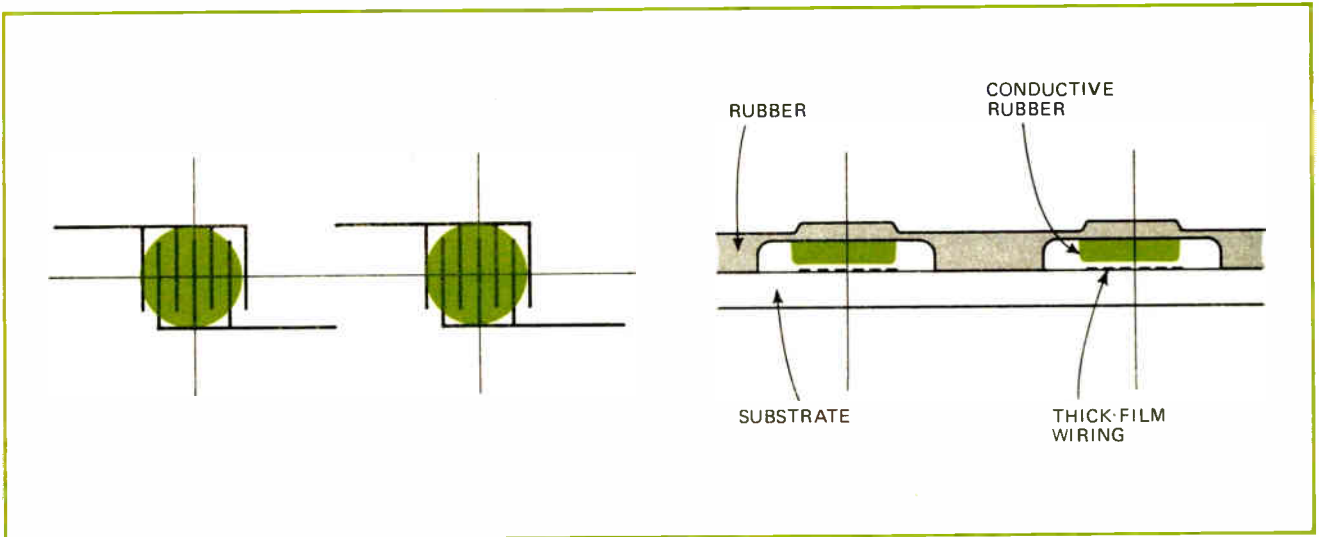

2. Input. Thick-film comb-shaped circuitry forms the contacts for keyswitches. The actuators are conductive elastomer buttons.

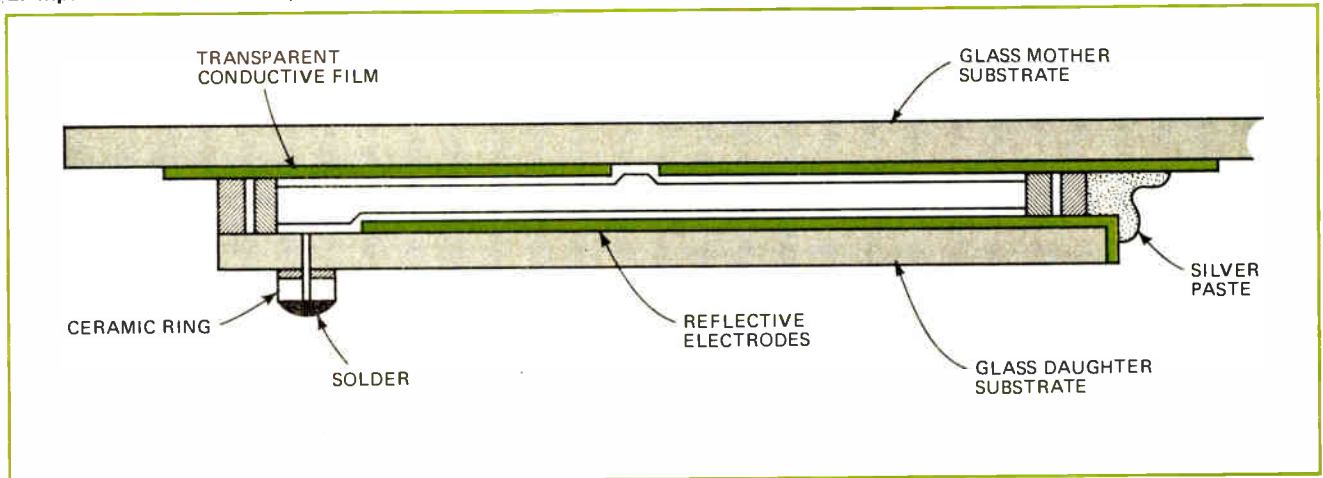

3. LCD. Liquid-crystal material is vacuum-injected between the substrate and a second glass plate (a daughter substrate) to make the dynamic-scattering display. A ceramic disk is then soldered onto the hole, and the hole is sealed.

efficient calculator operation, but also to permit integration of the display packaging into the glass substrate.

Depositing thin film

The first manufacturing process is coating a transparent conductive film of indium oxide on the substrate to form electrodes for the display. An evaporation-in-oxygen method ensures uniform quality and minimizes danger from chlorine gas.

Spraying methods proved to be unsatisfactory for coating the substrate. Spraying solutions in fine foggy forms presents difficulties in achieving uniformity in the coating. A successful spraying method would require a control system that would be costly to design and maintain. In addition, the temperature on the glass substrate would have to be regulated to prevent white blotches, unevenness, and pinholes in the glass that would increase the electrical resistance of the deposited electrodes, as well as add to the opacity of the glass.

Another important fact to consider is that expensive pollution-prevention equipment would be required to eliminate chlorine gas that would be a by-product of a spraying system. This gas can cause pinholes in the sub-

strate glass and erode parts of the furnace.

On the other hand, a vacuum-evaporation method can ensure uniform products by relatively simple control of the vacuum pressure and evaporation rate. Vacuum equipment can be automated by using leak valves and power-supply controls. If the glass substrate is initially clean and kept free from impurities, the hard-vacuum environment virtually eliminates the likelihood of pinholes from foreign particles on the substrate.

When the substrate is heated in the vacuum chamber, such impurities as moisture are almost completely excluded. When pressure within the chamber reaches 5×10^{-5} millimeters of mercury, a small amount of oxygen is sent through the leak valves. At between 3×10^{-4} and 5×10^{-5} mm of mercury, indium oxide powder is introduced into the chamber. This is evaporated onto the substrate at the rate of 300 to 500 angstroms per minute.

The electrodes, which are 500 to 1,000 Å thick, have a surface resistance of 100 to 400 ohms per square and transparency greater than 80%. The lower limit of surface resistance is determined by the requirements to keep opacity to a minimum, and the upper limit is a

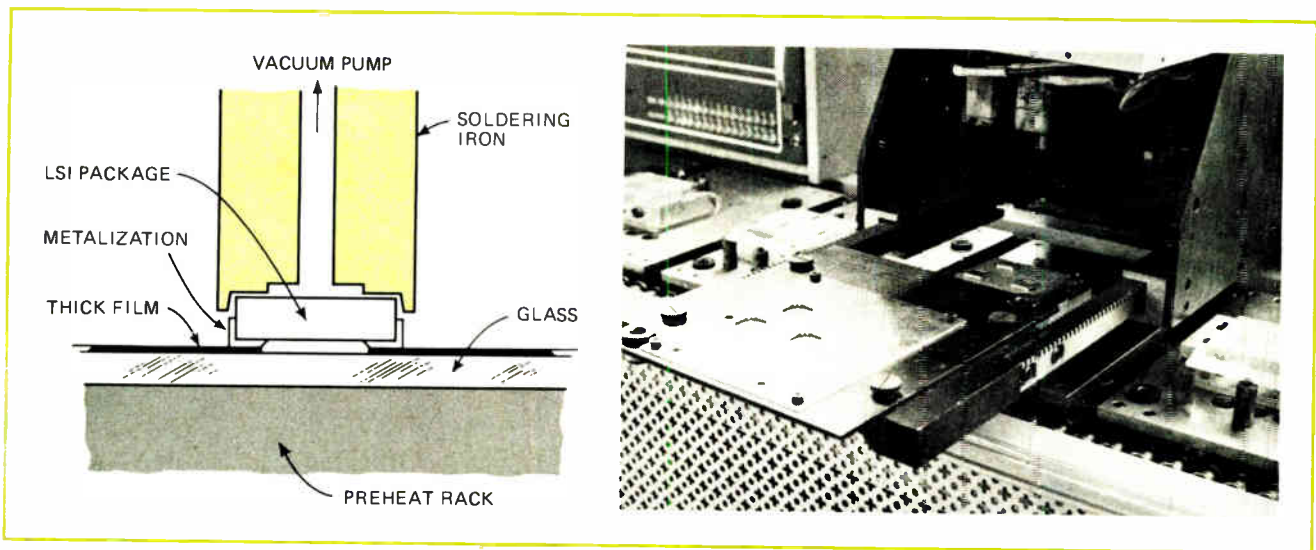

4. IC mount. A fixture is used to align the integrated circuits on the substrate and to apply heat for soldering.

function of an increment in resistance that takes place during the thick-film process that follows.

Surface resistance of the transparent electrodes after thick-film firing can increase by as much as four to seven times the value before firing. To prevent this increase, a silicon-dioxide film is coated over the transparent electrodes. This method, however, restricts the allowable temperature rise of the assembly to 200°C.

To overcome this temperature limitation, the width of the lead to each character segment was increased, and the driver's output impedance is kept down to 50 kilohms per segment.

Depositing thick film

After evaporation, the segments of each display digit are patterned by a photoresist method. Because the etching time of indium oxide is strongly influenced by temperature, an automatic temperature-control unit is required. The temperature is kept low, an average of 50°C, to minimize formation of chlorine gas. After the character segments and their leads are formed, an interface with the rest of the calculator circuits is made by ohmic connection through gold thick-film deposition.

Thick-film wiring interconnects components on the substrate and forms the contacts for the keyboard (Fig. 2). A gold-palladium paste is used instead of a simpler gold paste because gold alone tends to combine with the tin in solder to form intermetallic compounds, which reduce adhesion to the substrate. Although gold-bearing paste is used because of its reliability, silver-type pastes are being tested as a possible replacement.

Wiring widths are between 200 and 300 micrometers, and the distance between wires was set at 200 to 350 μm to provide tolerances wide enough for maximum assembly-line productivity. A vitreous glass paste with low softening point is used between the gold-palladium paste and the substrate to improve adhesion.

Fabricating the display

The liquid-crystal display operates in the dynamic-scattering mode. In this mode, when an electric field is applied to the nematic liquid crystal, incident light is

scattered, rather than transmitted. A reflective electrode is required behind the display digits, and this electrode in the COS system is an evaporated aluminum film.

The liquid-crystal material is introduced between electrodes by vacuum injection. After injection, a thick-film ceramic disk is soldered on to the injection hole, and the hole is sealed.

The substrate containing the transparent electrodes is pasted to a daughter substrate containing the reflective electrodes with a film spacer between them to form a cell (Fig. 3). The cell thickness must be kept within a tight tolerance to obtain the required electro-optical display characteristics.

Cell thickness is controlled by selecting a film spacer of uniform thickness that does not react to liquid-crystal materials. Adhesive materials must also be chosen carefully so that sealing will be hermetic. A mixture of silicon dopant and resin adhesive was chosen after it was proved in environmental and reliability tests. This mixture, which can be screen-printed, adheres well to a glass substrate. A silver paste around the edge of cells connects the reflective electrodes to the glass substrate.

Interconnecting the IC

To interconnect the calculator chip to the substrate, a fast, low-temperature solder is required because the chip can withstand temperatures only as high 190°C. But since there is a 10°C temperature drop between the silicon chip and the package leads, the solder temperature is 200°C.

Common tin-lead solder has a melting point of 183°C, but requires a soldering iron heated to 230°C to 240°C. To meet the temperature requirements, the solder chosen is composed of 43% tin, 43% lead, and 14% bismuth. Before soldering, the substrate is preheated to 140°C in an oven to prevent thermal shock from damaging the substrate. The soldering temperature of 200°C is then applied to the package for 20 seconds.

Because positioning is critical, a fixture (Fig. 4) is used to align the IC package for soldering. Lead pitch on the device is only 1.27 millimeter, and lead width is 0.6 millimeter. □

Rockwell Parallel Processing Systems (PPS) are more than CPU-ROM-RAM microprocessors. They're full-fledged microcomputers—with 12 LSI I/O controller options that not only shake hands with your peripherals, but introduce a lot of advantages in the process.

Example: With so many LSI I/Os to perform the complex but absolutely necessary functions of interfacing with or controlling peripherals, you need fewer circuits. And that saves you design time. Lets you use fewer parts per system. Lowers your design costs. And your production costs.

What's more, we've system-designed our LSI I/O controllers. They're intelligent controllers. You use the CPU to solve problems, not service peripherals. Result: easy software generation. And you can add or change I/Os to expand or modify

your system without redoing the total system software.

You can use PPS LSI I/Os with keyboards . . . displays . . . printers of many types . . . switching networks . . . semiconductor or magnetic memories . . . telephone transmission with a one-chip LSI MODEM-UART . . . asynchronous, serial or parallel data transmission. And if we haven't provided for your particular I/O, we'll design it for your volume application.

The overall PPS payoff: microcomputers that are versatile, powerful . . . and thrifty.

Our 4-bit microcomputers (PPS-4) accept 8-bit instructions and compute so fast (they add two 8-digit numbers in 240 usec.) that they're cost effective for many tasks you'd think required 8-bit systems.

Shake hands with the handshaking

(12 LSI I/Os are ready to shake)

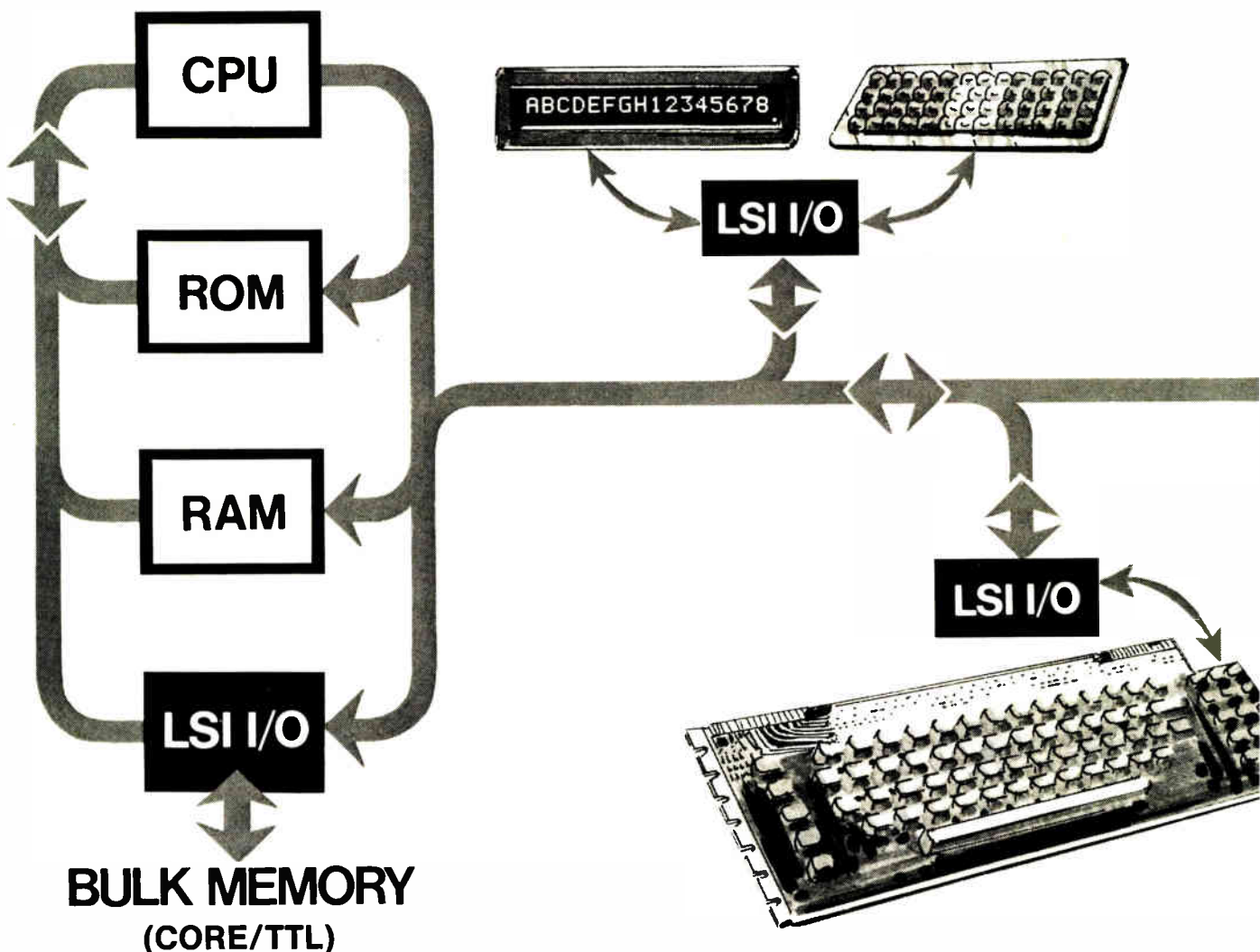

Availability? We're producing PPS-4 circuits in volume. (More than 225,000 PPS-4 micro-computer circuit sets have been delivered.) Design aids? Everything you need is waiting for your call—wherever you are in the world.

System compatible with our PPS-4 are our new 8-bit microcomputer circuits. (All PPS-4 I/Os are directly applicable.) PPS-8 software is complete. You can begin now defining your PPS-8 microcomputer, using our assembler-simulator design aids to take advantage of its 90 instructions.

Because we offer so many microcomputer options, we've streamlined our get-acquainted procedure. We now have a new brochure that tells you in minutes the data sheets you want for your application. To get your copy, phone (714) 632-3729, or TWX or TELEX (910) 591-1179,

or write: Ron F. Voigt, PPS Marketing Services, Microelectronic Device Division, Rockwell International, P.O. Box 3669, Anaheim, CA 92803.

Or circle the Reader Service Number below.

Ask now for a private PPS demonstration during National Computer Conference, Anaheim; or Paris Components Show, France; or Hannover Fair, Germany; or Tokyo Business Equipment Show, Japan.



Rockwell International

...where science gets down to business

experts: our PPS Microcomputers.

hands with your peripherals.)

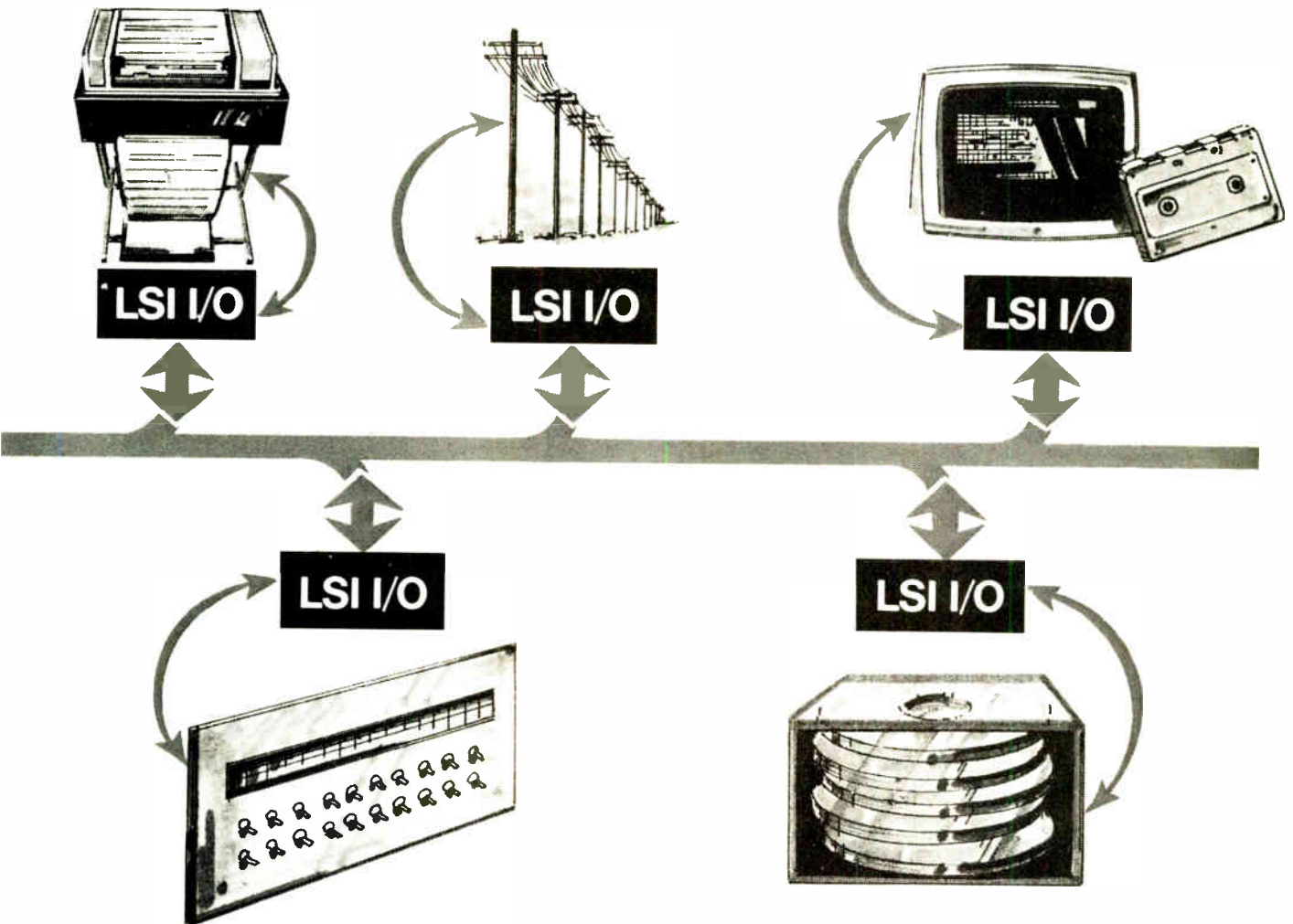

Increasing an instruction set without increasing word length

by C. W. Moser Jr.
Western Electric Co., Winston-Salem, N.C.

1. Decoder circuit. Instruction words in memory can have either of two meanings, depending upon state of flip-flop. With this two-set technique, each 4-bit word provides 30 possible instructions.

The number of instructions in a system-instruction set can be increased without increasing the word length. Normally, a 4-bit instruction word can be decoded as one of 16 possible instructions (i.e., $2^4 = 16$). If more than 16 instructions are required for a particular application, the instruction word can be lengthened, or the technique described below can be used.

Figure 1 shows an N-by-4-bit memory in which each

2. More sets. Maximum number of instructions obtainable from a 4-bit word is plotted as a function of the number of instruction sets (or decoders). Optimum area has fewest components per instruction.

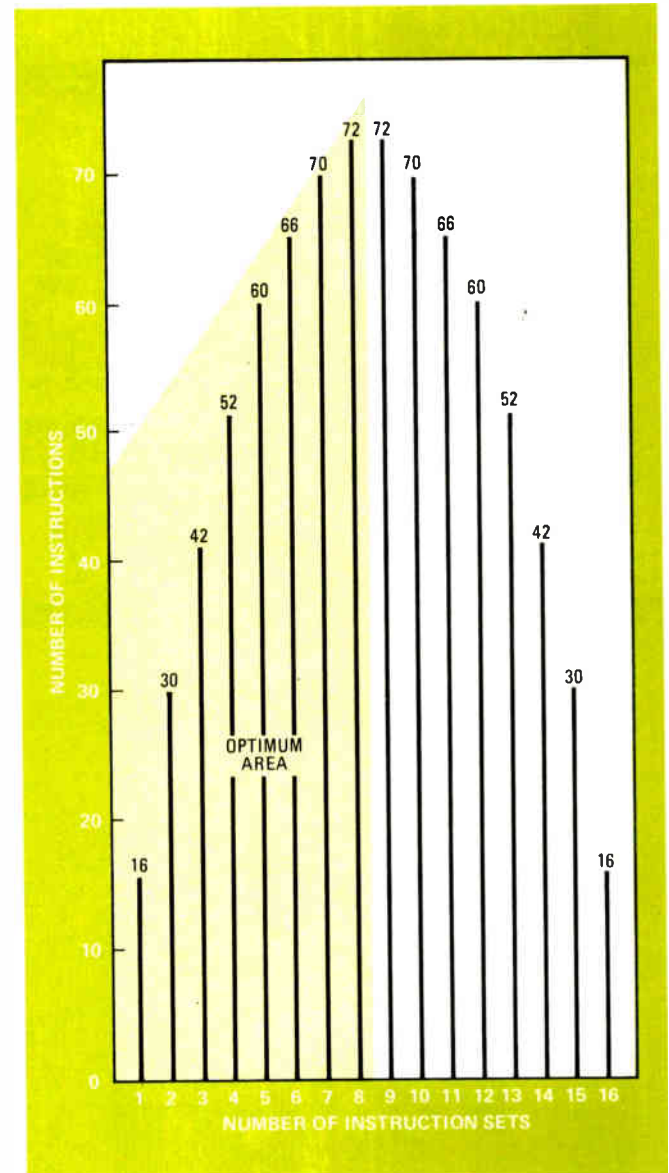
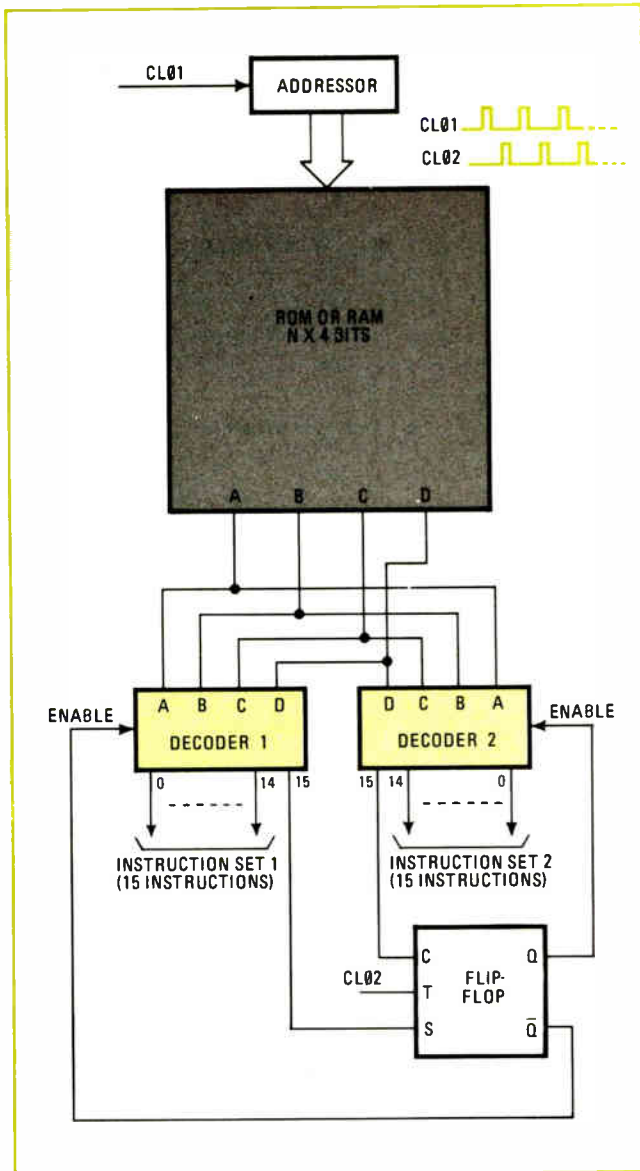

4-bit instruction word can be decoded as one of 30 possible instructions; these instructions are divided into two sets of 15 instructions each. A 4-bit instruction word in the memory can have either of two meanings, depending on the state of the flip-flop. If the flip-flop is clear, decoder 2 is disabled and decoder 1 is enabled; therefore the instructions in set 1 can be performed.

If it is necessary to perform an instruction that is in set 2, the flip-flop must be set to provide an enabling pulse to decoder 2. For this purpose, line No. 15 from decoder 1 is connected to the set lead of the flip-flop; thus a 1111 instruction from decoder 1 sets the flip-flop, disables decoder 1, and enables decoder 2 so that the instructions in set 2 can be performed. Similarly, line No. 15 from decoder 2 is connected to the clear lead of the flip-flop; thus, a 1111 instruction from decoder 2 clears the flip-flop, disables decoder 2, and enables decoder 1 so that instructions in set 1 can be performed.

If the number of instruction sets is increased, the total number of possible instructions increases up to a point, and then actually decreases as more sets are added. Fig-

ure 2 shows the number of possible instructions obtainable from a 4-bit word as a function of the number of instruction sets (or number of decoders). The total number of instructions decreases for more than nine instruction sets, because every set must include commands for enabling every other set. The shaded region of the graph is optimum in that fewer components are required per instruction than in the unshaded region.

This technique is most valuable in operations where one group of instructions (for example, instruction set 1) is performed many times and the second group is performed after the first group. Of course, this technique can be applied to systems that use words other than 4 bits long.

In some applications, a decrease in the total number of bits and an increase in the total number of words can be realized in comparison with similar applications that make use of longer words. This technique slightly lengthens the microprogram and the execution time because time must be allocated when accessing a different set of instructions. □

Low-cost field-strength unit uses simple buffer

by M. J. Salvati

Sony Corp. of America, Long Island City, N.Y.

1. Field-strength unit. Unity-gain FET buffer amplifier is heart of this inexpensive device for measuring field strength at frequencies from 150 kHz to 30 MHz.

Field strength at frequencies from 150 kilohertz to 30 megahertz is measured by feeding the output of a standard flat-frequency-response antenna into a tuned voltmeter. Commercially available broadband antenna-and-amplifier units suitable for this task cost about \$500; however, a setup identical in function and performance can be built for about \$5.

In the field-strength measurement, a vertical antenna

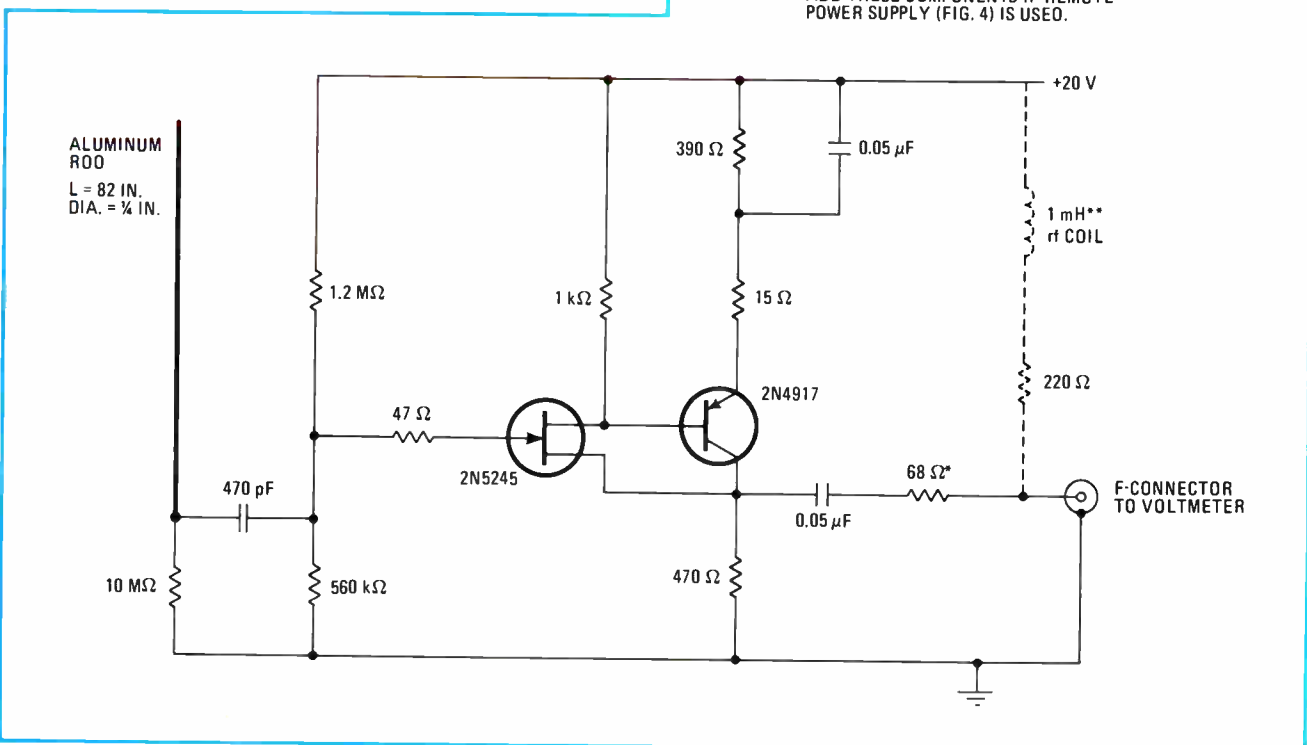

Today's Graphics.

Because you can't wait for tomorrow's solutions.

Tektronix' Graphic Terminal Family is steps ahead of however else you're now using your computer data.

Providing the most efficient utilization of that data. Faster than printout. More efficient than mere hard copy. Making analyzing extremely profitable. Giving you the answers now, when you need them.

Pictured is our 4014-1 Graphic Display Terminal, the biggest 19-inch, flicker-free display in the business. Priced at \$9,995. Also, our

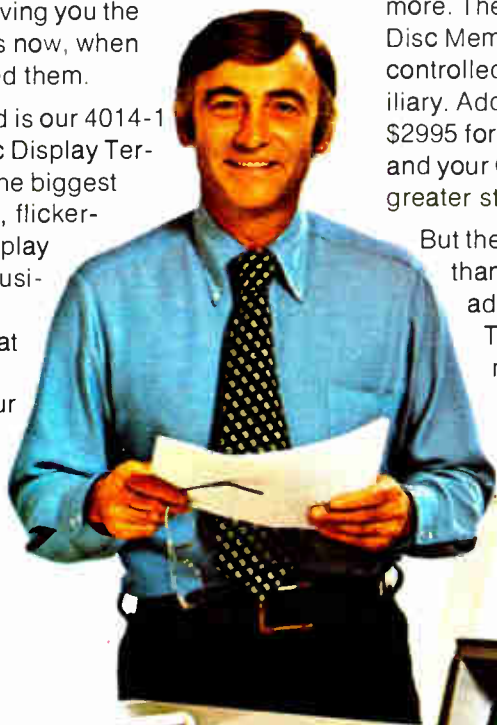

4010 Graphic Display Terminal. An 11-inch version of the same powerful Graphics tool, at \$4195. Both giving you your ideas in pictures.

Team either of these with our 4610 Hard Copy Unit at \$4295, and you've got a copy to refer to, add to, change, and then work with some more. Then there's our Flexible Disc Memory from \$3695 for user-controlled storage, off-line or auxiliary. Add our Graphic Tablets from \$2995 for fast, freehand digitizing, and your Graphics capacity is greater still.

But there's more to our Graphics than just low cost, more than advanced problem solving. There's more peripherals, more strong software support, more

advantages. Call your area Tektronix Applications Engineer for all the information. Or write us, today.

Tektronix, Inc.
Information Display Division
P. O. Box 500
Beaverton, Oregon 97077



TEKTRONIX®

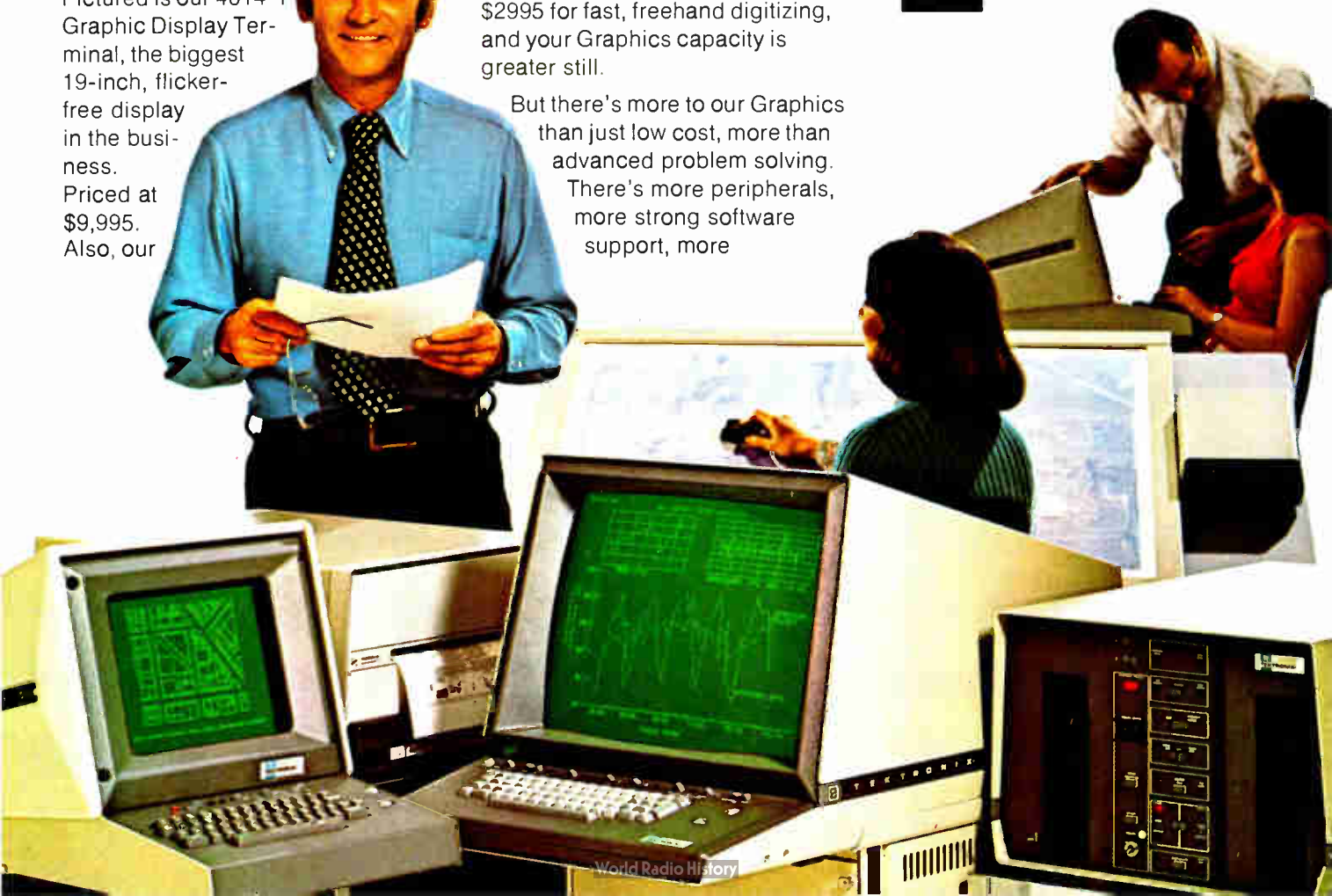

that is effectively two meters long provides an output, measured in microvolts, numerically equal to twice the ambient field strength (measured in microvolts per meter). This voltage cannot be applied directly to the tuned voltmeter because of the very high source impedance of the antenna at low frequencies. Instead, an impedance converter is used between the antenna and the tuned voltmeter (50-ohm or 75-ohm rfi receiver or spectrum analyzer). The 6-decibel loss resulting from the converter-to-voltmeter impedance match cancels the 6-dB gain produced by using an antenna two meters long; therefore, the voltage applied to the tuned voltmeter is numerically equal to the field strength, permitting direct measurement without any corrections for frequency or for antenna gain.

The heart of the device is a unity-gain buffer amplifier (shown in Fig. 1). The buffer uses a field-effect transistor and a pnp transistor connected to provide 100% negative feedback; the resulting stage has high input resistance, low input capacitance (about 4 pF), low output impedance, near-unity gain, and a frequency response that is flat to 85 MHz.

A biscuit tin about 9 inches in diameter supports the rod antenna and provides a no-cost, watertight enclosure for the buffer amplifier. At frequencies greater than 150 kHz, the loading on the antenna is determined primarily by the input capacitance—not the input resistance—of the buffer; therefore the construction technique must minimize capacitance in both the buffer amplifier and the antenna support. A suggested mechanical arrangement is shown in Fig. 2. For permanent outdoor installations, rubberized sealant should be used around the antenna-entrance hole, the Lucite sheet, and the lid. A photograph of a complete assembly is shown in Fig. 3.

The buffer amplifier can be battery-operated for intermittent use, but a remote power supply like the one in Fig. 4 is best for long-term or outdoor use. □

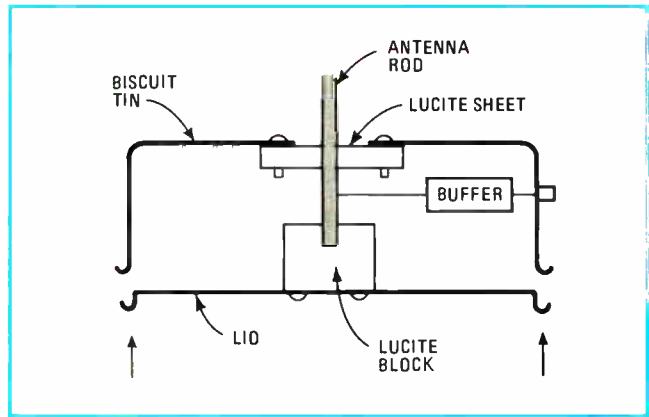

2. Assembly. Biscuit tin supports rod antenna and provides no-cost, watertight enclosure for buffer amplifier. (In photograph below, the biscuit tin lid is screwed to a wooden board so the device won't tip over in high winds.)

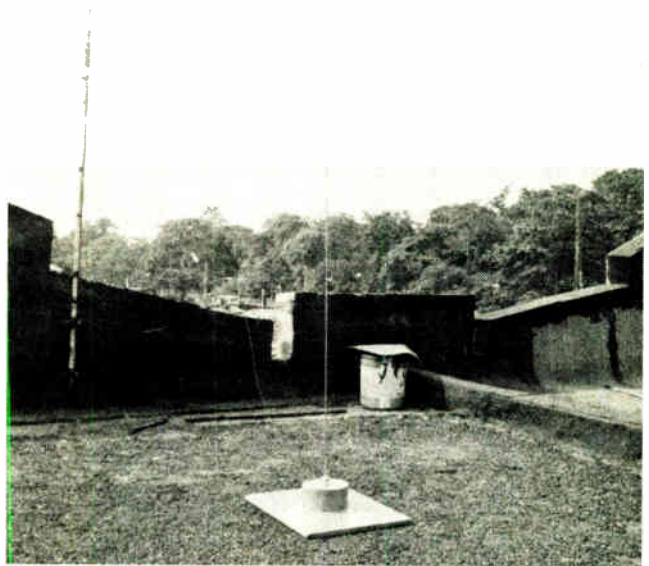

3. Working unit. Photograph of field-strength measurement device in operation. Simple device described here equals performance of commercial units, at vastly less cost.

4. Power supply. For long-term operation or outdoor use, this remote source is preferable to battery supply for field-strength measurements. It increases system cost by about \$10.

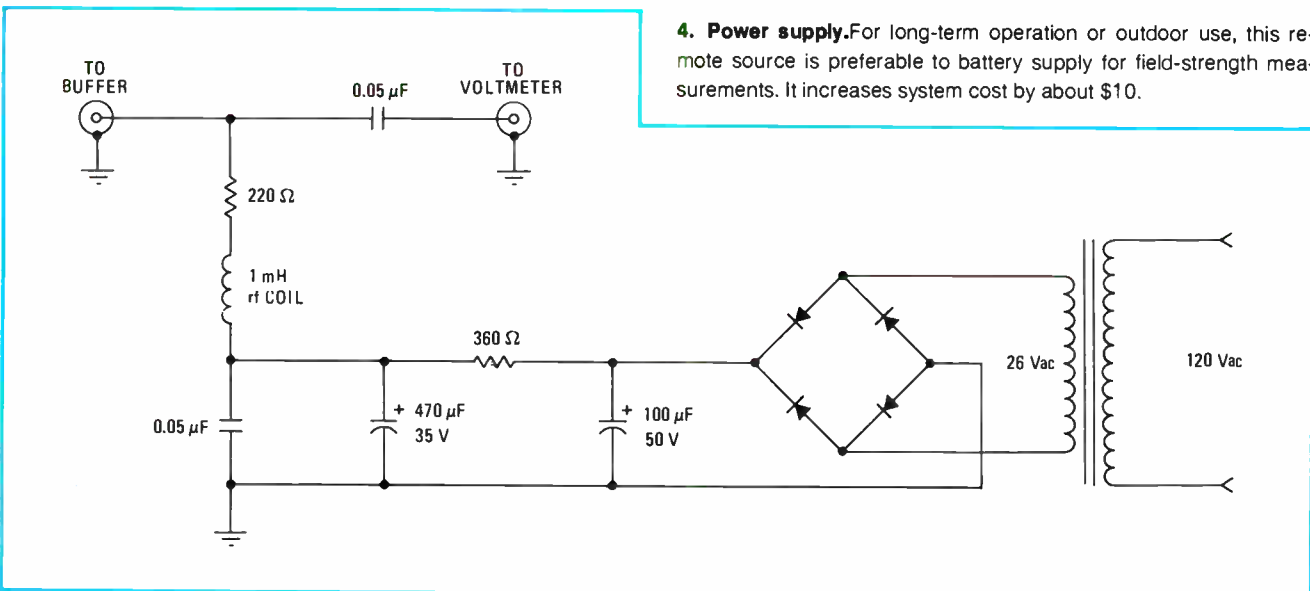

Bell modems versus the rest

Use data-communications modems? You'll want to check out the recent survey from Datapro Research Corp., 1805 Underwood Blvd., Delran, N.J. 08075, which **evaluates users' experiences with modems made by Bell System and by independent manufacturers.** The results show that although users are equally satisfied with the performance and reliability of both groups of equipment, **they rate Bell's maintenance service higher and prefer the better diagnostic facilities of the non-Bell modems.**

The survey also indicates that most modems operate at relatively low speeds. Of all the modems reported on, about two thirds operate at speeds of 2,400 bits per second or less and **only 10.8% operate at 9,600 bits or more per second.**

Paired-LED display monitors activity on phone or data lines

As you may already know, a pair of light-emitting diodes connected in parallel with reverse polarity makes a handy zero-beat-frequency indicator [*Electronics*, March 15, 1973, p. 119]. The applications for this type of display can be easily extended to monitoring the activity on a telephone line, notes Calvin R. Graf of San Antonio, Texas—simply use low-current LEDs for the display and a current-limiting 10-kilohm ½-watt resistor in series with the LEDs.

Such an indicator is particularly helpful when two or more phones are connected to the same line or when data terminals are being used. **The LEDs will display line activity, no matter where the extensions are located or how many there are.** Because the circuit makes use of changes that occur in line voltage level and polarity during normal operation, it does not affect line operation adversely.

Let's label the diodes LED₁ and LED₂. If the local and extension phones are not in use, LED₁ is bright, and LED₂ is dark. **When a call is dialed on the local phone, LED₁ flashes the dial pulses, while LED₂ remains dark.** If both phones are in use or if only the extension phone is in use, LED₁ is dark, and LED₂ is dim. A call on the line (phone ringing) causes both LEDs to flash 20 times per second.

Wire and cable guide tells all

If you have to specify wire and cable for a computer, telecommunication, process control, aerospace or electronic system, it will be worth your while to get hold of Brand-Rex's 70-page "Wire and cable engineering guide." The guide presents **detailed information on all electrical, mechanical and environmental properties of practically all types of wire and cable,** conductor materials, coatings, insulations and types of processing (coded, textile overbraided, shielded, jacketed, and so forth). **Copies cost \$10 each** from: Brand-Rex Co., Publication WC-74, Willimantic, Conn. 06226.

New EEs still in oversupply

Bad news in a shrinking job market— **once again, more electrical engineers were graduated in the 1974 class than any other type of engineer.** At 11,347, the EEs outnumbered the runners-up, civil engineers, by more than 3,000, reports the Engineering Manpower Commission of Engineers' Joint Council. EEs also accounted for 3,702 master's degrees and 700 Ph.D.s.

—Laurence Altman

You pick the instrument, we'll supply 4½ digit accuracy & resolution!



Model 267
Autoranging DC VM
From 100 μ V to 1000V DC **\$675.**



Model 268
DC Microvoltmeter
From 1 μ V to 1000V DC **\$839.**



Model 269
Digital Multimeter
DCV, ACV, DCmA,
ACmA, Ohms **\$649.**



Model 2210
Digital Multimeter
ACV, DCV, Ohms **\$525.**

Selected models feature:

- Resolution up to 1 μ V • Autoranging • Up to five functions
- Isolated and buffered BCD, standard

All models feature:

- Basic accuracy .02% of reading • Overload protection on all functions and ranges
- Simple, easy operation • Rugged construction for long-term reliability
- Plug-in ICs, displays and circuit boards for easy maintenance
- Large, easy-to-read displays • Delivery from stock

Call your nearest United Systems representative for complete specifications.

DigiTec

UNITED SYSTEMS CORPORATION

a subsidiary of

Monsanto

918 Woodley Road • Dayton, Ohio 45403 • Ph: (513) 254-4251 • TWX: (810) 459-1728

THE GENERAL AUTOMATION CHALLENGE:

At the risk of sounding brash, we'd like to tell you exactly where we stand in the minicomputer marketplace:

In computers and systems for communications, data management and industrial automation, General Automation is number one.

In these three areas, we offer a better package of total solutions, performance, price and product support than any computer company in the world.

No other computer company has worked so hard or dug so deep to understand the requirements of these three corners of the marketplace.

Involvement has always been our long suit.

We've never favored the sell 'em and leave 'em end of the business. Which is why we're *not* number one in volume hardware sales. We think it's better to be the best specialist than the biggest generalist.

The most mini for the money.

A good example is our family of SPC-16 computers. Quite simply, they are the world's most powerful minicomputers. They do more work in less time with less memory than any other mini you could buy. As a result, we offer the least expensive solutions instead of the least expensive minicomputers.

Our SPC-16 family has helped a lot of OEMs and end-users build a lot of powerful, low-cost

systems for a lot of tough, tight-budget applications.

Our family of mighty minis is also one of the primary reasons we offer so much capability in communications, industrial automation and data management systems.

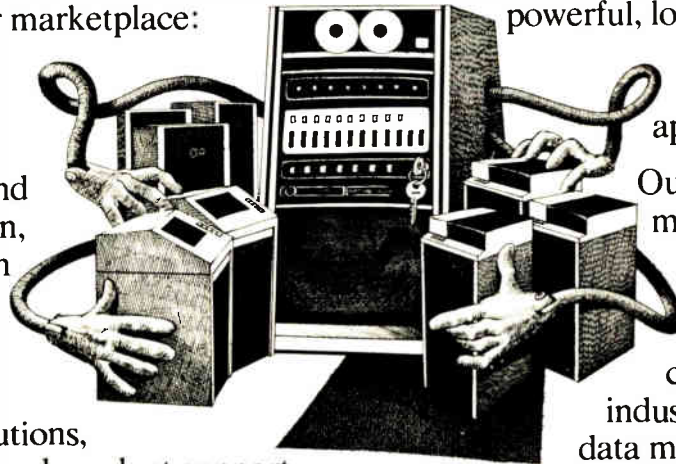

The best total communications systems.

General Automation is the major supplier of minicomputers for PABX control systems, front end processors, Telex message systems and message switching systems for the world's largest communications companies.

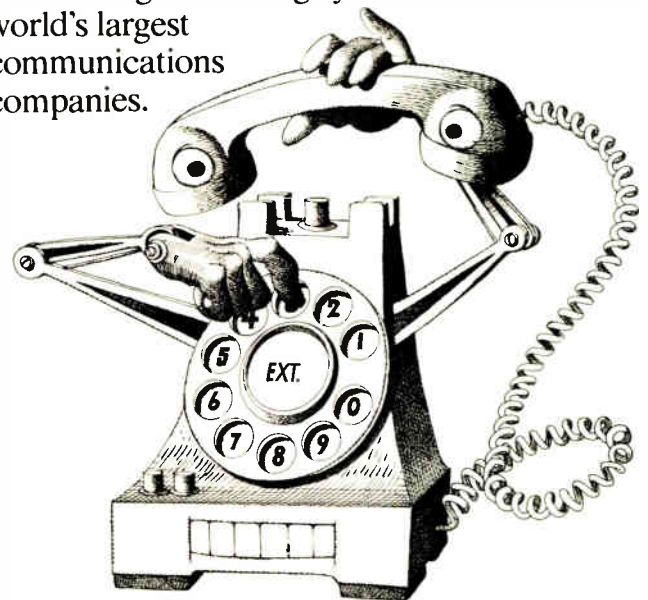

Our extensive experience has also made us the number one solver of tough problems for any company that needs a custom communications system.

If we can't solve your communications problem, nobody can.

The best total data management systems.

We can put you in better touch with your business by replacing a lot of time-consuming, non-productive status meetings, paperwork and guesswork with simple, automated systems that tell everyone who needs to know, everything they need to know, whenever they need to know it. No matter where they are or what they do or how they do it.

We can deliver a compatible, expandable, high-performance family of systems that can form a network offering batch data processing, real-time data entry and retrieval, decentralized control and custom applications software.



We have another family of on-line/batch systems that offers centralized control and a vast library of standard applications software.

In addition, we sell a low-cost, highly interactive turn-key system through distributors for companies that need economy more than system growth. And we manufacture the number one IBM 1130 replacement system.

Nobody can offer a better total solution in data management.

The best industrial automation systems.

General Automation has solved more industrial

automation problems than any minicomputer manufacturer in the world. As a result, we have invested more time and understand this field better than any minicomputer manufacturer in the world.

Our systems are working in such applications as automotive manufacturing and testing, process control, meat packing, electronics manufacturing, newspaper publishing, warehouse control, metalworking and dozens of others.

You couldn't bring your industrial automation problem to a more experienced minicomputer company.

Challenge us.

We'd like the opportunity to prove we're more aggressive than arrogant. Let us show you that for a total package of technology, experience, involvement, price and product support, no minicomputer company offers you more or understands your business better than General Automation.

Write or call General Automation, 1055 South East Street, Anaheim, California 92803. Or call (714) 778-4800.

In Europe, write General Automation, S.A., 24 rue du Sergent Bauchat, 75012 Paris, France. Telephone (1) 346/7973.

In Canada, write G. A. Computer Ltd., 880 Lady Ellen Place, Ottawa K1Z5L9, Ontario. Telephone (613) 725-3626.

**IF WE CAN'T DO IT, NOBODY CAN.
GENERAL AUTOMATION**



**there's a way to be sure
of controlled-expansion
alloys that meet your
fabricating requirements**

Uniform quality, time after time. Optimum fabricability in every production process. Full range for every application. Yours with Carpenter controlled-expansion alloys. Complete selection of low and high expansion, as well as glass- or ceramic-sealing grades for stamping, deep-drawing, etching, forming or coining. Excellent fabricability, high quality surfaces, uniform temper, minimum orange peel and camber in every grade. Like Kovar®, the most widely used glass-sealing alloy, and more. Result: predictable production on every job.

To put it all together, call your nearest Carpenter Service Center. Carpenter Steel Division, Carpenter Technology Corporation, Reading, Pa. 19603. European Office: 51, Square Vergote, 1040 Brussels, Belgium.

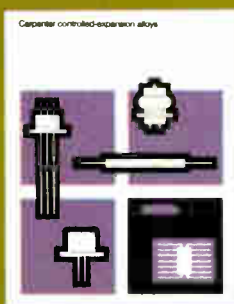

For more details, ask for this helpful new booklet on Carpenter controlled-expansion alloys.

CARTECH CARPENTER
TECHNOLOGY
CARPENTER STEEL DIVISION

**Carpenter
For Sure**

New products

Scope is combined with multimeter

Instruments, integrated into a hand-held package, share display, voltage probe, power supply; miniscope offers bandwidth of 1 megahertz

by Andy Santoni, Instrumentation Editor

One step toward simplifying field-service instrument requirements has been to mount a digital multimeter piggyback on an oscilloscope, as Tektronix did with the DM40 and DM43 options for its 400-series portable scopes [*Electronics*, June 13, 1974, p. 133]. The combinations are powerful test tools, but they're heavy (about 30 pounds), expensive (\$2,000), and require ac power.

Tektronix has now gone a step further by integrating the scope and multimeter functions in one compact and lightweight package. The hand-held instrument, model 213, combines a true-rms multimeter and an improved version of the company's model 211 miniscope. The new miniscope has a 1-megahertz bandwidth, compared with 500-kilohertz for the original 211.

The combined instrument is expected to have many applications in field-maintenance of electronic equipment, including computer peripherals, communications equipment, industrial control systems, and medical electronics.

In the oscilloscope mode, the model 213 offers 14 calibrated vertical voltage-deflection factors from 20 millivolts to 100 volts per division at rated bandwidth, extending to 5 mV/division at a 400-kHz bandwidth. As a side benefit of the instrument's current-measuring capability, the scope section can also display current waveforms, with vertical current-deflection factors from 5 microamperes per division to 100 mA/division in 14 steps. Current bandwidth is dc to 400 kHz on most ranges, dc to 200 kHz on the 5- and 10- μ A/division scales.

Horizontal-deflection factors are

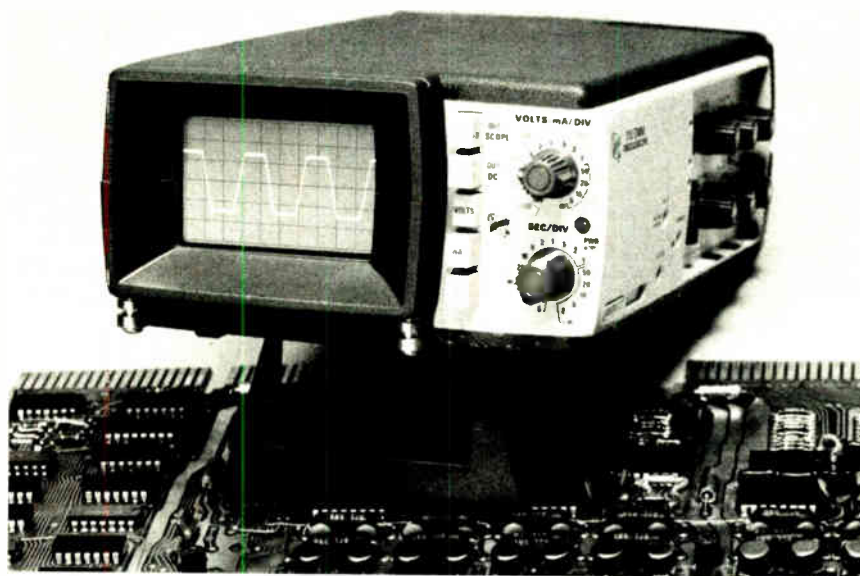

Shared display. Tektronix model 213 can operate in oscilloscope mode (above) or as a digital multimeter. The two functions also share other parts of hand-held instrument.

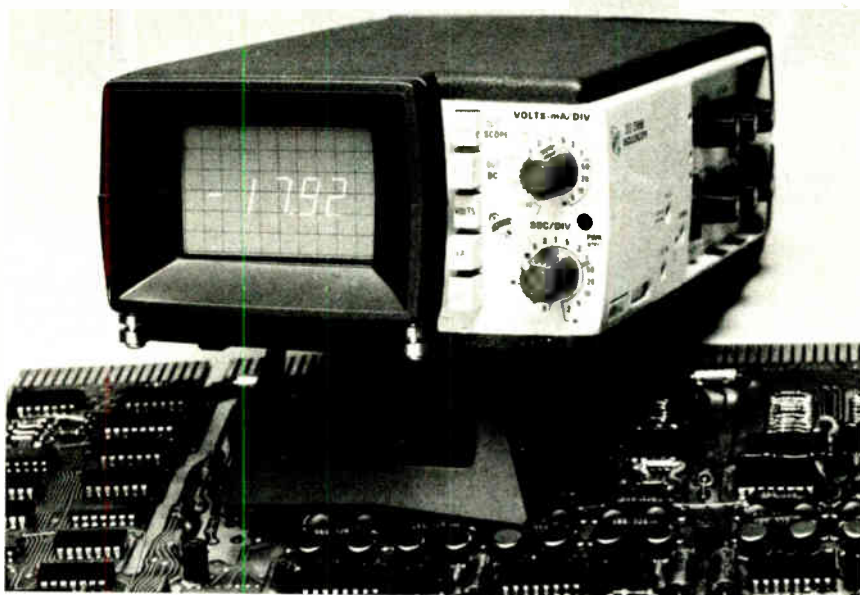



LAYERED ELASTOMERIC CONNECTOR

- Conductive layered elastomeric connecting device
- Alternating layers of conductive and non-conductive elastomers
- Variable thickness, lengths and widths
- Low cost
- Compensates for surface unevenness
- No special alignment required
- Easy disconnect
- No soldering required
- Offers low profile packaging
- Provides vapor tight seal of contact surfaces. Free sample and information available upon request.



Technical Wire Products Inc.

Eastern Division • 129 Dermody St., Cranford, NJ 07016 (201) 272-5500
 Western Division • 427 Olive St., Santa Barbara, CA 93101 (805) 963 1867

Circle 124 on reader service card

Power Line Disturbance Monitor

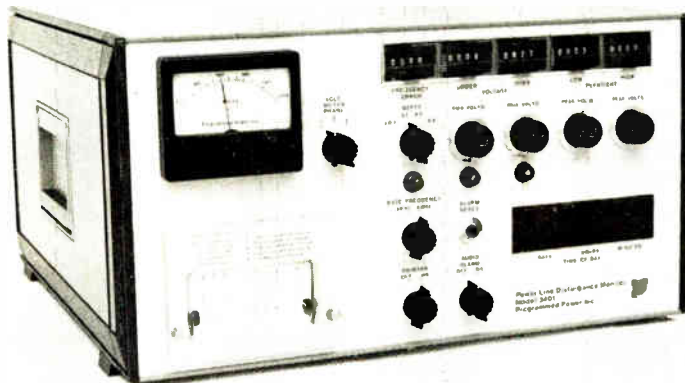

You may not need U.P.S. Monitor and evaluate. Then decide.

Transient risetime response: 0.2 μ s
 Monitors single or three phase power
 Transient amplitudes \pm 50 to 1000V
 50-60 Hz or 400-415-441 Hz
 Event registers:

- undervoltage and overvoltage
- under/overfrequency
- low-magnitude transients
- high-magnitude transients

Wide voltage range: 100-480 VAC
 Audio and visual alarms
 Time and event recorder
 Quartz crystal clock
 Solid state circuitry
 Portable and lightweight
 Easy to use: no attendant needed
 Virtually maintenance-free

Programmed Power Inc.

141 Jefferson Drive
 Menlo Park, CA 94025
 (415) 323-8454

Subsidiary of Franklin Electric



124 Circle 181 on reader service card

New products

from 2 microseconds to 500 milliseconds per division in 17 steps, and a variable sweep magnifier provides a maximum increase of five times in sweep rate.

The model 213's true-rms capability in the DMM mode makes the instrument especially useful when measurements of nonsinusoidal ac signals are required. Full-scale dc and ac-voltage ranges extend from 0.1 to 1,000 volts, dc and ac current ranges from 0.1 milliamperes to 1 A, and resistance ranges from 1 kilohm to 10 megohms. The 3½-digit (2,000 count)-plus-sign display occupies a 1.5-by-4-centimeter area on the cathode-ray tube.

Selection of either DMM or oscilloscope mode is made by means of a front-panel push-push switch. In either case, readout is displayed on the CRT which has six-by-10 divisions of 0.5 centimeter per division. The DMM and oscilloscope share a built-in voltage probe, current-input jacks, and input attenuators.

The two functions also share the instrument's power supply. The model 213 can be operated for three and a half hours on internal nickel-cadmium batteries, or from an ac line of a 90 to 136 v, 48 to 62 Hz. A no-charge option changes the ac voltage input to 180-250 v, and permits operation from 180-250-v dc supplies. A built-in battery charger operates whenever the unit is connected to line voltage.

A double-insulated case permits floating the model 213. Insulation voltage is 500 v rms or 700 v dc plus peak ac when operating from the internal battery. All of these features are packed into a case measuring less than 3 by 5¼ by 9 inches and weighing less than four pounds, including accessories.

The model 213 is priced at \$1,200, and delivery's from stock. By comparison, the model 211 is \$695; the 5-MHz, single-channel model 221 and the 500-kHz dual-channel model 212 are \$825; and the 500-kHz, dual-channel storage miniscope, the model 214, is priced at \$1,075.

Tektronix Inc., P. O. Box 500, Beaverton, Ore. 97077 [338]



OMI may just be the best thing that ever happened to metal.

Virtually every piece of metal that goes into a finished product has to be coated, plated, or treated. And, that's where OMI comes in. OMI does more in metal finishing than anyone else in the world. Look into any new development in metal finishing processing, equipment, or materials, and you'll probably find OMI technology behind it.

But making things happen in metal finishing is only part of OMI's story. Besides systems for metal and plastics plating, including selective spot plating equipment and surface conditioning, OMI is involved in "thick film" materials for microelectronic circuitry, continuous process equipment, pollution and waste treatment processes and equipment, base metal re-

covery, precious metal refining and marketing, power conversion equipment in the megawatt range...we could go on and on. However, we'd rather you'd write for our brochure "The World of OMI," and discover all the reasons why we changed our name from Oxy Metal Finishing, to Oxy Metal Industries, a name that more accurately describes our expanding capabilities and reflects our growing capacity to serve you.

Oxy Metal Industries Corp., 21441 Hoover Rd., Warren, Michigan 48089.

OMI

OXY METAL INDUSTRIES CORPORATION
UDYLITE • SEL-REX • PARKER

Circle 125 on reader service card

In a world by itself!

it's UNREEL™

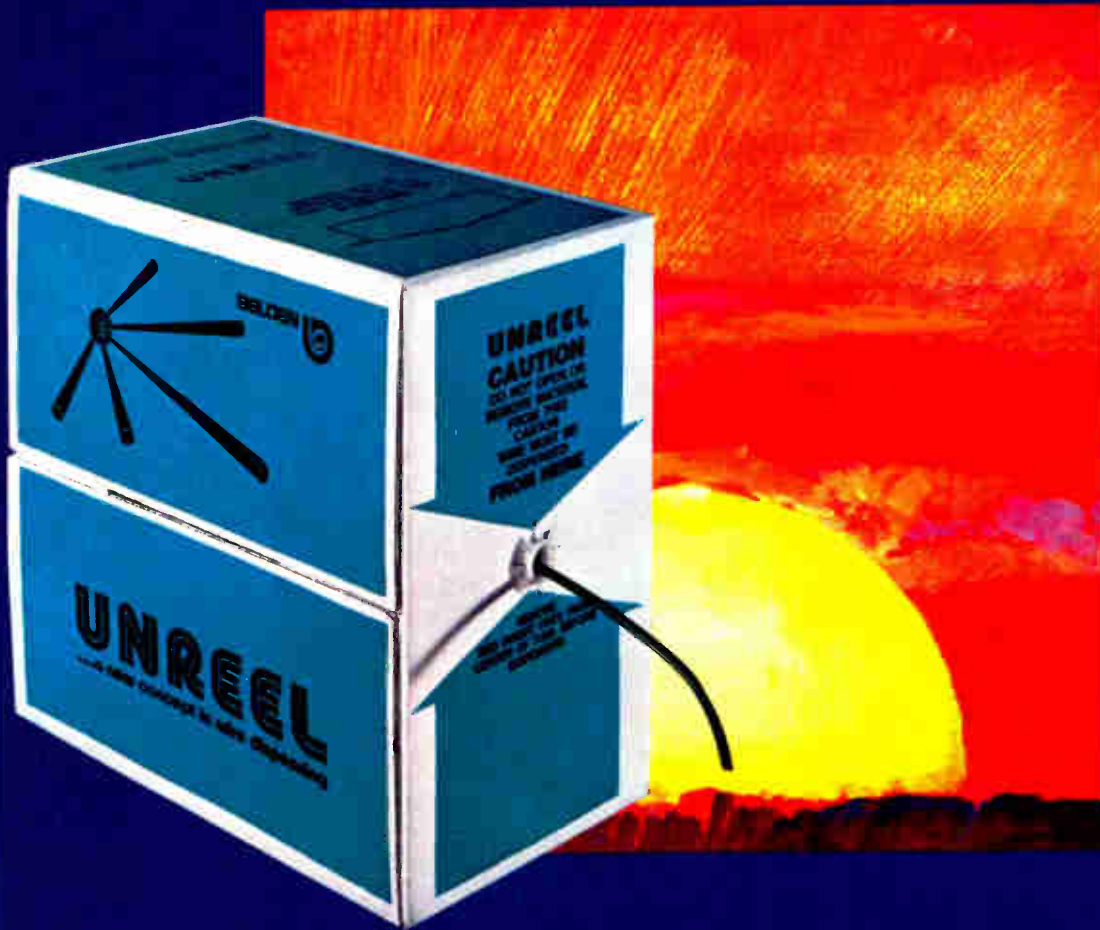

The incredible new package that dramatically slashes the installation cost of wire and cable. There's nothing else like it.

- Dispenses wire right from the package.
- Feeds directly into conduit for easy tangle-free installation.
- No snarls or backlash. Wire flows freely and stops instantly when pulling stops.
- Cuts man-hours in half.
- No reel inertia to overcome on stop and start.

- No need for any tensioning devices.
- Saves space in transportation and at job site.
- Just throw away the package when empty —no reels or spools to return.

Put UNREEL to work in your world. Call your Belden distributor or write: Belden Electronic Division, P.O. Box 1327, Richmond, Indiana 47374. Phone (317) 966-6661.

8-8-4

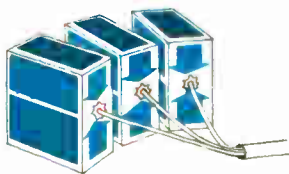

A snap to use. Feeds wire direct without kinks or tangles.



Saves time. No reels, spools or pipe racks to drag back and forth.

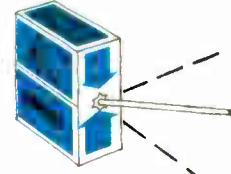

Feeds out from any angle without damaging wire.

BELDEN

UNREEL ... in a world by itself

Circle 126 on reader service card

World Radio History

Plastic relays are hermetically sealed

Low-priced commercial devices for telephone, data-transmission systems offer long life as well as protection against severe environments

by Lucinda Mattera, Components Editor

Traditionally, hermetically sealed devices come in fairly expensive metal cans. However, a Japanese relay manufacturer, Matsushita Electric Works Ltd., has developed a process for hermetically sealing a plastic package. Initially, the company will be offering three new series of sealed plastic relays, to be sold here by Arrow-M Corp. of Mountainside, N.J., a wholly owned subsidiary of Matsushita.

Because of their plastic housings, these commercial-grade relays are about half the price of their hermetically sealed metal counterparts, and they meet the leakage requirements of MIL-STD-883 at 85°C. The principal applications are expected to be in the communications industry for telephone and data-transmission systems.

Until now, it has been impossible to achieve a hermetic seal for a plastic housing. But Matsushita has found an organic-free plastic and an epoxy resin that are compatible, allowing the package to be sealed in a conventional manner. Each relay is first completely assembled, and all plastic parts are degassed. Then the relay is baked to exhaust whatever gas it contains. It is next backfilled with dry nitrogen (from which all moisture has been removed) and then sealed with an epoxy resin.

The three new series are sealed versions of earlier products. The series NFE relays are flatpack printed-circuit-board units, the

series KE relays are high-reliability types, and the series HCE devices are miniature power units.

The principal feature of all the relays is long life—a minimum of 10^8 mechanical operations, which is at least double that of comparable units. Also, the contacts for the new relays are simultaneously molded into one block, so that there are no screws or rivets to loosen.

The series NFE devices, which

In quantities of 1,000 and coil voltages up to 24 v, the dpdt model is priced at \$3.68 each, and the 4pdt model at \$4.49.

Because of their dual magnetic gap, the series KE cradle relays provide a large contact pressure of 11 grams nominally, making them highly reliable switching devices. Both a dpdt model and a 4pdt model are available. Current rating is 2 A maximum, and coil voltages from 3 to 110 v dc are offered. For coil voltages up to 24 v and in 1,000-unit quantities, the dpdt version costs \$4.02, and the 4pdt version costs \$4.42.

To increase contact life, the series HCE relays have arc barriers between each set of contacts and debris wells into which arc particles can fall. Three models are available—spdt, dpdt, and 4pdt—in dc coil voltages of 6 to 110 v, and ac coil voltages of 6 to 240 v. Current rating is 5, 3, or 1 A, depending on the model. Package size is 0.827 by 1.079 by 1.319 in. For quantities of 1,000 and coil ratings up to 24 v dc, price is \$3.37 for the spdt unit, \$4.06 for the dpdt unit, and \$4.42 for the 4pdt unit.

All the relays are available from Arrow-M's stock.

The company also recently announced [*Electronics*, Dec. 12, 1974, p. 133] a line of sealed plastic miniature reed relays. These series R spdt units can switch up to 20 w at 500 hertz.

Arrow-M Corp., 250 Sheffield St., Mountainside, N.J. 07092 [339]

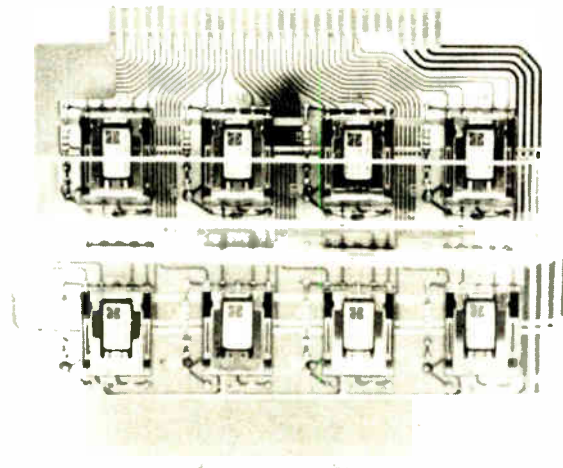

Taking an oil bath. Hermetic seal protects plastic-packaged relays from dust, moisture, and even oil, as shown here.

can be either double-pole or four-pole double-throw relays, contain a highly efficient magnetic circuit, as well as a built-in shock absorber. Operating power is as low as 260 milliwatts for the dpdt model and 400 mW for the 4pdt unit, while contact bounce is approximately 1.5 milliseconds. For either model, coil voltages range from 6 to 60 v dc, and maximum current rating is 2 amperes. The 4pdt package measures 0.425 by 0.953 by 1.165 inches.

Instruments

Panel meter has 0.5-inch LEDs

First of new series offers automatic zeroing and binary-coded-decimal output

A large display is essential in process instrumentation and other applications where readings must be taken at distances of 10 to 20 feet. And the 13-millimeter-high (½-inch) light-emitting-diode display of



Newport Laboratories Inc.'s latest 3½-digit digital panel meter looks even larger than it is.

The first of a new DPM series, the model 203 meter is expected to find large-volume usage in clocks, as a TV channel indicator, in point-of-sale equipment, and in both portable and rack-mounted equipment. Priced at \$81 each in quantities of 100, the automatic-zeroing unit offers 100 decibels of common-mode rejection, standard selection of 200-millivolt or 2-volt range, plus optional 20-v or 200-v scales, and standard provision for ratio measurements. The LED displays are electrically quiet. President Barrett B. Weeks, says that gas-discharge displays, though perhaps more satisfactory esthetically, generate electromagnetic interference.

Because of their MSI TTL design, the meters have binary-coded-decimal outputs—which usually come only as an option, comments Weeks. He adds that the TTL is still equal to or lower in cost than MOS circuitry.

The BCD is especially useful in voltmeters of the 3½ digit range and higher, where users often want data-logging and similar features in the equipment.

The meters make true average readings rather than absolute value measurements that include noise, as do some other digital meters on the market. "This gives better normal-mode noise rejection, which is especially significant if the signal has a large noise component," observes Weeks, who adds that it's an advantage in many process-control applications, and in the 200-millivolt full-scale range, where each least significant digit represents 100 microvolts.

Total error is ±0.05% of reading ±1.5 counts. Reading rate is four per second. The meter is protected against overvoltages to 100 v in the basic 0.2- and 2-v scales. Input impedance in these ranges is 1 megohm. Polarity setting is automatic.

The model 203 meter operates from 115/230 v ac. It fits in the standard cutout used by many in the industry, 99.7 by 42.7 mm. The unit is 120 mm deep, with the bezel 104 by 48 mm. The case is made of Lexan.

Newport Laboratories Inc., 630 E. Young St., Santa Ana, Calif. 92705 [351]

6,000-count panel meter uses single-slope conversion

Unlike most 3½-digit panel meters, which count to 2,000, Data Technology's model 3362 counts to 5,999. Using a single-slope converter to cut power consumption and operating temperature, the 3362 provides 4-digit resolution for the measurement of temperature (up to 60° or 600° in the desired scale), angle (beyond 360°), and such commonly encountered supply voltages as 5 v and 28 v. Traditional 3½-digit meters provide only 3-digit resolution in these ranges. The 3362 has three voltage ranges—600 millivolts, 6 v, and 60 v—resolution is 100 microvolts in its most sensitive range. Input resistance is 1,000 megohms in the two lowest ranges and 10 meg-



ohms in the 60-v range. Input-bias current is typically 1.5 nanoamperes. Maximum 90-day drift is 0.08% of reading at 23°C. Beckman 7-segment planar glow tubes are used for display. Read on command, hold on command, and display and polarity inhibits are standard features. Options include parallel binary-coded decimal outputs and a ratio/external reference input. Price of the 3362 is \$189 each in small quantities. The BCD option adds \$35, and the ratio option is an additional \$15. Delivery is from stock to 30 days.

Data Technology Corp., 2700 South Fairview, Santa Ana, Calif. 92704 [353]

Noise dosimeter computes daily noise exposure

Designed to determine if a person's total daily noise exposure is within the limits of the Occupational Safety and Health Act and the Walsh-Healey Act, the model SPL-105 is a pocket-size noise dosimeter with a detachable microphone that can be placed next to any part of the body. The battery-operated 4-digit instrument is equipped with an enclosed meter in a sealed case so that



If you test, handle, sort, or straighten leads on DIPs, there's a RAMSEY unit to fit your exact requirement... and your pocketbook.

For example, Ramsey's Model RH-905 I-C Handler, the top of the line. We've been saying no other I-C handler can do so much, so well, so fast, and we're prepared to prove it. It features 5 category sorts... it's software programmable, via convenient thumbwheel switches... convenient thumbscrew adjustments permit handling of a full range of package sizes and configurations... a unique photo detector system provides instant readout of the status of all input, output and test functions... it incorporates a built-in interface board... and its modular design permits easy interchange between mechanical and electronic sections to accommodate different package size configurations.

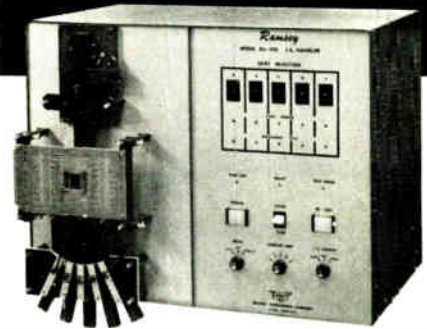

MODEL RH-905
I-C HANDLER

The Model RH-903 I-C Handler retains many of the features of the RH-905... but at a considerable saving in cost if you don't require the full capability of the higher priced unit. It features 3 category sorts, built-in interface board and the same photo detector system for instant status readout.

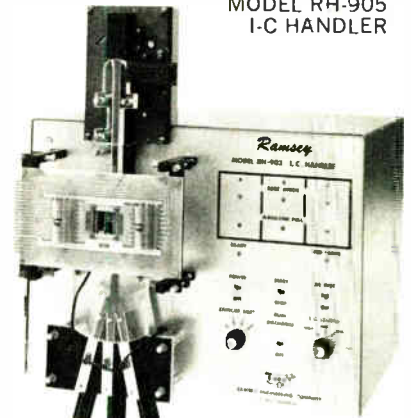

MODEL RH-903
I-C HANDLER

Then there's the manually operated Model RH-202, a lot of I-C handler for the money. It provides an easy, inexpensive way for you to automate your I-C testing. The Model RH-202 is completely self-contained... requires no air or power. It accommodates a variety of package configurations, 6- through 18-pin, or 24- through 40-pin. Precious metal contacts are individually replaceable. It incorporates a performance board for bypassing and decoupling for device compensation.

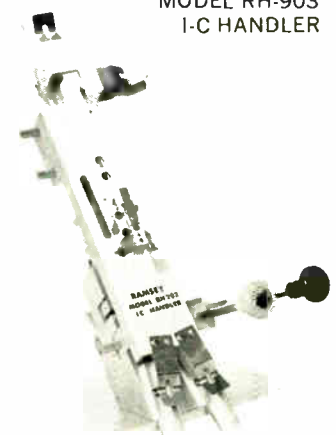

MODEL RH-202
I-C HANDLER

If people sitting at benches, using long-nose pliers to straighten DIP leads manually, sounds like a horse-and-buggy operation, take a look at Ramsey's RS-5618 Automatic Lead Straightener. It matches the continuous throughput of 17 to 20 persons straightening DIP packages manually. Operating continuously at speeds up to 5,000 devices/hour, it handles 6- through 18-pin DIP packages, straightening leads uniformly to any degree required for automatic or manual insertion into PC board hole locations.

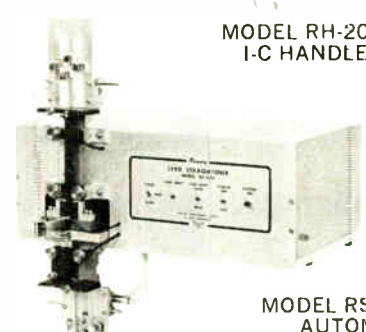

MODEL RS-5618
AUTOMATIC
LEAD STRAIGHTENER

For additional information, write or call
Ramsey Engineering Co., Electromechanical Products.

RAMSEY
ENGINEERING COMPANY
ELECTRO-MECHANICAL PRODUCTS

1853 W. County Rd. C, St. Paul, Mn. 55113 • Phone: (612) 633-5150
Cable: RAMCO TWX: 910-563-3553 TELEX: 29-7001



For bonding metal- to-metal- to-glass- to-glass-to- plastics- to-plastics- to-rubber-to- rubber-to- metal-to-etc- to-etc.

One drop goes a long way in fastening almost anything to almost anything.

Eastman 910[®] adhesive bonds fast, too. Almost instantaneously. With only contact pressure.

Tensile strength? Up to 5000 psi at room temperature.

New Eastman 910 MHT and THT/Grades hold when the heat's on. Even over 400° F.

For further data and technical literature, write: Eastman Chemical Products, Inc., Kingsport, Tennessee 37662.



New products

certified records can be maintained on the basis of its readings. It is A-weighted and has a range from 90 to 115 decibels. An accessory, the model MR-105 direct reading dB (A) meter, plugs into the side of the SPL-105 converting the unit into a direct-reading real-time dB meter. The dosimeter is available from stock.

Columbia Research Laboratories, MacDade Blvd. and Bullens Lane, Woodlyn, Pa. 19094 [354]

Digital gaussmeter spans dc to 400 Hz

The model 811 digital gaussmeter is a Hall-effect instrument with a frequency range of dc to 400 hertz. The 3½-digit (2,000-count) meter measures magnetic flux density over five



ranges from 20 gauss full scale to 200,000 gauss full scale. There are 110 Hall-effect probes in a variety of configurations available to work with the meter. Maximum error is less than 0.2% of reading. Drift is less than 0.1% of full scale over any time period.

F. W. Bell Inc., 4949 Freeway Drive East, Columbus, Ohio 43229 [355]

Low-cost tester tells when to recharge batteries

A low-cost battery tester and continuity checker that tests rechargeable batteries under typical load

NEW "FLAT PACK" DOUBLE BALANCED MIXERS

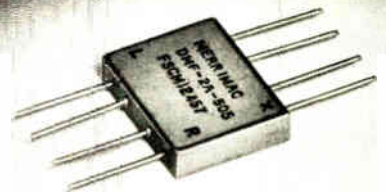

- Frequency range 10 MHz to 1000 MHz
- Low price
- Extremely compact, lightweight
- Custom models available

These new DMF-2A-505 double balanced mixers are ideal for high density packaging in stripline or printed circuit systems. Price is only \$26 in small quantities. Typical performance specs include: conversion loss less than 7 db, isolation 30 to 40 db, operating temperatures -54°C to +85°C, and weight 1.4 grams.

Contact Merrimac today for more details on standard and custom-engineered DMF-2A-505 mixers.

MERRIMAC INDUSTRIES INCORPORATED

41 FAIRFIELD PLACE, WEST CALDWELL, N. J. 07006
(201) 228-3890 • TWX 710-734-4314

U.S. EXPORT REPRESENTATIVE:
Dage Corporation, 203 324 3123
INTERNATIONAL SALES REPRESENTATIVES:
Brussels, Belgium — Eleutron, S.p.r.l., tel: 513 7384, tlx: 25437
Montreal, Canada — Mitac Electronics, Ltd., tel: 514 334 9140, twx: 610 421 3572
London, England — C. T. London Electronics Ltd., tel: 369 650, tlx: 15052
Paris, France — Datron, tel: 808 02 60, tlx: 68135
Munich, Germany — Selectron, GmbH, tel: 392 048, tlx: 215791
Tel-Aviv, Israel — Dage Israel Ltd., tel: 415645/410988, tlx: 34424
Breda, Netherlands — Datron, B.V., tel: 41'52, 41153, tlx: 54512
Stockholm, Sweden — Ajgers Electronic AB, tel: 08 88 03 20, tlx: 10526
Zurich, Switzerland — Invertag, SA, tel: 65 56 30, tlx: 52896

This NEW instrument



replaces most of what you now use to inspect R, L, and C components

It's the GR 1685 Digital Impedance Meter, which is in reality a complete incoming-inspection station for passive components. On each range it automatically measures series capacitance and inductance at either 120 Hz or 1 kHz and *measures resistance at dc*. A built-in digital limit comparator (optional) enables rapid GO/NO-GO sorting. The basic accuracy is 0.1% for dc and 1-kHz measurements and 0.5% for 120-Hz measurements. Measurement ranges are .01 pF to 20,000 μ F for capacitance, .01 μ H to 2000 H for inductance, and 0.1 ohms to 20 Megohms for resistance.

Other benefits include:

- For ac measurements, D and Q limits automatically indicated (adjust dial to determine values).
- Measurement speed up to four measurements per second.
- Lighted arrows indicate direction to turn range and D/Q limit dials.
- Parallel data output available for external equipment such as additional limit comparators, handlers, data printers, and card punches.
- Test fixture (optional) has PASS/FAIL lights.

The 1685 is equally convenient to use whether you screen many of the same type of components or measure the values of several different components. For complete information circle the number that appears below or call or write any GR Sales Office. You'll be surprised at the price, too.



General Radio

300 BAKER AVENUE, CONCORD, MASSACHUSETTS 01742

NEW YORK (N.Y.) 212 964-2722, (N.J.) 201 791-8990 • BOSTON 617 646-0550 • DAYTON 513 294-1500
CHICAGO 312 992-0800 • WASHINGTON, D. C. 301 948-7071 • ATLANTA 404 394-5380
DALLAS 214 234-3357 • LOS ANGELES 714 540-9830 • SAN FRANCISCO 415 948-8233
TORONTO 416 252-3395 • ZURICH (011) 55 24 20

GR COMPANIES • Grason-Stadler • Time/Data

Remote viewing at a price competitive models can't even approach.

This new, low-cost FS-100 Fiberscope with a 24" flexible length can reveal hidden flaws, peer into recesses, and trace vibrations to their source. Built with AO quality throughout, this battery-powered unit features a high resolution fiber bundle with a wide angle fixed focus objective lens and an adjustable eyepiece. For further information on the entire Fiberscope line, write or call American Optical Corporation, Fiber Optics Division, Southbridge, Massachusetts 01550. Tel. (617) 765-9711 Extension 2445.



Only \$295
Model FS-100
Fiberscope

AO
American
Optical

Circle 132 on reader service card

New products



conditions is marked to indicate levels at which batteries should be recharged. Priced at only \$18.75, the WT-537A has a standard scale for carbon-zinc and alkaline units, as well as a separate scale for mercury and nickel-cadmium batteries. Packaged in a high-impact orange case, the WT-537A measures 5.125 inches by 3.625 in. by 2 in., and weighs 10.5 ounces.

RCA Electronic Components, 415 South Fifth St., Harrison, N. J. 07029 [356]

Power-line recorder responds to transients up to 1 MHz

A portable four-pen power-line recorder responds to sags and surges over the full range from dc to 1 megahertz from 0 to 1,000 volts. The model 5209D uses separate pens to record sag duration, sag amplitude, surge duration, and surge amplitude. The duration range is from 10 microseconds full scale to 10 milliseconds full scale. The instrument uses phase-locking techniques to continuously compare an internally generated waveform with the line waveform; thus it cannot miss any transient within its range. Price of the recorder, which is built for laboratory or field use, is \$3,495; delivery is from stock.

Micro Instrument Co., Power Instrument Division, 580 Opper St., Escondido, Calif. 92025 [359]

NTI MODEL 525 DIGITAL MONOSCOPE SIGNAL GENERATOR

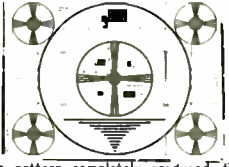

- A perfect monoscope pattern completely produced digitally.
- Influence and resolution of deflection distortion can be perfectly observed.
- Very effective for picture quality appraisal.

OUTLINE
As the signal itself of conventional monoscope cameras has deflection distortion, shading, modulation error, and signal tremor from induction, it is difficult to judge, whether the monitor deflection distortion or the signal itself is bad. This unit provides a purely electrical signal, where these defects are perfectly solved. Because of the appearance of this perfect signal, it can be considered that the application will be wider than for a conventional monoscope.

SPECIFICATION
Vertical analysis capability: Each scanning line.
Horizontal analysis capability: Max. analysis part is 1/10, 480 of the horizontal effective screen width. (At 200 MHz division, this corresponds to 100 MHz effect).
Contrast linearity: The contrast of 10 columns is within 1% of the rated value.
Output level: 1 Vp-p (synchronization 0.3 Vp-p, image 0.7 Vp-p) 1 system.
Output impedance: 75 Ω ± 5%
Noise: Hum noise below -60 dB.
Synchronized noise below -50 dB.
Outer dimensions: 480mm (width) × 100mm (height) × 380mm (depth). About 10 kg.

• Nippon Television Industry Corporation is the main manufacturer supplying TV use measuring instruments and signal equipment (700 series modulated chroma generator, Sync Gen. video distributor, TV use VHF modulator, UHF modulator, etc.) for testing to all the TV makers of Japan.

NIPPON TELEVISION INDUSTRY CORPORATION,
1-32-6, Nishi-Gotanda, Shinagawa-ku, Tokyo 141, Japan.

PINPOINT HEAT

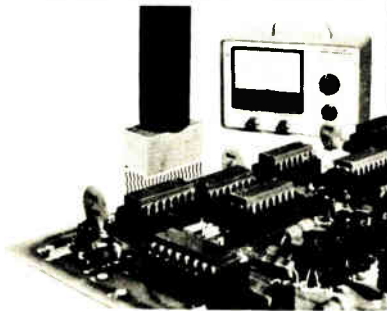

Heat any I. C. or semiconductor component to its rated temperature with a heat probe. Accuracy $\pm 1/2^\circ\text{C}$. Or check the component's temperature with a thermocouple probe. Accuracy $\pm 1^\circ\text{C}$. Model 810 Thermo-Probe does both. Reads out directly in $^\circ\text{C}$ and $^\circ\text{F}$ on a large $4\frac{1}{2}$ -inch meter. Temp. Range + 25°C to + 250°C .

PRICE \$272.50 F.O.B. South Laguna

Models with other temperature ranges available. For details write to:

MTI MICRO-TECHNICAL INDUSTRIES

P. O. Box 287 South Laguna, CA 92677
(714) 545-3734

132 Circle 184 on reader service card

Circle 185 on reader service card

Electronics/February 6, 1975

We'll go to any lengths to give you the best flexible-cable products.

Like our new matched-impedance transmission cable. It comes on a reel.

So you can cut it to length—from inches to yards.

That means you can forget about using short cable requiring a multitude of splices. Controlled impedance is available in popular ranges from 50 to 125 ohms.

Apart from cutting, our transmission cable can be terminated at each end automatically—without cable preparation of any kind—when you use our insulation-displacement terminals.

Transmission cable is the latest in our range of flexible cable and connectors. For further information, call (717) 564-0100. Or write AMP Incorporated, Harrisburg, Pa. 17105.

AMP
INCORPORATED



Circle 133 on reader service card

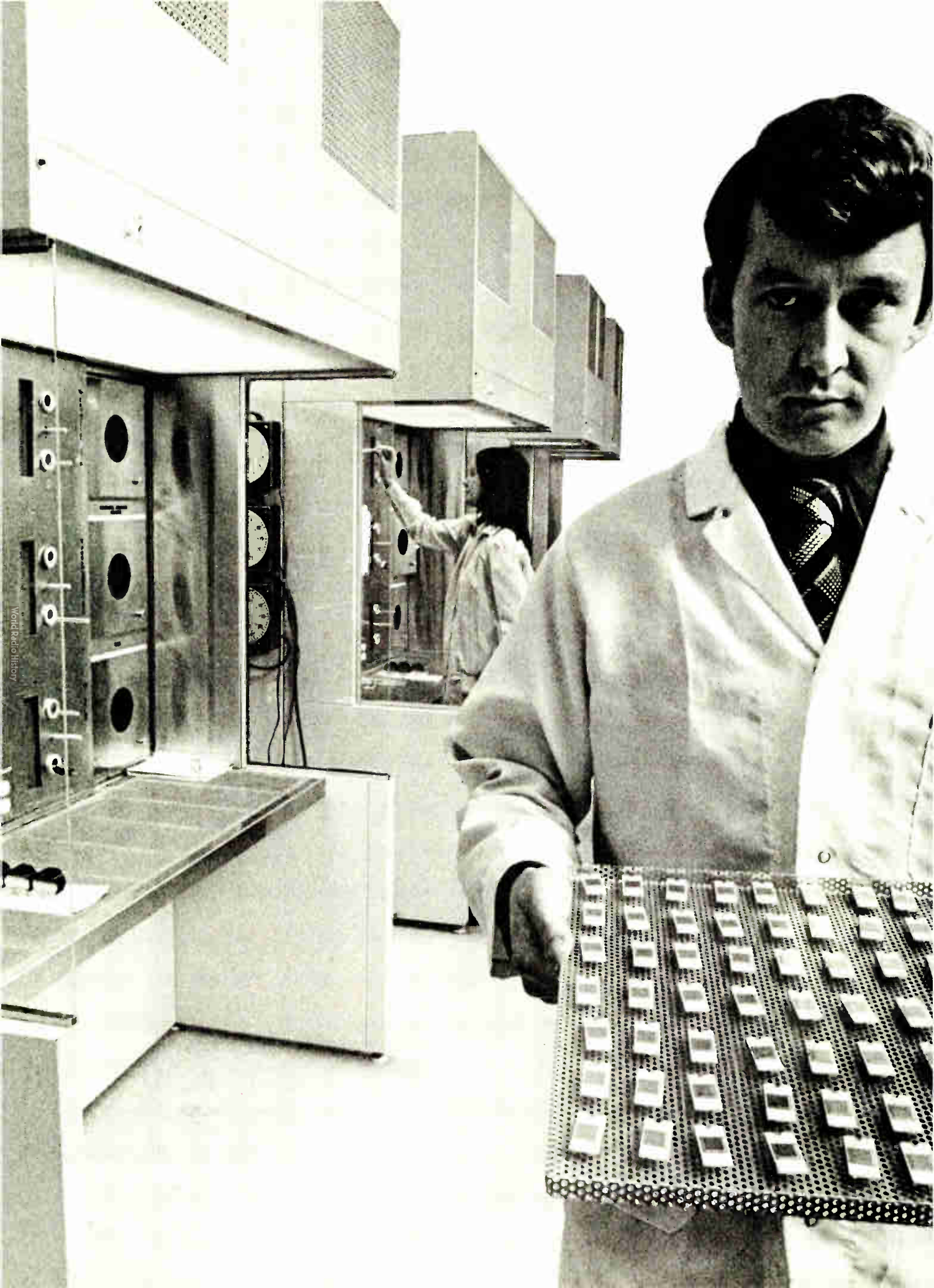

IT'S HERE. ANALOG DEVICES' \$39 12-BIT IC DAC.

No other 12-bit DAC-IC or module — gives you greater accuracy. Or a lower cost.

Introducing the AD562 — the revolutionary IC from Analog Devices Semiconductor that outperforms every other 12-bit DAC on the market.

Simply stated, the AD562 is a 12-bit IC digital to analog converter in a hermetically sealed, 24-pin DIL package.

It gives you guaranteed monotonicity over the full operating temperature range, with a maximum total error as low as $\frac{1}{4}$ LSB (0.006%) at 25°C, and a 3ppm/°C maximum gain temperature coefficient.

The logic inputs are positive-tri-state, and are specifically designed to be both TTL and CMOS compatible. In addition, both binary and BCD versions are available.

How the AD562 came about. The state-of-the-art AD562 could only come from a company like Analog Devices.

After all, we're the world's leading manufacturer of A/D and D/A converters for test and measurement instrumentation. And with converter products like the AD562, we're extending that leadership in integrated circuit form.

CMI — the new technology that made it possible. To give the AD562 its unmatched accuracy, we developed a process called CMI-Compound Monolithic Integration.

CMI is the partitioning of a complex function into a minimum number of monolithic chips, each specifically designed to work with the others, and assembled in a single package.

For greater performance, the AD562 features two chips. A monolithic, 12-bit precision, bipolar transistor current switch and control amplifier chip. And a compatible silicon-chromium thin-film resistor network containing the DAC bit-weighting and range resistors.

First, they're internally connected. Then, while the AD562 is powered, all the resistors are trimmed by a computer-controlled automatic laser trimmer.

The result is outstanding resolution and scale factor calibration. And state-of-the-art performance at a very low price.

The AD562 does even more for you. You'll find that the AD562 gives you a lot of operating advantages.

Like providing five pin-programmable output ranges, both bipolar and unipolar.

Acting as a two-quadrant multiplier when you apply a variable external reference voltage.

And offering a newly developed current switching cell structure which provides superior immunity to supply voltage variation, and reduces nonlinearities due to thermal transients as the bits are switched.

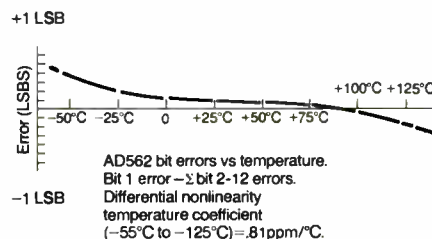

Three temperature ranges to choose from. You can specify the AD562 guaranteed for operation over three temperature ranges. The model K: 0 to +70°C. The model A: -25 to +85°C. And the model S: -55 to +125°C.

And best of all, prices start as low as \$39 in hundreds.

If you'd like more information on the AD562, call Analog Devices Semiconductor, Norwood, MA. 02062.

East Coast: (617) 329-4700

Midwest: (312) 297-8710

West Coast: (213) 595-1783

 **ANALOG
DEVICES**

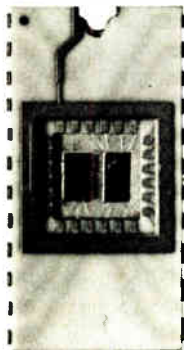

Components

LEDs offer high efficiency

0.43-inch-high readouts in red, yellow, and green challenge gas-tube displays

Despite the increasing popularity of red light-emitting-diode displays, LEDs emitting other colors, particularly green and yellow, have not made a significant dent in the market [*Electronics*, May 30, 1974, p.

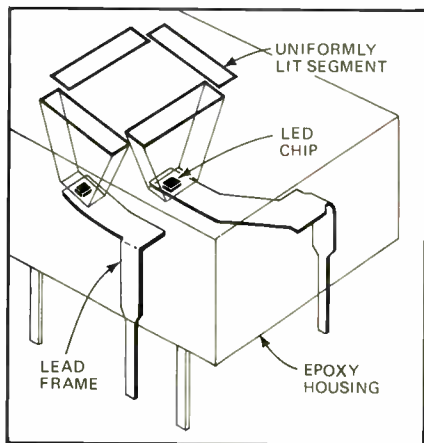

66]. Gas-discharge tubes still dominate in many high-ambient applications, such as avionics systems, clocks, appliances, point-of-sale terminals, and instrumentation.

Now, in a challenge to gas-discharge tubes, Hewlett-Packard Co. is introducing 0.43-inch seven-segment LED displays in high-efficiency red, yellow, and green that can be operated at four times the brightness of present LED displays. The red and yellow displays, designated the 5082-7650 and 5082-7660, respectively, are made from gallium arsenide phosphide on a transparent gallium-phosphide substrate [*Electronics*, May 2, 1974, p. 34]. The green 5082-7670 display is made from gallium phosphide on a transparent GaP substrate.

"These new displays can operate in two modes," says Donald Ben-

nett, optoelectronics product marketing manager in the HPA division. "One is the high-current, high-intensity mode. The other is the low-current, MOS-compatible mode." In the first, operating with a 20-milliampere current load, the displays are four times brighter than the older LED displays. In the second, at 5 mA, they have the same intensity as the older displays operating at 20 mA.

The high efficiency of the new red and yellow displays derives from GaP's transparency to light emitted by a GaAsP junction—as opposed to its opaqueness to the shorter wavelengths emitted by GaP junctions. When the GaAsP on GaP combination is backed by a reflecting lens, a much greater fraction of light can be collected at the output cavities, and the resulting colors appear brighter and clearer than do GaP-only systems. "In addition to competing with gas-discharge technology on its own ground," says Bennett, "these new color LEDs with their 5-v-supply requirement open up a whole new range of portable applications—particularly in instrumentation."

In order to maximize on/off contrast, the bodies of the displays have been painted to match the appearance of an unilluminated segment. And to provide an easier-to-read device, the emission wavelength of the red displays has been shifted from the standard GaAsP true red—655 nanometers—to the orange end of the red spectrum at 635 μm .

All of the displays, says Bennett, are meant to be used in conjunction with contrast-enhancing filters. All three color units are available now at \$3.95 per digit for 100-pieces.

Optoelectronics Product Marketing Manager, HPA Division, Hewlett-Packard, 640 Page Mill Rd., Palo Alto, Calif. 94304 [341]

Low-cost temperature switch is voltage-programable

A stable temperature-actuated solid-state switch can be programmed to operate at any temperature be-

tween a maximum of 50°C and a minimum of approximately -30°C, simply by changing the voltage across it. Actually, the device has no intrinsic low-temperature limit, but lowering the switching temperature means raising the programming voltage, so that the need to work with high voltages imposes a practical limit of about -30°C.

Built around a single-crystal metal-oxide material, the two-terminal Moxie switch is a true regenerative device. At its programmed transition temperature, it switches from an off state, in which it has a resistance of at least 30 kilohms, to an on state in which it has a saturation voltage drop of 5 to 10 volts. Once turned on, the Moxie switch stays on unless its current is interrupted, or a reverse current pulse is applied. In purely dc operation, therefore, the device is actually a latching switch. Since it is a completely sym-

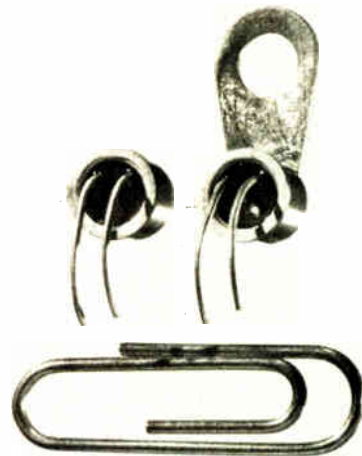

metrical bipolar device, the switch does not latch up when ac is applied. It shuts off whenever the current through it tries to reverse direction. If powered by a stable supply voltage, it can be precisely programmed by a single external resistor. Temperature stability is better than 0.1°C, and short-term drift is less than 0.05°C.

The Moxie switch is not a high-power device. The current through it should not exceed approximately 50 milliamperes. Packaged in a TO-18 case, it sells for 40¢ apiece in small quantities. Delivery of the

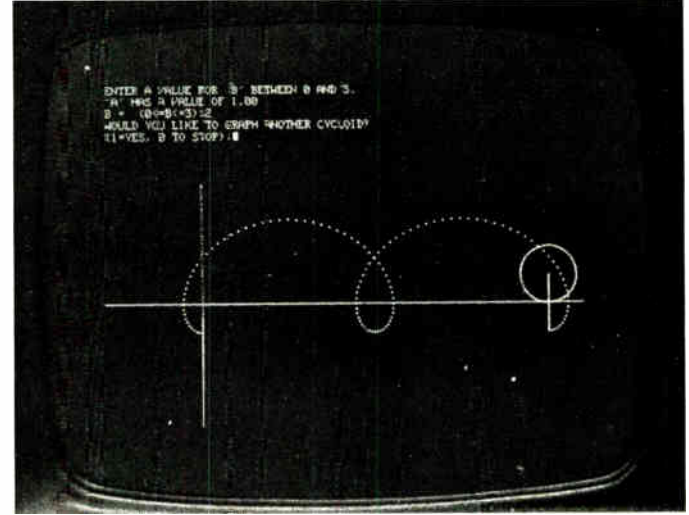
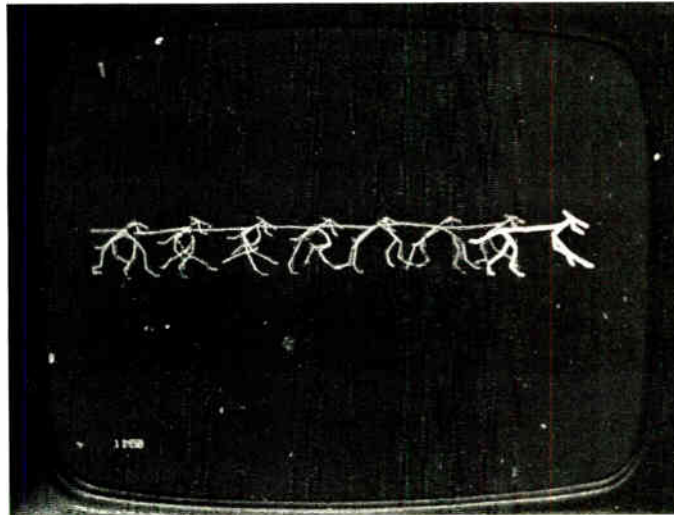
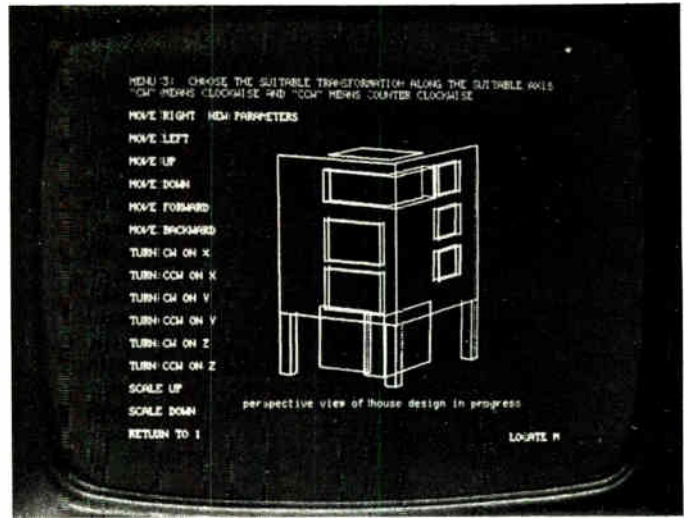
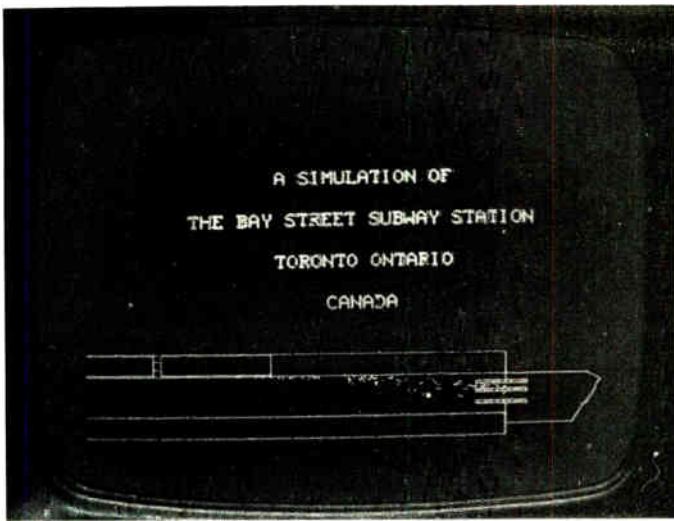

Digital announces a whole new way to look at graphics.

Right now is the time to look at graphics in a way you've never looked before.

Because graphics has come of age. And Digital feels you're about to see a tremendous increase in the use of graphic systems. In science, research, medicine, business and industry.

We've been making graphic systems almost as long as we've been making computers. And today, we may have the broadest range of computerized graphic systems available.

In our GT Series alone, we offer three multi-purpose graphic systems.

The GT40 includes a PDP 11/10 processor, 8K words of memory, keyboard, and 12" screen with light pen.

Extensive peripheral and application software is also available.

For expanded needs, the GT42 offers a 17" screen with light pen and communications interface.

And the powerful GT44 system provides a high performance PDP 11/40 processor with 16K words of memory, 17" screen with light pen, and our own DECwriter for hard copy.

Besides graphics, you can use these systems for virtually any computer application. And they're backed by an extensive array of peripherals and software. Plus Digital's worldwide service organization.

And should you already be a PDP-11 user, a graphic add-on may give you a totally new perspective on meeting your needs.

So if you're looking into graphics, be sure to see us. Write Graphics Group, Digital Equipment Corporation, Marlboro, Mass. 01752. Or call (617) 481-9511, Ext. 6936. European headquarters: 81 route de l'Aire, 1211 Geneva 26. Tel: 42 79 50.



digital

Introducing the incredible
Nitron EAROM memories...

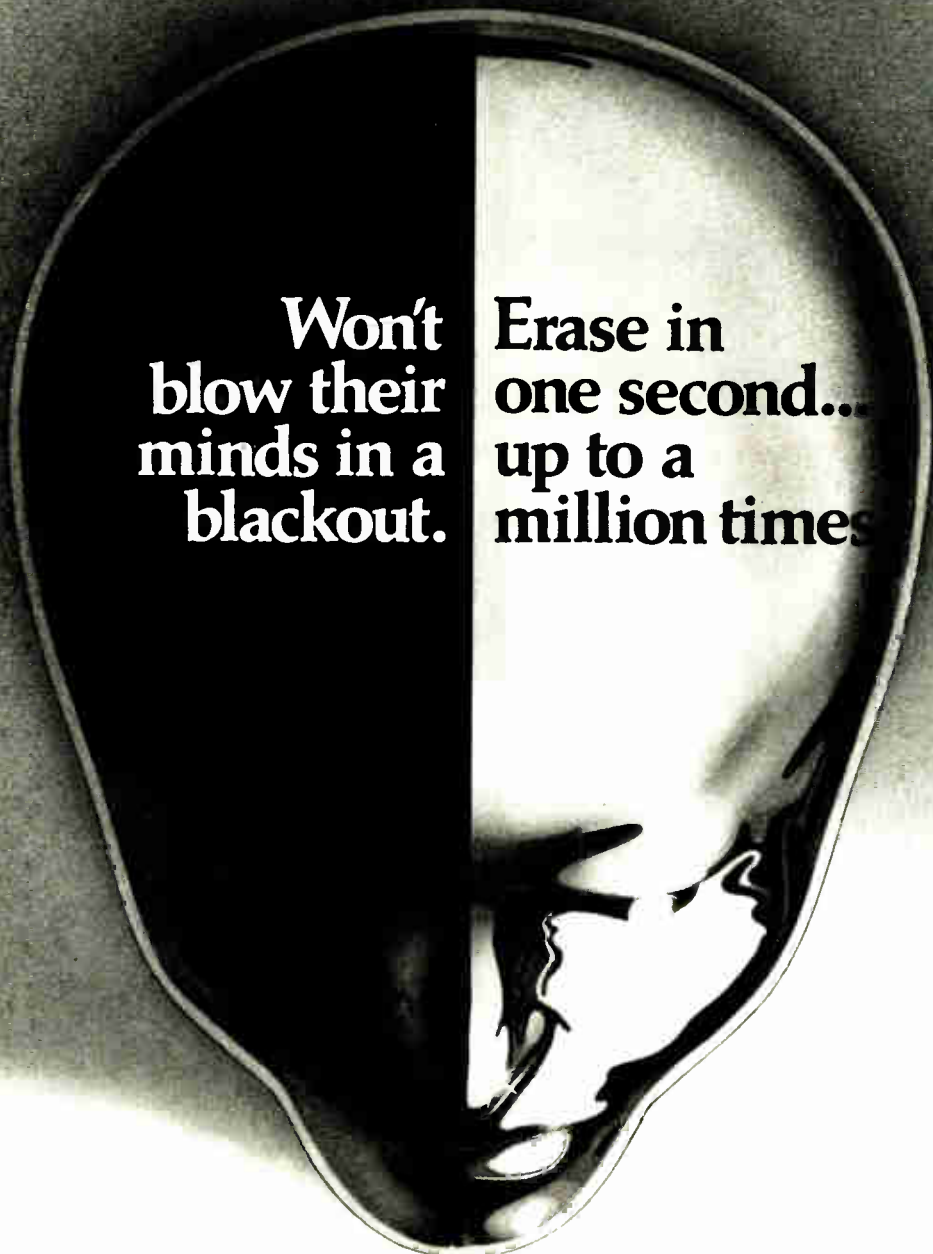

Won't
blow their
minds in a
blackout.

Erase in
one second...
up to a
million times

Our non-volatile, electrically alterable, read-only memories (EAROMs) are the tiny memory devices that do it all:

1. They can store data for years without power.
2. They're non-destructive and immune to external power interruptions.
3. They let you erase stored information in just one second, without ultraviolet irradiation.
4. They let you alter the memory as often as needed — up to a million times.
5. They're particularly useful for communications, computer peripherals, and very low power applications.
6. Standard products and custom capability.

Part Number	Description	Power Supplies (Volts)	Package	Notes
NC7001	64 x 1	±15	18 DIP	ROM Organization
NC7002	1024 x 1 512 x 2	±15	40 DIP	ROM Organization
NC7010	1024 x 1 512 x 2	±15	28 DIP	ROM Organization
NC7030	8 x 16	±15	18 DIP	Shift Register Stack
NIT-80C	1K x 8	±15	PC Board	8K Memory Module
NIT-80T	1K x 8	±15, +5	PC Board	8K Memory Module

Before you forget, call us at (408) 255-7550.
Or send the coupon for the full NITRON story.

NITRON A division of
MCDONNELL DOUGLAS 

NITRON, 10420 Bubb Road, Cupertino, CA 95014

Before I forget, please tell me more about NITRON memories.

name

company

title

address

city

state

zip

Circle 138 on reader service card

World Radio History

Before you forget, mail
the coupon on opposite page

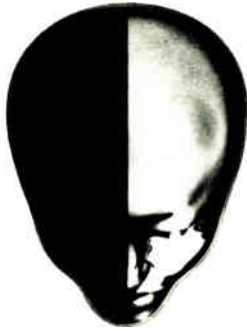

or contact your nearest
NITRON representative for
the facts about **EAROM**.

EASTERN REGION

R. H. STURDY CO., INC.
167 Worcester St., Wellesley Hills, MA 02181
Phone: (617) 235-2330
32 Horseshoe Road, Guilford, CT 06437
Phone: (203) 453-5424

GANS-FRYLING, INC.
2062 14th St. North, Arlington, VA 22201
Phone: (703) 527-3262
12027 Scaggsville Rd., Fulton, MD 20759
Phone: (301) 837-6311

TECHNOLOGY MARKETING ASSOCIATES
1010 E. Atlantic Blvd., Pompano Beach,
FL 33061 Phone: (305) 942-0774
450 Andalusia Ave., Ormond Beach, FL 32704
Phone: (904) 672-2314
10118 Shades Rd., Huntsville, AL 35802
Phone: (205) 883-7893

AD-EL-TEK CO.
14 S. Walnut St., Englewood, OH 45322
Phone: (513) 836-2741 or 836-8471
13201 Abbey Rd., North Royalton, OH 44133
Phone: (216) 237-4472

ELECTRO REP INC.
366 North Broadway, Jerico, NY 11753
Phone: (516) 938-0540

CENTRAL REGION

CARLSON ELECTRONIC SALES CO.
7448 N. Harlem Ave., Chicago, IL 60648
Phone: (312) 774-9022 or 774-4812
Northbrook Executive Ctr. Suite 209
10701 W. North Ave., Milwaukee, WI 53226
Phone: (414) 476-2790
453 N. Lindbergh, St. Louis, MO 63141
Phone: (314) 991-0262
2310 W. 75th St., Shawnee Mission, KA 66208
Phone: (913) 432-2144

WESTERN REGION

R. W. THOMPSON ASSOCIATES, INC.
4140 Transport St., Palo Alto, CA 94303
Phone: (415) 321-7388

ORION SALES, INC.
1310 Air Way, Glendale, CA 91201
Phone: (213) 240-3151
430 East Main St., Tustin, CA 92680
Phone: (714) 832-9687
5832 Kantor Court, San Diego, CA 92122
Phone: (714) 299-8322

INTERNATIONAL

KYOKUTO BOEKI KAISHA LTD.
7th Floor, New Otemachi Bldg.
2-1, 2-Chome, Otemachi, Chiyoda-ku
Tokyo, 100-91 Japan Telex: 781-02222044

SILVERSTAR, LTD.
20, Via Del Gracchi
20146 Milano, Italy Telex: 843-32634

TEKELEC AIRTRONIC
Cite des Bruyeres
Rue Carle Vernet
92310 Sevres, France Telex: 842-25997

KLAASING ELECTRONICS B.V.
Tramsingel 74
Breda, Holland Telex: 844-54598

JOHAN LAGERCRANTZ KB
Gardsvagen 10B, Box 3014
17103 Solna 3, Sweden Telex: 854-10363

New products

metal-oxide switch is from stock.
Multi-State Devices Ltd., 1330 Trans-Canada Highway, Dorval, Quebec H9P 1H8, Canada [342]

Epoxy-coated metal-film
resistors are highly stable

Designed to surpass the specifications of MIL-R-10509 characteristics C, E, and F, type VM epoxy-coated metal-film resistors are available in six power ratings from 0.1 watt to 2 W. Any resistance value from 30 ohms to 300 kilohms, for the 0.1-W units, up to 100 ohms to 10 megohms, for the 2-W resistors can be made. Tolerances of plus or minus 0.25%, 0.5%, and 1.0% are standard, with specials available to a limit of 0.12%. The power ratings of all VM resistors are based on continuous operation at an ambient temperature of 125°C. Operating temperature range is -55°C to 165°C with linear derating at 2%/°C above 125°C. Manufactured by the evaporation of a metal alloy onto a ceramic substrate with gold end bands, and finished with coatings of a proprietary silicon epoxy and paint, the VM series is highly moisture resistant, and typically exhibits less than 0.1 microvolt per volt of noise. Deliveries are currently running two to three weeks.

Vermont Precision Resistor Co., P.O. Box 1170, Stowe, Vt. 05672 [344]

Solid-state relays switch
45 amperes at 480 volts

By incorporating what the company calls a "Heat Spreader" into its latest line of solid-state relays, Optrol has been able to achieve current ratings as high as 45 amperes. The Heat Spreader is a high-efficiency thermal-transfer device which cools the relay's power SCRs by spreading their heat onto the device's die-cast aluminum base. Offered in 3, 5, 10, 25, and 45-ampere ratings, with voltage ratings of 120, 240, and 480 V, the relays use twin power SCRs

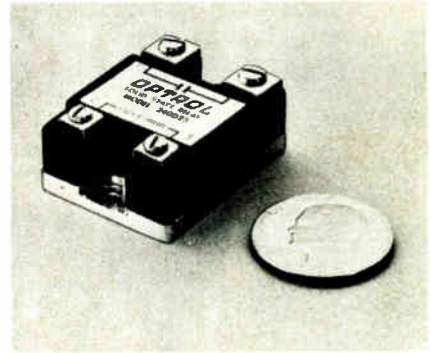

with built-in snubbers. (A snubber is a low-pass filter that protects the relay against damage and false triggering caused by transients.) The dual-SCR circuitry eliminates lock-on problems, and provides improved starting characteristics for inductive loads such as electric motors, solenoids, coils, and transformers. Resistive loads, such as traffic lights, are handled equally well. The relays all feature zero-voltage turn-on to prevent radio-interference problems, and they all include optical coupling for input/output isolation.

Optrol Inc., 5842 Research Drive, Huntington Beach, Calif. 92649 [343]

Time-delay relays are
accurate to within 1%

A line of time-delay relays which are accurate to within 1% for any voltage-temperature combination from -70°C to +125°C and from 20 to 30 volts dc, has a repeatability of within 0.1% at any fixed voltage and temperature. Rated at 10 amperes, the relays are double-pole double-throw units with reset times of just 10 milliseconds. Standard fixed time

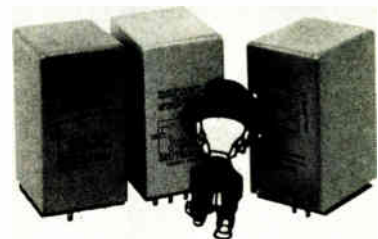

You buy more when you buy Data Precision

Today, more than ever before, Data Precision instruments are the smartest buy in the industry. Model for model they offer performance, flexibility and reliability at appreciably less cost than comparable competitive instruments.



Model 3500, 5-1/2 digit multimeter

Our Model 3500 5-1/2 digit multimeter delivers more features for less money than any other 5-1/2 DMM available. **\$995⁰⁰**

- Six month basic DC accuracy of $\pm 0.007\%$ of rdg., $\pm 0.001\%$ f.s., ± 1 LSD
- DCV, $1 \mu\text{V}$ to 1000 volts
- ACV, $1 \mu\text{V}$ to 700 volts RMS, 30 Hz to 100KHz
- Resistance, 1 milliohm to 12 Megohms
- 1000 M Ω Input Impedance through 10VDC
- Autoranging throughout
- BDC Output
- Remote Range
- Remote Trigger
- Ratiohmic™ Resistance Method 2 and 4 wire
- 20% Overrange
- TriPhasic™ Auto Zero
- Ratio DCV/DCV, ACV/DCV
- Isopolar™ High Stability Ref.
- 1/2 inch Planar Display

Contact your Data Precision representative or Data Precision directly. You may be surprised just how much more instrument you can buy, when you buy Data Precision.

Data Precision Corporation, Audubon Road, Wakefield, MA 01880 Phone (617) 246-1600

DATA PRECISION
...years ahead

COMPARE Our ticket printout with any paper tape

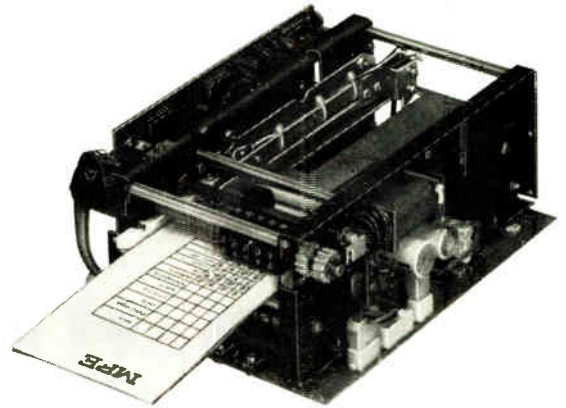

- | | |
|--|--|
| <input type="checkbox"/> Ease, speed & convenience of TAB card plus 2 copies | <input type="checkbox"/> Floating decimal point and column suppression |
| <input type="checkbox"/> Absolute optical encoder | <input type="checkbox"/> Special character wheels |
| <input type="checkbox"/> 12 VDC or AC power line | <input type="checkbox"/> Low peak power |
| <input type="checkbox"/> Indexing of up to 28 lines by 11 columns | <input type="checkbox"/> Printing mechanism available to OEMs |
| <input type="checkbox"/> Accepts pre-printed tickets | <input type="checkbox"/> Accepts BCD parallel inputs |
| <input type="checkbox"/> Accurate line registration | |

Call or write Sergio Lopez for discussion of your application.



MFE CORPORATION

Keewaydin Drive
Salem, N.H. 03079
Tel. 603-893-1921
TWX 710-366-1887
TELEX 94-7477

Circle 186 on reader service card

The Gould 6000 Data Acquisition System: 128 fully floating and integrating inputs, scans to 200 points/sec.

The portable and rugged Gould 6000 analog to digital data logger-reader is the best way to monitor and precisely record low frequency data. It accepts both analog and digital input signals, converts the data to digital form, displays the data for real-time monitoring and stores up to 500,000 readings on a 3M 1/4" computer grade mag-tape. It offers high noise rejection, high input impedance, programmable gain and much more.

Write Gould Inc., Instrument Systems Division, 3631 Perkins Ave., Cleveland, Ohio 44114. Or Kouterveldstraat Z/N, B-1920 Diegem, Belgium.



GOULD

Circle 187 on reader service card

New products

delays range from 500 ms to 180 seconds. Versions in which the time may be altered by changing an external resistor are also offered. The relays, which meet or exceed the requirements of MIL-R-6106 and MIL-R-83726, are said to be the first high-reliability units to attain their accuracy and repeatability. The relays consist of a Deutsch "E" series relay and a C-MOS digital timing circuit mounted in a package that measures approximately 1 by 1.25 by 1.75 inches.

In addition to the relays, Deutsch is producing a companion voltage sensor with time delay. Rated at 2 amperes, this unit picks up at a preset voltage and drops out when the voltage drops below a preset minimum for 150 ms. This unit is accurate to within 0.25 volt over the temperature range from -70 to $+85^{\circ}\text{C}$.
Deutsch Relays Inc., 65 Daly Rd., East Northport, N.Y. 11731 [345]

Three-inch solar cell develops 1 ampere at 0.5 V

A silicon solar cell three inches in diameter can supply up to 1 ampere at 0.5 volt. Because it uses no lenses to increase efficiency, the device is extremely thin—0.001 inch thick.

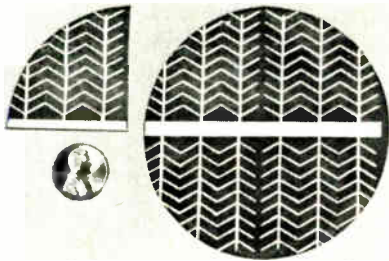

Priced at \$19.95, the cell (stock number 42,270) is claimed to deliver five times more power per unit cost than any previous cell. The unit can be ordered by mail; its price includes delivery charges. Smaller, cheaper, lower-power photocells are also available.

Edmund Scientific Co., 380 Edscorp Bldg., Barrington, N.J. 08007 [346]

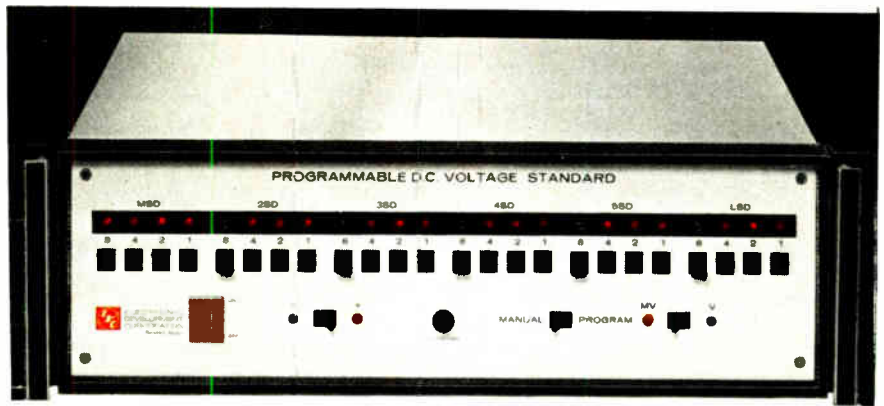

programmable microvolts for \$1,485

The EDC third generation 501 H has:

Speed: 50 μs switching and settling time
Ranges: 100 mV, 10 V, 100 V, 200 V DC
Resolution: 1 ppm to steps of 0.1 μV
Accuracy: $\pm 0.005\%$ of programmed value
Programming: TTL, BCD 8-4-2-1, other codes available including binary and ASC I
Options: Added resolution, ranging, CMOS compatibility
Accessories (field installable, plug-in): Serial-to-parallel converter, memory register, opto-isolators, ranging amplifier

For complete specs and prices on the 501 H and other EDC calibrators and standards, circle reader service number. To evaluate the 501 H in your application call Bob Ross at 617-268-9696.

"standards of excellence since 1958"
ELECTRONIC DEVELOPMENT CORPORATION
 11 Hamlin St., Boston, MA 02127

Circle 141 on reader service card

All in the Family

Addmaster's famous Model 601 Paper Tape Reader reads any standard tape at 150 characters per second asynchronously. It has a solid state light source, bi-directional stepper motor drive and the lid lifts for easy loading. It is available with or without TTL-interface including end-of-tape-sensing. Can be purchased in a stand-alone model with parallel or serial output . . . or with a fanfold box holding 150' of paper tape.

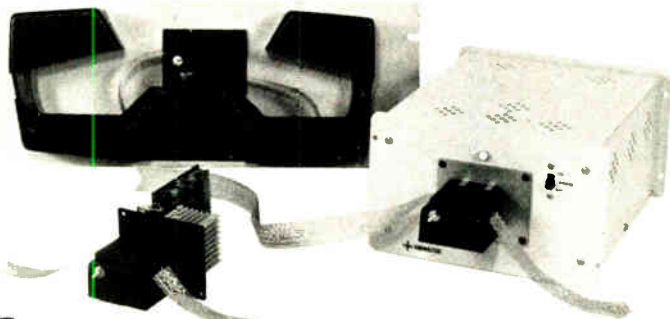

ADDMASTER CORPORATION

Write for catalog of Addmaster computer peripherals.

416 Junipero Serra Drive • San Gabriel, California 91776

Semiconductors

Schottky RAM draws 275 mW

256-bit memory has typical access time of 35 nanoseconds

A new Schottky TTL 256-bit random-access memory is as fast or faster than other devices of this type, but requires 50% to 60% less power, claims its developer, Advanced Micro Devices. The RAM, designed for use in high-speed core memories in digital systems, comes in two versions, the tri-state AM27LS00 and the AM27LS01, with open-collector outputs.

The address time over the commercial operating range, 0°C to 75°C, is 45 nanoseconds. The typical access time at room temperature is 35 ns, and a 55-ns access time is guaranteed over the military operating range, -55°C to +125°C.

But the AM27LS00/01s' main claim to fame, says Sven E. Simonson, technical director, is low-power design, which yields a high ratio of speed to power. Its typical dissipation rating is 275 milliwatts, compared with 500 to 700 mW for other standard 256-bit bipolar RAMs. The typical power-supply current of 55 milliamperes, he says, is less than 60% of the typical current of competing devices. The devices have a 10% power-supply tolerance.

"The AM27LS00/01 are true low-power designs—not just reworked high-power designs," says Simonson. "The process used is quite similar to that used in the ECL 10,000 devices. But added to it are Schottky diodes. The basic RAM matrix is ECL with current sources, which give us access speeds that vary little with temperature or input-voltage variations."

The 16-pin memories are organized 256 words by 1 bit with an 8-bit binary address field and separate data-input and output lines. In

addition to either a three-state or open-collector output, the devices have three active low-chip-select inputs. All inputs are buffered to represent an input of only 0.5 of a transistor-transistor-logic load. The power-supply voltage may be 4.5 v to 5.5 v.

The commercial parts in hermetic dual in-line packages are \$20.40 each in quantities of one to nine, \$17 for 10 to 99, and \$14.60 each in lots of 100 or more. Flatpacks are \$28.60, \$22.80, and \$20, respectively. Military parts in hermetic DIPs are \$37.75, \$31.40, and \$26.20 respectively, and the flatpacks are priced at \$54, \$45, and \$37.50 respectively.

Advanced Micro Devices Inc., 901 Thompson Pl., Sunnyvale, Calif. 94086 [411]

C-MOS content-addressable memory holds 8 8-bit words

Believed to be the first content-addressable memory (CAM) on the market, the SCL5533 (shown below) is a 64-bit device organized as eight 8-bit words. A CAM is a new type of computer component that is capable of telling whether an input word is stored in the memory. Since it performs an exact match search, the CAM should be useful in pattern-recognition systems, air-traffic control, signal sorting, and system-control applications. The CAM has several modes of operation. In its inter-

rogate mode, it responds with a yes or no when an input word is presented. In its learn mode, the CAM will write a word into memory if there is no match. Finally, the device has conventional read/write capability, and it can be used as a 64-bit random-access memory.

Typical interrogate time for an 8-bit word is 110 nanoseconds, and read access time is 150 ns. A chip-enable function allows many chips to be combined into a memory bank of any desired capacity. The device's inputs are compatible with C-MOS and its outputs are compatible with tri-state MOS or TTL. The quiescent power requirement of the static memory is 25 microwatts. Housed in a 48-pin ceramic dual in-line package, the SCL5533 costs \$21 in lots of 1,000. Delivery is from stock.

Solid State Scientific Inc., Montgomeryville, Pa. [413]

Six-function chip works with printing calculators

A calculator chip that performs the four basic arithmetic functions and also has percentage and memory operations, contains all of the logic needed to interface with a Seiko 102/104 printer or its equivalent. A line of output buffering allows the model 1022 MOS/LSI circuit to be calculating or accepting keyboard entries while a print operation is underway. The 12-digit cal-

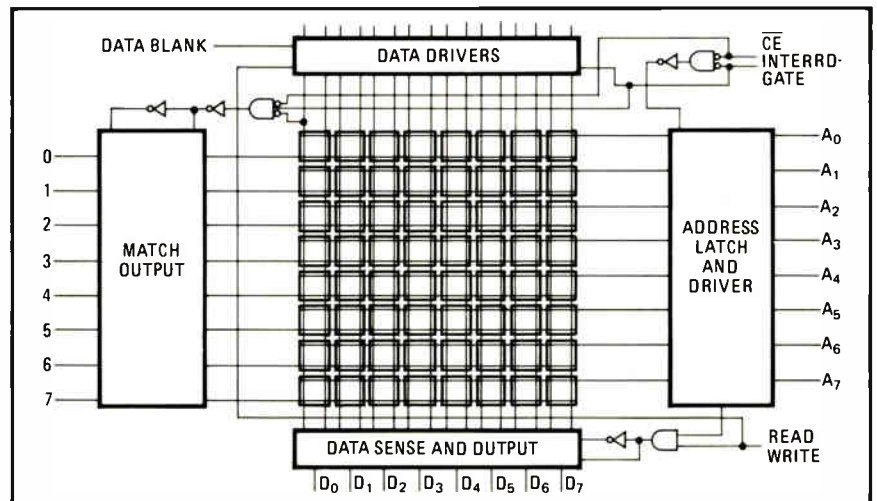

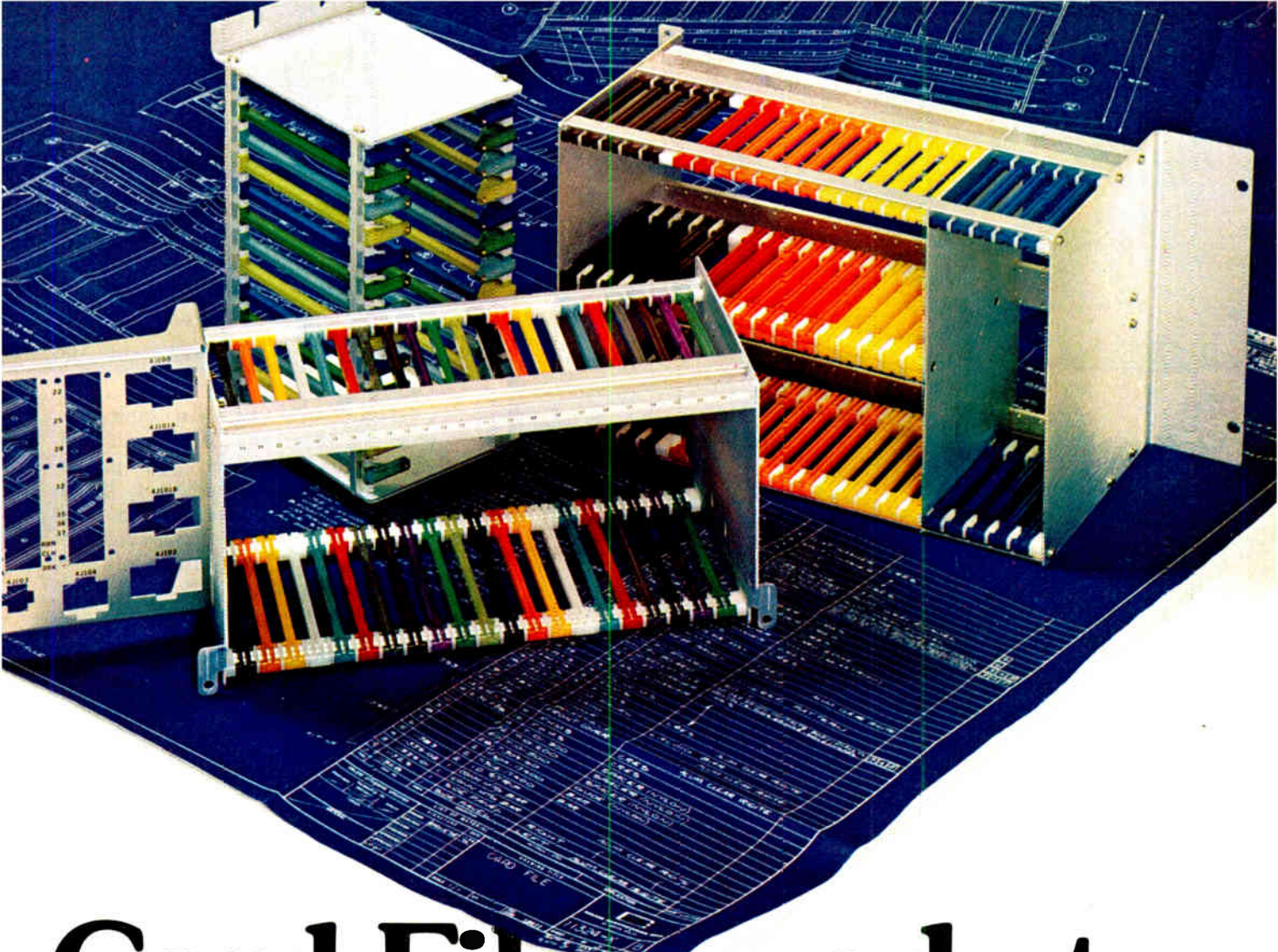

Card Files made to Order

Let us design and build card files to meet your card packaging demands. Whether you need a multi-row file, a drawer or a complex custom-made file... let us help.

We can make files for lots of cards or just a few. We can give you a connector mount right on the card guide, on aluminum bars or on separate nylon feet. We can punch, bend and cut sheet metal to meet any situation. We can provide mounting for I/O connectors, wire harnesses or any auxiliary components. We can make a card file to do just about anything.

The guides in our files are molded of high strength U.L. approved nylon and provide a strong durable holder for your cards. The nylon guides

Circle 143 on reader service card

protect cards and components from shock and vibration while their narrow profile allows for system cooling. Rigid extruded aluminum mounting bars hold guides in place and provide a rugged lightweight package. Aluminum or steel sheet metal designed for your particular need completes the system.

Before you start engineering your next card packaging system call us... let us help.

Scanbe Manufacturing Corp.
3445 Fletcher Ave. / El Monte, Ca. 91731
(213) 579-2300 / 686-1202 TWX (910) 587-3437



Design us in . . . we'll stay there



VARO SEMICONDUCTOR, INC.

P.O. BOX 676, 1000 N. SHILOH, GARLAND, TEX. 75040 (214) 272-4551 TWX 910-860-5178

Varo Sales Representatives

AL Buchanan & Abrams Assoc. 305-898-7444 • AZ W. W. Posey Co. 602-949-5873 • AR Whiteside Sales 214-231-9771 • CA (NO) W. W. Posey Co. 415-948-7771 • CA (SO) Corcoran Assoc. 213-823-4859 • CO Sage Sales 801-531-0531 • CT Comp Rep Assoc., Inc. 203-239-9762 • DE Tom Davis Marketers 302-998-0123 • FL Buchanan & Abrams Assoc. 305-898-7444 • GA Buchanan & Abrams Assoc. 305-898-7444 • IA Coombs Assoc. 312-298-4830 • IL (NO) Varo Semiconductor, Inc. 312-627-3802 • IL (SO) Beneke & McCaul 314-434-6242 • IN Technical Reps, Inc. 317-849-6454 • KS Beneke & McCaul 816-765-2998 • KY Technical Reps, Inc. 317-849-6454 • LA Whiteside Sales Co. 214-231-9771 • ME Comp Rep Assoc., Inc. 617-444-2484 • MD Tom Davis Marketers 703-591-7390 • MA Comp Rep Assoc., Inc. 617-444-2484 • MI Davis-Martensen Co. 313-474-8300 • MN Loren F. Green Assoc. 612-781-1611 • MS Buchanan & Abrams 305-898-7444 • MO Beneke & McCaul, Inc. 314-567-3399 • NB Beneke & McCaul 816-765-2998 • NJ (NO) Cooper-Simon & Co. 516-487-1142 • NJ (SO) Tom Davis Marketers 302-998-0123 • NM W. W. Posey Co. 602-949-5873 • NY (METRO) Cooper-Simon & Co. 516-487-1142 • NY (UPST) Bob Dean, Inc. 607-272-2187 • NC Buchanan & Abrams Assoc. 704-332-4974 • OH (NO) J. C. Hofstetter Co. 216-241-4880 & 216-725-4477 • OH (SO) J. C. Hofstetter Co. 513-296-1010 • OK Whiteside Sales Co. 214-231-9771 • OR C. K. Shanks & Assoc. 503-292-5656 • PA (E) Tom Davis Marketers 302-998-0123 • RI Comp Rep Assoc., Inc. 617-444-2484 • SC Buchanan & Abrams Assoc. 704-332-4974 • TX Whiteside Sales Co. 214-231-9771 • UT Sage Sales 801-531-0531 • VA Tom Davis Marketers 703-591-7390 • WA C. K. Shanks & Assoc. 206-632-4290 • WI Varo Semiconductor, Inc. 414-782-7590 • CANADA • ONT Cantronics, Ltd. 416-661-2494 • QUE Cantronics, Inc. 514-341-5207



New products

culator is housed in a 40-pin DIP and sells for \$45 in hundreds.

SMC Microsystems Corp., 35 Marcus Blvd., Hauppauge, N. Y. 11787 [412]

C-MOS analog multiplexers consume only 15 milliwatts

immediate prototype delivery on Grayhill rotary switches



**Adjustable stop switches
off-the-shelf
with the
form-fit-function
characteristics you need**

- Simple pin adjustment provides the right number of positions per pole
- Over 100,000 possible combinations
- Available now from your local Grayhill distributor

Here's the fast route to rotary switches for prototypes or small production runs. Grayhill Adjustable Stop switches, available from your local Grayhill distributor, cut procurement lead time. You no longer need to wait for even small quantities to be built to order. The Adjustable Stop feature is available in one-inch and half-inch diameter, single deck and multi-deck versions. Your distributor can supply 1-and 2-deck Adjustable Stop switches from stock (one or two poles per deck) and can quickly secure other variations from factory stock. Write for complete literature



561 Hillgrove Avenue • LaGrange, Illinois 60525
(312) 354-1040

New products

pins, TI had to get rid of three pins to put the new device into its 18-pin package. One pin was eliminated by multiplexing the data input and output ports together—making the device usable only in bus-oriented systems. A second pin was dropped by generating the chip's 5-volt supply on-board from the +12-v supply, thus making a separate 5-v input unnecessary. The third pin that was eliminated was the chip-select pin, a function that TI estimates is unused in 90% of the device's applications. Active power dissipation of the RAM is 350 milliwatts. Pricing, in quantities of 100 to 999, is \$26.73 each for plastic packaging, and \$30.69 for ceramic.

In a move similar to that of TI, National Semiconductor has announced the development of a 4-k n-channel silicon-gate RAM, to be housed in an 18-pin DIP. Called the MMS270, the device is expected to be available in production quantities by the middle of this year, the company says.

Texas Instruments Inc., Inquiry Answering Service, P. O. Box 5012, Dallas, Texas 75222 [414]

National Semiconductor Corp., 2900 Semiconductor Drive, Santa Clara, Calif. [415]

**1,024-bit, n-channel RAM
has 60-ns access time**

Representing RCA's initial entry into the n-channel market, the model MW7001ID is a static random-access memory, organized 1,024 by 1 bit that has a maximum access time of 60 nanoseconds. The LSI device, which is pin-compatible with the AMS 7001I, made by Advanced Memory Systems, has a 180-ns maximum cycle time, TTL-compatible inputs, and a maximum power dissipation of 650 milliwatts. In its standby mode, the memory consumes a maximum of 512 microwatts. Housed in a hermetic, ceramic, 22-lead, dual in-line package, the MW7001ID is priced at \$10.50 each in quantities of 1,000.

RCA Solid State Division, Box 3200, Somerville, N. J. 08876 [416]

MONOLITHIC CRYSTAL FILTERS

**the
State
of the
Art**

TELLING vs. SELLING

The purpose of this column is to disseminate information. Or, to be absolutely honest, to sell by informing. As a responsible engineering or procurement person, you're quite capable of making your own decisions, given the facts. So that's what we give you. We think that the more facts about monolithic crystal filters we present, the more likely you are to buy ours. That's our "let the buyer be aware" theory.

ON SPECIFICATIONS

Writing a component specification is a lot like writing a legal contract. Both can be precise and complete, or vague and ambiguous. Or misleading.

In specifying monolithic crystal filters, one simple method—the boundary method—guarantees desired selectivity—precisely, under specified conditions, without ambiguity. That's why all of PTI's standard specifications are boundary specs. While other methods of specification may make the filter appear in a more favorable light, we feel that this kind of "specmanship" is not in your best interest and hence not in ours.

And boundary specifications—since they are usually intimately related to system requirements—represent a "natural" for the equipment designer preparing a filter spec. One pitfall: in writing boundary specs don't try to include filter manufacturing tolerances. We'll take care of that. Specifying selectivity is only one part of the story. If you need guidance in any aspect of writing specifications for monolithic crystal filters, we may be able to help.



Piezo Technology Inc.

2400 Diversified Way Orlando, Florida 32804
305-425-1574

The Standard in monolithic crystal filters.

An autoranging DMM for only \$299?

Yes. And it's a KEITHLEY—no less. The new Model 168 is a full-function DMM. It measures ac/dc volts, ac/dc amps and ohms too. Autoranging, optional battery operation, two-terminal input, push-button operation and lighted function indicators are only a few of its added features. Send for full details now.

1-year accuracy guarantee, too!



KEITHLEY INSTRUMENTS
 J.S.A. 28775 AUROFA ROAD, CLEVELAND, OHIO 44139
 EUROPE: 14, AVENUE VILLARDIN, 1009 PULLY, SUISSE

Circle 190 on reader service card

Check Out Central Mississippi For Higher Profits

Ideal For Profit-Oriented Electronics Manufacturers

- Abundant & Trainable Labor Force
- Low Cost Location
- Lower Construction Costs
- Lower Site Costs
- Available Industrial Buildings
- Room For Expansion
- Financial Incentives
- Deep South's Distribution Center

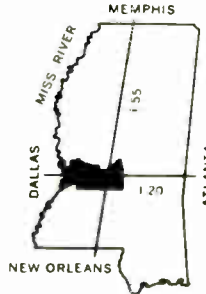

For detailed information about Hinds Rankin and Warren Counties in Central Mississippi write or call

Harry McLemore or George Kurts

CENTRAL MISSISSIPPI DEVELOPMENT DISTRICT

Post Office Box 22548
 Jackson, Miss. 39205
 Telephone (601) 948-6354

Circle 191 on reader service card

You don't have to buy a new car to get an electronic ignition.

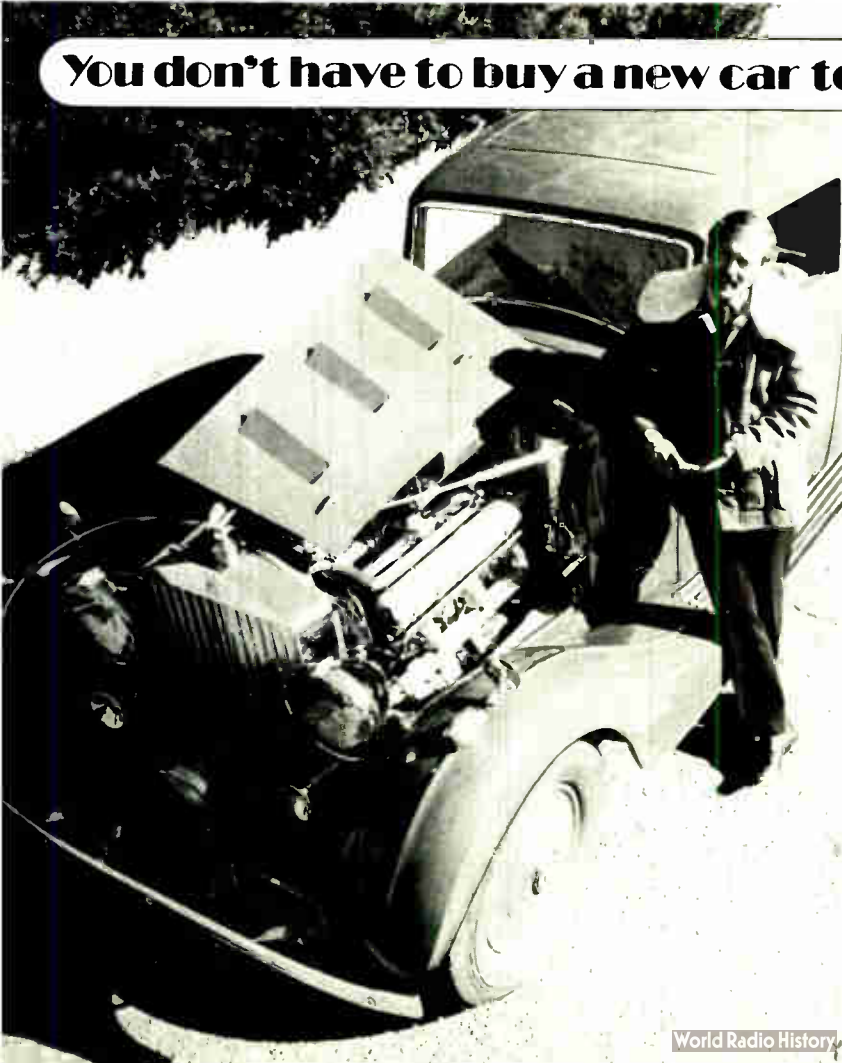

Lets face it. After 37 years, even a Phantom III can use a lift. That's why I put a Delta Mark Ten B Capacitive Discharge Ignition on my Phantom III to give her a spark I'd pit against any '75 model car. I went to Delta because they aren't Johnny-come-latelys. Delta's been making electronic ignition systems for over a decade.

Whatever kind of car you drive, you can give it the same great Delta performance I gave mine.

- Mark Ten B Capacitive Discharge Ignition Systems are manufactured by Delta Products, Inc., a company with a conscience, and with a proven record of reliability both in product and in customer relations.
- The Mark Ten B really does save money by eliminating the need for 2 out of 3 tune-ups. Figure it out for yourself. The first tune-up or two saved pays for the unit, the rest is money in your pocket. No bunk!
- Because the Mark Ten B keeps your car in better tune, you actually can save on expensive gasoline.
- With a Mark Ten B, spark plugs stay clean and last longer... fouling is virtually eliminated.



I want to know more about Mark Ten B CDI's. Send me complete no-nonsense information on how they can improve the performance of my car.

Name _____
 Address _____
 City _____ State _____ Zip _____



DELTA PRODUCTS, INC.

P.O. Box 1147 Dept. E Grand Junction, Colo. 81501
 303-242-9000

Mark Ten B, assembled	\$64.95 ppd	Standard Mark Ten, assembled	\$49.95 ppd
Mark Ten B, kit	\$49.95 ppd	DeltaKit	\$34.95 ppd

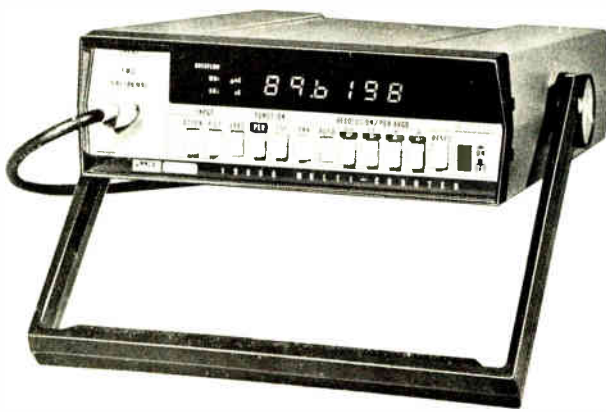

This may look like a multimeter... but it's really an autoranging multi-function counter

We've had a lot of comments that our new 1900A multi-function counter looks like our 8000A multimeter. We agree. In fact we planned it that way. Both are attractively styled and designed for user convenience. But inside they're vastly different instruments.

The 1900A is an advanced LSI/MOS multi-function counter with . . . autoranging in both frequency and period mode . . . 5 Hz to 80 MHz range with 25 mV sensitivity . . . event counting to 10^6 . . . automatic overflow . . . six digit LED display with automatic annunciation . . . all for the unbelievably low price of \$349.*

Plus you can order a rechargeable battery option, or a data output option that lets you use the 1900A in systems applications.

And just in case you're wondering - here is what the 26 range, 5 function 8000A multimeter looks like.

Phone your local Fluke distributor to-day for a demonstration, or contact us direct.



*U.S. price F O B, Buffalo, N.Y.



John Fluke Mfg. Co. Ltd.
Counter Division
 P.O. Box 1094 Station D
 Buffalo, N.Y. 14210
 Phone (716) 842-0311
 TWX 610-492-3214

For a demonstration circle 208 on reader service card.

148 Circle 148 on reader service card

THRU-LAY

For many contact applications, Thru-Lay is an excellent clad metal choice. Now you can buy metallurgically bonded (not solder bonded) Thru-Lay from PMC. Our large coils will also increase stamping productivity. If you use Thru-Lay, or are planning a product for Thru-Lay, why not call Mr. Harry Friedman at (617) 695-9312. Or write, **Polymetallurgical Corp., 262 Broadway, North Attleboro, MA 02761.** ☎✉

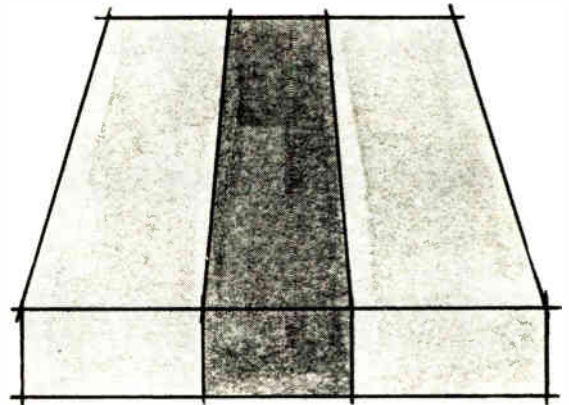

Circle 161 on reader service card



YOU'RE WHISTLING IN THE DARK...

if you think that heart disease and stroke hit only the other fellow's family.

GIVE... so more will live HEART FUND



Contributed by the Publisher

Data handling

Cartridge drive built for field

Unit has many features of large tape drives; stores 1,600 bits per inch

Though many tape drives using the ¼-inch 3M cartridge are designed as a step up from insufficiently rugged cassette drives, a new drive from Data Electronics Inc. is designed down from a ½-inch reel-to-reel drive. President Hal H. Georgens says the model CMTD-3000 drive is intended for a harsher field environment than the typical clean computer room.

Like a traditional tape drive, the new unit requires only a few moving parts—basically a motor and capacitor. The motor has a shock-resistant gimbal mount, and motor speed is controlled by an accurate tachometer pickup and servo system, rather than back-voltage from the motor. Other large-tape-drive features are a cast-aluminum mounting, rather than sheet metal, plug-in subassemblies for electronic and electromechanical modules, and optional tape-cleaner and hard-surface tape heads. The heads, a \$70 to \$80 option, provide more than 3,000 hours of tape life, three times that of conventional cartridge-drive tape heads, says Georgens.

The cartridge can be easily inserted and removed with only one hand.

The commercial version of the drive uses plastic ICs and other electronic components, the ruggedized version uses ceramic. Mechanical parts are identical.

Both drives are ANSI/ECMA-compatible with phase-encoded storage of 1,600 bits per inch and 23-megabit storage capability that can be transferred at 192 kilobits a second. One- or four-track serial or four-track parallel recording can be selected. Interfaces are TTL-compat-

ible, and the tapes can be read while writing. Up to eight drives can be connected, with a 3-bit address selecting one. Four drives can be mounted in a 7-inch-high, 19-inch-wide panel, for 92 megabits of storage. The individual deck is 4.4 by 5.9 by 6.9 in.

Running speeds are 30 in./s writing with bidirectional reading, and 90 in./s (optional 120 in./s) bidirectional search and rewind. Instantaneous speed variation is under $\pm 3\%$, with long-term variation under $\pm 2\%$.

Power required is +5 volts, regulated at 1.5 amperes, and ± 28 v, unregulated at 1.4 A (3-A surge), the company says.

The basic commercial drive is priced at \$600 to \$800 in quantities of 100, depending on options.

Data Electronics Inc., 370 N. Halstead St., Pasadena, Calif. 91107 [361]

Printers and plotters have 200-dot-per-inch resolution

The Versatec D900 series of electrostatic printers and plotters brings dual-array density and 200-dot-per-inch resolution to machines that accept economical 8.5-inch-wide paper. The series' dual-array writing head prints an overlapping dot pattern in a 16-by-16 matrix. Models include the LP-D960 printer, the D900 plotter, and the D900A printer/plotter. All use raster scan, a stationary writing head carrying a dual array of 1,600 styli evenly spaced at 200 to the inch, and the manufacturer's proprietary matrix electrostatic writing technique. The printer and printer/plotter can print 600 lines per minute asynchronous, with 100 columns per line and 12.5

characters per inch across the 8.5-inch paper. The plotter and printer/plotter can plot 1.25 in. per second in paper-drive increments of 0.005 inch. Plotting width is 8 in. Small-quantity prices are: \$6,700 for the LP-D960 printer, \$7,800 for the D900 plotter, and \$8,900 for the D900A printer/plotter. Delivery time is 30 days.

Versatec, 10100 Bubb Rd., Cupertino, Calif. 95014 [363]

Compact data terminal prints 34-character lines

A compact, stand-alone printer—the 5010 data terminal—prints 34-character lines at a rate of 110 characters per second, or 90 to 240 lines per minute, depending upon line length. Built around the same printing mechanism as Victor's top calculator line, the 5010 is expected to find applications in receive-only terminals, as a print-out device for circuit-board testers, in microcomputer systems, and in general data-logging and communications equipment. No parts move when the terminal is idle; its motor runs only when it is printing. Thus wear is reduced, and reliability is enhanced. Double-line buffering permits a new line to be received while the previous one is being printed. The terminal, which prints in two colors on standard 3.75-inch adding-machine paper, has an elongated-character mode in which it prints lines up to 17 characters wide at double width. The machine measures 12 by 18 by 6.5 inches, and weighs 16 pounds. Its small-quantity price is \$1,195.

Victor Comptometer Corp., 3900 North Rockwell St., Chicago, Ill. 60618 [365]

Impact printer bangs out 330 characters per second

Able to print at rates as high as 330 characters per second, or 125 lines per minute, the 102AL is a 132-column, serial, impact printer that makes extensive use of large-scale



QUALITY IN VOLUME

When you achieve it, you can offer true competitive value. That's just what we're doing at USCC/Centralab for 1975. MONO-KAP™ radial, and MONO-GLASS axial monolithic ceramic capacitors are now available to volume users *from stock* to eight weeks. Our investment and "learning curves" last year guarantee competitive responsiveness — USCC will welcome your specials and non-stock orders. Here's an offer you haven't heard lately — your money is going to buy more at USCC. Cash in on the best values in monolithic ceramic capacitors.

DISCRETE ASSEMBLY

MONO-KAP™ radial-leaded epoxy coated capacitors are reliable performers; they're rugged enough to work in MIL environments. 4.7 pF to 10 Mfd., 50 to 200 WVDC in 4 dielectrics, including Z5U, in a variety of case sizes featuring meniscus control to 0.032 inches. Large quantity orders from stock.

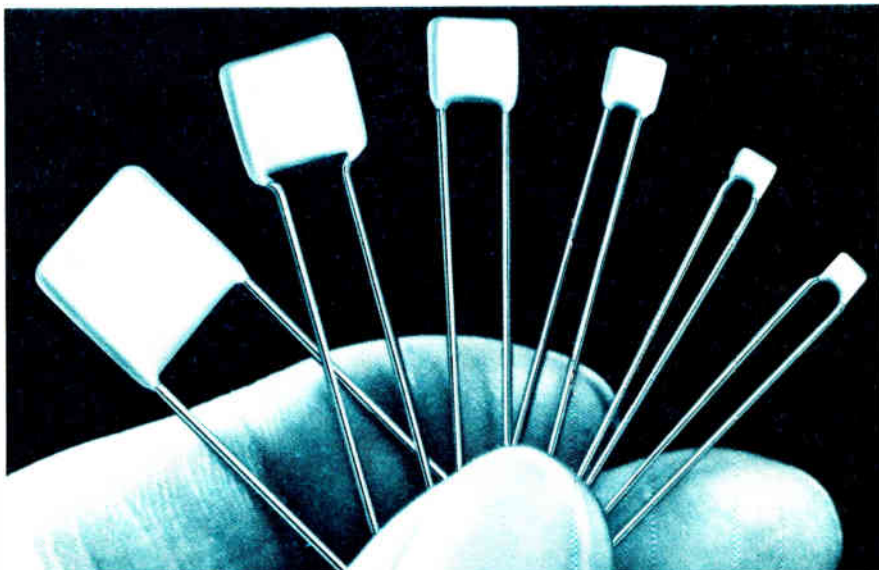

AUTOMATIC INSERTION

MONO-GLASS axials are glass encapsulated, designed for automatic PCB insertion; furnished reel-packed for high volume applications. They're available in 50 and 100 WVDC from 1pF to 1.0 Mfd.; four dielectrics: COG, X7R, Z5U and Y5V.

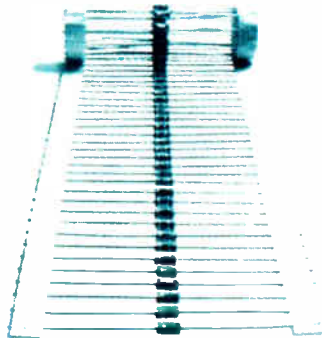

CUSTOM DESIGN

We're responsive to your design requirements; get USCC's new expanded 1975 catalog.



If you need a special call (213) 843-4222 or your nearest overseas location for assistance or evaluation samples. Remember. USCC/Centralab. Value.

FOR QUICK REFERENCE, SEE OUR PRODUCTS IN YOUR EEM, GOLD BOOK OR EBG PAGES.



USCC/Centralab

Electronics Division • Globe-Union Inc

2151 North Lincoln Street ■ Burbank, California 91504
(213) 843-4222 ■ TWX: 910-498-2222



New products

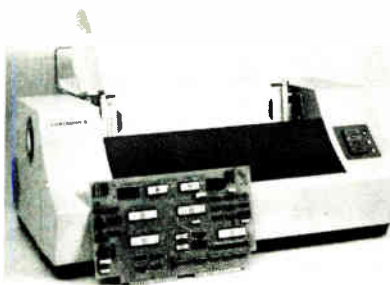

integration to minimize parts count and thus maximize reliability. The unit can produce an original and up to four copies. Its last printed line is always visible for immediate reading. In its standard mode, the printer produces a line of elongated boldface characters on command. Because it uses a dot-matrix technique for generating characters in a 9-by-7 pattern, the printer can easily handle a variety of foreign and specialized character sets. The small-quantity price of the 102AL is \$4,675; delivery time is 60 days. Centronics Data Computer Corp., Hudson, H. H. 03051 [364]

Endless-loop tape transport uses NAB A-size cartridge

The model A3 endless-loop tape transport is electrically controlled for remote operation and utilizes standard NAB A-size tape cartridges. Designed for machine-control, memory-refresh, telephone equipment, and other applications in which repetitive information is required or rewind is undesirable, the transport is modular in construction, to allow the addition of many differ-

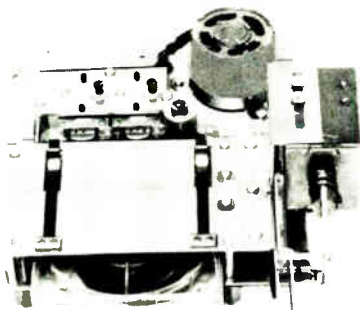

ent options for different purposes. The transport's high-traction, self-aligning pinch roller contains instrument ball bearings, thus eliminating tape-edge wear caused by the tape pulling up and down. Price of the A3 transport, in quantities of 1,000, is approximately \$65 each depending upon which options are selected; delivery time for sample quantities is three weeks.

Amilon Corp., 49-12 30 Ave., Woodside, N. Y. 11377 [366]

Computer system, including display, sells for \$5,400

Built into a single console, the 2220/2200S combines a CRT display, a tape cassette drive, a keyboard, 4,096 bytes of memory, and a central processing unit that contains a hardwired Basic interpreter. The price of the unit, which is a compact version of Wang's System 2200



computer, is \$5,400. A leasing plan is also available. Included in the minimum-price configuration are several frequently used manipulation statements and mathematical functions such as SIN, LOG, HEX, and CONVERT. Finally, the computer has the capability of operating one additional peripheral, such as a printer. Optional at extra cost are additional memory (up to 16 kilobytes), a matrix read-only memory which gives the user 14 pre-programmed matrix operations, and the capability to handle up to three additional peripherals. Delivery time for the 2220/2200S is four weeks after receipt of order.

Wang Laboratories Inc., 836 North St., Tewksbury, Mass. 01876 [368]



Large and medium scale integration: Keep up with this fast changing technology

Now, in one comprehensive volume, a complete working grasp at large and medium scale integration for electronics engineers engaged in the design of electronic systems, equipment and products.

A wealth of practical working data on large and medium scale integration has been culled from the most important articles in Electronics magazine by Samuel Weber, Executive Editor. Emphasis is on design problems at the system or subsystem level, as well as on the economics of today's design.

Whatever the design problem — from partitioning a digital system to working with a semiconductor company in producing the best LSI design, this book covers the full range of today's important technologies on a practical, rather than a theoretical, level.

It's yours for \$15.00. Keep up.

■ **FREE 10-DAY EXAMINATION** ■

McGraw-Hill Book Company
1221 Ave. of the Americas,
New York, N.Y. 10020



Send me a copy of Large and Medium Scale Integration (068815-X) for 10 days on approval. At the end of that time, I will either remit \$15.00, plus tax, postage, and handling, or return book without further obligation. (Remit in full with this coupon, plus any tax, and McGraw-Hill pays all postage and handling costs.)

Name _____

Address _____

City _____

State _____ Zip _____

Offer good only in the U.S. and subject to acceptance by McGraw-Hill. For prices outside U.S., contact McGraw-Hill Book Co.

23 K138-4018-3

Color your IC systems Cambion.

You can let your imagination soar, and still keep your most advanced IC packaging concepts practical. With Cambion's growing line of digital products, state of the art design ideas become a reality. And we can meet your needs with repeatable Quality, no matter how great the Quantity. Our variety of components is so extensive you won't have to think "specials".

Just take a look at our new Catalog 119. It features advanced new Cambi-Cards[®], card files, drawers, universal panels with and without premounted socket strips and power planes, specific logic function cards, general purpose and discrete component cards, plus strip connectors, cable assem-

blies, integrated socket strips, component socket adapters, cable cards and card extenders.

We also offer a complete NC wrapping service to speed economical production of your IC system designs.

Develop your system ideas to their fullest potential *without component restriction*. Get your own copy of the new Cambion Catalog. It has 22 more pages than its predecessor showing more new products to keep ahead of your design needs. And they all have the Cambion Double "QQ" approach: the Quality stands up as the Quantity goes on. Order your copy today. Cambridge Thermionic Corporation, 445EM Concord Avenue, Cambridge, Mass. 02138. Phone (617) 491-5400. In Los Angeles, 8703 La Tijera Blvd. 90045. Phone (213) 776-0472.

Standardize on

CAMBION[®]

... the Guaranteed Digital Products

Circle 152 on reader service card



Packaging & production

Big screen aids wafer inspection

Viewing head eliminates distortion, graininess, ghost images, reflections

Despite long strides toward automation in the semiconductor industry, certain key areas—such as inspection stations—remain in the hands of human operators. It is here that a wafer fabrication line, for example, can undergo drops in productivity due to the fatigue that workers suffer after long hours bent over binocular microscopes.

While it has not yet come up with a way of automating this particular job, Cobilt, a division of Computervision, has introduced a large-screen viewing head for microscopes that, according to Peter Wolken, vice president of marketing, will go a long way towards reducing eye-strain and muscle fatigue.

Called the model 730 Vistascan, the viewing head eliminates several of the problems that have kept this sort of system from use in jobs where particularly high resolution and accuracy are required—problems such as image distortion, graininess, ghost images and dis-

tracting surface reflections.

Using a specially designed optical system, the Vistascan is an aerial-image, biocular viewing head that presents a high-resolution, quality image at arm's length. And what is particularly important, he says, is that the image is flat and in focus over its entire field.

Other features of the Vistascan include an image diameter of 12 inches for convenient arms-length viewing; an image resolution that exceeds the visual acuity of any observer, as well as an essentially grainless display; a viewing surface that is free of ghost images and surface reflection; and a wide viewing angle of 25°.

In addition, says Wolken, the Vistascan performs well with low power illumination. Developed originally as an optional accessory for use with its CA-700 series inspection stations, Cobilt's model 730 viewing head can be used on a wide variety of microscope mountings, says Wolken. The viewing-head system will sell for about \$2,000 each. In addition, Cobilt will market a model 750 Vistascan microscope system, which includes scope and viewing head, for \$4,000 each.

Computervision Corp., Cobilt Division, 1135 East Arques Ave., Sunnyvale, Calif. 94086 [391]

Silicon carbide replaces quartz in diffusion furnaces

For many IC fabrication jobs, diffusion-furnace components made of quartz will suffice. For some diffusion cycles, however, silicon wafers must be processed for three to four days at 1,200°C. Under these conditions, quartz systems have a life measured in only days or weeks.

But now Norton Co.'s Industrial Ceramics division has developed a diffusion-furnace system made of silicon-carbide components, and the company promises longer life, higher productivity, and better cost performance.

Called the Crystar system, it is said to improve the processing of

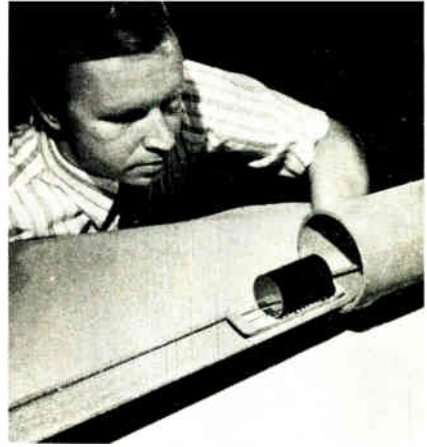

silicon wafers for semiconductor devices by making automated production and high-temperature operation possible on a broader scale than before.

Three silicon-carbide parts make up the system: a process tube, a paddle, and a wafer boat (see photo above). The process tube provides the controlled-atmosphere chamber in which wafers are processed. It needs no liner for support nor heat sink, thereby providing large wafer capability in existing furnaces. The paddle, a wheeled carrier for wafer boats, facilitates automatic insertion and withdrawal and eliminates quartz dust and sticking. The wafer boat provides support and assures separation of the wafers during processing. The process tube and wafer boats are treated with high-purity silicon, creating a nonporous, gas-tight body. These components may also be used separately in conjunction with quartz or other components.

The Crystar components can operate at 1,200°C to 1,300°C for months. In addition, Norton says, they have greater strength and better thermal-shock resistance than quartz. Prices for the tubes are \$1,000 to \$1,500; for the paddles, \$600 to \$700; and for the wafer boats, \$100 to \$500.

Norton Co., 1 New Bond St., Worcester, Mass. 01606 [392]

Backplane continuity tester is self-taught

The model N123 interconnection test system is a microprocessor-controlled continuity tester for manufacturers of small- and medium-size interconnection networks, including

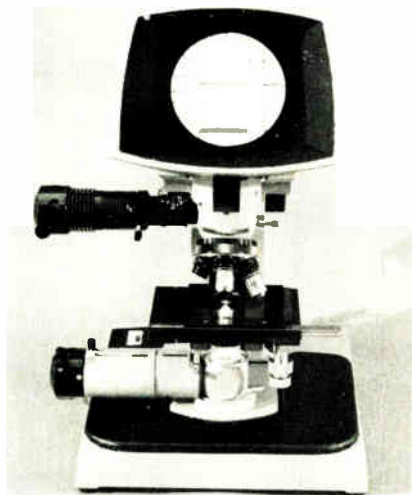

CMOS RAMs: 2-for-1 sale!

Our 512-bit CMOS RAM sells for about the same price as those other 256-bit RAMs. Two bits for the price of one!

In 100-999 quantities, our silicon-gate S2222A will run you \$15.36 a piece or just 3 cents a bit. 1000-4999 quantities really knock the price down—to \$10.75 each.

The price isn't the only thing that's low. Standby power is less than 20 nano-watts a bit, and operating power 15 microwatts a bit. With that little power, just think what you can do with our RAMs in terminals,

buffers, battery operated systems, portable calculators, time clocks, and military systems.

This is how our dense new CMOS RAM stacks up:

Access time: 400 ns
Cycle time: 940 ns
Single supply voltage: +10V
Standby voltage to sustain data: 3.5V
Static memory: no refresh
Temperature range: 0° to 70° C
Single read/write control line
Simple memory expansion: chip enable
16-pin dual in-line package

The S2222, a higher

performance version, is also available with standby power of less than 4 nano-watts a bit, 200 ns access time and 470 ns cycle time.

These days, you need to save every bit you can. Frank Rittiman will show you how. Call or write him at AMI, 3800 Homestead Road, Santa Clara, CA 95051. Phone (408) 255-3651.

Or contact your distributor.



**it's
standard
at AMI.**
AMERICAN MICROSYSTEMS, INC.

New products



backplanes, cable assemblies, and wiring harnesses. The system teaches itself the interconnection scheme by examining a known good network, and will find all wiring errors in a single pass. Both the interconnection pattern and the errors that are found can be printed out on a strip printer. The NI23 includes a strip printer along with a simple keyboard, a CRT display, and a magnetic-tape cartridge unit. Its basic price is under \$15,000; delivery time is 20 weeks.

Teradyne Inc., 183 Essex St., Boston, Mass. 02111 [393]

Visual comparator handles boards up to 16 × 16 inches

An optical circuit-board comparator allows an operator to compare production boards with a known good master board. The comparison is made on a magnified split-screen image in which corresponding narrow sections of both boards appear to flow out of the center line as moving mirror images. The full-color images are 3.6 times actual size, and can be increased to 7.2 times by an

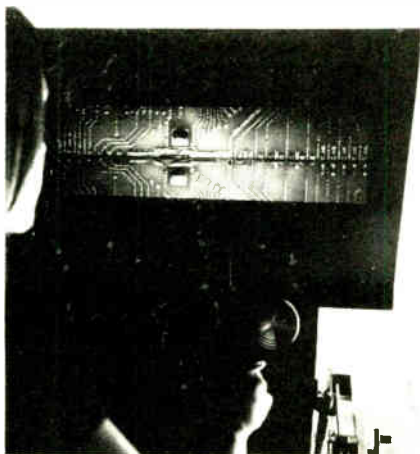

auxiliary magnifying lens. Image movement is under the operator's control so that he can start, stop, reverse, slow down, or speed up the machine. The manufacturer claims that the comparator can discern differences in line width or line position as small as two thousandths of an inch.

Metron Optics, P. O. Box 690, Solana Beach, Calif. 92075 [394]

Laser trimmer removes defects from MOS masks

A laser machine for the removal of defects from MOS photolithographic chrome masks completely vaporizes chrome spots as small as 1 micrometer and as large as 25 μm . The model LMT laser mask-trimmer is claimed to be particularly useful for

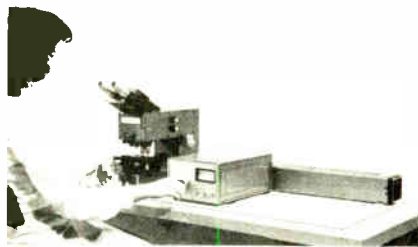

reworking hard-surface high-quality chrome masks such as are used for C-MOS circuits. It is said to produce edges as sharp as those produced by the photolithographic process itself. The trimmer also works well with emulsion masks. Price of the LMT is \$29,500 with a Bausch & Lomb or equivalent microscope, and \$39,500 with Leitz optics. Delivery time is 30 to 60 days.

Florod Corp., 5306 West 144 St., Lawndale, Calif. 90260 [395]

Connector packs 91 contacts into a size-15 shell

A line of circular connectors—the MD 73 family—uses a center-to-center contact spacing of 0.065 inch, thus making it possible to mount up to 91 contacts in a size-15 shell. Most other high-density circular

A little simple arithmetic about a Math major.

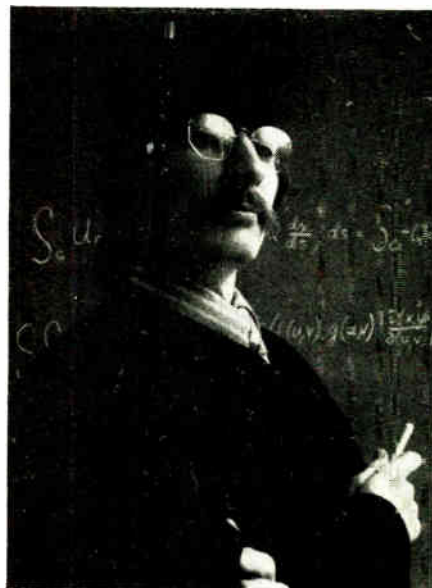

The cost of a higher education is getting higher. In fact, you could end up spending close to \$20,000 to put your child through college.

So maybe you should consider U.S. Savings Bonds. They're one of the most dependable ways to build funds for an education.

All you have to do is join the Payroll Savings Plan where you work. Then an amount you specify is set aside from your paycheck and used to buy Bonds.

Say your child is 3 years old now. If you buy a \$75 Bond a month through Payroll Savings, by the time he's 18, you'll have \$16,048 tucked away. A solid sum to get him started. See? A little simple arithmetic can add up to a lot.

Make the chances of your child's college education more secure. Join the Payroll Savings Plan now.

Now E Bonds pay 6% interest when held to maturity of 5 years (4% the first year). Bonds are replaced if lost, stolen or destroyed. When needed, they can be cashed at your bank. Interest is not subject to state or local income taxes, and federal tax may be deferred until redemption.



Take stock in America.

Join the Payroll Savings Plan.

AG Council A public service of this publication and: The Advertising Council.

THE NEW DIGITAL VOLKSMETER

World's lowest priced digital multimeter. Designed to be a more accurate replacement of delicate pointer-type meters.

LM-3



\$99.95*

Features include:

- Ruggedness—Ideal for field service use
- Auto Polarity—No more lead reversing or switching
- Full 3½ digits with 1% accuracy on all functions
- 13 ranges: 4 AC, 4 DC and 5 ohms
- 1 millivolt resolution with 500 volts and 20 megohms full scale
- Compactness—1.9" H. x 2.7" W x 3.9" D. Ideal for serviceman's tool case
- Options offered for special requirements: Rechargeable Batteries with Charger \$15; Leather Case \$16; High Voltage Probe \$30; Current Shunts \$6 each.

For immediate delivery fill in below.

* Special offer of \$99.95 with your check and coupon. Regular price—\$110.00, C.O.D. or valid Purchase Order. One year guarantee.

Name _____

Company _____

Address _____

City _____ State _____ Zip _____

Add 6% Sales Tax - California Residents

1 3456789101112 ★ 1 3456789101112

PH (714) 755-1139  TWX 910-322-1132
NON-LINEAR SYSTEMS, INC.
Box N, Del Mar, Calif. 92014

156 Circle 156 on reader service card

New products



connectors use a spacing of 0.080 inch and can typically hold only 61 contacts in the same-size shell. Potential applications for the new connector include instrumentation, telecommunications, and other systems in which efforts have been made to miniaturize the equipment. The MD 73 series is believed to be the first line of circular connectors to use the Twist/Pin concept, already proven in other types of connectors, in which seven helically wound wires form the contact pin. Each contact in the MD 73 series can handle 5 amperes and has a sea-level voltage rating of 1,000 volts rms. Prices range from \$35 to \$100 per mated pair, depending upon shell size and quantity. Samples can be delivered within eight weeks.

Malco, a Microdot Company, 220 Pasadena Ave., South Pasadena, Calif. 91030 [397]

Vacuum tool picks up, aligns dice and wafers

Operating from a standard shop-vacuum line, the Roto-Pic allows a user to pick up semiconductor wafers horizontally from trays and vertically from boats, as well as to pick up individual dice and align them without setting them down. The unit has a positive hold and release bar, which allows the operator to lift a finger without dropping the object. Rubber caps and various-sized tips are available, also a kit including vacuum pump and hoses.

Unitool Corp., 3740 Skypark Dr., Torrance, Calif. 90505 [399]

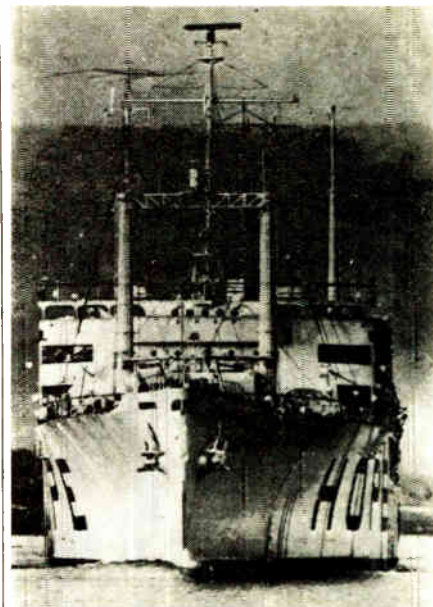

S.S. HOPE, M.D.

Doctor . . . teacher . . . friend to millions on four continents—this floating hospital is a symbol of America's concern for the world's disadvantaged. Keep HOPE sailing.

**PROJECT
HOPE**

Dept. A, Washington, D.C. 20007

RENT A MINI
1 DAY DELIVERY
DEC PDP 8I(4K)
DEC PDP 8L(8K)
ASR 33

FOR SALE

MINIS DEC • DG • CAI • GTE
HP • HIS • IBM • INT
LOCK • MICRO • SEL
VARIAN • XLO

PRINTERS MDS 4330 \$3950
CDC 9322 — \$2500
DP 2440 — \$7500

CARD READERS DOC M200 \$950
GDI 100, 110 \$750

PAPER DIGITRONICS
TAPE CHALCO • BRPE

MAG TAPE PERTEC • WANGCO
POTTER • AMPEX

617-261-1100

AMERICAN USED COMPUTER CORP.
P.O. Box 68, Kenmore Sta., Boston, MA 02215
member COMPUTER DEALERS ASSOCIATION

Circle 192 on reader service card

Is there a Teleprinter Serviceman in the House?

You can get one—quick. Just dial (609) 779-4129. You'll get the facts about RCA service: contractual, per call, or emergency. Coast-to-coast service is offered by RCA for the account of the manufacturer and large user. Check on it. Phone today, or if you prefer, write RCA Service Company, A Division of RCA, Bldg. 204-2, Camden, N.J. 08101.

RCA

Circle 193 on reader service card

The Quick Way to select HEAT SINKS



New!
New!
New!

astrodyne's easy to use Natural Convection HEAT SINK catalog provides data for more than 80 basic designs.

Patented 'T-fin,' low, medium and high power heat sinks are illustrated with dimensions and performance graphs for easy selection.

Send for your free Natural Convection Heat Sink catalog. NC-740

astrodyne, inc.

SUBSIDIARY OF ROANWELL CORPORATION
353 MIDDLESEX AVENUE / WILMINGTON, MASSACHUSETTS 01887
(617) 272-3850 TWX 710-347-0704

Circle 194 on reader service card

New literature

Power supplies. Forty-five new products, including regulated, unregulated, encapsulated subminiature, and constant-current power supplies, are described in a 24-page catalog available from Standard Power Inc., 1400 So. Village Way, Santa Ana, Calif. 92705. Circle 421 on reader service card.

Designing microwave circuits. Calculator application summary No. 5952-8924, entitled "Microwave Circuit Design with the HP 9820A & 9821A," tells how a new software package can be used to plot constant-gain and constant-noise-figure circles, to design impedance-matching ladders, to convert S, Z, Y, and H parameters to any or all of the three other types, and to perform many other microwave-oriented calculations and transformations. The summary is available from the Inquiries Manager, Hewlett-Packard Co., 1501 Page Mill Rd., Palo Alto, Calif. 94304 [422]

Prefinished metals. A 20-page catalog covering the Nickeloid family of plated and laminated prefinished metals is offered by the American Nickeloid Co., Peru, Ill. 61354. The catalog includes design data and product-selection tables, as well as fabrication and assembly techniques. It covers chromium, nickel, brass, and copper platings, in addition to vinyl laminates and bonded color finishes. [423]

High-dielectric capacitors. Brochure No. 49-04, published by Murata Corp. of America, Rockmart Industrial Park, Rockmart, Ga. 30153, lists the company's line of high-dielectric ceramic disk capacitors. It includes technical specifications, dimensional data, temperature characteristics, and testing criteria. [424]

Solid-state switch drivers. A line of TTL-compatible solid-state switch drivers for shunt/series and series/shunt p-i-n diode switches is described in a six-page bulletin from LRC Inc., 1001 Digital Dr., Hudson, N. H. 03051 [425]

Catch a Logic Pulse



The TEKTRONIX P6401 Logic Probe positively identifies logic states (high, low, abnormal, open, over voltage) of TTL and DTL circuitry. No level setting or adjustments; just touch and see.

To catch a single pulse as narrow as 10 ns, switch the probe to store. At the occurrence of a pulse, the indicator lamp (red for high, green for low) will light and remain lit until reset.

To detect the coincidence of logic levels at two points, simply connect a strobe lead to the second point.

For complete specifications and ordering information, write Tektronix, Inc., P.O. Box 500, Beaverton, Ore. 97077. In Europe, write Tektronix Limited, P.O. Box 36, St. Peter Port, Guernsey, Channel Islands.



TEKTRONIX®
committed to
technical excellence

Circle 157 on reader service card

For demonstration circle 206 on reader service card

Addmaster Corporation Mich Associates	141	Erie Technological Products Co., Inc. Altman Hall Associates Advertising	27	Premier Metal Products Corporation Commercial Press, Inc.	31
Advanced Micro Devices Keye Donna Pearlstein	11	Fabri-Tek, Inc. Midland Associates, Inc., Marketing and Advertising Services	58	Prime Computer Inc. Prime Advertising	108
* Alltech R.L. Thompson Company	16E	Fairchild Semiconductor, Inc. Carson/Roberts, Inc. Advertising Division of Ogilvy & Mather, Inc.	47	Programmed Power Inc. Moser & Associates	124
■ Airpax Electronics, Inc. Robert B. Walker & Associates, Inc.	52	Faultfinders, Inc. D.J. Moore Advertising, Inc.	81	Ramsey Engineering Company Midland Associates, Inc.	129
Aluminum Company of America-Chemicals Ketchum, MacLeod & Grove, Inc.	75	John Fluke Mfg Co., Ltd. Lennox Marketing Limited	15,148	RCA Service Company Al Paul Lefton Company, Inc.	157
American Microsystems, Inc. Wilton Coombs & Colnett Inc., Advertising	154	* Gardner Denver Company Buchen Advertising Inc.	1	RCA—Solid State Division	71,73
* American Microsystems, Inc. Wilton Coombs & Colnett Inc., Advertising	155	General Automation Albert, Newhoff & Burr	120-121	‡ Rental Electronics, Inc. Humphrey Browning MacDougall, Inc.	64
American Optical Corp., Fiber Optics & Industrial Prod. Div. Wilson, Haight & Welch, Inc., Advertising	132	General Radio Company Grad Associates	131	Rockwell International Electronics Group Campbell-Ewald Company Advertising	112-113
American Smelting & Refining Company Clyne Maxon, Inc.	6	■ Gould Inc./Instrument Systems Division Carr Liggett Advertising, Inc.	140	Rohde & Schwarz McCarthy, Scelba, DeBiasi Advertising Agency, Inc.	2nd Cover
American Used Computer Corporation McDavitt Advertising	156	■ Grayhill, Inc. Stral Advertising Company, Inc.	146	Sangamo Electric Company Batz-Hodgson-Neuwoahner, Inc.	95
■ AMP Incorporated Aitkin-Kynett Co., Inc.	133	Hanover 75 Schenkers International Forwarders, Inc.	79	Scanbe Manufacturing Corporation Wheeler & Company	143
* Ampex Cassy and Hull Ltd.	53	■ Heath/Schlumberger Scientific Instruments Advance Advertising Services	159	Scientific Atlanta/Optima Division Raniere, Saslaw, Mohr and Associates, Inc.	144
■ Amphenol RF Marsteller, Inc.	34	■ Hewlett-Packard Corporate Marketing Communications	17-26	* Selmart CPM Studio	1E
■ Analog Devices, Inc. Schneider Parker, Inc.	134-135	■ Hughes Aircraft Company Foote, Cone & Belding	50-51	* Seacosem Bazine Publicite	62,14E
AP Products Incorporated Marketing Communications Associates	79	* Industrial & Scientific Conference	10E	Siemens AG Linder Presse Union GmbH	43
‡ Arrow-M Corporation Haloff & Caine Associates	53	Intel Corporation Regis McKenna, Inc.	28-29	* Sodoco SAIA Stocker	2E
Astrodyne Astrodyne, Inc.	157	Interdata Shaw-Elliott Advertising	100-101	* Spectrol Reliance Limited JMR Advertising	6E-7E
‡ Beckman Instruments Inc., Hellpot Division N.W. Ayer/Jorgensen/MacDonald, Inc.	54-55	Keithley Instruments Chagrin Valley Marketing Associates	147	Sprague Electric Company Harry P. Bridge Company	8
Belden Corporation Fensholt Incorporated	126	Krohn-Hite Corporation Impact Advertising, Inc.	5	Syston Donner Concord Instruments Fred Schott & Associates	9
* Bishop Graphics, Inc. Walt Edler Graphics	45	Litronix, Inc. Bonfield Associates	12-13	■ Tanitor Electronics Devey, Thompson & Vignola Advertising, Inc.	6
‡ Busmann Mfg. Division of McGraw-Edison Co. Henderson Advertising Company	45	* Marconi Instruments Ltd. Russell Powell Advertising Ltd.	13E	Technit TWP Advertising	124
■ Cambridge Thermionic Corporation Chirurg & Cairns, Inc.	152	Merrimac Industries, Inc. Fletcher-Walker-Gessell, Inc.	130	■ Tektronix-IDD Young & Roehr, Inc.	116
Carpenter Technology Corporation Beaumont, Heller & Sperling, Inc.	122	■ MFE Corporation Brightman Company, Inc.	140	■ Tektronix, Inc. Tektronix, Inc.	157
Central Mississippi Development District Godwin Advertising Agency, Inc.	147	Micro Technical Industries R.E. Sylvester Advertising Agency	132	Teledyne Semiconductor Regis McKenna, Inc.	7
Cherry Electrical Products, Corp. Kolb/Tookey & Associates, Inc.	2	3M Nuclear Products, Conductive Plastics D'Arcy-MacManus & Masius	159	Teredyne, Inc. Quinn & Johnson, Inc.	68
■ Custom Electronics, Inc. Laux Advertising, Inc.	16	MOS Technology Henry S. Goodsett Advertising, Inc.	67	* Thomson CSF Bazine Publicite	38
■ Dale Electronics Inc., A Sub. of the Lionel Iones Corporation Swanson, Sinkey, Ellis, Inc. Advertising	4th Cover	National Electronics Lea Advertising	74	■ TRW, Cinch Connectors Stral Advertising Company, Inc.	98
■ Data Precision Allied Advertising Agency, Inc.	140	Neff Instruments Corp. Basso/Boatman, Inc.	56-57	U.S. Capacitor Corporation S. Michelson Advertising	150
Datatron, Inc. Lary Courney Company	3rd Cover	Nippon Television Showa Advertising	132	* U.S.C.C. S. Michelson Advertising	151
* Delta Design, Inc. Marketing Directions	15E	Nitron a division of McDonnell Douglas Corporation J. Walter Thompson Company	138-139	United Systems Corp. A Sub. of Monsanto Co. Advertising & Merchandising, Inc.	119
Delta Products, Inc. The William Loughran Company	147	Non-Linear Systems A & J Associates, Inc.	156	■ Unitrode Corporation Schneider Parker, Inc.	37
Digi-Data Corporation R & J Associates	16	‡ Oxy-Metal Mike/Dick Morrison/Poppe Tyson	125	‡ U.S. Instrument Rentals, Inc. United States Leasing Corporation	1
Digital Equipment Corporation Creamer, Trowbridge, Case & Bastford, Inc.	137	Phillips Elcoma Brockies Communications Systems	5E	Varo Semiconductor, Inc. Warren-Guild	145
Eastman Chemical Products, Inc., Industrial Chemicals J. Walter Thompson Company	130	* Phillips Industries Vaz Dias	54-55	Watkins-Johnson Company W-J Advertising	49
Electronic Development Corporation Advertising Assistance, Inc.	141	Phillips N.V. PR/T&M Division Brockies Communications Systems SA	64	* Wavetek Indiana Inc. Chapman Michetti Advertising	125
Electronic Memories and Magnetics Corporation S. Michelson Advertising	82	* Philippe Test & Measuring Instruments, Inc. G.A.D.	10	■ Woven Electronics Prentiss Court Advertising	30
■ Electronic Navigation Industries Hart/Conway Advertising—Public Relations	14	Photocircuits Ries Cappiello Colwell, Inc.	32-33		
■ Emerson & Cuming, Inc. Edwin F. Hall	161	■ Piezo Technology, Inc. Shatluck/Roether Advertising, Inc.	146		
* English Electric Valve Co., Ltd. The London Advertising Partnership	8E-9E	Polyometalurgical Corp. Horton, Church & Goff, Inc.	148		
EPC Labs, Inc. Superfine Productions	61	‡ Precision Monolithics, Inc. Marlborough Associates, Inc.	38		

■ For more information on complete product line see advertisement in the latest Electronics Buyer's Guide
 * Advertisers in Electronics International
 ‡ Advertisers in Electronics domestic edition

3M Introduces Gentle ionized air.

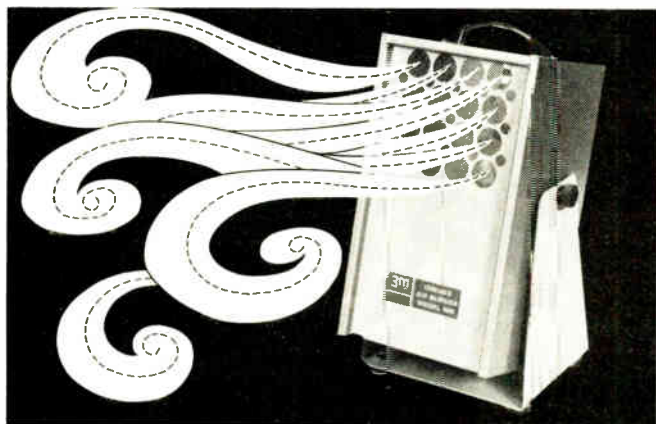

MODEL "909" IONIZED AIR BLOWER

Removes static charge without disturbing delicate components.

It's easy to put 3M's new Model "909" to work in electronic component assembly, where static charges can destroy or degrade MOS/FET's and I.C.'s in an instant. Just set the "909" on the bench or table, plug it in, and let it bathe the area with low-volume, low-pressure ionized air. With the "909's" free-standing base, you adjust the air flow in any direction. And inside, the safe self-contained nuclear static eliminators increase your yield and decrease field rejects.

Ask a 3M Static Analyst to tell you about 3M's leasing program, that will help you stamp out static at component assembly stations year after year. Mail the coupon today.

See Model "909" for the first time at Nepcon West

Nuclear Products

3M Company, 3M Center, Dept. BSE-25,
St. Paul, MN 55101



- Please have a 3M Static Analyst show me the gentle effectiveness of the "909" Ionized Air Blower.
- Please send more information.

NAME _____ TITLE _____

COMPANY _____ PHONE _____

ADDRESS _____

CITY _____ STATE _____ ZIP _____

PRODUCT MFD. _____

Circle 195 on reader service card

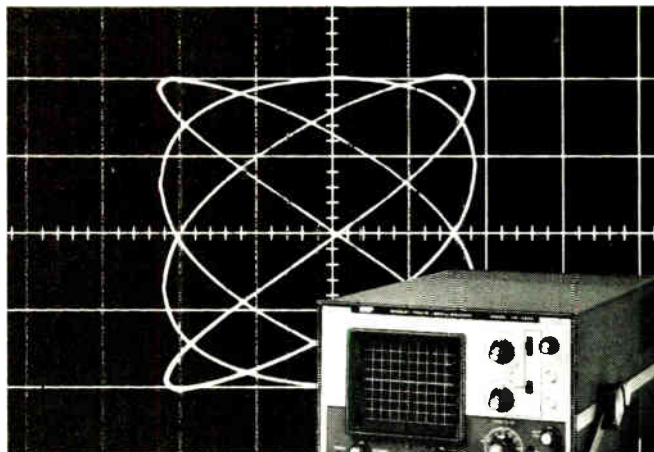

Heath's new 4530

...the 10 MHz scope that gives you more than you bargain for.

It's hard to find a better 10 MHz oscilloscope value than the new Heath/Schlumberger SO-4530. Features like wide-band triggering capability, sensitive 10 mV/cm vertical input, TV coupling and calibrated X-channel input make it a versatile, easy-to-use scope that every EE and lab tech will appreciate. And you don't have to pay a premium to get a scope with this flexibility.

Trigger circuits are digitally controlled, requiring only the level control and slope switch. Various trigger signals can be selected: a sample of the vertical input signal, a sample of the line voltage, or an externally applied trigger signal. In the TV trigger coupling mode, the 4530 can easily be triggered on the vertical or horizontal signal in a composite video signal. Trigger bandwidths are guaranteed to 15 MHz, AC and DC coupled. A low-pass filter with a 1 kHz cut-off is used in the TV coupling mode.

True X-Y operation doesn't require a dual trace scope. A calibrated X-input is provided on the SO-4530 with a maximum sensitivity of 20 mV/cm. This makes the 4530 one of the few single trace scopes available with two input channels.

High or low frequency waveforms are no problem since the 4530's wide range of time bases can be switched from 200 ns/cm to 200 ns/cm. And any sweep can be expanded five times.

Should servicing become necessary, the Operation/Service manual provides programmed trouble-shooting charts to help you quickly find and correct the problem. All integrated circuits have plug-in sockets, and all components are mounted on two circuit boards for easy access.

The SO-4530 is easy to operate, easy to service and offers a lot of performance for the money. Only \$420.00*, factory assembled and calibrated. Or order the easy-to-assemble Heathkit IO-4530, only \$299.95*.



Send for your free Heath catalogs

The latest Heath/Schlumberger Assembled Instruments Catalog features a complete line of high performance, low cost instruments for service and design applications. Our '75 Heathkit Catalog describes the world's largest selection of electronic kits — including a full line of lab and service instruments. Send for your free copies today.

HEATH COMPANY
Dept. 510-02
Benton Harbor, Michigan 49022

HEATH
Schlumberger

- Please send the 1975 Heathkit Catalog.
- Please send the latest Heath/Schlumberger Assembled Instruments Catalog.

Name _____

Title _____

Company/Institution _____

Street _____

City _____ State _____ Zip _____

*MAIL ORDER PRICES; F.O.B. FACTORY
PRICES & SPECIFICATIONS SUBJECT TO CHANGE WITHOUT NOTICE.

EK-449

Circle 159 on reader service card 159

INTRODUCING ONE OF A KIND.



the magazine and the market

The name of our new publication is the same as the name of the fastest-growing market in our economy—data communications. *Data Communications*—the first of its kind to offer:

- 100% editorial on data communications: In this issue—from the exclusive IBM cover story which takes you inside to . . . all-digital carriers to . . . breaking the logjam in dynamic data base systems . . . to new products—all data communications.
 - 100% request verification: each one of the 25,000 subscribers has individually requested *Data Communications*.
 - 100% data communications audience—the people who have the responsibility to buy, specify, recommend or approve the purchase or lease of productions associated with data communications.
- \$7,800 covers a full year's schedule of full pages in *Data Communications*, including free color, free bleed and special positions at no additional cost.

For complete advertising information, contact your local McGraw-Hill salesman.

data McGraw-Hill
COMMUNICATIONS
A McGraw-Hill Publication

Exclusive Economic and Industry Studies

For Financial Analysts,
Corporate Planners,
Business Economists,
Marketing Executives

Geared directly to the future, our Department of Economics offers more than 40 forecasting tools to help project the general economy and industrial growth over the short and long run.

EXAMPLES: Do you know that the current operating rate for the chemical industry is 86%? For synthetic materials, the utilization rate is 93%? That construction and mining machinery new orders are expected to be 8% higher in 1974 than in '73? That steel expects a 3% decline in physical volume of sales in 1974? That consumer income after taxes will increase 8% in 1975?

At a modest cost, our various services covering most industrial segments of the economy are available to you.



For more information write for our booklet, "Exclusive Economic Studies," or phone Douglas Greenwald, Chief Economist, (212) 997-2216.

Department of Economics
McGraw-Hill Publications Company
1221 Avenue of the Americas
New York, N.Y. 10020



Advertising Sales Staff

Pierre J. Braudé New York [212] 997-3468
Director of Marketing

Atlanta, Ga. 30309: Warren H. Gardner
100 Colony Square, 1175 Peachtree St., N.E.
[212] 997-3617

Boston, Mass. 02116: James R. Pierce
607 Boylston St. [617] 262-1160

Chicago, Ill. 60611:
645 North Michigan Avenue
Robert W. Bartlett (312) 751-3739
Paul W. Reiss (312) 751-3738

Cleveland, Ohio 44113: William J. Boyle
[716] 586-5040

Dallas, Texas 75201: Charles G. Hybbard
2001 Bryant Tower, Suite 1070
[214] 742-1747

Denver, Colo. 80202: Harry B. Doyle, Jr.
Tower Bldg., 1700 Broadway
[303] 266-3863

Detroit, Michigan 48202: Robert W. Bartlett
1400 Fisher Bldg.
[313] 873-7410

Houston, Texas 77002: Charles G. Hubbard
Dresser Tower, 601 Jefferson St., [713] 224-8381

Los Angeles, Calif. 90010: Robert J. Rielly
Bradley K. Jones, 3200 Wilshire Blvd., South Tower
[213] 487-1160

New York, N.Y. 10020
1221 Avenue of the Americas
Warren H. Gardner [212] 997-3617
Michael J. Stoller [212] 997-3616

Philadelphia, Pa. 19102: Warren H. Gardner
Three Parkway, [215] 997-3617

Pittsburgh, Pa. 15222: Warren H. Gardner
4 Gateway Center, [412] 997-3617

Rochester, N.Y. 14534: William J. Boyle
9 Greylock Ridge, Pittsford, N.Y.
[716] 586-5040

San Francisco, Calif. 94111: Don Farris
Robert J. Rielly, 425 Battery Street,
[415] 362-4600

Paris: Alain Offergeld
17 Rue-Georges Bizet, 75 Paris 16, France
Tel: 720-73-01

Geneva: Alain Offergeld
1 rue du Temple, Geneva, Switzerland
Tel: 32-35-63

United Kingdom & Scandinavia: Keith Mante
Tel: 01-493-1451, 34 Dover Street, London W1

Milan: Robert Saidel
1 via Baracchini, Italy Phone 86-90-656

Brussels: Alain Offergeld
23 Chaussee de Wavre
Brussels 1040, Belgium
Tel: 13-73-95

Frankfurt/Main: Fritz Krusebecker
Liebigstrasse 27c, Germany
Phone 72 01 81

Tokyo: Tatsumi Katagiri, McGraw-Hill
Publications Overseas Corporation,
Kasumigaseki Building 2-5, 3-chome,
Kasumigaseki, Chiyoda-Ku, Tokyo, Japan
[581] 9811

Australasia: Warren E. Ball, IPO Box 5106,
Tokyo, Japan

Business Department

Stephen R. Weiss, Manager
[212] 997-2044

Thomas M. Egan,
Production Manager [212] 997-3140

Carol Gallagher
Assistant Production Manager [212] 997-2045

Dorothy Carter, Contracts and Billings
[212] 997-2908

Frances Vallone, Reader Service Manager
[212] 997-6057

Electronics Buyers' Guide

George F. Werner, Associate Publisher
[212] 997-3139

Regina Hera, Directory Manager
[212] 997-2544

GUIDE TO DIELECTRIC MATERIALS



Short form catalog is a useful illustrated guide to product lines and literature. Eighteen different product lines are described. Useful applications and outstanding properties are listed. The catalog contains a reader service card for requesting more detailed information on specific product lines.

Circle 210 on reader service card

ECCOSORB® ANECHOIC CHAMBERS

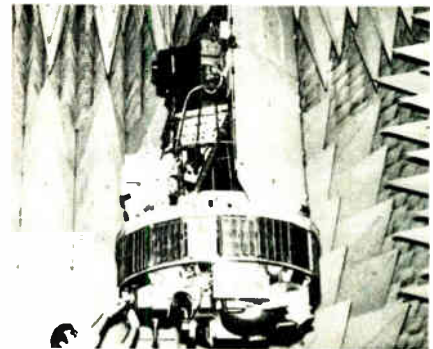

The most advanced anechoic and shielded chambers . . . used worldwide for antenna pattern, radar cross-section, VSWR and RF compatibility measurements. Send for data.

Circle 211 on reader service card

FREE SAMPLE RFI GASKET ECCOSHIELD® SV

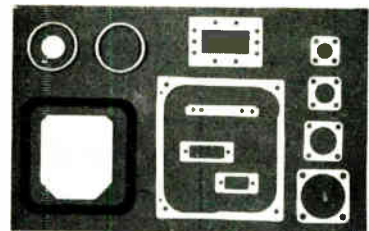

Eccoshield® SV is the flexible, compressible plastic with the conductivity of metal—available in many physical forms—for RF and hermetic seals. Insertion loss has exceeded 100 db.

Circle 212 on reader service card

Emerson & Cuming, Inc.



CANTON, MASS.
GARDENA, CALIF.
NORTHBROOK, ILL.

Sales Offices
in Principal Cities

EMERSON & CUMING EUROPE N.V., Devel, Belgium

**MEET
AT**

DEEC 75

**DESIGN ENGINEERS'
ELECTRONIC COMPONENTS
SHOW / MAY 12...14
Statler Hilton, Wash., D.C.**

Design Engineers' Electronic Component Show. Main Ballroom, Statler Hilton. Washington, D.C. Sponsored by the EIA Parts Division. DEEC is held in conjunction with the Electronic Components Conference.

Bigger and better than ever! A one-of-a-kind opportunity for OEM Design Engineers to meet face to face with technicians and engineers of leading component manufacturers.

It's the only show created especially for design engineers and component technical people.

For advance registration, fill out the coupon below and mail to: Tyler Nourse, Electronic Industries Assn., 2001 Eye Street, N. W., Washington, D.C., 20006.

**TECHNOLOGIES, INNOVATIONS, NEEDS,
INTERESTS, SOLUTIONS, MUTUAL CONCERNS**

I'll be there! Send me cost-free advance registration and additional details including list of exhibitors.

NAME _____

TITLE _____

COMPANY _____



ADDRESS _____ CITY _____ STATE _____ ZIP _____

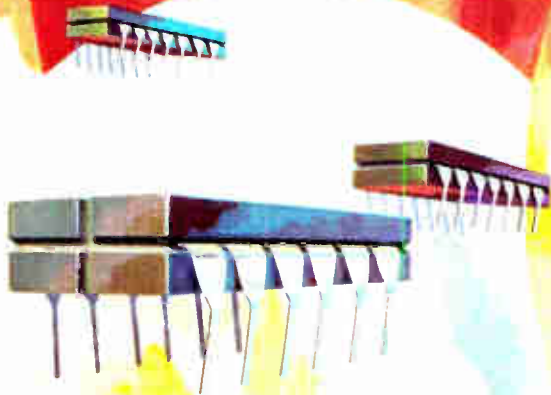

**ONE
ON
ONE**



Datatron's Hustler 44 dramatically reduces testing costs on wafers & packaged IC's

DEVICE	HUSTLER 44 COST PER DEVICE	OTHER TESTERS COST PER DEVICE	WRITE IN YOUR OWN COST PER DEVICE
 SSI GATE AT WAFER PROBE LEVEL	.0057¢	.0146¢	_____¢
 SSI GATE FINAL TEST OF INCOMING INSPECTION	.0271¢	.0652¢	_____¢

Faster Throughput

Let's face it. Regardless of the bells and whistles on an IC tester, the real name of the game is how much it costs to test a device — both at the wafer probe level and on packaged IC's in final test or incoming inspection.

When it comes to this welcome economy, Hustler 44 wins hands down. In fact, we invite you to compare our documented costs with those of any other tester.

How can Hustler 44 dramatically lower your IC testing costs?

Because functional and parametric tests are made simultaneously, which means IC's are tested faster.

Other testers perform parametric tests by using a switching matrix to apply a stimulus to an IC input and then sequentially monitoring all outputs. A slow process indeed.

Hustler 44 has a separate electronics card, containing forcing and monitoring circuitry, for each pin

of the device under test. All inputs and outputs are forced and monitored simultaneously. Test time is dramatically reduced. Actual IC operation is simulated. Makes it easier to expand your system, too. Up to 256 pins.

It's not magic. Just darned good analog and digital design.

Easier Programming

Another cost advantage. Our simple English language software doesn't require a computer programmer. Instead, it's designed for the typical test operator. Your people will be able to generate programs to test any IC after just a few hours of training in your plant. And programs can be generated, edited, listed and debugged while testing is in process.

No wonder so many Hustlers are being bought by people who really understand automatic testing.

8 Multiplexed Stations

Hustler 44 is versatile too. Hundreds of test programs can be stored

in memory. Up to 8 remote stations, equipped for manual operation, with automatic handlers or with wafer probers, can simultaneously test different devices.

Call Us Today

Both Hustler 44, and our 10MHz clock-rate tester, Hustler 45, can dramatically reduce your IC testing costs. So send for our brochure today. Or better yet, have a Datatron applications engineer come in and discuss your testing needs.



datatron, inc.

TEST SYSTEMS DIVISION

1562 Reynolds Ave., Santa Ana, California 92705 (714) 540-9330 • TWX 910-595-1589
Mailing Address: P.O. Box 11427, Santa Ana, California 92711

Circle 901 on reader service card

World Radio History

Don't cheat yourself on trimmer performance.

Compare element size
and see why Dale gives
you better value!

Low profile doesn't have to mean low performance. The larger cermet element in Dale Low Profile Trimmers gives you extra value for your money. Extra assurance of trouble-free performance. You get: **More Power** 1 watt at 70°C lets you derate for assured long-term stability. **Better Adjustability** — $\pm 0.10\%$ output resistance, $\pm 0.05\%$ output voltage ratio. **Low Noise** 1% Contact Resistance Variation standard. **Low T.C.** ± 100 PPM standard.

Immediate delivery
from stock...

Cermet Models

(781, 783, 784)

Wirewound Models

(721, 723, 724)

Phone 402-564-3131
today for complete details.

DALE ELECTRONICS, INC., 1300 28th Ave., Columbus, Nebr. 68601
In Canada: Dale Electronics Canada Ltd.
In Europe: Dale Electronics GmbH
8 Munchen 60, Falkweg 51, West Germany
A subsidiary of The Lionel Corporation



DALE
780
Low
Profile



Brand H



Brand B



Brand I



Brand E



Circle 902 on reader service card