

- 93 Linear LSI puts accurate a-d converter on a chip pair
- 103 High-level language eases microcomputer programing
- 114 Thermal design, part 8: Coping with pc-board problems

# Electronics®



1420 080120 AECA7 MAY76  
 CS OSBORNE JR  
 1202 W AVENUE H11  
 LANCASTER CA 93534

STAGE DUE 3/6

22 Athol Ave.  
 Edwards, CA, 93523 F

**European EEs speak out**  
 on design problems  
 on shortages  
 on 'national identity'  
 on U.S. technology

## COMPLETE CONTROL

We trust no one else with any of the processes that go into the manufacture of B-H Sleeving and Tubing. Every step — from original braiding to final finishing is under our complete control. We are solely responsible for the quality of every foot of B-H.

**FLEXIBLE  
VARNISHED TUBING  
MAGNETO TUBING  
SATURATED SLEEVING  
FIBRE GLASS TUBING  
& SLEEVING**

So if your specifications are exacting as to size, dielectric strength and flexibility we would like to show you how B-H products can meet them.

WRITE FOR SAMPLES



**Bentley, Harris Mfg. Co.**

CONSHOHOCKEN, PENNA.

CHICAGO OFFICE

440 W. Huron St.

## MATHEMATICS FOR RADIO AND COMMUNICATION

by **GEORGE F. MAEDEL, A.B., E.E.**

Chief Instructor, N. Y. School, RCA Institutes

To master the technicalities of radio—to read engineering literature intelligently—you must have the mathematical groundwork covered by these absorbing books prepared for home study. Book I (314 pp.) covers the algebra, arithmetic, and geometry; Book II (329 pp.) covers the advanced algebra, trigonometry, and complex numbers necessary to read technical books and articles on radio.

MAEDEL PUBLISHING HOUSE Room 108  
593 East 38 Street, Brooklyn, New York

Send me MATHEMATICS FOR RADIO AND COMMUNICATION as checked below. I enclose payment therefor with the understanding that I may return the book(s) within 5 days in good condition and my money will be refunded.

Name .....

Address .....

- Book I at \$3.75 plus 3c postage  
 Book II at \$4.00 plus 3c postage  
 Books I and II at \$7.75 postage prepaid  
 Foreign and Canadian prices 25c per volume higher.

## Recording Discs

NEW RECORDING DISCS known as "Black Seal Glass Base Recording Discs" may be described as all glass discs in either a thin, flexible weight, or medium weight in 10, 12 or 16 inch sizes; both weights are available with either two



or four holes; there are no fibre or other foreign material inserts; there are no metal grommets around the holes; and, finally, the holes of the discs are precision machined directly in the glass.

These discs are available from The Gould-Moody Co., 395 Broadway, New York, N. Y.

## Sectional Resistors

FOR USE IN RADIO CIRCUITS, power rectifiers and laboratories for measuring any high voltage a-c or d-c circuit of 250 to 30,000 volts, a new sectional resistor is available. The unit is designed to replace, in certain cases, the old box type resistor which had a high power consumption and was inconvenient to install or replace. Made up of individual, hermetically sealed units wire wound around a ceramic resistor spool, the resistor units have values of from 0.25 to one megohm and a rated current of 1 ma. Dimensions are 1 1/4 x 1 1/4 inches in diameter per section. The ceramic resistor spool is sectionalized, and adjacent sections are wound in opposite di-

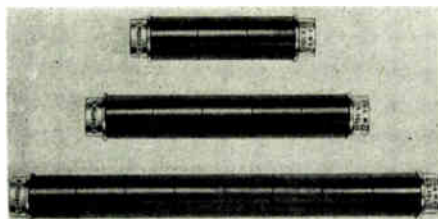

rections to obtain a non-inductive resistance.

Resistance is held within close tolerances permitting interchangeability of units having the same voltage rating. When a number of sections are mounted on one shaft, permanent taps may be taken off between any two sec-

## MICRO-PROCESSED BERYLLIUM COPPER COIL OR FLAT SPRINGS

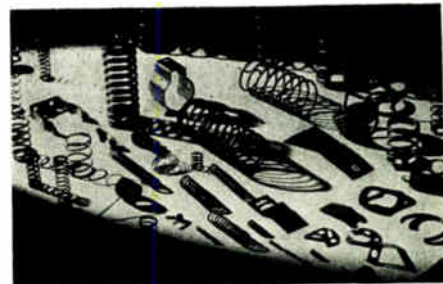

### Eliminate-Drift Set-Fatigue

I-S beryllium copper coil springs are definitely superior—the result of micro-processing, a radically different technique, for making beryllium copper springs, perfected by Instrument Specialties Company after eight years of metallurgical research. *Micro-Processing makes the difference.*

First—I-S springs are made with special machines and tools of our own design. Economical for short or long runs.

Second—Special heat-treatment—laboratory controlled for each production lot—assures the desired physical properties for each shipment of I-S springs.

Third—With the Carson Electronic Spring Tester, our laboratory predicts controls and tests to closer tolerances.\*

Fourth—Micro-Processed beryllium copper has higher strength and conductivity, better endurance, stability, and heat resistance than stainless steel or bronze. Better corrosion resistance and less drift than steel.

### \*COIL SPRING STANDARD PRODUCTION TOLERANCES

Inside diameter, up to 1/2 in. (any wire diameter) .003  
Load test at working length. 5%

### FLAT SPRING STANDARD TOLERANCES

Angles—within 1/2° in bends.  
Flatness—within .001 to .003 in. per inch of length.

Spring measurement has been revolutionized by the Carson Electronic Spring Tester—an exclusive I-S development. Measuring to ten-millionths of an inch without pressure, this superior precision instrument enables I-S to control and test within closer limits. Extensive spring research is constantly in progress in the I-S laboratory.

Write today for Bulletin #4 for further details on micro-processed beryllium copper springs. There is a difference. InSist on I-S.



**INSTRUMENT SPECIALTIES CO., INC.**  
DEPT. 5, LITTLE FALLS, NEW JERSEY

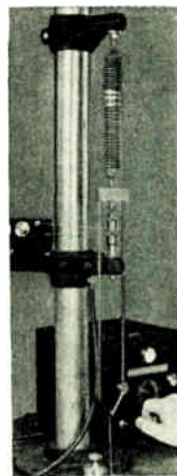

# Dialight sees a need:

(Need: The right switch for the right price.)

## See Dialight.

For the switch buyer, choice of function and esthetics, reliability, ease of mounting, and low cost are his prime concerns. He may need a pushbutton switch for panel, sub-panel or snap-in mounting. He may need a choice of bezels with or without barriers in black, gray, dark gray or white. He may need a legend that's positive, negative, or hidden until ener-



gized...one that's white when "off" and red, green, amber, blue or light yellow when "on"...or colored both "on" and "off." He may need a highly reliable switch proven in thousands of installations. Matching indicators with same front-of-panel appearance are also available. Obtainable from our world-wide distributor network.

The cap has a metal insert designed for proper heat dissipation. Cap is illuminated by a T-1 3/4 incandescent lamp in voltage range to 28V. Lamp can be easily replaced without special tools from front of panel.

More than 12 colors available in round, square, or rectangular shapes in six basic sizes - 1/2" to 1 1/2". Choice of engraved, hot stamped or replaceable film legends with positive or negative presentations.

Available with or without bezels. Bezel allows for simple snap-in mounting. Without bezel, switch can be used for panel or sub-panel mounting.

Terminals are gold plated for oxidized free solderability, and come in choice of solder blade or pc terminations.

NOW LISTED IN UNDERWRITER'S  
RECOGNIZED COMPONENTS INDEX.

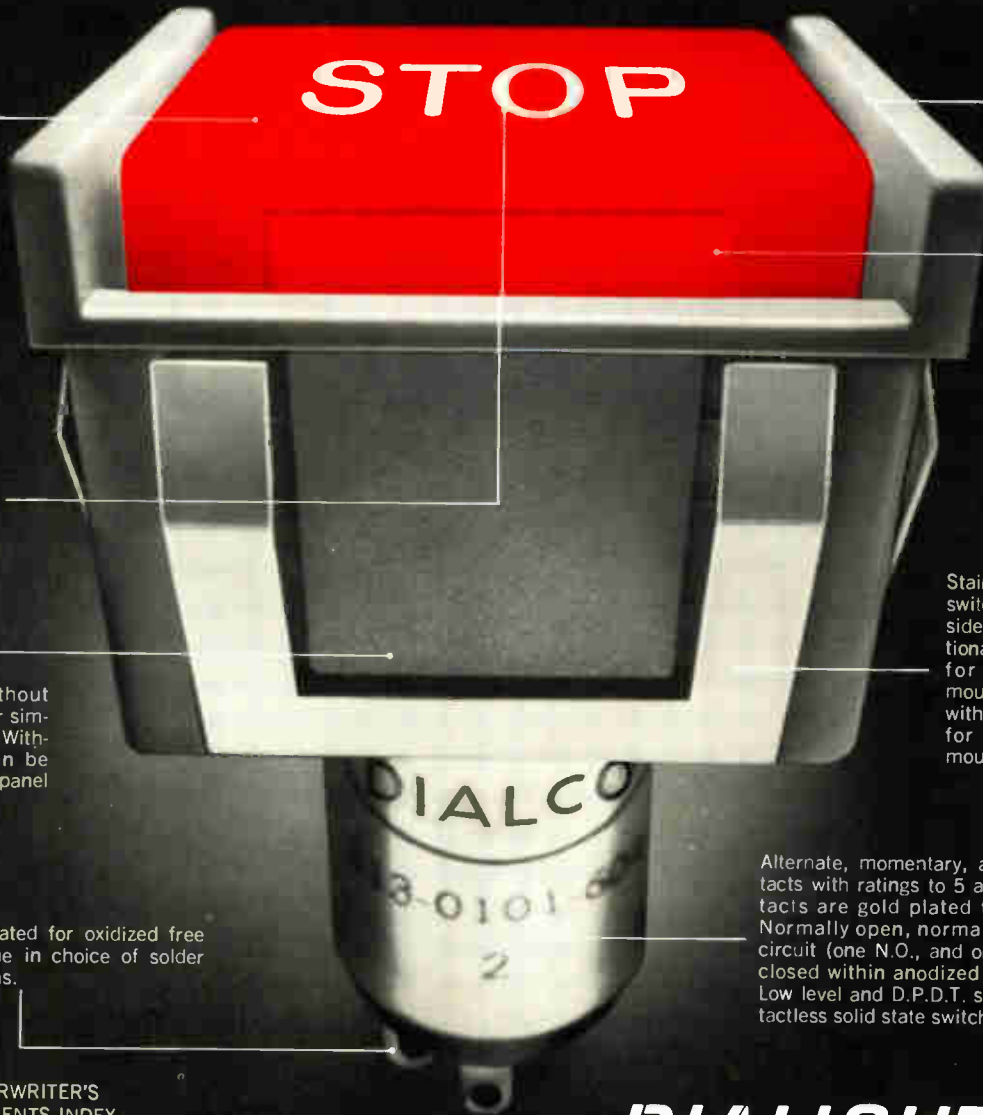

Bezels available in black, gray, dark gray or white and in round, square or rectangular shapes.

Fingertip grip simplifies insertion or replacement of pushbutton cap.

Stainless-steel clips lock switch into panel on four sides. No tools or additional hardware required for installing. Panel mounting switches come with required hardware for panel or sub-panel mounting.

Alternate, momentary, and snap-action contacts with ratings to 5 amps. All switch contacts are gold plated for high reliability. Normally open, normally closed, and two-circuit (one N.O., and one N.C.). Totally enclosed within anodized aluminum housing. Low level and D.P.D.T. snap action, and contactless solid state switches also available.

## DIALIGHT

Dialight Corporation, A North American Philips Company • 203 Harrison Place, Brooklyn, N. Y. 11237 (212) 497-7600

Circle 900 on reader service card



Only one OEM supplier makes minicomputers and tape decks and disc drives and plotters and card readers and line printers and software and firmware.

Hewlett-Packard's new OEM catalog shows how more than 100 OEM products work for a living.

Let them work for you. Write for the catalog.

Hewlett-Packard OEM Catalog, 1501 Page Mill Road, Palo Alto, California 94304.

HP minicomputers.  
They work for a living.

**HEWLETT**  **PACKARD**

Sales and service from 172 offices in 65 countries.  
1501 Page Mill Road, Palo Alto, California 94304

Electronics/June 27, 1974

22415

Circle 1 on reader service card 1

# SURPRISE!



**2½ times  
brighter green.**



**6 times  
brighter yellow.**



**6 times  
brighter red.**

HP brings you three new LED's that are many times brighter than our standard T-1 red lamps. All offer a 180° viewing angle, plus high axial luminous intensity and a good on-off contrast ratio. Ideal for front panel applications.

Our new green lamp (5082-4984) uses high-efficiency gallium phosphide to generate a typical luminous intensity of 2 mcd at 20 mA.

Our new yellow LED's are really yellow.

The 5082-4584 lamp offers 2.5 mcd typical at 10 mA.

And red has been dramatically brightened six times in output using non-saturating gallium arsenide phosphide. With a luminous intensity of 2.5 mcd at 10 mA our 5082-4684 high-efficiency red is unbeatable.

Just \$0.80\* in 100 quantities.

Contact Hall-Mark, Schweber or the Wyle Distribution Group for immediate delivery. Or, write us for more details.

They're the brightest way to improve your product.

**HEWLETT  PACKARD**

Sales and service from 172 offices in 65 countries.  
1501 Page Mill Road, Palo Alto, California 94304

01405

\*Domestic USA price only.

## 33 Electronics Review

MILITARY: Compression may help jam-proof RPV communications, 33  
CONSUMER ELECTRONICS: Chip tunes TV set electronically, 34  
Wariness greets new watch firm, 35  
SOLID STATE: C-MOS-on-sapphire yields powerful logic, 35  
Beams, too, pack power on a chip, 36  
INSTRUMENTS: Delay line perks up low-cost dual scope, 36  
MATERIALS: Low-energy ion beams alter materials, 38  
COMMUNICATIONS: ABC tests circularly polarized TV signals, 40  
NEWS BRIEFS: 42  
COMMUNICATIONS: New York Bell faces interconnect challenge, 42  
COMMERCIAL: Microprocessors ease changes in design, 44

## 56 Electronics International

JAPAN: Sony is converting bipolar devices to new structure, 56  
SWITZERLAND: Microprocessor runs beta-ray plating gage, 56  
JAPAN: Black matrix, dots yield storage tube, 57  
AROUND THE WORLD: 57

## 69 Probing the News

CONSUMER ELECTRONICS: A whole new game, 69  
COMMUNICATIONS: Maritime radio space reallocated, 72  
COMPUTERS: Japanese gird their lines, 77  
SPACE ELECTRONICS: Europe starts most ambitious venture, 80  
MICROPROCESSORS: Service bureaus spring up, 84

## 93 Technical Articles

SOLID STATE: Process packs a-d converter on two ICs, 93  
COMPUTERS: Language simplifies microcomputer programing, 103  
DESIGNER'S CASEBOOK: Electronic lock offers double protection, 110  
Regulating supply voltage all the way down to zero, 112  
THERMAL DESIGN: Part 8, Heat exchangers cool plug-in pc boards, 114  
ENGINEER'S NOTEBOOK: Capacitance-coupled logic is handy, 123  
Test circuit checks optical isolators, 124  
Examining worst-case fan-out of standard C-MOS buffers, 125  
YOU AND YOUR CAREER: European EEs face problems, too, 135

## 149 New Products

IN THE SPOTLIGHT: Fast 8-bit microprocessor is versatile, 149  
SEMICONDUCTORS: Driver circuit has high breakdown voltage, 153  
INSTRUMENTS: Pulse generator aims at high-speed logic, 161  
DATA HANDLING: CRT terminal is priced low, 169  
PACKAGING & PRODUCTION: Microprocessor controls tester, 177  
SUBASSEMBLIES: A-d converters provide high resolution, 187

## Departments

Publisher's letter, 4  
Readers comment, 6  
40 years ago, 8  
People, 14  
Meetings, 24  
Electronics newsletter, 29  
Washington newsletter, 53  
Washington commentary, 54  
International newsletter, 59  
Engineer's newsletter, 126  
New literature, 196

## Highlights

### Cover: Europe's EES face a changing world, 135

In Europe as in the U.S., electrical engineers worry about how soon to pick up on a new technology, the impact of microprocessors on job skills, and ways of improving communications between IC and system designers. So said eight European EEs who recently met in Amsterdam to give *Electronics* magazine their views. But one problem not found in the U.S. is language barriers.

### Sales of electronic games sag temporarily, 69

Having passed their first spectacular growth period, all-electronic TV games no longer directly threaten the electromechanical equipment of the amusement arcade. But even that equipment may be up to 50% electronic today.

### A-d converter fits on two chips, 93

Success in building the first monolithic analog-to-digital converter sprang partly from a new algorithm, which helped simplify the circuitry, but mainly from highly refined LSI linear processing, in which bipolar and MOS techniques are combined. Accuracy of the package is 0.05%.

### PL/M eases microcomputer programing, 103

It's faster to program a microcomputer in the high-level language called PL/M than in assembly language. PL/M is also more efficient in its use of memory space for programs running 1,000 bytes and more.

### And in the next issue . . .

Special report: microprocessor applications in industry, computers, instrumentation, communications, and consumer and commercial equipment.

EDITOR-IN-CHIEF: Kemp Anderson

EXECUTIVE EDITOR: Samuel Weber

MANAGING EDITORS: Lawrence Curran, *News*;  
Arthur Erikson, *International*

SENIOR EDITORS: John Johnsrud,  
H. Thomas Maguire, Laurence Altman,  
Ray Connolly, Stephen E. Scrupski

ART DIRECTOR: Fred Sklenar

ASSOCIATE EDITORS: John N. Kessler,  
Howard Wolff, Gerald M. Walker,  
Alfred Rosenblatt

DEPARTMENT EDITORS

*Circuit Design*: Lucinda Mattera  
*Communications & Microwave*:  
Stephen E. Scrupski

*Computers*: Wallace B. Riley  
*Consumer*: Gerald M. Walker

*Industrial*: Michael J. Riezenman  
*Instrumentation*: Stephen E. Grossman  
*Aerospace / Military*: Ray Connolly  
*New Products*: H. Thomas Maguire  
*Solid State*: Laurence Altman

COPY EDITORS: Margaret Eastman,  
Everett C. Terry

ASSISTANT EDITOR: Marilyn Offenheiser

ART: Charles D. Ciatto, *Associate Director*  
Patricia Cybulski, *Assistant Director*

PRODUCTION EDITOR: Arthur C. Miller

EDITORIAL SECRETARIES: Janet Annunziata,  
Julie Gorgoglione, Penny Roberts

FIELD EDITORS

*Boston*: Gail Farrell

*Los Angeles*: Paul Franson (Mgr.)

*Midwest*: Larry Armstrong (Mgr.)

*New York*: John N. Kessler (Mgr.)

*San Francisco*: Bernard Cole (Mgr.)

Judith Curtis

*Washington*: Ray Connolly (Mgr.)

Larry Marion

*Frankfurt*: John Gosch

*London*: William F. Arnold

*Paris*: Arthur Erikson

*Tokyo*: Charles Cohen

McGRAW-HILL WORLD NEWS

*Director*: Ralph R. Schulz

*Bonn*: Robert Ingersoll

*Brussels*: James Smith

*London*: Marvin Petal

*Milan*: Peter Hoffmann, Andrew Heath

*Moscow*: Axel Krause

*Paris*: Michael Johnson, Richard Shepherd

*Stockholm*: Robert Skole

*Tokyo*: Mike Mealey

PUBLISHER: Dan McMillan

DIRECTOR OF MARKETING: Pierre J. Braudé

ADVERTISING SALES SERVICE MANAGER:  
Wallis Clarke

BUSINESS MANAGER: Stephen R. Weiss

CIRCULATION MANAGER: Nancy L. Merritt

MARKETING SERVICES MANAGER:

Tomlinson Howland

RESEARCH MANAGER: Margery D. Sholes

The sun never sets on the electronics industries. The excitement, hard work, dumb luck, inspiration, and serendipity that makes electronics so challenging—and rewarding—has spread to the four corners of world. And our coverage goes there, too.

For example, in this issue alone you'll find a host of stories that have come from beyond the shores of the United States. First off, there's the cover story, a searching look at the European engineer today (see p. 135). As you read what eight contemporary EEs have to say about their profession, you'll find that engineers the world over face many of the same difficulties—and yet they have some problems, like language barriers, that you might not have been aware of.

Then, the Probing the News section this issue is chock-full of internationally oriented stories. One, by our Managing Editor, International, Art Erikson, reports on progress being made in reallocating maritime radio space (see p. 72). At the recent Geneva International Telecommunication Union meeting,

470-odd delegates from 90 member countries plowed through some 2,200 proposals for changes in existing regulations. But agreements were hammered out and will start to take effect in 1976. The story is important reading if you want to know what trends to watch for in communications gear.

Then, too, there's an article from our Tokyo bureau chief, Charlie Cohen, on the new crop of computers that have grown from the Japanese government's program of subsidies to computer makers (see p. 77), as well as a detailed look by our Frankfurt bureau chief, John Gosch, at who will produce what part for Spacelab, Europe's contribution to the U.S. post-Apollo manned space program (see p. 80).

And, there's a lot more international news in the Electronics Review section, as well as in the regular Electronics International and International Newsletter sections.



### We're looking for an editor

The expansion of our coverage of the electronics industries has created an opening on our editorial staff. Our editors travel extensively, write and edit technical articles, and cover stimulating new developments in electronic technology.

Specifically, the ideal candidate will have an engineering degree and extensive experience in the packaging and production of electronic products. Of course, writing ability is an obvious requirement.

We're part of McGraw-Hill, one of the world's best-known publishing companies, and we offer excellent working conditions and fringe benefits. What's more, the salary level is as good as or better than the industry rates for engineers.

If you qualify, send your résumé with salary requirements to: The Executive Editor, ELECTRONICS Magazine, 1221 Avenue of the Americas, New York, N. Y. 10020.

June 27, 1974 Volume 47, Number 13  
94,781 copies of this issue printed

Published every other Thursday by McGraw-Hill, Inc. Founder: James H. McGraw 1860-1948. Publication office 1221 Avenue of the Americas, N.Y., N.Y. 10020; second class postage paid at New York, N.Y. and additional mailing offices.

Executive, editorial, circulation and advertising addresses: Electronics, McGraw-Hill Building, 1221 Avenue of the Americas, New York, N.Y. 10020. Telephone (212) 997-1221 Teletype TWX N.Y. 710-581-5234. Cable address: MCGRAWHILL N.Y.

Subscriptions limited to persons with active, professional, functional responsibility in electronics technology. Publisher reserves the right to reject non-qualified requests. No subscriptions accepted without complete identification of subscriber name, title, or job function, company or organization, including product manufactured or services performed. Subscription rates: qualified subscribers in the United States and possessions, Canada, and Mexico \$12.00 one year, \$24.00 three years, all other countries \$25.00 per year, except Japan \$50.00 per year, Brazil \$40.00 per year, Australia and New Zealand \$60 per year, including air freight. Limited quota of subscriptions available at higher-than-basic rate for persons outside of field served, as follows: U.S. and possessions and Canada, \$25.00 one year; all other countries \$50.00. Single copies: United States and possessions and Canada, \$1.50; all other countries, \$2.00.

Officers of the McGraw-Hill Publications Company: John R. Emery, President; J. Elton Tsching, Executive Vice President-Administration; Gene W. Simpson, Group Publisher-Vice President; Senior Vice Presidents Ralph Blackburn, Circulation, Walter A. Stanbury, Editorial, John D. Hoglund, Controller; David G. Jensen, Manufacturing; Gordon L. Jones, Marketing; Jerome D. Luntz, Planning & Development.

Officers of the Corporation: Shelton Fisher, Chairman of the Board and Chief Executive Officer; Harold W. McGraw, Jr., President and Chief Operating Officer; Wallace F. Trendley, Senior Vice President, McGraw-Hill Publications Company and McGraw-Hill Information Systems Company; Robert N. Landes, Senior Vice President and Secretary; Ralph J. Webb, Treasurer.

Title registered in U.S. Patent Office; Copyright ©1974 by McGraw-Hill, Inc. All rights reserved. The contents of this publication may not be reproduced in whole or in part without the consent of copyright owner. Subscribers: The publisher, upon written request to our New York office from any subscriber, agrees to refund that part of the subscription price applying to copies not yet mailed. Please send change of address notices or complaints to Fulfillment Manager; subscription orders to Circulation Manager, Electronics, at address below. Change of address notices should provide old as well as new address, including postal zip code number. If possible, attach address label from recent issue. Allow one month for change to become effective.

Postmaster: Please send form 3579 to Fulfillment Manager, Electronics, P.O. Box 430, Hightstown, N.J. 08520.

# A new digital phasemeter that's accurate to $.05^\circ$ ?

$.05^\circ$  accuracy and  $.01^\circ$  resolution  
continuous precision measurement  
from  $0^\circ$ – $360.00^\circ$

no  $0/360^\circ$  ambiguity, right down  
to readings as small as  $.01^\circ$

5 digit Sperry readout

accuracy unaffected by amplitude differences

frequency range 10Hz to 5MHz

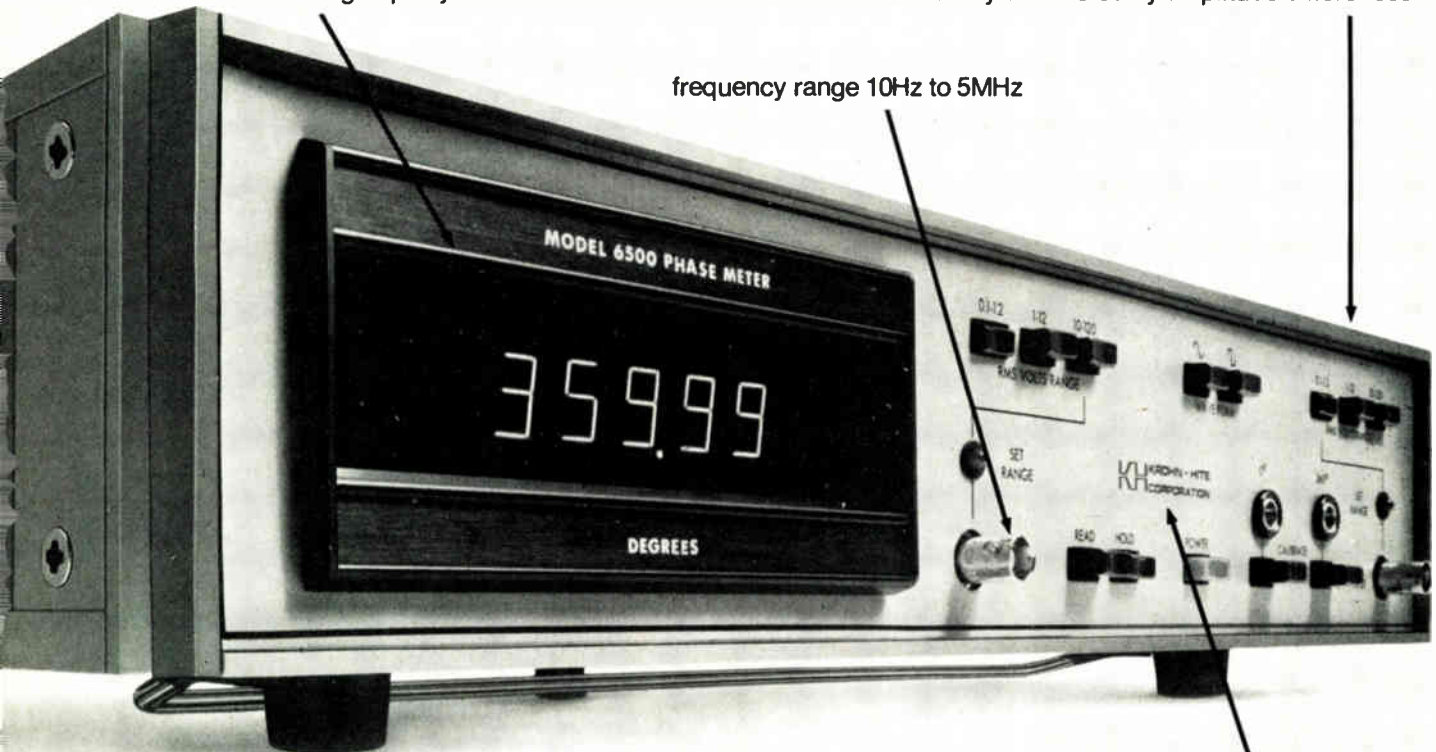

## Precisely.

and the best performance  
at the best price,  
only \$1995.—

for immediate action call  
(617) 491-3211, TWX 710  
320 6583, or contact your  
local KH representative,  
listed below.

## **KH** KROHN-HITE CORPORATION

SALES OFFICES: ALA, Huntsville (205) 534-9771; ARIZ., Scottsdale (602) 947-7841; CAL., San Jose (408) 292-3220, Inglewood (213) 674-6850; COLO., Denver (303) 934-5505; CONN., Glastonbury (203) 633-0777; FLA., Orlando (305) 894-4401; HAWAII, Honolulu (808) 941-1574; ILL., Des Plaines (312) 298-3600; IND., Indianapolis (317) 244-2456; MASS., Lexington (617) 861-8620; MICH., Detroit (313) 526-8800; MINN., Minneapolis (612) 884-4336; MO., St. Louis (314) 423-1234; N.C., Burlington (919) 227-3639; N.J., Haddonfield (609) 795-1700; N.M., Albuquerque (505) 299-7658; N.Y., E. Syracuse (315) 437-6666, Rochester (716) 328-2230, Vestal (607) 785-9947, Elmont (516) 488-2100; OHIO, Cleveland (216) 261-5440, Dayton (513) 426-5551; PA., Pittsburgh (412) 371-9449; TEX., Houston (713) 688-9971, Richardson (214) 231-2573; VA., Alexandria (703) 354-1222; WASH., Seattle (206) 624-9020; CANADA, Montreal, Quebec (514) 636-0525, Toronto, Ontario (416) 444-9111, Stittsville, Ontario (613) 836-4411, Vancouver, British Columbia (604) 688-2619.

Circle 5 on reader service card



# RAYTHEON DC WELDERS ARE ALIVE AND READY TO GO WHERE THE ACTION IS . . .

We have the broadest power range of DC welding equipment available.

If you want to weld the coolest package in town, contact the Marketing Manager, Raytheon Company, Production Equipment Department, 676 Island Pond Road, Manchester, N.H. 03103. (603) 668-1600.

RAYTHEON

## Readers comment

### Replicating ICs by X rays

**To the Editor:** Your article, "X-ray lithography highlights move to tiny IC patterns" [*Electronics*, May 30, p.29], does some injustice to our referenced conference presentation. Also it should have acknowledged that the original work on X-ray lithography was performed at Lincoln Laboratories.

The incorrect statements, such as "the X-ray technique appears to overcome some fundamental problems with electron-beam exposure of wafers," apparently resulted from a misunderstanding of our paper. We compare the X-ray technique to the parallel electron-image-projection technique. Electron-projection lithography does not use electron beams, but rather projects electron images onto the wafers.

On the other hand, direct electron-beam microfabrication will always be able to produce higher-resolution structures (about 0.05 micrometer), and for many applications, it is the most feasible technique. These two replication techniques complement direct device fabrication by electron beams by allowing batch production. The electron-beam systems are required to produce the high-resolution masks used for replication. In fact, we expect X-ray replication of device patterns will lag several years behind direct fabrication by scanning-electron-beam systems.

We would also like to clarify that we have not solved the problem of alignment, but have only proposed an approach that we believe can achieve an accuracy to 0.1  $\mu\text{m}$ . Also, "the technique appears about to emerge from the laboratory," would seem to be overly optimistic.

Paul Sullivan  
Hughes Research Laboratories  
Malibu, Calif.

### Converting solar energy

**To the Editor:** The article on solar energy [April 4, p.99] called photovoltaic devices the most simple and direct means of conversion known. This simplicity is of overriding value in space vehicles, but down here, the cost from sunbeam to power line is the important consideration.

Photovoltaic equipment does have a great future potential, especially for small to medium-size installations. For the real workhorse systems involving multi-megawatt stations, there are other means available for much lower-cost power. These systems use the energy as heat, rather than as photons.

The secret of high efficiency and low cost is in high-ratio concentration for power conversion at industrial-furnace temperatures. The technology is known, and materials are available for development of large conversion facilities. Such a plant would be environmentally clean and, of course, would not need the supply and processing of pellets. It appears that the cost could be as much as two to three times that of modern nuclear plants. However, this is at the beginning of the learning curve, and substantial reductions should be possible.

Warren M. Hubbard  
Consultant  
Chula Vista, Calif.

### Renaming the author

**To the Editor:** There was a minor error in the article, "Computerized text-editing and typesetting make headlines" [May 30, p.111]. My first name is Robert, not "Albert." I can't really object too much, however; if there were no errors in typesetting, there would be much less need for our system.

Robert L. Bushkoff  
Xylogic Systems Inc.  
Natick, Mass.

### Automating by voice control

**To the Editor:** I'd like to clarify your Update column [May 30, p.18] regarding the use of voice-encoding systems manufactured by Threshold Technology Inc. for automatic baggage-handling. Although other airlines have shown an interest in this equipment, systems have been sold and are being used only by United Air Lines and TWA. Additional systems, however, have been sold for other materials-handling applications.

Marvin B. Herscher  
Threshold Technology Inc.  
Cinnaminson, N. J.

# The last time someone announced 74C, it was a national campaign.



When we saw 74C coming down the tracks, we knew it would be the hottest and most logical CMOS line in a long time. Flags waved, bands played, and thousands of engineers suddenly found CMOS easier to design in. The only thing missing was Teledyne's big production volume and competitive pricing, and now you've got that too.

Here's what Teledyne 74C delivers: A mere 10 nanowatts per gate typical power dissipation. Operation on 3V to 15V power supplies. A big, guaranteed 1V noise margin. Typical noise immunity 45% of the supply voltage. Hefty outputs that drive MOS and bipolar logic (at least two LPTTL loads).

And 74C really simplifies design. 74C logic functions, pinouts and even numbers are identical to 7400 TTL, and every 74C device is compatible with every other 74C device. I/O specs are consistent (no interpreting a pile of data sheets to calculate what's compatible with what). Not to mention drastic cuts in the need for supply regulation, bypass capacitors and noise filtering.

The first batch is available now.

MM74C00	Quad 2-Input NAND Gate	MM74C107	Dual J-K Master-Slave Flip-Flop
MM74C04	Hex Inverter	MM74C160	Synchronous Decade Counter
MM74C20	Dual 4-Input NAND Gate	MM74C161	Synchronous 4-Bit Binary Counter
MM74C42	BCD-to-Decimal Decoder	MM74C192	Synchronous Up/Down Decade Counter
MM74C74	Dual D Flip-Flop	MM74C195	4-Bit Parallel-Access Shift Register

That's our national platform for 74C. But Teledyne's CMOS campaign has just begun. We'll soon be speaking softly about big values in proprietary devices compatible with 74C and custom CMOS for linear and digital applications. All with ultra-low power dissipation and high noise immunity.

 **TELEDYNE**  
**SEMICONDUCTOR**

1300 Terra Bella Avenue Mountain View, California 94043  
(415) 968-9241 TWX: 910-379-6494 Telex: 34-8416

**9102.**

# Remember the name. It's the best 2102 you can buy.

Specification	The Am9102	Anybody's 2102 including ours
*Stand-by Voltage	Guaranteed 1.6V DC Typical 1.0V DC	No Guarantee Typical 2.5V
*Stand-by Power	Guaranteed 64 mW Typical 16 mW	No Guarantee Typical 75 mW
Fan-Out	Guaranteed 2.0 TTL loads	Guaranteed 2.0 TTL loads
Access Time	Guaranteed .65 $\mu$ sec (9102) Guaranteed .50 $\mu$ sec (9102A) Guaranteed .40 $\mu$ sec (9102B)	Guaranteed 1.0 $\mu$ sec (2102) Guaranteed .65 $\mu$ sec (2102-2) Guaranteed .50 $\mu$ sec (2102-1)
Worst Case Noise Immunity	400 mV	200 mV
Logic Levels	TTL Compatible TTL Identical	TTL Compatible Not TTL Identical
Full Military		
Temperature Range	Yes	No
Power Dissipation	263 mW maximum	316 mW maximum
MIL-STD-883	Of Course	??

\*Retains data above guaranteed voltage.

We didn't invent the 2102. We weren't even the first alternate source. (And the way the device has taken off, we're obviously not going to be the last source.) We're just the best.

Advanced Micro Devices has something

better than the 2102: The Am9102.

If you want the traditional models, we've got them. But if you want more performance for no more money, if you want the most 2102 you can get, get the Am9102. Talk to Advanced Micro Devices, the next giant.

# Advanced Micro Devices

MEMORY

Corporate offices are at 901 Thompson Place, Sunnyvale, California 94086. Telephone (408) 732-2400/Southern California office: Beverly Hills (213) 278-9700/Mid-America: Des Plaines, Illinois (312) 297-4115/Edina, Minnesota (612) 835-4445/Eastern United States: Roslyn Heights, New York (516) 484-4990/Baltimore, Maryland (301) 744-8233/Lexington, Massachusetts (617) 861-0606/Britain: Advanced Micro Devices, Telephone Maidstone 52004/West Germany: Advanced Micro Devices, Munich, Telephone (089) 53 95 88.  
Southern Europe: Advanced Micro Devices, S.A., Neuilly, France, Telephone: 747-4194.  
Distributed nationally by Hamilton/Avnet and Cramer Electronics.

## TO BUILD SPECIAL UNITS MORE EASILY

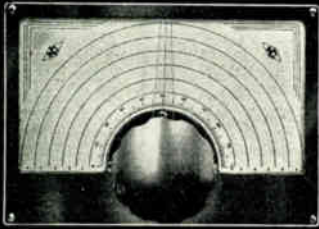

### A DIAL DESIGNED FOR INDIVIDUAL CALIBRATION

#### TYPE ACN DIAL

- Dial bezel acts as drilling template.
- Blank scales for direct calibration.
- Index holes in pointer for pricking calibration points.
- Scale removable without dismantling mechanism.
- Employs Velvet Vernier Drive Unit.

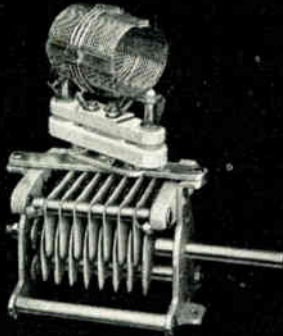

### A UNIT COMBINATION OF COIL AND CONDENSER

#### TYPE AR-16 COIL & TMK CONDENSER

- Plug-in coils fit swivel mount.
- Air-spaced coils or plain coil forms available.
- Low loss construction throughout.
- Rigid condenser frame for permanent calibration.
- Condenser mounts on panel, chassis or standoff insulators.
- Condenser capacities to 250 mmf.



### AN INSULATED COUPLING THAT WORKS AROUND CORNERS

#### TYPE TX-12

- Isolantite insulation.
- High quality flexible shafting.
- Fits 1/4" shafts.

NATIONAL COMPANY, INC.

MALDEN  MASS.

tions, permitting a multiplicity of resistance combinations on one complete unit. For switchboard mounting, insulators are available in 7.5, 15 and 30-kv sizes.

Westinghouse Meter Div., Newark, N. J.

## Relays

TWO TYPES OF LOCKING relays with electrical release are available for operation on any nominal voltage under 125 volts alternating or direct current.

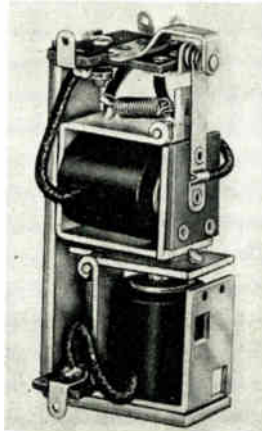

These are Type A.R.L. (top photo) which is a single pole double throw relay, and measures 1 7/8 x 2 7/8 x 1 inches; and Type A.J.L. (bottom photo) which is a double pole double throw relay and measures 3 1/2 x 1 3/4 x 1 inches. Features of these relays are: minimum mounting

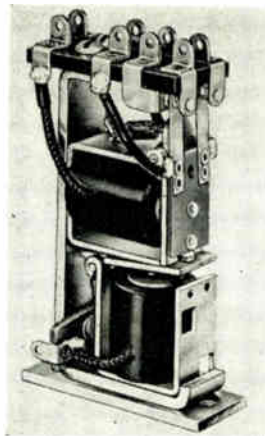

base area, small size and weight, ability to withstand vibrations. They have coils for momentary and continuous duty. The contact rating for Type A.J.L. is 5 amps non-inductive on 110 volts a.c., or 24 volts d.c. Standard operating voltages for both types are 6, 12 to 24 on d.c., and 6, 24 to 110 on a.c.

Allied Control Co., Inc., 227 Fulton St., New York, N. Y.

## New Carter AIRCRAFT TYPE GENEMOTORS

● **SENSATIONAL!!** That's the word for the new Carter Multi-Output Dynamotor. Since its introduction a year ago, Police Departments, Government Agencies, and manufacturers of Tank Radio Equipment have found it has no equal for small size, high efficiency, and extra light weight. It's the coming thing for all Transmitter and Receiver installations



● Write today for descriptive literature on Carter Dynamotors—D.C. to A.C. Converters—Magmotors—Heavy Duty Permanent Magnet Hand Generators—Special Motors—High Frequency Converters—Extra Small A.C. Generators—Permanent Magnet Dynamotors and Generators.

**Carter Motor Co.**  
CHICAGO ILLINOIS

1606 Milwaukee Ave. Cable: Genemotor  
Carter, a well known name in radio since 1922

## PLASTICS

VINYLITE - CELLULOID - ACETATE



**FABRICATED PARTS**  
Printed - Laminated

INJECTION MOLDING

DIALS, SCALES,  
WINDOWS, KNOBS  
AND SPECIAL PARTS for  
RADIOS, INSTRUMENTS,

—and—

COMMUNICATIONS and  
ELECTRICAL EQUIPMENT



PRINTING, DIE STAMPING,  
FORMING, MOLDING, ETC.



Bids cheerfully submitted

**THE EMELOID CO., INC.**

Plastic Fabricators Since 1919  
ARLINGTON, N. J.

# Announcing the Battery Status Indicator— a new LED/IC combination

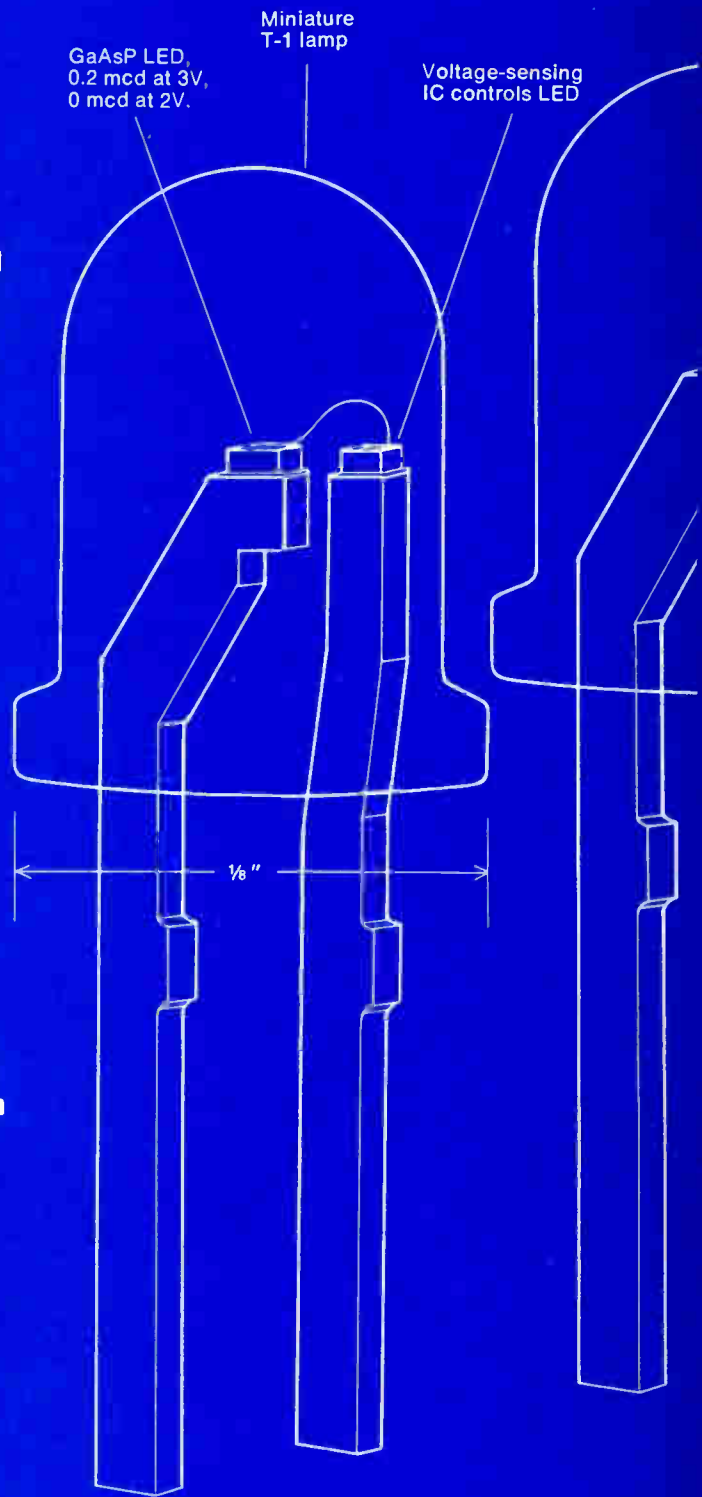

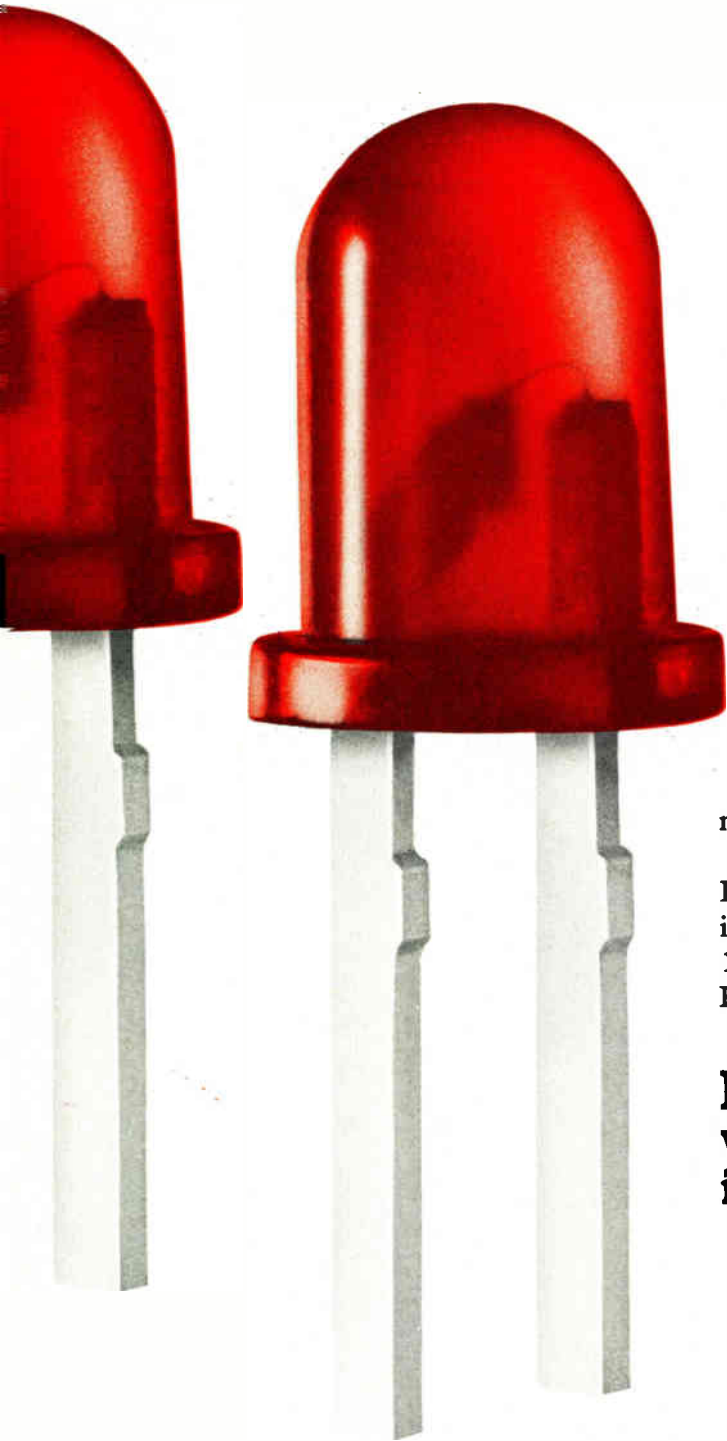

Dead batteries! Everyone hates 'em. And most battery powered equipment—cameras, tape recorders, calculators—don't warn you until it's too late.

Now Litronix—the world's largest manufacturer of LEDs—introduces the RLC-400 Battery Status Indicator. It's a red GaAsP warning light and voltage-sensing IC combined in one little T-1 lamp package. The light is on at 3V, off at 2V.

One of the nation's most prominent camera manufacturers uses it. Any battery-powered device that uses it may acquire an important competitive advantage at low cost.

The Litronix Battery Status Indicator will cost you only 60¢ in quantities of 1000. And you keep production costs down because you don't have to test, assemble and inventory several components.

If you need a warning light that goes on and off at different voltages, get in touch with us. We may be able to help you.

You can get a free sample of the Battery Status Indicator by writing us on your company letterhead. Or if you want more information quick, contact Litronix, 19000 Homestead Road, Cupertino, California 95014. Phone 408-257-7910. TWX 910-338-0022.

**No wonder  
we're No.1  
in LEDs**

**litronix**

Circle 13 on reader service card

# ENI

## THE WORLD'S LEADER IN SOLID STATE POWER AMPLIFIERS

Covering the frequency spectrum of 10 kHz to 560 MHz, ENI offers a full line of solid state power amplifier models with outputs ranging from 300 milliwatts to more than 1000 watts.

Capable of being driven by virtually any signal generator, frequency synthesizer or sweeper, ENI amplifiers are versatile and flexible sources of power for a wide variety of applications.

Completely broadband and untuned, these highly linear units will amplify inputs of AM, FM, SSB, TV and pulse modulations with minimum distortion. Although all power amplifiers will deliver their rated power output to a matched load, *only ENI power amplifiers will deliver their rated power to any load regardless of match.* ENI units are designed to internally absorb reflected power from a mismatched load.

Write to us for a copy of our *complete* catalog of amplifiers and power multicouplers.

### 3 WATT/MODEL 500L

- Flat 27 dB gain 2 MHz to 500 MHz
- 1.7MHz to 560MHz usable coverage
- Thin film construction
- 8dB noise figure
- Failsafe

### 40 WATT/MODEL 240L

- 20kHz to 10MHz coverage
- More than 40w linear power output
- Up to 150w CW & pulse output
- Works into any load impedance
- Metered output

### 20 WATT/MODEL 420L

- 150 kHz to 250MHz coverage
- 20 Watts power output
- Low noise figure
- 45db  $\pm$  1.5dB gain
- Class A linearity

### 100 WATT/MODEL 3100L

- 250 kHz to 105MHz coverage
- More than 100w linear output
- Up to 180w CW & pulse
- Works into any load
- Unconditionally stable



**ENI, 3000 Winton Road South,  
Rochester, New York, 14623.  
Call 716-473-6900.  
Or TELEX 97-8283 ENI ROC.**

## People

Gould's new research lab helps the divisions

Until recently, Gould Inc.'s electronic research centered on a couple of programs for ink-on-demand printing and semi-automatic transmissions for trucks. But the Chicago-based firm, which had \$600 million in sales last year, is stepping up those activities as research director Robert D. Carnahan begins channeling a healthy chunk of the company's research, development and engineering budget into a new electrical and electronic research laboratory.

Nonexistent a year ago, the lab today commands part of a sprawling site in Rolling Meadows, Ill., that's destined to become the corporate headquarters for the electrical, electronic, and automotive conglomerate. Carnahan's long-range strategy is for his lab to support the firm's electrical and electronic products divisions "by extending into areas that they can't address at operating levels."

Carnahan has added enough staff to reach what he calls "a critical mass. We can now define needs, configure programs, and develop a strategy that we can carry out," he explains. "From this point on, staffing will be tied to programs." Within two years, he expects the lab to be housing 70 people.

Gould's work with Dana Corp. on the semi-automatic truck transmission, and further work on a fully automatic version, points to one of the firm's goals. "We'll probably get into the heavy-duty truck market with electronics as our entrée," he says. "The field is rife with the need for on-board, off-board diagnostics, warnings systems, sensors, detectors, logic and signal transmission."

Carnahan holds a bachelor of science in metallurgical engineering and a doctorate in materials science, and much of Gould's projected research will also be basic in nature. "Part of our emphasis will be in solid-state materials and device physics," he says. "And that emphasis will lead us quite naturally into sensor device development and dis-



**Basics.** Gould's Carnahan is setting up research lab to back operating divisions.

play activities."

"There's a large opportunity in the general field of electronic ceramics for the development of thin-film devices using the kind of processes—vapor-phase vacuum deposition and sputtering—developed in the semiconductor industry," he points out.

Cox streamlines for steep growth

It's been a year and a half since 38-year-old Marshall G. Cox became president and chief operating officer of Intersil Inc. But only now, after some sharp pruning of the corporate product tree and more than a dozen top-level personnel changes, does he believe the semiconductor firm is poised to penetrate the markets it's best suited to serve.

In the lead at the Cupertino,

**Up, up and away.** Intersil's Cox cuts product types, gears up for strong sales.

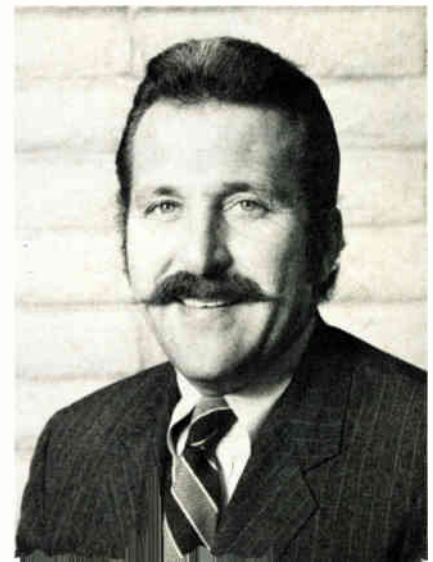



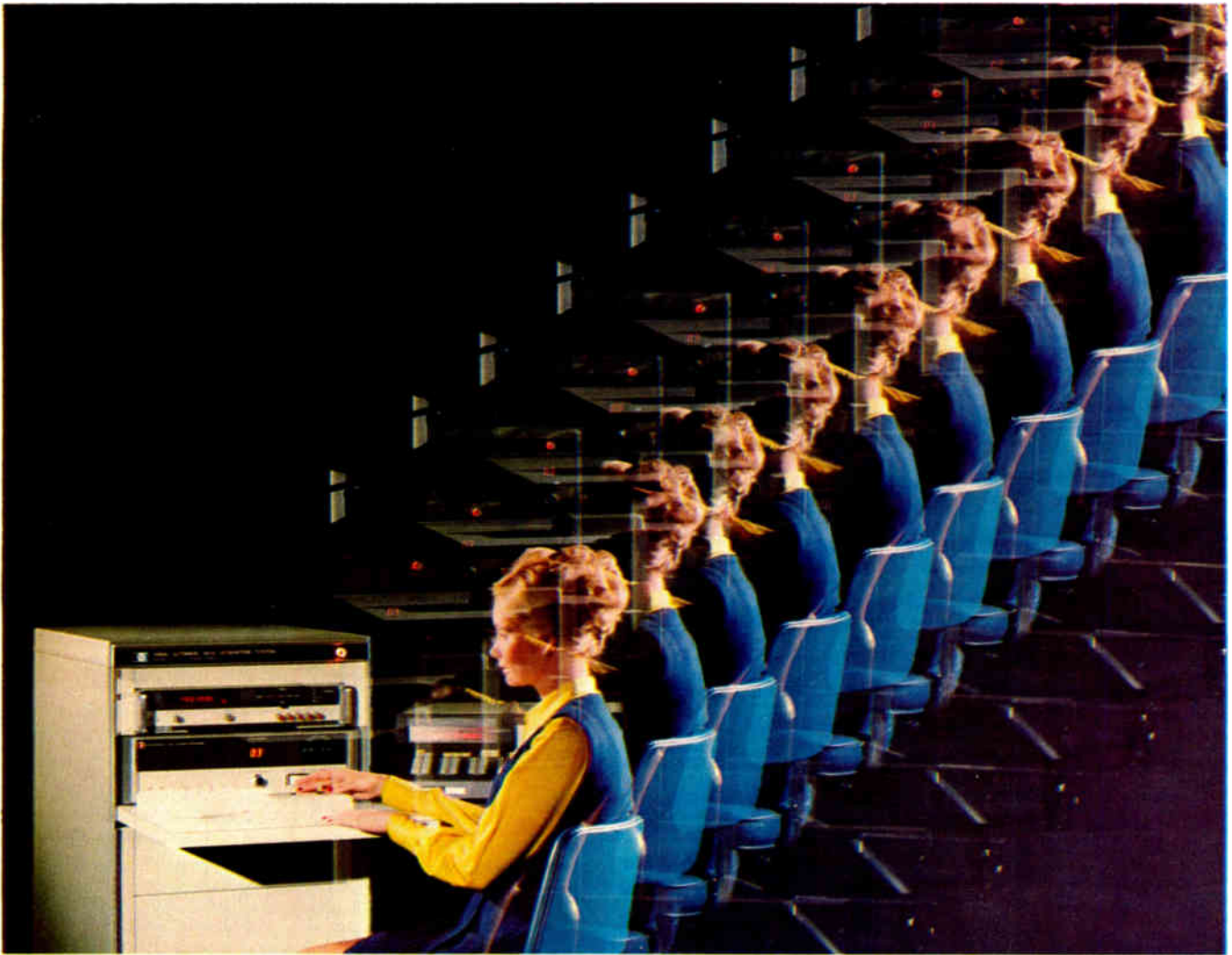

# Multiply your output...

...by adding one HP 3050A Automatic Data Acquisition System.

One 3050A can multiply your production output by as much as ten over manual test methods. Or, it can reduce testing time in R&D while boosting your testing capability. HP's 3050A eliminates most manual operations in AC V, DC V and Ohms Measurements. No more manual switching, no more visual monitoring or manual transcribing, no more data analysis... the unit's multi-channel scanner, DVM, and programmable calculator do all those things automatically. This system makes pass-fail decisions on the spot or prints out your test data, in the units you want, for rapid analysis. You get more efficient, more comprehensive testing while reducing testing errors.

Whether you have a manufac-

turing testing or an R&D application, easy-to-learn algebraic or BASIC programming language lets you program the system for your specific testing needs. You can select up to 100 individual channels, change ranges and functions on the DVM, analyze and store data, and print the results... all under calculator control.

Dry-reed relays and DVM resolution to  $1 \mu\text{V}$  lets you monitor low-level transducer outputs as well as large AC signals and DC levels to 200V. Computational power of the 9820A calculator controller (or optional 9821A and 9830A) allows you to do calculations and data analysis, thus eliminating data reduction tasks. You can convert measurements to engineering or scientific units, linearize and compensate transducer outputs, calcu-

late average values and standard deviation, perform design computations, and more... all automatically. And an optional page printer and X-Y plotter can save you hours preparing tabulated data and graphs.

Couple this capability with the system's operational simplicity—which lets you free skilled people for other tasks—and you can see why the 3050A is finding wide use in testing and data acquisition applications.

Contact your local HP field engineer for information on applying the 3050A to your testing situation. Or, write Hewlett-Packard.

094 48

**HEWLETT  PACKARD**

Sales and service from 172 offices in 65 countries.  
1501 Page Mill Road, Palo Alto, California 94306

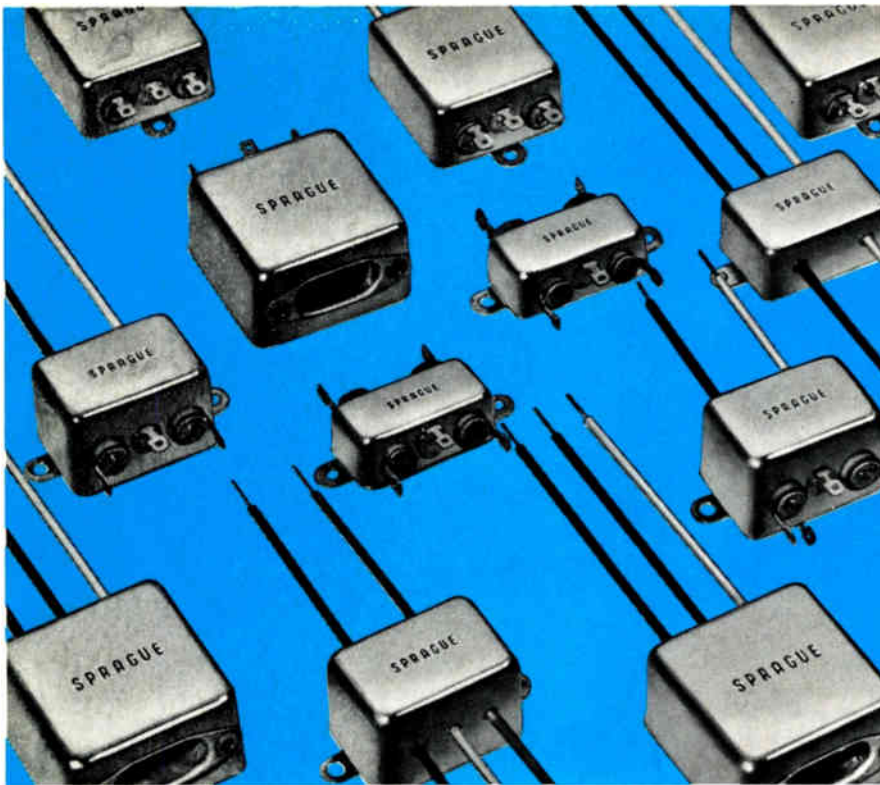

**FILTERS THAT WORK.  
FILTERS THAT FIT.  
FILTERS YOU CAN AFFORD.**

**Sprague JX5100 Series EMI Powerline Filters give you the right blend of efficiency/size/cost.**

The lower cost of these general-purpose filters makes them especially suitable for higher-volume production-assembled equipment such as computer peripherals, cash registers, credit card verifiers, electronic service instruments, etc.

Series JX5100 Filters are designed to protect equipment from line noise as well as to protect the line from equipment noise, particularly equipment with high impedance loads. Smaller in size than many filters with comparable performance, they control line-to-ground interference with a high degree of efficiency. Filtering both sides of the line, the need for two filters is eliminated.

Available in a wide variety of current ratings (1 to 30 amps) and several different terminal configurations, Series JX5100 Filters withstand a test voltage of 2100 VDC, assuring protection against high-voltage transients. Line-to-ground capacitance is only .01 $\mu$ F, and maximum leakage current (each line to ground, @115V, 60Hz) is 0.5mA.

Sprague maintains complete testing facilities for all commercial, industrial, and government interference specifications.

*For complete technical data, write for Engineering Bulletin 8210.11 to: Technical Literature Service, Sprague Electric Company, 35 Marshall Street, North Adams, Mass. 01247.*



**THE BROAD-LINE PRODUCER OF ELECTRONIC PARTS**

Calif. manufacturer will be many new faces recruited in recent months. Having served his own industry apprenticeship at Fairchild Semiconductor and Raytheon Semiconductor, Cox was not adverse to looking around for the people he wanted. From Litronix, for example, comes a new consumer product manager. From Fairchild, a senior process engineer now heads up pre-production R&D. The manager of microcomputer development is an old National Semiconductor hand, and so is the new manager of MOS process engineering, while the manager of bipolar process engineering is from Signetics.

Cox, who helped found Intersil Memory Systems (it merged in 1970 with its parent, Intersil), is concentrating on three product areas—precision analog devices, low-power consumer products, and memories. And he points out, for the record, that Intersil is now the only company to be producing bipolar and n-channel MOS and C-MOS memories.

Achieving this mix of technologies took at least one particularly hard decision—to abandon the p-channel process that Intersil had for long applied to random-access and read-only memories. But Cox is banking on the advantages of n-channel's higher speed.

The company last year doubled its sales to \$24 million and quadrupled its earnings. This calendar year Cox expects sales to jump to about \$40 million, next year to \$60 million, and by 1976 to be averaging a robust \$100 million. This is a far cry, indeed, from a company which as recently as 1972 Cox thinks could have been characterized as a small, high-technology company trying to serve too many market areas.

"We have situated ourselves very carefully in markets we believe will explode during the '70s and '80s," Cox says. "Semiconductor memories will average \$700 million by 1977 and \$1 billion by 1980. Precision analog circuits, now a \$100-million-yearly market, has been growing at a 25% rate, and consumer products such as electronic watches will rival sales of hand-held calculators in a few years."



**We'll go to any lengths  
to give you the best  
flexible-cable products.**

**Like our new matched-impedance transmission cable. It comes on a reel.**

**So you can cut it to the length—from inches to yards—to fit your particular specifications. That means you can forget about using short cable requiring a multitude of splices. Controlled impedance is available in popular ranges from 50 to 125 ohms. Apart from cutting, our transmission cable can be terminated at each end automatically—without cable preparation of any kind—when you use our insulation-displacement terminals. Because the cable is flat and flexible, it can be applied virtually anywhere: cable-to-cable, cable-to-discrete wire, cable-to-posts, cable-to-pc board.**

**Circle Reader Service Number 150.**

# Total capability: from cable to terminating equipment.

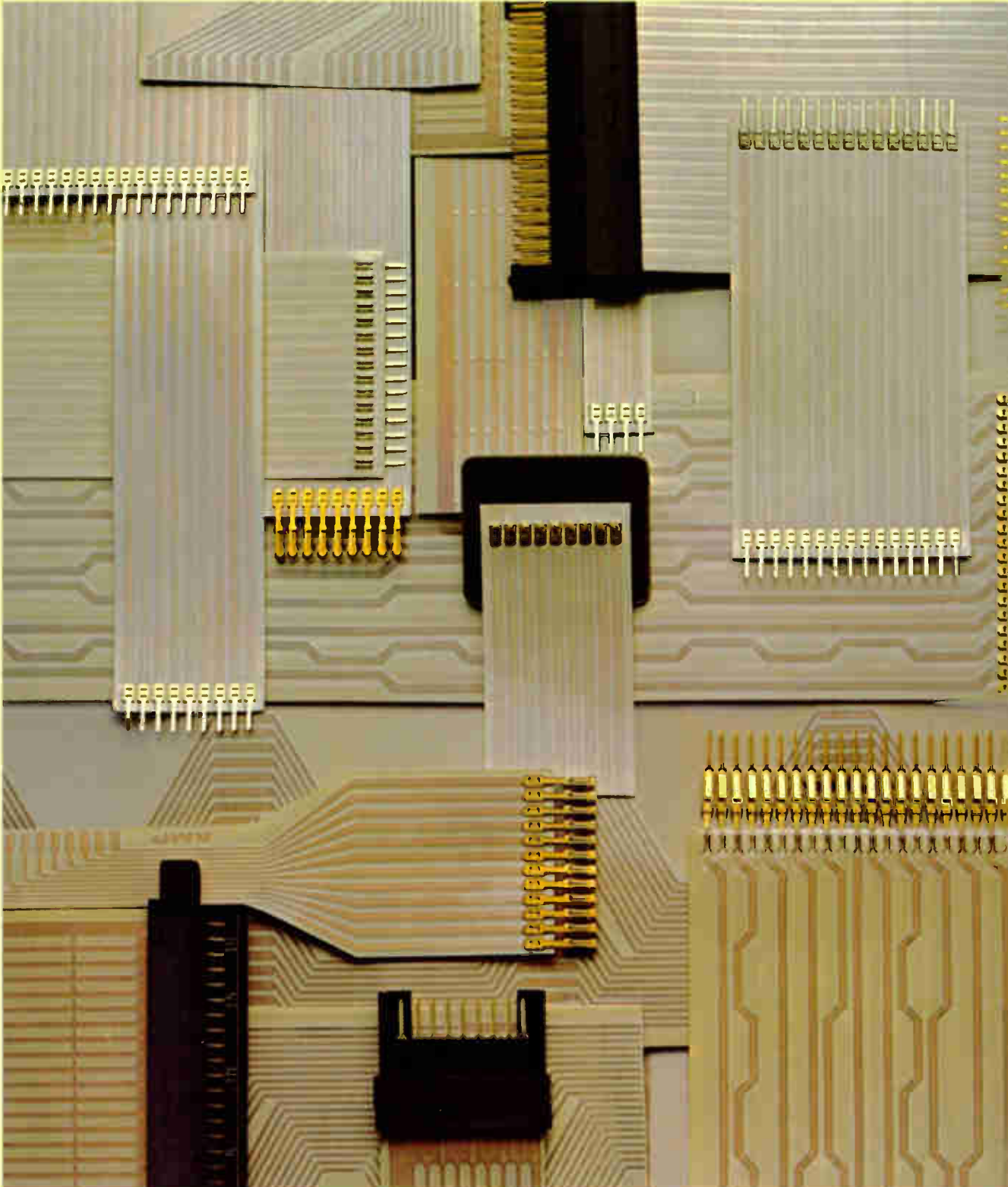



## **We do it all, so you can have it all.**

From one reliable manufacturer. Whether it's *parallel conductor cable*, pre-terminated jumper assemblies, or *flexible circuit patterns*, which give you compactness plus efficiency. In widths up to 22" .

## **A totally new idea in cable.**

We can also offer power and signal circuits, plus matched-impedance circuitry, on one cable. But best of all, we designed this unique "*combination*" cable to be cut incrementally.

## **The automatic way to low applied cost.**

We also supply application machines for flat cable assembly in your plant. At the lowest possible applied cost to you. And at the highest production rates possible. They're fast, reliable and easy. No need to prepare the cable. Just cut to length and our machine does the rest — economically.

# Are you still terminating leads on round-conductor flexible cable one at a time?

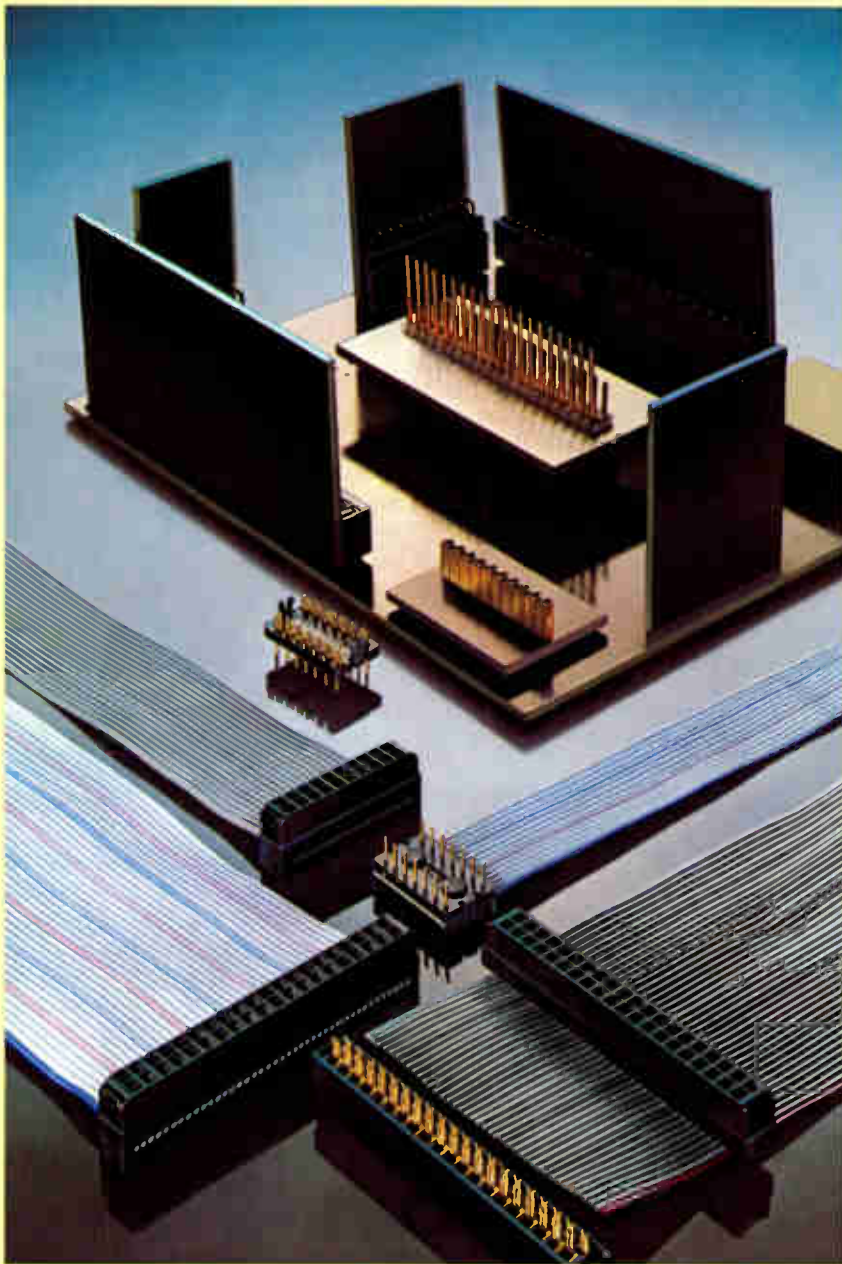

If you are, then it's time to be using AMP latch connectors. They let you terminate all leads simultaneously. Without pre-stripping or soldering.

These connectors are available in 10- to 60-position receptacles. And can mate with true .100 grid, two-row patterns of .025<sup>2</sup> posts. Inspection is simple—even during termination.

Our fork-type contacts provide redundancy and each locks into the cover for maximum point-of-contact pressure and cover retention.



Dual camming and latching beams on AMP contacts provide possible 4-point contact and positive locking for each connector cover.

Our versatile bench press terminates AMP latch connectors (Circle Reader Service Number 151) in seconds. And you can interconnect to pc-board spring sockets, DIP headers, directly to the board itself—or wherever high-density interfacing is required. Strain reliefs can be snapped on after termination and assembly.

AMPMODU post headers are available to accommodate AMP latch connectors. Our complete line includes single- and double-row, straight-through and right angles on .100", .125" and .150" center lines.

All in all, we have the experience and know-how to do just about everything for you. From cable to connectors to headers to terminating equipment. You can even have our cable with all connectors assembled and ready to plug into your equipment. So call (717) 564-0100 for more information. Or write AMP Incorporated, Harrisburg, Pa. 17105.

AMP and AMPMODU are trademarks of AMP Incorporated

**AMP**  
INCORPORATED

# ERIE RESPONDS. that's why WE'RE NO. 1 WORLDWIDE in Ceramic Capacitors



Forty years ago, ERIE foresaw a need and introduced the first ceramic capacitor to U.S. markets. Today, more than 7000 people—working in a million-plus square feet of plant space—in seven nations . . . are still dedicated to fulfilling customer needs. Our state-of-the-art ceramic technology continues to lead the way in the development of smaller, more efficient ceramic capacitors, both fixed and variable. And ERIE's line of high quality components is as broad as the markets we serve. So when knowledgeable people think ceramic capacitors, increasingly, they think ERIE. To remain number one in our competitive industry, we have to be responsive to your needs. We think we are. Try us.

ERIE TECHNOLOGICAL PRODUCTS, INC.  
Erle, Pennsylvania 16512



## Acorn Tube Socket

THE CERAMIC OF THIS new socket is of grade G Steatite, glazed on top and sides and impregnated in Cerese AA wax to prevent moisture absorption. It has very low losses at ultrahigh frequencies. Contacts are of grade C tempered phosphor bronze heavily silver plated to withstand 100 hours salt spray test, and are designed to hold the tubes with a minimum of insertion pressure under severe vibration tests. Contact jaws effect a scissor-hold on tube pin, and assure electrical contact. Another tube socket is of the lock-in type and utilizes a molded shell of mica-filled low-loss phenolic material for use at high frequencies.

A. W. Franklin Mfg. Corp., 175 Varick St., New York, N. Y.

## Vacuum Relay

THE PRINCIPAL OF ENCLOSING CONTACTS subject to arcing in a vacuum is used in a small, light weight antenna switching unit. The unit can handle an r-f potential of 20,000 volts at 30,000 feet altitude and provides instantaneous break-in for keying operations. The high vacuum prevents transfer of energy between the open contacts. The relay consists of a single pole double throw switch enclosed in a highly evacuated glass envelope. The armature when actuated by an external electromagnet transfers the circuit from receiver

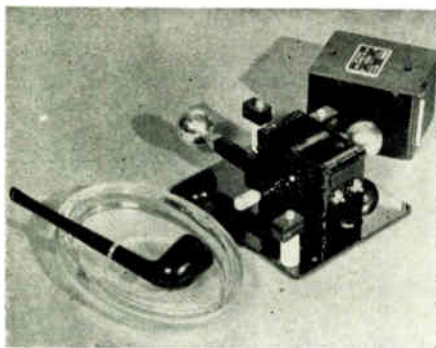

to transmitter. As the space between the open contacts is approximately 0.015 inches and because of the small mass of the armature, the transfer is fast enough for instantaneous break-in. This speed enables keying at 40 words per minute.

All maintenance is eliminated due to permanently fixed contacts which are enclosed in the glass envelope. This also makes the unit entirely independent of climatic conditions, altitude dirt or oxidation. Coils, which are capable of continuous operation, can be supplied for any of the common voltages. The unit weighs 24 ounces, including case, and measures 2½x5½x6¼ inches overall.

Bendix Aviation, Ltd., Burbank, Cal.

- *Laboratory Standards*
- Standard Signal Generators*
- Vacuum Tube Voltmeters*
- Square Wave Generators*
- U. H. F. Noisemeters*
- Pulse Generators*

*Measurements*

*Boonton*



*Corporation*

*New Jersey*



## ELECTRICAL COIL WINDINGS

Made To Specifications For

**PLANES — TANKS — SHIPS**

Radio Communication

Signal and Fire Control Equipment

Part of our production capacity, and all of our 25 years experience are available for war production. We're aiding scores of prime contractors to the Army-Navy-Air Corps and Maritime Commission

*May We Help You?*

Write - Wire - Phone

**COTO-COIL CO., INC.**

70 Willard Ave.

Providence, R. I.

Excellent Facilities for  
Electrical and Me-  
chanical Sub-contracts.  
Send for Facilities Rec-  
ord or Phone GAspee  
4371





# Interface your PDP-11 with a screwdriver.

Attention all you PDP-11 owners out there.

We've been watching you.

And a lot of you are doing the same kind of interfacing.

Hooking up standard peripherals. Converting analog signals to serial ASCII. Directly accessing storage memory. Hooking up remote instruments and custom peripherals that have BCD outputs. Doing the same thing over and over.

Hold it.

Our new DECKits can save you a lot of time and frustration.

DECKits are instant interfaces — basically just a few modules and a PDP-11 systems unit.

Just plug the modules into the systems unit, screw the unit into the PDP-11, and attach the connectors. Your equipment is interfaced.

There's no design time. No breadboarding.

No wirewrapping. The modules and design for each kit have been pretested and fully documented and are ready to solve your interface problem.

Start your interface now. Pick up your pencil and circle our number on the readers service card. We'll send you a complete description of all the DECKit interfaces now available.

We're Digital Equipment Corporation, Logic Products Group, Maynard, Massachusetts 01754. (617) 897-5111, extension 2785.  
In Canada: P.O. Box 11500 Ottawa, Ontario, K2H 8K8. (613) 592-5111.  
In Europe: 81 Route de l'Aire, 1211 Geneva 26. Telephone: 42 79 50.

**We think interfacing is so important,  
we've devoted an entire department to it.**

**digital**

## OPTO-ISOLATED SOLID STATE RELAY for

switching at 115 V.A.C. or 240 V.A.C.

13 amp continuous rating.

Zero voltage switch-on for low R.F.I.

Low level D.C. triggering 3 volts min.

High surge - 150 amp single cycle.

All solid state integrity.

Integral heat sink.

Used in:- Industrial Control, Office Machinery, Medical Electronics, Computer Systems.

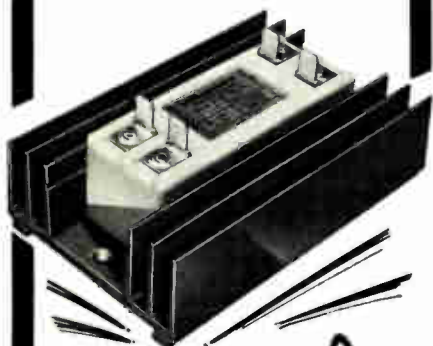

**FR**  
**ELECTRONICS LTD**  
 WIMBORNE - DORSET - ENGLAND  
 TELEPHONE: WIMBORNE 2442 - TELEX 41247

## Meetings

**Precision Electromagnetic Measurements Conference**, Royal Society, IEE, London, July 1-5.

**Electromagnetic Compatibility Symposium**, IEEE, San Francisco Hilton Hotel, San Francisco, July 16-18.

**Circuit Theory and Design Conference**, IEEE, IEE, London, England, July 23-26.

**Summer Computer Simulation Conference**, IEEE, Shamrock Hilton Hotel, Houston, Texas, July 24-26.

**The Second Jerusalem Conference on Information Technology**, The Jerusalem Economic Conference and its Computer Committee, Jerusalem, Israel, July 29-Aug. 1.

**IFIP Congress, International Federation for Information Processing**, IFIP, Stockholm, Aug. 5-8.

**Computer Communications International Conference**, IEEE, Stockholm, Sweden, Aug. 12-14.

**National Electronics Conference of New Zealand (Nelcon)**, New Zealand Section, IEEE, University of Auckland, Auckland, Aug. 26-30.

**International Congress on Data Processing**, AMK, Congress Hall, West Berlin, Sept. 4-7.

**International Switching Symposium 1974**, VDE, Sheraton Hotel, Munich, Sept. 9-13.

**Comcon Fall**, IEEE, Mayflower Hotel, Washington, D. C., Sept. 10-12.

**Western Electronic Show and Convention (Wescon)**, IEEE, Los Angeles, Sept. 10-13.

**Fourth European Microwave Conference**, Microwave Exhibitions and Publishers Ltd., Maison des Congres, Montreux, Switzerland, Sept. 10-13.

**European Solid State Devices Res. Conference**, Institute of Physics, IEEE, University of Nottingham, England, Sept. 16-19.

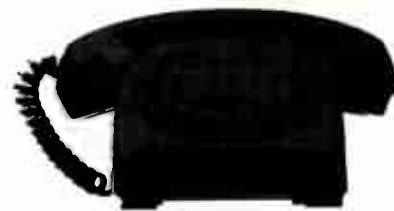

## Your closest SIGNETICS distributor is...

**ARIZONA**  
 Phoenix: Hamilton/Avnet Electronics (602) 275-7851  
 Phoenix: Kierulff Electronics (602) 273-7331

**CALIFORNIA**  
 Culver City: Hamilton Electro Sales (213) 870-7171  
 El Segundo: Liberty Electronics (213) 322-8100  
 Los Angeles: Kierulff Electronics (213) 685-5511  
 Mountain View: Hamilton/Avnet Electronics (415) 961-7000  
 Palo Alto: Kierulff Electronics (415) 968-6292  
 San Diego: Cramer Electronics (714) 565-1881  
 San Diego: Hamilton/Avnet Electronics (714) 279-2421  
 San Diego: Kierulff Electronics (714) 278-2112  
 Sunnyvale: Cramer Electronics (408) 739-3011

**CANADA**  
 Downsview: Cesco Electronics (416) 661-0220  
 Downsview: Cramer Electronics (416) 661-9222  
 Montreal: Cesco Electronics (514) 735-5511  
 Montreal: Hamilton/Avnet Electronics (514) 735-6393  
 Ottawa: Cesco Electronics (613) 729-5118  
 Ottawa: Hamilton/Avnet Electronics (613) 725-3071  
 Quebec City: Cesco Electronics (418) 524-3518  
 Vancouver: Bortek Electric Co. Ltd. (604) 736-7677

**COLORADO**  
 Denver: Cramer Electronics (303) 758-2100  
 Denver: Hamilton/Avnet Electronics (303) 534-1212

**CONNECTICUT**  
 Hamden: Arrow Electronics (203) 248-3801  
 Georgetown: Hamilton/Avnet Electronics (203) 762-0361  
 North Haven: Cramer Electronics (203) 239-5641

**FLORIDA**  
 Hollywood: Hamilton/Avnet Electronics (305) 925-5401  
 Hollywood: Schweber Electronics (305) 927-0511  
 Orlando: Hammond Electronics (305) 241-6601

**GEORGIA**  
 Atlanta: Schweber Electronics (404) 449-9170  
 Norcross: Hamilton/Avnet Electronics (404) 448-0800

**ILLINOIS**  
 Elk Grove: Schweber Electronics (312) 593-2740  
 Elmhurst: Semiconductor Specialists (312) 279-1000  
 Schiller Park: Hamilton/Avnet Electronics (312) 678-6310

**INDIANA**  
 Indianapolis: Semiconductor Specialists (317) 243-8271

**KANSAS**  
 Lenexa: Hamilton/Avnet Electronics (913) 888-8900  
 Lenexa: Hall-Mark Electronics (913) 888-4747

**MARYLAND**  
 Hanover: Hamilton/Avnet Electronics (301) 796-5000  
 Rockville: Pioneer Washington Electronics (301) 424-3300  
 Rockville: Schweber Electronics (301) 881-2970

**MASSACHUSETTS**  
 Burlington: Hamilton/Avnet Electronics (617) 273-2120  
 Newton: Cramer Electronics (617) 969-7700  
 Waltham: Schweber Electronics (617) 890-8484

**MICHIGAN**  
 Detroit: Semiconductor Specialists, Inc. (313) 255-0300  
 Livonia: Hamilton/Avnet Electronics (313) 522-4700  
 Troy: Schweber Electronics (313) 583-9242

**MINNESOTA**  
 Edina: Hamilton/Avnet Electronics (612) 941-3801  
 Minneapolis: Semiconductor Specialists (612) 854-8844

**MISSOURI**  
 Hazelwood: Hamilton/Avnet Electronics (314) 731-1144  
 St. Louis: Hall-Mark Electronics (314) 521-3800

**NEW MEXICO**  
 Albuquerque: Cramer Electronics (505) 265-5767  
 Albuquerque: Hamilton/Avnet Electronics (505) 765-1500

**NEW YORK**  
 Buffalo: Summit Distributors (716) 884-3450  
 Farmingdale, L.I.: Arrow Electronics (516) 694-6800  
 Rochester: Schweber Electronics (716) 328-4180  
 Syracuse: Hamilton/Avnet Electronics (315) 437-2642  
 Westbury: Hamilton/Avnet Electronics (516) 333-5800  
 Westbury: Schweber Electronics (516) 334-7474

**NORTHERN NEW JERSEY**  
 Cedar Grove: Hamilton/Avnet Electronics (201) 239-0800  
 Saddlebrook: Arrow Electronics (201) 797-5800

**SOUTHERN NEW JERSEY AND PENNSYLVANIA**  
 Cherry Hill, N.J.: Milgray-Delaware Valley (609) 424-1300  
 Moorestown: Arrow/Angus Electronics (609) 235-1900  
 Mt. Laurel, N.J.: Hamilton/Avnet Electronics (609) 234-2133

**CENTRAL NEW JERSEY AND PENNSYLVANIA**  
 Somerset, N.J.: Schweber Electronics (201) 469-6008

**NORTH CAROLINA**  
 Greensboro: Hammond Electronics (919) 275-6391

**OHIO**  
 Beechwood: Schweber Electronics (216) 464-2970  
 Dayton: Hamilton/Avnet Electronics (513) 433-0610  
 Cleveland: Arrow Electronics (216) 464-2000  
 Cleveland: Pioneer Standard Electronics (216) 587-3600  
 Kettering: Arrow Electronics (513) 253-9176

**TEXAS**  
 Dallas: Cramer Electronics (214) 350-1355  
 Dallas: Hamilton/Avnet Electronics (214) 661-8661  
 Houston: Component Specialties (713) 771-7237  
 Houston: Hamilton/Avnet Electronics (713) 526-4661

**UTAH**  
 Salt Lake City: Alta Electronics (801) 486-7227  
 Salt Lake City: Hamilton/Avnet Electronics (801) 262-8451

**WASHINGTON**  
 Bellevue: Hamilton/Avnet Electronics (206) 746-8750  
 Seattle: Cramer Electronics (206) 762-5722

# Hot line for Hi-Rel TTL.

Signetics is now on-call for total RB/RC/S TTL sourcing.

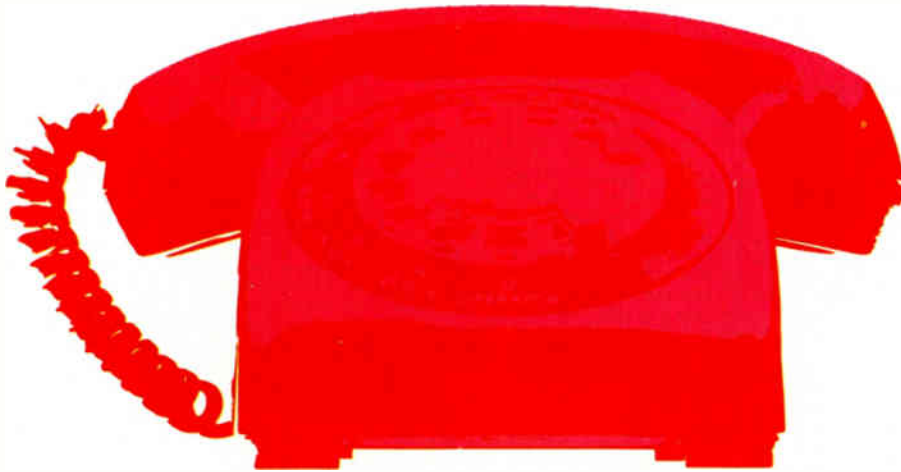

Not sometime. Not tomorrow. Today, when you need it. Hi-rel that looks like JAN reliability and acts like JAN reliability but comes cheaper and just as fast in RB, RC and S versions. The answer? Signetics MILrel Group. A major supplier of JAN ICs, and a super source for RB/RC/S from the people with the broadest TTL families in the industry.

Obviously, this kind of MILrel capability puts top-ranking quality into any hi-rel IC requirement. ASW, airborne computers, FC equipment, missiles, harsh-environment earthbound gear. What we can do for the generals' use, we can do for the general users. Yes sir, right away. In volume, straight from stock.

The Signetics MILrel Group is the only major Military IC supplier organized to support and service hi-rel customers exclusively. By our trained squads of hi-rel professionals, equipped to hustle up quick responses on price/delivery and order-status inquiries. The Signetics MILrel Group has also eliminated order foul-ups. There's simply no way to lose hi-rel parts in the huge volume of commercial runs. (That means less order-expediting, less production downtime, fewer headaches, and lower overall procurement costs.)

Signetics delivers any degree of specifications you stipulate. From full 38510 to RB, RC and S levels ... or even your own mix of processing requirements. And, in case your drawing has something other than RB/RC/S called out, here's a handy reference of equivalents to disperse the fog.

**signetics**

MIL-STD PREFIX/SUFFIX CROSS-REFERENCE CHART

SIGNETICS	T.I.	NSC	FSC
RB	SNC	BXX	QB
RC	SNM	CXX	QC
S	SN	DM54	M

And we can help you straighten out the tradeoffs. We've got the whole works in our definitive MILrel guidebook you can send for. It's an easy-to-grasp directory that takes you through the maze of applicable specs, certifications, reliability levels, slash sheets ... plus a comprehensive list of all our MILrel devices.

The clincher: over 90% of hi-rel products are on our distributor shelves at all times. Pick your distributor from the facing page, and one call gets results. Fast. For huge orders, that call summons immediate factory attention and scheduling. Call on Signetics for the fastest front-and-center MILrel delivery time in the industry.

CLIP THIS COUPON AND ATTACH TO LETTERHEAD FOR FAST ACTION

Signetics MILrel  
P.O. Box 3004-25  
Menlo Park, California 94025

On the double, send us your MIL/JAN/Hi-rel Guidebook, that makes sense of the Government's verbiage, and lists all those MILrel devices.

Name

Title

Mail Stop

Signetics Corporation, a subsidiary of Corning Glass Works, 811 East Arques Avenue, Sunnyvale, California 94086 (408) 739-7700



# **“When we shrunk our new CRT terminals, ‘real estate’ became critical. We had to go to copper-additive PCBs.”**

Chuck Serra, Manufacturing Manager, Applied Digital Data Systems.

“Our engineering people came to me with schematics for new CRT data terminals to package. They cut down on PC board area by 30% and added twice as many ICs. The only way I know to get this kind of density in thousand lot quantities is with photoprint additive boards.”

“We make terminals for about 40 OEMs, including some of the biggest in the business, as well as for hundreds of our own customers. I can’t afford to take chances.”

## **“We went to Photocircuits for a number of reasons:”**

“To begin with, Photocircuits developed the additive process so they know what it’s all about. Their product was right and so was their price.”

## **“Now I get 10-mil conductors with 10-mil spacing:”**

“Using the additive process with photoprinting, Photocircuits gives me the kind of density I have to have, in the quantities I need.”

“I also like the extra reliability of plated-through holes and soldermask on both sides of the board. This eliminates bridging, slivering and mini-void problems. Saves me a lot of touching up.”

## **“We’re a customer-oriented business, so I look for suppliers cut from the same cloth.”**

“I’m always making facility checks, unannounced. The first thing I look at is people, since PCBs are a highly-skilled business working to very close tolerances. At Photocircuits, everybody, from the top to the bottom, impressed me. I like their work and I like their attitude. In fact, when I asked about service, they gave me their home phone numbers willingly.”

## **“It sounds like I’m a shill for Photocircuits, but I’m not!”**

“Frankly, if they ever reneged on a promise, I’d jump on them with both feet. But I doubt if that would ever happen. In the 25 years I’ve been buying PCBs, Photocircuits has been the best supplier I’ve dealt with. On a scale of 1 to 10, with 10 being perfection, Photocircuits would get a 9. Everyone else would get a 7 or less.”

“It’s just that Photocircuits never let me down. When I needed something in a hurry, they gave it to me. And they’re genuinely nice people.”

“If they weren’t, I wouldn’t have agreed to do this ad.”

## **Photocircuits**

Division of Kollmorgen Corporation, Glen Cove, New York 11543 (516) 676-8000  
**Printed circuitry for mass-produced electronics**

# There's only one cermet film resistor with enough design improvements to set a new standard of quality.

Ultra thick solder coated wire leads are both weldable and solderable.

Capless design does away with problems associated with end cap construction.

Conformal coating provides outstanding insulation properties.

Alumina core is physically and thermally strong to resist fractures.

Crisp, clear, dual markings for easy identification.

We blended our extensive fixed resistor knowhow with 15 years of cermet experience to produce an outstanding cermet film resistor. And we've developed unique manufacturing techniques that let us provide consistent quality.

Available in preferred resistance values (E96 Series) from 10 ohm to 1 meg; higher values available on special order. 1/4 watt at 70°C; 1/8 watt at 125°C; 1% tolerance; 100 PPM. Size 0.250 L. by 0.090 D.

Available in tape reels if you prefer.

Approved to MIL-R-10509 for Style RN55, Characteristic D. Write Allen-Bradley Electronics Division, 1201 South Second Street, Milwaukee, Wisconsin 53204 for complete technical details on Type CC. International Division, Milwaukee, Wisconsin 53204. Canada: Allen-Bradley Canada Limited, Cambridge, Ontario. United Kingdom: Allen-Bradley Electronics, Limited, Jarrow, County Durham NE32 3EN.

**If you're really serious about cost, be serious about quality.**



## **Intel broadens computer-chipline with bipolar LSI**

Intel's drive to supply all segments of the LSI processor and computer-chip market by the end of the year is apparently on schedule. Two new chip designs are being planned for production—a more powerful version of Intel's 4004 microprocessor chip, software-compatible with the 4004, and the firm's first bipolar-LSI computer chips, a 6- or 7-chip set that is expandable by two-bit increments to cover the entire middle-level computer range.

Scheduled for entry in the fall, Intel's bipolar chips, are built with Schottky TTL technology. With cycle times as low as 70 nanoseconds, the new line is clearly capable of impacting the heart of the minicomputer market. Some chips in the set are: the microprogramed control unit; the arithmetic register unit; the carry and look-ahead chip; and a priority-interrupt chip.

## **Tau-Tron builds 1-GHz digital tester**

Tau-Tron Inc., known for its high-speed test equipment, is pushing speed even higher with its new 1-gigahertz test set for measuring bit-error rate. Scheduled for production by the end of September, the set is aimed at digital satellite, coaxial cable, millimeter wave, laser/optical fiber, and microwave radio communications. **Most communications testers generally stop at 150 megahertz.** Although Takeda-Riken of Japan has sold some 1-GHz test sets in the U.S. for close to \$50,000, Tau-Tron hopes to sell its set for less than \$25,000.

To get the speed, the company says it has adapted old-hat technology, **using commercially available high-speed emitter-coupled logic.** The set contains the MN-2 pseudo-random data generator, which produces a pseudo-random sequence at bit rates from 200 MHz to 1 GHz and excites the system under test.

## **RCA to invest \$27 million in Brazilian TV plants**

Using \$15 million in equity and \$12 million to be raised on the local capital market, RCA Corp. is setting up television plants in Brazil. **The agreement calls for export of \$380 million in products by January 1984.** The products involved include color and monochrome receivers for export and the local market, color modules and advanced solid-state assemblies for export, and black-and-white and color sets earmarked for other South American countries. Specific models and screen sizes have not been decided yet.

## **15 savings banks to set up funds exchange**

Fifteen Washington State savings banks and savings and loan institutions have been given the go-ahead on a joint-venture pilot project to **set up an electronic banking center** at a Bellevue, Wash., shopping mall near Seattle. The center will be electronically equipped to handle all deposits, withdrawals, mortgage payments, and funds transfers for the 15 banks. Customers will use plastic cards issued by the sponsors.

## **Burroughs ARTS-2 bid \$10 million below competitors'**

Burroughs Corp.'s low bid of about \$7.6 million for the FAA's Automated Radar Terminal System 2 (ARTS) is seen by competitors as notice that the company intends to "buy into" the market; **one industry source called the bid "astonishingly" low.** Lockheed's \$19.7 million bid was the highest and the three largest manufacturers of complete control



systems—Lockheed, Sperry Rand, and Cutler Hammer's AIL—each bid at least \$18 million for the contract to make 73 terminals for medium-density airports.

## **Mostek sampling first micro chip**

Mostek has been quietly sampling its first microprocessor, a p-channel ion-implanted depletion load device that the firm says is **at least as fast as the Intel 8080 in some applications**. Developed for a European terminal manufacturer and in production for the past six months, the chip's instruction set is organized for I/O applications—three classic accumulators on one chip offer two priorities of interrupts, and the I/O instructions use a ninth-bit flag so a peripheral can notify the processor that it's ready to accept output.

## **Congress to approve major U.S. purchases of computers**

The Internal Revenue Service and the Veterans Administration plan computer purchases of \$150 million and \$45 million, respectively. **The purchase, plus other major government computer orders, will be submitted to Capitol Hill for prior approval**—a move calculated to cool congressional criticism of the General Service Administrations's EDP policies.

## **Univac bubbles get 16,000 bits on 150-mil chip**

Sperry Univac's magnetic-bubble research project has succeeded in packing up to 16,000 bits on one chip approximately 150 by 150 mils. **This corresponds to 1.41 mil<sup>2</sup> per bit**, compared to 3.55 mil<sup>2</sup> for an experimental IBM MOS dynamic memory [*Electronics*, March 1, 1973, p. 38], 1.1 for an experimental IBM bipolar memory and 2.81 for the most recent bubble memory developed at Bell Laboratories.

William Doyle, manager of the project, sees a prospect within a couple of years of getting four times as many bits on a larger chip at the same density, using conventional photolithographic techniques to lay out the magnetic structure on top of the bubbly film. Eventually, predicts Doyle, **densities 36 times as great as those now attained will be achieved with electron-beam lithography, or 25 bits/mil<sup>2</sup>**.

## **TI readies line of tin sockets**

Designers bent on shaving precious pennies should look at a new line of tin-plated IC sockets to be introduced by TI in Attleboro, Mass. The latest version of TI's low-profile DIP sockets, **the new versions substitute tin for gold inlay on the contacts**. A 14-pin socket is priced at 8 cents in volume—about 25% less than gold-inlay sockets.

## **Addenda**

The first mile-long section of millimeter waveguide tubing will be placed in position in northern New Jersey in August as part of the Bell System's super-capacity transmission system. The project eventually will transmit 230,000 phone calls simultaneously, **twice the capacity of the most advanced coaxial systems now operating**. The waveguide, a hollow 2.5-inch tube inside a protective sheath, will carry digitally coded voice, data, and TV at 40 to 110 gigahertz. . . . AII Systems of Moorestown, N.J., says its shipboard satellite communications terminal, Seacomm, has received L-band signals from ATS-6. **This is believed to be the first reception by a commercial shipboard terminal from the NASA satellite.**

# Better than any IC or UJT for low cost timing circuits.

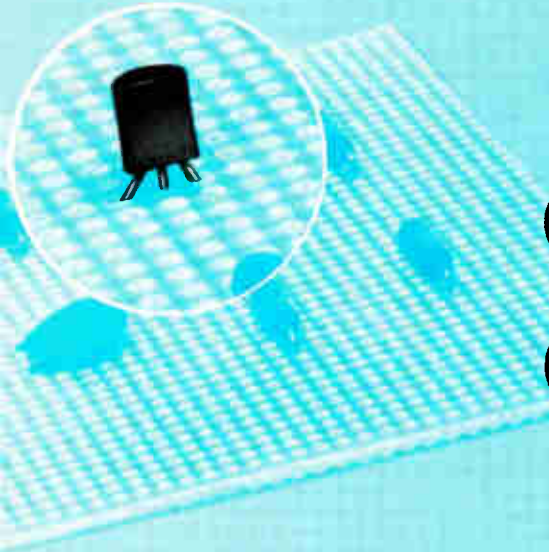

Unitrode PUTs provide design freedom unobtainable with conventional UJTs—at a fraction of the cost of comparable ICs or mechanical timing circuits.

By varying the external resistor values you can program turn-on voltage, turn-on current and turn-off current to meet your needs . . . in timing circuits, oscillators, sensing circuits or any application where a variable voltage level threshold is required.

## Unitrode Programmable Unijunction Transistors (PUTs)

Simple, versatile, low cost Unitrode PUTs meet the performance require-

ments of any timing circuit in frequencies from 50 KHz to .001 Hz, from microseconds to hours.

Millions of Unitrode PUTs have already cut costs in thousands of applications from smoke detectors and television sets to office machines and industrial processing systems. In fact, Unitrode produces a larger selection of PUTs than all other manufacturers combined. Fully planar passivated . . . low nano-amp leakage for long interval timing . . . in the plastic TO-92 and TO-98 package, and the hermetically sealed TO-18 package.

Send for a free sample. We'll also include data sheets and application notes to help you breadboard the lowest cost timing circuits ever.

Or, for faster action, call John Upton at (617) 926-0404. Unitrode Corporation, 580 Pleasant Street, Watertown, Mass. 02172.

### Try a free sample

Circle 31 on reader service card

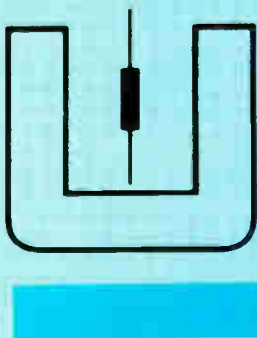

# UNITRODE

580 PLEASANT STREET, WATERTOWN, MA 02172

# ALLIED GLASS BASE RECORDING DISCS

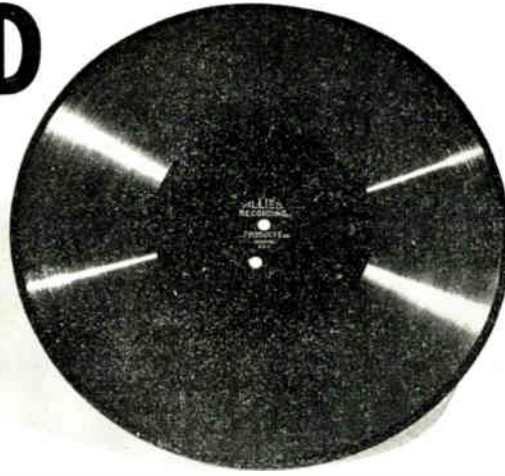

**FOR** six years, Allied has manufactured top quality, professional recording discs for an increasing number of critical users. Our change-over from aluminum to glass base discs was successfully accomplished more than a year ago. Control in manufacture, close inspection, and constant care in every manufacturing, packing and shipping detail—results a one quality, first quality line—guaranteed to be uniform whether you order one or a thousand discs. Our regular customers continue to send us repeat orders—indicating satisfaction. If you are not using Allied Glass Base Discs, a trial will convince you of their merits and superior quality. Your inquiry will receive our prompt and courteous attention.

**RECOATING SERVICE** for your old aluminum discs. Delivery in one week. Details on request.

It is economical and saves you money to buy direct from the manufacturer. **PROMPT DELIVERY** to any part of the United States, Canada, South America and some foreign countries.

## ALLIED RECORDING PRODUCTS CO.

21-09 43rd Ave.,

Long Island City, N. Y.

Phone: Stillwell 4-2318

Cable: Allrecord New York

## A MESSAGE TO ELECTRICAL DESIGN ENGINEERS .....

*of radio, communication, electrical, air-  
craft, automotive and  
electronic equipment*



B & C insulation materials include: Varnished Tubing, Saturated Sleeving, Varnished Cambric, Varnished Paper, and Extruded Plastic Tubing—all of the highest quality—manufactured to A.S.T.M. standards.

B & C insulation products are now being used in constantly increasing quantities and uses in the defense industries—including radio and electrical equipment and components, aircraft plants, leading industrials, and by many government departments.

We will welcome the opportunity to work with you on your insulation problems. Send us your specifications. Samples and prices will be submitted promptly. Our accelerated manufacturing schedule is now in operation.

## B & C INSULATION PRODUCTS, INC.

22 WEST 21st STREET, NEW YORK, N. Y.

CHICAGO OFFICE : 831 NO. WABASH AVE.

Sales representatives in principal cities

● Free sample display board  
=442 of tubing sent upon  
letterhead request.

## Low-Frequency Linear-Time-Base Generator

THIS PORTABLE GENERATOR (Type 215) is for use where oscillographic studies require sweep frequencies as low as one cycle every few seconds. It may be used in conjunction with an oscillograph provided with a long-persistence cathode-ray tube, or with photographic recording methods. Vibrations studies, stress and strain measurements, low-frequency electrical observation, electrocardiography and electroencephalography, may also be studied. The frequency range of the instrument corresponds to rotating speeds of 12 to 7500 rpm. Transient observation is provided for by a single-stroke sweep circuit. The generator provides a sweep frequency range of 0.2 to 125 cps. The maximum undistorted output signal is approximately 450 volts peak-to-peak, balanced to ground. The single sweep is initiated either manually or by an observed signal. Linearity is assured by a compensating circuit. It measures  $14\frac{1}{2} \times 8\frac{1}{2} \times 19\frac{1}{2}$  inches, and is rated at 115 or 230 volts alternating current, 40-60 cps. Power consumption is 50 watts and fuse protection is 1 amp. The primary voltage is selected by a switch in the instrument.

Allen B. DuMont Labs., Inc., Passaic, N. J.

## Thin Slot Insulations

TO PROVIDE NON-BULKING SLOT insulation for use in confined or limited space, a new thin type of insulation, called "Irv-o-slot" is available in seven different thicknesses, dielectric strengths and advantages. "Irv-o-slot" insulation consists of fish or Spauldo papers coated with resin, or bonded by means of a plastic insulator, to cambric, silk or Fiberglass. These insulations possess strength and toughness as protection



against mechanical stresses, and have high dielectric strength. The duplexed "Irv-o-slot" and Spauldo paper have good heat resistance. The bonded insulations have high moisture resistance. The insulation is flexible and easy to form. It is available in sheets and also tape form ready to be cut into slot strips.

Irvington Varnish & Insulator Co., Irvington, N. J.

# PROGRAMMABLE UNIUNCTIONS

## VERSATILITY

General Electric's 2N6027, 28 series programmable unijunction transistors (PUTs) continue to fascinate designers.

With just two resistors, you can vary key parameters ( $\eta$ ,  $R_{BB}$ ,  $I_P$ ,  $I_V$ ) of the PUT. It's like being able to design the ideal component for your circuit. Low leakage current and low peak point current permit use in long interval timer circuits...and they're excellent SCR trigger devices thanks to their fast, sure high-output pulse. GE PUTs, in plastic TO-98 packages, invite new applications... especially where performance and cost are important.

## GE EXPERIENCE

GE invented the unijunction...has manufactured and sold more unijunctions than anyone else...published most of the application notes on unijunctions...and offers users over 56 different unijunction types.

PRACTICE MAKES PERFECT.

## FREE DESIGN KIT

Available from any authorized GE distributor or by writing to General Electric Semiconductor, Electronics Park, 7-49, Syracuse, NY 13201,...includes PUT samples, specification sheets and useful application notes.



REMEMBER...for UNIUNCTIONS  
**it's still GE**

GENERAL  ELECTRIC

## Video compression may help jam-proof RPV communications

Air Force Avionics Lab seeks acceptable TV pictures using one to two bits per picture element

The Air Force wants anti-jam telemetry for airborne data links. And it is asking the Avionics Laboratory at Wright-Patterson Air Force Base, Ohio, to provide it. Early results have been encouraging, and the lab is building experimental hardware for bandwidth compression of TV video from remotely piloted vehicles. Most anti-jamming techniques are classed as spread-spectrum—increasing the bandwidth to force the opponent to distribute his power over a wider spectrum. But the bandwidth is usually compressed before being spread because the larger the difference between initial and spread bandwidths, the more jam-proof the transmission is.

The lab's effort resembles that directed at Picturephone-type digital imagery and satellite educational TV applications, except that it ignores the esthetics required for commercial pictures in favor of the minimum information needed to recognize and acquire RPV targets. Thus, by using spatial transforms, the information transmission branch of the laboratory's Systems Avionics division hopes to be able to represent each picture element in a 512-by-512-element video scan frame with only one or two bits. That's an important reduction from the six bits used in normal pulse-code-modulation techniques to describe each element with one of 64 differ-

ent shades of gray. This adds up to 1.5 million bits per 512-by-512-element frame, and, since 30 frames per second are typically transmitted, PCM techniques use 48 to 50 megabits per second.

"Our goal is to get that down to one megabit per second," notes John S. Flatz, technical manager of the information transmission branch. And toward that end, his group is also trying to reduce frame rate. So far, indications are that

elements each, and these are transformed by a computer that simulates a hardware processor, to be completed this fall. The transform hardware, which will process the pictures in real time, will use about 50 off-the-shelf chips, Noble estimates.

Video scan input from the RPV's TV camera would first go through an analog-to-digital converter module and be held for processing in memory—in the final hardware, pos-

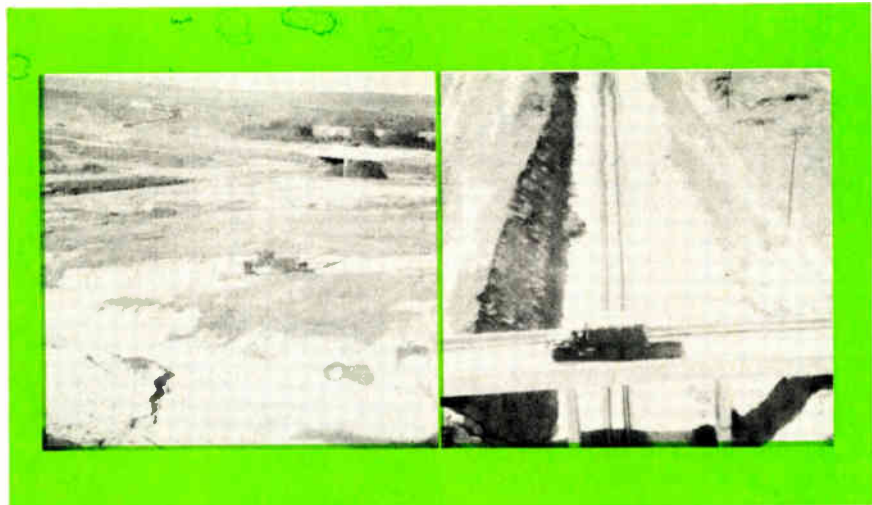

**Band squeeze.** Working from digitized photos, the Air Force's experimental band-compression scheme shows promise for target acquisition. Targets are discernible even though photos have been transmitted with an average of only two bits per picture element.

eight frames a second may be adequate for a human monitoring the pictures to identify a target from the RPV's video transmission, says Capt. Stephen C. Noble, project engineer for video compression. "Frame rates slower than 16 per second, in any case, would require a memory to store and repeat frames to reduce flicker."

Each frame is divided into 4,096 subpictures of eight-by-eight picture

sibly in six 4,096-bit RAMs. Since Noble is performing the transforms sequentially in the eight-by-eight-element subpictures, memory will be needed to store eight lines of picture information. The arithmetic logic unit in the hardware processor will be built out of Schottky transistor-transistor logic, and from there, the transformed picture information will be interfaced, perhaps through a buffer, to the RPV's communi-

cations equipment for relay.

The arithmetic logic unit is designed to perform two-dimensional, frequency-domain-type transforms using either Harr or Hadamard transforms, and it can be converted from one to the other by changing a read-only memory chip. Like the similar discrete Fourier transform, Harr and Hadamard versions change the information in the picture without significantly altering its meaning. But unlike the Fourier transform, they do not require multiplication during processing. This, Noble says, simplifies the ALU to an add-subtract module and reflects an effort to keep the on-board hardware for the pilotless planes to a minimum.

“Transform coding basically changes the elements into a new form, because that new form has some properties we want to exploit,” Noble explains. “In this case, we know that there’s redundant information in a picture, but it’s hard to sort it out in the picture domain. Putting it into the transform domain allows us to eliminate redundancy.” The 64 picture elements in each of the subpictures that make up a frame are transformed into 64 transform coefficients, only about half of which contain picture information. Efficiently assigning bits to the important coefficients is how the reduction in average bits per element, and therefore reduction in bandwidth, is achieved. □

different frequencies spread between 38 and 45 kilohertz,” says Robert Williams, manager of Magnavox’ tuner and remote engineering section. “When we detect the presence of an ultrasonic signal from the transmitter, an amplifier feeds it into a countdown circuit on the LSI chip, which counts to that frequency.”

Proprietary circuitry guards against false triggers—only a definite pulse duration and amplitude will activate the circuitry, thus differentiating the transmitted signals from the harmonics of the horizontal flyback transmitter or other signals in the horizontal section.

Each frequency is decoded immediately, and signals from the function keys are acted on immediately. “Because channel address is a two-digit entry, signals from the 10 numerical keys are stored for a second entry,” adds Williams.

Volume-control signals are fed to an on-chip audio step-attenuator that produces stair-step voltages in 16 discrete steps. These are applied to a voltage-control-gain block that raises or lowers the volume.

“The tuning system is a birdie counting scheme for varactor tuning,” Williams says. In essence, it’s a modified frequency-synthesis technique. “A single oscillator generates

## Consumer electronics

### MOS chip in remote-control unit helps tune TV set electronically

Most TV manufacturers admit the inevitability of all-electronic tuning. And most have several different schemes in the laboratory for doing away with such things as tuned circuits in the remote-control section, potentiometers in the tuner circuitry, and electromechanical channel displays on the front of the set. But Magnavox Co. has gotten to the market first with a top-of-the-line chassis that integrates most remote control, tuning, and display functions on a single 200-by-200-mil metal-oxide semiconductor chip.

Dubbed STAR—an acronym for silent tuning at random—the Magnavox system features a 6-inch-high channel number that appears on the TV screen, then shrinks to a point and disappears within three seconds, plus an ultrasonic-frequency remote-control transmitter that resembles a hand-held calculator. Two-digit channel numbers are punched on a 10-digit touch pad on the handset to give instantaneous access to all 82 vhf and uhf channels. Channels can be selected at random. In addition, function keys on the remote handset provide on-

off, mute, and volume control and channel-display recall.

Discrimination among the ultrasonic tones is done digitally within the p-channel chip, which is supplied by Mostek Corp. “From a basic frequency, we synthesize 15



**Electronic tuning.** Channels are displayed right on the TV screen in Magnavox tuner that replaces electromechanical tuning devices with a portable hand-held remote control set.

a series of pulses at 6-megahertz harmonic intervals, and each pulse represents a particular channel. When a channel function is activated, the circuitry starts counting the birdies until it reaches the channel," he explains.

For channel display, Magnavox has designed a standard character generator onto the chip. When new channel information is detected, or when the channel-recall signal is received, the chip's display section generates the appropriate channel number and transforms it into video for display on the TV screen.

The chip still has some bugs to be ironed out. The layout has been revised, according to Williams, but to start production in late September a couple of external flip-flops are being added to take care of a mix-up in the tuning and volume circuits. The sets, to be in production this fall, will retail from \$995 to around \$1,200. Industry officials put the premium paid for the system at between \$65 and \$85. □

## Wariness greets new watch firm

There's certainly skepticism among the electronic-watchmaking fraternity over the \$99 liquid-crystal-display watch made by tiny newcomer Princeton Material Sciences Corp. [*Electronics*, June 13, p. 35]. A retail price as low as that has many in the industry wondering how much, if any, profit the firm can be making.

"PMS could marginally make a profit, possibly by selling directly to a discount house, but it is impossible to make a profit under normal marketing conditions," comments Peter Stearns, marketing manager of Optel Corp., a company that's been delivering LCD watches retailing for about \$175 for more than a year. Stearns is referring to the fact that Princeton Material's first products are going directly to Alexander's, a New York discount house, instead of to an established watchmaker who, in turn, would distribute them through his regular outlets.

Some even doubt whether low-priced LCD watches could be manufactured profitably by any company—including giant Timex, the leader in the low-priced-watch business, which has promised an \$85 LCD watch for next fall [*Electronics*, May 16, p. 74]. Says a spokesman for American Microsystems Inc., a supplier of watch circuits: "Both Timex and PMS are taking a gamble. They are trying to create a market by foregoing profit. If they don't win, they could lose their shirts."

Then, too, others have accused Princeton Material of a one-shot attempt, using watch parts it was able to get hold of at a discount. This latter charge is vehemently denied by Princeton Material president Issai Lefkowitz, who formed the company in 1969 to manufacture liquid-crystal materials and displays. Lefkowitz points out that his company produced its first watch some time last year, and insists the firm now has the capability to "compete with Timex" in the low-priced digital electronic watch market.

Watch components are bought from about 10 suppliers, including the complementary-MOS driver chip from Intel, the quartz crystal oscillator from Motorola, and discrete components from Sprague Electric. Sprague, incidentally, acquired a 40% interest in Princeton Material about a year ago.

Still, if Princeton Material is to compete, and compete successfully, it will have a lot of growing to do. It employs less than 40 people and has a modest 10,000 square feet of floor space, mostly for manufacturing. As for sales figures, Lefkowitz is reticent, admitting only to "under \$5 million." □

### Solid state

## C-MOS on sapphire yields powerful logic

LSI-processor technology is becoming powerful enough to affect even the largest and highest-performance processing systems—those that have

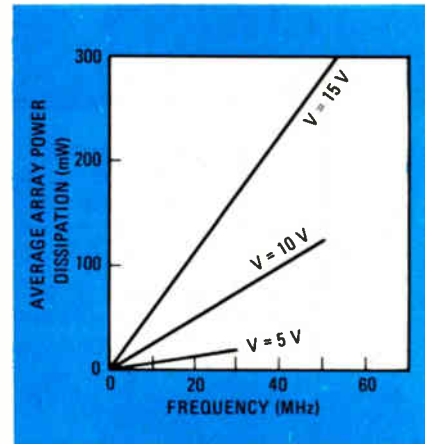

**Powerless.** Dissipation is low in RCA's C-MOS-on-sapphire adder array—only 10 mW at 30 MHz at a 5-volt supply level.

till now required the fastest transistor-transistor-logic packages. Evidence of this is the family of C-MOS-on-sapphire large-scale arithmetic logic circuits developed at RCA's Advanced Technology Laboratory in Camden, N.J.

Though earmarked under an Air Force Avionics Laboratory contract for an advanced signal-processing system, they have a commercial significance, too. The C-MOS-on-sapphire technology used to build these high-speed low-power large-scale integrated circuits for the military is quite similar to the process being used by the company for commercial circuits in pilot production at the Technology Center at RCA's Solid State division in Somerville, N.J. The company has already announced the development of commercial C-MOS-on-sapphire watch circuits, and, although RCA remains mum about future plans, this technology could well be transferred into a range of new microprocessor and other commercial LSI computer components.

The C-MOS-on-sapphire military circuits are extremely fast, low-power devices. An 8-by-8-bit multiplier array, containing 2,112 devices on a 210-by-214-mil chip, typically operates at data-throughput rates of 10 megahertz at power dissipations of less than 10 milliwatts—clearly equalling TTL speeds and as clearly bettering TTL packing density and power dissipation. What's more, the C-MOS-on-sapphire construction

gives the device typically 40% noise immunity, as well as providing it with radiation hardness.

Another component, a C-MOS-on-sapphire adder, is optimized for 9-bit operation on a 134-by-92-mil chip containing 425 devices. It dissipates less than 10 mw.

Finally, a 4-by-5-bit multiplier hybrid assembly operates at the impressive throughput rate of 30 MHz, in the meantime dissipating less than 300 mw.

The multiplier array is made up entirely of combinational logic, which is static, and therefore needs no clock signals and less complex circuitry. On the chip are included all the different cell types necessary to perform the logic sequences, from AND and NAND gates, half adders, and full adders to round-off circuits. In addition, input-gate protection is provided on the chip for ease of handling.

If interface circuits are added, the multiplier array can be expanded to larger-size multipliers and/or complement-type multipliers for bigger systems. The longer strings of gate delays will, of course, make these slower—by about 30%—but they will dissipate no more power than the smaller circuits.

The adder array, which includes overflow protection, performs additions on binary numbers (one's or two's complement) or normal sign-magnitude formats with corresponding outputs. Also, the design of the adder itself resembles the multiplier design in that it can be expanded to accommodate larger input words simply by using more adder arrays. □

## Beams, too, pack power on a chip

Sapphire-based C-MOS technology is one way of achieving high-performance LSI circuitry. As impressive is another method that combines Schottky TTL construction with a two-layer beam-lead metalization process to produce a 300-gate universal logic array suitable for com-

puter processing applications.

Developed by Raytheon Co.'s Missile Systems division, Bedford, Mass., the array's gates operate at an unusual 7-nanosecond propagation delay, yielding gate-speed power products of only 40 picjoules—at least as good as standard Schottky small-scale- and medium-scale-integrated TTL packages. Indeed, this LSI performance permits the use of standard Schottky clock rates of 5 to 10 megahertz, which means that no sacrifice in operating speed is required in the space-saving LSI format.

The 300 gates fit on a modest 160-mil-square silicon chip containing 60 drivers capable of interfacing with external circuitry, 120 drivers capable of driving up to 10 internal loads, and 120 expansion elements to be used as logic AND or logic OR expander gates. Typically, the gates dissipate 5.5 to 6 milliwatts per driver and 1 mw per OR expander.

The chip layout is extremely simple. The gates have been arranged in blocks of 12 and 13 elements. And the layout was composed completely by computer through the stepping or mirroring of these basic blocks.

Thus, individual blocks can be interconnected as standard logic functions simply by calling the metalization layout of a function from a computer library. The functions include AND/OR and NAND/NOR

gates, exclusive-OR and exclusive-NOR gates, flip-flops, four- and eight-bit selectors, four-bit adders, and four-bit arithmetic units.

Raytheon has utilized, in a variety of programs, beam-lead master arrays of 40- and 60-gate complexity which were essentially based on Bell Laboratories' gold beam-lead technology with diffused underpasses for interconnection cross-overs. But an improved low-capacitance beam-lead process, which provides two metal interconnection layers instead of one, has been developed by Raytheon for the 300-gate chips so that system speed and fan-out capability could be increased. □

## Instruments

### Delay line perks up low-cost dual scope

For \$750, the Heath Co.'s latest entry in the assembled, portable, dual-trace oscilloscope competition is unusual enough to catch the eye of a lot of design, test and service engineers. To be sure, dual-trace scopes can be bought for several hundred dollars less, but these won't come equipped with a delay line and the high deflection sensitivity (1 millivolt per centimeter) that are in-

**Dual traces.** Combination of TTL and low-cost printed-circuit-type delay line (arrow) ensures that entire waveform will be displayed in \$750 dual-trace oscilloscope from Heath.

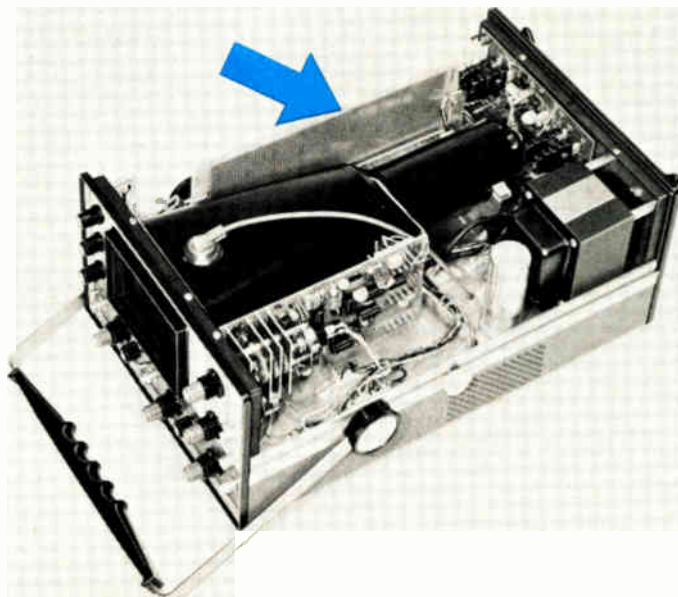



# The Easy, Low Cost Way to Display Difficult Signals

Slowly scanned, gray scale images, low repetition rate signals, and single-shot waveforms. All of these hard-to-view signals are easily displayed on the new TEKTRONIX 605 Variable Persistence Display Monitor—at normal intensity and without flicker. At the same time the 605 combines faster writing speed and wider bandwidth with low cost (\$1675) to provide more value for your display dollar.

Simply turning a dial varies the length of time a display is held on the 605 from a fraction of a second to more than 5 minutes. In the save mode viewing time is even longer.

Faster spot response time results from the 3 MHz bandwidth of the X and Y channels (3 times the bandwidth of comparable crt displays).

With the fast ( $1 \text{ div}/\mu\text{s}$ ) writing speed of the 605, even single-shot events are displayed as bright, easily viewed waveforms. The 605 has front panel controls and TTL compatible remote control inputs, a combination unique at such a low price. Real time monitoring applications are easy with the optional low cost time base (\$125), another feature not offered on other variable persistence displays.

Applications for the 605 are many and varied. Bright, gray scale raster scan plots are obtained for ultrasound, thermographic, and nuclear scanning and for viewing scanning electron microscope images. Resolution is improved in spectrum analysis. Valuable trajectory information is provided for radar

and sonar displays. With the time base option slow biophysical signals are easily monitored. In mechanical measurements flicker-free engine pressure/volume curves are readily plotted with no smear due to cycle-to-cycle variations. Uncluttered, single-shot vibration waveforms are easily displayed using the  $1 \text{ div}/\mu\text{s}$  writing speed.

For further information on how the 605 Variable Persistence Storage Monitor provides extra value in your display application contact your local Tektronix Field Engineer or write Tektronix, Inc., P. O. Box 500, Beaverton, Oregon 97005. In Europe write Tektronix, Ltd., P. O. Box 36, Guernsey, Channel Islands, U. K.



**TEKTRONIX®**

committed to  
technical excellence

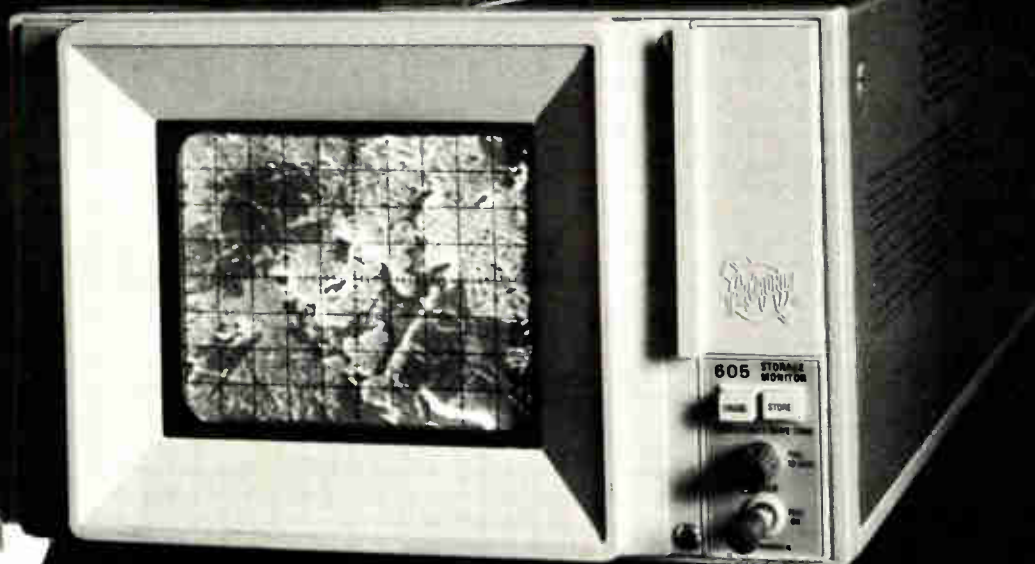
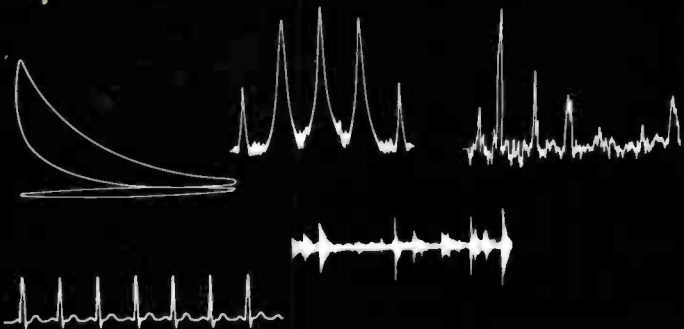

Gray scale capability and variable persistence storage of the 605 are used with a scanning electron microscope to study metal samples in a dental research laboratory.

For a demonstration circle 37 on reader service card.

Circle 37 on reader service card

cluded in Heath's model SO-4510.

The delay line gives the horizontal sweep a 20-nanosecond head-start before the waveform appears on the vertical plates. This assures the user of the scope that he is seeing the entire waveform at the left of the screen. Without a delay line, part of the leading edge of a fast signal may not be displayed.

The job of the delay line is to stall the vertical signal destined for the vertical plates so that the trigger signal, which has been picked off the vertical channel before the delay line's intervention, can unblank the trace and initiate the next horizontal sweep. But in earlier sweep circuits the process used up so many precious nanoseconds—from 300 to 600 ns—that relatively expensive coaxial delay lines were necessary, well out of reach of moderately priced scopes.

"TTL turned the trick for us," says design engineer Bob Ashton, "because it enabled us to build a sweep-triggering circuit which reduced the triggering time down to 140 ns. This meant we needed no more than a 160-ns delay line so we could turn to a relatively inexpensive printed-circuit-type delay line."

The model SO-4510 scope uses a cathode-ray tube with a 6-by-10-centimeter faceplate and a post-accelerator that improves trace brightness. However, it lacks the internal graticule necessary for parallax-free operation.

Triggering bandwidth is said to be two to three times the 15-megahertz vertical bandwidth in order to assure easy triggering on complex waveforms, and so no stability control is needed.

Though engineering accounts for the scope's performance, the Heath Co.'s unusual marketing structure can take much of the credit for the low price. "We don't have to load the price with the heavy sales overhead, as do some of our competitors, because we are essentially a direct-mail outfit," explains Charles Gilmore, marketing manager for the instrument line. "In fact, we are geared up to provide full customer services at much lower order values."

Deliveries will be made from the company's plant in Benton Harbor, Mich., beginning in early August. □

## Materials

### Low-energy beams alter materials

Producing thin films of materials by using low-energy bombardment ions has been found to cause some exotic alterations in the materials' properties. Researchers at Bell Laboratories, Murray Hill, N.J., who used ion beams to deposit films of various materials, have discovered that such films have radically different characteristics from the starting materials.

The deposition technique consists of bombarding a material with the ion beam, knocking off the atoms at or near the surface of the target, and then collecting these atoms on a substrate in a vacuum apparatus similar to that used for conventional

sputtering and evaporation.

The results so far:

- Corrosion resistance of some materials increases greatly.
- Transition temperature of some superconductive materials rises considerably.
- Binary and ternary compounds, such as sapphire, can be formed from elemental materials.
- Materials heretofore requiring extraordinary heating prior to deposition can be deposited "cold" on virtually any substrate.

While much remains to be done before developmental work can be started, Bell researcher Paul H. Schmidt expects that the technique will be competitive with sputtering, but have three significant advantages: 1) surface smoothness is much greater; 2) adhesive quality is, often, much improved; and 3) vacuum requirements are less severe.

In addition, Schmidt believes the technique can be used to coat wires and metal foils to improve corrosion resistance, abrasive materials with hard surfaces, and biological materials so they can be examined with a

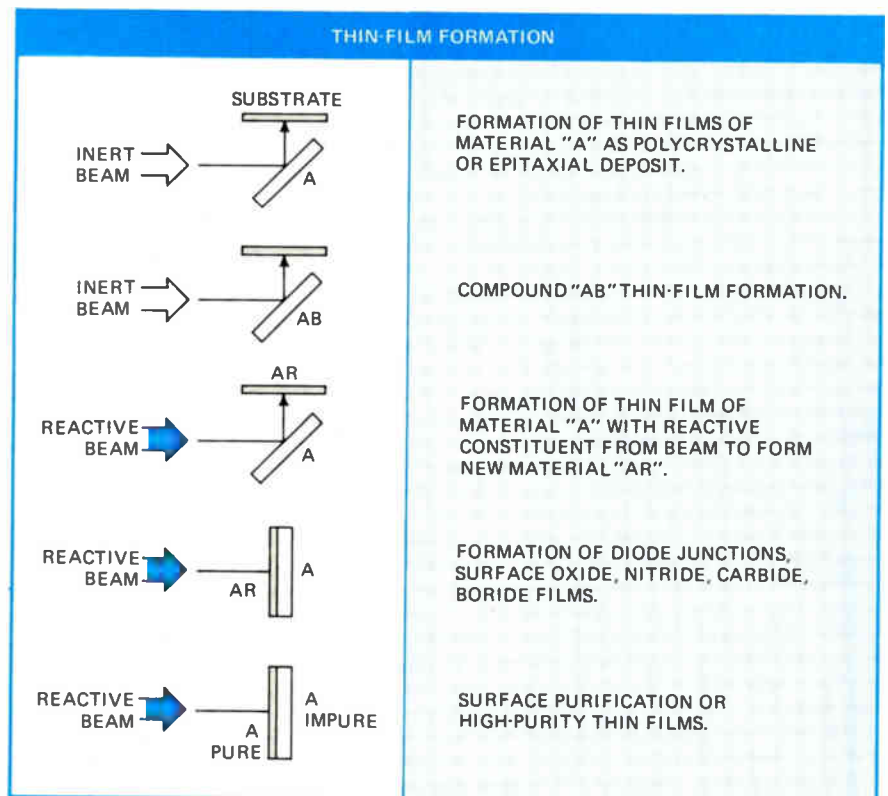

**Formations.** Films of various elemental and compound materials can be deposited by tailoring combinations of low-energy ions and reactive gases in experimental Bell technique.

# You know what kind of Function Generator you need.

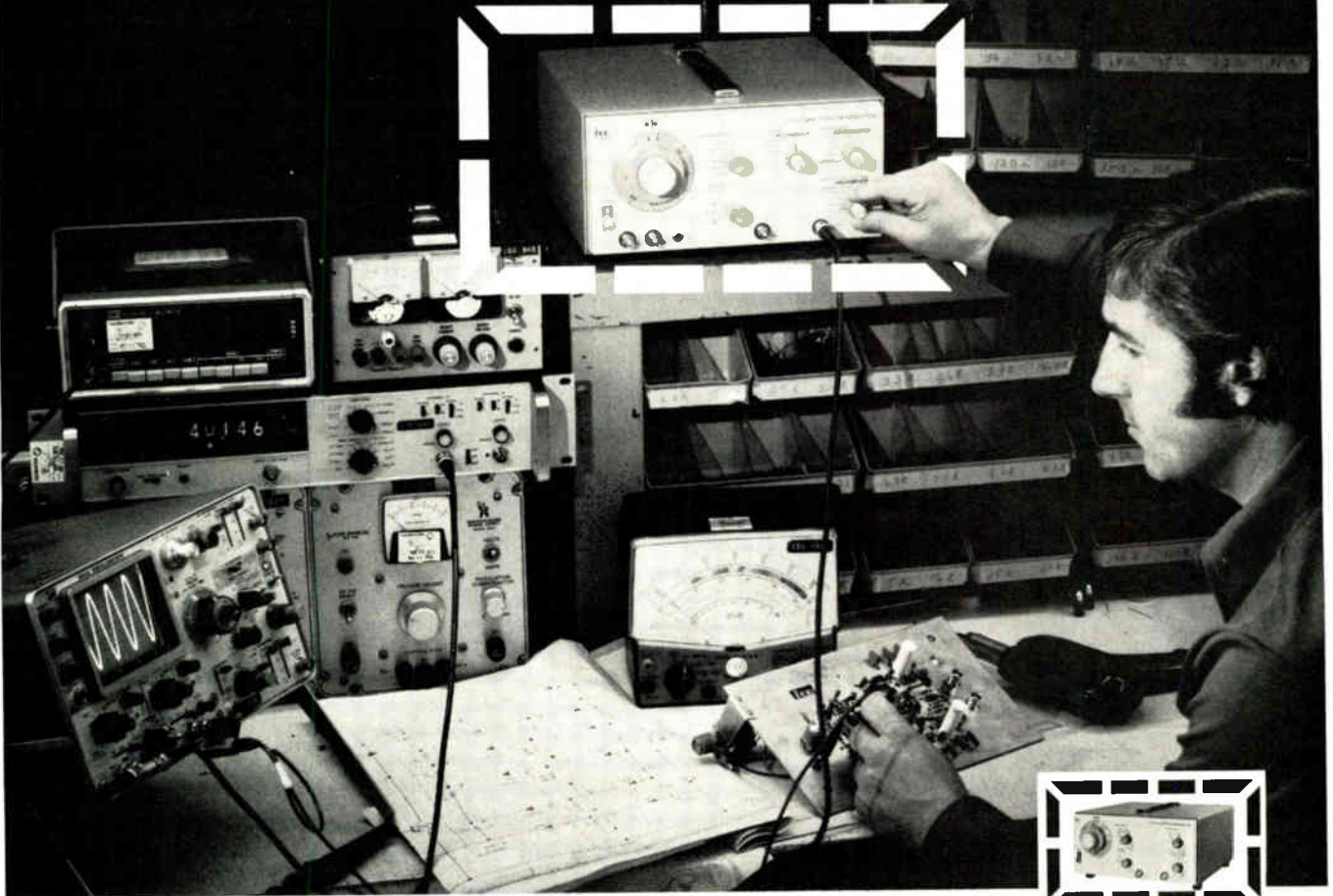

## So does INTERSTATE.

Our comprehensive Series 30 includes a function generator with your special requirements — PLUS more capability and time-saving features to give you a better price/performance value than any competitive model. Capabilities like: 3MHz frequency range; clean sine, square, triangle, sweep, adjustable d-c. and variable width pulse waveforms; and trigger, gate, tone burst, and sweep operating modes. Time-saving features such as a well-organized front panel, our direct-reading Sweep Limit Control, and an unbeatable Instruction Manual.

### The "\$495 Comparison" lets YOU be the Judge.

You can find out exactly how INTERSTATE outperforms a competitor like Wavetek. Check the number below to receive the "\$495 Comparison: Interstate F34, Wavetek 134 Function Generators" and a new Specifier Guide that outlines cost and capability right down both model lines.

### Our function generator will perform better than you expect, or we'll take it back.

Purchase an INTERSTATE function generator and use it for 15 days. If you're not totally satisfied, return it to us for a full refund of the purchase price — no explanations necessary.

Take us up on our offer. (USA ONLY) Call John Norburg, collect, at 714/772-2811.



**IEC**

**INTERSTATE  
ELECTRONICS  
CORPORATION**

Subsidiary of A-T-O Inc.



F31 \$295



F32 \$345



F33 \$395



F34 \$495



F35 \$595



F36 \$645

U.S. HEADQUARTERS: Dept. 7000, Box 3117, Anaheim, CA. 92803; OVERSEAS SALES OFFICES: AUSTRALIA, Parameters Pty., Ltd.; AUSTRIA, Ing Otto Folger; BELGIUM-LUXEMBOURG, Regulation-Mesure S.P.R.L.; FINLAND, Havulinna Oy; FRANCE, Tekelec Airtronic, S.A.; ITALY, Tekelec Airtronic; ISRAEL, Radat International Company Ltd.; JAPAN, Asahi & Co., Ltd.; NETHERLANDS, Tekelec Airtronic, N.V.; NEW ZEALAND, David J. Reid, Ltd.; REPUBLIC OF CHINA, Bons International Co., Ltd.; SPAIN, Telco, S.L.; SOUTH AFRICA, S'electronics (Pty Limited) SWEDEN, M. Stenhardt AB.; SWITZERLAND, Traco Trading Co., Ltd.; UNITED KINGDOM, Euro Electronic Instruments, Ltd.; WEST GERMANY, Tekelec Airtronic GMBH; CANADA, Radionics, Ltd.

TWX U.S.A. 910-591-1197

TELEX U.S.A. 655443 & 655419

Circle 39 on reader service card

scanning-electron microscope.

Schmidt and Edward G. Spencer, also a member of the technical staff at Bell, found that ion-beam-deposited films of copper and silver do not tarnish when exposed to air. And they expect to find similar corrosion-resistant properties in other metals and compounds.

In experiments with superconductors, too, they found that tungsten, which becomes superconductive at 0.012 kelvin, will become superconductive at 5 K when treated to the ion-beam technique. Likewise, molybdenum, which normally becomes superconductive at 0.9 K, becomes a superconductor at 7.5 K. And chromium, not previously known as a superconductor, was found to have a transition temperature of 1.52 K.

**Refinements.** Spencer and Schmidt also found that films can be made by direct bombardment of a compound or by the introduction into the ion beam of a reactive gas, which permits the oxide of the metal target to be formed directly. For instance sapphire ( $Al_2O_3$ ) can be formed either by using an  $Al_2O_3$  target or by bleeding oxygen over aluminum.

In addition to changing material properties, the ion-beam technique will deposit refractory metals on any substrate with a minimum amount of heating. This means that tungsten, for example, which melts at  $3,000^\circ C$ , could even be deposited on paper. Similarly, tantalum, niobium

and other typically high-melting-point materials can be deposited on virtually any substrate.

In their experiments, Schmidt and Spencer used a low-energy (about 3,000 volts) ion-beam generator. This was basically a cold-cathode, hollow-anode glow discharge into which one of the noble gases was injected. As the gas ionized, ions aimed at the target knocked off atoms of target material. Ion energies can vary from about 10 electronvolts to the kilovolt range.

The reason there is no heating of the substrate is that there is no radiation or secondary-electron heating because the glow discharge is maintained outside of the vacuum apparatus. In the case of sputtering, which has a comparable deposition rate, the glow discharge is within the vacuum, and, even though it operates at about 2,000 v, radiates large amounts of heat on the target.

Four different noble gases were used—neon, argon, krypton, and xenon. Films were deposited at room temperature on soft glass,  $Al_2O_3$ , and acetate substrates. All targets consisted of ultra-pure materials (greater than 99.99%). A period (30 to 60 minutes) of target bombardment always preceded deposition to ensure that the target was clean. Deposition rates ranged from 50 to 300 angstroms per minute over an area of  $2.5\text{ cm}^2$  with ion source conditions of 6 kilovolts and 1 milliamperes. Typical film thicknesses ranged from 1 to 5 micrometers. □

field vector is restricted to the horizontal plane. When reflected, the vector remains in the horizontal plane, so that antennas cannot discriminate between direct and reflected waves. Although circular polarization was known to the early TV antenna designers, horizontally polarized transmitting antennas were better developed, and once the trend was started, horizontal polarization became a way of life in TV transmitting.

To take maximum advantage of the interference reduction provided by circularly polarized signals, set owners will have to buy new antennas. However, these should not be significantly more costly than present antennas, since they are simply an assembly of metal rods placed in both horizontal and vertical orientations. Present antennas, it should be pointed out, will also receive the circularly polarized signals, but determining how well they perform is one of the subjects of the present tests.

Although nearly all frequency-modulation radio stations in the U.S. now use circularly polarized transmitting antennas, ABC's tests are the first for television transmissions, says Fred Zellner, ABC's manager for allocations and rf systems. ABC chose Chicago for the tests because interference grew rapidly during construction of the 100-story John Hancock building.

ABC, together with RCA Corp., designed an antenna assembly comprising a horizontally and a circularly polarized antenna. Regularly scheduled programs now are being transmitted alternately from the antennas—one or two days on one antenna, and a similar period on the other. Engineers from the Washington, D. C., telecommunications consulting firm of Smith and Powstenko are measuring picture quality. ABC also has hired a public-opinion consultant to poll viewers for their comments on how the pictures from the two antennas compare.

In circular polarization, the field vectors rotate as the wave propagates, so that a rod antenna's orientation is unimportant. Thus, for example, simple rabbit-ear antennas

---

## Communications

---

### Circularly polarized TV signals getting Chicago tryout by ABC

The American Broadcasting Company has moved into a second phase—daytime tests—of its experiments with circularly polarized television transmissions from its Chicago station, WLS-TV. Off-hours test-pattern studies, completed in late April, indicated that circularly polarized waves will probably give better reception in cities because of

fewer problems with reflections from large buildings. If the daytime tests confirm this, ABC will ask the Federal Communications Commission for permission to adopt the technique as a permanent method of transmission.

Up to now, all television transmissions have used horizontally polarized signals, where the electric

# The N-Channel RAM you've been waiting for.

**Simple to use.  
Fast. Low cost.**

Here's the first 1024-bit MOS RAM to combine speed with simplicity of use at a low cost — \$13.50 in quantities of 500.

With a typical access time of only 130 ns and guaranteed maximum of 200 ns, the EA 1502 RAM is about five times as fast as the popular 2102.

And consider how simple it is to use:

Data and address pins wire directly to TTL logic without level shifters or pull-up resistors. The RAM needs only two supplies: +12v and -12v. It can be OR-wired to expand capacity. And it dissipates only 0.16 mW/bit power.

To achieve low power dissipation we made the RAM dynamic. But to keep use simple, we designed it so

that one pulse on one pin refreshes the entire memory. The timing of the refresh pulse is not at all

critical: it may occur anytime within a 2-millisecond interval. And refreshing does not interfere with read/write cycles — your memory is never busy.

The pin-out of this 18-lead DIP is identical to the 1103. Although signal levels and shapes are different, you can replace 1103s with this speedier RAM without a total rework of your PC board.

The EA 1502 is in stock right now at our nationwide distributor, Cramer Electronics, and at Electronic Arrays, Inc., 550 East Middlefield Road, Mountain View, Calif. 94043. Phone (415) 964-4321.

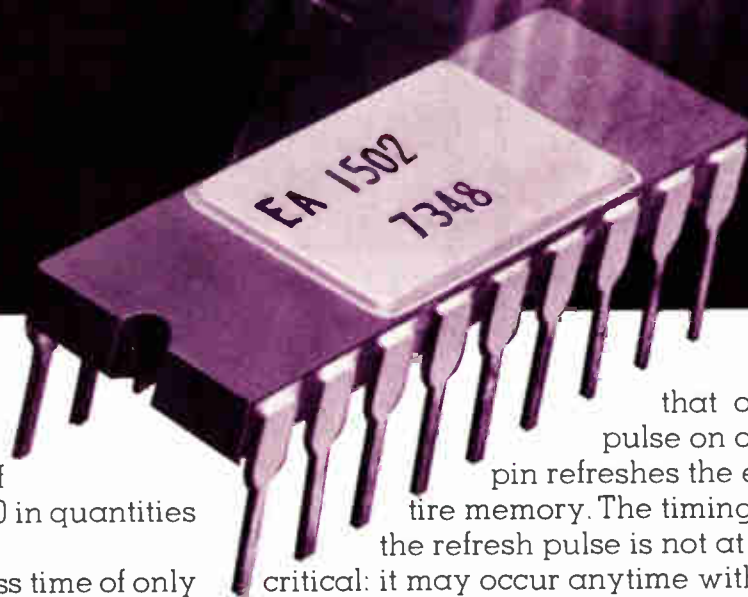

  
**electronic  
arrays**



**Recommended . . .**  
for all delicate and precise  
Electrical and Laboratory Equipment

**Leaves no residue of  
DIRT or STICKY GUM . . .**

**Available . . .**  
in small bottles with applicator,  
as illustrated, or in 8 ounce,  
16 ounce and gallon containers.

**DAVENOIL COMPANY**  
158 SUMMIT STREET • NEWARK, N. J.

**JACKSON**  
**Resistance-Capacity Tuned**  
**★ AUDIO OSCILLATOR**



Model 652

★ Here is a tried, proven and accepted  
★ Audio Oscillator whose brilliant performance sets it apart from other makes.  
★ Audio Frequency voltage is developed at its Fundamental Frequency—by the Resistance-Capacity Tuned Principle. This is not a "beat frequency" oscillator and contains no R.F. circuits. Operation is vastly simplified. Characteristic faults of old style methods are eliminated. Glass enclosed direct reading dial is accurate to within 3% or one cycle. Many other outstanding features. Price \$88.50.

★ Write for descriptive literature

★ **THE JACKSON ELECTRICAL  
INSTRUMENT COMPANY**

★ 123 Wayne Avenue Dayton, Ohio

**Low-loss H-f Coaxial Cable**

FOR RADIO, TELEVISION, CONTROL and test equipment is a new type of co-axial cable which meets the requirements of military specifications for h-f low-loss cables. The central conductor is insulated to a suitable diameter with a recently developed low-loss dielectric, then covered with a copper braid which serves as a concentric outer conductor. The entire assembly is protected by a jacket, or sheath, made of a synthetic plastic called Simplex-Plastex. The cable itself is flexible, easy to install, and can be used on the highest radio frequencies. Moisture is eliminated and there is no internal condensation.

Simplex Wire & Cable Co., Cambridge, Mass.

**Garreau**  
**Electroencephalograph**

THIS IS AN ELECTRONIC DIAGNOSTIC instrument which was recently redesigned from a cumbersome and unwieldy cabinet to a compact Lindsay Structure all-steel housing. In changing the housing, the manufacturer also transformed the instrument from a complicated apparatus which could be used only by a specialized laboratory, into practical piece of medical equipment which can be operated by a non-technical person. The instrument is mainly for use in neurology, but it can also be used in



detecting epileptic tendencies in men selected for aviation training, as well as in the diagnosis of brain injuries associated with head wounds.

It consists of a vacuum tube amplifier and an oscillographic recording system. Small electrodes are placed in selective positions upon the scalp of the patient. The minute electrical potentials generated by the brain are picked up by the apparatus and amplified and recorded as an oscillogram which reveals to the diagnostician such information as the presence and location of brain tumors, focus of scars causing epilepsy, and epileptic tendencies.

Electro-Medical Laboratory, Inc., Holliston, Mass.

★  
*Mounted and Unmounted*

**PHOTO  
ELECTRIC CELLS**

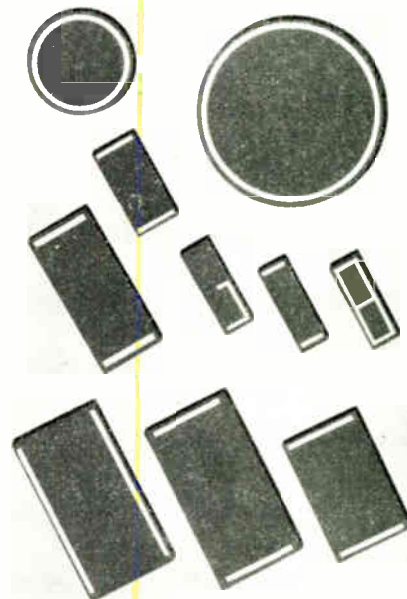

**A Unit for Every  
Type Application**

• Luxtron Photo-Electric Cells meet a wide variety of scientific and industrial requirements . . . measurement, analysis, indication, metering, control, signal, inspection, sound reproduction, etc. Available in a diversity of sizes, type, shapes and capacities, Luxtron units can also be produced to meet special needs. The Bradley Laboratories will gladly cooperate with engineers and designers; inquiries wanted. Write for illustrated literature.



**Luxtron**  
**PHOTO ELECTRIC CELLS**  
**BRADLEY LABORATORIES, INC.**  
82 MEADOW ST. • NEW HAVEN, CONN.  
\*Reg. U.S. Pat. Off.

should give equal reception in all orientations. More importantly, when a circularly polarized signal is reflected from, for instance, a building, it changes the direction of polarization—say, from clockwise to counterclockwise—and a specially designed receiving antenna would reject the reflected wave and accept only the directly transmitted wave. Also, a signal striking the antenna from the aft direction would be rejected. This would help improve reception in fringe areas, where there may be two stations transmitting in opposite directions on the same channel (so-called co-channel interference). □

---

**Communications**

---

## Phone add-on fight opens in New York

If the storm of protest over telephone-company interconnection fees breaks through the defenses manned by the New York Telephone Co., the market for both new and old types of telephone add-on equipment can be expected to broaden. At a public hearing last week on interconnect devices at the New York Public Service Commission's offices in New York City, a stream of witnesses—including city and state officials, as well as consumer groups and individual subscribers—challenged the telephone company to present evidence that add-on devices without the protective couplers for connecting such equipment to telephones have degraded telephone service.

If these groups win out in New York, a national precedent could be set for modifying, if not eliminating, the coupler requirement—or, at least, lowering phone-company fees. New York Telephone's opening statement was simply that the present tariffs (approved by the PSC in 1972) are designed to protect the network. A more definitive case for retention of such tariffs will be filed by the telephone company by Aug. 1, along with direct presentations

## News briefs

### **MIT sees color TV reliability up . . .**

Thanks to increased reliability and resultant savings in service charges, the total life cycle cost of color TV sets has declined in constant dollars from over \$1,200 in 1964 to about \$800 in 1972, according to a study just released by the Massachusetts Institute of Technology Center for Policy Alternatives. The 330-page report, covering color receivers and refrigerators, concludes that design changes to enhance reliability bring down the total cost of these appliances more effectively than attempts to improve the productivity of service organizations. Eventually, MIT expects to develop procedures to show manufacturers and Federal agencies how to design for minimum life-cycle costs.

### **. . . but TV sales slump**

The softening in TV sales for 1974 predicted at the beginning of the year [*Electronics*, Jan. 10, 1974, p. 103] appears to be continuing, according to midyear figures disclosed by marketing executives at a panel held at the Consumer Electronics Show in Chicago. The panel heard that between 8.5 and 9 million color sets and about 6.5 black-and-white sets will be sold by the end of the year. Last year the total was slightly over 9 million color and just under 7 million black-and-white sets.

### **GTE Sylvania to study data link problems**

Eyeing problems in high-frequency line-of-sight, troposcatter, and satellite tactical data links, the U.S. Navy has awarded a \$20,000 contract to GTE Sylvania Inc.'s Communications Systems division to evaluate low- and medium-frequency radio waves for short-range data links for the Marine corps. Sylvania will specifically analyze the propagation and noise characteristics of ground and sky waves in the 200-to-500-kilohertz radio band, and will investigate modulation error control and signal-processing techniques for the links. In addition, the company will design, on paper at least, a typical data-link system.

### **Univac innovates in its 90/30**

The third and latest model in Sperry Univac's new 90 series of computers, the 90/30, is a small-to-medium-scale unit that's intended to replace the seven-year-old Univac 9200 and 9300 computers. It not only makes major use of microprogramed logic, but the controllers for communication lines, magnetic-disk storage units, and other peripherals are integrated with the mainframe due to the use of MSI and LSI techniques.

### **House grants NASA \$3.3 billion**

The House of Representatives, acting on a compromise bill with the Senate, voted to authorize a maximum of nearly \$3.3 billion in spending by the National Aeronautics and Space Administration during the fiscal year beginning July 1. Major items include \$805 million for the space shuttle, \$313.3 million for space flight operations, \$250 million for tracking and data acquisition, and \$266 million for lunar and planetary exploration. The total is about \$19 million less than NASA requested. Of the reduction, \$10 million was made in the space-flight operations program. Actual expenditures will be set later by appropriations legislation.

### **Navy to look for Sanguine site**

The U.S. Navy says it will start looking in 1976 for Federally owned land suitable for its Sanguine submarine communications system [*Electronics*, May 2, p. 38]. Development work was suspended about two months ago, but the Navy has said it hopes to resume the project in the 1975 fiscal year starting July 1, if Congress approves. The proposed system, involving installation of a vast below-ground network of wires, has been fought by environmentalists and others. Because of such opposition, the Navy turned away from proposed sites in Wisconsin, Texas, and Michigan.

# We fit right in

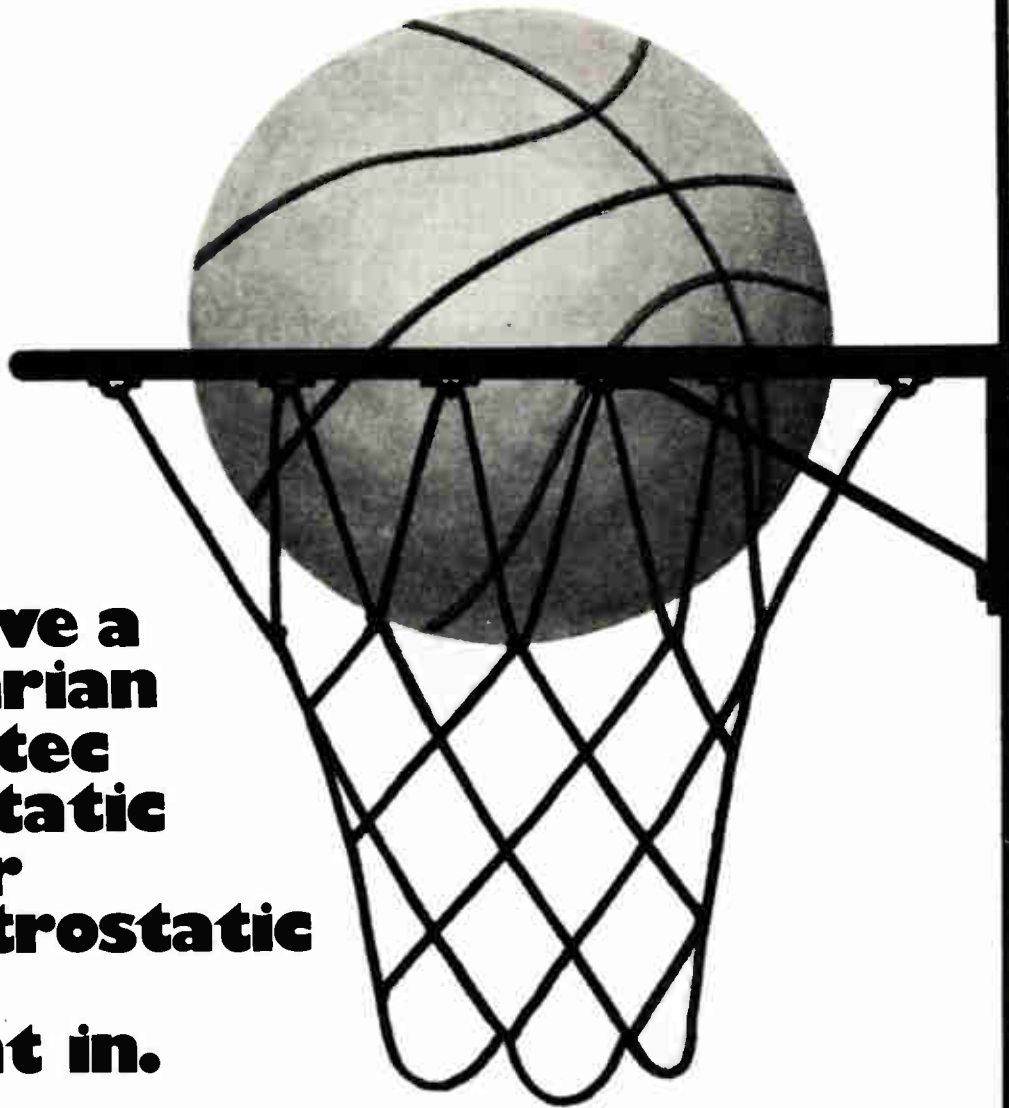

**If you have a  
Gould, Varian  
or Versatec  
electrostatic  
recorder  
our electrostatic  
paper  
fits right in.**

Our nationwide distribution system provides one source of supply, delivered when you want it as you want it, from inventory. And you'll save money in the bargain!

For your special needs we offer preprinted grids in any color and configuration.

For more information write or call Ray Newstead, Industrial Products Manager, Graphic Controls Corporation, Recording Chart Division, 189 Van Rensselaer Street, Buffalo, N.Y. 14210. Telephone: (716) 853-7500. Ext. 352.



RECORDING CHART DIVISION  
**GRAPHIC CONTROLS CORPORATION**  
189 VAN RENSSELAER STREET, BUFFALO, NEW YORK 14210



# For bonding metal- to-metal- to-glass- to-glass-to- plastics- to-plastics- to-rubber-to- rubber-to- metal-to-etc- to-etc.

One drop goes a long way in fastening almost anything to almost anything.

Eastman 910<sup>®</sup> adhesive bonds fast, too. Almost instantaneously. With only contact pressure.

Tensile strength? Up to 5000 psi at room temperature.

New Eastman 910 MHT and THT/Grades hold when the heat's on. Even over 400°F.

For further data and technical literature, write: Eastman Chemical Products, Inc., Kingsport, Tennessee 37662.



## Electronics review

from the manufacturers of the well-established telephone answering devices. But waiting in the wings for the interconnect charges to drop are the manufacturers of the relatively new add-ons, which include such things as automatic answering machines and dialers, intercom units, and even small private branch exchanges (PABXs).

Harry Newton, a New York City telecommunications consultant, testified that there are now at least 400,000 phone answering devices in use nationwide which are made by about 20 independent manufacturers. In addition, there are 65,000 phone-answering devices made by the Bell System in use. And the market is growing fast—by 50% to 60% a year, says Newton.

Newton says that if phone company tariffs—rules specifying not only fees but equipment requirements as well—for add-on equipment are disallowed the business would follow the course of pocket calculators with radical reduction in the size and cost of equipment.

**Certification.** The crucial questions are, of course, whether the protective devices are needed and, if they are, how can standards be established so that non-Bell System manufacturers can build them into the equipment. Several witnesses at the hearing suggested that the PSC itself set up a laboratory to determine the safety of add-on equipment and issue certification to approved manufacturers. But because of the cost involved, it appears that the Federal Communications Commission may be the only agency with the know-how, funds, and authority to conduct such tests.

When the FCC allowed the interconnection of customer-provided equipment to the telephone in the Carterfone decision of 1968, two regulatory systems were suggested, as pointed out by Commissioner of New York City's Department of Consumer Affairs, Elinor Gugenheimer. One proposal would ignore how customer-owned equipment is designed but would require that it be connected to the telephone system through a standard interconnecting device—the much-ma-

lined coupler. The other—and the one she favors—would be to establish standards for the electronic design of the add-ons and to institute a procedure for certifying them as sound. With this approach, the coupler might be omitted entirely from the telephone system.

Telephone subscribers also complained about the fees they're paying for couplers. In the New York City area, these include a \$46 installation fee plus a \$5.86 monthly charge, which means, pointed out one subscriber, that the telephone company may collect more than the cost of the added equipment in less than a year. One telephone-answering unit, Phone-Mate, for example, costs less than \$100. □

## Commercial electronics

### Micro chips aid design changes

Many digital engineers are discovering the advantages of putting their logic in the form of software and using one of the new single-chip microprocessors as a major component in their designs. But few companies have taken this approach as far as Digi-log Systems Inc., of Horsham, Pa., a designer and builder of special-purpose and custom-designed computer terminals.

Heretofore, the company had relied on hard-wired logic for a variety of terminal products. Included were two units displaying 16 lines of 40 and 80 characters, respectively, and each with a keyboard and an acoustic coupler for use with a telephone handset. There are also a terminal for use by travel agents that gives them direct access to an airline's computerized reservations system (still being tested by the airline); a CRT terminal with an attached tape-cassette drive, for use by insurance brokers; and a terminal for use in a chain of restaurants catering to motorists, enabling them to receive telephone messages while on the road by interrogating a central message center. [*Electronics*,



## Power, Peripherals, Price/Performance ...All At Your Fingertips.

Problem solving was never so cost effective, never so convenient. Because Hewlett-Packard's 9830 Calculator System now puts the computational power you need, where you need it most—right on your desk. It's always at your fingertips to give you immediate solutions to your most complex problems... and you don't have to be a computer expert to use it. Enter your data in any format you please—through the calculator keyboard or through a card reader, paper tape reader or digitizer. And get fast, precise answers any way you want them, from fully formatted text to graphs, pie charts, and histograms. Best of all, you communicate with the HP 9830 on your terms. HP BASIC Plus, coupled with the alphanumeric display and typewriter-like keyboard, lets you operate and program the system in a relaxed, almost conversational manner.

But along with the calculator simplicity and a calculator price—as low as \$300\* per month—you get big-machine power: 2k words of user memory, a high-performance cassette, and a 7.5k

word, built-in operating system ROM. Add plug-in ROM's and user memory modules and you triple that power. Add one or more cassettes—or Mass Memories with up to 4.8M words—and your problem-solving capability becomes almost dimensionless. Just as important, this power is so easy to use. With the 9830's unique, programmable cassette, you can program keys to do what you want them to do. Or you can add programs from HP's extensive software library to automatically execute the functions you need. Either way, a single keystroke then commands the 9830 to perform a complete series of steps.

For a closer look at the HP 9830, just return the coupon. We'll send complete details—or arrange a hands-on demonstration at your convenience.

\*Domestic U.S.A. price only. Leases, where available, include service contracts.

094-20



Sales and service from 172 offices in 65 countries.  
P.O. Box 301 Loveland Colorado 80537

Please tell me more about your HP 9830 Programmable Calculator System.

Information only.  Hands-on demonstration.

Name \_\_\_\_\_

Title \_\_\_\_\_

Company \_\_\_\_\_

Address \_\_\_\_\_

City \_\_\_\_\_ State \_\_\_\_\_

Zip \_\_\_\_\_ Phone \_\_\_\_\_

Hewlett-Packard Co.

Calculator Products Division; P.O. Box 301; Loveland, CO 80537

**816A**

May 10, 1973, p. 31].

But the necessity for a new design to build each individual product turned out to be too expensive when it came to a terminal earmarked for users of Western Union's Mailgram service—until Digi-log designed the terminal around Intel's 8008 micro-processor. Digi-log has now shipped several hundred units made in that configuration to Xonics Corp., the contractor building the terminals for Western Union. Digi-log has also used the same idea in designs for other customers.

Basically, its entire design approach has been reduced to a set of printed-circuit boards: three kinds of read-only memory, a read/write memory, synchronous and asynchronous input/output cards, a set of display drivers, a keyboard module that can generate any 8-bit code from any of 110 keys, and, last but not least, a processor board, called Microterm, which uses either the 8008 or the faster version of it, the 8008-1.

"We have no standard product," says Marvin Pollock, director of product applications, "but we use the Microterm to emulate any other product we want to." He cites one Digi-log customer who uses a single terminal design for three different applications, each of which is programmed for the Microterm and its microprocessor.

Perhaps the most effective use of the Microterm is in a program-development center built by Digi-log for its own use. Here the Microterm runs in three modes: to load a new program into a read/write memory; to emulate the processor while debugging that program; and finally to transfer the program into a reprogrammable read-only memory (ReProm). For the last, it uses Intel 1702 memories, which can be erased under ultraviolet light. It can also copy the contents of a known ReProm into a new one, thus doubling as a low-volume production unit. For larger volumes, the box can also drive a paper-tape punch to generate the data for the program mask of an Intel 1302, the mask-programmed equivalent to the 1702 memory. □

When you talk about  
high reliability hybrids,  
**Quote a Highly  
Reliable Source**  
—Raytheon/Quincy.

Did you know that we're a leading source of high reliability beam-lead and chip-and-wire hybrid microcircuits?

Do you know why? Because 98% of Raytheon/Quincy hybrids are purchased for military and medical electronics applications—the ones that demand high reliability. And you can quote us on that.

For complete data on Raytheon hybrids, contact Raytheon Company, Industrial Components Operation, 465 Centre Street, Quincy, Mass. 02169. (617) 479-5300.



# When battery life is critical, there's nothing even close to a TRW LVA zener

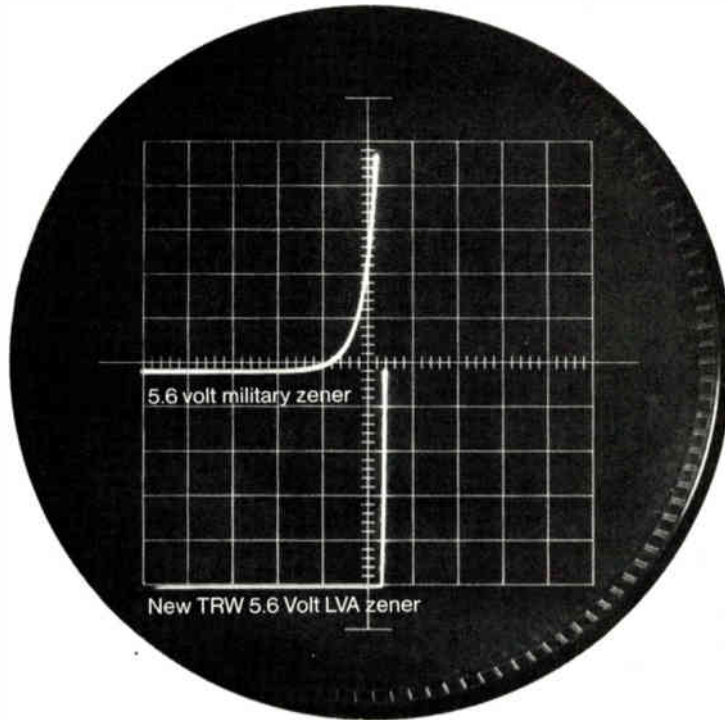

## The sharpest knee below 10 volts for up to 10 times the battery life.

In medical equipment, testing devices, watches, pocket pagers—wherever battery life is critical—no other zener can approach a TRW LVA.

TRW's Low Voltage Avalanche zeners are also ideal for instrumentation and logic circuitry where as highly stable zeners they provide extremely constant reference voltage yet draw as little as 50 microamps. True, they cost more. But where battery life is more important than a dollar or so, or

when you have to load in transistors and resistors to minimize battery drain, it pays to use TRW LVA's. For your convenience, they're available in several package configurations.

For more product information and applications assistance, write TRW Power Semiconductors, an Electronics Components Division of TRW, Inc., 14520 Aviation Boulevard, Lawndale, California 90260 or call John Power (213) 679-4561.

# **TRW** POWER SEMICONDUCTORS



**These products are available through the following authorized distributors:**

Almo Electronics  
Bell Industries  
Cramer Electronics Inc.  
De Mambro Electronics

Electronics Marketing Corp.  
Elmar Electronics Inc.  
Hall-Mark Electronics Corp.  
Harvey-Michigan Inc.

Lake Engineering, Ltd.  
Liberty Electronics  
Pyttronic Industries Inc.  
Rochester Radio

Semiconductor Concepts Inc.  
Summit Distributor  
R. V. Weatherford Co.  
Westates Electronics Corp.  
Wilshire Electronics

## France delays signing of space-agency pact

A little slippage can be expected in the timetable for setting up any new international agency. So no one was particularly surprised when the April 1, 1974 target date for signing the convention establishing the European Space Agency [Aug. 16, 1973, p. 69] was pushed back until this month. And now the agency's birth doesn't look likely until autumn. The official reason was France's request for a delay so that the new Giscard d'Estaing government could take another look at the proposition. But equally important is the inability of the French and the West Germans to agree on whether a Frenchman or a German should head ESA. Meanwhile, European space programs are continuing smoothly under the direction of ESRO, one of the two organizations ESA will supplant (see p. 80).

## LED display panel cost reduced

The problem a year ago with Litton's light-emitting-diode display panel [Aug. 16, 1973, p. 34] was to reduce the cost from \$1 a point to 10 cents a point. At the time, it was felt that the display, another possible flat-screen replacement for TV, wouldn't get down to the dime level until 1980 or so. But now Litton's Data Systems division in Van Nuys, Calif., says that it has not only solved the cost problem, but has managed to overcome heat and power handicaps. It has a contract from the U.S. Army Electronics Command to build a 6-by-6-inch panel, using low-power, off-the-shelf medium-scale ICs rather than custom LSI.

## Microprocessor chip too complex

A British maker of peripherals last year breadboarded a microprocessor chip that it said would put a minicomputer with roughly the power of a Digital Equipment Corp. PDP-11 onto a single 10-by-14-inch board. But IC makers approached by the company, Computer Electronics Ltd. [Aug. 16, 1973, p. 59], couldn't manufacture the chips in quantity. "We've shelved the project until the technology can catch up," says an official of the firm, explaining that IC makers "didn't feel they could give us a high enough yield for the complex chip." Among advances required to produce the 300-mil chip: larger slices of purer silicon which "in a year might be available," he says.

## Fairchild says yes to 200 X 200 CCD imager

A 200-by-200 CCD imaging array can be built. That's what the feasibility study performed by Fairchild Camera & Instrument for the Navy under an \$800,000-plus contract shows, says the company. The study, due to be completed next

month for the Navy's Electronic Systems Command [May 10, 1973, p. 25] is aimed at the development of large-area CCD arrays. The next phase is development, and Fairchild says it's hopeful that it can win the award. The phase of the program just completed called for fabrication of prototype cameras with emphasis on anti-blooming and on-chip amplification techniques. The ultimate goal is development of low-light-level cameras for all three services.

## Smart video camera getting around

A broad range of industries is using the smart video camera introduced by Reticon Corp. of Mountain View, Calif. [July 5, 1973, p. 32]. The camera, which can perform such tasks as inspecting parts on a production line, preparing production records, or printing inventory lists, is now being used by companies in the drug industry, plywood and plastic laminates manufacturing, and the diamond industry, among others. All told, says Reticon, several dozen units have been sold since they became available several months ago. Reticon also has improved the microcomputer control unit and has increased the array to 1,024 diodes from 512.

## A-m radio chip selling well

While Signetics Corp. has not yet captured the a-m radio market with its monolithic front end [Aug. 16, 1973, p. 40], it reports that its chip is selling well—mostly to General Motors' Delco subsidiary. Another good customer, says Signetics, is a Japanese radio manufacturer that supplies Volkswagen, and Signetics hopes to increase sales in Japan when that nation's consumer market opens up once again. The chip itself is designed to replace only the transistors and the interstage resistor-capacitor networks directly between the transistors.

## Big pay-TV test runs into problems

The question a year ago was: Would viewers accept pay television? While programming had begun in California, Pennsylvania, and Virginia, the big test was coming up: the attempt to crack a big, tough market—New York City—by Sterling Manhattan Cable [Aug. 2, 1973, p. 71]. Installation, scheduled for last fall, is still scheduled, but sterling—and all pay TV operators—have run into a shortage of capital, a well-financed anti-pay TV campaign by the National Association of Broadcasters, lack of good programs and new movies, and trouble arranging sports pickups. Insiders predict that the whole affair will have to wind up in the lap of the FCC.

—Howard Wolff

Intended to bring *Electronics* readers up to date on news stories of the past months.

# 5 big reasons to choose the HP sweeper

## 1. Coverage.

The HP 8620 family of solid-state sweepers covers 3 MHz to 18 GHz with unparalleled flexibility. Choose from 9 single-band plug-ins or combinations of RF modules to get multi-band coverage conveniently and compactly.

## 2. Performance.

HP sweepers invite comparison in such important areas as frequency accuracy and linearity, signal purity and stability. And they offer versatile modulation and leveling choices for even more value.

## 3. Power.

The solid-state HP 8620 family delivers high output power to fill virtually every measurement need. Standard units provide guaranteed 40 mW to 4.2 GHz and at least 10 mW all the way to 18 GHz.

## 4. Price.

HP sweepers are really competitively priced. Mainframes start at \$1230. Single band RF units range from \$1520 to \$2840, and a multi-band configuration such as a 0.1 to 6.5 GHz plug-in is only \$6790. It only takes three RF plug-ins to span from 0.1 to 18 GHz at a price of just \$14,755.

## 5. Availability.

Six weeks or less for everything in the 8620 family. You can plan your swept measurements with the assurance that your schedules will be met.

No other line of sweepers can match these 5 big reasons. We'll be glad to send you full details on the value-priced HP 8620 Sweeper line. Contact your nearest HP field office. Or write.

Domestic USA prices only.

04405B

HEWLETT  PACKARD

Sales and service from 172 offices in 65 countries.  
1501 Page Mill Road, Palo Alto, California 94304



# The 2102 to get as it is to

The Intel 2102 n-channel RAM is the most popular 1024 bit static memory available today. It is *the* general purpose RAM with more second sources than any other semiconductor memory component.

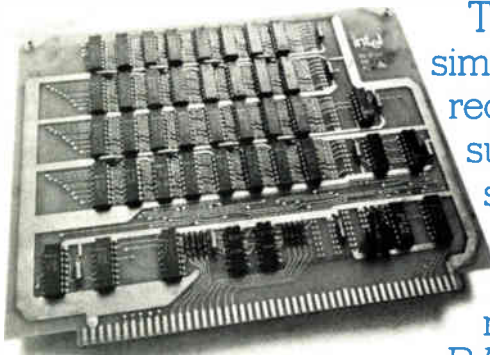

INTEL IN-26 MEMORY SYSTEM

The 2102 is extremely simple to use because it requires no peripheral supporting circuits, no special supplies, nor does it require the extra design effort needed by most RAMs to interface with TTL.

By using the 2102, you can achieve greater system economy because it does not require level shifters, MOS drivers, interface circuits, clocks, refresh and decode circuits, nor even pull-up resistors.

Every pin is TTL compatible, including the +5 volt  $V_{cc}$  supply and the three-state, OR-tie data output that simplifies memory expansion. To connect the 2102 to TTL, just add solder dots. In fact, the 2102 RAM performs exactly as if it were a TTL circuit.

The 2102 speed specs are efficient also. Guaranteed maximum access time is 1 microsecond, typical access time is 500 nanoseconds. Minimum read and write cycle time is also 1 microsecond.

The 2102 costs less per bit in quantity than penny candy. And when you

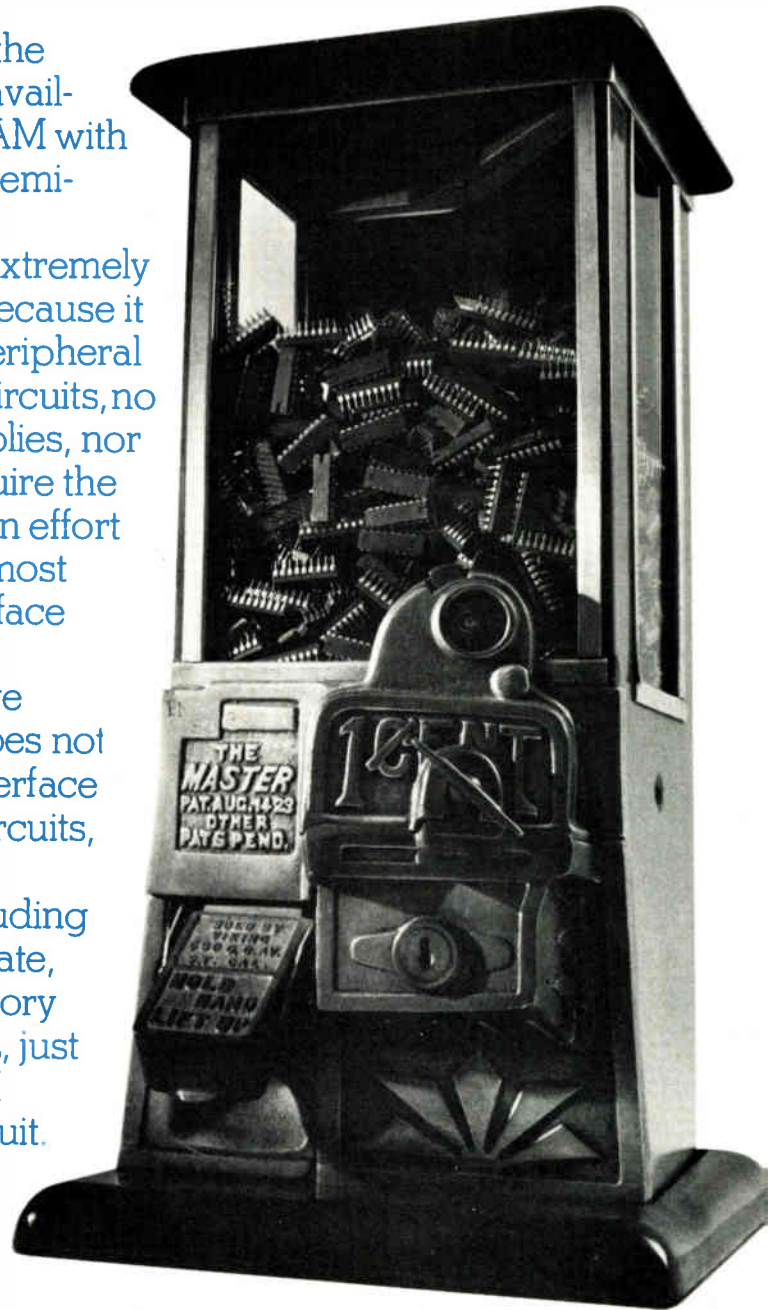

# RAM is as easy use.

# N-C HANNEL

subtract what you don't spend on design time, other parts, special supplies, boards and labor, the 2102 is easily the most economical static RAM for a wide range of applications.

What's more, the Intel 2102 is easy to get. We have been producing it in volume since early 1972 with the industry's most mature n-channel silicon gate technology. Today, we ship more 2102's than the combined outputs of the dozen or so announced second sources.

The Tektronix 31 Programmable Calculator uses the 2102 and millions of our 2102's are now being used in peripheral equipment, instrumentation and microcomputer

systems. It's a favorite with designers who want to simulate buffer, refresh and variable length registers with something more convenient and less costly than custom MOS registers.

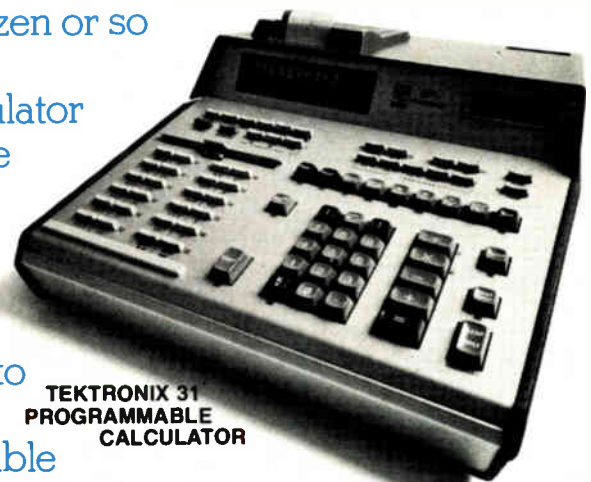

TEKTRONIX 31  
PROGRAMMABLE  
CALCULATOR

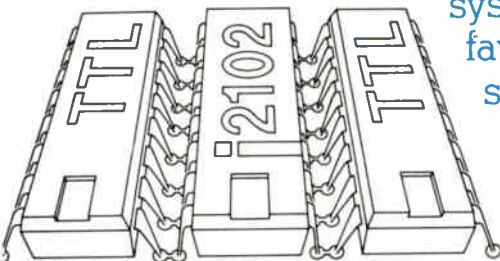

EVERY PIN IS TTL COMPATIBLE

The 2102 is only one of Intel's popular MOS RAMs available in volume and from distributor stock. Send for a full catalog of our products including RAMs, ROMs, PROMs, interface circuits and Microcomputers.

Write to: Intel Corporation, 3065 Bowers Avenue, Santa Clara, California 95051. (408) 246-7501.

## intel® delivers.



# SOUND SCRIBER

embossed groove

## DISC RECORDERS

for

**MICROPHONIC  
COMMUNICATION — CONFERENCE  
MOBILE—DICTATION RECORDING**

**Low Distortion  
Frequency Range 150-4000  
cycles**

### ★ REFERENCE RECORDERS

4 turntables operate continuously 2 hours without record change. 1 hour on each 7" disc (both sides) 300 grooves to the inch—22 rpm. Steel Cabinet. Approx. 35" x 20" x 15" Weight 225 lbs.

### ★ DUAL CONTINUOUS RECORDERS

Two 7" turntables with automatic timing unit operate continuously for 30 minutes without manual attention. 200 grooves to the inch. 33 rpm. Completely portable in leatherette or leather case. 18½"x13¼"x8¼" Weight 50 lbs.

### ★ PORTABLE RECORDERS

Completely self-contained single turntable unit with inbuilt microphone. 200 grooves to the inch 33 rpm. Leatherette or genuine leather covered container. 13"x9½"x8¼". Weight 24 lbs.

### ★ STANDARD DICTATION and TRANSCRIBING MACHINES

For all-electric recording and transcribing. Adaptable to every form of office dictation and sound recording. Records 200 grooves to the inch. 33 rpm. Sturdy, handsome walnut cabinets. 11¾"x10"x7¾" Weight 17 lbs.

7" indestructible plastic discs, .010 inches thick are filable and mailable. All equipment available for 6 volt storage battery and other current sources by use of suitable converters.

For detailed specifications—  
wire—phone—write

THE  
**SOUND SCRIBER**  
CORPORATION  
82 Audubon Street New Haven, Conn.

## Air Raid Siren

A NEW ELECTRONIC TYPE air raid siren called "Electro-Siren" is designed to give great volume for alarms. It makes use of a vacuum-tube tone generator which can either duplicate the rising and falling tone of a mechanical siren, or can be set at any pitch for best audibility over traffic or manufacturing noises. It can also be used to send code messages to air raid officials by dots and dashes. It has an arrangement so that a microphone can be used for voice announcements over the same system, which takes the place of a PA system. The unit operates from 110 volts source, but in case of current failure can be switched to 6 volt storage battery operation. It can also be used in police cars or other vehicles, operating from the car battery. The largest system can be operated continuously for four hours from a fully charged battery.

Audiograph Div., John Meck Industries, 1313 W. Randolph St., Chicago.

## Aircraft Relays

THREE NEW RELAYS for aircraft or tank service have been announced. The first of these is a single-pole relay which is available in two forms—a single circuit form with one normally open contact (CR2791-B100A), and a two-circuit form with one normally open and one normally closed contact (CR2791-B100C). It has a maximum continuous current rating of 20 amps at 12 or 24 volts, and a maximum make or break rating of 100 amps at 12 or 24 volts. The coil operates at 1.2 watts. The relay weighs 3 ounces in the normally open form, and 3.4 ounces in the normally open, normally closed form. Tip travel is ½ inch and tip pressure is 40 grams. The relay measures 1½x1½x1½ inches.

The high-voltage relay (CR2791-D100F) is designed especially for use with aircraft radio transmitting equipment. The use of ceramic insulation and double-break contacts permits control of circuits as high as 1,000 volts direct current. The contacts have maximum current ratings of 0.020 amp. at 1000 volts direct current, and 0.100 amp. at 500 volts direct current. This relay has a coil wattage of 1.2, a tip travel of ⅛ inch double-break, and a tip pressure of 25 grams. The contacts are arranged for double-pole, double-throw, double-break operation. The relay measures 2½x1½x1½ inches.

The two- and three-pole relays are provided in two forms. One form (CR2791-B100D,G) has one normally open circuit per pole, and the other (CR2791-B100F,J) has one normally open and one normally closed circuit per pole. These relays have maximum continuous current ratings of 8 amps. at 12 or 24 volts, and the maximum make or break ratings at 25 amps. at 12 or 24 volts. The coils operate at 1.2 volts. Both two-pole forms are 1½x1½x1½ inches, and

# —MICO— ENGRAVER

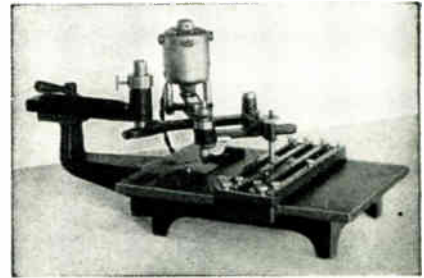

For lettering panels of steel, aluminum, brass, or bakelite, or for marking finished apparatus.

A sturdy machine for routine production as well as occasional engraving.

Attachments increase its versatility to include large work on flat or curved surfaces.

Excellent engraving can be produced by an inexperienced operator.

Catalogue on request  
Prompt Delivery

Priced from \$115 with type

Mico Instrument Co.

20 ARROW STREET  
CAMBRIDGE, MASS.

"Keep'em Moving"

**ACCURACY IS  
IMPERATIVE!**

INSIST ON  
INSTRUMENTS  
WITH



**PERMIUM**

Pivots—Alloy Jewel Bearings

- For Permanence
- Lifetime Accuracy
- Maintained Precision
- Less Maintenance
- Replaces Sapphire

Steel pivots corrode, rust—use the NEW  
HOMO-HEXTEROAXIAL WEAR-RESISTING  
ALLOYS (1000 times life of tool steel)  
"Used in preference to jewels."

**PERMIUM—AEROPOINT—PERMETTE**  
Non-corrosive • Non-magnetic  
Super Smooth • Less Friction

**THE PARALOY CO.**  
Manufacturing Engineers  
600 S. MICHIGAN AVE. • CHICAGO, ILL.

# SIEMENS

## Cost-Effective Solutions to Semiconductor Test Problems



### GENERAL PURPOSE IC TESTER COMPUTEST 716A

Low-cost parametric and functional tester for digital and linear circuits

### DIGITAL CIRCUIT TESTERS COMPUTEST 720 SERIES

Provides complete DC parametric and functional verification of digital IC's

### LINEAR CIRCUIT TESTER COMPUTEST 735

Tests operational amplifiers, regulators, comparators, sense amplifiers and custom linear circuits

### BENCH-TOP MEMORY TESTERS COMPUTEST 901 SERIES

Provides real-time verification of semiconductor memory performance from the device to the complete memory systems level

**FREE!**

Send for the Computest catalog of Semiconductor Test Equipment and our Semiconductor Program Library

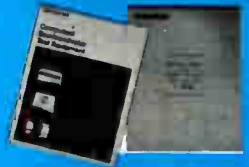

NAME \_\_\_\_\_  
COMPANY \_\_\_\_\_  
ADDRESS \_\_\_\_\_  
CITY \_\_\_\_\_  
STATE \_\_\_\_\_ ZIP \_\_\_\_\_

FOR APPLICATIONS ASSISTANCE . . .  
CALL US!

Siemens Corporation  
Electronic Systems Division  
Computest Products

3 Computer Drive, Cherry Hill, N.J. 08002 (609) 424-2400

Circle 52 on Reader Service Card

## **Laser safety standard at last sees the light**

Within the week, after nearly three years of discussion and dispute between laser manufacturers and the Government, the **Bureau of Radiological Health will publish a revised Federal standard for laser safety.** Alexander M. Schmidt, commissioner of the Food and Drug Administration which oversees the bureau, contends that the new standard is much improved over the one first proposed last December.

**But agreement seems unlikely on the hazards of Class II systems—lasers with outputs of between 1 and 5 milliwatts.** The first bureau definition, restricting Class II lasers to 1 mW, was labeled “ultraconservative” and “overzealous” by the Electronic Industries Association. Notes Allen M. Wilson, EIA’s chief engineer, **1-mW lasers would be useless to the construction industry, which accounts for 75% of civilian laser dollar sales.** And, though no one admits it officially, **manufacturers expect to go on selling 1-5-mW lasers but only to the construction industry.**

## **Inflation relief urged for aerospace fixed-price awards**

The Department of Defense is giving sympathetic consideration to a **plan by the aerospace industry for economic relief from the pressures of fixed-price contracts** in a period of soaring inflation—even though the request is generating some initial suspicion in a Congress disturbed by rising weapons costs. William B. Bergen, president of Rockwell International’s North American Aerospace group and a leader of the appeal, wants **wider use of price adjustment clauses in Government contracts, more phased procurements using shorter-term contracts, and improved means of measuring inflation on individual programs.**

Assistant secretary of defense Arthur Mendolia is encouraging DOD contract officers to make greater use of adjustment clauses and shorter-term awards to overcome company reluctance to bid on new contracts. But Bergen notes that Federal economic indices often reflect primarily commercial markets, and are not very relevant to aerospace.

## **House action on a-m radios unlikely despite Senate OK**

Despite the Senate’s passage in mid-June of **legislation that will require all consumer radios retailing for more than \$15 to receive fm as well as a-m signals,** chances for approval by the House of Representatives are poor, say congressional insiders. **No House action is scheduled on the bill, which slipped through the Senate on a 44-42 vote.** Most of the support for the bill comes from fm broadcasters anxious to reach the auto radio market, but the **radio manufacturers represented by the Electronic Industries Association have opposed it.** And EIA staff vice president for consumer products, Jack Wayman, says the association will testify against it when it comes up for consideration by the Interstate and Foreign Commerce Committee’s communications subcommittee.

## **U.S. court rules against voiceprints**

The prospects for the voiceprint as a new application of electronics to law enforcement have been dimmed by a June ruling of the U.S. Court of Appeals in Washington that **the technique is inadmissible as evidence, since it’s “not sufficiently accepted by the scientific community as a whole.”** While the ruling is applicable only to Federal courts under the Washington-based appeals court’s jurisdiction, it is expected to influence other courts as well. Some state courts and the U.S. Military Court of Appeals now accept voiceprint evidence.

## Mass transit derailed

"If we can get men to the moon and back, why can't we get people from one side of town to the other?" That question by one congressman is being posed with increasing frequency to embarrassed electronics and aerospace systems companies, which once viewed urban mass transit as the perfect vehicle for the transfer of high technology from space and defense programs to the nation's cities.

For years that dream of a long straight track toward a new major market was encouraged by the Department of Transportation through its Urban Mass Transportation Administration and its steadily increasing budget. Now, however, the dream has turned into a technological nightmare following a couple of badly engineered but expensive efforts, San Francisco's Bay Area Rapid Transit system [*Electronics*, Dec. 4, 1972, p. 47] and the Morgantown, W. Va., demonstration program of personal rapid transit.

### UMTA's Watergate

The more recent disaster—at Morgantown's system for linking the University of West Virginia's downtown campus with another on the little city's fringe—is proving to be UMTA's Watergate. Problems with the Morgantown experiment began not long after DOT took over the program in 1971. Despite its widely publicized dedication in October, 1972, just prior to the presidential election, the system won't begin operating until early next year. Even then it is unlikely to be completed. And it may never be if a disenchanted Congress cuts off funds.

The price tag for the three-station, 45-car system that runs no more than 2.2 miles is now \$64 million. If it is ever extended to the six stations and more than 70 cars originally planned, the cost will nearly double to \$125 million. Those figures far exceed what the university originally had in mind—\$13 million for a little system of small electric vehicles on a lightweight, elevated guideway.

What happened? First, DOT decided it needed a more substantial system designed to serve as a national prototype, not engineered simply to meet the needs of a small college town. Thus were the little cars proposed by Alden Self-Transit Systems Corp. of Milford, Mass., dropped in favor of far larger vehicles designed by Boeing Co. Of course, this meant enlarging the guideway into a cumbersome structure of steel and concrete.

Then an image-conscious White House entered the act, demanding an accelerated schedule for the sake of a national political cam-

paign. That further muddied the technological waters. UMTA was obliged to turn to concurrent design and production, that stumbling block of so many military projects in the past. The guideway builder, for example, was called upon to begin work before the new vehicle specifications were fixed.

### The penalties

The economic and engineering consequences of these judgments are history now. But the penalties are only beginning to be paid. Not only is Congress turned off on new technology for transportation, but so are many of the nation's city administrators.

Money for UMTA programs is coming hard in Congress this year. For example, the House Appropriations Committee's transportation panel has already eliminated \$18.1 million for the agency's fiscal 1975 budget request, wiping out two significant programs. One is a \$7.5-million dual-mode demonstration system that could handle vehicles adaptable to both automated guideway operation and conventional street driving. The other, priced at \$10.6 million for initial design and development, involved an improved personal rapid transit system to be built near Denver.

Another loser in the aftermath of Morgantown was Robert A. Hemmes, whose recent departure as UMTA R&D chief was never officially linked to the project's failure though no one in the agency disputes the connection.

UMTA's lost appropriations and Hemmes' lost job after Morgantown are but symptoms of the program's problems. Their roots lie in the apparent compulsion of DOT's administrators, abetted by anxious contractors, to overdesign new systems for competitive civilian markets as though they were going to the moon.

### Back to busing

Few people are surprised now that UMTA has retreated to playing it safe with the "proven technology" of Detroit's buses. UMTA's administrators know their jobs are secure when they smilingly acknowledge they "can give you money for all the buses you want." Of course, the record shows they are right. In one week in June, grants for buses included \$10 million to Honolulu, \$2.4 million to Kansas City, \$2.5 million to Tucson, and \$7 million to Cleveland.

It is enough to make Detroit comfortable with its conviction that electronics and aerospace technologies must first come down to earth before they can begin to challenge the bus.

—Ray Connolly

# WHAT IF BIG BEN WENT DIGITAL? [we could handle it]

Size is really no problem. Neither's your custom configuration.

Fact is, we don't saddle you with a couple of our standard displays and say, "that's it, friend, take it or leave it." We're set up to turn out what you want. Not just what we've got.

Our clock displays can be very versatile in design, for example. We go from small (.16") size numbers to big (1.0") character heights in 12 hour or 24 hour applications. Also for stop watches, timers, elapsed time indicators, etc. 3-1/2, 4 or 6 digit sizes with seconds in smaller character heights if desired. And placed in most any unique position to satisfy your esthetic demands.

Incidentally, our AM/PM indicator is a new wrinkle. Not two. Just one. The A changes to P and back at the right times.

Get together with our design guys. You'll be surprised at how flexible we can be. We'll help you bring creativity into digital time telling.

Nobody else can say all that.

The name's DiaDigit.™ It's a low power, high performance, mini cost gas discharge display in a single planar package. Has leads to mount directly into your PC board. No socket necessary. Easily interfaced with MOS devices.

You can get symbols, numbers, letters or combinations. For almost anything. Appliances, automotive, TV/radio. You name it. Any size. Which, as we said, means we build for your needs, so you don't design for what's available.

And, as for cost, in quantities, we're competitive with the big boys.

Delivery? Astounding. (Big Ben size takes slightly longer.)

So, isn't it time you talked to us?

For the finer points on DiaDigit, write Diacon, Inc. 4812 Kearny Mesa Road, San Diego, California 92111. Or phone 714/279-6992.

## DIACON

Circle 111 on reader service card

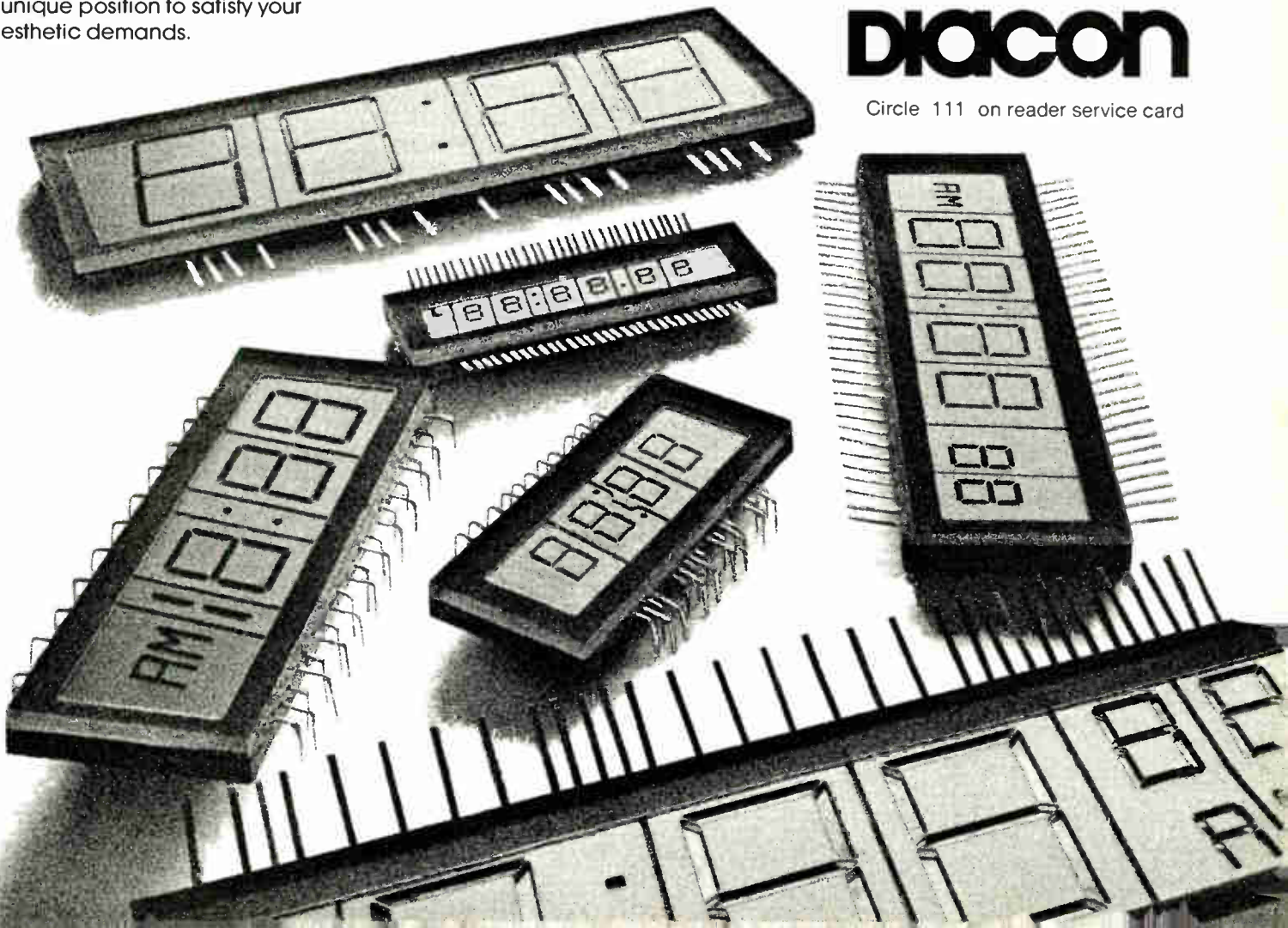

## Sony starts converting bipolar devices to new structure for higher performance

A novel transistor technology developed by two Sony Corp. engineers seems to defy conventional design rules, yet it gives superior device performance and higher production yield than standard double-diffused devices. Hajime Yagi and Tadaharu Tsuyuki design their devices with low emitter-doping concentrations (LECs)—typically an order of magnitude or two below those in the base, rather than several orders of magnitude higher.

Sony has been producing LECs for about three months and expects to convert all bipolar-device production, including integrated circuits, to the new structure over a five-year period. The Sony engineers emphasize that only the configuration is changed, and all device processing remains conventional. Furthermore, the features of the devices include two-dimensional, rather than three-dimensional, current flow, which is especially helpful in computer-aided design of ICs.

**Basics.** In the new technology, an electrical barrier in the emitter reflects the minority carriers injected into it, preventing them from becoming a component of the emitter current. A necessary, but easily met, condition is that minority-carrier lifetime in the portion of the emitter with low doping concentration should be high enough to make recombination current negligible.

The most usual barrier used in these devices is a low-doping/high-doping junction ( $n^+/n$  or  $p^+/p$ ) barrier. Also useful are a  $p/n$  junction barrier, and less commonly, MIS barrier and heterojunction barrier. A big difference in the new approach is that the base doping profile of transistors is unaffected by the emitter-doping conditions.

Transistor-current gain is a linear function of ion-implantation dosage in the base. Therefore, current gains in the order of 10,000 are possible in a single transistor, rather than re-

quiring a Darlington connection of two transistors.

Devices produced by this process include power transistors, low-noise transistors, symmetrical transistors, high-current-gain transistors, high-frequency transistors, phototransistors, junction-gate-controlled transistors, MIS gate-controlled transistors, and thyristors—including those

with gate turn-off characteristics.

An important reason for the improved performance is a self-ballasting effect in the LEC region, which makes current flow throughout the device more uniform and eliminates hot spots. However, saturation resistance is still a low 0.1 ohm, measured at collector current of 8 A and base current of 1 A. □

---

### Switzerland

---

## Microprocessor operates data-ray meter to gage plating thickness

To help its customers make sure they were not wasting money by plating on overly thick gold layers, Geneva-based Oxy Metal Industries (Suisse) SA decided to develop a highly sensitive thickness meter. And, since their design called for computing capacity, Oxy engineers built the meter around Intel's MCS-4 microprocessor system.

All this occurred back in 1972, when anyone designing a microprocessor into hardware was pioneering. The development model was ready in November of that year. It has since been refined, and the first production units are scheduled for delivery toward the end of June. But the new device, called the mc Betameter 100, is not the only piece of microprocessor hardware that Oxy has readied for the market. "We have sold a dozen RALS already," says Georges Matile, head of the company's electronics laboratories. In Oxy's lexicon, a RAL is a random-access loader, built around an MCS-4 for automated plating.

Oxy's Betameter, priced at \$5,000, works on the same basic principle as other nondestructive plating-thickness gages. The sample is bombarded with beta rays, and the resulting backscatter is picked up by a

geiger tube. The count from the tube is converted into micrometers of thickness by means of a calibration curve that takes into account the plating material, the base metal, and the radioactive source of the beta rays. This beta-ray technique also works for determining percentages of the metals making up an alloy.

The Oxy instrument has eight different calibration curves stored in a pair of 256-word, 8-bit programable read-only memories. A similar pair of PROMs is reserved for eight additional special curves if the customer wants them. Mainly because of these curves, the instrument shows an accuracy to better than 5%, in most cases, over a range of 0 to 100 micrometers.

Along with making possible calibration curves that match the measurement, the microprocessor improves the instrument's accuracy in two other main ways. It averages out the initial calibration readings, and it checks constantly to make sure the measurement attempted is within the limits of the instrument's setup. Warning lights show when conditions are poor or actually impossible. And, of course, there's a big plus in operating ease because

the sequence of steps during a measurement is programmed into the instrument via seven PROMs.

To take a reading of a plating thickness, the user sets the test duration—1 second is the minimum, but the usual time is between 5 and 15 seconds—and inserts a plastic “key” in the front panel to switch in the appropriate curve. Then the instrument has to be calibrated against two standards, themselves accurate to 40 atoms.

For each calibration—one for the low end, and one for the high end—the system actually takes a series of five readings, stores them, then discards the low and high ones, and finally averages out the remaining three.

Actual thickness readings can be based on a single measurement or the average of five, as for the calibration. Readout is a direct three-digit display of the thickness in mi-

croimeters. A sorting option indicates the condition of the plating on a sample. □

---

## Japan

---

### Black matrix, dots yield storage tube

Engineers at Tokyo Shibaura Electric Co. have developed a new storage oscilloscope tube using black-matrix technology and aimed it at the engineer's bench. Toshiba hopes for a sales spurt because the new tube costs a tenth as much as previous models.

Toshiba designers say that the utility of memory oscilloscopes with storage tubes should make for large demand, but the \$1,800 for the CRT alone tends to price these oscillo-

scopes beyond the budgets of most users. Toshiba's price tag of less than \$360 for a rectangular, 6-inch diagonal, direct-view storage tube is expected to open the way for less expensive equipment.

Price of the 10-megahertz scope is only \$1,800, compared with prices that range from \$2,900 to more than \$3,600 for competitive brands in Japan. Maximum memory writing rate is 0.25 kilometer per second for single events.

The phosphor dots in the new tube are able to provide memory action, as well as acting as fluorescent phosphor in the usual manner. This ability eliminates the usual storage mesh, which is extremely difficult to fabricate and the major factor in the high price of storage tubes. The phosphor dots can provide storage because they have the two characteristics needed—they have good dielectric qualities, and they are efficient emitters of secondary electrons. The black matrix provides a conductive path to a transparent, tin oxide conductive coating on the faceplate and allows collection of secondary electrons.

**Construction.** Fabrication of the tube faceplate starts with deposition of the tin-oxide coating on the inside surface. This is followed by the black matrix and then the phosphor dots, much like making color-TV tubes. Dot spacing is 0.2 millimeter, about half that used in the average 16-inch color picture tube. This spacing gives a total of more than 200,000 phosphor dots.

Just behind the faceplate is a so-called hybrid mesh, which both repels ions that might otherwise damage the screen and collects some of the secondary electrons emitted from the screen. The hybrid mesh can also be used to produce an electrical signal corresponding to the waveform stored on the screen. The mesh is similar to the ion-repeller mesh in conventional storage tubes.

When the tube is used for display of repetitive signals, it operates in the same manner as an ordinary cathode-ray tube. Transparency of the screen is about 60%, and decreased brightness is compensated for by improved contrast. □

## Around the world

### Computer puts “map” of harbor on screen

When the Swedish 255,000-ton supertanker *Sea Soldier* recently sailed into Rotterdam, bridge officers had a new navigation aid helping them: a computerized system that pictures the channel ahead directly on the main radar screen. The system—a joint effort by the Kockums shipyards of Sweden and Selenia of Italy—was on its maiden run, and, according to Kockums engineers, it was a great success.

Until now, similar systems—made by Sperry—have required a special screen, separate from the main radar screen. The Kockums-Selenia system integrates the ship's radar, made by Selenia, with the system for presenting the lines of the shipping lane, so that the bridge gets it on one screen.

A moving map of the shipping channel is displayed on the screen, enabling the navigator to see his own ship's position in relation to the channel limits as well as to other ships and obstacles. As the ship moves, the lines on the screen also move.

The system makes use of an anti-collision computer, made by Selenia, linked to the normal on-board SM-3 navigation computer, which is made by Kongsberg of Norway. The Selenia computer, linked to the radar screen, presents vectors and speeds of other ships that the anti-collision radar system picks up, while the Kongsberg computer presents the channel map.

The map is programmed into the computer by means of punched tape or by keyboarding. The ship can keep a library of tapes for the ports that it sails to and the channels it passes. When a ship enters a stretch for which there is no tape, the data can be put directly into the computer by keyboarding the local latitudes and longitudes, which are taken off a standard chart.

Other details—such as water depths—can also be programmed to appear on the screen. The system also provides an automatic alarm signal, through the collision-avoidance system, if the ship crosses a boundary line.

The system provides a motion picture as the ship moves ahead—“like moving on a map,” says Nils-Eric Thorell, a Kockums engineer. “You see your own ship in relation to other ships and to the limits. You can get an idea of where the other ships will be sailing.” Initially, the system will be installed in ships built at Kockums in Malmoe, Sweden.

# REI has one question for people who buy electronic test equipment.

## Why?

**When you need it fast . . . rent it.** Purchasing equipment usually involves long delivery lead times. When you rent your electronic equipment from REI it's a safe bet that you can get what you need within 36 hours of the time you call in your order, sometimes sooner. This fast service is possible because we maintain 9 Instant Inventory Centers throughout the U.S. and Canada, stocking millions of dollars worth of equipment.

**When you need it for only a short time . . . rent it.** Need equipment for a short-term project? Rent it from REI. When you don't need it any more, return it to us. It's the easy, low-cost way to use the equipment you need for just the time that you need it.

**When you care about what it costs . . . rent it.** Renting from REI can be less expensive than purchasing. There's no capital investment to adversely affect your company's cash flow. This means you'll get more mileage from your equipment budget. And, since you can treat your monthly payments as an expense in most situations, you'll also achieve tax advantages from renting.

All REI rental equipment is guaranteed to meet manufacturers' specifications and is operationally checked out prior to shipment. Routine maintenance is provided free of charge. Certification and calibration are available upon request. Our flexible arrangements include rental, rental-purchase and leasing packages to give you the use of equipment from one week to three years or more.

Get your free copy of our 1974 catalog that lists virtually every item in our rental inventory. Use reader service card, or write Rental Electronics, Inc., 99 Hartwell Ave., Lexington, MA 02173. For immediate information, call your local REI Instant Inventory Center listed below. Once you rent from REI, you may never buy electronic test equipment again.

## Rental Electronics, Inc.

A PEPSICO LEASING COMPANY

Burlington, MA (617) 273-2770 • Gaithersburg, MD (301) 948-0620 • Oakland, NJ (201) 337-3757 • Ft. Lauderdale, FL (305) 771-3500  
Des Plaines, IL (312) 827-6670 • Dallas, TX (214) 661-8082 • Mountain View, CA (415) 968-8845 • Anaheim, CA (714) 879-0561  
Rexdale, Ontario (PLC Leasing Ltd.) (416) 677-7513



## Think about renting. It's the smart way to go.



## **'Read-mostly' mass memory stores bits optically on glass**

France's Laboratoires d'Electronique et de Physique Appliquée has been experimenting with a promising candidate for low-cost "read-mostly" mass memories—**semiconductor-glass disks that can be read by a modified video-disk player**. LEP, a unit in the Philips group, uses metastable germanium-tellurium disks 8 centimeters in diameter to store bits optically as transparent spots 1 micrometer in diameter in the translucent glass.

**Bits are recorded by a low-power laser at a scanning rate of 1 megahertz.** Only 2 nanojoules of energy per micrometer square are needed to restore the glass to its stable state. **Packing density runs between  $10^6$  and  $10^7$  bits per square centimeter, about 10 times the capacity of magnetic disks.** The glass disks can be erased by heating them to 140°C. LEP's work so far indicates that the disks can survive five to 10 erasures.

## **German, U. S. firms team to form auto semiconductor firm**

VDO Adolf Schindling AG, west German vehicle-instrument maker, and Solid State Scientific Inc., of Montgomeryville, Pa., have agreed to form a joint semiconductor-manufacturing company. This move is apparently in anticipation of increasing use of solid-state devices in automotive accessories. **VDO owns 60% and Solid State 40% of the company, which is tentatively called VDO Elektronik and will probably be located in Switzerland.** Operations are scheduled to start in 1976.

The new facility's production targets are set quite high—"about 50 million integrated circuits a year, once the plant becomes fully operational with 300 to 400 people," says VDO. **The company's output, for VDO's own use and probably also for outside customers, will initially be complementary-MOS circuits only, but other types may be added later.** The German firm will provide the capitalization for the new venture, and Solid State's contribution will be its research and development potential, plus its production knowhow.

## **Electronic watches slated by firms in Japan, France**

Two new producers of electronic watches with liquid-crystal displays will hit the market in Japan and Europe within the next few months. **Casio Computer Co. of Japan, the consumer-calculator maker, plans to have its watch ready in August.** In France, television manufacturer Marcel Pizon has spun off a new independent company, Electronique Marcel Pizon, to make solid-state clocks and watches. The clocks went into production this month, and a line of watches is due out in the fall. **Pizon's first big target is to supply Swiss watchmakers with electronic movements, which he says they still fear "because the quartz doesn't go tick-tock."**

## **ITT cranks up in UK for worldwide boom in capacitors**

The ITT Capacitor division in the United Kingdom will more than double its production by early 1976 under plans that seek to exploit rising worldwide demand and include contesting tantalum technology in the Japanese marketplace. **Production for all types is targeted for 7 million per week from the current approximately 3 million, of which about 30% is exported.**

Japan, where the UK operation now ships 200,000 tantalum capacitors per week, is a primary target. **The company believes it has gotten**

ahead of the Japanese companies in that technology, and "we want to beat them on their home ground," says one top executive, who adds that ITT also is eyeing Hong Kong and Taiwan. Over-all export sales have been rising 1% a month. ITT's UK operation contributes \$130 million to the corporation's \$450 million annual revenue for its European components group.

## **Nippon Electric expands capacity for its computers**

To meet anticipated demand for its System 100 small computer and also for its ACOS series 77 computers, developed jointly with Tokyo Shibaura Electric Co. (see p. 77), Nippon Electric Co. is rushing to completion a computer plant in neighboring Ibaraki prefecture. **NEC is also enlarging its present computer plant on the outskirts of Tokyo.** The new plant is set up as a subsidiary, Nippon Electric Ibaraki Ltd.

**The Ibaraki plant will assemble CPUs for NEC's computers. At the start of operations next April, NEC plans to have more than 200 people working in almost 50,000 square feet of floor space.** Production for fiscal 1975 is expected to reach more than \$88 million. By the second half of fiscal 1976, the company plans to have more than 1,000 people at work in more than 215,000 square feet of space and production of more than \$176 million. The capital investment through the end of fiscal 1976 is expected to reach more than \$21 million.

## **Japanese agree to limit color-TV exports to Britain**

**The Japanese television industry is expected to limit exports to Great Britain of color receivers to about 100,000 sets for the second half of this year.** In a meeting between Japanese and British industry representatives held in Tokyo last week, the British maintained that total color sales would be 500,000 to 600,000 fewer sets than the 2.8 million sold last year. **The Japanese say they don't think business will be all that bad, but agreed in principle to limit exports to the neighborhood of last year's 275,000 sets.** Exports to Britain for the first half of this year are expected to reach the 160,000 sets agreed upon by Japanese and British industries last November.

## **Addenda**

Philips Data Systems division has strengthened its stance in the OEM market with a new minicomputer built around a general-purpose bus and a one-board LSI central processor. **The new P852m machine comes with standard memory modules of 4,096, 8,192, or 16,384 bits that have 1.2-microsecond access time.** . . . France is slowly building up an automatic automobile-telephone network. **The radio-link exchange at Lille, first city after Paris to get the new service, went on the air in mid-June with a start-up quota of 75 lines, slated to be increased to 200 next year.** Paris will get its third exchange soon, pushing the total there to more than 600 lines. Thomson-CSF is the kingpin supplier of the sets, which operate in the 150-megahertz band with 10 watts of emitter power. . . . West Germany's federal railways have introduced direct computer control of signaling and train-switching. **Controlled by a remotely installed computer supplied by Siemens AG are four signaling and switching stations along the Hanover-Bremen railroad line.** The computer, a model 304 process-control machine, uses a fixed program to check the routing of each train according to stored time schedules and then sets the track switches and the signaling gear.

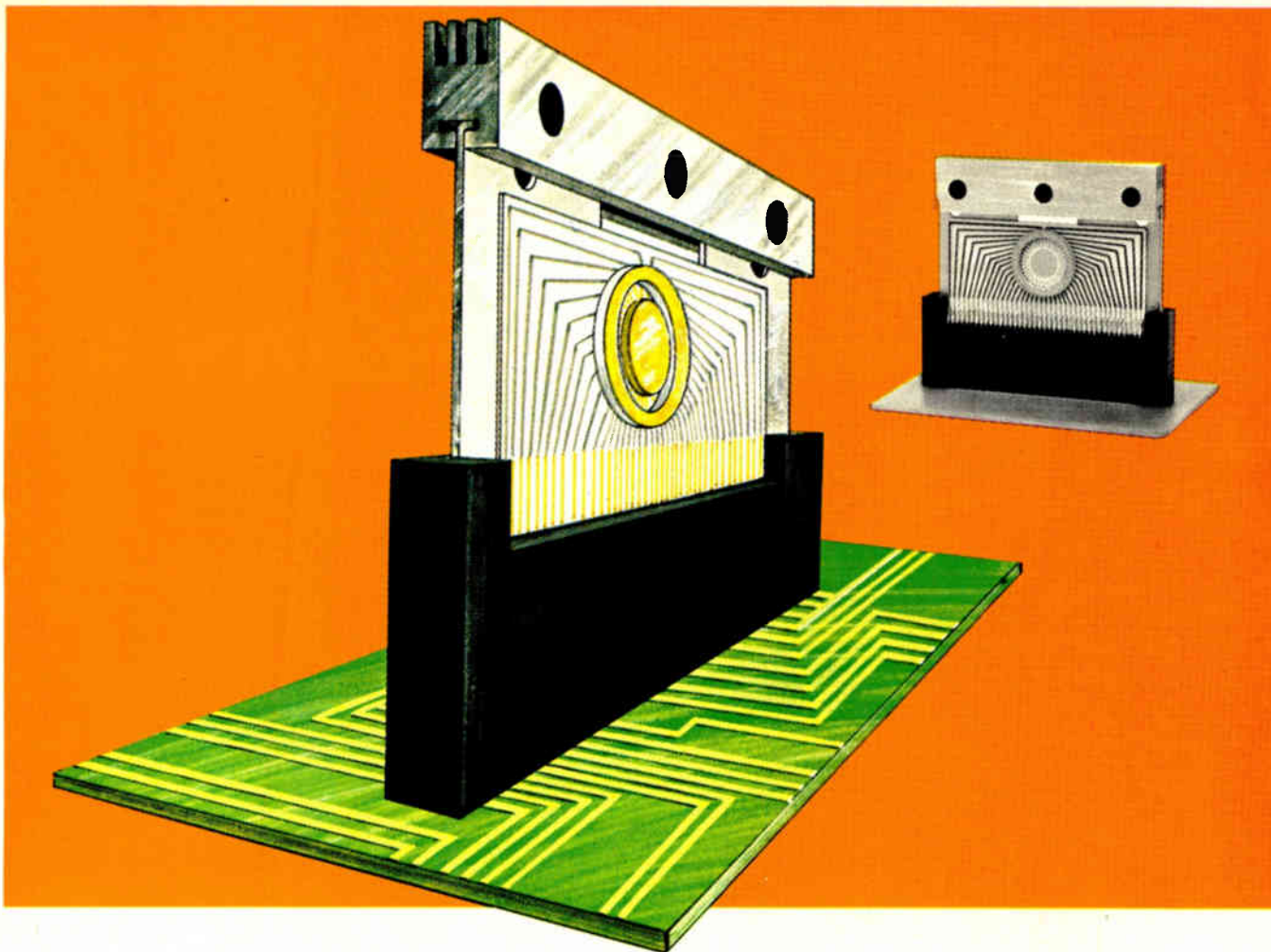

# The "3-D" Micro- Connector

LOADS  
80 CONTACTS  
INTO 2" x .300"

Elco's newest Series 8401 multi-level connector, for hybrid microelectronic packaging, can handle up to 80 interconnections within a 2" by .300" space. Comfortably and reliably. And with today's dense integrated-circuit packaging requirements, Series 8401 fits in perfectly. Answering the most exacting design parameters.

There's no other connector like the 8401. The .025" center-to-center receptacle contacts of this two-piece connector are offset into two different levels of mating. This forms a unique, three-dimensional device that significantly reduces the "peak" mating forces over conventional, single-level connectors.

The 8401 can accommodate either .025" thick ceramic substrates or p.c. boards in a variety of configurations: one single-sided, two single-sided (back-to-back), or one double-sided. There's even a special heat sink available that can also serve as a ground plane for the printed circuitry. From the simplest to the most complex application. Elco's new Series 8401 will do the job.

Mounting is no problem either. The connector has special keying hardware with threaded ends for standard hardware assembly. We know all the problems involved with hybrid packaging. That's why we designed the Series 8401 multi-level connector. Just another service in keeping with Elco's Total Connector Capability.

For full details and specifications on Series 8401, contact your local Elco representative, or:

Elco Corporation  
Willow Grove, Pa. 19090  
(215) 659-7000

Elco Corporation  
2200 Park Place  
El Segundo, Calif. 90245  
(213) 675-3311



Operations in USA, Australia, Belgium, Canada, Denmark, England, France, Germany, Israel and Japan. Sales offices throughout the world. In Europe, Elco Belge, 77 Blancfloerlaan, Antwerp, Belgium, Tel. 03-190064. In the Far East, Elco International, TBR Building, 2-10-2 Nagatacho, Chiyoda-ku, Tokyo 100, Japan, Tel. 580-2711/5. Copyright © 1973 Elco Corp. All rights reserved.

weigh 3.5 ounces. The three-pole forms are 1 1/4 x 1 1/4 inches and weigh 3.75 ounces. All four forms have a tip travel of 1/2 in. and a tip pressure of 28 grams.

These relays are designed for use from minus 40° C to plus 95° C. They are suitable for use from sea level to 40,000 feet, and are corrosion-proof, meeting Navy 200-hour salt-spray tests. They are good for mechanical frequencies of 5 to 55 cps at 1/2 inch maximum amplitude (1/8 inch total travel) applied in any direction. The contacts remain in the correct position when the relays are subjected to a linear acceleration of ten times gravity in any direction.

General Electric Co., Schenectady, N. Y.

## Literature

**Wire Data Chart.** A useful chart for persons who employ wire in their designs or specifications. In columnar tabulation are given the B & S, Washburn & Moen and Stubs or Birmingham diameters for gauge sizes 1 to 50. The B & S column shows feet per pound for each size of standard 5 percent phosphor bronze. Also a table of conversion factors for obtaining ft/lb

STANDARD WIRE GAUGES					
Diameter	B & S	WASHBURN & MOEN	STUBS OR BIRMINGHAM	WEIGHTS	
				Feet per Pound	Per Square Foot
.2893	1	1	1	3.500	1
.2876	1.5	1.5	1.5	2.825	2.84
.2860	2	2	2	2.475	2.50
.2843	2.5	2.5	2.5	2.225	2.25
.2827	3	3	3	1.975	1.99
.2810	3.5	3.5	3.5	1.725	1.74
.2794	4	4	4	1.475	1.49
.2777	4.5	4.5	4.5	1.225	1.24
.2761	5	5	5	1.000	1.01
.2744	5.5	5.5	5.5	.825	.83
.2728	6	6	6	.675	.68
.2711	6.5	6.5	6.5	.550	.55
.2695	7	7	7	.450	.45
.2678	7.5	7.5	7.5	.375	.37
.2662	8	8	8	.312	.31
.2645	8.5	8.5	8.5	.262	.26
.2629	9	9	9	.221	.22
.2612	9.5	9.5	9.5	.187	.18
.2596	10	10	10	.156	.15
.2579	10.5	10.5	10.5	.130	.13
.2563	11	11	11	.108	.10
.2546	11.5	11.5	11.5	.090	.09
.2530	12	12	12	.075	.07
.2513	12.5	12.5	12.5	.062	.06
.2497	13	13	13	.051	.05
.2480	13.5	13.5	13.5	.042	.04
.2464	14	14	14	.035	.03
.2447	14.5	14.5	14.5	.029	.02
.2431	15	15	15	.024	.02
.2414	15.5	15.5	15.5	.020	.02
.2398	16	16	16	.017	.01
.2381	16.5	16.5	16.5	.014	.01
.2365	17	17	17	.012	.01
.2348	17.5	17.5	17.5	.010	.01
.2332	18	18	18	.008	.00
.2315	18.5	18.5	18.5	.007	.00
.2299	19	19	19	.006	.00
.2282	19.5	19.5	19.5	.005	.00
.2266	20	20	20	.004	.00
.2249	20.5	20.5	20.5	.003	.00
.2233	21	21	21	.003	.00
.2216	21.5	21.5	21.5	.002	.00
.2200	22	22	22	.002	.00
.2183	22.5	22.5	22.5	.001	.00
.2167	23	23	23	.001	.00
.2150	23.5	23.5	23.5	.001	.00
.2134	24	24	24	.001	.00
.2117	24.5	24.5	24.5	.001	.00
.2101	25	25	25	.001	.00
.2084	25.5	25.5	25.5	.001	.00
.2068	26	26	26	.001	.00
.2051	26.5	26.5	26.5	.001	.00
.2035	27	27	27	.001	.00
.2018	27.5	27.5	27.5	.001	.00
.2002	28	28	28	.001	.00
.1985	28.5	28.5	28.5	.001	.00
.1969	29	29	29	.001	.00
.1952	29.5	29.5	29.5	.001	.00
.1936	30	30	30	.001	.00
.1919	30.5	30.5	30.5	.001	.00
.1903	31	31	31	.001	.00
.1886	31.5	31.5	31.5	.001	.00
.1870	32	32	32	.001	.00
.1853	32.5	32.5	32.5	.001	.00
.1837	33	33	33	.001	.00
.1820	33.5	33.5	33.5	.001	.00
.1804	34	34	34	.001	.00
.1787	34.5	34.5	34.5	.001	.00
.1771	35	35	35	.001	.00
.1754	35.5	35.5	35.5	.001	.00
.1738	36	36	36	.001	.00
.1721	36.5	36.5	36.5	.001	.00
.1705	37	37	37	.001	.00
.1688	37.5	37.5	37.5	.001	.00
.1672	38	38	38	.001	.00
.1655	38.5	38.5	38.5	.001	.00
.1639	39	39	39	.001	.00
.1622	39.5	39.5	39.5	.001	.00
.1606	40	40	40	.001	.00
.1589	40.5	40.5	40.5	.001	.00
.1573	41	41	41	.001	.00
.1556	41.5	41.5	41.5	.001	.00
.1540	42	42	42	.001	.00
.1523	42.5	42.5	42.5	.001	.00
.1507	43	43	43	.001	.00
.1490	43.5	43.5	43.5	.001	.00
.1474	44	44	44	.001	.00
.1457	44.5	44.5	44.5	.001	.00
.1441	45	45	45	.001	.00
.1424	45.5	45.5	45.5	.001	.00
.1408	46	46	46	.001	.00
.1391	46.5	46.5	46.5	.001	.00
.1375	47	47	47	.001	.00
.1358	47.5	47.5	47.5	.001	.00
.1342	48	48	48	.001	.00
.1325	48.5	48.5	48.5	.001	.00
.1309	49	49	49	.001	.00
.1292	49.5	49.5	49.5	.001	.00
.1276	50	50	50	.001	.00

values for 15 other common wire materials. On the reverse side of the card details of the composition, strength for hard and soft grades, percentage of elongation, and density are given. The card is heavy white celluloid, vest pocket size. Callite Tungsten Corp., Wire Division, Union City, N. J.

# CONSULT INSULINE

Now...

## for PRODUCTS and PARTS

ESSENTIAL IN THE MANUFACTURE OF

# ELECTRONIC APPARATUS

FOR war-order contractors we are in an excellent position to manufacture:—

- Metal Cabinets, Chassis, Panels, Racks, Boxes
- Metal Stampings; also Name Plates, Dials, etc.
- Completely assembled Screw Machine Products
- Hardware and accessories

We invite inquiries on SPECIAL WORK FOR MANUFACTURERS, such as: Screw Machine Parts, Engraving, Machining, Stamping, etc.

It will pay you to consult Insuline . . . now!

**INSULINE CORP. OF AMERICA**  
30-34 NORTHERN BLVD. LONG ISLAND CITY, N. Y.



# Streamline SHEET-METAL HOUSINGS



**GENERAL CABINET RACKS**

Featuring Beauty, Durability and Economy, these Streamline Cabinet Racks afford the BEST in enclosures for an endless variety of industrial electronic installations. The five cabinets made in this series accommodate 19" rack panels in heights from 8 3/4" to 35".

Call on our Sheet Metal Department for estimates on your special requirements. We make custom-built cabinets, panels and punched chassis for many types of commercial applications.

## MIDGET CONDENSERS



BUD precision-built midget condensers are made in many types and capacities for a variety of commercial requirements. They feature Alsimag 196 insulation, positive wiping rotor contact, electro-soldered rotor and stator assemblies, bright cadmium plated finish, and rugged mechanical construction. We will be pleased to furnish estimates on your requirements.

**BUD RADIO, INC.**  
CLEVELAND, OHIO

# SIEMENS

## The unvarying ingredient in every Siemens component: batch-to-batch quality.

Even though Siemens makes 50,000 different shapes and sizes of components, to meet virtually any need *and* the reality of your economics, we're best known for the efforts we devote to quality. Year after year, batch after batch. (We've made 500 million pot cores in the last 5 years alone.)

One of the reasons for our high level of quality and reliability is the two million dollars we invest every working day in research and development. Our R&D program has paid off well—90% of the components we offer today were not available 10 years ago.

R&D has also enabled Siemens to pioneer metallized polyester-film (MYLAR\*) capacitors, tuning-diodes, gas-filled SVP's\* and cradle relays. And there are more innovations on the way.

If you depend on electronic components, you can depend on Siemens. Batch after batch, the quality never varies.

\*DuPont registered trademark.

For details, get in touch with your local Siemens specialist, or fill in the coupon below.

Please indicate your specific area of interest and mail to:

Siemens Corporation, Components Division  
186 Wood Avenue South, Iselin, N.J. 08830

- |   |   |   |
|---|---|---|
| <input type="checkbox"/> BWO's                                      | <input type="checkbox"/> LCD's          | <input type="checkbox"/> Semiconductors   |
| <input type="checkbox"/> Capacitors                                 | <input type="checkbox"/> LED's          | <input type="checkbox"/> Opto-Electronics |
| <input type="checkbox"/> Ferrites                                   | <input type="checkbox"/> Planar Triodes |   |
| <input type="checkbox"/> Gas-Filled Surge Voltage Protectors (SVP®) | <input type="checkbox"/> Relays         |   |

Name \_\_\_\_\_ Title \_\_\_\_\_

Company \_\_\_\_\_ Tel. \_\_\_\_\_

Address \_\_\_\_\_

City \_\_\_\_\_ State \_\_\_\_\_ Zip \_\_\_\_\_

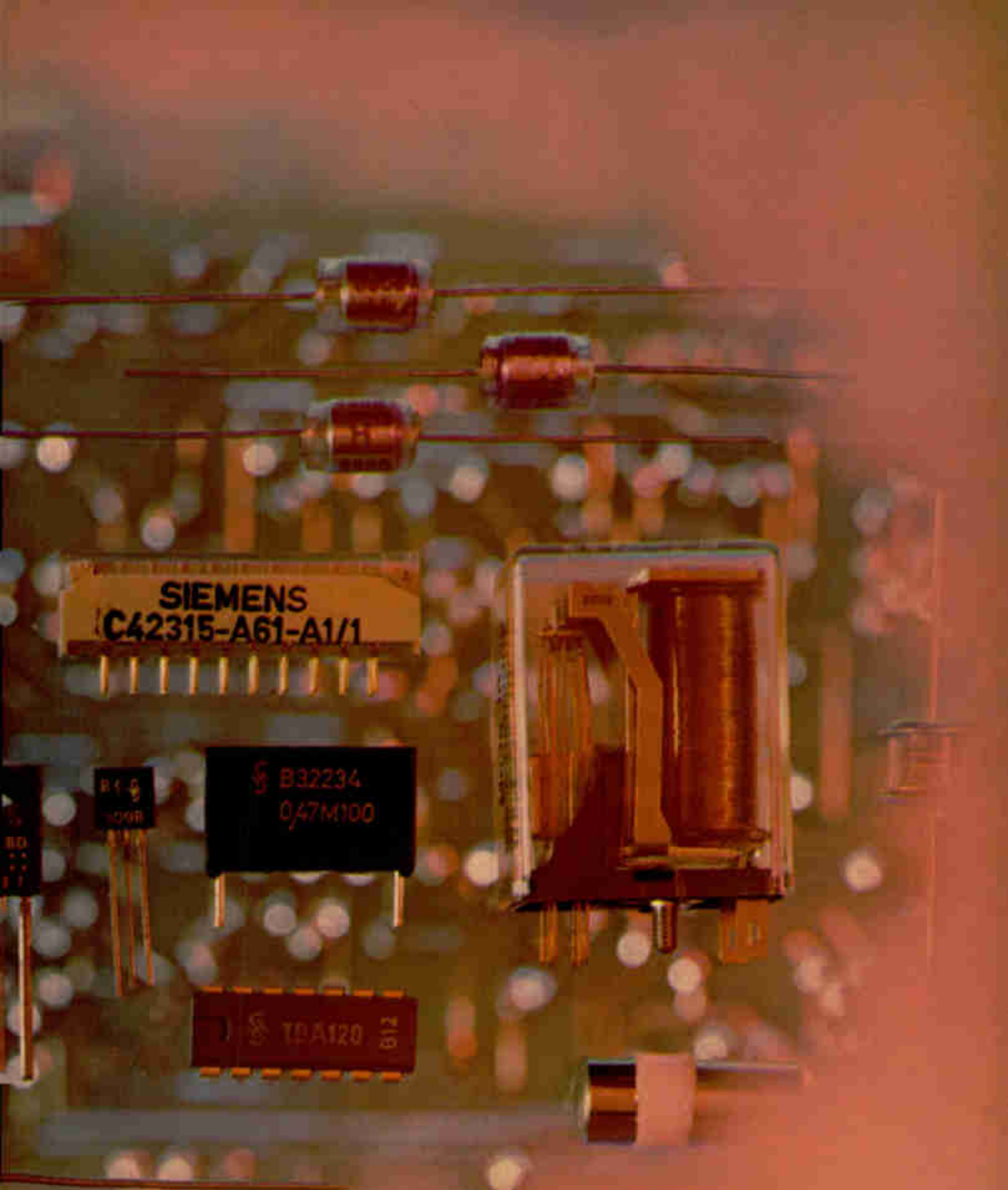

**Siemens Corporation**  
**Components Division**

186 Wood Avenue South, Iselin, N.J. 08830 (201) 494-1000

Circle 63 on reader service card

# Watts New



Sorensen introduces the new, higher power density DCR-B series lab/system dc power supplies. Designed specifically as an extension of the popular single-phase DCR-A series. Minimum panel height is 3½". Power output is up to 2700 watts. Noise and ripple are 50% lower than in previous models.

Other DCR-B advantages: low cost-per-watt; fast response time; choice of 32 new versatile models to cover a broad range of applications; exceptional efficiency and dependability; and new, less expensive overvoltage protection option that can be installed at the factory or in the field. For complete data, contact the Marketing Manager at Sorensen Company, a unit of Raytheon Company, Manchester, N.H. 03103. (603) 668-4500.

## Representative Specifications – DCR-B

Voltage Ranges: 0-10, 20, 40, 60, 80, 150, 300, 600 volts DC			
Efficiency: Up to 86% typical			
Panel Height	Cooling	Nominal Output Power (watts)	Price Range
3½"	convection	500	\$400-475
5¼"	convection	1000	575-690
7"	convection	1800	775-975
7"	fan	2700	1075-1125

**Sorensen**  
POWER SUPPLIES

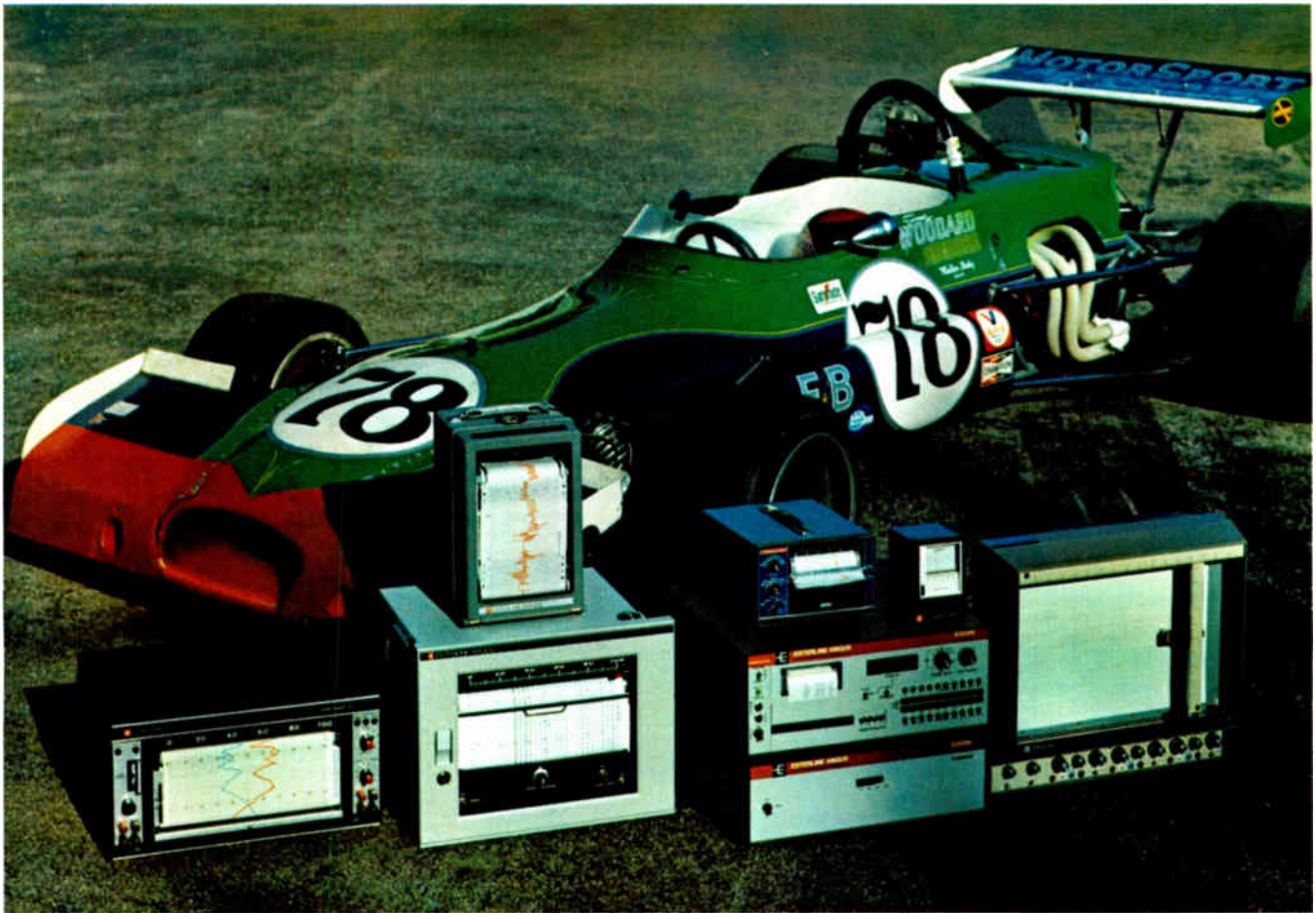

# You just won the data race

Seven different kinds of high performance recorders are here now to help you track processes, power, experiments, tests, and pollution. Graphic and digital recorders, up to 200 channels, save time, money, and data reduction. Check Esterline Angus for the most comprehensive line of dependable recorders in the world. Ask for complete catalog or a demonstration.

#### Prizes!

**Speed Servo® II.** Broad line of 0.3 sec. response, single and two-channel, ink or inkless, wide chart linear servo recorders.

**Direct writing.** Dozens of models measure and record all power parameters, also events. 1 to 40 channels.

**Multipoint.** Programmable. Ink or inkless writing up to 24 channels. Most dependable recorders of their type.

**Miniservo™.** New 10 cm-wide servo with 0.5 sec. response, sensitivity to 1 mV, many options, lowest price.

**Minigraph.** Compact, low cost inkless chart single, two-channel, time share, temperature and event recorders.

**D-2020 Data Systems.** 5 to 200 channels of data in digital printout of absolute or integrated measurements. Options include computer input, alarms, thermocouples.

**X-Y recorders.** Big line with many options including X-Y-Y'. (Available in Europe through Honeywell.)

Esterline Angus, Box 24000, Indianapolis, Indiana 46224.  
Tel. 317/244-7611.



**ESTERLINE ANGUS**

A UNIT OF ESTERLINE CORPORATION



This new Guardian Relay Catalog...



...is no small thing.

It's

## **THE BIG BOOK**

of relay facts, specs and ordering info.

(And it's yours free for the asking.)

**CIRCLE 66 ON THE READER SERVICE CARD**  
*for your very own personal copy. Free from your Guardian Angel.*



# **GUARDIAN®**

GUARDIAN ELECTRIC MANUFACTURING CO. 1566 West Carroll Ave., Chicago, Illinois 60607



# Announcing...

now there are more than  
300 ways to improve your  
harnessing production  
with the **TY-RAP<sup>®</sup>** system  
*(if you need another way . . . we'll make it)*

Anytime you have the opportunity to pick and choose exactly what you want, you increase design flexibility . . . you make a better buy. The TY-RAP line lets you do just that. You buy only what you need . . . without waste. There is a tie for just about every tying requirement, from 1/16" to 9" dia. Best of all, uniform reliability and most efficient production of your design is assured through the wide selection of tying aids and tools.

A major new benefit of the TY-RAP system is our national network of tool service centers to insure your continued high level of production efficiency.

If you are not a user of TY-RAP products, perhaps our evaluation service for cost reduction techniques will help you. Call us, we'll be pleased to conduct a study of your production operation.

Thomas & Betts Co., Elizabeth, N. J. 07207. (201) 354-4321. In Canada, Thomas & Betts Ltd., P.Q.

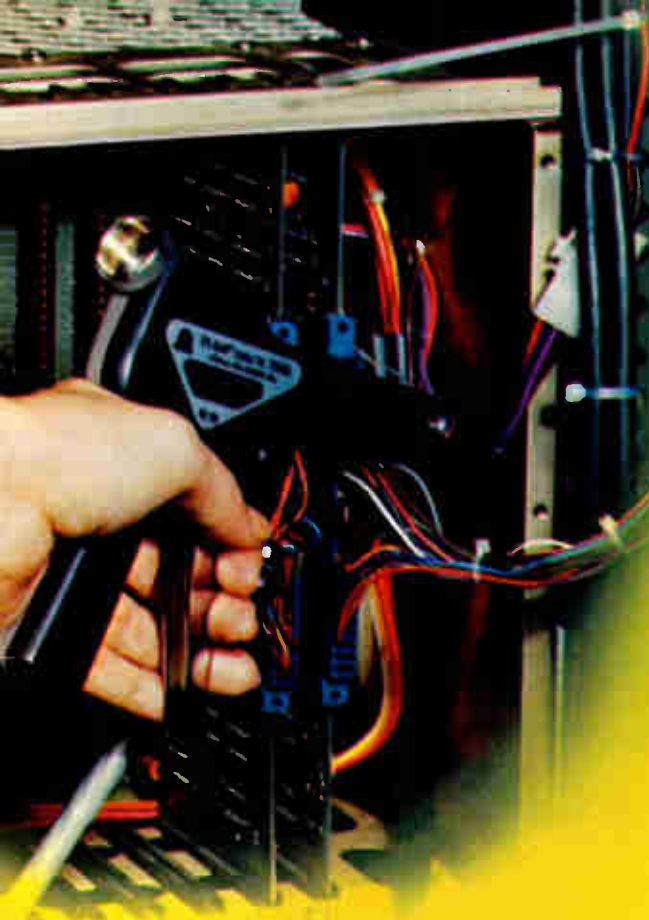

WT-193 mechanical tying tool gets into tight places . . . great for small volume harnessing or point-to-point tying.

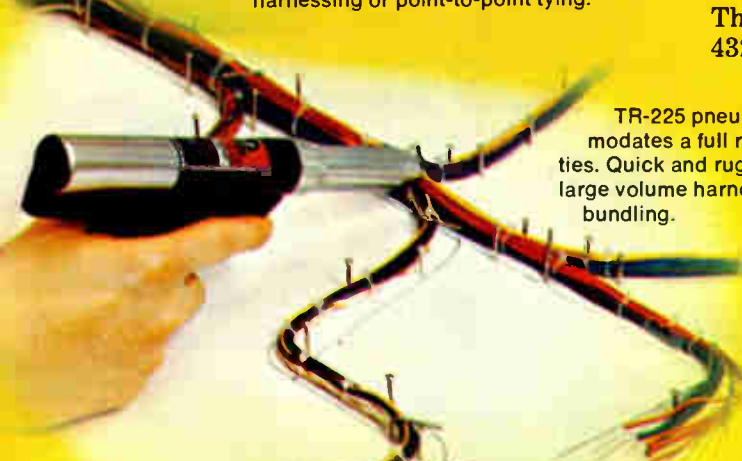

TR-225 pneumatic tool accommodates a full range of TY-RAP ties. Quick and rugged . . . ideal for large volume harnessing and cable bundling.

Circle 67 on reader service card



New TR-300 automatic tool applies ties in 8/10 of a second. Counterbalance system makes it a "feather-weight".

1/16" to 4"

1/16" to 3 1/2"

1/16" to 3"

1/16" to 1 1/4"

1/16" to 1 3/4"

1/16" to 2"

1/16" to 5/8"

Sold Only Through Authorized T&B Distributors



**THOMAS & BETTS**

Division of Thomas & Betts Corporation

# Teradyne's no-nonsense test system for semiconductor memories.



Introduced just months ago, the Teradyne J384 has already proved itself as *the* first practical answer to the memory testing problem, both on the production line and for incoming inspection. Because the J384 does the most testing for the least cost. Here are eight reasons why:

1. The computer-operated J384 tests all semiconductor memories, PMOS and NMOS, TTL and ECL.
2. Its unique *vector-list autocalibration* ensures consistent timing control from job to job, from test station to test station.
3. Its architecture lets you squeeze the last ounce of throughput out of each system. Up to four stations per satellite, up to four satellites per system. Stations can be multiplexed where test-plan length makes multiplexing practical; satellites can be time-shared where longer test plans are required. (And we can help make those test plans short.)
4. The J384 includes full dc parametric test capability as well as functional testing to 20 MHz.
5. It interfaces with wafer probers and automatic handlers without loss of performance, without expensive fixturing.

6. It makes programming and on-line editing easy; the J384 and your device specs speak the same language.

7. Its schmoo-plot and other data-processing capabilities make it a favorite among device engineers as well as production people.

8. Like all Teradyne systems, the J384 is designed and built to industrial standards. That means no calibration adjustments, no short-life components. And full 10-year warranty coverage on the circuit modules.

The J384 represents Teradyne's knowledge of what makes economic and technical sense on the semiconductor production line and in incoming inspection — knowledge gained by putting more than 700 computer-operated semiconductor test systems to work in plants all over the world.

For complete details on the J384, just call any Teradyne sales office. Or write: Teradyne, Inc., 183 Essex Street, Boston, Massachusetts 02111. In Europe: Teradyne Ltd., 12 Queens Road, Weybridge, Surrey, England.

## TERADYNE

# J384

CHICAGO (312) 298-8610 / DALLAS (214) 231-5384 / NEW ENGLAND (617) 458-1256 / NEW YORK (516) 364-9797 / SUNNYVALE (408) 732-8770  
LONDON (0932) 51431 / PARIS 265 72 62 / ROME 59 47 62 / MUNICH (0811) 33 50 61 / TOKYO (03) 406-4021

# Probing the news

Analysis of technology and business developments

## A whole new game

Makers of electronic amusements find soaring growth rate slowing amid shakeout

by Bernard C. Cole, San Francisco bureau manager

Six months ago, it seemed that electronics was going to take over yet another electromechanical stronghold—amusement games. But that's not going to occur quite yet because the market, perhaps approaching saturation, has slowed. After an interval of consolidation and intensive research, a period of impressive growth appears to be coming, but it won't be quite as spectacular as that of the last two years.

Although the traditional Chicago giants of the \$120-million-a-year amusement industry—Bally Corp., Gottlieb Inc., Williams Electronics, and Chicago Coin—are not as interested as they once were in the new technology, significant changes have taken place. Where there once were just pinball machines, now there are also the so-called Pong games, played by two persons who try to "hit" an electronic ball back and forth on a cathode-ray tube. Consisting mostly of the display, a TTL circuit board, and a cabinet, the electronic games made it possible for a lot of small companies—located mostly in San Francisco's Silicon Valley—to enter the field.

These newer companies really didn't need much capital to get started because the games were much easier to manufacture than their electromechanical counterparts and even easier to change—merely by replacing their logic boards—a helpful factor in a business where a game is old after three or four months.

Six months after the introduction of the first such video-electronic game in early 1972 by Nutting Associates of Mountain View, Calif., and the founding of Atari Inc. of Los Gatos, Calif., an industry

**Bouncing light.** "Flim-Flam" game by Meadows Electronics has three paddle sizes and player can vary speed of ball after it's hit. Video "Winner" game is basically a copy of Pong games. Made by Midway, it has only one size paddle that moves vertically.



leader, sales started climbing at an astounding rate, and 20 or so similar companies burst into existence. By the end of last year total sales of video games had risen to \$20 million a year. By the end of this year, sales are expected to reach about \$50 million for the year.

However, by last January, the curve started to flatten; most of the sales for the fiscal year had been chalked up in the first six or eight months. The market appeared to have been saturated, and many of the companies that had copied Atari's Pong before it was patented had disappeared. That left Atari,

Nutting, and a half-dozen companies that had come up with original game designs and who had learned the ins and outs of the amusement business. As a result, most industry sources speculate that TV games will gross no more than \$30 million in sales in the next fiscal year.

**Appeal fades.** This sag has left the makers of traditional games with the feeling that, while there's a niche for electronics, the TV games won't drive their electromechanical cousins into the sea. "TV games had a great year in 1973, but now the market has been saturated," says

## Probing the news

Ross Scheer, director of marketing for Bally. "Maybe applications of some electronics will be used somewhere, but not in a TV version."

Adds Frank Bracha, Bally's assistant vice president for engineering: "In paddle games such as Pong, we have seen a tremendous fall-off in game appeal. There are quite a few people manufacturing those games, and some of them will make a substantial amount of money this year. But while our sales of flipper [pin-ball] games are increasing, there seems to be degradation in the sales of TV games."

In agreement is David Marofsky, manufacturing vice president at Midway Manufacturing Co., a subsidiary of Bally in Schiller Park, Ill.

He says there is no question but that sales of TV games are dropping. "There is still a market out there, but it is nowhere as large as it once was," he says. "It will be limited to a few large manufacturers with new twists." Midway, which sold around 12,000 TV games in 1973-74, is projecting sales of 3,000 to 5,000 in 1974-75.

But the use of electronics is slowly penetrating traditional games in other ways. Arcade games—gun, driving, and bowling games, for example—are beginning to incorporate electronics for sound packages, timing devices, photocells, and speed controls on dc motors. "Midway is mixing electronics with stepper-type systems in almost all our arcade games," says Marofsky. "We began using electronics for sound systems in 1968 and then began using tape

decks and electronics for speed variations and programing."

Midway sells a table-tennis wall game that Marofsky estimates is about 50% electronic. It has a transceiver for remote control and logic for varying the speed of the reflected light "ball," depending on how it is hit and the number of hits. "It still uses a lot of light sockets, and scoring is done mechanically; but without electronics, the game is nothing," he says. "We are constantly blending electronics into our arcade line. And we have had very good experience with reliability. We have repair-and-return modular packages, and most of our distributors are stocking certain cards that they are getting a turnaround on."

**Combinations.** Some manufacturers are turning out mechanical arcade games that they could not have built without electronics. A new regulation bowling/scoring game—Bally Alley—is built around an Intel 4004 microprocessor. "It gives us computer control of the game," says Bally's Bracha, "for station-keeping, monitoring players, monitoring free games and credits, and monitoring the condition of the game. The whole design is based on utilization of microprocessor technology."

Adds Bally's Scheer: "Its cost is comparable to traditional bowling games, but its size is much smaller than the traditional 17 to 30 feet. And since it has remote control, we can hang it on the wall if we have to."

But the other electromechanical game manufacturers, such as Chicago Coin, are approaching electronics with caution. "Sure we are moving more and more into solid state, but very slowly and very carefully," says Jerry Koci, chief engineer at Chicago Coin. "Not too many of the servicemen understand and can repair solid state."

In fact, in an attempt to gain a marketing edge over similar games from competitors that use electronics, Chicago Coin has gone backward into electromechanical technology for a new driving game called Speed Shift. "Maybe electronics will eventually give us more reliability and longer life," says Bracha. "But we don't have enough history on games in the field." □

## Learning the business

While makers of traditional games are proceeding cautiously with electronics, the manufacturers of video games—the people who started the furor—have learned their lesson. Since public interest peaks and falls off quickly, the newer companies now realize that they must constantly introduce new games. They are now hitting the market with a whole new generation.

Atari has eight new games on the market; Ramtech of Sunnyvale, Calif., has five; Kee of Santa Clara has four; and Nutting has two. Two newcomers have come out with new innovative games also—Exidy Inc. of Palo Alto and Meadows Electronics of Sunnyvale.

Many of these games can be characterized as having gone beyond the primitive paddleboard concept plus TTL logic to a second and even third generation of games with much more sophisticated electronic innards: LSI, thick-film hybrids, custom MOS chips, ROMs, RAMs, and shift registers.

"The important thing in the amusement-game business," says Nolan Bushnell, the 30-year-old chairman of Atari, "is novelty and fast turnaround in production. The public likes new games and will play anything—electromechanical or electronic—as long as it is different and challenging.

"With an electronic game, you can design faster, produce it faster, and get it on the market faster. Because of its smaller size and relative quietness, it can be fitted into more locations. And electronic logic has more flexibility. You can do more things with it to produce an exciting, challenging, and entertaining game. And as the cost of components comes down in the future, it can be done much more cheaply."

With total industry volume down from about 50,000 units last year to about 40,000 this year, Bushnell believes that this development, although temporary, is all to the good. To him, it means the disappearance of the game copiers that saturated the market with low-quality games. The solid ones who are left are doing quite well, he says.

Atari manufacturing vice president Richard Mobilio estimates that the company's newest entry, Grand Trak 10, a racing game, will gross \$12 million on a 10,000-unit run this year. And other games are in the works, he says.

And what of the third generation? Bushnell, for one, is looking at microprocessors—not the 4-bit kind being used in the electromechanical games, but the 8- and 16-bit high-speed models. As soon as more are available, he is planning to design a whole line of games around them. H. R. (Pete) Kaufman, president of Exidy, concurs: "My God! When you think of some of the things you can do with microprocessors, it will be fantastic."

# An industry first.

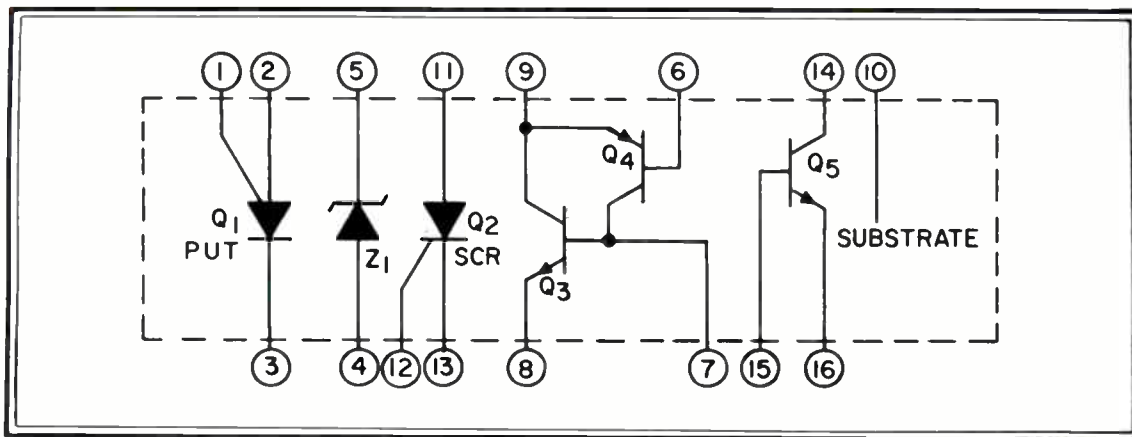

## RCA Solid State's CA3097E Thyristor/Transistor IC Array

There are so many ways to use it that we can't even begin to describe them to you.

We've put a programmable unijunction transistor (PUT), sensitive gate SCR, zener diode, p-n-p/n-p-n transistor pair and an n-p-n transistor ... all together in the 100 times improved plastic package system — RCA's new E-55 (16 lead DIP).

Check these characteristics and decide for yourself how to use the CA3097E in your system.

### Characteristics

- Programmable unijunction transistor (PUT)
  - peak-point current = 15 mA (typ) at  $R_G = 1\text{ M}$
  - $V_{AK} = \pm 30\text{ V}$
  - DC Anode Current = 150 mA
- Sensitive-gate silicon controlled rectifier (SCR)
  - 150 mA forward current (max.)
- Zener diode
  - $8\text{ V} \pm 10\%$
  - $Z_z = 15\ \Omega$  (typ.)

- DC Current 25 mA (max.)
- p-n-p/n-p-n transistor pair
  - $\beta \cong 8000$  (typ)
- @  $I_c = 10\text{ mA}$
- n-p-n transistor
  - $V_{CEO} = 30\text{ V}$  (min.)
  - $I_c = 100\text{ mA}$  (max.)
- Thermal and electrical component tracking with the design flexibility of discrete components
- Improved product reliability with the E-55 plastic packaging system, which demonstrates two orders of magnitude improvement in reliability over previous industry average.
- Operation over a temperature range of  $-55$  to  $+125^\circ\text{C}$ .

If the CA3097E can work for you, order now. It is available in quantity — at a price that will stop you in your tracks: \$1.35 (1K price).

Want to know more about the CA3097E? Write: RCA Solid State, Section 70F27, Box 3200, Somerville, New Jersey 08876. Or phone: (201) 722-3200, Ext. 3144.

**RCA Solid State**  
products that make products pay off

# KENYON

## BRINGS IT THRU

**K**ENYON is serving the Allied forces on the land . . . in the air . . . and under the sea. Whether it's an airplane flying for war or peace . . . whether it's a ship at sea or a submarine signalling beneath . . . whether it's a broadcasting station bringing the news . . . or a long-distance telephone call announcing a birth or a death . . . Kenyon Transformers are on the job. In the exigencies of war and along the by-ways of peace the efficiency and high fidelity of Kenyon Transformers are playing a part.

**KENYON TRANSFORMER CO., INC.**  
840 BARRY STREET  
NEW YORK, N. Y.



## ALLIED PRECISION BUILT LATCHING RELAYS

ALLIED presents a new line of mechanical lock, electrical release relays. They are designed for operation on any nominal voltage under 125 A. C. or 50 D. C. Current types are available in single pole double throw and double pole double throw.

This new line of relays has important features such as compactness, light weight, and minimum base mounting area. They are designed to meet Aircraft vibration tests and Army and Navy temperature and humidity requirements.

Allied Control Company, Inc. has specialized in the development of relays to meet critical test specifications. Special adaptations of standard relays to meet your specific requirements are solicited.

*Inquiries from aircraft and other designing engineers will receive prompt attention.*

**ALLIED CONTROL COMPANY, INC.**  
227 FULTON STREET  
NEW YORK CITY

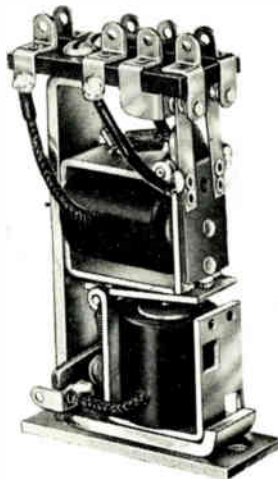

Type BJJ  
D.P.D.T.

**Definitions of Electrical Terms.** A new American Standard known as Definitions of Electrical Terms, C42, sponsored by the American Institute of Electrical Engineers, is now ready for general distribution. It is the first time the definitions of the important terms common to all branches of the art as well as those specifically related to each of the various branches have been assembled and printed under one cover. This glossary is the result of more than twelve years of work of a sectional committee. The thirty-four organizations represented on this sectional committee include the national engineering, scientific and professional societies, trade associations, government departments and miscellaneous groups.

The primary aim in the formulation of the definitions has been to express for each term the meaning which is generally associated with it in electrical engineering in America. The definitions have been generalized wherever practicable to avoid precluding the various specific interpretations which may be attached to a term in particular applications.

The book contains three hundred pages, size 8 x 11 inches, and is indexed. It sells for \$1.00 net each in U.S.A., and \$1.25 outside of U.S.A. The price is the same for single copies or quantities. Checks should be made payable to American Institute of Electrical Engineers, and addressed to their headquarters at 33 West 39th Street, New York, N. Y.

**Electronic Equipment.** A 16 page catalog listing various stock items in rheostats, resistors, tap switches, chokes and attenuators. It contains illustrations, descriptions, ratings, prices and other helpful information. A copy of catalog 18 may be obtained from Ohmite Mfg. Co., Dept. 4-A, 4835 Flournoy St., Chicago, Ill.

**Switches.** The application, overtravel, operating mechanism and maintenance and inspection of small precision limit switches is described and illustrated in a new listing of dimension sheets by the Square D Co, Milwaukee, Wisconsin.

**Induction Heating Data Sheet.** A data sheet covering the fundamentals of induction heating. It gives a description of induction heating, current, frequency, magnetic fields, and heat producing losses. This is the first of a series of data sheets and from now on they will be released monthly by the Induction Heating Corp., 389 Lafayette St., New York City.

**Rubber Conservation.** This booklet gives explicit instructions for the proper care of many types of rubber goods such as electrical tapes, wires and cables, mountings, etc. Harmful effects of grease, oil and solvents is also discussed. U. S. Rubber Co., Rockefeller Center, New York, N. Y.

Communications

# Maritime radio space reallocated

470 delegates to ITU conference manage to agree on changes in regulations that will start to take effect in 1976

by Arthur Erikson, Managing Editor, *International*

"It's like trying to put a quart of water into a pint jar," says FCC commissioner Robert E. Lee. The jar Lee has in mind is the overtaxed portion of frequency spectrum set aside worldwide for maritime mobile radiotelephone communications. The pouring—far too sloppy in Lee's view—was done early this month in Geneva during a seven-week meeting of the International Telecommunication Union. And Lee was there as head of the U.S. delegation.

At the meeting, officially called the World Administrative Radio Conference for Maritime Mobile Telecommunications, 90 ITU member countries painfully reworked the radio regulations for all kinds of ships' radio services, from on-board communications by walkie-talkie to international distress frequencies. The 470-odd delegates had to cope with mountains of paper to do the job: some 2,200 proposals for changes to the existing regulations were tabled at the conference.

By far the thorniest task was working out new allotments for the 176 channels reserved for maritime mobile radiotelephone services in the hf bands of 4, 6, 8, 12, 16 and 22 MHz. But the conference also hammered out agreements covering dozens of other services, including selective calling, narrow-band teletypewriter transmission, distress frequencies, and satellite transmission. Largely untouched, though, were the frequency plans

for broad-band telegraph transmission and oceanographic work.

The reworked regulations won't start going into effect until 1976 and won't be fully phased in until the 1980s. But upcoming changes portend important new business for makers of communications gear. A lot of hardware aboard some 60,000 ships and at nearly 3,000 coastal stations will be affected.

To be more specific, the hardware changes aboard ships at sea, once the new regulations start going into effect, will include:

- The number of ships carrying extensive vhf gear will undoubtedly increase, since the 156.8-MHz distress frequency used in the U.S. has been generalized and ships' movements allocations have been set for vhf maritime mobile bands.

- Ship-shore teletypewriter traffic should spurt, since the number of pairs of hf frequencies for narrow-band, direct-printing services will go from 112 channels to more than 250. Also, the conference blocked out a tariff scheme for Telex calls

between regular subscribers and ships.

- Higher-quality receivers will be needed at sea, since, along with the closer channel spacing in hf bands, a new calling concept was adopted: instead of sweeping through whole bands to pick up calls, operators will use just two narrow-band spot call frequencies in each band.

- Portable two-way radios will become more common on large tankers and cargo ships, since six channels in the 450-MHz band were tagged for use by on-board uhf portables worldwide.

**High time.** It's easy to see why ITU decided it was high time to rework the regulations covering communications on the high seas. The first exclusively maritime conference was held way back in 1967. But in the last seven years, there have been some radical changes in world shipping. For one, the number of passenger ships has dropped drastically while the number of cargo ships and tankers has climbed. Also, there's been a spurt in the growth of fishing

**Conferees.** Top trio of the U.S. delegation was, from left, L.R. Raish of White House Office of Telecommunications Policy, Robert E. Lee of FCC, and Gordon L. Huffcutt of State Department's Office of Telecommunications.





# Seven ways to tell a Darlington that's great from a Darlington that's merely good.

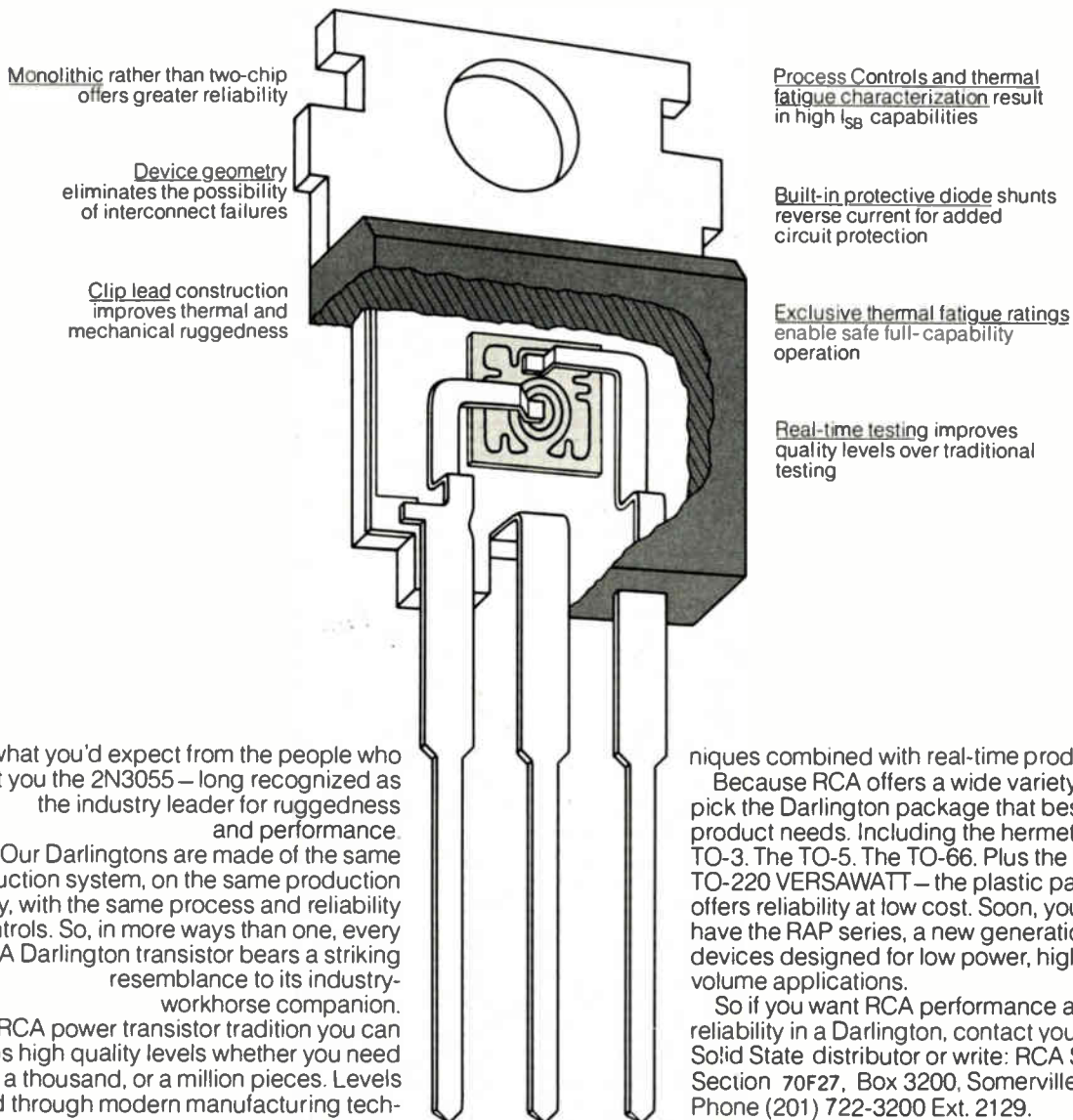

Monolithic rather than two-chip offers greater reliability

Device geometry eliminates the possibility of interconnect failures

Clip lead construction improves thermal and mechanical ruggedness

Process Controls and thermal fatigue characterization result in high  $I_{SB}$  capabilities

Built-in protective diode shunts reverse current for added circuit protection

Exclusive thermal fatigue ratings enable safe full-capability operation

Real-time testing improves quality levels over traditional testing

It's what you'd expect from the people who brought you the 2N3055 – long recognized as the industry leader for ruggedness and performance.

Our Darlings are made of the same construction system, on the same production facility, with the same process and reliability controls. So, in more ways than one, every RCA Darlington transistor bears a striking resemblance to its industry-workhorse companion.

Another RCA power transistor tradition you can look for is high quality levels whether you need a hundred, a thousand, or a million pieces. Levels achieved through modern manufacturing tech-

niques combined with real-time product control.

Because RCA offers a wide variety, you can pick the Darlington package that best suits your product needs. Including the hermetic steel TO-3. The TO-5. The TO-66. Plus the RCA TO-220 VERSAWATT – the plastic package that offers reliability at low cost. Soon, you'll also have the RAP series, a new generation of devices designed for low power, high volume applications.

So if you want RCA performance and reliability in a Darlington, contact your RCA Solid State distributor or write: RCA Solid State, Section 70F27, Box 3200, Somerville, N.J. 08876. Phone (201) 722-3200 Ext. 2129.

**RCA** Solid State

International: RCA, Sunbury-on-Thames, U.K., or Fuji Building, 7-4 Kasumigaseki, 3-Chome, Chiyoda-Ku, Tokyo, Japan.  
In Canada: RCA Limited, Ste. Anne de Bellevue 810, Canada.

## Probing the news

fleets. Above all, ITU has come under strong pressure from developing countries that want space in the spectrum, if only for prestige.

A lot of "have-not" countries came to the conference convinced that the switch to single-sideband for hf radiotelephony decreed at the 1967 conference would mean enough new channels to accom-

modate everybody when the changeover is completed at the end of 1977. But that's not the case, even though the 1974 conference did manage to squeeze out an additional 37 channels for radiotelephony from the maritime mobile spectrum. Ten were picked up by shifting channels currently assigned to telegraphy. The other 27 came as the conference adopted a 3.1-kilohertz carrier spacing between hf channels. Right now, the standard is

3.2 kHz in some bands, 3.5 in others.

At the very least, there will be a lot of crystal changing to do when the new hf radiotelephony frequency plan—Appendix 25 to the radio regulations—goes into force on Jan. 1, 1978. And many shipowners then will need more expensive receivers—with frequency synthesizers and sharper filters, for example—than they can get by with now. But it's not technical difficulties that trouble U.S. telecommunications officials and their counterparts in some of the other major maritime countries. To fit in some 40 new countries and take care of nations that felt they had received short shrift in the existing allocations, a whole new hf plan was patched together. "It was eyeball engineering," maintains L. R. "Bob" Raish, a consultant to the White House's Office of Telecommunications Policy and vice-chairman of the U.S. delegation at the conference. The new plan, he goes on, "will create chaos in the coastal radiotelephone business. It puts 25 years of working out natural sharing arrangements into the scrap heap."

Not everyone from the "have" countries was quite that vehement. Johannes Koppers, the top West German negotiator, terms the Appendix 25 revision as "not really good but not so bad that you cannot work with it." The Germans wanted allocations shared on the basis of expected traffic.

The Japanese contingent, however, left Geneva apprehensive about the Appendix 25 reworking. Its chief, Masso Hirano of the Radio Regulatory Bureau of Japan's Ministry of Posts and Telecommunications, is convinced that "it will take the greatest effort to implement it."

**Wait and see.** As for the conference chairman, Reginald N. Billington, he feels that it's very difficult to assess the full impact of the new allocation plan because it doesn't go into effect for another three and a half years, and no one knows yet what the traffic will be like then. But Billington, an official of the United Kingdom's post office, characterizes as "premature" a second important decision reached at Geneva, one that provides for two different selective calling systems. The idea is

## 8 CASES FOR SWITCHING TO NATIONAL® SCRs



16-1600 Amperes rms  
25-1700 Volts  
Power and Inverter SCRs  
Patented Regenerative Gate

*Call or write for full details*



**NATIONAL ELECTRONICS**

a varian division

geneva, illinois (312) 232-4300

for ships to have automatic receivers that respond when a shore station has a message for the ship. Along with individual codes for ships there is provision for codes that alert all ships that are equipped with automatic receivers.

The existing system, the brainchild of engineers at Siemens AG and the West German post office, was introduced into the radio regulations in 1967. Since then, some 1,000 ships—mainly German and Dutch—have been fitted with automatic receivers. The German system, known as SSFC (for sequence signaling frequency code), so far has worked well. But it does have its drawbacks, admit Koppers and other SSFC supporters. It requires a bandwidth of 3,000 hertz for the five frequencies that make up the signaling code. An even greater handicap is the fact that the five-frequency code allows only up to 10,000 call numbers compared to the capacity of at least a million call numbers that's wanted.

To that end, the U.S., Japan, and the Netherlands, primarily, have pushed development of digital selective calling systems. In fact, the CCIR, ITU's radio standards body, has worked up a tentative recommendation based on a signal format having a seven-bit code plus three checking bits. There's also a packing scheme for decimal numbers that covers literally millions of call-number possibilities. The study group that worked out the format hopes to get final approval by the CCIR at a July meeting. In that case, digital selective calling could start appearing aboard ships sailing the oceans of the world in about a year, some optimists think.

Like Billington, however, Koppers feels that would be far too early. "We fear interference in other channels because of the pulse transmission of digital systems."

Other important changes or additions to the radio regulations were less controversial. "For maritime satellites, we worked in some minimum provisions to allow implementation of them," says Raish. Essentially, the conference agreed on services where satellite channels can and cannot be used and established regulations for shipboard terminal operations. □

# Zip DIP's through incoming tests

If you're still hand-testing your DIP's, you're doing it the hard way. And the slow way. Now you can zip your DIP's through incoming tests ten times faster with our table-top Model 800 high-speed, automatic DIP test handler. Or, for that matter, any one of our other high-speed DIP test handlers and sorters. Why not get all the profitable particulars? Write or call IPT Corporation, 1140 W. Evelyn Ave., Sunnyvale, California 94086. Phone (408) 732-7550.



**IPT Corporation**  
High-Speed Automatic Test Handlers

## Probing the news

**Additions.** Two more new computers are in the Nippon-Toshiba ACOS series 77. They are, at top, the 400, a medium-size model, and the 300, also in the medium class.

nounced three computers [*Electronics*, June 13, p. 65]. They are the ACOS series 77 model 200 small computer, and 300 and 400 medium size models. Designed to compete with IBM's 370/115, 125, and 135, they will start shipping in October. Still to come are five models.

The Mitsubishi Electric Corp.-Oki Electric Industry Co. group has unveiled its Cosmo-700, with deliveries scheduled to start in December. The group will develop three more new machines. In line with Mitsubishi's strategy of not competing with IBM where the American giant is solidly entrenched, none of the group's computers will be large machines. Also, Mitsubishi has 20% of the market in small machines.

The third group, Fujitsu-Hitachi, says it's developing seven systems in its series, but refuses to say whether any will definitely be announced this year. However, since this combine has a larger market share than the other two, it can be expected to come out with entries in all sizes to compete across the board with Nippon-Toshiba and with IBM.

**Higher languages.** The Nippon-Toshiba machines, with virtual memory and ring protection, are oriented to higher level languages than previous models, including Fortran, Cobol, and PL-1. The operating system is mainly firmware. The main memory is all n-MOS, 1,024-bit chips at present, with 4,096-bit chips due in about a year. Logic is TTL. Memory speed for the 300 and 400 is read time of 1 microsecond and write of 1.35 $\mu$ s. The 200 will rent for about \$5,000 to \$12,400; the 300 for \$10,000 to \$20,000, and the 400 for \$12,400 to \$28,000. The group has ambitious sales targets for its new machines: for the 200, the five-year plan calls for 2,000 systems to be installed; for the other two models, the aim is more than 800.

The Cosmo-700 from Mitsubishi-Oki is designed to compete with IBM's 370/45, which also pits it



against the still-to-be announced Nippon-Toshiba System 500. It's the first in a series of four: the 300, 500, and 900 are still to come.

The Cosmos are software-compatible with the former Xerox Data Systems Sigma 5 and 7 control computers, made under license by Mitsubishi. This, says Mitsubishi, gives them general-purpose capability. Among the features of the new computers is an option of core or semiconductor memory. The reason, says Mitsubishi, is that many customers will use the machines for control applications, and core offers the advantage of nonvolatility. Another feature is the use of a color-TV picture tube and keyboard console, rather than the typewriter console used by most other computer makers. The console can display up to 2,000 alphanumeric or Japanese symbols and has a memory. The computer's main memory in its semiconductor configuration uses 1,096-bit n-MOS RAMs with expansion to 4,096-bit chips due in a year. Logic is TTL.

Although most of Mitsubishi's computer business is now control and scientific, it has its eye on sales of general-purpose machines to the Mitsubishi group of companies. No wonder, because that group claims to account for 10% of Japan's gross national product and an even larger percentage of Japan's computer use. The companies use mostly IBM computers, but Mitsubishi is hopeful because it says it now has the beginnings of a line that is broad enough to interest members of the group.

It wants to sell its new line on the basis of bringing the computer to the user. The company figures that



it can push the concept of a distributed computer system, rather than one large computer in a center. It reasons that most centers keep getting bigger, and that there is always the threat that any problem shutting down the center can bring a company's computer activity to a complete halt. Mitsubishi maintains that even with decentralization of this sort, the new computers would be powerful enough for most jobs because their use of virtual memory gives each user up to 16 megabytes of memory. And there is almost no limit to the number of users.

**Option.** In cases where a local computer can't do the job, there would still be recourse to a larger center because the communications processor is improved; Mitsubishi has developed software for this purpose, and the on-line data-management system has been developed.

Mitsubishi says it figures that systems using its computer should have a monthly rental of \$12,400 to \$35,000. This is based on the company's figure of \$28,000 to \$53,000 for equivalent IBM 370/145 installations. □

## Replace Gas Tubes With Solid-State TUBE-PAC!



TUBE-PAC is Semtech's new line of silicon tube replacements. A direct plug-in substitute for most popular gas tube type rectifiers, TUBE-PAC requires no special adaptors.

### OFF-THE-SHELF GAS TUBE REPLACEMENTS

Type	PIV-KV	Io Amp	Cathode Connection	Type	PIV-KV	Io Amp	Cathode Connection
STR3B25	4.5	0.5	1	STR5720	1.0	2.5	4
STR3B28	10	0.5	1	STR6587	16	0.23	2
STR4B32	10	1.25	1	STR6693	15	5	2
STR249C	10	0.5	1	STR6807	1.5	6.4	2
STR575A	15	2.5	2	STR6808	1.5	6.4	2
STR576A	25	0.5	2	STR6894	20	2.5	2
STR250R	60	0.25	2	STR6895	20	2.5	2
STR253	15	0.35	2	STR7018	2	2.5	1
STR577	25	0.3	2	STR7019	1	6.4	2
STR593	25	0.3	1	STR7454	25	6.5	1
STR615	2	2.5	1	STR7789	15	0.4	2
STR635	1	6.4	3	STR7790	20	1.0	2
STR672A	2.5	3.2	2	STR7792	25	2.0	2
STR816	7.5	.13	2	STR8008	10	1.25	2
STR866A	10	0.5	1	STR8080	25	2.5	2
STR872A	10	1.25	2	STR8253	20	0.25	2
STR5544	1.5	3.2	2	STR8434	20	1.8	2
STR5560	1.5	2.5	4	STR8435	20	1.8	2

Ask your Semtech Dealer about TUBE-PAC vacuum tube replacements.

## Reduce Energy Consumption by 80% with NEW TUBE-PAC!

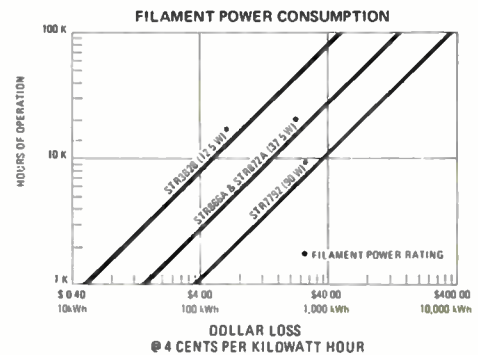

TUBE-PAC is a completely solid-state device. The energy normally used to power the gas tube rectifier filament is eliminated.

Semtech's TUBE-PAC is corona free and dissipates heat more effectively.

TUBE-PAC rectifiers reduce maintenance and last hundreds of hours beyond the normal replacement period for gas or vacuum tubes.

For information on TUBE-PAC gas tube replacements not listed, and TUBE-PAC vacuum tube replacements, contact the factory with your requirements.

"We're number 1 because we try harder"



652 Mitchell Road, Newbury Park, California 91320  
(805) 498-2111, (213) 628-5392 / TWX: 910-336-1264

CHICAGO: (312) 352-3227  
DALLAS: (214) 253-7644  
FLORIDA: (305) 644-5404  
NEW JERSEY: (201) 654-4884  
SAN FRANCISCO: (415) 328-8025  
EUROPEAN SALES: (Switzerland) (042) 232-242

Space electronics

## Europe starts ambitious venture

With green light from ESRO, design work begins on Spacelab, Europe's part in the U.S. post-Apollo program

by John Gosch, Frankfurt bureau

Hardly was the ink dry on the contract from the European Space Research Organization in Paris before some 120 specialists at West Germany's ERNO Raumfahrttechnik GmbH got busy on the design of Europe's contribution to the U.S. Space Shuttle venture: Spacelab.

Spacelab will be developed by a consortium of West European companies, with Bremen-based ERNO the consortium leader. The project, in which eventually thousands of engineers and workers will be involved, is part of the \$5.5 billion Apollo follow-up program that provides for putting manned laboratories into space during the next decade.

What's more, Spacelab represents Western Europe's biggest single space project to date. It also marks the first entry into manned space flight by non-American or non-Russian astronauts or cosmonauts. The

project's design and development cost is presently pegged at close to \$240 million, "but it could eventually run as high as \$400 million as a result of as yet unforeseen follow-up expenses or inflation," an ERNO spokesman says.

Participating in the Spacelab's development are 15 firms in nine European countries—Belgium, Denmark, France, Great Britain, Italy, The Netherlands, Spain, Switzerland, and West Germany, with the last footing 54.1% of the bill. The first Spacelab version is to be completed by 1979 and ready for launch a year later. "We are 99% sure that a contract to build a second one will come shortly," an ERNO project leader confides. Beyond that, he says, as many as four or even eight more may follow, so that during the 1980s there will be a fleet of up to 10 Spacelabs available.

The Spacelab's transport system,

the U.S.-developed Space Shuttle, consists of a lower stage for propulsion and a reusable upper stage, the orbiter. This stage, an airplane-like, rocket-propelled vehicle, will be designed to carry payloads into an earth orbit and to return them to ground.

The lab itself, which is roughly 12 feet in diameter by 42 ft long and weighs more than 2,100 pounds, will be housed in the orbiter and serves as a workplace for a crew of up to four people. The work they will perform will involve experiments in astronomy, physics, earth observations, navigation, materials research, biology, and medicine. The orbiter stage will serve as the astronauts' household and bedroom.

According to Hans-Joerg Pospieszczyk, in charge of the Spacelab's electrical/electronics systems design at ERNO, close to 40% of the vehicle's total design and development costs will be spent for electronic hardware and software, and a number of European firms active in this field can expect substantial business to come from the project.

Most of the Spacelab's electronic hardware is integrated into its control and data-management system (CDMS). Its prime purpose is to collect, process, display and record all data generated by the lab's experiments and its various flight subsystems, such as attitude-control equipment, and other gear like power-distribution units and environment-control equipment.

Responsible for the CDMS devel-

**Model.** This mock-up of the Space Lab shows Europe's role—the project might run as high as \$400 million out of the \$5.5 billion to be spent—in post-Apollo.

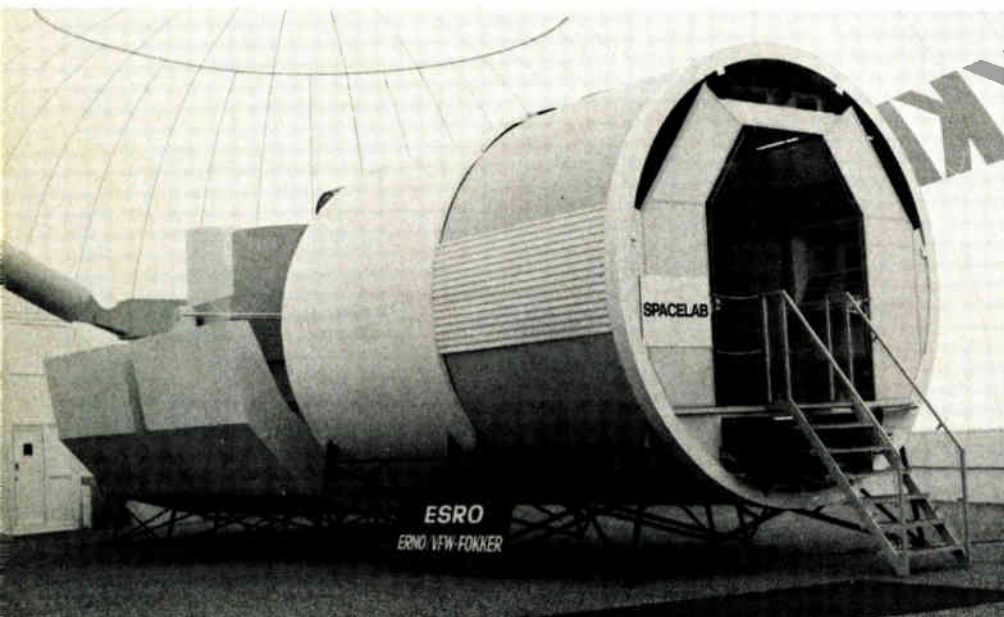

# DIVA Mini Maximizer Systems.

The lowest cost/byte in the industry.

**The big ones.** Large-capacity disc systems: 29, 58, 100, 116 Mbytes/spindle, up to 8-spindles/controller. Mini or IBM format. Systems are complete with controller interfaced to specified CPU, all interconnecting cables, diagnostic software, formatter program, and technical manuals. Optional I/O handlers are available for most mini software systems.

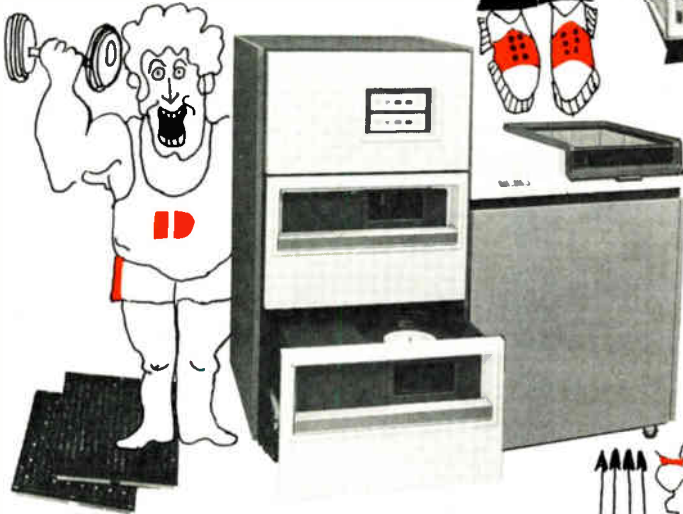

Circle 95 on reader service card

**Our little devil.** Cartridge disc: 1,288,000 words/disk. Ideal for small-to-medium-size systems. An inexpensive replacement for DEC's RK 11/RD 02 and RK 05 cartridge disc drives. Software compatibility is provided through optional I/O handlers for most DEC, Interdata, Data General, and DCC software systems. Controller operates up to 4 drives.

Circle 94 on reader service card



got a system that obsoletes and eliminates paper tape, cassettes, and punched cards.

Circle 93 on reader service card

**The eliminator.** Floppy disc: 3.1 Mbits/disk unformatted, up to 4 drives controller, IBM compatible. Big disc drive features like initial program load, overlapped seek (option), logical unit select switches, disc sectoring, DMA or programed I/O provide great all-around performance. Couple these with random access, track-to-track time of 6 ms and you've



**Move over, maxi.** DMT-1000 and DMT-1001 magnetic tape systems: 125 or 200 ips; 800 or 1600 bpi; 9 track; IBM compatible. DIVA controllers interface minis to these big tape drives that until now were usable only with big computers. Use any industry compatible 1/2-inch tape reels — from minis to 10.5-inch reels, as well as IBM wrap-around tape cartridges. 320 Kbytes/sec transfer, 500-ips rewind, 7-sec automatic load, photoelectric sensing, vacuum column guidance, air bearings, single capstan drive, and software compatibility are a few main features.

Circle 96 on reader service card



DIVA promises to maximize your mini for the lowest cost/byte in the industry and ship in 30-45 days. For complete details call any DIVA office.

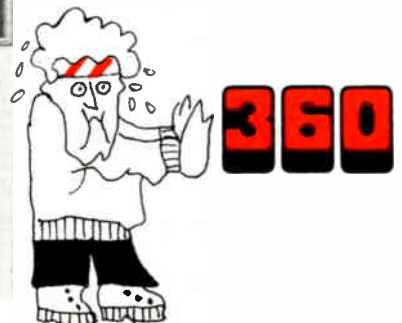

Mini maximizer systems

DIVA, Inc. 607 Industrial Way West / Eatontown, N. J. 07724 / Phone: 201-544-9000 / TWX 710-722-6645  
REGIONAL SALES OFFICES: California: 213-889-4180 / Massachusetts: 617-275-1436 / Washington D.C.: 703-370-5211

# SYSTRON-DONNER POWER SUPPLIES

The VALUPOWER® SERIES ... There is nothing like them in size or performance at the price! A truly unique innovation in DC Power Supply Technology ... it's your best value in slot range systems 5¼" full rack and half rack power for critical and sensitive IC circuits.

- Low noise for IC & systems use
- Unique patented construction & overload protection circuit for economy and reliability
- 1mV RMS ripple
- Adjustable current limiting
- Wide slots with remote programming
- 0.02% line regulation



**VPH Series**  
Up to 30VDC  
Up to 60 AMPS  
from \$400.

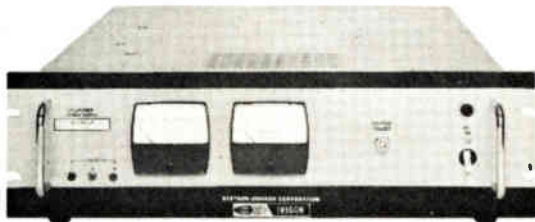

**VP Series**  
Up to 52VDC  
Up to 135 AMPS  
from \$595.

Voltage (Nominal)	Voltage Range (VDC)	Max. Current (Amps)	Load Regulation	Price \$ Non-Metered	Price \$ Metered	OV Option \$	Model
5	4.75 to 5.5	60	0.02%	425	475	Std.	VPH5-60 OV
	4.75 to 5.5	135	0.05%	595	645	80	VP5-135
8	7.7 to 8.5	115	0.05%	595	645	80	VP8-115
	± 11.5 to 15.5	2x13	0.02%	425	475	50	VPHD15-13 *
12	11 to 13	35	0.02%	400	450	50	VPH12-35
	11 to 13	90	0.05%	595	645	80	VP12-90
15	14 to 16	31	0.02%	400	450	50	VPH15-31
	14 to 16	85	0.05%	595	645	80	VP15-85
24	23 to 26	22	0.02%	400	450	50	VPH24-22
	23 to 26	60	0.05%	595	645	80	VP24-60
28	26 to 30	19	0.02%	400	450	50	VPH28-19
	26 to 30	50	0.05%	595	645	80	VP28-50
48	46 to 52	30	0.05%	595	645	80	VP48-30

\*Dual Output

Over 150 other models available in quarter rack, half rack, full rack and system modules from 0 to 300 VDC and up to 400 amps.

Write directly or call your local Scientific-Devices sales office for new catalog of specifications and applications of power supplies and digital power sources.

TRYGON ELECTRONICS  
SUBSIDIARY

SYSTRON  DONNER  
CORPORATION

1200 Shames Drive, Westbury, N.Y. 11590 (516) 997-6200

## Probing the news

opment effort is France's Engins Matra, a company which ERNO has worked with on other projects during the past eight years or so. Cooperating with Matra are the French electronics firms Thomson-CSF and Electronique Marcel Dassault; West Germany's AEG-Telefunken, Dornier System GmbH, and ITT subsidiary Standard Elektrik Lorenz AG; and Odetics Inc. of Anaheim, Calif.

At the heart of the CDMS will be three identical computers, the type M182E developed by Dassault for launcher programs but specifically repackaged for the Spacelab project. One of the three controls the acquisition of data from the experiments. Another handles all data from the flight subsystems, while the third serves as a back-up for subsystem and experiment data-processing.

The computers, which essentially prepare the data for telemetry, display, and for monitoring and check-out, are 16-bit machines with 32 kilowords of core memory, extendable to 64 kilowords. They feature a cycle time of 1.2 microseconds, and additions and multiplications can be performed in 2 and 7.5 microseconds, respectively. Data flow is over input/output channels capable of handling 550 kilowords per second. The computer software will come from West Germany's Dornier and from the German-Dutch VFW-Fokker combine which is ERNO's parent company.

Data acquisition and command distribution is by 14 SEL-supplied remote-acquisition units, which have standardized input interfaces for analog, discrete, and digital channels. Other Spacelab equipment will be wideband digital and analog signal units for down-link transfer of experiment data via transmitters in the orbiter.

Belgium's contribution to the Spacelab project is the ground support equipment, which will come from that country's Bell Telephone Manufacturing Co., another ITT subsidiary. Prime function of that equipment will be automatic check-out and simulation of Spacelab conditions during the various test and system integration phases prior to launch. □



# BOURNS trims more circuits than anyone else in the world!

## here's why...

### NOBODY KNOWS MORE ABOUT TRIMMERS THAN WE DO

Marlan E. Bourns, President of Bourns, Inc., invented the modern miniature TRIMPOT® trimming potentiometer. This company pioneered the industry, and has maintained its leadership position for over a quarter of a century.

### WE GIVE YOU WHAT YOU NEED

Bourns has the broadest line of trimming potentiometers in the industry. We produce just about any type, shape, size, style you're likely to need. We make them more readily available via a large factory inventory . . . and 91 stocking distributors.

Ready to simplify your specifying? Standardize on Bourns "Top Twenty". . . they cover 90% of your application requirements. Write for our Top Twenty Designer's Portfolio.

### YOU CAN DEPEND ON BOURNS

Trimming potentiometers are the *most* cost-effective method of adjusting, regulating and controlling circuits . . . and they will remain so for the foreseeable future. Bourns is the *most* capable, straightforward and reliable supplier of trimming potentiometers. Depend on Bourns.

QUALITY, SERVICE, VALUE — Bourns is No. 1

... you can depend on it!



Circle 83 on reader service card

BOURNS, INC., TRIMPOT PRODUCTS DIVISION • 1200 COLUMBIA AVENUE, RIVERSIDE, CALIFORNIA 92507



A Precision Crystal  
Secondary  
**FREQUENCY STANDARD**  
THAT HAS BEEN  
"Designed for Application"

A precision frequency standard capable of being adjusted to WWV or some other primary standard and putting out uniformly accurate calibrating signals with 10, 25, 100, 1000 KC intervals. Uses the new GENERAL ELECTRIC No. 18A 1000 KC crystal having a frequency temperature coefficient of less than one cycle /Me/°C. The crystal is sealed in Helium in a standard metal tube envelope.

The self-contained AC power supply has VRI 50-20 voltage regulator tube.

In addition to oscillator, multivibrators, and harmonic amplifier, a built-in mixer with phone jack and gain control on panel is incorporated.

**JAMES MILLEN MFG. CO. INC.**  
150 EXCHANGE ST. MALDEN, MASS.

**JAGABI "LUBRI-TACT"**  
**LABORATORY RHEOSTATS**

Four Sizes, Seventy-Six  
Ratings, Lubricated  
Sliding Contact

**BULLETIN 1620-E**



**JAMES G. BIDDLE CO.**  
Electrical Instruments  
1211-13 Arch Street Philadelphia, Pa.

**Tube Data Sheets.** Application, characteristics, operating conditions and performance of several kinds of tubes are given in these sheets released by Eitel-McCullough, Inc., San Bruno, California.

**Air Raid and Blackout Devices.** A four page booklet describes automatic air raid siren controls, automatic blackout relays and automatic auxiliary systems. A brief description of other items manufactured is also included. This may be obtained from the Automatic Electric Mfg. Co., Mankato, Minnesota.

**Quick Selector Catalog.** A 64 page book covers safety switches, nofuse breakers, multi-breakers, panelboards, motor control and motors. New application data on latest equipment has been included. Electrical ratings, physical dimensions and circuit diagrams help in the selection of equipment. This revise may be obtained from Dept. 70-N-20, Westinghouse Elect. and Mfg. Co., E. Pittsburgh, Pa.

**Electronics Parts and Equipment.** The purpose of this booklet is to introduce the type of jobs which can be done for manufacturers of signal apparatus, transmitting and receiving apparatus, devices and parts. Insuline Corp. has expanded its facilities for large scale production of complete jobs or special jobs such as screw machine work, stamping, engraving, machining, finishing, or assembly.

The booklet describes and illustrates such equipment as various types of cabinets, amplifier units, trim mouldings and plates, handles, heavy duty bases, chassis bottom plates, front chassis, panels, and over twenty-five different component parts.

Insuline Corp. of America, 30-30 Northern Boulevard, Long Island City, N. Y.

**Snubbing Mountings.** The application of bonded rubber vertical snubbing mountings for vibration control and shock absorption in equipment is described in a 20-page Bulletin No. 103. In addition to describing the complete line of mountings available, the booklet also contains basic engineering information. Lord Manufacturing Co., Erie, Pennsylvania.

**Photoelectric Cells.** A booklet describing the principle of operation, characteristics, temperature factor, fatigue effect, internal resistance, operating temperature, time lag, permanence, and spectral sensitivity. There is also a table of standard sizes. Emby Products Co., 1800 West Pico Blvd., Los Angeles, Calif.



**Woven Resistors  
for Heater Units**

High Frequency Circuits and many other uses

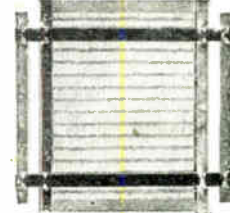

Non-inductive  
Flat - Thin  
Easily mounted  
in groups or  
separately.

**Ohm-spun**

Resistors are Widely Used Where above Features are Essential.

**New "RTS" Test Switches**

- A "Pull-out" Switch  
with spring return
- A "Push-in" type  
with spring return

Potential or Current Units  
"Make before break" or  
"Break before make"  
Momentary Contacts  
1, 2 or 3 units operated by one knob.  
Other types are described in Cat. #5, Sec. 1.

RTS Switches fit any test switch requirements where compact, positive switching in single or multiple units is desired.



One hole mounting-Sealable

**Phase Shifters**



**and  
Induction Regulators**

For complete data see Cat. #1, Sec. B2 and Cat. #1, Sec. B4.

**Tear Off and Mail Today**

To THE STATES COMPANY  
HARTFORD, CONN.

Send data.

Name ..... Title .....  
Firm .....  
City ..... State .....  
ELEC.

Microcomputers

# Service houses offer applications aid

Buyers of microprocessors are paying for the system support that's part of the price of higher computers but which chip makers don't provide

It's happened before and it will happen again—a new semiconductor technology has spawned a new semiconductor-related business. The technology in this case is the microprocessor; the business is the applications house.

There are about 10 of these small but active companies around the country. Most are less than a year old, but some approach the venerable age of two years. They exist because of the economics of the microprocessor. While a customer acquiring a full-sized- or mini-computer system expects a certain amount of system support for his money, he neither expects nor gets much when he purchases a \$300 micro from a semiconductor manufacturer. Enter the applications house.

Any list of these companies has to be incomplete because of the ease with which one can be started—and the speed with which it can close its doors. But they generally tend to cluster around industrial or semiconductor centers, or where their organizers have been working in other jobs. They often are started by two persons who are either hardware designers or programmers or both. And the new entrepreneurs more often than not harbor dreams of growing larger by expanding into other areas.

Take, as a case in point, a relative old-timer that's been designing since the fall of 1972. Applied Computing Technology of Irvine, Calif., has workers from computer, telemetry, and minicomputer firms, among them NCR, General Automation, and aerospace companies—what might be called the California mix—and its programmers total 25 years' experience. A good deal of the

firm's work has been in the automotive field with headlight aligning and antiskid systems. But now the company, which currently has annual sales of about \$750,000, would like to find a product niche to exploit, preferably in an industry with an annual volume of at least \$10 million.

Another "old" company, established about 18 months ago, is Prolog Corp. of Monterey, Calif. Its founders, Edwin Lee, president, and Matt Biewer, vice president and chief engineer, have worked together for about 10 years, most recently at MSI Data Corp., a builder of supermarket terminals that Lee helped found. "Initially the designs for MSI terminals were basically hard-wired logic," says Lee. "Then we discovered microprocessors. Matt took the Intel 4004 and redesigned most of MSI's designs in less than five months. And 12 weeks after he started the redesign work, MSI had 10 prototypes in the field." That showed the men the potential of microprocessors and led them to found Prolog.

Coming from the computer industry are Dale V. Schmidt and G. Graham Murray, founders of

Data/Ware Development Corp. of San Diego. Says Schmidt: "We concentrated on minicomputers, but we quickly saw that microcomputers would serve the purpose in many applications." For example, in a test system for Sony (see p. 177) "the mini was overkill. It was a competitive bid, and our competition proposed minis, but we did it with a micro."

The men who founded Varitel Inc. in Beverly Hills, Calif., in February 1973 again represent that necessary combination of software and hardware experience. Bruce Gladstone spent most of his professional life in aerospace systems instrumentation, and Meir Niv has spent about a decade doing machine-language programming and logic design. Varitel, which wants to stay small, is currently working on a display system for a maker of cable TV gear. It's also involved in a data-acquisition system for Aerospace Corp., a machine-tool controller, a computer tape-test system, and the medical instrumentation field. Gladstone projects results by September 1975 of "somewhere around the \$300,000 mark, including shipments and royalties." □

## Doing their bits

"We see the potential of microprocessors a bit differently than most people," says Edwin Lee, president of Prolog Corp. Instead of going after the data-processing and computer systems/hardware markets with high-speed 8- and 16-bit machines, assemblers, and high-level languages, Lee sees "90% of future business in dedicated controller applications" like traffic lights. These jobs won't be done by the high-speed, sophisticated 8- and 16-bit machines, he says, but by a simple and inexpensive one "that a machine-design engineer used to hard-wired logic will understand and put to work immediately." The answer, says Lee, is Intel Corp.'s 4-bit microprocessor, the 4004.

# STOP Nuisance Tripping!

## Type UPG/APG Electromagnetic Circuit Protectors with patented Inertial Delay.

Typical XFMR Transients  
(Peak currents to 20X  
nominal) results in  
NUISANCE TRIPS. Solution:  
Use Airpax Inertial Delay.

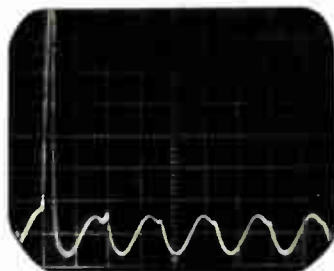

Airpax Type UPG/APG circuit protectors assure positive protection without nuisance tripping. This is accomplished by an exclusive Airpax inertial delay that provides tolerance of short duration inrush currents without decreasing steady state protection.

The UPG/APG line of low cost, compact circuit protectors offers series, shunt, and relay configurations with a choice of delays and ratings. Ratings are from 20 milliamperes to 30 amperes, 250 volts maximum at 60Hz, 250 volts at 400Hz, and 65 volts dc maximum. A SPDT auxiliary switch, for remote signalling or alarm, rated at 5 amperes, can be supplied with series trip types.

Available in 1, 2, and 3 pole versions, UPG/APG circuit protectors offer a choice of toggle, rocker arm, or thumbwheel actuators. All multipole assemblies can be furnished with a mix of current ratings, delays, internal circuit configurations, and terminal styles.

To get the full story on Airpax Type UPG/APG electromagnetic circuit protectors, write for Bulletin 2003.



# AIRPAX™

Airpax Electronics  
**CAMBRIDGE DIVISION**  
Cambridge, Maryland 21613  
Phone (301) 228-4600

**THE  
START OF  
SOMETHING  
BIG...**

**GIANT II™**

GENERAL INSTRUMENT ADVANCED N-CHANNEL ION IMPLANT TECHNOLOGY

**JUNE**

**monday** **1974**

*Stocked at distributors this date* **17**

**256x4  
STATIC  
RAM**

- \* Single +5V supply
- \* TTL compatible
- \* 1  $\mu$ sec typical Access Time / 1  $\mu$ sec Write Cycle
- \* "Power Down" capability

**NOW. THE FIRST IN THE GIANTII FAMILY**

**NEXT. 5K ROM**  
500 ns

**NEXT. 16K ROM**  
1.5  $\mu$ s

**NEXT. 1024 BIT S/R**  
DC - 2 MHz

**NEXT. UAR/T**  
60 kbaud

**AND MORE GIANTIIs COMING ...**

For complete information call toll-free 800-645-9247 (In New York State call 516-733-3107) or write, General Instrument Corporation, Microelectronics, 600 W. John St., Hicksville, N.Y. 11802

**GENERAL INSTRUMENT CORPORATION  
MICROELECTRONICS**



**FINALLY.  
A LOW NOISE GUARANTEE COMES TO  
IC FET OP AMPS.**

**The Analog Devices AD514 and how it came about.**



While everyone else was neglecting FET op amp noise performance, we were paying attention.

First we talked to people who worked with EKG amplifiers, pH electrode amplifiers, long term integrators—wherever noise was a problem.

Then we went to work.

The result is the AD514. An IC FET-input op amp carefully designed and processed for low noise. So you get a noise voltage level below  $5\mu\text{V}$  (p-p) max. And that's guaranteed. Because every AD514 is tested for noise parameters.

You also get a low bias current of  $10\text{pA}$  max, and a low  $V_{os}$  drift of  $25\mu\text{V}/^\circ\text{C}$ . And you'll find versions of the AD514 priced from \$5.90 to \$9.90 in hundreds.

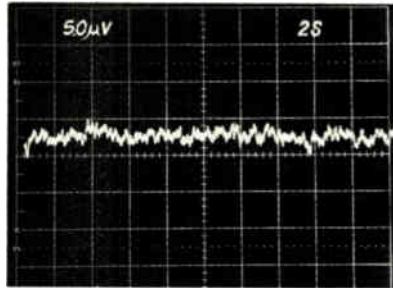

AD514 noise performance.

**But this isn't our first FET op amp.**

It all began back with our original, general purpose, low bias current IC FET op amp. It was the first IC FET op amp ever introduced anywhere by anyone.

That became the prototype for the AD523. An IC J-FET op amp with a  $0.25\text{pA}$  max bias current and a cost of \$18.75 in hundreds. Which was one-third to one-half the cost of conventional low bias current op amps.

You liked the idea. So you asked for another one. This time with low drift.

That's when we gave you the AD506L. It offers you  $10\mu\text{V}/^\circ\text{C}$  max drift.



Along with  $1\text{mV}$  max offset voltage to maintain that low drift—even after nulling. All for only \$16 in hundreds.

High speed came next in the AD528. With a unity gain slew rate of  $70\text{V}/\mu\text{sec}$ . that needs no external compensation. Plus a bandwidth of  $10\text{MHz}$  and a price of \$12 in hundreds.

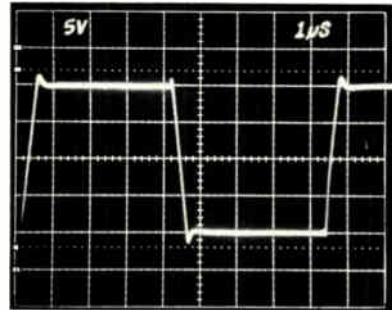

AD528 transient response.

Sometimes though, your budget is low and you're willing to trade off some speed to find a lower price. That's when the AD540, with a slew rate of  $6\text{V}/\mu\text{sec}$ . and a price of only \$4.45 in hundreds goes to work.

As you can see, we're prepared to give you the IC FET op amp performance you need in the quantities you want.

Now, if you'd like to know more, write for our IC FET op amp evaluation starter kit. Or call Analog Devices Semiconductor, Norwood, Mass. 02062. East Coast, (617) 329-4700. Midwest, (312) 297-8710. West Coast, (213) 595-1783.

 **ANALOG  
DEVICES**



This chip  
is the world's first  
SOS processor.



It makes all the  
stuff on the next page  
possible.

Silicon-on-sapphire isn't new. The aerospace industry and the military have recognized its high-speed, high-density and high-reliability characteristics for years.

But no one was ever able to use it in a computer processor.

Until now.

Now General Automation designers have built the world's first commercial processor using SOS technology.

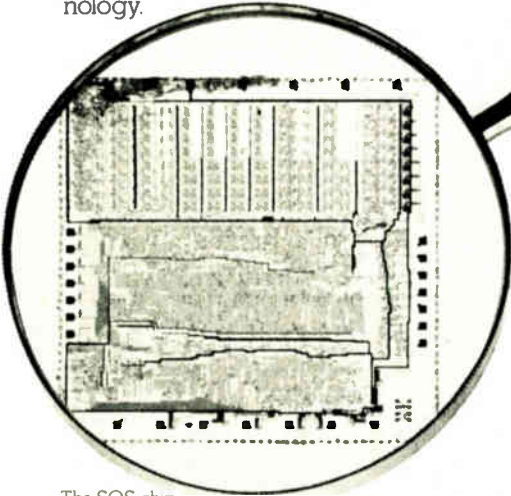

The SOS chip magnified 16 times

They've placed 2000 gates or the equivalent of 4000 to 5000 transistors on a single semiconductor chip.

An 800 times size reduction from its predecessor product, the SPC-12.

### The world's first microcomputer.

That tiny SOS chip has made it possible to bring you the LSI-12/16. A complete digital automation microcomputer with from 1K to 32K bytes of semiconductor memory.

We call it the world's first microcomputer because it's the only

always meant you had to make major concessions in performance.

With SOS you make none.

The LSI-12/16 has an instruction execution cycle time of 2.64 microseconds.

It's faster than any microprocessor on the market.

It's more powerful. And lower in cost. In board-only configuration with 1K memory, it costs only \$495 in minimum OEM quantities of 1000 per year. In short, we offer all the performance of a minicomputer at microprocessor prices.

### Breakthroughs across the board.

The LSI-12/16 is the first microproduct to successfully put all of the following on a single board:

A processor, power fail/auto

unique built-in ROM patch that lets the user retrofit new instructions to any ROM.

### Custom tailoring.

There's one more advantage the LSI-12/16 has that no other microproduct can offer. It's the systems backup and application expertise that General Automation gives you. Helping solve customer problems has always been our long suit. It still is.

We can customize I/O boards and match the LSI-12/16 exactly to your requirement.

Our microcomputer is available in one of two different configurations:

As a board-only system, packaged with memory, control console and processor on a single 7-3/4 by 10 inch printed circuit board.

Or the same board packaged in an enclosure with power supply, battery backup for semiconductor memory and card slots for additional I/O boards.

For more information, write



The LSI-12/16 with enclosure

restart, remote cold start, 16 bit parallel I/O interface and up to 2K bytes of semiconductor memory.

But we didn't stop there.

GA engineering has also overcome the problems associated with semiconductor memory. Like loss of data in the event of power failure.

We handled that by developing an auxiliary battery backup system that will activate immediately upon loss of power and will retain the contents of memory for up to 15 hours.

In case you're interested in more memory, we've designed a piggyback board that will give you an additional 2K of RAM or 8K of ROM.

And if there's ever an error in ROM programming, it can be corrected. The LSI-12/16 has a

General Automation, 1055 South East Street, Anaheim, California 92805. Or call us at (714) 778-4800.

Our European headquarters is at Centre Silic, Cidex L242, 94533 Rungis, Paris, France. Call 686-7431.

# GENERAL AUTOMATION

A new generation of computer processors is beginning. All because of this.

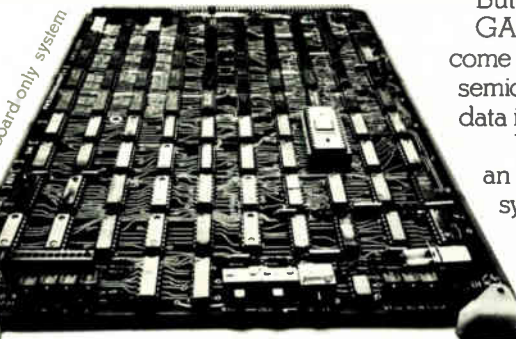

The board-only system

microproduct available that gives you the performance, the systems features, the reliability and the applications support you would normally expect from a minicomputer.

### More work, less money.

In the past this kind of size reduction

# Look what 5 volts can get you.

These five DPMs use the same 5VDC supply that powers the digital logic in your system.

This simplifies your design and improves reliability. It saves space, saves money, and reduces the amount of heat that's generated. And, because there's no line-power voltage near the DPM, internally generated noise is virtually eliminated.

So you get more reliable readings.

And here's what else you can get for 5 volts. BCD outputs. Overvoltage, polarity, and status indication. Automatic zero correction and programmable decimal points. Aluminum cases that install in a snap.

Each meter is given a seven-day burn-in before shipping. And we're shipping right now.

Our 5 volt DPMs are a whole new class of digital panel meters—a whole new way of thinking. Because now you can think of the DPM as a component, just like any other component in your system.

Take a look below. You'll find a meter that solves your particular problem. Then give us a call. Order a sample.

**A low-cost 3½ digit DPM for OEM applications.** An advance in price/performance capabilities for 3½ digit DPMs. LED display. Bipolar, single-ended input. Full scale range of 0 to ±199.9mV. 0.05% ±1 digit accuracy. Automatic zero and polarity. Normal mode rejection of 40dB at 60Hz or 50Hz. Common mode rejection of 60dB at ±200mV. Fully-latched DTL/TTL compatible outputs and control interface signals. Optional ratiometric input. Only ¾" deep. **\$89 in 100's. AD2010.**

**A high-performance 4½ digit DPM for systems applications.** Capable of performing precision measurements of floating differential voltages in noisy environments. LED display. Full scale range of 0 to ±1.9999V. 0.01% ±1 digit accuracy. Automatic zero and polarity. Normal mode rejection of 60dB at 60Hz or 50Hz. Common mode rejection of 120dB at ±300V. Optically-isolated analog section. Fully-latched DTL/TTL compatible BCD outputs and control interface signals. **\$199 in 100's. AD2004.**

**A simple, reliable 3½ digit DPM for high-visibility display applications.** Incandescent display. Bipolar, single-ended input. Full scale range of 0 to ±199.9mV. 0.05% ±1 digit accuracy. **\$89 in 100's. AD2001.**

**A high-performance 3½ digit DPM for systems applications.** The kind of performance you need for complex system interfacing and data processing. Incandescent display. True differential instrumentation amplifier input. Full scale range of 0 to ±199.9mV. 0.05% ±1 digit accuracy. Automatic zero and polarity. Normal mode rejection of 40dB at 60Hz or 50Hz. Common mode rejection of 80dB at ±2.5V. Fully-latched DTL/TTL compatible BCD outputs and control interface signals. **\$99 in 100's. AD2003.**

**A low-cost 2½ digit replacement for analog meters.** Incandescent display. Unipolar, single-ended input. Full scale range of 0 to +1.99V. 0.5% ±1 digit accuracy. Optional: variable reading rates, BCD outputs, and control signals. **\$59 in 100's. AD2002.**



**ANALOG DEVICES**  
Norwood, Mass. 02062.

## Call 617-329-4700

for everything you need to know about 5 volt DC-powered DPMs.

# Improved linear processing packs a-d converter onto two IC chips

Sophistication in mixing bipolar and MOS devices on the same chips, plus simplification of the circuitry by a new algorithm, has made the monolithic analog-to-digital converter a reality; the flexible package has many uses

by Gary Grandbois, *Siliconix Inc., Santa Clara, Calif.*

□ The technique of combining metal-oxide-semiconductor and bipolar processes on a common substrate, having been successfully applied to analog switches, is repeating that success with another linear-circuit design—an analog-to-digital converter system. This converter, which is capable of accuracy to 0.05%, is significant on two counts.

First, a new conversion algorithm greatly reduces the number of circuit elements. Second, and more important, improved large-scale-integration linear processing further condenses the conversion circuitry so that it all fits onto just two ICs. At last, the accuracy and stability requirements of the a-d converter are attainable in monolithic form.

The chip pair was originally intended to serve as a 3½-digit a-d converter for digital display systems, but it can also be used in a host of other converter applications. Examples include digital frequency meters, digital thermometers, optically isolated panel meters, and of course, the basic DVM, which can incorporate ac-voltage, current, and resistance-measuring converters to complete the digital-multimeter function.

The array of technologies used to put everything on

two chips (LD110/111) is impressive. The mainly analog processing chip (LD111) packs p-channel MOSFETs, npn and pnp bipolar transistors, and Schottky diodes into a 75-by-102-mil area. Between them, these elements provide a bipolar integrator, a bipolar comparator, two MOSFET-input unity-gain amplifiers, several p-channel MOS analog switches, and the level-shifting drivers that allow the analog and digital processors to interface directly. Bias-current matching has been improved and chip size kept small by using p-channel MOSFETs as constant-current bias elements in place of much larger resistive loads.

On the digital LD110 processor, low-threshold metal-gate p-channel MOS processing yields maximum density. The 1,400 transistors contained on the 128-by-129-mil chip combine the counting, storage, and data-multiplexing functions with the necessary control random logic.

Part 1 of this two-part article discusses the chip's design, its performance characteristics, component selection, and error considerations for the two chips. Part 2 describes the many jobs these devices can perform in a system.

## Part 1: The converter's design

One of the keys to integrating the a-d-converter function onto two low-cost chips is the new algorithm. This associates an automatic-zeroing circuit with a simplified conversion technique that's similar to dual-slope and voltage-to-frequency conversion schemes.

The auto-zero circuit does more than just eliminate the effects of offset and drift by automatically establishing the zero. For one thing, it allows use of a single reference voltage and full-scale calibration to measure bipolar analog inputs over two voltage ranges (2,000 volts and 200.0 millivolts). For another, it permits tolerances for external components to be relaxed pretty far, with no effect on the specified accuracy of 0.05% (of reading)—a change of 1 in the count for every 0.05% deviation.

Third, the p-channel MOSFET input buffer amplifier can only provide a high input impedance (10,000 megohms) and low input-bias current (4 picoamperes at 25°C) because the auto-zero circuitry eliminates most of the high differential offset voltage associated with a MOSFET differential input.

The conversion technique, as the block diagram in Fig. 1 shows, makes use of standard linear-circuit blocks. An input signal  $V_{IN}$  is switched through a buffer circuit to an integrator, the output of which goes both to the automatic-zeroing circuit and to the comparator. To correct for input-current and voltage-offset errors, the auto-zero output is then fed back through the input switch to the input.

Digitization of the analog signal is accomplished by a closed-loop discrete data-control system in which the sampled state of the comparator determines which of two discrete pulse widths the reference current can take. The control-logic module allows a BCD counter to accumulate counts during this process to produce the desired digital conversion. These counts are derived from the external clock signal by means of a two-phase clock-generator and time-base counter. The external clock signal may be of MOS or TTL levels.

Two intervals are required—one interval for the automatic-zeroing circuit (called the auto-zero interval) and one interval for digital conversion of the analog signal

**A-M-P Solderless**  
**WIRING DEVICES**

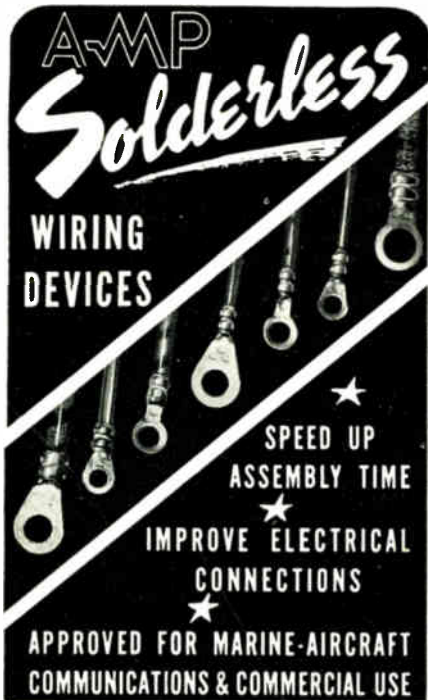

SPEED UP ASSEMBLY TIME  
 IMPROVE ELECTRICAL CONNECTIONS  
 APPROVED FOR MARINE-AIRCRAFT COMMUNICATIONS & COMMERCIAL USE

AMP solderless wiring devices eliminate the faults of soldered connections and give assured service under conditions of the lowest operating currents and over the range from DC to the highest radio frequencies, as well as under normal current rating.

The design of these thoroughly engineered electrical devices assure economy, efficiency and convenience in production. A few outstanding characteristics are listed below:

1. greater flexibility of installation
2. greater resistance to bending failure under repeated reversals of mechanical loading.
3. greater resistance to corrosion.
4. many types available with unique AMP "Diamond Grip" insulation support which protects wire, eliminates tape and insulation tubing illustrated at right. (Write for Bulletin #13)
5. facilitates insertion of wire.
6. more intimate electrical contact.
7. greater mechanical strength of the connection.
8. high safety factor for overload conditions.
9. greater tensile strength than required by government specifications.
10. quality of electrical joint can be determined by visual inspection.



Aircraft-Marine Products, Inc., maintains a research and experimental laboratory for new devices and uses and for your special problems having to do with electrical connections.



Write today for Bulletin #11... Complete description of AMP Solderless Wiring Devices and Bulletin #13 describing "Diamond Grip"

**AIRCRAFT-MARINE PRODUCTS, INC.**  
 Dep't B • 286 N. BROAD ST. • ELIZABETH, N. J.

# Backtalk

This department is operated as an open forum where our readers may discuss problems of the electronic industry or comment on articles which **ELECTRONICS** has published

## I-F Stability

If the inductance of the i-f coils in an i-f stage having two double tuned transformers are too high, the i-f tube will oscillate as a tuned grid-tuned plate oscillator. The following formula gives the maximum values of inductance that can be used:

$$L = \frac{A^2 \left( 1 + \sqrt{\frac{16\pi f C g_m R_p^2}{A^2}} \right)}{16\pi^2 f^2 C g_m R_p Q}$$

- where
- Q = average Q of the coils in cans
  - R<sub>p</sub> = plate resistance of i-f tube in ohms
  - g<sub>m</sub> = mutual conductance of i-f tube in mhos
  - C = grid-to-plate capacity of i-f tube in farads
  - f = intermediate frequency in cycles/second
  - L = average inductance of coils in henries
  - A = phase shift factor depending on the coupling factor K (the average coupling of the transformers)
- For K = 1 (critical coupling) A = 2.52  
 K = 0.9 (90% critical) A = 2.44  
 K = 0.8 (80% critical) A = 2.4  
 K = 0 A = 2.

A is obtained from:

$$A = \frac{(4X^2 + 1 - K^2) + 4K^2}{4X^2 + 1 + K^2}$$

where X is the solution of:  
 $8X^3 - 4X^2 + 2X(1 - K^2) - (1 + K^2) = 0$   
 Thus to determine values of A not given in the table above, substitute values of K in the cubic and solve for X. Then

Inductance of I-F Coils At Which the I-F Tube Will Oscillate

Values of Maximum L in Millihenries for Q = 100

B+	Tube	K = 1 (critical coupling)	K = .9 (90% critical coupling)	K = .8 (80% critical coupling)
250	6K7G	1.42	1.37	1.34
100	6K7G	2.15	2.05	2.
250	7A7	1.43	1.38	1.35
100	{ 7A7 12SK7G }	2.24	2.15	2.1
90	{ 1LN5 1N5 }	1.87	1.81	1.77
67.5	115	2.05	1.97	1.92
67.5	6SD7GT	1.38	1.33	1.31
67.5	7H7	0.805	0.776	0.762

# B-I-W-AIRCRAFT CABLES...

- LIGHTING AND POWER CABLE
- HIGH TENSION IGNITION CABLE
- RADIO POWER AND CIRCUIT CABLE
- MULTI-CONDUCTOR INSTRUMENT CABLE
- SHIELDING BRAID AND BONDING CABLE

To all engineers working in the aircraft industry, we have to offer a complete selection of electric wires and cables made to the latest specifications.

In many cases our products are designed to meet the requirements of new instruments, devices or controls, using construction most suitable for lightness and serviceability.

Write for our catalog AM-1 and Coaxial Cable Bulletin

## BOSTON INSULATED WIRE and CABLE COMPANY

Uphams Corners... Dorchester, Mass.

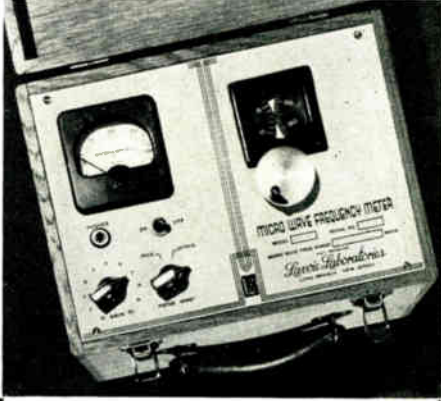

## UHF and MICROWAVE PRECISION WAVEMETERS

- PORTABLE
- BATTERY-OPERATED
- ACCURACY 0.1 %

Models Available  
 100-4000 Megacycles  
 with 2 to 1 frequency coverage on each Model.

*Lavoie Laboratories*

MICROWAVE EQUIPMENT  
 656-661 Broadway Long Branch, New Jersey



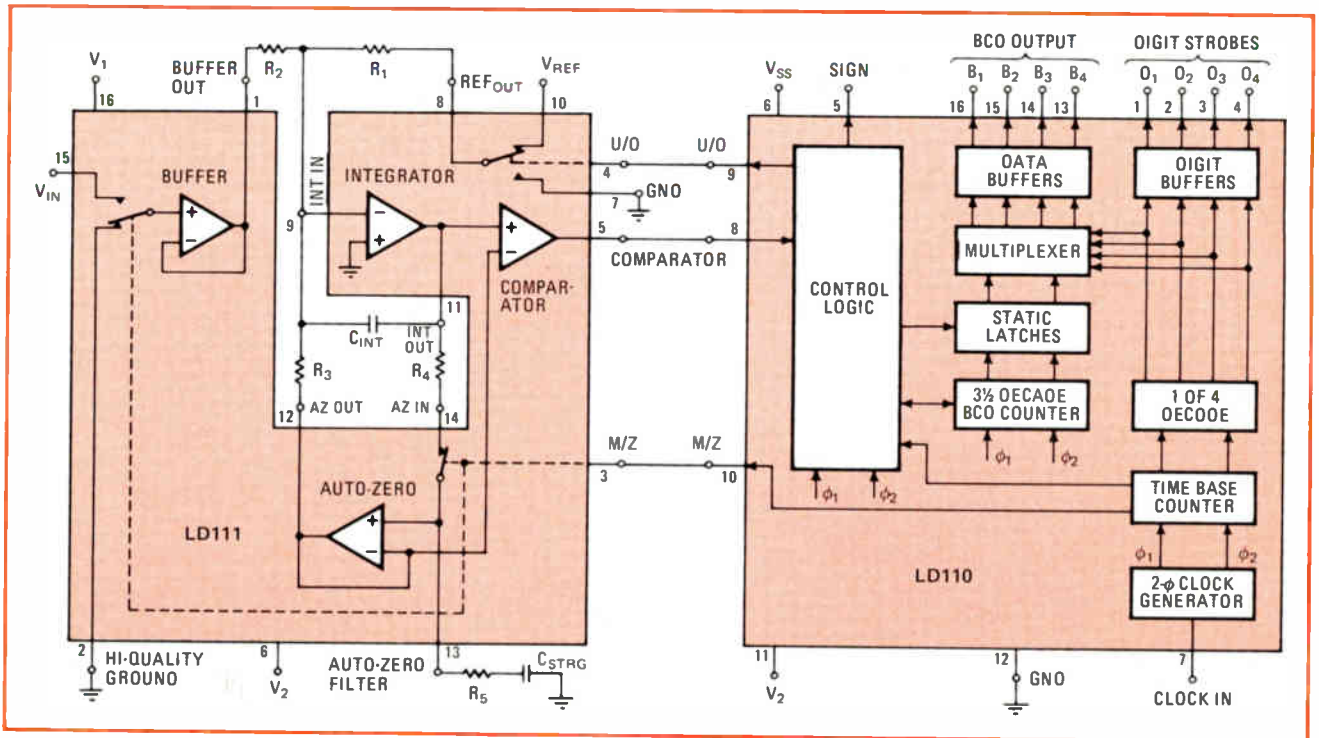

**1. Convertible pair.** On the analog chip (left), the input  $V_{IN}$  is switched through a buffer to an integrator and automatic-zeroing-correction circuit. Meanwhile, on the digital chip, the measuring interval is determined by the combination clock generator time and base-counter.

(called the measurement interval). Consequently, the clock frequency is divided into two sampling intervals, totaling 6,144 pulses and made up 4,096 pulses for the measurement interval, plus 2,048 pulses for the auto-zero interval.

### Building a converter system

Application of the LD110/111 two-chip a-d converter should begin with the selection of power supplies and clock frequency. The recommended supply voltages are

$V_1 = 12 \text{ v} \pm 10\%$ ,  $V_2 = -12 \text{ v} \pm 10\%$ , and  $V_{SS} = 5 \text{ v} \pm 10\%$ .

More latitude is allowed in the choice of clock frequency ( $f_{IN}$ ), 2 to 75 kilohertz being the recommended range. The sampling rate is  $1/6,144$  of the clock frequency (or sampling rate =  $f_{IN}/6,144$ ).

As with other integrating conversion schemes, line-frequency interference may be minimized by the selection of a particular clock frequency. If the auto-zero and measurement periods are integral multiples of the line-frequency ( $f_L$ ) period, line-frequency rejection will be maximized:

$$\Delta t_{ZERO} = 2,048/f_{IN}, \text{ where } \Delta t_{MEASURE} = 2\Delta t_{ZERO}$$

$$2,048/f_{IN} = n/f_L, \text{ where } n = 1, 2, 3, \dots 51$$

then

$$f_{IN} = 2,048 f_L/n$$

Once the clock frequency is chosen, the proper values for the external RC components may be determined. When a full-scale voltage range,  $V_{IN} \text{ F.S.}$ , is chosen, the relationship between the ratio  $R_1/R_2$  and the reference voltage  $V_{REF}$  is:

$$R_1/R_2 = (2,000/V_{IN} \text{ F.S.})(V_{REF}/8,192)$$

It also should be pointed out that  $R_1$ ,  $R_2$ , and  $V_{REF}$  are basically the only temperature-sensitive elements in the system. This is because the auto-zero interval makes the system essentially independent of changes, either in the amplifiers' offset voltages or in the values of the integrator capacitor, the storage capacitor, or resistors  $R_3$ ,  $R_4$ , and  $R_5$ .

Because of such considerations as temperature coefficients and availability, it is usually more convenient to select the reference voltage before assigning resistance values. This voltage should be greater than 5 v but less

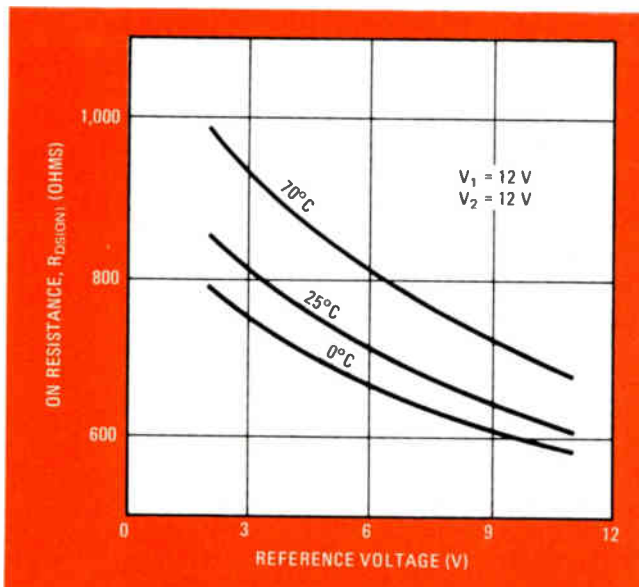

**2. Compensating for the effects of temperature.** The changes of switch resistance with temperature and reference voltage can cause errors. A large reference voltage will minimize the effects of the temperature—dependent on—resistance of the switch.

## How the circuitry works

Two-chip analog-to-digital conversion circuitry operation depends on the synchronous action of the three interconnecting circuits—the analog comparator, which conveys data on the integrator state; the up/down logic, which controls the pulse-width modulation of the reference voltage, determined by the comparator state; and the measure/zero logic, which controls the timing of the measurement and auto-zero intervals.

The analog circuitry is shown in the auto-zero (AZ) mode in Fig. 1, p. 94. When the buffer input is switched to ground, thus starting the auto-zero interval, it supplies the integrator input summing node (node 9 in the figure) with a current equal to the input buffer-offset voltage divided by the resistance of resistor  $R_2$  ( $V_{OS}/R_2$ ). The auto-zero interval allows the effects of temperature and drift to be impressed on the auto-zero storage voltage,  $V_{STRG}$ , maintained as a reference by the storage capacitor,  $C_{STRG}$ . Therefore, during the succeeding measurement interval, these effects will be balanced out.

In addition, the storage voltage acquires a voltage component, available at the auto-zero amplifier output, which provides a current through resistor  $R_3$ . This current derives from the reference voltage,  $V_{REF}$ , and the reference resistor,  $R_1$ , and is equal to  $-\frac{1}{2}V_{REF}/R_1$ —the  $\frac{1}{2}$  resulting from the 50% duty cycle of the up/down switch. Consequently, the net current provided to the integrator summing node is  $\pm\frac{1}{2}V_{REF}/R_1$ , depending on the state of the up/down switch.

The output of the integrator during the auto-zero interval is shown in the timing diagram of Fig. A, along with the pertinent timing points. At the beginning of this interval, there is a brief override period, during which the 50% duty cycle of the up/down logic is inhibited while the integrator output is brought to the storage voltage.

At the start of the measurement interval, the mea-

sure/zero logic switches the analog input voltage into the input buffer amplifier. This amplifier acts as a voltage-to-current converter. The additional current it now sends to the integrator summing node disrupts the balance achieved in the auto-zero interval, driving the integrator output away from the auto-zero equilibrium voltage.

The sense of this deviation is transmitted by the comparator to the control logic, which then attempts to return the integrator output to the storage voltage by using one of the two duty cycles available during the measure interval. For a high comparator output in the clock cycle preceding a set of eight cycles, the up/down logic is high for one clock cycle, low for seven—the pattern called duty cycle 1 in Fig. B. With a low comparator output in the last clock cycle of the set, the up/down logic will be high for seven cycles and low for one in the following duty cycle—labeled 2 in Fig. B. It can be seen from the figure that the high state of the up/down logic drives the integrator output voltage up. Therefore, the synchronous up/down BCD counter adds one count for each clock pulse when the up/down logic is high and subtracts one count for each clock pulse when the up/down logic is low.

It can be shown that:

$$\text{Net count} = V_{IN}(R_1/R_2)(8,192/V_{REF})$$

The measure of the input voltage is therefore a ratio of the reference voltage, and, significantly, the integral or time constant has no influence on accuracy.

Having digitized the analog input, this data must now be brought out to the display. The BCD counter is put on hold, and its contents are loaded into the latches along with under-range information decoded from the counter contents (5% of full scale). The counter is then cleared. The contents of the static latches are multiplexed to the push-pull data output buffers in BCD format.

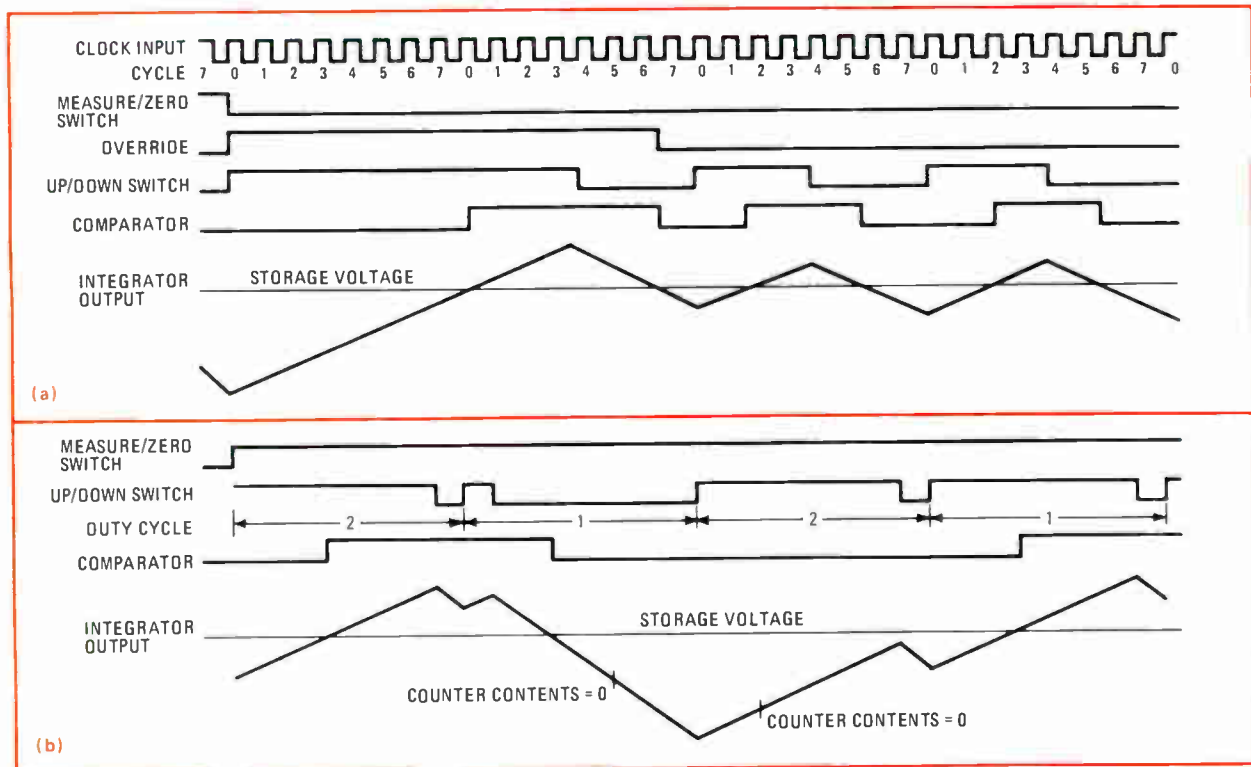

TABLE 1: VALUES FOR COMPONENTS OF THE AUTO-ZERO FILTER

Input frequency (kHz)	Integrator capacitor ( $\mu\text{F}$ )	Storage capacitor ( $\mu\text{F}$ )	$R_4$ ( $k\Omega$ )	$R_5$ ( $k\Omega$ )
2 - 10	0.1	1.0	68	15
10 - 20	0.039	0.1	240	47
20 - 40	0.022	0.1	120	33
40 - 75	0.01	0.1	82	18

than  $V_1$ . As  $V_{REF}$  is increased, the up/down switch's on resistance decreases (Fig. 2), but simultaneously the resistance of reference resistor  $R_1$  increases and reduces the proportion of the total resistance provided by  $R_1$  and switch. Consequently, a large reference voltage minimizes the effects of this switch's temperature-dependent on resistance.

In any case, it is very important for the reference voltage itself to have a low temperature coefficient to minimize drift and, thus, count error. The following equation quantizes the change in count that occurs for a fractional change in reference voltage:

$$\Delta count = -2,000 (V_{IN}/V_{IN F.S.})(\Delta V_{REF}/V_{REF})$$

In other words, the count decreases by 1 for each +0.05% change in the reference voltage.

As for external resistors,  $R_2$  should be chosen to supply a full-scale current of 20 microamperes into the integrator summing node (100 kilohms for 2,000 v, and 10 kilohms for 200.0 mv).  $R_1$ , the reference resistor, can then be determined from the next-to-last equation.

Remember, however, that the temperature-dependent on resistance of the up/down switch, which has a temperature coefficient of about 0.2%/°C, counts as part of the total resistance of  $R_1$ . And the error in count resulting from a change in this total resistance  $R_1$  parallels that of  $V_{REF}$ , being:

$$\Delta count = -2,000 (V_{IN}/V_{IN F.S.})(\Delta R_1/R_1)$$

Now the net count is proportional to the ratio  $R_1/R_2$  (see "How the circuitry works," p. 95), so equal temperature coefficients for these resistors should allow this ratio (and the count) to be maintained, even with a change in the ambient temperature. It is desirable, how-

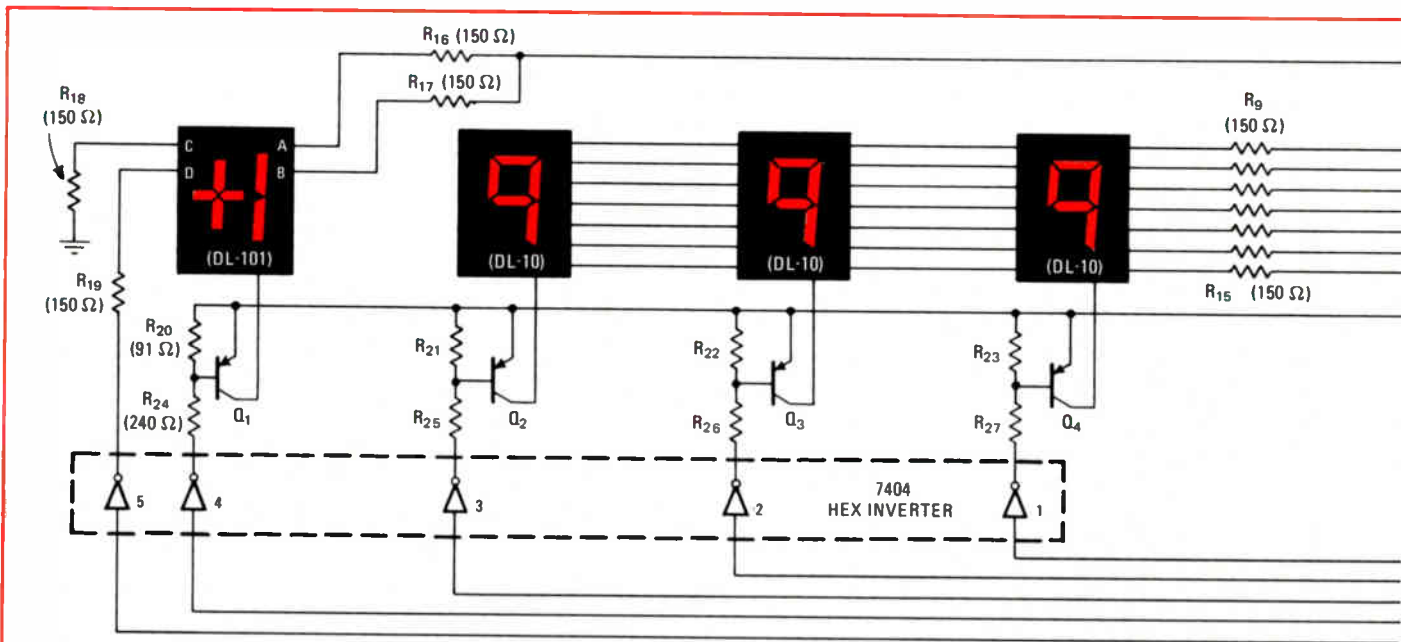

**3. Building a voltmeter.** The primary application of the LD110/111 converter set is digital voltmeters. In this typical +2,000-V digital voltmeter, the clock frequency of 24.5 kHz yields a sampling range of four samples per second. Capacitor  $C_5$  is adjusted for true zero output, after which it can be replaced with a fixed-value component. After this the only calibration required is from trimmer  $R_6$ .



ever, to use resistors with low temperature coefficients for  $R_1$  and  $R_2$  to reduce any errors resulting from the differences in these coefficients.

### Maintaining accuracy

The specified accuracy of the a-d converter will be maintained if the integrator capacitor ( $C_{INT}$ ) is chosen to hold the voltage swing of the integrator within 0.75 v of the storage voltage. This apparently arbitrary value results from two conflicting considerations. The first is the need to maintain a small integrator swing to reduce the error that can occur during the override interval. The second is the need for an integrator swing large enough to keep the error arising from a comparator offset to less than 0.1 of the least significant bit. To minimize these possible sources of error, the value of the integrator capacitor should approximately equal  $570 \mu\text{F} \cdot \text{Hz} / f_{IN}$ .

The storage voltage ( $V_{STRG}$ ) should be maintained between -2 v and -5 v for normal operation. The on resistance of the auto-zero switch is typically 11 kilohms at a storage voltage of -4 v ( $V_2 = -12$  v) and will increase significantly with an increasingly negative storage voltage. Resistor  $R_3$  can be selected to produce the desired  $V_{STRG}$ , provided ground is at zero potential, by the equation:

$$V_{STRG} = -\frac{1}{2} V_{REF} (R_3 / R_1)$$

Several tradeoffs must be made in selecting RC components for the auto-zero filter circuit ( $R_4$ ,  $R_5$ , and storage capacitor  $C_{STRG}$ ). Various component values for different clock-frequency ranges are presented in the table on p. 96, along with the recommended values for the integrator capacitor.

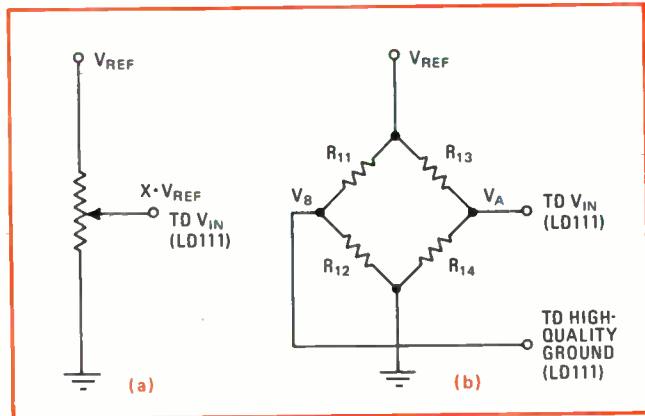

**4. Measuring ratios.** The a-d converter chips are ideal for ratio measurements. A typical potentiometer circuit is shown in (a), while for bridge measurements (b), the ground input of the LD 111 is used as the inverting input of a differential amplifier.

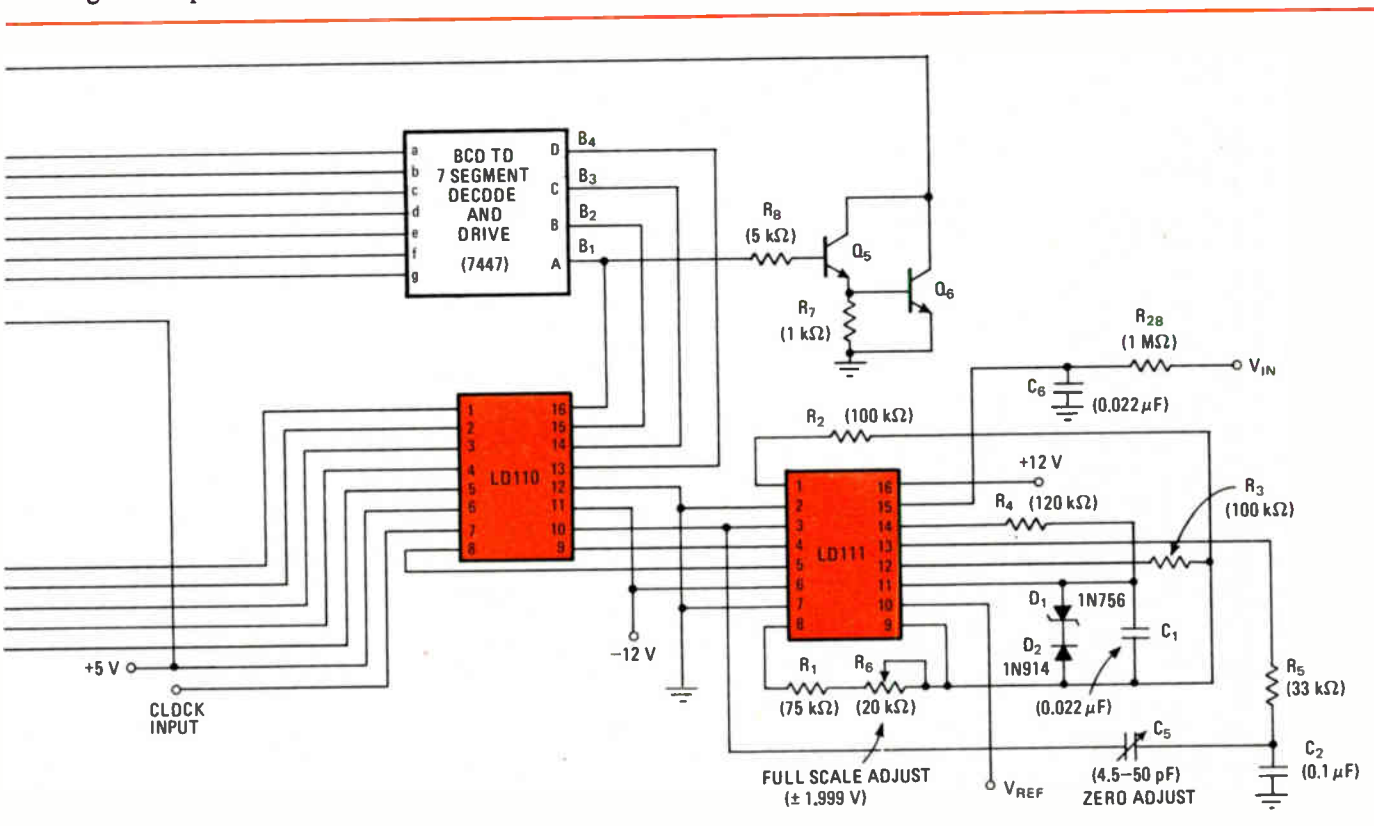

## Part 2: The converter's uses

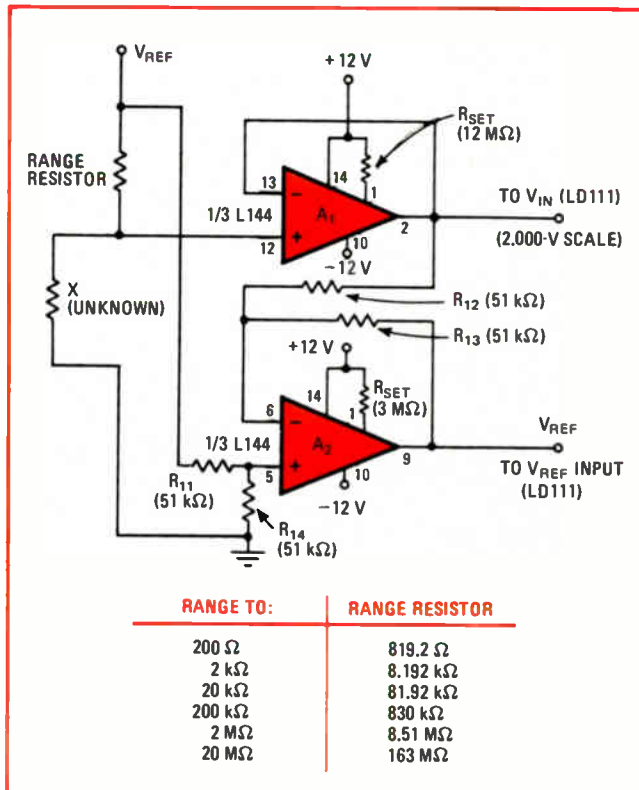

**5. Measuring resistance.** This circuit, combined with the converter pair, will measure resistance values accurately to 20 megohms. The buffer amplifier  $A_1$  should have a low input-bias current—less than 20 nanoamperes—for best accuracy.

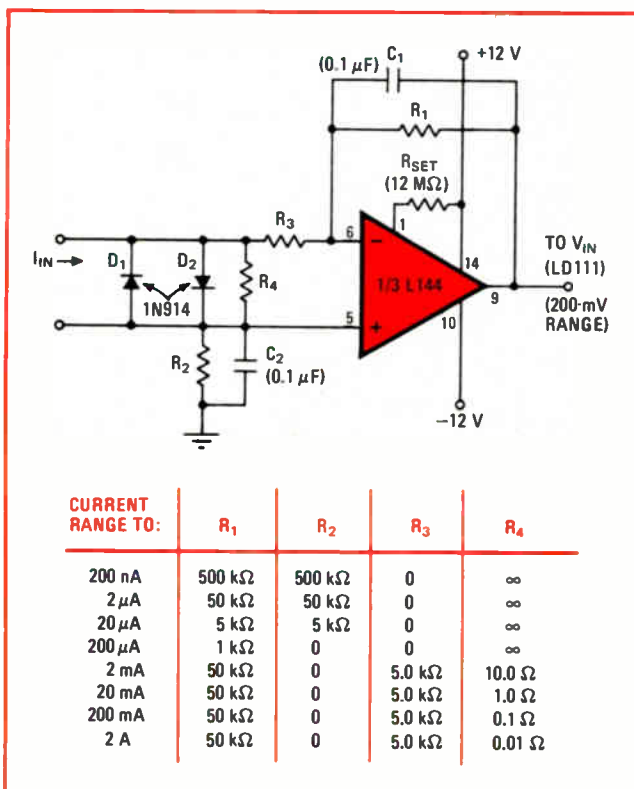

**6. Building an ammeter.** This current-to-voltage converter, used with the 200.0-mV range of a typical digital voltmeter, has eight decades of current range. The more sensitive ranges (up to 200 μA) use the amplifier in the differential mode.

Since the user of the LD110/111 two-chip a-d converter can choose from a wide range of external components, the a-d system is very flexible and can be adapted to a variety of digitizing applications.

The circuit in Fig. 3 presents the chip set in a typical  $\pm 2,000$ -V digital-voltmeter application. The clock frequency of 24.5 kHz yields a sampling rate of four samples a second. Capacitor  $C_5$  is adjusted for 0000 output with zero input and can be replaced by one of fixed value, once the proper value for the circuit board being used has been determined. The only calibration required after that is trimmer resistor  $R_6$ .  $R_1$  and  $R_2$  should be 5% metal-film resistors. All other resistors may be of 10% tolerance—an illustration of how this conversion technique reduces component cost, as well as cost.

The LD110/111 analog-to-digital converter automatically measures input voltage as a ratio. (See "How the circuitry works," p. 95, which summarizes the fact that the count is proportional to the ratio of the input voltage and the reference voltage in the equation: Net count =  $V_{IN} (R_1/R_2)(8,192/V_{REF})$ .) Obviously, therefore, the system can easily handle ratio-measurement applications. Ratio measurements that use the excitation voltage of the ratio device as their reference voltage are independent of variations in the excitation voltage.

Figure 4 shows some typical ratio-measuring circuits. The output of the potentiometer in Fig. 4a, which can represent position, level, etc., can be substituted in the equation quoted in parentheses above to demonstrate this capability:

$$\begin{aligned} \text{Net count} &= X V_{REF} (R_1/R_2)(8,192/V_{REF}) \\ &= (R_1/R_2)(8,192X) \end{aligned}$$

Bridge transducer measurements (Fig. 4b) can also be normalized to an external reference. Here the ground input of the LD111 can be used as the inverting input of a difference amplifier to provide a count proportional to the difference of the two input voltages  $V_A$  and  $V_B$ .

Ratio-measurement techniques can also be extended to measuring resistance. The circuit in Fig. 5 will accurately measure resistances to 20 megohms when associated with a buffer amplifier ( $A_1$ ) having a low input bias current ( $I_{IN}$ ) of less than 30 nA.

### More converters and instruments

Figure 6 shows a current-to-voltage converter with eight decades of current range. Intended for use with the 200.0-mV range of typical digital voltmeter, this circuit actually comprises two different circuits, as shown in the table of resistances included with the figure. The more sensitive ranges (up to 200 microamperes) use the amplifier in a differential mode to give an output equal to  $-2I_{IN}R_1$ . This configuration effectively cancels the contribution of the input-bias currents to the output voltage. (Since this error would be insignificant on the 200-μA range,  $R_2$  is eliminated.)

The less sensitive ranges (2 mA to 2 amperes) use the amplifier in an inverting configuration to provide an

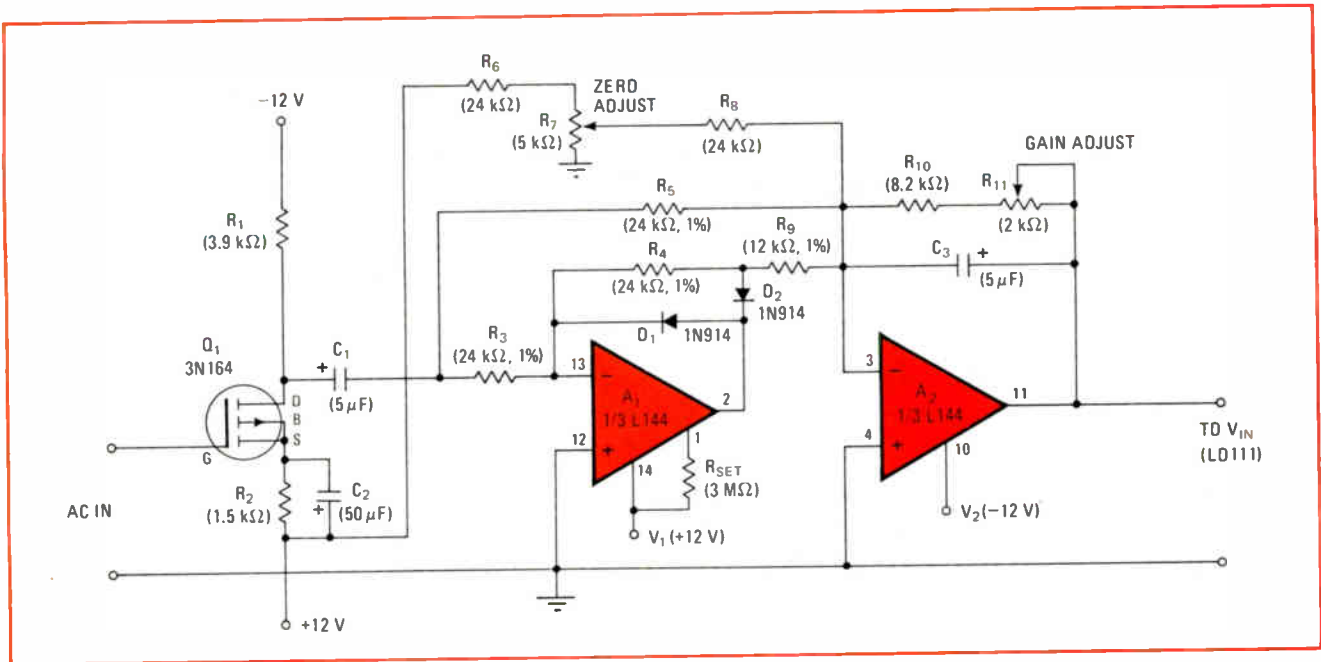

**7. Ac-dc.** Using the converter pair as an ac-to-dc converter requires keeping the input impedance and input bias currents at about the same value as those of the LD111 input, buffer amplifier. The circuit includes a p-channel enhancement-mode MOSFET input buffer amplifier.

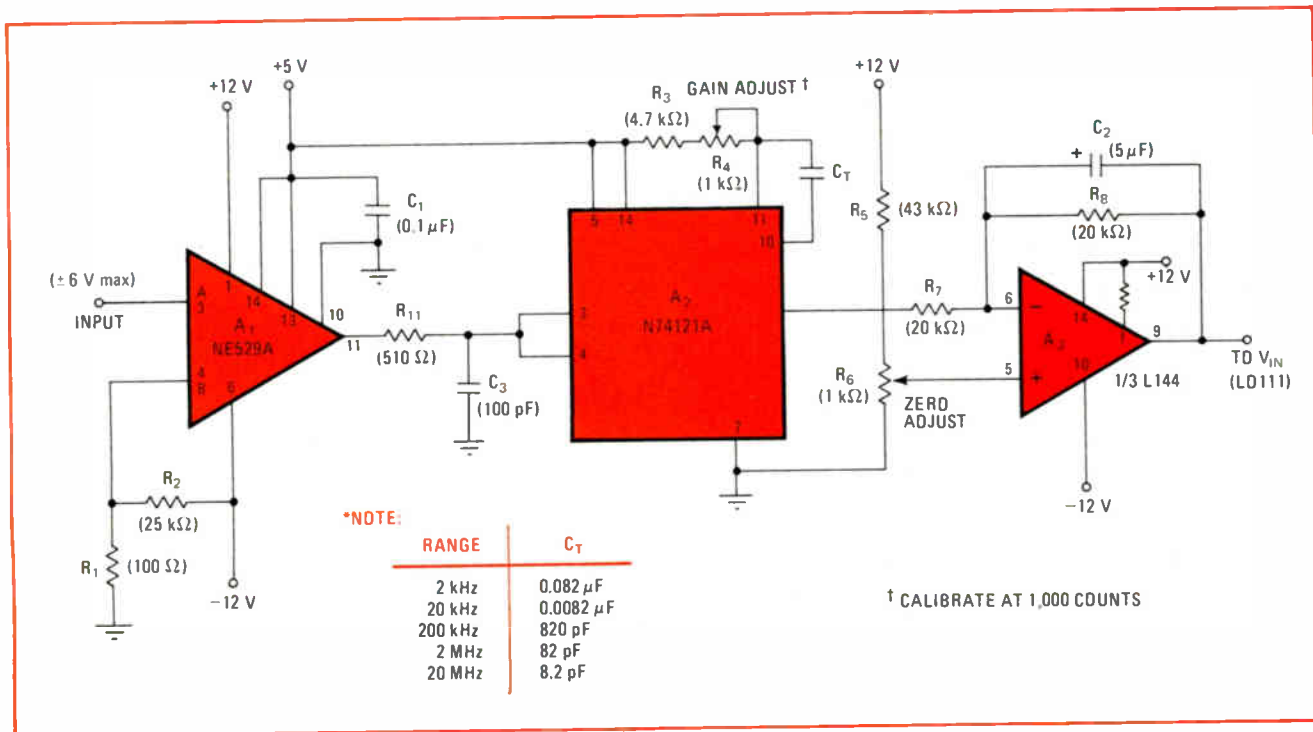

**8. Measure frequency digitally.** The basic 2-V digital-voltmeter circuit can be used to measure frequency when used with 74121-type monostable multivibrator. Here, frequency is converted to voltage by taking the average dc value of the one-shot's pulses.

output equal to  $-I_{IN}R_4R_1/R_3$ . Input protection is provided by diodes  $D_1$  and  $D_2$ .

When an ac-to-dc converter is designed with the LD110/111 converter set, the input impedance and input-bias currents should approximate those of the LD111 input-buffer amplifier. This is particularly necessary if the digital-voltmeter circuit of Fig. 3 is used, so that the same range resistors can be employed for both ac and dc measurements.

The ac-to-dc converter shown in Fig. 7 fulfills these

requirements. The circuit includes a p-channel MOS enhancement-mode FET-input buffer amplifier, coupled to a classical absolute-value circuit, which essentially eliminates the effect of the forward-voltage drop across diodes  $D_1$  and  $D_2$ . A filter removes the dc component of the rectified ac, which is then scaled to rms. The output is linear from 40 hertz to 10 kHz.

A digital frequency meter can be fashioned from the basic 2-v digital-voltmeter circuit by using the circuit shown in Fig. 8. Here, frequency is converted to voltage

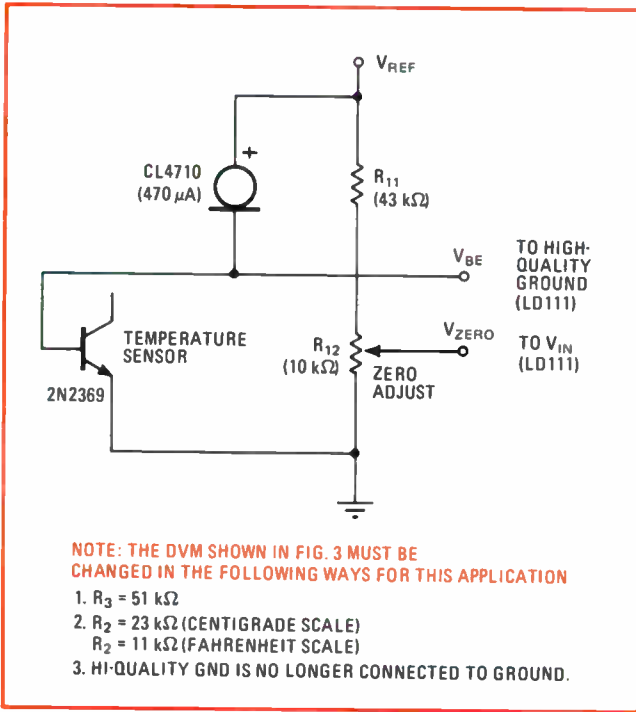

**9. Digital thermometer.** By changing the forward voltage drop across a pn junction, the converter system, will measure temperature as a voltage change across the temperature-sensitive junction. The temperature coefficient typically is  $-2.3 \text{ mV}/^\circ\text{C}$ .

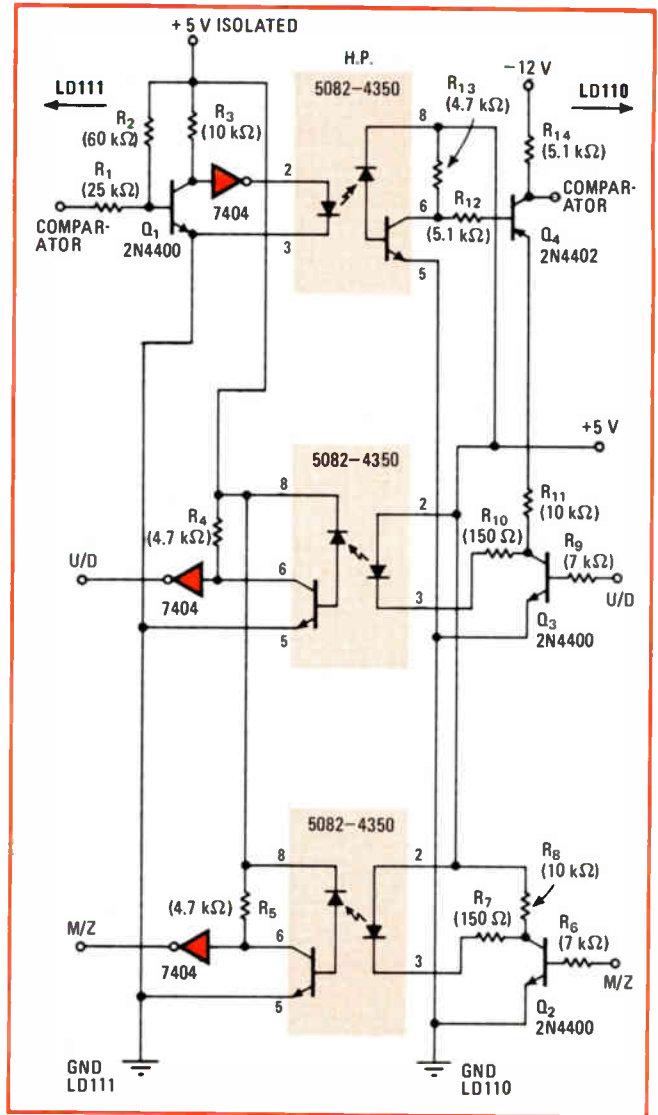

**10. In isolation.** A good technique for isolating the a-d circuit uses a high-speed optical coupler as an interface to the three a-d signals (measure zero, up/down, and comparator). This system is useful for medical, nuclear, and process-control instrumentation.

by taking the average dc value of the pulses from a 74121-type monostable multivibrator.

The one-shot multivibrator is triggered by the positive-going ac signal at the input of a 529-type comparator. The input signal to the comparator should be greater than 0.1 v peak to peak and less than 12 v peak to peak for proper operation. The amplifier not only acts as a dc filter, but it also provides zeroing. This circuit will maintain an accuracy to 2% over a range of five decades.

The converter system can also be used to construct a digital thermometer by using the change in forward-voltage drop across a pn junction as the temperature-sensitive element in the circuit (Fig. 9). This change is typically  $-2.3 \text{ mV}/^\circ\text{C}$ . The circuit has the base-emitter junction of a bipolar transistor biased with a  $470\text{-}\mu\text{A}$  current source.

With this element, the junction voltage  $V_{BE}$  is applied to the input buffer amplifier of the analog processor, which functions as a differential amplifier. The buffer

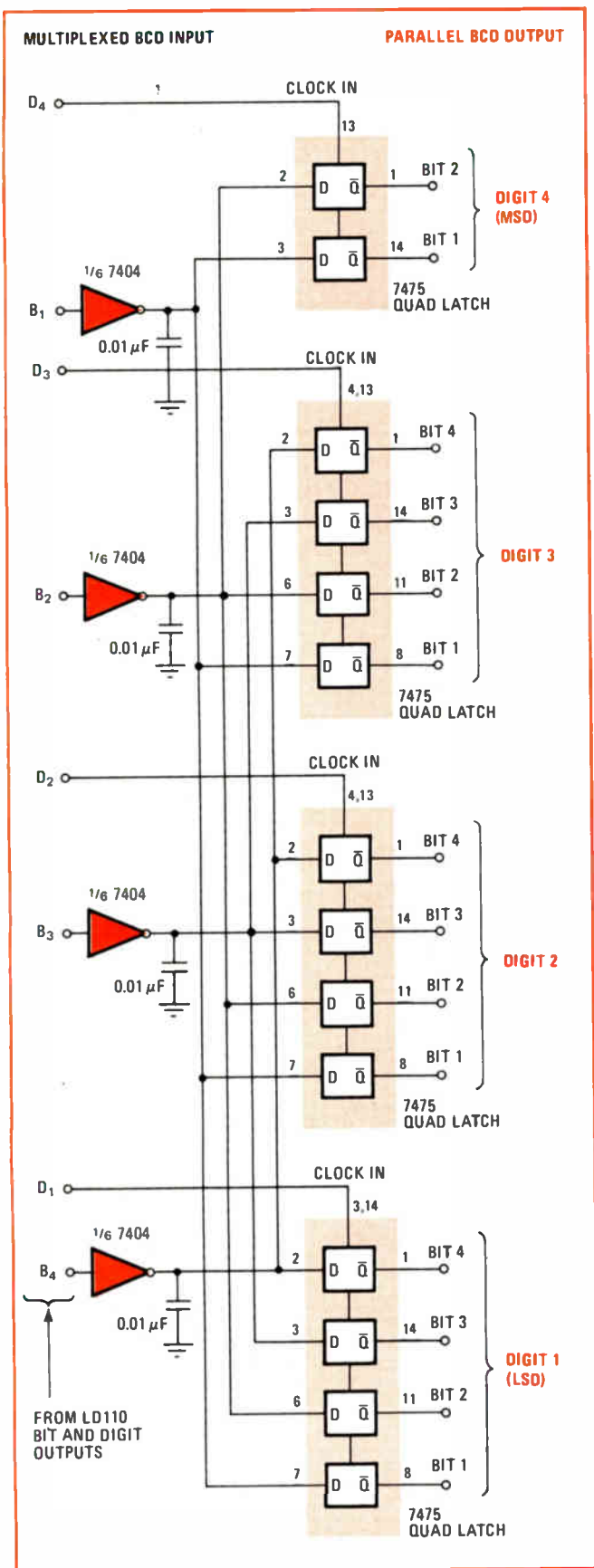

**11. Parallel output.** For those jobs where the BCD data for all four digits should be available in a parallel format—for example, as printer inputs—this multiplexed-BCD-to-parallel-BCD converter has four quad bistable latches activated by LD110 output.

resistor  $R_2$  is scaled to give a count proportional to temperature, as shown by the equation:

$$\text{Count} = 1,000 A [V_{\text{ZERO}} - V_{\text{BE}}(t)]$$

Gain  $A$  must be approximately 5 for the Celsius scale, 9 for the Fahrenheit scale.

### Some other Ideas

The isolation circuit of Fig. 10 provides a floating analog processor for measurement of off-ground signals, like those found in medical, nuclear, and process-control instrumentation.

The three analog-to-digital interface signals (measure/zero, up/down, and comparator) are isolated by high-speed optical couplers with a 2,500-v insulation. The TTL-level drive capability needed to interface the optical couplers with the LD110/111-system signals is provided by transistors  $Q_1$ ,  $Q_2$ , and  $Q_3$ . The isolators in the measure/zero and up/down channels are used in the noninverting mode, while the isolator in the comparator interface is used in the inverting mode. Transistor  $Q_4$  shifts the TTL-level signal to the MOS-level required at the LD110 comparator input.

Although the isolators tend to shorten the pulse width of the LD110/111-system signals, the unique conversion technique of the system automatically compensates for this. No additional adjustments are necessary.

The multiplexed BCD output of the converter is useful for digital displays, but there are other applications, such as printer inputs, in which the BCD data for all four digits should be available in a parallel format. The multiplexed-BCD-to-parallel-BCD converter of Fig. 11 will provide the proper interface for these jobs.

The converter consists of four quad bistable latches activated in the proper sequence by the digit strobe output of the LD110. The complemented outputs ( $\bar{Q}$ ) of the quad latch set will reflect the state of the bit outputs when the digit strobe goes high and will maintain this state when the digit strobe goes low. The latches will be updated with the next digit strobe.

Consequently, this parallel BCD output will not be affected by the blinking off of the digit strobes when the count exceeds 1,999 (overrange), and it can therefore be used to drive a non-blinking display up to a full-scale of 3,000 counts. The parallel BCD output can be put in a hold state if all digit strobes are clamped to ground to prevent the updating of the latches.

### What the future holds

The preceding examples indicate the multiplicity of uses possible for the scaling, ratio-measurement, and differential-input capabilities of the LD110/111. The next evolutionary step is to single-chip monolithic a-d converters, a prospect that grows more attractive as linear LSI processing becomes more powerful. First to arrive will undoubtedly be a low-speed a-d converter resembling the LD110/111 and aimed specifically at the market in high-performance digital multimeters. This will probably incorporate the various digital-multimeter functions into the linear front end. Medium- and high-speed a-d converters for control applications, although not in the range of today's single-chip technology, will surely become a reality in the not-so-distant future. □

# WHO MAKES THE MOST GLASS PRODUCTS FOR ELECTRONICS?

- CERDIP Sealing Materials . . . we sell the industry standard . . . including the lowest temperature sealing glasses on the market
- Substrates . . . you can choose standard sizes off the shelf, or order special glasses
- Diode Cases . . . we're the largest supplier in the world
- Infra-red Sealing Reed Switch Glass . . . we developed it to give you fast, efficient processing
- Glass Preforms . . . more than 1,200 shapes of IC frames, beads, and other preforms
- CRT Bulbs . . . more than 100 standard shapes, from 1" to 36", plus special shapes and sizes
- Quartz Crucibles . . . O.D. sizes up to 10"
- Chemically Machinable Glass Ceramics . . . for unique shapes and configurations
- Display Materials . . . cell sheets, back plates, mercury capsules and sealing frit, everything for flat panel displays

## CORNING MAKES IT!

We can do almost anything with glass for electronics.  
Got a problem? Write or call:



Electronic Materials Department

**CORNING**

CORNING GLASS WORKS

Corning, New York 14830

(607) 974-8866

# High-level language simplifies microcomputer programming

Just as Fortran and Basic sharply reduce the time and effort required to program large computers, so Intel's PL/M eases the programming of systems based on LSI microprocessors; here are step-by-step directions

by Gary A. Kildall,  
*Naval Postgraduate School, Monterey, Calif.*

□ The microcomputer is being applied to more and more tasks that are not economically feasible for a minicomputer, with its larger instruction set and higher speed and cost. Although the microprocessor is slower than the central processor of a minicomputer, it can easily perform many tasks that are complex enough to require extensive digital processing.

What's more, microprocessors, which serve as central processors of microcomputers and are generally made with MOS large-scale integration, are constantly attaining higher speeds and higher circuit density per chip. As the capabilities of microcomputers are being ever extended, programming aids are being developed to simplify their use, while minimizing design and development time. These aids sometimes require use of a larger computer; when this is the case, they can be used either on commercial time-sharing networks or on a user's own large in-house computer.

The microcomputer may be viewed as a ROM-driven LSI logic chip because the microcomputer can execute complicated sequences of instructions stored in an external memory. Thus, the microcomputer chip connected to a read-only memory containing the proper data can appear to be a single custom chip. In this way, the system designer can substitute microcomputer programming for traditional hard-wired logic design or custom chip fabrication, gaining advantages in reduced development time, ease of design change, and reduced production costs.

The application of microcomputers points up the common ground between software and hardware designers. While software-system designers can use microcomputers most effectively when they are aware of the hardware environment, the hardware designer is well advised to learn the basic techniques of the programmer.

These techniques include how to use assemblers, compilers, and processor simulators, which are effective tools in developing and debugging large and small microcomputer programs. This article introduces these programming tools to the hardware designer and specifically examines the advantages of the PL/M language, which make possible rapid design of systems around the MCS-8 microcomputer, made by Intel Corp.

The MCS-8 is based on the 8008 microprocessor, one of a new class of devices being offered by several manu-

1. **Symbolic.** This simple program for choosing the larger of two numbers takes nine lines of code in symbolic or assembly language, but typically only one line in a higher-level language, such as PL/M.

## Closing the loop

Readers who would like to discuss the PL/M language with Mr. Kildall may call him at (408) 646-2240 during the week of July 15, between the hours of 9 a.m. and 12 noon, Pacific Daylight Time.

LABEL	INSTRUCTION	COMMENT
TEST	SHL B	LOAD ADDRESS OF B
	LAM	LOAD B INTO ACCUM
	SHL A	LOAD ADDRESS OF A
	CPM	COMPARE B WITH A
	JFC L1	JUMP TO L1 IF B ≤ A
L1	LAM	LOAD A INTO ACCUM
	SHL C	LOAD ADDRESS OF C
	LMA	STORE ACCUM INTO C
	END	END OF PROGRAM



# ELECTRICAL CONTACTS

by **BRAININ**

For your regular—and unusual requirements

Contact rivets in silver, platinum, palladium and their alloys, and other materials supplied to your specifications. Also, to meet today's requirements, we are expanding our field to take care of sub-assemblies using contacts.

We specialize in laminated sheet and wire, bimetals, composite rivets and screws. Write to Brainin for your contact requirements. Inquiries invited in reference to materials and designs. Prompt, confidential attention given to all communications.



THERMOSTATIC BIMETAL  
PRECIOUS METAL PRODUCTS FOR ELECTRICAL MANUFACTURERS

**C. S. BRAININ CO.**

20 VANDAM STREET, NEW YORK, N. Y.



FOR EVERYTHING  
IN ELECTRONIC  
AND RADIO  
EQUIPMENT

You Can Depend on **ALLIED**

FOR:

- Electronic Tubes
- Test Equipment
- Public Address
- Xmitting Gear
- Photo Cells
- Receivers
- 15,000 Parts, etc.

★

All the leading lines:  
RCA, National, Ham-  
merlund, Mallory,  
Raytheon, Hallicraft-  
ers, Triplett, Thordor-  
son, Bliley, etc.

★

Here's everything in Radio and Electronic equipment for engineering communications, laboratory and industrial application. You'll want the 208 Page ALLIED Buying Guide handy. For your FREE copy, write Dept. 24-F-2.



**VAST COMPLETE STOCKS**

**IMMEDIATE DELIVERY**

**ONE DEPENDABLE SOURCE**

**GET YOUR 208 PAGE BOOK**

**ALLIED RADIO**  
833 W. JACKSON • CHICAGO

using this value of  $X$  and the value of  $K$  solve the equation above the cubic for  $A$ . About 20 percent should be allowed for being within regeneration limits.

In the table are values for 455 kc i-f calculated from the first formula for a  $Q = 100$ . For any other value of  $Q$  multiply by  $100/Q$ . Values are calculated on the handbook values of grid to plate capacity, mutual conductance and plate resistance.

J. J. ADAMS,  
Zenith Radio Corp.

## More on Conversion

Editor's Note—Late in March, **ELECTRONICS** wrote to many suppliers of components, materials and assemblers of communication and industrial electronic equipment to determine the impact of the stoppage of production of home radio receivers on April 22. The following letters are typical of the answers received:

"We are not doing any defense work. We have tried to get some of this work, visited Washington, but so far, no prints have been shown us.

"Our plant is ready for defense work, our people are ready, in fact they would like to work 48 hours per week without overtime if the Government would let them.

"We advised the Government that we were ready and if defense work could not be given us directly, they, the Government could have and use our plant for the duration without recourse or compensation, including the writer's service."

"For over a year we have tried to

• • •

## RECORDING VOICES



The Australian Broadcasting Service recorded the voices of the defenders of Tobruk. The messages of the Scottish gunners who manned this anti-aircraft position will be relayed to Scotland. The men are shown listening to their own voices after they had been recorded

# AC TO DC WITH BL RECTIFIERS

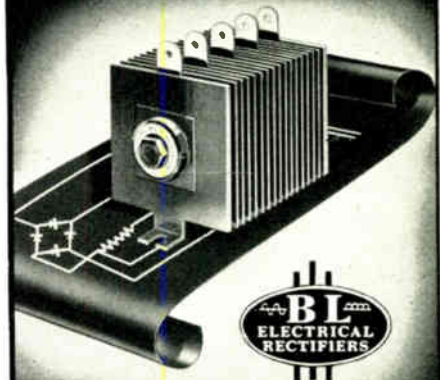

TO MEET  
YOUR SPECIFIC  
REQUIREMENTS

OVER twenty years of specialized engineering experience has served to make The Benwood Linze Company a Central Clearing House of information on Rectifiers and their applications.

A completely modern three story plant equipped with the latest production facilities is devoted to research, design and manufacture of selenium and copper sulphide rectifiers and rectifier transformer assemblies which incorporate these elements in addition to copper oxide and tube rectifiers. B-L rectifiers and assemblies are today serving America's Armed Forces and industry with service proved efficiency.

Now, with every thought concentrated on producing for America, the value of these years of experience is evident. If you have any problems involving conversion of electrical current from AC to DC, you will do well to join the hundreds of others who depend on the craftsmanship, engineering experience, and modern production facilities that B-L offers.

### APPLICATIONS

- Electronic Equipment
- Communication Systems
- Alarm Systems
- Signal Devices
- Photoelectric Cells
- Electro-Magnetic Equipment
- Radio Remote Control
- Broadcasting

### ASSEMBLIES

- Fast Battery Chargers
- Battery Boosters
- Electroplaters
- Cathodic Protection
- Aircraft Engine Starters
- Power Packs
- Motion Picture Rectifiers
- Voltage Adjusters

the **BENWOOD LINZE CO.**  
ENGINEERS • MANUFACTURERS

1805 Locust St. • St. Louis, Mo.



facturers as a result of recent advances in semiconductor electronics. The PL/M programing aid is a good example of the service that these manufacturers can offer to simplify the use of their products.

### Minimizing software costs

Like other programing tools, the PL/M approach automates the production of programs to counteract the rapidly increasing cost of software production at a time when hardware costs are decreasing. And, in addition to rapid production turnaround, the programs can be fully checked out early in the design process. What's more, the self-documentation of PL/M programs enables one programmer to readily understand the work of another, which dramatically reduces program-maintenance costs and provides transportability of software between programmers and to other Intel processors as they are introduced.

Additional cost reductions will also result from standardization of parts and modules, and alterability of the final program often outweighs benefits of random-logic designs or custom-chip fabrication.

The PL/M compiler, which is another program, translates the PL/M program into machine language. This compiler, which can be run on a medium- or large-scale computer, is available from several nationwide time-sharing services.

Last but not least, PL/M programs can be recompiled as improved optimizing versions of the compiler are released, as Intel has recently done. A recent revision of the PL/M compiler, for example, makes possible reduction of generated code by about 15%.

Although PL/M requires a cross-compiler—one that runs only on a larger machine—a resident compiler that uses the microcomputer itself to produce its programs is technically feasible with the advanced state of microcomputer development and today's inexpensive periph-

erals. Such a compiler would require several passes to reduce a PL/M source program to machine language, using the developmental system itself, and eliminating the need for large-system support.

A program for the Intel 8008 microprocessor is a sequence of instructions from its normal instruction set (see "Hardware for PL/M," p. 105) that performs a particular task. Given no programing aids, the designer must determine the machine codes that represent each of the instructions in his program and store these codes into program memory. This approach to programing quickly becomes unwieldy, in all but the most trivial projects.

Nearly all manufacturers of microprocessors (and mini- and maxicomputers as well) provide symbolic assemblers—programs that ease the programing task by eliminating the need to translate instructions manually into machine-readable form. The designer can express his program in terms of mnemonics, which are abbreviations that suggest individual instructions. Then the assembler translates each mnemonic instruction into its binary representation.

### Symbolic addresses

In addition, the programmer can refer to memory locations by symbolic name, rather than actual numeric address; the assembler translates these, as well as the instructions. The assembler usually runs on a larger computer, although both Intel Corp. and National Semiconductor Corp. have assemblers that run directly on their microcomputer-based development systems, and symbolic programs for Rockwell microcomputers can be assembled on a machine built around that unit by Applied Computer Technology Inc. The assembler requires significantly less development and check-out time than manual translation, and there are fewer coding errors.

LINE	STATEMENT
1	DECLARE MESSAGE DATA ('WALLA WALLA WASH'),
2	(CHAR, I, J, SENDBIT) BYTE;
3	
4	/* SEND EACH CHARACTER FROM MESSAGE VECTOR TO TELEPRINTER */
5	DO I = 0 TO LAST(MESSAGE);
6	CHAR = MESSAGE(I);
7	SENBIT = 0;
8	
9	/* SEND EACH BIT FROM CHAR TO TELEPRINTER */
10	DO J = 1 TO 11;
11	OUTPUT(0) = SENDBIT;
12	CALL TIME (91); /* WATTS 9.1 MS */
13	SENBIT = CHAR AND 1;
14	/* ROTATE CHAR FOR NEXT ITERATION */
15	CHAR = ROR (CHAR OR 1, 1);
16	END;
17	END;

2. **Serial sender.** To print a short message on a Teletype, this routine in PL/M transmits 11 pulses at 9.1-millisecond intervals for each character in the message, stopping after the last one. The pulse train consists of one start pulse, eight data pulses, and two stop pulses.

## Hardware for PL/M

The Intel MCS-8 microcomputer consists of the 8008 microprocessor plus a collection of standard read/write and read-only memories and shift registers. The 8008 is a single-chip MOS device with

- 8-bit parallel word size
- Seven 8-bit general-purpose registers
- 16,384-word address capability, in either read-only or read/write memory
- Up to 32 8-bit latched input and output ports

The MCS-8 instruction set includes register-to-register, register-to-memory, and memory-to-register transfers, along with arithmetic, logic, and comparison instructions. Conditional and unconditional transfers and subroutine calls are also provided. Input and output instructions read data from input ports and set data into output-port latches. Each of these instructions is represented in program memory by a sequence of one, two, or three 8-bit words.

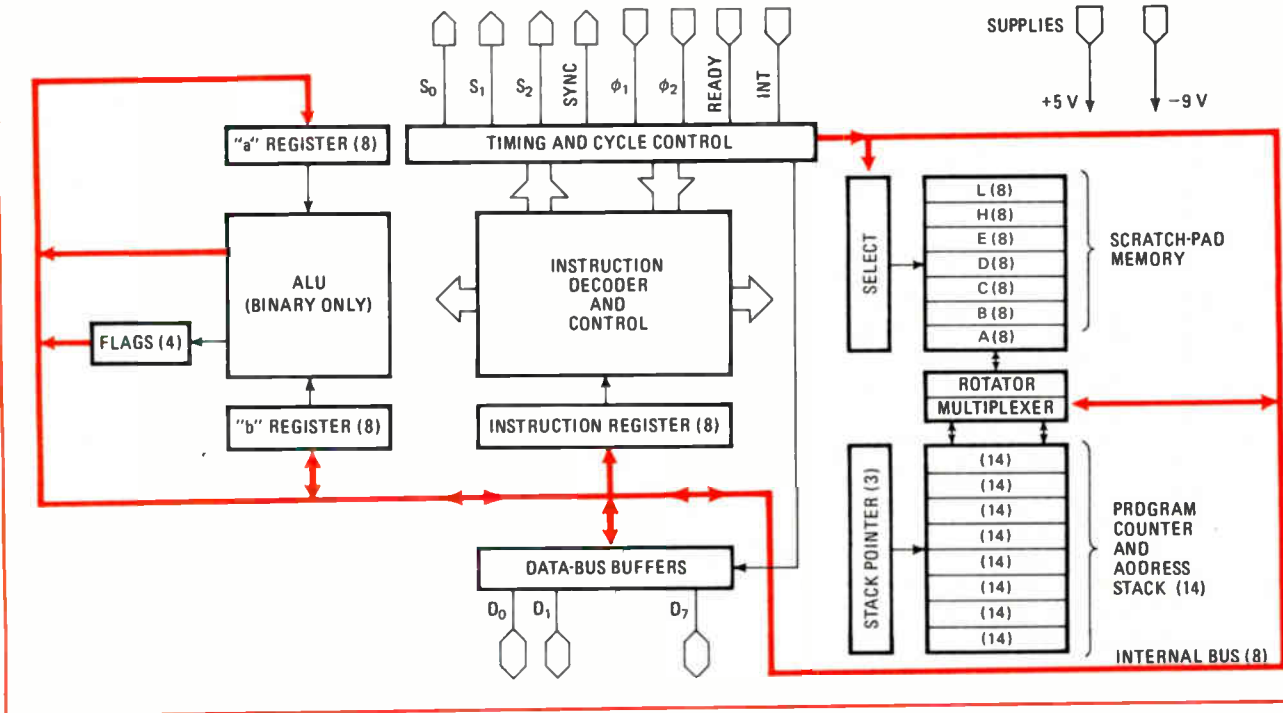

Assembly-language programming, however, is necessarily closely related to the machine architecture because instructions in symbolic code have a one-to-one correspondence with those in machine code. As a result, the programmer must spend much more time keeping track of the location of data elements and proper register usage than actually conceptualizing the solution to his problem.

On large-scale computers, high-level languages have been developed to provide important facilities independently of particular machine architectures, while eliminating the trivialities of assembly languages. These facilities include program-control structures, data types, and primitive operations suitable for concise expressions of programs in particular problem environments. For example, a problem environment may be one of numerical computation, in which application-oriented programming languages like Basic and Fortran are appropriate. Or the environment may be the control of a particular class of computer and all its functions, for which system languages, which are necessarily closely related to the machine architecture, are useful.

In a system language, program statements generally correspond directly with machine-level instructions, and conversely, every machine operation is reflected in a high-level language statement. Because of this corre-

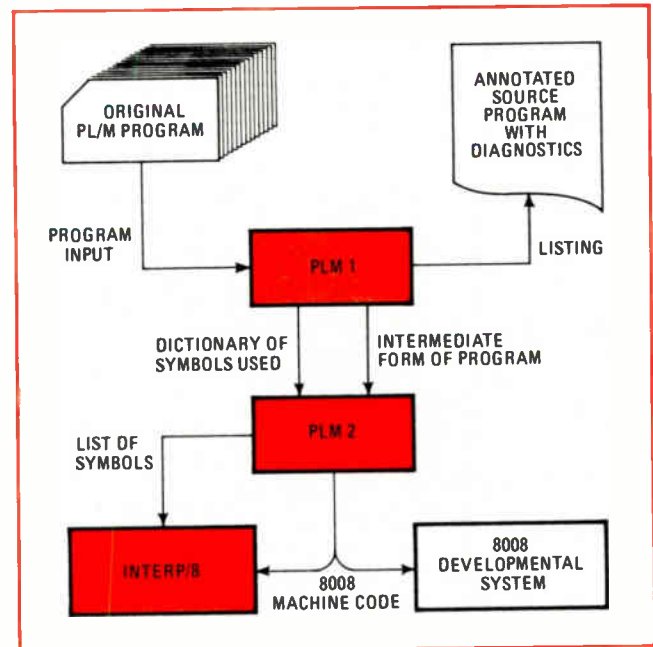

**3. Compiler.** Translating PL/M programs into machine language takes two passes with programs called PLM1 and PLM2, run by a larger machine. A third pass, with Interp/8, simulates the microprocessor on the big machine to check out the program.

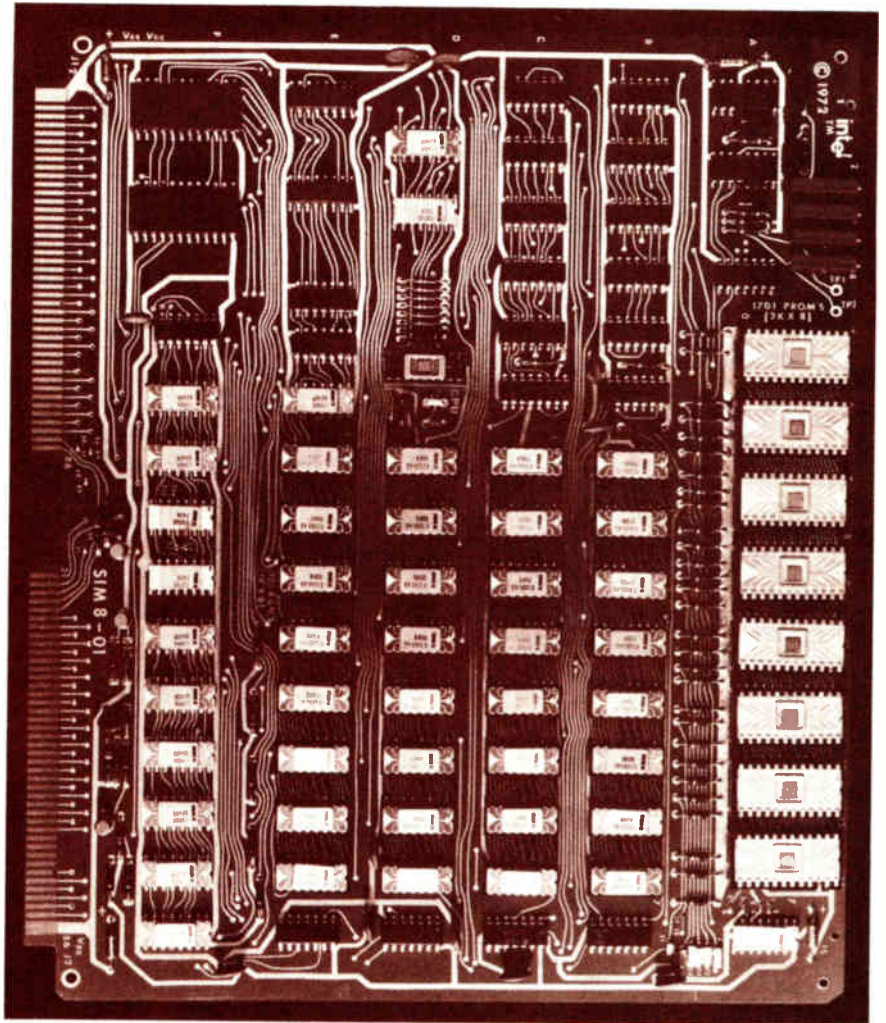

4. **SIM8-01:** This Intel product checks out a program written in MCS-8 machine code or compiled into machine code from the PL/M language. Erasable ROMs store the program, and a Teletype gives input/output.

5. **Intellec 8.** This developmental system can check out programs written in PL/M. It also serves as a prototype for production systems based on the MCS-8.

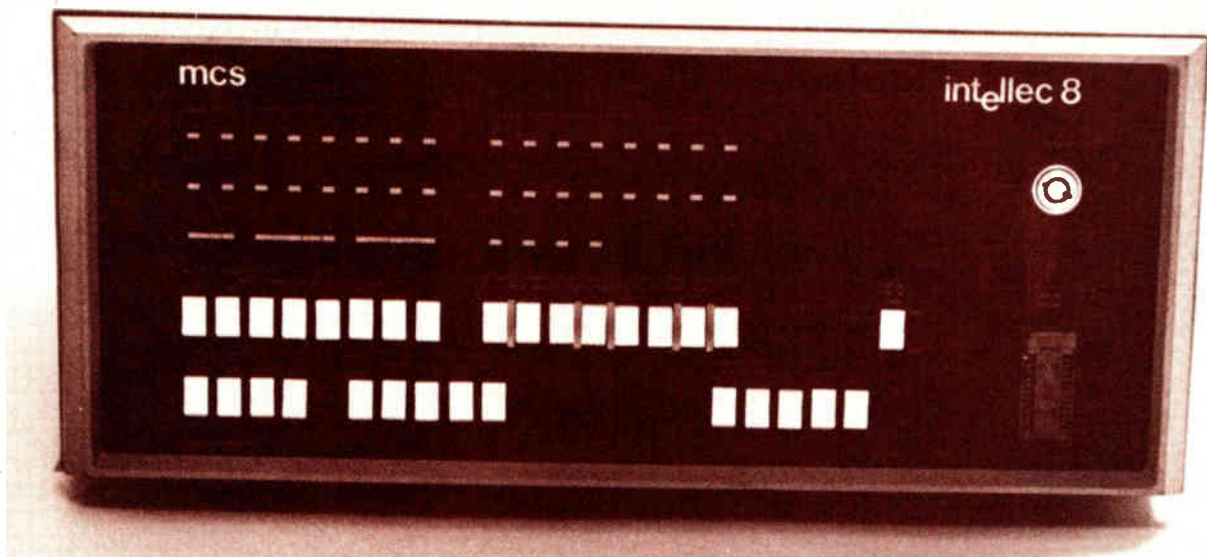

spondence, system-language programs usually translate efficiently to the machine-language level, and the programmer finds all the machine's facilities directly available to him. PL/M, an example of such a language, was designed for use with the 8008 microprocessor, and is also usable with Intel's newer 8080 microprocessor [*Electronics*, April 18, p. 95], which has more useful machine-level instructions and a considerably faster instruction cycle than its predecessor.

Nevertheless, some hardware designers, particularly those newly introduced to software systems, may prefer to work at a comfortable level, which may mean programming in absolute machine code initially and then moving to assembly language as more capability is required. Similarly, they can easily make the transition to a high-level language when programming in assembly-language becomes tedious.

In any case, the designer soon becomes familiar with various programming levels. One of these levels can then be intelligently selected as most appropriate for a given application. Each level has its own advantages. For example, a program in PL/M that compiles into about 500 bytes of memory space when using the 8008's instruction set might require perhaps as much as 30% less space if it were coded directly in assembly language. But larger programs running 1,000 bytes or more usually turn out to be more compact when written in PL/M than in assembly language because the compiler can keep track more easily of memory-reference areas, registers, and other resources. The amount of machine code generated in assembly language or PL/M varies, of course, with program complexity and style. Thus, an absolute comparison between the two is not possible.

### Simple coding

The PL/M language consists of a number of basic statement types in which complicated arithmetic, logical, and character operations on 8-bit and 16-bit quantities can be expressed in a form resembling usual algebraic notation. Relational tests can be expressed in a natural way to control conditional branching throughout the PL/M program.

For example, to move the larger of two numbers in locations A and B into the location called C, either the PL/M statement,

```
IF A > B, THEN C=A; ELSE C=B
```

or the nine-instruction assembly-language program shown in Fig. 1 can be used. The statement reads, "If the value of A is greater than the value of B, then set C to equal A; otherwise set C to equal B."

Additional language structures provide iteration control to permit program segments to be "looped," or executed repeatedly a prescribed number of times. Subroutine facilities include mechanisms that are useful for modular programming and construction of subroutine libraries.

The over-all structure of the PL/M language is most easily demonstrated by a simple example. Suppose a teleprinter is connected to the least-significant bit of an output port of the Intel 8008. A PL/M program that sends a short message to the teleprinter is shown in Fig. 2; it individually times the transmission of the bits

through the output port. This program can be translated into machine code loaded into the memory of the MCS-8, and then it is executed.

The program begins with a data declaration that defines a string of Ascii characters—the words "Walla Walla Wash" as shown in line 1. The 16 individual characters of this string are labeled from 0 to 15 so that they can be addressed by the program (spaces are characters, too). Four variables, or 8-bit memory locations, CHAR, I, J, and SENDBIT, are defined on line 2.

### Any names

These designations are wholly arbitrary; the programmer may use any names he wants, so long as he defines them before he uses them. CHAR holds each character of the message in succession for transmission, I identifies the position of the character in the message, and J controls the position of the bit in the character. The right-most bit of location SENDBIT is the next bit to be transmitted.

Since the instructions between lines 5 and 17 are executed repetitively, they are collectively called a loop. Before each repetition, the variable I is incremented until its value indicates the position of the last character in MESSAGE—in this case, 15.

First, the value of all bits in SENDBIT is set to 0 on line 7 to send a start pulse as the first bit (line 11). Then the individual bits of the selected character are sent in the inner loop between lines 10 and 16. This loop is executed 11 times, corresponding to the start pulse, 8 data bits, and 2 stop pulses, during each passage through the outer loop, beginning on line 5.

Each successive bit is sent on line 11, followed by a 9.1-millisecond time-out. This time delay is a standard feature in PL/M; the compiler implements it by inserting a wait loop in the program. The wait loop stores an appropriate number in a counter, decrements it once each processor cycle, and allows the program to continue when the counter reaches zero.

On each inner-loop iteration, the right-most bit of CHAR is selected on line 13 by the AND function, and it is stored in SENDBIT. The operation on line 15 places a 1 in the right-most position of CHAR and then rotates the result one step to the right. This step gradually fills CHAR with 1s, working from left to right in each iteration, so that two stop pulses, which are 1s, are sent properly on the 10th and 11th iterations.

The operation of the PL/M compiler and its PLM1 and PLM2 subdivisions is shown graphically in Fig. 3. PLM1 accepts a PL/M source program from a card reader, time-sharing console, or other input device. This first pass produces a listing of the source program, along with any error diagnostics, and analyzes the program structure. An intermediate file that contains a linearized version of the original program is written, and the symbols used in it are listed.

Although the linearized version does not resemble either an assembly language or PL/M, it has been reduced to a highly simplified form of the original program. PLM2 uses this intermediate file as input and generates machine code for the 8008 microcomputer.

A PL/M program can often be checked out by simulating the 8008 microcomputer's actions on a larger ma-

```

STRING COMPARISON PROGRAM
TYPE SOURCE STRING:  A B C D
TYPE TEST STRING:
    A B C D
* * * *
TYPE SOURCE STRING:  666 666 666
TYPE TEST STRING:    6
666 666 666
*** *** ***
TYPE SOURCE STRING:  AAAAAAAAABABABA
TYPE TEST STRING:   AB
AAAAAAAABABABA
    * * *
TYPE SOURCE STRING:  XXXXXXXX$
TYPE TEST STRING:   XXXX
XXXXXXXX
****
TYPE SOURCE STRING:  WALLA WALLA WASH
TYPE TEST STRING:   WALLA$
WALLA WALLA WASH
* *

```

**6. Test run.** Sample PL/M program produced this printout. Manually entered data is in color, and machine output is in black. Technique is valuable debugging tool.

chine. A third program, called Interp/8, is available for this purpose. The three programs PLM1, PLM2, and Interp/8 are written in ANSI standard Fortran IV, and will run on most larger computer systems.

A new version of the PL/M compiler is available for use with the extended instruction set of the 8080. Consisting of sections PLM81 and PLM82, it is accompanied by a new simulator called Interp/80. New coding is not required for the 8080. Working with old PL/M programs written for the 8008, the compiler can produce binary code requiring 10% to 20% less storage than the 8008 requires, and having the advantages of new interrupt and decimal-arithmetic capabilities.

Experience with PL/M will enable designers of future Intel microprocessors to incorporate new machine-level instructions that will make more efficient use of the PL/M language. Furthermore, if Intel so chooses, it can alter its processor architecture in future designs, as it did between the 8008 and 8080, without affecting the user of PL/M at all, except possibly to improve the performance of this application.

A number of microcomputer manufacturers are considering the use of high-level languages to augment their assembly-language products, although none have been announced yet. Several minicomputer producers, however, offer high-level applications languages, and at least one minicomputer company, Microdata Corp., provides a systems language. In fact, Microdata's MPL language [*Electronics*, Feb. 15, 1973, p. 95] closely resembles PL/M; both of them, in fact, were essentially

derived from the same basic system language.

Once the PL/M program is written and checked out, the machine code is punched on paper tape (Fig. 3) and loaded into memory of a microcomputer developmental system. Again, the program is verified, and all real-time and environmental considerations are checked out. Final production systems can then be developed from this prototype. The production system, for example, may use read-only memory for the program when the developmental system's memory is read/write.

#### How to go on the air

Given a PL/M program and an MCS-8 microcomputer, how does a programmer actually go through the compilation and execution process? As mentioned previously, the PL/M compiler is available from several nationwide time sharing services. These are the General Electric, Tymshare, National CSS, Applied Logic Corp., and United Computing Services facilities. Documentation for general programming is available from Intel Corp., and the time-sharing services provide system-dependent operating instructions.

Once the programmer has a contract with the commercial service, he is assigned a work area in the host system in which he can store PL/M programs. These programs are created on line by using the time-sharing service's editor, which allows the programmer to enter and alter program files. When a particular program is created, it is saved in a permanent file for subsequent compilation.

In the compilation process, PLM1 is executed first, using the saved PL/M program as input. Any diagnostic messages are printed at the time-sharing console. If no program errors are detected during the PLM1 pass, then the programmer can call for PLM2. This second pass leaves code in MCS-8 machine language, which corresponds to the original program in the user's work area.

With this code, the programmer may execute the Interp/8 program, which reads the machine code and simulates the actions of the MCS-8, as previously discussed. If execution errors appear during simulation, the programmer can alter the original PL/M program and repeat the compilation and simulation process. When the programmer is convinced the program is correct, he can punch the machine language on paper tape or other medium at his local console.

### Programming at home

When a large amount of development work is to be done, the user may find it feasible to purchase the PL/M compiler and CPU simulator directly from Intel and run them on an in-house computer system. The user, at his option, can program either in batch or time-sharing mode.

The machine code produced by the compiler can be executed in several different ways. The easiest method is with a developmental system, such as the Intel SIM8-01 or Intellec 8 (Figs. 4 and 5) or equivalent prototyping hardware. These systems include hardware and software for Teletype, as well as facilities for loading and checking out programs.

The machine code is loaded into the SIM8-01 from the Teletype into erasable read-only memories. These chips are then inserted into sockets on the prototype board, and the program is executed. With the Intellec 8 developmental system, the machine code is entered from the Teletype into read/write memory, where the program can be subsequently executed and tested. Both approaches bypass the simulation stage.

After testing the program on a developmental system, a production model making use of MCS-8 and a mixture of read-only and read/write memory can be tailored closely to the final application. Although the hardware is minimized in the production system to reduce costs, the programs remain the same as in the prototype.

### Developing systems

Intel Corp. has completed a number of projects using PL/M, including an assembler that runs on the Intellec 8 developmental system. This assembler's characteristics show the effectiveness of the PL/M approach to system development. For example, it has full macro capabilities, which means that a programmer can define special pseudo-instructions that cause the assembler to insert sequences of instructions in the main program during the assembly process. Macros are like subroutines, except that the main program executes them as it comes to them, instead of branching out of the main stream and then returning, as it does with subroutines.

The assembler is also capable of conditional assembly, which means that it can react to such external signals as the positions of console switches at the time of

assembly. Such signals indicate conditions that are not necessarily known to the programmer at the time he writes the code—such as the availability of particular output equipment to which the assembler's results are to be sent.

Another useful characteristic of the assembler is evaluation of expressions at assembly time, which permits the programmer to specify certain parameters algebraically instead of numerically or symbolically. Then when a program is assembled, the assembler evaluates the algebraic expressions and inserts the correct values in the machine-language program. The process requires the variables to be specified ahead of time, but it permits the programmer to alter these variables by changing their specification only once, rather than every time they are used in the program. It's a great time-saver and bug-killer.

While these characteristics are not uncommon in advanced assembly languages, high-level languages that can handle them are quite rare. Yet by using PL/M, the assembler was coded in approximately 100 man-hours, and it requires 6,000 bytes of program storage—equivalent to 3,000 words on a minicomputer with a 16-bit word size. Intel estimates that the project would have taken five times as long to code and debug directly in assembly language, with little or no reduction in program-memory space. The resulting assembler is easy to maintain and alter, and, equally important, it can be recompiled for Intel's new 8080 microprocessor without alteration.

### A practical example

PL/M permits many programming shortcuts, such as dividing a complex task into individual subtasks, or procedures, that are called upon when needed to simplify the job of writing the program itself. These procedures are conceptually simple and therefore easy to formulate and express in PL/M, as well as easy to check out before being incorporated in a larger program.

For example, consider a simple program for character manipulation—one that might be part of the work of a more comprehensive word-processing system. The function is relatively simple: the program asks the keyboard for two input-character strings, scans the first string for all occurrences of the second, echoes the first string, and types an asterisk under the starting position in the first string of each occurrence of the second string. A sample interaction with this program is shown in Fig. 6; all lines typed by the operator are in color.

Stated in this way, this example may seem to have little or no practical value. But it is almost identical to a program needed to fetch the strings from two different data-entry devices and do something more sophisticated than printing an asterisk when it finds a match.

This suggests a practical application—a teleprinter to check out a routine before it is embedded in a larger program. When all the bugs are out of the routine, the procedures that transfer data to and from the teleprinter can be replaced with other procedures that, for example, check sensors and turn indicators on and off. The new procedures, of course, have to be checked out in a real environment, but that's much easier when the main routine is known to be bug-free. □

## Electronic combination lock offers double protection

by Louis F. Caso  
Bethpage, N. Y.

If you need a doubly safe lock, try the electronic combination lock shown here. It will not unlock unless the correct combination of switches is depressed, and if the wrong combination is chosen, the lock will not open until it is reset with another combination.

The circuit in the figure is intended for installation in an automobile, but it can be easily modified for other

applications. When the correct combination of switches  $S_1$  through  $S_5$  is depressed, the output of the SET gate goes to logic 1, closing the contacts of RELAY<sub>1</sub>. When the car's ignition is turned off, this relay should be reset (contacts opened) by using switch  $S_6$ .

To open (set) the lock, switches  $S_2$ ,  $S_4$ , and  $S_5$  are depressed simultaneously. If an error is made, the output of the FAULT gate goes to logic 1, and the contacts of RELAY<sub>2</sub> will open. When this happens, the lock must be reset before the opening combination can be used again. Switches  $S_1$  and  $S_3$  are depressed simultaneously to reset the lock.

Any secret combination of push buttons can be selected by arranging the switches as desired. For most applications, the multiple-input logic gates can be obtained by interconnecting standard dual-input gates. □

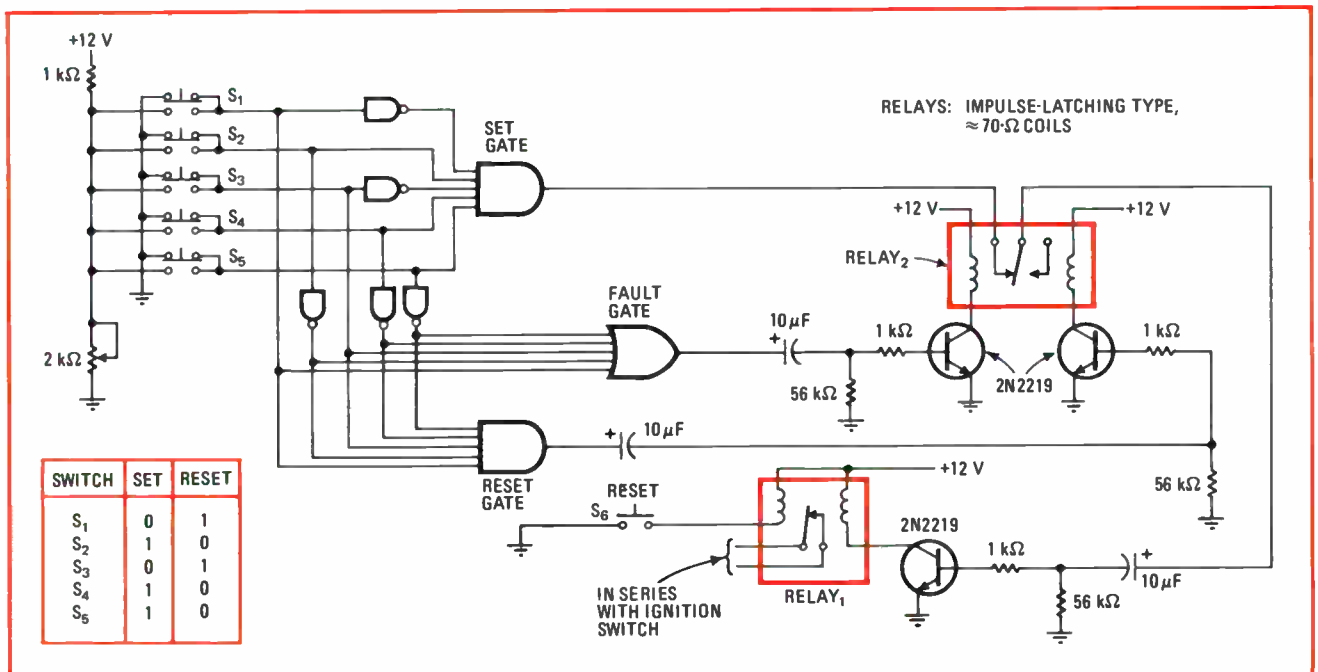

**Safe and sound.** To open this electronic combination lock, depress the correct combination of switches  $S_1$  through  $S_5$ . But if an error is made, the lock must be reset with another switch combination before it can be opened again (The switches are depressed simultaneously.) The circuit shown here is for locking an automobile ignition, but it can be readily adapted for other uses.

## Serial digital multiplier handles two five-bit numbers

by T.K. Tawfig and H.L. Hvims  
Allerød, Denmark

Because of the fast operating speeds of today's digital circuits, the serial type of digital multiplier can be regarded as a practical alternative to the parallel or serial/parallel type in many applications. The serial ap-

proach can mean a large savings in the number of ICs required to do the job.

The circuit shown is an expandable serial digital multiplier that can accept two 5-bit numbers in two's-complement form. It is useful in such applications as digital filters, signal correlators, and other digital systems that employ two's-complement notation. The multiplier circuitry is shown in (a), while the circuitry used to get the necessary control signals is shown in (b).

The multiplication process is started by a CLEAR-LOAD-MULTIPLY command, which is generated by a manual latch, and stops automatically upon completion. When this start command initiates the control sig-

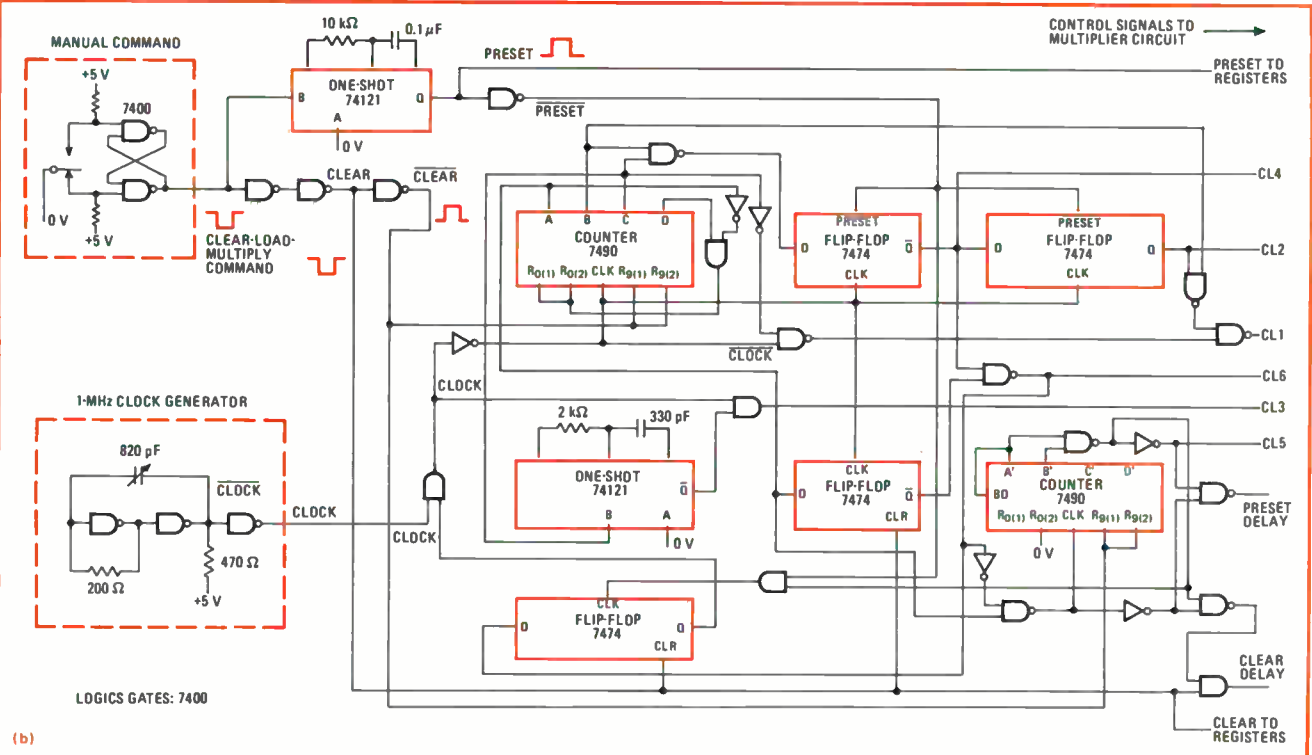
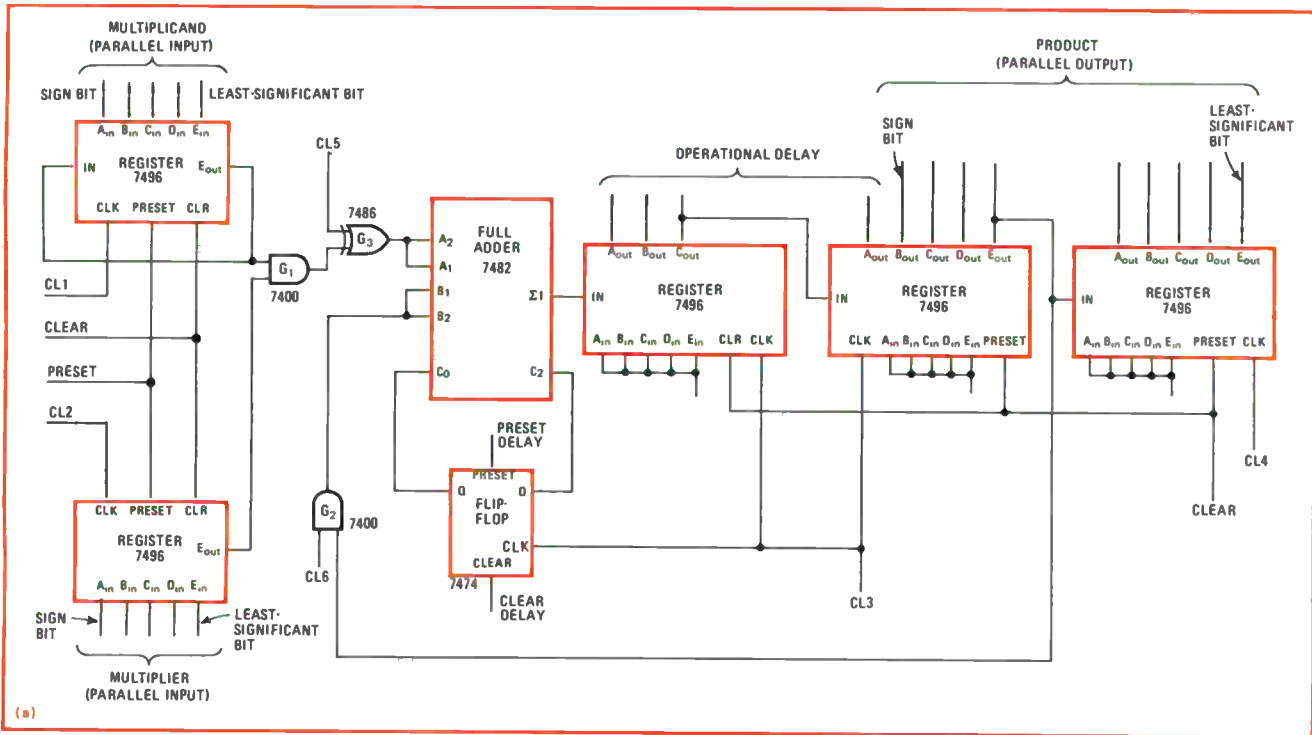

**Serial multiplication.** The number of ICs needed to build this digital multiplier is minimized because the circuit performs the multiplication serially. The two 5-bit two's-complement input numbers, however, as well as the output number, are in parallel form. The multiplier circuitry is given in (a), and the control-signal circuitry in (b). The system is easily expanded to accommodate larger numbers.

nals, the two numbers to be multiplied—the multiplicand and the multiplier—are loaded into their respective registers.

Each bit of the multiplicand is gated by each bit of the multiplier through gate  $G_1$ . To obtain the final product, the partial sums are added to the partial products. Gate  $G_2$  passes the partial sums, and gate  $G_3$  pro-

vides an inversion when the flip-flop delay is preset. This inversion causes the multiplicand to be subtracted when it is gated by the sign bit of the multiplier. An additional shift register provides an OPERATIONAL DELAY for spreading the sign bit. The final product is available in parallel form from the two output registers.

The basic clock frequency for the multiplier circuit is



1 megahertz. Naturally, a faster clock is needed if bigger numbers are to be multiplied. The number of clock pulses required to multiply two n-bit numbers (where n includes the sign bit) is  $2n(n-1)$ . Additionally, larger numbers will mean more registers in the multiplier circuitry and more counters in the control-signal circuitry.

(Some minor circuit changes must also be made.)

There is a useful rule of thumb to keep in mind to minimize modification when the multiplier is expanded. Choose the factor  $2(n-1)$  to be the nearest larger integer power of 2 and then set the extra bits introduced in the multiplicand and the multiplier to zero. □

## Regulating supply voltage all the way down to zero

by Brother Thomas McGahee  
Don Bosco Technical School, Boston, Mass.

Precision monolithic voltage regulators make it fairly easy to design a high-performance power supply with a minimum of external components. These regulators have one general fault, however—they cannot regulate to any voltage lower than their reference, which is usually about 7 v. Sometimes, a voltage divider can be used to reduce the reference voltage, but if the reference voltage is reduced below approximately 2 v, good regulation can no longer be maintained.

The circuit shown in the figure, on the other hand, allows the reference voltage to be adjusted all the way down to the offset voltage of the regulator's internal op amp. REGULATOR<sub>1</sub> and its associated circuitry form a bias supply that provides a voltage of about -7 v for the V<sup>-</sup> terminal of the main regulator (REGULATOR<sub>2</sub>). Since the noninverting input of this regulator is connected to the common ground of the circuit, its reference voltage appears to be +7 v with respect to this V<sup>-</sup> terminal.

There will be a 7-v drop across resistors R<sub>2</sub> and R<sub>3</sub>. When R<sub>1</sub> is set to its minimum value, the circuit's output voltage will be equal to the reference voltage. If the output is measured with respect to the V<sup>-</sup> terminal of REGULATOR<sub>2</sub>, it will be 7 v. But if it is measured with respect to the common ground, it will be zero.

The maximum voltage available at the output is determined by the value of resistor R<sub>2</sub>. For the component values shown here, the maximum voltage may be set anywhere from 16 to 39 v. But voltages above 30 v will not be regulated very well because the supply is using a 24-v transformer (T<sub>2</sub>).

The equation for the output voltage is:

$$V_{OUT} = R_1 V_B / (R_2 + R_3)$$

where V<sub>B</sub> is the absolute value of the bias voltage (7 v in this case). The bias supply normally will be producing about 12 milliamperes of current. Under worst-case conditions, however, it may be required to provide a maximum of 40 mA. Transformer T<sub>1</sub>, therefore, should be a 12-v unit capable of supplying at least 50 mA (since REGULATOR<sub>1</sub> will require some current itself).

The transistor at the output of REGULATOR<sub>2</sub> boosts the circuit's output current. Resistor R<sub>4</sub> acts as the current-limiting resistor. □

Designer's casebook is a regular feature in Electronics. We invite readers to submit original and unpublished circuit ideas and solutions to design problems. Explain briefly but thoroughly the circuit's operating principle and purpose. We'll pay \$50 for each item published.

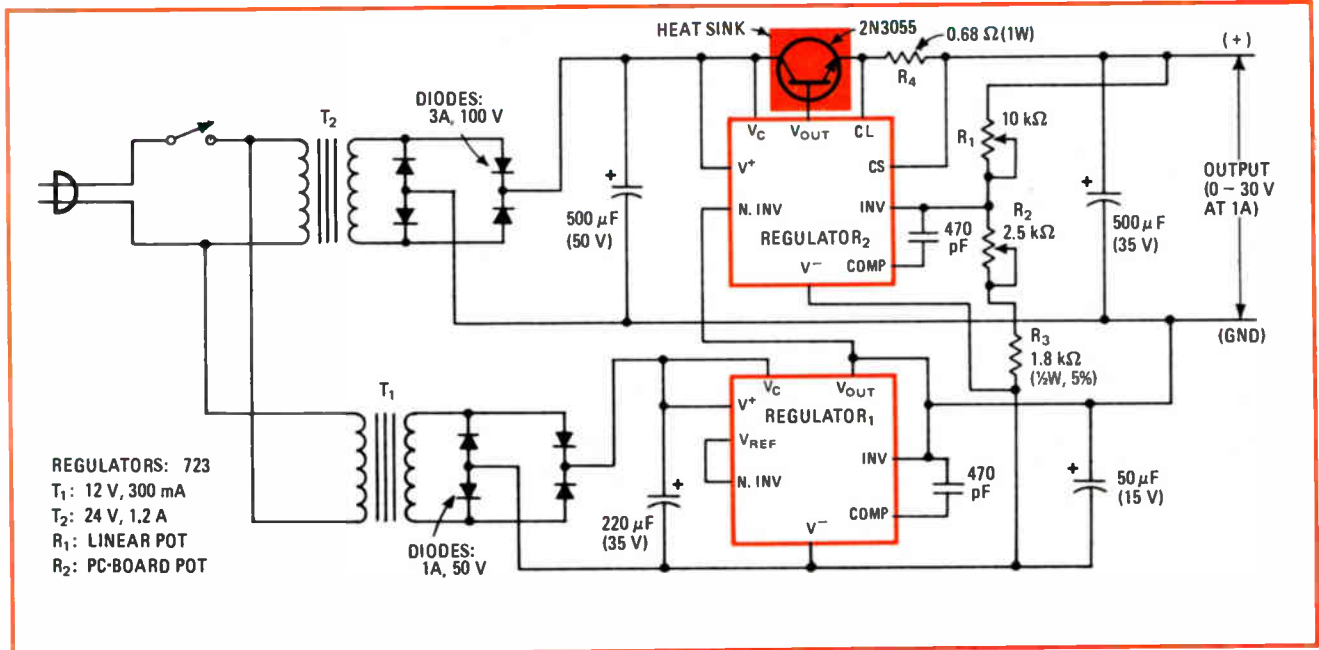

**Variable supply.** This power supply, which employs two IC voltage regulators, produces a regulated output voltage of between 0 and 30 v. REGULATOR<sub>1</sub> provides the bias voltage for REGULATOR<sub>2</sub> so that the latter device can operate with respect to a common ground. The lowest regulated output voltage, then, is approximately zero, rather than the reference voltage of REGULATOR<sub>2</sub>.

A New Standard For Accuracy!

# 3½ Digit A/D Converter

The LD110/LD111 A/D converter sets the pace for accuracy with a specification of 0.05% of reading,  $\pm 1$  digit. The set consists of two ICs, and with the addition of a reference voltage and clock becomes a full 3½-digit analog-to-digital conversion system. LD110/LD111 features and specifications make the converter set an ideal choice for digital display processors in

- DPMs
- DVMs
- Controllers
- Instrumentation
- Thermometers
- Scales
- Tachometers

## Specifications

- Accuracy of 0.05% of reading,  $\pm 1$  count
- $Z_{IN} > 1000 \text{ M}\Omega$
- 4 pA typical input bias current (25°C)
- 100  $\mu\text{V}$  resolution (200.0 mV range)
- 40 dB NMRR @ 60 Hz

## Features

- Auto-zero minimizes effect of offset, drift and temperature
- Auto-polarity
- Sampling rates from 1/3 to 12 samples/second
- Two voltage ranges: 2.000V and 200.0 mV
- TTL-compatible outputs
- \$28.60 per set (100-set price)

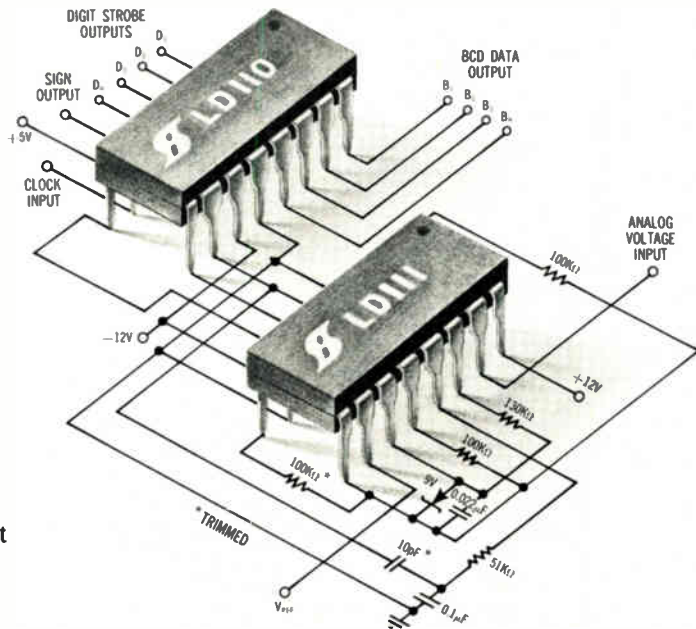

The unique conversion technique uses a single reference and a single full-scale adjustment to achieve a highly-accurate strobed 3½-digit output of up to 3100 counts plus sign. LD111 analog processor employs monolithic PMOS/bipolar construction and interfaces directly with the LD110 digital processor, which has a monolithic PMOS structure. For further information

## write for data

IC Applications: (408) 246-8000, Ext. 120



Siliconix incorporated

2201 Laurelwood Road, Santa Clara, California 95054



**Heroes All!**

The defense of Bataan will go down in history along with the Alamo as one of our most heroic stands. Despite the impossibility of getting supplies or reinforcements they held their posts with a vengeance . . . the type of defense that we are proud our armed forces can always be counted upon to deliver.

*Hallicrafters Sky Budds (illustrated) in use at a former Bataan listening post.*

the hallicrafters co.  
CHICAGO, U. S. A.

*Keep Communications Open*

secure government work without success. Since our civilian business definitely ends this week, it was necessary either to close down or secure defense work, and in a last supreme effort we were fortunate in stumbling across a defense item. At the present time we are converting and by the first of next week we will be 100 percent on government work.

"Just for the sake of clarification: I should like to go on record as saying that the fact that we have not converted and have not been doing war work in the past is because we were utterly unable to obtain any kind of contract despite several trips to Washington, Fort Monmouth and Dayton in an effort to get something!

"We have been making strenuous and diligent efforts to obtain war production business for many months. As a matter of fact, long before the curtailment of the radio industry was even contemplated.

"We have a beautiful plant, occupying some 75,000 square feet of space, a trained personnel all of them adept and skillful in the handling of small assemblies, and we know that we could be of real service if given the opportunity to perform.

"We have been successful in lining up a few jobs for the Fall which will take about 35 percent of our plant capacity, but it is far from being enough work to keep our organization together, particularly from April 1st to September 1st. If there is anything that you people can do to call this to the attention of the proper people, we certainly would appreciate it."

• • •

### RADIO DEVICE DIRECTS ARMY DOGS

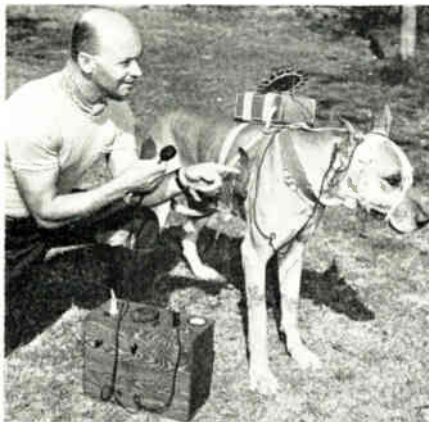

A short-wave device for transmitting instruction by remote control to army dogs on the battlefield enabling them to locate wounded soldiers, carry messages and supplies. The dog carries a small receiver on his back, to which is attached a small circular aerial. The dog wears a small head set from which he hears the commands of his master. It takes three months to train a dog and ten days to train the man. Carl Spita, noted animal trainer, will submit this to U. S. Army shortly



### SPECIALIZATION

in the design and manufacture of rotary electrical apparatus has developed a high degree of accuracy in Eicor Products that makes them the accepted standard wherever such equipment is used.

In achieving this distinction, our personnel has gained the experience and confidence so necessary in meeting today's tremendously increased needs for Eicor equipment.



**EICOR**

EICOR, Inc., 1050 W. Adams St., Chicago, U.S.A.  
Export: Ad Aurleno, 89 Broad St., New York

## LOOK TO LINGO FOR AM-FM

Lingo AM and FM radiators are creating new performance records throughout the broadcasting field. Improved designs and exclusive features are responsible for their high efficiency, unexcelled stability and low maintenance cost.

LOOK TO LINGO—  
for proven, factual  
information on modern  
antenna systems.

**LINGO**  
VERTICAL  
TUBULAR STEEL  
RADIATORS

JOHN E. LINGO & SON, INC., CAMDEN, N. J.



# Heat exchangers cool hot plug-in pc boards

When device power levels and packing densities rise, the thermal deficiencies of printed-circuit boards must be compensated by efficient heat exchangers

by Benjamin Shelpuk, *RCA Corp., Camden, N.J.*

□ On most counts, the plug-in printed-circuit board deserves its status as today's unofficial industry-wide standard. Mounting vertically in an equipment case, it can easily be withdrawn when replacement is necessary. Yet it is well protected from shock and vibration, being held rigidly in place by card slides.

Thermally, however, the plug-in printed-circuit board is much less impressive. Neither epoxy-glass nor paper-based boards are good heat conductors. Also, the thermal paths from hot devices on the boards to the outside world are often long and hinder cooling.

Proof of the board's inadequacy as a heat conductor is that a temperature gradient of 707°C is required to drive just 1 watt of heat through a piece of epoxy-glass board only 1 inch square and 20 mils thick. This determination was made from an equation that enables the designer to calculate thermal gradient whenever heat flow can be considered unidirectional. The equation is:

$$\Delta T_{\max} = QL/8Ktw$$

where

$\Delta T_{\max}$  = temperature gradient to the hottest spot in the board, in degrees centigrade

$Q$  = heat transfer by conduction along the board, in watts

$L$  = span of the board between card guides, in inches

$K$  = thermal conductivity of the board, in watts per inch°C

$t$  = board thickness, in inches

$w$  = length of each interface between board and card guide, in inches.

The equation assumes uniform power dissipation over the surface of the board and is realistic if the designer has optimized both heat spreading and component location on the board's surface.

One way to improve heat flow through a board is to use the copper conductors on its surface to transfer heat. Being a fine thermal conductor, the copper lowers thermal resistance significantly—though precisely how much it is lowered is difficult to calculate because the pattern etched into the conductor markedly reduces heat transfer. For instance, if just 10% of the copper is removed from a fully-clad board, thermal resistance of the overall board can increase by a factor of 17.<sup>1</sup>

Materials other than epoxy-glass can be used for pc-board construction to upgrade their heat-transfer char-

**1. Destined for the moon.** Rarefied atmospheres deny package designers the advantage of convective cooling. This assembly, part of a radar system carried on the Apollo 17, employs a highly conductive frame to absorb heat from the printed-circuit board.

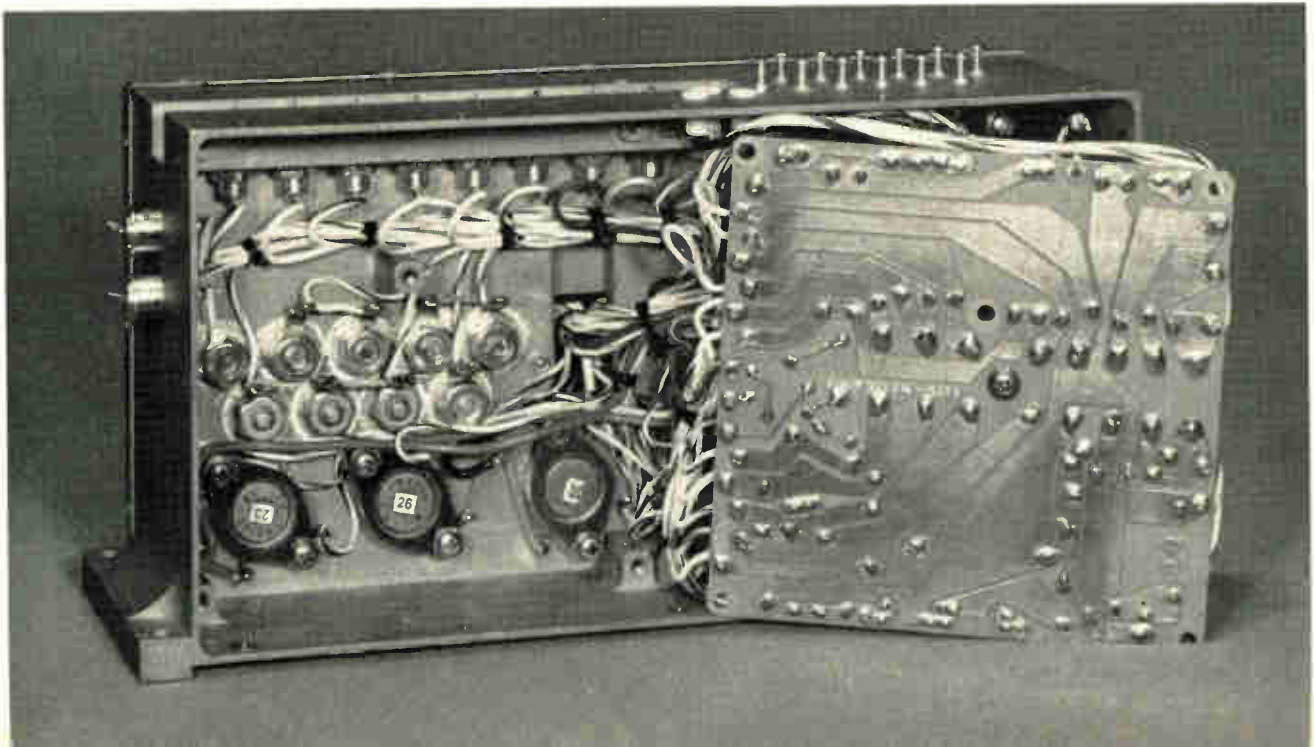

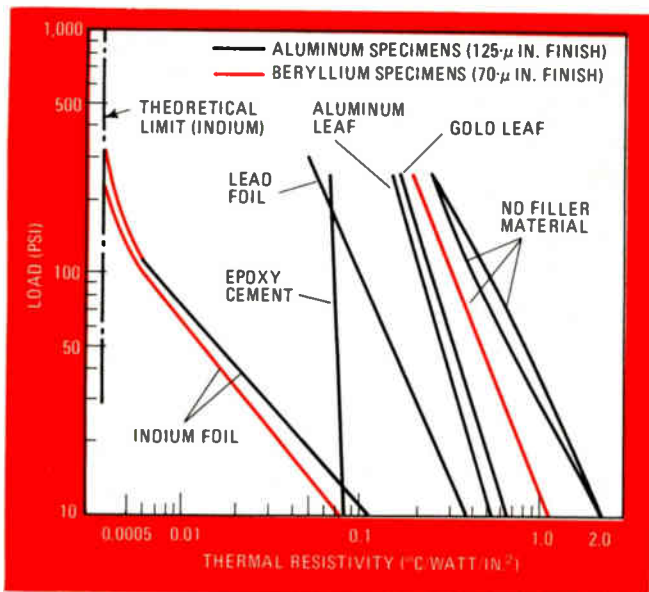

**2. Beware of the boundary.** Fillers between printed-circuit boards and the card slide, and high-compression forces aid heat flow across the interface. Data is based on research performed by MIT Instrumentation Laboratory.

acteristics. But generally they fail to improve heat transfer enough to compensate for the electrical constraints they impose. Instead, it is frequently better to switch to a heat-conducting frame to support the pc board.

### The heat-conducting frame

This technique was used to good effect for the Apollo 17, in a pc-board assembly that was part of the coherent synthetic aperture radar (CSAR). Figure 1 shows details of that assembly. Effective conductive cooling is a must in space, where the lack of atmosphere robs the designer of convective cooling. In the CSAR assembly, heat flowed from the board to the housing through the threaded bosses on which the board was mounted. Maximum temperature rise was kept low because the thermal path to a boss from any heat-producing component was kept short.

The Standard Hardware Program (SHP) developed by the U.S. Navy also utilizes heat-conducting frames to guarantee adequate heat transfer from its modules.<sup>2</sup>

However, only a poor thermal path from board to frame is provided by the usual card slides. The problem is that ease of maintainability and accessibility demands boards that slip easily in and out of card slides—but the thermal interface between such boards and slides is not good. Fortunately, card slides can often be modified to provide a large positive area of contact that will optimize heat flow across the interface.

Figure 2 summarizes the results of some interface resistivity studies.<sup>3</sup> It shows that various filler materials can be used to lower the thermal resistivity of board/slide interfaces. Note also the negative slope of the plots, which denotes that high compressive forces along the interface also lower thermal resistivity.

### Enter the ambient

Regardless of how effectively such conduction paths are enhanced, convective transfer to the ambient fluid

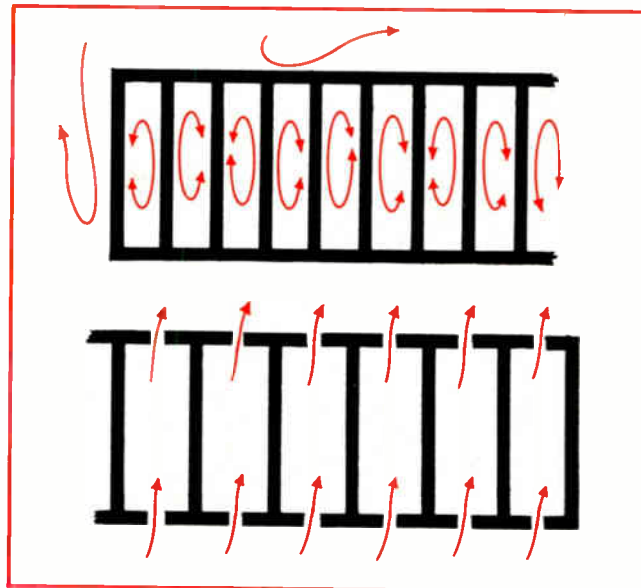

**3. Alternatives.** Closed convective system shown in (a) prevents contaminants from being swept in by a moving air stream. But switching to an open system (b) boosts cooling capability per unit volume tenfold—10 watts/in.<sup>3</sup> versus 1 watt/in.<sup>3</sup>

(usually air) often emerges as the principal heat-transfer mode in electronic equipment.

Two geometries are common in convective transfer. Figure 3a illustrates a closed system in which transfer is in effect a two-step process. Heat is moved from the board surfaces to the surrounding air by natural or forced convection, and the air is then cooled by natural- or forced-convection transfer to the equipment case.

In the open system shown in Fig. 3b, the air is not entrapped, but enters the enclosure, sweeps across the pc boards, and then exits carrying the heat to the environment. There is no intermediate transfer to and from the equipment case. But such a system is often unacceptable because it can transport moisture and other harmful contaminants.

In either type of convective system, orientation and spacing of the boards play an important role in determining component temperatures. So do the flow rate and temperature of the cooling medium. Table 1 lists the range of typical heat-transfer rates for both open and closed plug-in pc-board designs. Note that the power density for a well-designed closed system where the exterior cooling is by natural convection ranges

System type	Internal cooling mode	Exterior cooling mode	
		Natural convection (W/in. <sup>3</sup> )	Forced convection (W/in. <sup>3</sup> )
Open		0.5 - 1	5 - 10
Closed	Natural convection	0.1 - 0.25	0.2 - 1.0
Closed	Forced convection	0.2 - 0.8	0.5 - 3.0
Closed	Conduction	0.4 - 1.5	2.0 - 4.0

	RESISTANCE (°C / W)		ΔT°C	
	IN-LINE	COPLANAR	IN-LINE	COPLANAR
<b>CONDUCTIVE RESISTANCES</b>				
$R_{TJ}$ DEVICE-JUNCTION TO CASE	2.5	2.5	27.5	27.5
$R_{T1}$ DEVICE-INTERFACE	1.12	1.12	12.3	12.3
$R_{T2}$ THERMAL SPREADING RESISTANCE	0.65	0.65	7.1	7.1
$R_{T3}$ BASEPLATE RESISTANCE (VERTICAL)	4.83	4.83	3.4	3.1
$R_{T4}$ BASEPLATE RESISTANCE (HORIZONTAL)	1.97	—	39.8	0
<b>CONVECTIVE RESISTANCES</b>				
$T_{S0} - T_{S1}$ COOLING AIR TEMPERATURE RISE				26.3
$1/hA$ CONVECTION TRANSFER RESISTANCE	—	0.53	—	29.0*
			* INCLUDES $T_{S0} - T_{S1}$	
<b>TOTAL TEMPERATURE RISE °C</b>			<b>90.1</b>	<b>79.0</b>

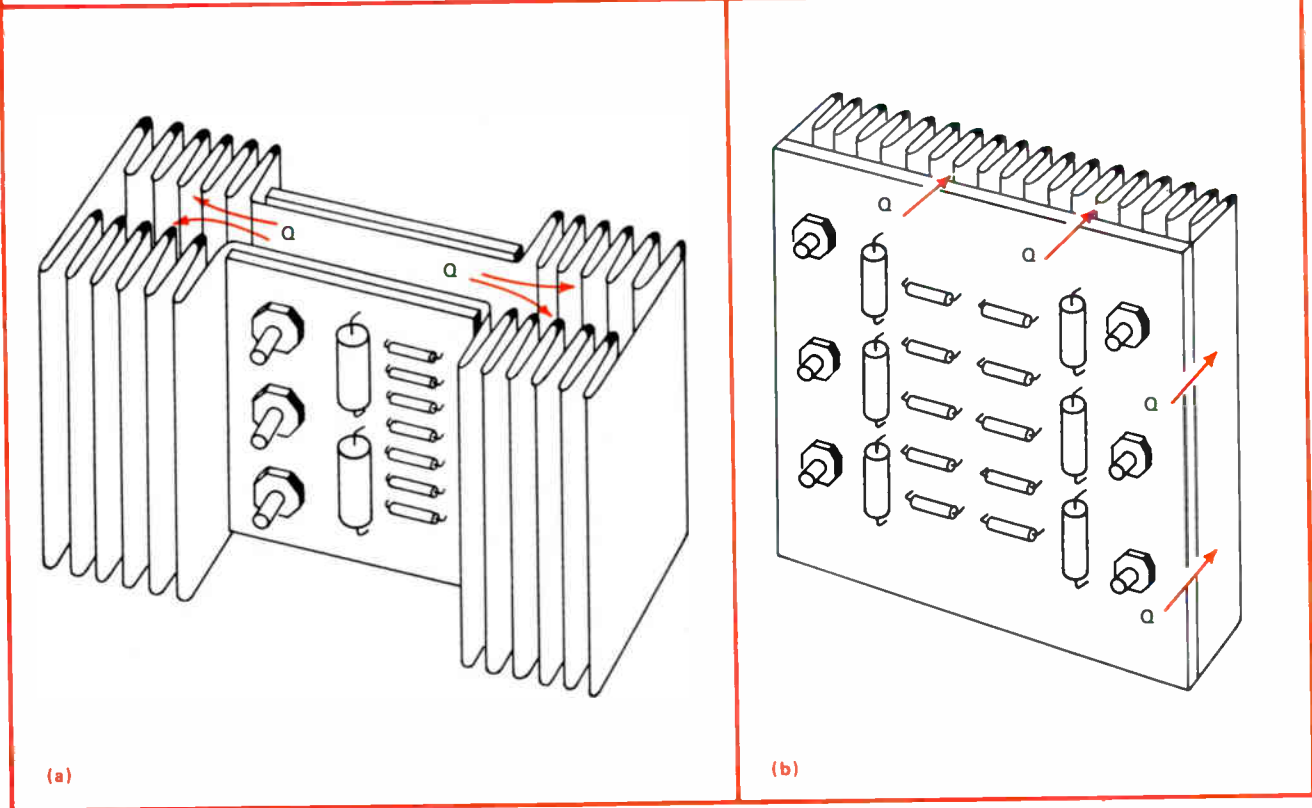

4. **Go coplanar.** The in-line construction (a) accounts for the large temperature rise—90.1°C. By contrast, the heat-transfer path in the coplanar structure (b) is very short, and temperature rise is significantly less—66.1°C.

from 0.10 w/in.<sup>3</sup> to 1.5 w/in.<sup>3</sup>. Also, for the internal forced-air cooling modes, total volume must not be so large that the space consumed by blowers and ducting becomes a significant fraction of the total volume. Otherwise, the listed values become invalid.

### Looking at one design

Assume that a designer attempts to house a 100-watt uhf radio transmitter-receiver combination in a standard cabinet designed to mount printed-circuit boards. Detailed analysis of a particular design reveals that the maximum power dissipation that can be rejected in such a cabinet (4.87 in. wide by 7.62 in. high by 19.56 in. deep) is limited to 56 w at sea level and to 28 w if the equipment is operated at high altitude, where there is little convective cooling. Clearly, plug-in pc-board construction would not be appropriate for this equipment.

The power dissipation of the equipment, broken down by its component modules, is given in Table 2. Checking the power densities of each module against the criteria of Table 1 indicates that forced-air convection is necessary in two modules—the transmitter and the power supply. Since the equipment is intended for the military, however, an open system with forced-air convection directly over the circuit cards would be unacceptable because of possible contamination. So a closed-system, forced-air cold plate is a likely alternative.

Forced-air cooling differs from natural convection in that the driving force circulating the air is a mechanical pump rather than natural buoyancy induced by temperature gradients. This significantly increases the value of the parameter known as film coefficient (*h*), thereby upgrading the effectiveness of the surface area (*A*) of the heat-exchanging structure.

The basic relationship for convective transfer across a boundary is:

$$Q = hA\Delta T$$

where

*Q* = power, in watts

*h* = film coefficient, in w/ft<sup>2</sup>-°C

*A* = area, in square feet

$\Delta T$  = temperature gradient, in degrees centigrade.

It turns out that the film coefficient is about an order of magnitude higher in forced convective transfer than it is in natural convection—2.6 to 7.9 w/ft<sup>2</sup>-°C compared with 0.2 to 0.4 w/ft<sup>2</sup>-°C.

But this improvement has to be traded off against the energy that must be expended on forcing air past the surface that needs to be cooled. This usually translates as electric power driving a fan or blower and can be defined as:

$$P_f = KvH \quad (1)$$

where

*P<sub>f</sub>* = fan power required to deliver the necessary air velocity, in watts

*K* = a constant of 0.023 w-minute/ft-lb

*v* = air flow rate, in ft<sup>3</sup>/minute

*H* = frictional air pressure loss, in pounds/ft<sup>2</sup>.

Thus design optimization comes down to the task of

Module	Peak power		Average power 50% duty cycle (W)	Power density (W/in. <sup>3</sup> )
	Transmit (W)	Receive (W)		
Guard receiver	1.8	1.8	1.8	0.09
Frequency/control	18.9	18.3	18.6	0.19
Main receiver	4.8	4.8	4.8	0.05
Transmitter	272.0	25.9	149	2.72
Power supply	98.5	35.2	66.5	0.76
Totals	396	86	241.7	0.96

maximizing the heat transfer required in terms of *Q* and *P<sub>f</sub>*.

As if this were not enough, the designer must usually restrict the physical size of the heat-exchanging structure to the smallest volume possible. In the case of the uhf transmitter-receiver, the space available for the rf power output stages, which dissipate 250 w, is 100 cubic inches, or roughly 8¾ by 5¾ by 2 in. The task requires that the junction temperatures of the rf power transistors be cooled to within safe limits.

### Cold-plate considerations

Two cold-plate configurations were analyzed to determine the temperature fields which develop in each. Figure 4a is a straightforward variation of the plug-in printed-circuit board; the transistors are stud-mounted on an aluminum plate 90 mils thick that has integral heat sinks at both ends. Figure 4b shows how the board and the heat exchanger can be repackaged so that they become coplanar. The coplanar structure proved to be superior because it considerably shortened the conduction paths between each transistor and the heat exchanger.

The assumptions and design constraints used in the analysis of these two configurations are:

- Each transistor dissipates 11 w.
- Power is dissipated uniformly on the pc board at 2.3 w/in.<sup>2</sup>.
- The equipment chassis is 90-mil-thick aluminum, with a thermal conductivity, *K*, of 4.4 w/in.-°C.
- Maximum transistor junction temperature is 150°C.
- Operating environmental temperature is 71°C.

The results of the analysis are listed in the table of Fig. 4. The critical  $\Delta T$ , which is the temperature rise from the ambient to each device junction, can be expressed as:

$$T_J - T_A = Q(R_{TJ} + R_{T1} + R_{T2} + R_{T3} + R_{T4} + 1/hA)$$

The values and definitions of the thermal resistances are in Fig. 4. The subscripts represent thermal resistances which are conductive paths. The quantity 1/hA is the thermal resistance across the convective interface of the heat-exchanger surface.

If the conductive resistances are assumed to be known, then the design goal is to assure that the value of 1/hA will be small enough to hold *T<sub>J</sub>* below 150°C. The film coefficient *h* is determined by the fluid dynam-

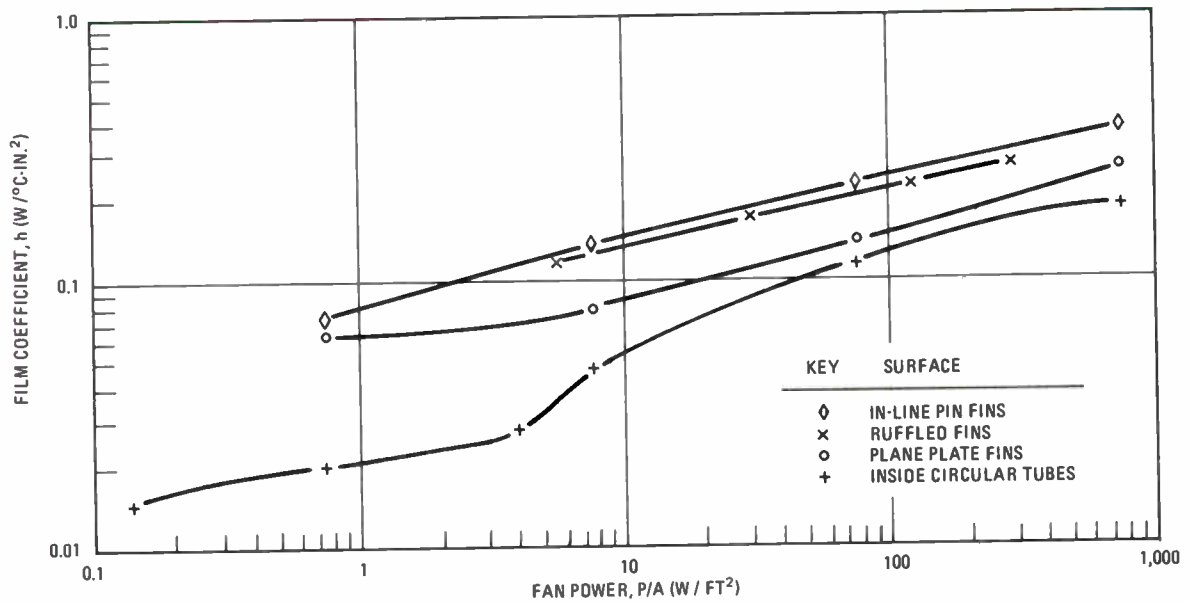

**5. Different geometries, equal areas.** In-line pin fin is the most effective convective surface, according to these plots of film coefficient,  $h$ , versus fan power.

ics of the system and is largely a function of fan input power. The heat-transfer surface area ( $A$ ) is a function of heat exchanger type and volume. Thus the required value of  $1/hA$  can be achieved by proper selection of heat exchanger type and size, and adequate fan power.

The analysis demonstrates that the in-line configurations of Fig. 4a won't do the job. If the in-line construction were selected, the  $90.1^\circ\text{C}$  rise would boost the junction temperature to  $161.1^\circ\text{C}$ , above the design limit of  $150^\circ\text{C}$ . Just how big this rise would be in actuality would depend on the value of  $1/hA$ , because  $1/hA$  has been assumed to be zero in the in-line case. But it really doesn't matter because the allowable gradient budget has been consumed in conduction drops. It is therefore impossible to maintain the desired temperature, regardless of the heat exchanger selected.

The horizontal baseplate resistance ( $R_{t4}$ ) with a resistance of  $1.97^\circ\text{C}/\text{w}$  is the major contributor to the temperature rise. If a designer wants to stick with the in-line design he might reduce this resistance by using a thick chassis.

However, the coplanar design will certainly do the job. Here a value of  $0.53^\circ\text{C}/\text{w}$  is required for  $1/hA$ , to maintain the hottest transistor below the maximum allowable temperature of  $150^\circ\text{C}$ . There is obviously a tradeoff between supplying more air to the heat exchanger and providing more heat exchange surface so that the exchange can make a closer approach to the exit air temperature.

Once the basic packaging structure has been selected, the next step in the design is to select a forced-air heat exchanger.

### Exchanging heat

The heat exchanger enables heat to cross the boundary from a conductive region to a moving fluid such as

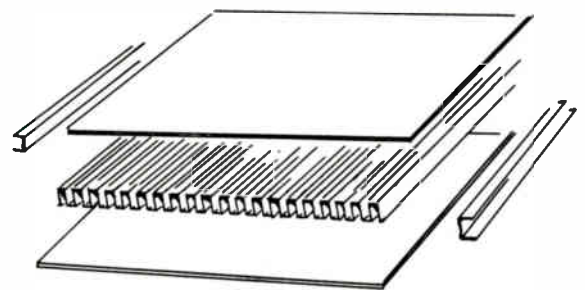

PLANE PLATE FIN

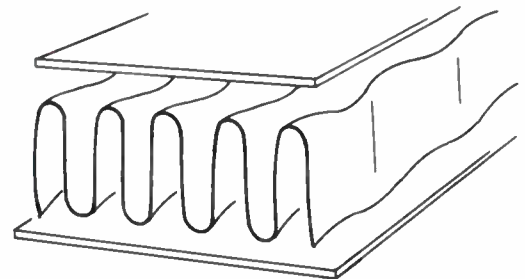

RUFFLED FIN

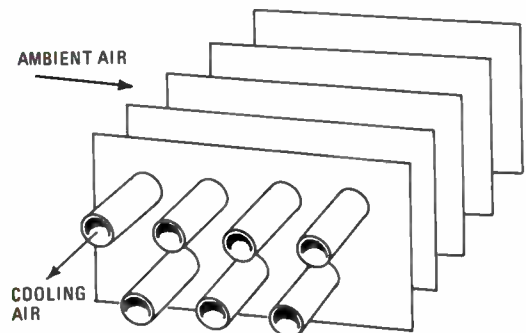

INSIDE CIRCULAR TUBE



air. Since its design is a major engineering challenge, it is worth summarizing the factors that go into a design analysis and to establish a design selection sequence.<sup>4,5</sup>

The prime considerations are the size and geometry of the heat exchanger structure. Heat transfer through the exchanger is expressed as:

$$Q = hA(T_H - T_S)$$

where

$h$  = film coefficient of heat transfer, in  $w/in.^2 \cdot ^\circ C$

$A$  = area, in square inches

$T_H$  = heat exchanger temperature

$T_S$  = cooling air temperature.

As has been shown in the example, the designer wishes to maximize both  $h$  and  $A$  so as to minimize the temperature gradient ( $T_H - T_A$ ).

The relationship which determines the air temperature rise in the heat exchanger is expressed in the equation:

$$Q = mc_p (T_{S0} - T_{S1})$$

where

$m$  = mass flow rate, in pounds per second

$c_p$  = specific heat of the fluid at constant pressure, in  $w\text{-sec}/lb \cdot ^\circ C$

$T_{S0}$  = cooling air temperature at the exchanger outlet, in  $^\circ C$

$T_{S1}$  = cooling air temperature at the exchanger inlet, in  $^\circ C$ .

The design goal here is to maximize the air flow rate ( $m$ ) so as to minimize the temperature drop to be provided by the exchanger. However, a price is paid in electrical power required to energize the fan as can be seen from Eq. 1. In this case, air flow rate,  $v$ , as well as the air pressure drop,  $h$ , must be minimized for minimum fan power consumption.

The key variables in this group of equations— $h$ ,  $H$  and  $v$ —are interrelated for a given type of heat-ex-

changer surface. By carefully evaluating these variables, it is possible to tailor a heat-exchange system to a given application.<sup>4,5</sup>

### Surface considerations

There is a considerable variation in the performance of various heat-exchanging surfaces. The value of  $h$  versus air power per unit cross-sectional area is plotted for a number of surfaces in Fig. 5. Note that the pin-fin exchanger delivers a value of  $h$  that is three and a half to four and a half times higher than the value of competing structures.

A useful figure of merit for evaluating a heat-exchanging surface is defined as the amount of heat exchanger surface contained in a unit volume or  $A/V$ . It is assigned the symbol  $\beta$ . From the standpoint of maximum  $\beta h$ , the ruffled fin provides the most heat transfer per unit of volume and thus offers the designer a very compact exchanger.

Figure 6 compares several surfaces on the basis of heat transfer per unit volume versus air friction power per unit volume. In effect, both the ordinate and abscissa in Fig. 5 have been multiplied by  $\beta$ . Thus the ordinate  $h$  becomes  $hA/V$ , expressed in  $w/in.^3 \cdot ^\circ C$ . The abscissa is the frictional air power per unit volume dissipated in the heat exchanger, expressed in  $w/in.^3$ . The values do not include other frictional losses or fan efficiency—typically 15% to 30% in small air-moving devices.

If the designer wants to include these losses, he can multiply the abscissa values by a number ranging from 7 to 13 to determine the approximate fan power. In the usual design operating range, this type of exchanger can reject 1.50 to 3.00  $w/^\circ C$  in.<sup>3</sup> with a fan power requirement of 300 to 750  $w/in.^3$ .

The form factor, which is the width-to-height ratio of a forced-air heat exchanger, depends heavily on the quantity of air passing through a given cross section. A

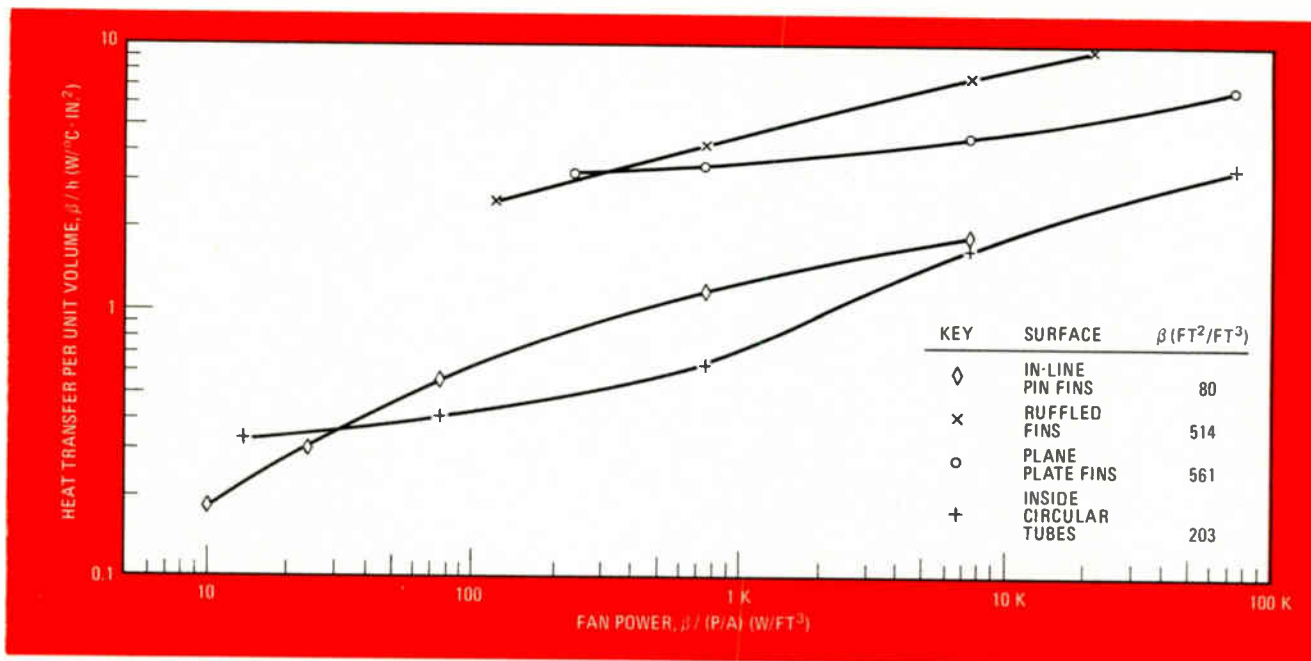

**6. Equal volumes.** By multiplying  $\beta$  (heat-exchanger surface area per unit volume) by the film coefficient and fan power, heat-exchanger surfaces can be compared on an equal volume basis. The ruffled-fin exchanger comes out on top.

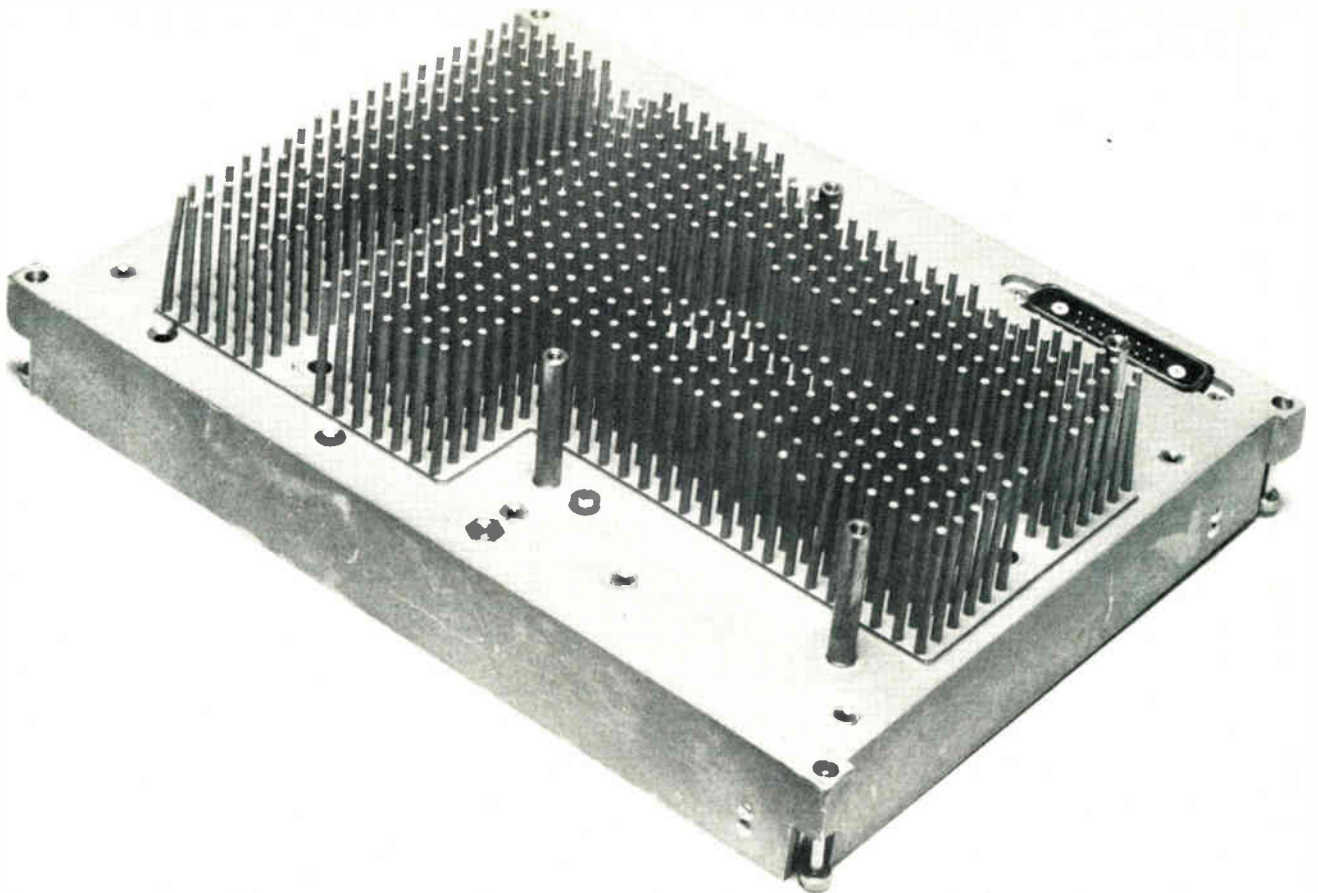

**7. Pin-fin exchanger.** Die-cast heat exchanger safely dissipates 100 watts of power and fits into a volume of just 50 cubic inches. Stud-mounted transistors are in valleys between pins.

high-performance heat exchanger will generally require a large cross section to minimize air temperature rise and acoustic noise.

Pressure drops can build up quickly if there are long narrow ducts and many turns in the path or if there are expansions and contractions in the cross section. The pressure drop due to these effects is of the form:

$$P = k_1 \rho v^2 / 2g$$

where

$P$  = air pressure, in lb

$k_1$  = a dimensionless constant related to geometry

$\rho$  = density of air, in lb/ft<sup>3</sup>

$v$  = air velocity, in ft/min

$g$  = 32.2 ft/s<sup>2</sup>.

It is wise to keep air flow rate low so that the air velocity ( $v$ ) does not exceed 500 to 800 ft to limit pressure-drop losses. A good value for air flow often used in military systems and a good starting point in any design is 4 lb/min/kw.

To return to the coplanar exchanger of Fig. 4b, a thermal budget for convective transfer can be calculated. The quantity  $1/hA$  had a calculated value of  $0.53^\circ\text{C}/\text{w}$  for each transistor. If the exchanger contains 12 transistors, the total heat transfer requirement is  $12 \times 1/0.53 = 22.6\text{w}/^\circ\text{C}$ . If the available volume for the exchanger is  $50\text{ in.}^3$  the required heat transfer per unit volume ( $\beta h$ ) is  $0.45\text{ w}/^\circ\text{C-in.}^3$ . This value of  $h$  is well within the capability of the heat exchangers shown in Fig. 6. Pin fins are selected because they can easily be integrated into the module enclosure. Pins spaced at

5.35 per lineal inch facilitate die-casting the exchanger.

To determine the fan power required, the following relationship can be used:

$$P_{\text{fan}} = (\beta P/A)(V r_p)$$

where  $(\beta P/A)$  is the power required per cubic foot, plotted as the abscissa in Fig. 6;  $V$  is the volume of the heat exchanger in cubic feet; and  $r_p$  is the ratio of fan power to core friction, assumed in this case to be 13. Since the required  $\beta h$  is  $0.45\text{ w}/^\circ\text{C-in.}^3$ , then for the in-line pin fin exchanger, Fig. 6 indicates a value of  $\beta P/A$  of  $0.045\text{ kw}/\text{ft}^3$ . Then:

$$P_{\text{fan}} = (0.045)(50/1728)(13)\text{kw} = 0.017\text{kw} = 17\text{w}$$

Thus a fan with 17 w of fan power will provide the required heat transfer. Figure 7 shows the actual design of the exchanger. Note that the fins are integral to the chassis, thus doing away with the thermal losses that would accompany an attempt to fasten pins on the chassis. The semiconductors are stud-mounted in the two rows in the spaces between the pins. A thermal test program has confirmed the validity of the predicted temperature profile.

By applying such design principles from the very beginning of a packaging design, equipment designers can avoid the compromises in reliability and power output which have plagued designs in the past. □

#### REFERENCES

1. Paul Dickenson, "Convenient Thermal Analysis Techniques for Printed Circuit Board Assemblies," Proc. National Electronics Packaging and Production Conference, 1967.
2. Standard Hardware Program, "Heat Transfer Considerations," Navord 37625, May 15, 1970.
3. R. M. Jansson, "The Heat Transfer Properties of Structural Elements for Space Instruments," Report E-1173, MIT Instrumentation Laboratory.
4. Kays and London, "Compact Heat Exchangers," (2nd ed.), McGraw-Hill Book Co., 1958.
5. W. H. McAdams, "Heat Transmission," (3rd ed.), McGraw-Hill Book Co., 1954.

# The standard voltage/current generator is programmable and employs a calibration-free, pulse-width modulation method.



- RANGE: OUTPUT VOLTAGE  $1\mu\text{V}$ -1199.999V; OUTPUT CURRENT 1mA-119.9999mA
- ACCURACY:  $\pm 0.001\%$  (DCV),  $\pm 0.004\%$  (DCA) TRACEABLE TO THE NATIONAL STANDARD
- STABILITY:  $\pm 0.0005\%$ -OF-SETTING A DAY
- PROGRAMMABLE BY 14 BUILT-IN MEMORIES, MANUAL AND EXTERNAL
- EXTERNALLY CONTROLLABLE
- CONTINUOUSLY VARIABLE OUTPUT SETTING

The 6120 is a standard voltage/current generator which employs a unique pulse-width modulation method (wherein the reference voltage is divided by pulse trains made by the logic circuits). Because of the pulse-width modulation method, the stability of the output is excellent and calibration-free.

The 6120 has 14 built-in memories into which output, limit level, polarity and range can be programmed. The programmed output can be taken out in either random, step, single-scan, or repeat-scan modes.

The 6120 is remotely controllable for systems application. The unique feature of the generator is its continuously variable 3 digits. Output setting of any 3 continuous digits can be continuously varied by one control switch. This is convenient in setting continuously varying output.

Thanks to these features, the 6120 has a wide range of application which includes application to an automatic test of components, and instruments such as variable capacitors, diodes, transistors, A/D converters, meters, PC boards, amplifiers and many others.

Illustrated below is one of the application examples.

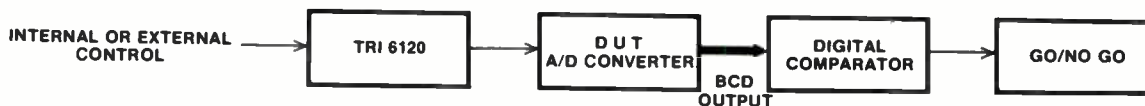

Programmed outputs in the 14 channels are fed into the input of the A/D converter in a desired scanning mode. The output of the BCD is then compared by the digital comparator. Compared linearity of the A/D converter is thus easily tested.

For further information and a demonstration, please call or write T.R.I. Corp.



505 West Olive Avenue • Sunnyvale, California 94086 • Tel: 408-733-9080

Solving a major problem in hybrid circuit chip assembly...

# The DIXON Robot.<sup>®</sup>

**It solder-dips and places 800 chips per hour!**

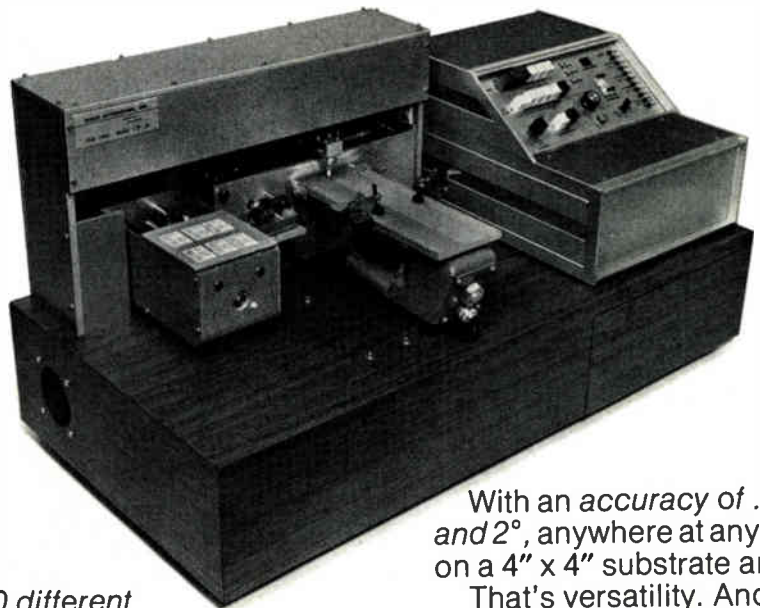

Our Model CR-10 Chip Assembly Robot... a precision machine that automatically places and solder-dips chip capacitors, IC's and resistors onto one or more substrates.

It can handle *mixed sizes* of square or rectangular chips from .080" to .500" in the same set-up. Up to

*30 different chips per substrate.*

At a rate of 800 an hour... placing a metered amount of solder paste or epoxy on both ends of the chip. Or 1400 an hour if solder-dipping isn't required.

With an *accuracy of .002" and 2°*, anywhere at any angle, on a 4" x 4" substrate area.

That's versatility. And flexibility.

*Programming* is a simple "walk-thru"... up to 60 chips placed per program. Programs can be permanently stored on a cassette for retrieval and later use.

The Robot does the work of many assemblers and with consistent quality. Without fatigue and coffee-breaks.

That's economy. And efficiency.

For more details and/or a demonstration of the Chip Assembly Robot, call Ken Dixon at (213) 325-0410. Or write him at the address below.

## How the simple, versatile Robot works.

1 Vacuum chuck picks up chip capacitor from vibratory feeder.

2 Chip capacitor is solder-dipped on both ends. Solder amount can be precisely metered.

3 Placement is accurate to .002" & 2° on 4" x 4" area. At the rate of 800 or 1400 an hour.

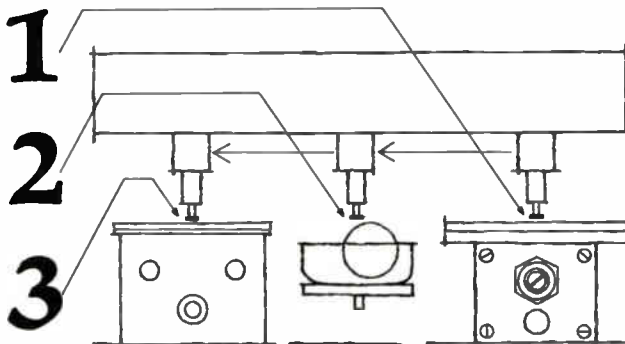

## Dixon Automation, Inc.

A Subsidiary of Excellon Industries  
23915 Garnier Street  
Torrance, California 90509  
Phone: (213) 325-0410  
Telex: 67-4562 Cable: Excellon Torrance

## Capacitance-coupled logic fills unusual jobs

by Stephen R. Pareles  
Cook College of Environmental Science, New Brunswick, N.J.

Capacitively coupling logic signals may prove to be a simple way to do several not-so-simple jobs. For instance, capacitive coupling can make short work of bidirectional pulse-edge detection, as well as comparison of an analog signal and a digital signal.

With the circuit of Fig. 1 and a single-trace oscilloscope, an analog signal and a digital signal can be displayed at the same time, allowing the two signals to be compared or synchronized. The circuit's output is the analog signal with superimposed digital cursors.

The capacitor serves as a bidirectional edge-detector for the buffered arbitrary logic train. Analog-level transients are produced by the capacitor from this input logic train. They are positive for leading pulse edges and negative for trailing pulse edges.

These transients are then cross-coupled with the analog signal through resistors that provide cross-current isolation (100-kilohm resistors are sufficient for most applications). A capacitance of 500 picofarads is ideal for slow horizontal sweep rates of up to about 100 hertz. Smaller capacitance values should be used for faster sweep rates to prevent the trailing edges of the transients from becoming observable.

Capacitive coupling can also be used to perform bidirectional edge-detection when a logic-level output is desired. The detector circuit, which is drawn in Fig. 2, can even handle variable pulse widths.

Normally, a 74121-type one-shot is only triggered by a positive transition at point D, following a low condition at points D and Q. When the input first goes high, point A1 goes high. Since point A2 is still high, point C momentarily remains low. When A2 goes low and C high, the one-shot is triggered by the positive edge at D. Point B is kept high throughout.

When the input goes low, A1 goes low before A2 goes high, so that C remains high. Point B, however, is momentarily low. When B goes high again, the one-shot is triggered by the positive edge at C, as before. The tables in Fig. 2 detail the circuit's operation at key points. □

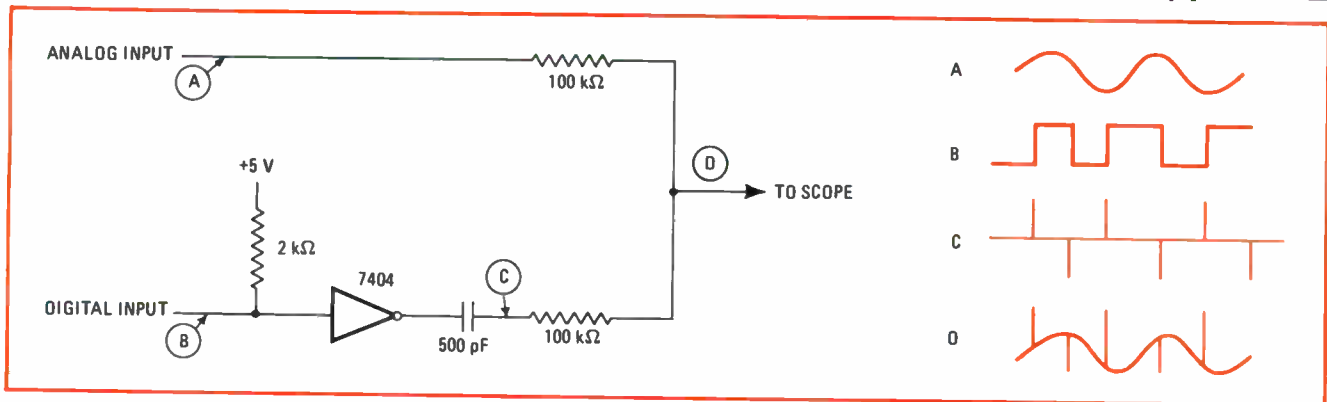

**1. Two-signal display.** A capacitor simplifies the task of observing two signals on a single-trace oscilloscope. The circuit's output becomes the analog input with superimposed digital timing cursors. The two 100-kilohm resistors provide the necessary cross-current isolation.

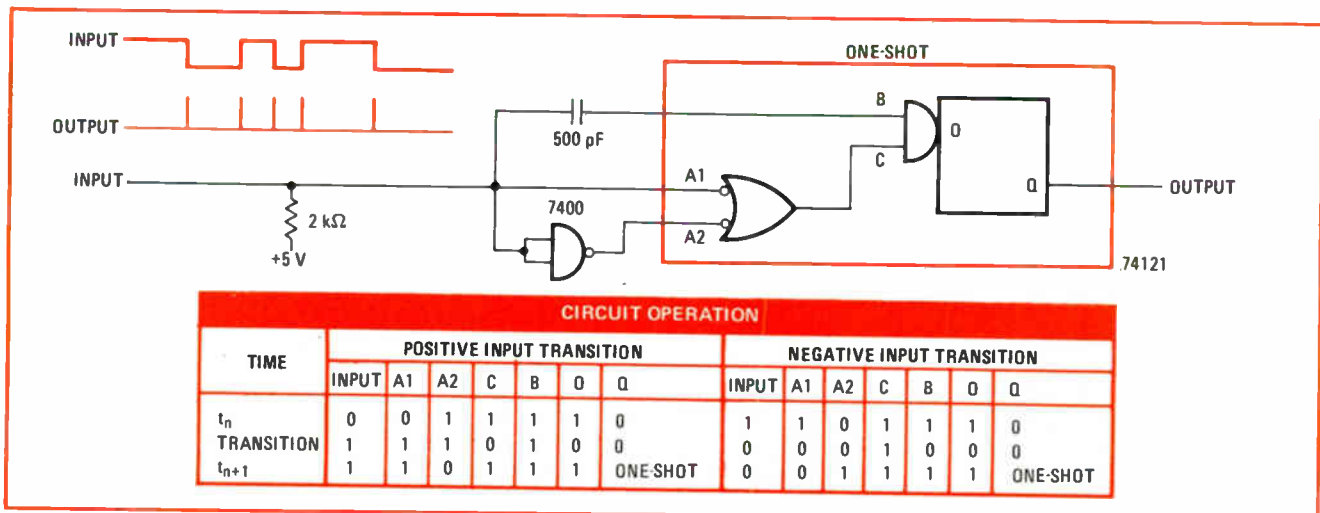

**2. Dual edge-detection.** Both the leading and trailing edges of the input-pulse train are detected by this capacitively coupled circuit.

# RECENT U.S. PATENTS

Each week the United States Patent Office issues grants to many hundreds of inventions that pass the acid test of that office. A few of those relating to electronics are reviewed here

## Non-communication Applications

**Frequency Generator.** A varying capacitor with a means to derive a signal from it. One capacitor is polarized with direct current and a high frequency is impressed upon the d-c polarizing potential. L. Hammond, March 2, 1940. No. 2,281,495.

**Temperature Compensation.** Means for temperature compensating a variable condenser throughout its capacity range, comprising a second variable condenser similar to and mechanically ganged with the first condenser, a fixed condenser having a temperature coefficient



opposite in sign to that of the two variable condensers, connected in series with the second. The two series-connected condensers are in parallel with the variable condenser. K. D. Smith, Bell Telephone Labs, Inc., Sept. 24, 1941. No. 2,281,461.

**Humidity Measurement.** Combination of an elongated hygroscopic element expanding and contracting with changes in humidity, and a three element tube as a measuring device. E. A. Keeler, Brown Instrument Co., March 31, 1938. No. 2,280,241.

**Welding Apparatus.** Apparatus using electron tubes to control the spacing of the electrode in an arc welding apparatus as a function of the voltage between an electrode and the work. V. J. Chapman, G.E. Co., Aug. 9, 1940. No. 2,280,629.

**Inspection System.** A light sensitive system with a set-up responsive solely

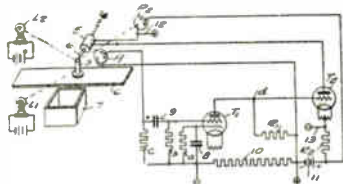

to the rate of change of illumination on the phototube. F. H. Gulliksen, WE&M Co., Sept. 7, 1939. No. 2,280,948.

**Number Displaying Device.** Use of a cathode ray tube in a character outline displaying apparatus. J. W. Bryce, I.B.M. Corp., April 10, 1940. No. 2,281,350.

**Flaw Detection.** A method for testing non-conductive material for flaws by subjecting the material to a high voltage discharge. Two means are provided for automatically checking or discontinuing the discharge at a flaw for a short interval, and establishing another current effective to prolong the interval for a predetermined short time after the checking or discontinuance of the discharge. L. J. Gorman and R. L. Morris, Consolidated Edison Co. Sept. 21, 1940. No. 2,280,119.

**Precipitation Circuit.** Electrical precipitation apparatus for cleaning gases, comprising the use of half wave rectifiers. H. J. White, Research Corp., Aug. 22, 1940. No. 2,280,330.

**Tube Testing.** Apparatus for simultaneously electrically treating and individually electrically testing a number of tubes. J. G. Pfeiffer, Western Electric Co., Dec. 1, 1939. No. 2,280,448.

## Ultra High Frequency Apparatus

**Generator.** Frequency determining apparatus made of rod-like inductance elements parallel to each other, electrically connected to each other and hav-

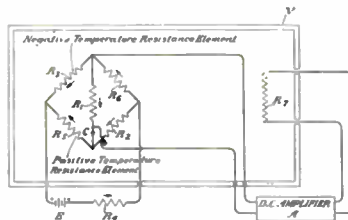

ing a balanced tuning condenser arrangement coupling one end together with shield surrounding the inductances. R. W. George, RCA. June 20, 1939. No. 2,277,638.

**Feedback Balancer.** In a high frequency relay system with receiving antenna connected to the input of an amplifier and a transmitting antenna con-





# TIMERS

LATEST  
In  
RELAYS  
DESIGNED  
SPECIFICALLY  
for  
ELECTRONIC  
CIRCUITS

They possess everything you seek in this type of instrument.

RELIABILITY  
•  
APPEARANCE  
•  
SMALL SPACE  
•  
Running Time  
Meters

Ask for Bulletin F1

Time Delay  
Relays



Used in power supplies to provide an adjustable or fixed time delay between the closing of the filament and the application of the plate voltage.

Write for Bulletin F2



The  
R. W.  
CRAMER  
COMPANY,  
Inc.

Specialists on Timers  
P. O. BOX 3  
CENTERBROOK,  
CONN.

# SAUTER

# Test circuit checks optical isolators

by D. Bruce Johnson  
Tullahoma, Tenn.

When you add your own voltmeter to this test circuit, you can accurately measure the current-transfer efficiency of an optically coupled isolator that has a phototransistor output. The test circuit also enables you to evaluate the current gain ( $h_{FE}$ ) of the coupler's phototransistor. Both parameters, which are measured to within  $\pm 3\%$ , can be read directly from the voltmeter's display over the useful current range of most couplers.

The test circuit employs an operational amplifier ( $A_1$ ) as a voltage-to-current converter to supply a maximum drive current of 10 milliamperes for the coupler's input light-emitting diode for the transfer-efficiency test. A pnp transistor is also wired as a voltage-to-current converter for providing a maximum base current of 10 microamperes to the coupler's phototransistor for the  $h_{FE}$  measurement. Another op amp ( $A_2$ ) acts as a current-to-voltage converter during both tests.

The coupler's transfer efficiency can be defined as:

$$\text{efficiency} = \left| \frac{I_C}{I_D} \times 100\% \right|_{I_B=0}$$

where  $I_C$  is the phototransistor's collector current, and  $I_D$  is the LED's forward current. The transfer function of

the voltage-to-current converter is expressed by:

$$I_D = E_i / 100$$

and the transfer function of the current-to-voltage converter is:

$$E_o = I_C R_{FB}$$

The coupler's transfer efficiency can now be written as:

$$\text{efficiency} = (100E_o / E_i R_{FB}) \times 100\%$$

For the circuit to provide direct reading, a ganged switch is used to control both voltage  $E_i$  and resistance  $R_{FB}$ . The product of  $E_i$  and  $R_{FB}$  is always 100, regardless of switch position. The transfer efficiency, therefore, simply becomes  $E_o \times 100\%$ —so that a 1-volt output indicates an efficiency of 100%.

A similar relationship exists for phototransistor  $h_{FE}$ , which is defined as:

$$h_{FE} = \left| \frac{I_C}{I_B} \right|_{I_D=0}$$

where  $I_B$  is the phototransistor's base current. In terms of the transfer functions of the test circuit, phototransistor  $h_{FE}$  can be written as:

$$h_{FE} = E_o(10^5) / E_i R_{FB}$$

Since the product of  $E_i$  and  $R_{FB}$  is 100, then  $h_{FE}$  equals  $1,000E_o$ —so that a 1-v output corresponds to an  $h_{FE}$  of 1,000.

If you use general-purpose 741-type op amps in the test circuit, you will be able to measure transfer efficiency to about 300% and  $h_{FE}$  to about 3,000. □

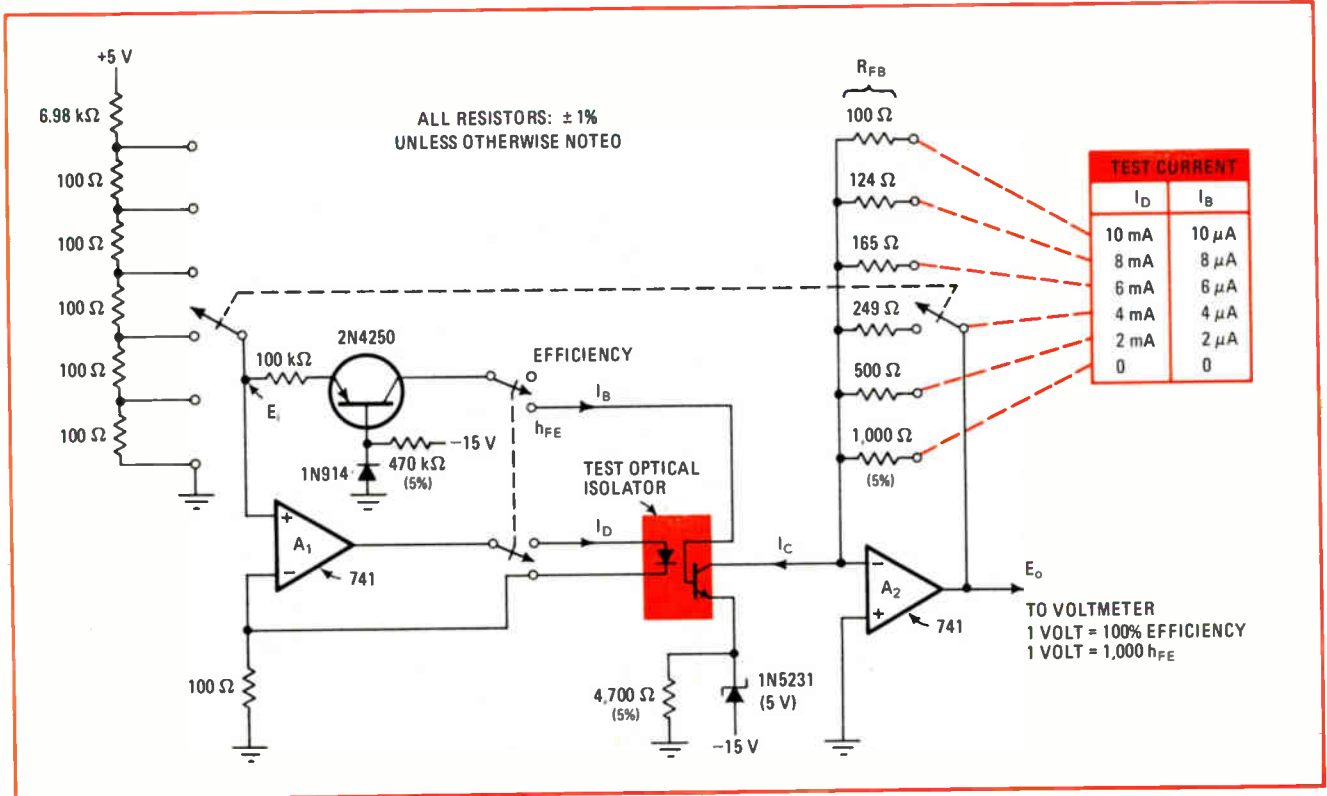

**Optical coupler checkout.** This test circuit, together with a voltmeter, provides a direct readout of the current-transfer efficiency of an optical coupler. The  $h_{FE}$  of the coupler's phototransistor can also be measured. Amplifier  $A_1$  and the transistor operate as voltage-to-current converters, while amplifier  $A_2$  is a current-to-voltage converter. A ganged switch acts as a range control for the test current.

# Examining worst-case fan-out of standard C-MOS buffers

by Rob Walker  
Fairchild Semiconductor, Mountain View, Calif.

Complementary-MOS buffers are normally used when an interface is needed between C-MOS and TTL circuitry. There are two more or less standard types of buffers that are generally employed—the inverting type 4049 device and the noninverting type 4050 device. Both are available from a variety of semiconductor manufacturers.

A cursory analysis of the data sheet for these buffers will lead many designers to believe that the maximum TTL fan-out of the buffers is less than two under worst-case conditions. Naturally, a buffer fan-out of only one increases component count and system cost. But if the tracking effects between TTL and C-MOS devices are taken into account, the true worst-case fan-out can be regarded as two TTL loads.

Table 1 shows the usual worst-case specifications given for the 4049 and 4050 buffers for a low-level output voltage. The available output current decreases with rising temperature, but increases for a higher supply voltage. Since one standard TTL load is normally assumed to be 1.6 milliamperes, the natural conclusion is that the type 4049 or type 4050 C-MOS buffer can't pos-

sibly drive two TTL loads under worst-case conditions.

However, a closer look at the true worst-case operating conditions shows this conclusion to be inaccurate—the worst-case fan-out of a C-MOS buffer can safely be taken as equal to two when the following factors are taken into consideration:

- Commercial-grade TTL is only specified to +75°C, permitting the maximum C-MOS temperature to be regarded as +75°C.
- The maximum low-level output voltage of 0.4 v for TTL is rather arbitrary. For example, Schottky TTL and low-power Schottky TTL, which are both certainly TTL-compatible, have a low-level output voltage that is less than or equal to 0.5 v.
- Commercial TTL is specified over a  $V_{CC}$  supply range of 4.75 to 5.25 v. It is only reasonable to assume the C-MOS buffers will be using the same supply.
- The maximum 1.6-mA low-level input current required by a TTL device is specified at a drive voltage of only 0.4 v and a supply voltage of 5.25 v. This required input current drops when the drive voltage is increased to 0.5 v and/or the supply voltage is reduced.

Table 2 is a summary of these true worst-case conditions—for a low-level output of 0.5 v, the C-MOS buffer fan-out is two, which represents a potential 50% components savings. What's more, if low-power Schottky-TTL devices are used instead of standard TTL devices, the C-MOS buffer fan-out jumps to more than nine. □

Engineer's Notebook is a regular feature in Electronics. We invite readers to submit original design shortcuts, calculation aids, measurement and test techniques, and other ideas for saving engineering time or cost. We'll pay \$50 for each item published.

TABLE 1			
SPECIFIED WORST-CASE CONDITIONS			
TEMPERATURE	-40°C	+25°C	+85°C
$V_{OL} = 0.4 \text{ V}, V_{DD} = 4.5 \text{ V}$	$I_{OL} = 3.1 \text{ mA}$	$I_{OL} = 2.6 \text{ mA}$	$I_{OL} = 2.1 \text{ mA}$
$V_{OL} = 0.4 \text{ V}, V_{DD} = 5 \text{ V}$	$I_{OL} = 3.6 \text{ mA}$	$I_{OL} = 3 \text{ mA}$	$I_{OL} = 2.5 \text{ mA}$

$V_{OL}$  = Low-level output drive voltage     $I_{OL}$  = Low-level output drive current     $V_{DD}$  = Supply voltage

TABLE 2				
PRACTICAL WORST-CASE LIMITS				
PARAMETER ( $T_A = 0 - 75^\circ\text{C}$ )	$V_{CC} = V_{DD} = 4.75 \text{ V}$		$V_{CC} = V_{DD} = 5.25 \text{ V}$	
	$V_{OL} = 0.4 \text{ V}$	$V_{OL} = 0.5 \text{ V}$	$V_{OL} = 0.4 \text{ V}$	$V_{OL} = 0.5 \text{ V}$
$I_{IL}$ (TTL)	1.402 mA	1.363 mA	1.6 mA	1.56 mA
$I_{OL}$ (C-MOS)	2.39 mA	2.94 mA	2.85 mA	3.41 mA
FANOUT	1.70 mA	2.16 mA	1.74 mA	2.18 mA

$V_{OL}$  = Low-level output drive voltage  
 $I_{OL}$  = Low-level output drive current  
 $I_{IL}$  = Low-level input current  
 $V_{CC}$  = TTL supply voltage  
 $V_{DD}$  = C-MOS supply voltage  
 $\text{Fanout} = I_{OL} / I_{IL}$   
 $T_A$  = Absolute temperature



## **Faster 1103 is also easier to use than the original**

Despite the hullabaloo over new faster and bigger random-access memories, **users' love affairs with the old 1103 may get even stronger as manufacturers quietly introduce better designs at the old prices.** Joining others on the market, the latest are from the 1103 inventor—Intel's A models—three new designs that use a single clock instead of three, have faster access (down to 145 ns, compared to the former 300 ns), and dissipate nearly a third less standby power. **Designers can now upgrade memory boards to meet 200-ns applications without having to turn to more expensive n-channel products.**

## **LED shows faults in circuit boards**

Are you using on-card power-supply regulation? **If so, a fault indicator for every circuit board in your system can be had almost for free by simply placing a light-emitting diode and its series current-limiting resistor across the IC regulator's input and output terminals.** *Voilà!* You have built what's called a BITE (Built-In Test Equipment) indicator, observes Stephen F. Moore, an engineer at Resdel Engineering Corp. in Arcadia, Calif. The LED will light if there's a fault in the regulator's output, but it uses little power when there is no fault.

When a circuit fault occurs, the regulator's output voltage rises, increasing the voltage difference across its input and output terminals so that the LED conducts. **The current-limiting resistor determines the point at which the LED becomes visible.** To control the LED turn-on point more closely, you can place a zener diode in series with the LED.

## **Center helps you get reliability in microcircuits**

The next time you need help on a microcircuit-reliability problem, consider enlisting the aid of the Reliability Analysis Center at Rome Air Development Center, Griffis Air Force Base, N.Y. The RAC, operated for RADC by the Illinois Institute of Technology Research Institute, **offers, at a fee, consulting services and special studies, either in support of your own investigation or by taking over your problem.**

One useful RAC service, in view of the growing complexity of LSI components, is device selection—**reviewing device construction, quality status, reliability history, failure modes, and so on, of components you are considering.** The RAC quarterly newsletter can be obtained by writing Lee Mirth, RAC project engineer, or calling (315) 330-4151.

## **We know it can add, but can it sing?**

Supporting the trend by calculator manufacturers of adding features to their product lines is this observation by Homer Potts, a Ph.D. at Chautauqua Laboratories, 915 E. Walnut, Pasadena, Calif., who writes: **"Is calculator music next? I have noticed that the HP-35 calculator emits a signal that can be picked up by a-m radio. The main signal comes from the display, but signals are also emitted during calculation. The tone appears to vary as the battery voltage changes, and it can, in fact, be an indication of battery strength."**

—Laurence Altman

**From instrumentation  
to computers,  
demanding OEMs**

**turn to CTS**

**for the best cermet trimmer values**

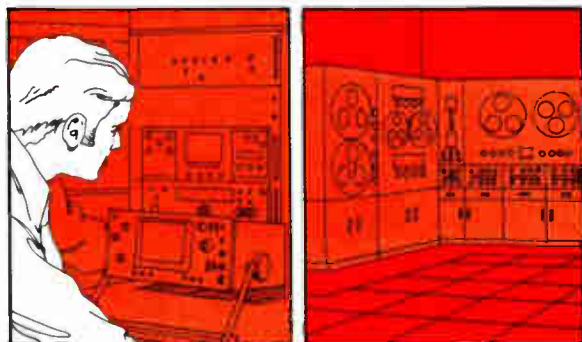
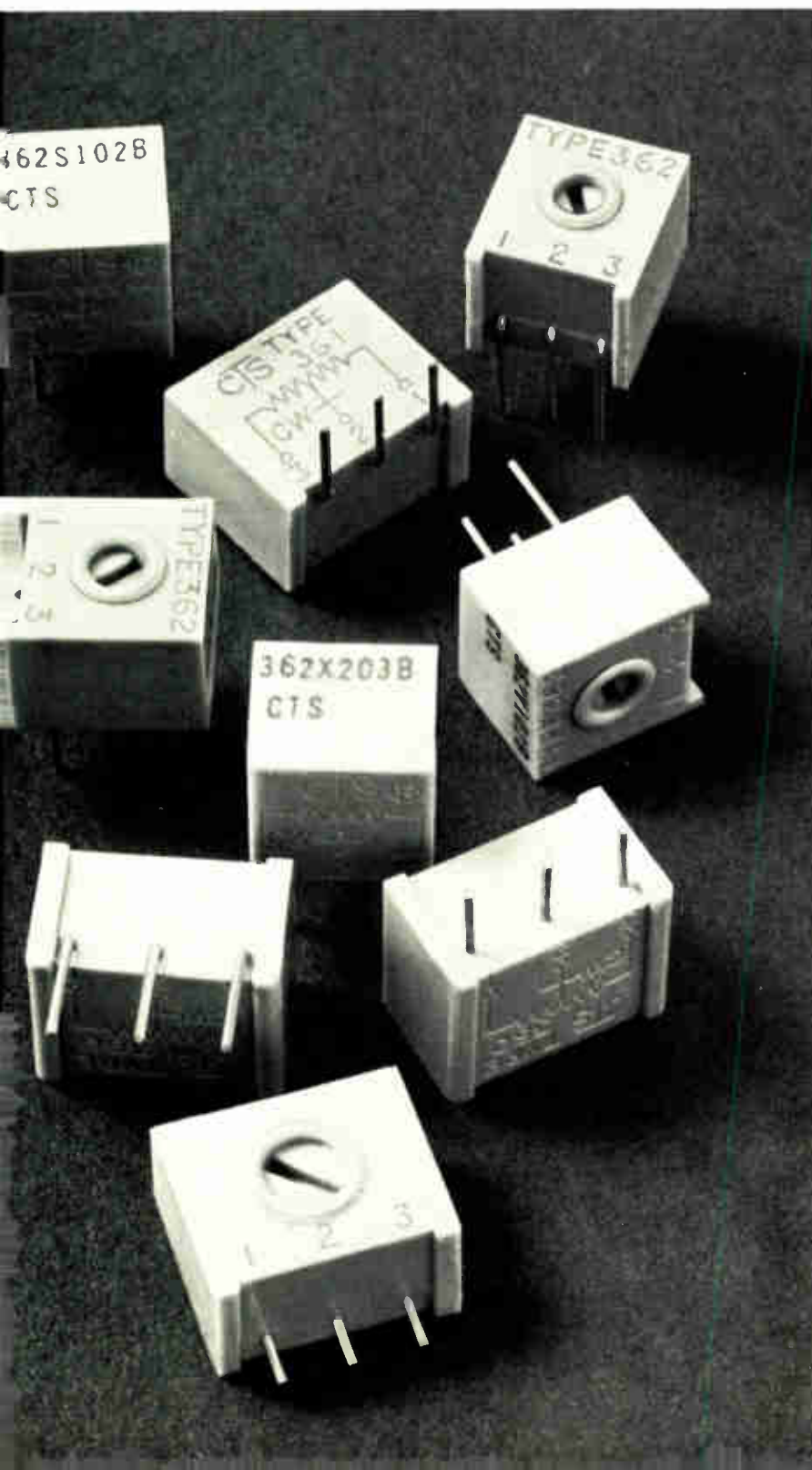

CTS is the "engineer's choice" for quality cermet trimmers. CTS delivers proven performance, uniformity and reliability . . . at economical prices. The best known calculators and all types of fine tolerance instruments incorporate CTS trimmers. Our industrial 360 Series satisfies a wide range of critical OEM applications.

Nine popular styles give you the pin spacing you need. Choose from top and side adjust .100", .125", .150" and TO-5. Plus top adjust .200" grid, too. Units are flux sealed, and feature a low TC cermet element. Settability: 0.03%.

- 1 watt power @ 25° C., ½ watt @ 85° C
- 1.5% average ENR noise resistance
- 0.5% average CRV

Available off-the-shelf from CTS Industrial Distributors. CTS of Berne, Inc., 406 Parr Road, Berne, Indiana 46711. Phone: (219) 589-3111.

Circle 127 on reader service card

**CTS CORPORATION**  
ELKHART, INDIANA



A world leader in cermet and variable resistor technology.



Introducing five Nova 2 systems  
for people who only want one.

Until now, the only way you could buy Nova 2's was five at a time.

Which obviously discouraged people who only wanted one.

So to make sure everyone who wants a Nova 2 gets one, we've come up with five different Nova 2 systems you can buy one at a time.

The smallest is built around our Real-Time Operating System. Which makes it a great little data acquisition satellite.

Next up the line is our Stand-alone Operating System. A small single-user computation system for people who don't need a disc.

Then there's the medium-sized Real-time Disc Operating System you can use to develop software and hardware interfaces, or to build your own medium-sized computation system.

Which is followed by a big Real-time Disc Operating System with more storage and faster output for higher throughput.

And for those who need a system with a built-in backup computer, there's the Dual Nova 2.

So no matter what you want to do, there's a Nova 2 system you can get to get it done.

And 60 days after we get your order, you'll get your system.

# DataGeneral

The computer company you can understand.

• Data General Corporation Southboro, Massachusetts 01772. (617) 485-9100.  
Datagen of Canada Ltd., Hull, Quebec (819) 770-2030/Data General Europe, Paris, France 504-23-44

# FUJI

## LEADING MAKER OF FERRITE CORES WIDE RANGE OF CORE FOR POWER SUPPLY

### POT CORES (ROUND)



SP1408 SP1811 SP2213 SP2616 SP3019 SP3622

### POT CORES (SQUARE AND SPECIALITIES)



CP0906 CP1309 CP2014 CP2323 SM-6 CP1715 X-25

### EE CORES



E-10 E-16 E-22 E-30 E-40 E-50 E-60

### UU CORES



RU-64

Newly developed H28 Material for power rated ferrite cores is best suited for direct-line-switching regulated power supplies. The low-loss, high saturation flux density and superior design of these ferrite cores assure top performance.

Both cores and transformer coils can be manufactured to your specifications.

**FOR YOUR POWER SUPPLY  
STANDARD CORES ARE  
ON OUR SHELF**



### FUJI ELECTROCHEMICAL CO.

Head Office: Hamagomu Bldg., 5-36-11, Shinbashi, Minato-ku, Tokyo, Japan  
TEL: 434-1271

Overseas Office: New York, TEL: (212) 532-5630  
Los Angeles, TEL: (213) 620-1640  
Düsseldorf, TEL: (211) 89031

TAD ISHIZUKA  
SAM YOSHINO  
TAD KOMURO



## European EE roundtable reflects universality of design problems

---

Like their U. S. counterparts, Europe's EEs are preoccupied with microprocessors, the system/component-design interface, and shortages; but some concerns are unique to each country

---

by Arthur Erikson, *Managing Editor, International*

**“You can make new products using the same technology  
... But there comes a day when you have to change.”**

□ *There is no such thing as a typical European electronics engineer; rather, there are British, French, Dutch, Italian, Belgian, and German engineers—each with a characteristic background and outlook. Nevertheless to get some insight into what concerns EEs in Europe these days, Electronics convened a meeting with eight of them from six countries for a long spring-afternoon’s talk (see “Editing the tapes,” p. 137).*

*Soon after the eight panelists settled into their places in a screened-off corner of the elegant breakfast room of the Hotel Victoria in downtown Amsterdam, the talk turned to the day-to-day problems EEs have to cope with, especially those caused by new components and new technologies. All the equipment designers nodded in agreement when Alain Quéau, the oscilloscope man from Schlumberger, remarked that one almost needs a crystal ball to pick the right IC technology. And nobody demurred when Henk Bremer, who heads the voltmeter/multimeter design effort at Philips Gloeilampenfabrieken, insisted that it’s as much a matter of when as of what. But sides formed when Robert Carey, who is in charge of developing numerical-control systems at Philips, contested the contention of Quéau and Olivetti’s Alfredo Olivei that it helps a lot if your company manufactures ICs, as well as equipment. Here’s what was said:*

**Quéau.** If your ICs are standardized, it’s very difficult to change from one family to another. We need almost a crystal ball to know which semiconductor processes will turn out to be the most economical. It’s easier for companies like Philips, which can manage its own production of ICs.

**Carey.** The point is that Philips manufactures ICs mainly for the mass market—television sets, radios, and so forth. In the industrial sector, where we work, the impact is minimal, and we have exactly the same problem as you have in deciding which techniques to apply. For example, we are just going over from TTL to C-MOS, and it was very difficult to decide where to apply C-MOS and where to apply TTL.

**Quéau.** And which C-MOS.

**Bremer.** Not only which C-MOS. There comes a moment when you have to change over from one family of instruments to a new one. Of course, you can make new products using the same technology and even with the same TTL sockets. But there comes a day that you have to change. You have to change to new mechanical designs, you have to look for new electronics, and then there is an enormous change of technology. But I think one of the most important things is to know when to change to a new technology and, of course, which one.

**Olivei.** Yes. The point of choice for big firms probably is overemphasized because big firms have available instruments like technological assessments and forecasts. They can know with some degree of certitude what will be in the near future the winning technology. The problems are immense for medium and small companies, which cannot make these assessments satisfactorily because it costs too much.

**Quéau.** But sometimes Philips has the same problem we have because if they use C-MOS and this C-MOS is used only by Philips, it will cost quite a lot.

**Carey.** We are in exactly the same position as small companies or medium-size companies, except that we operate within the framework of a larger company. Our larger company does make integrated circuits, that’s true, but we have to choose the optimum techniques for our problems, and maybe they are not supplied by our own company. And that’s not just the case with Philips, but with every large company.

*Bremer’s point that timing is as important as choice when changing technology was reiterated often by, among others, Marcel Nollet, who leads a group of engineers developing tracking and communications systems for satellites and earth stations at Bell Telephone Manufacturing Co., an ITT subsidiary based in Antwerp, Belgium.*

**Nollet.** There is a continuous evolution in technology for electronic components, and the main point we have to consider is when there will be the highest demand for a piece of equipment. Then we have to move quickly and do the design with the technology that exists.

**Quéau.** You have to be very careful. We made a bit of a mistake once because we were a little bit too fast in technology. It was an oscilloscope in 1962. We had the first 100-MHz scope with transistors in the world, so we lost two or three years in the shift to ICs because we were already working with transistors.

**Carey.** Sometimes you are forced to change. We are being forced in our readouts for machine tools to go over to C-MOS because we have to offer a digital readout that has to fit in a very, very small box, has to be mounted in a machine-tool plant, and has to give off absolutely no heat. We had to change over to a low-power solution.

**Quéau.** That’s a technical point of view—not an economic point of view.

**Carey.** It also has to do with economy because we have to have a low price. So we have the problem of what to do. Do we make a tradeoff between Schottky TTL or do we go to C-MOS? With C-MOS, we have lower cost in the power supplies, higher cost in the ICs. And then you need the crystal ball again. What’s C-MOS going to be like in 1975?

### **Microprocessors magnify the problem**

*Like most American EEs, all the hardware designers on the panel had microprocessors on their minds. Tonio Frühauf, leader of a group developing frequency synthesizers and related instruments at Rohde & Schwarz, in Munich, hit common ground when he emphasized the troubles that hardware people have with software, a problem most U.S. designers have shared. Giancarlo Monti, who does research in digital satellite-communications systems for the Italian SIT-Siemens, added some nuances to Frühauf’s viewpoint, and so did Carey, Quéau, and Olivei.*

**Frühauf.** We work with microprocessors, and the biggest problem so far is that, on one side, there’s hardware

## Editing the tapes

To make this report as clear and concise as possible, the transcripts of the recording tapes made at the *Electronics* roundtable had to be edited thoroughly to weed out repetitions, interruptions, and confusing statements that cropped up during these lengthy conversations. This was especially important because the native language of six of the eight panelists was not English.

Rather than attempt a word-for-word rendition, which would ramble, the dialogues are constructed from fair paraphrases, albeit using the panelists' actual words as much as possible. These dialogues do not strictly follow the chronological order of the transcript, but were paraphrased from statements made at different times during the taping. Moreover, a few company names have been cut out in spots where panelists were critical of products of certain manufacturers, and there was no one from these companies to respond to the criticism.

All eight of the electrical/electronics engineers who sat in on *Electronics*' roundtable in Amsterdam have solid design experience. And all have enough active career ahead of them that they're forced to keep on top of the changes in technology, in business conditions, and in society.

Although the panelists come from six different countries, they're not exactly representative of Europe's electronics industries. For instance, none is directly involved in entertainment electronics, a dominant market, but one in which American technology is no real threat. The Amsterdam panelists, by contrast, work in sectors that are very much affected by technological advances in the United States. That's why what these engineers have on their minds—as individuals and not as expounders of company views—is particularly pertinent. The panelists were:

■ Henk Bremer, who is Dutch, started to work for N.V. Philips in 1953, two years after he had won a degree in electrical engineering from the Groningen Technical College. He also holds a bachelor's degree in electronic engineering from Eindhoven Technical College. Bremer started as a development engineer for scientific instruments at Philips, then worked as a service engineer for test and measuring instruments. Now he's the technical-development manager for voltmeters and systems.

■ Robert Carey started his career at the National Engineering Laboratory in Glasgow, Scotland. While working there, he took a bachelor's degree at Strathclyde Univer-

sity. Later he moved to the Birnie Hill Institute to learn advanced machine-tool and control technology. Meanwhile, he completed requirements for a master of science degree at Strathclyde. Since early 1970, Carey has been working at Philips in Eindhoven, the Netherlands, where he is now manager of the Numerical Control department.

■ Patricia Foster is a senior communications engineer at British Aircraft Corp. in Great Britain. She is mainly involved in international spacecraft projects. Before signing on at BAC, Ms. Foster was a senior antenna engineer at Marconi Ltd., led a radioastronomy group at the University of Aberdeen, and worked at the Royal Radar Establishment. She did her undergraduate work at Edinburgh and holds a doctorate from the Cavendish Laboratory at Cambridge.

■ Tonio Frühauf studied first at the Darmstadt, then at the Munich technical college in Germany. After winning a Diplom-Ingenieur degree, he joined Rohde & Schwarz, where he now leads a group that designs frequency synthesizers and related instruments.

■ Giancarlo Monti has specialized in digital satellite-communications systems since graduation from the University of Bologna in 1968. He's now a project manager in the digital techniques laboratory at SIT-Siemens, which, despite its name, is a thoroughly Italian company.

■ Marcel Nollet of Belgium heads a tracking and communications group of the Line and Radio Transmission division of Bell Telephone Manufacturing Co., an ITT subsidiary based in Antwerp. Nollet participated in the design of tracking equipment for several earth stations, including the ELDO guidance station at Gove, Australia. He's a graduate of the technical college in Ostend.

■ Alfredo Olivei, another Italian, has done R&D in a variety of sectors—nonimpact printers, memory systems, and circuits—for Olivetti S.p.A. Now he's assistant to the corporate manager for advanced technologies. Olivei holds doctoral or postdoctoral degrees from the Universities of Grenoble, Pisa, and Rome.

■ Alain Quéau is the lead engineer for oscilloscope development at Schlumberger Instruments and Systems in France. Before joining SIS, Quéau did a stint as a junior research engineer in the U.S. with Tektronix and has done research in underwater warfare for the French navy. He holds a Ph.D. in electronics from the Ecole Nationale Supérieure d'Electrotechnique, d'Electronique, d'Informatique, et d'Hydraulique at Toulouse.

1. Marcel Nollet, Bell Telephone Mfg. Co. (Antwerp)
2. Tonio Frühauf, Rohde & Schwarz (Munich)
3. Alfredo Olivei, Olivetti (Ivrea)
4. Giancarlo Monti, SIT-Siemens (Milan)
5. Henk Bremer, Philips (Almelo)
6. Patricia Foster, British Aircraft Corp. (Filton)
7. Robert Carey, Philips (Eindhoven)
8. Alain Quéau, Schlumberger (St. Etienne)

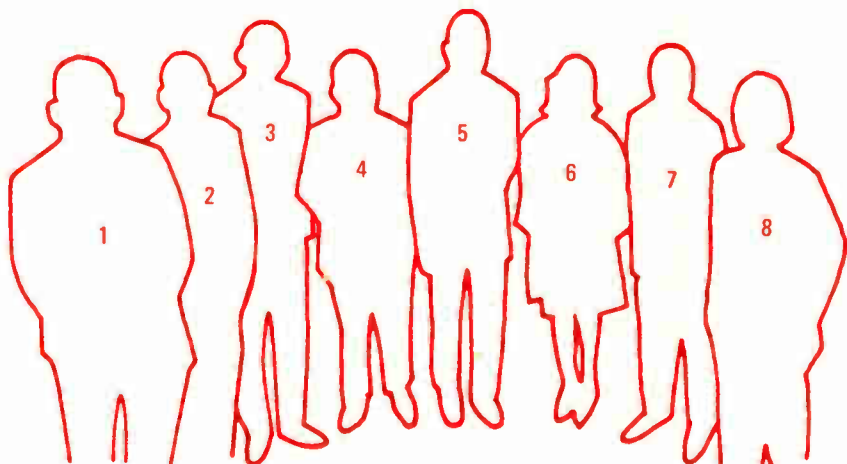





## S. S. WHITE FLEXIBLE SHAFTS

**For all POWER DRIVE and  
REMOTE CONTROL Uses**

If you need flexible shafts for any application which rates a priority, let us know your requirements. Our production is now entirely for war work and is going full blast to supply our flexible shafts for their many applications in planes, tanks, ordnance, naval, signal corps and other war equipment and for portable tools and other production machinery. Even so, you can count on us for the fullest cooperation in meeting your needs. Write us.

If you want sample shafts for experimental purposes we'll be glad to supply them.

**AT YOUR SERVICE**  
cooperation of our flexible shaft experts for working out actual applications. Send details.

### DATA FOR ENGINEERS

The following bulletins will be mailed to you on request:

**BULLETIN 1238** Flexible Shafts for Power Drives.  
**BULLETIN 38** Flexible Shafts for Remote Control.  
**BULLETIN 839** Flexible Shafts for Aircraft.

## S. S. WHITE

The S. S. White Dental Mfg. Co.  
**INDUSTRIAL DIVISION**  
 Department E, 10 East 40th St., New York, N. Y.



## FORMING WITHOUT DIES!

Are you in a rush for some duplicated metal parts? Do you have experimental work? In many cases you can make the parts faster with the "Di-Acro" System, and avoid entirely the expense and delay of making dies. An almost unlimited variety of work can be rapidly done by the combined use of 3 Di-Acro Precision Units,—Shear, Brake, Bender.

**Write for Catalog**  
 New 32-page catalog "Metal Duplicating Without Dies" gives full details, shows many parts which can be made.

**O'NEIL-IRWIN MFG. CO.**  
 321 8th Ave. S. Minneapolis, Minn.



## We Specialize in Transformers, Reactors, Filters (Electrical Wave) Jacks, Plugs and Kindred Items

*Your Problems are Our Business, too!*

**AUDIO DEVELOPMENT COMPANY**  
 2833 Thirteenth Avenue South, Minneapolis, Minnesota

nected to the output of the amplifier through coaxial transmission lines, with auxiliary electrodes within each of the transmission lines in adjustable relationship to the inner conductors, and an auxiliary transmission line connecting the auxiliary electrodes with means for adjusting the length of this auxiliary transmission line whereby a small amount of energy of predetermined phase and amplitude is introduced into the first transmission line from the second. F. H. Kroger, RCA. Jan. 31, 1939. No. 2,276,497.

**Centimeter Wave Generator.** Means for forming electrons from a gun into a beam, a hollow resonant electrode for shielding electrons from external fields, this electrode having an effective length equal to an integral number of half wave lengths of the oscillatory currents established therein, directing the beam

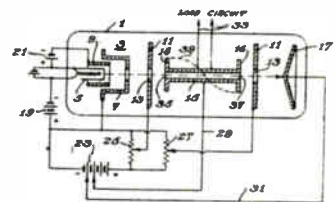

of electrons through the hollow electrode along its longitudinal axis and adjusting the velocity of the electrons so that the distribution of oscillatory potentials along the path of the electrode alters the energy of the electrons. E. G. Linder, RCA. June 29, 1939. No. 2,276,320.

### Aircraft Radio Applications

**Drift Corrector.** Apparatus for use on a navigable vehicle comprising an energy collecting means having a normal angular relation to the source of radiated energy and to the longitudinal axis of the vehicle, means for automatically keeping the vehicle upon a predetermined heading, and responsive to deviations of the vehicle from the predetermined course for angularly displacing the collecting means from its normal relationship to the longitudinal axis of the vehicle. C. J. Crane and R. K. Stout, Dayton, Oct. 18, 1939. No. 2,280,117.

**Glide Path.** Method of guiding aircraft along a linear inclined path on approaching a field for landing by radiating from several points on the field to define in space the inclined plane in which the desired linear and inclined approach path is located, producing on the aircraft from the visual image of three spots in the relative relationship as viewed from the aircraft, of three points in the inclined plane, one point being the desired point of contact of the desired approach path with the landing field and the other points being above and symmetrically located with respect to the first point. I. R. Metcalf, Research Corp., July 26, 1938. No. 2,280,126.

**“We have two tendencies—the younger engineers using too much software, the older ones too much logical hardware.”**

---

designing, and on the other side, there is doing the software. The software specialist normally doesn't know anything about hardware, so the engineer who wants to integrate a microprocessor into equipment has to know both. You don't have standard interfaces always, and there are many cases where you can think about solutions by hardware logic or by adding computer programs.

I've seen often that engineers say software is very, very complicated and they're afraid to work with it—especially older engineers. I try to explain to them that developing software is only a special way of developing digital-logic circuits. But it is very difficult to persuade them.

**Monti.** We have noted that the older engineers don't use software and prefer to use hardware logic, while the younger ones tend to use software, even when there is no necessity. So we have two tendencies—the younger engineers using too much software and the older ones too much logical hardware.

**Carey.** I haven't had a problem with older people. The average age in my group is about 26, and they are all hardware designers, basically. But we've had some experience finding software people and teaching them numerical control. It doesn't work. The best way to do it is to take your hardware people and teach them programming. You're best out of it that way. Unless there's a speed problem, it is always cheaper to use a software solution.

**Olivei.** An electrical engineer—a hardware engineer—cannot afford any longer not to know software. With microprocessors, it's a matter of knowing firmware—just what part hardware must play in a system and what part software has to play. It is antihistoric not to accept software. I studied at the University of Grenoble in 1964, and they were already teaching the rudiments of software at the IMAG [Institut de Mathématiques Appliquées de Grenoble].

**Carey.** In my bachelor's course in 1965, we were doing assembly language for English Electric computers, and in 1966, we were learning on-going Fortran as part of the normal syllabus.

**Quéau.** In our company in 1967 or 1968, all the hardware designers had a course of four hours a week in software for a year. Our case was a bit particular because one of our departments does nuclear work, and the people in that department had been using software for a long, long time. Also, it was the beginning of automatic test systems—Camac [computer-aided measurement and control] and all that—so we had the opportunity to make the move.

*These engineers are no strangers to computer-aided design, either. Bell Telephone's Nollet turned out to be the biggest booster for CAD among the panelists. Everyone who commented agreed that CAD is a powerful design tool, but no one considers it a panacea, particularly for analog circuits.*

**Nollet.** We have enough computer terminals in our

company that engineers can use them like a slide rule. For systems design, we even use them as peripherals for our test equipment. We format outputs so we can interface them digitally with the terminal, which calculates distributions and the like. CAD is especially valid for designing filters.

**Carey.** We have the same facility, but we don't use it very much—maybe because our work doesn't lend itself very well. We do simulations of systems; but once we have done the simulations, it's finished. We don't do detailed designs. We have tried computer design for printed-circuit-board layout—not the artwork—and we've had some problems. Now, we do most of our layouts by hand and then do the artwork by numerical control.

**Bremer.** Some of the engineers in my group use CAD for developing custom LSIs—for voltmeters, especially. But we do not use it, say, for analog circuits. At the moment, they are calculated by hand.

**Quéau.** We have a program for analog circuits, but we check it out by hand. There are lots of things that can interact in analog circuits, so you have to check. But what is nice with CAD is the number of parameters you can change and see the circuit's reaction. But the program has to be done by an intelligent person; you have to remember that the computer can only repeat, only repeat. The problem is to find the actual model.

**Olivei.** In our company, we do a lot of computer design for mechanical parts and for analog and digital circuits. For minimizing the area of chips, though, the computer gives just a first idea, and a person has to check for the final reduction.

### **Designing circuits**

*As users of ICs and microprocessors, the panelists inevitably got around to the interplay between circuit men at IC houses and equipment builders. Again, there was a parallel with the situation in the United States, as Carey points out.*

**Carey.** We have a problem in Europe, as someone was saying, that circuit designers are really disappearing. Everybody is a systems designer today. We're getting fewer and fewer circuit designers, and they're all going to circuit manufacturers. Certainly, in the digital area, nobody designs flip-flops anymore.

**Quéau.** You have the same problem in measurement equipment. You have to know how people make measurements. You can make the apparatus as accurate as you want, but the fellow using it will operate it with 10% or 20% error. If the design engineer doesn't know this, he will goof. That's why the designer must not be at the integrated-circuit company, he must be at an instrument company.

**Bremer.** Do you think that it is possible to have an instrument-development group here, say, and work with an integrated-circuits factory 200 kilometers or more away? We would specify the IC here, they would do the development work and make the circuit, and then send

# Solitron CMOS

## STANDARD 4000 SERIES

Our family has grown to 55 device types and is growing larger every day. We are pin-for-pin and electrically equivalent to all other 4000 series devices. All package styles available too! Epoxy, CER-DIP and Ceramic. Plus, we deliver!

## SPECIAL PROBLEMS . . . SPECIAL SOLUTIONS!

Need to interface CMOS to TTL? Try our newest member. The CM4104 Quad Level Voltage Translator. The CM4104 is useful in applications where CMOS devices are to be interfaced to TTL outputs when the CMOS system is operating at a higher voltage or in bus oriented systems (three-state outputs available) or in systems when high frequency CMOS oscillators are operated at low voltages to conserve power but must drive higher voltage logic or output devices.

Each 4104 consists of four level translators, each with a true/complement output. Enable inputs are shared resulting in a high impedance output when Enable input is low. The device is packaged in a 16 pin DIP. Available off the shelf! Watch for an announcement of a second source soon!

Write or call for a data sheet and samples.

Other 4100 series devices include:

CM4102	3½ Digit Counter/Decoder	CM4117	3½ Digit BCD to 7 Segment Liquid Crystal Driver
CM4108	16 Channel Multiplexer	CM4121	Programmable Counter
CM4116	Quad Bilateral Switch		(Digital Frequency Synthesizer)

## TIME KEEPING CIRCUITS

Solitron manufactures a variety of custom time keeping circuits, tailored to our customer's needs. We can help you with either a custom or one of our "old reliables".

CM4106	
CM4122	Liquid Crystal Display Watch Set
CM4120	LED Watch (Single Chip)



## CUSTOM CMOS

How about a full scale engineering review that could result in a custom chip that will put your product on the market with a competitive edge built in. We're in all kinds of equipment from Military to Medical.

Throw a real life design problem at us that we can't solve and win a Banana® stamped with your name. Just provide your spec, a statement about your problem, and your name and address on the coupon, and mail back to us. If we don't solve your problem, we'll send you a personalized Banana Pen.

© BIC registered trademark

HERE'S MY DESIGN PROBLEM TO TRY AND STUMP  
YOUR SOLITRON ENGINEERS:

Name \_\_\_\_\_  
Company \_\_\_\_\_  
Address \_\_\_\_\_  
City \_\_\_\_\_ State \_\_\_\_\_ Zip \_\_\_\_\_  
Phone \_\_\_\_\_

If you've read this far, you must be interested in some help. Call the friendly guys at Solitron. We can also help you with our other products listed below. Call or write for data, applications assistance, or just a friendly hello!

# GET A LITTLE HELP FROM A FRIEND SOLITRON SAN DIEGO

8808 Balboa Avenue, San Diego, California 92123 • Telephone (714) 278-8780 • TWX (910) 335-1221

While you are considering Solitron, check us out on:  
J-FETS • MOS-FETS • BRIDGES • DIODES • ZENERS  
RECTIFIERS • HI VOLTAGE ASSEMBLIES • CUSTOM CMOS

Circle 139 on reader service card



For your convenience, our Sales Department starts work at 7:30 A.M. Pacific Time. Dial toll free.

Out-of-State Call toll free. Dial: **800-538-7906** and ask about price and delivery.

## Get a Stewart-Warner quote before you buy!

Although we have a great new custom C/MOS capability—don't forget our 7400 TTL's and 930 DTL's. They're still our bread-and-butter, and wouldn't you rather do business with somebody who takes

bipolar seriously? There aren't too many of us left, but we've been at it for too long to run out on you now. So if you're looking for 7400's or 930's, get our quote before you buy. Call us directly or contact our

nearest representative or distributor.

**SYMBOL OF EXCELLENCE** **STEWART-WARNER MICROCIRCUITS DIVISION**  
**STEWART-WARNER CORPORATION**  
 730 E. Evelyn Ave. • Sunnyvale Ca 94086 • (408) 245-9200

Contact your nearest authorized representative, or get your quote on our out-of-state toll-free line—(800) 538-7906.

**ALABAMA**  
 POWELL ELECTRONICS INC  
 Huntsville, (205) 839 2731

**ARIZONA**  
 MIRCO ELECTRONIC DISTRIBUTORS  
 Phoenix, (602) 944 2281

**CALIFORNIA**  
 INTERMARK ELECTRONICS  
 San Diego, (714) 279 8200  
 Santa Ana, (714) 840 1322  
 Sunnyvale, (408) 738 1111

POWELL ELECTRONICS  
 Mountain View, (415) 968 0820

SEMICONDUCTOR  
 CONCEPTS INC  
 Woodland Hills, (213) 884 4560

**COLORADO**  
 INTERMARK ELECTRONICS  
 Denver, (303) 936 8284

**CONNECTICUT**  
 LYKES ELECTRONICS  
 Fairfield, (203) 250 4521  
 WILSHIRE ELECTRONICS  
 Hamden, (203) 281 1166

**FLORIDA**  
 LYKES ELECTRONICS  
 Miami, (305) 592 3260  
 Tampa, (813) 888 6646  
 POWELL ELECTRONICS INC  
 Miami Springs, (305) 892 3260  
 Orlando, (305) 858 1450

**GEORGIA**  
 LYKES ELECTRONICS  
 Atlanta, (404) 355 2223

**ILLINOIS**  
 BODELLE COMPANY INC  
 Chicago, (312) 223 9070

**LOUISIANA**  
 LYKES ELECTRONICS  
 New Orleans, (504) 486 7441

**MARYLAND**  
 POWELL ELECTRONICS INC  
 Beltsville, (301) 937 4030

**MASSACHUSETTS**  
 A-W MAYER CO. INC  
 West Newton, (617) 968 1111  
 GERBER ELECTRONICS  
 Dedham, (617) 329 2400  
 WILSHIRE ELEC./NEW ENGLAND  
 Cambridge, (617) 491 3300

**MICHIGAN**  
 DIPLOMAT/NORTHLAND ELECTRONICS  
 Farmington, (313) 477 3200  
 WEDEMEYER ELECTRONIC SUPPLY CO.  
 Ann Arbor, (313) 665-8611

**MINNESOTA**  
 ELECTRO COM CORPORATION  
 Minneapolis, (612) 788 8601  
 INDUSTRIAL COMPONENTS, INC  
 Minneapolis, (612) 831 2656

**NEW JERSEY**  
 WILSHIRE ELECTRONICS  
 Cinnaminson, (609) 786 8990

**NEW YORK**  
 HARRISON ELECTRONICS  
 CORPORATION  
 Farmingdale, (516) 293 7990  
 SEMICONDUCTOR CONCEPTS, INC  
 Mayhough, L.I., (516) 273 1234

WILSHIRE ELECTRONICS  
 Johnson City, (607) 797 1236  
 ZEUS COMPONENTS  
 Elmford, (914) 592 4120

**NORTH CAROLINA**  
 KIRKMAN ELECTRONICS, INC  
 Winston Salem, (919) 724 0541

**OHIO**  
 RPC OF OHIO  
 Cleveland, (216) 461 4700  
 STOTT'S FREIDMAN  
 Dayton, (513) 224 1111

**PENNSYLVANIA**  
 POWELL ELECTRONICS INC  
 Philadelphia, (215) 365 1900  
 RPC  
 Pittsburgh, (412) 782 3770

**TEXAS**  
 KA ELECTRONIC SALES  
 Dallas, (214) 834-7870  
 LENER COMPANY  
 Houston, (713) 228 1465

**UTAH**  
 ALTA LAND ELECTRONICS, INC  
 Salt Lake City, (801) 486 7227

**WASHINGTON**  
 INTERMARK ELECTRONICS  
 Seattle, (206) 767 3160

**CANADA**  
 FUTURE ELECTRONICS CORPORATION  
 Montreal 307, Quebec, Can., (514) 735 8778  
 Rexdale, Ontario, Can., (416) 677-7820  
 Ottawa 7, Ontario, Can., (613) 232 7757

## **“You have to have the instrument designer and the designer of the IC—digital and analog—on the same floor.”**

it back to the instrument maker.

**Quéau.** We have tried that, and it does not work at all. We hired someone [a digital IC designer] from an IC manufacturer, and he asked us, “What is the process?” We answered him, “What are the problems you will have?” It was funny—this fellow had never heard about the variation of  $V_{BE}$  with temperature—something analog people know very well. You need to have both on the same team.

**Bremer.** I agree. Our experience is that you have to have the instrument designer and the designer of the IC—digital and analog—on the same floor.

**Olivei.** Olivetti doesn't produce ICs itself and relies on outsiders like Philips and the U.S. producers. But there are Olivetti people stationed in the U.S. who do the liaison between Olivetti and the circuit makers. So we don't deal directly with the company, but with the Olivetti man. If we didn't have all these people in the U.S., we would have a lot of problems.

*As they talked about relations with IC suppliers, the Amsterdam panelists evoked their concern about second sources and shortages of all kinds of components and materials. Toward the end of this train of thought, Patricia Foster, a senior engineer for telecommunications at British Aircraft Corp., hit upon a problem that does not affect Americans when she reported coming across shortages of key materials created by political considerations, as well as shortages caused by supply and demand.*

**Olivei.** You have to have a guarantee that if your first supplier has a strike or a production problem, you don't have to stop your own production. You need a second supplier, probably not with the same volume of production, but enough to allow you to continue production. We usually try to have a second source, even for cost analysis.

**Quéau.** So you have to pay for two development contracts.

**Olivei.** Not necessarily, because the first supplier can pass on the knowledge developed to prepare the

circuit for another. It is difficult, but it has happened.

**Quéau.** But only when the characteristics you want are well below what is possible with the technology. If you give a custom design that is very difficult to achieve to one producer, say, Plessey, they will give you a circuit that they can manufacture. If you then send the layout to, say, Philips, their process will be slightly different, and it won't work. So you have to pay for two contracts.

**Frühauf.** Another problem is that most of the new devices come from America. You get samples, but you don't know if the manufacturer will still be producing the part a year from now. And if he stops making a special device that's designed into your equipment, you stop manufacturing your own instrument. It's very, very difficult. For microprocessors, you can get only one manufacturer [for identical chip sets], but they are so important now that you buy them, in spite of the fact that you don't have a second manufacturer.

**Carey.** There is always a risk inherent in large-scale ICs. But everybody has to take a risk; otherwise, you would stand still. We took a risk, for example, using a read-only memory which has a format of 512 by 10 bits. We hoped a second source would come along, but it took two years before one appeared. If the first company had gone kaput, we would have had to redesign using someone else's ROM with another format. That is something every engineer must be able to do—make a tradeoff study to see whether he wishes to accept this risk.

**Frühauf.** I still think it is more dangerous if we are dependent on American manufacturers than if we would be dependent only on European manufacturers.

**Carey.** If America stops supplying these solid-state devices, you'll find very quickly that the semiconductor houses of Europe will be buying engineers in America to manufacture the things here.

**Quéau.** What is dangerous is when the device design is good, but no one but you wants to use it. Then the manufacturer in the U.S. won't manufacture for a thousand pieces a year, or else you pay a lot for it.

**Foster.** Have any of you come across blanket refusals by American companies to deliver certain items? There's one particular kind of mesh for antennas that's made by about three firms in the States and nowhere else. This has suddenly become unavailable to Europeans. What our designers do is to make sure that someone in Europe is making it, even if we have to pay them to do it. And this is just one example of national political policies hindering supply.

**Quéau.** That's the problem; you have to have a source in the country where you need it. And that's why, many times, you give contracts to develop some things that already exist. In France we have been embargoed on Polaroid 10,000 film because we have been building atomic bombs for a long time, and this film can be used to take pictures of the explosions.

*The active hardware designers among the panelists all showed keen awareness of “natural” shortages—present and future. They are designing with that in mind, but as Quéau replied when asked how one can design without wire, “It's impossible.”*

**Carey.** You find a lot of large electronic equipment is going over to aluminum power lines because the long-term shortage of copper was taken into account by the equipment designer. That is what we've been doing—trying to find out what's happening with prices of materials and what do we have for a second source of supply. I think designers generally work with shortages of materials in mind, but not in the electronics sense—purely in the mechanical sense.

**Quéau.** But what about wire? You have a lot of plastic around the metal, and there's a shortage of wire because there's a shortage of oil to make plastics with.

**Carey.** That is not something a



## SENSITIVE GATE TRIAC's

3mA, 4mA, 5mA, 10mA and  
25 mA (IGT) All quadrant  
grating 50V to 600V ( $V_{DROM}$ )

Hutson TRIAC's and SCR's are ideally suited for solid state switches, motor speed controls, lighting, heating and air conditioning controls.

Patented Di-Mesa™ construction is designed to assure you of reliability and superior performance. Hutson's complete line of TRIAC's and SCR's are available as void-free, glass-passivated chips or in all standard package configurations.

Call on Hutson's state-of-the-art thyristor technology when you need reliability and economy.



Box 34235 • 2019 W. Valley View  
Dallas, Tex. 75234 (214) 241-3511  
TWX 910-860-5537

### Representatives:

New York City Area, 201/399-4350.  
Seattle 206/454-0300. Los Angeles  
213/240-3151. Dallas 214/231-6181.  
Baltimore 301/944-8262. Denver 303/  
757-7679. Ft. Lauderdale 305/772-  
5100. Chicago 312/286-1500. Detroit  
313/499-0188. Syracuse 315/699-  
2671. Indianapolis 317/888-2260. At-  
lanta 404/427-0241. Canada 416/638-  
1322. Beaverton 503/643-1644. Dayton  
513/433-2511. Phoenix 602/968-9037.  
Minneapolis 612/866-3035. Boston  
617/890-8040. Kansas City 816/765-  
2998.

### Distributors:

Elizabeth 201/345-2420. Los Angeles  
213/240-3151. Denver 303/934-5505.  
Chicago 312/323-9670. Canada 416/  
635-9880. Rochester 716/454-7800.  
Salt Lake City 801/486-7227. Belgium  
02362135. Brussels 02352135. Den-  
mark (01) 295622. England (09924)  
67161. Norway 472702272. Spain 234-  
62-62. Sweden 08-28-5940. Switzer-  
land 051-852201.

**“There is no such thing as a European engineer; there are British engineers, French engineers, Belgian engineers.”**

designer can take into his criteria. We had to do some very quick re-design recently because a company was unable to supply connectors to us for a year, also due to this plastic problem. But the designer couldn't foresee in the first instance that the connector would not be available.

### Europeans search for a style

*Amsterdam has a distinctive architectural style, and it was fitting that the panelists in Amsterdam got around to talk of the style of their designs. It uncovered conflicting views. Henk Bremer of Philips maintained that an international style has started to evolve, at least for the faces of instruments. The other panelists generally hewed to the line that the national outlooks of the designers and national differences in markets work against finding a “European” style.*

**Nollet.** A few years ago, instruments designed in Europe started to take on more and more an American look, and finally all the instruments came to have the same look on the outside. By doing this, European instrument makers came up. This is still so, more or less.

**Bremer.** I don't agree. Now, you tend to see that we have our own faces, which reflects the mix of the different people involved in the design. It's very important—not only for Philips, but for Europe—to find a style.

**Olivei.** From the long experience we have had with cathedrals, it is very difficult for Europeans to find a style.

**Carey.** It is a question of education and national background. There is no such thing as a European engineer; there are British engineers, French engineers, Belgian engineers—all with different characteristics and techniques. Dutch and German engineers are very much tied in with standards; they like to work with them. Italians say the standards are useless and design it their own way. I pointed out something to an Italian engineer that was against ISO standards, and he said, “Well, the standard is stupid; change it.” If you go to Germany,

they go too far; they have standards for everything you can imagine.

**Olivei.** Young and inexperienced engineers probably have different approaches in different countries, but experienced engineers—whether French, German, or Italian—have the same kind of approach to problems. Individual differences probably count more than national or academic backgrounds.

**Bremer.** No. Can you imagine the Citroën DS being developed by Germans or the Volvo by Spaniards?

**Carey.** And a Fiat 125 is surely not at all like a Volkswagen.

**Frühauf.** It's wrong to say the Citroën is built in France because the engineer is French. The real reason is that the French engineer has developed something for French customers, and if a German engineer had to develop a car for French customers, then I hope he would also build something like a Citroën. It's not the character of the engineer that determines the product, but the character of the market.

**Foster.** I don't think your argument is valid. I have seen two antennas with the same electrical specifications, built for the same customer—one built by an Italian firm, the other by a British firm. There is no getting away from the fact that the waveguide parts of the Italian one were much more elegant than the British one; both were made for a battleship.

**Frühauf.** If you design for the world market, you develop an instrument. Then you see another one almost like it from a European competitor, and you find that in America, somebody has thought just the same way as you because it's built for the same customer.

**Bremer.** For a company that makes and sells instruments all over the world, it is very difficult to find the right styling. It must not be Dutch styling, it must not be German styling, not European or American styling—it must be world styling. We have seen at Philips that this is a main problem for the conception of our instruments. Philips

**"You have to keep a firm grip on the industrial designers and try to instill some cost-consciousness into them."**

has a styling-design center in Eindhoven with more than a hundred people from all over the world—Chinese and so on—just to find a middle styling, the middle of the taste of everybody.

*But whether the look is national or stateless, it's important, the group agreed. And so are the controls that occupy the panels of instruments.*

**Carey.** For some instruments, you have to keep a firm grip on the industrial designers and try to instill some cost-consciousness into them. But looks are important. A sewage-pump manufacturer—and a sewage pump is something you never see—told me their sales of the pump went up 400% after they called in an industrial designer and made it beautiful. We have a power supply with a beautiful face that's generally stuck in a cupboard, but it is important.

**Bremer.** When you buy it, you see it.

**Quéau.** It makes the only difference in the choice when you want to sell something, and two or three instruments have the same performance characteristics.

**Nollet.** One of the most important considerations for the user is the controls, knobs, indicators, and adjustments that you have to make. Five or 10 years ago, there were so many calibrations and adjustments to make. There has been a lot of improvement.

**Carey.** Well, for instruments, you have electronics engineers designing for electronics. In numerical control, we are designing for people who operate machine tools. Every time I get a new man in my group, I put him in the factory, working with numerical controls for a few weeks so he learns the problems these guys have pressing all those buttons and touching all those knobs. And maybe when he designs a control he remembers the time he had to walk 10 feet down the machine to turn a knob and thinks about how you operate this and not just how economical it is. That is something that five or 10 years ago was not considered by the engineer—certainly not in

Europe. Also I think in America. I've worked with some American instruments that were terrible things to operate just because of the knobs on the panel.

#### Far from the soldering iron

*Perhaps the most distinguishing difference between EEs in Europe and their counterparts in the U.S. is the stability and job security of the Europeans. Young engineers in Europe may switch companies once or twice, but generally stay with the same firm after that. However, once an engineer has settled into his career, his company can't fire him easily and sometimes not at all. Nevertheless, an EE in Europe has many of the same problems as an American engineer does if design—and not management or marketing—is his career goal.*

**Nollet.** European engineers normally make their careers in the first or second company they work for. They also have to live and work in their national environment, so they don't have much job flexibility outside their own company and have to learn to develop themselves within it.

So you have to give development engineers tasks that broaden their use to the company. You can give them total responsibility for part of a project. After developing the technical and cost proposal, they can work with the customer and learn that customer satisfaction is a prime goal of the company, along with profit. That way, you develop engineers that can function as marketing men, production men, or quality-control men. So you can avoid a crisis for engineers who have to move out of design work.

**Foster.** That doesn't solve the problem because you haven't enough of this sort of job for all the engineers you've got.

**Bremer.** The question is: is there 100% matching between the number of engineers who are going from designing to marketing or applications?

**Nollet.** There is never 100% matching, but if you give the design engineers other responsibilities, they

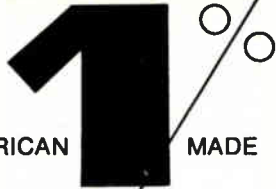

AMERICAN MADE

**Tolerance**

# SCHAUER

**1-Watt**

# ZENERS

**Immediate Shipment**  
**Low Prices**

ANY voltage from 2.0 to 16.0

Quantity	Price each
1-99	\$1.07
100-499	.97
500-999	.91
1000-4999	.86
5000 up	.82



All welded and brazed assembly  
No fragile nail heads

Gold plated leads

Write for complete rating data and other tolerance prices.

## Buy the kit— Save a lot



Kit contains a 51-piece assortment of SCHAUER 1% tolerance 1-watt zeners covering the voltage range of 2.7 to 16.0. Three diodes of each voltage packaged in reusable poly bags. Stored in a handy file box. Contact your distributor or order direct.

A \$54.57 value for  
**ONLY \$24<sup>50</sup>**

Semiconductor Division  
**SCHAUER**  
Manufacturing Corp.  
4514 Alpine Ave. Cincinnati, Ohio 45242  
Telephone: 513/791-3030

# 2000 pole double throw switch

How do you direct 2,000 low level transducer lines into a back-up computer without changing 200 cables? Easy. T-Bar® 48-pole latching relays. T-Bar makes high density switches and relays . . . designs and fabricates special switching systems . . . reliably and economically. If you switch a lot of lines — all at once or a few at a time — write or phone today for complete T-Bar literature.

**T-Bar**  
INCORPORATED  
SWITCHING TECHNOLOGY

141 Danbury Road  
Wilton, CT 06897  
Phone: 203/762-8351



**“Some managements are changing theories very fast about the differences between managers and technical people.”**

stay motivated. And for smaller projects, they can stay close to design.

**Quéau.** He is right, and the engineer will do a better job when he has the responsibility for the whole project, knowing the kinds of customers and the marketing. When there is a problem, he has to go out there and see what it is. So he is responsible from the beginning to the end, but not responsible for policy. That is a management thing.

**Frühauf.** We say in Germany that your salary grows quadratically with your distance from the soldering iron. If you are only happy doing technical things and you are a really good design engineer, even so, you have to move away from the soldering iron to get the money you need as you grow older. It's a bad situation: There are no old design engineers.

**Olivei.** Some managements are changing theories very fast about the differences between managers and technical people. Engineers do knowledge work, and for knowledge work, planning and doing are the same thing. So I don't see as much difference as in the past between a management career and a designer's career.

**Bremer.** The problem is: what is your intention—to grow and grow and grow so far that you cannot do the work you want to do? Then you are unhappy, and maybe the company becomes unhappy with your work. I believe there is a big job for the managers of the company to have a good policy for job guidance or job rotation. It would be a good idea to have several people in the factory to guide technical people to the right place.

**Carey.** That was right about a quadratic rule for the soldering iron, but you can stay in design engineering at a lower salary. In Europe, most people have individual contracts with their companies, and these contracts are hard to break. The engineer's salary curve, of course, saturates at a lower level than a manager's.

**Bremer.** There's a trend in Eu-

rope—at least in Holland—that some, not many, but part of the people in electronics don't want to become managers. You know, they say to themselves, “as an electronics engineer, I work 40 or 45 hours a week, and then I go home to my wife and children every night, and weekends I can go sailing and so on.” Well a manager works, let's say 60 or 70 hours a week—sometimes more. And the difference in salary—in effective salary after taxes—well, the difference is decreasing. Ten or 15 years ago, the goal of most people was to be a manager, but now, I don't think that's so.

**Quéau.** Quite right. A lot of engineers I know would rather stay in St. Etienne—out in the country—than go to Paris and become a manager. In the country, you can ski, fish, do what you want to do, and more people want to do that.

**Olivei.** But you have a responsibility towards your firm to try to undertake more important tasks and to search for more responsibility. Not just to have a better car, but morally.

**Monti.** But a technical career involves responsibility because it's so difficult to keep acquiring the new techniques you need to plan the work. I don't think it's an easy life.

## **Vive la différence (sometimes)**

*Throughout the Amsterdam tapes, comparisons between American and European EEs pop up fairly often. Except for job security, the group felt that most of the advantages were on the other side of the Atlantic. For starters, Rohde & Schwarz's Tonio Frühauf remarked early in the afternoon that, since most new devices come from U.S. semiconductor makers, American EEs learn about them sooner. And Frühauf had other concerns.*

**Frühauf.** I think European engineers must do the same work as American engineers with less money and with less time because companies can spend only 10% to 15% of their turnover for R&D. And the market for European manufacturers is rather smaller. The USA itself is



Take all the ideas you ever had about systems engineering.

Put them into a highly sophisticated technological environment.

And stir well.

At the Communication Systems Division of GTE Sylvania, your ideas are conceptual ingredients.

CSD is a highly integrated systems engineering and systems management proving ground.

A professional challenge.

An opportunity to assume an entirely new magnitude of involvement, in an atmosphere that recognizes innovative solutions and independent thinking.

It's your expertise.

Your talent and creativity.

Your ideas at work on some of the most advanced projects in state-of-the-art systems architecture and conceptual systems engineering.

# Your ideas at work

If you have a solid background in electronic systems engineering, and you'd enjoy following your solutions to their ultimate implementation, let us know about it.

The Communication Systems Division can offer you an outstanding opportunity to expand your professional horizons in the conceptual design and operations analysis of advanced command and control and communication systems.

*To investigate these opportunities, send your resume including salary history to James E. Gerraughty, GTE Sylvania, Communication Systems Division, 189 B Street, Needham, MA 02194*

An Equal Opportunity Employer M/F

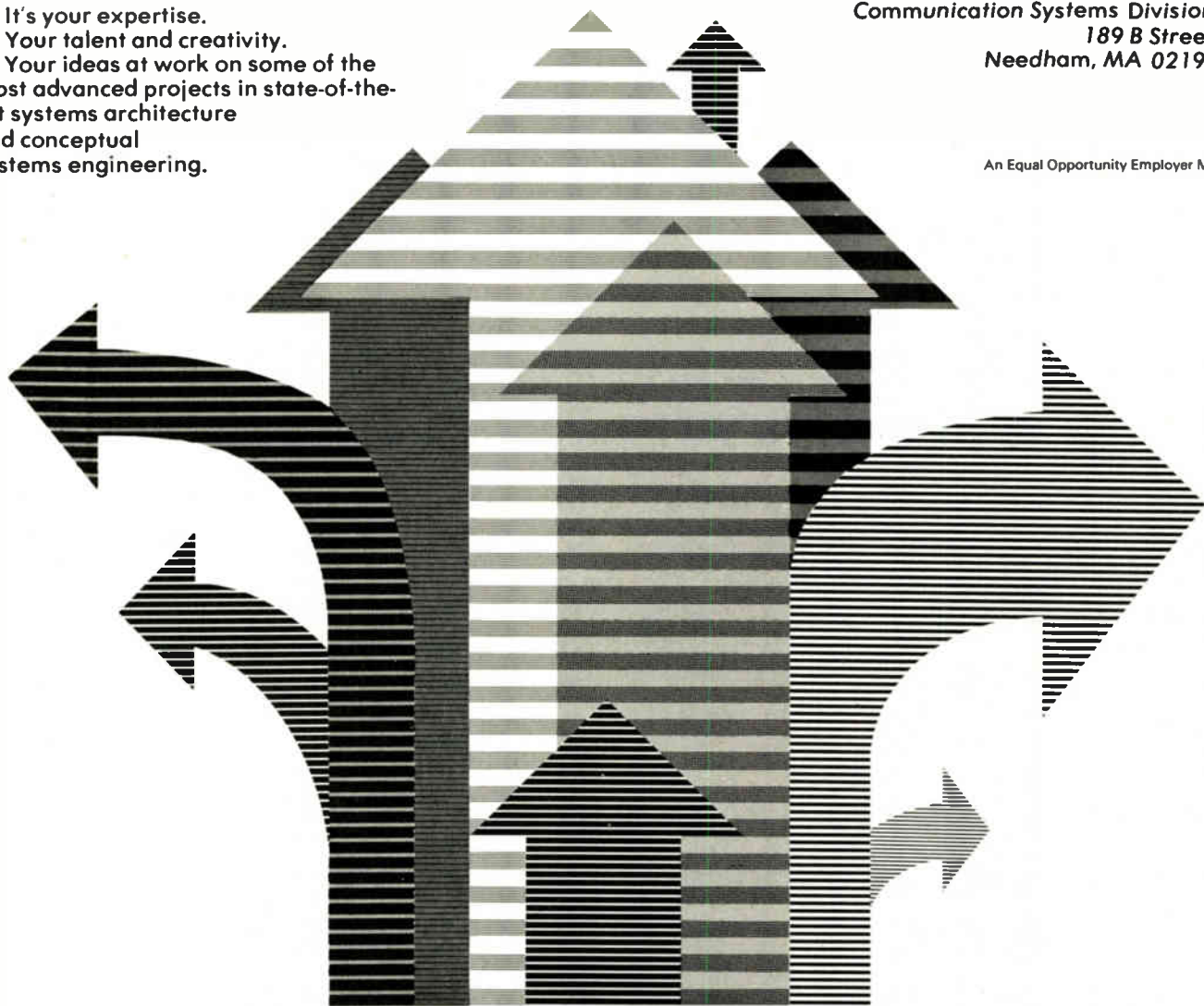

COMMUNICATION SYSTEMS DIVISION  
**GTE SYLVANIA**  
INCORPORATED

# When your design calls for the brightest readout...

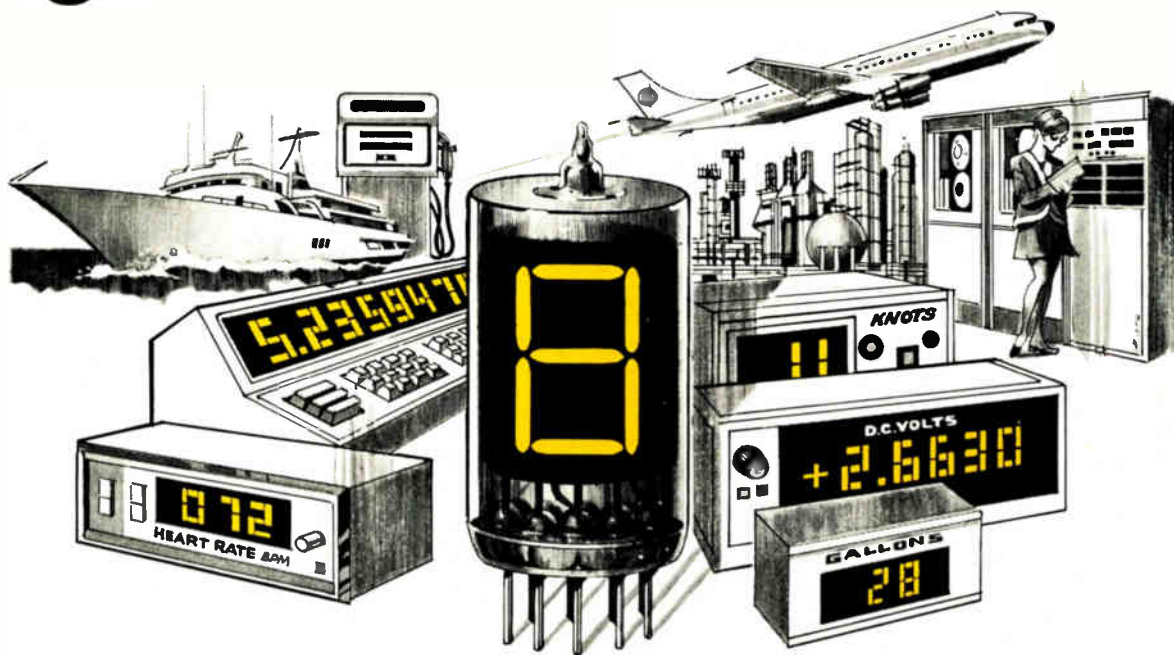

## consider all the advantages of RCA NUMITRON Display Devices.

In applications where brightness is critical RCA NUMITRON devices meet your most exacting requirements. They don't wash out, even in direct sunlight!

But brightness is just one important feature to think about when selecting display devices. Consider all the features that RCA NUMITRON devices have to offer:

- Unlimited color filter selection because of wide-spectrum light emission.
- Brightness is completely controllable — the device maintains uniform brightness, from segment-to-segment, even when operated at reduced voltages.
- High reliability and rugged construction. Life expectancy is more than 100,000 hours.
- Low-voltage operation (4.5 volts or 2.5 volts nominal).
- Compatible with IC decoder/drivers such as the RCA CD2500E family.
- Freedom from induced or radiated interference.
- Planar construction offers uncluttered,

wide-angle viewing.

- Operating temperature range from  $-50^{\circ}\text{C}$  to  $+125^{\circ}\text{C}$ .

RCA NUMITRON devices are rugged! The DR2200 Series can withstand shock of 200g and vibration of 20g max. over a 60 to 500 Hz frequency range. NUMITRON displays are flexible, too. Solderable base pins permit direct PC board mounting. The DR2000 series of devices fit low-cost 9-contact miniature sockets. DR2100 and DR2200 Series fit TO-5 10-contact sockets.

Bright, sharp, dependable — RCA NUMITRON devices offer many important performance advantages to designers of readout equipment for industrial, commercial, or military applications.

Ask for RCA's NUMITRON Display Devices Designer's brochure (NUM-421A). You'll get the latest application information and data. Contact your RCA representative or RCA NUMITRON Device Distributor, or write, RCA Commercial Engineering, Sec. 70F27 415 S. 5th St., Harrison, N.J. 07029.

**RCA** NUMITRON  
Display Devices

**“The different languages in Europe cost us a lot of money  
—I can’t guess what part of the GNP, but it’s a lot.”**

much bigger, and there’s the Buy American Act, so Americans buy American products. But we in Europe don’t have this nationalistic feeling—anyway, not in Germany—so the Americans can deliver their equipment here without difficulties. But we must compete in the world market, so our equipment must be as good as American equipment, even though we have less money to work with and fewer people.

**Quéau.** There’s a good answer for that. Since we can’t spend as much for R&D, we put in fewer components, and with less parts, our equipment can only be more reliable. But if you want to be competitive in the American market, your instrument must be cheaper because of the trade act.

*Besides small R&D budgets, language barriers are a disadvantage to EEs in Europe, even though English has become the lingua franca for technology.*

**Nollet.** In Europe, there is a problem for international projects. There’s egoism and nationalism, and the work is split up inefficiently. There’s also a lack of good communications because of the language problem.

**Quéau.** That is true maybe for governmental projects, but not for us, a multinational company. At Schlumberger, everybody had to learn English, and at Solartron [a Schlumberger company in the UK] everybody had to learn French. So both speak French and English—not very well, but they make the effort.

**Foster.** Sometimes I think it is safer for people to speak in their own language. Occasionally, we have had Telexes come from the Continent in English, and it has been very unclear what they meant.

**Bremer.** I agree that it’s a good thing to learn English and other languages so there will be no barriers between countries. But the barriers exist, and they dissipate a lot of energy. It is more or less a fiction that you don’t find in the U.S. because every man in the U.S. speaks English. The different languages in Europe cost us a lot of money—I

can’t guess what part of the GNP, but it’s a lot.

*The general topic of communications—written, as well as oral—had a further airing as the discussion turned to paperwork. Again, there was a comparison with American engineering.*

**Foster.** I think we have too much paperwork in Europe; every new development is preceded by lengthy theoretical studies, where perhaps an American firm would just go out and manufacture it—have a bash at it.

**Carey.** That’s not true. It’s just the other way around. In Europe, people jump into manufacturing and don’t do the paperwork first. In NASA and Minuteman projects in America, they started with systems management, which involves writing the specifications before you start to produce. In the past in Europe, people made something and then wrote the specifications. They haven’t said, first of all, the market wants this; but this is the specification, let’s make it.

**Quéau.** That is what you have to do first—do the paperwork. But not just any kind of paperwork—paperwork that covers the progression of a project.

**Nollet.** Objective-oriented paperwork.

**Quéau.** In my own experience, I have seen that the Americans start from the beginning because they believe they don’t have the background. We believe we have the background, and so we start somewhere about the middle of the project because we think we know. I think their approach is better than ours, for sometimes we have to start over and see how it really works.

#### **The EE’s burden**

*The majority of the engineers at the roundtable had come to Amsterdam to sit in on Eurocon ’74, organized by the Convention of National Societies of Electrical Engineers of Western Europe, together with the Institute of Electrical and Electronics Engineers’ Region 8. Eurocon ’74’s theme was “The Engineer in*

*Society,” and the panelists had a short exchange on the topic. The tapes indicate, though, that the preoccupation with day-to-day design problems outweighs concern for the sociological import of the equipment in question. Yet, as in the U.S., social consciousness is awakening as Tonio Frühauf and Robert Carey attest.*

**Frühauf.** Sometimes when we build automatic instruments, we think, but only a little bit, how they’re related to society. Because of the shortage of workers, you think of the people who will use these instruments—the operators—and you try to make them simple to use. And then you think there will be a need for only very stupid people because your instruments are so easy to operate that people don’t have to think. But this is only theoretical; it is not necessary for getting turnover.

**Carey.** We do something a little bit more practical. We make controls to replace the man who turns the wheels on machine tools, and we’ve been trying to study exactly what we’ve done. We’ve put in control features that you could say are redundant—cathode-ray tubes with nice displays so you can see what the control is doing, the possibility to talk with it through a keyboard. These things are redundant, but they are put in, really, to help the operator pass his day and keep him a little bit interested in what he’s doing. It costs money, but it seems to be worth it.

Otherwise, plant managers find that operators stay out sick, and the machines can’t run because you need a man to push the start button and put in the metal workpieces. But after he’s put in the punched tape and pushed the start button, there’s nothing for him to do but twiddle his thumbs until the piece is finished.

**Frühauf.** You think about saving money, you think about saving time, and so on, of course; but nobody thinks about sociological fallout. When engineers design television sets, nobody thinks about whether this is good or bad for their families. □

**Capacity Altimeter.** An oscillator and a pair of capacitors connected to it for varying the amplitude of oscillation, the capacity of one condenser being a function of its altitude above ground, the capacity of the other being variable. F. H. Shepard, Jr., RCA, Nov. 30, 1938. No. 2,280,725. See also No. 2,280,109 on a beat frequency altimeter, A. A. Varela, Washington, D. C., Apr 7, 1941.

**Guiding Beacon.** Guiding an aircraft by producing two overlapping radiation patterns extending over a plane in phase opposition to one another and having a common plane of polarization substantially intersecting the first

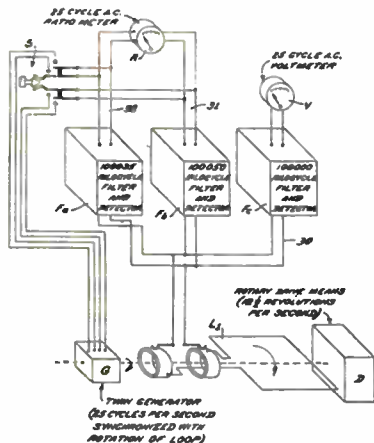

plane, receiving energy from the two patterns, and comparing the receiving energy from them to determine the first plane. A. G. Kandoian, International Tel. Development Co., Jan. 31, 1940. No. 2,280,514.

### Communication Circuits

**Noise Limiter.** Between a source of signals and a receiver is connected a non-linear impedance acting as a transfer between signal and receiver. This impedance is biased whereby the transfer means is non-conducting for signals exceeding predetermined cut-off amplitudes. Frequency selective circuits associated with the non-linear impedance vary the cut-off amplitudes as a function of the signal frequency. Charles Travis, Philco. July 27, 1939. No. 2,281,395.

**Alarm System.** In a radio telephone system for transmitting from a central station to a movable vehicle voice messages concerning how the vehicle should be manipulated, a tone generator and a microphone at the central station, with switching means so that either may be used. A person on the vehicle may detect from the failure to receive either the tone frequency or a voice message the fact that the system may be out of order. V. C. Chappell, General Railway Signal Co., Aug. 21, 1940. No. 2,280,420. See also No. 2,280,421 to Chappell.

## GENERAL CONTROL CO. NEW MASTER CAM LEVER SWITCH

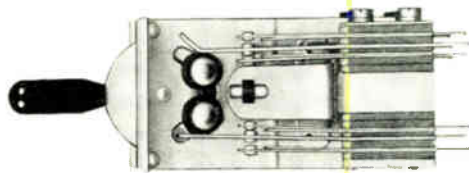

Seven years of building cam lever switches developed this new original MCL Switch featuring:

1. New single bolt assembly
2. New static shielding
3. New elimination of sliding friction
4. New all over tinned springs
5. New greater mechanical strength
6. New longer life construction
7. New gov't approved materials
8. New lower price



Fully interchangeable with your present GCL Switches. New catalog available showing complete mechanical and electrical specifications—Catalog No. MCL20

**GENERAL CONTROL CO.**  
CAMBRIDGE, MASS.



## Blackout Wanted in the drafting room!

You don't know what the word "black" means until you've put Eldorado to the test! The exclusive Typhonite process makes each of the 17 Eldorado degrees perfect, firm, opaque...gives the intensity of blackness you want! Improve your blueprints. Insist upon Typhonite ELDORADO!

Pencil Sales Department 59-J6

Joseph Dixon Crucible Co., Jersey City, N. J.

## PERMANENT MAGNETS FOR WAR USE

DELIVERY

2 to 8 weeks

depending on design and priorities.

Send us your inquiries.

**THOMAS & SKINNER STEEL PRODUCTS CO.**

1127 E. 23D ST.

INDIANAPOLIS, IND.

# We make the linear you need.

## **Only Intersil delivers them all.**

Come to us for the device you need most. We specialize in complex linears for the system design engineer, and we also make and deliver the hard-to-find alternate source devices you've been looking for.

## **Advanced proprietary devices.**

We manufacture a complete line of FET-input op amps such as the Intersil 8007, with 1 pA input current; its trimmed version (the 8007-1) with 2 mV  $V_{os}$  and 5  $\mu\text{V}/^\circ\text{C}$  drift; or our 8043, the industry's first monolithic dual FET input op amp. We make low noise op amps, high speed amps, low power amps in single, dual and triple monolithic versions.

And more! Our 8038 VCO generates sine, square, triangular, sawtooth and pulse waveforms. The 8048 and 8049 are the first monolithic log and antilog amplifiers. We make low power voltage comparators, analog multipliers, voltage regulators and other advanced linear functions.

## **Popular alternate-source devices.**

We offer a full selection of standard types such as the LM100 and LM105 voltage regulators, LM102 and LM110 voltage followers, LM101A, LM108A and UC4250 op amps, the LM111 comparator and the NE555 timer.

## **And i38510 linears.**

Data sheet linears, processed to MIL-M-38510 requirements, are immediately available through the i38510 program.

Ask for our 1974 Products Catalog, with data sheets, designer's guides, industry cross references and a complete listing of application notes. From Intersil, 10900 North Tantau Ave., Cupertino, CA 95014

## **Get 'em here. Intersil stocking distributors.**

Elmar/Liberty Electronics.  
Schweber Electronics.  
Semiconductor Specialists.  
Weatherford.

## **Intersil area sales offices.**

Boston (617) 273-2055.  
Chicago (312) 371-1440.  
Los Angeles (213) 532-3544.  
Minneapolis (612) 925-1844.  
New York (201) 567-5585.  
San Diego (714) 278-6053.  
San Francisco Bay Area  
(home office) (408) 257-5450.  
Upstate New York  
(315) 463-3368.

**Representatives in all major  
cities.**

# Intersil



# New products

## Fast 8-bit microprocessor is versatile

Rockwell's p-channel system comes with CPU chip, 256-by-8 RAM, direct-memory-access controller, and enlarged input/output chip

by Laurence Altman, Solid State Editor

The first microprocessor available as a standard product is less than two years old. But already, semiconductor manufacturers are introducing second-generation models with enlarged instruction capacities, higher speeds, and greater flexibility for an ever-expanding range of applications.

Intel and Motorola have already announced n-channel 8-bit additions to their microprocessor family [*Electronics*, April 18, p. 81]. Now, Rockwell International's Micro-electronic Device division, Anaheim, Calif., joins the club by adding an 8-bit system to its 4-bit version, already on the market. Built with p-channel technology, the PPS-8 offers more than 90 instruc-

tions, can directly address more than 16,384 bytes of read-only memory, plus a like amount of random-access memory. Complete instruction time is 4 microseconds.

The peripheral devices available are the RAM (a full 256 by 8 bits), the direct-memory-access controller (DMAC), and an expanded input/output chip, called the GPIO #2.

The microprocessor chip has somewhat the same organization as the 4-bit CPU in Rockwell's PPS-4, except that, instead of having save registers, the addresses were put directly into the first 32 addresses of RAM. This implements a 32-deep first-in, last-out stack.

Michel Ebertin, director of new-

product development at the division, points out that the PPS-8 follow-on system is constructed exactly like the PPS-4 system so the same memories and simulators can be used with both systems to give the user "instant system-upgrading." Says Ebertin, "We've kept the same bus system and the same timing, so that the same ROMs can be used with both systems; the same system simulators or assembler boxes can be used." In addition, all the input/outputs that were developed for the 4-bit system can be used in the 8-bit system because of a special instruction, called the IO4, which allows the 8-bit system to read in or out with only 4 bits.

**Flexibility.** Ebertin also points out

**One version.** Typical 8-bit parallel processing system includes microprocessor (in color), RAMs, and input/output and clock circuits.

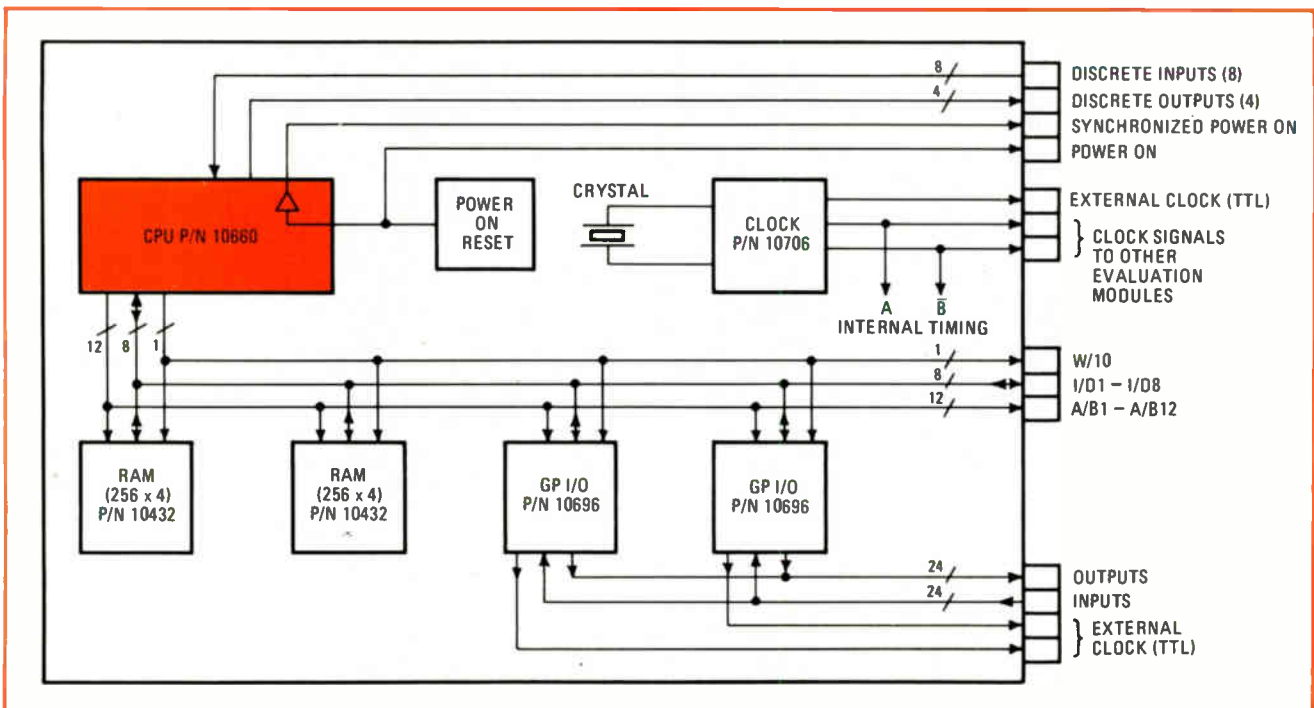

**Have it  
both ways.**

**300V complementary  
power in TO-5.  
Available now.**

**Fairchild Complementary TO-5 Power.**

	<b>NPN</b>	<b>PNP</b>
<b>40V/1A</b>	<b>2N4237</b>	<b>2N4234</b>
<b>50V/2A</b>	<b>2N5321</b>	<b>2N5323</b>
<b>60V/1A</b>	<b>2N4238</b>	<b>2N4235</b>
<b>75V/2A</b>	<b>2N5320</b>	<b>2N5322</b>
<b>80V/1A</b>	<b>2N4239</b>	<b>2N4236</b>
<b>100V/1A</b>	<b>2N5681</b>	<b>2N5679</b>
<b>120V/1A</b>	<b>2N5682</b>	<b>2N5680</b>
<b>200V/1A</b>	<b>2N3440</b>	<b>FT5415</b>
<b>300V/1A</b>	<b>2N3439</b>	<b>FT5416</b>

## New products

that the 8-bit system is designed so that most of its 90 basic instructions are modifiable for maximum flexibility. Says Ebertin, "We've included the capability for packed binary [-coded] decimal logic, so that in a sophisticated high-speed decimal machine, the speed of calculations can be doubled because now, one add-time calculates two digits, rather than one." What's more, the system has three levels of priority built in, as well as, via the new I/O devices, a daisy-chain priority group that allows the user to generate an additional eight levels of instruction on the third-level priority. And the DMAC is so constituted that burst data can be transferred in and out of the memory chips at the full clock rate.

Responsible for the high throughput rate is a multiplexing system. While the memory-access time in each case is 2  $\mu$ s and an instruction cycle takes 4  $\mu$ s, a full decimal addition or subtraction requires only three instruction cycles, or 12  $\mu$ s. Byte manipulation—moving a byte from one spot to another—also takes only 12  $\mu$ s, and a table search takes 12  $\mu$ s. Burst data is transferred at the full clock rate of 4  $\mu$ s per byte.

The new I/O circuitry, the GPIO #2, was developed to work directly with the CPU chip. The GPIO #2 actually does a lot of preprocessing. It has two 10-bit-port receiver/drivers, which, when +5 and -12-volt supplies are used, become fully TTL-compatible. The GPIO #2 receives commands from the CPU, which are stored in two function registers. These command the input/output ports, telling the device whether to copy and send the commands to the CPU, send them out either in parallel form or in serial form, or store the data in the CPU registers.

This flexibility is advantageous, for instance, in a point-of-sale terminal, where, as part of the operating sequences, one looks for a unique key depression or 8-bit character. Normally, this operation would have to be done in software and interleaved with other parts of the program. Now, with the GPIO #2, the user can detect it right in

the I/O device, which will ignore all codes coming in except the one that matches. Once the detection is made, an interrupt is sent to the CPU, which then takes up the remaining task. This allows the device to accommodate more functions than were possible in the 4-bit system.

The DMAC circuit operates on command from the I/O device that emits a signal freezing the CPU; that is, all of its drivers on the data line and on the address line float, which puts the CPU in a "halt" mode. Then the DMAC's RAM address lines become active, and the I/O devices can start sending or receiving information at full clock rate into and out of the memory.

**Coming.** Other peripheral devices at the conceptual stage for the PPS-8 system are a floppy-disk controller, a CRT controller, and a programmable I/O device. The programmable I/O points to a complete processing system—RAM, ROM, CPU, clock, and I/O—on one chip. By allowing the I/O device to be microprogrammed, the I/O function can be reduced to a one-chip device, and each customer could generate his own microprograms for it. But Ebertin says the p-channel process would have to be shelved because its devices are too large to accommodate this design, so a programmable I/O device will probably be fabricated on a sapphire substrate. But Ebertin predicts that the programmable I/O will be available by the early spring of 1975.

As for design aids, Ebertin points out: "Rockwell is on the General Electric and Tymshare systems, which allow full assembly simulators. This lets a user do his own program-generation and program-verification in basic machine language. In addition, we have some evaluation modules for the 4-bit system already available."

Also being designed is a new ROM loader, to be used with an electrically alterable ROM. These devices are scheduled to be available in the fall of 1974.

Microelectronic Device Division, Rockwell International, P.O. Box 3669, 3430 Miraloma Ave., Anaheim, Calif. 92803 [338]

You want it, Fairchild has it.  
*Both NPN and PNP 300V  
power in TO-5.*

Available in quantity right  
from the shelf of your friendly  
Fairchild Distributor.

So give him a call today.

And while you're at it, ask  
about our complete line of complementary TO-5 devices. Plus  
our high-current TO-5 hammer  
and relay drivers, 2N5536-39  
and 2N4895-97.

For complementary TO-5  
power, the source is Fairchild.

**MADE IN  
FAIRCHILD**

Semiconductor Components Group, Fairchild Camera  
& Instrument Corp., 464 Ellis St., Mountain View, CA 94040.  
Telephone (415) 962-5011. TWX: 910-379-6435.



# if it's a meter or meter relay,

Stock or Special...

# Simpson

## makes it.



### Stock:

Simpson distributors nationwide stock over 1,500 types, ranges, styles and sizes of panel meters, relays and controllers. They're all listed in Catalog 4200. Write for your free copy.

### Special:

Need a special or unusual meter? Let Simpson help you custom design it. Send us your specs and we'll send you a quote. But check our catalog first—that "special" may be a standard Simpson stock item.

*Get off-the-shelf delivery from your local electronics distributor.*



**SIMPSON ELECTRIC COMPANY**  
853 Dundee Avenue, Elgin, Illinois 60120  
(312) 695-1121 • Cable: SIMELCO • Telex: 72-2416

IN CANADA: Bach-Simpson, Ltd., London, Ontario  
IN ENGLAND: Bach-Simpson (U.K.) Limited, Wadebridge, Cornwall  
IN INDIA: Ruttonsha-Simpson Private, Ltd., Vikhroli, Bombay



Semiconductors

## Drivers offer more protection

---

Standard interface circuits' breakdown voltage is nearly tripled at 80 volts

---

Since its introduction several years ago by Texas Instruments, the 7545 family of interface-driver circuits has been an industry standard, produced by several manufacturers. Now, as the initial step of expanding its efforts in interface circuits, National Semiconductor Corp. has developed a high-voltage version, called the LM3611-3614 dual peripheral driver. This device will be followed by at least eight new interface product lines, says Stephen Fields, interface-marketing manager at National.

The principal difference between new driver circuit and the TI version is its breakdown voltage—80 volts, compared to 30 v for the standard 7545 models—thus providing added voltage protection against on-line spikes. The advantages of the 7545 series are high speed—25 to 30 nanoseconds—and a high sink-current capability—up to 300 milliamperes on each output.

The circuitry is simple: two gates drive two power transistors. The four models in the series are for the AND, NAND, NOR, and OR logic on the gate. The output emitters are tied to ground so that through either one of the two collectors it is possible to sink up to 300 mA.

The speed of the devices makes them useful as drivers in data processing and in memory devices, but other applications soon became apparent. Since they are so compact and have output breakdown voltages of about 30 v, it was found that these interface circuits can drive lamps, solenoids and relays.

But designers soon found out—and users did, too—that if a relay or solenoid were driven by one of these devices, there were often unpredict-

able inductive spikes, or kicks, higher than 30 v that would latch up and blow the outputs.

In addition, the high speeds of the device often complicated the designs for slow-speed applications, such as in relays and lamps, which don't operate well when driven with a 20-nanosecond edge. After about a year of design and production work, National is introducing the LM3611 series, designed for those applications where a higher breakdown voltage is required than that provided by its LM7545 series. To achieve the high voltage breakdown, National has applied the linear process that it uses with its high-voltage display-driver circuits. Characteristics of this process include high epitaxial resistance and substitution of another metal for gold.

"In essence, we have traded speed for an increase in output voltage breakdown," says Fields. "The breakdown voltage at 80 v is almost triple that of the earlier series." All other specifications are the same, except that the LM3611 series is slower by design, at 120 to 130 nanoseconds.

"They are pin-for-pin compatible with the 7545 series, with the same output sink capability of 300 mA," he adds. The price of the LM3611 series is \$1.90 each in quantities of 100, compared to \$1 each for the LM7545 series in similar quantities. In volume quantities, says Fields, the price is significantly lower for the LM3611. "One reason for the higher price is that this device needs a much more complex process to get the higher breakdown voltages," he adds.

National Semiconductor Corp., 2900 Semiconductor Drive, Santa Clara, Calif. 95051 [411]

---

## Stabistor diodes come in miniature glass packages

A line of 50 stabistors—diffused-silicon zener diodes with controlled forward-voltage characteristics—are packaged in subminiature glass housings. They are designed for a

broad range of circuits where stable, low-voltage references are required, including voltage-regulation, voltage-sensing, meter and relay protection, and computer circuits. The diodes are manufactured in double-plug packages, with silicon dice bonded to the ends of the plugs. Reference voltages are from 0.560 v to 3.700 v, and tolerances are typically  $\pm 5\%$ . Prices for the units, which come in DO-35 glass packages, start at 10 cents each in quantities of 25,000.

American Power Devices Inc., 7 Andover St., Andover, Mass. 01810 [414]

---

## Counter and timer circuits added to C-MOS products

A flexible 24-stage binary timer and a real-time five-decade counter have been added to the Motorola C-MOS family. Capable of counting from 1 to  $2^{24}$ , the MC14536 programmable timer consists of 24 counters, the last six stages of which are selectable by a 4-bit code. Varying the timer's input clock frequency provides a wide variety of intervals, while additional versatility is achieved with an on-chip oscillator, a monostable multivibrator output, and an internal clock-conditioning circuit with long rise and fall times. The second addition to the line, a decade counter designated the MC14534, counts events in real time and can be used to update multiplexed displays. The MC14534 contains five decade counters that have their outputs time-multiplexed by an internal scanner. The counters and scanner can be reset independently. The

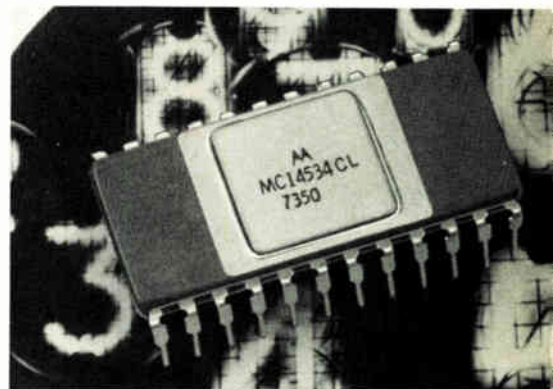

# Plenco indicated here.

To help resist corrosion, protect gauge life.

MARSH INSTRUMENT COMPANY, Skokie, Ill., a Unit of General Signal, manufactures process pressure gauges, including this new model—oil filled to dampen the damaging effects of pulsation and vibration.

The gauges must withstand severe corrosion, be resistant to the most punishing working conditions of pumps, compressors, hydraulic presses, off-shore pipelines and other heavy-duty equipment.

To Marsh and the molder, General Die Mold, Niles, Ill., this meant (among other special features) instrument cases molded of Plenco 512 Phenolic. A general-purpose compound, our 512 Black offers an excellent balance of physical and electrical properties plus resistance to the dampening fluids.

If you are under pressure to make your materials specifications measure up to requirements, indications may point to Plenco. They often do.

For an ever-increasing variety of fine companies.

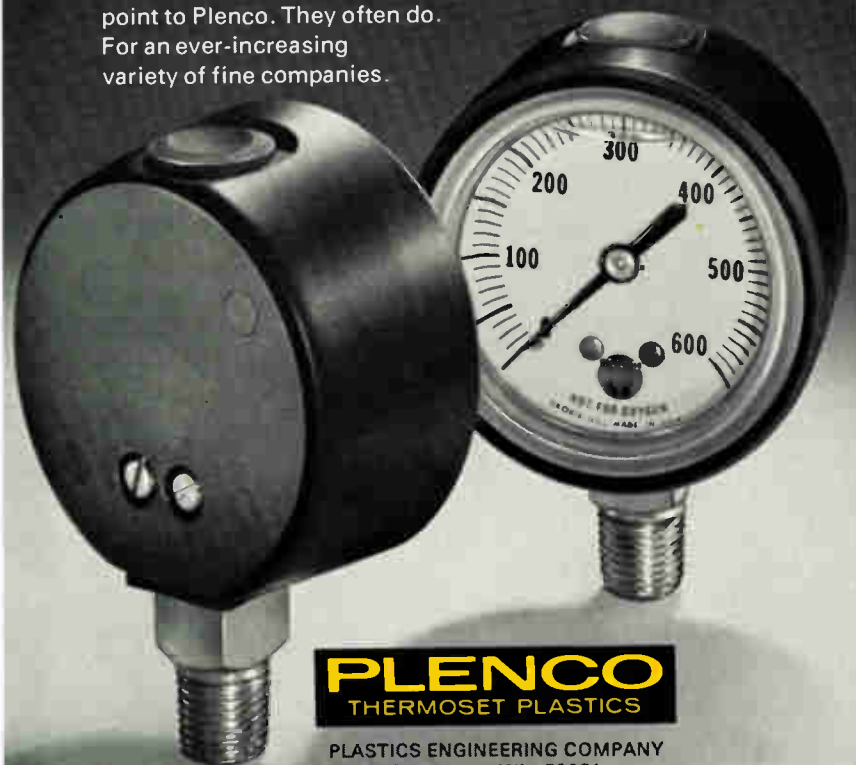

**PLENCO**  
THERMOSET PLASTICS

PLASTICS ENGINEERING COMPANY  
Sheboygan, Wis. 53081

Through Plenco research . . . a wide range of ready-made or custom-formulated phenolic, melamine and alkyd thermoset molding compounds, and industrial resins.

## New products

MC14534 can be used for continuous-counting displays or as an event counter in industrial control. Model CL, with a temperature specification of  $-40^{\circ}$  to  $+85^{\circ}\text{C}$ , is priced at \$21.83 each in 100-lots; and type L,  $-55^{\circ}$  to  $+125^{\circ}\text{C}$ , at \$39.29 each.

Motorola Semiconductor Products Inc., Box 20912, Phoenix, Ariz. 85036 [415]

Green LEDs dissipate  
112 milliwatts of power

For designers requiring a light-emitting-diode lamp for panel lighting, film-annotation, circuit-status indication, alphanumeric display or visual indication, the 521-9206 series

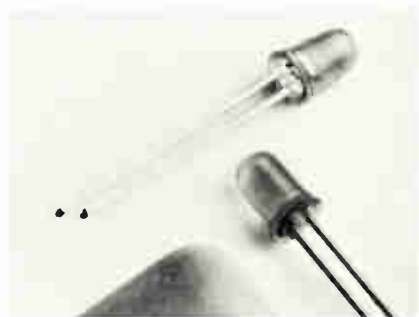

provides axial leads flexible enough for bending and rigid enough for direct mounting to a printed-circuit board. Moreover, the lamp also provides a wide viewing angle, life measured in years, and low power consumption, making it compatible with integrated circuits. Maximum ratings for the lamp include: power dissipation of 112 mw, linear derating from  $25^{\circ}\text{C}$  at  $1.49\text{ mw}/^{\circ}\text{C}$ , continuous forward current of 40 mA, peak pulse current of 1 A at  $1\text{ }\mu\text{s}$  pulse and 1% duty cycle, and peak reverse voltage of 5 v. Price is 55 cents each in 100-lots.

Dialight, 203 Harrison Pl., Brooklyn, N.Y. 11237 [416]

Diodes rated at 8–12 kV  
are small in size, cost

A manufacturing technique that permits the molding of 8- to 12-kilovolt miniaturized silicon diodes with



# TURN OVER A NEW LEAF

## 35 CMOS types ready for shipment by August

How do you evaluate a new semiconductor supplier? Usually you check the breadth and usefulness of his product line, the technical adequacy of his facility and staff, and his ability to design and deliver custom circuits when "standards" won't do the job in your application.

Here are Siltek's credentials:

We have a broad and growing line of the popular 4000-series CMOS circuits. Several types are available now, and we'll be offering 35 or more by August.

Our facility was designed, built and equipped exclusively for the manufacture of CMOS devices.

Our management team has a successful track record of both high-volume manufacture and custom circuit development with several U.S. companies. Take a closer look at our credentials; write today for specifications.

### SILTEK INTERNATIONAL LIMITED

Industrial Park  
Bromont, Quebec, Canada  
Phone (514) 534-2255  
TWX: 610-532-6566

- Please send me the specification sheet describing your CMOS Circuits.
- Please have a representative contact me

Name \_\_\_\_\_ Title \_\_\_\_\_

Company \_\_\_\_\_

City \_\_\_\_\_ State \_\_\_\_\_ Zip \_\_\_\_\_

Telephone \_\_\_\_\_

# **SILTEK**

# Problem solving... with Victoreen High Voltage Technology

## 1 UNORTHODOX CRT DRIVE

How did we meet ever-expanding requirements for increased bandwidth and lower power consumption, coupled with the availability of high-voltage zener-type diodes (Victoreen Corotrons)? With an unorthodox drive scheme for CRT's.

Instead of supplying the CRT anode with very high voltage, we ground the anode and supply a drive signal, riding at approximately —1800 volts, to the grid. The advantages? Being direct-coupled there are no reactive components to limit high-end frequency response or cause roll-off at the low end.

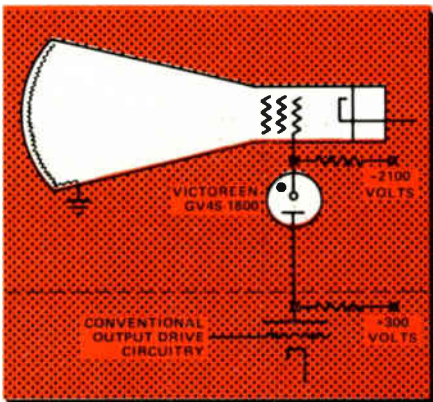

Even though the Corotron operates in the corona mode of discharge, it has no voltage jumps or jitters. Corotrons are not tied to "natural" operating voltages and are adjustable in manufacture from 350 to 30,000 volts.

## 2 FROG MUSCLES TO BRAIN WAVES

Colleges and universities, medical research laboratories and R&D firms need amplification of low level signals. Such signals are derived from frog-muscle experiments, brain-wave measurements, cardiac research, avalanche-breakdown, currents in ionization chambers as well as from a range of constant-current sources.

Victoreen MINI-MOX resistors are used widely to modify op-amp characteristics to:

1. Stabilize output and eliminate oscillation.
2. Define gain so measurements can be quantified.
3. Restrict bandwidth to the region of specific interest.

They typically have a voltage coefficient of —5 ppm/volt, full-load drift of less than 2% in 1000 hours, temperature coefficient of 30

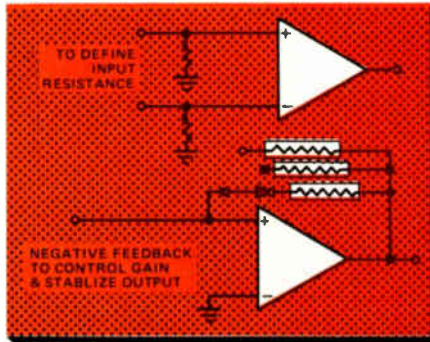

ppm, and a Quantech noise of less than 1.5 V/volt at 20M ohms. They are available in values from 100K to 10,000M ohms in 1, 2, 5 and 10% tolerances.

## 3 A PROBE FOR HIGH POTENTIAL

Two Victoreen MAXI-MOX resistors used in series can serve as a probe in radar circuitry capable of measuring voltages up to 60,000 volts. The probe, compatible with a number of voltmeters of different manufacture, has both short- and long-term stability. Short-term stability assures negligible drift and fluctuation during measurement, while long-term stability maintains the original calibration accuracy of the probe.

Each MOX-5 resistor used in the probe has a maximum operating voltage of 37,500 volts with a power rating of 12½ watts. The voltage coefficient is 1 ppm/volt over the complete voltage range of the MOX-5, while the temperature coefficient is better than 300 ppm for —55° to 125°C.

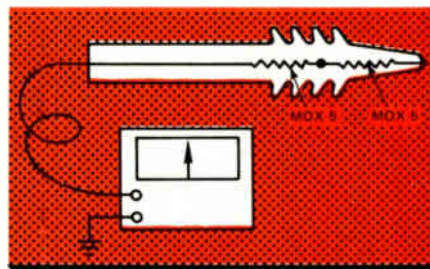

MAXI-MOX resistors have full-load drift less than 1% in 2000 hours of operation, and are available in tolerances of 1, 2, and 5% in values from 10K to 2,500M ohms. A silicone varnish conformal coating provides environmental protection while allowing a maximum hot-spot temperature of 220°C.

## New products

short silver leads also permits them to be sold for a relatively low price—\$1.70 each in quantities of 1,000. Electrical ratings of the new line are: model AM, 8 kv peak inverse voltage, 125 milliamperes; model AP, 10 kv, 100 mA; and model AR, 12 kv, 80 mA. Standard and fast-recovery types are available. The units

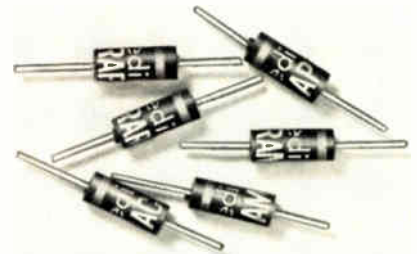

measure 0.380 inch long by 0.160 in. in diameter, with leads 0.030 in. in diameter that are 0.375 in. long. The diode junctions are said to display avalanche characteristics, high surge capabilities, and low leakage. Delivery is from stock.

Electrical Devices Inc., 21 Gray Oaks Ave., Yonkers, N.Y. 10710 [417]

## Dual-channel opto-isolator permits high densities

A pair of inverting optically isolated gates, each with a light-emitting diode and a integrated detector, is now available in a single package. This dual-channel configuration makes higher-density packaging possible. The photons are collected in the detector by a photodiode, then amplified by a high-gain linear amplifier that drives a Schottky-clamped open-collector output transistor. Delay times of 50 nanoseconds can be obtained with this high-speed integrated photon detector. Maximum dc and ac circuit-isolation between each input and output is maintained while DTL/TTL compatibility is achieved. The model 5082-4364 dual isolator is designed for use in high-speed digital applications where common-mode signals must be rejected. Typical applications include use as a line receiver and digital programming of

Victoreen Instrument Division  
of VLN Corp.  
10101 Woodland Avenue  
Cleveland, Ohio 44104



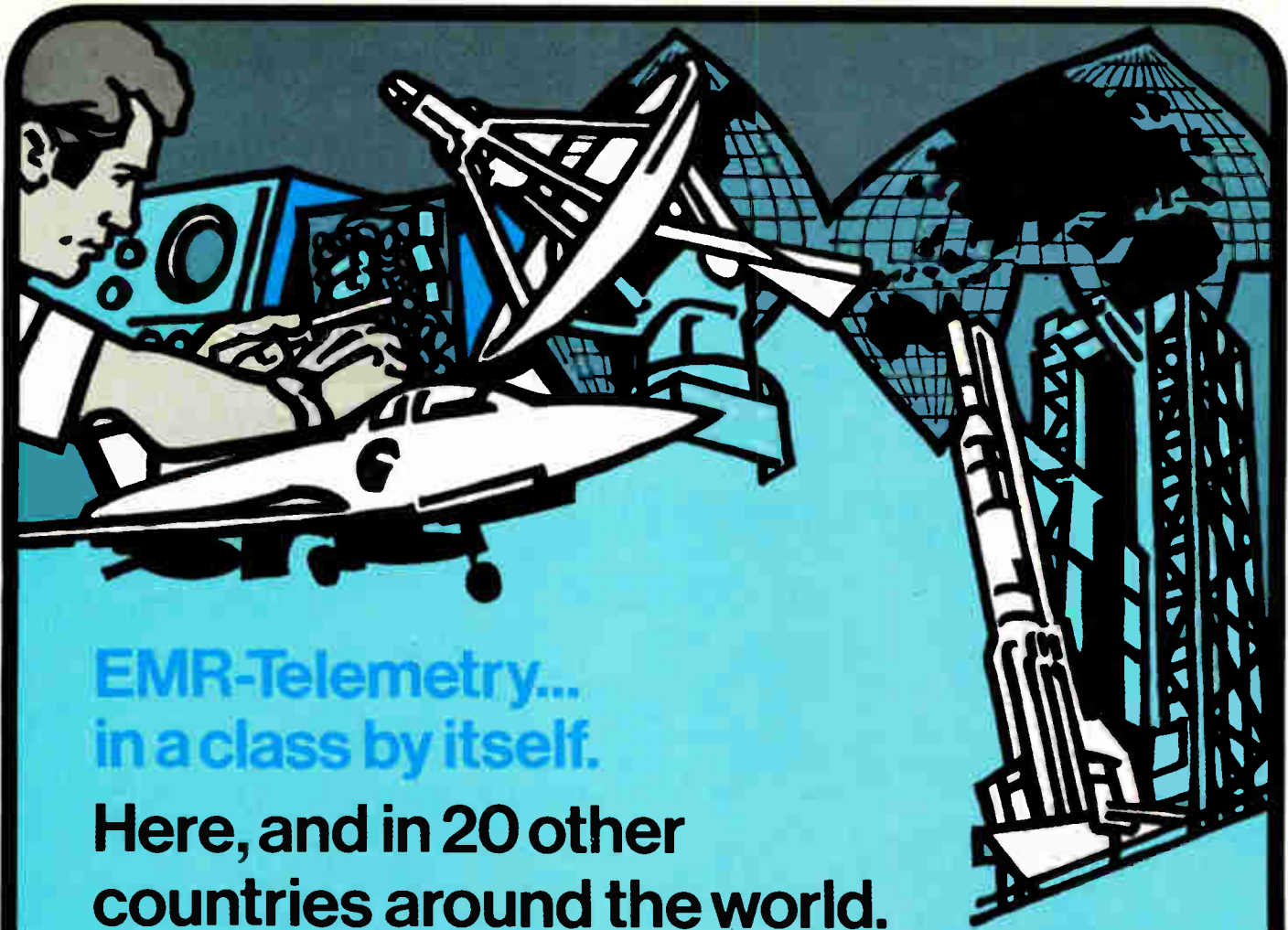

**EMR-Telemetry...  
in a class by itself.**

**Here, and in 20 other  
countries around the world.**

When you're good at what you do, your reputation spreads world wide. But, excellence in system design and total product breadth isn't enough when you're selling turnkey systems.

It takes installation know-how, software expertise, customer training, and an attitude that says . . . we care now, and will care in the future about your changing needs.

EMR customers respond to this philosophy with enthusiasm. We don't just sell hardware . . . we're there when you need us, world wide. They know it at the National Space Agency in Japan, at the India Aeronautical Development Establishment, and at every key data gathering station around the globe.

#### **Japan Space Program . . .**

By 1976, the Japanese National Space Development Agency expects to launch a variety of communication and scientific satellites. EMR will supply both frequency and time division multiplex ground stations for use at several stages of the program: for experimenters to check out their scientific and communications packages; for functional tests of each stage of the rocket boosters; and for a complete checkout and monitoring system in the blockhouse at the launch site.

#### **India Aircraft Flight Test Program . . .**

The India Aeronautical Development Establishment is using an EMR ground telemetry Data Readout Station consisting of a quick-look, van-mounted, checkout system coupled with a large FM-PAM/PDM and PCM computerized telemetry system. Real-time flight testing of aircraft will be accomplished with this facility.

**When can we help  
with your data  
gathering needs?**

**EMR** 

EMR Telemetry  
Weston Instruments, Inc.  
Box 3041, Sarasota, Florida 33578  
813-371-0811

# New DECADE AMPLIFIER MODEL 220



A highly stable amplifier giving gains of exactly 10 and 100 times. Operated by self-contained batteries. Through the use of special circuits the gain is independent of battery voltage, circuit constants and tubes within 2% from 10 to 100,000 cycles. Particularly useful with our Model 300 Electronic Voltmeter to increase its sensitivity, permitting voltage measurements down to 30 microvolts. Send for Bulletin 7.

## SENSITIVE ELECTRONIC AC VOLTMETER

MODEL 300

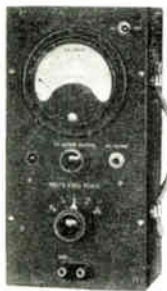

10 to 150,000 cycles.

1 millivolt to 100 volts in five ranges (to 1,000 and 10,000 volts with multipliers).

Logarithmic voltage scale.

AC operation, 115 volts, 60 cycles.

Accurate and stable calibration.

Ballantine Laboratories, Inc.

BOONTON

NEW JERSEY

**Voltage Bridge.** In a radio receiver in which there is a conductive connection between the power lines and the anode circuits of the tubes, a metal housing or chassis supports the receiver components and a means is provided for a lower impedance r-f path between the conductive connection and the chassis. Stray capacitance between the chassis and a high potential r-f portion of the receiver causes undesired currents to flow in the low impedance path. An impedance between the chassis and the r-f portion of the receiver causes equal and opposite currents to flow in the path, thereby preventing r-f voltages across the low impedance path. E. C. Freeland, Philco, Nov. 16, 1940. No. 2,281,488.

**Relay Circuit.** A rectified reaction tube circuit comprising a multigrad tube, a feedback circuit and a condenser in the feedback circuit for controlling the relation between the characteristic curve of anode current with respect to input to the circuit on increasing input and the characteristic curve for decreasing input. R. M. Kalb, BTL, Inc. April 26, 1941. No. 2,281,040.

**Voltage Compensator.** Circuit for compensating variations in voltage on

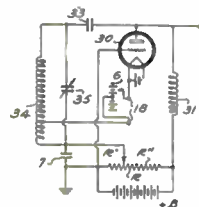

an r-f oscillator. R. E. Schock, RCA. August 20, 1938. No. 2,281,205.

**Relay Circuit.** In a telegraph system, two lines with means for impressing code telegraph signals on one of the lines and a thermionic repeater for relaying the signals to the other line. L. W. Franklin, Western Union Tel. Co., No. 2,280,308, Dec. 3, 1938.

**Variable Band-Pass Receiver.** A band-pass selector of adjustable bandwidth having a mean resonant frequency normally bearing a predetermined relation to the mean frequency of the carrier, the relation between the mean frequencies being subject to deviations which may be substantial as compared with the bandwidth of the signal, the selector initially having a pass band sufficiently wide to include the signal and the deviations, and means responsive to the mean frequency of the carrier signal for reducing deviations substantially to maintain said normal predetermined relation, and means for contracting the pass band of the selector in response to the translation of a carrier signal. H. A. Wheeler, Hazeltine Corp., Jan. 23, 1941. No. 2,280,139. See also No. 2,280,187 to N. P. Case, Hazeltine, July 10, 1940, on a system

# VARFLEX

*insulating tubing and sleeving has been specified for critical applications for twenty years.*

VARFLEX pioneered and developed treated FIBERGLAS tubing and sleeving.

VARFLEX varnished tubing has always been recognized for its high quality.

SYNTHOLVAR extruded electrical tubing is furnished in proven and recognized formulations.

VARFLEX is the only manufacturer with a complete line of insulating tubing and sleeving.

**VARFLEX CORPORATION**

Rome, N. Y.

## What Makes a Mailing Click?

Advertising men agree . . . the list is more than half the story. McGraw-Hill Mailing Lists, used by leading manufacturers and industrial service organizations, direct your advertising and sales promotional efforts to key purchasing power.

In view of present day difficulties in maintaining your own mailing lists, this efficient personalized service is particularly important in securing the comprehensive market coverage you need and want. Investigate today.

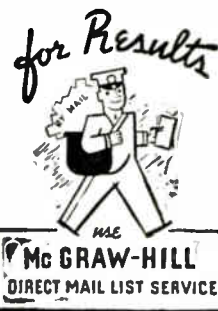

McGraw-Hill Publishing Co., Inc.

DIRECT MAIL DIVISION

330 West 42nd St., New York, N. Y.

# If you're getting this

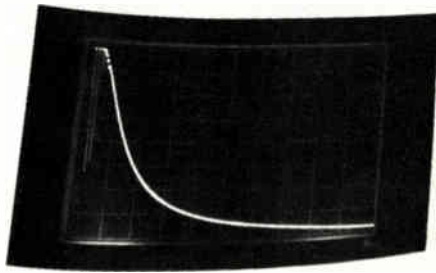

# when you want this

# or this

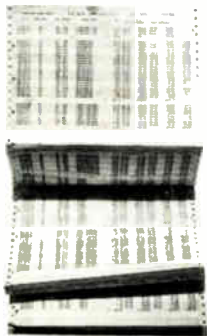

# or this

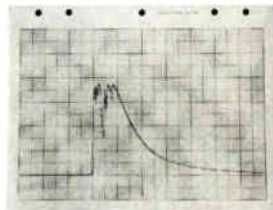

# then you need us.

Biomation waveform recorders perform a function that no other instrument can do: they capture important one-time analog (waveform) information, translate it into easily stored digital form, and hold it in memory until you want to study it.

You can then take this record and input it as a repetitive signal into your oscilloscope for visual inspection.

Or feed it into a digital computer for signal averaging, programmed analysis—even to perform closed-loop feed-back control operations.

Or play it out onto a strip chart recorder—to whatever time-base suits your needs.

The old faithful scope face snapshot just won't do the job any more, particularly where the events being studied are one-time occurrences and where pre-trigger data is useful to your work.

Please write and ask us for more information on the full line of Biomation recorders. It won't all fit on this page. But we assure you that if you're not now getting the record you need, a Biomation waveform recorder in your system will make it available. Write or call Biomation, 10411 Bubb Road, Cupertino, CA 95014, (408) 255-9500. Or circle the Reader Service number.

# biomation

## New products

floating power supplies, motors, and machine-control systems. Ground loops between system interfaces, such as a computer and peripherals, can be eliminated. Price is \$9.90 each in 100-lots.

Hewlett-Packard Co., 1501 Page Mill Rd., Palo Alto, Calif. 94304 [418]

### C-MOS dividers produce time base from line

Three C-MOS dividers, called the RED Series, provide high noise immunity and generate a time base from either 50-hertz or 60-Hz power lines. Depending on the type used, repetition rates of 10 pulses per second, 1 pulse per second, or 1 pulse per minute are generated. Selection of division for 50 Hz/60 Hz operation is determined by externally connecting the mode-select terminal to either the supply voltage or ground. All divider types have an input-enable that, when held at ground, will disable counting of input pulses and will hold count until input-enable is returned to the supply voltage. Applying a positive voltage to the reset input will clear all divider stages to zero count. The dividers are typically used where line-frequency accuracy is adequate for generating pulses for use in time-keeping circuits, i.e. digital or analog clocks. They can also be used where timing pulses are required for controlling instruments, time-delay circuits, counters, and general-pur-

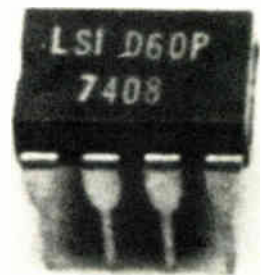

pose industrial controls. Price is \$5.90 in 100-lots.

LSI Computer Systems Inc., 22 Cain Dr., Plainview, N.Y. 11803 [420]



# “Scotchflex” Flat Cable Connector System makes 50 connections at a time.



“SCOTCHFLEX” IS A REGISTERED TRADEMARK OF 3M CO.

Build assembly cost savings into your electronics package with “Scotchflex” flat cable and connectors. These fast, simple systems make simultaneous multiple connections in seconds without stripping or soldering. Equipment investment is minimal; there’s no need for special training. The inexpensive assembly press, shown above, crimps connections tightly, operates easily and assures error free wiring.

Reliability is built in, too, with “Scotchflex” interconnects. Inside of connector bodies, unique U-contacts strip through flat cable insulation, grip each conductor for dependable gas-tight connections.

“Scotchflex” offers you design freedom, with a wide choice of cable and connectors. From off-the-shelf stock you can choose: 14 to 50-conductor cables. Connectors to interface with standard DIP sockets, wrap posts on standard grid patterns, printed circuit boards. Headers for de-pluggable connection between cable jumpers and PCB. Custom assemblies are also available on request.

For more information, write Dept. EAH-1, 3M Center, St. Paul, Minn. 55101.

**“Scotchflex” Your  
systems approach  
to circuitry.**



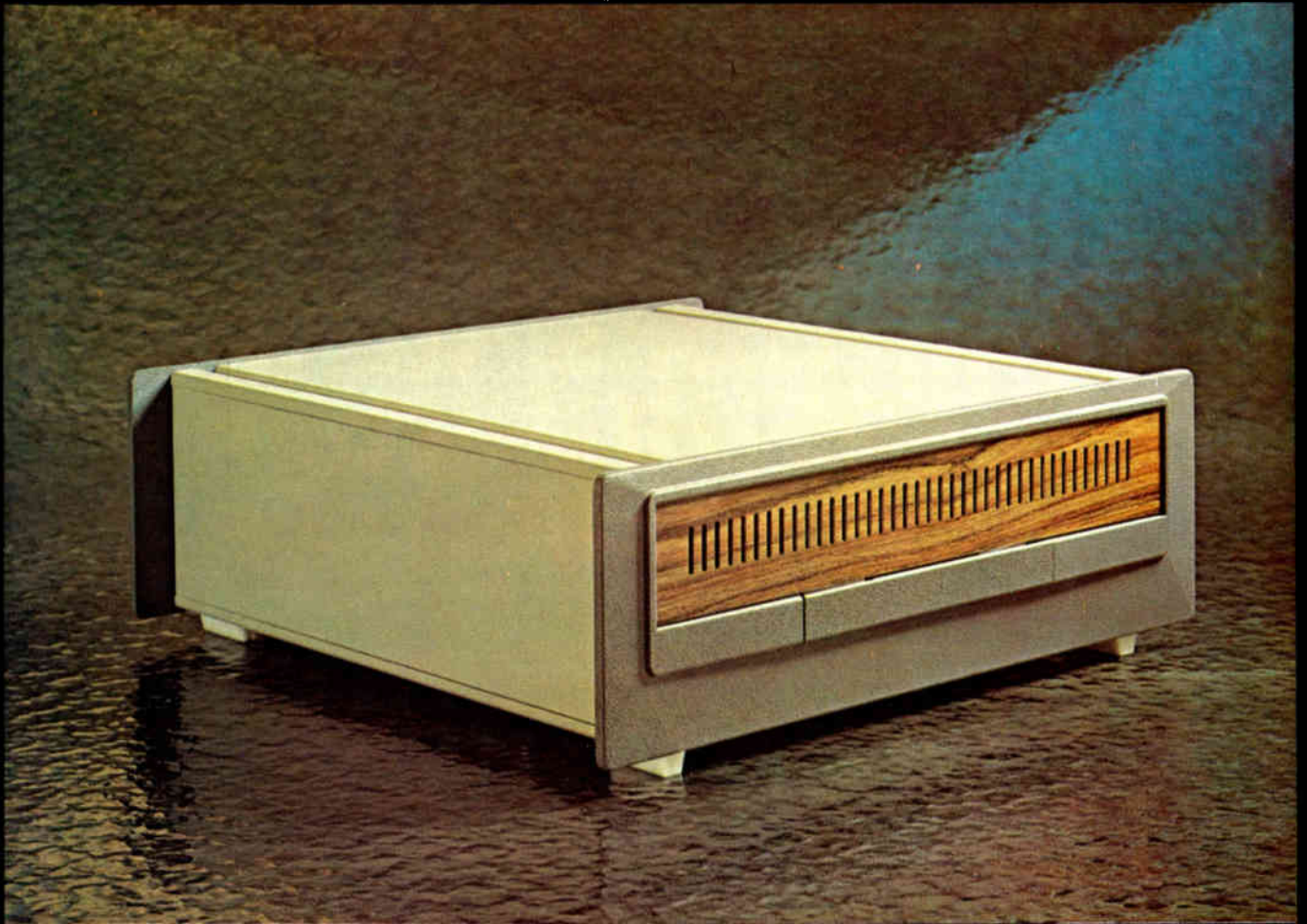

## ***The Optima Experience***

The Optima experience—it's colorful, stylish and now a great new way to package your electronics. We call it OptimaPAK. There is nothing like this case on the market today. Molded sculptured sides with handles neatly designed in... easily removed top and bottom panels and that's not all. The front and rear panels are part of a chassis assembly that slides right out of the front of the case or you may just want to mount it in a rack. We are eager to tell you all about OptimaPAK and share the Optima experience right now.

# **OPTIMA** pak

Write Optima Enclosures, a division of Scientific-Atlanta, Inc.  
2166 Mountain Industrial Blvd., Tucker, Georgia 30084 or call (404) 939-6340.

Other Scientific-Atlanta, Inc. divisions are • Cable Communications • Instrumentation • ElectroSystems • Southern Tool and Machine • Security

Circle 160 on reader service card

Instruments

## Pulser aims at high-speed logic

Generator offers risetime variable down to 1 ns; is near-perfect 50-ohm source

Putting emitter-coupled logic to work has top priority with engineers seeking faster switching times, but testing such circuits—with transition times of about a nanosecond—challenges the state of the art in waveform sources. So Hewlett-Packard's variable-transition pulse generator, with rise times in the 1-ns vicinity and repetition rates as high as 250 megahertz, is a welcome arrival.

What makes a variable-transition-time pulse generator so valuable is the fact that the propagation delay of an ECL device depends on transition time of the driving pulse. So it is important to apply pulses with specified transition times to check performance. Secondly, it is frequently necessary to measure component behavior within a circuit. With rise and fall times variable from 1 ns to 0.5 millisecond, the H-P 8082A can deliver the necessary pulse with the shape and transition times required. Pulse linearity is 5% or better for transition times of 5 ns or more.

Equally important to pulse shape and transition time is the source impedance. The 8082A is an excellent 50-ohm source, so that it may be connected directly to ECL circuits

without a terminating resistor and with little degradation of the pulse shape. Since the reflection coefficient is a mere 2%, the generator absorbs 98% of any reflected wave.

Two BNC connectors provide complementary outputs. Two companion switches invert the outputs at the ports and switch signal excursions positive or negative. Both amplitudes and offsets at the output ports are variable, however, but setting the amplitude controls to ECL defeats the various controls and produces standard ECL voltage levels,  $-0.9$  v and  $-1.7$  v. Dc offset may be varied over  $\pm 2$  v, pulse delay from 2 ns to 0.5 ms, and pulse width from 2 ns to 0.5 ms. Pulse period, delay, and width jitter is less than 0.1% of setting plus 50 picoseconds.

H-P engineers have simplified panel layout by placing pulse period, width and delay slide controls one above the other so as to avoid incompatible settings. The user need do no more than keep the width and delay controls to the left of the period control to assure meaningful settings.

An unusual feature is a copper heat pipe which conducts heat from heat-producing components to a heat sink at the rear of the cabinet. Thus no forced-air moving device is necessary, the acoustic noise is gone, and so too are the narrow power-line frequency constraints imposed by a forced-air cooling device. Thus the pulse generator operates over an unusually broad power-line frequency range—48 to 440 hertz. Line voltage source levels are switch-selectable—100, 120, 220 and 240 volts.

The model 8082A generator is

priced at \$3,355 in the U.S.

Inquiries Manager, Hewlett-Packard Co., 1501 Rage Oill Rd., Palo Alto, Calif. [351]

## Dual-beam oscilloscope offers 400-MHz bandwidth

A 400-MHz bandwidth, dual-beam oscilloscope is designed for analyzing simultaneous, fast, single-shot events or fast events occurring at very slow repetition rates. Called the 7844, the unit is essentially two oscilloscopes in one; both independently and simultaneously use the same cathode-ray-tube display. A

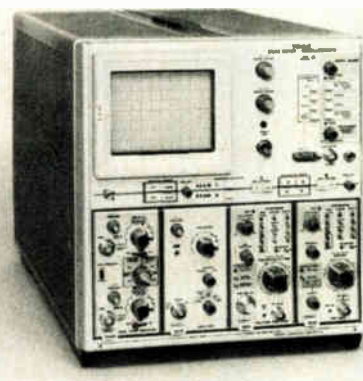

second version, the R7844, is functionally identical to the 7844 but is installed in a 7-inch-high rackmount cabinet. The 7844 and R7844 have four compartments from which the user can select from more than 30 plug-ins to suit special requirements. The 7844/R7844 can also be combined with a wide range of input amplifiers to give varied bandwidths. The 7844 dual-beam mainframe sells for \$5,900, and the rack-mounted R7844 sells for \$6,000.

Tektronix, Box 500, Beaverton, Ore. 97005 [354]

## Infrared thermometer checks board components

A portable, digital infrared thermometer, called the Heat Spy DHS series, provides instant non-contact surface-temperature measurements of circuit-board components as



## Another fine OEM product from C. Itoh

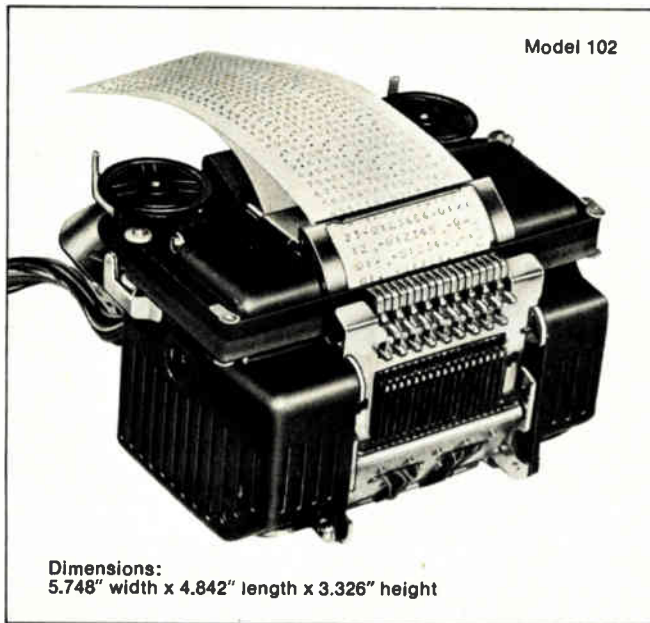

## Compact Digital Printing Mechanism

The Model 102 is a sophisticated printer especially developed for use by OEMs in top-quality electronic equipment. It is designed so that only the minimum essential elements are incorporated, using 18 columns x 13 characters, and with a print-out speed of 3 lines per second.

Other features include low consumption of electrical power (160mA max. at 15 V-DC) and a transistorized motor of long-life design.

The Model 102 Printing Mechanism is quite compact yet extremely reliable, which makes it ideal for electronic applications such as calculators, volt meters, measuring equipment and control terminals.

Furthermore, its attractive price makes it a "must" that you consider the Model 102 next time you are looking for a printer. Send in the coupon for full information on this fine product manufactured by the Shinshu Seiki Company.

### C. Itoh Electronics Inc.

5301 Beethoven St., Los Angeles, Calif. 90066 (213) 390-7778

East Coast Office: 270 Park Avenue, New York, N.Y. 10017  
(212) 953-5452/5447

New Jersey Office: (201) 347-7997 • Ohio Office: (513) 492-1159

C. Itoh Electronics Inc.  
270 Park Avenue, New York, N.Y. 10017

Please send me more information on your  
Printing Mechanism Model 102.

Name \_\_\_\_\_ Title \_\_\_\_\_

Company \_\_\_\_\_ Telephone No. \_\_\_\_\_

Street \_\_\_\_\_

City \_\_\_\_\_ State (Prov.) \_\_\_\_\_ Zip \_\_\_\_\_

Specific Application \_\_\_\_\_

## New products

line trouble are visible, and little time is needed for isolating system problems. The Datascope may be left on line indefinitely to record and display data. Using an endless-loop tape, the last 40 minutes of traffic, at 2,400 bits/s is always maintained. During on-line operation, data is delivered simultaneously to the display and tape unit. Spectron Corp., Moorestown, N.J. [357]

### Spectrum analyzer doubles as frequency synthesizer

A spectrum analyzer, called the series 6000, is also designed to double as a frequency synthesizer. As a spectrum analyzer, it has fre-



quency ranges of 0 to 11 MHz and 10 to 110 MHz, with dynamic ranges of better than 120 dB and 100 dB, respectively. With the substitution of plug-in modules, the unit becomes an eight-digit, programable frequency synthesizer with a range of 10 kHz to 110 MHz and a resolution of 1 Hz (0.01 Hz optional). Accessory-function plug-ins provide a-m/fm-input provisions, sweeps and markers, and phase/frequency comparison, for example.

Adret Corp., 1887 Lititz Pike, Lancaster, Pa. 17601 [358]

### Counter/printer works with positioning systems

A series of digital counter/printers, designed for use with positioning systems, coordinate-measuring machines, and plotting systems, features bidirectional counters for each



the price for  
moving up to a  
sweep/function  
generator  
just came down  
to \$149.50



Circle 165 on reader service card

Exact now offers a laboratory-quality sweep/function generator at a price you'd pay for less-useful sine-square oscillators. And you'll get so much more out of the new Model 195 than traditional audio test equipment, such as sine, square, triangle and swept waveforms . . . even pulses.

This new 2 Hz to 200 kHz instrument is the practical answer to many of your signal source needs, whether you're checking audio equipment, testing bread-boarded circuits or teaching at the high school or college level.

An internal sweep generator lets you sweep, either linearly or logarithmically, the entire audio range of amplifiers or speakers without changing ranges or even touching a knob. The Model 195 has three 1000:1 sweep ranges for frequency sweeping plus high and low level sine outputs with amplitude control. Or you can control the frequency by an external voltage (VCF).

The Model 195 is completely portable, operated by a 9-volt transistor battery, so you can forget 60-Hertz hum problems altogether. An optional rechargeable power supply and charger permits continuous operation from Ni-Cad battery power.

This is a true instrument . . . developed by by one of the world's leading designers and manufacturers of laboratory function generators and frequency synthesizers. Find out what the Model 195 can do on your bench, and move up to a better source of signals.

**Price: Model 195 \$149.50**

Optional rechargeable power supply, complete with battery and charger \$25.00 f.o.b. Hillsboro, Oregon. Instruments stocked in 36 locations across the United States.



(A subsidiary of Danalab, Inc.)

BOX 160, HILLSBORO, OREGON 97123  
(503) 648-6661 TWX 910-460-8811

In Europe, Africa and the Middle East, contact Danalab International S.A. 119/121, Rue Anatole France 1030, Brussels, Belgium, Tel: 2414550. Telex: 846-23662



ACTUAL SIZE

**IMMEDIATE DELIVERY!**  
**IN STOCK**



## Rectifier Power Transformers and Chokes

**SIGNAL HAS THE LARGEST SELECTION OF OUTPUT RATINGS AVAILABLE.**

- **Most Economical—No Minimum order Requirement.**
- **Ideal for Single or Dual DC Supplies.**
- **Wide Diversity of Ratings—5 to 300V, 0.1A to 200 Amp.**
- **Very High Current Units Up to 1000 Amps, Single and 3 Phase.**

**Signal  
transformer co. inc.**

1 Junius St., Brooklyn, N.Y. 11212  
 Telephone (212) 498-5111

Send for Free Catalog also listing extensive lines of Printed Circuit Plug-In Transformers, Flat Plug-Ins and Constant Voltage Transformers.

Circle 166 on reader service card

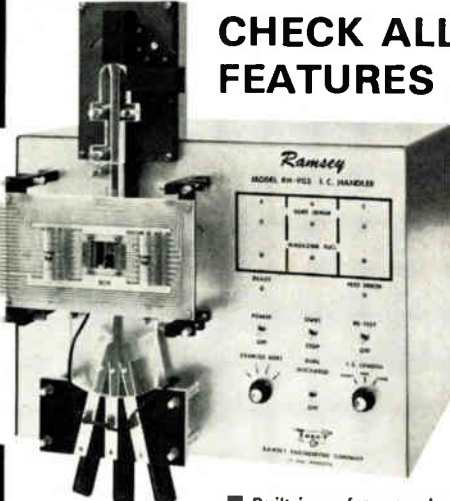

### CHECK ALL THESE FEATURES AGAINST ANY OTHER I-C HANDLER YOU MIGHT BE CONSIDERING

**MODEL RH-903**

- **Three-category sort, or two-category sort with dual discharge. In dual discharge, bins which have the same sort signal automatically gate from one to the other as one becomes full.**
- **Built-in performance board incorporating all bypassing and decoupling networks; can be used as a mother board, with dedicated compensation modules for specific DIP types, or used for insertion of discrete components as individual test parameters are encountered.**
- **Precision photo detectors monitor each operation and provide continuous visual indication of handler status at all times.**
- **Accommodates 6 thru 18 pin packages and adjusts for a wide range of package sizes via convenient thumb screw adjustments.**
- **Re-test capability.**
- **Built-in interface board for specialized interface requirements.**

For information, write or call Electromechanical Products, Ramsey Engineering Co.

**RAMSEY** 

**ENGINEERING COMPANY**

1853 W. County Road C, St. Paul, Minnesota 55113 (612) 633-5150

166 Circle 241 on reader service card

## New products

axis and the printer to read the data for each axis. The buffered outputs of each bidirectional counter are applied in parallel to the printer for all three axes (in a three-axis system). The printer contains circuitry to multiplex all three axes and to print them out, one underneath the other, with the appropriate axis symbol. It also features a three-digit presettable "item-sequence-number counter." This counter can be preset to some number other than zero. At the end of every print cycle, this counter is updated by one count. Price is \$2,000.

Keltron Corp., 225 Crescent St., Waltham, Mass. 02154 [359]

## Portable tester checks

thermal sensors, systems

Thermal switches, thermocouples, and continuous-wire fire-detection systems can all be checked with the H262C Tempcal 2 thermal-sensor-tester. This portable unit saves time by testing and troubleshooting thermal sensors in their normal operating locations. The H262C uses a heater for up to 1650°F. This temperature is preset, and thereafter the probe is automatically controlled and monitored by solid-state, digital-indicator circuitry. For bench-type operation, the thermocouple or



thermal switch is connected to and its operation monitored on the H262C.

Howell Instruments, 3479 W. Vickery Blvd., Fort Worth, Texas 76107 [360]

# If you're testing 1K RAM's or 4K RAM's without an MD-100 or MD-104... YOU'RE KIDDING YOURSELF!



**Reliability**—With more than 300 stand-alone MD-100/104 systems in use throughout the world today, Macrodata has set the industry standards for memory testers—and these two systems still provide the only way you can test memories effectively and obtain valid data.

**Pattern Sensitivity**—If one of those “it’s no problem” guys has been telling you that a few hardwired patterns are all you need to test RAM’s, watch out! They have decided that RAM’s aren’t really pattern sensitive, so they don’t bother to fully explore worst-case pattern conditions for these devices. They say that it’s not necessary, but you know better.

**Here’s Why You Need MD-100/104 Capability**

**Example #1:** In a recent test, six devices from separate

**Pattern Sensitivity Tests**

The adjacent curves are plots of individual device access times at different supply voltages. Each curve represents a different test pattern. Over the specified operating regions of the devices, these rhmo plots show the pattern sensitivities of the 1K and 4K RAMs. For example, while MARCH would make one think that the 4K device is operational, notice that the chip does not work during a portion of its MASEST curve. A MARCH test also indicates that the 1K device passes its access time specification at nominal voltage, but a GALPAT II test demonstrates much slower access time characteristics and that the 1K chip does not really pass at nominal voltage.

lots from the same manufacturer all failed under different unique patterns with identical set-up conditions of voltage, timing, etc.

**Example #2:** In another test, one device passed on all patterns for approximately 10 seconds and then failed due to heating problems. After being rehabilitated by coolant spray, the device again ran and passed until heat produced failure.

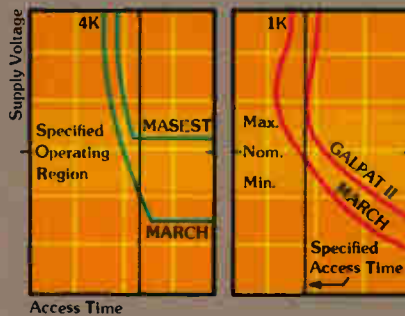

**Example #3:** For typical pattern sensitivity of 1K and 4K RAM’s, see the chart of V. vs. Access Time.

**Let’s Make A Deal**—If someone tells you that your semiconductor memory is not pattern sensitive and all you

need are fixed patterns to solve your test problems, send your device to us for the moment of truth. If we’re right, aren’t you just kidding yourself until you get an MD-100/104 on line? For action, call or send for a free brochure today.

## Macrodata



**Macrodata Corporation**, 6203 Variel Avenue, Woodland Hills, California 91364, Phone: (213) 887-5550, Telex: 65-1345  
**Sales Offices:** Northern California Area Tel. (408) 735-9560 • Scottsdale Tel. (602) 966-2179 • Minneapolis Area Tel. (612) 454-2034 • Chicago Area Tel. (312) 297-8746 • Cleveland Area Tel. (216) 461-8333 • Dayton Area Tel. (513) 293-3145 • East Coast Tel. (516) 543-8600 International: West Germany — Munich Tel. (0811) 34 56 00 Telex: (841) 521-5969 • Milan, Italy Tel. 871-988/899-248 Telex: (843) 34314 • Sweden and Norway — Stockholm Tel. (08)-380-370 • Tel Aviv, Israel Tel. 25 55 69 • Tokyo, Japan Tel. (03) 985-5266 Telex: (781) 272-2171 • Buckinghamshire, England Tel. High Wycombe (0494) 36 3 81 Telex: (851) 837236

# Christmas could come early for designers using this versatile switch from Spectrol...



## The Model 87 Half-inch Switch

- Up to 3 poles and up to 10 positions — a total of 18 switching combinations to choose from
  - Mounts directly on a printed circuit board
  - Design versatility permits unlimited applications and many cost saving benefits: logic switching, internal switching device for optional equipment add-ons, test point switching, adapting main-frame computers to peripheral equipment, standardizing printed circuit boards, selecting operational voltages, selecting calibration resistors, etc.
- Send for literature, and ask about free samples.

**Spectrol**

SPECTROL ELECTRONICS GROUP

UNITED STATES Spectrol Electronics Corporation 11010 E. Gale Avenue, City of Industry, Calif. 91745, U.S.A. • (213) 964-6262 • TWX 38100 584-1214  
UNITED KINGDOM Spectrol Reliance Ltd, Drexels Way, Swanton, Wiltshire, England • Swanton 21281 • TELEX 44892  
ITALY SP Electronica spa Via Carlo Pisacane 7, 20126 Pavia (Milano) Italy • 05 20 241 • TELEX 36041

Circle 168 on reader service card



## New products

Data handling

# CRT terminal is low-priced

Unit to sell for \$900 in 100-lots; hard-copy output is optional

The computer industry's lowest-priced cathode-ray-tube terminal is the first new product from Digital Equipment Corp's new Components group [*Electronics*, June 13, p. 52].



It's the VT-50 DECscope, priced at less than \$900 each in quantities of 100. The terminal will also be offered in small quantities, but only by one of DEC's previous groups, since the Components group will deal only with large-volume customers. Small unit prices have not yet been determined, but judging from the quantity prices, the VT-50 will sell for about 10% less than any equivalent terminal now on the market.

The terminal, which has an ANSI standard keyboard, displays 12 lines of 80 characters each, from the 64-character standard Ascii set. It can be connected to communications lines operating as fast as 9,600 bits per second, at that rate, the screen fills completely in less than one second.

The key to the terminal's low cost is in DEC's approach to building it. CRT terminals are usually put together from subassemblies, such as TV monitors, keyboards, and so on, purchased from various suppliers.

But DEC has designed the VT-50 to be assembled from basic electronic and mechanical components as simply and with as little labor as possible.

For example, component density is so low that insertion is easy, and heat is dissipated through normal air convection without fans. Besides reducing cost, lack of fans also reduces the amount of power drawn by the terminal and makes it practically noiseless while in use. Furthermore, the enclosure is injection-molded plastic; although this requires expensive tooling, it is cheap in large volumes.

An optional copier, integral with the terminal, can produce hard copy of the data displayed at any time. The electrolytic printer has a raised helical ridge on a rotating drum that scans the width of a strip of special paper. An electric arc, controlled by the displayed data, darkens the paper to form characters in a 5-by-7 matrix.

The principle is the same as that used in many types of facsimile machines.

Digital Equipment Corp., Components Group, 1 Iron Way, Marlboro, Mass. 01752 (After July 1) [361]

## Tape eraser handles reels, cartridges, cassettes

Designed for erasing magnetic tape, including digital-cassette type up to 1/4-inch wide, a universal hand-held

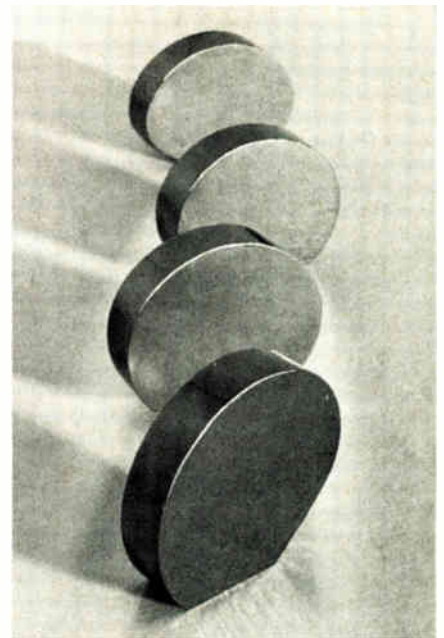

# Our compounds are your right answer for...

## DIODE DISPLAYS, INFRARED DEVICES, ELECTRONIC COMPONENTS

Asarco Intermetallics Corporation offers a wide range of III-V compounds used in the production of light emitting diodes (LED) and photoluminescent displays.

We provide gallium arsenide, gallium phosphide and indium phosphide in both polycrystalline and single crystal form. All polycrystalline materials are available as ingots. Gallium phosphide and indium phosphide are also available in granular form.

Gallium arsenide single crystals are boat grown with typical cross-sections of 19mm x 47mm for a (111) orientation and 33mm x 47mm for a (100) orientation.

You can order single crystals of our III-V compounds as ingots or slices, as cut or polished.

All materials are furnished in small quantities for evaluation or in large volume for production use. For more information contact us at 120 Broadway, New York, N.Y. 10005. Or call 212-732-9500.

# ASARCO INTERMETALLICS CORPORATION

for receiving a signal the amplitude of which may be less than that of an adjacent undesired carrier by means of an untunable broadly-responsive auxiliary signal-translating channel coupled to the main channel and including means for limiting to a uniform predetermined amplitude level all received carrier signals in the vicinity of and including the desired carrier signal plus other means selectively response to the desired carrier signal for deriving the carrier signal from the auxiliary channel and applying it to the main channel to develop therein a desired carrier signal, the amplitude of which is in excess of that of the undesired signals.

**Coupling Circuit.** A circuit for coupling two a-c input circuits of different frequencies to a common output circuit, comprising elements which present a high impedance to currents of the frequency of the input circuit be-

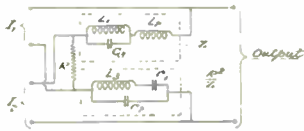

tween the terminals of which it is connected and a low impedance to currents of the frequency of the input circuit between the terminals of which it is not connected. C. D. Colchester and A. T. Starr, RCA, Nov. 5, 1940. No. 2,280,282.

**Loop Circuits.** The planes of a pair of loops of equal resistance and equal signal voltage pickup are arranged in a mutually perpendicular manner. Each loop is tuned to a desired signal frequency and the loops are reactively coupling loosely so that the signal current induced in one of the loops is in quadrature with the signal current induced in the other loop and means for applying the signal voltage developed across one of the loops between the control electrode and cathode of the tube. R. A. Weagant, RCA, July 2, 1940. No. 2,280,562.

**Static Eliminator.** Method of eliminating r-f disturbances while maintaining desired signal energy, including an antenna system and a counterpoise and coil connected to each with a movable

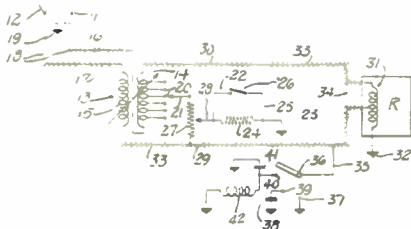

phase shifting coil connected to the counterpoise. The currents in the counterpoise are transmitted to ground through a variable resistor. Samuel Whisk, Brooklyn, N. Y. October 6, 1941. No. 2,280,461.

To former manufacturers of commercial

## • BROADCAST RECEIVERS TRANSMITTERS & ALLIED EQUIPMENT

**Ferranti makes  
TRANSFORMERS**  
for every Industrial and  
ELECTRONIC application

Quality transformers for every industrial, electronic, sound, communication, and laboratory use. — Air cooled transformers and reactors for every industrial application. Miniature aero transformers for aircraft and portable work. — High power plate and filament transformers. — Solenoids, relays. — Filters, equalizers, modulation sets and rectifiers — TO YOUR SPECIFICATIONS.



IF you are operating ALL OUT on war production for the Army, Navy, Air and Signal Corps, Coast Guard, Maritime Service, etc.

**FERRANTI ELECTRIC**  
with increased manufacturing facilities, is in a position to make Prompt Deliveries.

**Quantity Production on  
Quality Components at  
competitive prices . . . .**

### • IF YOU MANUFACTURE

Receivers, Compasses, Transmitters, Transceivers, Fire Controls, Walkie-Talkies, Test Apparatus, Direction Finders, Filters, Rectifiers, Power Supplies, Aero Equipment, Portable Systems, Marine Equipment, Measuring Apparatus, Communications Devices.

Consult Ferranti

FERRANTI ELECTRIC INC., RCA BLDG., NEW YORK, N. Y.

**QUANTITY PRODUCTION at COMPETITIVE PRICES**

Sixty Years of Development

## NEW BULLETIN READY

Write for new Engineering Bulletin on the VIBROTEST . . . the insulation testing instrument having an amazing combination of advantages: (1) self-contained power source produces constant potential of 500 volts; (2) compact, readily portable; (3) easily read scale showing Ohms and Megohms—also, A.C. and D.C. volts; (4) ingenious circuit design with standardization of synchronous vibrator; (5) can be operated with one hand, level or at an angle. New Bulletin—generously illustrated—gives specifications, uses, prices. Write for it today.

**ASSOCIATED RESEARCH, INCORPORATED**  
427 SOUTH DEARBORN STREET • CHICAGO, ILL.



# VIBROTEST



## WAXES • COMPOUNDS for ELECTRICAL INSULATION

Zophar offers prompt service on Insulating Compounds for a wide variety of electrical applications, including:

. . . insulation for CONDENSERS, TRANSFORMERS, COILS, power packs, pot heads, sockets, wiring devices, wet and dry batteries, etc. Also WAX SATURATORS for braided wire and tape. WAXES for radio parts.

Special compounds made to your order.

# ZOPHAR MILLS INC.

130-26th St.

Brooklyn, N. Y.

FOUNDED 1846

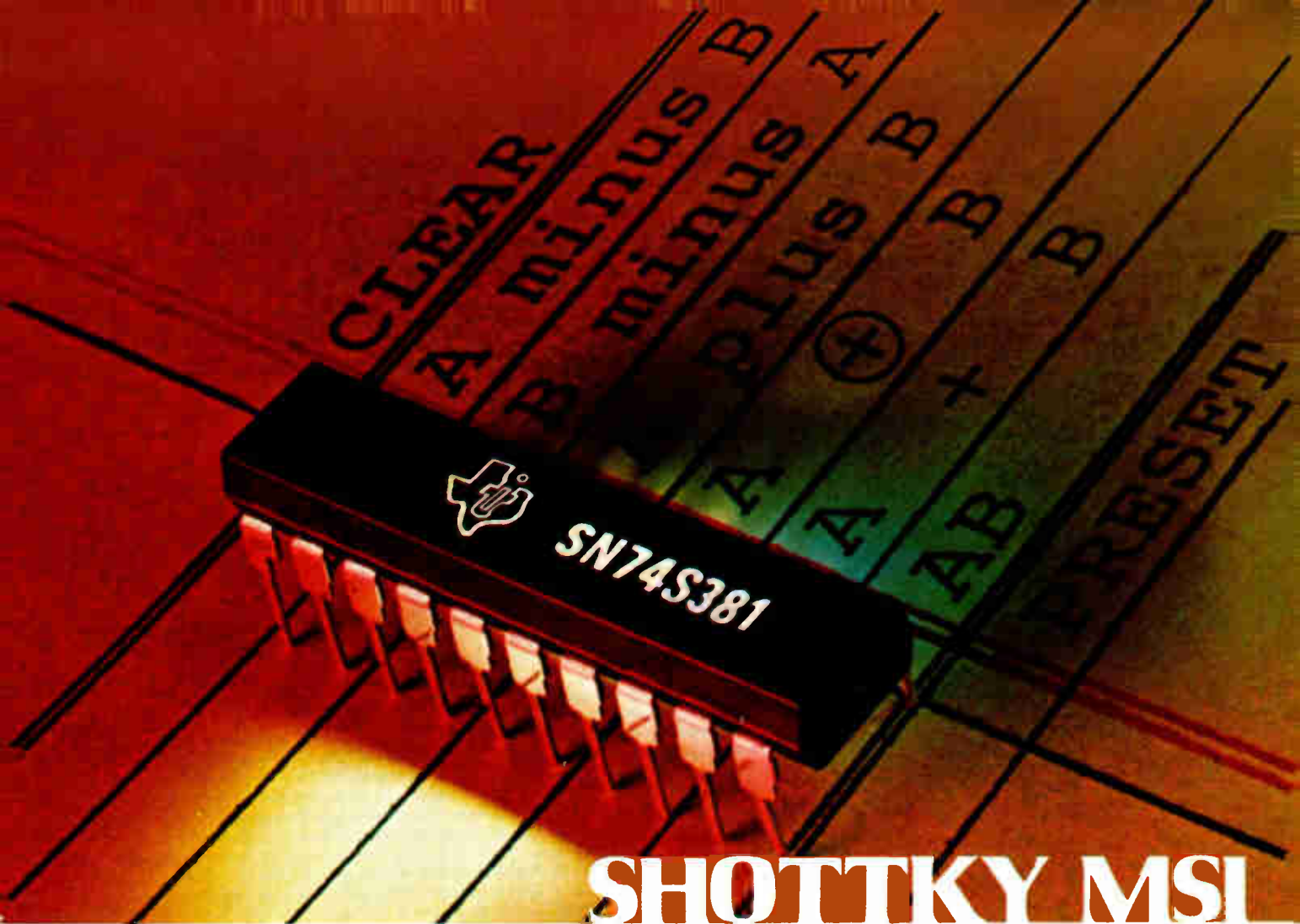

# SHOTTKY MSI

## A mini-ALU.

Delivering basic arithmetic and a little Boolean.  
... in a space-saving 20-pin package.

TI's new SN74S381 4-bit binary ALU gives you the most useful arithmetic/logic functions in a compact 20-pin, 300-mil-wide plastic package — offering up to a 58% reduction in p-c board area when compared to current 24-pin functions.

And, the 74S381's versatile three-port architecture features full-carry look-ahead. This makes it a basic building block for high density, high performance digital processors in any multiple of 4-bits.

Arithmetic operations include addition and subtraction, (A minus B) and (B minus A)

without external manipulation of operands.

Logic operations are: AND. OR. Exclusive OR. Also,

CLEAR (set to minimum) and PRESET (set to maximum).

Couple this functional versatility with a 16-bit typical add time of 25 ns (using a 74S182 look-ahead), a 100-999 piece price of \$4.40, and you have efficiency plus economy.

The SN74S381N is available from your local authorized TI distributor or from TI directly. For data sheets indicate by type number and write: Texas Instruments Incorporated, P. O. Box 5012, M/S 308, Dallas, Texas 75222.

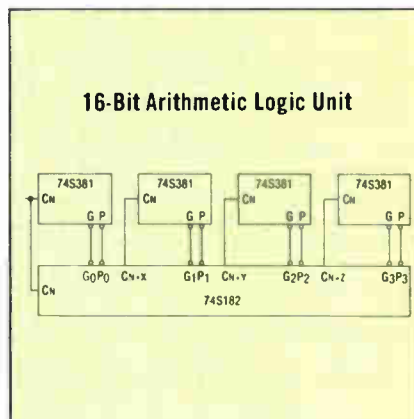

TEXAS INSTRUMENTS  
INCORPORATED

## New products

bulk eraser, called the model R24017, can be used for reel-to-reel, cassette and eight-track cartridge tapes, and for computer and other professional applications using up to 1/4 in. tape. A handle permits moving the eraser across the reel or cartridge, obliterating the recording in a matter of seconds without having to rewind tape. Background noise is reduced below normal erase-head level. Operation is at 110-120 v, 4 A, 50-60 Hz ac. The model R24017 measures only 4 by 2 1/4 inches. It is priced at \$26.50.

Robins Industries Corp., 75 Austin Blvd., Commack, N.Y. 11725 [364]

### Miniature tape drive uses 3M cartridge

The model 600 digital tape drive, which occupies 3 1/2 by 7 inches of panel space and which may be



mounted in any plane, uses the 3M data cartridge as the tape medium. Moreover, the tape drive is compatible with proposed ANSI and ECMA specifications. Designed to meet both OEM needs and end-user applications, the 600 is offered both with and without the electronics. Digital data is recorded on 1/4-inch tape in up to four tracks, written at a density of 1,600 bits/inch, phase-encoded, at 30 inches/second. This results in a data-transfer rate of 48,000 bits/s. The 600 operates at 90 in./s in bidirectional high-speed

search. Price starts at less than \$300. Quantex, 200 Terminal Dr., Plainview, N.Y. 11803 [363]

### Tablet/cursor's resolution is 1,000 lines per inch

The model 200 graphics-input table is provided as a separate package, along with a cursor, for converting drawings, maps, and other data into digital signals for input to a display, memory, or CPU for processing. The package is designed for use with digitizing electronics. The tablet features resolutions up to 1,000 lines per inch, and holds errors to  $\pm 0.005$  inch. The model 200 tablets are available in sizes from 11 by 11 in. to 36 by 48 in. Prices range from \$2,000 to \$6,500.

Electrak Corp., 16634 Oakmont Ave., Gaithersburg, Md. 20760 [366]

### Tape reader operates to 300 characters/second

A medium-speed photoelectric tape reader, called the model R2000, offers bidirectional reading speeds to 300 characters per second continuously, and up to 200 characters per second asynchronously. The R2000 uses a deep-socket reading technique that reads tapes with up to 60% transmissivity. This technique also allows read-head exposure to ambient light with no effect on the reading. The unit reads 5-, 7- and 8-level tapes interchangeably. A direct-drive sprocket capstan also minimizes edge guidance, tape drag, skew, and wear problems. Prices in a single quantity start at \$546.

Tally Corp., 8301 S. 180th St., Kent, Wash. 98031 [367]

### Two computer systems added to Century line

Two new members of the Century series computers are the Century 151, a low-cost, high-performance computer with MOS memory, and

# Energy Saver



## New Electronics Buyers' Guide... Easy-to-use, single volume source for:

- Information on over 4,000 products
- Over 6,000 company listings and phone numbers — both home and field offices
- **EBG EXCLUSIVE:** quick access to over 800 helpful catalogs through a timesaving Direct Inquiry Service
- More than 1,400 pages of data

Here is the international world of electronics at your fingertips. Find suppliers... fast... accurately... and locally! Don't have a copy? Use coupon below, today.

## Electronics Buyers' Guide

A McGraw-Hill Publication  
1221 Ave. of the Americas, N.Y. N.Y. 10020

Yes, send me \_\_\_\_\_ copies (copy) of the energy saving Electronics Buyers' Guide. I've enclosed \$15.00 (USA and Canada only; elsewhere send \$25.00). Full money back guarantee if not satisfied.

NAME \_\_\_\_\_

COMPANY \_\_\_\_\_

STREET \_\_\_\_\_

CITY \_\_\_\_\_

STATE \_\_\_\_\_ ZIP \_\_\_\_\_



# DELEVAN

# DEPENDABILITY

# DOESN'T

# COST

There's a lot more than meets the eye in Delevan's lineup of miniature RF inductors and transformers. Like the unmatched dependability built into each component. Thanks to a lot of things that go on at the factory. Hard-nosed quality controls . . . complete material analysis . . . advanced in-plant environmental testing . . . automated techniques for winding, soldering and molding . . . and conscientious people who take pride in true "no-fault" production. And of course, the dependable delivery and service you always get from Delevan.

# IT PAYS

Remember . . . the proven reliability of these superior made-in-U.S.A. inductive devices means greater reliability for the products and assemblies *made from them*. Sure, you can save a few pennies by using cheaper components. But this could be expensive in terms of premature failure of the finished product. When your company's reputation is on the line, you can't afford *not* to use Delevan components. Their premium performance more than justifies their use . . . because Delevan dependability pays for itself. Why not prove it to *yourself!*

**Delevan**  
Division



AMERICAN  
PRECISION  
INDUSTRIES INC.

270 QUAKER RD./EAST AURORA, N.Y. 14052  
TELEPHONE 716/652-3800 TELEEX 091-293  
OTHER DIVISIONS OF AMERICAN PRECISION INDUSTRIES INC.:  
GASCO • DUSTEX

## New products

the Century 201, a high-performance on-line system with multiprogramming capabilities and large-capacity files. The 151 offers full hardware and software compatibility with larger Century computers. The basic Century 151 has a 32,000-



word memory which can be expanded to 128,000 words. Cycle time is 750 nanoseconds, with each cycle reading or writing up to three bytes of data. Price is \$133,695, and rental is \$2,675 a month on a five-year contract. The Century 201, which offers multiprogramming and a memory-access time of 650 nanoseconds is priced at \$300,000 or can be rented for \$5,525 per month.

The National Cash Register Co., Dayton, Ohio 45479 [365]

## Graphic data digitizer can use ordinary pen

The model E241 graphic-data digitizer is designed so that the user places graphic source material, such as a strip chart, map or photograph, on the Orthoplex sensor, then pressure from a ball point pen or any similar stylus causes the instrument to generate the X and Y coordinates of the contact point. Other features include a seven-segment digital display for the X-Y coordinate values and slanted working surface for easy access to the coordinate positions. The model E241 can be used as a stand-alone digitizer with independently selectable X-Y zero and scale

# BUSS®

the complete line of fuses, holders, blocks and clips to protect all electronic and electrical circuits and devices.

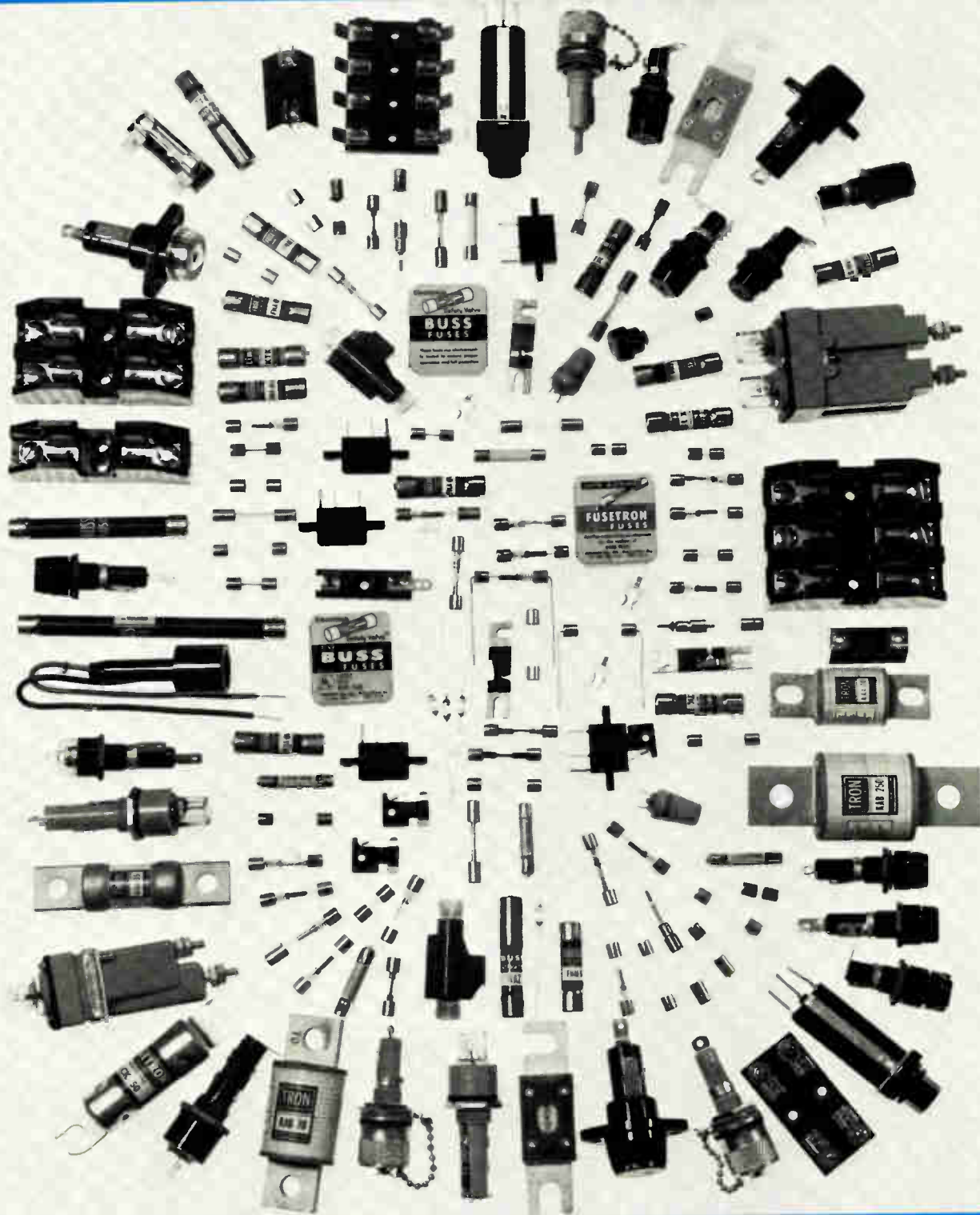

BUSSMANN MANUFACTURING  
a McGraw-Edison Company Division  
St. Louis, Missouri 63107



# OUR ANGLE: The FIRST Digital Phase Angle Voltmeter



... This NEW DPAV provides complete analysis of complex AC waveforms at discrete frequencies and displays the results on a high readability 4½ digit display. Parameters measured are Total, Fundamental, In-Phase, and Quadrature voltage plus Phase Angle. Phase angle is displayed directly in degrees from 0° to 360° with a resolution of 0.1°.

The Model 220 operates phase-sensitively at a single factory-set frequency from 30 Hz to 32 KHz. The Model 225 has the capability of operating with two to four pre-specified frequencies. Both models have a total voltage measuring capability from 30 Hz to 100 KHz.

The DPAV can be used on the bench or in Automatic Test (ATE) applications. Remote programming, 10MΩ input isolation auto ranging, and BCD output options allow for complete hands-off operation necessary in automated test consoles. Priced from \$2950.00.

Let our sales engineering representative demonstrate our NEW angle to you. Call toll-free (800) 645-9200 for his name and address.



**NORTH ATLANTIC industries, inc.**

200 Terminal Drive, Plainview, New York 11803 • Phone (516) 681-8800  
California District Office: 13418 Wyandotte Street, N. Hollywood, CA 91605 • Phone (213) 982-0442

Circle 174 on reader service card

## MAGNETIC INSTRUMENTATION

### Gaussmeters • Fluxmeters

Magnetizers • Stabilizers • Demagnetizers

Automatic Magnet Processing Systems

Alnico Permanent Magnets • EI Laminations



**Thomas & Skinner, Inc.**

1120 East 23rd Street, Indianapolis, Indiana 46205 • 923-2501

174 Circle 242 on reader service card

## New products



settings, or be connected to a variety of data-processing instruments, including several widely used calculators. Additional interface cards can be inserted.

Elographics Inc., 1976 Oak Ridge Turnpike, Oak Ridge, Tenn. 37830 [368]

## Chip set cuts size, cost of scientific calculator

Miniaturized, low cost, full-function scientific calculators are possible with a chip set of two arrays programmed to provide a full range of scientific functions, but requiring only 20 keys for entry and control. Previous calculators capable of this level of performance have required from 35 to 40 keys. Double shifting has been used to allow each of the 20 keys to assume up to three roles in defining entry or function commands. To avoid confusion, functions that can logically be paired have been combined as the two upper-case functions on a given key. In this manner, less frequently used functions are shifted and grouped in logical pairs to ensure ease of keyboard learning and operation.

MOS Technology Inc., 950 Rittenhouse Rd., Norristown, Pa. 19401 [370]

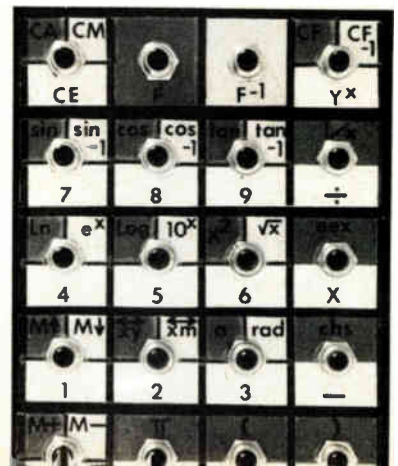

*A flexcircuit for the "Silent 700."*

# We did it for Texas Instruments.

The "Silent 700.\*" A powerful improvement over data terminals using conventional paper tape and noisy impact printers.

To help keep the Model 733 ASR teletypewriter silent, Texas Instruments needed a way to provide 42 conductors between the thermal print head and its electronics. And to do it without using a bulky, stiff, relatively heavy 42-conductor cable.

A Schjeldahl flexcircuit was the answer.

Dynamic characteristics of this application dictate a requirement for one million flexes without conductor failure. This called for conductors, insulation and adhesive to be something more than ordinary materials.

For improved reflow soldering of closely spaced connections, pad areas are electrolytically plated. And the flexcircuit had to be producible in volume.

An almost continuously flexing flexcircuit. Schjeldahl did it for Texas Instruments.



**Schjeldahl Company**

Electrical Products Division  
Northfield, Minnesota 55057  
Phone: (507) 645-5633

*The state of the art people in volume flexible circuits*



# And we can do it for you.



**Today the "hot-spot" temperature  
will approach 200 C, with a  
90% chance of moisture, and  
contamination could be severe.**



## Protect your systems with silicone compounds.



Sooner or later, the electronic devices you design will have to stand up to persistent and inherent problems: corrosion, high heat, water, chemicals, oils, salts. Anything but rosy.

But think about this. Dow Corning dielectric compounds handle harsh environments, and retain excellent electrical properties from  $-40$  to  $200$  C. They're ideal for high voltages, and a wide range of frequencies. Won't dry out, bleed, or melt; are oxidation resistant, odorless, and practically nonvolatile. And they fill several functions at the same time.

For instance, Dow Corning® 2 compound is a dielectric sealer that prevents copper corrosion. Use it on connectors or communications cables. If you need a good lubricant, a water repellent, and a corrosion preventive for switches or terminals, try Dow Corning® 3 compound. And Dow Corning® 4 compound, a moistureproof dielectric sealer, is great for high-altitude ignition systems.

We have a heat-sink system, too. Pot diodes and transistors for excellent thermal conduction. Then, for maximum protection, apply our heat-sink compound between the device and chassis.

Versatility, economy, performance, and easy application. Good reasons why silicone compounds should be your design tools. Write for full information to Dow Corning Corporation, Dept. C-3335, Midland, Michigan 48640.

*Silicones; simply the best way to protect electronic circuits.*

# DOW CORNING

DOW CORNING

## New products

Packaging & production

### Microprocessor controls tester

Chip set can program system to check out virtually any device

Because they are much lower in cost and complexity than minicomputers, microprocessors are spurring the development of reasonably priced automatic test systems. One of the latest is a system, the model 400, developed by Data/Ware Development Corp. for in-factory tests. The company has delivered one to Sony Corp. of America for testing color-TV tubes, and the system, which is completely automatic, has many other uses, particularly in checkout of devices.

The test is organized in a familiar manner for automated checkout. An Intel MCS-4 microprocessor chip set controls the input/output buffer, which, in turn, programs and controls power supplies, measuring instruments and a relay matrix. To the MCS-4 are added both read-only and random-access memory. Both fixed and programmable sources can be used; the filament voltage for the tubes can be fixed, for example.

This system provides for programming the points at which forcing voltages are applied to the unit under test, the voltage values, the measurement points, and the measurement-current scale. Proper selection of these parameters adopts the model 400 to almost any device to be tested, says Data/Ware vice president Dale V. Schmidt.

In checking color-TV tubes, each gets more than 20 different tests, results are compared to preselected limits, and go/no-go indication is provided. Results for the test are printed, along with the serial number of the tube tested.

The model 400 can contain multiple power supplies, providing maximum outputs of 1,000 volts and power of 100 watts. Measure-

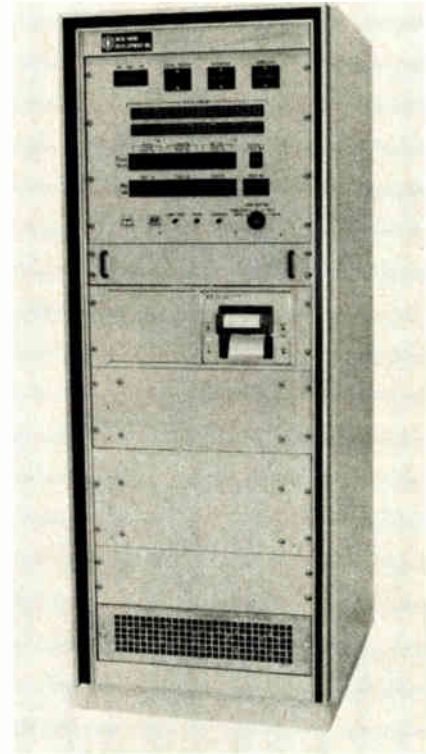

ments are made by a programmable digital ammeter that is accurate to within 0.1% and has ranges of 1 microampere to 2 amperes, full scale. The relay matrix uses 32 double-pole, double-throw, telephone-type relays.

Go/no-go signals, LED digital readouts, audible alarm, and a 10-column printer are among the outputs. Programs are stored in ROMs, each containing 4,096 words, which can be changed as desired.

Price and availability of the system depend on the specific capabilities required.

Data/Ware Development Corp., 11585 Sorrento Valley Rd., San Diego, Calif. 92121 [391]

### Laser scribing system

runs at 48 strokes/minute

A semiautomatic scribing machine, which uses a laser to create accurately edged kerfs, is called the Laserscribe Mini. It scribes silicon, germanium, gallium arsenide, gallium phosphide and related semiconductor materials. The mechanical/electrical components of a dia-

Visual images are fleeting—so, for the record, ... you need pictures. No telling when or how often they can prove invaluable.

# THE CHAMP

...PICTURE TAKER



Circle 178 on reader service card

That's why so many of your peers are routinely snapping pictures while looking at specimens and samples with Bausch & Lomb's StereoZoom 7 visual-photographic system. The Champ's superb optical system which gives unbeatable visuals will put the images on film right while you're looking. And they will be available as often as you want to refresh your memory, make comparisons, prove points.

There's a choice of most camera formats with the new Integrated Cameras, Series II with optional exposure meter. They're integral, but do not interfere with the optical system and interchange to fit varying needs.

**Be ready. Write for our new Stereomicroscope catalog 31-15 and our free demonstration offer.**

**BAUSCH & LOMB**   
SCIENTIFIC OPTICAL  
PRODUCTS DIVISION

62306 Bausch Street, Rochester, N.Y. 14602

StereoZoom, Reg. T.M.  
Bausch & Lomb.

## New products

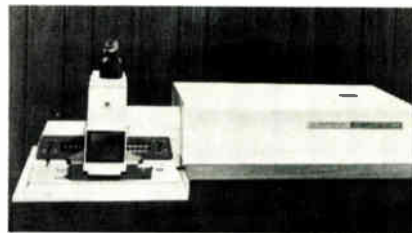

mond-scribing machine and viewing and focusing optics are also offered. The Laserscribe Mini can scribe a 2.0-mil depth at maximum speed with a typical kerf width of 1 mil; scribing speed is typically 48 strokes per minute. The Laserscribe Mini costs \$15,750 when the user provides his own Tempress Model 1713C Diamond Scribe, or \$19,750 if the unit must be supplied.

Quantronix, 225 Engineers Rd., Smithtown, New York 11787 [393]

Circuit board checker  
handles 250,000 tests/s

Designed for low-volume production operation, the Datatester 4400 computer-controlled, semi-automatic circuit board test system can also be used as a trouble-shooting and repair station. The system's processor provides a stored program, which permits the testing of boards, devices, and entire modules with the patterns and timing needed for functional tests, in addition to testing of LSI boards and devices, and sequential logic boards. The system handles all sequential functional testing by outputs of any digital logic circuit having up to 1,000 inputs. It performs 250,000 tests per second and requires a maximum of five seconds per output for test count response. Price is \$6,475, and delivery time is 60 days.

Data Test Corp., 2450 Whitman Rd., Concord, Calif. 94518 [394]

Test clip works with  
16-pin IC packages

The A23-2115 test clip, combined with one meter of 16-core cable is suitable for IC packages with up to

# Cost Cutter

NEW Electronics Buyers' Guide ...

Easy-to-use, single volume  
source for:

- Data on over 4,000 products
- Over 6,000 company listings and phone
- **EBG EXCLUSIVE:** quick access to over 800 catalogs through a Direct Inquiry Service. numbers

The international world of electronics at your fingertips. Find suppliers...fast...accurately ...and locally! For your copy send \$15.00 (USA and Canada only; elsewhere send \$25.00) to address shown below.



# Electronics Buyers' Guide

A McGraw-Hill Publication  
1221 Ave. of the Americas, New York, N.Y. 10020

# Get Less For Your Money.

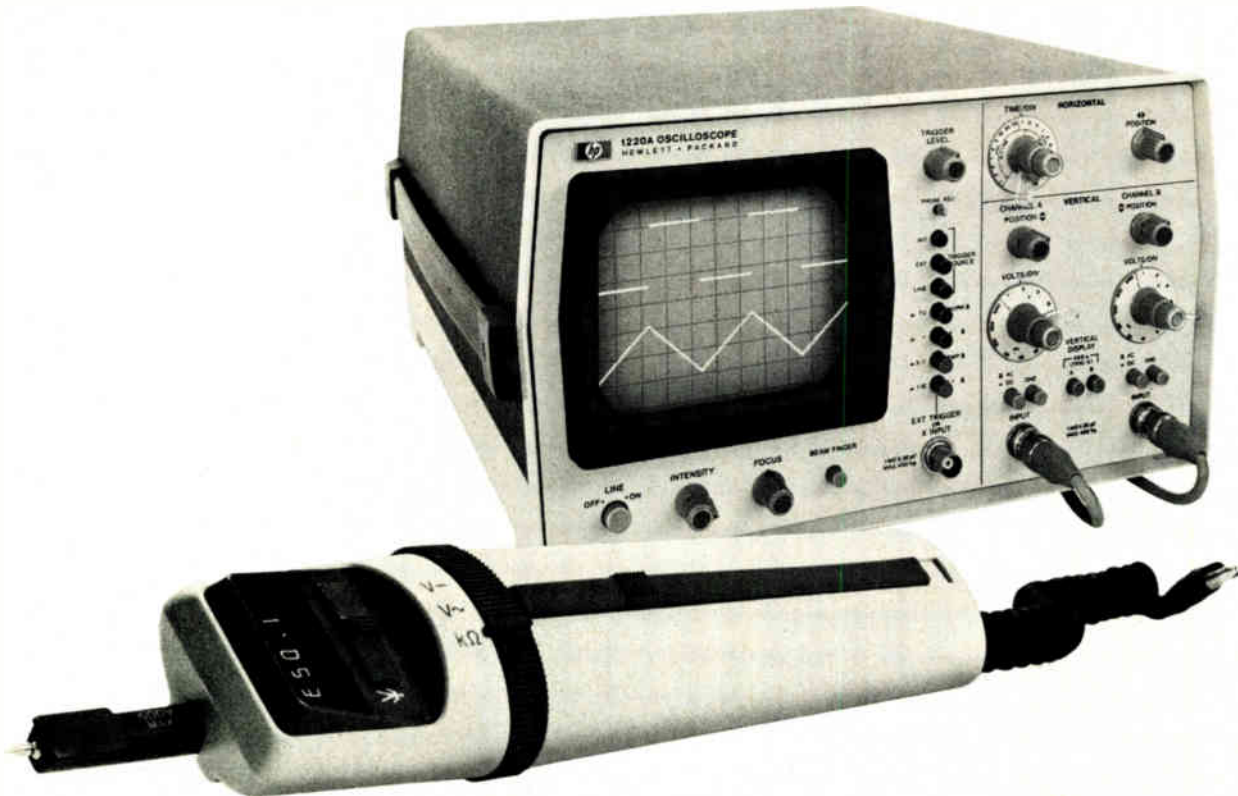

Get a pair of HP basic test instruments that give you less—less measurement hassle because they're so easy to use. Less downtime because they're all solid-state. Less weight and bulk because this scope and probe multimeter were designed to be part of your lightweight travel kit.

Imagine a 3½-digit probe multimeter that is completely self contained, weighs only seven ounces, fits in the palm of your hand—and so advanced it AUTO ranges, AUTO zeros, and has AUTO polarity. It's practically foolproof. Completely portable. And it's absolutely unique—there's nothing else like it anywhere. At any price. And it's just \$310\*. That's a surprisingly low price for a state-of-the-art instrument built to HP's

most exacting standards.

Or get our bright, full 5-inch diagonal display oscilloscope that gives you a whole lot less of those squinting, guessing, knob-tweaking measurements you'd just as soon do without. It's a dual channel, 15 MHz lightweight (only 15 pounds) with the sensitivity, accuracy, and big-scope conveniences most troubleshooters are likely to need. And best of all, it sells for only \$695\*.

There you are, a top-quality scope and probe multimeter for a lot less money. They're backed by HP's reputation and worldwide service and support facilities. So why gamble? There's less chance of error when you get your measurement instruments from the measurement leader. To get the full

story on our 970A probe multimeter or the 1220A oscilloscope, just fill out and return the coupon.

\*Domestic U.S.A. prices only.

**HEWLETT  PACKARD**

Sales and service from 172 offices in 65 countries.  
1501 Page Mill Road, Palo Alto, California 94306

Send information about your  
 probe multimeter    scope.  
 Name \_\_\_\_\_ Dept. \_\_\_\_\_  
 Company \_\_\_\_\_  
 Address \_\_\_\_\_  
 City \_\_\_\_\_  
 State \_\_\_\_\_ Zip \_\_\_\_\_

Hewlett-Packard Co.  
1501 Page Mill Road  
Palo Alto, California 94306

# FERRIS INSTRUMENTS

## for RESEARCH • DESIGN AND PRODUCTION

• *Manufacturers of*

**ULTRA HIGH FREQUENCY  
SIGNAL GENERATORS**

**STANDARD SIGNAL GENERATORS**

**CRYSTAL CONTROLLED  
SIGNAL GENERATORS**

**RADIO NOISE METERS**

**MICROVOLTERS\***

*Write for catalog E-4; illustrates and gives complete details  
and specifications for the complete line of Ferris Instruments.*

## FERRIS INSTRUMENT CORPORATION

Boonton • New Jersey

Reg. U.S. Pat. Office



**TAYLOR**  
**LAMINATED PLASTICS**  
Vulcanized Fibre • Phenol Fibre  
SHEETS, RODS, TUBES, FABRICATED PARTS  
**TAYLOR FIBRE COMPANY**  
Norristown, Pennsylvania

### *You Can Get A Priority On Time!*

Bogen industrial sound systems save countless hours of precious time. Any man—anywhere in your plant—can be located in a second. An important message can be sent to all the workers while production continues at top speed. Air raid and fire alarms can be issued automatically—instantly.

Time is priceless today—and Bogen systems can save it for you. Let us show you how.

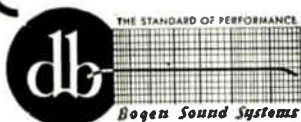

**DAVID BOGEN CO., Inc.**  
663 Broadway, New York City

**Piezo Circuit.** A network for producing exaggeration of the carrier with respect to the modulation side bands comprising a parallel resonant circuit tuned to the carrier frequency and arranged between cathode and a ground. The circuit is of low resistance and a piezo crystal is connected in shunt with

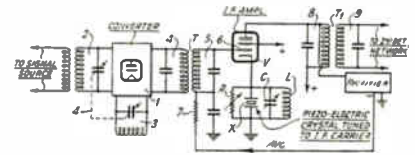

it and tuned to the carrier frequency. Degeneration is applied so that the amplitudes of the side band components are decreased uniformly with respect to the carrier frequency. W. vB. Roberts, RCA, Jan. 7, 1939. No. 2,280,605.

**Automatic Selectivity Control.** In a superheterodyne, means for automatically adjusting the degree of selectivity of the i-f circuit including a device which is responsive to energy of a frequency equal to the difference between the i-f and the signal energy representative of an undesired adjacent channel frequency. Julius Weinberger, RCA, Nov. 25, 1935. No. 2,280,563.

**Frequency Modulation.** The following patents relate to various aspects of frequency modulation: No. 2,280,569 on a detector circuit passing waves of carrier frequency with maximum intensity, and attenuating waves of lesser and greater frequency as a function of their frequency spacing from the carrier frequency, and combining the total wave energy to produce a resultant wave of varying amplitude and constant frequency. W. G. Crosby, RCA. No. 2,280,570, also to Crosby, refers to a system for receiving f-m signals by a double channel system, one channel passing a wide band and the other a narrow band with means for varying the bandwidth of the system. No. 2,280,530 to G. Mountjoy, RCA, July 17, 1940, is on a detector for f-m waves comprising a pair of rectifiers, each rectifier having a resonant input circuit and an audio output circuit, the input tuned circuits being oppositely and equally mistuned with respect to the center frequency of the modulated waves. The output circuits are arranged in phase opposition, and the inputs are arranged in series with each other and with the rectifiers. The tuned circuits are connected by capacity to the rectifiers and the individual tuned circuits are sufficiently coupled together magnetically to cancel out the effect of the capacity coupling. No. 2,280,822 to C. W. Hansell, RCA, July 1, 1938, on a relaying system. A repeater comprising an oscillator and an amplifier excited by the oscillator has means for holding by the amplifier the oscillator frequency equal to the frequency of the repeated circuits. No. 2,280,707 to R. D. Kell, RCA,

# Surprise!

## Linear voltage controlled crystal oscillator M-21

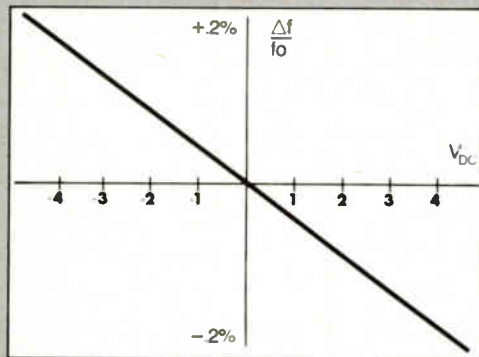

- Frequency Deviation up to  $\pm 2\%$
- Linearity  $\pm 1\%$
- Excellent short-term Freq. Stability
- Temp. Stability  $\pm 40$  ppm ( $-30^{\circ}\text{C}$  to  $+70^{\circ}\text{C}$ )
- Output: Sine Wave 1 to 5 Vpp
- Center Frequencies 1 to 30 MHz
- Single Power Supply Required (+12V)
- Low Cost

Send your inquiry stating your particular needs. The above specifications are not absolute maximum limits.

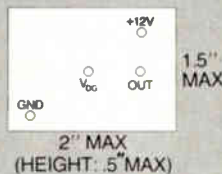

## Canadian Marconi Company

C.G.P. Avionics Division,  
2442 Trenton Ave., Montreal Canada, H3P 1Y9.  
Tel. (514) 343-3103, TWX 610-421-3564. Telex: 05-267563



Circle 240 on reader service card

## New products

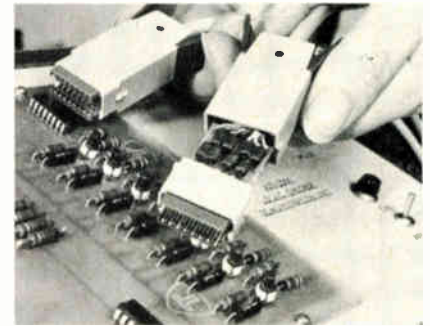

16 pins, and is intended for connection to test equipment such as oscilloscopes, IC comparators and LED displays. Housed within the test clip are 16 inductors, one in series with each pin, which provide compensation for the cable capacitance when testing TTL and similar devices. Price is \$38.00 each.

Jermyn, 712 Montgomery St., San Francisco, Calif. 94111 [395]

PC connectors are offered with 10 positions

A line of printed-circuit connectors, featuring solder terminations, folded ribbon contacts and tin/lead plating (as an option) is designated the 117 series. The unit is available in 10 widely used contact positions, from 6 to 43, to suit most commercial requirements. The solder-termination feature provides for flush installation on printed-circuit boards measuring from 0.054- to 0.071-in. thick.

Amphenol Industrial division, 1830 South 54th Ave., Chicago, Illinois 60650 [396]

IC pattern board built for rugged environments

Designated the modular universal integrated-circuit pattern board, Series 11, a pluggable wire-wrap circuit board offers low profile, high-density design and hard-mounted pin connectors, which make it suitable for difficult environments, including military applications. The board also offers up to 150 IC positions and 120 input-output connectors. It is suitable for use in any size

## UNINTERRUPTIBLE SELF-CONTAINED POWER SYSTEMS

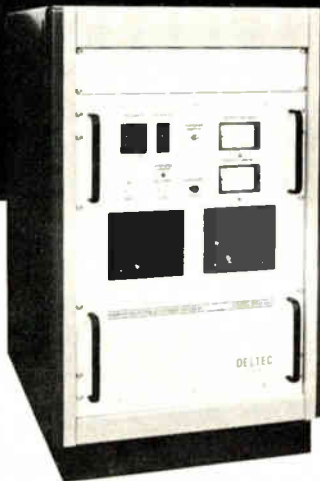

- Transient-Free
- Regulated Stable Power
- Load Isolation
- Maintenance-Free
- Models Available to 1800VA

MODEL DSU-1810 1800VA, \$2995

Voltage spikes, dips, transients and power outages can cause costly and fatal loss of critical information. Eliminate these potential hazards with a Deltec On-Line UPS.

Computer systems, instrumentation systems, and communications systems are provided constant, pure and regulated AC power with DSU Series UPS. Write or call for complete specifications.

3849 Gaines Street  
San Diego, California 92110  
Telephone (714) 297-4466

**DELTEC**  
CORPORATION

Phone free (800) 645-9200 for your local distributor.

# If your printed wiring can't stand the heat, switch to Norplex G-30.

Ordinary laminates just can't take the extreme temperatures generated by high density electronic systems.

But Norplex G-30 is no ordinary copper-clad laminate/prepreg material. It's a woven glass impregnated with polyimide resin, which assures you an outstanding combination of processing and operating characteristics.

For example, its exceptional heat resistance permits continuous operating temperatures in the 400°-500° F. range. G-30 gives you unexcelled dimen-

sional stability, flexural strength and processability. In multilayer applications, it also eliminates the smearing of resin during hole drilling, and minimizes cracking of plated-through holes.

Thus, Norplex G-30 performs with unequalled excellence in such demanding applications as aerospace electronics, computers, and com-

munications equipment.

Send coupon for our brochure on G-30 glass-polyimide, a new breakthrough in circuit technology. Or phone: 608/784-6070.

**Norplex® laminates**  
by **UOP**

Circle 181 on reader service card

© 1974 UOP

Norplex Division, UOP  
(Universal Oil Products Company)  
Norplex Drive,  
La Crosse, Wis. 54601

Please send me your brochure on  
G-30 glass-polyimide.

Name \_\_\_\_\_

Title \_\_\_\_\_

Company \_\_\_\_\_

Address \_\_\_\_\_

City \_\_\_\_\_ State \_\_\_\_\_ Zip \_\_\_\_\_

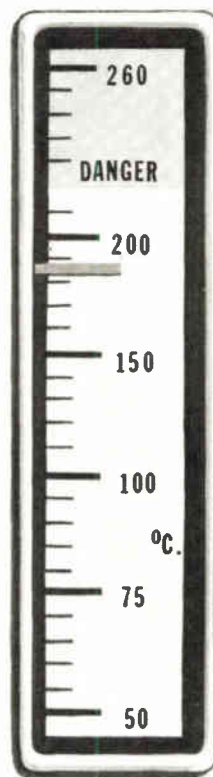
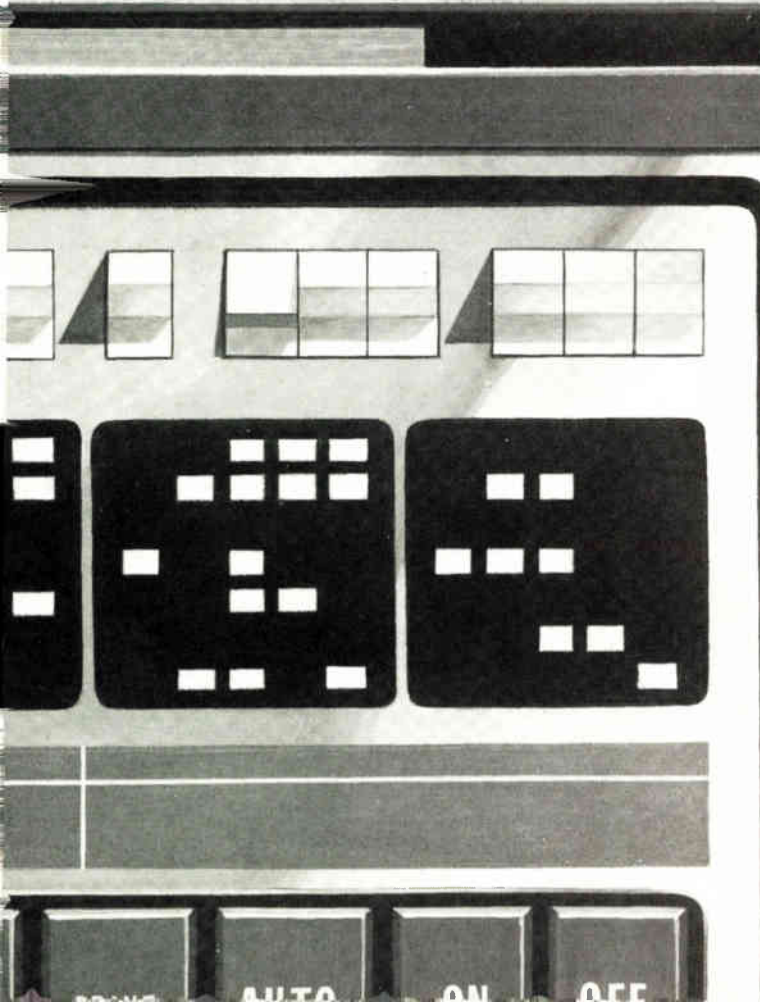

# Now you can turn to MCL for reliable high power r-f and microwave testing.



Many customers remember us for the "extras" engineered and built into our microwave cavities, e.g., our potted anode bypass assembly.

But some may not be aware that today MCL also offers one of the industry's largest and most diverse power oscillator, amplifier and systems lines.

The same extra margin of reliability and performance customers have learned to expect from our cavities is also a feature of our instrumentation products.

For a recommended solution to your high power testing problem—without obligation—write us today.

MCL, Inc., 10 North Beach Avenue,  
La Grange, Illinois 60525.  
Or call (312) 354-4350.



Circle 182 on reader service card

## Own your own holder to hold your own!

Hold your own copies of Electronics in specially designed slipcase holders. They'll keep your Electronics library neat and handy—a permanent information file, issue by issue.

Just complete the coupon and mail to Jesse Jones. He'll process your order upon receipt, postpaid.

**ELECTRONICS BOXER**  
Jesse Jones Box Corporation  
2250 E. Butler St., Philadelphia, Pa. 19137

Please send me:  boxes @ \$4.25 each;  3 boxes @ \$12.00;  6 boxes @ \$22.00.  
My check or money order is enclosed.

Name: \_\_\_\_\_

Address: \_\_\_\_\_

City: \_\_\_\_\_

State: \_\_\_\_\_

Zip: \_\_\_\_\_



## New products

production-run from breadboarding to manufacture of thousands of units.

Garry Manufacturing Company, 1010 Jersey Avenue, New Brunswick, N.J. 08901 [397]

Thick-film trimmer also tests, sorts in one operation

An automatic abrasive thick-film trimmer, designated Model MT-200 Auto Trimmer, tests, trims and sorts in one operation. After initial setup, all the operator need do is load the machine, the rest is automatically done at rates from 2,000 to 2,500 trims per hour. The Auto Trimmer first tests for resistance value, resis-



tors above or below predetermined values are rejected, and then it trims the acceptable resistors to 0.1% of specified value. The substrates are then off-loaded automatically down either a "reject" or "good" chute. Price is \$10,400.

Comco Inc., 9421 Telfair Ave., Sun Valley, Calif. 91352 [398]

Ceramic caster produces 6-inch tape continuously

The model 103 ceramic caster is developed primarily for casting thin sheets of ceramic for multilayer-ceramic capacitor manufacture. From an organic slurry, the model 103 continuously casts 3- to 6-inch-wide tape on a polyethylene or polypropylene carrier at speeds of up to 30 feet per minute. Ceramic thicknesses range from 0.0005 to 0.005 inch. The ceramic/binder slurry dries as it winds through a self-contained 30-foot spiral path onto a central take-up reel. The model 103





Phosphor Bronze, 100% of surface gold plated, 30 micro inches thick.

Copper Alloy 725, 3% of surface gold striped, 100 micro inches thick.

## Cut gold plating 90% on contact springs with CA-725.

CA-725 is the copper-base spring alloy that is rapidly becoming the standard of the electronics industry. Bare CA-725 has outstanding wrap-resistance stability. It's easy to solder and has good corrosion resistance without gold plating. Some gold is still used for resistance stability in critical circuits. But can be concentrated only where you need it... at the contact points.

That means proven cost reductions: Actual experience has confirmed CA-725's ability to cut gold plating by 90%. This substantially reduces the cost of the finished part even with increased gold thickness at the contact points. One main frame-connector user reports bare CA-725 connector springs with heavier gold at the contact points outlasted former springs by 10 times in wear tests.

Stay ahead of your competition: Copper Alloy 725 is rapidly gaining acceptance with the

largest electronic component users. You should know more about it. It is available from your regular brass and copper suppliers. Gold-striped material is available from composite metal producers. Call them today. Or write to Dept. 7173, The International Nickel Company, Inc., One New York Plaza, New York, N.Y. 10004.

The amount of gold you save depends on your design. Here is our calculation for an average-size connector spring:

Design	Spring Alloy	Gold Plating Thickness		Relative Amount of Gold Required
		At Contact	Overall	
Overall plating	CA-510 (Phosphor Bronze)	30	30	10
Stripe	CA-725	100	Bare	1

# INCO

THE INTERNATIONAL NICKEL COMPANY INC ONE NEW YORK PLAZA, NEW YORK, N.Y. 10004

Circle 183 on reader service card

# THE SECOND REVOLUTION

## IS HERE!



**SCAN CONVERSION  
DISPLAYS THAT LOOK  
LIKE PHOTOS...  
WITH EXCLUSIVE  
EXTRA-VISION™ LITHOCON II™  
IMAGE STORAGE SYSTEMS**

Princeton revolutionized low-cost scan conversion with Lithocon® image storage tube technology. Now, our second revolution brings you Lithocon II™ image storage systems with Extra-Vision™ advances. The proof is in the viewing: As the heart of our improved PEP-400-R and 402-R Video-Graphic Image Storage Terminal, it makes possible performance levels which obsolete all other scan conversion technologies. Now you can get displays of scan conversions on your monitor that look like electronic photos. With excellent image fidelity, gray scale, stability, resolution, retention time and erase speed.

**Features you can see:** Image reading time of over two hours, with single frame erase. Resolutions of 2,300 to 3,500 TV lines per diagonal. Extended dynamic range (64 gray levels). Capability for slow-scan operation. Up to 36-times area magnification. Image integration. From 525-line to 1,225-line TV rasters.

Solid state reliability, backed by a full year warranty.

See for yourself. Ask for a demonstration, at your lab or ours. If your scanner or camera output's interface is compatible, it's as easy as just hooking up your X, Y and Z-axis leads to the new PEP-400-R or 402-R. Prices begin under \$3,800. Less in OEM quantities.

**Phone or write today.** For more information, literature, or a demonstration. Or just to tell us about your imaging problems.



**PRINCETON ELECTRONIC PRODUCTS, INC.**  
P.O. Box 101, North Brunswick, New Jersey 08902  
Telephone: (201) 297-4448

## New products

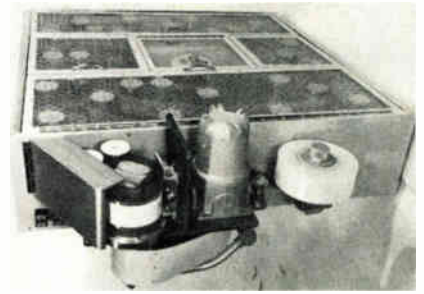

is priced at \$18,000 to \$20,000, depending on options.

Cladan Inc., 11404 Sorrento Valley Rd., San Diego, California 92121 [399]

## Encapsulators offer heater plate, vibration

A line of vacuum encapsulators, the Encapsu-Vac 4010 series, specifically designed for curing epoxies, offers both heat and vibration techniques. The heater plate, which is SCR-controlled, permits heating the mold to allow curing of the plastic inside the chamber. The encapsulator also has a vacuum oven that maintains temperatures of 125°C maximum continuously. In addition, a vibration capability operates when epoxies are poured into the mold cavities. The amplitude of vibration has a separate SCR-con-



trolled adjustment. Three models are priced at from \$1,425 to \$2,225.

Aremco Products, Inc., P.O. Box 429 Ossining, New York 10562 [400]

# Industrial designers like the way they look. Engineers like the way they work.

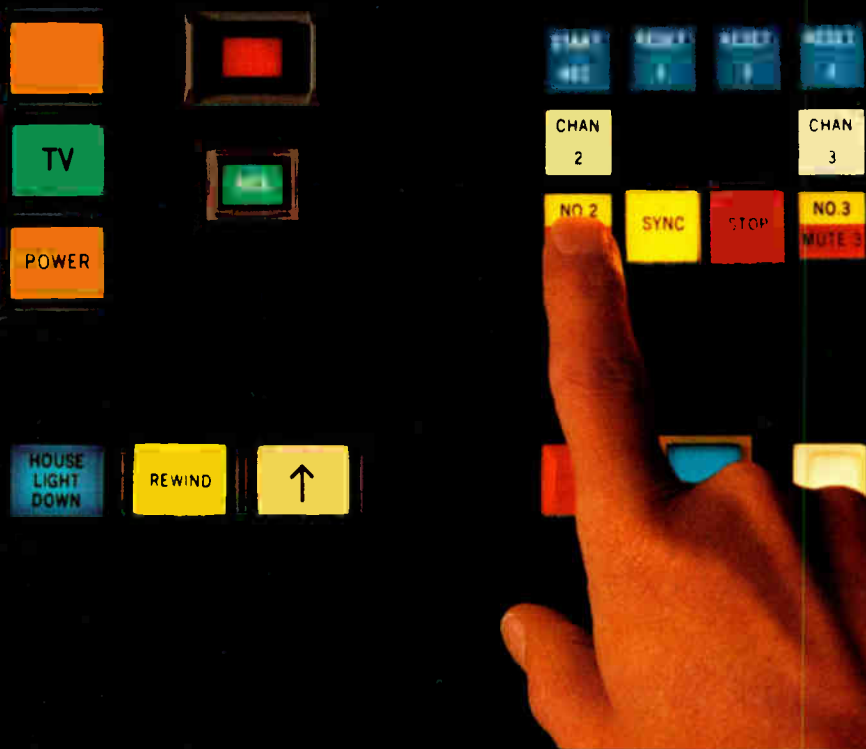

**MAIN PHOTO:**  
Series 3 (right) and Series 4 (left)

**LOWER PHOTO:**  
Series 4, (left) lowest cost, all three energy levels, snap-in mount.

Series 2, (back) with modular design, up to 4 lamps and 4 poles, military versions.

Series 1, (right) with bushing mount, panel seal, military versions.

Series 3, (front) the smallest in our line, with snap-in or matrix mount.

If you've got a particular idea about what a lighted push-button should look like, we've got four important numbers for you: Series 1, 2, 3 and 4.

They represent one of the biggest selections of lighted pushbuttons in the world.

So you get to choose from a long list of options, depending upon the switch you select. Like buttons available in popular, highly consistent colors. Either transmitted or projected. Legending includes hot stamp, engraved or film insert, with an optional hidden legend available. Barriers and housings come in a choice of colors. Lighting is single or multiple lamp. Mounting either single unit, strip or matrix. You can also choose between round or square configurations, and most of them offer front-of-panel relamping without tools.

But your choice doesn't end at the front of the panel. In back of the button, there are three energy levels available—solid-state, low-energy and power. You can choose among solder, quick-connect, P.C. board mount or screw terminals. They're all U.L. and C.S.A. listed, with military-listed variations available. Circuitry can be single-pole, single-throw through four-pole, double-throw. With momentary or alternate action.

And, even though each of the four Series has its own particular advantages, they all have one thing in common: the kind of reliability you'd expect from the company that pioneered lighted pushbutton switches.

If you'd like more information on any or all of the MICRO SWITCH lighted pushbuttons, call toll-free 800/645-9200 (in N. Y. 516/294-0990, collect) for the name of your nearest Branch Office or Authorized Distributor.

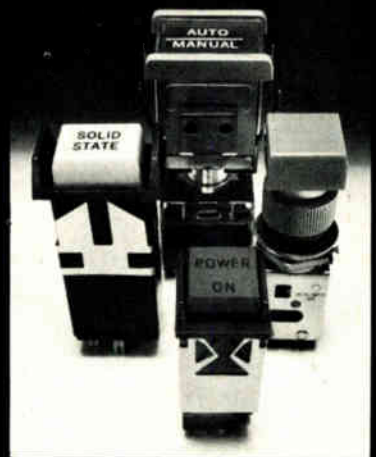

**MICRO SWITCH**

FREEPORT, ILLINOIS 61032

A DIVISION OF HONEYWELL  
Circle 185 on reader service card

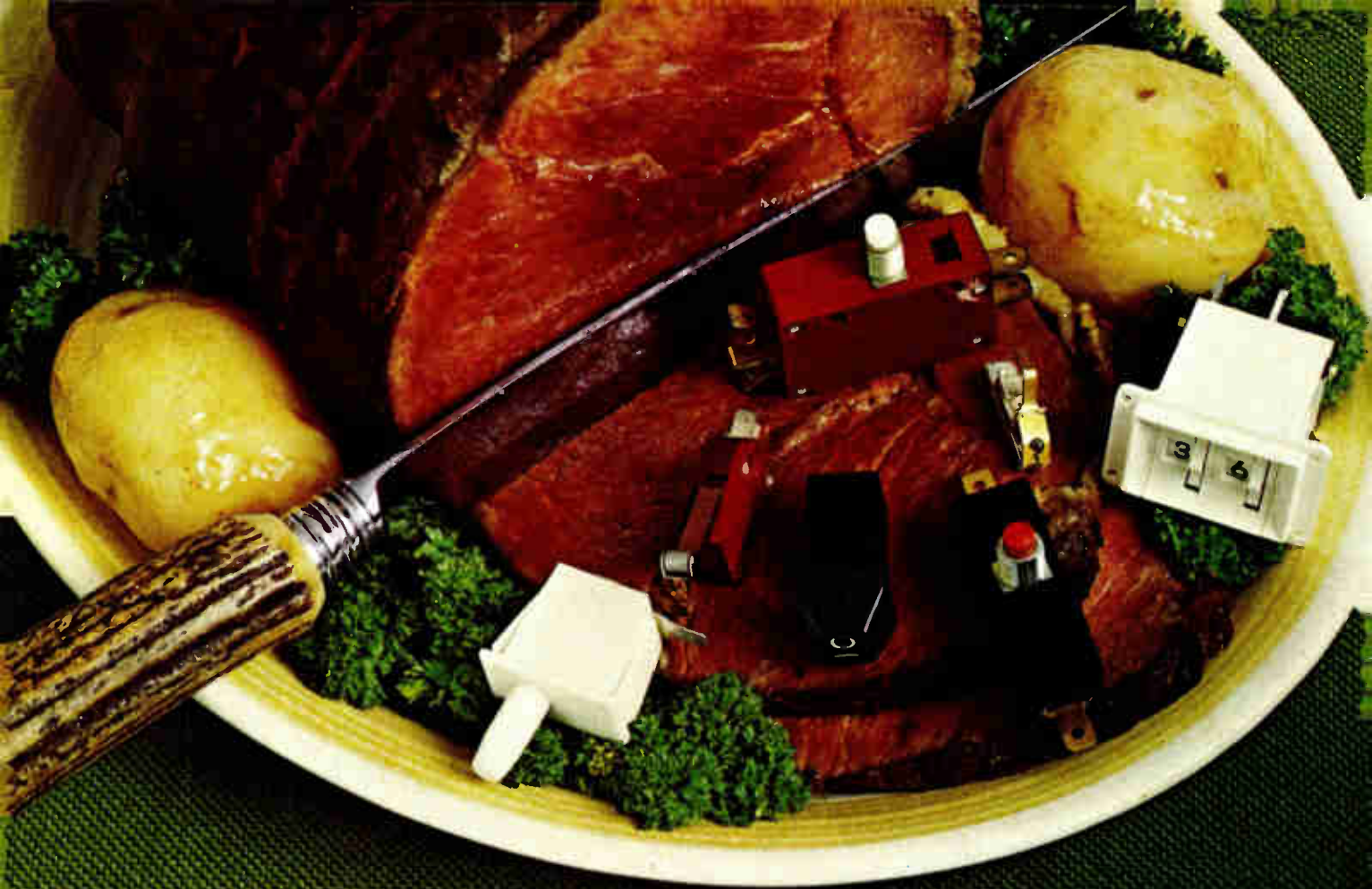

# We're a meat and potatoes kind of company

## ... but our products work

When it comes to basics—designing and manufacturing products that work and keep on working year after year—Cherry really shines. And, if you are the type that prefers old-fashioned good customer service, straight talk and actions that speak louder than any words, Cherry has what you like.

Let's talk good honest value for a minute. Take quality and price: We fabricate most of our own components (moldings, stampings, springs, printed circuits, etc.) so we can control quality all the way. And we're loaded with automatic equipment, so we can handle high volume with low unit costs.

When you need a switch or keyboard, you discuss your application with a *technically trained* Cherry

representative. Then our engineers try to solve your problem with an inexpensive "standard." But if you need a custom design, that's what you get. And when our man gives you a delivery date, count on it. We won't wreck our reputation or your schedules with pie-in-the-sky promises.

Give us a try, We think you'll like doing business with Cherry.



Let us send you our complete menu of meat and potatoes switches: the new Cherry catalog. TWX 910-235-1572... or PHONE 312-689-7700... or circle the reader service number.

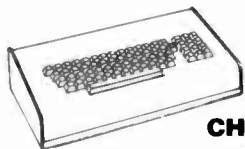

ELECTRONIC DATA ENTRY KEYBOARDS

# CHERRY



CHERRY ELECTRICAL PRODUCTS CORP. • 3600 Sunset Avenue, Waukegan, Illinois 60085

Circle 186 on reader service card



ELECTRONIC DESK TOP CALCULATORS

## New products

Subassemblies

# Converters give high resolution

Analog-to-digital units also offer fast conversion time at low prices

In analog-to-digital converters, high resolution and speed don't usually go along with low prices, but such is the case with two families of devices developed by Zeltex Inc.

One family is the 3000 series, with 13- and 14-bit resolution and with speeds up to 40 kilohertz. The other is the 2000 series of eight-bit devices with a full-conversion time of 8 microseconds.

Both groups use thick-film resistor networks and also make use of digital large-scale-integration technology in a novel circuit configuration that incorporates the successive-approximation technique of conversion.

The model ZAD3014 is a 14-bit, 35-microsecond device that is accurate to within 0.005% and sells for \$249 for a single unit. The ZAD3013, which is pin-compatible, offers 13-bit resolution, a conversion time of 25 microseconds, and accuracy to within 0.01%. This model is priced at \$229. Both of these mod-

els in the 3000 series offer four user-selectable input voltage ranges (0 to +5, 0 to +10,  $\pm 10$ , and -10 volts) and three codes (binary, offset binary and 2s complement). The units are packaged in DIP-compatible modules that measure 1.98 by 3.6 by 0.4 inches.

In the 2000 series, the ZAD2010 is a fully militarized model offering eight-bit resolution and an 8-microsecond conversion time over the range from -55°C to +125°C. The ZAD2000 is a commercial version of the same device and is intended for applications where small size and low price are required. Both models in the series are housed in the Zeltex  $\mu$ verter package that measures 1.76 by 1.98 by 0.4 in.

Maximum user flexibility has been designed into the 2000 series, the company says. Four input ranges are built in and are selected by external jumpers. The units are DIP-compatible and can be mounted into sockets or on printed-circuit boards. The commercial model sells for \$59 in single units, and the military version for \$95. Delivery time for both is two weeks.

Zeltex Inc., 1000 Chalomar Rd., Concord, Calif. 94520 [391]

## Thin-film resistor networks put in dual in-line housings

Allen-Bradley Co., Milwaukee, has extended its thin-film resistor technology into a standard line of precision thin-film resistor networks in dual-in-line packages. Previously available in flat pack and chip circuits, the networks are built from integrated films of chromium cobalt vacuum-deposited on glass substrates. Interconnections are metal film, and the lead frame provides a mechanical and soldered junction.

Package configurations include standard 14-, 16-, 20-, and 24-pin DIPs, with package widths of 0.300, 0.600, and 0.900 inch. Resistance range of the network is from 1,000 ohms to 10 megohms standard, with 10  $\Omega$  to 50 M $\Omega$  available on special order. Resistor tolerances are as low as  $\pm 0.01\%$ , and resistance matching

## CONNOR-WINFIELD

# TCXO

# VCXO

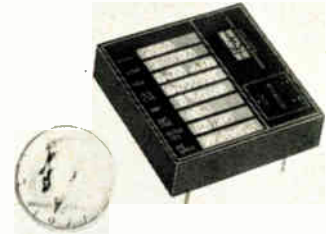

### Specifications

**Supply Voltage:** 5Vdc  $\pm 1\%$  10 to 75 ma  
or  
any fixed voltage between 8 and 15V with  $\pm 1\%$  regulation 4 to 50 ma.

**Output Waveform:** TTL - Square only.

0.6 to 10.0V Square or  
Sine into 600 $\Omega$  to 15K $\Omega$   
with a 12Vdc supply.

**Warm-up Time:** 10 seconds.

**Dimensions:** 1.75" x 1.75" x 0.5".

**Termination:** .03" diameter gold-plated pins.

**Delivery:** Ten days to 8 weeks.

**Frequencies Available:** Any fixed frequency from .00005 Hz to 30 MHz.

### TCXO

#### Frequency Tolerance:

Model C12A  $\pm .000055\%$  +25°C to +35°C

Model C12B  $\pm .00015\%$  0°C to +50°C

Model C12C  $\pm .00025\%$  -25°C to +65°C

### VCXO

#### Frequency Tolerance:

Model V12A  $\pm .00005\%$  +25°C to +35°C

Model V12B  $\pm .0002\%$  +20°C to +40°C

Model V12C  $\pm .0005\%$  0°C to +50°C

Model V12D  $\pm .001\%$  -25°C to +75°C

**Voltage Control:** +10V +200 ppm  
-10V -200 ppm.

**CONNOR-WINFIELD CORP.**



West Chicago,  
Illinois 60185  
Phone 312-231-5270

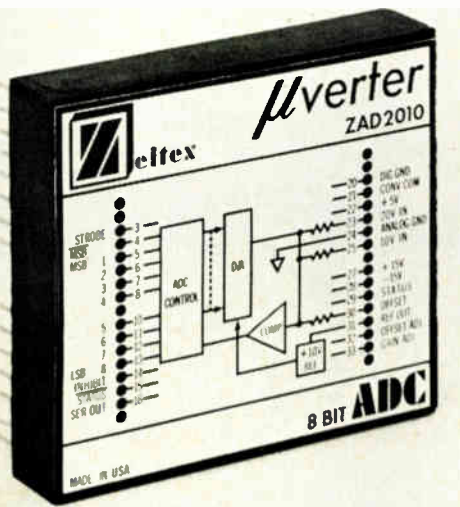



**“Okay, okay.  
You tell me where we can find  
twenty thousand RAMs a week  
for that much less than the 2102  
and I’ll tell you where to find  
the Easter bunny.”**

## **Give him the good news:**

You can find all the 1K RAMs you need right now—right here at AMI. We have 4006, 4008 and 4008-9 RAMs ready for immediate delivery. They’re pin-for-pin with Mostek’s. But you can get more of ours—faster. (Stands to reason that when you have larger production facilities you can produce more.) The price is right, too. For example, the 4008-9 is yours for just \$3.50 in quantities over 1000. You get the advantages of a 2102 system, while saving a bundle with our 4006 family. You can get an application note on how to do it, and a free sample, by writing to

Frank Rittiman, AMI, 3800 Homestead Road, Santa Clara,  
CA 95051. Phone: (408) 255-3651. Or ask your distributor.

**AMI**  
AMERICAN MICROSYSTEMS, INC.

# The charge of the 1K RAMs.

No more waiting for your 4006 family.

You have a perfect combination of price/performance for your 1024 bit MOS RAM applications. Use them for buffer or scratch pad memories. Or for peripherals, terminals, displays, programmable calculators, cash registers, optical scanners, spectro-analyzers.

And we give you more than fast deliveries. We give you specs like these:

P/N	S4006	S4008	S4008-9
No. of Bits	1024x1	1024x1	1024x1
Access Time	400 ns	500 ns	800 ns
Cycle Time	650 ns	900 ns	1000 ns
Power Supply	+5V, -12V	+5V, -12V	+5V, -12V

**And this is how the S4006/8/8-9 looks on paper:**

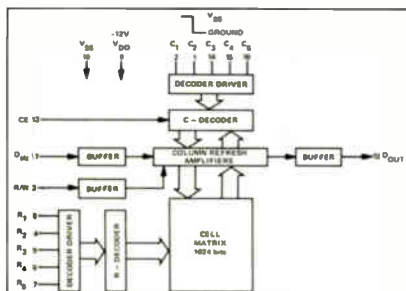

**AMI**  
AMERICAN MICROSYSTEMS, INC.

## New products

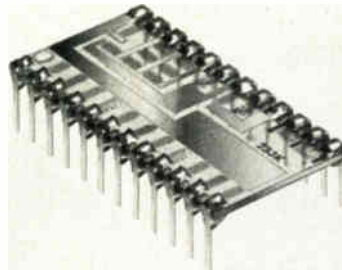

is as low as  $\pm 0.005\%$  at  $25^\circ\text{C}$ . Temperature coefficient of resistance is  $\pm 25$  ppm/ $^\circ\text{C}$ , or as low as  $\pm 5$  ppm/ $^\circ\text{C}$ ; TCR tracking is  $\pm 5$  ppm/ $^\circ\text{C}$  standard.

In addition, power rating is 50 milliwatts per resistor, although the firm will provide up to 250 mw per resistor on custom orders. Delivery on standard networks is less than 6 weeks; custom orders take 8-10 weeks. Prices of the resistor networks range from \$5 to \$50, depending on specifications.

Allen-Bradley Co., 1201 S. Second St., Milwaukee, Wis. 53204. [382]

Signal processors are available in DIP form

A family of rf signal processing components, housed in 14-pin dual in-line packages, are compatible with standard DIP devices used in logic and dc circuitry. Four units, priced at \$9.50 each for 10 to 49 pieces, are offered. The devices are the model FD-1 series wideband miniature frequency doubler, the

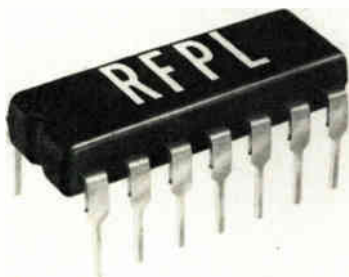

DBM-14 double balanced mixer, the 2PD-5 miniature broadband rf power divider/combiner, and the DC-14 series miniature broadband

bidirectional coupler. The FD-1 for example, offers a 5-to-500-megahertz input frequency range and a 10- to 1,000-MHz output frequency range. Input power is +10 dBm.

Rf Power Labs Inc., 11013 118th Place, N.E. Kirkland, Wash. 98033 [383]

Op amp settles to 0.1% in less than 50 nanoseconds

The model 9823 op amp provides a settling time to 0.1% in less than 50 nanoseconds. The 9823 is intended for use with current-output devices such as digital-to-analog converters, photodiodes, ion gauges and photomultiplier tubes. Further, the 9823 features fully differential input and may also be used in general-purpose wide-band applications in non-in-

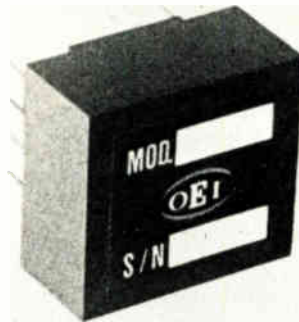

verting, inverting and differential circuits. Other features include a minimum slewing rate of 30 volts per microsecond and a 75-megahertz minimum gain-bandwidth product. Price is \$66 each for 1-2, \$59.50 each for 3-9, and \$54 each for 10-29 pieces.

Optical Electronics Inc., Box 11140, Tucson, Ariz. 85734. [385]

Design kit provides opto-electronic aids

An opto-electronic design kit intended to aid designers of devices for industrial control, instrumentation, monitoring, inspection, and gaging, consists of six opto-elec-

## DEFENSE REQUIREMENTS

# ELECTRICAL COIL WINDINGS & TRANSFORMERS

Designed to meet specific requirements or to your specification.

**COIL WINDINGS**  
**ELECTROMAGNETS**  
**SOLENOIDS**  
**COIL ASSEMBLIES**

**PAPER INTER-LAYER SECTION**  
**BOBBIN WOUND**  
**FORM WOUND**

Equipped for vacuum and pressure impregnation—varnish or compound.

*An experienced organization at your service prepared to assist in design or cooperate on problems.*

**DINION COIL COMPANY**  
P.O. BOX D CALEDONIA, N. Y.

**ARGON HELIUM KRYPTON**  
**NEON XENON MIXTURES**

*Linde*  
**RARE GASES**  
**AND MIXTURES**

*. . . Spectroscopically Pure*  
*. . . Easily removed from bulb without contamination*

Scientific uses for Linde rare gases include—

1. The study of electrical discharges.
  2. Work with rectifying and stroboscopic devices.
  3. Metallurgical research.
  4. Work with inert atmospheres, where heat conduction must be increased or decreased.
- Many standard mixtures are available. Special mixtures for experimental purposes can be supplied upon request.

The word "Linde" is a trade-mark of

**THE LINDE AIR PRODUCTS COMPANY**  
Unit of Union Carbide and Carbon Corporation  
30 E. 42d St., New York **UCC** Offices in Principal Cities  
In Canada: Dominion Oxygen Company, Ltd., Toronto

May 31, 1940, on a method of producing frequency modulation by generating frequency stabilized waves and applying a portion of the waves to establish saw-tooth waves which are combined with the desired modulation to produce pulses having an amplitude and a width corresponding to the modulation. The amplitudes of the pulses are limited to derive currents of square wave form, and the square waves are differentiated to form a series of pulses having a spacing corresponding to the modulation. These pulses produce waves of substantially constant mid-frequency and an extreme frequency corresponding to the applied modulation. No. 2,280,607 to W. vB. Roberts, RCA, Aug. 29, 1940, on an f-m receiver tuning indicator. A direct voltage component is produced in a discriminator network which is zero upon accurate adjustment of the tuning to the desired station. This direct current is used to provide a visual indication, the amount of which can be varied. No. 2,280,545 to R. E. Schock, RCA, June 18, 1940, on a frequency modulating detector comprising two rectifiers on each side of a push-pull circuit.

**Automobile Radio System.** A removable self-contained radio receiver including a storage battery and means for electrically connecting the set in the circuit with the car generator to cause both the set battery and the vehicle battery to receive charging current when the engine is running. A switch forms part of the set and is removable with it to permit charging current to flow to the set battery but not in a reverse direction. D. J. Barrett and L. G. Pacent, Sept. 11, 1940. No. 2,280,465.

**Wide Band Amplifier.** An amplifier for producing uniform ratio between input current and output voltage and having resistance and capacity in shunt with the input to which the current is supplied. The current has frequencies extending over a wide band and having intensities only slightly above the noise level. In the intermediate frequency portion of the band above the carrier of the most intense noise the currents are attenuated without changing the characteristic relation between intensity of voltage on the resistance and capacity and the frequency in the high frequency portion of the band. At a later stage of the amplifier low frequency currents are attenuated to produce uniform amplification at all frequencies below said high frequency portion and thereafter accentuating voltages in the high frequency portion of the band by an amount sufficient to overcome the attenuation produced by the shunt resistance and capacity, said accentuation occurring at a point in the amplifier subsequent to a stage following the point where the low frequency accentuation occurs to avoid overloading the last stage with currents to be attenuated. D. E. Norgaard, G.E. Co., May 1, 1941. No. 2,280,532.

# G. A. W. CARBONYL IRON POWDER



Manufactured by  
**GENERAL  
ANILINE WORKS**  
435 Hudson Street,  
N. Y. C.

## SETTING A NEW HIGH IN IRON CORE PERFORMANCE

Available in three types, G.A.W. Carbonyl Powder—combining high effective permeability and highest Q value—is of increasing importance to leading core manufacturers supplying the carrier and high frequency fields where the highest efficiency is required.

*Write for further  
information*

Distributor of G. A. W.  
Carbonyl Iron Powder:

**ADVANCE**  
**SOLVENTS & CHEMICAL CORPORATION**  
245 FIFTH AVENUE NEW YORK, N. Y.



## Do you Create and Control Waveshapes?

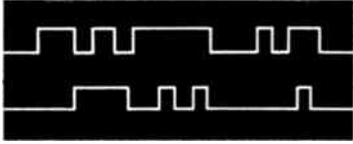

Our flexible systems can help you with: *PCM Communications Testing*: Bit and block error rate test measurements up to 1000 MHz. *Data and Word Generators*: Serial data generators to 500 MHz; Parallel words to 100 MHz. *Pulse Shaping*: Digital control with 200 picoseconds accuracy.

**tau-tron**  
INC  
11 Esquire Road, North Billerica, Mass. 01862  
Tel: (617) 667-3874

Circle 190 on reader service card

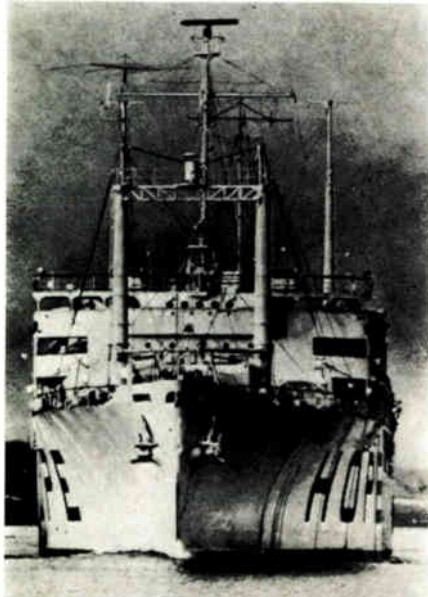

## S.S. HOPE, M.D.

Doctor . . . teacher . . . friend to millions on four continents—this floating hospital is a symbol of America's concern for the world's disadvantaged.

Keep HOPE sailing.

**PROJECT  
HOPE**

Dept. A, Washington, D.C. 20007

## New products

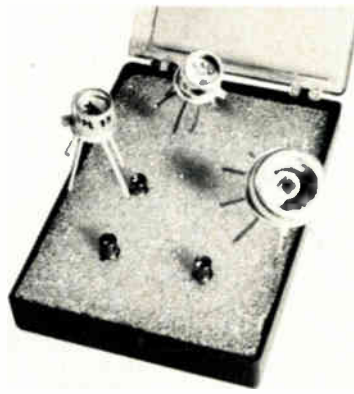

tronic switches and other devices, together with a 96-page illustrated circuit design handbook on how to use them in a diverse range of applications. The six solid-state devices combine advanced photosensitive silicon elements (both LED- and filament-responsive) with C-MOS technology, to provide integrated buffer amplifiers, adjustable-threshold triggers and light-to-frequency converters. Price is \$75.

Integrated Photomatrix Inc., 1101 Bristol Rd., Mountainside, N.J. 07092 [386]

## Dual delay module provides delays of 10 to 1,000 ns

An ECL/TTL-compatible, pc-board-mounted programmable dual delay module provides output pulses within 1 ns of digitally-selected nominal times in a range of 10 ns to 1,000 ns after trigger. The unit is designed to trigger on ECL/TTL positive or negative edges, and programing is accomplished by three decades of remotely generated BCD inputs for the control of each of two independently timed ECL/TTL outputs.

Technitrol Inc., 1952 E. Allegheny Ave., Philadelphia, Pa. 19134 [389]

## Power-supply modules allow variable design

Expanding the SM series sub-modular power supply line, 10 new low-voltage models incorporate a "building block" concept, which is

said to combine the benefits of multiple-output design and single-output modularity. The basic building block is a sub-modular power supply with built-in rectifier, filter, regulator, protective circuits and exclusive logic-inhibit function. Other building blocks include an ac transformer, heat sink assemblies and protective thermostats. The new models, designated -050, cover the range of 4.20 v to 4.75 v or 0.16 A to 75 A and are for use in low-voltage applications such as memories, solid-state optical devices, and emitter-coupled logic. The new units, which range in price from \$10 to \$175, require no external components for adjustments.

Powertec Inc., 9168 DeSoto Ave., Chatsworth, Calif. 91311 [388]

## Op amp handles audio and servo applications

The IS741H75 operational amplifier with a 75-watt output is designed for audio and servo power applications. The unit is a cast hybrid, thermally compensated true differential amplifier joioed to a heat sink. Continuous rms currents of 5 amperes can be maintained at the output, and loads as low as 1.0 ohm can be safely driven. The power supply pins are rated  $\pm 45$  volts. In addition, output short-circuit protection, a 3 MHz unity-gain bandwidth, 60 db open-loop gain, and single-supply compatibility are also

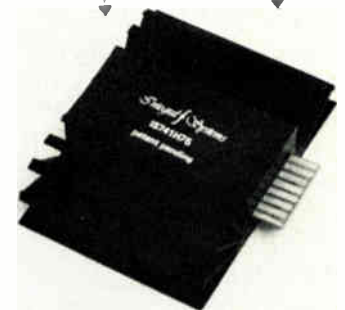

features. Price is \$25 each in 100-lots

Integral Systems, 500 Waltham St., N. Wilmington, Mass. 01887 [387]

# You know TRW for chassis and engine parts.

## But do you know our resistor capability?

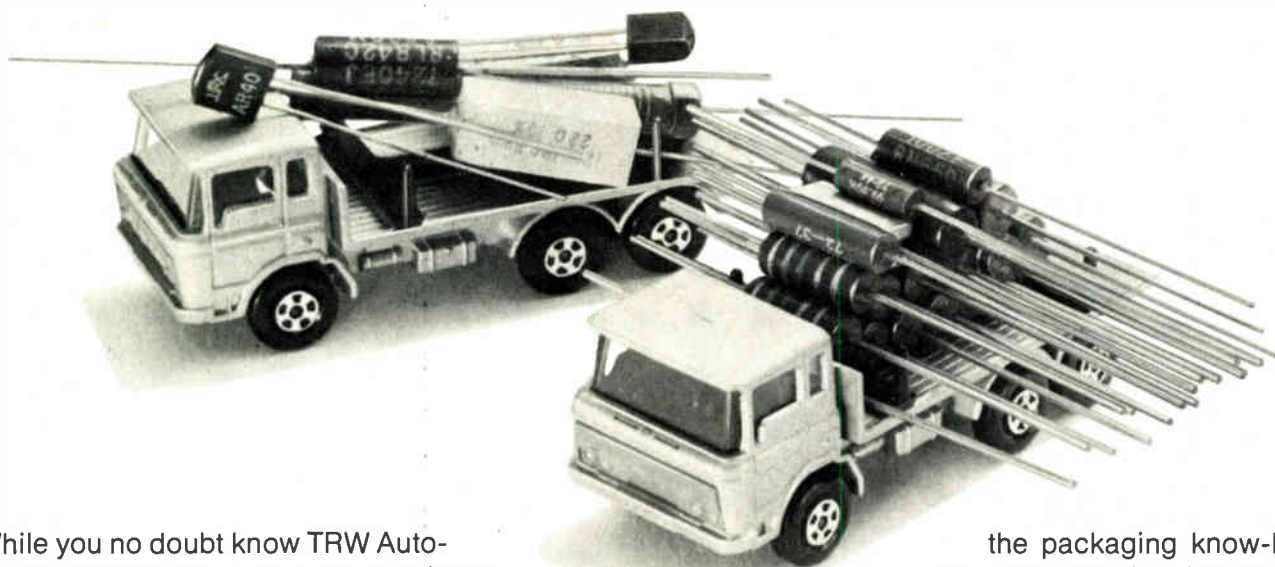

While you no doubt know TRW Automotive Worldwide, you may *not* know TRW/IRC—the resistor branch of the family.

TRW/IRC offers the broadest line of fixed resistors in the business—used by the *billions* in consumer, industrial, and military applications. This is a total resistor technology: carbon comp.'s, Metal Glaze™, wirewound, thin-film, networks, strips, and resistive functions for specific applications. We can give you *any* of the proven technologies, at reliability levels to meet automotive demands.

In fact, our resistors are already designed into automotive safety devices, electronic controls, ignition systems, fuel injection, adaptive brake systems and, of course, AM and FM radios, and mobile communications equipment.

TRW/IRC offers a high-volume, multi-source (four domestic plants) production capability. *Plus*

the packaging know-how for cost-effective interfacing with your assembly equipment. So get to know us. Send for the TRW/IRC Resistors Catalog. TRW/IRC Resistors, an Electronic Components Division of TRW, Inc., Greenway Road, Boone, N.C. 28607. (704) 264-8861.

**TRW/IRC Fixed Resistors  
Greenway Rd., Boone, N.C. 28607**

**Please send your latest catalog  
on TRW/IRC Resistors for  
Automotive Applications**

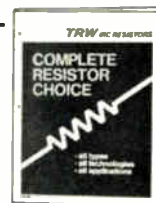

Name	Title	
Company		
Address		
City	State	Zip



## **TRW** IRC RESISTORS

# “We’ve Got A Great Instrument”



Carl Pehlke, President and Chairman

In fact, we’ve got a lot of great instruments. Perhaps we’ve grown complacent. Maybe we haven’t been ardent enough in telling our customers Texscan IS the world leader, with a complete line and a single source that no other has.

With our design and design capabilities, we’re coming on even stronger in the CATV, sweeper, spectrum analyzer, oscilloscope, attenuator and oscillator business.

We’ll be telling you more later. For now, though, why is Texscan *the* leading supplier? For openers, take a look at the chart below:

PRODUCT	Number of Models		
	TEXSCAN	TELONIC	WAVETEK
Laboratory Sweep Generators	26	8	7
Spectrum Analyzers	6	0	0
Display Oscilloscopes	3	3	1
Attenuators	83	18	8
Oscillators	149	0	0
Filter types	8	6	0

Based on latest catalog information

## Texscan

THE WORLD LEADER AND  
COMING ON EVEN STRONGER.

U. S. Sales Offices: Albuquerque 505-298-2575, Bayside (N.Y.) 212-423-7330, Binghamton (N.Y.) 607-748-0509, Blue Bell (Pa.) 215-542-1490, Cedar Rapids 319-363-2489, Cleveland 216-243-8430, Dallas 214-363-5291, Dayton 513-298-3033, Depew (N.Y.) 716-685-4111, Detroit 313-482-1229, Dover (N.J.) 201-366-7518, Hamden (Conn.) 203-288-5246, Hazelwood (Mo.) 314-731-5200, Hazlet (N.J.) 201-264-1851, Honolulu 808-941-1574, Huntsville (Ala.) 205-837-1601, Independence 816-737-1414, Indianapolis 317-257-7231, Los Angeles 213-478-1586, Mt. Penn (Pa.) 215-672-5565, Northbrook (Ill.) 312-882-7140, Orlando 305-859-2160, Palo Alto 415-494-3331, Seattle 206-763-2233, Syracuse 315-454-9314, Ulster Park (N.Y.) 518-372-6649, Winston-Salem 919-722-9671, Waban (Mass.) 617-969-3372, Wheaton (Md.) 301-942-9420. Canadian Sales Offices: Downsview 416-638-0218, Halifax 902-455-0670, Montreal 514-735-4565, Ottawa 613-728-4624, Vancouver 604-732-7317, Winnipeg 204-475-1732.

decassette  
two  
digital equipment corporation

digital

digital equipment corporation maynard mass

# Wherever Digital computers are, Digital cassettes are going.

Digital's dual magnetic tape cassettes aren't everywhere yet. But wherever Digital PDP-8 and PDP-11's are used, DECcassettes are rolling.

That's because DECcassettes are the first truly reliable alternative to paper tape. Digital's own 1 mil tape with heavy mylar backing guards against tape failure. A special reel-to-reel drive design extends the life of tape performance. And single track recording coupled with error checking circuits protects against intrusion of noisy external signals.

Yet, with all these features, a DECcassette costs less than paper tape. And 15% less than other cassette-type systems. The single-unit price before liberal OEM quantity discounts is only \$2990.

Every DECcassette is also supported with the diagnostics and systems software you need to

get your research, development, monitoring, data communications and other applications running in a minimum amount of time.

For stand-alone systems, CAPS-8 and CAPS-11 give you the convenience of a magnetic tape resident programming system and the adaptability of a paper tape system.

Editor, relocating assembler, linker, debugger and file utility routines, combined with a concise, easy-to-use command language and a standard cassette file structure, enables easy extension of the system, too.

Operating systems software such as DOS/BATCH-11, RT-11 and OS-8 come complete with handlers that support the DECcassette. COMTEX-11 communications executive and other types of applications software are available on cassettes, thus elim-

inating the need for other more costly input devices.

Now you know why wherever Digital computers are, Digital cassettes are going.

Check into one yourself, whether you need a total system or just the drive itself.

Once you do, you'll be rolling, too. Delivery 30 days after receipt of order.

Call or write for complete information, Digital Equipment Corporation, Maynard, Mass. 01754. (617) 897-5111, Ext. 2949. European headquarters: 81 route de l'Aire, 1211 Geneva 26. Tel: 42 79 50. Digital Equipment of Canada Ltd., P.O. Box 11500 Ottawa, Ontario, K2H 8K8 (613) 592-5111.

digital

# We improved our micro resist.

New KODAK Micro Resist 747 is the purest, most stringently controlled resist we've ever made.

It's filtered to a value of 0.5 micrometer, and there are less than 10 parts per million of metal ions. (Less than three parts per million each of sodium, lithium, potassium, tin, or gold.) Viscosity and solids are also closely controlled.

And there are processing solu-

tions of equally high quality: KODAK Micro Resist Developer, Thinner, and Rinse. All of which help you get more uniform coatings and better process reliability. And *that* means economy.

There's convenience, as well. This negative-working resist comes in four ready-to-use viscosity grades: 30, 45, 60, and 110 centistokes.

# We couldn't improve our offer.

## Technical assistance.

We'd be pleased to share our experience in microelectronics with you. As a start, why not send for the comprehensive six-page data sheet on KODAK Micro Resist 747? Or have a representative demonstrate it for you. Either way, just use the coupon.



**Eastman Kodak Company**

PHF

Dept. 412-L, Rochester, N. Y. 14650

Please have a representative demonstrate KODAK Micro Resist 747.

Please send detailed information.

Name \_\_\_\_\_

Title \_\_\_\_\_

Company \_\_\_\_\_

Address \_\_\_\_\_

City \_\_\_\_\_ State \_\_\_\_\_ Zip \_\_\_\_\_

For information on sales outside the U.S. and Canada, contact the International Photographic Division, Eastman Kodak Company, Rochester, N. Y. 14650, U.S.A.

6-48

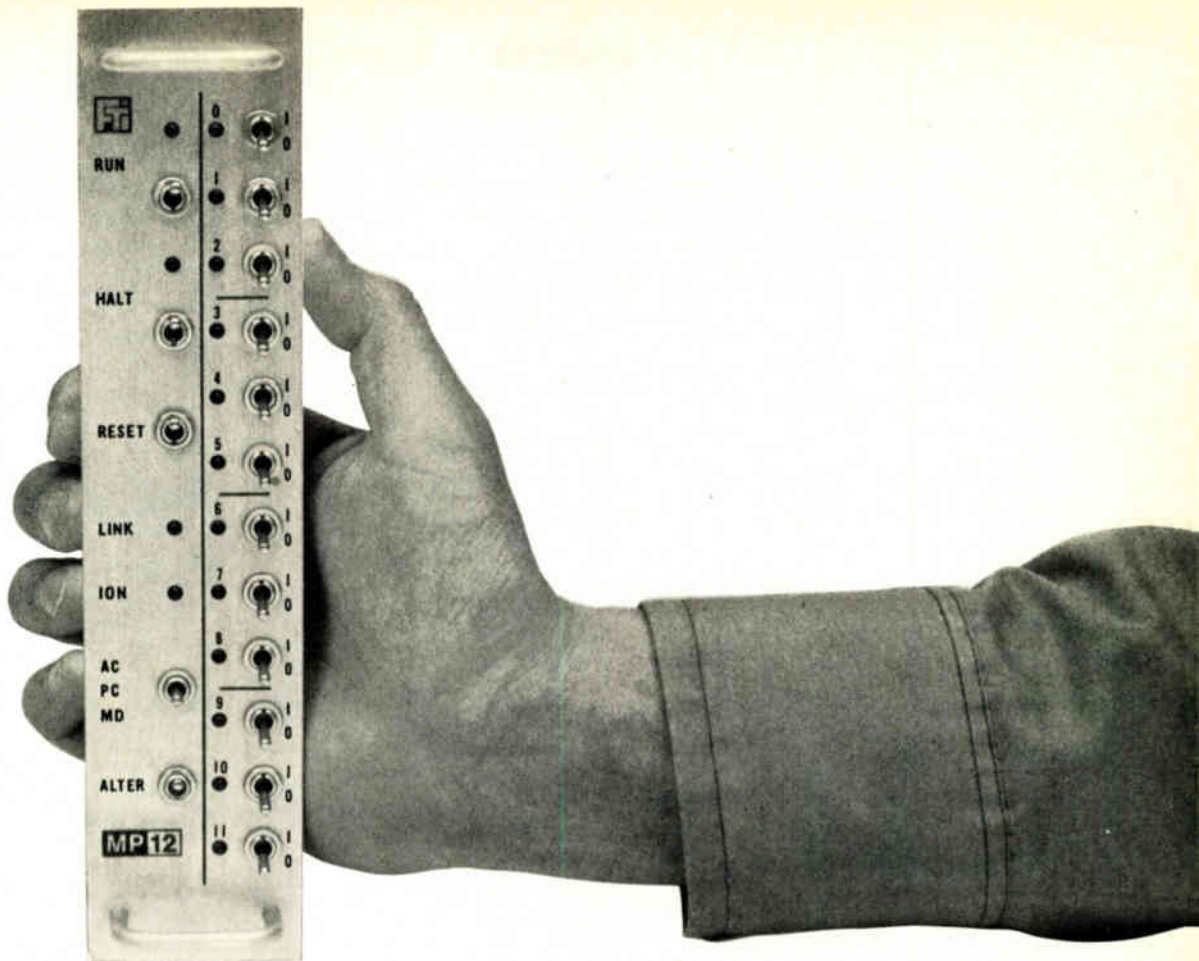

## ANNOUNCING AN EXCITING NEW OEM SYSTEM COMPONENT.

It's the MP12... Fabri-Tek's new microprocessor that performs like a minicomputer. The MP12 helps you get your application system up and running faster, easier and with more capability than ever before. No MOS microprocessor can match its performance in data acquisition, automated assembly, point-of-sale and other dedicated digital control applications.

**Completely Operational**—The MP12 CPU is a completely self-contained operational unit. All the digital electronics you need are built in along with 4K of reliable core memory, an operating console, power fail-auto restart and more. Everything comes in a compact 2.0" x 9.5" x 15.0" package.

**Supporting Software**—You also get all the software you need to develop and check out your own application programs. MP12 supplied programs are completely documented and include assembler, debug, loaders,

360/370 cross-assembler, source edit utility, processor diagnostic and utility sub-routines. Instruction set is PDP-8 compatible.

**Easy Interfacing**—You never had a processor so easy to interface. In fact, it's plug-in easy. The MP12 comes with all the timing and control necessary to interface with almost any peripheral. And it has enough power to drive up to 64 peripherals... printers, teletypes, CRT's, card equipment, on and off-line storage devices.

**Quick Delivery, Low Price**—There's a lot more you'll like about Fabri-Tek's MP12. Delivery and price, for instance. It's available for off-the-shelf delivery for as little as \$990 in quantities of 100. It can actually help you cut your overall manufacturing costs.

The MP12 could be the most useful component you've ever seen. For complete specifications and option information just write to MP12 at the address below.

**FABRI-TEK INC.**  
**COMPUTER SYSTEMS**

5901 South County Road 18 • Minneapolis, MN 55436 (612) 935-8811

**SALES  
OFFICES IN:**

Boston  
(617) 969-5077  
Chicago  
(312) 437-4116

Dallas  
(214) 661-3155  
Denver  
(303) 753-0631

Detroit  
(313) 487-5940  
Long Beach  
(213) 420-2493

New Jersey  
(201) 964-4770  
Orlando  
(305) 857-1050

Phoenix  
(602) 266-4448  
Sunnyvale  
(408) 739-4780

Hong Kong  
K-331383  
Munich  
089-755-8298

Tokyo  
(03) 432-6901  
United Kingdom  
Maidenhead 37321-4

## DIACON'S AUTOMATIC ENVIRONMENTAL STORAGE HANDLER:

- 200 DEVICES IN 029 CARRIERS
- RELIABLE • SIMPLE
- EASY TO MAINTAIN

Fewer moving parts inside the environment (two bushings only) provide long, maintenance-free operation. The Diacon storage handler is quiet and mechanically uncomplicated. Which helps eliminate down-time. Operates on 120 or 240 V.

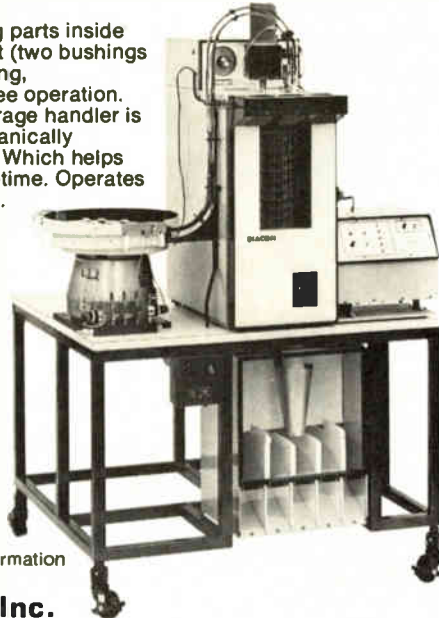

For complete information and specs, write:

**DIACON, Inc.**  
4812 Kearny Mesa Rd.  
San Diego, Calif. U.S.A.  
(714) 279-6992

Circle 196 on reader service card

## The first



**\$109.5**  
fully  
loaded

### at this price!

$\pm 1\mu V$  resolution

5 full functions

26 ranges

Lead-compensated ohms

For immediate information on Systron-Donner's new Model 7205 5½-digit Multimeter, call us collect on our Quick Reaction line: (415) 682-6471. Or you may contact your Scientific Devices office or S-D Concord Instruments Division, 10 Systron Drive, Concord, CA 94518. **Europe:** Systron-Donner GmbH, Munich, W. Germany; Systron-Donner Ltd., Leamington Spa, U.K.; Systron-Donner S.A., Paris (Le Port Marly) France. **Australia:** Systron-Donner Pty. Ltd. Melbourne.

**SYSTRON**  **DONNER**

## New literature

**Resistors.** Electro-Science Laboratories Inc., 1601 Sherman Ave., Pennsauken, N.J. 08110. Product bulletin #31-74 covers a low-cost, ruthenium-based, low-firing resistor system. Also discussed are complementing conductive, dielectric, and protective-coating compositions for thick-film circuits, multilayer MSI, and LSI arrays using low-cost soda-lime-glass substrates. Circle 421 on reader service card.

**Socket hand tool.** A hand tool for inserting sockets into electronic circuit boards is described in a bulletin available from Garry Manufacturing Co., 1010 Jersey Ave., New Brunswick, N.J. 08901. [422]

**Connectors.** A catalog from Malco, 5150 W. Roosevelt Rd., Chicago, Ill. 60650, describes high-density cylindrical connectors called the MARC-43 and -53 series. General descriptions, test data, descriptions of accessories, and modifications are also provided in the 21-page booklet. [423]

**Power supplies.** Optical Radiation Corp., 1090 Lousons Rd., Union, N.J. 07083. Xenon point-source lamps and power supplies are discussed in a brochure containing mechanical and electrical data, polar plots, brightness-distribution information, and spectral-irradiation charts. [424]

**Temperature controllers.** Thermo Electric, Saddle Brook, N.J. 07662, has published a catalog on solid-state output relays to switch 2, 10, 25, and 40 amperes at 240 volts ac with the Half-Size 100 and 100 series temperature controllers. [425]

**Variable-resistance components.** An updated short-form catalog from Bourns Inc., 1200 Columbia Ave., Riverside, Calif. 92505, contains information on the Trimpot product line, which includes potentiometers, controls, and variable resistors. [426]

**Thermoplastic polyester.** General Electric Plastics Business Department, 1 Plastics Ave., Pittsfield, Mass. 01201. A 16-page brochure

Gerber's interactive design system integrates your engineering creativity with the speed and productivity of the computer. Here's a complete system with all the software necessary to produce any schematic, master artwork, NC drill tape, assembly drawing, parts list, interconnect list, detail drawing. At your fingertips.

Here's the system that lets your designers design, leaves the drafting to us. To slash lead time. Make your engineering profit center even more productive and profitable.

All designed, built and serviced by Gerber Scientific. A name synonymous with great hardware. Leadership. And now synonymous with great software.

Call or write for complete information. The Gerber Scientific Instrument Company, Hartford, Connecticut, 06101. (203) 644-1551.

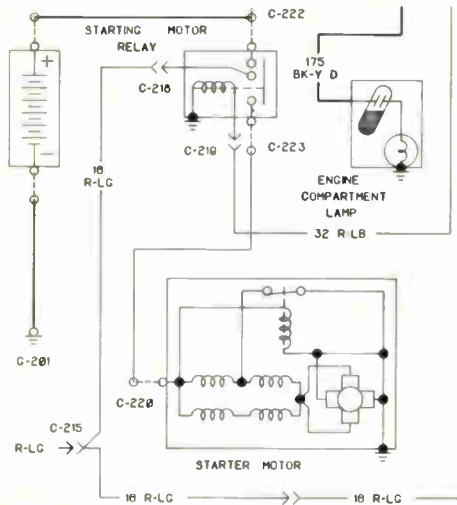

**GERBER SCIENTIFIC**

Circle 197 on reader service card

# Designing Machine.

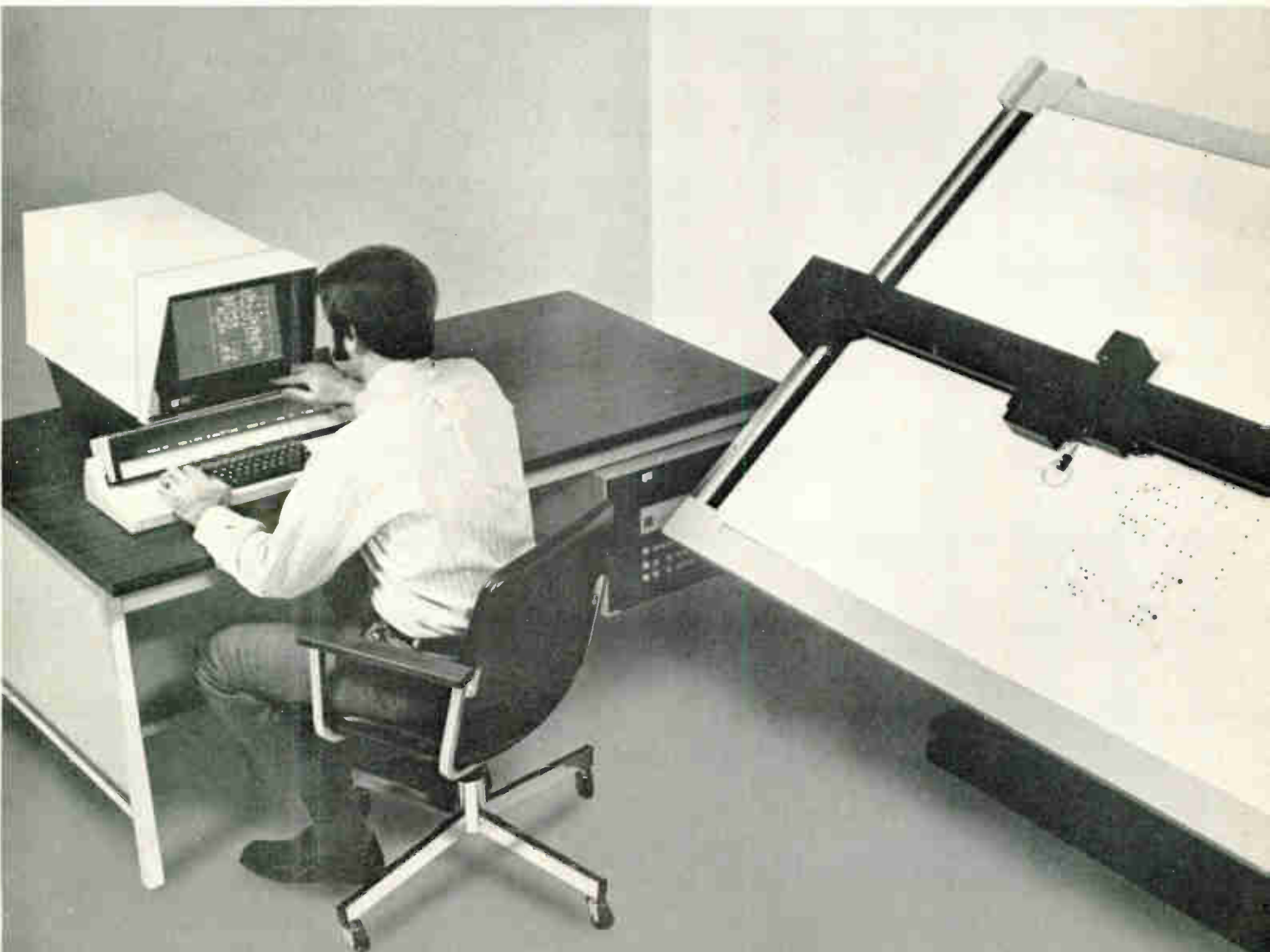



# TRANSISTOR SOCKETS

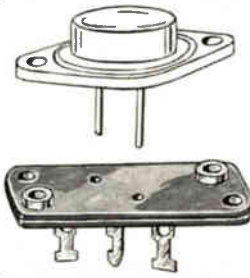
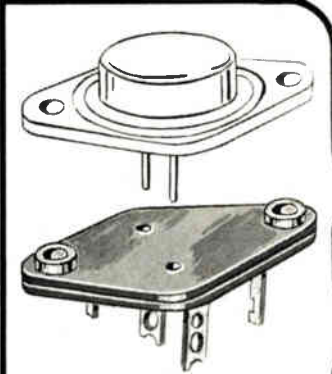

IN STOCK FOR  
IMMEDIATE DELIVERY  
MODIFICATIONS AVAILABLE

- For TO-3, TO-66, NPN, PNP, Transistors
- Ready to assemble mounting hardware kits for other types, styles, Transistors.
- Mica Insulators
- New catalog on request.

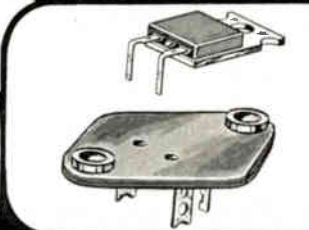

**KEYSTONE**  
ELECTRONICS CORP.

49 BLEECKER ST., NEW YORK, N.Y. 10012 • (212) 475-4600

Circle 245 on reader service card

## New literature

describes insulating and packaging capabilities of Valox resin, a thermoplastic polyester for connectors and integrated circuits. [427]

**Photosensitive devices.** Hamamatsu Corp., 120 Wood Ave., Middlesex, N.J. 08846. A brochure provides detailed specifications on more than 100 types of photosensitive devices, such as photomultipliers, phototubes, photoconductive cells, light sources, memory tubes, and video equipment. [428]

**Interconnecting.** An expanded series of interconnecting leads and hermetic connectors for high-voltage applications is described in catalog #73-218 from AMP's Capatron division, Elizabethtown, Pa. [429]

**Access control.** The line of Identilogic electronic access-control systems is described in a 16-page catalog from Eaton Corp., Box 25288, Charlotte, N.C. 28212. These control systems provide security at building-access points. [423]

**Diamond-scribing.** A 68-page manual from American Coldset Corp., Semiconductor Tool division, 529 Fifth Ave., New York, N.Y. 10017, describes diamond-scribing tools and processes for use with semiconductor wafers. [431]

**Memory chip.** Nortec Electronics Corp., 3697 Tahoe Way, Santa Clara, Calif. 95051, has issued a brochure giving information on seven random-access memories, two read-only memories and four shift registers. Photographs and specifications are provided. [432]

**Photomultiplier.** A 36-page publication from Emitronics Inc., Gencom division, 80 Express St., Plainview, N.Y. 11803, gives drawings and specifications on more than 70 photomultiplier tubes. [433]

**Frequency multiplexing.** Frequency-multiplexing electronics to expand tape-recorder capability is described in a bulletin from Tri-Com Inc., 12216 Parklawn Dr., Rockville, Md. 20852 [434]

**BLILEY  
CRYSTAL AND  
COMPONENT OVENS**

- Oven Temperatures: 60° C, 70° C, 75° C, 85° C
- Stability:  $\pm 1^\circ$  C to  $\pm 0.1^\circ$  C over temp. range  $0^\circ$  C to  $+60^\circ$  C
- Warmup Time (@  $-20^\circ$  C): 20 min.  $\pm 1^\circ$  C  
30 min.  $\pm 0.1^\circ$  C
- Oven Voltages: 12 or 27 Vdc
- Internal Design Details:
  - Crystal Ovens: Sockets for MIL-types HC-32/U, HC-6/U, HC-36/U & HC-13/U
  - Component Ovens: Cavity sizes up to 2.7 cubic inches

Detail Specification Sheets Available On Request

**Bliley** *if you buy quality*

**BLILEY ELECTRIC COMPANY**  
2545 West Grandview Boulevard  
Erie, Pennsylvania 16512

# What you can't see can hurt you.



Unless you have mass, atomic-absorption, infrared and X-ray spectrographs, scanning and transmission-electron microscopes, scanning electron microprobes, X-ray fluorescence. Or us.

## New independent analytical service.

Airco's new Analytical Services provides a full line of services for industrial, scientific and educational applications. We offer full gas analyses including calibration gas, gas identification and gases in metals and ceramics. We also provide environmental, organic and inorganic analyses. And we have portable instrumentation to conduct on-site analyses for many areas.

As a major supplier of industrial and rare and

specialty gases, we have an experienced staff and fully equipped lab to handle any analysis problem. They'll provide a complete gas analysis from any supplier (you don't even have to tell them who it's from) and they won't hesitate to tell you when a gas isn't as pure as it should be, even if it's ours.

For complete information, write or call Hank Grieco, Airco Industrial Gases, 575 Mountain Ave., Murray Hill, New Jersey 07974 (201)464-8100.

**AIRCO**  
Industrial Gases



## audiodescs

have consistently pioneered the major advances in recording-disc convenience, utility and performance. Here is the unparalleled record.

**FIRST** with a truly flawless surface — free from waves, swirls and thick-and-thin spots.

**FIRST** to provide ultra-high-frequency characteristics for perfect lifelike reproduction.

**FIRST** with engineered thread-action to facilitate effective control under any system.

**FIRST** to achieve complete freedom from deterioration—Audiodescs do not dry out.

**FIRST** with glass-base recording blanks when aluminum Audiodescs "went to war"

**FIRST** with a thin, flexible glass-base disc, completely interchangeable with metal-base types.

**FIRST** with all three drive-pin holes in glass discs, simultaneously eliminating chipping and breakage hazards.

**FIRST** with Safety Cartons for reshipping valuable glass-base Audiodesc recordings.

**FIRST** to provide special re-usable wood cases for shipping and storing, with full protection against dust and damage.

**FIRST** with a complete line of blanks—six types of Audiodescs meet all recording and price requirements.

**FIRST** with complete national distribution—Audiodescs are conveniently available everywhere

### FIRST IN THE MINDS OF RECORDING ENGINEERS

RED LABEL • YELLOW LABEL • BLUE LABEL • MASTERS • REFERENCE

Call your jobber—or write for free folder, "Audiodescs"



### Industrial Applications

**Temperature Control Apparatus.** A Wheatstone bridge made up of negative and positive temperature resistance elements with a d-c amplifier across the bridge balance point which controls a heating element to raise the temperature in a chamber. V. B. Bagnall, AT&T Co. Aug. 15, 1940. No. 2,278,633.

**Printing Press Control.** A photoelectric registering system. Hermann Kott,

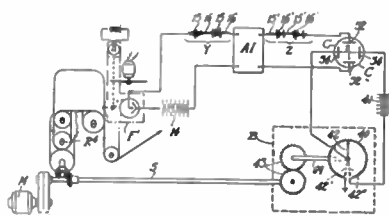

to Speedy Gravure Corp. June 2, 1938. No. 2,278,933.

### Recording Apparatus

**Magnetron Receiver.** Method of using a magnetron in a superregenerative circuit by varying the shunt impedance

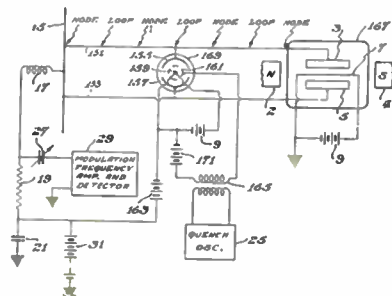

of a transmission line at a voltage loop at a quench frequency. R. A. Braden, RCA. Feb. 29, 1940. No. 2,277,841.

**Sound Film Recording.** Two patents, Nos. 2,274,529 and 2,274,530, to M. E. Collins, RCA, the first comprising means for continuously projecting a light beam on a motion picture film with a means to overmodulate a galvanometer to eliminate light beam from film, means for advancing the film, a second light source and means for periodically projecting the second light source on the film. The overmodulating means eliminates the first light beam during the advancement of a predetermined length of film, this length of film having images thereon made by the second light source. The second patent involves intercepting a certain frequency portion of a light beam and utilizing this portion to maintain the total light of the beam at a constant intensity.

**Sound Film Projector.** Mechanical equipment for moving sound film for television scanning. C. F. Matke and R. V. Terry, BTL, Inc. Jan. 10, 1941. No. 2,275,540.

## METAL SHIELDED WIRE

PAT. 2066201

Easily Formed — Adds Support  
Lightweight — Protects

READILY TRIMMED  
ELIMINATES ELECTRICAL INTERFERENCE, MOISTURE, ETC.  
Let us solve your Shielding Problems

**UNIFORM TUBES**  
SHURS LANE, ROXBOROUGH  
PHILADELPHIA, PENNA.

IN THESE TRYING DAYS  
YOU CAN  
**DEPEND ON TERMINAL**

Yes . . . now more than ever, the radio industry is looking to us for Parts and Electronic Equipment. The reason for this lies in our ability to supply much needed material with utmost speed and maximum efficiency:

The largest stock in our history is available to manufacturers, Government Agencies, and other organizations engaged in war work.

In other words, You Can Depend on Terminal — Your Most Reliable Source of Supply!

**TERMINAL RADIO CORP.**  
85 CORTLANDT STREET  
New York City • WOrth 2-4416

**If you want to (or must) know more about what's happening in electronics in German-speaking areas of Europe, there's only one thing to do:**  
**Subscribe to Elektronik**



# And Why?

## **ELEKTRONIK is the leader**

In Europe ELEKTRONIK is the largest-circulation German-language magazine for applied electronics and EDP. The West-German electronics sector is a branch of industry with an above-average rate of growth, and ELEKTRONIK is its spokesman.

## **Well-chosen and precise information**

Our editors see what is necessary and what is superfluous, so in ELEKTRONIK you get the right balance: well-presented information that can be easily absorbed divided into different areas of interest.

## **What ELEKTRONIK brings**

Important News from R&D - New Products: Components and Equipment - Measurement Engineering and Automatic Testing Equipment - Analog and Digital Techniques - Circuit Techniques - Semiconductors and IC's - Electronics in Industry, Science, Medicine, Telecommunications, Navigation, Traffic and Utilities, Automobiles, Watch and Clock Industry, Cameras - Electronic Computing Methods and Calculators/Computers - Control Engineering - Process Control and Automation - Electronics for Energy - News from Industry, Stock Exchange, Meetings and Exhibitions - Facts and Figures from Industry, Trends and Forecasts.

## **Up-to-the-minute news by air-mail**

ELEKTRONIK appears once a month. Our own correspondents follow up the latest news where it's happening. If you choose to take out a subscription by air-mail, you'll be reading this news within a few days, at a price of \$29 or approx. DM 72.50.

## **ELEKTRONIK represents its readers**

The professional qualifications, jobs (58% are engineers and scientists) and earnings of ELEKTRONIK readers are far above average. Just like the service their magazine gives them. And this is what is increasing our readership all over the world. Our readers know that achievement has its reward, and that is why they are prepared to pay for what we can offer them.

## **20 000 copies sold**

We don't give our magazine away. ELEKTRONIK is too informative and valuable for that. Every one of the more than 20 000 copies printed monthly is sold to a paying subscriber.

Of course we have a few sample copies if you're interested in seeing what we have to offer. Our representative in the U.S. would be pleased to send you one to help you decide on a regular and rewarding subscription to ELEKTRONIK.

Affix  
postage  
here

# **Elektronik**

**INTA Advertising, Inc.  
1560 Broadway  
New York, N. Y. 10036**

Affix  
postage  
here

# **Elektronik**

**INTA Advertising, Inc.  
1560 Broadway  
New York, N. Y. 10036**

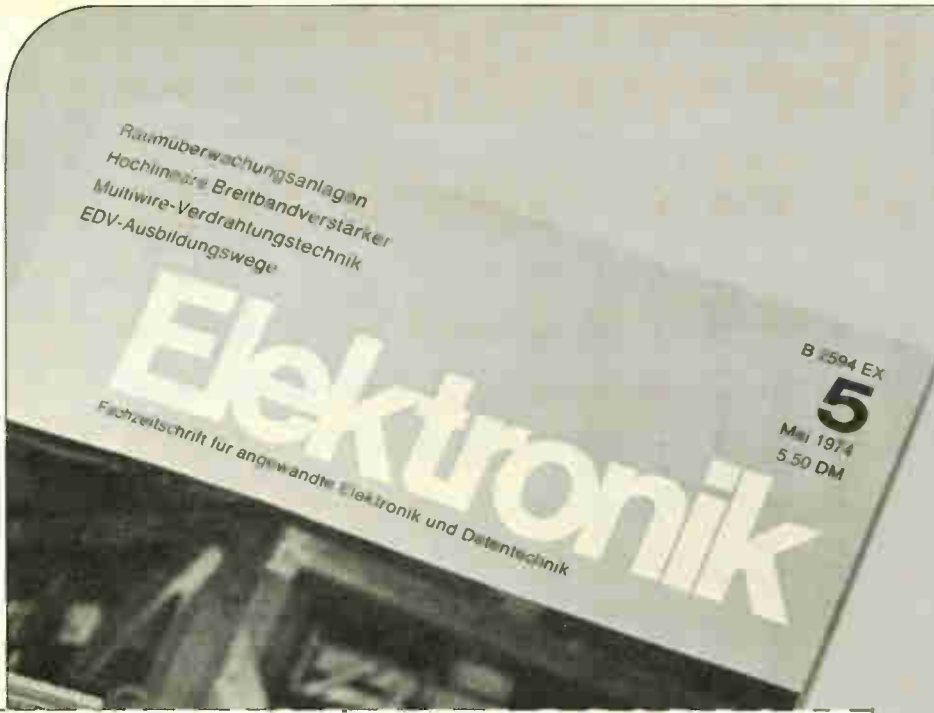

So you see,  
there's no better  
way of keeping  
up on electronics  
in the German-  
speaking Europe  
than by taking  
out a subscription  
for ELEKTRONIK.

Subscription  
order  
forms

**Please start my subscription to ELEKTRONIK at once. You may bill me after service starts and advise on method of payment.**

- ELEKTRONIK by air mail = DM 72.50 (or approx. \$ 29)
- ELEKTRONIK by surface mail = DM 54.- (or approx. \$21.60) beginning on ..... 1974 back-dated to ..... 197
- Standing order
- I will renew subscription, otherwise it expires at the end of one year

_____	_____
Last Name	First Name
_____	_____
Street	Town/City
_____	_____
Country	Principal job function
_____	_____
	Signature

If you wish to receive a sample copy, simply enter your name and address.

**Please start my subscription to ELEKTRONIK at once. You may bill me after service starts and advise on method of payment.**

- ELEKTRONIK by air mail = DM 72.50 (or approx. \$ 29)
- ELEKTRONIK by surface mail = DM 54.- (or approx. \$21.60) beginning on ..... 1974 back-dated to ..... 197
- Standing order
- I will renew subscription, otherwise it expires at the end of one year

_____	_____
Last Name	First Name
_____	_____
Street	Town/City
_____	_____
Country	Principal job function
_____	_____
	Signature

If you wish to receive a sample copy, simply enter your name and address.

If you wish to find  
out more about us,  
visit our stand at  
**WESCON 74** in  
**Los Angeles,**  
**10 to 13**  
**September 1974.**

# The world's biggest little black box is on the road



It's a unique display of TRW Electronic Components' newest products, circuit applications and ideas—coming right to you.

Picture a typical electronics chassis, grown to mammoth proportions. In fact, to the size of a 40-foot tractor-trailer; far and away the world's *biggest* "little black box." Inside, you'll find components which look like nothing you've ever seen before—because the scale is *giant*. Five feet high for some.

Our technical experts will be on hand to answer your questions on more than 1000 different products from the 14 separate divisions that form TRW Electronic Components.

And the show is on the road right now. We're zig-zagging our way across country, stopping at 155 plants in 27 states. Watch for announcements when we'll be in your area. TRW's little black box is where electronics is, and we're bringing it where you are. Because we *are* TRW.

**TRW**® **ELECTRONIC COMPONENTS**

# SEARCHLIGHT SECTION

- CLASSIFIED ADVERTISING
- BUSINESS OPPORTUNITIES
- USED OR SURPLUS EQUIPMENT

**SAME DAY SHIPMENT**  
Minis & Peripherals

**PDP SPECIALISTS**  
8, 8I, 8L & 11

**NEW 300 LPM PRINTERS**

**PDI CARD READERS**

**BRPE PUNCHES**

**\$750 Minis**

**TELETYPE 35 & 37**  
**DEC & HONEYWELL Modules**  
617/261-1100

Send for Free Report "Maintenance of Computers"

**AMERICAN USED COMPUTER CORP.**  
P.O. Box 68, Kenmore Sta., Boston, MA 02215  
member COMPUTER DEALERS ASSOCIATION

CIRCLE 951 ON READER SERVICE CARD

## HERMETIC SEALING

GLASS/CERAMIC TO METAL  
CONNECTORS • HEADERS  
CUSTOM SEALS  
1 C FLAT PACKS • RELAY BASE  
FEED THRU TERMINALS  
TESTING SERVICES  
Hermetic Sealing Since 1959

**DETORONICS Corporation**  
10660 E. Rush, S. El Monte, CA. 91733  
(213) 579-7130—TWX 910 587-3436

CIRCLE 956 ON READER SERVICE CARD

## FREE CATALOG

### HARD-TO-FIND PRECISION TOOLS

Lists more than 2000 items—pliers, tweezers, wire strippers, vacuum systems, relay tools, optical equipment, tool kits and cases. Also includes ten pages of useful "Tool Tips" to aid in tool selection.

**JENSEN TOOLS**  
4117 N. 44th Street, Phoenix, Ariz. 85018

CIRCLE 953 ON READER SERVICE CARD

## FREE ALARM CATALOG

Full line of professional burglar and fire alarm systems and supplies. 96 pages, 450 items. Off the shelf delivery, quantity prices.

**mountain west alarm**  
4215 n. 16th st., phoenix, az. 85016

CIRCLE 957 ON READER SERVICE CARD

## free catalog

**POTTING APPLICATORS**  
MANUAL OR AIR OPERATED  
2½cc 6cc 12cc 30cc  
FOR POTTING, ENCAPSULATING ETC.

**PHILIP FISHMAN CO., INC.**  
7 CAMERON ST. WELLESLEY, MASS. 02181

CIRCLE 954 ON READER SERVICE CARD

## EMPLOYMENT OPPORTUNITIES

Send New Ads to:  
Electronics  
Class. Adv. Dept.  
P.O. Box 900, N.Y., N.Y. 10020

RADAR SYSTEMS GROUND AND AIRBORNE. AUTOMATIC TRACKING ANTENNA SYSTEMS. NIKE AJAX. NIKE HERCULES. M-33. MSQ-1A. MPS-19. MPS-9. SCR 584. TPS-1D. TPS-28. FAA-ASR-2. AIRBORNE SYSTEMS. APN-84. APN-102. APS-20. APS-27. APS-45. DPN-19. DIGITAL COMPUTERS. IBM 650. IBM 704.

LARGEST INVENTORY OF RADAR AND MICROWAVE EQUIPMENT IN THE WORLD.



**RADIO RESEARCH INSTRUMENT CO.**  
3 QUINCY ST., NORWALK, CONN. 06850 (203) 853-2600

CIRCLE 952 ON READER SERVICE CARD

# Job-seekers... be the first to know with McGraw-Hill's Advance Job Listings

By having our new weekly ADVANCE JOB LISTINGS sent First-Class (or by Air Mail, if you prefer) to your home every Monday you can be the first to know about nation-wide openings you qualify for both in and out of your field.

This preprint of scheduled employment ads will enable you to contact anxious domestic and overseas recruitment managers BEFORE their advertisements appear in upcoming issues of 22 McGraw-Hill publications.

To receive a free sample copy, plus information about our low subscription rates (from one month to 12), fill out and return the coupon below.

ADVANCE JOB LISTINGS / P.O. BOX 900 / NEW YORK NY 10020

PLEASE SEND A SAMPLE COPY  
OF ADVANCE JOB LISTINGS TO:



NAME

ADDRESS

CITY

STATE

ZIP

E 6/27/74



# Europe's most integrated team in IC's!

Neither an energy crisis nor a fire could beat this Plessey Semiconductors team. Despite these difficulties the team returned production to full stream with minimum delay to maintain normal delivery. The team would like to thank

its customers for bearing with it during this difficult time and Plessey Semiconductors would like to thank the team for its valiant efforts.

When you use Semiconductor devices you can't do better than have this team behind you.

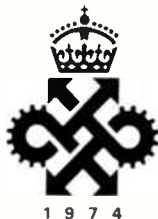

*This Queen's Award for Outstanding Technical Innovation demonstrates Plessey leadership in advanced technology and products in the IC field.*



**INTEGRATED CIRCUITS from**  
**PLESSEY Semiconductors**

Cheney Manor, Swindon, Wiltshire SN2 2QW  
Telephone: Swindon (0793) 6251 Telex: 449637

USA: Plessey Semiconductors -  
170 Finn Court, Farmingdale, Long Island, New York 11735, Tel: 516 694 7377, Telex: 961457;  
1674 McGaw Avenue, Santa Ana, California 92705, Tel: 714 540 9979, Telex: 685 544

SC 128



## We take your reputation seriously.

That's why we build and test our Standard Power Modules so carefully.

A basic component like the power supply can put an expensive machine out of business. And, while the shutdown may be temporary—the loss of reputation and customer confidence may be permanent.

This is why many O.E.M.'s are taking another look at their power supply "economies." When they do, North Electric looks better and better.

This is because our line of Standard Power Modules offers the highest levels of engineering and quality control in the industry—the same standards that have made North the leading custom power source for more than 40 years.

That's why, when North delivers power—you can bet your reputation on it.

Send for a catalog today, or call your North Product Manager at 419/468-8874.

MODEL	11000	12000	13000	14000	15000	16000	17000	18000
VDC	AMPERES							
5.0	3.9	5.3	11.3	13.0	20.0	32.5	49.0	82.0
12.0	2.8	4.2	8.0	10.5	15.0	23.0	36.0	58.0
15.0	2.4	3.7	7.5	9.5	14.0	20.5	27.0	47.0
18.0	2.1	3.3	6.0	8.0	13.0	18.0	26.0	40.0
24.0	1.5	2.8	4.2	7.0	11.0	15.0	21.0	33.0
28.0	1.4	2.4	4.0	6.3	9.0	14.0	20.0	29.0
36.0	1.2	2.2	3.1	5.6	8.0	11.0	14.0	23.0
48.0	.95	1.8	2.6	4.2	6.0	8.0	10.0	18.0

### DUAL OUTPUT SUPPLIES

MODEL	VDC	AMPS
N63052	+15 12	400MA
MODEL	VDC	AMPS
N60052	+15 12	1.0A

### MODEL 10000

VDC	AMPS
0-7.5	2.10
0-16	1.25
0-25	0.85
0-33	0.68

Listed here are the more popular models—many other voltages are available.

**NORTH**   
ELECTRIC COMPANY

North Electric Company / Galion, Ohio 44833 / A United Telecom Co.

SP-18

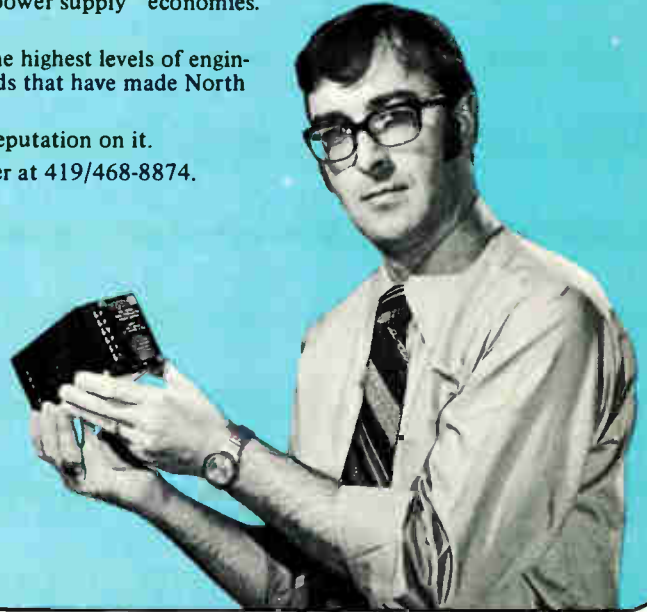

Circle 204 on reader service card

## Disc announces a me-too encoder.



If you're using that big-name Model 70 encoder on your OEM product, Disc can save you 10% or even more. Easily. Because our new Model 702 shaft-position encoder is a plug-compatible replacement for the old design.

Disc's 702 also features some welcome improvements. Like the latest in differential electronics and solid state devices. In a reliable, high-quality encoder with a 100,000-hour LED light source and rugged industrial design.

If you are an OEM user, *try one free*. And if the 702 doesn't match or beat the performance of your present encoder, return it undamaged for a full refund.

If it does, we will save you money on your next quantity order. You'll like the Disc discount structure, and our four-week delivery on standard resolutions.

Write or call for details.



### DISC Instruments, Inc.

102 E. Baker St., Costa Mesa, Calif. 92626. Phone (714) 979-5300

### Disc Instruments Division

Finnigan GmbH

Dachauer Strasse 511, 8 Munchen 50, Germany, Phone: (0811) 142291 (2)

### Disc Instruments Division

Finnigan Instruments Ltd.

Paradise, Hemel Hempstead, Herts, England, Phone: (0442) 57261

## With a very original price.

# Electronics advertisers

June 27, 1974

<b>Advanced Micro Devices</b> Keyes/Donna/Pearlstein	10-11	<b>Diacon</b> Rogondino Advertising and Marketing	196	<b>‡ GTE Sylvania Communications Systems Division</b> Allied Advertising Agency, Inc.	145
<b>• AEG Telefunken</b> Werbeagentur Dr. Kuhl GmbH	61	<b>• DIALIGHT Corporation</b> Michel-Cather, Inc.	2nd Cover	<b>‡ Guardian Electric Mfg. Co.</b> Kolb/Tookey and Associates, Inc.	66
<b>Airco Industrial Gases</b> Gimbel, Hammond, Farrell & Walsh, Inc.	199	<b>Digital Equipment Corporation</b> Schneider Parker, Inc.	22-23	<b>■ Hewlett-Packard</b> Richardson, Seigle, Rolfs & McCoy, Inc.	15
<b>■ Airpax Electronics</b> Welch, Mirabile & Co., Inc.	85	<b>Digital Equipment Corporation</b> Creamer, Trowbridge, Case & Bastford, Inc.	193	<b>■ Hewlett-Packard</b> Richardson, Seigle, Rolfs & McCoy, Inc.	1
<b>• Alcatel</b>	46	<b>Disc Instruments, Inc.</b> Jansen Associates, Inc.	204	<b>■ Hewlett-Packard</b> Tallant/Yates Advertising, Inc.	2
<b>Allen Bradley Company</b> Hoffman, York, Baker & Johnson, Inc.	28	<b>Diva, Inc.</b> Halloff & Caine	81	<b>■ Hewlett-Packard</b> Tallant/Yates Advertising, Inc.	45
<b>American Microsystems, Inc.</b> Wilton Coombs & Colnett Inc. Advertising	188-189	<b>‡ Dixon Automation (Subsidiary of Excellon Industries)</b> Graham & Sparkman Advertising etcetera	122	<b>■ Hewlett-Packard</b> Tallant/Yates Advertising, Inc.	179
<b>American Smelting and Refining Company</b> Clyne Maxon, Inc.	169	<b>Dow Corning Corp.—Fluids, Emulsions, Compounds Division</b> Ketchum, MacLeon & Grove, Inc.	176-177	<b>■ Hewlett-Packard</b> Richardson, Seigle, Rolfs & McCoy, Inc.	41
<b>■ AMP Incorporated</b> Aitkin-Kynett Co., Inc.	17-20	<b>Eastman Chemical Products, Inc., Industrial Chemicals</b> J. Walter Thompson Company	44	<b>Houston Instrument</b> Ray Cooley and Associates, Inc.	207
<b>■ Analog Devices, Inc.</b> Schneider Parker, Inc.	88-89, 92	<b>Eastman Kodak Co.—GMD GD Photofabrication Microelectronic</b> Rumrill-Hoyt, Inc.	194	<b>Hutson Industries</b> Greene, Webb Associates, Inc.	142
<b>• Anritsu Electric Co., Ltd.</b> Diamond Agency Co., Ltd.	67	<b>‡ Elco Corporation</b> Mort Barish Associates, Inc.	61	<b>• Industrie Blossl s.a.s.</b>	8E
<b>Bausch &amp; Lomb, Inc.</b> Wolff Assoc., Inc.	178	<b>Electronic Arrays</b> Bonfield Associates	49	<b>Intel Corp.</b> Regis McKenna, Inc.	50-51
<b>• Bayer A.G.</b> Werbeagentur	121	<b>■ Electronic Navigation Industries</b> Hari Conway Co., Inc.	14	<b>International Nickel Company</b> Ogilvy & Mather, Inc.	183
<b>Blomation, Inc.</b> Paul Pease Advertising, Inc.	158	<b>Electronik Magazine</b>	200-200A	<b>Intersil, Inc.</b> Tycer-Fultz	148
<b>‡ Bourns, Inc.</b> Marlborough Assoc., Inc.	83	<b>Emr-Telemetry</b> Carol Marketing Associates	157	<b>■ Interstate Electronics Corp.</b> Chris Art Studio Inc.	39
<b>Brand-Rex</b> Creamer, Trowbridge, Case & Bastford, Inc.	163	<b>■ Erie Technological Products Co., Inc.</b> Altman Hall Associates Advertising	21	<b>IPT Corporation</b> Rock Advertising Design	75
<b>■ Busman Mfg. Division of McGraw-Edison Co.</b> Henderson Advertising Company	173	<b>• Esterline Angus, A Unit of Esterline Corporation</b> Odiome Industrial Advertising, Inc.	64-65	<b>• Isola</b>	66
<b>Bitley Electric Company</b> Barber/Drullard Division of Barlow/Johnson	198	<b>Exact Electronics</b> Hugh Dwight Advertising	165	<b>C. Itoh &amp; Co. (America) Inc.</b> AC&R Advertising, Inc.	164
<b>Canadian Marconi Company, Telecommunications Division</b> Lunan/Hoffman Advertising, Ltd.	180	<b>•‡ Excellon Industries</b> Graham & Sparkman Advertising etcetera	132-133	<b>ITT General Controls</b> D'Arcy-MacManus & Masius	208
<b>Cherry Electrical Products, Corp.</b> Kolb/Tookey and Assoc., Inc.	186	<b>• Excellon Industries</b> Graham & Sparkman Advertising etcetera	132-133	<b>■ Keystone Electronics</b> Lawrence Nelson Advertising	198
<b>• Computer Components, Inc.</b>	12E	<b>Fabri-Tek Inc.</b> Midland Associates, Inc. Marketing and Advertising Services	195	<b>Krohn-Hite Corp.</b> Impact Advertising, Inc.	5
<b>Connor-Winfield Corporation</b> Lester Advertising Inc.	187	<b>Fairchild Semiconductor, Inc.</b> Carson/Roberts, Inc. Advertising Division of Ogilvy & Mather, Inc.	150-151	<b>Litronix, Inc.</b> Bonfield Associates	12-13
<b>‡‡ Corning Glass Works, Electronic Materials Dept.</b> Pierce Brown Associates, Inc.	76-77, 102	<b>F.R. Electronics Ltd.</b> T.W. Brooke Smith	24	<b>• LTT</b>	11E
<b>CTS Corporation</b> Reincke, Meyer & Finn, Inc.	127	<b>Fuji Electrochemical Co., Ltd.</b> General Advertising Agency, Inc.	134	<b>Macrodata Company</b> JMR Advertising	167
<b>• Cushman</b> Murphy Advertising, Inc.	83	<b>General Automation</b> Chiat-Day Inc., Advertising	90-91	<b>M C L, Inc.</b> HWH Associates Inc. Advertising & Sales Promotion	132
<b>■ Dale Electronics, Inc., A Sub. of the Lionel Corporation</b> Swanson, Sinkay, Ellis, Inc. Advertising	4th Cover	<b>■ General Instrument Corporation, Semiconductor Comp. Div.</b> Norman Allen Associates, Inc.	130-131	<b>■ Micro Switch Division of Honeywell</b> N.W. Ayer & Son, Inc.	185
<b>Data General Corporation</b> Scali, McCabe, Sloves, Inc.	128-129	<b>General Instrument Corporation, Microelectronics Div.</b> Norman Allen Associates, Inc.	86-87	<b>3M Electro Products Division</b> Batten, Barton, Durstine & Osborn, Inc.	159
<b>Data Precision</b> Allied Advertising Agency, Inc.	208	<b>The Gerber Scientific Instrument Co.</b> Charles Palm & Co., Inc.	197	<b>National Electronics</b> Lea Advertising	74
<b>■ Datel Systems, Inc.</b> John Donland Advertising	3rd Cover	<b>‡ Graphic Controls Corp.</b> Conklin, Labs & Beebe, Inc.	175	<b>North Atlantic Industries, Inc.</b> NOAT Advertising Company	174
<b>■ Delevan Division, American Precision Industries, Inc.</b> Comstock Advertising, Inc.	172	<b>G.T. Sheidahl—EPD</b> Chuck Ruhr Assoc. Advertising, Inc.	175	<b>North Electric Co.—Electronics Div.</b> Marc Associates	204
<b>Delec</b> Manning/Bowen and Associates	180			<b>• Oscilloquartz SA, Neuchatel</b> M.R. Hofer Werbeagentur BSR/EAAA Bern	10E
<b>‡ Diacon</b> Gardner DeSpain & Associates	55			<b>• Philips Elcoma</b> Intermarco nederland	55, 2E

• <b>Phillips N.V. PR/T &amp; M Division</b> Rockies Communications Systems SA	42-58
<b>Photocircuits</b> Ries Cappiello Colwell, Inc.	26-27
<b>Plastics Engineering Company</b> Kuttner & Kuttner, Inc.	154
<b>Plessey Semiconductor</b> Rumrill-Hoyt, Inc.	203
<b>Princeton Electronic Products, Inc.</b> Mort Barish Associates, Inc.	184
• <b>Procond S.p.A.</b> Quadragnone	77
<b>Ramsey Engineering Co.</b> Midland Associates, Inc.	166
‡ <b>Raytheon Company, Industrial Components Operation</b> Provandie Eastwood & Lombardi, Inc.	46
• <b>RCA Electronic Components</b> Al Paul Lefton Company, Inc.	102
<b>RCA Solid State Division</b> Marsteller, Inc.	71, 73
<b>RCA Electronic Components</b> Al Paul Lefton Company	146
‡ <b>Rental Electronics, Inc.</b> Humphrey Browning MacDougall, Inc.	58
• <b>Rhone Progil</b>	63
• <b>Rohde &amp; Schwarz</b>	1E
<b>Schauer Manufacturing Corp.</b> Nolan, Keeler & Stiles	143
• <b>Schlumberger</b> Scott MacTaggart Advertising	13E-16E
<b>Scientific Atlanta/Optima Division</b> Raniere, Saslaw, Mohr and Associates, Inc.	160
<b>Semtech Corporation</b> Adgraphix Corporation	79
• <b>Sesocsem</b> Bazaine Publicite	52
• <b>SGS-ATES</b> McCann-Erickson	5E-6E
• <b>Siemens A.G. Munich</b> Linder Presse Union GmbH	56
‡ <b>Siemens Corporation</b> Stiefel/Raymond Advertising, Inc.	62-63
‡ <b>Siemens Corp.—Electronic Systems Division, Computest Products</b> JL Associates	52
<b>Signal Transformer</b> Russell Technical Services, Inc.	166
<b>Signetics Corp., Sub. of Coming Glass Works</b> Hall Butler Blatherwick, Inc.	24-25
<b>Silconix</b> Robertson West, Inc.	113
<b>Sitek International Ltd.</b> Hall & McKenzie	155
<b>Simpson Electric Co.</b> Amerad Advertising Services, Inc.	152
<b>Soltron Devices, Inc.</b> Sol Advertising Agency	139
‡ <b>Sorenson Company, A Unit of Raytheon Company</b> Provandie Eastwood & Lombardi, Inc.	64
<b>Sorenson Production Equipment Dept. Raytheon Company</b> Provandie Eastwood & Lombardi, Inc.	6

• <b>Spectrol Electronics Corp.</b> J M R Inc.	168
■ <b>Spectrum Control, Inc.</b> Egon Jackson Advertising	162
<b>Sprague Electric Company</b> Harry P. Bridge Company	16
<b>Stewart-Warner Microcircuits</b> J M R Advertising	140
<b>Syston Donner Concord Instruments</b> Fred Schott & Associates	9, 196
<b>Tau-Tron, Inc.</b> Billings & Reece, Inc.	190
■ <b>T-Bar, Incorporated</b> The Robert A. Paul Advertising Agency, Inc.	144
• <b>TEAC Corp.</b> Dentsu Advertising Ltd.	76
■ <b>Tektronix Inc.</b> McCann Erickson, Inc.	37
<b>Teledyne Semiconductor</b> Regis McKenna, Inc.	7
<b>Teradyne, Inc.</b> Quinn & Johnson, Inc.	68
<b>Texas Instruments Incorporated, Semiconductor Group</b> Tracy-Locke Advertising Inc.	170
<b>Texscan Corporation</b> Bruce Bottum Associates	192
‡ <b>Thomas &amp; Betts Company</b> McCarthy, Scelba, DeBiasi Advertising Agency, Inc.	67
<b>Thomas &amp; Skinner, Inc.</b> Bell-Catterlin & Hedgecock Advertising, Inc.	174
‡ <b>T.R.I. Corporation</b>	121
■ <b>TRW, Electronic Components Division</b> The Bowes Company	201
■ <b>TRW/IRC Resistors</b> Gray & Rogers, Inc.	191
■ <b>TRW Electronics, Semiconductor Division</b> The Bowes Company	47
■ <b>Trygon Electronic Subsidiary of Syston Donner Corporation</b> RAMA Advertising Inc.	82
■ <b>Unitrode Corporation</b> Culver Advertising, Inc.	31
<b>Universal Oil Products, Norplex Division</b> Campbell Mithun, Inc.	181
• <b>Vero Electronics Ltd.</b> British Overseas Media Bureau Ltd.	62
<b>Victoreen Instrument Division</b> Dix & Eaton, Inc.	156
• <b>Wandel und Goltermann</b> Werbeagentur	12E
■ <b>Woven Electronics</b> Prentiss Court Advertising	8

### Classified & Employment Advertising

F. J. Eberle, Manager 212-971-2557

<b>EQUIPMENT (Used or Surplus New) For Sale</b>	
American Used Computer Corp.	202
Detronics Corp.	202
P. Fishman Co., Inc.	202
Jensen Tools and Alloys	202
Mountain West Alarm Supply Co.	202
Radio-Research Instrument Co., Inc.	202

- For more information on complete product line see advertisement in the latest Electronics Buyer's Guide
- Advertisers in Electronics International
- ‡ Advertisers in Electronics domestic edition

### Advertising Sales Staff

**Pierre J. Braudé** New York [212] 997-3468  
London 01-493-1451  
Director of Marketing

**Atlanta, Ga. 30309:** Joseph Lane  
100 Colony Square, 1175 Peachtree St., N.E.  
[404] 892-2868

**Boston, Mass. 02118:** James R. Pierce  
607 Boylston St. [617] 262-1160

**Chicago, Ill. 60611:**  
645 North Michigan Avenue  
Robert W. Bartlett (312) 751-3739  
Paul W. Reiss (312) 751-3738

**Cleveland, Ohio 44113:** William J. Boyle  
[716] 586-5040

**Dallas, Texas 75201:** Charles G. Hubbard  
2001 Bryant Tower, Suite 1070  
[214] 742-1747

**Denver, Colo. 80202:** Harry B. Doyle, Jr.  
Tower Bldg., 1700 Broadway  
[303] 266-3863

**Detroit, Michigan 48202:** Robert W. Bartlett  
1400 Fisher Bldg.  
[313] 873-7410

**Houston, Texas 77002:** Charles G. Hubbard  
2270 Humble Bldg. [713] CA 4-8381

**Los Angeles, Calif. 90010:** Robert J. Rielly  
Bradley K. Jones, 3200 Wilshire Blvd., South Tower  
[213] 487-1160

**New York, N.Y. 10020**  
1221 Avenue of the Americas  
Warren H. Gardner [212] 997-3617  
Michael J. Stoller [212] 997-3616

**Philadelphia, Pa. 19102:** Warren H. Gardner  
Three Parkway,  
[212] 997-3617

**Pittsburgh, Pa. 15222:** Warren H. Gardner  
4 Gateway Center, [212] 997-3617

**Rochester, N.Y. 14534:** William J. Boyle  
9 Greylock Ridge, Pittsford, N.Y.  
[716] 586-5040

**San Francisco, Calif. 94111:** Don Farns  
Robert J. Rielly, 425 Battery Street,  
[415] 362-4600

**Paris:** Alain Offergeld  
17 Rue-Georges Bizet, 75 Paris 16, France  
Tel: 720-73-01

**Geneva:** Alain Offergeld  
1 rue du Temple, Geneva, Switzerland  
Tel: 32-35-63

**United Kingdom & Scandinavia:** Keith Mantle  
Tel: 01-493-1451, 34 Dover Street, London W1

**Milan:** Robert Saidel  
1 via Baracchini, Italy Phone 87-90-656

**Brussels:** Alain Offergeld  
23 Chaussee de Wavre  
Brussels 1040, Belgium  
Tel: 13-73-95

**Frankfurt/Main:** Fritz Krusebecker  
Liebigstrasse 27c, Germany  
Phone 72 01 81

**Tokyo:** Tatsumi Katagiri, McGraw-Hill  
Publications Overseas Corporation,  
Kasumigaseki Building 2-5, 3-chome,  
Kasumigaseki, Chiyoda-Ku, Tokyo, Japan  
[581] 9811

**Osaka:** Ryji Kobayashi, McGraw-Hill  
Publications Overseas Corporation, Kondo  
Bldg., 163, Umegae-cho Kita-ku, Japan [362] 8771

**Australia:** Warren E. Ball, IPO Box 5106,  
Tokyo, Japan

### Business Department

**Stephen R. Weiss, Manager**

[212] 997-2044

**Thomas M. Egan,**  
Production Manager [212] 997-3140

**Carol Gallagher**  
Assistant Production Manager [212] 997-2045

**Dorothy Carter,** Contracts and Billings  
[212] 997-2908

**Frances Vallone,** Reader Service Manager  
[212] 997-6057

### Electronics Buyers' Guide

**George F. Werner,** Associate Publisher  
[212] 997-3139

**Regina Hera,** Directory Manager  
[212] 997-2544

# We have the **X-Y OEM RECORDER** for YOU

Thousands in use  
world wide

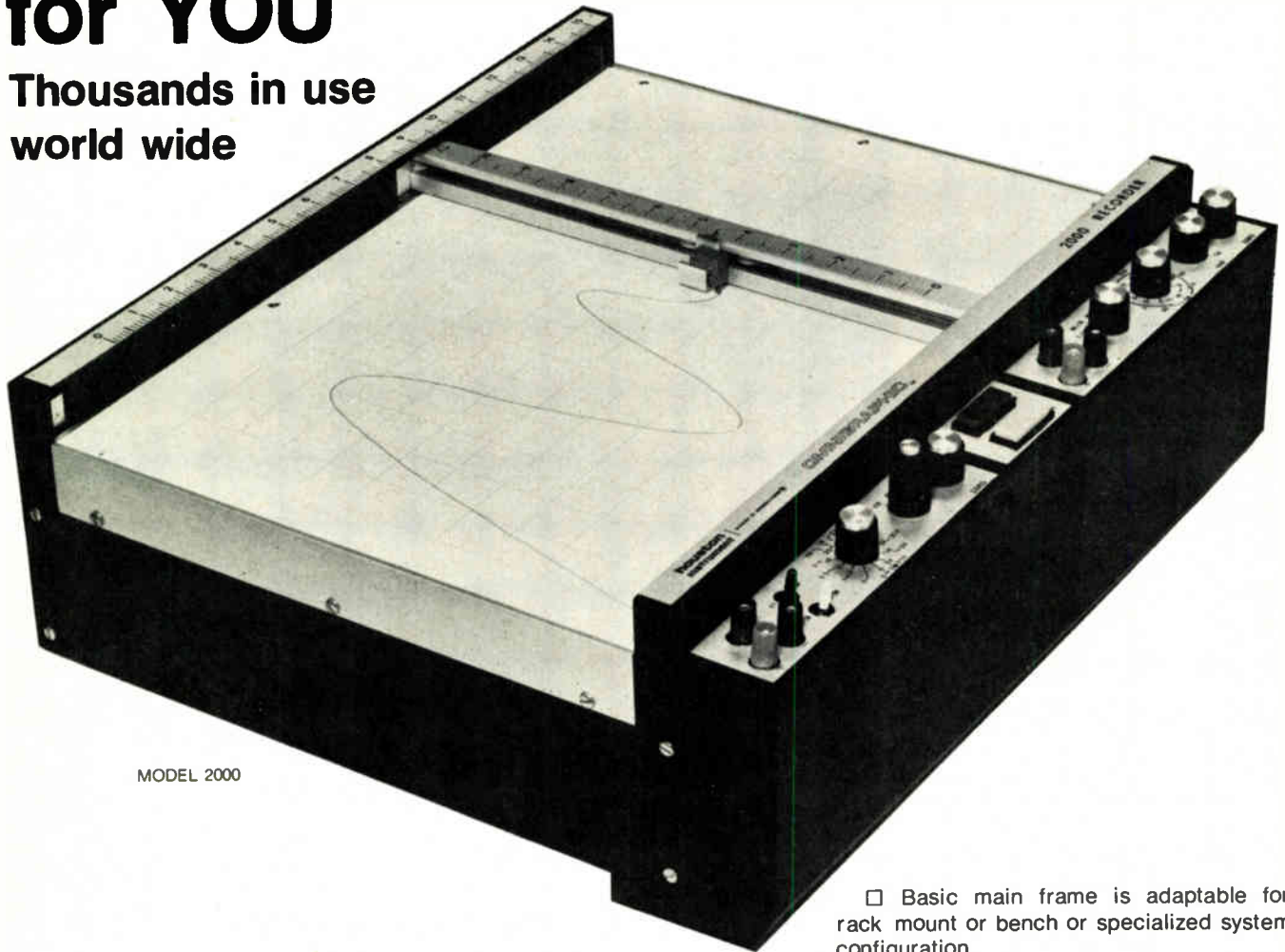

MODEL 2000

## Ask for OEM Discount

- Basic main frame is adaptable for rack mount or bench or specialized system configuration.
- All controls and functions are in modular form that plug in and plug out for maximum flexibility. 27 modules now available.
- 30 in./sec. speed standard with 40 in./sec. available.
- $\pm$  0.2% accuracy; pen lift—local or remote control standard.

Write today for complete brochure and special OEM price discounts.

**THE  
RECORDER  
COMPANY** | **houston  
instrument**

ONE HOUSTON SQUARE (at 8500 Cameron Road) AUSTIN, TEXAS 78753  
(512) 837-2820 TWX 910-874-2022 cable HOINCO

European Office Rochesterlaan 6 8240 Gistel Belgium Telephone 059-27445 Telex BAUSCH 19399

**Telautograph System.** An electrostatic capacity at the receiver is varied as the scribing point of the receiver moves in one direction of a coordinate system, and means at the receiver for establishing the frequency of an alternating current by the capacity. Under

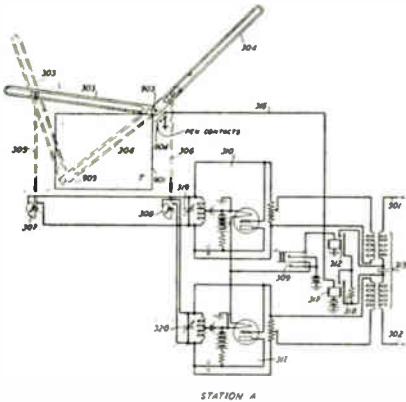

the control of this variable frequency a force for changing the capacity which is proportional to the instantaneous difference of a variable-frequency current from a transmitter and the frequency of alternating current established at the receiver. V. E. Rosene, BTL, Inc. Nov. 15, 1939. No. 2,274,638.

**Sound Record.** A negative sound film record is made on film and is then treated with a light sensitive dye. The dye in the areas not occupied by the sound wave envelope is then removed. E. W. Kellogg, RCA. Aug. 20, 1940. No. 2,268,752.

**Microfacsimile System.** Producing a series of picture signals from subject matter moved through the transmitter at a uniformly relatively slow rate, means for producing horizontal and vertical synchronizing signals and means for rapidly and cyclically scanning substantially each element of the subject matter to be transmitted at a relatively rapid rate in bi-dimensional directions so that each element of the subject matter is scanned a relatively large number of times during its passage through the transmitter to produce a series of picture signals, and for projecting the produced light images on a recording medium in minified form. A. N. Goldsmith, RCA. Aug. 22, 1939. No. 2,275,898.

**Transmission System.** Method of eliminating spurious additions to radio

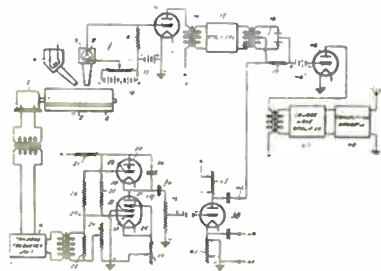

signals. D. R. Goodard, RCA, April 16, 1940. No. 2,274,829.

TIME-TESTED *veteran* IN

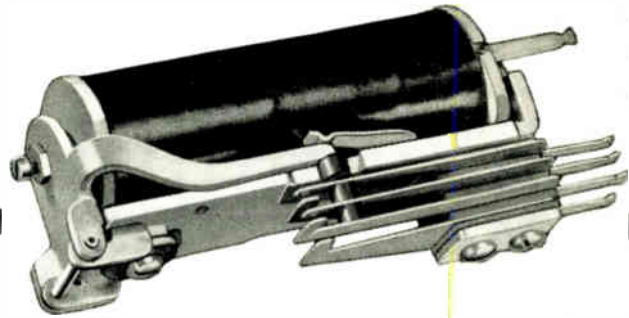

## ELECTRICAL REMOTE CONTROL APPLICATIONS

Designed and made by the originators of the dial telephone system, the Automatic Electric's Class A "telephone type" relay has been used as standard in that service for a generation. And because the Class A relay has proved so dependable and durable, it is now providing these advantages in hundreds of industrial products important to the war program.

Only one of the scores of electrical control devices offered by Automatic Electric, the Class A relay can be supplied in a limitless variety of contact and coil combinations—for d-c or a-c operation, slow acting or quick acting, and with almost any desired contact load capacity. If you are engaged in war production, write for a copy of our new catalog 4071-C.

AMERICAN AUTOMATIC ELECTRIC SALES COMPANY  
1033 W. Van Buren Street, Chicago, Ill.

**AUTOMATIC ELECTRIC**  
RELAY MAKERS SINCE 1898



**You can write this ad . . .**

Set down, if you will, all the qualities you would like in an instantaneous recording blank. . . . Make no compromise with quality. . . . We have an idea that you will find these exact things in the new

**ADVANCE GLASS BASE  
INSTANTANEOUS RECORDING BLANKS**

Stillwell 4-7837

**ADVANCE RECORDING PRODUCTS CO.**  
36-12 34th STREET LONG ISLAND CITY, N. Y.

# General Controls' versatile family of printers

Fast Printouts from 1 to 20 digits on tickets or tapes—ink or pressure-sensitive printing!



Versatility... Models are available that offer functions and printouts for totalizing, parallel entry, time/date indication,

BCD input, subtractive predetermining and additive predetermining which facilitate data monitoring functions beyond the scope that's been available.

Models offer anywhere from 1 to 20 digits in standard and custom frames. Each decade can be customized for you with



up to 12 letters or numbers to meet your particular read-out requirement.

Find out more about this advanced line of printers. For full information and



free catalogs, write or call Manager, Printers/Counters, ITT General Controls, International Telephone and Telegraph Corporation, 801 Allen Avenue, Glendale, Calif. 91201. Telephone (213) 842-6131.

GENERAL CONTROLS **ITT**

Circle 208 on reader service card

## the world's most accurate 4½ Digit Multimeter



**\$675**

No other 4½ digit DMM offers as many standard features, as much proven reliability and overall performance as the Model 2440.

100µ V to 1000 VDC (accuracy ±0.007% of reading ±1 l.s.d. for six months.) The most accurate 4½ digit meter available.

100µ V to 500 VAC

2-wire and 4-wire resistance, 100 milliohms to 12 megohms.

DC/DC ratio, AC/DC ratio

Standard features include:

- Auto-Ranging
- Remote-Ranging
- Auto-Zeroing
- Remote-Triggering
- Isolated BCD output

Documented by full test data and Certificate of Conformance.

**DATA PRECISION**  
...years ahead

Data Precision Corporation  
Audubon Road, Wakefield, Mass. 01880 (617) 246-1600

### CALL YOUR LOCAL OFFICE FOR A DEMONSTRATION

AL	(205) 533-6896
AZ	(602) 984-9518
CA (In)	(408) 733-9050
CA (S)	(714) 840-7150
CO	(303) 448-5294
CT	(203) 526-7647
FL	(813) 294-5815
GA	(404) 487-7117
HI	(808) 282-8296
IL	(312) 693-0282
IN	(317) 293-9827
MA	(617) 273-0188
MD	(301) 852-2200
MI	(313) 482-1229
MN	(612) 781-1611
MO (W)	(816) 737-0066
MO (E)	(314) 731-2331
NC	(919) 787-5818
NJ	(212) 925-8711
NJ (N)	(201) 863-6680
NM	(505) 286-6471
NY	(212) 448-0220
NY (S)	(516) 482-3500
OH (N)	(216) 725-4580
OH (S)	(513) 298-2033
OR	(503) 238-0001
TX (N)	(214) 234-4137
TX (S)	(713) 461-6487
UT	(801) 298-3181
WA	(206) 763-2210
CAN (W)	(416) 787-7208
CAN (W)	(613) 772-5874
CAN (E)	(514) 731-8328



**YOU'RE WHISTLING IN THE DARK...**

if you think that heart disease and stroke hit only the other fellow's family.

**GIVE... so more will live**  
**HEART FUND**



Contributed by the Publisher

# Electronics

Please enter my subscription to **ELECTRONICS** for three years at \$24.

52520

1.  I prefer one year at \$12  Payment enclosed  Bill my company  Bill me

CHARGE MY SUBSCRIPTION TO

<input type="checkbox"/> AMERICAN EXPRESS	<input type="checkbox"/> MASTER CHARGE
<input type="checkbox"/> DINERS CLUB	<input type="checkbox"/> BANKAMERICARD
ACCT. NO. _____	
DATE CARD EXPIRES _____	
INTERBANK NO. _____	1st No's above name on Mastercharge only.

NAME \_\_\_\_\_ TITLE \_\_\_\_\_  
 COMPANY \_\_\_\_\_ DIV. or DEPT. \_\_\_\_\_  
 COMPANY ADDRESS \_\_\_\_\_  
 CITY \_\_\_\_\_ STATE \_\_\_\_\_ ZIP \_\_\_\_\_  
 Check here if you wish publication to be sent to home address STREET \_\_\_\_\_ CITY \_\_\_\_\_ STATE \_\_\_\_\_ ZIP \_\_\_\_\_

Above rates apply only to those who answer all questions listed below. All others pay higher than basic price of \$25.00 per year.

Signature \_\_\_\_\_

2.  1 PLANT  2 DEPARTMENT Indicate the primary product manufactured or service performed at your plant (Box 1) and in your department (Box 2). Be sure to indicate applicable letter in each of the two boxes even if they are the same letter.

- |   |  |  |
|---|--|--|
| A. Large computers  | K. Industrial controls, systems and equipment                        | U. Research and development organizations which are a part of an educational institution                                 |
| B. Mini-computers   | L. Sub-assemblies  | V. Government Agency and military  |
| C. Computer peripheral equipment                                    | M. Passive electronic components                                     | W. Industrial companies using and/or incorporating electronic products in their mfg., research or development activities |
| D. Data Processing Systems (systems integration)                    | N. Active electronic components                                      | X. Utilities   |
| E. Office and business machines                                     | O. Materials and Hardware  | Y. Broadcasting, sound and motion pictures and recording studios   |
| F. Test and measuring equipment                                     | P. Aircraft, Missiles, space and ground support equipment            | Z. Commercial users of electronic equipment (railroads, pipelines, police, airlines)                                     |
| G. Communications systems and equipment                             | Q. Oceanography and support equipment                                | 9. College, University   |
| H. Navigation and guidance or control systems                       | R. Medical electronics   |  |
| I. Consumer entertainment electronic equipment                      | S. Industrial equipment containing electronic components or products |  |
| J. Other consumer electronic equip. (appliances, autos, hand tools) | T. Independent R&D laboratory and consultant                         |  |

3.  Indicate your principal job function (place applicable number in box. If numbers 9, 10, or 11 are used, fill in name of college or university)

1. General and corporate management
2. Design and development engineering
3. Engineering services (evaluation, quality control, reliability, standards, test)
4. Basic research
5. Manufacturing and production
6. Engineering support (lab assistant, technician)
7. Purchasing and procurement
8. Marketing and sales
9. Professor at \_\_\_\_\_
10. Senior student at \_\_\_\_\_
11. Graduate student at \_\_\_\_\_

4.  Indicate your principal job responsibility (place applicable number in box)

1. Management 2. Engineering

5. Are you engaged in or do you supervise the design or redesign of electronic components or equipment? (check one)

YES  NO

6. Estimated number of employees at this location. (check one)

1 to 49  50 to 249  250 to 999  over 1,000



FIRST CLASS  
PERMIT No. 42  
HIGHTSTOWN, N.J.

---

# **BUSINESS REPLY MAIL**

NO POSTAGE STAMP NECESSARY IF MAILED IN U.S.

---

Postage will be paid by

# **Electronics**

McGRAW-HILL, INC.  
SUBSCRIPTION DEPT.  
P.O. BOX 514  
HIGHTSTOWN, N.J. 08520

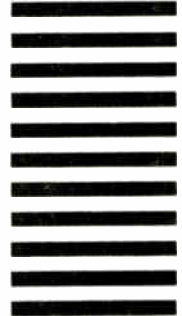

For additional information on products advertised, new products or new literature, use the adjacent business reply cards.

Complete entire card. Please print or type.

Circle the number on the Reader Service postcard that corresponds to the number at the bottom of the advertisement, new product item, or new literature in which you are interested.

To aid the manufacturer in filling your request, please check the appropriate industry classification box.

Postage is prepaid in U.S. Correct amount of postage must be affixed for all mailings from outside the U.S.

All inquiries from outside the U.S. that cannot reach Electronics before the expiration dates noted on the Reader Service postcard must be mailed directly to the manufacturer. The manufacturer assumes all responsibilities for responding to inquiries.

### Subscriptions & Renewals

Fill in the subscription card adjoining this card. Electronics will bill you at the address indicated on the card.

### ELECTRONICS

June 27, 1974

card expires September 10, 1974

NAME \_\_\_\_\_ TITLE \_\_\_\_\_

COMPANY \_\_\_\_\_

STREET \_\_\_\_\_

CITY \_\_\_\_\_ STATE \_\_\_\_\_ ZIP \_\_\_\_\_

#### Industry Classification (check one)

- |  |  |
|--|--|
| <input type="checkbox"/> a Computer & Related Equip.               | <input type="checkbox"/> f Consumer Products             |
| <input type="checkbox"/> b Communications Equip. & Systems         | <input type="checkbox"/> g Industrial Controls & Equip.  |
| <input type="checkbox"/> c Navigation, Guidance or Control Systems | <input type="checkbox"/> h Components & Subassemblies    |
| <input type="checkbox"/> d Aerospace, Underseas Ground Support     | <input type="checkbox"/> j Independent R&D Organizations |
| <input type="checkbox"/> e Test & Measuring Equip.                 | <input type="checkbox"/> k Government                    |

1	21	41	61	81	101	121	141	161	181	201	221	241	261	343	363	383	403	423	443	463	483	503	713
2	22	42	62	82	102	122	142	162	182	202	222	242	262	344	364	384	404	424	444	464	484	504	714
3	23	43	63	83	103	123	143	163	183	203	223	243	263	345	365	385	405	425	445	465	485	505	715
4	24	44	64	84	104	124	144	164	184	204	224	244	264	346	366	386	406	426	446	466	486	506	716
5	25	45	65	85	105	125	145	165	185	205	225	245	265	347	367	387	407	427	447	467	487	507	717
6	26	46	66	86	106	126	146	166	186	206	226	246	266	348	368	388	408	428	448	468	488	508	718
7	27	47	67	87	107	127	147	167	187	207	227	247	267	349	369	389	409	429	449	469	489	509	719
8	28	48	68	88	108	128	148	168	188	208	228	248	268	350	370	390	410	430	450	470	490	510	720
9	29	49	69	89	109	129	149	169	189	209	229	249	269	351	371	391	411	431	451	471	491	701	900
10	30	50	70	90	110	130	150	170	190	210	230	250	270	352	372	392	412	432	452	472	492	702	901
11	31	51	71	91	111	131	151	171	191	211	231	251	271	353	373	393	413	433	453	473	493	703	902
12	32	52	72	92	112	132	152	172	192	212	232	252	272	354	374	394	414	434	454	474	494	704	951
13	33	53	73	93	113	133	153	173	193	213	233	253	273	355	375	395	415	435	455	475	495	705	952
14	34	54	74	94	114	134	154	174	194	214	234	254	274	356	376	396	416	436	456	476	496	706	953
15	35	55	75	95	115	135	155	175	195	215	235	255	275	357	377	397	417	437	457	477	497	707	954
16	36	56	76	96	116	136	156	176	196	216	236	256	338	358	378	398	418	438	458	478	498	708	956
17	37	57	77	97	117	137	157	177	197	217	237	257	339	359	379	399	419	439	459	479	499	709	957
18	38	58	78	98	118	138	158	178	198	218	238	258	340	360	380	400	420	440	460	480	500	710	958
19	39	59	79	99	119	139	159	179	199	219	239	259	341	361	381	401	421	441	461	481	501	711	959
20	40	60	80	100	120	140	160	180	200	220	240	260	342	362	382	402	422	442	462	482	502	712	960

### ELECTRONICS

June 27, 1974

card expires September 10, 1974

NAME \_\_\_\_\_ TITLE \_\_\_\_\_

COMPANY \_\_\_\_\_

STREET \_\_\_\_\_

CITY \_\_\_\_\_ STATE \_\_\_\_\_ ZIP \_\_\_\_\_

#### Industry Classification (check one)

- |  |  |
|--|--|
| <input type="checkbox"/> a Computer & Related Equip.               | <input type="checkbox"/> f Consumer Products             |
| <input type="checkbox"/> b Communications Equip. & Systems         | <input type="checkbox"/> g Industrial Controls & Equip.  |
| <input type="checkbox"/> c Navigation, Guidance or Control Systems | <input type="checkbox"/> h Components & Subassemblies    |
| <input type="checkbox"/> d Aerospace, Underseas Ground Support     | <input type="checkbox"/> j Independent R&D Organizations |
| <input type="checkbox"/> e Test & Measuring Equip.                 | <input type="checkbox"/> k Government                    |

1	21	41	61	81	101	121	141	161	181	201	221	241	261	343	363	383	403	423	443	463	483	503	713
2	22	42	62	82	102	122	142	162	182	202	222	242	262	344	364	384	404	424	444	464	484	504	714
3	23	43	63	83	103	123	143	163	183	203	223	243	263	345	365	385	405	425	445	465	485	505	715
4	24	44	64	84	104	124	144	164	184	204	224	244	264	346	366	386	406	426	446	466	486	506	716
5	25	45	65	85	105	125	145	165	185	205	225	245	265	347	367	387	407	427	447	467	487	507	717
6	26	46	66	86	106	126	146	166	186	206	226	246	266	348	368	388	408	428	448	468	488	508	718
7	27	47	67	87	107	127	147	167	187	207	227	247	267	349	369	389	409	429	449	469	489	509	719
8	28	48	68	88	108	128	148	168	188	208	228	248	268	350	370	390	410	430	450	470	490	510	720
9	29	49	69	89	109	129	149	169	189	209	229	249	269	351	371	391	411	431	451	471	491	701	900
10	30	50	70	90	110	130	150	170	190	210	230	250	270	352	372	392	412	432	452	472	492	702	901
11	31	51	71	91	111	131	151	171	191	211	231	251	271	353	373	393	413	433	453	473	493	703	902
12	32	52	72	92	112	132	152	172	192	212	232	252	272	354	374	394	414	434	454	474	494	704	951
13	33	53	73	93	113	133	153	173	193	213	233	253	273	355	375	395	415	435	455	475	495	705	952
14	34	54	74	94	114	134	154	174	194	214	234	254	274	356	376	396	416	436	456	476	496	706	953
15	35	55	75	95	115	135	155	175	195	215	235	255	275	357	377	397	417	437	457	477	497	707	954
16	36	56	76	96	116	136	156	176	196	216	236	256	338	358	378	398	418	438	458	478	498	708	956
17	37	57	77	97	117	137	157	177	197	217	237	257	339	359	379	399	419	439	459	479	499	709	957
18	38	58	78	98	118	138	158	178	198	218	238	258	340	360	380	400	420	440	460	480	500	710	958
19	39	59	79	99	119	139	159	179	199	219	239	259	341	361	381	401	421	441	461	481	501	711	959
20	40	60	80	100	120	140	160	180	200	220	240	260	342	362	382	402	422	442	462	482	502	712	960

If the cards below have already been used, you may obtain the needed information by writing directly to the manufacturer, or by sending your name and address, plus the Reader Service number, to Electronics Reader Service Department, Box 2530, Clinton, Iowa 52732.

# Electronics

P.O. Box No. 2530  
Clinton, Iowa 52732

Affix  
Postage here

# Electronics

P.O. Box No. 2530  
Clinton, Iowa 52732

Affix  
Postage here

## Electronics Reprint Service

Bulk reprints of editorial matter can be ordered from current or past issues. The minimum quantity is 500 copies. Prices quoted on request: call 609-448-1700 Ext. 5494, or write to address below.

**Bringing Sight to the Blind**  
8 pages \$2.00  
Key no. R-408

**Logic's New Design Tools**  
16 pages \$3.00  
Key R-406

**U.S. Market Report**  
28 pages \$2.00  
Key R-404

**European Market Report 1974**  
24 pages \$2.00  
Key R-402

**Japan Market Report 1974**  
18 pages \$2.00  
Key R-400

**The Pervasiveness of Electronics**  
Complete issue 284 pages \$2.00  
Key no. R-328

**The Optical Spectrum**  
\$2.00 Key no. R-326

**Semiconductor Memory Systems**  
16 pages \$3.00 Key no. R-324

**New Electronic Displays**  
10 pages \$2.00 Key no. R-322

**Planar Interconnection Techniques**  
13 pages \$3.00 Key no. R-320

**Automotive Electronics**  
16 pages \$3.00 Key no. R-318

**Hybrid Circuit Technology**  
16 pages \$3.00 Key no. R-316

**Leadless, Pluggable IC Packages**  
**Reduce Costs** 7 pages \$2.00  
Key no. R-312

**Penetration Color Tubes are Enhancing Information Displays** 6 pages \$2.00  
Key no. R-310

**Program for Transition from Non Linear to Linear Transistor Model**  
6 pages \$2.00 Key no. R-308

**Charge Coupling Improves Its Image**  
8 pages \$2.00 Key no. R-306

**Electromagnetic Spectrum Chart**  
Key no. R-213 \$2.00

**Electromagnetic Spectrum Report**  
16 pages plus Wall Chart \$4.00  
Key no. R-211

**Active Filters**  
96 pages \$4.00 Key no. R-032

**Circuit Designer's Casebook**  
162 pages \$6.00 Key no. R-031

To order reprints or for further information, please write to:

**Electronics Reprint Department**  
P.O. Box 669  
Hightstown, N.J. 08520

Only orders with cash, check, or money order will be accepted. No invoicing will be done.

**FREE!!** 70 page Handbook

# ENGINEERING PRODUCT HANDBOOK

## A/D and D/A Converters

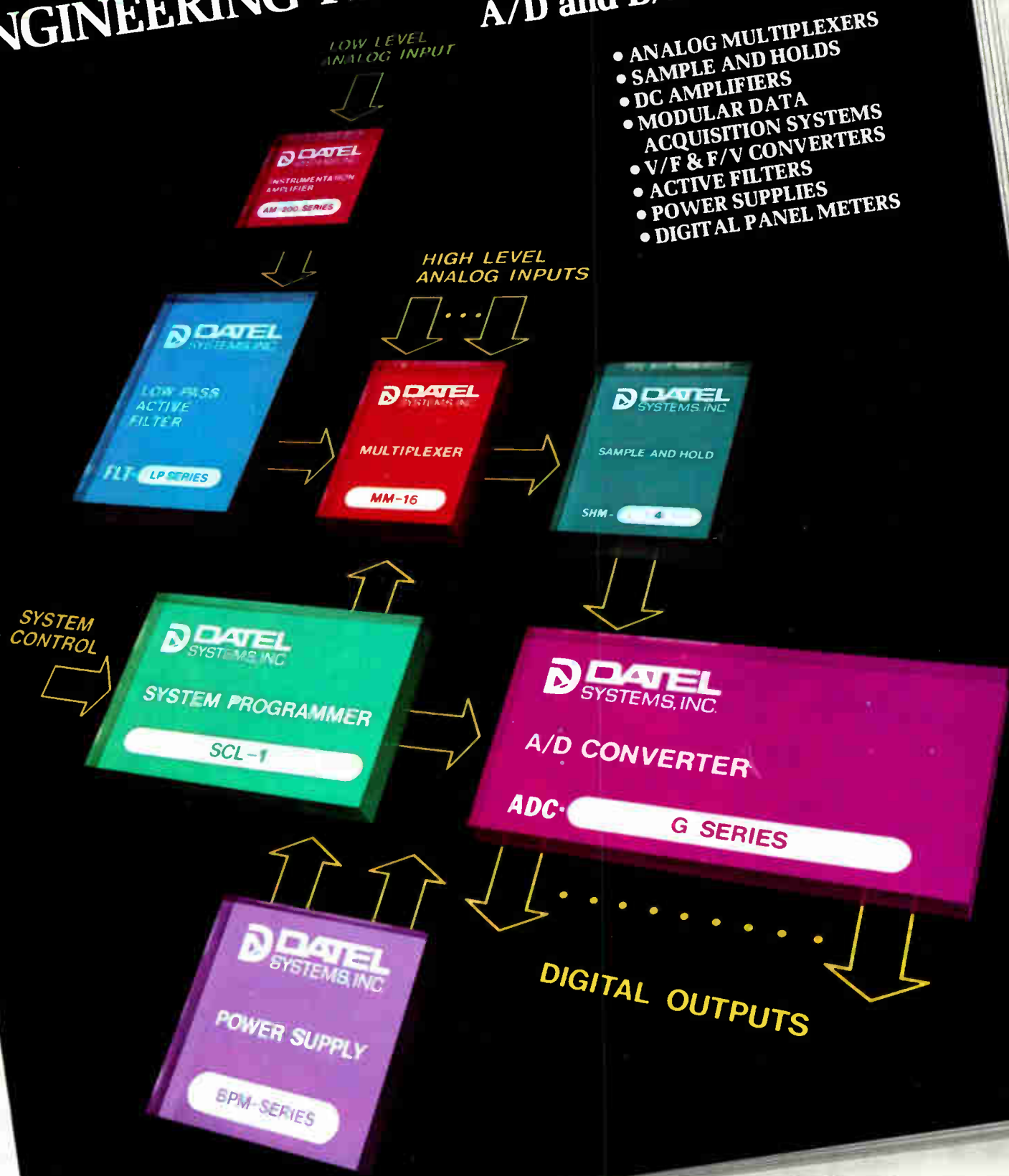

- ANALOG MULTIPLEXERS
- SAMPLE AND HOLDS
- DC AMPLIFIERS
- MODULAR DATA ACQUISITION SYSTEMS
- V/F & F/V CONVERTERS
- ACTIVE FILTERS
- POWER SUPPLIES
- DIGITAL PANEL METERS



1020 Turnpike Street, Canton, Ma 02021

• TEL (617) 828-8000

• TELEX 924461 • TWX 710-348-0135

FOREIGN SUBSIDIARIES

WEST GERMANY / DATALEK SYSTEMS GmbH-8 MUNCHEN 71 • TEL 089 / 78 40 45 • TELEX 5212855

FRANCE / DATEL SYSTEMS SARL, 750 16 PARIS, FRANCE • TELE 603-06-74 / 603-05-31

DATEL (UK) LTD. • BASINGSTOKE, HAMPSHIRE, RG-24-9NT • TELE BASINGSTOKE (0258) 66721

Circle 901 on reader service card

# Can your resistors handle emergencies?

## Here's how to make sure:

When a resistor is confronted by a high energy pulse current, it should do one of two things: "Open"...in order to protect valuable circuit components or shrug off the pulse to assure that the circuit remains functional.

In a simple "open or shut" case like this, it's not hard to decide which choice is best for your product. But the going gets tougher when you try to match your "worst case" requirements with a resistor that's functional in performance, size and price. At this basic selection level, you often find you need to know a lot more about a resistor's emergency capabilities than most companies can tell you.

Which is why we get a lot of phone calls at Dale... and also why we've prepared some helpful new information on resistive pulse handling and fusing.

Let's say, for example, that you're planning to use one of Dale's 5-watt RS wirewounds in a transistor emitter circuit. These new tables and formulas will show that it can withstand millisecond pulses up to 24,000 watts! However, if you want the same circuit

24,000 Watts  
...learn how to  
figure the pulse handling  
capability of your resistors.

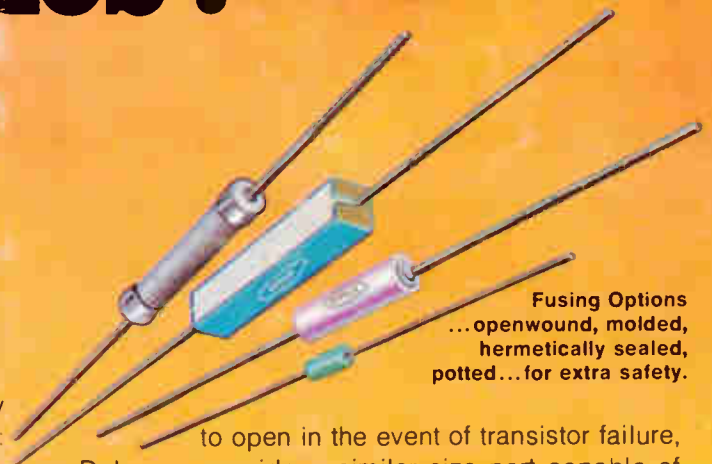

Fusing Options  
...openwound, molded,  
hermetically sealed,  
potted...for extra safety.

to open in the event of transistor failure, Dale can provide a similar size part capable of opening in milliseconds at a pulse time/size level you specify.

This kind of "open or shut" option lets you be certain you're designing in the kind of extra protection that can make your products more valuable...and it's available throughout Dale's broad resistor line. Drop us a line or give us a call. In this sophisticated world, you'll be glad to find that someone is working at making the basics better.



Write for these new publications.

DALE ELECTRONICS, INC.

1300 28th Avenue, Columbus, Nebraska 68601

A subsidiary of The Lionel Corporation In Canada:

Dale Electronics Canada Ltd. In Europe: Dale Electronics GMBH,

8 Munchen 60, Falkweg 51, West Germany

Circle 902 on reader service card

