

- 100 Calculator-based measurement and control systems
- 116 Thermal design, part 6: analysis by network analogs
- 123 Computer program simplifies active-filter design

Electronics®

FILM CARRIERS
AUTOMATE IC
ASSEMBLY



1420 DB0120 AECAT MAY76
CS OSBORNE - JR
1202 W AVENUE H11
LANCASTER CA 93534

Ludwig Lectures.

Getting a fix on fast settling.

In numerous linear-circuit applications where the nature of the signal is pulse-like or step-like it is essential to reach a new level quickly and accurately after a large signal transition. However, we find that we cannot predict this performance from the classical specifications of frequency response and slew rate. Therefore, a direct specification — settling time — was established which defines the maximum total time required from the occurrence of an abrupt input transition until change is *satisfactorily complete*.

A slight misunderstanding...

The major areas of concern are in defining the input conditions, and what it means for the output change to be satisfactorily complete.

The real settling spec ought to cover these by defining a settling time to within X% (for example .01%) of final value for a large signal change (usually 10V) on the input. But both must be stated.

Close, but no cigar.

Some vendors base "Settling Time" specs on a small step change at the input and you still don't know what will happen in the large signal case. But the issues of "satisfactorily complete" on the output is full of cute pitfalls — let me show you.

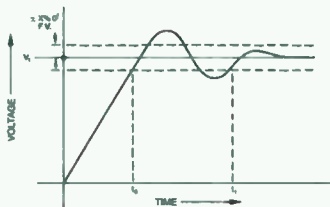

Notice in the curve that the output first occurs with $\pm X\%$ a full-scale-error-to-final-value at t_0 but doesn't stay within this error band. It thereafter bangs around due to the underdamped nature of the system. The real settling time should be stated as t_1 .

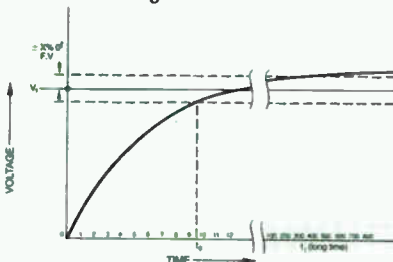

Now look at graph B. The response is critically damped and settling seems to occur at t_0 . But watch out. If we look far down scale we note that the apparent final level V_1 wasn't the final level at all.

Circle 900 on reader service card

Question, how long do you wait to define what V_1 (final level) really is? You have to figure that out.

This long settling "tail" often occurs with time constants long compared to any computable electrical time constants in the system and is usually the result of less than ideal thermal management or slight pole/zero mismatch. If you're trusting your vendor's settling time measurements, make sure that you (and your vendor) understand his definition and their use of it, otherwise you're in trouble.

Who needs it?

Anyone handling signals having discontinuities needs fast settling. For example, following a multiplexer, on a PAM Bus, at the output of a DAC, in building a precision square wave, at the input to an oscilloscope, etc.

How good can you have it?

At Philbrick we give you *guaranteed* settling time because we figure your system has to always meet its spec — not just typically and that's more than just important. We offer a host of op amps, discrete modules, hybrid IC's and monolithic IC's with state of the art settling including our T099 units, 1322 (300 ns to .1%), 1324 (1 μ sec. to .01%), guaranteed. The star of the show is our new DIP unit with FET inputs, the 1430, which offers 100 ns to .1% and 200 ns max to .01%. And you

don't give up dc performance to get it. The 200 ns to .01% is just what you need for a fast 12 bit system and open loop gain of 200K plus, input currents of 10 pA, and offset voltage of 1mV give you the dc accuracy to go with it. The 50 mA output capability will let you drive almost anything, but you don't pay for it with high quiescent current and its attendant power consumption.

Don't settle for less.

You could have the fastest settling op amp in the world and get lousy system settling unless you're very careful. Some of the common pitfalls that catch people are things like too much load capacity, too much summing point capacity, too high a circuit impedance for the stray and input capacities, use of inductive wire-wound resistors, and not figuring on the effect of current source output capacities in current-to-voltage converter applications. You've got to handle your power supplies very carefully too, by bypassing up close to the unit with the right kind of capacitor.

In any event, to make sure you get the right story on settling time and use the information properly, telephone, (617) 329-1600. Or write us, Dedham, Mass. 02026. In Europe, Tel. 73.99.88, Telex: 25881. Or write, 1170 Brussels, Belgium.

 **TELEDYNE
PHILBRICK**

Dave Ludwig
Director of Engineering

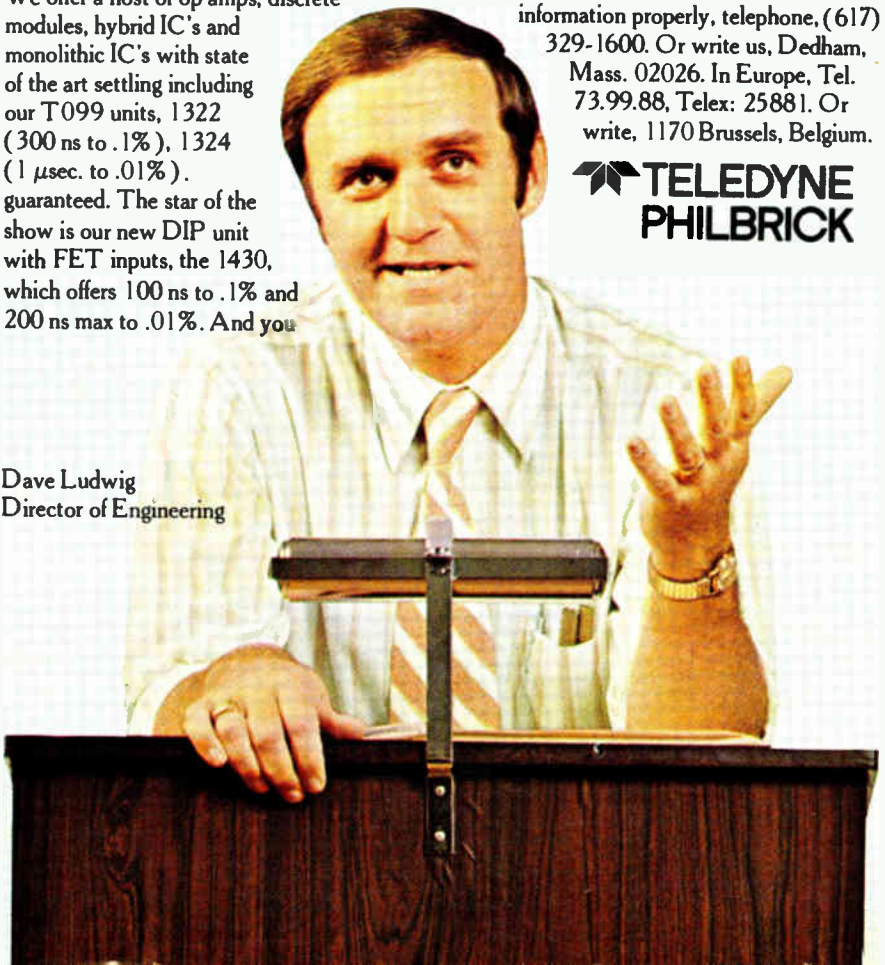

SURPRISE!

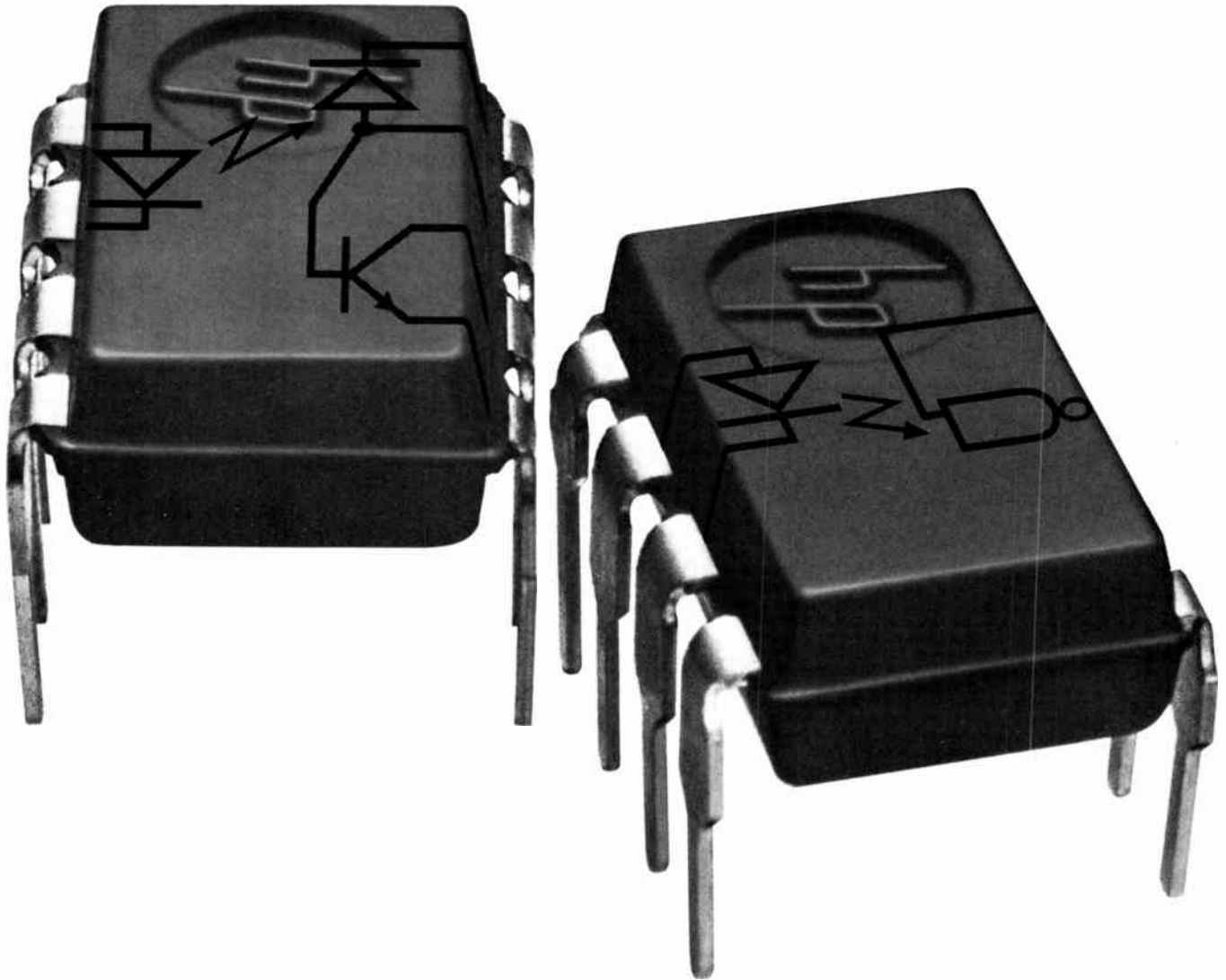

A high-speed isolator breakthrough.

Two new optically-coupled isolators take advantage of our advanced photo IC capability giving speeds four times faster than other opto couplers. The 5082-4360 Series optically-isolated gates operate up to 20M bits. This device has a photo detector IC circuit consisting of a photo diode and high-frequency linear amplifier. It is completely TTL compatible at the input and output and it's capable of feeding eight TTL gate loads. The 5082-4350 Series isolators operate up to 4MHz bandwidth. This device consists of a monolithic photo detector with a photo diode and high frequency transistor on the same substrate, making it ideal for linear and digital applications. The 5082-4350 Series prices start at \$1.70 in 1K quantity; the 5082-4360 Series is priced at \$4.50 in 1K quantities. Detailed specs are as close as your nearby HP distributor.

01323A

HEWLETT  PACKARD

Sales and service from 172 offices in 65 countries.
1501 Page Mill Road, Palo Alto, California 94304

Handle Troublesome Signals Easily With HP Variable-Persistence Scopes.



Because the unique capabilities of variable persistence in HP's 180 systems tackle these difficult measurement problems with much more ease than the conventional scope you're probably now using.

Dim traces—low rep-rate signals are brightened by the integrating characteristics of variable persistence so you can observe them clearly in normal ambient light...even at rep-rates below 1 Hz.

Transients—digital noise pulses or other single-shot events are made visible by the high writing speed of HP's mesh-type storage and variable persistence.

Slow-moving waveforms—electromechanical events or transducer outputs that appear as a "bouncing ball" on conventional scopes will be displayed as a continuous trace with variable persistence, allowing more accurate voltage

and timing measurements.

Two storage mainframes give you a choice of writing speeds. And a broad selection of plug-ins lets you tailor your scope to meet specific needs. To get the maximum performance for your storage-scope dollar, look to HP.

For more information about the 180 system, contact your local HP field engineer. Or, write Hewlett-Packard, 1501 Page Mill Road, Palo Alto, California 94306.

HEWLETT  PACKARD

Sales and service from 172 offices in 65 countries.
1501 Page Mill Road, Palo Alto, California 94306

084/3



29 Electronics Review

MEMORIES: Bell makes 500,000-bit bubble memory, 29
Bubbles break into applications at NASA, 30
CCD memory designs evaluated, 31
Siemens gets on 4k RAM wagon, 32
SOLID STATE: Josephson junctions push toward computers, 32
PACKAGING & PRODUCTION: Coax connections cure crosstalk, 34
COMMERCIAL: Modified X-ray units are back at airports, 36
ORGANIZATIONS: Components firms have their own show, 36
MICROWAVE: Constrained lens suits multi-beam satellite, 40
NEWS BRIEFS: 38
MATERIALS: Air-firable metals may cut hybrid costs, 42
New ceramic can slice capacitor size and cost, 43

52 Electronics International

WEST GERMANY: System displays aircraft position, 52
GREAT BRITAIN/FRANCE: Transmission systems replace slip rings, 52
AROUND THE WORLD: 53

65 Probing the News

ELECTRONICS ABROAD: 'Good old days' fade in Japan, 65
COMPANIES: Chrysler Huntsville's auto odyssey, 68
Sprague savors its comeback, 72
CONSUMER ELECTRONICS: The first big year for watches, 74
INDUSTRIAL ELECTRONICS: Volvo eliminates assembly line, 78

89 Technical Articles

PACKAGING & PRODUCTION: Film carrier automates IC packaging, 89
DESIGNER'S CASEBOOK: Controlled current source is precise, 96
Single bipolar transistor inverts pulses on command, 97
Norton quad amplifier can be a low-cost function generator, 98
INSTRUMENTS: Whether to automate by calculator or minicomputer, 100
Building an instrumentation system around a programable calculator, 104
YOU AND YOUR CAREER: EE performance evaluations win praise, 111
CIRCUIT DESIGN: Computerizing an active bandpass filter design, 123
ENGINEER'S NOTEBOOK: All-electronic metronome is accurate, 130
Different-color LEDs can switch each other, 131
Comparing the power of C-MOS with TTL, 132

143 New Products

IN THE SPOTLIGHT: Plating process provides uniformity, 143
SEMICONDUCTORS: TRW introduces rf power transistors, 145
INSTRUMENTS: Thermometers have wide range, 157
DATA HANDLING: Microprocessor runs data recorder, 168
PACKAGING & PRODUCTION: Tester checks microprocessors, 183
SUBASSEMBLIES: Linking computers, signal processor, 194
COMPONENTS: Connector works in the field, 207
MATERIALS: 214

Departments

Publisher's letter, 4
Readers comment, 6
40 years ago, 8
People, 14
Update, 18
Meetings, 20
Electronics newsletter, 25
Washington newsletter, 49
International newsletter, 55
Engineer's newsletter, 134
New literature, 221
New books, 224

Highlights

Cover: Film-carrier method packages ICs fast, 89

Lead frames carried on plastic film are gang-bonded to IC chips almost entirely automatically in the latest technique for reducing the costly labor content of packaged integrated circuits. The process achieves 10 times the assembly rates of the wire-bonding approach.

Japan's boom is ending, 65

Soaring inflation, soaring wages, tight money, and possibly a 25% drop in profits—problems all too familiar in the West—are now being encountered by Japanese electronics companies.

Whether to automate with a calculator, 100

Measurement and control systems can now be automated either with a minicomputer or, at much lower cost and with much less sophistication, by a programable calculator. Sometimes the choice is difficult, so Part 1 of this two-part article compares how well (or poorly) each satisfies various system requirements.

How to automate with a calculator, 104

Part 2 discusses the problem of interfacing a programable calculator with an instrumentation system, describes some applications, and lists some off-the-shelf equipment that makes it simple to customize a system.

EEs differ on promotion, agree on evaluations, 111

Whether they supervise others or are themselves supervised, readers who filled in *Electronics'* March 7 questionnaires agree that performance evaluations today are generally fair and thorough. But though promotions seem to work out well from a supervisor's and presumably a company's viewpoint, individuals often feel they have too little control over whether they become managers or rise as engineers.

And in the next issue . . .

Special report: passive components thrive in the IC era . . . minicomputers in action, part 8: how minis are automating newspaper typesetting.

EDITOR-IN-CHIEF: Kemp Anderson

EXECUTIVE EDITOR: Samuel Weber

MANAGING EDITORS: Lawrence Curran, *News*;
Arthur Erikson, *International*

SENIOR EDITORS: John Johnsrud,
H. Thomas Maguire, Laurence Altman
Ray Connolly, Stephen E. Scrupski

ART DIRECTOR: Fred Sklenar

ASSOCIATE EDITORS: John N. Kessler,
Howard Wolff, Gerald M. Walker

DEPARTMENT EDITORS

Aerospace: William F. Arnold
Circuit Design: Lucinda Mattera
Communications & Microwave:

Stephen E. Scrupski

Components: Joel DuBow

Computers: Wallace B. Riley

Consumer: Gerald M. Walker

Instrumentation: Michael J. Riezenman

Military: Ray Connolly

New Products: H. Thomas Maguire

Packaging & Production: Stephen E. Grossman

Solid State: Laurence Altman

COPY EDITORS: Margaret Eastman,
Everett C. Terry

ASSISTANT EDITOR: Marilyn Offenheiser

ART: Charles D. Ciatto, *Associate Director*
Patricia Cybulski, *Assistant Director*

PRODUCTION EDITOR: Arthur C. Miller

EDITORIAL SECRETARIES: Janet Annunziata,
Julie Gorgoglione, Penny Roberts

FIELD EDITORS

Boston: Gail Farrell

Los Angeles: Paul Franson (Mgr.)

Midwest: Larry Armstrong (Mgr.)

New York: Alfred Rosenblatt (Mgr.)

San Francisco: Bernard Cole (Mgr.)

Judith Curtis

Washington: Ray Connolly (Mgr.),

William F. Arnold

Frankfurt: John Gosch

London: Michael Payne

Paris: Arthur Erikson

Tokyo: Charles Cohen

McGRAW-HILL WORLD NEWS

Director: Ralph R. Schulz

Bonn: Robert Ingersoll;

Brussels: James Smith;

London: Marvin Petal;

Milan: Peter Hoffmann, Andrew Heath;

Moscow: Axel Krause;

Paris: Michael Johnson, Richard Shepherd;

Stockholm: Robert Skole;

Tokyo: Mike Mealey

PUBLISHER: Dan McMillan

DIRECTOR OF MARKETING: Pierre J. Braudé

ADVERTISING SALES SERVICE MANAGER:

Wallis Clarke

BUSINESS MANAGER: Stephen R. Weiss

CIRCULATION MANAGER: Nancy L. Merritt

MARKETING SERVICES MANAGER:

Tomlinson Howland

RESEARCH MANAGER: Margery D. Sholes

What ever happened to...? That's one of the most asked of questions—especially in electronics, where the pace of technology and marketing is so frenetic. So, we have started a new column, called Update, designed to bring you up to date on last year's newsmakers. On page 18 you will find a rundown on how some of the ideas that were hot a year ago have fared. And in subsequent issues, we'll be updating other developments, looking at the successes as well as the failures.

We think that the new column adds a different and valuable perspective to our news pages. And, if you wonder what ever happened to something in particular, let us know. If we find an interesting story there, we'll run it in Update.

And speaking of updating, our Packaging and Production Editor, Steve Grossman, has put together a what's-the-status report on film-carrier IC packaging techniques (see page 89). We have been following this cost-cutting route for bonding chips to lead frames since General Electric revealed the details of its technique—called MiniMod and later acquired by Texas Instruments—more than three years ago. In fact, we first reported on the film-carrier concept in 1967.

But the technique and its variants were slow to catch on. And, still, manufacturers using the approach are reluctant, understandably, to give details that might help their competitors. Yet after assembling the bits and pieces of available data and, with the help of our field bureaus, digging out the behind-the-scenes details, we have found that the film-carrier idea is one whose time has come.

May 16, 1974 Volume 47, Number 10
94 249 copies of this issue printed

Published every other Thursday by McGraw-Hill Inc. Founder James H. McGraw 1860-1948. Publication office 1221 Avenue of the Americas, N.Y., N.Y. 10020, second class postage paid at New York, N.Y. and additional mailing offices.

Executive, editorial, circulation and advertising addresses: Electronics, McGraw-Hill Building, 1221 Avenue of the Americas, New York, N.Y. 10020. Telephone (212) 997-1221. Teletype TWX N.Y. 710-581-5234. Cable address MCGRAW HILL L N Y.

Subscriptions limited to persons with active, professional, functional responsibility in electronics technology. Publisher reserves the right to reject non-qualified requests. No subscriptions accepted without complete identification of subscriber name, title, or job function, company or organization including product manufactured or services performed. Subscription rates: qualified subscribers in the United States and possessions, Canada, and Mexico \$12.00 one year, \$24.00 three years, all other countries \$25.00 per year, except Japan \$50.00 per year, Brazil \$40.00 per year, Australia and New Zealand \$60.00 per year, including air freight. Limited quota of subscriptions available at higher-than-basic rate for persons outside of field served, as follows: U.S. and possessions and Canada, \$25.00 one year, all other countries \$50.00. Single copies: United States and possessions and Canada, \$1.50, all other countries, \$2.00.

Publisher's letter

For those who have wondered how the Japanese electronics giants are weathering current world-wide economic pressures, we have the answer. As Mike Mealey, Tokyo bureau chief for McGraw-Hill World News, spells out in the Probing the News story starting on page 65, the boom times have ended.

Consumer spending is down. Industrial companies are cutting back on capital investment. The cost of energy has skyrocketed. Prices, fed by inflation, are soaring. Labor demanded a one-third jump in wages.

What's more, with the domestic market riddled with problems, the push will be strong in export markets, where resistance is building to Japanese wares and where rising pricetags will limit sales. Put together, all these factors add up to a 25% erosion of profits for the Japanese electronics industry.

How do engineers feel about the way career evaluations are handled? Generally, they believe evaluations are performed fairly, although their own freedom to make career choices is much too limited. Yet, a hefty majority of engineering supervisors—the raters—feel that promotion systems work well.

That's one of many divergences of opinion that we uncovered through the questionnaire that we included in the March 7 issue. We know you will find the article starting on page 111 instructive as you compare your company's program and your own experience with the results that we have compiled.

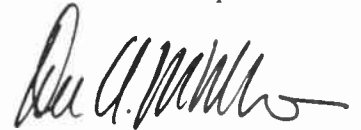

Officers of the McGraw-Hill Publications Company: John R. Emery, President; J. Elton Tuohy, Executive Vice President-Administration; Gene W. Simpson, Group Publisher-Vice President; Senior Vice Presidents: Ralph Blackburn, Circulation; Walter A. Stanbury, Editorial; John D. Hoglund, Controller; David G. Jensen, Manufacturing; Gordon L. Jones, Marketing; Jerome D. Luntz, Planning & Development.

Officers of the Corporation: Shelton Fisher, President; Wallace F. Trendly, Group President; McGraw-Hill Publications Company and McGraw-Hill Information Systems Company: Robert N. Landes, Senior Vice President and Secretary; Ralph J. Webb, Treasurer.

Title registered in U.S. Patent Office. Copyright © 1974 by McGraw-Hill Inc. All rights reserved. The contents of this publication may not be reproduced either in whole or in part without the consent of copyright owner.

Subscribers: The publisher upon written request to our New York office from any subscriber, agrees to refund that part of the subscription price applying to copies not yet mailed. Please send change of address notices or complaints to Fulfillment Manager, subscription orders to Circulation Manager. Electronics at address below. Change of address notices should provide old as well as new address, including postal zip code number. If possible, attach address label from recent issue. Allow one month for change to become effective.

Postmaster: Please send form 3579 to Fulfillment Manager, Electronics, P.O. Box 430, Hightstown, N.J. 08520.

the KEPCO JMK

is the best system power supply you can buy

It's not (hardly) a stripped-down 'OEM module' and we didn't really design it as just another lab-bench supply (though lots of people use them that way).

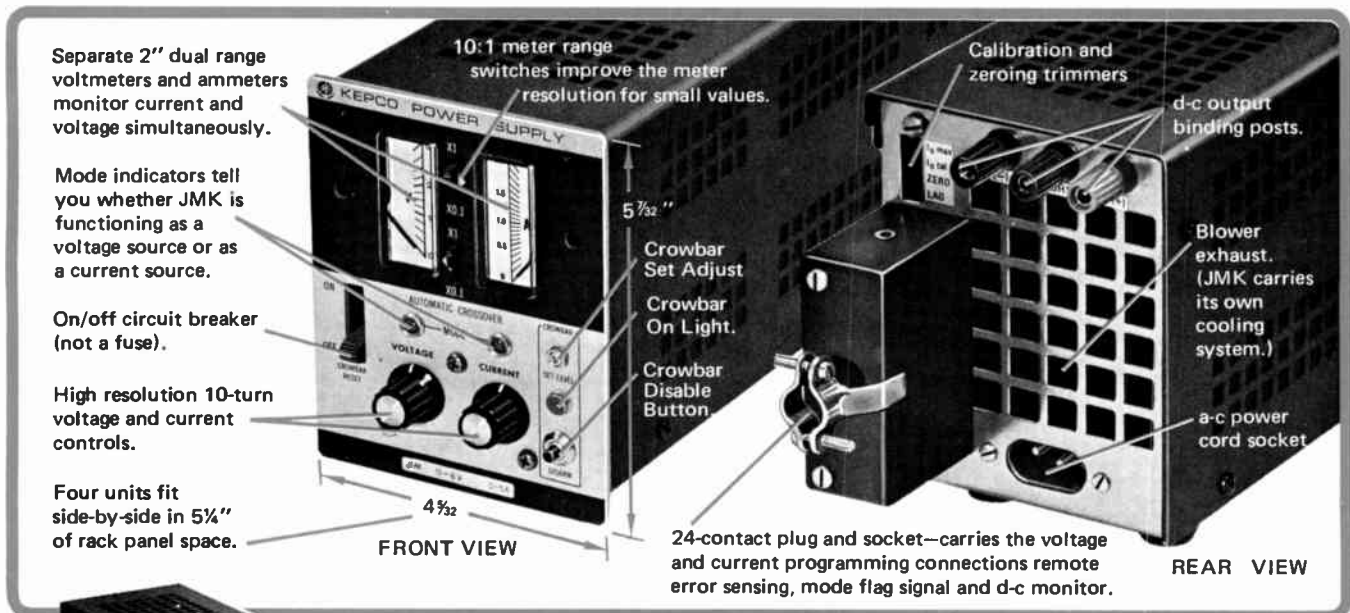

Kepeco designed JMK to answer the special needs of the system designer for practical rack-mount systems power supplies.

The shape of JMK, for example, minimizes precious panel space—four of them will fit in a 5 1/4" high drawer (Model RA-24) which has provision for slide mounting. The connections to JMK are all at the rear so they don't clutter your panel—moreover, they're all *plug-in*. That means you don't need to fool with a screwdriver and wire-list to mount or remove a JMK. Just plug it into its prewired cable connector.

Kepeco's JMK doesn't have hot radiator fins protruding in all directions—nor does it require elaborate derating for the elevated temperature of jammed systems racks. JMK has its own built-in blower system exhausting air (heated only about +15°) directly to its rear. You'll get *full output* from your JMK from -20°C to +71°C, no derating, no baking the equipment above.

JMK is fully programmable, you can control it with resistance, analog signals, or digital instruction with up to 12-bit resolution.* JMK, as an automatic crossover power supply, can be controlled in either mode with a degree of precision and stability that is close to standards-lab performance (5 ppm source effect, 50 ppm load effect, 50 ppm temperature effect coefficient. . .).

Kepeco designed JMK for the systems man who needs a full-performance, programmable power supply to run his test program (on instructions from the computer) or a stable current source to energize sensitive circuits, or perhaps an ultra-stable voltage supply to which repeatable measurements can be referred.

Kepeco's catalog contains the full specifications for the 14 JMK models ranging from 0—6 volts at 5 and 10 amperes to 0—100 volts at 0.5 and 1 ampere. Write to Dept. EK-14 for your free copy.

*Using a low-cost digital programming accessory.



KEPCO®

KEPCO, INC. • 131-38 SANFORD AVENUE • FLUSHING, N.Y. 11352 • (212) 461-7000 • TWX # 710-582-2631 • Cable: KEPCOPOWER NEWYORK

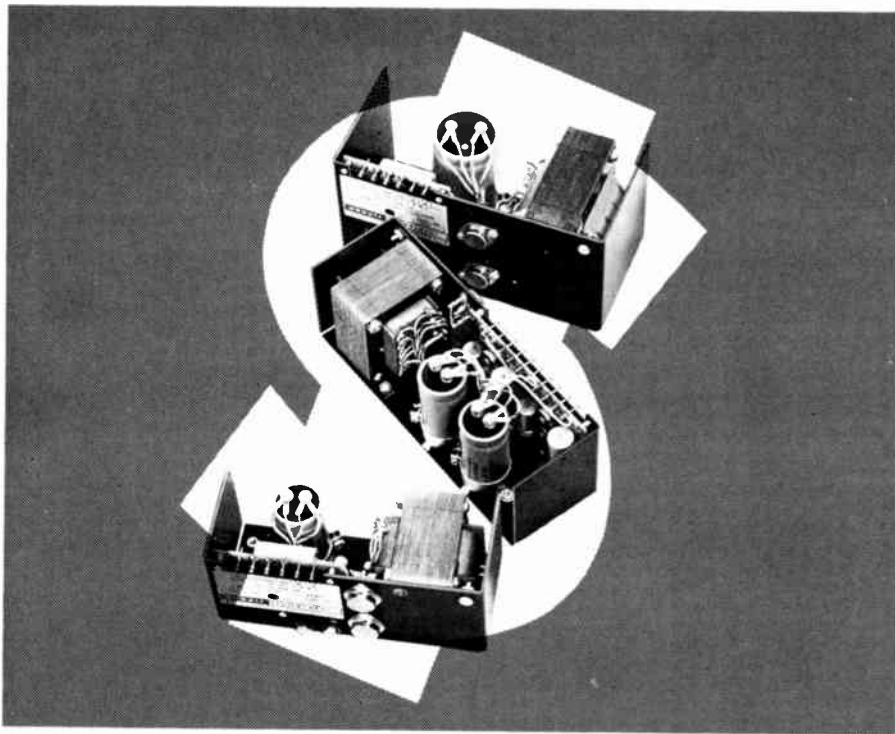

Start Getting Your Money\$worth Out of Power Modules





Now, you can really start getting your moneysworth out of power modules with Abbott's new LOW COST series. Designed to give you 100,000 hours of trouble-free operation (that's 11½ years), these reliable units meet the needs of OEM engineers. Their purchase price is about \$7 per year of service. The model LC series feature:

- 47-420 Hz Input Frequency
- 0.1% Regulation
- +50°C. Ambient Operation
- Single and Dual Outputs
- 1 Day Stock Delivery

These units provide more quality per dollar compared to similar items on the market. See table below for prices on some of our LC models. Many other LC models are listed in our catalog.

If analyzing the many similar power supplies on the market is confusing; if you are concerned about the long-term reliability of those units, then decide on an Abbott power supply for your system. Your best buy in OEM power modules is ABBOTT.

Abbott also manufactures 3,000 other models of power supplies with output voltages from 5 to 740 VDC and with output currents from 2 milliamps to 20 amps. They are all listed with prices in the new Abbott Catalog with various inputs:

60  to DC
 400  to DC
 28 VDC to DC
 28 VDC to 400 
 12-24 VDC to 60 

5V @ 6 Amps	5V @ 10 Amps	12V @ 10 Amps	15V @ 4 Amps	28V @ 1 Amp	±12V @ 1.2 Amps	±15V @ 4 Amps
LC5T6	LC5T10	LC12T10	LC15T4	LC28T1	LLC12T1.2	LLC15T4
\$72	\$81	\$99	\$81	\$72	\$99	\$135

Please see pages 581-593 of your 1973-74 EEM (ELECTRONIC ENGINEERS MASTER Cotolog) for complete information on Abbott Modules.

Send for our new 56 page FREE catalog.

abbott transistor

LABORATORIES, INCORPORATED
 general offices eastern office
 5200 W. Jefferson Blvd./Los Angeles 90016 1224 Anderson Ave./Fort Lee, N.J. 07024
 (213) 936-8185 Telex: 69-1398 (201) 224-6900 Telex: 13-5332

Readers comment

Arguing plastic packages

To the Editor: Although most of us are aware of ECOM and RADC activities, including RAC, we're fully aware of the differences of opinion between the two ["Military argues over plastic semis," *Electronics*, Feb. 21, p. 38]. I fail to see how the industry is served by airing simplified subjective opinion.

Historically, plastic's main weaknesses have been its nonhermeticity and difficulty in matching coefficients of expansion, leading to moisture, saline, and bonding problems. So RADC (Barber/Brauer) does have a problem. On the other hand, ECOM's (Reich/Hakim) results in Panama (in small quantities) would appear to point toward epoxy-B's dramatic improvement (an order of magnitude over silicone and phenolic materials).

I would tend to agree with Bernie Reich in that failure modes for plastic are known and that screens may weed out the actual or latent failures. I don't agree with what appears as an editorial comment that suppliers have shown little interest in supplying screened parts during this period of shortage. We buy tens of millions annually.

I sympathize with RADC's concern and the probable logistics implications regarding moisture and salt-spray environments, but the dogmatic stand belies some of the benign π_E (environmental) conditions of volume 11 (TR-67-108) and MIL-NDBK-217B.

R. C. Foster
 Xerox Corp.
 Rochester, N. Y.

■ *We believe the article to be objective. On screening, Reich points out that, although suppliers are willing to burn in the parts, they are reluctant to make environmental tests.*

Correcting a counter gate

To the Editor: There was a slight error in one of the diagrams of my Designer's casebook, "External gate doubles counter speed," [*Electronics*, Feb. 7, p. 102]. The extra gate in figure (b) should be an OR gate, instead of a NOR. The description in the text was correct.

Jeffrey Mattox
 Boxborough, Mass.

Now you have an alternate source for 2GHz & 3GHz microwave transistors



TRW's new 2GHz & 3GHz microwave amplifier parts are available right now, off-the-shelf, from any authorized TRW distributor. So, soon as you qualify these parts, you are no longer at the mercy of a single-source manufacturer!

And here's some more news: our transistors are not simply "just as good" as the originals; they're better! Gold metalized to last longer. Metal migration failure is virtually non-existent. The 2GHz parts can also withstand infinite VSWR and overdrive. Yet TRW's gold metalized parts cost the same as ordinary aluminum ones (maybe less!).

These are practically drop-in parts. You can use them right now, in your present amplifiers—and, of course, in future designs. That means instant

improvement in the reliability of your amplifiers. Part for part:

	2GHz PART NUMBERS 3GHz			
	Aluminum	Gold	Aluminum	Gold
1W	MSC2001	TRW2001	MSC3001	TRW3001
3W	MSC2003	TRW2003	MSC3003	TRW3003
5W	MSC2005	TRW2005	MSC3005	TRW3005
10W	MSC2010	TRW2010	—	—

For details, call Don Comm, (213) 679-4561.

Or write TRW Semiconductors, an Electronic Components Division of TRW Inc. 14520 Aviation Blvd., Lawndale, California 90260.

TRW[®] SEMICONDUCTORS



These products are available through the following authorized distributors:

Almo Electronics
Bell Industries
Cramer Electronics Inc.

Electronics Marketing Corp.
Elmar Electronics Inc.
Hall-Mark Electronics Corp.

Pyttronic Industries Inc.
Rochester Radio
Semiconductor Concepts Inc.

R. V. Weatherford Co.
Westates Electronics Corp.
Wilshire Electronics

Higher component density...

Lower insertion costs...with

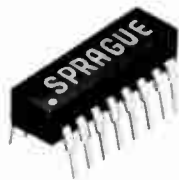

MULTI-COMP®

DIP MONOLYTHIC® CERAMIC CAPACITORS

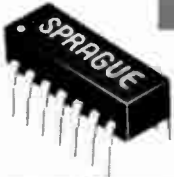

STANDARDIZED DESIGN* FOR
BETTER AVAILABILITY, BETTER PRICES

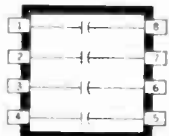

TYPE 939C
(4 capacitor sections)

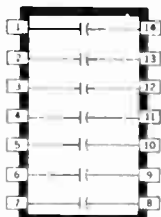

TYPE 934C
(7 capacitor sections)

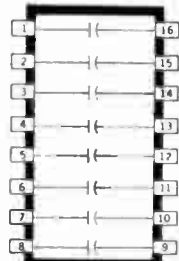

TYPE 936C
(8 capacitor sections)

Compatible with ICs and other standard DIP devices. Especially useful for noise bypassing and signal coupling in high-frequency signal or data processing systems. Molded package provides mechanical protection and reliability under severe environmental conditions. Monolithic® construction . . . alternate layers of ceramic dielectric material and metallic electrodes are fired into an almost indestructible homogeneous block. Standard ratings, 18 pF to 0.1 μ F @ 100 WVDC. Temperature range, -55 C to +70C.

*Other circuit configurations (including internally-paralleled capacitor sections, commoned capacitor leads, and various ratings within single package) are available on special order.

Sprague puts more passive component families into dual in-line packages than any other manufacturer:

- TANTALUM CAPACITORS
- CERAMIC CAPACITORS
- TANTALUM-CERAMIC NETWORKS
- RESISTOR-CAPACITOR NETWORKS
- PULSE TRANSFORMERS
- TOROIDAL INDUCTORS
- HYBRID CIRCUITS
- TAPPED DELAY LINES
- SPECIAL COMPONENT COMBINATIONS
- THICK-FILM RESISTOR NETWORKS
- THIN-FILM RESISTOR NETWORKS
- ION-IMPLANTED RESISTOR NETWORKS

For more information on Sprague DIP components, write or call Ed Geissler, Manager, Specialty Components Marketing, Sprague Electric Co., 35 Marshall St., North Adams, Mass. 01247. Tel. 413/664-4411.

THE BROAD-LINE PRODUCER OF ELECTRONIC PARTS



40 years ago

From the pages of Electronics, May, 1934

Needed—better antennas

For years an antenna has been any old piece of wire strung up any old place with any old kind of insulation. And for years the increase of man-made static has accelerated.

The year 1934 will be a year of tremendous public interest in short waves; late in the year may see the first high-fidelity receivers. Both short-wave sets and high-fidelity, wide-range sets suffer more than broadcast reception from natural and man-made static. Short-wave signals are weak and may come across thousands of miles of space, high-fidelity receivers will pass to the loud speaker tones (and noises) now lost in the narrow-band receivers universally employed.

Already the antenna problem has become acute. Set manufacturers are encouraging listeners to use two antennas: a high, long wire, well insulated and brought to the receiver through a shielded transmission line; and another high, shorter antenna, brought to the short-wave set through a transposed lead-in.

A campaign on the part of all the radio industry to encourage listeners to put up high, clear, well insulated antennas will hasten the day of noise-free short-wave reception.

Chicago's electronic 'frisker'

Prisoners taken into the Chicago Detective Bureau can now be "frisked" for concealed weapons by means of a magnetic exploring device, with tube amplifiers operating an alarm. The main wall-plate detects the presence of any iron or steel, even a saw-blade on a prisoner, and the small exploring coil permits localizing the metal body or weapon.

World Broadcasting, Berlin

[H. Mogel, German Post Office] Five more directed antenna systems for sending German programs to South America, Africa and the Far East have been added to the three antennas used for covering North and Central America. All the continents except Australia now receive a two hour broadcast.

you can see why...



the time is right with **PANAPLEX™** clock panel displays

PANAPLEX clock panels are designed to be read. These large, bright, easy-to-see, pleasing numerals are easily read in any light — even bright sunlight.

These four- and six-digit clock panels are compatible with MOS clock chips, and have the high reliability and quality that has made the PANAPLEX family of displays the choice of calculator manufacturers.

PANAPLEX clock panels can display either 12- or 24-hour time systems and have integral AM/PM indicators and colons.

Available in two standard sizes (0.5 and 0.7 inch), these thin panels (0.2 inch excluding tubulation) offer design flexibility that's hard to beat.

The soft, neon-orange color is easy to read at a glance: — no magnifier

needed, no eyestrain, no LED-red fatigue factor.

For additional information on the PANAPLEX clock panels, write Burroughs Corporation, Electronic Components Division, P. O. Box 1226, Plainfield, New Jersey 07061, or call (201) 757-3400 or (714) 835-7335.



You can see the difference

Burroughs



Circle 9 on reader service card

The Am25S10.

(The S is for Simple.
See also: Schottky, Speed,
System Space Saving, Signal
Processing, Shifting
and Scaling.)

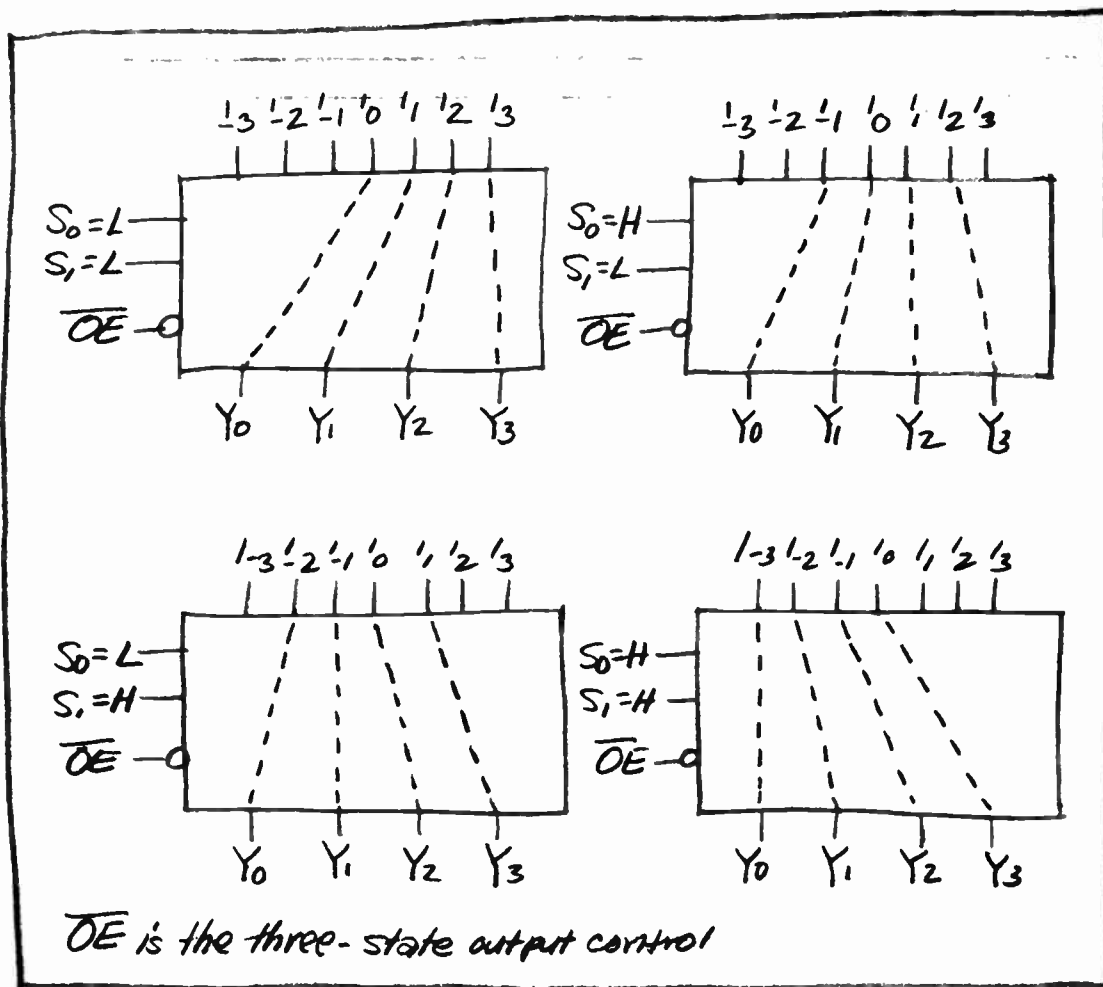

The four shift positions of the Am25S10

Now there's a faster, easier, more compact way to shift data. The Am25S10.

You can shift an N-bit word N places either up or down, logically, arithmetically or end around. The Am25S10 is a 4-bit shifter with three-state outputs for bus organized systems.

It has a data propagation delay of 6.5 nanoseconds.

If you want a fast reason why we're going to be the sixth largest maker of integrated circuits in the nation, try the Am25S10.

Sensational.

Advanced Micro Devices

Corporate offices are at 901 Thompson Place, Sunnyvale, California 94086. Telephone (408) 732-2400/Southern California office: Beverly Hills (213) 278-9700/Mid-America: Des Plaines, Illinois (312) 297-4115/Edina, Minnesota (612) 835-4445/Eastern United States: Roslyn Heights, New York (516) 484-4990/Baltimore, Maryland (301) 744-8233/Lexington, Massachusetts (617) 861-0606/Britain: Advanced Micro Devices, Telephone Maidstone 52004/West Germany: Advanced Micro Devices, Munich, Telephone (089) 53 95 88.
Distributed nationally by Hamilton/Avnet and Cramer Electronics.

**By 1980 electronic circuitry
will control, correct and protect
virtually all automotive systems.**

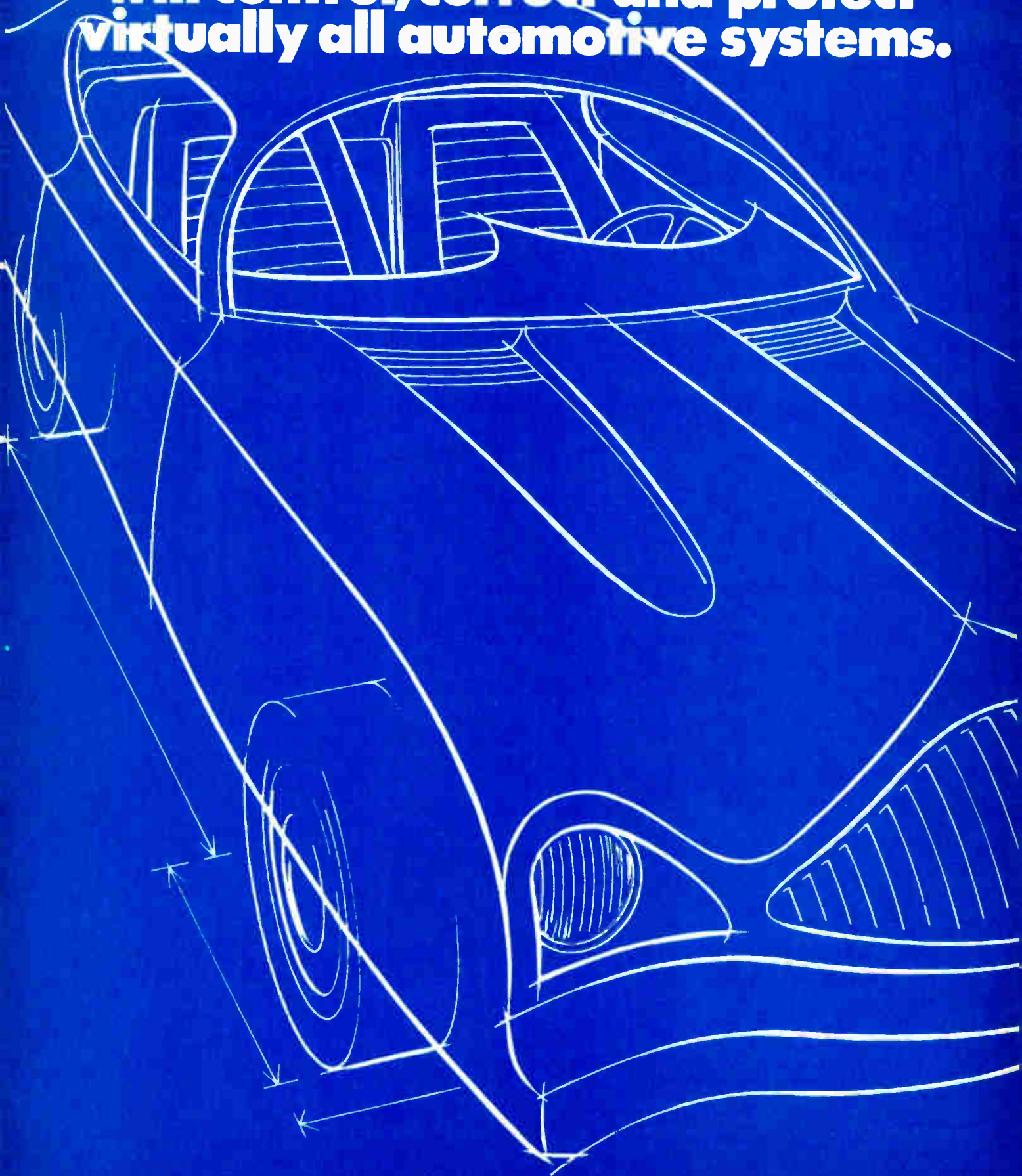

In 1974 Mepco/Electra will make passive components for almost any automotive application.

We're committed to meet the stringent requirements of automotive electronics. And we have been for years. Our engineers work closely with auto-makers developing specifications and components to meet the rapidly expanding demands of electronics for automotive systems.

Mepco/Electra makes the complete line of passive components from ceramic and electrolytic capacitors to metal and carbon film resistors... from carbon and cermet trimmers to microcircuits. Our components are designed for use in such diverse systems as: seat belt interlocks, high speed warning devices, electronic ignitions, anti-skid braking, AM/FM radios, automatic door locks and solid state digital clocks.

And in the future... devices like emission controls, air bag controls, electronic fuel injection, logic spark advance circuitry and more.

Doesn't it make sense to look for components with proven reliability?

Rugged components that won't quit when hit by rapid temperature changes, dampness and dirt. Want to know more? Call or write Mepco/Electra, Inc., Morristown, N.J. (201) 539-2000.

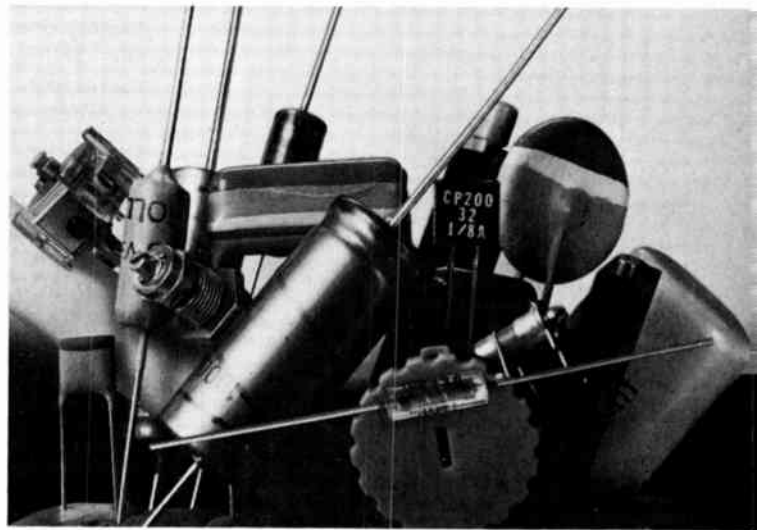

Talk to the man from MEPCO/ ELECTRA



Sold through
North American Philips
Electronic Component
Corporation

Plant Locations:
Morristown, New Jersey
San Diego, California
Mineral Wells, Texas
Canandaigua, New York
Oakland, California.



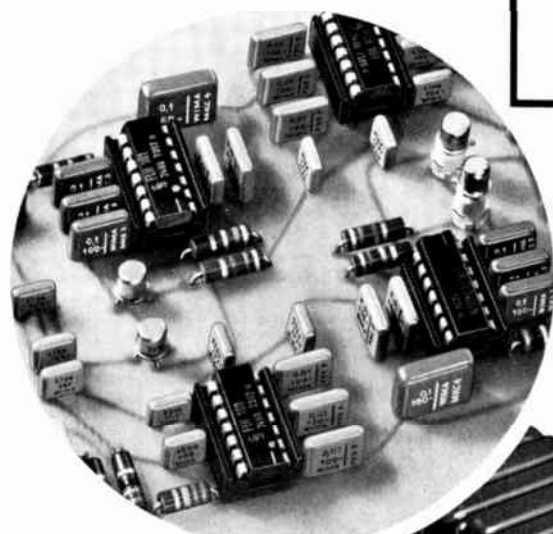

IC'S
require
small
C'S

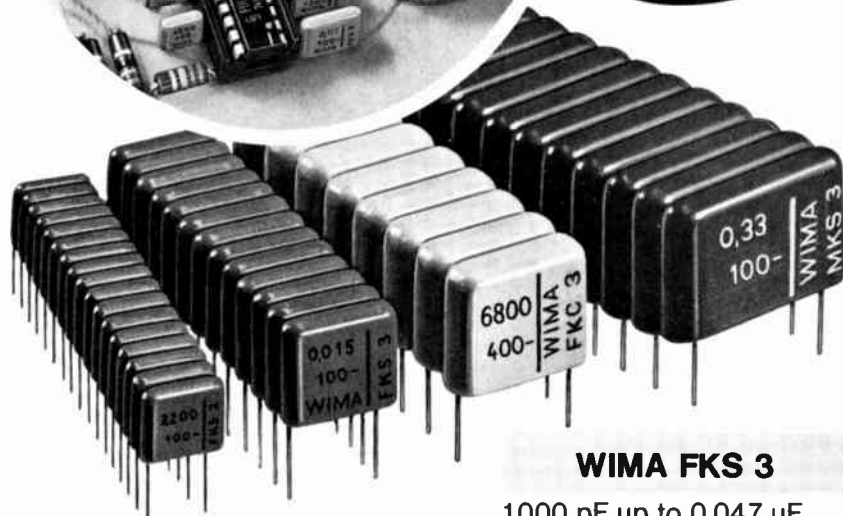

WIMA FKS 3

1000 pF up to 0.047 μ F

WIMA FKC 3

100 pF and up

WIMA MKS 3

Up to 0.47 μ F

WIMA FKS 2 min

P.C.M. 5 mm
1000 pF to 0.047 μ F

Cast-moulded capacitors

are an excellent aid in designing your IC-equipped printed boards. Use the new plug-in WIMA® capacitors which are smaller and have regular dimensions.

Write for our new catalogue.



WILHELM WESTERMANN

Spezialfabrik
für Kondensatoren
D-68 Mannheim 1
Fed. Rep. of Germany
Augusta-Anlage 56
P. O. Box 2345
Tel.: (0621) 40 80 12

But Randlett is confident. "We feel we can dominate in technology," Randlett says. "By the end of the year we will have introduced a line of converters combining dielectric isolation techniques and thin-film technology, which we feel will have the best cost-performance ratio." Philbrick claims better speed and lower error rate using its new technique, and faster settling time in quad current switches. It also claims that its prices will be lower than the competition's.

Having developed a highly qualified staff over the last few years, Philbrick brought in Randlett to regroup for a production push.

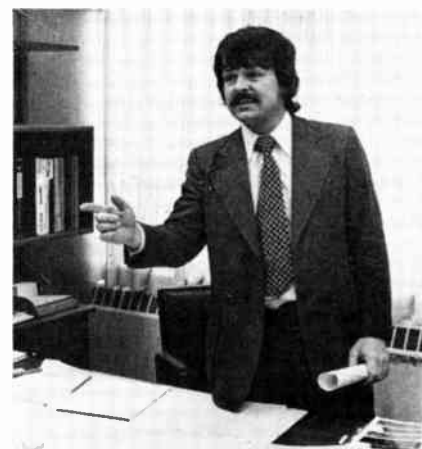

Group effort. Randlett believes productivity will be enhanced by his team approach.

In 1967, after working at IBM for two years as a staff engineer, Randlett and two physicians founded Vertek, which made pulmonary-analysis equipment, and later sold it to Hewlett-Packard. Randlett then got into the analog-to-digital-converter business with the founding of Adac, which eventually was merged with Dynamic Measurement Corp.

At Philbrick, he has organized his staff into teams of three to five people, with each team following its work throughout all phases of production. The group leader must be able to communicate with all areas of the company.

The value of the team concept is accountability. "The groups can see results in terms of the number of products and the money they can generate," says Randlett.

Our Hustler 45 is a big name dropper



When it comes to testing dynamic RAMS and LSI random logic.

Our new Hustler 45 — a 10 MHz parallel functional tester has been purchased by some of the world's largest IC users. Here are a few reasons.

Extremely High Throughput

The Hustler 45 is in a class by itself when it comes to functionally testing MOS & Bipolar memories, shift registers and logic arrays at rates to 10 MHz.

In fact, Hustler can test access time or propagation delay on all pins simultaneously. With 1 ns resolution!

How does Hustler 45 accomplish this? With a separate high slew rate electronic card (PEC) for each pin. With drivers and comparitors located just inches from the device under test. With a RAM behind each pin. With 4 fully programmable clock phase periods. And an independent error strobe. With a computer programmed pattern generator. (optional)

Each pin can act as an input, output or be disconnected. All inputs are exercised in parallel. All outputs are measured in parallel. Throughput is dramatically increased. IC's are tested as they actually operate in the real world.

Functional Flexibility

Hustler 45 is flexible too. With 100 pin capability. And behind each pin a fast

access RAM configurable to 4096 bits. Which means you can perform high speed functional & dynamic tests on large arrays — even complete memory boards.

Interfacing is just as versatile. Choose from a low cost, manual insertion, single station test head. Or a universal test head for operation with wafer probers, automatic handlers, temperature chambers or manual insertion fixtures — single station or multiplexed two station.

Parametric Tests, Too

You can specify Hustler 45 as a stand-alone system for 10 MHz functional and dynamic testing with sequential parametric testing. Or couple it with our field-proven Hustler 44 to also perform parallel parametric tests on devices with up to 256 pins — with time sharing of up to 8 remote stations and data logging of test results.

Simple English Language Programming

Hustler 45 software is simple. Your techs and engineers can generate programs after a few hours of training. Using simple English language programming designed for the test operator — not a computer expert.

In a Nutshell

Our Hustler 45 offers unmatched speed, versatility and programming ease at a surprisingly low price. So talk to a Datatron field engineer before you decide on any high speed tester. And send for our informative brochure.

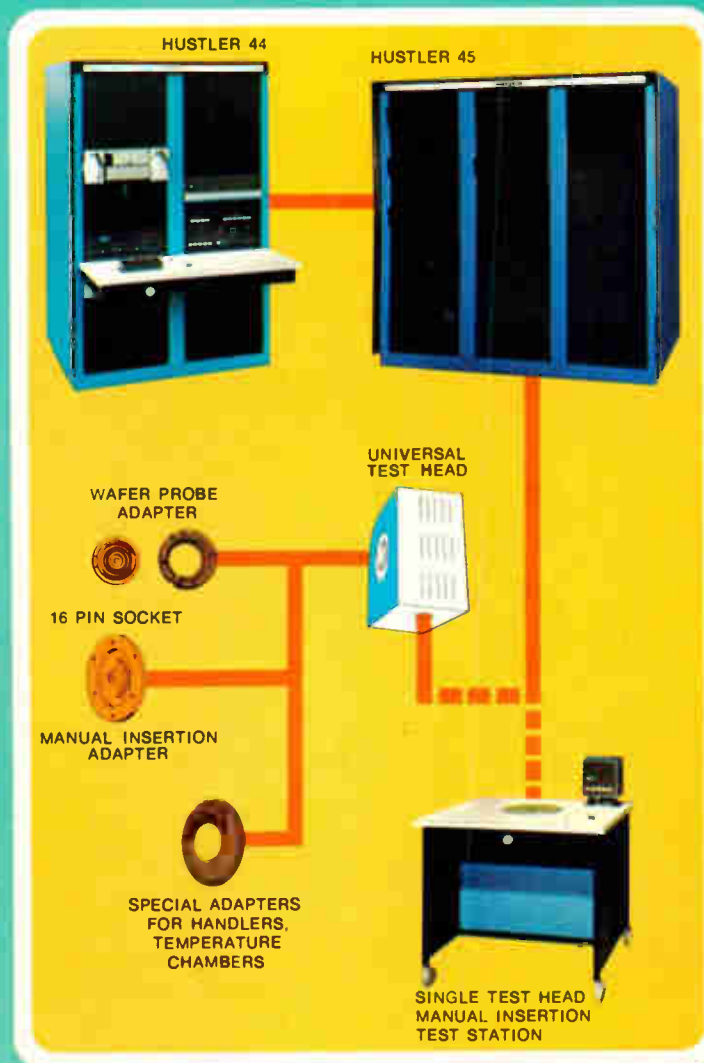

datatron inc.

1562 REYNOLDS AVENUE • SANTA ANA, CALIFORNIA 92711 • (714) 540-9330

Circle 17 on reader service card

Leader in Capacitor Dielectrics since 1948!

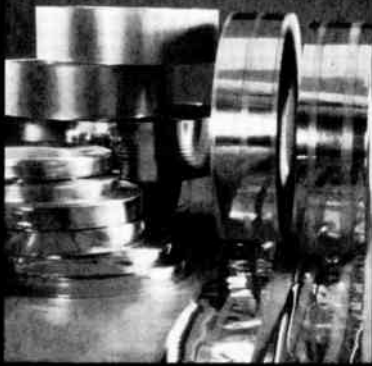

All Films — All Gages

- Polyester
- Polypropylene
- Polysulfone
- Polycarbonate

Metalized — All Modes

- Duomet™ (both sides)
- Heavy Edge
- Heavy Metal
- Series Pattern
- Single Side

Write or phone for Free
Samples and Literature



ATLAN-TOL INDUSTRIES, INC.

Am-Met Division
29 Knight Street
Norwalk, Conn. 06852, U.S.A.
(203) 853-9494

Update

A year ago, the FAA and Congress were about to collide head on over aircraft collision-avoidance systems. Specifically, the issue was Sen. Frank E. Moss' (D., Utah) bill requiring the FAA to select a national CAS standard by June 30, 1974 [May 10, 1973, p. 49]. And that's about where things still stand. Hearings on the bill are scheduled for May 21, and the warring parties are still adamant: the FAA wants a ground-based system, the Air Transport Association wants an airborne system, the general aviation lobby doesn't want its members to pay for any system, and the military says its planes already cost too much.

With much ballyhoo and optimism, Multipoint Distribution Service was launched about a year ago as the future third type of television network [May 10, 1973, p. 65]. The system combines the features of over-the-air, cable, and closed-circuit TV with point-to-point microwave transmission. Now, says Mark Foster, president of Microband National Systems Inc., his omnidirectional closed-circuit system is in full-scale operation in four cities—Chicago, Washington, New York, and Houston. Three others—Philadelphia, Baltimore, and Miami—are just coming on the air. Foster says the bulk of the time is being used for pay TV; corporate communications are coming onstream.

RCA Corp. called itself the first manufacturer of color television sets to add built-in cable capability when it announced some top-of-the-line XL-100 sets incorporating the feature [May 24, 1973, p. 42]. But after finding that most consumers apparently don't mind having a separate converter/selector sitting atop their sets, RCA never got its sets to market. A spokesman explains that the trend in the industry is to shrink the number of chassis and models being offered, so RCA decided to keep its cable sets off retailers' shelves.

Computerized nationwide design networks have been started from time to time down through the years, and last year's entry was one that could handle printed-circuit boards [May 10, 1973, p. 32]. The company, ADREC Inc. of Sherman Oaks, Calif., says the network is still in existence, but several other things have changed since then. There's a new product line of interactive graphics, plus backplane wiring for wire-wrap machines. And, says president A.T. Materna, ADREC has signed with a large manufacturer to provide IC designs.

The DOD's "design-to-cost" philosophy of cost-cutting was relatively new last year when defense contractors met with Pentagon officials to complain strongly about the concept [May 10, 1973, p. 36]. But since then, the vendors' ire appears to have dissipated for, in the words of one old Washington hand, "Industry just accommodated itself."

Shouldn't police departments be eager to buy a laser communicator that can be kept lined up even between two moving vehicles? American Laser Systems of Santa Barbara, Calif., thought the answer would be "yes" when it put together its system [May 24, 1973, p. 34]. But that hasn't been the case because, as the company found out, police departments just don't have very much money to spend on sophisticated secure communications systems. However, the Sixth Fleet is testing one in the Mediterranean.

—Howard Wolff

Intended to bring *Electronics* readers up to date on news stories of the past months.

The first modular instrumentation calculator.

Just \$5905 as shown.

It's our 31/53 Calculator Instrumentation System

A powerful, yet inexpensive calculator combined with our TM 500 power supply and system software. You add the instrumentation modules you need. It's all there and it's portable. Now that's versatility!

With our 31 Calculator, you can read input from our DMM's and counters. You can log data selectively, calculate results and output data or trigger signals.

Programming? Little more than natural math. Go ahead, write your own. Also, our standard software gives you data logging (on the optional printer) and data capture on the 31 at operator selected intervals.

For numerical monitoring or

analysis, there's our 21/53 for \$2895 less plug-ins. And in case you wondered, our TM 500 plug-ins are less expensive, too.

Energy monitoring.

Quality control testing. Laboratory and production instrumentation.

The applications go on, and so does our system's potential. Just add the main-

frames and modules you need. We have a graphic calculator system, too. Let our sales engineer fill you in. Pick up your phone and call our nearest center. Or write

Tektronix, P.O. Box 500,
Beaverton, Oregon 97005

Our programmable calculators. Natural. Powerful. Significantly less expensive.



TEKTRONIX®



For a demonstration circle 132 on reader service card
Circle 19 on reader service card

MEET A GROUP OF SCHEMING INDUSTRIALISTS.

They're from the smaller towns of Georgia, welcoming new business with inducements like a mayor who calls you by name. A doctor when you need him. Conservative government. Room to grow, and willing hands to help.

In Georgia, non-profit corporations and industrial authorities erect and lease buildings for new businesses. We also offer assistance in financing, a competitive tax structure, and construction costs 14% below the average.

Our Quick Start Program will train your employees, free.

You'll be located in the transportation and distribution center of the Southeast.

And, you'll be served by astute industrialists who make the quality of life agreeable.

For you, and for them.

Send for more information on the industrial climate in Georgia's smaller towns.



Georgia Department of Community Development/Industry Division, Dept. EL-46
Box 38097/Atlanta, Georgia 30334

Please send me information on Georgia's industrial opportunities, including the "1974 Industrial Survey of Georgia."

Name	Title	Company		
Address	City	State	Zip	



Meetings

Microwave Power Symposium, International Microwave Power Institute, Marquette University, Milwaukee, Wis., May 28-31.

Submillimeter Waves and Their Applications International Conference, IEEE, Sheraton Biltmore, Georgia Tech., Atlanta, June 5-6.

Consumer Electronics Show, EIA, McCormick Place, Chicago, Ill., June 9-12.

Chicago Spring Conference on Broadcast and Television Receivers, IEEE, Marriott Motor Hotel, Chicago, June 10-11.

Power Electronics Specialists Conference, IEEE, Bell Laboratories, Murray Hill, N. J., June 10-12.

Quantum Electronics International Conference, IEEE, Hyatt Regency, San Francisco, June 10-13.

Symposium on Human Resources and Medical Programs of the Department of Defense, EIA, Pick-Congress Hotel, Chicago, June 11-12.

Automotive Electronics Conference and Exposition, Electronics Representatives Association, Cobo Hall, Detroit, June 11-13.

International Microwave Symposium, IEEE, Atlanta, Ga., June 12-14.

Utilities Telecommunications Council Annual Meeting, UTC, Chalfonte-Haddon Hall Hotel, Atlantic City, N. J., June 16-20.

Design Automation Workshop, IEEE, Holiday Inn, Denver, June 17-19.

International Conference on Communications, IEEE, Leamington Hotel, Minneapolis, June 16-19.

1974 Government Microcircuit Applications Conference, DOD, NASA, AEC, U. of Colo, Boulder, (clearance required), June 25-27.

Precision Electromagnetic Measurements Conference, Royal Society, IEE, London, July 1-5.

From the voltmeter house...

**The most
important
announcement
you'll see
this year about
digital
voltmeters**

**Introducing
the new Fluke...**

8600A 20,000-count DMM



8800A 200,000-count DMM



New automatic digital multimeters use advanced Fluke LSI technology. They're accurate and complete—just as they come from the box. Everything you need is built-in. They're small, tough and reliable. Maximize multimeter measure power for little more than half the price you're used to paying.

The 26-range Fluke 8600A, \$599

Here's what you get: a 4½ digit auto-ranging multimeter with five ranges of dc volts, five ranges of ac volts, five ranges of dc current, five ranges of ac current, and six ranges of resistance. Own a digital multimeter with a basic dc accuracy of 0.02% and autozero on all functions. Get up to 1000 megohms input resistance for minimum loading.

All dc ranges from 200 mV through 1200 volts are continuously protected to $\pm 1200V$ dc or 1700 volts peak ac. AC bandwidth to 100 kHz offers 10 μV resolution. From 200 ohms full scale through 20 megohms full scale, the 8600A takes a continuous 250V rms or dc. A front panel fuse protects all ac and dc current ranges from 200 μA full scale to 2 A full scale.

Optionally, a rechargeable battery pack with charger is built right in . . . no bulky snap-on's or external chargers. For true portability, the Fluke 8600A offers 8 hours off-line operation for slightly more money.

Weight, 5 pounds (2.3 kg). Two 8600A's fit neatly in a standard EIA rack. Rack mounting kits are optional. Optional low-cost printer output is fully isolated and TTL/DTL compatible for use in datalogging applications.

Accessories, we've got 'em galore. There's a best buy high voltage probe that measures one kV to 40 kV. There are two RF probes, a 20 kHz to 250 MHz probe and a 1 GHz probe. To measure high currents there's a clamp-on probe that reads 2 to 600 amperes. Other accessories include deluxe test leads, rack kits, dust covers and two different carrying cases.

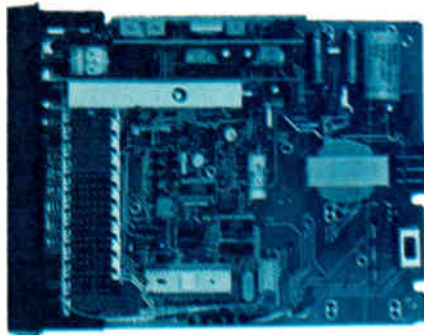

Notice the clean functional layout and careful workmanship of the Fluke 8800A.

The .005% Fluke 8800A, \$1099

Here's what you get: a 5½ digit auto-ranging multimeter with full guarding on five ranges of dc volts, four ranges of ac volts, and six ranges of 4-wire ohms. With a basic accuracy of 0.005% and common mode rejection better than 120 dB, it's the top voltmeter for the money.

The 8800A gives you full guarding, 1000 megohm input resistance on the 200 mV, 2V and 20V ranges, excellent ac accuracies over the entire frequency range of 30 Hz to 100 kHz and autoranging on all functions. Completely isolated four-terminal ohms measurement on the 200-ohm full scale through 20-megohm full scale ranges with less than 4 volts open circuit voltage.

For datalogging, add low-cost isolated printer output. Weight is 10 pounds (4.5 kg). Width of 9 inches (23 cm) allows the Fluke 8800A to fit conveniently into a standard EIA rack.

Both instruments feature LED readout with easy-to-read numbers. Both instruments use a proprietary Fluke digital LSI chip for low parts count, high performance and extraordinary reliability. And, remember, Fluke has more LSI experience in instrumentation than anybody else.

These instruments are rated for a minimum 10,000 hour MTBF as a result of exhaustive Fluke environmental testing. They are rugged and will take a lot of abuse and still work well within specs.

Fluke backs you up after the sale

When you buy a new Fluke instrument, you may be gone from the salesman's short term prospect list, but you're not forgotten. We have technical and service centers throughout the United States, Canada, Europe and Japan. The one nearest you will give you super service on both in and out of warranty repair. We also invite you to become a member of our user's group, for service notes and seminars on getting the most out of your Fluke instrument.

Maximize measure power now

Fluke invites you to try one or both of these new multimeters on your bench right away. Call your nearest Fluke sales engineer for details or simply dial our hotline.

In the continental U.S., dial our toll-free number 800-426-0361 for the name and address of your nearest local source. Abroad and in Canada, call or write the office nearest you listed below. John Fluke Mfg. Co., Inc., P.O. Box 7428, Seattle, Washington 98133. Phone (206) 774-2211. TWX: 910-449-2850. In Europe, address Fluke Nederland (B.V.), P.O. Box 5053, Tilburg, The Netherlands. Phone 013-67-3973. Telex: 844-52237. In the U.K., address Fluke International Corp., Garnett Close, Watford, WD2 4TT. Phone, Watford, 33066. Telex: 934583. In Canada, address ACA, Ltd., 6427 Northam Drive, Mississauga, Ontario. Phone 416-678-1500. TWX: 610-492-2119.



For data out today, dial our toll-free hotline, 800-426-0361.



**Uniform
resistors
reduce
costs.**

**If you're really
serious about cost,
be serious about quality.**

That could be money in your pocket. Allen-Bradley's exclusive hot molding process offers physical consistency that can reduce your installation costs. Bodies are a uniform size with clean squared ends, free from coatings which adversely affect automatic handling equipment. Lead

lengths and diameters are precise. Resistors with uniform physical characteristics, accurately placed on tape reels, eliminate insertion machine jam-ups. And trouble free assembly means less production down-time; lower cost. That's A-B quality. Consistent shipment after shipment. If you

think all resistors are the same, send for our free booklet, "7 ways to tell the difference in fixed resistors." Allen-Bradley Electronics Div., 1201 S. 2nd St., Milwaukee, WI 53204. Export: Bloomfield, NJ 07003. Canada: Allen-Bradley Canada Ltd., Cambridge, Ont. U. K.: Jarrow, Co. Durham NE32 3EN.

EC80



ALLEN-BRADLEY
Milwaukee, Wisconsin 53204

Common Market easing entry for U.S. wafers

It looks like U.S. companies are winning easier access to the Common Market's semiconductor wafer customers. The European Economic Community's commission has proposed a regulation shifting wafers to a new tariff position and **cutting duty on imports to the nine member countries from 17% to 9%**. The proposal is due to come up for approval by the council of ministers in early June.

If the regulation is adopted, it will mean a **success for U.S. trade negotiators, who protested against the duty** through the machinery of the General Agreement on Tariffs and Trade. Wafers were, in fact, grouped together with microstructures in the higher duty position in early 1972.

McGraw drops meter reader

The energy crisis has claimed another victim. McGraw-Edison Co. has withdrawn its automatic meter-reading system, Armeter, and is about to close that division of the company. T. Schuyler Banghart, general manager of the Armeter division, says the Elgin, Ill., company is making the move because of the **energy shortage and difficulties with AT&T's tariff structure**. McGraw-Edison makes components for utilities.

"Automatic meter reading was a high priority among utilities four or five years ago when we began working on the system, but now the energy crisis has put a financial bite on the utilities and it's low priority," he says. Banghart adds that McGraw-Edison, which invested several million dollars in the project, **will try to sell or license the technology** used in the Armeter transponder, which was developed jointly with American Microsystems Inc.

Price cuts loom for scientific calculator makers

Watch for Texas Instruments to set off a round of price cuts by scientific calculator manufacturers, despite the fact that the calculator giant is still limiting slashes of its SR-50 unit to direct mail. Industry sources are **predicting a \$20 price cut to \$149.50**, even though delivery times are still quoted at eight weeks.

While a Hewlett-Packard spokesman admits that last month's price reductions on its HP-35 and HP-45 were due in part to competition from the SR-50, he indicates that the firm **will not respond to further price cuts by TI** at this time. H-P, which hopes to have the U.S. blanketed through retail outlets by year-end, also attributes its new prices of \$225 and \$325 to a cosmetic redesign that paid off in manufacturing efficiencies.

TI, which has been exceptionally aggressive in pricing, used last week's National Computer Conference to lower the price on its hexadecimal calculator, aimed at computer programmers and designers, from \$295 to \$249.50.

Space-funding forecasts paint grim picture . . .

A grim picture of future Federal space program funding is contained in new data presented to Congress by NASA and the Department of Defense. Where contractors previously looked to the Pentagon to offset declines in spending for civilian space programs, the Director of Defense Research and Engineering has indicated to the Senate Aeronautical and Space Sciences Committee that **military space expenditures will remain essentially flat at about \$2 billion annually** for fiscal years

1975-1979. Outlays of \$1.9 billion in fiscal 1975 are forecast to rise to \$2.2 billion in fiscal '79, an increase believed insufficient to offset inflation.

NASA, meanwhile, is circulating figures that show the Nixon Administration has apparently dropped its commitment to a constant budget level of \$3.4 billion annually. Money made available to NASA over the fiscal years 1973-1975 will be more than \$1 billion short of the goal, with more than \$900 million of that divided about equally between fiscal '74 and '75.

. . . as engineering job drop is seen in aerospace

The decline in jobs for engineers, scientists, and technicians in the aerospace industry will continue through December, recording a **drop of nearly 4% in 18 months**, according to a forecast by the Aerospace Industries Association of America. Following an overall upturn in U. S. aerospace jobs during the last quarter of 1973, which pushed total industry employment to 962,000 by December, the number of workers is expected to slip back to 948,000 by June and then decline further to 940,000 by December.

Employment of engineers and scientists did not benefit from the 1973 upturn, however, most of which resulted from an unexpected Middle East demand for military and transport aircraft following the October war, says AIAA. This generated jobs for production workers and, to a lesser extent, for technicians. Jobs for engineers and scientists dropped from 167,000 in June 1973 to 164,000 in December. They are expected to decline further to 162,000 by June of this year and then down to 160,000 in December.

McGurk urges computer users to form group

The formation of a nationwide computer users' association has been proposed by Dan McGurk, president of the Computer Industry Association. McGurk wants such a group to represent the user in three primary areas: **standards, data security, and telecommunications interconnection**. The CIA president says he has committed \$50,000 of CIA money toward formation and organization of such a group and he called for matching amounts from at least two other associations, companies, or individuals.

But George Glaser, president of the American Federation of Information Processing Societies, says **it's unlikely that AFIPS would be a contributor**. Glaser questioned the need for a users' association on the grounds that users are so diverse.

Supermarket POS making inroads

Electronic checkout systems, either stand-alone or minicomputer-controlled, **have started serious penetration of supermarkets**. According to a report just released by the Supermarket Institute, some 21 companies are now manufacturing electronic cash registers, store-wide systems, or new combined item-code printing equipment and electronic scales. It's estimated that only about 500 supermarkets are now using this equipment, but by fall, when check stands equipped to scan the Uniform Product Code labels are ready, installation totals will soar, says SMI.

Better than any IC or UJT for low cost timing circuits.

Unitrode PUTs provide design freedom unobtainable with conventional UJTs—at a fraction of the cost of comparable ICs or mechanical timing circuits.

By varying the external resistor values you can program turn-on voltage, turn-on current and turn-off current to meet your needs . . . in timing circuits, oscillators, sensing circuits or any application where a variable voltage level threshold is required.

Unitrode Programmable Unijunction Transistors (PUTs)

Simple, versatile, low cost Unitrode PUTs meet the performance require-

ments of any timing circuit in frequencies from 50 KHz to .001 Hz, from microseconds to hours.

Millions of Unitrode PUTs have already cut costs in thousands of applications from smoke detectors and television sets to office machines and industrial processing systems. In fact, Unitrode produces a larger selection of PUTs than all other manufacturers combined. Fully planar passivated . . . low nano-amp leakage for long interval timing . . . in the plastic TO-92 and TO-98 package, and the hermetically sealed TO-18 package.

Send for a free sample. We'll also include data sheets and application notes to help you breadboard the lowest cost timing circuits ever.

Or, for faster action, call John Upton at (617) 926-0404. Unitrode Corporation, 580 Pleasant Street, Watertown, Mass. 02172.

Try a free sample

Circle 27 on reader service card

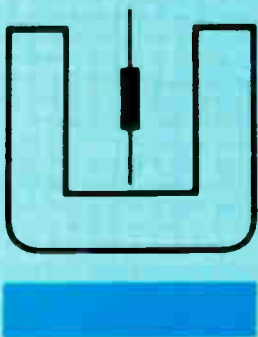

UNITRODE

580 PLEASANT STREET, WATERTOWN, MA 02172

Hickok static card readers are known for their reliability and accuracy. Our unique "brush" design is the reason.

Our 22 column badge and 80 column card readers have a reputation for rugged dependability and accurate performance even in hostile environments.

It's Hickok's multistrand continuous brush design that does it. The brushes are molded into a holder to insure proper alignment with the inserted card. At least three strands pass through each hole in the card to make contact, with only the brush assembly moving. The card is locked into place and released only when the scan is com-

pleted. This design insures accurate readings even when cards are poorly punched or damaged from humidity, contaminants or warpage. Hickok static card readers will tolerate misalignment up to .009" greater than EIA standards.

Whatever your application — programming/control, data collection, identification — Hickok's full line of static card readers can meet it. Our readers are being used on film processing machines, circuit board testers, security systems, teaching machines, quality control systems, employee attendance/payroll

systems, teletype controllers, industrial machine controls.

You can select from a variety of electronic packages to interface the reader to your system. If need be, we'll tailor and modify our card readers to meet a customer's specific needs.

We've been in the electronics business for 60 years, and have been a static card reader specialist for 16 years. We understand the electrical and mechanical aspects of your data input and collection problems. Call our application engineers today and find out how we can solve yours.

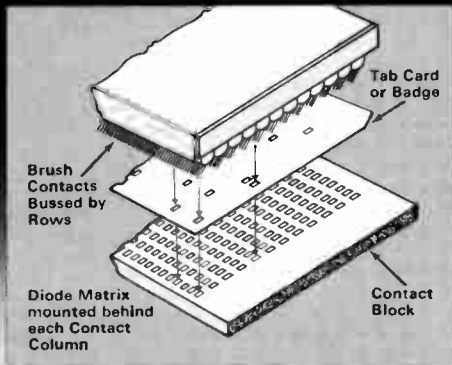

80 Column Card Reader

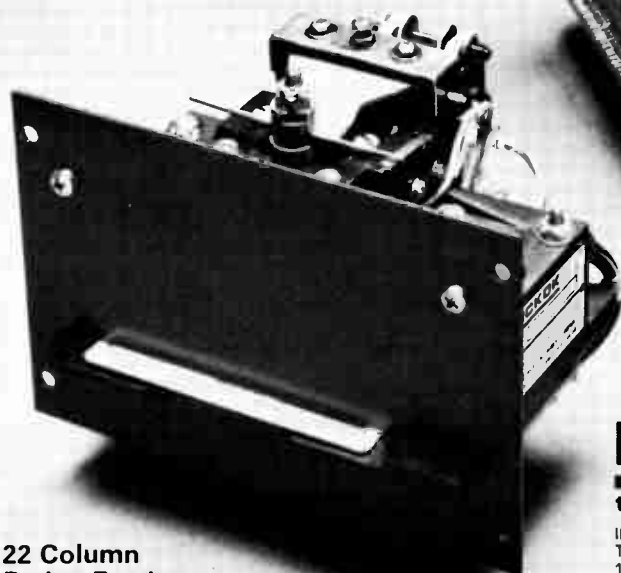

22 Column Badge Reader

Circle 28 on reader service card

HICKOK

the value innovator

INSTRUMENTATION & CONTROLS DIVISION
THE HICKOK ELECTRICAL INSTRUMENT CO.
10514 Dupont Avenue • Cleveland, Ohio 44108
(216) 541-8080 • TWX: 810-421-8286

Bubble memory of 500,000 bits could compete with disks

Developed at Bell Labs, the bubble store fits in the palm of the hand, a fraction of rotating memory size

Alert to potential applications in telephone-company electronic switching centers, Bell Laboratories has developed "the first working, fully populated magnetic-bubble memory." Moreover, the Bell prototype's capacity of a half-million bits could be readily scaled up to a million-bit design. If it is decided to develop the memory for production, such a unit could replace fixed-head rotating disk and drum memories in as little as two years, states Peter I. Bonyhard, supervisor of the subsystems group in Bell's magnetics department in Murray Hill, N.J.

The prototype stores 460,544 bits on two ceramic substrates measuring 2½ by 1½ inches. Each substrate holds 14 garnet chips, and each chip contains 16,448 bits. The substrates fit between a pair of high-permeability plates, which help form the magnetic field that biases the bubbles. Altogether, the half-million-bit store measures 3¾ inches long, 1¾ inches wide and 13/16 inches high and fits easily into the palm of the hand. It weighs about 1½ pounds.

Because two substrates containing the additional storage elements could be slid in between the biasing plates, a megabit memory would be no larger, points out Paul C. Michaelis, the engineering physicist within the subsystem group who coordinated the design of the memory system. In addition, control and detection electronics in a fully

engineered system could fit on a single side of a 5-by-8-in. printed-circuit board with multi-level wiring, he estimates, while the driver electronics providing the rotating field and master clock for the T, bar, and chevron propagating structure might occupy about 4 in.³ All told, the memory might occupy less than a third of a cubic foot, a fraction of the volume occupied by rotating memories. Total power would be just a few watts.

System operating times for the bit/slice organized memory are in the same ball park as for fixed-head disk units. Average access time to data is 2.7 milliseconds, and a full read/write cycle takes 5.1 microseconds, according to Michaelis. Data rate for a 14-bit parallel word is 700 kilobits per second. Error rates—or the probability of obtaining a false output—have been checked out at 1.6×10^{-12} per read cycle, says Michaelis, quite acceptable for an operational system.

Each 250-by-185-mil memory chip is organized into 64 minor storage loops of 257 bits each. A single major loop acts as the communications link between data stored in the minor loops and the outside world. With the bit/slice organization, each of the 14 chips on a substrate contains one bit of a word. Output is 14 parallel bits in groups or pages of 64 words.

Michaelis remarks that the oper-

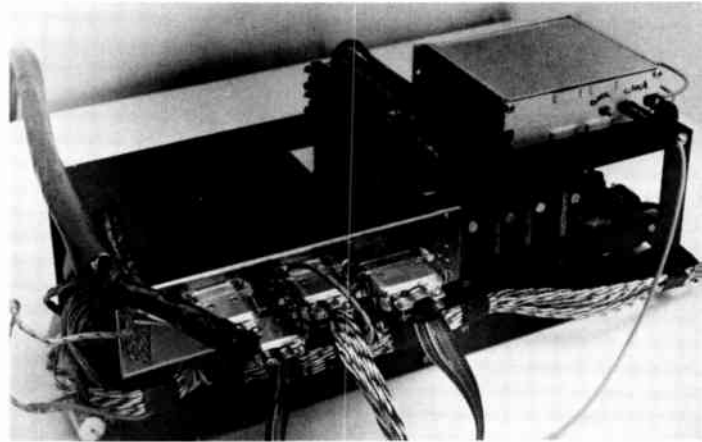

Bubble power. Bubble memory chips containing 16,448 bits are placed on 2½-by-1½-in. ceramic substrate in prototype developed at Bell Labs.

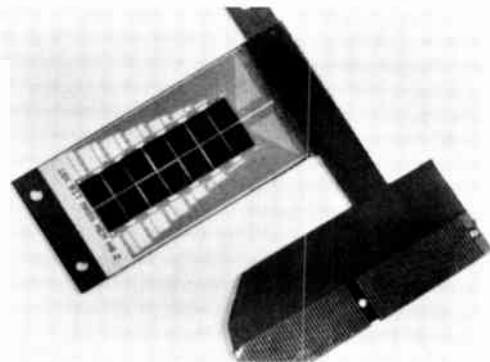

ating characteristics of the chips turned out to be quite "forgiving." Nominally, the chips operate with a bias field of 90 oersted ± 4.5 oersted. This range is broad enough for yields to be relatively high, he adds.

For example, the first 30 1½-in. wafers processed in the laboratory had a yield of device 15%, says A.J. Perneski, supervisor of the device and subsystem fabrication group. And he hopes to do even better in the future, using what he calls "straightforward" processing.

Typical semiconductor processing

techniques are employed, he points out, beginning with a non-magnetic substrate of gadolinium gallium garnet on which a 6-micrometer-thick film of magnetic samarium yttrium-iron-gallium garnet is grown epitaxially. This is followed by an aluminum-copper metalization layer, a silicon dioxide spacer layer, then a permalloy layer in which the propagating structure is patterned, and a final silicon-dioxide passivation layer. Altogether there are only four relatively simple layers, three photomasks, and an ion-implantation step on the magnetic garnet layer that prevents the formation of unwanted "hard" bubbles, according to Perneski.

Two of the prototype memories have been built and are being evaluated by Bell engineers concerned with switching systems. As Michaelis observes, "We're at the point now where bubble memories have proved a viable technology. They should have a design life of 20 years. Moreover, there are no mechanical failures or periodic maintenance to worry about."

However, Bell has not yet made the decision regarding production of

the bubble memories, nor will it say when such a decision can be expected. □

Bubbles break into applications at NASA

While Bell Labs engineers consider ground-based applications of bubble memories (previous story), their colleagues at Rockwell International Corp. are looking for bubbles to burst into space applications. Researchers at the firm's Electronic Research division have developed a 61,440-bit bubble memory that could be an important building block on the way to units with memories of up to 100 million bits.

The 61-kilobit memory consists of six 10,240-bit serial shift register chips mounted in three multilayer ceramic packages. Using the experience gained in developing the 10,240-bit chips, Rockwell is working on larger 100-kilobit devices for spacecraft recorders, and it is this work that may lead to multi-million-bit bubble memories. Rockwell

received a \$328,000 NASA contract for three chips incorporating 4-micrometer bubbles that have a data density of 2.5 million bits per square inch.

If Rockwell successfully develops a multimillion-bit memory using this approach, bubbles would supplant the present magnetic-tape transports now used in satellites. A big advantage over the mechanical memories would be higher reliability since no moving parts are required.

Thomas T. Chen, who is presenting a paper on the 10,240-bit serial shift registers at this week's International Magnetics Conference in Toronto, says the firm is now assembling and checking out the system. The 61-kilo-bit memory measures 3 by 5 by 1 inches, and its six chips in their three multilayer ceramic packages are mounted in a closed, temperature-compensated, magnetic bias structure.

The module is operated at 25 kilohertz, and can accept asynchronous input data up to this frequency. A two-level thick-film chevron detector developed by Rockwell is used to sense the bubbles. Signal

Small bubbles in amorphous films look promising

Although the 4- or 5-micrometer diameters of the magnetic bubbles in the memories developed by Rockwell and Bell Labs may seem small, they are much larger than need be. So say physicists in the Applied Research department at IBM's Research Laboratories in Yorktown Heights, N.Y.

The company is concentrating on "small bubbles," with diameters of at most 1 μm , which could yield denser, faster memories with lower power dissipation. Moreover, the researchers are using IBM's electron-beam lithography techniques to fabricate the small bubbles in thin amorphous films, rather than in carefully structured garnet material. The advantage here is cost—sputtering amorphous film a few micrometers thick on a substrate made of a material such as glass is relatively simple. It avoids both the elaborate crystal pulling, cutting and polishing procedures involved in preparing the single-crystal garnet substrate and the following epitaxial step.

Recently, in fact, IBM succeeded in building the first sizable small-bubble arrays, packing approximately 8,000 bits onto a 40-by-40-mil chip. (Last year, the company reported a 100-bit small-bubble shift register.) The bubbles are contained in a film of gadolinium-cobalt-molybdenum alloy sputtered on a glass substrate. Atop the al-

loy, permalloy T-bar, Y-bar, and chevron propagating structures are electroplated with linewidths as small as 1 μm . The amorphous film has nominal 2- μm -diameter bubble domains and is approximately 2 μm thick.

IBM built several of the arrays in order to study the effects on bubble propagation of varying magnetization levels. It found that the drive field required for device operation was linearly dependent on the saturation magnetization of the bubble material over a range of 350 to 1,200 gauss.

Characteristics of the bubbles in the amorphous film are claimed to be at least as good as those in garnet. For instance, the drive field to propagate the bubbles around the permalloy structure could be in the range of the fields required with the larger bubbles. The 8,000-bit test array itself is organized in the major/minor loop manner also used in Bell's device. IBM next intends to make a fully functioning device.

A technical paper describing the work done on determining the drive fields needed for operating the small-bubble devices is being given this week at the International Magnetics Conference in Toronto. Authors include M.H. Kryder and K.Y. Ahn of the IBM Research Lab.

level is about 150 microvolts per milliampere and the signal-to-noise ratio is better than 6 to 1.

Rockwell's 10,240-bit chip is basic to the larger systems. R.L. Stermer of NASA Langley Research Center says that it will be used as a building block for a bubble memory up to 100 million bits. At InterMag, Stermer, Chen, and other Rockwell scientists are presenting projected data on a 51-million-bit memory using the 100-kilobit devices.

The 5.12×10^7 -bit bubble recorder uses design goals typical of the operation requirements for a small scientific satellite tape recorder. Four memory cards will hold eight coil assemblies, each containing sixteen 100,000-bit serial registers. A total of 1.28×10^7 bits per track is contained on a single 6-by-7-in. card. A bubble memory element of the order of 100,000 bits capacity was necessary to maintain an acceptable parts count. Estimated capability of the recorder includes an operational power dissipation of 4 to 6 watts and zero standby power dissipation.

NASA wants to develop the new data recorder so that it can be easily adapted to a variety of spacecraft that could be launched in "the late seventies or early eighties," but officials note that it is not tied to any specific satellite program at this time. □

CCD memory designs evaluated

While manufacturers are working out the last bugs in the production of 4,096-bit MOS memory ICs [*Electronics*, March 21, p. 70] and the first production units are beginning to appear [*Electronics*, May 2, p. 87], an even more efficient semiconductor memory technology is emerging. Researchers are studying charge-coupled devices (CCDs) with an eye toward putting as many as 65,000 bits on a single chip. Last week, at the National Computer Conference in Chicago, James E. Carnes of RCA Laboratories, Prince-

ton, N.J., discussed various memory organizations.

A major advantage of CCD technology is the small bit cell—perhaps half a square mil per bit, compared to 5 to 10 square mils per bit in the 4,096-bit metal-oxide-semiconductor arrays. If half the chip area is devoted to overhead circuits such as regenerators and input-output stages, and half to storage, then 32,000 to 65,000 cells can easily fit on a chip 300 mils square. That chip size is huge by today's MOS standards, but because the manufacturing process for CCDs is inherently simpler than for MOS, yield can be high, even of such large sizes. Other CCD arrays, for use as imagers in television cameras, have been built successfully on chips as large as 500 by 750 mils [*Electronics*, March 21, p. 29].

But when it comes to memories, two major tradeoffs have to be considered, according to Carnes. The first is between total storage capacity and power dissipation. The CCD memory is a dynamic shift register that must cycle continuously, even when its stored data is not in immediate use. The power it dissipates in

New crystal for thinner watches

What has kept the small electronic watch from becoming any smaller has been the conventional quartz crystal, which vibrates in the X-Y direction. Statek Corp's latest tuning-fork-shaped crystal, the tiniest so far developed, could halve watch thickness, especially as it also has a 20°C "turning point."

"Turning point" is the temperature at which such a crystal's frequency changes least with temperature. From the watchmakers' viewpoint, the trouble with earlier Statek tuning-fork crystals was partly their low turning points—at most 10°C, well below the average temperature to which a watch is subjected. But 20°C is much nearer skin temperature and should be satisfactory for a watch, says the Orange, Calif., company's marketing manager, Michael S. Nusbaum.

The crystals, which can be batch-processed using photolithography



like ICs, come in leadless ceramic flatpacks 400 mils long, 150 wide, and 65 high. The package's clear glass top allows the crystal to be laser-tuned after assembly. Small bonding pads make the leadless device ideal for automated assembly.

By June Statek expects to be producing 50,000 crystals a month, A unit price of \$2.50 is being quoted for quantities of 100,000.

this standby mode is minimized if the clock frequency is low. However, whenever charge is transferred from one bit-storage cell to the next, a fraction is left behind; and this charge build-up gradually reduces the distinction between stored 1s and 0s. Because of this degradation, a long chain of CCDs must be interrupted at intervals with special regenerating stages that restore the original charge states.

The stored information, however, degrades as a function of time, as well as of the number of stages traversed. Therefore, the lower the standby clock frequency, the closer together the regeneration stages must be placed. These regeneration stages are much larger than the individual CCD storage cells, so that large numbers of closely spaced regenerators sharply reduce the chip's total capacity.

The second major tradeoff is between storage capacity and access time, says Carnes. In a CCD memory, no bit can be read except from an input-output circuit incorporated into the shifting loop. The loop can have several input-output stages interspersed along its

length, to provide several opportunities to read a particular word as it progresses through the register, and thus to reduce the access time. But these input-output stages, like the regenerators, are larger than the bit-storage stages and reduce the total capacity of the chip. □

Siemens gets on the 4k RAM wagon

Enter another supplier in the market for multi-kilobit random-access memories. This summer, West Germany's Siemens AG will offer samples of a dynamic MOS 4,096-bit read/write memory based on n-channel silicon-gate technology.

Erich Gelder, the company's marketing manager for integrated circuits, says this makes Siemens Europe's first semiconductor producer to come out with a 4k RAM. It also puts the Munich firm in the league of the half dozen or so American companies that either already supply such devices or are planning to do so shortly [*Electronics*, March 21, p. 70]. The samples will be priced at about \$80 each. Volume deliveries will start next year.

That Siemens is hitting the market with a 4-k RAM at a relatively early stage is no accident. According to Gelder, work on the device began two years ago and has been considered a high-priority project ever since. Research and development money, amounting to "several million marks," was readily made available by company management because the device was intended for Siemens computers. The memory will now be sold to outside customers as well.

Device specs. Designated the S142, the new device uses n-channel silicon-gate fabrication methods for speed and area-saving. Information is stored in a three-transistor element with an area of roughly 1,200 square micrometers (about 1.8 mil²). The device packs a total of 15,160 transistors into 4.4 by 4.1 millimeters. In addition to the memory elements, the chip contains the address

and timing circuitry, the read amplifiers, and other peripherals. Every 2 milliseconds, 64 refresh cycles refresh the binary signals in the 4,096 elements.

The S142's electrical and mechanical specifications resemble those of Intel's 2107. The S142 uses a 12-volt timing pulse from which all others are derived. Inputs and output are TTL-compatible. Typical time values for the device are an access time of 350 nanoseconds and a read-refresh cycle of 600 ms.

The supply voltages are 12 v, +5 v, and -5 v. Power consumption under operating conditions is 400 mw, under standby conditions only 10 mw. The device, which has a temperature range from 0 to 70°C comes in a 22-pin dual in-line package. □

Solid state

Josephson junctions inch computerward

The first Josephson junctions to perform useful computer functions have been fabricated in experimental circuits at IBM's Research Laboratories in Yorktown Heights, N.Y. The result is a heretofore unheard-of combination of switching speeds measured in trillionths of seconds and power dissipation levels

down in the microwatt range.

The circuits consist of:

- A three-input, two-output gate with a 165-picosecond rise time.
- A 1-bit full adder with a minimum add time of 500 ps for a worst-case data path.
- A memory cell that switches between states in 600 ps.

According to Juri Matisoo, manager of devices and circuits within the exploratory memory group at IBM, "The results are interesting because even from devices having relatively coarse dimensions we've obtained performance in memory, logic, and adder circuits that is appreciably better than what's being achieved with conventional semiconductor technology."

The Josephson junctions [*Electronics*, March 1, 1971, p. 38] in the IBM devices consist of two superconducting films separated by a thin oxide insulating layer. Such devices can switch extremely rapidly—in picoseconds—between two stable states with very little power dissipation.

Josephson junctions in the IBM devices use 5-mil-wide lines of a vacuum-deposited lead alloy placed one atop the other and separated by a 20- to 30-angstrom-thick oxide layer. This is placed atop a niobium ground plane which, in turn, has been rf-sputtered onto 1-inch-diameter oxidized silicon wafers. Semiconductor photoprocessing techniques were used to form the

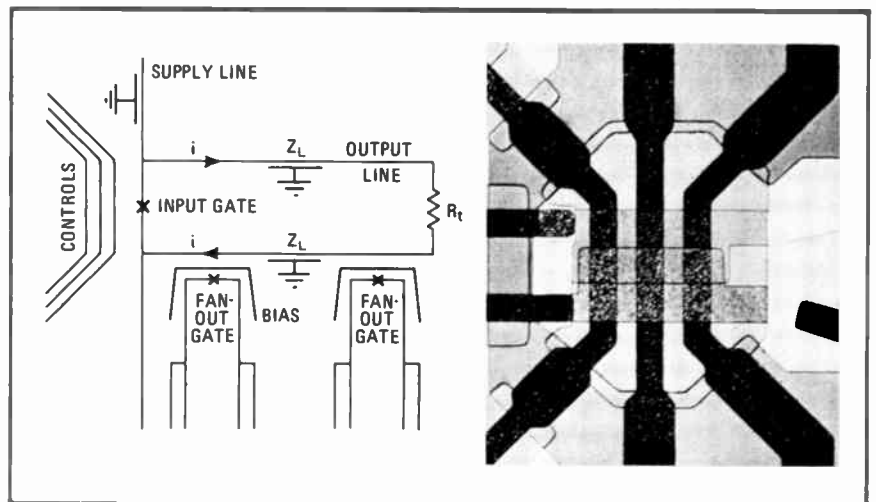

Cold logic. Superconducting logic circuit based on Josephson junction has three input control lines (left of schematic) and two output gates. Input control line portion is in photo.

Picture video copies like these as part of your system.

\$2950, single unit price.

Hard copies are the record keeper of modern display systems. They're a time-saver, too, providing output for busy people to read at their leisure. Unfortunately, however, copy quality has been inconsistent. Until now. Look at our versatile, low-cost 4632 Video Hard Copy Unit!

Our 4632 gives your systems consistent high quality, high resolution, grey scale and black and white copies on 8½" x 11" paper. In other words, copies you can read.

It interfaces quickly to alphanumeric or graphic display terminals and scan converters. All you need is access to one of these video sources:

1. Composite video; 2. Video, horizontal drive, vertical drive; 3. Video, composite sync. And it operates at any standard line rate.

The 4632 is a dry process performer using 3M® Dry-Silver paper. It's light and compact, yet built sturdily for hard use and designed for easy servicing.

We have more display ideas for your system, too. Such as scan converters and a full line of monitors and displays. OEM and end user quantity discount prices available. For the complete picture, phone your nearby Tektronix office or write:

Tektronix Information Display Division,
P. O. Box 500, Beaverton, Oregon 97005.



Graphics. The mind's eye, for those who think tomorrow.

For a demonstration
circle 32 on reader service card

Circle 33 on reader service card

patterns. At the junctions, the lead lines overlap a 4-by 5-mil area while the input gate measures 235 by 55 micrometers. Critical superconducting temperature for lead is 7.2 K; operation is at liquid helium's temperature of 4.2 K. The three-input gate, for instance, consists of three superconductive control lines passing over a Josephson junction gate, plus a resistor-terminated output line that serves as a control for two fanout gates. The magnetic field across the input gate is created by the current in each of the input control lines and is therefore a function of how the currents are superimposed. AND, OR, and invert gates are formed by adjusting the directions of the supply and control currents.

Before the circuit was built, IBM points out, its operation was simulated on a computer using a model consisting of three Josephson junctions and 28 transmission-line sections corresponding to the physical layout. In a high-speed test, the gate was operated with bursts of pulses with 700-ps rise times, tightly spaced so as to simulate a repetition rate of about 1 gigahertz. The circuit is being described in detail this week in a paper by IBM's W.H. Henkels at the International Magnetics Conference in Toronto.

The next phase in the IBM work includes such things as determining the best way to interconnect the logic circuits on the power-supply line and studying the problem of reflections encountered on the lossless interconnections, according to Matisoo. □

Solid state

Josephson-device design optimized

A new configuration of Josephson-junction devices may make them ideal parametric amplifiers for operation in the range of 100 gigahertz to 300 GHz. Although some experimental Impatts, LSA diodes, and tubes can operate as signal sources

beyond 100 GHz, such devices rapidly lose efficiency as amplifiers as they approach the millimeter-wave range.

Josephson-junction devices, each of which consists of a thin insulator sandwiched between contacts made of superconductors, have been used as parametric amplifiers before. However, the new geometry, developed by researchers at the Aerospace Corp., El Segundo, Calif., operates in a multi-idler mode, greatly relaxing operational requirements. In this mode, the pump frequency is not critical and can assume values slightly below the signal frequency. In other parametric amplifiers, which operate in a degenerative mode, the pump frequency must be twice the signal frequency.

The self-oscillating negative-resistance design of the Aerospace Corp. device is relatively simple. The oscillation frequency depends on the voltage across the device. At 9 GHz, this is 20 millivolts; at 90 GHz, only 0.2 mv. The same junction then acts as pump and variable reactance.

Niobium exhibits Josephson effects (tunnelling of paired electrons at zero voltage via superconductive currents) up to 700 GHz. Aerospace Corp. has already built a 9-GHz amplifier and a 100-GHz mixer. The goal of the project is to construct an amplifier that operates at 100 GHz.

Tradeoffs. The Josephson junction has not been widely used, partly because it requires cooling with liquid helium to 4° kelvin.

Also, the device requires critical adjustment, and it must be made of expensive superconductive material, such as niobium. Hence, operation at lower frequencies, where other satisfactory amplifiers are available, isn't very attractive. At millimeter-wavelengths, however, the choices are rather limited.

In its present configuration, the Aerospace Corp. design gives 12 decibels gain and a narrow bandwidth (a characteristic of the multi-idler model) of 100 megahertz. Although the multi-idler mode is noisier than the degenerative mode, it is still quite low compared to other forms of microwave amplification. For example, the noise temperature of an amplifier is typically below 100°K (under 1.5 dB). The device is expected to be most useful at high frequencies. "At 300 GHz, there isn't any competition," says Helmut Kanter, staff scientist at Aerospace.

The next steps planned by Kanter are to quantify the noise and overload characteristics and to move to higher frequencies. □

Packaging & production

Coax connections cure crosstalk

By marrying coaxial cable with the printed-circuit board, it is possible to transmit digital signals at subnanosecond rates with virtually no

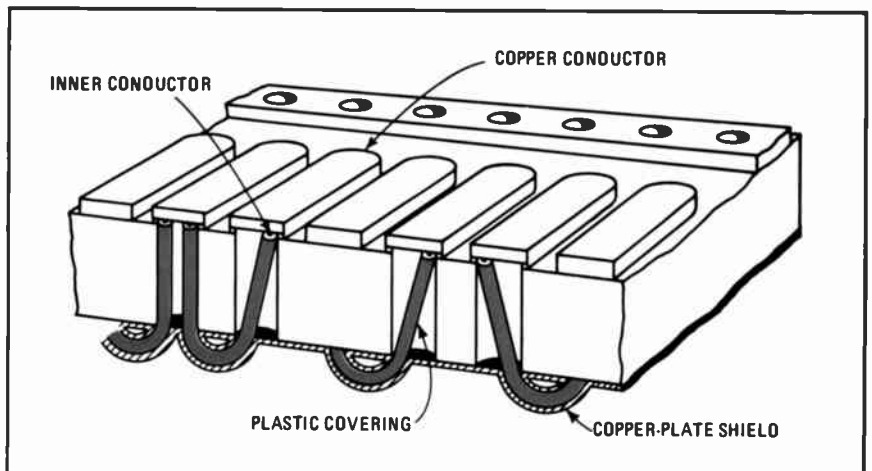

Anatomy. Tiny coaxial cables with a plated shield virtually eliminate crosstalk.

Look at That!

Four Opto-Isolators in One Money Saving Package.



The Bright Guys do it again. By packaging four independent opto-isolator channels into one 16-pin DIP—the new ILQ-74 quad isolator—we've created the first family of perfectly compatible single, dual and quad opto-isolators.

And because the ILQ-74 has the same specs as the ILD-74 dual and IL-74 single opto-isolator, they mix and match ideally. You can absolutely minimize parts counts regardless of the number of channels per board.

The new ILQ-74 quad pares down the cost per

channel to 83¢ in 1K quantities and even more in higher volumes. In multi-channel designs, the quad replaces single and dual isolators, to save still more on parts handling, assembly labor and board area.

All three are compatible with TTL and lots of linear circuits. All three have a breakdown voltage of 1500V, typical transfer ratio of 35% and coupling capacitance of only 0.5pF. All three have passed UL safety tests.

Now's the time to replace outmoded transformers and relays with economical, efficient Litronix opto-isolators. Isolate high-voltage transients and eliminate both ground loop feed-through and common mode noise in long lines the solid-state way.

Only Litronix makes a compatible family of quad, dual and single opto-isolators. Call or write for complete data and application notes.



litronix

Litronix, Inc. 19000 Homestead Road, Cupertino, California 95014
(408) 257-7910 TWX: 910-338-0022
European Headquarters: Litronix, Inc. Bevan House, Bancroft Court
Hitchin, Hertfordshire SG5 1LW England Tel: 2676 Telex: 825-497

crosstalk. This makes possible interconnection of as many as 700 coaxial cables on a pc board measuring only 2 by 3 inches. Called Picowire by its developers at AMP Inc., Harrisburg, Pa., the technique was spurred by development of emitter-coupled logic, which generates rise and decay times of about a nanosecond.

Until now, digital designers have been using multilayer boards or mechanically wrapped back panels to transmit fast-switching signals from point to point. As rise times reached the low-nanosecond range, various forms of controlled-impedance techniques—stripline, microstrip and twisted pair—were added in printed-circuit boards to preserve pulse fidelity.

But these techniques have one common flaw: lack of shielding. This causes crosstalk between adjacent leads and all the headaches that go with spurious signal-generation in logic circuits.

But Picowire uses coax which, because of its shield, is free of crosstalk. The 40-gage wire has a 10-mil Teflon covering. Shielding is added by a copper-plating process that surrounds each coated wire with a copper jacket, forming a true coaxial geometry. The tiny wires are connected point to point in a chain-stitch fashion, by means of a tape-controlled wiring machine which can connect over 500 wires per hour.

Edward Dowling, manager for the advanced packaging product department of the General Product group, points out that Picowire eases the problem of aligning the leading edges of pulses in digital systems, which is vital to synchronous operation.

"With Picowire, a designer can select the lengths of coax he needs to provide the proper propagation delays," he says. Dowling says Picowire interconnections provide nominal impedances ranging from 30 to 75 ohms and can be connected between points spaced as close as 50 mils. AMP is preparing to make the boards in-house or to license others to make them. Dowling says Picowire is cheaper than a four-layer board with controlled-impedance

interconnections, and it prices out about the same as a mechanically wrapped board—Wire-wrap or Termpoint. □

Commercial electronics

Modified X-ray units are back at airports

More than 190 X-ray machines designed to examine passenger hand baggage at 52 U.S. airports are now operating under a new Federal radiation-safety standard, thanks to consumer activist Ralph Nader and a Federal judge.

Moreover, the Federal Aviation Administration says it plans to have a notice of proposed rulemaking before the end of June to permit public comment on their safety prior to final adoption of the baggage-inspection technique.

The issuing of the standard near the end of April and the FAA's planned rulemaking notice were part of a Government agreement with the Nader group, which had obtained a court order temporarily banning the use of X-ray machines.

Standard. The performance standard for carry-on baggage at airports was proposed last October, and put into effect April 25. For other X-ray equipment—excepting medical and dental diagnostic systems, which already have their own standards—the Food and Drug Administration's Bureau of Radiological Health said the new standard would take effect for remaining X-ray equipment on April 10, 1975.

The safety standard provides that X-ray emissions can be no greater than 0.5 milliroentgen in 1 hour at 5 centimeters (about 2 inches) from the equipment.

It also requires that:

- A barrier or other means be used to make it impossible for any part of an operator's body to enter the primary X-ray beam.
- Each cabinet door have at least two safety interlocks to disconnect the system as the door is opened.
- A locked control that will not

function with the key removed be installed.

- A control be available inside walk-in cabinets to prevent X-ray generation by an outside operator
- Audible and visible warning signals be inside the cabinet with cautionary labels outside.

The FAA said 26 systems made by Astro-Physics Corp., Harbor City, Calif., are now back in service after being modified to meet the interlock requirements. They, along with 29 others made by Bendix Corp., Ann Arbor, Mich., were temporarily taken out of service after failing to meet the standard. The Bendix units are still undergoing modification.

In its rulemaking notice, the FAA will solicit comments on the adequacy of the new standard, operator training requirements, establishment of limits on operator working times, environmental considerations raised by the X-ray devices, and public exposure. □

Organizations

Components firms have their own show

Tired of talking to the tire-kickers, literature-gatherers, and students that frequent larger computer, instrument, and telephone shows, three vice presidents from three components companies have banded together under EIA's aegis to start their own: a show strictly limited to manufacturers of passive, active, electromagnetic, or electromechanical electronic components.

Thirty firms—a roster that reads like a components industry "Who's Who"—set up booths in Washington, D.C., at the new Design Engineers' Electronic Components Show (Deecs). Attendance figures are not complete, but attendees of this week's concurrent Electronic Component Conference guaranteed a nucleus of equipment and systems design engineers.

"Many shows have taken the component manufacturer and made a second-class citizen out of him,"

An offshore plant will reduce your electronics manufacturing costs.

On paper.

The competitive challenge of imports hasn't hit any market harder than electronics. An offshore plant with low labor rates seemed to offer a convincing way to regain the profitability edge. Until the plant was built and local realities set in. Restrictive labor regulations, stretched logistics, and unfamiliar conditions all tended to eat up those paper profits. It didn't really take a palace revolution to put you in the red.

Universal Instruments Corporation has quietly pioneered a different approach to help you combat the stacked deck of import price competition in electronics. We reasoned that if we could take the handwork out of electronic assembly, you could avoid the pitfalls of chasing cheap labor around the world to keep your manufacturing costs down.

Now, computer-controlled automated assembly systems developed and refined by Universal over the past 15 years are providing a better answer to imports—in markets as diverse as color television and seat belt interlock systems.

For example: a flexible complex of Universal sequencers and component insertion machines controlled by worker and supervisory computers adjusts rapidly to meet changes in production schedules at a

major U.S. electronics manufacturer. To keep their plant competitive by turning out 85,000 circuit modules—enough for more than 10,000 color TV sets—per day.

For the new generation of automotive electronics, the Universal In-Line Assembly System can put together circuit boards for digital clocks, anti-skid controls, fuel injection and other devices faster and more economically than any other system. It can assemble approximately 1,260,000 boards per 10-month seven-hour single-shift production year. A production advance that enables electronics and auto makers to meet this high volume demand—profitably—at home.

Then there's the flexible new "Quadraser" that handles circuit boards automatically, computer-controlled wire termination systems, and the "Multisert" system that inserts up to ten components at once. Plus emerging production technology developments from Universal to help make your present domestic production at least as cost-effective as past offshore production. Even in 1985, when U.S. manufacturers will need over one billion circuit boards.

Because we know there's no way except better technology to keep all of us in the electronics business.

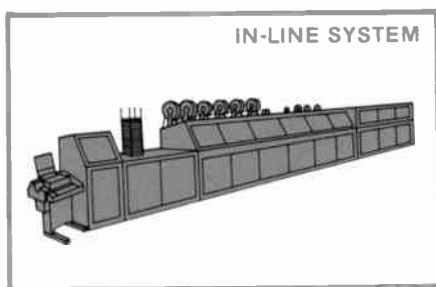

IN-LINE SYSTEM

The most cost-effective system available for high volume circuit board production.

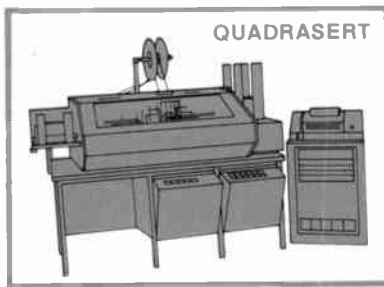

QUADRASERT

Combining automated board handling with moving table insertion for added flexibility in high volume circuit board production.

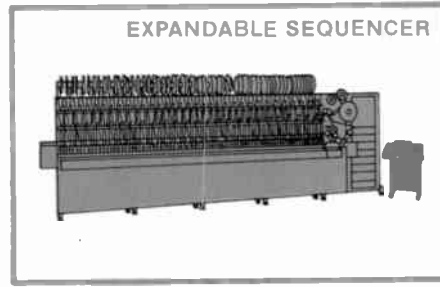

EXPANDABLE SEQUENCER

Add-on flexibility from 20 to 95 stations permitting growth without production obsolescence in your component sequencing operation.

Write or call us today for complete technical literature and production specifications on these and other Universal systems—including a wide line of insertion machines, sequencers, and wire wrap systems—as well as information on our extensive contract facilities for electronic assembly.

 **Universal** INSTRUMENTS CORPORATION
P.O. Box 825 / Binghamton, New York 13902
Tel: 607-772-7522 • Twx: 510-252-1990

U.I.C. Sales and Service Offices in California: Santa Ana; Colorado: Denver; Florida: St. Petersburg; Illinois: Palatine; New Hampshire: Manchester; New York: Binghamton; North Carolina: Raleigh; Pennsylvania: Levittown; Texas: Dallas. Also offices in Armegatan, Bombay, Copenhagen, Frankfurt, London, Milan, Montreal, Paris, Sidney, Tel Aviv, Tokyo, and Toronto.

says Clyde J. Schultz, marketing vice president at Switchcraft Inc., Chicago. "They just haven't made an effort to satisfy the needs of the components people," adds J. Earl Templeton, vice president at Illinois

Tool Works, and president of ITW's electronic group. "The fact is they're working for too many masters: systems, instruments, materials, semi-conductors."

Components companies are not a

large part of any show any more, although most shows admit them, and even welcome them. "But these shows are oriented toward equipment and systems, and companies don't send components engineers,"

News briefs

IBM discovers new storage effect

An information storage effect that handles phase and amplitude data over a bandwidth of 10^8 to 10^{10} hertz or higher has been discovered at IBM. Storage takes the form of a stable pattern of electrons trapped in a photo-sensitive piezoelectric crystal. The pattern is produced by interference between two input signals, one electrical and the other acoustic. Information is read by applying a signal at the same frequency as that of the original input, which causes the sample to radiate an echo. Information is erased by shining a light on the sample.

FCC gives RCA expenditure approval

RCA Global Communications Inc. and RCA Alaska Communications Inc. have received Federal Communications Commission approval to spend an additional \$1 million on three satellites for domestic service. The FCC temporarily and partially waived its ruling against granting the RCA companies domestic satellite construction permits pending a decision on whether RCA should be required to establish a separate domsat subsidiary in order to make domsat operations more visible to the commission.

Motorola withdraws IC process

Officials at Motorola Semiconductor claim they have solved a problem that affected its linear IC production lines last summer. The problem, phosphorous contamination resulting from glass passivation, was spotted by customer Zenith Radio, causing Motorola to quietly recall deliveries produced over at least a 10-week period. Motorola had increased the amount of glass passivation on certain of the plastic-cased ICs in order to improve reliability, but early failures occurred due to moisture leakage. Motorola has returned to its original process.

GA introduces SOS minicomputer

General Automation, having produced the industry's first silicon-on-sapphire microcomputer [*Electronics* Dec. 6, 1973, p. 39] is keeping the lead with a full 16-bit sos minicomputer, which it introduced at the National Computer Conference. The single-board processor has the full-size capability and 1.8-microsecond cycle speed of the company's SPC-16 minicomputer, excellent performance for that size of computer. With 1,000 words of memory, the LSI-16 model is priced at under \$1,000 in 200 lots.

Transponder requirement is halted

General-aviation interests, long opposed to the cost of installing automatic altitude reporting transponders, again appear to have halted the implementation of the Federal Aviation Administration's requirement that transponders be used in high-density terminal areas. The FAA has proposed a six-months postponement of the effective dates on which aircraft must carry the 4,096-code radar bea-

con transponders and altitude encoders, claiming that supply problems make it impractical or impossible for aircraft operators to obtain the equipment in time.

Postal Service orders electric vans

AM General Corp. has won a U.S. Postal Service competition for 350 electric-powered light delivery vans with a \$1.95 million bid. The award, the largest yet for electric vehicles in the U. S. [*Electronics*, March 7, p. 70], was made through the General Services Administration as part of a program that calls for 1,000 trucks in fiscal 1976 and an additional 5,000 vehicles in fiscal 1977 each costing \$5,595. Bidding against the Wayne, Mich. unit of American Motors Corp. were Otis Elevator Corp., Stockton, Calif., and Electromotion Corp., Bedford, Mass.

DMM fits in shirt pocket

A shirt-pocket-size digital multimeter from Data Technology, Santa Ana, Calif., built with the capability of larger bench models, offers a capacitance range along with the usual DMM functions. The model 21 measures capacitance as high as 2 microfarads with an accuracy to within 0.15% of reading plus 0.05% of the range setting. Price, with test leads, is set at \$269.

Dana Labs to use elastomer connectors

Dana Laboratories is substituting elastomer connectors for the mechanical connectors it has used so far for the liquid-crystal display in the Danameter [*Electronics*, Jan. 24, p. 32]. The new connectors, made by Teknit, will act as a Band-aid in the digital VOM to prevent the abrasion encountered with the old connectors. Dana will also retrofit meters with an elastomer shim between the metal connector and the display contacts.

Duplicator makes 2 copies/second

A new Xerox duplicating system, called the model 9200, makes two copies a second on most standard paper, collates up to 50 originals into as many as 999 sets, prints on both sides of a sheet, and includes three reduction modes to reduce originals to 8½-by-11-inch size. Containing MOS LSI control logic on plug-in boards, plus four high-intensity stroboscopic lamps and a selenium-coated belt of flexible nickel, the 9200 will be available first to customers in the Chicago area in late 1974.

Audio power standards are set

After more than a decade of consideration, the Federal Trade Commission has ordered manufacturers of home-entertainment audio amplifiers to aid consumers by standardizing their power output claims. Effective Nov. 4, 1974, manufacturers will be required to disclose, for example, an amplifier's rated minimum sine-wave continuous average power output in watts per channel.

Give Us Your EMI Problems...



...and we'll
give you a
stock answer...



...or a custom one!

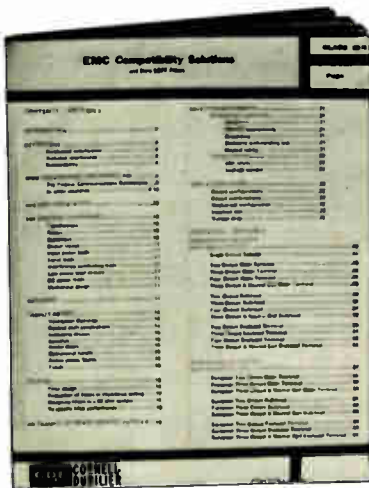

Everything you wanted to know about
filtering and EMC is in the book...
Your's for the asking!

There's a good chance that a standard CDE filter... or one of the thousands of designs on file will solve your EMI problem. If not, our EMI/EMC Systems Engineering Group will design one to meet your exact parameters. They're backed by the most comprehensive laboratories in the country, both east and west coast, with manufacturing and engineering services available to... evaluate the threshold levels of virtually any product, sub-system or system... establish the protective action to take in controlling the emission and susceptibility levels to comply with domestic and international EMI specifications limits... produce the appropriate filter or filter system. Write for this new 44 page brochure which details EMI Control Techniques, Shielding, Cabinet Design, Definitions, Filter Design, Safety requirements and the full line of CDE stock filters with schematics, insertion loss curves dimensional drawings, and complete specifications.

Circle 39 on reader service card

CDE **CORNELL-DUBILIER**

150 Avenue L, Newark, N. J. 07101

CDE — The People to People Company
— the mark of quality is on everything we make.



Templeton says. "They're watching their bucks, and the days of platooning engineers into these shows have gone by."

The man. "The guy we're looking for is the components engineer, and every company of any size has them. But many of them never show up at the current shows," Schultz says.

"We're getting a smaller audience, but our audience is more concentrated in the people that have a professional business interest in components," says Bruce E. Vinke-mulder, sales vice president at Grayhill Inc., La Grange, Ill. Adds

Deecs exhibitors

Included in the exhibitors at Deecs were these mainstays of the components business: Airco Speer Electronics, Allen-Bradley Co., AMP Inc., AVX Ceramics Corp., Belden Corp., Burndy Corp., Centralab Electronics, Grayhill Inc., Indiana General Corp., Illinois Tool Works Inc., P. R. Mallory & Co.

Also present were Ohmite Mfg. Co., Stackpole Carbon Co., Statek Corp., Switchcraft Inc., TRW Cinch Connectors, TRW/IRC Fixed Resistors, Union Carbide Corp., Varadyne Inc., and Vitramon Inc.

Schultz: "It's engineers talking to engineers. They're talking new requirements, of course, but more important, they're talking substitutions because of shortages."

The show is taking a different tack from the large shows: booths are staffed with design engineers from the component firms, and "not with sales engineers, and not with reps," Vinkemulder points out. "It's designed as a conference vehicle where the guy with the problem can talk directly to the guy with the answer," he says. "They can sit down and make the design decision—and make all the tradeoffs—in a half-hour."

There's still a lot of custom design in the components industry, and with that in mind, Deecs is pushing the engineering conference setup.

It's eschewed the show biz of oversized backdrop booths for more utilitarian tabletops and displays. Exhibitors are limited to two booths.

But the EIA has been lax about promoting Deecs to the membership. Several major components firms in the Midwest learned about the show less than a week before it opened; "There's a definite need for a National Components Show," says one, "and we would have exhibited had we been contacted." □

Microwaves

Constrained lens fits multi-beam satellite

One of the key problems in the next generation of synchronous altitude satellites concerns how to pick up signals and transmit them to a number of widely separated receiving stations. Philco Ford's Western Development Laboratories division in Palo Alto, Calif., is attempting to solve the problem by using a wide-band microwave constrained lens and feed array that uses printed-circuit technology for simultaneous multiple co-frequency band pencil beams from a single aperture.

At an altitude of 22,500 miles, the frequency re-use multiple-beam concept requires sidelobes below 34 decibels for at least 37 beam positions over a 15° conical field of view. But to avoid co-channel interference, radiation from all adjacent channels must be below a predetermined level relative to the radiation of the beam at a given spot on the earth. Typically, this ratio is required to be 27 to 30 dB.

Consequently, as the number of simultaneous co-frequency beams per satellite increases, the sidelobe level per beam must decrease to meet a given isolation requirement. If only two beams are required, each covering its own 3-dB beam-width spot, the 30-dB maximum sidelobes per beam is enough to meet the isolation specifications. But for six beams, the required sidelobe level per beam is 34 dB.

In a year and a half of research, Philco Ford engineers found three ways they could go to produce the low sidelobe multiple re-use pencil beams necessary: multiple-feed horn antennas with one large reflector, or phased microwave arrays, or a combination approach.

Multiple feed-horn antennas with one large reflector would result in the lightest possible satellite. But this approach has a serious drawback: as a feed horn is moved off axis to keep a well-shaped beam, the transmission deteriorates, the side lobes rise and interference increases.

With phased microwave arrays, there is complete control of the aperture: every point in the array can be made to have whatever phase and amplitude are necessary. But for simultaneous multiple transmission, a separate set of waveguides is needed for each beam.

Philco engineers settled on a combined approach. The combination they found most suitable is one of two types of constrained microwave lenses. These typically are space-fed arrays, and their receiving surface consists of a set of pick-up horns connected to rf transmission lines that run up through the lens to another set of horns.

With one kind of lens, which has a waveguide configuration, the minimum cross-section size of each wave pipe in the lens is limited by a certain cutoff frequency. The other kind, the TEM (transverse electromagnetic) lens, has waveguides similar in structure to coaxial cable, but its cutoff frequency is not dependent on geometry. These will transmit assigned frequencies so long as certain electrical characteristics are not changed.

Philco Ford's WDL scientists are now building a 5-foot-diameter prototype using the printed-circuit approach that will operate in C band at 4 to 6 gigahertz. The lens itself is about 1 foot thick at the edge and 6 inches thick at the center. It contains 400 printed-circuit TEM waveguide elements 6 inches to 1 foot long.

Philco Ford developed techniques so that each triplet of pickup horn, delay-line guide, and re-radiating

This is why...

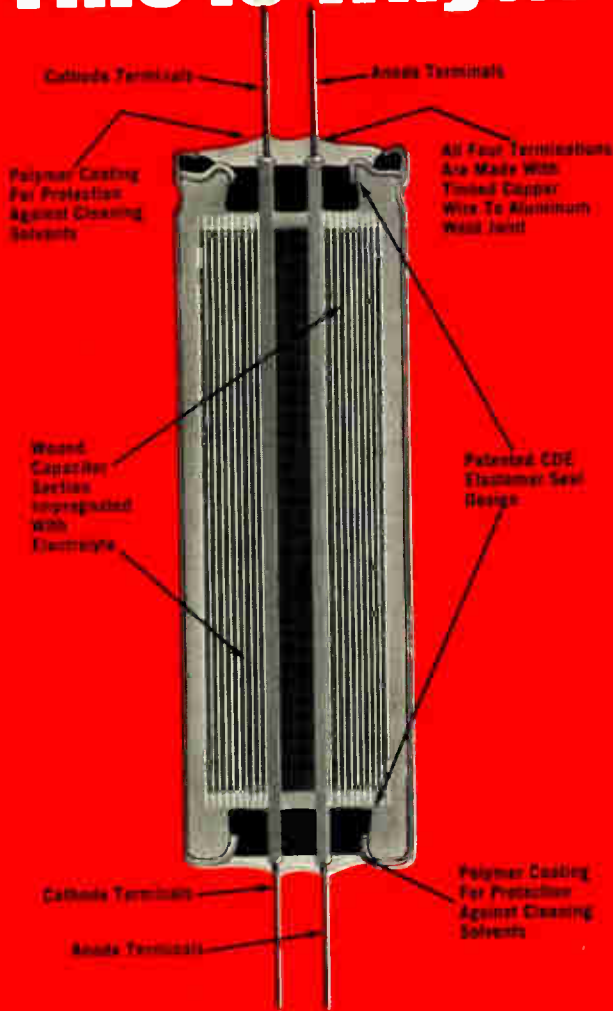

this is Best...

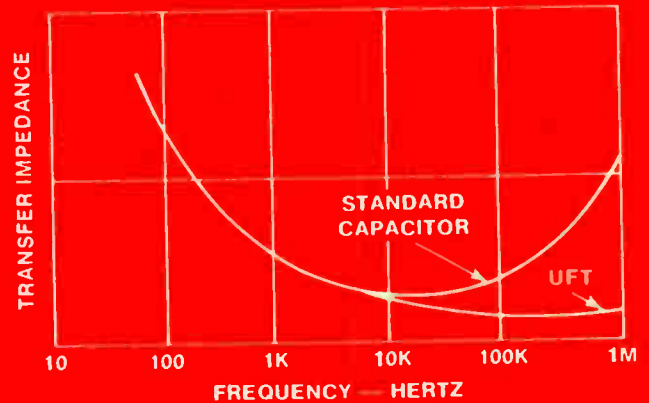

DESIGNER'S KIT #1 — for those really serious about designing power supplies. Here's what you get: 12 pg. brochure, Designing Switching Regulators, giving theory of operation, detailed description, schematics, curves and component selection ... Application and Designers notes ... Engineering Inquiry and Sample Request Form ... a Library of Article Reprints of recent technical articles describing power supply design ... Construction features of the UFT ... detailed specification brochure ... and more!

YOURS ON LETTERHEAD REQUEST ONLY!!!

FILTER NETWORK...

Provided by Unique Construction Assures Low Inductance at high frequencies

CDE leads the way again...with the development of the most advanced aluminum electrolytic capacitor, the UFT. This 4 leaded construction offers new design freedom... with low transfer impedance at high frequencies. Applications are growing. However, one of the most significant is switching regulators. These high efficiency power supplies have typically been plagued with noise problems. The UFT offers great isolation from ground loops, excellent noise filtering for both source and output voltage ... with a transfer impedance that actually decreases above 10 KHz. There's an 8 page data sheet that details all the specs, yours by circling the reader service number. BUT, if you're really serious about designing power supplies, we'll send you our DESIGNER'S KIT #1 ... yours on letterhead request only.

CDE **CORNELL-DUBILIER**

150 Avenue L, Newark, N. J. 07101

CDE — The People to People Company
— the mark of quality is on everything we make.

Circle 41 on reader service card

When you talk about
high reliability hybrids,
**Quote a Highly
Reliable Source**

—Raytheon/Quincy.

Did you know that we're
a leading source of high reliability
beam-lead and chip-and-wire
hybrid microcircuits?

Do you know why? Because
98% of Raytheon/Quincy hybrids
are purchased for military and
medical electronics applications—
the ones that demand high
reliability. And you can quote us
on that.

For complete data on Raytheon
hybrids, contact Raytheon Company,
Industrial Components Operation,
465 Centre Street, Quincy, Mass.
02169. (617) 479-5300.

RAYTHEON

Electronics review

element can be printed as a mass-production item. The guides are a flattened-out version of TEM coaxial cable called microstripline—two flat pieces of metal with a third, a conductor, sandwiched in between.

The cards are made of fiber glass with very thin copper foil bonded to their surfaces. The copper foil is photo-etched with the patterns that become the pickup, guide, and re-radiating elements.

These printed-circuit guides will feed an array of 2-inch diameter feed horns about 5 feet away. In the final version, 100 of these horns will be in a cluster 2 feet in diameter. □

Materials

Air-firable metals may cut hybrid costs

Thick-film users who have glumly watched noble-metal prices soar out of sight can take heart from a new series of base-metal, air-firable, thick-film materials that can save about 50% in metalization costs. Developed by Engelhard Industries, East Newark, N.J., the new materials promise to have a vital impact on hybrid manufacture, where thick-film metalization provides the interconnection between components.

Air-firing does away with a reducing atmosphere, such as hydrogen, which has been necessary to prevent oxidation of the metalization during firing—the high-temperature process which transforms the film into a durable conductor intimately bonded to its ceramic substrate.

Both nickel and aluminum are in the series, and they are attractive alternatives to popular, though costly, palladium-silver. The aluminum offers conductivity comparable to palladium-silver and is an economical substitute for large-area conductor requirements. Though lower in conductivity, nickel lends itself well to metalizing in visual displays.

Engelhard is also offering gold and silver films in its new metalization series. "We describe these

materials as molecular bonding," says Paul Sayers, applications engineer at Engelhard, "because, unlike the fritted films, they form true chemical bonds with the ceramic substrates."

Fritted films, so called because they are filled with tiny glass particles, have some drawbacks, he adds. They develop a glass interface between the film and the substrate, vulnerable to cracking during the temperature cycling in the thick-film process. Also, if a fritted film becomes a wire-bond pad, there will be glass present at the surface. Thus, since less metal is presented for wire bonding, bondability suffers. □

New ceramic cuts capacitor costs

The rapid price rise of precious-metal inks used to contact the individual ceramic layers in multilayer capacitors may be reversed by a form of barium-titanate ceramic with a high dielectric constant. The material was developed by Siemens AG, Munich, Germany, and independently by Erie Technological Products, Erie, Pa.

Inks, which are used to form contacts on the edges of a capacitor, account for more than half the materials costs of capacitors. The new ceramic has a dielectric constant of 50,000, compared to the 5,000 to 8,000 of conventional high-dielectric-constant materials. This means fewer ceramic layers are needed to realize a given capacitance. This, in turn, results in an 80% reduction in capacitor size, a decrease of about 80% in the amount of precious-metal inks needed, and about 25% reduction in cost. Alternatively, for the same cost, higher capacitance can be achieved, rivalling some tantalum devices.

The material was developed at Siemens in 1972, but the pressure of producing a standard product has made the marketing of these capacitors sluggish and delivery slow. But Erie is considering a large-scale marketing effort in late 1974. □



the first production Serial Analog Memory

RETICON
SAM-64

"SAM™ DID IT."

The SAM™64 is the first of a family of monolithic Serial Analog Memory devices to be introduced by RETICON. It provides 64 independent capacitive memory cells, each of them individually addressable by two independent shift registers. The Read-in register sequentially time samples the analog input signal and stores it in the memory cells. The Read-out register then reconstructs the stored information to its original form. Any desired delay may be achieved by simply delaying the initiation of the Read-out register or by varying clocking rates while maintaining constant relation between the initiation of Read-in and Read-out.

Time base correction (or delay as shown in the photo) to compensate for wow and flutter of recording systems can be easily achieved. Other applications include real time Fourier transforms, digital filtering, drop-out correction, bandwidth/time compression or expansion, analog FIFO, chirp Z transforms and many others.

Several devices may be cascaded to store a complete TV line. Over 10 MHz sampling rates and 50 dB S/N ratio have been achieved.

The SAM-64 comes in a 16 lead ceramic/gold dual-in-line package, available from inventory. Call for more information.

RETICON®

Reticon Corporation • 450 E. Middlefield Rd. • Mt. View, California 94043
(415) 964-6800 HOTLINE (415) 964-3033 TWX 910-379-6552



MECL 10,000 or...Schottky TTL?

A few tips to help you become a winner!

10K or Schottky TTL... which logic form offers the best performance per dollar? And, just how competitive will that design be? We now have available an objective study that evaluates many of the points which you should consider when selecting a logic family for use in high speed systems or sub-systems. Here are a few items from that comparison.

Propagation delay

MECL 10,000 circuits are faster than comparable Schottky parts.

PART	SPEC.	MECL (NS)	TTL-S	RATIO
Gate	Typ.	2.0	3.0	1.5
	Max.	2.9	5.0	1.7
Flip-Flop	Typ.	3.0	5.0	1.7
	Max.	4.5	7.0	1.6
MSI	Typ.	4.0	8.0	2.0
	Max.	6.0	12.0	2.0
LSI ALU	Typ.	8.0	14.0	1.75
	Max.	11.0	22.0	2.0

Toggle Rates

MECL 10,000 flip-flops are faster than Schottky TTL equivalents.

CIRCUIT	SPEC.	MECL (MHZ)	TTL-S
Dual "D" Flip-Flop	Min.	125	—
	Typ.	160	90
Dual J-K Flip-Flop	Min.	125	80
	Typ.	140	125
4-Bit Shift Register	Min.	150	75
	Typ.	200	110

Circuit power vs frequency

MECL 10,000 power dissipation is constant with frequency.

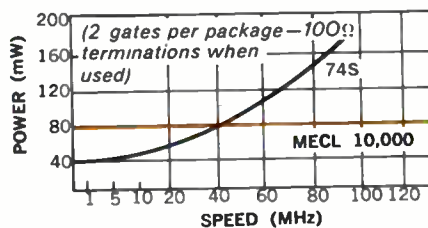

Additional design considerations

High speed, high performance systems require techniques geared to handle high-frequency signals. MECL 10,000 is designed for high speed environments and provides advantages that are not available from any form of TTL. Advantages such as: lower logic swings to reduce crosstalk between lines... complementary outputs eliminating additional inverter devices... wired-OR connections to cut back propagation delays... open-emitter outputs for system flexibility... and the capability of driving transmission lines without the necessity for auxiliary line drivers.

Competition — today and next year

In addition to engineering merits, you must consider the competitive life of your design. The product life cycle must incorporate cost-performance advantages over present competitive equipment and be flexible to take advantage of future technologies offering greater performance.

MECL 10,000 is an open-ended technology. You may apply MECL III as needed and take advantage of latest state-of-the-art circuits such as 1 GHz flip-flops and sub-nanosecond gates.

The choice is yours!

For your copy of the comparison study, write to Motorola Semiconductor Products Inc., P.O. Box 20912, Phoenix, Arizona 85036 and ask for MECL Design File #4. Better yet, call your local Motorola distributor for immediate evaluation devices. You'll find out first-hand why MECL 10,000 is specified for new designs... and upgrading of present systems.

MECL, MECL 10,000 and MECL III are trademarks of Motorola Inc.



MOTOROLA MECL
... new logic capabilities for the 70's!

Circle 45 on reader service card

COORS CERAMICS MAKE

Easy to say, you say, but is it true?

We honestly think it is. Consider these facts: We're one of the world's largest producers of technical ceramics for industry. We've been making high-alumina and beryllia ceramics for electronics for over 30 years. During this time we've manufactured millions of parts and components for thousands of applications and hundreds of customers — most of whom are still our customers. We think this proves something. We hope you agree and will read on. You may discover a way Coors ceramics can make your electronics better.

PACKAGES

Circuit packages—for discrete devices, hybrid circuits, IC chips — all available from Coors. Types include power transistor headers, DIPs, cerpacs, and specials made specially for you. Ceramics include beryllia or black or white alumina. Noble-metal coatings and low-temp sealing glasses are standard, as are moly-manganese metallization and all popular plating processes. Our usual fine ceramics with controlled densities, dimensions, and finishes ensure highest hermeticity when vacuum-tightness is demanded. We have the facilities and experience for continuous, high-volume production runs, plus the flexibility for speedy preproduction development.

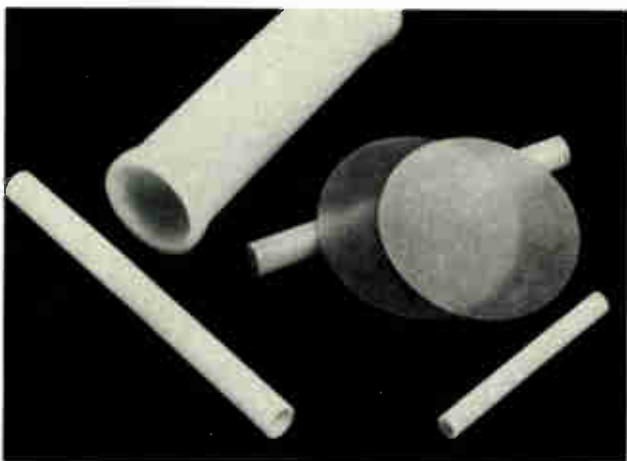

VISTAL®

A translucent high-alumina ceramic, Vistal has excellent transmittance values in the visible and IR regions of the spectrum. This plus high dielectric, electrical-insulation, strength and temperature properties makes Vistal an outstanding material choice for demanding optical applications. Available in disc and tube form.

TUBES

Our ceramic tubes are used for furnace linings, thermocouple-lead and -sensor protection, gas sampling, target and sight envelopes, combustion experiments, and undoubtedly a number of other things we know nothing about. Available in mullite, silicon-carbide*, or high-alumina ceramic, they are strong, straight, refractory, dimensionally precise (stay with us), gas-tight, noncontaminating, corrosion-proof, and resistant to thermal shock. We stock many popular shapes and sizes for fast delivery. Others quickly made to order.

*Crystar® brand

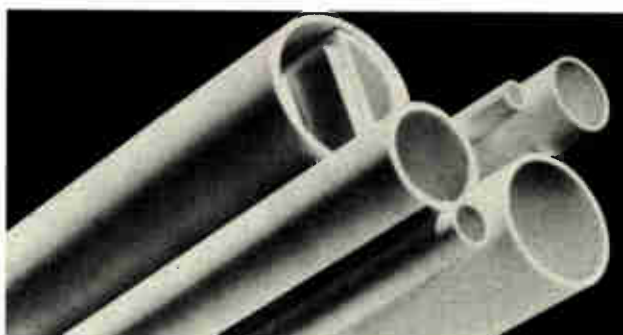

BETTER ELECTRONICS



HOUSINGS

Many leading manufacturers of electron tubes specify Coors ceramic housings for their klystrons, thyratrons, TWTs, magnetrons, and other high-power devices. Have for years. The reason, we've found, is they like the consistently high quality of our alumina and beryllia ceramics. Particularly pleasing properties: excellent dielectric characteristics, uniformly high densities, good mechanical strengths, good thermal conductivity, high temperature capability, easy metallization. What's not to like?

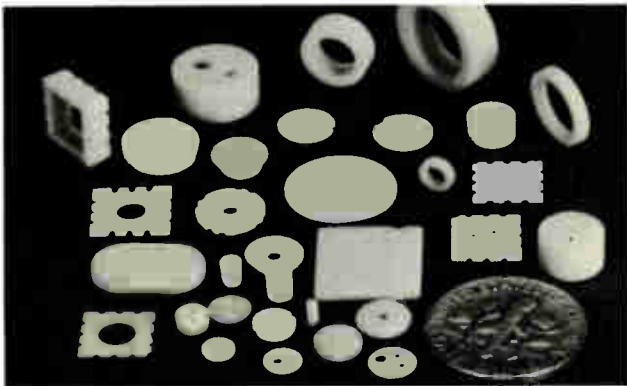

MICROCERAMICS

Microceramics is a term coined a few years ago to describe a very large variety of very small ceramic components for microelectronic applications. Spacers, headers, supports, insulators, standoffs, frames, mounting pads—you name it, we probably produce it... in alumina or beryllia ceramic... and large volumes. If you use microceramics but don't buy them from us, it would probably be worth your while to find out why not. To coin a phrase, we could both be losing money.

SUBSTRATES

Substrates for thick- and thin-film circuit bases are something of a specialty at Coors. As one of the industry's largest producers we make all practical shapes and sizes in practically any volume. For thick-film work we offer a widely used, economical 96% alumina ceramic; for thin-film, a well-established 99.5%. For circuits that lend themselves to gang-type processing we point with pride to our Strate-Breaks®, prescored substrates which, after processing, break into smaller individual units. And for small orders and quick deliveries, we have a special prototype service, including laser-scribing equipment. With all this capability we're sure we can handle your substrate requirements too. Give us a chance.

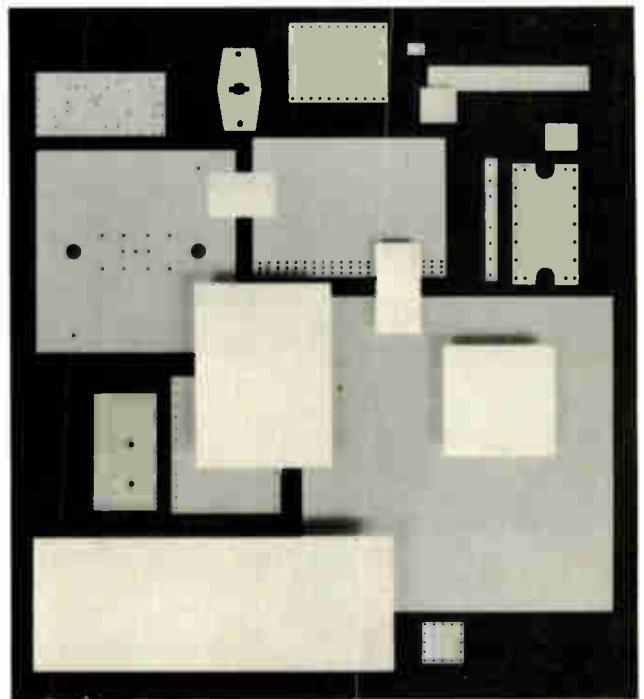

SEND FOR MORE INFORMATION using this magazine's information-request card. For faster service, write or phone:

COORS PORCELAIN COMPANY

Sales Dept., 600 Ninth St.,
Golden, CO 80401
(303) 279-6565. Telex 45593.



FOR BETTER ELECTRONICS

THE \$5.00 FUNCTION GENERATOR

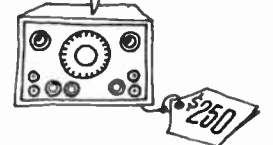
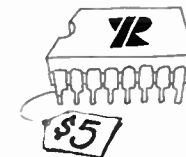
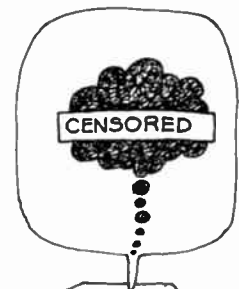
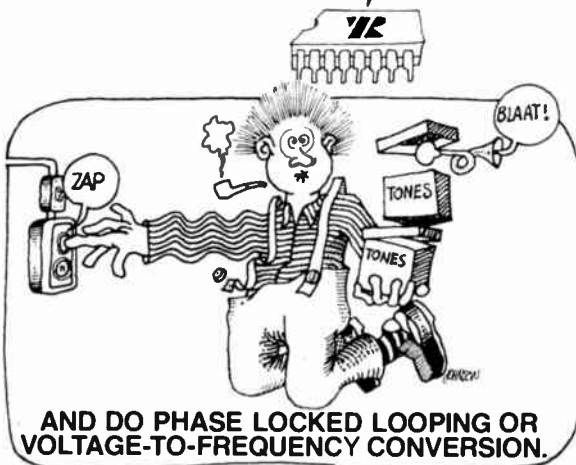
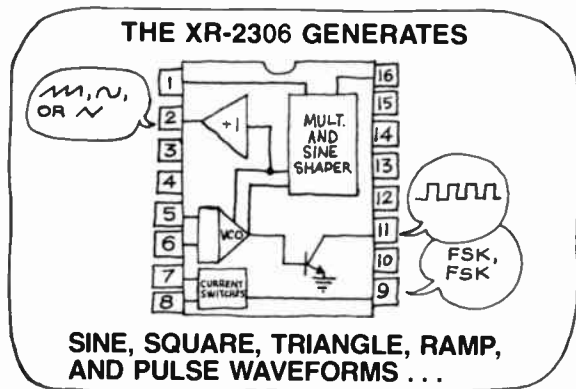

The XR-2306 monolithic function generator shows how easy and inexpensive it is to build lab-quality function generators and signal generators into instrumentation, control and communication systems.

Add a passive network, a small potentiometer or two, and any power supply from 10V to 26V—split or single—to the XR-2306 and you have a neat little function generator that sweeps linearly through a 3,000:1 range typically. AM, FM and frequency-shift the waveforms if you like. Or build AM, FM, FSK, PSK and tone signal generators, voltage-to-frequency converters and phase-locked loops.

The XR-2306 does it all with a minimum of extra parts because the VCO, analog multiplier and sine shaper of a

quality bench instrument are on the monolithic chip.

Total harmonic distortion typically is only 2.0% without adjustment and 0.5% with adjustment. Stability is excellent, typically 20ppm/°C and supply sensitivity a mere 0.01%/V. Furthermore, the VCO frequency range is 0.01 Hz to more than 1 MHz, amplitude modulation capability is 100%, and duty cycle is adjustable from 0.1% to 99.9%.

Building a function generator into a system with our circuit costs only one-tenth as much as buying an instrument. It costs as little as \$4.95 in 100-up quantities. But we wouldn't kid you. If you really want an instrument that looks like a Wavetek, you'll have to add a power supply, a box and big knobs.



EXAR SPEAKS YOUR LANGUAGE

EXAR INTEGRATED CIRCUITS Products of Rohm Corp. 16931 Milliken Ave., Irvine, CA 92705 (714) 546-8780 TWX 910-595-1721

EXAR REPRESENTATIVES: Arizona/Colorado/New Mexico BARNHILL FIVE (602) 947-7841 California - North LOGAN SALES (415) 369-6726 California - South DE ANGELO & ROTHMAN CO (213) 398-6239 Washington/Oregon SDR SQUARED (206) 747-9424 Illinois/Wisconsin M & S SALES (312) 992-1053 Ohio/Indiana/Kentucky MC FADDEN SALES (614) 221-3363 New York City M O S ASSOCIATES (516) 694-5923 Pennsylvania/Southern New Jersey HARRY NASH ASSOCIATES (215) 657-2213 Oklahoma/Texas/Louisiana/Arkansas EVANS & MC DOWELL (214) 238-7157 Michigan D E M ASSOCIATES (313) 755-6660 North Carolina/South Carolina/Virginia/Maryland COMPONENT SALES (301) 484-3647 Maine/New Hampshire/Vermont/Massachusetts/Connecticut COMPONENT SPECIALISTS (617) 667-4181 Minnesota ELECTRONICS INNOVATORS (612) 884-7471

Air Force promises more industry funds for RPVs . . .

Anxious to keep defense electronics contractors turned on to the potential of remotely piloted vehicles (RPVs), the Air Force would like to counter industry grumbling that most of the growth in RPV budgets is being spent at Air Force laboratories. But when USAF Secretary John L. McLucas said major increases in future RPV funding will contain more money for drone instrumentation, he only partly won over company officials at an RPV symposium at Dayton, O., in early May.

McLucas called fiscal 1974 RPV dollars the "low ebb," explaining that, as the programs switched from trial status to normal management, they began competing for funds against other established programs, like the F-15 fighter. Research and development money for RPVs, he said, will almost double from fiscal 1974 to 1975, to be followed by approximately a 50% increase each year for several years. But he conceded that the money spent with industry "represents a very small fraction of the Air Force RDT&E budget." The service will spend \$13 million on RPVs in fiscal 1974, \$25 million in fiscal 1975.

. . . and sees more avionics required to prevent crashes

The Air Force secretary's call for more and better RPV instrumentation seemed to his industry audience to be addressed as much to the service's project managers as to contractors. On RPV avionics, McLucas declared "Drones do not offer an escape from the demanding requirement of high reliability. I get the feeling that some people mistakenly think that all RPVs, being unmanned, are meant to be expended," adding that "it isn't progress to develop a system which performs well in the air but crashes on landing because of inadequate instrumentation."

The future of RPVs as Comsat aircraft, he said, "is not quite so clear" as it is in reconnaissance and electronic warfare, since more experience is needed on effectiveness, vulnerability, and cost.

OTA plans to study mass transit, solar energy first

The Congress' fledgling Office of Technology Assessment disclosed plans for its initial projects in early May and is calling on likely contractors to submit their qualifications. Organizations found qualified to research a given problem will receive copies of "assessment solicitations." The projects include assessments of: the state of the art of automatic train control technology for rapid rail transit systems, the systems' potential for development, and the testing procedures they will need; community transit planning technology, including a look at planning criteria, and solar heating and cooling technology.

The programs "frankly provide some great opportunities for industry to get Government money to do what is really no more than good market research," observes one OTA official. Firms interested in transit should write the Office of Technology Assessment, c/o Administrative Officer, Transpo-1, U.S. Congress, Washington, D.C. 20510.

National satellite net for criminal justice is proposed . . .

A nationwide criminal justice telecommunications system, using satellites and run by a Federally chartered but private not-for-profit corporation, will be proposed in a bill being drafted by the Department of Justice for presentation to Congress later this year. An outgrowth of the Law Enforcement Assistance Administration's Project Search, it will call for creation of "a Comsat of criminal justice," says LEAA chief

Washington newsletter

Donald E. Santarelli. Project Search began in 1969 as a multistate effort to develop a prototype computerized criminal justice information system that later successfully demonstrated coast-to-coast fingerprint transmission by satellite.

LEAA officials say the Comsat approach is designed to anticipate congressional criticism of expanding Federal law enforcement authority and expenditures. Santarelli sees the concept as leaving the administration and control of criminal justice "to state and local governments, where it belongs." Costs of the network would also be borne by the participating state, local, and Federal law enforcement agencies.

**. . . but challenges
to separate satellite
develop quickly**

Questions about the need for a separate and independent satellite for law enforcement, as called for in the National Criminal Justice Telecommunications system, developed quickly in Washington following LEAA's proposal. And LEAA's Santarelli is already **hinting that the agency might settle for "at least a piece" of a bird.**

Virtually all domestic satellite operators already formed would be willing to provide channels for the system, say company representatives. Some of them are as yet uncertain about the need for a separate, non-profit corporation. **There are also questions within the telecommunications community about the system's getting a satellite orbital slot and spectrum space from the FCC.** From the legal side, the LEAA proposal also raises the "police-state-like issues" of invasion of privacy and citizens' rights, in the view of one Senate Judiciary Committee staffer.

**All-channel-radio
bill hit in Senate
by EIA . . .**

Radio manufacturers are lobbying hard against the passage of S.585, the all-channel radio bill that would require receivers sold in the U.S. consumer market to have an fm as well as an a-m capability. The latest argument against the bill by the Electronic Industries Association was delivered in a letter by Jack Wayman, staff vice president of EIA's consumer electronics group, to Sen. John O. Pastore, chairman of the Senate Commerce Committee that is now considering the bill.

In an apparent appeal to the Rhode Island Democrat's widely known preference for network broadcasting over cable television interests, Wayman **opposed the argument that the all-channel TV bill, mandating uhf on TV receivers, is a precedent for fm radio,** adding that "if the all-channel radio becomes law, we can well see cable-system operators urging that their financial difficulties be alleviated by Federal legislation requiring cable connection for every television receiver." Moreover, it is **"by no means farfetched" to suggest that stereophonic and quadraphonic broadcasters could later ask Congress for similar privileges.**

**. . . as advantages
of ICs for a-m/fm are
seen as limited**

The argument in favor of S.585, to the effect that costs of a-m/fm radio receivers "will markedly decrease as new technological developments, such as microchips used in electronic calculators, are employed in the manufacture of radios" was also disputed by the EIA consumer group. **ICs will not reduce radio prices, argued Wayman, because "only 10-25% of an a-m/fm radio receiver's circuitry can be integrated,"** whereas calculators, which have 10 to 15 times as many transistors as a radio, are amenable to having 90% of their circuitry put on chips.

S-D puts the accuracy back into high speed DVMs



FILTER FOR EMERGENCY ONLY

Make 30 accurate readings a second... even with noisy inputs

Most DVM's offer no noise rejection without using input filters—and that limits them to 2 or 3 readings/second. But Systron-Donner's Model 7110A makes 30 readings/second with 60 dB of normal mode noise rejection **without** using filters. DC accuracy in the presence of noise? Typically $\pm 0.005\%$. That's because the 7110A uses dual slope integration which provides built-in noise rejection without filters. Fully-guarded construction and isolated inputs/outputs also help to kill noise. Only the presence of extremely noisy signals requires a filter; it's there if you need it.

Other Model 7110A features:

- true rms or averaging AC
- adapts to many systems interfaces
- DC voltage resolution to ± 1 microvolt
- $\pm 1,000$ volt overload protection on all functions and ranges
- true 4-wire DC ratio system in basic unit
- field or factory expandable

At \$1995 for the basic unit or \$3,400 fully-loaded, Model 7110A outperforms DVMs costing much more. For immediate details, call collect on our Quick Reaction Line: (415) 682-6471, or contact your Scientific Devices office or Systron-Donner at 10 Systron Drive, Concord, CA 94518. **Europe:** Munich, W. Germany; Leamington Spa, U.K.; Paris (Le Port Marly) France. **Australia:** Melbourne.

SYSTRON  DONNER

Albuquerque, (505) 268-6729; Baltimore, (301) 788-6611; Boston, (617) 894-5637; Burlington, NC (919) 228-6279; Chicago, (312) 297-5240; Cleveland, (216) 261-2000; Denver, (303) 573-9466; Dayton, (513) 298-9904; Dallas, (214) 231-8106; Detroit, (313) 363-2282; Ft. Lauderdale, (305) 721-4260; Hamden CT (203) 248-9361; Huntsville, AL (205) 536-1969; Houston, (713) 623-4250; Indianapolis, (317) 783-2111; Kansas City, KS (913) 631-3818; Los Angeles, (213) 641-4800; Minneapolis, (612) 544-1616; New York City area (201) 871-3916; Norfolk, (804) 499-8133; Orlando, (305) 841-8180; Philadelphia, (215) 825-9515; Phoenix, (602) 834-1682; Rochester, NY (716) 334-2445; San Antonio, (512) 694-6251; San Diego, (714) 249-6642; San Francisco area (415) 964-4230; Seattle, (206) 454-0900; St. Louis, (314) 842-2535; Syracuse, (315) 457-7420; Washington, DC area (703) 451-6500.

System uses airborne sensors to display aircraft position

A new moving-map navigation system from West Germany's Teldix GmbH continuously indicates an aircraft's position using inputs from on-board navigational aids. In contrast to other systems, it does not depend on ground radio stations for its operation. This is a decided advantage when flying over enemy territory.

Built for the German version of the German-French-developed Transall C160 military transport, the Teldix automatic map-display system AKT5 uses speed and drift information from the plane's doppler-radar equipment and course data from a gyro platform or a magnetic compass. Using a small built-in hybrid computer, the system calculates aircraft position and displays it by way of illuminated cross-hairs moving under the map.

Production ahead. The AKT5 is the result of a three-year-development effort that was triggered by research at Stuttgart University's Institute for Aerial Navigation. Now that flight tests have been successfully completed, the AKT5 is slated to go into all of West Germany's 100-odd Transalls, once Bonn's defense ministry gives the go-ahead.

The system's accuracy, a Teldix spokesman says, is "excellent for this type of equipment." When input signals are errorless, the firm guarantees an indicating accuracy within 0.5% over the distance flown. But the flight tests have shown the

error to be much better than that—0.1%, Teldix says.

Contained in the AKT5 is a rolled-up map that comes in 110 different sections, each 40 by 40 centimeters in area and carrying a specific number for identification. By push-button operation, the navigator can bring the section of interest into view on the display. He can select any of six different map-scale factors between 1:500,000 and 1:20 million. The latter scale factor, for example, is for a section showing a geographical area of 6,000 by 6,000 kilometers.

Simplicity. System operation is exceedingly simple. Before takeoff, the navigator merely sets the light mark under the map to the point of departure, and, from then on, the computer handles most of the rest. Besides calculating the aircraft's position during flight, the computer determines and displays the number of the map section in which the plane happens to be.

And when the aircraft crosses the boundaries of that section, the computer figures out and indicates the number of the section into which the plane is headed. The navigator pushes map-control buttons until right section is in view.

During its calculation, the computer takes into account gyro drift, map scale, and other factors that the navigator feeds into it via controls on the system's operating panel. The computer uses both digital and

analog techniques, depending on data-input devices. Analog methods are employed, for example, in determining the coordinates needed to move the light marker.

In addition to indicating the aircraft's position, the AKT5 system can also calculate the aircraft destination. To do this, the navigator first sets the light mark so that it coincides with the destination point. Then, by push-button operations, he feeds the end-point-coordinate values into the computer. The computer continuously calculates the difference between the coordinates of the aircraft position and those of the destination, figures out both the distance and the direction to that point, and displays the results on cockpit instruments. □

Great Britain/France

Systems replace data slip rings

The obvious way to get performance information out of a rotating machine is simply to fit the main shaft with a set of data slip rings, the way it has been done for years. But for all their simplicity, slip rings have their drawbacks. For one thing, sliding contacts generate noise even when they are made of expensive metals. For another, they wear out.

Now researchers on both sides of the English Channel have come up with better ways. At Britain's University of Manchester, Barry Jones has worked out a scheme based on infrared transmission and a four-channel time-division multiplexer. At France's Laboratoire Central des Industries Electriques, Angel Carballeira does away with slip rings by means of ultrasonic transmission and frequency-division multiplexing. Both systems had an airing at

Plotting. Computer-controlled navigation display for the German version of the Franco-German Transall military transport runs on airborne data generators alone.

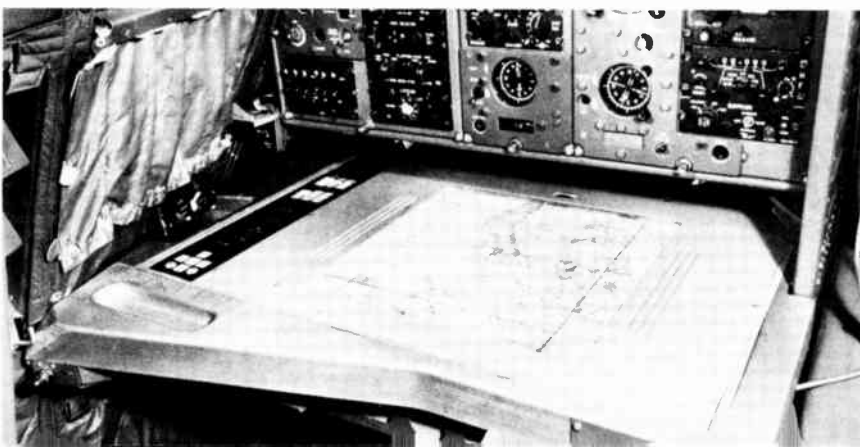

the late-April Eurocon '74 meeting in Amsterdam.

Infrared. The Manchester method takes advantage of the fact that perhaps the cheapest way to pick a single channel of data off a rotating shaft is to mount an infrared emitter on the axis and line up a receiving photodiode opposite it. But the limit with this approach is two channels—an emitter/receiver pair at each end of the shaft.

To up the data-transmission capacity, Jones puts a rotating transmitter on the shaft. Its circuitry time-division-multiplexes samples from four channels, then pulse-width-modulates them for transmission to a single fixed receiver. The receiver has to be followed by a demultiplexer/demodulator synchronized with the transmitter, of course. But even so, Jones says that a four-channel system costs no more than four sets of slip-rings, and when more channels are needed the savings should be considerable.

Jones says the crucial component that makes possible the transmitter's small size and thereby minimizes centrifugal forces is an MOS integrated-circuit four-channel multiplexer, made by Siliconix. This device has four MOS switches feeding into a single output, and each switch is turned on and off by bipolar circuitry on the same chip. That dispenses with numerous discrete items. Another factor is that circuitry for pulse-width modulation is simple, and filters are all that are needed in the receiver for handling the decoding.

The present system, says Jones, is a halfway house to systems with eight or more channels, which will be much better than slip rings. Eight channels can be obtained quite simply by using an eight-channel MOS multiplexer that's now available. Alternatively, Jones suggests that he can fix more than one diode to the end of a shaft and get them all to be effectively stationary in relation to passing data pulses.

Ultrasonic. The system developed at LCIE by Carballeira can handle 50 or so channels in frequency division. As its name indicates, LCIE is an industry-supported facility, and

Around the world

Swedish plan stresses strong computer industry

Sweden now has its mini-answer to the French Plan Calcul. And if it's accepted by the government and parliament, it might be called Plan Pengar—the Money Plan. The proposal, as presented by a royal commission established in 1971 to look at the future of Sweden's computer industry, calls for close to \$100 million to be invested in research and development, special projects, and marketing over the coming five years. In addition, the commission recommended that the state invest about \$75 million in the same period for computer and data-processing education—starting with junior high school courses.

The commission, which included members of parliament, industry, the government, and trade unions, said bluntly that significantly increased support to research and development, and strengthened educational measures, are essential economic measures that must be taken if Sweden is to have competent computer users and for the Swedish computer industry to be internationally competitive.

Ultrasonic instrument probes ocean temperatures

To help in mapping temperature profiles in the ocean, Matsushita Electric Co. has developed a bathythermosender that measures the spacing between ultrasonic pulses to measure water temperatures at various depths. The new instrument, which was developed by Matsushita's Wireless Research Laboratory, looks almost primitive. The instrumentation is built into an iron pipe 38 millimeters in diameter and 170 mm long.

A small thermistor protrudes slightly from the weight that plugs the front end of the pipe. Inside the pipe are temperature-sensing and oscillator circuits, powered by five N-size miniature dry cells. A piezoelectric ultrasonic transducer is mounted piggyback on the rear plug. The transducer launches radial vibrations at 50 kilohertz that travel to the rear. Since there is no forward radiation, no confusing signals are reflected from the bottom, and the pulses are easy to receive. Individual pulses are 2 milliseconds wide, and their spacing is varied from 50 ms to 100 ms for temperatures from 0°C to 30°C. Thus, pulse spaces are increased by 2 ms per °C. Pulses from the pinger can be received for a distance of 1 kilometer, which with a moving boat is equivalent to a depth limit of about 500 meters.

this system was developed at the behest of the state-owned public utility Electricité de France. The lab first tried the idea of transmitting data by ultrasonic waves to get temperature readings from inside large oil-filled transformers.

Like the transformer application, that for rotating machinery is mainly intended for temperature readings. The transducers, actually, are quartz crystals mounted in pairs. Usually, one is cut for 15-megahertz operation, the other for 14.5 MHz. There's an associated oscillator for each crystal, and the oscillator outputs are mixed to get a nominal 500-kilohertz difference signal, which is amplified to drive a lead-zirconate ultrasonic transmitter.

Because of the different cuts for the crystals, they track differently in temperatures, giving a frequency shift of about 30 hertz per °C for the

mixer output. What's more, the shift is linear over a range from 20°C to about 130°C. The sensitivity is better than 5×10^{-3} °C.

At the receiving end, a lead-zirconate transducer picks up the ultrasonic signal, which is processed by a kind of superheterodyne receiver. Channel selectivity in the receiving circuitry is some 5 kHz, which means at least 50 sets of sensors can be monitored. Because only frequency counts here, signal level is not important. As long as it is higher than the noise at distances of several meters between transmitter and receiver, then signal level is adequate.

LCIE packages its sensors as thick-film hybrid circuits. The modules can withstand accelerations up to 6,500 g. Drift of individual crystals because of acceleration is automatically controlled by the way the crystals are mounted. □

Here are two of the world's best oscilloscopes.

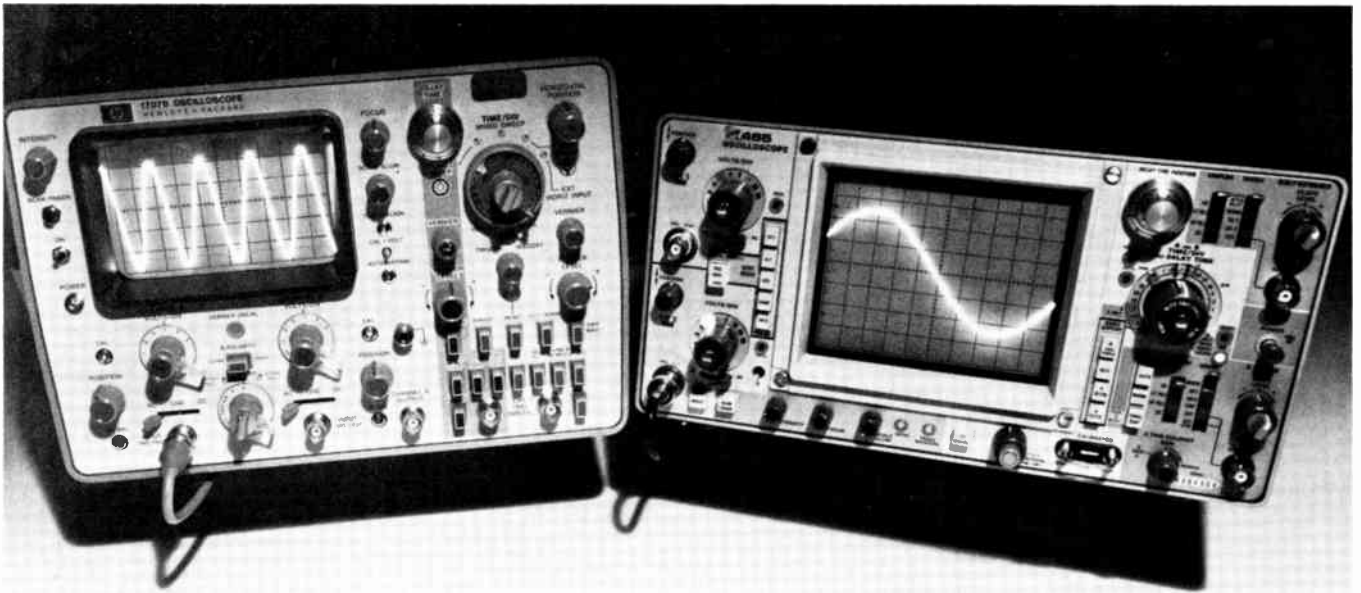

Hewlett-Packard 1707B

Tektronix 465

Here's why you shouldn't own either one.

You can lease one for as little as \$45 per month.

We can give you immediate delivery on either the Hewlett-Packard 1707B or the Tektronix 465, in quantity.

The Hewlett-Packard scope lease is \$45 per month for 36 months. The Tektronix 465 is \$50 per month for 36 months.

Anyway you choose, leasing is the best thing that ever happened to a tight capital equipment budget. You pay for your scope as you use it ... and you pay for it out of the profits it generates.

Call your closest Instant Inventory Center and ask us about short term rentals, delivery, and other lease terms for scopes or any other electronic equipment you need, up to and including minicomputers.



Anaheim, California (714) 879-0561
Dallas, Texas (214) 661-8082
Fort Lauderdale, Florida (305) 771-3500
Gaithersburg, Maryland (301) 948-0620
Burlington, Massachusetts (617) 273-2770
Mountain View, California (415) 968-8845
Oakland, New Jersey (201) 337-3757
Rexdale (Toronto) Ont., Canada (416) 677-7513
Des Plaines, Illinois (312) 827-6670

Rental Electronics, Inc.

A **PEPSICO** leasing company.

French electronics companies eye election impact

French finance minister Valery Giscard d'Estaing has the edge over Socialist-Communist rival François Mitterand in the May 19 race for the French presidency. But the polls show that 200,000 votes could swing it either way. **At stake for the electronics industry is the independence of Thomson-Brandt**, the country's largest builder of components and electronics equipment. Mitterand has pledged to nationalize the Thomson group if he wins. A Giscard victory would mean little change for Thomson or any other French company, as Giscard has been shaping the country's economic policy since 1969. However, **Giscard has said he would take a fresh look at the national computer maker, Compagnie Internationale pour l'Informatique**, and possibly recommend a new structure and new types of collaboration. This could mean an opening for a U.S. partner in Unidata, the CII-Siemens-Philips computer alliance.

High-resolution sonar contract goes to Marconi

The British government is providing Marconi Space and Defence Systems Ltd. with \$2 million to develop **two highly accurate scanning sonars capable of detailed mapping and depth measurement of the sea bed and close monitoring of undersea operations**. The systems will use the within-pulse, sector-scanning technique, in which a complete scan takes place within a single pulse and allows very high resolution. Engineering of both units will be similar, but one will have a range of 500 yards and resolution of 0.3°, while the other will have a range of 650 yards and resolution of 0.5°. One or both units will be installed in a Royal Navy hydrographic ship, and if they're successful there'll probably be a production run.

One main reason for building such expensive sonars is that **very large modern tankers often risk striking their hulls on the mass of sunken ironmongery that two wars have left in some parts of the English Channel and the southern North Sea**. Ordinary sonars can't map these wrecks with sufficient accuracy. Another important reason is that **some of the oil rigs soon to be towed into the North Sea in large numbers will have drafts of 300 feet and more**, and towing routes will have to be chosen carefully.

Computer market in France to show healthy growth

French producers of data-processing equipment now think that the total value of installed computers will double during the next four years. Market figures released this month by the country's capital-electronics and office-machine trade associations peg the end-1973 total at \$4.3 billion. **The figure will hit \$8.8 billion by the end of 1977, they estimate.**

Fastest-growing segment of the computer market will be office types. Some 84,500 of them, worth some \$1.95 billion, should be in service by the end of 1977. That works out to an average annual gain better than 30%. For regular computers, growth is tagged at 17.5% yearly through 1976, followed by a slight slide to 15% in 1977. With that growth, the value of regular computers would reach \$6.85 billion.

Sensational growth is also predicted for data-transmission equipment in France. From some 12,200 terminals worth \$155 million at the beginning of 1974, there is a spurt expected to 55,400 terminals worth \$900 million at the beginning of 1978.

International newsletter

Court puts cable TV under government wing

The European Court of Justice has ruled broadly in favor of Common Market states extending their broadcasting monopolies to cover cable TV. The decree came in response to a complaint by the operator of an unauthorized CATV network in Biella, Italy, who had refused to pay rental on TV receivers in his network.

The case reflected the thorny problem of CATV in Europe, where state monopolies are gingerly experimenting with private participation in CATV projects. The court pointed to the difference between interfering with the free movement of goods on the one hand and monopolizing services on the other. Most Treaty of Rome rules on monopoly refer only to trade in goods.

But the controversy continues. For one thing, the local court in Biella has still to rule, and at this stage the European Court's decree is largely advisory. For another, there is a loophole through which the Italian plaintiff might squeeze. The court noted that the state monopoly cannot discriminate against nationals of member states on grounds of nationality. And that poses the question of some state broadcasting organizations permitting foreign stations to be transmitted in their territories by CATV networks, but restricting development of competitive national programs.

Single IC generates tones for organ's top octave

Intermetall GmbH, the German member of the ITT Semiconductor Group, will soon go to market with an integrated circuit that can produce all 13 tones of the highest octave in an electronic organ, a job that formerly took three Intermetall organ ICs. The largest deviation of the 13 tones from the tempered-tone scale is but $\pm 0.011\%$ percent. Designated the SAH 200, the IC is an MOS device needing only one supply voltage, -22 volts, and one clock pulse generator in its periphery. The circuit comes in a 16-pin dual in-line plastic package.

British in trials of conference TV link to Stockholm

The British Post Office is experimenting with extending its conference television service to the Continent. A studio has been set up in Stockholm, and between now and the end of the year businessmen in Stockholm and five major British cities will be able to confer by closed-circuit TV. If it proves popular and technically viable it will be continued. During the experimental period, the charge is about \$240 an hour. Up to five people can be televised simultaneously at each end. The video signals go by microwave link through France, Belgium, Germany, and Denmark to Sweden, and the sound goes by 8-kilohertz-bandwidth cable across the North Sea. The Dutch are interested in being included in the experiment and are building a studio for operation later this year.

Laser market in West Germany to spurt ahead

West Germany is Europe's largest user of laser equipment, with consumption expected to rise from an estimated \$200 million in 1973 by about 50% during each of the following two years. According to a recent industry analysis, American suppliers, with an 80% share, are the leading contenders on the West German laser market. Accounting for half of West German laser consumption are government research institutes. They are followed by industrial users, who take a 25% share. While purchases from institutes will remain steady, the demand from industrial organizations should increase by 100% annually during the next few years.

**A
LOT
MORE
FOR A
LITTLE
LESS**



BOURNS®
NEW

**SINGLE-TURN CERMET TRIMMING
POTENTIOMETER**

- VASTLY IMPROVED ADJUSTABILITY
- TWELVE TERMINAL STYLES
- SEALED FOR WAVE SOLDERING

45¢

In production quantities

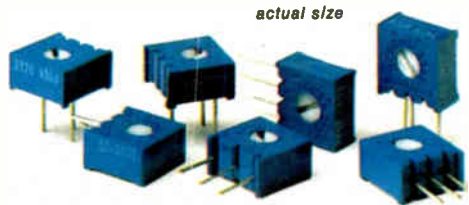

Meet Bourns new Model 3386, a product that both buyer and engineer can love . . . with super adjustability that makes for easy, accurate trimming, AND at a budget balancing price. Most importantly, it's a BOURNS product . . . and that means **QUALITY** and **PERFORMANCE** you can believe-in, and **SERVICE** you can depend-on.

SIGNIFICANT SPECIFICATIONS

- typical CRV less than 1% • infinite resolution • TC of ± 100 PPM/ $^{\circ}$ C to 200K ohms • power of .5 watt at 85 $^{\circ}$ C • thin $\frac{3}{8}$ " square size



For complete details, contact your local Bourns representative or distributor, or the factory direct.



TRIMPOT PRODUCTS DIVISION • 1200 COLUMBIA AVE., RIVERSIDE, CALIF. 92507

GENERAL ELECTRIC ROTRON
PAMOTOR BODINE
ROBBINS & MEYERS AMPHENOL
INC INDIANA GENERAL

Need another prime* source?...

** If we've missed any, we apologize*



For fast help on INDUCTION MOTORS
call Bill Samaras (815) 889-4105

For assistance on UNIVERSAL/DC MOTORS
call Art Grau (815) 889-4107

Circle Card No. 58 for data on FHP MOTORS/GEARMOTORS

If you need UNIVERSAL/DC . . .
INDUCTION . . . SHADED POLE
FHP motors, gearmotors, fans
or blowers—Call Howard now.

When price, quality and delivery are *prime* considerations—look into what Howard can offer you. Today, because of greatly expanded facilities, you (just as many other major firms) can depend on Howard as a *prime* source for more of your FHP motor, fan and blower needs. Geared to work closely with O.E.M. customers, Howard can meet your particular design requirements.

Prototypes and production models can be developed to your specifications.

And delivery is much earlier than you'd expect! With the broadest line of FHP motors, gearmotors, fans and blowers in the industry—Howard is large enough to insure dependable service, small enough to respond to your individual needs. Our customer service representatives and phone numbers are listed below.

*For another reliable prime source
call Howard now!*

Call

HOWARD

HOWARD INDUSTRIES / Division of MSL Industries, Inc.
One North Dixie Highway, Milford, Illinois 60953

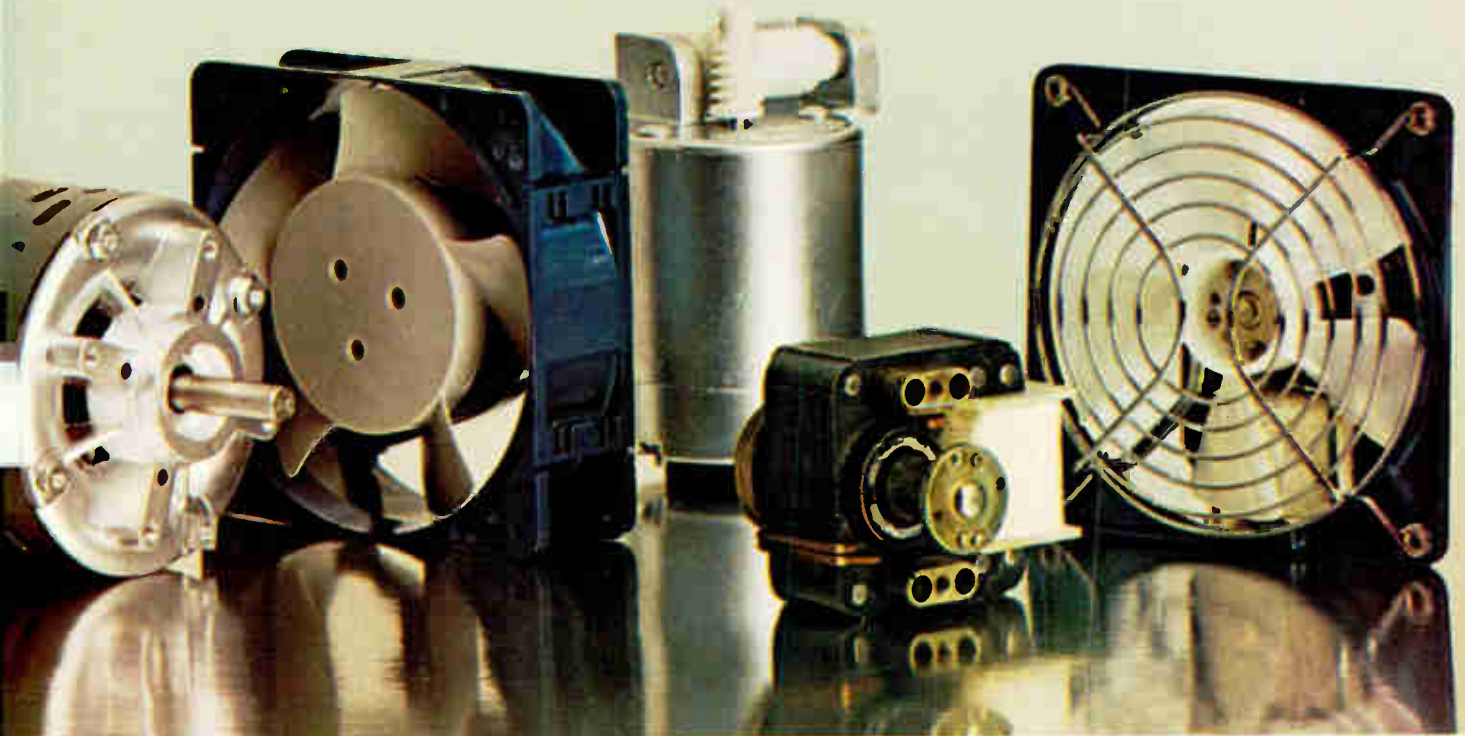

If you need SHADED POLE MOTORS—FANS, BLOWERS
call Larry Taylor (815) 889-4106

Circle Card No. 59 for data on FANS/BLOWERS

SIEMENS

The unvarying ingredient in every Siemens component: batch-to-batch quality.

Even though Siemens makes 50,000 different shapes and sizes of components, to meet virtually any need *and* the reality of your economics, we're best known for the efforts we devote to quality. Year after year, batch after batch. (We've made 500 million pot cores in the last 5 years alone.)

One of the reasons for our high level of quality and reliability is the two million dollars we invest every working day in research and development. Our R&D program has paid off well—90% of the components we offer today were not available 10 years ago.

R&D has also enabled Siemens to pioneer metallized polyester-film (MYLAR*) capacitors, tuning-diodes, gas-filled SVP's* and cradle relays. And there are more innovations on the way.

If you depend on electronic components, you can depend on Siemens. Batch after batch, the quality never varies.

*DuPont registered trademark.

For details, get in touch with your local Siemens specialist, or fill in the coupon below.

Please indicate your specific area of interest and mail to:

Siemens Corporation, Components Division
186 Wood Avenue South, Iselin, N.J. 08830

- | | | |
|---|---|---|
| <input type="checkbox"/> BWO's | <input type="checkbox"/> LCD's | <input type="checkbox"/> Semiconductors |
| <input type="checkbox"/> Capacitors | <input type="checkbox"/> LED's | <input type="checkbox"/> Opto-Electronics |
| <input type="checkbox"/> Ferrites | <input type="checkbox"/> Planar Triodes | |
| <input type="checkbox"/> Gas - Filled Surge Voltage Protectors (SVP*) | <input type="checkbox"/> Relays | |

Name _____ Title _____

Company _____ Tel. _____

Address _____

City _____ State _____ Zip _____

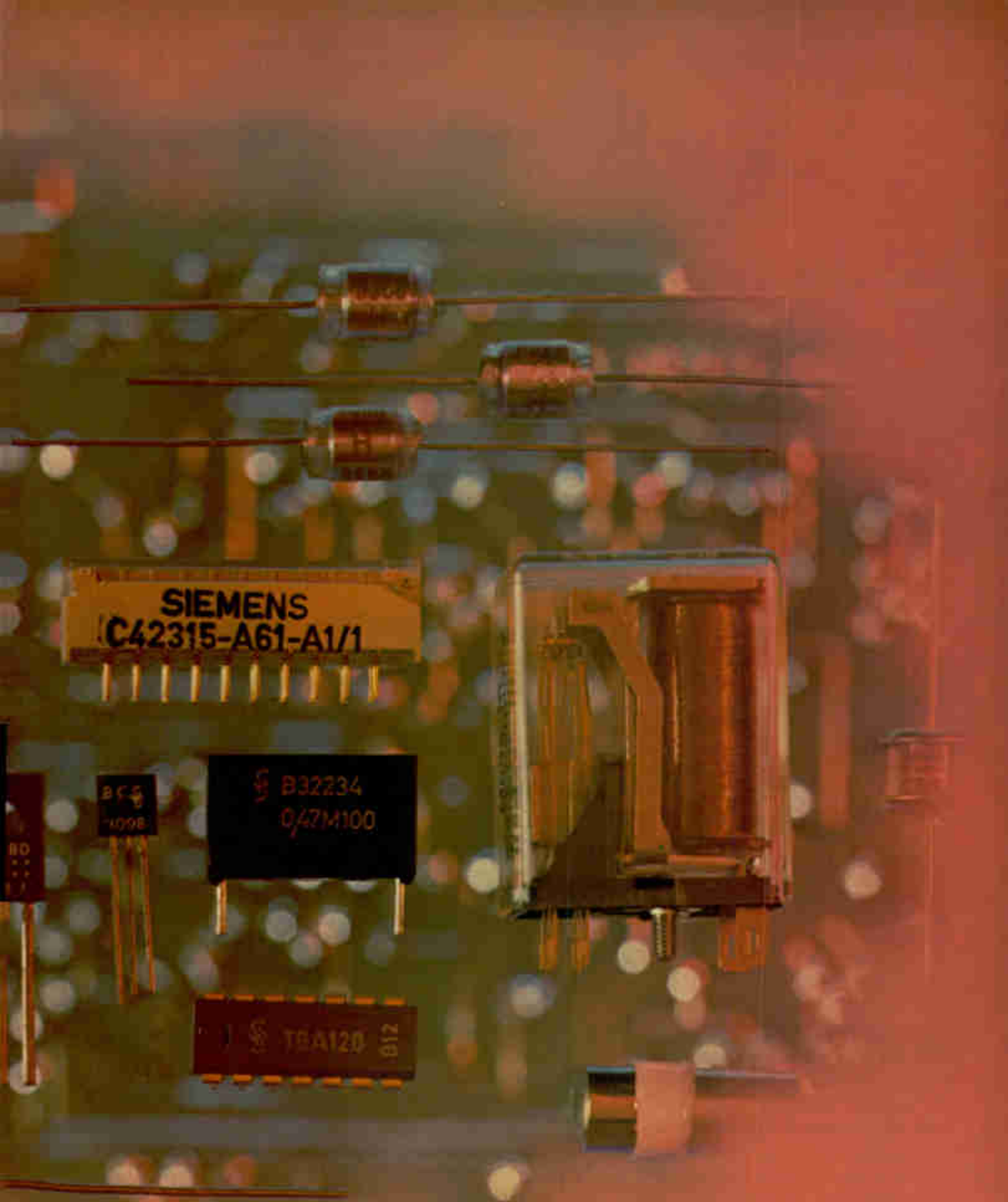

Siemens Corporation
Components Division

186 Wood Avenue South, Iselin, N.J. 08830 (201) 494-1000

Circle 61 on reader service card

Your Guardian Angel
(and dramatic engineering
developments) bring you

solenoids



NEW! If the solenoid you're now using in your product lasts five years...you can now figure on 500 years.

These new Guardian solenoids perform the 1 million operations you expect of a traditional-life tubular solenoid . . . and keep right on . . . and on. For 100 million operations. Making them ideal for business machines, computers, testing equipment, medical electronics equipment, anyplace where a life expectancy of 1 million operations just won't do. Where 100 million is more like it.

NEW! This unique design increases mechanical life from 1 million to 100 million...at just a little more cost.

The amazing part is how little more cost for so much more life! Only about 25% more than our traditional-life tubular solenoids. Yet you get 10,000% more life! The secret is in the cost saving design of the new steel shell.



Get all the long-life facts.

in this brand new 72-page Guardian Solenoid Catalog. It's proof Guardian's No. 1 in solenoids...and plans to stay there.

that last 100 times longer*

*And that's a minimum. Life tests have already gone past 100 million operations ...and are still running!

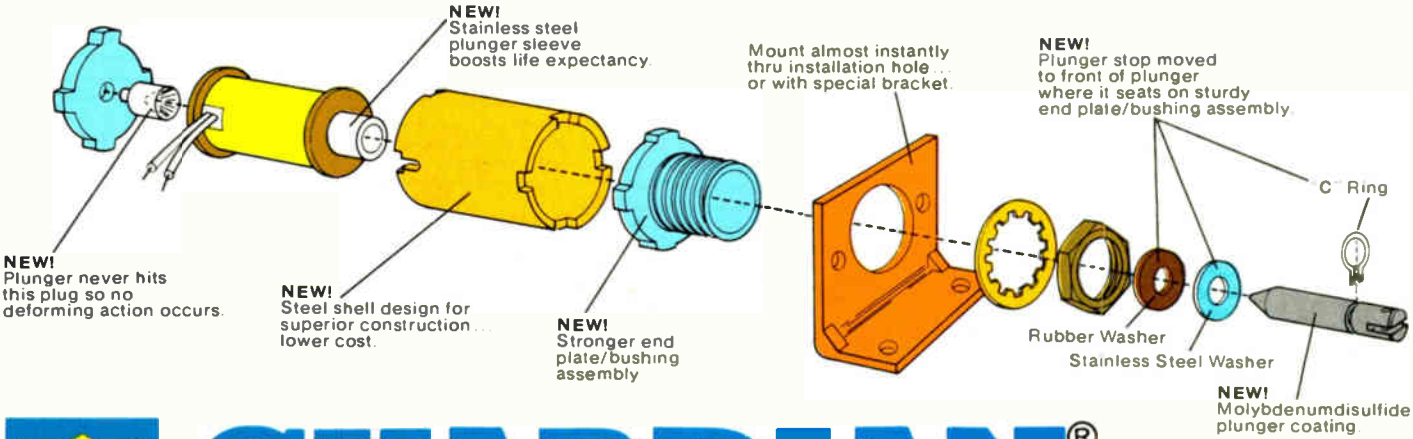

GUARDIAN®

GUARDIAN ELECTRIC MANUFACTURING CO. • 1566 West Carroll Ave., Chicago, Illinois 60607

Circle 63 on reader service card

Start with our new Blue Streak™ cable

... it's loaded with features designed to lower your installed costs. For instance, every fifth conductor is color coded for quick identification and the Blue Streak immediately identifies polarity. The unique cable construction permits clean conductor separation for breakouts and easy insertion into connector assemblies. Available in 50 conductors or less — solid or stranded wire — this U/L listed self-extinguishing cable is the perfect companion for the new one-piece connectors.



New cable connector system...It's designed to lower your installed costs.

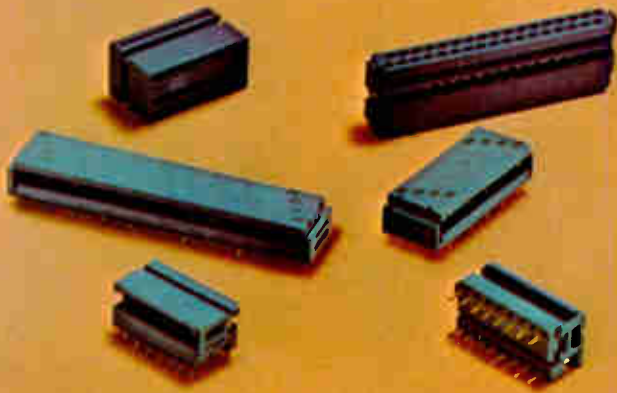

A perfect crimp every time

... because our Blue Streak hand tools feature the Shure-Stake® principle which makes the tool responsible (not the installer) for the compression connection. Your installer must complete the set compression stroke before the connector can be removed. It's as fool proof and reliable as a compression connector tool can be. A full line of bench mounted tools with interchangeable dies are also available.

The Ansley Team — One Piece Connectors — Shure Stake® Hand Tools and Blue Streak™ Cable — all combine to offer you the most reliable connection package at the lowest installed cost.

Ansley

ANSLEY ELECTRONICS CORP.

Subsidiary of Thomas & Betts Corporation 

3208 Humboldt St., Los Angeles, Ca. 90031

Tel. (213) 223-2331, TWX 910-321-3938

SOLD COAST TO COAST THROUGH AUTHORIZED ANSLEY DISTRIBUTORS.

Circle 64 on reader service card

Our new insulation displacing flat cable connectors install in 1/3 the time

... simply because they come to you in *one* piece. Two benefits result; assembly of the connector itself is eliminated and the time consuming job of lining up the cable on the connector is no longer necessary.

To install — simply insert the cable end into the connector and crimp. It's that easy — fast — and reliable! Speaking of reliable — our new connectors feature an exclusive "tulip" contact design which provides 4 contact points per conductor. In addition, the front of the "tulip" contact is designed to act as a strain relief on the wire.

We'll be more than happy to send you a test report on contact reliability.



Probing the news

Analysis of technology and business developments



'Good old days' fade in Japan

Electronics industries, troubled by inflation, soaring wages, and investment cutbacks, see 25% profit decline in 1974

by Mike Mealey, McGraw-Hill World News

Declining consumer spending, cutbacks in capital investments by industry, skyrocketing inflation, and whopping wage increases will combine in 1974 to cut the profits of the Japanese electronics industries by 25%. The decline bears out the fears of Japanese economists, who suspected that last year's boom would be short-lived [*Electronics*, Nov. 22, 1973, p. 90].

On a unit basis, most consumer-electronics goods won't grow at all, and production of color-television sets, traditionally one of the biggest profit makers among the electronics industries (30% to 35% until last year), will probably decline about 10%, to 7.8 million units from 8.7 million. Also, predicts the Electronic Industries Association of Japan, radio production will dip to 17.4 mil-

lion from 20.4 million, car radios to 7 million from 7.6 million, while hi-fi amplifier production will chalk up an increase: to 3.5 million units from 2.8 million.

The outlook for industrial electronics is not much brighter. Computer sales will rise 15% to 20% in value, thanks to inroads being made by minicomputers. In terms of units, peripheral-equipment sales will gain an estimated 20%, and desktop-calculator sales will be up 15% to 20%. However, because of the tremendous competition in the big calculator market, the actual value of sales will be up only 5% to 10%. Semiconductors will see an essentially flat year because the increased output of the biggest users, computer makers, will be eaten up by fall-offs among other big customers,

especially in the consumer field.

Communications equipment will gain 5% at most in sales, however, while heavy-duty appliances and motor-goods sales will decline about 7%. Sales of numerical-control machine tools are expected to suffer a 20% drop, but officials of Fujitsu Fanuc, which controls well over 90% of the market, say that it will match 1973 production.

Pressure. The biggest problems for electronics are sagging consumer demand and the government's tight-money policy, aimed at discouraging capital investment by industry. Private institutions are estimating that private consumption this fiscal year will fall 2% below the 1973 gain, growing only 5% in real terms over the level of a year ago. Private investment is expected to decline

Probing the news

about 2% in real terms below the outlays of 1973.

Moreover, while there is no longer a shortage of materials, the electronics companies are paying as much as 40% more for petrochemical products, such as plastics, and an average of about 20% more for other needed materials. And pay increases that have been agreed upon by major producers are running 30% to 35%.

On the average, this has resulted in price increases averaging 15% to 20% and, in some instances, as high as 40%. Yoshihiro Kayama, a specialist in the electronics industries at Nomura Research Institute, says that, for some products, 12% price hikes instituted last fall no longer are enough to sustain a good return for the manufacturer. But he adds that, because of government pressure, makers are reluctant to increase retail prices again. The government, fighting a wholesale price rise of 35% during the past year, is adamant in demands that industry live with smaller profit margins.

Kayama says that price markups instituted during the past six months will mean that total sales gains by electronics could possibly approach 10%—or only half of the growth recorded in 1973. He looks for that performance to dent profits by 25%, and most of the major producers agree with that outlook. Says Masao Adachi of the Electronic Devices group at Hitachi, predictions of such profit declines "are probably pretty close to the mark."

Because of big wage increases, the ratio of labor costs to total sales will probably climb from the present 15% to nearly 20%; moreover, the industry is going to be hard-pressed to carry out extensive modernization because of tight money.

Cutbacks. The result is that most of the major makers are curtailing the number of models offered in individual appliance lines in an effort to ease the pinch of declining unit sales. But Japan Victor Corp., part of the Matsushita group, has taken a unique approach to the problem. It has cut back color-television production by 20%, then converted those assembly lines to production

of audio equipment, one of the few consumer-electronics products expected to attract customers in greater numbers this year. Production of tape recorders will probably grow 7% this year, stereo sets by 10% to 15%, and stereo components by a healthy 25%.

JVC's approach is one that's not generally open to other major producers, however, because of their vertical production and management structures. As Hitachi's Adachi explains, each product division is left to its own devices to produce profits, and, moreover, because of the sheer volume of production, single factories are seldom devoted to production for more than one division.

Because of the limited numbers of options available to allay the effects of lagging sales to both consumers and industry, tremendous pressure is being put upon export departments to get sales moving overseas. Here again, though, electronics officials face big stumbling blocks. Because of rising price tags on Japanese goods, significant export gains are going to be difficult—if not impossible—to achieve. While trade with developing nations continues to boom, both in terms of consumer



Bearish. Masao Adachi of Hitachi agrees profits will decline by 25% in 1974.

and industrial-electronics goods, unit volume still is not appreciable; the key to export growth lies in the hands of U.S. and European buyers.

Nomura's Kayama predicts that exports to the U.S. will remain even, at best, in terms of unit sales, while products shipped to Europe will experience a slight increase. Performance will be hindered by the fact that price tags for some Japanese products will be higher than the selling prices of domestic products they compete with. □

The Japanese seek cheaper labor

It's ironic that labor costs in Japan, which were once so low that they attracted foreign investment, are now so high that they are forcing Japanese electronics firms to build plants offshore. To Americans, the 30% to 35% wage increase granted this year borders on the incredible. But considering the 35% inflation, and the fact that raises are granted almost *pro forma* with contract negotiations conducted on the company-union level, it's not that surprising. All this, coupled with protectionist clamor abroad for barriers against Japanese goods and the desire to get closer to sources of materials, has induced leading manufacturers to build or plan facilities in America, Asia, and Europe.

After starting plants in the UK and San Diego, Sony shortly will announce plans to build a color-television plant in France. Hitachi also will announce that it is going into a developing nation—probably somewhere in Southeast Asia—to produce semiconductors.

Toko will soon be producing variable condensers in Malta, and similar ventures are being eyed by component makers for the U.S. Nomura Research Institute's Yoshihiro Kayama says that the U.S. will see a "lot more investment" in the next few years.

Contrary to attitudes toward Japanese export goods, "countries are welcoming Japanese investment," he says, and Japanese are finding that production costs even in the U.S. will not be much greater than in Japan in the not-too-distant future, television sets aside. Sony, it is estimated, will spend \$16.5 million overseas this year, while Matsushita will spend more than \$20 million during the next two years. This is in addition to a sum in the neighborhood of \$100 million it will spend to acquire Motorola's Consumer Products division, providing that sale gets U.S. Government approval.

An industry first.

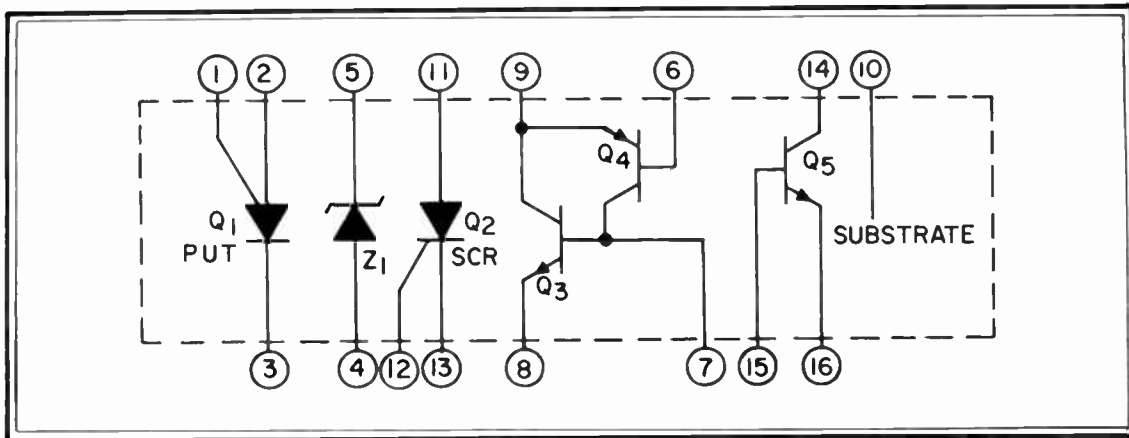

RCA Solid State's CA3097E Thyristor/Transistor IC Array

There are so many ways to use it that we can't even begin to describe them to you.

We've put a programmable unijunction transistor (PUT), sensitive gate SCR, zener diode, p-n-p/n-p-n transistor pair and an n-p-n transistor ... all together in the 100 times improved plastic package system — RCA's new E-55 (16 lead DIP).

Check these characteristics and decide for yourself how to use the CA3097E in your system.

Characteristics

- Programmable unijunction transistor (PUT)
 - peak-point current = 15 mA (typ) at $R_G = 1\text{ M}$
 - $V_{AK} = \pm 30\text{ V}$
 - DC Anode Current = 150 mA
- Sensitive-gate silicon controlled rectifier (SCR)
 - 150 mA forward current (max.)
- Zener diode
 - $8\text{ V} \pm 10\%$
 - $Z_z = 15\ \Omega$ (typ.)

- DC Current 25 mA (max.)
- p-n-p/n-p-n transistor pair
 - $\beta \cong 8000$ (typ)
 - @ $I_c = 10\text{ mA}$
- n-p-n transistor
 - $V_{CEO} = 30\text{ V}$ (min.)
 - $I_c = 100\text{ mA}$ (max.)
- Thermal and electrical component tracking with the design flexibility of discrete components
- Improved product reliability with the E-55 plastic packaging system, which demonstrates two orders of magnitude improvement in reliability over previous industry average.
- Operation over a temperature range of -55 to $+125^\circ\text{C}$.

If the CA3097E can work for you, order now. It is available in quantity — at a price that will stop you in your tracks: \$1.35 (1K price).

Want to know more about the CA3097E? Write: RCA Solid State, Section 70E16, Box 3200, Somerville, New Jersey 08876. Or phone: (201) 722-3200, Ext. 3144.

RCA Solid State
products that make products pay off

International: RCA, Sunbury-on-Thames, U.K./RCA, Fuji Building, 7-4 Kasumigaseki, 3-Chome, Chiyoda-ku, Tokyo, Japan/RCA, 103 Nanking E. Road, Sect. 2, 2nd Floor, Taipei, Taiwan. In Canada: RCA Limited, Ste. Anne de Bellevue 810, Canada

Companies

Chrysler Huntsville's auto odyssey

From Saturns to Imperials, Chrysler's electronics operations made successful transition from space to car business

by Gerald M. Walker, Associate Editor

What's a nice space-electronics firm like Chrysler Corp.'s Huntsville, Ala., Electronics division doing in a place like Detroit and automotive electronics? The answer is that it's now doing about 10 projects for current-model cars. These range from radios and digital clocks to electronic ignition, seat-belt interlocks, and emission-control devices.

In addition, the facility has taken a lead in introducing some of these products into American cars. And having survived the transition from high-cost, low-volume NASA business to high-volume, low-cost auto products, the Huntsville division is preparing to introduce other electronic controls into automobiles—including new microprocessors.

Established in 1956, the division's original job was to provide engineering services in support of the Redstone and Jupiter missile programs, as well as for several space-vehicle projects of that period, including Jupiter C, Juno 11, and Mercury-Redstone. A high-water mark in its NASA period came in the early 1960s when Chrysler won the Saturn 1 and 1B contracts and Huntsville assumed all static-test and ground-support-engineering functions for both stages.

But before NASA's work wound down in 1969, the facility had already begun seeking a new role. Today, the engineering department insists that the division has won over Detroit, not despite its sophisticated space orientation, but because of the design, test, and systems know-how learned while shooting for the moon.

The changes have been quite no-

ticeable. For one, far fewer engineers are on hand, now that Government projects constitute a minor percentage of the work. For another, engineers accustomed to working with the state of the art had to ease back into more common components that perform less com-



Space helped. John L. Webster says know-how gained in NASA work has paid off.



Testers. Allen G. Seitz, above, handles reliability and analysis jobs. W. Frank Henley, right, is in charge of design and manufacture of test equipment.

plex tasks. And the design challenges changed from products requiring high reliability for a short period of time at any cost to products that must last five years under the hood of a car, are neglected by their owner, are often serviced by untrained mechanics, yet still must be cost-competitive.

Asset. Nevertheless, John L. Webster, manager of electronic-product development, points out that space-age organization proved to be a major plus in meeting the



Seven ways to tell a Darlington that's great from a Darlington that's merely good.

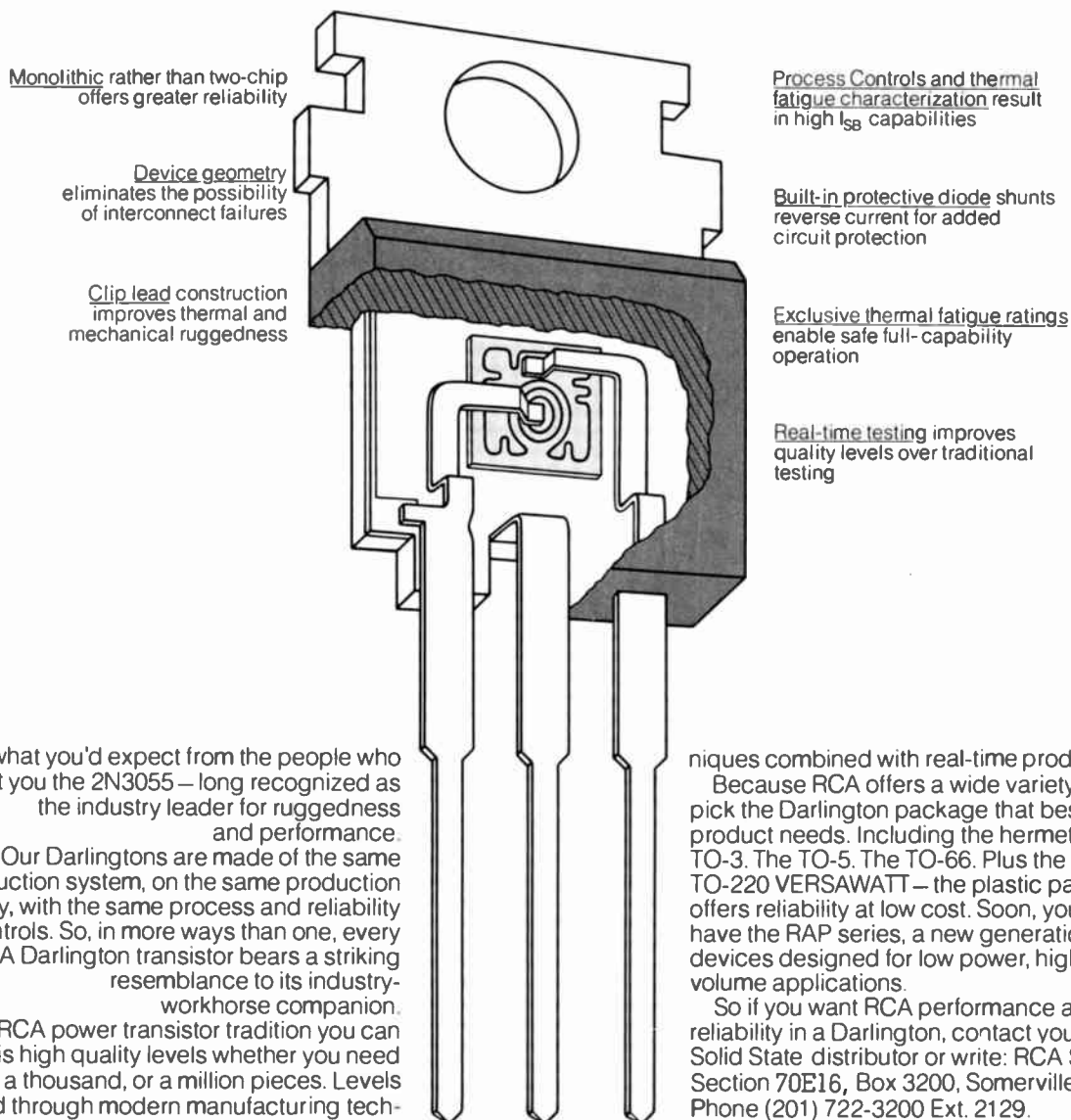

It's what you'd expect from the people who brought you the 2N3055 — long recognized as the industry leader for ruggedness and performance.

Our Darlington's are made of the same construction system, on the same production facility, with the same process and reliability controls. So, in more ways than one, every RCA Darlington transistor bears a striking resemblance to its industry-workhorse companion.

Another RCA power transistor tradition you can look for is high quality levels whether you need a hundred, a thousand, or a million pieces. Levels achieved through modern manufacturing tech-

niques combined with real-time product control.

Because RCA offers a wide variety, you can pick the Darlington package that best suits your product needs. Including the hermetic steel TO-3. The TO-5. The TO-66. Plus the RCA TO-220 VERSAWATT — the plastic package that offers reliability at low cost. Soon, you'll also have the RAP series, a new generation of devices designed for low power, high volume applications.

So if you want RCA performance and reliability in a Darlington, contact your RCA Solid State distributor or write: RCA Solid State, Section 70E16, Box 3200, Somerville, N.J. 08876. Phone (201) 722-3200 Ext. 2129.

RCA Solid State

International: RCA, Sunbury-on-Thames, U.K., or Fuji Building, 7-4 Kasumigaseki, 3-Chome, Chiyoda-Ku, Tokyo, Japan.
In Canada: RCA Limited, Ste. Anne de Bellevue 810, Canada.

Probing the news

new challenges, once the auto production arm of Chrysler got used to the idea. Unlike other diversification efforts by aerospace-electronics companies—projects that often led to the design of solutions in search of problems—Huntsville patiently waited for the auto producers to set the goals.

Vendors, too, had to make adjustments. Electronic-components firms that might have sold perhaps a dozen \$200 transistors to Huntsville during the NASA period are now likely to be supplying more than a million 10-cent devices. This change probably caused the most trauma in the quality-control sections for both Chrysler and its suppliers. But testing disciplines used for space vehicles came to the rescue for cars.

These test operations are really two-sided. One side, headed by W. Frank Henley, handles design and manufacture of test equipment. The other side, headed by Allen G. Seitz, does reliability and analysis tasks. Both men are alumni of Government quality control and testing. The reliability and analysis section is an 11-man group devoted to tracking the causes for electronic failures in the field, at the auto-assembly plant, and on the Huntsville production floor.

Records. Using computer-stored records, this group is primarily responsible for finding failure mechanisms in components and analyzing how changes in specs, tighter controls by vendors, or improved handling will reduce breakdowns. "We probably keep more records on semiconductor devices in the auto environment than any semiconductor company," Seitz remarks.

The test section is involved with equipment development, not only for use at the Huntsville plant, but on the assembly line and by the car dealer or garage. For example, pollution-control requirements have led to the development of a portable emission analyzer weighing 18 pounds that is being marketed to dealers, service stations, and garages. These may also be sold to state and municipal auto-inspection stations. Using an infrared beam that simultaneously determinates the precise amount of hydrocarbons and carbon monoxide coming out of an engine's exhaust, the unit will be used to "tune" antipollution devices now going into cars. While all of Huntsville's auto-electronics products presently go to Chrysler and American Motors Corp. assembly plants, this analyzer will be sold directly to users.

As for further diversification beyond automotive products, Webster believes that there's little need to look elsewhere. Waving to a plant addition of 120,000 square feet about to be opened, he remarks, "There's so much auto business that we're up to our ears for as far as we can see. The Government, by requirements that push electronic answers, and the auto companies, by interest in improving performance for gas savings, are making the future of electronics." □

THINKING ABOUT LSI?

Our new 'LSI Feasibility File' will help answer your questions about development procedures, costs, and how to evaluate the technology on your own terms.

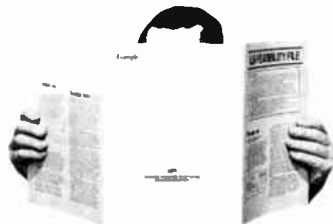

It also explains how we can help.

The decision to employ the advanced technologies of Large-Scale Integration is seldom an easy one. And the facts on which to base your decision aren't always easy to come by. That's why we've just published our LSI Feasibility File. In it you'll find a lot of factual information about the technology and how you might be able to use individually developed LSI subsystems to improve your product. Use the coupon below to order your copy today. We're sure it will help.

MICRO POWER SYSTEMS

3100 Alfred Street, Santa Clara, CA 95050, Phone: (408) 247-5350, TWX: 910-338-0154
Japan: Yas Kanazashi, 21 Mori Bldg., 2-2-5 Roppongi, Minato-ku, Tokyo, Phone: 586-0471

If LSI subsystems can improve your product's performance, slash production costs and fatten profit margins, one or all of these three publications may tell you how. Ask for your copies now.

- LSI FEASIBILITY FILE—How to evaluate the technology and "get started" with LSI.
- LSI COST ANALYSIS FILE—How to cope with the numbers game, including four specific case histories.
- LSI DEVELOPMENT & SUPPORT—An illustrated description of our capabilities and unusual way of doing business.

TELL US ABOUT YOUR POTENTIAL APPLICATION:

Name _____
Title _____
Company _____
Address _____
City _____
State _____ ZIP _____



WE CAN HELP.

if it's a meter or meter relay,

Stock or Special...

Simpson

makes it.



Stock:

Simpson distributors nationwide stock over 1,500 types, ranges, styles and sizes of panel meters, relays and controllers. They're all listed in Catalog 4200. Write for your free copy.

Special:

Need a special or unusual meter? Let Simpson help you custom design it. Send us your specs and we'll send you a quote. But check our catalog first—that "special" may be a standard Simpson stock item.

Get off-the-shelf delivery from your local electronics distributor.



SIMPSON ELECTRIC COMPANY
853 Dundee Avenue, Elgin, Illinois 60120
(312) 695-1121 • Cable: SIMELCO • Telex: 72-2416

IN CANADA: Bach-Simpson, Ltd., London, Ontario
IN ENGLAND: Bach-Simpson (U.K.) Limited, Wadebridge, Cornwall
IN INDIA: Ruttonsha-Simpson Private, Ltd., Vikhroli, Bombay

KATY INDUSTRIES



ELECTRICAL EQUIPMENT GROUP

Companies

Sprague savors its comeback

Recession was just one of the problems that caused maker of components and semiconductors to lose a million dollars a month at one point

by Gail Farrell, Boston bureau

Most electronics companies suffered through the recession of the early 1970s and then snapped back when the economy improved last year. But for Sprague Electric Co., the comeback has been far more satisfying, because its troubles ran deeper than the recession and more than a favorable economic climate was needed to get it back in the black.

And back in the black it is. In 1973, Sprague realized profits of \$11.6 million on sales of more than \$197.6 million, and 1974 promises to be even better. So far, the company has chalked up a record first quarter: \$54.2 million in sales, \$5.4 million in profits.

Four years ago, however, the storm clouds were big and menacing. A 10-week strike at the main North Adams, Mass., plant, while not affecting other operations, scared off customers. Sprague watched its share of the total market in components, including semiconductors and relays, slide from 2% to 0.7%. Already burdened with high overhead from its capital-intensive business and heavy losses, the company had to cut prices to get back into the market at the end of the strike. Meanwhile, customers had signed contracts with other suppliers, and Sprague found itself with low prices and less business.

Furthermore, the semiconductor division, a drain on the company since it was started in 1965, was weakened by the TTL price war of the late 1960s. When recession followed on the heels of the strike, Sprague found itself struggling to keep its head above water—for a while, losses were as high as \$1 million a month. In 1971 sales slumped

to \$117.86 million, down from \$127.5 million in 1970, and losses mounted to \$8.02 million.

In 1970 Neil W. Welsh, who had taken over from founder Robert C. Sprague as chairman of the board and chief executive officer, together with president and chief operations officer Bruce R. Carlson, undertook a program to turn Sprague around. That program included careful cash management to keep losses down. But to get operations costs under control Carlson says the company "had to take drastic and not necessarily pleasant steps. I'm not a believer in the meat-ax approach as a desirable tool of management, but in emergency times drastic measures are sometimes called for."

Job totals dropped, promising programs were cut back, R&D was slashed, and capital equipment expenditure was kept to about \$5 million

Drivers. Bruce R. Carlson, left, Sprague's president, and Neil W. Welsh, chairman, have led the company's comeback to the point where its first quarter of 1974 saw sales soar to a record \$54.2 million, with \$5.4 million of that on the books as profit.

a year, the level of depreciation on old equipment. And neither Welsh nor Carlson had qualms about getting rid of product lines or divisions, even in traditional product areas, if they were unprofitable or did not fit into long-term plans.

TTL, an area where Robert Pepper, technical assistant to Welsh, confesses, "we didn't bring a whole lot of innovation or manufacturing capacity," was de-emphasized, and more attention was paid to linear in-



tegrated circuits for the consumer market. Though the wire-wound-resistor operation in Nashua, N.H., was profitable, Welsh says it was a case of "either beef up or get out," so Sprague chose to sell the facility and concentrate its money elsewhere. Subsidiaries were also shown the door: Vectrol was sold in 1972, Dynacor and Pirgo in 1973.

Doing more. One result of Sprague's effort to tighten up operations was a marked increase in productivity. Although capital-equipment expenditures were kept low for several years—they are not quite back to about \$11 million—Carlson says, "A lot of things came to fruition in 1973 that had been in the works for two to three years." The result was a rise in output per employee from \$11,300 per year in 1971 to \$14,800 in 1973, well above the industry average of \$12,000 to \$13,000.

Also during this period, decision-making was decentralized into three operations groups, for capacitors, for other passives, and for semicon-

ductors. This move, Carlson says, "strengthened our ability to reach quickly to the market, and as a result, when volume came along in 1973, we were able to carry much of the increase through to profits." Still, the cutbacks in capital spending did limit the company's ability to react. For example, Sprague could have used the etched-foil plant for aluminum electrolytics a year before it opened in Clinton, Tenn., in November 1973, had there not still been problems of cash flow.

At the same time as it was cutting back on expenditures and unloading unprofitable operations, Sprague took a major gamble that has paid off handsomely on the balance sheets. The company invested \$3.4 million in Mostek Corp. over a period of one and a half years and now owns 42% of the stock in the Carrollton, Texas, MOS maker, an investment worth \$50 million. "Mostek took a good deal of nerve, with our losses increasing," Carlson admits now, "but the opportunity that appeared to be there was suf-

ficiently attractive that we could not back away from it." With this initial experience Sprague went on to invest in other companies with products ranging from liquid-crystal displays to loudspeakers, as well as retaining a large minority interest in the thin-film division it sold to Hybrid Systems Corp. "We don't necessarily believe the others we've invested in will be Mosteks," concedes Carlson, "but we hope two or three will be significant investments with significant equity appreciation."

This year Carlson expects a good increase in sales volume, though not as dramatic as 1973. He will also work on another

basic strategy to "maximize our participation overseas—potential market growth is greater outside the U.S." Overseas sales now account for 20% to 25% of the total, and this may increase to 40% over the next few years. He is particularly interested in the "transnational sourcing concept" of selling a product anywhere in the world from any source in the world, working to avoid tariff barriers as much as possible for the most profitable results.

Carlson now feels Sprague's turnaround is completed "in the sense that we have done what it was necessary to do in order to get through a period of higher demand and increasing costs. But there is no question that in some product lines we have farther to go than in others." Welsh notes that "we have a lot to do in paper, film, and oil-filled caps." By the mid-1960s it was believed that these would be replaced by semiconductors, but instead demand kept increasing. So Sprague started pouring more money and effort into them and reports that area "made the most dramatic improvement over 1972 outside of ICs."

Moving fast. The semiconductor division, which didn't show a profit until the last quarter of 1972, is now the fastest growing division, and Carlson terms it "a significant factor in our turnaround." Welsh sees "a tremendous market in the IC area" for all types of electronic control in cars, and he feels that ceramics should take off with fuel injection.

But despite the record first quarter, there still may be some clouds on the horizon. Nearly 20% of Sprague's sales is to the automotive industry, which of course was hit hard by the energy crisis. This may be partly offset by increased demand for options like stereo radios in smaller cars and by the increasing penetration of electronics in areas such as fuel injection. Welsh also believes the dip in auto sales will not last, and he expects to see sales pick up within a year. But he also foresees materials shortages "for the next four or five years across the line, although if we get enough high-purity aluminum the foil situation will ease. But some of the materials we once used may not be available again as suppliers find more profitable things." □



Consumer electronics

Is 1974 the year of the digital watch?

C-MOS and display suppliers, eyeing sales of 1.5 million units, think so, but watch companies are less enthusiastic

by Marilyn Offenheiser, Assistant Editor

Digital electronic watches are getting close to the \$100 retail price threshold, now that sales in 1974 are expected to reach as much as a million and a half units—not much to watch makers but a good market for the makers of C-MOS circuitry and displays. Timex says it will have a model on the market this summer at that price, and Speidel, known as a maker of watchbands, says it too is entering the low-price watch market. And Rockwell's Microelectronics Group will soon join other suppliers of components making whole watches

—Hughes, AMI, Intel, and Solitron. Even though one semiconductor supplier calls 1974 "the inceptual year for digital watches," watchmakers like Benrus, Bulova, Gruen, and Hamilton are less sanguine. They base their conservatism on that familiar drawback—the display, with light-emitting diodes using too much power and liquid crystals promising a life of only two years or so. Still, with each watch's electronics costing \$35 to \$80, depending on display, and 45 million watches of all kinds sold in the U.S. alone last

The time is here. Hamilton's Pulsar, below, uses light-emitting-diode display. At right are quartz-crystal C-MOS movement, top, and liquid-crystal display from Cox Electronics Systems. Shortcomings of the two displays—LEDs draw too much power, while liquid crystals have relatively short life—are said to be holding back quicker development of market.

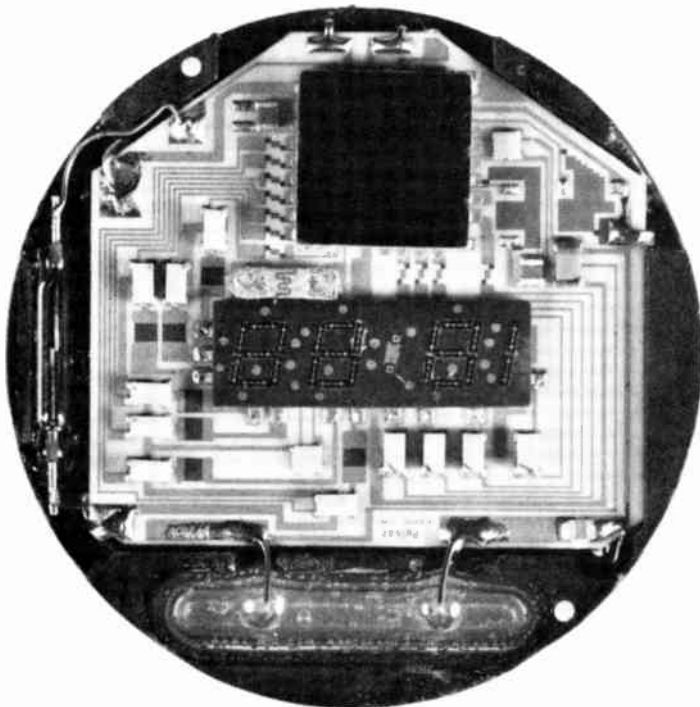

year—worldwide, the figure was 180 million—it's easy to see why there is excitement among component and display suppliers. They include American Microsystems Inc., Hughes, Intersil, Intel (maker of the Microma watch), Inselek, Ilixco, Integrated Display Systems, Optel, and RCA.

John Bergey, president of the Hamilton Watch division of HWM Industries, predicts liquid crystals and LEDs will split almost evenly in 1974, and that digital watches this year will have a mean price of \$210. Hamilton, which made the first digital watch, Pulsar, sold 50,000 digital watches last year.

Yet the Swiss and the Japanese are confident that mechanical watches will be their bread and butter for a long time to come. And even though Switzerland's Ebauches and Japan's Seiko, Citizens, and Sharp are set to introduce digital timepieces, they agree with watch-industry statistics that cite only a 22% market share for digital timepieces in 1980. In contrast, RCA's Sanford Roth, planning administrator for timekeeping products,



MC14510CP	Now \$3.75	Down
MC14536CP	Now \$5.75	Down
MC14555CP	Now \$1.50	Down
MC14556CP	Now \$1.50	Down
MC14581CL	Now \$7.15	Down

More than meets the eye

In CMOS MC14500 series price cut

Price reductions are rare in these days of spiraling inflation, so cuts as high as 56% across practically the complete MC14500 CMOS series should be welcome. We suspect they are. But there is greater significance to these reductions than meets the eye at first glance.

Looking beyond the obvious, it becomes clear that an entire family of outstanding MSI logic functions is placed for the first time in a price range where its devices can compete successfully with small scale ICs, with the "simple gate" design approach. Thus, for designers who elect to use MC14500 Series MSI functions, the system savings related to space, handling, simplicity and reduced PC board requirements become pure bonus.

Our price cuts shape up this way. Of the 39 MC14500 Series types available in the CP plastic packages, 34 received healthy cuts and none went up. Seventy percent of the CL commercial grade ceramic types were reduced, and a few went up very slightly. All wide temperature range AL ceramic types were significantly reduced.

Here are just a few typical examples using 1,000 to 4,999 quantity prices.

BCD Up/Down Counter,	MC14510CP	Now \$3.75,	Down from \$4.77
Programmable Timer,	MC14536CP	Now \$5.75,	Down from \$9.94
Dual Binary to 1 of 4 Decoder/Demultiplexer, (*inverting)	MC14555CP	Now \$1.50,	Down from \$2.60
	MC14556CP*		
4-Bit ALU,	MC14581CL	Now \$7.15,	Down from \$9.75

We've lost track of the number of times we've heard, "Your CMOS MC14500 Series is an outstanding logic family, but I just can't afford it." Now, with yields taking off, and quantities like a million devices hitting the warehouse shelves in May, we can price them where you can afford them. With that many units available, you shouldn't encounter delivery problems. Motorola sales offices and franchised distributors will be pleased to provide further details when they accept your order.

Refresh your memory on what's available. Ask Motorola Semiconductor Products Inc., P.O. Box 20912, Phoenix, AZ 85036 for an up-to-date CMOS* Selector Guide, or circle the reader service number.



MOTOROLA CMOS

—MOS for contemporary systems

*Trademark of Motorola Inc.

Circle 75 on reader service card

10 MHz to 18 GHz detectors using field-replaceable diodes



2-WEEK DELIVERY

You no longer need to sweat out long delivery cycles for crystal detectors, WILTRON can currently supply you with high-performance detectors on a 2-week basis. These are the same detectors that have been time-proven in WILTRON quality instrumentation.

What's more, WILTRON detectors have field-replaceable diodes—an exclusive advantage in the upper part of this frequency range. Replacement diodes are only \$50.

And note that either positive or negative polarities are available as are any of the three common connectors: N, APC, or SMA. No need for adapters.

Other performance parameters are also high. Swr, for example, is unsurpassed and flatness is ± 1 dB over the full range.

CALL NOW

Call Walt Baxter at WILTRON today and get these high-convenience detectors on their way to you.



930 E. MEADOW DRIVE • PALO ALTO, CA. 94303
(415) 321-7428 • TWX 910-373-1156

Probing the news

predicts 25% as a market share in five years.

Bergey, who says Hamilton is working on a solution that will call up the LED display momentarily without a pushbutton, also says the display that will break the digital watch market open hasn't been invented yet. Meanwhile, he sees LEDs being used in the more expensive watches, liquid crystals in cheaper models.

Other attempts at improving the displays are also being made. Inter-sil is trying to modify the one-chip LED module used in its Chronus 1 stopwatch, some liquid-crystal makers are backlighting the displays, and Benrus, says Nicholas Mercurio, senior vice president of operations, is going to introduce a new liquid crystal this fall that will "be very clear without using another light source."

Despite the failings of the displays, a plus for the future of digital watches is that the C-MOS circuitry continues to become simpler. Intel's Tony Livingston, product manager of C-MOS watch circuits, says his company has succeeded in reducing the circuit's components from 50 to 25 and expects to get down to 10.

On the whole, display makers have achieved simplicity by switching to field-effect liquid crystals from the dynamic scattering types. Not only do the new ones provide a clearer readout, but they use less power, and have no need for voltage-conversion components. AMI's Glenn Dumas adds that using a hybrid approach also reduces the components on the substrate. This, combined with AMI's decision to go with liquid crystals and thus get along with only one chip (LEDs require two) and by refining design to eliminate components, tends to reduce complexity still further.

Optel's marketing manager, Peter Stearns, says his company is working on new packaging techniques to reduce complexity, while Integrated Display Systems president Tom Saldi says his company is using new materials. "We've gotten watch thickness down to 0.300 inch," says Saldi, "and we have a prototype watch 0.100 in. thick in test now." □

Proven Ideal for Instrumentation Manufacturers!

High Frequency Counters from PLESSEY.

Most leading manufacturers of 512 MHz counters have one great thing in common: Plessey high-speed divider circuits in the front end of their instruments. The reason for their unanimous choice? Plessey makes the best possible device for their application. Yours, too.

In fact, Plessey Semiconductors offers a comprehensive line of high-frequency dividers up to 1 GHz... all state-of-the-art... all ideal for virtually every counter application.

Divide by 2, 4, 5 or 10

You can specify Plessey counter IC's to divide by 2, 4, 5 or 10. With some decade devices, you get BCD outputs, too. And you get guaranteed frequency of operation over the entire temperature range of 0°C to +70°C on commercial grades, -55°C to +125°C on MIL Grades.

Higher Frequency, Lower Power Consumption

You've probably heard this statement from Plessey before. As usual, nobody even comes close to our input frequencies of up to 1,000 MHz. With an incredibly low power drain, as you can see from the tables.

Plessey offers Custom Counters, too

Send for our data sheet with all the facts. Whatever your counter application, we bet you'll find Plessey has the best approach. And, in the rare case where we don't have a standard counter for your exact requirements, let us quote on a custom. For more information, write or call today. **You'll find it pays to specify Plessey.**

YOUR CHOICE OF HIGH FREQUENCY COUNTERS

Type*	Modulus	Speed (MHz)**	Power Drain (mA typ)
SP600A & B	+4	250	16
SP601A & B	+4	150	16
SP602A & B	+2	500	12
SP603A & B	+2	400	12
SP604A & B	+2	300	12
SP607B	+2	600	12
SP613B	+4	700	60
SP614B	+4	800	60
SP615B	+4	900	60
SP616B	+4	1,000	60
SP620B	+5	400	55
SP621B	+5	300	55
SP622B	+5	200	55
SP630B	+10	600	70
SP631B	+10	500	70
SP632B	+10	400	70
SP634B	+10 w/BCD outputs	700	80
SP635B		600	80
SP636B		500	80
SP637B		400	80

* Guaranteed operating temperature for "A" types—55°C to +125°C. "B" types 0°C to +70°C.

** Guaranteed input frequency range (sine wave).

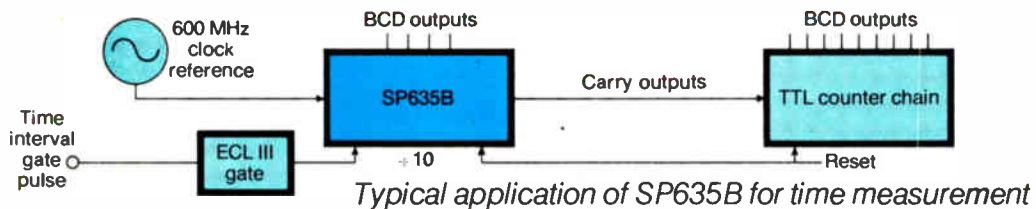
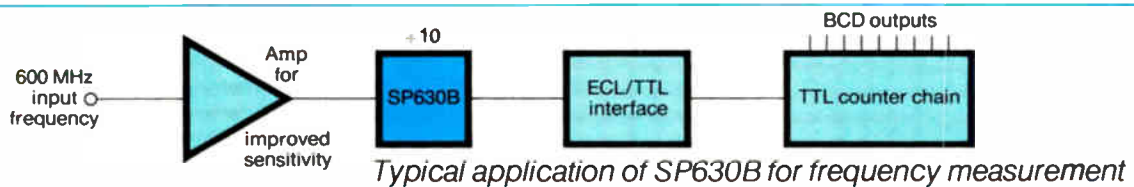

PLESSEY SEMICONDUCTORS

1674 McGaw Avenue, Santa Ana, California 92705, (714) 540-9945



**24-HOUR
DELIVERY!**



SWITCHES



INDICATORS



LAMPS

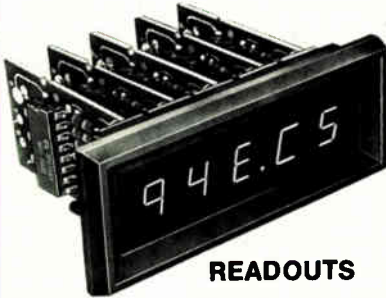

READOUTS

**SAME-DAY SERVICE ON
POPULAR TEC-LITE DEVICES &
ACCESSORIES FOR 1-99 UNITS**

That's right, your order is shipped within 24 hours of receipt — even if you order just 1 item!

We've picked a number of various indicating devices—including our broad line of LED's—for this unique turnaround service. Choose from —

- Switch/indicators and indicators with replaceable lamps
- Green, red and yellow LED's
- Momentary action switches
- LED readouts in sizes to .770"
- Incandescent, neon and LED lamps, plus LED displays

You'll find all the above — and more — in TEC's QUICK DRAW Catalog No. 955, which includes detailed descriptions, prices and ordering information. See your TEC-REP or write or call direct.



9800 North Oracle Road
Tucson, Arizona 85704
(602) 297-1111

INCORPORATED

Probing the news

Industrial electronics

Computers permit Volvo to drop assembly line

Teams of workers assemble cars, system by system, on computer-controlled wagons in Swedish plant

by Robert Skole, McGraw-Hill World News

When Volvo opens its American auto assembly plant in Chesapeake, Va., in the fall of 1976, it will be using a revolutionary assembly method made possible by electronics. Instead of the one-man-one-task assembly line first used by Henry Ford for the Model T, the Swedish company will use a computer-controlled technique that allots each system in a car to a team of workers.

This team approach already is in and working at Volvo's plant located in Kalmar, Sweden. But without computer control, the workers would still have to follow the old tighten-a-bolt work pattern.

At Kalmar, as will happen at Chesapeake, each car being assembled moves around on its own transport wagon. The wagons may be controlled by a central computer, or they may be taken off the line and moved manually. But where the Kalmar plant turns out 30,000 cars a year in one shift, the American plant will produce 100,000 cars an-

nually working two shifts per day.

The way the system works in Sweden, there are 25 teams of about 15 workers each. Each team is responsible for an entire system in the car—interior, electrical controls, wheels, and so on. The team decides for itself how it will work: one person might install an entire system, several people might work together, or each might be responsible for one special detail.

As each body moves into the plant, it is assigned an individual wagon. This is rubber-wheeled and powered by four 12-volt batteries, which are good for one full shift between chargings, at a top speed of 1.8 kilometers per hour. The wagons have three functions: to transport the cars, to carry information, and to serve as a work platform. Volvo will not say how much it paid for the wagons and control system.

When a car body is assigned to a wagon, the wagon number, body number, and details of the car to be

Easy does it. Volvo worker moves battery-operated robot wagon from one position in assembly plant to another. Computer-controlled system will be used in new American plant



the new function generator that breaks some old habits ...for just \$245

At a price that competes with a lot of oscillators and other limited signal sources, Exact's new Model 190 Function Generator will speed up your test program and save you money, too.

Smaller than your telephone book, the 190 gives you pushbutton selection of sine, square, triangle, ramp and pulse waveforms at frequencies from 0.1 Hz to 1 MHz . . . all in one instrument.

It offers some features once found only in more sophisticated generators, such as TTL pulse output, a voltage controlled frequency (VCF) input and DC offset. And if you need complete portability, there's a companion Model 191 for battery operation at only \$350.

Here are the details:

- Waveforms: Sine, square, triangle, pulse and ramp.
- Sine Frequency Response: 0.1 db to 100 kHz; .5 db from 100 kHz to 1 MHz.
- Sine Wave Distortion: Typically 0.5% .
- Variable Time Symmetry for ramp and pulse operation.
- TTL Pulse Output: 25 ns risetime, will sink 20 TTL loads.
- VCF (Voltage Controlled Frequency) Input: Accepts dc to wideband ac frequency modulation, requiring 10-volt input for 1000:1 (three decades) frequency control.
- DC Offset: Variable $\pm 10V$.
- Output: 20 V p-p open circuit, 10 V p-p into 600 ohms.
- Size and Weight: 7 $\frac{3}{8}$ " wide, 2 $\frac{7}{8}$ " high, 8 $\frac{1}{2}$ " deep, weight 2 lbs.
- Delivery: Immediate.
- Price: Model 190 (AC Model) \$245
Model 191 (AC-DC with battery pack and charger) \$350
f.ob. Hillsboro, Oregon

 **EXACT**
electronics, inc.
(A Subsidiary of Danalab, Inc.)
BOX 160, HILLSBORO, OREGON 97123
(503) 648-6661 TWX 910-460-8811

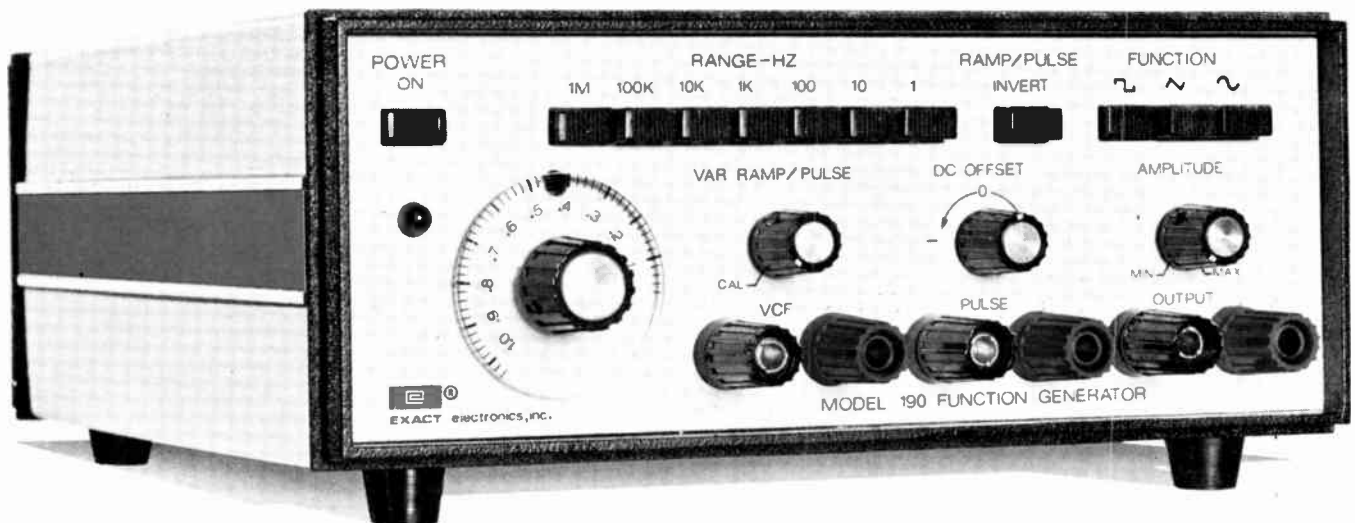

Instruments stocked at these sales and service centers:

Alabama
BCS Associates, Inc., Huntsville, 205/881-6220

Arizona
PLS Associates, Inc., Tempe (Phoenix), 602/957-9110

California
Coherent Marketing Associates, Palo Alto, 415/327-2217
Feeger, Lucas, Wolfe, Inc., North Hollywood, 213/877-5518
Feeger, Lucas, Wolfe, Inc., Newport Beach, 714/540-4412
Feeger, Lucas, Wolfe, Inc., San Diego, 714/277-0993

Colorado
PLS Associates, Inc., Denver, 303/771-0140

Florida
BCS Associates, Inc., Orlando, 305/896-4881

Illinois
Pivan Engineering Inc., Chicago, 312/539-4838

Indiana
Pivan Engineering Inc., Indianapolis, 317/253-1681

Kansas
Pivan Engineering Inc., Shawnee Mission (Kansas City), 913/722-1030

Maryland
Electronic Marketing Associates, Inc., Kensington, 301/881-5300

Massachusetts
Measurement Consultants Corp., Waltham, 617/890-4400

Michigan
Carter, McCormic and Peirce, Inc., Farmington (Detroit), 313/477-7700
Carter, McCormic and Peirce, Inc., Kalamazoo, 616/349-9666

Minnesota
Pivan Engineering Inc., Minneapolis, 612/537-4501

Missouri
Pivan Engineering Inc., St. Louis, 314/567-3636

New Mexico
PLS Associates, Inc., Albuquerque, 505/255-2330

New York
Measurement Technology, Inc., Great Neck (Long Island), 516/482-3500
KLM Associates, New Hartford, 315/735-8525
KLM Associates, North Syracuse, 315/458-6214
KLM Associates, Rochester, 716/442-0820

North Carolina
BCS Associates, Inc., Greensboro, 919/273-1918

Ohio
Carter, McCormic and Peirce, Inc., Cleveland, 216/333-5650
Carter, McCormic and Peirce, Inc., Dayton, 513/278-5873

Oklahoma
Palatine Sales Inc., Tulsa, 918/622-0321

Pennsylvania
Carter, McCormic and Peirce, Pittsburgh, 412/824-3760
Electronic Marketing Associates, Inc., King of Prussia (Philadelphia), 215/248-5050

Texas
Palatine Sales Inc., Austin, 512/451-7463
Palatine Sales Inc., Richardson (Dallas), 214/231-9489
Palatine Sales Inc., Houston, 713/777-4477

Washington
Hayes Technical, Seattle, 206/763-2210

Wisconsin
Pivan Engineering Inc., Brookfield (Milwaukee), 414/786-1940

Canada
Atlas Electronics, Ltd., Toronto, 416/781-6174
Atlas Electronics, Ltd., Montreal, 514/489-8495

In Europe, Africa and the Middle East, Contact Danalab International S.A.
119/121, Rue Anatole Franch 1030, Brussels, Belgium. Tel: 02-414550.
Telex: 846-23662

We chose to call our new Real-Time Spectrum Analyzer **Omniscient*** and we'll continue to!

With a name like that you have to measure up, and the EMR Model 1510 does. It goes anywhere, does any job... It's a Fourier Analyzer, a Spectrum Averager and a Display in one convenient, portable package. And most important, it performs its tasks digitally... no interactive controls to fumble with... no complicated computer interface problems.

But to be Omniscient there must be more... and there is!

- Switch it on, it's ready to operate without calibration
- Analyze a signal repeatedly and get repeatable answers... over and over again
- 60 dB dynamic range at the input and no gimmickry
- Foolproof LED display of signal amplitude, frequency and averaging time
- Control setting status appears on graticule of CRT for permanent photographic record
- Availability of many options... Peak Hold, 3-D Display, Computer Interface, Low Frequency Sync, Any Window, etc.

*Possessed of universal or complete knowledge —

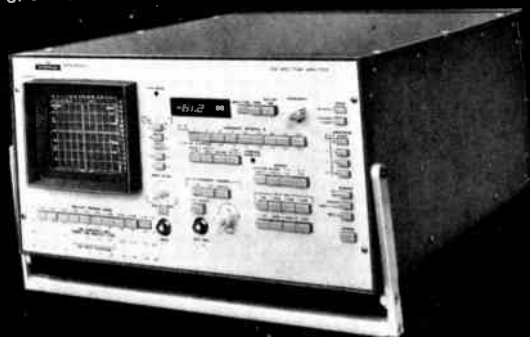

Well... What else could we call it?

Write today for a comprehensive technical brochure or call for a demonstration.

EMR

EMR
Schlumberger

EMR Telemetry
Weston Instruments, Inc.
Box 3041, Sarasota, Florida 33578
813-958-0811

Circle 80 on reader service card

Probing the news

assembled are recorded in one of the four PDP 11/40 computers in the plant.

The wagons, which Volvo calls robot carriers, move from team to team through the plant, guided by an inductive cable buried in the concrete floor. Each wagon carries its own receiver, transmitter, and logic control system, which contains C-MOS circuits. The control system was conceived by Volvo and developed and built by Digitron Co. of Switzerland.

The robot carriers move along the inductive wire automatically. But a worker can stop a carrier, and even pull it off the line, through a manual control device containing nine push-buttons and a potentiometer. Light-emitting diodes signal whether the carrier is positioned properly over the inductive cable, whether it is operating manually or automatically, and whether there is a failure.

Signals. Three computers are used for quality control, production control, and process control, and a fourth serves as back-up for process control. The control system for directing wagons around the plant employs what can be described as a barrier system. When a carrier reaches an inductive loop where a decision to turn or stop has to be made, the carrier transmits a signal to the computer, and only then does the computer reply with the correct control signal.

Each assembly team station has its own computer terminal, consisting of a CRT screen and keyboard. Here are displayed information about production rates for the day, number of cars in that area of the plant, and also any information—such as notice of errors—needed by that specific team.

Teams can enter data to, say, notify the computer that a car has been taken off the line for some reason, and then that it has been returned. Each team station has room available for stacking cars, enabling it to set its own production pace within general limits. Throughout the plant, there is a total of 32 CRT displays, 18 printers (for logging information), and intercom and telephones at each team station. □

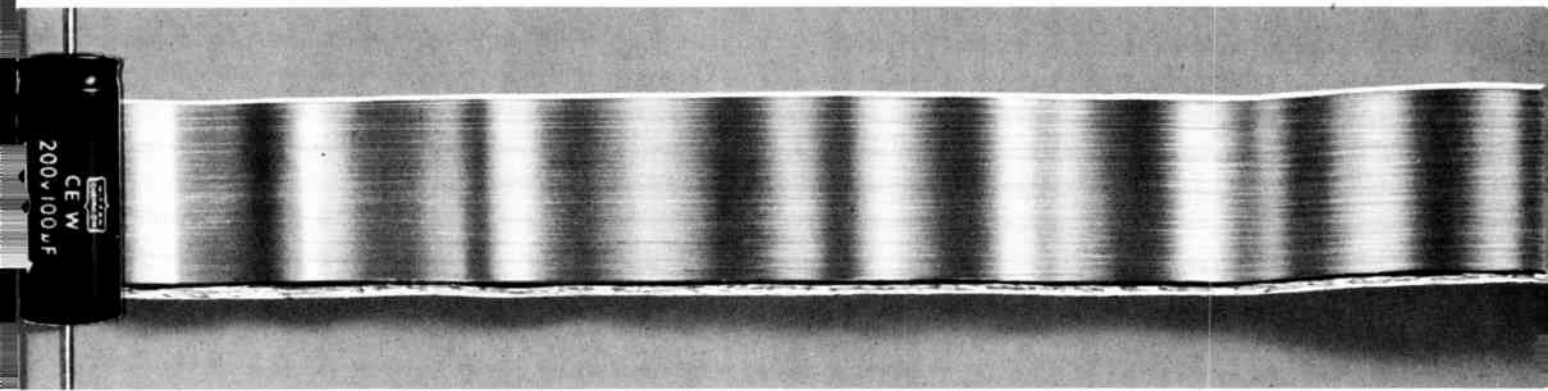

The world's largest manufacturer of miniature aluminum electrolytics wants to show you their etchings.

In the production process of electrolytic capacitors, the etching and forming of the foil is one of the most critical processes. The design of the foil directly affects performance and life.

This is why United Chemicon designs, etches and forms all its own foil and achieves complete quality control of every one of the over 60 million miniatures we sell each month. We know that we must use exactly the right type of foil to meet our customers' specific performance characteristics. That's why we welcome special, tough applications.

Now that you know more about our etchings, you should also know that our special machinery division designs, develops and builds all our machinery. Every capacitor is automatically aged and 100% tested.

This control guarantees an unparalleled degree of product uniformity, predictability and reliability of supply.

Shouldn't you know us?

Write, call 315/474-2954
or wire for full information
and latest technical bulletins.

6.3 to 500 WV, op temps from -40° to +85° C.
We solicit inquiries to your specs, as broader temperature ranges and performance characteristics are available.



United Chemicon.

World's largest manufacturer of miniature aluminum electrolytics. You should know us.

©1974 United Chemicon, Inc. 731 James Street Syracuse, New York 13203 315/474-2954 TELEX 937439



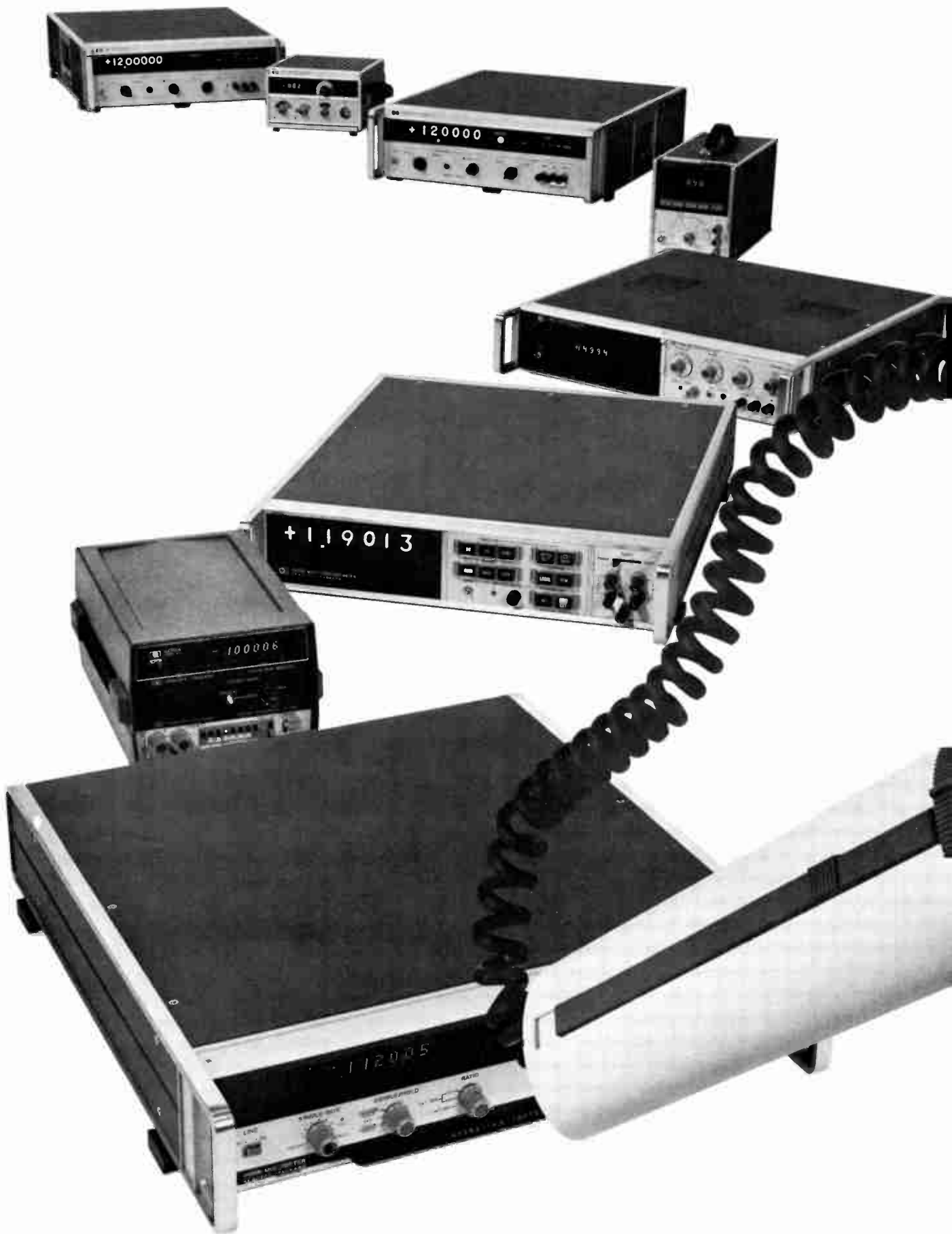

HP's Family Planning Means A DVM To Match Your Budget And Your Needs.

An HP DVM Built For Your Needs . . . all the way from troubleshooting in the field to complex systems in the plant. Whether you need a general-purpose instrument or one dedicated to a specific task such as measuring true RMS, we can supply it. With our modular and plug-on approach we can even combine general-purpose and specialized functions. HP's innovation and advanced technology are on your side to help solve your measurement problems. Look at the capability you can obtain in just five instruments from our broad product line.

Low-cost 970A Probe Multimeter packs a lot of performance in a seven-ounce package. Probably the easiest-to-operate probe multimeter ever made,



this 3½-digit instrument has only two selectors; one for choosing DC V, AC V or ohms, the other for inverting the LED readout. With AUTO ranging, AUTO polarity and AUTO zero you only have to touch the probe to your test point to take a reading. And it's overload-protected. Powered by a nickle-cadmium battery, this one is completely portable. Use it in the lab or pocket it and take it with you in the field. It's designed to simplify your measurement tasks from start to finish. You can operate it single-handed, right side up or upside down. The inverting switch lets you read the display either way. And you read it right at the test point. At just \$310* the 970A probe multimeter is a real bargain.

Self-Test 3490A makes double use of its internal ICs to bring you HP's "Self-Test" capability without extra cost. The basic 5-digit 3490, ready to measure AC, DC and ohms, sells for only \$1,785*. At low added cost you can have isolated BCD output and remote control or the versatile General Purpose Interface Bus for systems applications. Compare the 3490A with any other multimeter in its class and you'll find an unusual blend of features and performance for the money.

Snap-On 3470 Series lets you custom-build your own measurement system. Starting with a 4½- or 5½-digit LED display unit, you add only those modules you need. Get 4½-digit DC only for \$530*, or 5½-digit DCV/DCA/Ohms for

\$1,200*. Add a battery pack for \$220*, BCD output for \$189* or an HP "Self-Test" accessory for only \$50*. With this series you don't have to worry about obsolescence.

Multi-Mode 3450B lets you add up to 12 modes of high-accuracy measurement capability to your automated system. You can have true RMS, 4-terminal ohms and the unique limit test in addition to the usual functions. The 3450 is both fast and accurate. You get 15 readings/sec. and DC accuracy to ±(0.008% of reading + 0.002% of range). Prices start at \$3,785* for the 5-digit DC volts and Ratio model, go to \$6,616* for total 12-mode capability.

Speed Star 3480C/D is systems oriented, but fine for the bench as well. This 4-digit, ±0.01% unit in DC delivers a fast 1,000 reading/sec. Get the exact capability you need by selecting plug-ins. For example, you can have DC, ohms and true RMS AC for \$3,370* (isolated BCD output and remote control are low-cost options). Sample and hold option lets you take peak readings or do transient analysis.

HP's family of DVM's also includes high-performance AC V, DC A and ohms (Model 3469B at \$760*), resolution of 1 PPM (Model 3462A at \$5,835*), true RMS to 100 MHz (Model 3403C from \$1,895*) and for systems use, the 2402A with outstanding noise rejection at high measurement speeds from \$8,000*. No matter what your measurement needs, check HP for a solution to your problem. For more information on how HP's DVM family can help you, contact your local HP field engineer or fill out the coupon below and mail it in.

For helpful information on DVM measurement techniques, send for our 72-page application note AN-158 entitled "Selecting the Right DVM."

*Domestic U.S.A. prices.



Sales and service from 172 offices in 65 countries.
1501 Page Mill Road, Palo Alto, California 94306

094-004

I'm interested in your DVM line. Please send me:

More information on the 970A Probe Multimeter.

More information on the DVM family.

Application Note 158 "Selecting the Right DVM."

Name _____ Dept. _____

Company _____

Street _____

City _____ State _____ Zip _____

Mail coupon to:
Hewlett-Packard, 1501 Page Mill Road, Palo Alto, California 94306

E4/16/74

NEW VALUES HIGH ENERGY

TYPE	$I_C(\text{max.})$	V_{CE0}	V_{CEV}	$V_{CE0}(\text{sus.})$	$V_{CE}(\text{sat.})$ @ I_C, I_B	Power Dissipation (max.)	h_{FE} min./max @ I_C, V_{CE}
DTS-701	1.0 A	800V	—	600V	—	50W	20/— @ 150mA, 5V
DTS-708	3.0 A	900V	900V	600V	2.0V max. @ 1.0A, 250mA	50W	—
DTS-709	3.0 A	900V	900V	600V	1.0V max. @ 2.0A, 800mA	50W	—
DTS-710	3.0 A	900V	—	600V	—	50W	10/50 @ 150mA, 5V
DTS-712	3.0 A	900V	1200V	700V	—	50W	2.5/— @ 2.0A, 5V
DTS-714	3.0 A	900V	1400V	700V	—	50W	2.5/— @ 2.0A, 5V
DTS-723	3.0 A	1000V	1200V	750V	0.8V max. @ 1.0A, 250mA	50W	10/— @ 500mA, 5V
DTS-801	2.0 A	800V	—	700V	—	100W	20/— @ 200mA, 5V
DTS-812	5.0 A	900V	1200V	700V	—	100W	2.2/— @ 3.5A, 5V
DTS-814	5.0 A	900V	1400V	700V	—	100W	2.2/— @ 3.5A, 5V

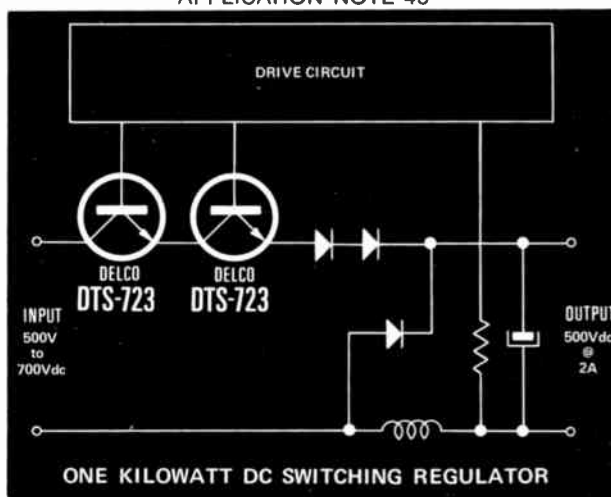
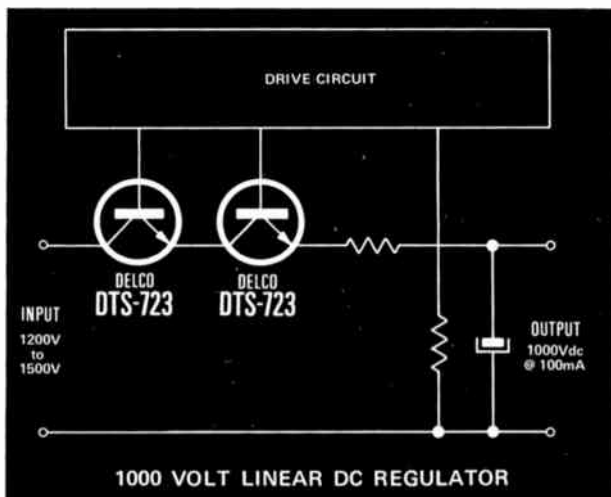

Delco Electronics has made it possible for your Delco distributor to offer you better values than ever on these ten silicon high-power transistors. What's more, he has them in stock now and there's a healthy factory inventory to back him up.

These high quality, high voltage devices are all NPN, triple diffused, and packaged in Delco's solid-copper TO-204MA (TO-3) case.

Some are specifically designed for use in high voltage switching circuits where inductive loads or fault conditions pose problems. Some are ideal for linear regulators and power amplifiers.

In fact, all the devices share Delco's reputation for being ideal where circuit conditions and high energy requirements are a concern. And because they're 100 percent pulse energy tested, you know they're rugged.

The circuit diagrams in this ad will give you a quick reading of how these ten transistors can meet your needs.

Applications literature and complete device data are available from your Delco distributor.

Give him a call for the information you need and the delivery promises and prices you'll like.

**NOW AVAILABLE FROM THESE DISTRIBUTORS
IN PRODUCTION QUANTITIES.**

ALABAMA, Birmingham
Forbes Distributing Co., Inc.
(205) 251-4104

ALABAMA, Huntsville
Powell Electronics
(205) 539-2731

ON DELCO'S TRANSISTORS.

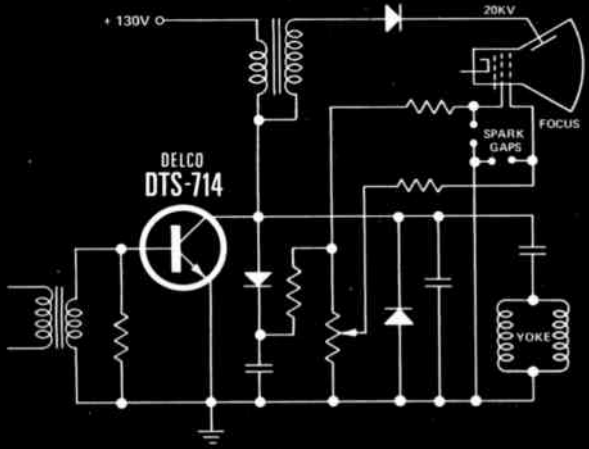

130V MONOCHROME HORIZONTAL CRT DEFLECTION

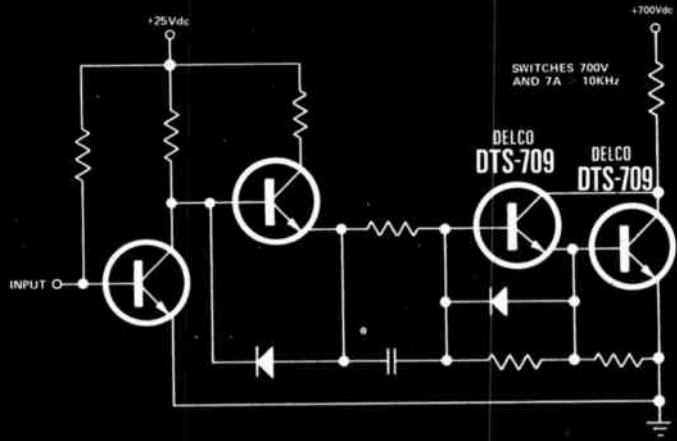

HIGH SPEED SWITCHING CIRCUIT

APPLICATION NOTE 54

ARIZONA, Phoenix
Sterling Electronics, Inc.
(602) 258-4531

CALIFORNIA, Goleta
R.P.S. Electronics, Inc.
(805) 964-6823

CALIFORNIA, Los Angeles
Kierulff Electronics, Inc.
(213) 685-5511

CALIFORNIA, Los Angeles
R.P.S. Electronics, Inc.
(213) 748-1271

CALIFORNIA, Palo Alto
Kierulff Electronics, Inc.
(415) 968-6292

CALIFORNIA, San Diego
Kierulff Electronics, Inc.
(714) 278-2112

CALIFORNIA, San Diego
R.P.S. Electronics, Inc.
(714) 292-5611

COLORADO, Denver
Kierulff Electronics, Inc.
(303) 371-6500

CONNECTICUT, Norwalk
Harvey Electronics
(203) 853-1515

FLORIDA, Miami Springs
Powell Electronics/Florida
(305) 592-3260

FLORIDA, Orlando
Powell Electronics/Florida
(305) 859-1450

ILLINOIS, Rosemont
Kierulff Electronics, Inc.
(312) 678-8560

ILLINOIS, Skokie
Bell Industries
Electronics Distributors Div.
(312) 282-5400

INDIANA, Indianapolis
Graham Electronics Supply, Inc.
(317) 634-8202

INDIANA, Indianapolis
Harvey-Indiana
(317) 297-4910

MARYLAND, Baltimore
Radio Electric Service Co.
(301) 823-0070

MASSACHUSETTS, Needham Heights
Kierulff Electronics, Inc.
(617) 449-3600

MASSACHUSETTS, Newton
The Greene-Shaw Co., Inc.
(617) 969-8900

MICHIGAN, Farmington
Harvey-Michigan
(313) 477-1650

MINNESOTA, Minneapolis
Stark Electronics Supply Co.
(612) 332-1325

MISSOURI, Kansas City
Walters Radio Supply, Inc.
(816) 531-7015

MISSOURI, North Kansas City
LCOMP-Kansas City
(816) 221-2400

MISSOURI, St. Louis
LCOMP-St. Louis
(314) 647-5505

NEW JERSEY, Clifton
Wilshire Electronics/New Jersey
(201) 365-2600 (212) 244-8930

NEW YORK, Binghamton
Harvey Electronics
(607) 748-8211

NEW YORK, Buffalo
Summit Distributors, Inc.
(716) 884-3450

NEW YORK, Farmingdale
Wilshire Electronics/Long Island
(516) 293-5775

NEW YORK, Woodbury
Harvey Electronics
(516) 921-8700 (212) 895-9260

OHIO, Cincinnati
United Radio, Inc.
(513) 761-4030

OHIO, Cleveland
Pattison Supply Co.
Industrial Electronics Division
(216) 441-3000

PENNSYLVANIA, Philadelphia
Almo Electronics
(215) 676-6000

PENNSYLVANIA, Pittsburgh
RPC Electronics
(412) 782-3770

SOUTH CAROLINA, Columbia
Dixie Radio Supply Co., Inc.
(803) 253-5333

TEXAS, Dallas
Adleta Electronics Company
(214) 741-3151

TEXAS, Fort Worth
Adleta Electronics Company
(817) 336-7446

TEXAS, Garland
Kierulff Electronics, Inc.
(214) 271-2471

TEXAS, Houston
Harrison Equipment Co., Inc.
(713) 224-9131

WASHINGTON, Seattle
Kierulff Electronics, Inc.
(206) 763-1550

IN CANADA
ONTARIO, Scarborough
Lake Engineering Co., Ltd.
(416) 751-5980

ALL OVERSEAS INQUIRIES:
General Motors Overseas Operations
Power and Industrial Products Dept.,
767 Fifth Avenue, New York, N.Y.
10022. Phone: (212)-486-3723.

Delco Electronics
Regional Sales Offices

Union, New Jersey 07083
Box 1018 Chestnut Station
(201) 687-3770

Van Nuys, California 91404
Box 2968
(213) 988-7550

General Sales Office
700 E. Firmin, Kokomo, Ind. 46901
(317) 459-2175
Operator (317) 457-8461



Delco Electronics, Division of General Motors.

This chip
is the world's first
SOS processor.



It makes all the
stuff on the next page
possible.

Silicon-on-sapphire isn't new. The aerospace industry and the military have recognized its high-speed, high-density and high-reliability characteristics for years.

But no one was ever able to use it in a computer processor.

Until now.

Now General Automation designers have built the world's first commercial processor using SOS technology.

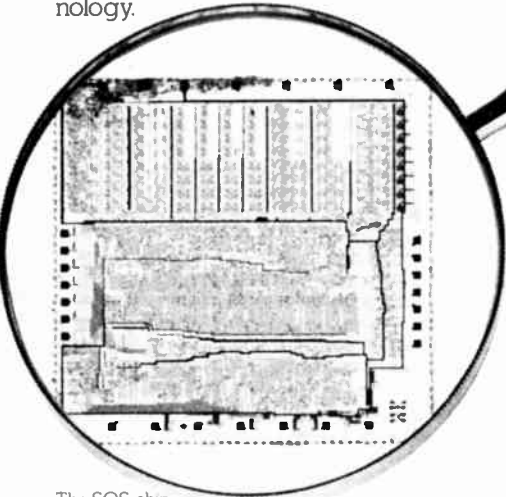

The SOS chip magnified 16 times

They've placed 2000 gates or the equivalent of 4000 to 5000 transistors on a single semiconductor chip.

An 800 times size reduction from its predecessor product, the SPC-12.

The world's first microcomputer.

That tiny SOS chip has made it possible to bring you the LSI-12/16. A complete digital automation microcomputer with from 1K to 32K bytes of semiconductor memory.

We call it the world's first microcomputer because it's the only



The board only system

microproduct available that gives you the performance, the systems features, the reliability and the applications support you would normally expect from a minicomputer.

More work, less money.

In the past this kind of size reduction

always meant you had to make major concessions in performance.

With SOS you make none.

The LSI-12/16 has an instruction execution cycle time of 2.64 microseconds.

It's faster than any microprocessor on the market.

It's more powerful. And lower in cost. In board-only configuration with 1K memory, it costs only \$495 in minimum OEM quantities of 1000 per year. In short, we offer all the performance of a minicomputer at microprocessor prices.

Breakthroughs across the board.

The LSI-12/16 is the first microproduct to successfully put all of the following on a single board: A processor, power fail/auto

unique built-in ROM patch that lets the user retrofit new instructions to any ROM.

Custom tailoring.

There's one more advantage the LSI-12/16 has that no other microproduct can offer.

It's the systems backup and application expertise that General Automation gives you. Helping solve customer problems has always been our long suit. It still is.

We can customize I/O boards and match the LSI-12/16 exactly to your requirement.

Our microcomputer is available in one of two different configurations:

As a board-only system, packaged with memory, control console and processor on a single 7-3/4 by 10 inch printed circuit board.

Or the same board packaged in an enclosure with power supply, battery backup for semiconductor memory and card slots for additional I/O boards.

For more information, write

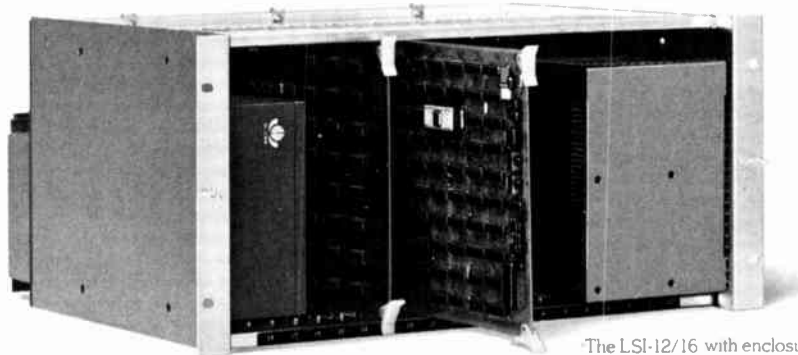

The LSI-12/16 with enclosure

restart, remote cold start, 16 bit parallel I/O interface and up to 2K bytes of semiconductor memory.

But we didn't stop there.

GA engineering has also overcome the problems associated with semiconductor memory. Like loss of data in the event of power failure.

We handled that by developing an auxiliary battery backup system that will activate immediately upon loss of power and will retain the contents of memory for up to 15 hours.

In case you're interested in more memory, we've designed a piggyback board that will give you an additional 2K of RAM or 8K of ROM.

And if there's ever an error in ROM programming, it can be corrected. The LSI-12/16 has a

General Automation, 1055 South East Street, Anaheim, California 92805. Or call us at (714) 778-4800.

Our European headquarters is at Centre Silic, Cidex L242, 94533 Rungis, Paris, France. Call 686-7431.

GENERAL AUTOMATION

A new generation of computer processors is beginning. All because of this.



10,000 meters later...



A little over a year ago we introduced a new 4½ digit multimeter.

The 245.

Small enough to fit in the palm of your hand. Big enough to do whatever you wanted it to do.

Almost immediately people recognized it as "a revolutionary step in miniaturized instrumentation."

It still is.

Today, more than 10,000 Model 245's later, it is still the smallest, lightest and most accurate 4½ digit multimeter you can buy.

It sells for less than \$300.00.

\$295.00
COMPLETE.

Model 245 is a rugged, truly miniature, lab-quality 4½ digit multimeter that measures AC volts, DC volts, AC current, DC current and resistance with .005% resolution and a basic accuracy of ±.05% with 100% overranging.

DC Volts, 1 volt to 1000 volts full scale, 100µV resolution.

AC Volts, 1 volt to 500 volts RMS full scale, 100µV resolution, 30 HZ-50kHz.

DC Current, 1 ma to 1A f.s., 1µA resolution.

AC Current, 1 ma to 1A f.s., 1µA resolution, 30 HZ-50kHz.

Resistance, 1 KΩ-10MΩ full scale, 100 milliohms resolution.

To get your hands on this remarkable instrument, simply contact your local sales representative for immediate delivery.

AL	(205) 533-5896	MA	(617) 273-0198	NY (S)	(516) 482-3500
AZ	(602) 994-9519	MO	(301) 552-2200	OH (N)	(216) 725-4560
CA (N)	(408) 733-9000	MI	(313) 482-1229	OH (S)	(513) 298-3033
CA (S)	(714) 540-7160	MN	(612) 781-1611	OR	(503) 238-0001
CO	(303) 449-5294	MO (W)	(816) 737-0066	TX (N)	(214) 234-4137
CT	(203) 525-7647	MO (E)	(314) 731-2331	TX (S)	(713) 461-4487
FL	(813) 294-5815	NC	(919) 787-5818	UT	(801) 268-3181
GA	(404) 457-7117	NJ (S)	(215) 925-8711	WA	(206) 763-2210
HI	(808) 262-6286	NJ (N)	(201) 863-5660	CAN (W)	(416) 787-1208
IL	(312) 593-0282	NM	(505) 265-6471	CAN (W)	(613) 772-5874
IN	(317) 293-9827	NY (N)	(315) 446-0220	CAN (E)	(514) 731-9328

Data Precision Corporation, Audubon Road,
Wakefield, MA 01880
Phone (617) 246-1600

 **DATA PRECISION**
...years ahead

Film-carrier technique automates the packaging of IC chips

With wages rising and offshore assembly losing some of its appeal, automation is replacing traditional labor-intensive wire-bonding—slashing production costs and boosting assembly rates tenfold

by Stephen E. Grossman, *Packaging & Production Editor*

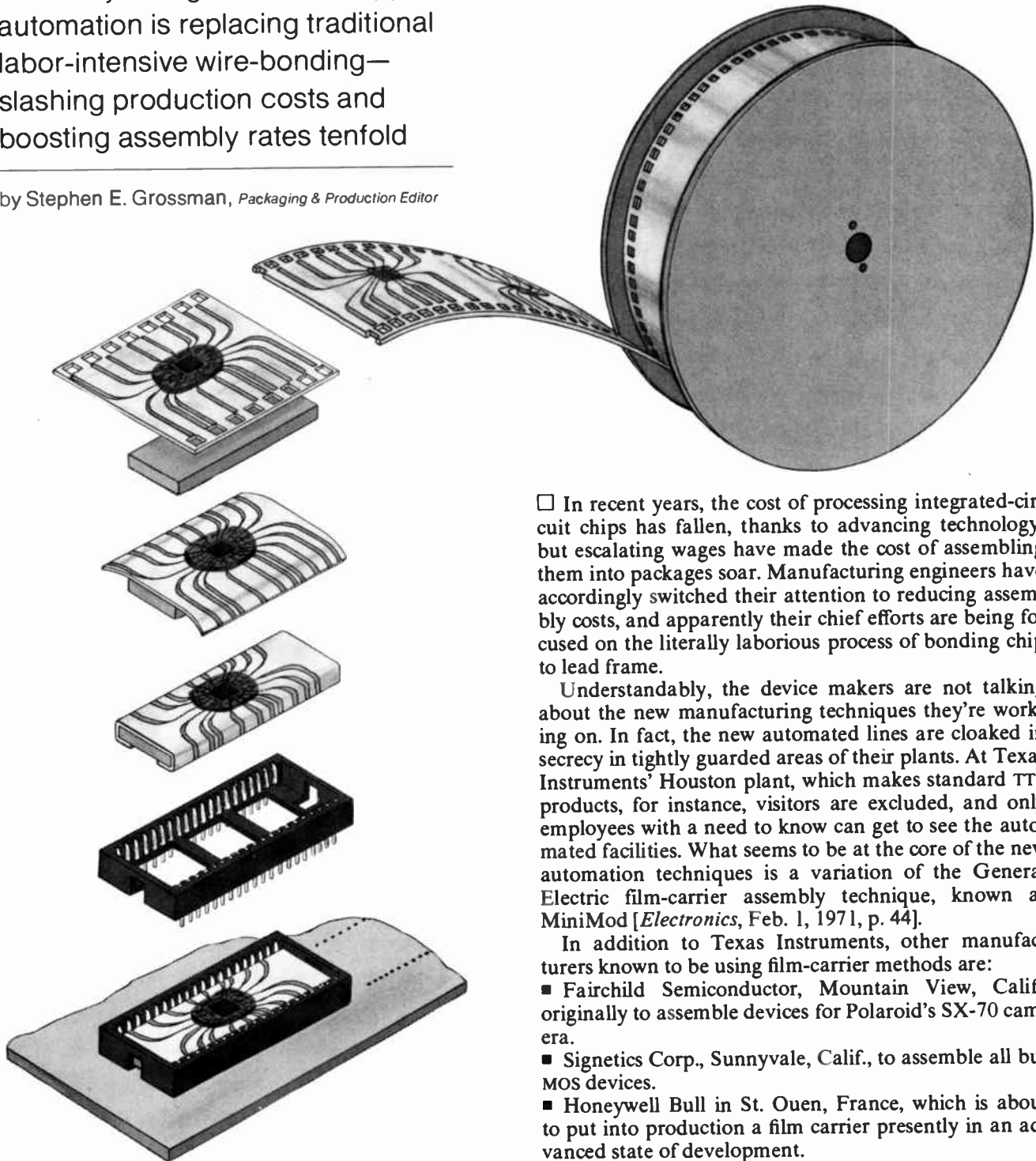

□ In recent years, the cost of processing integrated-circuit chips has fallen, thanks to advancing technology, but escalating wages have made the cost of assembling them into packages soar. Manufacturing engineers have accordingly switched their attention to reducing assembly costs, and apparently their chief efforts are being focused on the literally laborious process of bonding chip to lead frame.

Understandably, the device makers are not talking about the new manufacturing techniques they're working on. In fact, the new automated lines are cloaked in secrecy in tightly guarded areas of their plants. At Texas Instruments' Houston plant, which makes standard TTL products, for instance, visitors are excluded, and only employees with a need to know can get to see the automated facilities. What seems to be at the core of the new automation techniques is a variation of the General Electric film-carrier assembly technique, known as MiniMod [*Electronics*, Feb. 1, 1971, p. 44].

In addition to Texas Instruments, other manufacturers known to be using film-carrier methods are:

- Fairchild Semiconductor, Mountain View, Calif., originally to assemble devices for Polaroid's SX-70 camera.
- Signetics Corp., Sunnyvale, Calif., to assemble all but MOS devices.
- Honeywell Bull in St. Ouen, France, which is about to put into production a film carrier presently in an advanced state of development.

MiniMod and its variants use a plastic carrier, resembling movie film, that has lead frames mounted along its surface. A gang-bonding technique, faster and potentially more reliable than wire-bonding, attaches each film-mounted lead frame to an IC chip in a single, swift stroke. The bonded chips are reeled onto a take-up spool, ready to be attached to a flexible or rigid board or encapsulated in a ceramic or plastic IC package.

Such film-carrier techniques are the great hope of hard-pressed IC-manufacturing engineers, not just because they promise to reduce the labor content of each IC, but because they can increase production volume tenfold and ease lead time in plants that long since may have become capacity-limited. (In recent years, offshore assembly had lightened the delivery burden a little, but it had become evident that there would never be enough hands in the Orient or anywhere else to deliver the product in the quantities forecast for the coming years.) And there is a dividend because the gang bond, an integral part of the film-carrier technique, may eliminate the perennial headache in small-chip, high-volume IC assembly—the wire bond.

Wire-bonding woes

Wire-bonding is the most commonly used method of making connections from the silicon IC chip to the outside world. Although it has the advantage of not imposing tight dimensional tolerances, wire bonding is usually a manual, one-bond-at-a-time process and is therefore slow and costly.

Typically, an operator peers through a microscope to position the bonding tool by hand and to bond a wire to a pad on the chip and then to a finger of the lead frame, again by hand. She repeats the sequence at each chip pad. Thus, if she is assembling 14-lead devices, she must make 28 bonds per device—one at each end of 14 wires. At one bond per second, she finishes about one IC per minute, or about 60 per hour. Assume her labor costs her employer \$10 an hour, then the labor content of the device, for wire-bonding alone, is about 16 cents. This is a heavy labor burden for a device that must sell for less than a dollar. Also, 16 cents is more than the cost of the chip (maybe no more than a penny) or the package (worth about a nickel).

There are automatic wire-bonders on the market, but they can't, as yet, deliver products in the volumes that manufacturing engineers seek—upwards of a 1,000 devices per hour.

Worse still, the wire bond is responsible for many IC field failures. The failure often occurs at the heel where the bonder tool has work-hardened the wire, forming small microcracks. So if the bond experiences any stress, whether from thermal excursions, physical shock, or perhaps lift-off due to the expansion of the plastic encapsulating material, failure is very likely. A wire bond seldom survives a pull of more than 15 grams.

A number of techniques have challenged the wire bond. The controlled-collapse flip chip has IBM's backing, and beam-lead devices are on stream at Western Electric. But these alternatives are costly and do not adapt easily to the large catalog of chip geometries in major IC houses.

Thus, a welcome is assured any technique that ade-

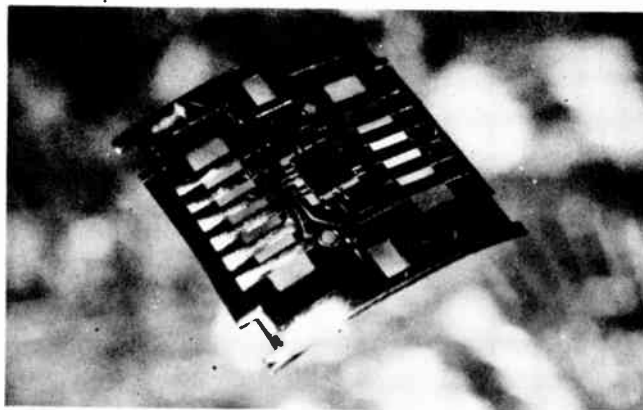

1. **Chip shot.** When an IC is mounted on a film carrier, no die-attach is necessary, and wire bonding is replaced by gang bonding, which boosts assembly rates tenfold. Film-carrier assembly may become standard throughout the IC industry within five years.

quately bonds small-chip ICs in volume at a reasonable cost. And automated film-carrier assembly appears to be receiving that welcome.

In the film-carrier approach, a film, usually polyimide, carries a copper lead frame. Figure 1 shows a chip mounted to such a film carrier. Note that 15 inner leads support the chip over the window in the film but only 11 function as circuit connectors. These leads are gang-bonded (i.e. bonded simultaneously, as a gang) to the pads on the chip by an inner-lead bonder. The two narrow rectangular regions enable the outer leads to be formed by a blanking or punching operation, which removes the extremities of the film so that the outer leads can extend in a cantilever fashion. They are later gang-bonded to a package—a dual in-line, perhaps, or a flexible or rigid circuit board.

The sprocket holes along the sides of the film serve two functions: they enable the drive mechanism in the inner-lead bonder to advance the film after a chip has been bonded, and they also serve to register the lead frame precisely over the chip, ensuring that each lead is centrally located over its own pad on the die.

These two functions mesh with the needs of gang-bonding, which requires a transport system to handle the film and a means of registering lead frames over chips, as well as a tool to apply heat and pressure.

Gang-bonding

Figure 2 illustrates a typical bonding sequence. In Fig. 2(a), the film, with lead frame attached, is positioned directly above the row of chips. The gang-bonder descends (b and c), attaching all leads to the bonding pads in a single stroke. In (d), the carrier assembly rises, lifting the bonded chip free of the table. Finally, the film-transport system moves the film to the right, bringing a new lead frame into bonding position, and the row of chips shifts left, bringing the next chip into bonding position and completing the bonding cycle (e).

Several companies have inner-lead bonders for film carriers in development, but West Bond's model 8800 film bonder (Fig. 3) is on the market right now. With reel motors, X-Y table for manual registration, and lead former, it carries a price tag of \$11,665.

Designed for solder reflow, the 8800 employs a step-

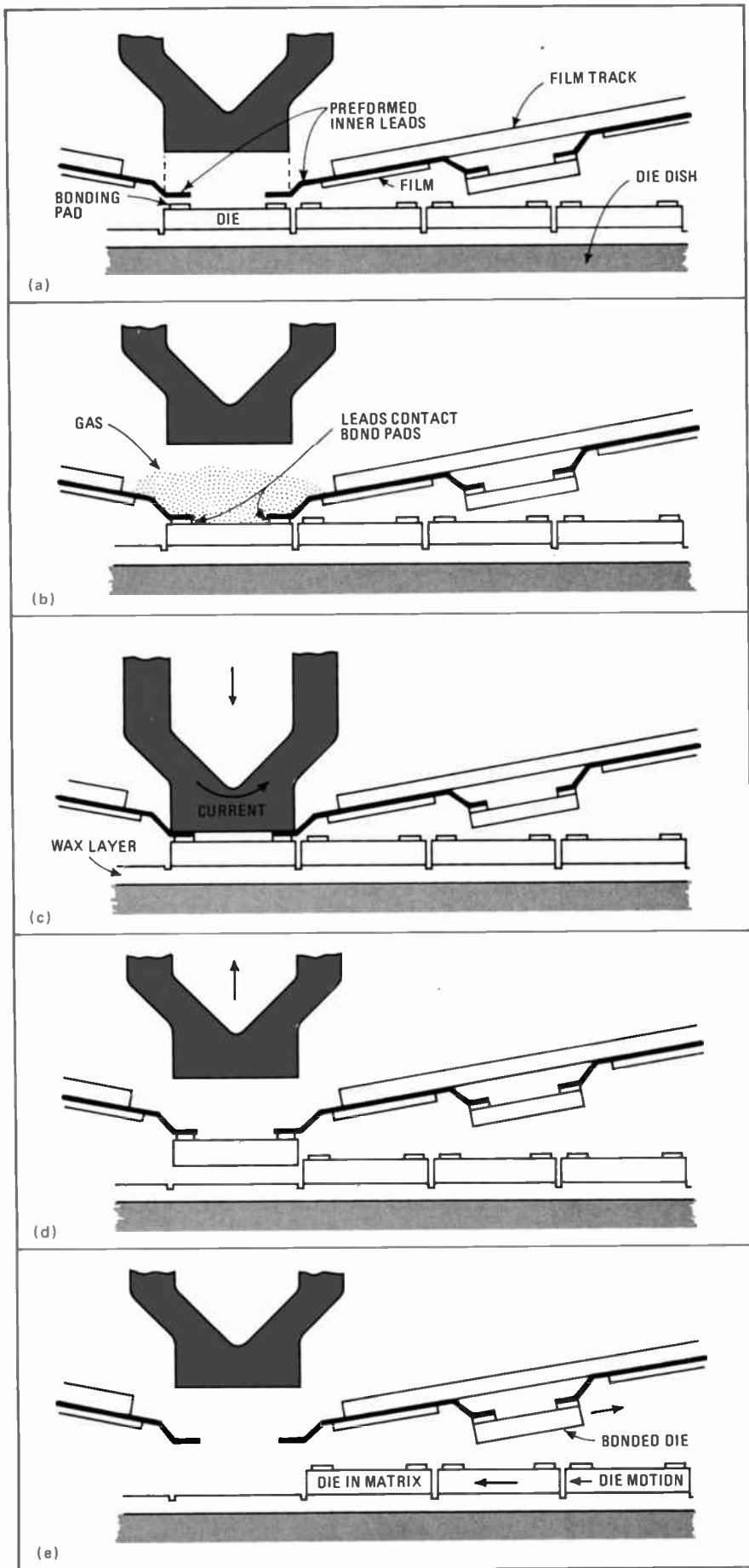

2. Bonding a film carrier. For alignment (a), preformed inner leads are lowered to position just above the bonding pads on the die, which is secured to the plate by wax. Die is viewed optically and aligned, manually or automatically. As bonding step begins (b), film is positioned to bring inner leads into contact with die bumps. An inert gas flushes away the ambient environment. In bonding (c), tool descends, pressing inner leads against die pads. Pulsed electric current heats the bonding tool, forming bond between the leads and the bonding pads. Heat also melts the wax, which releases the die. After bonding (d), the film track is raised, lifting the bonded die clear of the wax. Finally, film is indexed (e) to the right, bringing a new set of inner leads into bonding position. X-Y table is indexed to the left, bringing the next die into bonding position.

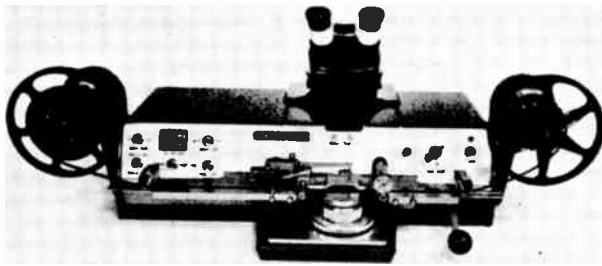

3. In the flesh. West Bond's machine bonds chips to lead frames carried by film. Stepper motor advances the film in 5-mil increments at speeds of 1.5 inches per second. Each chip is aligned manually by positioning the circular anvil directly below the microscope.

per motor to advance the film and an induction motor to provide the necessary film tension. An anvil work holder, shown directly below the microscope, supports the chips. The bonding-tool travel is motorized and requires about 375 milliseconds to move into the bonding position. It can bond approximately 1,000 chips per hour.

This bonding rate is more than 10 times faster than wire-bonding rates. It is directly due to the replacement of the many steps of wire-bonding with the single gang-bonding step, in which all leads are bonded to all chip pads at once.

Moreover, the actual bonds are stronger. Bond strengths of 60 grams per lead are readily attainable—about four times better than with wire. Also, the copper leads, typically 3 mils wide by 1.4 mils thick, provide a better thermal path than a 1-mil wire.

Then there is the matter of gold. Conventional gold-plated lead frames today sell for about 3 cents each in high volume, but about half the cost is the gold in the die-attach area. Since the film-carrier technique requires no die-attach, the film-carrier lead frame in the 16-mm format could eventually fall below 2 cents apiece.

On the debit side, the plastic carrier plays essentially no role once the bonding is done, yet unprocessed polyimide film comes expensive at about 1/2 cent per device. There are also stability problems, since even small changes in the film's dimensions, on the order of a mil or so, go a long way toward hampering efforts to achieve high-volume automation.

Changes all around

A switch to gang-bonding breaks new ground, because the materials and the geometry have changed. The leads are copper foil, not the round gold and aluminum wire familiar from wire bonding. So the process engineer, who spent years bringing respectability to the wire bond, must begin again, selecting and then perfecting a technique that can deliver a reliable, inexpensive bond. Fortunately, he has a wide choice of both bonding methods and bonding metals.

Thermocompression bonding, as the name suggests, employs heat and pressure to create adhesion between mating parts. A combination of plastic deformation and diffusion brings the molecules of the mating materials

into intimate contact, thereby creating adhesion. Though temperature is raised to achieve a bond, it is not elevated to the point where the mating metals actually melt.

Eutectic bonding depends on an alloy being formed between two mating materials. The composition of the alloy is described as eutectic when the molten material, as it cools, goes from liquid to solid instantly, without passing through a semisolid, mushy stage.

Soldering is unique in that it makes use of a third metal, which may be an alloy, to bond both the mating parts. Its success depends on the ability of the solder to wet and form sound bonds with both mating parts. A drawback of soldering is that the joining surfaces must be fluxed, and since fluxes are usually corrosive, all traces of them must be removed after the bond is formed.

Selecting metals suitable for joining the silicon chip to the lead frame requires a process engineer to choose from a wide range of metallurgical alternatives, many of which are closely guarded company secrets. Nonetheless, there are certain metallurgical systems whose usefulness is common knowledge.

Building bumps

The metallurgical systems used for gang-bonding usually require a bump, perhaps 1 mil high, on each pad of the chip. The bump provides a bond interface with the lead frame on the film carrier. Not all the bumps will be exactly the same height, yet they must be bonded simultaneously. But if they are ductile, the higher ones will be compressed as the bonding tool forces the leads against the chip, assuring that both high and low bumps bond to the lead frame.

The bump is built on a first-level metalization, usually aluminum. It consists of one, or perhaps two, barrier metals, plus a capping material, which is selected for the best bonding properties possible with the bonding method selected—eutectic, solder, or thermocompression. The barrier metals prevent the aluminum and capping metal from diffusing into each other. The layers are built up on the silicon chip by means of one or more varieties of thin-film deposition techniques. (See "A guide to film-carrier metallurgy," p. 93).

However, compatibility problems are not confined to the device. The film carrier has its problems, as well. Marrying a flexible material to a thin metal foil has posed some monumental technical problems. A major requirement is that the copper remain securely bonded to the film. This isn't so easy because the film carrier encounters a number of harsh environments. First, a chemical etchant removes unwanted copper to form the lead frames, a second etchant may remove the windows, and then, if thermocompression bonding techniques are employed, the carrier must survive thermal cycling to temperature extremes as high as 350°C. Finally, the carrier is again subjected to an elevated temperature when a device is encapsulated.

Dimensioning the film and the circuit pattern has been another major obstacle. Tolerance buildups of more than a mil are unacceptable. As Fig. 4 shows, if the leads shift off the pad centers by just 2 mils, the actual bonding area common to the pad and its mating

A guide to film-carrier metallurgy

Capping materials

GOLD

A forgiving material for capping because it doesn't workharden and lends itself well to thermocompression bonding at temperatures of about 300°C. Time-pressure-temperature values can be varied considerably and still yield good bonds. Thermocompression bonds to titanium-silver, silver, indium, aluminum, silicon and lead are possible. Can be reflow-soldered with popular soldering alloys. Losing popularity in high-volume, low-cost production because of soaring gold prices.

TIN

Solders poorly to gold but can be thermocompression-bonded to it. However, forms a weak intermetallic, which is weakened by low-temperature cycling.

LEAD

Solders well; good thermocompression bond intermediate. Commonly alloyed with tin to form a eutectic solder.

GOLD-TIN-LEAD

Can be evaporated in place, but tends to be weak. Requires remelting to form a pad.

COPPER

Is soft, solderable and cold-weldable. Also lends itself to thermocompression-bonding. Because it oxidizes, requires a protective layer such as nickel or silver. Should not be deposited directly on silicon because it diffuses into a chip and changes device properties. Also diffuses into copper, forming an intermetallic.

SILVER-TITANIUM

Provides a good thermal match to silicon. If evaporated, is usually graded silver-rich at the surface to enhance solderability or bondability.

ALUMINUM

Is poor thermal match to silicon. The metal is ductile, however, so that it cold-flows when stressed. What's more, it is difficult to solder, but is frequently ultrasonically bonded. Aluminum can form a brittle intermetallic known as "purple plague" when mated to gold. However, if temperature is held low and there is sufficient alumi-

num, this need not be a worrisome problem. Forms a weak bond to silver.

SILVER-TITANIUM

Developed for solar cells, has an excellent thermal match to silicon and good bondability. Can be graded on evaporation for a titanium contact and barrier and a silver thermocompression pad. However, the silver is vulnerable to oxidation.

Barrier metals

TANTALUM, TUNGSTEN, MOLYBDENUM, TITANIUM

Called refractory metals because of their high melting temperatures. Diffuse very slowly into neighboring materials and are therefore good as barrier metals—provided that work functions are carefully matched to ensure that ohmic rather than Schottky junctions are formed.

CHROMIUM NICKEL, IRON, COBALT, MANGANESE

Called transition metals because outer valence shells are filled and are similar chemically. Are easier to process than the refractory metals.

First-level metalization

ALUMINUM

Is an important first-level metalization. Goes down where it is wanted and goes well over silicon-dioxide passivation steps. Can be processed to form an ohmic rather than a Schottky barrier form.

GOLD OR DOPED GOLD

Similar to aluminum, but doesn't form an oxide. Is easier to bond but more costly than aluminum. Requires a barrier to prevent its diffusion into silicon.

Solders

If low-temperature, are useful and do not damage chip even though their melting temperatures are usually above the processing temperatures that the chip will experience after being soldered to the lead frame. Are sometimes hard to apply. If thin, may cause diffusion problems. Most solders bond well to copper. Usually require flux, followed by a flux, removal step. Gold diffuses into solders so that soldering of gold, especially thin-film gold, can be a problem, since a poor bond—or even no bond—may be the result.

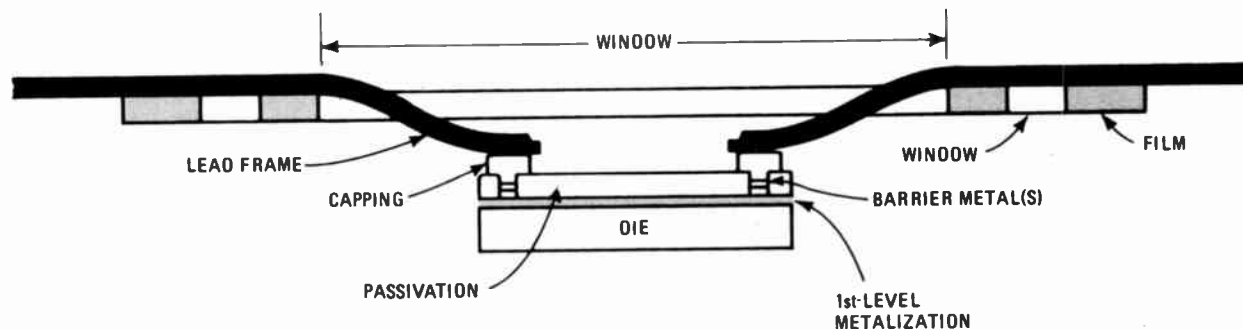

lead is greatly reduced, weakening the bond considerably. Also, the lead on the left almost bridges both pads and may cause a short circuit. Accurate registration helps speed production, too, because it shortens the time required by an operator to accurately superposition each lead frame over the chip. It also improves yield.

The year 1971, when MiniMod was introduced, was unkind to the film-carrier innovation because it meant abandoning manual wire-bonding at a time when major

IC manufacturers were deeply committed to the process. In about 1964, they had begun to invest huge sums in establishing assembly operations overseas—in Hong Kong, Taiwan, and Malaysia—where inexpensive labor was plentiful and they could hope to raise volume and lower costs. Moreover, in the recession of the early 1970s, manufacturing engineers were hard pressed for the R&D funds to examine this new technology.

Nonetheless, some companies pressed on. Texas Instruments acquired the MiniMod process from General

Electric. A company called International Micro Industries was formed in Cherry Hill, N.J., with the express purpose of mastering film-carrier assembly. And by early 1974, two manufacturers had disclosed some results of their developments at professional meetings—Honeywell Bull and Fairchild.

Honeywell Bull, in St. Ouen, France, is employing film-carrier in a technique that it terms tape-automated bonding (TAB).¹ Its carrier is described as polyimide, bearing a tin-plated copper lead frame. A gold-tin eutectic bond is formed at 280°C, the bonding tip being raised 50°C above that point during the bonding step. The heat from the tip melts a wax, freeing the chip from a glass plate. Honeywell Bull's Gérard Dehaine estimates that film-carrier assembly has cut costs some 20% to 30%. Shear strength of the bonds ranges from 60 to 100 grams—more than four times greater than that obtainable in wire-bonding. Dehaine adds that his company is in an advanced pilot production and will use the technique soon in upcoming hardware.

Fairchild put film carrier to use in assembling modules for Polaroid's SX-70 camera.² Its engineers used a 16-mm film to carry chips that were then fastened to a 70-mm flexible circuit to form the camera's flash-firing assembly. They also used the technique to fabricate the exposure-control module. Frank Perrino, manager of the project, says that assembly rates of around 1,000 ICs per hour were achieved. A solder-reflow technique was used to attach the outer leads of the circuits to the modules. A heat-sinking arrangement kept the heat from reaching the inner leads and lifting them off the chip. Perrino estimates that adding the pad regions required for film-carrier gang-bonding added no more than a penny to the cost of the chip.

A film-carrier market?

Several suppliers are eager to capture a portion of the film-carrier market of a billion units or more that may be just over the horizon. Though IC manufacturers are assembling the circuits in-house, they are also encouraging vendors to develop the capability to etch frames to their specifications. Pricing is a challenge. The IC houses hope for film-mounted lead frames in a 16-mm format at a penny apiece—about half the price of traditional stamped lead frames.

Some large companies, confident that film-carrier is a coming technology, are backing up their convictions with intensive development and marketing efforts. Jack Norrie, marketing manager for AMP Inc.'s Electronics Product group in Winston-Salem, N.C., points out that offshore assembly may be losing some of its luster. Says Norrie: "Labor rates are rising in the Orient, so that domestic assembly teamed with film-carrier is becoming an attractive alternative. Manufacturers expect film-carrier to be cost-competitive, even with offshore." Norrie adds that watches, cameras, and calculators have helped steer development money to the manufacturing-engineering groups, and film-carrier will play an important role in assembly.

Minnesota Mining & Manufacturing Co. is another major company actively engaged in film-carrier technology. William Foster of 3M's Electronic Products division in St. Paul, Minn., expects that within five years

the bulk of ICs will be assembled by film-carrier techniques. Foster is convinced of manufacturers' dissatisfaction with offshore assembly: "Some would like to bring assembly back onshore, even if film-carrier offered no savings. . . . I would not be surprised to see several semiconductor manufacturers beginning to consume tape in substantial quantities by the end of this year."

Stewart M. Harris, market manager for duPont's Electronic Materials division, thinks that the ease of making changes in lead-frame patterns is crucial to the growing interest in film-carrier. Says Harris: "The current hard-tooled stamped lead frames confined chip designers to one chip size and pad geometry. However, the modern trend to chemically etched film carriers, which we market, enables change without prohibitive expense."

Some companies, such as Sheldahl (formerly Schjeldahl) of Northfield, Minn., a major supplier of flexible circuits, question the return on the capital investment required. Steve Gurley, marketing manager for Sheldahl's Electrical Product division, forecasts that even if the entire small-chip IC industry were to switch to film-carrier assembly, the total film-carrier market may not exceed \$30 million in the foreseeable future. And if that pie must be divided among too many suppliers, payback on investment may be a long way off. There is no question that the IC manufacturers would like to buy the film carrier on the outside. But if they enforce a price of 1 cent per lead frame, they could destroy the marketing incentive, says Gurley.

The most pressing technological challenge confronting film-carrier suppliers is to meet the demand for tight-tolerance dimensioning—the requirement that the dimensioning from sprocket hole to lead be held to a mil or less. Also, IC manufacturers expect adhesion of copper to film to withstand 270°C for 5 seconds—a stiff requirement.

There are at least two ways to form a circuit. The subtractive technique predominates. It begins with the bonding of a 1-ounce copper foil (1.4 mil thick) to the film with an adhesive, then photoresist techniques form the image of the desired lead frame in a step-and-repeat fashion along the film-mounted copper laminate. Finally, the unwanted copper is etched away in essentially the same manner that copper is removed from a rigid printed-circuit-board laminate.

But there is another way which A.J. Siegmund, product manager at MacDermid Inc., Waterbury, Conn., thinks may be more economical. Instead of using an adhesive to attach a copper foil, copper is deposited in an additive fashion. That is, the photoresist is applied first, covering those regions where copper is not wanted. Then a combination of electroless deposition and electroplating builds up the lead frame to the required thickness. A second resist and etch step would form the windows in the film. Siegmund believes that the additive technique is less likely to build in those destructive stresses that develop in some adhesive systems. He estimates that the additive approach will cost less than 5 cents per square inch.

One company that has been working steadily on film-carrier techniques is International Micro Industries,

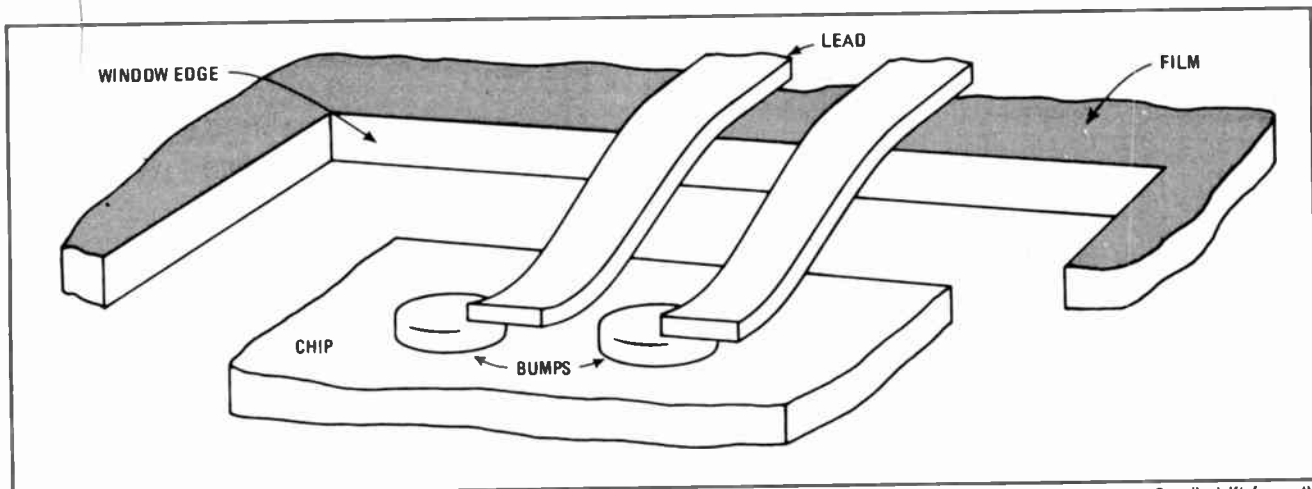

4. Fatal mismatch. Failure to register leads accurately on the pads of the chip defeats film-carrier bonding. Note how a 2-mil shift from the true position produces an inadequate bond area and causes the left lead almost to short-circuit the two bonding pads.

Cherry Hill, N.J.. Thomas Angelucci, president of the firm, says it began three years ago to develop both bonding equipment and film, since at that time they couldn't purchase a satisfactory film carrier. To make the film carrier for their system, which they call ECTA the company begins with 24-inch wide polyimide film and slits it to width—mostly 16-millimeter, which adapts well to TTL chips.

Users may complain about its \$25-per-pound price tag, but there is, at present, no other material that delivers the performance of polyimide. Known as H-film and Kapton (the latter is a duPont trademark), this thermosetting-type plastic boasts two qualities that put it out in front of rival materials—high-temperature survival, and dimensional stability. Being a thermosetting material, it doesn't melt, and it won't char until raised to over 800°C.

It carries a continuous temperature rating of 250°C and can withstand short-term thermal excursions to 400°C. So it withstands both soldering and thermocompression bonding temperatures. As for dimensional stability, it expands and contracts no more than 1 mil per inch when heated to 200°C.

Polyimide does have one fault; it absorbs more water than some competing films. However, this poses no serious threat to its use as a carrier because the film can be readily passed through a drying oven prior to processing and encapsulating.

Pick a polyester?

At \$1.25 per pound, users would certainly prefer to switch to a polyester film such as polyethylene terephthalate, better known by its duPont trademark, Mylar. Despite the fact that it melts at 250°C, polyester may be the film of the future. For lead-attach, bonding temperatures (280°C) are seldom applied for more than 1 second. Thus, the heat traveling down the lead cannot raise the polyester to its melting point.

Films are commonly marketed in thicknesses ranging from 0.5 to 5 mils. Though 5-mil film is common, manufacturers would like to go to thinner, narrower film to save money. As an example, switching from 35-millimeter-by-5-mil to 16-mm-by-2-mil film offers an 84% savings in polyimide. And since the larger film may repre-

sent one eighth of the cost of the circuit, this is a sizable saving. However, the thinner film tends to stretch and also proves difficult to punch. Moreover, Cutter Palmer, a technical consultant with duPont's film department, believes that at the current stage of film-carrier development, the cost of the film is negligible.

What's ahead

The current state of the art, which employs manual registration of each chip, has brought bonding rates to about their present 1,000 an hour. However, manufacturing engineers have their sights set on raising throughput above 2,000 units per hour, which makes fully automated registration a necessity. "If you can achieve 2,400 devices per hour, you are really flying along," says Frank Perrino, a product manager at Fairchild. "This doesn't allow much time for any step in the process. You must advance, register, and bond, then allow the bonds to cool before moving on to the next device—and all in 1½ seconds."

To break through that 1,000-unit-per-hour rate barrier, manufacturing engineers are endeavoring to reduce, and perhaps eliminate entirely, operator participation in the chip-alignment phase. One answer may be a sensor to register alignment optically by a servo system.

As for the film, if the price of the carrier does approach the hoped-for penny lead frame, then engineers will intensify their efforts to replace polyimide with an alternative. There may even be attempts to do away with the film completely. After all, its role is essentially sacrificial. Once the chip is bonded in place, it has no further use. So why not eliminate the film and find an alternative, non-consumable carrier?

Manufacturing engineers have built a fine track record automating complex assemblies at macroscopic levels. There is no reason why the microscopic dimensions of IC assembly should form an insurmountable barrier. In time, engineers will hurdle the obstacles and bring full automation to integrated-circuit assembly. □

REFERENCES

1. Gérard Dehaine, Michel Leclercq, and Pierre Sigel, "Tape Automated Bonding, a New Multichip Module Assembly Technique," Proceedings of the 23rd IEEE-EIA Electronic Components Conference, 1973, p. 69.
2. Frank A. Perrino, "Beam and Beamless Tape Packaging," Proceedings of the 11th IEEE-NEMA Electrical Insulation Circuit Conference, 1973, p. 205.

Controlled current source is versatile and precise

by Jerald Graeme
Burr-Brown Research Corp., Tucson, Ariz.

A precision voltage-controlled current source can be made by placing a pair of complementary field-effect transistors in the feedback loop of an operational amplifier. The resulting circuit will have a differential input, as well as a bipolar output current that can be used to drive either grounded or floating loads. From signals of up to ± 10 volts, the circuit develops a ± 10 -milliamper output, accurate to within $\pm 0.01\%$.

Signal voltages are usually derived from control voltages, but sometimes it is better to derive signal currents from the control voltages for either testing or driving certain loads. For example, a voltage-controlled current source can provide a simple programmable bias current for transistor testing.¹ Or it can be used for resistance measurement, since contact resistance will not affect the

test signal supplied by a current source. A current output is also needed for process-control instrumentation or for driving a meter or a dc torque motor.

These varying applications may involve unipolar or bipolar output currents, single-ended or differential inputs, grounded or floating loads or sources, and varying degrees of accuracy. The circuit shown in the diagram can satisfy all of these requirements, and it is simpler than many previous not-as-versatile current sources.^{1,2}

The circuit here consists of opposing FET current sources that are controlled by high-gain feedback around an op amp. The difference in FET currents produces the output current, and this difference current is controlled by summing the feedback, at the amplifier input, from the current-sensing source resistors (R_S). At feedback equilibrium, the sum of the two feedback signals is directly related to the differential input signal. The circuit's output current is given by:

$$I_o = -nE_i/R_S$$

where n represents the desired resistance-ratio factor.

Differential inputs and high power-supply rejection are provided by an attenuator network at the inverting amplifier input; it matches the feedback network con-

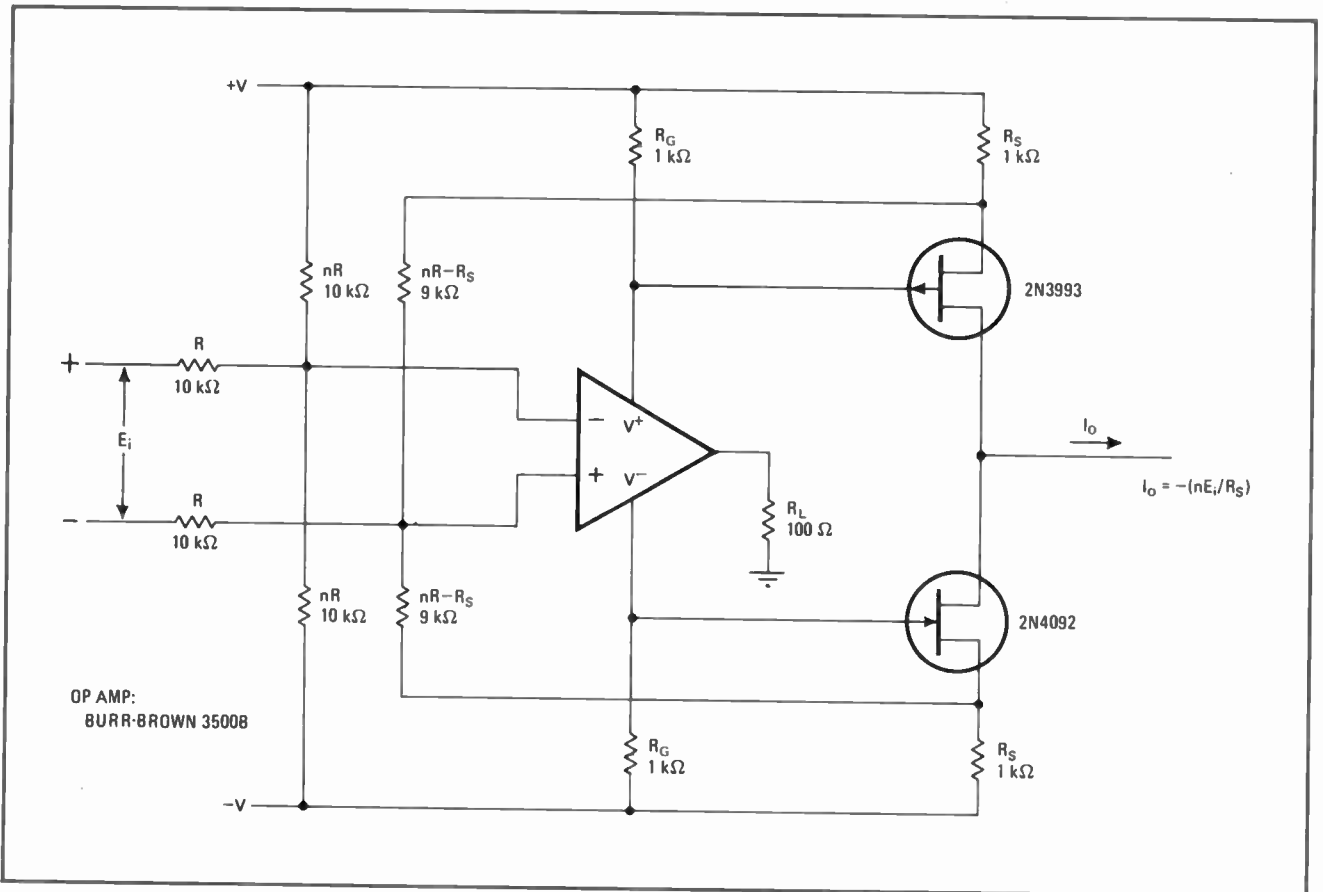

Current drive. Voltage-controlled current source can accept a single-ended or differential input, supply a unipolar or bipolar output, and handle a grounded or floating load or source. The difference current developed by the complementary FETs is sensed by resistors R_S and fed back to the amplifier input, where it is summed with the input signal voltage. Both FET gates are driven from the op-amp supply terminals.

nected to the other amplifier input. This is analogous to the matched input and feedback networks connected to an op amp to form the common difference amplifier.²

To simplify biasing and improve large-signal bandwidth, the gates of both FETs are driven from the op-amp supply terminals, rather than from the op-amp output terminal. Quiescent biasing for the FETs is obtained from the quiescent current drains of the op amp, and no level-shifting bias must be set up from the amplifier to the FETs.

Large-signal bandwidth is also improved by the reduced output swing required from the amplifier. Only a 1-volt swing is needed across amplifier load resistor R_L to obtain the rated output current, which is drawn through the supply terminals for maximum drive to the FETs.

Additionally, the lower amplifier output swing is not as greatly bandwidth-limited by the amplifier slewing-rate limit, as it is in other designs. Optimum bandwidth is achieved by making resistor R_L small enough to limit output swing without excessively lowering amplifier gain. Large-signal bandwidth is then limited by the amplifier's maximum common-mode swing rate.

The circuit's output current is controlled by the input voltage to within the accuracies of the resistors selected and within the gain-bandwidth and power-supply-rejec-

tion limitations of the op amp used. Most accuracy limitations caused by the FETs are overcome by the feedback, except for the small contributions from gate-drain leakage currents.

Output current is limited to the I_{DSS} level of the FETs but can be boosted by using the transconductance multiplying technique sometimes employed for common FET controlled current sources.¹ Output impedance is multiplied, through the feedback, from that of the FETs to the practical limit imposed by stray and parasitic effects—it is around 10^{12} ohms shunted by 10 picofarads.

By virtue of the circuit's differential inputs, common-mode signals are eliminated by a common-mode rejection that is adjustable to over 90 decibels. The primary common-mode-rejection limitations are the accuracies of the resistor ratios and the resistor matches, except for the noncritical match between the FET gate resistors (R_G).

The common-mode rejection can be adjusted by trimming the input resistors. Prior to this adjustment, any desired nulling of dc offset voltage should be performed by trimming the resistors denoted as nR. □

REFERENCES

1. J. Graeme, "Applications of Operational Amplifiers—Third Generation Techniques," McGraw-Hill, New York, 1973.
2. G. Tobey, J. Graeme, and L. Huelsman, "Operational Amplifiers—Design and Applications," McGraw-Hill, New York, 1971.

Single bipolar transistor inverts pulses on command

By Dale Hileman
Sphygmometrics Inc., Woodland Hills, Calif.

An ordinary bipolar transistor can be made to function as a command inverter—that is, it will pass a pulse signal without modifying the pulse, but it can invert the

signal upon command. The command is a simple reversal of the polarity of the supply voltage.

To do this usually requires several gates, involving perhaps dozens of parts and interconnections. The command inverter shown here, however, requires only three parts: a single bipolar transistor and two ordinary resistors.

The key to this circuit's operation is that the role of a transistor's emitter and collector can be interchanged if the supply polarity is reversed. When the polarity of the invert control signal is normal, the transistor operates as an emitter-follower, so that the polarity of the output

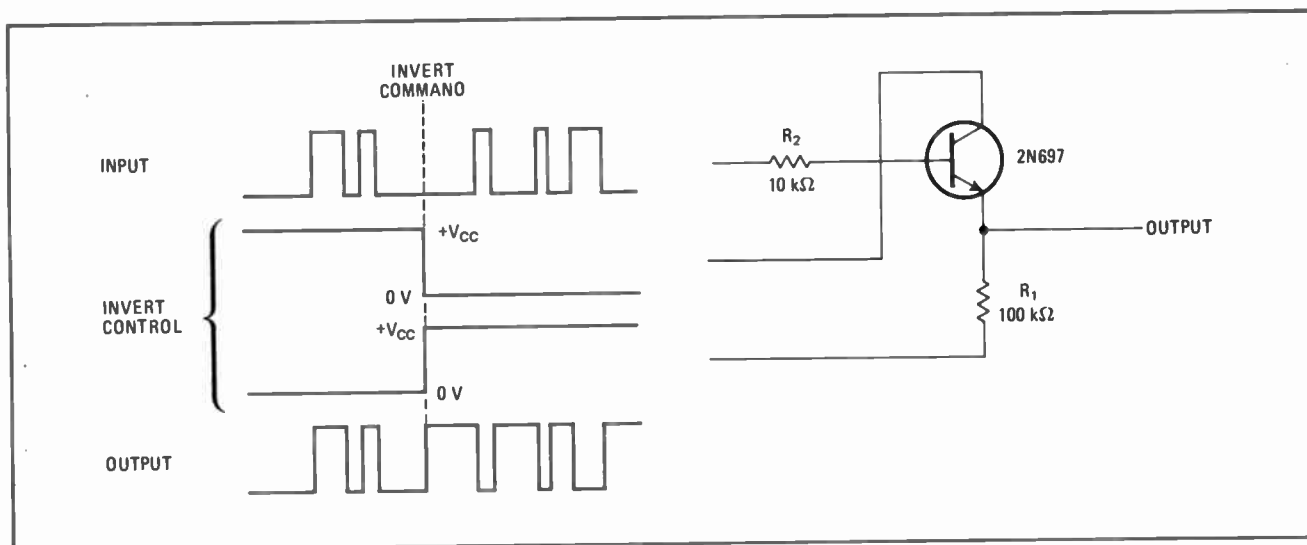

Command inverter. With normal supply polarity, this bipolar transistor operates as an emitter-follower, passing the input pulse train to the output without modifying it. But when the supply polarity is reversed, the transistor's emitter acts as its collector, and the transistor's collector acts as its emitter. Now the polarity of the input pulse train will be inverted at the transistor's output.

pulse train is the same as the polarity of the input pulse train.

The invert command reverses the polarity of the supply voltage, making the transistor's collector act as an emitter and its emitter act as a collector. Now the circuit becomes an inverting amplifier, with resistor R_1 serving as the collector load resistor. Under this condition, resistor R_2 simply limits the transistor base current to a safe value.

Any general-purpose npn or pnp bipolar transistor may be used in the circuit, and the precision of neither resistor R_1 nor resistor R_2 is critical. This command inverter will work with virtually any value of supply voltage and any input pulse level that the transistor will tolerate. □

Designer's casebook is a regular feature in *Electronics*. We invite readers to submit original and unpublished circuit ideas and solutions to design problems. Explain briefly but thoroughly the circuit's operating principle and purpose. We'll pay \$50 for each item published.

Norton quad amplifier can be a low-cost function generator

by P. Vlcek
Orbit Controls Ltd.,
Cheltenham, Gloucester, England

A versatile function generator that minimizes hardware as well as cost can be built with one of the newly introduced Norton quad amplifiers [*Electronics*, Dec. 6, 1973, pp. 116-120]. The price of the complete generator is less than \$3, and the entire unit can fit on a circuit board as small as a 1½-inch square.

Only a single Norton amplifier is needed to obtain a

sine-wave generator (a). When resistor R_1 and capacitor C_1 are omitted from this circuit, the resulting configuration is the standard one for a Norton-amplifier square-wave generator, with the timing current passing through capacitor C_2 .

The addition of integrating capacitor C_1 to this square-wave generator produces a reasonably accurate sine wave at the output. Resistor R_1 , which helps to match the circuit's time constants, can be used to adjust the output sine wave for minimum distortion.

A similar circuit can be used to add a sine-wave output to the conventional hookup for a square-wave/triangular-wave generator built with two Norton amplifiers. As shown in (b), the triangular output acts as the input for the sine-shaper amplifier.

For the component values given here, the circuit's operating frequency is around 700 hertz. Resistor R_1 is the adjustment for minimum sine-wave distortion, and resistor R_2 is the adjustment for the symmetry of the square and triangular waves.

The fourth amplifier in the Norton quad package can be connected as an output buffer for all three output waveforms. □

Economical approach. Norton quad amplifier, which is one of the newer ICs, reduces the circuitry and the cost of waveform generation. If a single amplifier is used, as in (a), a sine wave can be generated, with provision (through resistor R_1) for minimizing distortion. With three amplifiers, as in (b), triangular, square, and sine waveforms can be obtained, and the fourth amplifier can act as a buffer.

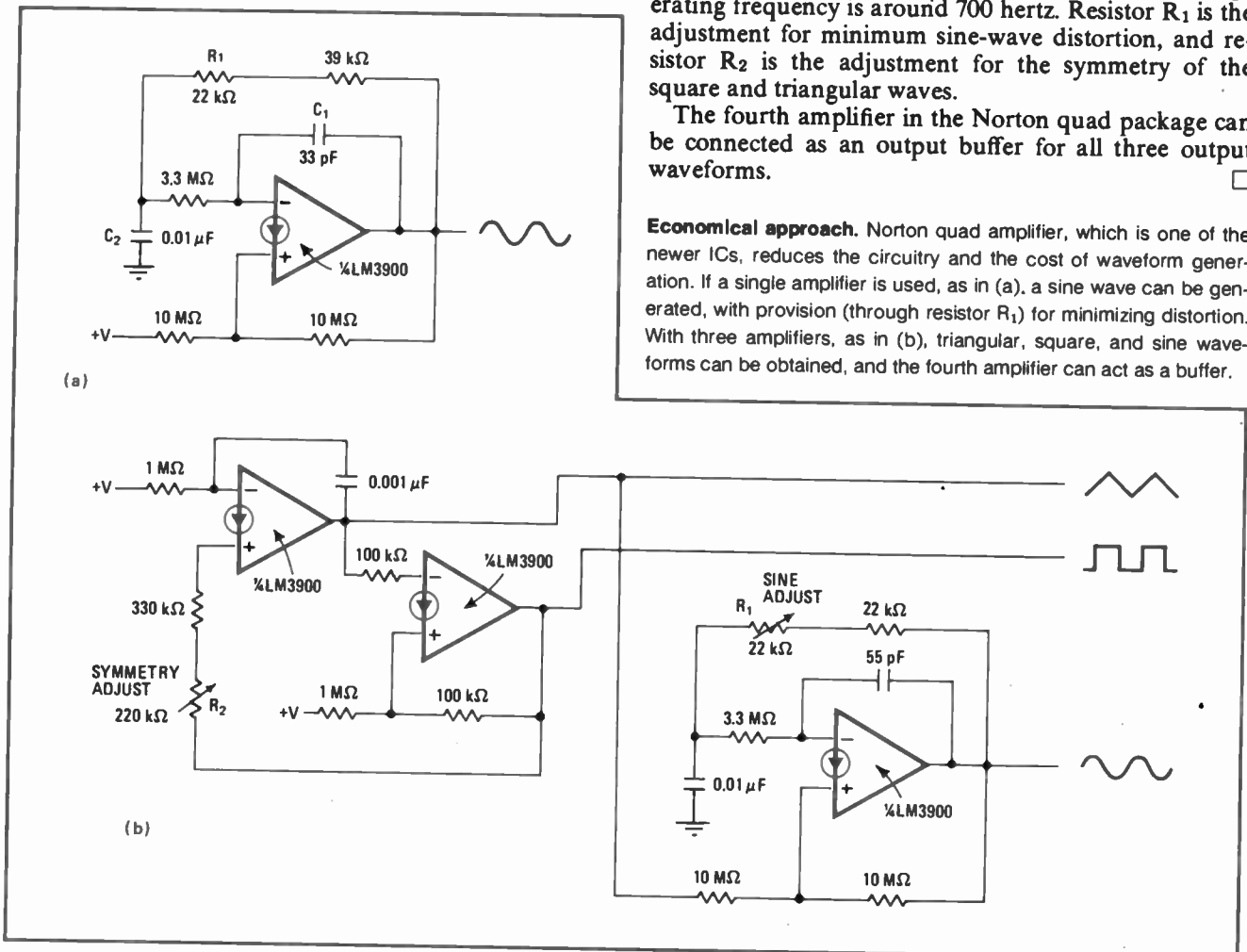

Part 1: When to use a programmable calculator or a minicomputer to automate a system

When it's unclear whether a given instrumentation system can be automated with a calculator, a rational decision requires seven factors to be considered—from language needs to size of memory

by P. David Fisher and Stephen M. Welch,
Michigan State University, East Lansing, Mich.

Wedding calculators and instruments

This two-part article shows how the versatile programmable calculator can be used to automate an instrumentation system economically. Part 2 appears on pg. 104.

□ A programmable calculator can serve as the brain of an automated instrumentation system if that system does not need the speed and memory capability of a minicomputer or if it cannot run to the cost of the mini itself, plus the cost of its peripherals, plus the cost of its software development. But for any given instrumentation system, the choice between calculator and minicomputer can be difficult.

At least seven factors must be taken into account

- Program entry methods.
- Languages.
- Instruction sets.
- Execution speeds.
- Memory characteristics.
- Costs.
- Input/output features.

All these factors must be balanced against system requirements, user characteristics, and plans for future expansion.

Entering the program

In minicomputers, merely preparing programs for execution can easily be the most manpower-consuming phase of system implementation. A contributory factor is the need to use software to translate the program into machine language before it can be executed—a process that can take up more than half the debugging cycle.

With calculator-based systems, by contrast, programs are entered and edited through the keyboard and are interpreted directly by the hardware at execution time. The assembly, or compilation, phase is completely eliminated, and debugging time is about halved. This capability may be mimicked on minicomputers with interactive software packages, but at the expense of dedicating a large chunk of main memory to the task.

Programmable calculators have three language levels. The first may be called keystroke language and resembles assembly-level computer language (Fig. 1a). It is found both in older calculators and in the lower-priced members of many newer product lines. These machines have a basic set of instructions, each of which is represented by a unique code, is stored in memory, and executed sequentially in the order programmed.

Programming at the equivalent level on a minicomputer, though it maximizes the flexibility of the machine, is very difficult and time-consuming and requires the attention of a specialist. To a lesser extent, this is also the case with keystroke-language calculators. The user has to break his problem down into an organized string of operations, and he must pay attention to addressing. On the other hand, he need not worry about fixed- versus floating-point formats, index registers, assemblers, loaders, and so on.

The next language level on a calculator is called formula language. No comparable minicomputer-language type exists, except for a few routines written by end-users. Basically, programs are entered in the form of algebraic statements to be evaluated (Fig. 1b). As before, the statements are keyed in directly, without needing to be translated by software. In addition, however, the hardware has the capability of interpreting statements in the order dictated by the well-known mathematical hierarchy.

At the formula-language level, the calculator user is

freed from many of the minicomputer user's problems in moving quantities into and out of working registers and in allocating temporary storage. The calculator user needs less programming experience, too, since he can also organize the program at the statement level as opposed to the single-instruction level.

The top language level is occupied by those machines capable of handling a full-fledged scientific programming language. The most common one is Basic (Fig. 1c), which has the great advantage of being implemented on many computers. Thus, programs developed for these calculators will remain useful, should system needs expand to the minicomputer level. On the other hand, the expanded power of Basic and other such languages (which include arrays and often the options of string variables and matrix operations) again requires the attention of programming specialists.

Different Instructions

One major difference in orientation between calculators and minicomputers lies in their instruction sets. In minicomputers, the emphasis is on processing the binary patterns that make up computer words. These patterns may therefore be shifted and logically altered, tested, and transferred from one part of the machine's environment to another. Numeric processing, particularly addition and subtraction, is handled by binary integer arithmetic. Full integer multiplication and division are rarer, and floating-point hardware (or micro-programming) is almost always an expensive option.

In calculators, on the other hand, the emphasis is on numerical processing, and logic arithmetic is available only to a very limited extent as an option on the most expensive machines. Some byte processing is possible, however, if the byte is treated as a numerical value. On the other hand, floating-point capability is standard. In addition, a wide variety of mathematical and input/output functions, which require subroutines on minicomputers, is present as firmware and may be activated by a single keystroke. This feature can greatly reduce memory requirements and simplify programming.

When no single key exists for a task that must be executed frequently, the calculator user may resort to subprograms. The depth to which subroutine calls may be nested, however, is more restricted in calculators than in minicomputers. The execution of a "call-subroutine" instruction requires the storage of a return address in both minicomputers and calculators, and the number of return addresses that may be stored simultaneously determines the allowable depth of nesting. In calculators, which use special registers to store return addresses, much less space is available than in minicomputers, where central memory is used. While the actual limit of nesting varies widely from machine to machine, common programming practice suggests that four levels are the bare minimum for comfortable programming, and 10 to 15 levels are more than adequate.

A convenient alternative to subprograms is provided by the calculator's "user-definable" keys. A special routine is stored in memory and is activated by a single stroke of such a key. If the user changes the programming, he in effect redefines the key and so tailors the keyboard to his specific needs. For instance, depressing one

(a) KEYSTROKE LANGUAGE	
ADDRESS	INSTRUCTION
00	CLEAR
01	STOP
02	$z \rightarrow a$
03	STOP
04	z^2
05	$z \rightarrow b$
06	STOP
07	$z \rightarrow c$
08	4
09	c^*
0A	a^*
0B	b^-
0C	CHANGE SIGN
0D	PRINT
0E	10
0F	$z \leftrightarrow m$
10	INCREMENT
11	IF $z = m$
12	STOP
13	$z \leftrightarrow m$
14	GO TO 01
15	END

(b) FORMULA LANGUAGE	
0.	$0 \rightarrow m$
1.	Enter A, B, C
2.	$B \uparrow 2-4 AC \rightarrow x$: Print x
3.	IF $m+1 = 10$ STOP, ELSE
4.	$m+1 \rightarrow m$: GO TO 1

(c) 'BASIC' LANGUAGE	
100	FOR J=1, 10
110	READ A, B, C
120	PRINT $B \uparrow 2-4 * A * C$
130	NEXT J
140	End

1. **Languages.** All three of these calculator programs compute the value of the expression B^2-4AC for 10 different sets of arguments. Keystroke language (a) is similar to computer assembly language, while Basic (c) is the same as the well-known interactive language that is widely used with computers. Intermediate in complexity, formula language (b) usually has no direct minicomputer counterpart.

OPERATION	CALCULATOR	MINICOMPUTER
ADD/SUB	15 ms	0.3–0.5 ms
MULT/DIV	20 ms	0.3–0.6 ms
x^2	25 ms	0.3–0.7 ms
SQUARE ROOT	30–50 ms	2–4 ms
e^x	20 ms	3.5–7.5 ms
LOG	20 ms	4.6–9.7 ms
SINE	40–140 ms	4.5–9.1 ms
ARCTANGENT	70–140 ms	4–8 ms

2. Speed comparison. Execution times for a few commonplace instructions show speed difference between calculators and minicomputers. All of these figures assume floating-point operands.

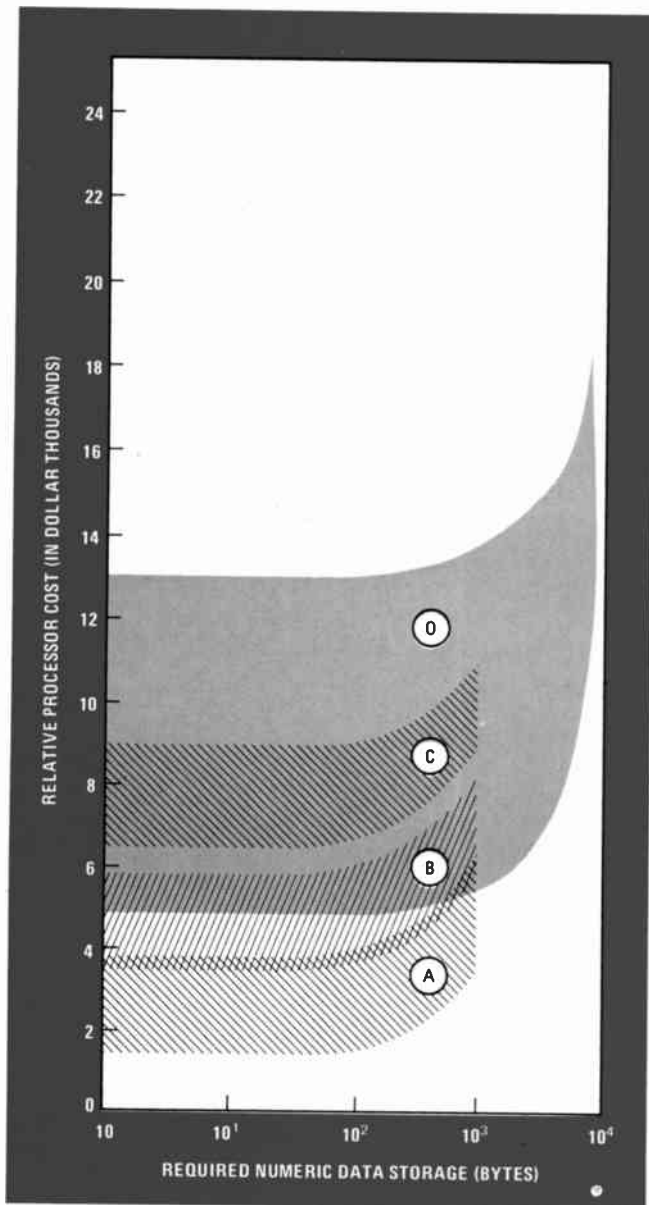

3. Memory costs. Although calculator and computer memory costs are byte for byte about the same, the inefficiency with which calculators use memory to store data makes them much more costly if a great deal of storage is needed. Areas A, B, and C represent costs of calculators that use keystroke, formula, and Basic languages, respectively. Area D is for minicomputers.

key might automatically calibrate an instrument, and depressing another might cause a measurement to be taken. To save memory, some manufacturers sell read-only memories (ROMs) for special routines. In fact, at least one manufacturer even sells basic firmware in the form of separately marketed, preprogrammed ROMs, which the user selects to fit his unique requirements and plugs into special slots in the mainframe. The ROMs provide various mathematical and statistical functions, as well as special input/output routines for mass-storage devices and other peripherals.

Relative speeds

Calculators are much slower than minicomputers. Although calculator speeds vary over a considerable range, generally they have execution times in the range of a few milliseconds to hundreds of milliseconds per instruction. Minicomputers, except for a few special instances, have instruction-cycle times of less than 5 microseconds. Of course, a simple arithmetic operation, such as addition, requires many instruction cycles in a minicomputer, but only a single keystroke instruction in a calculator. So the actual difference in execution time for the complete operation is not as large as might be expected. Nevertheless, computers have speed advantages for complex numerical calculations. This fact, which eliminates calculators from consideration for high-data-rate applications like communication processors, does not preclude their use in many measurement and control tasks, in which data is often limited in both amount and speed.

Memory characteristics

Calculator memories usually have one of two basic structures. The basic element in each is the keystroke, represented by a binary code, though the codes are generally not available to the user for bit manipulation as in minicomputers.

The first memory structure distinguishes between register memory, where data is stored, and step memory, where programs are stored. Various size combinations are available, ranging up to several thousand program steps and several hundred registers. The advantage to the user is the freedom to select the right memory size for his needs, but the complication of interfacing two separate memories to the external world is a distinct drawback.

The second type of calculator memory structure uses the same space for both instructions and data and may be conceptualized either as a string of instructions or as a string of registers. Basic machine configurations range from 100 to 200 registers up to options providing 10 times as many registers. Such a structure makes for easier interfacing but uneconomic data storage—it takes between eight and 14 keystrokes to specify a single data number, whereas an instruction can be specified by a single keystroke. This contrasts with minicomputer memories in which an instruction needs one or two words and floating-point data only two or three words.

For calculator users who require extra storage, several mass-storage devices are available. Most common are tape-cassette transports, which may be built into the mainframe or bought as separate units. They extend

storage into the tens of thousands of instructions. Often, however, they do not use the tape-storage medium efficiently. One manufacturer advertises the ability to put 48,000 instruction steps on one 300-foot cassette tape—a sad contrast to the 150,000 to 200,000 bytes that may be stored on the same tape when it is used with a typical minicomputer's cassette peripheral.

The second type of mass-storage peripheral that is beginning to be used with high-level programmable calculators is the disk drive. Disk drives range in size from 1.2 to 4.9 megabytes, consistent with many minicomputer systems, and typically allow the user to access files by name, all the required directory lookup procedures being handled by hardware. Minicomputers, on the other hand, often require relatively bulky software packages to achieve the same performance.

The bottom line

Comparing the costs of programable calculators and minicomputers is made difficult by differences in the principal cost-determining factors for the two classes of devices. For calculators, base prices are set by language level and memory size. Under \$2,000 is the starting price for keystroke-language machines, between \$2,000 and \$4,000 the least paid for formula-language machines, and \$5,000 to \$7,000 has to be paid for machines that respond to Basic. Typical minicomputer base prices are in the range of \$5,000 to \$10,000, and different language levels merely represent different software packages, which usually cost less than \$500. (All these figures are based on machines with a minimum-size central processing unit and one peripheral device with hard-copy output.)

Comparison of memories above and beyond minimum configurations requires great care. Byte for byte, the cost of calculator and minicomputer memory is about the same: 25 to 33 cents per byte. In actual applications, however, the tradeoff between register memory and program memory, mentioned earlier, becomes important (Fig. 3). Once the need for numeric data storage increases beyond 1,000 registers: calculator costs skyrocket. Minicomputer costs, on the other hand, stay fairly stable until more than about 40,000 bytes are needed. More than 8,000 bytes of quick-access mainframe memory are seldom available in a calculator, although a few machines with minicomputer-like architecture may provide as much as 32,000 bytes.

Input/output features

Important input/output considerations include character-processing capabilities, character codes, data rates, and transmission modes. To a minicomputer, a character code is just another bit pattern and can therefore be logically altered or tested and be packed together by shift instructions for efficient storage. The code may also be freely transmitted back and forth to external devices. In calculators, the emphasis on numerical processing diminishes their ability to handle nonnumeric data. To process alphabetic data, as opposed to merely outputting preprogrammed titles or legends, a Basic-level machine with string variables as an option is generally needed. Short character strings may be processed on lower-level machines with special pro-

graming provided by the manufacturer, but this is cumbersome at best.

As far as the data codes themselves are concerned, two conflicting trends are evident. On the one hand, the American Standard Code for Information Interchange (ASCII), intended for data communications, is widely used. Appropriately enough for general communications, it enables a wide variety of messages to be interchanged. But the requirements of instrument systems are generally limited to just the 10 numeric digits plus a few control characters, so that binary-coded-decimal (BCD) codes are also widely used. Consequently, a suitably broad line of interface products must contain both BCD and ASCII capabilities.

For calculators, a rough upper limit on the data rates of interfaces is 1 kilobyte per second. This rate is sufficient to handle user interactions, typical peripherals (printers, tape-cassette transports, and so on), low-speed communications channels, and most instrument interfaces. Still, hardware offering higher rates may be found: one manufacturer claims a 90-kilobyte transmission rate for a disk system with 512-byte blocks.

For high-speed data transmission, a minicomputer is necessary. In minicomputers, data-transfer rates through the working registers top out at 100 to 150 kilobytes per second. Much higher rates may be obtained by using direct memory access (DMA), which transfers data without the intervention of the CPU. With DMA, data rates of 1 to 2 megabytes per second may be achieved.

One serious shortcoming of calculator input/output structures is the lack of a hardware-interrupt capability, although appropriate software can compensate for it in some cases. The lack poses no serious problem for many automatic testing or production-control applications, because of the sequential nature of the tasks—that is, step one must be completed before step two can start, so there is no risk of overlap. However, as calculator control expands and starts to encounter different or more complex situations, calculator manufacturers will have to provide hardware-interrupt capability.

Modes of data transfer may be classified as synchronous or asynchronous, and as parallel or serial. Synchronous communication is to be avoided. Its need not just for common data rates but also for common clocking between the mainframe and the peripheral seriously complicates interfacing, since peripherals seldom, if ever, operate at processor speeds. While a few calculator manufacturers have fallen into this trap, most rely on asynchronous communications. In the asynchronous mode, data is never transmitted unless the readiness of both devices has been established, usually by some form of handshake procedure.

A byte may be presented to an external device in two basic ways. All the bits may be transferred at once on different lines (parallel), or they may be transmitted one at a time on a single line (serial). The former method is commonly used between local system components, while the latter is useful for long-distance communications, where the cost of separate conductors would be prohibitive. Both schemes are available in minicomputers and calculators, but parallel transmission is preferred for automated instrumentation systems. □

Part 2: How to build an automated system around a programmable calculator

The present lack of a standard interface between calculators and programmable measurement and control devices may soon be remedied; off-the-shelf modules make it easy to customize systems

by P. David Fisher and Stephen M. Welch,
Michigan State University, East Lansing, Mich.

Closing the loop

The authors will be available to discuss these articles with readers between noon and 5 p.m. (Eastern Daylight Savings Time) on May 20, 21, and 22. Telephone them at (517) 355-5241.

□ By costing much less than a minicomputer, the programmable calculator opens up whole new areas of measurement and control to automation. Less obviously, it can also be used to upgrade automation instrumentation systems that at present employ inflexible hard-wired logic or relatively inflexible paper tape.

In either situation, the system designer will run into the problem of how to interface the calculator to various programmable instruments. His other requirements—for an improvement in calculator efficiency, maybe, or in the over-all system's data communications—are easier to satisfy, thanks to the availability of a large variety of off-the-shelf electronic modules. In fact, the interface problem in calculator-based automated instrumentation systems is so crucial that a discussion of it will precede descriptions of three typical systems and of the modular hardware that can be used to customize them at a reasonable cost.

System costs are still made too high by the lack of a good standard interface between their various measurement, recording, communications, and control elements. The problem is elementary. If two or more programmable elements are to exchange information across an interface, the input/output structure of each must be compatible with respect to the cables and connectors, the signal levels, the timing of the signals, the logic convention, the types of control messages, the sequencing and interpretation of these messages, the data format, and so on, that each of them employs. But manufacturers of programmable-system components have not yet been able to agree collectively on a set of interface standards.

In fact, many companies have not yet faced these issues within their own product lines. One manufacturer, for instance, offers a package composed of a programmable calculator and a graphic terminal which require an interface modification kit—a \$700 accessory—to make their I/O structures compatible.

The issues involved in selecting a set of interface standards are complicated. Nevertheless, just such a set of standards is being drafted by a committee formed by the International Electrotechnical Commission.¹ One of its proposals applies to automated instrumentation systems, or portions of them, that use the byte-serial bit-parallel representation of digital data and in which the data rate across any interface-signal line is no greater than 10^6 bits per second. Systems based on programmable calculators fulfill these criteria, and calculator I/O structures may therefore ultimately conform to this standard. Hence, before considering specific applications of calculator-based systems, let us review the proposed interface standard as it applies to calculator-based measurement and control systems.

A bus-oriented system

The standard describes an I/O structure that, for a calculator-based system, is organized around buses, with each component being hard-wired to every other component in the system (Fig. 1). Sixteen signal lines are grouped into a data bus, a flag bus, a transfer bus, and a control bus.

The data bus is a set of eight signal lines (DIO 1 through DIO 8). Four distinct classes of data—encoded address data, basic data, control data, and status data—

are transmitted over these lines. Because data is transmitted serially as 8-bit bytes, such an interface structure is referred to as a "byte-serial bit-parallel programmable-instrument interface."

The two signal lines of the flag bus are INT (interrupt) and EOS (end of string). They are used to establish which of the four types of message is being transmitted over the data bus in any given time interval. The EOS control line is also used to identify the last byte in a given message.

In principle, any element connected to the transfer bus is capable of being a source of data (talker) or a receiver of data (listener). For unambiguous communications there can be only one talker at any instant of time, but there can be any number of simultaneous listeners. The three transfer-bus signal lines that enable data to be exchanged asynchronously between an addressed talker and all addressed listeners are DAV (data available), RMD (refuse more data), and DNA (data not available). They are basic to the handshake process that transfers the data bytes between various system components (Fig. 2).

Data is exchanged as follows. When all of the listeners are ready to accept a data byte, RMD is set in the high state and DNA in the low state. The talker drives DIO 1 through DIO 8 so as to present the desired data byte to be transmitted. When the data on the lines has settled down, the talker sets DAV low, indicating to the listeners that the data is valid and may be read. Once all listeners have accepted the data, DNA goes high, telling the talker to remove the present data from the lines and set DAV high.

The fourth group of signal lines in the interface is the control bus. The three lines in this group are SRQ (service request), BCL (bus clear), and REN (remote enable). It is worth noting that the SRQ line would enable calculator-based systems, which lack any hard-wired interrupt capability, to operate under a form of software interrupt.

So far as the present draft of the proposed interface standard is concerned, the bus structure has only two physical limitations. At least 15 devices must be capable of being connected to the bus, and the total transmission-path length over the interconnecting cables must be at least 16 meters.

Systems applications

Although the diagram of Fig. 1 indicates the basic nature of the interface bus, it gives no hint of the wide variety of useful systems that can be built around it. In general, the calculator could fill the roles of system controller, on-line data processor, interface for interaction between the system and a human operator, and even supplier of a limited amount of data storage. Other components that can be connected directly to the bus include clocks, mass-storage devices, communications and display equipment, process controllers, and such process-monitoring devices as recorders, alarms, scanners, and analog-to-digital converters—all this in addition to the usual programmable electronic measurement and stimulus instruments, like power supplies, signal generators, multimeters, frequency counters, and so on.

These basic components can be interconnected into

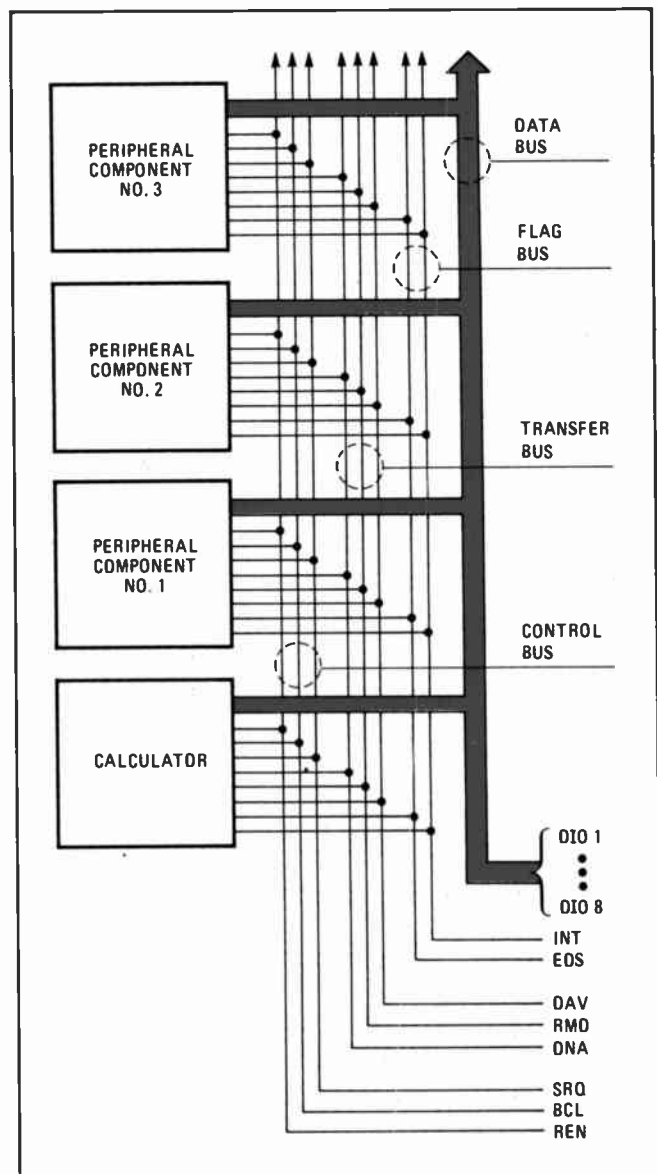

1. Bus structure. Proposed interface standard has all system components hard-wired to each other by means of a standard bus structure. Data transfer through the bus is of the byte-serial, bit-parallel variety, and is at rates of 1 megabit per second and below.

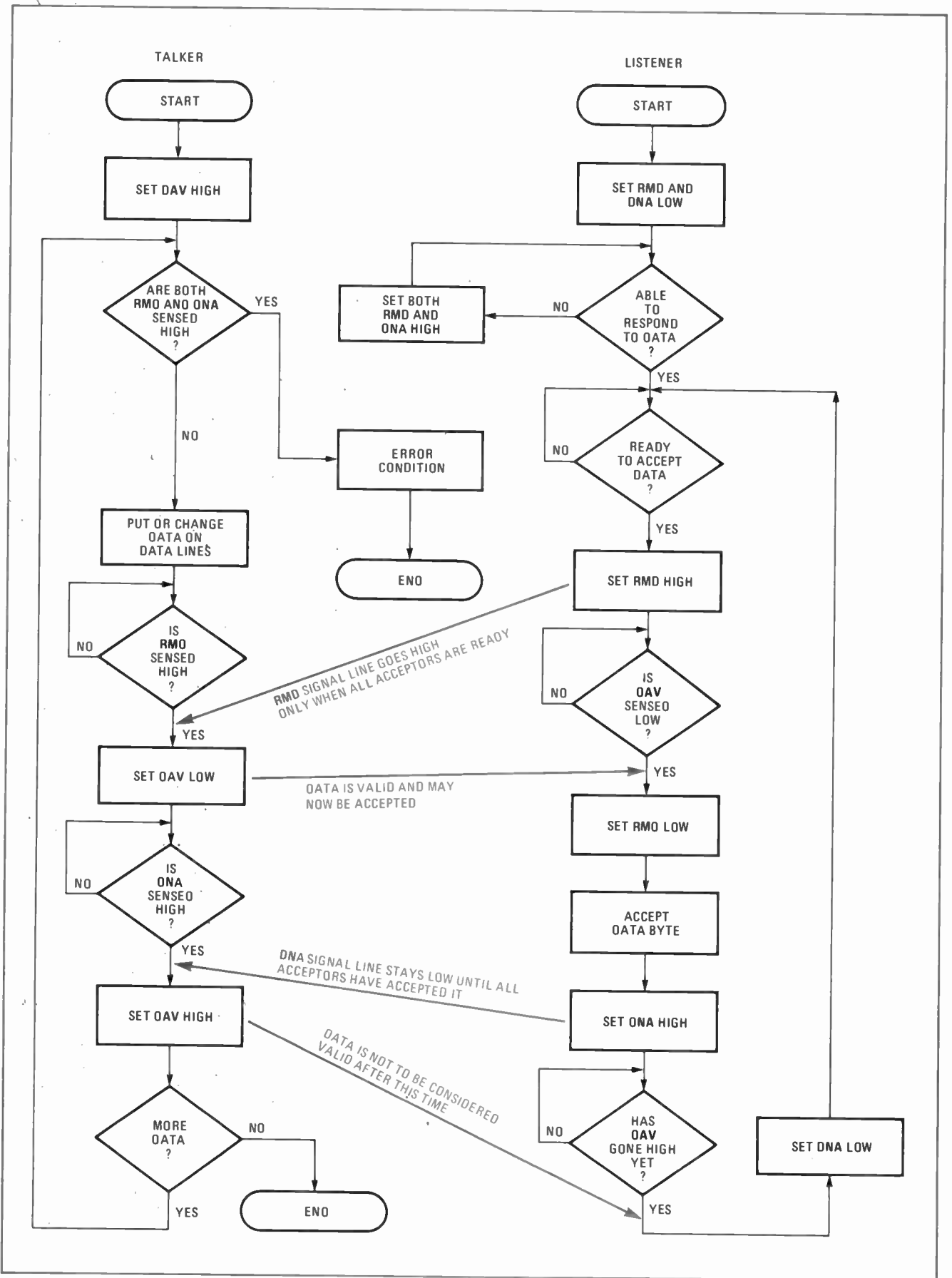

2. **Shake hands.** To ensure that only one system component "speaks" at a time, this handshaking procedure must be performed every time a byte of data is transferred. The DAV line is controlled by the talker, while the RMD and DNA lines are controlled by the listener (or listeners).

very varied automated instrumentation systems. The three examples that follow are: a test system, in which stimuli are applied to the device under test and its responses noted; a feedback system for controlling the temperature and humidity inside an environmental test chamber; and a remote data-acquisition system, which has no direct control over the devices that generate the data it is gathering.

An automated network analyzer

Engineers working with analog signals must routinely determine the transfer function of two-port networks, since it provides them with the information needed to predict the network response to any arbitrary signal. In the laboratory or on the production line, the transfer function is determined experimentally by sweeping the frequency of a test signal and then measuring both the gain (or insertion loss) of the two-port network and the phase shift between the input and output ports.

The Hewlett-Packard Co., Palo Alto, Calif., recently introduced a fully automated, calculator-based, network-analyzer system for making gain-phase measurements in the range of 50 hertz to 13 megahertz.² The basic system can be complemented by various peripherals—such as recorders or communications gear—if the user's application so requires. The calculator is the system controller and provides on-line data-processing capabilities, limited data-storage capabilities, and a convenient interface with the operator.

A good illustration of this system's performance capabilities is a filter-analysis problem in which such parameters as insertion loss, stop-band rejections, passband ripple, group delay, and delay distortion must be measured and displayed. A manual data-acquisition and control system takes about 30 minutes to acquire the necessary raw experimental data, which then has to be analyzed to yield the parameters. In contrast, the calculator-based system acquires the raw data, extracts the parameters, and records or displays the results, all in less than a minute. The speed is limited neither by the processing capabilities of the calculator nor by the I/O data rates, but rather by the time required for the synthesizer, the analyzer, and the two-port device under test to reach steady state at each test frequency. In large-volume applications, a single calculator could simultaneously control and analyze data derived from several network analyzers.

Controlling an environment

Often, scientists studying a certain biological community isolate it in a laboratory chamber and then determine important causal relationships by carefully manipulating conditions within the chamber. An example might be the relationship between soil temperature and mortality rates of a certain insect species. Studies of this nature, along with field observations, aid in the development of efficient and effective pest-management strategies.

But the traditional hard-wired environmental-chamber controllers have three major deficiencies. Most of them do a very poor job of simulating natural conditions. Sunrise and sunset, for example, they imitate crudely by switching a light on or off. Secondly, they do

not accurately simulate natural conditions in those cases where they must simultaneously control two or more interacting environmental parameters. Finally, although hard-wired controllers are not particularly expensive, they are very inflexible, and a new controller, or set of controllers, is typically needed for each experiment.

Atmar and Ellington,³ two entomologists at New Mexico State University, recognized these problems, and in 1971 designed and built a calculator-based environmental-chamber-control system (Fig. 3). Through software, they control simultaneously the temperature and relative humidity of each of two environmental chambers. Their system comprises eight sensors, an analog scanner, an a-d converter, a digital demultiplexer, a set of output relays, a clock, and a calculator. The control system can maintain the temperature in the chamber to within $\pm 0.3^\circ\text{F}$ over the range of 40°F to 125°F and the relative humidity to within $\pm 3\%$ over the range of 30% to 95%.

From their first two years of experience with calculator-based measurement and control systems, Atmar and Ellington have derived three observations that can be generalized to other environmental-test chambers. First, because of the relatively long time constants associated with changing the temperature or humidity of a large chamber, the processing speed of a calculator is more than adequate for any practical situation. Second, a calculator-controlled system is at least as accurate as a hard-wired unit for the control of a single variable, largely because the system can be made to automatically recalibrate itself at regular intervals. (For the control of more than one variable, of course, the calculator-based system is expected to be vastly superior to hard-wired units.) Third, the calculator-based system competes very favorably with hard-wired controllers in cost because of its flexibility.

Arguments similar to these might be advanced to show that calculator-based monitoring and control system might be cost-effective in various manufacturing processes. The manufacturer of integrated circuits is an example.

Measurement at a distance

The final application example deals with the problem of data acquisition and data management. This total system comprises a central computing facility and several remote data-acquisition sites. The remote sites might be positioned throughout a production area where assorted quality-control data is being gathered, or they might be used to monitor inventories or perhaps discharges from a plant into either a river or the atmosphere.

Suppose a given application has the following system requirements:

- Data should be acquired automatically and stored in computer-compatible form at each remote site without needing the help of the central site.
- Data should be acquired at regular intervals throughout the day.
- Data should be acquired at any other time during the day when an operator requests it or a critical event occurs (for instance, when the discharge rate of a certain pollutant from a stack exceeds a predetermined thresh-

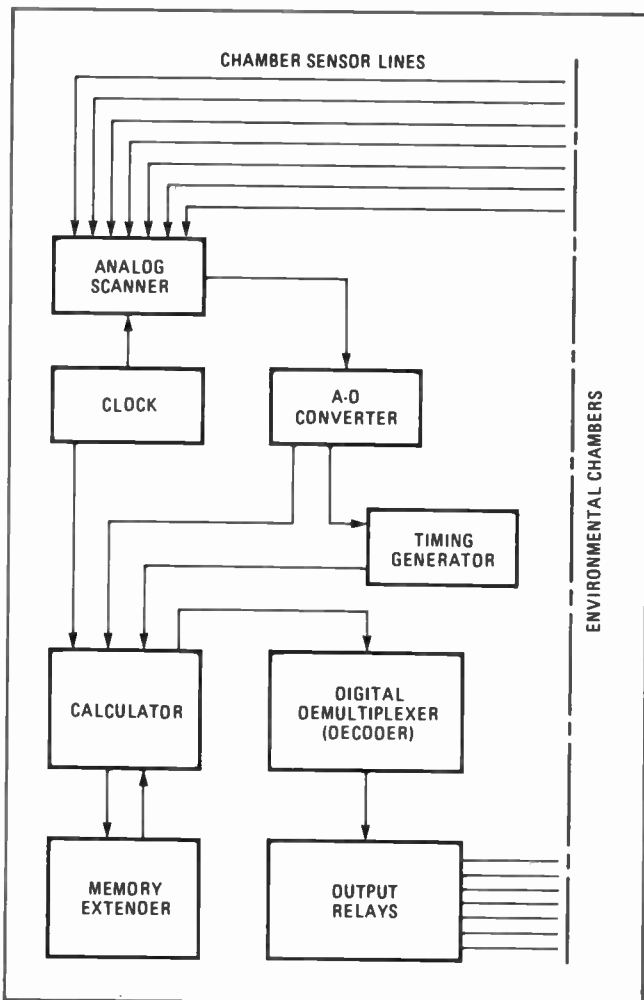

3. Environmental controller. Calculator-based control system for environmental chambers can control more complex situations with greater refinement than hard-wired controllers. It also costs less in the long run because it can be used for many different experiments.

hold or when a temperature exceeds a preset limit).

- Data summaries should be transmitted to the central site at regular intervals and/or on request.
- The remote site should be capable of notifying the central site immediately if a critical event occurs.
- There should be a convenient interface for operator interaction and a simple procedure for the operator to follow in redefining specific data-acquisition tasks.

The calculator-based system of Fig. 4 meets these requirements. The system possesses three basic modes: an idle mode, a data-acquisition mode, and a communications mode.

The data-acquisition mode can be entered as a result of a command from an operator, or a command from the central site, or a signal from the real-time clock, or an alarm. In this mode, data is read and stored temporarily in the calculator along with the time of day. After all data is read, a new file is created and the information transmitted to the mass-storage peripheral. After the data transfer has been completed, the system returns to the idle mode.

The communications mode can be entered as a result of a command from an operator, or a command from the control site, or a signal from an alarm. Upon entering the communications mode, the calculator branches to any one of several different routines. If it enters the mode in order to dump data into the central site, the data is acquired one last time and written, along with the time of day, in mass storage, a trailer record is written at the end of the file, and data records are then transmitted to the central site. After data transfer is complete, the remote site returns to the idle mode.

These three examples demonstrate that calculator-based systems have important applications. The design engineer is limited only by the processing speed of the calculator and the availability of peripherals compatible with the calculator's input/output structure. And this latter problem will be eliminated if calculator and peripheral manufacturers offer a standard I/O structure such as the byte-serial, bit-parallel instrument interface currently under development by the International Electrochemical Commission.

Customization costs come down

The system designer who selects a calculator-based system can elect to interface with existing programmable instruments, or he can go further and customize his system by drawing upon off-the-shelf electronic modules. His over-all needs will determine if the simpler approach is also the more prudent. However, customized systems are becoming more attractive each day as growing numbers of low-cost data-acquisition and data-communications function modules become available.

Four representative sets of such modules are: Signetics' 2535 universal asynchronous first-in, first-out buffer register; Analog Devices' STX1003, SRX1005, SCL1006 and SMX1004/SMC1007 serial-data-exchange modules; General Instrument's UAR/T universal asynchronous receiver/transmitter; and Datel's DAS-16 modular data-acquisition system.

The Signetics 2535, an asynchronous buffer memory consisting of 32 8-bit words, basically augments the data-handling capabilities of the calculator itself. Both

input and output can be either serial or parallel and have a data rate of dc to 1 MHz in either mode of operation. The unit is fully compatible with the proposed byte-serial, bit-parallel interface standard and in fact uses the same three-wire handshake for inputting and outputting data.

Communications considerations

One important application of a calculator in conjunction with Analog Devices' serial-data exchange (Serdex) modules would be with the calculator serving as a digital terminal in a control room and selecting, monitoring, and controlling remote analog processes. Such a system could operate with or without a man in the loop. With the Serdex modules, byte-serial, bit-parallel data may be conveniently transformed into the asynchronous serial ASCII format used in many standard peripherals. Because of their control-character codes, the units seem intended primarily for Teletype or computer-based systems. However, these codes can be modified so that they are fully compatible with calculator-based systems, as well.

General Instruments' universal asynchronous receiver/transmitter will help improve data communications in, say, a hostile factory environment. It can accept binary characters from either a peripheral device or a calculator and will receive/transmit these characters with appended control and error-detecting bits. All characters contain 1 start bit, 5 to 8 data bits, 1 or 2 stop bits and either odd, even, or no parity. Even the transmission rate may be externally selected.

When a programable instrument takes more, or more elaborate, measurements than an application needs, yet several measuring devices are needed, Datel's data-acquisition module may be the answer. It contains in one package an analog scanner (eight or 16 channels), a sample-and-hold amplifier, an a-d converter (8, 10, or 12 bits), and a system controller that includes all the control logic needed to interface the unit with a byte-serial, bit-parallel calculator I/O bus.

As the use of calculators in measurement and control systems expands, a special-purpose calculator may be expected to appear. It will not be a mere desk-top instrument but, through serial data links, will extend its influence over large areas. Different versions will be rack-mountable or ruggedized to adapt them to different environments.

There is also no question that instrumentation-oriented calculators will benefit from computer technology. Features like interrupt processing, previously limited to computers, will appear. Also calculator I/O structure will continue to evolve, to permit simpler and more efficient routing of information within the system, as well as to peripherals. Moreover, as users committed to these systems expand their planning horizons, upward compatibility within calculator product lines will become more important. □

REFERENCES

1. A copy of proposed standard can be obtained by writing the IEEE Standards Office and asking for "Standard Interface Systems for Programmable Measuring Apparatus—Part II."
2. G.E. Nelson, P.L. Thomas, and R.L. Atchley, "Faster Gain-Phase Measurements with New Automatic 50-Hz-to-13 MHz Network Analyzers," Hewlett-Packard Journal, October 1972, pp. 12-20.
3. J.W. Atmar and J.J. Ellington, "An Advanced Environment Chamber Control System," J. Environmental Entomology, Vol. 2, 1973, pp. 88-94.

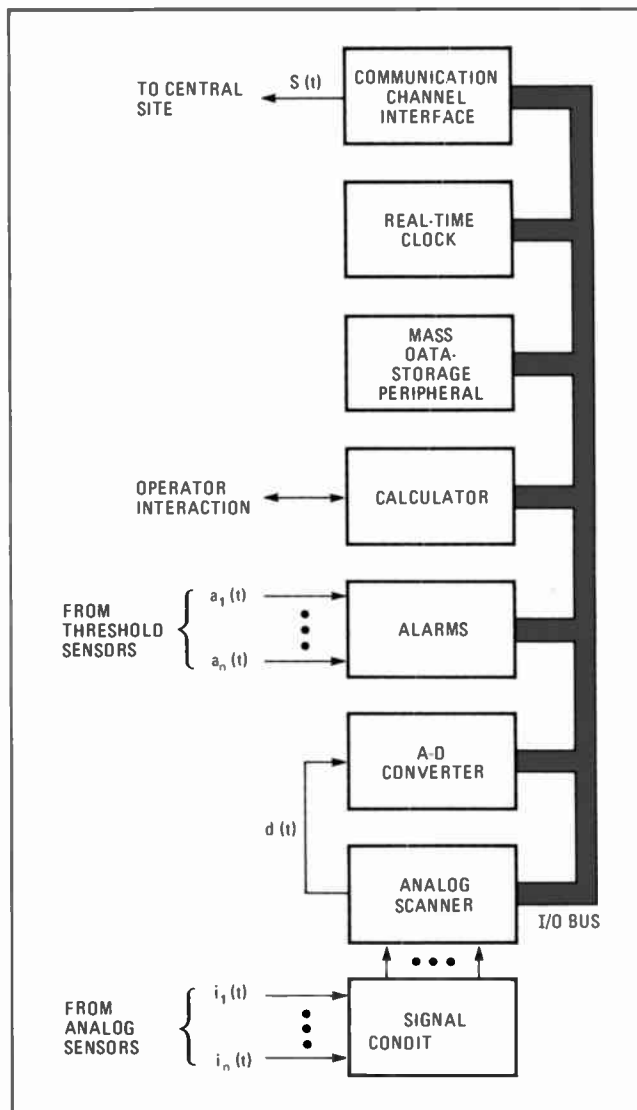

4. Data acquisition. Calculator-based remote data-acquisition system gathers and stores data automatically for transmission, on command, to central site. System is smart enough to alert central site when an emergency develops.

The widest selection of analog CMOS switches and multiplexers.

Available now.

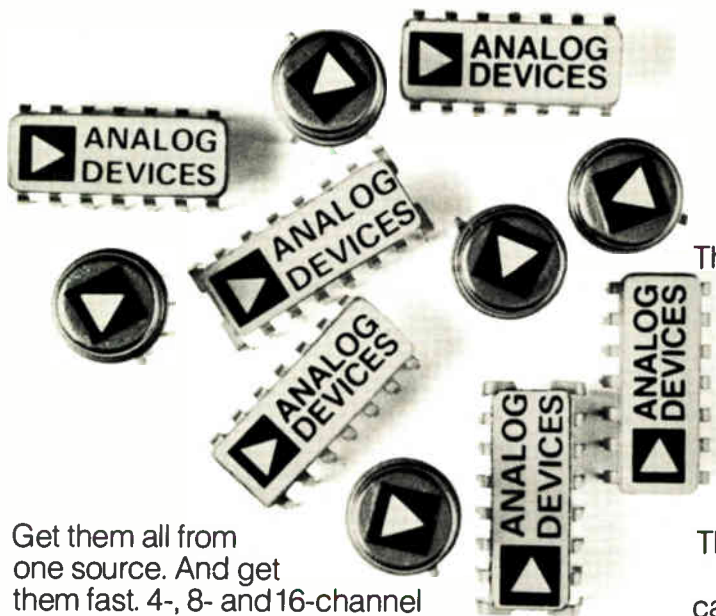

Get them all from one source. And get them fast. 4-, 8- and 16-channel multiplexers. Quad and dual SPDT switches.

Some of our designs you've never seen before. They'll give you specs, functions, and package options you can't order anywhere else.

And we've got other designs you'll recognize right away. You probably ordered them from someone else a while ago — and you're still waiting for delivery.

Check them out. They'll give you the design benefits of CMOS — and the lowest power dissipation you can get.

The multiplexers:

AD7501 8-channel
AD7502 differential 4-channel.
AD7503 8-channel.

AD7506 16-channel.
AD7507 differential 8-channel.

The switches:

AD7510/AD7511/AD7519 quads.
AD7512 dual SPDT.

AD7513 dual.

AD7516 quad.

Get it only from us. Again, only from us.

A replacement for HI1818.
Replaces DG506.
Replaces DG507.

You can't get them anywhere else. Another that's ours alone. Use it instead of DG200. Instead of CD4016A.

The price is right.

So give us a call — to order or to ask for our new catalog. It'll tell you everything you need to know about our entire line of analog CMOS switches and multiplexers.

Our analog CMOS switches and multiplexers, like our AD7520 CMOS DAC, are more innovative uses of advanced technology — to keep you (and us) a step ahead of everyone else.

Analog Devices, Inc., Norwood, Mass. 02062.

 **ANALOG
DEVICES**

EE performance evaluations win more praise than blame

Whether in supervising or subordinate positions, engineers who responded to *Electronics'* questionnaires agree on criteria for rating performance but differ on promotion systems

by Gerald M. Walker, *Associate Editor*

□ Freedom to choose the direction of one's career—up the pay scale as an engineer or upward into management—is just too limited. So feel most engineers in supervised positions who replied to a March 7 *Electronics'* questionnaire on performance evaluations, though they also generally believe they are evaluated fairly.

But a good three quarters of responses to the second questionnaire, for supervisors of engineers, maintain that promotion systems work "fairly well." Only 12% of this group consider they work "poorly."

This difference in viewpoints runs through several other responses, notably those concerning competence to judge performance and what to do about below-par performance. But unanimity exists to a surprising degree on the fairness of evaluations, what ought to be evaluated, and even on the merits of upward evaluation of the supervisor by those under him.

To judge by this sampling, formal performance evaluations are virtually universal. Moreover, just over three quarters of both groups say these ratings are done annually. In addition, some form of person-to-person review of the evaluation is generally practiced.

Ninety-five percent of the supervisors actually show the written evaluations to their subordinates. Not quite jibing on this score, but generally in agreement, some 74% of supervised EEs say they see their own evaluations, 59% add they sign or initial the reports, and 42% reply that they add comments of their own to the evaluations.

Significantly, 95% of the supervisors reporting use of formal, written evaluations indicate that the format for measuring engineers is devised, not by the engineering department, but by the personnel department. Thus, EEs are often judged on general work habits.

Satisfaction with the way performance eval-

uation is working is widespread but far from universal. For instance, over 60% of nonsupervising engineers reply their bosses are doing "a reasonably good job" of evaluating performance. And over two thirds of the supervisors indicate that they evaluate differently, i.e. better, today than the way they were being evaluated as beginners. Most state that they are more objective and stricter than was the case in the past.

Nevertheless, some comments from the nonsupervisory EEs reveal discontent. A senior systems analyst in data/voice communications complains, "The boss remains aloof from the group, unaware of day-to-day operation. He's also unaware of his men's career goals. He had no idea I had a master's in management with a career goal of management. In his evaluation he stated I wanted to stay on the technical ladder."

Commenting on how fair evaluations are, a 34-year-old senior engineer remarks, "Fair? Well, yes. But competent, no. I'm a better man than my boss—my success lies in working quietly around him. So how does he evaluate that?"

Concurring, an EE for a company in digital signal-processing systems says that his boss "doesn't do much of anything except play ping-pong."

Most other complaints about the fairness issue center

around technical competence. After all, if supervisors don't understand engineers' individual assignments, some doubt must arise over their ability to rate performance objectively. In addition, a couple of EEs wonder if they are being blocked from doing more and better work by the inability of their bosses to make full use of their knowhow. One engineer, in fact, confides that because of the trifling assignments he gets, he is working to only 20% of his capability and doesn't understand why no one has

Who responded

Engineers in supervised positions who responded to the questionnaire generally had about five to 10 years of experience. Most were 26 to 35 years old, and just 21% were over 40.

As for the supervisors, an equal percentage of responses came from those aged 31 to 35 and 41 to 45—24% each—and 22% were over 46. The majority had up to 15 years of experience.

Most of the supervised worked at companies in computers, components and space and aircraft, in that order. The supervisors came mainly from communications, radar, and space and aircraft firms. However, no single product category claimed more than 15% of the total, so that the response was spread fairly well across all types of manufacturers.

The two coasts dominated the geographical makeup of the sample, with most respondents located in California and New York.

noticed the situation. A few others made similar observations.

For their part, the supervisors comment that they are generally doing a better job than was done in the past. A semiconductor-company manager points out, "I evaluate performance against preestablished and negotiated [with the individual] goals." Another military-products supervisory EE adds, "I am much harder [than his previous bosses] now since I feel that I know most of the qualities needed to perform the work that I manage."

The engineering section manager for a tape-recorder company states, half jokingly, "Even with my best engineers I always find some weak point to discuss. My supervisors always found me nearly 'perfect.'"

Both sides of the coin

Some of the respondents, who both evaluate and are evaluated, filled out both questionnaires. In this group a slightly different picture of the effectiveness of engineering promotion emerges. On the nonsupervisory portion of the questionnaire, a resounding majority agree there is not enough opportunity for choosing a technical or management career ladder. But, with their supervisors' hats on, half of this same group report that the promotion system is working "poorly." Thus, those EEs who considered the promotion system from both above and below lean more toward the negative view of promotion than the supervising-only group.

Comments on the dual-ladder promotion system from this dual-role group suggest that the management path is their only path to advancement. It appears that some of those in the position of giving and receiving formal evaluations are aware of being on a management track and regret it. As one communications-equipment designer sums it up, "We have the dual-ladder system, but some ladders are more equal than other ladders, that is, the management ladder offers a bit more opportunity than the technical ladder."

Should evaluation be a two-way street?

While an understandably high percentage of nonsupervisors (92%) favor "up evaluation" of their managers' performance, a surprisingly large number of supervisors (64%) agree that subordinates should evaluate their bosses. Asked to weigh the different aspects of a manager's performance, over half of the nonsupervisors check technical and administrative performance as of equal importance. Of the remainder, a high number se-

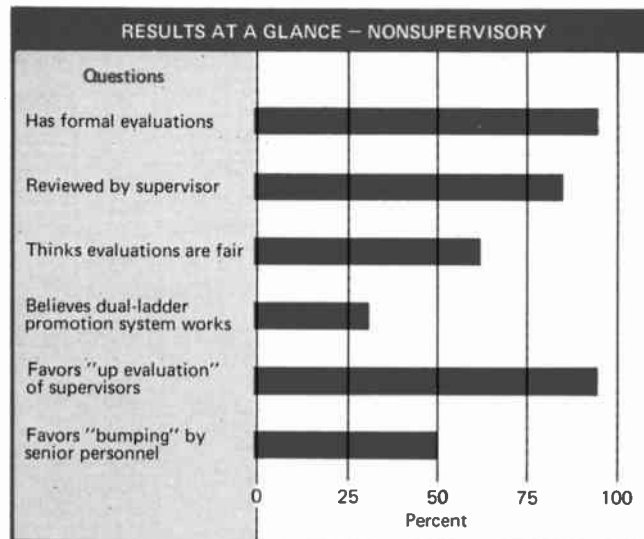

lect administrative capability over technical performance. There's a certain amount of ambivalence on this point—many complain that their superiors should have the technical capacity to understand a subordinate's work yet expect their bosses to concentrate on administration tasks with equal vigor.

"We don't have 'up evaluation,' but we should," a Southeastern respondent writes. "If anonymity can be preserved, it doesn't have to go any higher than the immediate supervisor, need not be seen by upper management."

A veteran of 22 years in engineering echoes the feeling of many others on the management side when he states that he would like to know his shortcomings and good points as a manager from the people he evaluates. However, "I don't ask for it [upward evaluation]," an X-ray instrumentation firm executive moans, "but I get it anyway—they tell me when I'm wrong."

"Too many managers become upward-oriented only. Evaluation by subordinates could vastly improve the quality of supervision as well as total output," a manager for a Midwest company suggests.

Disagreeing, an Eastern engineering department manager scoffs, "Evaluation by subordinates will let a manager look for popularity votes. A popular manager is not necessarily a good manager."

And, reflecting the orientation of an employee in Government contracting, a defense agency supervisory engineer concludes, "Although I think they [subordinates] will fear reprisal, the evaluation will bring problems to light that would not otherwise be discussed."

What's being rated and rewarded

One subject on which supervisors and nonsupervisors agree wholeheartedly is the most important performance characteristics to be rated. Both list technical performance or capability and ability to get a job done properly as the two most important criteria (see "What managers should rate," p. 112). Supervisors add a few others, including self-improvement and motivation, ability to work with others, and adaptability.

Under the heading of getting the job done fall a number of related job qualities, such as quality of work,

What managers should rate

Both supervisors and supervised were asked to list the most important criteria for judging engineering performance. Here, side by side, are the most-mentioned characteristics, in order of importance:

Supervisors	Nonsupervisors
Technical performance, capability	Technical performance
Meeting objectives and schedules	Goal achievement
Self-improvement, motivation	Future potential
Ability to work with others	Self-development
Dedication, dependability	Communication

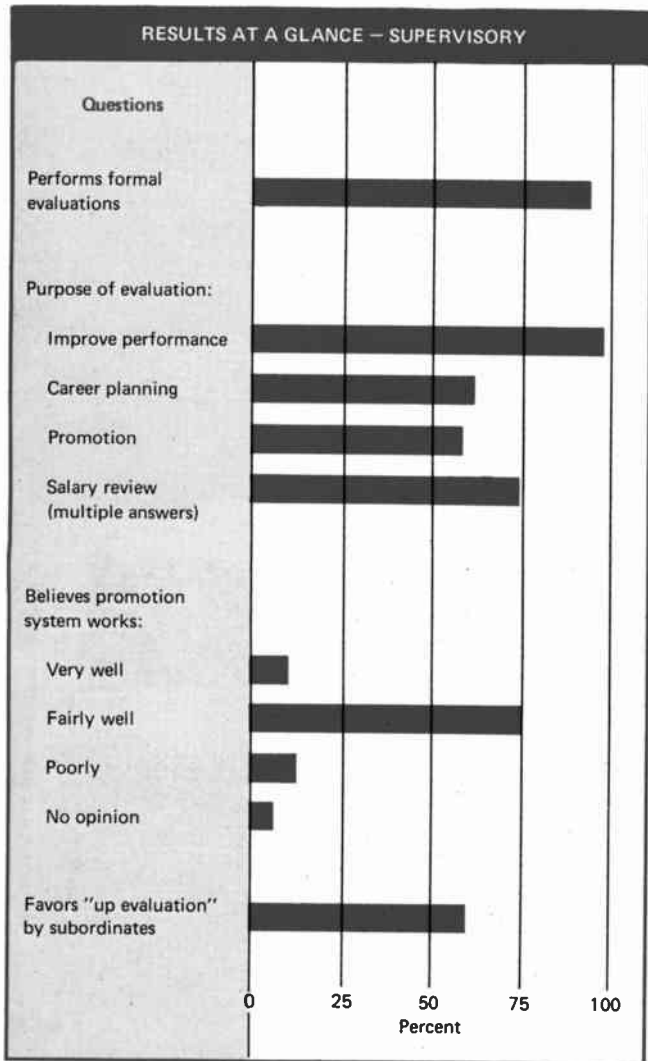

quantity of work, ability to meet time schedules and cost constraints, as well as willingness to accept responsibility. Several readers also add that contribution to the company's growth as well as to the individual engineer's potential is an important checkpoint. A few young EEs point out that, for now, the most important aspect of their job performance is the ability to learn and only later will it become contribution to the design effort.

The main purpose of employee evaluations, say 93% of the supervisory respondents, is to improve performance. However, almost three quarters also list salary review as an important reason, and two thirds include career planning as another major goal.

Promotion decisions are often considered the most important objective of an evaluation. But they do not get quite as many mentions; only three out of five supervisors stress them.

And what happens to an EE whose performance is under par? The most common course of action, according to supervisors in this sampling, is to explain and discuss deficiencies with the engineer and attempt to find the reasons. More important, they report, is to define an improvement program and plan a course of action. Some feel it's their responsibility to change the job environment, transfer personnel, or at least create an opportunity for improvement.

Low on the list of responses are punitive measures such as those that limit merit increases and set a time limit for improving performance. Judging from the comments of nonsupervisory personnel, however, these steps are more usual than the supervisors care to admit. In fact, a few point out that cuts in pay raises are the most important reflection of their performance.

Still, one young engineer for a computer company proposes that EEs should get pay bonuses in recognition for outstanding performance and be docked in pay for a short time as a result of unsatisfactory performance. Much more common are complaints about not receiving high enough merit raises, no matter what the performance rating system, thanks to the wage freezes imposed on many companies.

Layoffs and bumping

The practice of dealing with layoffs by moving senior engineers to lower-level jobs and bumping out junior employees is not directly related to performance evaluations. But readers were asked their opinions of this way of retaining senior personnel, albeit at lower wages, during employee cutbacks.

The nonsupervisory engineers are almost evenly split on the issue. Half favor "bumping," 44% don't, and 6% have no opinion. Ordinarily a vote in favor of bumping indicates the presence of older EEs among the respondents, but this was not the case here. Over 60% of the nonsupervisory EEs that favor bumping are under 35 and have less than 10 years of working experience.

In addition, comments favoring bumping often come from EEs in their early 20s. One of the strongest statements comes from a 23-year-old West Coast EE who contends, "I agree [with bumping] to a point. After 20 to 30 years at a company, I think that the company has a moral obligation to the person to help him as much as possible."

An aircraft-company engineer, however, points out that there are dangers to the individual in bumping, even if he does retain a job. He states, "In the aerospace industry, demotions in bad times bump managers back to being engineers. A manager cannot devote his career to management, because when demoted he becomes an obsolete engineer. If he tries to keep up in engineering as a safeguard, he neglects management."

Providing a balanced view, a 50-year-old guidance and control systems engineer opines, "From a personal standpoint, I would prefer bumping. However, new lower-priced talent with the latest technological capability must also get its day if the company is to perpetuate and be able to compete."

Supervisors were asked how they choose those who are terminated in layoffs, and most list those with the lowest performance as of least value to the company, department, product line, or team effort. But 21% mention that they base termination on seniority and high salary, as well.

Taking a militant stand, a project manager for a California aerospace firm comments: "None of our jobs is really safe until engineers organize a professional association to protect ourselves from layoffs. We need an association that could also tell management how we want to be evaluated and when." □

ENTER ↑

This is your key to unprecedented calculating power. Only Hewlett-Packard offers it.

In 1928 a Polish mathematician, Dr. Jan Lukasiewicz, invented a parenthesis-free but unambiguous language. As it's evolved over the years it's come to be known as Reverse Polish Notation (RPN), and it's become a standard language of computer science.

Today, it's the only language that allows you to "speak" with total consistency to a pocket-sized calculator. And the only pocket-sized calculators that use it are Hewlett-Packard's.

ENTER↑ is the key to RPN because it enables you to load data into a 4-Register Operational Stack with the following consequences:

1. You can *always* enter data the same way, i.e. from left to right, the natural way to read any expression.
2. You can *always* proceed through your problem the same way. Once you've entered a number you ask: "Can I operate?" If yes, you perform the operation. If no, you press **ENTER↑** and key in the next number.
3. You can see *all* intermediate data anytime, so you can check the progress of your calculations *as you go*.
4. You almost never have to re-enter intermediate answers—a real time-saver, especially when your data have eight or nine digits each.
5. You don't have to think your problem all the way through beforehand to determine the best method of approach.
6. You can easily recover from errors since each operation is performed sequentially, immediately after pressing the appropriate key, and all data stored in the calculator can be easily reviewed.
7. You can communicate with your calculator efficiently, consistently and without ambiguity. You always proceed one way, no matter what the problem.

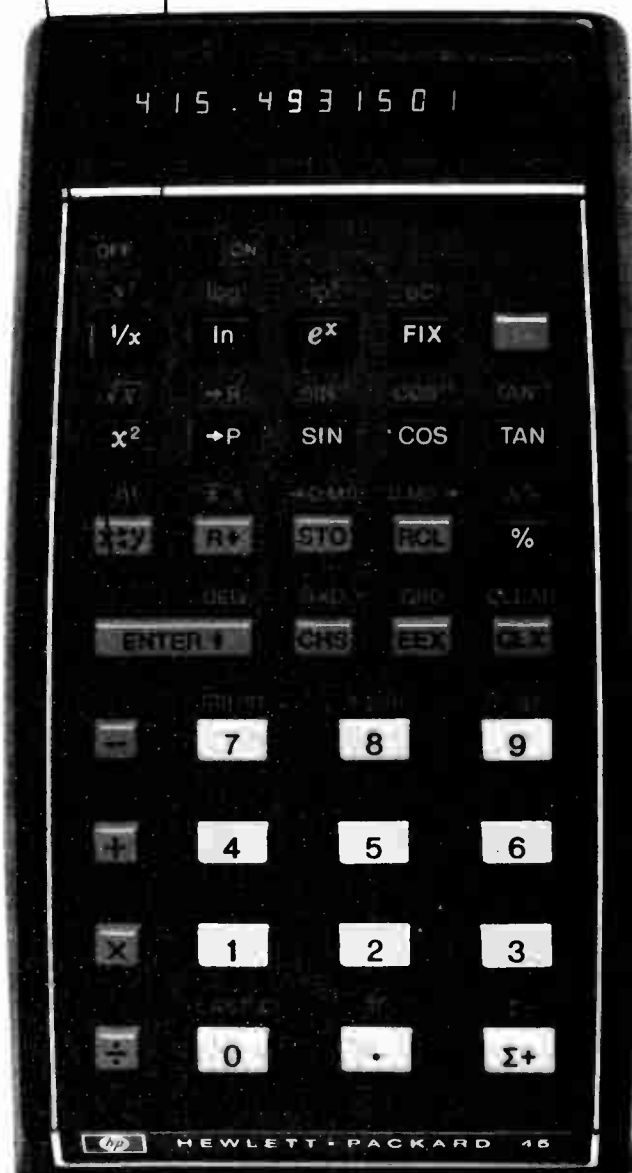

The HP-45 uses RPN.

That's one reason it's the most powerful pre-programmed pocket-sized scientific calculator. Here are 8 others:

1. It's pre-programmed to handle 44 arithmetic, trigonometric and logarithmic functions and data manipulation operations beyond the basic four (+, -, ×, ÷).

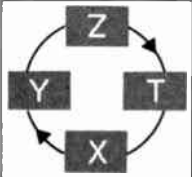
2.  It offers a 4-Register Operational Stack that saves intermediate answers and automatically retrieves them when they are required in the calculation.

3.  It lets you store up to nine separate constants in its nine Addressable Memory Registers.

4. It gives you a "Last X" Register for error correction or multiple operations on the same number. If you get stuck midway through a problem, you can use the "Last X" Register to unravel what you've done.

5.  It displays up to 10 significant digits in either fixed-decimal or scientific notation and automatically positions the decimal point throughout its 200-decade range.

6.  **D.MS** **D.MS** → It converts angles to degrees/minutes/seconds. In seconds.

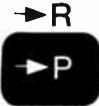
7.  **→R** **→P** It converts polar coordinates to rectangular coordinates... or vice-versa. In seconds.

8.  Its Gold "Shift" Key doubles the functions of 24 keys which increases the HP-45's capability without increasing its size.

The HP-35 uses RPN too.

If the HP-45 is the world's most powerful pre-programmed pocket-sized scientific calculator, the HP-35 is runner-up. It handles 22 functions, has a 4-Register Stack, one Addressable Memory Register and also displays up to 10 digits in either fixed-decimal or scientific notation.

*Domestic U.S.A. prices, not including applicable state and local taxes.

New low prices.



HP-45: \$325*

HP-35: \$225*

Now the exceptional value of these exceptional instruments is even more apparent, because we've cut their prices by \$70*. You can now own the world's most powerful pocket-sized pre-programmed scientific calculator, the HP-45, for only \$325*. The HP-35 now costs just \$225*.

Send for our booklet "ENTER vs. EQUALS."

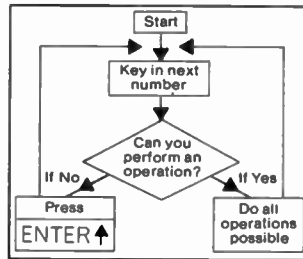

It demonstrates the superiority of Dr. Lukasiewicz' language by comparing it to other calculators' systems on a problem-by-problem basis, and it explains the algorithm shown left which lets you evaluate any expression on a calculator that uses RPN and an Operational Stack. This booklet is must reading for anyone seriously interested in owning a powerful pocket-sized calculator.

The coupon gets you detailed specifications of either the HP-45 or the HP-35 plus the booklet.

Just check what you want and send it along. We'll get your information back to you by return mail.

Hewlett-Packard makes the most advanced pocket-sized computer calculators in the world.



Sales and service from 172 offices in 65 countries.
Dept. 214F, 19310 Pruneridge Ave., Cupertino, CA 95014.

614/10

Hewlett-Packard
Dept. 214F
19310 Pruneridge Avenue
Cupertino, CA 95014
Please send the booklet, "ENTER vs. EQUALS:"
 Detailed specifications on your HP-35.
 Detailed specifications on your HP-45.
 HP-35(s) at \$225* each plus state and local taxes.
(Check enclosed.)
 HP-45(s) at \$325* each plus state and local taxes.
(Check enclosed.)

Name _____
Company _____
Street _____
City _____ State _____ Zip _____



Network analog maps heat flow

Equivalent lumped-parameter calculations by the finite-difference method resolves thermal factors early in the design cycle

by Carl J. Feldmanis, Air Force Flight Dynamics Laboratory, Wright-Patterson AFB, Ohio

□ It isn't easy to predict thermal conditions of an electronic system at the drawing-board stage. But knowledge of heat factors is crucial if a designer is to curtail the endless prototyping hours, which run up engineering costs. He must be confident that no temperature in the system will ever rise above some critical point. If it does, performance suffers, and devices fail. A well-engineered thermal system demands, then, that the designer have the analytical tools he needs to predict the thermal performance at every critical point.

A designer may approach thermal analysis from several directions. He may have designed a structure, has assumed a certain ambient temperature, and wants to check that no temperature in a device junction will exceed a critical value.

Or perhaps he may assume certain device temperatures and wants to compute the maximum thermal-resistance values that can be tolerated along certain thermal-resistance paths. Regardless of which variables are chosen as the dependent ones, the fundamental equations remain the same.

Fortunately, an effective method, called the finite-difference technique, is growing in popularity for solving such heat-transfer problems. The approach is to treat thermal relationships as analogs of electrical-network elements.

To proceed with this method of analysis, the designer first partitions the physical system into a number of subvolumes and places a node at the center of each volume element. Then he interconnects all nodes with the appropriate thermal impedances to simulate the flow of heat.

Thus, the thermal system takes on the appearance of an electrical network, and the designer can mobilize all the well-known methods for solving electrical networks, such as Cramer's rule, matrix inversion, and reduction by determinants.

The strength of the finite-difference approach presented here is that it enables a designer to form a circuit model of this thermal system and then vary resistances, power levels, and temperatures at will to achieve a satisfactory design. The network model need not be planar. It is crucial, however, for the designer to make sure that enough temperature nodes are selected so that the model becomes a workable approximation of the actual thermal system.

Computer simplifies calculations

A computer solution begins by converting the physical system into a network consisting of nodes connected by thermal impedances.¹ All the resistances and capacitances of the system are calculated and then presented in a form acceptable to the particular computer program.

Using this lumping process implies that the lump or node is at a uniform average temperature. By proper selection of the node size, any degree of accuracy can be obtained.

Program capacity should be considered, as well as expected temperature gradients and machine time. Unfortunately, there are no general rules for assigning the right volumetric size to each node. This consideration, then, becomes a matter of engineering judgment that improves with experience.

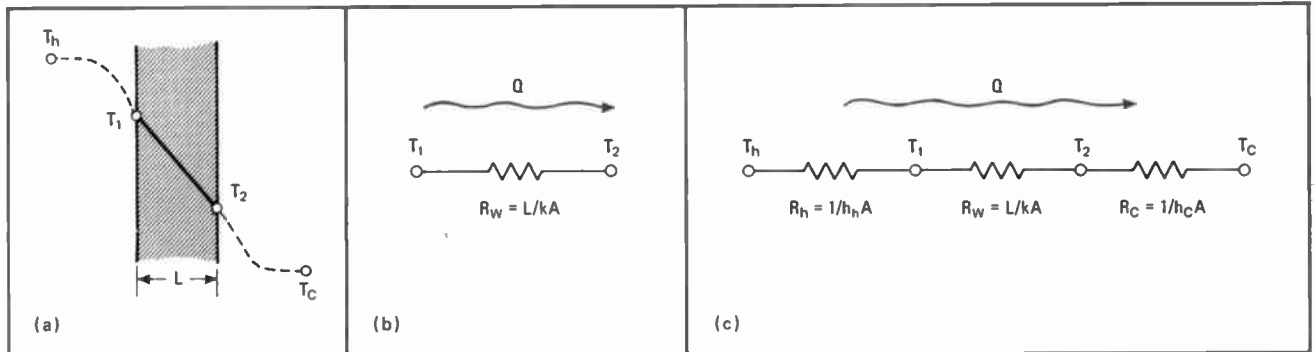

1. **Willing wall.** A planar surface of arbitrary area and thickness is the simplest geometry encountered in heat transfer (a). A resistor becomes the equivalent circuit element (b). Adding resistors for the convective interfaces (c) completes the circuit to the adjoining ambients.

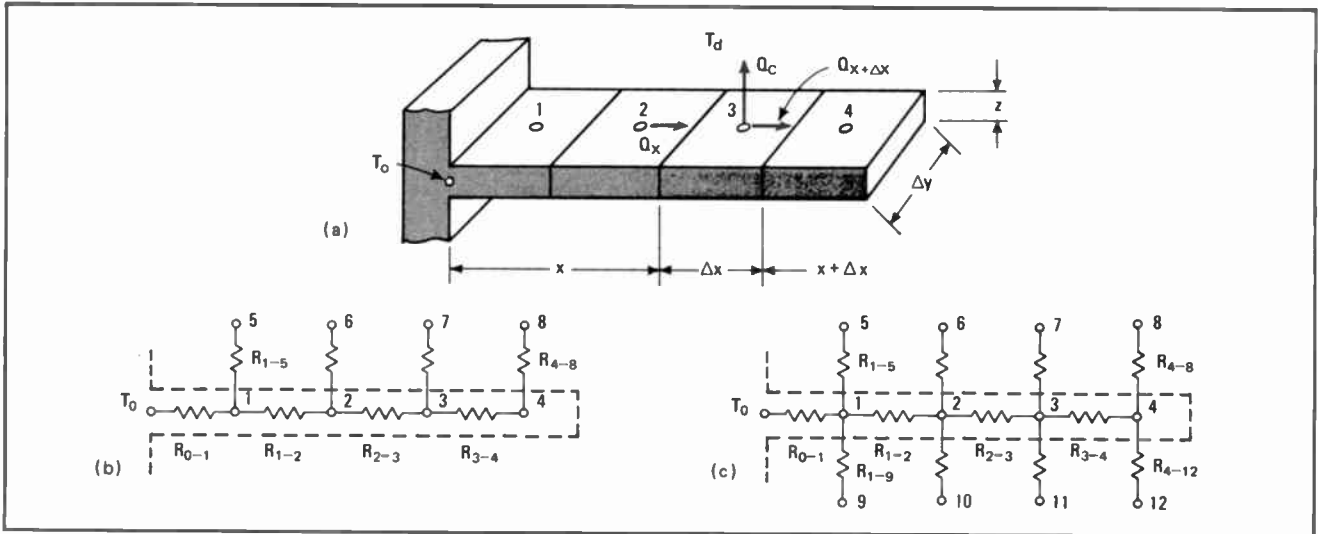

2. Fine fin. A thin wall projecting from a surface is an efficient convective interface (a). Network shown in (b) represents heat flow if convection occurs at top surface only. Adding resistors as in (c) simulates heat flow from top and bottom.

The heat-flow/current analog stems from a fundamental Kirchoff-law expression: the sum of the energy entering (or leaving) a node is zero:

$$\sum_i Q_i = 0$$

There are also terminal equations that relate the temperatures at the nodes to the heat flow between nodes. The flow is represented graphically by thermal impedances, or, in the steady-state case, thermal resistances are connected between the nodes.

The most time-consuming step is to convert the physical problem to a network equivalent, and a good starting place is to examine heat transfer in a simple geometric case—the plane wall.

Through the wall

Heat flow through a plane wall is analogous to current flow through a resistor. Figure 1 depicts flow from the warmer region at left to the cooler region at the right. The flow can be expressed as:

$$Q = (kA)(T_1 - T_2)/L$$

or

$$Q = (T_1 - T_2)/(L/kA) = (T_1 - T_2)/R$$

where Q is the heat-transfer rate in British thermal units per hour, k is the thermal conductivity in BTU/[(h)(ft)(°F)], T_1 and T_2 are the wall temperatures in °F, and L is the wall thickness in feet. L/kA is thermal resistance in (°F)(h/BTU).

Figure 1(b) is the circuit equivalent of the plane wall. In Fig. 1(c), two thermal resistors have been added to account for convection transfer at each wall. Note that the heat-transfer coefficients may be different (h_h , h_c), depending on the coolant flow and whether it is turbulent or laminar.

The convection-heat transfer to and from the wall can be expressed by the following equations:

$$Q = (T_h - T_1)/(1/h_h A) = (T_2 - T_c)/(1/h_c A) \\ = (T_h - T_1)/R_h = (T_2 - T_c)/R_c$$

Expression L/kA is called the conduction resistance, and expression $1/hA$ is called the convection resistance.

In any case involving heat transfer between two points at temperatures T_1 , T_2 , where $T_1 - T_2 = \Delta T$, the heat flow (analogous to Ohm's law) can be expressed as the equation:

$$Q = \Delta T/R$$

The relationship between the temperatures and the heat flow, therefore, for the plain wall with convection can be expressed as follows.

$$Q = (T_h - T_c)/[(1/h_h A) + (L/kA) + (1/h_c A)] \\ = (T_h - T_c)/(R_h + R_w + R_c)$$

A thin fin

The fin geometry is common in both natural and forced convection-cooling hardware because it offers a large surface area for convective-heat transfer. A fin attached to a hot wall or some heat-generating source is shown in Fig. 2. Heat from the hot wall flows along the fin, and from there, by convection, to the ambient air or other ultimate heat sink. Under steady-state conditions, heat entering the element must equal the heat leaving the element, or:

$$Q_{in} = Q_{out}$$

and

$$Q_x = Q_{x+\Delta x} + Q_c$$

where Q_c is heat lost by convection.

Heat entering the element at position x can be expressed in accordance with Fourier's law:

$$Q_x = -kA/\Delta x (T_b - T_a)$$

where $A = (Z)(\Delta y)$

Similarly, the heat leaving the element at position $x + \Delta x$ will be:

$$Q_{x+\Delta x} = -kA/\Delta x (T_c - T_b)$$

Heat leaving the element by convection will be

$$Q_c = (h\Delta A)(T_b - T_d)$$

where $\Delta A = \Delta x(\Delta y)$.

A designer may want to solve such a problem for any

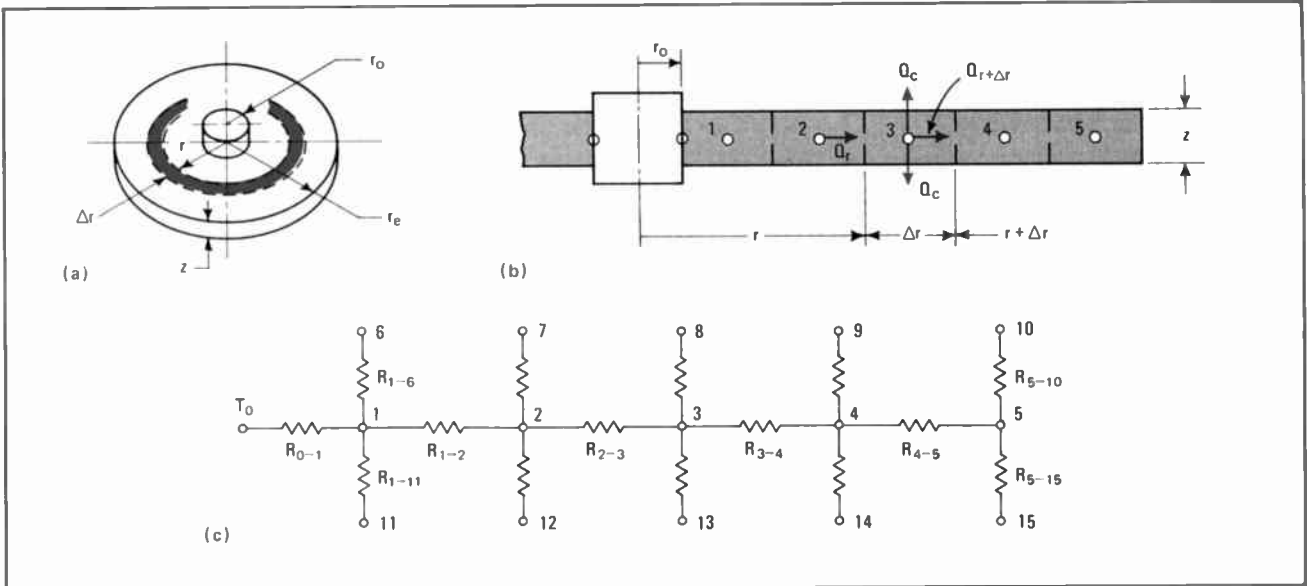

3. Cylindrical. Stacks of round, thin fins (a) dissipate heat efficiently. Analyzing designated concentric rings Δr wide (b) yields equivalent conduction resistors (horizontal) and convection resistors (vertical) arranged as shown in (c).

of several variables: heat flow in watts, temperature, or perhaps the heat-transfer coefficient (h). There are analytic techniques for the solution; however, solving a network analog is far simpler.

Figure 2(b) is the network representation of the fin when only one side of it takes part in transferring heat by convection; the other side and end are considered insulated.

Conduction resistances of the fin can be determined as follows:

$$R_{0-1} = \Delta x / 2kA$$

$$R_{1-2} = R_{2-3} = R_{3-4} = \Delta x / kA$$

where $A = Z(\Delta Y)$.

Convection resistances are:

$$R_{1-5} = R_{2-6} = R_{3-7} = R_{4-8} = 1/hA$$

where $A = \Delta x(\Delta y)$.

If heat is dissipated by convection from both sides of the fin, then the circuit must be changed accordingly, as in Fig. 2(c). Thermal resistances are determined as in the previous example, except that half-thicknesses are assumed for determining the conduction resistances:

$$A = (Z/2)(\Delta y)$$

When heat is dissipated to the ambient air (assumed to be at constant uniform temperature) all the ambient nodes (5, 6, 7, 8, 9, 10, 11 and 12) can be combined into one node, which then represents the temperature of the ambient air.

A circular fin of rectangular cross section is another effective shape for transferring heat to a surrounding ambient. Its design ensures a large surface area for effective convection to the ambient.

Figure 3(a) shows such a fin with the heat source assumed to be located at its center. The easiest way to analyze the flow is to divide the fin into concentric cylindrical sections, or rings, with equal concentric thicknesses, Δr , as shown in Fig. 3b. The network shown in Fig. 3(c) is a circuit equivalent when heat is convected

from both the top and the bottom surfaces. Heat loss at the edge has been neglected. However, it could easily be included in the analysis.

A cold plate

The air-cooled plate has an excellent capability to sweep large quantities of heat away from board-mounted discrete devices. The plate shown in Fig. 4(a) consists of equipment-mounting surfaces with finned air-flow passages attached for forced-air cooling.

Figure 4(b) shows the network for both the plate section and the air stream. Note that resistors R_{2-3} , R_{4-5} , etc., have been drawn to account for the temperature rise of the moving air stream. The flow resistances are:

$$R_{2-3} = R_{4-5} = R_{6-7} \dots = 1/c_p w$$

where c_p is the specific heat at constant pressure in BTU/lb/°F and w is the coolant flow rate in lb/h.

When the node regions are of equal size, then the convection resistances are:

$$R_{3-10} = R_{5-11} = R_{7-12} \dots = 1/wc_p (e^\beta - 1)$$

where $\beta = hA_c/wc_p$. If the plate had no fins, then:

$$A_c = (\Delta x)(\Delta y)$$

However, since the air-flow passage has fins, the fin surface area must be added to the surface area of the plate. Figure 4(c) shows a section of finned plate. Note that heat from the baseplate flows along each fin that extends into the air stream, causing a temperature gradient to develop perpendicular to the flow. The gradient hinders effective heat transfer near the cover plate because convective transfer is dependent on temperature difference, and the difference between the cover plate and the coolant stream is quite small.

The term η is introduced to predict the convective heat-transfer capability of the structure. Then:

$$Q = hA \eta_0 \Delta T_m$$

where A is the total heat-transfer surface area.

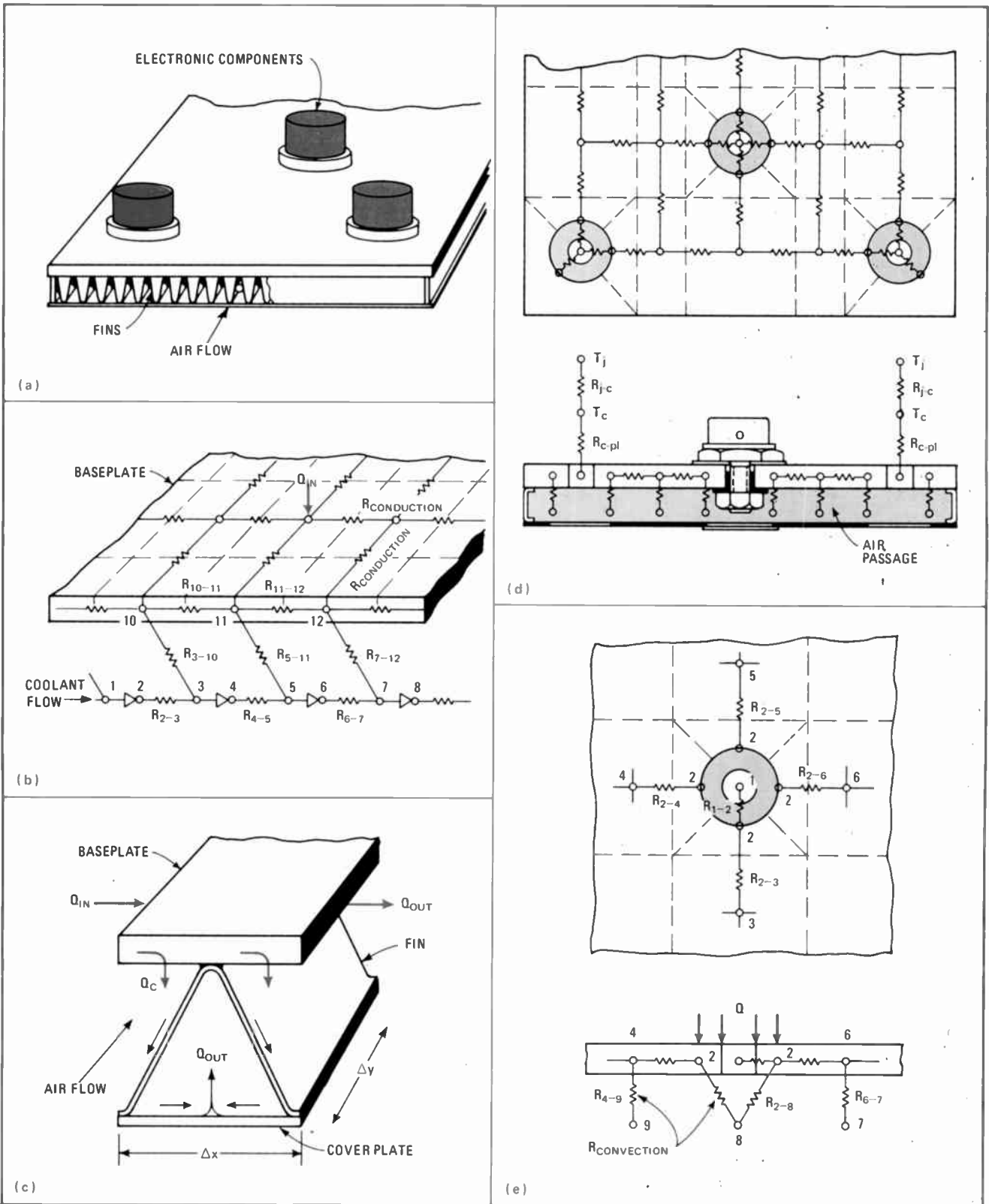

4. Cold plate. Fastening components to a plate, then forcing air through finned passages effectively dissipates the heat (a). Circuit diagram accounts for heat flow along the surface, as well as convective transfer to the coolant flow (b). Cross section of the passage denotes the various thermal paths (c). Top view of the plate (d) shows the thermal-circuit paths along the surface. Convective coupling resistors to the flow stream are drawn in the profile view. Cross-hatched region (e) is a critical path between the device and the coolant base plate.

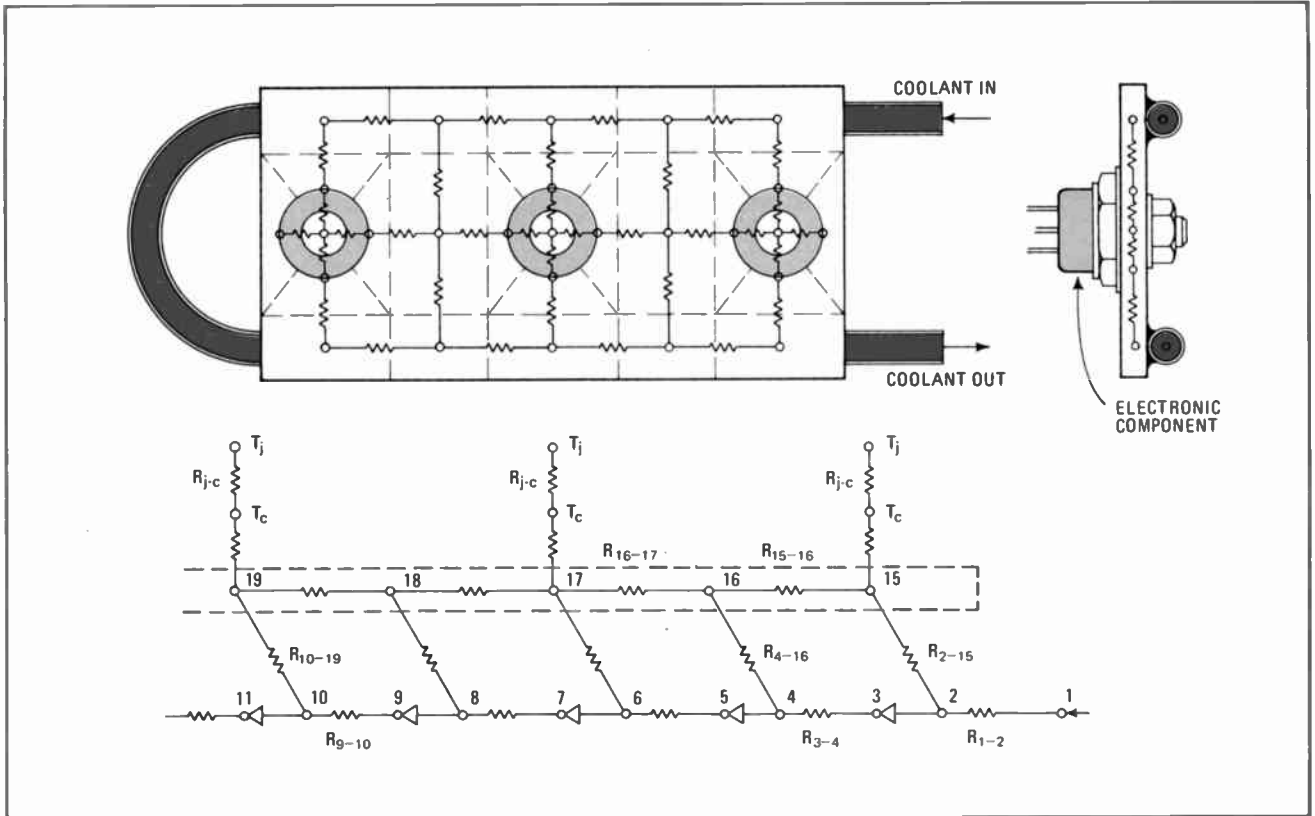

5. 'Round the bend'. U-shaped coolant line attached to a plate forms a liquid-cooled cold plate. Circuit topography on surface is the same as that of air-cooled plate. Coupling resistors, drawn diagonally, represent heat flow from plate to coolant line.

For an asymmetrically loaded cold plate, as shown in Fig. 4(a), the total heat-transfer surface area is expressed as:

$$A = A_b + A_f + A_c$$

where: A_b = baseplate surface, area, A_f = fin surface area, and A_c coverplate surface area

The over-all fin and cover-plate effectiveness can be determined from the following equation:

$$\eta_o = 1 - (A_f/A)(1 - \eta_f) - (A_c/A)(1 - \eta_c)$$

Where η_f and η_c are the effectiveness of the fin and base-plate, respectively.

Effectiveness of a flat, constant cross-section fin can be determined from an equation widely used in heat-exchanger design:

$$\eta_f = \tan h(ml)/(ml)$$

where $m = (2h/kz)^{1/2}$.

It is assumed here that the baseplate has an effectiveness of unity ($\eta_c = 1$) at each node.

Figure 4(d) is a network equivalent of a portion of the air-cooled plate. Once values are assigned to the known quantities, then network equations can be written. Techniques are covered in a number of volumes dealing with network analysis. The equations can then be solved by computer.

It may develop that such a network as is shown in Fig. 4(d) is not satisfactory for analyzing the configuration shown because it represents too crude an approximation. More nodes may be required.

Node count depends heavily on the thermal load

placed upon the assembly. Concentrated high-heat loads may require more nodes, closely spaced around the component-mounting areas. If nodes are added to represent regions exposed to the cooling-air stream, they must be connected to the stream by convection resistances.

The boundary

A refinement that improves the accuracy of the network model is to model the thermal paths in the shaded region shown in Fig. 4(e). These paths are critical in the analysis because heat crosses the interface boundary along these surfaces and then develops a temperature gradient that lies in the plane of the baseplate. Four nodes have been assigned to the outer circle of the ring. However, these node points can be combined into a single node if the temperatures about the circle's circumference are assumed to be the same. When this is the case, this equation can be used to determine the thermal resistance of the annular region:

$$R_{1-2} = (r_2 - r_1)/(kA_m)$$

where A_m is a mean of the area defined as:

$$A_m = (A_2 - A_1)/[\ln(A_2/A_1)]$$

The conduction resistances R_{2-3} , R_{2-4} , R_{2-5} , and R_{2-6} are the sums of the trapezoidal and rectangular node regions shown in Fig. 4(e). As far as the convection resistance is concerned, the part of the ring (node 1) covered by the washer and nut will not participate in the convective transfer. The active transfer area exposed to convection-heat transfer is the total rectangular area

Why analyze?

A designer embarks on the thermal-analysis course to make sure that no component in his system will exceed its maximum operating temperature. First thought usually goes to heat producers—semiconductors and resistors. But equally as important are nearby components, wires, and circuit boards.

A useful analytic technique helps a designer answer the question: Is any critical temperature exceeded? If the answer is yes, he must alter parts placement and structural geometries; perhaps it may be necessary to substitute materials with lower thermal resistances so that heat transfer is improved.

What complicates packaging architecture is that the thermal requirements are only part of the packaging designer's responsibility. He must also satisfy mechanical, electrical, manufacturing, and maintainability requirements—a huge order, indeed.

minus the covered position. This is represented by:

$$R_{2-8} = 1/wc_p(e^\beta - 1)$$

where $\beta = hA_2/wc_p$.

Natural convection and radiation also carry heat away from the external surfaces of the plate and the components, but they can be neglected if the forced-convection transfer coefficients are reasonably high.

Cooling with liquid

When power levels soar into the kilowatt range, then designers often turn to liquid-cooling. This changes the analysis somewhat. Figure 5 shows a simple cold plate with three heat-dissipating components attached. Heat from the components enters the plate (shaded area) and travels to the liquid stream. Conduction resistances are determined in the same way as in the air-cooled systems. What differs is the convective-heat transfer. In an air-cooled plate, all nodes are exposed to forced-convection heat transfer, but in liquid-cooling, only the nodes adjacent to the coolant line connect to the coolant flow. In the network (Fig. 5b), the flow resistances are:

$$R_{1-2} = R_{3-4} = R_{5-6} = 1/wc_p$$

When temperature gradients through the coolant-line

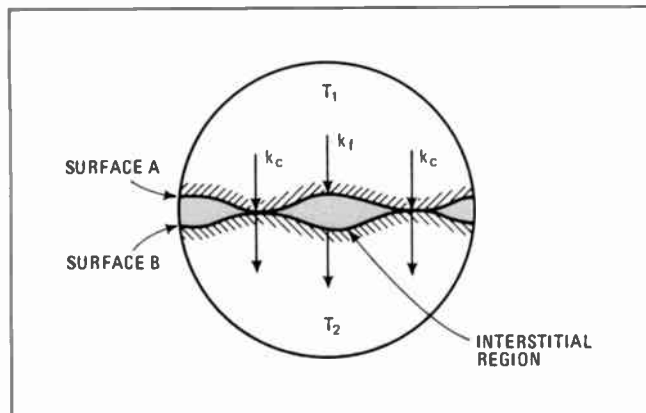

6. Bridgehead. Heat flow across mating interface of two materials travels both through contacting points and interstitial regions. Thermal coefficients k_c and k_t account for thermal coupling.

wall can be neglected, then the coolant-coupling resistances are:

$$R_{2-15} = 1/hA_c$$

where A_c is the convection-heat-transfer area.

A figure of merit, η , is introduced to weight the effectiveness of the area A_c :

$$R_{2-15} = 1/hA_c\eta$$

Heat capacity of the liquid must also be considered, and this capacity can be determined from the following expression:

$$C = \rho c_v A \Delta x.$$

where A is the cross section of the tube, c_v is the specific heat at standard volume, and ρ is the density of the fluid used for cooling.

Crossing the Interface

Regardless of the mounting technique used, a thermal resistance always develops at the interface between a component and its mounting surface. There is a wealth of data available about idealized joints that have uniform pressure distribution, controlled flatness, and surface finish. However, since these ideal conditions are seldom realized, an analytical technique that considers these factors is required.^{2,3,4}

Heat traveling across the boundary of two mating surfaces consists of the two components shown in Fig. 6. Heat flows through the contact points (k_c) and through the interstitial gaps (k_t). Therefore, the thermal conductivity is the sum of both terms:

$$K = k_c + k_t$$

The total heat transfer across the contact area is

$$Q = KA\Delta T = (T_1 - T_2)/(1/KA)$$

When only limited information about interface surface conditions is available, thermal conductance across the area of direct contact may be determined from the following expression:

$$K = 1.56k_A/(i_a + i_b) + 2n\bar{a}k_m$$

in which

$$k_m = (2k_1 k_2)/(k_1 + k_2)$$

where k_1 and k_2 are the thermal conductances of the mating materials, i_a and i_b are the root-mean-square values of surface irregularity (roughness plus waviness) for surfaces a and b, respectively, \bar{a} is the average radius of the contact points, and n is the number of contact points per unit area.

If approximate values of i_a and i_b can be obtained, then $n\bar{a}$ values as a function of the stress distribution at the bolted interface may be determined from charts published several years ago.³ □

REFERENCES

1. NASA CR-65581, "Thermal Analyzer Computer Program for the Solution of General Heat Transfer Problems," NASA Manned Spacecraft Center, Houston, Texas, February 1967.
2. K.G. Lindh et al., "Studies on heat transfer in Aircraft Structure Joints," University of California, Report No. 57-50, May 1957.
3. J.E. Fontenot, "Thermal Conductance of Contacts and Joints," Boeing Document No. D5-12206.
4. C.A. Whitehurst, "The Thermal Conductance of Bolted Joints," NASA CR 94738, May 1968.

HYBRID THINK SMALL

Here's a crystal clock oscillator that's even smaller than our K1091A. Fits the same circuits, same sockets. And even costs less in volume quantities. The K1100A is available from 250 kHz to 20 MHz, and, like the K1091A, is TTL compatible, has $\pm 0.01\%$ stability from 0°C to $+70^{\circ}\text{C}$, and uses the standard +5V dc input.

Write or call today for full specs and prices on both the K1091A and the new K1100A.

RUSH!

4-WEEK VOLUME DELIVERY (K1100A) IN STOCK FREQUENCIES (4.0, 4.9152, 5, 10, 20 MHz). 6 WEEK DELIVERY (K1100A) FOR ANY DISCRETE FREQUENCY FROM 4 TO 20 MHz. 8 WEEK DELIVERY (K1100A) FOR ANY DISCRETE FREQUENCY FROM 250 kHz TO 4 MHz.



MOTOROLA

COMPONENT PRODUCTS DEPT.

2553 N. Edginton
Franklin Park, Illinois 60131
Phone: (312) 451-1000

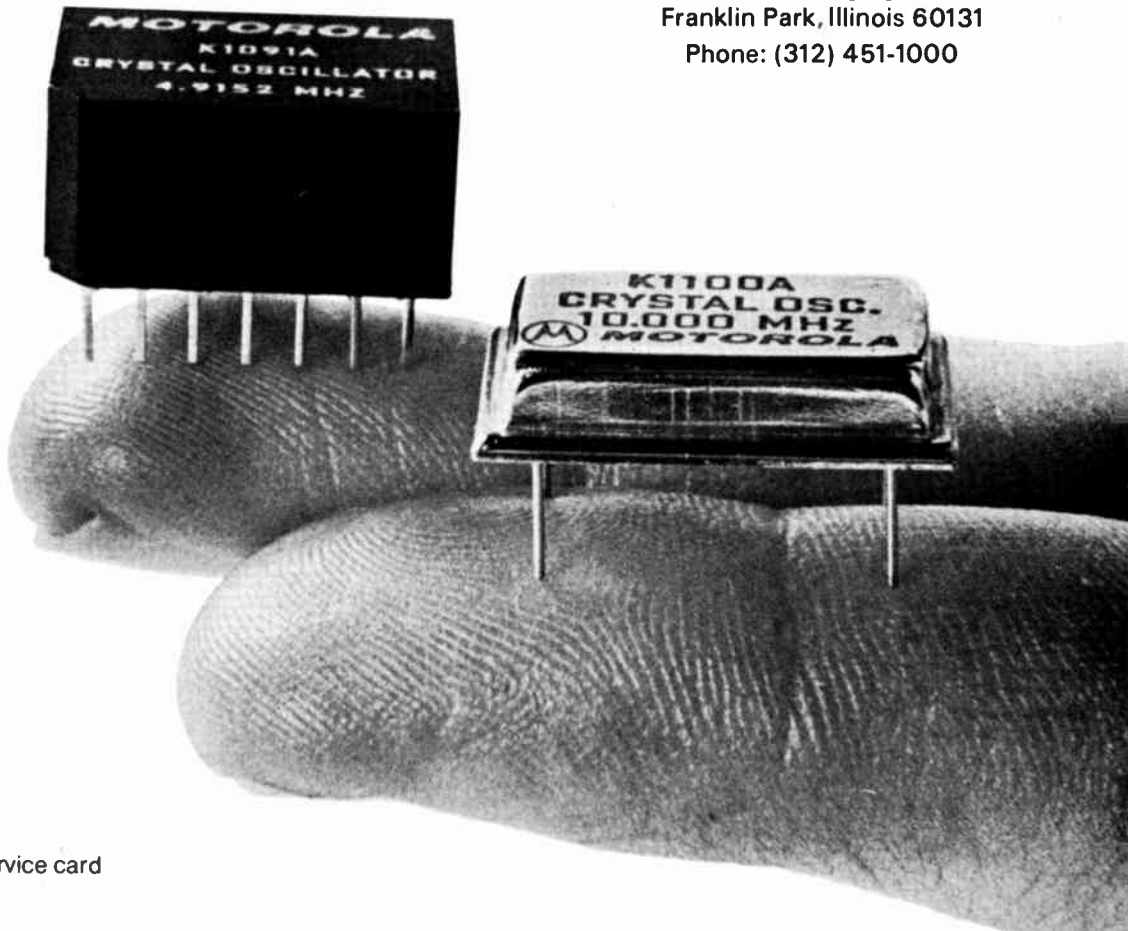

Active bandpass filter design is made easy with computer program

RCBAND time-shared software automatically determines the component values needed to build an active bandpass Butterworth or Chebyshev filter, in addition to predicting the circuit's frequency response

by Russell Kincaid and Frederick Shirley, *Sanders Associates Inc., Nashua, N.H.*

□ With the assistance of a computer and the right program, the often tedious task of designing filters can be considerably simplified. The time-shared program presented here, for instance, lets the computer crank out all of the numbers needed for an active band-pass filter design.

The program, which is called RCBAND, accurately computes the component values needed to provide the desired frequency response and permits the engineer to modify his initial design easily. RCBAND can produce either a Butterworth or Chebyshev filter characteristic, and its output data can provide both a tabulation and a graph of the predicted frequency response. The program is available* without a surcharge from the User Program Library of Tymshare Inc., which is located in Palo Alto, Calif.

Program structure

RCBAND employs the state-variable bandpass filter (see "Examining the state-variable filter," p. 125) as the basic filter section that is cascaded to produce the desired filter response. Up to 20 of these sections can be synthesized. The program normally analyzes the design as a series of single-pole sections, but custom filters can also be analyzed if the engineer specifies each section individually.

Only the basic filter specifications need be known to use the program—the number of poles desired, the type of filter characteristic, the center frequency, the bandwidth, and the gain. Or these inputs can be specified for each individual filter section, rather than for the entire filter.

The flow chart in Fig. 1 shows how RCBAND is structured. The program is written in NBASIC, the newest version of Tymshare's advanced SuperBASIC language. RCBAND is organized in a command-level format—that is, the computer prints a colon (:) and waits for further

*Copies of the RCBAND program listing can be obtained from Frederick Shirley, Sanders Associates Inc., 95 Canal St., M/S NCA1-6705, Nashua, N.H. 03060

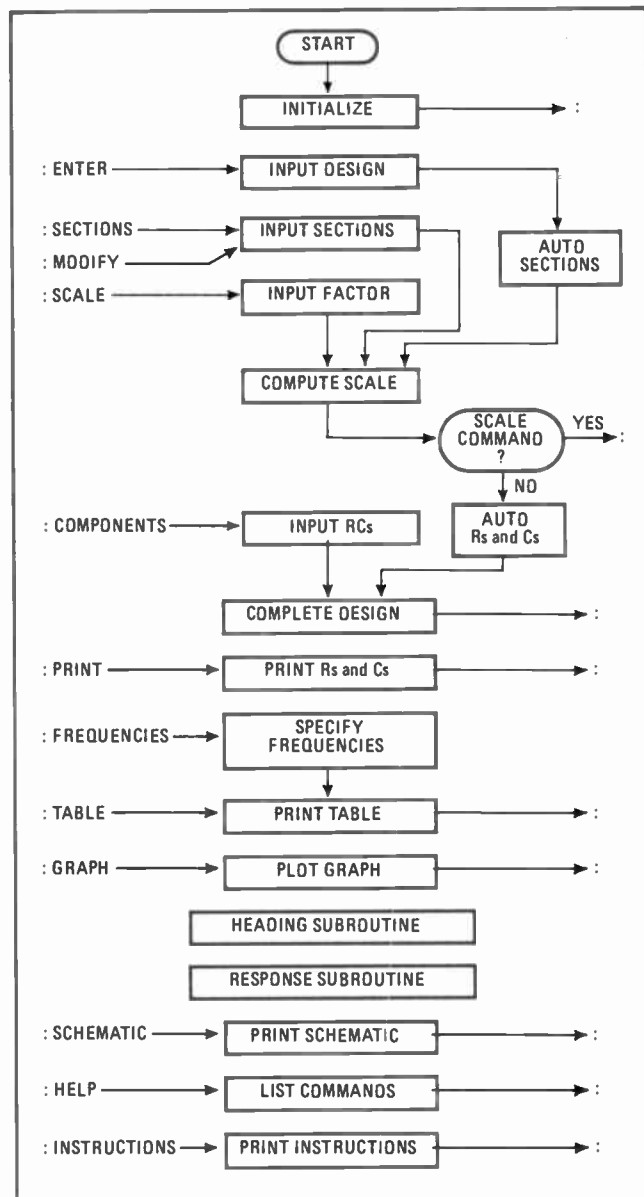

1. Filter design made easy. The RCBAND computer program designs active bandpass filters by using the three-amplifier state-variable filter as a basic building block. As this flow-diagram shows, program control is returned to the user after each subroutine instruction is completed. RCBAND automatically computes component values, predicts frequency response, and permits easy modification.

Closing the loop

Readers who wish to discuss the RCBAND computer program with the authors may call Russell Kincaid at (603) 885-4633 or Frederick Shirley at (603) 885-6239, during business hours the week of May 20.

Designing bandpass filters

Bandpass filters can be made either by cascading low-pass and high-pass filter sections or by cascading stagger-tuned resonators. The low-pass/high-pass approach is best for wideband applications, while the stagger-tuned-resonator approach is best applied to narrowband filters.

The dividing line between the wide and narrowband approaches is determined by how much gain a section (a pole-pair) can provide and still have excess gain to operate the feedback loop. A two-resonator filter, for example, will have unity gain in the passband because the gain of one section offsets the skirt attenuation of the other. If the bandwidth of the over-all filter is increased by making the center frequency of one section higher or the center frequency of the other section lower, the filter gain will be decreased.

Another point to be considered in deciding between the two design approaches is the filter's skirt attenuation. For a resonator-type filter, the skirt attenuation is approximately 6 decibels per bandwidth octave, whereas for a low-pass/high-pass filter, the skirt attenuation is 6 dB per absolute octave. This means that a filter with a 2-kilohertz bandwidth centered at 10 kHz will provide an attenuation of 6 dB at 13 kHz if it's a one-resonator design. Or its attenuation will be 6 dB at 22 kHz if it's an equivalent low-pass/high-pass design.

The engineer must also choose between active and passive filter designs. Generally, an active filter is cheaper and lighter than a passive filter at low operating frequencies, specifically in the audio ranges, where an active filter works well. The frequency limitation of an active design lies in the amplifier.

The amplifier's performance can be estimated from its response curve of open-loop gain versus frequency. At those frequencies where amplifier gain is less than 60 dB, filter operation will be poor. And at higher frequencies, if amplifier gain is less than 40 dB, the filter will not work properly.

The low-pass pole existing in the amplifier tends to push the peak filter response to lower frequencies. Although this can be compensated for by trimming, the amplifier's pole frequency typically varies by 3:1 from unit to unit, so that trimming is difficult and rather temperature-sensitive.

Usually, the (Fairchild) 741-type operational amplifier

will work well up to about 1 kHz, and the (National Semiconductor) LM101-type op amp, which has feed-forward compensation, will operate satisfactorily at frequencies up to around 10 kHz. Even higher frequencies can be handled by dielectrically isolated op amps such as the (Harris) HA2600-type unit.

The filter-circuit configuration chosen to implement a single filter section will also have some effect on performance. A filter section can contain one, two, or three op amps. Although it's the most expensive to build, the three-amplifier approach has two distinct advantages over the other two circuits—it is the least sensitive to component variations and the easiest to tune. This three-amplifier circuit is commonly referred to as the state-variable filter.

At least three parameters are needed to specify the response of a bandpass filter: center frequency, bandwidth, and gain. These parameters are functions of resistance and capacitance, as well as amplifier gain and bandwidth. For optimum performance, it is best to make the parameters depend on resistor ratios and RC products only. This is because the temperature tracking of resistors and RC products is controllable, but variations in amplifier gain and bandwidth are not.

When the filter's design frequency approaches the amplifier's upper limit (the frequency where the gain is down to 60 dB), the sensitivity of the circuit to amplifier gain and bandwidth becomes increasingly important. High-Q designs require more amplifier gain and are less tolerant of frequency shifts caused by amplifier-bandwidth limitations.

Filter sections can be arranged in any order without affecting the over-all filter response. Also, the gain of one section may be raised, and the gain of another section reduced by a corresponding amount. The Q of a filter section tends to be highest at the band edges, and odd-ordered filters generally contain a low-Q center-frequency section.

These simple considerations can be used to advantage in particular applications. For example, in a three-stage low-level preamplifier filter, the center-tuned section would be first, providing high gain to raise the signal above circuit noise. The remaining sections could then have reduced gain to avoid the undesirable condition of overdrive distortion.

directions from the user after completing each subtask. This format is indicated in the flow diagram by the command-level symbol (a colon) at the input and at the output of each subroutine function.

Since all the input specifications are stored, the user has maximum freedom to initiate, modify, or investigate a design in a truly interactive time-sharing mode. A byproduct of this type of organization is a set of aid commands that the user can call for at any time if he needs assistance in working with the program. Two of these aid commands—HELP and INSTRUCTIONS—are shown in Fig. 2.

The HELP subroutine prints a list of all the commands available through the program's input command routine, and the INSTRUCTIONS subroutine prints a brief explanation of the RCBAND program. Another subroutine that is included for user convenience is the

SCHEMATIC listing, which is also shown in Fig. 2. It prints a circuit diagram of the standard state-variable filter section.

The front end of the program documents the run and initializes the variables, default actions, and user-defined number functions. Although initialization is not necessary in NBASIC, it does serve to increase computational efficiency if the program is to be compiled into a run-only machine-language version.

RCBAND is easy to use

The default conditions override the normal NBASIC error messages in case of input error or a program bug. This enables RCBAND to maintain complete control of the interaction between the user and the computer so that the user need never be aware of the NBASIC source language while working with the program.

There are three user-defined number functions—they present computer-output data and accept user-input data in formats that are meaningful to the engineer. One function rounds numbers to the number of places specified by the user so that the printout contains only the number of digits required, regardless of number magnitude. A second function interprets user input in either scientific (1.23E3) or engineering (1.23 K) units. And the third function presents output data in engineering units that are five digits in length (101.86 K rather than 1.0186327E+05).

Subroutines help the user

An input-command routine directs computation to one of several subroutines. At the completion of a subroutine, control is transferred back to the command level, the printer advances two lines, types a colon (:),

and waits for the user to type an alphanumeric command like TABLE or GRAPH.

The ENTER subroutine prompts the user and accepts the input specifications he enters at his computer terminal. An alternate method of entering input data is provided by the SECTIONS subroutine, which permits the user to define a custom filter by specifying each resonator individually. This subroutine is also used when changing a section by the MODIFY command. The AUTO SECTIONS subroutine computes the specifications for each state-variable filter section from the over-all design objectives given through the ENTER subroutine.

The frequency scale for the table and graph printouts is controlled by the SCALE subroutine. The last portion of this subroutine is called by both the ENTER and SECTIONS subroutines for the initial selection of the frequency scale. The COMPONENTS subroutine permits the

Examining the state-variable filter

Although it requires three operational amplifiers, the state-variable active filter can operate at fairly high frequencies and can develop large values of Q. Moreover, the operating frequency, gain, and Q of this filter circuit are independent of each other, and the circuit itself is not overly sensitive to fluctuations in component values over the range of operation.

The state-variable filter consists of a summing amplifier (A_1) and two integrators (A_2 and A_3). The circuit's bandpass response is taken at the output of integrator A_2 . The natural frequencies, ω_1 and ω_2 , of integrators A_2 and A_3 are, respectively:

$$\omega_1 = 1/R_6C_1 \text{ and } \omega_2 = 1/R_7C_2$$

The transfer function of these integrators can be defined in terms of their natural frequencies (which are, of course, expressed in radians per second):

$$e_{out} = -\omega_1 e_1/s \text{ and } e_2 = -\omega_2 e_{out}/s$$

where s is complex frequency. Let three resistance ratios be defined for summer A_1 :

$$\beta_1 = R_2/R_1 \text{ and } \beta_2 = R_2/R_3 \text{ and } \beta_3 = R_5/R_4$$

Then the transfer function of summer A_1 can be written as:

$$e_1 = \frac{-\beta_1 e_{in} - \beta_2 e_2 + [R_4/(R_4 + R_5)]}{[1 + R_2[(R_1 + R_3)/(R_1 R_3)]]} e_{out}$$

Now the transfer function of the entire circuit can be expressed as:

$$e_{out}/e_{in} = \frac{\beta_1 \omega_1 s / [s^2 + [(1 + \beta_1 + \beta_2)/(1 + \beta_3)] \omega_1 s + \beta_2 \omega_1 \omega_2]}{[1 + R_2[(R_1 + R_3)/(R_1 R_3)]]}$$

The principal filter specifications are center frequency (ω_o), damping factor (ζ), and gain constant (k):

$$\begin{aligned} \omega_o &= (\beta_2 \omega_1 \omega_2)^{1/2} \\ \zeta &= \frac{1}{2} [\omega_1 / (\beta_2 \omega_2)]^{1/2} [(1 + \beta_1 + \beta_2)/(1 + \beta_3)] \\ k &= \beta_1 \omega_1 \end{aligned}$$

These variables permit the filter's transfer function to be written in the standard format of a second-order equation:

$$e_{out}/e_{in} = ks / (s^2 + 2\zeta\omega_o s + \omega_o^2)$$

The filter's 3-dB bandwidth (b_o) and center-frequency

gain (g_o) can be computed from this last equation:

$$\begin{aligned} b_o &= 2\zeta\omega_o = \omega_1 [(1 + \beta_1 + \beta_2)/(1 + \beta_3)] \\ g_o &= \beta_1 [(1 + \beta_3)/(1 + \beta_1 + \beta_2)] \end{aligned}$$

A multiple-pole bandpass filter can be built as a series of one-pole-pair sections like the one shown here. Each pole pair in the over all filter transfer function is used to specify the resistor and capacitor values in the corresponding circuit section. The frequency response of any section is completely determined by center frequency ω_o , 3-dB bandwidth b_o , and center-frequency gain g_o .

To simplify the computation, six of the nine unknown component values can be preset to reasonable values:

$$\begin{aligned} R_4 &= 1 \text{ kilohm} \\ R_2 &= R_3 = 10 \text{ kilohms} \\ C_1 &= C_2 = 0.01 \text{ microfarad} \\ R_6 &= R_7 \times C_2/C_1 \text{ ohms} \end{aligned}$$

These are the computer-selected component default values used by the RCBAND design program. The remaining three resistor values can be determined from these preset component values and the three known filter parameters:

$$\begin{aligned} R_7 &= [1/(\omega_o C_2)](R_2/R_3)^{1/2} \\ R_1 &= [\omega_o/(b_o g_o)](R_2 R_3)^{1/2} \\ R_5 &= R_4 [(\omega_o/b_o)(R_3/R_2)^{1/2} \\ &\quad [1 + (R_2/R_1) + (R_2/R_3)] - 1] \end{aligned}$$

The preselected values suggested for capacitors C_1 and C_2 are scaled by RCBAND to place the values of resistors R_6 and R_7 within the range of 10 kilohms to 100 kilohms. When necessary, the values of resistors R_2 and R_3 are also scaled, with resistor R_2 decreasing in value and resistor R_3 increasing in value so that resistor R_5 is always positive in value.

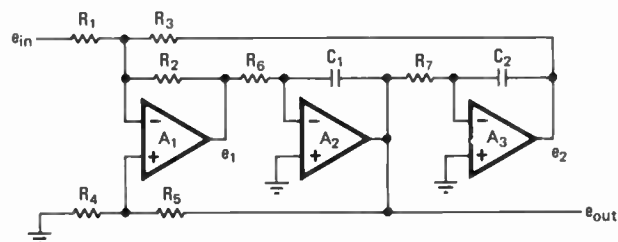

TABLE

CHEBYSHEV BANDPASS RC-ACTIVE FILTER

1.0000 KHZ CENTER 4 POLES
 100.00 HZ WIDTH 6.02 DB GAIN
 .5 DB RIPPLE

FREQ (HZ)	GAIN (DB)	PHASE (DEG)	DELAY (SEC)
910.00	-21.77	318.7	1757.3 U
915.00	-19.29	315.3	2103.7 U
920.00	-16.59	311.1	2583.7 U
925.00	-13.63	305.8	3884.9 U
930.00	-10.34	299.0	4381.5 U
935.00	-6.65	289.6	6259.8 U
940.00	-2.48	275.6	9737.5 U
945.00	1.98	252.7	16172. U
950.00	5.53	217.1	22439. U
955.00	6.52	178.6	18857. U
960.00	6.21	150.0	13417. U
965.00	6.02	128.3	11140. U
970.00	6.14	108.8	10741. U
975.00	6.38	89.3	10957. U
980.00	6.52	69.5	10944. U
985.00	6.46	50.2	10395. U
990.00	6.27	32.2	9568.6 U
995.00	6.09	15.7	8889.0 U
1.0000 K	6.02	.0	8611.3 U
1.0050 K	6.09	-15.6	8799.2 U
1.0100 K	6.27	-31.9	9365.8 U
1.0150 K	6.45	-49.4	10058. U
1.0200 K	6.52	-68.0	10496. U
1.0250 K	6.40	-86.9	10450. U
1.0300 K	6.18	-105.4	10145. U
1.0350 K	6.03	-123.6	10286. U
1.0400 K	6.12	-142.9	11487. U
1.0450 K	6.44	-166.3	15026. U
1.0500 K	6.31	-197.9	19825. U
1.0550 K	4.27	-233.7	18454. U
1.0600 K	.56	-261.4	12228. U
1.0650 K	-3.38	-279.0	7767.6 U
1.0700 K	-6.98	-290.5	5278.3 U
1.0750 K	-10.18	-298.6	3845.9 U
1.0800 K	-13.05	-304.7	2956.9 U
1.0850 K	-15.64	-309.5	2365.4 U
1.0900 K	-18.01	-313.3	1948.8 U

GRAPH

GAIN, PHASE OR TIME DELAY? GAIN
 AUTOMATIC SCALING? NO
 DB PER PRINT POSITION? .5
 DB MAXIMUM? 10

CHEBYSHEV BANDPASS RC-ACTIVE FILTER

1.0000 KHZ CENTER 4 POLES
 100.00 HZ WIDTH 6.02 DB GAIN
 .5 DB RIPPLE

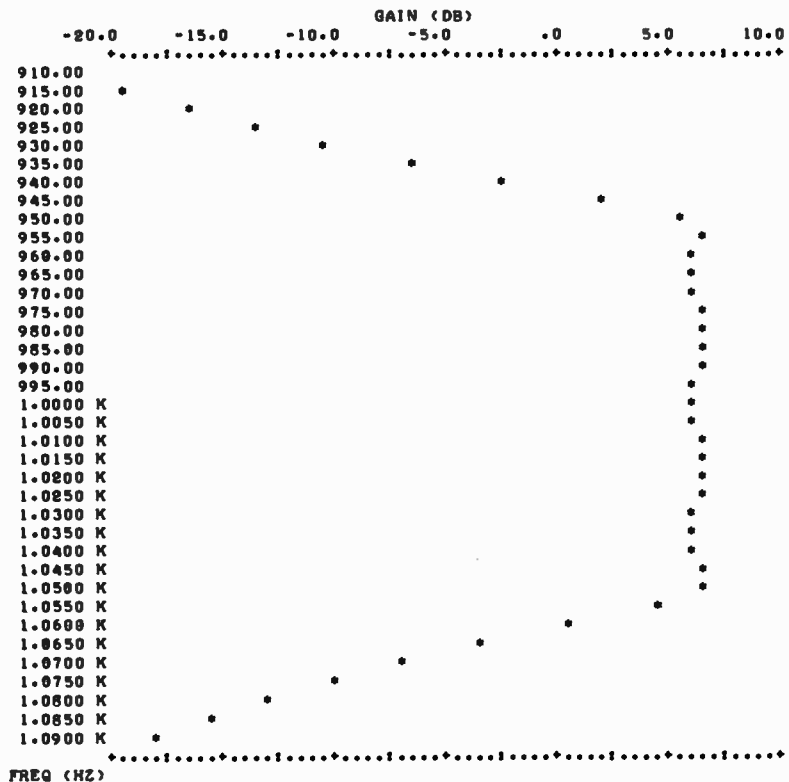

of 6.02 decibels, and a passband ripple of 0.5 db.

This data is given to RCBAND through the ENTER command. An unacceptable input—one that is ambiguous or out of range—is brought to the user's attention by an error routine so that corrected data can be reentered immediately. This prevents a computer run from aborting needlessly.

Applying the program

The PRINT command will provide a tabulation, as shown in Fig. 3, of the computed component values in each of the four filter sections. The section parameters (center frequency, bandwidth, and gain) are also printed to help the designer check and/or align the filter response. This printout, as well as the other major program printouts, are spaced on 8½-inch pages with a short heading on each page labeling the results. (The format is suitable for inclusion in engineering reports.) The data is presented in engineering units, rather than scientific notation, to make the printout easier for the engineer to interpret.

The TABLE and the GRAPH commands produce a tabulation and a plot, respectively, of the frequency response of the example filter. These two printouts, which are included in Fig. 3, give the response in engineering units—gain is in decibels, phase in degrees, time delay in seconds, and frequency in hertz.

The GRAPH subroutine used in RCBAND minimizes printout time by returning the printer carriage, once the actual data point is plotted, instead of wasting computer time by "printing" spaces all the way across the page. The user may select the scale for the gain axis, as done here, or he may let RCBAND determine it automatically. The scale for the frequency axis may also be user-selected through the SCALE command.

The schematic of the four-pole Chebyshev filter is drawn in Fig. 4, showing the final component values for all four filter sections. Needless to say, it still remains for the designer to select the operational amplifiers that are best for his application.

If narrowband 741-type operational amplifiers, which have a 60-dB bandwidth of 1 kHz, are used, the response

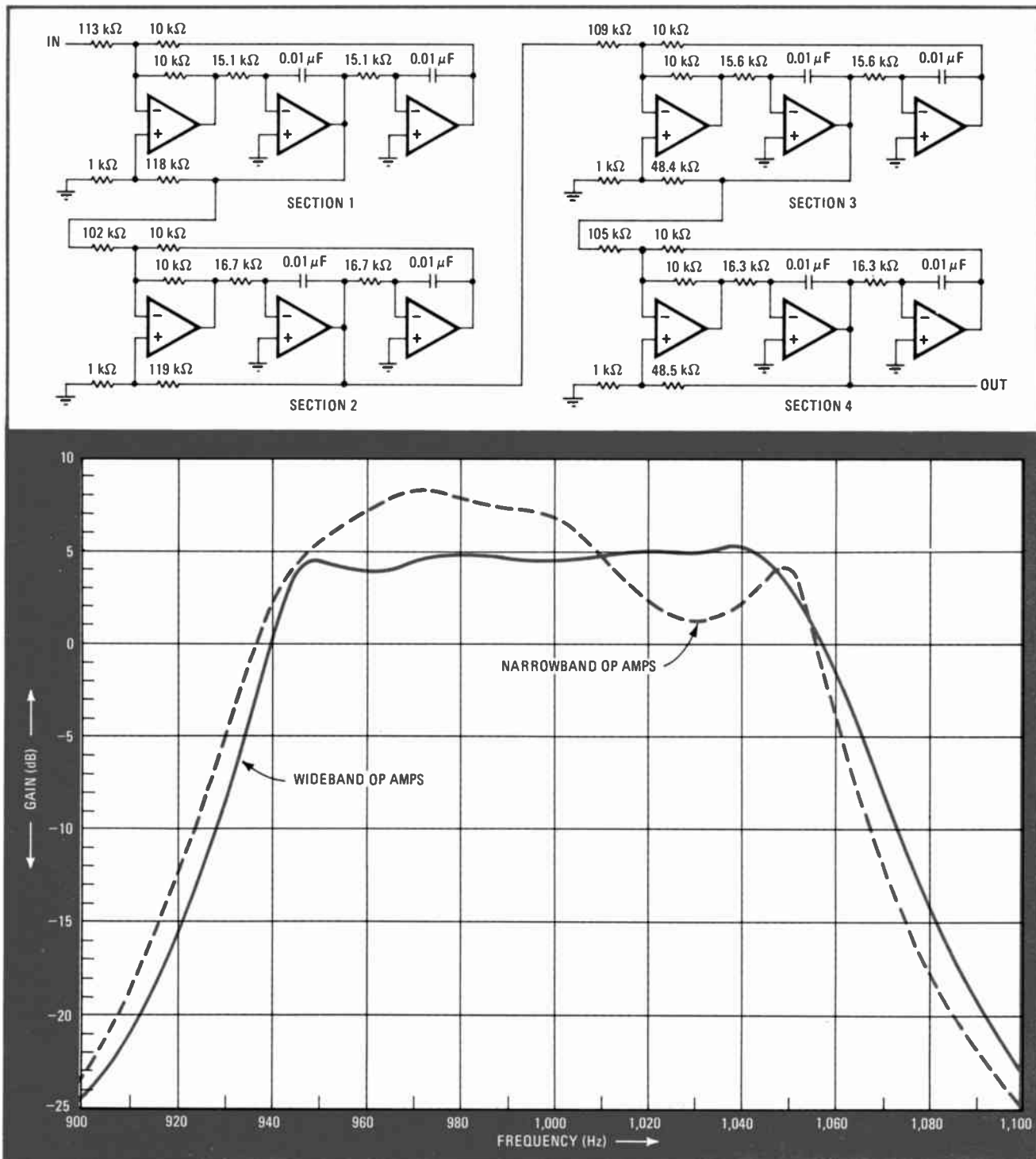

4. The real thing. Schematic shows the circuit configuration and component values of the four-pole Chebyshev filter described in the RCBAND printouts of Fig. 3. This filter's gain-versus-frequency response curve is closer to ideal when wideband op amps (like LM101-type units) are used than when narrowband op amps (like 741-type units) are used. Of course, the op amp chosen depends on the application.

curve drawn as a dashed color line in the gain-versus-frequency plot of Fig. 4 is obtained. On the other hand, if LM101-type operational amplifiers, which provide a 60-dB bandwidth of 10 kHz (with a 3-picofarad compensation capacitor), are used, the frequency response plotted by the solid color line results. Notice the similarity of the filter response predicted in the GRAPH printout of Fig. 3 to the filter response of the practical filter plotted in Fig. 4. □

BIBLIOGRAPHY

- P. Geffe, "RC-Amplifier Resonators for Active Filters," *IEEE Transactions on Circuit Theory*, December 1968, pp. 415-419.
- R. Kincaid and F. Shirley, "Get Something Extra in Filter Design," *Electronic Design*, June 21, 1969, pp. 114-121.
- D. Rife, "The Easy Way to Design Bandpass and Band-Reject Filters," *Frequency Technology*, March 1970, pp. 13-17.
- Graeme, Toby, and Huelsman, "Operational Amplifiers—Design and Applications," McGraw-Hill, New York, 1971, pp. 282-326.
- F. Shirley, "Improve Your Curve Plotting with SuperBASIC Software," *Electronic Design*, April 29, 1971, pp. 62-63.
- R. Brandt, "Active Resonators Save Steps in Designing Active Filters," *Electronics*, April 24, 1972, pp. 106-110.
- G. Shapiro, "BASIC Program Performs Low-Pass-to-Bandpass Transformations," *EDN*, Jan. 5, 1973, pp. 98-100.

Open a Savings Account with our new megapower SCRs



When you invest in IR's new Megapower SCR Family Savings Plan you start earning dividends three important ways.

First, you can eliminate over 70% of the devices and parts normally needed (see the 3-phase converter "savings account" below for full details). That gives you a lower total system cost, plus more reliability.

Second, having fewer parts cuts assembly time sharply, increases reliability and makes your field servicing that much easier, too.

Third, Megapower SCRs give you more production power with only a minimum change in your equipment size.

If you want to parallel Megapower SCRs, there's a special bonus. Our epitaxial process

yields SCRs of virtually identical switching characteristics, so you eliminate expensive current balancing equipment. It also produces the high voltage SCRs you need. Specifically: 700A(av), 500 to 2100V; 850A(av), 500 to 2000V; 1000A(av), 500 to 1500V, and 1600A(av), 500 to 1200V.

IR'S 4800 Amp, 3-PHASE CONVERTER SAVINGS ACCOUNT

Parts Per Assembly	4800A Assy. Using 3-550A SCRs Per Leg	4800A Assy. Using 1-1600A SCR Per Leg	Parts Saved Per Assy.
1. SCRs	18	6	12
2. Heat Sinks	21	9	12
3. Clamps	18	6	12
4. Fuses	18	6	12
5. Balancing Reactors	18	0	18
6. Trigger Pulse Pwr. Amplifiers	6	0	6
7. Isolated Gate Drive Windings	18	6	12
Totals	117	33	84

There is also an extra dividend in overall productivity because Megapower SCRs will keep your equipment on line longer. Their surge capability is so high, they can ride through massive overloads without resorting to protective fuses.

Open a savings account today. Call your IR branch office, or bank headquarters (213) 678-6281; Telex: 67-4666. International Rectifier, 233 Kansas Street, El Segundo, CA.

International Rectifier

International Rectifier, 233 Kansas Street, El Segundo, CA 90245. . . . *the innovative power people*



All-electronic metronome provides accurate beat rate

by Dennis R. Morgan
 General Electric Co. Electronics Laboratory, Syracuse, N. Y.

For the engineer who is also a music enthusiast, here is a precision electronic metronome that can be adjusted to the desired beat rate, is accurate to within 1 beat per minute, and can be assembled from standard parts. The circuit, which can be powered from any garden-variety 9-volt transistor-radio battery, can generate audible clicks (beats) even beyond the standard metronome range—from about 15 to 380 times a minute.

A 10-turn potentiometer that has a turns-counting dial is used to set the metronome's beat rate. The circuit can be calibrated so that the setting of this potentiometer is accurate to well within 1 beat per minute over the standard metronome range of 40 to 208 beats per minute. Furthermore, the circuit is relatively insensitive to variations in battery voltage, in particular to the reduced voltage that results from aging.

The figure shows two versions of the circuit—the one given in (a) is a pocket-sized metronome that has an 8-ohm earphone output, and the one given in (b) is a more powerful metronome with a regular 8-ohm speaker output. This latter circuit develops a hefty output power level of approximately 0.01 joule.

In both circuits, a constant-current generator (transistor Q_1) is used to charge capacitor C_1 . When this capacitor's voltage reaches the firing point (above 6 v) of the

Rhythm reminder. Electronic metronome circuits are accurate to within 1 beat per minute over the standard metronome range of 40 to 208 beats per minute. Circuit (a) has an earphone output, while circuit (b) has a speaker output. In each case, a 10-turn potentiometer is used to set the beat rate. Both circuits are battery-operated. A typical calibration curve shows the linearity of the output beat rate.

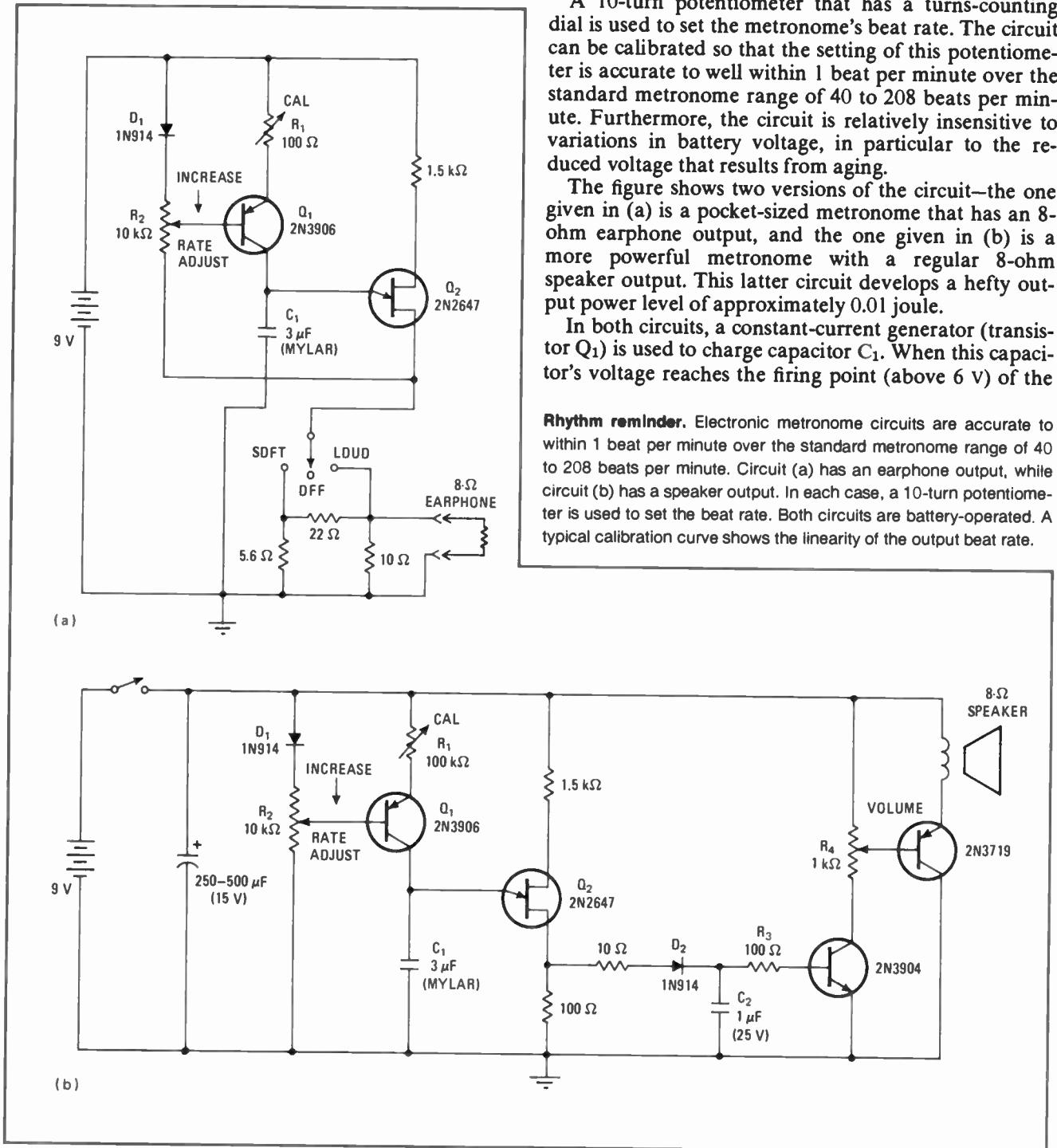

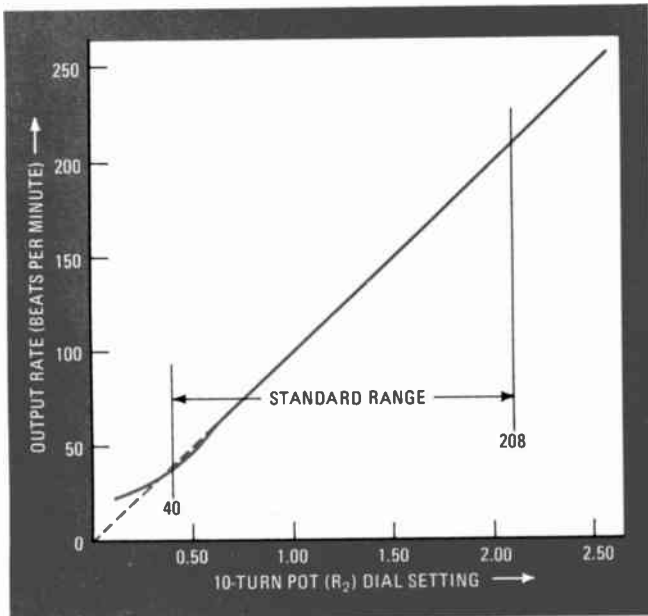

unijunction transistor (Q_2), the capacitor is discharged and an output pulse is generated. The capacitor's charging current, and hence the operating frequency, is directly proportional to the voltage across variable resistor R_1 , a voltage that varies linearly with the setting of potentiometer R_2 . Diode D_1 compensates for the base-emitter drop of transistor Q_1 .

Either circuit is calibrated by adjusting resistor R_1 to obtain the upper standard beat-rate limit (208 beats per minute) and then adjusting the stop on potentiometer R_2 's turns-counting dial to get the lower standard limit (40 beats per minute). A typical calibration curve is given in the figure. (Plenty of patience and a good stopwatch are also needed for good calibration results.)

Metronome (a) includes a loud and soft control over volume within its on/off switch. Metronome (b) employs a pulse stretcher, made up of diode D_2 , capacitor C_2 , and resistor R_3 , to increase the available energy from the 9-v battery. This circuit's volume control, resistor R_4 , can be replaced with a fixed resistor to obtain maximum output, if desired. □

Different-color LEDs can switch each other

by F. Gerard Albers
University of Dayton, Dayton, Ohio

The inequality of threshold voltages of light-emitting diodes of differing colors can be used to minimize the circuitry needed for a display, especially if the application is not a critical one. The voltage drop across a LED that is conducting, therefore, can control another LED of a different color.

In the two-color display of (a), the green LED will light when the switch is open. But when the switch is closed, the red LED lights, producing a voltage drop of

approximately 1.5 v, which is slightly below the threshold of the green LED. This lamp, then, goes out.

The concept can be expanded to multiple-unit displays, as in (b). The red LED, which is controlled by gate G_1 , will disable the yellow and green LEDs when it is illuminated. If the red LED is not conducting, the display depends on the output of gate G_2 .

When G_2 's output is low, the yellow LED will conduct, producing approximately a 2.0-v drop at the resistor node. The green LED remains disabled because its threshold is now approximately 2.1 v because of diode D_1 . When G_2 's output is high, the yellow LED turns off and the green LED turns on.

The luminous intensity of such a display is quite acceptable, even in a well-lit room. And the difference in luminous intensity between the three LEDs is negligible. The 500-ohm resistor limits gate current and establishes the proper voltage drops for the LEDs □

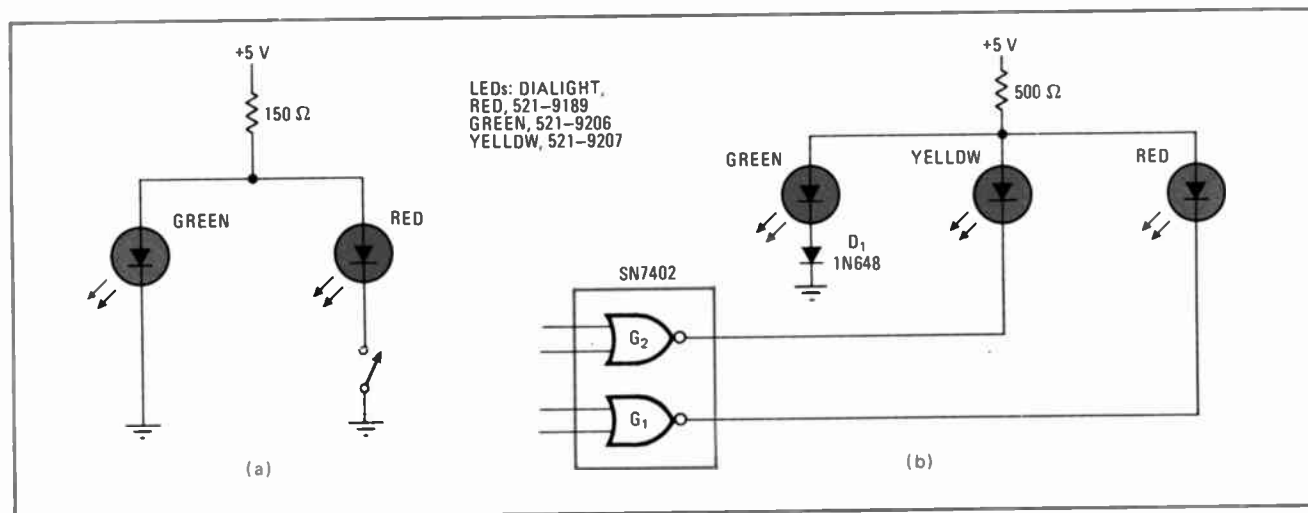

Paring display circuitry to a minimum. The different threshold voltages of LEDs of differing colors can be used to select the colors in a display. For the two-color display of (a), only the green LED conducts when the switch is open, and only the red LED conducts when the switch is closed. Similarly, a three-color display (b) can be obtained by employing two switches (gates G_1 and G_2) and a diode (D_1).

Comparing the power of C-MOS with TTL

by Colin Crook
Motorola Semiconductor Products Inc., Phoenix, Ariz.

The low power dissipation of complementary-MOS circuitry is legendary by now. You've been told, time and time again, that it is lower—considerably lower—than equivalent TTL designs. How much lower is somewhat astonishing—as large as an order of magnitude or more.

Here is a set of tables that clearly demonstrates the vast difference in power requirements between C-MOS and TTL. This difference results in a significant saving in

overhead for system-support needs, like power supplies and cooling equipment. The tables make a systems-level power comparison between C-MOS and TTL by examining a representative logic system—an industrial controller and sequencer.

This typical system consists of 500 IC packages: there are 200 quad NAND gates, 150 dual flip-flops, and 150 4-bit arithmetic logic units. Table 1 gives the device type numbers used for the C-MOS and TTL systems.

At medium frequencies, the dynamic power of C-MOS is significant compared to its dc power, so that certain loading and frequency conditions will be assumed. For this example, every output node of a gate package is loaded by 50 picofarads, every output node of a flip-flop package by 30 pF, and every output node (eight in all) of an arithmetic-logic-unit package by 15 pF. A reasonable assumption for the operating frequency is that

TABLE 1			
LOGIC SYSTEM			
Device	Number of packages	C-MOS type	TTL type
Quad NAND gate	200	MC14011CP	MC7400P
Dual flip-flop	150	MC14027CP	MC7473P
Arithmetic logic unit	150	MC14581CL	MC74181P

TABLE 2				
DC POWER AT 5 VOLTS: C-MOS vs TTL				
Device	Per-package power	System power	Total C-MOS system dc power	
			Typ	Max
Gate	C-MOS: Typ = 25 nW Max = 75 μW	C-MOS: X 200 Typ = 5 μW Max = 15 mW	Gates = 5 μW	15 mW
	TTL: Typ = 40 mW Max = 110 mW	TTL: X 200 Typ = 8 W Max = 22 W	Flip-flops = 7.5 μW	105 mW
Flip-flop	C-MOS: Typ = 50 nW Max = 700 μW	C-MOS: X 150 Typ = 7.5 μW Max = 105 mW	ALUs = 37.5 μW	525 mW
	TTL: Typ = 80 mW Max = 200 mW	TTL: X 150 Typ = 12 W Max = 30 W	TOTAL = 50 μW	645 mW
ALU	C-MOS: Typ = 250 nW Max = 3.5 mW	C-MOS: X 150 Typ = 37.5 μW Max = 525 mW	Current at 5 V = 10 μA	129 mA
	TTL: Typ = 470 mW Max = 750 mW	TTL: X 150 Typ = 70.5 W Max = 112.5 W	Total TTL system dc power	
			Typ	Max
			Gates = 8 W	22 W
			Flip-flops = 12 W	30 W
			ALUs = 70.5 W	112.5 W
			TOTAL = 90.5 W	164.5 W
			Current at 5 V = 18.1 A	32.9 A

TABLE 3			
C-MOS DYNAMIC POWER AT 5 VOLTS			
Device	Per-package power	System power	Total system power
Gate	At 200 kHz = 1.2 mW	Average = 3.6 mW	Gates = 720 mW
	At 1 MHz = 6.0 mW	200 X 3.6 mW = 720 mW	Flip-flops = 270 mW
Flip-flop	At 200 kHz = 0.6 mW	Average = 1.8 mW	ALUs = 180 mW
	At 1 MHz = 3.0 mW	150 X 1.8 mW = 270 mW	TOTAL = 1.170 W
ALU	At 200 kHz = 0.4 mW	Average = 1.2 mW	
	At 1 MHz = 2.0 mW	150 X 1.2 mW = 180 mW	

half of all the nodes switch at 1 megahertz, and the other half switch at 200 kilohertz.

Because of its enhanced noise immunity at higher supply voltages, C-MOS is often operated at 10 volts. For this reason, we will compare the dc, as well as dynamic, power consumption of C-MOS at both 5- and 10-v supply voltages to the dc power of TTL at 5 v.

At operating frequencies of 1 MHz or less, the dynamic power of TTL is negligible compared to its dc power. In fact, TTL dynamic power does not become relevant until the operating frequency exceeds 10 MHz. Therefore, there is no real need to compute TTL's dynamic power separately.

Table 2 shows the dc power requirements of C-MOS and TTL when the system supply voltage is 5 v. As you can see, the entire C-MOS system consumes only 50 microwatts typically and 645 milliwatts maximum. In con-

trast, the same system built with TTL devices requires 90.5 watts typically and 164.5 w maximum.

In Table 3, the dynamic power of a 5-v C-MOS system is computed. Here, the total system power consumption is found to be 1.17w. Table 4 gives the total dc power for a 10-v C-MOS system; it is 190 μ w typically and 2.58 w maximum. The total dynamic power for this same 10-v C-MOS system is evaluated in Table 5; it is 5.04 w average.

Table 6 summarizes the results of all the preceding tables. Roughly speaking, TTL consumes about 100 times more power than C-MOS, even when worst-case dynamic operating conditions are taken into consideration for the C-MOS system. □

Engineer's Notebook is a regular feature in Electronics. We invite readers to submit original design shortcuts, calculation aids, measurement and test techniques, and other ideas for saving engineering time or cost. We'll pay \$50 for each item published.

TABLE 4
C-MOS DC POWER AT 10 VOLTS

Device	Per-package power	System power	Total system power	
			Typ	Max
Gate	Typ = 50 nW Max = 300 μ W	X 200 Typ = 10 μ W Max = 60 mW	Gates = 10 μ W	60 mW
Flip-flop	Typ = 200 μ W Max = 2.8 mW	X 150 Typ = 30 μ W Max = 420 mW	Flip-flops = 30 μ W	420 mW
ALU	Typ = 1.0 μ W Max = 14 mW	X 150 Typ = 150 μ W Max = 2,100 mW	ALUs = 150 μ W	2,100 mW
			TOTAL = 190 μ W	2.58 W
			Current at 10 V = 19 μ A	258 mA

TABLE 5
C-MOS DYNAMIC POWER AT 10 VOLTS

Device	Per-package power	System power	Total system power	
Gate	At 200 kHz = 4.8 mW At 1MHz = 24 mW	Average = 14.4 mW 200 X 14.4 mW = 2,880 mW	Gates = 2,800 mW	
Flip-flop	At 200 kHz = 3.0 mW At 1 MHz = 15 mW	Average = 9.0 mW 150 X 9.0 mW = 1,350 mW	Flip-flops = 1,350 mW	
ALU	At 200 kHz = 1.8 mW At 1 MHz = 9.0 mW	Average = 5.4 mW 150 X 5.4 mW = 810 mW	ALUs = 810 mW	
			TOTAL = 5.04 W	

TABLE 6
TOTAL SYSTEM POWER: C-MOS vs TTL

Logic	Dc		Ac	Totals
	Typ	Max		
TTL	90.5 W 18.1 A at 5V	164.5 W 32.9 A at 5 V	Assume small compared with dc power	Max = 164.5 W Typ = 90.5 W Power supply average = 25.5 A at 5 V
5-volt C-MOS	50 μ W 10 μ A at 5 V	645 mW 129 mA at 5 V	1.170 W	Max = 1.82 W Typ = 1.17 W
10-volt C-MOS	190 μ W 19 μ A at 10 V	2.58 W 258 mA at 10 V	5.04 W	Max = 7.62 W Typ = 5.04 W

Engineer's newsletter

EE jobs: a return to the salad days?

After the nagging softness of the past few years, the EE job market is getting good again, at least for starting graduates. Despite the uncertainties about the economy, some 95% of the engineering schools surveyed by the Engineers Joint Council report that **demand for graduates is running 5% to 20% stronger this year than last.** Moreover, this year's graduating class of EEs is smaller than last year's, so there could be a return to the good old days of would-be employers scrambling to hire the personnel they need. **The specialty in greatest demand: semiconductor-device design.**

Heat helps you to fine-tune voltage-reference zeners

Determining the true zero-temperature-coefficient point of a voltage-reference zener can improve its stability, says James Williams, a senior engineer at the Instrumentation Laboratory of Massachusetts Institute of Technology, Cambridge, Mass. The zero-TC point of a temperature-compensated zener is always specified at some standard current, usually 7.5 milliamperes. Although a zener will meet the drift specified on its data sheet for this standard current, its performance can be enhanced by finding the actual bias point at which the zero-TC occurs.

To do this, the zener is biased by a constant-current source through a precision ($\pm 0.005\%$) 100-ohm resistor. Now, at the specified current (usually 7.5 mA), **hold a hot soldering iron about 1 inch away from the zener for around 5 seconds, and observe the drift on the voltmeter.** After the diode cools, adjust the current source a few tenths of a percent in either direction and repeat the process. **If the drift decreases, repeat the process until the zener is fine-tuned.** If the drift increases, the current source must be changed in the other direction. Finally, when you obtain minimum drift, read the voltage across the 100-ohm resistor and compute the current through it. This is the optimum zero-TC current for that particular zener.

Magnetize fluids to put them where you want them

Even EEs are occasionally faced by mechanical problems, such as lubricating and sealing the shaft on an adjusting knob, damping a meter movement, marking and sorting semiconductor chips, and so on. Such simple, yet frustrating, problems can sometimes be solved by **suspending magnetic particles in various liquids so that they can be shaped, retained, or moved by a magnetic field to the desired location.**

Several kits for use in mixing fluids for various applications are available at \$100 each from Ferrofluidics Corp., 144 Middlesex Turnpike, Burlington, Mass. 01803. **The kits concentrate on such applications as lubrication, damping, printing, and general engineering design.** The company also makes the magnetic fluids in production quantities.

Reprint your own product designs

Is your production cycle hung up on delays in obtaining photostats of drawings? Print your own. For \$150 you can buy a machine capable of **printing drawings as wide as 18 inches from blueprints, black-line prints, sepias, linens, or film.** For complex production jobs, a \$675 machine handles drawings 42 in. wide. Write Teledyne Rotolite of 328 Essex St., Sterling, N.J. 07980.

Digital introduces the GT44 Graphics System.

For \$34,500 you get the price/performance leader in graphics computing.

There's nothing comparable for the price.

Complete with hardware and software. Including our advanced 16-bit PDP-11/40 CPU, 16K words of 980 nano-second internal memory, two 1.2-million word removable cartridge disks, new 17-inch CRT display, display processor (complete with character and vector generation) and light pen, Digital's own 30 cps console

terminal, and our graphics-supported disk operating system with BASIC.

And it's a totally flexible system. Add peripherals. Develop new software using the CRT. Monitor and direct experiments, design interactively. In fact, do any of the things you wanted a graphic computer capability for and couldn't afford till now. But don't take our word. Come to

Digital and see for yourself. Draw your own conclusions.

Contact your local Digital office, or write: Digital Equipment Corporation, Maynard, Mass. 01754. European headquarters: 81 route de l'Aire, 1211 Geneva 26. Digital Equipment of Canada Ltd., P.O. Box 11500, Ottawa, Ontario K2H 8K8.

digital



Ahem.

Our new 9LS/TTL Low Power Schottky lets you design at 2mW per gate at twice the speed.

TTL SPEED-POWER CHART

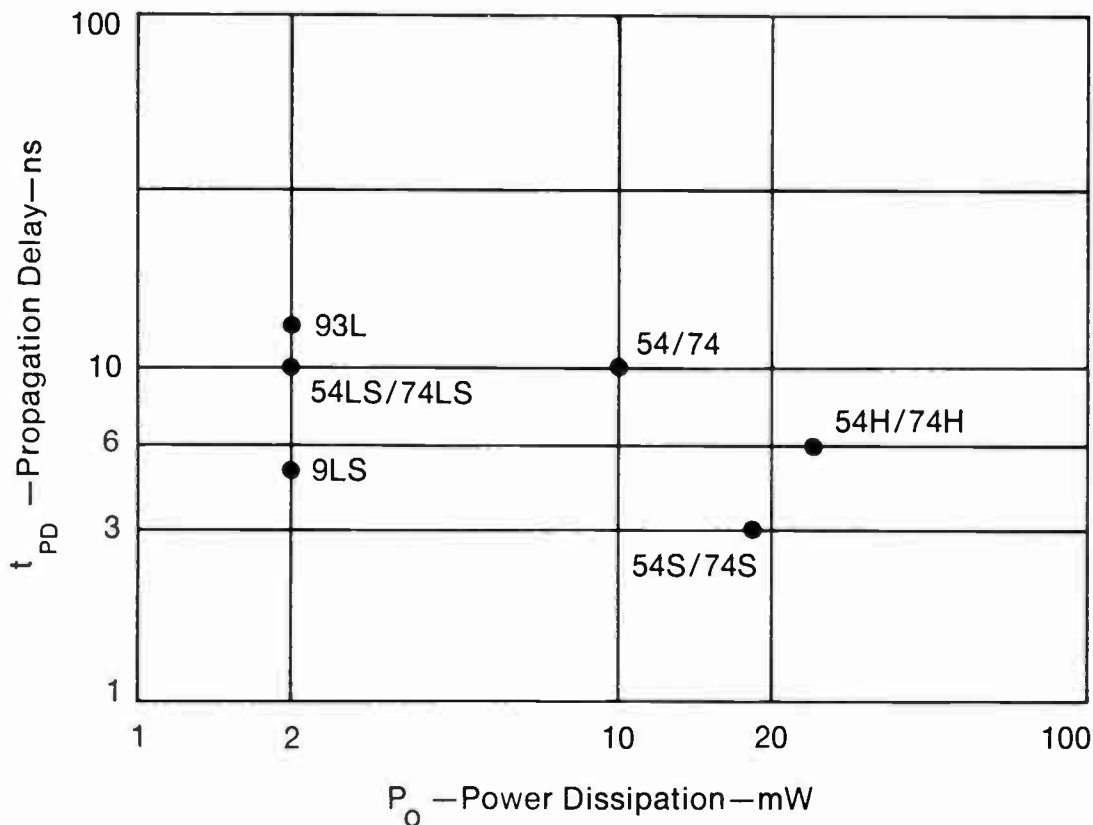

HERMES LOOP ANTENNA

THREE SAMPLE SITES
ON THE NORTH AMERICAN
CONTINENT —

DIFFERENT LATITUDES
DIFFERENT CLIMATE



FROBISHER BAY, CANADA



MARSHFIELD, MASS.

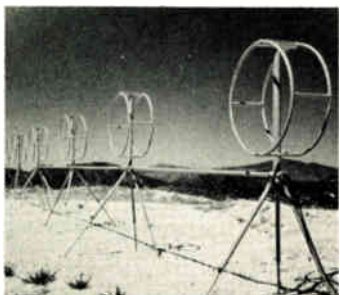

NEAR SAN DIEGO, CALIF.

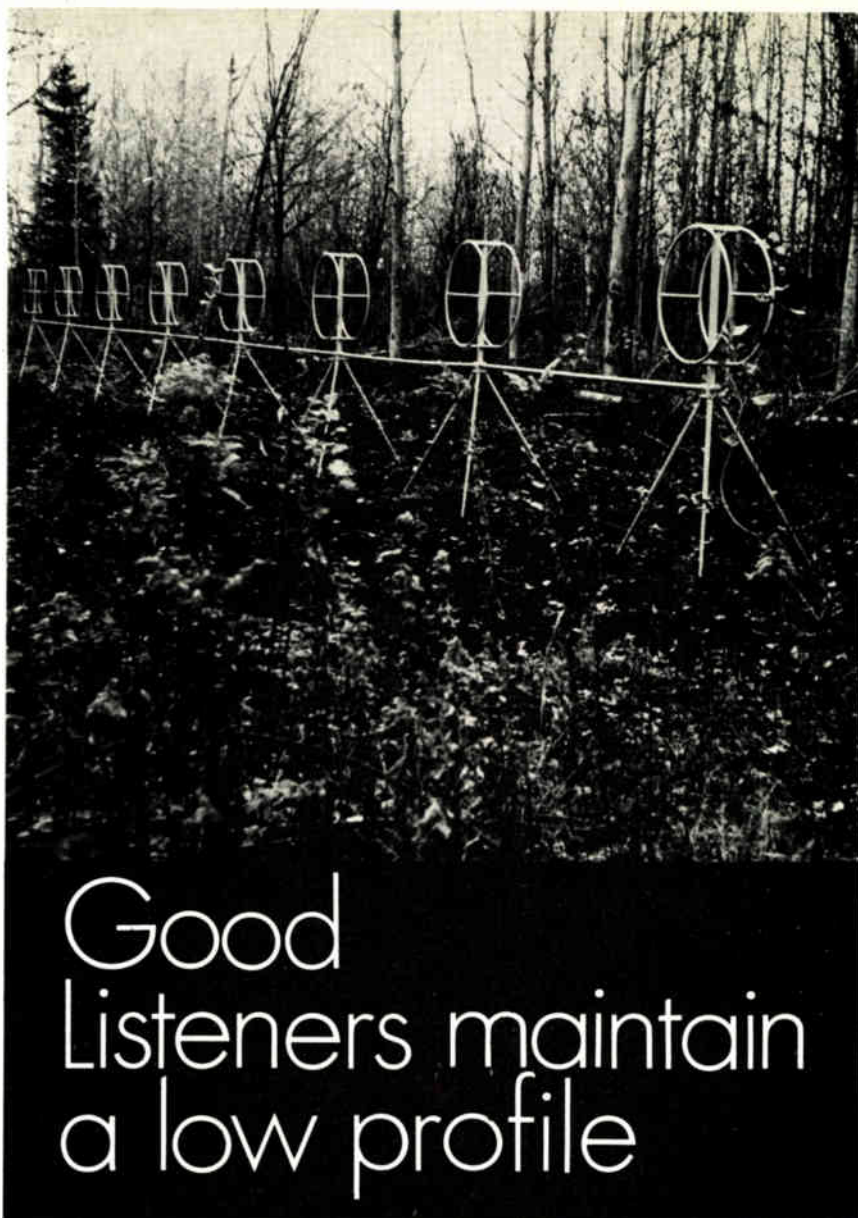

Good Listeners maintain a low profile

Even in the solitude of the forest depths, from rooftops, arctic tundra, swamps to sweltering tropics, 'neath snow, sand or ice, the Hermes Loop antenna keeps an ear to the sky. The amazing aperiodic antenna does away with vast log periodic and rhombic arrays - those towering antenna farms.

Excellent directional characteristics in rosette configuration, the Hermes loop antenna provides an omnidirectional broadband receiving array in space merely 1/100th that of the traditional antenna farm. More than 53 government agencies around the world have pressed the loop antenna into service. A new, even more compact version is available. Only Hermes Electronics makes it.

**2-32MHz
BROADBAND**



ASK US Send for our Brochure

Hermes Electronics Limited
Suite 315
2020 F Street NW
Washington, DC 20006 USA
202-296 2978
TWX 710 822 1106

First, the Fabulous 43...

Then, the Super 70...

And now--

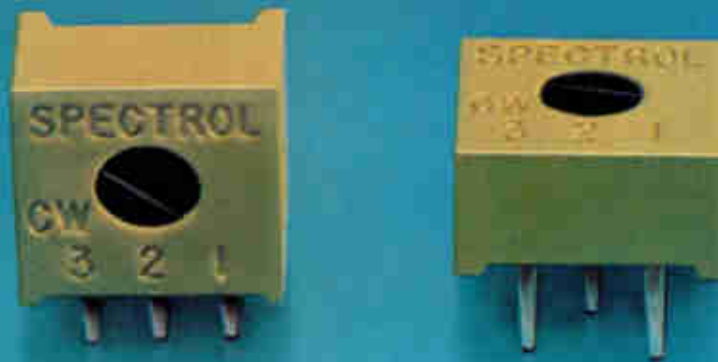

The "Set-sational" 63!

If you liked our $\frac{3}{4}$ -inch and $1\frac{1}{4}$ -inch rectangular cermet trimmers, you'll love our new single-turn $\frac{3}{8}$ -inch square cermet, the Model 63. Its superior Spectrol design virtually eliminates springback problems and provides reliable setability. It plugs right into those 362, 3389, and 72 sockets, and it's competitively priced.

The 63's are available from the factory and 75 distributor outlets. For free samples, all you have to do is ask.



SPECTROL ELECTRONICS GROUP

UNITED STATES Spectrol Electronics Corporation 17070 E. Gale Avenue, City of Industry, Calif. 91745, U.S.A. • (213) 964-6565 • TWX (910) 584-1314

UNITED KINGDOM Spectrol Reliance Ltd. Drakes Way, Swindon, Wiltshire, England • Swindon 21351 • TELEX: 44692

ITALY SP Elettronica spa Via Carlo Pisacane 7, 20016 Pero (Milan) Italy • 35 30 241 • TELEX: 36091

Circle 139 on reader service card

P&B's reputation is important to you when you need Solid State Time Delay Relays.

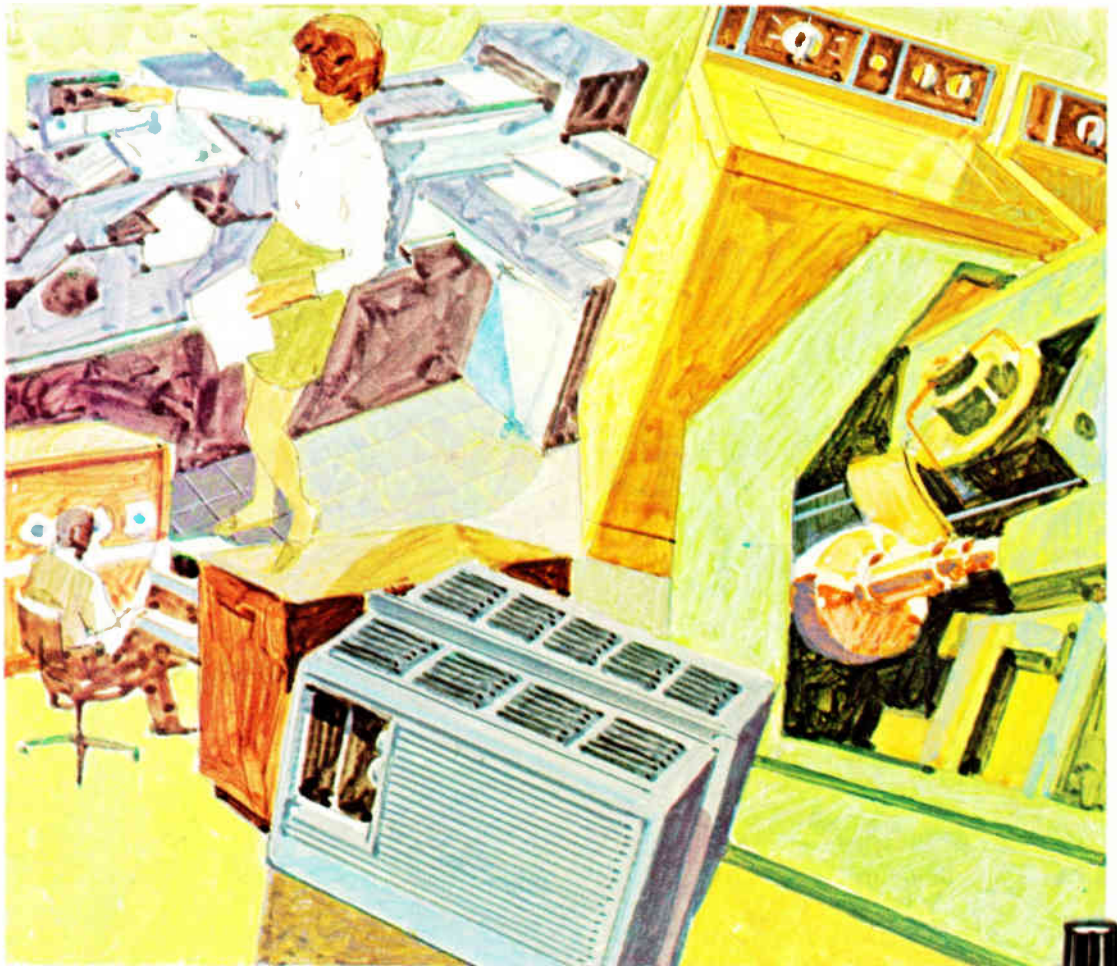

It's built on quality, design variety, performance and economy.

P&B is the industry's largest producer of solid state/hybrid time delay relays. Types and styles range from low-cost economy models to sophisticated units with excellent performance characteristics.

For precision and versatility, P&B's CD Series is an obvious choice. Within the CD Series are models which feature 7 timing ranges from 0.1 second to 180 seconds, temperature range of -40°C to $+55^{\circ}\text{C}$, recycle time of less than 60 ms and repeatability of $\pm 1\%$. And, some models can control up to 25 amperes when used with an external relay.

If economy and small size fit

your requirements, our compact R-13 Series costs less than \$7.00 in quantity. They operate with less than 240 milliwatts of DC power, and are available in 9 timing ranges from 1 to 300 seconds. Other features include fast recycle time, repeatability of $\pm 3\%$ and contact ratings from dry circuit to 5 amperes.

In between are hundreds of other models and styles offering knob adjustable, external resistor adjustable, or factory pre-set timing cycles. Contact ratings range from dry-circuit to 10 amps, 120 volts AC resistive. They're all available from your authorized P&B distributor.

Should you need a specific solid state time delay relay that we don't offer from stock, we'll design one to meet your requirements. And you'll receive the benefit of our engineering skills and knowledge gained through producing the most reliable relays possible for over forty years.

Our solid state/hybrid time delay relays and all their variations are described in detail in our 226-page relay catalog. For a free copy, simply call your local P&B representative. Or write Potter & Brumfield Division of AMF Incorporated, Princeton, Indiana, 47670. Our telephone: 812 385 5251.



Solving switching problems
is what we're all about.



FEEL FREE TO USE OUR NAME . . .

(when specifying sweepers).

Wavetek has a sweeper for just about every use imaginable —with frequency coverage from 0.5 to 1400 MHz. All are all-solid-state with excellent linearity characteristics. Crystal-controlled markers and pin-diode leveling are standard. So is the remote programming capability. And to complement our line of sweepers, we've introduced a new X-Y display scope that sells for just \$475. It has a 12" diagonal CRT and four ranges of sensitivity to 1 mV/division. Attenuators and detectors to complete your test set-up are also available. To get more information, be sure to use our complete name: Wavetek Indiana, Inc., P.O. Box 190, Beech Grove, Indiana 46107. Tel: (317) 783-3221 TWX 810-341-3226

SWEEPER MODELS		
1001A	0.5 MHz to 300 MHz	\$ 995
1002	1 MHz to 500 MHz	1095
1004	500 MHz to 1 GHz	995
1005	700 MHz to 1.4 GHz	995
1801A	1 MHz to 950 MHz	1445
2000	1 MHz to 1.4 GHz	1375
2001	1 MHz to 1.4 GHz	1695
SCOPE MODEL		
1901A	12" X-Y Display	\$475
ATTENUATOR MODELS		
5001	0-1 dB in 0.1 dB steps	\$80
5010	0-10 dB in 1 dB steps	80
5070	0-70 dB in 10 dB steps	80
5080	0-80 dB in 1 dB steps	185



WAVETEK
INDIANA INCORPORATED

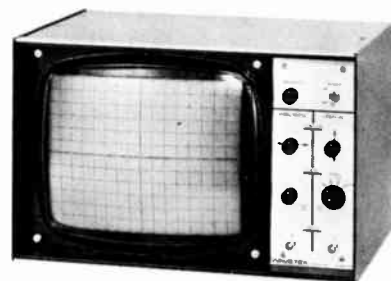

New products

Plating process provides uniformity

Circuit boards' through-holes are electroplated with ductile copper of same thickness as on boards, enhancing strength of hole walls

by Stephen E. Grossman, Packaging & Production Editor

Plating a mere thousandth of an inch of high-quality copper in the holes of a printed-circuit board is a tough assignment. But MacDermid Inc. of Waterbury, Conn., has developed a dull-finish copper electroplating bath that does the job efficiently. What's more, the company claims it enables easier maintenance than other techniques.

Electroplating copper from a liquid bath is popular among printed-circuit-board manufacturers because it builds up copper rapidly on the circuit lines and in the through-holes. Once coated with copper, the plated-through holes provide electrical connections between the circuit patterns on both sides of the board.

MacDermid, a chemical supplier, says that its plating bath has a high throwing power—better than one to one—which means that it plates out as much metal in the hole as it does on the board surface. The copper is unusually ductile, which is a vital property because the plated-through hole is subjected to severe elongation when the board passes through a hot soldering bath. In soldering, the board expands and contracts. The plating must survive such torture, adhering tightly to the hole wall without cracking.

While the quality of the deposited copper is important, it isn't the sole criterion. Another problem confronting electroplaters is maintaining the bath. According to Brian Mason, product manager at MacDermid, the new plating process enables the user to continuously filter his plating bath over carbon, thus ensuring that the bath is maintained free of contaminants. "The two addition agents used in the process,"

he says, "improve anode efficiency and control the grain structure of the deposited copper. But, unlike addition agents often used in bright-copper plating baths, they do not co-deposit with the copper and cause brittleness."

Conventional bright-acid and pyrophosphate plating baths deposit copper that has a high-gloss finish. MacDermid's material, called Hi-Spec Matte Acid Copper, has a satin sheen. This surface, the company

says, offers a topography that is more compatible with electroless copper deposits and provides superior adhesion for photoresists and subsequent copper or tin-lead deposits in pattern plating.

Monitoring the bath is said to be easy, since the user needs do little more than analyze copper and sulfuric-acid levels by means of conventional titration methods.

MacDermid Inc., 50 Brookside Rd., Waterbury, Conn. 06720

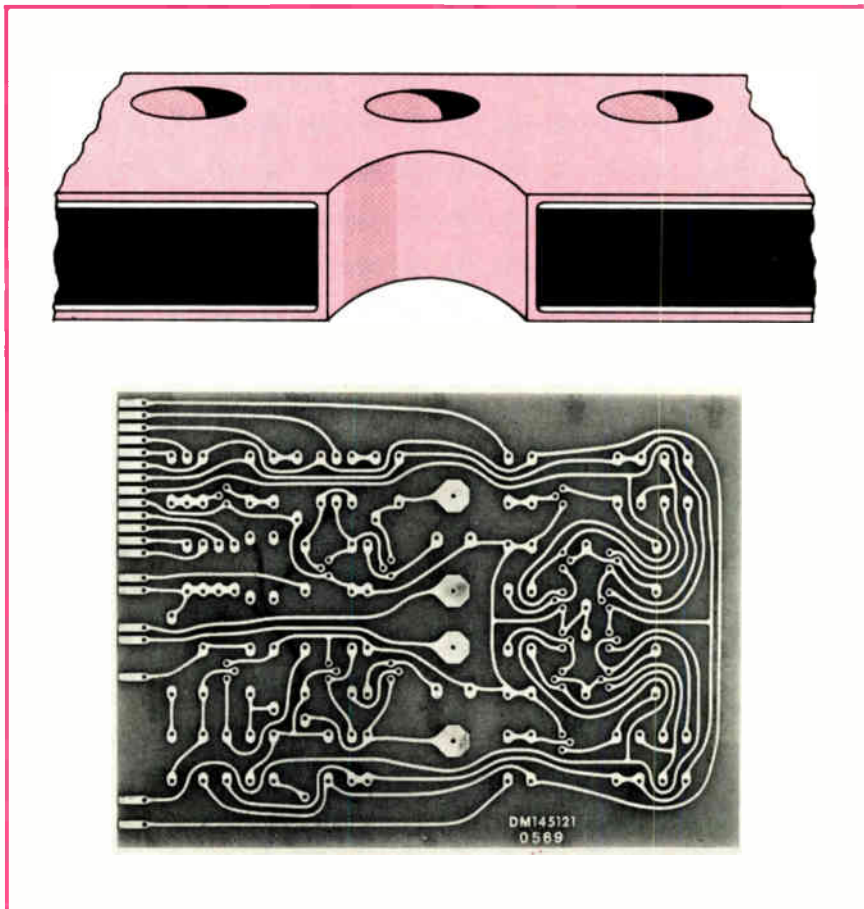

Finished. With the MacDermid dull-finish electroplating approach, ductile copper builds up in through-holes at about same rate as on surface.

INTRODUCING THE 4000 TESTER. AGAIN.

Even a great test system can be improved. So, we've done it. Presenting System Four. Still the same great 4000 — but not really. Now it's greater.

We kept all the features that made the 4000 the most successful semiconductor test system ever — which means you get the same results: high throughput, reliability and versatility.

You get four-channel multiplexing; simultaneous testing on four stations at 100 tests per second. You can measure both voltage and current, and make comparisons with programmed go/no go limits. And, we offer every imaginable option to expand and customize your system for your specific requirements.

Here's what's new: A solid state memory to replace that pesky magnetic disk. It operates reliably over a broader line voltage specification — with stand-by power, just in

case. And it stores 900 programs (expandable to 1800), with no timing problem, and no down-time for disk maintenance.

Also new is the totally re-designed logic — TTL instead of primitive RTL. Plus standard Lambda power supplies; all-solid state operational amplifiers; and next generation direct read-out. Remember the old cooling system? We fixed that too.

System Four is still the definitive system in automatic production testing and wafer probe testing of ICs and transistors. And it's backed by a nation-wide service organization second to none. Also, it's cheaper now.

Call us about it.

GCA/SUNNYVALE DIVISION ●●▲

1050 Kifer Road, Sunnyvale, CA 94086 / (408) 732-5330 / TWX: 910-339-9211



Semiconductors

TRW launches rf power transistors

28-V parts withstand infinite VSWR, and thermal design ensures ruggedness

New vhf and uhf power transistors from TRW Semiconductors are priced low to help share in the growth of rf communications, one of the fastest growth areas in electronics. The new parts, rated to 50 watts vhf and 30 w uhf, represent the Lawndale, Calif., operation's new standard line of 28-volt parts for high-volume applications.

The transistors withstand infinite VSWR at all phase angles, and the latest advances in thermal design ensure ruggedness. All parts—even low-power ones—use emitter ballasting, which has often been restricted to high-power transistors.

The parts are packaged in low-parasitic ceramic packages, a move away from the molded plastic package that TRW has used in many products in the past. Product manager Robert Baughan says that the production cost is lower for ceramic packaging than it is for molded plastic packaging.

Metalization is gold rather than aluminum, to reduce metal migration in uhf devices. Migration has been a major cause of failure in uhf and microwave devices using the light metal. The gold also gives improved oxide-step coverage and better bonding strength to gold wire than does aluminum.

The company is aiming the rf-transistor line at a host of applications including use in aircraft, marine and tactical radios, radio relay, electronic countermeasures equipment and instrumentation. In the vhf range, devices are specified for output power of 4, 8, 15, 25, and 50 watts.

The output of TRW PT9731, for example, is rated at 25 w and a gain of 10 DB. The unit is priced at

\$13.85 each in quantities to 999. TRW PT9733, rated at 50 w and gain of 7 dB, is priced at \$20.30 each in the same quantities.

In the uhf-transistor range, devices are specified for 4, 10, 20, and 30 w. As an example, TRW PT9704A is equivalent in performance to 2N6105A, with rated output power of 30 w and gain of 7.8 dB. The device is priced at \$25 each in quantities from 1 to 999. All transistors in the line are available from stock.

TRW Semiconductor Operations, 14520 Aviation Blvd., Lawndale, Calif. [411]

Subminiature IC switch is light activated

The series IPI-15/17 light-activated switches are based on an MOS integrated circuit that includes a silicon

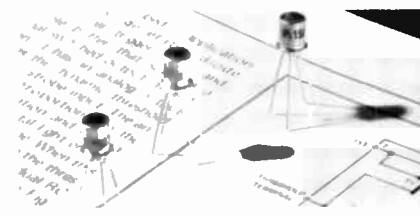

planar photodiode. The photodiode is integrated with a Schmitt trigger, buffer amplifier, and control circuitry on an MSI chip. In operation, the output is switched on when the incident illumination exceeds a selected upper threshold level and is switched off when the illumination falls below a lower threshold level.

Integrated Photomatrix Inc., 1101 Bristol Rd., Mountainside, N. J. 07092 [420]

Two DTL/TTL opto-isolators are placed in one package

A pair of inverting optically isolated gates, each with a light-emitting diode and an integrated detector, are available in a single package [*Electronics*, April 18, p. 25]. Designed to facilitate greater packing density on a printed-circuit board, maximum dc and ac circuit isolation between each input and output is maintained while DTL/TTL compati-

bility is achieved. Moreover, photons are collected in the detector by a photodiode, and are then amplified by a high-gain linear amplifier that drives a Schottky-clamped open-collector output transistor. Delay times of 50 nanoseconds can be obtained with this photon detector. The model 5082-4364 dual isolator is priced at \$12.90 in 1 to 99 quantities and \$9.90 for 100 to 999. Hewlett-Packard Co., 1501 Page Mill Rd., Palo Alto, Calif. 94304 [414]

Display circuit integrates with microprocessor system

An LSI circuit is designed to integrate with the company's parallel-processing system microprocessor to extend the system's capability. The circuit, called a general-purpose keyboard and display device, is compatible with the control and bus structure of the microprocessor circuits and with TTL systems. The input-output characteristics of the circuit allow a wide range of displays to be used, as well as switches and keyboard functions. In operation, the input keys are sampled and the displays are refreshed at a rate of about once every 7 milliseconds.

Rockwell International, Microelectronics Group, Box 3669, 3430 Miraloma Ave., Anaheim, Calif. 92803 [415]

Sample-and-hold op-amp is priced as low as \$14.85

A monolithic sample and hold operational amplifier, called the HA-2425, is designed to be less expensive than the modules or hybrids it replaces. The unit is priced at \$14.85 in 100 lots. And, in addition to offering a slew-rate-to-droop-rate ratio of 5×10^6 , the unit has a DTL/TTL-compatible control input, bandwidth of 2 MHz, 50-nanosecond aperture time and a slew rate of 5 V/ μ s. The design consists of an op amp with its output in series with an analog switch that features a leakage current of 1 nA maximum and 10 pC charge transfer. The switch is

the Champ

problem solver



Bausch & Lomb StereoZoom 7 Microscope with Coaxial Illuminator is the answer to your need for full field, full aperture illumination; full color, high contrast imaging and better resolution.

This unique form of incident illumination eliminates surface glare from highly reflective surfaces and also effectively illuminates low contrast objects.

You zoom over a magnification range of 15X through 280X. Field diameter ranges from 0.55 in. through 0.03 in. Working distance is 3.0 in.—0.56 in.

Send today for our catalog 31-15 and our FREE DEMONSTRATION offer.

BAUSCH & LOMB 

SCIENTIFIC OPTICAL
PRODUCTS DIVISION

StereoZoom. Reg. T.M.
Bausch & Lomb

62305 Bausch Street, Rochester, N. Y. 14602

Circle 146 on reader service card

MAGNETIC INSTRUMENTATION

Gaussmeters • Fluxmeters

Magnetizers • Stabilizers • Demagnetizers
Automatic Magnet Processing Systems
Alnico Permanent Magnets • EI Laminations



Thomas & Skinner, Inc.

1120 East 23rd Street, Indianapolis, Indiana 46205 • 923-2501

146 Circle 261 on reader service card

New products

buffered by a MOS FET-input unity-gain amplifier. Connection of an external capacitor to the switch forms a sample-and-hold or track-and-hold circuit. With the switch closed the device functions as an op amp, and any of the standard op amp

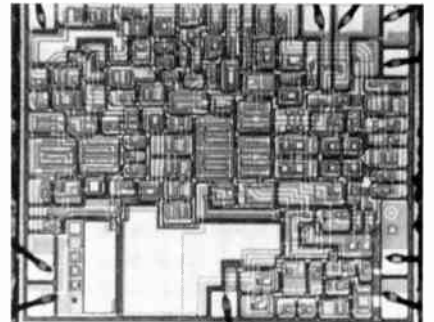

feedback networks may be connected around the device, to control gain and frequency response, for example.

Harris Semiconductor, Box 883, Melbourne, Fla. 32901 [413]

4,096-bit RAMs access
at 230 and 300 nanoseconds

Two n-channel MOS/LSI 4,096-bit dynamic random-access memories, designated the models MCM6605L and MCM6605L-1, provide access times of 230 and 300 nanoseconds, respectively. Both devices have TTL-compatible outputs and are intended for the replacement of core and smaller semiconductor memories in a wide range of computer applications. Developed jointly with American Microsystems Inc., the memories share common photomasks and processing with AMI 4,096-bit memories. Price ranges from \$33.30 to \$50, depending on type and quantity.

Motorola Semiconductor Products Inc., Box 20924, Phoenix, Ariz. 85036 [416]

Monolithic ICs control
SCRs and triacs

The L120 and L121 monolithic integrated circuits each act as a complete control system for SCRs or

Celanex tunes in the best cost and performance picture.



By injection molding rotor and stator strips in Celanex thermoplastic polyester, instead of slower compression molding in alkyd resins formerly used, South American manufacturers cut finished part costs, speed production and improve performance of these TV tuners.

Among the many advantages of Celanex in this application are its excellent dimensional stability and electrical properties. Its impact strength and resistance to wear. Its moldability and fast-cycling characteristics. And the long shelf-life of parts molded of Celanex eliminate an especially knotty problem caused by the hot, humid Brazilian climate.

No wonder numerous television manufacturers worldwide are tuning in to Celanex thermoplastic polyester. Particularly since it also has the highest flammability rating (VE-O by UL 94 to 1/32") from Underwriters' Laboratories.

Compared to thermosets, metals and other thermoplastics, Celanex can do a lot to improve your products and finished part costs. Let us give you the facts. Write Celanex Plastics Company, Dept. X-609, 550 Broad Street, Newark, N.J. 07102.

Celanese Plastics Company is a division of Celanese Corporation. Canadian Affiliate: Celanese Canada Ltd. Export: Amcel Co., Inc., and Pan Amcel Co., Inc., 1211 Avenue of the Americas, New York 10036.

Circle 147 on reader service card



**CELANESE
ENGINEERING
RESINS**

Tuner shown actual size. Molded by Begli Componentes Ltda. São Paulo, Brazil.

**A TOUGH TEAM
FOR TOUGH TIMES:**
CELCON[®]
acetal copolymer
CELANESE[®] NYLON.
CELANEX[®]
thermoplastic polyester



The electronics company is hypothetical. The opportunity for profit is real.

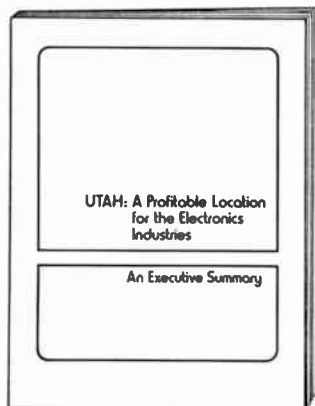

A new research study indicates that expected net profit for an electronics manufacturer varies widely, depending entirely on plant site location.

The methodology examines the critical cost/benefit factors in each of eleven cities, representing major manufacturing areas throughout the country.

National statistics were used to develop a hypothetical electronic computer manufacturing plant, (SIC Classification 3575) employing 1000 persons and having annual sales of \$35 million. The results will surprise you (and are applicable to other SIC classifications as well).

To get your complimentary copy of the 24-page Executive Summary of the study, simply drop your business card in an envelope and mail to:

John Rencher, Director
Utah Industrial Promotion
Division
No. 2 Arrow Press Square,
Dept. E-516-4
Salt Lake City, Utah 84101

New products

triacs. The L120 device is aimed at jobs in phase-type control systems. The firing angle of the SCR or triac can be varied continuously and linearly, between 0° and 180°. The output pulses have the same polarity as the power line. The L121 is designed for application in burst-type control systems. Its action determines the number of half cycles of output power to be transferred to the load in a set base-period. In each base-period, the duty cycle can be varied from 0 to 100% continuously. The firing pulses produced

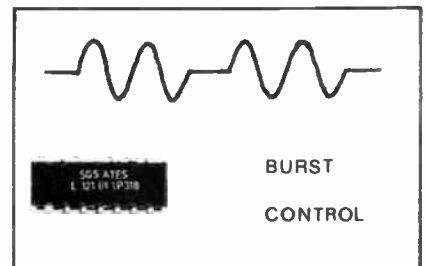
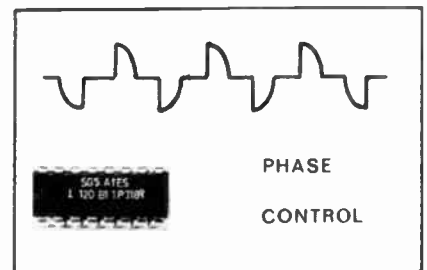

have the same polarity as power line. Price for each of the devices is \$6 for 1 to 99 pieces and \$4 for 100 to 999 pieces.

SGS Ates Semiconductor Corp., 435 Newtonville Ave., Newtonville, Mass. 02160 [417]

Modulators are designed for telephone applications

The SL 10001A and SL 10001B bipolar monolithic integrated-circuit double-balanced modulators are designed primarily for use in telephone transmission equipment. The devices are also suitable for applications where a modulation function is required, and are conventional "tree configuration" multiplier circuits. Internal bias is provided, which allows direct bal-

Carpenter controlled-expansion alloys. Uniform. Optimum fabricability. Every time.



Carpenter Kovar[®] is the most widely used glass-sealing alloy.

Stamp, deep-draw, etch, form, or coin. Many grades are available tallormade for the process you use. You get the best possible fabricability.



You get a broad selection of low and high expansion, as well as glass- or ceramic-sealing grades. In every form and size. For every job.



A call to your Carpenter Service Center will bring some of the finest technical assistance in the industry.

The quality is always consistent. Always uniform. So production stays uniform.



Call your Carpenter Service Center today. For prompt and complete information on all Carpenter controlled-expansion alloys. And ask for our free, informative booklet. Carpenter Steel Division, Carpenter Technology Corporation, Reading, Pa. 19603. European Office: 51, Square Vergote, 1040 Brussels, Belgium.



High-quality surfaces, uniform temper, minimum orange peel, and camber.



CARTECH CARPENTER
TECHNOLOGY
CARPENTER STEEL DIVISION

SCR CONTROLLED BRIDGE RECTIFIERS & POWER SWITCHES

NEW

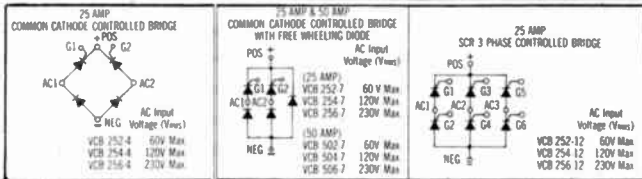

TYPICAL CIRCUITS

COMPLETE STANDARD LINE INCLUDES:
IN PRESS-FIT PACKAGES: 25A AC POWER SWITCH; 25A HALF-WAVE POWER SWITCH; 25A CENTER TAP CONTROLLED BRIDGE AND 25 AMP COMMON CATHODE CONTROLLED BRIDGE. IN ELECTRICALLY ISOLATED EPOXY BARRIER PACKAGES WITH INTEGRAL MOUNTING PAD: 25A & 50A COMMON CATHODE CONTROLLED BRIDGE WITH FREE WHEELING DIODE, SINGLE AND THREE PHASE; 50A COMMON CATHODE CONTROLLED BRIDGE, SINGLE AND THREE PHASE; 25A SCR CONTROLLED BRIDGE, SINGLE AND THREE PHASE. CUSTOM DESIGN AVAILABLE.

The VCB series of 25A and 50A controlled bridges and power switches are available in a 3/4" press-fit package, with three mounting options and in epoxy packages. All units are hermetically sealed.

The epoxy packages are explosion proof and electrically isolated with double isolation available. SCR's are glass passivated. All chips are soldered to an integral copper mounting pad for improved thermal characteristics, typically $<1^{\circ}\text{C/W}(R_{\theta jc})$. Epoxy barriers have been placed between standard .250" Faston and/or #10-32 terminals. Spacing exceeds NEMA standards.

Typical applications include DC motor speed controls, temperature controllers, battery chargers, inverters, frequency changers, D.C. power supplies, and servo systems.

All units are available in 60V, 120V or 230V, (V_{rms}), with 200V, 400V and 600V DC Blocking Voltages.

Typical economical pricing:

VCB252-7 (200V, 25A) \$9.00 ea.,
100 qty.



Design us in . . . we'll stay there

VARO SEMICONDUCTOR, INC.

P.O. BOX 676, 1000 N. SHILOH, GARLAND, TEX. 75040
(214) 272-4551 TWX 910-860-5178

New products

anced transformer input, or single-ended capacitor drive. The modulars/demodulators feature a carrier and signal suppression of 50 decibels, noise level of -112 dBm, intermodulation suppression of -58dB, and supply current of 4 milliamperes. Output is via a two-stage common-collector circuit providing a low output impedance. A pair of diodes are provided for optional limiting of the carrier input.

Plessey Semiconductors, 1674 McGaw Ave., Santa Ana, Calif. 92705 [418]

Static CMOS RAM

offers 256 bits

Using silicon-on-sapphire techniques, a 256×1 random-access memory, designated the INS4200S, offers read cycle times of 180 nanoseconds, with write cycle times of 140 ns. Quiescent power dissipation is 40 microwatts. In the operational mode, power dissipation is 26 milliwatts. Input capacitance is rated at 6.5 pF at 25 C°, and supply voltage ranges from 5 to 15 volts. The INS4200S also offers a three-state

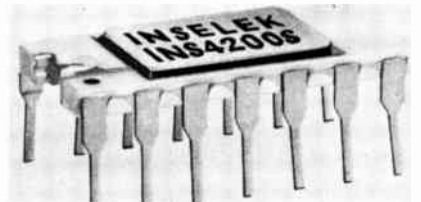

TTL-compatible output, full address decoding and bipolar compatible pin-outs in a 16-pin dual in-line package. A minimum of additional components are required due to the three-chip selected inputs, especially when used with large memory arrays. Fully compatible with other CMOS and TTL logic devices, the read-only memory is designed for use in scratch-pad, buffer, and main memory applications where high speed and low power are prime considerations. The device is priced as low as \$26 when ordered in quantities of 100-999.

Inselek Inc., 743 Alexander Rd, Princeton, N.J. 08540 [419]

Why Parylene works where other microelectronic protection fails:

Controlled conformality

There's a uniform coating of parylene all the way around the half-mil tip of this phonograph needle. That's true conformality, and only parylene gives it, in precisely controlled thicknesses from .002 to 3 mils, in one step. Unlike spray or dip coatings, parylene won't bridge or puddle, or thin out at sharp edges, creating potential failure points. The parylene coating is completely uniform, no matter how dense or intricate the module. And because it's applied at room temperature, there's no component discomfort.



△200°C thermal shock protection

This hybrid microelectronics relay has undergone 200 45-minute cycles from -120 to 80°C, simulating earth-orbiting conditions. This X-ray shows all leads remain intact. Parylene protection was at work, on the transformer core and then the whole assembly before packaging (TO-116). There was no appearance of corona up to 5000 V_{dc}; leakage was reduced from 10μA to <.001μA at 1000V. RTV encapsulation suffered dimensional mismatch, straining and snapping leads, with 500 V/mil bulk breakdown.

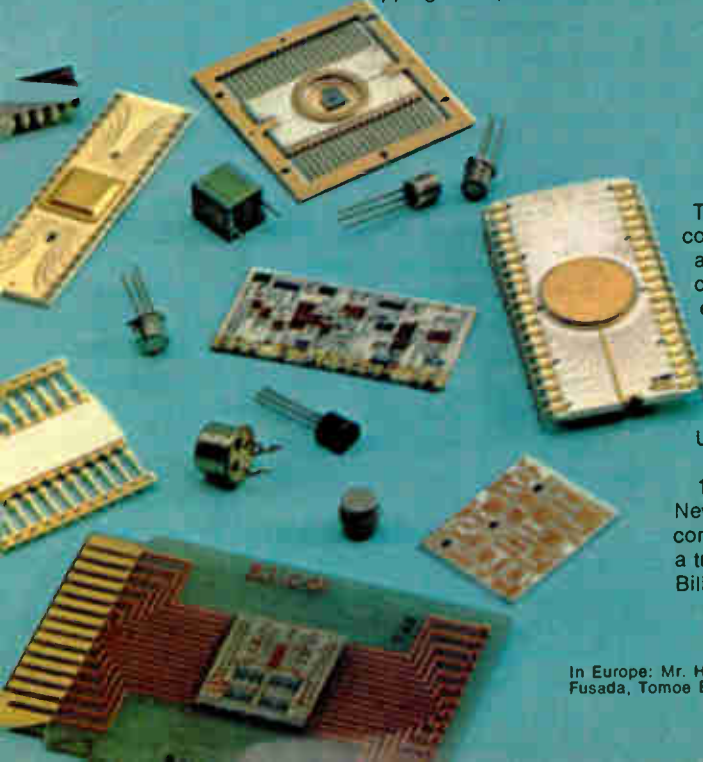

Crevice penetration in hybrids

This beam lead has a 0.3 mil parylene coating all the way to the weld. Parylene penetrates deep within small crevices, maintaining clearance while putting a coherent coating under beam leaded chips and air bridges. No area is left unprotected, preventing shorts and allowing the designer great latitude in component spacing and sizing. And parylene secures loose debris while preventing breakoff of pigtailed during shock and vibration loadings.

Lead Strengthening

It took up to 75 grams pull to break these 1 mil wires. Bare 1 mil aluminum wires, for instance, exhibit bond strengths of 3-5.5 grams; coated with 1 mil of parylene, pull strength increases by 60-70 grams.

So wire and bond are stronger, and sideward shorts and loop collapse during extreme g-loads are prevented. Parylene coatings will penetrate the less than 1 mil clearance between beam lead bonded chips and the substrate, giving such strong coating coverage that the chip cannot be lifted without destroying it.

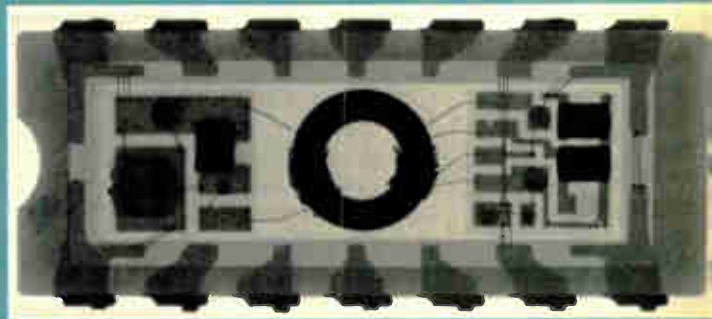
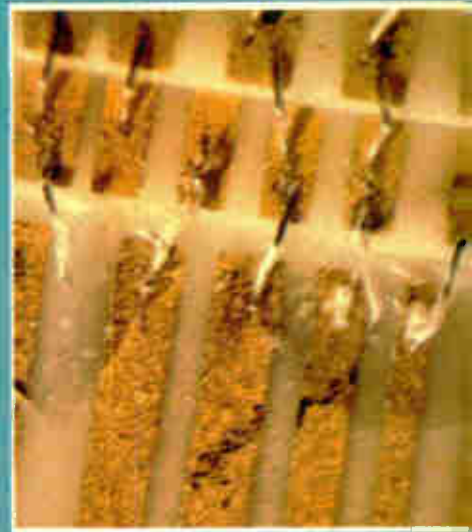

X-ray courtesy NASA Lewis Research Center and Sterer Engineering

Broad cost effectiveness

These are some of the circuit modules now being protected with a conformal coating of parylene. Because nothing else offers parylene's combined protection against thermal cycling, shock, vibration, humidity, solvents, radiation, ionic contamination. Better barrier protection than liquid coatings like silicones, epoxies, and urethanes. On hybrids you can combine parylene with a hermetic seal for optimum environmental protection . . . and parylene alone will often do the job, and at less cost than hermetic seals. Parylene is compatible with active devices, and meets the tough requirements of MIL-I-46058C.

For long term reliability, parylene provides a cost-effective solution.

Union Carbide invented the parylene system. Various patents apply; commercial use of the patented technology is licensed. Write for our 16-page brochure: Union Carbide Corp., 270 Park Avenue, Dept. RFB-65, New York, N.Y. 10017. For instant communication, and information about a trial run at reasonable cost, call Bill Loeb at (212) 551-6071.



In Europe: Mr. H. Torre, Union Carbide Europe S.A., 5 Rue Pedro-Meylan, 1211 Geneva 17. In Japan: Mr. N. Fusada, Tomoe Engineering Co. Ltd., Shin Shin Kai Bldg., 14-1 Nihonbashi 3-Chome, Chuo-Ku, Tokyo.

Circle 151 on reader service card

Fight chassis squeeze with these miniaturized "flat oval" capacitors

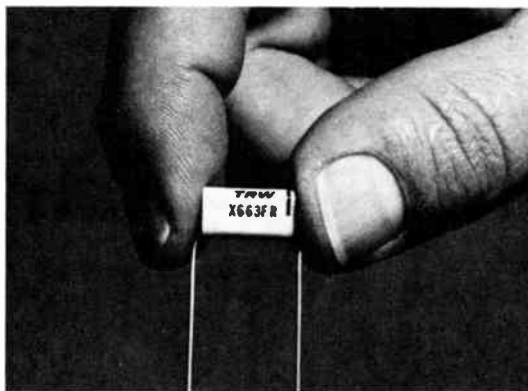

Buy yourself some elbow room—and save some weight in the bargain—with TRW's flat oval, metallized Mylar* capacitors.

This is ultra-miniaturization with *no* compromise on reliability. Capacitances: .01 to 10.0 mfd in 50, 100, 400, 600 vdc. Temp.: -55°C. to 100°C (to 125°C with derating). High IR—30,000 megohm-microfarads minimum; typically much higher. Low DF — usually less than 1.0%. Tolerances to $\pm 1\%$. Self-healing.

With their flat oval design, these metallized Mylar miniatures offer maximum space savings. And for maximum flexibility in assembly, they are available with axial or radial leads—Types X663F and X663FR respectively. Instrument quality, either way.

Write for catalog or application engineering assistance. TRW Capacitors, an Electronic Components Division of TRW, Inc., Box 1000, Ogallala, Neb. 69153. (308) 284-3611.

*Du Pont T.M. for polyester film

TRW CAPACITORS

The honeymoon is over.



(Time to get serious about uninterruptible power sources.)

America's romance with energy is cooling off. We're running out of steam, out of waterfalls, out of electricity from any source. And as our power becomes less available, brownouts and blackouts become more likely. (Just ask your computer.) Fortunately, there's still time to install an Elgar Uninterruptible Power Source. It will protect your computer system against voltage dropouts and brownouts (regulation to $\pm 2\%$; up to 40 dB line transient reduction) and give 10 minutes of backup power in the event of a blackout. Write or call for details today... while you still have the energy.

Elgard Uninterruptible Power Sources are available in 500 VA to 15kVA models. They supply up to ten minutes of instantaneous reserve in case of power failure; and they have self-contained, maintenance-free batteries. Ideal for IBM Systems 3 and 7, DEC PDP Series, Burroughs Banking Systems, and Litton/Sweda P.O.S. Systems. Priced from \$1,895.



8225 Mercury Court, San Diego,
CA 92111 Phone (714) 565-1155

THERE'S A BETTER WAY TO GO.



Energy shortages tell us we have to change our driving style. Now! It doesn't mean we have to go back to horse and buggy days. But it does mean we have to make every drop of gas give us the most go for our money. Anyone with horse sense knows that a well-tuned car gets better mileage, and in times of fuel shortages, better mileage means a lot.

The Mark Ten B Capacitive Discharge System keeps your car in better tune so it burns less gas. Using Mark Ten B is more than horse sense. It's the smart move under the hood, helping a nation survive an energy crisis and keeping you on the road. Delta Mark Ten. The best way to go.



DELTA PRODUCTS, INC.

P.O. Box 1147, Dept. E
Grand Junction, Colo. 81501
(303) 242-9000

Please send me free literature.

Enclosed is \$ _____ Ship ppd. Ship C.O.D.
Please send: _____ Mark Ten B assembled @ \$59.95 ppd. _____ Mark Ten B Kit @ \$44.95 ppd. (12 volt negative ground only) _____ Standard Mark Ten assembled, @ \$44.95 ppd. _____ 6 Volt: Neg. Ground Only _____ 12 Volt: Specify _____ Pos. Ground _____ Neg. Ground _____ Standard Mark Ten Deltakit[®] @ \$29.95 ppd. (12 Volt Positive or Negative Ground Only)

Car Year _____ Make _____

Name _____

Address _____

City/State _____ Zip _____

Now you can Intermix low level, high level and simultaneous sample & hold inputs



With amplifier-per-channel System 620

SYSTEM 620. A BETTER MOUSETRAP

In less than 2 years, our amplifier-per-channel System 620 has become industry's most popular high speed data acquisition system. Today, thousands of channels are performing reliably in the field. In scores of applications from Turbine Engine Test to Earthquake Engineering. Now System 620 is even more flexible than before. With 3 input amplifier options, four analog-to-digital converters and several computer interfaces to choose from. So here's the latest chapter on System 620, the new approach in data acquisition.

LOW LEVEL AMPLIFIERS

Our field proven low-level differential amplifiers are perfect for strain gages & thermocouples since transducer signals are isolated right at the source. Our specs are impressive, too. With gain accuracy of 0.01%, 2 microvolt stability and 120 dB common mode rejection. More protection, too. If one channel gets wiped out by an overload, the rest don't feel a thing.

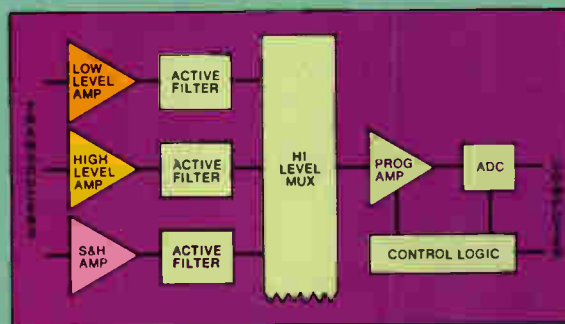

NEW HIGH LEVEL AMPLIFIERS

Since high gain isn't always required, we've added an amplifier option which, for just \$80 a channel, provides system gain of 1 to 400. That's more than adequate for many applications. Yet, retains all the features of our low-level amplifiers.

NEW SIMULTANEOUS SAMPLE & HOLD AMPLIFIERS

Low level sample & hold amplifiers are absolutely necessary in applications such as transient and vibration analysis, where data must be grabbed in a few nanoseconds or time correlation of data is important.

Low level, high level and sample & hold amplifiers can be freely intermixed in System 620.

And each amplifier in the system includes an active low pass filter with selectable cutoff frequency. Another important point. Continuous analog output is available on all channels.

FOUR ADC OPTIONS

System 620 now has four analog-to-digital converters to choose from. If you need high accuracy, we can give you 14 bits at 20kHz. In most systems our economical 12 bit, 10 kHz analog-to-digital converter will suffice. Or if higher speed is your need, specify 12 or 15 bits at 50 kHz.

COMPUTER INTERFACE

System 620 has been interfaced with a number of computers, both large & small. Interface hardware and software is available for most popular computers.

For the up-to-date story on System 620 — the new approach to data acquisition — phone or send for our brochure today.



1088 E. Hamilton Rd., Duarte, Calif. 91010
Tel. (213) 357-2281 TWX 910-585-1833

Circle 155 on reader service card

Accuracy, simplicity, speed and economy. That is the best way to describe them.

Electroglas's newest lines of Wafer Scribes and Wafer Probers incorporate the unique and exclusive Electroglas/Xynetics Linear Motor for X-Y motion and control. This new system gives more accuracy with maximum simplicity.

THE NEW 1034X AUTOMATIC WAFER PROBER FEATURES:

- High speed chuck with less than 20 mSec up/down time.
- Stage travel speed of 5.0" (127mm) per second.
- One G acceleration/deceleration.
- Five by ten inch stage travel.



**Model 1034X
Automatic
Wafer Prober**

AT THE HEART OF THESE TWO NEW PRODUCTS is this linear motor. It has only one moving part — an electromagnetic forcer block which rides on a cushion of air and moves over a ferromagnetic platen with accuracy and stepping resolution of 0.5 mil or 10 μ . All with NO FRICTION, NO WEAR.



**Electroglas/Xynetics
X-Y Motion System**

AN ADDITIONAL NEW FEATURE OF THE 1400 AX WAFER LASER SCRIBER is the most powerful commercially available YAG laser. It will scribe at better than 10" per second with a kerf width of less than .001" and a depth of .002", with no chipping or cracking.

**INCH OR METRIC
SYSTEMS OPTIONAL**

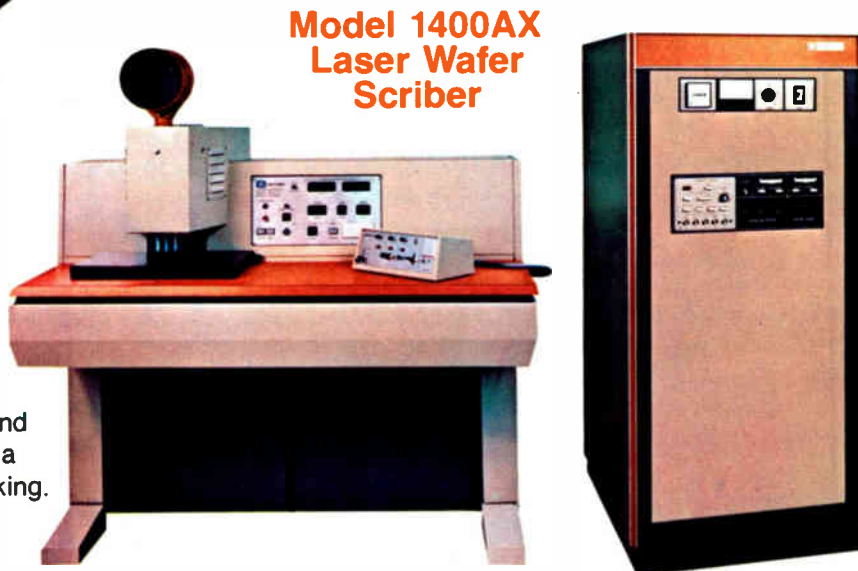

**Model 1400AX
Laser Wafer
Scriber**

 **electroglas**
A XYNETICS COMPANY

2901 Coronado Drive Santa Clara, CA 95050 408/246-6500

See these two new systems at
**Semicon/West
Booth No. 439**

Instruments

Thermometers have wide range

One digital panel unit works with thermocouples, two with platinum probes

Three digital panel thermometers are being introduced to the U.S. market by Schneider Electronique of Rungis, France. The model TT 400, designed to work with thermocouples, gives digital linearization points for every 10°C change in temperature. The other two, the TT 2000 and TT 2120, which are for use with platinum probes, provide resolution of 0.1°C and 0.01°C.

The TT 400 is available with isolated binary-coded-decimal output or with a standard analog output card, which allows it to be used as a receiver to display temperature or as a generator in a regulation loop.

The TT 2000 and TT 2120 resistance thermometers, for industrial applications, have memorized display to facilitate reading. Outputs are coded for either digital recording or digital comparison; in the latter use, the unit can regulate temperature.

The TT 400 has an external cold junction that is fully compensated between -10°C and +80°C ambient temperature. The cold junction can connect directly on the rear panel of the TT 400 or near the thermocouple itself.

Digital linearization is used extensively; by incorporating large read-only memories, the company was able to include all points of the standard tables with a conformity of ±1°C. Depending on the thermocouple used, temperature range can be from 0°C to 800°C or -200°C to +1,370°C. Display rate is adjustable from 0.1 to 10 seconds. Input impedance is greater than 1,000 megohms, and offset current is less than 1 nanoampere. Rejection rate in normal mode is greater than 50 decibels at 50 hertz, and in common

mode it is 140 dB in dc, and 120 dB at 50 Hz. Response time is 1 second. The unit has automatic zero-calibration and temperature stability of 10⁻⁴/°C.

Temperature range of the TT 2000 is from -100 to +400°C, with resolution of 0.1°C and accuracy within ±1°C. Temperature coefficient is ±2°C with ±25°C of deviation. The TT 2120, with a temperature range of -120°C to +120°C, is accurate within ±0.2°C and has resolution of 0.01°C, while temperature coefficient is ±0.3°C for ±25°C of deviation.

Both units can take 10 readings per second and have a response time of 400 milliseconds. Normal-mode rejection is 50 dB at 50 Hz, while common-mode rejection is 100 dB at 50 Hz. Input impedance of the TT 2000 is greater than 100 megohms.

Price of the TT 400 is \$375; the TT 2000, \$375; and the TT 2120, \$425.

Schneider Electronics Inc., 3 Hazel St., Peabody, Mass. [351]

Digital panel meters are easily customized

A continuing problem for firms that make relatively small quantities of instruments is obtaining satisfactorily labeled and specified digital panel meters with minimum cost and trouble. Tekelec Inc., has developed a meter and system that it feels will minimize the problem.

The company's 3½- and 4½-digit meters with liquid-crystal display can be specified with a wide variety of range and zero offset, plus any engineering units, all at only \$29 over the cost of the basic meter in quantities of 100. Single quantity price is \$59, and the meters themselves are a low \$67.50 for a 3½-digit version or \$98.50 for 4½-digit model, also in quantities of 100.

The Tekelec meters are in the TA 300 series, and use back-lit transmission field-effect displays, plus a single MOS and single bipolar chip. The range is set by a single external resistor. Because a precision wire-

wound resistor with excellent temperature and time stability is required, so Tekelec maintains an inventory for models requiring 100 millivolt to 1,000 volt full scale and 100 nanoamperes to 10 amperes full scale. Likewise, a single resistor and a high-stability voltage source set the offset, and Tekelec inventories these parts for positive or negative offsets to 50% of full scale.

For many users, the label is even more of a problem than the electri-



cal components. The company has a special machine that can make small quantities of labels without the usual high tooling cost, which is often \$100 or more. The machine makes ¼-inch-high red, orange, or silver letters or numerals on a dark background. Up to 18 characters and spaces can be printed. Typical labels would be °C, gallons per hour, miles per hour and pounds/square inch.

Tekelec Inc., 31829 West La Tienda Drive, Westlake Village, Calif. 91361. [352]

Function generator operates from 2 Hz to 200 kilohertz

The model 30 function generator features 2 Hz to 200 kHz simultaneous sine, square and triangle waveforms with internal linear or logarithmic sweep capability. External capacitors may be added for unlimited frequency down ranging. Sweep mode and voltage-control mode give a frequency change of 1000:1, either linearly or logarithmically. Full voltage control of generator requires only 0 to 1 volt, either dc for programming discrete

TEKTRONIX HAS A NEW LINE TO TEST YOUR MEMORY

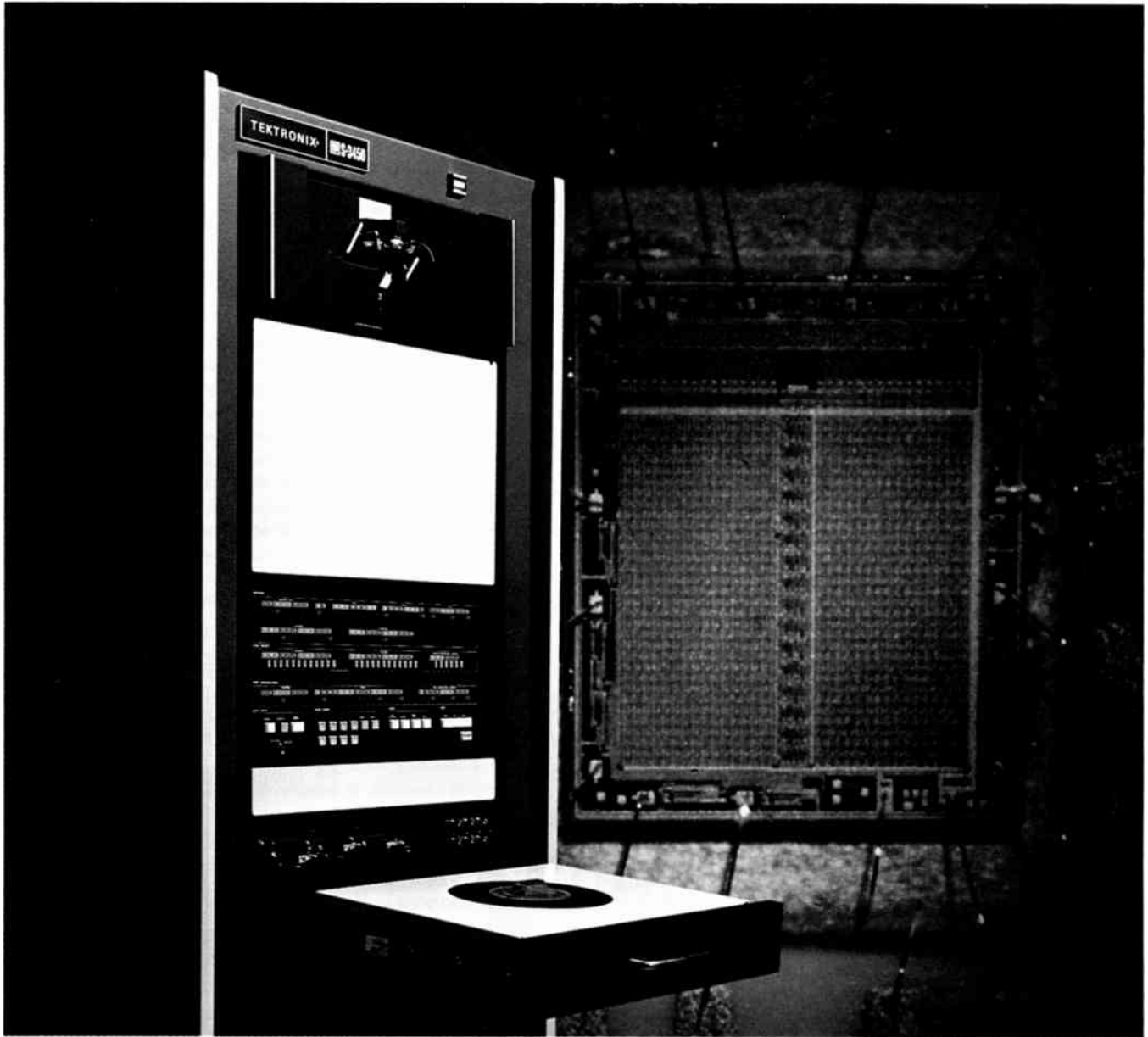

Meet the latest additions to the growing lines of TEKTRONIX Automated Test Equipment, the S-3400 Series of Semiconducting Memory Test Systems. These S-3400 systems are modularly constructed, fully programmable, stand alone semiconductor memory testers; capable of performing dc parametric, and functional tests on semiconductor memory devices.

The S-3400 systems have been designed and built to give you a system that can completely and effectively test all semiconductor memories. With interfaces available for wafer probers and automatic device handlers, a total package may be configured to supply you with a complete solution for your semiconductor memory testing requirements.

The S-3400 series joins with our S-3100 series and S-3260 Automated Test Systems to bring to you a wide range of test and measurement solutions. For more information contact the Systems Applications Engineer nearest you listed on the opposite page, circle the reader service card or write Box 500 A, Beaverton, OR 97005

frequencies or ac for fm operation.
Wavetek, Box 651, San Diego, Calif. 92112
[360]

Digital rf power meter covers 1-18,000 MHz

A digital rf power meter for measurement of continuous-wave and swept rf power covers the range of from 1 to 18,000 megahertz. Called the model 4020, the meter features a wide dynamic range of +10 dBm to -40 dBm, without autoranging and



offers a fast response for real-time read out on oscilloscopes. The four-digit display provides direct information of power in both 50- and 75-ohm systems in dBm with a linearity of ± 0.04 dB for any 10-dB range. Resolution is 0.01 dB over the full dynamic range. Price starts at \$1,725.

Systron-Donner Corp., 735 Palomar Ave., Sunnyvale, Calif. 94086 [353]

Analyzer measures transistor noise

An rf transistor noise analyzer, the model 340B, directly measures transistor noise figure from 0 to 40 decibels. The instrument provides measurements for both bipolar and field-effect transistors, tested at frequencies between 1 and 60 megahertz. Operation of the instrument requires the use of the company's model 1340 front panel, frequency plug-in head, which is selected for one of the five test frequencies available. Each plug-in head contains a socket for the transistor under test, a selection switch, which determines

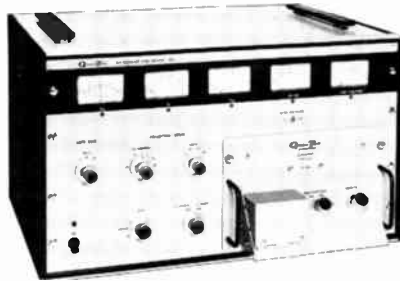

base resistance, a tuning control to compensate for base capacitance, and an sine wave oscillator for test calibration. Price is \$2,500.

Quan-Tech division, Scientific-Atlanta Inc., Randolph Park West, Rte. 10, Randolph Township, N.J. 07801 [354]

Semiconductor curve tracer permits scope display

For use with an oscilloscope, the model IT-1121 semiconductor curve tracer displays operating parameters



of almost all type of discrete semiconductors. These devices include bipolar transistors, diodes, SCRs, triacs, and FETs. Extra leads are provided for testing larger devices or for in-circuit tests. All major controls are stepped in a 1,2,5 sequence. Price is \$89.95.

Heath Co., Benton Harbor, Mich. 49022 [355]

Gain phase meter plug-in is accurate to within $\pm 0.1^\circ$

The model 305-PA-3009 plug-in module is designed for insertion into the company's series 305 gain

Call the Tektronix Systems Application Engineer nearest you.

CALIFORNIA

Palo Alto 94303
3750 Fabian Way
Phone (415) 326-8500
(Info. Disp. Prod. 415-321-7728)

Van Nuys 91406

16930 Sherman Way
Phone (213) 987-2600
From L.A. call: 873-6868

GEORGIA

Atlanta 30341
2251 Perimeter Park
Phone (404) 451-7241

MARYLAND

Baltimore
1526 York Road
Lutherville 21093
Phone (301) 825-9000
From Harrisburg, Lancaster and
York Area call: ENterprise 1-0631

MASSACHUSETTS

Boston
244 Second Avenue
Waltham 02154
Phone (617) 890-4550

NEW MEXICO

Albuquerque 87108
1258 Ortiz Drive, S.E.
Phone (505) 268-3373
Southern N.M. Area: ENterprise 678

NEW YORK

Endicott
3214 Watson Blvd.
Endwell 13760
Phone (607) 748-8291

TEXAS

Dallas 75240
4315 Alpha Road
Phone (214) 233-7791

HOME OFFICE

Tektronix Industrial Park
Box 500
Beaverton, Oregon 97005
Phone (503) 644-0161



TEKTRONIX®
committed to
technical excellence

30-MIL-center-tapped thin-film-NiCr resistor-chips.
10 Ω to 510K Ω .
24-hour turnaround.

Our chips, your game.
From Hybrid Systems,
naturally.
resistor-chips
To be precise...

RESISTANCE RANGE: 10 Ω to 510K Ω .
TEMPCO: 0 to +50 PPM/ $^{\circ}$ C.
TRACKING MATCH: \pm 1 PPM/ $^{\circ}$ C.
POWER DISSIPATION: 250 mW.
NOISE: 0.01 μ V/Vmax.
RESISTANCE TOLERANCE: \pm 1 and \pm 5% (or tighter, by request).
TEMPERATURE: -55 $^{\circ}$ C to +125 $^{\circ}$ C.
MIL-STD-883 A or B.
GLASS PASSIVATED
CONFIGURATION: chips, wafers, multi-chip trays, tube packs.

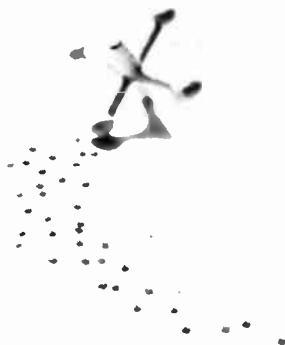

For Fast Action, Call:

In USA: (617) 272-1522 (or TWX 710-332-7584)
In Europe: Hybrid Systems Europa GmbH, 61 Darmstadt,
Luisenplatz 4, Germany Tel. 6151-291595

Hybrid Systems Corporation
Burlington, Massachusetts 01803

Hybrid Systems
CORPORATION

New products

phase meters. With the addition of the module, the series 305 is able to make phase measurements with an accuracy to within $\pm 0.1^{\circ}$ in the signal frequency range of from 50 hertz to 50 kilohertz, $\pm 25^{\circ}$ from 2 Hz

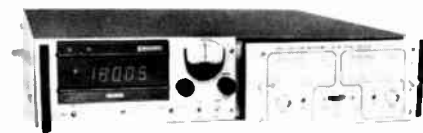

to 500 kHz and from $\pm 0.3^{\circ}$ to $\pm 2^{\circ}$ out to 11 MHz. Further, the model 305-PA-3009 provides digital readout with a resolution of up to 0.01 $^{\circ}$.

Dranz Engineering Laboratories Inc., 2385 S. Clinton Ave., S. Plainfield, N.J. [357]

Three phase wattmeter responds to any waveshape

Called the Digiwatt, a three-phase digital wattmeter incorporates transducers, which work as quarter square multipliers, in each phase. With this feature, the instrument



can respond to signals of any waveshape over a wide range of frequencies. The transducers are coupled to the circuits under test by toroidal transformers. Range of the Digiwatt is from 10 watts to 100 kilowatts, and voltage is from 1 v to 500 v rms.

Ormandy and Stollery, Regal Works, Station Rd., Brightlingsea, Essex, England [358]

Oscillographic recorder has seconds-to-minutes speeds

Offering a seconds-to-minutes chart-speed-reduction option, the model 7402A two-channel oscil-

Data General Corp. — the mini-computer star — really packs its PC boards. Typical is this 15" x 15" edition with 126 integrated circuits, 12 levels of logic, 15 time states.

Most test system companies just shook their heads. So Data General has been handling all its own circuit testing.

Until recently.

DGC brought 80 of these boards to us. Many doctored to incorporate particularly tough combinations of particularly troublesome faults. We ran them using the MIRCO 410 Logic-Circuit Test System and a test program developed with FLASH Test Generation Software. Result: fault isolation, on the average, in 1/24th the time.

DGC bought. MIRCO Systems and Software. Wouldn't you? Shouldn't you?

**The board
nobody could test
BUT Data General.
And now us...
in 1/24th the time.**



MIRCO

MIRCO SYSTEMS, INC.
2106 W. Peoria, Phoenix, Az. 85029 • Phone (602) 944-4691
The only name you need to know in circuit testing

See us at Booth 2, NEPCON/EAST

Circle 161 on reader service card

Simple

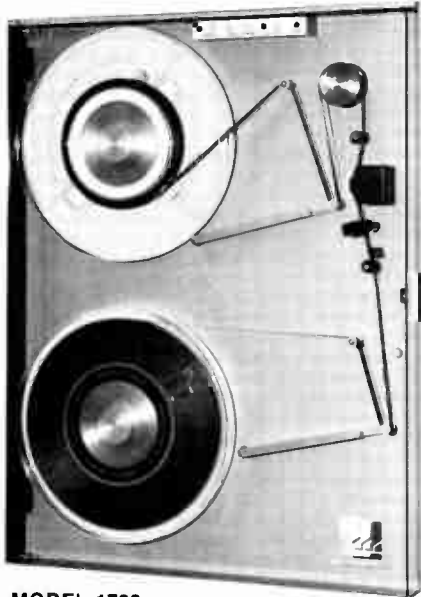

MODEL 1700

... and basic—our design goals. Look behind a Digi-Data transport and you will be amazed at its simplicity—at no loss of function. Our simple machines feature

- Speeds to 45 ips
- NRZI or PE
- OEM or formatted configurations
- 7, 8½ and 10½ inch models

Simplicity means reliable performance at a low price—the lowest. We'll be happy to send you all the details.

DIGI-DATA CORPORATION

8580 Dorsey Run Road, Jessup, Md. 20794, (301) 498-0200



Circle 162 on reader service card

New products

lographic recorder adds chart speeds of 125, 25, 5, and 1 millimeter per minute to the recorder's standard speeds of 125, 25, 5, and 1 millimeter per second. The instrument is suited for long-term measurements on a production line or for

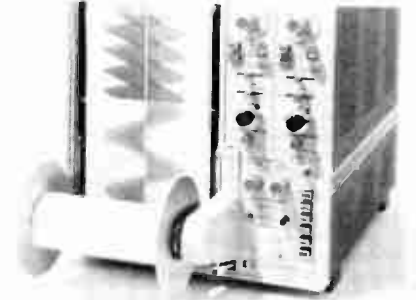

laboratory testing. The model 7402A is priced at \$125, and the option is priced at \$150.

Hewlett-Packard Co., 1501 Page Mill Rd., Palo Alto, Calif. 94304 [356]

Desk top digitizer has resolution to 0.001 inch

A graphics digitizer, called the Trak 200, converts drawings, maps, and other analog graphic data into computer compatible form, with resolu-

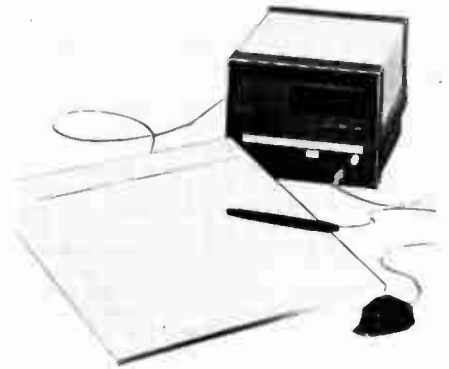

tions to 0.001 inch. The instrument has no moving parts except for the cursor, which requires no adjustment during the life of the equipment. The Trak 200 is available with either a binary or BCD controller. Price, which ranges from \$5,000 to \$50,000, includes software.

Electrak Corp., 11200 Lockwood Dr., Silver Spring, Md. 20904 [359]

RELEASE AGENTS

for Potting, Encapsulating, Laminating, Filament Windings, and Lay-ups.

- Save money by reducing rejects and increase speed.
- Increase production output.
- No cleaning prior to painting or bonding.
- Dependable multiple releases.
- No mold build-up.
- Retention of details.
- Use with all epoxies.



We have several standard release agents (both silicone and non-silicone types) to meet most needs. We also make custom solutions to meet unusual requirements. Aerosol spray cans or bulk.

Please tell us what your application is and we will send you by return mail complete information and prices on the proper release agent plus a FREE 16-ounce SAMPLE. Or else call us for even faster answers.

Have a nice day!

CONTOUR
chemical company

3 draper street • woburn, mass. 01801 • tel: (617) 935-5910

162 Circle 263 on reader service card

A flexcircuit for "sunshine" calculators

We did it for Rockwell.

A better calculator for the money — Rockwell International's aim in the development of its new private label liquid crystal display calculator. To meet this goal, Rockwell designers developed a light-collecting prism for improved display read-out under varying light conditions, including sunlight.

And to facilitate this design improvement, Rockwell employed a Sheldahl flexcircuit. This flexcircuit makes 84 connections between the back-lighted prism-aided liquid crystal display and the calculator's driving logic. Flaps located on each side of the display aperture flex a full 180 degrees to form pressure pads for display connections.

Flexcircuitry's low bulk permits circuits to the upper edges of the display to be routed through limited space between the calculator case and the display ends. The back of the display is left completely open for light entry and prism placement. The flexcircuit has 132 plated-through holes to provide for a matrix that reduces 84 display connections to 28 logic connections.

Rockwell's calculator design is another case where flexcircuitry fits available space and can be produced in volume.

Perhaps Sheldahl flexcircuitry can help in your design problems. Just call or write Sheldahl for further information.

Sheldahl did it for Rockwell International.



Sheldahl

Electrical Products Division
Northfield, Minnesota 55057
Phone: (507) 645-5633

The state of the art people in volume flexible circuits.

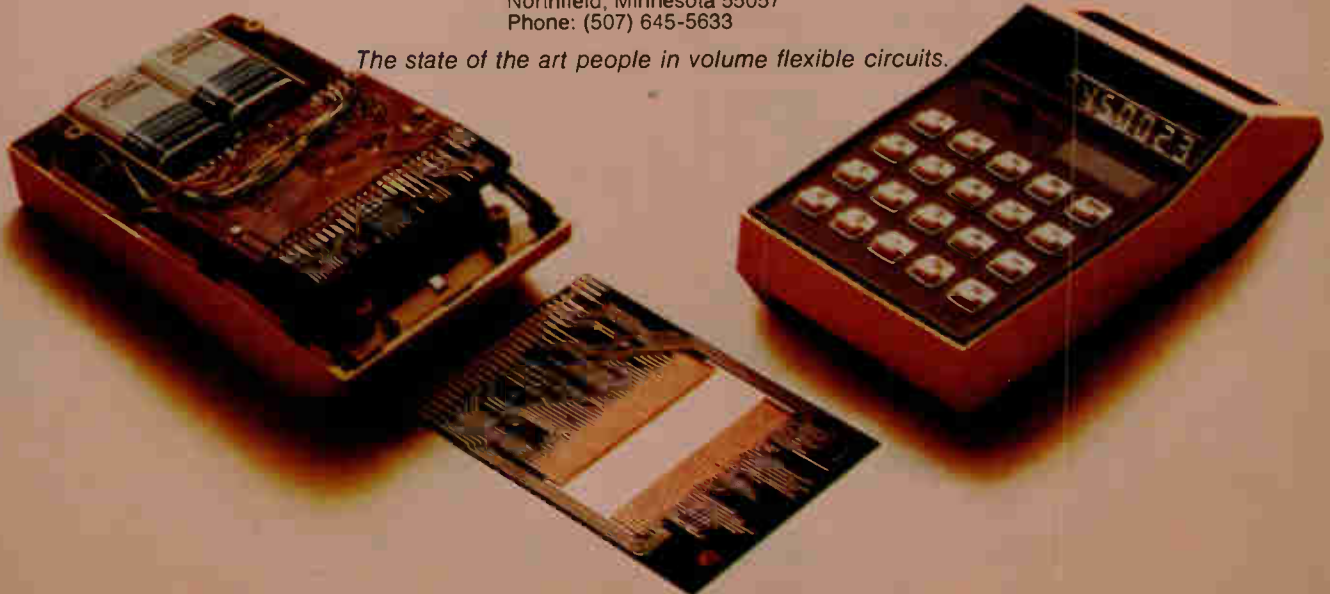

And we can do it for you.

© 1974 G.T.S. Co.

Circle 163 on reader service card

cradle[®]

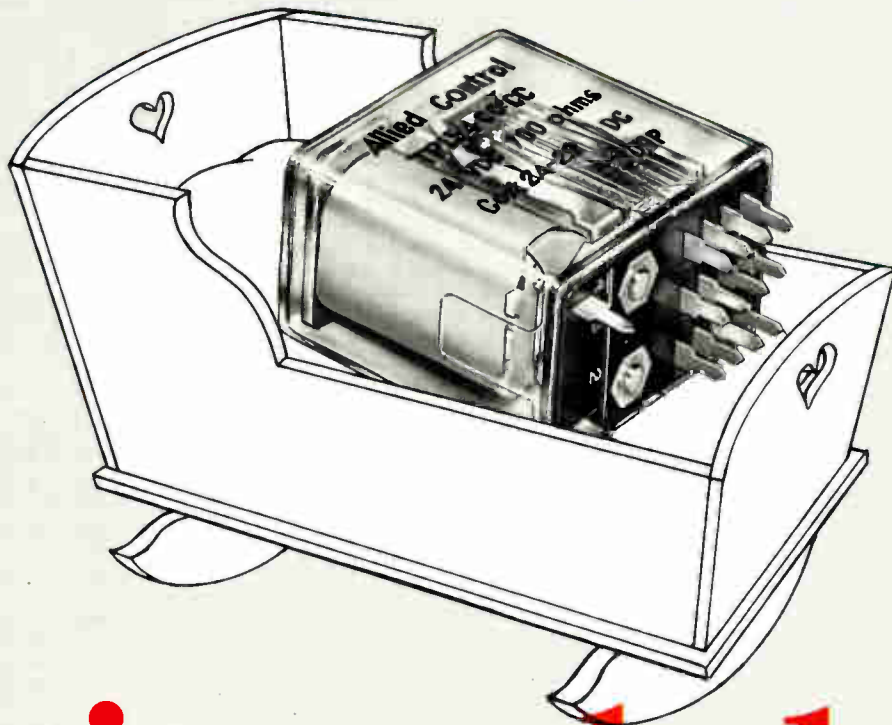

...is our baby.

Rock-a-bye our relay . . . it's reliable, it's registered, and it's ours, all ours. No one else can make that statement. So when you come across a so-called 'cradle-type', remember it's not the real thing . . . unless it has our little R. Then you'll know you can count on Allied's proven Cradle reliability . . . 100 million mechanical operations . . . contact selection to match application . . . high density package . . . mounting versatility . . . and, of course, U/L recognized. For full information contact Allied Control Company, Inc., 100 Relay Road, Plantsville, Conn. 06479. (203) 628-9654.



ALLIED CONTROL COMPANY, INC.

Where Control Is The Key

A COMPLETE LINE OF RELAYS • INDUSTRIAL CONTROL SYSTEMS • SOLENOID VALVES

vactec phototransistors

VACTEC, INC.
2423 Northline Industrial Blvd.
Maryland Heights, Mo. 63043
Phone (314) 872-8300

Vactec npn epitaxial large chip, high sensitivity phototransistor. An enlarged section of the wafer forms the colorful background.

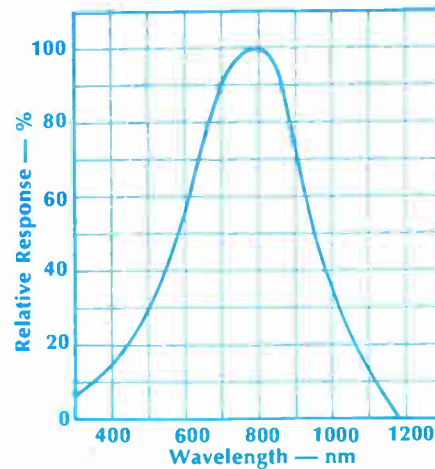
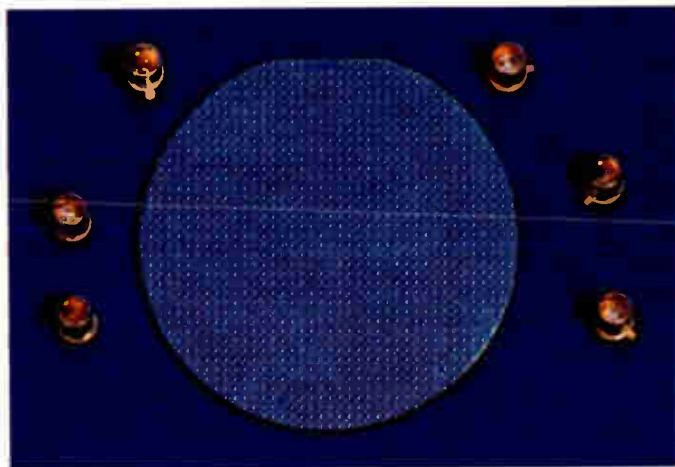

Standard Vactec phototransistors provide very high sensitivity and good blue response. Liberal design flexibility is also offered with trade-off for some characteristics, including: light current; response time; spectral sensitivity; and breakdown voltage. Selection of packages are TO-18, co-axial, pill, non-hermetic TO-18 size and special arrays on 50-mil or 25-mil centers.

Custom design is practical for quantities as low as 10M per year. Masking charges are nominal. Our automatic test capability includes 100% sort (with light applied) for I_{CEO} , breakdown voltage and dark current. Vactec can also second-source practically anyone's phototransistors. Write for Bulletin VTTA-1 today.

Circle 165 on reader service card

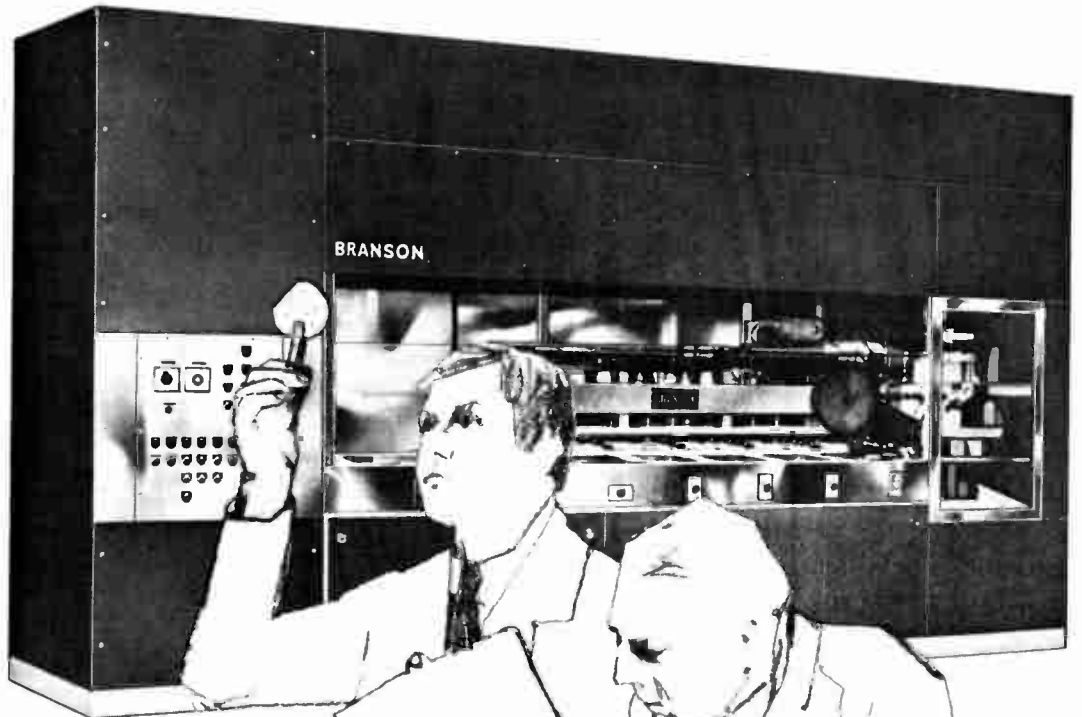

Production Cleaning Problem?

Branson Ultrasonics — the Sound Solution

Ultrasonic cleaning is the only way to meet cleaning specifications for semi-conductors or precision mechanisms. You can even clean complete assemblies, with improved yields, and in far less time — making ultrasonics the economical solution.

Branson systems, customized from standard modular generators and immersible transducers, pay off in precision, consistency, and efficiency.

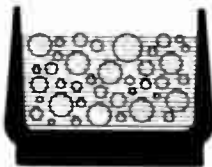

Cleaning Division
Dept. E, Progress Drive
Stamford, Conn. 06904
(203) 359-2800

BRANSON



Custom Branson Ultrasonic Cleaning Systems are used throughout industry to clean all types of products, such as ring and precision gears; integrated circuits; fuel injector nozzles; printed circuit boards; bearings; electrical devices.

Ask The Man Who Uses One

He works for these
companies:

Fairchild
Hamilton Standard
ITT Avionics
ITT-Europe
NCR
Rank Xerox
Raytheon
RCA
Siemens
Sperry
Sycor
U.S. Air Force
U.S. Navy
Western Electric
Xerox

He knows the real value of flexibility and economy in computer-controlled test systems. He needs a system that is truly interactive, easy to program, capable of conducting any type of functional or dynamic testing, able to handle any kind of digital, analog, and HF unit under test, and ready for today's — and tomorrow's — complex test requirements.

With the IE System 390, the software is the key. User-oriented software, with an English-language test program, makes it easy to conduct tests and fault isolate down to a component level on a variety of test units, with minimal hardware changes.

Send us your test requirements, and we'll show you how the System 390 can meet all of them efficiently and economically. We'll also send you our User Catalog.

Contact:

Instrumentation Engineering, Inc.,
769 Susquehanna Avenue,
Franklin Lakes, N.J. 07417;
telephone: 201-891-9300.

Instrumentation
Engineering 
The System 390

Ask The Man Who Uses One.

Los Angeles Office:
213-884-8241

Washington, D.C., Office:
703-451-1422

Europe Offices:
Siemens AG
D 7500 Karlsruhe 21
595-2591
D 8000 Munich
7200-7131

Data Handling

Microprocessor runs recorder

One of the first "smart" instruments is programmable data-acquisition system

"Smart" terminals are already finding wide use in business data-processing applications. Now it looks as if the availability of microprocessor chips heralds the era of "smart" instruments and instrument accessory systems.

One of the first may well be a smart digital data-acquisition system developed by Doric Scientific. The multipoint Digitrend 220 recorder uses an Intel 8008 microprocessor control, plus semiconductor memory, and can scan and record 20 to 1,000 points at speeds to 20 points per second.

The points can be programmed for up to six functions per system. Standard ranges and functions are four linear dc voltages with resolution to 1 microvolt and automatic ranging at high speed, six thermocouple inputs (J, K, T, E, S, and R) with built-in cold-junction compensation and digital linearization for direct temperature display in C° or F°, and two ranges of current transmitter inputs to handle process signals of 4-20 milliamperes and 10-50 mA.

Special functions, ranges, and scaling for standard or nonstandard transducers are available at an additional cost. Point skipping is included at no cost when point programming is ordered.



Group programming is available instead of point programming for a single function by groups of 10 points. This feature is extremely convenient for large systems where the first couple of hundred points can be point-by-point programmed and the other hundreds can be group programmed.

Time of day is displayed and recorded in hours, minutes, and seconds, also included is a power-failure indication. Precision self-test is a built-in feature.

Among the nine interface circuit cards that are available as options to couple to peripheral equipment are: external alarm relays, computer access with parallel BDC output, serial output for 7-track or 9-track incremental magnetic tape recorder, serial output for paper-tape punch, serial output for Teletype, and output drive for modem.

A fixed data panel is available for entering data to be recorded prior to each scan. This feature is also available with an auto-calendar circuit, which automatically advances the date every 24 hours. Optional selective alarm provides up to 32 independent alarm points.

The use of plug-in read-only memories and programable ROMs in the Digitrend 220 permits selection of desired features and allows future expansion at a minimum additional cost. The base price is approximately \$3,000 with 60 day delivery. Doric Scientific Corp., 3883 Ruffin Road, San Diego, Calif. 92123. [361]

Magnetic-tape subsystem has up to eight transports

A magnetic-tape subsystem, which can include up to eight magnetic-tape transports, is available in seven- and nine-track models. The transports read and write tape at 75 inches per second, and have a data density of 556 and 800 bits per in. on the seven-track model, and 800 bits per in. on the nine-track model. The data transfer rate is 60,000 characters per second. The magnetic-tape units use a vacuum column for tape buffering and tension

control, and a tape cleaner to maintain the integrity of the tape and read/write head. A read-after-write head checks the validity of data. The new transports rewind at a speed of 200 in. per second in the vacuum column. A 10½-in. reel can be rewound in 2 minutes. The first unit in a system is priced at \$9,900. Any additional units the user may purchase cost \$6,700.

Data General Corp., Southboro, Mass. 01772 [410]

Data-entry terminal transmits to 1,200 b/s

The model TR-10 data-entry and retrieval terminal offers a single-line 32-character buffered alphanumeric-display panel, and a double line of 64 characters is optional. Local and remote full or half-duplex operation is available at transmission rates of from 110 to 1,200



bits per second. The terminal also provides a 10-key keyboard and 10 additional keys are available as options. Portability is another feature; the TR-10 weighs only 10 lb. In addition, special formatting and interfaces are optional. Price of the TR-10 is \$875, with quantity discounts available.

VMF Industries Inc., 216 N. Fehr Way, Bay Shore, N.Y. 11706 [365]

Low-speed modem offers high sensitivity

Operating at 303 bits per second and slower, series 3100 data modems have an active filter in the re-

Micaply® Substrates and Circuits

For Thick/Thin Film Applications

Thick/thin film resistor-conductor circuits utilizing Micaply Ohmega™ Resistor-Conductor Laminates



Circuits of Micaply Ohmega™ offer designers a proven epoxy glass substrate with both the resistor and conductor layers completely covering the substrate on one or both sides. **Selective etching produces conductors complete with integral thin film type resistors as shown at the right.** The circuits shown above are examples of its use to replace more expensive thick/thin film resistor circuits and discrete resistor circuits.

Complete design assistance and circuit production are available. Contact us for an evaluation of your requirement and comprehensive technical literature. Find out how Micaply Ohmega™ can reduce your circuitry cost.

- Much lower cost than conventional materials and processing.
- 25 or 100 ohms-per-square sheet resistivity.
- Line widths consistent with thin film microelectronic techniques.
- Subtractive etching process — no screening, firing, or vacuum equipment required.
- 10" x 36" sheets for processing economy.
- Can be easily drilled and cut.
- Can be multilayered for higher density.
- Resistors can be laser trimmed.

Hybrid microcircuits utilizing Micro-Thin Copper Clad Laminates (a low cost ceramic substrate alternative)

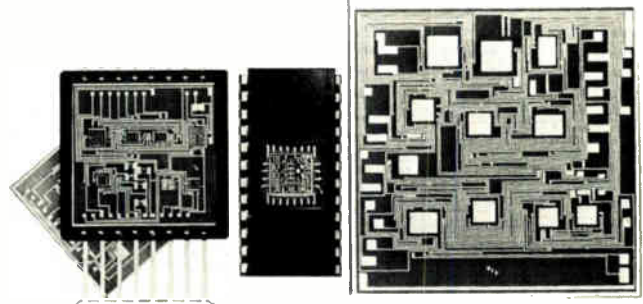

Micaply® Micro-Thin Copper Clad Laminates make possible lower cost hybrid microcircuits. Epoxy glass microcircuits like the ones shown above eliminate the cost and costly processing of ceramic in many applications. Micro-Thin is an epoxy glass laminate completely clad on one or both sides with 100 microinches of copper. Using conventional etching techniques conductors with line widths as fine as two mils can be produced.

Complete design assistance and prototype service is available. Contact us for an evaluation of your requirement and for comprehensive technical literature. Find out how Micaply® Micro-Thin can reduce your microcircuit costs.

- Much lower cost than metal coated ceramic substrates.
- 100 microinch copper clad epoxy glass.
- Can be easily drilled and cut.
- 10" x 12" sheets for processing economy.
- Etched line widths as fine as two mils.
- Can be multilayered for higher density.
- Active and passive chips are easily bonded.
- No screening, firing, or vacuum equipment required.

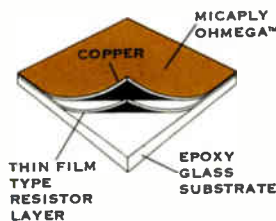

Before Etching

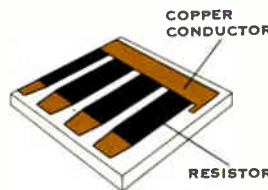

After Etching



Request complete literature on Micaply Ohmega™ and Micro-thin Copper Clad Laminate materials and production services.

**See us at
NEPCON '74 EAST
Booth 4546**

The **Mica** Corporation

10900 Washington Boulevard, Culver City, California 90230, (213) 839-5282, TWX: 910-340-6365, Telex: 674999

Micaply International, Ltd. Silloth, Cumberland, England, Silloth 571, Telex: 64120, Cable: Micaply Silloth

New products

ceiver section to provide telephone-line sensitivity to -50 dbm. The transmitter section of the modem is said to minimize transmission error by providing coherent frequency-shifting. Three basic models are available: originate acoustic, answer/originate acoustic, and answer acoustic. Users may specify that the units be equipped for use with data-access arrangements supplied by the



telephone company. Options include EIA terminal interface cable, model 33 teletypewriter cable, and a second EIA connector to join two terminals to a single model 3100. Price is \$230 to \$300 each in lots of 50.

Novation Inc., 18664 Oxnard St., Tarzana, Calif. 91356 [364]

Magnetic head conforms to read-after-write format

A $\frac{1}{4}$ -inch digital magnetic head, constructed in a read-after-write format, meets standards proposed to ANSI by the Minnesota Mining & Manufacturing Co. and is compat-

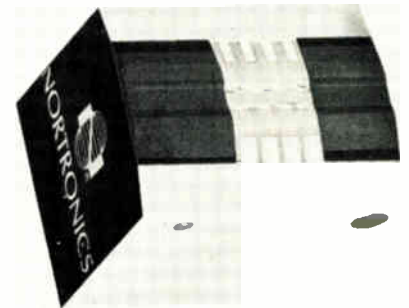

ible with the 3M cartridge system. The model DQ-42D dual-gap head offers block construction, which permits track-to-base dimensions with a tolerance of ± 0.001 to be custom-tailored to individual needs. The head will operate to speeds of 90 inches per second.

Nortronics Co. Inc., 8101 Tenth Ave., N. Minneapolis, Minn. 55427 [366]

Tape reader is compatible with Intel microcomputer

The model R808 paper-tape reader is the first in a series of peripherals that are plug-for-plug compatible with the Intel Corp. Intellec series of microcomputers. The company says the R808 will permit users to load programs almost 12 times faster than is possible with a teletypewriter, providing a load rate of 3 minutes, compared to 35 minutes by the other method. The R808, which uses a photo-electric character-detector, is interfaced through

GREAT CONNECTIONS!



On September 30, 1927, the Yankee's immortal Babe Ruth connected with his 60th homer off Tom Zachary of Washington, a single-season record, achieved in 154 games. His record held until October 1, 1961, when another Yankee, Roger Maris, blasted his 61st homer in a 165-game season.

SPECTRA-STRIP made another great connection



SPECTRA-STRIP connected with Federal Sign & Signal Corp., and was awarded the manufacture of inter-connection assemblies for 35 major freeway traffic information sign faces, each with 32 Spectra-Strip cable assemblies. Signs warn drivers of congestion ahead, allowing them to take alternate routes. Data is furnished by the Highway Patrol and by embedded loop detector systems to a computer center which instantly controls the sign messages.



SPECTRA-STRIP flat ribbon cable, uniquely bonded or laminated, encompasses both round and flat conductors. It is available from 14 to 34 AWG, and in widths up to 100 conductors. They can be standard or custom color-coded to meet your special needs. SPECTRA-STRIP also has a total capability for creating and producing custom interconnecting harness assemblies to meet your particular design requirements.

S
SPECTRA-STRIP
CORPORATION

7100 Lampson Ave., Garden Grove, CA 92642 (714) 892-3361
385 Putnam Ave., Hamden, Conn. 06517 (203) 281-3200

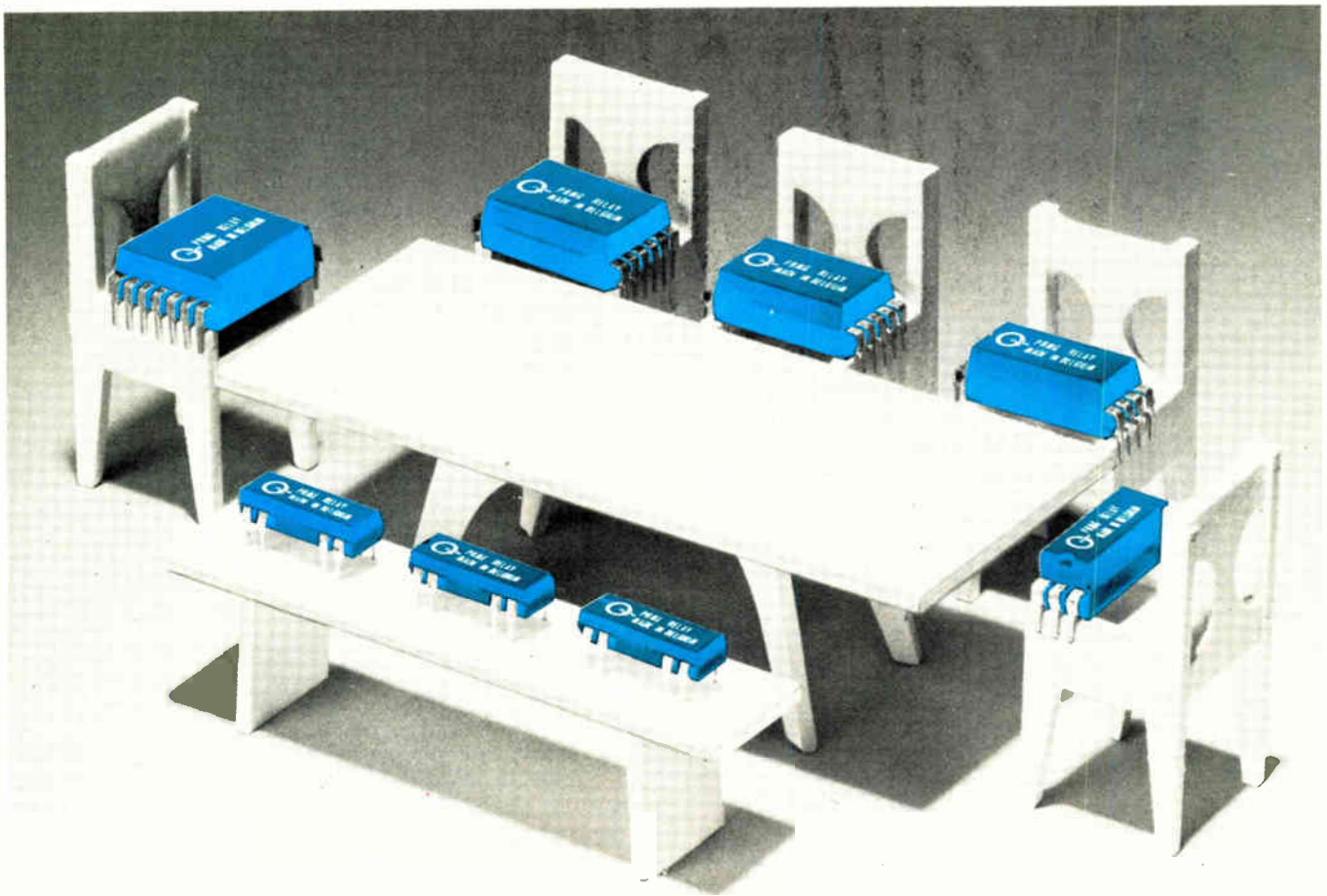

THE PRME DIP RELAY NOW HAS BIG BROTHERS AND SISTERS...

CLARE PRMG

A new family of low cost epoxy molded dry reed relays.

PRMG sealed contact reed relays provide switching performance with telecommunication reliability, offer load handling capability from low-level to 10 VA, versatile multipole contact arrangements from one to five contacts, rugged epoxy molded construction, and at economical prices.

Like the proven and demonstrated reliability of the Clare PRME, PRMG relays are rated for millions of operations, because we make every part ourselves... including the hermetically sealed capsules.

We manufacture our reed capsules on automated machines in a white-room environment.

PRMG relays have maximum switching ratings of 150 Vdc, 0.75 Amp. They are available with both in-line and staggered 10 M x 1 M (1 M = 2.54 mm, 0.100 inch) terminal patterns. The low profile PRMG package will permit 0.5 inch PCB centers.

For more information contact C.P. Clare & Co.
3101 West Pratt Blvd., Chicago, Illinois 60645.
Telephone (312) 262-7700 - Telex 25-3775.



C. P. CLARE & COMPANY a subsidiary of
GENERAL INSTRUMENT CORPORATION

Look what \$450 buys!



New 2 MHz sweep function generator

It's the only one at that price... Systron-Donner's Model 411 sweep function generator. Check these features: **Frequency** in 6 decade ranges from 0.02 Hz to 2 MHz—Dial accuracy 2% of full scale typical—**Waveform outputs:** sine, square, triangle, ramp and a T²L compatible sync pulse square wave. **Plus:** Model 411 is the only low cost sweep function generator which allows the operator to set the upper frequency limit to dial accuracy. **Contact:** your nearest Scientific Devices office or Systron-Donner at 10 Systron Drive, Concord, CA 94518. For immediate details call our Quick Reaction line (415) 682-6471 collect.

SYSTRON  **DONNER**

Circle 172 on reader service card

\$6.00
50 ohms/
200 ohms

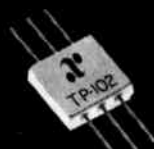

TRANSFORMER

MODEL TP-102

- 1-500 MHz Min. Frequency Range
- 0.4dB Insertion Loss
- 1.5:1 VSWR
- 3/8" Square by 1/8"

anzac
ELECTRONICS



39 Green Street, Waltham, Mass.
(617) 899-1900 • TWX 710-324-6484

Are you in High-Speed Digital Communications?

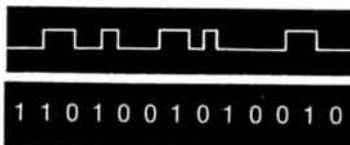

We make really fast test equipment. *Imagine!* Bit rates to 1.0 GHz and a BERT, too. If you work in high-speed PCM communications, state-of-the-art device design, or other engineering R&D, you should contact us. We also have pulse sources and data/word generators. Call or write.

tau-tron
INC



11 Esquire Road, North Billerica, Mass. 01862
Tel: (617) 667-3874

Circle 265 on reader service card

New products

two ribbon cables, tied directly to the Intellec I/O board. Additional microperipherals can be added by daisy-chaining the ribbon cables. The software driver routine for each microperipheral is located in one additional programmable ROM memory, which is located in memory below the five system-monitor/PROM-writer chips sup-

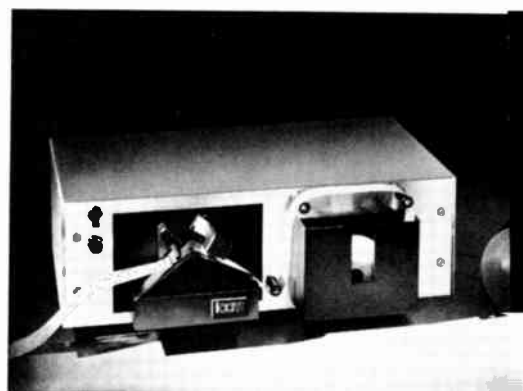

plied by Intel. Price of the model R808 is \$995.

iCOM Inc., 21243 Ventura Blvd., Woodland Hills, Calif. 91364 [363]

Time-division multiplexers have stored programs

Three models of time-division multiplexers, called the 900 series, are designed for point-to-point and multipoint data-communications

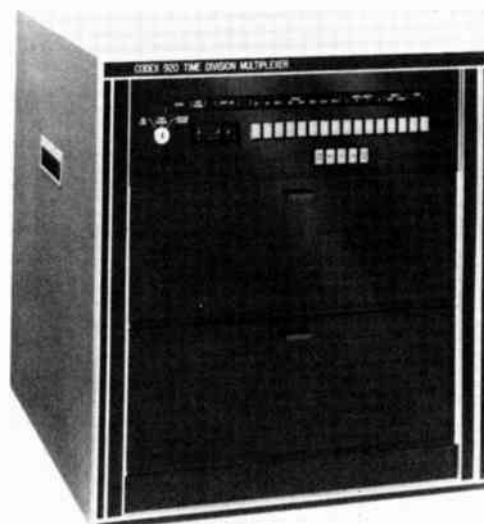

172 Circle 264 on reader service card

Electronics/May 16, 1974

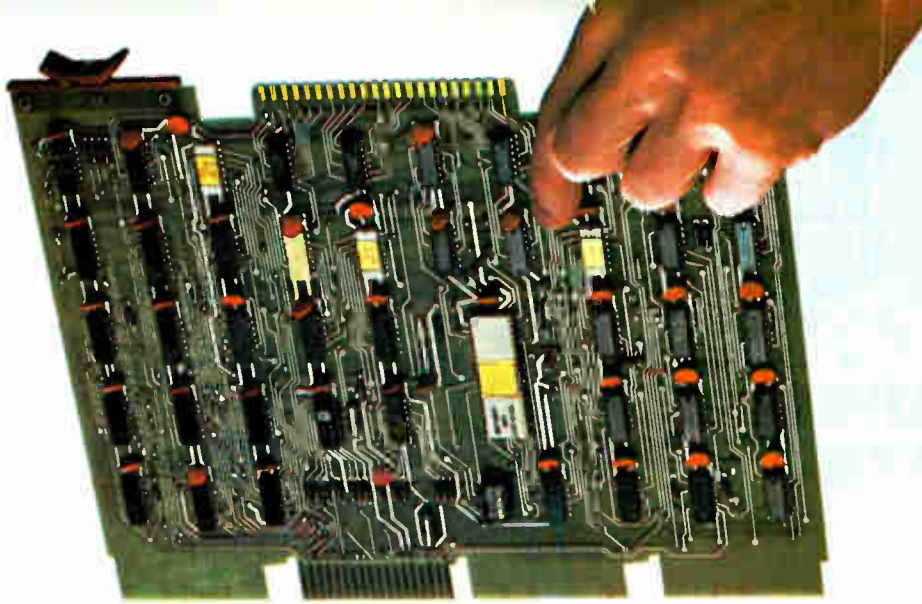

Plug this in, and you've just designed a custom data acquisition interface.

Nothing to it.

Just plug in a few modules and tap in your instructions.

The new PDM70 programmable data mover will sample your sources, transmit your data in serial ASCII to a remote computer, and return control instructions to local devices. If you want, it can also communicate interactively, without

computer intervention, between sources and local peripherals.

Off-the-shelf modules connect the PDM70 to any computer, to analog and digital input devices, and to such computer peripherals as Teletypes, X-Y recorders, storage oscilloscopes, printers, modems, and LED displays.

System prices start at \$2000.

Write, and we'll tell you more.

We're Digital Equipment Corporation, Logic Products Group, Maynard, Mass. 01754. (617) 897-5111, extension 2785.

In Canada: P.O. Box 11500, Ottawa, Ontario, K2H 8K8. (613) 592-5111.

In Europe: 81 route de l'Aire, 1211 Geneva 26. Telephone: 42 79 50.

We think interfacing is so important, we've devoted an entire department to it.

digital





**“Okay, okay.
You tell me where we can find
twenty thousand RAMs a week
for that much less than the 2102
and I’ll tell you where to find
the Easter bunny.”**

Give him the good news:

You can find all the 1K RAMs you need right now—right here at AMI. We have 4006, 4008 and 4008-9 RAMs ready for immediate delivery. They’re pin-for-pin with Mostek’s. But you can get more of ours—faster. (Stands to reason that when you have larger production facilities you can produce more.) The price is right, too. For example, the 4008-9 is yours for just \$3.50 in quantities over 1000. You get the advantages of a 2102 system, while saving a bundle with our 4006 family. You can get an application note on how to do it, and a free sample, by writing to

Frank Rittiman, AMI, 3800 Homestead Road, Santa Clara,
CA 95051. Phone: (408) 255-3651. Or ask your distributor.

AMI
AMERICAN MICROSYSTEMS, INC.

The charge of the 1K RAMs.

No more waiting for your 4006 family.

You have a perfect combination of price/performance for your 1024 bit MOS RAM applications. Use them for buffer or scratch pad memories. Or for peripherals, terminals, displays, programmable calculators, cash registers, optical scanners, spectro-analyzers.

And we give you more than fast deliveries. We give you specs like these:

P/N	S4006	S4008	S4008-9
No. of Bits	1024x1	1024x1	1024x1
Access Time	400 ns	500 ns	800 ns
Cycle Time	650 ns	900 ns	1000 ns
Power Supply	+5V, -12V	+5V, -12V	+5V, -12V

And this is how the S4006/8/8-9 looks on paper:

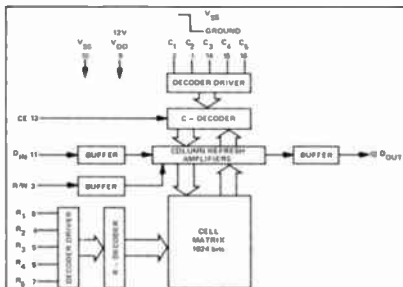

AMI

Circle 266 on reader service card

New products



its own acoustic coupler. Communications speed is 10, 15, 30, or 120 characters per second, and transmission mode is either half or full duplex. Price of the terminal is \$1,570 with a two-line display or \$1,190 with a one-line display and a 500-character memory. The acoustic coupler is priced at \$480. Delivery is from stock.

Termiflex Corp., Box 1123, 17 Airport Rd., Nashua, N.H. 03060 [368]

Tape reader is built for use with plotters

The Complot model MTR-3 magnetic-tape reader is designed specifically for use with the Complot plotter series. It is available as either a seven- or nine-track reader that offers a density of 200, 556, or 800 bits-per-inch. The plotter, buffered for off-line use, has such features as forward and reverse block advance and a hardware vector generator, which is said to reduce computer time.

Houston Instruments, 1 Houston Square, Austin, Texas 78753 [370]



The pollution problem. Maybe your engineers deserve a little help.

The engineers will be the ones to find the technical solutions to pollution problems. There's no doubt about it.

But pollution is a people problem, too. And the engineers' technological approach to pollution isn't going to solve people problems.

Maybe this booklet can help. It lists some of the things all people can do to fight pollution. And with all the people supporting your engineers we'll have a better chance of winning the fight.

For a free copy or a list of bulk rates write to Keep America Beautiful, Inc., Box 1771, Radio City Station, New York, New York 10020.

Keep America Beautiful

Advertising contributed for the public good



People start pollution. People can stop it.

Gerber's interactive design system integrates your engineering creativity with the speed and productivity of the computer. Here's a complete system with all the software necessary to produce any schematic, master artwork, NC drill tape, assembly drawing, parts list, interconnect list, detail drawing. At your fingertips.

Here's the system that lets your designers design, leaves the drafting to us. To slash lead time. Make your engineering profit center even more productive and profitable.

All designed, built and serviced by Gerber Scientific. A name synonymous with great hardware. Leadership. And now synonymous with great software. Call or write for complete information. The Gerber Scientific Instrument Company, Hartford, Connecticut, 06101. (203) 644-1551.

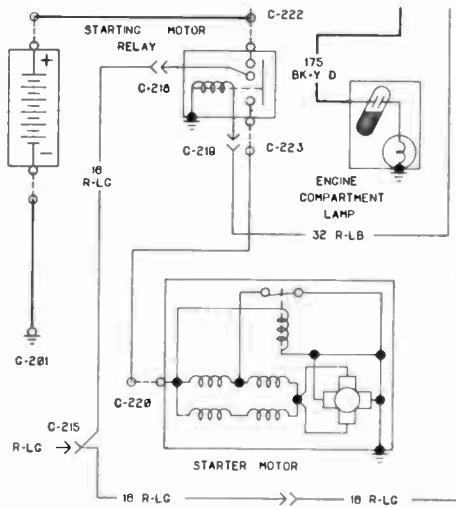

GERBER SCIENTIFIC

Circle 178 on reader service card

Designing Machine.



plaskon[®] thermosets

all set for tomorrow business

All set for changing times with advanced service, advanced products. The Plaskon Thermosets of Allied Chemical. Here yesterday, today . . . ready to be part of your tomorrow business.

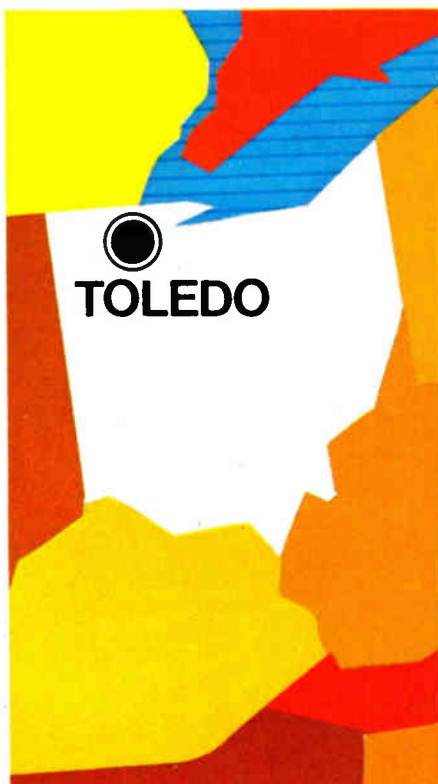

1. Consolidated Service.

All marketing, manufacturing and technical services newly coordinated, newly centralized in Toledo. All set for top quality control, prompt attention to your needs.

2. Innovative Products.

All ready for what you do that's new. A prime example: MX-2342—our improved epoxy resin for the encapsulation of electronic devices.

3. Plaskon Quality.

The Plaskon name backs a promise. Our entire thermoset line—ureas, melamines, alkyds, epoxys, DAP's and phenolics, specialty products for electrical and automotive markets—is created to do outstandingly the tasks you set.



Plaskon[®]

THERMOSETS

General Office: ALLIED CHEMICAL CORPORATION, PLASTICS DIVISION, 2829 Glendale Avenue, Toledo, Ohio 43614 (419) 382-5611
Regional Offices: Morristown, N.J. Des Plaines, Illinois Los Angeles, Calif.

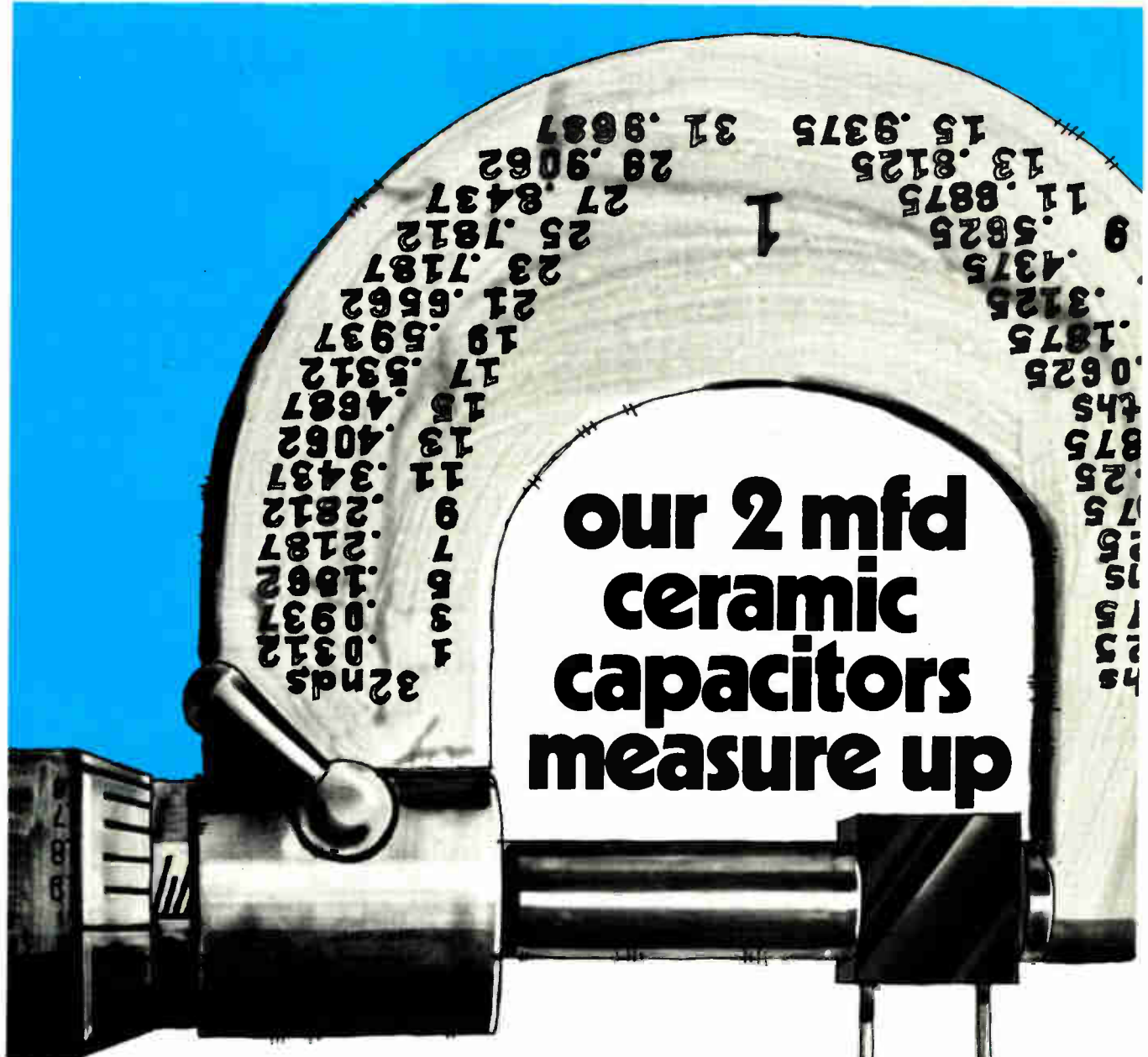

our 2 mfd ceramic capacitors measure up

Now AVX offers the CKR08 with 2 mfd capacitance in just 40% more space than a 1 mfd capacitor. It's a 2 mfd standard with all the advantages of ceramic dielectric.

The advanced design of the AVX CKR08 helps make your conceptual circuitry a reality faster. AVX provides you with the ceramic capacitors needed for tomorrow's designs today.

When you need ceramic capacitors, AVX delivers the quantities you need up to spec, on time and within budget.

For complete information, write AVX Ceramics, P.O. Box 867, Myrtle Beach, S.C. 29577. Telephone: (803) 448-3191. TWX: (810) 661-2252.



THE CERAMIC CAPACITOR MANUFACTURER

Dependable, high-density, planar stack memory systems from Datacraft.

Dependable because we run them through a demanding and torturous seven-day continuous burn-in.

Dependable because we insist on using only the finest of quality components.

Dependable because potential failure points are eliminated as we identify them. That's why we can give a warranty on every planar memory.

And, we know they're dependable because we use them in our own high-speed, highly-reliable Datacraft Computer Systems.

And, like you, we're not easy to please. Contact us for all the facts. Datacraft, 1200 Gateway Drive, Fort Lauderdale, Florida 33309, Telephone (305) 974-1700.

Datacraft®

SUBSIDIARY OF HARRIS-INTERTYPE CORPORATION



DATA-CRAFT CORPORATION
DC-38 MEMORY
DATA-CRAFT® MEMORY SYSTEMS

Circle 181 on reader service card

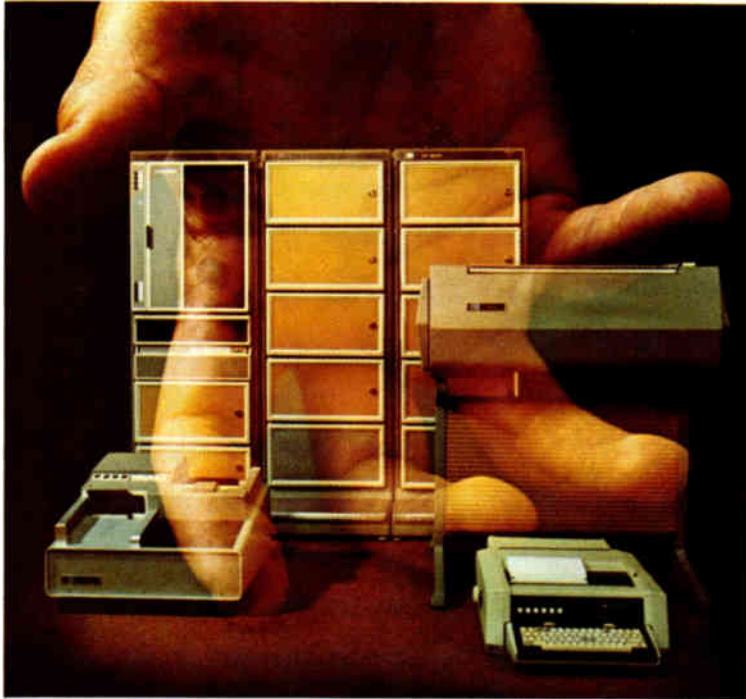

This \$170,000* system gives you more computer access than any \$300,000 system in existence.

HP's 3000 Minicomputer System gives you four languages: COBOL; BASIC; FORTRAN and HP's System Programming Language. A powerful Editor and File Manager. And concurrent accessibility from both terminals and batch peripherals.

This innovation works for a living.

If you do, call us.

HP minicomputers.
They work for a living.

HEWLETT  PACKARD

Sales and service from 172 offices in 65 countries.
1501 Page Mill Road, Palo Alto, California 94304

*Domestic USA prices. 22412

182 Circle 182 on reader service card

Electronics/May 16, 1974

Packaging & Production

Tester checks microprocessors

Built-in computer checks devices, has flexibility to use future programs

The whole question of how to thoroughly test semiconductor-memory components hasn't been laid to rest yet, and already there's a component that promises an even bigger testing challenge—the microprocessor. It appears to require a completely different test approach from other semiconductor devices—one more akin to checking out a large computer than to testing logic or memory devices.

Macrodata Co. has developed a new test system, the MD-104M, to test microprocessors and related parts adequately. The tester is priced at \$30,000 to \$40,000, rather than the \$150,000 to \$200,000 now typically required for such a system.

The only adequate way to check a microprocessor, contends William C. W. Mow, Macrodata president, is to find out if the instruction set, which may have 75 or more instructions, works. Testing the part for its logic patterns as it's clocked won't ensure that the part is good, he says.

Microprocessors, like semiconductor memories, are pattern-sensitive; the sequence in which the instructions are programed can affect operation of the part and uncover subtle problems. Another problem is that so few microprocessor chips are in use that people can only guess at the most prevalent failure modes, says marketing vice president Joseph Rivlin.

Computer. The MD-104M includes a 10-megahertz special-purpose computer with 64 data bits (the MD-104 uses 16 bits for memory testing) plus parametric capability and interfaces to test microprocessors. An interface board is now offered with the system for the Intel 8080, and boards will be forth-

coming for other parts that are or will be on the market.

Programing will be the key to testing the microprocessor, and, although the best techniques are not yet clear, Macrodata says the system is flexible enough to accommodate the programs that are ultimately proven optimum. The tester's computer, which can perform such exercises as loops and branches, address 65,000 addresses directly, and it can be expanded to several million. In this way, the MD-104M can, in effect, simulate the operation of the computer in a real environment.

Modular. The parametric capability of the system is provided in modular form, with the test operation able to choose up to the five or six parameters that are deemed most critical. Typical examples for a device manufacturer would be probe continuity, leakage, a unique dynamic test for drain current while the device is being clocked, and breakdown. The device user might choose thresholds and input and output leakage. These tests, on plug-in cards, would also provide the capability for classification into categories.

Timing tests are also possible, but Rivlin suspects they won't be considered vital for microprocessors. The system also tests memories and other parts. Testing time, however, may be very important. Mow says it may run about ½ minute because of the enormous number of steps required. The MD-104M is designed to support two test heads, and four of the MD-104M's can be controlled by a single MD-1041 controller, so that eight positions can be run simultaneously.

Macrodata Co., 6203 Variel Ave., Woodland Hills, Calif. 91364 [391]

Marking system prints up to 20,000 components/hour

A marking machine that prints identification marks on magnetic or nonmagnetic axial-lead components operates at speeds of up to 20,000 components per hour. The U-1220 series provides manual or automatic



feed. When the devices are printed they are dried and cured in an infrared oven that consumes 2 kilowatts of power. Components may vary from 2½ inches to 3½ in. in length including leads. The component body may measure up to 1 in. in length to 0.200 in. in diameter. The leads must be straightened and centered to alignment with the body's outside diameter to within ±0.0312 in.

Markem Corp., 150 Congress St., Keene, N.H. 03431 [394]

Turret bobbin winder can produce 550 coils/hour

Designed for small shops requiring the advantages of automated winding equipment, without the expense of large-scale machinery, the model 315-RT coil-winding machine handles all types of random-wound bobbin coils, solenoids, repeater

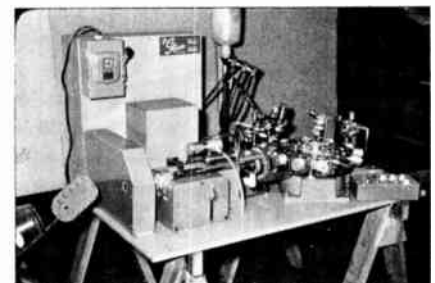

coils, and insulating linen for relay coils. Output is determined by coil configuration and operator efficiency. However, typically, at 300 turns, 550 coils an hour can be produced. At 500 turns, 370 coils per

Different hopes for different folks.



People want different things from a college education.

But they all agree on one thing. It takes more than brains to get a diploma.

Why not make the burden a little easier? Start buying U.S. Savings Bonds now.

Bonds are a dependable way to build a college fund for your children. And an easy way to start saving them is by joining the Payroll Savings Plan. Start a college fund

now with U.S. Savings Bonds. They just might let your kids spend more time studying and less time working to stay in school—whatever they hope to be.



Take stock in America.

Buy U. S. Savings Bonds

Now U. S. Bonds pay 5 1/2% interest when held to maturity of 3 years, 10 months 15 days, the first year. Bonds are replaced if lost, stolen or destroyed. When needed they can be cashed at your bank. Interest is not subject to state or local income taxes, and federal tax may be deferred until redemption.



The U. S. Government does not pay for this advertisement. It is presented as a public service in cooperation with The Department of the Treasury and The Advertising Council.

New products

hour can be produced, and at 700 turns, 285 coils per hour can be wound. Maximum coil diameter and coil length that can be handled are to 2½ inches, wire sizes handled are 22 to 40, and winding speeds are provided up to 4,000 rpm. By eliminating bench, cutter ejector, and wax applicator found on many turret-type machines, the cost of the 315-RT is kept down; price is \$6,900.

Geo. Stevens Manufacturing Co. Inc., 6001 N. Keystone Ave., Chicago, Ill. 60646 [393]

Bubble tester checks for leaks in hermetic seals

The model 481 gross-leak bubble tester checks for leaks in semiconductors, microelectronic devices and other hermetically sealed components. The unit features a tank with a transparent front and a lid that minimizes the loss of fluorinert va-

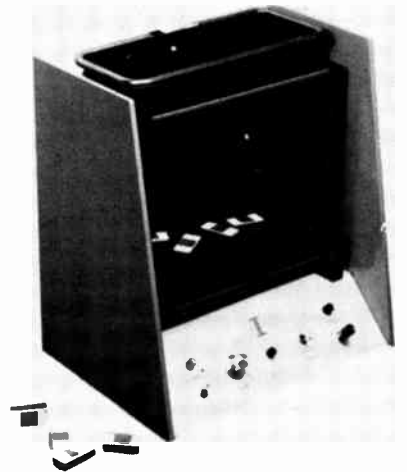

por. The unit plugs into any 120 v outlet, offers a solid-state temperature-controlled immersion heater, and a built-in timer. Price is \$285.

Trio-Tech Inc., 2435 N. Naomi St., Burbank, Calif. 91504 [395]

Packaging panels are offered in metric size

The 8136-MG16, 8136-MG17, and 8136-UMG2 are metric packaging panels measuring 100 millimeters



Chances are you own a continuously tunable electronic filter. So by now you probably realize that continuously tunable filters are low performance instruments with, at best, 5% accuracy. And with poor reproducibility of settings, poor frequency accuracy and poor phase drift characteristics. And although continuously tunable filters provide infinite resolution, most users find infinite resolution neither important nor desirable unless there's corresponding accuracy.

But all this isn't why we say "junk it."

WHAT YOU SET, ISN'T WHAT YOU GET.

Take a look at the graph. As you can see, the front panel filter settings don't tell you the -3dB cutoff frequencies, the bandwidth, the noise bandwidth, and the center frequency. Or the insertion loss. You have to measure them — a time consuming, costly procedure.

THERE'S A BETTER WAY.

Ithaco offers two types of filters with switch selectable frequency settings. One type has 3 decimal digit frequency resolution for the user who not only needs resolution but also wants to know where he is without measuring.

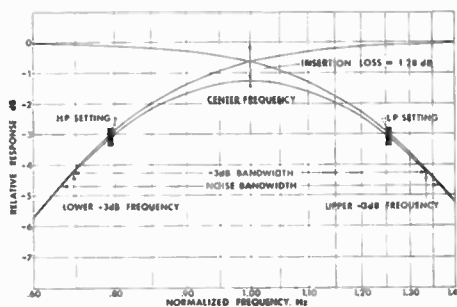

Normalized gain, attenuation, phase, and pulse response curves are printed on top of the filter. The other type uses the internationally accepted 1/10 decade [1/3 octave] frequency step — so you can operate with octave, decade and other convenient band pass settings, and still have sufficient frequency resolution for general lab and data acquisition applications. These filters have all the information shown on the graph printed on top — for all filter settings. And that's why we say "take your laboratory filter and junk it."

MORE NAILS IN YOUR FILTER'S COFFIN . . .

Standard accuracy of all Ithaco filters is $\pm 1\%$ in frequency, $\pm 2^\circ$ in phase, and $\pm .1\text{dB}$ insertion loss — all at least twice as good as the best the competition can offer. Plus, output drift is an order of magnitude lower than the competition. And self-noise is minimal. Best of all, Ithaco filters are competitively priced.

NOW THAT YOU NEED A NEW FILTER . . .

Write to Ithaco Inc., 735 W. Clinton Street, Ithaca, N. Y. 14850. Or, if you can't wait [we understand] call 607-272-7640, TWX 510-255-9307.

Take your laboratory filter and junk it.

ITHACO

Circle 185 on reader service card

Give your switches a better-than-outside chance.

Keep them safe from the destructive elements that can stop switch performance cold. APM makes it easy, with molded leak-proof seals that shrug off dust, dirt, gas and liquid contaminants . . . stand up to pressures and temperatures that can put undefended switches out of business.

They're the Clean Fighters—a team of custom-molded boots that seal out trouble for all pushbutton, toggle and rotary switches.

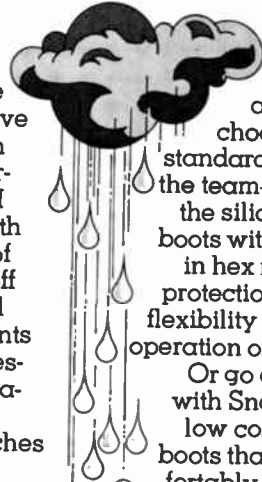

THE CLEAN FIGHTERS **APM-HEXSEAL**
DIVISION OF APM CORPORATION

For critical applications, choose the MIL-standard member of the team—Hexseals®, the silicone rubber boots with a molded-in hex nut for extra protection, complete flexibility for fingertip operation of the switch.

Or go commercial with Snapseals®, the low cost neoprene boots that snap comfortably over manually operated switches in seconds. Write or call for literature and samples:

APM-Hexseal
44 Honeck St.,
Englewood, N. J.;
(201) 569-5700.

Circle 186 on reader service card

Is the STATE-OF-THE-ART CREEPING UP on YOU?



The Center offers several informal programs for Engineers and Technicians who want to advance or keep abreast of the State-of-the-Art!

We have courses for you, or others in your organization; that will help bridge the gap from relays (or wherever you're at) to today's latest devices.

We have LOW COST "hands-on" learning programs which include: TTL, ECL and MOS, Digital I.C.'s, Transistors, Zeners, UJT's MOS/FET's & J/FET's . . . plus more.

SEND FOR FREE CATALOG

or Call Gene Presta at 513/296-1020

Yes, I'm interested in learning about your programs!

Name _____

Street _____

City _____ State _____ Zip _____

The Center for technical development Inc.

Phone: 513/296-1020
2876 CULVER AVENUE
DAYTON, OHIO 45429
E574

186 Circle 267 on reader service card

New products

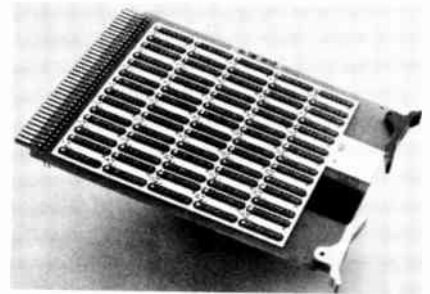

by 160 mm. The panels are 1/16-inch double-sided versions with collector voltage and ground-connection planes at preselected positions adjacent to the IC rows. The MG16 version contains 14-pin patterns, the MG17 16-pin patterns, and the UMG2 contains 12 rows with 49 contact assemblies per row. The panels also contain two-piece machined contact assemblies available with either tin- or gold-plated outer sleeves.

Augat Inc., 33 Perry Ave., Attleboro, Mass. 02703 [396]

Soldering system handles ceramic hybrid circuits

The model BR-8, belt reflow soldering system, is designed for high speed production soldering of ceramic hybrid circuits. The compact bench-top instrument uses back-side heating through a thin Teflon-coated fiberglass transfer belt. Circuits placed on the belt travel over

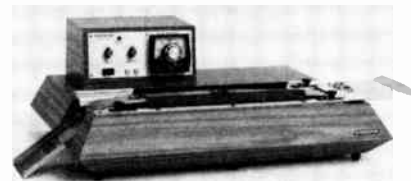

two temperature-controlled heating stages and then move through a high-speed cooling zone. Unlike other hybrid soldering processes that apply heat equally to both components and substrates, this system maintains low component temperatures with very rapid heating cycles. The 2½-inch wide belt, which travels at up to 40 in. per minute, will

If you're testing 1K RAM's or 4K RAM's without an MD-100 or MD-104... YOU'RE KIDDING YOURSELF!



Reliability—With more than 300 stand-alone MD-100/104 systems in use throughout the world today, Macrodata has set the industry standards for memory testers—and these two systems still provide the only way you can test memories effectively and obtain valid data.

Pattern Sensitivity—If one of those “it’s no problem” guys has been telling you that a few hardwired patterns are all you need to test RAM’s, watch out! They have decided that RAM’s aren’t really pattern sensitive, so they don’t bother to fully explore worst-case pattern conditions for these devices. They say that it’s not necessary, but you know better.

Pattern Sensitivity Tests

The adjacent curves are plots of individual device access times at different supply voltages. Each curve represents a different test pattern. Over the specified operating regions of the devices, these shmoo plots show the pattern sensitivities of the 1K and 4K RAMs. For example, while MARCH would make one think that the 4K device is operational, notice that the chip does not work during a portion of its MASEST curve. A MARCH test also indicates that the 1K device passes its access time specification at nominal voltage, but a GALPAT II test demonstrates much slower access time characteristics and that the 1K chip does not really pass at nominal voltage.

Here's Why You Need MD-100/104 Capability

Example #1: In a recent test, six devices from separate

lots from the same manufacturer all failed under different unique patterns with identical set-up conditions of voltage, timing, etc.

Example #2: In another test, one device passed on all patterns for approximately 10 seconds and then failed due to heating problems. After being rehabilitated by coolant spray, the device again ran

and passed until heat produced failure.

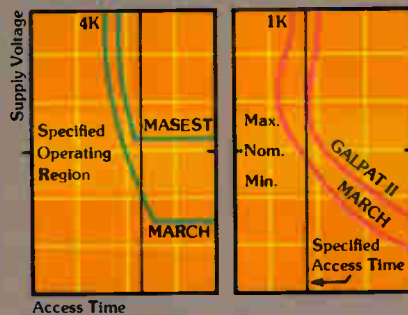

Example #3: For typical pattern sensitivity of 1K and 4K RAM's, see the chart of V. vs. Access Time.

Let's Make A Deal—If someone tells you that your semiconductor memory is not pattern sensitive and all you

need are fixed patterns to solve your test problems, send your device to us for the moment of truth. If we're right, aren't you just kidding yourself until you get an MD-100/104 on line? For action, call or send for a free brochure today.

Macrodata



Macrodata Corporation, 6203 Varie! Avenue, Woodland Hills, California 91364, Phone: (213) 887-5550, Telex: 65-1345
Sales Offices: Northern California Area Tel. (408) 735-9560 • Scottsdale Tel. (602) 966-2179 • Minneapolis Area Tel. (612) 454-2034 • Chicago Area Tel. (312) 297-8746 • Cleveland Area Tel. (216) 461-8333 • Dayton Area Tel. (513) 293-3145 • East Coast Tel. (516) 543-8600 **International:** West Germany — Munich Tel. (0811) 34 56 00 Telex: (841) 521-5969 • Milan, Italy Tel. 871-988/899-248 Telex: (843) 34314 • Sweden and Norway — Stockholm Tel. (08)-380-370 • Tel Aviv, Israel Tel. 25 55 69 • Tokyo, Japan Tel. (03) 985-5266 Telex: (781) 272-2171 • Buckinghamshire, England Tel. High Wycombe (0494) 36 3 81 Telex: (851) 837236

ALCOSWITCH®

Instrument Grade Miniature Right Angle Toggle Switches with smooth bushings mount directly into PC board. Terminals are silver clad with optional gold for dry circuit applications. Epoxy sealed terminals inhibit contamination. SPDT or DPDT with long life. Rated 2 amps @ 250 VAC, 4 amps @ 125 VAC.

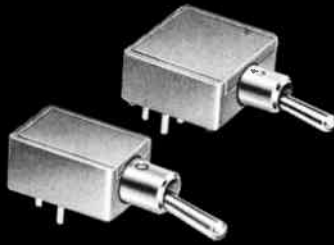

MTMS Series

ALCO ELECTRONIC PRODUCTS, INC.
1551 OSGOOD STREET, NORTH ANDOVER, MASS. 01845

Circle 112 on reader service card

ALCOSWITCH®

New! Economy priced Miniature Slide Switches. Improved actuator coil spring gives smooth tactile operation with contact wiping action. Designed for PC or hand wiring. Both models available with or without mounting tabs. Rated 0.5 amps @ 125 VAC.



ALCO ELECTRONIC PRODUCTS, INC.
1551 Osgood Street, North Andover, Mass. 01845

Circle 188 on reader service card

"PLAGUE FREE"

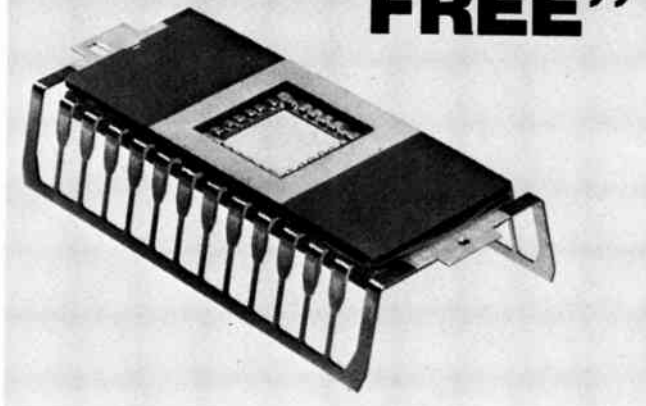

All aluminum bonding, Post to Pad. Lower sealing temperatures in the assembly of Diacon packages makes for higher electrical yields of 8 to 36 lead Diacon package systems for surface-sensitive devices.

For information, call or write...

DIACON, INC.

4812 Kearny Mesa Road
San Diego, California 92111
(714) 279-6992



188 Circle 268 on reader service card

New products

accommodate over 1,000 2-inch-square substrates per hour. Solder reflow temperatures up to 400°C are maintained within 2°C.

Browne Corp., 203 Chapala St., Santa Barbara, Calif. 93101 [397]

Ultrasonic assembler also checks switch contacts

An ultrasonic assembly system stakes plastic and metal switch assemblies together, and also checks the position of the switch contacts automatically before accepting them. Parts are manually loaded on the rotary system at the front work table, then ultrasonically staked together. After assembly, the switch contacts are checked by an electrical sensing circuit to see if any are too high. A similar test is used to determine if any of the contacts are too low. Switch slide assemblies with high or low contacts are air ejected immediately after the test station. Good parts remain on the rotary table until they reach the accept chute.

Sonics & Materials Inc., Kenosia Ave., Danbury, Conn. 66810 [398]

Panel rack assemblies handle 26 positions

A family of panel rack assemblies and accessories are designed to complement the company's 324 family of wire-wrapping panels. The rack assemblies are available with either 1/8-inch thick standard Retma end plates or 3/32-in.-thick flush end plates. The racks are available in six positions and 13 positions spaced on 1.2 in. centers, and may be expanded to 11 positions and 26 positions on 0.6-in. centers. Connectors may be removed from the power panel without having to desolder, and the power panel may be removed for automatic or semi-automatic wrapping. Price in quantities of 10, with 26 connectors and 2 power panels mounted, is \$329.

Mupac Corp., 646 Summer St., Brockton, Mass. 02402 [399]

again



semiconductor data handbook

second edition

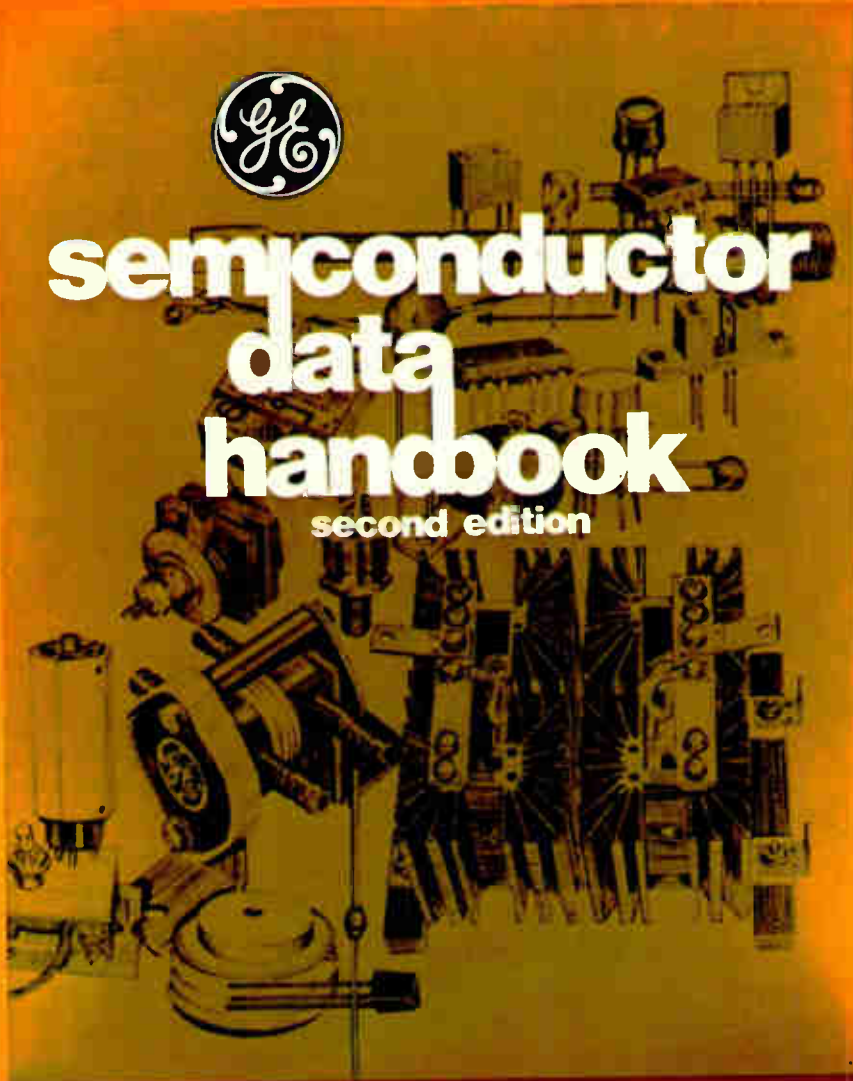

New 1484 page 2nd edition Semiconductor Data Handbook from General Electric...leading supplier of transistors unijunctions, diodes, rectifiers, varistors, SCRs and triacs.

To get your copy, contact any authorized GE distributor, GE Electronic Components Sales Office, or send \$4.95 plus tax to GE Semiconductor, Electronics Park, 7-49, Syracuse, N.Y. 13201.

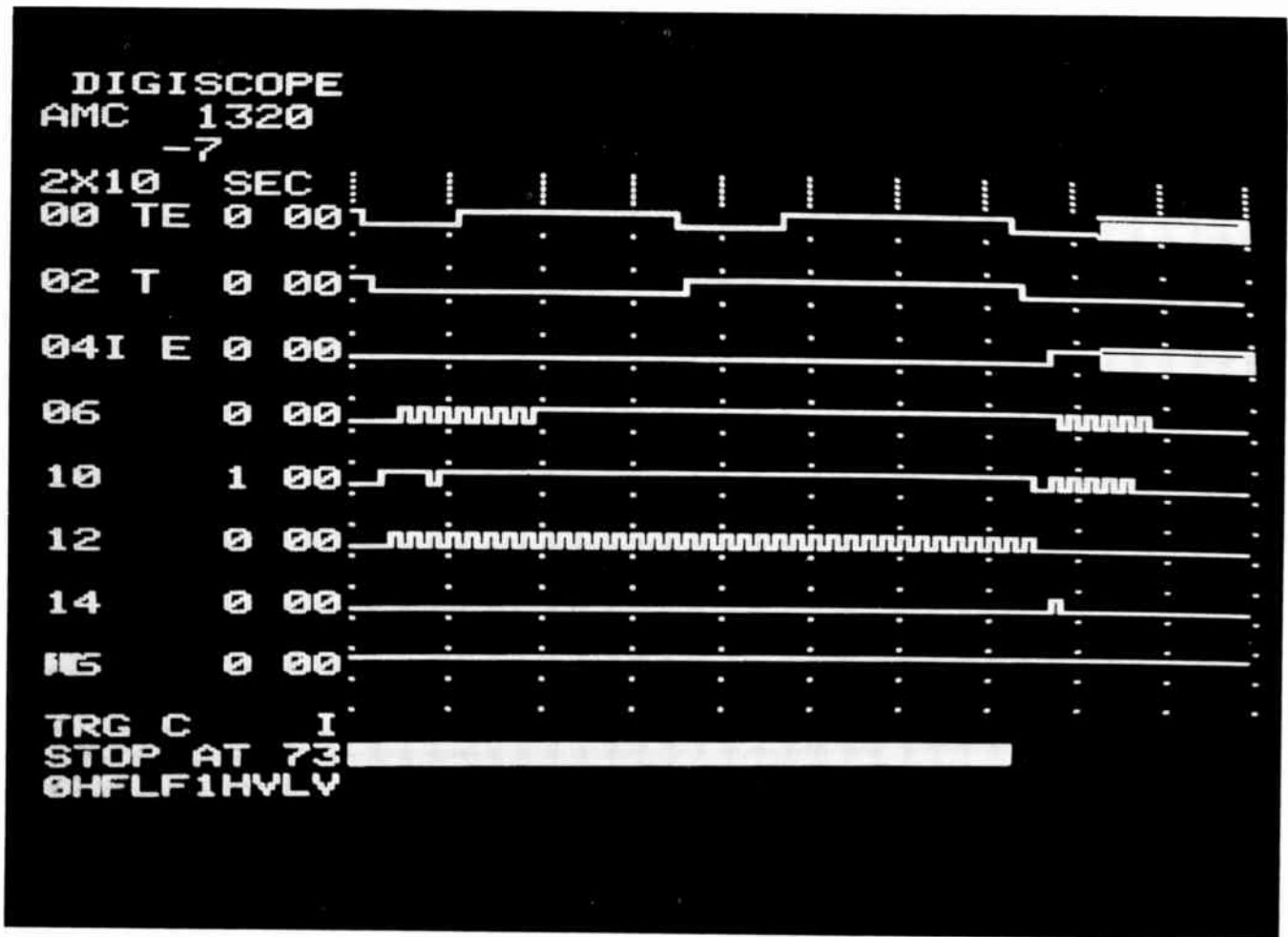

Digital timing, analog problems—only the Digiscope shows you both

"A radically new logic state analyzer from E-H Research gives you the equivalent of an 8 or 16 gun, 50 MHz, real time scope display of logic timing. It lets you see such analog parameters as glitches, ringing, rise and fall times, and voltage levels."

— Jerome Lyman,
 ELECTRONIC PRODUCTS
 Magazine, 1/19/74

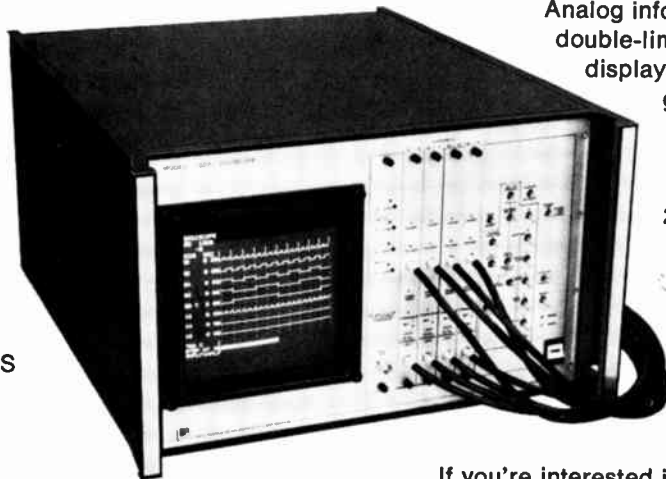

The Digiscope gives you eight channels of digital data simultaneously acquired at 50 MHz, up to 100 bits of pre-trigger lookback, and single shot measurements without sacrificing critical analog information in the signals.

Now Digiscope lets you see such anomalies as glitches (Channel 14), slow rise times (Channel 6), low "one" levels (Channel 12), high "zero" levels and ringing (Channel 10) that are often the cause of mysterious system failures.

Analog information is preserved with unique, double-limit threshold comparators. Screen displays all instrument settings for photographic recording.

You can trigger on any logical combination of the eight inputs. Probe impedance is greater than 20 megohms, shunted by less than 8pF, so you don't have to worry about a probe loading the circuit. We think when you see it, you'll agree: Digiscope is the most efficient, error-free test instrument ever made for designing, debugging, and maintaining digital electronic equipment.

If you're interested in the whole story about this radically new logic state analyzer, let us know. We'll send you the AMC 1320 Digiscope brochure immediately.



**E-H Research
 Laboratories, Inc.**

515-11th Street, Box 1289
 Oakland, California 94604
 (415) 834-3030

European Subsidiary: P. O. Box 1018, Eindhoven, The Netherlands, (040) 433704

Everything you need in ferrites



Broad Product Line: Ferroxcube offers a complete array of sizes and shapes of ferrite cores. They're made in Saugerties, N.Y. and stocked throughout the U.S.A. Toroids for pulse transformers, pot cores or square cores for precision filters, transformer cores in all sizes and shapes— E, U, I, specials and read-only memory cores—you can trust Ferroxcube to provide the optimum core for your inductors.

Unsurpassed Materials Technology: Ferroxcube, the acknowledged U.S. leader in ferrite technology, offers a wide range of standard materials for your cores. Chances are that one of them has exactly the *right combination of characteristics* for your application. And, you can depend on Ferroxcube to deliver the same uniform,

product characteristics year after year for consistent, optimum circuit performance in your designs.

24-hour Availability: Standard components are available for 24-hour delivery from any of seven warehouses conveniently located in Boston, New York, Saugerties, Philadelphia, Chicago, Santa Clara and San Diego.

If you're up on the advantages of ferrites, discover the added values of dealing with Ferroxcube. Ask for the new 1973 catalog. If you're new to ferrites and the design possibilities they open up, talk to one of our applications engineers. Call 914•246-2811, TWX 510-247-5410 or write Ferroxcube, Saugerties, N.Y. 12477.

Ferroxcube linear ferrites—made in Saugerties, N.Y. and stocked in seven U.S. locations.



FERROXCUBE CORPORATION, SAUGERTIES, N.Y. 12477

A NORTH AMERICAN PHILIPS COMPANY

Distributed through North American Philips Electronic Components Corporation with warehouses in Boston, 617-449-1406; New York, 516-538-2300; Saugerties, 914-246-5861; Philadelphia, 215-927-8262; Chicago, 312-593-8220; Santa Clara, 408-249-1134; San Diego, 714-453-9250

16402

Hybrid analog switches from DICKSON

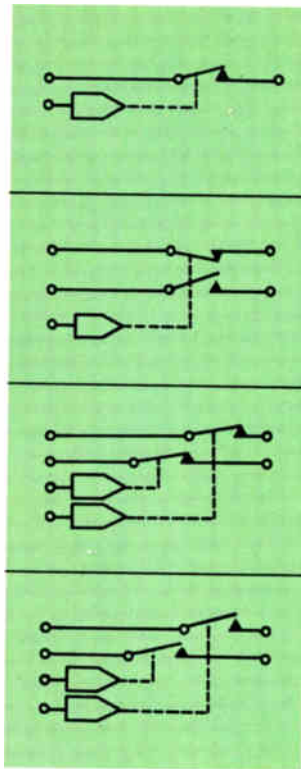

These versatile Dickson analog switches may be just the circuits you need for your system. They offer a variety of switching functions in standard 6, 10 and 12 lead packages. Ideal for use in multiplexing, sample and hold circuits, A/D and D/A conversion.

Models DAS2126, DAS2132, DAS2133, DAS2136 and DAS2137 operate from DTL, RTL or TTL logic. Model DAS2110 operates from a 0 to 15V drive signal.

All of these standard Dickson units provide fast switching speeds, handle AC signals through 1 MHz, and have the quality and dependability you expect from a leading supplier of high-reliability semiconductors. Shipments are being made from stock. Custom analog switches are also available.

MODEL NUMBER	TYPE	LOGIC LEVEL	R _{on} Typ.	t _{on} μsec	V _{out} volts	PACKAGE
DAS2110B1	SPST	high-level inverting	30	0.3	±10	TO-5 6 lead
DAS2126B3	SPDT/DPST	low-level alternating	30	1.5	±10	TO-8 12 lead
DAS2132B1	DUAL SPST	low-level non-inverting	30	0.5	+10 -9	TO-5 10 lead
DAS2133B1	DUAL SPST	low-level non-inverting	30	0.5	±10	TO-5 10 lead
DAS2136B1	DUAL SPST	low-level inverting	30	0.5	+10 -9	TO-5 10 lead
DAS2137B1	DUAL SPST	low-level inverting	30	0.5	±10	TO-5 10 lead

CUSTOM ANALOG SWITCHES ALSO AVAILABLE

CUSTOM CAPABILITIES

For your copy of a 16-page brochure giving complete information on Dickson custom hybrid capabilities, drop us a note on your letterhead.



DICKSON
ELECTRONICS CORPORATION
PHONE (602) 947-2231 TWX 910-950-1292 TELEX 667-406
P. O. BOX 1390 • SCOTTSDALE, ARIZONA 85252



FREE Fiber Optics Catalog

Features the complete AO line of fiber optics products—from Inspection Fiberscopes and Light Guides to Illuminators, Image Conduits, Faceplates and Custom Components. Includes the four newest remote inspection fiberscopes now available.

Describes the principle, technology and techniques used to make flexible light and image transmissions a proven, practical fact. Write today for your FREE copy of the AO Fiber Optics catalog to American Optical Corporation, Fiber Optics Division, Southbridge, Mass. 01550.

AO
American Optical

Circle 269 on reader service card

The Brush 440 portable recorder. A general purpose recorder that does more.

The Brush 440 has four 40 mm channels, two event markers, eight pushbutton chart speeds, and built-in signal conditioners. There's pressurized ink writing and linearity guaranteed to 99½%.

Write Gould Inc., Instrument Systems Division, 3631 Perkins Avenue, Cleveland, Ohio 44114. Or Kouterveldstraat Z/N, B-1920 Diegem, Belgium.



GOULD

The Frenchtown Connection.

At Plessey Frenchtown, we're known for our connections. Ceramic packages, headers and screened substrates that introduce your chips, transistors and integrated circuits to the outside world.

We have screened ceramics. Flat or shaped ceramic parts screened with custom metals and alloys in intricate circuit patterns. Our in-house screen making capability gives us complete control over the finished product. Enables us to maintain 5-mil lines on 5-mil spaces.

We're in plated ceramics. Single or multiple layers of precious metals to your exact specification. And proprietary plated products like our LID. A ceramic package that provides the same number of leads as a standard IC package. But in about one fifth the space. And a fraction of the cost.

Finally, we build brazed parts and assemblies. Hermetic semiconductor packages, transistor headers and microwave components requiring complex ceramic to metal bonding.

If you have a device that's trying to get in touch with the outside world, get in touch with Plessey Frenchtown.

We've got the right connections.



PLESSEY INCORPORATED
MATERIALS DIVISION

320 Long Island Expressway South, Melville, N.Y. 11746 (516) 694-7900

Offices in: Cherry Hill, New Jersey; Rochester, New York; Chicago, Illinois; Dallas, Texas; Los Angeles, California; Mountain View, California; Phoenix, Arizona; Charlotte, North Carolina; Reading, Massachusetts. Representatives in Boulder, Colorado; Cleveland, Ohio.

NEED PTC's

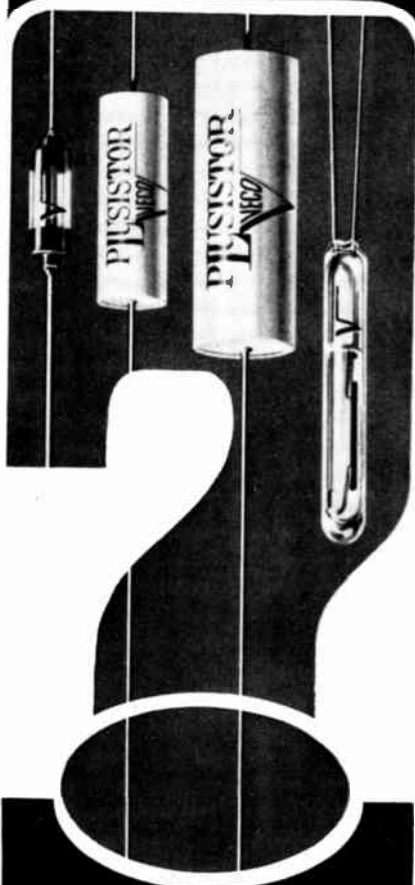

VECO's solid state, silicon, positive temperature coefficient thermistors have all the features needed for control, protection or compensation problems.

- Equivalent to T.I. Sentsor*.
- IMMEDIATE delivery from stock.
- +0.7%/°C resistance within a -60°C to +150°C range.
- linear derating to 0 at 150°C.
- standard 10% resistance values from 10Ω to 10KΩ.
- available in four sizes & bodies.
- plus built-in reliability and high performance standards.

*Sensistor is Reg. TM of Texas Instruments, Inc.

SPECIFICATIONS & APPLICATION
INFORMATION FROM:

VECO
**VICTORY
ENGINEERING
CORPORATION**
VICTORY ROAD, SPRINGFIELD,
NEW JERSEY 07081
(201) 379-5900 • TWX 710-983-4430

New products

Subassemblies

Interface cards link systems

'Universal' programming
system on a card fits into
data-acquisition rack

Large instruments can interface a computer with signal-processing modules, such as active filters and oscillators. The user can make his own interface with filters, reed relays, or resistors, but few small interface subsystems are available. Frequency Devices Inc. describes its FC-103 Universal Programming Card System as "a system on a card with a memory" that can fill the gap in this market.

A line of four-pole low-pass Butterworth and Bessel filters is available with it now, and high-pass, bandpass, and band-reject filters, as well as elliptic filters and low-distortion quadrature sine-wave oscillators will be available in the future. The 2-by-3-inch modules can be plugged directly into a socket on the 6-by-9 1/8-inch card, which fits into a data-acquisition rack.

The FC-103 can program the frequency of a module over a 5,000-to-1 range in 500 equal increments. Four models cover ranges of 0.1 to 50 hertz, 1 to 500 Hz, 10 Hz to 5 kilohertz, and 100 Hz to 50 kHz. The FC-103 is frequency-programmed with 11-bit binary-coded decimal, while the 103B is programmed with 9-bit binary coding.

Dual in-line switches can program data locally; and local, on-card data or remote data can be se-

lected from the computer or through a local dual in-line switch. On-card dual in-line switches can set up to 16 address values; the correct value must be present on the four address lines to access the card. The card can also bypass the filter completely.

Reed-relay switches, shielded for maximum isolation between the analog and digital grounds, interface between the analog and digital segments. Frequency Devices says that the use of relays eliminates the problems of on-resistance and leakage current that is inherent in semiconductor switches. The state of the filter, including its frequency, bypass mode, and a flag indicating whether or not the address is accepted, are monitored by data-indicator lines.

Address-decoding to facilitate the programming of several cards on a single data bus, on-card programming, filter bypass, and memory are

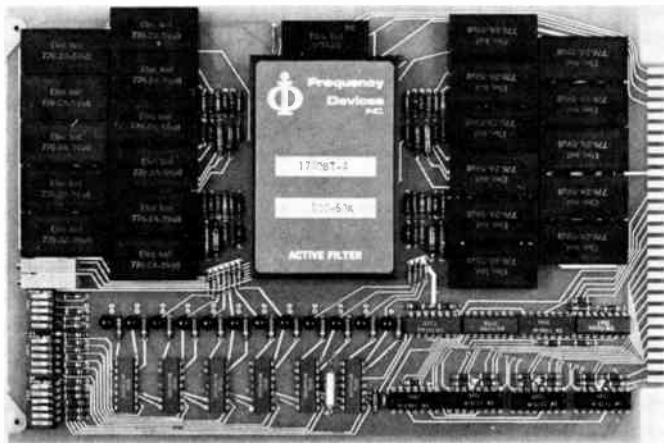

available as delete options. They can be added to an existing card at any time.

The FC-103 is aimed at computer-controlled data acquisition and processing in such applications as spectral analysis, prefilters for digital filters, and domain filtering, or in dedicated systems, it is designed to function like the front end of a Fourier fast-transform analyzer. The company claims that the unit can also vary the frequency of the analog filter with a minimum of software in applications where sam-

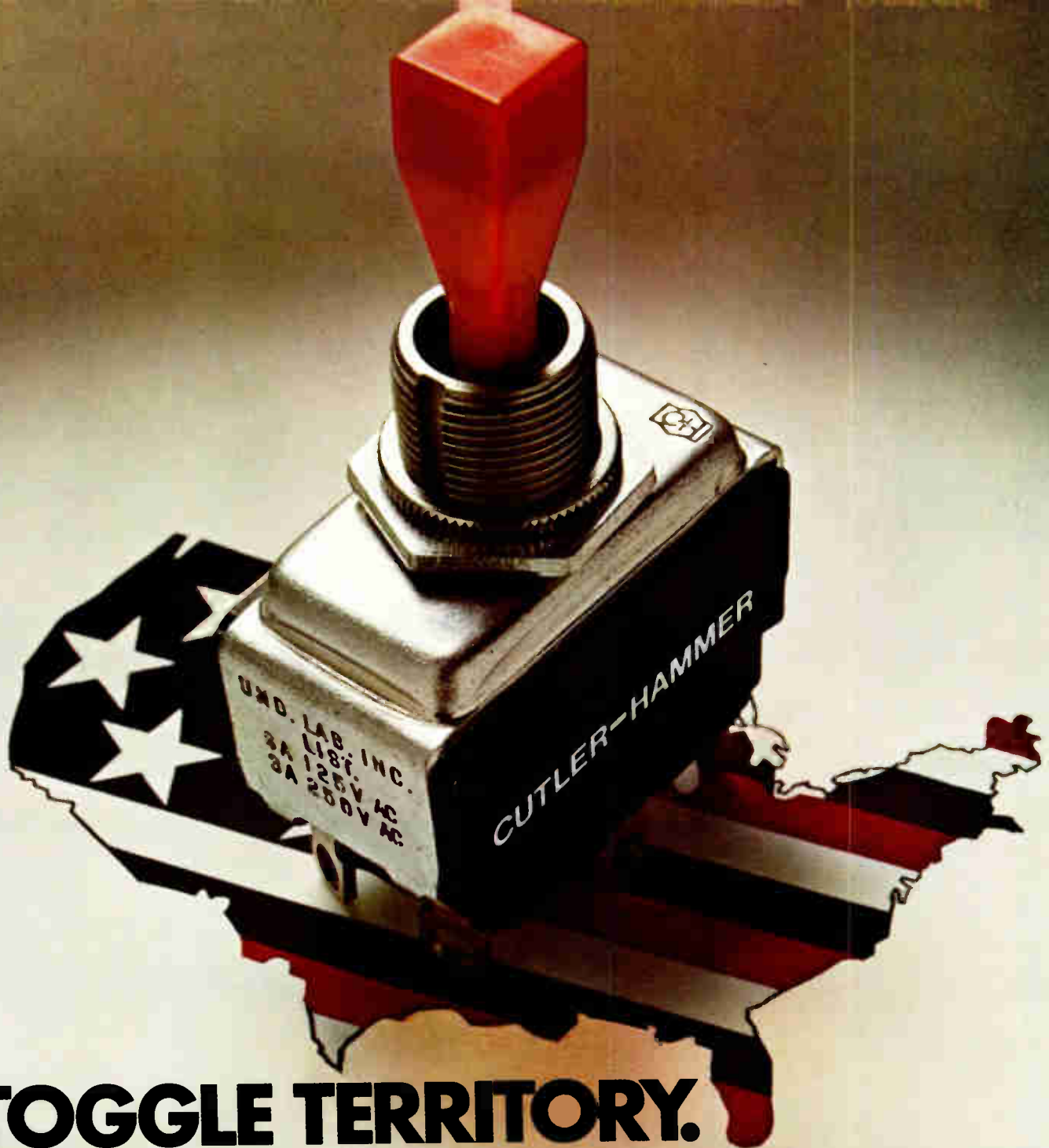

TOGGLE TERRITORY.

It's anywhere you are in the whole land.

It's anywhere you have to put your hands on exactly the right toggle switch to complete your design.

Especially if you need extraordinary design flexibility, distinctive appearance and proved performance in your toggle switches.

Cutler-Hammer not only provides the broadest line of toggle switches available, but offers you the greatest selection of ratings, terminations,

hardware, toggle shapes, materials and colors.

AC-rated. AC/DC. Low energy. Dry-circuit capability, or up to 25 amps. One, two and four poles. Select Cutler-Hammer Designer Line, miniature, slow-make/slow-break or hesitation switches from the complete Cutler-Hammer line. We have thousands of varieties ready for delivery. And if the toggle you need isn't among those thousands, we'll work with you to build exactly what you want.

You needn't look very far to get the finest quality in toggle switches. Wherever you are in the U.S.A., get the toggle you want. Because we cover Toggle Territory best. With

more distributors than anyone else. Call your Cutler-Hammer Sales Office or Stocking Distributor. Or write for full-line catalog LD-110A.



Switch
to No.1

More than just switches:
prompt availability,
field help, innovation,
quality assurance, too.



CUTLER-HAMMER
SPECIALTY PRODUCTS DIVISION, Milwaukee, Wis. 53201

Circle 113 on reader service card

MONOLITHIC CRYSTAL FILTERS



SAVING ENERGY

It's an important topic these days. Especially to the communications industry. In almost every field, better communications means energy saved. As the cost of energy increases, so does the challenge to provide more and better communications equipment and systems.

Our company is involved in only a small area of communications — monolithic and tandem monolithic crystal filters. But, we see our responsibility in the total order of things. Whether it's reliable delivery of parts or production prototypes for your next generation of equipment, we're ready to help you save energy for everyone.

SPEAKING TO THE DEAF

Our monolithics find their way into some fascinating and unusual applications. For instance — a narrow-band FM system which allows children with severely impaired hearing to participate in normal classroom activities. One of the requirements of the system was that both the students' receivers and the teacher's transmitter allow unhindered movement by the wearer. Another was freedom from interference, including interference from other systems in nearby classrooms. Cost was also an important factor. One of our standard 10.7 MHz tandem monolithic crystal filters in each receiver takes care of the interference. Its size is consistent with the needs of the wearer. Its cost is consistent with educational budgets.

What's your production application? Talk with us about it. We may be able to help. And if your interests include teaching the deaf, we'd be happy to put you in touch with the manufacturer of this equipment.

Pi

Piezo Technology Inc.

2400 Diversified Way Orlando, Florida 32804
305-425-1574

The Standard in monolithic crystal filters.

New products

pling rates vary as a function of time.

The FC-103 is priced from \$254 to \$350 for one to nine units, depending on options selected. Prices range from \$160 to \$225 each for 100 units. The 1740BT Butterworth filters and 1740LT Bessel filters cost \$69 each for one to nine units and \$46 for 100 units. Evaluation quantities are available in two to four weeks.

Frequency Devices Inc., 25 Locust St., Haverhill, Mass. 01830 [381]

Dc-to-dc converters provide dual output with low noise

The D15 series of dc-to-dc converters provide dual outputs of ± 15 volts dc at ± 100 milliamperes, regulated to 0.01% with an 11-millivolt noise content. The standard input is a single 5-volt dc or a 12-v dc input;

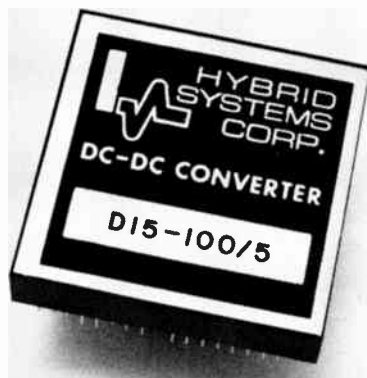

both offer an efficiency of 65%. Further, all six sides of the miniature module are tightly shielded by a continuous conductively coated copper layer. Transfer isolation is 80 picofarads and 10^9 ohms. Price of the converter in quantities of one to nine is \$69 each.

Hybrid Systems Corp., 87 Second Ave., Burlington, Mass. 01803 [383]

Analog-to-digital converters are priced at \$48 each

Two analog-to-digital converters, designated the models 4116 and 4117, are priced at \$48 each, an

Help college help you.

Businesses like yours gave over \$340,000,000 to higher education last year.

It was good business to do so. Half of all college graduates who seek work go into business. The more graduates there are, and the better educated they are, the more college serves the business community.

Your money was vital to colleges. It relieved financial pressures, made planning more flexible, and contributed to the kind of basic and applied research that puts new knowledge and technology at the service of industry.

So that colleges can continue to help you, give to the college of your choice now. For information on ways to do it, please write on your letterhead to Council for Financial Aid to Education, Inc., 6 East 45th Street, New York, N.Y. 10017. Ask for the free booklet, "How Corporations Can Aid Colleges and Universities."



Council for Financial Aid to Education, Inc.

Advertising contributed for the public good.



Dialight sees a need:

(Need: The right switch for the right price.)

See Dialight.

For the switch buyer, choice of function and esthetics, reliability, ease of mounting, and low cost are his prime concerns. He may need a pushbutton switch for panel, sub-panel or snap-in mounting. He may need a choice of bezels with or without barriers in black, gray, dark gray or white. He may need a legend that's positive, negative, or hidden until ener-



gized...one that's white when "off" and red, green, amber, blue or light yellow when "on"...or colored both "on" and "off." He may need a highly reliable switch proven in thousands of installations. Matching indicators with same front-of-panel appearance are also available. Obtainable from our world-wide distributor network.

The cap has a metal insert designed for proper heat dissipation. Cap is illuminated by a T-1 3/4 incandescent lamp in voltage range to 28V. Lamp can be easily replaced without special tools from front of panel.

More than 12 colors available in round, square, or rectangular shapes in six basic sizes - 1/2" to 1 1/2". Choice of engraved, hot stamped or replaceable film legends with positive or negative presentations.

Available with or without bezels. Bezel allows for simple snap-in mounting. Without bezel, switch can be used for panel or sub-panel mounting.

Terminals are gold plated for oxidized free solderability, and come in choice of solder blade or pc terminations.

NOW LISTED IN UNDERWRITER'S
RECOGNIZED COMPONENTS INDEX.



Bezels available in black, gray, dark gray or white and in round, square or rectangular shapes.

Fingertip grip simplifies insertion or replacement of pushbutton cap.

Stainless-steel clips lock switch into panel on four sides. No tools or additional hardware required for installing. Panel mounting switches come with required hardware for panel or sub panel mounting.

Alternate, momentary, and snap-action contacts with ratings to 5 amps. All switch contacts are gold plated for high reliability. Normally open, normally closed, and two-circuit (one N.O., and one N.C.). Totally enclosed within anodized aluminum housing. Low level and D.P.D.T. snap action, and contactless solid state switches also available.

DIALIGHT

Dialight Corporation, A North American Philips Company • 60 Stewart Avenue, Brooklyn, N.Y. 11237 (212) 497-7600

Circle 197 on reader service card

We've measured:

**Auto
crashes
Aircraft
stresses
Biomedical
parameters
Jet engine
distortions
Ship
signatures
Turbine
vibration**

for:

Boeing, Dornier,
FIAT, General Electric,
Grumman,
Hawker-Siddley,
Hughes, Liberty Mutual,
Lockeed, Martin,
McDonnell-Douglas,
New York University,
Republic,
Rockwell International,
SUD Aviation,
SAAB, United Aircraft,
Westinghouse,
the US Government,
and many more!

**What
can we measure
for you?**

*Telemetry/Communications
Products & Systems*



DATA-CONTROL SYSTEMS, INC.
Commerce Drive, P.O. Box 584
Danbury, Ct. 06810 ■ (203) 743-9241

New products

amount that decreases to \$40 for quantities of 100. The model 4116 is an eight-bit binary converter, while the model 4117 is a 2½-digit BCD version. Differential nonlinearity for both models is specified at a guaranteed maximum of ± 0.1 least-significant bit. Overrange capability is also offered.

Teledyne Philbrick, Allied Dr. at Rte. 128,
Dedham, Mass. 02026 [384]

Regulated power supplies
have three dc outputs

A series of 300-watt switching-regulated power supplies that feature three dc outputs measure 5.05 inches wide by 3.65 in. high by 16.12 in. long. The units provide 5 volts at 50 amperes, regulated primary output, and ± 12 V, ± 15 V or



± 18 V semiregulated at 8 A each for the remaining two outputs. Designated the LH300T series, the supplies offer 75% efficiency on all three outputs, and overvoltage protection is provided on the 5-V channel. Price is \$460, plus \$30 if regulation is needed on the secondary outputs. LH Research Inc., 2052 S. Grand Ave., Santa Ana, Calif. 92705 [385]

Low-pass active filters
operate over 50:1 range

A series of four- and six-pole low-pass filters operate over a 50-to-1 tuning range and require a single transistor per pole for tuning. Resistor value is determined from a tuning formula and is the same value for all poles. Using 1% metal-film resistors, the cut-off frequency can be set within $\pm 3\%$ and is stable

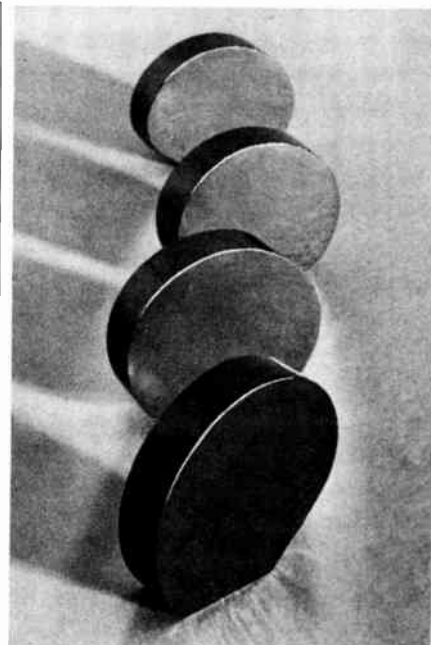

**Our compounds
are your right
answer for...**

**DIODE DISPLAYS,
INFRARED DEVICES,
ELECTRONIC COMPONENTS**

Asarco Intermetallics Corporation offers a wide range of III-V compounds used in the production of light emitting diodes (LED) and photoluminescent displays.

We provide gallium arsenide, gallium phosphide and indium phosphide in both polycrystalline and single crystal form. All polycrystalline materials are available as ingots. Gallium phosphide and indium phosphide are also available in granular form.

Gallium arsenide single crystals are boat grown with typical cross-sections of 19mm x 47mm for a (111) orientation and 33mm x 47mm for a (100) orientation.

You can order single crystals of our III-V compounds as ingots or slices, as cut or polished.

All materials are furnished in small quantities for evaluation or in large volume for production use. For more information contact us at 120 Broadway, New York, N.Y. 10005. Or call 212-732-9500.

**ASARCO
INTERMETALLICS
CORPORATION**

The most complete line anywhere.

Intersil's line of analog switches includes more functions, more technologies and a wider range of prices than that of any other semiconductor manufacturer. Delivery is off-the-shelf for most devices, available in commercial, industrial and military versions. We make all three basic types:

1. Low cost J-FET analog gates.

At less than \$1 per channel, the IH5009-thru-5038 series replaces reed relays in multiplexing, gain-ranging and similar applications. Gates are available in "virtual-ground" versions, with effective R_{ON} from 5 to 50 ohms, and positive-signal versions. Configurations range from SPST and SPDT through 4PST.

Intersil

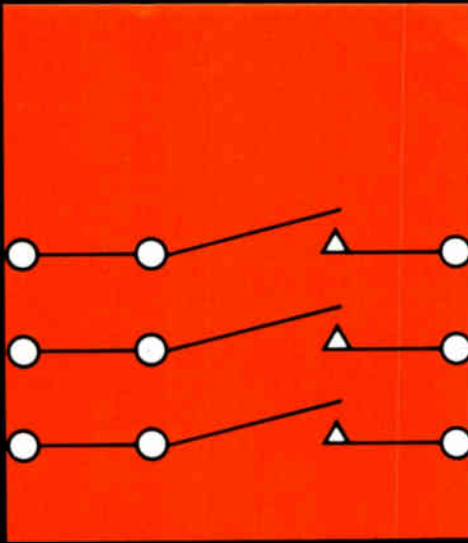

We make the analog gate you need.

2. Floating-body monolithic CMOS analog gates.

Low power IH5040 series CMOS gates are free from latch-up and channel-to-channel shorting. They come in commercial and military temperature ranges, with configurations from SPST and SPDT through 4PST.

3. DG-type switches, D-type drivers and G-type gates.

For years, Intersil has been making these devices, and is currently shipping the complete line of these driver-switch combinations you can't get anywhere else. DG111 through DG164 analog gates are available in all popular package types, as well as in high-reliability versions.

Ask for our new product catalog.

All product data sheets, designer's guides, cross references and a complete listing of detailed application notes are in our new 1974 Products Catalog. From Intersil, 10900 North Tantau Ave., Cupertino, CA 95014.

Get 'em here.

Intersil stocking distributors.

Elmar/Liberty Electronics.
Schweber Electronics.
Semiconductor Specialists.
Weatherford.

Intersil area sales offices.

Boston (617) 861-7380.
Chicago (312) 371-1440.
Los Angeles (213) 532-3544.
Minneapolis (612) 925-1844.
New York (201) 567-5585.
San Diego (714) 278-6053.
San Francisco Bay Area (home office) (408) 257-5450.
Upstate New York (315) 463-3368.

Representatives in all major cities.

Circle 199 on reader service card

1
AMERICAN MADE
Tolerance
SCHAUER
1-Watt
ZENERS

Immediate Shipment
Low Prices

ANY voltage from 2.0 to 16.0

Quantity	Price each
1-99	\$1.07
100-499	.97
500-999	.91
1000-4999	.86
5000 up	.82



All welded and
brazed assembly

No fragile
lead heads

Gold
plated
leads

Write for complete
rating data and other
tolerance prices.

Buy the kit-
Save
a lot



Kit contains a 51-piece assortment of SCHAUER 1% tolerance 1-watt zeners covering the voltage range of 2.7 to 16.0. Three diodes of each voltage packaged in reusable poly bags. Stored in a handy file box. Contact your distributor or order direct.

A \$54.57 value for
ONLY \$24⁵⁰

Semiconductor Division

SCHAUER
Manufacturing Corp.

4514 Alpine Ave. Cincinnati, Ohio 45242

Telephone: 513/791-3030

New products

to $\pm 0.05\%/^{\circ}\text{C}$ with temperature. Either Butterworth or Bessel-type response functions are available. Other specifications include cut off frequencies, extending from 1 hertz to 50 kilohertz, gain internally set to +1, and an initial output offset voltage of ± 2 millivolts, which can be adjusted to zero by means of an external trimming potentiometer. Price of four-pole models is \$79, and six-pole models are priced at \$109.

Datel Systems Inc, 1020 Turnpike St., Canton, Mass. 02021 [387]

D-a converters include
deglitching circuit

The RDA-series digital-to-analog converters are for use in reconstructing TV and other video signals. The 8-bit and 10-bit converters include a



deglitching circuit to remove spike discontinuities from the analog output. Input word rates of 15-MHz are possible, and output amplifiers for applications requiring greater drive are optional. Prices on the 5½-by-6-inch edge-connector modules range from \$850 to \$950.

Computer Labs, 1109 South Chapman St., Greensboro, N.C. [386]

Filter-duplexer operates
like passive switching device

Designated the model SB-A100, a solid-state filter-duplexer is designed for the Tacan Frequency range. The unit operates like a passive switching device, diverting receiver and transmitter signals to and from a common antenna without

VCXO's:
Unmatched
Versatility.

Damon continues to be recognized as the leader in the design and production of low noise VCXO's. Backed by the technical expertise of our engineering team, Damon offers VCXO's with unique performance characteristics:

Highest
Modulation Rate

Modulation Rate:

DC to 200 KHz

Peak Deviation:

.03% of C.F.

Center Frequency:

1 to 140 MHz

F.M. Distortion:

Less than 5%

Widest
Deviation Bandwidth

Peak Deviation:

0.5 to 300 KHz

Linearity: $\pm 3\%$

Center Frequency:

0.1 to 60 MHz.

Frequency Stability:

Less than 100 PPM,

0° to 50°C

Exceptional
Spectral Purity

Center Frequency:

40 to 120 MHz

(overtone VCXO)

Peak Deviation:

10 to 30 KHz

Linearity: $\pm 1\%$

Damon Electronics: The recognized leader in state-of-the-art, dependable VCXO's. Damon also manufactures a high-quality line of crystal filters.

For further information,
write or call
Ed Doherty, ext. 666.



ELECTRONICS DIVISION

80 WILSON WAY WESTWOOD MASS 02090 TEL (617) 449-0800

**narda...
the source**

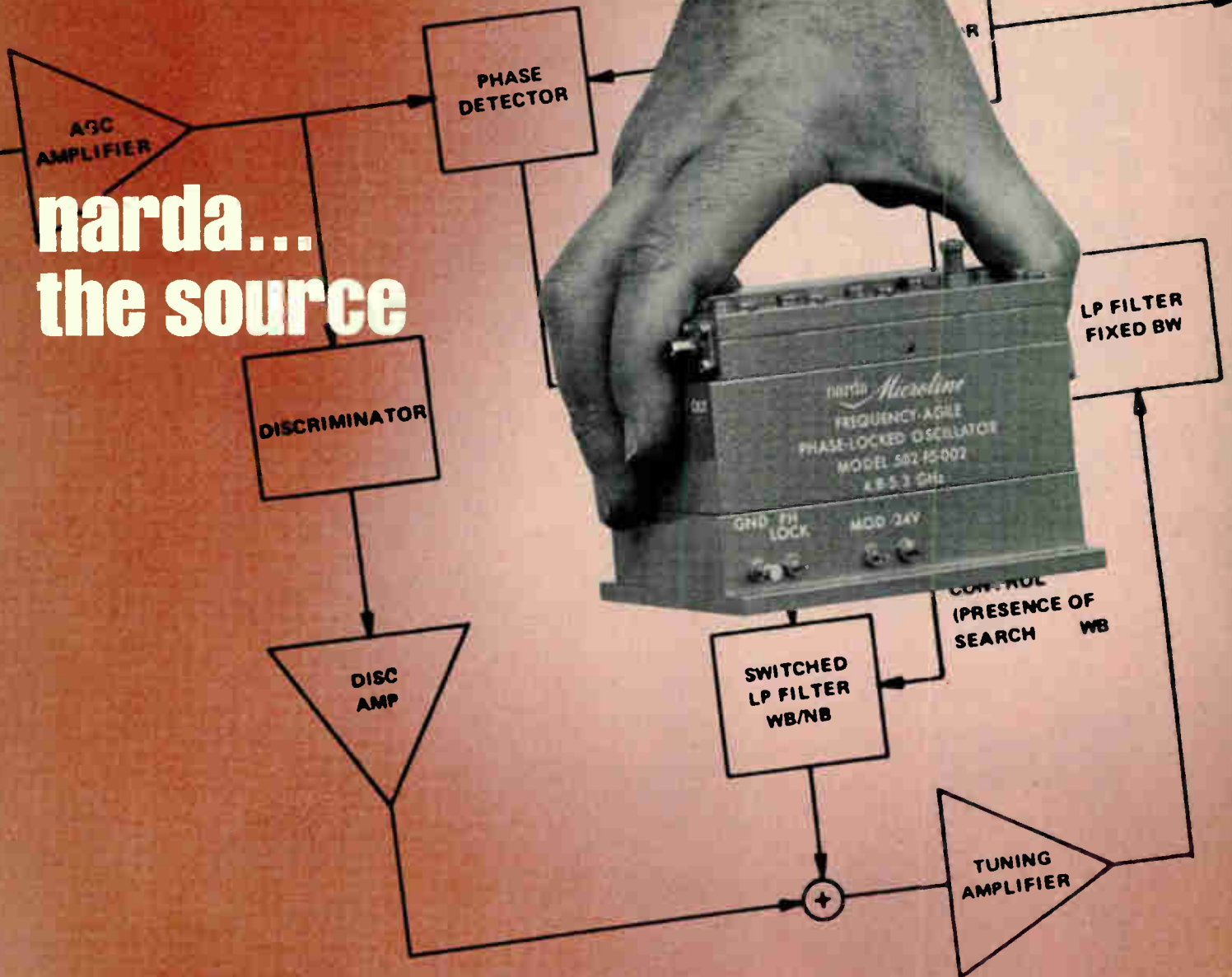

Frequency Agile Phase-Locked Oscillators provide long-term stability and optimum system performance

Benefits You Get With Narda Sources:

- Solid State, Fully Automatic
- Cannot Lock to Incorrect Harmonic
- Locks To Sequential Frequency Commands In Any Increment
- Wide Dynamic Range: Input Reference Signal Level -3dBm to +20dBm
- Wide Frequency Range (500 MHz)

Narda's Solid State Signal Sources automatically adjust to a changing input reference signal. The source will track a sweeping input signal, or if switched to a new input will lock to it within 0.1 second, in sequential frequency commands in any increment.

These devices are particularly well suited for applications which require exceptional operating stability and outstanding spectral purity such as: microwave radio transmitters, receivers in communications systems, transmitter exciters, receiver local oscillators, doppler radar frequency references and frequency reference standards for laboratory experiments.

Write for complete information . . . Model 461-F5-001 from 4.5 to 4.8 GHz, Model 502-F5-002 from 4.8 to 5.3 GHz.

Other models available covering the frequency range of 900 MHz to 8.0 GHz.

Circle 201 on reader service card

wherever microwaves go... **narda**

THE NARDA MICROWAVE CORPORATION • PLAINVIEW, L.I., NEW YORK 11803
516-433-9000 • TWX: 510-221-1867 • CABLE: NARDACORP PLAINVIEW NEW YORK

NEW! Systems Integration through Switching!

How do you reconfigure four data acquisition channels and 500-600 transducer leads from each of eight test stations — frequently, reliably, quickly, without distorting low level analog signals? Easy. Integrate your system with a matrix switch using 60-circuit T-Bar "Pluggables" that mate directly with wrappable connectors.

T-Bar makes high density multi-pole switches and relays — designs and fabricates special switching systems — reliably and economically. That's all we do. And we've been doing it for 15 years. If you switch a lot of lines — all at once or a few at a time — write or phone today for T-Bar's new Series 6900 Pluggable Switching Catalog.

Tbar INCORPORATED
SWITCHING COMPONENTS DIV.
141 Danbury Road, Wilton, CT 06897
Telephone: 203/762-8351

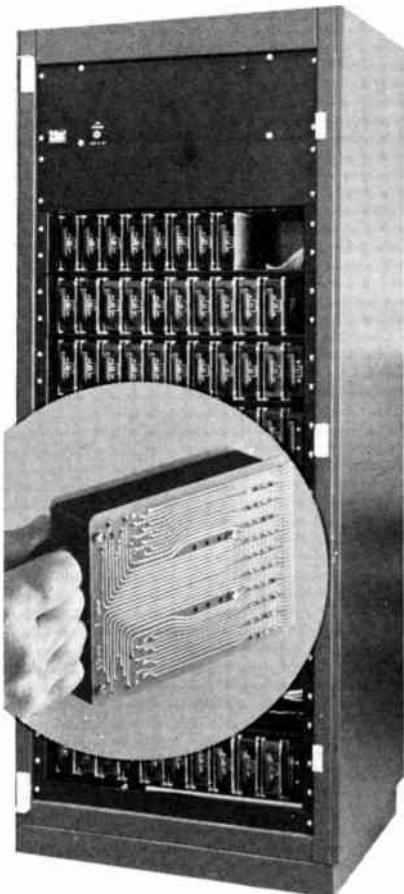

New products

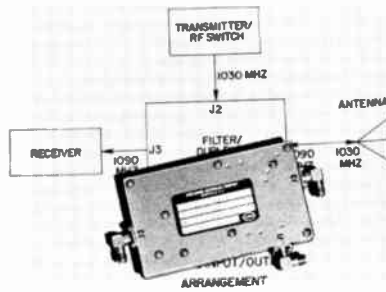

external bias or switching. Out-of-band or unwanted-signal rejection is provided with internal filtering and receiver-limiter protection. Transmitter frequency is 1,030 MHz \pm 0.2 MHz, and receiver frequency is 1,090 MHz \pm 0.2 MHz.

Engelmann Microwave Co., Skyline Dr., Montville, N.J. 07045 [388]

Amplifier will drive any three-wire synchro

A synchro amplifier called model C70 3718 005 is designed for driving multiple synchro loads with impedance as low as 50 ohms, line-to-line. The unit is suitable for use where available synchro information does not have the power to drive additional instruments or where the synchro information available cannot accept errors caused by excessive loading. The amplifier requires power of 115 v, 400 hertz, and generates all other necessary power requirements.

Kearfott division, The Singer Co., 1150 McBride Ave., Little Falls, N.J. 07424 [389]



NEUSES

NUMBERING AND LETTERING KIT

Use for marking almost any type of background materials with non-fading, vivid, easy-to-read clean marking. Ideal for marking switchboard panels, junction boxes, sub-assemblies, chassis, cables and wire.



Contains peg rubber stamps (1/8", 1/4", 3/16", 3/4"), A to Z, numbers, symbols, stamp repair equipment. Red, Yellow, Black and White oil-base, non-fading inks. Everything needed for all marking requirements, all in sturdy steel carrying case. 12 3/4" L x 7 1/2" W x 5" D.

No. N-2315 Kit \$69.85

P. K. NEUSES, INC.

Box 100 — Arlington Heights, Ill. 60006

PRECISION TELE-COMMUNICATION TOOLS

Circle 274 on reader service card

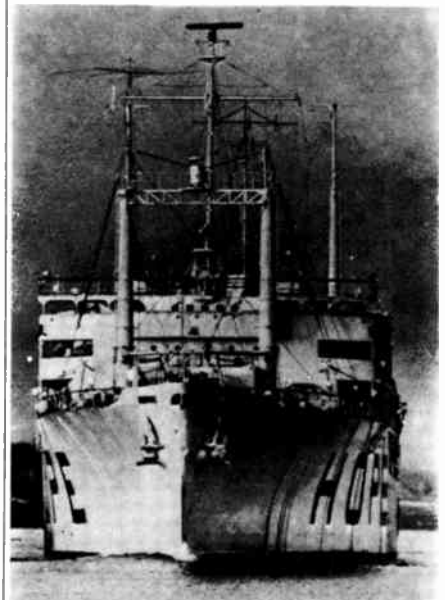

S.S. HOPE, M.D.

Doctor . . . teacher . . . friend to millions on four continents—this floating hospital is a symbol of America's concern for the world's disadvantaged. Keep HOPE sailing.

**PROJECT
HOPE**

Dept. A, Washington, D.C. 20007

There's a little tiger in every Cherry switch

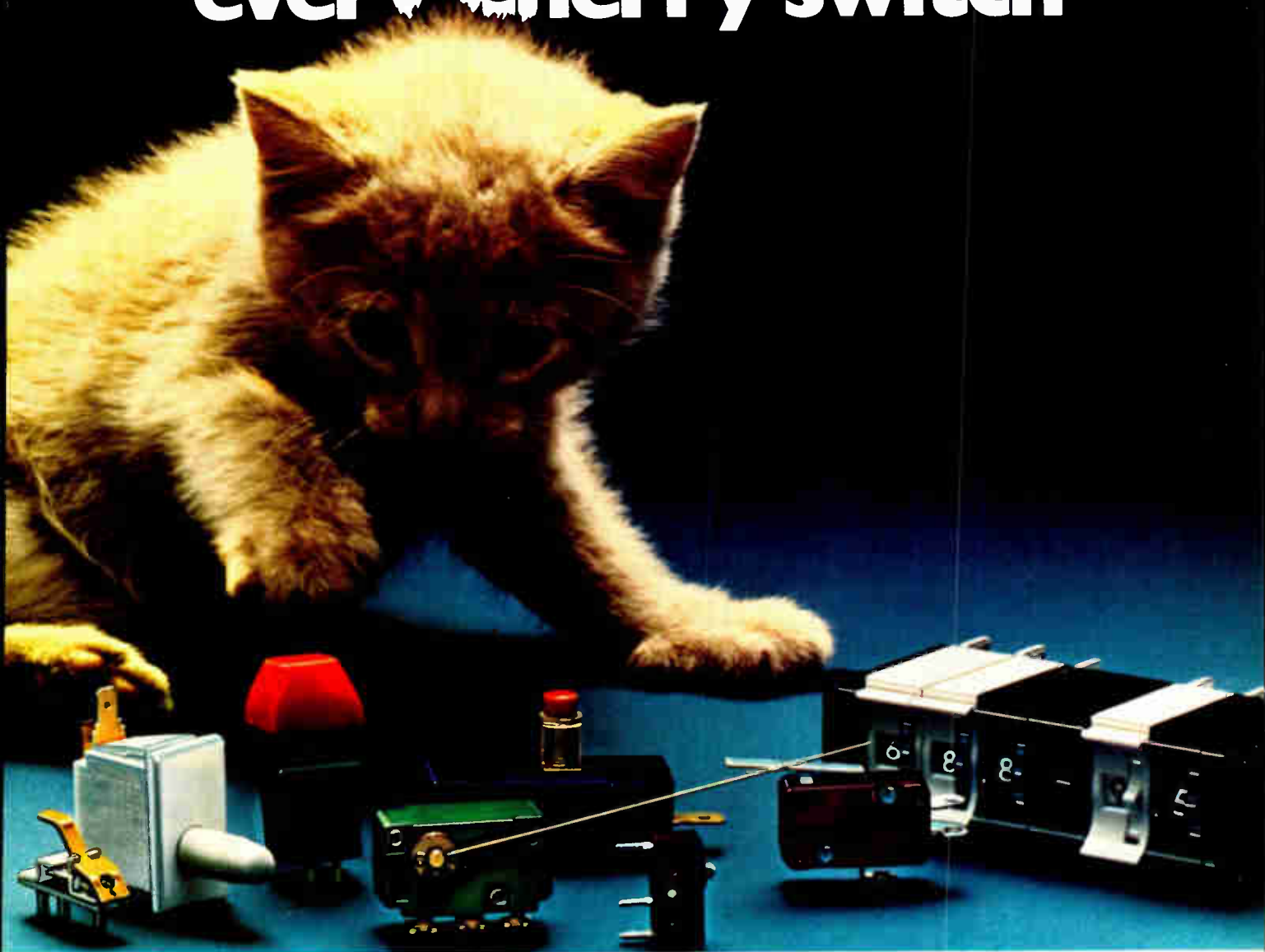

...but we're pussycats to do business with

Our products are tough, but our people aren't... and that's the beauty of dealing with Cherry.

You see, we can control the quality of our switches because we fabricate most of our own parts (moldings, stampings, springs, printed circuits, etc.) And we can keep the price down because we're loaded with automatic equipment to handle high volume.

But the real difference is in the *people* you work with at Cherry... from your first contact with a technically trained sales representative... through careful analysis and recommendations by engineers

who are really concerned about *your* problem... to production scheduling and customer service men who follow-up and expedite to make sure we keep our delivery promise to you.

Of course we're proud of our modern facilities and equipment... but what we're proudest of is our reputation for customer service. Try some.

Test a free sample "tiger" from the pussycats at Cherry. Ask for our latest catalog which contains complete information on all our switches and keyboards, and we'll include a free sample switch. Just TWX 910-235-1572... or PHONE 312-689-7700... or circle the reader service number below.

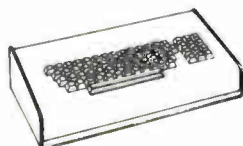

CHERRY

CHERRY ELECTRICAL PRODUCTS CORP. • 3608 Sunset Avenue, Waukegan, Illinois 60085

ELECTRONIC DATA ENTRY KEYBOARDS • ELECTRONIC DESK TOP CALCULATORS

Circle 203 on reader service card



SEE THE INTERFACE FOREST

75450A Dual Peripheral Driver
75450 Dual Peripheral Driver
75451A Dual Peripheral AND Driver
75451 Dual Peripheral AND Driver
75452 Dual Peripheral NAND Driver
75453 Dual Peripheral OR Driver
75454 Dual Peripheral NOR Driver

8T09 Quad Tri-State Driver
8T10 Quad Tri-State D-Latch
8T13 Dual Party Line Driver
8T14 Triple Line Receiver
8T15 Dual Communications Line Driver
8T16 Dual Communications Line Receiver
8T23 Dual IBM Party Line Driver
8T24 Triple IBM Line Receiver

8T26 Quad Tri-State Transceiver
8T30 Dual Transceiver/MOS Port Controller
8T34 Quad Bus Transceiver
8T37 Hex Line Receiver
8T38 Quad Bus Transceiver
8T93/94 Hex Bus Receiver
8T95/96/97/98 Hex Tri-State Driver
8T380 Quad Line Receiver
10114 Triple Differential Line Receiver
10115 Quad Differential Line Receiver
10116 Triple Differential Line Receiver

8T18 High Voltage to TTL Translator
8T80/90 Interface Buffers
54/7406 Hex TTL to High Voltage Buffer
54/7407 Hex TTL to High Voltage Buffer
54/7416 Hex TTL to High Voltage Buffer
54/7417 Hex TTL to High Voltage Buffer
54/7426 Quad 2 NAND TTL to High Voltage Gate/Buffer
1017 Dual TTL to ECL Translator
1039 Quad ECL to TTL Translator
10124 Quad TTL to ECL Translator
10125 Quad ECL to TTL Translator
10190 Quad MST to ECL Translator
10191 Quad ECL to MST Translator

521 Dual Ultra High Speed Comparator
522 Dual Ultra High Speed Comparator
526 High Speed Comparator
527 High Speed Comparator
529 High Speed Comparator
 μ A710 Differential Voltage Comparator
 μ A711 Dual Voltage Comparator

PERIPHERAL DRIVERS

LINE DRIVERS/RECEIVERS

TRANSLATORS/BUFFERS

VOLTAGE COMPARATORS

SIGNETICS
INTEGRATED
CIRCUITS

For a logical look at interface problems, consider Signetics. Interface devices in depth. Priced to move. Moving in carloads.

Beyond our host of industry standard interface circuits, Signetics' own family of dual high speed comparators is light years ahead. They've smashed the barriers of speed vs. input parameter tradeoffs and packed high speed TTL gates with a precision linear amplifier on a single monolithic chip. Our full spectrum of interface circuits covers A/D conversion, memory sensing, optical data coupling and ECL/TTL combinations with elegant solutions to a whole gamut of interface problems.

Signetics finds solutions to problems before others will even tackle them. Like our 8T23-8T24 combination for IBM channel-to-control interface, or the 8T26 which cuts out a bunch of circuitry in high speed, bi-directional, tri-state bus transceivers. Within the 8T family, there are built-in latches, tri-state outputs, built-in hysteresis—a slew of

(BECAUSE OF THE TREE).

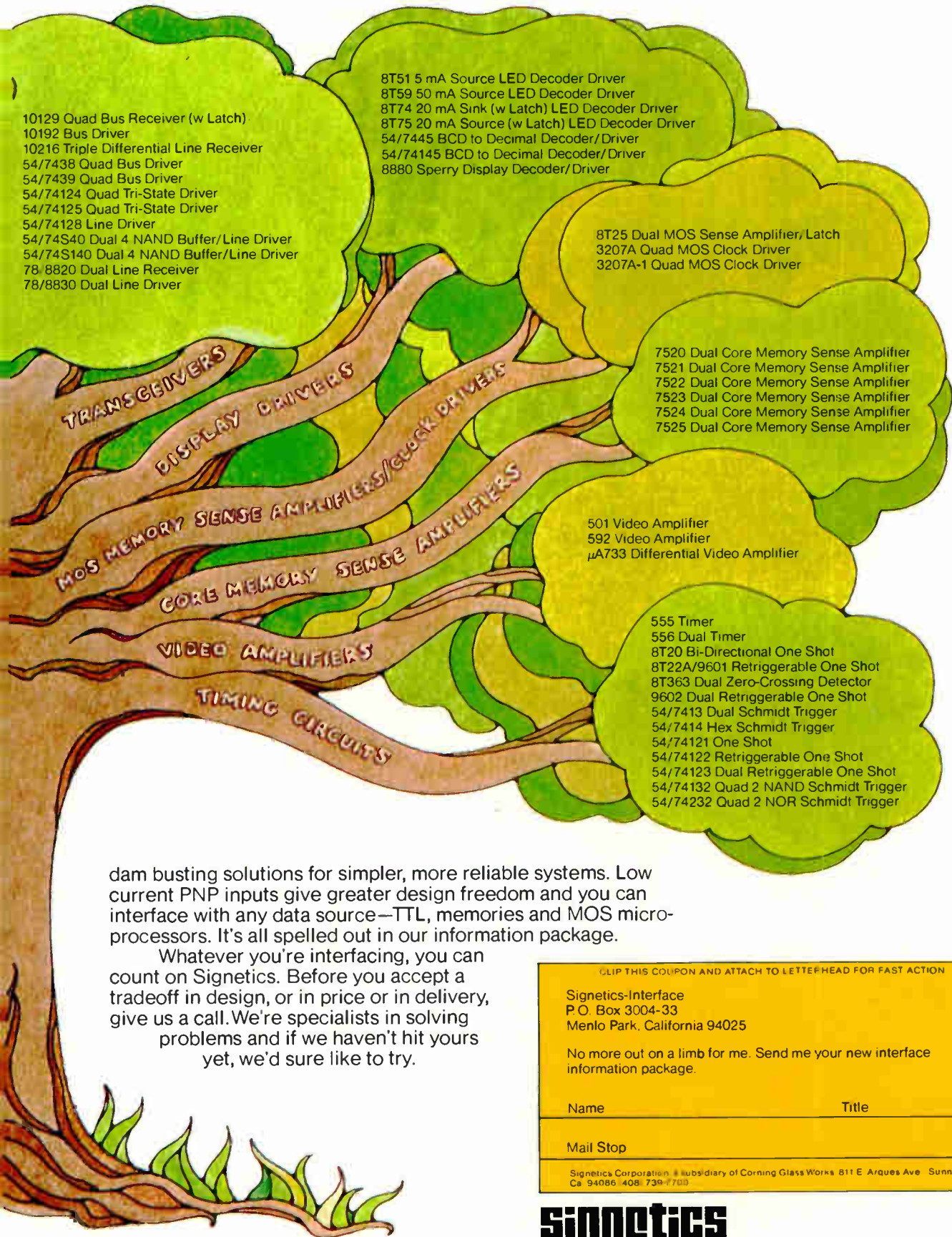

10129 Quad Bus Receiver (w Latch)
 10192 Bus Driver
 10216 Triple Differential Line Receiver
 54/7438 Quad Bus Driver
 54/7439 Quad Bus Driver
 54/74124 Quad Tri-State Driver
 54/74125 Quad Tri-State Driver
 54/74128 Line Driver
 54/74S40 Dual 4 NAND Buffer/Line Driver
 54/74S140 Dual 4 NAND Buffer/Line Driver
 78-8820 Dual Line Receiver
 78/8830 Dual Line Driver

8T51 5 mA Source LED Decoder Driver
 8T59 50 mA Source LED Decoder Driver
 8T74 20 mA Sink (w Latch) LED Decoder Driver
 8T75 20 mA Source (w Latch) LED Decoder Driver
 54/7445 BCD to Decimal Decoder/Driver
 54/74145 BCD to Decimal Decoder/Driver
 8880 Sperry Display Decoder/Driver

8T25 Dual MOS Sense Amplifier, Latch
 3207A Quad MOS Clock Driver
 3207A-1 Quad MOS Clock Driver

7520 Dual Core Memory Sense Amplifier
 7521 Dual Core Memory Sense Amplifier
 7522 Dual Core Memory Sense Amplifier
 7523 Dual Core Memory Sense Amplifier
 7524 Dual Core Memory Sense Amplifier
 7525 Dual Core Memory Sense Amplifier

501 Video Amplifier
 592 Video Amplifier
 μ A733 Differential Video Amplifier

555 Timer
 556 Dual Timer
 8T20 Bi-Directional One Shot
 8T22A/9601 Retriggerable One Shot
 8T363 Dual Zero-Crossing Detector
 9602 Dual Retriggerable One Shot
 54/7413 Dual Schmidt Trigger
 54/7414 Hex Schmidt Trigger
 54/74121 One Shot
 54/74122 Retriggerable One Shot
 54/74123 Dual Retriggerable One Shot
 54/74132 Quad 2 NAND Schmidt Trigger
 54/74232 Quad 2 NOR Schmidt Trigger

dam busting solutions for simpler, more reliable systems. Low current PNP inputs give greater design freedom and you can interface with any data source—TTL, memories and MOS micro-processors. It's all spelled out in our information package.

Whatever you're interfacing, you can count on Signetics. Before you accept a tradeoff in design, or in price or in delivery, give us a call. We're specialists in solving problems and if we haven't hit yours yet, we'd sure like to try.

CLIP THIS COUPON AND ATTACH TO LETTERHEAD FOR FAST ACTION

Signetics-Interface
 P.O. Box 3004-33
 Menlo Park, California 94025

No more out on a limb for me. Send me your new interface information package.

Name _____ Title _____

Mail Stop _____

Signetics Corporation • subsidiary of Corning Glass Works 811 E. Arques Ave. Sunnyvale Ca 94086 408-739-7700

signetics



Everybody talks
about the weather.

**EMR is doing
something about it...**

**For the National Oceanic
& Atmospheric Administration**

NOAA's new SMS/GOES Synchronous Meteorological Satellite will usher in a new era in satellite borne weather instrumentation. Once in orbit NOAA will commence processing and distributing weather data from the new Visible/Infrared Spin-Scan Radiometer (VISSR), which produces improved pictures of the earth's cloud cover. At the heart of VISSR are eight EMR Integrated Photoelectric Sensors. On earth the data from VISSR is processed by EMR Digital Interface Electronics using the latest PSK demodulation and bit synchronization techniques.

For NASA

NASA is responsible for launching SMS/GOES into orbit. EMR-Telemetry systems at the Kennedy Space Center and various tracking stations throughout the world will gather vitally needed data.

For Philco-Ford

Philco-Ford's WDL Division is building this advanced meteorological satellite. Critical data is being processed through EMR PCM Bit Synchronizers, PCM Decommutators and Displays during development and pre-launch checkout.

**For the Bureau d'Etudes
Météorologiques Spatiales**

France is typical of the many world-wide users of SMS/GOES who will use EMR Digital Interface Electronics to process vital weather data.

*We're not only talking about the weather...
we're doing something about it!*

Now...
what are we going
to do for you?

EMR EMR
Schlumberger

EMR Telemetry
Weston Instruments, Inc.
Box 3041, Sarasota, Florida 33578
813-958-0811

New products

Components

Connector works in the field

Micro-Pierce designed to move termination process out of plant

As the telephone industry seeks replacements for hard-wired connections to keep spiraling labor and operating costs under control, the Amphenol Industrial division is introducing a solderless connector

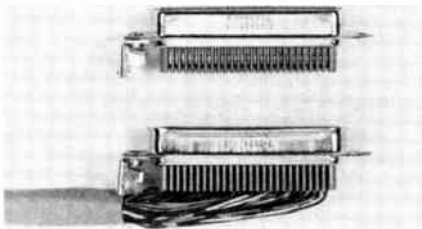

that can be terminated in the field. Essentially a replacement for the Amphenol-patented Micro-Ribbon connector for push-button telephones, the new Micro-Pierce series is available at equivalent prices.

Applications. Amphenol believes that, besides opening new applications for telephones—especially installing connectors on all telephone equipment in central offices—the solderless termination will be popular in other applications, including business machines, computers and peripherals, data communications, and instrumentation. "With more than 250 Micro-Ribbon connectors in the field, it's the biggest single connector utilized in the telephone industry," says James L. Pratt Jr., the firm's telecommunications marketing manager.

Cables in use now are terminated in the manufacturing plant; installers are forced either to use standard cable lengths or order specific lengths from the factory. "What we're trying to do," Pratt explains, "is to move the termination process from the factory to the field."

To apply the connector in the

field, the conductor is guided and pressed into the termination end of the connector. A cutting surface on the connector shears the insulation at four contact points, and a curved surface makes electrical contact by displacing the conductor material without cutting it—important for maintaining the tensile strength of the conductor.

"When the conductor is seated in the contact trough, electrical contact is made at four points, and the displaced insulation provides a gas-tight seal," Pratt says. The dielectric extends beyond the back of the connector, helping to hold the wire for termination and relieving the strain on each connector.

System. Amphenol has also developed a complete termination system for applying the connector to the cable, which it will sell or lease to customers. Included are two hand tools that will terminate from one to 50 contacts at a time, a semiautomated bench-mounted tool for factory installation of 50 contacts at once, and a conversion unit to convert factory soldering equipment to insulation-piercing type.

Amphenol Industrial Division, 1830 S. 54th Ave., Chicago, Ill. 60650 [391]

Selector switch offers 11 discrete positions

A linear slide-selector switch with 11 discrete positions is called the Swift Action Switch because of its fast snap-detent action. Actuation force from position is a minimum of 10 ounces with 0.150 inch of travel. Contact rating is 20 volts dc maximum, while current rating is 1 to 10 milliamperes and maximum capacitance is 60 picofarads between the

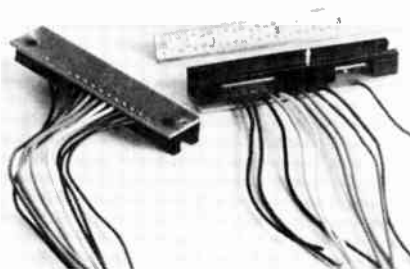

YOUR SAKATA REPRESENTATIVE CAN DELIVER RESISTORS

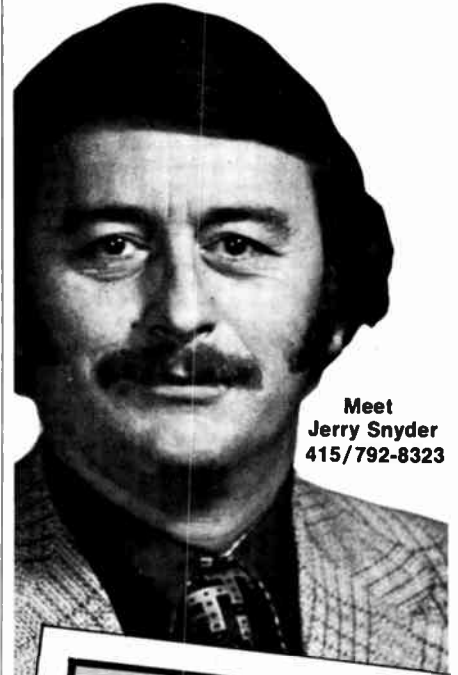

Meet Jerry Snyder
415/792-8323

RESISTORS

carbon composition
carbon film
metal film
wire wound

Faster (often out of stock), up to 10% less cost

Jerry Snyder (pictured above) is the Sakata representative for California and Nevada. All of our representatives can give you faster delivery and better prices on a wide variety of top quality components. These include resistors (composition, carbon and metal film), capacitors, (ceramic disc, electrolytics), panel meters, lamps and tape heads. Write or phone for our price and delivery before you buy. Free catalog and engineering available. Delivery of many items from stock.

sakata international, inc.

312/593-3211

651 Bonnie Lane, Elk Grove Village, Illinois 60007
resistors • capacitors • lamps • meters • tape heads

Save time, money
with SAKATA

If
you
think all card
readers
are alike...

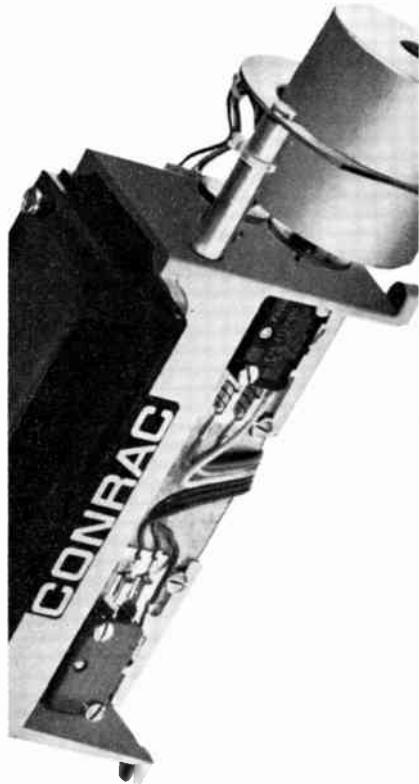

take a look
at
CONRAC

Take a good, long look before you specify... check and compare all the features offered by the CONRAC A-31 Series Magnetic Card Reader. Here are only a few: • Read or write on Standard Magnetic Cards • Industry Compatible Credit Cards— IATA, ABA, THRIFT, NTT • Card remains stationary and visible at all times—minimizing chances of card loss, damage or jamming • Card-in-place switch—insures proper insertion of card before operation • USA designed and made for OEM applications requiring rugged, long life • All this plus more and it's one of the lowest priced. ⁵⁰⁰

Write For Descriptive Literature.

CONRAC CRAMER DIVISION
CORPORATION

Mill Rock Road, Old Saybrook, Conn. 06475
(203) 388-3574

New products

common and switching circuits. Tests show the unit has a life expectancy of 25,000 cycles, the company says.

Sonitronic Inc., 32-02 Linden Pl., Flushing, N.Y. 11354 [343]

Subminiature indicator need little mounting area

The 252 series of subminiature indicator lights using T-1 incandescent lamps requires only a 0.193-inch panel-mounting clearance hole. Connections are brought out as flex-

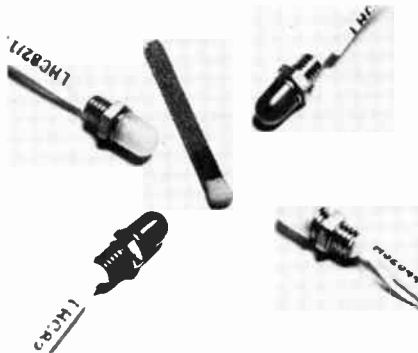

ible wire leads, and the opening is sealed so that the unit is moisture- and dustproof. Life of the lamp is rated at 60,000 hours at 5 volts. A variety of materials and finishes is available. The devices conform to military specifications. Price is \$2.09 in 1,000-lots.

Dialight, 203 Harrison Place, Brooklyn, N.Y. 11237 [345]

Cold-cathode circuit monitors TV-tube voltage

A neon cold-cathode-circuit component, called the A-401, is designed to monitor and shut down the picture-tube voltage in a TV set when excessive voltage is detected. The unit may also be used to monitor the capacitor voltage in medical-electronic equipment. When the critical voltage is reached, the component directly triggers an SCR crowbar circuit, thus protecting the capacitor. Initial breakdown voltage of the A-401 is 100 to 110 v dc, mea-

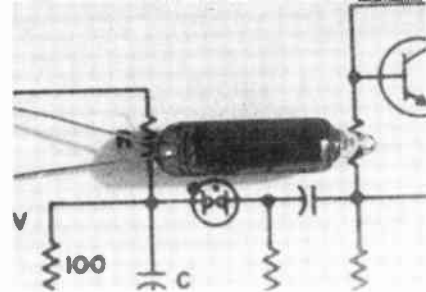

sured in the dark. Breakdown stability is ± 3 v of initial, and life is 100 hours continuous at 2.5 milliamperes dc.

Signalite, 1933 Heck Ave., Neptune, N.J. [344]

Time switch provides 24-hour on-off control

Designed to provide 24-hour on-off control in a variety of applications, including process equipment and such home appliances as fans, the series 2400 time switch has 96 self-contained clips offering on-off operation in 15-minute increments or multiples. No tools are needed to change the schedule. The single-pole, double-throw snap-action contacts are rated at 20 amperes, non-inductive to 480 v ac. The unit can be supplied with an optional time delay for use where many time switches control large quantities of motors.

Zenith Controls Inc., 830 W. 40th St., Chicago, Ill. 60609 [346]

Semiconductor fuses come in fire-resistant packages

Semiconductor protective fuses with ratings of 130 volts, 10 to 800 amperes, are designated the SF13X series. The line of devices use fire-

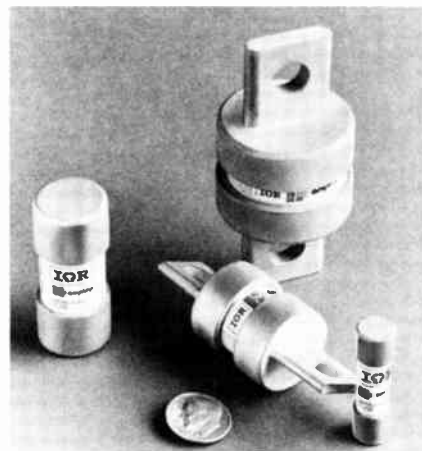

New products

resistant metal-ceramic packages, permitting higher case temperatures without the effects of thermal fatigue. Maximum peak voltage is 183 V, and maximum arc voltage is 220 V. Price for a 130-v, 100-A version is \$4.20 in small quantities.

International Rectifier Corp., 233 Kansas St., El Segundo, Calif. 90245 [347]

Green LED glows with 800-microcandela intensity

Three green light-emitting diodes, designated the TIL211, 222, and 223, are priced in 100-lots, at 46 cents, 48 cents, and 48 cents, respectively. The 211 features a 0.120-inch nominal lens diameter, a forward

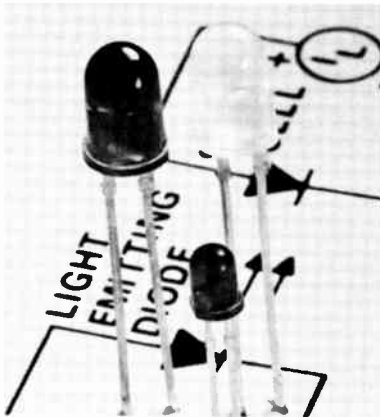

current of 25 milliamperes, and a minimum luminous intensity of 800 microcandelas. The models 222 and 223 emit a minimum luminous intensity of 1 millicandela when forward-biased at 25 milliamperes. The 222 has a filled-epoxy lens, while the 223 has a clear diffused lens.

Texas Instruments Incorporated, Box 5012, M/S 308, Dallas, Texas 75222 [348]

Miniature reed relays offer contact combinations

With an over-all length of 1.14 inch, series 46 open-type miniature reed relays can be densely mounted on pc boards. A newly designed terminal, spaced on 1-in. centers with a 0.150-in. grid, offers good accessibility and protection against dam-

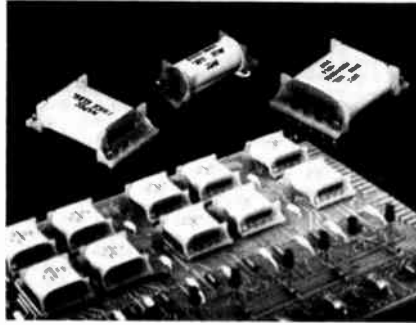

age. Five different coil forms provide a multiplicity of contact combinations. Included are form A, B, and C dry-reed contacts and form A and B mercury-wetted contacts. Magnetic latching relays are available with 1A and 2A contact combinations. Magnetic shielding is available on all relays. Contact ratings for form A and B mercury-wetted relays is 50 watts; for form A and B dry reed relays, 10W; for form C dry-reed relays, 2.8 w. Delivery is from stock.

North American Philips Controls Corp., Cheshire, Conn. 06410 [349]

Miniature lights require no mounting hardware

A series of miniature lights for commercial and industrial applications, designated Rib-Loc, install from the front of the equipment panel and require no mounting hardware. The units feature polyamid-molded ribbed housings that fit into 0.312-inch punched holes. Other features include heat-resistant polycarbonate lenses in a variety of colors, two lens-cap styles, and T-1 $\frac{3}{4}$ incandescent or neon lamps.

Eldema Division, Genico Technology Corp., 18435 Susan Rd., Compton, Calif. 90221 [350]

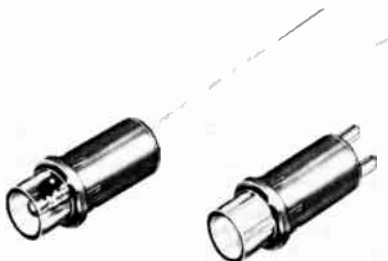

We've made a great tape transport a lot better.



take a look at CONRAC

Now, there's no reason for you to "trade-off" when specifying an audio cassette tape transport...not if you specify the Conrac CAS-4. Here are only a few reasons why: • USA designed and manufactured • 3 motor design • No mechanical clutches or brake bands required • Designed for remote control • OEM priced. 501

Write for descriptive brochure

CONRAC CRAMER DIVISION
CORPORATION

Mill Rock Road, Old Saybrook, Conn. 06475
(203) 388-3574

ULTRA-MATCHED TRANSISTORS...*made easy!*

$V_{OS} - 100\mu V$

$TCV_{OS} - 0.5\mu V/^{\circ}C$

$\Delta h_{FE} - 3.0\%$



Max!

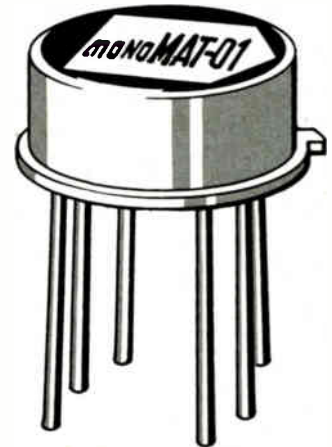

YOUR TOUGHEST APPLICATION HAS MET ITS MATCH!

Unparalleled matching at a price you can afford — and with off-the-shelf delivery too! The monoMAT-01 makes it easy to realize your toughest-spec special purpose amplifier designs! And super-matching isn't the only feature monoMAT-01's got — the extremely linear V_{be} vs $\log I_c$ is ideal for current sources, log-antilog and multiplier circuits. Micro-power circuitry will love the extremely low noise and high beta at very low collector currents ($h_{FE} = 590$

typ at $I_c = 10nA$). Of course, the monoMAT-01 receives Precision Monolithics' famous "Triple-Passivation Process" for the ultimate in reliability and long term stability.

Try one and see! (It's easy! — the 6 pin TO-99 type package directly replaces most popular duals.) You'll find the monoMAT-01 is more than a match for your toughest dual transistor application! Get 'em off-the-shelf from your Precision Monolithics distributor!

GUARANTEED MIN/MAX SPECIFICATIONS

	monoMAT-01AH	monoMAT-01H	monoMAT-01FH	monoMAT-01GH	
$V_{OS} @ 25^{\circ}C$	0.1	0.1	0.5	0.5	mV
$TCV_{OS} (-55^{\circ} \text{ to } +125^{\circ}C)$	0.5	0.5	1.8	1.8	$\mu V/^{\circ}C$
$h_{FE} @ I_C = 10\mu A$	500	330	250	250	•
$I_{OS} @ I_C = 10\mu A$	0.6	0.8	3.2	3.2	nA
$TCI_{OS} (-55^{\circ} \text{ to } +125^{\circ}C)$	90	110	150	150	$\mu A/^{\circ}C$
$I_B @ I_C = 10\mu A$	20	30	40	40	nA
BV_{CEO}	45	60	60	45	V
Price @ 100 pcs.	\$6.00	\$5.00	\$3.75	\$2.50	•

AUTHORIZED DISTRIBUTORS

NEW YORK METROPOLITAN AREA Harvey Radio, Woodbury, N.Y.: (516) 921-8700 • **NEW ENGLAND AREA** Gerber Electronics, Dedham, Mass.: (617) 329-2400 • **UPSTATE NEW YORK** Harvey Federal Electronics, Binghamton, N.Y.: (607) 748-8211 • **NORTHEAST** Newark Electronics, Woburn, Mass.: (617) 935-8350 • **BALTIMORE-WASHINGTON** Whitney Distributors, Baltimore, Md.: (301) 944-8080 • **PHILADELPHIA** Hallmark Electronics, Huntingdon Valley, Pa.: (215) 355-7300 • **MICHIGAN** RS Electronics, Detroit, Mich.: (313) 491-1000 • **SOUTHEAST** Kirkman Electronics, Winston-Salem, N.C.: (919) 724-0541 • **EAST CENTRAL** Pioneer/Cleveland, Cleveland, Ohio: (216) 587-3600 • **Pioneer/Dayton**, Dayton, Ohio: (513) 236-9900 • **CENTRAL** Hallmark Electronics, Elk Grove Village, Ill.: (312) 437-8800 • **Minneapolis**, Minn.: (612) 925-2944 • **St. Louis**, Mo.: (314) 521-3800 • **TEXAS-OKLAHOMA** Sterling Electronics, Houston, Texas: (713) 623-6600 • **Dallas**, Texas: (214) 357-9131 • **SOUTHWEST** Sterling Electronics, Albuquerque, N.M.: (505) 345-6601 • **Phoenix**, Ariz.: (602) 258-4531 • **WEST** Westates Electronics Corp., Chatsworth, Calif.: (213) 341-4411 • **Sterling Electronics**, San Carlos, Calif.: (415) 592-2353 • **Intermark Electronics**, Sunnyvale, Calif.: (408) 738-1111 • **Denver**, Colo.: (303) 936-8284 • **Salt Lake City**, Utah: (801) 359-0531 • **San Diego**, Calif.: (714) 279-5200 • **Santa Ana**, Calif.: (714) 540-1322 • **Almac-Stroom**, Seattle, Wash.: (206) 763-2300 • **Portland**, Ore.: (503) 292-3534.



1500 SPACE PARK DRIVE, SANTA CLARA, CALIFORNIA 95050
TEL. (408) 246-9225 • TWX 910-338-0528 • CABLE MONO

If you've got a problem with hot DIP's one of these ideas will probably solve it

No. 14 of a Series

Heat build-up in DIP circuits can degrade performance, ruin reliability and in some cases, it can get completely out of control, (such as when many digital DIP IC's are jammed together on high-density boards).

Whether you are using digital DIP's or high-powered linears like big op amps or voltage regulators, there's an IERC DIP-cooling system that will provide just the amount of power dissipation you need for good circuit

performance, reliability and economy. In fact, the four ideas shown here will solve most DIP cooling problems. Dissipators are coated with Insulube® 448 (500-V. dielectric); can be mounted directly onto p-c lines.

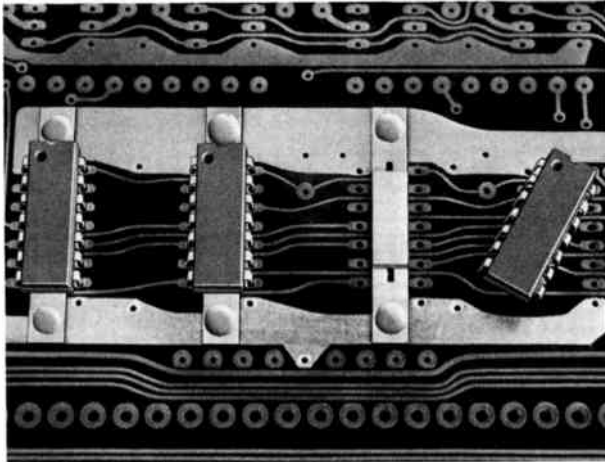

Thermal runaway is a worry when DIP density gets high such as on digital boards. One cheap solution is IERC conduction bases soldered to plated lands or ground planes. Bases control runaway by providing heat path from hot DIP bellies to lands or planes. Expect 75 to 125 mw more power with the same substrate temperature rise above ambient, or about 10°C cooler temperature with same power.

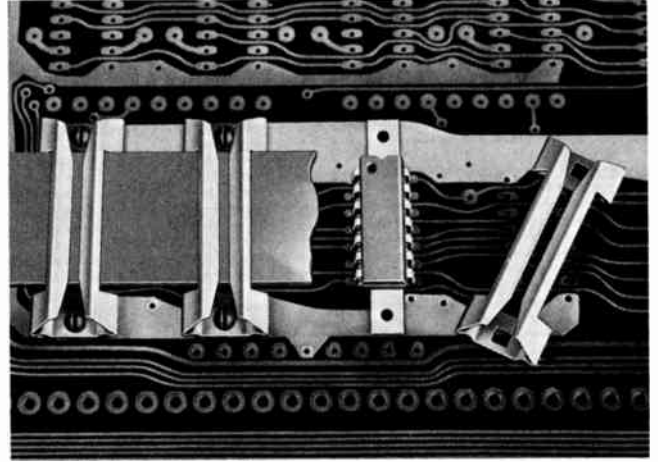

Forced air cooling for your high-density power IC DIP boards may look like the only answer, but IERC DIP conduction bases and retainer clips could make you forget it. Base gets heat from DIP bottom, clip from top and payoff is 200 mw improvement in power handling capability on G-10 boards. Solder bases to lands or ground planes and you get even more. Copper strip helps equalize DIP temperature differentials for more predictable performance and gives a little extra dissipation to boot.

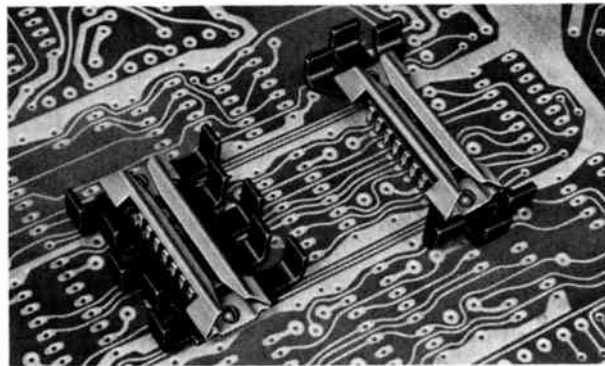

Tear up the data sheet on many op amps and other power linear IC's in DIP packages unless you use thermal management or more circuits. They just won't operate that way without overheating. But clip those DIP's in our LIC or PB1 Staggered Finger dissipators with our retainer and you'll get specified performance and more. For instance, a DIP in our LIC is worth two bare devices (100% power increase), and the shorter PB1 will give you about 400 mw, or 57% more power than a bare DIP with the same substrate temperature rise.

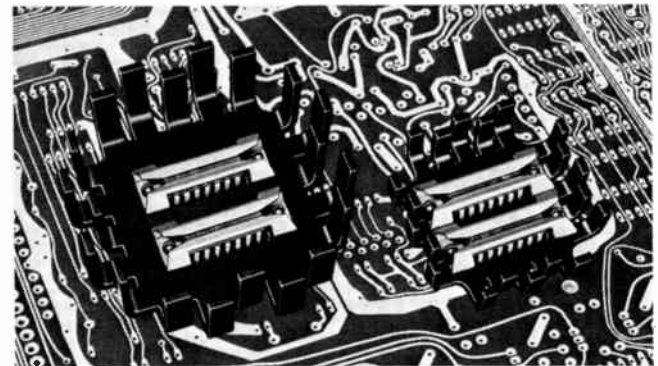

Finding happiness together in our HP1 dissipator are Darlington amplifier and resistor network that replaced discrete resistors and several amplifiers. HP1, capable of dissipating about 10 watts, gives Darlington five times the power handling capability while it lets designer use a versatile, convenient resistor net in a power circuit without fretting over fast aging and premature failure. Smaller UP using half the board area permits operating two DIP's at four times the power possible with bare devices.



For more information

on heat sinks and dissipators for milliwatts to kilowatts, send for the IERC Short Form Catalog today. It covers the most complete line of thermal problem solving devices available anywhere.

IERC



Heat Sinks/Dissipators

INTERNATIONAL ELECTRONIC RESEARCH CORPORATION / A SUBSIDIARY OF DYNAMICS CORPORATION OF AMERICA / 135 WEST MAGNOLIA AVENUE, BURBANK, CALIFORNIA 91502

Monsanto introduces its HT SERIES *(a breakthrough in High Technology)* with three new Frequency Counters

Monsanto's new HT Series (High Technology) instruments designed specifically for communications, is the 8700 family of Frequency Counters. As a part of Monsanto's ongoing R & D program to produce digital instrumentation of optimum reliability and performance, these counters offer outstanding specifications. Only through the judicious use of tested technology, human engineering prin-

ciples, and state-of-the-art circuitry and components, could the demanding standards of this series be accomplished. To further fulfill the promise of the series, each instrument is housed and protected in a contemporary, designer-styled aluminum enclosure that facilitates calibration and maintenance while providing an appearance as advanced as the technological innovations it contains.



8700 Series
prices range from
\$595.

The 8700 Series of Frequency Counters consists of three separate models with ranges of 150 MHz, 550 MHz and 1 GHz.

All models feature: Frequency and Ratio mode/Opti-ranging for optimum display resolution/Full 9 digit, Monsanto, easy-to-read amber LED display/10 mV rms sensitivity with AGC/Selectable input impedances of 50 ohms and 1 megohm/High stability oven controlled crystal oscillator/Options included: parallel BCD output, IF subtraction, higher stability TCXO oscillator, high overload input protection/Available from stock/Generous OEM quantity discounts.

UNITED SYSTEMS CORPORATION
918 Woodley Road, Dayton, Ohio 45403
Ph (513) 254-6251 Twx (810) 459-1728
a subsidiary of

Monsanto

Monsanto

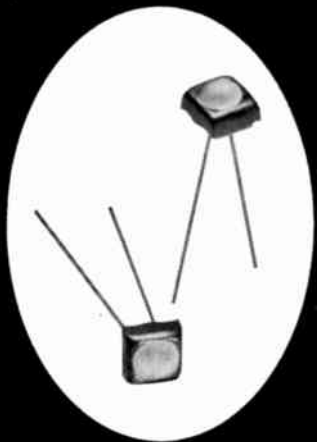

CERMA-CEL™ TRIAC's SCR's

Hutson Cerma-Cel™ TRIAC's and SCR's are designed as an economical intermediary step for manufacturers wanting to change from discreet components to the use of chips, as well as where area is limited. Cerma-Cel™ is easily adaptable to a wide variety of mounting positions and techniques depending on the RMS current required in the application. Cerma-Cel™ is available in voltages from 50V through 600V in both TRIAC's and SCR's. Hutson offers a 6 Amp Cerma-Cel™ with IGT of 500 μ a, and an 8 Amp with IGT of 25 mA; and an 8 Amp TRIAC. Cerma-Cel™ TRIAC and SCR Chips are hermetically sealed, passivated with proprietary, void-free inorganic glass and feature Hutson's patented Di-Mesa construction.

In addition to its Cerma-Cel packages, Hutson's complete line of TRIAC's and SCR's are available in all popular packages in current ratings to 60 Amps and voltage ratings to 800V. Call or write Hutson for complete information.



**HUTSON
INDUSTRIES**

Box 34235 • 2019 W. Valley View
Oallas, Tex. 75234 (214) 241-3511
TWX 910-860-5537

Distributors:

New York City 201/399-4350 Seattle
206/454-0300 Los Angeles 213/240-
3151 Dallas 214/231-6181 Baltimore
301/944-8262 Denver 303/757-7679
Ft Lauderdale 305/772-5100 Chicago
312/286-1500 Detroit 313/499-0188
Syracuse 315/699-2671 Indianapolis
317/888-2260 Atlanta 404/427-0241
Canada 416/638-1322 Beaverton 503/
643-1644 Dayton 513/433-2511
Phoenix 602/968-9037 Minneapolis
612/866-3035 Waltham 617/890-8040
Kansas City 816/765-2998

Distributors:

Elizabeth 201/345-2420 Los Angeles
213/240-3151 Denver 303/934-5505
Chicago 312/323-9670 Canada 416/
635-9880 Rochester 716/454-7800
Belgium 02362135 Brussels
02352135 Denmark (01) 295622
Norway 472702272 Spain 234-62-62
Sweden 08-28-5940 Switzerland
051-852201

New products/materials



A chromium for microelectronics applications is produced by a chemical vapor-deposition process that yields a metal 99.996% pure. Called Marz, the metal is made into coarse granules, nominally a -10 to +18 mesh, which can be used as an adhesive. Another application is in the production of photomasks. The company says the chromium has a typical life expectancy 10 times higher than that of photo emulsions. Price ranges from \$150 to \$225 per pound, depending on mesh size and amount.

Material Research Corp., Rte. 303, Orangeburg, N.Y. 10962 [476]

A glass-epoxy copper-clad laminate has been formulated to reduce tool wear in punching and stack-drilling operations. Firebran 670P has a mat core to minimize abrasiveness and is said to eliminate halos around punched or drilled holes, problems that often occur with conventional glass-fabric laminates. Price is about \$1.80 per square foot.

Synthane-Taylor, Valley Forge, Pa. 19482 [477]

A woven-glass fabric and epoxy-resin copper-clad laminate, designated G-10 Flexible, can be folded around corners or shaped into tubes

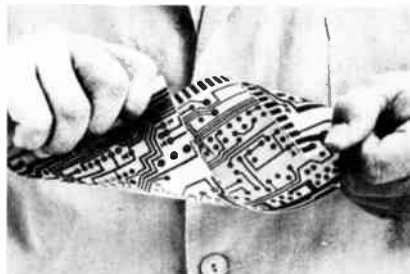

(Continued on page 220)

Different hopes for different folks.



People want different things from a college education.

But they all agree on one thing. It takes more than brains to get a diploma.

Why not make the burden a little easier? Start buying U.S. Savings Bonds now.

Bonds are a dependable way to build a college fund for your children. And an easy way to start saving them is by joining the Payroll Savings Plan.

Start a college fund now with U.S. Savings Bonds. They just might let your kids spend more time studying and less time working to stay in school—whatever they hope to be.



Take stock in America.

Buy U. S. Savings Bonds

Now E Bonds pay 5 1/2% interest when held to maturity of 5 years, 10 months (4% the first year). Bonds are replaced if lost, stolen, or destroyed. When needed they can be cashed at your bank. Interest is not subject to state or local income taxes, and federal tax may be deferred until redemption.

The U. S. Government does not pay for this advertisement. It is presented as a public service in cooperation with The Department of the Treasury and The Advertising Council.

1000 dB/ DECADE SLOPE ACTIVE FILTERS

FOR MAXIMUM ADJACENT FREQUENCY REJECTION

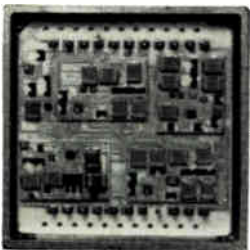
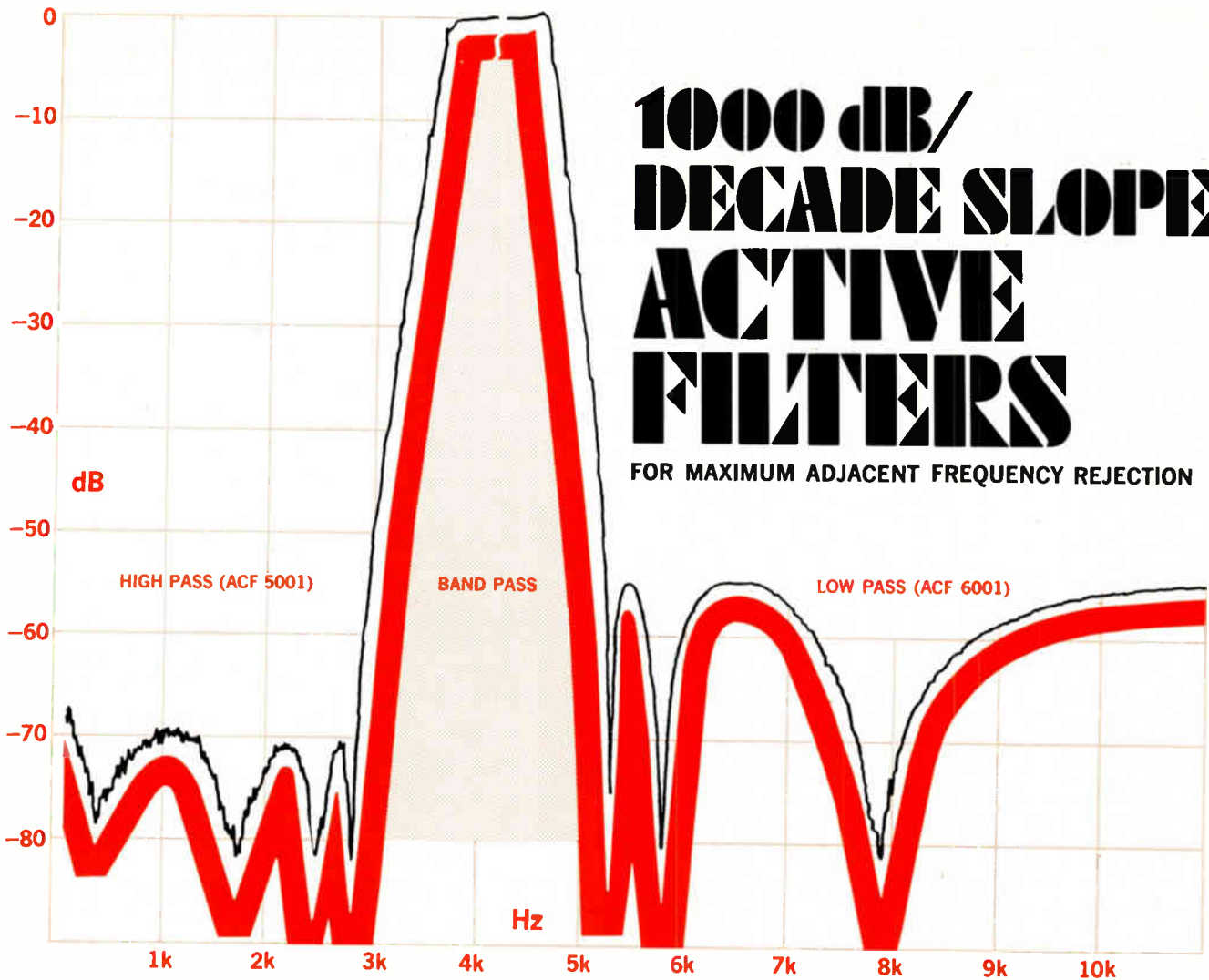

General Instrument's new state-of-the-art active filters are designed for use in telecommunications systems, data and signal processing, biomedical, navigational, seismographic and other applications . . . wherever critical frequency rejection is a must.

Available in both high pass (ACF 5001) and low pass (ACF 6001) versions, these filters can be used together as a band pass filter. Each is packaged in a 1.6" x 1.6" x .25" hermetically sealed metal plug-in case.

Both filters are 8th order Cauer Elliptical in design with characteristics in the 3 to 6 kHz range.

For complete information on these, or any other General Instrument hybrid active filter, fill in and mail the adjacent coupon, or call (516) 733-3243.

GI'S GOT IT!

General Instrument Corporation,
Hybrid Division,
600 W. John St., Hicksville, N.Y. 11802

Please send me complete information on the following
General Instrument Hybrid Active Filters:
(check boxes indicating your interest)

- | | |
|---|--|
| <input type="checkbox"/> 1000 dB Elliptical | <input type="checkbox"/> Linear Phase |
| <input type="checkbox"/> Low Pass | <input type="checkbox"/> Cauer |
| <input type="checkbox"/> High Pass | <input type="checkbox"/> Universal |
| <input type="checkbox"/> Band Pass | <input type="checkbox"/> C-Message |
| <input type="checkbox"/> Band Rejection | <input type="checkbox"/> 1000 Hz Notch |
| <input type="checkbox"/> Butterworth | <input type="checkbox"/> 50 or 60 Hz Rejection |
| <input type="checkbox"/> Chebyshev | <input type="checkbox"/> Comb |
| <input type="checkbox"/> Bessel | <input type="checkbox"/> Leap-Frog |
| <input type="checkbox"/> Bi-Quad | <input type="checkbox"/> Custom |

NAME _____ TITLE _____

COMPANY _____

ADDRESS _____

CITY _____ STATE _____ ZIP _____

**GENERAL INSTRUMENT CORPORATION
HYBRID DIVISION**



Data Communications—the new business every business must have.

Data communications is indeed a puzzle to most of the people working in the market. In fact, many don't realize that they have data communications needs or what their needs are.

The people responsible for planning a data communications system for their company must decide alternative systems approaches, carriers, hardware, and vendors—all in the context of economics, government regulation, and future technology development.

Putting together all the pieces of this puzzle—that's what the new McGraw-Hill magazine, **Data Communications**, is all about. **Data Communications** will be published bi-monthly beginning with our May-June issue.

Our editorial is 100% data communications and we know our approach is correct because we have tested it with two pilot issues, a year apart.

Our audience is 100% data communications because to qualify, they must have responsibility to buy, specify, recommend or approve the purchase or lease of products associated with data communications.

Our subscribers are 100% request verified—not only are they qualified but each one of the 25,000 has individually requested **Data Communications**.

If you want to cover the fastest-growing market in our economy, take a full-year's schedule of full pages in **Data Communications** for only \$7,800, which includes color, bleed and special positions. We'll even do your color separations at minimal cost.

For complete advertising information, contact your nearest McGraw-Hill office.

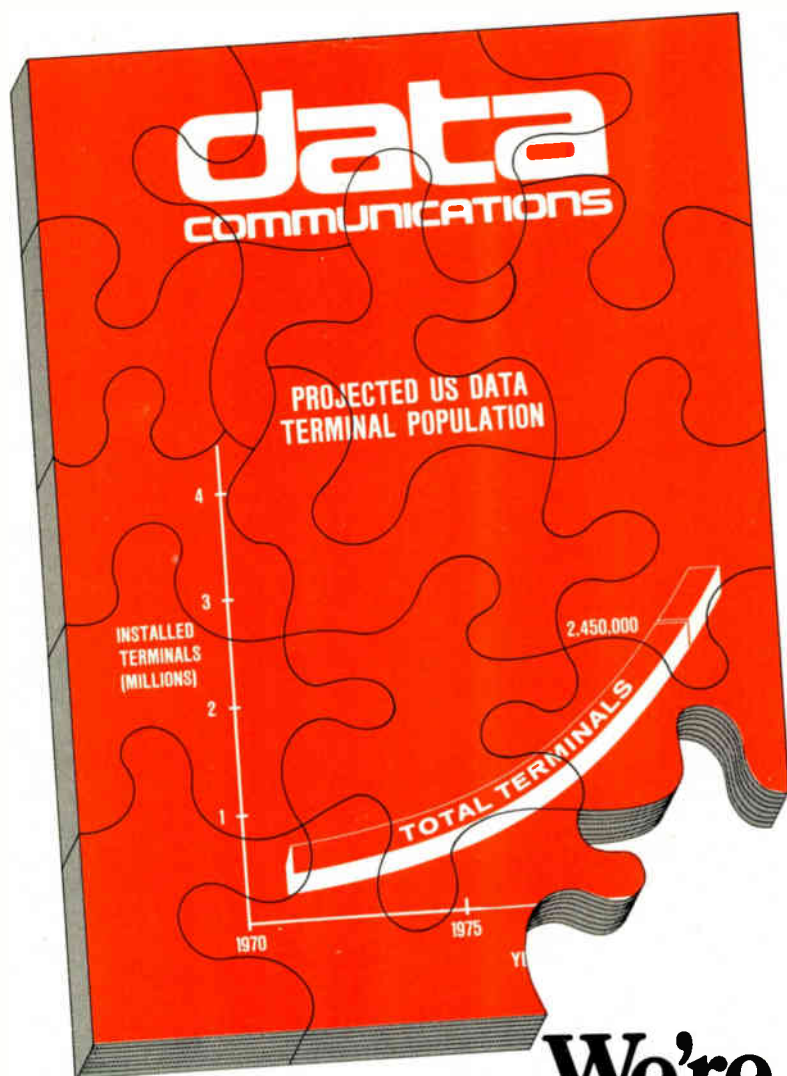

data **McGraw-Hill**
COMMUNICATIONS
the magazine and the market.

We're
putting it
all together
for you.



We can't make supply problems go away. We can make them less of a burden to our customers.



If ever there was a time for positive thinking about wire and cable availability, this is it. We all know the material problem. It's up to all of us to work around it. At Brand-Rex, anything we *can* do, we *will*.

Here are some of the things we've already done:

Organized a company-wide program to promote a "Yes We Can" attitude — asking all our employees to do everything possible to minimize customer inconvenience.

Set up systems which uncover customer purchase patterns. Purpose: Allow us to project future material needs. Result: the best possible service to existing customers, given the circumstances. While it may mean

closing the door on some attractive new business, we're willing to pay that price to preserve what we feel are our most important business relationships.

Called on our engineers to design around shortages wherever possible and to suggest acceptable alternatives wherever practical.

Asked our purchasing department to search out new materials and new vendors, from around the world if necessary. And to work closely with long-term vendors in meeting our requested deliveries.

Instructed our salesmen to keep customers up-to-date on the copper/plastics picture, and insisted on complete honesty in their relaying information both ways.

We're realistic. We don't expect these steps to solve every material shortage. But they should help ease customer procurement problems.

At Brand-Rex, we're committed to filling every order we take. On time, or as close as it is humanly possible to be. Any time we do have a problem, we'll let you know what it is and what it's going to mean to you. And we'll do everything we can to make it less of a burden.

That's our pledge. It's a lot to live up to, but we think it's the least we can do. As time goes by, we'll try to find even better ways to serve you. And if I'm sure of anything, it's this: *We can* do it.



Harry Wasiele, Jr.
President, Brand-Rex Company

Brand-Rex

Willimantic, Conn. 06226

Circle 217 on reader service card



MINUTES

0 0 0 0 0 0

GENERAL  ELECTRIC

All Time Meters are not created equal.



Only General Electric gives you reliability like this . . .

Our new Type 240 elapsed-time meters are recognized under the Component Program of Underwriters' Laboratories, Inc. Inside is a GE Telechron synchronous motor with proven dependability, and the all-new time-keeping mechanism never requires maintenance. Even the outside case is made of tough GE Noryl® for impact resistance. When you specify GE time meters, you can stop worrying about reliability.

Resetting is easy . . . just push the button.

Reset your hours or minutes indicator to zero simply by pushing the button. No knobs. No wasted motion. Just fast and accurate resetting every time. Push-button reset is available on Type 240 in behind-panel or BIG LOOK® style in 2½" and 3½".

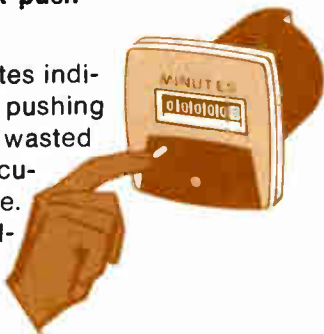

GE time meters go where you want.



Slip the new Type 240 into *existing* mounting holes . . . just order from a variety of optional mounting-stud positions. And no new punching or dimensional drawing changes are needed to replace older GE Type 235 or 236 time meters. You can replace whatever you're using with new Type 240's. And get crisp, readable style to improve your panel or equipment.

The time meter you need is ready.

There's the all-new, behind-panel model (with glass window) for a neat, trim look. Or the wide-eyed BIG LOOK style that matches your other GE panel meters. Or choose the weather-proof conduit case, the round case, the square case, or the portable-stand case. In 120, 208, or 240-volts a-c and 50 or 60 Hertz. No one can match your design requirements like General Electric.



For a catalog of GE's full line of panel meters, contact your nearby authorized GE Distributor, Modification Center, or GE Sales Office. Or write to General Electric Company, Section 592-46, One River Road, Schenectady, N.Y. 12345.

Specify General Electric... just for good measure.

New products/materials

to adjust to space limitations. The unetched laminate passes a solder dip test of 400°F for 20 seconds and retains shear and tear qualities at operating temperatures of 300°F.

Norplex, 1300 Norplex Dr., LaCrosse, Wis. 54601 [478]

Epo-Tek H61 is a thermally conductive and electrically insulating epoxy for use with hybrid and optoelectronic devices. The 100%-solids material can be used to coat active chip and wire devices and to bond chip components in devices where electrical conductivity is not required. The material, in flowable paste form, is screen-printable. A 3-ounce evaluation kit is priced at \$15.

Epoxy Technology Inc., 65 Grove St., Watertown, Mass. 02172 [479]

A **silicon-core iron** for making core stops in relays is said to eliminate hard spots and inconsistencies in machining, thus boosting produc-

tion rates by as much as 30%. Called B-FM, it is also for use in solenoid switches and armatures and meets

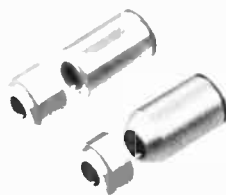

the requirements of the National Association of Relay Manufacturers Specification 102, Issue I.

Carpenter Technology Corp., 101 W. Bern St., Reading, Pa. [480]

A **solder mask** for printed-circuit applications cures with ultraviolet light, instead of heat. Called Dynacure SM-15, the 100%-solids material is screen-printable, contains no solvents, and cures to a hard scratch-resistant finish in 3 to 6 seconds. The second side of two-sided work can be screened and cured al-

most immediately after processing the first side.

Dynachem Corp., Santa Fe Springs, Calif. [401]

A **new glass**, called IP745, is used to passivate high-voltage diodes and forms the structural package for each device. The glass is applied to a rotating, brazed subassembly in a deionized water slurry. The rotation forms a bead, which maintains its form by surface tension during the conveyor furnace firing. The glass will act as a permanent barrier to ion-migration. IP745 is specifically designed to increase yield to 98% or 99% over 60 V, reduce snapback, and tighten voltage distribution. Moreover, IP745 permits thicker plating on leads, since it is chemically strong, which in turn increases solderability and yield on the board. In production quantities, price can be as low as \$45 per kilogram.

Innotech, 181 Main St., Norwalk, Conn. 06851 [402]

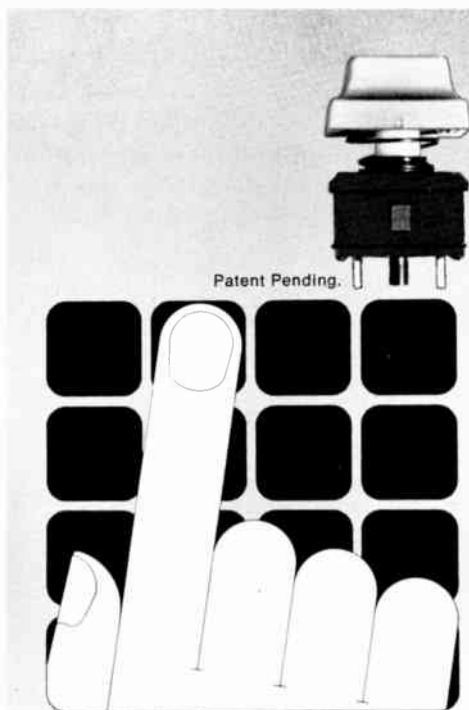

it's what's under the cap that counts

Stackpole economical Lo-Pro™ keyswitches are setting a new standard of value in cost-conscious applications like desk top calculators, data terminals, and communications equipment.

- completely enclosed switch with only 6 parts.
- coil spring cross point contacting with controlled wipe.
- specially designed terminal, base and housing protect against flux contamination.
- less than 7/16" body profile, .160" or optional .100" total stroke, latch or momentary.

Check under the Stackpole cap. You'll find pace-setting low initial cost, functional long life, and operating accuracy. Write for Bulletin No. 77-103. Stackpole Components Company, P.O. Box 14466, Raleigh, N.C. 27610. Phone: 919-828-6201.



New literature



Data conversion. A reference for the data-conscious engineer has been published by Hybrid Systems Corp., 87 Second Ave., Burlington, Mass. 01803. The softbound handbook discusses a variety of data-handling modules and binary codes. It de-

scribes various types of digital-to-analog and analog-to-digital converters available, the meanings of their specifications, and ways to test them. There are also chapters on sample-and-hold modules and analog multiplexers. Price is \$1.50. Circle 421 on reader service card.

Oscilloscope. Scientific & Industrial Instruments Co., B-14 Industrial Estate, Pologround, Indore-3, India. A data sheet gives specifications and general information on solid-state oscilloscope model EE 601. [422]

Capacitors. American Technical Ceramics, 1 Norden Lane, Huntington Station, N.Y. 11746, has published a 16-page catalog on uhf microwave-capacitor kits and a 200-page rf-capacitor handbook, which discusses the design and uses of miniature chip and leaded capacitors. [423]

Terminal. A brochure providing information on the Keyview CRT dis-

play and data-entry terminal, which dials in data in increments of 10 bits per second from 10 to 9,990 b/s, has been released by Information Design Inc., Civil Air Terminal, Bedford, Mass. 01730. [425]

Communications monitors. A 10-page technical bulletin from Cushman Electronics Inc., 830 Stewart Dr., Sunnyvale, Calif. 94086, describes the company's line of communications-service monitors for testing and maintaining two-way radios and microwave radios below 1 gigahertz. [426]

Etcher. Chemcut Corp. 500 Science Park, State College, Pa. 16801. A two-page technical sheet provides information on the system 547 spray ether, which handles circuit boards measuring from 6 by 6 inches to 40 inches by any length. [435]

Photoresist stripping. An applications note on the use of plasma in-

a new choice in Plug-In Rotaries

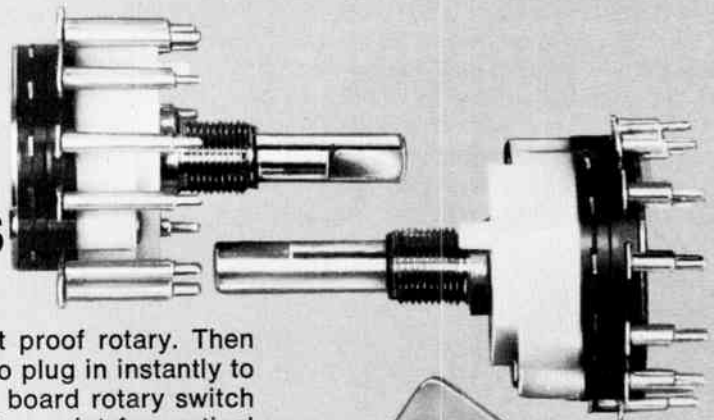

Start with Stackpole's exclusive environment proof rotary. Then add terminal pins facing front or rear, ready to plug in instantly to your PC board. Or design in a Stackpole PC board rotary switch with 12 terminals ending at a common junction point for vertical or horizontal mounting or mating to an edge-board connector.

Eliminate wiring harnesses, hand wiring errors, costly intermediate assembly. Pin termination switches are available as standard off-the-shelf switches as well as with binary codes and special switching sequences. Yet they cost less than \$2.00.

Call Stackpole. They're plugged in to your needs. Stackpole Components Company, P.O. Box 14466, Raleigh, N.C. 27610. Phone: 919-828-6201.



STACKPOLE
COMPONENTS COMPANY

New literature

strumentation for removal of photoresist from aluminum substrates is available from Tegal Corp., 860 Wharf St., Richmond, Calif. 94804. [436]

Connectors. Components Corp., Denville, N.J., has published a



short-form catalog providing information on the Digi-Klip line of board-to-board connectors, which allows designers to configure mother and daughter boards according to individual requirements. [427]

Signal capture. Macrodyne, 1900 Maxon Rd., Schenectady, N.Y. 12301, is offering a bulletin that discusses Erdac III, a four-channel transient-signal-capture and tape-recording system. [437]

Mixers. Anaren Microwave Inc., 185 Ainsley Dr., Syracuse N.Y. 13205. A 12-page specifications bulletin provides information on the family of 22 biased and unbiased mixers covering from 0.5 to 18 GHz in 11 overlapping ranges. [438]

Programs. Wang Laboratories, 836 North St., Tewksbury, Mass. 01876, is offering complimentary copies of the company's Programmer magazine, a publication aimed at users of

calculator and computer products. [428]

Modems. Modems, frequency-division multiplexers, and diagnostic testers are the subject of a 12-page brochure being offered by DataStat Inc., 246 Sobrante Way, Sunnyvale, Calif. 94086. [429]

Resistors. Vishay Resistor Products, 63 Lincoln Highway, Malvern, Pa. 19355. Bulletin AB-104 describes how its Bulk-Metal resistors reduce size and improve specifications of a-d converters. [430]

Power systems. Time Mark Corp., Box 15127, Tulsa, Okla. A 12-page applications guide is available to advise designers on the installation of phase loss, low-voltage, and phase-reversal protection in three-phase power systems. [431]

Couplers. Elgin Electronics Inc, Walnut St., Waterford, Pa. 16441,

low cost circuit protection against high voltage/high energy surges

Stackpole Special Purpose Resistors (SPRs) help protect systems where high energy surges and high voltages would destroy valuable equipment. Check these characteristics:

- Best solution for protecting against high voltages in limited space.
- Unlike wire-wound resistors, SPRs are non-inductive, can be made in rods, rings, discs, or sleeves with wire leads or metal contacts.
- SPRs do not fuse out; they return to nominal value after absorbing the energy surge.
- Maximum voltage gradient 10 kilovolts/in., resistivity range from 2 ohm-cm. to 10,000 ohm-cm.

Write on your letterhead for samples to test in your next system design. Stackpole Carbon Co., Electronic Components Div., St. Marys, Pa. 15857. Phone: 814-781-1234. TWX: 517-693-4511.



Bulletin No. 83/84-101 gives full specification data, size ranges and application guidance. Ask for it.



has announced an eight-page applications guide featuring 25 different coupler models. The guide also provides installers with a reference to voice-connecting and data-access-arrangement services offered for use with customer-provided equipment. [432]

Cathode-ray tubes. Thorn Radio Valves & Tubes Ltd., Mollison Ave., Brinsdown, Enfield, Middlesex, England, An industrial cathode-ray-tube catalog provides information on oscilloscope, radar, display, and monitor tubes. It also provides charts and comparative information. [433]

Process control. A brochure from Data General Corp., Southboro, Mass. 01772, describes the modules—computers, programing, peripherals—that make up process-control equipment specifically built around small computers. A typical system using a backup computer is

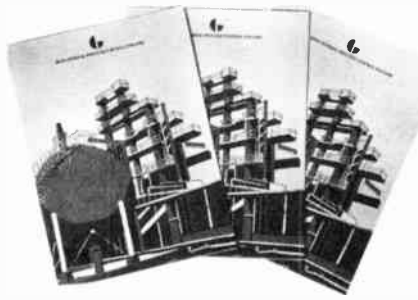

explained and diagramed. [434]

Spectrum analyzers. Federal Scientific Corp., 615 W. 131st St., N.Y. 10027. A four-page catalog provides information on how to use on-line real-time spectrum analyzers to test and service high-quality tape recorders. [371]

Directional couplers. Hyletronics Corp., Newtown Rd., Littleton, Mass. 01460, has published a brochure describing the line of 3 dB, 90°

directional couplers. The line covers from 0.25 to 18 GHz in octave bandwidths. [372]

Multiplying d-a converter. A six-page catalog describes the model 869 four-quadrant multiplying digital-to-analog converter. Block and functional diagrams, illustrations of the four quadrant and multiplier modes, charts, and specifications are provided. [373]

Rf and i-f components. A 32-page catalog on rf and i-f components, including microwave mixers, modulators, and amplifiers, is available from Varian, Beverly division, Salem Rd., Beverly, Mass. 01915 [374]

Sensors. Sensor Technology Co., 905 Dexter Ave. North, Seattle, Wash. 98019. An illustrated catalog describes the company's ultrasonic noncontact product line and provides information on each of its sensing devices. [375]

need an inductor? check these facts about ferrites

FACT 1: cost of ceramic ferrites is 1/10 of steel alloys for low frequency applications, yet ferrites offer extremely high resistivity and low coercive force.

FACT 2: for power applications, ferrite cores can operate at higher frequencies than laminated steel with better permeability and higher Q.

FACT 3: higher perm ceramic ferrite inductors require fewer turns, resulting in lower distributed capacity, material savings, and improved performance.

FACT 4: as the country's largest producer of ceramic ferrite material, Stackpole offers unique mold-to-size capability, numerous tooled shapes, and its Ceramag® family of materials for frequencies from 1.0 KHz to 400.0 MHz and permeabilities from 7.5 to 7500.

Call for help. Stackpole Carbon Company, Electronic Components Div., St. Marys, Pa. 15857. Phone: 814-781-1234. TWX: 510-693-4511.

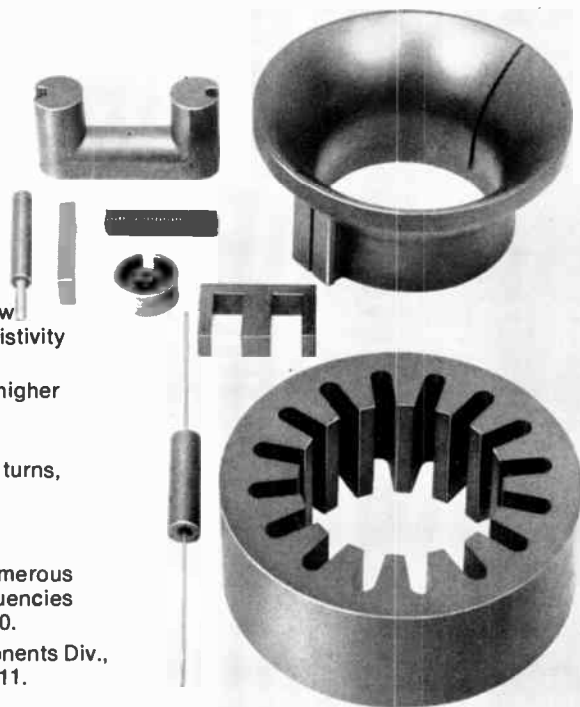

Warrick Controls won't tolerate inconsistency. Plenco 482 shapes up. Consistently.

The components of these liquid level controls must meet the uniformly close tolerances necessary for exacting assembly. Lundsten Plastics Corp., Novi, Mich., molds these contact blocks, housings and shuttles for the manufacturer, Warrick Controls, Berkley, Mich. They chose Plenco 482, a general purpose compound because:

"It molds easily, with uniform consistency and within exacting tolerances. This is important because all the components must be fitted into a balanced product. Plenco 482 is very satisfactory in this application."

Easy-flowing, fast-curing Plenco 482 offers non-critical operational qualities and easy processing for a variety of molding methods: compression, transfer or injection.

It's just one of a wide variety of thermoset plastics from Plenco. Call on us for the selection, service and experience you need to shape up your product.

PLENCO THERMOSET PLASTICS

PLASTICS ENGINEERING COMPANY
Sheboygan, Wis. 53081

Through Plenco research . . . a wide range of ready-made or custom-formulated phenolic, melamine and alkyd thermoset molding compounds, and industrial resins.

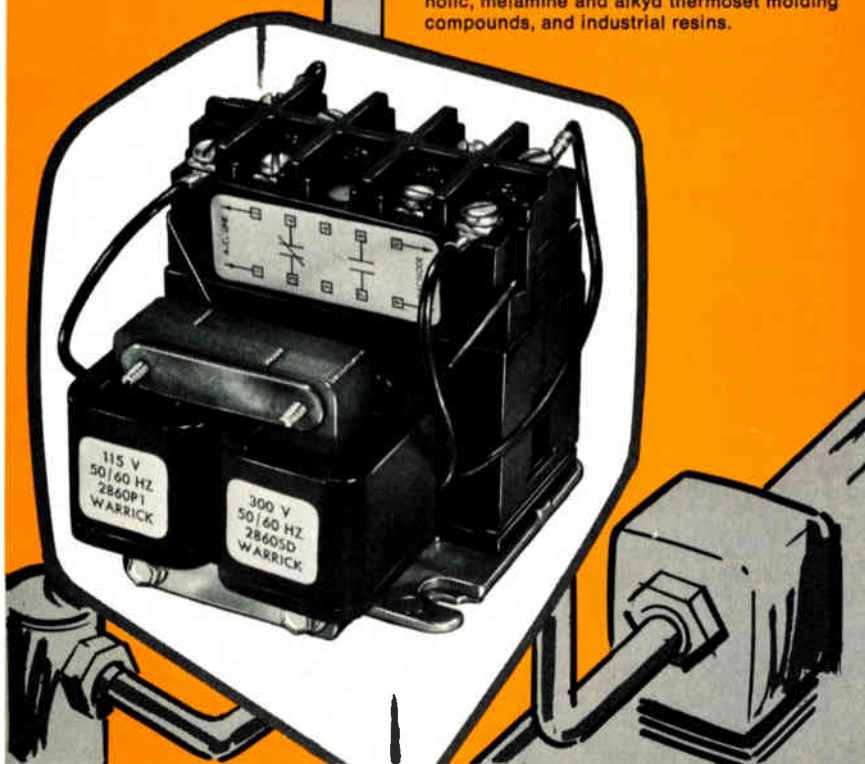

New books

Environmental Control in Electronics Manufacture, P.W. Morrison, Van Nostrand Reinhold Co., New York, 1973, 474 pp., \$23.95.

Written by Western Electric engineers and members of the technical staff of Bell Laboratories, this book presents a systematic approach to the identification and control of contaminants in microelectronics manufacture. It should be of interest to the process engineer striving to improve his production line.

Although aimed primarily at microelectronics, this volume should prove valuable to engineers engaged in the manufacture of any precision devices.

The authors define a product contaminant as a substance or energy that can adversely affect the product; they then go on to classify a contaminant as physical matter, organic or inorganic chemical, or a viable organism. The reader learns both the origin of contaminants and their means of transport.

Contaminants are discussed in the light of how they threaten yield and reliability of semiconductor and thin-film fabrication processes. One case history, for example, describes a bit of sleuthing that enabled engineers to track down a malfunction in a tantalum capacitor. Current leakage was traced to tantalum-carbide inclusions in the oxide layer. The culprit was carbon, supplied by pump oils that had back-streamed into the sputtering chamber.

Chapters 3 and 4 explain how to use instrumental analysis and microscopy to identify contaminants. The principles in the beginning chapters are then applied to actual manufacturing situations.

Clean rooms, vital to controlling manufacturing environments, are covered in detail; so is their design, the materials used for clean-room construction, and floor-space requirements, plus the economics of building and operating a controlled-environment facility.

With demands growing for stricter pollution control, chapter 15 is must reading because it provides a clear and concise approach to identifying and treating liquid and airborne-waste products. There are

updating from

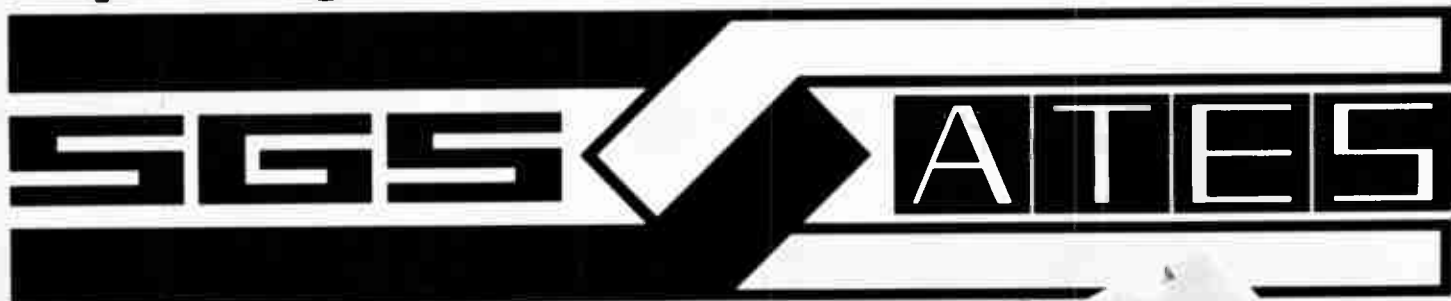

PENTAWATT[®]

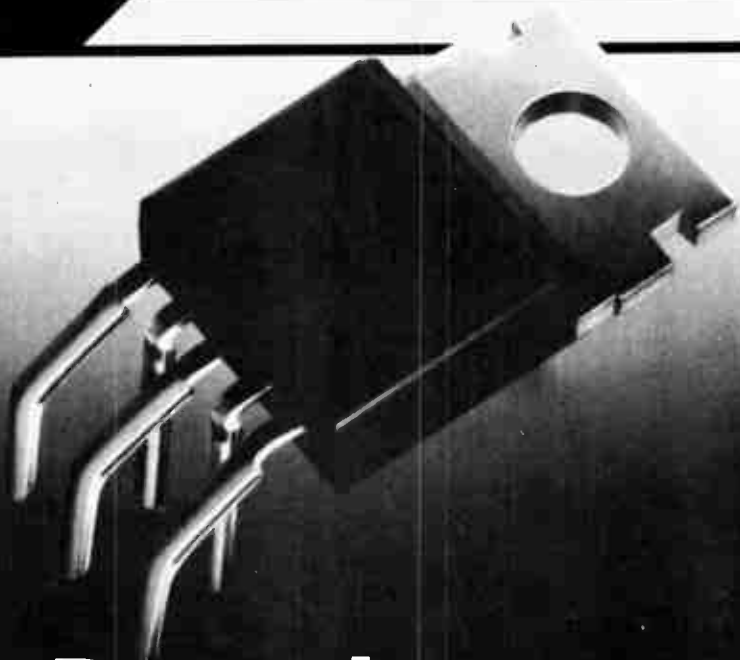

**Rugged, compact,
5 legged,**



hatched for a hot life



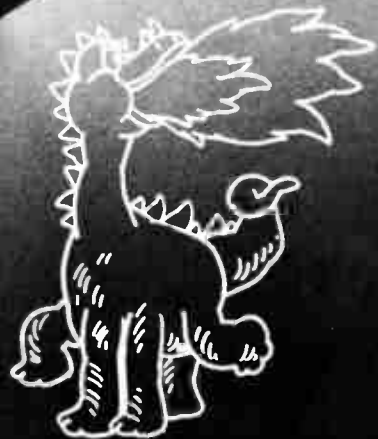

PENTAWATT® **The 5-lead plastic power package**

We designed a 5-lead power plastic package for linear ICs. We saw fit to patent our assembly, calling it Pentawatt®, because we know it is going to become an industry standard, as have all the power packages introduced by SGS-ATES to date. And we want to protect our customers against poor imitations.

Pentawatt® is designed for automotive and industrial applications. It is compact and rugged. It has the power dissipation capability of a TO-3 metal can. And, being plastic with 5 leads, it offers the most economic and versatile solution

to power IC applications in adverse environments. And we're putting lots of applications into the Pentawatt®. I.e., a 50W amplifier, voltage regulators, other special devices for the automotive industry, regulated power

supplies, boosters and actuators, and a fully protected monolithic complementary Darlington transistor pair. All very soon. So, look out for devices in Pentawatt®, the 5-lead plastic power package. They're bound to change your world.

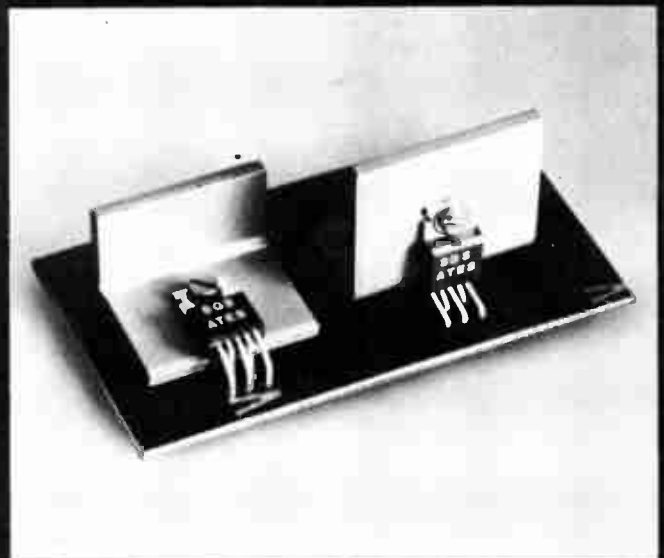

SGS-ATES



Energy Saver



New Electronics Buyers' Guide... Easy-to-use, single volume source for:

- Information on over 4,000 products
- Over 6,000 company listings and phone numbers — both home and field offices
- **EBG EXCLUSIVE:** quick access to over 800 helpful catalogs through a timesaving Direct Inquiry Service
- More than 1,400 pages of data

Here is the international world of electronics at your fingertips. Find suppliers... fast... accurately... and locally! Don't have a copy? Use coupon below, today.

Electronics Buyers' Guide

A McGraw-Hill Publication
1221 Ave. of the Americas, N.Y. N.Y. 10020

Yes, send me _____ copies (copy) of the energy saving Electronics Buyers' Guide. I've enclosed \$15.00 (USA and Canada only; elsewhere send \$25.00). Full money back guarantee if not satisfied.

NAME _____

COMPANY _____

STREET _____

CITY _____

STATE _____ ZIP _____

New books

also some helpful diagrams of various waste-treatment systems.

—Peter E. Kukanskis,
MacDermid Inc.

MOS Field-Effect Transistors and Integrated Circuits, Paul Richman, Wiley Interscience, 1973, \$14.95

Transistors have come a long way since 1970. At that time, a good field-effect (both junction and MOS) transistor textbook was published, Richard Cobbold's "Theory and Application of Field-Effect Transistors." Cobbold's remains a useful text, but Paul Richman's new book illustrates the maturing of a technology as it moves from the research laboratory to the production environment.

Richman's book provides a good summary of MOS theory and technology before 1973. Although billed as a textbook, the problems included are generally of the discussion type, and he provides no specific "answers." His is a "pedagogic monograph," rather than a self-study-type text.

By covering devices and processing, the text brings the novice up to snuff in most aspects of today's MOS technology. The approach is standard; he considers surface-state theory and MOS transistors before getting into technology.

This volume is basically oriented toward devices and processing. Previous texts in field-effect transistors had a stronger emphasis on hooking up MOS transistors and on circuit analysis. A good mixture of the two approaches is used in Cobbold's book, which also is very strong on detailing assumptions behind derivations.

Richman's book discusses such current topics as parasitic-MOS-substrate devices, silicon-on-sapphire technology, local-oxidation technology and metalization systems. It has mainly qualitative discussions of nitrate insulators and MNOS technology. Although weak on actual MOS circuitry and integrated-circuit structures, especially complementary-MOS technology, Richman provides a good introduction to MOS technology for those interested in device physics and processing.

—Joel Dubow, Components Editor

DSA-500 REED SWITCH

Standard size pressurized reed switch with silver contacts.

Suitable for switching high voltage loads, or high inrush loads.

Breakdown voltage
1200 volts D.C.

Switching voltage
500 volts D.C.

Max. power
50VA.

Max. Current
3 amps.

Max. Inrush Current
6 amps.



FR
ELECTRONICS LTD
WIMBORNE - DORSET - ENGLAND
TELEPHONE: WIMBORNE 2442 - TELEX 41247

Britain's major manufacturer
of Reed Switches



EMPLOYMENT OPPORTUNITIES

Send New Ads to:

Electronics
Class. Adv. Dept.
P.O. Box 900, N.Y., N.Y. 10020

POSITIONS VACANT

Positions Available-Electrical & Electronic Eng's. Over 1000 US client co's pay our fees for selected technical referrals. Est. 1959. Send resume with presal. Atomic Personnel, Inc., Box L, 1518 Walnut St., Phila., Pa. 19102.

**REMEMBER
TO USE
ZIP CODE**

Q. Whom do I contact or call to renew my classified ad or make corrections?

A. Write Electronics, Class. Adv. Dept., P.O. Box 900, NY, NY 10020 or call: (212) 997-6585 or 6586. Give full company name, size of ad, & date or dates it is scheduled to appear.

Job-seekers... be the first to know with McGraw-Hill's Advance Job Listings

By having our new weekly ADVANCE JOB LISTINGS sent First-Class (or by Air Mail, if you prefer) to your home every Monday you can be the first to know about nation-wide openings you qualify for both in and out of your field.

This preprint of scheduled employment ads will enable you to contact anxious domestic and overseas recruitment managers BEFORE their advertisements appear in upcoming issues of 22 McGraw-Hill publications.

To receive a free sample copy, plus information about our low subscription rates (from one month to 12), fill out and return the coupon below.

ADVANCE JOB LISTINGS / P.O. BOX 900 / NEW YORK NY 10020

PLEASE SEND A SAMPLE COPY
OF ADVANCE JOB LISTINGS TO:



NAME _____

ADDRESS _____

CITY _____

STATE _____

ZIP _____

E5/16/74

CLASSIFIED ADVERTISING

SEARCHLIGHT SECTION
 BUSINESS OPPORTUNITIES
 USED OR SURPLUS EQUIPMENT

HERMETIC SEALING

GLASS/CERAMIC TO METAL
CONNECTORS • HEADERS
CUSTOM SEALS
I C FLAT PACKS • RELAY BASE
FEED THRU TERMINALS
TESTING SERVICES
Hermetic Sealing Since 1959

DETRONICS Corporation

10660 E. Rush, S. El Monte, CA. 91733
(212) 579-7130—TWX 910 587-3436

RADAR SYSTEMS GROUND AND AIRBORNE AUTOMATIC TRACKING ANTENNA SYSTEMS. NIKE AJAX. NIKE HERCULES M-33. MSQ-1A. MPS-19. MPS-9. SCR 584. TPS-1D. TPS-28. FAA-ASR-2. AIRBORNE SYSTEMS. APN-84. APN-102. APS-20. APS-27. APS-45. DPN-19. DIGITAL COMPUTERS. IBM 650. IBM 704.

 LARGEST INVENTORY OF RADAR AND MICROWAVE EQUIPMENT IN THE WORLD.
RADIO RESEARCH INSTRUMENT CO.
 3 QUINCY ST., NORWALK, CONN. 06850 (203) 853-2600

CIRCLE 953 ON READER SERVICE CARD

SAME DAY SHIPMENT
Minis & Peripherals

PDP SPECIALISTS
8, 8I, 8L & 11

NEW 300 LPM PRINTERS

PDI CARD READERS

BRPE PUNCHES

\$750 Minis

TELETYPE 35 & 37
DEC & HONEYWELL Modules
617/261-1100

Send for Free Report "Maintenance of Computers"

AMERICAN USED COMPUTER CORP.
P.O. Box 68, Kenmore Sta., Boston, MA 02215
member COMPUTER DEALERS ASSOCIATION

CIRCLE 954 ON READER SERVICE CARD

free catalog
POTTING APPLICATORS
 MANUAL OR AIR OPERATED
 2½cc 6cc 12cc 30cc
 FOR POTTING, ENCAPSULATING ETC.

PHILIP FISHMAN CO., INC.
 7 CAMERON ST. WELLESLEY, MASS. 02181

CIRCLE 956 ON READER SERVICE CARD

FREE CATALOG
HARD-TO-FIND PRECISION TOOLS
 Lists more than 2000 items—pliers, tweezers, wire strippers, vacuum systems, relay tools, optical equipment, tool kits and cases. Also includes ten pages of useful "Tool Tips" to aid in tool selection.

 **JENSEN TOOLS**
 4117 N. 44th Street, Phoenix, Ariz. 85018

CIRCLE 957 ON READER SERVICE CARD

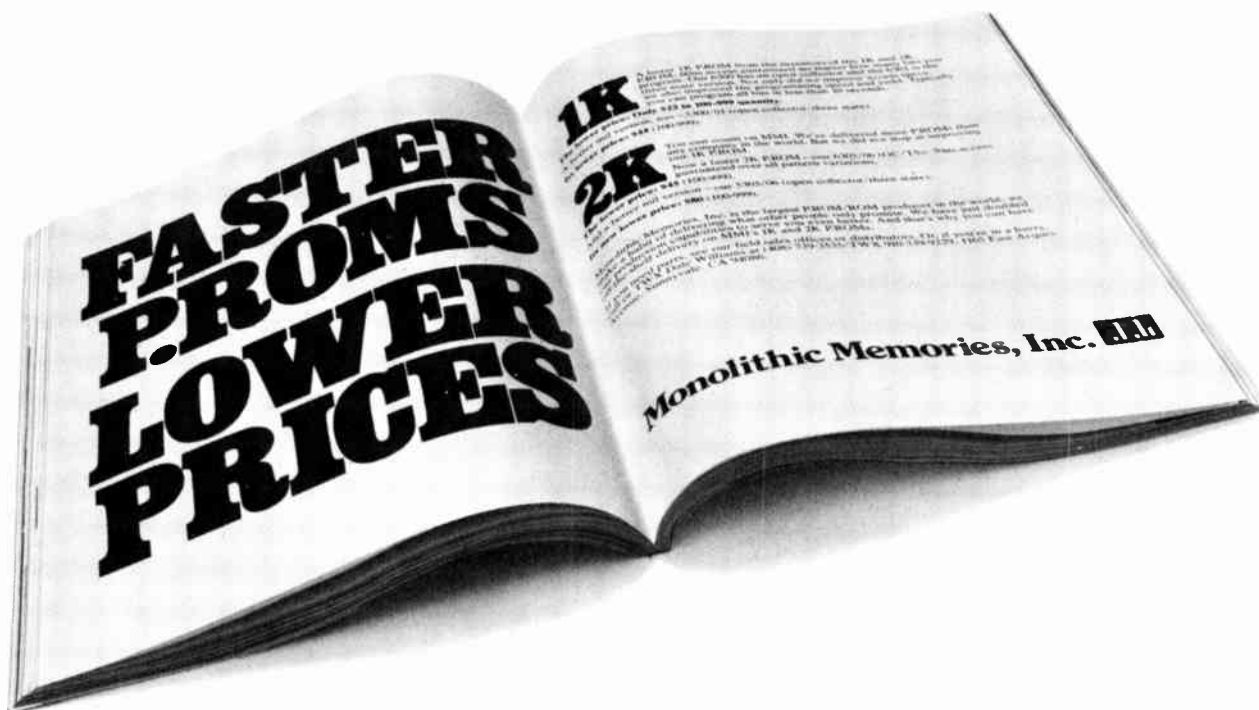

**We created an industry standard.
You created an industry shortage.**

The 2K PROM.

Monolithic Memories, Inc. is the largest PROM/ROM producer in the world; we make a habit of delivering what other people only promise.

With the help of our recently expanded production facilities, we now offer immediate availability on faster 2K PROMs (70ns) that come in open collector and three state versions. Mil versions, too.

Our numbers: MM1 6305J/6306J (OC/TS) commercial.
MM1 5305D/5306D (OC/TS) military.

Your numbers: \$45 (6305J/06J) (100-999).
\$80 (5305D/06D) (100-999).

Come and get 'em.

Monolithic Memories, Inc., 1165 East Arques Avenue, Sunnyvale, CA 94086, (408) 739-3535/TWX 910-339-9229.

Monolithic Memories, Inc. 

EASTERN AREA SALES OFFICE: (617) 653-3158 • NEW ENGLAND REGION: (617) 475-8883 • NEW YORK REGION: (607) 748-3211 • CENTRAL AREA SALES OFFICE: (214) 239-9148 • MINNEAPOLIS REGION: (612) 922-9122 • WESTERN AREA SALES OFFICE: (714) 556-1216
Representing your best buy in memories: ALABAMA, Huntsville (205) 539-1771; ARIZONA, Phoenix (602) 264-7971; CALIFORNIA, Palo Alto (415) 369-4671; COLORADO, Denver (303) 423-1020; CONNECTICUT, North Haven (203) 239-9762; FLORIDA, Orlando (305) 423-7615; ILLINOIS, Chicago (312) 593-0200; INDIANA, Ft. Wayne (219) 432-5591; Indianapolis (317) 359-9283; IOWA, Cedar Rapids (319) 393-8703; KANSAS, Kansas City (913) 236-4646; KENTUCKY, Louisville (502) 893-7303; MARYLAND, Baltimore (301) 825-3330; MASSACHUSETTS, Boston (617) 444-2484; MICHIGAN, Detroit (313) 358-2020; Grand Rapids (616) 451-8901; St. Joseph (616) 983-7337; MINNESOTA, Minneapolis (612) 929-6721; MISSOURI, St. Louis (314) 432-2830; NEW JERSEY, Teaneck (201) 692-0200; NEW YORK, N.Y./L.I. (201) 692-0200; NORTH CAROLINA, Raleigh (919) 834-6591; OHIO, Cincinnati (513) 521-2290; Dayton (513) 298-9546; Cleveland (216) 228-7525; PENNSYLVANIA, Willow Grove (215) 674-3850; Pittsburgh (412) 344-7277; TEXAS, Dallas (214) 239-9148; Houston (713) 721-1054; WASHINGTON, Seattle (206) 455-2778; WISCONSIN, Wauwatosa (414) 786-6330.

The Essential Three

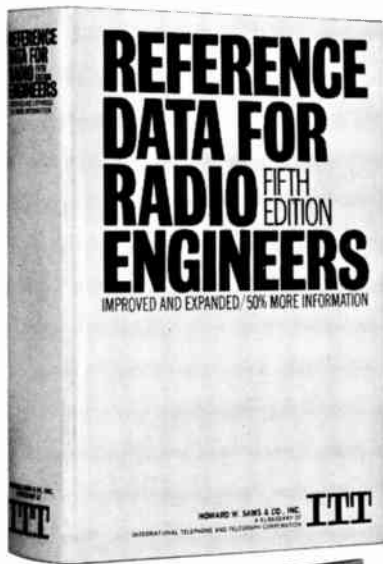

Reference Data For Radio Engineers Edited by staff of ITT
1196 pages, fully illustrated and indexed, \$20.00

Table of Contents

- Frequency Data
- International Telecommunication Recommendations
- Units, Constants, and Conversion Factors
- Properties of Materials
- Components or Parts
- Fundamentals of Networks
- Filters, Image-Parameter Design
- Filters, Modern-Network-Theory Design
- Filters, Simple Band-Pass Design
- Attenuators
- Magnetic-Core Transformers and Reactors
- Rectifiers and Filters
- Bridges and Impedance Measurements
- Magnetic Amplifiers
- Feedback Control Systems
- Electron Tubes
- Electron-Tube Circuits
- Semiconductors and Transistors
- Transistor Circuits
- Microminiature Electronics
- Modulation
- Transmission Lines
- Waveguides and Resonators
- Scattering Matrices
- Antennas
- Electromagnetic-Wave Propagation
- Radio Noise and Interference
- Broadcasting and Recording
- Radar Fundamentals
- Wire Transmission
- Switching Networks and Traffic Concepts
- Digital Computers
- Navigation Aids
- Space Communication
- Electroacoustics
- Nuclear Physics
- Quantum Electronics
- Information Theory
- Probability and Statistics
- Reliability and Life Testing
- Miscellaneous Data
- Fourier Waveform Analysis
- Maxwell's Equations
- Mathematical Tables

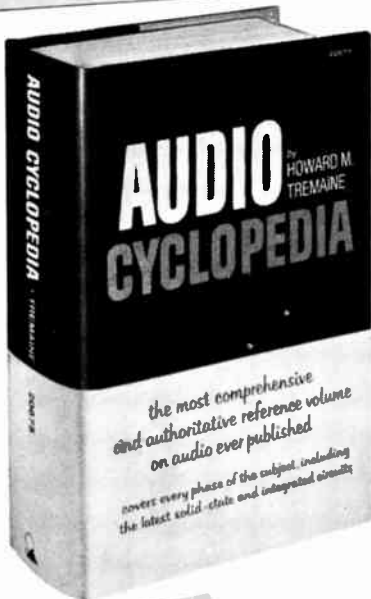

Audio Cyclopedia by Howard M. Tremaine
Over 1700 pages, easy-to-use Q & A format, \$29.95

Table of Contents

- Basic Principles of Sound
- Acoustics, Studio Techniques, and Equipment
- Constant-Speed Devices, Motors, and Generators
- Microphones
- Attenuators
- Equalizers
- Wave Filters
- Transformers and Coils
- Sound Mixers
- VU and Volume Indicator Meters
- Vacuum Tubes, Transistors, and Diodes
- Audio Amplifiers
- Disc Recording
- Cutting Heads
- Recording and Reproducing Styli
- Pickups
- Magnetic Recording
- Optical Film Recording
- Motion Picture Projection Equipment
- Loudspeakers, Enclosures, Headphones, and Hearing Aids
- Power Supplies
- Test Equipment
- Audio-Frequency Measurements
- Installation Techniques
- General Information, Charts and Tables

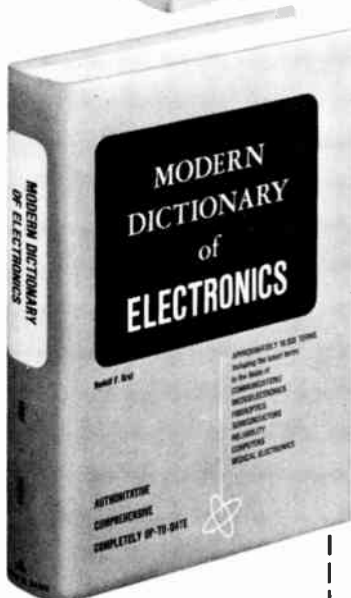

Modern Dictionary of Electronics by Rudolf F. Graf
Over 18,000 terms, completely up-to-date, \$12.95
Includes the latest terms in the fields of:

- Communications
- Microelectronics
- Fiberoptics
- Semiconductors
- Reliability
- Computers
- Medical Electronics

With today's exploding technology, it's critical that you keep your reference library current.
Get your copies now at your bookstore or use this handy order form.

E 054

HOWARD W. SAMS & CO., INC. E 054
4300 West 62nd Street
Indianapolis, Indiana 46268

Please send the following reference books:

_____ quantity	REFERENCE DATA FOR RADIO ENGINEERS at \$20.00 each (\$24.00 in Canada)	_____ Name	_____ Title
_____ quantity	AUDIO CYCLOPEDIA at \$29.95 each (\$35.95 in Canada)	_____ Company	_____
_____ quantity	MODERN DICTIONARY OF ELECTRONICS at \$12.95 each (\$16.95 in Canada)	_____ Address	_____
		_____ City	_____ State _____ Zip

Check or Money Order enclosed for \$ _____
(Include sales tax where applicable.)

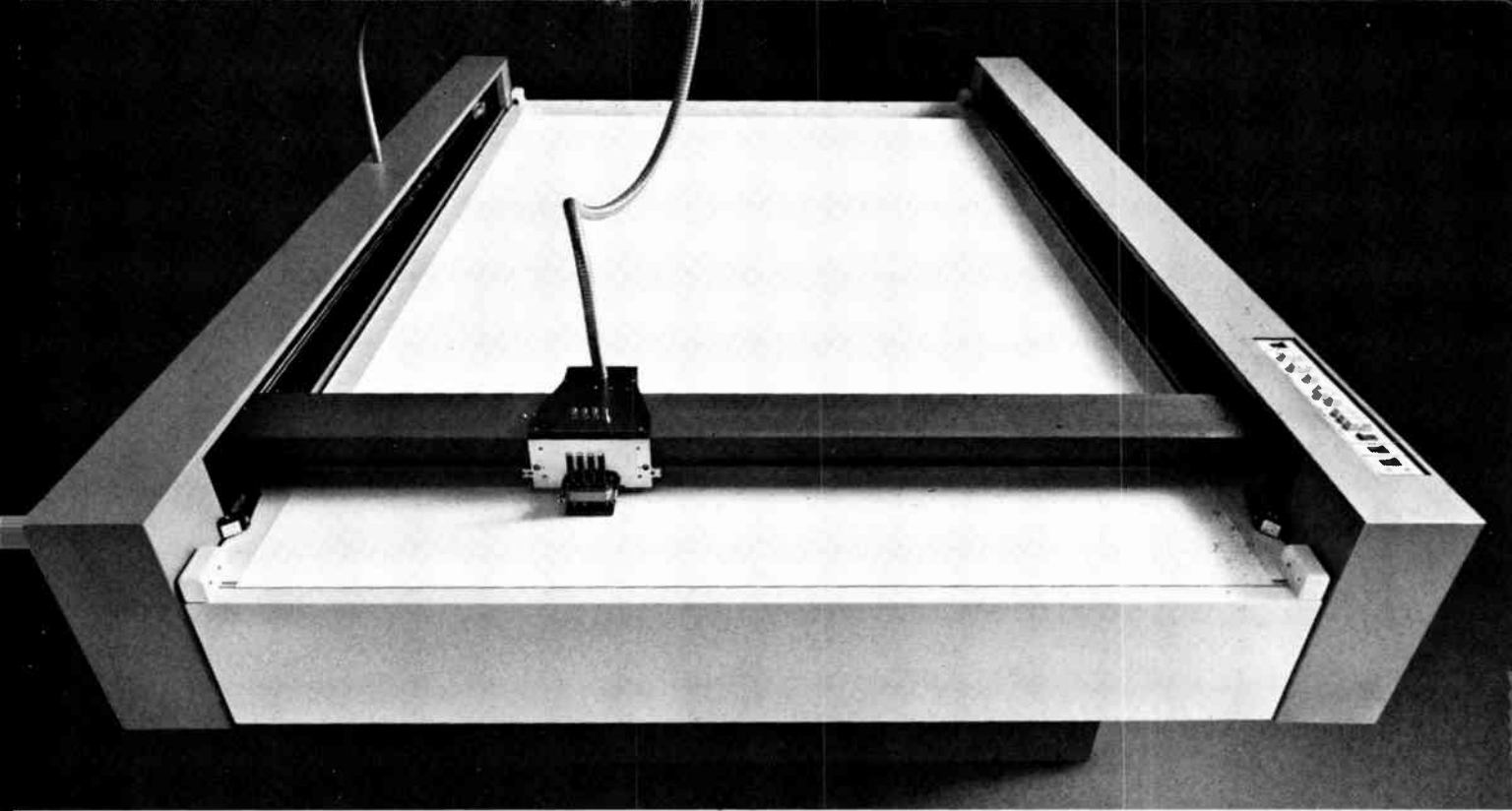

It draws faster than ink flows.

We call it the 748. It's big. And it's fast.

Its 4 inking pens move at speeds over 40 inches a second. That's faster than ink flows, so we had to figure out a pressure inking system that lets the ink catch up to the pens.

If you make integrated circuits or maps, or if you have precision drafting needs, this is the new tool.

The 748's plotting area is 48" x 82". It can scribe

coated materials and cut strippable film. At peak speeds!

The quality of its line is not impaired by its incredible speed. And like all CalComp flatbed plotters, the new 748 offers easy-to-use software for most computers.

We service it in 29 countries. But the way we've made it, you won't be calling us very often.

Do call us to see it. Our number is (714) 821-2011. Or

write California Computer Products, Inc., EM-M5-74, 2411 West La Palma Avenue, Anaheim, California 92801.



CALCOMP

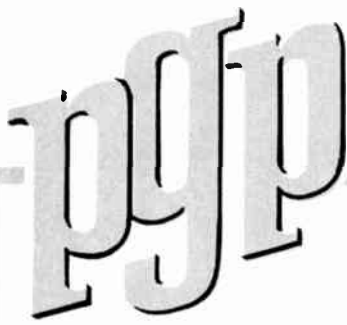

subsidiary of

GERALD METALS Inc.

Leading Refiner of:

- Gold and Platinum Group Metals

Purchaser of:

- Precious Metal Scrap
- Concentrates
- Solutions
- Catalysts

Supplier of:

- Bullion
- Sponge

Member:

New York Mercantile Exchange



industries, inc.

subsidiary of GERALD METALS INC.

13429 Alondra Boulevard
Santa Fe Springs, California 90670
Tels: (213) 921-7464 (213) 773-7922

New York Office: One Battery Park Plaza
New York, New York 10004

Tel: (212) 425-4160

Electronics advertisers

May 16, 1974

Abbott Transistor Labs Inc. Technical Adv. Agency	6	Coming Glass Works, Electronic Materials Dept. Pierce Brown Associates, Inc.	233.235
Adret Electronique Psycho Publicite	10E	Cramer Division of Conrac McCarthy, Scelba, DeBiasi	208-209
Advanced Micro Devices Keye/Donna/Pearlstein	10-11	‡ Cutler-Hammer, Inc. Campbell-Mithun, Inc.	195
AEROCOM Jacster Enterprises, Inc.	17E	Damon/Electronics Division Giardini/Russell, Inc.	200
Alco Electronic Products, Inc. Marketronics Advertising	188	Datacraft Resource Marketing, Inc.	181
Allen Bradley Company Hoffman, York, Baker & Johnson, Inc.	24	Data Control Systems, Inc. Ads & Images	198
Allied Chemical Corporation (Specialty Chemical Division) Perspectus, Inc.	179	■ Data Precision Advised Advertising Agency, Inc.	88
Allied Control Corp. Cooper Advertising, Inc.	164	DATATRON-TESTER DIVISION Larry Courtney Company	17
American Microsystems, Inc. Wilton Coombs & Coinett, Inc. Advertising	176-177	Diacon Rogondino Advertising & Marketing	188,236
American Optical Corp. Fiber Optics & Industrial Prod. Div. Wilson, Haight & Welch, Inc., Advertising	192	Delco Electronics Division, General Motors Corp. Campbell-Ewald Company	84-85
American Smelting and Refining Company Clyne Maxon, Inc.	198	Delts Products, Inc. The William Loughran Company	154
AMF/Potter & Blumfield Division Fuller & Smith & Ross, Inc.	140-141	■ Dialight Corporation Michel-Cather, Inc.	197
■ Analog Devices, Inc. Schneider Parker, Inc.	110	Dickson Electronics Corporation N.A. Winter Advertising Agency	192
‡ Ansley Electronics Corp. S. Michelson Advertising	64	Digi-Data Corporation R & J Associates	162
Anzac Electronics Ken Puleo Advertising	172	Digital Equipment Corporation Creamer, Trowbridge, Case & Basford, Inc.	135
• AOIP DP Industrie	13E	Digital Equipment Corporation Schneider, Parker, Inc.	193
■ APM-Hexseal The Sommer Agency, Inc.	186	• Duncan Electronics (A Division of Systron Donner) Enyart & Rose	15E
Atlan-Tol Industries, Inc.- AM-MET Division Michael London Associates	18	‡ Eastman Kodak Company, Business Systems Markets Div. J. Walter Thompson Co.	15
■ AVX Ceramics Allied Advertising Agency, Inc.	180	E-H Research Laboratories, Inc. Hal Lawrence, Inc.	190
• Bayer A.G. Werbeagentur	81	■ EL Instruments, Inc. Langeler-Stevens, Incorporated	174
Ballantine Laboratories, Inc. MLF Graphics	236	Electroglass, Inc. Roy Minor/Graphic Arts	156
Bausch & Lomb, Inc. Wolf Assoc., Inc.	146	‡ Elgar Corp. Chapman Michetti Advertising	153
‡ Bourns, Inc. Marlborough Assoc., Inc.	57	Emr-Telemetry Carol Marketing Associates	80,206
Brand-Rex Creamer, Trowbridge, Case & Basford, Inc.	217	Exact Electronics Hugh Dwight Advertising	79
Branson Instruments Co. Langler-Stevens, Inc.	166	Exar Integrated Systems Regis McKenna, Inc.	48
Burroughs Corp. Conti Advertising Agency, Inc.	9	Fairchild Semiconductor, Inc. Carson/Roberts, Inc. Adv., Division of Ogilvy & Mather, Inc.	136-137
California Computer Products Dailey & Associates Advertising	231	‡ Ferroxcube Black-Russell-Morris	191
• Canon Amsterdam N.V. Euro Advertising B.V.	62	■ Fluke Manufacturing Co., John Bonfield Associates	21-23
Carpenter Technology Corp. Beaumont, Heller & Sperling, Inc.	149	F. R. Electronics Ltd. T. W. Brooke Smith	227
Celanese Plastics Company D'Arcy-MacManus International, Inc.	147	• Function Modules, Inc. Leon Richman Design, Inc.	159
• Celdis Ltd. May, Winfield & Associates, Ltd.	8E-9E	• Ganz Measuring Instruments Hungexpo, Varosliget	20E
The Center for Technical Development Div. of Kurz-Kasch, Inc. Ethos, Inc.	186	GCA/Sunnyvale Moser & Associates	144
Cherry Electrical Products, Inc. Kolb/Tookey and Assoc., Inc.	203	General Automation Chiat-Day, Inc. Advertising	86-87
■ Clairax Corporation Black-Russell-Morris	4th Cover	■ General Electric Co., Semiconductor Products Department Advertising & Sales Promotion Syracuse Operation	189
Clare Electronics Markcom	171	■ General Electric Company, Utility & Process Automation Products Dept. Robert S. Cragin, Inc.	218-219
Contour Chemical Co. Engineered Advertising, Inc.	161	• General Instrument Europe S.P.A. Studio Sigismondi	18E
Coors Porcelain Co. Business Mail & Media Service Co.	46-47		
■ Cornell-Dubilier Electronics McCarthy, Scelba, DeBiasi Advertising Agency, Inc.	39,41		

■ General Instrument Corporation, Microelectronics Div. Norman Allen Associates, Inc.	215
General Magnetics McCarthy/Scelba/DeBiasi Adv. Agcy., Inc.	3rd Cover
• General Radio Grad Associates	3E
Georgia Department of Community Development Gerald Rafshoon Advertising, Inc.	20
The Gerber Scientific Instruments Co. Charles Palm & Co., Inc.	178
• Goertz Austria	77
■ Gould, Inc./Instrument Systems Div. Carr Liggett Adv., Inc.	192
G.T. Schjeldahl Co. Chuck Ruhr Assoc. Advertising, Inc.	163
‡ Guardian Electric Mfg. Co. Kolb/Tookey and Associates, Inc.	62-63
Hermes Electronics Ltd. Public & Industrial Relations Limited	138
■ Hewlett-Packard Dance Fitzgerald Sample, Inc.	114-115
■ Hewlett-Packard Richardson, Seigle, Rolfs & McCoy, Inc.	1
■ Hewlett-Packard Tallant Yates Adv., Inc.	2
■ Hewlett-Packard Richardson, Seigle, Rolfs & McCoy, Inc.	182
■ Hewlett-Packard Tallant/Yates Advertising, Inc.	82-83
■ Hickok Electrical Instrument Co. Carr Liggett Advertising, Inc.	28
‡ Howard Industries Kolb/Tookey & Associates, Inc.	58-59
Hutson Industries Greene, Webb Associates, Inc.	214
Hybrid Systems Corporation Henry Scammell Associates	160
Instrumentation Engineering, Inc. Fletcher-Walker-Gessell, Inc.	167
International Electronic Research Corp. Van Der Boom, McCarron, Inc., Advertising	212
International Rectifier Corp., Semiconductor Division William E. Wilson Company	129
‡ Intersil, Inc. Tyce-Fultz	199
Ise Electronics Corp. Shinwa International, Inc.	175
■ Ithaco, Inc. Stahlka/Faller, Inc.	185
■ Kepeco, Inc. Weiss Advertising	5
Litronix, Inc. Regis McKenna, Inc.	35
Microdata Company JMR Advertising	187
• Magnetil Marelli S.p.A. Publicor	15
■ MEPCO/ELECTRA, INC. Weilborn Advertising, Inc.	12-13
The Mica Corporation Robert A. White Advertising	169
Mirco Power Systems Associated Ad Ventures, Inc.	70
Micro Systems, Inc. McAward Associates	161
Monolithic Memories, Inc. Paul Pease Advertising, Inc.	229
Mostek Corporation David W. Evans, Inc./Texas	211
Motorola Communications & Electronics, Inc. Marsteller, Inc.	122
Motorola Semiconductor Products, Inc. E B Lane & Associates, Inc.	44-45, 75
■ Narda Microwave McCarthy, Scelba, DeBiasi Advertising Agency, Inc.	201

Neff Instruments Corp. Larry Courtney Company	155
■ Neison Ross Electronics, Div. Polarad Electronics McCarthy-Scelba-DeBiasi Advertising Agency, Inc.	236
• Nortron Technik Marketing	15E
PGP Industries, Inc. Centormedia, Inc.	232
• Phillips Elcoma Intermarco nederland	63
• Phillips N.V. Pli/T & M Division Brookies Communications Systems, SA	54
■ Piezo Technology, Inc. Shattuck/Roether Advertising, Inc.	196
P.K. Neuses, Inc. J.J. Carroll & Associates/Advertising	202
Plastics Engineering Company Kuttner & Kuttner, Inc.	224
Plessey Incorporated TCI Advertising, Inc.	193
‡ Plessey Semiconductors Basso/Buechting/Boatman	77
‡ Precision Monolithics, Inc. Marlborough Associates, Inc.	210
■ Raytheon Company, Industrial Components Operation Provandie Eastwood & Lombardi, Inc.	42
• RCA Ltd. Marsteller Ltd.	60-61
RCA - Solid State Division Marsteller, Inc.	67, 69
■ RCL Electronics, Inc. Morway Advertising Agency	14
‡ Rental Electronics, Inc. Humphrey Browning MacDougall, Inc.	54
Reticon Corporation The House Agency	43
• Rifa MK Marknads Kommunikation AB	64
• Rohde & Schwarz	57
Sakata International, Inc. David H. Stremmel & Co.	207
Howard W. Sams & Co. Aitkin-Kynett Co., Inc.	230
Schauer Manufacturing Corp. Nolan, Keelor & Slites	200
• Seacosem Bazaine Publicite	16E
SGS-ATES International McCann-Erickson	225-226
• Siemens Aktiengesellschaft Linder Presse Union GmbH	52
‡ Siemens Corporation Stiefel/Raymond Advertising, Inc.	60-61
Signetics Corp., Sub. of Corning Glass Works Hall Butler Blatherwick, Inc.	204-205
• Silec Societe Mexim	19E
Siliconix Robetson West, Inc.	99
Simpson Electric Co. Amerad Advertising Services, Inc.	71
• SMK Europe	7E
Spectra-Strip Corp. Wiltshire Newport, Inc.	170
■ Spectrol Electronics Corp. J M R, Inc.	139
Sprague Electric Company Harry P. Bridge Company	8
• Sprague Perez Publicite	58-59
Stackpole Carbon Company, Electronics Components Division Ira Thomas Associates, Inc.	220-223
Syston Donner Concord Instruments Fred Schott & Associates	51, 172

WHO MAKES MORE THAN 1,200 GLASS PREFORMS?

Need flat pack IC frames, beads, or other glass materials for hermetic encapsulation? Corning's MULTIFORM and CLEARFORM® products can have walls as thin as .015" and holes as small as .008". And more than 1,200 standard shapes to choose from. Or custom made to your spec in a range of thermal expansions capable of matching most metals and glasses. And they even come in colors for easy identification. Interested? Write or call:

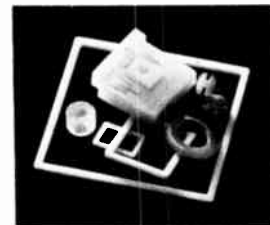

CORNING MAKES IT!

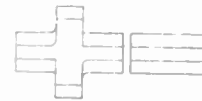

Electronic Materials Department
CORNING
 CORNING GLASS WORKS
 Corning, New York 14830
 (607) 974-8866

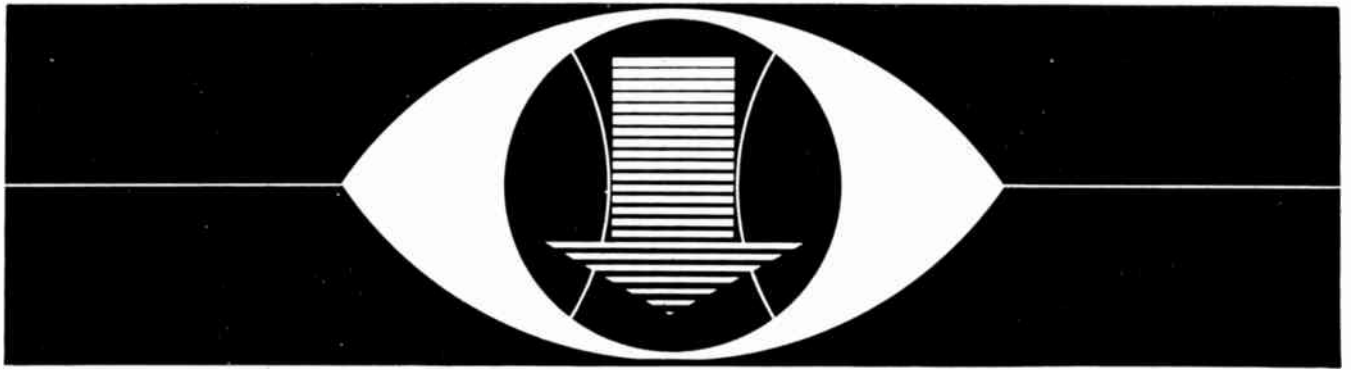

Can you find a fault with a film over a 0.000001 cm^2 area?

The natural answer is: NO.
The true answer is: YES,
with the

LEM-2 ellipsometric Laser microscope offering:

- Non-destructive contact-less inspection
- A wide range of thickness of dielectric films and coatings that can be measured
- Response to a variation in the film thickness less than one atomic layer
- Extra simple operation

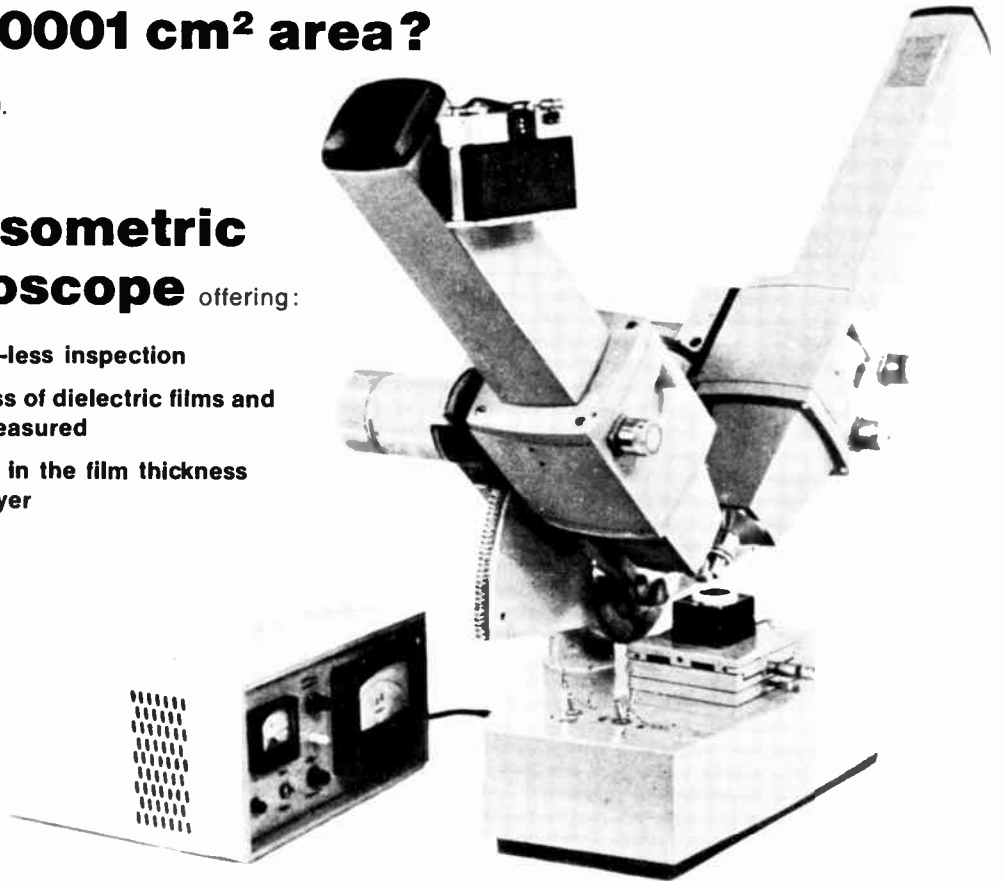

The LEM-2 is the first means to measure the thickness of dielectric films in mini-size "ports" in protective layers employed in planar techniques of production of integral circuits and individual semiconductor devices

the LEM-2 is also capable of:

- measuring the optical parameters of semiconductors & metals,
- investigating adsorption and desorption,
- detecting flaws in dielectric coatings with great sharpness.

Exporter: V/O TECHMASHEXPOR

35, Mosfilmovskaya · Moscow V-330 USSR · Telex: 7568 · Agents:

AMTORG TRADING CORPORATION 355 Lexington Avenue, New York, N.Y. 10017

50th ANNIVERSARY
of Amtorg Trading Corporation this year

TECHMASHEXPOR

Tau-Tron, Inc. Billings & Reece, Inc.	172
■ T-Bar, Incorporated The Robert A. Paul Advertising Agency, Inc.	202
■ TEC, Inc. TEC-AD	78
• Tekelec Airltronic S.P.F.D.	5E,20E
‡ Tektronix, Inc. McCann Erickson, Inc.	158-159
■ Tektronix-IDD Young & Roehr, Inc.	19,33
Teledyne Philbrick Ingalls Associates, Inc. Advertising	2nd Cover
Thomas & Skinner, Inc. Bell-Catterlin & Hedgecock Advertising, Inc.	146
■ TRW/CAPACITORS Gray & Rogers, Inc.	152
■ TRW Electronics, Semiconductor Division The Bowes Company	7
■ Union Carbide Corp. J. J. Lane, Inc.	151
‡ United Chemicon, Inc. Spitz Advertising Agency, Inc.	81
United Systems Corp., A sub. of Monsanto Co. Advertising & Merchandising, Inc.	213
■ Unitrode Corporation Culver Advertising, Inc.	27
Universal Instrument Corp. Conklin, Labs & Bebes, Inc.	37
Utah Industrial Promotion Division Harris & Love, Inc./Advertising	148
Vactec, Inc. Coleman & Associates Advertising	165
Varo Semiconductor, Inc. Warren-Guild	150
■ Victory Engineering Corporation A.D. Adams Advertising, Inc.	194
V/O Techmasheport Vneshtorgreklama	234
Wavetek Indiana Chapman Michetti Advertising	142
Wiltron Company Frank Burkhard Company	76
Wima, Westermann Oliver-Beckmann GmbH	16
• Yokogawa Electric Works, Ltd. General Advertising Agency, Inc.	195

Classified & Employment Advertising
F. J. Eberle, Manager 212-971-2557

EQUIPMENT (Used or Surplus New) For Sale	
American Used Computer Corp.	228
Detronics	228
Philip Fishman Co., Inc.	228
Jensen Tools	228
Radio Research Instrument Co.	228

■ For more information on complete product line see advertisement in the latest Electronics Buyer's Guide
* Advertisers in Electronics International
‡ Advertisers in Electronics domestic edition

Advertising Sales Staff

Pierre J. Braudé New York [212] 997-3468
London 01-493-1451
Director of Marketing

Atlanta, Ga. 30309: Joseph Lane
100 Colony Square, 1175 Peachtree St., N.E.
[404] 892-2868

Boston, Mass. 02116: James R. Pierce
607 Boylston St. [617] 262-1160

Chicago, Ill. 60811:
645 North Michigan Avenue
Robert W. Bartlett (312) 751-3739
Paul W. Reiss (312) 751-3738

Cleveland, Ohio 44113: William J. Boyle
[716] 586-5040

Dallas, Texas 75201: Charles G. Hubbard
2001 Bryant Tower, Suite 1070
[214] 742-1747

Denver, Colo. 80202: Harry B. Doyle, Jr.
Tower Bldg., 1700 Broadway
[303] 266-3863

Detroit, Michigan 48202: Robert W. Bartlett
1400 Fisher Bldg
[313] 873-7410

Houston, Texas 77002: Charles G. Hubbard
2270 Humble Bldg. [713] CA 4-8381

Los Angeles, Calif. 90010: Robert J. Rielly
Bradley K. Jones, 3200 Wilshire Blvd., South Tower
[213] 487-1160

New York, N.Y. 10020
1221 Avenue of the Americas
Warren H. Gardner [212] 997-3617
Michael J. Stoller [212] 997-3616

Philadelphia, Pa. 19102: Warren H. Gardner
Three Parkway.
[212] 997-3617

Pittsburgh, Pa. 15222: Warren H. Gardner
4 Gateway Center. [212] 997-3617

Rochester, N.Y. 14534: William J. Boyle
9 Greylock Ridge, Pittsford, N.Y.
[716] 586-5040

San Francisco, Calif. 94111: Don Farns
Robert J. Rielly, 425 Battery Street.
[415] 362-4600

Paris: Alain Offergeld
17 Rue-Georges Bizet, 75 Paris 16, France
Tel: 720-73-01

Geneva: Alain Offergeld
1 rue du Temple, Geneva, Switzerland
Tel: 32-35-63

United Kingdom & Scandinavia: Keith Mantle
Tel: 01-493-1451, 34 Dover Street, London W1

Milan: Robert Sadel
1 via Baracchini, Italy Phone 87-90-656

Brussels: Alain Offergeld
23 Chaussee de Wavre
Brussels 1040, Belgium
Tel: 13-73-95

Frankfurt/Main: Frnz Krusebecker
Liebigstrasse 27c, Germany
Phone 72 01 81

Tokyo: Tatsumi Katagiri, McGraw-Hill
Publications Overseas Corporation,
Kasumigaseki Building 2-5, 3-chome,
Kasumigaseki, Chiyoda-Ku, Tokyo, Japan
[581] 9811

Osaka: Ryji Kobayashi, McGraw-Hill
Publications Overseas Corporation, Kondo
Bldg., 163, Umegae-cho Kita-ku, Japan [362] 8771

Australia: Warren E. Ball, IPO Box 5106,
Tokyo, Japan

Business Department

Stephen R. Weiss, Manager
[212] 997-2044

Thomas M. Egan,
Production Manager [212] 997-3140

Carol Gallagher
Assistant Production Manager [212] 997-2045

Dorothy Carter, Contracts and Billings
[212] 997-2908

Frances Vallone, Reader Service Manager
[212] 997-6057

Electronics Buyers' Guide

George F. Werner, Associate Publisher
[212] 997-3139

Regina Hers, Directory Manager
[212] 997-2544

**WHO
MAKES
CRT
BULBS
IN
100
SHAPES?**

Corning makes over 100 standard shapes from 1 to 36-inches. Or we'll make one in nearly any shape and size you specify. CRT's still provide the cheapest per digit display capability compared to flat-panel displays. Interested? Write or call:

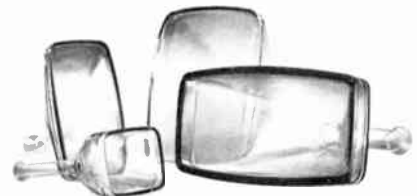

**CORNING
MAKES
IT!**



Electronic Materials Department

CORNING
CORNING GLASS WORKS

Corning, New York 14830
(607) 974-8866

DIACON'S AUTOMATIC ENVIRONMENTAL STORAGE HANDLER:

- 200 DEVICES IN 029 CARRIERS
- RELIABLE • SIMPLE
- EASY TO MAINTAIN

Fewer moving parts inside the environment (two bushings only) provide long, maintenance-free operation. The Diakon storage handler is quiet and mechanically uncomplicated. Which helps eliminate down-time. Operates on 120 or 240 V.

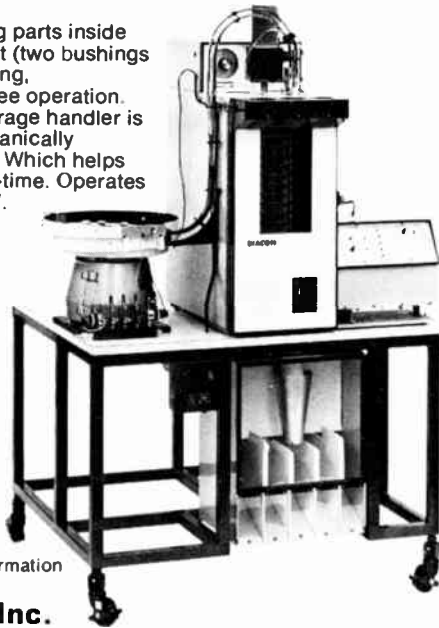

For complete information and specs, write:

DIACON, Inc.
4812 Kearny Mesa Rd.
San Diego, Calif. U.S.A.
(714) 279-6992

Circle 236 on reader service card

Buy the Ballantine 3/24 DMM

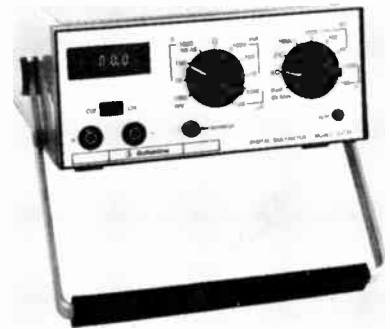

24 Ranges — 3 Full Digits

- AC Volts, AC Current, Ohms, DC Volts, DC Current
- Fully Overload Protected
- 300 Hour Dependable Battery Life
- Pocket Size — Weighs Under 2 Pounds
- 0.2% DC Accuracy — AC to 20 kHz

Available from Stock
Factory/Distributor

\$195
complete



Ballantine Laboratories, Inc.

P.O. Box 97, Boonton, New Jersey 07005
201-335-0900, TWX 710-987-8380

Circle 237 on reader service card

Workhorse Spectrum Analyzer... **100Hz to 25MHz**

The new Nelson Ross Model 236 is a multi-purpose, easy to use, workhorse Spectrum Analyzer with outstanding performance features and an exceptionally low price of \$3275.

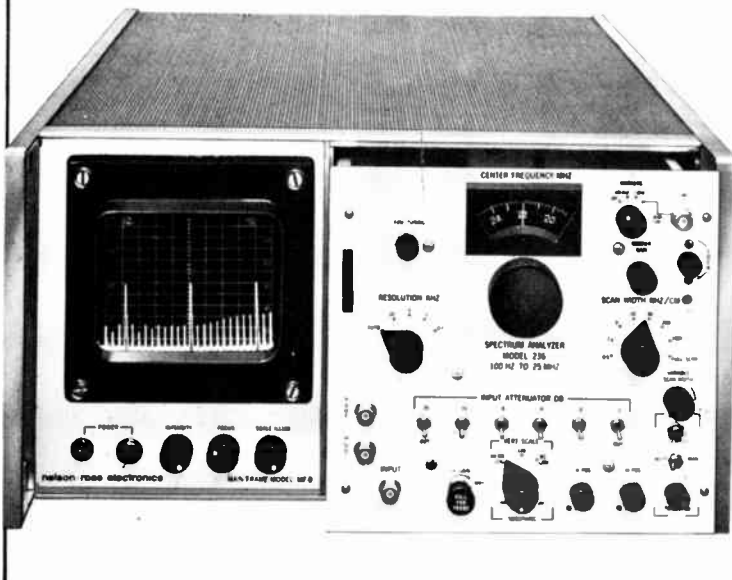

- Preset 0-25MHz quick-look scan and 0-10MHz adjustable scan widths
- 100Hz resolution, automatic and adjustable modes
- -105 dbm (1.25 μ V) sensitivity
- >60 db dynamic range for IM and Harmonic Distortion analysis
- Self-checking: Crystal frequency marker combs at 1MHz and 100KHz intervals. Absolute level reference

Numerous other versatile NR Spectrum Analyzers are available from sub-audio through microwave, 0.5Hz to 6.5GHz; complete free standing analyzers with interchangeable plug-ins, or just the plug-in analyzers for your TEK and HP scopes.

Call or write to the "Specialists"; complete specifications are yours for the asking; or, circle the reader service number.

**nelson • ross
electronics**

A DIVISION OF POLARAD ELECTRONICS CORP.
5 Delaware Drive, Lake Success, N.Y. 11040
516-328-1100 • TWX: 510-223-0414

236 Circle 89 on reader service card

Electronics/May 16, 1974

Electronics

52490

Please enter my subscription to **ELECTRONICS** for three years at \$24.

1. I prefer one year at \$12 Payment enclosed
 Bill my company Bill me

CHARGE MY SUBSCRIPTION TO

<input type="checkbox"/> AMERICAN EXPRESS	<input type="checkbox"/> MASTER CHARGE
<input type="checkbox"/> DINERS CLUB	<input type="checkbox"/> BANKAMERICARD
ACCT NO _____	
DATE CARD EXPIRES _____	
INTERBANK NO _____	1st No's above name on Mastercharge only

NAME _____ TITLE _____

COMPANY _____ DIV or DEPT _____

COMPANY ADDRESS _____

CITY _____ STATE _____ ZIP _____

Check here if you wish publication to be sent to home address
 STREET _____ CITY _____ STATE _____ ZIP _____

Above rates apply only to those who answer all questions listed below. All others pay higher than basic price of \$25.00 per year.

Signature _____

2. PLANT DEPARTMENT
- Indicate the primary product manufactured or service performed at your plant (Box 1) and in your department (Box 2). Be sure to indicate applicable letter in each of the two boxes even if they are the same letter.
- | | | |
|---|--|--|
| A. Large computers | K. Industrial controls, systems and equipment | U. Research and development organizations which are a part of an educational institution |
| B. Mini-computers | L. Sub-assemblies | V. Government Agency and military |
| C. Computer peripheral equipment | M. Passive electronic components | W. Industrial companies using and/or incorporating electronic products in their mfg., research or development activities |
| D. Data Processing Systems (systems integraticn) | N. Active electronic components | X. Utilities |
| E. Office and business machines | O. Materials and Hardware | Y. Broadcasting, sound and motion pictures and recording studios |
| F. Test and measuring equipment | P. Aircraft Missiles space and ground support equipment | Z. Commercial users of electronic equipment (railroads, pipelines, police, airlines) |
| G. Communications systems and equipment | Q. Oceanography and support equipment | 9. College, University |
| H. Navigation and guidance or control systems | R. Medical electronics | |
| I. Consumer entertainment electronic equipment | S. Industrial equipment containing electronic components or products | |
| J. Other consumer electronic equip. (appliances, autos, hand tools) | T. Independent R&D laboratory and consultant | |

3. Indicate your principal job function (place applicable number in box. If numbers 9, 10, or 11 are used, fill in name of college or university)
1. General and corporate management
 2. Design and development engineering
 3. Engineering services (evaluation, quality control, reliability, standards, test)
 4. Basic research
 5. Manufacturing and production
 6. Engineering support (lab assistant, technician)
 7. Purchasing and procurement
 8. Marketing and sales
 9. Professor at _____
 10. Senior student at _____
 11. Graduate student at _____

4. Indicate your principal job responsibility (place applicable number in box)
1. Management
 2. Engineering

5. Are you engaged in or do you supervise the design or redesign of electronic components or equipment? (check one)
- YES NO

6. Estimated number of employees at this location. (check one)
- 1 to 49 50 to 249 250 to 999 over 1,000

FIRST CLASS
PERMIT No. 42
HIGHTSTOWN, N.J.

BUSINESS REPLY MAIL
NO POSTAGE STAMP NECESSARY IF MAILED IN U.S.

Postage will be paid by

Electronics
McGRAW-HILL, INC.
SUBSCRIPTION DEPT.
P.O. BOX 514
HIGHTSTOWN, N.J. 08520

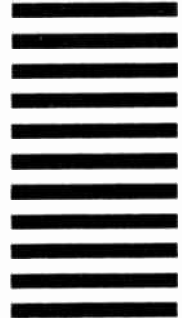

For additional information on products advertised, new products or new literature, use the adjacent business reply cards.

Complete entire card. Please print or type.

Circle the number on the Reader Service postcard that corresponds to the number at the bottom of the advertisement, new product item, or new literature in which you are interested.

To aid the manufacturer in filling your request, please check the appropriate industry classification box.

Postage is prepaid in U.S. Correct amount of postage must be affixed for all mailings from outside the U.S.

All inquiries from outside the U.S. that cannot reach Electronics before the expiration dates noted on the Reader Service postcard must be mailed directly to the manufacturer. The manufacturer assumes all responsibilities for responding to inquiries.

Subscriptions & Renewals

Fill in the subscription card adjoining this card. Electronics will bill you at the address indicated on the card.

ELECTRONICS

May 16, 1974

card expires July 30, 1974

NAME _____ TITLE _____

COMPANY _____

STREET _____

CITY _____ STATE _____ ZIP _____

Industry Classification (check one)

- | | |
|--|--|
| <input type="checkbox"/> a Computer & Related Equip. | <input type="checkbox"/> f Consumer Products |
| <input type="checkbox"/> b Communications Equip. & Systems | <input type="checkbox"/> g Industrial Controls & Equip. |
| <input type="checkbox"/> c Navigation, Guidance or Control Systems | <input type="checkbox"/> h Components & Subassemblies |
| <input type="checkbox"/> d Aerospace, Underseas Ground Support | <input type="checkbox"/> j Independent R&D Organizations |
| <input type="checkbox"/> e Test & Measuring Equip. | <input type="checkbox"/> k Government |

1	21	41	61	81	101	121	141	161	181	201	221	241	261	343	363	383	403	423	443	463	483	503	713
2	22	42	62	82	102	122	142	162	182	202	222	242	262	344	364	384	404	424	444	464	484	504	714
3	23	43	63	83	103	123	143	163	183	203	223	243	263	345	365	385	405	425	445	465	485	505	715
4	24	44	64	84	104	124	144	164	184	204	224	244	264	346	366	386	406	426	446	466	486	506	716
5	25	45	65	85	105	125	145	165	185	205	225	245	265	347	367	387	407	427	447	467	487	507	717
6	26	46	66	86	106	126	146	166	186	206	226	246	266	348	368	388	408	428	448	468	488	508	718
7	27	47	67	87	107	127	147	167	187	207	227	247	267	349	369	389	409	429	449	469	489	509	719
8	28	48	68	88	108	128	148	168	188	208	228	248	268	350	370	390	410	430	450	470	490	510	720
9	29	49	69	89	109	129	149	169	189	209	229	249	269	351	371	391	411	431	451	471	491	511	900
10	30	50	70	90	110	130	150	170	190	210	230	250	270	352	372	392	412	432	452	472	492	702	901
11	31	51	71	91	111	131	151	171	191	211	231	251	271	353	373	393	413	433	453	473	493	703	902
12	32	52	72	92	112	132	152	172	192	212	232	252	272	354	374	394	414	434	454	474	494	704	951
13	33	53	73	93	113	133	153	173	193	213	233	253	273	355	375	395	415	435	455	475	495	705	952
14	34	54	74	94	114	134	154	174	194	214	234	254	274	356	376	396	416	436	456	476	496	706	953
15	35	55	75	95	115	135	155	175	195	215	235	255	275	357	377	397	417	437	457	477	497	707	954
16	36	56	76	96	116	136	156	176	196	216	236	256	338	358	378	398	418	438	458	478	498	708	956
17	37	57	77	97	117	137	157	177	197	217	237	257	339	359	379	399	419	439	459	479	499	709	957
18	38	58	78	98	118	138	158	178	198	218	238	258	340	360	380	400	420	440	460	480	500	710	958
19	39	59	79	99	119	139	159	179	199	219	239	259	341	361	381	401	421	441	461	481	501	711	959
20	40	60	80	100	120	140	160	180	200	220	240	260	342	362	382	402	422	442	462	482	502	712	960

ELECTRONICS

May 16, 1974

card expires July 30, 1974

NAME _____ TITLE _____

COMPANY _____

STREET _____

CITY _____ STATE _____ ZIP _____

Industry Classification (check one)

- | | |
|--|--|
| <input type="checkbox"/> a Computer & Related Equip. | <input type="checkbox"/> f Consumer Products |
| <input type="checkbox"/> b Communications Equip. & Systems | <input type="checkbox"/> g Industrial Controls & Equip. |
| <input type="checkbox"/> c Navigation, Guidance or Control Systems | <input type="checkbox"/> h Components & Subassemblies |
| <input type="checkbox"/> d Aerospace, Underseas Ground Support | <input type="checkbox"/> j Independent R&D Organizations |
| <input type="checkbox"/> e Test & Measuring Equip. | <input type="checkbox"/> k Government |

1	21	41	61	81	101	121	141	161	181	201	221	241	261	343	363	383	403	423	443	463	483	503	713
2	22	42	62	82	102	122	142	162	182	202	222	242	262	344	364	384	404	424	444	464	484	504	714
3	23	43	63	83	103	123	143	163	183	203	223	243	263	345	365	385	405	425	445	465	485	505	715
4	24	44	64	84	104	124	144	164	184	204	224	244	264	346	366	386	406	426	446	466	486	506	716
5	25	45	65	85	105	125	145	165	185	205	225	245	265	347	367	387	407	427	447	467	487	507	717
6	26	46	66	86	106	126	146	166	186	206	226	246	266	348	368	388	408	428	448	468	488	508	718
7	27	47	67	87	107	127	147	167	187	207	227	247	267	349	369	389	409	429	449	469	489	509	719
8	28	48	68	88	108	128	148	168	188	208	228	248	268	350	370	390	410	430	450	470	490	510	720
9	29	49	69	89	109	129	149	169	189	209	229	249	269	351	371	391	411	431	451	471	491	511	900
10	30	50	70	90	110	130	150	170	190	210	230	250	270	352	372	392	412	432	452	472	492	702	901
11	31	51	71	91	111	131	151	171	191	211	231	251	271	353	373	393	413	433	453	473	493	703	902
12	32	52	72	92	112	132	152	172	192	212	232	252	272	354	374	394	414	434	454	474	494	704	951
13	33	53	73	93	113	133	153	173	193	213	233	253	273	355	375	395	415	435	455	475	495	705	952
14	34	54	74	94	114	134	154	174	194	214	234	254	274	356	376	396	416	436	456	476	496	706	953
15	35	55	75	95	115	135	155	175	195	215	235	255	275	357	377	397	417	437	457	477	497	707	954
16	36	56	76	96	116	136	156	176	196	216	236	256	338	358	378	398	418	438	458	478	498	708	956
17	37	57	77	97	117	137	157	177	197	217	237	257	339	359	379	399	419	439	459	479	499	709	957
18	38	58	78	98	118	138	158	178	198	218	238	258	340	360	380	400	420	440	460	480	500	710	958
19	39	59	79	99	119	139	159	179	199	219	239	259	341	361	381	401	421	441	461	481	501	711	959
20	40	60	80	100	120	140	160	180	200	220	240	260	342	362	382	402	422	442	462	482	502	712	960

If the cards below have already been used, you may obtain the needed information by writing directly to the manufacturer, or by sending your name and address, plus the Reader Service number, to Electronics Reader Service Department, Box 2530, Clinton, Iowa 52732.

Affix
Postage here

Electronics

P.O. Box No. 2530
Clinton, Iowa 52732

Affix
Postage here

Electronics

P.O. Box No. 2530
Clinton, Iowa 52732

Electronics Reprint Service

Bulk reprints of editorial matter can be ordered from current or past issues. The minimum quantity is 500 copies. Prices quoted on request: call 609-448-1700 Ext. 5494, or write to address below.

Bringing Sight to the Blind
8 pages \$2.00
Key no. R-408

Logic's New Design Tools
16 pages \$3.00
Key R-406

U.S. Market Report
28 pages \$2.00
Key R-404

European Market Report 1974
24 pages \$2.00
Key R-402

Japan Market Report 1974
18 pages \$2.00
Key R-400

The Pervasiveness of Electronics
Complete issue 284 pages \$2.00
Key no. R-328

The Optical Spectrum
\$2.00 Key no. R-326

Semiconductor Memory Systems
16 pages \$3.00 Key no. R-324

New Electronic Displays
10 pages \$2.00 Key no. R-322

Planar Interconnection Techniques
13 pages \$3.00 Key no. R-320

Automotive Electronics
16 pages \$3.00 Key no. R-318

Hybrid Circuit Technology
16 pages \$3.00 Key no. R-316

Leadless, Pluggable IC Packages
Reduce Costs 7 pages \$2.00
Key no. R-312

Penetration Color Tubes are Enhancing Information Displays 6 pages \$2.00
Key no. R-310

Program for Transition from Non Linear to Linear Transistor Model
6 pages \$2.00 Key no. R-308

Charge Coupling Improves Its Image
8 pages \$2.00 Key no. R-306

Electromagnetic Spectrum Chart
Key no. R-213 \$2.00

Electromagnetic Spectrum Report
16 pages plus Wall Chart \$4.00
Key no. R-211

Active Filters
96 pages \$4.00 Key no. R-032

Circuit Designer's Casebook
162 pages \$6.00 Key no. R-031

To order reprints or for further information, please write to:

Electronics Reprint Department
P.O. Box 889
Hightstown, N.J. 08520

Only orders with cash, check, or money order will be accepted. No invoicing will be done.

3 WIRE SYNCHRO TO LINEAR D.C. CONVERTER

ACCURACY 1/2 %



MAC 1422-1

Provides a linear conversion of a synchro angle to a DC Voltage

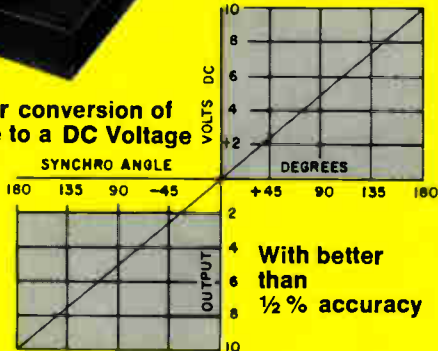

With better than 1/2 % accuracy

Specifications

Accuracy: $\pm 1\%$ over temperature range
 Input: 11.8V, 400 HZ line to line 3 wire synchro voltage
 Output Impedance: less than 10 Ohms
 Input Impedance: 10K minimum line to line
 Reference: 26V $\pm 10\%$ 400HZ (Unit can be altered to accommodate 115V if available at no extra cost)
 Operating temp. range: -25°C to $+85^{\circ}\text{C}$
 Storage temp. range: -55°C to $+100^{\circ}\text{C}$
 DC power: $\pm 15\text{V} \pm 1\%$ @ 75ma (approx.)
 Case material: High permeability Nickel Alloy
 Weight: 6 Ozs. Size: 3.6" x 2.5" x 0.6"

SOLID STATE SINE-COSINE SYNCHRO CONVERTER - NON VARIANT

This new encapsulated circuit converts a 3 wire synchro input to a pair of dc outputs proportional to the sine and cosine of the synchro angle independent of a-c line fluctuations.

- Complete solid state construction.
- Operates over a wide temperature range.
- Independent of reference line fluctuations.
- Conversion accuracy — 6 minutes.
- Reference and synchro inputs isolated from ground.

Specifications Model DMD 1508-2

Accuracy: Overall conversion accuracy 6 minutes. Absolute value of sine and cosine outputs accurate to $\pm 30\text{MV}$
 Temperature Range:
 Operating -40°C to $+85^{\circ}\text{C}$
 Storage -55°C to $+125^{\circ}\text{C}$
 Synchro Input: 90V RMS $\pm 5\%$ LL 400Hz $\pm 5\%$
 DC Power: $\pm 15\text{V DC} \pm 10\%$ @ 50MA
 Reference: 115VRMS $\pm 5\%$ 400Hz $\pm 5\%$
 Output: 10V DC full scale output on either channel @ 5ma load
 Temperature coefficient of accuracy:
 ± 15 seconds/ $^{\circ}\text{C}$ avg. on conversion accuracy
 ± 1 MV/ $^{\circ}\text{C}$ on absolute output voltages
 Size: 2.0" x 1.5" x 2.5"
 Units are available with wider temperature ranges and 11.8V LL, 26V reference synchro inputs. Information will be supplied upon request.

A.C. LINE REGULATION

A new method has been developed which allows us to provide a low distortion highly regulated AC waveform without using tuned circuits or solid state active filters of any kind.

The result is a frequency independent AC output regulated to 0.1% for line and load with greater than 20% line variations over a wide temperature range.

Features:

- 0.1% total line and load regulation
- Independent of $\pm 20\%$ frequency fluctuation.
- 1 watt output
- Extremely small size
- Isolation between input and output

Specifications: Model MLR 1476-1
 AC Line Voltage: 26V $\pm 20\%$ @ 400Hz $\pm 20\%$
 Output: 26V $\pm 1\%$ for set point
 Load: 0 to 40ma
 Total Regulation: $\pm 0.1\%$
 Distortion: 0.5% maximum rms
 Temperature Range: -55°C to $+125^{\circ}\text{C}$
 Size: 2.0" x 1.8" x 0.5"

Other units are available at different power and voltage levels as well as wider temperature ranges. Information will be furnished upon request.

4 QUADRANT MAGNETIC ANALOG MULTIPLIER

DC x DC = DC OUTPUT

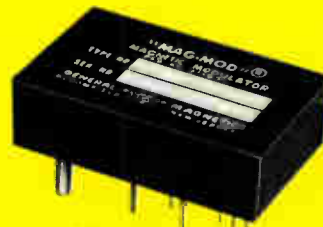

MCM 1478-1

Specifications Include:

Transfer Equation: $E = XY/10$
 X & Y Input Signal Ranges: 0 to $\pm 10\text{V peak}$
 Maximum Static and Dynamic Product Error: 1/2% of point or 2MV, whichever is greater, over entire temperature range
 Input Impedance: X = 10K, Y = 10K
 Full Scale Output: $\pm 10\text{V peak}$
 Minimum Load for Full Scale Output: 2000 ohms
 Output Impedance: Less than 10 ohms
 Bandwidth: 1000Hz
 DC Power: $\pm 15\text{V}$, unless otherwise required, at 20ma
 Size: 1.3" x 1.8" x 0.5"
 Output is short circuit protected

Product Accuracy is $\pm 1/2\%$ of all theoretical product output readings over Full Temperature Range of -55°C to $+125^{\circ}\text{C}$.

Maximum Output Error for Either

X = 0, Y = 10V
 Y = 0, X = 10V
 X = 0, Y = 0

would be ± 2 MV over Entire Temperature Range.

There is No Substitute for Reliability



GENERAL MAGNETICS • INC

135 Bloomfield Ave., Bloomfield, New Jersey 07003 - Tel. (201) 743-2700

Circle 901 on reader service card