

- 65 Auto makers look over microprocessor capabilities
- 109 ASTAP: a program that analyzes big circuits
- 114 Cutting engineering time with programmable calculators

Electronics®



1470 080120 AECA7 MAY76
CS OSBORNE, JR
1202 N AVENUE H11
LANCASTER, CA
93534

Maddox Speaks.

DAC's make the difference in displays.

Some really *clear, sharp* pictures are being generated for demanding computer CRT Display jobs like Air Traffic Control, Avionic Heads-Up, and others.

To get sharp, clean output on high speed X-Y deflection displays you have to start with good spot definition and intensity and then drive it with a clean deflection signal. And that's where high-speed display DAC's come in.

Here's how.

Display DAC's convert digital position commands to analog voltage levels which will position the spot on the CRT face. New commands are usually clocked in at a steady update rate. The spot is positioned to the start of a line or character and then moved by progressive commands to draw the line.

If the DAC's behave, all is well, but often lines wiggle, and show intensity variations.

Who's the culprit?

Glitch, (transient *spike* or bump in the DAC output) and *differential non-linearity*, (a wrong size step in a series of steps).

Display DAC's are "de-glitched" to achieve very low output glitch values, and are designed to have damn good differential linearity.

How to define spec limits?

First, determine maximum allowable glitch voltage as measured through a test filter which simulates your deflection circuit's passband. The test filter is the key. You can even lump together the effects of glitch and differential non-linearity. Then, ramping the DAC and comparing its band-limited output to an

ideal ramp, you can check the errors. And after limits are set for intensity variation and wiggle, you can graphically arrive at ramp error limits for the DAC's.

Among other things.

You can also have an inherent lack of line fidelity due to the staircase-like DAC output. Smaller steps through greater DAC resolution will help. But beware, for the limits of maximum available update rate and minimum picture refresh rate set a resolution limit for line drawing. We can show you some filter techniques that can improve ramp fidelity by 10 to 1 or more, solving this staircase problem.

Settling is really important, too, and long settling tails must be absent so that line starting points will land where you planned.

Things like large-signal settling time, slew rate, zero offset, large scale linearity, and scale factor can normally be obtained much better than available deflection circuits, so use care; don't over-specify the DAC's. Save yourself some money.

Talk to the experts.

There are a lot more parameters to be considered in specifying high-speed display DAC's, so if you are into this, or going to be, probably the best approach is to consult us. After all, we have standard products such as our 12 or 13 bit DAC's (Models 4014 and 4017), and a lot of display knowledge and real experience. We've built and shipped more high-speed display DAC's than anybody else in the world.

Telephone, toll-free (800) 225-7883, in Mass. (617) 329-1600. Or write us, Dedham, Mass. 02026. In Europe, Tel. 73.99.88, Telex: 25881. Or write, 1170 Brussels, Belgium.

 **TELEDYNE
PHILBRICK**

Circle 900 on reader service card

Ed Maddox, Sr. Engineer



SURPRISE!

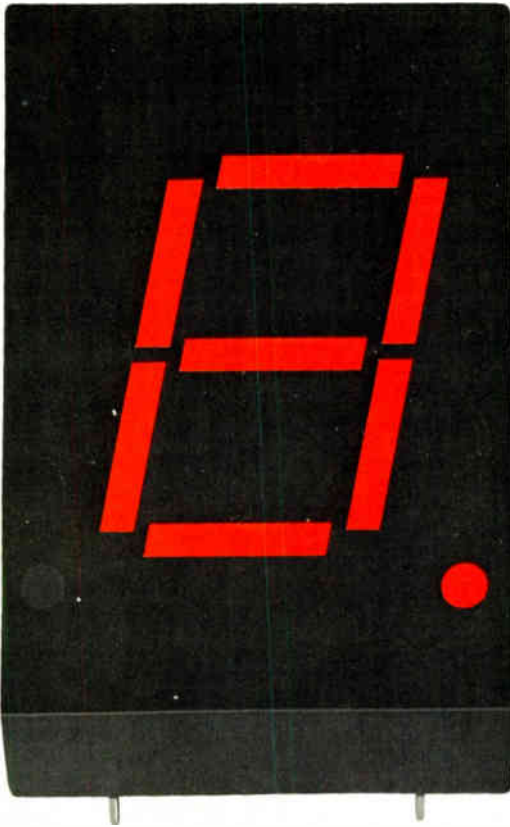

HP's new 5082-7750 series



5082-7730 series

HP displays are bigger than ever!

Now you can get a big, readable 0.43 inch LED display without sacrificing the simplicity and economy of single chip per segment design.

Bright enough to clearly see 20 feet away. HP's 5082-7750 series display features the same wide viewing angle, excellent readability and the same pin configuration as our 0.3 inch 5082-7730 series displays.

Just \$3.50 each in 100 quantities*.

Contact Schweber, Hall-Mark or the Wyle Distribution Group for immediate delivery. Or, write us for more details. This is one display you won't want to miss.

01403A

*Domestic USA price only.

HEWLETT  PACKARD

Sales and service from 172 offices in 65 countries.
1501 Page Mill Road, Palo Alto, California 94304

FOR NEW STANDARDS IN POWER METERS — THINK HP

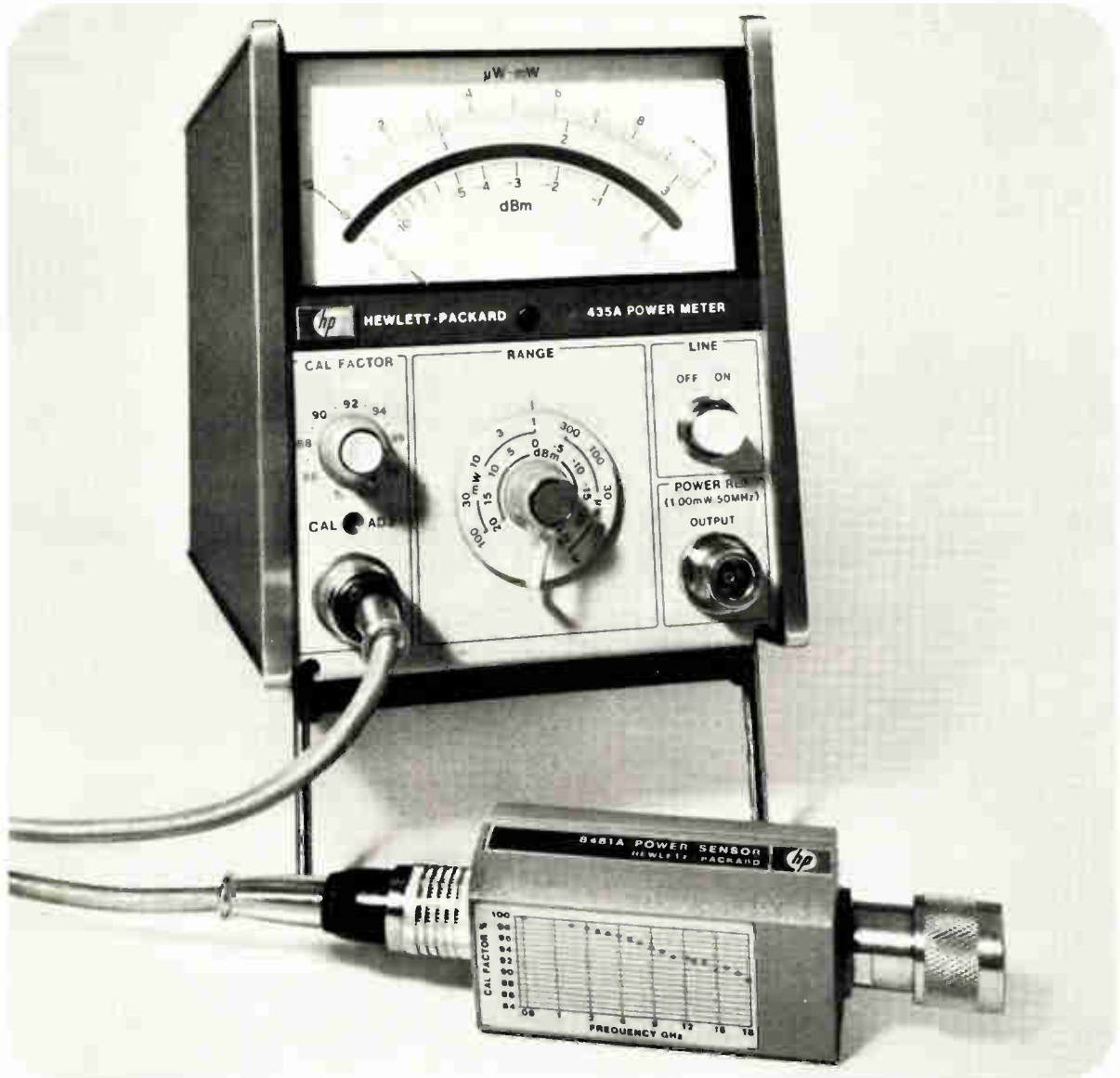

Measuring microwave power? Here's a big step forward.

With the new HP 435A Power Meter you get high accuracy plus convenience. A major error source, mismatch uncertainty, is virtually eliminated because the thermocouple Power Sensor (HP 8481A) has extremely low SWR (1.2 from 30 MHz to 12.4 GHz; 1.3 from 12.4 GHz to 18 GHz). This brings significant improvement in overall measurement accuracy.

This low SWR is achieved through the use of a unique silicon-integrated thermocouple element. The thermocouple is minute, yet dimensionally precise, resulting in good match over a wide frequency range (10 MHz to 18 GHz). And this same silicon technology produces a thermocouple that is sensitive, yet rugged. You can measure over a wide dynamic range (0.3 μ W to 100 mW), with a substantial safety margin against burnout from inadvertent overload. Such broad frequency and power coverage in a single unit means real operating convenience.

To confirm that the sensor/meter calibration is

accurate, a precision RF power reference is built into the 435A.

The 435A is ideal for field use as well as lab and production. An FET chopper circuit in the power sensor permits it to be operated up to 200 feet from the meter. The meter can be operated from an optional internal rechargeable battery.

HP 435A Power Meter, \$550; HP 8481A Sensor, \$350.

Get the full story on this big advance in power measuring. Give your local HP field engineer a call or write for complete data.

Domestic USA prices only.

HEWLETT  PACKARD

Sales and service from 172 offices in 65 countries.
1501 Page Mill Road, Palo Alto, California 94304

04302

29 Electronics review

DISPLAYS: Double-junction LED glows red, yellow, green, 29
COMMUNICATIONS: Will mm waves carry intracity data: 30
NAVIGATION: C-LAD steers ships by microcomputer, 31
TRADE: Are the Russians really coming? 31
COMMERCIAL ELECTRONICS: Vehicle-tracking unit to cost \$500, 32
MATERIALS: Recycling of silicon is practical, 32
PRODUCTION: How phosphorus destroys ICs, 34
TRADE: Multinational views dominate Senate hearing, 36
INSTRUMENTS: Indicator shows miles per gallon of gas, 38
NEWS BRIEFS: 40
COMPUTERS: Control Data expands network capabilities, 42

52 Electronics International

JAPAN: Negative resistance shown in dual FET device, 52
GREAT BRITAIN: After quad sound, it's ambisonics, 53
AROUND THE WORLD: 53

65 Probing the News

AUTOMOTIVE ELECTRONICS: Car makers eye microprocessors, 65
COMMUNICATIONS: Digital networks catch on with police, 68
COMPANIES: General Automation faces new threats, 72
EDUCATION: EE enrollments recovering from slump, 75

81 Technical Articles

SPECIAL REPORT: Microprocessors open a new world of applications, 81
N-channel MOS yields new microprocessor generation, 88
In switch to n-MOS, microprocessor gets a 2- μ s cycle time, 95
DESIGNER'S CASEBOOK: IC logic simplifies binary conversion, 103
Storing computer data with a cassette recorder, 104
Making music with IC timers, 106
CIRCUIT ANALYSIS: Program quickly analyzes large-scale ICs, 109
CALCULATOR USE: Converting tables to equations cuts programs, 114
ENGINEER'S NOTEBOOK: Logic tester checks variety of ICs, 116
Oscilloscope probes can do many jobs, 117
Continuous monitor for seven-segment displays, 118

127 New Products

IN THE SPOTLIGHT: Minicomputer family adopts 4k RAM, 127
Counter/timers cover 80 MHz to 1 GHz, 130
INSTRUMENTS: Counter/timers are programmable, 140
PACKAGING & PRODUCTION: IC socket keeps board profile low, 151
SUBASSEMBLIES: Changing voltage to frequency, and vice versa, 164
MATERIALS: Jacketing for cables is tough, 173

Departments

Publisher's letter, 4
Readers comment, 6
40 years ago, 8
People, 14
Meetings, 20
Electronics newsletter, 25
Washington newsletter, 49
Washington commentary, 50
International newsletter, 55
Engineer's newsletter, 120
New literature, 180

Highlights

Cover: Versatility is microprocessor's bag, 81

Microprocessors clear the way to extremely low-cost computer-controlled systems. In the first of the set of three technical micro-processing articles in this issue, rules are given on where and when to use these as-yet unfamiliar devices and how to choose from the variety now available. Paper sculpture on the cover is by Leo Monahan of Group West, Los Angeles.

A microcomputer in many a 1980 car, 65

The news from Detroit is that microprocessors now being developed for automobile engine control could be in volume production by the early 1980s.

Microprocessors push on faster with n-MOS, 88

The new n-channel metal-oxide-semiconductor devices outdo the first generation of p-channel microprocessors in speed and instruction power. Needing fewer memory and peripheral support chips, they also economize on space and assembly costs, as Motorola's latest chip set proves.

Processor on a chip has 2- μ s cycle time, 95

N-channel MOS technology is also crucial to Intel's latest 8-bit device. As a result, the microprocessor is 10 times faster than its p-channel predecessor and is easy to interface, since it fits in a standard 40-pin package.

And in the next issue. . .

A line of minicomputers bred from the new 4k semiconductor RAMs. . . a special report on computer networks. . . preview of the National Computer Conference.

EDITOR-IN-CHIEF: Kemp Anderson

EXECUTIVE EDITOR: Samuel Weber

MANAGING EDITORS: Lawrence Curran, News;
Arthur Erikson, International

SENIOR EDITORS: John Johnsrud,
H. Thomas Maguire, Laurence Altman
Ray Connolly, Stephen E. Scrupski

ART DIRECTOR: Fred Sklenar

ASSOCIATE EDITORS: John N. Kessler,
Howard Wolff, Gerald M. Walker

DEPARTMENT EDITORS

Aerospace: William F. Arnold
Circuit Design: Lucinda Mattera
Communications & Microwave:
Stephen E. Scrupski

Components: Joel DuBow

Computers: Wallace B. Riley

Consumer: Gerald M. Walker

Industrial: Alfred Rosenblatt

Instrumentation: Michael J. Riezenman

Military: Ray Connolly

New Products: H. Thomas Maguire

Packaging & Production: Stephen E. Grossman

Solid State: Laurence Altman

COPY EDITORS: Margaret Eastman,
Everett C. Terry

ASSISTANT EDITOR: Marilyn Offenheiser

ART: Charles D. Ciatto, Associate Director
Patricia Cybulski, Assistant Director

PRODUCTION EDITOR: Arthur C. Miller

EDITORIAL SECRETARIES: Janet Annunziata,
Julie Gorgoglione, Penny Roberts

FIELD EDITORS

Boston: Gail Farrell

Los Angeles: Paul Franson (Mgr.)

Midwest: Larry Armstrong (Mgr.)

New York: Alfred Rosenblatt (Mgr.)

San Francisco: Bernard Cole (Mgr.)

Judith Curtis

Washington: Ray Connolly (Mgr.),

William F. Arnold

Frankfurt: John Gosch

London: Michael Payne

Paris: Arthur Erikson

Tokyo: Charles Cohen

McGRAW-HILL WORLD NEWS

Director: Ralph R. Schulz

Bonn: Robert Ingersoll;

Brussels: James Smith;

London: Marvin Petal;

Milan: Peter Hoffmann, Andrew Heath;

Moscow: Axel Krause;

Paris: Michael Johnson, Richard Shepherd;

Stockholm: Robert Skole;

Tokyo: Mike Mealey

PUBLISHER: Dan McMillan

DIRECTOR OF MARKETING: Pierre J. Braudé

ADVERTISING SALES SERVICE MANAGER:
Wallis Clarke

BUSINESS MANAGER: Stephen R. Weiss

CIRCULATION MANAGER: George F. Werner

MARKETING SERVICES MANAGER:
Tomlinson Howland

RESEARCH MANAGER: Margery D. Sholes

Microprocessors, the long-awaited computer on a chip, are beginning to roll off the assembly lines. The single-chip microprocessing units, or MPUs, "together with a handful of matched memory and logic circuits, provide equipment designers with the full power of computer hierarchy at unprecedentedly low cost." That's how Solid State Editor Larry Altman, in the report starting on page 81, describes the impact of these tiny devices that pack a lot of computing power.

Originally, we planned to run Altman's microprocessor round-up as the second part of his logic-design report [*Electronics*, Feb. 21, p. 81]. But with the MPU emerging at such a fast clip as a major product in its own right—fast becoming a rival technology to conventional logic—we decided that these up-and-coming devices merited the separate treatment given them in this issue.

And included in the microprocessor report are detailed articles on two of the second-generation MPUs. You'll find the story behind Motorola's M6800 family and Intel's 8-bit 8080 MPU on page 88 and page 95, respectively.

The design of microprocessors, fascinating as it is, is only part of the story. The other part is applications. On page 65, you'll find a Probing the News article on the move by automakers to equip cars with computer control—an evolutionary step that can be made only because of microprocessor-based cost breakthroughs.

Larry Armstrong, who heads our Midwest bureau, in interviewing user and producer alike, found that MPUs will be designed into Detroit's products by the time 1980 rolls

Publisher's letter

around. Moreover, they will make possible a number of safety, economy, and convenience features that are just too expensive now.

Although the kind of mass market represented by Detroit is still a few years off, the microprocessor has been designed into a host of sophisticated products. So, we plan to start a new series called "Microprocessors in Action." An analog of our well-received "Minicomputers in Action," the series will bring you the case histories of a number of successful microprocessor applications. Watch for it in upcoming issues.

Manpower is one of the limits on how fast the electronics industries can grow. In the days when we were racing the Russians to the moon, engineering schools couldn't turn out EEs fast enough, even though the glamour of the space race drew a large number of students into engineering.

Under the depressing effects of the last few years—cutbacks in Government research and development, economic recession, widespread underemployment of engineers—EE enrollment fell off. Now, though, things are definitely looking up.

The immediate prospects are for another round of manpower shortage as EEs from the smaller, recession-hit classes enter the job market. On page 75, you'll find the heartening story about the engineering schools' efforts to recruit more students in the wake of a marked upward swing in job prospects.



April 18, 1974 Volume 47, Number 8
93,515 copies of this issue printed
Published every other Thursday by McGraw-Hill, Inc. Founder: James H. McGraw 1860-1948. Publication office 1221 Avenue of the Americas, N.Y., N.Y. 10020; second class postage paid at New York, N.Y., and additional mailing offices.
Executive, editorial, circulation and advertising addresses: Electronics, McGraw-Hill Building, 1221 Avenue of the Americas, New York, N.Y. 10020. Telephone (212) 997-1221. Teletype TWX N.Y. 710-581-5234. Cable address: MCGRAWHILLN.Y.

Subscriptions limited to persons with active, professional, functional responsibility in electronics technology. Publisher reserves the right to reject non-qualified requests. No subscriptions accepted without complete identification of subscriber name, title, or job function, company or organization, including product manufactured or services performed. Subscription rates: qualified subscribers in the United States and possessions, Canada, and Mexico \$9.00 one year, \$18.00 three years; all other countries \$25.00 per year, except Japan \$50.00 per year, Brazil \$40.00 per year, Australia and New Zealand \$60 per year, including air freight. Limited quota of subscriptions available at higher-than-basic rate for persons outside of field served, as follows: U.S. and possessions and Canada, \$25.00 one year; all other countries \$50.00. Single copies, United States and possessions and Canada, \$1.00; all other countries, \$1.75.

Officers of the McGraw-Hill Publications Company: John R. Emery, President; J. Elton Tuhig, Executive Vice President-Administration; Gene W. Simpson, Group Publisher-Vice President; Senior Vice Presidents: Ralph Blackburn, Circulation; Walter A. Stanbury, Editorial; John D. Hoglund, Controller; David G. Jensen, Manufacturing; Gordon L. Jones, Marketing; Jerome D. Luntz, Planning & Development.
Officers of the Corporation: Shelton Fisher, President; Wallace F. Trendly, Group President, McGraw-Hill Publications Company and McGraw-Hill Information Systems Company; Robert N. Landes, Senior Vice President and Secretary; Ralph J. Webb, Treasurer.

Title registered in U.S. Patent Office; Copyright ©1974 by McGraw-Hill, Inc. All rights reserved. The contents of this publication may not be reproduced either in whole or in part without the consent of copyright owner.

Subscribers: The publisher, upon written request to our New York office from any subscriber, agrees to refund that part of the subscription price applying to copies not yet mailed. Please send change of address notices or complaints to Fulfillment Manager, subscription orders to Circulation Manager, Electronics, at address below. Change of address notices should provide old as well as new address, including postal zip code number, if possible, attach address label from recent issue. Allow one month for change to become effective.

Postmaster: Please send form 3579 to Fulfillment Manager, Electronics, P.O. Box 430, Hightstown, N.J. 08520.

When you've got to power noise sensitive logic,
what do you want for the job?

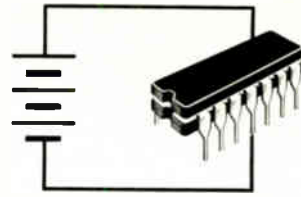

When your system draws a pulsating load current,
what do you want for the job?

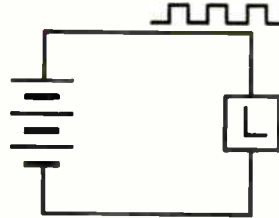

When your specs call for adjustable voltage,
what do you want for the job?

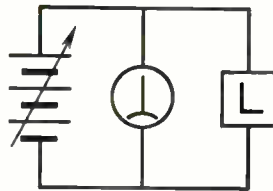

When your programmed level must be accurately reproduced, when the current limit must be adjustable and square (not folded back), when you want a power supply that doesn't lose half its current rating at +71°C (or at -20°C). . . .

the power supply you want for your job is the

KEPCO **JQE**



Quarter-rack
100 watts



Half-rack
250 and
500 watts



Full-rack
1000 watts

JQE Power Supplies are *linear* voltage stabilizers (not complex switching units). They can be adjusted or remotely programmed from true zero to maximum output with better than 0.01% linearity. They vary less than 0.0005% for 105–125V a-c source changes and have such low output impedance that a zero to full load change influences the stabilized output by less than 0.005%. Ripple and noise is well under 200 microvolts rms, 1 millivolt p-p.

31 JQE linear voltage stabilizers are manufactured in 4 sizes: 100 Watts, 250 Watts, 500 Watts and 1000 Watts in voltage ranges from 0–6V to 0–150V. Metered bench and rack-panel style and unmetred modular form for the OEM. Adjustable overvoltage protection available.

If *your* job needs a linear voltage stabilizer, call Kepco for the details on the JQE, or write Dept. V-14



KEPCO[®]

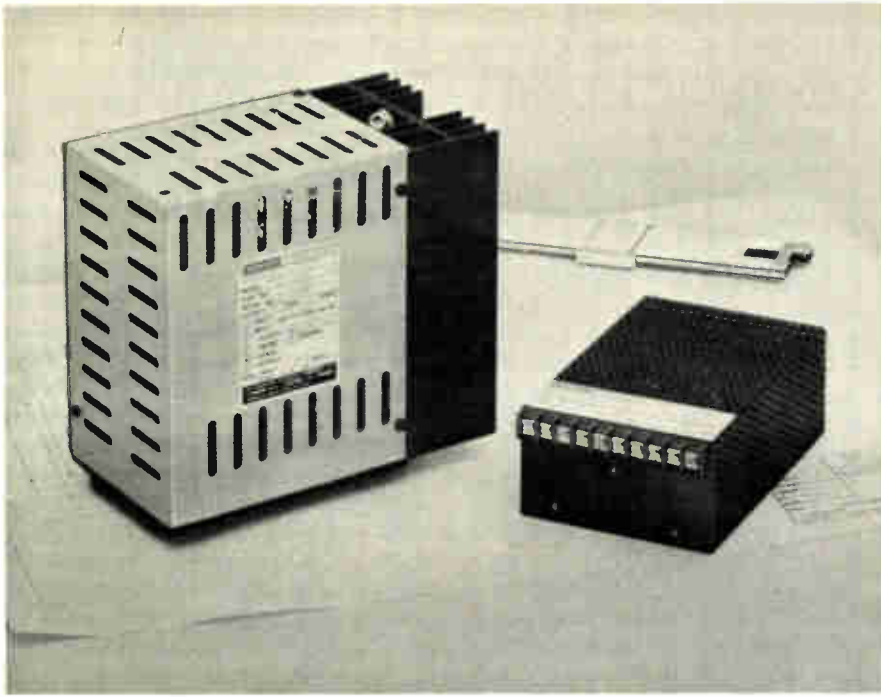

Reduce Your Power Supply Size and Weight By 70% for \$49

A new way has been found to substantially reduce power supply size and weight. Consider the large power supply shown at left in the above photo — it uses an input transformer, into a bridge rectifier, to convert 60 Hz to 5 volts DC at 5 amperes. This unit measures 6½" x 4" x 7½" and weighs 13 pounds. It sells for \$170 in small quantities. For just \$49.00 more, Abbott's new model Z5T10, shown at right, provides the same performance with 70% less weight and volume. It measures only 2¼" x 4" x 6" and weighs just 3 pounds.

This size reduction in the Model Z5T10 is primarily accomplished by eliminating the large input transformer and instead using high voltage, high efficiency, DC to DC conversion circuits. Abbott engineers have been able to control the output ripple to less than 0.02% RMS or 50 millivolts peak-to-peak

maximum. This design approach also allows the unit to operate from 100 to 132 Volts RMS and 47 to 440 Hertz. Close regulation of 0.15% and a typical temperature coefficient of 0.01% per degree Centigrade are some of its many outstanding features. This new Model "Z" series is available in output voltages of 2.7 to 31 VDC in 9 days from receipt of order.

Abbott also manufactures 3,000 other models of power supplies with output voltages from 5 to 740 VDC and with output currents from 2 milliamps to 20 amps. They are all listed with prices in the new Abbott catalog with various inputs:

- 60 A to DC, Regulated
- 400 A to DC, Regulated
- 28 VDC to DC, Regulated
- 28 VDC to 400 A , 1 ϕ
- 24 VDC to 60 A , 1 ϕ

Please see pages 581-593 of your 1973-74 EEM (ELECTRONIC ENGINEERS MASTER Catalog) for complete information on Abbott Modules.

Send for our new 56 page FREE catalog.

abbott transistor

LABORATORIES, INCORPORATED
general offices eastern office

5200 W. Jefferson Blvd./Los Angeles 90016
(213) 936-8185 Telex: 69-1398

1224 Anderson Ave./Fort Lee, N.J. 07024
(201) 224-6900 Telex: 13-5332

Readers comment

Making honest dice

To the Editor: The circuit described by Per J. Johnsen in Readers comment [*Electronics*, Dec. 6, 1973, p.6] on "Electronic dice ease tough decisions" [Aug. 16, 1973, p.118] will result in loaded dice.

The decoder input he gave was 2, 3, 6, 7, 10, 11. This depends upon a straight binary-count output from the B, C, D outputs of the 7492A. In fact, the outputs are not straight binary, and the decoder input code would be 2, 3, 6, 10, 13, 14. The dice would show a 6 twice per sequence and one undefined output.

R. M. Stitt
Burr-Brown Research Corp.
Tucson, Ariz.

■*Mr. Johnsen replies:* I was surprised to see that there was an error in the circuit because when I built it originally, it worked nicely. The difference then, however, was that I had put the A section of the counter in front.

When I recorded the circuit, I got the bright idea that the A section of SN7492 could be omitted, since the rest was an independent divide-by-6 counter. Unfortunately, I was unaware that this section did not count in a straight binary way. With the A section included, the table stated in my note is correct, since 0-5 is a straight binary sequence.

Correcting UGLI equation

To the Editor: I wish to point out an error in the equation of the figure for "UGLI may scare off large custom ICs" [*Electronics*, Feb. 7, p. 42]. It should read:

$$(A + jB)(C + jD) = (AC - BD) + j(BC + AD) = X + jY$$

G. Victor Wintriss, Comdr., USN
Fleet Combat Direction
Systems Support Activity
San Diego, Calif.

'Pong' belongs to Atari!

To the Editor: Your article, "Anyone for tennis—via color TV" [*Electronics*, March 7, p.32] refers to another supplier's game as "Pong." The word "Pong" is a very valued trade mark of Atari Inc.

Tony Seidel
Atari Inc.
Los Gatos, Calif.

TRW LVA diode... the sharpest knee below 10 Volts.

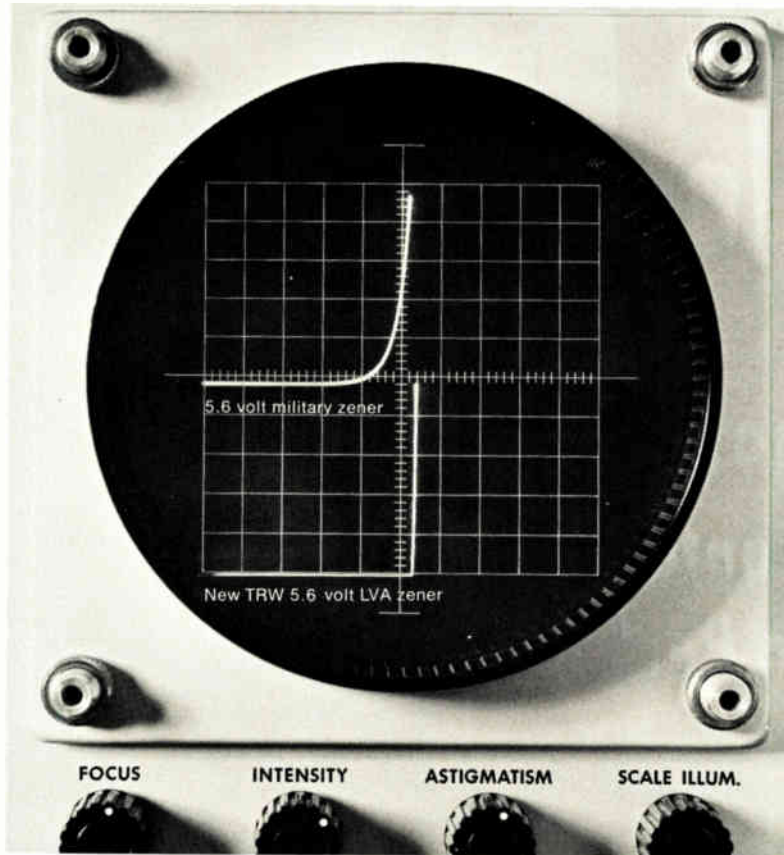

The current saver.

No other zener can approach TRW's LVA performance below 10 volts. Available for operation down to 4.3 volts, TRW LVA diodes minimize power consumption in portable-battery operated equipment. They're also ideal for instrumentation, where, as reference elements, they draw as little as 50 μ Amps.

TRW LVA's are available in various package configurations, including passivated chip form for hybrid-

compatible packages. If you have a need for a low current voltage regulator or any other product that demands low current consumption, you should check out TRW LVA zeners. When it comes to current, they're really misers!

For product information and applications assistance write TRW Semiconductors, an Electronic Component Division of TRW Inc., 14520 Aviation Boulevard, Lawndale, California 90260. Phone (213) 679-4561.

These products are available through the following authorized distributors:

Almo Electronics
Bell Industries
Cramer Electronics Inc.
De Mambro Electronics

Eastern Radio Corp.
Electronics Marketing Corp.
Elmar Electronics Inc.
Hall-Mark Electronics Corp.

Harvey-Michigan Inc.
Liberty Electronics
Powell Electronics
Pytronics

Semiconductor Concepts Inc.
Summit Distributor
R. V. Weatherford Co.
Westates Electronics Corp.

TRW[®] SEMICONDUCTORS

Another Sprague Breakthrough!

PRODUCTION-ORIENTED SOLID TANTALUM CAPACITORS

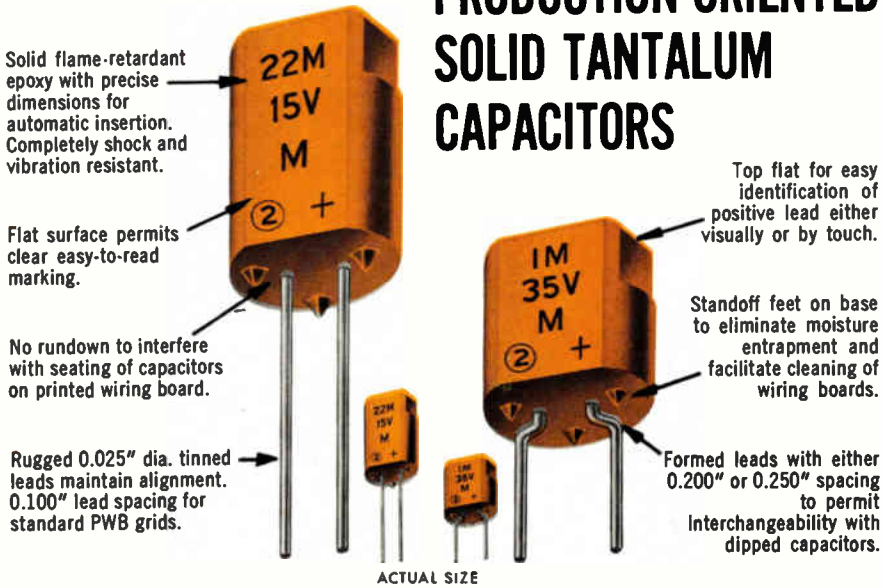

Type 198D Low-cost Econoline* Tantalum Capacitors Lead in Performance!

When it comes to low-cost solid tantalum capacitors, the new Sprague Type 198D Econoline Capacitors outperform all other designs. Here are some additional advantages:

- Low d-c leakage
- Low dissipation factor
- Wide voltage range, 4 to 50 VDC
- Capacitance range from 0.1 to 100 μ F
- Withstand severe temperature cycling and temperature shock over -55 C to +85 C
- Speedier handling for insertion
- Easier-to-read markings

The new Sprague Type 198D epoxy-encased Econoline Capacitor is tooled for mass production and priced competitively with imported dipped units. Investigate this new Sprague breakthrough without delay.

Call your nearest Sprague district office or sales representative, or write for Engineering Bulletin 3546 to: Technical Literature Service, Sprague Electric Co., 35 Marshall Street, North Adams, Mass. 01247.

*Trademark

THE BROAD-LINE PRODUCER OF ELECTRONIC PARTS



40 years ago

From the pages of Electronics, April, 1934

Technical employees organize

For several years past, while the unemployment problem has been at its worst, thoughtful observers of the conservative course of the "regular" engineering societies have felt that the social and economic situation of technical men would have to be given more attention and help, or else new organizations of engineering employees, built on wage issues alone, would arise to claim the interest and membership of employed engineers and younger men. Already such movements have come in several quarters. One trade union of "technicians" has obtained 2,000 members in New York, and has 3,000 more in Buffalo, Philadelphia, Pittsburgh, Baltimore, Chicago, and St. Louis. At first the membership of the new "Federation" was drawn chiefly from the unemployed, but later accessions have come 75 per cent from among men with jobs, who seek to better their conditions.

Mental courage

Mental courage may not receive any acclaim because most frequently it isn't even observed.

This mental courage demands, however, certain assistance.

In the first place, it demands DETERMINATION to face the situation at whatever cost.

Then it demands a STUDY of the situation, its conditions, its necessities, the means to meet it, the possible help to be obtained, the cooperation to be had, an analysis of what must be done, and planning along proper and essential lines.

Usually it demands considerable SACRIFICES.

It demands a FIGHT to put the right methods across.

Finally it demands a FAITH and belief in plans and people.

But happily it MOST ALWAYS BRINGS SUCCESS where failure might have ensued.

There has not been for a long period such a time as now when such mental courage is needed, for the rich and the poor, the worker and the executive are in some distress.

you can see why...



the time is right with **PANAPLEX™** clock panel displays

PANAPLEX clock panels are designed to be read. These large, bright, easy-to-see, pleasing numerals are easily read in any light — even bright sunlight.

These four- and six-digit clock panels are compatible with MOS clock chips, and have the high reliability and quality that has made the PANAPLEX family of displays the choice of calculator manufacturers.

PANAPLEX clock panels can display either 12- or 24-hour time systems and have integral AM/PM indicators and colons.

Available in two standard sizes (0.5 and 0.7 inch), these thin panels (0.2 inch excluding tubulation) offer design flexibility that's hard to beat.

The soft, neon-orange color is easy to read at a glance: — no magnifier

needed, no eyestrain, no LED-red fatigue factor.

For additional information on the PANAPLEX clock panels, write Burroughs Corporation, Electronic Components Division, P. O. Box 1226, Plainfield, New Jersey 07061, or call (201) 757-3400 or (714) 835-7335.



You can see the difference

Burroughs



Circle 9 on reader service card

NEWS

MAINSTREAM

AMD/MOS/APRIL ONE

Am1002
Dual 128-Bit Static Shift Register

Am1101A
256-Bit Random Access Memory

Am1101A1
256-Bit Random Access Memory

Am1402A
Quad 256-Bit Dynamic Shift Register

Am1403A
Dual 512-Bit Dynamic Shift Register

Am1404A
Single 1024-Bit Dynamic Shift Register

Am1405A
512-Bit Dynamic Recirculating Shift Register

Am1406/1506
Dual 100-Bit Dynamic Shift Register

Am1407/1507
Dual 100-Bit Dynamic Shift Register

Am2102
1024-Bit Static Random Access Memory

Am2505
512-Bit Dynamic Recirculating Shift Register

Am2512
1024-Bit Dynamic Recirculating Shift Register

Am2802
10 MHz Quad 256-Bit Dynamic Shift Register

Am2803
10 MHz Dual 512-Bit Dynamic Shift Register

Am2804
10 MHz Single 1024-Bit Dynamic Shift Register

Am2805
512-Bit Dynamic Recirculating Shift Register

Am2806
1024-Bit Dynamic Recirculating Shift Register

Am2807
512-Bit Dynamic Recirculating Shift Register

Am2808
1024-Bit Dynamic Recirculating Shift Register

Am2810
Dual 128-Bit Static Shift Register

Am2814
Dual 128-Bit Static Shift Register

Am2841
64 x 4-Bit FIFO Memory

Am2855
Quad 128-Bit Static Shift Register

Am2856
Dual 256-Bit Static Shift Register

Am2857
512-Bit Static Shift Register

Am3114
Dual 128-Bit Static Shift Register

Am3341
64 x 4-Bit FIFO Memory

Am4055/5055
Quad 128-Bit Static Shift Register

Am4056/5056
Quad 128-Bit Static Shift Register

Am4057/5057
512-Bit Static Shift Register

(To be continued...)

More than two dozen mainstream MOS parts, all in one place: Advanced Micro Devices.

Every one is silicon gate. Every one is available in military temperature range. Every one is built to MIL-STD-883 at no extra charge.

And one is N-Channel. The 2102. A 1024-bit Static Random Access Memory.

Every MOS part we make is guaranteed to be as good or better than the original. Every part is available for immediate delivery.

If you're getting into MOS, if you want spec sheets or app notes or a thousand parts, talk to Advanced Micro Devices, the next giant.

Advanced Micro Devices

Corporate offices are at 901 Thompson Place, Sunnyvale, California 94086. Telephone (408) 732-2400/Southern California office: Beverly Hills (213) 278-9700/Mid-America: Des Plaines, Illinois (312) 297-4115/Edina, Minnesota (612) 835-4445/Eastern United States: Roslyn Heights, New York (516) 484-4990/Baltimore, Maryland (301) 744-8233/Lexington, Massachusetts (617) 861-0606/Britain: Advanced Micro Devices, Telephone Maidstone 52004/West Germany: Advanced Micro Devices, Munich, Telephone (089) 53 95 88.
Distributed nationally by Hamilton/Avnet and Cramer Electronics.

INTRODUCING MONO-GLASS



A JEWEL OF A CAPACITOR

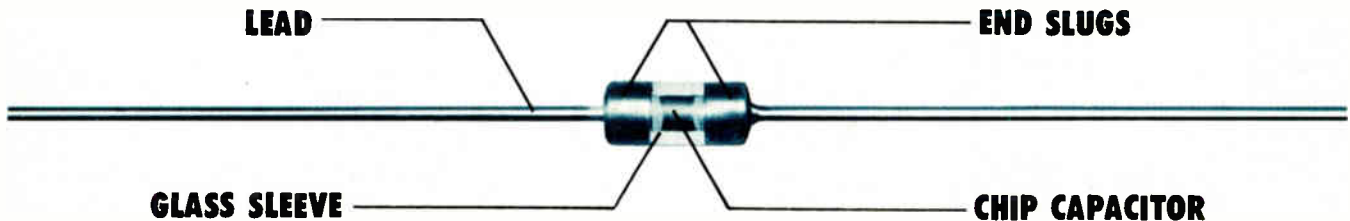

U.S. Capacitor Corp. has done something elegant for high volume capacitor users . . . **MONO-GLASS.**

This glass encapsulated monolithic ceramic capacitor offers something special: for the Design Engineer looking for cost reduction and dependability; for the purchasing agent looking for low price with fast delivery; for the incoming Q.C. inspector who is looking for reliability.

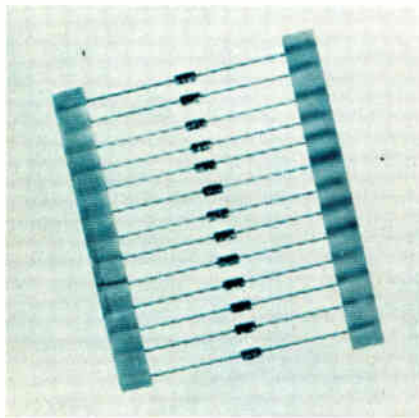

AUTOMATIC INSERTION:

If you use it, you know the substantial savings in time and cost. **MONO-GLASS** is designed for automatic insertion with the same equipment used for diodes and resistors. Reel packed and ready for your machines.

DURABILITY:

Our hermetically sealed, glass-to-metal construction offers these advantages: solderless internal contacts that won't reflow in your wave-soldering process; no glass fracturing during lead forming—stress is transferred to the end slugs rather than the glass sleeve.

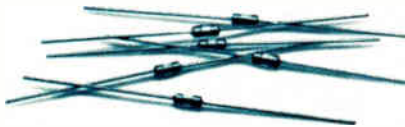

HIGH VOLUME; LOW PRICE

USCC's production capability for chip capacitors is second to none. **MONO-GLASS** is produced by a simple assembly technique. Combine these two and you get the best possible delivery for high quantity requirements, at a budget price.

WIDE SELECTION:

Four case sizes are available200 x .100; .250 x .100; .300 x .150 and .400 x .150. The 50 and 100 WVDC units offer up to .01 mfd in COG dielectric, to .18 in X7R and up to 1.0 mfd in the Y5V dielectric.

RELIABILITY:

USCC is the proven leader in state-of-the-art, demonstrated on N.A.S.A. life support and guidance systems. Commercial as well as military aerospace applications benefit from the high reliability features of our products—the best available.

MONO-GLASS is our lowest priced ceramic axial lead capacitor, offering a new quality capability for communications, navigation and guidance, computer business machines or anywhere that high volume, low price is required.

Write or call for an evaluation sample, more technical data or applications help for your special requirements. Remember, USCC-Centralab.



USCC/Centralab

Electronics Division • Globe-Union, Inc.

2151 North Lincoln Street • Burbank, California 91504

(213) 843-4222 • TWX: 910-498-2222



Circle 13 on reader service card

RCL

SWITCH ENGINEERING HANDBOOK



AN EASY-TO-READ
NEWLY EXPANDED
TECHNICAL CATALOG OF
INDUSTRY'S MOST
COMPLETE SELECTION
OF

MINIATURE ROTARY SWITCHES

INCLUDING MILLIMETER
CONVERSION DRAWINGS OF
EVERY RCL SWITCH!

RCL

General Sales Office
RCL ELECTRONICS, INC.
700 South 21st Street
Irvington, New Jersey 07111

People

Lyndes to tap market for paper-tape readers

In the past five years, Horace C. Lyndes has faced a recession and blindness, but had an idea he would not abandon. Now his own company, Teleterminal Corp., Burlington, Mass., is incorporated, and the first 50 units of his photoelectric paper-tape reader are nearing completion. Lyndes' product, the Fly Reader 45, has a maximum reading speed of 450 characters per second—higher than most on the market—and its price of \$625 for 1 to 10 units places it in the lower-priced range.

Lyndes started out as a mechanical engineer with a degree from the University of New Hampshire, and became interested in paper-tape readers while with DI/AN Controls Co. and later with Adar Associates. He felt he could improve on the product and by the beginning of 1970 he had a working prototype. But due to the recession he wasn't able to find any venture capital, so he turned to consulting work to keep afloat. By 1971, he was back working on his device, redesigning and tooling it.

He completed development in 1972 and actually had some units in the field when he was forced once again to stop business, this time due to cataracts. He was blind for a year before an operation restored his sight.

Moving up. With his sight restored, he is now ready to enter the marketplace, this time financed privately. He tried his luck in the venture capital market, but with no success. "Venture capital people are looking for another Viatron or another IBM," he complains, "but I think they will find more Viatrons. They are looking for the big break, not for the guy in a cellar with a good product in a modest market." Lyndes is out of the cellar and into an office, but Teleterminal is still essentially a two-man operation.

He admits that paper-tape readers aren't exactly a glamorous product. "They're kind of a staple," he says. "But paper tape is still the cheapest way of keying in data, and



Set to go. Horace C. Lyndes has his first 50 paper-tape readers in production.

as long as there are teletypewriter terminals around there is a need for readers. It is not a boom market, but it has consistently shown 10% to 15% growth." He estimates the total market is \$40 million, with the Teletype Corp, Skokie, Ill. holding half of it. Mechanical readers hold half of the rest of the market, but Lyndes feels photoelectric readers will gradually take over that share.

National's Landrum homes in on consumers

Novus Electronic Products "has only true consumer products in the offing," says Gene Landrum, recently named general manager of the division. Novus was formed just last October by National Semiconductor to penetrate the consumer products market through retail outlets such as drug, department, and hardware stores.

Landrum's working philosophy is that consumer products must be just that. "Many calculators are designed for engineers by engineers," he points out. "Those people know too much about calculators and aren't consumer-oriented."

The latest example of the Novus approach to consumer marketing is its planned deal with Scott Paper Co., Philadelphia, Pa., to sell calculators through coupons on Scott products.

Currently, the Novus division

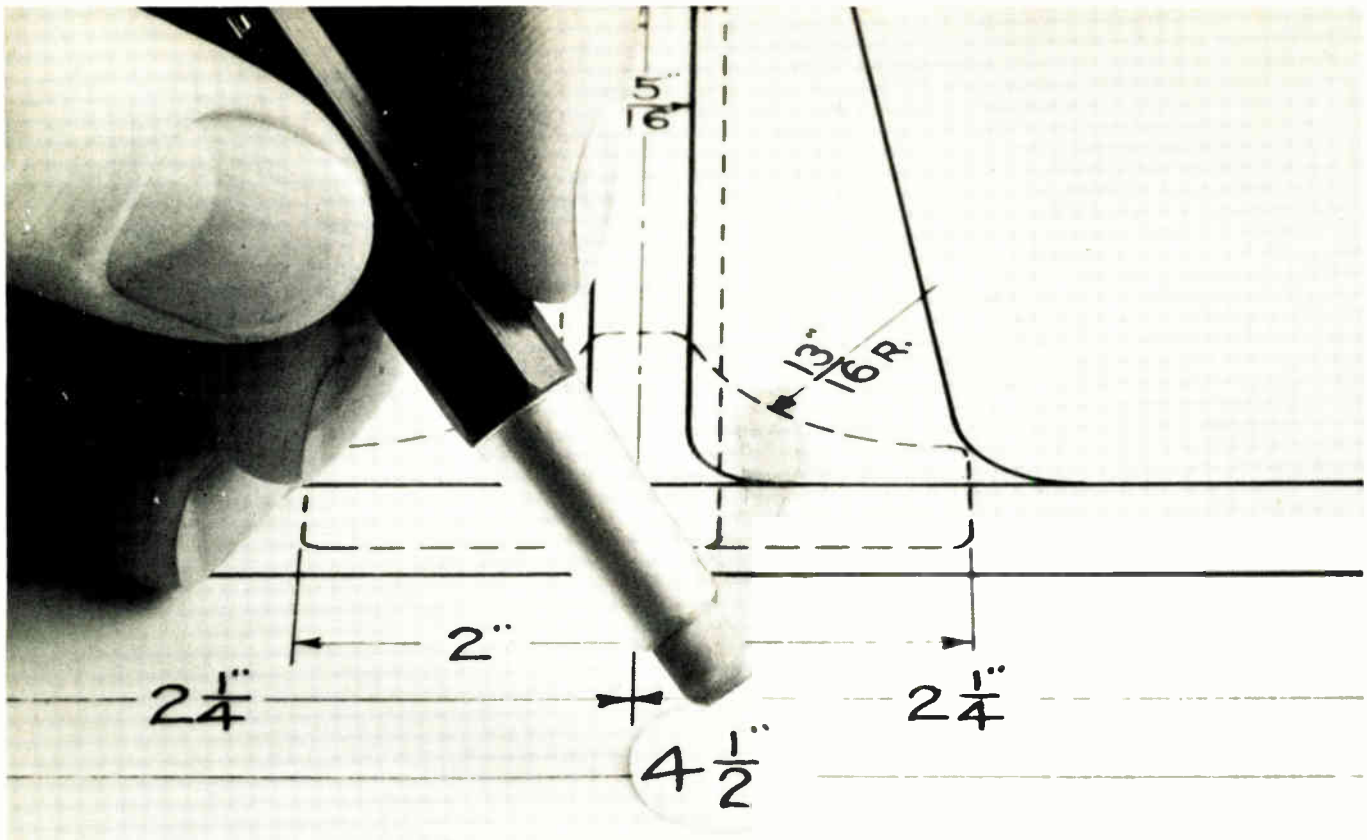

Get the drop on redrawing drudgery.

Shortcuts with Kodagraph materials can turn drafting hours into minutes.

Nobody likes to retrace a whole drawing just because a few revisions are necessary. You don't have to if you make a second original on Kodagraph wash-off film. Simply wet-erase what you don't want—using plain water and a soft eraser—draw in the new details and the job is done.

If on the other hand, you're faced with repetitive details, draw them once. And then order as many Kodagraph film or paper reproductions as you need. Cut them out,

tape down on drawing form, rephotograph and you have a new original.

When you need to restore a battered, old drawing, have a reproduction made on Kodagraph film. Stains virtually disappear. Weak lines come back strong. And you end up with a crisp, legible black-on-white print.

Get the details.

Write for information on how you can reduce drafting time with photoreproduction techniques. Eastman Kodak Company, Business Systems Markets Division, Dept. DP760, Rochester, N.Y. 14650

Kodak products for engineering data systems.



Pulse withstand capacitors for colour T.V.

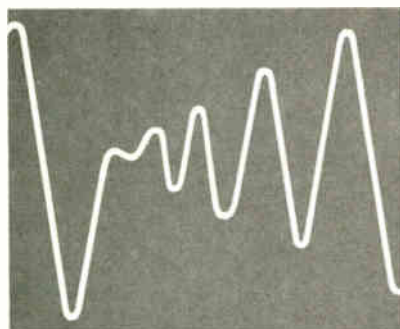
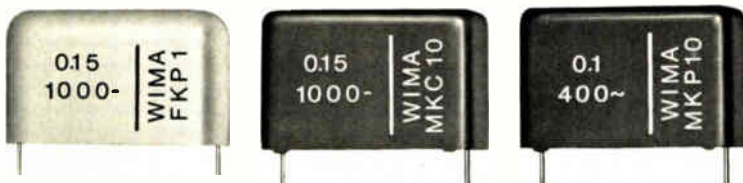

WIMA FKP 1

Polypropylene film and extended foil electrode capacitors encapsulated in cast resin. Self-healing properties. Suitable for sharp-edged or short rise time pulses in thyristor deflection circuits.

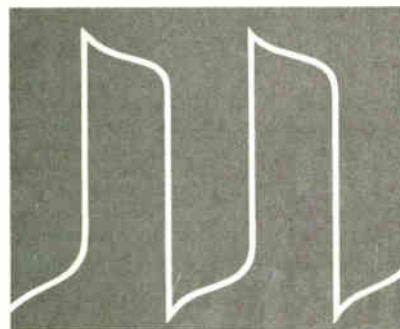

WIMA MKC 10

Metallized polycarbonate capacitors. Particularly suitable for stringent pulse and surge conditions. Low power factor at high frequencies. Self-healing properties. Plastic case design.

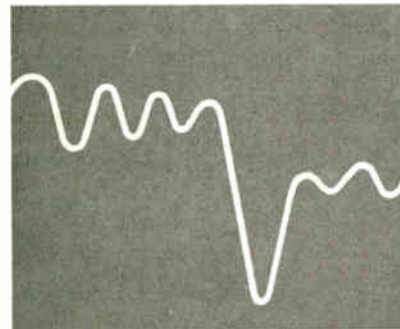

WIMA MKP 10

Metallized polypropylene capacitors in plastic cases. Self-healing properties. Suitable for both high current and pulse circuits owing to low dielectric losses.

- Other special capacitors in metal cases.
- One year successful field experience in equipment by leading manufacturers.
- Suitable for advanced solid-state equipment.
- For professional electronics.



WILHELM WESTERMANN

Spezialfabrik
für Kondensatoren
D-68 Mannheim 1
Fed. Rep. of Germany
Augusta-Anlage 56
P. O. Box 2345
Tel.: (621) 40 80 12

Write for our new catalogue.

People

markets low-cost calculators aimed at housewives and students. Landrum wants to keep those customers while adding such products as clocks with LED displays, electronic slide rules along the lines of the HP-35, low-cost electronic printers, electronic scales for the home, and maybe an electronic chess game.

Looking at the market. "Anything that can sell" is a possible Novus item, says Landrum, with the qualification that "I believe in looking at the marketplace first. If the volume to be produced will allow us to do it at a profit, then we'll take steps to pursue" that product line.



Supermarket sales. National's Landrum manages new consumer products division.

This approach, says Landrum, will help put National in the number two slot of worldwide calculator manufacturers, and will also contribute to National's "dominant" position in the general electronics market. To succeed, Landrum depends on Novus' "very success-oriented" sales team and National's capacity to produce 70% of its own components.

A native of Florida, Landrum graduated from Tulane University with a B. A. in business administration and went to California to join the Singer Friden Co., where he became national sales manager.

He co-founded two companies—Unicom Systems Inc., Cupertino, Calif., and Eldorado Computer Co., Concord, Calif. before joining the Novus division of National Semiconductor.

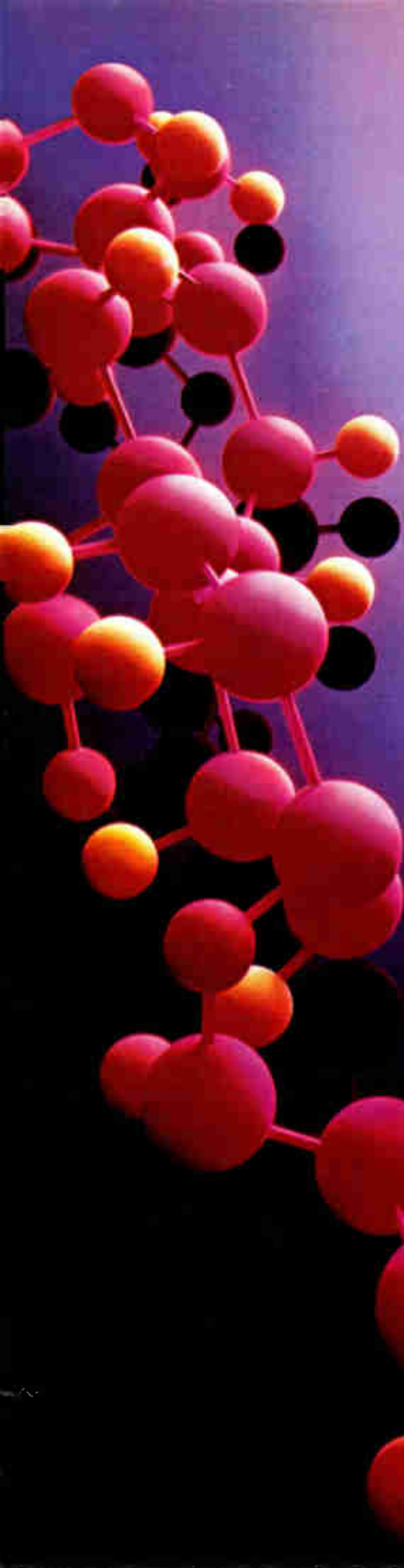

Carborundum works on the frontiers of high temperature materials technology. And exciting plastics happen.

Like Ekkcel™

Ekkcel's exciting performance is a direct outgrowth of the Carborundum high temperature technology. An aromatic copolyester, Ekkcel has long-term thermal stability and strength at temperatures in excess of 550°F. Plus extremely low moisture absorption, excellent friction and wear properties, outstanding dielectric characteristics, and superior flammability resistance — Ekkcel satisfies Underwriters Laboratory specification VE-0. All of which are excellent reasons why designers like Ekkcel.

What about moldability?

Ekkcel can be processed in standard injection molding equipment. And it runs like a dream for fast cycle times and minimal rejects. So processors like Ekkcel, too.

Go tell Tracy . . .

If you have an application requiring performance at high temperatures, tell us about it. Write or call: Tracy O'Rourke, General Manager, Engineered Plastics Group, The Carborundum Company, P. O. Box 337, Niagara Falls, New York 14302. (716) 278-2441.

Carborundum Ekkcel. It lives up to its name.

CARBORUNDUM



When we say Brand-Rex Vylink™ wires



Vylink is the Brand-Rex trade name for its tough irradiated PVC insulated wire and cable. A thermosetting material, it has superior heat resistance, is unaffected when accidentally touched by a solder iron and has outstanding cut-through, abrasion and chemical resistance -- all in addition to vinyl's inherent non-flammability (It meets UL's FR-1 requirements), high dielectric strength and insulation resistance.

Five important processing and operating characteristics of Vylink and conventional PVC insulated wires are compared in the following panels. Test procedures and Vylink's properties are detailed in Brand-Rex specification BR-790. Write for your copy to Brand-Rex Company, Willimantic, Conn. 06226. Tel. (203) 423-7771.

Heat Resistance

After 96 hours at 350°F, Vylink is unaffected; conventional PVC flows. Vylink wire provides far greater protection against current overloads and high temperature environments. It is recommended for shrink-tubing and wave solder cable terminations where wires are exposed to heat guns or solder baths -- an excellent low-cost substitute for the premium-priced "high temperature" wires usually used in this application.

Solder Resistance

When a weighted solder iron (1½ lbs. force) is applied to the wire surface, conventional PVC insulation melts almost instantly; Vylink, though it may exhibit slight surface discoloration, shows no substantial change -- even after several minutes. Regardless of method -- hand gun, solder dip, wave soldering -- Vylink insulation will neither shrink back nor melt. Shorts due to soldering are avoided. Circuit integrity is assured.

and cables are tough, we prove it.



Cut-through Resistance

The relative resistance of *Vylink* and conventional PVC insulated wires to penetration may be demonstrated by applying a 90° V cutting edge attached to a weighted plunger perpendicularly to samples of each. To have the specimens cut through in the same length of time, *Vylink* wire must be subjected to at least 5 times the weight. This extra toughness makes thinner insulation walls possible without compromising physical properties. The result—lighter weight, smaller diameter, but equally reliable, cable.

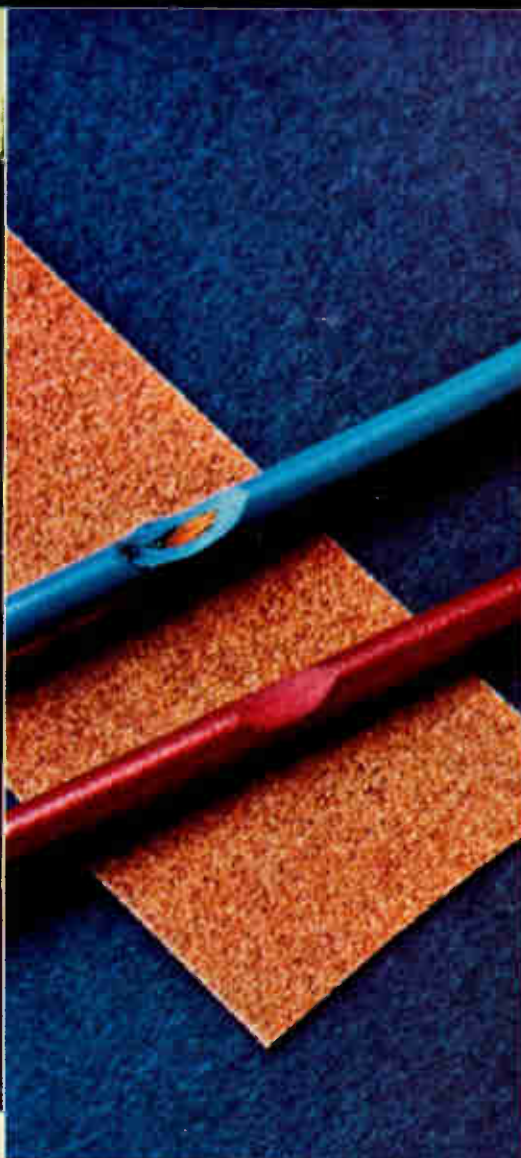

Abrasion Resistance

In this test, a predetermined weight presses a conventional PVC wire sample against a moving 400 grit aluminum oxide abrasive tape until the insulation has been worn away and conductor exposed. By comparison, more than half the insulation remains when the same amount of tape abrades *Vylink* insulated wire under identical conditions. This toughness permits the use of thinner insulation which UL recognizes by rating 6½ mil wall *Vylink* wire at 125 volts (UL Style 1472).



Chemical Resistance

Electronic bombardment of the specially formulated *Vylink* compound causes a change in the molecular structure and transforms this PVC material from a thermoplastic to a thermosetting plastic. *Vylink*, like all thermosets, is generally inert to chemicals and solvents. When *Vylink* and conventional PVC are boiled for two hours in MEK (methyl ethyl ketone), a good solvent for vinyls, *Vylink* is virtually unaffected; conventional PVC is completely dissolved.

BRAND-REX

4,000 solutions in search of a problem

Tests were conducted on 16 (26/30) AWG with 1/32" insulation.

BRAND-REX CO., A PART OF FLORENCE CORPORATION

Circle 19 on reader service card

THE LINE PRINTER FOR THE LONG RUN



**OEMs select it
because users prefer it.**

This line printer is designed for the long runs—applications where printing is measured in hours instead of minutes. It's a line printer. Full 132 columns, 200 lines per minute. That means 200 lpm regardless of line length!

It's reliable. Quiet. Quality print. No duty cycle limitations. A one year warranty to back it up.

Drive it as hard as you want. Over a thousand Tally Line Printers in the field and not a single mechanical failure! As an OEM, that means Tally printers won't eat you alive in service calls.

Tally has the data processing printer. A printer with all the data processing features your user expects. Eight channel VFU. 64 character set. 96 character upper and lower case option. Various fonts. Foreign languages.

Enhance your computer system with this super reliable, long run line printer. Find out all the features. Write or call Tally Corporation, 8301 So. 180th Street, Kent, Washington 98031. (206) 251-5647.

TALLY®

Meetings

Electronic Components Conference, IEEE, EIA, Statler Hilton Hotel, Washington, D.C., May 13-15.

Pittsburgh Conference on Modeling and Simulation: ISA, University of Pittsburgh, Pa., April 24-26.

National Computer Conference, AFIPS/IEEE Computer Society, McCormick Place, Chicago, Ill., May 6-10.

International Instruments, Electronics, and Automation Exhibition, Olympia, London, England, May 13-17.

International Magnetics Conference (Intermag) '74, IEEE, Four Seasons Sheraton Hotel, Toronto, Canada, May 14-17.

Society for Information Display International Symposium, Town and Country Hotel, San Diego, Calif., May 21-23.

International Instrumentation Symposium, Instrument Society of America, Hilton Inn, Albuquerque, N. M., May 21-23.

Semicon/West '74, SEMI, San Mateo Fairgrounds, San Mateo, Calif., May 21-23.

International Symposium and Technical Exhibition on Electromagnetic Compatibility, Swiss Federal Telecommunications Authority, Montreux, Switzerland, May 23-29.

Microwave Power Symposium, International Microwave Power Institute, Marquette University, Milwaukee, Wis., May 28-31.

Power Electronics Specialists Conference, IEEE, Bell Laboratories, Murray Hill, N. J., June 10-12

Quantum Electronics International Conference, IEEE, Hyatt Regency Hotel, San Francisco, Calif., June 10-13.

Utilities Telecommunications Council Annual Meeting, UTC, Chalfonte-Haddon Hall Hotel, Atlantic City, N. J., June 16-20.

Your closest SIGNETICS distributor is...

Phoenix: Hamilton/Avnet Electronics (602) 275-7851
Phoenix: Kieruff Electronics (602) 273-7331

Culver City: Hamilton Electro Sales (213) 870-7171
El Segundo: Liberty Electronics (213) 322-8100
Los Angeles: Kieruff Electronics (213) 685-9525
Mountain View: Hamilton/Avnet Electronics (415) 961-7000
Palo Alto: Kieruff Electronics (415) 958-9292
San Diego: Cramer Electronics (714) 565-1881
San Diego: Hamilton/Avnet Electronics (714) 279-2421
San Diego: Kieruff Electronics (714) 278-2112
Sunnyvale: Cramer Electronics (408) 739-3011

Downsview: Cesco Electronics (416) 561-0220
Downsview: Cramer Electronics (416) 861-9222
Montreal: Cesco Electronics (514) 735-5511
Montreal: Hamilton/Avnet Electronics (514) 735-6393
Ottawa: Cesco Electronics (613) 729-5118
Ottawa: Hamilton/Avnet Electronics (613) 725-3071
Quebec: Cesco Electronics (418) 524-3518
Vancouver: Bowtek Electric Co. Ltd. (604) 736-7677

Denver: Cramer Electronics (303) 758-2100
Denver: Hamilton/Avnet Electronics (303) 534-1212

Hamden: Arrow Electronics (203) 248-3801
Georgetown: Hamilton/Avnet Electronics (203) 762-0361
North Haven: Cramer Electronics (203) 239-5641

Hollywood: Hamilton/Avnet Electronics (305) 925-5401
Hollywood: Schweber Electronics (305) 927-0511
Orlando: Hammond Electronics (305) 241-6601

Atlanta: Schweber Electronics (404) 449-9170
Norcross: Hamilton/Avnet Electronics (404) 448-0800

Elk Grove: Schweber Electronics (312) 593-2740
Ermhurst: Semiconductor Specialists (312) 279-1000
Schiller Park: Hamilton/Avnet Electronics (312) 678-6310

Indianapolis: Semiconductor Specialists (317) 243-8271

Lansing: Hamilton/Avnet Electronics (913) 888-8900

Hanover: Hamilton/Avnet Electronics (301) 796-5000
Rockville: Pioneer Washington Electronics (301) 424-3300
Rockville: Schweber Electronics (301) 881-2970

Burlington: Hamilton/Avnet Electronics (617) 273-2120
Newton: Cramer Electronics (617) 969-7700
Waltham: Schweber Electronics (617) 890-8484

Detroit: Semiconductor Specialists, Inc. (313) 255-0300
Livonia: Hamilton/Avnet Electronics (313) 522-4700
Troy: Schweber Electronics (313) 583-9242

Edine: Hamilton/Avnet Electronics (612) 941-3801
Minneapolis: Semiconductor Specialists (612) 854-9844

Hazelwood: Hamilton/Avnet Electronics (314) 731-1144

Albuquerque: Hamilton/Avnet Electronics (505) 785-1500

Buffalo: Summit Distributors (716) 884-3450
Farmingdale, L.I.: Arrow Electronics (516) 694-6800
Rochester: Schweber Electronics (716) 328-4180
Syracuse: Hamilton/Avnet Electronics (315) 437-2642
Westbury: Hamilton/Avnet Electronics (516) 333-5800
Westbury: Schweber Electronics (516) 334-7474

Cedar Grove: Hamilton/Avnet Electronics (201) 239-0800
Saddlebrook: Arrow Electronics (201) 797-5800

Cherry Hill, N.J.: Murray-DeWaters Valley (609) 424-1300
Moorestown: Arrow/Angus Electronics (609) 235-1900
Mt. Laurel, N.J.: Hamilton/Avnet Electronics (609) 234-2133

Somerser, N.J.: Schweber Electronics (201) 469-6008

Greensboro: Hammond Electronics (919) 275-6391

Belchwood: Schweber Electronics (216) 464-2970
Dayton: Hamilton/Avnet Electronics (513) 433-0610
Cleveland: Arrow Electronics (216) 464-2000
Cleveland: Pioneer Standard Electronics (216) 587-3600
Kettering: Arrow Electronics (513) 253-9176

Dallas: Cramer Electronics (214) 350-1355
Dallas: Hamilton/Avnet Electronics (214) 661-8861
Houston: Component Specialties (713) 771-7237
Houston: Hamilton/Avnet Electronics (713) 528-4661

Salt Lake City: Alta Electronics (801) 486-7227
Salt Lake City: Hamilton/Avnet Electronics (801) 262-8451

Belleveue: Hamilton/Avnet Electronics (206) 746-8750
Seattle: Cramer Electronics (206) 762-5722

Now, a 576-bit RAM for men of few words.

Target-designed 64 x 9 for 45ns buffers and scratch pads.

Making small talk just got easier. With still another world's first from Signetics. Our 82S09 RAM of 576 bits: the largest bit count ever put into a bipolar RAM with more than one bit per word. This 64 x 9 is available now in volume, and multiple-sourced.

What's in it for you? Say you've got a scratch pad or buffer that only calls for 16 to 128 words. Till now your choices were all bad news. Either you wasted memory capacity with oversized organization and gadgety multiplexing schemes, or you strung together a lot of little RAMs. Either way, you lost. In terms of high tabs for extra circuitry, bigger boards, and the power to keep them going. Not to mention penalties in memory speed.

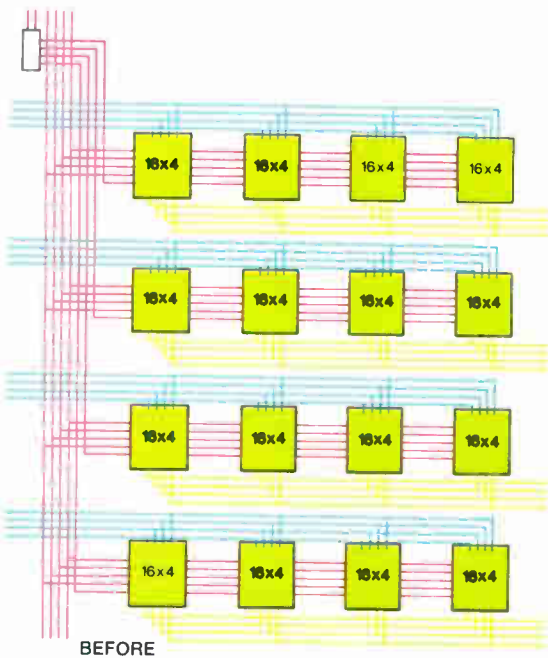

For small, dense memory applications, the unique 82S09 RAM—with new cell design and enhanced 64 x 9 organization—shrinks board space requirements, lowers component count and power cost, but slams out all the speed you can handle. (Schottky technology delivers 45ns, worst case.) With all the traditional bipolar RAM features in the bargain. Full decoding. Chip enable. Open collector. And a vital bonus, the ninth bit for parity.

If the picture still needs a little focussing, take a minute to scan our Comparison Chart, based on production of 200 systems.

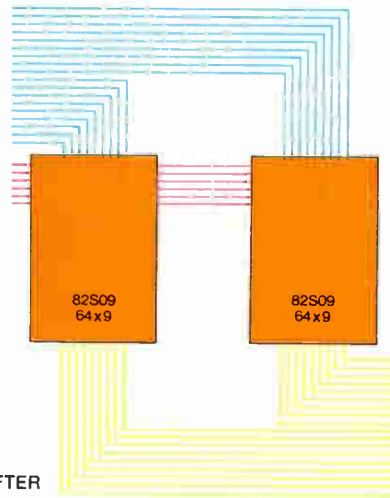

		"Before"	"After"
Parts Cost*	Decoder	\$ 2.80	\$ 0.00
	8225/7489	96.00	85.20
		<u>\$98.80</u>	<u>\$85.20</u>
Board Space		1.5	1.0
Access Time (1)	Decoder	20ns	0
	8225/7489	50ns	45ns
		70ns	45ns
Power Dissipation	Decoder	0.1 Watt	0
	8225/7489	6.4 Watts	1.7 Watts
		<u>6.5 Watts</u>	<u>1.7 Watts</u>
Solder Connections	Decoder	16	0
	8225/7489	256	56
		<u>272</u>	<u>56</u>

(1) Even with 3101A (35ns), the total 64 x 16 array access time is 55ns.
*Signetics 100-up published price.

Okay, talk may be cheap. So make us lay it on the line. Today, from your local distributor.

CLIP THIS COUPON AND ATTACH TO LETTERHEAD FOR FAST ACTION

Signetics—RAMs
P.O. Box 3004-16
Menlo Park, California 94025

Spec sheets first, please, on the 82S09, the new bipolar 45ns Schottky RAM you've raved about and said is available now.

Name _____

Title _____ Mail Stop _____

Signetics Corporation, a subsidiary of Corning Glass Works

signetics

When it comes to breadth of product line, certain names are standouts.

In growing numbers, electronic designers are realizing they needn't look further than the Beckman catalog for thousands of standard, highest-quality components.

They look to us for more than 1,000 standard trimmers. Or our full line of precision potentiometers delivered in literally millions of versions since 1943. Or our array of turns-counting dials. And hundreds of basic microcircuit products — everything from D/A and A/D converters to ladder networks, hybrid amplifiers and regulators, ECL terminators and more.

Standards aren't the whole story, either. What backs up our catalog is as important as the hardware: excellence of custom service.

In custom microcircuit hybrids, for example, we produce on time schedules few others could meet. We build to customer design and specifications, or we supply the design help when needed. And practically any of our products can be custom-altered and produced fast.

So extensive is our entire line, in fact, that we're the second largest user of semiconductor chips in the nation.

Then, Beckman distributors across the country are kept stockpiled with the full standard line. So that delivery is as fast as any in the industry, and usually faster. We even maintain an express system that gets

requested literature to customers in a few days — not weeks, or months. Call toll-free (800) 437-4677.

Yet with all the broad line, top quality, fast delivery and thorough service, there's no catch to the cost. Our prices are definitely competitive.

As we see it, it's no wonder the Beckman catalog is something of a standard itself.



ELECTRONIC

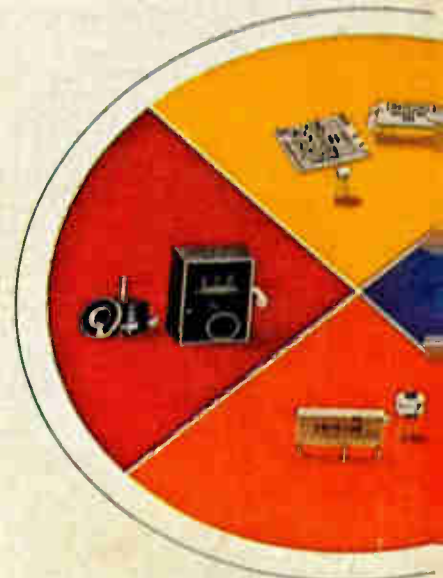

Beckman[®]

HELIPOT DIVISION

Sears
fall and
winter
1973

Beckman®

COMPONENTS

PRECISION
POTENTIOMETERS

DIALS

TRIMMERS

VOLTAGE
REGULATORS

AMPLIFIERS

D-TO-A, A-TO-D
CONVERTERS

RESISTOR
NETWORKS

ECL
TERMINATORS

MOTOR-POTS

SWITCHES

CUSTOM HYBRID
MICROCIRCUITS

Beckman Electronic Component Distributors

EASTERN REGION

Arrow/Angus
P. O. Box 126
Moorestown, N. J.
(609) 235-1900
(215) 928-1800

Arrow Electronics, Inc.
5207 East Dr.
Baltimore, Md.
(202) 737-1700
(301) 247-5200

Arrow Electronics, Inc.
900 Route 110
Farmingdale, N. Y.
(516) 694-6800

Arrow Electronics, Inc.
295 Treadwell St.
Hamden, Conn.
(203) 248-3801

Arrow Electronics, Inc.
No. 15 A Street
Burlington, Mass.
(617) 273-0100

Arrow Electronics, Inc.
285 Midland Ave.
Saddle Brook, N. J.
(201) 797-5800

Harvey R & D Electronics
44 Hartwell Ave.
Lexington, Mass.
(617) 861-9200

Kierulff Electronics, Inc.
49 Bestpage Rd.
Hicksville, N. Y.
(516) 433-5530

Kierulff Electronics, Inc.
5 Industrial Dr.
Rutherford, N. J.
(201) 935-2120

Lynch-Gentry Associates, Inc.
1932 Drew Street
Clearwater, Fla.
(813) 443-2697

Lynch-Gentry Associates, Inc.
3470 Bowman Dr.
Winter Park, Fla.
(305) 671-7649

**Marshall Industries
G. S. Marshall Products Group**
88 Needham St.
Newton Highlands, Mass.
(617) 965-5115

**Marshall Industries
G. S. Marshall Products Group**
230 Sherwood Ave.
Farmingdale, L. I., New York
(516) 293-4141

M & C Sales
1106 Burke St.
Winston-Salem, N. C.
(919) 723-1001

M & C Sales
904 Bob Wallace Ave.
Huntsville, Ala.
(205) 539-8476

**Ossmann Component
Sales Corp.**
395 Cleveland Dr.
Buffalo, N. Y.
(716) 832-4271

**Ossmann Component
Sales Corp.**
411 Washington Ave.
Kingston, N. Y.
(914) 338-5505

**Ossmann Component
Sales Corp.**
280 Metro Park
Rochester, N. Y.
(716) 442-3290

**Ossmann Component
Sales Corp.**
132 Pickard Building
Syracuse, N. Y.
(315) 454-4477

**Ossmann Component
Sales Corp.**
1911 Vestal Parkway East
Vestal, N. Y.
(607) 785-9949

CENTRAL REGION

Magnuson Electronics
2420 Oakton St.
P. O. Box 130
Mount Prospect, Ill.
(312) 956-0700

Magnuson Electronics
1246 West 7th St.
St. Paul, Minn.
(612) 227-8495

Norvell Electronics
10210 Monroe Dr.
Dallas, Tex.
(214) 350-6771

Norvell Electronics
6440 Hillcroft Ave.
Houston, Tex.
(713) 774-2568

Norvell Electronics
3340 S. Memorial Dr.
Tulsa, Okla.
(918) 663-1247

Sheridan Sales Co.
Box 37826
Cincinnati, Ohio
(513) 761-5432

Sheridan Sales Co.
Box 4457
Cleveland, Ohio
(216) 524-8120

Sheridan Sales Co.
Box 423
Dayton, Ohio
(513) 277-8911

Sheridan Sales Co.
33708 Grand River Ave.
Farmington, Mich.
(313) 477-3800

Sheridan Sales Co.
P. O. Box 677
Florissant, Mo.
(314) 837-5200

Sheridan Sales Co.
Suite 5009
1717 Penn Ave.
Wilkinsburg, Penn.
(412) 244-1640

WESTERN REGION

Almac/Stroum Electronics
8888 S. W. Canyon Rd.
Portland, Ore.
(503) 292-3534

Almac/Stroum Electronics
5811 Sixth Ave. South
Seattle, Wash.
(206) 763-2300

**Marshall Industries
G. S. Marshall Products Group**
5633 Kendall Court
Arvada, Colo.
(303) 423-9670

**Marshall Industries
G. S. Marshall Products Group**
835 W. 22nd Street
Tempe, Ariz.
(602) 968-6181

**Marshall Industries
G. S. Marshall Products Group**
9674 Telstar Ave.
El Monte, Ca.
(213) 686-0141

**Marshall Industries
G. S. Marshall Products Group**
8057 Raytheon Rd.
San Diego, Ca.
(714) 278-6350

**Marshall Industries
G. S. Marshall Products Group**
788 Palomar Ave.
Sunnyvale, Ca.
(408) 732-1100

Wyle Distribution Group:

Elmar Electronics
6777 East 50th Avenue
Commerce City, Colo.
(303) 287-9611

Elmar Electronics
2288 Charleston Road
Mt. View, Ca.
(415) 961-3611

Liberty Electronics
124 Maryland Street
El Segundo, Ca.
(213) 322-8100

Liberty Electronics
3130 North 27th Avenue
Phoenix, Ariz.
(602) 257-1272

Liberty Electronics
8248 Mercury Court
San Diego, Ca.
(714) 565-9171

Liberty Electronics
5305 Second Avenue South
Seattle, Wash.
(206) 763-8200

There's more to resistors than resistance



If you're really serious about cost, be serious about quality.

If you think all resistive components are the same, listen to what these users have to say about Allen-Bradley fixed composition resistors:
Buyer—"A-B has shipped nearly four million parts without a single reject or problem. The quality is superb. I've spent 12 years in production control and purchasing. I've seen the amount of down-time, rework and field retrofit caused by others."

President—"We have used many millions of Allen-Bradley hot-molded resistors. The uniformity of quality from one shipment to the next is truly outstanding."
Engineer—"When we use A-B resistors instead of some other make, it's one less component we have to worry about."
"We learned the hard way. The subtle things make the difference. They all

add up to the top quality we want in our products."
Purchasing Agent—"We wish we had more Allen-Bradleys."
Write for Publication RD. Allen-Bradley Electronics Division, 1201 South Second Street, Milwaukee, WI 53204. Export: Bloomfield, NJ 07003. Canada: Allen-Bradley Canada Limited, Cambridge, Ontario. United Kingdom: Jarrow, Co. Durham NE32 3EN.



Realm of 4k is divided into three parts . . .

A measure of stability is surfacing in the 4,096-bit random-access-memory business. Despite recent delays in Texas Instruments' production schedules [*Electronics*, March 7, p. 25], **RAM suppliers are increasingly committing to the TI pinout** for their product introductions over the next 12 months. Three camps have been formed on the pinout question—the 22-pin TI version, the different 22-pin Motorola/AMI version, and the 16-pin multiplex design from Mostek, which Fairchild also will supply.

But the number of suppliers designing their 4k RAMs with TI's pinout indicates that it could become the industry standard. Among them are Intel, National, Signetics, Intersil, Microsystems International Ltd., and Western Digital. Some are one-transistor designs, others use three-transistor cells. Intel, one of the earliest with a three-transistor, 22-pin design, **claims to be shipping already in small volumes its fast 300-nanosecond 2107A version.** And according to Mike Markkula, North American marketing manager, "We will be shipping tens of thousands of the 2107As by July."

. . . as AMS reports surging interest for p-channel

In a related 4k memory development, Advanced Memory Systems' 7004—the industry's only 4,096-bit p-channel RAM design—is drawing added interest because of start-up n-channel production problems. According to Herbert Woo, international marketing manager, "Designers are building memory boards using the 2k model 7002 memory, **but including an extra address line to accommodate future update to 4k.**"

Woo says that, although the 7004 is slower than the n-channel products, "it uses an established p process that's highly reproducible in large quantities."

Dual Isolator to feature gated outputs

To meet the growing demand for high-speed optical isolators, Hewlett-Packard will introduce next month **the industry's first dual optical isolator with gated outputs.** The device, which is TTL-compatible and operates from a 5-volt supply, offers high common-mode rejection (20 V at 1 megahertz) with typical delay times of 40 nanoseconds.

Rick Nis, marketing manager for optoelectronics, says that the new device's two channels will offer **the same high isolation and high speed—in the same size package**—as the popular single-channel device. The new isolator is attractive for high-speed digital applications such as line receivers, digital programming of floating power supplies, motors, and other machine-control systems.

National Semiconductor also is cranking up its optoelectronics capability with plans to introduce within a few months **its first optical isolator**, a six-lead transistor output device.

H-P is developing C-MOS on sapphire

An indication of how fast silicon-on-sapphire technology is moving into the real world of digital processing is Hewlett-Packard's decision to develop its own complementary-MOS-on-sapphire circuits for a new generation of minicomputers. **H-P is also in a major development program to identify the minicomputer design that best utilizes this technology.**

Paul Ely, general manager of H-P's Data Systems division, Santa Clara, Calif., says in-house C-MOS-on-sapphire technology, which H-P hopes will provide input/output, processor, and memory, offers "the most attractive speed-power-cost trade-offs for minicomputer applications."

Another manufacturer, General Automation, has developed a mini-computer with custom C-MOS-on-sapphire CPU chips built by Rockwell International's Microelectronic Device division. [*Electronics*, Dec. 6, 1973, p. 39].

Macrodata delivers inexpensive testers for microprocessors

IC tester maker Macrodata, which has been expanding from memory testing to other IC test areas during the last year, **has delivered five low-cost systems for the fast-growing microprocessor market, and will shortly introduce a system to the market.** The under-\$50,000 MD-1041, based on the MD-104 memory exerciser, will check the Intel 8008, 8080, and 4004 microprocessor CPUs, plus new designs coming from National, Motorola, and other firms. The system will check the processors from function rather than just logic, an important consideration since the powerful chips have shown sequence sensitivity. The system is oriented toward incoming inspection, R&D, and wafer-probe uses.

Fast MNOS memory coming from SEMI

Electronic Memories will introduce at the National Computer Conference, May 6 to 10, an MNOS memory system with a cycle time as fast as 80 nanoseconds. Access time is 150 ns. **This compares with a 650-ns cycle for core versions.** The system, to be made at the company's Phoenix SEMI semiconductor operation, is interchangeable physically and electrically with Electronic Memories' Micro-3000 core-memory systems. The price will be about 1 cent a bit in quantities of 100, slightly more than the core, and boards laid out 16,384 bits by 20 as well as 8,192 bits by 20 will be offered.

Electrolytic cell shows promise as display with memory

Researchers at Thomson-CSF's Corbeville, France, laboratories may put a new lease on life for a display device proposed and then discarded in the 1930s—the electrolytic cell. Thomson's experimental display, on the company's stand at the recent Paris Components Show, has seven segments—actually tin oxide electrodes deposited on a glass plate. A metal plate forms the other electrode for the cell and the space between the two is filled with an electrolyte. When 5 volts or so are applied across the electrodes, **cathode metal plates out onto the energized front electrodes in about 200 milliseconds and stays plated for about 15 days unless erased by a reverse potential.** The power requirement for the plating is 100 microwatts for each square centimeter of the display.

Thomson-CSF won't say what metal and what electrolyte it uses for these experimental cells, but the developers think the new devices could turn out to be cheaper to produce than liquid-crystal displays. Spacing between the cathode and anode is a relatively large 200 micrometers, compared to something like 10 micrometers for liquid crystal.

Better than any IC or UJT for low cost timing circuits.

Unitrode PUTs provide design freedom unobtainable with conventional UJTs—at a fraction of the cost of comparable ICs or mechanical timing circuits.

By varying the external resistor values you can program turn-on voltage, turn-on current and turn-off current to meet your needs . . . in timing circuits, oscillators, sensing circuits or any application where a variable voltage level threshold is required.

Unitrode Programmable Unijunction Transistors (PUTs)

Simple, versatile, low cost Unitrode PUTs meet the performance require-

ments of any timing circuit in frequencies from 50 KHz to .001 Hz, from microseconds to hours.

Millions of Unitrode PUTs have already cut costs in thousands of applications from smoke detectors and television sets to office machines and industrial processing systems. In fact, Unitrode produces a larger selection of PUTs than all other manufacturers combined. Fully planar passivated . . . low nano-amp leakage for long interval timing . . . in the plastic TO-92 and TO-98 package, and the hermetically sealed TO-18 package.

Send for a free sample. We'll also include data sheets and application notes to help you breadboard the lowest cost timing circuits ever.

Or, for faster action, call John Upton at (617) 926-0404. Unitrode Corporation, 580 Pleasant Street, Watertown, Mass. 02172.

Try a free sample

Circle 27 on reader service card

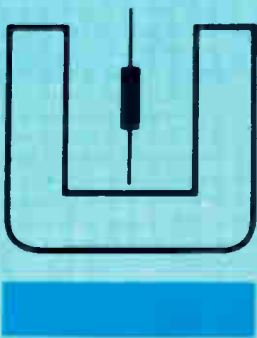

UNITRODE

580 PLEASANT STREET, WATERTOWN, MA 02172

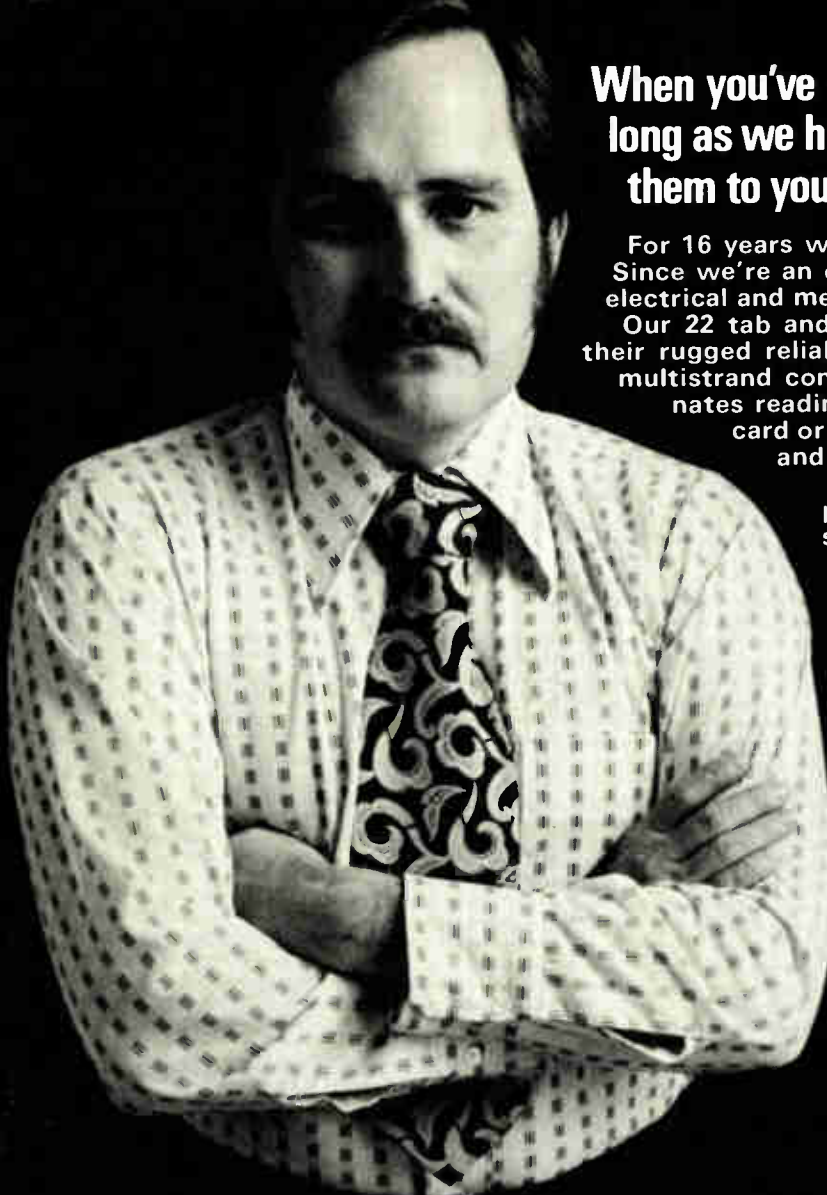

When you've made static card readers for as long as we have, you've learned how to tailor them to your customer's specific needs.

For 16 years we've been a static card reader specialist. Since we're an electronics company, we understand the electrical and mechanical aspects of card readers.

Our 22 tab and 80 column card readers are known for their rugged reliability and accuracy. We owe that to the multistrand continuous brush design. This design eliminates reading errors caused by contaminants on the card or misalignment. Cards are locked into place and released only when the scan is completed.

You can select from a variety of electronic packages to interface the reader to your system. There are packages like TTL-compatible scanners with two operating modes, sequential scanning and addressable by column number.

Many of our competitors do not want to be bothered with the reader modifications customers ask for. Not us. This is one of the major advantages of specifying a Hickok static card reader. In the sixty years we've been in the electronics business, we've learned how to work closely with our customers. We have years of experience in tailoring our card readers to meet our customer's specific needs.

Put our 16 years of card reader experience to work on your data input and collection problems. Find out how we can solve your card reader problems. Call our application engineers today.

HICKOK

the value innovator

Instrumentation & Controls Division
The Hickok Electrical Instrument Co.
10514 Dupont Avenue—Cleveland, Ohio 44108
(216) 541-8060—TWX: 810-421-8286

Circle 28 on reader service card

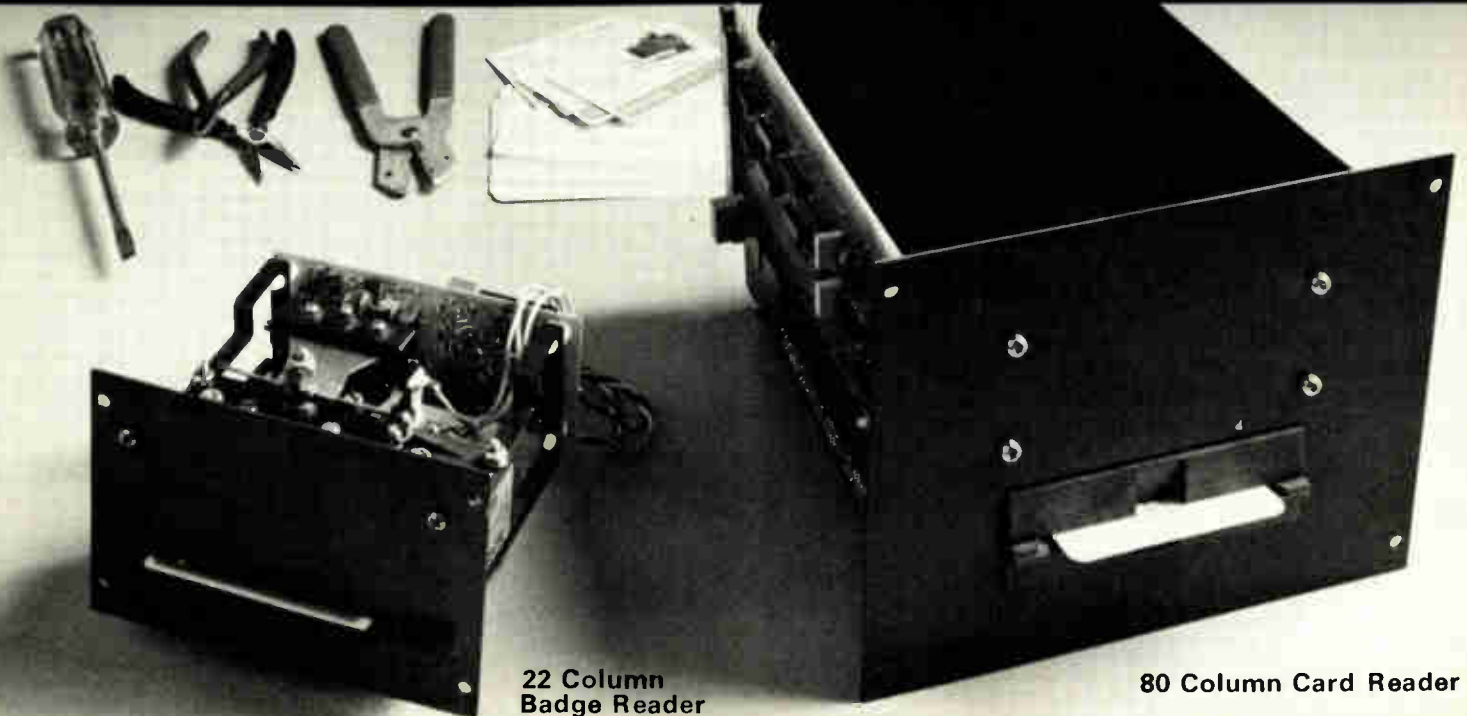

**22 Column
Badge Reader**

80 Column Card Reader

Double-junction LED emits bright, clear colors over broad spectrum

Developed at Siemens, the double diode changes color by varying the drive at the two junctions

Researchers at Siemens AG have designed a new kind of variable-color light-emitting diode. The LED shines with a distinct red, green, or yellow, or any color in between, and has a wide spectral range. Siemens researchers have achieved these results by putting two differently doped gallium-phosphide layers with integrated pn junctions on the same crystal.

Up to now, most LEDs that produce three colors in a single device have used one pn junction, with the n and p layers doped to give green and red. Yellow is obtained by mixing these two colors. According to Siemens researchers, however, with single-junction LEDs, traces of red creep into the green and vice versa. What's more, the spectral range of single-junction LEDs is usually quite narrow.

Two is better. To solve these problems, Siemens turned to a double-junction LED—a double-diode structure on a single crystal—even though it is more complicated to produce. Either junction can be separately driven to give a clear red or a clear green. If both junctions are driven simultaneously, the light emitted is yellow. By using different drive currents at the two junctions, the color varies from greenish-yellow to reddish-yellow.

In the Siemens LED, the drive currents applied to the junctions are from 10 to 20 milliamperes at about

2 volts. The emission efficiency for the green is from 0.5% to 0.1% and for the red around 1%.

Not all parameters—for example, life expectancy and brightness—have been determined for the device. As for the brightness of the red, green and yellow colors, Manfred Plihal, a researcher involved in the development of the variable LED, expects it to be about the same as that of the single-color LEDs Siemens is offering.

Applications. Siemens sees a wide range of possible applications for a variable-color LED. It could be used as an indicator lamp for showing four operating states of a system: red, green, yellow, and off (no light). Another potential application is as a warning light on a car dashboard, where the LED would go from green to red when a certain speed limit was exceeded. An experimental multicolor indicator with several dozen LEDs on tachometer and ther-

mometer scales will be demonstrated next week on the Siemens stands at the Hanover Fair in West Germany.

The new LED consists of an n-doped gallium-phosphide substrate, with a gallium-phosphide layer grown by a Siemens-developed liquid-phase epitaxial process on both substrate surfaces.

The two layers—one nitrogen-doped for green and the other zinc-oxygen-doped for red—contain the respective light-emitting pn junctions. Then, p contacts are mounted on the upper and lower surfaces. The common n contact is made by etching away part of the substrate's upper p layer.

The variable LED measures about 0.4 millimeters on each side and 300 micrometers thick, with the substrate taking up about 160 μm and each of the two layers around 70 μm . The experimental three-lead device comes in a TO-18 header,

Glowing results. The Siemens color LED consists of two layers on an n-doped gallium-phosphide substrate: one is nitrogen-doped for green light, the other zinc-doped for red.

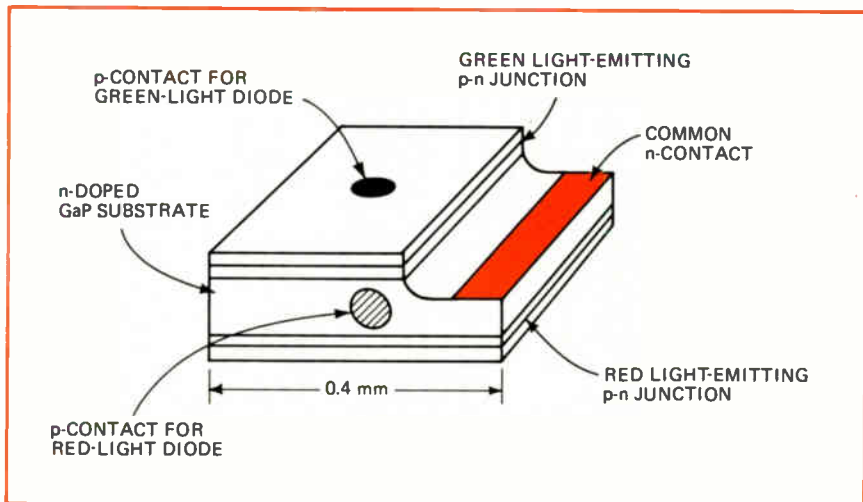

but a commercial one may come in a different package. Because of the low power dissipation—40 milliwatts maximum—there is no need for a heat sink. □

Communications

Millimeter waves to carry intracity data?

Even though the Federal Communications Commission has not formally opened up new millimeter-wave frequencies, the Norden division of United Aircraft Corp. is off and running with a low-cost transceiver intended to carry short-haul intracity voice and data messages in digital form.

Anticipating a large market among common carriers and private businesses with large data-transmission needs, the Hartford, Conn., company has developed a system that operates at 1.544 megabits per second and 6.312 Mb/s at carrier frequencies of 22 or 39 gigahertz. And it has already found at least

one customer—Datran, a common carrier specializing in data transmission—that says it has already proposed using it for a customer in the Houston area.

The Norden system consists of 30-pound roof-top installation comprising an antenna 21 inches in diameter and a transceiver mounted on a 3-inch-diameter antenna mast. A remote power supply is mounted inside the building. The system uses a Gunn diode as the millimeter-wave signal source (with 50 milliwatts output), and digital information is applied to the diode by frequency-shift keying, directly at the output frequency. A simple twisted pair carries power and digital signals from digital processing equipment, such as a multiplexer, inside the building. The system costs \$8,250.

Norden uses a pulse-cancellation technique borrowed from radar technology to allow the system to both send and receive simultaneously in the same 50-megahertz channel. Although the receiver "sees" both the transmitted and received pulses, digital manipulations help it recognize the transmitted pulses and ignore them (the com-

pany says it has applied for a patent on the technique).

The range of the system (between line-of-sight installations), according to Norden's Lou Ebrrel, design engineer in charge of applications, is about two and a half to five miles, depending on the intensity of rainfall in the path. (The system cuts off completely at about 2.3 inches of rain per hour over the entire path, but this is a relatively rare occurrence, Ebrrel says.)

Datran, Vienna, Va., says it would like to use the system later this year for the Houston customer, who will transmit data at 56 kilobits per second. The Norden system will carry the customer's data from his building to Datran's building, about three miles away, where it will be applied to Datran's microwave network.

Datran also points out that the system could prove valuable in industrial-park complexes, where individual millimeter-wave units could be scattered throughout the complex. Each unit could send signals to a central location where messages could be brought down to the normal 6-GHz band for transmission

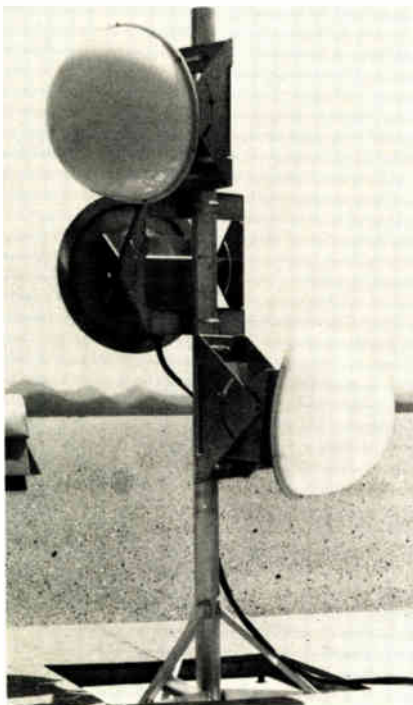

For intracity calls. Norden's new transceivers are designed for rooftop mountings.

Datran files interstate tariffs

Following hard on the heels of AT&T's filings for interstate digital data-transmission tariffs [*Electronics*, April 4, p. 75], Datran, Vienna, Va.—the only common carrier specializing in digital data transmission—has filed its own interstate tariffs with the Federal Communications Commission. At the same time, the company asked the FCC to delay approval of AT&T's tariffs for at least four months, to prevent AT&T from preempting the market.

Datran's tariffs cover the company's links between Houston and St. Louis, which include Oklahoma City, Tulsa, and Kansas City. Datran has filed for service speeds of 2,400, 4,800, and 9,600 bits per second. Its rates are based on airline distance and speed of transmission, and users will also pay a monthly charge for the local distribution channel, a one-time installation charge, and a monthly charge for use of Datran's customer interface unit.

Monthly rates for Datran's long-haul channels are 75 cents per mile for 2,400 b/s and 4,800 b/s and 90 cents per mile for 9,600 b/s. AT&T's filing with the FCC was: 40 cents per mile for 2,400 b/s, 60 cents for 4,800 b/s, 90 cents for 9,600 b/s, and \$4.00 for 56 kilobits/s (and a monthly charge for local distribution channels, interface units and a one-time installation charge).

Datran, however, is hoping to one-up AT&T with a money-back performance guarantee—99.95% of all 1-second intervals will be free of error, the company says, or the subscriber's bill will be credited for the period of substandard performance. AT&T, in filing for its Dataphone Digital Service, said its objective was to provide at least 99.5% error-free seconds, but that better performance has been achieved in trials between New York and Boston.

via a microwave relay.

The FCC, however, has yet to approve the use of the frequencies. A Commission spokesman says that the docket (18920) which covers 18, 22, 25, 27, and 39 GHz, is not controversial, but it still may be a couple of months before there is any action. However, Norden says that the equipment can be operated now under a developmental license, pending the final ruling. □

Navigation

C-LAD steers ship via computer

After several years of development, the Coast Guard is ready to release to manufacturers the design of its Loran-Assist Device (C-LAD) [*Electronics*, Sept. 11, 1972, p. 32]. Developed by Johns Hopkins University Applied Physics Laboratory, C-LAD is a navigation and autopilot system used with a Loran-C receiver. Once in production, the Coast Guard estimates, the units can be sold for about \$3,000 each.

C-LAD is connected to the outputs of the Loran-C receiver that provides a ship's latitude and longitude. The coordinates of the ship's destination are input to C-LAD by means of thumbwheel switches. Loran-C uses hyperbolic coordinates specified in microseconds and mathematically transformed into a grid on a chart specified in yards.

C-LAD provides a reading of the ship's course and its distance from its present position to its destination in thousands of yards. The same mathematical solution to the distance to be traveled also gives the bearing angle from the ship's position to its destination. C-LAD updates its course information every 8 seconds, and errors in the calculation converge to zero as the ship approaches its destination.

Autopilot. The ability to determine the present position-destination bearing also allows C-LAD to act as an autopilot. In that mode, a user dials in the bearing angle to the des-

Are the Russians really coming, Or: the missing metal-film resistors

Last month's IEEE Intercon 74 seemed like an auspicious kick-off for the first trade-show appearance in the U.S. of electronic-component marketers from the Soviet Union. That very week, in a quiet conversation at the Russian exhibit booth, J. Guchin, an Electronorgtechnica official, said that General Electric had just signed a million-dollar order with Electronorgtechnica, the USSR's trading organization that handles exports of metal-film resistors, vacuum tubes, and semiconductors.

What is smooth? By the Russians' indications, all was going smoothly and as planned. Not so, say sources within General Electric. And herein lies a tale of what it could be like to do business with the Soviet Union.

Destined for GE's television-receiver-assembly plant in Portsmouth, Va., the resistors would begin arriving late in 1974, according to Guchin, with most of the shipment to come next year. But the agreement, which was actually signed seven months ago, specified that delivery was to have started five months ago, says one GE man in a position to know.

So far, no production quantities have been received. Engineering samples were acceptable, he continues, but promised preproduction

samples have never showed up. The next shipment commitment is due in another few months, he continues, but, "I'll believe it when I see it."

Dealing with the Russians. In placing its order with the Russians, General Electric, which maintains a sales office in Moscow, apparently wanted to open a two-way trading avenue.

Moreover, the price quoted for the resistors was a very good one, according to a GE source, even with the American tariff added on. But while promises apparently come quite cheaply, delivery and actual business dealings with the Russians are other matters.

It was extremely difficult to maintain working relationships with the Russians, says another GE man. Letters and telegrams went unanswered for months at a time. And in face-to-face talks, it seemed to be the practice never to meet the same men twice. "There was a brand new crew of faces every time," he continues. And this seemed to be by design, so that no rapport could be established between the negotiators.

Is there any advice for others counting on Soviet suppliers? Yes, replies one GE man dryly, "Back up your program with regular sources."

tion and C-LAD compares it with the bearing determined by the Loran-C coordinates. The user can also set up a maximum course deviation, or corridor width. When a ship leaves the corridor, a C-LAD relay is closed, turning on a light that indicates drift to left or right. This output can be used to drive simple servomechanisms on the rudder to keep the ship on course. When the ship returns to the corridor, rudder correction ceases.

At the heart of C-LAD is Intel's MCS-4 microprocessor chip, which contains an arithmetic unit, logic control address, and address to con-

trol subroutine handling. It is a 4-bit parallel microprocessor with 16 general-purpose and index registers and a cycle time of 10.8 microseconds [*Electronics*, April 24, 1972, p. 112]. The microprocessor supports two types of memory: six Intel 4002 read/write chips for a scratchpad that can store four 20-digit numbers each, and Intel's 1702 programmable-read-only memory instruction memory—when in production, this would be replaced by a read-only memory. There are also chips to interface to the receiver and a clock to drive the logic.

Charles R. Edwards of Johns

Electronics review

Hopkins lab says: "We program C-LAD as though it is a mini, but it's really a microprocessor." Subroutines have been developed for the system; the labs have invented an intermediate language that minimizes the amount of data in store.

Prototypes of C-LAD have been in the field for about six months, and development plans for its manufacture are expected to be released next month. But companies are already beginning to express interest in the product. Navigation Systems Inc., Silver Spring, Md., a subsidiary of Decca Navigator Co. Ltd. of England, which makes Loran-C receivers, is "taking a look at the market [for C-LAD]" a spokesman says. "We want to see what it will do and at what price." But he feels it can offer the shortest route to a particular point, and that it offers potential to fishermen. □

Commercial electronics

Vehicle-tracking unit could cost only \$500

A simple vehicle-tracking system developed by an avocational rock-hound and mapmaker for \$5,000 appears to do much the same job as the \$1.8 million position-and-azimuth-determining system (PADS) that Litton Industries designed for the U.S. Army [*Electronics*, July 31, 1972, p. 22].

But being somewhat less accurate and reliable, the unit—which its inventor says could be produced to sell for \$500—is not suitable for military use. It does, however, permit dead reckoning to within 6%, or a few hundred feet for a trip of several miles.

As an on-board tracking system, it looks promising for locating police cars, fire engines, and taxicabs in a city. The system was conceived by Dale Hileman of Topanga, Calif., and developed into a working, all-digital model with help from Bob Phillips, president of the consulting firm, Fundamental Products, North Hollywood, Calif.

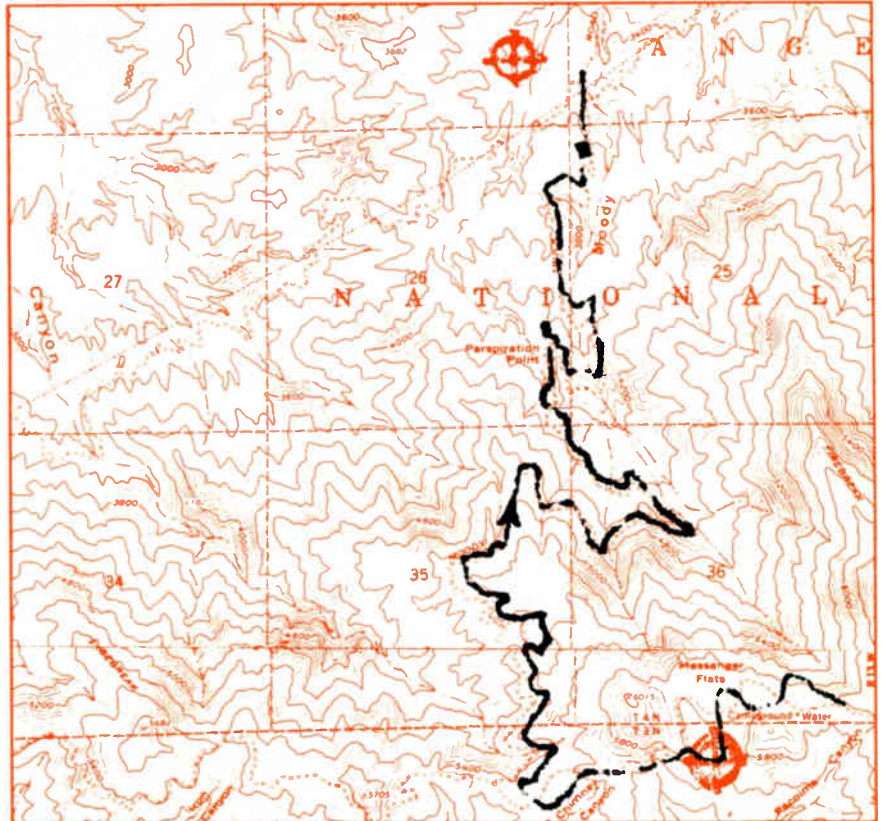

On the trail. Tracings from Hileman's vehicle-tracking system superimposed on a map.

It derives distance information from a pulse pickup from the vehicle's odometer-speedometer. To determine heading, Hileman developed a magnetic compass using a constantly rotating pickup coil, and the sine-wave output generated by it is processed to give any of 32 position headings.

The data from the distance and heading sensors are combined in a small "computer," for display on a specially made digital X-Y plotter that uses pulse-operated motors. The computer, built mainly with discrete components, measures 12 by 6 by 6 inches. Hileman, though working on converting it to C-MOS and reducing its size, is mainly interested in selling the concept.

Magnetic effects. The system is independent of the car's motion and of any externals other than the earth's magnetic field. The compass sensor is mounted on a gimbal that allows front-back motion, and travel over hills produces relatively minor errors, about 1% for a very steep slope. The biggest error is caused by the large magnetic mass of the car.

The big market, he feels, is in vehicle location. "Our system could store locations digitally, then transmit them over the existing radios in a vehicle. To correct for the cumulative error, it could be checked automatically and corrected by passing near a proximity detector—which could be passive lines in the street every few miles."

This combination of dead reckoning plus proximity could be built for less than \$500 in quantity, he says. It would overcome the problems with proximity, dead-reckoning, and triangulation systems. □

Materials

Recycling of silicon found to be practical

Silicon-wafer reclamation, considered an "R&D wonder for seven years," according to the president of Silicon Valley's six-month-old Silicon Material Inc., is beginning to

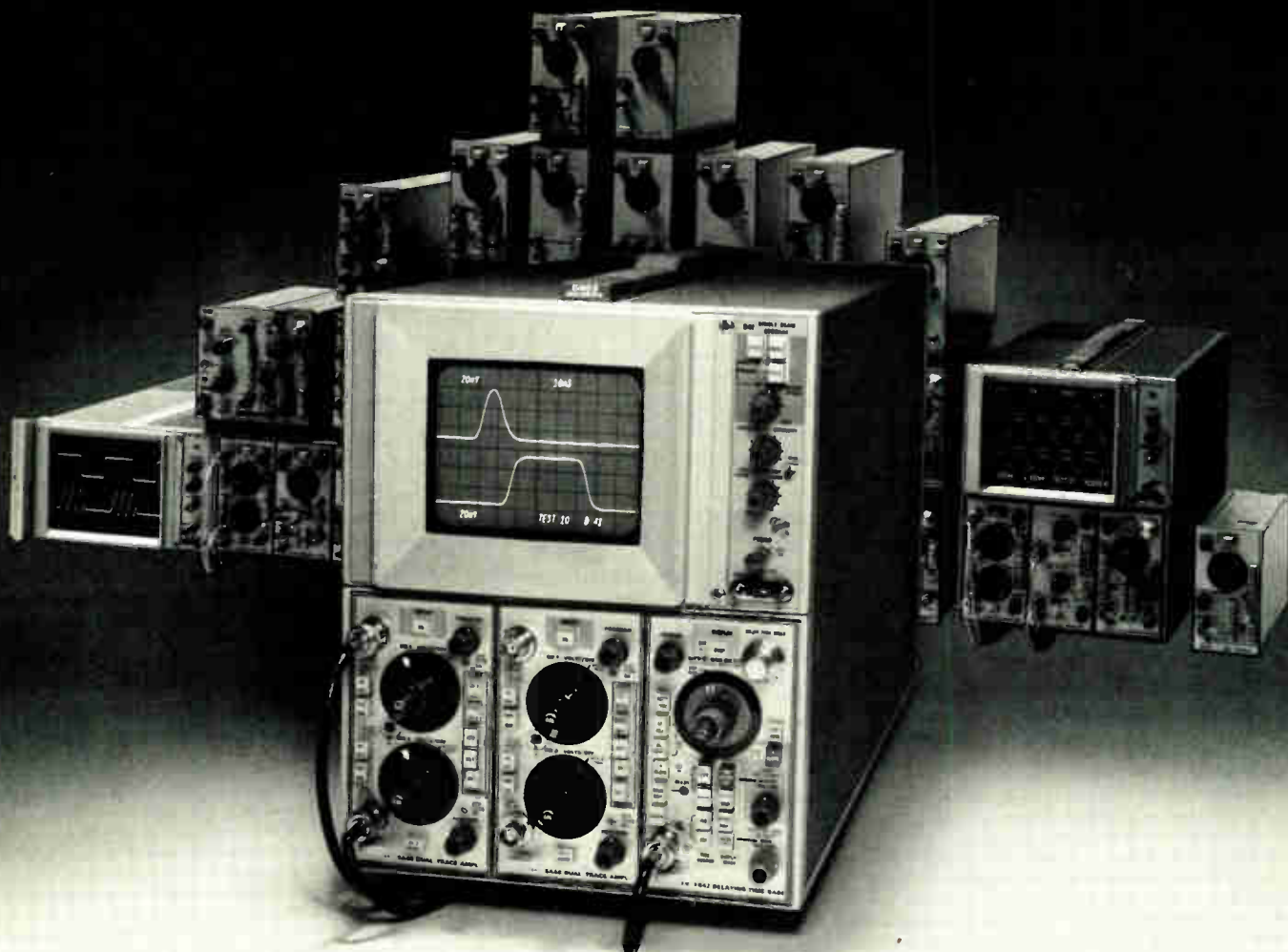

Capture Those Hard to View Signals at Low Cost

Single shot events; high speed, low repetition rate signals; changes in successive sweeps, very slow signals; repetitive signals obscured by random noise—all of those hard to display waveforms are easy to view using the new 5403/D41 Variable Persistence Storage Oscilloscope from Tektronix.

You vary waveform storage time for the 5403/D41 simply by turning a dial. Normal intensity viewing time ranges from milliseconds up to 5 minutes and a waveform can be saved for up to an hour by simply pushing a button.

With a writing speed of 5 div/ μ s, 60 MHz bandwidth and the added convenience of a 3 plug-in mainframe, the 5403/D41 saves you hundreds of dollars over the price of other variable persistence storage oscilloscopes. Complete with 60 MHz vertical amplifier and 10 ns/div time base, the 5403/D41 is priced from only \$2450. What's more; with the flexible, easy-to-use 5403/D41 you can add unique

convenience features: CRT readout of deflection factors, and user programmable CRT readout of test identification data.

Versatile, Modular Family. The 5403/D41 Variable Persistence Storage Oscilloscope is the latest addition to the versatile, modular 5000 Series. With this flexible family you can tailor the oscilloscope best suited to your measurement needs by choosing from 2 mainframes (60 MHz or 2 MHz bandwidth), 7 display modules, and 21 diverse plug-ins. 5000 Series measurement flexibility includes a 60 MHz dual trace amplifier, a 10 ns/div sweep rate delayed time base, an easy-to-use dc to 1 GHz sampler, a dc to 100 kHz spectrum analyzer, a 10 μ V/div differential amplifier, a differential comparator accurate to 0.20%, a four trace amplifier (8 traces with two amplifiers), and a semiconductor curve tracer.

The flexible 5000 Series is designed to handle your present measurements and is expanding to meet your future needs.

To learn more about the new 5403/D41 Variable Persistence Storage Oscilloscope and how this low cost instrument can make difficult signals easy to measure, contact your local Tektronix Field Engineer or write Tektronix, Inc., P.O. Box 500, Beaverton, Oregon 97005. In Europe write Tektronix, Ltd., P.O. Box 36, St. Peters Port, Guernsey, C.I., United Kingdom.

For a demonstration circle 32
on reader service card

Circle 33 on reader service card



TEKTRONIX®
committed to
technical excellence

pay off as a result of the silicon shortage.

SMI president John E. Lawrence, opened his Mountain View, Calif., shop after estimating that the weekly supply of "virgin" silicon is about 800,000 wafers but the demand is 1 million wafers. Lawrence is looking at that 20% gap, urging semiconductor firms to have their defective wafers reclaimed at SMI.

So far, SMI has rung up \$70,000 in orders, and Lawrence expects that figure to jump to \$1 million by the end of the year. The firm's present processing capacity is 30,000 wafers a week, and this will reach 50,000 a



Recycler. John Lawrence, president of SMI, developed means of recycling silicon.

week in June, Lawrence says. A reclaimed silicon wafer costs 35% as much as a virgin wafer—\$2.50 for a 3-inch wafer that originally cost \$7.

In-house facilities. Even though he believes "there will be adequate supplies of silicon by the fourth quarter, SMI's "lower cost will always keep us in business." Lawrence does admit that "every semiconductor company with sales over \$50 million a year will develop its own in-house" reclamation facility.

Such firms as Signetics, Tektronix, Fairchild, AMI, National, Intel, and Sprague, which have sent in experimental wafer batches, will use the firm for six months, says Lawrence, and then develop their own

wafer-processing facilities.

But Lawrence, in fact, hopes to work with companies that wish to set up their own facilities. SMI would set up the facility and work with that firm's employees for two years, when the facility and all rights to the process would be sold.

The process. SMI uses a proprietary gettering process to neutralize contaminants electrically. Next, oxides, metals, nitrides, polysilicons, and other surface impurities are removed chemically. The diffused impurities are removed by diffusing phosphorus into the wafer to a depth of 1 micrometer. The phosphorus attracts the impurities, and the phosphorus layer is then removed chemically and mechanically. Moreover, as the phosphorus is diffused, the silicon substrate heats up, creating dislocations in the crystal lattice that absorb any remaining contaminants.

The process will not work with wafers with diffusions less than 0.7 μm deep, since these wafers have no space left to absorb impurities from below. Nor can gold-doped wafers undergo reclamation because gold precipitates into dislocations in the bulk silicon and affects device performance negatively.

While it is true that the few other contaminants—not absorbed by the phosphorus—are also drawn into dislocations in the bulk silicon, these do not affect the performance of a device, Lawrence says. This leaves the surface, where most semiconductor activity occurs, free of impurities. "We're taking advantage of bulk defects to absorb surface defects in the wafer," Lawrence says.

SMI is reclaiming wafers for 34 companies, mostly on an experimental basis. Stanley G. Billingsley, materials control manager at Hewlett-Packard Co.'s Santa Clara, Calif., integrated circuit department, says that the several hundred wafers SMI sent to H-P were "at least

equivalent to virgin materials and worked as well with no more problems than with new material." H-P previously scrapped its defective wafers, says Billingsley, because "historically, there was nothing you could do with a bad IC." H-P now has an order for several hundred at SMI and awaits the test runs to determine whether or not the wafers can be used for new products, as well as test wafers.

Economics. Financial considerations seem to be the impetus for SMI's growing list of customers. "It's a very attractive process economically," says Electronic Arrays' director of processing techniques, Joseph J. Curry. The Mountain View, Calif., firm went to SMI, says Curry, "because manufacturers can't provide the volume [of wafers] we need. This process provides us with a good measure of protection against any further shortage." EA has already made products with the reclaimed wafers, finding them "no better or worse" than virgin wafers. □

Production

How phosphorus abets IC destruction

If the silicon dioxide used to passivate a plastic-encapsulated semiconductor device contains excessive amounts of phosphorus, this material, laid down to protect the chip, may actually hasten its destruction. This is the finding of Motorola researchers—senior engineers Wayne Paulson and Ralph W. Kirk, who was formerly of Motorola, but now with Hewlett-Packard. Their results were presented at an IEEE Reliability Physics Symposium early this month. Since silicon dioxide is a glass and extremely brittle, phosphorus is often added to the silicon dioxide to reduce the microscopic cracks that might otherwise form.

Paulson and Kirk point out, however, that there is an optimum percentage by weight that can be added—between 2% and 6%. They say that raising the phosphorus level

New! A 600-watt, 5V, 100 amps switching regulated power supply that has four outputs, measures just 3.9" x 7.5" x 16.12", weighs only 14 lbs., is 75% efficient and costs only \$493.*

And LH has 84 other equally exciting models to choose from — all of them smaller, lighter, more efficient and priced lower than competitive switchers.

250 to 1500 watts

LH offers 7 standard wattage ratings — 250, 300, 500, 600, 1000, 1200 and 1500** watts. This is the most comprehensive line of high-efficiency switchers available anywhere.

4 outputs

Standard LH switchers are available with single, dual, triple or quad DC outputs.

Low DC voltage, high power outputs

Primary voltages are at 5 VDC; 50, 100, 200 and 300 amps**. 2nd and 3rd voltages are standard ± 12 , ± 15 and ± 18 V at 8 amps each; 4th voltage is 24V at 2 amps. Other voltages available.

Input voltages externally selectable

110/220 VAC, 47 to 440 Hz, can be selected by simply changing a jumper on the front terminal strip. DC input, 24 to 300 VDC, also available.

6 case configurations

All LH switchers use one basic proven design and package it in six

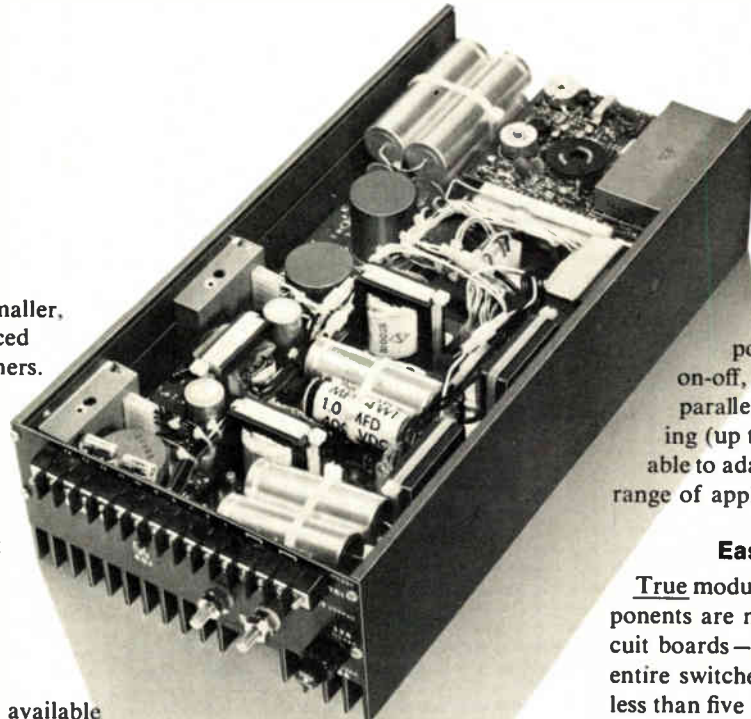
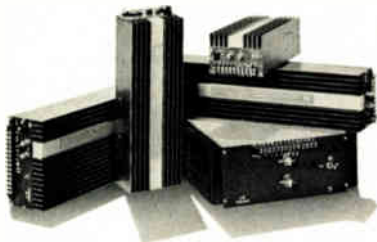

A number of options

Over-voltage protection, power fail detection, remote on-off, thermal cutoff, DC input, paralleling, master-slave paralleling (up to 10 units) — all are available to adapt LH switchers to a wide range of applications.

Easy maintenance

True modular construction — all components are mounted on just three circuit boards — make servicing easy. The entire switcher can be disassembled in less than five minutes.

different case shapes — wide and short or narrow and long — for customer convenience. With a nominal power density of 1.37 watt/cu. in., LH switchers pack more power into a smaller package than any other switchers you can buy.

80% efficient

On single output models, over 80% of the primary input power is delivered to the output terminal. On models with dual, triple and quad outputs, efficiency averages 75%.

Lighter weights

For example, LH's 250-watt single output model weighs only 7 lbs.; the 1200-watt, quad output unit, just 30 lbs.

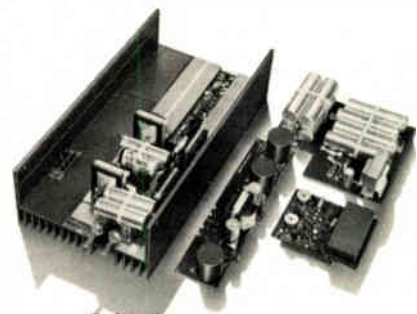

Priced as low as 63¢/watt

Watt-for-watt, LH units are the lowest priced switching regulated power supplies you can buy. In 1 to 24 quantity, a 250-watt single output model sells for \$360; a 1200-watt quad goes for \$1245.

Ask for full-line folder

The LH rep in your area has a new six-page folder that fully describes the 85 standard LH switchers, and discusses possible options and modifications to meet specific requirements.

Ask him for a copy today.



*1000 pc. qty.

**Available Sept. '74

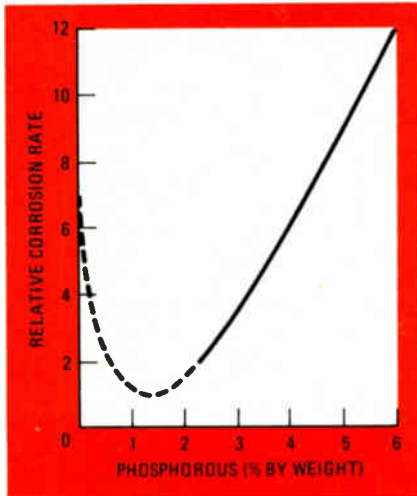

Just a pinch. The quantity of phosphorus added to passivation is critical.

above this range speeds corrosion of aluminum metalization.

The studies were performed on a silicon-dioxide glass 15,000 to 17,000 kiloangstroms thick, deposited on a 10,000-kiloangstrom-thick aluminum substrate. The corrosion product was aluminum hydroxide, which forms at a negative electrode in the presence of an applied electrical bias.

The aluminum hydroxide appeared first at the glass-aluminum interface, cracking the glass, and then spread out over the metalized pad area. Although the corrosion rate was difficult to determine, it was speeded by raising the temperature and the humidity.

The two researchers explain the failure mechanism this way: phosphorus from the glass reacts with water vapor to form acids. These acids provide hydrogen ions, which combine in a two-step chemical reaction to form the aluminum hydroxide. □

Trade

Multinational views dominate hearings

Organized labor appears to be fighting a losing battle against U.S. multinational electronics companies and aerospace exporters who are driving

to expand the American share of the world's technology markets.

Recognizing the increasingly global nature of the electronics and aerospace businesses, members of the Senate Finance Committee showed far more interest in industry's support of the Trade Reform Act of 1973 than they did to the strong opposition of the AFL-CIO as the committee began April hearings. The Administration bill, H.R. 10710, already passed by the House, is now before the Senate.

Opposing views. Opposition by the AFL-CIO to the bill by George Collins, assistant to the president of the International Union of Electrical, Radio, and Machine Workers, was particularly strong against re-importation of electronics under tariff schedule categories 806.30 and 807, in which duties are charged only on value-added by off-shore assembly.

Views of manufacturers differed significantly on some specifics of the bill, however, and in at least one case, were opposed. For example, the Aerospace Industries Association of America, the Electronics Industries Association, and were solid in their support of provisions that permit importation of U.S. components exported for offshore assembly with duty only on the value added by labor. But they were divided on the issue of assessment of countervailing duties against foreign products dumped in the U.S. market at prices lower than those of their home market.

Option. Where the EIA opposes the bill's option that would permit the Secretary of the Treasury to waive countervailing duties for up to four years for trade negotiation purposes, both the AIAA and Wema support the provision. AIAA's president, Karl G. Harr Jr., offered unqualified support of the provision, while Wema urged deletion of the one-year limitation on a countervailing duty waiver on products produced "in foreign-government-owned or controlled facilities." That limit, according to William R. Hewlett, "may be much too short to permit negotiation of a satisfactory agreement on subsidies" by foreign governments to their exporters.

Hewlett, president and chief executive of Hewlett-Packard Co., testified on behalf of Wema with C. Lester Hogan, president and chief executive of Fairchild Camera & Instrument Corp. Hogan addressed himself to the value-added provisions and non-tariff trade barriers—such as the new European Rules of Origin for products sold in EEC.

Strong industry support for trade negotiations on an industry-by-industry basis was questioned by some senators, who asked how this could be accomplished with countries that buy such U.S. products as commercial aircraft or farm goods but have no comparable domestic industries available to export.

An inhibitor. The White House Office of the Special Trade Representative believes mandatory sector bargaining would inhibit its flexibility. Similarly, the Special Trade Representative is uneasy with industry demands that the section of the bill calling for consultation with industry prior to trade negotiations be further strengthened.

EIA president V.J. Adduci urged expanding the role of the 26 industry advisory committees to give them responsibility for policy recommendations as well as for developing technical information to be used by U.S. negotiators.

All of the industry groups urged the elimination of the requirement that minutes of meetings of the advisory groups be made publicly available. "Without this change," EIA's Adduci noted, "any spokesman of any foreign country or industry will be made fully privy to the recommendations of these committees." □

Automotive

Indicator shows miles per gallon

Imagine jamming your foot down on the accelerator of your car and immediately being able to see that you're using four times as much gasoline as you do in normal accel-

Give Us Your EMI Problems...



...and we'll
give you a
stock answer...

...or a custom one!

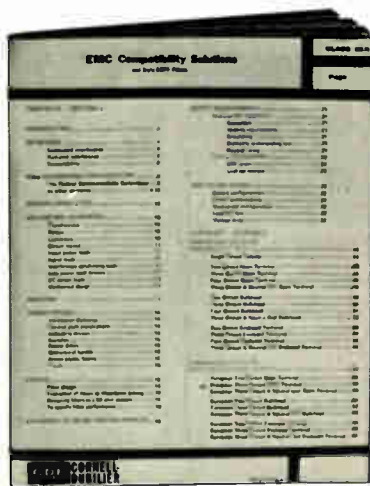

Everything you wanted to know about filtering and EMC is in the book... Your's for the asking!

There's a good chance that a standard CDE filter... or one of the thousands of designs on file will solve your EMI problem. If not, our EMI/EMC Systems Engineering Group will design one to meet your exact parameters. They're backed by the most comprehensive laboratories in the country, both east and west coast, with manufacturing and engineering services available to... evaluate the threshold levels of virtually any product, sub-system or system... establish the protective action to take in controlling the emission and susceptibility levels to comply with domestic and international EMI specifications limits... produce the appropriate filter or filter system. Write for this new 44 page brochure which details EMI Control Techniques, Shielding, Cabinet Design, Definitions, Filter Design, Safety requirements and the full line of CDE stock filters with schematics, insertion loss curves dimensional drawings, and complete specifications.

Circle 37 on reader service card



150 Avenue L, Newark, N. J. 07101

CDE — The People to People Company
— the mark of quality is on everything we make.



The Crystal Filter with a Pedigree



Every crystal filter created by Damon is 100% performance tested. Ten to twelve critical parameters (including temperature performance) are measured and recorded. You get a certified performance report, parameter by parameter, with each Damon filter. No extra charge.

You may think of Damon filters as high-reliability, high-quality, high-price for aerospace and defense applications. You're only half right. New production capabilities, competitive prices and prompt delivery are making us a lot of industrial friends too—without compromising our high standards.

Damon: The economical crystal filter with aerospace blood lines.

Damon also manufactures a full line of VCXO's.

To receive a complete new Crystal Filter Catalog, write or call Ed Doherty, ext. 666.



ELECTRONICS DIVISION

80 WILSON WAY, WESTWOOD, MASS. 02090 TEL. (617) 449-0800

Electronics review

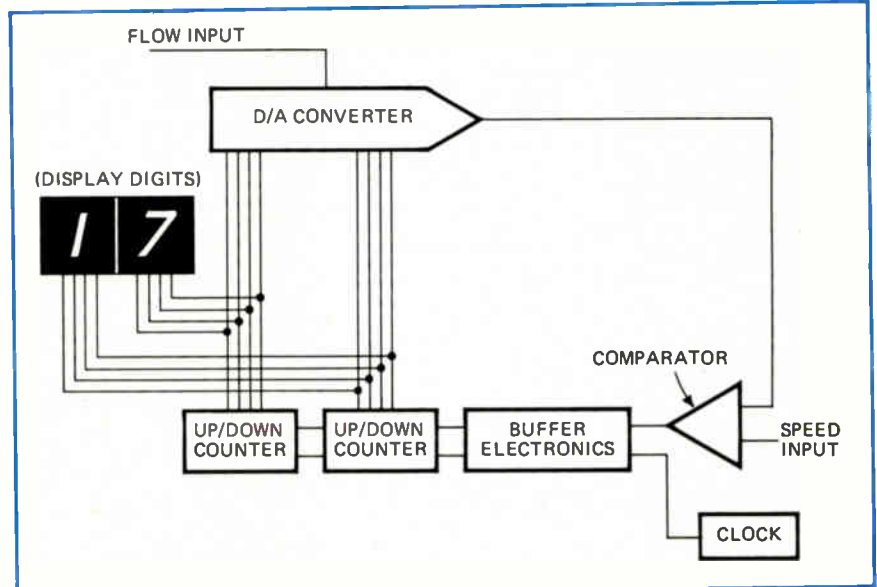

Miles-per-gallon meter. Key to the system is a hybrid pressure transducer with a vacuum reference etched on a silicon chip and a Wheatstone bridge composed of four resistors.

eration. Well, two National Semiconductor engineers, Duane Tandeske and Richard Billette, are showing auto makers and accessory makers a system that tells a driver how many miles per gallon he's getting. One version of the indicator may be installed on next year's cars.

Tandeske and Billette developed a breadboard system which has been inspected by two of the Big Three automakers.

Key to the system is a hybrid-IC pressure transducer, the National LX3700D, which has a vacuum reference etched out of a silicon chip, and a Wheatstone bridge arrangement of four piezoelectric resistors diffused into the same chip [*Electronics*, Dec. 4, 1972, p. 83]. Two National op amps serve as buffer amplifier and output amplifier.

The system operates by sensing the instantaneous rate of fuel consumption and the instantaneous speed of the car and finding their ratio by feeding the sensed data into a tracking ratiometric analog-to-digital converter. Fuel is sensed by using the LX3700D to measure a pressure drop across the wide and narrow parts of a venturi tube in the gas line between the fuel pump and the carburetor. The voltage increases as the gas flowing through the line increases. Speed is measured by sensing the voltage produced by a

tiny generator at the end of the speedometer cable. The tracking ratiometric a-d converter is one that has its internal reference-voltage source replaced by one of these two inputs.

Essentially, the circuit tries to make the flow-rate input match the speed input. If the flow rate goes up while speed remains constant, the counters will count down until their input to the d-a converter equalizes the inputs to the comparator. If the speed goes up while the flow rate is constant, the counters count up.

In practice, both variables will move. The results displayed, according to Billette, are startling. Jamming the foot down on the accelerator causes the miles-per-gallon reading to drop by a factor of four or five—from 19 to four miles per gallon, for example—in seconds.

One representative of the "specialty" market (auto stores) estimates that the average driver will save \$100 a year watching a miles-per-gallon indicator. But how much he will have to spend for such a device in the first place is problematical. As an accessory, the system will probably cost around \$70. As a hybrid IC sold to the automakers to put in their own packages, with shared display (possibly a digital clock) and speed pickup, usage-rate indicator might add \$10 to the cost

This is why...

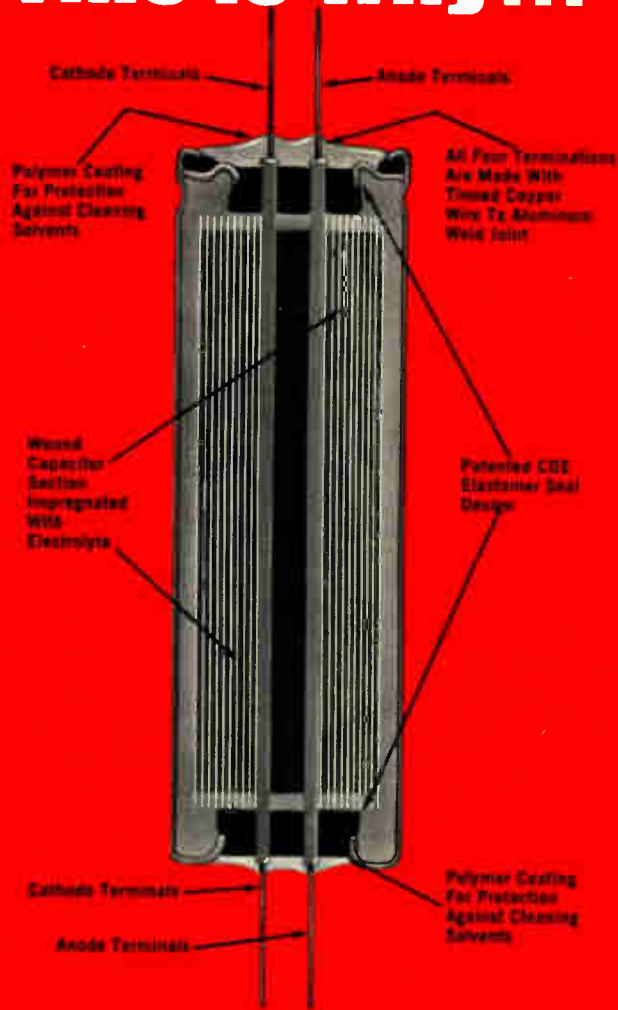

this is Best...

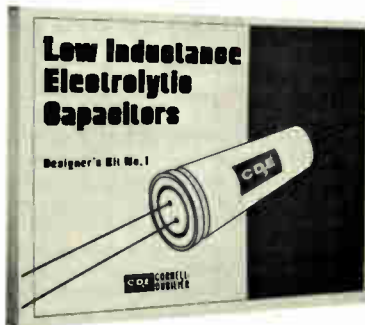
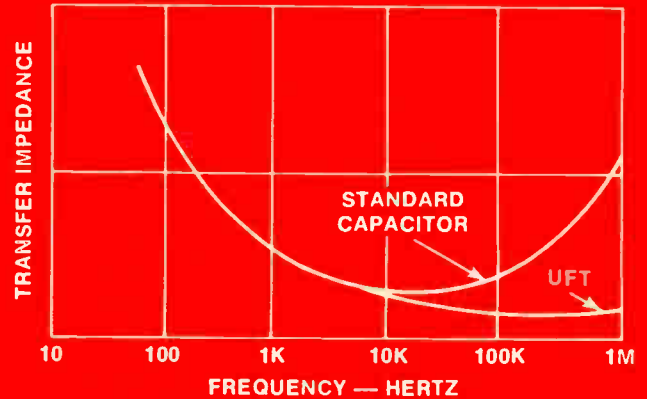

FILTER NETWORK...

Provided by Unique Construction Assures Low Inductance at high frequencies

DESIGNER'S KIT #1 — for those really serious about designing power supplies. Here's what you get: 12 pg. brochure, Designing Switching Regulators, giving theory of operation, detailed description, schematics, curves and component selection... Application and Designers notes... Engineering Inquiry and Sample Request Form... a Library of Article Reprints of recent technical articles describing power supply design... Construction features of the UFT... detailed specification brochure... and more!

YOURS ON LETTERHEAD REQUEST ONLY!!!

CDE leads the way again...with the development of the most advanced aluminum electrolytic capacitor, the UFT. This 4 leaded construction offers new design freedom... with low transfer impedance at high frequencies. Applications are growing. However, one of the most significant is switching regulators. These high efficiency power supplies have typically been plagued with noise problems. The UFT offers great isolation from ground loops, excellent noise filtering for both source and output voltage... with a transfer impedance that actually decreases above 10 KHz. There's an 8 page data sheet that details all the specs, yours by circling the reader service number. BUT, if you're really serious about designing power supplies, we'll send you our DESIGNER'S KIT #1... yours on letterhead request only.

CDE CORNELL-DUBILIER

150 Avenue L, Newark, N. J. 07101

CDE — The People to People Company
— the mark of quality is on everything we make.



Circle 39 on reader service card

GRALEX

for everything
you've always
wanted in
DPMs

1.99

+1.293

+1.9577

- 2½, 3½ and 4½-digit models
- Right-on-spec performance
- Easy-to-read displays
- Off-the-shelf interchangeability
(for replacement of most other
DPMs — panel cut-outs, connectors,
wiring, specs, etc.)
- Down-to-earth prices
- Right-on-time deliveries
- Keep-on-working reliability
(backed up by our 1-year full warranty
on parts and labor!)

GRALEX
INDUSTRIES

DIVISION OF GENERAL MICROWAVE CORP.
155 Marine St., Farmingdale, N.Y. • 516-694-3607

Electronics review

of making a car. It's not clear how much that would add to the price.

There is nothing to stop anyone else from buying the same parts and

packaging them for automakers. That's fine with National because the firm is the only manufacturer of the LX3700D, and without an IC

News briefs

Matsushita-Motorola deal challenged

The prospect of antitrust-law violation in Motorola's proposed sale of its home-TV-receiver business to Matsushita Electric Industrial Co. has been raised by Sen. Birch Bayh. The Indiana Democrat, voicing concern for the eventual loss of U.S. jobs, has asked Attorney General William Saxbe to determine if the acquisition by the world's largest maker of TV receivers [*Electronics*, March 21, p. 41] would violate Federal guidelines on horizontal mergers. Bayh also asked for a similar investigation by Sen. Philip Hart's subcommittee on antitrust and monopoly in the Senate Judiciary Committee.

Meanwhile Matsushita and Motorola have issued a joint statement that the proposed transaction is not anticompetitive, since the combined penetration of the U.S. color-TV market by the two firms totals less than 10%.

Collins' Wilson moves to aid Memorex

With a lure of a salary guarantee in addition to the usual stock options, the Bank Of America has induced Robert C. Wilson, savior of Collins Radio Co., to try some of his magic on the troubled Memorex Corp., which lost \$119 million on sales of \$177 million in 1973 and whose current president and founder, Laurence L. Spitters, has resigned, effective April 26.

The Bank Of America will accept Memorex preferred stock in place of \$40 million of current Memorex debt, reduce the interest rate on the balance to 4% for a 3½-year period, and extend the company a \$35 million line of credit—all contingent on Wilson's taking over. He's scheduled to arrive May 15, when Collins will move executive vice president Donald R. Beall to its presidency.

Decibels go digital in multimeter

United Systems Corp., Dayton, Ohio, has introduced what appears to be the first inexpensive general-purpose digital multimeter with a decibel scale. The DMM is for use in the installation and maintenance of data-communications equipment. Called the Digitec 2180, the 3½-digit instrument sells for \$395, which is about half the price of comparable DMMs.

MCI charged with monopoly

Giant AT&T and two Illinois Bell companies filed a triple damage, antitrust countersuit against MCI Communications Corp. on April 1, charging the small specialized common carrier with attempting to monopolize the private-line market and the business of other specialized common carriers.

Cassette recorders may explode

Cassette tape recorders manufactured by Norelco, Voice of Music, Sharp, and Wollensak may explode, says Kenneth Komoski, director of the Educational Products Information Exchange Institute. Komoski says the use of long-life alkaline batteries when connected to ac power lines for built-in recharging can result in battery leakage or explosion. The Institute is filing a charge of hazardous practice against these manufacturers to the Federal Trade Commission.

Western Electric cuts staff by 3,000

Because of a flattening of parent company AT&T's telephone sales, manufacturing division Western Electric has cut its staff by 3,000 people. The company attributes two thirds of the cut to attrition. Thirty engineers and about 1,000 production workers are involved. A spokesman says the cuts don't portend a drop in AT&T sales.

S-D's ATE system saves you **\$75,000**/year*

But the best reason for buying it is **MUSDBASIC.**

What's MUSDBASIC? It's the only ATE software system in existence that allows you to write and de-bug programs while performing actual testing of PC boards and instruments. We call it Multi-User S-D BASIC. It's an English test language that took two years to perfect.

The beauty of all this is that only one 3600 series CATSystem is needed to write programs and test simultaneously. That's because S-D's multi-user BASIC provides two terminals for time-sharing the entire system, including the instruments. Also, up to 6 more terminals can be added with this time-sharing feature.

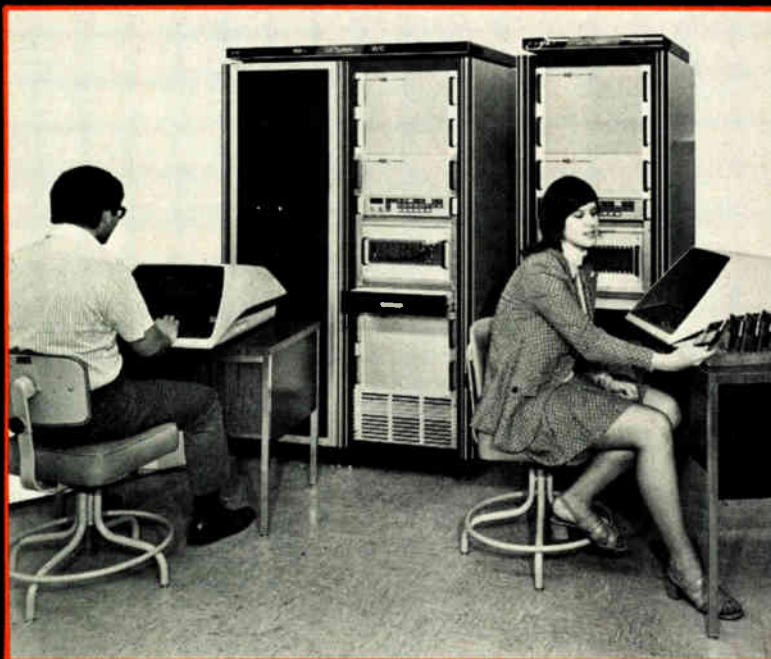

HE PROGRAMS WHILE SHE TESTS. ONLY WITH CATSystems.

It's no secret that many ATE systems take a year to put into operation because programs can't be written while testing goes on. Who wants to write programs at night or on weekends?

State-of-the-art S-D CATSystems feature off-the-shelf test instruments and the powerful PDP-11 computer for field-proven reliability. Every CATSystem has a wide bandwidth input adaptor system with quick, easy disconnect—and with zero force.

In fact, you'll save more than the \$75,000 we propose. The \$75,000 is just the amount you save on a CATSystem without MUSDBASIC!

For full details on CATSystems, contact your Scientific Devices office or Bob LaPointe at S-D, 10 Systron Drive, Concord, CA 94518. Phone (415) 676-5000. In Europe; Munich, W. Germany; Leamington Spa, U.K.; Paris (Le Port Marly) France. Australia: Melbourne.

*Based on manual vs. CATS testing of 60,000 PC boards (200 types). Manual testing costs \$99,800. CATS \$25,000. Price of CATSystem used in this study (yours for the asking) \$97,500.

SYSTRON  DONNER

Circle 41 on reader service card

transducer that is insensitive to vibration and fail-safe, the system is not workable. □

Computers

CDC expands network capabilities

To capitalize on the increasing importance of computer networks as a means of boosting performance and reliability, Control Data Corp. has developed a family of four large-scale computer systems, called the Cyber 170, designed specifically for such applications. The family includes the models 172, 173, 174 and 175, all compatible with the company's older Cyber 70 and 6000 series systems.

Included with the family is a host communications processor, part of a network-communications system, including both hardware and software that provide an interface between communications channels and the associated computers and terminals. This processor performs packet switching and other functions similar to those of the interface message processors in the Department of Defense Advanced Research Projects Agency Network (Arpanet).

CDC will add this capability to its existing Cybernet computer network, and enable non-CDC computers to tie into the net.

Monolithic. Cyber 170 also displays a number of other characteristics, some of which are more significant as a first for CDC than they are for the industry. For example, the line is the company's first built wholly with off-the-shelf IC's.

All models of the Cyber 170 also have metal-oxide semiconductor memories, assembled from 1,024-bit chips. They have 400 nanoseconds access time and come in modules of 4,096 words, expandable to 262,144 words, each with 60 bits plus 8 redundant bits coded for single-error correction and double-error detection. The new machines will lease for \$18,000 to \$75,000 a month. □

Super Cop



Super protection with the unique adjustable Crowbar Overvoltage Protector. Makes the Sorensen SRL a great supply for lab/system uses. Fast front panel adjustment of overvoltage level without removing the load . . . instant front panel meter monitoring of set point, plus these additional SRL features: resistance and signal programmability; fast response time—70 to 150 μ sec.—through full load range; low—3½" to 7"—rack panel height; high power-density . . . in 14 models with outputs from 250 to 2000 watts. SRL—the super choice for maximum reliability, stability and value in medium power, low voltage applications. For complete data, contact the Marketing Manager at Sorensen Company, a unit of Raytheon Company, Manchester, N.H. (603) 668-4500.

Representative Specifications—SRL

- Voltage Mode
 - Regulation (combined line & load) .01%
 - Ripple (PARD) rms: 350 μ v.
 - p-p: 20 mv.
 - Temperature Coefficient Δ /°C .01% + 200 μ v.
- Current Mode
 - Regulation (combined line & load) .02% + 4 ma.
 - Ripple (PARD) rms: 0.5 to 30 ma.
 - Temperature Coefficient Δ /°C .01% + 1 ma.
- Voltage Ranges
 - 0-10 volts to 0-60 volts (14 models)
- Price Range
 - \$500-1025

Sorensen
POWER SUPPLIES



Everybody talks
about the weather.

**EMR is doing
something about it...**

**For the National Oceanic
& Atmospheric Administration**

NOAA's new SMS/GOES Synchronous Meteorological Satellite will usher in a new era in satellite borne weather instrumentation. Once in orbit NOAA will commence processing and distributing weather data from the new Visible/Infrared Spin-Scan Radiometer (VISSR), which produces improved pictures of the earth's cloud cover. At the heart of VISSR are eight EMR Integrated Photoelectric Sensors. On earth the data from VISSR is processed by EMR Digital Interface Electronics using the latest PSK demodulation and bit synchronization techniques.

For NASA

NASA is responsible for launching SMS/GOES into orbit. EMR-Telemetry systems at the Kennedy Space Center and various tracking stations throughout the world will gather vitally needed data.

For Philco-Ford

Philco-Ford's WDL Division is building this advanced meteorological satellite. Critical data is being processed through EMR PCM Bit Synchronizers, PCM Decommutators and Displays during development and pre-launch checkout.

**For the Bureau d'Etudes
Météorologiques Spatiales**

France is typical of the many world-wide users of SMS/GOES who will use EMR Digital Interface Electronics to process vital weather data.

*We're not only talking about the weather...
we're doing something about it!*

Now...
what are we going
to do for you?



EMR Telemetry
Weston Instruments, Inc.
Box 3041, Sarasota, Florida 33578
813-958-0811

NEW VALUES HIGH ENERGY

TYPE	$I_C(\text{max.})$	V_{CE0}	V_{CEV}	$V_{CE0}(\text{sus.})$	$V_{CE}(\text{sat.})$ @ I_C, I_B	Power Dissipation (max.)	h_{FE} min./max. @ I_C, V_{CE}
DTS-701	1.0 A	800V	—	600V	—	50W	20/— @ 150mA, 5V
DTS-708	3.0 A	900V	900V	600V	2.0V max. @ 1.0A, 250mA	50W	—
DTS-709	3.0 A	900V	900V	600V	1.0V max. @ 2.0A, 800mA	50W	—
DTS-710	3.0 A	900V	—	600V	—	50W	10/50 @ 150mA, 5V
DTS-712	3.0 A	900V	1200V	700V	—	50W	2.5/— @ 2.0A, 5V
DTS-714	3.0 A	900V	1400V	700V	—	50W	2.5/— @ 2.0A, 5V
DTS-723	3.0 A	1000V	1200V	750V	0.8V max. @ 1.0A, 250mA	50W	10/— @ 500mA, 5V
DTS-801	2.0 A	800V	—	700V	—	100W	20/— @ 200mA, 5V
DTS-812	5.0 A	900V	1200V	700V	—	100W	2.2/— @ 3.5A, 5V
DTS-814	5.0 A	900V	1400V	700V	—	100W	2.2/— @ 3.5A, 5V

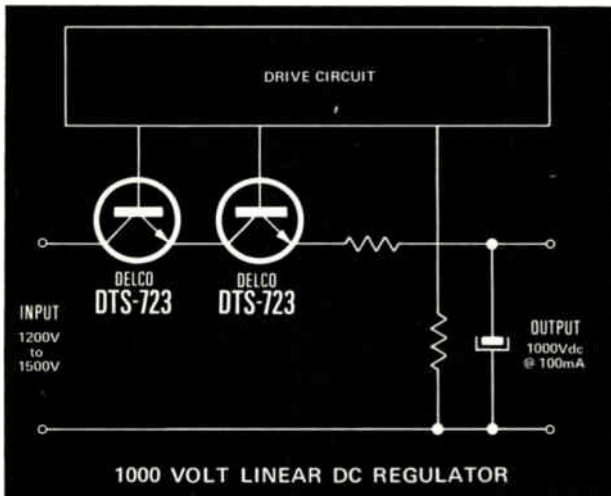

APPLICATION NOTE 45

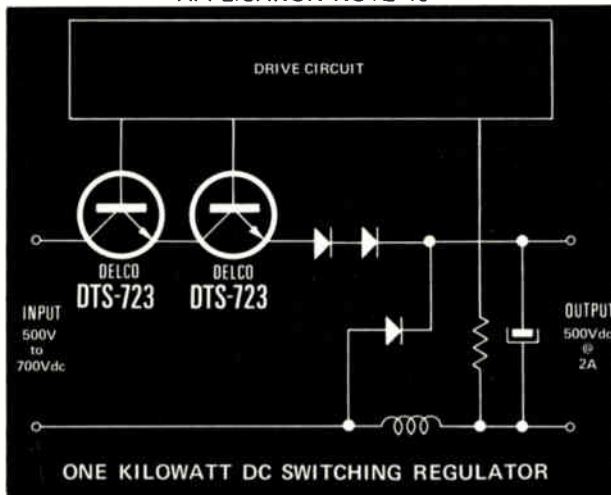

APPLICATION NOTE 46

Delco Electronics has made it possible for your Delco distributor to offer you better values than ever on these ten silicon high-power transistors. What's more, he has them in stock now and there's a healthy factory inventory to back him up.

These high quality, high voltage devices are all NPN, triple diffused, and packaged in Delco's solid-copper TO-204MA (TO-3) case.

Some are specifically designed for use in high voltage switching circuits where inductive loads or fault conditions pose problems. Some are ideal for linear regulators and power amplifiers.

In fact, all the devices share Delco's reputation for being ideal where circuit conditions and high energy requirements are a concern. And because they're 100 percent pulse energy tested, you know they're rugged.

The circuit diagrams in this ad will give you a quick reading of how these ten transistors can meet your needs.

Applications literature and complete device data are available from your Delco distributor.

Give him a call for the information you need and the delivery promises and prices you'll like.

**NOW AVAILABLE FROM THESE DISTRIBUTORS
IN PRODUCTION QUANTITIES.**

ALABAMA, Birmingham
Forbes Distributing Co., Inc.
(205) 251-4104

ALABAMA, Huntsville
Powell Electronics
(205) 539-2731

ON DELCO'S TRANSISTORS.

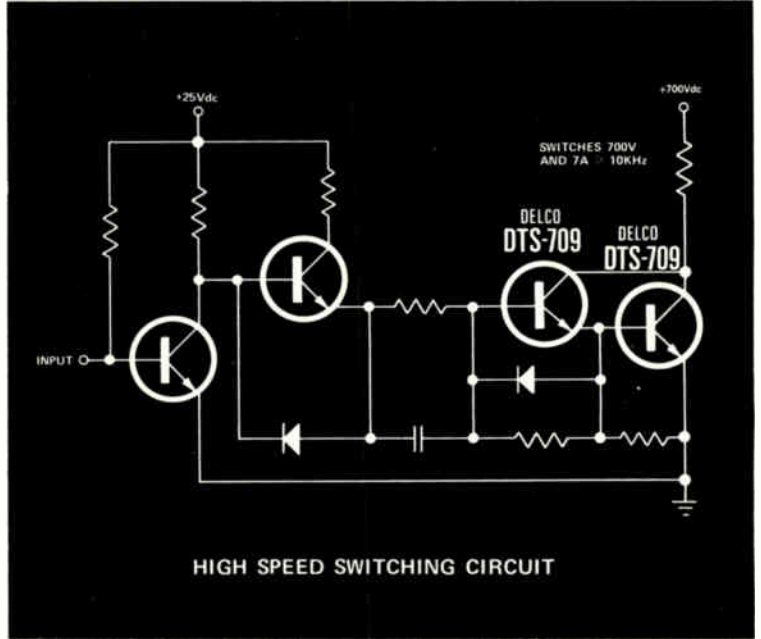
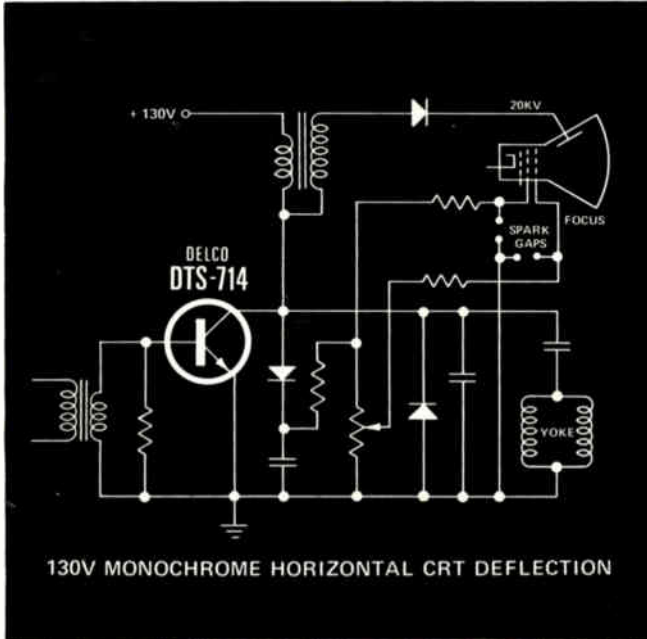

APPLICATION NOTE 54

ARIZONA, Phoenix
Sterling Electronics, Inc.
(602) 258-4531

CALIFORNIA, Goleta
R.P.S. Electronics, Inc.
(805) 964-6823

CALIFORNIA, Los Angeles
Kierulff Electronics, Inc.
(213) 685-5511

CALIFORNIA, Los Angeles
R.P.S. Electronics, Inc.
(213) 748-1271

CALIFORNIA, Palo Alto
Kierulff Electronics, Inc.
(415) 968-6292

CALIFORNIA, San Diego
Kierulff Electronics, Inc.
(714) 278-2112

CALIFORNIA, San Diego
R.P.S. Electronics, Inc.
(714) 292-5611

COLORADO, Denver
Kierulff Electronics, Inc.
(303) 371-6500

CONNECTICUT, Norwalk
Harvey Electronics
(203) 853-1515

FLORIDA, Miami Springs
Powell Electronics/Florida
(305) 592-3260

FLORIDA, Orlando
Powell Electronics/Florida
(305) 859-1450

ILLINOIS, Rosemont
Kierulff Electronics, Inc.
(312) 678-8560

ILLINOIS, Skokie
Bell Industries
Electronics Distributors Div.
(312) 282-5400

INDIANA, Indianapolis
Graham Electronics Supply, Inc.
(317) 634-8202

INDIANA, Indianapolis
Harvey-Indiana
(317) 297-4910

MARYLAND, Baltimore
Radio Electric Service Co.
(301) 823-0070

MASSACHUSETTS, Needham Heights
Kierulff Electronics, Inc.
(617) 449-3600

MASSACHUSETTS, Newton
The Greene-Shaw Co., Inc.
(617) 969-8900

MICHIGAN, Farmington
Harvey-Michigan
(313) 477-1650

MINNESOTA, Minneapolis
Stark Electronics Supply Co.
(612) 332-1325

MISSOURI, Kansas City
Walters Radio Supply, Inc.
(816) 531-7015

MISSOURI, North Kansas City
LCOMP-Kansas City
(816) 221-2400

MISSOURI, St. Louis
LCOMP-St. Louis
(314) 647-5505

NEW JERSEY, Clifton
Wilshire Electronics/New Jersey
(201) 365-2600 (212) 244-8930

NEW YORK, Binghamton
Harvey Electronics
(607) 748-8211

NEW YORK, Farmingdale
Wilshire Electronics/Long Island
(516) 293-5775

NEW YORK, Woodbury
Harvey Electronics
(516) 921-8700 (212) 895-9260

OHIO, Cincinnati
United Radio, Inc.
(513) 761-4030

OHIO, Cleveland
Pattison Supply Co.
Industrial Electronics Division
(216) 441-3000

PENNSYLVANIA, Philadelphia
Almo Electronics
(215) 676-6000

PENNSYLVANIA, Pittsburgh
RPC Electronics
(412) 782-3770

SOUTH CAROLINA, Columbia
Dixie Radio Supply Co., Inc.
(803) 253-5333

TEXAS, Dallas
Adleta Electronics Company
(214) 741-3151

TEXAS, Fort Worth
Adleta Electronics Company
(817) 336-7446

TEXAS, Garland
Kierulff Electronics, Inc.
(214) 271-2471

TEXAS, Houston
Harrison Equipment Co., Inc.
(713) 224-9131

VIRGINIA, Richmond
Meridian Electronics, Inc.
(804) 353-6648

WASHINGTON, Seattle
Kierulff Electronics, Inc.
(206) 763-1550

IN CANADA
ONTARIO, Scarborough
Lake Engineering Co., Ltd.
(416) 751-5980

ALL OVERSEAS INQUIRIES:
General Motors Overseas Operations
Power and Industrial Products Dept.,
767 Fifth Avenue, New York, N.Y.
10022. Phone: (212)-486-3723.

Delco Electronics
Regional Sales Offices

Union, New Jersey 07083
Box 1018 Chestnut Station
(201) 687-3770

Van Nuys, California 91404
Box 2968
(213) 988-7550

General Sales Office
700 E. Firmin, Kokomo, Ind. 46901
(317) 459-2175
Operator (317) 457-8461



Delco Electronics, Division of General Motors.

This chip
is the world's first
SOS processor.



It makes all the
stuff on the next page
possible.

Silicon-on-sapphire isn't new.

The aerospace industry and the military have recognized its high-speed, high-density and high-reliability characteristics for years.

But no one was ever able to use it in a computer processor.

Until now.

Now General Automation designers have built the world's first commercial processor using SOS technology.

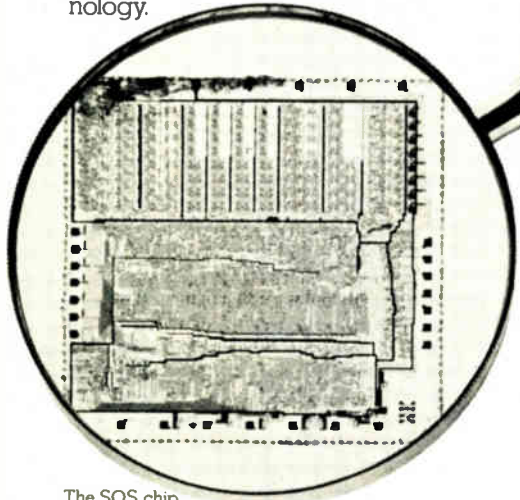

The SOS chip magnified 16 times

They've placed 2000 gates or the equivalent of 4000 to 5000 transistors on a single semiconductor chip.

An 800 times size reduction from its predecessor product, the SPC-12.

The world's first microcomputer.

That tiny SOS chip has made it possible to bring you the LSI-12/16. A complete digital automation microcomputer with from 1K to 32K bytes of semiconductor memory.

We call it the world's first microcomputer because it's the only

always meant you had to make major concessions in performance.

With SOS you make none.

The LSI-12/16 has an instruction execution cycle time of 2.64 microseconds.

It's faster than any microprocessor on the market.

It's more powerful. And lower in cost. In board-only configuration with 1K memory, it costs only \$495 in minimum OEM quantities of 1000 per year. In short, we offer all the performance of a minicomputer at microprocessor prices.

Breakthroughs across the board.

The LSI-12/16 is the first microproduct to successfully put all of the following on a single board: A processor, power fail/auto

unique built-in ROM patch that lets the user retrofit new instructions to any ROM.

Custom tailoring.

There's one more advantage the LSI-12/16 has that no other microproduct can offer.

It's the systems backup and application expertise that General Automation gives you. Helping solve customer problems has always been our long suit. It still is.

We can customize I/O boards and match the LSI-12/16 exactly to your requirement.

Our microcomputer is available in one of two different configurations: As a board-only system, packaged with memory, control console and processor on a single 7-3/4 by 10 inch printed circuit board.

Or the same board packaged in an enclosure with power supply, battery backup for semiconductor memory and card slots for additional I/O boards.

For more information, write

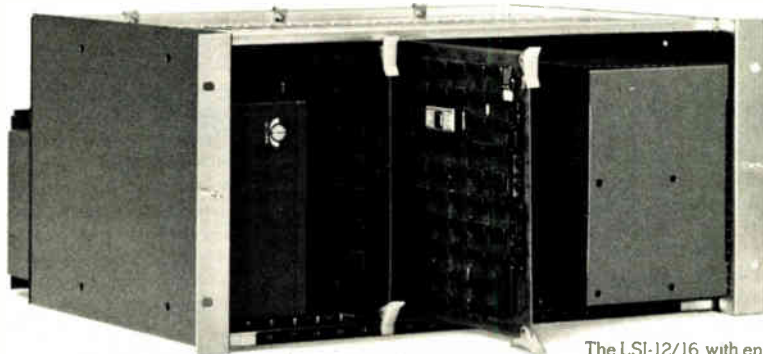

The LSI-12/16 with enclosure

restart, remote cold start, 16 bit parallel I/O interface and up to 2K bytes of semiconductor memory.

But we didn't stop there.

GA engineering has also overcome the problems associated with semiconductor memory. Like loss of data in the event of power failure.

We handled that by developing an auxiliary battery backup system that will activate immediately upon loss of power and will retain the contents of memory for up to 15 hours.

In case you're interested in more memory, we've designed a piggyback board that will give you an additional 2K of RAM or 8K of ROM.

And if there's ever an error in ROM programming, it can be corrected. The LSI-12/16 has a

General Automation, 1055 South East Street, Anaheim, California 92805. Or call us at (714) 778-4800.

Our European headquarters is at Centre Silic, Cidex L242, 94533 Rungis, Paris, France. Call 686-7431.

GENERAL AUTOMATION

A new generation of computer processors is beginning. All because of this.

See the LSI-12/16 in the Computerworld Caravan — and at the National Computer Conference.

microproduct available that gives you the performance, the systems features, the reliability and the applications support you would normally expect from a minicomputer.

More work, less money.

In the past this kind of size reduction

The board only system

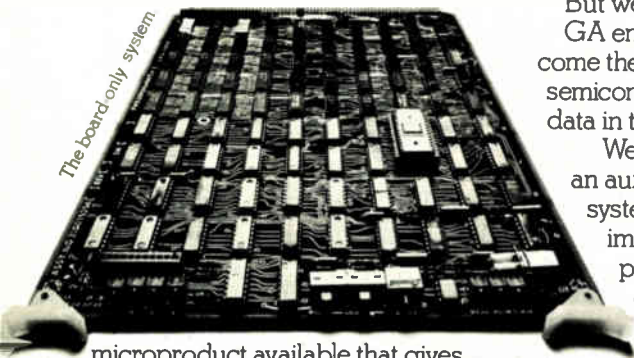

THE NEW XR-2207 IS A PRECISION VOLTAGE CONTROLLED OSCILLATOR WITH SIMULTANEOUS SQUARE AND TRIANGULAR WAVE OUTPUTS, EXCELLENT FREQUENCY STABILITY, SUPER-WIDE SWEEP RANGE, MINIMAL FREQUENCY DRIFT, AND ULTRA-LINEAR SWEEP DRIVE.



By providing 30 ppm/°C frequency stability, 3000:1 sweep range, and 0.15% /V frequency drift in the XR-2207, Exar produced a precision VCO that can easily do those tough FSK, FM generation jobs. With a minimum of external circuitry, you can use the XR-2207 in applications such as two-channel FSK generation for modems, as the VCO portion of phase-locked loop systems, and voltage to frequency conversion that formerly required crystal controlled oscillators.

With only one capacitor and four resistors, four discrete precision frequencies are generated; two TTL keying inputs enable selection between frequencies. You can also sweep your frequency over a wide 3000:1 range with the use of one extra resistor and a little voltage.

So, if you've been putting together lots of parts

for tough waveform generation, the XR-2207 can save you time and money. It's the easy way to generate variable-frequency square and triangular waves (pulse and sawtooth too!) for every application.

The XR-2207 operates with either single or dual supplies from $\pm 4V$ to $\pm 13V$ over a 0.1 to 1 MHz frequency range. Seven device types are available in 14 pin ceramic and plastic packages for both commercial and military applications. Call or write for the XR-2207 data sheet and application notes.

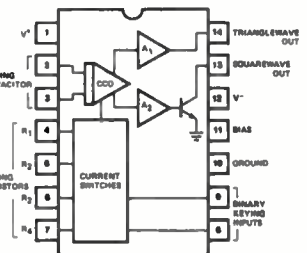

EXAR SPEAKS YOUR LANGUAGE

EXAR INTEGRATED CIRCUITS Products of R.ohm Corp. 16931 Milliken Ave., Irvine, CA 92705 (714) 546-8780 TWX 910-595-1721

EXAR REPRESENTATIVES: Arizona/Colorado/New Mexico BARNHILL FIVE (602) 947-7841 California - North LOGAN SALES (415) 369-6726 California - South DE ANGELO & ROTHMAN CO. (213) 398-6239 Washington/Oregon SDR SQUARED (206) 747-9424 Illinois/Wisconsin M & S SALES (312) 992-1053 Ohio/Indiana/Kentucky MC FADDEN SALES (614) 221-3363 New York City M. O. S. ASSOCIATES (516) 694-5923 Pennsylvania/Southern New Jersey HARRY NASH ASSOCIATES (215) 657-2213 Oklahoma/Texas/Louisiana/Arkansas EVANS & MC DOWELL (214) 238-7157 Michigan D E M ASSOCIATES (313) 755-6660 North Carolina/South Carolina/Virginia/Maryland COMPONENT SALES (301) 484-3647 Maine/New Hampshire/Vermont/Massachusetts/Connecticut COMPONENT SPECIALISTS (617) 667-4181 Minnesota ELECTRONICS INNOVATORS (612) 884-7471

Trade groups resist threat to IR&D reimbursement

Government electronics and aerospace contractors are set to oppose **another congressional challenge to Federal reimbursement of companies' independent research and development costs** by releasing an in-depth study calling for a uniform Federal policy on IR&D as well as bid and proposal (B&P) costs. The comprehensive study, a joint effort of the Electronics Industries Association, the National Security Industrial Association, and the Aerospace Industries Association of America, is designed to **counter an investigation of IR&D now in progress at the General Accounting Office.**

The GAO study was initiated last year at the request of Sen. William Proxmire (D., Wis.) and Sen. Thomas McIntyre (D., N.H.), chairman of the research and development subcommittee of the Armed Services Committee. **While calling for a Government-wide policy for "reasonable" reimbursement of IR&D and B&P costs, the industry associations will resist establishment of a new agency to administer or oversee the policy while urging that individual companies retain the right to set the amount and type of effort each undertakes in these two areas.**

Army RFPs set for Shorads; \$61 million available

Army requests for proposals are expected to be issued no later than early May for the **Short Range Air Defense System (Shorads) using one of three European missiles** licensed for U.S. production—the Crotale (France), the Rapiers (U.K.), or the Roland (FRG-France). The fiscal 1975 defense budget calls for \$61 million to develop Shorads, **with \$35 million earmarked for five systems and 100 test missiles. The remaining \$26 million calls for upgrading 1,500 Chaparral missiles.**

NASA struggles to save Earth Observatory program

Contractors selected to perform systems definition studies for the **\$100 million Earth Observatory Satellite (EOS) program** have an added mission: helping the National Aeronautics and Space Administration **save the embattled program from budget cutting by the White House Office of Management and Budget.** NASA will use the studies by General Electric, Grumman, and TRW to justify the program as a fiscal 1976 new start. It might be tough, as OMB has already frozen some funds and delayed EOS more than a year.

The \$600,000 six-month design studies are due in the fall, just in time for a confrontation with OMB. **But even if NASA wins, it won't be able to select a spacecraft contractor until April 1976.**

Mitre to install minicomputer instruction system

Minicomputers could boost computer-assisted instruction (CAI), according to **Mitre Corp., which is installing prototype systems late this spring in two community colleges, Northern Virginia Community College in Alexandria and Phoenix College, Phoenix, Ariz. Developed under a \$5.5 million National Science Foundation project, Mitre's system is called Ticcit, for time-shared, interactive, computer-controlled, information television. Ticcit's pair of Data General Nova 840 minicomputers, backed by disk drives, feed 128 keyboard terminals, equipped with Sony 12-inch Trinitron color TV sets. Estimated production cost would be \$500,000 to \$1 million per system. The military might be one market, since the Navy is acquiring one Ticcit system and could buy more, says a Mitre project officer.**

Can Congress reform trade?

"It's a special interest bill," argues the AFL-CIO's George Collins of the Trade Reform Act of 1973. "It does nothing about industry's massive investment abroad, about tax loopholes on overseas profits, about the shifting production beyond our shores or the export of taxpayer-subsidized technology."

But the complaints of Collins, assistant to the president of the International Union of Electrical, Radio, and Machine Workers, on behalf of his own union, as well as two other AFL-CIO affiliates, produced little interest and less sympathy at the Senate Finance Committee's hearings on the trade bill. Already voted by the House, H.R. 10710 seems certain of passage in some form this session, barring an impeachment of the President that could bring Senate action to a halt in this election year.

Collins' testimony on behalf of "more than two million members who have been prime victims of the decline in this nation's international trade position and the lack of a comprehensive foreign trade policy" began with Arizona's conservative Republican Paul Fannin the only member present and concluded with Fannin gone and a committee staffer listening politely from the chairman's seat.

Industry's opposing view

Manufacturers of electronics and aerospace hardware got a lot more mileage out of their presentations, which contrasted sharply with those of labor (see p. 36). Beyond their agreement with labor that the U.S. has long lacked a national foreign trade policy, officials of the electronics and aerospace industries associations offered nothing that agreed with the AFL-CIO perspective.

The differences are of long standing, of course. Fundamentally, they turn on the issue of multinational corporate expansion. Labor is naturally interested in jobs being created and maintained within the U.S. Manufacturers are naturally interested in sales and the profits they create, contending that the markets for electronics must be viewed globally.

Specific issues that derive from this fundamental dispute are much more complex and have economic and legal ramifications of no appeal to the general public. One typical example involves Items 806.30/807 of the U.S. Tariff Schedule, under which products assembled from U.S. components in offshore plants may be re-imported with tariffs payable only on the value added by foreign labor and any non-U.S. components.

As expected, organized labor calls 806/807 "a loophole" that has become a \$1 billion annual business for U.S. multinational electronics companies at the expense of American jobs. But manufacturers, to no one's surprise, argue that repeal or suspension of 806/807 would "cause a decline in U.S. production and U.S. employment" and "make worse the U.S. net trade balance and the balance-of-payments deficit," according to V. J. Adduci, president of the Electronic Industries Association.

Is anyone listening?

The problems for the Congress in resolving these and other conflicting positions in the current trade legislation in the country's favor seem to be that few—and sometimes none—of the members are listening during the public hearings process. And, as one Senate committee staffer conceded, few members "read the published testimony. Either they don't care, or they don't have the time."

Neither industry nor labor can do much about those senators and congressmen who don't care about legislation affecting their future success or failure. But for those legislators who don't have the time—and they are increasing in number as congressional staffs and budgets have failed to expand proportionately with the executive branch—there is an option available. Simply put, it would consist of making the public hearings process an adversary proceeding, pitting proponents of a given bill against their opposition during the questioning period subsequent to formal testimony.

Such an approach would have obliged EIA president Adduci to rebut the charge of the AFL-CIO's Collins that offshore operations are costing jobs in the American economy. And Collins, similarly, would have been required to respond to EIA's contention that Items 806/807 are "essential if U.S. manufacturers are to compete in U.S. electronics markets."

As the congressional hearings process now operates, members of the Senate and the Congress get more data and less useful information than they need to make an informed judgment. This could prove disastrous for the U.S. electronics industries and their workers as the Congress pushes to develop the nation's first comprehensive foreign trade policy. At a time when foreign managements and labor are working closely with their governments to compete in the world's marketplace, neither U.S. labor nor management is being well served by the present legislative system. —Ray Connolly

Some data generators can do only **one** thing.

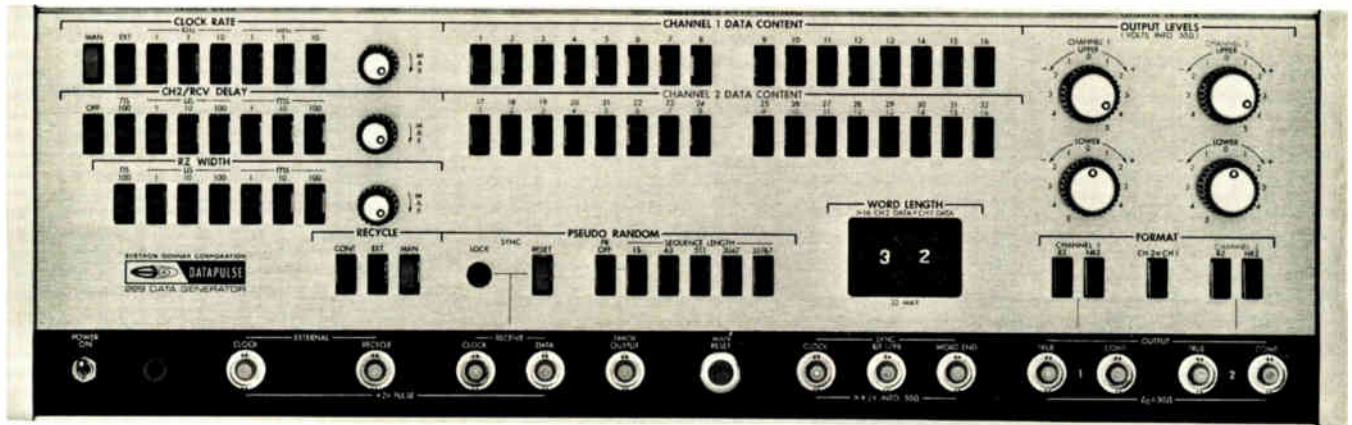

But S-D's Model 229 offers **all** these capabilities:

- 1. Single/Dual Channels** 32/16 bits with variable word length. Variable delay between channels. Data rate to 10 Mbps. Output formats: RZ (with variable width) and NRZ. Adjustable output levels.
- 2. Pseudo-random** sequence generator with word lengths from 15 to 32,767 bits per word.
- 3. Comparator** bit-by-bit error check simultaneous with data generation for full duplex operation with either pseudo-random or programmable data patterns.

All of this capability comes standard on Systron-Donner's Model 229 for \$2,025.00. Remote programming and error display are optional. Applications include testing of tape/disc memory systems and high speed digital communication systems. Get in touch with us and we'll tell you about others especially suited for the 229.

Contact your Scientific Devices office or Systron-Donner at 10 Systron Drive, Concord, CA 94518. For immediate details, call our Quick Reaction line (415) 682-6471 collect.

SYSTRON  DONNER

Negative resistance shown in dual FET device

A new negative-resistance device, based on the functional integration of two complementary field-effect transistors, has been developed by researchers at Matsushita Electronics Corp.'s research laboratory.

The device, which has voltage-controlled negative resistance, differs from the tunnel diode and other such devices in having a valley cur-

rent that is essentially zero—in the order of nanoamperes—over a wide range of voltages in excess of the valley threshold voltage. Matsushita thus characterizes its devices as having lambda characteristics, in contrast to the N-shaped characteristics of the tunnel diode, and proposes to call the new device the lambda diode.

Peak-to-valley current ratios are in the order of 10^5 for practical devices, about 10^4 times greater than those for tunnel diodes. Peak voltages run in the range of 0.5 to 5 volts, and valley voltage thresholds in the range of 2.5 to 12 v, making for easy interface with other devices.

A number of the new devices can be integrated on a single chip, and they can also be integrated on the same chip with bipolar devices. What's more, they can be fabricated to have predetermined characteristics—unlike the tunnel diode, which often had to undergo successive etching and testing until the characteristics were trimmed to fit specifications. Fabrication is easier because operation depends on feedback in a circuit equivalent to two FETs and not on exotic physics.

The device is fabricated in two epitaxial n-type isolation regions in p-type material. The n-channel depletion-type J-FET is fabricated with two diffusions, the p_2 diffusion for the gate and the n^+ diffusion for the source and drain. The same p_2 diffusion forms the source and drain of the p-channel depletion type J-FET, while the n^+ diffusion forms the gate and also the "substrate" connection. In between these two diffusions there is a p_1 diffusion to form the p channel. With this structure, the source and drain extend completely through the p-well and into the p-type material, but this has negligible effect on the transistor characteristics.

The sources of the two transistors are connected together, and the gates of each are connected to the drain of the other transistor. Because channels of these depletion transistors are normally conducting, current increases as voltage across the composite device is increased from zero. But the voltage drop across the individual transistors biases the gate of the other transistor in a manner that tends to reduce

Curves. By integrating two field-effect transistors, workers at Matsushita Electronics have come up with negative-resistance device, which they call a lambda diode. A third FET gives a "lambda transistor" where current peak depends on gate voltage.

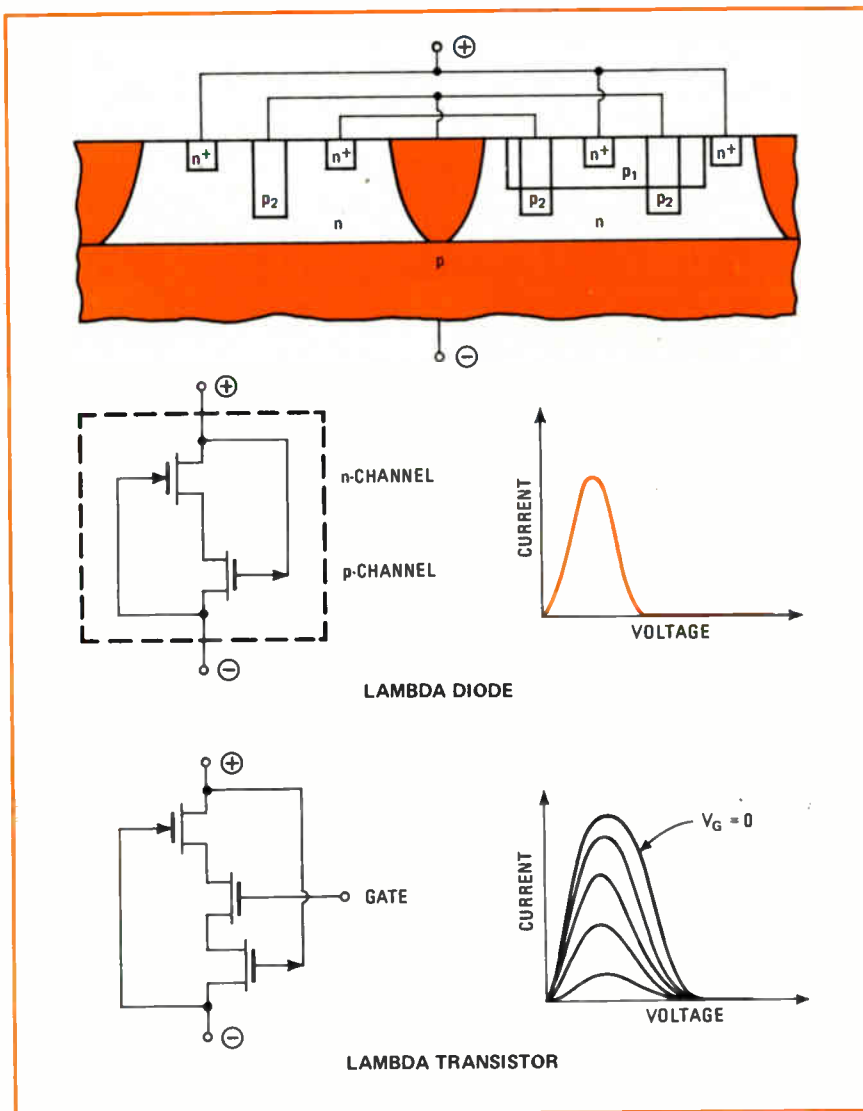

the current flowing through the transistor.

Therefore, device current goes through a peak, typically a fraction of a milliampere to 1 milliampere. Current through the device then decreases until it reaches the valley-current threshold, where both transistors are pinched off, and leakage current through the device is in the nanoampere order. Terminal current remains at this low value for further increases in terminal voltage until zener breakdown occurs at one of the gates.

Applications for which the lambda diode can be used include discrete and integrated memories, switches, oscillators, and amplifiers. Initial applications will be for consumer products produced by Matsushita Electric Industrial Co. Matsushita Electronics, a joint venture of Matsushita Electric and Philips Gloeilampenfabrieken, is a subsidiary of Matsushita Electric. □

Great Britain

After quad sound, it's ambisonics

With quadraphonic sound still reverberating in the consumer marketplace along comes ambisonics. According to the British academics who have invented it, ambisonic sound is fundamentally different from quadraphonic.

Quadraphonic sound is essentially the pure sound of, say, an orchestra divided up into four portions according to rules, which may be pretty arbitrary, and pumped at the listener from the four corners of a room. Ambisonics, on the other hand, is the sound made by the orchestra as heard at one point in the concert hall, determined by where the microphone complex is placed, and including all the reverberations and other effects that are heard at that point.

Crosstalk. The ambisonic developers say that the defect of stereo and quadraphonic reproduction is that too often the listener is aware

Around the world

BPO is still at work on analog systems

Eventually, all telephone traffic and a good portion of television video traffic is likely to travel in digital form, but that doesn't mean no new analog transmission systems will be developed and installed. For one thing, there always will be circumstances in which economics favor analog transmission—short, lightly used links, for instance. For another thing, digitization won't be widespread tomorrow, allowing ample time to get the investment back on new and improved analog systems. For both these reasons, the British Post Office is investing in new analog systems.

One development is for high-capacity telephone-trunk transmission using an 18-tube coaxial cable and frequency-division multiplexing in each tube over the 4–60-megahertz band. This gives a capacity of 10,800 telephone circuits per pair of tubes, or 86,400 circuits in the 16 tubes that will be in operation. The other pairs of tubes are for standby; they're switched into operation within milliseconds in the event of trouble. The first 100 miles of cable will be installed this year between Birmingham and Manchester.

The BPO is considering using the same types of coaxial pairs and line repeaters to carry television signals. In that case, four TV channels, each with a 5.5-MHz bandwidth will be double-sidebanded onto carriers at approximately 12.6, 26.2, 39.7, and 53.2 MHz. Long-distance TV transmission is already well taken care of by microwave links.

that the total sound is emanating from two or four discrete points in the room. They say that this drawback has been largely eliminated, in normal circumstances, by dividing up the total sound for transmission to four or more separate speakers rather differently than has so far been done in quadraphonics. How it's divided up the inventors won't say, except, that it has been done after a lot of study on how acoustics can be used to achieve different psychological effects. In other words, the crosstalk between the speakers creates the right illusion.

Point source. Peter Felgett, professor at Reading University, who worked out the encoding and decoding technique, says the ambisonic approach started in the 1930s with a British patent for using a directional microphone for stereo sound reproduction. The microphone complex that Felgett is using at present has four separate cardioid mikes. They are only fractions of an inch apart, with their faces aligned to form an upside-down equilateral tetrahedron—an inverted three-sided pyramid and its base.

Felgett says that microphone arrangement provides all necessary information to identify the direction of incoming sounds, including reverberations, and the height of the mike in relation to the sounds. For

the normal speaker layout, where they are all on the floor, the height data is redundant, but it could be used in expensive layouts that have some speakers on the wall.

The psycho-acoustics work was done by Michael Gerzon, a mathematician at Oxford University. An important part of it is mapping the total ambient sound so that a listener sitting in the middle of the speaker complex hears everything coming from the right direction. Because there's a limit on the number of speakers that people will use, the map has to be modified, using the directional information to create an illusion of directionality for points between the speakers. Though the height data isn't used with four ground-level speakers, Felgett says that some illusion of height can be obtained.

Felgett and the company he's working with, IMF Ltd. of High Wycombe, have built their experimental systems for two information channels and four speakers because that's the established configuration and will interest most people. However, three channels and four speakers will enhance psycho-acoustic accuracy higher up the frequency range. If four channels are available six speakers can be used, three high and three low, and the recorded height information can be used. □

Why square ferrite cores?

save up to 40% in space
save up to 40% in assembly time
save up to 30% in inventory

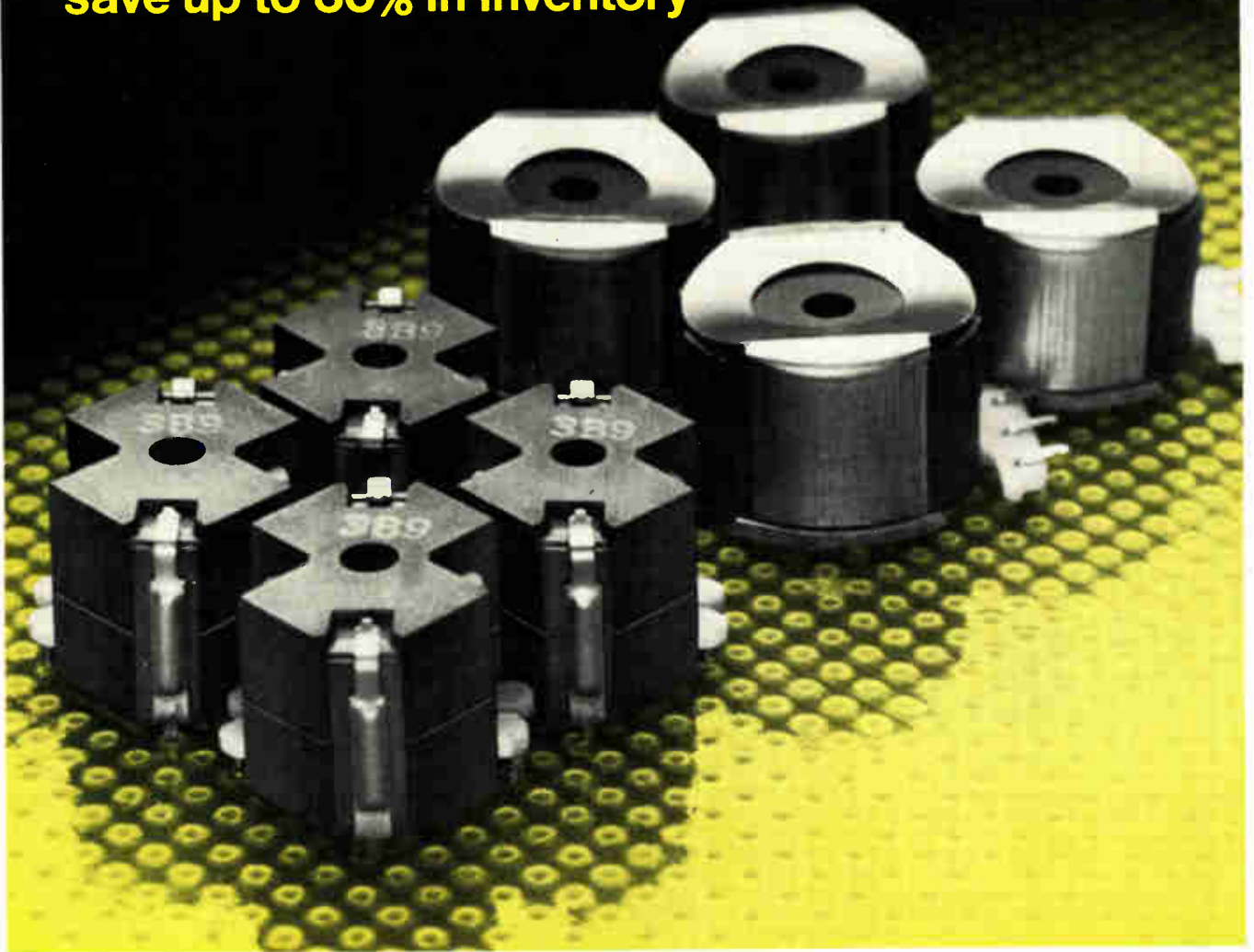

Ferroxcube's new RM Series square cores save up to 40% in pc board space over round pot cores. Furthermore, RM Series saves up to 40% in assembly and mounting time. Two simple, gold-plated clips hold them together and readily snap them into place on the pc board.

Your parts inventory is reduced since the economical mounting clips replace more expensive pot core mounting assemblies.

Ferroxcube's RM cores are available

with a choice of ferrite material: choice of ungapped, fixed-gap or adjustable-gap types, with smooth precise tuning of inductance to an accuracy of better than 0.03% in adjustable models.

RM cores now in stock. For complete information call 914-246-2811, TWX 510-247-5410 or write Ferroxcube, Saugerties, N.Y. 12477.

Ferroxcube linear ferrites—made in Saugerties, N.Y. and stocked in seven U.S. locations.

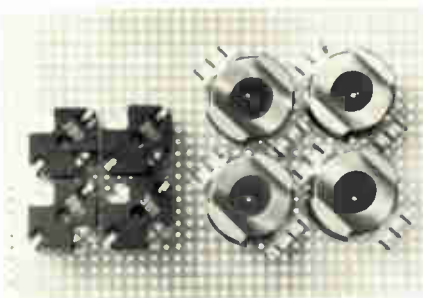

FERROXCUBE CORPORATION, SAUGERTIES, N.Y. 12477
A NORTH AMERICAN PHILIPS COMPANY

Distributed through North American Philips Electronic Components Corporation with warehouses in Boston 617-449-1406, New York, 516-538-2300, Saugerties, 914-246-5861, Philadelphia, 215-927-6262, Chicago, 312-593-8220, Santa Clara, 408-249-1134, San Diego, 714-453-9250

Siemens, Phillips plan cooperation in IC development

Philips Gloeilampenfabrieken of the Netherlands and West Germany's Siemens AG have agreed to expand their cooperation in semiconductors. The two firms had worked together in developing discrete semiconductor devices under an agreement existing since 1959. **Now the deal has been extended to cover integrated circuits as well.** Both firms will exchange IC licenses and patents and will make available their knowhow in IC development and fabrication. However, establishment of joint IC production and sales facilities have not been negotiated.

The deal puts together two firms with considerable expertise in their respective IC specialties. While Eindhoven-based Philips is unquestionably Europe's leader in integrated circuits for consumer applications, Siemens, of Munich, has a strong hand in ICs for industrial uses because of its involvement in professional electronics and computers.

With new color tube, GTE-Sylvania aims to increase market share

GTE-Sylvania figures it will wind up with a respectable market share among independent setmakers when its "new generation" color-TV receivers start reaching the market starting in late summer next year. The company figures it can win customers because **its new in-line color tube can be fitted to current chassis designs with practically no changes in circuitry.**

Sylvania unveiled the tube for Europeans at the Paris Components Show earlier this month and **expects to get it into pilot production at its Belgian plant by early next year.** Like Philips Gloeilampenfabrieken, Sylvania has opted for a 110° design with a large neck, in-line gun, large striped screen, and slotted shadow mask. Philips bills its tube as self-converging: the saddle-yoke deflection system takes care of convergence except for some small dispersions corrected dynamically. Sylvania uses a low-gradient magnetic deflection yoke—either saddle or toroidal—and pairs it with a quadripole winding to handle dynamic convergence. Combined with the in-line gun arrangement, Sylvania claims, the design simplifies convergence setups so that a maximum of six to eight adjustments will do. **There are also savings in copper for neck hardware and no power penalty in the deflection circuits.**

Mullard material may cut surface-wave acoustic filter costs

Mullard Ltd. hopes to get the price of acoustic surface-wave intermediate-frequency filters for TV sets down by making the substrate out of bismuth silicon oxide instead of lithium niobate, which is the usual ASW substrate material. The complicated specification of TV i-f filters makes them a natural for surface waves because it means a bulky electronic module can be replaced by a single, simple, plug-in microdevice. But so far, no component maker has got the ASW filter price down to the \$2 or so that the electronic filter costs.

The wave-propagation velocity on bismuth silicon oxide is half that on lithium niobate, and the slower speed means substrate area can be halved. Mullard engineers think that area saving should be sufficient to bring down the cost to electronic filter levels, even though the bismuth silicon oxide crystals have to be grown specially because there's no other market. The company plans to make a large evaluation batch at its Southampton plant to check out the economics, but there'll be no decision for a year to two.

Japan's electronics production should climb 11.6% this year

Japan's electronics output will grow 11.6% in 1974, according to a forecast by the Electronic Industries Association of Japan. Production value during the year is estimated at \$15.7 billion. Consumer electronics production is expected to rise 6.2%, totaling \$6.5 billion, while industrial electronics equipment output is figured to rise 19.8%, hitting \$4 billion. **Electron tubes, semiconductors, and integrated circuits should gain 11.7% over 1973, with value estimated at \$2.3 billion.**

TV-set output is expected to decline 11.5% although only dropping 1.7% in value during 1974, with production hitting 12,760,000 sets. Computer output, on the other hand, is expected to gain 24.9% in 1974, with 590,000 units to be produced. Electronic measuring equipment will be up an estimated 22.4%, with 194,800 units to be manufactured.

Asian imports are increasing headache to France

The French government is finding it hard to stem the flow of consumer electronics into France from Southeast Asia in general and from Japan in particular. Franco-Japanese trade in products like radios, television sets, and tape recorders is **producing a deficit twice as large as that predicted by government planners four years ago.** In addition, European economic community rules prohibit new protectionist measures.

From now on, that deficit is likely to grow larger. An agreement covering the most sensitive products ran out at the end of March and even though import quotas will stay for radio and TV sets, the French will have to depend on Japanese goodwill for other products. If pocket calculators are any measure of that goodwill, the French can not hope for much. Imports of those products jumped 50% last year to reach \$26 million—about the same as last year's imports of all Japanese radios, TV sets, and tape recorders put together.

Demand in West Germany for components shows no let-up

Market researchers at Valvo GmbH, a Philips subsidiary and West Germany's largest electronic components supplier, see the country's components demand continuing strong for the rest of this decade. Gert Lorenz, a managing director at Valvo, expects **demand to rise from last year's \$1.5 billion level to more than \$2.6 billion in 1980.** Scoring the biggest gains, Lorenz says, will be semi-conductors, with a share of the total components volume growing from 26% now to 34% within the next six years. The Valvo director puts the one for Western European components market at \$4.3 billion. That, he says, compares with \$5.4 billion for the U.S. Of note is the different structure of the American and West European markets, Lorenz points out. While the volume for tubes, including picture tubes, is roughly the same on both continents—\$1.2 billion—semiconductors account for twice as much volume in the U.S. as in Western Europe—\$2 billion versus \$1 billion.

Matsushita is Japan's top money maker

Matsushita Electric Industrial Co. leads the list of top corporate income earners in Japan for 1973, according to government tax authorities, with approximately \$394 million on sales of about \$4.15 billion. **Matsushita edged out Toyota Motor Co. to regain the top spot after four years.** Consolidated sales by Matsushita in 1973 were up 20% with gains of 38% in home appliances, sales, and 37% each in industrial equipment and in lighting equipment, tubes, and semiconductors.

**Why is Corning
running an 8-page ad
on its components,
now, during the worst
component shortage
since 1942?**

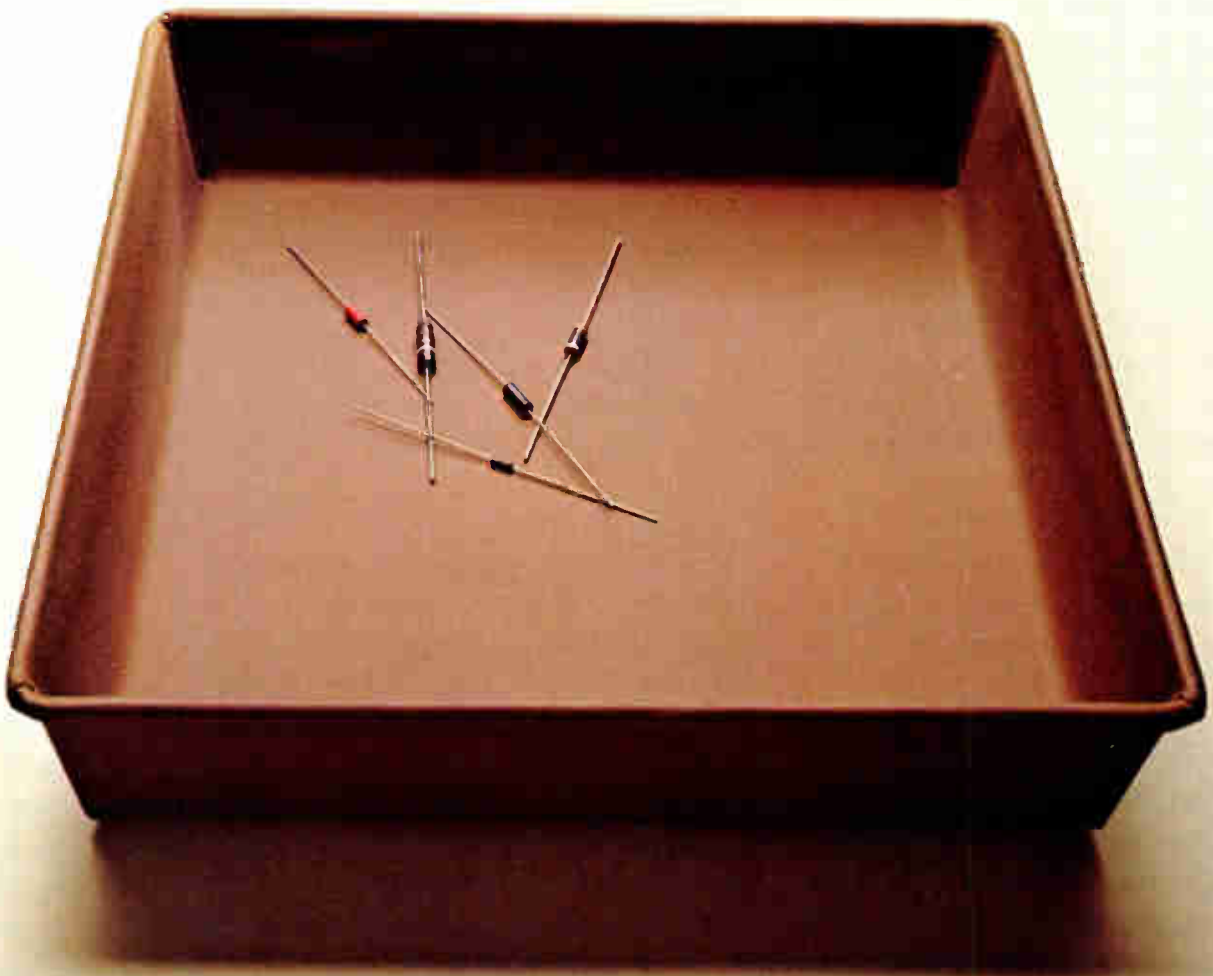

Here's why:

To our customers— We know your production and design plans depend on a clear and accurate picture of component availability. And since Corning's components represent such a large percentage of total supply, we'd like to show you where we stand today... and tell you what you can expect from us in the future.

To our prospects— We believe we're the first component supplier to emerge from a backlog situation. We'd like to update you on our new capacity, expanded lines, and developments.

That's why we're running this 8-page report.

The metal film resistor shortage and what we're doing to end it-

Demand for our metal film resistors soared during the past 18 months. There were two reasons...

First, designers continued their move away from carbon comps and wirewounds to metal films as they recognized the superior price/performance value that metal film resistors offer. The effect of lower metal film prices combined with the tighter tolerance needs of upgraded circuits suddenly created demands far beyond the industry's most optimistic forecasts.

And second, we were deluged with larger metal film resistor orders because other suppliers couldn't deliver as fast as we could. Demand was heaviest for the 1/4 and 1/2-watt styles.

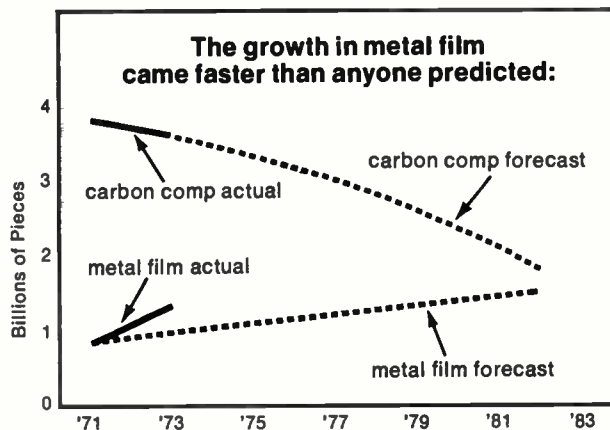

Industry demand vs. Corning production.

At its worst, order lead times ranged from 24 to 60 weeks and longer—compared to 6-week deliveries that were normal for us the year before.

But fortunately we had already begun a major metal film resistor expansion program. As such, we were able to meet an exceptionally high percentage of all promised shipments, and then gradually reduce lead times to a current

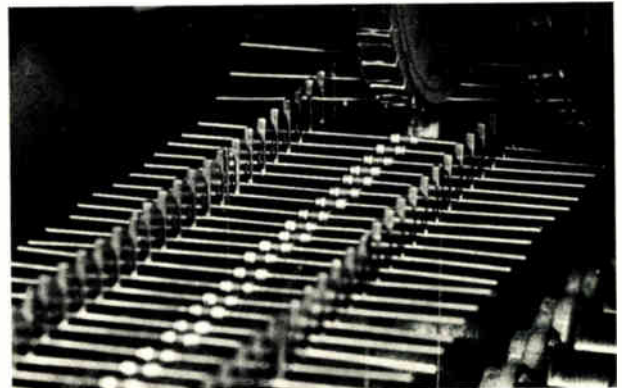

Our engineering staff developed many new techniques in all phases of resistor production.

average of 12 weeks—with 6-week delivery on several styles.

Our expansion program came in three phases, which let us move faster than the “brick and mortar” route to expansion.

Immediately, we moved to a full 3-shift-per-day 7-day-per-week production schedule. Our production and quality control staff was expanded quickly by transferring many experienced people back to our plants. And many more were hired and trained.

Secondly, we designed, tested and installed new high speed automated equipment and improved techniques in practically every stage of manufacturing. More than 18 state-of-the-art devices were developed by our engineering staff in this program.

Thirdly, we significantly expanded our basic resistor manufacturing operations at both Wilmington, N.C. and Bradford, Pa. This included a doubling of our resistor substrate capacity to keep us free from shortages in basic raw materials.

Just these last two stages required a multi-million dollar investment in capital equipment and facilities—all geared to increase output.

Throughout, our chief concern was keeping absolute control on product quality. More resistors—but bad resistors—is no progress at all! So we moved quickly—but at a pace and on a plan that would not risk quality problems that could cancel out production gains.

Corning is a major supplier of metal film resistors.

As a result of this expansion, we're now shipping more than twice as many metal film resistors as we did in 1970. We supply more metal film resistors than anyone else in the U.S. today.

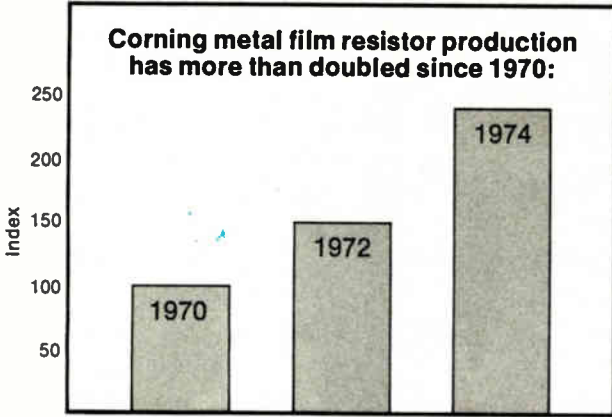

New additions you can expect to see this year.

Our current resistor line includes precision, semi-precision and general purpose parts—in a wide range of sizes and styles including ER and our flame-proof resistor line.

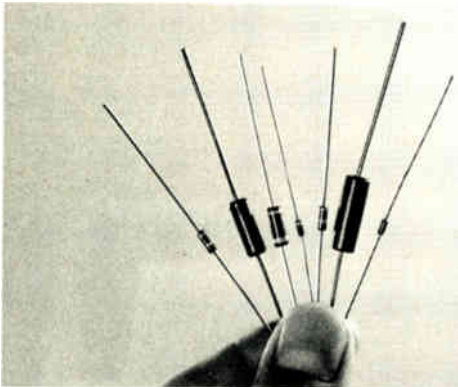

We are adding substantially increased capacity for precision parts with temperature coefficients of 50ppm/°C. And 25ppm/°C. parts are in the final stages of development. This will extend the range of our metal film performance capabilities significantly. As soon as samples of our 25 ppm resistors are available for evaluation, we'll let you know.

What to expect in the next 3 to 5 years.

We believe the metal film resistor supply situation will greatly improve in the second half of this year. But we also expect metal films to continue

to be the fastest growing segment of the discrete resistor market.

As the lower power requirements of new designs make wirewounds less popular, and the needs for greater precision (particularly in automotive and instrumentation applications) make carbon comps less suitable—we expect to see an annual demand growth of at least 10 to 12 percent. And we've geared our production to meet this demand.

Keeping tabs on our progress.

Throughout the shortage, we've regularly surveyed our customers to measure how we're doing versus other suppliers.

The result of the latest reading is shown below...

How users rate Corning's metal film resistors				
	Corning	Firm A	Firm B	Firm C
Buyers' ranking of				
—best quality	#1	#3*	#3*	#2
—best value for cost	#1	#4	#3	#2
—best distributor availability	#1	#4	#3	#2
Engineers' ranking of				
—best quality	#1	#4	#2	#3
—best value for cost	#1	#4	#2	#3

*tie

We're pleased—but not totally.

Obviously, we're still having to say "no" too often to new orders from new customers.

We hope we can change that soon. We're working at it. And we'll keep you posted as our metal film resistor supply backlogs further ease.

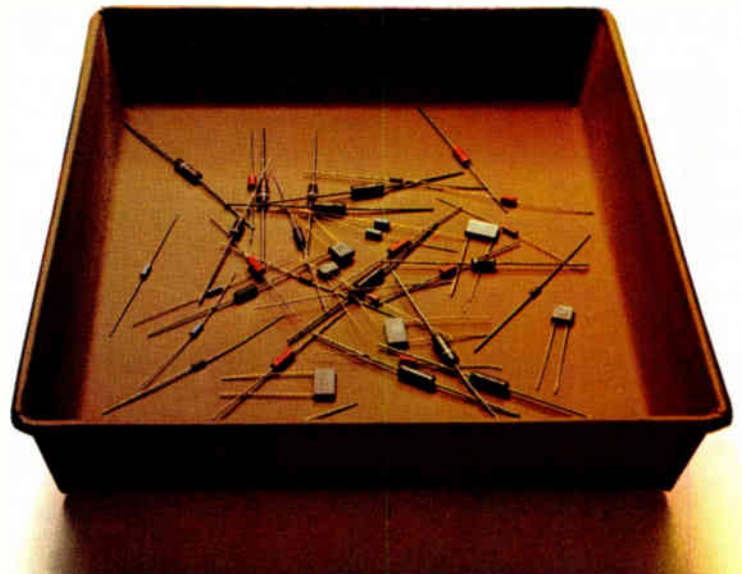

The Capacitor Shortage:

And what we're doing to end that too-

Corning has begun a major expansion into the ceramic capacitor market. And we're gearing our initial operations to very large volume production of a relatively tight line of low cost parts.

For the past three years we've been supplying a major portion of the computer industry's axial monolithic ceramic capacitor needs. And have initially concentrated on miniature size, epoxy-cased ceramic capacitors for automatic insertion applications.

Now, with a number of new product developments nearing completion, we are planning the introduction of a high volume low cost commercial axial ceramic line and an expansion into commercial radials in a major way.

Corning's expansion into ceramic capacitors.

During the past year, we've more than doubled our capacitor production. And because capacitor production is far more labor-intensive than resistor production, this has required a significantly enlarged technical and manufacturing staff, plus facilities expansion at our Raleigh, N.C. plant.

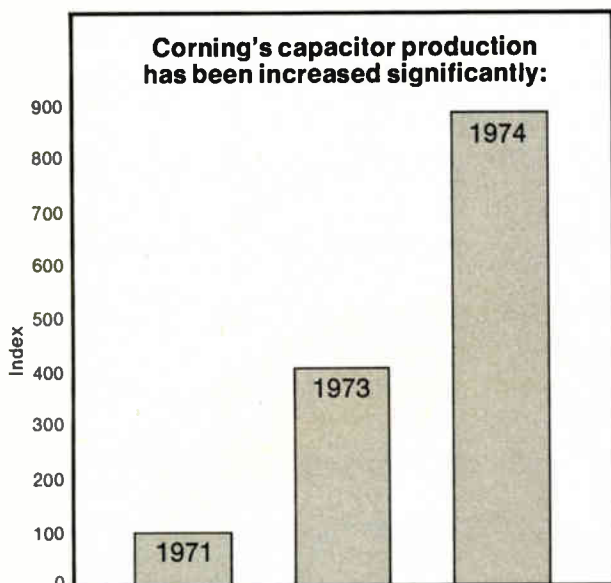

But 1973 increases will be eclipsed by the size of our expansion schedule this year and beyond.

1975 production will triple 1973 levels. 1978 production will have tripled again. And 1980 production will be 70 percent over 1978 levels.

But our expansion program is just beginning.

And the impact on longer term ceramic capacitor supply will go far in precluding another ceramic capacitor shortage.

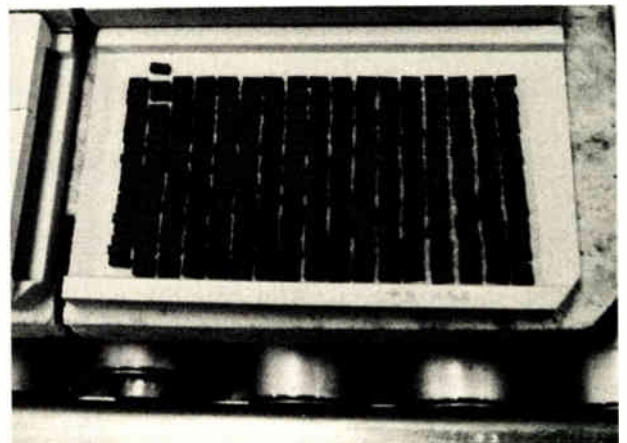

Ceramic chip inventories are being built at this very minute.

Glass and Glass-K™ Capacitors.

Our glass-dielectric capacitors have been in strong demand for applications where high stability

over a wide temperature range is required. In the fall of '73, delivery lead times rose to 30 weeks, but 8- to 10-week schedules are now more typical and distributor stocks are being rapidly replenished. Soon availability will be back to normal.

The same holds true for our Glass-K glass-ceramic capacitors — which combine the volumetric efficiency of a monolithic ceramic with the stability of a glass-dielectric.

New developments nearing completion.

Our new "spin-seal" conformal-coated axial could be the industry's long-term answer to a truly low cost automatically insertable ceramic capacitor.

Using techniques we originally developed for — and currently use in producing — our resistor line, this epoxy-jacketed series has the uniformity and handling characteristics necessary for automatic insertion. But at lower cost in larger volume production. The "spin-seal" technology permits us to manufacture axials at much higher speeds than are possible with molded case styles. Throughout, coating thickness is automatically gauged and controlled to keep uniformity and performance exact.

As soon as evaluation samples are available in quantity, we'll announce their availability.

Industry demand forecasts:

Currently, molded axials represent 25 percent of the leaded ceramic capacitor market. Through 1980 they'll continue to move in on radials based on current trends to automatic insertion. As such, axials will remain a prime area of concentration for us.

When our "spin-seal" axials are ready, we expect to be able to supply axials at prices that

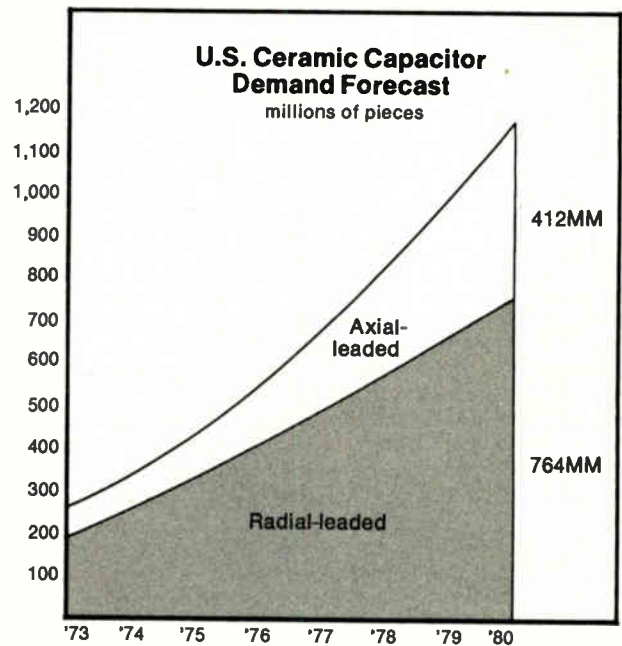

encourage a switch away from radials. This should push axial growth even faster.

But we'll also be ready with our radial line, to provide whichever types of ceramic capacitors your production requires.

In short, Corning plans to become a major factor in all types of ceramic capacitors in the years ahead.



The Tantalum Capacitor Shortage:

And what's available now-

During 1973, we concentrated on keeping our distributors supplied as fully as possible with tantalum capacitors from our Components Incorporated subsidiary.

By year end, this meant that a major percentage of the tantalum capacitors being sold through distribution were ours.



Recently, we introduced two more tantalum lines into distribution and availability on both should be excellent soon in most areas of the country.

1. Our TK line:

These low cost, radial leaded, epoxy dipped solid tantalum capacitors have capacitance values in the 0.1 to 330MFD range—with working voltages of 6 to 50VDC and tolerances of $\pm 10\%$ and $\pm 20\%$. Their low-profile configurations

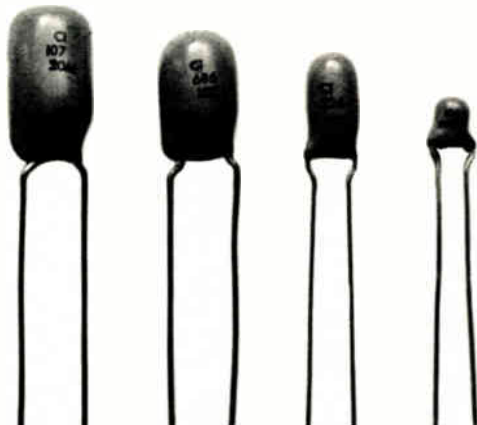

and availability with a choice of lead bends make them well suited for convenient insertion and assembly.

Incidentally, our companion line of DIPATAN® TD series epoxy-coated radials are now in fairly good availability in most areas, too.

2. Our MINITAN™ line:

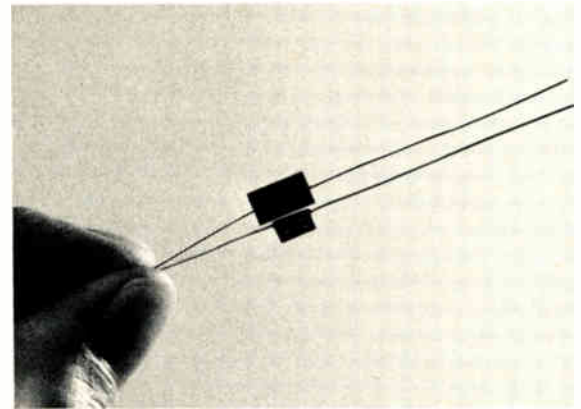

These microminiature solid tantalum capacitors are epoxy-sealed in a polyester sleeve. They're available in both cylindrical cordwood and rectangular modular form, with a choice of axial or radial leads. Capacitance values are 0.001 to 220MFD, working voltages are 2 to 50VDC, and tolerances are $\pm 10\%$ and $\pm 20\%$. They're in excellent supply. We can meet your needs now.

Supply problems exist elsewhere.

Industry wide, supply problems are still enormous for axial-leaded, metal-can-enclosed solid tantalum capacitors. These parts have soared in demand because of their wide use in high volume machine-insertion applications.

Corning, like other suppliers, has been unable to gear up quickly to new demand levels for these metal-cased parts, because their fabrication is labor intensive and the very skilled workmanship required cannot be expanded rapidly without risk of quality.

We are in the process of training additional personnel and have supplemented existing facilities, but frankly it will take months to catch up with current demand levels for both our MILITAN® hermetically sealed ER line and our ECONOTAN® epoxy-sealed consumer and industrial line.

In the meantime...

In the meantime, we suggest you take a closer look at our MINITAN and TK series as good alternatives to your immediate needs.

Our distributors have assumed a pivotal role:

Corning component availability -

In spite of shortages, we've made significant gains in distributor availability across all three Corning component lines. Progress here can be seen in the chart below.

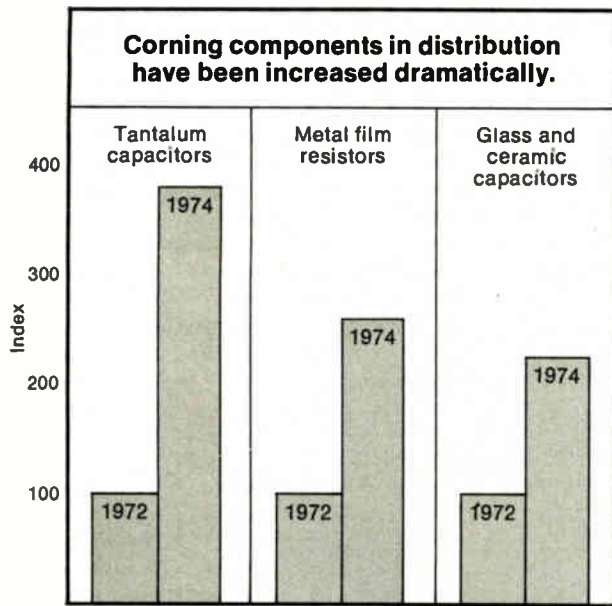

We believe that a strong, well supplied authorized distributor network is the **only way** a component supplier can responsively meet the large and growing needs of the thousands of firms across the electronics marketplace.

That's why our distributors are now our largest "customer," and why they'll be assuming an even more pivotal role in Corning's future marketing and supply plans.

An expanded distributor supply center.

To make this work, we've added a major new distributor supply center at a location separate from our plants. This supply center literally buys Corning components from all locations in anticipation of future distributor needs. In the fullest sense, it's become a "Distributor's distributor." And it operates under a strict policy that prevents our OEM sales group from tapping into distribution supplies.



Frankly, it will take a few months before our new distributor supply center builds inventory to levels where we can once again meet our goals of shipping distributor orders directly from off-the-shelf stocks.

But each week we're making progress. For example, our lead time on RN55D metal film resistors has dropped from 22 to 11 weeks. CK12, 13, 14 BX ceramic capacitors are now available for off-the-shelf delivery from your local distributor.

Strong emphasis on distribution means more firms will be introduced to Corning components than ever before. Engineers and buyers who've never used our resistors and capacitors will be buying them in future months.

We'll keep you posted.

By being first to ease component supply, Corning hopes to make new friends and win new long-term users. This in turn will let us keep expanding in increments large enough to achieve low cost pricing for our parts.

We'll keep you posted.



What Corning makes:

Metal film resistors—precision, semi-precision and general purpose—including ER and flame-proof types. Precision resistors with TC's down to 50ppm/°C.—with 25ppm/°C. parts coming on later in the year.

Ceramic capacitors—miniature, precision multi-layer axials with molded epoxy cases have been our main area of emphasis. Lower cost commercial axials and commercial radials will be our major area of expansion in future months.

Solid tantalum capacitors—axials in metal cans (in both hermetically sealed and epoxy-sealed

types). Low cost, low profile epoxy-dipped radials in a range of types and sizes. Microminiature axials and radials—epoxy-sealed in both cylindrical and rectangular cases.

Glass capacitors—a complete line of precision, fused monolithic glass-dielectric capacitors. Introduced 30 years ago and still the ultimate in stability.

Glass-K™ capacitors—miniature, multilayer, molded-case axials that combine the volumetric efficiency of ceramics with the stability that only a glass dielectric can provide.

Our Distributor Network:

ALABAMA: Huntsville; Cramer/EW (205)539-5722. **ARIZONA:** Phoenix; Liberty Electronics (602)257-1272. **CALIFORNIA:** Culver City; Avnet* (714)522-8220/(213)836-7200. Gardena; Bell Industries Electronics Corp. (213)321-5802. Los Angeles; Liberty Electronics (213)322-8100. Mountainview; Elmar Electronics (415)961-3611. San Diego; Liberty Electronics (714)565-9171. Sunnyvale; Acacia Sales* (408)735-0100. **COLORADO:** Commerce City; Elmar Electronics (303)287-9611. Denver; Cramer Electronics (303)758-2100. **CONNECTICUT:** North Haven; Cramer Electronics (203)239-5641. **FLORIDA:** Hollywood; Cramer/EW (305)923-8181. Hamilton/Avnet Electronics (305)925-5401. Orlando; Cramer/EW (305)894-1511. **ILLINOIS:** Chicago; Bell Industries (312)282-5400. Schweber Electronics (312)593-2740. **INDIANA:** Indianapolis; Graham Electronics Supply (317)634-8202. **MARYLAND:** Baltimore; Radio Electronics Service Company (301)823-0070. **MASSACHUSETTS:** Watertown; Sterling Electronics (617)926-9720. Newton Centre; Cramer Electronics (617)969-7700. **MINNESOTA:** St. Paul; Ragon Electronics (612)488-0201. **NEW JERSEY:** Cherry Hill; Cramer Electronics (609)424-5993. **NEW MEXICO:** Albuquerque; Cramer Electronics (505)265-5767. **NEW YORK:** Freeport; Milgray Electronics (516)546-6000. Hauppauge; Cramer/Long Island (516)231-5600. Rochester; Cramer/Rochester (716)275-0300. Syracuse; Cramer/Eastern (315)437-6671. Westbury; Schweber Electronics (516)334-7474. Woodbury; Harvey Electronics (516)921-8700. **NORTH CAROLINA:** Winston-Salem; Cramer/EW (919)725-8711. **OHIO:** Cincinnati; Sheridan Associates (513)761-5432. Cleveland; Schweber Electronics (216)464-2970. Columbus; Hughes-Peters (614)294-5351. **PENNSYLVANIA:** Philadelphia; Almo Electronics (215)676-6000. **TEXAS:** Dallas; Solid State Electronics (214)352-2601. Houston; Hamilton/Avnet Electronics (713)526-4661. **UTAH:** Salt Lake City; Cramer Electronics (801)487-4131. **WASHINGTON, D.C.:** Cramer/EW (301)948-0110. Milgray/Washington (301)864-1111. **WASHINGTON:** Seattle; Liberty Electronics/NW (206)763-8200. Almac/Stroum* (206)763-2300. **CANADA:** Montreal; Cesco Electronics, Ltd. (514)735-5511. Toronto; Cesco Electronics, Ltd. (416)661-0220.

* Tantalum Capacitors only.



CORNING
ELECTRONICS

Probing the news

Analysis of technology and business developments

Microprocessors steer to Detroit

Car makers testing devices for sensing and control applications, but obstacles are unreliability, input/output interfaces

by Larry Armstrong, Midwest bureau manager

The concept of computers to control functions in automobiles has been bandied about Detroit for at least five years without becoming a reality. But with increasing volumes and varieties of microprocessors becoming available, the Big Three auto makers are now finding ways to cost-effectively implement the sophisticated and glamorous concept that they now regard as inevitable as death, taxes—and, of course, increasing Government pollution and safety legislation.

To date, all on-board microprocessor work has been limited to each company's advanced-development projects, which is to say that production volumes are still a way down the road. With traditional caution, the auto makers peg volume introductions to the early-1980 time frame; more enthusiastic semiconductor vendors tend to place it in the 1978 or 1979 model years. The major obstacles now are device unreliability and the need for input/output devices and interfaces.

"Knowing the lead time to develop an automotive product, I can say with quite a bit of confidence that there will not be any significant usage in the 1970s," says John L. Webster, manager of electronic-product development at Chrysler Corp.'s Huntsville (Ala.) division, which has an impressive track record for automotive electronic firsts. "But I think we'll have a few hundred thousand of them in cars in the early '80s."

Auto makers say they are now learning to program and use microprocessors, as well as trying to determine optimum system configurations. Potential applications for engine management include spark

timing, combustion control, emission control, automatic-transmission control, and cruise control—all of which manufacturers say could be controlled by a single microprocessor.

Detroit watchers, on the other hand, are betting that the Big Three will take the more traditional approach: individual functions based on dedicated custom MOS LSI, each justified in terms of cost, consumer value, and reliability, and introduced one by one. A second-generation system would combine the separate engine-control functions into a subsystem under the control of a single microprocessor, perhaps tied to a central processor that coordinates other satellite microprocessors for safety functions (including antiskid braking), driver-assistance features (such as diagnostic and fuel economy readouts), and interior-temperature control.

"Whether it should be done in one microprocessor or many is still an open issue," says Shaun S. Dev-

lin of Ford's Vehicle Control department in Dearborn, Mich. And, mirroring his counterparts at GM and Chrysler, he adds, "It really comes down in the final analysis to economics."

Ideally, the manufacturers would like to see a single box that could be applied, regardless of the options a customer chooses. Variability could be built into the software and isolated to a section of a read-only memory that would be plugged into a standard CPU.

Solutions. Detroit agrees that microprocessors, along with custom LSI and probably programmable logic arrays, are an inevitable solution to future electronic-applications problems. And while certain specifications—noise immunity, wide-temperature operation, and the ability to tolerate some aberrations in power supply—will have to be standard on microprocessors shipped to Detroit, the auto makers haven't decided on, and currently don't agree on, other parameters of the device

Actuators have them worried

Talk to automobile manufacturers about the use of microprocessors, and they'll agree on two things: the device will inevitably appear under the hoods of their products, and some of the biggest problems they have to solve concern the input/output electronics associated with microprocessors.

Perhaps the greatest interface problem is the one presented by the actuators. The starter solenoid, for example, produces transients on the order of 70 volts, and window-lift motors, windshield-wiper motors, and fuel-injection solenoids all require sizable starting-current surges.

"All these things were made to operate with pieces of metal that come together, and now we've got to find better ways to do the work—ways that are compatible with semiconductor driving," says John T. Auman, a General Motors executive engineer. "If you look at that very critically, you realize that it's the tail tending to wag the dog."

Probing the news

that would provide the best performance. Vendors report that the auto people have adaptations of every available product on the road.

General Motors pioneered computers in cars with minicomputers in the trunks of its highly publicized Alpha series auto of the future. The microprocessor, an early 4-bit building block from Intel Corp., made its debut in the Alpha IV. While GM officials aren't saying what the devices are being used for, they're pretty well satisfied with what's commercially available. "We know exactly what we want in a microprocessor, and we think that microprocessors, for the most part, to take care of our requirements are available," notes John T. Auman, an executive engineer on GM's advance-product-engineering staff.

No injection. In a less splashy program, Ford used a Digital Equipment Corp. PDP-11 to control spark timing, exhaust-gas recirculation, and fuel injection. Ford has since evolved that program into a microprocessor and custom-LSI system for timing spark ignition and positioning the exhaust-gas-recirculation valve. The fuel-injection portion of the earlier attempt has been abandoned as too complex to justify its benefits.

"It's a very classic control problem," reports Devlin, "but it's higher-speed than most, in a terrible environment, and we don't know enough about the car to cast anything in the concrete of a hard-wired system."

Ford, unlike GM, opted for the custom route with a 12-bit microprocessor, because the auto maker didn't see anything on the market that could do the job. "There's no such thing as a general-purpose, industrial-control microprocessor," says Ron H. Temple, Devlin's co-researcher at Ford. "Standard microprocessors are not fast enough, nor are they accurate enough at the speed we need to carry our numerical calculations," Devlin adds.

Wants 12 bits. "We need interrupts—we've got to relate to asynchronous things happening in the engine, and we can't afford the memory consumption to do status-

checking," Temple explains. "And we need 12 bits, at least; otherwise, we end up doing double precision all the time to get the accuracy we need. We need signed multiply and divide: we're using formulas involving square roots, for example, to compensate for things in the engine that we correct for temperature and flows."

Settles for 8. Chrysler, on the other hand, disagrees with the need for a 12-bit machine. "Admittedly, there are a few instances that require this precision, but not enough to need a 12-bit format in a microprocessor," Webster comments. "An 8-bit device may miss on a few of the informations you're processing but all you do is stick in another word and you've got it. A processor of higher order would be wasteful," he says.

Chrysler is developing microprocessors in three applications—entertainment, engine electrical, and body electrical, or instrument panel. Its first work was with the MCS-4 chip set from Intel, and it's now studying larger processors, including General Automation's LSI 12/16 silicon-on-sapphire chip (see p. 72). "We're looking to SOS for speed, primarily," Webster says.

Engine functions, especially those that maximize fuel economy at minimum emissions, are getting the bulk of the auto makers' attention. "Because of the increasing amount of legislation on emissions and fuel economy, we'll be forced into more and more precise and more sophisticated control of the engine," says Ford's Temple.

Economy. And even putting aside the potential threat of legislated engine control, Detroit will probably find consumers willing to pay for a fuel-economy option as they see fuel costs pushing toward a dollar a gallon. Using 1973 Environmental Protection Agency figures on gasoline consumption, Robert B. Hood, manager of Fairchild's Advanced Automotive Products department, estimates that using microprocessors for engine control could yield a factor of 1.8 to 2.0 improvement in economy.

Barring the way to speedier implementation of microprocessor-based systems in autos are Detroit's doubts about reliability, and a lack

of input and output interfaces.

"The electronics industry has a long ways to go to supply something as complicated as a microprocessor chip," comments one automobile official. "It's still learning how to sell us a simple transistor that meets our reliability needs. Microprocessors have a heck of a lot more wire bonds, and I hope they beat the wire bonds by the time we get around to using them. Today's devices just aren't going to make it through the thermal cycles we have to live through.

When it comes to obstacles, at least one, system reliability, will have to be worked out between Detroit and its vendors. "They want to understand all a microprocessor's failure modes," says Floyd Kvamme, vice president and director of marketing for National Semiconductor. "Most things they've used to date have degraded gracefully. With most of the things electronics companies have proposed, when the system blows, the car stops running."

Interconnects. Auto manufacturers emphasize, and some semiconductor manufacturers recognize, that only a small percentage of the cost and problems of eventual on-board microprocessor systems are in the microprocessors themselves. "Microprocessors are here; what we're waiting for are the input and output devices," Webster says, "and frequently the people in the electronics side of the house ignore that problem."

Adds GM's Auman: "The problems of reliability and cost as they associate themselves with the interconnect, with the sensors, and with the actuators are really the first-order problems that have to be solved."

"The bulk of the problem really lies in the interfacing elements—both the input and the output," echoes Fairchild's Hood. "For instance, using an inductive pickup for wheel positioning or crankshaft positioning requires fairly good signal processing to get a digital signal that can be fed to a microprocessor," he explains.

"We're trying to come up with good digital sensors that that don't need a lot of analog-to-digital converters for," Auman says. □



It may not be sexy. But to an engineer, it's dynamite.

Finally, someone has put its family of High Rel products between the covers of a book.

That someone is RCA Solid State. The people who created an entire organization exclusively to tackle your IC High Rel problems. And this High Rel Data Book is a good place to start.

Almost 600 pages of problem-

solving facts including application notes, design features, operating considerations. Even a cross index to the other RCA Solid State Data Books.

To an engineer searching for High Rel digital CMOS building blocks; linear IC's for military or industrial applications; RF devices or power transistors, this is the

place to look. The first place.

So if you've always wanted to know about High Rel products, but didn't know where to go, you do now. Available from your RCA distributor, your nearest RCA sales office or direct from us (send \$2.00).

Write: RCA Solid State, Section 70D18, Box 3200, Somerville, N.J. 08876.

International: RCA, Sunbury-on-Thames, U.K., or Fuji Building, 7-4 Kasumigoseki, 3-Chome, Chiyoda-Ku, Tokyo, Japan.
In Canada: RCA Limited, Ste. Anne de Bellevue 810, Canada.

RCA Solid State

Communications

Police are buying digital systems

Cleveland is about to announce winner of \$600,000 contract, Los Angeles plans to equip 200 cars, and many other departments get in line

by William A. Arnold, Aerospace Editor

Police cars are starting to respond to a different kind of call: digital communications. Although far from being universal, digital electronics is being bought or considered for scores of law-enforcement units because digital technology speeds response time, makes better use of available frequencies, and otherwise improves communications between cars and with headquarters.

Cleveland is expected soon to announce a contract to equip 125 cars with mobile digital-communications terminals. The \$600,000 award for an initial system will go either to the tiny Kustom Electronics Inc. Data Communications division in Chanute, Kan., or IBM's Data Processing division, White Plains, N.Y. Other police departments talking or buying digital communications include Las Vegas; Seattle; San Francisco; Minneapolis; Boston; Rochester, N.Y.; New York City; Chicago; Palm Beach, Fla.; and the states of Massachusetts and North Carolina.

A potentially big purchase will be

made by the Los Angeles police department, which plans to outfit 200 cars within the next year. William A. Shand, marketing manager for Atlantic Research Corp., Alexandria, Va., predicts that the specialized Los Angeles system will be expanded eventually to include approximately 1,000 cars.

Shand adds that he's sold 15 units to Dearborn Heights, Mich., and is awaiting an order for another 15 from Hampton, Va. Other manufacturers include the big and the small in mobile communications: Coded Communications Corp., E-Systems Inc. (which bought GTE Sylvania's system), Motorola Inc., RCA Corp., Sunrise Electro-Service Corp., Teletype Corp., and Xerox Corp.

Giving impetus to digital gear is the Justice Department's Law Enforcement Assistance Administration. LEAA provides funds for demonstration systems, such as those in Kansas City and Cleveland, where departments can test and get used to the idea. The well-heeled

agency also can pump a great deal of money into new police equipment, often with the police departments paying only 10% of the cost of the gear.

Furthermore, LEAA has practically endorsed digital electronics in the report of a survey of departments using digital gear. The study was performed by Urban Sciences Inc. of Wellesley, Mass., a subsidiary of Senter Security group of New York City. It was done for the Law Enforcement Standards Laboratory of the Commerce Department's National Bureau of Standards, which performs services for LEAA's research arm, the National Institute of Law Enforcement and Criminal Justice.

But the market isn't just lying there, ripe for the picking. IBM spokesmen concede that the giant computer corporation hasn't sold any equipment and has no potential business at the moment. Atlantic Research's Shand says, "Everything is LEAA money." Companies "won't

Keeping In touch. This sample digital police communication system uses phone lines (in white below) and rf links (zigzag lines).

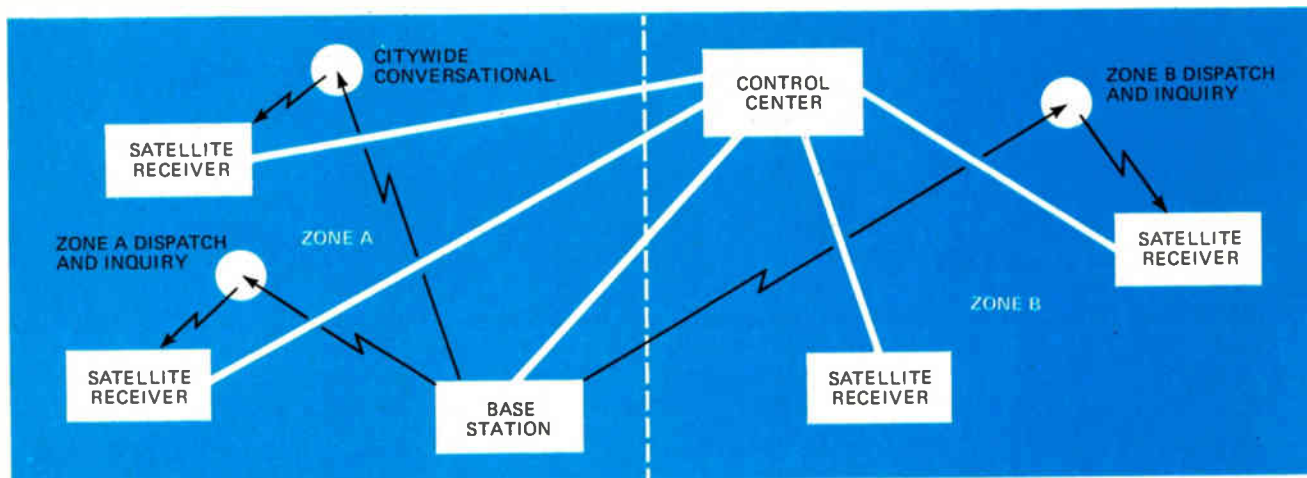

An industry first.

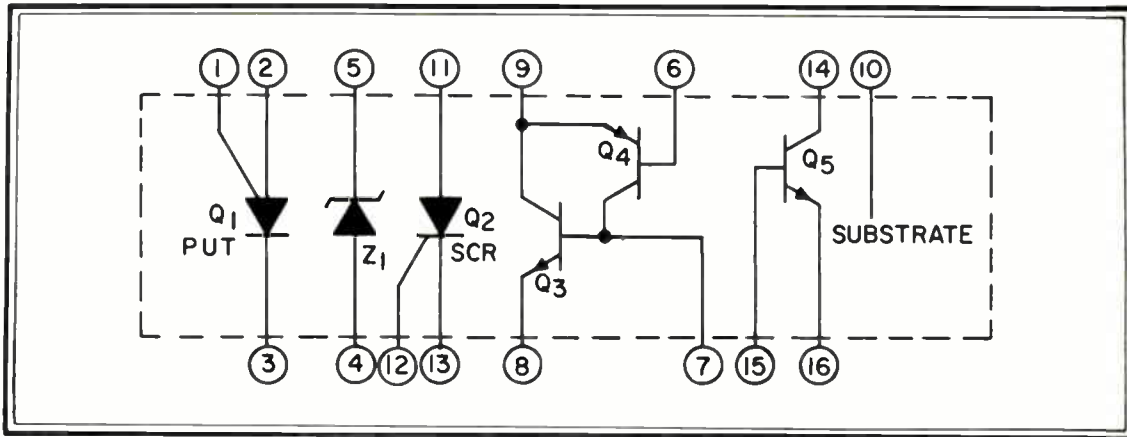

RCA Solid State's CA3097E Thyristor/Transistor IC Array

There are so many ways to use it that we can't even begin to describe them to you.

We've put a programmable unijunction transistor (PUT), sensitive gate SCR, zener diode, p-n-p/n-p-n transistor pair and an n-p-n transistor ... all together in the 100 times improved plastic package system — RCA's new E-55 (16 lead DIP).

Check these characteristics and decide for yourself how to use the CA3097E in your system.

Characteristics

- Programmable unijunction transistor (PUT)
 - peak-point current = 15 mA (typ) at $R_G = 1\text{ M}$
 - $V_{AK} = \pm 30\text{ V}$
 - DC Anode Current = 150 mA
- Sensitive-gate silicon controlled rectifier (SCR)
 - 150 mA forward current (max.)
- Zener diode
 - $8\text{ V} \pm 10\%$
 - $Z_z = 15\ \Omega$ (typ.)

- DC Current 25 mA (max.)
- p-n-p/n-p-n transistor pair
 - $\beta \cong 8000$ (typ)
- @ $I_c = 10\text{ mA}$
- n-p-n transistor
 - $V_{CEO} = 30\text{ V}$ (min.)
 - $I_c = 100\text{ mA}$ (max.)
- Thermal and electrical component tracking with the design flexibility of discrete components
- Improved product reliability with the E-55 plastic packaging system, which demonstrates two orders of magnitude improvement in reliability over previous industry average.
- Operation over a temperature range of -55 to $+125^\circ\text{C}$.

If the CA3097E can work for you, order now. It is available in quantity — at a price that will stop you in your tracks: \$1.35 (1K price).

Want to know more about the CA3097E? Write: RCA Solid State, Section 70D18, Box 3200, Somerville, New Jersey 08876. Or phone: (201) 722-3200, Ext. 3144.

RCA Solid State
products that make products pay off

Probing the news

sell if cities have to buy units themselves." The real problem, he avers, "is that the equipment isn't as cheap as the real market wants."

Even a 20-unit system costs \$120,000, "a big chunk for a city to bite off," Shand says. And, if a company has to produce 15 at a time, there's no way to get the price down. He advocates changing the designs to reduce the price, largely by integrating circuits on chips. But, the "chip manufacturers aren't interested unless you can order 5,000 chips," Shand concludes.

Developing standards. The Government's next step is to contract with Urban Sciences to develop minimum performance requirements for units, says Marshall J. Treado, program manager for communications systems at the NBS standards laboratory. While he emphasizes that the Government will do no compliance testing and that the standards will be voluntary, it is obvious that a set of standards will make it easier for departments to buy equipment with Government help.

The Urban Sciences study [*Electronics*, Feb. 7, p. 59] cites the advantages of increased speed, ability to handle a greater volume of communications, and inherent security of digital signaling.

The report concludes that "digital communications represents one of the most useful means that technology can offer for improving communications operations for law enforcement."

The study surveyed 16 law-enforcement agencies using digital communications ranging from status-only to fuller, more computerized, communications, and it evaluated 15 car terminals from 10 manufacturers.

The available equipment from manufacturers will meet user needs and provide a "flexible choice of system configurations," the report states, but "operating experience with these equipments is limited, so no quantitative conclusions can be made with regard to maintenance and service performance."

Marketing managers will be glad to learn that two-way digital com-

munications is a definite requirement, according to the law-enforcement agencies surveyed, as is a system that provides "full-text" and "status" capability. Half of the departments indicated that they plan to equip all of their vehicles with digital gear, while the other half would equip according to varying work loads. For the base station, about half want both visual and hard-copy terminals, while the rest specify visual information displays only.

For the vehicles, about 40% require CRT-type displays with printers added in selected cars, about 35% want both for all cars, approximately 20% had no definite opinion, and only 5% wanted only a two-way printer. More than half of the departments said they wanted automatic polling of mobile units for status updating.

For the future, companies should reduce the size of their car terminals. All police agencies surveyed "voiced considerable concern over the bulk" of many of the digital terminals available, the study says. Front-seat space is limited, and most police departments would like as much of the digital gear as possible to fit in the trunk of their cruisers.

The agencies also think that systems should be compatible with automatic vehicle-monitoring networks and with computer-aided dispatch systems. Also, among other objectives, displays should be readable in direct sunlight, messages should not be displayed while no officer is in the vehicle, multiple-chan-

nel systems should have channel-switching controls, and these systems should provide digital identification of which radio channels are in use.

Overall, departments like using digital communications. About 80% mention security and improved response time, while 55% like the reduction in channel utilization, confirms Treado. Using a digital system, one police department reports a 140-fold increase in patrol queries and a 15-second response time from the patrol car to the FBI's National Computer Information Center and other computerized data banks.

During slow nights, some patrolmen swing around motels and check license plates, which has brought about an astonishing increase in the number of hits, or identifications of cars sought as stolen or in connection with crimes. "The hits per time on the air go up drastically," says Treado. "If you can check 100 times more license plates, you'll probably get 100 times more hits."

How big is the market? "I think there's a very large potential market," says John L. Aker, Kustom's data-communications manager. He lists Motorola and IBM as formidable competitors, even though Kustom beat out IBM in Kansas City [*Electronics*, Dec. 6, 1971, p. 39]. Sunrise, which has sold a digital system for a New York City taxi fleet [*Electronics*, Feb. 7, p. 39] and offers the highest transmission rate of any system, also is interested in the police market, says William Smith, president. □

Cutting congestion, but not traffic

Police-communications systems are using the proven advantages of digital technology to update law-enforcement electronics. Instead of slow voice transmission with its inherent delays, garbles, and relays, digital gear will let a patrolman in a squad car quickly query a base station or a central data bank for the desired response. One great advantage of digital communications is that it dramatically lessens frequency congestion while allowing for an increase in traffic volume.

A typical terminal in a squad car can weigh up to 45 pounds, use CRT, light-emitting diode, plasma, or hard-copy display for the digital information, and have a keyboard with numerical keys for codes and other keys for special functions. One bugaboo has been the allegation that digital systems are less secure than voice, even though they need no voice-scrambling apparatus. However, if one is stolen, that unit can be left out of the network because, since the unit is selectively addressed, it can also be selectively "deaddressed."

The MACRODATA MD-107 Memory System Analyzer!

Imagine a tester that can handle plated-wire, core, or semiconductor memories . . . that can test complete computer memory systems, memory boards, or memory chips . . . that can operate at 10 MHz and compare up to 160 data bits at any of 16,000,000 addresses.

The Macrodata MD-107 Memory System Analyzer does it all.

- Macrodata's Cascaded Computer Control Testing Concept
- Minicomputer, Microprogrammable Processor, and CRT Display
- Key-

- board Entry of Test Programs
- Split Cycle Timing Capability
- Sophisticated Address Manipulation Capability
- Simple Software Language with Display of Directive Action for Operator Based on Test Results
- Extensive Sync Capability
- CRT Display of Device Inputs/Outputs for Test Monitoring
- CRT Message Display for Easy Program Debug
- Complete system under \$50,000.

For the full story, send for the MD-107 brochure, or call us directly.



SYSTEM BLOCK DIAGRAM

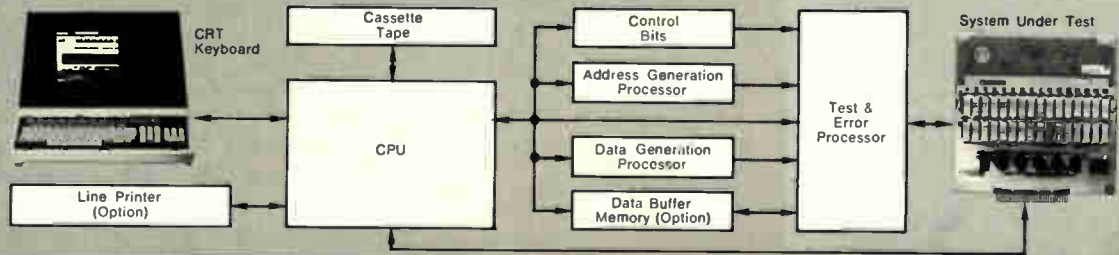

Macrodata



Macrodata Corporation, 6203 Variel Avenue, Woodland Hills, California 91364, Phone: (213) 887-5550, Telex: 65-1345
 Sales Offices: Northern California Area Tel. (408) 735-9560 • Southwestern Area Tel. (213) 644-3611 • Scottsdale Tel. (602) 947-7841 • Minneapolis Area Tel. (612) 636-1770 • Chicago Area Tel. (312) 455-5100 • Cleveland Area Tel. (216) 461-8333 • East Coast Tel. (516) 343-8600 • International: West Germany Munich Tel. (0811) 34 56 00 Telex: (841) 521-5969 • Milan, Italy Tel. 871-988/899-248 Telex: (843) 34314 • Sweden and Norway — Stockholm Tel. (08)-380-370 • Switzerland and Austria — Bern Tel. (031) 22 44 81 Telex: (845) 33172 • Tel Aviv, Israel Tel. 25 55 69 • Tokyo, Japan Tel. (03) 985-5266 Telex: (781) 272-2171 • Buckinghamshire, England Tel. High Wycombe (0494) 36 3 81 Telex: (851)837236

Companies

GA moves to meet new competition

Maker of minicomputers and automated systems, which grossed \$30 million in 1973, faces squeeze from mini, semiconductor firms

by Paul Franson, Los Angeles bureau manager

At its inception in 1967, General Automation Inc., the Anaheim, Calif., maker of minicomputers and computer-based automation systems, placed itself in a growth arena—the industrial-automation business. The company's 1973 sales of \$30 million are largely derived from that business, which was chosen because one of GA management's basic tenets was to go after industries that were ready to turn to computer-based automation.

But the still-young company faces some of its most serious challenges as it sets its sights on sales of \$200 million by 1978. It is offering more visible competition to such larger minicomputer manufacturers as Digital Equipment Corp. and Data General Corp., and it has to contend with possible inroads into its

Competitor. GA's SOS processor chip, the 12/16, is designed to battle semiconductor companies in the market.

business from semiconductor microprocessor manufacturers.

GA has made some moves to counter the technology thrust of the semiconductor community. It has developed its own silicon-on-sapphire microprocessor CPU for use in its minicomputers, and it has invested in an MOS supplier in Mountain View, Calif.

On the business-strategy side, GA is even more aggressively exploiting the automotive industry's readiness to automate, as well making acquisitions that have positioned it in other growth markets.

Founder and chairman Lawrence A. Goshorn was the main architect of the firm's strategy in choosing its markets, but he admits to at least one miscalculation. Fortunately, that market remains promising. His criteria were four: Go after fields in which the leaders "had a minimum amount of energy; when the timing was right to position GA as the leader; where the industry was ready to turn to computer-based automation; and where the market size was right—"large enough, but not too large."

'Mistake' in timing. The "mistake" he admits was to underestimate the automotive market. "Through 1985, \$10 billion will be spent on automation." Yet GA has done well, both because it was well positioned, and because it concentrated on some 200 submarkets—for example, carburetor manufacturing and testing, and transmissions, tires, and diagnostic centers.

General Automation has concentrated right from the start on three major markets for both OEMs and end users: industrial automation, communications, and scientific sys-

tems. The industrial segment includes the lucrative automotive market, which accounts for about 11% of its business, with many test, alignment, and assembly systems used worldwide on automobile production lines.

The industrial-automation business accounts for about 13% of sales, and special systems are used in electrical and electronic production for coil winders, parts inserters, printed-circuit-board drilling machines, and wire wrapping.

Data communications, a major growth market, accounts for about 16% of business, with about a quarter of GA's sales in the business and scientific arena. Here GA 18/30 systems compete with IBM 1130s in disk monitoring systems, and with IBM 1800s in supervisory control.

In all these markets, GA is up against stiff competition from the biggest and the most successful firms in the electronics industries—though, perhaps fortunately, none is a competitor across the board.

Chip makers threaten. But for the future—a future that may already be here—president Raymond J. Noorda says the semiconductor companies are the most serious threats to minicomputer makers. However, Goshorn says, "I do believe that we're going to see more companies integrating semiconductor capacity into their companies, particularly as we see the rampant semiconductor companies try to become everything to everyone."

GA's response has been two-fold. First, there is the silicon-on-sapphire microcomputer; second, GA is investing in a semi-captive MOS house, Synertek of Mountain View, Calif. Noorda feels that GA is in bet-



ter shape than rivals whose micro-processors, say, have been developed by semiconductor houses. "We feel that we have something proprietary to offer our customers." He adds, "the OEM customer wants to put you out of his business and do as much as possible himself. If he can make the fundamental product himself more cheaply by buying a few chips, he will. If you expect him to keep you, he has to know you will continue to have something to offer. We will have very low-cost, high-performance 'iron' product for the OEMs."

GA has delivered sample SOS microcomputers to a number of customers, including RCA Corp., but doesn't expect product flow to start until late summer, says marketing vice president Michael Ford. "It takes three to nine months for customers to need the flow. We have 40 customers that could turn into big buyers, with a dozen already committed." He estimates that requirements could be 15,000 to 17,000 or 30,000, depending on acceptance of the customers' products.

SOS deal. In view of GA's sour attitude toward the semiconductors suppliers that are now competitors, the firm's relationship with SOS supplier Rockwell Microelectronics is interesting. Noorda points out that both companies have contributed a lot to the development of the 12/16. GA has exclusive use of its parts, of course, but "we're anxious for Rockwell to develop the SOS technology and sell it to others. We don't want to have the only SOS products; it's a very lonely position."

General Automation also has made a number of significant moves toward vertical integration through acquisitions and investments in suppliers, customer-marketing arms, and a new venture in Japan. Last year, the firm acquired Dynamil Inc., a manufacturer of multilayer circuit boards.

A significant GA investment is in Silicon Valley. There, Synertek expects to start supplying GA with 1103 and 2102 MOS random-access memories later this year and eventually to supply a major part of its memory needs. Other Synertek investors are Victor Comptometer and American Telecommunications. At present, GA buys these MOS prod-

Hands on the tiller

Although Lawrence A. Goshorn has relinquished the presidency and day-to-day management of General Automation Inc. to Raymond J. Noorda, no one should conclude that Goshorn is moving out of the picture in the company he founded and shaped. He remains chairman of the board and chief operating officer, and he intends to concentrate on product planning, financing, acquisitions, and executive hiring, plus technology, an area of great interest. The 38-year old Goshorn, who contends that he can serve better outside of the hectic daily routine, states, "Ray is a much better administrator than I am."

Goshorn is a soft-spoken but emphatic Kentuckian (he moved to Arizona when he was 11), with a BS in computer engineering and MS in control engineering from Arizona State University. He served five years in the Navy and has been director of engineering at Decision Control (now Varian Data Machines), manager of technical marketing at Computer Control Co. (now part of Honeywell Information Systems), and he started out at General Electric Co.'s process-control computer department, where he helped design and develop some of the industry's earliest computers. Goshorn sees his strength in technical concepts, but his marketing insight has obviously helped General Automation.

One of Goshorn's favorite topics is that semiconductor companies are aggressively going after the markets that his and other minicomputer makers have opened. "Up to now, component companies have been going after loose-toothed tigers that roll over and die—old industries like electro-mechanical calculators, meters, relays, and watches. They won't find such an easy fight when they try to take over the computer business. The computer companies themselves are young, aggressive, and already electronics-based. They won't fall down and let the components companies have the business."

Goshorn isn't interested in helping the suppliers who are now becoming his competitors, hence his internal SOS-design group, and investment in MOS maker Synertek. He's also stated in the past that Texas Instruments, which is pursuing the minicomputer and automation markets, as well as making ICs, isn't a GA supplier for precisely that reason.

President Noorda has had a strong background in process and automation control at General Electric—in fact, he was responsible for hiring Goshorn at GE. After 21 years, Noorda decided that a lot of things he wanted to do technically couldn't be done at the giant company, and he joined his old friend's firm.

Noorda feels his main contribution at GA has been to make it work on a business-like basis. "Before, they were going after too many markets in a somewhat haphazard way, and if there's one thing I learned in the 10 years I spent in marketing, it's that you've got to concentrate on a few markets to do well in any of them." Now, Noorda spends more and more time with legal and financial people and requirements—areas that Goshorn appears to have left without many tears. "He keeps telling me about all the opportunities I've gained," says Noorda, smiling.

ucts from other MOS suppliers. Goshorn points out that semiconductor memory will account for 70% to 80% of the microcomputer business. Meanwhile, the company and its investors are involved in a lawsuit with major MOS maker American Microsystems Inc., which claims that Synertek management has misappropriated AMI trade secrets and recruited its employees.

In forward integration, GA announced in February that it is acquiring Tal-Star Computer Systems Inc., Princeton, N. J., GA's major printing-industry computer cus-

tomers for four years. Its systems are used to automate production, typesetting, printing, and distribution of many major U. S. newspapers. Goshorn expects expansion downward to smaller systems. And last year GA acquired Data Systems Engineering Inc., in Anaheim, a system development and product development company.

GA's foreign business already accounts for significant 27% its sales. And in December, the company received approval for a 50-50 joint venture with Koyo Electronics Industries Co. in Tokyo. □

Only one of these synchronous motors



is a genuine Synchron[®] Motor.

Synchron motors are made in five major styles. Speeds from 900 rpms to one revolution per week. Torque from 8 through 98 oz-in at one rpm. Hundreds of output options.



Look alike aren't perform-alikes.

Not by a mile. And once a motor is installed in your product, who cares what it looks like? As long as it does its job, is trouble-free and lasts a specified time.

But how do you know which of the three will perform the best? Do you gamble and just pick one, assuming they're all about the same? Hardly. You specify the one that's made by a company that's just as interested in how well the motor performs as you are . . . who will stand by it 100% . . . who will deliver it when you need it . . . at a fair price.

But most of all, from a company dedicated to helping you solve your problems with the best product made. The motor on the left is the one we're talking about. It's the genuine Synchron.

Call or write for complete Synchron motor specifications and the name of your Hansen representative.

MALLORY



HANSEN MANUFACTURING CO.
a division of P. R. MALLORY & CO. INC.
Princeton, Indiana 47670

We make every Synchron motor as if our name were on your product.

Education

EE enrollment recovers from slump

But the short-term outlook is for a shortage, now that engineers from recession-hit classes are beginning to enter the job market

by Mary Chalupsky, staff writer

EE enrollments are making a comeback from the recession-fed decline of the early 1970s as college administrators push to make curriculums more flexible, broader-based, and more appealing.

Still, some administrators say the short-term prospect is for a shortage of graduate EEs. Their forecast is based on smaller 1974 graduating classes that reflect the diminished interest in electrical engineering on the part of 1970's freshmen. Manpower cutbacks, particularly in the aerospace industry, frightened potential students, and schools are still struggling to attract people.

Another recession now, says John Alden, director of the Engineers Joint Council, could really hurt those efforts. And looking still further ahead, Alden points out that a decline in the U.S. birth rate is beginning to slow elementary-school enrollment. This could mean another reduction in college enrollment and, ultimately, yet another problem for industry.

One approach being taken by en-

gineering school administrators is to widen their curriculums in subjects like sociology, business, economics, and humanities. Thus, the traditional approach to engineering education, with concentration on math and the sciences, is evolving into more flexible programs based upon the demands of a new breed of engineer.

"The guy with the slide rule, flat top, and white socks isn't the engineer of today," says one educator. "In fact, a pocket calculator is replacing the symbolic slide rule."

At the same time, more students are transferring to engineering programs from liberal arts curriculums as well as from junior and community colleges. That shift stems from a growing scarcity of jobs for graduates in the humanities.

David Boylan, dean of the college of engineering at Iowa State University, Ames, Iowa, terms the new emphasis on engineering education a "multi-disciplinary outlook." However, he points out, "although companies would like a broader-

educated individual, they are still looking for the specialized engineer."

But most administrators agree on their major predicament—that for the short term there's more demand for engineers than there are graduates entering the profession. One school reports that requests from industry recruiters are so plentiful that the recruiters are referred to other institutions. Some schools simply turn them away.

Spending. Another tack being taken by colleges is to increase recruiting budgets—double, in some instances—with college representatives promoting their programs via TV, stepping up direct mail, and increasing contact with high school counselors and science instructors. At Georgia Institute of Technology, an institution that draws easily from the southeastern part of the U.S., administrators are starting students early. They are skipping recruitment at the high school level and going straight to elementary and junior high students, with favorable re-

EE ENROLLMENT 1970 - 73								
	1970		1971		1972		1973	
	1st year	total	1st year	total	1st year	total	1st year	total
AEROSPACE	3,213	12,836	1,407	6,819	1,028	4,656	966	3,923
BIOMEDICAL	43	212	88	363	182	590	156	862
ELECTRICAL	11,911	54,183	9,958	50,103	8,255	45,061	9,141	43,447
TOTAL	15,167	67,231	11,453	60,285	9,465	50,307	10,263	48,232

Source: Engineering Manpower Commission of Engineers Joint Council

Numbers picture. While over-all totals have been dropping for aerospace and electrical engineering, the amount of the slide has decreased significantly for the latter discipline. At the same time, the total of first-year students increased in 1973 for the first time in three years.

Probing the news

sults. And the University of Michigan has gone on the road with a mobile unit that travels to shopping centers, schools, and fairs to demonstrate basic experiments in an effort to attract more students into engineering.

So while technical schools try to train more new engineers, industry

has to wait for the lag to work itself out. According to a forecast by one New York consultant, a 50% increase in demand for technical manpower during 1973 is being carried over into 1974. Behind the surge in demand are the energy crisis and accompanying environmental problems, increased research and expenditures, and continuing technical breakthroughs.

In fact, the energy crisis has

brought a renewal of interest among students. But many administrators are apprehensive about the long-lasting effect of the energy shortage on engineering education. While some see it as a top drawing card, others assert that energy reverberations could have an adverse effect by causing a complete reversal in the economy.

Administrators also point to relatively untapped sources of students: minority groups and women. Opinion here is mixed, for while the Massachusetts Institute of Technology notes that 20% of 1974's freshmen will be women and Columbia University reports that the enrollment of women has doubled, other schools say minority groups aren't responding to enrollment drives as expected.

Eyes on goals. Another change noted by administrators of engineering schools in general, and EE programs in particular, is in the students themselves. They agree that undergraduates today are more serious and goal-oriented than they were five years ago. For one thing, there is less anti-technology feeling now, what with concern about energy and environmental problems. MIT's James Bruce, associate dean of engineering, says the about-face is logical because the problems of the world today are of a technical nature, and they can be solved only by technical people. Moreover, he notes, engineering has evolved from device-oriented to a people-oriented discipline, with emphasis placed on social and urban concerns.

At the California Institute of Technology, Charles Wilts, EE department head, says that he feels EEs have remained at the forefront of the engineering spectrum. "The future of electronics is very, very bright and is limited only by the ingenuity of man," he says. "Everyone recognizes it as a relevant and useful field with a major part in the solutions of today's energy-related problems."

And Demetrius Paris, director of the EE department at Georgia Tech, offers this summation: "The future looks good, and enrollments can only go up. Since determining decisions are made in the market, then that's where industry's needs will be met." □

THINKING ABOUT LSI?

Our new 'LSI Feasibility File' will help answer your questions about development procedures, costs, and how to evaluate the technology on your own terms.



It also explains how we can help.

The decision to employ the advanced technologies of Large-Scale Integration is seldom an easy one. And the facts on which to base your decision aren't always easy to come by. That's why we've just published our LSI Feasibility File. In it you'll find a lot of factual information about the technology and how you might be able to use individually developed LSI subsystems to improve your product. Use the coupon below to order your copy today. We're sure it will help.

MICRO POWER SYSTEMS

3100 Alfred Street, Santa Clara, CA 95050, Phone: (408) 247-5350, TWX: 910-338-0154
Japan: Yas Kanazashi, 21 Mori Bldg., 2-2-5 Roppongi, Minato-ku, Tokyo, Phone: 586-0471

If LSI subsystems can improve your product's performance, slash production costs and fatten profit margins, one or all of these three publications may tell you how. Ask for your copies now.

- LSI FEASIBILITY FILE—How to evaluate the technology and "get started" with LSI.
- LSI COST ANALYSIS FILE—How to cope with the numbers game, including four specific case histories.
- LSI DEVELOPMENT & SUPPORT—An illustrated description of our capabilities and unusual way of doing business.

TELL US ABOUT YOUR POTENTIAL APPLICATION:

Name _____
Title _____
Company _____
Address _____
City _____
State _____ ZIP _____



WE CAN HELP.

Here's a good reason to buy HP Modular Power Supplies

Value Plus . . . at HP that means selection, performance, reliability, price! HP value plus starts with a broad selection of models and ratings in our 62000 Series. Performance? It's yours with 0.01% line and load regulation, 1mV rms/2mV p-p ripple and noise. Long a leader in the field, HP reliability means trouble-free design utilizing conservatively rated, quality components, plus built-in protective features. All this . . . and they're competitively priced (with quantity and OEM discounts).



and another

Program Support . . . just as important, HP assures you of total program support, now and later. We have accessories to make your system designing easy, like: rack mounting trays, panels, slides and a compatible cooling unit. In fact, HP will build your entire system right to the custom front and rear panels.

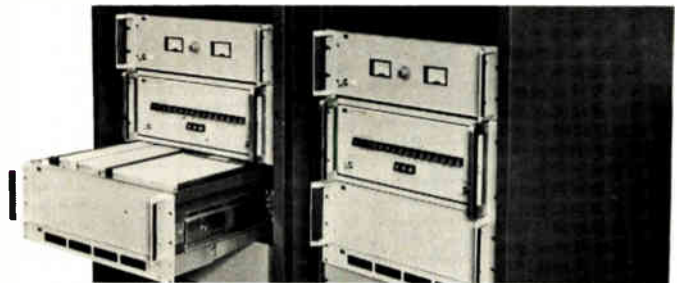

and another

Switching Regulated Supplies . . . with advanced transistor switching design and up to 80% efficiency . . . which means a lot more power in a smaller, cooler operating package, with over-voltage, overcurrent, overtemp. reverse voltage and protected remote sensing standard . . . 4V to 28V; with up to 300 Watts output.



and another

Confidence . . . HP confidence is one feature you don't see, but it's reflected in every HP Laboratory, Modular, Industrial and Digitally Programmable Power Supply. This leadership is backed by the most comprehensive service manuals, a selection guide and catalog, a 140-page power supply handbook, application assistance and a world-wide network of 172 sales and service offices in 65 countries . . . now that's confidence . . . that's Hewlett-Packard.

For new standards in power supplies — think HP.

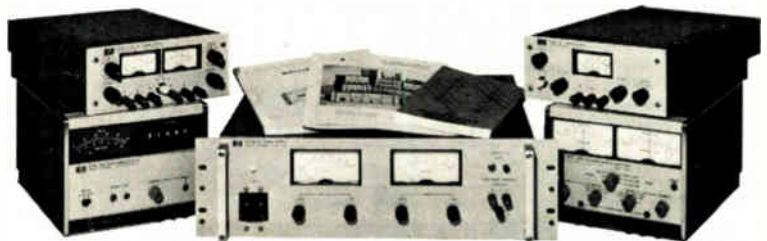

HEWLETT  PACKARD

Sales and service from 172 offices in 65 countries.

1501 Page Mill Road, Palo Alto, California 94304

21302R

**Before we wrote the only
Computer User Plan, we built
today's best planned computer.
The Prime 300.**

*The Prime
Computer User Plan.*

PRIME

PRIME 300

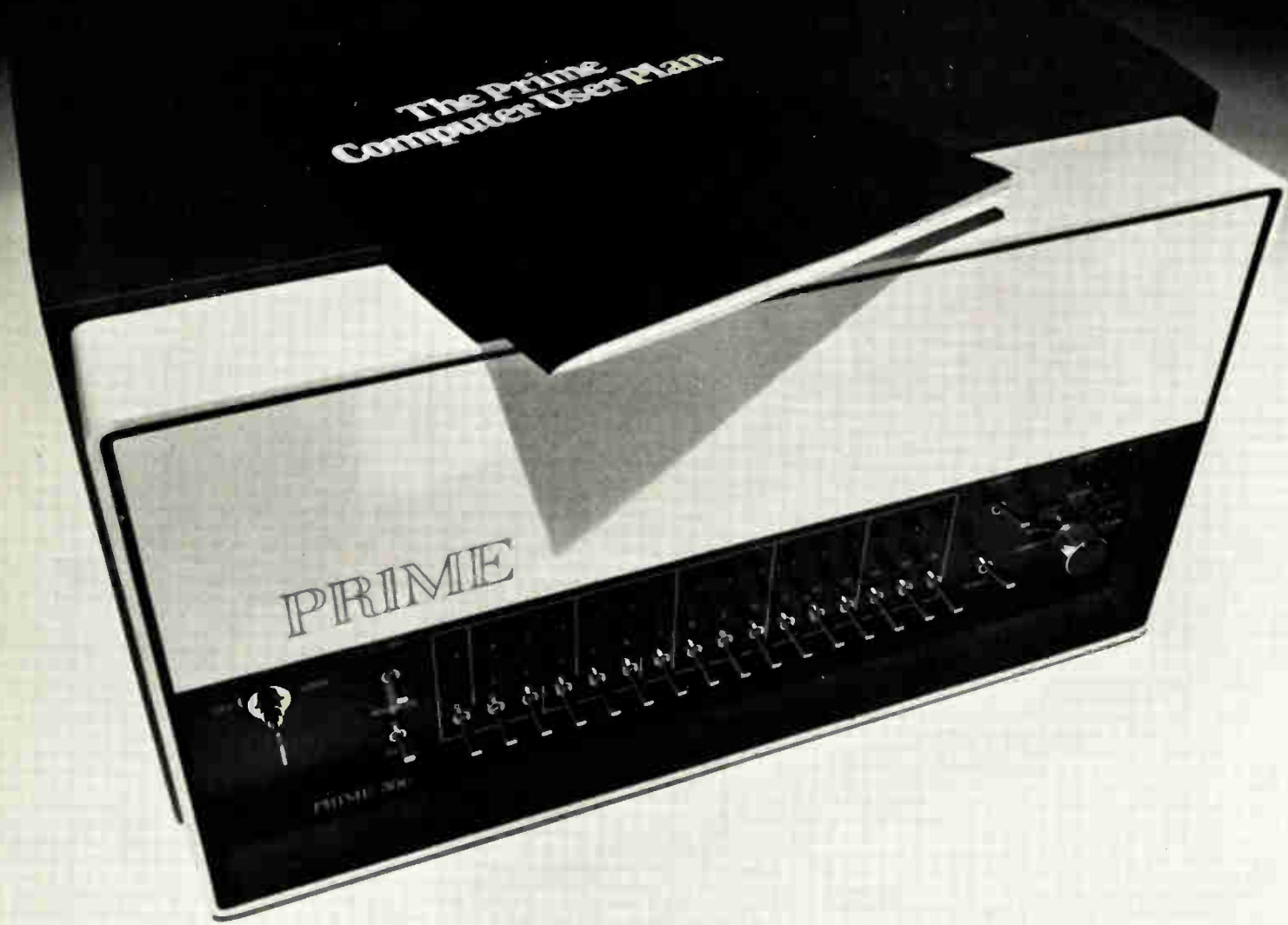

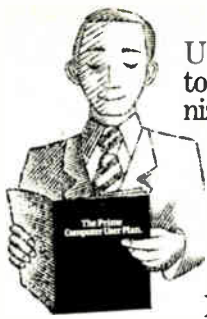

The Prime Computer User Plan brings common sense to buying a computer. It recognizes the simple fact that your needs might change someday.

The Plan introduces the first two-year guaranteed trade-in policy. It details the upward and downward compatibility features only

Prime offers. In short, it gives every assurance you can always put a Prime system to use.

We consider The Plan a new way to buy, use and upgrade computer systems. We also give you the systems to consider: The Prime 100, 200 or 300. The chart below is a preview of what to expect in each.

Standard Processor Features	
Prime 300 Central Processor (1 board)	<ul style="list-style-type: none"> Virtual Memory—automatic paging, mapped address translation to 256K words, restricted execution mode, and memory protect.
Prime 200 Central Processor (1 board)	<ul style="list-style-type: none"> Stack Procedure Instructions Micro Verification Routines** Hardware Multiply/Divide and Double Precision Arith.* DMC/DMT Capability* Automatic Program Load From Input Devices (PTR, TTY, CR, MT, Disk)*
Prime 100 Central Processor (1 board)	<ul style="list-style-type: none"> Memory Byte Parity Processor Byte Parity Full Addressing Modes—direct, indirect, and indexed in both sectored and relative modes Virtual Instruction Package (VIP)—automatic trapping of unimplemented instructions and substitution of functionally equivalent software subroutines.
	<ul style="list-style-type: none"> 8-Channel Programmable DMA 4 Channel Full Duplex Asynchronous Serial Interface Multi-level Vectored Priority Interrupt System
	<p>* Optionally available on Prime 100 and 200</p> <p>**Optionally available on Prime 200</p>

The chart suggests there's a little 300 in every Prime computer. Naturally, we planned it that way. Our 300 is just the reverse of the big box with a little computer inside.

Other 300 features will tell you just how big it is. For instance, there's high-speed MOS memory with 32K words per board. Up to 256K words per system. There's floating point arithmetic and writable control store, too. In short, there's everything you'll need in the computer you can plan with. Work out a multi-function system or plan a multi-user arrangement. The diagram that follows is just one way to go.

The Prime 300 supports a multi-user, virtual memory Disk Operating System (DOS VM) and a foreground/background Real Time Operating System (RTOS VM).

A Prime 300 with virtual memory easily accommodates over a dozen users. What's more, each is guaranteed 64K words of virtual memory available to program in FORTRAN, BASIC, Macro Assembler and Micro Assembler.

The system files and paging space are all provided by cartridge disk. Our new diskettes offer low cost storage for personal user files.

A Prime 300 is good. How good can best be seen in The Plan. It shows how to upgrade from the 100 right on to the 300. In the process, you don't change software. The time and expense of reprogramming are gone. You can also use the 300 as a software development system. The software will run on 100's or 200's without modification. The Plan guarantees this kind of system compatibility.

The Plan also goes into system integrity features. Memory Byte Parity and Processor Byte Parity are standard in the Prime 300. Micro-verification routines (also standard) and controller loop-back allow you to isolate faults to a single board.

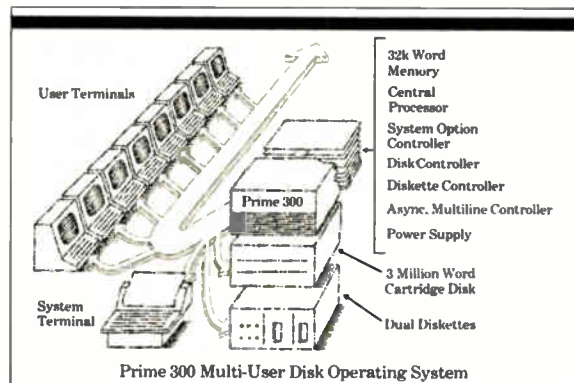

The Plan then spells out our total service options. They run from comprehensive on-call service contracts to Prime's unique Air Spare System. With Air Spare, we'll air express, for a minimal charge, any backup boards you may need from our nearest service center. We'll make repairs on faulty boards and have them back in no time. Meanwhile, you'll be operating full-time thanks to Prime.

There's more to The Plan. The best way to discover how much is to have your own. Send for it. The coupon below, like the Prime 300, will make it all possible.

To: Prime Computer, Inc.
23 Strathmore Rd.
Natick, Ma. 01760

- Send The Plan
 Send the Planner
(He'll call for an appointment.)

Name _____

Title _____

Company _____

Address _____

City _____

State _____

Zip _____

PRIME

Learn more about The Plan at the National Computer Conference, Booth 109.

Remember the time you wanted something special in 3½ digits?

Your time has come.

When we at Analog Devices introduced the 5-volt digital panel meter, we said there'd be more—a lot more. Look what we can offer you in 3½ digits alone.

Why so many? To give you a choice. So you won't have to order or build specials anymore. Because now we've made what you need a standard.

Let's say you need 3½ digit resolution. You can get it displayed in Numitron, LED, or even Sperry.

In Numitron, we can even give you a choice of green or red.

Now you have to power it. Most of our meters are 5 volts DC

because so much of what you're working on is in TTL logic. But if you need one that can run on 115 volts AC, you've got it. The AD2006 with Sperrys—in AC or DC. It's our latest DPM. But not our last.

You may even be designing something that will end up in another country. We can help you there too. With meters that will operate on voltages in Europe, the U.K., Japan, and just about anywhere else.

If you look closely, you'll see that one meter isn't a meter at all. It's a remote display. Sometimes you need that kind of thing.

But then giving you what you need is what it is all about. Like reliability. And extra features like card edge connectors. Ratiometric inputs. .05% accuracy. And low prices. Ours start at \$49 in hundreds for the remote display.

Now, would you like to see what we can do for you in 4½ digits—or 2½ digits? Give us a call. We'll see that you get a copy of the "Designer's Guide to Digital Panel Meters." And any other help you may need.

Analog Devices, Inc., Norwood, Mass. 02062. On the East Coast, call (617) 329-4700. In the Midwest, (312) 297-8710. And on the West Coast, (213) 595-1783.



 **ANALOG
DEVICES**

Then it was special. Now its a standard.

Single-chip microprocessors open up a new world of applications

Having freed system designers from the constraints of hard-wired logic, microprocessors are achieving new highs in performance and radically reducing the cost of computer control

by Laurence Altman, *Solid State Editor*

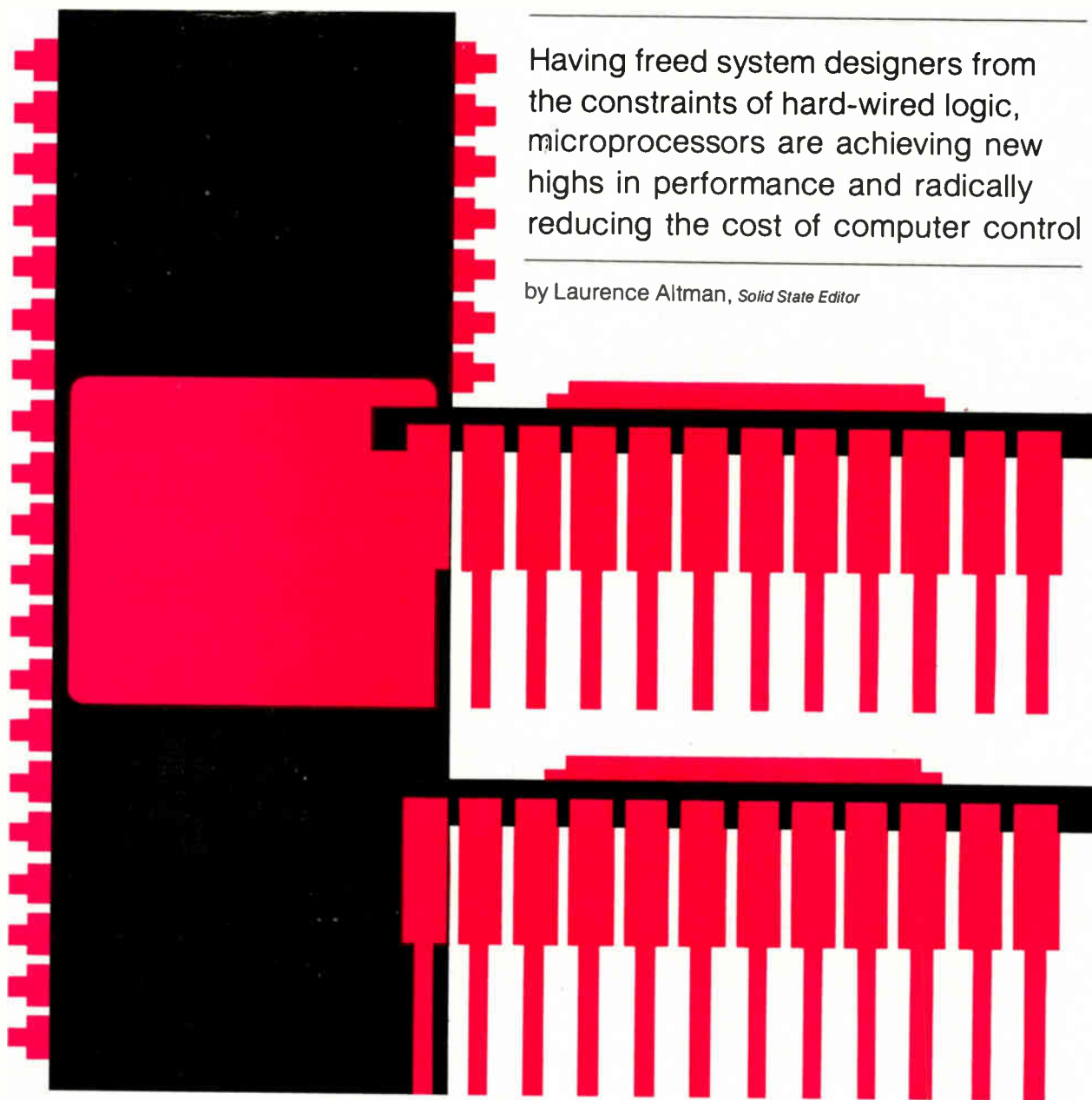

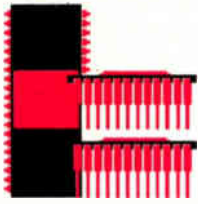

□ The first single-chip high-performance microprocessors are rolling off the production lines, splendid confirmation of the power of large-scale integration. These second-generation microprocessors, together with a handful of matched memory and logic circuits, provide equipment designers with the full power of computer hierarchy at unprecedentedly low cost—about the price of a dozen medium-scale TTL integrated circuits.

Inexpensive computer control—that is the miracle of the new microprocessor. All the other advantages inherent in its innovative organization are secondary, even the versatility that results from the ability to simulate logic with software and to reprogram corrections and system changes quickly with no changes in hardware.

The implications of such cheap, distributed one-quarter-horse computer power are only beginning to be understood. A Teletype computer terminal capable of transmitting 300 bits of data per second can now be implemented with 12 LSI packages costing less than \$300. Traffic-light controllers can be built with 12 microprocessor family packages, where an equivalent TTL design requires 200. A simple gas-pump meter needs one microprocessor and only nine other packages, an electronic scale needs eight chips. A digital instrument panel displaying five functions can be built from a five-chip microprocessor family, plus display circuits. A microprocessor control system already is operating in experimental automobiles, monitoring dozens of oper-

ational parameters at a potential component cost of less than \$200. No other electronic method could perform these functions at a practical cost.

Indeed, the microprocessor is really the first truly general-purpose LSI logic device—calculator chips are decidedly special-purpose. That's because the microprocessor, replacing hard-wired logic, offers the twin advantages of LSI circuitry and programmability.

Software-implemented logic, few packages, low power-supply and cooling requirements, and few pc cards and connectors simplify system re-evaluation, re-design, and testing. They also reduce assembly costs and inventory requirements.

Using software programs to affect the behavior of the processor instead of hardware interconnections may be an unfamiliar technique to many circuit designers, but pays off by boosting system performance. A typical software program consists of a series of orders or commands to the processor stored in a companion read-only memory. Since ROMs are easy to program—and programmable ROMs easy to reprogram—the microprocessor's behavior can be much more conveniently adapted to a changed application than if extensive, time-consuming changes in hardware were necessary. New designs, too, can be turned around faster because a standard microprocessor architecture can be used along with a different ROM program for each new application.

Designing systems with microprocessors is still largely

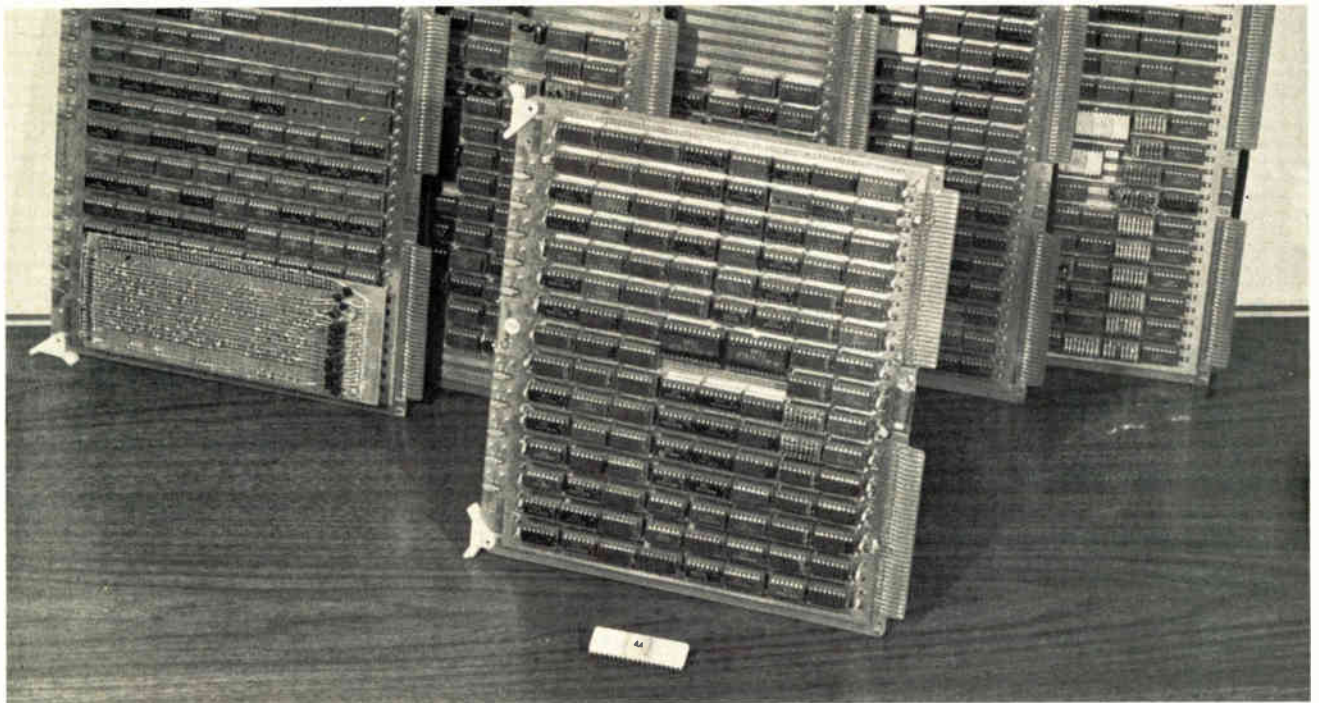

1. The big attraction. Built using standard TTL hardware, this microprogrammable processor circuit requires 451 packages on five circuit boards. Using advanced MSI logic and read-only-memory programming, it requires 114 packages on one board. Yet the same circuit, when built with today's n-channel LSI techniques, can be packed into one 40-pin microprocessor package—Motorola's new M6800 system.

uncharted, but some rules of thumb are beginning to emerge. Since a complete microprocessor system requires from five to 50 ICs—including clocks, control logic and memory, and peripheral buffering—microprocessors should only be considered for a sequential digital design requiring more than 50 hard-wired logic ICs. Such a design will have more than a trivial number of steps to its logic flowchart and will also have some logic or arithmetic data-processing requirements. At the same time, the speed cannot be too fast, say, not more than 5 to 10 microseconds per instruction.

These system requirements, clearly less stringent than those handled by today's minicomputers, would cost \$2,000 to \$20,000 to build with hard-wired logic. But with microprocessors costing a 10th of that, their range is almost inexhaustible: point-of-sale terminals, electronic cash registers, inventory-control systems, credit-card verification systems, process, numeric, and machine control, automatic test systems, digital instruments, traffic controllers, communications systems, peripheral controllers, navigational systems, game machines. This is the domain of the microprocessor.

How to choose a microprocessor

Selecting a central processing unit (CPU), the major component in a microcomputer design, is a matter of deciding the best way to process the data. For example, data word length may be fixed by the processor design or it may be variable if the design allows multiple processor chips in parallel. A variable data word length is to be preferred when the needs of a variety of applications must be satisfied. For instance, a 16-bit CPU chip could be programmed into 4-bit words for BCD display control, calculators, or cash registers, 8-bit words for CRT terminals or data concentrators, 12-bit words for handling the output of a-d converters, 16-bit words for general-purpose processing, or even 24- to 32-bit words for high-accuracy or high-throughput applications.

Instruction power is the next feature to watch out for in a CPU chip. Because the power of individual instructions and methods of counting may vary widely, the number of instructions in the set executed by a microprocessor is a poor index of its usefulness. The only realistic method of comparing instruction sets is to experiment with programs typically required for the intended applications and to compare the execution times and number of bits of storage they use.

Often overlooked in choosing a microprocessor is its interface structure—that part of the CPU which connects the arithmetic and logic unit and the control memory with the input/output peripheral circuitry. Clearly, this structure should adapt easily to a variety of system parameters without imposing a high overhead in hardware or software. The application may demand anything from a simple low-cost bus (either parallel or serial) having separate input, output, and address lines and

heavily dependent for its control on the processor, to a sophisticated, high-speed, bidirectional bus with addresses and data multiplexed over the same lines. For maximum flexibility, look for provisions for input/output control, which allow convenient interfacing with peripheral components of varying response time. On the other hand, fixed I/O timing may provide higher I/O speed. In any case, the microprocessor I/O circuitry should directly interface with the 5-volt bipolar logic required to drive I/O lines; if not, buffers will be necessary, adding expense and needing more in the way of power requirements and board space.

Since the memory is often a major portion of the system cost, its selection is nearly as crucial as the CPU's. Read/write memories (random-access memories or RAMs) are best used for variable data storage and for program storage during program development. Programs for prototype or preproduction systems are often stored in a programmable ROM, while a ROM is used during high-volume production.

What's available

The rush with which microprocessor devices are appearing—and will continue to appear throughout the year, according to semiconductor manufacturers—is a tribute to the intensity of the demand for them. They fall into three classes.

The pioneering 4-bit microprocessor systems were

What a microprocessor is . . .

. . . but first, what it isn't. A microprocessor is not a computer but only part of one. To make a computer out of a microprocessor requires the addition of memory for its control program, plus input and output circuits to operate peripheral equipment. Also, the word is not short for microprogrammable central processing unit. For, though some microprocessors are controlled by a microprogram, most are not.

What a microprocessor is, then, is the control and processing portion of a small computer or microcomputer. Moreover, it has come to mean the kind of processor that can be built with LSI MOS circuitry, usually on one chip. Like all computer processors, microprocessors can handle both arithmetic and logic data in a bit-parallel fashion under control of a program. But they are distinguished both from a minicomputer processor by their use of LSI with its lower power and costs, and from other LSI devices (except calculator chips) by their programmable behavior.

In short, if a minicomputer is a 1-horsepower unit, the microprocessor plus supporting circuitry is a ¼-hp unit. But as LSI technology improves, it will become more powerful. Already single-chip bipolar and C-MOS-on-sapphire processors are being developed that have almost the capability of the minicomputer.

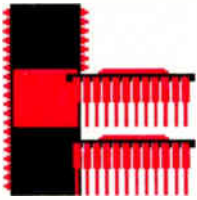

built largely with p-channel MOS calculator technology, examples being Intel Corp.'s MCS-4, Rockwell International Corp.'s PPS-4 system, and Microsystem International Ltd.'s MC-1. Next came the 8- and 16-bit p-channel processor sets that are extensions of the early 4-bit units. These devices, while intended for applications up to the minicomputer level, generally require either multichip CPUs or considerable peripheral circuitry. Intel's MCS-8 and National Semiconductor Corp.'s IMP-16 are the most popular examples of each kind. Into the third and newest class, considered by many to be the second generation of microprocessors, fall the new n-channel 8-bit systems like Motorola's MC6800 and Intel's 8080 chips, which, together with matched memory and input/output circuit interfaces, form a completely self-contained large-capacity microcomputer family of chips (see pp. 88-100).

Introduced late in 1972, the 4-bit microprocessor units were the first to provide the microprogrammable parallel processing required in many keyboard and slow-throughput terminal and process-control applications. Indeed, using as few as two devices, like Intel's 4004 CPU chip plus a 1,024-bit ROM, a 4-bit microprogrammed dedicated computer could cost less than \$50.

Intel's basic MCS-4 system, however, was designed for general applications. Its single-chip CPU performs all

control and processing functions and interfaces directly with ROMs, which store microprograms and data tables, and RAMs, which store data and pseudo-instructions. This system communicates with input/output devices, found here on each ROM and RAM chip. In addition, a 10-bit parallel shift register is provided to expand the system's I/O capability. Thus just four chips are needed for complete microcomputer capability.

Even this relatively simple 18-pin 4-bit package provides up to 45 instructions, cycling in 10.8 microseconds with standard two-phase clock operation. The system can drive up to 4,096 8-bit ROM words (16 chips), 1,280 4-bit RAM characters (16 chips), 128 I/O lines (without a shift register), and unlimited I/O capability with shift registers. And, adding even more to the MCS-4's flexibility and further accelerating the design cycle, the CPU and RAMs may be interfaced with conventional electrically programmable and erasable ROMs, allowing fast program development and quick prototype realization.

Equally versatile is Rockwell's 4-bit PPS system, which comes complete with five compatible support circuits: a 256-by-4-bit RAM, a 1,024-by-8-bit ROM, a RAM-ROM combination chip containing a 704-by-8-bit ROM and 76-by-4-bit RAM, an I/O buffer, and a multiphase clock generator (Fig. 2).

The CPU in this system can directly address up to

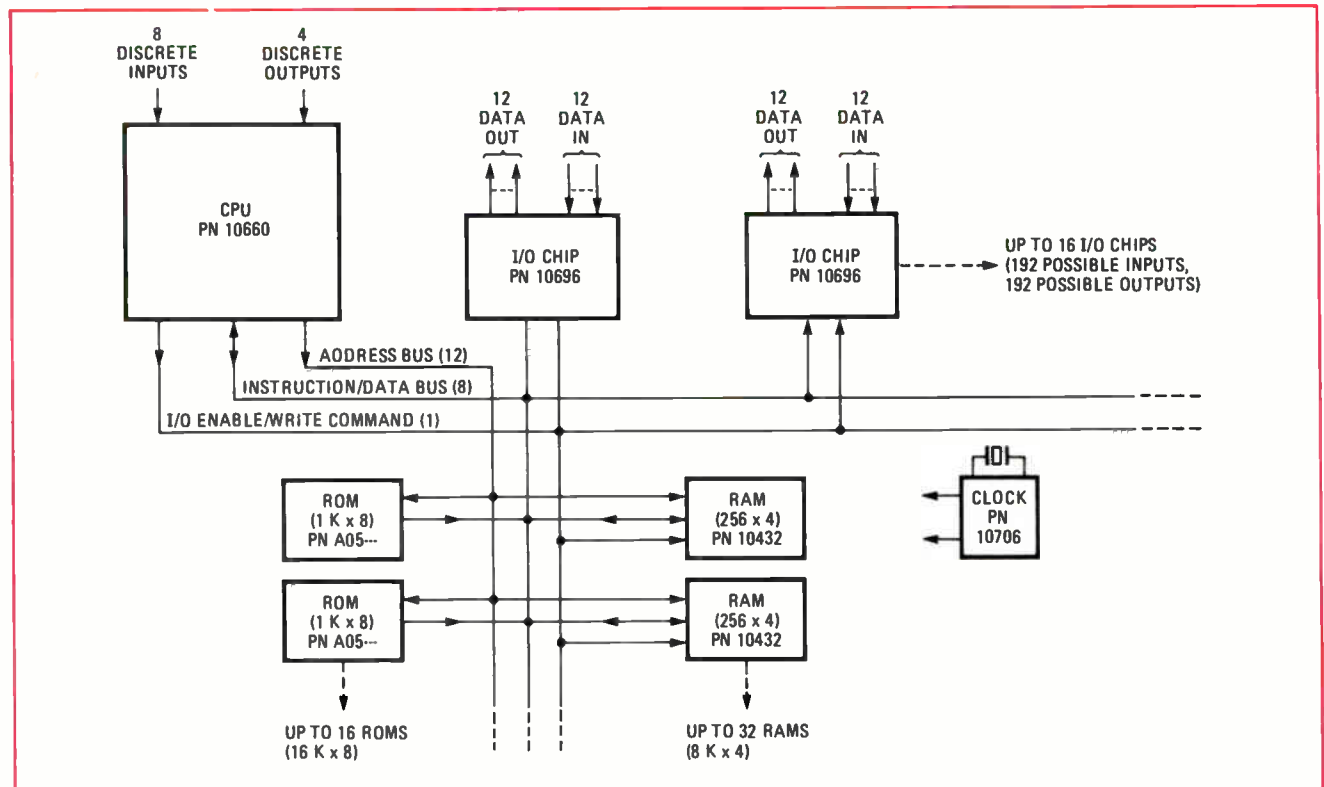

2. Four bits' worth. In Rockwell's self-contained 4-bit PPS system, versatility is a major design asset. Five compatible elements—CPU, RAM, ROM, a RAM-ROM combination chip, and an input/output buffer—provide up to 4,096 8-bit ROM words and 4,096 4-bit RAM words.

4,096 8-bit ROM words and as many 4-bit RAM data words over its 12-bit parallel address bus. This large number of data words gives this family the capability of a 4-bit minicomputer. The basic instruction set contains 50 instructions, and instruction fetch and execution time is a speedy 5 microseconds.

Apart from power and clock-signal requirements, 21 multiplexed lines interconnect the CPU with ROM, RAM, and I/O circuits. These lines, as shown in Fig. 2, are functionally grouped into 12 parallel address lines, eight parallel data lines, and one write command and I/O enable line. The address lines originate at the CPU and are time-multiplexed within it to provide direct addressing capability for up to 4,096 locations on both ROM and RAM. In addition, the ROM has two chip-select inputs and the RAM has one chip-select input, which may be directly controlled by discrete outputs from the CPU or I/O circuits to expand on memory without the need for auxiliary circuitry.

The move to eight bits

For greater capacity, both Intel and Rockwell are extending their 4-bit p-channel systems to 8-bit capability. The Intel MCS-8 is an 8-bit fixed instruction set and consists of a single MOS chip in an 18-pin DIP. Also on the chip is an 8-bit data/address I/O bus that interfaces the processor with external memories. It contains a total of 14 instructions, which can control a lot of memory and I/O circuitry. It does, however, require substantial TTL circuitry to implement most 8-bit systems, a condition corrected by Intel's newer, very flexible 8080 chip.

Rockwell's soon-to-be-announced 8-bit system is a completely self-contained system. Prototypes will be operational in July, with deliveries to begin late in 1974. The PPS system consists of a CPU, RAMs, ROMs, clock generator, a direct-memory-access controller, and an assortment of general-purpose I/O devices, all of them accessible on the same bidirectional data/instruction bus (Fig. 3). This bus provides 8-bit parallel communication within the computer at a rate of 500 kilohertz—a most important factor for systems savings.

With this setup, more than 90 instructions can be executed in 4 microseconds each, which covers a ROM access for instruction fetch and a RAM access for data fetch, as well as the processing of the data. In addition, the system can be supplemented with special-purpose and custom I/O devices for specific applications. Examples are a 1,200-baud modem device and a keyboard/display controller with independent input and output buffers.

In Microsystem International's 4-bit system, the CPU contains two memory pointers—the usual program counter and a data pointer—which allow logical as well as physical separation of program and data. Both pointers are 12 bits long and can directly address 4,096 memory locations. Each memory location contains 4

bits of data. Up to 34 kilobytes may be addressed over field switching in the typical MC-1 microcomputer.

Even more powerful is National Semiconductor's multi-chip CPCP CPU, shown in Fig. 4, from which National's IMP-16 systems can be built. It can provide computing power that ranges from simple 4-bit keyboard address capability right up through full 16-bit minicomputer capability. In IMP-16 systems, processing is done by four 4-bit arithmetic logic units controlled by microprogrammable ROMs. With this arrangement, data exchange happens over a 16-bit-wide data bus, while I/O and control operations take place over a set of 16 general-purpose addressable registers (called FLAGS).

Consisting of a five chips, this CPU is contained on a board along with 256 words of random-access and 512 words of read-only on-card memory. Also available on the card are external interface circuits such as an address bus, data input and output buses, additional control FLAGS, system timing lines, and an interrupt input.

In essence, the IMP-16, which is expandable to 32 bits, is composed of four 4-bit ALU slices, each with control registers, ALU logic, and I/O data lines. The control ROM contains all control logic and microinstruction storage necessary to control the ALU chips. A total of 43 instructions is available though, if one considers the multiplicity of branch conditions, I/O FLAGS, and general-purpose accumulators in the system, the effective instruction count comes to well over 150. (For smaller systems, National now also provides 4-bit and 8-bit versions of the IMP-16.)

The microprocessors now appearing from a good

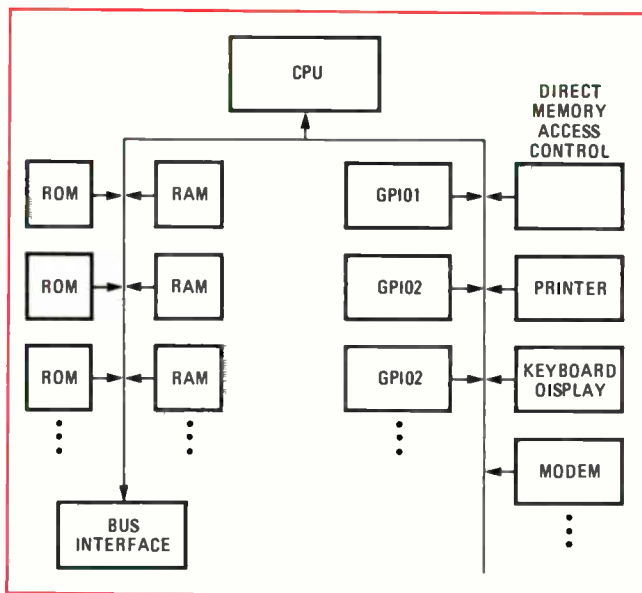

3. Twice four is eight. This 8-bit microprocessor chip set, which also is fabricated by Rockwell, contains more than 90 instructions with 4-microsecond execution times. All of the components shown work directly off the CPU.

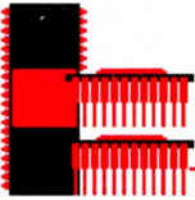

many semiconductor manufacturers take full advantage of the knowledge gained in the past two years and incorporate those features that have proven most effective for the greatest variety of applications. What is obviously wanted is a single-chip 8-bit CPU device, offering 70 instructions or more, at speeds above 1 megahertz, with an extremely flexible input and output structure, and requiring only a few support memory and logic circuits to do most 8-bit jobs. Above all, these support circuits must be easy to use—that is, work directly with the CPU without requiring additional buffers and power supplies. Moreover, the CPU must be able to work directly with standard memory products. This adds up to a need for a self-contained 8-bit micro-computer set of chips—one CPU, and maybe five or six matched memory and logic hang-on packages.

The new generation

To build them, most manufacturers have settled on n-channel technology because it can pack many memory and logic structures onto one CPU chip, provides high capacity, and operates at high speed from 5-v (TTL) power supplies. Since the new n-channel memories

would be directly compatible with such CPU chip, ease of use falls out automatically.

Besides the 8-bit n-channel microprocessors that have already arrived from Intel and Motorola, standard n-MOS products are being planned by Texas Instruments, American Microsystems, Signetics, National, Fairchild, General Instruments, and Western Digital. Rockwell and MOS Technology Inc. are staying with p-channel, and RCA has already announced a C-MOS microprocessor prototype.

The Signetics device, called PIP for programable integrated processor, is a single-chip 8-bit unit in a 40-pin DIP. The customary address logic, control memory and ALU are organized around a bidirectional 8-bit data bus, and there are also 15 address lines for handling external memory and I/O circuitry. In the PIP device, the address logic handles all instructions. It also includes a return address stack that lets eight subroutine levels be stacked.

As for RCA's C-MOS microprocessor, the two-chip 8-bit design has all the advantages that C-MOS circuits offer. (A single-chip version is under way.) It can operate off power supplies providing anywhere from 5 to 15 v, it

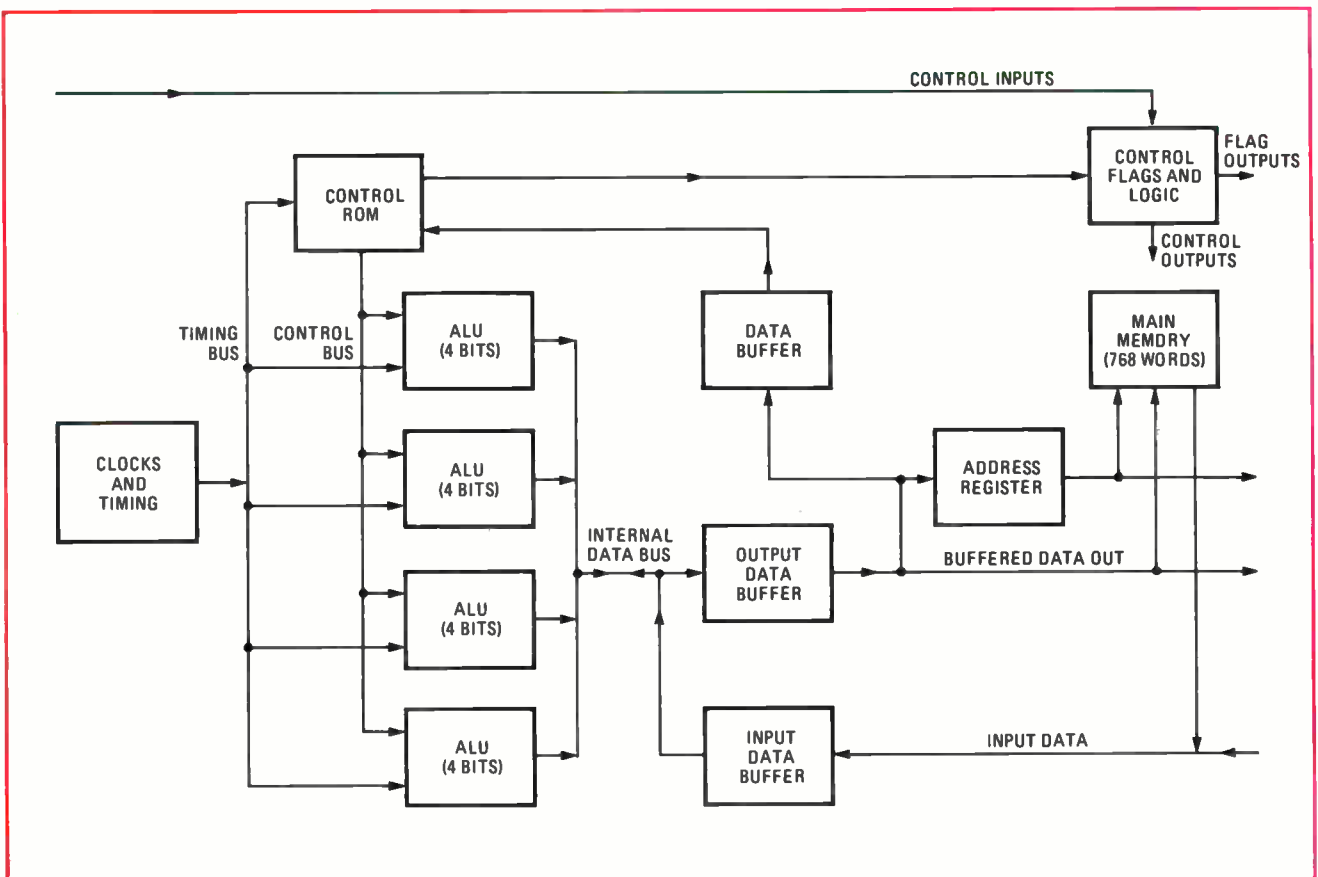

4. Sixteen-bit systems. The block diagram of National Semiconductor's IMP-16 microprocessor system shows that the system is made up of four 4-bit ALU slices with control registers, ALU logic, and I/O data lines. Altogether 43 instructions are available.

has high noise immunity, and it dissipates power at the microwatt level. Needing so little power and being easy to use, the chip set will be particularly useful for low-cost high-volume applications, and the C-MOS process could make it especially attractive for use in cars.

The microprocessor will come in a 40-pin package and can be used with any mixture of RAM, ROM, and peripheral I/O circuits. It is capable of addressing up to 65,536 8-bit bytes, so that quite large and flexible processing systems could be implemented, even though it has only 25 instructions. What's more, when operating from a typical supply of 10-12 v, the machine cycle time is a respectable 3 microseconds. And using a standard 1-microsecond RAM, the chip set has a maximum 6- μ s fetch-execute time for any instruction.

Another manufacturer favoring C-MOS for microprocessors is Intersil, which is developing a 12-bit single-chip CPU to work with its C-MOS and n-channel memories. Intersil chose a 12-bit structure so that designers could use software programs that already exist for PDP-8A systems—and in fact, when combined with appropriate memory and I/O hang-ons, the 12-bit unit can perform all the MSI functions of the PDP-8A mini-

computer but needs only a fraction of the packages.

The implications of all this activity are tremendous. Indeed, many observers feel that the MOS microprocessor families now just emerging will have a bigger impact on the electronics industries than any other semiconductor device has had so far. Quite soon, too, improved LSI structures should result in single-chip microcomputers combining the CPU, I/O, and memory in one LSI device. Moreover, the same sort of excitement is being generated around the bipolar LSI processor work that's now a priority in many semiconductor laboratories; for that technology, too, points to full-instruction minicomputer capability on a few LSI chips, but at even faster speed.

The next two articles take a look at the first two n-channel microprocessors—Motorola's M6800 chip set and Intel's 8080 chip. Both are second-generation devices, offering high speed, ease of use, and flexible control capability for many new applications. □

BIBLIOGRAPHY

George Reyling Jr. and Alan J. Weissberger, "Microprocessor components and systems," (unpublished, but available from the authors, National Semiconductor Corp., 2900 Semiconductor Drive, Santa Clara, Calif. 95051).

5. The rising generation. N-channel silicon-gate technology is bringing enlarged capacity, great versatility, and high speed to today's new microprocessor chips. This Intel 8080 CPU offers altogether 78 instructions in an 8-bit system.

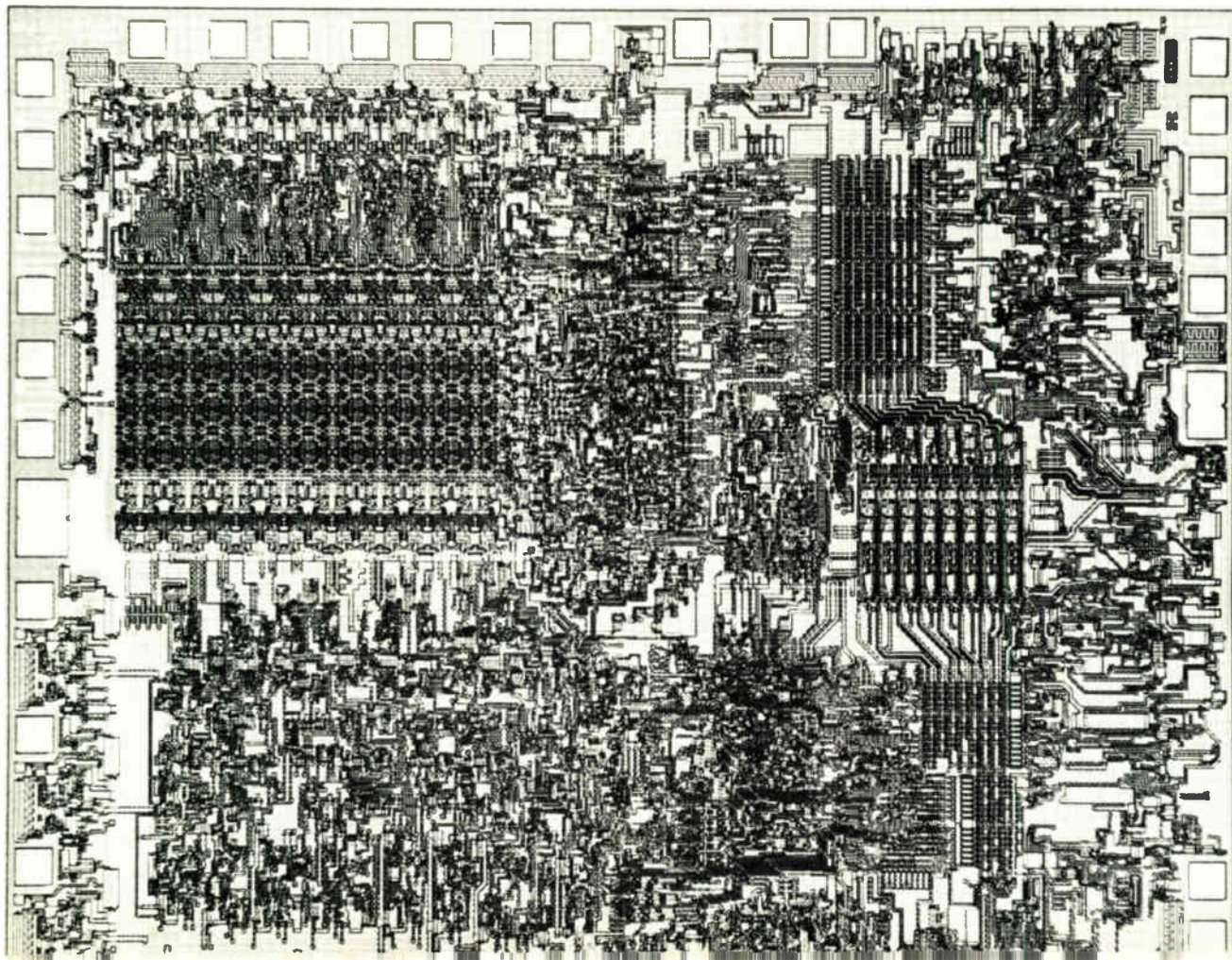

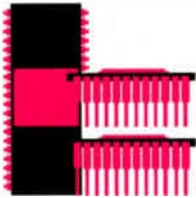

N-channel MOS technology yields new generation of microprocessors

The latest microprocessor chips are faster than p-MOS devices and handle many more peripherals; often, too, as in Motorola's M6800 family, a CPU chip will come in a matched set of memory and input and output chips, simplifying system production

by Link Young, Tom Bennett, and Jeff Lavell,
Motorola Semiconductor Products Inc., Phoenix, Ariz.

□ The great promise that programmable LSI circuits have for all kinds of control applications is fulfilled in the second generation of microprocessors, such as Motorola's and Intel's 8-bit devices. These new n-channel MOS chips have many more instructions and need much less in the way of costly systems circuit support than did the first wave of 4- and 8-bit p-channel systems. Their level of computing power is also high, and they are versatile and easy to use.

The n-channel metal-oxide-semiconductor microprocessors are completely self-contained. They are designed to work directly with a minimum number of memory and peripheral support chips, all of which are supplied in coordinated families to allow them to operate off the same voltage and power-supply conditions as the central processor chip.

A typical set contains the CPU chip, a random-access memory for fast scratch-pad logic control, a read-only memory for storing the system's program parameters, and a set of input and output chips. These input/output chips enable the CPU to control a large variety of industrial and communications equipment: process and manufacturing control systems, peripheral and terminal hardware, parameter-control systems of all types—from microcomputers in the automobile to control systems

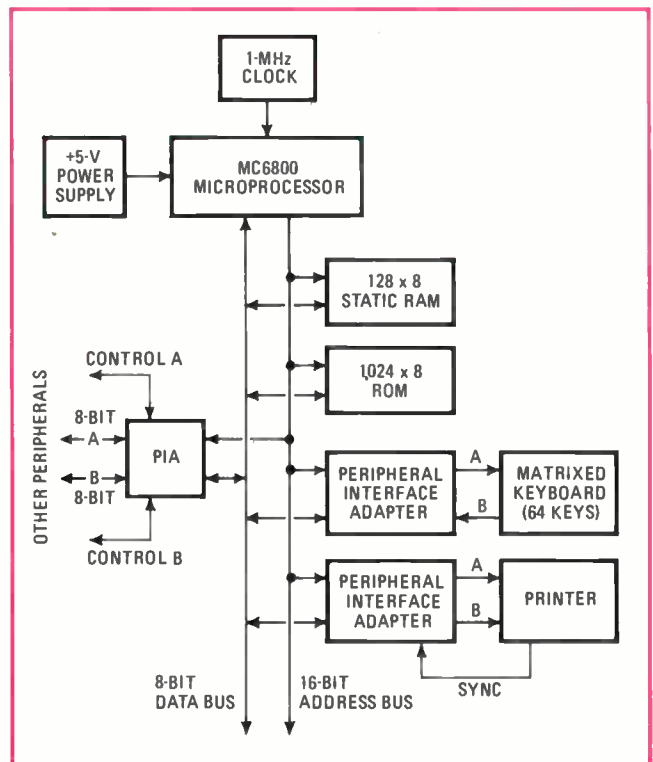

1. **Eight-bit family.** Motorola's M6800 family of components is organized around the concept of the parallel data bus. Consequently, all memory and peripheral interface adapter (PIA) chips are simply designed to hang on its CPU's eight bidirectional data lines.

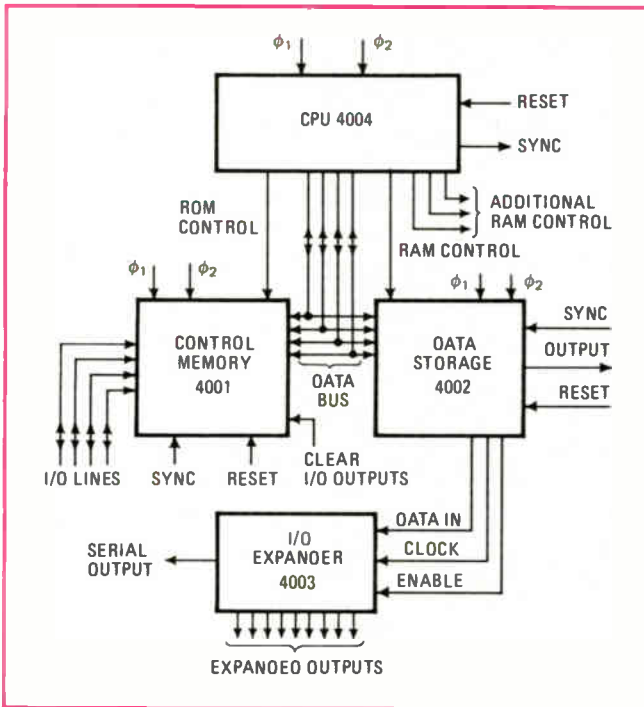

2. Basic computer. One of the first microcomputer chip sets to have been fabricated comes from Intel. Called the MSC-4, it consists of four simple LSI blocks and provides 45 instructions with an instruction cycle time of 10.8 microseconds.

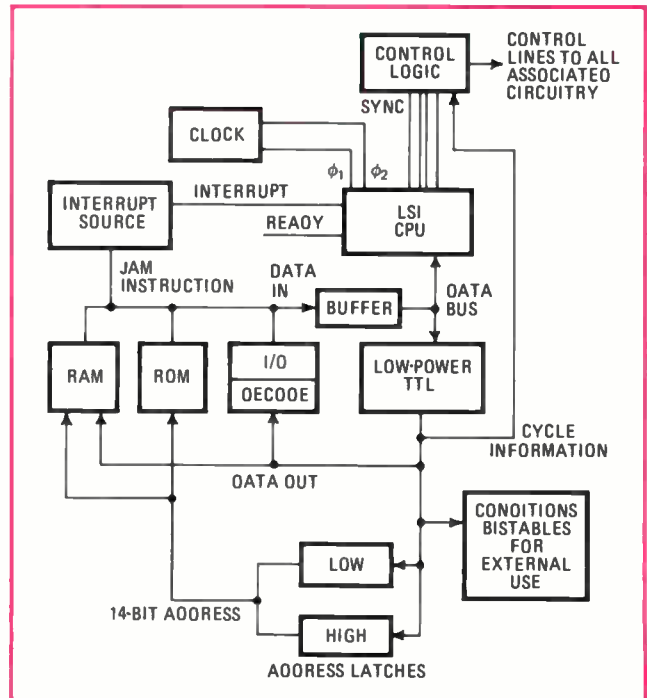

3. Heavy duty. The first 8-bit microcomputer system, Intel's MSC-8, can interface with over 16,000 8-bit words of read-only, random-access, or shift-register memory. Its drawback: substantial external circuitry is needed for most applications.

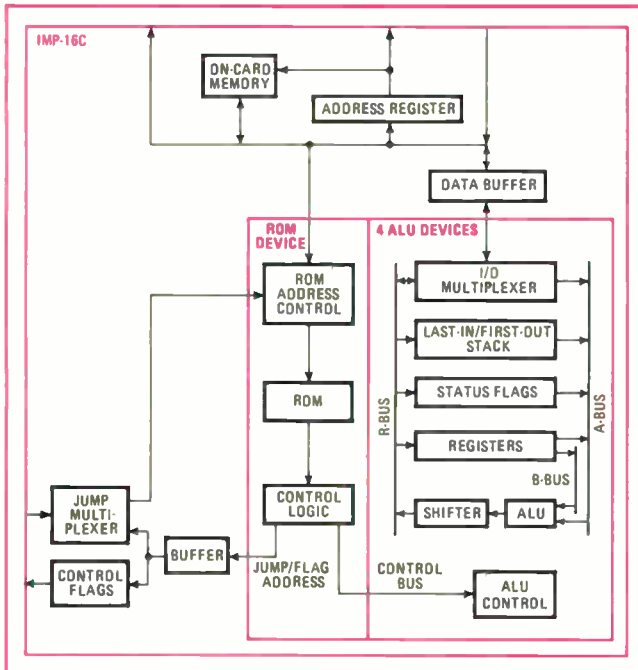

4. Sixteen bits on a board. National's IMP-16 architecture supplies a full 16-bit minicomputer capability on a single pc board. Micro-programable ROMs control the four 4-bit arithmetic logic units that do the processing. Four- and 8-bit versions are also available.

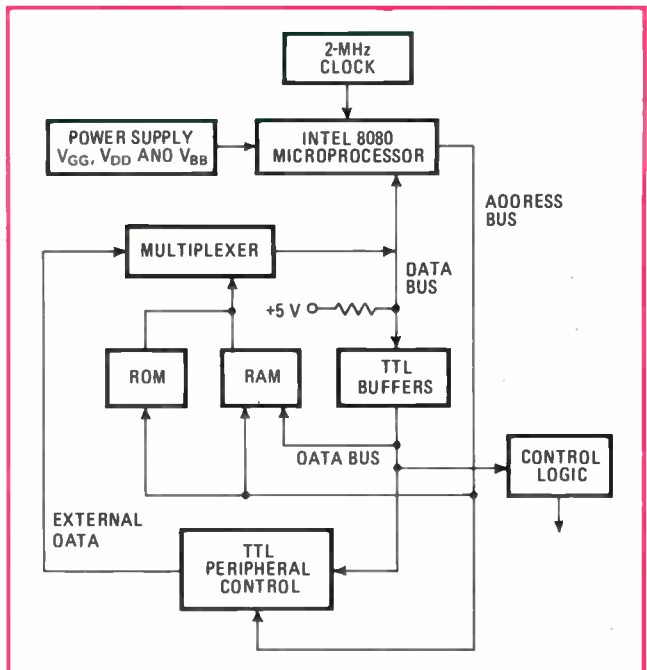

5. Straightforward. The new n-channel microprocessor chips make designing microcomputers simply a matter of choosing a family of matched components. This Intel 8080 system, for example, requires only a half a dozen standard products.

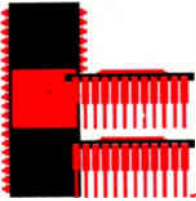

for traffic lights—and anywhere else that random-logic computer control needs optimizing.

These second-generation n-channel units expand considerably on the system benefits offered by the first microprocessors. Over 70 instructions may be available, as against about 40 for the largest p-channel unit. As few as four packages are required to build a complete 8-bit microcomputer. Moreover, in the Motorola family, the M6800, TTL compatibility is achieved with only a single +5-volt power supply, instead of the usual three supplies. Therefore, board space, package count, and component costs are reduced, even while system capacity is increased.

Other benefits to the system

Consequently, as with all microprocessor system designs, board layouts are simplified. The complex interconnections required for large numbers of conventional ICs are replaced by ROMs. The only interconnect wiring on printed-circuit cards runs between the various address and data buses and input/output devices.

The cost savings are not limited to direct circuit component costs but they extend to other, related, system hardware costs. Connectors can be decreased in number, cabling can be simplified, the card cage can be reduced in size, and so on. Associated indirect costs also fall, of course, since assembly takes less time, documentation is simpler, and maintenance is easier.

Equally important to cost savings in hardware systems is the ability of system engineers to build a proposed design quickly. No hardware logic need be simulated, optimized, or breadboarded. The logic design portion of the cycle now becomes the manipulation of functional building blocks, where the control sequence takes the form of writing a software program into an ex-

ternal ROM. Breadboarding consists of interconnecting a few LSI packages.

Design changes, too, are simply a case of modifying the control program, in contrast to designing and laying out the logic afresh. The various microprocessor manufacturers offer the use of simulators, so that most of the design can be verified even before it is committed to hardware. This all cuts at least 90% from the design time.

The numerous instructions and system versatility despite the very few packages stems directly from the organization of the new CPU chips. For example, the MC6800 chip is organized around the popular parallel data bus concept (Fig. 1), so that all the memory and peripheral interface chips simply hang on the MC6800's eight bidirectional data lines (16 address lines are provided). Up to 10 LSI chips can be directly attached to the bus for operation up to 1 megahertz. To drive still more peripherals, a bipolar extender can be added.

This direct access to a variety of interface and peripheral equipment, obtained with a minimum of packages (see "The M6800 microprocessing family," p. 92) is a tremendous advance on many of the early microprocessor chip families—even though the first single-chip microprocessor was introduced just two years ago.

Intel's MCS-4 and MCS-8 and Rockwell's PPS-4, which all used p-MOS silicon-gate technology, were excellent starting points, in that they were self-contained sets of circuits requiring no external logic. In the 4-bit MCS-4, for example, the CPU, random-access memory, and read-only memory interfaced optimally as a set (Fig. 2). However, these first microprocessors had major limitations. Selecting correct memory locations required complex address logic: 12-bit addresses needing three 4-bit words had to be multiplexed onto the CPU's input

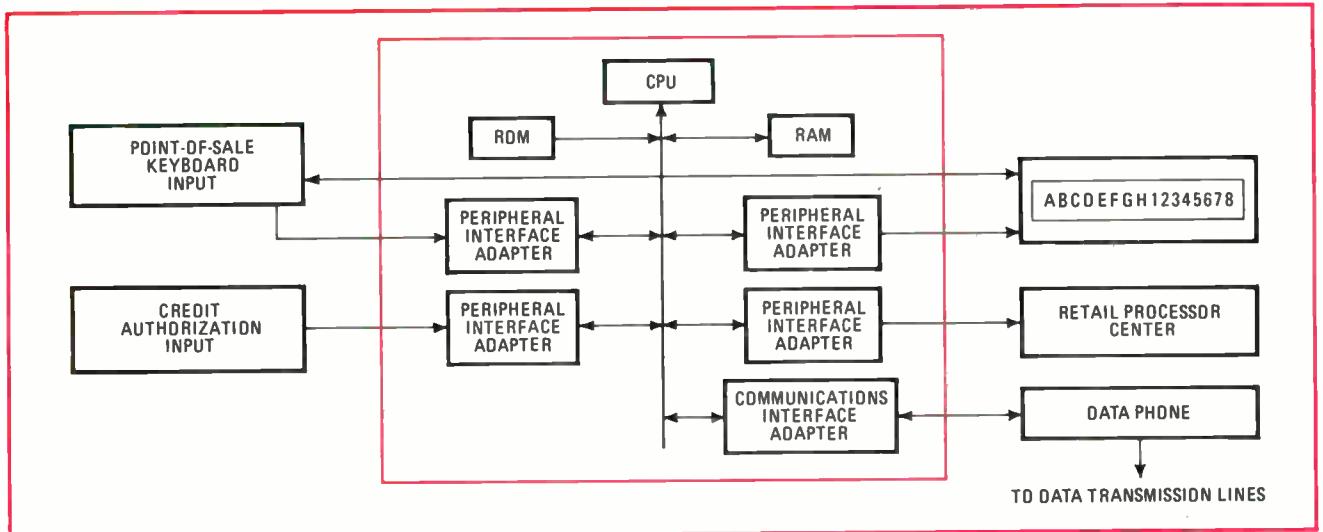

6. Selling well. With microprocessor design techniques, systems such as this point-of-sale installation are capable of being implemented with only five or six circuit blocks, which are designed to work directly with the basic CPU family.

matrix. All instructions operated on complex 4-bit data signals, as did even simple word fetches for each instruction. Still more restrictive was the fact that input and output access was serial, not parallel, limiting the number of peripherals that could work with the CPU. Instruction speeds were also slow—it could take 80 microseconds to execute one—and power-supply requirements were complex and costly.

For larger systems, the 8-bit MSC-8 microprocessor chip set (Fig. 3) could be used, but it was not a self-contained system, requiring external TTL for any application. It was, however, quite powerful: the 8008 CPU of that system can interface with 16,384 8-bit words of read-only, random-access, or shift-register memory. It was also quite economical to build: all communication between functional units and the CPU is carried out over the single 8-bit data bus, a sync line, a ready line, an interrupt line, and just three status lines. Its low cost, together with its respectably fast instruction execution time of 12.5 microseconds, makes the 8008 microprocessor still very useful for moderate-performance systems in point-of-sale terminals, credit-card verifiers, calculators, and other keyboard-addressed applications.

It does, however, fall short of being a useful general-purpose microprocessor chip set, primarily because, unlike its 4-bit predecessor, the MCS-4, it is not a system of compatible parts. Indeed, it requires many small-scale packages to build even a moderately powerful system—a simple modem hook-up would need about 50 TTL packages, increasing circuit board area and systems costs.

Another problem is addressing it. True, its 18-pin package saves board space, but it must be multiplexed both for address and data on common input/output pins, which in the end lengthens excessively the time it takes to execute an instruction. Not only that, the need for seven control registers on the CPU chip makes it difficult to manage the logic cycles, limiting subroutines and creating problems in programing and interrupt handling. Finally, its outputs are compatible, not with standard TTL, but with rarely used low-power TTL, so that circuits are needed to boost voltage level in most applications.

Most of these problems were overcome with National Semiconductor's IMP-16 (Fig. 4), a 16-bit microprocessor set that for the first time provided full mini-

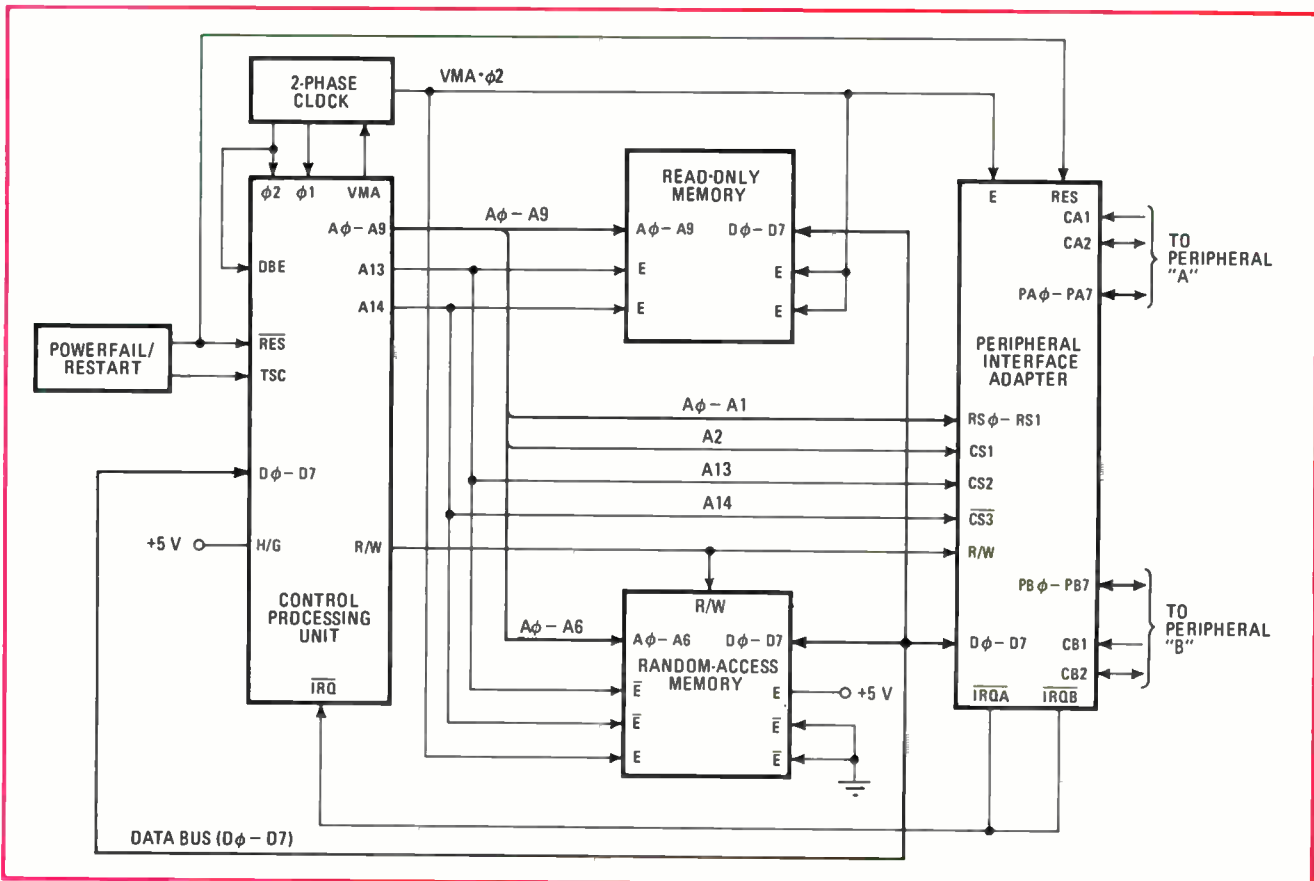

7. At a minimum. The minimum M6800 system configuration contains four functional blocks but can be expanded to 10 modules of memories, I/O adapters, and even additional CPUs on the same data bus with no external interface packages.

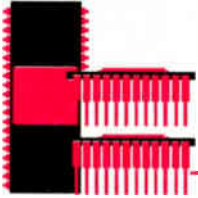

computer CPU capability on a single board. Designed to operate on both ends of the MCS-8 performance curve, this p-channel microprocessor unit is central to a family of systems with typical execution times of 4.5 to 10 μ s for a system and 9 to 18 μ s for a 8-bit system. Although it gained wide strong acceptance for many 16-bit mini-computer applications, it has been less used for 8-bit systems because the designer is forced to use micro-programming—a far more complicated task than the programming techniques required for any of today's 8-bit microprocessors. (Because of this, National has now designed 4-bit and 8-bit versions of the basic IMP system.)

The problem then from a design point of view is how to incorporate the maximum system flexibility into an 8-bit unit, make it self-contained, have it offer a large variety of instructions, but nevertheless require the fewest possible external parts. Motorola's newly announced MC6800 microprocessor set and Intel's 8080 are exam-

ples of just such a system (Fig. 5). Using implanted n-MOS silicon-gate technology instead of slower p-MOS and operating from a single clock, each is based on a single 40-pin package containing a CPU chip that's far more versatile than previous microprocessor products. (For details of the 8080, see pp. 95-100.)

The M6800 family

The M6800 microprocessor set incorporates many of the qualities of the 8080, but exhibits additional flexibility because it requires fewer external circuits to implement most control and communication systems. The fact that the family can operate from a single +5-V power supply immediately reduces system cost by about \$20 over a typical 8080 system, which needs three power supplies. What is more, the peripheral memory and input/output logic adapters, instead of needing external logic packages, have been designed so that they

The M6800 microprocessing family

The family comprises five chips: a single-chip central processor unit, a 128-by-8-bit static random-access memory, a 1,024-by-8-bit read-only memory, and one from each of two groups of input/output interface circuits—a peripheral interface chip designed to provide a buffer to terminal and peripheral systems, and a communications interface adapter circuit for interfacing communications hardware. They all operate from one 5-V power supply, and for many applications require far fewer interface packages than other microprocessor sets.

Basis of the M6800 family is the CPU chip (MC6800) packaged in a 40-pin DIP (see figure). Built with ion-implanted, n-channel silicon-gate technology, this chip contains all the functions required for multi-instruction processing: an arithmetic and logic unit, instruction decode and address registers, an instruction register, all of the clock and logic circuits required for timing, and a full complement of data-bus input and output matrices and address bus drivers.

The equivalent of about 120 MSI TTL packages, the chip provides 72 self-contained basic instructions that have decimal and binary arithmetic capability. The variable-length instructions include double-byte operations

(such as increment or decrement, load, store and/or compare) and have tri-state outputs, two-accumulator capacity, and enough registers to provide seven addressing modes. A typical instruction time is under 5 microseconds, and there is direct memory access on the chip. Up to 64 bytes of memory can be addressed in any combination of RAM, ROM, or peripheral registers.

All other members of the set (see table) have been designed specifically to work directly with the CPU chip from the same 5-V power supply. The peripheral adapter (MC6820) is a bidirectional unit with two parallel 8-bit outputs that can either drive two peripherals or, if tied together, provide a higher throughput. The adapter can interface with Teletype and display terminals, with cassettes and test equipment, with keyboards and control panels, and even with large computers for time-shared expansion of computer capability.

The communications interface adapter (MC6850), on the other hand, couples the processor to most standard modems for communications with other computer systems via telephone lines. For still more system flexibility, it's possible to use without adapters not only the static RAM and ROM in the table but other memories, too.

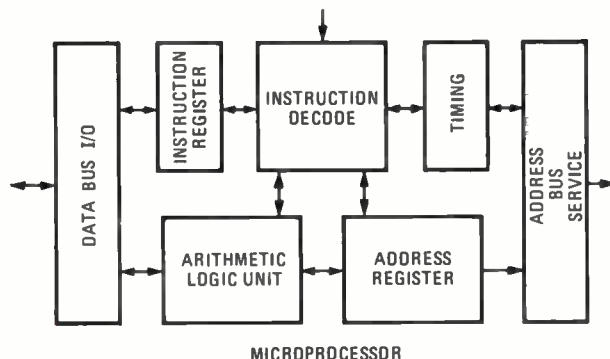

MICROCOMPUTER FAMILY OF CIRCUITS

- 8-bit microprocessing unit
- 128-by-8 static random-access memory
- 1,024-by-8 read-only memory
- Peripheral interface adapter
- Asynchronous communications interface adapter
- 0-600-b/s low-speed modem (compatible with Bell 100 series)
- Quad, bidirectional data/address bus extender

can work directly with the chip containing the CPU.

The smallness of the package count is dramatically illustrated by the comparison of the breadboard, engineering model, and final chip design of an MC6800-type CPU (see photograph on p. 82). The breadboard, a gate-to-gate implementation of the CPU employing basic gates and flip-flops, needs five 10-by-10-inch boards containing 451 packages. The engineering model is a functional implementation of the design and made extensive use of MSI logic packages and programmable ROMs to reduce package count to a mere 114, packed into a single 10-by-10-in. board by means of today's most effective hardware logic techniques. Yet all this is replaced by the single 40-pin package containing the CPU chip. The example epitomizes the impact LSI chip design is having on the implementation of complex computer functions.

The new n-channel microprocessors go still further, by addressing themselves to other parts of the system as well. For the families of circuits are designed to minimize assembly costs by reducing the number of ancillary parts necessary to realize a design.

Consider the block diagram of a typical small terminal, a generalized point-of-sale terminal (Fig. 6). Since every CPU needs several peripheral interfaces, one key

to cost-effective designs with a microcomputer lies in the input/output interface.

Indeed, anything that has to interface with a microcomputer ought to be compatible with the data-bus arrangement and with the particular addressing scheme. Moreover, this bus-compatibility requirement holds good for not only in the input/output area but in the memory area as well. Consequently, since a microprocessor is a word-oriented system, more and more word-oriented memories are beginning to appear.

The M6800 family is directed at just these system needs. It includes flexible input/output adapters and word-oriented memories, in addition to the basic microprocessing unit, as indicated in the minimum system configuration of Fig. 7. This system can maintain its 1-MHz level of operation even when expanded to 10 modules (memories, input/output adapters and additional CPUs) on the principal data bus, with no external interface package.

In order to handle applications that require 1-MHz operation with more than 10 modules on the data bus, bus extenders are provided. For systems that do not require 1-MHz operation, up to 30 modules can be added to the data bus without requiring bus extenders—for example, more than 20 modules can be added to the data

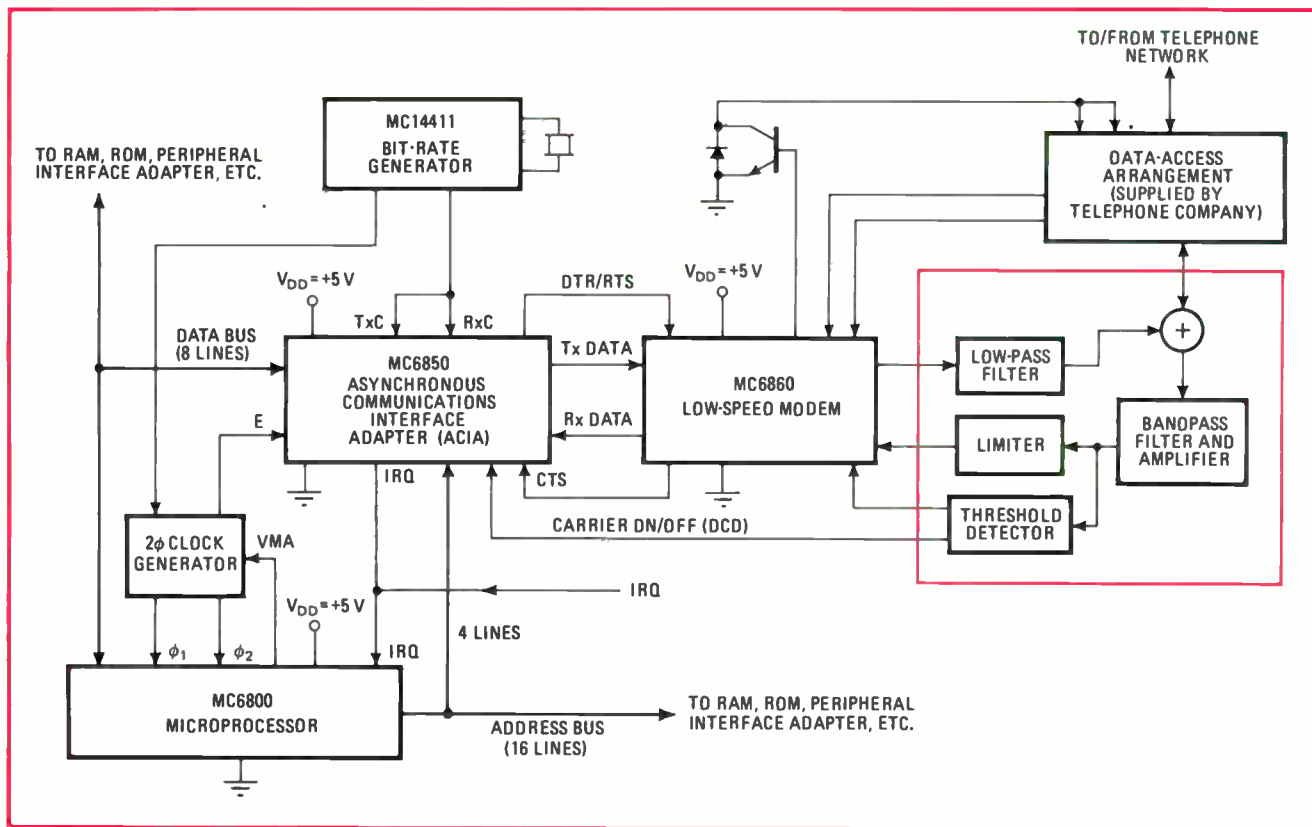

8. Communicating. A boon for communications systems, this microprocessor setup can be implemented using standard communication interface adapters (CIAs). These adapters' function is to give the CPU system access to any standard modem.

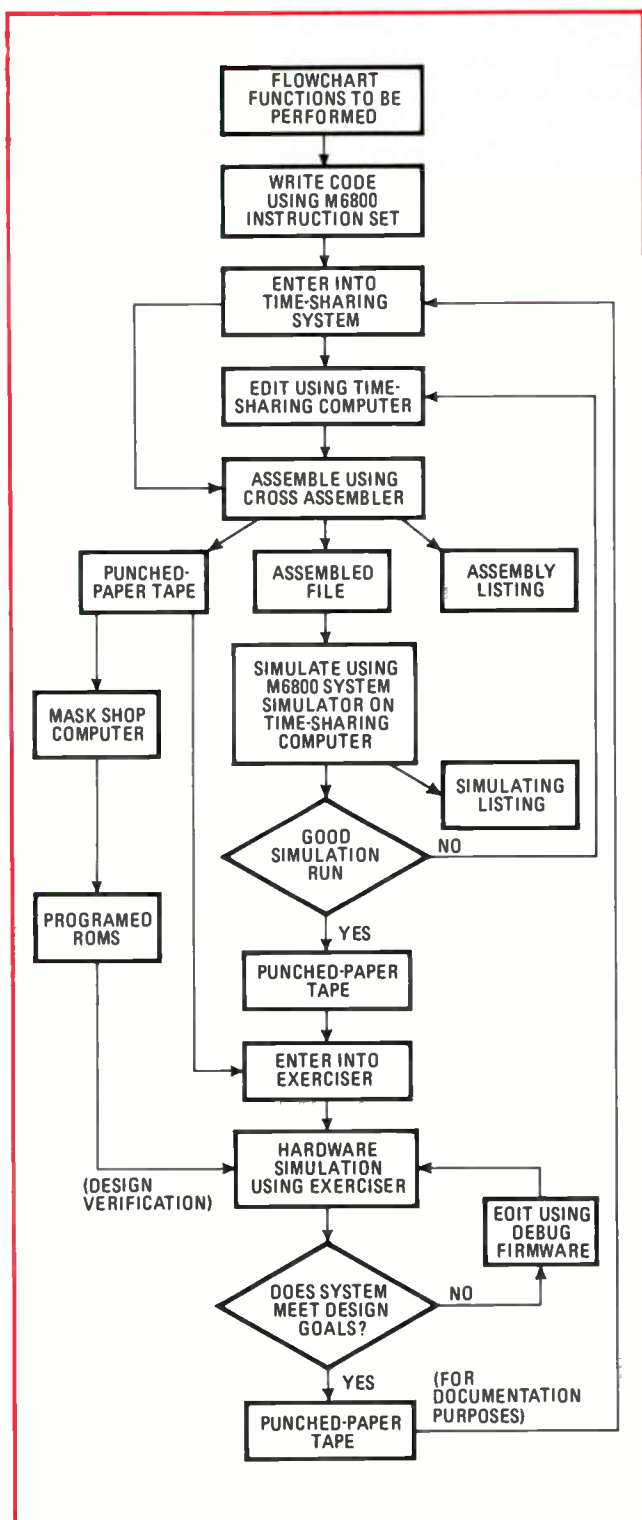
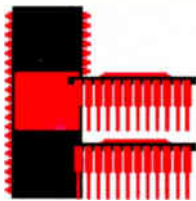

9. Working up the software. This design sequence, which is organized for ease of use with the GE time-sharing network, allows the designer to enter his specific program, which is then simulated on a cross assembler resident in the GE computer.

bus in a design for a typical 500-KHz control system.

Another example of how few packages are necessary with microprocessors is given by a typical modem communications system (Fig. 8). Here the asynchronous communication interface adapter performs the basic serializing/deserializing function required to interface the modems with the CPU. It also provides such additional logic capability as start, stop, and parity compensation. It can be used with a line driver/receiver for high-speed data transmission up to 5,000 bits per second, or with standard modems like the single-chip Bell 100 Series low-speed modem. Significantly, the 116 TTL and modem packages formerly required by this system are here replaced by only seven packages. The assembly costs alone are reduced by as much as two thirds.

Using the microprocessor

Most microprocessor manufacturers supply the software required to program their devices in a form usable with readily available computer systems. The software programs for the MC6800, for instance, are currently available on the ubiquitous GE time-sharing network. A designer might use them in the sequence shown in Fig. 9. Working with the GE edit program, the designer enters his specific applications program, which is simulated on a cross assembler resident in the same host computer. The cross assembler checks for obvious errors and violations and indicates them to the designer.

After the program has been assembled, the designer has two choices—to go to hardware directly, or to simulate his system by making use of the large GE host computer containing all the parameters of the particular system. If he chooses to simulate and his program works, he can then go to the hardware stage. If his program does not run, the simulator will pinpoint his problem areas, and he can modify his program and go through the loop again. This process can be continued until the designer is completely satisfied with his program.

In addition, exercisers, hardware, and programs are provided by many manufacturers to verify breadboard operation. In the system that is described in Table 1, the designer chooses the cards required to breadboard his system, plugs them into the machine, cables the input/output cards to his various peripherals, reads his program in through the TTY, or equivalent, network that interfaces to the debugging card. His program is contained in the read/write memory until it is debugged.

Then, in the debugging stage, a panel switch enables the flexible RAM to look like the appropriate ROM. If his program does not run, the exerciser will help him find out why and enable him to modify the program.

It's estimated that exercising aids like the off-the-shelf software and the Motorola Exorciser can save the designer from six to 12 man-months by providing him

TABLE 1

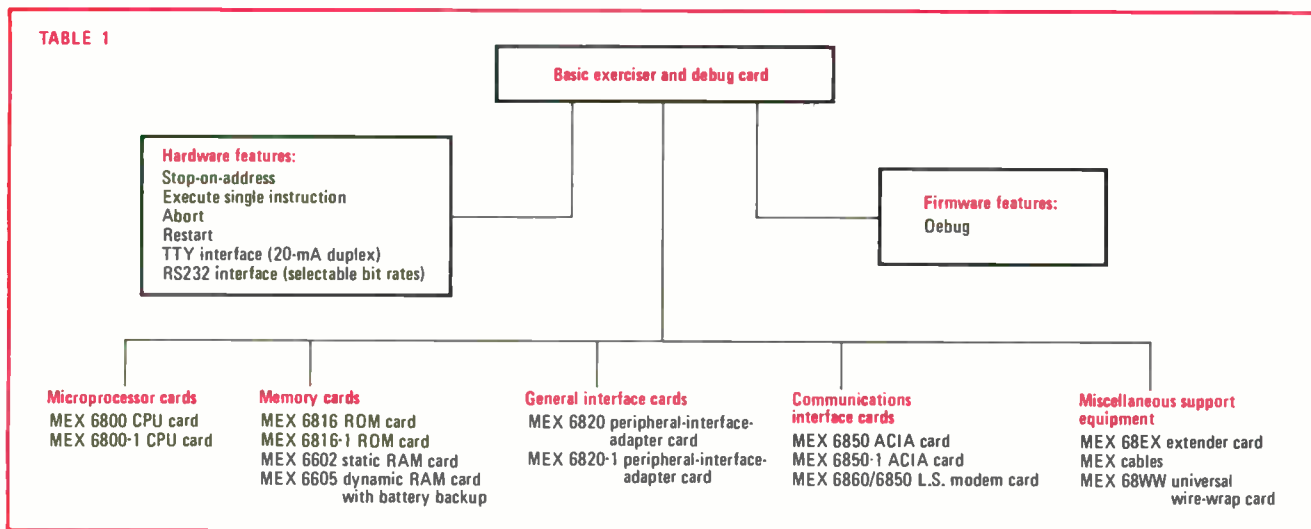

with a convenient method of communicating with the microcomputer.

Systems that are based on microprocessors are cheaper to manufacture, require shorter design cycles—and are also easier to modify or upgrade. The personality or function of the system, being determined by a master control program stored in a memory, is changed simply by modifying that program.

In the case of market testing, systems can be adapted in the customer's own environment to meet his needs better. For the first time a manufacturer has the capacity to make his product smarter and add features at any instant simply by expanding his master control pro-

gram. A whole range of products becomes potentially available by simply adding LSI modules with their associated features.

System flexibility mostly depends on the new type of memory used, and here the choice is rich. For example, an inexpensive, volatile read/write buffer memory could be used in conjunction with a cassette or a floppy disk for very low-cost systems requiring moderate speed. For faster systems, such as modem interfaces, ROMs, programable ROMs, or even dynamic RAMs with battery backup could be used. In this area, the emerging 4,096-bit RAMs appear to offer the best speed/cost tradeoff. □

In switch to n-MOS microprocessor gets a 2- μ s cycle time

Intel's 8-bit successor to its 4-bit p-MOS CPU chip has 30 extra instructions, is 10 times faster

by Masatoshi Shima and Federico Faggin,
Intel Corp., Santa Clara, Calif.

□ The first microprocessors borrowed many desirable architectural features from minicomputers—but not their speed. The 8-bit Intel 8080, however, achieves typical execution times of 2 microseconds, which are comparable to those of many of today's minis.

In so doing, it improves on the speed of its predecessor, the Intel 8008, by an order of magnitude or more, and, since it also adds 30 new instructions to the 48 shared with the 8008, it can be considered the start of a second, more powerful generation.

The key to both improvements is the shift from the 8008's p-channel MOS technology to n-channel MOS. Indeed, the decision to develop the 8080 was taken about 18 months ago, as soon as high-volume production of silicon-gate n-channel devices was feasible. The goal was a single-chip central processing unit (CPU) compatible with but markedly superior to the earlier 8008. The 8080's characteristics were to include:

- A 10:1 speed improvement over the 8008.
- None of the known limitations of the 8008 (such as interfacing problems and lack of multiple interrupts).
- Improved functional capability plus retention of all

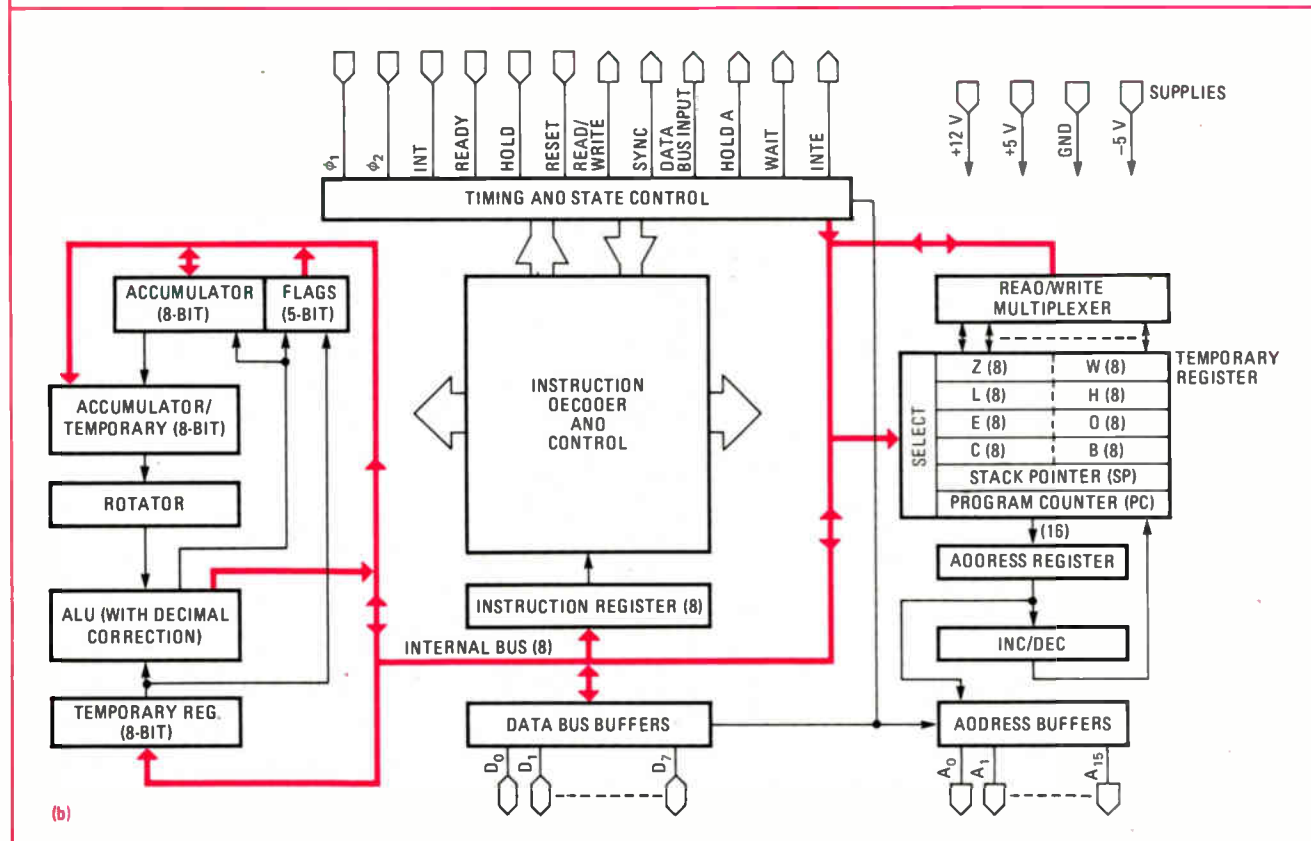
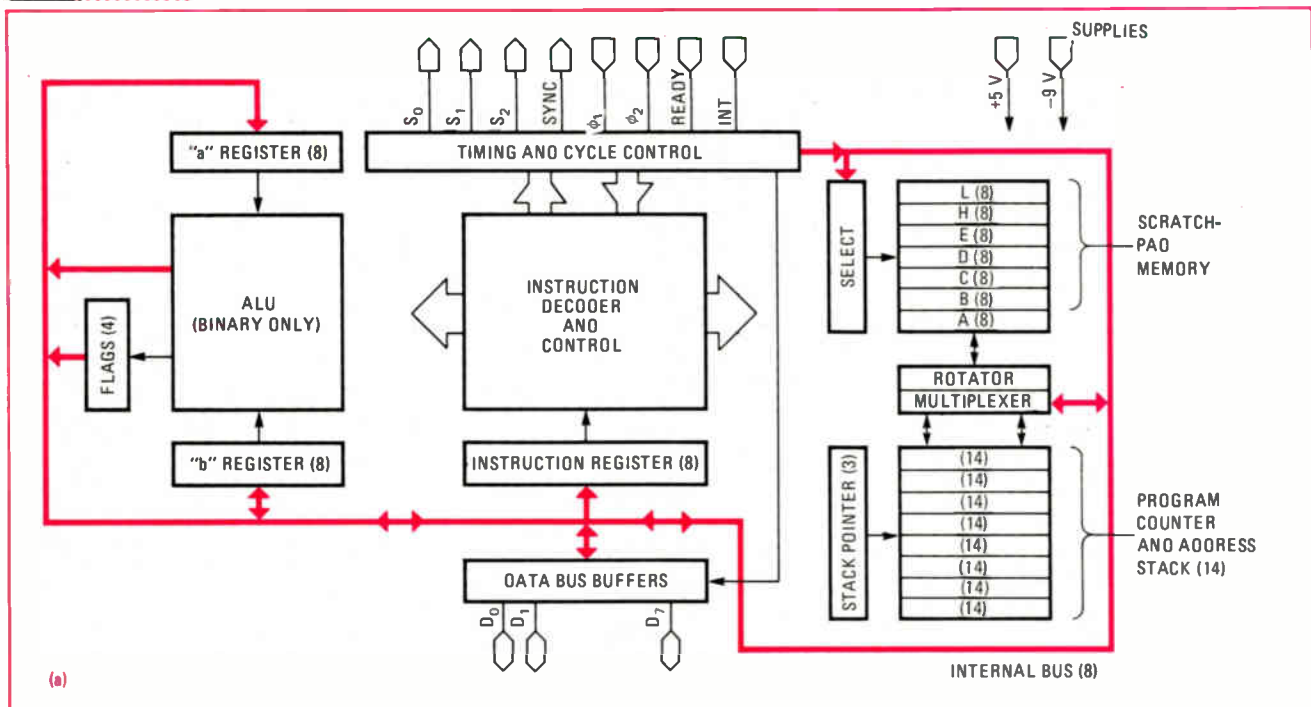
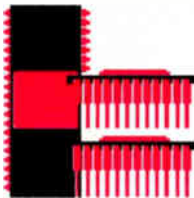

1. **Comparison.** Intel's earlier single-chip microprocessor, the 8008, has a separate scratch-pad memory and address stack (a). In the 8080, these have been combined into the six 16-bit registers (b). The accumulator has been moved into the arithmetic and logic unit, avoiding the use of the internal bus for data transfers between the scratch pad and the ALU during arithmetic and logic operations.

of the various features and instructions of the 8008.

- Economic feasibility—a small chip and conventional packaging.

If the higher mobility of electrons versus holes were the only difference between the n-channel and p-channel technologies, only a 2.4:1 improvement in speed could have been expected. But n-channel's lower threshold allows use of a 5-volt supply for internal logic, with a 4:1 improvement in speed-power product.

There are other contributions to higher speed. The higher substrate concentration of the n-channel starting material, combined with the lower supply voltage, allows channels to be shorter than with p-channel technology, so that input capacitance is lower and size smaller. Finally, lower junction capacitances and lower resistivities of diffusion and polysilicon areas, which result from the n-channel process and the use of substrate bias, reduce the interconnection time constants by a factor of four—and, in logic circuits of this type, one of the limiting speed constraint lies in the electrical properties of the interconnections.

The interfacing requirements were simplified because n-channel technology allows a big reduction of the power dissipation of individual output buffer circuits, so that the 8080 could be packaged in a 40-pin package to include 30 buffers as against the 12 of the 8008. In the 8008, each output buffer sinks two low-power TTL loads (440 microamperes) for a total dissipation of 250 milliwatts. Eight of the 8008 buffers are shared (time-multiplexed) for addresses and data outputs, reducing the number of package pins but increasing the complexity of the interface. The 8080's 30 output buffers, on the other hand, are six times faster, sink 1.9 milliamperes each, and dissipate a total of 150 mw. The 100 mw saved was used to improve the speed of the internal circuits (a 40-pin ceramic package allows a maximum dissipation of about 750 mw, so the power budget was limited).

The layout effort took 18 man-months because it required great care to minimize parasitics and to optimize signal flow for increased speed and smaller size. The result was a 165-by-191-mil chip that is smaller than

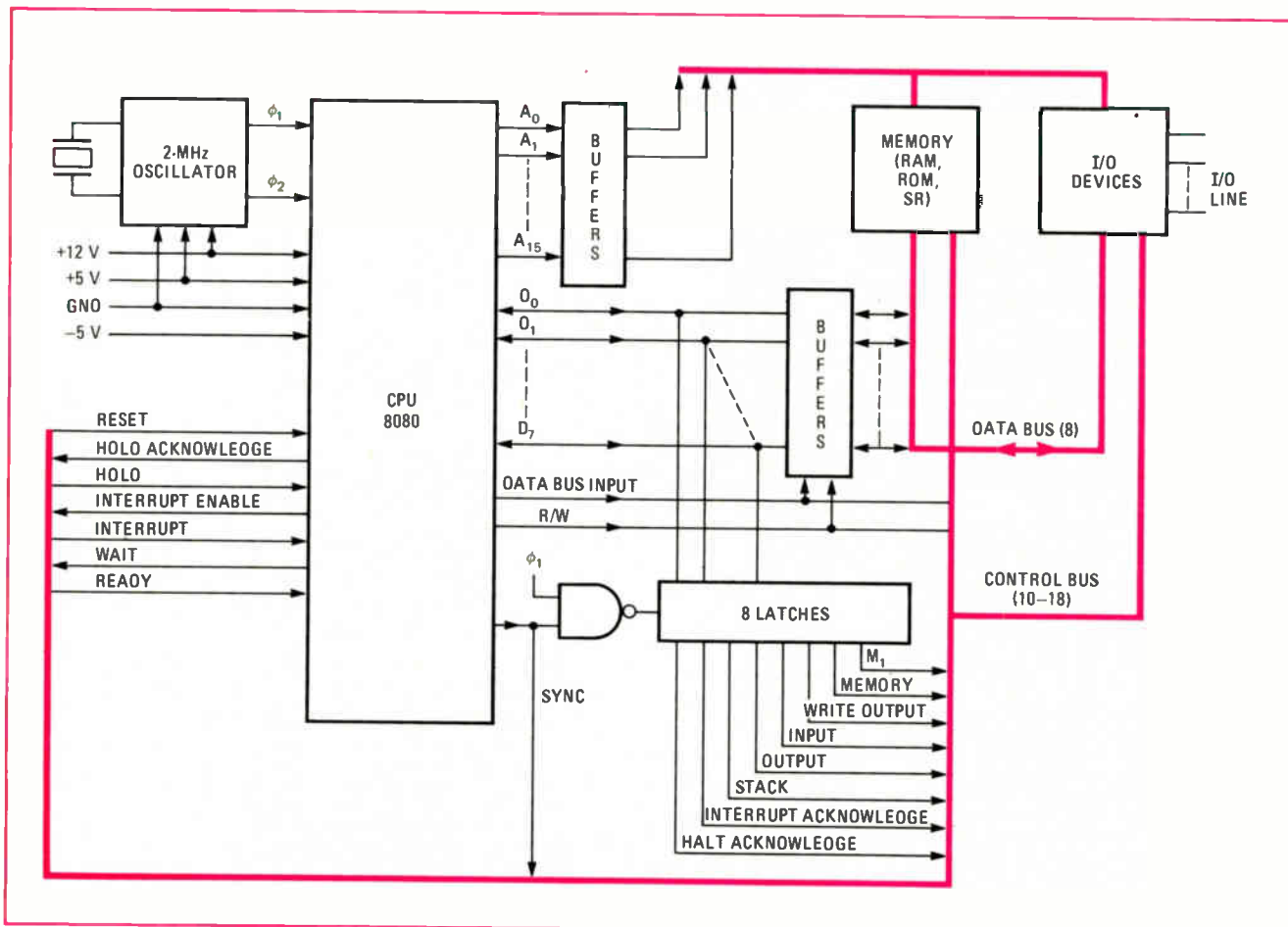

2. 8080 at work. When connected in a microprocessor system, the 8080 requires only six external TTL packages, as against the 20 needed by the 8008. The address bus can access up to 64 kilobytes of memory and up to 256 input and 256 output ports.

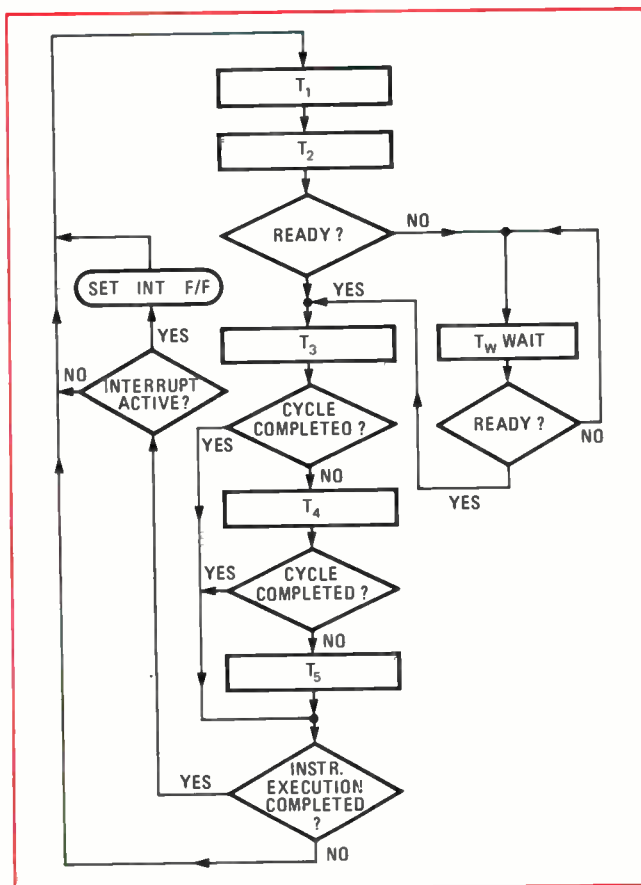
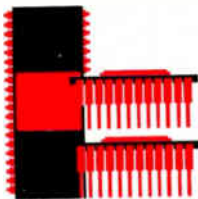

3. State diagram. A typical machine cycle requires three to five states. The operation is basically as follows: during T_1 , the content of the internal address register is sent to the address bus; during T_2 , READY is tested; during T_3 , data is transferred between the CPU and memory or I/O devices; T_4 and T_5 are used when necessary to complete the instruction execution; and finally, the circuit goes back to T_1 for the next machine cycle. Only after the last state of the last machine cycle is the interrupt request line tested.

many of today's single-chip calculators. Great effort went into both logic and circuit design minimization, as a result of which the complex functions of the 8080 were implemented in only about 5,000 transistors.

The effectiveness of a CPU can be measured by its execution speed and memory storage requirements for a representative class of practical benchmark programs. The real improvement in performance is highly dependent on specific applications. If the 8080 had only the same 48 instructions as the 8008, it would handle the same problems about eight times faster (and five times faster than the 8008-1, a high-speed version of the 8008). However, with the 30 new instructions, the 8080 offers speed improvements on the order of 10:1 to 20:1 with smaller storage requirements—from 95% to 70% for an equivalent program written for the 8080.

The internal organization of the 8080 is shown in Fig.

1b, while Fig. 1a shows the same detail for the 8080.

The most important change concerns the internal memory organization. The 8008 has separate memories: an address stack—eight 14-bit registers which comprise one program counter storing the current effective address and seven others that store the addresses of nested subroutines—and a scratch pad, which contains the 8-bit accumulator and six additional 8-bit registers used for memory addressing and temporary storage of operands. In the 8080, these memories have been combined into a single internal 16-bit-wide memory with paired 8-bit register organization. The 8080's program counter and stack pointer, also each 16 bits wide, replace the 8008's internal address stack.

The 8008 has an internal 3-bit stack pointer, which gives the user up to seven levels of nesting of subroutines. The 8080's 16-bit stack pointer can address up to 64 kilobytes of external stack memory, providing essentially as many nesting levels as needed.

The 8080's accumulator and its associated circuitry have been moved into the arithmetic logic unit (ALU) section, to speed up the operation of the processor (data transfers between memory and ALU on the internal data bus are therefore not required for arithmetic and logic operations). Notice that the 8080 memory is double-ended—information can be transferred from the internal bus 8 bits at a time, while 16-bit transfers can take place from the address register.

Extra benefits

This organization yields a number of other new features for the 8080. The most important are:

- New instructions allow the contents of any register pair (B-C, D-E, H-L, or ACCUMULATOR-FLAGS) to be quickly stored and retrieved by being "pushed into" or "popped from" the top of the external memory stack. This is a fast way to save the machine status (the contents of the registers) when an interrupt occurs and then restore the status after the interrupt has been serviced. The stack can also be used as an extension of the internal registers.
- Other new instructions allow easy manipulation of addresses and the memory stack, since the registers B-C, D-E and H-L, and STACK POINTER can be incremented and decremented with 16 bits in parallel.
- The temporary register pair W-Z can be used as a program counter to hold a direct address to quickly load or store H-L or ACCUMULATOR. Also possible are double precision additions between any register pair and H-L.
- Fast, parallel transfers of H-L to PROGRAM COUNTER or STACK POINTER are now possible with a minimum amount of internal control logic.
- The addition of decimal correction to the ALU section enables binary and BCD arithmetic to be performed at about equal speeds.
- The addition of many new, easy-to-use control and

The 8080's inputs and outputs

The Intel 8080 takes four control inputs and generates six control outputs:

SYNC—output; a synchronizing signal that indicates the beginning of each memory cycle.

DATA BUS INPUT—output; a signal that indicates when the data bus is in the receiving mode, i.e. when data is expected by the CPU.

READY—input; a signal to the CPU that valid data is available. If not activated, the CPU enters a WAIT state.

WAIT—output; a signal that acknowledges that the CPU is in the WAIT state.

WRITE—output; a signal that tells the memory and output devices that valid data from the CPU is available on the data bus.

HOLD—input; a signal used by an external device to request access to the CPU address and data bus. Request is granted upon completion of memory access and it is acknowledged on the HOLD ACKNOWLEDGE output pin. The CPU address and data buses become floating (in a high-impedance state), but internally, the CPU completes the execution of the current memory cycle. After that, the CPU idles for as long as HOLD is active. HOLD and HOLD ACKNOWLEDGE can be used for DMA (direct memory access) control and in multiprocessor applications.

HOLD ACKNOWLEDGE—output; signals acknowledgment of the HOLD state.

INTERRUPT REQUEST—input; the interrupt input is sampled at the end of the current instruction cycle and if the internal software control interrupt enable flip-flop is set, it initiates the interrupt servicing sequence.

RESET—input; a signal that clears the content of the program counter so that program execution will start from location zero in memory.

INTERRUPT ENABLE—output; a signal that displays the status of the interrupt enable flip-flop.

The CPU also provides eight status bits on the data bus at SYNC time:

HALT ACKNOWLEDGE—a response to the HALT instruction.

INTERRUPT ACKNOWLEDGE—follows the acceptance by the CPU of an interrupt request.

INPUT CYCLE—indicates that the address bus holds the address of an input device.

OUTPUT CYCLE—indicates that the address bus holds the address of an output device.

MEMORY READ—indicates that the data bus will have data coming from memory.

M₁—indicates that the current cycle is for fetching the first byte of an instruction.

STACK—indicates that the address bus holds the push-down stack address.

WRITE OUTPUT—indicates that the data bus will have data for memory write or for an output operation.

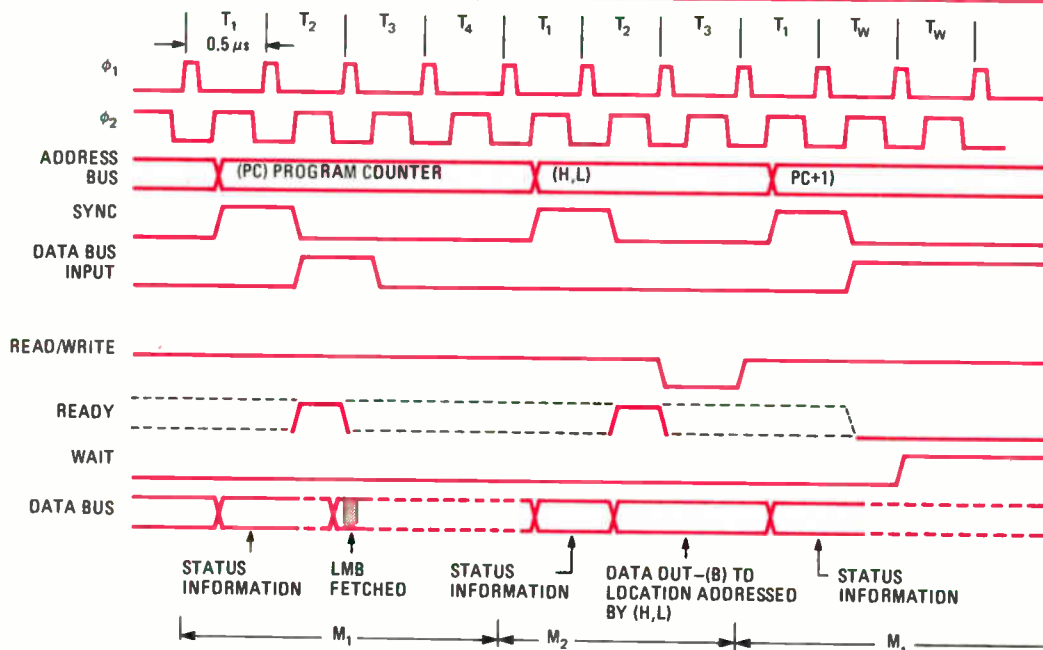

4. Timing. The instruction LMB (load the content of register B into the location addressed by the contents of registers H and L) requires two machine cycles (M₁ and M₂). During M₁, the address bus holds the program counter contents, and during M₂ it holds the contents of the H-L register pair. DATA BUS INPUT shows when the CPU expects data from the data bus. WRITE shows when data from the CPU is available on the data bus. READY shows that valid data is available to the CPU. The bottom waveform shows the corresponding data-bus actions.

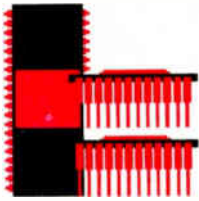

status signals simplifies interfacing, allows direct memory access, and helps in program debugging.

Figure 2 shows how the 8080 interfaces with outside chips to make a microprocessor system. An external crystal-controlled oscillator supplies two non-overlapping clocks, ϕ_1 , and ϕ_2 . Buffers interface to external address and data buses, and a gate and eight latches set up status bits during sync time. All inputs and outputs are TTL-compatible, with the exception of the two clocks, which require +12 v. A memory and the input-output devices complete the system.

The amount of external interface logic necessary to implement any system depends on that system's complexity. The minimum requirement is six packages of conventional TTL (the 8008 needs at least 20).

External signals are organized on three buses. An address bus with 16 lines addresses up to 65 kilobytes of memory and up to 256 input and 256 output ports. A bidirectional eight-line data bus carries data to and from memory and I/O ports. A control bus synchronizes

to the address bus, SYNC is true, and the data bus has status information pertaining to the cycle that is currently being initiated. T_1 is always followed by another state, T_2 , during which the condition of the READY input is tested. If READY is true, T_3 is entered; otherwise, the CPU will go into the wait state (T_w) and stay there for as long as READY is false. READY thus allows the CPU be synchronized to a memory with any access time and to any I/O device. Also, by controlling the READY line, the user can single-step through his program.

During T_3 , the data coming from memory is available on the data bus and is transferred into the instruction register (during M_1 only). The instruction decoder and control sections then generate the basic signals to control the internal data transfers, the timing, and the machine-cycle requirements of the new instructions.

At the end of T_4 , if the cycle is complete, or else at the end of T_5 , the 8080 goes back to T_1 and enters machine cycle M_2 , unless the instruction required only one machine cycle for its execution. In such cases, a new M_1 cycle is entered. The loop is repeated for as many cycles and states as required by the instruction.

It is only during the last state of the last machine cycle that the interrupt request line is tested and a special M_1 cycle is entered, during which no program-counter incrementing takes place and INTERRUPT ACKNOWLEDGE status is sent out. During this cycle, one of eight possible single-byte calls will be sent to the CPU by the interrupting device.

Execution times

Instruction state requirements range from a minimum of four states for non-memory referencing instructions, like register and accumulator arithmetic instructions, up to a maximum of 18 states for the most complex instructions—such as XTHL (exchange the contents of registers H and L with the content of the top two locations of the stack). At the maximum clock frequency of 2 megahertz, this means that assembly-language instructions can be executed in 2 to 9 μ s.

As an example of 8080 timing, Fig. 4 shows the timing diagram for the one-byte, two-cycle instruction LMB (load the content of register B into the memory location addressed by the contents of registers H and L). This example also illustrates the timing when a WAIT state is entered after the execution of LMB. Notice that seven states (a total of 3.5 μ s) are required to fetch and execute the LMB instruction. The same instruction would require 28 μ s by the 8008, 17.5 μ s by the faster 8008-1.

Though this example demonstrates an 8:1 improvement in speed over the 8008, the real impact of the new 8080 will not be as a replacement for the 8008. The 8008 has, after all, adequate speed for a large number of applications. The 8080 will be used in new systems that were not feasible before because the first-generation microcomputers were not powerful enough. □

COMPARING THE GENERATIONS

	INTEL 8008	INTEL 8080
Technology/threshold voltage	p/1.5–2.5 V	n/0.8–1.4 V
Supply voltage	+5, –9 V	+12, +5, 0, –5 V
Number of pins on package	18	40
Number of interface chips	20	6
Number of instructions	48	78 (48 + 30)
Instruction execution speed	12–22 μ s	2–9 μ s
Internal memory type/number of bits	dynamic/168 bits	static/104 bits
Chip size (mils)	124 x 173	164 x 191
RAM size/speed (typical systems)	256/1 μ s	1,024/500 ns
ROM size/speed (typical systems)	2,048/1 μ s	4,096/600 ns

the CPU, external memory, and I/O devices, and also has the job of handling interrupts, direct-memory-access (DMA) controls, and CPU status information.

Instructions in the 8080, as in the 8008, use one, two, or three bytes of storage. Each instruction requires from one to five machine (or memory) cycles for fetching and execution. Machine cycles are called M_1 , M_2 , . . . , M_5 . Each machine cycle requires from three to five states— T_1 , T_2 , . . . , T_5 —for its completion. Each state has the duration of one clock period (0.5 microsecond). There are three other states (WAIT, HOLD, and HALT) which last one to an indefinite number of clock periods, as controlled by external signals. Machine cycle M_1 is always the operation-code fetch cycle and lasts four or five clock periods. Machine cycles M_2 , M_3 , M_4 , and M_5 normally last three clock periods each.

To understand the basic operation of the 8080, let's refer to the simplified state diagram shown in Fig. 3, starting at cycle M_1 and state T_1 .

During T_1 the content of the program counter is sent

WHO MAKES THE MOST GLASS PRODUCTS FOR ELECTRONICS?

- CERDIP Sealing Materials . . . we sell the industry standard . . . including the lowest temperature sealing glasses on the market
- Substrates . . . you can choose standard sizes off the shelf, or order special glasses
- Diode Cases . . . we're the largest supplier in the world
- Infra-red Sealing Reed Switch Glass . . . we developed it to give you fast, efficient processing
- Glass Preforms . . . more than 1,200 shapes of IC frames, beads, and other preforms
- CRT Bulbs . . . more than 100 standard shapes, from 1" to 36", plus special shapes and sizes
- Quartz Crucibles . . . O.D. sizes up to 10"
- Chemically Machinable Glass Ceramics . . . for unique shapes and configurations
- Display Materials . . . cell sheets, back plates, mercury capsules and sealing frit, everything for flat panel displays

CORNING MAKES IT!

We can do almost anything with glass for electronics.
Got a problem? Write or call:



Electronic Materials Department

CORNING

CORNING GLASS WORKS

Corning, New York 14830

(607) 974-8866

The frequency synthesizer that takes you from .01 Hz to 20 MHz without stopping at the bank

Exact makes it low cost

The new Model 801 Frequency Synthesizer takes its place between the highly sophisticated (and highly expensive) synthesizers and the less versatile RC and LC oscillators. Now at a reasonable cost, you can have a signal source with crystal controlled stability, high frequency accuracy and resolution, and the capability of remote control programming.

Exact makes it simple

Simple to operate, simple to calibrate, simple to maintain. Just six plug-in circuit boards plus a plug-in power supply perform all frequency synthesis functions. Convenient test points make location of faulty cards quick and easy. And, in case of trouble, you can substitute a new card without extensive recalibration.



Price: Model 801 \$1,995.
f.o.b. Hillsboro, Oregon

NEW!

The new Model 802 offers all the capability of the Model 801 plus -69.99 dbm to $+26.99$ dbm amplitude control with 0.01 dbm resolution. All 801 options are available plus an ASCII interface option. Price Model 802 \$2,650.



(A Subsidiary of Danalab, Inc.)
BOX 160, HILLSBORO, OREGON 97123
(503) 648-6661 TWX 910-460-8811

Exact makes it stable and accurate

The Model 801 offers frequency stability of 10 ppm/year and accuracy of .001% of setting. Bandswitching by decade ranges maintains a constant 6-digit resolution throughout the frequency range. Outstanding signal purity with low phase noise and low harmonic and non-harmonic spurious outputs permit accurate measurement of narrow band communications circuits. Non-harmonic spurious is -60 db and harmonic levels are below -40 db from 1-to-20 MHz, -50 db below 1 MHz.

Exact makes it versatile

In one instrument, the Model 801 offers frequency coverage from 1 Hz to 20 MHz, or 0.01 Hz to 20 MHz as an option, for an extremely stable source of signals typically requiring more than one instrument. Frequency accuracy is $\pm .001\%$, or by using the Model 801's phase lock input, it can be slaved to an external frequency standard for even higher accuracy. Options include digital programming, low frequency extender (to 0.01 Hz), and rack mounting adapters.

IC logic units simplify binary number conversion

by Harvey F. Hoffman
Norden Division, United Aircraft Corp., Norwalk, Conn.

A variety of digital arithmetic processing applications require one arithmetic notation to be converted to another. Six of the most widely used conversions can be accomplished easily with a pair of medium-scale integrated circuits called arithmetic logic units. The table lists these six conversions and their associated rules.

The function chart for an arithmetic logic unit is given in Fig. 1. As an example of how to wire the ICs, consider circuit (a) in Fig. 2 for converting an 8-bit number in two's-complement notation to a number in signed-binary notation. The number to be converted is N, and the converted number is P. The eighth bit (N_7 , P_7) is the sign bit, and the least significant bit is the first number bit (N_0 , P_0).

The function-select inputs are $S_0 = 0$, $S_1 = S_2 = S_3 = 1$, and the mode (M) input controls the sign bit. The arithmetic function (when $M = 0$) that may be performed is A plus (A OR \bar{B}) with no carry (C_n) input to the first unit. (A and B are the input numbers.) The logic operation (when $M = 1$) for these same function-select inputs is A OR B, no matter the state of the first unit's carry input.

If number A is set to zero and the carry-in term is set to one, then to arithmetic operation ($M = 0$) is \bar{B} plus 1, which is the binary representation of a negative number in two's-complement notation. With number A again set to zero, the logic operation ($M = 1$) gives an output of B.

Therefore, if the inverse of the sign bit is applied to

ARITHMETIC-NOTATION CONVERSION RULES

From signed binary to two's complement:

- If sign bit is negative, complement each number bit and add 1 to result.
- If sign bit is positive, output number equals input number.

From two's complement to signed binary:

- If sign bit is negative, complement each number bit and add 1 to result.
- If sign bit is positive, output number equals input number.

From signed binary to one's complement:

- If sign bit is negative, complement each number bit.
- If sign bit is positive, output number equals input number.

From one's complement to signed binary:

- If sign bit is negative, complement each number bit.
- If sign bit is positive, output number equals input number.

From two's complement to one's complement:

- If sign bit is negative, subtract 1 from number.
- If sign bit is positive, output number equals input number.

From one's complement to two's complement:

- If sign bit is negative, add 1 to number.
- If sign bit is positive, output number equals input number.

Notes:

- The sign bit is the most significant bit.
- A logic 1 in the sign bit location represents a negative number.
- A logic 0 in the sign bit location represents a positive number.

the mode (M) input, the A inputs are held at zero and the number in two's-complement form is applied to the B inputs. The resulting output is then in signed binary notation. If only the magnitude of the number is required, the sign bit, P_7 , should not be used.

This notation conversion is completely reversible. That is, the identical circuit may be used to convert

S_0 S_1 S_2 S_3	Arithmetic ($M = 0, \bar{C}_n = 1$)	Logic ($M = 1$)
0 0 0 0	$F = A$	$F = \bar{A}$
1 0 0 0	$F = A + B$	$F = \bar{A} + \bar{B}$
0 1 0 0	$F = A + \bar{B}$	$F = \bar{A}B$
1 1 0 0	$F = \text{minus } 1 \text{ (2's comp.)}$	$F = \text{Logic } 0$
0 0 1 0	$F = A \text{ plus } A\bar{B}$	$F = \bar{A}\bar{B}$
1 0 1 0	$F = A\bar{B} \text{ plus } [A + \bar{B}]$	$F = \bar{B}$
0 1 1 0	$F = A \text{ minus } B \text{ minus } 1$	$F = A \oplus B$
1 1 1 0	$F = A\bar{B} \text{ minus } 1$	$F = A\bar{B}$
0 0 0 1	$F = A \text{ plus } A\bar{B}$	$F = \bar{A} + B$
1 0 0 1	$F = A \text{ plus } B$	$F = \bar{A} \oplus \bar{B}$
0 1 0 1	$F = AB \text{ plus } [A + \bar{B}]$	$F = B$
1 1 0 1	$F = AB \text{ minus } 1$	$F = AB$
0 0 1 1	$F = A \text{ plus } A \text{ (} 2 \times A \text{)}$	$F = \text{Logic } 1$
1 0 1 1	$F = A \text{ plus } [A + B]$	$F = A + \bar{B}$
0 1 1 1	$F = A \text{ plus } [A + \bar{B}]$	$F = A + B$
1 1 1 1	$F = A \text{ minus } 1$	$F = A$

1. Functional capability. The operation of an arithmetic logic unit is outlined in the table for all possible selection (S_0 , S_1 , S_2 , and S_3) inputs. The input numbers are A and B, and the output number is F. When the unit's mode (M) input is low, it produces the arithmetic function given in the middle column. When the mode input is high, a logic operation takes place, as indicated in the right-hand column.

from signed-binary notation to two's-complement notation.

The wiring connections for the four other conversions listed in the table are also shown in the figure. Circuit (b) is for converting from one's-complement notation to

signed-binary notation, or vice versa. Circuit (c) is for converting from two's-complement notation to one's-complement notation. And circuit (d) is for converting from one's-complement notation to two's-complement notation. □

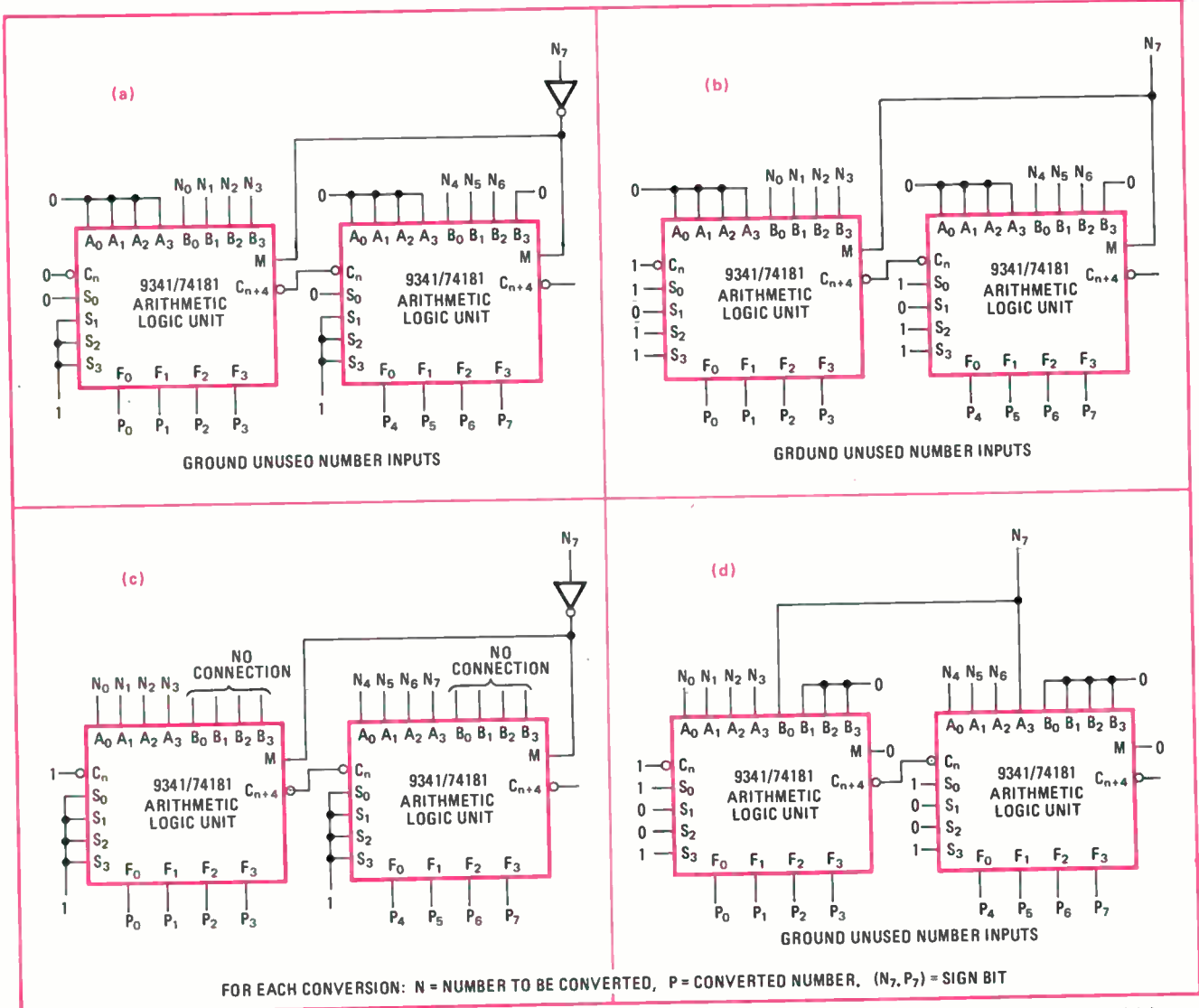

2. Number conversion. Two arithmetic logic units can be interconnected to change a number's arithmetic notation. The circuit of (a) converts two's-complement notation to signed-binary notation, or vice versa; circuit (b) converts one's complement to signed binary, or vice versa; circuit (c) converts two's complement to one's complement; and circuit (d) converts one's complement to two's complement.

Storing computer data with a cassette recorder

by Richard Eckhardt
Massachusetts Institute of Technology, Cambridge, Mass.

Two simple interface circuits permit data from a teletypewriter to be recorded and played back on a portable cassette tape recorder. This means that a conventional tape recorder can be employed as a compact

reusable storage device for minicomputers, with a teletypewriter operating as the only input/output equipment. And remember that a single 120-minute cassette will hold as much information as 600 feet of paper tape.

Teletypewriter data is transmitted at the rate of 10 characters per second (110 bits per second), a frequency that is far too low for most audio recorders. Therefore, the data is converted to tone bursts at a frequency the recorder can use. On playback, the tone bursts are detected, and the original data format is reconstructed.

The teletypewriter-to-recorder interface circuit (a) can be driven either directly by the teletypewriter output or by the circuitry that drives the teletypewriter.

The output of a teletypewriter resembles the opening and closing of a switch. In the interface circuit, this switching waveform is first filtered slightly to remove bounce, and then it is used to gate a unijunction oscillator. If a teletypewriter driver is used instead as the input device, its drive current is fed to the base of a transistor that simulates the teletypewriter's switching action.

The circuit's output is a sawtooth waveform having a frequency of 6 kilohertz. It is applied to the recorder's auxiliary input (high-impedance low-sensitivity input). If the recorder does not have this input, it can be simulated by placing a 470-kilohm resistor in series with the microphone input.

The recorder-to-teletypewriter interface circuit (b) detects the recorder's output, and then rectifies and filters it so that a positive voltage is developed whenever a tone is present. A bleeder resistor is placed across the recorder output lines to produce the proper decay when the tone is removed. This decay voltage is then used to turn on a two-transistor driver that operates the teletypewriter. The output of this detector circuit can also be used to drive a reed relay to produce switch closures like those of a standard teletypewriter output.

It should also be noted that both interface circuits run off of a 9-volt supply, which can often be taken from the recorder's battery pack. □

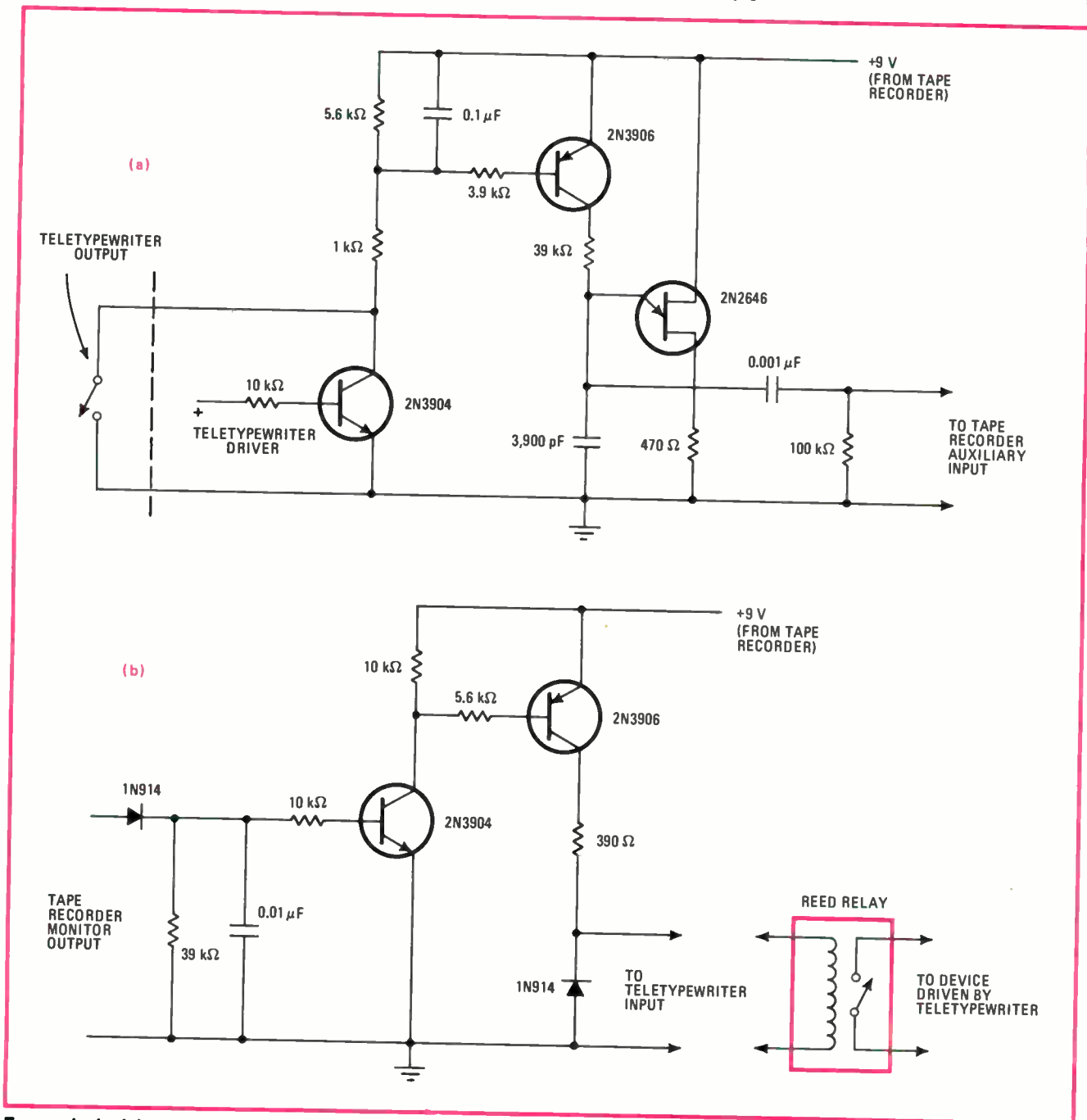

Economical minicomputer data storage. Interface circuits for an everyday cassette tape recorder enable the unit to record and playback teletypewriter information. The recording circuit (a) can be driven by either the teletypewriter itself or by a teletypewriter driver. The playback circuit (b) can drive the teletypewriter directly or interface with a relay driver. The recorder's battery can run both circuits.

Making music with IC timers

by Kenneth R. Dugan
General Telephone and Electronics, Clearwater, Fla.

The versatile 555-type IC timer has yet another application—as a poor-man's music synthesizer for playing the musical signature of simple songs. Two timers are needed: one generates the rhythm, while the other produces the tones.

The circuit shown is intended for use as an audible alarm for a telephone exchange; it plays the first 10 notes of "A Pretty Girl Is Like a Melody." With the CONTROL INPUT lead of Timer₁ returned to the V_{CC} supply line, the tune will recycle continuously. But if a relay or flip-flop is connected to this lead, the number of times that the tune recycles can be controlled.

Since the output for Timer₂ is a pulse train having a duty cycle between 40% and 60%, a low-pass filter is used to soften the somewhat harsh audio quality of this waveshape. The setting of the STYLE switch causes the notes to either step or glide through the tune.

When used in conjunction with a diode bridge that detects the presence or absence of a ringing generator on the telephone line, the circuit can be programmed to play a distinctive musical signature as a personalized telephone bell signal. Of course, many different combinations of resistors and capacitors can be used to obtain the desired music frequencies.

TONE-GENERATOR FREQUENCIES FOR "A PRETTY GIRL IS LIKE A MELODY"

COUNT	TONE CAPACITOR (μF)	FREQUENCY (Hz)
0	0.042	329
1	0.040	349
2	0.038	370
3	0.033	440
4	0.038	370
5	0.036	392
6	0.034	415
7	0.033	440
8	0.027	523
9	0.033	440

One less IC package is needed if a dual 556-type timer is employed, as done here, instead of two individual 555-type timers. □

Designer's casebook is a regular feature in Electronics. We invite readers to submit original and unpublished circuit ideas and solutions to design problems. Explain briefly but thoroughly the circuit's operating principle and purpose. We'll pay \$50 for each item published.

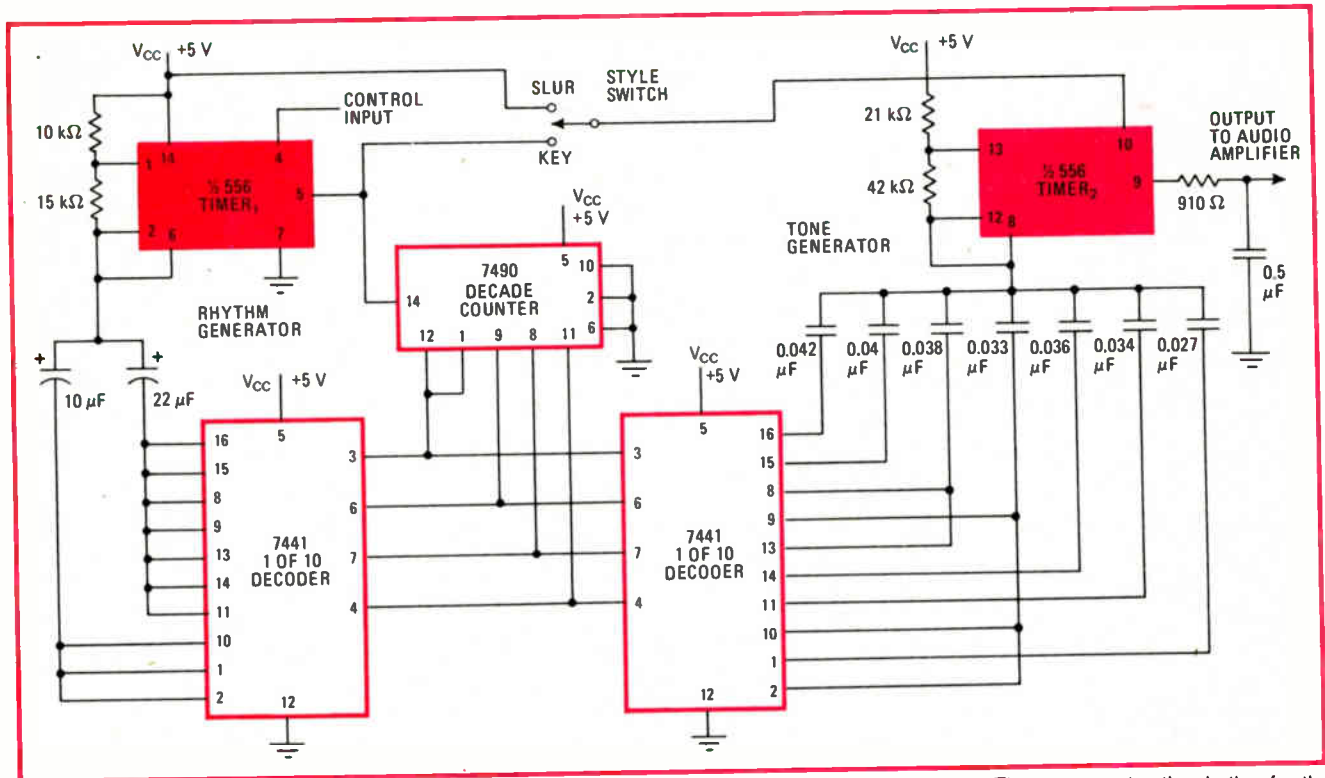

Tuneful timers. This music synthesizer, which relies on two IC timers, can play a simple 10-note song. Timer₁ generates the rhythm for the tune, while Timer₂ generates the tones. If the CONTROL INPUT is tied to the supply line, the tune recycles continuously. The position of the STYLE switch determines whether the tones are played individually or blended. This circuit plays "A Pretty Girl Is Like a Melody."

150 Microwatt Triple Op Amp

The L144 monolithic triple op amp draws only $50\mu\text{A}$ of current per amplifier, from a $\pm 1.5\text{ V}$ supply. What's more, it is

AVAILABLE NOW FROM YOUR LOCAL DISTRIBUTOR!

L144 features include:

- Monolithic triple op amp in DIP or Flatpac packages
- Wide power supply range— $\pm 1.5\text{ V}$ to $\pm 15\text{ V}$
- Internal compensation
- Programmable power dissipation
- Programmable input bias current
- Single programming resistor
- 80 dB gain with $20\text{ K}\Omega$ load
- Cost effective: \$1.63 per single op amp⁽¹⁾

⁽¹⁾L144CJ 100-piece price

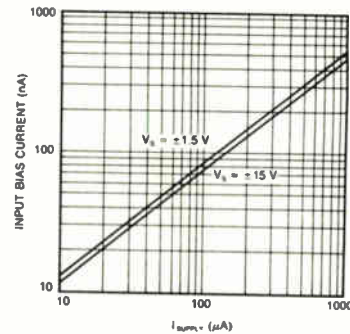

Applications examples:

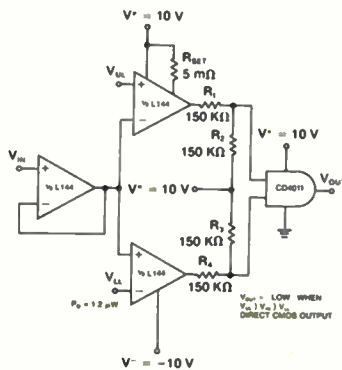

DOUBLE-ENDED LIMIT COMPARATOR

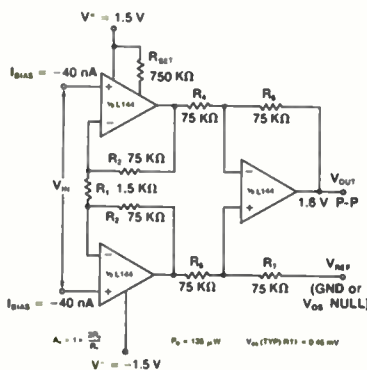

INSTRUMENTATION AMPLIFIER

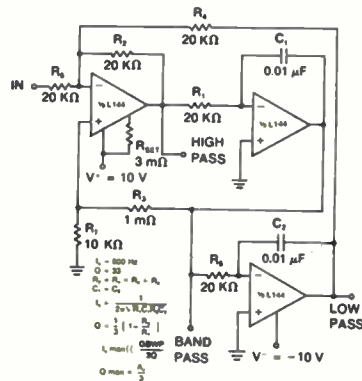

ACTIVE FILTER

The L144 is a practical industry-standard operational amplifier for use when low current drain, low voltage, low power, or very small physical size are controlling criteria. If your circuit requirements are unique—and whose aren't—our applications people are eager to help.

For complete information

write for data

IC Applications: (408) 246 8000, Ext. 120



Siliconix incorporated

2201 Laurelwood Road, Santa Clara, California 95054

Here are two of the world's best oscilloscopes.

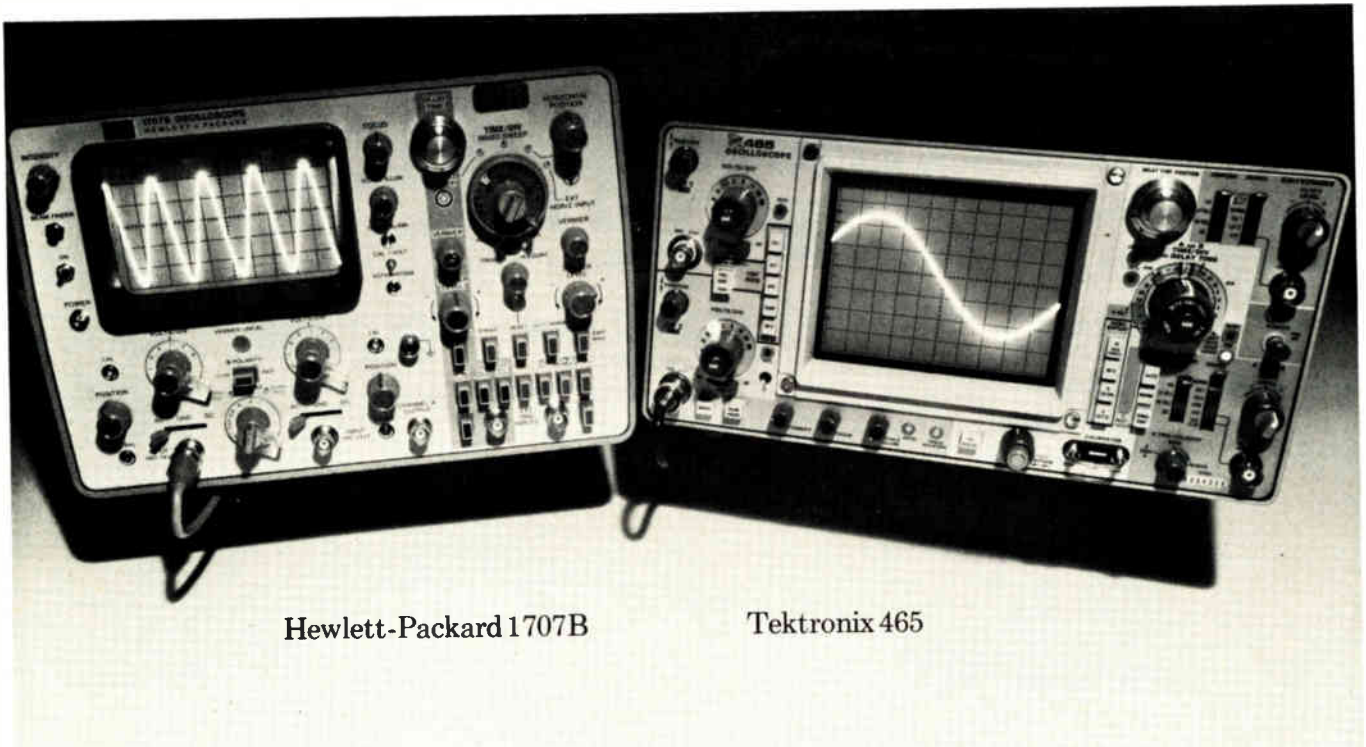

Hewlett-Packard 1707B

Tektronix 465

Here's why you shouldn't own either one.

You can lease one for as little as \$45 per month.

We can give you immediate delivery on either the Hewlett-Packard 1707B or the Tektronix 465, in quantity.

The Hewlett-Packard scope lease is \$45 per month for 36 months. The Tektronix 465 is \$50 per month for 36 months.

Anyway you choose, leasing is the best thing that ever happened to a tight capital equipment budget. You pay for your scope as you use it ... and you pay for it out of the profits it generates.

Call your closest Instant Inventory Center and ask us about short term rentals, delivery, and other lease terms for scopes or any other electronic equipment you need, up to and including minicomputers.



Anaheim, California (714) 879-0561
Dallas, Texas (214) 661-8082
Fort Lauderdale, Florida (305) 771-3500
Gaithersburg, Maryland (301) 948-0620
Burlington, Massachusetts (617) 273-2770
Mountain View, California (415) 968-8845
Oakland, New Jersey (201) 337-3757
Rexdale (Toronto) Ont., Canada (416) 677-7513
Des Plaines, Illinois (312) 827-6670

Rental Electronics, Inc.

A **PEPSICO** leasing company.

Program called ASTAP makes fast work of analyzing large-scale circuits

No programming experience is needed to use this new software program, though it can handle networks containing thousands of elements and can perform dc, ac, and transient analysis as well as statistical simulation

By G. W. Mahoney, D. A. Mehta, H. Qassemzadeh, T. R. Scott, and W. T. Weeks, IBM Corp., System Products Division, Hopewell Junction, N.Y. and A. J. Jimenez, IBM Corp., General Systems Division, Boca Raton, Fla.

□ Paralleling the development of more complex circuits, particularly large-scale ICs, circuit-analysis programs are becoming more and more indispensable as design tools. They are helping to speed up design cycles, reduce redesign, and enhance reliability prediction. Yet the demands being made of these programs continue to grow. Their capacity must be expanded to handle today's larger and denser circuits. What's more, they must operate ever faster to keep computational costs low and to improve computer turnaround time.

Advanced Statistical Analysis Program (ASTAP), a newly introduced software system, features those two essential characteristics: extensive capacity and high speed. ASTAP is basically a batch program that requires an IBM S/360 or S/370 computer, as well as suitable peripherals and memory storage. It was released just last year [*Electronics*, April 26, 1973, p. 40] and is avail-

able as one of IBM's Installed-User programs.

Unlike earlier programs, which are limited to one or two analysis modes, ASTAP can perform dc, ac, and transient analyses. This means that the same language can be used for all three analysis modes, and data can be transferred easily from one mode to another. Furthermore, since ASTAP employs a user-oriented language, the engineer need not have previous programming experience. ASTAP can analyze networks containing thousands of elements, and it can accept new device models without reprogramming.

Analysis capabilities

With this new software package, the designer can predict how circuit performance will be affected by component tolerances, component aging, or ambient temperature. He can also simulate his circuit statistically so that

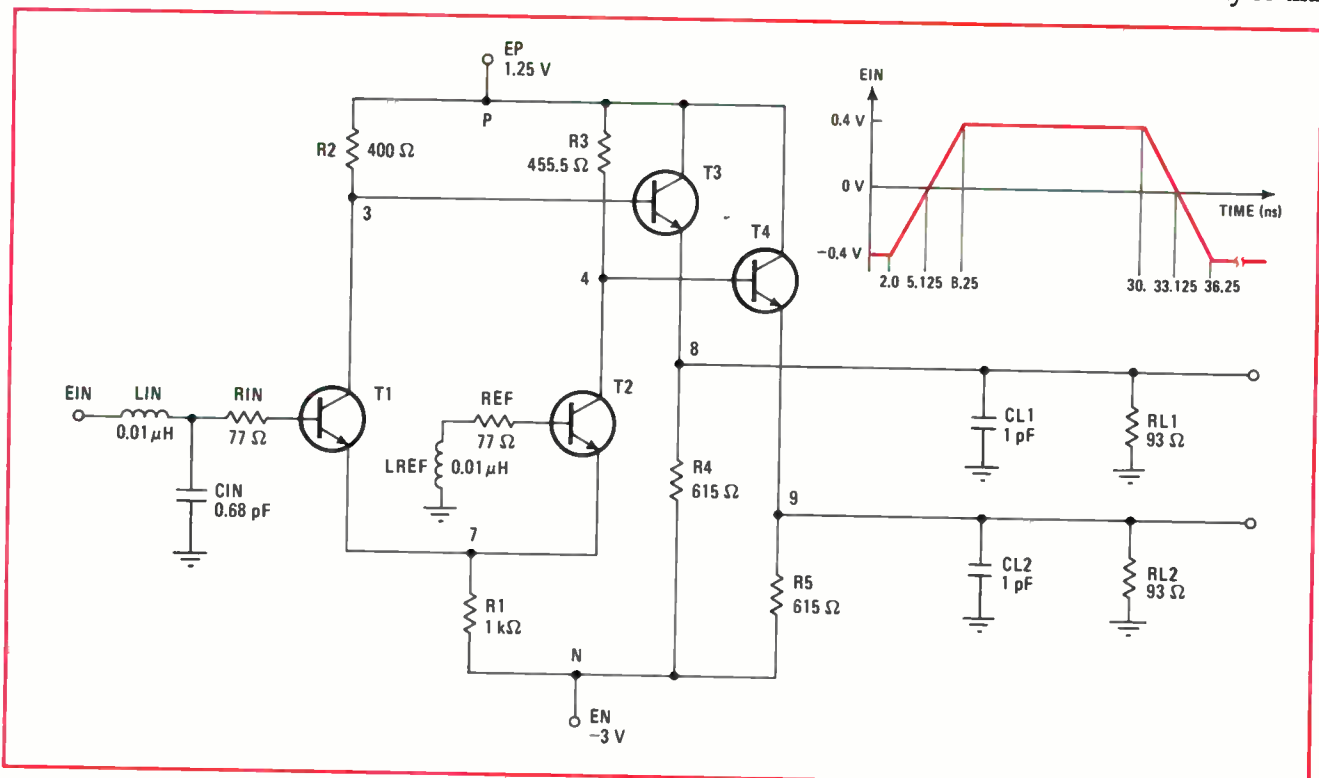

1. **Determining propagation delay.** A computer transient analysis can be used to find the turn-on and turn-off delays of this current-switch logic circuit. With ASTAP, the analysis can be done with either nominal element values or statistically distributed element values.

ASTAP versus Sceptre

ASTAP (Advanced Statistical Analysis Program) is one of the newer high-power general-purpose circuit-analysis computer programs. It can handle exceptionally large circuits very quickly, and it can perform a dc, ac, or transient analysis for a linear or nonlinear network. The program can also provide a Monte-Carlo statistical simulation for all three analysis modes, and it permits unlimited model nesting.

One of ASTAP's chief competitors is Sceptre (System for Circuit Evaluation and Prediction of Transient Radiation Effects), a tried-and-true nonlinear computer program that is used principally for transient analysis. While Sceptre is currently limited to a capacity of around 300 elements, ASTAP can accommodate up to approximately 3,000 elements.

Like Sceptre, ASTAP employs a model library, rather than taking the built-in-model approach. The languages used by both of these programs permit arbitrary device models to be described easily and then stored in the programs' model libraries. This means that a user can choose the model that suits his design best from the model library. He is not restricted to a single model that is built into the program, nor does he need a programmer's assistance if he wishes to change models.

Additionally, ASTAP employs an implicit-integration technique to solve transient responses. This eliminates the time-constant pattern that plagued the explicit integrators used in programs like Sceptre. It should be noted, however, that a recently released version of Sceptre does provide an implicit-integration approach.

he can estimate the output variations due to these effects. Even quality-assurance determinations, like yields and defect levels, can be predicted with ASTAP.

The program can compute the transient response of both linear and general nonlinear networks. The output for this analysis mode is in two formats: a tabulated one and an automatically scaled printer plot. Variable-order formulas¹ are used for the implicit numerical integration of the differential equations used in the solution. The time step-size during integration is controlled automatically, and even initial conditions can be determined automatically prior to a transient analysis.

Dc analysis can also be performed for linear and general nonlinear networks, and dc problems are solved automatically by adding pseudo-reactive elements to the network, converting the elements to a transient form. The resulting network is then integrated until dc levels are reached. Approximate dc solutions may be entered by supplying a set of initial conditions from which the correct dc levels are found. In this way, the network may be put in the region of the desired state of a multi-state network.

For a steady-state small-signal ac analysis, ASTAP can accept a linear or nonlinear network for which an operating point is specified. The network is automatically linearized at the operating point, and the resulting network is analyzed in the frequency domain. General frequency dependencies can be expressed for all types of elements. The real and imaginary components, as well as the magnitude and phase components, of complex

value response variables may be tabulated and plotted against frequency. In addition, transfer functions represented by seven different types of matrix parameters (i.e., Z, Y, S, etc.) may be requested as outputs. Bode and Nyquist plots are also available.

The operating point for a nonlinear network can be supplied by the user, or it can be obtained automatically from a dc or transient analysis. In determining this point automatically, the user can supply one network description for both modes of analysis; this requires a common topology. Or he can supply a separate network description for each mode, permitting elements to be added or deleted at will during the ac analysis.

Furthermore, a network can be simulated statistically for either ac, dc, or transient analysis. A Monte-Carlo technique is used to compute the probability distribution of a system's output parameters from known distributions of its inputs. Element values are specified in terms of a tolerance and a statistical distribution. Nonlinearities are entered as statistical tables that give a tolerance and distribution to the nonlinear curve. Parameters may also be statistical variables and may be used to define other element and parameter values, as can general statistically dependent or tracking relationships.

The basic output of a statistical simulation consists of histograms of specified output parameters. For a transient or ac analysis, outputs such as delay or transition times and bandwidths may be defined as output parameters. Moreover, for these two analysis modes, envelope plots can be obtained that display the envelope of the responses as functions of time or frequency. A scatter diagram indicating the correlation of one output to another can also be requested.

Data is entered into ASTAP for all three modes of analysis with a common input language. This free-form language is easy to use and almost entirely unrestrictive. For example, there are no limits on the length of names, the number of points in a table, and the number of continuation cards.

Device descriptions

For large-signal analysis, semiconductor devices require equivalent circuits that contain nonlinear elements. With ASTAP, any element voltage or current can be used to describe a nonlinear dependence that defines any element value in the network description. Fortran-like expressions and tables of points can be employed for defining element values, and Fortran function-type subroutine references, which may be Fortran-supplied, system-supplied, or user-supplied, can be included in these expressions. (Two examples of system-supplied subroutines are a diode equation and a field-effect-transistor characteristic.) Parameters may be defined along with the elements, enabling them to be used as auxiliary quantities in element-value expressions or for establishing special outputs.

ASTAP's modeling facilities considerably simplify the process of describing networks that are formed by repetitive subnetworks—for example, an equivalent circuit representing a transistor. In ASTAP, the subnetwork can be defined in terms of basic elements as a model itself, and this model can be used repeatedly to build a more complicated network. Each time the model is called for,

individual element values within the model may be changed. A model can also be referenced to another lower-level model. This model nesting can be carried to any level.

Another advantage of ASTAP's language is that it allows arbitrary device models to be described easily. The designer can express characteristic device equations that constitute mathematical device models in terms of mathematical expressions or tables defining linear or nonlinear dependent elements. Therefore, the designer is given a good deal of freedom in defining element values in device models, but he must exercise care in constructing his definitions so that the model is physically realizable.

Also, the designer must be certain that element values are mathematically valid under all circumstances. For example, values of R, C, or L elements must never be identically zero, and expressions or tables defining these elements must be greater than zero for all values of the independent variable. The user must avoid situations where element values become unrealistically large or small, leading to possible overflow or underflow conditions. Most problems of this sort can be avoided as long as the user is careful to define dependent elements over all possible values of the independent variables.

The program's model library provides additional flexibility. Any model can be stored in one of two libraries—the user-model library or the program-model library. Once stored, models in either library can be referenced by any user. The program-model library is intended for standard general-usage models at a given installation. Models may be stored or deleted from this library only through the use of a special key. Any user may store his model in the user library.

No internal size limits

Because ASTAP employs dynamic storage allocation to manage program data, there are no internal restrictions on the various dimensions—such as the number of elements or the number of nodes—of a problem. The size of the network that can be analyzed by ASTAP is limited only by the amount of main storage available. Under virtual storage on an IBM 370 machine, even this restriction is removed. Furthermore, the program is automatically extendable to the amount of storage specified for each job. On an IBM 360 computer, networks of up to about 200 elements can be analyzed using 220 kilobytes of storage, and networks of up to 3,000 elements require less than 1.5 megabytes of storage.

In the solution of a network, a tableau formulation² of the network equations is used for all three analysis modes. This approach combines traditional topological concepts with a modification of an earlier tableau formulation³. Only the voltages across and currents through the network elements are employed in the modified tableau.

Sparse-matrix techniques are used to solve the linearized equations that occur in the solution of the general network equations. When the linear equations are being solved, the growth of fill-in elements is controlled by the joint action of a weighted-tree selection scheme and an optimal ordering strategy. The user can select any one of three techniques to solve the linear equa-

tions. The three methods provide a tradeoff between the amount of storage needed and computation speed, allowing the user to optimize ASTAP for his installation. The first method is the slowest but uses the least storage, the second is faster but uses more storage, and the third is the fastest but requires the most storage.

Default values are built into ASTAP for all the run controls. For most standard analyses, these controls need not be set, and they can be overridden if necessary. The program also has a rerun facility that permits a network to be modified and then re-analyzed. In this

```

MODEL DESCRIPTION
MODEL CURRENT SWITCH ( )
ELEMENTS
  RIN, 1-2 = .077
  REF, 5-6 = .077
  R1, 7-N = 1.0
  R2, P-3 = .4
  R3, P-4 = .4555
  R4, 8-N = .615
  R5, 9-N = .615
  RL1, 8-GND = .093
  RL2, 9-GND = .093

  LIN, EIN-1 = .01
  LREF, 5-GND = .01

  CIN, 1-GND = .68
  CL1, 8-GND = 1
  CL2, 9-GND = 1

  T1 = MODEL JCNTRAN (2-3-7)
  T2 = MODEL JCNTRAN (6-4-7)
  T3 = MODEL JCNTRAN (3-P-8)
  T4 = MODEL JCNTRAN (4-P-9)

  EP, P-GND = -1.25
  EN, N-GND = 3
  EIN, GND-EIN = TABLE EIN(TIME)

  PTONDIN = (TRISE(VRL2,0) - 5.125)
  PTONDOUT = (TFALL(VRL1,0) - 5.125)
  PTOFFDIN = (TFALL(VRL2,0) - 33.125)
  PTOFFDOUT = (TRISE(VRL1,0) - 33.125)

FUNCTIONS
  TABLE EIN, 0,-.4, 2,-.4, 8.25,.4, 30,.4,
              36.25,-.4, 50,-.4

FEATURES
  GROUND = (GND)

MODEL JCNTRAN (B-C-E)
ELEMENTS
  RE, 6-E = .0005
  RC, C-5 = .008
  RB, B-4 = (.182 + DLOG(3/(JE+.1)))/20)
  CRB, B-4 = 2.5
  CC1, B-5 = (.6264/(.8-DMIN1(0,VCC1)**.333)
  CC2, 4-5 = (.108/(.8-DMIN1(0,VCC1)**.333)
  CE, 4-6 = (0.4+10.4*JE+DMAX1(.01,JE/5)**4.4)
  JE, 4-6 = (DIODEQ(2.5E-13,38.1,VJE))
  JC, 5-4 = (.983*JE)

EXECUTION CONTROLS
ANALYZE CURRENT SWITCH (TRANSIENT)
CURRENT SWITCH EMITTER FOLLOWER USING
BIPOlar JUNCTION TRANSISTORS.

RUN CONTROLS
STOP TIME = 50
MAXIMUM STEP SIZE = .5
TOPOLOGY

OUTPUTS
PRINT PTONDIN,PTONDOUT,PTOFFDIN,PTOFFDOUT
PRINT IRE.T1,IRE.T2,IRE.T3,IRE.T4
PLOT N1,N2,N3,N4
PRINT,PLOT (LABEL=(PROPAGATION DELAY),
COMMON SCALES) VRL?(VRL2-IN-PHASE),
VRL1(VRL1-OUTOF-PHASE),EIN

```

2. Nominal transient analysis. Nominal element values are used here as the input data to ASTAP. The program will tabulate the input-to-output propagation delays of the circuit drawn in Fig. 1, as well as plot the voltage (with respect to ground) at nodes 1, 2, 3, and 4.

MODEL DESCRIPTION
MODEL CURRENT SWITCH ()

CURRENT SWITCH EMITTER FOLLOWER CIRCUIT.
STATISTICAL DESCRIPTION.

ELEMENTS

PTRACK = DISTRIBUTION NORMAL (.077, 15%)
RIN, 1-2 = D NORMAL (PTRACK, 5%)
REF, 5-6 = D NORMAL (PTRACK, 5%)

PS = D NORMAL (.15, 8%)
R1, 7-N = D NORMAL (6.67*PS, 3.6%)
R2, P-3 = D NORMAL (2.66*PS, 3.6%)
R3, P-4 = D NORMAL (2.97*PS, 3.6%)
R4, 8-N = D NORMAL (4.1*PS, 3.6%)
R5, 9-N = D NORMAL (4.1*PS, 3.6%)
RL1, 8-GND = .093
RL2, 9-GND = .093

LIN, EIN-1 = .01
LREF, 5-GND = .01

CIN, 1-GND = .68
CL1, 8-GND = 1
CL2, 9-GND = 1

T1 = MODEL JCNTRAN (2-3-7)
T2 = MODEL JCNTRAN (6-4-7)
T3 = MODEL JCNTRAN (3-P-8)
T4 = MODEL JCNTRAN (4-P-9)

EP, GND-P = 1.25
FN, GND-N = -3
EIN, GND-EIN = TABLE EIN(TIME)

PTONDIN = (TRISE(VRL2,0) - 5.125)
PTONDOUT = (TFALL(VRL1,0) - 5.125)
PTOFFDIN = (TFALL(VRL2,0) - 33.125)
PTOFFDOUT = (TRISE(VRL1,0) - 33.125)

PIDBG = DISTRIBUTION 3 (4, 20, 47.3)

FUNCTIONS

TABLE EIN, 0,-.4, 2,-.4, 8.25,.4,
30,.4, 36.25,-.4, 50,-.4
DISTRIBUTION 3 (NORMAL) MIN=4, MEAN=20,
MAX=47.3, SIGMA=9.1

FEATURES

GROUND = (GND)

MODEL JCNTRAN (B-C-L)

DIFFUSED NPN JUNCTION TRANSISTOR MODEL.
STATISTICAL DESCRIPTION. -

ELEMENTS

RE, 6-F = .0005
RC, C-5 = .008
PIDB = D NORMAL (PIDBG, 20%)
RB, B-4 = (2/PIDB**(.8+DLOG(3/(JE+.1)))/PIDB)
CRB, B-4 = TABLE 1 (PIDB)
PY = D NORMAL (0.27, 20%)
CC1, B-5 = (2.32*PY/(.8-DMIN1(0,VCC1)))**.33333)
CC2, 4-5 = (0.4*PY/(.8-DMIN1(0,VCC1)))**.33333)
CF, 4-6 = (0.4 + (2.6*PIDB**0.464*JE)
+ DMAX1(0.01, JE/5)**4.4)
PISAT = (2.5E-13*(20/PIDB)**.84)
JE, 4-6 = (DIODEO(PISAT, 38.1, VJE))
PBETA = (1200*(1 - 1/PIDB)/PIDB)
PALPHA = (PBETA/(1 + PBETA))
JC, 5-4 = (PALPHA*JE)

FUNCTIONS

TABLE 1, 5, 3.5, 10, 3.5, 20, 2.5, 40, .1, 50, .1

FEATURES

GLOBAL = (PIDBG)

EXECUTION CONTROLS

ANALYZE CURRENT SWITCH (TRANSIENT)
CURRENT SWITCH EMITTER FOLLOWER
USING BIPOLAR JUNCTION TRANSISTORS.

RUN CONTROLS

STOP TIME = 50
MAXIMUM STEP SIZE = .1
CASES = 100

OUTPUTS

PRINT LIN, VRL1, VRL2
PRINT IRE.T1, IRE.T2, IRE.T3, IRE.T4
PLOT N1, N2, N3, N4
HISTOGRAM PTONDIN, PTONDOUT, PTOFFDIN, PTOFFDOUT
HIST (SAMPLE=(0, 30, 50)) VRL2
PLOT (ENVELOPE, COMMON SCALES,
LABEL=(IN PHASE DELAY)) EIN, VRL2
PLOT (ENVELOPE, COMMON SCALES,
LABEL=(OUT OF PHASE DELAY)) EIN, VRL1
SCATTERGRAM PTONDIN, VS PIDBG
SCATTERGRAM PTOFFDIN, VS PIDBG

END

way, parameter studies can be carried out under any of the analysis modes. During the re-analysis, only the analysis phase of the program is repeated; the set-up phase is executed only once.

Error checking is performed throughout a program run. Either warnings or error messages may be issued; an error message will terminate the job. There are over 300 diagnostic messages designed to assist the user find the problem so that he can continue his job run.

A sample problem

As an illustration of how ASTAP works, the propagation delay of a current-switch emitter-follower logic circuit will be investigated through both a nominal transient analysis and a statistical transient analysis. Figure 1 shows the circuit. The propagation delays between its input and output are defined as the time differences between zero-crossings of the input signal and the corresponding zero-crossing of the output signals.

When many of these circuits are tied together to form various logic functions, it is necessary to know the delay through the logic chain and the statistical distribution of this chain delay. The sample-problem circuit is first analyzed by using nominal values for the circuit parameters, and then statistical distributions are assigned to the parameters so that a statistical simulation can be performed. In actual practice, a nominal transient analysis need not be performed first, since the nominal results are part of the statistical analysis output.

The equivalent circuit in Fig. 1 includes parasitic elements, like lead inductance and stray capacitance—in this case, LIN, CIN, LREF, CL1, and CL2. All the circuit elements and nodes are named, and model reference names are given to the transistors—T1, T2, T3, and T4. Element values may be expressed in any consistent set of units. Here, the units are volts, milliamperes, kilohms, picofarads, microhenries, and nanoseconds.

Figure 2 shows what the input data to ASTAP looks like for this circuit. Individual elements are assigned nominal values, which are all numeric constants except for the independent voltage source, EIN. The value of this independent input signal is given by a table of points (under the FUNCTIONS heading) that describes the time-dependent input pulse shown in Fig. 1.

The use of parameters for defining special output quantities is shown under the ELEMENTS group. Parameters PTONDIN and PTONDOUT define the turn-on in-phase and out-of-phase delays, respectively. Parameters PTOFFDIN and PTOFFDOUT define the turn-off in-phase and out-of-phase delays, respectively. The values of these parameters are established by the system-supplied mathematical functions of TRISE and TFALL.

The basic variables computed during an analysis consist of all the element voltages and currents. These variables can be used for output quantities or in general mathematical expressions for defining element values.

3. Statistical transient analysis. In this ASTAP input data listing, element values for the current-switch circuit are represented as statistical distributions, rather than nominal numerical constants. Even the circuit's four transistors are modeled statistically. This type of simulation allows actual manufacturing variations to be taken into consideration.

Node voltages can also be requested as output data, as long as a ground node is defined explicitly. (This is done here under the FEATURES heading.) A node name that is prefaced by the letter N refers to a node voltage that is referenced to ground. One of the PLOT statements requests node voltages N1, N2, N3, and N4.

Under the ELEMENTS group, the transistor model references—T1, T2, T3, and T4—refer to transistor model JCNTRAN, which is a modified Ebers-Moll model that is not driven into saturation. Whenever the transistor model reference name is listed, the elements that make up this model are inserted automatically into the overall circuit.

As mentioned previously, the equations defining the nominal element values for the transistor model can be translated directly into Fortran-like expressions, which can be general provided that they represent physically meaningful relationships. Additionally, standard Fortran library functions or functions supplied by the system or user may be used in these expressions.

For example, the current source JE, which models the base-emitter junction characteristic, references the system-supplied function, DIODEQ. This sort of generality of element definition permits models to be developed easily for a variety of devices. And the model data can be described in either tabular or equation form.

The EXECUTION CONTROLS-heading contains the major program instructions. It is here that ASTAP is told to do a transient analysis of the current-switch circuit: ANALYZE CURRENT SWITCH (TRANSIENT). A stop time of 50 ns is set under the RUN CONTROLS listing. This is the only transient run control that must be set, since all the other program controls have assigned default values. The maximum step size can be specified, as done here, to assure that the program properly describes the pulse rise times needed for this problem.

In addition to the circuit's four propagation delays, the OUTPUTS listing requests a printout of the emitter current in each of the transistors and a plot of four node voltages. The quantities requested here for tabular printout are grouped in one block at each time point, and each PLOT statement produces a separate plot.

For the Monte-Carlo statistical transient analysis of the current-switch circuit, the constant values used for the elements in the previous nominal transient analysis are described as statistical distributions instead. In general, the Monte-Carlo technique assumes the variables to be statistically independent. However, elements are sometimes dependent on a common factor; such element and parameter dependence is called tracking.

Figure 3 shows the input data for the statistical description of the current-switch circuit. Resistors R1 through R5 depend on the sheet resistivity of the material used to fabricate them. Additional variations within their dimensional tolerances produce yet another statistical spread about their nominal resistance values.

In the program listing, parameter PS represents the sheet resistivity. It is normally distributed about a nominal value of 0.15 and varies $\pm 8\%$ from this nominal at ± 3 -sigma points of the distribution. The nominal values of resistors R1 through R5 are each defined as some factor of parameter PS in order to model the tracking between these elements as a function of sheet resistivity.

In addition, each resistor has an independent normal distribution of $\pm 3.6\%$ about its nominal value. The lead resistors, RIN and REF, form a separate independent tracking group with respect to parameter PTRACK.

An appropriate statistical description of the transistor model is called for under the MODEL JCNTRAN heading. Such a description can include nonlinear elements, as well as correlate the relationships between dependent and independent parameters. The model elements can be described in either equation or table format.

Many of the elements of the transistor model are nonlinear. Also, they are correlated with each other. To describe this correlation to the program, independent parameters are found on which the parameters of interest depend. For instance, several transistor parameters depend on total base doping; and an intrinsic current, IDB, which is proportional to the sheet conductivity, is an independent parameter that is correlated with the total base doping.

To request ASTAP to run a statistical simulation for any of the modes of analysis, the CASES run control is set equal to the number of individual statistical analysis runs needed for the simulation. For each individual analysis run, values for the statistical elements and parameters are randomly selected from their associated distributions.

The outputs produced for the first three OUTPUT statements are similar to those obtained for the nominal transient analysis. However, special outputs are available for showing statistical responses.

The HISTOGRAM statement generally requests the program to plot histograms of the single-valued variables listed in the statement. Here, the first HISTOGRAM listing asks for histograms of the four delay parameters. For variables that are functions of time, the SAMPLE option can be requested to sample a certain variable at specified times. In the example, variable VRL2 is sampled at 0, 30, and 50 ns.

Another available statistical output for variables that are functions of time (or frequency) can be requested by the ENVELOPE option in a standard PLOT statement. This instruction produces an envelope of all the responses of each variable over all the cases in the statistical simulation. The mean value at each time point is also plotted with the upper and lower envelope values. The example shows how to request envelope plots for the in-phase and out-of-phase outputs.

The SCATTERGRAM statement requests another form of statistical output—a scatter diagram of one or more variables plotted against another variable over all the statistical cases. This sort of diagram can be used to determine visually the correlation between variables. In the example, the turn-on and turn-off in-phase delays are plotted against a transistor parameter (PIDBG) to evaluate the correlation of the circuit's delay with this parameter. □

REFERENCES

1. Gear, C.W., "The Automatic Integration of Stiff Ordinary Differential Equations," Proceedings of IFIPS Congress, 1968, pp. A81-A85.
2. Weeks, W.T., Jimenez, A.J., Mahoney, G.W., Qassemzadeh, H., and Scott, T.R., "Network Analysis Using a Sparse Tableau with Tree Selection to Increase Sparseness," Proceedings of IEEE International Symposium on Circuit Theory, 1973, Toronto, Canada.
3. Hachtel, G.D., Brayton, R.K., and Gustavson, F.G., "The Sparse Tableau Approach to Network Analysis and Design," IEEE Transactions on Circuit Theory, Vol. CT-18, No. 1, January 1971, p. 101.

Converting tables to equations cuts program length for calculator use

Eight basic equations can describe most tables of physical variables, and all the other factors can be handled by power-series expansions; lengths of the programs can often be reduced by more than half

by Roger Story, Hewlett-Packard Co., Loveland, Colo.

□ Modern programable calculators are unquestionably the answer for those individuals and organizations whose needs do not justify the expense of even a mini-computer and its peripherals. Of course, when compared to computers, calculators have certain shortcomings, particularly in their storage capacity. Users of calculators are finding that many programs, often written with computer execution in mind, cannot be run with the 4,000 words of memory to which a programable calculator is typically limited.

Store equations, not tables

The solution to this problem, in many cases, is to use curve-fitting techniques to convert tabular or graphic data into equation form. In many scientific programs, it turns out, much of the program's length is taken up by tables of data. For these programs, dramatic reductions in length can be obtained if the data is calculated as it is needed, instead of simply being pulled out of a look-up table. In addition to reducing memory requirements, replacing tables with equations may allow increased accuracy through interpolation between data points.

Obviously, not all data is amenable to this treatment. Tables with only a small number of entries, for example, probably require less space than would the equations needed to reproduce them. More often than not, however, considerable space can be saved by using equations. By way of illustration, our department recently developed a program for the design of power transformers. The program, written in Basic, was run on a time-shared computer terminal. By rewriting the program to use equations rather than data tables, we were able to reduce its memory requirement from 7,000 words to 4,000 and thus were able to run it on an HP-9830 calculator.

Although reducing the memory requirements was the motivation behind the rewriting of the program, the use of equations turned out to have another important advantage: the information in the program is more easily updated because an equation is much easier to change than a data file. Although for purely mathematical data this may not be much of an advantage, much industrial data is constantly in need of revision—either to eliminate small errors that have been discovered through ex-



MODEL 1. $y = a + bx$	MODEL 5. $y = a \exp(bx)$
MODEL 2. $y = a + b/x$	MODEL 6. $y = ax^b$
MODEL 3. $1/y = a + bx$	MODEL 7. $y = a + b \ln(x)$
MODEL 4. $1/y = a + b/x$	MODEL 8. $y = a + bx + cx^2$

1. Equations. Most tables or curves of physical variables can be represented by one of these eight equations. Canned programs for fitting data to equations and for estimating quality of the fit are available from calculator and computer manufacturers, as well as from operators of computer-time-sharing services.

WIRE GAUGE	TURNS/IN.	
10	8	$y = ae^{bx}$ $a = 2.83$ $b = .109$ $x = \text{Wire gauge}$ $y = \text{Turns/in.}$
15	15	
20	26	
25	37	
30	65	
35	114	
40	224	
44	340	

2. Exponential. Turns-per-inch data in table is represented by exponential equation with constants as shown. The data shown here applies to double-film coated wire.

perience in the use of the data or because of changes in some process on which the data is based. For these situations, equations can be of significant value, even when memory space is not severely limited.

Writing the equations

Nearly any data table can be converted into an equation by developing a power-series expansion for it. The only proviso is that the data be sufficiently well ordered for the series to converge. It turns out, however, that many tables involving physical variables can be represented by an exponential function or by one of the handful of other functions listed in Fig. 1. When this can be done, program length can be reduced even more than with a straightforward power-series approach.

To get a feel for the kinds of savings equations can provide, consider the reduction of wire tables to equation form. In the design of most magnetic components, one refers to a table of wire sizes to determine such parameters as turns per inch, ohms per foot, cross-sectional area, and turns per square inch. Two listings of turns per square inch are needed—one for layer-wound coils, and one for random-wound coils. Thus, for the 37 wire gauges spanning #8 through #45, 185 data entries, or about 740 16-bit words, must be stored.

All of this data happens to be of the form $y = a \exp(bx)$. The wire-table excerpt of Fig. 2, for example, shows the values of a and b needed to write the equation for turns per inch of double-film coated wire. By taking advantage of the exponential nature of the wire-table data, the 185 data entries can be reduced to five equations, or 50 words. The saving in this case is 73%.

What's more, equations are particularly useful when the original data is in the form of a family of curves. When designing the filter for a power supply, for example, certain parameters describing the diodes, the transformer, and the various filter components are re-

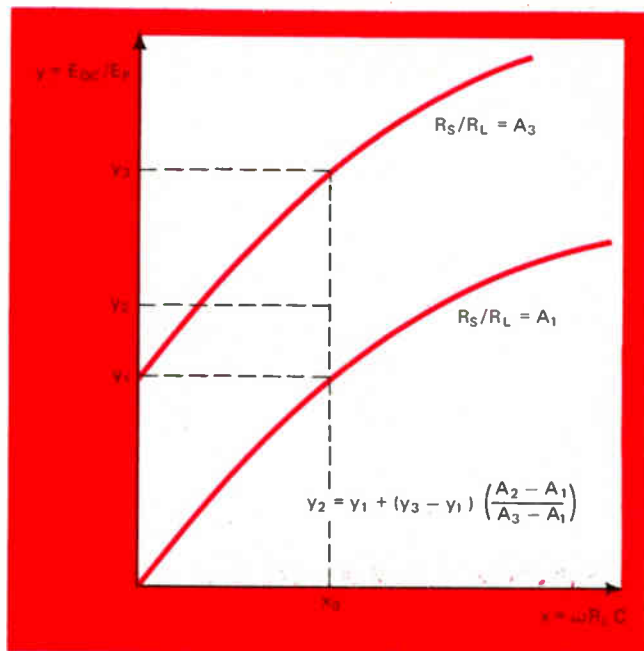

3. Interpolation. Family of Schade voltage curves shows how ratio of dc voltage to peak voltage (y -axis) varies with changes in the product of frequency, load resistance, and filter capacitance (x -axis) for different values of the ratio of source resistance to load resistance. For such values of R_s/R_L as A_2 , for which no curve is plotted, the formula provides a linear interpolation that can greatly increase the accuracy of the calculated results.

lated by a family of curves known as Schade curves. For a capacitor-input filter following a full-wave rectifier bridge, the Schade curves, which relate power-supply ripple to power-supply loading, are plotted for values of the ratio of source resistance to load resistance.

Plotting curves

A total of 23 curves—14 for voltage and nine for current—is needed for a typical application. To represent each curve with sufficient precision for most design work requires at least 20 data points per curve. The storage needed for this example is thus 460 data entries, or 1,840 words.

The Schade voltage curves are found to be of the form $y = a + b/x$ (Fig. 3) while the current curves satisfy the relationship $1/y = a + b/x$. The coefficients of these equations are data entries, each pair defining a curve. The memory capacity required to store 23 curves in equation form is 46 entries (184 words) for the coefficients and 129 words for the two equations. The total of 313 words represents a saving of 83%. If the coefficients of the equations can themselves be fitted to an equation, still greater simplification will result.

However, one problem with families of curves is that data points frequently fall between the curves. When high accuracy is not required, it is probably sufficient to use the curve that comes closest to the one that is needed. For higher precision, a linear interpolation can yield greatly increased accuracy, as illustrated by the Schade-curve example of Fig. 3. The formula shown in Fig. 3 is, of course, universal; once the values of y_3 and y_1 are taken from the curves, it simply interpolates between them. □

Production logic tester checks a variety of ICs

by T.K. Tawfiq
Allerod, Denmark

A complete stand-alone IC logic tester, which is ideal for small production lines, can be built at low cost by making use of Hewlett-Packard's model 10529A logic comparator. This production IC tester performs full functional testing of a logic circuit, yet is compact enough to fit on a small metal plate.

The performances of two identical circuits—that of the device being tested, and that of a reference device—are compared. All possible binary combinations are applied to the inputs of both devices, and the states of their outputs compared. A defective IC will light the display on the logic comparator.

The figure shows the schematic for the tester, and the photograph depicts an assembled tester (excluding the main body of the logic comparator). Three decade counters are connected in series; their outputs, which are designated A through M, are brought out to a row of jacks. The clock signal is applied to a BNC-type connector before it is gated to the counter chain.

To fix the duration of a test, a patch cord is run from the STOP jack to the counter output jack following the last-used counter output. This output goes high at the end of the test cycle, preventing the clock from reaching the counter input. When the test ends, the light-emitting diode on the top card turns on. The START push button manually clears the counters for a new test cycle.

The power-supply terminals labeled 7.5–30 volts dc and GND are for the counters, while the ones labeled 5 v and DEVICE GND are for the package being tested. Here, a 22-pin socket serves as the socket for the device to be checked, and a 16-pin dummy package receives the probe of the logic comparator.

The pins of the dummy package are connected in parallel to the pins of the IC test socket. These same pin connections are also brought out to two rows of jacks and numbered to correspond with the two sets of socket pins. Patch cords can be used to connect the pin jacks to the appropriate supply terminals and counter outputs.

To test a device, begin by inserting a reference circuit into the logic comparator and plugging the comparator's probe into the dummy package. Next connect the dc power supply to the tester's supply terminals, and then run patch cords from the 5-V and DEVICE GND jacks to the appropriate numbered jacks of the IC to be tested. The on-indicating LED in the logic-comparator's display will now light.

Using a data sheet as a guide, connect patch cords be-

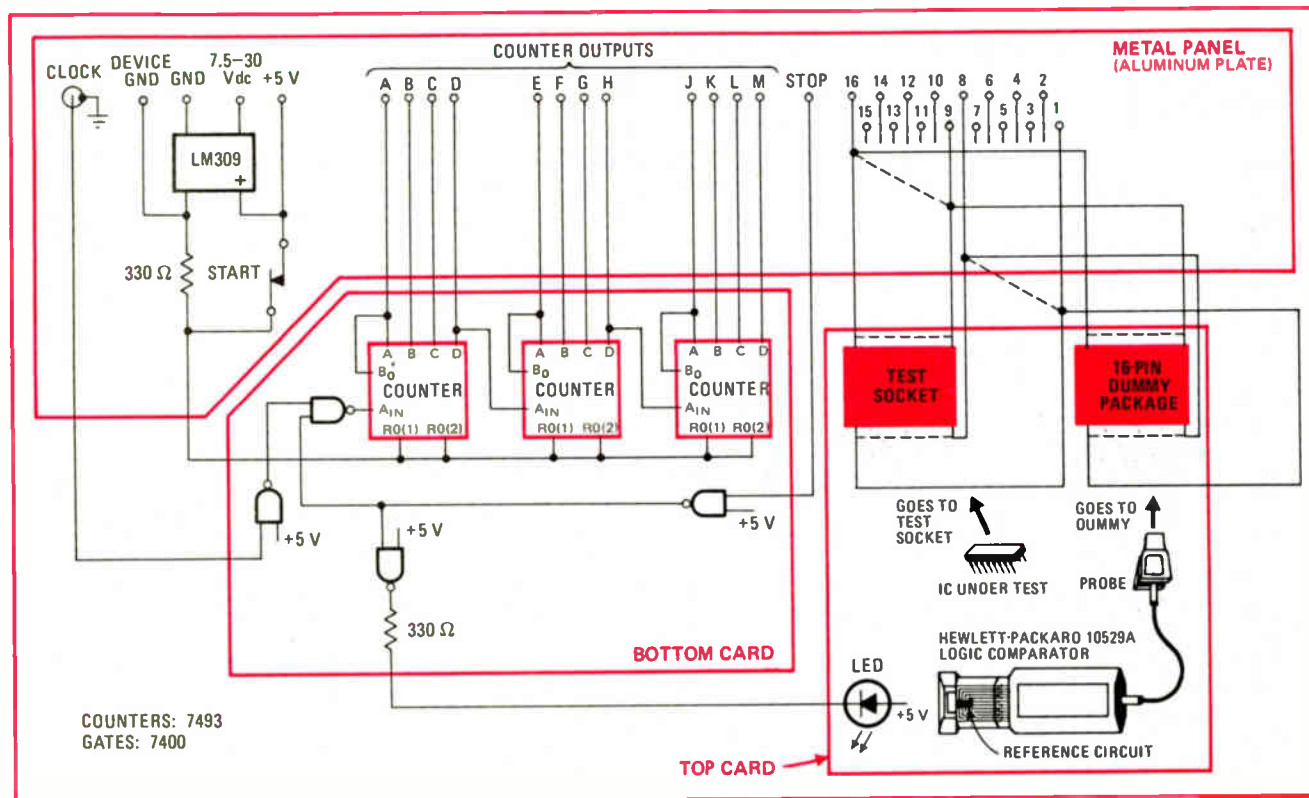

Functional checkout. Compact IC tester makes a complete functional check of many different logic circuits. The performance of the device under test is compared with that of a reference circuit. Series-connected decade counters provide the necessary binary inputs for the test device. A defective unit will light the display on the logic comparator. The assembled tester occupies a small metal panel (see photo).

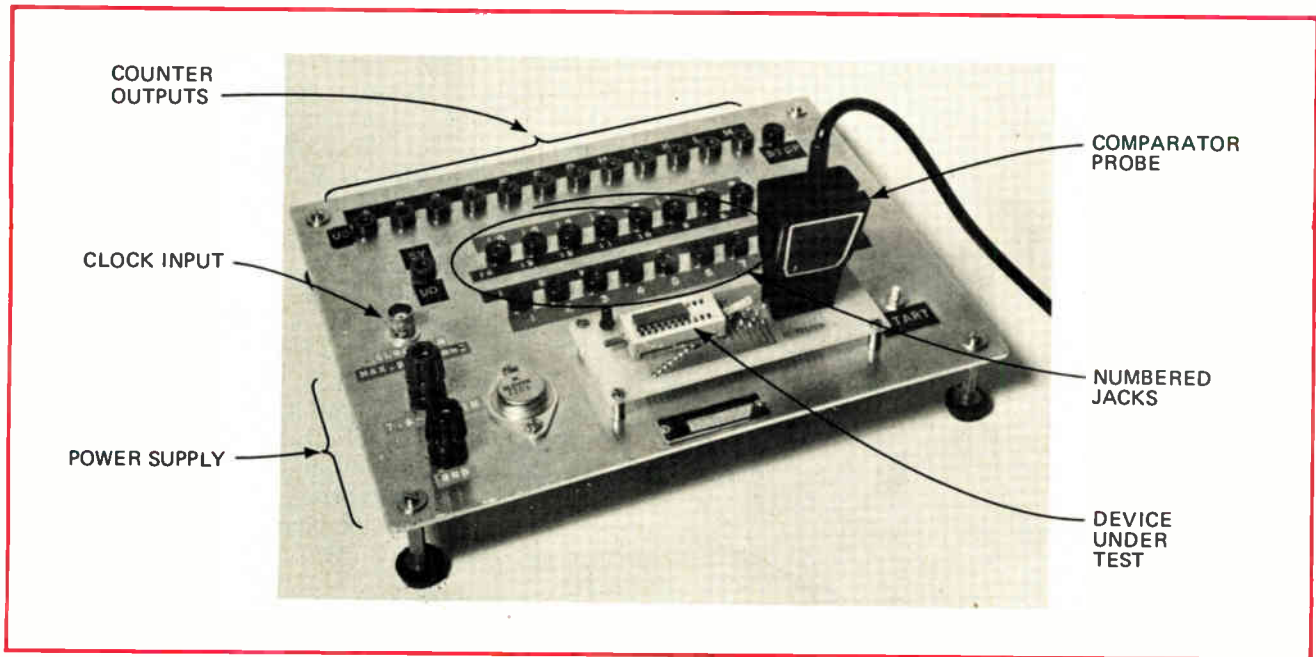

tween the counter output jacks and the numbered jacks to the inputs of the IC to be tested. Run another lead from the STOP jack to the jack following the last-used counter output. The clock signal generator can now be hooked up to the CLOCK jack. (The maximum clock amplitude should not exceed 5 v, nor the maximum clock frequency 10 megahertz.)

After inserting the test device, depress the START button and observe the LED display on the logic comparator. If any LED position in this display lights, the test device is defective. At the end of the test cycle, the LED on the top card lights.

To speed up the testing process, patch-cord connection charts can be prepared for various logic ICs. □

Oscilloscope probes can do many jobs

by Arthur D. Delagrange
Naval Ordnance Laboratory, Silver Spring, Md.

If you walk into a design prototyping area and see oscilloscope probes sprouting not only from scopes but from oscillators, counters, meters, filters, and even power supplies, don't jump to the conclusion that either you or the engineer who works there is a bit daffy. On the contrary, when you are working with breadboarded circuits, especially the sloppy variety, scope probes are useful for getting signals both in and out of a circuit.

Scope probes are handy, shielded, insulated lines that have a built-in ground connection. They attach readily to component leads on one end and are equipped with BNC-type connectors on the other, as is most test equipment. An ordinary probe from one maker will work fine on equipment from another manufacturer.

For example, a Tektronix P6011 1× probe has a series resistance of about 300 ohms. This is insignificant when the probe is used with a measuring instrument providing an input resistance of 1 megohm, which is generally the case. A 1× probe is also usually acceptable for inserting signals into circuits that have an input impedance of 1 kilohm to 1 megohm. However, if the

exact input signal amplitude or phase must be known, it may be necessary to measure the signal at the circuit, instead of at the driving source.

A Tektronix P6012 10× probe has a series resistance of 9 megohms; it operates into an input resistance of 1 megohm shunted by a capacitance of 15 to 47 picofarads. Many measuring instruments other than oscilloscopes have a similar input impedance, and the probe works equally well with them. At low frequencies (roughly those below 1 kilohertz), it is not even necessary to adjust the capacitance.

Sometimes when you're inserting a signal, you must either greatly attenuate the voltage (as for a preamplifier) or insert a current rather than a voltage (as for the virtual ground of an op-amp circuit). For these sorts of jobs, a series resistance is necessary, and the 10× probe with its 9-megohm resistance is handy.

If it is properly matched to the input impedance of a measuring instrument, a probe is accurate from dc to well up in the megahertz region. In fact, a probe can often improve the accuracy of your measurements, suffering from neither the noise picked up by unshielded test leads nor the loading caused by high-capacitance shielded cables.

When you insert a sine wave with a scope probe, there is no loss in accuracy provided that the signal's amplitude and phase are measured at the circuit. And if you are applying complex waveforms to your circuit, you must also check to see that distortion has not occurred because of attenuation and phase shift. □

Continuous monitor for seven-segment displays

by Kenneth J. Wellington
Syracuse University, Syracuse, N.Y.

One of the major drawbacks of seven-segment displays is the ever-present possibility that one of the segments may fail and go undetected for some time. All the readings taken in the interim would, of course, be erroneous.

Here's a circuit that solves this problem by testing every segment automatically once every second. It is a full-time monitor that can be used with either incandescent or light-emitting-diode displays operating from a segment supply voltage of between 5 and 15 volts.

Unlike other failsafe circuits, this one does not require a separate differential amplifier for each segment being monitored. Instead, the circuit uses a resistor at each segment and a single multiple-input NAND gate to which the segment resistors are connected.

The gate is a complementary-MOS device that has its high-impedance inputs tied to the open-collector outputs of a decoder/driver. The segment resistors perform as the pull-down resistors for the multiple-input C-MOS NAND gate.

When the blanking-input/ripple-blanking-output (BI/RBO) line of the decoder/driver is activated, all seven of this device's outputs become open circuits, and the NAND gate checks the continuity between each segment and the segment supply voltage. An open filament or LED will result in a logic 1 at the gate's output.

The monitoring circuitry for each digit of the over-all display is identical to that drawn within the dashed color rule in the diagram. The outputs from all the digits drive the C-MOS NOR gate, whose output is inverted and shifted to TTL levels by the transistor. The translated gate output is then stored by the data latch.

A 555-type timer, operated in its astable mode, generates the waveform for controlling the BI/RBO line of each decoder/driver in the overall display. The inverters activate the BI/RBO output of each decoder/driver for 500 microseconds once every second. Since these inverters have open-collector outputs, the normal operation of an individual display's ripple-blanking is not affected.

The data latch is strobed at the end of the 500- μ s pulse. Its Q output will normally be a logic 0, but will go to logic 1 if a segment failure is detected. This output can be used to turn off the display, turn on a warning light, or indicate in some other way when a segment has failed. □

Engineer's Notebook is a regular feature in Electronics. We invite readers to submit original design shortcuts, calculation aids, measurement and test techniques, and other ideas for saving engineering time or cost. We'll pay \$50 for each item published.

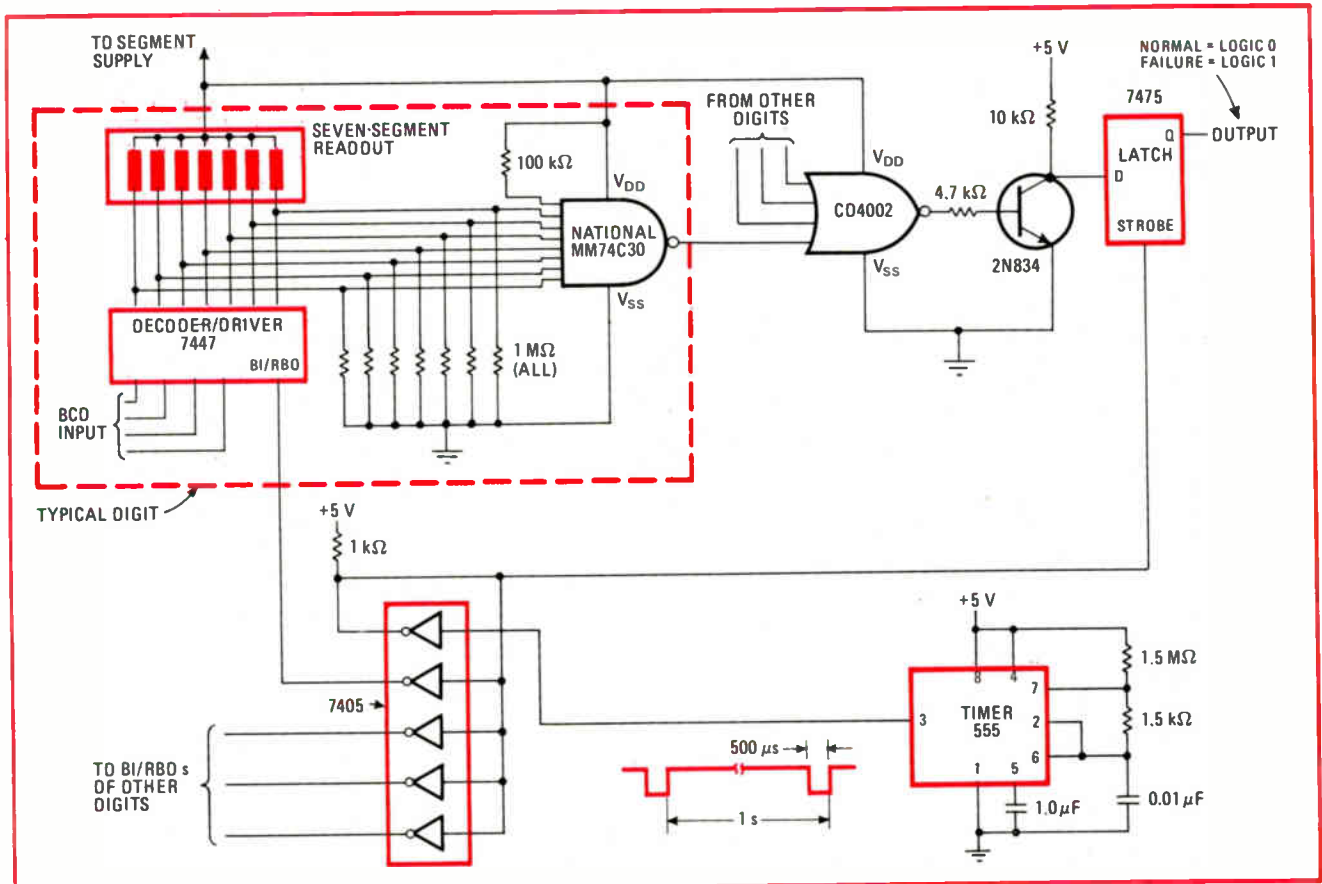

Watching for failures. Open segments in a seven-segment readout are detected by this failsafe circuit, which automatically checks the continuity of each segment once a second. As long as the segments are operating normally, the output of the latch remains at logic 0. If a segment fails, this output goes to logic 1. Either incandescent or solid-state readouts can be monitored by the circuit.



Chances are you own a continuously tunable electronic filter. So by now you probably realize that continuously tunable filters are low performance instruments with, at best, 5% accuracy. And with poor reproducibility of settings, poor frequency accuracy and poor phase drift characteristics. And although continuously tunable filters provide infinite resolution, most users find infinite resolution neither important nor desirable unless there's corresponding accuracy.

But all this isn't why we say "junk it."

WHAT YOU SET, ISN'T WHAT YOU GET.

Take a look at the graph. As you can see, the front panel filter settings don't tell you the -3dB cutoff frequencies, the bandwidth, the noise bandwidth, and the center frequency. Or the insertion loss. You have to measure them — a time consuming, costly procedure.

THERE'S A BETTER WAY.

Ithaco offers two types of filters with switch selectable frequency settings. One type has 3 decimal digit frequency resolution for the user who not only needs resolution but also wants to know where he is without measuring.

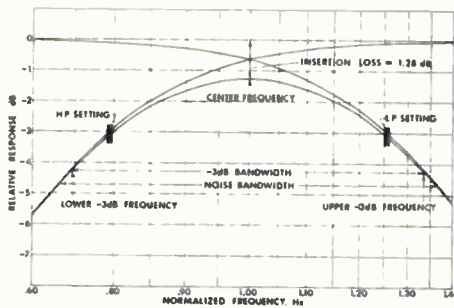

Normalized gain, attenuation, phase, and pulse response curves are printed on top of the filter. The other type uses the internationally accepted 1/10 decade [1/3 octave] frequency step — so you can operate with octave, decade and other convenient band pass settings, and still have sufficient frequency resolution for general lab and data acquisition applications. These filters have all the information shown on the graph printed on top — for all filter settings. And that's why we say "take your laboratory filter and junk it."

MORE NAILS IN YOUR FILTER'S COFFIN...

Standard accuracy of all Ithaco filters is $\pm 1\%$ in frequency, $\pm 2^\circ$ in phase, and $\pm .1\text{dB}$ insertion loss — all at least twice as good as the best the competition can offer. Plus, output drift is an order of magnitude lower than the competition. And self-noise is minimal. Best of all, Ithaco filters are competitively priced.

NOW THAT YOU NEED A NEW FILTER...

Write to Ithaco Inc., 735 W. Clinton Street, Ithaca, N. Y. 14850. Or, if you can't wait [we understand] call 607-272-7640, TWX 510-255-9307.

Take your laboratory filter and junk it.

ITHACO

Circle 119 on reader service card

To control load conditions, use IC voltage regulators

Here's a novel idea for those versatile three-terminal IC voltage regulators—use them to control load conditions instead of supply conditions, suggests John van den Heuvel, Singer Business Machines, San Leandro, Calif. **Adding a single resistor between the regulator's output and ground terminals will produce a very effective constant-current load** between the regulator's input and ground terminals.

This load characteristic can be obtained even at relatively low current levels because these regulators have excellent temperature and voltage stability. Also, the device's internal current limiting and thermal shutdown, which make it virtually indestructible, **protect the power transistor at the output of a circuit from gross overvoltages.**

To determine the resistor value needed, just divide the regulator's output voltage by the difference between the constant current desired and the regulator's output quiescent current. **For larger constant-current levels, a power transistor can be included at the regulator's output.** (Its base is connected to the IC's output pin, its collector to the IC's input pin, and its emitter to the load resistor, which is then returned to the IC's ground pin.)

DTL is on the way out . . .

If you're designing any equipment around diode-transistor logic, better get back to the drawing board. That's the advice of Charles Clough, marketing vice president for Texas Instruments, who says **DTL is fading fast as a market, and as a result it's hard to get and prices are rising rapidly.** In this semiconductor "crunch," Clough says you can do much better with the newer logic families.

. . . and 8k RAMs will never arrive

And if you're waiting for an 8,192-bit RAM, forget it. According to the "Gordon Moore Rule of Four" (Moore is vice president of engineering at Intel Corp.), **it's not worth merely doubling the capacity of a semiconductor memory.** Previously RAMs have increased by factors of four—from 256 to 1,024 to 4,096 bits. So **the next level of integration in a RAM should be 16 kilobits,** but that probably won't happen for two or three years yet.

Lighten the load of cable tying

Have your shop manager check out Panduit Corp.'s new tool for tying cable. It's fully automatic, hand-held, and less than 2 pounds in weight (a fraction of the weight of other tiers) and ties cable bundles 1/16 in. to 3/4 in. in diameter. Operating from air pressure, the tool holds 100 cable ties that meet Mil Spec standards. Write Panduit Corp., 17301 Ridgeland Ave., Tinley Park, Ill. 60477

Service helps user cope with parts shortages

Information Handling Services of Englewood, Colo.—the people who run the VSMF (Visual Search Micro Film) service—have announced the addition of a new **Integrated Circuit Parameter Retrieval** system to their Design Engineer's package. **The service will list approximately 16,000 of the ICs most commonly used** and, by grouping similar devices side by side, provide the user with **large numbers of alternate sources.** The service begins in June.

ZELTEX' 12 bit, 10 μ sec ADC is just one of our strong, fast, silent types.

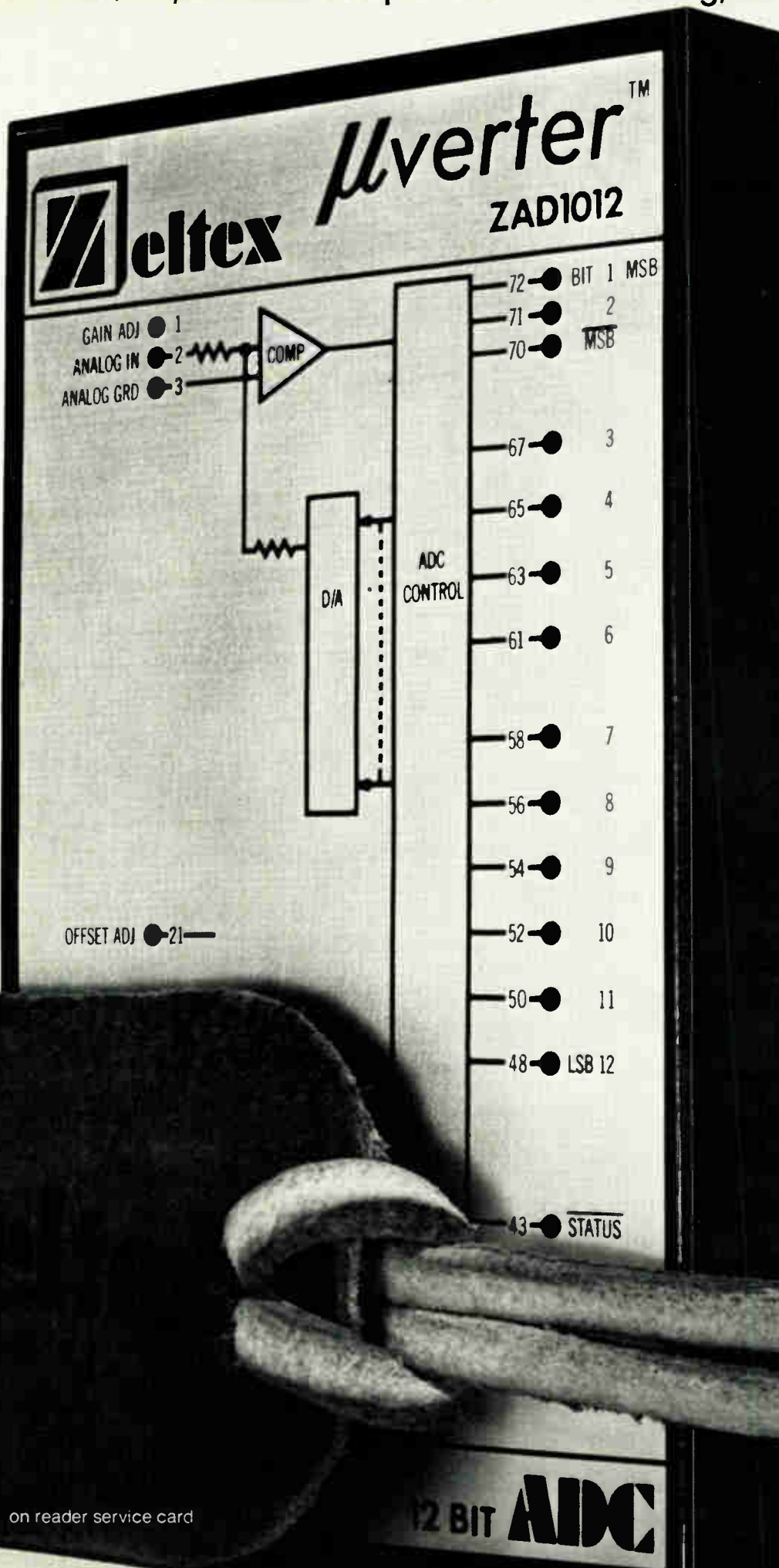

And, aside from performance like 8 bits at 3 μ seconds up to 12 bits at 10 or 20 μ seconds, you get:

- Lowest noise/repeatability error of any ADCs on the market
 - Zeltex' unique thick film small size packaging
 - Fully monotonic over their full specified temperature range
 - All fully specified to $\pm 1/2$ LSB linearity
 - Models pin interchangeable for upgrading specs.
- Plus they truly meet their specifications so you are getting a lot of converter for your money.

The new ZAD 1000 Series is a result of Zeltex' unique product design and manufacturing technologies which have produced a comprehensive line of D/A and A/D converter problem solvers.

So phone (415) 686-6660 to find out how you can put Zeltex' great Micro Giants to work solving your systems design problems.

ZELTEX, INC.
 940 Detroit, Concord
 California 94518
 (415) 686-6660
 TWX 910-481-9477

Zeltex INC.
 The Micro Giants.

12 BIT **ADC**

Electronics & Automobiles

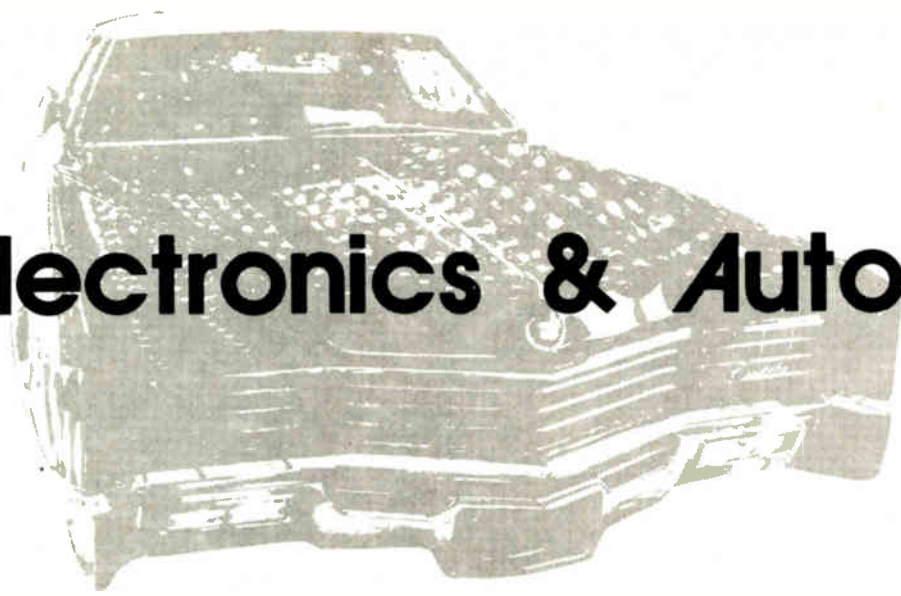

**New Devices and Componentry. . . Computer-Aided Design. . . Automatic Test & Inspection. . .
Laboratory Instrumentation. . . Displays. . . On-Board Equipment. . .
Diagnostic Systems. . . New and Applicable Technology**

It's Coming! A conference and exposition exclusively concerned with automotive electronics—to be presented in the world's capital of automotive engineering and production. The first annual Automotive Electronics Conference and Exposition in Cobo Hall, Detroit, June 11, 12, 13, 1974!

Automotive electronics—everything from systems and IC chips to passenger safety devices—will have the exclusive attention of thousands of automotive engineering professionals in Detroit next June. Engineers who use electronics in the manufacturing of the vehicle, or who design and specify electronics for "on board use". The leadership manufacturers of high-reliability electronic components and devices, instruments and testers, EDP mainframes and peripherals, will be there to provide hands-on demonstrations and description of new and important hardware. Automotive designers and production engineers will be there to evaluate and compare, and to forecast their future needs to electronic suppliers. Three full days of professional show-and-tell among the suppliers and the users of electronics for autos, trucks, and buses. And all under one beautiful roof in Detroit. . . the "world headquarters for automobiles".

CONFERENCE SESSIONS

Three conference sessions will be held concurrently, starting at 9:30 a.m. daily and running until noon. Authoritative author/panelists telling it how it is—and how it needs to be.

EXPOSITION HOURS

The Cobo Hall equipment expo will open at 11:30 a.m. daily and run until 6 p.m. (Visitors can sit in on morning sessions, then attend the show in the afternoon.)

SPECIAL FILM THEATER

New and relevant technical films will be screened in a special film theater starting at noon daily.

For detailed exhibit information and application, write, or telephone today.

Robert D. Rankin, General Manager
Automotive Electronic Conference & Exposition
5544 E. La Palma Avenue
Anaheim, CA 92807

A copy of the Preview Program, available—April may also be requested
(714) 528-2400

AUTOMOTIVE ELECTRONICS

Conference and Exposition
Cobo Hall, Detroit, June 11, 12, 13

Sponsored by Electronic
Representatives Association

Endorsed by the Engineering
Society of Detroit



BOURNS NEW LOW-COST DIGITAL DIAL

**COUNT ON IT...
AND SAVE!**



Bourns new Model H-357 KNOBPOT® Dial is the lowest cost digital turns-counting dial we know of. It's designed for use with 1/4-inch shaft (Dia.) precision potentiometers — or other rotating devices. The H-357 is ruggedly made, features exceptional readout accuracy . . . and pairs nicely with Bourns Model 3540 low-cost 10-turn wirewound potentiometer.

Best of all, the H-357 is a BOURNS product . . . and costs only \$5.00 each in production quantities.

FEATURES INCLUDE: Rugged, industrial grade construction • Large, easy-to-read numbers • Protective lens covers readout • Readability of 1 part in 2,000 • Readout accuracy of 0.1% • Size (7/8" Dia.) and appearance compatible with Bourns KNOBPOT potentiometer family • Brake available at no additional cost.

Delivery is off-the-shelf. For complete details, contact your local Bourns field office, representative or the Factory direct.



TRIMPOT PRODUCTS DIVISION • 1200 COLUMBIA AVE., RIVERSIDE, CALIF. 92507

HERMES LOOP ANTENNA

THREE SAMPLE SITES
ON THE NORTH AMERICAN
CONTINENT —

DIFFERENT LATITUDES
DIFFERENT CLIMATE



FROBISHER BAY, CANADA



MARSHFIELD, MASS.

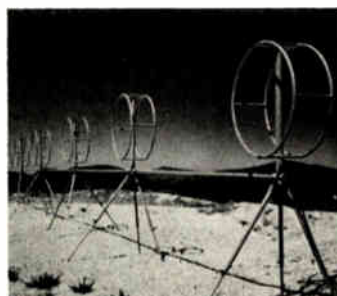

NEAR SAN DIEGO, CALIF.

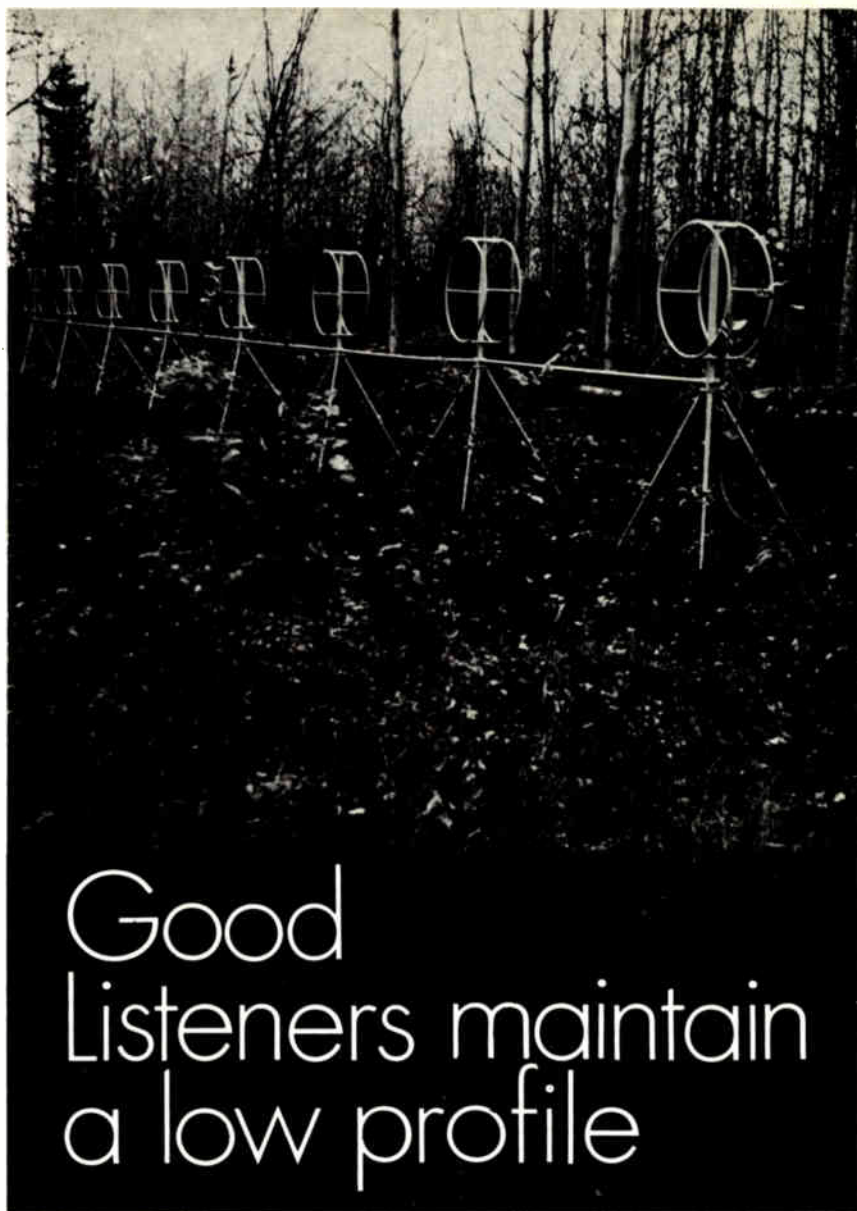

Good
Listeners maintain
a low profile

Even in the solitude of the forest depths, from rooftops, arctic tundra, swamps to sweltering tropics, 'neath snow, sand or ice, the Hermes Loop antenna keeps an ear to the sky. The amazing aperiodic antenna does away with vast log periodic and rhombic arrays - those towering antenna farms.

Excellent directional characteristics in rosette configuration, the Hermes loop antenna provides an omnidirectional broadband receiving array in space merely 1/100th that of the traditional antenna farm.

More than 53 government agencies around the world have pressed the loop antenna into service.

A new, even more compact version is available. Only Hermes Electronics makes it.

**2-32MHz
BROADBAND**

ASK US Send for our Brochure

Hermes Electronics Limited
Suite 315
2020 F Street NW
Washington, DC 20006 USA
202-296 2978
TWX 710 822 1106



Celanex tunes in the best cost and performance picture.



By injection molding rotor and stator strips in Celanex thermoplastic polyester, instead of slower compression molding in alkyd resins formerly used, South American manufacturers cut finished part costs, speed production and improve performance of these TV tuners.

Among the many advantages of Celanex in this application are its excellent dimensional stability and electrical properties. Its impact strength and resistance to wear. Its moldability and fast-cycling characteristics. And the long shelf-life of parts molded of Celanex eliminate an especially knotty problem caused by the hot, humid Brazilian climate.

No wonder numerous television manufacturers worldwide are tuning in to Celanex thermoplastic polyester. Particularly since it also has the highest flammability rating (VE-O by UL 94 to 1/32") from Underwriters' Laboratories.

Compared to thermosets, metals and other thermoplastics, Celanex can do a lot to improve your products and finished part costs. Let us give you the facts. Write Celanex Plastics Company, Dept. X-609, 550 Broad Street, Newark, N.J. 07102.

*Tuner shown
actual
size.
Molded by
Begli Componentes Ltda.
São Paulo, Brazil.*

**A TOUGH TEAM
FOR TOUGH TIMES:
CELCON[®]
actual copolymer
CELANEX[®] NYLON.
CELANEX[®]
thermoplastic polyester**



**CELANEX
ENGINEERING
RESINS**

Celanex Plastics Company is a division of Celanex Corporation, Canadian Affiliate: Celanex Canada Ltd. Export: Amcel Co., Inc., and Pan Amcel Co., Inc., 1211 Avenue of the Americas, New York 10036.

Circle 125 on reader service card



SCHOTTKY RAMS

Performance for pennies. TI's new SN54S/74S189 and SN54S/74S289. Fast. Stable. Versatile.

Either one of these fully-clamped Schottky RAMs will outperform standard TTL RAMs. As much as 60% at the system level and up to 40% at the component level—whether in processors or peripherals, military or industrial applications.

Their highly useful organization—16 words of 4-bits each—and fast 35-ns maximum address access time (enable time 17-ns) make them ideal candidates for your new designs. Or, as a pin-for-pin replacement for older 64-bit RAMs you're now using.

The SN54S/74S189 has a

3-state totem pole output that drives system data bus-lines directly. External pull-up resistors are not required.

The SN54S/74S289 (3101A

equivalent) has an open-collector output to use whenever data-bus line impedances are defined by other sources. Both have PNP inputs biased for standard 54S/74S threshold levels.

But the best is price. Both the SN74S189N and SN74S289N are only \$4.24 in the 100-piece quantity. At under 7¢/bit, that's less than other 64-bit Schottky RAMs now on the market.

For data sheets, indicate by type number and write: Texas Instruments Incorporated, P. O. Box 5012, M/S 308, Dallas, Texas 75222.

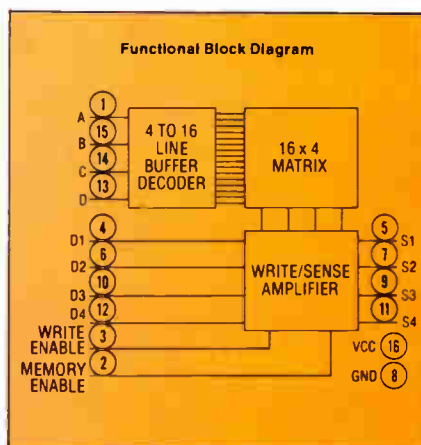

TEXAS INSTRUMENTS
INCORPORATED

Minicomputer family adopts 4k RAM

Semiconductor device is main memory in new H-P line to bow at NCC; extensive microprogramming capability for user is designed into machines

Predictions that 4,096-bit semiconductor memories would break into the mainframes of computers this year have been fulfilled with the introduction by Hewlett-Packard of a new family of minicomputers using 4,096-bit random-access memories as the main memory. The first two models of the new family of 16-bit minicomputers will be demonstrated at the National Computer Conference and Exposition, running May 6-10 in Chicago.

In addition to employing semiconductor main memory, the machines can be microprogrammed by the user to an unprecedented extent, enabling him to tailor a minicomputer more precisely to his specific application.

Use of the new memory system, H-P points out, makes it possible to achieve reductions in size, weight, power consumption, and cost, as well as improvements in memory speed and reliability. The 4k MOS RAMs are being supplied to H-P by Texas Instruments, Motorola, and Mostek. What's more, H-P says, devices of other vendors are under test. H-P expects that mean time between failures of the new minicomputers will be from two to 15 times better than core-based ma-

chines, and extensive tests are underway to confirm that expectation. In addition to the memory, the processor, power system, and mainframe packaging of the machines are all new.

The first two models to be introduced are fully microprogramed.

year to twice as many words, all within the mainframe.

There are 42 new instructions, including 28 index register instructions, bit and byte manipulation instructions, move and compare firmware, and floating-point hardware (optional on the 2105A and standard on the 2108A). Another option is fast Fortran processor firmware which, by speeding a number of popular Fortran routines, causes some programs to run as much as 28 times faster than before, the company says.

The program and I/O compatibility are maintained throughout the new family. Compatibility is also maintained with earlier (HP 2100) minicomputers. Emulating earlier processors, the new series delivers comparable performance when running earlier programs.

The entire instruction set of the earlier models is microprogramed within the new mini's processor-control address space. Emulation of earlier processors occupies less than an eighth of the new units' much enlarged processor-control address space. There is no loss in speed from the emulation procedure.

H-P user-accessible processors treat language instructions as direc-

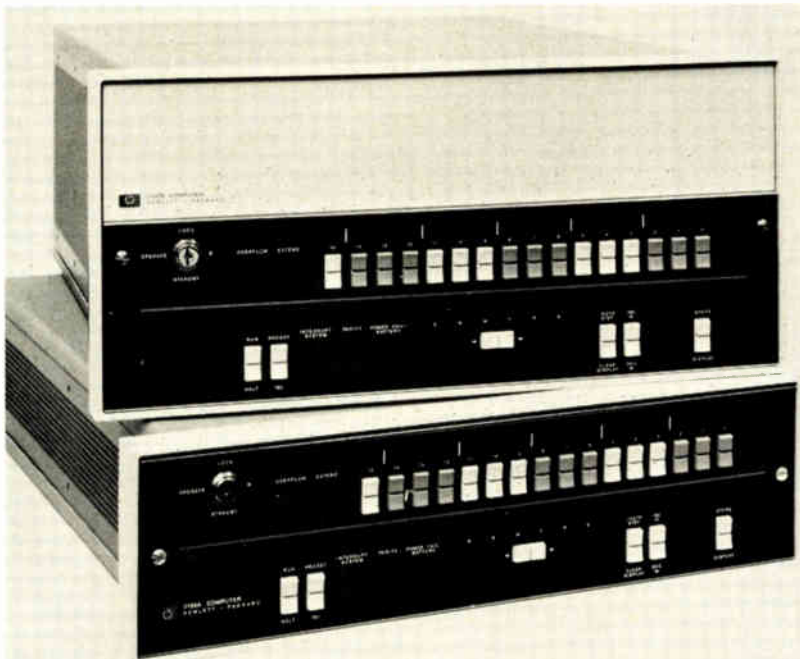

Beginnings of family. The model 2108A, at top, and the 2105A are the first in a line of minicomputers from Hewlett-Packard that uses 4,096-bit semiconductor memories for main storage. The machines are fully microprogramed with a 24-bit processor.

Memory parity, power-fail provisions, and extended arithmetic units are standard on both. The smaller unit, designated the model 2105A, is only 5¼ inches high and can contain within its mainframe 32,768 16-bit words of memory. It has four powered input/output channels. The model 2108A, which is 8¾ in. high, has nine powered I/O channels and a 32k memory, expandable later this

YOUR SAKATA REPRESENTATIVE CAN DELIVER CAPACITORS

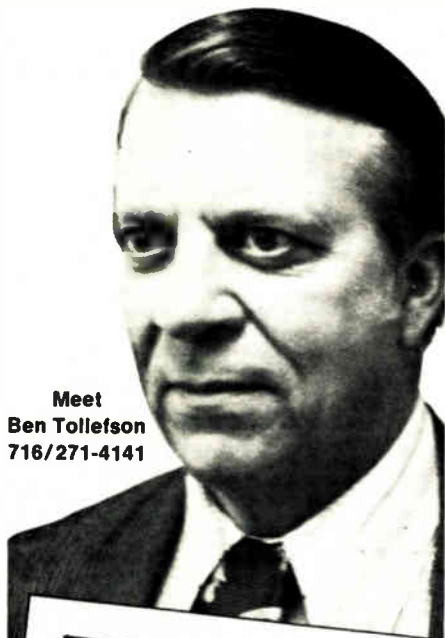

Meet
Ben Tollefson
716/271-4141

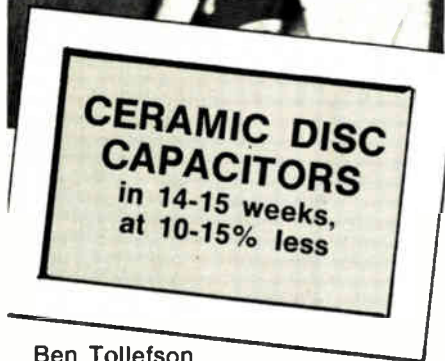

Ben Tollefson (pictured above) is the Sakata representative for the upper New York area. Like all Sakata representatives, he can give you faster delivery and better prices on a wide variety of top quality components. These include resistors (composition, carbon and metal film), capacitors, (ceramic disc, electrolytics), panel meters, lamps and tape heads. Wire or phone for our price and delivery before you buy. Free catalog and engineering available. Delivery of many items from stock.

sakata international, inc.

312/593-3211

651 Bonnie Lane, Elk Grove Village, Illinois 60007
resistors • capacitors • lamps • meters • tape heads

Save time, money
with SAKATA

New products

tives to processor programs, which actually execute the instructions much more rapidly than they can assembly-language instructions. The new processor, common to both models, now has control address space for 4,096 24-bit words, up from the 1,024 words of earlier units, and 14 16-bit hardware scratch-pad registers. These are useful in storing temporary values locally during computing operations, adding speed by avoiding main-memory references.

For specific needs. Processor-control store and scratch-pad registers are easily accessible by the user. He can tailor microroutines precisely to his own needs, using writeable control store or programable-ROM writer options. Firmware microcode instructions can be plugged into the processor.

From the front panel, as many as four ROM-stored programs can be loaded by the user. A LOAD button and a new bootstrap loader automatically set the program counter to the starting address of the bootstrap program.

Beyond the usual direct memory access, a two-channel selector is available that connects any two peripherals, under program control, directly to the memory system. The two-channel selector contains control logic, memory address, and word-count registers not contained in the direct-memory-access facilities commonly found in minicomputers.

All H-P device interfaces include the ability to use the selector at no extra charge. This controller is dynamically assignable under program control to any two device channels simultaneously.

Memory-protect is obtainable on either new model, to protect the integrity of operating systems against accidental modifications. Memory-protect sets up a fence that divides memory space into areas, separating the operating system from user programs. If any part of a user program seeks to modify system space, the system will interrupt and take control.

Any of the more than 70 peripherals attachable to earlier H-P pro-

cessors can be plugged into the new computers through powered I/O channels. As many as 34 more I/O channels can be added to either mainframe with an external extender.

An efficient power module copes with a wide range of power fluctuations and brownouts. If the power line should fail for as long as 10 cycles, the new minicomputers will operate normally, instead of going into a power-fail routine with loss of a single power cycle. Specified performance is maintained even if line voltage drops to 88 volts or as low as 176 V in a 220-V connection. Line frequency may vary from 47 to 66 hertz. Power supply efficiency is above 70%. The model 2105A consumes less than 300 watts; typical power consumption for the model 2108A is 400 w.

Power can be removed from everything but the semiconductor memory with a front-panel STANDBY switch. An optional power standby system—battery and charging and automatic-switching circuitry—preserves memory content for at least two hours if a total line failure is experienced. Power failure detection and automatic restart is available.

Self-protection. Unusual environmental immunity has been designed into the new minicomputers. Not only do they operate normally with varying line frequencies or low line voltages, but they protect themselves automatically against high-voltage conditions, and function to specification at temperatures from 0° to 55°C. Also, they are tested to withstand the same shock and vibration conditions as are H-P instruments.

Availability of both models is restricted to purchasers of five or more. The price to OEMs for model 2105A is \$7,400 each with 16k memory; \$11,000 with 32k memory. The price of model 2108A, with the same memory but with more I/O channels and with floating point as standard, is \$1,000 higher. First deliveries are expected in June.

Inquiries Manager, Hewlett Packard Co., 1501 Page Mill Road, Palo Alto, Calif. 94304 [338]

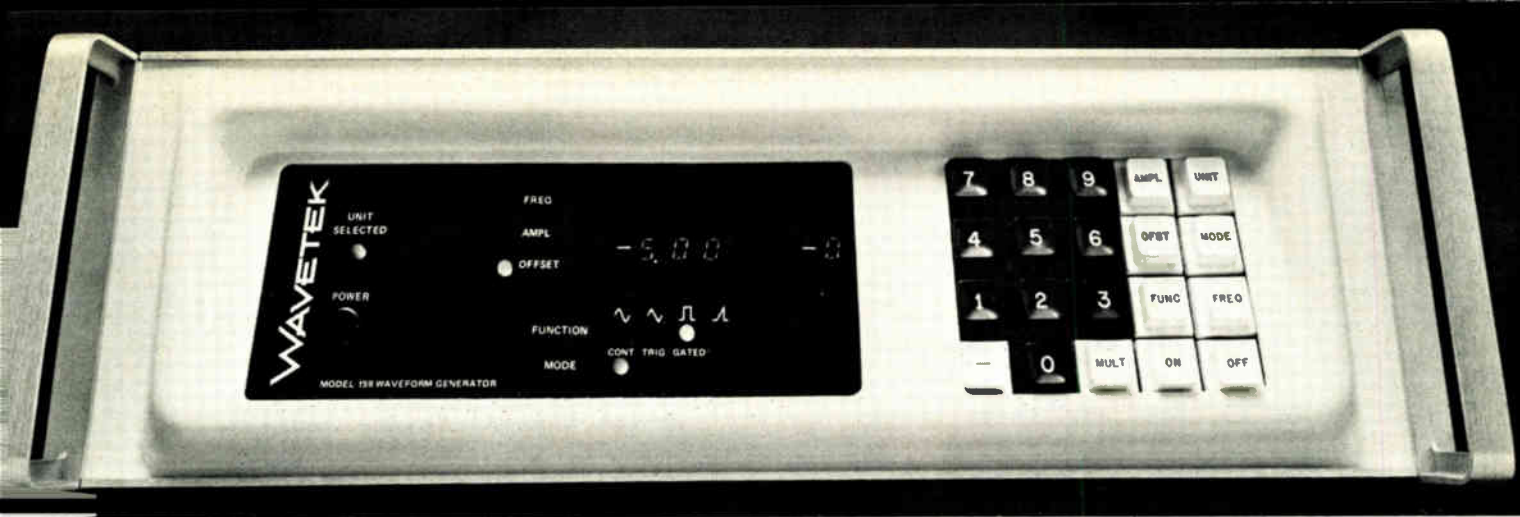

Program waveforms with or without lifting a finger.

With. Your finger, and Model 159's keyboard, can generate sines, squares, triangles, and ramps. Control frequency, amplitude, and offset to three digits. Reverse phase, polarity, activate triggered and gated modes at the touch of a button. A bright L.E.D. display shows



each command as you enter it on the keyboard.

Without. Model 159 and its remote-control-only version, Model 158, can be programmed by all types of remote ASCII sources, including computers, TTYs, even other Model 159



keyboards. Model 158/159 ranges: frequency—1 Hz to 3 MHz; amplitude—20 mV to 10 V; DC offset—up to ± 5 V. For more information, circle our reader service number or contact Wavetek direct.

WAVETEK[®]

P.O. Box 651
San Diego, CA 92112
Tel. (714) 279-2200 TWX 910-335-2007

Circle 129 on reader service card

Counter/timers cover 80 MHz to 1 GHz

Line of portable instruments to be introduced at Hannover Fair features factory-modular design, with extensive use of common subassemblies

by Arthur Erikson, Managing Editor, International

In recent years, fast-paced technology changes and heavy competition have sent prices of digital counter/timers tumbling by as much as 50%. And though prices have at the moment firmed up somewhat, instrument makers have to give customers a lot more for their money to hold their market shares.

Philips Industries so far has stuck to the upper and lower brackets of the counter/timer market, but now the company has readied an assault on the mid-range, which last year accounted for about \$16 million of

the \$30-million counter/timer market in Western Europe. After a sneak preview early this month at the Paris Components Show, a new family of Philips counter/timers will have its big premiere at the Hannover Fair in late April.

Designated the PM6610 series, the family has five basic models—all portables—that span a frequency range from 80 megahertz to 1 gigahertz. The price tag for the bottom-of-the-line PM6611 runs roughly \$800. For the most sophisticated version, the top-of-the-line PM6615, the basic price will be

around \$1,950. Sensitivity for the whole family is 10 millivolts, and time resolution for all models is 100 nanoseconds.

Jan C. van der Windt, product line manager for Philips counter-timers, calls the new family of instruments "factory-modular." All five basic models and the many different options possible were designed at the same time at the Philips group counter/timer supply center in Stockholm, using as many common parts and subassemblies as possible.

With that strategy, a large multi-

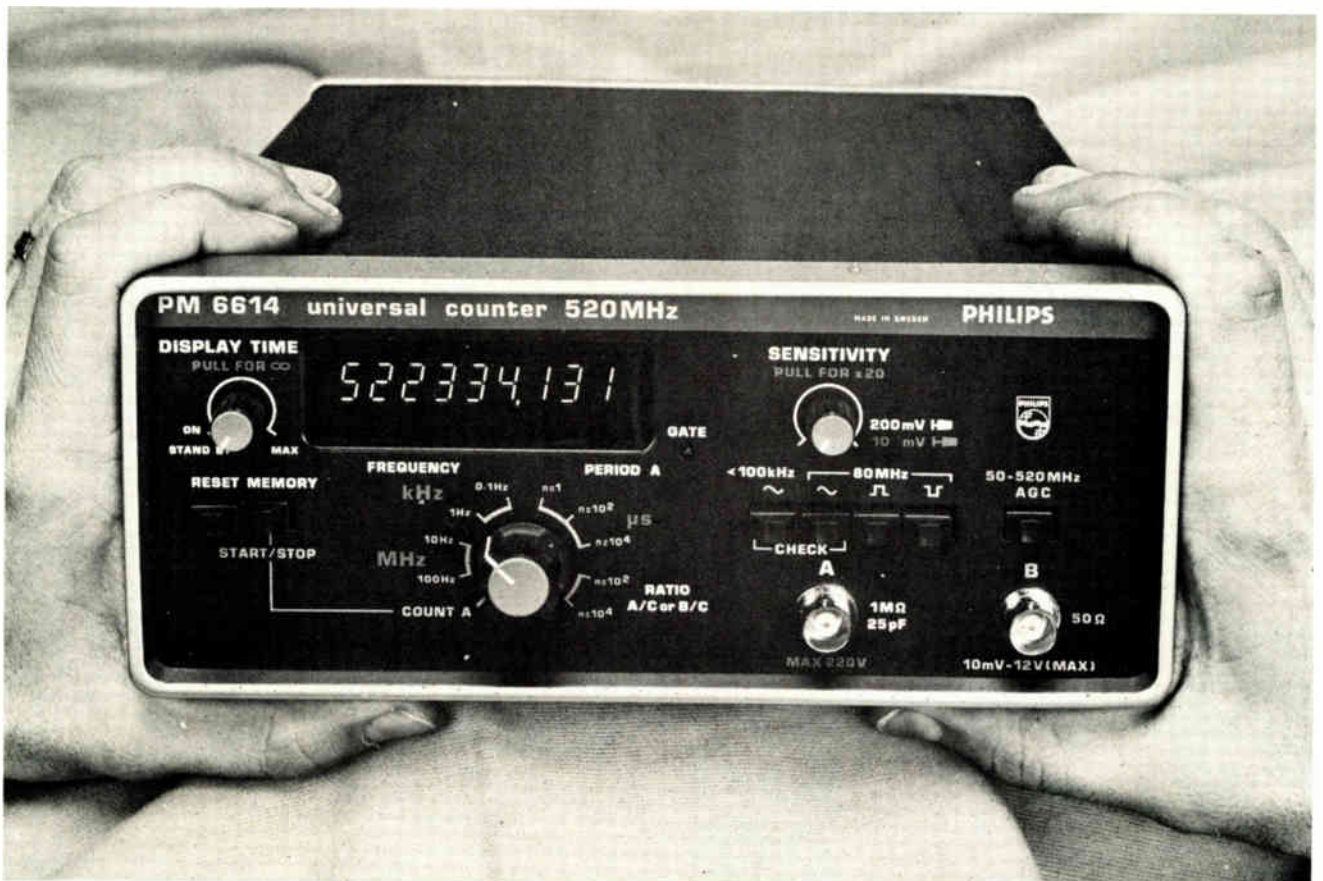

The first modular instrumentation calculator.

Just \$5905 as shown.

It's our 31/53 Calculator Instrumentation System

A powerful, yet inexpensive calculator combined with our TM 500 power supply and system software. You add the instrumentation modules you need. It's all there and it's portable. Now that's versatility!

With our 31 Calculator, you can read input from our DMM's and counters. You can log data selectively, calculate results and output data or trigger signals.

Programming? Little more than natural math. Go ahead, write your own. Also, our standard software gives you data logging (on the optional printer) and data capture on the 31 at operator selected intervals.

For numerical monitoring or

analysis, there's our 21/53 for \$2895 less plug-ins. And in case you wondered, our TM 500 plug-ins are less expensive, too.

Energy monitoring.

Quality control testing. Laboratory and production instrumentation.

The applications go on, and so does our system's potential. Just add the main-

frames and modules you need. We have a graphic calculator system, too. Let our sales engineer fill you in. Pick up your phone and call our nearest center. Or write

Tektronix, P.O. Box 500,
Beaverton, Oregon 97005

Our programmable calculators. Natural. Powerful. Significantly less expensive.



For a demonstration circle 82 on reader service card
Circle 131 on reader service card

New products



Low package count. In PM6610-series counters from Philips, four custom C-MOS circuits handle the functions that would otherwise require about 50 TTL packages.

purpose C-MOS circuit could be incorporated to cut costs and boost performance—and in fact each of the new models contains four identical ceramic C-MOS packages. Other major common subassemblies include a thin-film hybrid front-end circuit, a special transistor-heated crystal oven for the time base, and a nine-digit “mini planar Pandicon” gas-discharge display. “By designing everything at once,” maintains van der Windt, “we cut design costs by half.”

The C-MOS circuit serves in both the instrument’s time base and decade counters, a pair for each purpose. The chip itself measures 9 square millimeters (3.77 by 2.42 mm) and has the equivalent of 450 gates on it. The functions available are four decade counters plus latches, a multiplexer, and a three-stage output for cascading decades. About 90% of the functions avail-

able are used by the decade counters and rather less than 50% in the time base. The clock rate at 10 volts is guaranteed as 10 MHz. “Actually,” says van der Windt, “it usually measures out between 15 and 17 MHz.”

Van der Windt’s list of advantages that can be traced back to the LSI/C-MOS packages is a long one. Among other things, the instrument has a high 100-nanosecond time resolution, very low power consumption for the digital circuitry, small size, and high reliability. However, the benefits of the front-end circuitry are equally remarkable, he points out.

In the rf channel, there’s a multi-stage p-i-n diode circuit that attenuates the input signal to a level just slightly above 5 to 6 millivolts, the value of the trigger window. For the user, this means no worries about the level of the input signal, as long as its amplitude lies between 10 mV

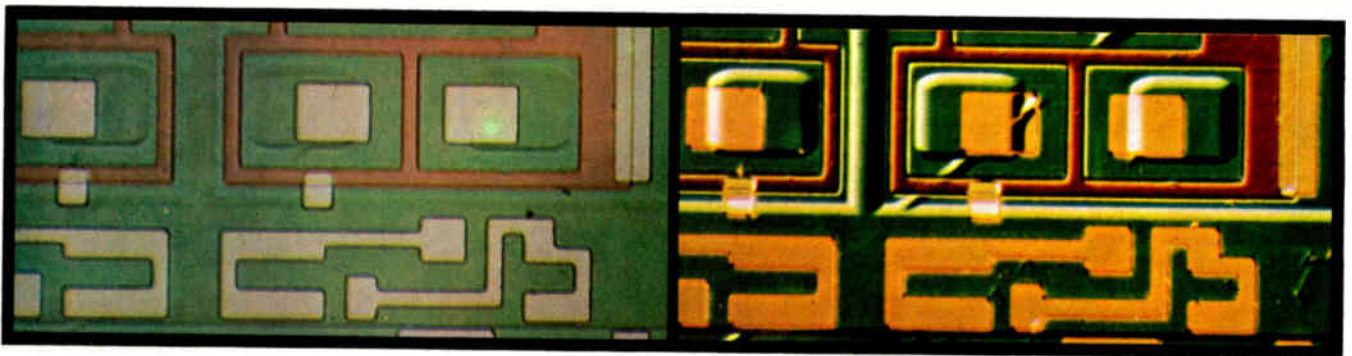

If this is all you're seeing, this is what you're missing.

The AO DICV Series 10 Differential Interference Contrast Microscope can make a big difference. A standard brightfield microscope reveals only what is shown in the specimen on the left.

Now look at the specimen on the right. With this ability to reveal significant detail in outstanding relief in black and white or color, the AO DICV Series 10 can help you spot surface irregularities, inclusions and faults.

By using incident light, after Nomarski, it provides contrast enhancement of opaque

and semi-opaque materials. Helps you make critical quality control checks of semi-conductors, integrated circuits and metallurgical samples.

AO DICV Microscopes convert quickly from interference contrast to brightfield.

So if you can't afford to miss something, you can't afford to overlook the AO DICV Microscope. For details, write American Optical Corporation, Scientific Instrument Division, Buffalo, N.Y. 14215.

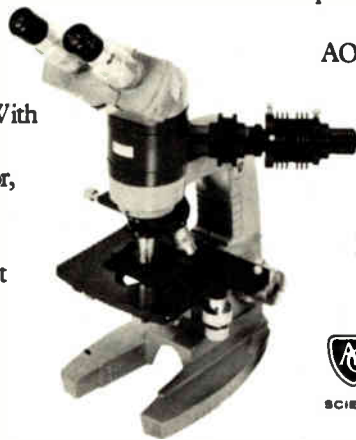

AMERICAN OPTICAL CORPORATION
SCIENTIFIC INSTRUMENT DIVISION • BUFFALO, N.Y. 14215

For built-in reliability, design with "Scotchflex" Flat Cable/Connector Systems.

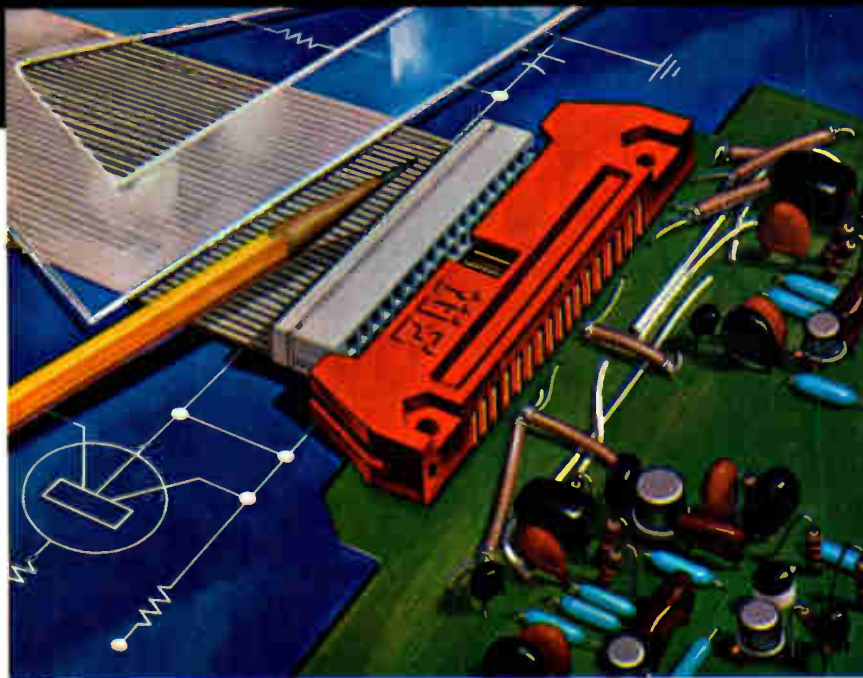

"SCOTCHFLEX" IS A REGISTERED TRADEMARK OF 3M CO.

"Scotchflex" Flat Cable and Connectors can offer you trouble-free packaging for your next generation equipment.

There's built-in reliability for your circuit inter-connects. Our flat, flexible PVC Cable has up to 50 precisely spaced conductors. The gold plated U-contacts are set into a plastic body to provide positive alignment. They strip through the insulation, capture the conductor, and provide a gas-tight pressure connection.

Assembly cost reductions are built-in, too. "Scotchflex" Connectors make up to 50 simultaneous connections without stripping or soldering. No special training or

costly assembly equipment is needed.

Off-the-shelf stock offers you flat cable in a choice of lengths and number of conductors from 14 to 50. Connector models interface with standard DIP sockets, wrap posts on .100 x .100 in. grid, or printed circuit boards. Headers are available to provide a de-pluggable inter-connection between cable jumpers and printed circuit boards (as shown). Custom assemblies are also available on request.

For full information on the "Scotchflex" systems approach to circuitry, write to Dept. EAH-1, 3M Center, St. Paul, Minn. 55101.

3M
COMPANY

PRINTED CIRCUIT RELAYS Without Socket or Soldering

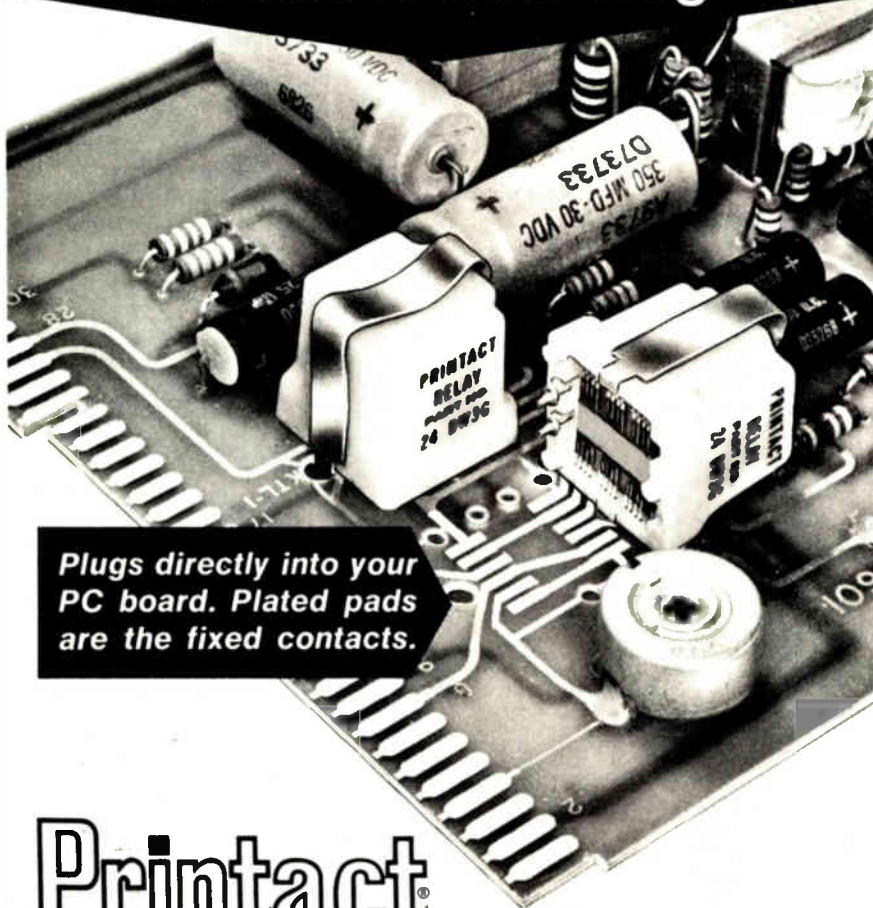

Plugs directly into your PC board. Plated pads are the fixed contacts.

Printact® MAGNETIC LATCHING AND NON-LATCHING RELAYS

Fully utilizing printed circuit technology Printact provides custom features. This compact low cost general purpose relay can be used in RF, Thermocouple and other specialized circuitry. The pivoting contact armature, hinged to a permanent magnet, is the only moving part. Elimination of pigtailed, return springs, and mechanical inter-connections assures long life and reliability for millions of cycles.

Relays with 6, 12, or 24 Vdc 500 mw coils have 2, 3, or 4 double break contact blades. Each blade can switch a form C or A and B in separate circuits, up to 2 amps. These small lightweight highly reliable Printact relays can save you space, time, money and manhours.

General purpose PC Boards for point-to-point wiring or solder-in mounting for multi-pole switching, cost less than plug-in sockets.

For a sample and catalog NOW write direct or call (212) EX 2-4800 for specs, design aids, and cost data on relays and PC boards.

Executone PRINTACT DIV. Box 1430, Long Island City, N. Y. 11101

Inherent Custom Features:

- **Low Thermal EMF**
Less than 2 micro-volts
- **Cross Talk Isolation**
70-50 db. over 50-500 Mhz
- **Characteristic Impedance**
75 ohms PC board pads
- **Low Contact Bounce**
Less than 0.5 ms
- **Bifurcated Blades**
Contact resistance stability
- **Encapsulated Coil**
Corrosion protection
- **Switching Versatility**
Blade functions as 2 poles
- **Plug-In Replacement**
Without solder or socket

New products

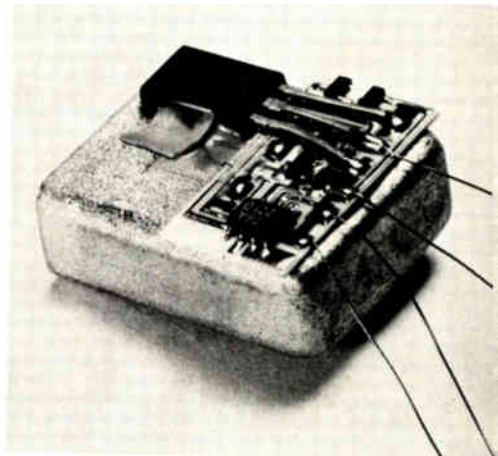

Ovenized. A transistor heats the crystal oven that is incorporated into high-stability versions of the PM6610 series.

and 12 v. (In other words, the dynamic range is 62 db.) Better still, the p-i-n diode attenuator eliminates false counts from noise on the measured signal. The noise is suppressed so much that it cannot span the trigger window. Actually, most models in the line offer two input channels, one for signals up to 80 MHz and one for signals higher than that. For noise-free low-frequency measurements, there's a low-pass filter that wipes out signal components that are higher than 100 kilohertz.

Van der Windt sees telecommunications servicing as a major market for medium-range counters, and for that reason the first model of the family to be marketed by Philips will be the PM6614. It spans the frequency range from 10 Hz to 520 MHz, has two input channels and the choice of four time bases (as do all models in the line). Other options include a battery pack for portable operation, binary-coded-decimal output to drive a printer, and a digital-to-analog converter that converts any three consecutive digits or the two least significant digits of the nine-digit readout. Room for the batteries and the BCD, a-d or printed-circuit cards is designed into the basic instrument.

Philips Industries, P.O. Box 42099, S-126.12, Stockholm, Sweden [339]
Philips Test and Measuring Instruments Inc., 400 Crossways Park Dr., Woodbury, N.Y. 11797 [364]

At last.



A FULL RANGE, 5-FUNCTION 3½ DIGIT MULTIMETER

\$189⁰⁰

Data Precision's new Model 134 is the least expensive full function digital multimeter you can buy.

A real workhorse.

Designed as the first real alternative to analog meters, the Model 134 delivers digital precision at analog prices.

Measurements appear on a bright, 7-segment planar gaseous display, a full half inch tall and 3½ digits wide.

And they're precise measurements. Approximately 5 to 10 times more accurate than what you'll get from an analog meter. And a great deal easier to read.

Model 134 measures DC and AC volts, DC and AC current and resistance through a total of 22 range scales. No interpolations are necessary.

And the specs speak for themselves: basic accuracy of $\pm 0.2\%$ reading $\pm 0.2\%$ f.s. with autopolarity, auto-decimal positioning and 100% overrange. Optional Isolation and High Voltage Probes available.

To get your hands on a 134, simply contact the representative nearest you for immediate delivery.

AL (205) 536-1941	MD (301) 552-2200	OH (N) (216) 243-7430
AZ (602) 948-8410	MI (313) 482-1229	OH (S) (513) 298-3033
CA (N) (408) 733-9000	MN (612) 781-1611	OR (503) 238-0001
CA (S) (714) 540-7160	MO (W) (816) 737-0066	TX (N) (214) 234-4137
CO (303) 449-5294	MO (E) (314) 731-2331	TX (S) (713) 461-4487
CT (203) 525-7647	NC (919) 275-3725	UT (801) 268-3181
HI (808) 262-6286	NJ (215) 925-8711	WA (206) 763-2210
IL (312) 593-0282	NM (505) 265-6471	
IN (317) 293-9827	NY (N) (315) 446-0220	CAN (W) (416) 661-1404
MA (617) 273-0198	NY (S) (516) 482-3500	CAN (E) (514) 731-9328

Data Precision Corporation
Audubon Road, Wakefield, MA 01880 (617) 246-1600

DATA PRECISION
...years ahead

FAST RECOVERY POWER RECTIFIERS

Reverse Recovery(T_{rr}) 200ns and 2 μ s

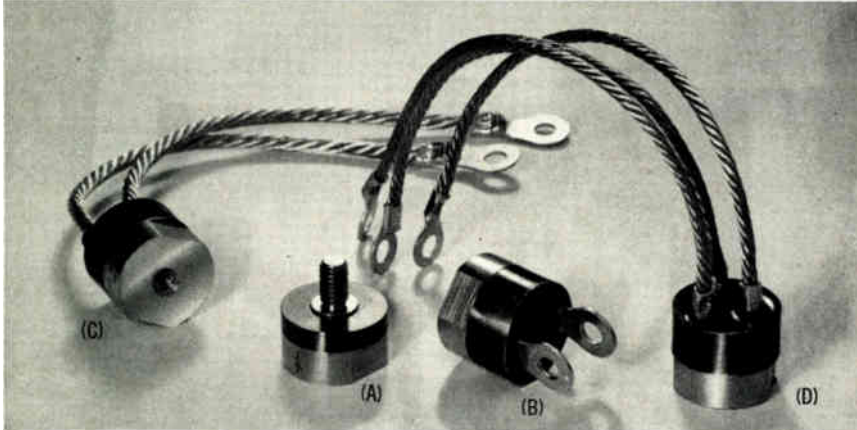

CUPAC 150

... the power house

CuPac 150 is specifically designed for high frequency-high power applications. CuPac 150 is capable of supplying up to 150 amperes with proper heat sinking. Available as half wave rectifier, doublers, center taps and three phase half wave bridge circuits.

Internally, CuPac 150 utilizes Semtech's Metoxilite rectifiers mounted on an (OFHC) oxygen-free hard copper insert base. Inherent rugged design and reliability enables the CuPac 150 to be used in stringent commercial, industrial, military and space applications.

Body Dimensions: 1.12" D x .70" H (+ stud)

FAST RECOVERY — (T_{rr}) 200ns. (Fig. A)

Peak Inverse Voltage: 50, 100, 200 & 400V.

V_F (max.) @ 100A: 1.40V, T_j @ 25°C;

1.35V, T_j @ 100°C.

Reverse Current (max.) @ PIV:

25 μ A @ 25°C; 1 MA @ 100°C.

MEDIUM RECOVERY (T_{rr}) 2 μ s.

PIV: 50, 100, 200, 400, & 600V.

V_F (max.) @ 100A: 1.22V, T_j @ 25°C;

1.17V, T_j @ 100°C.

Reverse Current (max.) @ PIV:

25 μ A @ 25°C; 1mA @ 100°C.

CUPAC 150, LO- V_F

Peak Inverse Voltage: 30 & 50V.

Reverse Recovery: 85ns (typ.) & 100ns (max.)

• 1/2 WAVE RECTIFIER

	@ 25°C	@ 100°C	@ 150°C
V_F (typ.) @ 20A	.86V	.77V	.72V
V_F (typ.) @ 60A	.95V	.88V	.85V
V_F (typ.) @ 100A	1.02V	.97V	.93V

• DOUBLERS & CENTER TAPS Figs. (B) & (C)

Body Dimensions: 1.12" D x .9" H (+ leads).

FAST RECOVERY (T_{rr}) 200ns

PIV: 50, 100, 200 & 400V.

V_F (max.) @ 50A: 1.40V @ 25°C; 1.35V @ 100°C.

Reverse Current, per leg (max.):

13 μ A @ 25°C; 500 μ A @ 100°C.

MEDIUM RECOVERY (T_{rr}) 2 μ s.

PIV: 50, 100, 200, 400 & 600V.

V_F (max.) @ 50A: 1.22V @ 25°C; 1.17V @ 100°C.

Reverse Current, per leg (max.):

13 μ A @ 100°C; 500 μ A @ 100°C.

• 3 PHASE 1/2 WAVE BRIDGE Fig. (D)

Body Dimensions: 1.12" D x .9" H (+ leads).

FAST RECOVERY (T_{rr}) 200ns

PIV, per leg: 50, 100, 200 & 400V.

V_F (max.) @ 33A: 1.40V, T_j @ 25°C;

1.35V, T_j @ 100°C.

Reverse Current, Per Leg @ PIV:

10 μ A @ 25°C; 350 μ A @ 100°C.

MEDIUM RECOVERY (T_{rr}) 2 μ s.

PIV, Per Leg: 50, 100, 200, 400 & 600V.

V_F (max.) @ 33A: 1.22V, T_j @ 25°C;

1.17V, T_j @ 100°C.

Reverse Current, Per Leg @ PIV:

10 μ A @ 25°C; 350 μ A @ 100°C.

• DOUBLERS & CENTER TAPS

	@ 25°C	@ 100°C	@ 150°C
V_F (typ.) @ 10A	.86V	.77V	.72V
V_F (typ.) @ 30A	.95V	.88V	.85V
V_F (typ.) @ 50A	1.02V	.97V	.93V

• 3 PHASE 1/2 WAVE BRIDGE

	@ 25°C	@ 100°C	@ 150°C
V_F (typ.) @ 5A	.86V	.77V	.72V
V_F (typ.) @ 15A	.95V	.88V	.85V
V_F (typ.) @ 25A	1.02V	.97V	.93V

NEW "STUD"

... Super stud rectifier



Semtech Corporation introduces the DO-5 Stud, a new series of high current silicon stud rectifiers for high frequency applications. Capable of supplying up to 50 amperes with proper heat sinking, the DO-5 Stud has been specifically designed for industrial, military and space applications. Metoxilite rectifiers are used internally, the base is a DO-5 configuration and terminals offer easy soldering properties.

Body Dimensions: .69" D x .45" H.

FAST RECOVERY (T_{rr}) 150ns

PIV: 100, 200, 300 & 400 V.

I_R (@ PIV), Per Leg: 13 μ A @ 25°C;

500 μ A @ 100°C.

V_F (max.) @ 50A: 1.40V @ 25°C;

1.35V @ 100°C.

MEDIUM RECOVERY (T_{rr}) 2 μ s.

PIV: 100, 200, 300, 400 & 600V.

I_R (@ PIV), Per Leg: 13 μ A @ 25°C;

500 μ A @ 100°C.

V_F (max.) @ 50A: 1.22V @ 25°C;

1.17V @ 100°C.

LO- V_F "STUD"



... Low forward voltage drop.

LO- V_F stud rectifier is specifically designed for high frequency, high power applications.

VERY FAST RECOVERY (T_{rr}) 100 ns.

Peak Inverse Voltage: 30V.

	@ 25°C	@ 100°C	@ 150°C
V_F (typ.) @ 10A	.86V	.77V	.72V
V_F (typ.) @ 30A	.95V	.88V	.85V
V_F (typ.) @ 50A	1.02V	.97V	.93V

"We're number 1 because we try harder"



SEMTECH CORPORATION

652 Mitchell Road, Newbury Park, California 91320
(805) 498-2111, (213) 628-5392 / TWX: 910-336-1264

CHICAGO: (312) 352-3227

DALLAS: (214) 253-7644

FLORIDA: (305) 644-5404

NEW JERSEY: (201) 654-4884

SAN FRANCISCO: (415) 328-8025

EUROPEAN SALES: (Switzerland) (042) 323-242

What you can't see can hurt you.

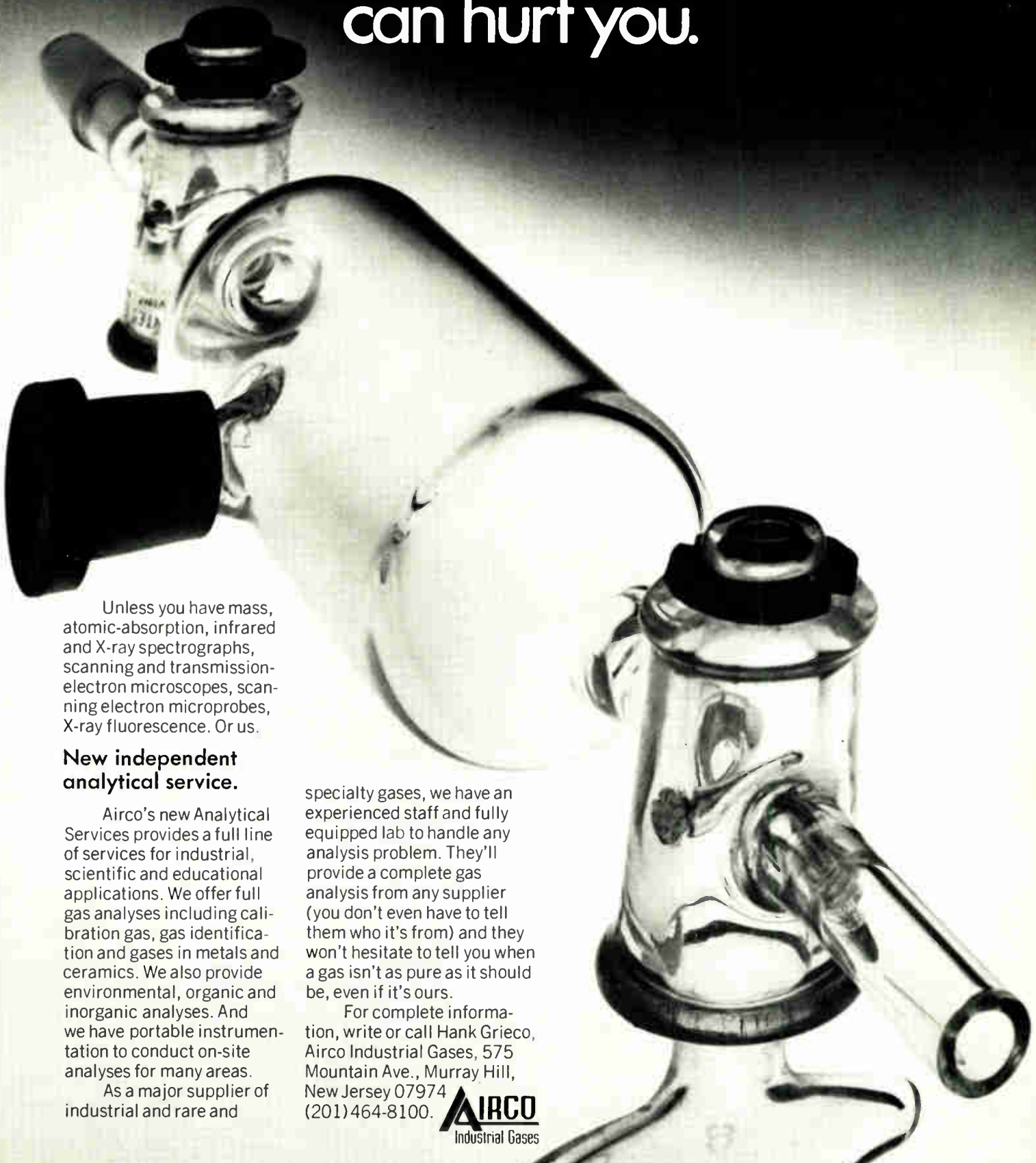

Unless you have mass, atomic-absorption, infrared and X-ray spectrographs, scanning and transmission-electron microscopes, scanning electron microprobes, X-ray fluorescence. Or us.

New independent analytical service.

Airco's new Analytical Services provides a full line of services for industrial, scientific and educational applications. We offer full gas analyses including calibration gas, gas identification and gases in metals and ceramics. We also provide environmental, organic and inorganic analyses. And we have portable instrumentation to conduct on-site analyses for many areas.

As a major supplier of industrial and rare and

specialty gases, we have an experienced staff and fully equipped lab to handle any analysis problem. They'll provide a complete gas analysis from any supplier (you don't even have to tell them who it's from) and they won't hesitate to tell you when a gas isn't as pure as it should be, even if it's ours.

For complete information, write or call Hank Grieco, Airco Industrial Gases, 575 Mountain Ave., Murray Hill, New Jersey 07974 (201) 464-8100.

AIRCO
Industrial Gases

You can save time and money with our VHF TV tetrodes/cavities from 2 kW up to 30 kW.

Our newest line of high gain tetrodes with Pyrobloc* grids gives you ruggedness -reliability- low cost.

* THOMSON-CSF Trade mark.

Common Amplification (Class A)		Peak Video output (Class B)		Cavity type
TH 298	2 kW	TH 298	3 kW	TH 18124
TH 361	5 kW	TH 361	15 kW	TH 18116
TH 371	10 kW	TH 371	30 kW	TH 18117

TYPICAL GAIN 16 dB

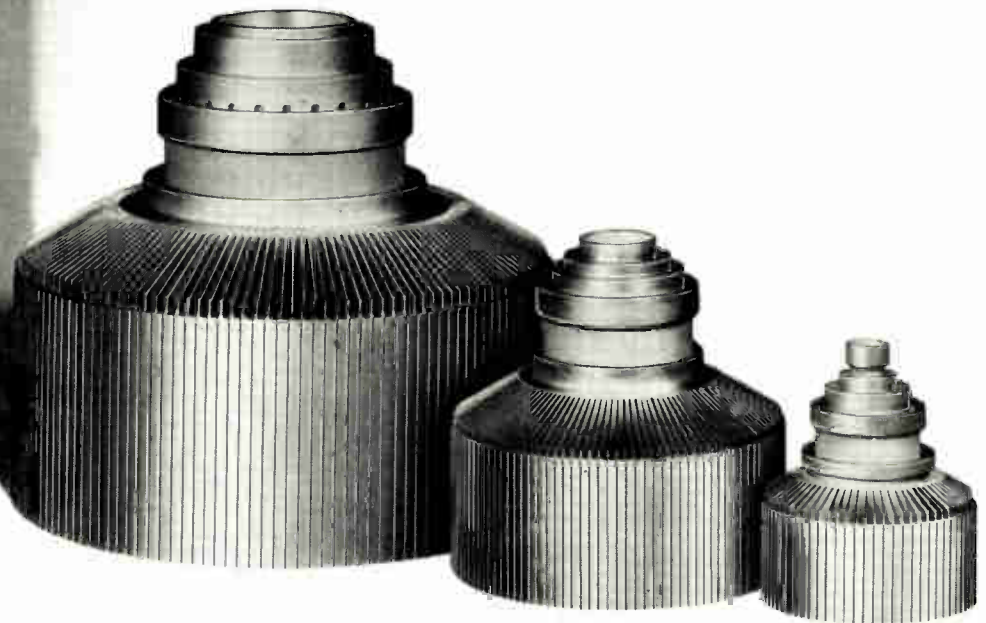

THOMSON-CSF

THOMSON-CSF ELECTRON TUBES, INC. / 50 ROCKEFELLER PLAZA / NEW YORK, N.Y. 10020 / TEL. (212) 489.0400

France - THOMSON-CSF Groupement Tubes Electroniques / 8, rue Chasseloup-Laubat / 75737 PARIS CEDEX 15 / Tél. 566 70.04

Germany - THOMSON-CSF Elektronenröhren GmbH / Am Leonhardsbrunn 10 / 6 FRANKFURT/MAIN / Tél. 70 20.99

Italy - THOMSON-CSF Tubi Elettronici SRL / Viale degli Ammiragli 71 / ROMA / Tél. 638 14.58

Japan - THOMSON-CSF Japan K.K. / Kyosho Building / 1-9-3 Hirakawa-cho / Chiyoda-ku / TOKYO / 〒102 / Tel. (03) 264.6341

Sweden - THOMSON-CSF Elektronrör AB / Box 27080 / S 10251 STOCKHOLM 27 / Tél. (08) 22 58.15

United Kingdom - THOMSON-CSF Electronic Tubes Ltd / Bilton House, Uxbridge Road, Ealing / LONDON W 5 2TT / Tel. (01) 579 55.11 / Telex : 25 659

Circle 138 on reader service card

THE SUPER 70

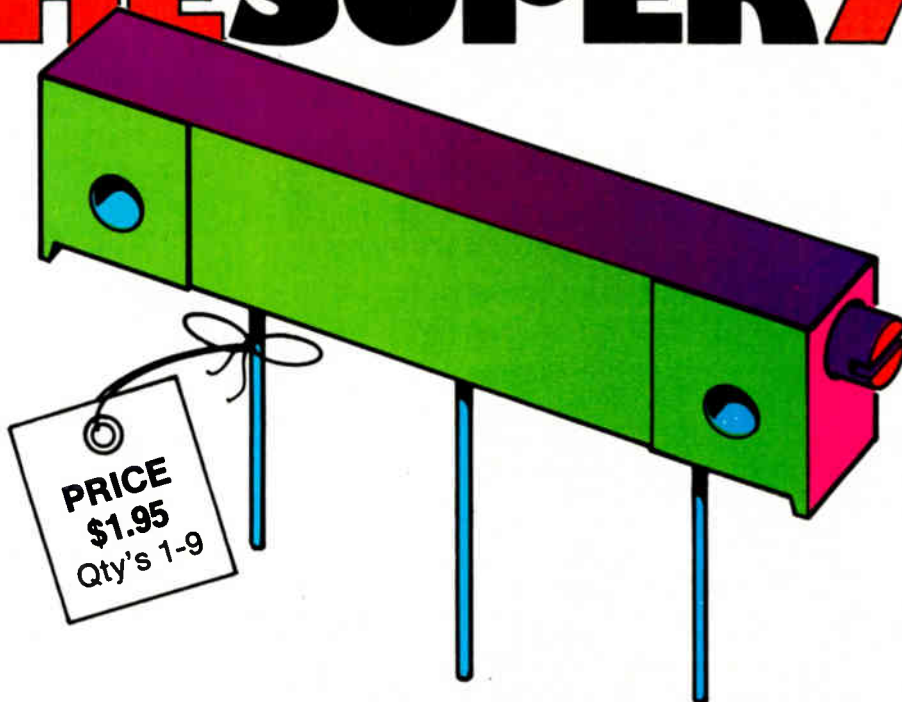

**The new 1-1/4-inch cermet trimmer
that replaces all these...**

55	215	949	3051	AB-MH
56	235	993	3052	AB-NP
58	272	995	3059	AB-NX
78	276	2855	6011	AB-RP
140	450	3011	6022	AB-RH
185	650	3012	AB-MP	ET-12

...with the most advanced features, too!

- Improved wiper and unique slider block design
- Excellent setability and stability
- TEMPCO of 100 PPM/°C
- 1 W @ 85°C
- Five configurations
- Conforms to MIL-R-22097.

Send for data sheet and quantity price information, or contact your local Spectrol representative or distributor.



SPECTROL ELECTRONICS GROUP

UNITED STATES Spectrol Electronics Corporation 17070 E. Gale Avenue, City of Industry, Calif. 91745, U.S.A. • (213) 964-6585 • TWX (910) 584-1314

UNITED KINGDOM Spectrol Reliance Ltd. Drakea Way, Swindon, Wiltshire, England • Swindon 21351 • TELEX: 44692

ITALY SP Elettronica spa Via Carlo Pisacane 7, 20016 Pero (Milan) Italy • 35 30 241 • TELEX: 32242



triacs & SCRs

3 Ampere

Sensitive Gate TRIAC's.
3mA, 4mA, 5mA, 10mA and
25mA DC Gate Current.
All Quadrant Gating.
50 to 600 Volts (V_{DRM})

4 Ampere

Sensitive Gate SCR's.
200 Microamp,
1mA DC Gate Current.
30 to 600 Volts (V_{DRM})

If it's a TRIAC or SCR you need, Hutson's state-of-the-art thyristor technology assures reliability and economy. All Hutson TRIAC's and SCR's available as void-free, glass-passivated chips or in standard package configuration. Call or write Hutson for complete information.



Box 34235 • 2019 W. Valley View
Dallas, Tex. 75234 (214) 241-3511
TWX 910-880-5537

Hutson Ind., International

30 Rue Pierre Semard, Yerres,
91 France. Tel.: Paris 925-8258
TELEX 21-311.

Distributors:

New York City 201/399-4350, Seattle
206/454-0300, Los Angeles 213/240-
3151, Dallas 214/231-6181, Baltimore
301/944-8262, Denver 303/757-7679,
Ft. Lauderdale 305/772-5100, Chicago
312/286-1500, Detroit 313/499-0188,
Syracuse 315/699-2671, Indianapolis
317/888-2260, Atlanta 404/427-0241,
Canada 416/638-1322, Beaverton 503/
643-1644, Dayton 513/433-2511,
Phoenix 602/968-9037, Minneapolis
612/866-3035, Waltham 617/890-8040,
Kansas City 816/765-2998.

Distributors:

Elizabeth 201/345-2420, Los Angeles
213/240-3151, Denver 303/934-5505,
Chicago 312/323-9670, Canada 416/
635-9880, Rochester 716/454-7800,
Belgium 02362135, Brussels
02352135, Denmark (01) 295622,
Norway 472702272, Spain 234-62-62,
Sweden 08-28-5940, Switzerland
051-852201.

New products

Instruments

Counter/timers are programmable

Factoring types permit
transducer readouts
in any desired unit

Electronic instrumentation does not always interface easily with industrial transducers—but United Systems' 8100 series of programmable factoring counter/timers should make the job easier. Each instru-

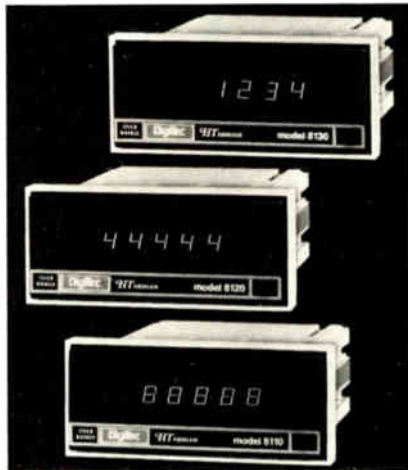

ment in the panel-mountable series contains a crystal-controlled clock and a programmable divide-by-N chip which combine to yield a time base that can be varied from 0.05 millisecond to 13 seconds in steps of 0.05 ms. This enables standard transducers to produce readouts in any desired units—English today and, if necessary, metric tomorrow—when some pin-to-pin wiring is changed.

The three instruments in the 8100 series feature full five-digit Monsanto LED displays. The model 8110 is a frequency counter that will transform the output of any frequency-producing transducer into any desired units. The model 8120, a totalizer, accumulates the output of any pulse-producing transducer and then factors it to read in such units as dozens, gross, cases, etc. The

8130 is a timer that is designed to measure time intervals and produce a direct reading in any desired units proportional to the time interval.

The trio also belongs to United Systems' new HT series [*Electronics*, March 7, p. 25] and have the same distinctive case design. Operating power is either 115 or 230 volts ac, at any frequency from 50 to 400 hertz. The meters mount in a standard panel cutout measuring 3.75 inch wide by 1.72 in. high.

The instruments, which are being sold under the Digitec tradename, cost \$275 apiece and are obtainable from stock. Substantial quantity discounts are available.

United Systems Corp., 918 Woodley Road,
Dayton, Ohio 45403 [361]

Digital panel instrument
is all things to all users

The biggest problem confronting the user of digital panel meters is how to interface them into his systems. To help him, Analogic Corp., Wakefield, Mass., has developed a 3½-digit (2,000-count) panel meter with a built-in edge connector into which a customized signal-conditioning network (see photo) can be plugged. Thus, for just a few dollars' worth of parts—typically \$1 to \$3—a user can convert the instrument into a pH meter, a linearized cold-junction-compensated thermocouple meter, a microwave power meter, a position of force indicator, or any of

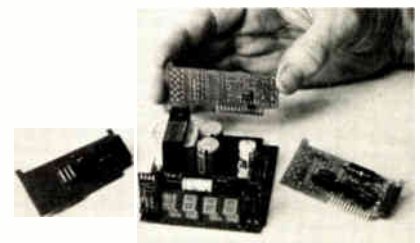

hundreds of other measuring instruments.

According to Bernard M. Gordon, President of Analogic, more than 200 instruments have already been designed and are described in a handbook which will be available later this month. The instrument, it

Nylon. Everything you want for electrical applications.

Connectors, switches, terminal blocks—just about everything electrical or electronic—gets a head start on performance and economics when you mold in Celanese Nylon.

For good reasons. Like the fact that Celanese Nylon has U/L rating on electrical properties of 105°C. Great me-

chanical strength and toughness. Plus high dielectric properties, so you can design more compact units with thinner walls. Good thermal properties. And fine processability.

There are many formulations of Celanese Nylon, including fast-cycling, high-flow grades, super mold re-

lease grades, glass-reinforced and heat-stabilized. We'll be glad to help select the best one for your electrical or electronic application.

Write for a copy of our brochure on Celanese Nylon. And a U/L Yellow Card. Celanese Plastics Company, Dept. N-507, 550 Broad Street, Newark, N.J. 07102.

Celanese Plastics Company is a division of Celanese Corporation. Canadian Affiliate: Celanese Canada Ltd. Export: Amcel Co., Inc., and Pan Amcel Co., Inc., 522 Fifth Ave., New York 10036



A TOUGH TEAM FOR TOUGH TIMES: CELCON[®] CELANEX[®] CELANESE[®] NYLON.

acetal copolymer thermoplastic polyester



**CELANESE
ENGINEERING
RESINS**

Circle 141 on reader service card



Domestic or Professional YOUR potentiometer is here



With our range of preset, rotary spindle, slider and rectilinear potentiometers—all designed around the prime requirements of noise-free operation and long life—we have brought new standards of quality and reliability to the potentiometer market for domestic or professional use.

In a technology not normally associated with dramatic breakthroughs we have introduced new ideas to component design and manufacture.

Like our Series PT preset pots which are fully enclosed in flame retardant plastic for protection from environmental factors. And the new PL40 slider pot, with its enclosed track and specially designed wiper movement that eliminates jitter, giving ultra-smooth operation.

Of course we also provide the usual options, like matched pairs for stereo applications, various terminal arrangements, earth screening and mains switches.

There's also the new PL25, a 20-turn rectilinear preset control for radio and tv varicap tuning applications.

In short, in any situation calling for high quality potentiometers, the discerning engineer should turn to Piher.

Write or ring for full details.

U.K. - PIHER International LTD.,
Romar House, The Causeway,
Staines, Middlesex, England.
Tel: Staines 56157. Telex 934167.

U.S.A. - PIHER International Corp.,
1239 Rand Road, Des Plaines,
Illinois 60016, U.S.A.
Tel: 312 297 1560. Telex 282154.

Germany - PIHER International GmbH.,
85 Nurnberg, Tuchergartenstrasse 4,
W.Germany.
Tel: 0911 533 051. Telex 623354.

France - PIHER International SARL,
83, Rue Etienne Dolet, 94230,
Cachan, France.
Tel: 656 26 07. Telex 27107.

Italy - PIHER International S.P.A.,
Via Caserio 34, 20154 Milan, Italy.
Tel: 314532/316213.

Head Office - Riera Cañado,
s/n Apartado de Correos 53,
Badalona (Barcelona), Spain.
Tel: 389 03 00. Telex 59521.

 **PIHER**

Circle 143 on reader service card

should be noted, provides regulated voltages of ± 12 volts dc and +5 v dc to the plug-in board so that active as well as passive components can be used in the signal-conditioning circuitry.

Even if its novel pluggable-transform feature is ignored, the new meter is impressive. It has a symmetrical, balanced, bipolar, true-differential front end, a power transformer that lets it run off any ac line voltage, a choice of LED or Beckman gas-discharge display, and a single-unit price of \$119, which drops to \$97 for quantities of 100 and up. A straight panel meter version, without the pluggable-transform capability, costs \$109 in singles, and \$87 in hundreds. Delivery of the meter is from stock.

Analogic Corp., Audubon Road, Wakefield, Mass. 01880 [363]

Low-cost generator operates up to 1 MHz

When is a frequency synthesizer not a frequency synthesizer? When it does not use the phase-lock technique, says Schneider Electronics Inc. The company prefers to call its model GF102 a frequency-synthesized generator, because the device reconstructs the sine wave by successive steps—a technique that keeps costs low.

Price of the GF102 is in fact \$495. It generates both sine and square waves in the range from 0.01 hertz to 100 kilohertz. The GF102A, priced at \$595, operates at up to 1 megahertz.

The sine-wave reconstruction works like this: the output from an 18-megahertz crystal-controlled oscillator is divided into segments, the length of which depends on the setting of thumbwheel switches. These segments are fed into a complex TTL system, which generates a code that goes to a digital-to-analog converter and an output amplifier. Each code constitutes an address which the converter sees as another step in building the sine wave. The duration of each step depends on the code that is going through the



thumbwheel switches. Between frequencies of 0 to 10 kHz there are 400 steps per sine wave, and up to 100 kHz there are 40 steps per sine wave.

Sine wave output has harmonic rejection of better than 50 decibels up to 10 kHz, 45 dB up to 100 kHz, and better than 40 dB for the model 102A. The nonharmonic rejection is respectively 50, 40, and 60 dB at 1 kHz from the carrier. Distortion is lower than 0.5% on the 102, and lower than 1% on the 102A.

As for the relative noise level, at 10 kHz it is 100 dB, and at 10-100 kHz, it is 90 dB. Relative noise level is also 90 dB in the 102A. Output voltage is 10 watts peak to peak. Attenuation is 50 dB with an accuracy within 0.1 dB.

The square-wave output has a rise and fall time of less than 50 nanoseconds. The duty cycle, which is fixed at 50%, has an accuracy within better than 0.5% for frequencies above 10 kHz, while below 10 kHz displacement is less than 100 microseconds. Output voltage is 5 volts on 50 ohms, and impedance is 50 ohms $\pm 5\%$.

For both sine and square waves, output is floating, and frequency is accurate to within 0.005%. Internal impedance of both the 102 and 102A is 50 ohms $\pm 5\%$, while inductance in the 102A is 15 microhenrys $\pm 20\%$. Both units have a maximum output power of 0.2 watt and can operate in a temperature range of 0-50°C, with a temperature coefficient of 0.001%/°C. Since the units are digital, there is no drift over time.

Although the reconstructed-sine-wave technique limits the units to frequencies of not more than 1 MHz and introduces some phase jitter, Schneider believes the 102 and 102A can be used in most applications except control of trans-

BODINE TRAN-BAL[®]

Fluorescent Lighting From D.C. Power

- Transistorized inverter ballast for operating fluorescent lamps from low voltage D.C. current.
- Designed for applications requiring long life, reliability and efficiency.
- Models can be synchronized to prevent beat notes between lamps in multiple lamp installation.
- Rapid start and instant start models from 4 to 40 watts.
- Eliminate lamp flicker with high frequency operation.
- Protection against reverse polarity available.
- Replaceable transistors and in line fuses.
- Solves many photo electric problems.

BODINE CO.
MANUFACTURERS OF ELECTRONIC EQUIPMENT
236 MT PLEASANT ROAD • COLLIERSVILLE TENNESSEE 38017
Area Code 901/853-7211

Circle 144 on reader service card

Are you in High-Speed Digital Communications?

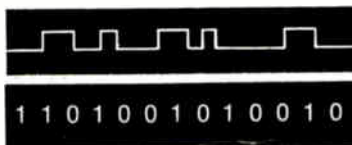

We make really fast test equipment. *Imagine!* Bit rates to 1.0 GHz and a BERT, too. If you work in high-speed PCM communications, state-of-the-art device design, or other engineering R&D, you should contact us. We also have pulse sources and data/word generators. Call or write.

tau-tron
inc

11 Esquire Road, North Billerica, Mass. 01862
Tel: (617) 867-3874

\$500*

BALANCED



MIXER MODEL MD-108

- DC - 500 MHz
- 7dB Conversion Loss
- 30dB Isolation
- 8 - Pin Relay Header

* 500 piece qty. 1-49 pieces (\$7.00)
50-499 pieces (\$6.00).

anzac
ELECTRONICS



39 Green Street, Waltham, Mass.
(617) 899-1900 • TWX 710-324-6484

Circle 221 on reader service card

New products

mitters. And on the plus side, Schneider claims there is no limit on low frequency: the sine wave always starts at zero.

Both instruments are one-half 19-inch-rack size. Delivery time is 8 days.

Schneider Electronics Inc., 3 Hazel St., Peabody, Mass [352]

Error rate tester has automatic synchronization

The use of emitter-coupled logic throughout a new bit error rate tester from Tau-tron Inc. yields a good increase in speed for only a small increase in cost over conventional testers, according to Tau-tron vice president John Connolly. The tester has a frequency range of 1 hertz to 75 megahertz, a minimum width of 5 nanoseconds, and a price of \$1,800.

Designated the MB-1, the unit is the latest addition to a line of plug-in, modular instruments that provide various electrical stimulus and measuring functions. Intended for use in production, they are a departure for a company known principally for its expensive, laboratory-type test equipment and instruments.

The new tester provides automatic synchronization, with two error thresholds of 20 errors in 100 bits, and 2×10^4 errors in 10^5 bits. A burst-error-rate indicator lights whenever the auto sync error threshold is exceeded. The unit can also be synchronized manually from the front panel or by an external-standard level.

The unit operates at six different sequence lengths. A six-position code switch selects the number of bits per frame, expressed as 2^{n-1} where n equals 6, 9, 11, 15, 17, or 20. Frame sync is derived from a 20-bit digital comparator. After link-up, error rates are displayed on a four-digit LED display with overflow and gate time indicators.

Also measured by the MB-1 is block error, something Connolly says few units above a few megahertz do. A four-position switch se-



NEW

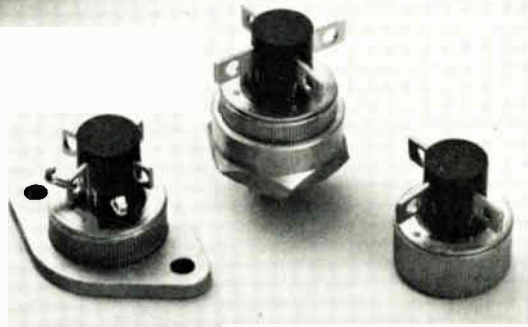

SCR CONTROLLED BRIDGE RECTIFIERS AND POWER SWITCHES

The VCB series of 25A and 50A controlled bridges and power switches are available in a 3/4" press-fit package, with three mounting options and in epoxy packages. All units are hermetically sealed.

The epoxy packages are explosion proof and electrically isolated with double isolation available. SCR's are glass passivated. All chips are soldered to an integral copper mounting pad for improved thermal characteristics, typically $<1^{\circ}\text{C}/\text{W}(\text{R}_{\theta\text{JC}})$. Epoxy barriers have been placed between standard .250" Faston and/or #10-32 terminals. Spacing exceeds NEMA standards.

Typical applications include DC motor speed controls, temperature controllers, battery chargers, inverters, frequency changers, D.C. power supplies, and servo systems.

All units are available in 60V, 115V or 230V, (V_{RMS}).

Typical economical pricing: VCB252-7 (200V, 25A) \$9.00 ea., 100 qty.

PRESS-FIT

ELEC. ISO. EPOXY BARRIER PACKAGES

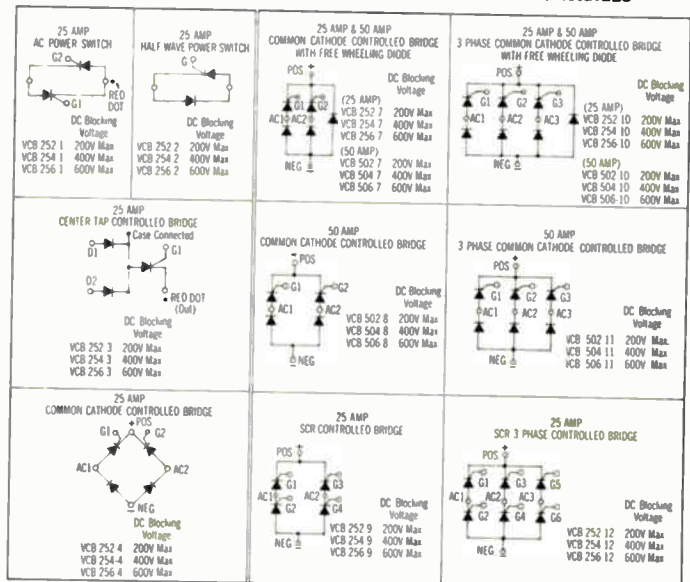

Design us in . . . we'll stay there



VARO

VARO SEMICONDUCTOR, INC.

P.O. BOX 676, 1000 N. SHILOH, GARLAND, TEX. 75040 (214) 272-4551 TWX 910-860-5178

For Capacitance at High Voltage and High Current

With low loss, stability of capacitance, easy variability and puncture-proof dielectric, Lapp Gas-Filled Capacitors provide for high-voltage application the same operating advantages as open-air plate capacitors—in compact design.

From the earliest days of high-power radio transmission, Lapp gas-filled capacitors have provided a high order of reliability. Available for broadcast or industrial RF generator use to 85kv peak, at current ratings to 390 amps at 1 MHz, and capacitances to 22,000 pf.

Write for Bulletin 302. Lapp Insulator Division, Interpace Corporation, LeRoy, N. Y. 14482.



Gas-filled Capacitors by **Lapp**

INTERPACE
CORPORATION

New products

lects bit rate or block lengths of 10,000 or 1,000 bits per frame. Block error is also displayed on the LED panel.

A three-position switch selects the counter mode; "time rate" selects bit or block error mode, "frame" displays errors per pseudo-random bits sequence, and "totalize" accumulates error pulses on an internal time base or a time defined by the external counter gate.

The unit is intended for standard communications markets such as microwave radio, as well as offbeat applications like magnetic recording. The 7-by-8-by-19 inch unit is priced at \$1,800, or \$3,500 when Tau-tron's MN-1 random-sequence generator, frame, and power supply are included.

Tau-tron Inc., 11 Esquire Rd., No. Billerica, Mass. 01862 [362]

Noise-power ratio
is displayed digitally

One of the most useful techniques for testing broadband communications channels is measurement of the noise-power ratio. An automatic white-noise loading receiver, designated the model 2092C, was designed for this type of test and can be used in conjunction with existing generators in the semiautomatic mode. The receiver automatically adjusts its sensitivity to the incoming noise level, intermodulation noise level, or residual noise level. The noise-power ratio is automatically determined and the result presented in a three-digit display. Programable control and digital output permit use of the unit in automatic test systems at central radio sites and satellite ground stations. Price is \$3,500.

Marconi Instruments, 111 Cedar Lane, Englewood, N.J. 07631 [353]

Frequency synthesizer
covers to 20 MHz

Designed to allow users of test oscillators to economically step up to frequency synthesis, the model 801

**This member
of our family
is still the
thriftiest ASR
terminal
around.**

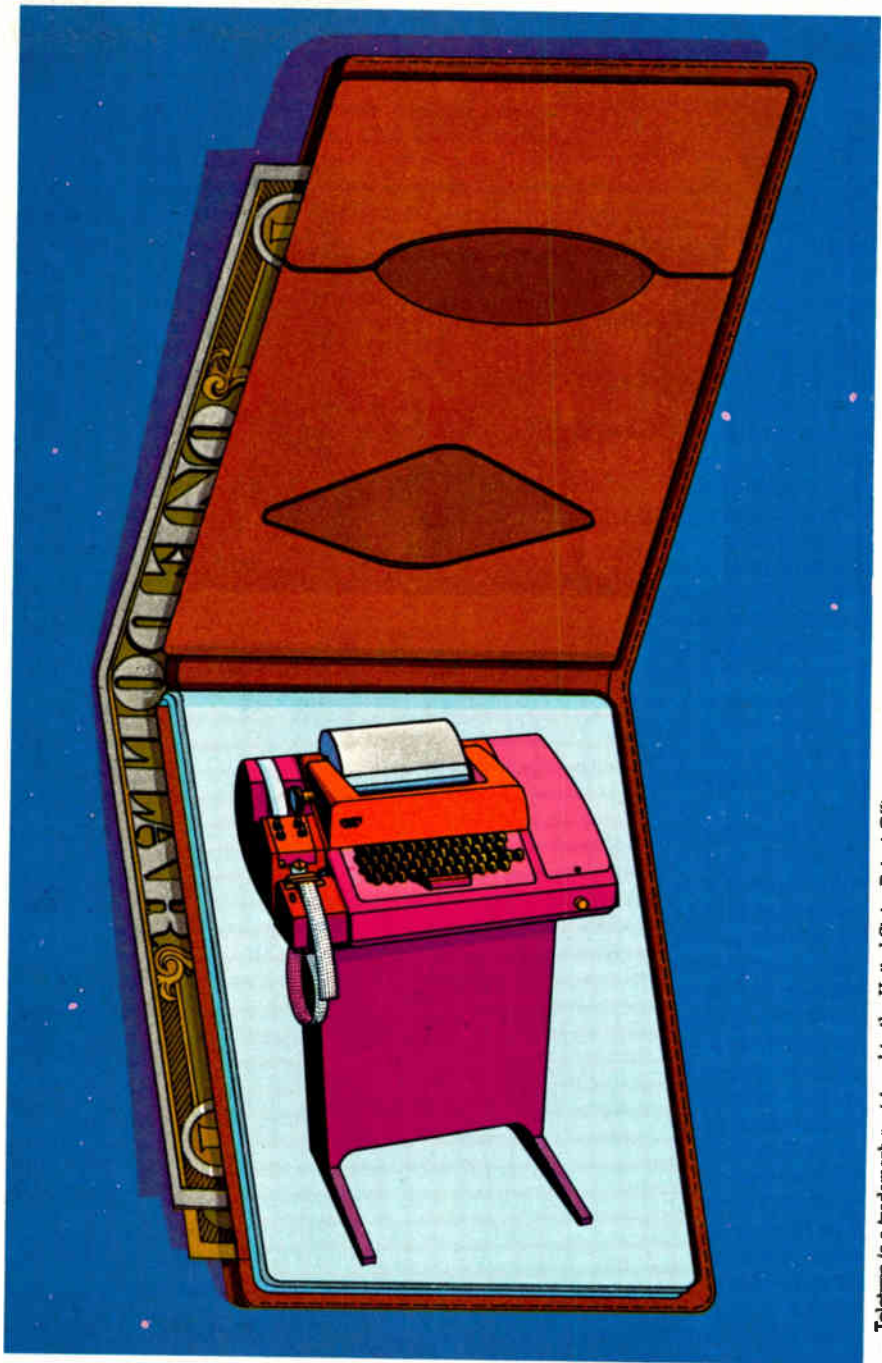

Teletype is a trademark registered in the United States Patent Office.

Dollar for dollar, the Teletype® model 33 is the least expensive, most reliable data terminal in its class. Because once you see how well it performs, you won't believe its price.

That's one reason why the model 33 is the most popular terminal in the industry. But it's hardly the only reason.

The model 33 is designed and built for extremely reliable operation at 100 wpm. And since

it operates on the eight-level ASCII code, it speaks the language most computers understand. Both mini-computers and maxi-computers. Which makes compatibility another reason behind its popularity.

Then there are some reasons you can't see. But they're there just the same. Like complete technical sales and service back-up to help you with installation and maintenance.

Available in three basic configurations, the model 33 is a lot of machine. At a very small price.

It takes more than manufacturing facilities to build the machines Teletype Corporation offers. It also takes commitment. From people who think service is as important as sales. In terminals for message communications and computers.

That's why we invented a new name for who we are and what we make. The computercations people.



The computercations people.

For more information about any Teletype product, write or call: **TERMINAL CENTRAL**, Teletype Corporation, Dept. 53P, 5555 Touhy Avenue, Skokie, Illinois 60076; Phone 312/962-2500.

Centralab perspective:

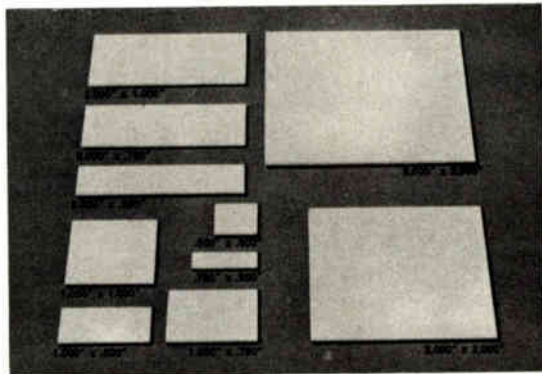

95% Alumina Substrates Now you can get standard sizes from your Centralab Distributor.

For the first time, anywhere, your Centralab Distributor is now stocking 10 of the most popular sizes of substrates. He can provide fast delivery on 100 to 10,000 pieces at prices as low as 5 cents each, depending on size and quantity. All are 95% alumina . . . white . . . in .025" thickness . . . 25-50 microinch surface finish . . . for up to 1700°C use. They match your specifications for dimensional tolerance, dielectric and mechanical strength and more.

Until now, prototype and limited production quantities of ceramic substrates were only available on factory orders with the usual minimum billing. We've changed that . . . to help you quickly and economically meet your need for the finest precision substrates.

Get complete specifications from your Centralab Distributor or send coupon.

Centralab Distributor Products
5757 N. Green Bay Ave. Dept. AS-2
Milwaukee, Wisconsin 53201

Name: _____

Company: _____

City: _____ State _____ Zip _____

DISTRIBUTOR PRODUCTS



CENTRALAB
Electronics Division
GLOBE-UNION INC.

New products

frequency synthesizer offers a signal source with crystal-controlled stability, high frequency accuracy and resolution, and remote-control programming. The unit offers coverage to 20 megahertz in four synthesized digits, plus two additional vernier digits. Using the first four digits, frequency error is $\pm 0.001\%$ and, by using the instrument's phase-lock input, the unit can be slaved to an external frequency standard for higher accuracy. Price is \$1,995.

Exact Electronics Inc., Box 160, Hillsboro, Ore. 97123 [357]

Sound-level meter includes
miniature microphone

The model db-202 sound-level meter provides a remote miniature microphone, which is placed next to the user's ear to determine sound-level measurements. In this way, sounds are measured in real time. Pendant-type and boom microphones are also offered. The small pendant microphone is attached to a subminiature 5-foot shielded cable, while the boom microphone, which is smaller than a pencil, is attached directly to the sound meter.

Metrosonics Inc., Box 18090, Rochester, N.Y. 14618 [358]

Portable oscilloscope
has 120-MHz bandwidth

Providing a remote dc switching function for optimum control-panel layout, the model PM3260 portable oscilloscope operates over a line variation of 90 to 250 volts and 46 to 440 hertz. Its basic specifications include a 5-millivolt-per-division sensitivity, as well as a 5-nanosecond-per-division maximum sweep rate. Bandwidth is 120 megahertz. In addition, the 3-nanosecond rise time can be displayed in separate, alternate, chopped, or X-Y mode, and a 1-MHz chopping rate helps to eliminate interference in the displayed signals. Price is \$1,850.

Test and Measuring Instruments Inc., 224 Duffy Ave., Hicksville, N.Y. 11802 [359]

A flexcircuit for low-light home movies.

We did it for Kodak.

In turning the idea of low-light home movie making into the reality of the KODAK XL-55 Movie Camera, Kodak engineers solved tough design problems at every step. Among these problems, the design of a circuitry system of minimal bulk and maximum reliability.

They accomplished this with a Schjeldahl flexcircuit.

Flexing in four planes, this Schjeldahl flexcircuit has two 180 degree fold-over sections. This provides circuit reversal, transfers conductors to opposite sides of the circuit without the expense of plated-through holes and permits placement of seven conductors in a five conductor space — all without two-sided circuitry.

This Schjeldahl flexcircuit makes all electrical connections in the camera and carries all electronic components. For manufacturing efficiency, a hardboard back-up section permits auto insertion of components and continuous process wave soldering.

The flexcircuit fits available space and is designed for volume production. It does for Kodak what flexcircuitry does best.

Perhaps Schjeldahl flexcircuitry advantages can help in your design problems. It only takes a call to Schjeldahl to find out.

Schjeldahl did it for Kodak.



Schjeldahl Company

Electrical Products Division
Northfield, Minnesota 55057
Phone: (507) 645-5633

The state of the art people in volume flexible circuits

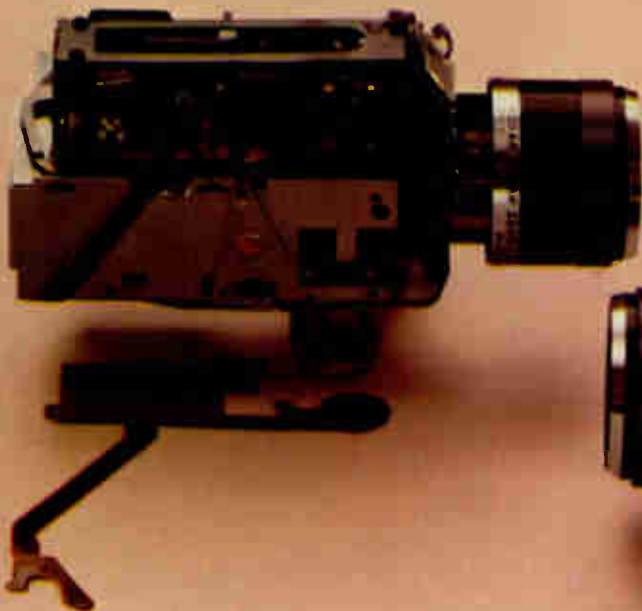

And we can do it for you.

Circle 149 on reader service card

© 1973 G.T.S. Co

Now you can intermix low level, high level and simultaneous sample & hold inputs



With amplifier-per-channel System 620

SYSTEM 620. A BETTER MOUSETRAP

In less than 2 years, our amplifier-per-channel System 620 has become industry's most popular high speed data acquisition system. Today, thousands of channels are performing reliably in the field. In scores of applications from Turbine Engine Test to Earthquake Engineering. Now System 620 is even more flexible than before. With 3 input amplifier options, four analog-to-digital converters and several computer interfaces to choose from. So here's the latest chapter on System 620, the new approach in data acquisition.

LOW LEVEL AMPLIFIERS

Our field proven low-level differential amplifiers are perfect for strain gages & thermocouples since transducer signals are isolated right at the source. Our specs are impressive, too. With gain accuracy of 0.01%, 2 microvolt stability and 120 dB common mode rejection. More protection, too. If one channel gets wiped out by an overload, the rest don't feel a thing.

Circle 150 on reader service card

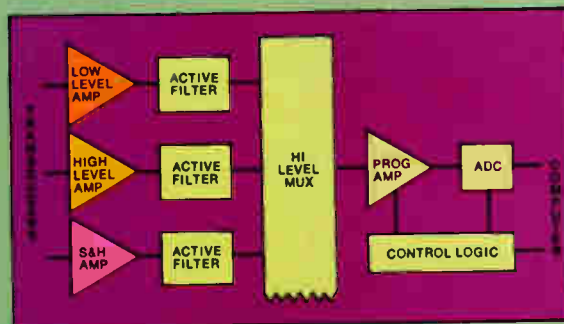

NEW HIGH LEVEL AMPLIFIERS

Since high gain isn't always required, we've added an amplifier option which, for just \$80 a channel, provides system gain of 1 to 400. That's more than adequate for many applications. Yet, retains all the features of our low-level amplifiers.

NEW SIMULTANEOUS SAMPLE & HOLD AMPLIFIERS

Low level sample & hold amplifiers are absolutely necessary in applications such as transient and vibration analysis, where data must be grabbed in a few nanoseconds or time correlation of data is important.

Low level, high level and sample & hold amplifiers can be freely intermixed in System 620.

And each amplifier in the system includes an active low pass filter with selectable cutoff frequency. Another important point. Continuous analog output is available on all channels.

FOUR ADC OPTIONS

System 620 now has four analog-to-digital converters to choose from. If you need high accuracy, we can give you 14 bits at 20kHz. In most systems our economical 12 bit, 10 kHz analog-to-digital converter will suffice. Or if higher speed is your need, specify 12 or 15 bits at 50 kHz.

COMPUTER INTERFACE

System 620 has been interfaced with a number of computers, both large & small. Interface hardware and software is available for most popular computers.

For the up-to-date story on System 620 — the new approach to data acquisition — phone or send for our brochure today.



1088 E. Hamilton Rd., Duarte, Calif. 91010
Tel. (213) 357-2281 TWX 910-585-1833

New products

Packaging & production

IC socket keeps board profile low

Terminals are on same side as sockets, giving over-all height of 0.355 inch

Each printed-circuit board in a densely packaged electronic system should have a low over-all profile. But that goal can be difficult to achieve if the designer uses wire-wrapped tails, because they jut out

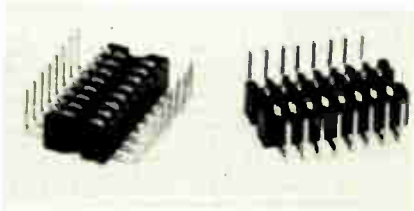

from the side of the board opposite the component side.

This problem is eliminated by an integrated-circuit socket developed by Robinson-Nugent Inc. Socket and terminals are mounted on the same side of the board, and the result is an over-all board height of 0.355 inch. The close proximity of socket contacts and wiring terminals also makes it easy to identify pins and component leads, thus eliminating a major cause of wiring errors.

"The pressure for a low profile is growing," says Marc Amster, Robinson-Nugent's national sales manager, "because designers are eager to mount many IC functions in equipment such as point-of-sale terminals, reservations systems, and credit-card validators—and still end up with a compact package."

The contact/terminal system developed by the Indiana company is also said to provide a good electro-mechanical mating of socket contact and IC lead. Since the contact bears on the flat side rather than on the edge, contact surface area is about 60% greater, lowering contact resistance and increasing the reliability of the contact interface.

Made from a spring-tempered beryllium copper, the contact provides a good mating with IC leads ranging in thickness from 8 to 18 mils. The socket is available with either gold- or tin-plated contacts. Socket bodies are molded of glass-filled nylon and are end-notched to facilitate mounting either singly or in series with #2 fillister-head, self-tapping screws.

Robinson-Nugent Inc., 802 E. Eighth St., New Albany, Ind. 47150 [391]

Panel mount accepts any dual in-line LED

A universal panel mount accepts any dual in-line LED display packaged with a 0.3-inch row spacing. The unit consists of a one-piece nylon bezel, a circular polarizing window, and a one-piece socket assembly that is located behind the panel, thus eliminating the need for individual DIP sockets. Dual in-line displays with 14 or 16 pins can be accommodated in presentations from two to eight units. The socket as-



sembly has wire-wrapping terminations and a 20-pin capacity. Further, no mounting holes are needed other than a single panel cutout, and after installation of the bezel, the display package aligns itself.

Industrial Electronic Engineers Inc., 7720-40 Lemona Ave., Van Nuys, Calif. 91405 [393]

Pc connector eliminates need for interfaces

A printed-circuit connector, which eliminates the need for a hybrid interface between electrical and electronic circuitry, substitutes for as many as four conventional inter-

OPTO-ISOLATED SOLID STATE RELAY for

switching at 115 V.A.C. or 240 V.A.C.

13 amp continuous rating.

Zero voltage switch-on for low R.F.I.

Low level D.C. triggering 3 volts min.

High surge — 150 amp single cycle.

All solid state integrity.

Integral heat sink.

Used in: Industrial Control, Office Machinery, Medical Electronics, Computer Systems.

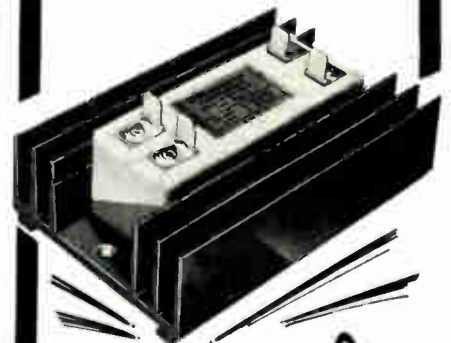

AR
ELECTRONICS LTD
WIMBORNE - DORSET - ENGLAND
TELEPHONE: WIMBORNE 2442 · TELEX 41247

FREE...



1974 Heath/Schlumberger electronic instrumentation catalog.

The new '74 Heath/Schlumberger instrumentation catalog is here... 32 pages of high performance electronic equipment... all at budget-stretching prices. Whatever it is that you need in electronic equipment for test and design work, R&D applications or for teaching, Heath/Schlumberger has it...

at less than you planned to spend. 600 MHz frequency counter with 7-digit LED readout and complete programmability for only \$795* (left)... dual trace 15 MHz scope only \$595*... multi-range, multi-speed strip chart recorder system just \$335*... a patchable mini-computer interface system, just \$1250*... the famous Malmstadt-Enke Lab Stations... dozens of plug-in circuit cards... power supplies... generators... digital multimeters... and hundreds of other instruments. To get your FREE copy of this catalog now, visit your local Heathkit Electronic Center or use the coupon below.



at less than you planned to spend. 600 MHz frequency counter with 7-digit LED readout and complete programmability for only \$795* (left)... dual trace 15 MHz scope only \$595*... multi-range, multi-speed strip chart recorder system just \$335*

... a patchable mini-computer interface system, just \$1250*... the famous Malmstadt-Enke Lab Stations... dozens of plug-in circuit cards... power supplies... generators... digital multimeters... and hundreds of other instruments. To get your FREE copy of this catalog now, visit your local Heathkit Electronic Center or use the coupon below.

HEATH
Schlumberger

Heath/Schlumberger Instruments
Dept. 531-286
Benton Harbor, Michigan 49022

Please send 1974 Electronic Instrumentation catalog.

Name _____

Title _____

Company/Institution _____

Address _____

City _____ State _____ Zip _____

*Mail order prices; F.O.B. factory. **EK-419**

New products

connect techniques. It does away with many connections among logic boards, flexible cable, barrier blocks and terminal blocks. Designated the PCB Block, the connector permits direct plug-in of 0.200-inch-contact-spaced pc boards on which components or flat flexible cable can be mounted. The block also provides 300-volt insulation between circuits, and each circuit can carry up to 5 amperes. Blocks can accommodate six, 12, 18, 24, 30 and 36 circuits.

Amerace Corp., Control Products division, 2330 Vauxhall Rd., Union, N.J. 07089 [394]

Terminating machine offers low deflection

The UTM-2 universal terminating machine provides high-volume installation of open-barrel strip termi-

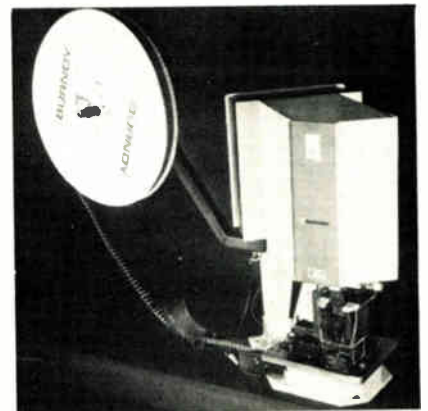

nals and contacts, with end- and side-feed capability. Low deflection is achieved by using a 5-ton steel press and a roller clutch, which insure crimps of consistent quality and long tool life. A dial permits fast selection of crimp and insulation height for a wide range of AWG sizes without changing the crimp tooling.

Burdy Corp., Norwalk, Conn. 06852 [396]

IC socket board replaces solder joints

An integrated-circuit socket board with 108 patterns is a wire-wrapping system; it contains a two-piece wire-wrapping-to-wire-wrapping connec-

The case for Liquid Crystal Displays

Liquid crystal displays; light emitting diodes; incandescent and fluorescent displays and "Nixie" tubes are popping up frequently in circuit designs as the trend to digital readout continues. Each has a purpose and the design engineer should become familiar with all types. We make liquid crystal displays.

The display of the future?

Our display is a sandwich of two plates, joined and hermetically sealed at the perimeters. A space of about .005" separates the plates, and this is filled with a nematic liquid crystal solution.

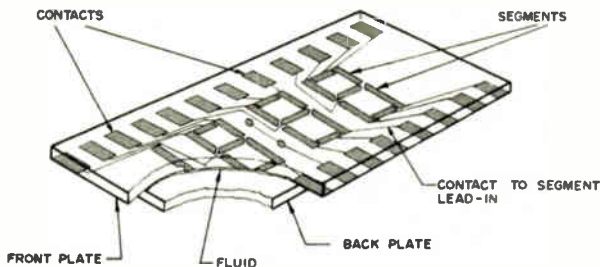

When the liquid is not electrically excited, its long, cigar-shaped molecules are parallel to one another in a position perpendicular to the plates. Thus, the liquid appears transparent. Applying an electric current creates ion activity which leads to turbulence and causes the liquid to scatter incident light. The visual effect is that of a frosted glass. LCD's can be made completely transmissive for back-lighting, reflective for ambient light or semi-reflective for dual mode operation.

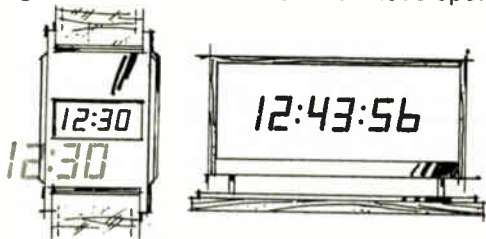

Producing an image — digital or other — simply requires a conductive surface the shape of the desired image on the glass plate toward the viewer. Current flowing from the conductive image on the front plate through the crystal liquid to the common-ground back plate causes the liquid to change from clear to a frosted appearance in the current-carrying area.

These images are almost always in the form of seven segments that make up the numerals 1 through 0. Energizing the proper segments produces the desired numerals. Lead-ins connect the segments to external contacts on the sandwich (display).

Consider the advantages.

Liquid crystal displays have a number of distinct advantages. Simplicity is the reason for several of these. The elements are few and passive — very little can go wrong with an LCD and this means reliability and long life.

Simplicity means low cost, too — lower than that of most comparable displays. Packaging costs are low because LCD's can be driven directly by MOS and C/MOS circuits. In our dynamic scattering displays very narrow character widths are possible and still provide a good viewing angle — 60 degrees in many cases.

Low power consumption makes the LCD a logical choice where power limitations rule out other display types. Watch type LCD's use only 30 μ W, for example, with all segments energized at 15 volts.

LCD's offer the greatest flexibility of any display type. Several standard displays are immediately available from Hamlin's stock. Special displays with virtually any type of image can be produced with surprisingly low preparation or "tooling" cost. Because of the LCD's simplicity, lead time on specials is only a matter of weeks.

A few limitations.

LCD's have limitations, too. Operating temperature range is one. Liquid crystals slow down and may even cease to function at temperatures below 0°C. Above 50-60°C, crystals go into solution and will not function normally.

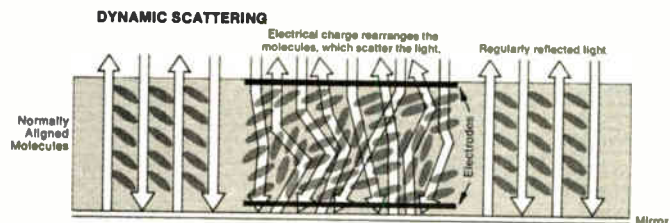

Extremes do not damage LCD's. Once the temperature returns to normal, operation is automatically resumed.

LCD's do not generate light, and they are somewhat difficult to read under low ambient light conditions. (Side or back lighting can remedy this.) Visibility under medium to high ambient light conditions is excellent.

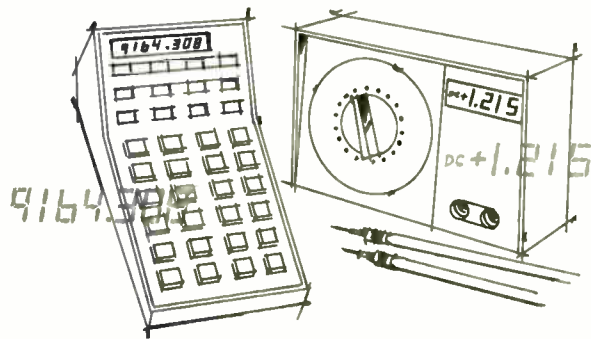

In the majority of display applications, MOS and C/MOS compatibility, reliability, flexibility and low power requirement are important considerations. No other display type can match the liquid crystal display on these jobs. They could become the display of the future. And that's the case for the LCD. For specification and application data, write Hamlin, Inc., Lake Mills, Wisconsin 53551. Or call, 414/648-2361. (Evaluation samples are available at moderate cost.)

HAMLIN
INCORPORATED

NEW! Build and test circuits as fast as you can think! No soldering or patch cords!

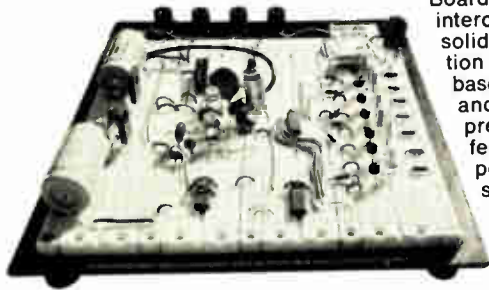

Four new Continental Specialties Proto Boards let you make all circuit and power interconnections with common #22 AWG solid hook-up wire, while power distribution buses make wiring a snap. Aluminum base plates offer solid work surfaces and perfect ground plane. Rubber feet prevent scratching. Each Proto Board features one or more 5-way binding posts to tie into system or power supply ground. All are compatible with ICs (digital or linear), in TO5s, DIP packs and discrete components. Each is completely assembled, ready-to-use.

PAT. PENDING

Proto Board Model No.	14 Pin DIP Capacity	Size (L"xW")	Price (U.S. only)
101	10	5.8"x4.5"	\$29.95
102	12	7.0"x4.5"	\$39.95
103	24	9.0"x6.0"	\$59.95
104	32	9.5"x8.0"	\$79.95

Order today — or send for free selection guide, with applications, photos, specs and more.



Continental Specialties Corp.
325 East St., Box 1942
New Haven, CT 06509
Telephone (203) 624-3103

CANADA: Available thru Len Finkler, Ltd., Downsview, Ontario
Circle 154 on reader service card

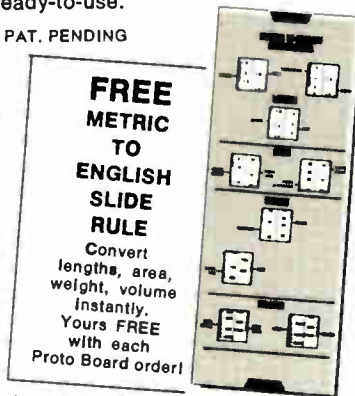

New products

tor, which eliminates the need for solder joints on the feed-through pins. With the system, there is no need for bridged pins, copper pads, or gold-plated copper fingers on the input and output of the panel, so that tolerances on the routing of the panels need not be exact. This re-

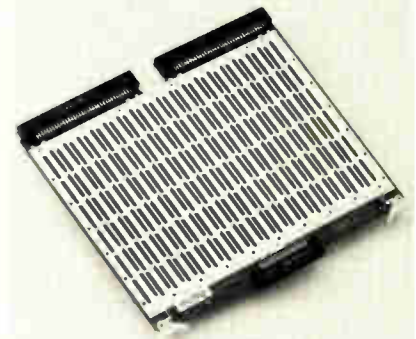

duces the chances of misalignment of edge fingers to the connector contacts. Price is less than \$170 for 10 pieces.

Mupac Corp., 646 Sunner St., Brockton, Mass. 02402 [395]

LOW-COST ABSOLUTE OPTICAL ENCODERS



- BCD outputs are DTL/TTL compatible.
- Available range up to 99,999.
- Ultra-reliable LED light source.
- Low-torque, high-speed operation.
- Rugged heavy duty industrial design.
- Operates at 5 VDC.
- External electronics not required.

Contact Theta application specialists today for further details, and ask for our brochure.

Theta **INSTRUMENT CORP.**

Specialists in Digital Automation
Fairfield, New Jersey 07006
Phone: 201 - 227-1700

DIP sockets contain built-in heat sinks

A series of dual in-line sockets, called the PD1000 series, has built-in heat sinks for 14-, 16-, and 18-pin integrated circuits. The heat sink is located under the IC, where most heat occurs and packaging density is not affected. The socket insulator features a closed-entry front end that is probe-proof and is designed to accommodate a finned extrusion for heat dissipation. The resultant increase in thermal conductivity improves the reliability of high-wattage ICs. Also offered are a tuning-



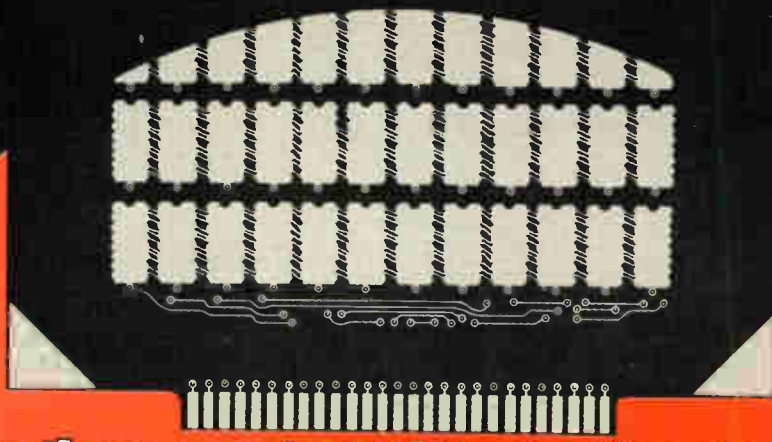

Whether your board looks like this...

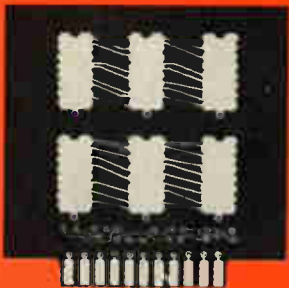

or this...

We can build a CUSTOM C/MOS circuit for you that looks like this...

Also remember our standard lines of 7400 TTL's and 930 DTL's.

Out-of-State Call toll free. Dial: **800-538-7906** and ask about price and delivery.

We can optimize your design and save you money, too!

You don't have to have a big hairy system full of complex devices to get economies out of custom C/MOS.

Even if your module has as few as a half dozen standard C/MOS devices in it—we may be able to provide you with a single custom C/MOS circuit that will do it all...cost you less than you think...and could save your com-

pany thousands of dollars in production costs.

Many designers have switched to C/MOS because of its inherent low-battery drain and high noise immunity. And now many users of standard C/MOS devices are looking to **custom C/MOS** circuits to optimize their designs and save money, too. They see no reason to go on using 5 or 6 stand-

ard devices where 1 custom circuit will do.

For less than you think, we may be able to provide you with a prototype custom C/MOS circuit that could give your company a competitive edge. It costs nothing to send in the coupon and be brought up to date on the custom C/MOS scene. Do it now!



Name _____
Company _____
Phone _____
Address _____
City _____ State _____ Zip _____

Briefly, my application is: _____

Please call me, I want to talk about custom C/MOS.
 Please send me more information.

SW SYMBOL OF EXCELLENCE STEWART-WARNER MICROCIRCUITS DIVISION STEWART-WARNER CORPORATION
730 E. Evelyn Ave • Sunnyvale, Ca 94086 • (408) 245 9200

You say you want a

low-profile snap-in-mounting push button switch or matching indicator that is interchangeable with most 4-lamp displays... available in a full range of cap colors... with a choice of bezels with or without barriers in black, gray, dark gray or white.



and a

legend presentation that's positive (like this one) or negative (like the one below) or just plain (like the one above)... one that's white when "off" and red, green, yellow (amber), blue or light yellow when "on"... or colored both "on" and "off."



and a

highly reliable switch proven in thousands of installations... available in momentary or alternate action... N.O., N.C. or two circuit (one N.O., one N.C.)... that accommodates a T-1 3/4 bulb with midget flanged base, incandescent, in a range of voltages from 6-28V.



*etc.
etc.
etc.*

***Now, for the first time
Dialight gives you
custom panel designing
with a standard line of
push-button switches and
matching indicators***

Dialight offers a broader range of switch and indicator possibilities than you'll find anywhere in a standard single-lamp line. Sizes: 3/4" x 1", 5/8" and 3/4" square and round. Send today for our new full-color catalog.

DIALIGHT

A North American Philips Company
Dialight Corporation, 60 Stewart Ave., Brooklyn, N.Y. 11237

New products

fork contact design and various plating options to meet environmental requirements.

Teradyne Inc., 183 Essex St., Boston, Mass. 02111 [397]

Universal panel disconnect suits modular systems

A universal panel disconnect, called the model PD-20 and designed for modular component systems, uses the Elcon helix connector, which provides many points of contact with the male pin. This feature provides low contact resistance and low

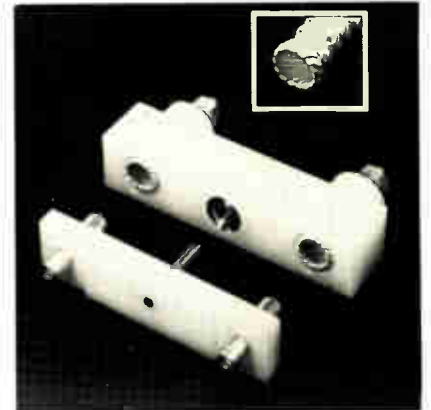

temperature rise in high-current applications—a 2,000-ampere load applied for one minute results in a 75-millivolt drop through the helix connector. Insertion and retraction forces of 5 pounds nominal permit easy removal and insertion of the modular panels.

Elcon Division, Icore International Inc., 180 N. Wolfe Rd., Sunnyvale, Calif. 94086 [398]

Chip-removal machine uses shaving action

A chip-removal machine has a four-directional pendulum arm and a positive-rake angle scraper, the depth of which is adjusted so that the machine does not injure conductor paths, land areas or substrates. Using a shaving rather than a cutting action, the tungsten carbide scraper slices smoothly without creepage or roughness. The arm can

Monsanto introduces its **HT SERIES** *(a breakthrough in High Technology)* with four Universal Counter/Timers

Monsanto's new HT Series (High Technology) of frequency and time instruments designed to meet the rigid requirements of laboratory and field use, is the 8500 family of Universal Counter/Timers. They constitute another major achievement in our continuing R & D program to produce digital instrumentation of ultimate reliability and performance. These demanding standards have been realized by using field proven technology, unique designs

and state-of-the-art components and circuitry. The application of human engineering principles enables simple and self-evident use of the instrument. Our proudest achievements, these HT Series instruments are housed in attractive, designer-styled, diecast aluminum enclosures that provide an outward appearance as advanced as the technological innovations they contain.



8500 Series
 prices range from
\$650.

The 8500 Series of Universal Counter/Timers consists of four separate models with ranges of 50 MHz, 150 MHz, 550 MHz and 1 GHz.

All models feature: Complete Counter-Timer functions of Frequency, Period, Period Average, Time Interval, Time Interval A to B, Ratio and Totalize/Full 9 digit, Monsanto, easy-to-read amber LED display/Opti-ranging for optimum display resolution/10 mV rms sensitivity with AGC for VHF & UHF measurements/High stability, oven controlled, crystal oscillator/Optional parallel BCD output/Optional higher stability TCXO oscillator/Available from stock/Generous OEM quantity discounts.

UNITED SYSTEMS CORPORATION
 918 Woodley Road, Dayton, Ohio 45403
 Ph (513) 254-6251 Twx, (810) 459-1728
 a subsidiary of

Monsanto

Monsanto

Information only circle 157 on readers service card.

Demonstration wanted circle 268 on readers service card.

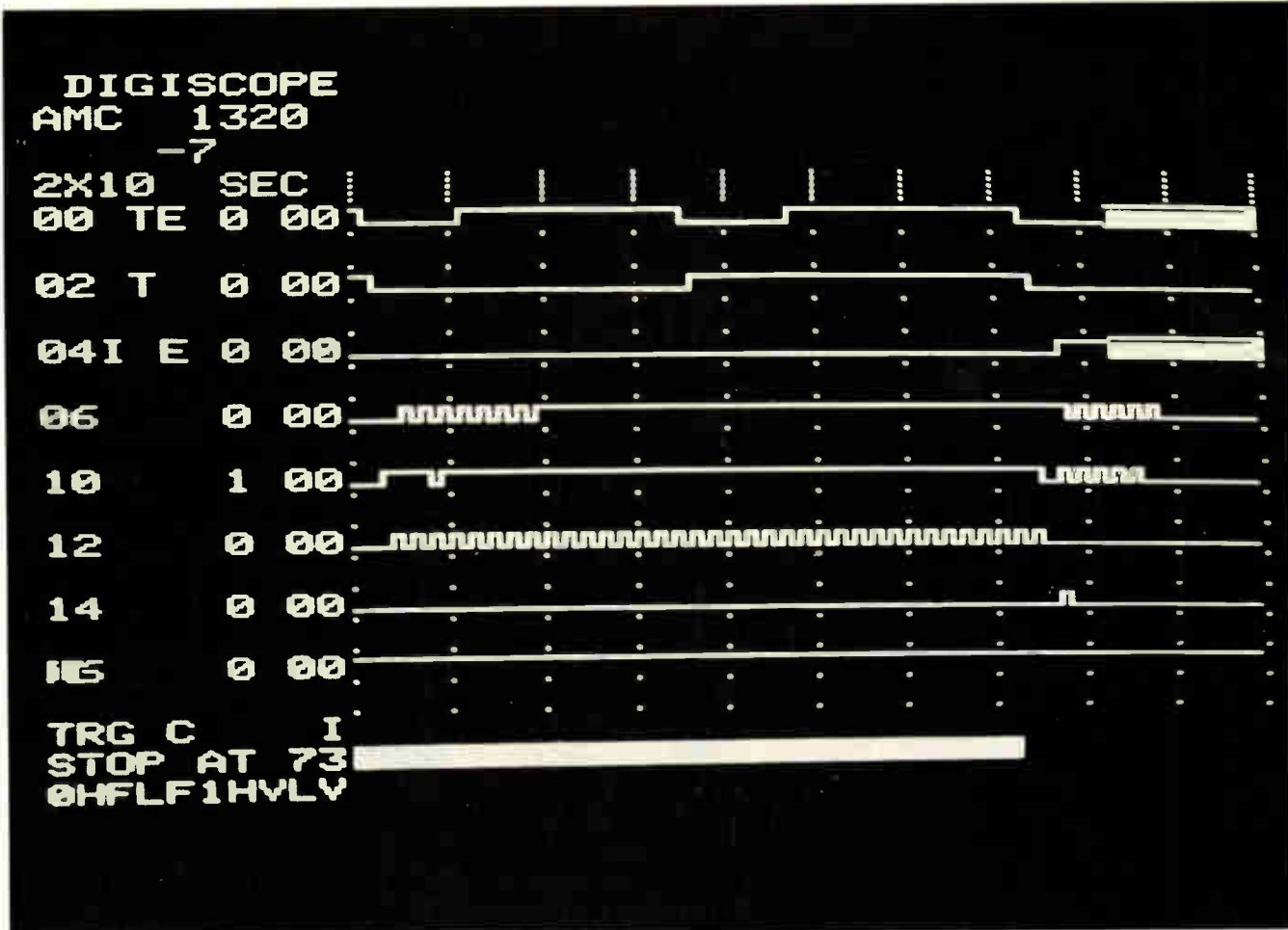

Digital timing, analog problems—only the Digiscope shows you both

"A radically new logic state analyzer from E-H Research gives you the equivalent of an 8 or 16 gun, 50 MHz, real time scope display of logic timing. It lets you see such analog parameters as glitches, ringing, rise and fall times, and voltage levels."

— Jerome Lyman,
ELECTRONIC PRODUCTS
Magazine, 1/19/74

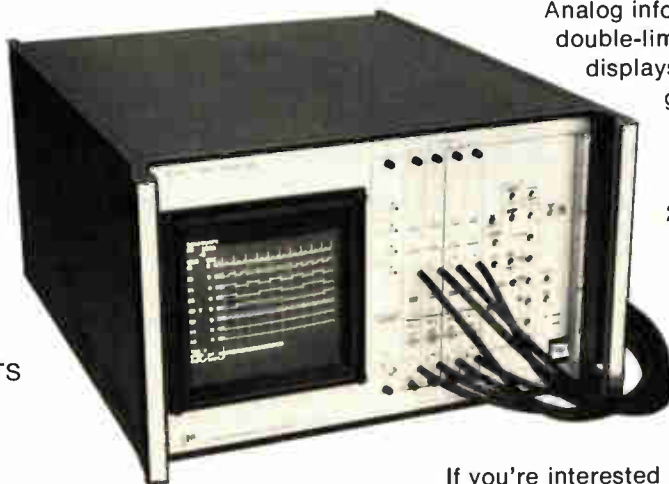

Analog information is preserved with unique, double-limit threshold comparators. Screen displays all instrument settings for photographic recording.

You can trigger on any logical combination of the eight inputs. Probe impedance is greater than 20 megohms, shunted by less than 8pF, so you don't have to worry about a probe loading the circuit. We think when you see it, you'll agree: Digiscope is the most efficient, error-free test instrument ever made for designing, debugging, and maintaining digital electronic equipment.

If you're interested in the whole story about this radically new logic state analyzer, let us know. We'll send you the AMC 1320 Digiscope brochure immediately.

The Digiscope gives you eight channels of digital data simultaneously acquired at 50 MHz, up to 100 bits of pre-trigger lookback, and single shot measurements without sacrificing critical analog information in the signals.

Now Digiscope lets you see such anomalies as glitches (Channel 14), slow rise times (Channel 6), low "one" levels (Channel 12), high "zero" levels and ringing (Channel 10) that are often the cause of mysterious system failures.



**E-H Research
Laboratories, Inc.**

515 - 11th Street, Box 1289
Oakland, California 94604
(415) 834-3030

European Subsidiary: P. O. Box 1018, Eindhoven, The Netherlands, (040) 433704

Stop Nuisance Tripping!

Type UPG/APG Electromagnetic Circuit Protectors with patented Inertial Delay.

Typical XFMR Transients
(Peak currents to 20X
nominal) results in
NUISANCE TRIPS. Solution:
Use Airpax Inertial Delay.

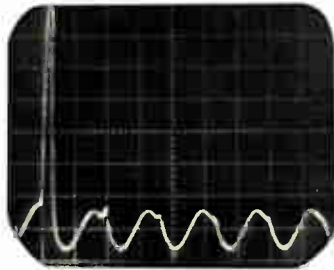

Airpax Type UPG/APG circuit protectors assure positive protection without nuisance tripping. This is accomplished by an exclusive Airpax inertial delay that provides tolerance of short duration inrush currents without decreasing steady state protection.

The UPG/APG line of low cost, compact circuit protectors offers series, shunt, and relay configurations with a choice of delays and ratings. Ratings are from 20 milliamperes to 30 amperes, 250 volts maximum at 60Hz, 250 volts at 400Hz, and 65 volts dc maximum. A SPDT auxiliary switch, for remote signalling or alarm, rated at 5 amperes, can be supplied with series trip types.

Available in 1, 2, and 3 pole versions, UPG/APG circuit protectors offer a choice of toggle, rocker arm, or thumbwheel actuators. All multipole assemblies can be furnished with a mix of current ratings, delays, internal circuit configurations, and terminal styles.

To get the full story on Airpax Type UPG/APG electromagnetic circuit protectors, write for Bulletin 2003.



AIRPAX™

Airpax Electronics
CAMBRIDGE DIVISION
Cambridge, Maryland 21613
Phone (301) 228-4600

Circle 161 on reader service card

To Cool Hot Power Semiconductors Call your local Electronic Distributor...

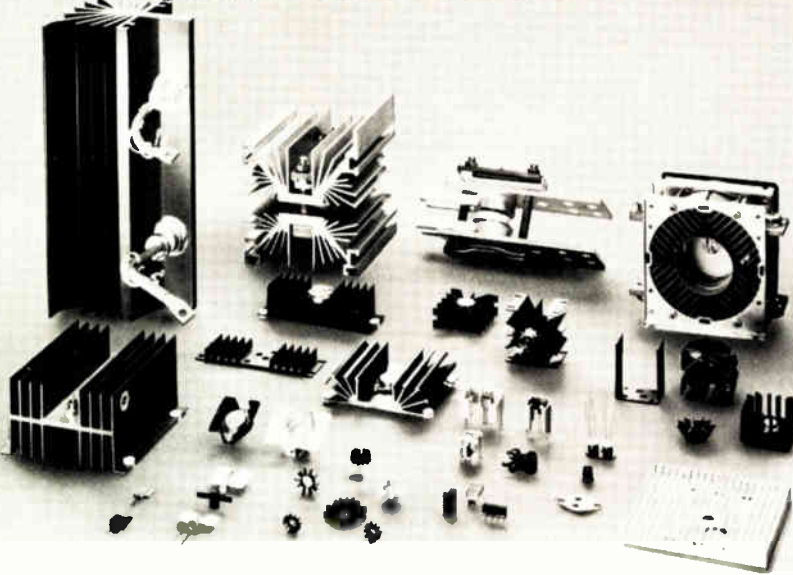

Phone your local distributor today for your free copy of the Wakefield Distributor Products Catalog #103, which contains product and applications data on heat sinks, extrusions, thermal joint compound and thermally conductive epoxy. For complete product information on semiconductor cooling extrusions including cross sections for 101 shapes, ask for your copy of the NEW Wakefield Distributor Extrusion Bulletin #104A.

See your 1974 Thomas Register, "SINKS, HEAT" Section, Volume 5, page 8114, for Wakefield shortform Distributor Products Catalog.



Phone distributor or check coupon to request any of these Distributor Catalogs which contain listings of Wakefield Thermal Products.



WAKEFIELD ENGINEERING, INC.
Wakefield, Mass. 01880 (617) 245-5900

ALABAMA		
CRAMER/EW/Huntsville	(205) 539-5722	
Hall-Mark/Huntsville	(205) 539-0691	
ARIZONA		
CRAMER/Phoenix	(602) 263-1112	
ARKANSAS		
CARLETON-BATES/Little Rock	(501) 562-9100	
CALIFORNIA		
● CALIFORNIA ELECT/Los Angeles	(213) 477-8561	
● CRAMER/Irvine	(213) 771-8300	
● CRAMER/San Diego	(714) 565-1881	
● CRAMER/Sunnyvale	(408) 739-3011	
● ELMAR/Mountain View	(415) 961-3611	
● NEWARK ELECT/Inglewood	(213) 678-0441	
COLORADO		
● CRAMER/Denver	(303) 758-2100	
● NEWARK ELECT/Denver	(303) 757-3351	
CONNECTICUT		
● CRAMER/North Haven	(203) 239-5841	
● NEWARK ELECT/Westport	(203) 226-6921	
FLORIDA		
● CRAMER/EW/Hollywood	(305) 923-8181	
● CRAMER/EW/Delando	(305) 894-1511	
● HALL-MARK/Orlando	(305) 855-4020	
● NEWARK ELECT/FT. Lauderdale	(305) 587-2372	
GEORGIA		
● CRAMER/EW/Atlanta	(404) 448-9050	
● HALL-MARK/Atlanta	(800) 633-2918	
ILLINOIS		
● CRAMER/MT. Prospect	(312) 593-8230	
● NEWARK ELECT/Chicago	(312) 638-4411	
● OHM ELECT/Palatine	(312) 359-5700	
INDIANA		
● FORT WAYNE ELECT/Fl. Wayne	(219) 423-3422	
● GRAHAM ELECT/Indianapolis	(317) 634-8202	
● PIDNEER/Indianapolis	(317) 632-5676	
KANSAS		
● HALL-MARK/Lenexa	(913) 888-4747	
● RADIO SUPPLY/Great Bend	(316) 793-3507	
● RADIO SUPPLY/Myoming	(616) 241-6681	
● RADIO SUPPLY/Wichita	(316) 267-5216	
MARYLAND		
● CRAMER/EW/Hanover	(301) 354-0100	
● CRAMER/EW/Galthersburg	(301) 948-0110	
● NEWARK ELECT/Beltsville	(301) 937-5085	
● PYTRONIC/Savage	(301) 792-7000	
MASSACHUSETTS		
● CRAMER/Newton	(617) 969-7700	
● NEWARK ELECT/Woburn	(617) 935-8350	
● RUSH IND/Woburn	(617) 935-2400	
MICHIGAN		
● CRAMER/Livonia	(313) 425-7000	
● NEWARK ELECT/Dak Park	(313) 548-0250	
● NEWARK ELECT/Myoming	(616) 241-6681	
● RS ELECT/Detroit	(313) 491-1012	
● WEDEMEYER/Ann Arbor	(313) 665-8611	
MINNESOTA		
● CRAMER/Edina	(612) 835-7811	
● GOPHER/St. Paul	(612) 645-0241	
● NEWARK ELECT/Minneapolis	(612) 331-6350	
MISSOURI		
● HALL-MARK/St. Louis	(314) 521-3800	
NEW JERSEY		
● CRAMER/Cherry Hill	(609) 424-5993	
● CRAMER/Moonachie	(201) 935-5600	
● GENERAL RADIO/Camden	(609) 964-8560	
● NEWARK ELECT/Kenilworth	(201) 272-8410	
● ROUTE ELECTRONICS/Springfield	(201) 379-7710	
NEW MEXICO		
● CRAMER/Albuquerque	(505) 265-5767	
NEW YORK		
● CAR-LAC ELECT/Bohemia	(516) 567-4200	
● CRAMER/East Syracuse	(315) 437-6671	
● CRAMER/Endwell	(607) 754-6661	
● CRAMER/Hauppauge	(516) 231-5600	
● CRAMER/Rochester	(716) 275-0300	
● GENESSEE RADIO/Buffalo	(716) 873-9661	
● HILKRAY/Freepport	(516) 546-6000	
● NEWARK ELECT/Plainview	(516) 822-5000	
● NEWARK ELECT/Rochester	(716) 473-8600	
NORTH CAROLINA		
● CRAMER/EW/Winston-Salem	(919) 725-8711	
● HALL-MARK/Raleigh	(919) 832-4465	
● KIRKMAN ELECT/Winston-Salem	(919) 724-0541	
● PYTRONIC/Raleigh	(919) 782-6370	
OHIO		
● JOHN BECKER ELECT/Dayton	(513) 226-1341	
● CRAMER/Cincinnati	(513) 771-6441	
● CRAMER/Cleveland	(216) 248-8400	
● HUGHES-PETERS/Cincinnati	(513) 351-2000	
● HUGHES-PETERS/Columbus	(614) 294-5351	
● NEWARK ELECT/Cincinnati	(513) 874-5115	
● NEWARK ELECT/Cleveland	(216) 361-4700	
● PIDNEER/Cleveland	(216) 587-3600	
● PIDNEER/Dayton	(513) 236-9900	
● RPC ELECTRONICS/Cleveland	(216) 461-4700	
OKLAHOMA		
● HALL-MARK/Tulsa	(918) 835-8458	
OREGON		
● CENTRAL DIST/Portland	(503) 234-0711	
PENNSYLVANIA		
● PIDNEER/Pittsburgh	(412) 782-2300	
● PYTRONIC/Carnegie	(412) 276-6722	
● PYTRONIC/Harrisburg	(1-800) 232-0640	
● PYTRONIC/Montgomeryville	(215) 643-2850	
● RPC ELECTRONICS/Pittsburgh	(412) 782-3770	
PUERTO RICO		
● CRAMER/San German	(809) 892-1130	
TEXAS		
● ALTAIR/Houston	(713) 462-3029	
● ALTAIR/Richardson	(214) 231-5166	
● CRAMER/Dallas	(214) 350-1355	
● HALL-MARK/Dallas	(214) 231-5101	
● HALL-MARK/Houston	(713) 781-6100	
● NEWARK ELECT/Dallas	(214) 271-2511	
● NEWARK ELECT/Houston	(713) 782-4800	
UTAH		
● CRAMER/Salt Lake City	(801) 487-3681	
● NEWARK ELECT/Salt Lake City	(801) 486-1048	
WASHINGTON		
● CRAMER/Seattle	(206) 762-5755	
● STERLING ELECT/Seattle	(206) 762-9100	
WEST VIRGINIA		
● RPC ELECTRONICS/Wheeling	(304) 232-7630	
WISCONSIN		
● CRAMER/Dak Creek	(414) 764-1700	
● NEWARK ELECT/Brookfield	(414) 781-2450	

● Principal stocking points

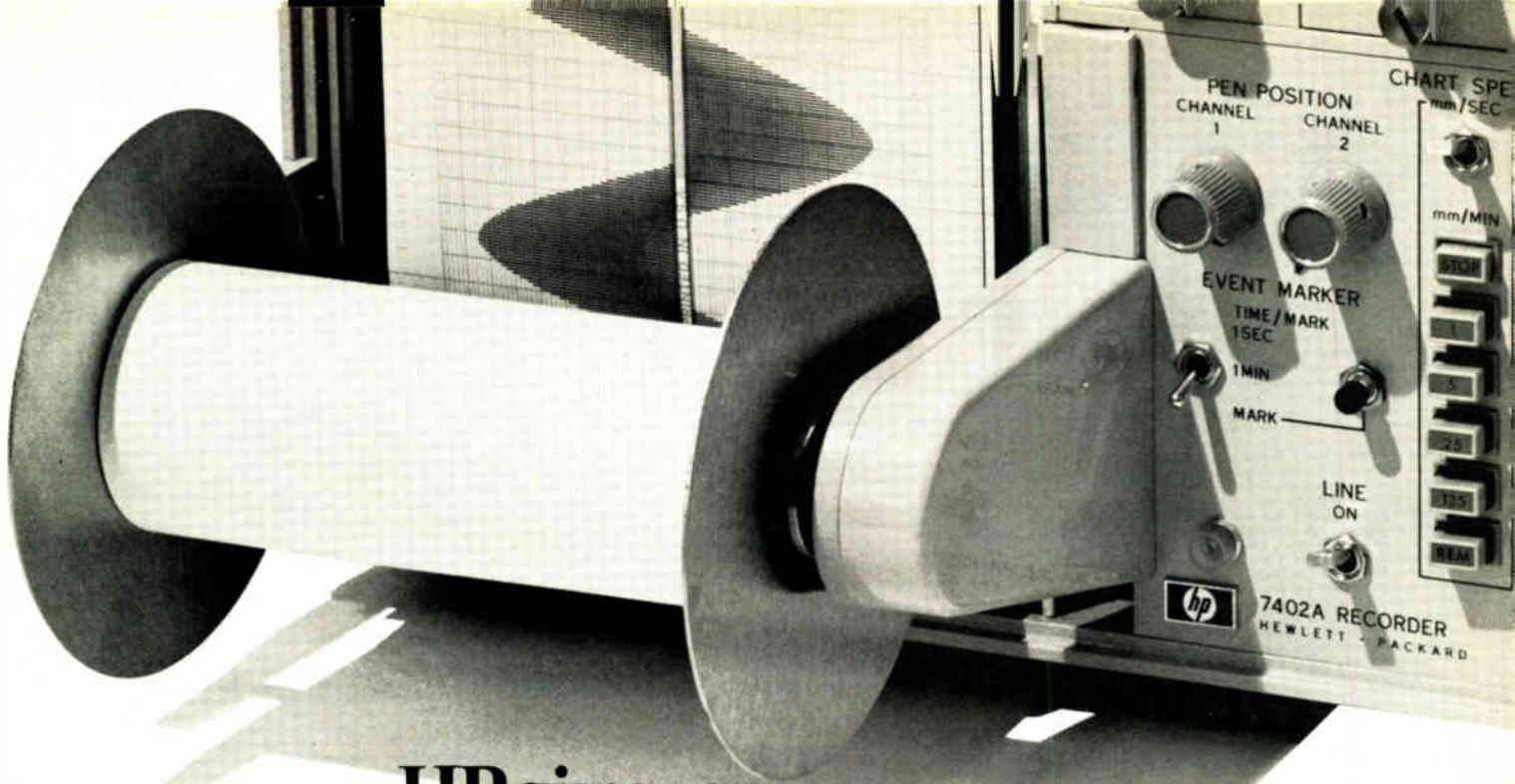

**HP gives you
weeks of continuous data,
marking by the minute or second,
a 50 or 100 mm picture
and full remote control...**

**all rolled up into one low cost, plug-in
oscillographic recorder.**

Now there's a way to get precisely the recorder you want, without paying for more recorder than you need. Start with Hewlett-Packard's two-channel 7402A Oscillographic Recorder. For just \$2,000* you can have two versatile 1mV/div DC plug-ins.

Then build from there.

For long-term measurements, add our seconds-to-minutes (60:1) chart speed reducer at \$150. You can choose from eight speeds, 1mm/min to 125mm/sec. And there's an optional take-up available that neatly rolls up enough paper for up to 58 days of continuous operation. It's \$110.

You can have a combination event marker and minutes-or-seconds timer

with both TTL and contact closure remote control. It only adds \$125.

High or low gain plug-in modules, priced from \$145, provide increased capability when you need it.

But no matter how you customize your 7402A, HP gives you standard features you'll want to have in almost any situation. To study a single channel in minute detail, you can double picture size from 50 to 100mm. The performance-proven writing system

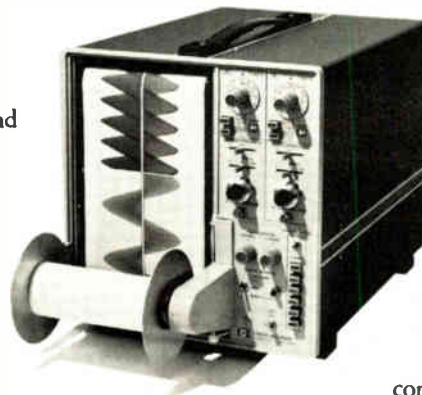

puts down a crisp, bone-dry trace with non-fatiguing stainless steel pens. And since full remote control capability can be built in, you can easily use a 7402A recorder as part of a computerized data system.

There's more. Just compare the 7402A with recorders costing even twice as much. It gives you features, options and HP reliability. All rolled up into one. For details, write Hewlett-Packard, 1501 Page Mill Road, Palo Alto, California 94304.

11406
*All prices domestic U.S.A. only

HEWLETT  PACKARD

Sales and service from 172 offices in 65 countries.
1501 Page Mill Road, Palo Alto, California 94304

Circle 163 on reader service card

Everything in precision voltage sources from A to B.

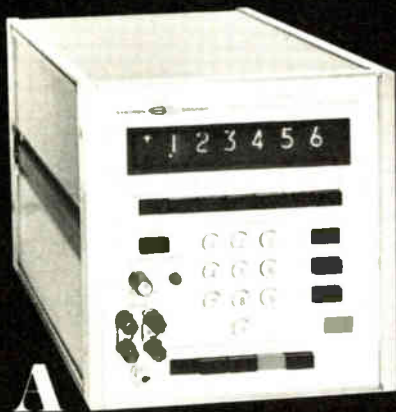

A
6-digit Model M106 A. Accuracy $\pm 0.002\%$. Range ± 1 microvolt to $\pm 1,000$ VDC in 4 ranges. Solid-state voltage selections and digital display. Isolated remote BCD programming optional. A proven, versatile performer for bench, production or computer-controlled test systems... with a low basic price of \$2,375.



B
5-digit Model M106 B. Same as A version except: Accuracy $\pm 0.008\%$, range $\pm 10 \mu\text{V}$ to ± 100 VDC in 3 ranges. (± 1000 VDC ranges optional). No need to pay for super-precision if you don't need it: basic price is only \$1,795.

For further details on both A and B. Contact your Scientific Devices office or Systron-Donner at 10 Systron Drive, Concord, CA 94518. For immediate details, call our Quick Reaction line (415) 682-6471 collect.



SYSTRON-DONNER

New products

Subassemblies

Unit changes V to Hz, Hz to V

Closed-loop design permits converter to operate in either direction

A designer at Datel Systems Inc. set out to build a voltage-to-frequency converter, but discovered that his closed-loop design could also do frequency-to-voltage conversions. This was the inadvertent birth of a series of "universal" converters: the VFV-10K, covering frequencies from 0 to 10 kilohertz, and the VFV-100K, covering 10 to 100 kHz. The respective unit prices of \$59 and \$79 are comparable to those of modules that can convert in one direction only, Datel says.

The converters use a charge-balancing feedback method to generate an extremely linear and temperature-stable output pulse frequency. Since this is a closed-loop feedback system, it can be used as a v-to-f or f-to-v converter depending on where the feedback loop is broken. In v-to-f applications, the integrator puts out a voltage to control timing of the pulses, and the pulses feed back as a charge to the summing point of the integrator.

If the loop is broken, the user can inject his own pulses and use the in-

tegrator output as the voltage output of an f-to-v converter. The integrator compares the input voltage with output frequency and integrates the error, giving linearity within $\pm 0.005\%$ maximum in the 10K, and $\pm 0.05\%$ maximum in the 100K. Linearity holds all the way from full scale to zero.

Different operating characteristics can be determined by external pin connection, including v-to-f or f-to-v conversion, v-to-f with voltage inputs of either 0 to +10 volts or 0 to -10 v, v-to-f with current inputs of either 0 to +1 milliampere or 0 to -1 mA, f-to-v with output of either 0 to +10 or 0 to -10 v, v-to-f with either positive or negative output pulses, and v-to-f with output logic levels either DTL/TTL-compatible or C-MOS-compatible.

Both units have full-scale and zero-offset adjustments, and inputs and output have a 10% overrange. Widths of the output pulses are constant, 75 milliseconds for the 10K and 7.5 microseconds for the 100K, with a repetition rate proportional to input voltage or current. If a step in voltage or current is applied to the input, the output pulse frequency settles to 0.01% of its new value after one pulse. In the f-to-v mode, the 10K accepts input pulse widths of 10-60 μs ; and the 100K, widths of 1-6 μs .

The VFV series can replace an analog-to-digital converter in many applications; it can measure the difference between two frequencies as an analog value and, subtracting the

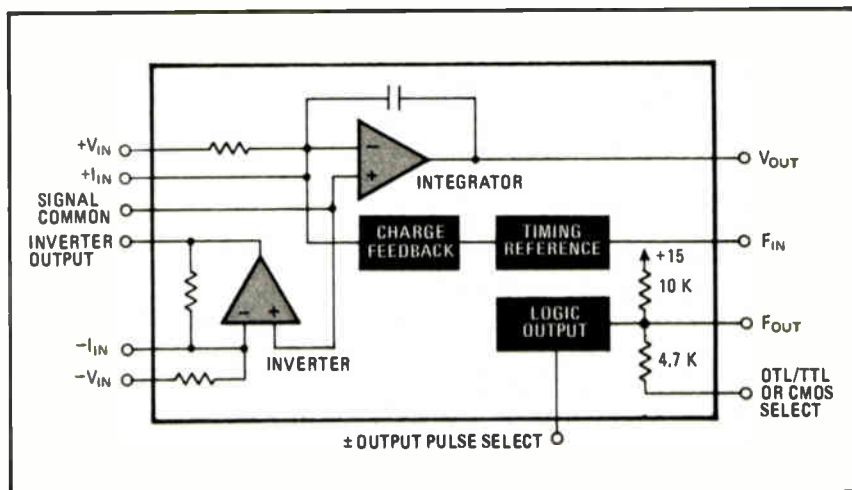

This is a
4000 series
C/MOS logic
IC...



Actual Size

These are also
4000 series
C/MOS logic
IC's...



Actual Size

Now—for hybrid circuits... Amperex introduces microminiature **LID** versions of 14 of the most popular C/MOS logic IC's of the 4000 series.

Until now, hybrid circuit manufacturers have had only two ways to use C/MOS logic: the conventional packages that traded away space for C/MOS performance... or individual C/MOS chips trading away production-economy and yield to get C/MOS performance.

Now there's a third choice—C/MOS IC's in micro-miniature LID packages—and now you have C/MOS performance in small space with production-economy and high circuit yields.

With Amperex LID C/MOS IC's, you get a 20 times reduction in volume that allows you to take full advantage of the inherent high-density possibilities of C/MOS circuitry... and you get fully pre-tested packaged devices that mount directly, economically and reliably onto the substrate by ordinary reflow solder techniques. Your costly semiconductor-bonding operations are eliminated along with the need for expensive equipment and the skilled labor to handle it.

We can deliver LID versions of 14 of the most popular of the 4000 series C/MOS IC's off-the-shelf, in production quantities. They are available, with either 14 or 16 terminals, as indicated at right. Delivery schedules on others of the 4000 series can be obtained via telephone.

For technical data and details of how you can design C/MOS circuitry into your hybrid IC's with LID densities and LID economy... or for information on the full line of Amperex LIDS for hybrids... write: Amperex Electronic Corporation, Solid State and Active Devices Division, Slatersville, Rhode Island 02876. Tel: 401-762-9000.

TYPE	FUNCTION	TERMINALS
LFG4000	Dual 3-Input NOR Gate Plus Inverter	MA-14
LFG4001	Quad 2-Input NOR Gate	MA-14
LFB4009	Hex Buffer/Converter (Inverting)	MA-16
LFB4010	Hex Buffer/Converter (Non-inverting)	MA-16
LFG4011	Quad 2-Input NAND Gate	MA-14
LFF4013	Dual "D" Type Flip-Flop	MA-14
LFR4015	Dual 4-Stage Static Shift Register	MA-16X
LFS4016	Quad Bilateral Switch	MA-14
LFC4017	Decade Counter/Divider	MA-16X
LFC4020	14-Stage Ripple-Carry Binary Counter	MA-16X
LFR4021	8-Stage Static Shift Register	MA-16X
LFG4023	Triple 3-Input NAND Gate	MA-14
LFF4027	Dual J-K Master-Slave Flip-Flop	MA-16
LFG4030	Quad Exclusive-OR Gate	MA-14



Actual Size

Amperex®

TOMORROW'S THINKING IN TODAY'S PRODUCTS

Sold through
North American Philips Electronic Component Corporation

If
you
think all card
readers
are alike...



take a look
at
CONRAC

Take a good, long look before you specify... check and compare all the features offered by the CONRAC A-31 Series Magnetic Card Reader. Here are only a few: • Read or write on Standard Magnetic Cards • Industry Compatible Credit Cards— IATA, ABA, THRIFT, NTT • Card remains stationary and visible at all times—minimizing chances of card loss, damage or jamming • Card-in-place switch—insures proper insertion of card before operation • USA designed and made for OEM applications requiring rugged, long life • All this plus more and it's one of the lowest priced. ⁵⁰⁰

Write For Descriptive Literature.

CONRAC CRAMER DIVISION
CORPORATION

Mill Rock Road, Old Saybrook, Conn. 06475
(203) 388-3574

New products

values of the voltages, can be used for high-voltage isolation of a signal. In digital data transmission, it can convert pulses driven over a line back to the original signal.

Both units measure 2 by 2 by 0.375 inches. Delivery time is 4 weeks, starting in June.

Datel Systems Inc., 1020 Turnpike St., Canton, Mass. 02021 [381]

Data-acquisition modules run off minicomputer supply

Data-acquisition modules—small integrated subsystems that sit in a minicomputer on the same printed-circuit boards as the digital logic circuits—are a new kind of animal. But Data Translation Inc. is betting that their appeal is growing. As its first product, the Framingham, Mass. company has introduced the Datab series of modules, one 16-channel

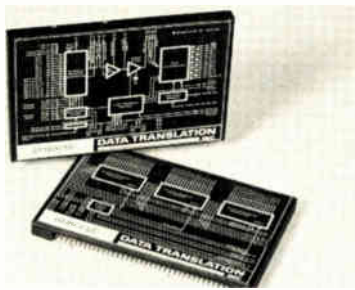

and the other 64-channel, which run off the minicomputer's 5-volt power supply through a dc-dc converter.

The company believes its larger system is the first module to offer 64-channel data-acquisition capability. Until now, it says, users either had to build their own systems or buy one in a rack-mountable chassis. The larger system includes a 16-channel DT1620 data-acquisition module and a 48-channel DT48EX expander module, each in a plug-in package measuring 3 by 4.6 by 0.375 inches. (The DT1620 is also available separately). Cycle time is 20 microseconds, and throughput rate is 50,000 12-bit words per second with accuracy to within $\pm 0.03\%$. The unit can be short-cycled by pin-strapping to 10

bits, giving a 40% increase in throughput.

The DT1640 is a 16-channel module of the same small size. But its cycle time is slower—40 microseconds—and throughput is 25 kilohertz for each 12-bit word. Both single-ended and differential inputs are available, with system accuracy within $\pm 0.03\%$ worst case.

Both units provide multi-channel multiplexing, sample-and-hold, 12-bit analog-to-digital conversion, and all programing and control logic in a plug-in module small enough to fit the 0.5-inch spacing that is common to minicomputers. Temperature coefficient is ± 30 parts per million per degree centigrade, and full-scale voltage inputs of ± 5 volts, ± 10 V, and 0 to +10 V are pin-selectable.

To prevent digital logic noise from getting into analog circuits, both systems have maximum separation between analog and digital circuits within the module, as well as a maximum of ground-plane shielding for the analog circuitry. Ground loops are further prevented by bringing all analog and digital grounds together at one point. A metal housing protects the modules from electromagnetic and electrostatic noise in the computer.

Sales will be to OEM houses—units have already been designed for Digital Equipment Corp.'s PDP-11 and Data General's Nova line—and probably to systems companies as well. Interface of the Datab series to terminals is left to the OEM.

Price of the DT1640 is \$495, or \$395 in quantities of 100. Price of the two-module 64-channel system is \$1,195 for a single unit; the DT1620 is priced at \$595 as a separate unit.

Delivery time is 4 weeks.

Data Translation Inc., 109 Concord St., Framingham, Mass. 01701 [382]

Compact thick-film networks provide variety of circuits

Standard and custom micro-networks for end-users consist of various conductors and mounting pads laid out on a ceramic substrate.

Trimmed thick-film resistors and chip capacitors and inductors are added. Input and output terminals are connected to the specified re-

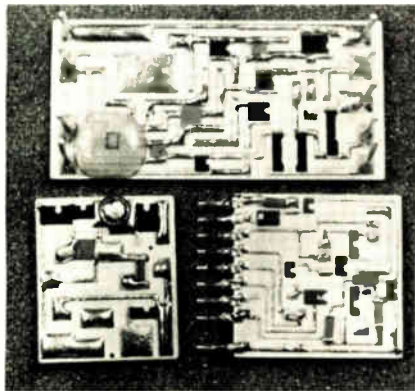

quirements of the circuit, and the user then bonds the semiconductors on the mounting pads provided. A wide variety of circuits can be developed this way, and in ordering, the customer need only furnish the circuit schematic with passive components identified, the quantity required, size limitations, maximum electrical and environmental stresses to be encountered, active devices to be bonded or not, and bonding technique preferred.

Solitron Devices Inc., 256 Oak Tree Rd., Tappan, N.Y. 10983 [384]

Telephone tone filters operate to 1,633 hertz

The series 882 telephone tone filters are pretuned band-pass active devices. Center frequency is set $\pm 0.5\%$ to a standard tone frequency of 697, 770, 852, 941, 1,209, 1,336, 1,477, or 1,633 hertz, and Q is set to $18 \pm 10\%$. Gain is set at unity at the bandpass center frequency and, in addition,



each unit has an input impedance of 30 kilohms and can supply ± 2 milliamperes output current with less than 1-ohm output impedance. Center frequency temperature coefficient is less than ± 100 ppm/ $^{\circ}\text{C}$ over 0° to 70°C .

Helipot Division, Beckman Instruments Inc., D962, Fullerton, Calif. 92634 [385]

Miniature amplifier covers 5 to 400 MHz

A miniature amplifier, designated the A-M series, is flat ($+1.0$ decibel) over the range from 5.0 megahertz



to 400 MHz with a nominal gain of 12 dB. Other specifications include a noise figure of 5 dB maximum, with the input-output impedance available in either 50 or 75 ohms. Constructed with solder pin connections, the enclosure is 1 by $\frac{3}{4}$ inch. Price is \$27 in quantities up to 100. Delivery is from stock.

Spectrum Microwave Corp., 328 Maple Ave., Horsham, Pa. 19044 [387]

Mounted keyswitches are aligned in a metal plate

Arrays of the Lo-Pro keyswitches are provided premounted and aligned in a metal plate, ready for insertion into a pc board. The company claims that savings in assembly cost are achieved through the elimination of handling individual switches and the elimination of an extra pc board, cables and connectors. The arrays are available in 1 by

We've made a great tape transport a lot better.

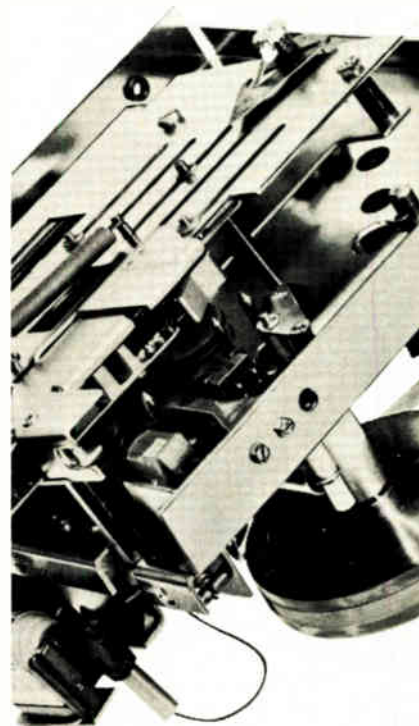

take a look at CONRAC

Now, there's no reason for you to "trade-off" when specifying an audio cassette tape transport...not if you specify the Conrac CAS-4. Here are only a few reasons why: • USA designed and manufactured • 3 motor design • No mechanical clutches or brake bands required • Designed for remote control • OEM priced. 501

Write for descriptive brochure

CONRAC CRAMER DIVISION
CORPORATION

Mill Rock Road, Old Saybrook, Conn. 06475
(203) 388-3574

TRIMLINE ENCLOSURES BY PREMIER METAL PRODUCTS CO.

337 Manida St., Bronx, N.Y. 10474 / (212) 991-6600
OVER 1300 ITEMS IN OUR CATALOG



Complete catalog
and prices on request.

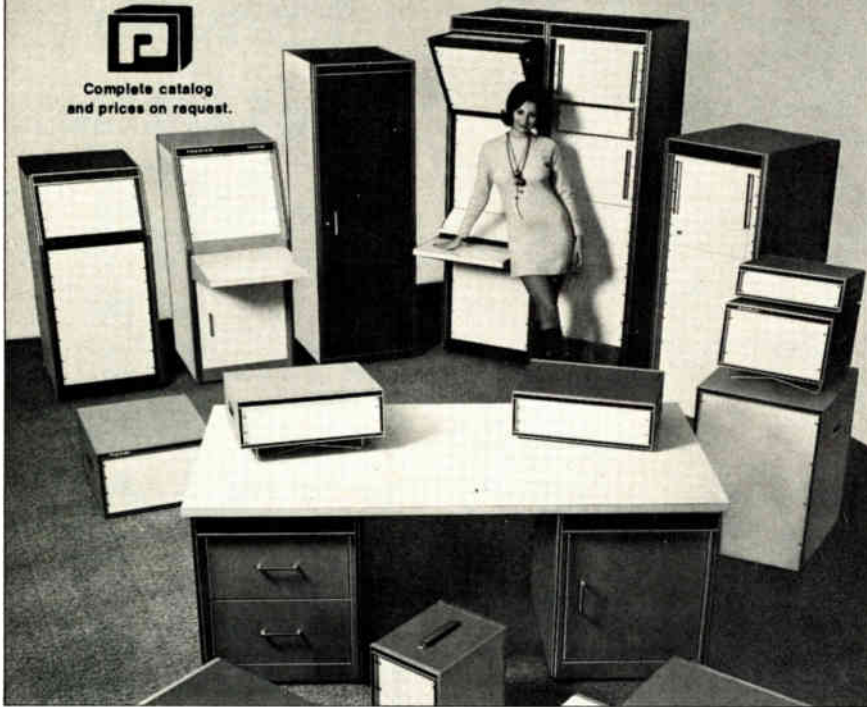

Circle 168 on reader service card

Noise sensitivity problems go away

with *Topaz Ultra-Isolation Transformers*

Box-shielding techniques achieve maximum coupling between windings while offering a very low impedance for common-mode noise to ground.

Primary to secondary effective interwinding capacitances of:
0.005 picofarads
0.001 picofarads
0.0005 picofarads

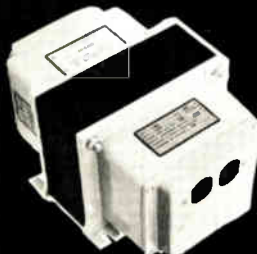

SPECIFICATIONS:
Common-Mode Noise Rejection:
to more than 145 dB.
Transverse Noise Suppression:
greater than 125 dB at 1 kHz.
Input/Output Voltages Available:
115, 230, 240 and 480 VAC
at 50 or 60 Hz.
Models Available:
125 VA to 20 kVA 1 phase;
3 kVA to 60 kVA 3 phase.

Priced from \$75.00

TOPAZ SOLUTIONS TO
ELECTRONICS POWER PROBLEMS

3855 Ruffin Road, San Diego, CA 92123 Phone (714) 279-0831

168 Circle 214 on reader service card

New products

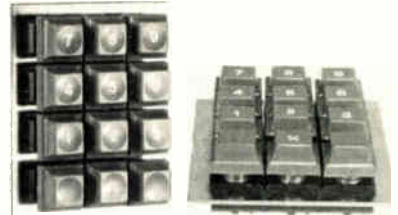

4, 2 by 4, 3 by 4, and 4 by 4 keys. The mounting plates are also available in special shapes to receive other components such as LEDs.

Stackpole Components Co., Box 14466, Raleigh, N.C. 27610 [388]

Solid-state timer is convertible

The model 1013U ac solid-state convertible timer offers on-delay or off-delay, normally open or normally closed static output by means of one



positive detent selector switch. Static output is rated for more than 100 million operations. The convertible unit also has an optically isolated ac control circuit with transient protection to 1,500 volts. Time ranges are from 0.02 to 2.6 seconds to 0.5 to 250 seconds.

Industrial Solid State Controls Inc., 435 W. Philadelphia St., York, Pa. 17405 [389]

Op amp is aimed at medium-power audio uses

Designed for medium-power audio applications, a low-noise operational amplifier, called the model

Electronics/April 18, 1974



We take your reputation seriously.

That's why we build and test our Standard Power Modules so carefully.

A basic component like the power supply can put an expensive machine out of business. And, while the shutdown may be temporary—the loss of reputation and customer confidence may be permanent.

This is why many O.E.M.'s are taking another look at their power supply "economies." When they do, North Electric looks better and better.

This is because our line of Standard Power Modules offers the highest levels of engineering and quality control in the industry—the same standards that have made North the leading custom power source for more than 40 years.

That's why, when North delivers power—you can bet your reputation on it.

Send for a catalog today, or call your North Product Manager at 419/468-8874.

MODEL	11000	12000	13000	14000	15000	16000	17000	18000
VDC	AMPERES							
5.0	3.9	5.3	11.3	13.0	20.0	32.5	49.0	82.0
12.0	2.8	4.2	8.0	10.5	15.0	23.0	36.0	58.0
15.0	2.4	3.7	7.5	9.5	14.0	20.5	27.0	47.0
18.0	2.1	3.3	6.0	8.0	13.0	18.0	26.0	40.0
24.0	1.5	2.8	4.2	7.0	11.0	15.0	21.0	33.0
28.0	1.4	2.4	4.0	6.3	9.0	14.0	20.0	29.0
36.0	1.2	2.2	3.1	5.6	8.0	11.0	14.0	23.0
48.0	95	18	2.6	4.2	6.0	8.0	10.0	18.0

DUAL OUTPUT SUPPLIES	
MODEL	N63052
VDC	AMPS
±15 12	400MA
MODEL	N60052
VDC	AMPS
±15 12	1.0A

MODEL	10000
VDC	AMPS
0-75	2.10
0-16	1.25
0-25	0.85
0-33	0.68

Listed here are the more popular models—many other voltages are available.

NORTH 
ELECTRIC COMPANY

North Electric Company / Galion, Ohio 44833 / A United Telecom Co.

SP-18

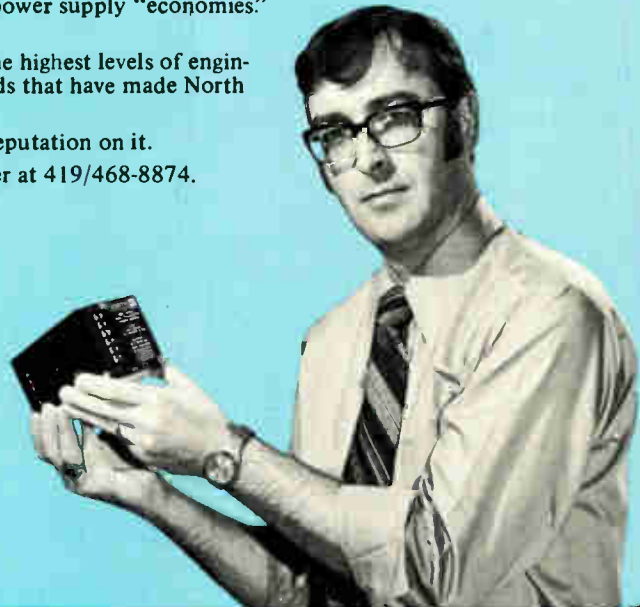

Circle 169 on reader service card

New Coaxial Switches For ATE

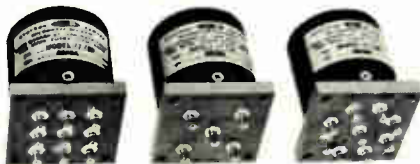

Systron-Donner's remotely programmable coaxial switches handle high-speed signal switching and multiplexing in 50 and 75 ohm systems. Choose from these 3 models:

Model Number	7714	7718	7732
Pole arrangement	1X4 (1P4T)	1X8 (1P8T)	3X2 (3P2T)
Rise time	<500ps	<1ns	<350ps
Transient aberrations (Pk - Pk, 1 ns step)	2%	2%	1%
Price	\$130	\$185	\$165

For full details, call your Scientific Devices office or contact S-D at 10 Systron Drive, Concord, CA 94518. For immediate details, call our Quick Reaction line (415) 682-6471 collect.

SYSTRON  **DONNER**

Circle 264 on reader service card

The Brush recorder module. It gives your system the competitive edge.

OEM recorder modules give you design flexibility along with all the Brush exclusives.

Choose single or dual channel, low profile or vertical models. There's a wide range of chart speed options.

Plus Brush exclusives like pressurized ink writing and Metrisite® servo loop feedback system that assures 99.5% linearity.

Write Gould Inc., Instrument Systems Division, 3631 Perkins Avenue, Cleveland, Ohio 44114. Or Kouterveldstraat Z/N, B 1920 Diegem, Belgium.



 **GOULD**

Circle 265 on reader service card 169

FUJI

8K BYTES COMPLETE MEMORY CARD & 65K BYTES DRAWER FOR ADD-ON MEMORY



MB2000

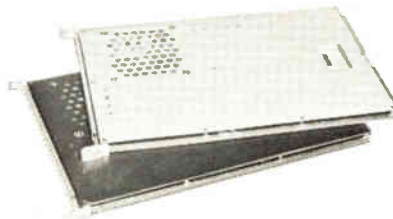

CMS2400 series

The CMS2401 and CMS2402 are 3 wire-3D core memory systems, fully contained on a single printed circuit card. The dimensions are 10" x 15" x 0.5". It mounts on 0.6" connector centers. The single memory card has a maximum capacity of 4096 words x 18 bits per word, smaller capacity by means of depopulation. Eight cards can be bussed to provide up to 32K words x 18 bits capacity. Also byte control is standard so that the 4K-18 can be logically alterable as 8K-9. Low power consumption, high reliability and rugged structure are key advantages of the CMS2400 series.

SPECIFICATIONS:

	Access time	Cycle time	Temp. range	Power supply voltage
CMS2401	330 ns	1 μs	0°C to +50°C	+5V ± 3% 1.6A max., -5V ± 3% 0.2A max.
CMS2402	280 ns	750 ns		+15V ± 3% 3.5A max.

FUJI ELECTROCHEMICAL CO., LTD.

Head Office: Hamagomu Bldg., 5-36-11, Shinbashi, Minato-ku, Tokyo, Japan. TEL: 434-1271
Overseas Office:
New York, TEL: (212) 532-5630 / Los Angeles, TEL: (213) 620-1640 / Düsseldorf, TEL: (211) 89031

Circle 170 on reader service card

New products

2731, is a dual device with two amplifiers in one package. This enables the user to design two combinational circuits with a minimum of extra components. With the addi-

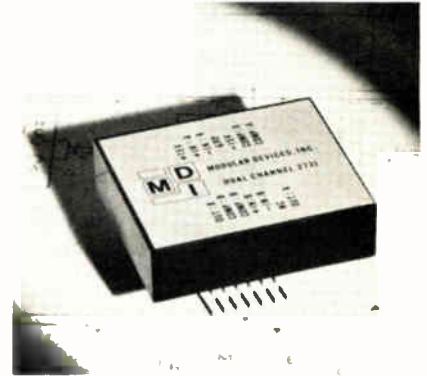

tion of an output transformer, the module can drive a speaker to 4 watts continuous peak power. Output power is 2 w per channel. The unit comes in a 14-pin dual in-line configuration for pc-board mounting. Price is \$39 in small quantity.

Modular Devices Inc., 1385 Lakeland Ave., Airport International Plaza, Bohemia, N.Y. 11716 [386]

Sample-and-hold module offers fast acquisition

The model 5025 sample-and-hold module provides an acquisition time of 30 nanoseconds for a 20-volt signal-level change and also offers a

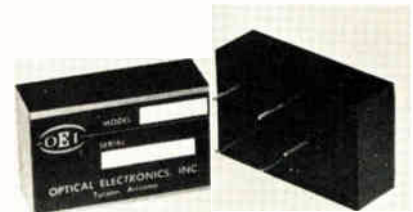

signal bandwidth of typically 50 megahertz. Slewing rate is greater than 600 volts per microsecond. Other specifications include a 50-ns maximum settling time and a 100-picosecond maximum aperture uncertainty. Price ranges from \$160 to \$130, depending on quantity.

Optical Electronics Inc., Box 11140, Tucson, Ariz. 85706 [390]

Variations of Light



National Semiconductors Limited offers a complete line of photoelectric devices, including:

- photocells
- photodiodes
- phototransistors
- photoelectric arrays
- optoelectronic couplers
- customized photoelectric devices



NATIONAL SEMICONDUCTORS LTD

331 Cornelia Street, Plattsburgh, N.Y. 12901 (518) 561-3160
2150 Ward Street, Montreal 378, Quebec (514) 744-5507
On the West Coast, call: Varigon. (213) 644-3611

170 Circle 215 on reader service card

Memory Options Unlimited

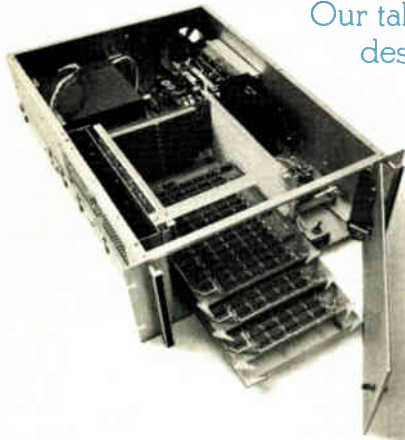

Our talent for combining design and manufacturing skills is only one reason large and small OEMs choose us to produce their memory systems. The other is the range of options we offer.

For some OEMs,

we create systems with our standard card sets. For others, we design special cards. And we produce everything from cards to systems with power supplies, cooling fans, cables, even self testers. Some examples follow.

We designed a 48 megabit solid-state system with our IN-60 20K x 10 serial memory card to replace a rotating drum memory with a 1 MHz data rate.

The IN-62 88 kilobit serial card was designed into a 500 kilobit, 10 MHz memory to replace a small fixed head disc. The system can be expanded to several million bits, operates on batteries should power fail and has its own internal cooling.

And the IN-50, our 100 nanosecond random access card, is the basis for what we believe to be the world's fastest large buffer memory. Used with an analog to digital converter, the memory offers a data rate of 80 MHz—1.3 gigabits a second.

As for custom cards, how about an 8K x 18, 650 nanosecond RAM designed to fit a special card rack? Or an 8K x 12, 450 ns design for a point of sale computer, or 1K x 20 for an intelligent CRT terminal?

The list is almost endless. Intel Memory Systems boards have cycle times ranging from 100 nanoseconds to 1 microsecond and go into anything from telephone network monitors to ground support equipment.

And our customers will tell you that service is grade A+ on both short and long production runs. We have a long list of customers. The list, a catalog with details on standard and custom memory system products along with the name of our nearest representatives are yours for

the asking.

If you call Intel at (408) 246-7501, demand to be connected to the Memory Systems

Division. Intel only makes the chips—we make the systems.

We have our own billion-bit production plant at 345 Middlefield Road, Mountain View, California 94042.

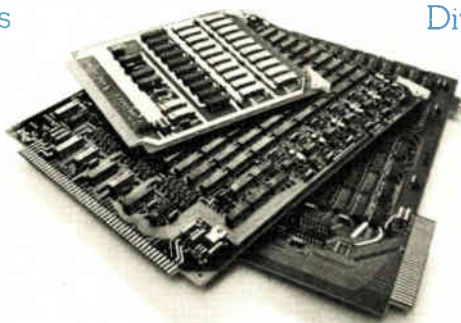

Memory Options Unlimited
intel memory systems

A DIVISION OF INTEL CORPORATION

Who's got the track record for automotive IC development?

When you need custom-developed integrated circuits for automotive applications, why go with a company that hasn't won its spurs? Pick ITT instead. We've already developed circuits for speedometers, tachometers, digital clocks and flashers; they're being installed daily by the automotive industry. And we have more developments on the way. When you need custom circuits for electronic ignition, instrument voltage regulators, fuel injection, automatic dimmers or any of the other automotive applications, look up the company that has the track record. Write today for details of our custom circuit capability.

ITT...Logically

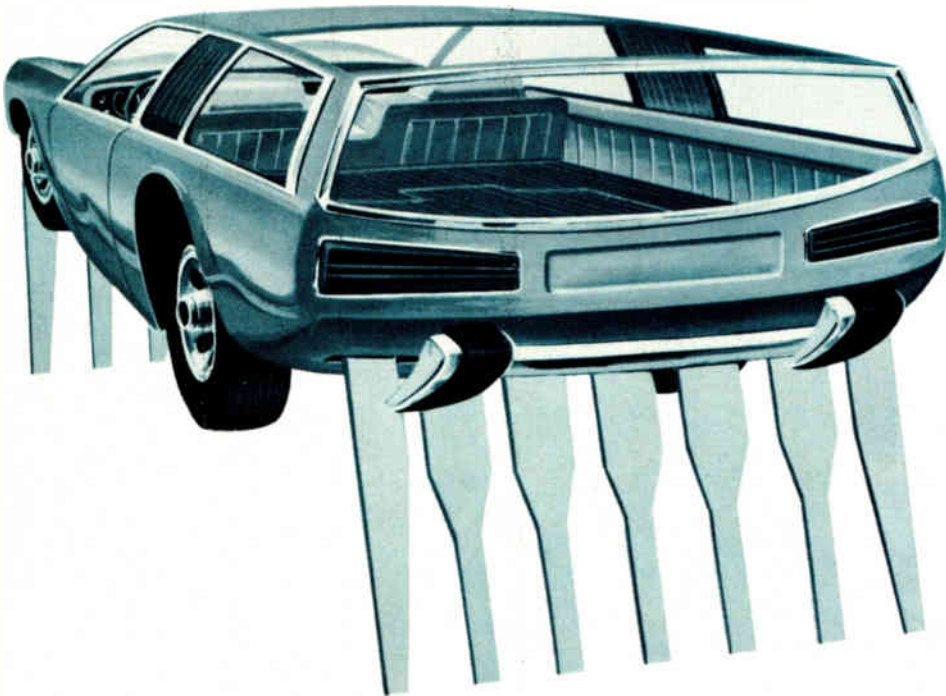

semiconductors

ITT Semiconductors is a division of International Telephone and Telegraph Corporation, 500 Broadway, Lawrence, Mass. 08142 Phone 617-688-1881. Factories in West Palm Beach, Florida • Lawrence, Massachusetts • Footscray, England • Colmar, France • Freiburg, Germany • Cascais, Portugal • Taipei, Taiwan • Sydney, Australia

ITT

New products

Materials

Jacketing for cables is tough

High tear-resistance of thermoplastic urethane permits reduced thickness

As a jacketing material for flexible cable, polychloroprene—better known as neoprene—has been widely used for generations to shield the wires from weather and abrasion. But now a new thermoplastic urethane material made by the Uniroyal Chemical Co. is challenging neoprene. A key factor is the tear strength of urethane—250 to 400 pounds per lineal inch, which is 10 times higher than that of neoprene.

Admittedly, at \$1.20 to \$1.75 per pound it is more costly than neoprene, which sells for 55 cents a pound. However, the extraordinarily high resistance to tearing means that the wall thickness can be reduced and still provide the same protection to the enclosed wires. What's more, since urethane is a plastic, rather than a rubber, no vulcanizing step is required. Doing away with this step, which requires curing with heat and pressure, lowers cable-fabrication cost, putting urethane in a cost-competitive position.

As one example of the desirability of the new material, Mohawk Wire and Cable Corp., Leominster, Mass., switched from neoprene to thermoplastic urethane for television-camera cables, reducing the jacket from a 0.10-inch to a 0.055-in. wall thickness and still providing equivalent protection.

Another advantage of the urethane, which Uniroyal calls Roylar, is its tensile strength, 6,000 psi compared to 1,500 to 1,800 psi for neoprene. This property enables the jacket to play a second role by acting as a support cable. In one application, a urethane-sheathed cable supports a sonar detector lowered from a helicopter. The cable suc-

cessfully survives pulls of 50 to 100 pounds as the aircraft flies about searching for submarines.

Times Wire and Cable Co., Wallingford, Conn., a manufacturer with a reputation for innovation, is replacing polyvinyl chloride (PVC) jacketing on many multiconductor and coaxial cables with the urethane. PVC has been in very short supply recently. David Peterson, marketing manager for OEM-engineered products at Times, says that a urethane-jacketed cable has delivered high performance in the sub-zero temperatures in Canada's Hudson Bay. Says Peterson: "PVC won't crack at low temperatures, but it does stiffen. However, the urethane not only resists cracking but stays flexible at temperatures all the way down to -80°F."

As for supply, neoprene has become hard to obtain due to shortages of chlorine, which is an important ingredient in its manufacture. The basic material for thermoplastic urethane is corncobs.

Uniroyal Chemical Co., Division of Uniroyal, Inc., Spencer St., Naugatuck, Conn. [476]

Clear taping film aids printed-circuit artwork

A clear, antistatic, stable-based polyester film is specifically designed for use in the preparation of printed-circuit artwork. Called Accufilm CTF, the film is dust- and lint-free and it will not stick to the cylinders of reproducing equipment, such as white print or diazo machines. The taping film is also resistant to humidity and temperature changes and is available in sheets and rolls, with a thickness of either 0.005 or 0.007 inch.

Bishop Graphics Inc., 7300 Radford, Ave., North Hollywood, Calif. 91605 [478]

Graphite adhesive bonds glass-to-metal fixtures

Graphi-Bond 551-R is a graphite-base adhesive for the repair and restoration of glass-to-metal seal fix-

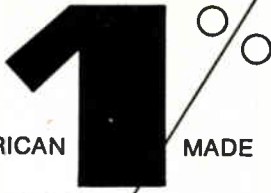

AMERICAN MADE

Tolerance

SCHAUER

1-Watt

ZENERS

Immediate Shipment Low Prices

ANY voltage from 2.0 to 16.0

Quantity	Price each
1-99	\$1.07
100-499	.97
500-999	.91
1000-4999	.86
5000 up	.82



All welded and brazed assembly

No fragile nail heads

Gold plated leads

Write for complete rating data and other tolerance prices.

Buy the kit— Save a lot



Kit contains a 51-piece assortment of SCHAUER 1% tolerance 1-watt zeners covering the voltage range of 2.7 to 16.0. Three diodes of each voltage packaged in reusable poly bags. Stored in a handy file box. Contact your distributor or order direct.

A \$54.57 value for
ONLY **\$24⁵⁰**

Semiconductor Division

SCHAUER

Manufacturing Corp.

4514 Alpine Ave. Cincinnati, Ohio 45242

Telephone: 513/791-3030

OEM'S \$



MODEL 5110
U.S. Pat. No. 3,735,269

FREQUENCY SYNTHESIZER

- **Low Cost** AS LITTLE AS \$1,880 IN OEM QUANTITIES
- **DC to 2 MHz**
- **0.001 Hz Resolution**
- **Full Programmability** BINARY OR BCD
- **No Switching Transients**
- **Direct Digital Techniques**
NO MIXING OR PHASE LOCKING
- **High Spectral Purity** -70db SPURIOUS
-55db HARMONIC
- **High Stability** $\pm 2 \times 10^{-8}/^{\circ}\text{C}$ STANDARD
 $\pm 2 \times 10^{-10}/^{\circ}\text{C}$ OPTIONAL
(OR YOUR OWN EXTERNAL REFERENCE STANDARD)

SOME APPLICATIONS

- Automated Test Systems
- High Speed Signal Processing
- Computer controlled frequency generation, sweeping & hopping (FSK)

For immediate information on how Rockland can meet your specific application and delivery requirements — call our local rep or Dave Kohn directly at.

ROCKLAND

Rockland Systems Corporation 230 W. Nyack Road, West Nyack, N.Y. 10994
(914) 623-6666 TWX 710-575-2631

New products/materials

tures. Suitable for use at temperatures to 5,400°F, the material will not deteriorate rapidly in the sealing atmosphere, as some glass-to-metal seals do, when exposed to temperatures of around 1,900°F, and will in



many instances outlast the base material. The new adhesive, which allows users to repair and retain fixtures that may otherwise have been discarded, is available in 1-pint and 1-quart containers priced at \$25 and \$40, respectively. Delivery time is two weeks.

Aremco Products Inc., Box 429, Ossining, N.Y. 10562 [479]

Conductive epoxy designed for microcircuit chip-bonding

Developed for microelectronic chip-bonding applications requiring rapid curing at relatively low temperatures, an electrically conductive silver epoxy called Epo-Tek H20E can be cured in 45 seconds at 175° C, 5 minutes at 150° C and 90 minutes at 80° C. The two-part system, because of its fast-curing properties, is suitable for use with the latest generation of high-speed automated epoxy-bonding equipment. Pure silver powder is dispersed in both the epoxy and the hardening agent. Pot life is four days at room temperature, and shelf life is two years at room temperature. Refrigeration is not recommended in shipping or storage. A 1-ounce trial kit is priced at \$22.

Epoxy Technology Inc., 65 Grove St., Watertown, Mass. 02172 [480]

NEW: Only General Electric offers you all these benefits in green Solid State Lamps (LED's)!



Four new lamps — Two light outputs

You can select both the lamp size and light output you need with GE's new green bright visible SSL's. The two brightest, SSL44-2 and the 1/8" longer SSL44L-2, provide a *minimum* initial light output of 1.8 millicandela with a typical output of 2.4 mcd. Equivalent light outputs for the standard, less expensive SSL44-1 and SSL44L-1 are 0.8 minimum and 1.4 typical mcd.

Available now

These new GE green SSL's are in stock now, ready for off-shelf delivery. Contact your GE SSL distributor or your local GE representative today to get the newest spec sheets, delivery dates and prices. (Or circle request number at bottom of ad.)

Exclusive GE guarantees

Only GE gives you all these guarantees on every visible SSL you buy: Initial light output will be at or above the published minimum. Each lamp made is inspected at rated current for light output and forward voltage; reverse voltage at 10 μ A is 3 volts or greater. General Electric will refund the lamp purchase price to the original purchaser or provide replacements for all returned lamps not meeting these guarantees.

FREE: Designers data kit

Write today on your company letterhead to get our free Designers Data Kit, which includes a free sample of our new green lamp as well as complete technical data. General Electric, Miniature Lamp Products Dept., Inquiry Bureau, Dept. M, Nela Park, Cleveland, Ohio 44112.

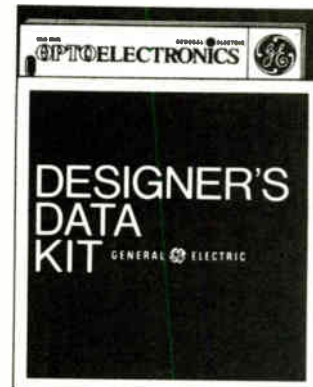

GE electronic distributors (listed alphabetically by company name)

Almac/Stroum Electronics
Seattle, WA

Almo Electronics
Philadelphia, PA

Barnhill Five, Inc.
Denver, CO

Brill Electronics
Oakland, CA

Carlton-Bates Co.
Little Rock, AR

Cramer Electronics
Albuquerque, NM

East Syracuse, NY

Endwell, NY

Irvine, CA

Mt. Prospect, IL

Newton Center, MA

North Haven, CT

Sunnyvale, CA

Electra Distributing Co.
Nashville, TN

Electronics Marketing Corp.
Columbus, OH

Electronics Parts Co.
Denver, CO

Electronic Supply
Riverside, CA

Elmar Electronics
Mt. View, CA

General Electric Supply Co.
Rochester, NY

General Radio Supply Co.
Camden, NJ

Gerber Electronics
Dedham, MA

Graham Electronics Supply Co.
Indianapolis, IN

G. S. Marshall Co.
El Monte, CA

Hamilton/Avnet Electronics
Albuquerque, NM

Bellevue, WA

Burlington, MA

Cedar Grove, NJ

Culver City, CA

Dallas, TX

Denver, CO

Georgetown, CT

Hanover, MD

Hazelwood, MO

Hollywood, FL

Houston, TX

Livonia, MI

Lenexa, KS

Mt. Laurel, NJ

Mt. View, CA

Phoenix, AZ

Salt Lake City, UT

San Diego, CA

Schiller Park, IL

Syracuse, NY

Westbury, NY

Hammond Electronics
Orlando, FL

Harpe Electronics, Inc.
Chattanooga, TN

Hughes/Peters, Inc.
Cincinnati, OH

Columbus, OH

Kierulff Electronics, Inc.
Los Angeles, CA

L Comp
North Kansas City, MO

Lykes Electronics Corp.
Atlanta, GA

Milgray Electronics
Freeport, NY

Newark Electronics
Chicago, IL

Salt Lake City, UT

Oil Capitol Electronics Corp.
Tulsa, OK

Olive Industrial Electronics, Inc.
St. Louis, MO

Pioneer Standard Electronics
Cleveland, OH

Dayton, OH

R. S. Electronics
Detroit, MI

Rem Electronics
Warren, OH

Rochester Radio Supply Co., Inc.
Rochester, NY

Rome Electronics, Inc.
Rome, NY

Schweber Electronics
Atlanta, GA

Beachwood, OH

Bridgeport, CT

Danbury, CT

Elk Grove Village, IL

Hollywood, FL

Rochester, NY

Rockville, MD

Somerset, NJ

Waltham, MA

Westbury, NY

Semiconductor Specialists, Inc.
Elmhurst, IL

Indianapolis, IN

Pittsburgh, PA

Southeastern Radio Supply Co.
Raleigh, NC

Standard Electronics, Inc.
Cheektowage, NY

Sterling Electronics
Dallas, TX

Houston, TX

Western Electromotive
Culver City, CA

Zack Electronics
San Francisco, CA

GENERAL  ELECTRIC

CHIEF SCIENTIST Air Force Avionics Laboratory

The United States Air Force is looking for an R&D manager, with a broad scientific and technical applications background and recognized ability, to serve as Chief Scientist for the Air Force Systems Command, Air Force Avionics Laboratory, Wright-Patterson AFB, Ohio. The Laboratory provides new avionics technology, products and services to the Air Force by performing R&D and managing R&D contracts with industry and universities oriented to new AF systems in planning or development. The Laboratory is at the leading edge of navigation, communication, electronic warfare, surveillance, reconnaissance, and weapon delivery technologies. It is a leader in electronic component and device development and is now pioneering in system avionics.

The Chief Scientist:

- Is the top level advisor and consultant to the Commander on all scientific and technical matters.
- Coordinates all scientific and technical activities.
- Evaluates the Technical Program of the Laboratory.
- Identifies research requirements and tasks appropriate to research laboratories.
- Analyzes advancements in a wide variety of areas to determine applicability to laboratory programs and effects on Laboratory objectives.
- Represents the Laboratory to the general research community.

In addition to a broad inter-disciplinary knowledge of electromagnetic technologies—e.g., computer hardware and software, radar, laser, E/O and communications—the Chief Scientist must have a Doctoral degree in a directly relevant field.

Salary ranges from \$32,806 to \$36,000, depending on qualifications. Please send a detailed resume or Standard Form 171, specifying this position to:

ASD/DPCE
ATTN: Mr. M. E. Semler
Wright-Patterson AFB, Ohio 45433

U.S. Citizenship Required
An Equal Opportunity Employer (M/F)



POSITIONS VACANT

Positions Available—Electrical & Electronic Eng's. Over 1000 US client co's pay our fees for selected technical referrals. Est. 1959. Send resume with pres. sal. Atomic Personnel, Inc., Box L, 1518 Walnut St., Phila., Pa. 19102.

EMPLOYMENT SERVICES

Growth Positions, \$14-30,000. Fees Paid. Nationwide. Longberry of Pittsburgh. Suite 962-G, Two Gateway Center, Pittsburgh, Pa. 15222.

CLASSIFIED ADVERTISING

SEARCHLIGHT SECTION

BUSINESS OPPORTUNITIES
USED OR SURPLUS EQUIPMENT

COILS TOROIDS - BOBBINS
Self-Supporting

OLIVAX
GRANBY, QUEBEC
CANADA

Tel: (514) 378-9977 — TWX 610-532-6510

CIRCLE 950 ON READER SERVICE CARD

IMMEDIATE DELIVERY Minis & Peripherals DEC—HIS—NOVA SEL—HP—MOHAWK

CPU, Card, Printer, Tape, Disk
NEW • MOHAWK 4320 PRINTERS

PDP 11 PERIPHERALS
CPU, MEMORY

PDP 8 CPU \$1500

\$750 Minis

TELETYPE 35 & 37
DEC & HONEYWELL Modules
617/261-1100

Send for Free Report "Maintenance of Computers"
AMERICAN USED COMPUTER CORP.
P.O. Box 68, Kenmore Sta. Boston MA 02215
member COMPUTER DEALERS ASSOCIATION

CIRCLE 951 ON READER SERVICE CARD

Q. Whom do I contact or call to re-new my classified ad or make corrections?

A. Write Electronics, Class. Adv. Dept., P.O. Box 900, NY, NY 10020 or call: (212) 997-6585 or 6586. Give full company name, size of ad. & date or dates it is scheduled to appear.

Ohms 500
10 1K
20 2K
50 5K
100 10K
200 20K

SPECTROL CERMET Any 2 "MICRO" POTS

Model No. 41-2-1
for \$1
3/8 x 3 x .160" rectangular, 15-turn wedge-shaped pins, for easy pc work. 4 watt 20% screw-driver side.

Model No. 53-1-1
3/16 dia. x 5/16" high. Single-turn, 3-leads. screw-driver top. 1/2 watt. TO-5 transistor size. fits transistor sockets.

Model No. 53-2-1
5/16" cube, single-turn, screw-adjust, front. 1/2 watt 20%

Buy 3 or more 10% discount

Lowest Prices • Factory Marked
Buy 100 — Take 20%

Largest Selection TTL IC's

Type	Sale	Money Back Guarantee			
SN7400	\$0.30	SN7485	.55	SN74125	.71
SN7401	.30	SN7465	.30	SN74139	1.25
SN7402	.30	SN7461	.35	SN74140	1.25
SN7403	.30	SN7462	.35	SN74145	1.55
SN7404	.35	SN7464	.30	SN74148	4.50
SN7405	.35	SN7467	.50	SN74152	1.61
SN7406	.45	SN7470	.50	SN74153	1.25
SN7407	.55	SN7471	.55	SN74152	4.95
SN7408	.55	SN7472	.50	SN74153	1.60
SN7410	.30	SN7473	.55	SN74154	2.10
SN7411	.35	SN7474	.55	SN74155	1.55
SN7413	.95	SN7475	1.00	SN74156	1.45
SN7415	.55	SN7476	.65	SN74157	1.55
SN7416	.55	SN7478	.95	SN74158	1.55
SN7417	.55	SN7480	.65	SN74160	1.95
SN7420	.30	SN7481	1.25	SN74161	1.95
SN7421	.55	SN7482	.99	SN74163	1.95
SN7422	.35	SN7483	1.25	SN74164	2.95
SN7425	.50	SN7485	1.41	SN74165	2.10
SN7426	.36	SN7486	.50	SN74166	2.05
SN7430	.30	SN7489	4.50	SN74172	2.86
SN7432	.35	SN7490	1.49	SN74174	3.20
SN7437	.55	SN7491	1.35	SN74175	3.20
SN7438	.55	SN7492	1.35	SN74176	2.10
SN7440	.30	SN7493	1.35	SN74177	2.10
SN7441	1.40	SN7494	1.35	SN74179	2.10
SN7442	1.50	SN7495	1.35	SN74180	1.20
SN7443	1.50	SN7496	1.35	SN74181	4.90
SN7444	1.50	SN74106	.95	SN74182	1.20
SN7445	1.50	SN74107	.70	SN74185	2.50
SN7446	1.65	SN74108	.95	SN74192	1.95
SN7447	1.45	SN74112	.95	SN74193	1.95
SN7448	1.50	SN74113	.95	SN74194	1.95
SN7450	.30	SN74114	.95	SN74195	1.25
SN7451	.30	SN74121	.60	SN74196	2.50
SN7453	.30	SN74122	.95	SN74197	2.50
SN7454	.30	SN74123	1.20	SN74198	2.65
		SN74125	.71	"DIP" Packages	

Terms: add postage. Rated: net 30
Phone Orders: Wakefield, Mass. (617) 245-3829
Retail: 16-18 Del Curmine St., Wakefield, Mass.
(off Water Street) C.O.D.'S MAY BE PHONED

POLY PAKS

P.O. BOX 942S, LYNNFIELD, MASS. 01940

"IC's"
Semi's
Parts

CIRCLE 952 ON READER SERVICE CARD

FREE CATALOG

HARD-TO-FIND PRECISION TOOLS

Lists more than 2000 items—pliers, tweezers, wire strippers, vacuum systems, relay tools, optical equipment, tool kits and cases. Also includes ten pages of useful "Tool Tips" to aid in tool selection.

JENSEN TOOLS
4117 N. 44th Street, Phoenix, Ariz. 85018

CIRCLE 953 ON READER SERVICE CARD

RADAR SYSTEMS GROUND AND AIRBORNE. AUTOMATIC TRACKING ANTENNA SYSTEMS. NIKE AJAX. NIKE HERCULES M-33. MSQ-1A. MPS-19. MPS-9. SCR 584. TPS-1D. TPS-28. FAA-ASR-2. AIRBORNE SYSTEMS. APN-84. APN-102. APS-20. APS-27. APS-45. DPN-19. DIGITAL COMPUTERS. IBM 650. IBM 704.

LARGEST INVENTORY OF RADAR AND MICROWAVE EQUIPMENT IN THE WORLD.

RADIO RESEARCH INSTRUMENT CO.
3 QUINCY ST., NORWALK, CONN. 06850 (203) 853-2600

CIRCLE 954 ON READER SERVICE CARD

free catalog

POTTING APPLICATORS
MANUAL OR AIR OPERATED

2 1/2cc 6cc 12cc 30cc
FOR POTTING, ENCAPSULATING ETC.

PHILIP FISHMAN CO., INC.
7 CAMERON ST. WELLESLEY, MASS. 02181

CIRCLE 956 ON READER SERVICE CARD

FOR LESS THAN
\$6.00

SUB-ASSEMBLIES
Per loaded hour

OLIVAX
GRANBY, QUEBEC
CANADA

Tel: (514) 378-9977 — TWX 610-532-6510

CIRCLE 957 ON READER SERVICE CARD

176

Electronics/April 18, 1974

Another introductory offer to new members of the ELECTRONICS AND CONTROL ENGINEERS' BOOK CLUB

	404/445 ELECTRONIC CIRCUITS MANUAL by J. Markus Pub. price, \$22.00 Club price, \$15.75		286/515 INTEGRATED CIRCUITS: A Basic Course for Engineers and Technicians by R. G. Hibberd Pub. price, \$10.25 Club price, \$8.45	
	637/458 DESIGNING WITH TTL INTEGRATED CIRCUITS by Texas Instruments Inc. Pub. price, \$19.50 Club price, \$13.50		100/810 MOS/LSI DESIGN AND APPLICATION by Carr & Mize Pub. price, \$18.50 Club price, \$13.50	
	404/437 SOURCEBOOK OF ELECTRONIC CIRCUITS by J. Markus Pub. price, \$21.50 Club price, \$17.50		313/059 HANDBOOK OF SEMI-CONDUCTOR ELECTRONICS, 3/e by P. Hunter Pub. price, \$29.85 Club price, \$21.50	
	484/368 COMMUNICATION SYSTEMS DESIGN by P. F. Panter Pub. price, \$19.50 Club price, \$13.50		287/341 STANDARD HANDBOOK OF ENGINEERING CALCULATIONS by T. G. Hicks Pub. price, \$19.50 Club price, \$14.25	
	491/364 THE DESIGN OF DIGITAL SYSTEMS by J. B. Peatman Pub. price, \$15.50 Club price, \$11.75		124/035 HANDBOOK OF PHYSICS, 2/e by Condon and Odishaw Pub. price, \$37.45 Club price, \$14.95	
				773/777 NOMOGRAPHS FOR ELECTRONICS by R. L. Peters Pub. price, \$27.50 Club price, \$19.95
				649/170 OPERATIONAL AMPLIFIERS by Tobey, Graeme & Huelsman Pub. price, \$15.00 Club price, \$11.50
				353/387 MINICOMPUTERS FOR ENGINEERS & SCIENTISTS by G. Korn Pub. price, \$17.75 Club price, \$10.50
				209/731 STANDARD HANDBOOK FOR ELECTRICAL ENGINEERS, 10/e by Fink and Carroll Pub. price, \$34.85 Club price, \$24.95

Save time and money by joining the
Electronics and Control Engineers' Book Club



HERE is a professional club designed specifically to meet your day-to-day engineering needs by providing practical books in your field on a regular basis at below publisher prices.

How the Club operates: Basic to the Club's service is its publication, the *Electronics and Control Engineers' Book Club Bulletin*, which brings you news of books in your field. Sent to members without cost, it announces and describes in detail the Club's featured book of the month as well as alternate selections which are available at special members' prices.

When you want to examine the Club's feature of the month, you do nothing. The book will be mailed to you as a regular part of your Club service. If you prefer one of the alternate selections—or if you want no book at all for that month—you notify the Club by returning the convenient card enclosed with each *Bulletin*.

As a Club member, you agree only to the purchase of four books over a two-year period. Considering the many books published annually in your field, there will surely be at least four that you would want to own anyway. By joining the Club, you save both money and the trouble of searching for the best books.

MAIL ATTACHED POSTPAID CARD

(If card removed, send coupon below)

ELECTRONICS AND CONTROL ENGINEERS' BOOK CLUB
582 Princeton Road, Hightstown, New Jersey 08520

Please enroll me as a member of the Electronics and Control Engineers' Book Club and send me the two books indicated below. I am to receive the higher priced of the two for just \$1, and my first selection at the special Club price. A small charge for postage and handling will be included. These books are to be shipped on approval, and I may return them both without cost or further obligation. If I decide to keep the books, I agree to purchase as few as four additional books (including this first selection) during the next two years at special Club prices (guaranteed 15% discount, often more).

Write Code No. of
bonus book
here

Write Code No. of
first selection
here

Name _____

Address _____

City _____

State _____ Zip _____

E33257

The HS-200S... a wire memory offering speed, capacity, cost and reliability of ample proportions.

This is our latest wire memory. It gives you access time of 180 ns and cycle time of 250 ns. Memory elements, of course, consist of our own special development, magnetic wires. Non-destructive read-out is featured. HS-200S means maximum reliability at minimum cost. In fact, you get a 65 kilo-byte assembly with an MTBF figure of 10,000 hours. HS-200S is a component precisely matched to computers of the new age.

Wire Memory System HS-200S Specifications

1. **Memory elements** Non-destructive read-out
2. **Storage capacity** 8 kwords/80 bits, 16 kwords/40 bits, 32 kwords/20 bits
3. **Access time** 180 nanoseconds
4. **Cycle time** Write-in Read-out 250 nanoseconds
5. **Interface levels** TTL logic . . . H +2.4—+5V L -0.5—+0.5V
6. **Dimensions** 500×300×112mm (Basic unit capacity is 65 Kbytes. Expansion to one megabyte is possible.)
7. **Required power** +30V, +15V, +5V, -15V

Please contact our sales department if you have special requirements.



TOKO, INC.

Head Office: 1-17, 2-chome, Higashi-Yukigaya, Ohta-ku, Tokyo, Japan
 New York: Toko New York Inc.
 350 Fifth Avenue, New York, N.Y. 10001 U.S.A. Tel: 565-3767
 Los Angeles: Toko, Inc. Los Angeles Liaison Office
 3440 Wilshire Blvd., Tishman Building, Suite 1106 Los Angeles, Calif.
 90010, U.S.A. Tel: 380-0417
 Düsseldorf: Toko, Inc. Europe Liaison Office
 4 Düsseldorf, Kölner Straße 246, Düsseldorf, W. Germany Tel: 78-7064

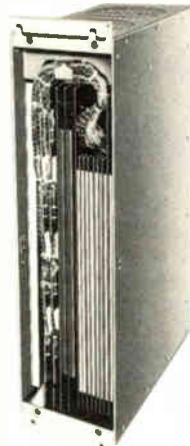

New literature

Microwave components. RLC Electronics Inc., 83 Radio Circle, Mt. Kisco, N.Y. 10549, has released a new catalog on the company's line of precision microwave components. The 80 pages list more than 200 standard, passive, and coaxial components, such as filters, switches, attenuators, terminations, and detectors. Circle 421 on reader service card.

D-a converters. From Dattel Systems Inc., 120 Turnpike St., Canton, Mass. 02021, comes a new brochure describing the DAC-HR series of digital-to-analog converter modules and giving applications information, specifications, and mechanical dimensions. [422]

Magnetic foil. The use of magnetic foil for determining the amount of shielding required in electronic circuits is discussed in a data sheet available from James Millen Manufacturing Co., 150 Exchange St., Malden, Mass. 02148 [423]

Semiconductor materials. A catalog of bonding agents, etchants, and other materials for semiconductor applications is available from the Transene Co. Inc., Rte. 1, Rowley, Mass. 01969 [424]

Powder cores. A technical bulletin describing the performance characteristics of moly-permalloy powder cores, which can operate at up to six times the flux density of other cores, can be obtained from Magnetic Core Corp., Box 368, Newburgh, N.Y. 12550 [425]

Dc op amps. A 20-page catalog giving details of the company's line of dc operational amplifiers is available from Modular Devices Inc., 1385 Lakeland Ave., Airport International Plaza, Bohemia, N.Y. 11716. Block diagrams, specifications, and applications and price data are provided. [426]

Test equipment. Baynton Electronics Corp., 2709 N. Broad St., Philadelphia, Pa. 19132, has issued a 64-page catalog with information on electronic test equipment. Included

Circle 180 on reader service card

Team up with PERMAG MAGNETS

The Permag team's a winner. Permanent magnets, assemblies, Alnico, and ceramics. What a lineup! 24 hour off-the-shelf delivery. Design and engineering assistance. Complete magnetizing, grinding, and cutting facilities. Call or write for our new catalogs. Permag . . . worth cheering for.

Consult your Yellow Pages for address and telephone number of Permag near you.

Cable Address: MAGNETS NEWYORK

YOUR NO. 1 SOURCE FOR ALL MAGNETIC MATERIALS

ALL ACROSS THE COUNTRY

if it's a meter or meter relay,

Stock or Special...

Simpson makes it.



Stock:

Simpson distributors nationwide stock over 1,500 types, ranges, styles and sizes of panel meters, relays and controllers. They're all listed in Catalog 4200. Write for your free copy.

Special:

Need a special or unusual meter? Let Simpson help you custom design it. Send us your specs and we'll send you a quote. But check our catalog first—that "special" may be a standard Simpson stock item.

Get off-the-shelf delivery from your local electronics distributor.



SIMPSON ELECTRIC COMPANY
853 Dundee Avenue, Elgin, Illinois 60120
(312) 695-1121 • Cable: SIMELCO • Telex: 72-2416

IN CANADA: Bach-Simpson, Ltd., London, Ontario
IN ENGLAND: Bach-Simpson (U.K.) Limited, Wadebridge, Cornwall
IN INDIA: Ruttonsha-Simpson Private, Ltd., Vikhroli, Bombay



Micaply Ohmega™

A different way to design without discrete resistors.

For printed circuits and microelectronics

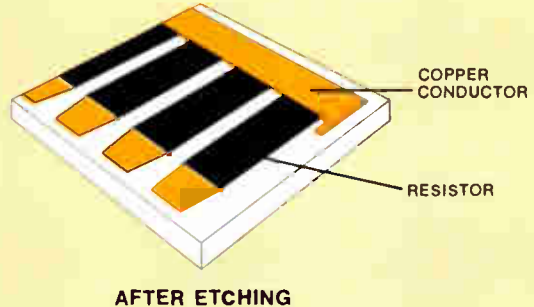
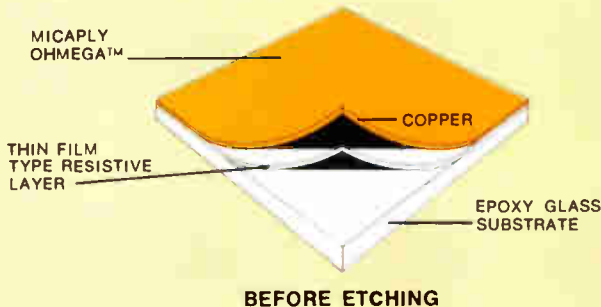

Micaply Ohmega™ can reduce costs and eliminate the need for discrete resistors. And it's available immediately.

It's a proven resistor-conductor laminate with a bi-layer cladding on one or both sides.

Etch integral resistors and conductors on the same surface. The entire process is subtractive.

No screening, firing or vacuum equipment is required.

- 25 and 100 ohms-per-square materials.
- Line widths consistent with thin film microelectronic techniques are possible.
- 10" x 36" sheets for processing economy.
- Design assistance and circuit

production available.

It's being used now for termination resistor networks, calculator circuits and microelectronics. Get the facts. Write today.

The **Mica** Corporation
Culver City, California
(213) 870-6861 and
Micaply International, Silloth, England

Circle 182 on reader service card

Is the STATE-OF-THE-ART CREEPING UP on YOU?

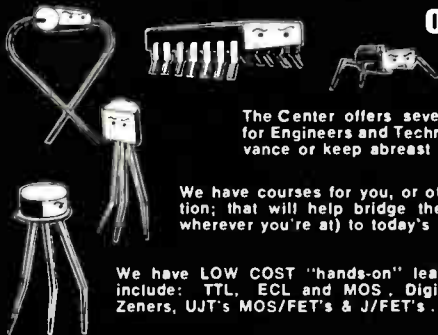

The Center offers several informal programs for Engineers and Technicians who want to advance or keep abreast of the State-of-the-Art!

We have courses for you, or others in your organization; that will help bridge the gap from relays (or wherever you're at) to today's latest devices.

We have LOW COST "hands-on" learning programs which include: TTL, ECL and MOS, Digital I.C.'s, Transistors, Zeners, UJT's MOS/FET's & J/FET's... plus more.

SEND FOR FREE CATALOG

or Call Gene Presta at 513/296-1020



Yes, I'm interested in learning about your programs!

Name _____

Street _____

City _____ State _____ Zip _____



Phone: 513/296-1020
2876 CULVER AVENUE
DAYTON, OHIO 45429
E474

182 Circle 217 on reader service card

The Ballantine 512 MHz DIGITAL COUNTER

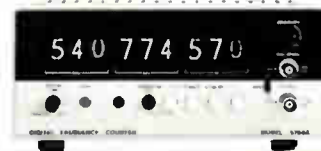

The 5700A Frequency Counter. Range 10 Hz to more than 512 MHz. Nine digit display. Carrier measurements to 1 Hz resolution in 2 seconds of keyed transmitter time. Selective signal tone checks to 0.1 Hz resolution. Sensitivity 10 mV rms with AGC. Stability 3/10⁷/month. 3/10⁹/day optional.

- HIGHEST SENSITIVITY
- BEST RESOLUTION
- FASTEST COUNT RATE
- LOWEST PRICE **\$945**

Meets FCC Requirements



Ballantine Laboratories, Inc.
P.O. Box 97, Boonton, New Jersey 07005
201-335-0900, TWX 710-987-8380

Circle 218 on reader service card

New literature

are specifications and prices for signal generators, frequency converters, power supplies, counters, timers, microwave components, production tools, and other parts. [427]

Spectrum analyzer. An applications note from Sivers Lab, Box 420 18, S-126 12 Stockholm 42, Sweden, gives ideal measurements for the YIG-tuned, wide-dispersion spectrum analyzer designated model PM 7800. [428]

Microwave laminates. Keene Corp., Chase-Foster Laminates division, 199 Amaral St., Box 4305, E. Providence, R.I., has published a four-page bulletin on Di-Clad microwave stripline laminates. Di-Clad is a lamination of polytetrafluoroethylene-coated glass fabric with copper cladding on one or both surfaces. [429]

Wideband couplers. A seven-page catalog from Werlatone Inc., Rte. 22, Brewster, N.Y., contains specifications and outline drawings of the company's line of wideband directional couplers, which are available in both printed-circuit and connector versions. [430]

Optical components. A 62-page catalog of optical components and coatings from Spectrum Systems, Barnes Engineering Co., 44 Commerce Rd., Stamford, Conn. 06904, covers interferometer flats and windows, laser reflectors, quartz lenses, and Littrow prisms. [431]

Wall chart. A wall chart, including design tips, applications notes, process technology, and a selector guide to Darlington power transistors is available from Motorola Semiconductor Products Division, Box 20924, Phoenix, Ariz. 85036 [432]

Temperature controls. Love Controls Corp., 1714 S. Wolfe Rd., Wheeling, Ill. 60090. A line of single and dual digital setpoint temperature controls is described in bulletin 9460. [433]

Op amps. Siliconix Inc., 2201 Laurelwood Rd., Santa Clara, Calif.

IN CALCULATOR CHIPS...

CZL-550...

**a super-powerful, four function,
eight digit calculator chip with direct
segment LED drive, supplied with the
digit driver, at a super-low price.**

For complete information call (516) 733-3354 or write:
General Instrument Corporation, Microelectronics,
600 West John Street, Hicksville, N.Y. 11802

GI'S GOT IT!

Circle 220 on reader service card

Own your own holder to hold your own!

Hold your own copies of Electronics in specially designed slipcase holders. They'll keep your Electronics library neat and handy—a permanent information file, issue by issue.

Just complete the coupon and mail to Jesse Jones. He'll process your order upon receipt, postpaid.



ELECTRONICS BOXER
Jesse Jones Box Corporation
2250 E. Butler St., Philadelphia, Pa. 19137

Please send me: boxes @ \$4.25 each; 3 boxes @ \$12.00; 6 boxes @ \$22.00.
My check or money order is enclosed.

Name: _____

Address: _____

City: _____

State: _____

Zip: _____

MAGNETIC INSTRUMENTATION

Gaussmeters • Fluxmeters

Magnetizers • Stabilizers • Demagnetizers

Automatic Magnet Processing Systems

Alnico Permanent Magnets • EI Laminations



Thomas & Skinner, Inc.

1120 East 23rd Street, Indianapolis, Indiana 46205 • 923-2501

Different hopes for different folks.



People want different things from a college education.

But they all agree on one thing. It takes more than brains to get a diploma.

Why not make the burden a little easier? Start buying U.S. Savings Bonds now.

Bonds are a dependable way to build a college fund for your children. And an easy way to start saving them is by joining the Payroll Savings Plan.

Start a college fund

now with U.S. Savings Bonds. They just might let your kids spend more time studying and less time working to stay in school—whatever they hope to be.



Take stock in America.

Buy U. S. Savings Bonds

Now 5. Bonds pay 5% interest when held to maturity of 5 years (10 months if the first year). Bonds are replaced if lost, stolen or destroyed. When needed they can be cashed at your bank. Interest is not subject to state or local income taxes, and federal tax may be deferred until redemption.

 The U. S. Government does not pay for this advertisement. It is presented as a public service in cooperation with The Department of the Treasury and The Advertising Council.

New literature

95054, has published an applications note that provides information on multiple micropower operational-amplifier integrated circuits for use where low current drain and low voltage are important. The bulletin outlines the functions of the devices, elements of programming, and the effects of slew-rate limiting. [434]

Power supplies. Deltron Inc., Wisahickon Ave., N. Wales, Pa. 19454. Bulletin 118A gives details of a new series of laboratory power supplies and also advises on the use of integrated circuits that give line and load regulation of 0.01% and ripple of 250 microvolts. [435]

Ac motor control. Ramsey Controls Inc., 333 Rte. 17, Mahwah, N.J. 07430., presents a discussion of adjustable-frequency ac motor speed control in a booklet that also gives information on applications.

Components. A catalog of more than 3,500 rf coils, rf chokes, and other electronic components has been released by J.W. Miller division, Bell Industries, 19070 Reyers Ave., Box 5825, Compton, Calif. 90224. A selection guide is included along with specifications, prices, and schematics. [437]

Microwave diodes. A 16-page catalog of microwave semiconductors, available in chip and beam-lead form for microstrip and stripline applications, is obtainable from Alpha Industries Inc., 20 Sylvan Rd., Woburn, Mass. 01801 [436]



The Bright Guy's Jumbo Diffused LED Digits are Lighter on the Eyes, Easier on the Wallet and Bolder than the other guys.



Help out yourself and your customers by putting Litronix DL-747 0.6" diffused LED digits into that new control, instrument, clock or point of sales display. You'll save money and get bolder brighter displays.

Everybody benefits because we produce these jumbos with our Encapsulated Light Diffusion process, which makes them look better while reducing their cost. The ELD process captures the LEDs' light in special light pipes molded in a high contract background plastic.

Brightness is high — 5.0 mcd at 20mA. But the light is soft and the digits are perfectly shaped — you can see how the segments are mitered.

The DL-747 jumbos are our second

family of low-cost, diffused LED digits.

DL-746	±1 overflow	common anode
DL-747	seven segment	common anode
DL-749	±1 overflow	common cathode
DL-750	seven segment	common cathode

We also use the ELD process to produce equally neat DL-707 0.3" digits.

You can't get more economical, reliable displays. Prices in 1K quantities are only \$3.60 for the 0.6" digit series. And the savings really rise when you figure in the savings on support components.

See our diffused LED digits for yourself. Call or write today.



litronix

Litronix, Inc. 19000 Homestead Road, Cupertino, California 95014
(408) 257-7910 TWX: 910-338-0022
European Headquarters: Litronix, Inc. Bevan House, Bancroft Court
Hitchin, Hertfordshire SG5 1LW England Tel: 2676 Telex: 825-497

Electronics advertisers

April 18, 1974

Abbott Transistor Labs Inc. Technical Advertising Agency	6	Deico Electronics Division, General Motors Corp. Campbell-Ewald Company	44-45	L-H Research Inc. Van Der Boom McCarron	35
Adret Electronique Psycho Publicite	13E	Dialight Corporation Michel-Cather, Inc.	156	Litronix, Inc. Regis McKenna, Inc.	185
Advanced Micro Devices Keye Donna Pearlstein	26E	Eastman Kodak Company, Business Systems Markets Division J. Walter Thompson Co.	15	Microdata Company JMR Advertising	71
Advanced Micro Levises Keye/Donna/Pearlstein	10-11	E-H Research Laboratories, Inc. Hal Lawrence Inc.	160	The Mica Corporation Robert A. White Advertising	182
AEG Telefunken Werbeagentur Dr. Kuhl GmbH	15	Electronics & Control Engineers Book Club	177, 178-179	Micro Power Systems Associated Ad Ventures, Inc.	76
Airco Industrial Gases Gimbel, Hammond, Farrell & Walsh., Inc.	137	Electronic Memories and Magnetics Corporation S. Michelson Advertising	190	Motorola Semiconductor Graham & Gillies Limited	9E
Alpax Electronics Welch, Mirabile & Co., Inc.	161	Emr-Telemetry Carol Marketing Associates	43, 187	3M Electro Products Division Batten, Barton, Durstine & Osborn, Inc.	133
Alcatel	30E	Exact Electronics Hugh Dwight Advertising	102	National Semiconductors Limited Griener Harries Maclean Ltd.	170
Allen Bradley Company Hoffmin, York, Baker & Johnson Inc.	24	Exar Integrated Systems Regis McKenna Inc.	48	Neff Instruments Corp. Larry Courtney Company	150
American Optical Scientific Instrument Division Wilson, Haight & Welch, Inc.	132	Executone, Inc., Printact Relay Division J.A. Richards	134	North Electric Co.—Electronics Div. Marc Associates	169
Ampere Electronic Corp. Sam Groden, Incorporated	165	Fairchild Systems Technology Hall Butler Blatherwick, Inc.	159	Permag Corporation Schneider, Allen, Walsh, Inc.	180
Analog Devices Inc. Schneider Parker, Inc.	80	Ferroxcube Black-Russell-Morris	54	PGP Industries, Inc. Centromedia, Inc.	188
Anritsu Electric Co., Ltd. Diamond Agency Co., Ltd.	21E	Forl Agence Domenach	62	Philips Eicom Intermarco nederland	29E
Anzac Electronics Ken Puleo Advertising	144	F.R. Electronics Ltd. T.W. Brooke Smith	151	Philips N.V. Pfl/T & M Division Brookies Communications Systems S.A.	54
Automotive Electronics— Conference & Exposition	122	Fuji Electrochemical Co., Ltd. General Advertising Agency, Inc.	170	Pihl International Ltd. Scott MacTaggart Advertising	142-143
Ballantine Laboratories, Inc. MLF Graphics	182	General Automation Chiat-Day, Inc. Advertising	46-47	PRD Caroe Marketing, Inc.	158
Beckman Instruments, Inc., Hellpot Division N.W. Ayer/Jorgensen/MacDonald, Inc.	22-23	General Electric Co., Miniatura Lamp Division Carr Liggett Advertising, Inc.	175	Premier Metal Products Corp. Commercial Press, Inc.	168
The Bodine Company Tech-Nik	144	General Instrument Corporation, Microelectronics Division Norman Allen Associates, Inc.	183	Prime Computer, Inc. Wilson, Haight & Welch, Inc.	78-79
Bourns, Inc. Marlborough Assoc., Inc.	123	General Magnetics McCarthy/Scelba/DeBiasi Advertising Agency, Inc.	3rd Cover	Procond S.p.A. Quadrangolo	24E
Brand-Rex Creamer, Trowbridge, Case & Basford, Inc.	18-19	General Radio Grad Associates	7E	Ramsey Engineering Co. Midland Associates Inc.	158
Burroughs Corp. Conti Advertising Agency, Inc.	9	Gould, Inc./Instrument Systems Division Carr Liggett Advertising, Inc.	169	RCA Ltd. Marsteller Ltd.	60-61
Canon Amsterdam N.V. Euro Advertising B.V.	25E	Gralex Industries Division of General Microwave Corp. Industrial Marketing Associates	40	RCA—Solid State Division Marsteller, Inc.	67, 69
The Carborundum Company Stahlka/Faller Inc.	17	G.T. Schjeldahl Co. Chuck Ruhr Associates Advertising, Inc.	149	RCL Electronics, Inc. Morvay Advertising Agency	14
Celanese Plastics Company D'Arcy-MacManus International, Inc.	125, 141	Hamiln, Inc. Franklin/Mautner/Advertising	153	Rental Electronics, Inc. Humphrey Browning MacDougall, Inc.	108
Celdis Ltd. May, Winfield & Associates Ltd.	16E-17E	Hansen Mfg. Co. Keller-Crescent Co.	74	Rifa Mik Marknadskommunikation AB	57
The Center for Technical Development Div. of Kurz-Kasch, Inc. Ethos, Inc.	182	Heath/Schlumberger Scientific Instruments Advance Advertising Services	152	Rockland Systems Rolf Johnsen, Inc.	174
Centralab Electronics Div., Globe-Union Inc. Action Communicators	148	Hermes Electronics Ltd. Public & Industrial Relations Limited	124	Rohde & Schwarz	1E
Cherry Electrical Products Kolb Tooky & Associates Inc.	14E-15E	Hewlett Packard Richardson, Seigle, Rolfs & McCoy, Inc.	1	Sakata International, Inc. David H. Stremmel & Co.	128
Cialrex Corporation Black-Russell-Morris	4th Cover	Hewlett-Packard Richardson, Seigle, Rolfs & McCoy, Inc.	2	Schauer Manufacturing Corp. Nolan, Keelor & Stites	173
Continental Specialties Corp. Robert A. Paul	154	Hewlett-Packard McCarthy, Scelba, DeBiasi Advertising Agency, Inc.	77	Schlumberger Scott MacTaggart Advertising	58-59
Cornell Dubilier Electronics McCarthy, Scelba, DeBiasi Advertising Agency, Inc.	37, 39	Hewlett-Packard Phillips Ramsey Advertising & Public Relations	163	Semtech Corporation Adgraphix Corporation	136
Corning Glass Works, Electronic Material Department Pierce Brown Associates, Inc.	101	Hickok Electrical Instrument Co. Carr Leggett Advertising, Inc.	28	Seecosem Bazaine Publicite	4E, 63
Corning Glass Works, Electronics Products Division Warner, Bicking & Fenwick, Inc.	57-64	Hutson Industries Greene, Webb Associates, Inc.	140	Siemens Aktiengesellschaft Linder Presse Union GmbH	52
Cramer Division of Conrac McCarthy, Scelba, DeBiasi	166, 167	Intel Corp. Regis McKenna, Inc.	171	Signetics Corp., Sub. of Corning Glass Works Hall Butler Blatherwick, Inc.	20-21
CTS Corporation Reincke, Meyer & Finn, Inc.	189	Ithaco, Inc. Stahlka/Faller, Inc.	119	Silec Quartz International	31E
Dale Electronics, Inc. Swanson, Sinkey, Ellis, Inc.	22-23	ITT Semiconductors Hall & McKenzie Advertising	172	Silconix Robertson West, Inc.	107
Damon/Electronics Division Giardini/Russell, Inc.	38	Kepec Inc. Weiss Advertising	5	Siltek, Inc. Hall & McKenzie	27E
Data Control Systems, Inc. Ads & Images	188	Lapp Insulator Division, Interpace Corp. Wolf Associates, Inc.	146	Simpson Electric Co. Amerad Advertising Services, Inc.	181
Data Precision Allied Advertising Agency, Inc.	135			Sorenson Company, A Unit of Raytheon Company Provandie Eastwood & Lombardi Inc.	42
				Spectrol Electronics Corp. J M R Inc.	139
				Sprague Perez Publicite	2E-3E

Sprague Electric Company Harry P. Bridge Company	8
• Stettner & Co. Time for Werbeagentur GmbH	12E
Stewart-Warner Microcircuits JMR Advertising	155
Systron-Donner Computer Systems Division Fred Schott Associates	41
Systron-Donner Concord Instruments Fred Schott Associates	51, 164, 169
Tally Corporation Bonfield Associates	20
Tau-Tron Inc. Billings & Reece, Inc.	144
• TEAC Corp. Dentsu Advertising Ltd.	123
• Tekelec Altronic S.P.F.D.	11E, 23E, 64E, 32E
Tektronix-IDD Young & Roehr, Inc.	131
■ Tektronix Inc. McCann Erickson, Inc.	33
Teledyne Philbrick Ingalls Associates, Inc. Advertising	2nd Cover
Teletype N.W. Ayer & Son, Inc.	147
Texas Instruments Incorporated, Semiconductor Group Tracy-Locke Advertising Inc.	126
Theta Instrument Corp. Fletcher-Walker-Gessell Inc.	154
Thomas & Skinner, Inc. Bell-Catterlin & Hedgecock Advertising, Inc.	183
Thomson CSF Bazine Publicite	138
Toko, Inc. Hakuhodo, Inc.	180
■ Topaz Electronics Jansen Associates, Inc.	168
■ TRW Electronics, Semiconductor Division The Bowes Company	7
United Systems Corp. A Sub. of Monsanto Co. Advertising & Merchandising, Inc.	157
■ Unilrode Corporation Culver Advertising, Inc.	27
U.S. Capacitor Corp. S. Michelson Advertising	12-13
Varo Semiconductor, Inc. Warren-Guild	145
Wakefield Engineering Amsterdam Advertising Inc.	162
• Wandel und Goltermann Werbeagentur	62
Wavetek San Diego Chapman Michetti Advertising	129
Wima, Westermann Oliver-Beckmann GmbH	16
• Yokogawa Electric Works, Ltd. General Advertising Agency, Inc.	17
Zellux Moneyworth Advertising	121

We chose to call our new Real-Time Spectrum Analyzer **Omniscient*** and we'll continue to!

With a name like that you have to measure up, and the EMR Model 1510 does. It goes anywhere, does any job ... It's a Fourier Analyzer, a Spectrum Averager and a Display in one convenient, portable package. And most important, it performs its tasks digitally ... no interactive controls to fumble with ... no complicated computer interface problems.

- But to be Omniscient there must be more ... and there is!**
- Switch it on, it's ready to operate without calibration
 - Analyze a signal repeatedly and get repeatable answers ... over and over again
 - 60 dB dynamic range at the input and no gimmickry
 - Foolproof LED display of signal amplitude, frequency and averaging time
 - Control setting status appears on graticule of CRT for permanent photographic record
 - Availability of many options ... Peak Hold, 3-D Display, Computer Interface, Low Frequency Sync, Any Window, etc.

*Possessed of universal or complete knowledge —

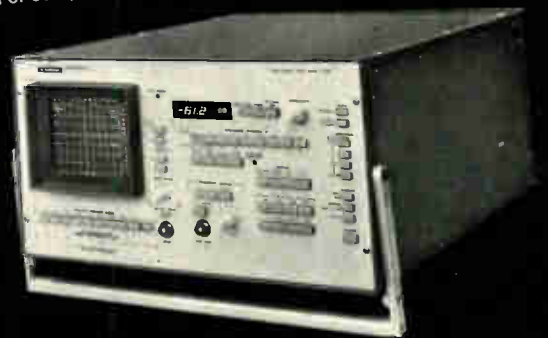

Well... What else could we call it?
Write today for a comprehensive technical brochure or call for a demonstration.

EMR EMR
Schlumberger

EMR Telemetry
Weston Instruments, Inc.
Box 3041, Sarasota, Florida 33578
813-958-0811

Circle 187 on reader service card

Classified & Employment Advertising

F. J. Eberle, Manager 212-971-2557

Equipment (Used or Surplus New) For Sale	
American Used Computer Corp.	176
P. Fishman Co, Inc.	176
Jensen Tools and Alloy	176
Olivax	176
Poly-Paks Inc.	176
Radio Research Instrument Co.	176
Wright-Patterson - AFB OHIO.	176

- For more information on complete product line see advertisement in the latest Electronics Buyer's Guide
- Advertisers in Electronics International
- ‡ Advertisers in Electronics domestic edition

pyp

subsidiary of

GERALD METALS Inc.

Leading Refiner of:

- Gold and Platinum Group Metals

Purchaser of:

- Precious Metal Scrap
- Concentrates
- Solutions
- Catalysts

Supplier of:

- Bullion
- Sponge

Member:

New York Mercantile Exchange



industries, inc.

subsidiary of GERALD METALS INC.

13429 Alondra Boulevard
Santa Fe Springs, California 90670
Tels: (213) 921-7464 (213) 773-7922

New York Office: One Battery Park Plaza
New York, New York 10004
Tel: (212) 425-4160

Advertising Sales Staff

Pierre J. Braudé New York [212] 997-3468
London 01-493-1451
Director of Marketing

Atlanta, Ga. 30309: Joseph Lane
100 Colony Square, 1175 Peachtree St., N.E.
[404] 892-2868

Boston, Mass. 02116: James R. Pierce
607 Boylston St. [617] 262-1160

Chicago, Ill. 60611:
645 North Michigan Avenue
Robert W. Bartlett (312) 751-3739
Paul L. Reiss (312) 751-3738

Cleveland, Ohio 44113: William J. Boyle
[716] 586-5040

Dallas, Texas 75201: Charles G. Hubbard
2001 Bryant Tower, Suite 1070
[214] 742-1747

Denver, Colo. 80202: Harry B. Doyle, Jr.
Tower Bldg., 1700 Broadway
[303] 266-3863

Detroit, Michigan 48202: Robert W. Bartlett
1400 Fisher Bldg.
[313] 873-7410

Houston, Texas 77002: Charles G. Hubbard
2270 Humble Bldg. [713] CA 4-8381

Los Angeles, Calif. 90010: Robert J. Rielly
Bradley K. Jones, 3200 Wilshire Blvd., South Tower
[213] 487-1160

New York, N.Y. 10020
1221 Avenue of the Americas
Warren H. Gardner [212] 997-3617
Michael J. Stoller [212] 997-3616

Philadelphia, Pa. 19102: Warren H. Gardner
Three Parkway,
[212] 997-3617

Pittsburgh, Pa. 15222: Warren H. Gardner
4 Gateway Center, [212] 997-3617

Rochester, N.Y. 14534: William J. Boyle
9 Greylock Ridge, Pittsford, N.Y.
[716] 586-5040

San Francisco, Calif. 94111: Don Farris
Robert J. Rielly, 425 Battery Street,
[415] 362-4600

Paris: Alain Offergeld
17 Rue-Georges Bizet, 75 Paris 16, France
Tel: 720-73-01

Geneva: Alain Offergeld
1 rue du Temple, Geneva, Switzerland
Tel: 32-35-63

United Kingdom & Scandinavia: Keith Mantle
Tel: 01-493-1451, 34 Dover Street, London W1

Milan: Robert Saidel
1 via Baracchini, Italy Phone 87-90-656

Brussels: Alain Offergeld
23 Chaussee de Wavre
Brussels 1040, Belgium
Tel: 13-73-95

Frankfurt/Main: Fntz Krusebecker
Liebigstrasse 27c, Germany
Phone 72 01 81

Tokyo: Tatsumi Katagiri, McGraw-Hill
Publications Overseas Corporation,
Kasumigaseki Building 2-5, 3-chome,
Kasumigaseki, Chiyoda-Ku, Tokyo, Japan
[581] 9811

Osaka: Ryji Kobayashi, McGraw-Hill
Publications Overseas Corporation, Kondo
Bldg., 163, Umegae-cho Kita-ku, Japan [362] 8771

Australasia: Warren E. Ball, IPO Box 5106,
Tokyo, Japan

Business Department

Stephen R. Weiss, Manager
[212] 997-2044

Thomas M. Egan,
Production Manager [212] 997-3140

Carol Gallagher
Assistant Production Manager [212] 997-2045

Dorothy Carter, Contracts and Billings
[212] 997-2908

Frances Vallone, Reader Service Manager
[212] 997-6057

Electronics Buyers' Guide

George F. Werner, Associate Publisher
[212] 997-3139

Regina Hera, Directory Manager
[212] 997-2544

**If you
wanted our
equipment
last year
but
couldn't
afford it...**



**...call us
now!**

We've added new lines that out-perform our older, high quality products, but at a lower cost to you . . . thanks to some nifty packaging and clever circuit design.

We have two new lines of FM telemetry equipment:

- A 5 1/4" FM Multiplex/Demultiplex line for Aerospace applications at less than \$1,000 per channel, complete!
- An Industrial FM line that provides aerospace specifications in an industrial package, at an even lower cost!

We also have a new PCM Decom that's priced to sell for under \$4,000!

And, a Tunable Bit Synchronizer that sells for less than \$4,500!

Sound interesting? Call (203) 743-9241 today for details. (Ask for Joe Lombardo)



DATA-CONTROL SYSTEMS, INC.
Commerce Drive, P.O. Box 584
Danbury, Ct. 06810 ■ (203) 743-9241

Control Logic Programming

turn to CTS

for DIP set-up switches

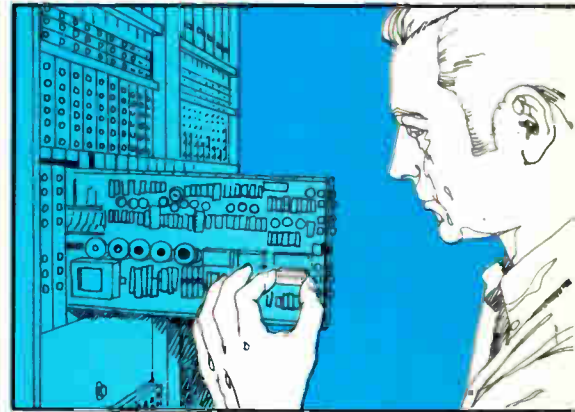
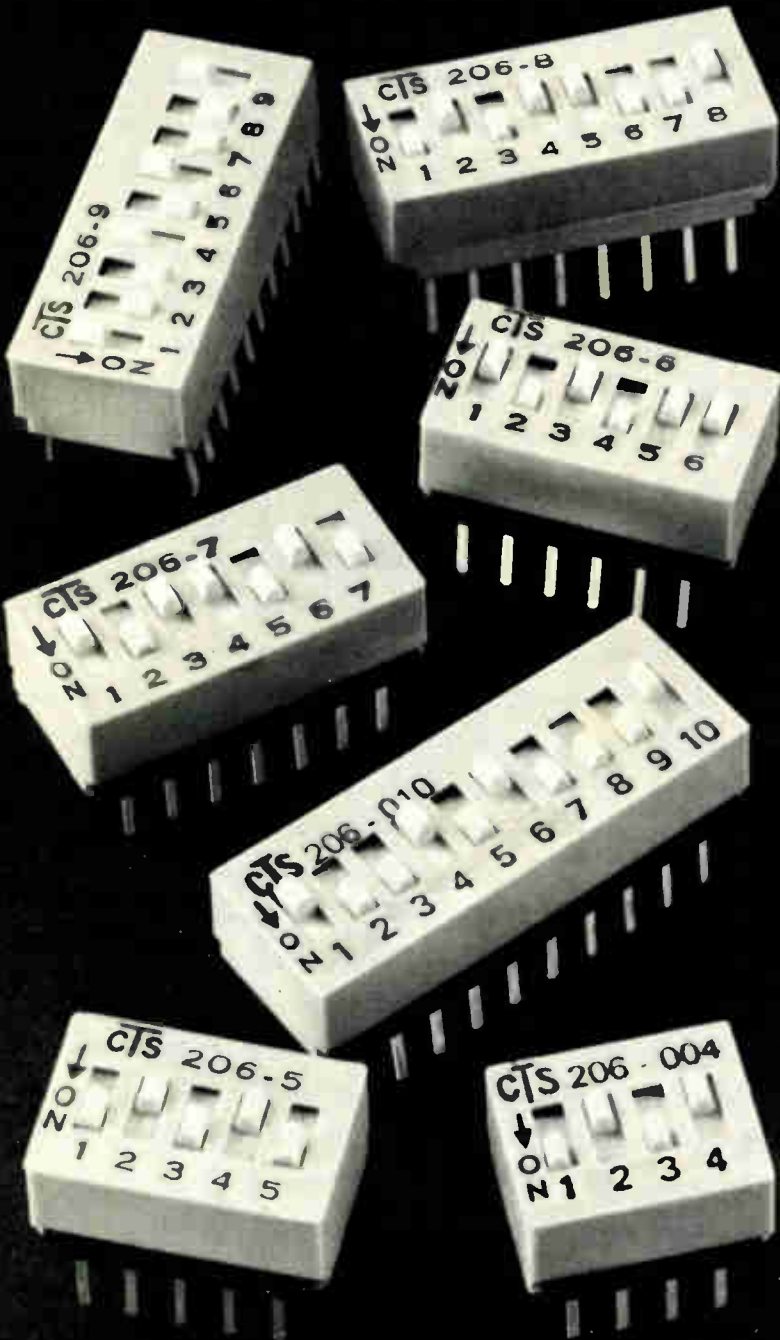

New CTS 206 Series switches will streamline your logic programming. These dual-in-line packages mount on the same PC board as other circuit components, eliminating the need for special mounting hardware/interconnection wiring. Program up to 10 different functions and/or signal levels with one compact switch.

CTS offers 7 different packages with 4 through 10 individual SPST slide switches per package. Automatic insertion saves you time and money. Units have .100" x .300" centers for inserting into either PC boards or standard IC sockets. Gold plated contacts that wipe on make and break assure low contact resistance over long life.

Designed for computer, computer peripheral, communication, test equipment and numerous other programming applications. Use good logic, turn to CTS. Find out more about our new, economical 206 series switch today. CTS Keene, Inc., 3230 Riverside Avenue, Paso Robles, California 93446. Phone: (805) 238-0350.

Circle 189 on reader service card

CTS CORPORATION
Elkhart, Indiana



A world leader in cermet and variable resistor technology.

**TREAT THIS 300 NSEC,
NMOS MEMORY
LIKE A COMPONENT**

**JUST
PLUG
IT IN**

You're looking at the new MICRORAM 3000N, a complete NMOS semiconductor memory on a single printed circuit card assembly. Just plug in a power supply ($\pm 15\text{VDC}$, $+5\text{VDC}$) and you have a fully functional memory system that cycles at 300 nsec, and accesses at 180. (A high speed version that cycles at 180 nsec. is available, too.)

The MICRORAM 3000N is available for delivery to meet your production schedules. It mounts on a printed circuit card 11.74" by 15.4", and is basically compatible with our MICROMEMORY 3000 core memories. The standard 16K by 20 configuration is alterable to 32K by 10. Numerous other capacities and word lengths are also available.

Like all members of the MICROMEMORY 3000 Family, the MICRORAM 3000N is available either as a single card memory or as a multi-card system in a chassis containing up to 16 memory cards, power supply, self-test and interface cards and various other options.

Get the full story on the MICRORAM 3000N from your local EMM office or call Commercial Memory Products Marketing Department at (213) 644-9881.

**EMM ELECTRONIC
MEMORIES
COMMERCIAL MEMORY PRODUCTS**

A Division of Electronic Memories & Magnetics Corporation
12621 Chadron Ave., Hawthorne, Calif. 90250
Belgium 03/76.69.75; United Kingdom 01/751-1213; W. Germany 0811/74.30.40

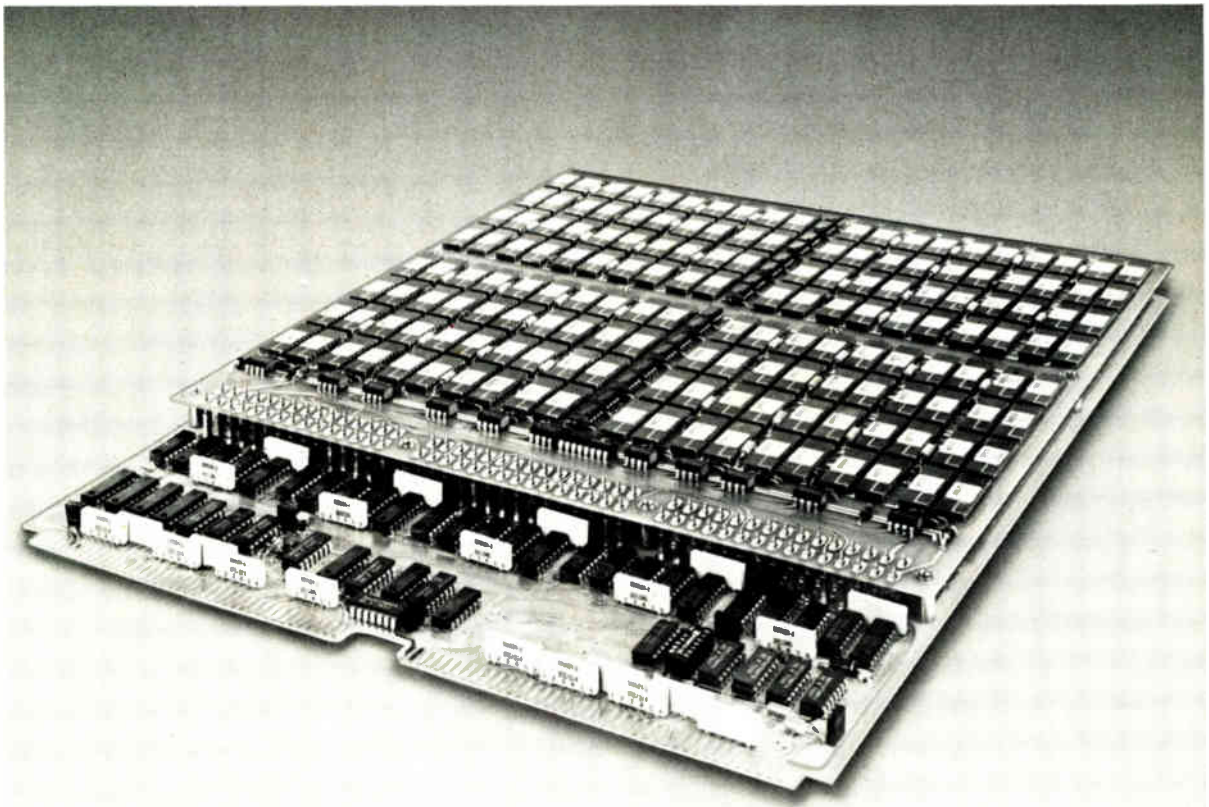

Electronics

Please enter my subscription to **ELECTRONICS** for three years at \$18

52470

1. I prefer one year at \$9 Payment enclosed
 Bill my company Bill me

CHARGE MY SUBSCRIPTION TO

<input type="checkbox"/> AMERICAN EXPRESS	<input type="checkbox"/> MASTER CHARGE
<input type="checkbox"/> DINERS CLUB	<input type="checkbox"/> BANKAMERICARD
ACCT NO _____	
DATE CARD EXPIRES _____	
INTERBANK NO _____	1st No's above name on Mastercharge only

NAME _____ TITLE _____
 COMPANY _____ DIV. or DEPT _____
 COMPANY ADDRESS _____
 CITY _____ STATE _____ ZIP _____
 Check here if you wish publication to be sent to home address STREET _____ CITY _____ STATE _____ ZIP _____

Above rates apply only to those who answer all questions listed below. All others pay higher than basic price of \$25.00 per year.

Signature _____

2. 1 PLANT 2 DEPARTMENT Indicate the primary product manufactured or service performed at your plant (Box 1) and in your department (Box 2). Be sure to indicate applicable letter in each of the two boxes even if they are the same letter.
- | | | |
|---------------------------------------------------------------------|----------------------------------------------------------------------|--------------------------------------------------------------------------------------------------------------------------|
| A. Large computers | K. Industrial controls, systems and equipment | U. Research and development organizations which are a part of an educational institution |
| B. Mini-computers | L. Sub-assemblies | V. Government Agency and military |
| C. Computer peripheral equipment | M. Passive electronic components | W. Industrial companies using and/or incorporating electronic products in their mfg., research or development activities |
| D. Data Processing Systems (systems integration) | N. Active electronic components | X. Utilities |
| E. Office and business machines | O. Materials and Hardware | Y. Broadcasting, sound and motion pictures and recording studios |
| F. Test and measuring equipment | P. Aircraft Missiles space and ground support equipment | Z. Commercial users of electronic equipment (railroads, pipelines, police, airlines) |
| G. Communications systems and equipment | Q. Oceanography and support equipment | 9. College, University |
| H. Navigation and guidance or control systems | R. Medical electronics | |
| I. Consumer entertainment electronic equipment | S. Industrial equipment containing electronic components or products | |
| J. Other consumer electronic equip. (appliances, autos, hand tools) | T. Independent R&D laboratory and consultant | |

3. Indicate your principal job function (place applicable number in box. If numbers 9, 10, or 11 are used, fill in name of college or university)
- General and corporate management
 - Design and development engineering
 - Engineering services (evaluation, quality control, reliability, standards, test)
 - Basic research
 - Manufacturing and production
 - Engineering support (lab assistant, technician)
 - Purchasing and procurement
 - Marketing and sales
 - Professor at _____
 - Senior student at _____
 - Graduate student at _____

4. Indicate your principal job responsibility (place applicable number in box)
- Management
 - Engineering

5. Are you engaged in or do you supervise the design or redesign of electronic components or equipment? (check one)

YES NO

6. Estimated number of employees at this location. (check one)

1 to 49 50 to 249 250 to 999 over 1,000

FIRST CLASS
PERMIT No. 42
HIGHTSTOWN, N.J.

BUSINESS REPLY MAIL

NO POSTAGE STAMP NECESSARY IF MAILED IN U.S.

Postage will be paid by

Electronics

McGRAW-HILL, INC.
SUBSCRIPTION DEPT.
P.O. BOX 514
HIGHTSTOWN, N.J. 08520



Electronics

Please enter my subscription to **ELECTRONICS** for three years at \$18

52470

1. I prefer one year at \$9 Payment enclosed
 Bill my company Bill me

CHARGE MY SUBSCRIPTION TO

<input type="checkbox"/> AMERICAN EXPRESS	<input type="checkbox"/> MASTER CHARGE
<input type="checkbox"/> DINERS CLUB	<input type="checkbox"/> BANKAMERICARD
ACCT NO _____	
DATE CARD EXPIRES _____	
INTERBANK NO _____	1st No's above name on Mastercharge only

NAME _____ TITLE _____
 COMPANY _____ DIV or DEPT _____
 COMPANY ADDRESS _____
 CITY _____ STATE _____ ZIP _____
 Check here if you wish publication to be sent to home address STREET _____ CITY _____ STATE _____ ZIP _____

Above rates apply only to those who answer all questions listed below.
 All others pay higher than basic price of \$25.00 per year.

Signature _____

2. 1 PLANT 2 DEPARTMENT
- Indicate the primary product manufactured or service performed at your plant (Box 1) and in your department (Box 2). Be sure to indicate applicable letter in each of the two boxes even if they are the same letter.
- | | | |
|---------------------------------------------------------------------|----------------------------------------------------------------------|--------------------------------------------------------------------------------------------------------------------------|
| A. Large computers | K. Industrial controls, systems and equipment | U. Research and development organizations which are a part of an educational institution |
| B. Mini-computers | L. Sub-assemblies | V. Government Agency and military |
| C. Computer peripheral equipment | M. Passive electronic components | W. Industrial companies using and/or incorporating electronic products in their mfg., research or development activities |
| D. Data Processing Systems (systems integration) | N. Active electronic components | X. Utilities |
| E. Office and business machines | O. Materials and Hardware | Y. Broadcasting, sound and motion pictures and recording studios |
| F. Test and measuring equipment | P. Aircraft Missiles, space and ground support equipment | Z. Commercial users of electronic equipment (railroads, pipelines, police, airlines) |
| G. Communications systems and equipment | Q. Oceanography and support equipment | 9. College, University |
| H. Navigation and guidance or control systems | R. Medical electronics | |
| I. Consumer entertainment electronic equipment | S. Industrial equipment containing electronic components or products | |
| J. Other consumer electronic equip. (appliances, autos, hand tools) | T. Independent R&D laboratory and consultant | |

3. Indicate your principal job function (place applicable number in box. If numbers 9, 10, or 11 are used, fill in name of college or university)
1. General and corporate management
 2. Design and development engineering
 3. Engineering services (evaluation, quality control, reliability, standards, test)
 4. Basic research
 5. Manufacturing and production
 6. Engineering support (lab assistant, technician)
 7. Purchasing and procurement
 8. Marketing and sales
 9. Professor at _____
 10. Senior student at _____
 11. Graduate student at _____

4. Indicate your principal job responsibility (place applicable number in box)
1. Management
 2. Engineering

5. Are you engaged in or do you supervise the design or redesign of electronic components or equipment? (check one)

YES NO

6. Estimated number of employees at this location. (check one)

1 to 49 50 to 249 250 to 999 over 1,000

FIRST CLASS
PERMIT No. 42
HIGHTSTOWN, N.J.

BUSINESS REPLY MAIL
NO POSTAGE STAMP NECESSARY IF MAILED IN U.S.

Postage will be paid by

Electronics
McGRAW-HILL, INC.
SUBSCRIPTION DEPT.
P.O. BOX 514
HIGHTSTOWN, N.J. 08520

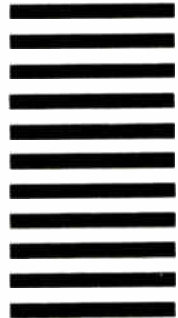

For additional information on products advertised, new products or new literature, use the adjacent business reply cards.

Complete entire card. Please print or type.

Circle the number on the Reader Service postcard that corresponds to the number at the bottom of the advertisement, new product item, or new literature in which you are interested.

To aid the manufacturer in filling your request, please check the appropriate industry classification box.

Postage is prepaid in U.S. Correct amount of postage must be affixed for all mailings from outside the U.S.

All inquiries from outside the U.S. that cannot reach Electronics before the expiration dates noted on the Reader Service postcard must be mailed directly to the manufacturer. The manufacturer assumes all responsibilities for responding to inquiries.

Subscriptions & Renewals

Fill in the subscription card adjoining this card. Electronics will bill you at the address indicated on the card.

ELECTRONICS April 18, 1974 card expires July 2, 1974

NAME _____ TITLE _____

COMPANY _____

STREET _____

CITY _____ STATE _____ ZIP _____

Industry Classification (check one)

- | | |
|--------------------------------------------------------------------|----------------------------------------------------------|
| <input type="checkbox"/> a Computer & Related Equip. | <input type="checkbox"/> f Consumer Products |
| <input type="checkbox"/> b Communications Equip. & Systems | <input type="checkbox"/> g Industrial Controls & Equip. |
| <input type="checkbox"/> c Navigation, Guidance or Control Systems | <input type="checkbox"/> h Components & Subassemblies |
| <input type="checkbox"/> d Aerospace, Underseas Ground Support | <input type="checkbox"/> j Independent R&D Organizations |
| <input type="checkbox"/> e Test & Measuring Equip. | <input type="checkbox"/> k Government |

1	21	41	61	81	101	121	141	161	181	201	221	241	261	343	363	383	403	423	443	463	483	503	713
2	22	42	62	82	102	122	142	162	182	202	222	242	262	344	364	384	404	424	444	464	484	504	714
3	23	43	63	83	103	123	143	163	183	203	223	243	263	345	365	385	405	425	445	465	485	505	715
4	24	44	64	84	104	124	144	164	184	204	224	244	264	346	366	386	406	426	446	466	486	506	716
5	25	45	65	85	105	125	145	165	185	205	225	245	265	347	367	387	407	427	447	467	487	507	717
6	26	46	66	86	106	126	146	166	186	206	226	246	266	348	368	388	408	428	448	468	488	508	718
7	27	47	67	87	107	127	147	167	187	207	227	247	267	349	369	389	409	429	449	469	489	509	719
8	28	48	68	88	108	128	148	168	188	208	228	248	268	350	370	390	410	430	450	470	490	510	720
9	29	49	69	89	109	129	149	169	189	209	229	249	269	351	371	391	411	431	451	471	491	510	900
10	30	50	70	90	110	130	150	170	190	210	230	250	270	352	372	392	412	432	452	472	492	702	901
11	31	51	71	91	111	131	151	171	191	211	231	251	271	353	373	393	413	433	453	473	493	703	902
12	32	52	72	92	112	132	152	172	192	212	232	252	272	354	374	394	414	434	454	474	494	704	951
13	33	53	73	93	113	133	153	173	193	213	233	253	273	355	375	395	415	435	455	475	495	705	952
14	34	54	74	94	114	134	154	174	194	214	234	254	274	356	376	396	416	436	456	476	496	706	953
15	35	55	75	95	115	135	155	175	195	215	235	255	275	357	377	397	417	437	457	477	497	707	954
16	36	56	76	96	116	136	156	176	196	216	236	256	338	358	378	398	418	438	458	478	498	708	956
17	37	57	77	97	117	137	157	177	197	217	237	257	339	359	379	399	419	439	459	479	499	709	957
18	38	58	78	98	118	138	158	178	198	218	238	258	340	360	380	400	420	440	460	480	500	710	958
19	39	59	79	99	119	139	159	179	199	219	239	259	341	361	381	401	421	441	461	481	501	711	959
20	40	60	80	100	120	140	160	180	200	220	240	260	342	362	382	402	422	442	462	482	502	712	960

ELECTRONICS April 18, 1974 card expires July 2, 1974

NAME _____ TITLE _____

COMPANY _____

STREET _____

CITY _____ STATE _____ ZIP _____

Industry Classification (check one)

- | | |
|--------------------------------------------------------------------|----------------------------------------------------------|
| <input type="checkbox"/> a Computer & Related Equip. | <input type="checkbox"/> f Consumer Products |
| <input type="checkbox"/> b Communications Equip. & Systems | <input type="checkbox"/> g Industrial Controls & Equip. |
| <input type="checkbox"/> c Navigation, Guidance or Control Systems | <input type="checkbox"/> h Components & Subassemblies |
| <input type="checkbox"/> d Aerospace, Underseas Ground Support | <input type="checkbox"/> j Independent R&D Organizations |
| <input type="checkbox"/> e Test & Measuring Equip. | <input type="checkbox"/> k Government |

1	21	41	61	81	101	121	141	161	181	201	221	241	261	343	363	383	403	423	443	463	483	503	713
2	22	42	62	82	102	122	142	162	182	202	222	242	262	344	364	384	404	424	444	464	484	504	714
3	23	43	63	83	103	123	143	163	183	203	223	243	263	345	365	385	405	425	445	465	485	505	715
4	24	44	64	84	104	124	144	164	184	204	224	244	264	346	366	386	406	426	446	466	486	506	716
5	25	45	65	85	105	125	145	165	185	205	225	245	265	347	367	387	407	427	447	467	487	507	717
6	26	46	66	86	106	126	146	166	186	206	226	246	266	348	368	388	408	428	448	468	488	508	718
7	27	47	67	87	107	127	147	167	187	207	227	247	267	349	369	389	409	429	449	469	489	509	719
8	28	48	68	88	108	128	148	168	188	208	228	248	268	350	370	390	410	430	450	470	490	510	720
9	29	49	69	89	109	129	149	169	189	209	229	249	269	351	371	391	411	431	451	471	491	701	900
10	30	50	70	90	110	130	150	170	190	210	230	250	270	352	372	392	412	432	452	472	492	702	901
11	31	51	71	91	111	131	151	171	191	211	231	251	271	353	373	393	413	433	453	473	493	703	902
12	32	52	72	92	112	132	152	172	192	212	232	252	272	354	374	394	414	434	454	474	494	704	951
13	33	53	73	93	113	133	153	173	193	213	233	253	273	355	375	395	415	435	455	475	495	705	952
14	34	54	74	94	114	134	154	174	194	214	234	254	274	356	376	396	416	436	456	476	496	706	953
15	35	55	75	95	115	135	155	175	195	215	235	255	275	357	377	397	417	437	457	477	497	707	954
16	36	56	76	96	116	136	156	176	196	216	236	256	338	358	378	398	418	438	458	478	498	708	956
17	37	57	77	97	117	137	157	177	197	217	237	257	339	359	379	399	419	439	459	479	499	709	957
18	38	58	78	98	118	138	158	178	198	218	238	258	340	360	380	400	420	440	460	480	500	710	958
19	39	59	79	99	119	139	159	179	199	219	239	259	341	361	381	401	421	441	461	481	501	711	959
20	40	60	80	100	120	140	160	180	200	220	240	260	342	362	382	402	422	442	462	482	502	712	960

If the cards below have already been used, you may obtain the needed information by writing directly to the manufacturer, or by sending your name and address, plus the Reader Service number, to Electronics Reader Service Department, Box 2530, Clinton, Iowa 52732.

Affix
Postage here

Electronics

P.O. Box No. 2530
Clinton, Iowa 52732

Affix
Postage here

Electronics

P.O. Box No. 2530
Clinton, Iowa 52732

Electronics Reprint Service

Bulk reprints of editorial matter can be ordered from current or past issues. The minimum quantity is 500 copies. Prices quoted on request: call 609-448-1700 Ext. 5494, or write to address below.

Bringing Sight to the Blind

8 pages \$2.00
Key no. R-408

Logic's New Design Tools

16 pages \$3.00
Key R-406

U.S. Market Report

28 pages \$2.00
Key R-404

European Market Report 1974

24 pages \$2.00
Key R-402

Japan Market Report 1974

18 pages \$2.00
Key R-400

The Pervasiveness of Electronics

Complete issue 284 pages \$2.00
Key no. R-328

The Optical Spectrum

\$2.00 Key no. R-326

Semiconductor Memory Systems

16 pages \$3.00 Key no. R-324

New Electronic Displays

10 pages \$2.00 Key no. R-322

Planar Interconnection Techniques

13 pages \$3.00 Key no. R-320

Automotive Electronics

16 pages \$3.00 Key no. R-318

Hybrid Circuit Technology

16 pages \$3.00 Key no. R-316

Leadless, Pluggable IC Packages

Reduce Costs 7 pages \$2.00
Key no. R-312

Penetration Color Tubes are Enhancing

Information Displays 6 pages \$2.00
Key no. R-310

Program for Transition from Non Linear

to Linear Transistor Model
6 pages \$2.00 Key no. R-308

Charge Coupling Improves Its Image

8 pages \$2.00 Key no. R-306

Electromagnetic Spectrum Chart

Key no. R-213 \$2.00

Electromagnetic Spectrum Report

16 pages plus Wall Chart \$4.00
Key no. R-211

Active Filters

96 pages \$4.00 Key no. R-032

Circuit Designer's Casebook

162 pages \$4.00 Key no. R-031

To order reprints or for further information, please write to:

Electronics Reprint Department
P.O. Box 669
Hightstown, N.J. 08520

Only orders with cash, check, or money order will be accepted. No invoicing will be done.

3 WIRE SYNCHRO TO LINEAR D.C. CONVERTER

ACCURACY 1/2 %



#MAC 1422-1

Provides a linear conversion of a synchro angle to a DC Voltage

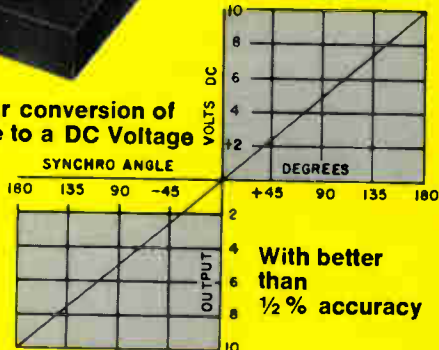

Specifications

Accuracy: $\pm 1\%$ over temperature range
 Input: 11.8V, 400 HZ line to line 3 wire synchro voltage
 Output Impedance: less than 10 Ohms
 Input Impedance: 10K minimum line to line
 Reference: 26V $\pm 10\%$ 400HZ (Unit can be altered to accommodate 115V if available at no extra cost)
 Operating temp. range: -25°C to $+85^{\circ}\text{C}$
 Storage temp. range: -55°C to $+100^{\circ}\text{C}$
 DC power: $\pm 15\text{V} \pm 1\%$ @ 75ma (approx.)
 Case material: High permeability Nickel Alloy
 Weight: 6 Ozs. Size: 3.6" x 2.5" x 0.6"

A.C. LINE REGULATION

A new method has been developed which allows us to provide a low distortion highly regulated AC waveform without using tuned circuits or solid state active filters of any kind.

The result is a frequency independent AC output regulated to 0.1% for line and load with greater than 20% line variations over a wide temperature range.

Features:

- 0.1% total line and load regulation
- Independent of $\pm 20\%$ frequency fluctuation
- 1 watt output
- Extremely small size
- Isolation between input and output

Specifications: Model MLR 1476-1
 AC Line Voltage: 26V $\pm 20\%$ @ 400Hz $\pm 20\%$
 Output: 26V $\pm 1\%$ for set point
 Load: 0 to 40ma
 Total Regulation: $+0.1\%$
 Distortion: 0.5% maximum rms
 Temperature Range: -55°C to $+125^{\circ}\text{C}$
 Size: 2.0" x 1.8" x 0.5"

Other units are available at different power and voltage levels as well as wider temperature ranges. Information will be furnished upon request.

SOLID STATE SINE-COSINE SYNCHRO CONVERTER - NON VARIANT

This new encapsulated circuit converts a 3 wire synchro input to a pair of dc outputs proportional to the sine and cosine of the synchro angle independent of a-c line fluctuations.

- Complete solid state construction.
- Operates over a wide temperature range.
- Independent of reference line fluctuations.
- Conversion accuracy — 6 minutes.
- Reference and synchro inputs isolated from ground.

Specifications Model DMD 1508-2

Accuracy: Overall conversion accuracy 6 minutes. Absolute value of sine and cosine outputs accurate to $\pm 30\text{mV}$
 Temperature Range:
 Operating -40°C to $+85^{\circ}\text{C}$
 Storage -55°C to $+125^{\circ}\text{C}$
 Synchro Input: 90V RMS $\pm 5\%$ LL 400Hz $\pm 5\%$
 DC Power: $\pm 15\text{V DC} \pm 10\%$ @ 50MA
 Reference: 115VRMS $\pm 5\%$ 400Hz $\pm 5\%$
 Output: 10V DC full scale output on either channel @ 5ma load
 Temperature coefficient of accuracy:
 ± 15 seconds/ $^{\circ}\text{C}$ avg. on conversion accuracy
 ± 1 MV/ $^{\circ}\text{C}$ on absolute output voltages
 Size: 2.0" x 1.5" x 2.5"

Units are available with wider temperature ranges and 11.8V LL, 26V reference synchro inputs. Information will be supplied upon request.

4 QUADRANT MAGNETIC ANALOG MULTIPLIER

DC x DC = DC OUTPUT

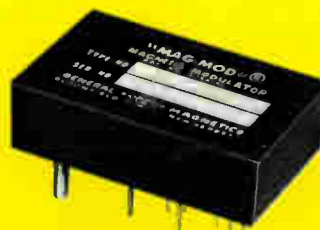

#MCM 1478-1

Specifications Include:

Transfer Equation: $E = XY/10$
 X & Y Input Signal Ranges: 0 to $\pm 10\text{V}$ peak
 Maximum Static and Dynamic Product Error: 1/2 % of point or 2MV, whichever is greater, over entire temperature range
 Input Impedance: X = 10K, Y = 10K
 Full Scale Output: $\pm 10\text{V}$ peak
 Minimum Load for Full Scale Output: 2000 ohms
 Output Impedance: Less than 10 ohms
 Bandwidth: 1000Hz
 DC Power: $\pm 15\text{V}$, unless otherwise required, at 20ma
 Size: 1.3" x 1.8" x 0.5"
 Output is short circuit protected

Product Accuracy is $\pm 1/2\%$ of all theoretical product output readings over Full Temperature Range of -55°C to $+125^{\circ}\text{C}$.

Maximum Output Error for Either

X = 0, Y = 10V

Y = 0, X = 10V

X = 0, Y = 0

would be ± 2 MV over Entire Temperature Range.

There is No Substitute for Reliability



GENERAL MAGNETICS · INC
 135 Bloomfield Ave., Bloomfield, New Jersey 07003 - Tel. (201) 743-2700

Circle 901 on reader service card

Extend the spectrum you control...

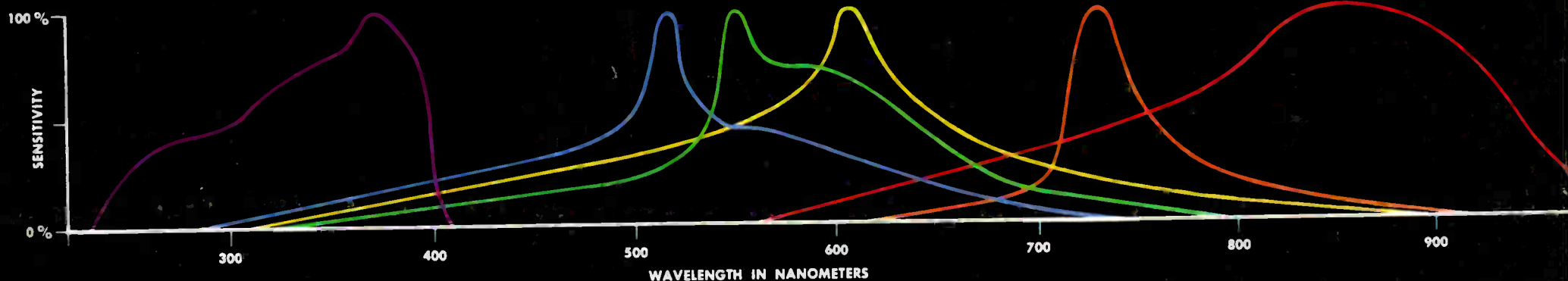

with Clairex Photoconductors and Phototransistors

With Clairex solid-state sensors and opto-isolators you can sense, measure, and control throughout the visible spectrum and beyond—wavelengths from 245 to 1100 nanometers.

For complete specifications or for design assistance with your "light" problems, call (914) 664-6602 or write Clairex®, 560 S. Third Ave., Mount Vernon, N.Y. 10550.

CLAIREX ELECTRONICS®
A DIVISION OF CLAIREX CORPORATION