

Video imagers, delay lines readied for market

Designing stable trimming networks for less

110 Precision monolithic op amp gets chopper-stabilized treatment

Electronics®



A NEW TV STAR

THE
VIDEO
DISK

Celanex. It even sounds electrical.

For electrical-electronic applications, Celanex thermoplastic polyester performs small wonders. One reason is that glass-filled Celanex combines all the advantages of DAP, alkyds and phenolics. With none of their disadvantages.

The parts illustrated feature some other good reasons for choosing Celanex. In the Airpax slide switch (a), for example, Celanex SE-O grade combines excellent electrical properties with wear resistance, low coefficient of friction. And it received sole support approval from UL.

In the Permonite TV cathode ray tube socket (b), Celanex 3310 replaced polysulfone. Celanex withstands high voltage and high temperatures. Remains dimensionally stable. Replacing alkyds and nylons, Celanex combines fine electrical properties with fast

cycling and ease of molding in this high voltage contactor coil (c) by Essex International Controls Division, Inc. And the small grey TV tuner shaft (d) takes good advantage of another Celanex property—the lowest moisture absorption of any high-strength engineering plastic.

Celanex is also the high-strength insulating material for Magnum Electric Corporation's new, slimmer terminal strips (e). And Celanex's high dielectric strength assures an RMS breakdown voltage of more than 3,000 volts for the thin barriers between terminals. Celanex also contributes high arc track resistance and chemical inertness.

Plus all that, Celanex is one of the most processable plastics available. Molding is easier. Cycles faster. Which adds up to a very remarkable, performance-



boosting, cost-saving engineering resin. Get the facts on Celanex. And on Celcon and Celanese Nylons. Write Celanese Plastics Co., Dept. X-607, 550 Broad Street, Newark, N. J. 07102.

Celanese Plastics Company is a division of Celanese Corporation. Canadian Affiliate: Celanese Canada Ltd. Export: Amcel Co., Inc., and Pan Amcel Co., Inc., 522 Fifth Ave., New York 10036

Celanex: the original thermoplastic polyester

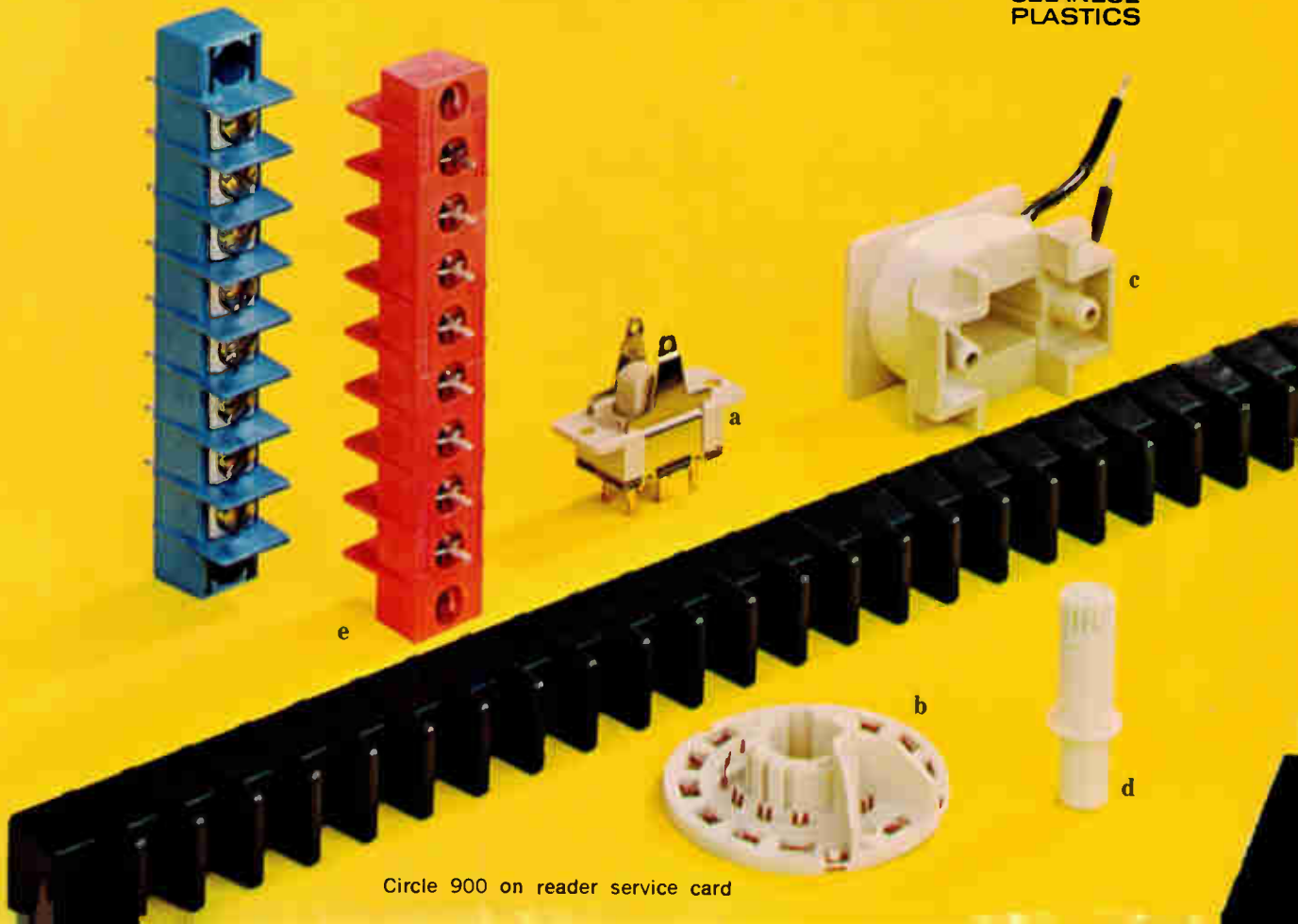

Circle 900 on reader service card

mighty mods...



Now... High Efficiency, Switching Regulated Power Supplies

The new Switching Regulated Series is the most recent addition to the expanding line of Hewlett-Packard Modular Power Supplies. The MIGHTY MODS started with the 62000 Series — a complete line of modular power supplies with coverage from 3 to 48 volts, up to 192 watts.

The new Switching Regulated Supplies, Series 62600, feature advanced transistor switching design with up to 80% efficiency. You get more power in a smaller, cooler operating package... with 4 to 28 volts, up to 300 watts, 0.2% combined line and load regulation, 20mV rms/30mV p-p ripple and noise. And, HP thinks ahead to give you all the protection you need: overvoltage, overcurrent, over-temperature, reverse voltage and protected remote sensing. What it all adds up to is: selection, performance, reliability plus competitive pricing (with quantity and OEM discounts). Whether it's a modular, laboratory, or digitally programmable power supply — be confident when you specify... specify HP.

For detailed information, contact your local HP field engineer. Or write: Hewlett-Packard, Palo Alto, California 94304. In Europe, Post Office Box 85, Meyrin-Geneva, Switzerland.

HEWLETT  **PACKARD**

21303

Circle 1 on reader service card



Ask Fairchild about EMR Telemetry...

Ask them what happened back in 1967 when the Air Force developed a new support fighter plane concept . . . a modest-priced plane specifically to support combat troops. The plane they envisioned would incorporate features that would give it maximum survivability, maximum fire power, and low operating/maintenance costs. Fairchild gave the Air Force that plane . . . the A-10A. Superior in every aspect! Best of show! Winner of a fly-off competition!

Ask them about EMR Telemetry's role in their success and the sophisticated, mini-computer controlled data acquisition system that compiled the in-flight test results.

EMR Airborne System included:

- Signal Conditioning/Pre-sample Filtering
- PCM and FM Multiplexers
- L-Band Transmitter
- Magnetic Tape Recorder
- Time Code Generator & Display

EMR Ground System included:

- EMR Mini Telemetry/Computer System, consisting of a DEC PDP-11/20
- EMR PCM synchronizing and demultiplexing products
- EMR FM demultiplex products
- Telemetry Receiver
- Time Code Tape Search

A complete end-to-end data acquisition system with software.

Write for our new condensed catalog

**Judge us
by the companies
we help**

EMR EMR
Schlumberger

EMR Telemetry
Weston Instruments, Inc.
Box 3041, Sarasota, Florida 33578
813-958-0811

33 Electronics Review

SOLID STATE: N-channel is key to new logic families, 33
CCD image array is biggest ever, 33
CONSUMER ELECTRONICS: Corvus cuts bait for fisherman, 34
Kitchens to be invaded by microprocessors, 35
MEETINGS: Wescon breaks taboos on dealers, orders, 36
AVIONICS: Canada's JETS goes to CAE, 36
GOVERNMENT ELECTRONICS: Firms blast FAA award as "rotten", 38
NEWS BRIEFS: 38
TRADE: Hogan urges sales to Eastern Europe, 42
COMPUTERS: IBM's loss may mean a new ball game, 44

56 Electronics International

FRANCE: A pacemaker for nervous system, 56
GREAT BRITAIN: Diodes challenge light-link lasers, 56
IC packaging for tight packing, 56
AROUND THE WORLD: 57

71 Probing the News

SOLID STATE: For CCD, imagers are just the beginning, 71
GOVERNMENT: North Carolina wants to make interface rules, 74
ELECTRONICS ABROAD: Europeans, Japanese eye P-O-S market, 76
COMMUNICATIONS: U.S. exports lag behind R&D leadership, 80

93 Technical Articles

CONSUMER ELECTRONICS: Design cuts costs for video-disk system, 93
CIRCUIT DESIGN: Nomograph aids trimming-network design, 100
DESIGNER'S CASEBOOK: Triac trigger has wide dynamic range, 105
Integrated multiplier simplifies wattmeter design, 106
Handy supply provides fixed and variable outputs, 107
SOLID STATE: Op amp combines MOS and bipolar on one chip, 110
OPTOELECTRONICS: Microchannel plates aid night viewing, 117
ENGINEER'S NOTEBOOK: C-MOS switches sample-and-hold circuit, 127
Packaged power circuits satisfy control applications, 128

139 New Products

IN THE SPOTLIGHT: Off-shelf card cages save engineers' time, 139;
32-bit mini addresses a megabyte directly, 142
SEMICONDUCTORS: Inverting op amp slews at 320 V/ μ s, 145
INSTRUMENTS: X-Y recorder samples repetitive inputs, 152
COMPONENTS: V-tails hold socket in place during soldering, 159
PACKAGING & PRODUCTION: Machine cleans 600 wafers an hour, 167
MATERIALS: 180

Departments

Publisher's letter, 4
Readers comment, 6
40 years ago, 13
People, 18
Meetings, 24
Electronics newsletter, 29
Washington newsletter, 53
Washington commentary, 54
International newsletter, 59
Engineer's newsletter, 131
New literature, 182

Highlights

The cover: Color pictures go on record, 93

A video disk looks like an iridescent audio record but stores 100 times as much information, which its playback unit handles 100 times faster. A West German invention, the system is inexpensive to manufacture, and the first production models will operate through PAL color-TV sets. Cover is by Art Director Fred Sklenar.

Charge-coupled devices aim at many markets, 71

CCDs have made their biggest splash recently as imaging arrays in cameras. But important applications for this significant new technology are also emerging in analog signal processing, large-scale memories, and infrared systems.

Microchannel plates halve night-viewing cost, 117

The three cascaded stages of a standard light-intensifier tube together achieve rather less gain than a one-stage tube containing a microchannel plate in front of its phosphor receiving screen. The 90% size reduction and 50% price reduction invite commercial uses.

Chopper-stabilized op amp fits on single chip, 110

An ingenious combination of the MOS and bipolar processes enables the complex circuitry of a precision operational amplifier to be packed on one small chip—it's the first production device to incorporate both processes.

And in the next issue . . .

Designing with microprocessors . . . a look at the optical spectrum, complete with chart . . . ceramic DIPs for half the price.

Coming Oct. 25

A special issue devoted to the growing pervasiveness of electronics.

EDITOR-IN-CHIEF: Kemp Anderson

EXECUTIVE EDITOR: Samuel Weber

MANAGING EDITORS: Lawrence Curran, *News*;
Arthur Erikson, *International*

SENIOR EDITORS: John Johnsrud,
H. Thomas Maguire, Laurence Altman
Ray Connolly

ART DIRECTOR: Fred Sklenar

ASSOCIATE EDITORS: John N. Kessler,
Howard Wolff, Gerald M. Walker

DEPARTMENT EDITORS

Aerospace: William F. Arnold
Circuit Design: Lucinda Mattera
Communications & Microwave:

Lyman J. Hardeman
Components: Joel DuBow

Computers: Wallace B. Riley

Consumer: Gerald M. Walker

Industrial: Alfred Rosenblatt

Instrumentation: Michael J. Riezenman

Military: Ray Connolly

New Products: H. Thomas Maguire

Packaging & Production: Stephen E. Grossman

Solid State: Laurence Altman

Special Issues: Harry R. Karp

COPY EDITORS: Margaret Eastman,
Everett C. Terry

ASSISTANT EDITOR: Marilyn Offenheiser

ART: Charles D. Ciatto, *Associate Director*
Patricia Cybulski, *Assistant Director*

PRODUCTION EDITOR: Arthur C. Miller

EDITORIAL SECRETARIES: Janet Annunziata,
Julie Gorgogliano, Penny Roberts

FIELD EDITORS

Boston: Gail Farrell

Los Angeles: Paul Franson (Mgr.)

Midwest: Larry Armstrong (Mgr.)

New York: Alfred Rosenblatt (Mgr.)

San Francisco: George Sideris (Mgr.)

Judith Curtis

Washington: Ray Connolly (Mgr.),

William F. Arnold

Frankfurt: John Gosch

London: Michael Payne

Paris: Arthur Erikson

Tokyo: Charles Cohen

McGRAW-HILL WORLD NEWS

Director: Walter A. Stanbury

Bonn: Robert Ingersoll;

Brussels: James Smith;

London: Marvin Petal;

Milan: Peter Hoffmann, Andrew Heath;

Moscow: Axel Krause;

Paris: Michael Johnson, Richard Shepherd;

Stockholm: Robert Skole;

Tokyo: Mike Mealey

PUBLISHER: Dan McMillan

ADVERTISING SALES MANAGER: Pierre J. Braude

ADVERTISING SALES SERVICE MANAGER:

Wallis Clarke

BUSINESS MANAGER: Stephen R. Weiss

CIRCULATION MANAGER: George F. Werner

MARKETING SERVICES MANAGER:

Tomlinson Howland

Multinational, one of the business world's buzzwords, could easily be applied to electronics. Indeed, if there ever was a truly international technology, it's electronics. Since the early days of radio, it has been the labors of workers around the world that has led to electronic progress.

In this issue you'll find a good example of an important international electronics development—the video disk recorder, which is getting its initial push into the hectic consumer products market by West German researchers. And as we point out in the article, Dutch, French, and U.S. companies are active in working up their own disk-based challengers to the various competing tape-based systems.

What the disk approach has going for it, of course, is the potential low cost of the prerecorded disk. Made of plastic, the disks lend themselves to being mechanically reproduced by the millions. Even with high-speed recording and banks of cassettes being recorded in parallel, production of prerecorded tapes is inherently more costly. Yet the technology for cramming all the necessary video data onto a reasonably sized disk—and reading it out again and again—is exacting.

Nonetheless, the day of non-broadcast entertainment lighting up the world's TV screens is close—be the medium tape or disk, and the technique magnetic, mechanical, or optical. So for details of the first disk-based system to be readied for market, turn to page 93.

One of the most exciting parts of bringing you the latest news in electronics is watching a promising new technology actually make the

perilous leap from the shelter of a laboratory to the rigors of the marketplace.

The Probing the News story on page 71 gives you a chance to watch one the steps in the journey to commercial acceptance of such a technology—charge-coupled devices. So far, the big news in CCDs has been in imaging—especially the development of solid-state television cameras.

But as the Probing the News story illustrates, there is far more going on in the field of charge-coupled devices than just imaging. Memory and signal-processing applications are being pursued at a host of companies. What's more, work is being done on combining CCDs and other technologies, such as MOS and MNOS, on one chip. Here, certainly, is a technology that bears watching.

And watching it for us was Al Rosenblatt, our New York bureau chief, who put together the story, which is based on interviews by Rosenblatt and by our string of field bureaus. Rosenblatt, by the way, brings to his post a fine mixture of electronics training and editorial experience. A holder of an EE degree from Cooper Union, he has a dozen years of electronics journalism behind him. For the past seven years, he has been with *Electronics*, first as a technical editor, and for the past 2½ years, as New York bureau manager.



September 27, 1973 Volume 46 Number 20
91,536 copies of this issue printed

Published every other Thursday by McGraw-Hill, Inc. Founder James H. McGraw 1860-1948. Publication office 1221 Avenue of the Americas, N.Y., N.Y. 10020, second class postage paid at New York, N.Y. and additional mailing offices.

Executive, editorial, circulation and advertising addresses: Electronics, McGraw-Hill Building, 1221 Avenue of the Americas, New York, N.Y. 10020. Telephone (212) 997-1221. Teletype TWX NY 710-581-5234. Cable address MCGRAWHILL NY.

Subscriptions limited to persons with active, professional, functional responsibility in electronics technology. Publisher reserves the right to reject non-qualified requests. No subscriptions accepted without complete identification of subscriber name, title, or job function, company or organization, including product manufactured or services performed. Subscription rates: qualified subscribers in the United States and possessions, Canada, and Mexico \$8.00 one year, \$12.00 two years, \$16.00 three years, all other countries \$25.00 per year, except Japan \$50.00 per year and Brazil \$40.00 per year, including air freight. Limited quota of subscriptions available at higher-than-basic rate for persons outside of field served, as follows: U.S. and possessions and Canada, \$25.00 one year, all other countries \$50.00. Single copies: United States and possessions and Canada, \$1.00, all other countries, \$1.75.

Officers of the McGraw-Hill Publications Company: John R. Emery, President, J. Elton Tuohy, Executive Vice President-Administration, Gene W. Simpson, Group Publisher-Vice President, Senior Vice Presidents: Ralph Blackburn, Circulation, Walter A. Stanbury, Editorial, John B. Hoglund, Controller, David G. Jensen, Manufacturing, Gordon L. Jones, Marketing, Jerome D. Luntz, Planning & Development.

Officers of the Corporation: Shelton Fisher, President, Wallace F. Traudly, Group President, McGraw-Hill Publications Company and McGraw-Hill Information Systems Company, John J. Cooke, Senior Vice President and Secretary, Ralph J. Webb, Treasurer.

Title registered in U.S. Patent Office, Copyright © 1973 by McGraw-Hill, Inc. All rights reserved. The contents of this publication may not be reproduced either in whole or in part without the consent of copyright owner.

Subscribers: The publisher, upon written request to our New York office from any subscriber, agrees to refund that part of the subscription price applying to copies not yet mailed. Please send change of address notices of complaints to Fulfillment Manager, subscription orders to Circulation Manager, Electronics, at address below. Change of address notices should provide old as well as new address, including postal zip code number. If possible, attach address label from recent issue. Allow one month for change to become effective.

Postmaster: Please send form 3579 to Fulfillment Manager, Electronics, P.O. Box 430, Hightstown, N.J. 08520.

SIMPLE VOLTAGE STABILIZATION

your key to low cost reliability

The ferroresonant voltage stabilizing principal depends on the saturation of a portion of the transformer's iron by the use of a resonating capacitor. The squarish waveform in the tank winding is amplitude isolated from the primary winding (and, therefore, the line's noise) and will collapse if overloaded to protect itself and your load.

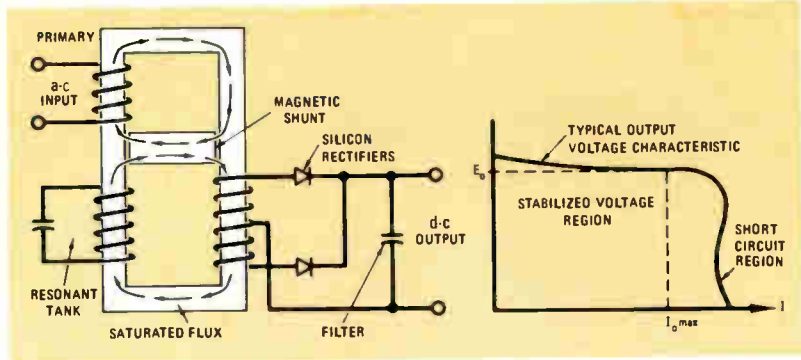

Why do things the hard way? There's a nice, easy way to provide stable, transient-free, d-c voltages in your system . . . the Kepco PRM modules. Low cost power supplies which, by their elegant simplicity, yield rich dividends in reliability and longevity.

There's no clamped-down high voltage to break out of its regulator and mess up your circuits; no noise-generating switches or oscillators to confuse your logic; no delicate transistors requiring elaborate protection. Kepco's PRM power supplies use a self-stabilizing resonant transformer, oil-filled a-c capacitor, some silicon rectifiers and husky aluminum electrolytic filters. That, plus some copper wire is it!

Voltage is controlled by the saturation flux of the transformer's iron lamination. You can't get more rugged than that. There's no need for auxiliary overvoltage crowbars, trigger circuits, current limiters or even fuses! PRM's are inherently protected for every sort of abuse.

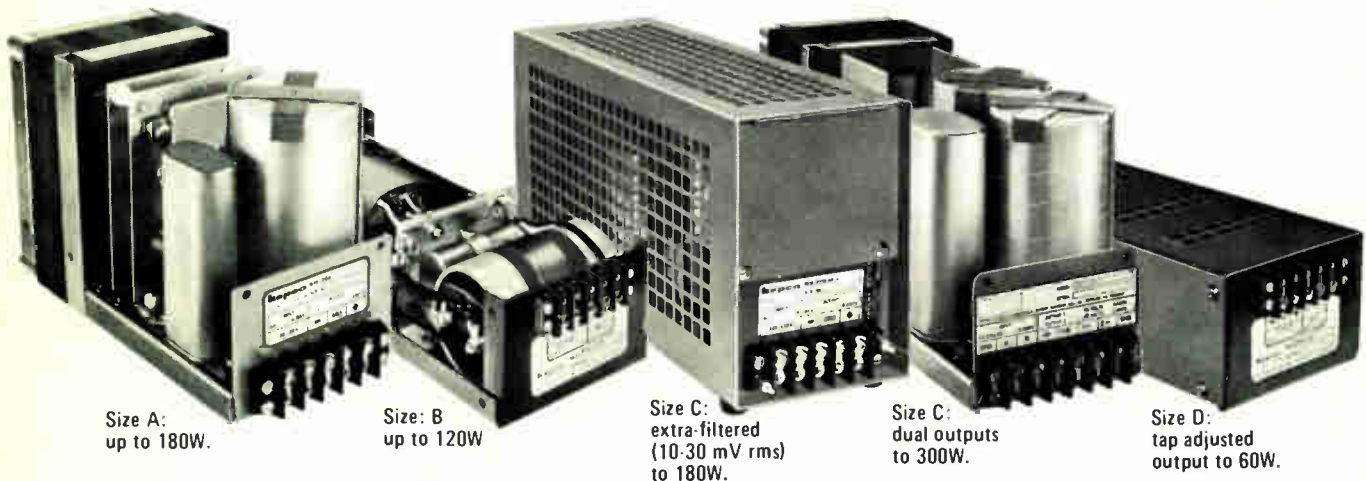

Size A:
up to 180W.

Size B:
up to 120W

Size C:
extra-filtered
(10-30 mV rms)
to 180W.

Size C:
dual outputs
to 300W.

Size D:
tap adjusted
output to 60W.

- $\pm 1\%$ source effect (the "line regulation" for a 100-130V a-c unstable source).
- 100-300 mV rms ripple, spike free! Rejects line noise by more than 120 dB.
- Outputs from 4.5V d-c to 240V d-c.
- Built to exceed 200,000-hour service life.

For complete specifications and applications notes, write Department O-14

KEPCO®

KEPCO, INC. • 131-38 SANFORD AVENUE • FLUSHING, N.Y. 11352 • (212) 461-7000
TWX # 710-582-2631 • Telex: 12-6055 • Cable: KEPCOPOWER NEWYORK

When You Buy a Power Supply, Why Not Get the Best?

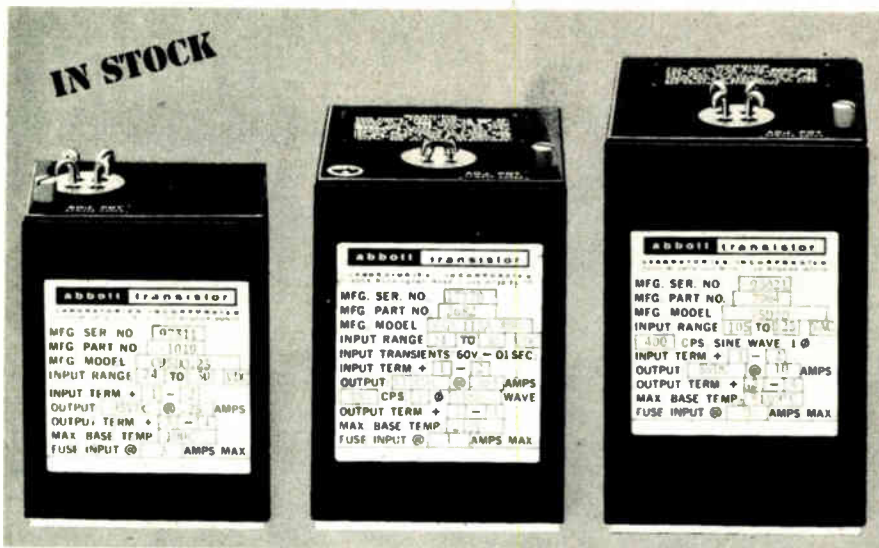

28 VDC to DC
(55,463 Hrs.)
Model C95D

28 VDC to 400 A
(61,387 Hrs.)
Model 53D

400 A to DC
(56,148 Hrs.)
Model W5D

Abbott's New Hi-Performance Modules

are designed to operate in the stringent environment required by aerospace systems — (per MIL-E-5100K or MIL-E-5272C) and MIL-STD-461 for electromagnetic interference.

RELIABILITY — MTBF (mean time between failures) as calculated in the MIL-HDBK-217 handbook can be expected in excess of 50,000 hours at 100°C for all of these power modules. The hours listed under the photos above are the MTBF figures for each of the models shown. Additional information on typical MTBF's for our other models can be obtained by phoning or writing to us at the address below.

QUALITY CONTROL — High reliability can only be obtained through high quality control. Only the highest quality components are used in the construction of the Abbott power module. Each unit is tested no less than 41 times as it passes through our factory during fabrication — tests which include the scru-

tinizing of the power module and all of its component parts by our experienced inspectors.

NEW CATALOG—Useful data is contained in the new Abbott Catalog. It includes a discussion of thermal considerations using heat sinks and air convection, a description of optional features, a discussion of environmental testing, electromagnetic interference and operating hints.

WIDE RANGE OF OUTPUTS — The Abbott line of power modules includes output voltages from 5.0 volts DC to 3,650 volts DC with output currents from 2 milliamperes to 20 amperes. Over 3000 models are listed with prices in the new Abbott Catalog with various inputs:

- 60A to DC, Regulated
- 400A to DC, Regulated
- 28 VDC to DC, Regulated
- 28 VDC to 400A, 1 ϕ or 3 ϕ
- 24 VDC to 60A, 1 ϕ

Please see pages 581 to 593 of your 1973-74 EEM (ELECTRONIC ENGINEERS MASTER Catalog) for complete information on Abbott modules.

Send for our new 56 page FREE catalog.

abbott transistor

LABORATORIES, INCORPORATED
5200 W. Jefferson Blvd./Los Angeles 90016 (213) 936-8185
1224 Anderson Ave./Fort Lee, N.J. 07024 (201) 224-6900

6 Circle 6 on reader service card

Readers comment

Calculating aperture time

To the Editor: The discussion in "Choosing a sample-and-hold amplifier is not as simple as it used to be," by Patstone and Dunbar [*Electronics*, Aug 2, p.101], could use some clarification in regard to aperture time.

The statements, "the error caused by the aperture time increases both with the aperture time itself and with the rate of change of the input signal," and "Aperture time . . . may be regarded as a timing delay," are inconsistent. The former is correct, but the latter is not. In addition, the implication that the operating time of the switch is the main cause of aperture time is usually not true. Generally, the low-pass filtering action of R and C during sampling is the main cause, and it will result in finite aperture time, even if the switch is infinitely fast.

In theory, the effect of this could be removed by properly equalizing the reconstructed signal. In practice, however, this is unrealistic, and the product of aperture time and signal rate of change must be regarded as an error. Any timing jitter must be added to the RC time constant.

Walter S. Friauf
National Institutes of Health
Bethesda, Md.

■ *The authors reply:* We disagree that the two statements Mr. Friauf quotes are inconsistent and that the latter is incorrect. The aperture time can be regarded as a timing delay. Assume that a sample-and-hold amplifier has a 10-nanosecond aperture. If the hold command is advanced by 10 ns from the point the signal sample is wanted, then aperture-time error will be completely eliminated from the hold error if the aperture-time uncertainty is zero. This does not mean, though, that the total hold error will be zero because errors in the hold mode can be broken into several components:

Errors dependent on signal amplitude and rate of change are aperture-time error, aperture-uncertainty-time error, and phase-shift error (from RC network and RC amplifier). Other errors are hold-jump voltage and hold-offset voltage, which can both be adjusted to zero, as well as decay rate,

What would a power supply designer want to know about TRW's new Darlington family?

We asked our sales and applications engineers. And they said we should tell you 5 things:

1. It operates up to 450 Volts.
2. It offers fast switching — 250 Nsec.
3. It operates up to 25 Amps continuously.
4. It costs under \$5.00 (in quantity).
5. It is immediately available, in quantity, right off the distributors' shelves.

They assured us those five facts were enough to get any power supply designer pretty excited about our new Darlington. Were they right? Signify in the usual manner—casting your vote at the nearest office of any authorized TRW distributor. Or call John Powers, collect, at (213) 679-4561; or write TRW Semiconductors, an Electronic Components Division of TRW, Inc., 14520 Aviation Blvd., Lawndale, California 90260.

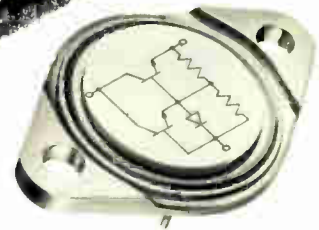

TRW SEMICONDUCTORS

These products are available through the following authorized distributors:

Almo Electronics
Bell Industries
Cramer Electronics Inc.
De Mambro Electronics

Eastern Radio Corp.
Electronics Marketing Corp.
Elmar Electronics Inc.
Hall-Mark Electronics Corp.

Harvey-Michigan Inc.
Liberty Electronics
Powell Electronics
Pytronics

Semiconductor Concepts Inc.
Summit Distributor
R. V. Weatherford Co.
Westates Electronics Corp.



(2X actual size)



the EMI suppressors

**Series JX2000/3000 Subminiature Filters . . .
Broadest Line of Ultra-Small Interference
Control Components Available . . .
in 4 weeks or Faster!**

- High performance filters available in 5 different circuits—Feed-thru, L, PI, T, 2L . . . for a wide variety of applications, including power and control lines.
- High insertion loss characteristics . . . based on requirements of MIL-F-15733.
- Hermetically-sealed . . . with glass-to-metal seals in corrosion resistant metal cases.
- Small in size yet big in reliability . . . particularly useful for industrial and military high-density packaging applications.
- Excellent stability, even under adverse environmental conditions, over operating temperature range of -55 C to +125 C.
- Threaded-neck construction . . . effectively isolates input and output terminals.

**selected units NOW available
OFF-THE-SHELF from your
Sprague Industrial Distributor**

For complete information, write for our new 16-page Engineering Bulletin 8132 to: Technical Literature Service, Sprague Electric Company, 509 Marshall St., North Adams, Mass. 01247.



THE BROAD-LINE PRODUCER OF ELECTRONIC PARTS

Readers comment

which depends on length of time in the hold mode.

The phase-shift error due to the low-pass filtering action of the R and C does indeed contribute to the hold error. However, as Mr. Friauf mentions, this phase error can theoretically be reduced to zero by properly equalizing the reconstructed signal. The Philbrick model 4853 uses an effective phase-compensation network to reduce the maximum phase shift at 20 kilohertz to only 0.01°. Therefore, the hold error due to phase shift is only 1.745 millivolts maximum for the full ±10-V input signal at this frequency. Given such a phase-compensation circuit, which is common to high-speed sample-holds, and the fact that the jump and offset errors can be adjusted to zero, then the operating time of the switch does contribute most of the initial hold error.

Rainfall monitors

To the Editor: Part 4 of your mini-computer series, "Minicomputer points the way to sewer-system improvements" [*Electronics*, May 24, p. 114] was very interesting. A similar concept is being applied in St. Paul, Minn., and in Cleveland.

A computer-based telemetered rain-gauge and sewage-level monitoring system was first operated in Minneapolis-St. Paul in April 1969. It is similar to the one in San Francisco but uses only nine rain gauges. However, the system includes remote control and monitors 34 gates. Inflatable dams control the diversion of flows in the system, besides monitoring rain and sewage level. It is based on a Digital Equipment Corp. PDP-9 computer.

The city of Cleveland, Ohio, has been accumulating similar data since April 1972; its system includes 12 rain gauges and is based on a General Electric GEPAC-30 data-collection system, itself built around an Interdata computer.

Robert L. Callery, P.E.
Watermation Inc.
St. Paul, Minn.

■ In addition to the two systems noted by Mr. Callery, Seattle, Wash., monitors its storm-drain and sewage system through a Xerox Sigma 2 computer.

AMP cuts on-board programming problems down to size.

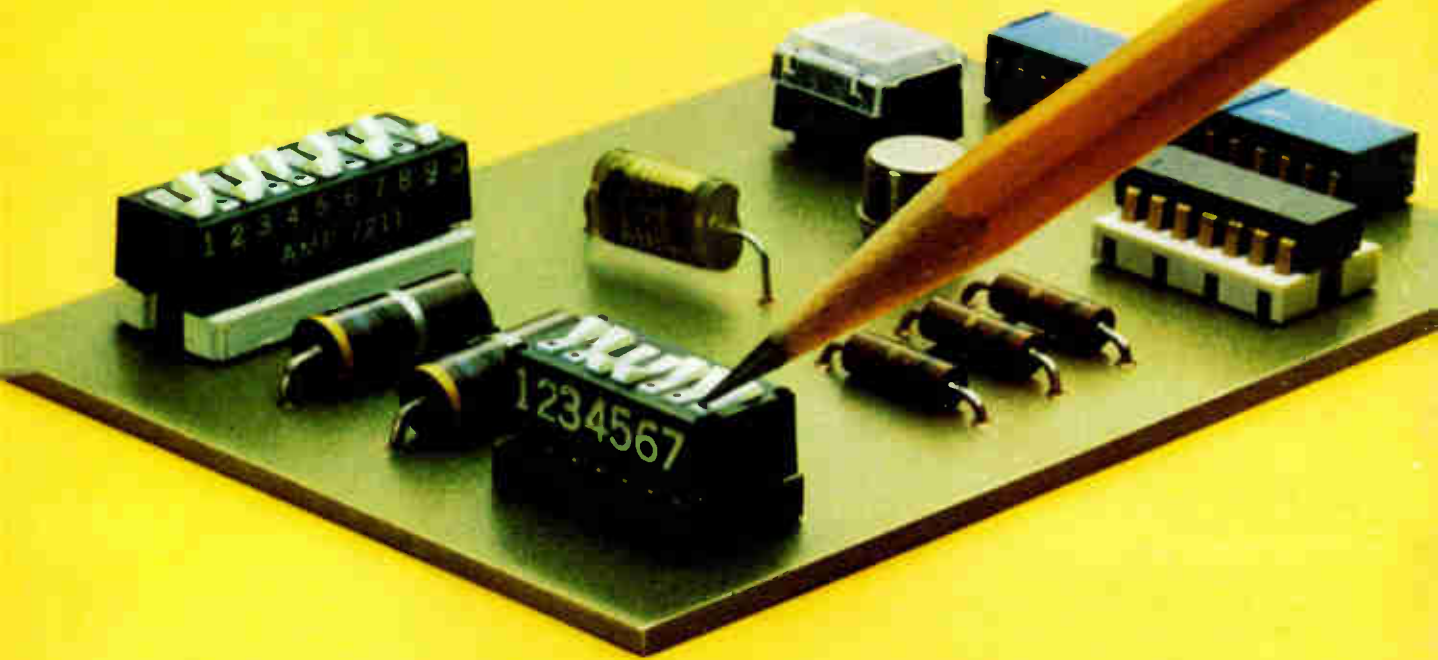

Down to the size of a DIP header — with our miniature Dual In-Line Switch. Because you can use it to program IC's right on the board without remote wiring, it cuts packaging costs, too.

This versatile switch gives you 4 to 10 single-pole, single-throw switches packaged in a housing with leads on .100 x .300-inch centers. Rocker buttons operate at the touch of a pencil to permit instant programming of data input terminals,

computer peripherals, testing and control instrumentation. Plug it into a DIP header or into one of several other AMP IC interconnection products. Or flow solder it directly into the pc board. Gold-over-nickel plating on phosphor bronze contacts makes the DIP switch ideal for "dry circuit" applications. Protective covers are available

for all switch sizes, 4 to 10 positions.

For information on other AMP switches, just turn the page.

Easy rocker action ensures fast, positive "on-off" switching: off-center rocker design prevents accidental closing from vibration.

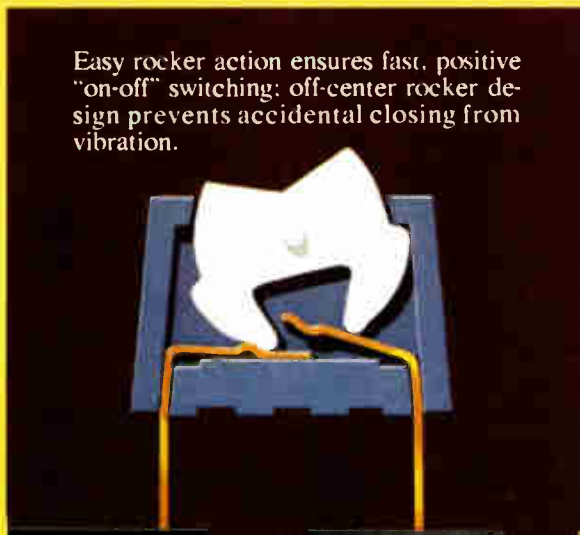

AMP pc board switches match

AMP pc board switches are suitable for a broad range of digital memory, sequencing, X-Y coordinate, input/output, and other program switching applications. Some are designed to be mounted to the same pc board as other circuit components. Other AMP switches can be panel mounted and interconnected to mother/daughter board with AMP pc connectors for fast, dependable connect/disconnects. All provide savings in packaging space and assembly costs by performing required program functions without remote switch wiring.

Thumbwheel switches offer broad interconnection flexibility.

Wide choice of back-end design options include contacts for use with post and receptacle interconnection systems or wrap-type and TERMI-POINT clip wiring methods, as well as extended board terminals. Extended board terminals can be flow soldered and will accept pc edge connectors and soldered wires. Compact 10-position switches can be used singly or in "ganged" units; are easily mounted in panel cutouts—from front or rear. Decimal and BCD outputs are standard, with optional coded formats available for special data entry, control or programming applications.

PC rotary switches minimize output leads.

All coding is internal to reduce required number of tab outputs and simplify on-board mounting. Output capabilities include 8-position BCO, 10-position BCD, 16-position hexadecimal plus single-pole decimal versions. Small diameter, low profile styles available with coin slot, bar-type knob or thumbwheel, to meet specific packaging requirements. Switch tabs can be flow soldered or hand soldered to etched circuit patterns.

Decimal rotary switch kits eliminate need for external switch wiring.

Because they can be readily designed into the logic board with related components, switch kits offer substantial savings in space and costs. Fully assembled switches in matrix configurations need less space than a pinboard of equal output.

Multilayer rotary switch provides easy coding changes.

A wide variety of coded outputs are possible in volume requirements by simple substitution of internal pc circuit discs. Output capabilities include decimal, hexadecimal and hexadecimal complement codes with up to 6 contacts and 16 positions per switch layer. Switches are stacked on a common shaft for space-saving installation. Available with post contacts for flow soldering directly to pc board, or with pin type receptacles snapped over posts for terminating to pc board connectors.

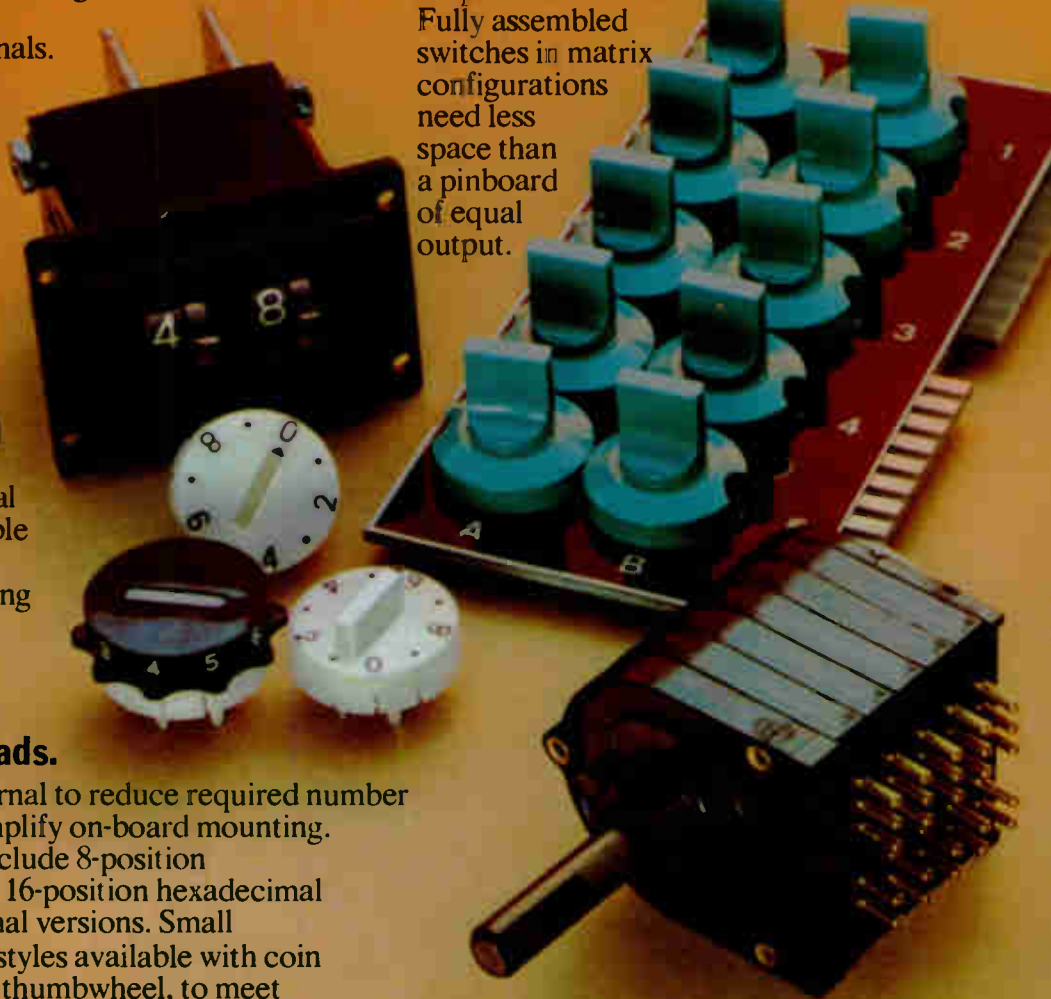

your programming needs.

Matrix slide switches feature unique visual readout, greater positioning accuracy.

Roll-up design of the visual display indicator tape simplifies verification of data prior to entry, and permits maximum slide positions in minimum switch size. Ball detent slide positioning ensures positive, accurate slide setting at required switch location, prevents wear and abrasion between pc board conductors. The special, 5-position version replaces two switch units for compact, hand held calculators and similar applications. Other row and column matrix switches are available with up to 50 data entry output slides, and as many as 40 positions per slide.

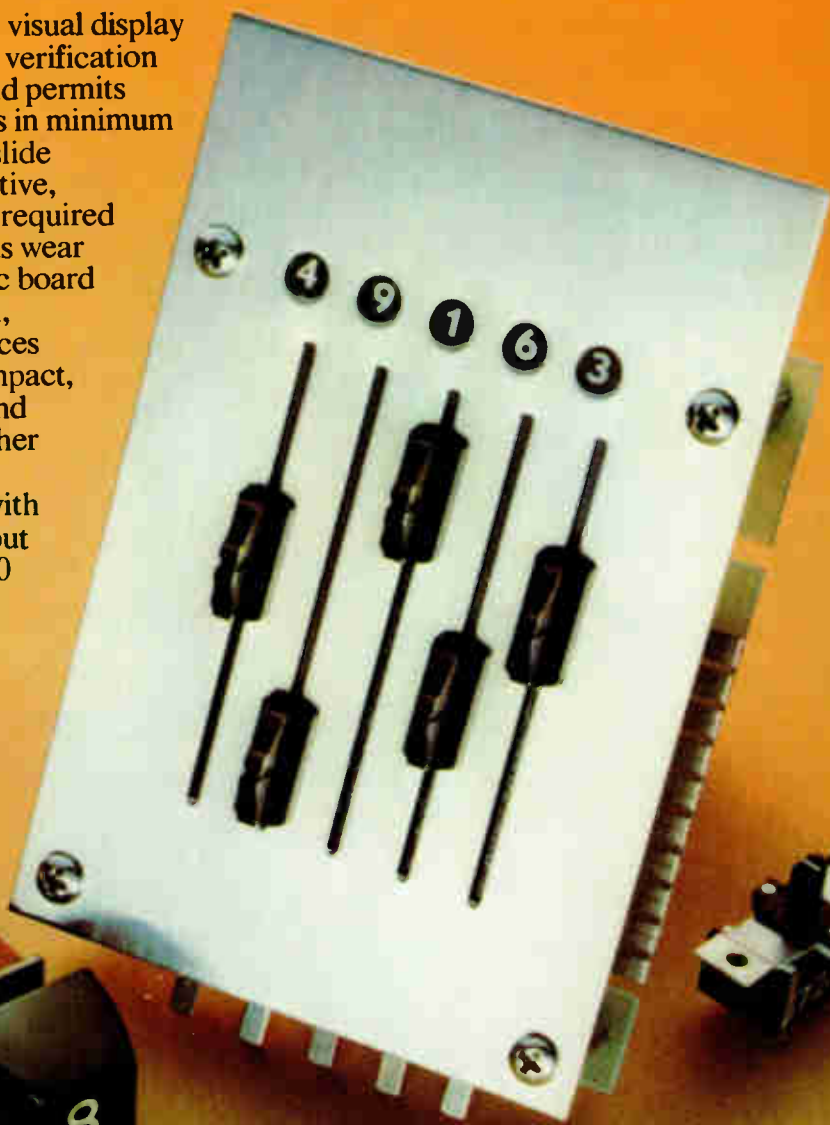

Versatile pushbutton keyboard switch.

Fast acting pushbutton offering a choice of switching functions can be manufactured for specific needs: one SPNO or SPNC; two SPNO or SPNC; one NO and one NC in the same switch.

A contact bounce of less than 1 millisecond makes this the ideal component for momentary switching applications. Gold-over-nickel contacts meet low-level logic current requirements. Pushbutton switches can be snapped into panel cutout or soldered directly to pc board.

AMP also has switch designs for unusual applications.

Developing special products to help individual customers speed production and reduce electrical assembly costs has always set AMP apart. So it is with AMP switches. In addition to our complete line of rotary, slide, rocker, thumbwheel and keyboard switches for electronic packaging, we offer products designed especially for automotive, appliance, and other industrial and commercial applications. AMP engineering specialists will work with you to adapt...or develop new ideas for your special needs.

Appliance switch contact assembly.

Automotive dashboard toggle switch.

Automotive safety belt sensing switch.

Calculator slide switch.

Brake safety switch.

AMP engineering... the key to reliable switch performance. Worldwide.

Standard or special, every AMP switch is backed by the full resources of our engineering and customer services staffs. More than 700 qualified application, sales and service engineers are ready to assist you from the earliest stages of equipment design, to determine the best programming or switching method. AMP products and services are available at AMP plant locations and distribution centers in 16 international markets throughout the world. In United States, district offices are located in California, Georgia, Illinois, Massachusetts, Michigan, Minnesota, New Jersey, Ohio, Pennsylvania, Texas, and the District of Columbia.

For more information on AMP pc board switches, circle reader service number 75, or write AMP Industrial Division, Harrisburg, Pa. 17105.

AMP
INCORPORATED

AMP District Offices.

NEW ENGLAND DISTRICT
Suite 107, Riverside Park
Weston, MA 02193. (617) 891-7500

NEW YORK DISTRICT
25 Commerce Drive
Cranford, N.J. 07016
(212) 285-9575 (N.Y.)
(201) 276-4382 (Cranford)

MID-ATLANTIC DISTRICT
400 W. Swedesford Rd.
Berwyn, Pa. 19312
(215) 647-6060

SOUTH ATLANTIC DISTRICT
955 L'Enfant Plaza North, S.W.
Suite 4010
Washington, D.C. 20024. (202) 484-9596

GULF DISTRICT
2220 Parklane Drive, N.E.
Suite 485
Atlanta, GA 30345. (404) 934-6363

OHIO DISTRICT
Landings Office Bldg. — Suite 207
3040 Riverside Dr.
Columbus, OH 43221. (614) 486-0276

LAKE DISTRICT
30555 Southfield Rd. — Suite 440
Southfield, MI 48075. (313) 645-5590

ILLINOIS DISTRICT
1050 Morse Ave.
Centex Industrial Park
Elk Grove Village, IL 60007
(312) 439-5800

NORTH CENTRAL DISTRICT
4600 W. 77th St. — Rm. 319
Minneapolis, MN 55435. (612) 920-8210
TWX (910) 576-2849

SOUTHWESTERN DISTRICT
Frito Lay Tower — Suite 1440
Exchange Park, Dallas, TX 75235
(214) 352-4852-4853
TWX (910) 861-4227

SOUTHERN PACIFIC DISTRICT
1840 S. Wilmington Ave.
Compton, CA 90220. (213) 537-4490
TWX (910) 346-7044

NORTHERN PACIFIC DISTRICT
Vallco Park
10300 N. Tantau Ave.
Cupertino, CA 95014. (408) 255-3830

40 years ago

From the pages of *Electronics*, September 1933

American Radio Manufacturers are now operating under a "Code of Fair Competition for the Electrical Industry" which was approved by President Roosevelt on August 4. In the necessarily broad regulations thereby established for this highly ramified industry, there is no formal recognition of that select class of professional laborers to whose creative effort the principal commodities of every radio manufacturer owe their origin. There exists, nevertheless, a vital connection between the corporate welfare of every radio manufacturer and the productivity of his engineering employees. Unless the teachings of industrial history are mockery, the radio industry will be distinguished for years to come by an essential dependence upon inventive thought, both technical and artistic. Periods in which this industry has provided large employment for labor and legitimate return on invested capital have always been preceded by exceptionally productive engineering activity. The recurrence of this sequence has been too consistent to suggest anything but a causal relation.

A choice is now presented squarely to all radio engineers and their employers: whether to revive conditions favorable to inventive engineering efforts or to continue with price-lowering as the main objective of engineering thought. Such a revival would provide sufficient centrifugal force to throw the industry out of the vicious competitive circle in which it is now spinning. Competition in ideas, rather than competition in prices, is still a sane and profitable activity. Furthermore, this revival of creative engineering is the most direct means of reconciling the Government's requirement of effectiveness of invested capital which is vital to the industry. Recognition of this principle is an obligation to be shared alike by engineers and by their employers, in striving toward that rehabilitation of the industry which we all confidently anticipate.

It is no secret that the editors of *Electronics* decry the manner in

which shoddy radio sets have been sold to the depression-ridden public under the guise that the merchandise is merely low-priced and therefore in keeping with the times.

It is freely admitted that small sets, even cheap sets, may inoculate with the joys of radio reception a portion of the public otherwise deprived of receivers, or that in time this public will return for better merchandise.

But we view with alarm the mounting tide of shoddy automobile radio sets selling at such low prices they attract many buyers, many of whom are doomed to disappointment. Complaints received in a single week on one of the cheap sets bearing a well known name, involve lack of sensitivity, excessive vibrator trouble, speaker rattle, mounting difficulties, blown condensers, poor soldering, loose rivets in vibrator mounting, oscillation, instability, and critical operation as regards tubes. Of this particular set, widely advertised, an experienced dealer in the Northwest said, "We have had more trouble with this receiver than with any other model in our experience."

This indicates not only cheap merchandise but receivers shoddy in electrical equipment and workmanship.

The admirable purpose of having "a radio set in every room" has now achieved such proportions in some homes, that when several members of the family are tuning in their different favorite programs, the resulting Babel is intolerable. A return to headphone or "pillow" radio on some of the sets in such a home would be a welcome relief.

Some smart manufacturer of cigar-box radios will probably shortly make this feature available by providing his little set with a cut-off jack, so that a headphone unit can be plugged in, at the same time cutting out the loudspeaker. The little set will then become a true bedside radio, capable of operating a comfortable headphone or radio pillow. And the headphone people might find a renewed market.

AMP

INCORPORATED

AMD:

Tell us, Mr. Max. Do you use the AMD 2503 Successive Approximation Register in your A-to-D converters because it requires fewer packages? Because of its high speed? Or because its unique "single edge" triggering makes it refreshingly easy to use?

Mr. Max:

Yes.

Solomon Max doesn't like to waste words. Or money. If you get the idea that we built exactly what he needed, you're right.

Besides our 8-bit Am2503, we've got a whole family of other successive

approximation registers available for immediate delivery. Eight to 12 bits. Serial or parallel data outputs. Standard or new low power.

All with all the logic for a cost-competitive A-to-D converter, ring counter or serial-to-parallel converter on a single chip. All MIL-STD-883. (We even have SAR "dice" available for the ardent do-it-yourselfers.)

It's all part of our master plan. By making exactly what people like Solomon Max want, we're going to be the sixth largest maker of integrated circuits in the U.S. by 1975.

DEVICE	FUNCTION	POWER		SPEED*	
		Std.	Low Power	Std.	Low Power
Am2502/25L02	8-bit SAR with serial or parallel data outputs	341mW	131mW	15MHz	3.5MHz
Am2503/25L03	8-bit SAR with expandable parallel output and input enable	315mW	115mW	15MHz	3.5MHz
Am2504/25L04	12-bit SAR with serial or parallel data outputs	472mW	157mW	15MHz	3.5MHz

*Guaranteed minimum clock frequency



Advanced Micro Devices, Inc.

(#15, going on #6.)

Circle 211 on reader service card

FROM DELCO, THREE POWER TRANSISTORS.

	TYPE	V _{CEO}	V _{CEV}
	DTS-708	900V	900V
	DTS-709	900V	900V
	DTS-710	900V	—

We'd like to simplify your life while you simplify your high energy circuits.

These three new devices are all NPN,

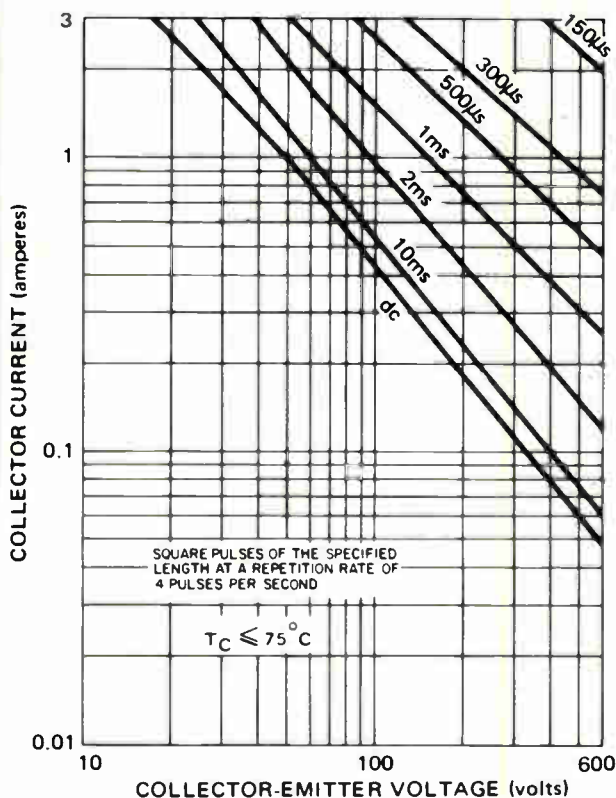

triple diffused and packaged in Delco's solid copper TO-204MA packages (TO-3 to you old-timers) for man-sized power handling.

DTS-708 and 709 are designed for use in high voltage switching applications—where inductive loads or fault conditions may be giving you problems now. The DTS-710 is ideal for linear regulators and power amplifiers.

Safe Operating Curves on the data sheets let you know where it's at. And our applications engineering assistance is available, too.

You probably know about our reputation for making really tough transistors—for high peak energy handling. You'll find we can deliver, too.

All of the Delco distributors listed have the DTS-700 series in stock.

Give yours a call now for the prices you'll like and the data you'll need.

NOW AVAILABLE FROM THESE DISTRIBUTORS IN PRODUCTION QUANTITIES.

ALABAMA, Birmingham 35233
Forbes Distributing Co., Inc.
1416 Fourth Ave., South
(205) 251-4104

ALABAMA, Huntsville 35807
Powell Electronics
803 Oster Dr.
(205) 539-2731

ARIZONA, Phoenix 85005
Sterling Electronics, Inc.
1930 N. 22nd Ave.
(602) 258-4531

CALIFORNIA, Goleta 93017
Radio Product Sales, Inc.
350 E So. Kellogg Ave.
(805) 964-4764

CALIFORNIA, Los Angeles 90022
Kierulff Electronics, Inc.
2585 Commerce Way
(213) 685-5511

CALIFORNIA, Los Angeles 90015
Radio Products Sales, Inc.
1501 South Hill Street
(213) 748-1271

NEW 900-VOLT SILICON

V _{CEO(sus)}	I _C = I _A	V _{CE(sat)}	h _{FE} Min/Max	I _C
600V		2.0V (I _C = 1A, I _B = 250mA)	—	3A
600V		1.0V (I _C = 2A, I _B = 800mA)	—	3A
600V		—	10/50	3A

CALIFORNIA, Palo Alto 94303
Kierulff Electronics, Inc.
3969 East Bayshore Road
(415) 968-6292

CALIFORNIA, Redwood City 94063
Cramer/San Francisco
695 Veterans Blvd.
(415) 365-4000

CALIFORNIA, San Diego 92123
Kierulff Electronics, Inc.
8797 Balboa Avenue
(714) 278-2112

CALIFORNIA, San Diego 92111
Radio Products Sales, Inc.
7889 Clairemont Mesa Blvd.
(714) 292-5611

COLORADO, Denver 80222
Cramer/Denver
5465 E. Evans Place
(303) 758-2100

CONNECTICUT, Norwalk 06851
Harvey/Connecticut
112 Main Street
(203) 853-1515

FLORIDA, Miami Springs 33166
Powell/Gulf Electronics
1740 N.W. 69th Avenue
(305) 885-8761

FLORIDA, Orlando 32809
Powell/Gulf Electronics
2032 Palm Ridge Way
(305) 859-1450

ILLINOIS, Rosemont 60018
Kierulff Electronics, Inc.
9340 William Street
(312) 678-8560

ILLINOIS, Skokie 60076
Bell Industries
Electronics Distributors Div.
7701 N. Austin Ave.
(312) 282-5400

INDIANA, Indianapolis 46204
Graham Electronics Supply, Inc.
133 So. Pennsylvania St.
(317) 634-8202

MARYLAND, Baltimore 21204
Radio Electric Service Co.
1026 Cromwell Bridge Road
(301) 823-0070

MASSACHUSETTS, Needham Heights 02194
Kierulff Electronics, Inc.
14 Charles Street
(617) 449-3800

MASSACHUSETTS, Newton 02195
The Greene-Shaw Co., Inc.
Chapel Bridge Park
70 Bridge Street
(617) 969-8900

MICHIGAN, Farmington 48024
Harvey/Michigan
23461 Industrial Park Dr.
(313) 477-1650

MINNESOTA, Minneapolis 55401
Stark Electronics Supply Co.
112 3rd Ave., North
(612) 332-1325

MISSOURI, Kansas City 64111
Walters Radio Supply, Inc.
3635 Main Street
(816) 531-7015

MISSOURI, North Kansas City 64116
LCOMP Kansas City
1520 Taney Street
(816) 221-2400

MISSOURI, St. Louis 63144
LCOMP-St. Louis
2605 S. Hanley Road
(314) 647-5505

NEW JERSEY, Clifton 07015
Wilshire Electronics/New Jersey
312 Clifton Avenue
(201) 365-2600 (212) 244-8930

NEW YORK, Binghamton 13902
Harvey/Federal
P.O. Box 1208
(607) 748-8211

NEW YORK, East Syracuse 13057
Cramer/Syracuse
6716 Joy Road
(315) 437-6671

NEW YORK, Rochester 14623
Cramer/Rochester
3259 Winton Road South
(716) 275-0300

NEW YORK, Woodbury 11797
Harvey/New York
60 Crossways Park West
(516) 921-8700 (212) 895-9260

OHIO, Cincinnati 45237
United Radio, Inc.
7713 Reinhold Drive
(513) 761-4030

OHIO, Cleveland 44125
Pattison Supply Co.
Industrial Electronics Division
4550 Willow Parkway
(216) 441-3000

OHIO, Dayton 45414
Kierulff Electronics, Inc.
2030 Drill Avenue
(513) 278-9411

PENNSYLVANIA, Philadelphia 19114
Almo Electronics
Roosevelt Blvd. at
Blue Grass Road
Northeast Industrial Park
(215) 676-6000

PENNSYLVANIA, Pittsburgh 15328
RPC Electronics
620 Alpha Drive
RIDC Park
(412) 782-3770

SOUTH CAROLINA, Columbia 29202
Dixie Radio Supply Co., Inc.
1900 Barnwell Street
(803) 253-5333

TEXAS, Dallas 75201
Adleta Electronics Company
1907 McKinney Ave.
(214) 741-3151

TEXAS, Fort Worth 76102
Adleta Electronics Company
South Expressway at E. Vickery
(817) 336-7446

TEXAS, Garland 75041
Kierulff Electronics, Inc.
2815 National Drive
(214) 271-2471

TEXAS, Houston 77004
Harrison Equipment Co., Inc.
1816 McGowen St.
(713) 224-9131

UTAH, Salt Lake City 84115
Cramer/Utah
391 West, 2500 South
(801) 487-3681

VIRGINIA, Richmond 23220
Meridian Electronics, Inc.
1001 West Broad Street
(703) 353-6648

WASHINGTON, Seattle 98108
Kierulff Electronics, Inc.
5940 6th Ave. South
(206) 763-1550

IN CANADA

ONTARIO, Scarborough
Lake Engineering Co., Ltd.
123 Manville Rd.
(416) 751-5980

Delco Electronics
Regional Sales Offices
Union, New Jersey 07083
Box 1018 Chestnut Station
(201) 687-3770

El Segundo, California 90245
354 Coral Circle
(213) 640-0443

General Sales Office
700 E. Firmin, Kokomo, Ind. 46901
(317) 459-2175
Operator (317) 457-8461



Delco Electronics, Division of General Motors.

INDUSTRY'S BEST DELIVERY!

MINIATURE ROTARY SWITCHES

Any catalog item
ONE WEEK (ARO)
(up to 1,000
pieces!)

WIRE-WOUND RESISTORS

PRECISION WIRE-WOUND RESISTORS

Tolerances through
 $\pm .01\%$
**3 WEEK
DELIVERY!**
(up to 1,000
pieces per line
item!)

POWER WIRE-WOUND RESISTORS

**6-8 WEEKS
DELIVERY** (up to
10,000 pieces
per line item!)

WRITE, WIRE OR PHONE
FOR IMMEDIATE ATTENTION

RCL

ELECTRONICS, INC.
700 South 21st Street
Irvington, New Jersey 07111

Telephone:
(201) 374-3311

TWX:
(710) 999-5511

People

Vollmer to fill
RCA computer void

Can a scientist with roots in academia find success and fulfillment as head of a technological enterprise whose merit will be measured in dollars and cents? Jim Vollmer will soon find the answer to that question. With a Ph.D. in physics, and early work teaching at college, Vollmer now has the responsibility for taking RCA's former computer manufacturing facility and coming up with a new product line that makes best use of the human resources—1,000 people with all kinds



The way is digital. Jim Vollmer says he'll stick with digital products.

of skill and experience—and the physical plant in Palm Beach, Fla. Even though he's had managerial responsibility as director of RCA's Advanced Technology Laboratories, Vollmer probably faces his biggest challenge in the Florida assignment.

Since RCA pulled out of the computer business almost two years ago, the main function of the Palm Beach division has been to fulfill what Vollmer calls "RCA's legal and ethical obligations of service to its old computer customers."

In many ways, Vollmer's background and temperament should help find a successful solution in terms of products, people, and plant. While his early training in sci-

ence was what he calls "a solitary kind of thing . . . rarely involving a team effort," it nonetheless gave him a keen insight into the course of techno-scientific developments.

Then, there is the matter of Vollmer's personality. He speaks easily and is outgoing with a stated concern about the people working with him and those who may become future customers. And this concern manifested itself in a shift in emphasis "from science to technology as a means of improving daily life."

A key concept here is innovation—Vollmer calls it "the means by which ideas get into the marketplace" or "a way for society and individuals to put invention to use."

At the labs, he experienced some of the problems of turning invention to practical use. He graduated from Harvard's Advanced Management Program in 1971.

What are the guidelines for establishing a route back into the marketplace? "Whatever we go," says Vollmer, "it will be digital in nature and will involve high technology." The new areas, he says will be "sophisticated in themselves, but electronics-poor." Such areas, he says, include hotels and motels, transportation, and recreation.

In his early years Vollmer dropped out of medical school because he admits that at that time he "was more interested in things than in people." After receiving his Ph.D., Vollmer taught physics at Temple University. He left teaching to lead a research group in the Industrial division at Honeywell.

Lately, he has taken up golf, which is what he calls "a humbling experience" and an example of "pure physics" that he hasn't mastered yet—he feels thankful for scoring as low as 102.

New Fabri-Tek chief
mapped comeback

Fabri-Tek Inc. is a textbook case of how a small company with a firm scientific and engineering base can be hit hard by the recession and yet rebound with vigor. The Min-

Don't overdraw. Use these Kodak shortcuts:

The snappy restoration shortcut.



Why waste time retracing your old, battered drawings? Restore them by making sharp, clean photographic reproductions on Kodagraph film. Weak lines come back strong and clear. Stains virtually disappear. And instead of gray lines on yellow, you'll have snappy, contrasty, black-on-white prints.

The drop-of-water shortcut.

Why retrace the whole design for a few revisions? Just

order a second original on Kodagraph wash-off film. Then use a drop of water and erase unwanted details.

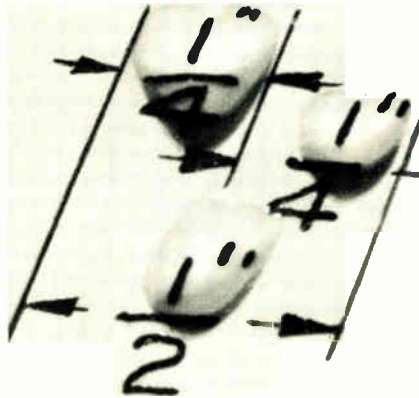

Draw your design revisions on the film and you're done.

The multiplication shortcut.

Why draw the same detail over and over? Kodagraph film will do the job for you. That way you draw the detail just once. Make as many photoreproductions as you need. Cut them out, paste them down, and make a

Kodagraph film print of the paste-up.

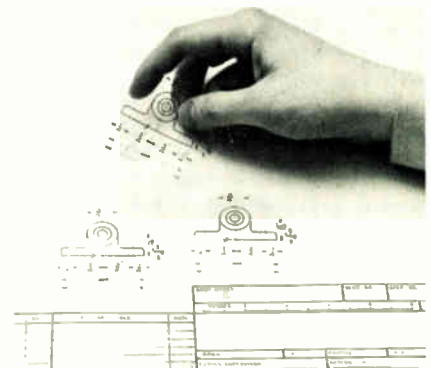

Now you have a superb second original for subsequent printmaking.

Get the facts from Kodak.

Drop us a line for more facts on how you can reduce drafting time and save money too, with Kodagraph films and papers. Eastman Kodak Company, Business Systems Markets Division, Dept. DP884, Rochester, N.Y. 14650.

Kodak products for engineering data systems.



People

neapolis-based core-memory maker has sailed out of the recession, and its fiscal 1973 results show the first profit in three years.

The architect of the upswing was Lyle D. Altman, hired from Control Data Corp. in 1970 as vice president for corporate development. Altman, recently named president of the

company, started the turn towards profits by "de-acquisitioning" several subsidiaries, and by changing the product mix to emphasize end-user, rather than OEM, products.

In the lean years, Fabri-Tek sold off Fabri-Tek Instruments, Fabri-Tek Micro-Systems, and Digiac Corp., a maker of electronic educa-



Profit maker. Lyle Altman of Fabri-Tek found profits in "de-acquisitioning."

tional systems. Although it has since reacquired Digiac, a larger portion of expected sales will come from businesses developed in-house. Two years ago, Fabri-Tek introduced add-on memories for IBM computers and has since started producing add-ons for Hewlett-Packard, DEC, and Data General equipment.

Stacks are level. "Generally within the memory area, a good part of our expansion is trending toward products instead of stacks," Altman says. "The stack business has grown in the past year, and will stay at a relatively high level, but it doesn't have the expansion opportunity that we would like to see."

Altman is also pushing the firm further into the components business. Its National Connector division, a manufacturer of custom cylindrical, printed-circuit-board, and plate connectors, is now introducing standard products, and subsidiary Fabri-Tek Circuits Inc. is expanding its capacity for producing pc boards.

The firm is also considering marketing semiconductor memories. "If we were to design a standard memory to be used by a dozen mini-computer makers, for example, we could do it at much less cost."

Computer course. Altman, with a business degree from the University of Nebraska, joined IBM's first group of computer people in 1954, fresh from the Air Force, and moved from an EDP rep to aerospace-industry marketing manager before he joined CDC, where he became CDC corporate vice president and general manager of the Western division.

Like many Minnesotans, Altman spends much of his leisure time fishing, in Canada and nearer home.

the world's largest selection of EMI FILTERS becomes the easiest to spec.

FREE CATALOG

Only ADC offers 400 established standard EMI filter designs. And now, with our new, unique catalog selection guide, finding the one that's best for your specific need is easier than ever. Just count to four.

- 1 choose one of four current ratings
- 2 select from five circuit configurations
- 3 pick one of four filter network configurations
- 4 spec one of five capacity to ground/loss characteristics combinations

That's all there is to it. In four simple steps you've eliminated 399 of your possible choices and now have the 4-digit model number of the one EMI filter that's best for your job. Now, all you do is check the table in the catalog for the available case sizes and you're home free.

And free is how you get this unique spec guide. Just circle the appropriate number on the Reader Service Card and your guide will be on its way.

Special Requirements? We would be pleased to assist in developing a special design for you.

ADC PRODUCTS 4900 West 78th Street, Minneapolis, Minnesota 55435
Tel: (612) 835-6800 - TWX: 910-576-2832 - TELEX: 29-0321

ADC

GREATEST YIELD IN THE ELECTRICAL FIELD

**ALLEGHENY LUDLUM STEEL
GIVES YOU MORE FOR YOUR MONEY**

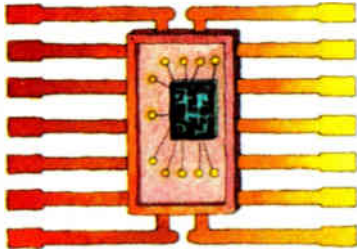

Critical demands for leadframes in semiconductors are more than semifilled by Allegheny Ludlum. Our product range and consistently high quality fill numerous needs.

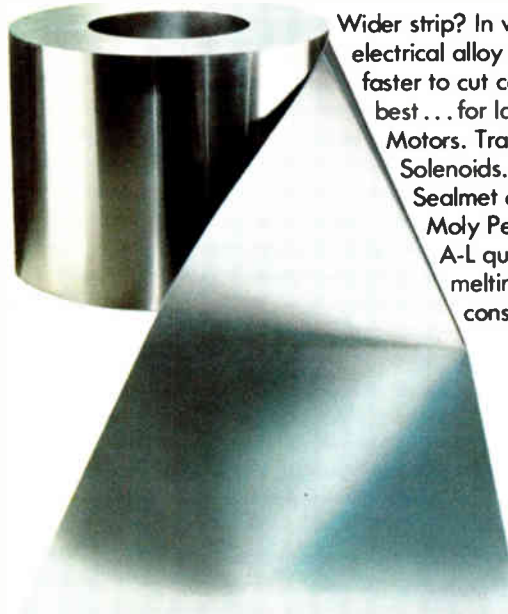

Wider strip? In widths up to 25 inches, our electrical alloy strip yields more good parts faster to cut costs. Sheet? Plate? Bar? Get the best... for laminations and shieldings.

Motors. Transformers. Generators. Relays. Solenoids. Vibrators. Cores. Check our Sealmet alloys. Or Ohmaloy. Mumetal. Moly Permalloy, etc.: all products of strict A-L quality control... from computerized melting to final shipment... for consistently superior characteristics.

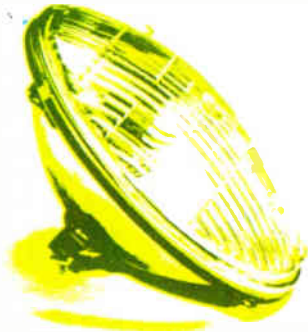

We can earn your seal of approval... with special steels for glass-to-metal seals: AL 42 and 4750. Sealmet 1 and 4. AL 430Ti. And others. All meet tightest tolerance requirements... for sealed-beam headlights, fluorescent lights, electronic tubes.

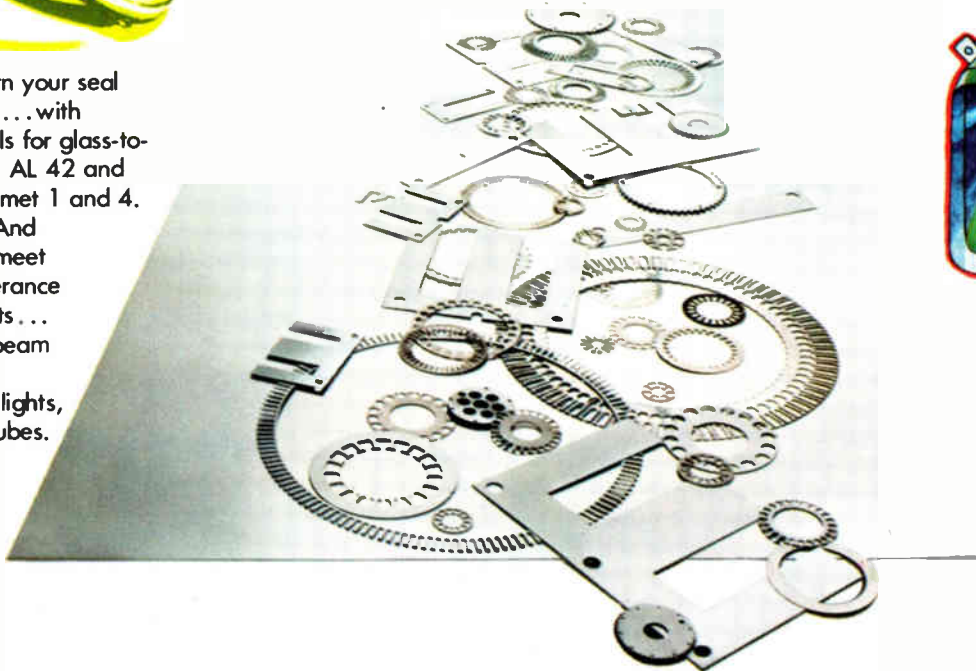

A pioneer in developing magnetic shielding materials, we stock Mumetal and Moly Permalloy for prompt delivery. Our Research Center, most elaborate in stainless and specialty alloys, helps solve special shielding problems.



For more on how America's leading producer of stainless and specialty alloys can help you in the electrical field, write: Allegheny Ludlum Steel. Dept. 331, Oliver Building, Pittsburgh, Pa. 15222.



Allegheny Ludlum Steel
Division of Allegheny Ludlum Industries

Tektronix' new programmable calculators: Natural. Powerful. Significantly less expensive.

Natural

The new Tek 21 and 31 programmable calculators are designed for easy interaction between you and the machine. There are no machine rules or languages to learn. The new calculators have English-like programming keys and a simple keyboard that does math the way you write it.

Both machines have over 30 math functions built in. There are no extras or options to purchase: the math functions commonly used are standard.

Powerful

With one of our calculators, you can solve problems directly from the keyboard. Data can be stored in the calculator's memory and recalled by keystrokes. Or, you can put an entire routine into the program memory and have your calculator run programs,

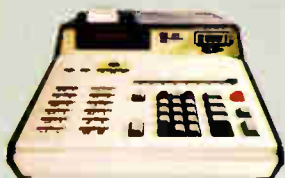

Tek 21

Silent alphanumeric thermal printer

Easy-to-read display: 12 digits, 2 signs

6 status messages: radians, degrees, learn, busy, stop, address incomplete
10 error messages

Complete editing capability — insert, delete, step forward, step back

English-like programming keys

24 user-definable keys
Built-in math ROM with 35 math functions

Register arithmetic keys



Circle 22 on reader service card

For a demonstration circle 23 on reader service card

execute key commands, and recall data automatically for you.

Memory capacity needs vary from one discipline to another. The data storage and program memories of our calculators are more than sufficient to meet most needs. However, the machines can be adapted to meet the needs for large capacities (up to 8,192 program steps, 1,010 data registers, or a combination of both on the Tek 31). Magnetic cards, cartridge tapes and plug-in PROMs (programmable read-only memory) can be added to expand memory or to perform specific functions. Input and output peripherals can be interfaced to provide more power.

Less Expensive

Through advanced design, based on unique concepts and unfettered by

unnecessary computer-based technology, Tektronix is able to offer more problem-solving performance per dollar. The Tek 21 is only \$1,850, and the Tek 31 only \$2,850. Compare those prices, and all the features of Tektronix calculators, with any other scientific programmable calculators.

Programming

With both the Tek 21 and 31, you instruct the machine in simple English, plus common math symbols. The Tek 21 has eight keys for functions you define yourself. In your own language. The Tek 31 has 24 user-definable keys. In addition to conditional and unconditional branching, the 31 has full editing capabilities, symbolic addressing and nesting of sub-routines. Plus alphanumerics, so the calculator actually can communicate with you.

Output

Operations and results are simple to read on both the Tek 21 and Tek 31. A large, bright display flashes to indicate that the machine has exceeded its range or that it has been asked to perform an illegal math operation. In addition, a silent thermal printer, with alphanumerics on the Tek 31, gives a hard copy of results.

We invite you to try one of our calculators. We are confident that, when you experience the ease of operation plus the overall performance, you will choose a Tek 21 or 31 programmable calculator.

For a free, full-color brochure on Tek 21 and 31 programmable calculators, please fill in and mail the coupon.



Tape cartridge for program entry

Programmable flag

Via first class mail, send me your 16-page brochure on the Tek 21 and 31 programmable calculators.

- Please add me to your mailing list.
I am in the market for a calculator within
 30 days 60 days
 90 days or more

I would like to have a sales engineer call
 Yes No

My area of professional activity is _____

Other calculators I am considering are _____

Name

Title

Firm

Address

City

State

Zip

Tektronix, Inc.
P.O. Box 500
Beaverton, Oregon 97005

Attn: Colin Barton



Prices do not include silent alphanumeric printer (\$700.00—Tek 31, \$450.00—Tek 21) and additional memory.

LAY YOUR CARDS on the table ...



Don't "throw-in" a potentially winning circuit design just because you need a special timing or current switching component. Adlake offers mercury wetted contact relays, dry reed relays, and load relays . . . custom motor start-winding timers, fault grounding switches, pulse start dual time delays, and bistable AC/DC switches as standard catalog items . . . or how about a full line of hybrid timers, transfer timers, pulse latches, and power pulse latches for special applications.

You need **RELIABLE, PRACTICAL, and ECONOMICAL** special components. And Adlake's design engineers, with decades of experience, can tell you if a special current or timer device can be built reliably, practically, and at reasonable cost — 24 to 48 hour turn-around time is not unusual.

*Before you decide to
"reshuffle" your circuit design
... CONTACT ADLAKE ...*

*our innovative engineers can design
and build the special
component
you need.*

PULSE START DUAL TIME DELAY

Provides two preset time delay functions to a common load. A momentary "switch-closure (or pulse)" to the selected timing terminal starts the output circuit (120 VAC, 5A). At the pre-selected time, the circuit switches off.



POWER PULSE LATCHES, SERIES HR-1000

Power Pulse Latches are designed for main power switching control of machine tools, assembly line systems, display sign flasher/control systems, and other power switching applications requiring long life, highly reliable, heavy current switching. With rated positive "gate" voltage applied to the all solid state input circuit, successive control pulses will alternately switch the load contacts "on" and "off". Output is DPST (N.O. or N.C.) high current mercury displacement switch contacts which will switch up to 100 amps per pole at 120 VAC.

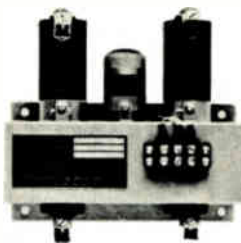

MOTOR START WINDING TIMER

Dependable silent delay timing of start winding contactor. Same unit operates on voltage input from 120 to 460 V.A.C. Output capable of controlling up to 220 V.A.C. contactor coil. All solid state output insensitive to shock, dirt and most other environmental influences.



ADLAKE CAN GIVE YOU AN UNBEATABLE HAND!

THE ADAMS & WESTLAKE COMPANY



ELKHART INDIANA 46514
219 - 264 1141
TELEX 25 8458
CABLE ADLAKE

Meetings

International Conference on Engineering in the Ocean Environment: IEEE, Washington Plaza, Seattle, Sept. 25-28.

Semicon East: SEMI, Holiday Inn and Nassau Coliseum, Westbury, N.Y., Oct. 2-4.

International Exhibition of Industrial Electronics (Elettronica 2): Turin, Italy, Sept. 29-Oct. 8.

Engineering in Medicine and Biology: AEMB, Hotel Leamington, Minneapolis, Sept. 30-Oct. 4.

Symposium on Semiconductor Memory Testing: IEEE, Rickshaw Inn, Cherry Hill, N.J., Oct. 2-3.

National Electronics Conference: IEEE, Regency Hyatt O'Hare Hotel, Chicago, Oct. 8-10.

Optical Society of America Annual Meeting: OSA, Holiday Inn—Downtown, Rochester, N.Y., Oct. 9-12.

International Telemetry Conference/USA: ITC, Sheraton Northwest, Washington, D.C., Oct. 9-11.

Instrumentation-Automation Conference: ISA, Astrohall, Houston, Oct. 15-18.

Canadian Computer Show and Conference: CIPS, Exhibition Park, Toronto, Oct. 16-18.

American Society for Information Science Annual Meeting: ASIS, Hilton, Los Angeles, Oct. 21-25.

Connector Symposium: Connector Study Group, Cherry Hill Inn, Cherry Hill, N.J., Oct. 24-25.

Northeast Electronics Research & Engineering Meeting (NEREM): IEEE, Boston, Nov. 6-8.

Conference on Magnetism and Magnetic Materials: AIP, IEEE, Statler-Hilton, Boston, Nov. 13-16.

National Telecommunications Conference: IEEE, Hyatt Regency Hotel, Atlanta, Nov. 26-28.

signetics MOS

DEVICE SELECTOR

INSTRUCTIONS

Set arrow in lower window at Register Length, Bit Capacity, Character Size or Function.

Read Device Type and Specification in upper windows.

SIGNETICS MOS DEVICE SPECIFICATION

TYPE	V _{SS}	V _{DD}	V _{GG}	V _{BB}	PROCESS	PKGS.
2580	+5	0	-12	-	P-SG	N, I

SHIFT REGISTERS	REGISTER LENGTH	ORGANIZATION	SPEED (MHz)
STATIC — METAL GATE	16	16 x 2	1.0
	25	25 x 2	1.0
	32	32 x 2	1.0
	50	50 x 2	1.0
	100	100 x 2	1.0
	100	100 x 2	3.0
STATIC — SILICON GATE	50	50 x 2	1.5
	100	100 x 2	1.5
	200	200 x 2	1.5
	32	32 x 6	2.0
	40	40 x 6	2.0
	80	80 x 4	1.5
	240	240 x 2	1.5
	250	250 x 2	1.5
	256	256 x 2	1.5
	128	128 x 2	1.5
	132	132 x 2	1.5
	1024	1024 x 1	1.5
DYNAMIC	100	100 x 2	3.0
	512	512 x 1	2.5
	1024	1024 x 1	2.5
	512	512 x 1	3.0
	1024	1024 x 1	3.0
	256	256 x 4	8.0
	512	512 x 2	8.0
	1024	1024 x 1	8.0
MEMORIES			
RAM STATIC			
RAM DYNAMIC			
ROM			
CHARACTER GENERATOR			
SPECIAL CIRCUITS			
RECEIVER-TRANSMITTER	UAR/T	8 BIT	0.32
FIRST-IN, FIRST-OUT BUFFER	FIFO	32 x 8	1.0

PACKAGE DESCRIPTIONS

A Package: 14-Pin Silicone DIP
 B Package: 16-Pin Silicone DIP
 I Package: Ceramic DIP
 K Package: 10-Pin TO-100
 N Package: Silicone DIP
 T Package: 8-Pin TO-99

TA Package: 8-Pin TO-99
 V Package: 8-Pin Silicone DIP
 XA Package: 18-Pin Silicone DIP
 XC Package: 22-Pin Silicone DIP
 Y Package: 24-Pin Ceramic DIP

© 1973, PERRYGRAF Div. Nashua Corp., L.A., Cal. 90064 Printed in U.S.A.

FREE

Pick up a FREE MOS SELECTOR SLIDECHART and dial yourself the broadest MOS line in the industry. On one side, you choose a function (say, an 8k ROM), set the pointer, and read off all the major specs. The reverse side, a cross-reference guide, instantly converts any of 114 "Brand X" devices to the Signetics part number. Makes ordering our MOS as easy as getting and using them.

From Signetics you get everything you want, with no blue sky. Super. So's the slidechart. Send. Get. Quick.

CLIP COUPON TO YOUR LETTERHEAD. SAVE TIME & TROUBLE.

Signetics/MOS Selector
 811 E. Arques Ave., Sunnyvale, Calif. 94086

I deserve to have a FREE MOS SELECTOR SLIDECHART, and I shall use it well and sincerely.

Name	Title
Company	Mail Stop
Address	
City	State
Zip	Phone

Signetics Corporation. A subsidiary of Corning Glass Works.

signetics

Growing with the

Amphenol's new telephone connector system saves space, saves time, saves material.

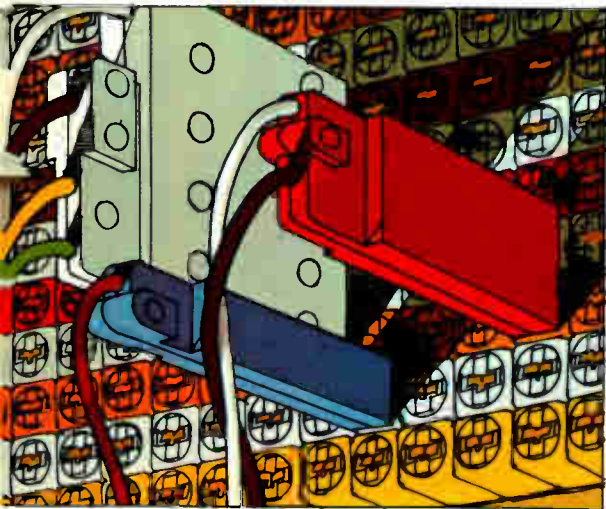

It's called Circuit Concentration Bay (CCB) and was first used to alleviate the problem of overcrowded distributing frames in a major Colorado telephone company central office. More than five miles of cable were actually eliminated in this installation. Floor space requirements were reduced by 80 per cent.

As more and more phone companies gain experience with CCB, it is also becoming clear that the savings in labor are at least as great as the space savings. Instead of the tedious, time-consuming job of hand soldering each connection, the craftsman uses color-coded miniature patchcords to complete circuits in about one-twentieth the time. And circuit interruptions found in normal distributing frames are virtually eliminated.

The savings in space, materials and labor due to Amphenol's CCB system are adding up to tremendous cost reductions and improved service for phone companies across the country.

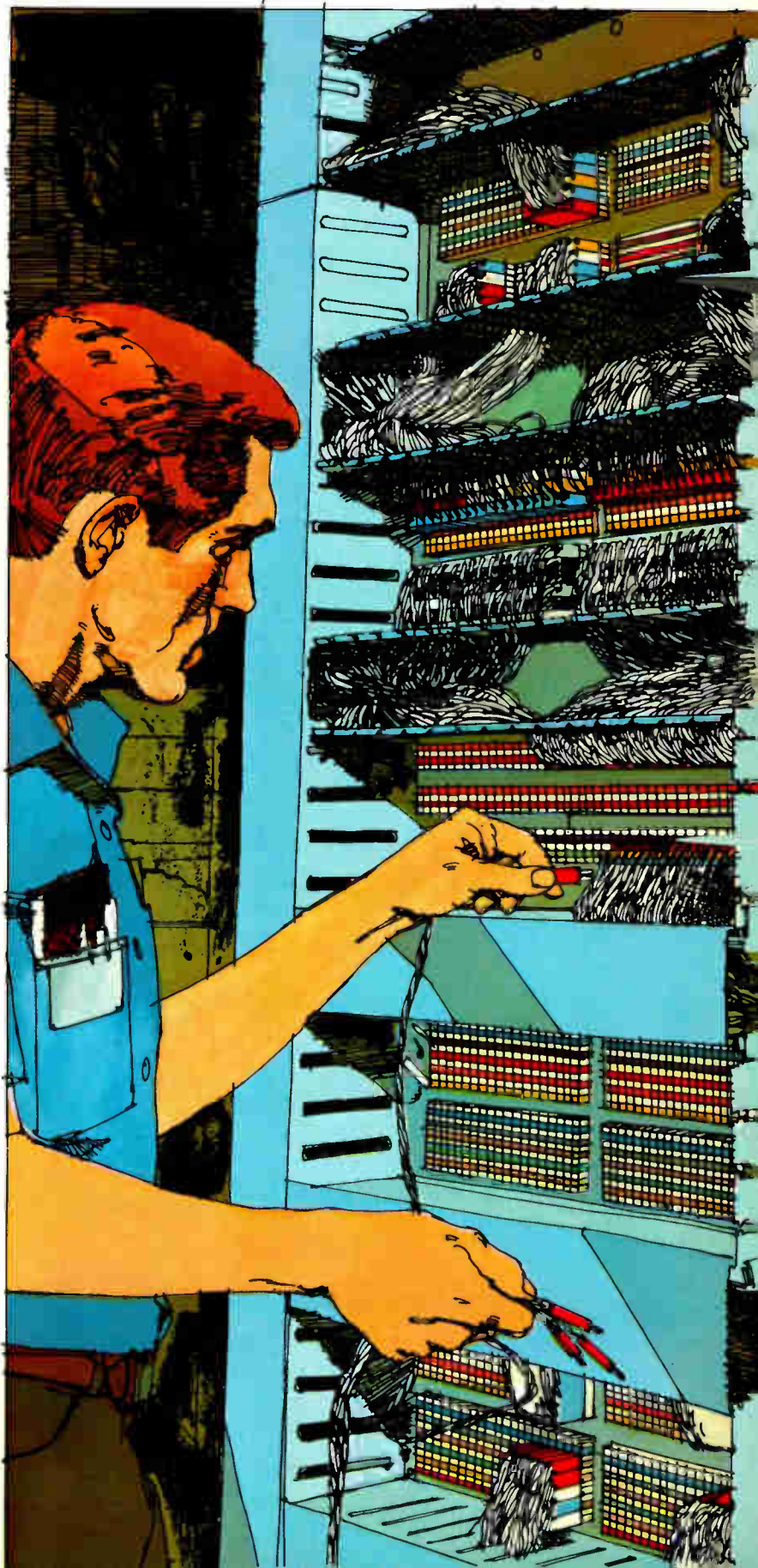

new electronics

Amphenol connectors help a mini-computer control a 70,000 vehicle intersection.



A sophisticated traffic control computer was installed last year to tame an unusually busy intersection in Campbell, California.

Environmental problems are tough because the controller is located right at the intersection. It must remain unaffected by temperature variations between 0 and 120°F. and by voltage variations of plus or minus 10 per cent. It must perform faithfully for years to come.

That's why Amphenol's 5015 series connectors were selected. Our "Old Vet" has a service record in tough environmental conditions that no one can match. Some "Old Vets" are in service after over 30 years on the job.

That's important to Campbell, California because their traffic controller has a lot of work ahead of it.



Amphenol digital turns-counting dials help load a ship by computer.

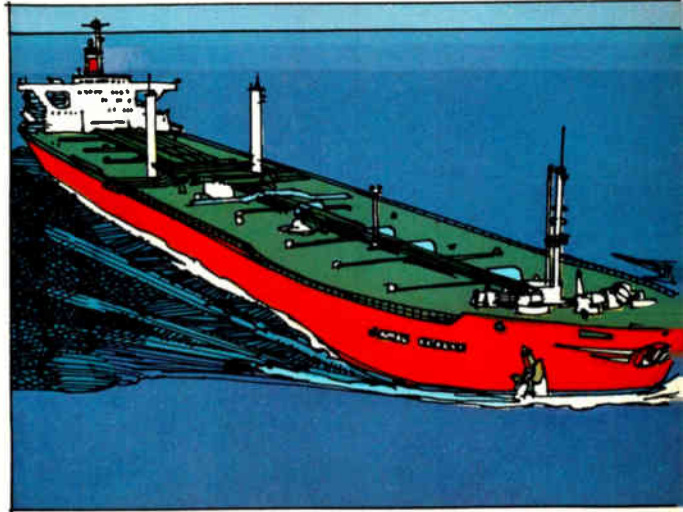

Unless a ship's cargo is distributed just right, stresses can cause extensive hull damage. So proper load distribution is critical. That's why one of the world's largest shipbuilders

has developed an electronic cargo distribution computer. It presents cargo placement and hull stress information continuously.



The Swedish manufacturer

selected Amphenol dials for this computer because they're so easy to read. A magnifying window significantly enlarges the numerals and vernier scale, and digital readout is angled to the perpendicular for easy viewing from all positions.

Easy readability of the computer input devices is essential because a misread digit, when fed into the computer, could cause a disastrous error in loading.

**BUNKER
RAMO**

AMPHENOL

For more information, contact these manufacturing/sales facilities. United States: Amphenol Sales Division, 2875 S. 25th Av., Broadview, Il. 60153 Canada: Amphenol Canada Ltd., 44 Metropolitan Rd., Scarborough, Ont. Great Britain: Amphenol Ltd., Thanet Way, Tankerton, Whitstable, Kent, England West Germany: Amphenol-Tuchel Electronics GmbH, 8024 Deisenhofen bei Munchen, West Germany France: Usine Metallurgique Doloise, 92a98 Avenue de Gray, 39100-Dole, France Australia: Amphenol Tyree Pty. Ltd., 10-16 Charles St., Redfern, N.S.W. 2016, Australia India: Amphetronix Ltd., 105 Bhosari Industrial Area, Box 1, Poona 26, India Japan: Daiichi Densoh Kogyo K.K., 20, 3-Chome, Yoyogi, Shibuya-ku, Tokyo, Japan 151

Circle 27 on reader service card

Pulse handling:
there's more to
resistors than
resistance.

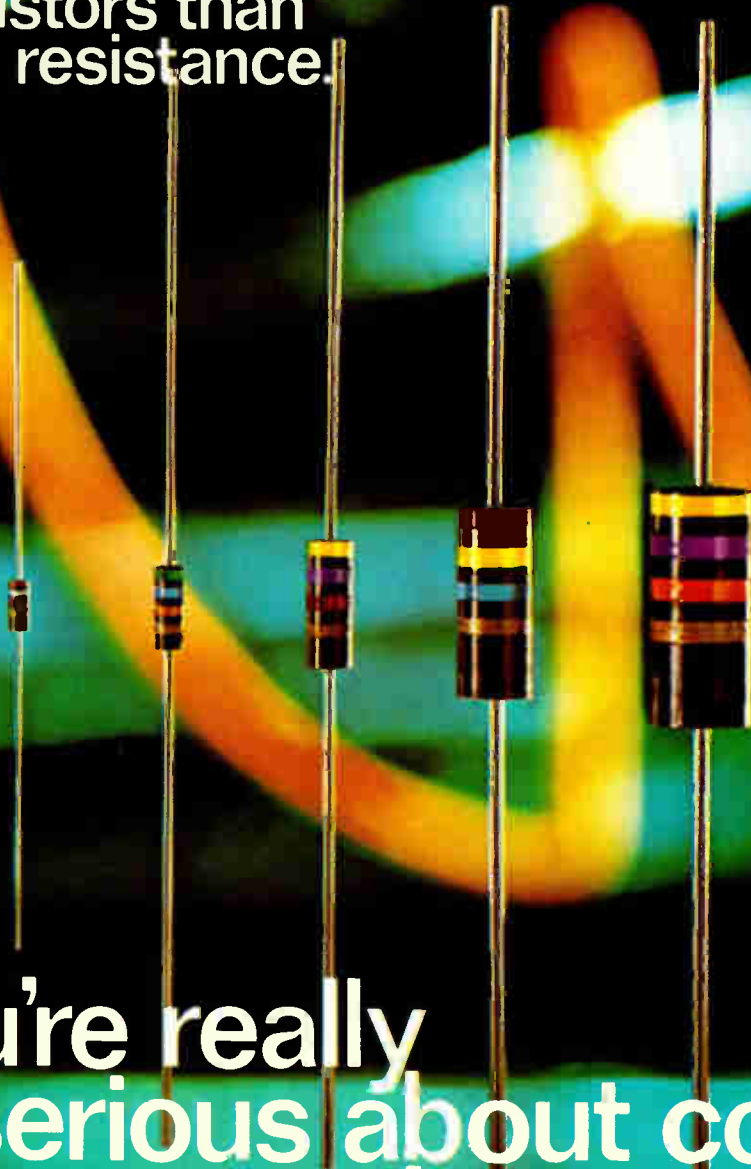

If you're really
serious about cost,
be serious about quality.

Experience shows that Allen-Bradley fixed composition resistors can withstand far greater pulse energy levels than resistors manufactured by some other technologies.

For example, a pulse equivalent to the energy from the rapid discharge of a $10\mu\text{f}$ capacitor charged to 600 volts (1.8 watt-seconds) will have an insignificant effect on Allen-Bradley $\frac{1}{4}$ watt resistors.

This performance is characteristic of the hidden values built into all Allen-Bradley composition resistors by our exclusive hot molding process. Quality that can make important differences in your design and procurement decisions.

Ask your Allen-Bradley distributor for "7 ways to tell the dif-

ference in fixed resistors." Or write: Allen-Bradley Electronics Division, 1201 South Second Street, Milwaukee, WI 53204. Export: Bloomfield, NJ 07003. Canada: Allen-Bradley Canada Limited, Cambridge, Ontario. United Kingdom: Jarrow, County Durham NE32 3EN.

A-B Type	Rated Watts	Pulse Energy Capability Watt-Seconds	Equivalent Energy Source
BB	1/8	0.45	$2\mu\text{f}$ @ 670 volts
CB	1/4	1.8	$10\mu\text{f}$ @ 600 volts
EB	1/2	6.4	$32\mu\text{f}$ @ 630 volts
GB	1	16	$32\mu\text{f}$ @ 1000 volts
HB	2	44	$32\mu\text{f}$ @ 1650 volts

EC70



Hinkelman to head major watch venture

A major new digital watch venture, Electronic Timepieces Inc., sees big changes ahead, but will stick with proven technology in its first watch products. Its president is Thomas D. Hinkelman, former vice president of corporate planning at Fairchild, and James F. Lovette, Fairchild's former display marketing manager is vice president of marketing.

The Los Altos, Calif., company, rumored to have substantial backing from a major semiconductor company, **expects to sell 200,000 watches per month within two years.** "Conventional" 32-kHz LED watches will be the first products, out early next year, but ETI will introduce much higher-efficiency GaP displays in 1974.

The company also thinks that **electrochromic displays are closer than many people suspect. These displays seem to overcome problems with liquid crystals** that have discouraged ETI from rushing into liquid crystals. Likewise, while C-MOS will be used in the first watches, the company says that alternate technology should be in development by the end of 1974.

New company seeks value-added net for data communications

Telenet Communications Corp., a six-month-old company now based in Washington, D. C., will apply in mid-October to the Federal Communications Commission for certification to build a commercial value-added-network (VAN) exclusively for data communications. The application will come right after Telenet gets a new president, Lawrence G. Roberts, who was the architect of Arpanet, the packet-switching network for the Defense Department's Advanced Research Projects Agency.

Because the FCC Common Carrier Bureau staff seems to support the merits of VAN systems, **Telenet could receive its authorization in as little as three to six months.** Telenet also plans to use the packet-switching concept [*Electronics*, Feb. 15, p. 32], to lease transmission links from a variety of common carriers, install data-communications processors and other equipment, and then sell specially tariffed services to its customers. The values added for the customer are such functions as terminal-speed conversion and error control.

Telenet officials admit that the application is being prepared, but will not reveal network details until after the document has been filed. However, a reliable source says that **Telenet will integrate multi-access (multiple-city) domestic-satellite links into its configuration.**

Motorola enters bipolar LSI logic race

Integrated injection logic (I²L) isn't the only bipolar logic entered in the high-density LSI race [*Electronics*, Sept. 13, p.35]. Motorola is varying an old idea to make its **transistor-resistor-logic (TRL), which provides TTL compatibility and much higher density than conventional TTL parts.** The gate structure adds input resistors to a Schottky transistor.

Motorola last month quietly introduced parts using the new process. The firm has produced 400 gates on chips 125-mils-square for a gate size of 38 square mils. In comparison, conventional TTL has 112 gates on a chip 133 by 144 mils. The new circuits are slower, however, at a propagation delay of 25 nanoseconds, instead of 10 ns. **But Motorola is aiming them at the computer-peripheral market, where high speed is not as important as low cost.** In a typical tape-drive system, eight LSI chips would replace 105 SSI/MSI parts for a 42% savings at the system level.

MOS array seen as challenge to CCD's in image applications

The best indication yet that MOS technology is suitable for imaging and will become a strong competitor to charge-coupled devices for many applications is Reticon Corp.'s new 1,024-diode MOS linear array, possibly the highest resolution solid-state imager available.

The array is on a chip, 1,088 mils long by 90 mils wide, that contains the 1,024 diodes, along with the multiplex switches and control registers. At its maximum video rate of 40 MHz, the array can scan an 8½ by 11-in. page in a fraction of a second. The array is twice as big as previous models.

The 1,024-diode arrays cost less than \$1,000 each in quantity, and John Rado, president of the Mountain View, Calif., firm, expects the price to drop. He doubts that CCDs can follow the same curve because they require several more processing steps than diode arrays.

AT&T terminal is uncomfortably like computer, says CIA

The Computer Industry Association, self-appointed watchdog over IBM's activities [*Electronics*, Aug. 2, p.66], is now sniffing after American Telephone and Telegraph Co. At a meeting sponsored by the CIA in Washington, D.C., association president Dan McGurk claimed that **last March's FCC order, barring AT&T's entry into the data processing business, may be violated by the Bell System's new Teletype model 40**, which he says can be turned into a powerful data processing system with only a few modifications. In February, in a statement filed with the FCC's Common Carrier Bureau, AT&T had said that Teletype Corp., an AT&T subsidiary, **"has no plans to undertake any activities [with the model 40] that would violate FCC rules concerning the furnishing of data-processing services by the Bell System."**

Computer entry terminal is a ballpoint pen

A ballpoint pen under development at Stanford Research Institute, Menlo Park, Calif., **"can do anything a Rand tablet can at a cost of tens rather than thousands of dollars,"** says Hewitt D. Crane, the SRI staff scientist who invented it. He suggests it might be used, for example, by a teller to automatically update the computer record of a bank account, so that records of transactions would not have to be retranscribed at the end of the day.

The laboratory prototype is a ballpoint pen with a swiveled shaft. An optical sensor at the end of the pen tracks a small light on the shaft. **As the direction and angle of writing change, the variations in sensor output tell the computer what letter is being printed.**

Addenda

Signetics Corp., Sunnyvale, Calif., expects to join the growing roster of charge-coupled-device manufacturers. Lawrence Regis, named general manager of Signetics' MOS department this month, said CCD products are "definitely part of Signetics' long-range plans." Regis was formerly vice president of Advanced Memory Systems Inc., of Sunnyvale, Calif. . . . Robert H. F. Lloyd will be replaced soon as president of Advanced Memory Systems, Inc., Sunnyvale, Calif. **Lloyd was elected chairman of the board but demoted to acting president** this month because of investor unhappiness with the company's third quarter loss of nearly \$650,000 [*Electronics*, Aug. 30, p. 74].

C-LINE POWER DARLINGTONS

...how and where to use them

new application notes contain more than 15 Power Darlington circuits

Here in one place is everything you've always wanted to know about Darlington... how to design for higher speed, lower saturation voltage and high gain in less space. Major applications include pulse and switching circuits, power supplies and linear amplifiers. Example applications are illustrated below.

SWITCHING REGULATOR

Unitrode Power Darlington are optimized for switching-regulator service with very fast switching, low $V_{CE(sat)}$ and high current gain. In this circuit, the full load efficiency is better than 95%.

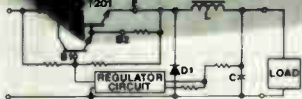

PUSH-PULL INVERTER

The high current gain of the Unitrode Darlington allows it to be driven directly from a logic-level multivibrator. The low $V_{CE(sat)}$ not only raises efficiency, but indirectly reduces the magnetizing inductance requirement of the transformer. At 10KHz and full load, the circuit attains an inversion efficiency of approximately 90%.

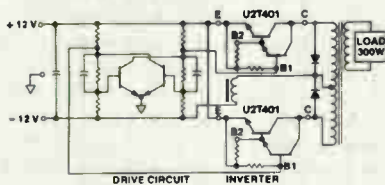

HIGH SPEED SWITCH FOR INDUCTIVE LOADS

Used with loads such as solenoids, phase shifters and small DC motors, this circuit is not only a switch, but (in the ON state) a constant current source which can drive an inductive load to its steady-state current in less than the time constant of the load itself.

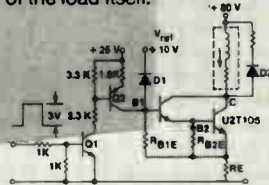

MOTOR CONTROLLER

Unitrode Power Darlington are most suited for applications where high-speed jogging, fast dynamic braking or high slew rates are required, and conventional power transistors will not satisfy the highest speed requirements.

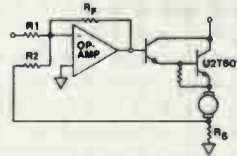

In all applications presented, the circuits have been proven with Unitrode's U2T Series Power Darlington in both NPN and PNP types - from 2 to 20 amps, 60 to 150 volts in TO-33, 3 pin TO-66 and 3 pin TO-3 packages. 100 quantity prices for the series range from \$1.25 for 5A, 60V devices to \$5.40 for 20A, 150V types.

Unitrode Corporation, Dept. 17 Y, 580 Pleasant Street, Watertown, Mass. 02172 Tel. (617) 926-0404

Use the Reader Service Card for your free copy of the new Power Darlington Application Booklet.



UNITRODE quality takes the worry out of paying less.

Unitrode Sales Representatives: ALA., Huntsville, 20TH CENTURY MARKETING INC. (205) 772-9237; ARIZ., Scottsdale, FRED BOARD, ASSOC. (602) 994-9388; CAL., Burlingame, BROOKS TECHNICAL GROUP (415) 347-5411, Escondido, ANDREW ELECTRONICS SALES (714) 743-3015, Sherman Oaks, UNITRODE CORP. (213) 783-1301; COL., Littleton, SIMPSON ASSOC., INC. (303) 794-8381; CONN., Hamden, COMPAR NEW ENGLAND (203) 288-9276; FLA., Boca Raton, CONLEY & ASSOC. INC. (305) 395-6108, Oviedo, CONLEY & ASSOC. INC. (305) 365-3283, Tampa, CONLEY & ASSOC. INC. (813) 933-3183; ILL., Chicago, CARLSON ELECTRONICS SALES CO. (312) 774-0277; MD., Baltimore, DANIEL & COMPANY (301) 825-3330; MASS., Newton Highlands, COMPAR NEW ENGLAND (617) 969-7140; MICH., Detroit, RATHSBURG ASSOCIATES, INC. (313) 882-1717; MINN., Minneapolis, CHARLES E. BOHLIG CO. (612) 922-7011; MO., St. Louis, CARLSON ELECTRONICS SALES CO. (314) 991-0262; N.Y., Clifton, N.J., COMPAR NEW YORK, INC. (201) 546-3360, Albany, COMPAR ALBANY, INC. (518) 489-7408, Endwell, COMPAR ALBANY, INC. (607) 723-8743, Fairport, COMPAR ALBANY, INC. (716) 271-2230, Liverpool, COMPAR ALBANY, INC. (315) 471-3356; N.C., Burlington, P. J. NAHSER, INC. (919) 226-8053; OHIO, Cincinnati, BAEHR, GREENLEAF & ASSOC., INC. (513) 891-3826, Cleveland, BAEHR, GREENLEAF & ASSOC., INC. (216) 221-9030, Columbus, BAEHR, GREENLEAF & ASSOC., INC. (614) 486-4046, Dayton, BAEHR, GREENLEAF & ASSOC., INC. (513) 426-5485; PENN., Willow Grove, DANIEL & COMPANY (215) 674-3850, Pittsburgh, COVERT & NEWMAN CO. (412) 563-0303; TEX., Houston, SEMICONDUCTOR SALES ASSOC. (713) 461-4197, Richardson, SEMICONDUCTOR SALES ASSOC. (214) 231-6181; UTAH, Salt Lake City, SIMPSON ASSOC., INC. (801) 521-3622; WASH., Bellevue, N.E.M.C.O. (206) 747-6863; CANADA, Downsview, Ontario, KAYTRONICS LTD. (416) 638-5511, Montreal 267, Quebec, KAYTRONICS LTD. (514) 487-3434.

*A flexcircuit for the Silent 700.**

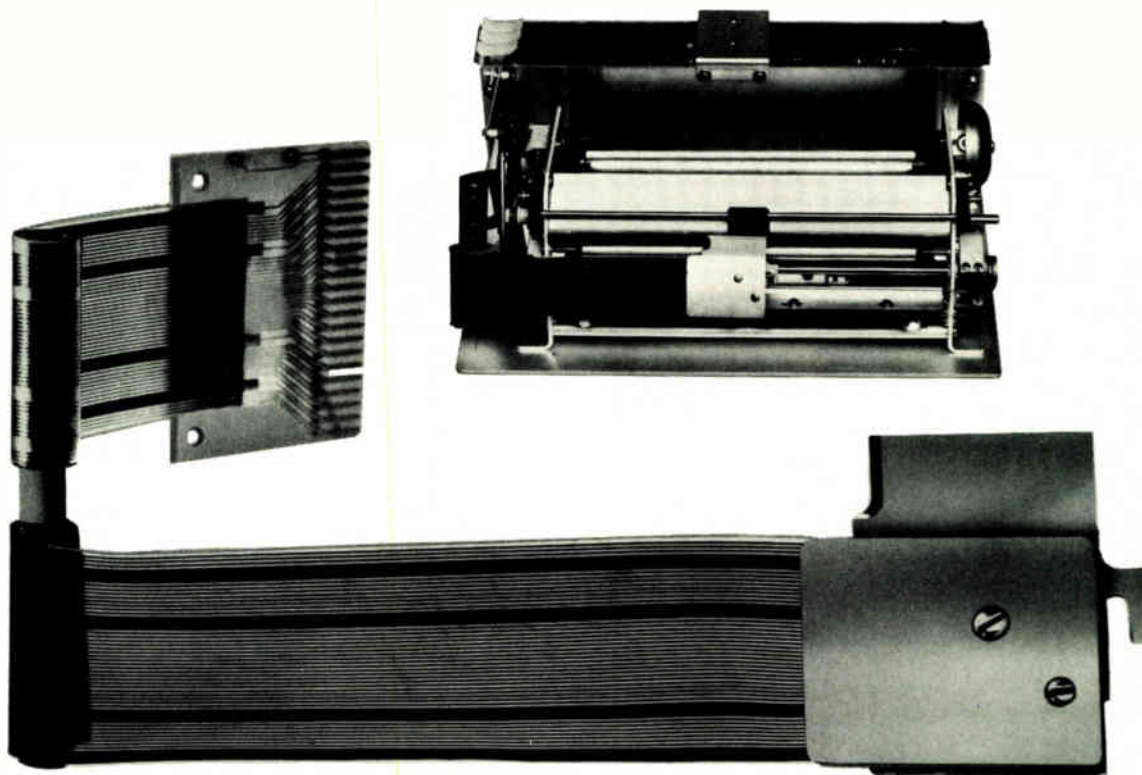

We did it for Texas Instruments.

The Silent 700.* A powerful improvement over data terminals using conventional paper tape and noisy impact printers.

To help keep the Model 750 and 751 printers silent, Texas Instruments needed a way to provide 42 conductors between the thermal print head and its electronics. And to do it without using a bulky, stiff, relatively heavy 42-conductor cable.

A Schjeldahl flexcircuit was the answer.

Not only light and flexible, the flexcircuit had to be able to coil and uncoil a million times without failure. That required conductors, insulation and adhesive to be something more than ordinary materials. For improved reflow soldering of closely spaced connections, pad areas are electrolytically plated. Of course, the flexcircuit had to be producible in volume.

An almost continuously flexing flexcircuit. Schjeldahl did it for Texas Instruments.

 **Schjeldahl Company**
Electrical Products Division
Northfield, Minnesota 55057
Phone: (507) 645-5633

**Trademark of Texas Instruments, Incorporated*

The state of the art people in volume flexible circuits

And we can do it for you.

© 1973 G.T.S. Co.

N-channel process seen as the key to new logic families

Teamed with ion implantation N-channel processing has yielded a 16-bit CPU and more are in the offing

Semiconductor manufacturers are closing in on the n-channel process as the means of developing second-generation LSI MOS logic families. Now used mainly in memory, the n-channel process, with the help of ion implantation, is pushing into the logic realm, lowering the voltage-supply requirements and increasing the density and speed over today's equivalent p-channel MOS products. With n-channel, circuits can potentially operate at double or triple speed and at bipolar supply levels, while they may even compete with TTL circuits in the higher-performing calculator and processor markets.

For example, in two to three months, General Instruments' Microelectronics division of Hicksville, N.Y., will be delivering a metal-gate n-channel custom 16-bit parallel-processor-unit chip that eventually will be offered as a standard product. According to Edgar Sack, vice president of the Microelectronic division, it is the n-channel ion-implantation process that permits a circuit as complex as this 16-bit CPU to be put on a single chip. Sack also points out that the ion-implantation n-channel process, which gives enhancement- and depletion-load capability, is used to obtain power-down mode.

8 now, 16 later. Other manufacturers are also developing n-channel processors to extend the perform-

ance of the device. At Intel Corp., Santa Clara, Calif., the major development effort this year has been the 8080—an 8-bit, n-channel, extended version of the p-channel 8008. It will be faster (2- μ s instruction cycle versus 12.5 and 20 μ s for the two speeds of 8008 versions), but the extensions of operating flexibility are considered at least as important by William Davidow, microcomputers manager. Davidow won't comment

GI to expand n-MOS

The use of n-channel technology won't be limited to processors. At General Instruments, Edgar Sack predicts that ion-implanted n-channel will become an alternative to C-MOS. In his view, n-channel's smaller circuits and fewer process steps will tip the balance in its favor.

As for using the n-channel process in memories, GI is also planning to enter the peripheral segment of the market with ion-implanted n-channel products. Among these a 1,024-bit static RAM has a particularly fast (300-ns) access time for this product type, compares favorably with the most dynamic p-channel RAMs, and has the advantage of being easier to use because it requires only one 5-volt clock. Also coming is a 18-channel analog multiplexer and a 5,120-bit ROM.

on the possibility of the company's developing a 16-bit processor chip. A 16-bit CPU, however, is in exploratory development at National Semiconductor Corp., according to Jerome Larkin, MOS manager. It is much too early, however, for Larkin

to say what MOS process will be used or what the performance characteristics will be. In general, the chip will have the same applications as a 16-bit version of the general-purpose controller/processor (GPC/P) chip set, but will be slower and cheaper so that National can be more competitive in the lower-cost end of the microcomputer market.

Signetics Corp., Sunnyvale, Calif., is using silicon-gate n-channel MOS. Joseph Kroeger, MOS applications manager, says that development of the 8-bit CPU [*Electronics*, March 1, p. 63] is perking along nicely and that it should be ready this winter or next spring.

Specifications for the device have been revised since March. Rather than the 8,192 bytes reported earlier, as many as 32,768 bytes of memory will be directly addressed. There will be at least 64 instructions in the instruction set, and possible cycle times will range from under 6 μ s to a worst case of around 12 μ s. The chip is designed to use standard memory chips, as Intel's 8008 does, but will likely compete with Intel's upcoming 8080, rather than the 8008, an 8-bit p-channel microprocessor. □

CCD image array is biggest ever

A charge-coupled-device imaging array with 60,000 elements in its basic sensor has been successfully operated in an experimental camera system by RCA Corp. This development comes about a month after Fairchild Camera & Instrument

Corp. disclosed it was offering a complete CCD camera with a 10,000-element array plus electronics [*Electronics*, Aug. 30, p. 36].

The silicon chip on which RCA's CCD array is fabricated measures approximately $\frac{1}{2}$ by $\frac{3}{4}$ inch, larger than any other MOS device produced commercially, says Roy A. Minet, manager of market planning for imaging devices at the company's Electronic Components division, Lancaster, Pa. Minet predicts that, with such a chip, RCA is well on the way to developing a CCD image-array sensor that could duplicate the performance of the company's own commercially available 2/3-in.-diameter silicon target vidicon.

A vidicon replacement. RCA's goal is to produce devices compatible with standard 525-line TV receivers, points out Karl H. Zaininger, head of solid-state-device technology at RCA's Sarnoff Research Center, Princeton, N.J. Once the 2/3-in. vidicon is duplicated, applications include low-light-level surveillance and closed-circuit TV systems. Broadcast quality units, which rely on 1-in.-diameter vidicons, would have to come later. However, marketing planner Minet would not project exactly when a CCD imager would be brought to market—two to three years from now is his estimate.

Operating in a camera system, with a standard television receiver which, unlike the Fairchild system, requires no modification, the 60,000-element RCA array produces a picture that covers most of the screen. According to Minet, an array of 80,000 sensing elements would probably come "pretty close to duplicating a standard 2/3-in. silicon target vidicon."

The chip follows work performed at the Sarnoff Center for a \$200,000-plus contract with the Navy. Last March, RCA sent the Naval Electronic Systems Command, Washington, a dozen CCD chips, each measuring 275 by 375 mils and containing more than 20,000 imaging elements. Since then, RCA has also operated chips like these in a camera system where the picture occupies as little as one quarter of

the television screen.

The RCA imagers, which are being produced at both the Lancaster and Princeton centers, operate with the vertical-frame-transfer system, developed by Bell Laboratories, Murray Hill, N.J., over a year ago. This system incorporates an imaging section and a storage section of the same size. Thus, the "60,000-element" device actually consists of more than 120,000 CCD elements. A third section on the chip is a horizontal readout register which operates at standard TV rates—with one frame produced every 1/60 of a second, the chip output can be fed directly into the video input of an ordinary TV receiver.

The chip itself employs surface-channel technology using aluminum metalization and three-phase gating structures, according to Zaininger. "We have proven the feasibility of the over-all approach, and we're well enough along to know we can achieve manufacturability," he adds.

Process problems and tradeoffs. With so large a chip, consistency of the manufacturing process and yields are of paramount importance. Actually, problems associated with fabricating the CCD imagers are basically the same as those encountered with ordinary MOS LSI technology, states engineer Jim Carnes. Foremost are short circuits that occur between the closely spaced (0.1-mil) aluminum gate lines. Another problem is pinholes in the oxide layer built up on the silicon base. "We get a break, though, on some of the other LSI problems because

with our surface-channel approach, we have very few openings through the oxide for interconnections," Carnes says. □

Electronic firm cuts bait for fishermen

After just a year of manufacturing calculators, a tiny firm emerged with its own line at this summer's National Office Machine Dealers Association show in New Orleans, La. But unlike many another small company, Corvus Corp. is a subsidiary of Mostek Corp., the Dallas-based metal-oxide semiconductor manufacturer.

The fledgling company reflects the aggressiveness of its parent in seeking out new MOS LSI markets. Last month, its line of electronic fishing gear made for sporting-goods giant Garcia Corp, attracted attention.

Extensions. The first work for Garcia was fishfinders—relatively basic sonar devices with spinning light displays. "They were simply extensions of our systems capability," comments C. Michael Bowen, marketing manager at Corvus. "They use no Mostek technology. But we intend to on future designs, and that's, of course, where we'll get a heavy edge."

Last month's offerings were an abrupt styling and technology deviation from the highly mechanical, black-box approach seen on most gear aimed at the fisherman. Corvus

Two jolly fishermen. Berry Cash of Mostek (left) and Corvus' C. Michael Bowen put electronics in fishfinders. Corvus is a wholly-owned subsidiary of Mostek.



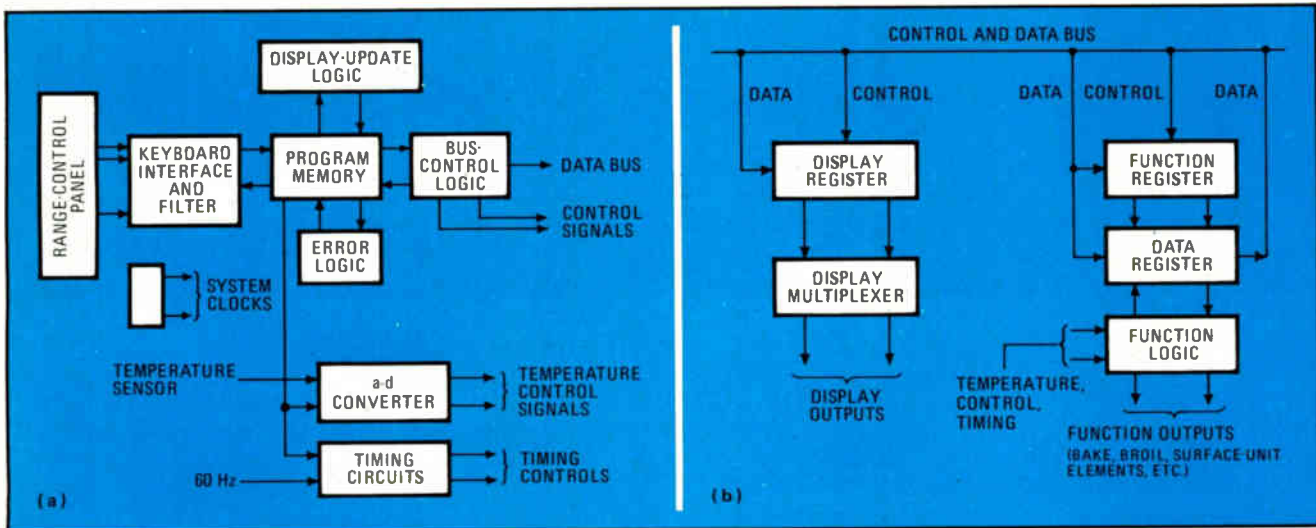

Kitchen computer. AMI's chip set controls up to 13 electric range functions with a string of logic blocks identical to the block at the right above. These blocks time-share the general logic section (at the left), much as peripherals connected to a minicomputer's bus structure time-share the central processor. The system is distributed over four MOS LSI chips.

digitized the sonic signals to provide a low-cost "flasher/recorder"—a fishfinder that utilizes a strip chart recorder as well as the flashing display to yield a permanent chart of the presence of fish and the structure of the lake bottom. Garcia also showed what is billed as the fishing industry's "first oxygen-temperature probe"—an electronic fishing aid that uses a rechargeable potassium chloride sensor to monitor the oxygen content and temperature of water.

Electronics in recreation. Corvus still has not tapped the MOS LSI potential of this segment of the leisure-time market, but is fast building toward it. "Now that we've got these displays digitized," Bowen says, "the next step is to build a chip that encompasses many functions. Now we're working to find enough functions to cost-justify it." He foresees a single unit that would have the flasher/recorder and oxygen-temperature capabilities, as well as several navigational functions, such as speedometer, motor temperature, navigational alarms, and possibly even automatic pilot.

Corvus' calculator line, sold under the Unisonic label, exploits the capabilities of several different Mostek chips. Handheld versions feature four functions plus square root and percent. Desktop models retain those six functions and add

reciprocals, and one desktop calculator incorporates the Mostek clock/calendar circuit. □

Kitchen is invaded by microprocessors

General-purpose microprocessor chip sets for appliances, such as ranges, washers, dryers, mixers, and the like, will become the next generation of kitchen controls. Engineers at American Micro-systems Inc., Santa Clara, Calif., base that prediction on the success of a microprocessor chip set that AMI is producing as a custom product for control of electric ranges.

AMI officials say that the organization and performance characteristics set the stage for such microprocessors, even though the present product is hard-wired rather than program-controlled.

A different program. Alex Goldberger, standard-product development manager, has in mind a general-purpose design that could be modified with different programs. In fact, W. Bert Braddock and William Becker, two engineers responsible for the custom design, say they might have made the set programmable if they had not started out from ground zero in appliance control at

the time they got the range-control assignment.

Knottier problems than programability had to be solved first, they say. These problems included: handling 13 control functions with a rational logic organization, protecting the logic from the heavy noise transients found in appliances, and keeping down system costs by putting all but a few components on the chips.

Problems solved. The organizational problem was solved by stringing identical logic blocks along a data and control bus. The blocks time-share a general-logic section, much as peripherals connected to a minicomputer-bus structure time-share the computer. The other goals were met by building into the chips digital noise filters, an analog-to-digital converter, output-drive transistors with twice the current ratings of standard MOS LSI outputs, a digital-clock circuit, and the logic-clock oscillator.

The filters are delay lines, rather than resistor-capacitor networks. These filters cause the logic to ignore any output shorter than the time it would take a housewife to firmly press the touch switches on the range-control panel. The other elements were developed with the factory-standard process used for the logic circuits—ion-implanted, p-channel MOS.

In effect, the design is a process-control system, complete with input-output interfaces, display terminal, program memory (sequencer), data memory (registers in function-logic blocks), and central processor. These are distributed on four MOS LSI chips.

Suppose that a housewife wants the system to "process" a roast while she goes shopping. Using the panel switches on the digital clock she sets the times the oven is to be turned on and off, and she selects the oven temperature.

After the keyboard interface filters and decodes the inputs, the error logic validates the data (for instance, the clock cannot be set to 12:72 o'clock, nor can the oven be set to a dangerous temperature). Valid settings update the display and are routed via the bus to the appropriate function blocks.

Timing-control blocks compare time signals from the clock with the baking schedule, turning on the oven for the desired time. The oven temperature, sensed by a transducer and encoded by the a-to-d converter, is compared in a tempera-

ture-control section with the selected temperature. The control outputs switch a triac (a semiconductor power-control device similar to a silicon-controlled rectifier), which feeds line power to the oven-heating elements.

Automatic cleaning. Some functions are automatically combined. For instance, one touch switch activates an oven-cleaning cycle that locks the oven door, heats the oven to an "ashing" temperature for a set time, waits until the oven cools to a safe temperature, and unlocks the door.

The unit's temperature is adjusted by turning triacs on or off by means of drive signals. Braddock says similar control outputs could control relays, solenoids, or motor-drive power transistors.

Each of the control outputs has a minimum current rating of 10 milliamperes, and each chip handles a total output load of at least 100 mA. The display chip operates a display-driver circuit. The triacs and display driver are the only semiconductor components added to the MOS chip set. □

Two tests of the idea were made without fanfare this year. Schweber Electronics, a distributor based in Westbury, N.Y., was invited to exhibit at IEEE Intercon in March. That trial balloon flew well, says Larson, so two California-based distributors—Kierulff Electronics, of Los Angeles, and Elmar Electronics, of Mountain View, were invited to Wescon. Kierulff took three booths—one for itself and one each for two subsidiaries. Elmar declined because it received the second invitation too late to prepare for the show, Larson says.

Welcomed into the fold. Larson backs the presence of distributors at exhibits because they account for millions of dollars in sales, especially of connectors and semiconductors. In recent years, many major producers of such components were directed toward negotiating high-volume contracts. Most lower-volume sales are made through distributors.

The ban on booking orders on the exhibit floor died this year, as well. Wescon followed the lead of Intercon in dropping that tradition [*Electronics*, March 15, p. 95]. Wescon allowed deliveries to be made from an upstairs room.

Wescon again nudged Intercon out of first place as the best-attended electronics meeting in America. The 1972 and 1973 Intercons had attendances of 24,300 and 25,000 respectively, compared with Wescon's 29,631 and 27,727. □

Meetings

Wescon '73 breaks taboos on orders, distributor booths; attendance surprising

Although smaller than the Wescons of old, this year's Western Electronic Show and Convention in San Francisco was bigger than had been expected. Some 27,725 persons crowded into the single-floor exhibit area and five conference rooms, giving Wescon the bustling air of pre-recession days.

The loss of Wema as a cosponsor of the show has had no apparent effect, and the Electronic Manufacturers Representatives Association of Northern and Southern California stepped into the organizational gap, co-sponsoring the show with the IEEE. As usual, the largest contingent at Wescon was the instrument manufacturers, many of them Wema members. Distributors were

also active, joining with manufacturers and reps in a pre-show conference.

As part of the slow evolution of American electronics meetings toward European-style industry trade fairs, distributors will probably join manufacturers and reps as regular exhibitors at future Wescons and also at IEEE Intercon shows in the East. Donald Larson, manager of both shows, favors opening them to distributors to attune the shows more closely to the actual workings of the electronics marketplace. He expects the backing of the IEEE conference board, and the board has already agreed in principle to make the shows more useful as a marketing tool.

Avionics

Canada's JETS awarded to CAE

In a program eagerly sought by competing U.S.-based companies, Canada has awarded CAE Electronics Ltd., Montreal, an \$18.7 million contract for work on the first phase of its \$75 million joint en-route terminal systems (JETS) automated air-traffic-control system. Two U.S. companies—Sanders Associates, which will supply the displays, and

Critical Path™ test fixturing

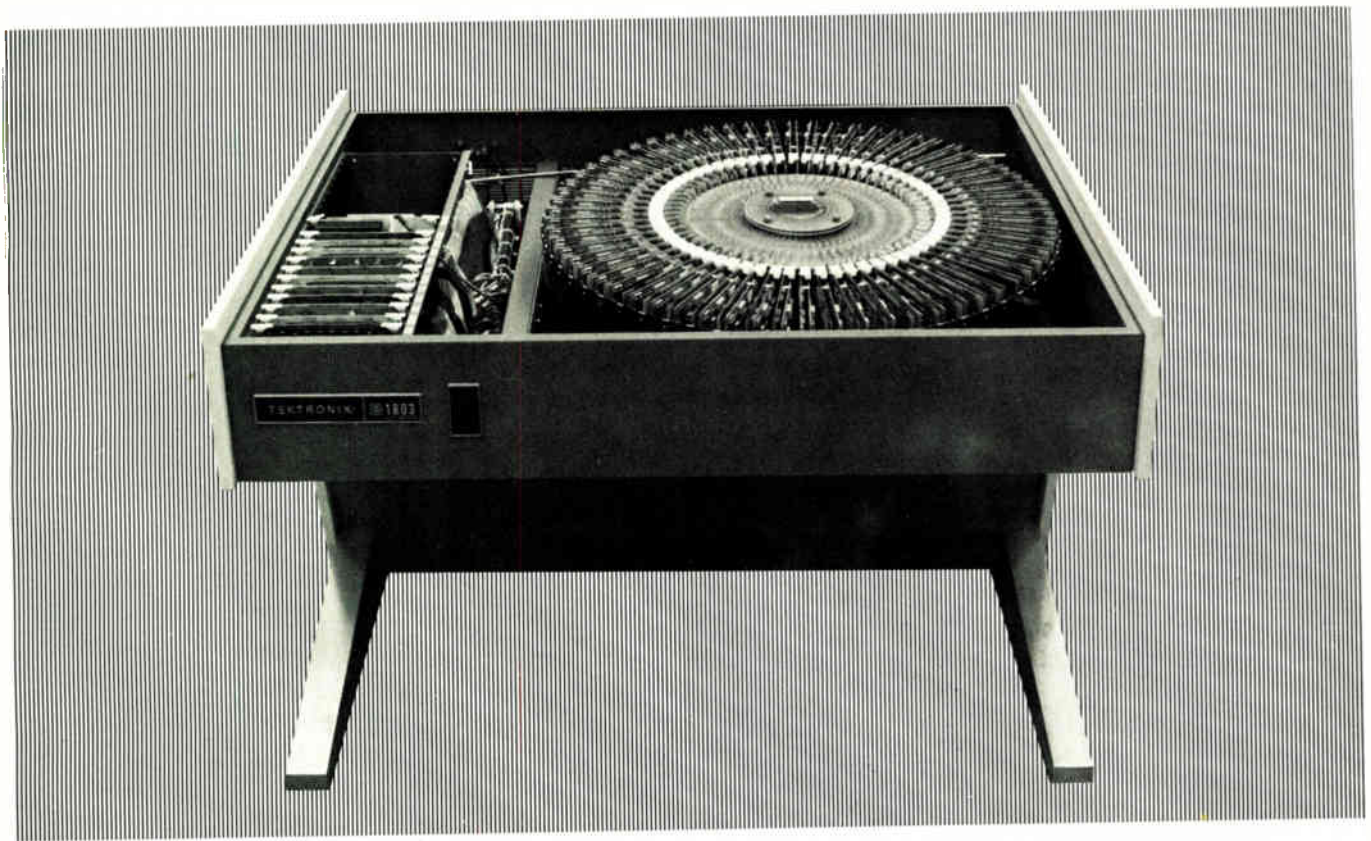

The lower cost answer to the test system fixture problem

Users of modern high-speed function testers find that fixturing is one of the most critical and expensive parts of their systems. The 1803 Test Station, a part of our S-3260 Super Test System, using Critical Path™ fixture design solves the problems.

Connection of a Device Under Test (DUT) to a high speed (up to 20 MHz) function tester demands that the signal environment be free from leakage, aberrations and reflections, yet it must be flexible enough to accommodate many different devices. Most often in the past, the only practical fixtures have been dedicated, expensive custom-built assemblies. The owners of such fixtures have found that inordinate amounts of capital are invested in them.

The 1803 Test Station presents the first practical high-speed test fixture scheme. It uses pin electronic cards to bring signal generation and detection devices as close to the DUT as possible. Critical Path design permits clean signal paths to and from the device. To change DUTs on an 1803, the user need only change a small inexpensive socket board.

The S-3260 is the ultra-modern test system designed to test modules, discrete components, IC's of all types, and p.c. boards. Capable of performing DC, Timing and Function testing, it accesses up to 64 I/O pins. Built around a powerful minicomputer, seven-phase clock generator, and power supplies, the S-3260 is capable of applying test patterns up to 64 bits wide at rates from 600 Hz to as high as 20 MHz.

Not being a special purpose, limited usage machine, the S-3260 will not become obsolete as your testing requirements change. Already delivered systems are being used in R/D, manufacturing and QC environments. To learn more about the system designed to solve your testing needs, contact your Tektronix field engineer, or write to Tektronix, Inc., P. O. Box 500A, Beaverton, Oregon 97005.

**AUTOMATED
TEST
EQUIPMENT**



TEKTRONIX®

committed to
technical excellence

Interdata, which will supply the computers—are teamed with CAE to upgrade radar traffic surveillance in the program to link Canada's major cities.

Assumed to be the front-runner, CAE was selected on the basis of "price, extent of Canadian content involved, distribution of labor across the various regions of Canada, as well as the technical competence of the contractor," according to an official government statement. Losers include Raytheon, Sperry-Univac with Texas Instruments, Litton of Canada, RCA Ltd. with Thomson-CSF of France, Computing Devices of Canada with Plessey Co., and Leigh Instruments Ltd. with Selenia of Italy.

The U.S. companies saw the combined terminal and en-route JETS approach as a springboard to international markets because other countries, not having comparable traffic, won't need the highly automated U.S. dual-terminal and en-route systems.

Slated to be completed in the mid-1980s, JETS initially will consist of 11 systems—two in special centers in Ottawa, seven in en-route centers in Gander, Moncton, Montreal, Toronto, Winnipeg, Edmonton, and Vancouver, and one each in terminal centers in Montreal and Toronto. Based around minicomputers at each center, JETS uses a common computer complex with additional dedicated processors for displays at the centers.

The cost of the first phase will total \$30 million when completed in 1978. The electronics will allow air-traffic controllers to know a plane's position, altitude, ground speed and "history trail," showing previous positions. □

Government electronics

Firms blast FAA award as 'rotten'

Several avionics manufacturers are so enraged over a proposed Federal Aviation Administration sole-source

News briefs

IEEE announces two firsts

Responding to pressures for change from its members, the IEEE has announced two firsts: Ronal W. Larson, an associate EE professor at Georgia Tech, has been elected a congressional fellow. Larson will spend about nine months a year in Washington, D.C. working with a Congressman or committee concerned with legislation on subjects for which an understanding of electrical engineering is important.

Secondly, the institute has initiated a Technology Forecasting and Assessment Project aimed at developing, over a three-year period, a comprehensive forecast of electrotechnology and an assessment of the impact of that technology on public policy and on IEEE programs, particularly career planning.

Commercial microwave market to surge

In contrast to the unexciting outlook for the military sector of the microwave product market, commercial and industrial sectors will show a growth of about 10% to 30% annually during the seventies, according to market research firm Arthur D. Little Inc., Cambridge, Mass. These sectors include telecommunications, air-traffic control, collision-avoidance radar for automobiles, and microwave ovens.

Collins receives Afsatcom award

The Air Force has picked Collins Radio Co., Richardson, Texas, as the single contractor for systems and equipment development for its satellite-communications system, Afsatcom. The program could lead to awards totalling more than \$125 million for the design of 14 types of uhf terminal systems ranging from airborne to mobile and fixed ground stations, as well as a family of modular uhf transceivers for DOD line-of-sight communications.

FCC stays TV channel allocations

An Electronic Industries Association proposal to reduce the number of channels available on TV tuners by 20% was turned down by the Federal Communications Commission as not having enough technical or economic benefits to outweigh a "serious detrimental impact." The EIA had proposed to limit the uhf tuner range to channels 14 to 69 and force channels 70 to 83 to give way to land-mobile use over the next three years.

Univac automates supermarket checkouts

Picking up on an automatic checkout system developed by RCA Corp., Sperry Univac, Blue Bell, Pa., is offering major supermarket chains a checkout unit designed to speed checkout time by about 45%. The initial system will be available late this year on a special short-term lease arrangement. The system, which has been tested in Cincinnati for over a year, is also expected to cut checkout errors by 75%. Furthermore, the unit will allow grocery chains to install a scanning system capable of reading Universal Product Code symbols.

Oil-delivery trucks go electronic

Electromechanical oil-delivery truck calculators can now be converted to electronic operation—the Emerson Electric Corp., Hatfield, Pa., has introduced an MOS-based transaction computer to carry out chores that include tracking the volume of oil being delivered and the printing out of a bill based on the per-gallon price.

On the way to fusion power

Researchers at Sandia Laboratories have produced a 228-joule beam in a 55-nanosecond pulse from a hydrogen-fluoride laser. The power output of about 4 billion watts is still far short of that needed for a laser-fusion power plant. But Sandia researchers believe that the output can be scaled up to more than 1,000 joules by using one of the Labs' larger electron-beam machines. This would be an important step toward the 100,000-joule lasers needed for fusion power.

Who makes more than 21 types of display drivers?

Whether you're driving cold cathode, incandescent, gas discharge or LED displays, ITT is your most promising source of drivers. Some time ago, sensing the coming growth in digital display applications, we accelerated our driver development program. As a result we now offer nine different types of decoder drivers, with output currents from 6.4 to 80 mA and output voltages from 15 to 55V. Our 12 types of segment/digit drivers range from 9 to 90 V and 3.8 to 250 mA. Some accept multiplexed inputs. Remember, the first step toward solving display driver problems is to find the common denominator.

We're doers, not talkers!

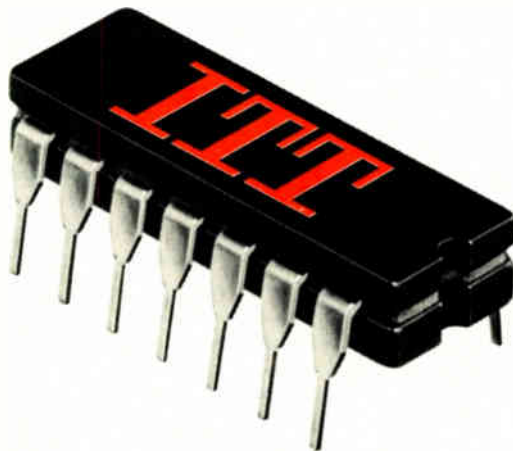

ITT

semiconductors

ITT Semiconductors is a division of International Telephone and Telegraph Corporation, 3301 Electronics Way, West Palm Beach, Florida 33407. Phone 305/842-2411. Factories in West Palm Beach, Florida • Lawrence, Massachusetts • Footscray, England • Colmar, France • Freiburg, Germany • Cascais, Portugal • Sydney, Australia.

SWAROVSKI

LIQUID CRYSTAL DISPLAYS

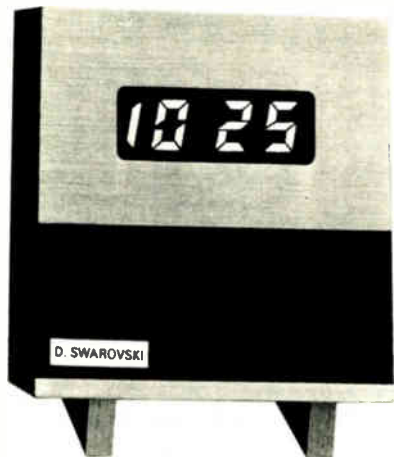

DIGITAL, CHARACTER, ALPHANUMERIC AND ANALOG DISPLAYS

for
Clocks, Watches,
Table + Pocket Calculators,
Computers, Counters,
Testing + Measuring Devices
Advertising

- Low power consumption
- High contrast
- Transmissive or reflektive displays available

D. SWAROVSKI & CO.
Liquid cristal display division
A-6112 Wattens /Austria
Telex 05-3656

Please send me an offer:
for: 100, 300, 500, 1000 pieces
Please send me information and material
Name:
Address:

Electronics review

award for air-traffic-control training simulators that they are threatening to go to Congress or to the courts for satisfaction. "It's rotten right straight through," protests one company official about the award the FAA is negotiating with Space Research Corp., North Troy, Vt., [*Electronics*, Sept. 13, p. 59]. The companies estimate that the contract is worth up to \$8 million, and they say it is the forerunner of future domestic buys and a larger world market.

Charging that the specifications were "wired" for SRC, the companies allege that the FAA misled them into thinking the procurement would be competitively bid, and then the agency quietly chose SRC. In confirming the negotiations, the agency says administrator Alexander P. Butterfield approved the sole-source award some time ago. SRC says that it is producing operating systems and will meet the FAA's requirements.

After the FAA terminated a \$5.3 million contract with GTE-Sylvania, it advertised in April its intention to solicit qualified firms for a possible procurement. FAA evaluation teams visited 11 companies and attended demonstrations of equipment, including SRC hardware. On July 26, the agency stated its intention to award a sole-source contract to SRC and later told some companies that the demonstrations were only market surveys and not competitive evaluations.

"Are they trying to tell us that Space Research is the only company in the country that's qualified?" asks one company source. For fear of reprisals in future competition, none of the companies would speak for attribution. The list of competitors includes Austin Electronics, E-Systems, Litton, Logicon, and Sperry-Univac. "Why did they (FAA) call us to spend money if they knew it was sole-source to begin with?" asks another source.

Charges. Among their allegations, the companies charge that: they had only seven days to respond to the FAA's solicitation; an objective evaluation was impossible because the makeup of the FAA teams kept changing; companies that qualified

in the first bidding suddenly became disqualified in the second round; the agency wouldn't give consistent answers; under the rules, the FAA doesn't have to give its reasons if it stays with sole-source procurements; and an SRC unit in the company's Barbados facility got low points from an earlier FAA evaluation. "The whole thing stinks," says one company source.

An SRC official says the company has two improved models operating at North Troy and Dorval Airport, Montreal. "We're talking about something we have on the shelf," he says. "In a little time, we will have the model the FAA has asked us to produce."

Says an FAA official. "We wanted to see something that would work. We were looking for a demonstrable model." □

Communication

FCC clears five for domsat race

The marketplace is the only approval needed now for builders of domestic satellite systems. The Federal Communications Commission recently approved construction of five systems, including satellites and ground stations, totaling \$335 million. These entrants, plus the already approved Western Union system [*Electronics*, Jan. 18, p. 110] and the proposed reapplication by CML Satellite Corp., which is jointly owned by Comsat, MCI, and Lockheed, makes a total of seven contending systems.

It remains to be seen which of the seven will fall out of the domsat market, which FCC staff members estimate can prove profitable for five operators at most [*Electronics*, Jan. 18, p.110].

The FCC has approved American Satellite Corp., AT&T, Communications Satellite Corp., GTE Satellite Corp., combined with Hughes Aircraft Co.'s National Satellite Service Inc., and RCA's Global Communications and Alaska Communi-

THE BRIGHT GUYS' NEW QUAD ISOLATOR SAVINGS PLAN

Distributors

Arizona: Hamilton/Avnet,
Phoenix (602) 269-1391
Kierulff, Phoenix
(602) 273-7331
California: Hamilton/Avnet,
Mountain View (415) 961-7000
San Diego (714) 279-2421
Hamilton Electro,
Culver City (213) 870-7171
Kierulff, Palo Alto
(415) 968-6292
San Diego (714) 278-2112
Wesco Electronics,
Los Angeles (213) 685-9525
Colorado: Hamilton/Avnet,
Denver (303) 534-1212
Kierulff, Denver (303) 343-7090
Florida: Hamilton/Avnet,
Hollywood (305) 925-5401
Georgia: Hamilton/Avnet,
Norcross (404) 448-0800
Illinois: Allied, Chicago
(312) 421-2400
Hamilton/Avnet, Schiller Park
(Chicago) (312) 678-6310
Kierulff, Rosemont
(Chicago) (312) 678-8560
Kansas: Hamilton/Avnet,
Prairie Village (Kansas City)
(913) 362-3250
Maryland: Hamilton/Avnet,
Hanover (Baltimore)
(301) 796-5000
Pioneer, Rockville (301) 427-3300
Massachusetts: Electrical Supply,
Cambridge (617) 491-3300
Gerber, Dedham (617) 329-2400
Hamilton/Avnet, Burlington
(617) 273-2120
Kierulff, Needham Heights
(617) 449-3600
Michigan: Hamilton/Avnet,
Livonia (313) 522-4700
Minnesota: Hamilton/Avnet,
Bloomington (612) 854-4800
Missouri: Hamilton/Avnet,
Hazelwood (St. Louis)
(314) 731-1144
New Jersey: Arrow, Saddlebrook
(201) 256-7331
Hamilton/Avnet, Cherry Hill
(609) 662-9337
Cedar Grove (201) 239-0800
Haddonfield (609) 429-1526
New Mexico:
Century, Albuquerque
(505) 265-7837
Kierulff, Albuquerque
(505) 247-1055
New York: Semiconductor
Concepts, Hauppauge
(516) 273-1234
Hamilton/Avnet, Syracuse
(315) 437-2642
Westbury, L.I. (516) 333-5812
Arrow, Farmingdale
(516) 694-6800
Summit, Buffalo (716) 884-3450
North Carolina: Pioneer,
Greensboro (919) 273-4441
Ohio: Arrow, Dayton
(513) 253-9176
Kierulff, Dayton
(513) 278-9411
Texas: Hamilton/Avnet, Dallas
(214) 638-2850
Houston (713) 526-4661
Kierulff, Garland (Dallas)
(214) 271-2471
Utah: Hamilton/Avnet,
Salt Lake City (801) 262-8451
Washington: Hamilton/Avnet,
Seattle (206) 624-5930
Kierulff, Seattle
(206) 763-1550
Canada: Preloc, Montreal
(514) 389-8051
Ottawa (613) 237-6150
Electro Sonic Ind. Sales,
Toronto (416) 924-9301
Hamilton/Avnet, Montreal
(514) 735-6393
Toronto (416) 677-7432
Ottawa (613) 725-3071
L. A. Varah, Vancouver, B.C.
(604) 736-6411
Future Electronics
Montreal (514) 735-5775
Ottawa (613) 232-7757
Toronto (416) 677-7820



Only the Bright Guys can give you the threefold, planned savings that you get with their new opto-isolator — the Quad Iso-Lit 74.

Money: The ILQ-74's price per channel is only 83¢ in 1K quantities.

Time: You save time because you're handling only one part instead of four.

Space: You save P.C. board space because of reduced package count.

The ILQ-74 features a minimum 1500 volt isolation with 35% typical current transfer

ratio. Coupling capacitance is only 0.5pF, and it's TTL compatible.

Replace those outmoded transformers and relays with solid-state, highly efficient, low cost opto-isolators which isolate high voltage transients and eliminate both ground loop feedthrough and common mode noise in long lines.

Only the Bright Guys offer all three configurations—single, dual and quad—as part of a full line of opto-isolators.

Call or write for complete information.

the bright guys
litronix

Litronix, Inc. • 19000 Homestead Road • Cupertino, California 95014 • (408) 257-7910 TWX: 910-338-0022

European Headquarters: Litronix, U. K. Branch • Bevan House, Bancroft Court • Hitchin, Hertfordshire SG5 1LW England • Tel: Hitchin 2676 Telex: 825 497

cations groups. But the commission, in pursuing its "open skies" policy [*Electronics*, July 3, 1972, p. 72], wants to encourage new approaches and services to be competitive with AT&T in the new communications field.

In granting Hughes-GTE Satellite's request, the FCC authorized the combine to provide interstate-message toll-telephone service to its 12 million subscribers. Also, the com-

mission gave Comsat only interim approval, pending sharper separation of the company's domestic and international operation. American Satellite has until the end of 1973 to build its earth stations, RCA has only 18 months remaining, AT&T has 18 months, and GTE-Hughes has 24 months.

Pushing competition. In all, the commission has opened up new markets and competition for AT&T

in the transmission of data, radio and television broadcasting, and private-line business communications when the approved systems become operational in the next two years. Specifically, the FCC said that:

■ American Satellite, jointly owned by Fairchild Industries and Western Union International, could begin the \$18 million first phase of its planned network by building four

Hogan urges U. S. to allow more semiconductor sales to Eastern Europe

Department of Defense opposition to sales of semiconductor devices and production technology to Eastern European countries could cost the American semiconductor industry the opportunity to completely dominate the worldwide semiconductor market. C. Lester Hogan, president of Fairchild Camera & Instrument Corp., made that defiant statement at the opening of the

markets larger than the domestic market. "We think we can conquer if we don't do anything foolish," he said.

Crown jewels. By "foolish," Hogan explained that he means proposals for restrictive trade legislation that Congress is considering and defense officials' fears that selling semiconductor technology to Russia would "give away the crown jewels" of military electronics.

The Defense Department's fears are misdirected, Hogan indicated. American semiconductor firms contribute to military security by staying ahead in semiconductor technology and would continue to do so with new advances, even after selling current process technology and devices to Eastern Europe, he said.

"We should use technology sales as a tool to obtain a disproportionate share" of the \$5 billion Eastern European market that will exist from 1973 to 1980. "If we don't accept the terms, we are damned fools," Hogan said. Capturing the Eastern market would ensure that the U.S. becomes dominant as the world supplier in 1980, and it would retain that position for some 20 years, he predicted.

Eliminating trade deficits. Such dominance could also eliminate the United States' international trade deficit, now \$4.5 billion, Hogan added. The semiconductor industry's positive trade balance could climb from this year's \$350 million to more than \$1 billion, he estimated. Also, the semiconductor industry would bring back to the U.S.

"industry after industry."

MOS LSI has already reversed the roles of Japan and the U.S. in the calculator market, he noted. Two years ago, Japan had 75% of that market and the U.S. 25%; now the U.S. has 75%, he said. The radio industry is coming back, and the U.S. is likely to become the major producer in a few years when radio circuits are produced as single chips. And, as digital-watch sales climb, "the watch business will be an American industry, not a Swiss industry—we'll put the mechanical watch out of business in maybe 10 years."

Top officials at the Department of Commerce are sympathetic to this strategy, Hogan said, although lower-echelon "dinosaurs" use red tape to impede trade with Eastern Europe. However, American firms were allowed to indirectly participate with Sescosem, a French firm, in setting up a semiconductor plant in Poland, he noted.

As for proposed trade legislation, Hogan said the exemptions that favor American semiconductor firms, items 806.30 and 807.00 of the U.S. Tariff Act, are "safe for now" because of the electronics industries' strenuous lobbying efforts. He said the industries should continue lobbying to oppose trade restrictions and taxes on overseas operations of multinational firms. Furthermore, "we must flex our muscles" to get such countries as Japan and France to liberalize or ease capital investment and trade policies "unfairly detrimental to U.S. firms."



Western Electronic Show and Convention in San Francisco, where he was the keynote speaker.

American producers are on the verge of "owning the world market," he said, but still face strong competition from European and Japanese firms, as well as a world trend that will soon make overseas



VEB ELEKTROMAT DRESDEN

Betrieb für Projektierung, Automatisierung
und Rationalisierung der elektronischen Industrie
DDR-808 Dresden, Karl-Marx-Straße

Beveling Machine 781-01

We have developed one of the most economical methods for beveling crystal chips.

High-voltage semiconductor components with or without contact electrodes are beveled in a dry-grinding process by means of an elastic grinding disk.

The angle is steplessly adjustable between 3° and 45° .

High productivity is achieved by working four disks simultaneously. Furthermore, time is saved in the subsequent etching process.

Ask us for detailed information.

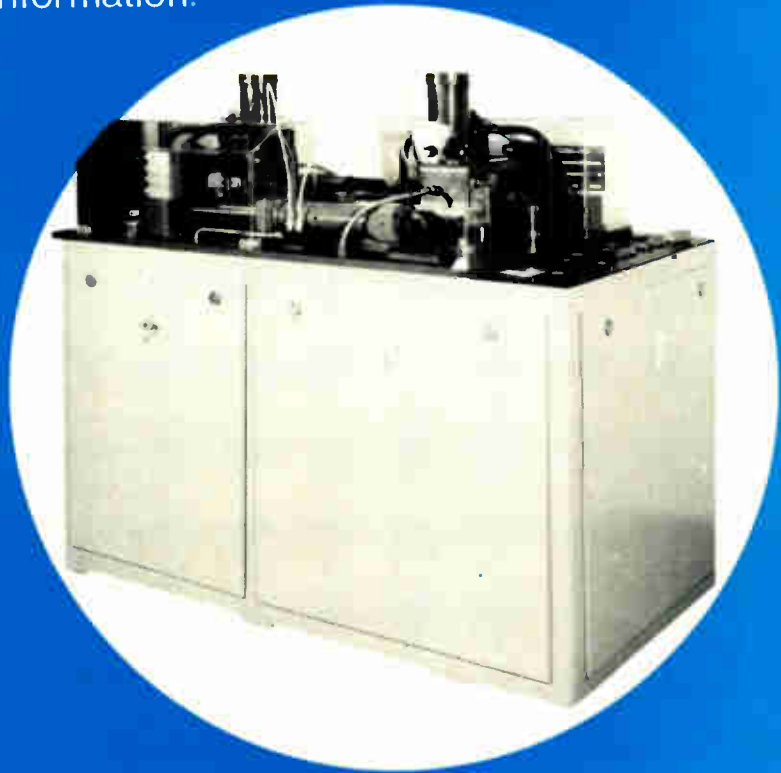

DNVEST EXPORT



Volkseigener Außenhandelsbetrieb der
Deutschen Demokratischen Republik
DDR-108 Berlin, Johannes-Dieckmann-Straße 7/9

syntronic

YOKE PROBLEM SOLVERS

Which deflection yoke should you use?

We constantly find new design concepts to resolve yoke problems for display engineers. Ask Syntronic for a recommendation on your application.



SYNTRONIC
INSTRUMENTS, INC.

100 Industrial Rd., Addison, IL 60101
Phone: (312) 543-6444



Electronics review

earth stations and leasing transponder space from Telesat Canada's ANIK-2 satellite.

■ AT&T could invest \$32 million to build five earth stations for its system, which has its satellite space leased from Comsat. And "to assure equality of treatment," the Bell System must make available interconnections to other satellite carriers at rates at least as favorable as those accorded other Bell companies.

■ Comsat, under interim authority, could spend \$181 million to build, launch, and operate four satellites to lease to AT&T [*Electronics*, April 12, p.48]. Since then, Comsat has agreed to buy four satellites from Hughes for \$65.9 million.

■ Hughes-GTE can spend \$52 million for five earth stations and lease channels from National Satellite, which will put up three satellites at a cost of \$42 million.

■ The RCA companies can invest about \$10 million to build earth stations and use ANIK-2 in the first phase of the system to serve Alaska and the contiguous U.S. American Satellite and RCA must also get expected FCC approval for their second-phase systems.

Although part of the commission's approval pleased him, AT&T Long Lines president Richard R. Hough said, "It is difficult—extremely so—to understand why the Federal Communications Commission approved GTE's paralleling system that from the outset will cost the communications user more, millions of dollars more." Before the commission's decision, Hough had debated GTE's proposal before the commission, arguing that it would degrade service and run up costs. GTE Satellite vice president, James L. Clark, told the commission that the system would benefit the public and be economical. However, the FCC, besides spurring competition, approved the GTE system as a way to compare AT&T's cost and performance.

The other companies seemed pleased with the decisions. American Satellite particularly noted the commission's admonition to Bell about equal interconnection prior-

ities. CML, left at the starting gate, has asked the commission to delay processing its application until it soon can refile for a new system that uses new technology and smaller satellites. □

Computers

IBM-Telex decision to aid independents

The big gainers—regardless of the final outcome of the Telex-IBM case—appear to be the nonparticipants in the suit. The Federal court decision requires the computer giant to pay Telex Corp. \$352.5 million in damages for monopolistic business practices.

The small independent computer companies, says A. G. W. Biddle, executive director of the Computer Industry Association, derive "a two-stage benefit: first, investors now know that the computer industry is alive and well, and secondly, IBM will have to release its interface specifications."

Biddle sees the release of interface specifications by IBM as re-arranging the market for peripheral equipment and giving a strong impetus to new technological development.

Telex vice president and general counsel J. B. Bailey calls it "a whole new ball game" for the small independent companies. But for Telex itself, the glory of winning the first major court case to go against IBM carried a high price. The money IBM has been ordered to pay the Oklahoma firm is substantially less than the \$1.2 billion sought.

Moreover, IBM won a countersuit charging Telex with the theft of trade secrets by hiring away IBM people and misusing IBM-copyrighted materials. For that, Telex was ordered to pay IBM \$21.9 million in damages.

If IBM, on appeal, succeeds in having the decision reversed and if Telex fails, Telex' penalty could conceivably wipe out the company. Telex suffered a substantial loss

ENI

The world's leader in solid state rf power amplifiers

Once upon a time if you wanted broadband RF power, you had to settle for bulky tube-type power amplifiers. No more. Because ENI has developed a full line of all-solid-state Class A power amplifiers, covering the frequency spectrum of 10 kHz to 560 MHz, with power outputs ranging from 300 milliwatts to over 1000 watts. And there's more to come.

Driven by any signal generator, frequency synthesizer or sweeper, ENI's compact portable amplifiers, like the ones shown below, are versatile sources of power for general laboratory work, RFI/EMI testing, signal distribution, RF transmission, laser modulation, data transmission, NMR, ENDOR, ultrasonics and more.

Completely broadband and untuned, our highly linear units will amplify inputs of AM, FM, SSB, TV and pulse modulations with minimum

distortion. Although all power amplifiers deliver their rated power output to a matched load, only ENI power amplifiers will deliver their rated power to any load regardless of match.

We also designed our amplifiers to be unconditionally stable and failsafe—you need never fear damage or oscillation due to severe load conditions (including open or short circuit loads).

ENI instrumentation amplifiers come complete with an integral AC power supply and an RF output meter. Ruggedized amplifiers capable of operating under severe environmental conditions are available.

For a **complete** catalog of power amplifiers and multicouplers, write: ENI, 3000 Winton Road South, Rochester, New York 14623. Call 716-473-6900. TELEX 97-8283 ENI ROC.



40 WATT/ MODEL 240L

- 20KHz to 10MHz coverage
- More than 40w linear power output
- Up to 150w CW & pulse output
- Works into any load impedance
- Metered output

Extraordinary performance in a wide range of transducer drive applications. Deliver up to 150w into any load regardless of its impedance. Compatible with all signal and function generators, the 240L is a high quality laboratory instrument for ultrasonics, biological research & electro-optic modulation.

100 WATT/ MODEL 3100L

- 250 KHz to 105MHz coverage
- More than 100w linear output
- Up to 180w CW & pulse
- Works into any load
- Unconditionally stable

Designed to replace bulkier and less efficient tube type amplifiers, the Model 3100L will provide reliable and maintenance free operation. NMR, ENDOR, ultrasonics and laser modulation are just a few of the applications for this versatile source of RF energy.

20 WATT/ MODEL 420L

- 150KHz to 250MHz coverage
- 20 Watts power output
- Low noise figure
- 45dB \pm 1.5dB gain
- Class A linearity

The widest band solid state power amplifier available at its 20w power level, the ENI 420L is a truly state-of-the-art instrument. As a drive source for high resolution acousto-optic modulators and deflectors the Model 420L is invaluable. Its Class A linearity will amplify AM, FM, TV and pulse signals with minimum distortion.

.3 WATT/ MODEL 500L

- Flat 27dB gain 2MHz to 500 MHz
- 1.7MHz to 560MHz usable coverage
- Thin film construction
- 8dB noise figure
- Failsafe

This compact unit can deliver more than 300 milliwatts from 1.7MHz to 560MHz at low distortion. A thin film microelectronic circuit is the heart of this general utility laboratory amplifier. Extremely wide band response at a very modest price.

Three basic lamp solutions from General Electric for your design problems.

Immediate delivery on Solid State Lamps (LED's).

GE has a complete line of competitively priced infrared and visible SSL's now ready for off-shelf delivery from your GE distributor or GE representative. The line includes a new small infrared SSL-65 with a .050" diameter. Our visible

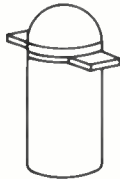

SSL's feature high efficiency GaP pellet material and the GE-patented light reflector for bright, uniform light. GE will refund your cost or provide a replacement lamp for all lamps not meeting published specifications.

Improve your product communications with Green Glow Lamps.



Our Green Glow Lamp (G2B) has exactly the same electrical and physical characteristics as our high-brightness C2A red/orange/yellow glow lamp. You can use the G2B alone for 120 volt green indicator service. Or together with the C2A to emphasize multiple functions with colors.

Uses include: safe-unsafe functions, dual state indications and multiple operations in up to 5 colors (with color caps). They can be operated in series with any appropriate current limiting resistor. Both the G2B and C2A can save money because of their low cost, small size and rugged construction.

Simplify circuitry with these newest Wedge Base Lamps.

Now you can design simple, low-cost, non-complex socketry by using these GE Wedge Base Lamps. They're available in two sizes, the GE T-1 $\frac{3}{4}$ with a .240" max. diam. and the GE T-3 $\frac{3}{4}$ with a .405" max. diam. These all-glass sub-miniature

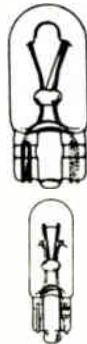

lamps are small enough to solve the space problem posed by indicator lights. Their wedge-based construction virtually ends corrosion problems because they won't freeze in the socket. And the filament is always positioned in the same relation to the base.

Send today for information.

For free technical information on any or all of these lamps, just write: General Electric Company,

Miniature Lamp Products Department, #4454-M, Nela Park, Cleveland, Ohio 44112.

GENERAL  **ELECTRIC**

Electronics review

during the last fiscal year.

On the other hand, although IBM will undoubtedly be hit hard if it has to fork over such a large sum, it has shown great flexibility in the past and will probably be only inconvenienced. It'll also probably find new ways to compete, as it often says, "vigorously." "In any case, an appeal will be very difficult to sustain," says CIA's Biddle. "Judge Christiansen's decision is very well put together, and whoever tries to find a legal error in it—the usual basis for an appeal—will have to try very hard indeed."

But IBM chairman Frank T. Cary contends that the ruling "goes beyond that of any judicial precedent and contains serious errors of fact and law. . . . It is not completely clear how the judge arrived at the actual damages of \$117.5 million. However, this award, before being trebled to a total of \$352.5 million, suggests that Telex could have, in a period of three years, increased its profits more than 10-fold."

In fact, Telex' net income for fiscal 1969 was \$1.75 million, grew to \$6.77 million in 1970, and then began a decline that ended in losses of \$13.3 million in fiscal 1973, ending March 31.

If the decision is sustained, IBM will have to change its marketing practices substantially. For example, it won't be able to charge its customers a penalty for prematurely terminating a long-term lease. IBM is also ordered to make interface design details of new equipment available to the public at the time of announcement, and to price separately the functionally different components of a system, such as processors, memories, and tapes and other peripherals, regardless of whether the components are in the same cabinet or separate cabinets.

Telex, on the other hand, was ordered not to hire any employees away from IBM for two years without the court's permission, and not to permit any former IBM employee working for Telex now or in the future to undertake a project similar to his IBM assignment until he has been away from that assignment for two years. □

Great performance requires control



When you expect exacting performance, put your money on someone who can control the act.

Especially with connectors. Without control, they can be terrible tigers. With control they're pussycats... gently purring and performing to perfection.

At Deutsch we take the terror out of connectors. A long time ago we discovered if you want a thing done right the first time... control it yourself. Making great connectors requires "do-it-yourself control" throughout every infinite phase of the manufacturing process.

At Deutsch we control the whole thing. This is the way we keep a step ahead of the industry. This means a giant step for you in getting connectors that give you great performance again and again and again.

We fabricate all metal components. We compound, mill and mold our own temperature and fluid resistant insert material. Every contact, shell and insert is made to strict tolerances. Even the machinery is designed and built to our rigid specifications. Control is absolute.

If a tiger of a connector problem has got you down (and it probably has unless you are using Deutsch), give us a call and we'll tell you more about our act. A telephone call or a letter will bring one of our trained Deutschmen to your arena.



DEUTSCH

ELECTRONIC COMPONENTS DIVISION

Municipal Airport • Banning, California 92220
Telephone (714) 849-6701 • TWX 714-841-7210

"A Step Ahead."

All Meter Relays are not created equal.

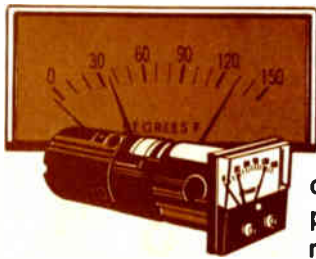

General Electric gives you new lower ranges, increased advantages.

You can monitor and control from full-scale input signals as low as 5 micro-amps or 5 millivolts with GE's new meter relays. Get ranges down to 150°F full scale on new GE pyrometers. Their built-in high-impedance signal amplifier (solid state, for long life) saves trouble by eliminating thermo-couple lead resistance calibrations. Saves money by letting you use smaller-gage wire on long lead runs, too. It's GE for extra performance . . . and then some.

New alarm-reset meter relay saves space . . . saves trouble. A new option from GE.

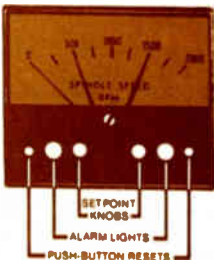

There's no need to mount extra alarm lights and reset buttons alongside this new GE meter relay. It instantly indicates and shuts off when over-limits occur. Restarts are made by simply pushing the button. Because everything is built in, you save panel space and extra mounting expense. Just one of many GE options.

They're all in the General Electric family.

All GE meter relays and pyrometers will match your other BIG LOOK® or HORIZON LINE® panel instruments. Sizes range from 2½" to 4½", single or double setpoint, AC or DC rated. They're all optical (non-contacting), with DPDT load relays and rugged pivot-jewel movements. GE pyrometers also offer built-in cold-junction and copper-error compensation, mirror scales, and t/c break protection. GE application assistance is also there when you need it.

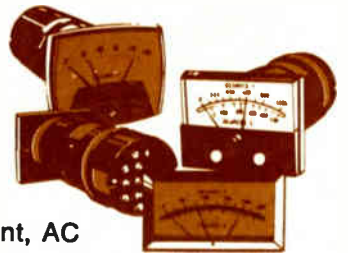

GE quality and reliability don't just happen.



We build them in. Through rigid inspection of every component.

Through "clean-room" techniques to ensure spotless assembly. Through rigorous

shock and repeatability tests for flawless performance. GE builds meter relays and pyrometers you can depend on.

**Specify
General Electric...
just for good measure.**

For a complete catalog of GE panel meters, see your nearby Authorized GE Distributor, Modification Center or Sales Office. Or write to General Electric Company, Section 592-47, One River Road, Schenectady, N.Y. 12345.

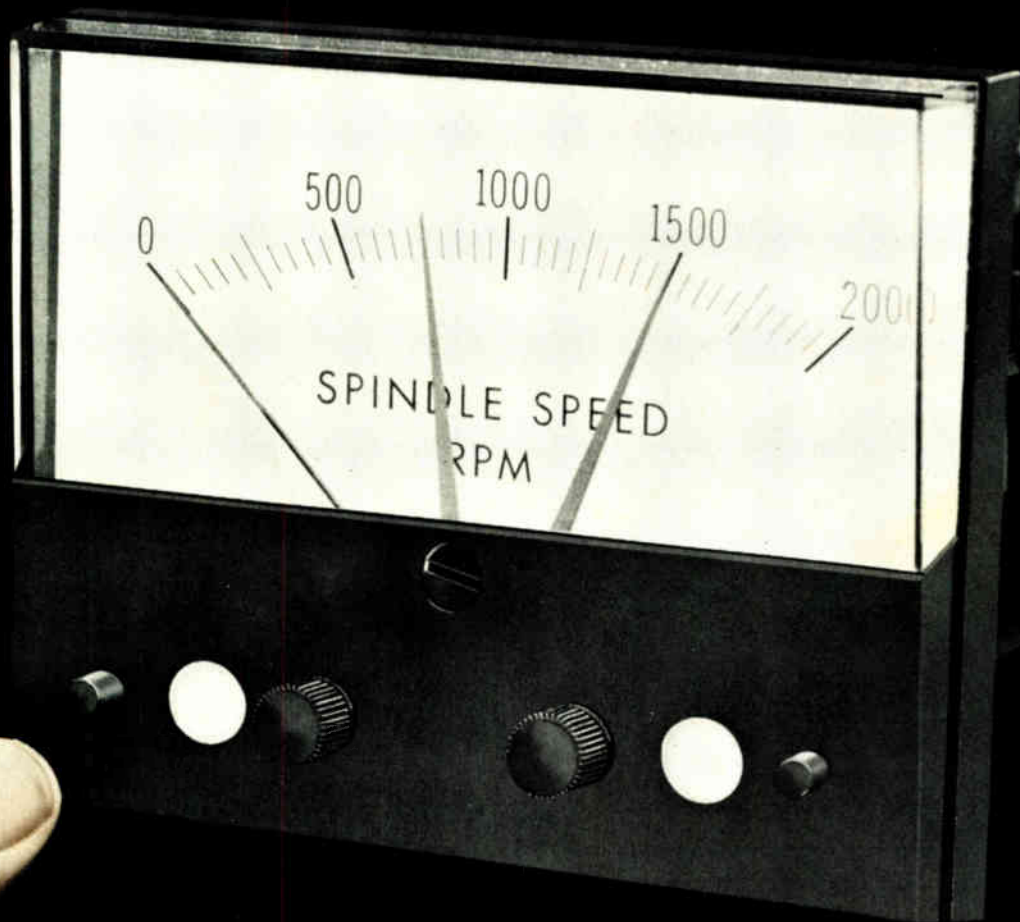

GENERAL  ELECTRIC

Simple



Display 4 digit \$325



Display 5 digit \$550



Display 4 or 5 digit



Snap-On DC



Display 4 or 5 digit



Snap-On DC/AC/OHMS



Display 4 or 5 digit



Snap-On Sensitive DC/DC CURRENT/OHMS



Display 4 or 5 digit



Snap-On DC/AC/OHMS



Display 4 or 5 digit

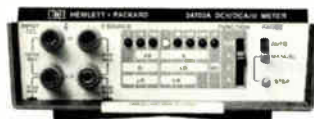

Snap-On Sensitive DC/DC CURRENT/OHMS



Addition

— lets you match your exact needs and budget. Any combination can grow with battery pack (\$200) or BCD (\$175). Contact your local HP field engineer. Or, call Hewlett-Packard, Palo Alto, California 94304. In Europe: HPSA, P.O. Box 85, CH-1217 Meyrin 2, Geneva, Switzerland. In Japan: Yokogawa - Hewlett - Packard, 1-59-1, Yoyogi, Shibuya-Ku, Tokyo, 151.



DC Voltmeter 4 digit \$475
5 digit \$700



Multimeter 4 digit \$600
5 digit \$825



Multifunction Meter 4 digit \$875
5 digit \$1100



Battery Pack ==



Portable Multimeter 4 digit \$800
5 digit \$1025



BCD ==



BCD Data Center 4 digit \$1050
5 digit \$1275

HEWLETT  PACKARD
DIGITAL VOLTMETERS

093/45

The boxes may seem quite similar. The specifications can appear identical. But when it comes to performance, as seen on a screen, the picture suddenly changes.* Because that's where the Wavetek 2001 shows its class. The width of its crystal-controlled markers is adjustable for wide- or narrow-band operation and the

amplitude is always the same. The equal spacing between markers is an indication of the RF output linearity. The kind of output you need for precise work. The kind of output most people will gladly pay \$1,695 to get.

*Measurement conditions for both units were the same: 10 MHz harmonic markers measured directly at the RF output connector using an HP Model 423A detector.

1 MHz to 1.4 GHz freq. range
 +10dBm to -80 dBm calibrated output
 200 KHz to 500 MHz sweep width
 P.I.N. diode leveling
 Plug-in markers accurate to .005%

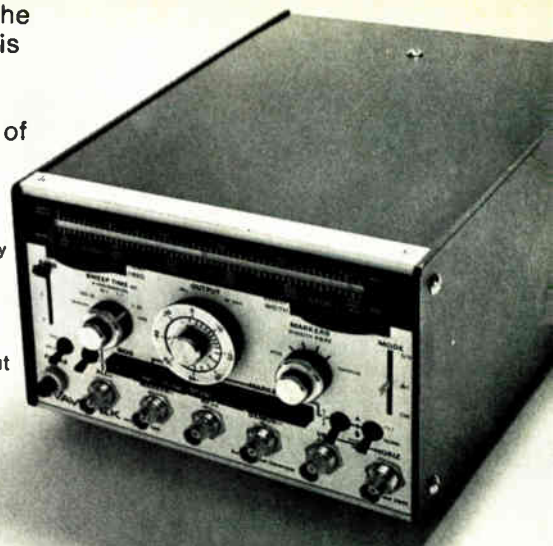

Anyone who thinks sweep generators look alike must not be an oscilloscope.

Wavetek 2001.

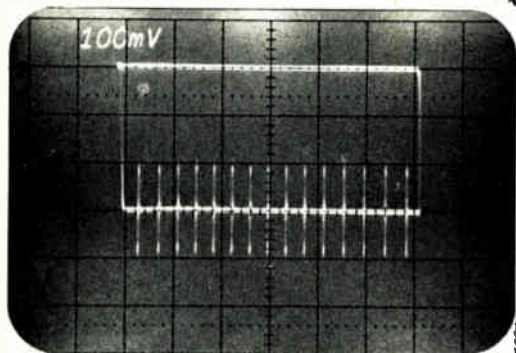

A major competitor.

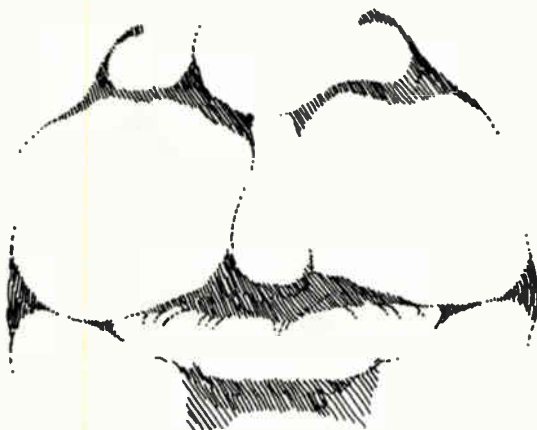
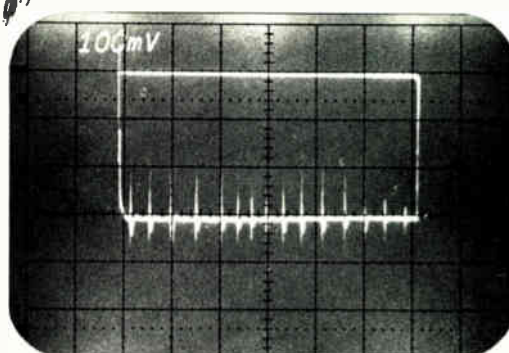

WAVETEK®

INDIANA INCORPORATED
 P.O. Box 190, 66 North First Avenue
 Beech Grove, Indiana 46107
 Tel. (317) 783-3221 TWX 810-341-3226

Butterfield expected to leave FAA

Federal Aviation Administration director Alexander P. Butterfield is expected to resign soon, according to increasingly widespread reports by agency insiders and industry sources. The appointment of the former Air Force colonel and member of President Nixon's staff was never popular outside the White House. Now he has **lost his support inside the White House** following his bombshell disclosure of the existence of the Nixon tapes before the Senate Watergate committee.

Compounding Butterfield's problems are a reported falling out with his immediate superior, Transportation Secretary Claude S. Brinegar, **the apparent failure of his program for reorganizing the FAA, and dissatisfaction within the agency with his leadership.** His last minute pull-out from the First International Aerospace Show, Sao Paulo, Brazil, to which he sent a much lower-level substitute, is read by some as another sign of trouble. One scenario has Butterfield staying on the job until the still vacant FAA deputy's post is filled with a candidate who can be promoted to the top spot. **Butterfield's successor is expected to come from the airline industry,** following what had, in effect, become a tradition at the agency.

Winning Raytheon bid on Cobra Dane was high, RCA claims

Losing out to Raytheon Co. in the competition for the large Air Force phased-array radar known as Cobra Dane has made both RCA and General Electric predictably unhappy. But what bugs RCA in particular is that **it proposed using design-to-cost techniques at a price \$1.5 million under Raytheon's \$39.5 million fixed-price-plus-incentive contract** from the AF Electronic Systems division, Hanscom Field, Mass. The 100-foot-tall Cobra Dane structure at Shemya AF station, Alaska, will track Soviet missile-development test flights in the Pacific, replacing the FPS-17 detection and FPS-80 tracking radars.

\$205 million-plus forecast for U.S. airport electronics

At least \$205 million in landing-approach electronics, plus added millions of dollars in radar and traffic control equipment, will be needed in the next five years to keep pace with projected growth in new airports, according to the FAA's new plan for the national airport system. To match expected growth in air traffic, **the 10-year plan anticipates \$6.3 billion being spent to build 40 major terminals and 656 other new airports,** 614 of them by 1977 and the other 82 by 1982. Future versions of the plan will break out electronics needs for airline and general-aviation airports.

Coast Guard to buy traffic systems for two major ports

A decision on how to launch communications and surveillance systems for vessel traffic in the New York and New Orleans harbors is to be reached shortly by the Coast Guard. Sources say the service's most likely procedure will be to choose by competitive means **a single contractor-operator, who would set up the systems and also service them under a long-term lease.** Total cost of the vhf, radar, 6-gigahertz microwave, and television equipment needed for the first phases in New York and New Orleans, another phase in the Puget Sound system, and another at Port Valdez, Alaska, where the Alaska pipeline ends [*Electronics*, April 24, 1972, p. 40], is **estimated at \$10 million.**

Lowering the overhead

The distinction between economy and parsimony—perhaps best defined some 175 years ago by British political philosopher Edmund Burke—has been discovered by the Department of Defense. And even though Burke contended that parsimony requires neither sagacity nor judgment, a Pentagon establishment hard pressed to build an inventory of economical weapons is going to try it anyway.

The Air Force will be the first to invoke the new parsimony, and contractor overhead charges—a subject known to have long troubled Defense Secretary James Schlesinger—will be the first target. Beyond striving for true economies with the design-to-cost weapons acquisition program [*Electronics*, Sept. 13, p. 59], the Pentagon expects to nuzzle contractors early and often on allowable overhead as well.

As AF staff chief Gen. George S. Brown recently put it to the National Security Industrial Association, “anywhere from 50 to 60% of Air Force procurement dollars consumed in prime contractor plants are indirect or overhead costs.” It is an area that Brown believes is ripe for cost reduction and one that has too long been ignored. Brown’s warning to NSIA’s industry management membership: “You will have to face that responsibility squarely.”

Same old song?

Defense electronics and aerospace contractors who heard the general lay out the program were more distressed by what he didn’t say. His failure to deal with the service’s own enormous overhead and spell out any plans to reduce it left his industry audience convinced that the onus for defense spending excesses was being dumped totally on them. As for DOD’s critics in the Congress and cynics in general, the threat of parsimony in the Pentagon was no more than “the same old song we have heard since the time of Robert McNamara. It is,” said one of them, “about as likely as snow in Los Angeles.” But DOD officials at every level insist that the warning of an assault on allowable overhead is no snow job.

What gave Brown’s disclosures a definite ring of authenticity was his detailing of nine specific areas where indirect contractor costs will be challenged on the grounds that they range from “carelessness to outright abuse.” First on the Air Force list is idle plant capacity and equipment whose costs, Brown warned, “will not be recognized on contracts when a reasonable time for divestment or more appropriate utilization has elapsed.” Tougher scrutiny of charges to

maintain special capabilities for in-house work “that could be done at less cost by subcontracting” is also programmed.

Indirect charges to Government for middle-management staff and support functions are also slated for review. It is “luxury thinking in an era that has no room for luxury” for contractors to keep program staff and support functions up to strength even after personnel directly assigned to programs have been cut as a program’s requirements change. Increased use of personnel pools from which corporate project managers can draw is another concept outlined in the cost-control effort. Managers will be required to man projects for normal forecast workloads, rather than the peak levels that Brown says are traditionally used. Project directors will requisition additional personnel during peaks and return them when they are no longer needed.

Impact on engineers

One engineering manager opposed to the concept argues that “it will never work at the professional level. Good engineers won’t be treated like contract labor. They will go elsewhere to look for job stability, and the rest will probably form a union.” Despite such forecasts of chaos, the Air Force intends to give the plan a try.

General Brown’s assertion that it is “unrealistic” for “some contractors to expect DOD to participate in and absorb costs for a constant or increasing level of independent R&D, even though their business base may be decreasing” is one that produced fewer criticisms from his audience. Admitting that IR&D budgets “are a far cry from what we’d all like to see done,” Brown warned of closer monitoring of these overhead charges. That caution prompted a number of his listeners to begin taking notes for future reference.

In his own words, the general’s list of abuses “is almost endless.” It includes “excess computer capacity, excessive engineering staffs, pension and retirement costs, fringe benefits that grow two to three times faster than salaries,” as well as other charges.

Though it was quickly established that contractors didn’t like what they heard, they should not ignore the source. All that General Brown said originated within the Office of the Secretary of Defense. That has been established. And contractors would do well to note it the next time they review their overhead costs for allowables.

—Ray Connolly

One 18 GHz box does it all! FM, pulsed RF, CW 5-day delivery



Why pay for CW only? Systron-Donner's Model 6057 frequency counter measures virtually any microwave signal from 20 Hz to 18 GHz with 1 Hz resolution. CW and AM measurements are fully automatic; FM and pulse modulated carriers use a simple 3-step operation to get direct answers.

The 6057 is priced at \$5,450, which is just about what you'd expect to pay for comparable instruments *without* FM and pulsed RF capability. However, S-D gives you a choice. If it's CW only you need to measure, then choose our Model 6016 at \$4,575, or for only \$3,695 you get a Model 6092 manual T.O. measuring system.

For details, a demo or 5-day delivery, call your Scientific Devices office (listed below). Or call collect S-D's Quick Reaction Line (415)-682-6471.

In Europe: Systron-Donner – Munich, W. Germany;
Leamington Spa, U.K.; Paris (Le Port Marly) France.
In Australia: Systron-Donner – Melbourne.

SYSTRON  DONNER

Albuquerque, (505) 268-6729; Baltimore, (301) 788-6611; Boston, (617) 894-5637; Burlington, NC (919) 228-6279; Chicago, (312) 297-5240; Cleveland, (216) 261-2000; Denver, (303) 573-9466; Dayton, (513) 298-9904; Dallas, (214) 231-8106; Detroit, (313) 363-2282; Ft. Lauderdale, (305) 721-4260; Hamden CT (203) 248-9361; Huntsville, AL (205) 536-1969; Houston, (713) 623-4250; Indianapolis, (317) 783-2111; Kansas City, KS (913) 631-3818; Los Angeles, (213) 641-4800; Minneapolis, (612) 544-1616; New York City area (201) 871-3916; Norfolk, (703) 499-8133; Orlando, (305) 424-7932; Philadelphia, (215) 825-9515; Phoenix, (602) 834-1682; Rochester, NY (716) 334-2445; San Antonio, (512) 694-6251; San Diego, (714) 249-6642; San Francisco area (415) 964-4230; Seattle, (206) 454-0900; St. Louis, (314) 731-2332; Syracuse, (315) 457-7420; Washington, DC area (703) 451-6500.

French develop pacemaker for nervous system

French researchers have developed an electronic control device applicable to the human nervous system. Experiments this summer have proven that the equipment can be used both for emergency resuscitation applications and for more prolonged application where a patient's nervous system has been permanently damaged.

The device consists of a small control module regulating the amplitude, rhythm, and frequency of a small electrical charge transmitted to the nerves themselves by wires. The development has been headed by Roger Gariod, chief of the measures, control, and electronic processing laboratory at the Laboratoire d'Electronique et de Technologie de l'Informatique, a state research organization controlled by the Commissariat a l'Energie Atomique.

Solutions. Gariod explains that the principal problem in previous experiments of this kind has been biological rejection of the electrodes attached to the nerves and infection problems where the wires penetrate the skin. Gariod claims to have resolved both problems.

First, the metal electrodes have been replaced with carbon fiber, which has had no biological reaction with the nerves. Second, the signal is transmitted by means of two electromagnetic sensors placed on the outside of the patient's skin and on the inside close to the nerves themselves.

So far, Gariod's tests have been carried out on the motor nerves of the diaphragm, located in the neck, thus controlling the respiratory system. The device has worked satisfactorily in a dog for six months, and last June the system was successfully used for the first time in a Grenoble hospital to revive a dying patient. Gariod explains that the device worked so well that the patient's respiratory system continued



Implant. Researcher checks dog fitted with pacemaker for six months.

to work on its own after the electrodes had been removed.

Gariod has not completed his tests yet, but as a first application the device could be used to replace, either permanently or temporarily, such cumbersome equipment as iron lungs. For the long term, Gariod and his team are thinking in terms of possible applications for stimulating nerve impulses to the brain. □

Great Britain

Diodes challenge light-link lasers

When, and if, optical fibers become widely used as signal carriers, the signal source probably will be a laser. Double heterostructure gallium-aluminum-arsenide lasers are favored candidates, but there is a life problem that may never be satisfactorily solved. In that case, gallium arsenide infrared-emitting diodes may be used.

Diodes can't approach a laser for power—0.5–1 milliwatt at present,

compared to 20 mw and up from a laser—but it seems life won't be a problem. At the Caswell Laboratories of Plessey Co., researchers have built diodes that have been running long enough to project a life of 15,000 hours to half-power, starting with 500 microwatts. Later designs have shown degradation of less than 1% from 500 microwatts over 1,000 hours, suggesting a much longer half-life or higher power over the same life.

Team. Bob Goodfellow, a Plessey researcher, says 500 microwatts is adequate in conjunction with present low-loss fibers—10 decibels per mile or less—to pump signals such as public television over a few miles without intermediate boost.

Company tests, in a trial link to assess this transmission scheme, showed that the signal from a 500-microwatt diode could attenuate by 30-dB before picture degradation set in. With fiber attenuation of 10-dB per mile, three-mile optical TV links are possible.

In this test, a 5.5-megahertz monochrome TV signal was applied to the diode via an amplifier, and the power of the infrared signal out varies to follow the waveform; the signal travels in power amplitude modulated form. Maximum modulation frequency obtained using the full power spread of the diode is 33 MHz, and rise time to full power is 5 to 10 nanoseconds. A big advantage of the diodes is that optical power out is closely linear to dc power in, and no digital conversion of a TV signal is necessary.

Goodfellow says that the diodes have to be designed for high radiance and elaborately heat sunked. He uses an approach that is based on a technique by Charles A. Burrus of Bell Laboratories. The diode emits from a 2-mil-diameter circle in the center of a recess etched into a gallium arsenide top layer. Under this layer is zinc-doped p-GaAs,

then silicon oxide insulation, and, finally, gold electroplating. A 2-mil hole is left in the insulation. The gold plating through this hole forms the lower contact. The end of the fiber fits into the recess, and the emission goes straight into its core, which is 2 mils in diameter. □

Packaging for tight IC packing

As logic IC switching times go down, the proportion of total system delay taken up by interconnect delay time goes up. And sooner or later some radical new form of construction will be necessary. Researchers at International Computers Ltd. have devised a possible format, which is being described at a conference on hybrid microcircuits at Kent University, Canterbury, England.

Trevor Hughes, one of ICL's microsystems researchers, says a 2-inch-square test module with 10 resistor chips—tantalum thin film on silicon—mounted on it has shown it will dissipate 100 watts—10 w per chip—with film temperature steady at about 60°C. The resistor chips stand in for integrated circuits, although ICs that dissipate as much as 10 w may never be made, but Hughes wants to work with worst cases.

The main snag is that the module

is not simple. The 2-in.-square substrate is solid copper, with one surface in contact with a pipe carrying cooling water. The other surface has the backs of the chips bonded to it. Thus, there's a low-thermal-impedance path direct from chip to water. And interconnection between chips is via gold tracks on both sides of a sheet of polyimide laid over the substrate. ICL calls this a superstrate.

Copper. Yener Gurler, who worked on the substrate, says copper is better than aluminum because it's not porous, it has better thermal conductivity, and it's much easier to plate and to process like a thick-film substrate. The substrate is a power plane, so it's necessary to form pillars on it to carry current to higher planes and add an insulation plane where pillars are not required. Further, there have to be fairly large holes in the insulation for bonding the chips to the copper.

The pillars have to be accurately located and of very small diameter, preferably less than 125 microns. Gurler says that this precision is achieved by applying dry film resist, exposing to ultraviolet light through a photographic mask, and electroplating in the holes. Sharp edged pillars 250 microns high can be made in this way. The resist also has cavities where the chips will lay, and these are electroplated, too.

An insulator is fired onto all the surface that is not plated, then the whole surface is planed level, and

the plating in the chip cavities etched away. In fact, the etching cuts about 4 mils into the substrate, which is finally about 10 mils below insulator top-face level. A gold ground plane is added over the insulator and more pillars built.

Base. The other half of the structure, ultimately laid down on the substrate, is the polyimide film with gold tracks and chips attached to it. The film is 25 microns thick. First, it's etched from both sides to make 25-micron-diameter through-holes. Then, it's covered with a thin film of chrome, followed by gold, followed by electroplated gold to a total thickness of just over 3 microns. That structure forms a base for electroplated gold interconnect tracks, 25 microns thick and 125 microns wide. The track pattern is formed in photoresist before the final plating stage. The gold also fills the through-holes.

To fit the chips in, holes are etched in the polyimide, leaving short lengths of gold track projecting into them. These overhangs form beam leads for chip attachment. Finally, the chrome and gold base metalization is removed.

A 24-chip ring oscillator has been built in this way, and compared for speed with an identical oscillator wired conventionally on a pc board. Interconnect delay has been cut by a factor of seven, from an average of 845 picoseconds per stage to 125 picoseconds. □

Around the world

Audio novelties crop up at Berlin show

With 31 ICs, 46 transistors, and 53 diodes, a clock-radio by West Germany's Loewe Opta ranks as one of the most sophisticated yet designed for consumer applications. The four-band unit, designated R-12 Sensotronic, has fully electronic time indication and features touch tuning—stations are selected by just touching small sensor plates. It also provides for preprogramming of station switch-on and switch-off times, and has a "week-end" button that overrides the alarm.

Another of the novelties shown at the Radio and Television Exhibition in West Berlin was a headphone allowing wireless reception of a TV set's sound so that other people in a room, who may not want to listen to the TV program, don't have to hear it. Developed by Nordmende KG, the Solarphon headset picks up a sound-modulated

infrared light beam, separates the audio signals from it, and amplifies these signals for the listener.

Hand-held wirer speeds prototype circuits

Developed for the laboratory worker who wants to build up an experimental circuit, a new tool from Siemens AG offers a fast way of wiring board-mounted components. The hand-held tool is similar to a ball-point pen, but mounted at the top is a small roll of enamel-insulated copper wire. The wire feeds through the center of the tool, unwinding as it is pulled. The wire is first soldered to a pin and then pulled to other pins where preliminary connection is made by wrapping the wire a few times.

Other international developments in electronics

Turn to stories on pages 42, 76, 93, and 117.

Here are two of the world's best oscilloscopes.

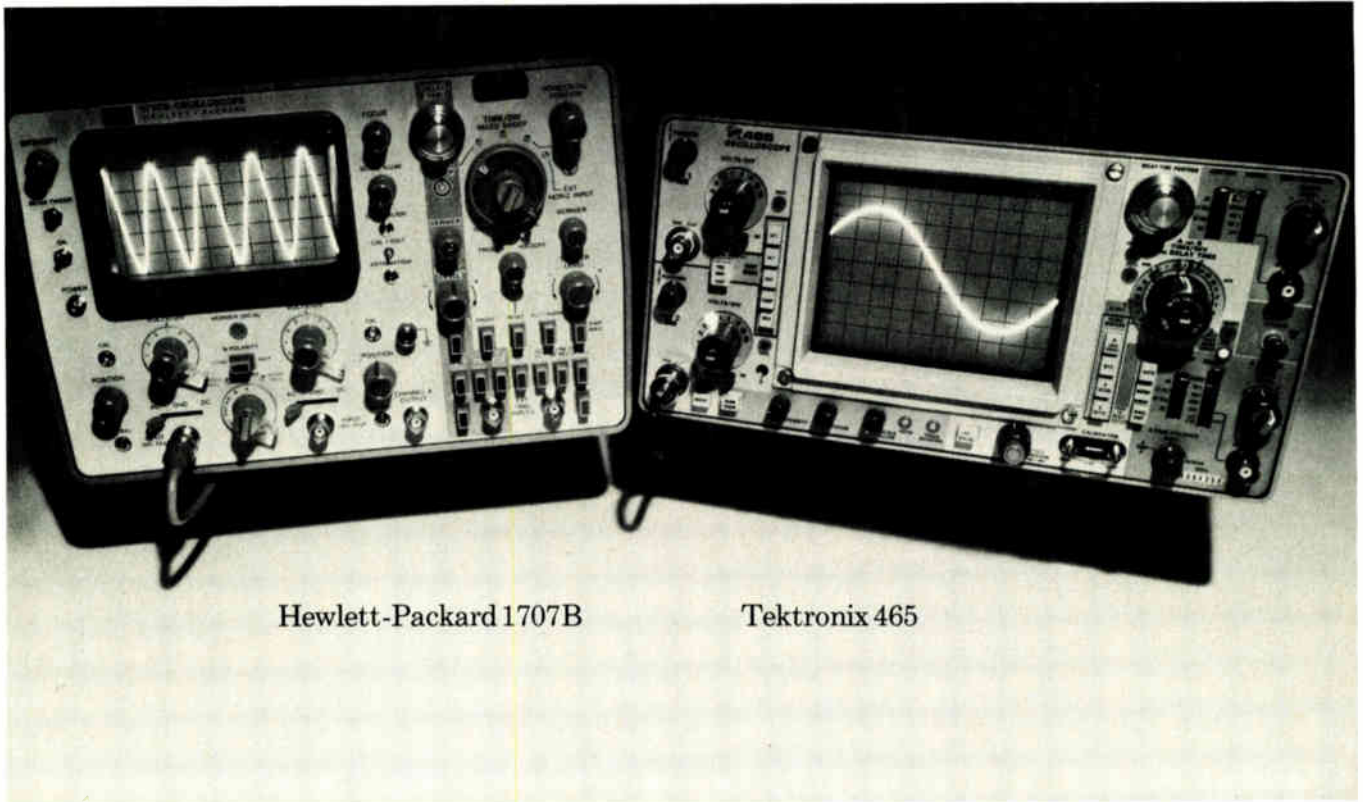

Hewlett-Packard 1707B

Tektronix 465

Here's why you shouldn't own either one.

You can lease one for as little as \$45 per month.

We can give you immediate delivery on either the Hewlett-Packard 1707B or the Tektronix 465, in quantity.

The Hewlett-Packard scope lease is \$45 per month for 36 months. The Tektronix 465 is \$50 per month for 36 months.

Anyway you choose, leasing is the best thing that ever happened to a tight capital equipment budget. You pay for your scope as you use it ... and you pay for it out of the profits it generates.

Call your closest Instant Inventory Center and ask us about short term rentals, delivery, and other lease terms for scopes or any other electronic equipment you need, up to and including minicomputers.



Anaheim, California (714) 879-0561
Dallas, Texas (214) 661-8082
Fort Lauderdale, Florida (305) 771-3500
Gaithersburg, Maryland (301) 948-0620
Lexington, Massachusetts (617) 861-0667
Mountain View, California (415) 968-8845
Oakland, New Jersey (201) 337-3757
Rexdale (Toronto) Ont., Canada (416) 677-7513
Rosemont, Illinois (312) 671-2464

Rental Electronics, Inc.

A **PEPSICO** leasing company.

French bemoan high level of foreign investment . . .

French government economic planners are alarmed over the penetration of U.S. firms into the electronics industry in France. Experts responsible for monitoring economic performance during the current five-year plan point out that **more than 60% of French telecommunications business—long an ITT preserve—is still foreign-owned and most of the shareholders are American.**

A new progress report warns that in the telecommunications industry alone annual foreign investments have jumped from \$46 million in 1970 to more than \$80 million last year. **This would not be so bad, the planners say, if French industry had been equally active abroad. In fact, French investment abroad in telecommunications rose to just \$17 million last year.** The report says the real danger for the French industry is in the “fundamental imbalance” between the two sets of investment figures. To this malady the officials add **complaints of insufficient research and a lack of success in building bridges to other electronics industries in Europe.**

. . . and offer plan to strengthen domestic industry

To put things straight, the planners' report suggests a formidable list of remedies. First it prescribes **renewed efforts to stem the flow of Japanese consumer electronics onto the French market.** Then, it calls on the biggest French electronics company, the Thomson-Brandt group, to **find European industrial partners in the consumer product field.** Third, it suggests that **French companies should get a bigger share of the telephone business** by comparison with ITT's big slice. And, it recommends **a heavier dose of government aid to promote French research** into measuring equipment, instrumentation, data-processing, and, above all, into passive components, which it claims have been badly neglected at the expense of military and space research.

Now a 118° color tube, from Toshiba

Toshiba is soon to introduce a color-TV receiver with 118° deflection—4° above Sony's 114° versions brought out last year—in a 16-inch (15-inch V in U.S) tube. It's an in-line-gun type with Toshiba's black-stripe matrix. **As power saving is of major concern in Japan these days, the new tube has been designed to perform at 95 watts, the same as a standard 90° tube.** By reducing the size of the neck from 36.5 mm to 29.1 mm and using a square neck configuration, Toshiba was able to reduce power from 125 W normally needed to drive a 118° tube.

British set to go on tactical communications set-up

The British Army is to get an extensive new tactical communications system to replace the cancelled international project Mallard, in which Britain was a partner. **Development is estimated to cost about \$40 million spread over the next four years, followed by production orders of about \$250 million.** Plessey is prime contractor and will do most of the development work.

The network will be entirely mobile and basically independent of particular military formations, though working closely with them. It will be based on more than 100 stored-program switching exchanges, each essentially a Plessey modular communications computer in a truck. Military headquarters big enough to need multiple channel links will use a

similar unit, but local formations will use single-channel links to headquarters or directly to node exchanges.

All communication will be by vhf or uhf radio, except for final handset lines and where a link between a headquarters and a local formation is semi-permanent, when cable is likely. It's intended that a local transmitter will normally be able to get into at least two multiple-channel exchanges, so that more than one path to destination is available. Thus, local transmitters will have an omnidirectional range of up to about 20 miles. All path selection and switching will be automatic, and the aim is that any connection can be made by any path within a few seconds. **Signals will be coded digital, and encompass speech, telegraph, facsimile and computer data.**

France's Crotale missile may not reach U.S. Army

In its eagerness to sell as many of its Crotale low-altitude missiles as possible, French vendor Thomson-CSF may have lost its best potential customer. **Following French-government-approved sales of Crotale systems to Libya, industry sources in Paris say the U. S. Army is likely to drop Crotale** in favour of one of the two rival systems, British Aircraft Corp. Rapier or the all-weather Roland missile built by Aerospatiale of France and Messerschmitt-Boelkow-Blohm of West Germany.

French sources complain that the U.S. has already stated that the Crotale is the best system of its kind and that any decision in favour of another missile would have to have political rather than technical motivations. Thomson-CSF points out that any Crotales supplied to the U.S. military would be produced by Rockwell International under license from the French company and that the U.S. would be free to develop its own guidance program and also to improve on the original design. Thus, performance might well differ from the complete systems supplied to Libya or indeed to those used by the French forces.

Sony puts ferrite and chromium on one tape

Sony Corp.'s audio equipment division has unveiled a new tape that combines ferrite and chromium dioxide. The Duad ferri-chrome cassettes will be on the Japanese market in November. In producing this tape, **Sony lays down on an 18-micrometer plastic base a 5-micrometer layer of ferrite and over that another layer of chromium dioxide 1 micrometer thick.** The tape exhibits the performance of ferrite in low and mid frequencies and maintains the quality of chromium dioxide in the upper frequencies, according to Sony, **while showing a 4.5-5-dB improvement at the low frequencies.** The company also introduced a tape deck using a narrow-gap head to play the new tape. This machine has a switch to transfer from normal ferrite to Duad to regular chromium dioxide tapes and has both Dolby and the Japanese noise-reduction circuits.

Grundig sells TV sets in France, home of Secam

Grundig is off to a head start over rival AEG-Telefunken in its race for a share in France's buoyant color-TV market. The first Grundig Secam-standard sets hit the market in the Paris region last week, and industry sources expect that Telefunken will have its French plant on stream early next year. **Grundig is adding spice to its sales drive by also launching an ultrasonic remote-control system for its Secam sets—the first of its kind on the French market.**

A CAMBION DOUBLE "QQ" PRODUCT LINE

Color your IC systems Cambion.

You can let your imagination soar, and still keep your most advanced IC packaging concepts practical. With Cambion's growing line of digital products, state of the art design ideas become a reality. And we can meet your needs with repeatable Quality, no matter how great the Quantity. Our variety of components is so extensive you won't have to think "specials".

Just take a look at our new Catalog 119. It features advanced new Cambi-Cards[®], card files, drawers, universal panels with and without premounted socket strips and power planes, specific logic function cards, general purpose and discrete component cards, plus strip connectors, cable assem-

blies, integrated socket strips, component socket adapters, cable cards and card extenders.

We also offer a complete NC wrapping service to speed economical production of your IC system designs.

Develop your system ideas to their fullest potential *without component restriction*. Get your own copy of the new Cambion Catalog. It has 22 more pages than its predecessor showing more new products to keep ahead of your design needs. And they all have the Cambion Double "QQ" approach: the Quality stands up as the Quantity goes on. Order your copy today. Cambridge Thermionic Corporation, 445EM Concord Avenue, Cambridge, Mass. 02138. Phone (617) 491-5400. In Los Angeles, 8703 La Tijera Blvd. 90045. Phone (213) 776-0472.

Standardize on

CAMBION[®]

... the Guaranteed Digital Products

Circle 61 on reader service card



Signetics takes a back seat



Whether you're talking designs, devices, or deliveries.

As you read this, we're shipping about 25% of all U.S. commercial orders for ECL 10k, and booking much more. And we're on contract with major computer manufacturers to design and produce new ECL 10k and CML devices for their 1975 lines. What that means to you is that Signetics is a prime for the latest, broadest, available-now line of high-technology ECL 10k.

We're talking deliverable realities — get our wall chart (see coupon) and you'll see it's dated. As of that date, everything on it is in production and available. It all adds up to many more new, Signetics-originated designs and much greater across-the-board

ECL 10k availability for you.

Case in point: the speed breakthrough to 15ns in the 10139 ECL PROM. Brand new. Unique. Obviously destined to be the heart of some of the fastest new computers and add-on memories going on the drawing boards right now. Yours, perhaps. At ECL system speeds, you now achieve non-volatile microprogramming with unprecedented ease. Delivery: from stock.

The highest gate function density around is the 10100 Quad Gate. Flexible enough to fit anyone's system. Enough designers agree, that the 10100 now has the highest usage of any quad gate —voila!

to no one in ECL 10k.

Down have plummeted the prices, so that it's now the lowest cost unit around, too.

Delivery: from stock.

What's the fastest parity in the world? We spec 4ns on our 10170 9 + 2. Byte organized and expandable. At least a year ahead of anything else. Delivery: from stock.

And for you folks out there in add-on memory land, here are two advanced translators to keep you jiggling without Geritol while you solve add-on interface problems. The 10190 Quad Line Receiver/MST translator — a powerhouse — and the 10191 Hex ECL 10k-to-MST high-density translator with six per package. Talk directly to major CPU ECL with your ECL 10k.

Stack it all together and it reads like this. If you're going to buy ECL memory, you ought to buy from the company that specializes in ECL. If you're looking for high-technology ECL, you'll find it at the company that has gone in deliberately to develop high-technology ECL. If you want to choose from the widest line of ECL available now, then the only place to go is where that widest available line exists. Now.



That's what Signetics has become. The ECL source to go to first.

Check this partial list, for openers, and note the delivery times. Then get our chart for the full listing. And if what you want isn't on the chart, and it's a commercially feasible device — we'll build it! That's how over 80% of our Signetics-originated ECL designs got started, from customer requests.

PARTIAL LISTING OF SIGNETICS-ORIGINATED ECL 10k:			
DEVICE	FUNCTION	REMARKS	DELIVERY
10139	32 x 8 PROM	Fastest PROM alive: 15 ns Only ECL PROM. Allows non-volatile microprogramming at ECL system speeds.	From Stock
10145	16 x 4 RAM	Fastest RAM alive: 9ns Scratch pad buffer memory. Ideal for register files and control stores.	From Stock
10190	Quad Line Receiver/ MST Translator	Solves add-on memory interface problem. Powerful line receiver.	From Stock
10191	Hex ECL 10k-to-MST Translator	Solves add-on memory interface problem. High density	From Stock
10100	Quad Gate	Highest gate function density. Lowest price.	From Stock
10112	Clock Driver	More flexible than 10110, 10111. Optimized to drive 10133.	From Stock
10158/59	Quad 2-to-1 Multiplexers	Lower cost/function. Lower power dissipation. 10159 has powerful enable.	4-6 weeks
10171/72	Dual 1-of-4 Decoder/ demultiplexer	Additional logic function. Completes demultiplexer line.	From Stock
10113	Quad ExOR	Higher density than 10107. Lower cost per gate. Powerful output enable feature.	From Stock
10170	9 + 2 Parity	Expandable. Fastest parity — 4ns. Byte organized.	From Stock

Start moving in the best circles. Get up on ECL 10k with our brand-new, dated (and frequently updated) wall chart of ECL deliverables. It's free. Clip. Write. Mail.

CLIP THIS COUPON TO YOUR LETTERHEAD FOR FAST RESPONSE.

Signetics—ECL 10k
811 East Arques Avenue
Sunnyvale, Calif. 94086

Hello there... I'd like a chart, please. I can't believe I read the whole ad, but I did get the point that you're coming on strong as front runner in ECL 10k.

Name _____ Title _____

The address you can get off my letterhead, which I have not forgotten to attach.

Signetics Corporation. A subsidiary of Corning Glass Works.

signetics

Tektronix TM 500 Series puts it all together

Tektronix has taken a new approach to test and measurement instruments. The TM 500 Series is modular, multifunctional, synergistic, cost effective, and more. It includes the features you've been looking for.

Presently, the TM 500 Series includes 24 general purpose plug-in test instruments. All new ways to think of Tektronix. Digital counters to 550 MHz. Signal sources ranging from below 1 mHz to above 1 GHz. Pulse generators to 250 MHz. Digital multimeters with 4½ digit LED readout and temperature measurements from -55° C to +150° C. Plus signal processors, power supplies, and CRT monitors.

All the modules are interchangeable. So you can make combina-

tions of instruments to meet your particular needs. When new instruments are introduced (and many will be soon), you simply plug them into the power unit. You can use a single compartment (TM 501), a triple compartment power unit (TM 503), or two 503's combined for a standard rackmount installation.

Connections between modules and/or external equipment are made through the power unit rear interface board and optional rear panel connectors. Approximately 30 input-output lines are available in each compartment for special set-ups you might want to make. This intracompartiment interface feature also permits multifunction applications resulting in a synergistic effect. Instruments working

together perform more functions than the same instruments working independently. Many modules include serial BCD so information can be transferred directly to a computer or calculator.

The TM 500 is compact too. A three-compartment power unit is only 6"x8.7"x15.3". That means the TM 500 is two to six times smaller than comparable instruments. So you save bench space. And it's light weight, easy to carry. A package including a general purpose counter, multimeter, and power supply weighs 14 to 18 pounds!

Cost? All TM 500 plug-in modules are competitively priced with instruments of comparable capabilities. Because TM 500 instruments share the fixed costs of

Modular, compact, synergistic, multifunctional, versatile, cost effective and more.

Circle 64 on reader service card

For a demonstration circle 65 on reader service card

power supplies, cabinets, etc., they consistently provide the lowest cost per test/measurement function. And, because the instruments are modular, cost of maintenance is lower too.

For complete details, contact your Tektronix Field Engineer. Or write or phone for our new 12 page, full color brochure and 24 data sheets. They show why the TM 500 is the finest test and measurement series available today. Tektronix, Inc. P.O. Box 500, Beaverton, Oregon 97005. In Europe, write Tektronix Ltd., Guernsey, C. I., U.K.

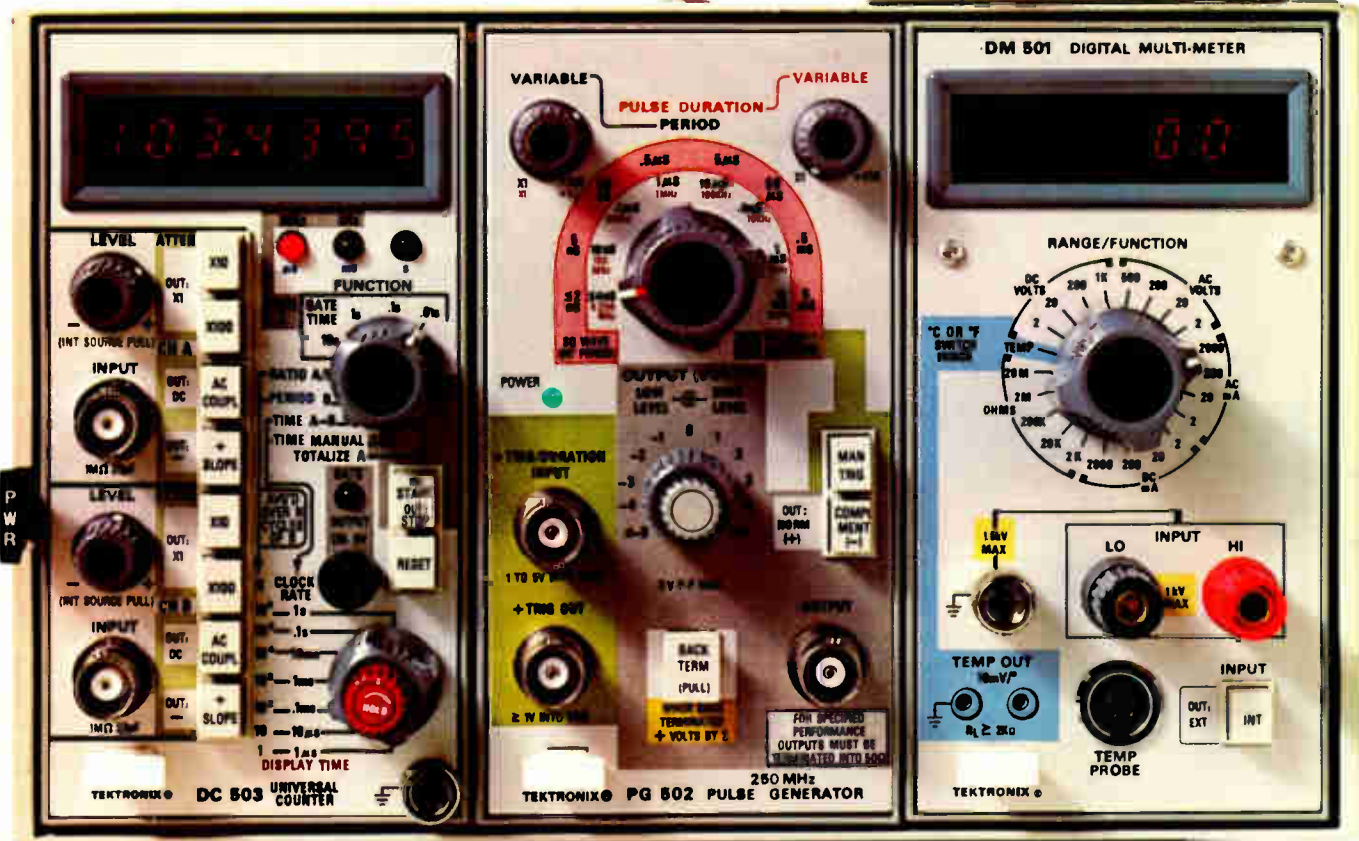
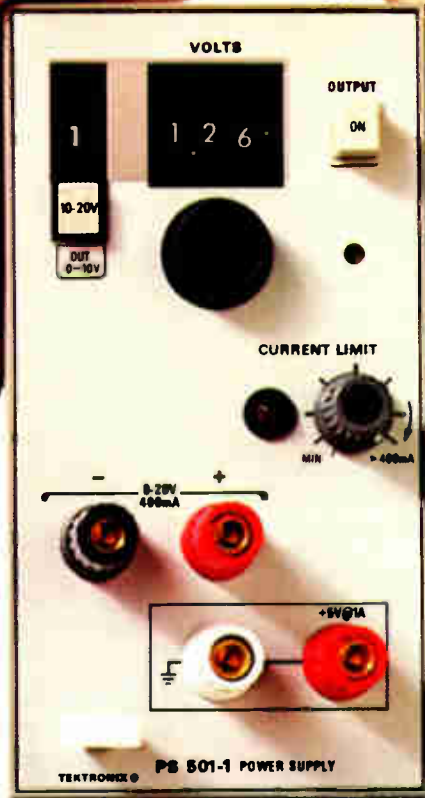

Optically coupled logic gate;
totem pole output circuit
1 MHz data rate

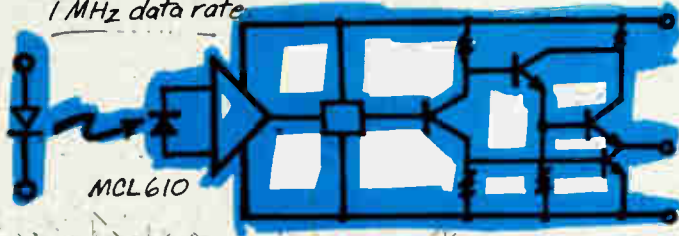

LED optically
coupled to photo-
diode. FAST!

MCD2
MCD2 M
(MCD2M are
matched sets)

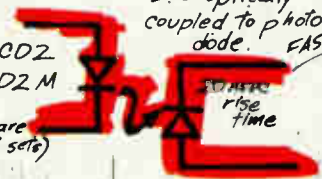

MCA2

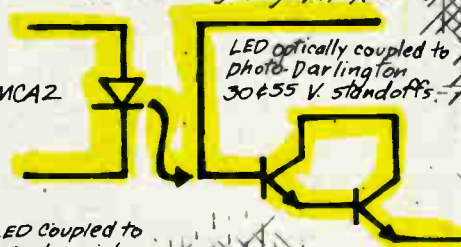

LED optically coupled to
photo-Darlington
30 & 55 V standoffs.

LED Coupled to
photo transistor
output: 15KV

MCT26
MCT2
MCT2 E



2.5KV
breakdown

LED coupled
to SCR
Up to 600V
ratings



M52



MSR 100 SOLID STATE RELAYS

Adds an optical-isolator to
other circuitry to form a rugged,
one-piece solid state relay.

Just a few reasons why we're

If your circuits could use a little peace and quiet, or if you're not getting delivery of the product you really need, we have a large line of opto-isolators (optical couplers) that will help solve your problems. At TTL logic levels. With isolation of 10^{11} ohms. In a variety of output configurations and specifications. Blessed freedom from electromechanical switches and the inherent problems in data coupling! Not only do we give you the biggest assortment of emitters and detectors inside the package, we also give you many design ideas in a new book of applications notes. Over sixty pages of circuit designs and solutions. It's FREE to you, if you'll write us on your letterhead and simply ask.

We've also got a line of solid state relays, with AC or DC inputs, that will help with your power switching requirements.

Specify the O/I's with the reputation for outstanding quality.

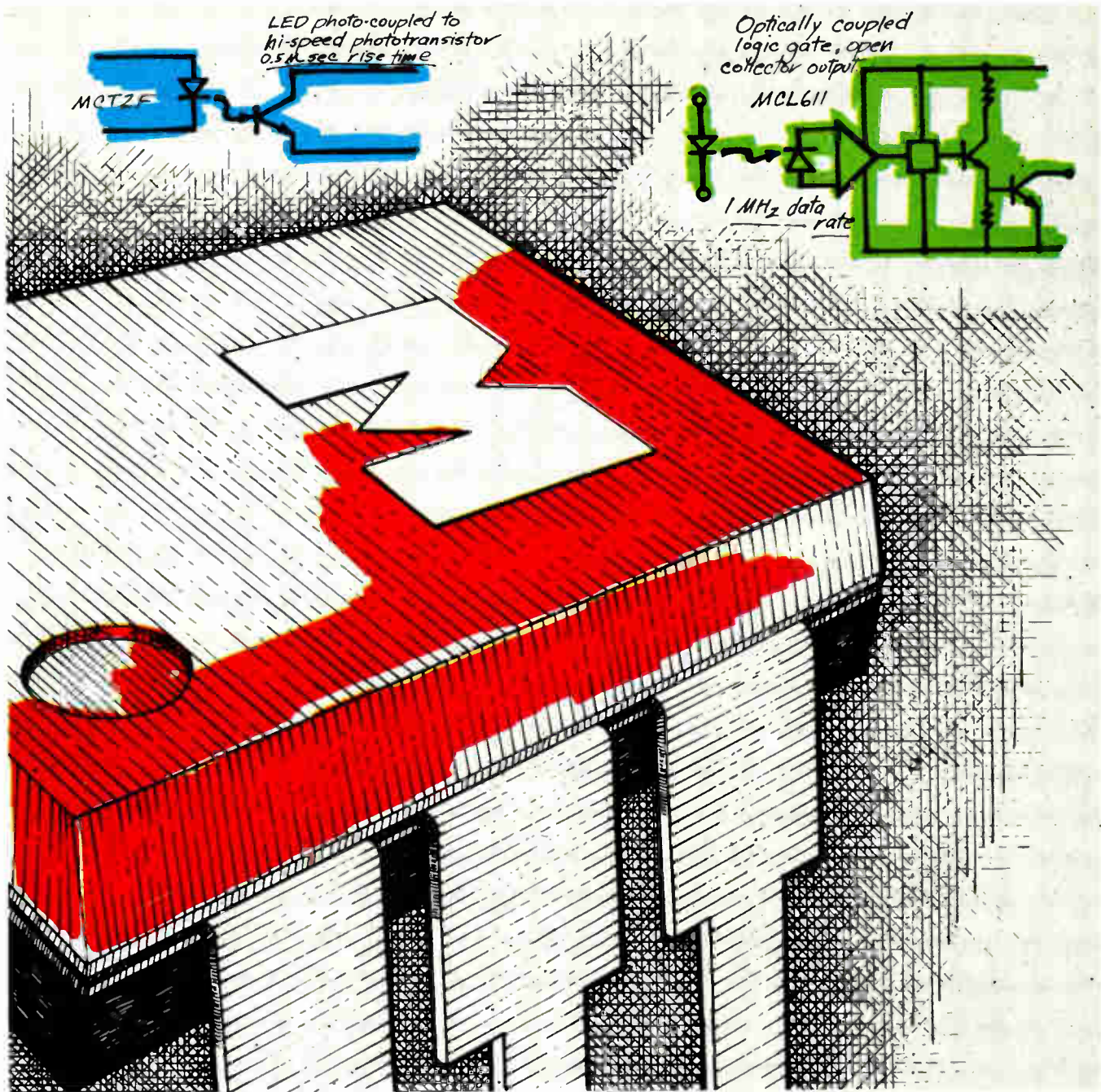

first in Opto-Isolators.

Putting innovation to work.

Monsanto Commercial Products Co. Electronic Special Products
 10131 Bubb Road, Cupertino, CA. 95104 (408) 257-2140
 A unit of Monsanto Company

Monsanto

EASTERN HAMILTON/AVNET Atlanta, GA (404) 448-0800 Baltimore, MD (301) 796-5000 Boston, MA (617) 273-2120 Cedar Grove, NJ (201) 239-0800 Long Island, NY (516) 333-5800 Miami, FL (305) 925-5401 Mount Laurel, NJ (609) 234-2133 Syracuse, NY (315) 437-2642 KIERULFF ELECTRONICS, Garthersburg, MD (301) 948-0250 Hicksville, NY (516) 433-5530 Rutherford, NJ (201) 935-2120 Paoli, PA (215) 647-2612 Needham Heights, MA (617) 449-3600 SCHWEBER ELECTRONICS, Atlanta, GA (404) 449-9170 Rockville, MD (301) 881-2970 Hollywood, FL (305) 927-0511 Raleigh, NC (919) 832-8881 Rochester, NY (716) 328-4180 Westbury, NY (516) 334-7474 Somerset, NJ (201) 469-6008 HAMMOND ELECTRONICS, Orlando, FL (305) 241-6601 SEMICONDUCTOR SPECIALISTS, INC., Pittsburgh, PA (412) 781-8120
 MIDWEST HAMILTON/AVNET, Chicago, IL (312) 678-6310 Dallas, TX (214) 638-2850 Detroit, MI (313) 522-4700 Houston, TX (713) 526-4661 Kansas City, MO (913) 362-3250 Minneapolis, MN (612) 854-4800 St. Louis, MO (314) 731-1144 HARRISON EQUIPMENT, Houston, TX (713) 224-9131 KIERULFF ELECTRONICS, Garland, TX (214) 271-2471 SEMICONDUCTOR SPECIALISTS, INC., Dayton, OH (513) 278-9455 Chicago, IL (312) 279-1000 Detroit, MI (313) 255-0300 Indianapolis, IN (317) 243-8271 Minneapolis, MN (612) 854-8842 Kansas City, MO (816) 452-3900 St. Louis, MO (314) 428-6100 Dallas, TX (214) 358-5211 SCHWEBER ELECTRONICS, Elk Grove Village, IL (312) 593-2740 Cedar Rapids, IA (319) 366-0774 Beachwood, OH (216) 464-2970 Troy, MI (313) 583-9242 WESTERN ALTA ELECTRONICS, INC., Salt Lake City, UT (801) 486-7227 ELMAR ELECTRONICS, Mountain View, CA (415) 961-3611 Denver, CO (303) 287-9611 HAMILTON ELECTRO SALES, Culver City, CA (213) 870-7171 HAMILTON/AVNET, Denver, CO (303) 534-1212 Mountain View, CA (415) 961-7000 Phoenix, AZ (602) 269-1391 Salt Lake City, UT (801) 262-8451 San Diego, CA (714) 279-2421 Seattle, WA (206) 624-5930 KIERULFF ELECTRONICS, Palo Alto, CA (415) 968-6292 Phoenix, AZ (602) 273-7331 Denver, CO (303) 343-7090 Seattle, WA (206) 763-1590 San Diego, CA (714) 278-2112 LIBERTY ELECTRONICS, Phoenix, AZ (602) 264-4438 Seattle, WA (206) 763-8200 El Segundo, CA (213) 322-8100 WESCO ELEC., Los Angeles, CA (213) 685-9525 WESTERN RADIO, San Diego, CA (714) 235-6571 CANADA CANADIAN DYNAMICS LTD., Vancouver, BC (604) 325-3201 Calgary, ALB (403) 265-6500 CESCO ELECTRONICS, LTD., Montreal (504) 735-5511 Ottawa (613) 729-5118 Toronto (416) 638-5250 Quebec (418) 524-4641 Vancouver (604) 433-7834 HAMILTON/AVNET, Montreal (514) 735-6393 Ottawa (613) 725-3071 Toronto (416) 677-7432 SCHWEBER ELECTRONICS, Toronto (416) 925-2471 SEMICONDUCTOR SPECIALISTS, Ontario (416) 678-1444

New **TY-RAP**[®] Tool completes one million ties every month

Triggered 70,000 times each day without a misfire!

As you read this message, the production model of this pneumatic hand tool, TR-225, is continuing its life cycle test... 1,000,000 cycles per month without a falter.



This 20 ounce tool ties wire bundles from 1/16" to 4" diameter with just about every regular and "Slim Line" type TY-RAP[®] cable tie... 16 sizes in all. It reduces operator fatigue... and is particularly well suited for close-up work, break-out points and tying in confined places in equipment.



Our other new production tool, the high speed TR-300, automatically positions a TY-RAP tie around bundle, cinches to a preset tension, locks tie securely and trims evenly... all in 8/10 of a second... and on bundle diameters ranging from 1/32" to 5/8".

Write for new catalog. The Thomas & Betts Co., Elizabeth, New Jersey 07207, (201) 354-4321. In Canada, Thomas & Betts Ltd., P.Q.

Sold Only Through Authorized T&B Distributors



THOMAS & BETTS

Division of Thomas & Betts Corporation

Circle 68 on reader service card

524

Tooling Technology Offers Systems Approach to Production Wiring

With over 14 years of experience plus the world's largest team of wire tying and harnessing specialists T&B has developed a systems approach to wiring that makes harnessing a cost-controlled proposition.

Part of the "systems" approach is the new TR-225 tool which reduces operator fatigue through the use of pneumatic operation. Of particular note is the rugged construction, providing reliable performance in a production environment... (the tool has been cycled 1,000,000 times per month without a falter). It is light weight and human engineered for both men and women operators. The tool accommodates the majority of TY-RAP® tie sizes... 16 in all... with bundle ranges from 1/4" to 4". A further convenience for the operator is that the long narrow nose gets into confined areas easily. If your production volume is such that it does not require the exclusive use of the TR-225 perhaps the new WT-193 hand tool would supplement your operation.



This tool accommodates the same bundle range as the TR-225. With a similar narrow nose and long barrel, it is well suited for close-up work, breakout points and in tough to reach places. This particular design gives the operator the convenience of a long tying stroke with one squeeze of the trigger... the tie is cinched to a preset tension and trimmed flush with the head. The speed of tying is good for smaller volume tying as compared to the pneumatic TR-225.

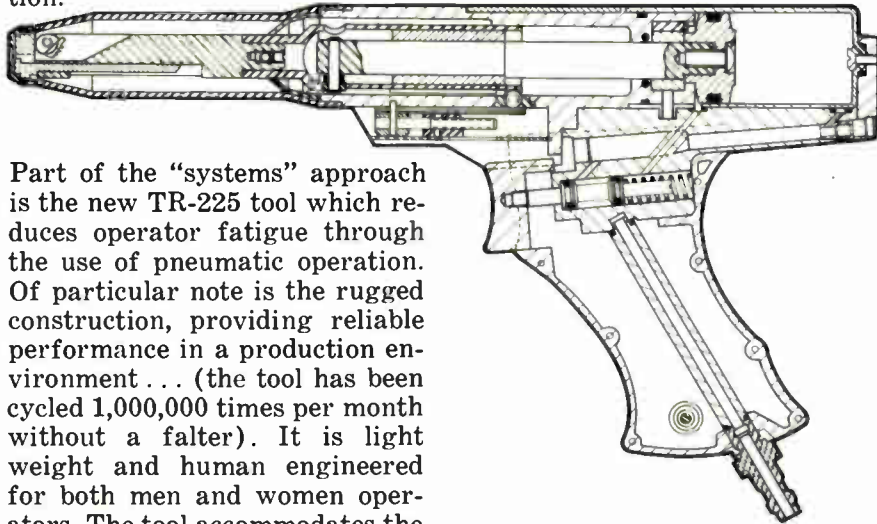

If an evaluation of your tying requirements reveals a high volume of tying bundles in 1/4" to 5/8" diameter, consideration of our new automatic production tool (TR-300) would be wise.

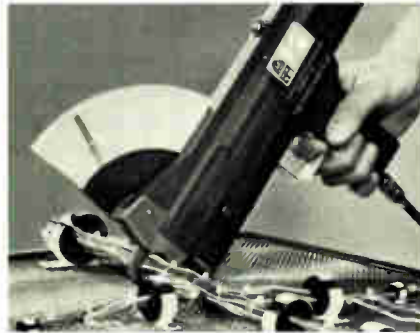

Used in conjunction with our complete series of harnessing aids (routing clamps, corner posts, breakout springs) wires are routed with few nails to facilitate both fabrication and tying.

With good harness board preparation, the TR-300 can offer 4-5 times quicker installation than hand tying. This tool slides a TY-RAP tie under and around the bundle, cinches it to a preset tension, locks it and trims it flush with the head... all in 1/10 of a second.

Our harnessing specialists will review your tying operation and recommend appropriate tooling.

Another TY-RAP product which facilitates harness fabrication is the new harness board. Set-up costs just about disappear when you adapt this board into your present operation. It is a fully reusable modular board that can be enlarged by snapping the interlocking panels together. Metal screening covers the self-healing polyethylene foam center. Both sides can be used. The harnessing aids are installed easily since standard nails are pushed into the board by hand. Cat. No. HBF-02-03.

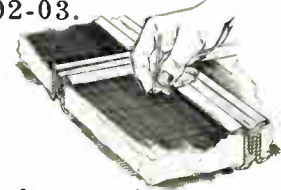

One of the most important considerations in using plastic ties is the reliability of the tie's locking device. Only TY-RAP self-locking ties have a patented, non-magnetic, stainless steel,



locking wedge embedded in the cable tie head. You get a grip of steel everytime with TY-RAP self-locking ties.

The TY-RAP system was developed by T&B to answer all types of production wiring and harness fabricating needs whether large volume or small. Your production rates, system flow and total installed costs are major concerns of ours. In our evaluations of harness fabricating techniques used across the country, operator performance, fatigue factors and process convenience appeared as major considerations in the cost structure of harnessing. Our harnessing specialists are equipped to study these costs as well as all pertinent factors involved in your wiring and harnessing operations. Write or call us today.

The Thomas & Betts Co., Elizabeth, New Jersey 07207, (201) 354-4321. In Canada, Thomas & Betts Ltd., P.Q.

529



Log ratio modules used to be expensive, clumsy, and hard to apply. Not any more.



Analog Devices introduces the world's first and only log ratio module that operates on either current or voltage. \$42 in 100's.

Before the Model 756, log ratio modules could only operate from true current source inputs. Or you could build your own for current or voltage using op amps and log amplifiers.

That meant more time and more expense. Not to mention the extra space requirements.

Now you can forget about extra log modules, bulky subtractors and assorted circuits. We've packed a current log ratio module that can also handle seven decades of voltage ratio into one cubic inch of convenience. The Model 756. With an overall performance of 1% referred to its input.

Two separate channels allow true log ratio. Channel one is a high quality FET amp with 10pA bias current. It can process up to 4 decades of input current with less than 1% error. And channel two, though intended as a reference, is also capable of up to 3 decades of signal processing.

The sum total is a dependable log/antilog ratio module with two continuously variable signal inputs. It makes photometry, acoustical and light measurements, gas chromatography, data compression, transducer linearization, exponentiation, and many other applications easier for you.

So send for the specs and our Product Guide. Model 756 is just one of the many non-linear function modules we bring you to help cut your costs and make circuit design simpler.

We also have log amplifiers. Log transconductance elements to build your own circuits. Multiplier/dividers. Multifunction modules. And a divider that'll hold a ¼% accuracy over a very wide dynamic range of 100:1.

Coming: A module that lets you take true RMS measurements at a truly low price. And more.

Analog Devices, Inc., Norwood, Mass. 02062.



Call 617-329-4700

for everything you need to know about non-linear circuits.

For CCDs, imager is the beginning

Work is going on in U.S. and Canada with objective of using devices in signal-processing and memory systems as well

by Alfred Rosenblatt, New York bureau manager

When Fairchild Camera & Instrument Corp. announced last month that it was offering a commercial camera system using an imaging array made of charge-coupled devices, there was much oohing and aahing about the future of such imagers. But little notice was taken of other work going on across the continent and aimed at using CCDs for memories and signal processing.

In these areas, companies like Bell Laboratories, Hughes Aircraft Co., Rockwell International, Texas Instruments, RCA Corp., and Fairchild have all gone beyond the technology development stage and are working toward specific applications. In Canada, too, Bell-Northern Research Ltd. in Ottawa is testing 8,192-bit shift-register chips from "a prototype production facility," says Doug Colton, manager for new CCD memory and signal-processing devices.

Signal the sea. In the Navy, while Fairchild's development of imaging arrays is heavily funded by the Naval Electronic Systems Command, signal processing is also gaining attention. According to David A. Barbe of the Naval Research Laboratory, Washington, the man who monitors CCD technology for the Systems Command, Navy interest in CCDs at this time is directed heavily toward finding out what and how much signal processing can be done on a purely analog basis. The aim is to dodge the conventional route of digital signal processing with all the complexity introduced by its need for analog to digital and d-a converters.

Accordingly, Westinghouse Electric Co., Baltimore, and TRW Systems group, Redondo Beach, Calif.,

have just received small six-month \$40,000 contracts from NRL to study parameters of CCD devices and come up with systems analyses that determine (1) what signal processing levels and capabilities are achievable and (2) what the cost/performance tradeoffs are for CCD devices in signal processing.

Analog signal processing applications of particular interest to the Navy, says Barbe, include, in addition to delay lines: filter banks for radars, recursive filtering, post-detection interrogators, scan conversion, forward-looking sonar-beam forming, sonar correlators, and

video time compressors/expanders.

Significant news was also made last week when RCA Corp. said it had fabricated and tested in a camera system a CCD device measuring approximately $\frac{1}{2}$ by $\frac{3}{4}$ inches and having 60,000 elements in its image-sensing area (see p. 33). Although fabrication problems with this chip still exist, RCA points out that it is the largest single chip ever to have been fabricated using the metal-oxide-semiconductor process. RCA said it had also operated, several months before, a camera system using a 20,000-element CCD chip (128 by 160 elements) of the same type that

The competition: MOS imaging arrays

Although most of the excitement for solid-state imagers has been directed toward the new CCDs, the excitement is more for the potential of that technology and less for the product—there still are few commercially available charge-coupled imaging devices. MOS imaging arrays, however, have been available from a number of manufacturers for linear and area applications for almost three years: linear devices ranging from 64 to 1,000 linear diode elements for industrial optical character readers and facsimile equipment, and area imagers with up to 2,500 elements for low-resolution video cameras.

Although the MOS and the CCD image arrays have application areas in common, preliminary experience by equipment manufacturers indicates that each will dominate in its own realm. The MOS image array appears to be most useful for small-scale jobs—low-resolution image tubes, and the like. CCD imagers appear to be most useful for the large-scale jobs—full-resolution facsimile and TV quality video.

A new approach to MOS imaging may widen the applications of that technology and make it more suitable for large-scale imaging. Developed at General Electric's facility in Schenectady, N.Y., the image sensor consists of a two-dimensional array of coupled MOS charge-storage capacitors that operate by collecting minority carriers, generated by photon energy, in the bulk silicon near the MOS capacitors. The collected charge is stored under the capacitor electrodes in the surface-inversion region of the silicon-oxide interface. The signal is read out by injecting the charge into the bulk and detecting the resultant substrate current. With this technique, the GE researchers have built experimental 1,024-bit area imaging devices capable of detecting 10 shades of gray in normal room light.

Probing the news

was delivered to the Naval Electronic Systems Command last March. This chip was also very large by conventional MOS standards, measuring 275 by 375 mils. By contrast, MOS LSI chips are pushing the state of the art when they measure 200 mils square.

For phones. At Bell Laboratories, engineers are developing a 16-kilobit shift register for "one particular application" in the nationwide Bell telephone system, says John Copeland, supervisor of the CCD memory group. The design follows the development of a 4,000-bit chip that had operating results with which Bell was "quite pleased," he adds. The new shift register, designed by engineer R. H. Krambeck on a 4-millimeter square chip, contains multiple taps and relies on a "conductively connected" CCD design which Bell plans to describe in the January issue of the IEEE's

"Transactions on Electron Devices."

The C4D technology, as Bell calls it, uses a two-phase cell design and surface channels, which need one less processing step than buried channels. Moreover, it is completely compatible with MOS transistor processing, except for an ion-implantation step that implants barriers to give directionality to the two-phase cell design. Both tungsten and polysilicon metalization have been used, with Bell leaning toward polysilicon, Copeland says. Transfer rate of the shift register will be about 1.5 megahertz. Access time is about 50 microseconds—a good deal faster, Copeland points out, than the 5 to 10 milliseconds of disk files. Total system power would be less than 1 microwatt per bit.

Hughes Aircraft already has CCD devices "in prototype infrared systems," says Hans Dill, manager of the solid-state device research department of Hughes Research Laboratories. Dill declines to be too specific, but admits to Hughes having

"a very large and pioneering effort in both surface-and buried-channel CCDs applied to infrared systems—for processing devices such as delay lines, filters, serial/parallel converters, and storage and imaging."

One application, which has reached the prototype stage, replaces an electromechanical delay line in a radar system with a CCD shift register. Particularly useful here is the CCD's combination of analog storage capability and digital clocking, Dill points out.

Hughes target. CCD imagers in the visible as well as the infrared ranges for target acquisition are receiving attention at Hughes. Dill expects CCDs could lower costs of infrared systems enough to make commercial applications economically feasible. The company already makes, for example, an infrared imager for use in fire departments and law enforcement, called the Probeye, that's expensive because, as yet, it has to depend on vacuum tubes.

HP COUNTERS PROMISE A LOT — AND DELIVER IT ALL.

The counter system that



5301A — 10 MHz Module: 10 Hz to 10 MHz range. Direct counting and totalizing to over 10 MHz. Automatic or manual gating. Input waveform selector. External gate control. \$145.

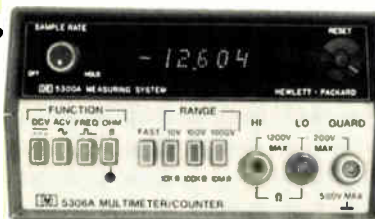

NEW 5306A — Digital Multimeter/Counter Module: Six-digit frequency readings to 10 MHz. Five full digits of AC/DC volts, ohms. Floating, guarded input. Automatic zero adjust. Up to 10 readings/sec. Overload protection. \$450.



5303B — 525 MHz Counter Module: DC to 525 MHz range, burst or CW frequency. 50Ω or 1 MΩ input. Automatic gain control. Fuse protected front end. Optional high stability time base (FCC Type-Approved). \$800.

The heart of HP's versatile frequency/time/volts/ohms measurement system is the sophisticated six-digit HP 5300A mainframe (\$395) which contains basic counting circuitry. Snap this mainframe onto the bottom module you need and it instantly becomes one of six feature-loaded instruments — each with traditional HP quality and ruggedness... each operating

from power line or optional battery pack.

Best of all, once you have the mainframe, it's the low cost way to build a complete workshop of first-line instruments.

It's the one system that truly does stay on top of your needs — and your budget.

Send for a free detailed brochure on HP's 5300 Series Counters.



Battery Pack Module: Sandwiches in between any mainframe/module combination. Permits up to 5 hours of continuous operation. Battery level indicator. Recharge while in use. Carrying handles and shoulder strap. \$195.

02306

All prices domestic U.S.A. only.

Buried-channel devices, with their better signal-to-noise ratio, are preferred at Hughes, says Dill. Making things easier is the ion-implantation capability originally developed by Hughes for both commercial (wristwatch) circuits and military semiconductor devices.

At Rockwell International's Microelectronics Device division in Anaheim, Calif., CCD efforts are aimed at commercial memories. "The effort has really spurred ahead in the last six months," says R. L. Doty, vice president, advanced development. The next step is application developments.

In the company's Electronics Research division, also in Anaheim and where the bulk of Rockwell CCD work remains, metal-nitride-oxide-semiconductor (MNOS) technology is being used for CCDs to yield nonvolatile nondestructive readout devices. According to Barry French, a group leader in advanced technology, Rockwell has demonstrated 10-cell units for the Navy,

and is now working on a 128-cell MNOS CCD operating at 10 MHz. The parts use CCD for addressing MNOS memory cells.

More delay. In delay-line development, French's department is working on the masks for a 128-by-128-cell series-parallel-series CCD array. This unit will use a transverse string of CCDs for high-speed serial input, then transfer the data to parallel strings of slower cells. Output is obtained from the second transverse string of CCDs. "This gives N^2 cells of delay with only $2N$ transfers," French says, and adds that the design can be used in imaging or as a digital recirculating memory of 16 kilobits and 5 to 10 megahertz in speed.

As for Fairchild, it continues to develop the CCD devices called for in the one-year Navy contract running until next April (for which it nosed out RCA and TI). Required are two arrays—one with an imaging area of 244 by 190 elements, and the other 500 by 500 (the latter unit

would be compatible with existing broadcast receivers). Both will be two-phase, buried-channel designs which, because of the inherently better signal-to-noise ratios, the Navy seems to prefer to surface-channel designs for low-light-level imagers.

An array chip incorporating 100 by 100 imaging elements, of the kind used in its commercially announced TV camera, is the largest one built by Fairchild thus far, says James Early, director of research at Fairchild's R&D Laboratories in Palo Alto, Calif. The company has also delivered to the Naval Electronics Systems Command a 1,000-element linear array.

Other devices being developed by Fairchild, both in Palo Alto and at its Space & Defense Systems division, Syosset, N.Y., include a scanner for a post office facsimile, and a page reader for the Army. □

Reporting for this article was provided by Laurence Altman, Ray Connolly, Larry Armstrong, George Sideris, Paul Fran-
son.

stays on top of your needs.



NEW 5307A — High Resolution Module: Range, 5 Hz to 2 MHz and 50 to 1×10^7 counts/minute (CPM). Measures frequency and RPM much faster than conventional counters... 0.0001 Hz or 0.001 CPM resolution in less than 1 second. \$350.



5304A — 10 MHz Timer/Counter Module: DC to 10 MHz range. 100 nsec. time interval accuracy. Unique "Time Interval Holdoff" ignores input ringing or contact bounce. Two DC coupled amplifiers with attenuators, slope, polarity and gain control. \$325.

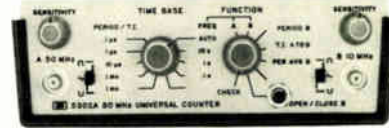

5302A — Universal 50 MHz Counter Module: 10 Hz to 50 MHz range. Automatic or manual gating. 100 nsec. time interval accuracy. Period, period average, ratio and totalize functions too. Input waveform selector. \$275.

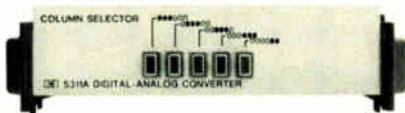

Digital-to-Analog Converter Module: Sandwiches in between modules — even with battery in place. Permits high resolution analog plots of digital measurements. Galvanometer and potentiometer recorder output. \$295.

HEWLETT  PACKARD

Sales, service and support in 172 centers in 65 countries.
Palo Alto, California 94304 Offices in principal cities throughout the U.S.

Government

Can a state cut in on FCC?

That's what North Carolina wants to do by regulating interconnects in a case that could have profound influence on equipment makers

by William F. Arnold, Washington bureau

The outcome of a major battle now shaping up between the Federal Communications Commission and the North Carolina Public Utilities Commission could severely injure the interconnection equipment market and also hurt other segments of the communications industry.

In a classic Federal-state struggle, North Carolina has proposed to ban on Nov. 1 all subscriber-owned interconnect equipment within the state and to make telephone companies own, maintain, and be responsible for all such equipment used in intrastate phone service. The state will hold its first hearings on Oct. 1, the FCC on Oct. 30, but legal and lay observers predict the fight will go to the Supreme Court.

If sustained, the North Carolina rule would almost certainly blight the interconnection equipment market and have adverse repercussions in such communications industries as computer carrier services, specialized common carriers, land mobile radio, corporate internal communications networks, and others that at some point plug into or use telephone systems. The attorney general of the state of Nebraska has told that state's public service commission that it has jurisdiction over interconnect equipment in the state, and other states are eyeing developments closely—as are nervous communications executives in the affected industries. Already, the North Carolina proposal has had a chilling effect on the interconnect market, as parties begin to sit it out to see what happens, report interconnect sources.

At stake is the growth of markets in various communications services. At issue are various intertwined

questions, the chief among them being: how far does a state's authority extend in the communications field, or, conversely, where does the FCC's authority stop? Some say that discussion of the issue is overdue and points up the need for a national communications policy based on Federal recognition that a national communications network exists. Finally, there's the big mystery: why did the state act as it did at this time? No one has an official answer to that one.

What is it? To add to the controversy, North Carolina has not given a good definition of an interconnection, nor has it defined the difference between interstate and intrastate interconnections—nor can it, say observers close to the proceedings. Moreover, if it has jurisdiction over interconnections, does that jurisdiction extend all the way back to equipment suppliers or just far enough to make sure there's no harm to the equipment, asks a lawyer involved in the tussle. And, compounding the complexity, North Carolina's own attorney general questions the state commission's authority.

To industry, "the overriding issue is that if each state can establish its own rules, then all industries will have to deal with 50 different entities," observes Glenn R. Petersen. Petersen is general manager of the mobile-radio department of General Electric's communications systems division, Lynchburg, Va., and head of the Electronic Industries Association's land mobile section. For land mobile radio, it would mean additional equipment and different operating procedures, all adding up to higher costs, he says.

In agreement is Harold Y. Greenberg, director of telecommunications programs, the Computer and Business Equipment Manufacturers Association, who says, "From a manufacturer's point of view, it would mean different installation, maintenance, and manufacturing standards. From a logistics standpoint, he'd be faced with an impossible situation." And there would be Federal rules on top of the differing state regulations, a chaotic situation, he points out.

One association, the North American Telephone Association, representing the interconnect equipment manufacturers and suppliers, filed a strong protest to the southern state, saying that North Carolina can't proceed with its proposed rule because it has a state law requiring cooperation with the other states. Moreover, in pointing out the diversity of the nation's communications networks, the trade group said that "competition is not merely a price regulator, it is a reflection of public recognition that no monopoly, however large, can fulfill the diversity of consumer demands." It was this association that petitioned the FCC to hold hearings Oct. 30 on the jurisdictional questions of North Carolina's proposal.

Lined up. Because of these issues, many individual corporations, trade groups, and committees have also weighed in against North Carolina's proposals on jurisdictional or economic grounds. Among them are: the National Retail Merchants Association, the Utilities Telecommunications Council, IBM, RCA Service Co., ITT, the Independent Data Communications Manufacturers Association, several railroads,

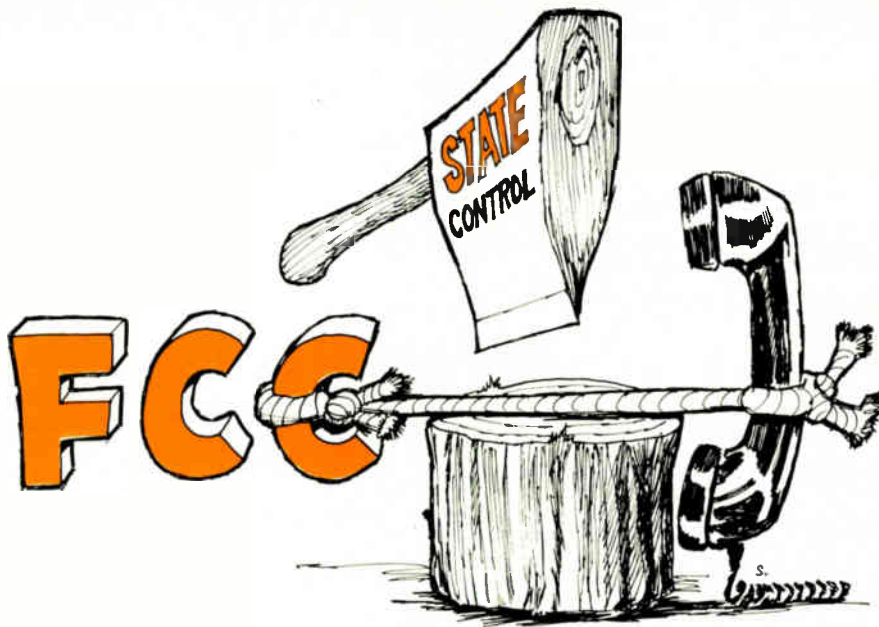

the Federal General Services Administration, the Federal Aviation Administration, and the *ad hoc* telecommunications committee representing Westinghouse, DuPont, Ford, Exxon, Olin, and U.S. and Bethlehem Steel Corps.

In addition to pointing out that the companies' radio paging and mobile radio systems would be adversely affected, the *ad hoc* committee warned that the rule "could so affect telecommunications usefulness in North Carolina that industrial management might consider it a factor in selecting a plant site."

Strongly supported by North Carolina's independent phone companies, Southern Bell approved the state commission's move, but said that it construed interconnection to mean telephone instruments, data modems, and the like, not private-line devices such as automatic voice recording or alarm systems. It believes the latter equipment should be permitted "through telephone-company-provided arrangements and monitored carefully to minimize any adverse service or economic impact." It says that its experience shows that there has been "a degradation of service" with the introduction of customer-provided terminal equipment.

However, AT&T has yet to prove it to the FCC. In the latest round in a continuing correspondence [*Electronics*, May 10, p. 50] the FCC staff asked Bell for key, additional figures to back up its claim. AT&T an-

swered that another, costly survey would be needed. But "we're going to reply again to them to get some kind of measurable or statistical data," says an FCC staffer. "The data reported to date by them is . . . crude."

The new FCC query should be going out shortly, he says. AT&T claims that the potential harm to the phone network by privately furnished interconnect equipment justifies its desire for installation of its own protective devices.

Keep calm. Is North Carolina serious? Despite the alarm some have raised, others are more relaxed. "Everybody's excited by a lot of if's," says Sumner Katz, assistant general counsel for the National Association of Regulatory Utility Commissioners, an association of state utility commissioners. "Nothing's really happened yet. The fears are unjustified." Katz sees the state's action as a way to investigate a needed problem.

More or less agreeing, an official with an involved trade group says "they didn't realize what they bit off when they started all this. They're looking for a graceful way out." But a representative of another involved trade group isn't so sure. "North Carolina has operated in an intransigent manner," he says, pointing out that the public utilities commission didn't call off its Oct. 1 hearing as the FCC requested and is only going to keep its rulings in abeyance until the FCC decides.

Industry also awaits the answer to another question: what will the FCC do? Observers in the commission and industry insist that the FCC will try to assert jurisdiction. They point to the speed with which the agency accepted the North American Telephone Association's petition to hold hearings on the jurisdictional issue. Common Carrier Bureau chief Bernard Strassburg has already told the South Carolina Commission that any carrier refusing interconnections proposed under the interstate message toll tariff would violate the Communications Act. But an attorney with an interested trade group comments that, although there's precedent, this is an "historical watershed," and that with the "broad emotional appeal of the administration's new federalism, you just can't tell" how the commissioners will vote.

Moreover, if the FCC does move, does it have the right to move? Here, opinion divides as to whether or not the Communications Act gives it the jurisdiction because the act is ambiguous at best in crucial sections. Some sources point out that the commission usually wins whenever it goes into court on issues of authority. "If it doesn't, it'll have to ask Congress for a new act," suggests one industry trade group official.

Another interested party, however, sees the issue in a different way. "In effect, the FCC reared the interconnect industry [with the Carterfone decision]. If the companies can't sell equipment because of North Carolina, it can't let the industry go down the drain." □

Electronics abroad

Foreign P-O-S makers fight giants

Americans are grabbing lion's share of business, but native firms want part of market, estimated at \$1.85 billion in Western Europe in next decade

The world is a giant store, so far as the manufacturers of point-of-sale systems are concerned, and until now, it's been largely an American store. But even as most systems sales are rung up by the international arms of U.S. companies active in the field, European and Japanese manufacturers are marshaling their resources to take on such American giants as Singer, NCR, Pitney Bowes-Alpex, and—last but not least—one of the more recent entries in the business, IBM.

Their excitement has been intensified recently by projections like that made by Frost & Sullivan Inc., the New York and London market-research firm. Frost & Sullivan estimates that \$1.85 billion will be spent on electronic checkout hardware over the next decade by retailers in Western Europe. The survey goes on to say that three countries—France, Germany, and Great Britain—will account for two-thirds of the European P-O-S market, and Scandinavia will be another concentrated market area for the equipment manufacturers.

But, Frost & Sullivan points out, there are major differences between European and American retail operations that affect point-of-sale markets. For one thing, European department and variety stores frequently include supermarkets under the same roof, so systems have to be able to handle both types of businesses.

No credit. Also, credit-card sales in many European stores are "non-existent or negligible at best." The result is that credit verification may not be a necessary part of P-O-S systems there. And, perhaps most important, data-communications costs

in Europe are so high that systems relying on data transmission capabilities simply won't meet the needs of the market.

In France, CIT-Alcatel, part of the Compagnie Générale d'Electricité, has had to scale down its ambitious plans to break into the business. Three years ago, the CIT-Alcatel Transac division developed a complete point-of-sale system, including magnetic-strip price tags and credit cards linked through on- or off-line data-processing equipment to a computer. Now Transac has decided on a less ambitious venture in its struggle to gain a foothold and plans to concentrate on the sale of a mini-cassette recorder and converter to link the point-of-sale system to a computer.

Transac's P-O-S marketing chief, Beryl Joncour Legrand, explains

that the investment risk involved in launching manufacturing facilities for a new range of equipment was too great in the face of potentially overwhelming competition from the American giants. Nevertheless, Transac has moved quickly with its own system and has sold 800 units so far.

Legrand says that the complete terminal requires too much investment for many small- and medium-size stores. He points out that the simpler cassette system can be linked directly to old electromechanical cash registers, as well as to electronic hardware.

Hope for a market. Transac is hoping that the switch to electronic cash registers and to associated computer systems will still leave a market for less expensive peripheral equipment. What's more, Transac

The competition. Makers of electronic P-O-S systems overseas face the kind of competition from U.S. companies typified by this Singer 900 installation in an Italian store.



Which air movers for your system?



Rotron® has the answer.

There are at least three major reasons why you can rely on Rotron to provide the best possible answer to your air moving need.

1. Rotron makes the widest selection of fans and blowers in the industry.
2. Rotron has a reputation for producing only the finest air movers. It's a reputation well earned, and one Rotron intends to keep.
3. Rotron offers you this superior selection and quality at hard-nosed competitive prices.

What's more, Rotron field application engineers will be glad to work directly with you where custom solutions may be required. You get the benefit of more than 20 years experience in developing specific answers to specific air moving problems.

Finally, Rotron products are available through a large, nationwide network of stocking distributors, to meet your needs in fast off-the-shelf delivery time.

Next time an air moving question arises, check Rotron. You'll like the answer. Get more information now by writing for Rotron's Quick Reference Catalog.

Why settle for less when the best costs no more?



ROTRON INC., Woodstock, N. Y. 12498 ☐ 914 • 679-2401 ☐ TWX 510-247-9033
Pacific Div., Burbank, Cal. 91506, 213 • 849-7871 • Rotron B.V., Breda, Netherlands, Tel.: 79311, Telex: 844-54074

18726

Probing the news

says its equipment offers performance that compares favorably with more complicated systems. The cassette recorder-converter, the Transacorder 1025, can handle 15 to 100 cassettes an hour.

One of the first big French stores to take an interest in electronic P-O-S systems was the Société Française

des Nouvelles Galeries Réunies, which has installed Transac systems in several stores.

All the way. But this month, only two years after Transac introduced its cassette system, the same chain-store group decided to go all the way and equip 60 of its biggest stores with complete Singer systems, linked to between 30 and 40 Singer System 10 computers.

That story may be repeated sev-

eral times as the market picks up quickly. So Transac is trying to minimize the risk of losing other potential clients by negotiating a cooperative deal with a U.S. company. The idea is to arrange a cross-licensing agreement so that Transac can supply its equipment as part of a P-O-S system supplied by one or more of the big American manufacturers. However, so far, Transac has had no takers.

In contrast, France's largest electronics company, the Thomson-Brandt subsidiary, Thomson-CSF, is ignoring the potential point-of-sale market altogether—at least for the time being.

The uphill battle against seemingly insurmountable odds being waged by CIT-Alcatel is duplicated throughout western Europe. Germany finds its P-O-S market dominated by foreign firms, although two native companies—Anker Werke AG and Nixdorf Computer AG—are doing their best to turn the game around in the early going in favor of the home team.

Anker, the country's No. 2 maker of conventional cash registers, has been in the electronic point-of-sale market only since last year. The company, which believes that the crossover between electronic and conventional electromechanical registers in West Germany will come in 1980, has sold 200 of its terminals so far in West Germany, Denmark, and France. Nixdorf, a relative newcomer to P-O-S, has an order for 100 terminals from a chain of German photo-supply stores called Photo-Porst.

The situation in Great Britain is similar to that in Germany: two home-grown competitors are challenging the Americans with their own systems.

The market there is estimated at more than a thousand terminals a year for the next three years, with 790 already installed this year—in what is becoming a familiar refrain, mostly equipment made by U.S. firms.

However, the Plessey Co. Data Systems division has turned its light-pen data-capturing system into an inventory setup. The pen, which reads an optical bar code on supermarket goods, has been incorporated into a reordering device from

THERE'S A SIMPLE REASON WHY WE TRY TO HELP YOU USE LSI TO IMPROVE YOUR PRODUCT:

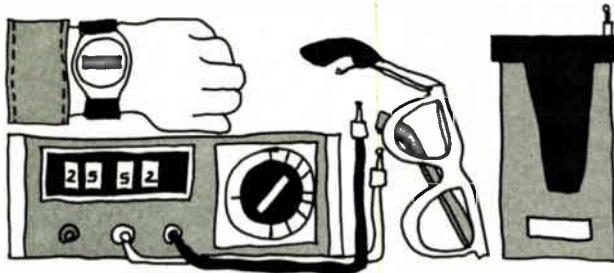

YOU SELL OURS.

When we say we want to help you apply advanced semiconductor technologies to improve your product, we mean it. Because we're motivated.

The reason for our incentive is simple: If your product works better or costs less or becomes more competitive in the marketplace, it will succeed. And when you succeed, we succeed. Because you sell our product.

We've built our business by helping manufacturers use state-of-the-art LSI technologies and processes to extend their own design and manufacturing capabilities. And our people have the know-how and track record to do it for you if it can be done.

We've been involved in developing and producing some of the world's most sophisticated integrated circuits. Like High-Density CMOS, a technique using a silicon-gate system of multi-layer interconnect to optimize the utilization of silicon real estate. And precision Bipolar ICs incorporating high-value thin-film resistors.

We'd like you to think about your product in our terms. If what we know could be of benefit, you should know about it—now. Call, write, or circle reader service number 245 today. We both may have a lot to gain.

WE CAN HELP, TOO.



MICRO POWER SYSTEMS

3100 Alfred Street, Santa Clara, CA 95050. Phone: (408) 247-5350, TWX: 910-338-0154
Japan: Yas Kanazashi, 21 Mori Bldg., 2-2-5 Roppongi, Minato-ku, Tokyo, Phone: 586-0471

store to warehouse that requires no computer. A pen-type reader also is part of Plessey's library checkout system. A gas-station self-service system, using a credit card that unlocks the pumps, is being offered to fleet operators by the Revenue Systems division of GEC-Elliot Automation.

The company also has a more sophisticated service-station system in which the customer must punch out a five-digit code to activate the pumps.

The Japanese also have two manufacturers in the market: Tokyo Shibaura Electric Co. (Toshiba) and Fujitsu Ltd. Toshiba has sold

Singer moves in

Riding high on the soaring U.S. market, Singer has scored its first big success in Europe. With a claimed 50% of the U.S. electronic P-O-S business, Singer is moving fast to gain a head start in Europe. This month, it signed a \$6 million deal with the Nouvelles Galeries group to supply between 1,500 and 2,000 electronic terminals, plus 30 to 40 System 10 computers. Singer figures that by 1978, Europe should have installed a total of 60,000 machines worth \$210 million.

around 150 units, employing an optical bar code with five lines per digit, but the company must sell 150 of its systems a month to make a profit.

Optimism the rule. Toshiba expects point-of-sale business in Japan to take a sharp upturn soon and feels that it can undersell American competitors in Japan. But neither Toshiba nor Fujitsu has revealed any plans it might have to sell its systems in the U.S.

The biggest installation so far sold by Toshiba has been to a seven-store chain of clothing shops. The off-line machines store data in a cassette on standard computer tape. Most of the rest of the Toshiba terminals are in five department-store chains—two in Tokyo, two in Osaka, and one in Kobe. □

Reporting for this article was provided by Gerald Walker in New York, Michael Payne in London, Richard Shepherd in Paris, John Goesch in Frankfurt, and Charles L. Cohen in Tokyo.

New SOLID-STATE FET-INPUT MULTIMETER

from
SIMPSON
of course

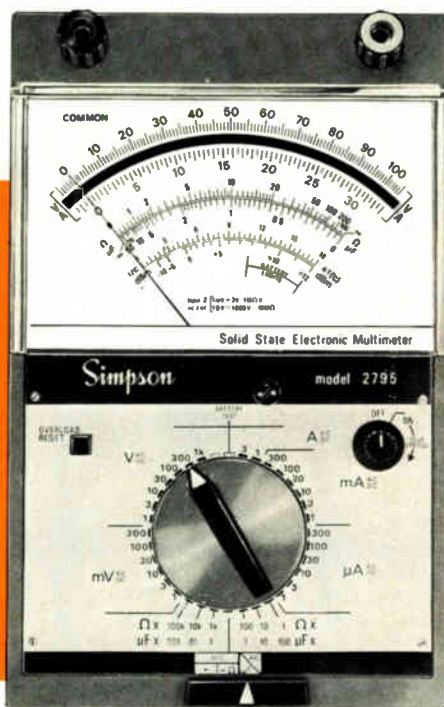

**Model
2795**
PORTABLE,
LABORATORY
ACCURACY,
SOLID-STATE
ELECTRONIC
MULTIMETER

- 68 Switch Selectable Functions:
 - 13 AC and DC Voltage Ranges (as low as 1 MV, full scale)
 - 14 AC and DC Current Ranges (as low as 1 μ A, full scale)
 - 6 low power (IC compatible) Resistance Ranges
 - 6 completely self-contained Capacitance Ranges
- Plus 12 Output Ranges
- Circuit Breaker Overload Protection
- High FET-Input Impedance
- $\pm 1\%$ Accuracy for AC and DC
- Negligible Voltage Drop
- Simple, Straight-Forward Operation
- Size: 8.07" High, 5.04" Wide, 3.94" Deep. Only 3.3 lbs.

2795 MULTIMETER supplied complete with batteries, test leads and operator's manual. Complete accessories available.

\$250⁰⁰

WRITE FOR BULLETIN L-1010 . . . OR CONTACT YOUR SIMPSON INSTRUMENTATION PRODUCTS DISTRIBUTOR FOR OFF-THE-SHELF DELIVERY

Simpson
INSTRUMENTS THAT STAY ACCURATE



SIMPSON ELECTRIC COMPANY

5200 W. Kinzie Street, Chicago, Illinois 60644

Phone (312) 379-1121

EXPORT DEPT.: 400 W. Madison St, Chicago, Ill 60606. Cable Simelco

IN CANADA: Bach-Simpson Ltd., London, Ontario

IN INDIA: Ruttonsha-Simpson Private Ltd., International House, Bombay-Agra Road, Vikhroli, Bombay

Communications

U.S. exports lag behind R&D lead

Broad NAE survey of U.S., foreign telecommunications research urges greater attention to trade, selected research hikes

by Ray Connolly, Washington bureau manager

Leadership in research and development in most telecommunications technologies still rests with the United States. But its mission-oriented nature is limiting exports and opening U.S. markets to increasing competition from abroad.

These are the conclusions of a new National Academy of Engineering survey of U.S. and foreign telecommunications research and applications, released Sept. 21 in Washington. The 10-month study by industry and academic experts labels over-all U.S. outlays on telecommunications research as adequate, but calls for increases in selected development areas to ensure future markets. It also wants more attention paid to communications trade problems by the departments of Commerce and State, plus serious research on human factors (see "Software and people problems").

The NAE report to the National Science Foundation was drafted by a 20-man panel, chaired by Henri G. Busignies, senior vice president and chief scientist of International Telephone & Telegraph Corp. It is scheduled for publication and sale by the Commerce department's National Technical Information Service, Springfield, Va.

Lanced. U.S. telecommunications may even be wounded by its own lance, abetted by the rapidly growing multinational corporations, the report points out. While the "vast amount of U.S. telecommunications R&D applicable to the balance of trade question is open, unclassified, and available to all countries' exploitation," the data flow has been expedited by "the advent of large international companies." Thus, the study concludes, "U.S. research re-

sults do not directly produce a favorable balance of trade for the U.S. Much more important is the rate of exploitation of the results which depends upon the perception of the market, upon the level of development funding, and upon national regulatory, subsidy, and industry-support policies." While other nations have sponsored studies into these factors, the report notes that the U.S., until recently, has not.

Significant development segments singled out by the panel as areas "where good decisions are needed to help ensure future markets for the U.S." include: digital speech transmission, computer networking, biomedical equipment, switching

systems, satellite earth terminals, mass-transit system command and control communications, EDP remote terminals, U.S.-based medical-data banks, and equipment based on microprogramming.

In addition to heavy television and radio-receiver imports, "foreign sales in the U.S. are now building momentum in the 'value-added' equipments peripheral to our common-user networks," the survey warns, as well as in microwave transmission equipment, and high-power vacuum-tube hardware. These trends have been in strong contrast to those followed by computers, which continue in favor of the U.S., even though its share of

Software and people problems

The U.S. needs to give much more support to research into the human factors of telecommunications, contends a National Academy of Engineering panel's report to the National Science Foundation. That support is needed to develop telecommunications engineering as a specialty, to exploit the potential for communications in education and medicine, to improve the efficiency of the man-computer interface, and to combat the problem of "excessive communication" and its potential for saturating man's capabilities.

In calling for increased U.S. efforts in interdisciplinary research, the NAE panel notes that America is doing less well in societal and national needs—not matching its "exploitation of telecommunications in the public interest" to its undoubted leadership "in the 'hard' telecommunications sciences." Greater interdisciplinary competence should be sought "in the larger university environment."

On making men work with machines, the panel concedes that "we understand the machine much better than the man. There are both hardware and software design issues, but software issues are dominant and growing. We have almost no predictive design technology in this area."

The major hardware needs identified with data entry by the panel include "better terminal printers and large screen displays"—both of which are "major cost problems." Nevertheless, the panelists see industry able to overcome the machine problems and urge increased Federal funding be directed toward gaining knowledge of the human operator.

As for the future of communications and terminals in education, the panel recommends only the continuation of such experiments as those of NSF and the Department of Health, Education, and Welfare as training and education aids.

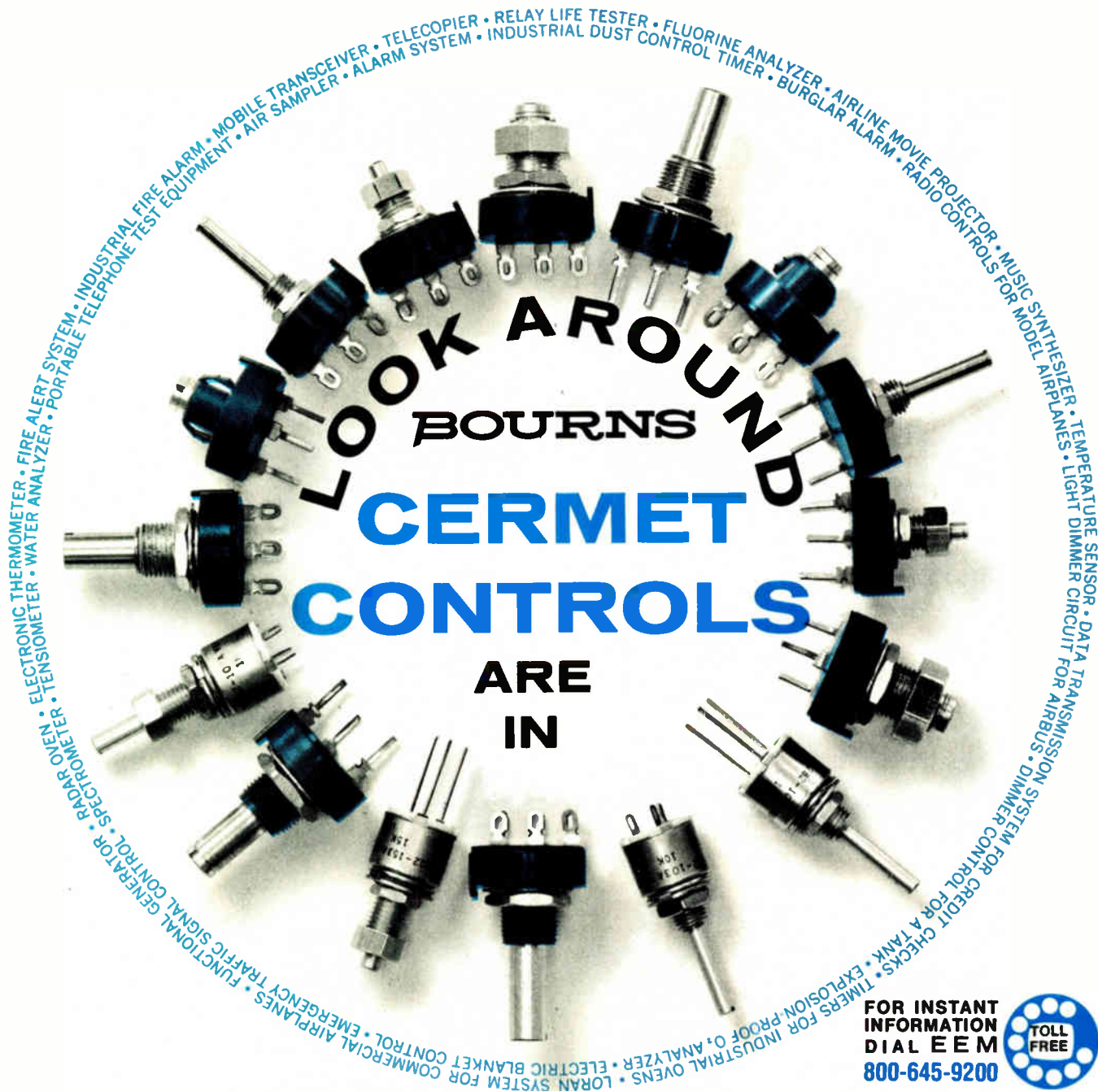

FOR INSTANT
INFORMATION
DIAL E E M
800-645-9200



Take an idea... or do your own thing. Applications for Bourns Cermet Controls turn up everywhere.

Cermet resistance elements offer you a wide advantage in performance over their old-fashioned carbon counterparts. Look for:

- BETTER STABILITY
- HIGHER POWER RATING
- SUPERIOR TEMPCO (± 150 ppm/ $^{\circ}$ C)

Bourns Controls **save space, too.** The $\frac{3}{4}$ " diameter models extend only $\frac{1}{4}$ " behind the panel — that's not far out.

Take a look at our new brochure on Panel Control Potentiometers — 24 pages of cutaways, photos, specifications and prices. Ask for it anywhere Bourns products are sold, or direct from the factory.

HIGH PERFORMANCE

Series 3852: $\frac{3}{4}$ " dia.; metal bushing, locking or non-locking; 2 watts at 70 $^{\circ}$ C; res. to 5 meg., $\pm 10\%$. Typical price per piece \$2.40; (2M) \$0.81.

Series 3862: $\frac{1}{2}$ " dia.; 1 watt at 125 $^{\circ}$ C; res. to 5 meg., $\pm 10\%$. Typical price per piece \$4.20; (2M) \$1.18.

COMMERCIAL

Series 3859: $\frac{3}{4}$ " dia.; plastic bushing or quickly installed snap-in version; 2 watts at 70 $^{\circ}$ C; res. to 5 meg., $\pm 10\%$. Typical price per piece \$1.95; (2M) \$0.66.

MULTI-TURN VERNIER DRIVE

Series 3856: $\frac{3}{4}$ " dia.; metal bushing; 3 $\frac{3}{4}$ turns; 2 watts at 70 $^{\circ}$ C; res. to 5 meg., $\pm 10\%$. Typical price per piece (2M) \$2.01.

Now look at the Controls. **Stocked in depth by Bourns distributors all over. 24-hour delivery on standards.**



TRIMPOT PRODUCTS DIVISION • 1200 COLUMBIA AVE., RIVERSIDE, CALIF. 92507

Help college help you.

Businesses like yours gave over \$340,000,000 to higher education last year.

It was good business to do so. Half of all college graduates who seek work go into business. The more graduates there are, and the better educated they are, the more college serves the business community.

Your money was vital to colleges. It relieved financial pressures, made planning more flexible, and contributed to the kind of basic and applied research that puts new knowledge and technology at the service of industry.

So that colleges can continue to help you, give to the college of your choice now. For information on ways to do it, please write on your letterhead to Council for Financial Aid to Education, Inc., 6 East 45th Street, New York, N.Y. 10017. Ask for the free booklet, "How Corporations Can Aid Colleges and Universities."



Council for Financial Aid to Education, Inc.

Advertising contributed for the public good.



Probing the news

the world computer market is slipping in the face of growing competition. "The situation in the middle ground of computer communications and switches is not yet clear" the report adds.

Switched. One U.S. problem is that it is "without exportable switching products" because most switching research is performed by AT&T's Bell Laboratories for the specific needs of the Bell System. Gaps exist in teletypewriter-network switching research where AT&T does not have a requirement, the report asserts, and U.S. manufacturers are left without sufficient support. And in other areas recently opened to competition by the Federal Communications Commission, U.S. manufacturers other than AT&T's Western Electric "have been left at a disadvantage to foreign manufacturers."

Many other nations, on the other hand, "prepare their national manufacturers for exporting and for meeting import competition through a multiplicity of incentive schemes," according to the panel, which calls for Government incentives in selected telecommunications-switching research. "To be effective," the report argues, "this support should begin at universities with specifically directed NSF grants, extend through industrial R&D, and include provision for lease and purchase by Government agencies of working advanced switching systems."

Beyond the Bell system and its estimated annual \$400 million R&D outlay, other heavyweight supporters of U.S. communications research include the Department of Defense with \$250 million and NASA, whose share is expected to be halved to about \$50 million this Federal fiscal year as it phases out satellite communications R&D, except in support of its own needs. And the space agency "will probably cut it by more in the future," the report concludes. This \$700 million annual R&D expenditure by the U.S. telecommunications leaders, plus an estimated additional investment by private industry, are "well adapted to their needs," the panel notes. Yet it cautions that "the thrust of the de-

velopment effort in the U.S. is not in the direction of creating items suitable for export or to compete with products imported to meet the needs" that are beyond the missions of these groups.

Despite all of this, the panel concludes that present levels of U.S. telecommunications hardware R&D are generally sufficient, except for some areas such as transportation. The needs, in the panelists' view, lie largely in software, as well as in better monitoring of foreign developments for U.S. marketing decisions, Federal support of international standards, and such basic areas as possible spectrum expansion. "The problems of balance of trade," they point out, "do not necessarily justify more R&D in microprogramming, optics, switching systems, or better telecommunications curricula in our universities. The problems are too complex to permit of such straightforward solutions." Trade balances "tend to be overlooked in the ordering of over-all R&D priorities" within the U.S.

Transportation. The panel's single strong call for more Federal attention to, and funding of, hardware R&D came in the area of rail-transportation command and control. In addition to calling for a broader Federal review of that market's needs, the panel urged funding increases at the expense of highway-vehicle communications research if budget restrictions make that necessary. The level of present urban transit-communications R&D "is far below that supportable by the opportunity for significant improvements."

In the area of very-wideband transmission technologies, the report says it has no specific recommendations, even though it notes that several foreign countries—Japan in particular—have some strong programs in progress. These efforts to boost the capacity of coaxial tubes to 30,000 voice channels, to increase microwave radio links to 2,700 voice channels per rf channel, and to investigate classes of waveguides of reduced attenuation "seem to be principally in the nature of advanced development, founded on the same base of research knowledge."

With their advice that the Com-

The Book of MOS.

It's incredible. Some people still think we're just a custom MOS supplier. When here we are with the broadest range of standard MOS products on the market.

To help spread the word about these off-the-shelf items, we've printed a new standard products guide. This little book lists our RAMs, ROMs, shift registers, multiplexers, timing circuits, discretes, music circuits, UARTs, keyboard encoders and character generators. Even off-the-shelf LSI circuits for things like programmable processors, digital clocks and calculator kits.

Our distributors have all these ready and waiting for you in quantity. And they also have plenty of our booklets to give away. If one doesn't land on your desk soon, call your nearest distributor and

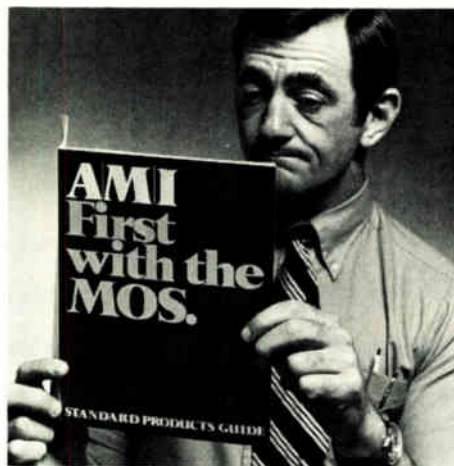

It'll make a believer out of you.

demand a copy. Or write us.

And if our standard products aren't exactly what you're looking for, we'll be happy to discuss designing a custom circuit for you.

We've already created more than 800 of them. That makes us number one

in the business.

We also have more MOS production processes going for you than anyone else in the world. P-Channel, N-Channel, Silicon Gate, Ion Implant and C-MOS.

So there you have both sides of our story: standard and custom. Whichever you choose, you'll be getting MOS products you can really have faith in.

AMI
AMERICAN MICROSYSTEMS, INC.

American Microsystems, Inc.,
3800 Homestead Road,
Santa Clara,
California 95051.

A Tough Capacitor For A Tough Environment

At Nippon Chemical Condenser Co., Ltd., we have devoted a lot of time and energy to improve the various characteristics of miniature scale electrolytic capacitors. Our goal was a product that would withstand problems created by a tough environment; a capacitor that would give top performance in both high and low temperature extremes. The result of our research is a capacitor that will function smoothly at temperatures above 85°C, as well as in bone-chilling conditions that send the mercury to -40°C.

What this means to you is a capacitor that you can rely on, in either the arid Sahara or the freezing Arctic. A capacitor that gives you greater diversity with regard to operating conditions. Moreover, our products are manufactured on one of the world's most highly automated assembly lines, and under quality control techniques that insure precision and uniformity.



OUR PRODUCTS

Aluminium Electrolytic Capacitors
Foil Tantalum Electrolytic Capacitors
Solid Tantalum Electrolytic Capacitors
Electret Condenser Microphone



NIPPON CHEMICAL CONDENSER CO., LTD.

7-8, 2-chome, Yutaka-cho, Shinagawa-ku, Tokyo,
Japan Tel: 785-1251 Cable Add: NICHEMICON
TOKYO Telex: TK-4618

UNITED CHEMI-CON, INC.
1128 Lexington Ave., Rochester N.Y. 14606,
U.S.A. Tel.: (716) 647-1050 Telex: 230978325

Probing the news

merce and State departments take "a more active role" in pursuit of "truly international standards" for telecommunications, the NAE panelists appeared to reflect, albeit mildly, widespread industry unhappiness with Federal interest in pushing issues certain to affect future markets. The report also urges close Federal monitoring of overseas expansion of optical communications technology, a field in which the U.S. "is the unquestioned world leader." World competition, says the panel, "is likely to be strong and relative progress in the application of this technology bears watching."

Hard look at Japan. One of the most comprehensive sections of the 63-page report is in the 19 pages devoted to a survey of Government and industry telecommunications-research programs in Western Europe, Canada, and Japan—with the last receiving the largest share of attention. Prepared by ITT telecommunications director Lynn Ellis, the section wraps up foreign research activities by areas of technology, as well as by country.

Wideband propagation research at frequencies above 10 gigahertz and in support of 2,700-channel microwave systems at 6.4 to 7.1 gigahertz is being pushed strongly by the governments of Japan, Germany, and Italy, and "appears to lead any R&D being done in the U.S.," according to Lynn. Since those frequency bands are allocated in the U.S. to a multiplicity of non-common-carrier services, he points out that U.S. manufacturers will not be able to compete for hardware sales in overseas markets as they develop.

As for microwave equipment and systems, Lynn observes that "Japan can be considered a microwave paradise." In addition to the 2,700-channel equipment, Nippon Telephone & Telegraph is guiding advanced development work on a 400-megabit, four-phase microwave system at 20 GHz that is phase-shift-keyed. Planned for commercial service by 1975, 20 prototype transceivers are undergoing acceptance tests prior to field tests in a 60-kilometer chain with 13 hops. □

Norplex...your reliable hand for printed circuit boards right on through turn-on time

Just the right laminates to handle your applications. Just the right team to help assure they keep on performing, right on through turn-on time. That's Norplex.

Because reliability is what Norplex is all about. In finest-quality, true-to-specs printed circuit board materials. And in customer service through Norplex representatives who are more than just salesmen. They are laminate specialists who want the job done right . . . your way.

And Norplex can offer you a wide choice of grades, foil thicknesses and sheet sizes . . . the widest in the industry. Plus a research and engineering staff geared to designing laminates with special properties for unusual applications. They're available when you need them.

With plants in both Franklin, Indiana and La Crosse, Wisconsin, Norplex has the answers for all your printed circuit board requirements. Start the Norplex team working for you by calling or writing for our latest literature. Norplex Division, UOP (Universal Oil Products Company), Norplex Drive, La Crosse, Wisconsin 54601. Telephone: 608/784-6070.







Norplex[®] laminates
by **UOP**

© 1973 UOP





Circle 85 on reader service card

Rectifier Product Matrix

RCA Rectifiers	 DO-1						 DO-26					
	I_o	0.125A	0.75A	0.75A	1A	1A	2A	0.5A Ava- lanche	0.75A	0.75A Insulated	1A	1A Insulated
I_{FSM}	30A	15A	15A	35A	35A	35A	35A					
$V_{RRM}(V)$	50		1N536		1N2858A							
	100	1N3754	1N440B	1N537		1N2859A	40266					
	200	1N3755	1N441B	1N538		1N2860A	40267		1N3193	1N3253	1N5211	1N5215
	300		1N442B	1N539		1N2861A						
	400	1N3756	1N443B	1N540	1N1763A	1N2862A			1N3194	1N3254	1N5212	1N5216
	500		1N444B	1N1095	1N1764A	1N2863A						
	600		1N445B	1N547		1N2864A		40808	1N3195	1N3255	1N5213	1N5217
	800							40809	1N3196	1N3256	1N5214	1N5218
	1000									1N3563		

RCA Rectifiers	 DO-15		 DO-4			 DO-5			
	I_o	1A	1.5A	5A	6A	10A	12A	20A	40A
I_{FSM}	30A	50A			160A	140A	240A	350A	800A
$V_{RRM}(V)$	50	44001	1N5391	1N1612	1N1341B	40108	1N1199A	1N248C	1N1183A
	100	44002	1N5392	1N1613	1N1342B	40109	1N1200A	1N249C	1N1184A
	200	44003	1N5393	1N1614	1N1344B	40110	1N1202A	1N250C	1N1186A
	300		1N5394		1N1345B	40111	1N1203A	1N1195A	1N1187A
	400	44004	1N5395	1N1615	1N1346B	40112	1N1204A	1N1196A	1N1188A
	500		1N5396		1N1347B	40113	1N1205A	1N1197A	1N1189A
	600	44005	1N5397	1N1616	1N1348B	40114	1N1206A	1N1198A	1N1190A
	800	44006	1N5398			40115			
	1000	44007	1N5399						

Fast Recovery Types

RCA Rectifiers	 DO-26		 DO-15		 DO-4		 DO-5	
	I_o	1A			6A	12A	20A	40A
I_{FSM}	35A				125A	250A	300A	700A
$V_{RRM}(V)$	50		44933		43879	43889	43899	40956
	100		44934		43880	43890	43900	40957
	200	TA7892	44935		43881	43891	43901	40958
	300				43982	43892	43902	
	400	TA7893	44936		43983	43893	43903	40959
	500							
	600	TA7894	44937		43984	43894	43904	40960
	800	TA7895						
Reverse Recovery	Time t_{rr}							
	Typ.	200 ns	200 ns		200 ns	200 ns	200 ns	200 ns
	Max.	500 ns	250 ns		350 ns	350 ns	350 ns	350 ns

RCA SOLID STATE OFFERS YOU A BROAD LINE OF RECTIFIERS WITH THE BEST CHARACTERISTIC YOU CAN ASK FOR RIGHT NOW...

AVAILABILITY

RCA's broad line of standard and fast recovery rectifiers is only a phone call away. Go ahead... try us out. Pick out a type and order it. You'll be delighted at the speed with which you can get the finest rectifiers available. Just call your local RCA solid state distributor or RCA directly.

Want more information? Write RCA Solid State, Sec. 70I-27, Box 3200, Somerville, N.J. 08876. Or phone: (201) 722-3200.

RCA Solid
State

INTERNATIONAL: RCA, Sunbury-on-Thames, U.K., or Fuji Building, 7-4 Kasumigaseki, 3-Chome, Chiyoda-Ku, Tokyo, Japan. In Canada: RCA Limited, Ste. Anne de Bellevue 810, Canada.

Lockheed Introduces 192

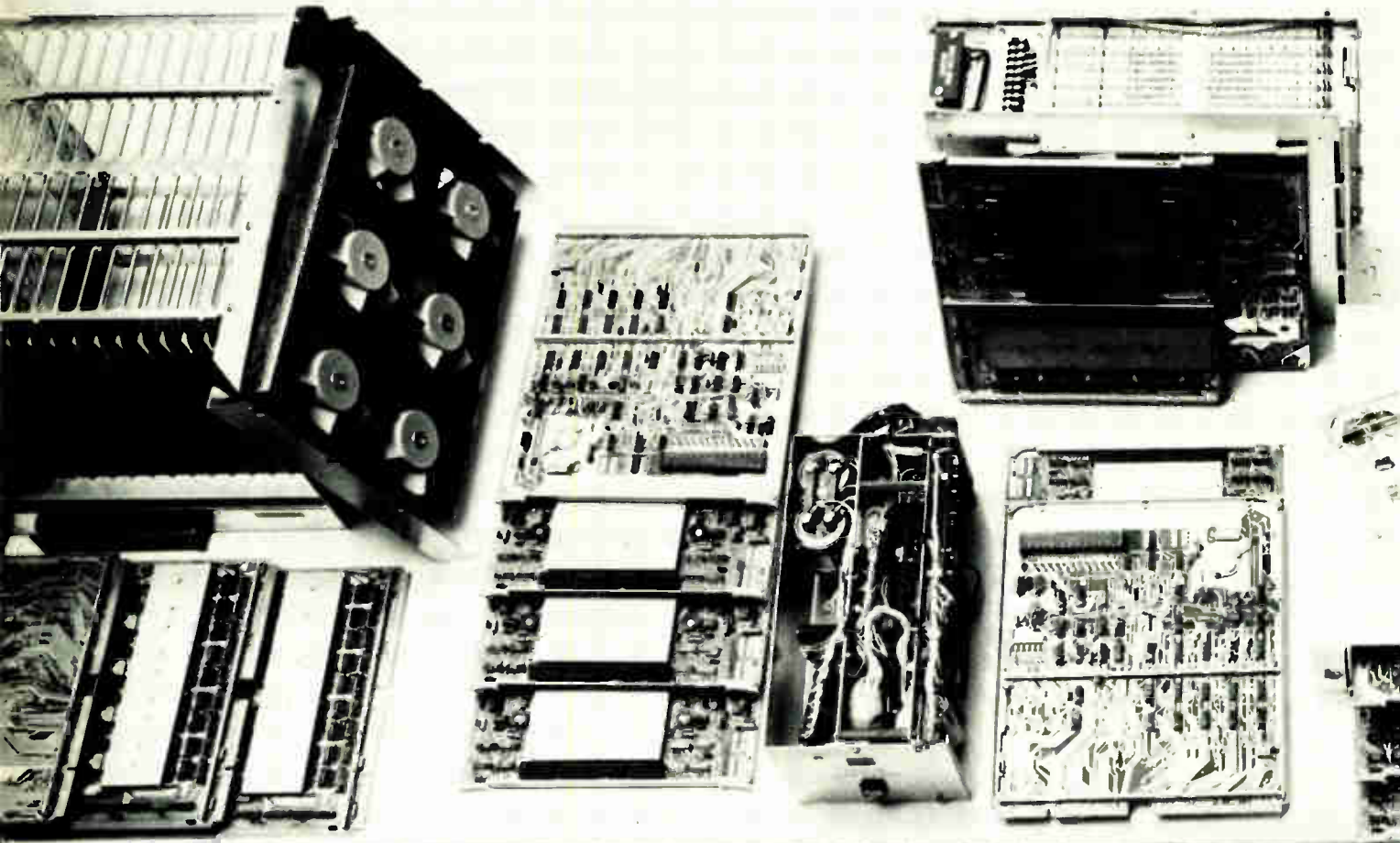

Lockheed Electronics
SENTINEL Memory System
makes it all possible. With
SENTINEL you have the advantage of
buying a customized memory, while
paying only a standardized price.

SENTINEL consists of standard modular

memory boards, power supplies and chassis.
These can be combined in 192 ways to
satisfy almost any customer's specific need.

Because SENTINEL is modular, it gives
you flexibility in putting together your own
system. Or we can do it for you at half the
cost and time of starting from scratch.

New Memory Products.

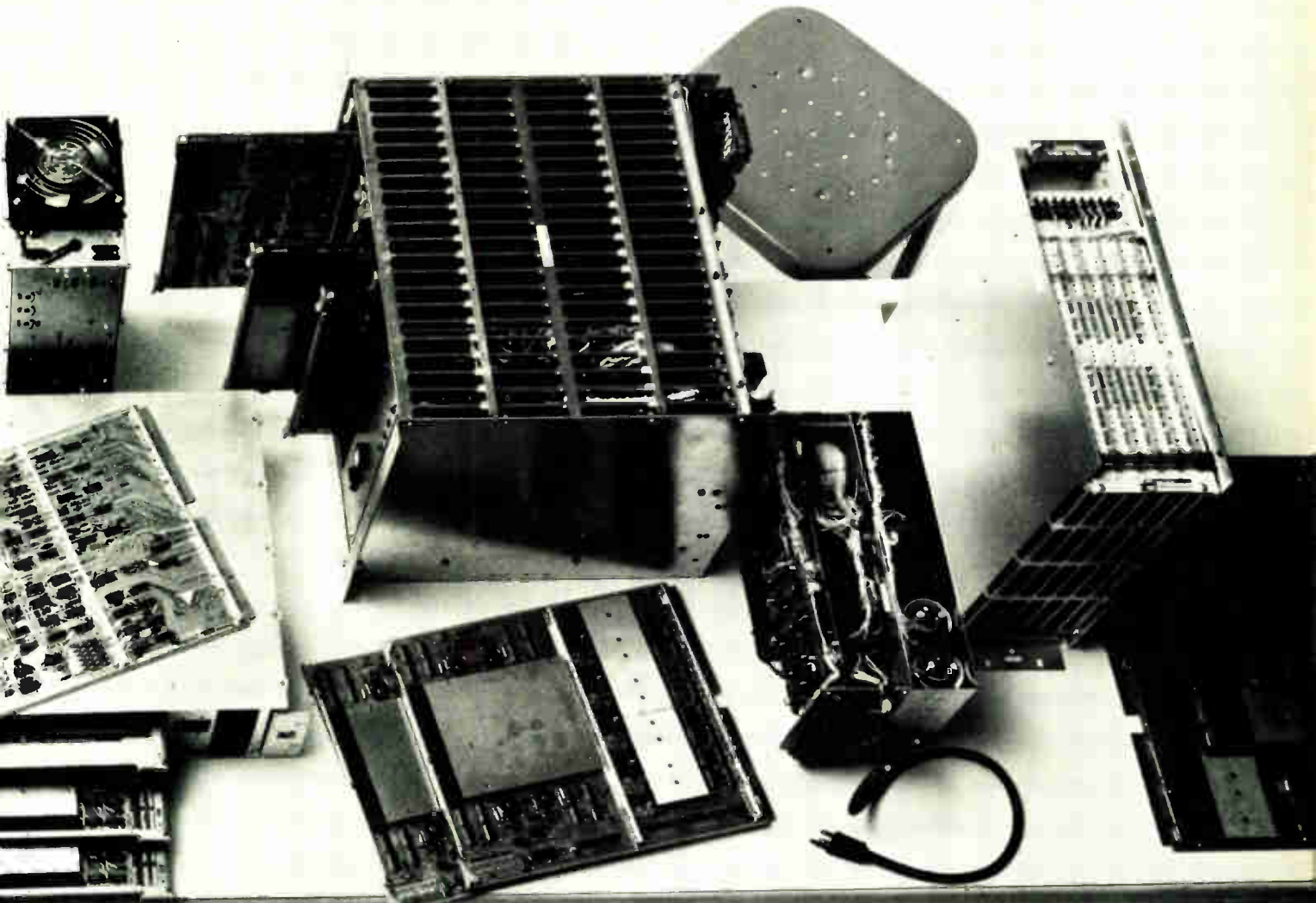

One of the beauties of the SENTINEL Memory is that you don't have to buy the entire system to get exactly what you need. SENTINEL flexible combinations include assemblies from 4K by 18 up to 128K by 36 or any combination in between

in modular increments of 4K, 8K or 16K words... all at submicrosecond speeds.

For more information on SENTINEL, write Lockheed Electronics, 6201 East Randolph Street, Los Angeles, California 90040. Or call (213) 722-6810.

At Lockheed we build custom memories from stock.

Lockheed Electronics Data Products Division.

\$5,600 BUYS A NEW 16K NOVA 2.

Data General Corporation Department E
Southboro, Massachusetts 01772

- Please send me more information on Nova 2.
- Please have a salesman call on me.
- Please add my name to your mailing list.

Name

Title

Company

Street

City

State

Zip Code

Telephone

Nova 2 is so inexpensive that it even looks good with a quantity-one price tag of \$5,600*. And after our liberal quantity discounts are applied, the price looks even better. Especially when you consider what your money buys.

It buys a Nova 2 that includes a high-speed, multi-accumulator central processor unit, a 16-bit word length, I/O system with programmed data transfer, 16-level programmed priority interrupt, high-speed Direct Memory Access data channel, programmer's console, 4-slot main-frame, and power supply.

It buys 16,384 16-bit words of 1000-nanosecond memory. That's twice the memory of other computers with comparable price and performance.

It buys a product concept whose reliability has been proven in over 7,000 installations around the world.

It buys a Nova 2 that's backed by a comprehensive customer-support organization that can provide documentation, training, field and factory service, and applications know-how.

It buys a Nova 2 that's entirely compatible with Data General's options, peripherals, interfaces and software.

\$5,600. You get a lot for your money.

*Minimum order, five systems.

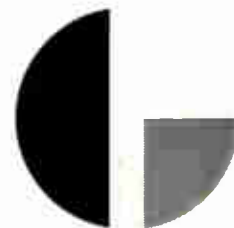

DATA GENERAL
CORPORATION

Southboro,
Massachusetts 01772
(617) 485-9100

NEW FAST ANSWER FOR ELECTRONIC NOISE PROBLEMS...



Ceramag® Ferrite Beads on Lead Tape

Stackpole Ceramag® ferrite beads provide a simple, inexpensive means of obtaining RF decoupling, shielding and parasitic suppression without sacrificing low frequency power or signal level.

Now beads are available with leads, cut and formed or on lead tape. Most equipment that is capable of automatic insertion of lead tape components can be modified to accept this special Stackpole bead.

No other filtering method is as inexpensive . . . and now as fast to insert in your circuit. Starting with a simple ferrite bead (a frequency-sensitive impedance element) which slips over the appropriate conductor, Stackpole has available a variety of materials and shapes providing impedances from 1 MHz to over 200 MHz. The higher the permeability, the lower the frequency at which the bead becomes effective.

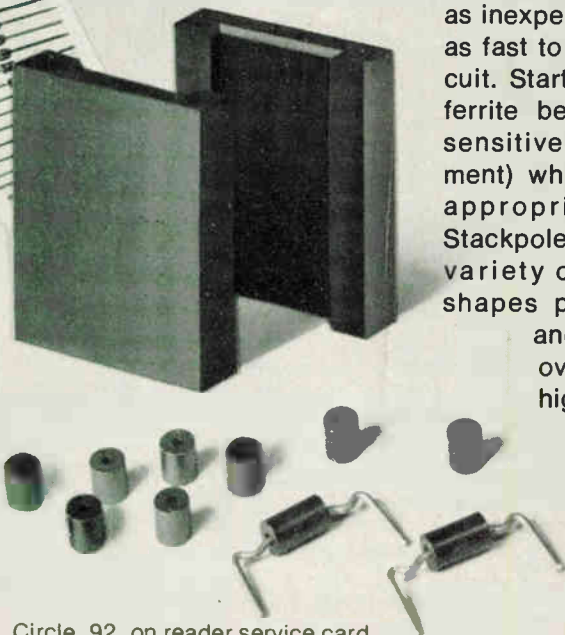

CERAMAG® FERRITE BEAD CHARACTERISTICS

GRADE NUMBER	24	7D	5N	11
Initial Permeability	2500	850	500	125
Volume Resistivity @ 25°C	1.0x10 ²	1.4x10 ⁵	1.0x10 ³	2.0x10 ⁷
*Effective Suppression At:	1 MHz	20 MHz	50 MHz	100 MHz
Curie Temperature	205	140	200	385

*A tutorial guide on how these passive components behave with frequency and geometry is available from the Electronic Components Div.

Impedance varies directly with the bead length and log [O.D./I.D.]. Beads are available in sleeve form in a range of sizes starting at .020" I.D., .038" O.D., and .050" long. The bead on lead tape is .138" O.D. and .175" long. Where quantities warrant, other beads on leads and/or lead tape are a design possibility. Tight mechanical tolerances are held in sizes and shapes as varied as the pair of giant, mating channels shown on the left which are used to eliminate the effect of transient noise in computers.

Sample quantities of beads are available for testing. Consult Stackpole Carbon Company, Electronic Components Div., St. Marys, Pa. 15857. Phone: 814-781-8521. TWX: 510-693-4511.



Design simplicity cuts costs for German color-video disk system

The plastic disk material is the least expensive video storage medium in use today, a specially designed scanner enables mechanical playback through TV sets, and the pressing technique provides fast reproduction

by Gerhard Dickopp, *Telefunken Fernseh und Rundfunk GmbH*, and Horst Redlich, *Telefunken-Decca GmbH, Berlin, Germany*

□ Development of the television disk system (TED) now makes possible low-cost playback of color pictures, together with accompanying sound, on standard TV receivers. And even though the disks are recorded only on one side, their cost—compared with competing tape systems—is attractive for the consumer market.

Single-disk PAL (phase-alternating line) video-playback units will become available at the beginning of 1974, and a disk-changer playback unit will follow about a year later. With the changer, it will be possible to play 12 disks in almost uninterrupted sequence—the dead time between two disks will be only about 5 seconds.

Essentially, TED is to picture-storage technology what the phonograph record was to audio recording. Like the phono record, the video disk provides high information density, low-cost recording medium, simple playback equipment, random access to any desired portion of a recording, and economical, high-speed duplication.

The video disk stores more than 100 times the capacity of an audio record, and the video-disk scanner can handle a flow of information that's also 100 times faster than a phonograph pickup can. Moreover, the video disk player can freeze a frame on the TV screen and speed up or slow down action.

The video disk, like the sound record, is pressed plastic in the form of foil about 0.1 millimeter thick, only slightly heavier than newsprint. Information is carried in relief inside a groove that spirals inward. The disk's outer diameter is 21 centimeters (about 8 inches), of which 10 to 20 cm are occupied by the spiraling track.

The video track has a width of only 3.5 micrometers and a depth of less than 1 μm . In marked contrast to conventional sound-recording surface structure, deformations inside the groove, which are shaped like sine waves, have minimum period of about 2 μm and peak-to-peak amplitude of 0.3 to 0.4 μm (Fig. 1). The disk is scanned by a sensor shaped in cross-section roughly like the front curve of a sled runner with a diamond tip at the rear on the bottom of the runner, which is solid. The disk rotates toward the curved front of the runner-shaped sensor.

To simplify playback-equipment design, the disk is laid out for constant rotational speed. One revolution

produces a complete TV-picture frame. Since the track spirals become progressively smaller during playback, the disk area for each TV picture also becomes smaller; therefore the groove containing the innermost frame occupies only about 1 square millimeter.

At a bandwidth of nearly 3 megahertz and a 40-decibel video-signal-to-noise ratio, the area of the innermost groove translates into a storage density of more than a half-million bits per square millimeter. A standard 21-cm disk has a playback time of 10 minutes, but a 30-cm diameter would be required to provide 20 to 30 minutes.

Both video and audio signals are frequency-modulated. The composite video signal on the disk includes constant periodic synchronizing and blanking pulses, as well as the varying picture information pulses. Putting

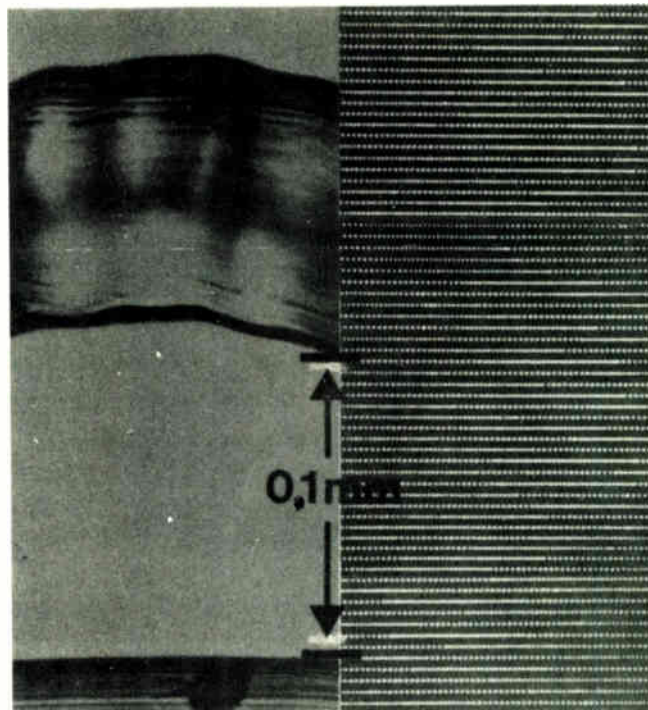

1. Groovy. Comparison of the video disk's grooves (right) with those of a phonograph record dramatizes the high density of the TV-storage track's width of only 3.5 micrometers.

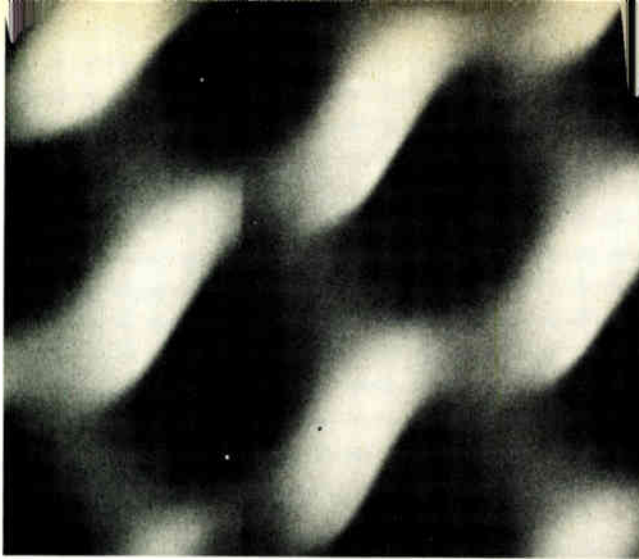

2. **Close up.** View of the video disk through an electron microscope shows the surface after a cutting from a master disk. Procedure is similar to mechanical cutting of audio records.

exactly one TV picture into a winding leads to a radial arrangement of synchronizing and blanking pulses on the disk surface. During scanning, synchronization is maintained when the scanner skips from one winding into an adjacent one, which makes possible reproduction of still pictures and frame repetition, as well as fast-motion and slow-motion scenes.

Making the disk

Images and sound can be recorded by laser or electron beams or by the mechanical cutting process used for conventional records. Although the first two methods offer original-speed and original-frequency recording, Teldec presently prefers the last (Fig. 2).

Recordings can be pressed from standard motion-picture-film sources or, in the future, from video magnetic tape for picture information and from audio tape for sound. Prior to recording, the composite video signal and the sound signals are each frequency-modulated, then additively superimposed, and finally recorded in the video-disk track (Fig. 3).

The audio and video signals must be manipulated to ensure that there is no noticeable signal interaction, despite the overlapping of picture and sound channels. To prevent picture distortion by sound signals, the sound-

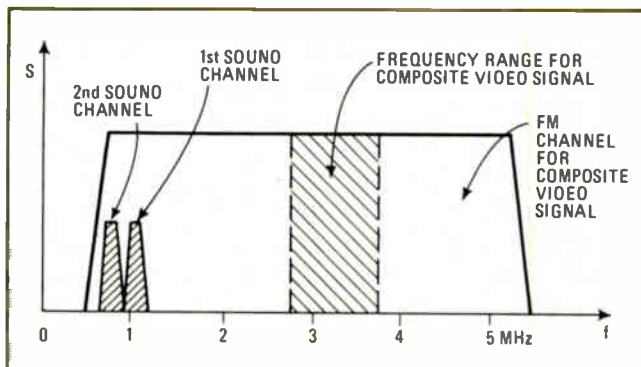

3. **Channel selection.** Audio and video channels are assigned the frequencies above, but prior to recording, the composite video signal and the sound signals are frequency-modulated and then additively superimposed in the track.

carrier amplitude is lowered by about 30 dB with respect to the picture carrier. This limits the sound-carrier deformations in the track to a peak-to-peak amplitude of only slightly more than 100 Å, a value corresponding to a small fraction of the chain length of the molecules in the disk material. Since amplitudes of this magnitude are hardly traceable, even with an electron/scan microscope, they are adequate for good, interference-free sound reproduction.

Channel overlapping can also cause sound distortion by the picture if strong video-signal frequency components get into the sound channels. To eliminate this possibility during the recording process, the sound-carrier amplitude is raised when strongly structured picture contents are encountered.

This interference-suppression raises the question: If, in order to prevent the sound signals from distorting the picture, it is necessary to lower the sound carrier amplitude by 30 dB with respect to the picture carrier, then why is the picture not distorted as a result of the sound carrier's raised amplitude portions?

The sound is, indeed, distorted at the picture segment in question, but since the distortion is present only where the picture contents are strongly structured, the human eye does not detect it. This is an optical "cover-up," an effect also known in acoustics, whereby noise components in the same frequency range as that of the information signal have a smaller interference effect.

Color signals are encoded in a trisequential technique, TriPAL, for equipment operating by the PAL color-TV standard. In TriPAL (Fig. 4) the color signals red, green, and blue are recorded sequentially and in line-by-line fashion, but only in the low-frequency range up to about 500 kHz. For good picture definition, the luminance signal's high-frequency components, the so-called mixed highs, are also put into each line.

The signal-to-noise ratio achieved by this encoding technique is just as good for color as it is for black-and-white signals. Thus the full dynamic range of the video channel is also available for color recording. A slight variation of the TriPAL technique, TriPAL-D (for disk), which is tailored to the video disk's needs, involves pre-compensation methods during color encoding to solve the problem of color streaks that sometimes mar pictures recorded by conventional sequential techniques.

Worldwide compatibility

Although the color-encoding technique for the video disk is independent of the different color-TV systems in use around the world, the only design considerations needed to accommodate them are the two different line and frame frequency norms. Consequently, only two disk versions are needed—a 1,500-rpm type for 625-line/50-Hz norms used in Europe and an 1,800-rpm type covering all 525-line/60-Hz systems used in the U.S., Japan, and elsewhere.

With equal physical dimensions, both versions will yield practically the same playback time if the inside diameter of the track spiral on the 1,800-rpm disk is made smaller than that of the spiral on the 1,500-rpm type. This reduction in the recording track is convenient because the surface structures on the 1,800-rpm version have longer wavelengths at a winding diameter corre-

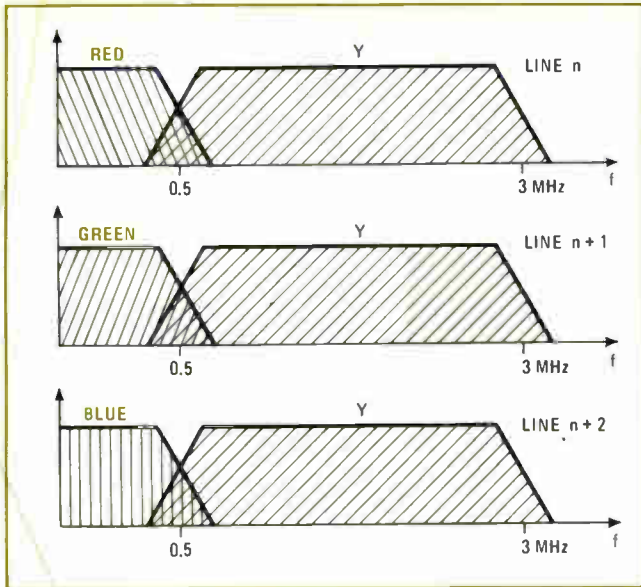

4. Color encoding. In encoding process called TriPAL, the color signals are recorded sequentially in line-by-line fashion, and pre-compensation process prevents streaking.

sponding to that of a 1,500-rpm type.

Techniques for duplicating the video disk and the sound recorded are similar. In both operations, a stamper is made from a master by electroplating methods. The stamper then serves to transpose its cut surface onto plastic material in a one-step-process.

The video-disk material is rolled-up polyvinyl-chloride foil. Although the normal press cycle is from 10 to 20 seconds, it can be reduced to a few seconds, and eventually, it will be cut to less than one second.

Since a TED does not require any time-consuming, expensive, after-treatment, such as metalization, it will be possible in the future to press video disks at speeds comparable to printing newspapers. To shorten duplication time, video disks carry information on only one side, which is justified by the disk material's low cost.

As the groove spirals toward the center, the scanner covers less linear distance, which means that the density of the "hills and dales" becomes higher toward the center. The information density, however, is nearly the same over the entire disk because the signal-to-noise ratio of the picked-up signal is higher at that part of the disk where the hill-and-dale density is lower.

In recording, a master frequency generator synchronizes three pieces of equipment: the film scanner, the generator for producing the synchronizing and blanking pulses, and the recording turntable. In playback, the synchronizing pulses come from the disk in such a manner that there is one TV picture per disk revolution; in other words, the composite video signals are all picked up from the disk at once.

Scanning, the key decision

A high-density storage disk can be scanned by electrical, magnetic, optical, or mechanical techniques. For this application, Telefunken/Teldec chose a mechanical pressure-scanning technique and developed a special sensor for the task, but this technique differs greatly from the system used for sound-record playback.

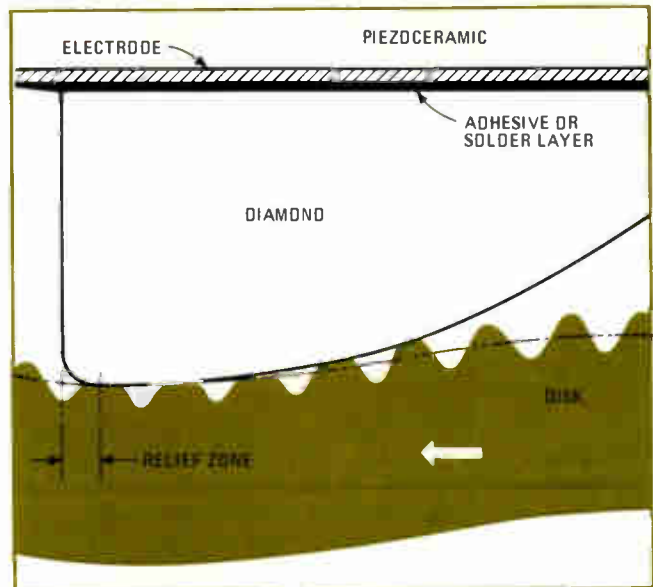

5. On the skids. The key to pressure scanning used in Teldec system is the precise shape of the scanner, which is designed to skid along the disk surface with minimum of wear.

In selecting the scanning device, these factors were considered:

- The cost for the scanning method should be in proportion to that of the disk and the playback equipment.
- The scanning method should make the system usable in as many applications as possible.
- The method should be as nearly immune to obsolescence as possible.

An important criterion for determining the efficiency of a scanning technique is resolution of the scanning device, but this is not the only one. Applicability must also be considered. To illustrate: From the point of view of resolution, a focused electron beam would be efficient, as is evidenced by the electron-scan microscope, with which resolutions of several hundred angstroms can be obtained. But this method is also the most expensive and therefore unsuitable for a mass-produced product.

And although the other scanning methods in use today cost much less, resolutions are nearly equal. In optical systems, the maximum resolving power depends on the wavelength of the light with which the size of the scanned spot can be determined. With a helium-neon laser as a light source, the minimum diameter of this spot is from 1 to 2 μm . Mechanical and electrical systems using suitable scanning devices can scan somewhat smaller spots, but neither system will yield a reduction of more than one order of magnitude.

Trying to refine the scanning device further would not be practical for another reason. The resolution limits discernible today—at least those for a mass-duplicated information carrier—are not set by the scanning methods, but by the surface quality of the storage medium. Even electron-beam scanning would not significantly improve the quality of a reproduced signal. A quality improvement or an increase in storage density could be achieved only by improving the information-carrying surface.

The classical mechanical scanning method for the sound record is based on the capability of the turntable

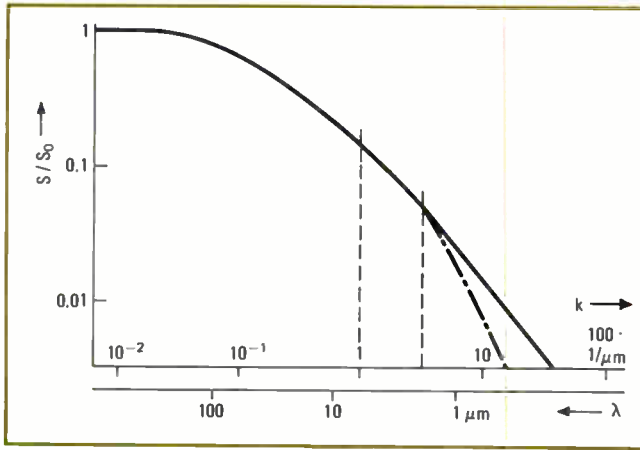

6. Scanner performance. This curve, the output voltage of the scanner as a function of wavelength at constant frequency, is used to analyze the efficiency of the skid-shaped scanner.

to move the recorded track against the pickup needle. The needle movement is then converted by an electro-mechanical transducer into an electrical signal. But, because of the needle's inherent mass, the conversion of groove deflections into a corresponding scanner motion takes place only within a limited frequency range. For a "motion scanner," this range, whose upper practical limit can be around 100 kHz at the most, will suffice for single or even multichannel sound reproduction but not for good picture reproduction. For that, a scanning system is required to have a frequency range that is higher by a factor of 50 to 100.

In pressure scanning, the scanner is virtually motionless, and during the scanning process it converts pressure pulses coming from the disk surface into electrical signals. Figure 5 shows one possible basic configuration for the pressure scanner. The illustration represents a

cut along a track's longitudinal axis and through both the disk and the scanner, although the relative sizes of the components has been changed for the sake of clarity. Specifically, it shows a diamond scanning tip in contact with the disk surface with the tip rigidly attached to a piezoelectric transducer body.

When the disk moves under the scanner, the surface deforms as a result of tracking forces and disk elasticity. During the scanning process, the scanner senses the total force acting upon it—that is, it registers the pressure integral over the entire contact area. If that area extends only over a half-wavelength of the recorded hill-and-dale structure, it is obvious that pressure pulses will be sensed in rhythm with the passing hills, regardless of the shape of the scanner tip.

However, if the tip rests on several hills, an asymmetrical skid-like shape for the tip is best. This shape causes the surface deformation, and thus the pressure, to increase gradually at the tip's front end. At its sharp-edged rear end, the deformation and pressure decrease rather abruptly.

A mathematical analysis of the pressure integral over the whole skid shows that the scanner registers a "force" signal that approximates the signal behavior at the scanning tip's edge. Figure 6 shows the curve for the information-carrying variable force exerted on the skid as a function of wavelength. The values correspond roughly to the conditions of the disk/scanner contact described above.

The solid curve (Fig. 6) has two ranges. In the horizontal range, the distance over which the skid bears down on the surface is short, compared with the wavelength. In the slanting range of the curve, the opposite conditions exist. Here, the bearing length is large, compared with the wavelength, and the amplitude of the scanned signal decreases in the proportion $1/k$. This

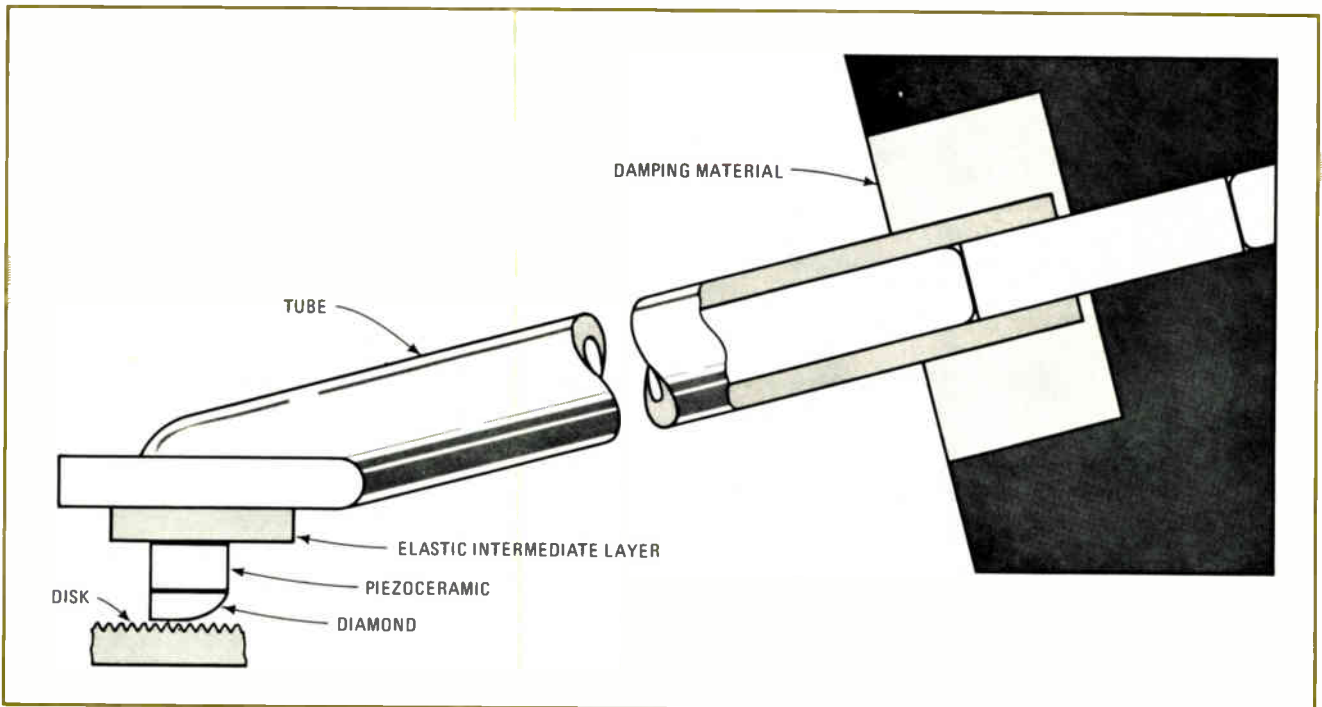

7. Under pressure. The scanning skid is connected by an adhesive to a piezoelectric transducer, which generates an electrical signal from the diamond-tipped pressure scanner riding on the disk.

is where video-disk scanning primarily takes place. During the scanning of extremely short wavelengths, the skid's rear edge is not arbitrarily sharp. This makes for the more pronounced signal drop, as indicated by the dot-dash-lined portion of the curve in this figure.

It follows that the resolving capability of the pressure scanner is determined by the length of the pressure-relief zone at the skid's rear edge. With present scanners, that zone is about $0.5\ \mu\text{m}$ long, so that wavelengths of $1\ \mu\text{m}$ are clearly detectable. The force exerted on the skid represents the primary signal, but what is processed is the electrical signal generated in a suitable electromechanical transducer. That signal depends, not only on the force that excites it, but to a large extent on the scanning-system design (Fig. 7). The scanning skid is connected to a piezoelectric transducer by an adhesive or solder layer. The transducer, in turn, is attached to a small supporting tube by an elastic intermediate damping layer.

The actual size relationship between the most important scanner components and the disk track appears in Fig. 8. It shows a cut through the scanner transverse to the track. The structure can be approximated in the form of the equivalent circuit on the right of Fig. 9 in which the portion enclosed by the dotted line (with elements concentrated for clarity) shows the behavior of the piezoelectric transducer body. The ceramic transducer is bonded tightly by an adhesive layer to the diamond, which is excited by a low-resistance source. The whole structure is connected to the supporting tube, assumed to be at rest, by the elastic intermediate layer, which acts as a strong damping spring.

At a constant exciting-force amplitude, the scanner's output signal will follow a predictable frequency curve (Fig. 9) in which the upper resonance point corresponds approximately to the lowest resonance frequencies for the ceramic. The lower resonance point is the system's oscillating behavior to which the scanner's total mass and the elastic layer's spring characteristics contribute.

The usable frequency range for the scanner as now designed extends from several hundred kilohertz to more than 6 MHz. In the middle of this range, at around 3 MHz, the skid moves through a distance of only a few angstroms as a result of the forces acting upon it. The scanner's average output voltage is 10 to 20 mV.

These signals are so much higher than the scanner and preamplifier noise that, given a disk with an ideal surface, they would allow a signal-to-noise ratio of more than 60 dB in the reproduced signal—in other words, the scanning system has a signal-to-noise "store" of around 20 dB. As small as this "dB reservoir" may presently be, there are indications that, with an ideal surface, usable signals for picture reproduction will be possible from a track only $0.5\ \mu\text{m}$ wide.

This "dB-reservoir" could be made even bigger if there could be better mechanical matching between the scanner and the disk. And because the mechanical input impedance at average picture-carrier frequencies is several decimal powers higher than the disk's mechanical internal impedance, the benefits derivable from pressure-sensing systems are far from fully exploited by the present disk.

The disk's one-TV-picture-per-revolution arrange-

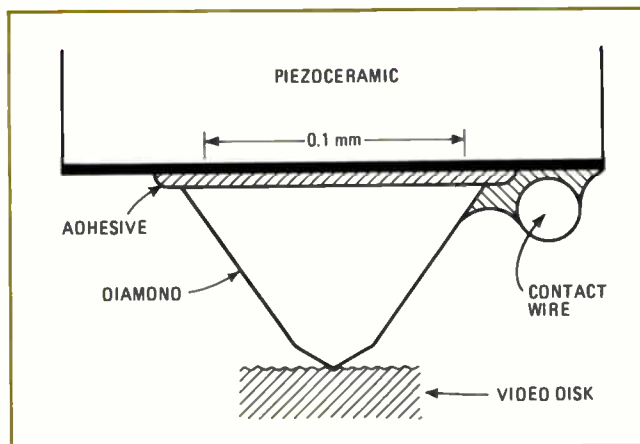

8. Cross section. A better illustration than Fig. 7 of the actual size relationship of the skid scanner, piezoceramic transducer, and the disk surface underscores the simplicity of the pressure scanner.

ment necessitates a high scanning speed—around 10 meters per second. At that speed, the force with which the scanner bears upon the disk is subject to considerable variations, caused by the disk's unevenness; therefore, a signal-encoding process that necessitates pressure-amplitude evaluation during scanning would hardly be suitable for the TED disk.

However, encoding processes that put the information along the time axis have proven suitable. In this process, the application of frequency modulation has been found advantageous for all signal components laid in the track.

During the scanning process, both the disk and the skid are subject to wear from mechanical contact. If the tracking force is kept below 0.1 gram—which can easily be done with the scanner support used—wear results primarily from handling, rather than from playback. If the disk is handled carefully, it can be played more than a hundred times without serious reduction of the signal-reproduction quality. To compensate for the amount of wear that the diamond skid does sustain, the playback unit incorporates a repolishing system that keeps the scanner's tip in good condition. In this process, lasting only a few seconds, the diamond is abraded to a depth of less than $100\ \text{\AA}$.

Displaying video information

In an ordinary record player, sound is picked up by having a low-speed turntable move the disk against the pickup device. However, video-disk playback requires high rotational speeds. The disk is driven only at its center, and while rotating, it hovers on a rotation-induced air cushion above a stationary plate. During playback, the foil adapts to the surface of the stationary plate, which makes for quiet operation. Thus, the disk's floppy characteristic turns out to be an advantage, not only in low cost and fast duplication, but also in the simplicity possible in the playback unit.

Like the audio groove, the track on the video disk serves both an information track and as the guide for the scanning device. Since the track spiral on the video disk has a uniform spacing density over the whole recorded area, the playback unit can operate with a simple course control, designed as a forced-advance sys-

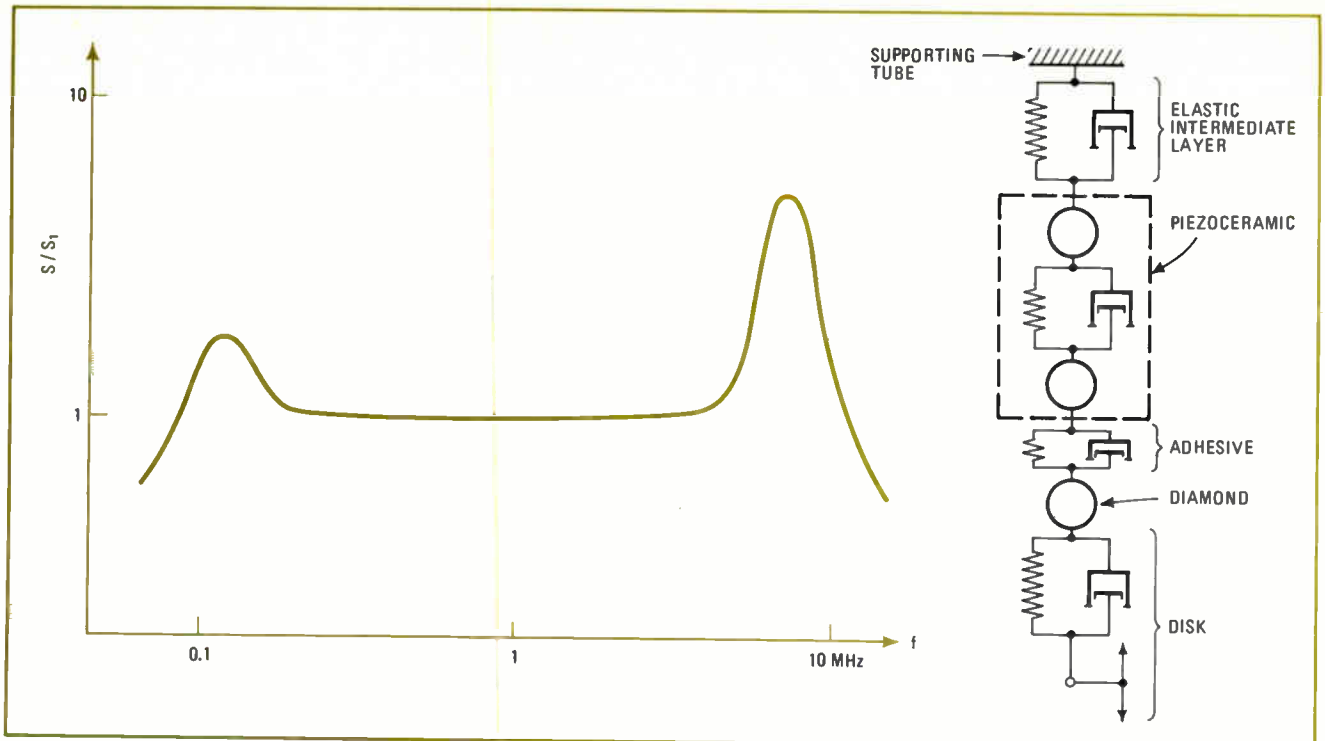

9. **Response under pressure.** The structure of the pressure-scan design is approximated by the equivalent-circuit diagram, right, and its predictable output signal for constant exciting force is depicted in graph, left.

tem for the scanner. The track itself needs only to handle the job of fine control. To do this, the scanner is elastically attached to the forced-advance system and is held on the disk surface by the support tube's spring tension.

The scanner support allows accurate tracking, despite the scanner's light bearing force. The support, which is

capable of compensating for any appreciable vertical and horizontal disk wobble and for any inaccuracies in the scanner's advance, thus eliminates the need for high-precision items in the playback unit. And since it is a low-cost item, the support satisfies the requirement that a playback unit's cost be in same category as that of the disk. What's more, the scanner support, in combina-

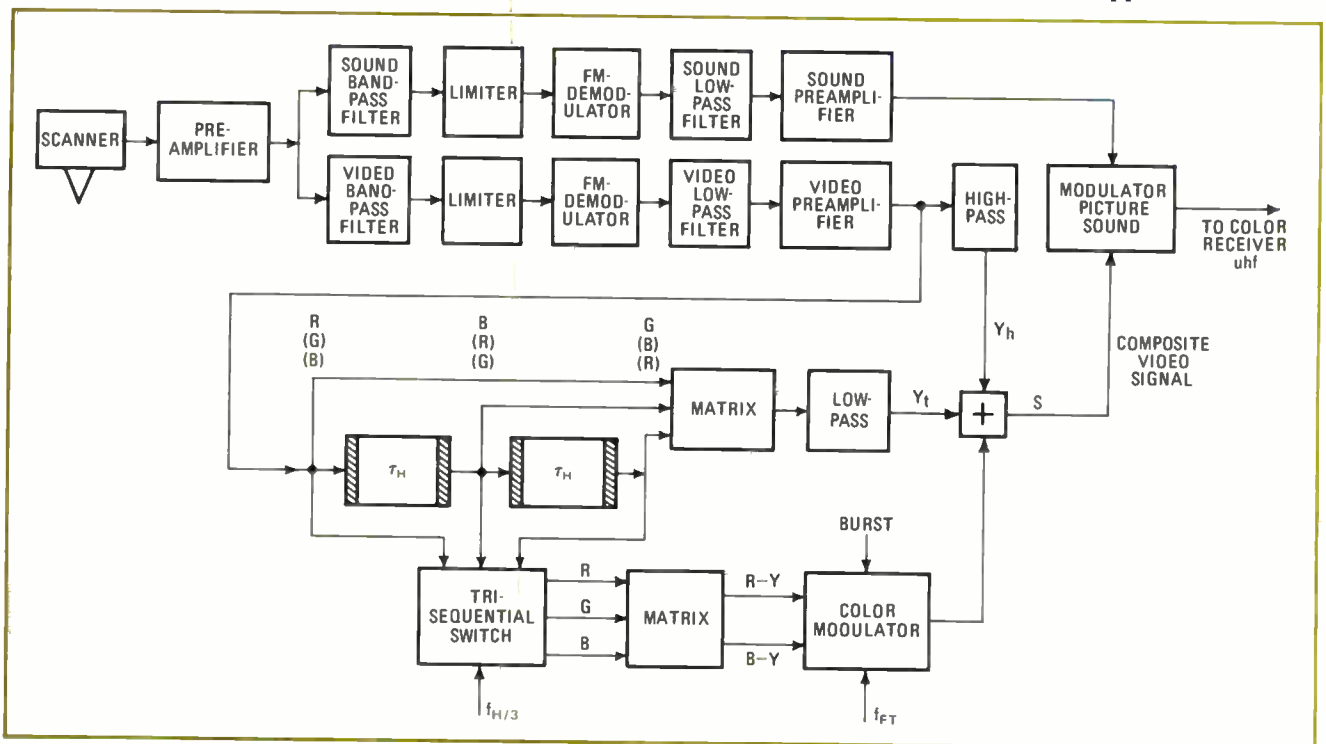

10. **From disk to screen.** This simplified block diagram shows the signal-processing function of the video-disk playback unit. Again the emphasis is on simplicity in order to keep the cost of the player in close relationship to the low cost of the disk.

Jockeying for the disk market

All of the big international manufacturers of consumer-electronics equipment, as well as a few newcomers in Europe, Japan, and the U.S., are either developing or evaluating video-disk systems in the hope of a huge market by the end of this decade.

Among the early disk developments are:

- The Telefunken-Decca system will be introduced this fall when production begins on the PAL playback unit in Telefunken's West Berlin factory. The unit will be priced at \$460, or half the price of 26-inch color-TV receivers. The video disks will be priced between \$4 and \$10. The player measures 18 inches by 6.3 in. by 12.2 in. and weighs about 31 pounds.
- N.V. Philips has demonstrated a video disk, VLP, which is optically scanned by a helium-neon laser. The video program, about 30 minutes long, is pressed in the surface of a transparent disk with a reflective protective coating. Philips plans to introduce VLP in 1975 at a price comparable to that of a color-TV set.
- MCA Inc., a newcomer to video hardware, has also demonstrated an optical-scanning-type disk that is similar to the Philips version. MCA wants to license production of Disco-Vision. Mylar disks, 12 in. in diameter, are pressed from electro-optically modulated masters onto nickel-plated stampers. Target cost for production quantities is less than 40 cents each.
- The French entry, Thomson-CSF, more pessimistic than other developers, does not expect a worthwhile video-disk market in France for another 10 years. Thomson-CSF has opted for a flexible disk and a laser-optical reader, but has not revealed marketing plans since demonstrating a laboratory model of the player. However, CSF reportedly wants to sell American manufacturers on its system.
- U.S. color-TV giants RCA and Zenith Radio are also vague as to when they will market their video-disk systems. RCA favors an electrostatic, capacitive-discharge, pressed disk, and introduction of developmental models has been set for 1975. Zenith, which played up its disk unit in its 1973 annual report, has not officially settled on a scanning system.

tion with the disk's air-cushion suspension, is responsible for the playback unit's high degree of shock and vibration resistance.

Because of the forced-advance system, the scanner support permits repetition of TV scenes. If the forced-advance is switched off, the scanner will jump back in its groove, which repeats the scene recorded in that groove. The scanner jumps back so fast that the motion does not show up on the picture "frozen" on the TV screen, and neither the scanner nor the disk is damaged. A slight decrease of signal-reproduction quality is noticeable only after many scene repetitions.

Except for a switch to control the forced-scanner advance to implement automatic-scene repetition, the playback unit requires no additional devices. However, reproduction of still pictures and fast-motion and slow-motion scenes does call for an additional component. This is a tiny electromagnet, which, excited momentarily, lifts the scanner from the track by a few micrometers and then drops it into an adjacent track. If the scanner is advanced this way at each disk revolution, while

the scanner-advance is switched off, a still picture is obtained. By varying the scanner advance speed and by backward and forward jumps at appropriate times, fast and slow-motion pictures can be displayed. A jump occurring during their vertical-blanking interval will not cause any noticeable picture distortion.

Signal-processing circuitry

In the simplified block diagram for the complete signal-reproduction circuitry (Fig. 10), the upper section is for sound-signal processing. Following the preamplifier, which functions as an impedance converter, is a band-pass filter for the sound channel. The normal playback unit has one sound channel, which makes it usable with present-day TV sets. However, a modified playback unit for special applications has a second sound channel with a cross-talk attenuation value greater than 50 db. This channel can be used for reproducing a second language, or, in combination with the first channel, for stereophonic sound.

The circuit for video processing, like the one for sound processing, contains only frequency-demodulation components. It is identical to the circuit used for playback of a black-and-white recording.

The circuit for processing color signals (Fig. 10) is not exactly the same as that designed into the playback unit. First, a high-pass filter selects the high-frequency components of the luminance signal contained in each line's video signal. The corresponding low-frequency luminance components are recovered from the sequentially recorded red, green, and blue signals by means of a trisequential switch and a matrix. The color signal is fed to the summation point, S, together with the high- and low-frequency components of the luminance signal. By summing, the composite video signal is obtained. Finally, that signal, together with the sound signal, is applied to a uhf modulator, which feeds the combined video/sound signals to the color receiver's antenna terminals.

Compensation for time errors

Because of the irregularities in disk rotation, slight variations in the scanned line frequency can occur. Under worst-case conditions, these variations have a magnitude of 0.1%.

There are two ways to prevent such variations from affecting the picture. The first method consists of using a short time constant in the horizontal flywheel circuit of the color-TV receiver. This time constant varies for sets on the market today. While most Japanese receivers have a sufficiently short time constant, European and American sets often have too long a time constant to guarantee good picture stability at the line-frequency deviations encountered. European set-makers have recently designed a receiver that allows the time constant to be automatically changed by a specific amount when a certain channel-button is operated. These receivers are suitable for direct hookup to virtually any video recording system on the market today.

However, if TV receivers lack that feature, as do those sold in the American market, an electronic balancing circuit designed around a controllable delay in the playback unit can compensate for time errors. □

Impedance-sensitivity nomograph aids design of trimming networks

Adding a fixed-value impedance to a trimming network makes the circuit less sensitive to the variable component's value so that the stability of the variable resistor, inductor, or capacitor is not so critical

by Lawrence R. Odess, *Motorola Israel Ltd., Tel-Aviv, Israel*

□ Most circuits require final adjustment to meet specified design parameters. This adjustment is often accomplished by varying one or more of the circuit's impedance values. Unfortunately, variable-impedance components—like potentiometers, trimmer capacitors, and variable inductors—are usually considerably less stable than comparable fixed-value components, with respect to temperature, humidity, and time. And those variable components that provide good stability tend to be rather costly.

To utilize a variable impedance without degrading circuit stability, the circuit's sensitivity to the value of the variable component must be minimized. This can be done by adding an extra fixed-impedance component to the trimming network for the circuit. The technique is useful for all three types of trimming networks—resistive, inductive, and capacitive.

Generally, a trimming network consists of a fixed impedance as well as a variable impedance. The impedance ratio of these two components determines the network's trimming range and sensitivity. Typical trimming networks for the three kinds of passive components are shown in Fig. 1.

The addition of a second fixed impedance to any one of these trimming networks results in the circuit of Fig. 2. It is less sensitive to the value of the variable impedance, and the arrangement can be used for a resistive or capacitive trimming network.

The sensitivity function—the sensitivity of the total network impedance to the variable impedance—for any one of these trimming networks can be defined as:

$$S(Z_T, Z_v) = \left(\frac{Z_v}{Z_T} \right) \left(\frac{dZ_T}{dZ_v} \right)$$

where Z_v is the actual value of the variable impedance, and Z_T is the total network impedance. For the network of Fig. 1a, the sensitivity function becomes:

$$S(R_T, R_v) = (R_v/R_F) / [1 + (R_v/R_F)]$$

This function reaches a maximum when R_v is adjusted to its highest value ($R_v = R_V$). Similarly, both the inductive and capacitive trimming networks of Fig. 1 are most sensitive when the variable component is at its maximum value.

On the other hand, the sensitivity function for the network of Fig. 2 reaches a maximum value at a specific setting of the variable impedance. The total impedance of this circuit can be written as:

$$Z_T = Z_{F1} + \frac{Z_{F2}Z_v}{Z_{F2} + Z_v} = Z_{F1} + \frac{Z_{F2}}{k + 1}$$

where:

$$k = Z_{F2}/Z_v$$

Differentiating Z_T with respect to Z_v yields:

$$(dZ_T/dZ_v) = Z_{F2}^2 / (Z_{F2} + Z_v)^2 = k^2 / (k + 1)^2$$

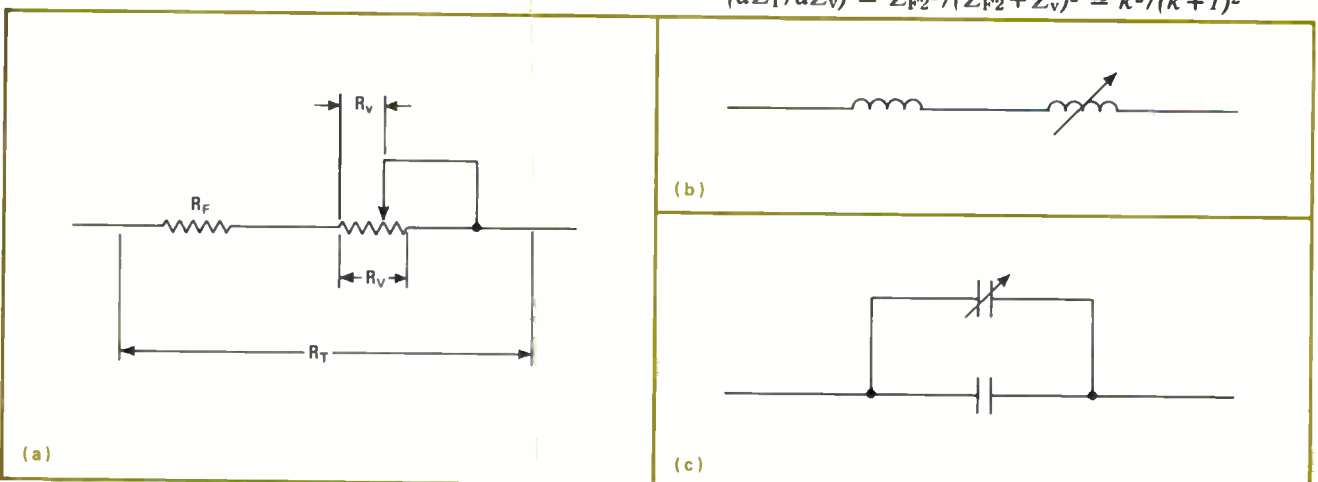

1. Conventional configurations. These standard trimming networks are highly sensitive to the value of the variable resistor (a), inductor (b), or capacitor (c). The variable component, therefore, can be expensive if the network must provide reasonably good stability.

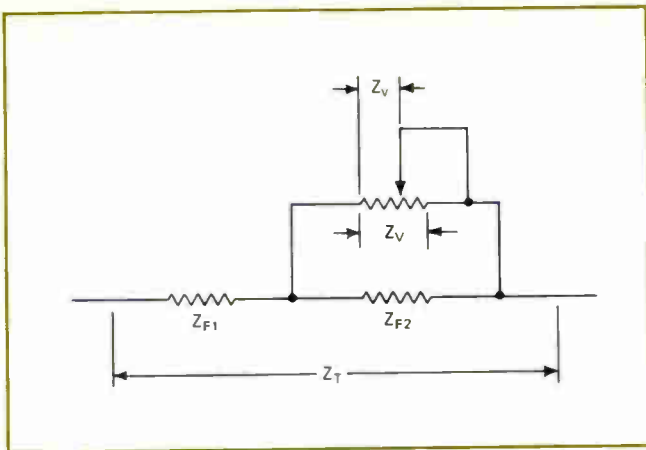

2. A better arrangement. Two fixed-value impedances, rather than just one as in the circuits of Fig. 1, reduce the sensitivity of this trimming network to the value of the variable impedance. Less-expensive less-stable adjustable components can then be used.

The sensitivity function can now be computed:

$$S(Z_T, Z_v) = [Z_v / (Z_{F1} + Z_{F2}/(k+1))] [k^2 / (k+1)^2]$$

which can be reduced to:

$$S(Z_T, Z_v) = k / [(k+1)((k+1)(Z_{F1}/Z_{F2}) + 1)] \quad (1)$$

The maximum value of this sensitivity function can

be found by differentiating Eq. 1 and then equating the differential to zero:

$$Z_{F2}[1 + (Z_{F1}/Z_{F2}) - (Z_{F1}Z_{F2}/\hat{Z}_v^2)] = 0$$

where \hat{Z}_v is the value of variable impedance that maximizes the sensitivity. The equation can be rewritten as:

$$Z_{F1} + Z_{F2} - Z_{F1}k^2 = 0$$

where k is the value of impedance ratio that maximizes the sensitivity. This equation becomes:

$$Z_{F2}/Z_{F1} = k^2 - 1 \quad (2)$$

Substituting for Z_{F2}/Z_{F1} in Eq. 1 yields an expression for the maximum sensitivity:

$$\hat{S}(Z_T, Z_v) = (k-1)/(k+1) \quad (3)$$

or:

$$\hat{S}(Z_T, Z_v) = 1 - 2 / [(1 + Z_{F2}/Z_{F1})^{1/2} + 1]$$

Figure 3 shows how the sensitivity function varies with impedance ratio k for two different ratios of fixed impedances Z_{F1} and Z_{F2} . The upper curve is for a fixed impedance ratio (Z_{F1}/Z_{F2}) of 1:8 and the lower curve for a ratio of 1:1.

The two fixed impedance values can be chosen so that the sensitivity does not exceed a desired value. Solving for k in Eq. 3 gives:

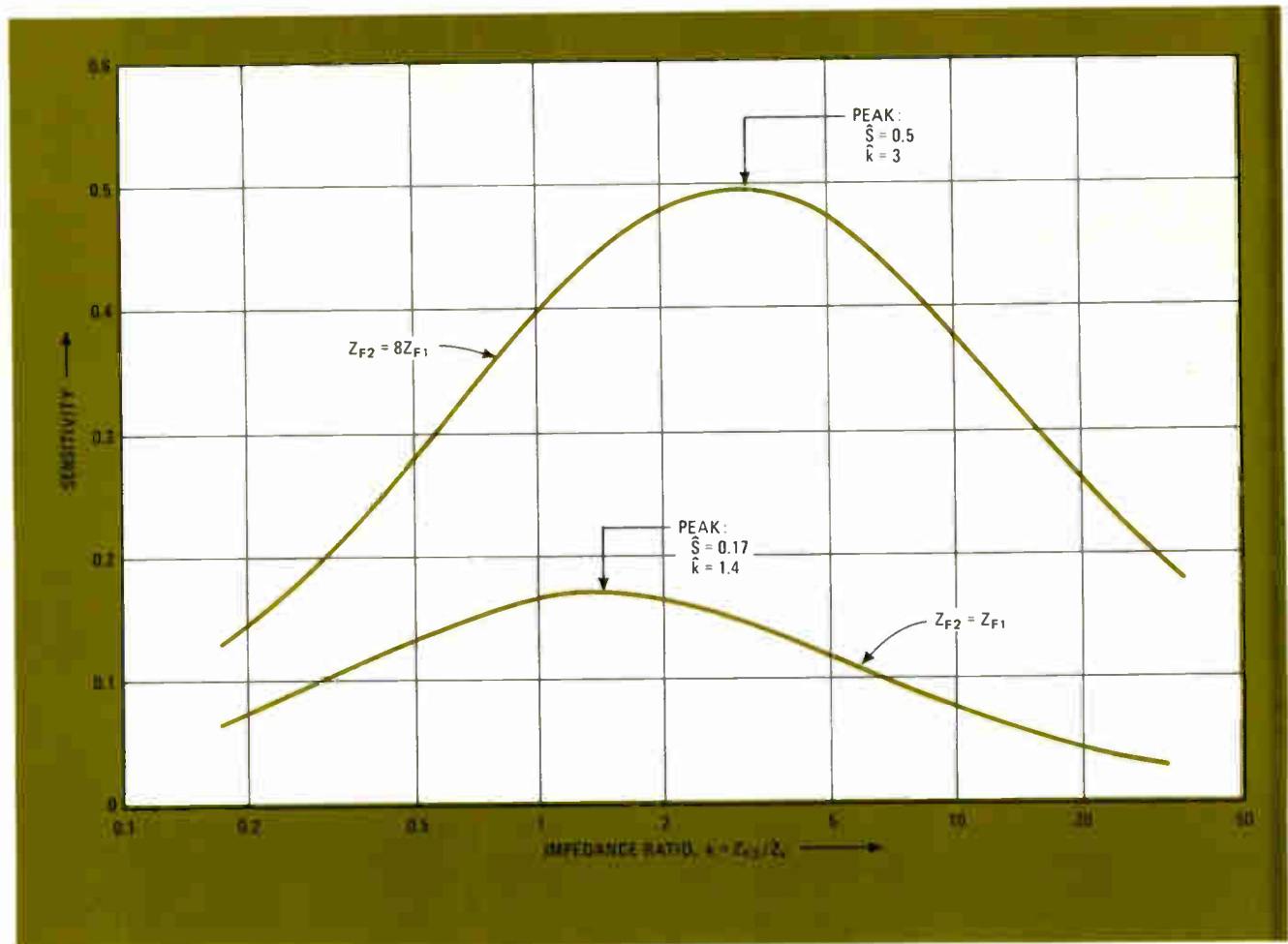

3. A look at sensitivity. Variation of the sensitivity function of the network of Fig. 2 is plotted for two different ratios of the fixed impedances, Z_{F1} and Z_{F2} . The peak value of sensitivity, \hat{S} , occurs at impedance ratio k , which is not necessarily the maximum value of impedance ratio k .

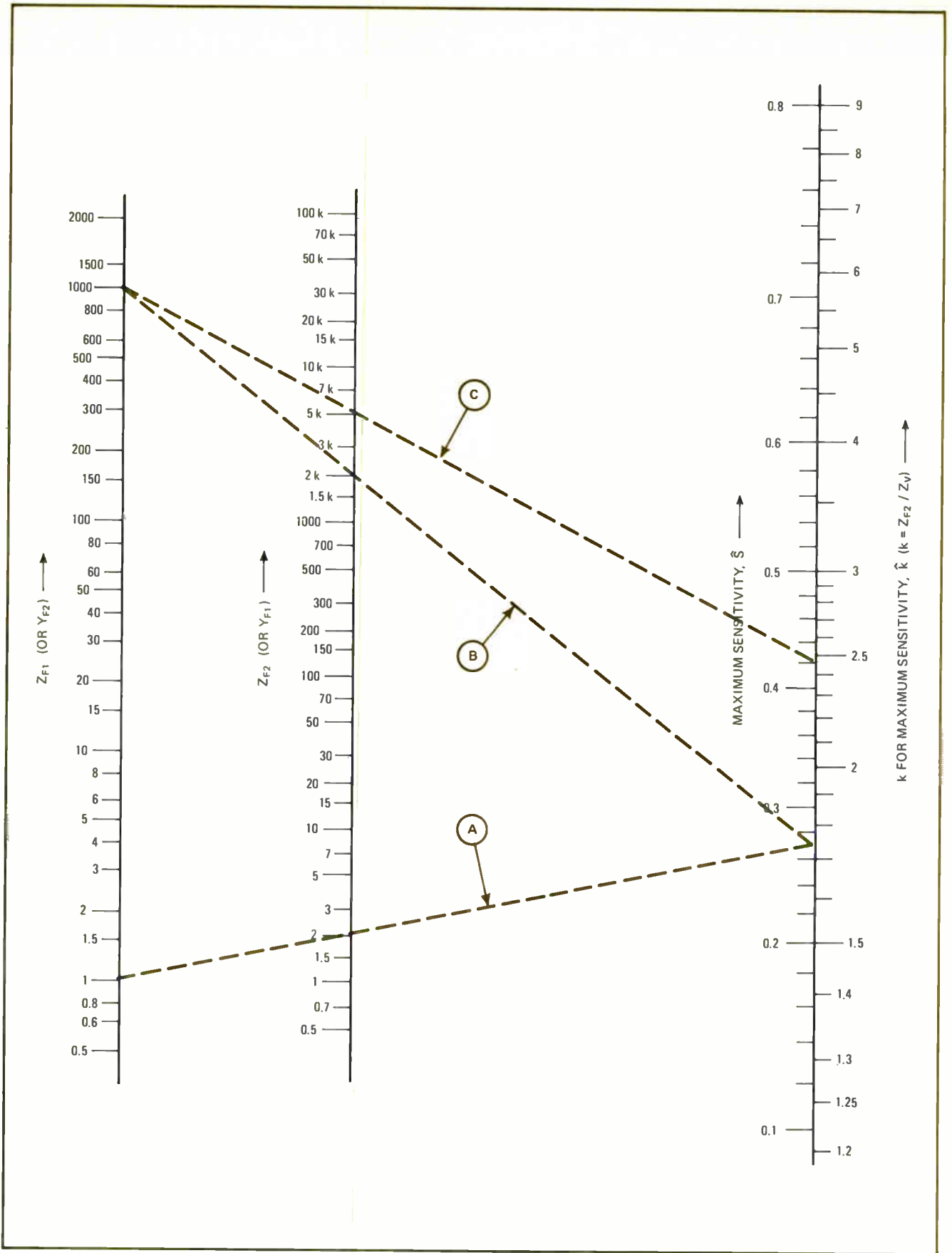

4. **Design aid.** Nomograph helps to determine the fixed-component values needed to limit the maximum sensitivity of the improved network. The value of impedance ratio \hat{k} can also be read from the same right-hand axis. The left-hand and center axes can be used for impedances (resistors and inductors) or admittances (capacitors). Units for values must be consistent within the same determination.

$$\hat{k} = (1 + \hat{S}) / (1 - \hat{S})$$

where \hat{S} is the maximum value of $S(Z_T, Z_V)$. Substituting this result into Eq. 2 yields:

$$Z_{F2} / Z_{F1} = 4\hat{S} / (1 - \hat{S})^2$$

which determines the ratio of fixed impedances needed to limit sensitivity to the desired value.

Comparing sensitivities

Since the variation of sensitivity with impedance ratio k is fairly flat at peak value \hat{S} over a wide range of k , the maximum value of sensitivity is a good figure of merit for comparing the various trimming networks. (The network that provides the smallest maximum sensitivity is the most desirable.)

To compare the networks of Fig. 1 with the network of Fig. 2, the trimming range must first be computed. For the resistive network of Fig. 1a:

$$R_{Tmax} / R_{Tmin} = (R_F + R_V) / R_F = 1 + (R_V / R_F) \quad (4)$$

and the maximum sensitivity is:

$$\hat{S}_R = R_V / (R_F + R_V) = (R_V / R_F) / [1 + (R_V / R_F)] \quad (5)$$

For the impedance network of Fig. 2:

$$\frac{Z_{Tmax}}{Z_{Tmin}} = Z_{F1} + \frac{Z_{F2}Z_V / (Z_{F2} + Z_V)}{Z_{F1}}$$

or:

$$\frac{Z_{Tmax}}{Z_{Tmin}} = 1 + \frac{Z_{F2}}{Z_{F1}} \left[\frac{1}{(1+n)} \right] \quad (6)$$

where:

$$n = Z_{F2} / Z_V = k_{min}$$

which is less than 1 for most practical cases. For equal ranges, Eqs. 4 and 6 are equal:

$$R_V / R_F = (Z_{F2} / Z_{F1}) [1 / (1+n)]$$

Substituting for Z_{F2} / Z_{F1} (Eq. 2) yields:

$$R_V / R_F = (\hat{k}^2 - 1) / (1+n)$$

Maximum sensitivity \hat{S}_R (Eq. 5) can now be expressed in terms of the impedance ratio, \hat{k} :

$$\hat{S}_R = \frac{(\hat{k}^2 - 1)}{(\hat{k}^2 - 1) + (1+n)} = \frac{(\hat{k} - 1)(\hat{k} + 1)}{\hat{k}^2 + n}$$

Dividing this last equation by Eq. 3 gives the ratio of the maximum sensitivity of the resistive network (\hat{S}_R) to that of the impedance network (\hat{S}_Z):

$$\frac{\hat{S}_R}{\hat{S}_Z} = \frac{(\hat{k} + 1)^2}{(\hat{k}^2 + n)} = 1 + \frac{2\hat{k} + 1 - n}{\hat{k}^2 + n}$$

Since \hat{k} is usually greater than 1 and n is usually less than 1, then:

$$(2\hat{k} + 1) \text{ is greater than } n$$

and:

$$\hat{S}_R / \hat{S}_Z \text{ is greater than } 1$$

This means that the maximum sensitivity of the resistive trimming network is generally larger than that of the impedance network, making the circuit of Fig. 2 the better design choice. For example, suppose $Z_{F2} = 2Z_{F1}$ and $Z_V = 2Z_{F2}$, then $\hat{k} = 1.732$ and $n = 0.5$, and $\hat{S}_R = 2.13\hat{S}_Z$, indicating that the sensitivity of the impedance

network is twice as good as that of the resistive network.

The same sensitivity comparison can be made between the inductive network of Fig. 1b and the network of Fig. 2; it will produce identical results. Similarly, an analysis for the capacitive network of Fig. 1c gives a sensitivity ratio of:

$$\hat{S}_C / \hat{S}_Z = 1 + (2k + 1 - m) / (\hat{k}^2 + m)$$

where \hat{S}_C is the maximum sensitivity of the capacitive network and m represents an admittance factor for the network of Fig. 2:

$$m = (Y_{F1} + Y_{F2}) / Y_V$$

Since this factor is usually less than 1, maximum sensitivity \hat{S}_C is almost always greater than maximum sensitivity \hat{S}_Z .

Selecting component values

The nomograph of Fig. 4 provides a convenient method of determining \hat{S}_Z and \hat{k} from the values of fixed impedances Z_{F1} and Z_{F2} (or fixed admittances Y_{F1} and Y_{F2}). And, of course, the nomograph can also be used to determine Z_{F2} , given \hat{S}_Z and Z_{F1} . The units employed for the component values of the left-hand and center axes must be the same for each determination; the units may be ohms, kilohms, microhenries, picofarads, etc.

If the impedance (resistance or inductance) values of Z_{F1} and Z_{F2} are known, align a straight-edge to intersect the value of Z_{F1} on the left-hand axis, and the value of Z_{F2} on the center axis. At the intersection of the straight-edge with the right-hand axis, read the value of \hat{k} to the right of the right-hand axis and the value of \hat{S} to the left of the right-hand axis.

In the same way, if the admittance (capacitance) values of Y_{F1} and Y_{F2} are known, use a straight-edge to intersect the value of Y_{F2} on the left-hand axis, and the value of Y_{F1} on the center axis. Then the values of \hat{k} and \hat{S} can be read at the intersection of the straight-edge with the right-hand axis.

For instance, when $Z_{F1} = 1 \text{ kilohm}$ and $Z_{F2} = 2 \text{ kilohms}$, the lower dashed color line (A) may be drawn, intersecting the right-hand axis at $\hat{S} = 0.268$ and $\hat{k} = 1.732$. The same result can be obtained with the middle dashed color line (B) if the axes are considered to be scaled in ohms. For the upper dashed color line (C), aligning $Z_{F1} = 1 \text{ kilohm}$ with $Z_{F2} = 5 \text{ kilohms}$ produces an intersection at $\hat{S} = 0.420$ and $\hat{k} = 2.45$.

Occasionally, the value of \hat{k} may fall outside the available range of k . For the case of resistors and inductors, this situation can occur if the largest possible variable impedance, Z_V , is less than the value of Z_V needed to produce \hat{k} . For a capacitive network, this will occur if Y_V is less than the value of Y_V corresponding to \hat{k} . If such is the case, the nomograph should not be used. Instead, the value of the maximum sensitivity is found by substituting $k = Z_{F2} / Z_V$ in Eq. 1:

$$S(Z_T, Z_V)_{max} = Z_{F2}Z_P / [Z_{F1}(Z_{F2} + Z_V)]$$

where Z_P is Z_{F1} , Z_{IF2} , and Z_V in parallel.

Moreover, besides improving the sensitivity function, this modified trimming arrangement increases resolution during trimming, which permits a further reduction in the cost of the variable component. □

CMOS Analog Switches

TTL-controlled switches handle full $\pm 15V$ signal swing
with only $\pm 15V$ supplies.

New DG200 and DG201 devices provide channel and gain selection for analog signals up to $\pm 15V$ power supply levels without exceeding switch signal handling levels (see typical applications circuit below). Devices feature:

- Monolithic CMOS construction; drivers and gates on a single chip.
- Low r_{DS} over full temperature and signal range.
 $< 100 \Omega$ for DG200 (dual SPST)
 $< 250 \Omega$ for DG201 (quad SPST)
- Static protection on all terminals.
- Break-before-make switching action.
- Independent pairs of sources and drains for maximum flexibility.
- Direct TTL, DTL and CMOS compatibility.

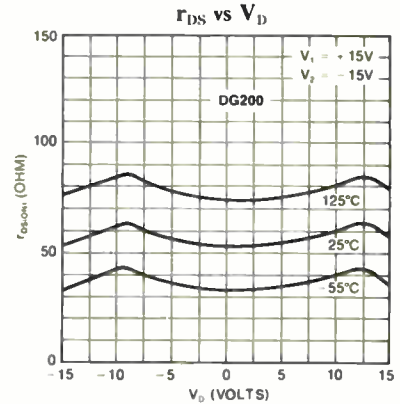

With supply voltage levels less than $\pm 15V$, the maximum analog signal always equals supply voltage.

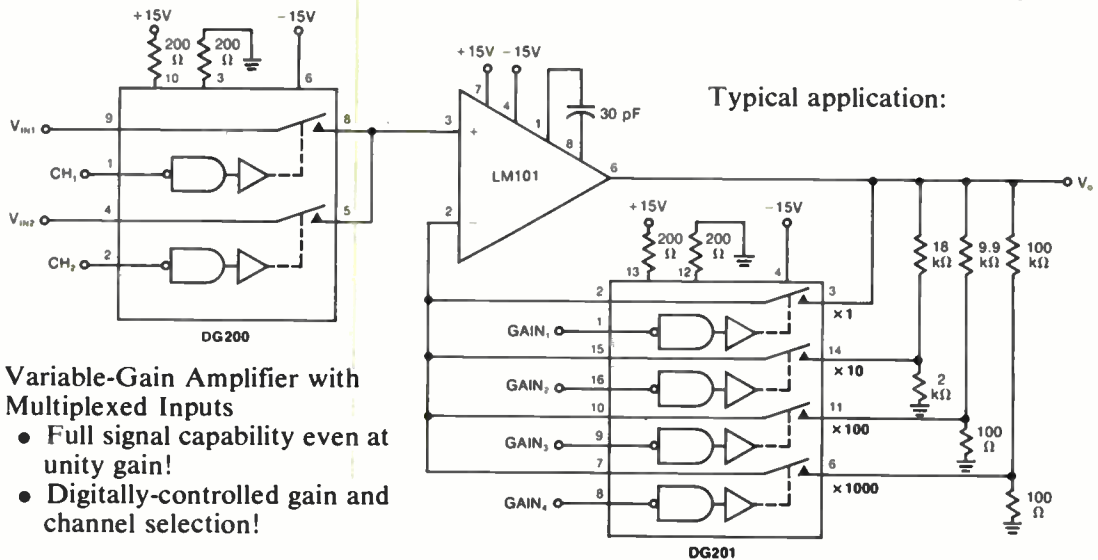

Variable-Gain Amplifier with Multiplexed Inputs

- Full signal capability even at unity gain!
- Digitally-controlled gain and channel selection!

The DG200 and DG201 are ideal devices for digital computer interface with this analog world. If your switching problems are unique—and whose aren't—our applications people are eager to help. For complete information

write for data

Applications Engineering: (408) 246-8000 Ext. 802



Siliconix incorporated

2201 Laurelwood Road, Santa Clara, California 95054

Precision triac trigger has wide dynamic range

by Ronald Sans
Tampa, Fla.

Standard triac triggering circuits do not generally provide an input dynamic range that is broad enough for precise driving of ac loads. But if the ac line is made to synchronize a voltage comparator to a zero-voltage switch, a triac trigger can be built to handle input signals over a 50-decibel dynamic range at frequencies of 10 hertz to 10 kilohertz. The circuit is useful whenever the triggering parameters of a triac must be controlled precisely, as for the currently popular light-box type of music display.

The zero-voltage switch produces a 100-microsecond pulse that begins 50 μ s before the line voltage reaches zero. Every 8.3 milliseconds, therefore, an output pulse from the zero-voltage switch passes through diode D_1 to resistor R_1 and capacitor C_1 . The leading edge of this

pulse charges capacitor C_1 , while the trailing edge discharges C_1 through resistor R_1 . The dynamic range of the circuit is determined by the setting of resistor R_1 . (When R_1 is set to about 47 kilohms, the dynamic range is approximately 30 dBm.)

Input signals of less than -30 dBm (0 dBm for a 600-ohm reference) turn off the triac; signals equal to -30 dBm just turn on the triac; and signals of 0 dBm or higher produce a full-power output. Since the circuit's output is based on the exponential discharge of capacitor C_1 , the output power of the circuit varies logarithmically and depends on the values chosen for resistor R_1 and capacitor C_1 .

The input signal is applied to the full-wave rectifier, which is capable of accepting signals of less than -50 dBm. The rectifier produces a negative voltage that is filtered by capacitor C_2 and then fed to the inverting input of the voltage comparator. Capacitor C_2 determines how much delay or damping there is; the higher the input frequency, the smaller the capacitor can be.

A conventional Darlington amplifier is used as the output trigger. A higher frequency response can be obtained by using high-frequency operational amplifiers instead. □

Driver for ac loads. Triac triggering circuit operates over wide dynamic range, providing precision control for an ac load like a music display. Audio input power levels can range from -50 to 0 dBm. The setting of resistor R_1 determines the circuit's dynamic range, while the value of capacitor C_2 determines the circuit's damping factor. The circuit is synchronized to the ac line.

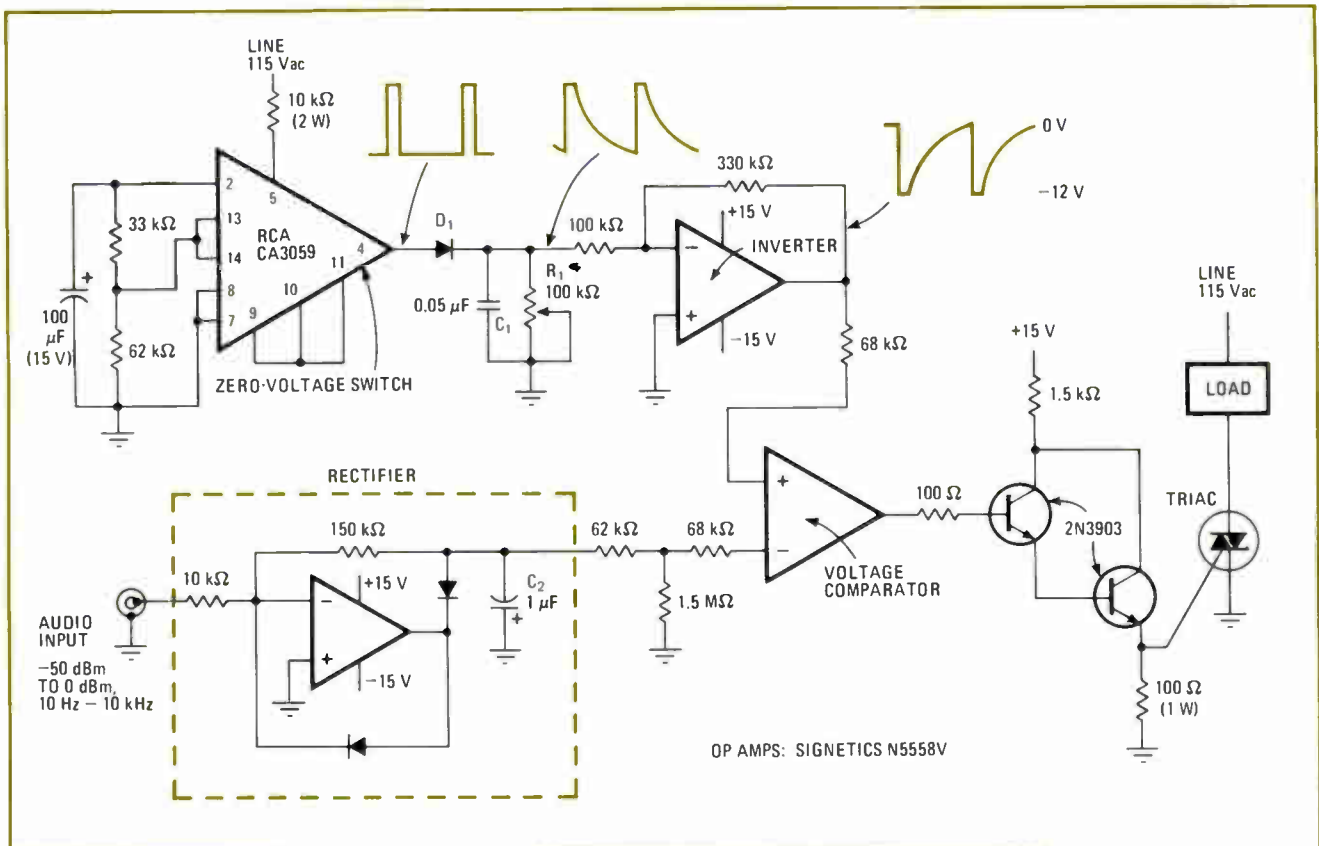

Integrated multiplier simplifies wattmeter design

by Donald DeKold
Santa Fe Community College, Gainesville, Fla.

A broadband wattmeter can be built simply and inexpensively with an IC multiplier as the heart of a power-to-voltage transducer circuit that has an output voltage that is directly proportional to the instantaneous load power. The circuit's frequency response extends from dc to several kilohertz. When the output is applied to a simple meter movement or a digital voltmeter, the circuit makes a complete handy power meter.

The maximum load power that the circuit can handle while retaining its proportional output is 2 kilovolt-amperes; this power may be real or reactive. The maximum load voltage, $e_L(t)$, can be 400 volts, while the maximum load current, $i_L(t)$, can be 5 A. The transducer's output voltage is given by:

$$e_{out} = Ke_L(t)i_L(t)$$

where, for the design being shown here, $K = 0.005$ V/VA. Output voltage e_{out} can vary from -10 to $+10$ V, depending on what the instantaneous polarities and

magnitudes of the load voltage and load current are.

The circuit's voltage and current ranges can be modified easily by simply changing two resistors—resistor R_1 for the current and resistor R_2 for the voltage. Changing the value of these range resistors also alters the value of constant K , thereby producing a wattmeter of whatever range is desired.

Load current is sensed by a current-shunt element, resistor R_1 , and is amplified by a factor of -20 as it passes through operational amplifier A_1 . The output from this op amp is applied to the V_x input of the multiplier. In this case, input V_x must not exceed ± 10 V, restricting load current $i_L(t)$ to a peak value of ± 5 A.

Load voltage, which is derived from the voltage divider set up by resistors R_2 and R_3 , is applied to the V_y input of the multiplier. This multiplier input is also limited to ± 10 V, which holds load voltage to ± 400 V.

The output of the multiplier is a differential voltage (from the V_{out+} and V_{out-} terminals) that is proportional to the product of inputs V_x and V_y . This output depends on a number of factors: the magnitude and polarity of inputs V_x and V_y , the values of gain resistors R_x and R_y , the values of multiplier load resistors R_{M1} and R_{M2} , and the bias currents established by resistors R_4 and R_5 and the supply voltages. For the component values shown, the multiplier's output is approximately $V_x V_y / 10$. (The proportionality constant may be varied somewhat by trimming resistor R_5 .)

Measuring power. IC multiplier produces output that is proportional to the power being dissipated in the load. The circuit is a power-to-voltage transducer that can be used to measure power levels as high as 2 kilovolt-amperes by simply connecting its output to a meter movement or a digital voltmeter. Since all offset voltages are trimmed to zero, fairly accurate measurements can be made over the full output range.

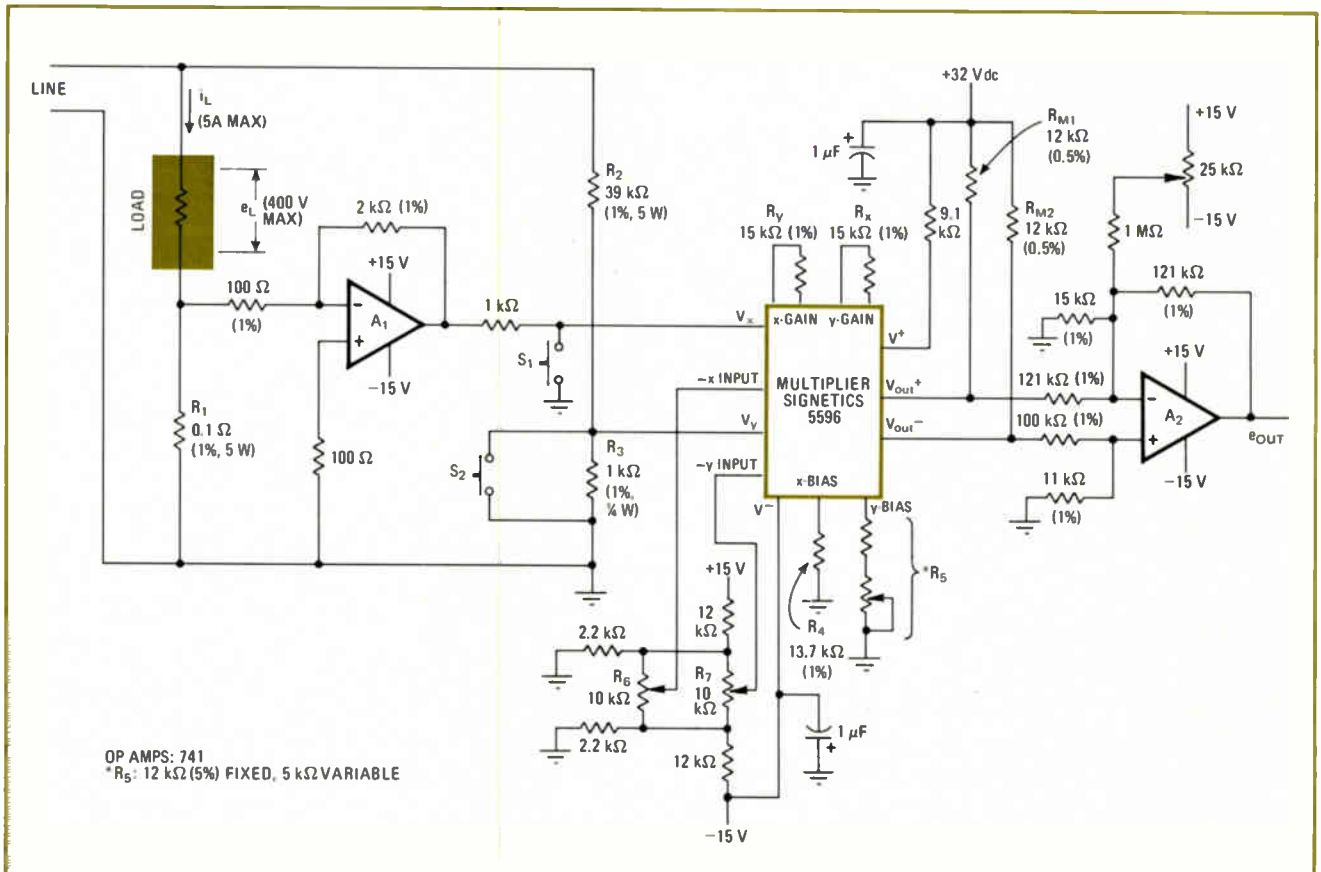

The differential multiplier output is applied to operational amplifier A_2 , which acts as a level shifter and develops a single-ended output voltage. The signal gain through this stage is -1 . Resistor R_6 permits A_2 's offset voltage to be adjusted to within a few millivolts of zero.

In general, when ac power is developed in the load to which the circuit is connected, the load voltage is:

$$e_L(t) = E_{pk} \sin \omega t$$

And the load current becomes:

$$i_L(t) = I_{pk} \sin(\omega t + \phi)$$

so that the power in the load can be expressed as:

$$p(t) = [E_{pk} I_{pk} \cos \phi / 2] - [(E_{pk} I_{pk} / 2) \cos(2\omega t + \phi)]$$

In this last equation, a sinusoidal time-varying component is present that is twice the frequency of the load current or load voltage and that has an average value of zero. The dc term in the power expression represents the average real power dissipated in the load.

The circuit's output voltage reflects these analytical

relationships—it has both a dc component and an ac component of twice the input frequency. When e_{out} is applied to an ordinary average-reading dc meter, the response of the meter is directly proportional to the average real power dissipated in the load.

The transducer circuit is fairly accurate, since the dc offset voltages produced by the multiplier and the level shifter are eliminated. Switches S_1 and S_2 apply a 0-v dc input to the multiplier's V_x and V_y inputs, so that resistors R_6 and R_7 can be used to trim the offset of each of these inputs to zero. (This is most easily accomplished while sensing an ac power signal with an oscilloscope at the output; each voltage input is trimmed for an ac null at the output.)

Precision components, as indicated in the diagram, should be used for best results. It is also essential that the supply voltage be stable since the offset trim voltages are derived from these sources.

Simultaneous readings made with this circuit will deviate nominally from each other by only 1% for the upper 75% of the 2-kva output range. □

Handy supply provides fixed and variable outputs

By John Predescu

Buchler Instruments Division, Nuclear-Chicago Corp., Fort Lee, N.J.

The advantages of today's integrated three-terminal voltage regulators are fully exploited by a versatile power supply that, besides being inexpensive (about \$15) and easy to put together, provides a switch-selectable fixed or variable output. The variable output, which can be adjusted between 8 and 17 volts, is ideal

for C-MOS logic, and the fixed output of 5 v is ideal for TTL circuits. Output current is 200 milliamperes.

The double-pole double-throw switch permits the same IC regulator and diode bridge to be used for both the fixed and variable outputs. The switch bypasses the operational amplifier network and taps the transformer's secondary voltage at the halfway point. A 5-v output can then be obtained from the IC regulator without exceeding this device's power dissipation rating.

If a second supply circuit is built and the positive side of its output grounded, a complete ± 15 -v op-amp supply can be made. Regulation is better than 1%. □

Designer's casebook is a regular feature in Electronics. We invite readers to submit original and unpublished circuit ideas and solutions to design problems. Explain briefly but thoroughly the circuit's operating principle and purpose. We'll pay \$50 for each item published.

Convenient power supply. Line-powered supply, which makes use of a single three-terminal 5-volt IC regulator, offers switch-selectable fixed and variable outputs. The variable (8- to 17-v) output is obtained by employing a conventional op amp in the regulator's output loop. For the fixed (5-v) output, only half the transformer secondary voltage is taken so that the regulator's power rating is not exceeded.

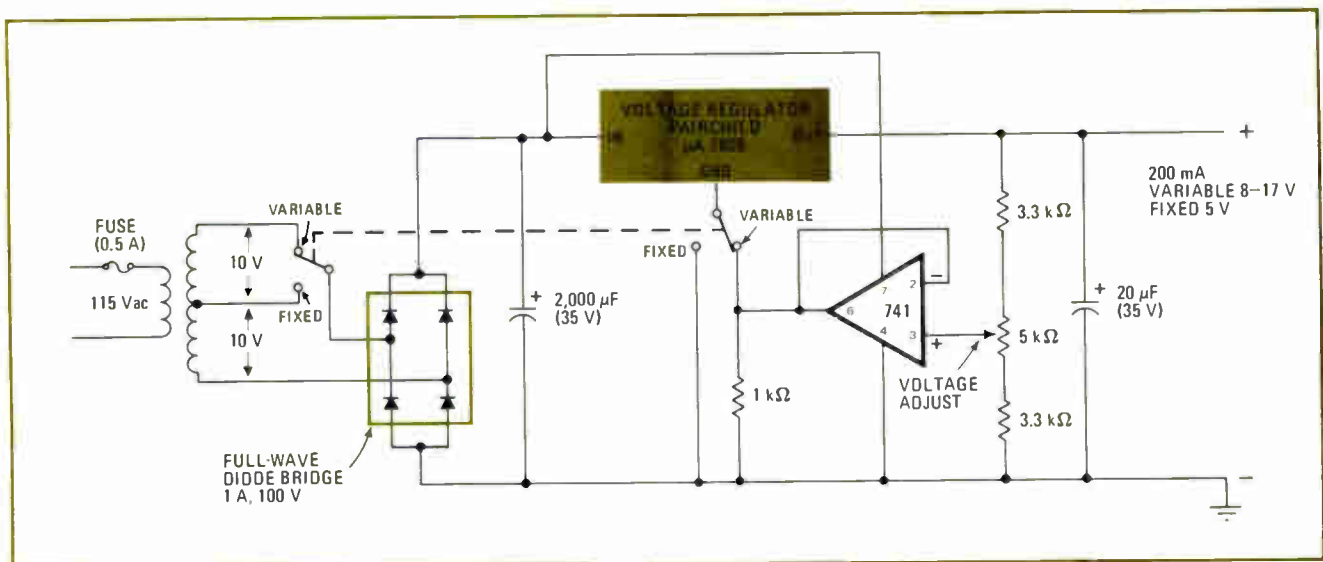

**TRW makes
electronic components for
telephones and
mobile communications and
automobiles and
computers and
television sets and
instrumentation and
aircraft and missiles
and...**

So?

So...

We are one of the few companies producing *both* high-volume and high-technology electronic components for today's growth industries.

Only a company that can cut a broad swath across the fields of all major electronics users has the cross-over capability in manufacturing to handle all your needs, whatever they are.

We are that kind of company. We can give you what you need. High-technology, high-volume — or both. Because we specialize in both, and in a big way. We make over 300 different kinds

of electronic components for the major OEM's in all the major industries. We have the technology and production savvy — plus the sheer size — to be the source for whatever you need.

Perhaps we already make it in one of our 30 plants. Certainly, we *can* make it, even building a new plant if necessary. As we have for others.

In short, we can do more for you precisely because we do so much for so many others in such a range of industries. And because we are TRW.

TRW ELECTRONIC COMPONENTS

10880 Wilshire Blvd., Los Angeles, CA. 90024

Connectors • Resistors • Semiconductors • Capacitors • Motors • Functions and Assemblies • PC Boards • Potentiometers • Transformers • Coils and Inductors • Wire and Cable

Chopper-stabilized op amp combines MOS and bipolar elements on one chip

Clever direct-coupled chopper-stabilized circuit boosts dc performance of wholly monolithic precision operational amplifier; dielectric isolation keeps bipolar elements tiny enough to pack complex circuitry on small chip

by Don Jones and Robert W. Webb, *Harris Semiconductor, a division of Harris-Intertype Corp., Melbourne, Fla.*

□ With the development of the first chopper-stabilized op amp to fit on a single chip [*Electronics*, Aug. 16, p. 85], the full benefit of monolithic integrated circuitry has at last been brought to the design of a precision operational amplifier. Combining on the same chip a low-current MOSFET input structure—its high input offset voltage nulled out by a MOS chopper-stabilized circuit—with dielectrically isolated bipolar elements, to get high density and high output parameters, the new op amp performs as well as the more expensive and tougher-to-use chopper modules, yet will eventually cost as little as general-purpose monolithic op amps.

In more detail, the low dc current characteristics of the MOSFET inputs permit an offset current of only 0.1 nanoampere at 25°C, while current drift is only 1 picoampere/°C. The chopper circuit cuts the normally high offset voltage of the MOSFETs to a low 50 microvolts at 25°C, while voltage drift is kept down to 0.2 microvolt/°C.

Low input specifications like these make the chopper a good choice for those precision applications—thermocouple amplifiers, biomedical instrumentation, and analog-to-digital converters—that till now have been reserved for modules.

A troublesome parameter in designing with op amps is offset-voltage drift. Input offset voltage can generally be adjusted to a very low value with the help of an external potentiometer or selected fixed resistors, but this adjustment is good only for the ambient temperature (and point in time) at which it was made. With a few degrees of change in temperature or after a few months, the offset voltage may again make its presence felt.

The steadying influence

Stabilization of the offset voltage in an amplifier can be accomplished by adding an auxiliary dc amplifier to the main amplifier, then chopping the signal from this amplifier and feeding it back against the input of the main amplifier. This auxiliary amplifier needs only a limited frequency response, not being responsible for amplifying the main signal, but clearly it must have very low offset-voltage drift.

In Fig. 2a, which shows the basic scheme for stabilized op amps, A_1 is the main amplifier, and A_2 the auxiliary. If the gain of A_2 is large, the effective input offset voltage of the entire circuit will be nearly that of A_2 alone. This is because the input offset voltage of A_1

must be divided by the gain of A_2 to determine its contribution to the offset of the entire circuit. The open-loop dc gain of the entire circuit is the product of the gains of A_1 and A_2 .

Figure 2b shows a classical chopper amplifier which is often used as the auxiliary dc amplifier in a stabilized op-amp design. Chopper switch S_1 functions as a modulator which changes the incoming dc level to an ac waveform with a proportional amplitude, and with a phase angle of either 0° or 180°, depending on input polarity. The chopped signal is then amplified by an ac-coupled amplifier. Ground level of the amplified signal is restored by a second chopper switch, S_2 , which may be regarded as a synchronous demodulator. Filtering then recreates an amplified replica of the incoming dc or low-frequency signal, which is then summed at the main amplifier input.

When properly constructed, this circuit will have ex-

1. Big linear. Circuit of chopper-stabilized op amp calls for a complex chip. To the multiple stages of the operational amplifier are added the active switching and sample-and-hold circuits of the chopper section. In all, 256 active elements are on the HA-2900 chip, which measures 93 by 123 mils. Device comes in a TO-99 can.

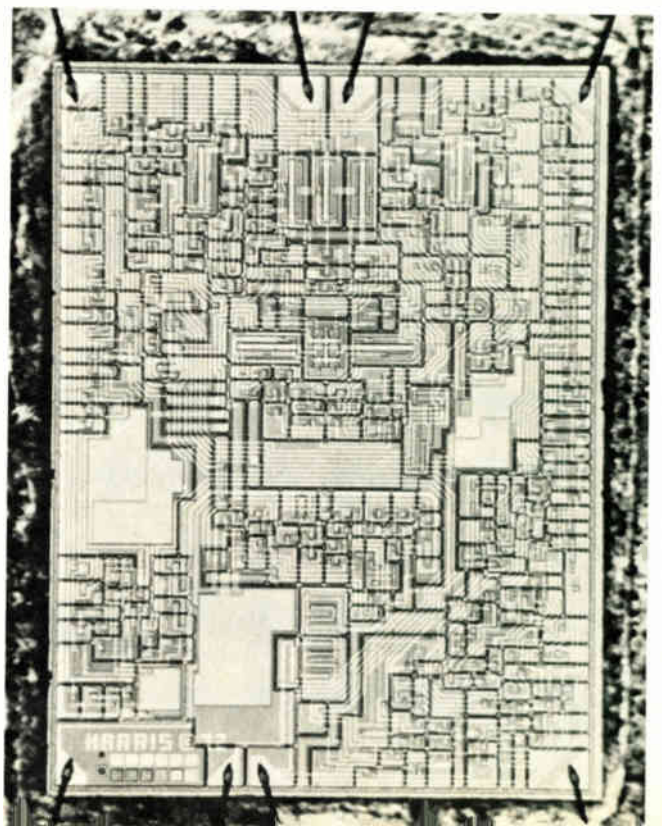

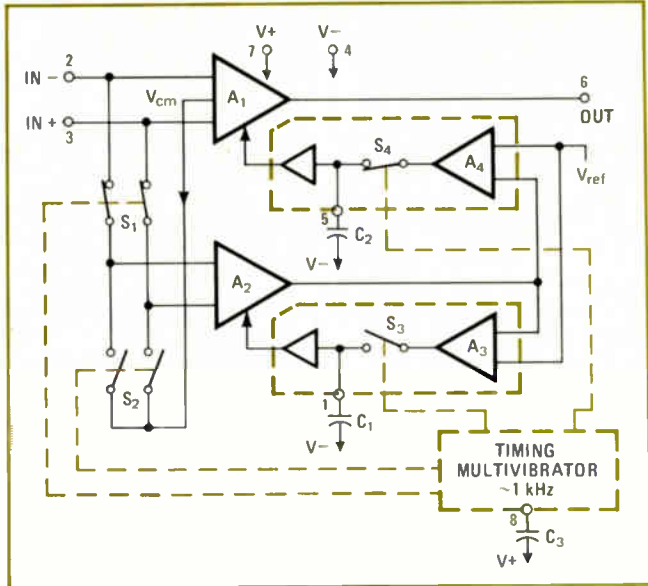
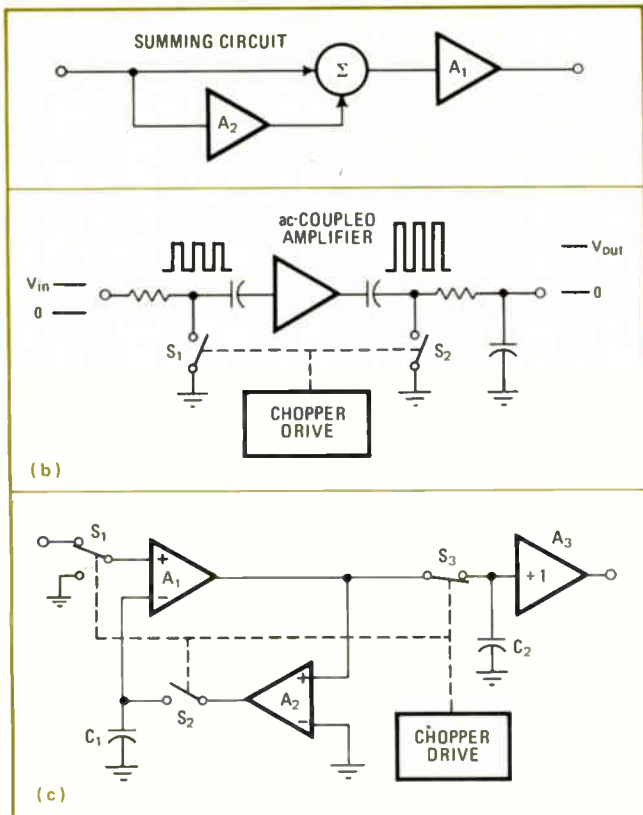

3. The layout. Block diagram for the HA-2900 shows the complexity of a chopper-stabilized amplifier. No fewer than four amplifiers are used; A₁ is the main amplifier, A₂ is the auxiliary stabilizing amplifier, A₃ is the sample-and-hold amplifier in the self-zeroing loop of A₂, and A₄ is a second sample-and-hold amplifier, having the job of holding the previous signal during the zeroing interval.

2. Basic chopper. In any chopper-stabilized configuration (a), an auxiliary dc amplifier, A₂, chops the input ac waveform (b) in such a way that its phase and polarity, when added to the input of the main amplifier, A₁, produce a minimum dc voltage offset. In the HA-2900 (c), however, a direct-coupled amplifier periodically disconnects itself from the input signal and adjusts the offset voltage to zero.

tremely low offset-voltage drift. The amplifier, being ac-coupled, does not contribute to the dc offset. The most critical element is S₁, since any coupling, whether dc or ac, of the drive signal to the contacts may introduce an offset error.

A different concept is illustrated in Fig. 2c. This is a scheme for a direct-coupled amplifier, in which the amplifier periodically disconnects itself from the input signal and adjusts its offset voltage to zero. With S₁ and S₃ up, the circuit functions as a dc amplifier. When S₁, S₂, and S₃ go down, the amplifier input is grounded and A₂ forces the output of A₁ to ground. Switch S₂, and capacitor C₁ form a sample-and-hold, so that the correction signal for zeroing the offset of A₁ is stored on C₁ and S₂ opens. Here S₃, C₂, and A₃ form a second sample-and-hold; its function is to store the previous output of A₁, while self-zeroing is taking place, and so to remove most of the signal discontinuity.

The chopper for a chip

In choosing a chopper design for monolithic integration, the last scheme (Fig. 2c) is the most attractive, even though the block diagram is more complex. This design does not require large-value resistors, as the others do, and it needs only a few external capacitors to ground, so that a standard 8-pin can be used.

Performance also is helped. The absence of coupling capacitors provides much faster recovery from over-

driven conditions—a notorious problem with traditional chopper-stabilized amplifiers. The response of the sample-and-hold filter—flat to half the chopper frequency—greatly reduces settling times. Also, this scheme may be readily modified to provide a stabilized amplifier with full differential inputs, a highly desirable feature for low-error applications.

A complete diagram of the circuit is shown in Fig. 3, where A₁ is the main amplifier, A₂ is the auxiliary stabilizing amplifier, A₃ is the sample-and-hold amplifier in the self-zeroing loop of A₂, and A₄ is the sample-and-hold amplifier that holds the previous signal during the zeroing interval.

One obvious difference between this arrangement and those previously discussed is that the input circuitry is completely symmetrical with respect to the two input lines. This produces a true differential input, in contrast to most stabilized amplifiers which are either inverting-only or noninverting devices.

During the period in which A₂ is stabilizing A₁, S₁

From tube to chip

For about thirty years, the chopper-stabilized operational amplifier has been used when the best possible dc performance was required. It began by being constructed out of vacuum tubes and mechanical relay choppers. Then, when solid-state components arrived, it was made with modular and hybrid techniques. Recently IC technology was applied to produce a two-chip chopper-stabilized amplifier in which one chip held the chopper circuit while the other held the main operational amplifier. Now, by combining the bipolar and MOS processes, full chopper-stabilized op-amp performance has been realized on one chip.

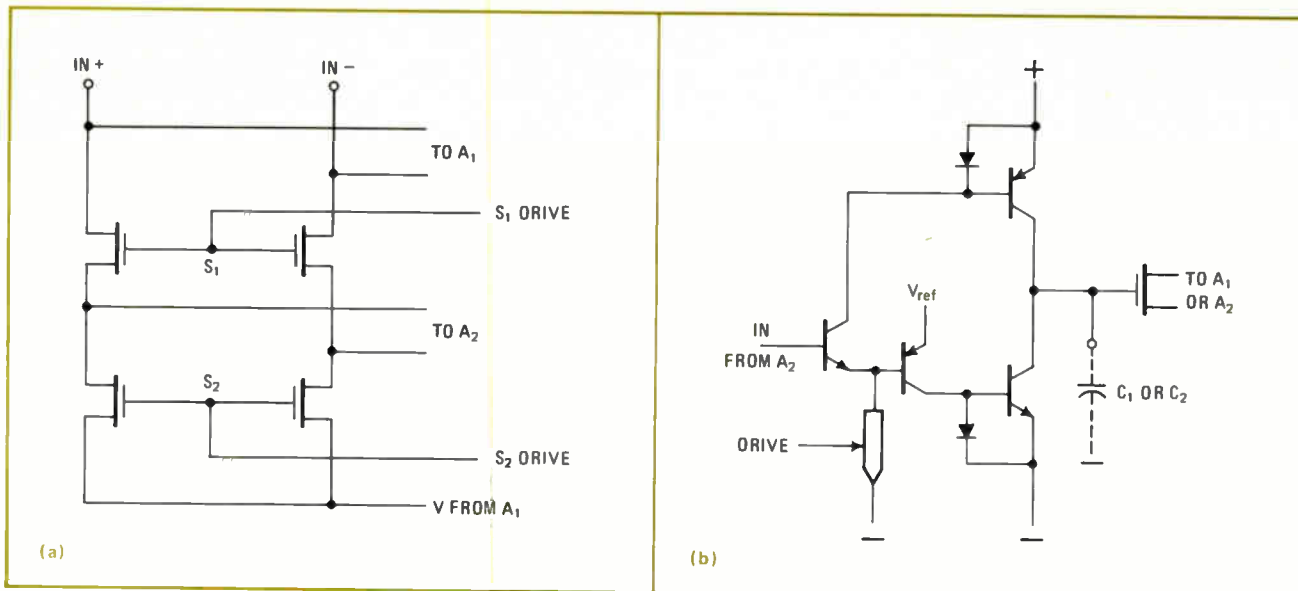

4. Low and high. The chopper switches S_1 and S_2 in (a) are made up of n-channel MOSFETs. Their very low offset characteristics allow them to handle low levels of voltage and current without distortion. In the sample-and-hold circuit shown in (b), the switches are made from bipolar devices which are capable of handling the high current drive of this stage.

and S_4 are closed while S_2 and S_3 are open. The dc and low-frequency components of the input are amplified by A_2 and applied as a correction signal to A_1 . The effective input offset voltage is nearly the same as that of A_2 alone.

To keep the offset voltage of A_2 extremely low, it is periodically zeroed. Switch S_1 opens and S_2 closes, disconnecting A_2 from the input terminals and shorting the inputs of A_2 together—not at ground level, but to a level equal to that of the input common-mode voltage. This

results in an extremely high common-mode-rejection ratio.

Like most other monolithic op amps, this device does not have a ground terminal; so when S_3 closes, the output of A_2 is forced to equal an internally generated reference voltage, rather than being forced to ground. The same is true of A_1 because it is referenced to the same voltage. The consequence of this is that C_2 charges to a level which will maintain the offset voltage of A_2 at zero. In the meantime, S_3 has opened, so that C_1 main-

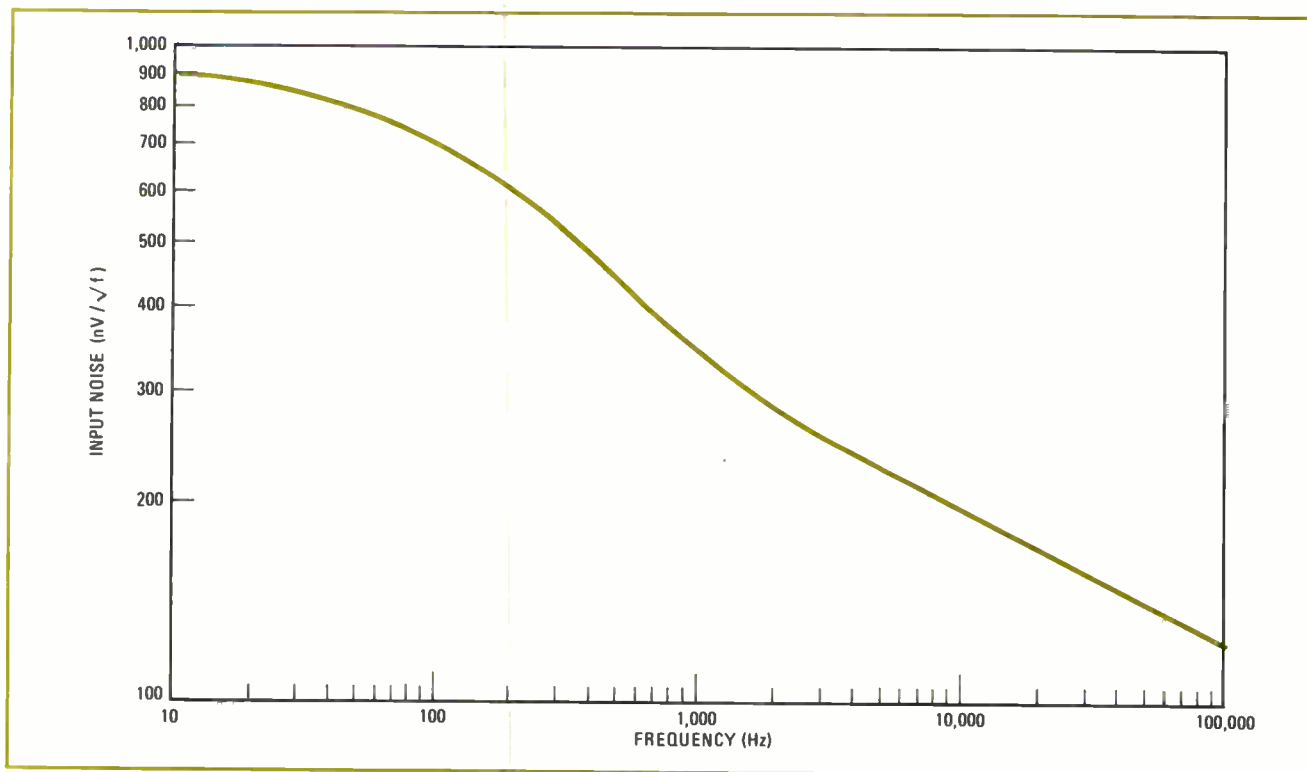

5. Quiet chopper. Unlike many other chopper-stabilized op amps, which suffer from intolerable noise from the chopper circuit, the HA-2900, as is indicated in this noise-frequency plot, encounters only the more familiar and easier to deal with $1/f$ random-frequency noise.

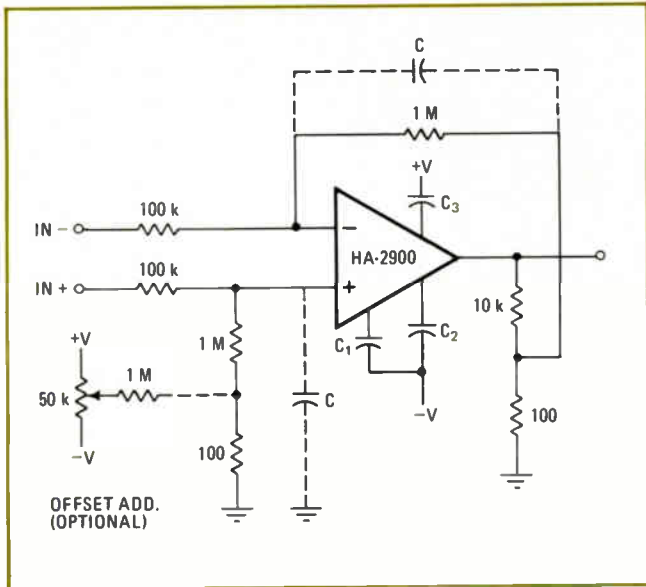

6. Gains are high. The chopper-stabilized circuit benefits this typical 60-dB-gain amplifier configuration. Voltage gain is 1,000, at a bandwidth of about 2 kHz. Flexibility is provided because either of the two input terminals may be grounded for inverting or noninverting operation, or the inputs may be driven differentially.

tains its previous level. The offset of A_2 has now been zeroed and can return to its task of stabilizing A_1 .

Note that the opening and closing times of S_1 through S_4 are interleaved. This allows the transient spikes generated when a switch is opened or closed to settle out before other signal paths, which could be affected by these transients, are actuated. The timing multi-vibrator generates a triangular waveform. Different levels of this

triangle are detected by four comparator circuits referenced to different points on a voltage divider to produce the four desired switch-driving signals.

Switches S_1 and S_2 (Fig. 4a) are each composed of two n-channel MOSFETs which make excellent no-offset choppers for the low levels of voltage and current involved. Switches S_3 and S_4 (Fig. 4b) are complementary bipolar current switches because appreciable current drive is required and offset voltage is not critical at these points. This is the first time in op amp design that MOS and bipolar processes have been used together in a standard monolithic product.

A_1 and A_2 are each n-channel MOSFET input amplifiers, which produce the extremely low input currents. Normally, MOSFETs would not be suitable as dc amplifier input stages because of their high offset voltage drift; again, chopper stabilization effectively removes that drift, while retaining their high input impedance.

Single-end MOSFET input stages are used in the sample-and-hold circuits as buffers to sense capacitor voltages. The correction signal from each sample-and-hold circuit alters a current generator which feeds one of the MOSFET sources in the inputs of A_1 and A_2 . The output stage of A_1 is a conventional complementary bipolar follower with short-circuit protection.

All this complex circuitry boils down to the simple functional op amp packaged with standard op-amp pin-outs in a TO-99 can. Three external capacitors are required for operation, one for multivibrator timing and two for the sample-and holds.

The chopper device's good dc input parameters, bandwidth (3 megahertz typical), and respectable slew rate (2.5 volts per microsecond), along with its fast settling time, make it excellent for general-purpose designs.

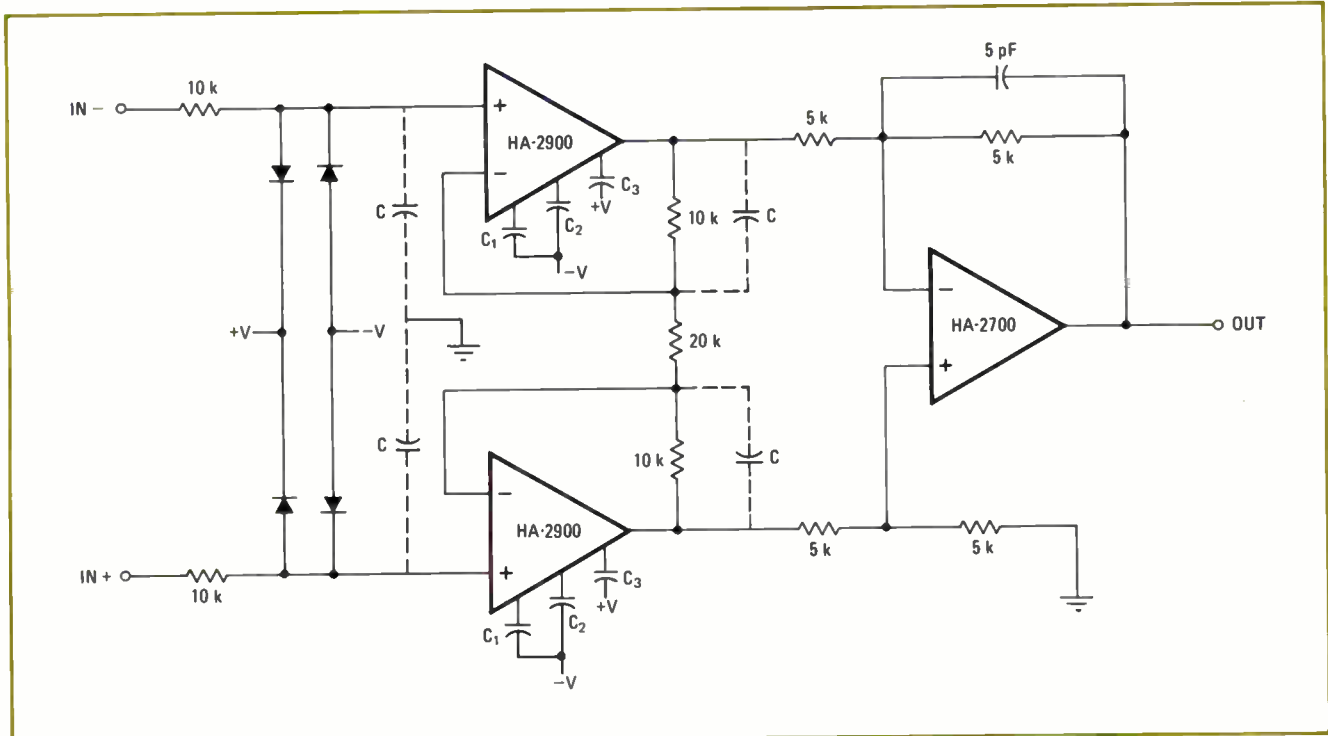

7. Quality. For the most demanding precision applications, two chopper-stabilized op amps can be used with a high-gain output amplifier to form an instrumentation amplifier. This differential configuration provides excellent common mode rejection over a ± 10 -V common-mode input signal. A simple diode-protection scheme is also included on the input.

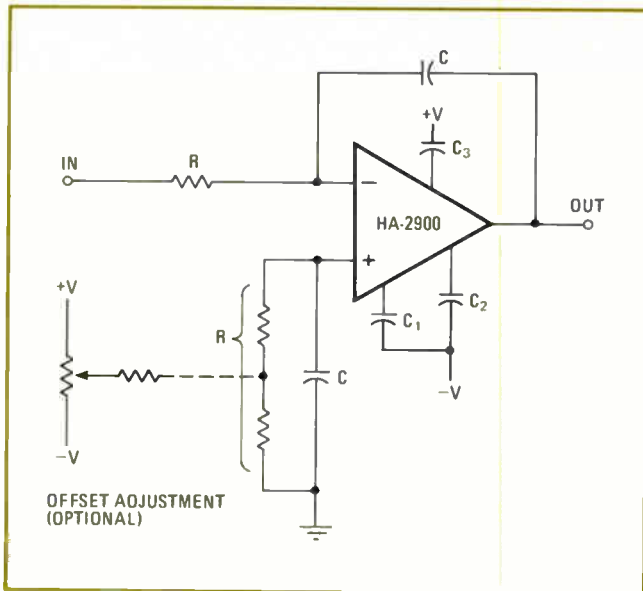

8. Integration with care. Chopper-stabilized op amps make good integrators. This precision device allows accurate integration over eight decades of frequency. With it, analog-to-digital converters can be made with six-digit resolution.

But not discussed so far is the op amp's equivalent input noise rating.

Where the noise is

As in most other chopper-stabilized amplifiers, the voltage noise is several times higher than in most non-stabilized amplifiers. In this chopper design, however, this noise is due not to the chopper action, but—as shown in Fig. 5—is a $1/f$ -type random voltage noise, which is higher than usual because of the extremely high impedance of the MOSFET input stage.

Synchronous noise is in fact generated by the choppers, but it is primarily a common-mode current noise, which can be minimized by matching the impedances at the two input terminals. With matched impedances up to 100 kilohms, the synchronous noise seen at the output is well below the random noise level. Indeed, even the effect of random current noise is not discernible at this impedance level.

The low drift of a chopper-stabilized amplifier is obviously required in such applications as precise analog

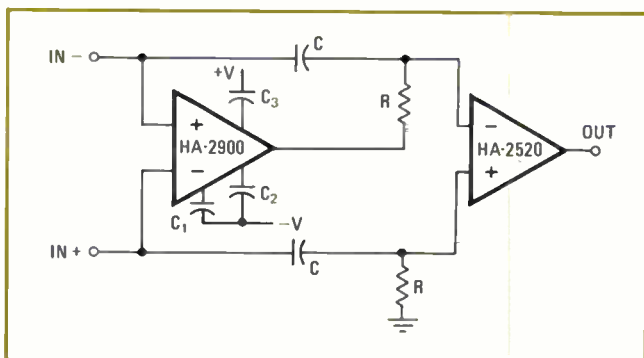

9. Team play. Combining the good dc parameters of a chopper-stabilized op amp with the wide bandwidth and fast slew rate of the conventional op amp makes a fast, low-drift amplifier well able to buffer digital-to-analog systems.

computation and precision dc instrumentation. Other applications are less obvious. For example, a chopper-stabilized op amp eliminates the technician's need to adjust a trimmer setting or a designer's need to select resistors to zero the amplifier for minimum input voltage offset. Or it may be important to eliminate the recalibration that corrects for amplifier's drift with time and temperature.

But to realize the full potential for accuracy of an ultra-low-drift amplifier, some care is required in the physical layout of the system. When mounted on a typical breadboard of pc card that is adequate for an ordinary op amp application, drifts on the order of $1 \mu\text{V}/^\circ\text{C}$ may be expected.

If this is good enough, the designer need go no further. If not, he must take external effects into account. These include thermocouple and electrochemical emfs generated at the junctions of dissimilar metals (solder points, connectors, internal junctions in resistors and capacitors), leakage across insulating materials, static charges created by moving air, and improper grounding and shielding practices. The chief concern is to insure that the networks going to the two amplifier inputs are identical and at the same temperature.

Uses usual and unusual

Figure 6 shows a typical high-gain amplifier application. Gain is 1,000, bandwidth about 2 kilohertz. Either input terminal may be grounded for inverting or noninverting operation, or the inputs may be driven differentially.

Symmetrical networks at the device inputs are recommended for any of the three operating modes, to eliminate chopper noise and obtain the best drift characteristics. Total input noise, with $C = 0$, is about $30 \mu\text{V}$ rms. This noise can be reduced, at the expense of bandwidth, by adding capacitors as shown.

A differential instrumentation amplifier with a high input impedance is shown in Fig. 7. This well-known configuration has excellent common-mode rejection over $\pm 10\text{-V}$ common-mode input signals. Protection diodes are included to prevent the device input terminals from exceeding either power supply.

Another good application for the chopper stabilized op amp is in integrating circuits (Fig. 8). Integrators have been around as long as op amps, and are used in analog computation, active filters, timers, waveform generators, control systems, and a-d converters. An op amp for a precision integrator should have the high gain, low offset voltage, low bias current and wide bandwidth that are all available with the chopper amp. The gain allows accurate integration over eight decades of frequency. Dual-slope a-d converters can now easily be made with six-digit resolution.

Figure 9 illustrates one of several methods of producing a composite amplifier that combines the low dc characteristics of the chopper with the ac characteristics of a wideband and/or high-slew-rate amplifier. One application for this type of circuit is as a buffer amplifier for a fast, high-accuracy d-a converter, where a large offset voltage would be disastrous. The combined frequency response of the circuit may be tailored for optimum settling time within a very narrow error band. □

THE AMAZING STORY OF THE 2K RAM THAT ATE TOPEKA, KANSAS.

Once upon a time there was a 2K RAM named MM5262.

Born at National, MM5262 was very big and very strong.

Much bigger than the little 1K RAMs around him, yet just as fast.

MM5262 could read and write, you know. And he had a wonderful memory.

Well, although he was bigger and better than the little 1K RAMs, MM5262 was, of course, not the only 2K RAM around.

But MM5262 never worried too much about them, because they were never around. You could never seem to find one of those 2K RAMs when you wanted them. But MM5262 was there, ready and waiting for people who wanted him.

And people loved and wanted him because of many things.

He drank only half as much power as 1K RAMs, for example. His standby power was only 2.5 milliwatts per bit. And he cost 10-20% less on a system basis.

And he had within him address registers, chip select registers and data output latches so people could easily and inexpensively implement his memory.

He also had a couple of brothers who often traveled with him: A sense amp named DM8806 (which offered Tri-State® Logic output), and a driver named MH0026.

But one day MM5262 got very nervous. He heard rumors about a big brute of a RAM called 4K.

He worried about what might happen to him.

He worried so much that one day he went out and ate Topeka, Kansas. (You may have read about it in the newspapers.)

But later MM5262 calmed down.

Because he learned that the big 4K RAMs wouldn't really be around much for some time yet, and that even when they got to town people would still need and love him, too.

Which proves that you shouldn't go around eating Topeka, Kansas prematurely.

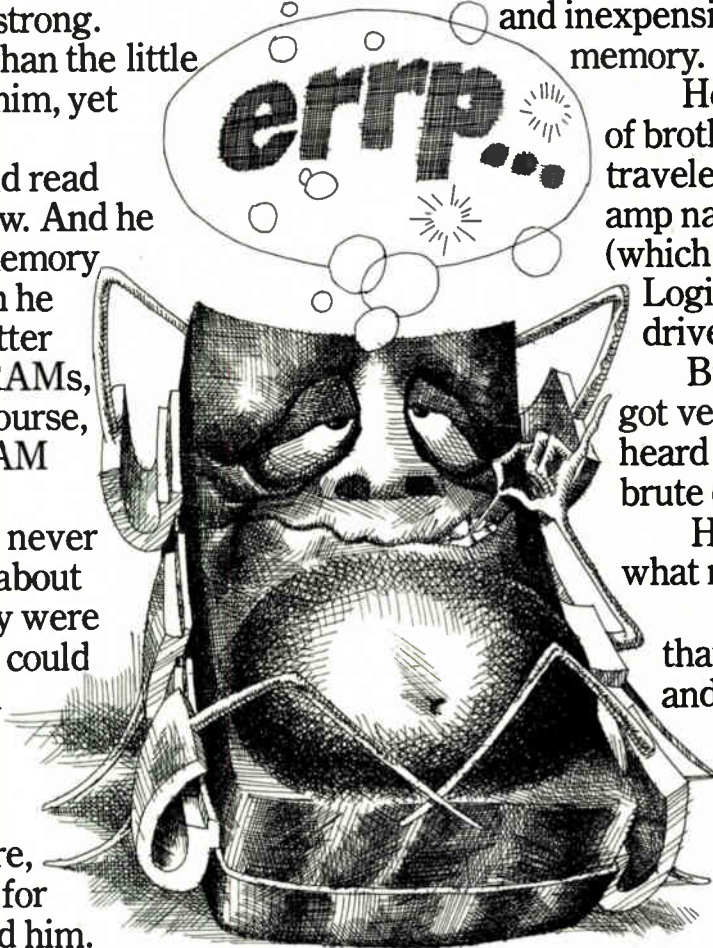

NATIONAL.

National Semiconductor Corp., 2900 Semiconductor Drive, Santa Clara, Calif. 95051; Scottsdale, Ariz. (602) 945-8473; Mountain View, Calif. (415) 961-4740; Sherman Oaks, Calif. (213) 783-8272; Tustin, Calif. (714) 832-8113; Miami, Fla. (305) 446-8309; Chicago, Ill. (312) 693-2660; Indianapolis, Ind. (317) 255-5822; Lenexa, Kan. (816) 358-8102; Glen Burnie, Md. (301) 760-5220; Burlington, Mass. (617) 273-1350; Farmington, Mich. (313) 477-0400; Minneapolis, Minn. (612) 888-4666; Englewood Cliffs, N.J. (201) 871-4410; Syracuse, N.Y. (315) 455-5858; Dayton, Ohio (513) 434-0097; Dallas, Tex. (214) 233-6801.

Two cables. Two minutes. That's all it takes to test a 20,000-point backplane.

Two little cables are all that connect Teradyne's new N151 Test System to your backplane — whether your backplane has 1,000 or 100,000 points.

In the N151, the pin electronics are on "fixture cards" that plug into your backplane. With two sets of fixture cards, you can be testing one backplane while you're setting up the next one for test. With three sets of cards, you can set up one while testing another while servicing another. The test system is moved from one job to another as fast as you can plug and unplug those two cables.

Now, about the test system itself. It's computer-operated with all solid-state switching, of course. But it requires no programming. You just connect a prototype or a known good backplane and tell the system to learn what's connected to what. (If you already have your own data base, IBM-compatible magnetic tape and translation software are available.) The N151



will then give you a complete connection list to double-check against your drawings. After that, it tests your production backplanes at high speed (typically, two minutes for 20,000 points),

reporting all shorts and opens in your own nomenclature on a CRT display or line printer. Programs are stored on magnetic-tape cartridges for quick call-up when you want them.

Price? Less than you might expect for a system that solves the backplane-testing problem so completely.

There's much more to tell about this unique test system, and we tell it in a detailed brochure, yours for the asking.

Write: Teradyne, 183 Essex St., Boston, Mass. 02111.

In Europe, Teradyne Europe S.A., 11 bis, rue Roquépine, 75 Paris 8^e, France.



TERADYNE

CHICAGO (312) 298-8610 / DALLAS (214) 231-5384 / NEW ENGLAND (617) 458-1256 / NEW YORK (516) 364-9797 / SUNNYVALE (408) 732-8770
LONDON (093-28) 61111 / PARIS 265 72 62 / ROME 59 47 62 / MUNICH (0811) 33 50 61 / TOKYO (03) 406-4021

Microchannel plates advance night-viewing technology

New generation of image-intensifier tubes have improved gains yet are a 10th the size and half the cost of earlier tubes; commercial applications include low-light-level television surveillance

by Martin J. Needham, Mullard Ltd., London, England

□ For a good many years now, image-intensifier tubes have been helping a few people see better in the dark. But low-light-level viewing could become a much more popular pursuit now that the microchannel plate has emerged as the key component in the tubes.

For the first time, image-intensifier tubes have been constructed with intensification factors as high as 100,000 in spaces as small as 65 cubic centimeters, including power supply. Their production cost is projected at as little as \$750, or about half that of cascade tubes which, until recently, have dominated the field. Better still, tubes containing microchannel plates have improved resolution, lower distortion, and a built-in control for highlight suppression.

All these advantages have led to many new applications. For example, the potentially lower cost of production allows the microchannel-plate tube to serve as a pre-amplifier for a conventional television camera tube, opening up the use of low-light-level surveillance in industrial security systems where cost is important. For the military, traditionally the largest user of image intensifiers, microchannel-plate tubes are now so much smaller that they can be used even in helmet-mounted binoculars.

Image intensification

In the conventional intensifier tube, an intensifier stage consists of a photocathode input surface, an electron lens/intensifier, and a phosphor viewing screen.

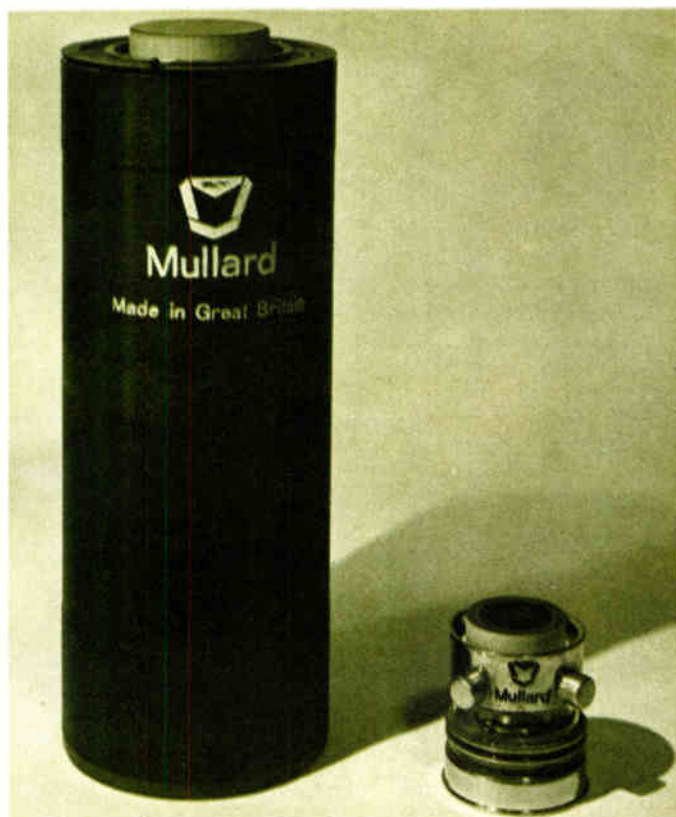

Carries big stick. Low-light-level intensifier tube that incorporates microchannel plate (right) competes favorably with more conventional cascade intensifier tube (left), which is about 10 times its size.

The light that falls on the photocathode triggers the emission of electrons, which are accelerated across a potential of several thousand volts towards the phosphor screen. They are focussed onto the screen by deflection plates charged with similar high voltages and, on hitting the screen, are converted back into light at higher intensities. As in optical lenses, the image is inverted in the process. To allow operation with only a single low-voltage battery connection, the high-voltage power supply is generally provided by solid-state circuitry encapsulated in the tube assembly.

A single intensifier stage of this kind can achieve a luminous gain of only about 100. Since this is not good enough for most night-viewing applications, three such

stages are usually coupled together with fiber-optic windows. The resulting assembly of three tubes is known as a cascade image intensifier and is diagramed in Fig. 1.

Recent developments in intensifier technology, however, make it possible to increase the gain of a single intensifier stage by building in a level of electron multiplication just in front of the phosphor screen. This is the function of the microchannel plate (see "Inside a microchannel plate," p. 121). Because the plate has a variable gain that may exceed 10,000, the resulting tube has an over-all gain ranging beyond that of the conventional three-stage cascade intensifier.

Two approaches to microchannel intensifier tube design have emerged—the wafer tube and the inverter tube. The main difference between them is in the focus-

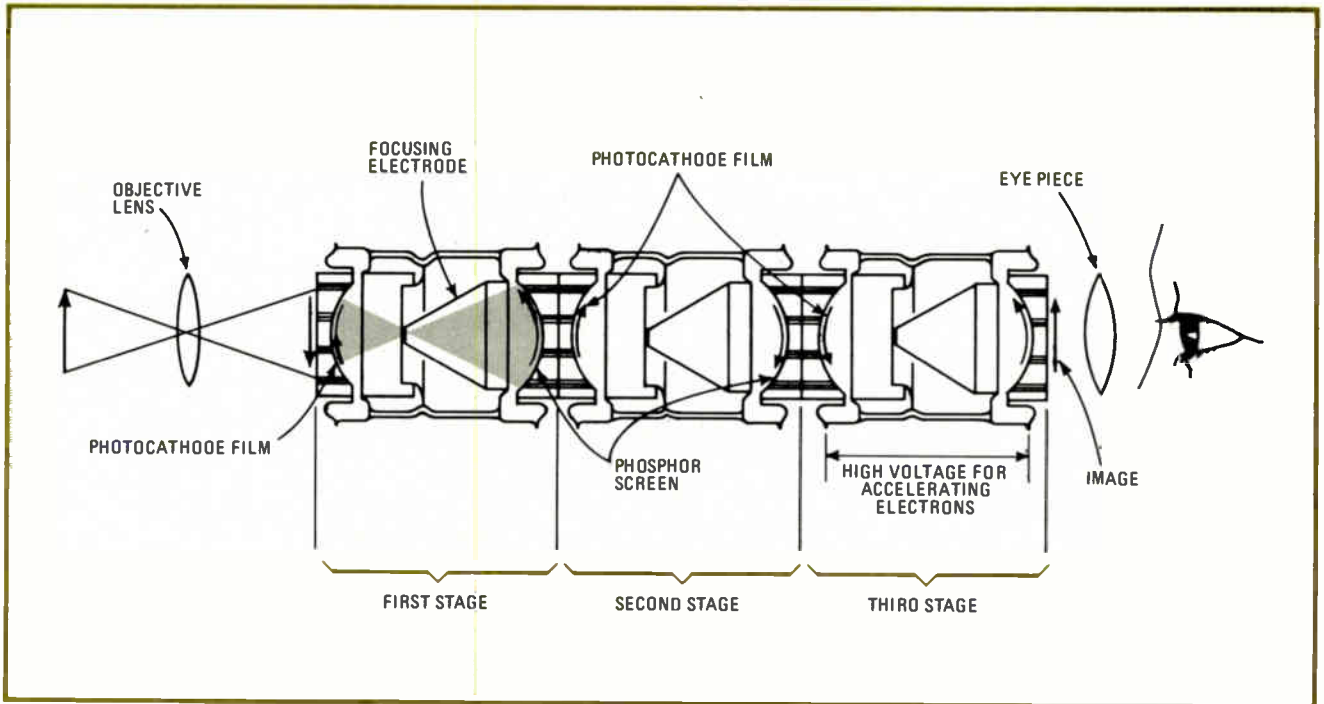

1. Cascade intensifier. In the conventional image intensifier, a photocathode, an electron lens/intensifier, and a phosphor viewing screen make up a stage, and three stages are cascaded to yield an over-all gain of up to 100,000. But such a device is bulky, even when coupled with fiber-optic lenses, and may weigh as much as 1 kilogram, including power supply.

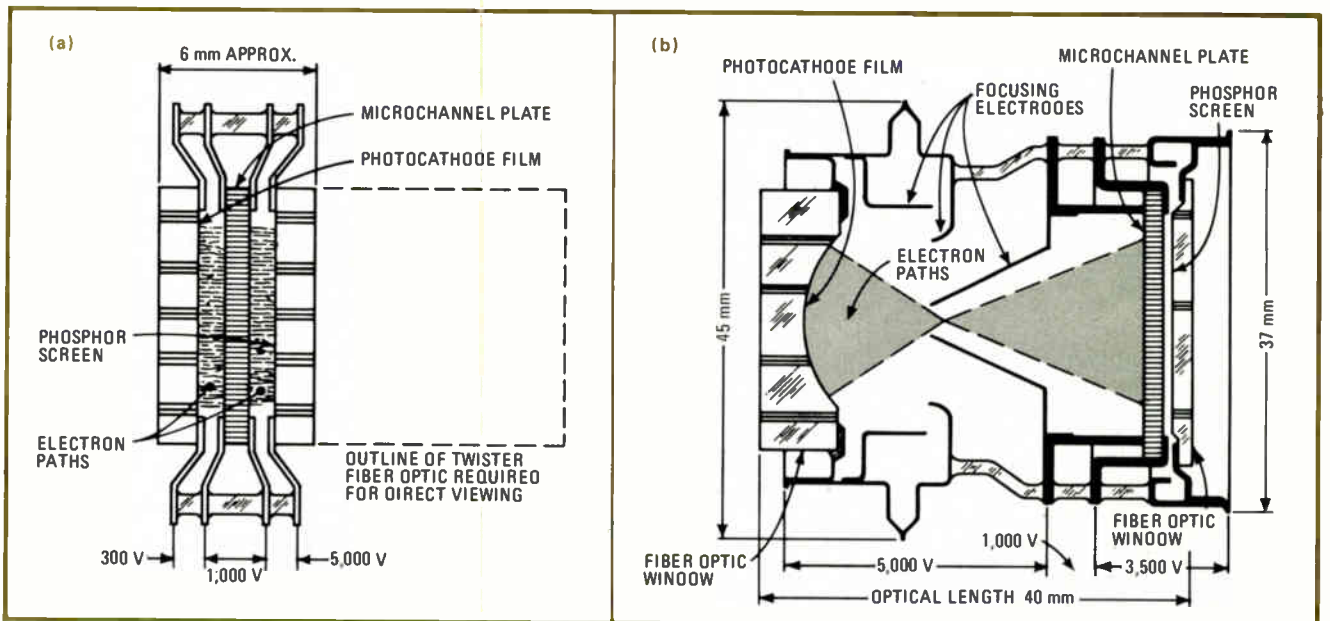

2. Microchannel tubes. Of the two types of microchannel intensifier tubes, the wafer tube (a) has the shortest optical length but, when used in direct-viewing systems, requires a twisted fiber-optic output window to re-invert the image which has been inverted by an objective input lens. Inverter tube designs (b) have an optical length of about 40 mm, are capable of gains of about an order of magnitude greater.

ing of the electrons between the photocathode and the channel plate.

In the wafer tube (Fig. 2a), so-called proximity focusing—in which the close proximity of the two electrode limits the sideways spread of electrons—is used for electrons both entering and leaving the channel plate. This means the tube can have an over-all length of as little as 6 millimeters.

Alternatively, in the inverter tube (Fig. 2b), electrons leaving the photocathode are electrostatically focused

on the channel plate (much as electrons in a conventional cascade-tube are focused on its phosphor-coated output window), and proximity focusing is used between the channel plate and the output screen.

Engineers at Mullard Ltd. have concentrated more on the development of the inverter type of microchannel tube because it can combine long tube life with high screen brightness and good image quality. In a wafer tube, electrons travel almost parallel to the axis of the tube and arrive at the channel plate with low

energy—typically 300 electron-volts. In the inverter tube, however, electron energy at the channel plate surface is much greater (typically 5 kiloelectronvolts) but the angle of entry into the plate varies from the center to the edge of the plate.

Any such variation in angle of entry, however, causes

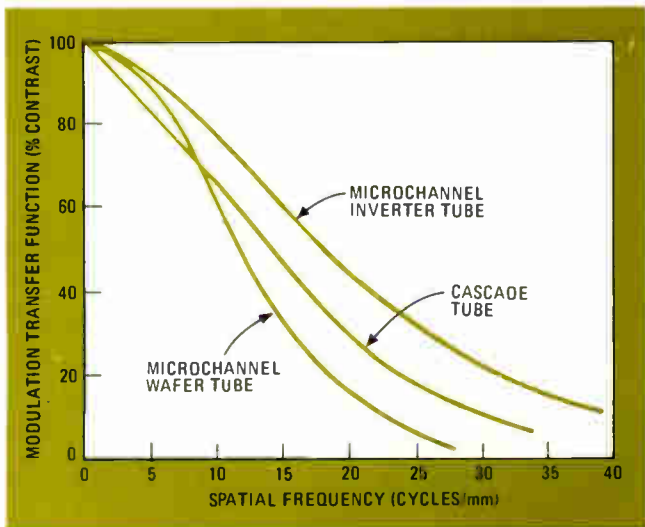

3. Measure of quality. Microchannel inverter tube maintains the highest modulation transfer function—the ratio of contrast between light and dark lines in an original image to the contrast in a reproduction—for all spatial frequencies of light and dark lines.

a difference in the penetration of electrons into the plate, and that causes a variation from channel to channel in the number of secondary electrons produced by the semiconducting channel walls (see p. 121)—and that causes an undesirable variation in gain across an image being intensified. The problem is that those electrons which enter a channel almost parallel to the axis of the channel take longer to intersect the channel walls, so that secondary emission is reduced and gain is decreased. In the inverter tube, this results in an area of low gain in the center of the tube and a dark spot in the intensified image.

Several methods of circumventing this problem have been tried, the most satisfactory of which is to cover the entrance of the channels with a thin film of aluminum. This serves to scatter the incoming electrons, giving them an even distribution of penetration into the channels that is virtually independent of their angle of incidence.

The aluminum film does result in the loss of some energy in the incident electrons. But this loss is minimal for electrons with high energy; for incident electrons with energies of approximately 5 keV, the over-all detection efficiency of electrons entering the channel plate is reduced only about 5% by the film.

Other inverter-tube advantages

Other advantages that result from depositing a thin film of aluminum on the channel-plate surface include

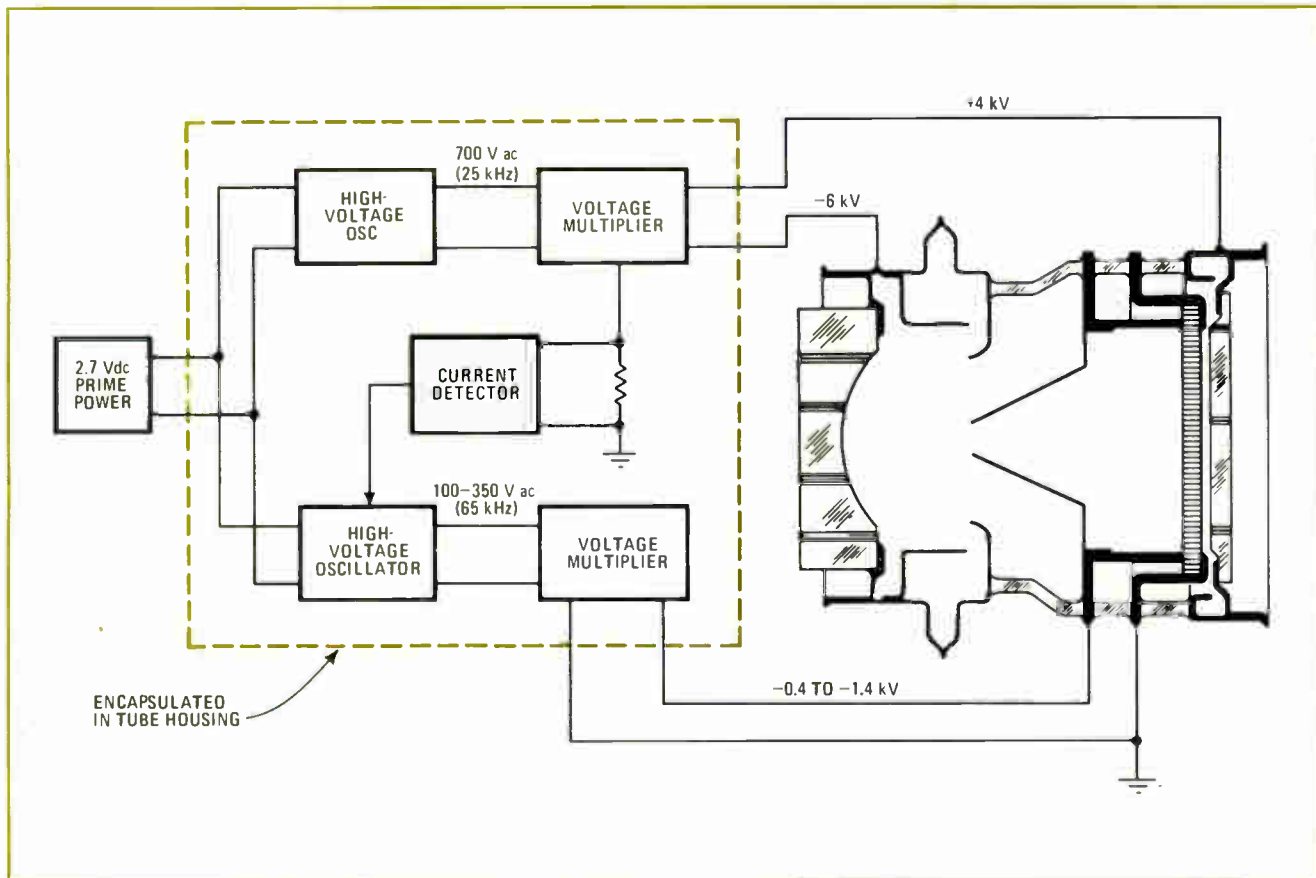

4. Automatic gain. Typical high-voltage power supply that has been designed for the inverter-type microchannel tube includes automatic gain control and is totally self-contained. It requires only a single 2.7-volt battery as a prime power source. The high-voltage supply is usually encapsulated with insulating rubber and built into the over-all tube housing.

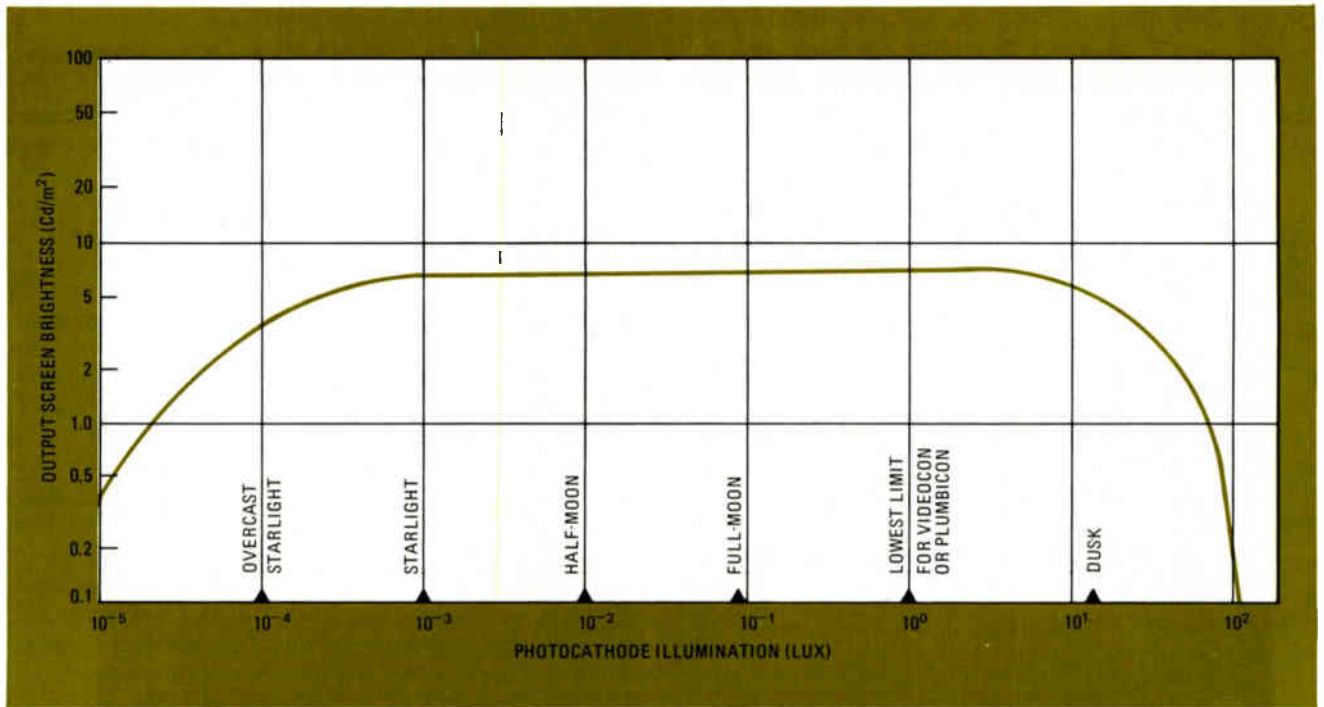

5. **Gain response.** Output of tube using automatic gain control in Fig. 4 is maintained at a constant screen brightness of just over 5 candelas per square meter, regardless of whether input illumination is only starlight or the equal of full daylight.



6. **Night driver.** Night-viewing binoculars developed at Mullard are an example of the new applications made possible by the reduced size of microchannel-plate intensifiers. The helmet-mounted microchannel unit shown, which includes batteries and necessary optical lenses, enables scenes to be viewed easily even in starlight.

lower ion noise and longer tube life.

During the multiplication process along the semiconducting channel walls and the resulting electron bombardment of the phosphor screen, positive ions are produced which travel toward the photocathode. The aluminum film prevents these ions from leaving the channel-plate input and bombarding the photocathode. This results in tube life in excess of 5,000 hours with negligible change in photocathode sensitivity. Also, such tubes can be operated with high channel-plate gains without noise being induced by positive-ion feedback.

In the wafer tube, however, the need to maintain adequate resolution restricts the spacing between the photocathode and the channel plate to a maximum of approximately 0.1 mm. This limits the voltage between these elements to 300–400 v and thus limits electron energy at the entrance to the channel plate to about 300 ev. It is therefore not possible to deposit an aluminum membrane on the channel plates used in the wafer tube since most of the electrons would be unable to penetrate the film.

In the wafer tube, then, noise caused by positive ion bombardment of the photocathode restricts gain to about 20,000 and therefore limits its usefulness at very low light levels. This ion bombardment of the photocathode also reduces the tube's operational life, especially when operated at a screen brightness in excess of 1 candela per square meter.

Noise characteristics

Another noise effect in microchannel-plate intensifiers arises chiefly because every primary photoelectron entering the plate does not produce an equal number of secondaries. This variation results in a signal-to-noise ratio at the output of the channel plate which is four times that of the input. This is equivalent to reducing the illumination at the photocathode by a factor of four and is an especially critical factor in applications requiring highest viewing sensitivity. The visual effect of noise is that of image sparkling or scintillation under low levels of illumination.

One way to minimize this effect is to place the phosphor screen close enough to the channel plate to sufficiently limit the spreading of the electron beam intersecting the viewing screen. Another solution is to increase the persistence of the viewing screen. This technique works well for fixed images, but it has a tendency

Inside a microchannel plate

The microchannel plate is an array of tiny channel electron multipliers which can be used for amplifying an electron beam containing spatial information. Each cylindrical channel (A) combines the function of the dynode structure in a conventional photomultiplier with the function of a resistor chain that divides voltage potential among the separate dynodes.

Each channel is a glass tube about 40 times as long as its diameter. The inner surface of the channel is made semiconducting through a reduction process so that it will emit secondary electrons when bombarded with primary electrons that have been accelerated in an electric field. The resistance between electrodes deposited at each end of a channel is approximately 10^{14} ohms.

Electrons enter the multiplier and strike the wall to produce secondary electrons which are accelerated axially along the channel by an electric field applied between the electrodes. Transverse energy of emission causes the electrons to traverse the channel so that they again collide with the channel wall and produce still more secondary electrons. This process is repeated many times so that a large number of electrons emerge from the channel output.

The over-all gain of a channel depends upon the ap-

plied voltage, the length-to-diameter ratio of the channel, and the secondary emission characteristics of the semiconductor on the channel wall. Since the gain does not depend upon the absolute size of the channel, the overall dimensions can be chosen to match the intensifier-tube design without changing its gain.

Channel fabrication. Techniques used in the manufacture of channel plates are similar to those used for fiberoptic plates. Coaxial glass rods, with a soluble glass core surrounded by an insoluble glass cladding, are drawn down to the required diameter in two stages (B). The multiple fibers are then fused, and the total bundle sliced into wafer plates and polished.

To finish the channel plates, the core glass is etched out and the remaining channel glass is reduced to form the semiconducting surface on the channel walls. Finally, the electrodes to the plate are added by evaporating nichrome obliquely over the polished faces of the plate.

Microchannel plates manufactured by this technique have a thickness of about 0.5 mm and a channel diameter of 12 micrometers (C). The resistance between electrodes of 20-mm diameter plates is 150 to 300 megohms, and for an electron gain of 1,000, an applied voltage of approximately 900 V is required.

(a) ELECTRON MULTIPLICATION INSIDE ONE CHANNEL

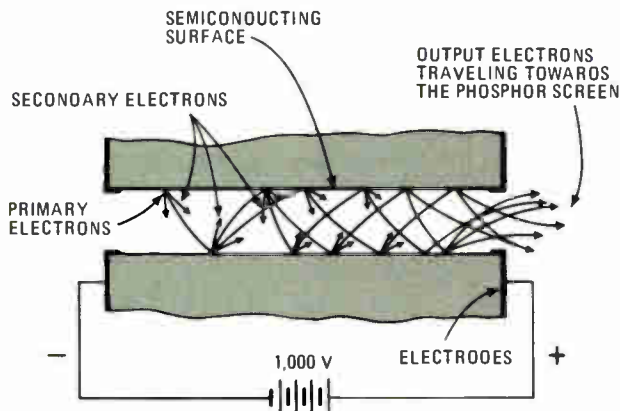

(b) SCANNED-ELECTRON MICROGRAPH OF ETCHED PLATE

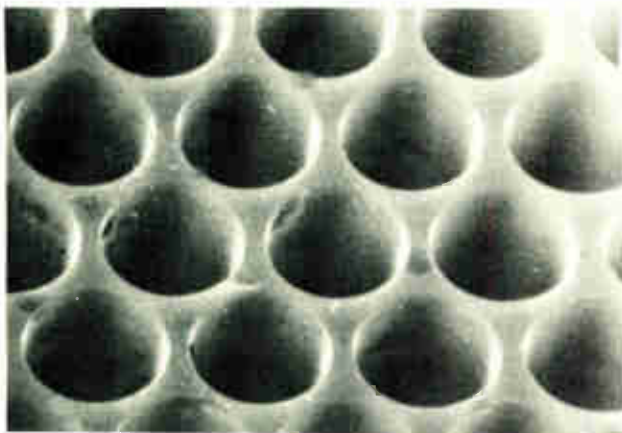

(c) MICROCHANNEL PLATE MANUFACTURING PROCESS

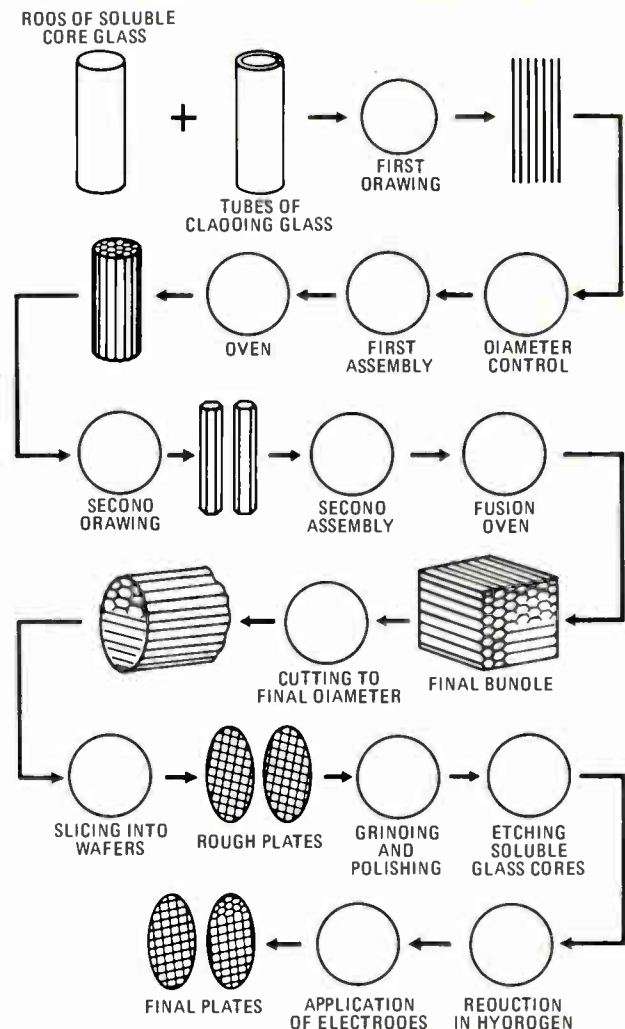

IMAGE INTENSIFIERS COMPARED			
	TUBE TYPE		
	25-mm cascade tube (3 sections)	18-mm inverter tube	18-mm wafer tube
SIZE			
Optical length	190 mm	40 mm	30 mm
Over-all diameter (including encapsulated power supply)	70 mm	52 mm	43 mm
Image diameter	25 mm	18 mm	18 mm
Weight (including power supply)	880 g	140 g	106 g
PERFORMANCE			
Limiting resolution (spatial frequency)			
a) at image center	25 cycles/mm	38 cycles/mm	22 – 28 cycles/mm
b) at image edge	23 cycles/mm	38 cycles/mm	22 – 28 cycles/mm
Modulation transfer function (MTF)			
a) contrast at 5 cycles/mm	83%	92%	85%
b) contrast at 20 cycles/mm	30%	43%	18%
Distortion of image at 80% of diameter	22%	14%	None
Luminance gain	20,000 to 50,000 (not adjustable)	Continuously variable to 100,000	Continuously variable to 15,000
Localized highlight suppression	None	Yes	Yes
Noise generated by intensification process	None	See footnote (1)	See footnote (1)
Sensitivity (minimum detectable illuminance at 5 cycles/mm)	2.5×10^{-6} lux	10^{-5} lux	10^{-5} lux
POWER SUPPLY			
Input voltage	6.75 V	2.7 V	2.7 V
Approximate maximum current	35 mA	25 mA	25 mA
Automatic gain control	Some control	Good control	Good control
Approximate cost in full production	\$1,900	\$800	\$1,200

(1) Equivalent to reduction in light level at input by a factor of 4.

to blur the detail of rapidly changing images.

Image sharpness is often measured in terms of the smallest achievable resolution element. This figure of merit, however, only defines the highest observable spatial frequency of an image and does not indicate any degradation of contrast in the image for spatial frequencies lower than the resolution limit. (Spatial frequency is the number of changes from dark to light and back to dark again, in a unit distance over the surface of the image, often measured in cycles per millimeter.)

A more meaningful measure of image quality is the modulation transfer function, which is the ratio of contrast in an original image to the contrast in a reproduction as a function of spatial frequency. The modulation transfer function (MTF) indicates contrast for lower spatial frequencies, which is important at low light levels. Furthermore, the MTF is compatible with the optical transfer functions used by the designers of other optical components so that functions of individual components of a system can be multiplied together to yield a quality measure for the entire system.

Better image quality

In the wafer tube, the distance between its photocathode and the surface of the microchannel plate has a significant effect on the tube's MTF. Even under the most favorable conditions, with a 0.1-mm gap and a voltage potential of about 300 V between the two surfaces, the spread of electrons leaving the photocathode limits the tube's image quality.

In the inverter tube, however, electrostatic focusing

reduces this spread of electrons and MTF is mainly dependent on the number of channels per unit area, and on the proximity focusing between the channel plate and the phosphor screen.

Typical modulation transfer functions for each of the three main types of image intensifier tubes are plotted in Fig. 3. The cascade tube is Mullard model XX-1060, and the inverter tube is Mullard Model XX-1301. Data for the wafer tube is taken from published data of other manufacturers.

Pin-cushion distortion

Another important parameter which degrades image quality in the inverter tube is pin-cushion distortion, which results from electrostatically focusing electrons on a channel plate which is flat instead of concave. This distortion, which causes a point at the edge of a reproduced image to appear closer to the viewer than it actually is in the original scene, can be reduced by increasing the length-to-diameter ratio of the electrostatic focusing cavity feeding the channel plate.

In many practical applications, however, a strong need exists to keep the length of the intensifier tube at a minimum. With these two conflicting design goals in mind, the Mullard model XX-1301 inverter-type tube was designed with a length-to-diameter ratio of 2. For such a tube, pin-cushion distortion has been limited to 14%, which is generally better than existing cascade tubes.

The pin-cushion effect can be reduced, if necessary, by using an objective lens with compensating barrel-

type distortion. When the inverter tube is used as an input to a television camera, normal television compensation circuitry can also reduce the effects of pin-cushion distortion.

One of the most useful properties of channel-plate intensifiers is the localized saturation of individual channels within the plate. Each channel, acting as an independent electron multiplier, can saturate without affecting neighboring channels.

The effect of localized saturation can be used to advantage for highlight suppression in applications where there are bright point sources of light such as car headlights and street lights. In these situations, local channel saturation reduces the gain for bright sources without reducing gain in darker parts of the image. And since recovery time from saturation of the channel is less than the response time of the eye, the highlight suppression is as effective on a moving image as on a static one.

Increasing tube life

Aside from the techniques already discussed, another step must be taken in the manufacture of microchannel-plate intensifiers to increase tube life.

During the multiplication process of the microchannel plate, gas is released as a result of the electron bombardment of the channel walls. Initially, a large quantity of gas is released, making it necessary to reduce the outgassing rate of the channel plate before finally sealing the tube from its vacuum pump. The tubes are therefore aged for several hours with a screen brightness (and therefore electron current within the channels) that is much greater than it would be in normal operation.

This aging process stabilizes the tube, reducing the outgassing rate of the channel plate during operation to a negligible level. Inverter tubes prepared in this way have operational lives that are in excess of 5,000 hours

at a screen brightness of 10 cd/m².

As in all other electronic equipment, the design of the power supply must not be overlooked. In the inverter tube, a high-voltage supply (about 10 kv between photocathode and screen) is required, and voltage taps must be distributed as shown in Fig. 4. For most applications this supply must be readily portable and powered from a low-voltage battery.

Although these requirements can be met from multiple tapings of a single high-voltage multiplier with a manual gain control, the inverter tube is ideally suited to a supply with automatic gain control. To achieve agc, the photocathode-to-screen voltage is supplied from a fixed-voltage oscillator and voltage multiplier. Current through this loop is detected, and the feedback signal is used to bias another high-voltage oscillator, which drives a second high-voltage multiplier for the channel plate. The total power-supply circuitry can be constructed on a small printed-circuit board and packaged in the same housing with the tube. A 2.7-volt power source is required at a maximum operating current level of 25 mA.

Such power supplies yield constant screen brightness over a wide range of input illumination of the photocathode (Fig. 5). The response time of the feedback is faster than the eye's, so the tube and power-supply system is useful in viewing moving images. The response time, combined with the effect of highlight suppression discussed earlier, makes the tube useful in situations where there are bright flashes, such as gun flash in rifle sights for night viewing.

Applications

Although microchannel tubes were originally designed for military night-viewing binoculars suitable for driving, its reduced size and weight and improved performance compared with conventional cascade tubes



7. Bird's-eye view. Typical picture produced by microchannel-plate inverter-tube binoculars illustrates image obtainable when the tube's photocathode is illuminated at an intensity of about 3 lux (about one-quarter moon). Pin-cushion effect of inverter tube has been reduced by objective lenses with compensating barrel-type distortion.



8. Surveillance monitor. Image on cathode-ray-tube display is produced by system in which microchannel inverter tube is coupled to vidicon camera. Target, which is 25 meters away, is illuminated only by the stray light that was used to take this picture (i.e., conditions which are an approximation of starlight).

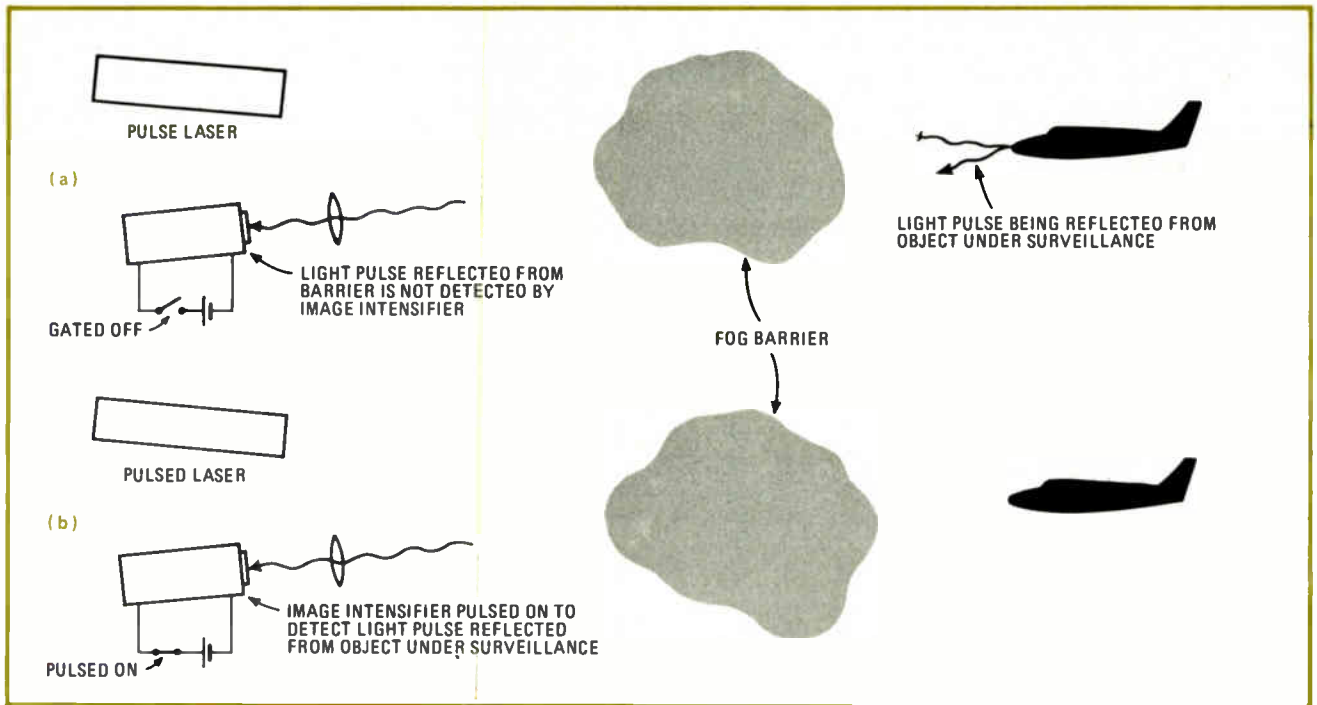

9. Clearing the fog. Gated viewing system makes use of image intensifier to "see through" fog barrier. Intensifier is gated off during period in which light is being reflected from barrier (a), but is pulsed on when light is reflected from target (b). High-gain intensifier system is capable of reducing the barrier-to-target illumination ratio by factors of over 5,000.

are leading to new applications. These fall into three categories: direct viewing, low-light-level television, and gated viewing.

For direct viewing, where the user views the phosphor screen at the output of the tube directly, the main effort has been to develop head-mounted binoculars suitable for driving at night. Such binoculars must be designed for a wide field of view (approximately 50°) and an optical magnification factor of approximately unity. They are capable of producing the image quality shown in Fig. 7.

The relatively small size and weight of the microchannel tube has also led to the manufacture of various hand-held starlight telescopes weighing only 1 or 2 pounds. To improve the versatility of these telescopes, a selection of screw-on objective lenses with different fields of view is often necessary. The uses of these telescopes vary from medium-range weapon sights to pocket viewers suitable for general security work.

Image intensifiers are used in low-light-level television for both military and civilian applications (Fig. 8). In one instance, a major chemical company is now using an intensifier as a preamplifier for a conventional television camera as part of a security and fire protection system. In such surveillance systems, the intensifier tube can increase the sensitivity of the standard Plumbicon or vidicon far below their present minimum illumination requirements—which is about 1 lux at their input, or halfway between full moonlight and full daylight.

Fiber optic coupling between the intensifier and camera tube simplifies the design and keeps weight and size to a minimum. If automatic gain control is used in the intensifier tube's power supply, the camera system can operate over a wide range of input illuminations while

maintaining a fixed operating level at the camera tube. Also, the saturation effect of the intensifier tube prevents permanent damage to the camera in the event of a sudden overload.

Another important and somewhat unusual application for the microchannel image intensifiers is in gated viewing. Here, image intensifiers can be gated on for periods of less than 1 microsecond, enabling the user to see through barriers of fog, mist, or smoke screens.

The principles of gated viewing are illustrated in Fig. 9. A laser is pulsed to illuminate a target at a given range within the field of view of the image intensifier detecting system. As in microwave radar, the time taken for the energy pulse to travel to and return from the target is dependent on the target's distance.

If the switching of the intensifier tube is properly timed, only light which has been reflected from a particular range will be detected. Since light reflected from intermediate ranges is not detected, the system is capable of penetrating partially opaque barriers with relative target-to-barrier gains in excess of 10 million.

Future Intensifier developments

Now that image intensifiers have reached the point where they are practical for use in night-viewing systems, researchers are refining production methods to reduce costs and improve tube performance. A large effort is being made to extend intensifier sensitivity to even lower light levels—below the minimum detectable illuminations of about 10^{-6} lux achievable today.

For the microchannel tube, this requires improvements in photocathode sensitivity, which presently ranges from about 200 to 400 microamperes per lumen. It seems reasonable now to hope that this sensitivity will be tripled in the next several years. □

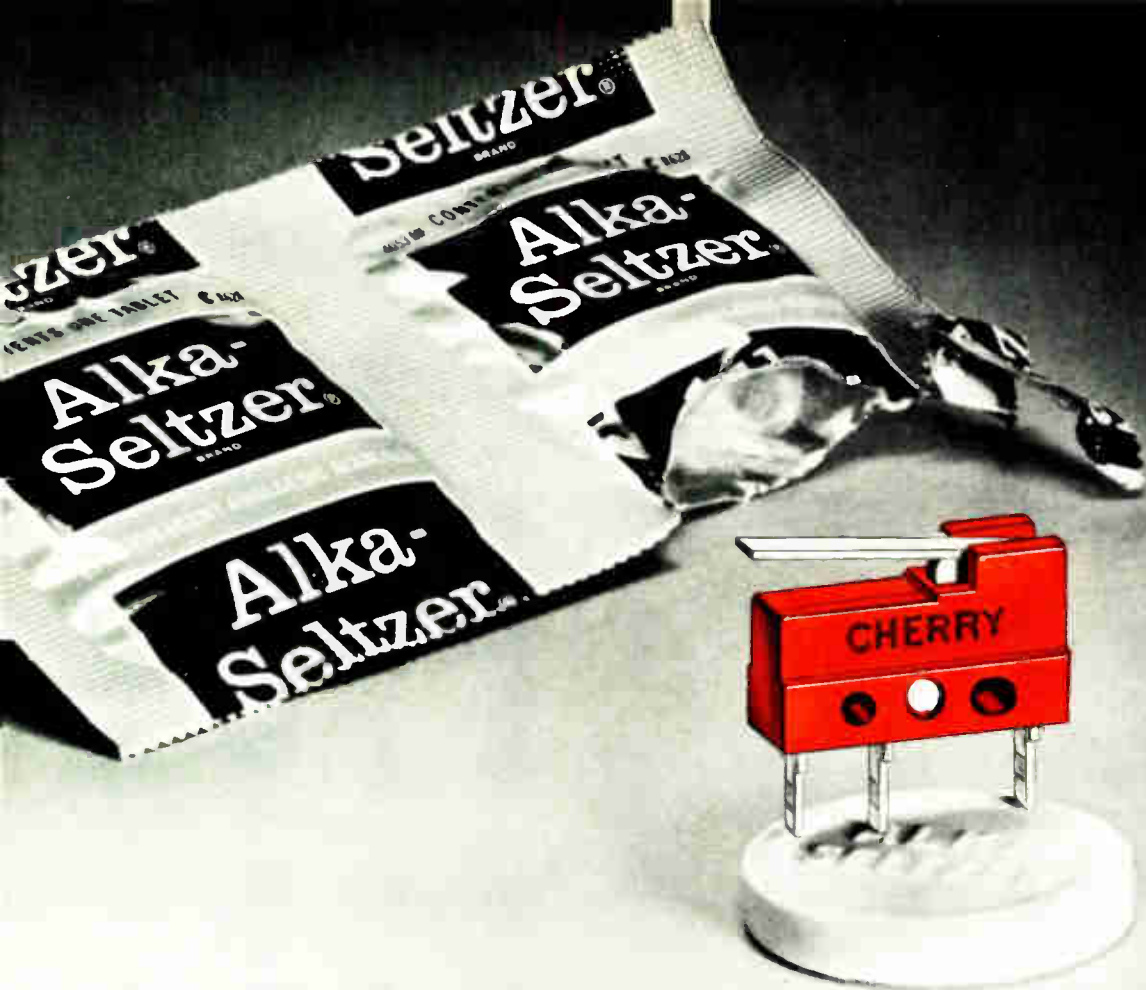

TRY 'EM...YOU'LL LIKE 'EM

Instant relief for design congestion: Cherry Subminiature snap-action switches.

When your design is afflicted with circuit congestion brought on by acute lack of space, here's the prescribed cure: Cherry 5 and 10 amp subminiature switches! Compact, easy-to-take size . . . refreshingly dependable coil spring action . . . plus long overtravel to combat assembly line headaches. You get Speedy snap-action relief in the dosage you prescribe: Either individual switches or space-saving multiple switch modules. Consultation available if design distress persists . . . Cherry diagnoses proven in over 160 million cases.

Try 'em: Send for free sample switch.
You'll like it.



E61-00A
Standard Force Basic 10 amp.
Circle Reader Service No. 190

E63-00A

"Goldie" Low Energy 0.1 amp.
Circle Reader Service No. 189



E62-50K
Roller Actuator 10 amp.
Circle Reader Service No. 191

CHERRY



TWX 910-235-1572 . . . or PHONE (312) 689-7600 . . . or WRITE:

CHERRY ELECTRICAL PRODUCTS CORP.
3608 Sunset Avenue, Waukegan, Illinois 60085



Cherry affiliates worldwide • Hirose Cherry Precision Co., Ltd., Tokyo • G. W. Engineering Pty. Ltd., Sydney
Cherry Electrical Products (U.K.) Ltd., St. Albans, Herts • Cherry Mikroschalter GmbH, Bayreuth, Germany

Dramatic new product opportunities ... yours with new 3C8 ferrites

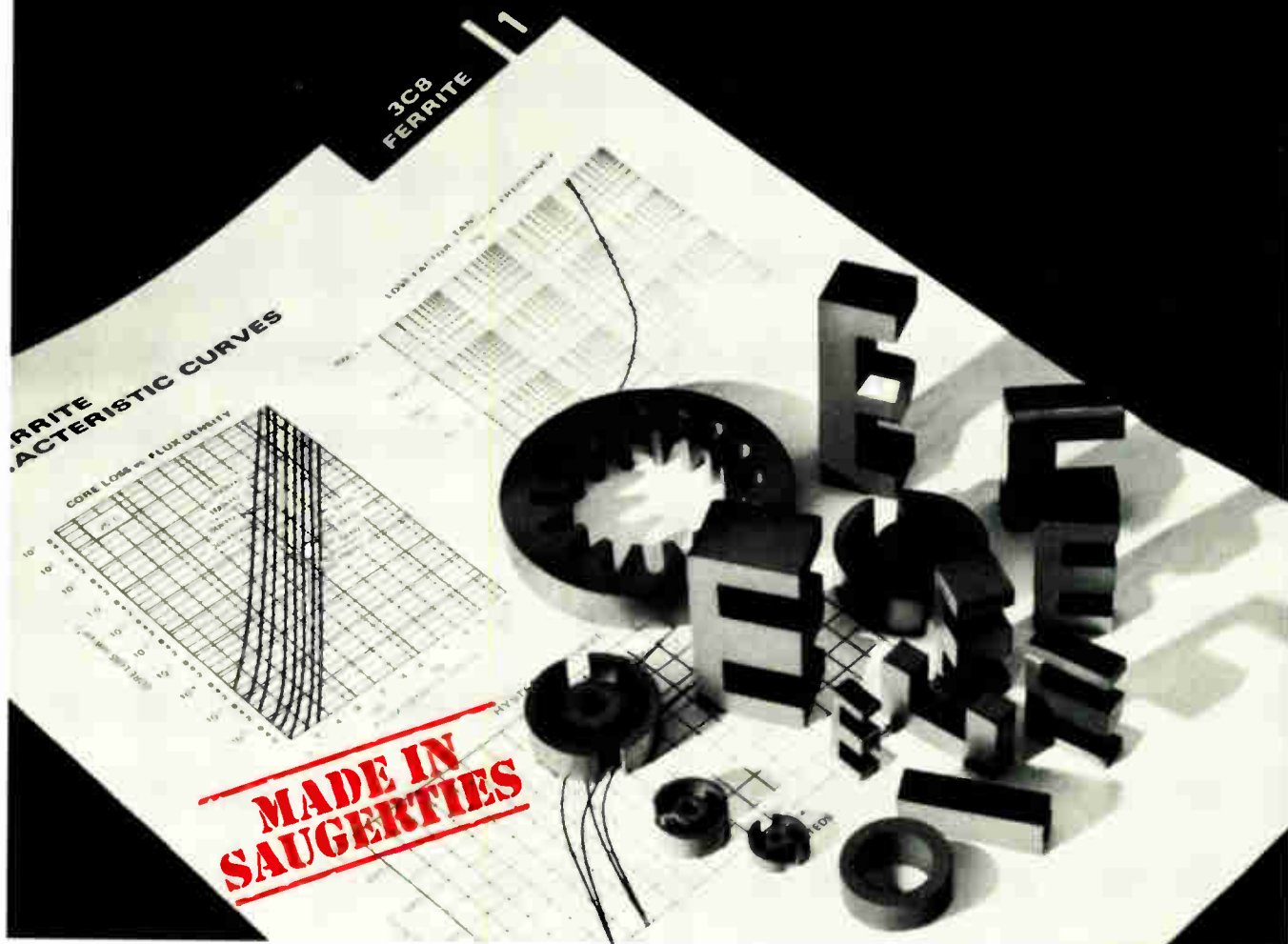

The market is ripe for product breakthroughs. Just look, for example, at the growth of such items as the hand-held calculator, small camera flashguns, ultra-mini portable radios and recorders. The key to these tremendous sales successes is high frequency power conversion circuits.

And the key to still *more* efficient, high-frequency power conversion is Ferroxcube's new 3C8!

This important new ferrite material gives significantly higher flux densities at higher temperatures, and lower losses at high excitation levels than any other magnetic core material. It is available in practical size cores for use up to kilowatt power levels.

3C8 is already being used with great success in: inverters, battery chargers, fluorescent lamp ballasts,

strobe light devices for highway markers and harbor buoys, power oscillators, power amplifiers, ultrasonic generators.

In all of these circuits Ferroxcube's 3C8 material has led to greater efficiency, lower cost, less weight, and smaller sized units. In one power supply, for example, the size of the core was reduced from 13 lbs. at 60Hz to 4 lbs. at 20,000 Hz and the volume from 35 to 9 cu. inches—savings of 70 to 75%!

Can 3C8 improve your present products or suggest new products and markets for your company? If you've got the imagination, we've got the core! Call 914•246-2811, TWX 510-247-5410 or write today.

Ferroxcube linear ferrites—made in Saugerties, N.Y. and stocked in seven U. S. locations.



FERROXCUBE CORPORATION, SAUGERTIES, N.Y. 12477
A NORTH AMERICAN PHILIPS COMPANY

Distributed through North American Philips Electronic Components Corporation with warehouses in Boston, 617-449-1406, New York, 516-538-2300, Saugerties 914-246-5861, Philadelphia 215-927-6262, Chicago, 312-593-8220, Santa Clara, 408-249-1134, San Diego, 714-453-9250

16404

C-MOS switch speeds up sample-and-hold circuit

by J.E. Buchanan
Westinghouse Electric Corp., Systems Development Division, Baltimore, Md.

With a complementary-MOS switch, a simple low-power analog sample-and-hold circuit offers relatively fast operating speeds as well as high accuracy. The C-MOS switch cancels the unwanted charge transferred between the switch driver and the holding capacitor. This problem is frequently encountered in short-acquisition-time applications where a low-value holding capacitor must be used.

When a C-MOS switch is used to perform the switching function for the conventional sample-and-hold configuration of (a), circuit response can be improved considerably, especially if relatively fast acquisition times are needed, along with short hold times. This basic arrangement becomes troublesome as the holding capaci-

tor is made smaller in value so that it can be charged or discharged more quickly when the switch is turned on.

Turning the switch off causes a proportionally greater amount of charge to be transferred to the capacitor because of the capacitance from the switch driver to point A. In effect, a capacitive divider is formed between the switch driver and the holding capacitor. (If a JFET is used as the switch, this divider is created by the device's gate-source junction capacitance.) The polarity of the charge transfer depends on the type of switch used and the voltage polarity required to turn the switch off.

As the value of the holding capacitor decreases, the voltage remaining across the capacitor after the switch is turned off becomes smaller than or larger than (depending on switch driver polarity) the voltage before switching. Capacitor voltage, therefore, no longer represents the true signal level and becomes progressively more erroneous as the value of the switch capacitance approaches that of the holding capacitor.

Also, the switch driver is often required (for switch biasing considerations) to have a voltage swing that is two to three times greater than the full-scale signal level stored by the holding capacitor. This large driver-volt-

Sampling with C-MOS. In basic arrangement of sample-and-hold circuit (a), unwanted charge is transferred to holding capacitor because of switch (gate) capacitance. This limits the minimum holding capacitance and, therefore, the swiftness of the acquisition time. Installing a C-MOS switch, as shown in (b), eliminates this problem by canceling the unwanted charge so that it does not affect capacitor voltage.

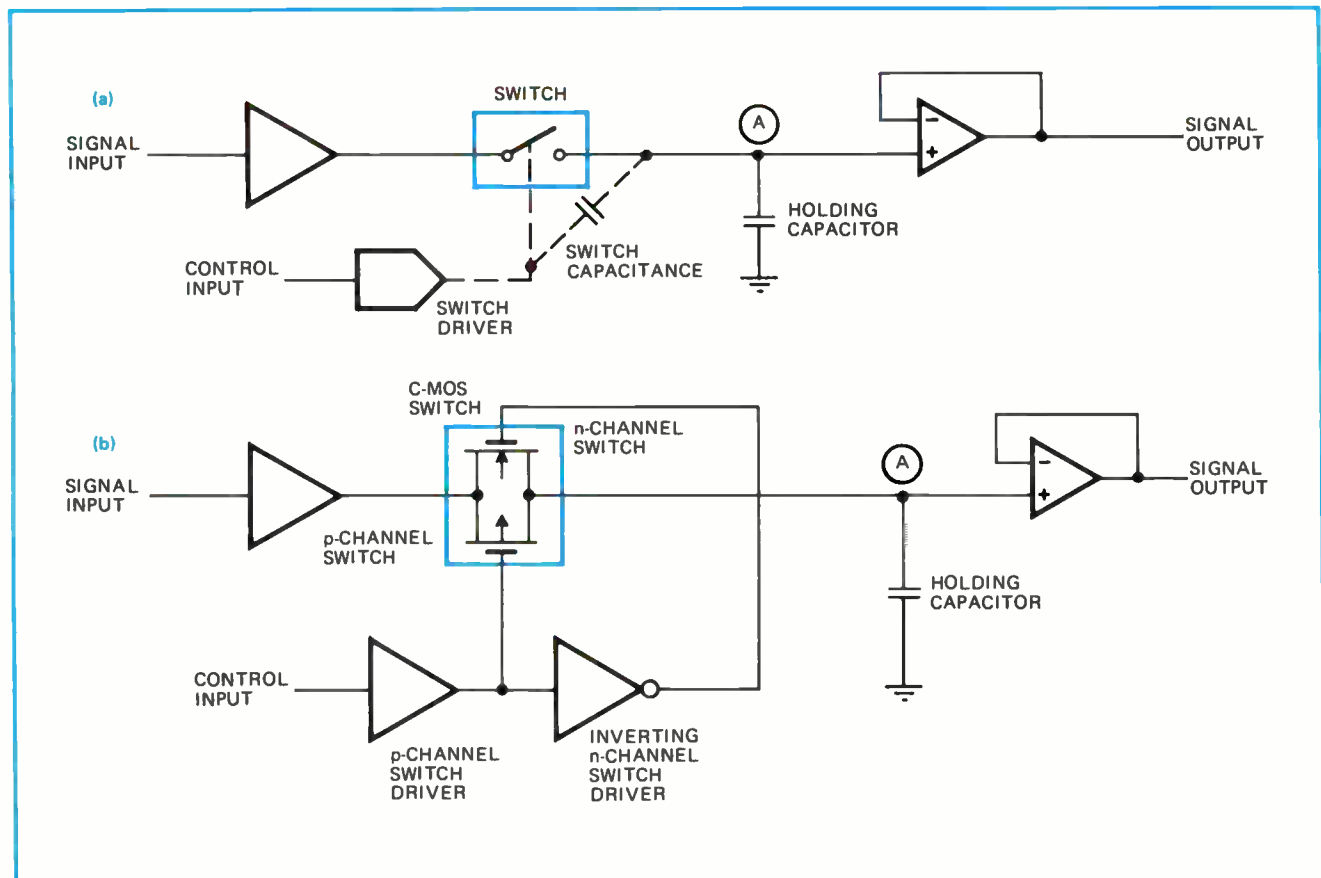

age swing further increases the charge-transfer error across the holding capacitor.

A brute-force solution is to increase the drive capability of the input amplifier so that the holding capacitance can be kept large with respect to the switch capacitance. This is a power-robbing approach, however, and is not always practical. Furthermore, the maximum output current of a typical IC op amp (about 10 milliamperes) also limits the holding capacitance that can be used for a given acquisition time. Suppose, for example, the capacitor is 1,000 picofarads. The acquisition time is then:

$$dv/dt = (10 \text{ mA})/(1,000 \text{ pF}) = 10 \text{ V}/\mu\text{s}$$

Of course, the effects of switch resistance and amplifier slew rate must also be considered. Many low-on-resistance JFET switches have a gate-source junction capacitance on the order of 10 to 30 pF, so that even a holding capacitance of 1,000 pF is not adequate for high-accuracy applications.

There are other solutions to the charge-transfer problem. For example, a level change that is equal but opposite to that of the switch driver can be coupled into the node at point A by using a capacitor that has nearly the same value as the switch capacitance. Naturally, schemes such as this one have temperature-tracking

problems, may require some initial trimming, and add to the complexity of the circuit.

But the C-MOS switch effectively provides an equal charge transfer in and out of the "holding" node without any of these problems. Since it is an integrated device, fabricated on a common substrate, its n-channel and p-channel MOSFETs and their associated capacitances are closely matched initially and tend to track each other with changing temperature.

The C-MOS switch is inserted as shown in (b). Both the n- and p-channel MOSFETs are biased so that they operate over the center range of the voltage being switched (or that can be switched). Since opposite voltage polarities are required to turn on the two parallel switches, there must be two switch drivers. (One simply inverts the gate voltage of the other.) When the C-MOS switch is turned off, nearly equal and opposite signals are coupled to the holding capacitor, effectively cancelling the unwanted capacitor voltage change.

The match between the n- and p-channel devices is not perfect and, to some extent, is a function of the level being switched. For a signal level of 0 to 5 volts and a 470-pF holding capacitor, the error due to mismatch can be held to less than 10 millivolts when an RCA type 4016 C-MOS switch is used. □

Packaged power circuits satisfy control applications

by Larry Carver and Bryan Bixby
International Rectifier Corp., Semiconductor Division, Los Angeles, Calif.

Design engineers can now benefit from a new class of devices—power hybrid circuits—that blend the technologies of microcircuitry and power semiconductors. In many cases, these circuits do away with the need for special packaging, sophisticated heat sinking, and

complicated isolation. Complete control circuits composed of diodes and thyristors are now available in a single convenient package.

As with integrated circuits, the designer is no longer selecting an individual component. Instead, he looks through a variety of standard packaged circuits to find the one that will meet his job requirement, and so takes advantage of the lower cost of a volume-produced item.

For example, a family of these power hybrid circuits, tradenamed Pace/Pak, is intended to perform a number of everyday control functions. There are three series of devices—PH400, P100, and P200—which can carry currents of up to 10, 25, and 50 amperes, respectively. In quantity, they cost approximately \$5 to \$50.

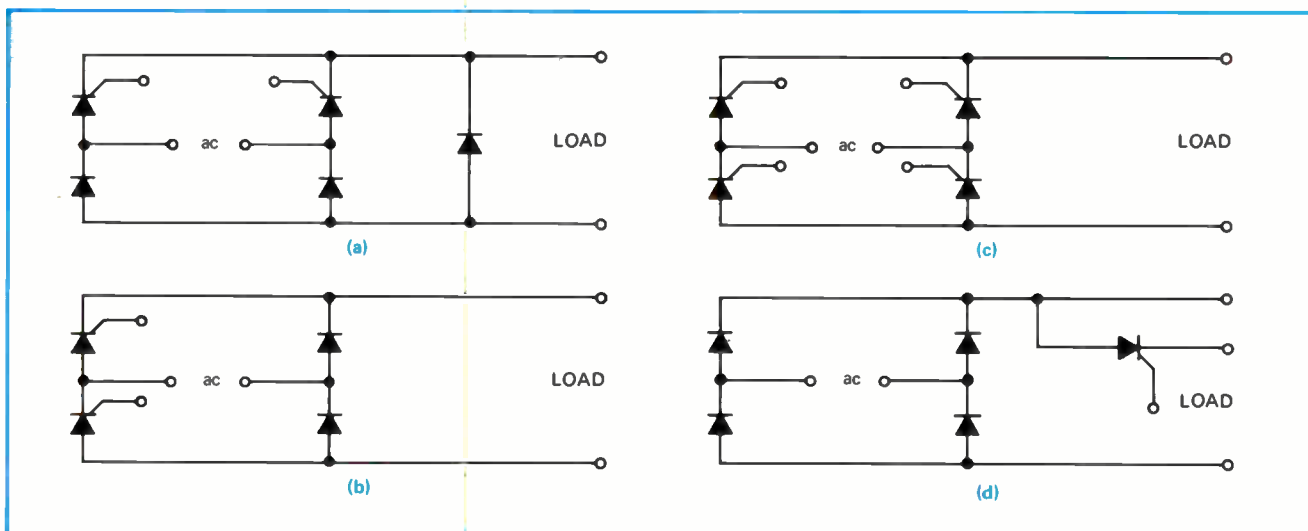

1. **Power supply circuits.** Packaged SCR/diode arrays satisfy a variety of power supply needs. Circuit (a) requires only one SCR gate drive source, while circuit (b) requires two. Circuit (c) is for motor control applications, and circuit (d) can provide crowbar protection.

Figure 1 shows several of these circuits intended for dc power supply applications. The circuit of Fig. 1a is available with or without the free-wheeling diode, which is required if the load will be inductive. Since the cathodes of the SCRs are common, only a single gate drive source is needed. The circuit of Fig. 1b provides the free-wheeling path for the load without employing an extra diode, but requires two isolated gate drives.

Although most appropriate for motor control applications, the circuit of Fig. 1c can be used to control an inductive current. The circuit of Fig. 1d places the SCR across the dc output for use as a crowbar to protect a load from short circuits or line transients. The SCR can interrupt the circuit or reduce output voltage to zero.

The circuits in Fig. 2 can be used as controlled power supplies—either a center-tapped (Fig. 2a) or a full-wave bridge (Fig. 2b) unit. With these, the load (or filter) connected to the output of the bridge must appear to be resistive or capacitive. If the load appears to be inductive, the output SCR may lose control and switch to its fully on state.

These circuits can also be used as the switching device in controlled battery chargers. Even with an inductance in the circuit (for form factor improvement), they will work with a single SCR. The battery voltage forces the current to fall whenever the supply voltage falls below the battery voltage. This occurs every half cycle. After the current reaches zero, the battery voltage reverse-biases the SCR until the supply voltage again exceeds the battery voltage.

There are many applications where a solenoid must be energized rapidly, held in position, and then released rapidly to operate a mechanical device under controlled conditions in a very short period of time. The full SCR bridge shown in Fig. 3 is ideal for this application. When an energize demand signal is applied to the bridge, it turns fully on and produces the output waveform of Fig. 3a, applying full line voltage to the load.

With the right load characteristics, the energize demand signal can be an overdrive condition that forces

the load current to rise rapidly and operate the mechanical output from the solenoid's magnet in a minimum amount of time. Once the mechanical change of state is achieved, it may be necessary to reduce the output current to some lower level to limit the power dissipated in the solenoid or to reach a hold level of current in preparation for a rapid release of the solenoid.

A reduced output level is easily achieved by phasing-back the firing angle of the SCRs to obtain the output voltage shown in Fig. 3b. The average output voltage varies with the phase-back angle as a cosine function—to halve the output voltage, for example, the phase-back angle is 30° .

When required, the solenoid can be released rapidly by phasing the firing of the SCRs fully back and using the line voltage to force the current to zero. Because of the inductive nature of the load, the output waveshape of Fig. 3c is obtained for this condition. The load generates a voltage sufficiently above the line voltage to force the load current through the supply. But, of course, the flux change required to generate this voltage results in the decay of solenoid current.

In this type of operation, the control circuits must have a sufficient end stop (turn-off time) so that the SCRs are reverse-biased long enough to regain their blocking capability. A turn-off time of 50 microseconds, which converts to a maximum phase-back angle of approximately 179° , is generally adequate.

With this type of power module, very precise control can be exercised over magnetic loads, including the instant that power is applied, the hold power, the timing, and the rate of discharge. □

Engineer's Notebook is a regular feature in Electronics. We invite readers to submit original design shortcuts, calculation aids, measurement and test techniques, and other ideas for saving engineering time or cost. We'll pay \$50 for each item published.

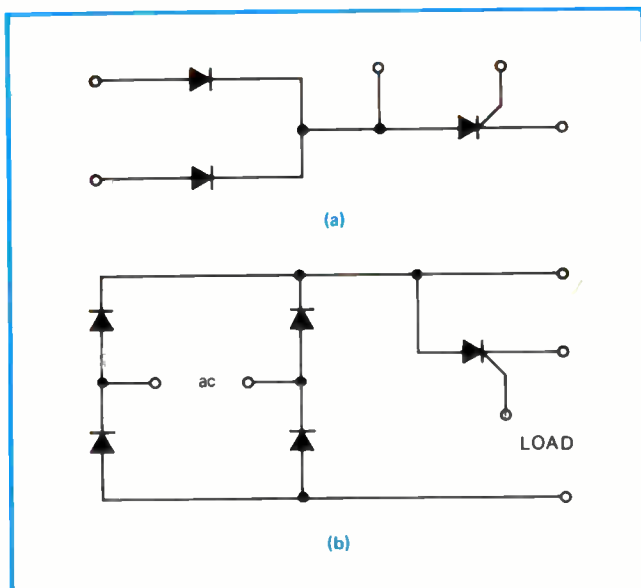

2. Controlled supplies. Center-tapped circuit (a) and full-wave bridge circuit (b) are intended for driving non-inductive loads.

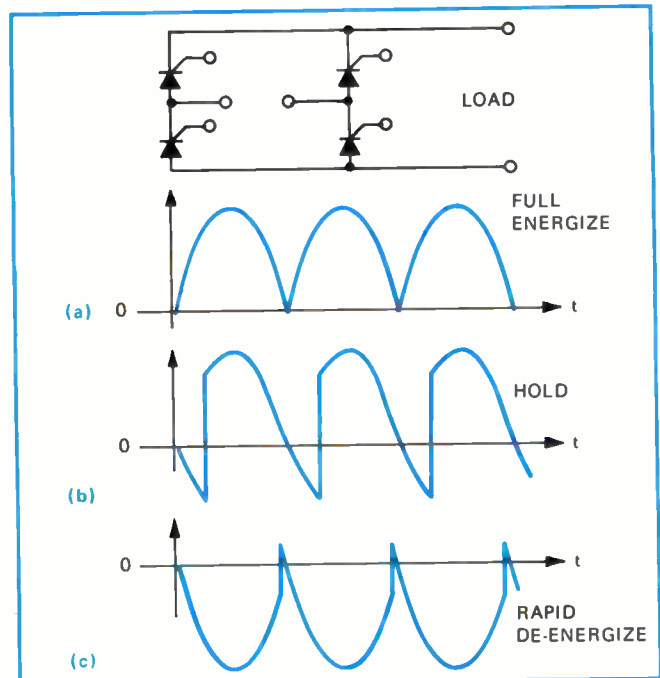

3. Solenoid control. Full SCR bridge permits precise control of magnetic loads. Output waveforms are shown for fully energizing a solenoid (a), maintaining a desired hold level (b), or quickly discharging the solenoid (c). Timing can also be precisely controlled.



This three year old \$3.00 thumbwheel switch is still pretty revolutionary.

We called it revolutionary then and indeed it still is. The 1776 was the first thumbwheel with a revolving code disc that lowered prices. It was the first with switch terminals that plugged into PC mother boards. You got efficient terminal bussing and high density mounting. It eliminated interface wiring and, because it's dip soldered, lowered assembly costs. It went for a bargain counter price of \$3.00 and less than \$2.00 in quantity. It was revolutionary because of all these good things, plus large, easy-to-read dial characters, plastic window readout protection, and

double width switches with triple legend area. Its large range of available codes, along with fast delivery from our nationwide sales and distribution system quickly made it an "off-the-shelf" switch. You got into the spirit of '76 and bought a bundle of them. Now, the 1776 has a skinny little brother that's only .350" wide. We call it the 1976 because it's a little ahead of its time. It's been designed for minimum package dimensions but has all the features of its big brother. It fills a real need when your design gets tight dimensionally. So get in the spirit of the

new '76 and check both of these switches. Write for our thumbwheel switch catalog. ELECTRONIC ENGINEERING COMPANY of California, 1441 East Chestnut Avenue, Santa Ana, California 92701.

EECC

First in design
Distributed by G. S. Marshall Company,
Hall Mark Electronics and Schweber
Electronics.

Thumbwheel switches • Dual in-line packaging • Punched tape readers

Circle 130 on reader service card

Learn how to program microprocessors

Microprocessors would probably be replacing traditional hard-wired logic even faster than they are now, if it weren't that their engineer-users find it hard to write programs for them. To help overcome this difficulty, Intel Corp. will offer **hands-on workshops in microprocessor programing beginning in October.**

At present nine sessions of two to three days each are scheduled to be held in San Jose, Calif., at intervals through December. Others may be offered later, in the San Francisco Bay area or elsewhere, if enough interest is shown. Intel has arranged with Compata Inc., a California software and consulting firm, to provide instructors. **The cost is \$250 to \$350 per session.**

Heterodyne counters handle 100-MHz bandwidth

Although the transfer oscillator technique used in many microwave-frequency counters has superior sensitivity and frequency range, it does have a serious drawback: it cannot measure signals with a substantial amount of frequency modulation on them. **The relatively narrowband phase-locked loop in a transfer oscillator will break lock if the input signal has a bandwidth greater than about 1 megahertz.**

Heterodyne-type counters, on the other hand, can tolerate bandwidths in excess of 100 MHz. They are **ideal for measuring the center frequency of a modulated carrier**, or for monitoring the output of an inexpensive signal generator with a lot of incidental fm.

The many functions of function modules

By now, differentiators and integrators are everyday fare in a variety of circuits, but don't forget that other sophisticated mathematical operators can also be bought as packaged items. Often referred to as function modules, these handy devices can simplify your design, as well as make it more compact and less expensive to build. With them, it is possible to multiply, divide, square, find square roots, generate a number of trigonometric functions, or compute logarithms. **Applications include modulation, demodulation, detection, waveform generation, and equation solving.** The circuit on page 106, for example, employs a multiplier to produce a power equation for obtaining a simple wattmeter.

Tubes that gain from semiconductors

Cross-fertilization of photomultiplier tubes with III-V semiconductor technologies is extending the usefulness of these devices. **In precision applications, new gallium-phosphide dynodes with a gain of 100 can detect single electrons.** Gallium-arsenide and indium-gallium-arsenide-phosphide photocathodes allow luminous sensitivities in the range of 100 microamperes per lumen (20%), or more.

Suppliers of these tubes include RCA and, quite recently, Varian, which is offering a tube with a 120-picosecond rise time. That allows gigabit-per second information rates.

Wiring made easier

Speed up your breadboard wiring with a new wire-wrapping kit from Augat Inc., Attleboro, Mass., 02703. The benchtop self-contained dispenser holds almost two miles of **pre-cut and stripped 30-gauge insulated wire in lengths ranging from 1 to 9 inches**, as well as a stripper and 500-foot spool of bulk wire.



THE INCREDIBLY FAST 5900+. 100 READINGS PER SECOND IN THE 4½ DIGIT MODE.

**You can either make it better.
Or you can make it cheaper.**

Now, do both.



The challenge infuriates an engineer. Excellence cannot traditionally be compromised by economics. But if you can't afford it, you won't buy it. So sometimes we have to do both.

Above you see one of the "plus" machines from Dana. "Plus" because it is truly a better machine. And "plus" because it is priced to give you a new level of quality for the money.

The 5900+. A new standard.

This new unit may well be the world's most accurate and stable 5-digit multimeter.

It delivers 0.001% total accuracy.

It has 350 volts RMS protection on all ohms measurements.

It provides true systems capability. It has 5 DC ranges, 60% overrange, and full ratio capability. Its basic price is \$1795. Nothing at that price is comparable in accuracy and quality.

The 5000+ DVM. The price is lower. The standards aren't.

This new DVM is the lowest priced 5-digit multimeter we've ever produced. Yet because it was engineered and built by men who have been dealing with units costing ten times as much, the 5000+ reflects their standards.

It is absolutely reliable. (Silicon solid state circuitry plus LED display.)

It has 5 DC ranges capable of measuring from 1 μ V through 1000V.

It offers autoranging in all functions and 100% overranging on all ranges.

It's available as a complete multimeter. Its basic price is \$995. Nothing with its features and its quality is available for the price.

Examine these products and study their incredible performance/price. Contact Cliff Hamilton at Dana Laboratories, Inc., 2401 Campus Drive, Irvine, California 92664. Or call collect at (714) 833-1234. Ask him about these *plus* machines.

**NOW WITH TRUE
RMS CONVERTER**

DANA[®]

Others measure by us.

“When Foxboro changed from P.C. boards to Augat panels for FOX 2 process computer systems, we had some doubts about how much development time we would actually save.

“6,000 man-hours convinced us.”

Ben Franklin, Manager, Equipment Product Engineering,
Systems Operations Division, The Foxboro Company



Ben Franklin

"Augat panels provided significant savings in our overall development time, and helped us bring our new FOX 2 process computer systems to the market-place faster. And Augat's precision-machined socket contacts helped us maintain our high standards of reliability.

"Why the change from P.C. boards? P.C. boards inherently have a long development cycle, high development cost and lower initial hardware cost. In the development of the FOX 2 System, the timing was critical to get the system designed and released to the market. By selecting the Augat packaging approach, we shortened the development cycle significantly and minimized the cost of rework with no overall effect on hardware cost.

"But no one likes to gamble with new methods, so our initial evaluation of the Augat system was unusually thorough. We liked what we saw — a good, quality product and a company with lots of experience and a positive attitude towards customer service. Since our past experience with other, less-precision sockets had been comparatively unsatisfactory, we decided to try their wire-wrapped plug-in panels. The results far exceeded our expectations.

"With Augat, we achieved superior modularity, minimum downtime, easier field service, and a system that allows our logic to evolve with the technology. And all this while saving 6,000 man-hours of engineering time. That's not bad."

As you can see, Augat offers you plug-in flexibility allowing component and wiring changes to be made in minutes (saving precious and expensive man-hours), plus tapered-entry sockets and machined contacts that offer unsurpassed reliability.

All of which just might tell you why Augat has become the world's leading producer of wire-wrapped panels and other IC interconnection products. But Augat has more to offer than just hardware. Augat's technical experience is ready to help solve your interconnection requirements.

Call or write to us today. We'll send you our free brochure and complete product information. Augat, Inc., 33 Perry Avenue, Attleboro, Massachusetts 02703. Represented and distributed internationally.



The FOX 2

Plug into Augat. Foxboro did.

**NEW 1/2-AMP
IC VOLTAGE
REGULATORS
AVAILABLE
IN VOLUME**



New 78M Series: 0.5 Amp Monolithic 3-Terminal Positive Voltage Regulators. Now available in production quantities.

We've got new 78M medium current voltage regulators. And we've got lots of them. The 78M series is available in 7 fixed output voltages: 5, 6, 8, 12, 15, 20, 24 Volts. It's a pin-for-pin replacement for all popular 3-terminal voltage regulators (including our own 7800 series). It's available in TO-220 and TO-5 packages.

Improved system design. The 78M reduces system design time, eliminates outboard transistors and resistors, reduces board space, protects on-card circuitry, increases reliability.

Simple to use: Complete, self-contained, one chip in one package. Insert, connect terminals, and add the normal line decoupling capacitor. Requires no other external components. Optimum operation with no design time.

Superior performance: In addition to improved temperature coefficient and ripple rejection, the 78M series provides output

voltage tolerance better than $\pm 5\%$. Line regulation 0.01%/Volt. Output impedance 0.03 Ω . Output current rated at 0.5 Amp (usable to 0.75 Amp, depending on input voltage and heat sinking considerations).

Self protecting: Internal current limiting thermal shut-down and safe area compensation protect device and circuit from current, power, and temperature fluctuations. Resets automatically.

Versatile & compact: Use locally, at the power source, on a remote chassis, on PC cards, whatever is most convenient and efficient. Because it's compact, you can miniaturize your design. Result: simpler, smaller, cheaper, easier-to-use power supply and circuitry.

LOW COST: In time and money, less than any other alternative. The 78M series is the lowest cost 3-terminal voltage regulator available today.

1 Amp version: For those systems that require 1.0 Amp output, our improved 7800 series (usable to 1.5 Amps with proper heat sinking) is now in volume production. It offers all the features of the 78M at slightly higher prices.

Write for: Complete data package and new 80-page voltage regulator handbook.

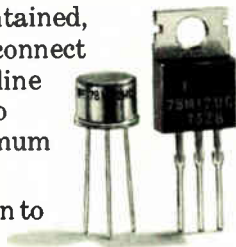

PERFORMANCE COMPARISON: DISCRETES VS. NEW 78M

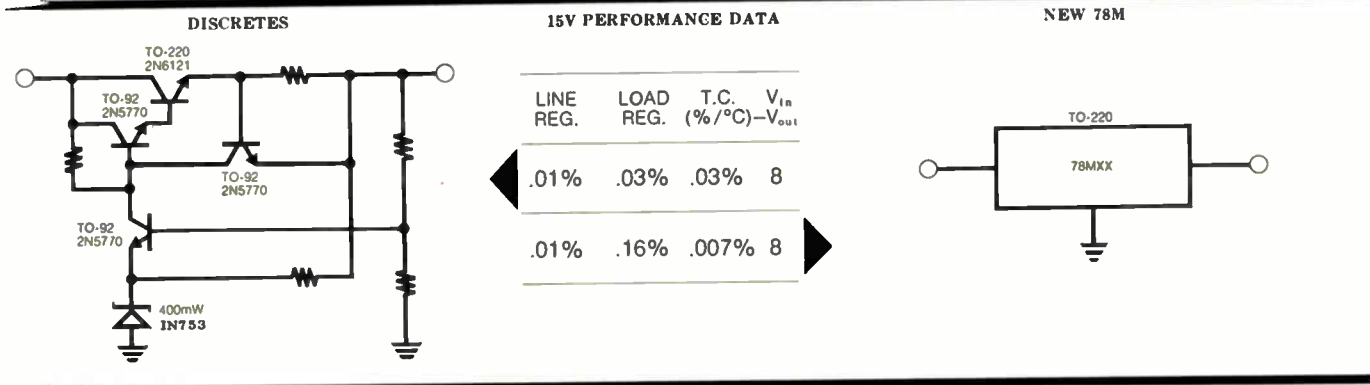

MADE IN FAIRCHILD



Color enhances the legibility of your CRT displays and substantially speeds comprehension of the information being viewed.

Four clearly distinguishable colors are obtained on the viewing screen of a CRT display by controlling the voltage of a single beam through a multiphosphor screen. These multiphosphor screen CRT's are particularly well suited for sophisticated displays (airborne, tactical, spaceborne, shipboard, etc.) where severe environmental conditions as well as high performance requirements are imposed.

HV (kV) TYPE	7	9	11	13	15	17
E 20	Red	Orange	Yellow	Green		
E 21	Red	Orange			Yellow	Green
E 11	Red					White
Multi-persistent		short				long

Penetration CRT's manufactured by THOMSON-CSF provide very high brightness and outstanding picture contrast together with the good resolution of high quality monochrome displays. Multiphosphor techniques developed by THOMSON-CSF have been adapted to multipersistence penetration screens to add variable persistence capability to radar presentation.



THOMSON-CSF

THOMSON-CSF ELECTRON TUBES, INC. / 50 ROCKEFELLER PLAZA / NEW YORK, N.Y. 10020 / TEL. (212) 489.0400

France - THOMSON-CSF Groupement Tubes Electroniques / 8, rue Chasseloup-Laubat / 75737 PARIS CEDEX 15 / Tél. 566 70.04

Germany - THOMSON-CSF Elektronenröhren GmbH / Am Leonhardsbrunn 10 / 6 FRANKFURT/MAIN / Tél. 70 20.99

Italy - THOMSON-CSF Tubi Elettronici SRL / Viale degli Ammiragli 71 / ROMA / Tél. 638 14.58

Japan - THOMSON-CSF Japan K.K. / Kyosho Building / 1-9-3 Hirakawa-cho / Chiyoda-ku / TOKYO / 〒102 / Tel. (03) 264.6341

Sweden - THOMSON-CSF Elektronrör AB / Box 27080 / S 10251 STOCKHOLM 27 / Tél. (08) 22 58.15

United Kingdom - THOMSON-CSF Electronic Tubes Ltd / Bilton House, Uxbridge Road, Ealing / LONDON W 5 2TT / Tel. (01) 579.1857 / Telex : 25 859

Saving engineers' time for design

Interest in off-the-shelf card cages as a cost-savings approach increases; connectors, cards, wire-wrap service are often available with the racks

by Stephen E. Grossman, Packaging & Production Editor, and Marilyn Offenheiser, Assistant Editor

The card cage—a rack designed to hold printed-circuit boards—is not a recent arrival, but it is coming into its own, particularly as more and more value-minded packaging engineers seek to slash design and manufacturing costs. If a circuit designer selects an off-the-shelf system at the prototype stage, he can avoid the costly and agonizing rework and endless engineering-drawing changes that plague most projects as they pass from prototype to the production phase.

Make or buy? Often, a design engineer will argue that the nature of his design is unique, and therefore, off-the-shelf packaging hardware is out of the question. But the experienced packaging engineer, who is familiar with the costs of tooling, realizes the wisdom in urging his colleague to take one more pass through the catalogs to see if the card cage can be purchased.

What's more, packaging engineers know that many card-rack suppliers provide printed-circuit connectors, input/output connectors, printed-circuit cards, and wire-wrap cards or service. Some vendors also provide power-supply modules and logic modules. In fact, a circuit designer can sometimes develop a complete electronic subsystem with both electronic components and the package procured from a single vendor. And purchasing and expediting departments welcome single-source buying because it eases their burdens of buying and bringing the components into the house.

Neil Bosland, who heads the packaging department at Litton's Revenue Control Systems in Plainfield, N.J., says, "Often, 50% of technician time and 15% of engi-

neering time is saved on a project by selecting card cages." And engineers elsewhere report savings that range from 30% to 80%, depending on the nature of the project.

What's available. The tables on pages 140 and 141 list some of the major suppliers of card-rack systems. Many of the companies listed in the tables also do custom work with a fast turnaround time.

Vendors who provide in-house wire-wrap service include Cambion, Electronic Engineering (EECO), Elco, Mupac, Stanford Applied Engineering, and Vero. Two companies, Augat Inc., and Scanbe Manufacturing Co., make this service available via referral to certified wire-wrapping facilities. Included in the tables are the sizes of the various structures, as well as quantity and sizes of cards that they will house. Not listed is the tremendous variety of accessories that are available.

As shown in the tables, some of

the vendors provide the cards, as well. In column 8 of the tables, a ratio expresses the maximum number of ICs to the volume of the housing (independent of the mounting flanges on the housing). This ratio is not a figure of merit, but rather a quick reference index to the maximum packaging capability of the enclosure. The number of ICs that will end up in the rack will depend on how circuits are partitioned—i.e., which circuit will end up on which card. Thermal considerations can also determine the card-spacing in the rack and maximum density of devices permissible on a given card.

In addition to other advantages, a user-inventory benefit is cited by some suppliers in favor of off-the-shelf cage systems. Says Jeff Wheeler, marketing manager at Scanbe, "We stock a half-million parts to provide an array of off-the-shelf packaging systems." This means reduced inventory for the user.

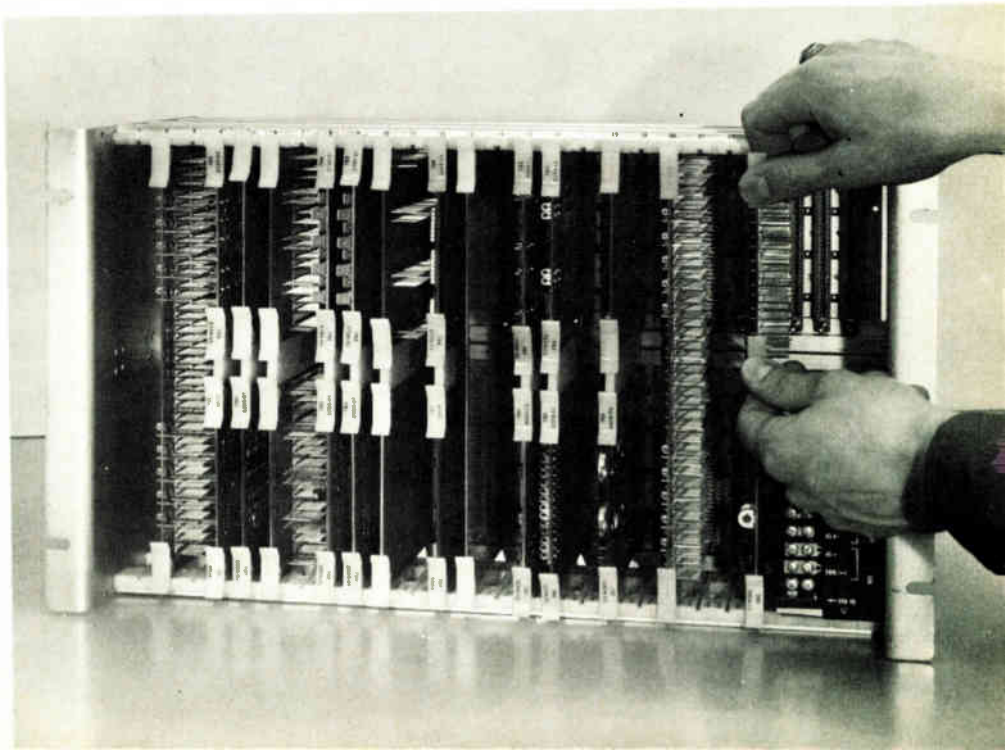

New products

PART 1: OFF-THE-SHELF CAGE ASSEMBLIES

Manufacturer	Dimensions (Width ⁽¹⁾ x height x depth) (inches)	Cards					Maximum ICs/ package volume	Accessories				
		Quantity	Size (depth x height) (inches)	Center-to- center spacing (inches)	Type	Maximum ICs/ card						
Augat Inc., 33 Perry Ave., Attleboro, Mass. 02703 (617) 222-2202	16.6 x 8.7 x 9.1	13	7.0 x 7.4	1.2	Wire-wrap pins, 1/8-in. thick glass epoxy 2-oz. copper circuitry (both sides tin-plated) (2)	60	780/1315 in. ³	Extender cards, enclosures, special cards, interface plugs, adapter plugs, removable back panels				
									72	936/1315 in. ³		
	17.2 x 5.1 x 6.6	13	4.9 x 4.4	1.2		Wire-wrap pins, 1/16-in. thick double- sided board	12				(156-312)/580 in. ³	
					18				230/580 in. ³			
										24		312/580 in. ³
Cambion, 445 Concord Ave., Cambridge, Mass. 02138 (617) 491-5400	17.00 x 5.22 x 6.81	13 (wire wrap)	4.5 x 4.5	1.25	1/16-in., epoxy glass G-10, 70 input- outputs/card	24	312/604 in. ³	250 types of logic, memory & special-purpose cards, extender cards, backplanes, power supplies				
		26 (PC board)	4.5 x 4.5	0.625								
		32 (PC board)	4.5 x 4.5	0.50								
	17.00 x 10.47 x 12.00	13 (wire wrap)	9.75 x 9.25	1.25	1/16-in., epoxy glass G-10, 40 input- outputs/card	126	1,638/2,140 in. ³					
Electronic Engineering Co. (EECO), 1441 East Chestnut, Santa Ana, Calif. 92701 (714) 835-6000	16.33 x 5.21 x 5.69	30	3.48 x 3.88	0.5	1/16-in., epoxy glass, FR4 PC or wire wrap socket cards	20	600/484 in. ³	5 V, 8 A power supply, extender & accessory cards, cable cards				
	16.33 x 10.45 x 5.69	60	3.48 x 3.88	0.5	"	"	1,200/975 in. ³					
	16.33 x 17.47 x 5.69	120	3.48 x 3.88	0.5	"	"	2,400/1,605 in. ³					
	16.18 x 6.97 x 7.25	30	5.82 x 6.25	0.5	"	70	2,100/817 in. ³	Extender cards, power supplies, cables, I/O connectors				
	16.18 x 13.96 x 7.25	60	5.82 x 6.25	0.5	"	70	4,200/1,638 in. ³					
Elco Corp., Willow Grove, Pa. 19090 (215) 659-7000	16.875 x 3.343 - 9.718 x 5.5 - 11.00	41 (maximum)	11 x 9 (maximum)	0.4 (minimum; wider spacing: 0.2-inch increments)	-	-	-	Connectors, front panels, marking strips, connector mounting straps				
Electronic Molding Corp., 96 Mill St., Woonsocket, R.I. 02895 (401) 769-3800 or (800) 556-6969 (Toll free)	16.60 x 8.69 x 7.45	13 (3)	7.00 x 7.35	1.2 (3)	1/16- or 1/8-in., 2- or 3- level wire wrap	60 (4)	780/1,038 in. ³ (5)	Extender & blank cards				
Mupac Corp., 546 Summer St., Brockton, Mass. 02402 (617) 588-6110	17.0 x 5.22 x 9.0 (6)	13	6.0 x 4.5	1.2	1/16-in. with connector, wire wrap, 108 input- outputs/card	36	468/800 in. ³	Extender cards, cable cards, power supplies, breadboard cards, blank copper- clad cards				
	17.0 x 5.22 x 9.0 (6)	26	6.0 x 4.5	0.6	"	36	936/800 in. ³					
	17 x 5.22 x 12.50 (6)	13	4.5 x 9.5	1.2	"	64	832/1,110 in. ³					
	17 x 5.22 x 12.50 (6)	26	4.5 x 9.5	0.6	"	64	1,664/1,110 in. ³					

Notes:

1. Exclusive of mounting flanges - standard EIA notched 19-inch panel.
2. Also available in 1/16-inch board material.
3. PC cards can also be spaced on 0.6-inch centers to provide for 26 cards.

4. Custom layouts can raise ICs/card to 70 for a 910/1,038 in.³ IC density.
5. Utilizing high-density packaging 1,820/1,038 in.³ can be achieved.
6. Also available in half-rack widths: 8 inches wide.
7. Available in kit form or completely assembled at no additional cost.

PART 2: OFF-THE-SHELF CAGE ASSEMBLIES

Manufacturer	Dimensions (Width ⁽¹⁾ x height x depth) (inches)	Cards					Maximum ICs/ package volume	Accessories	
		Quantity	Size (depth x height) (inches)	Center-to- center spacing (inches)	Type	Maximum ICs/ card			
Scanbe Manufacturing Corp., 3445 Fletcher Ave., El Monte, Calif. 91731 (213) 579-2300	17 x 5.25 x 8.75	27	2 x 2 to 4.5 x 8	Variable; (0.5 minimum)	Wire wrap; edge- connector provided	-	840/688 in. ³	Hinged front panel, extender cards	
	17 x 6.0 x 8.75	27	2 x 2 to 4.5 x 8	Variable; (0.5 minimum)	"	-	980/833 in. ³		
	17 x 2.25 x 8.60	14	4.5 x 6.0	1.2	1/16-in.; edge- connector, 72-pin wire wrap	40	560/450 in. ³	Hinged front panel, extender cards, termination cards	
	17 x 8.75 x 9.7	14	7.0 x 7.0	1.2	1/16-in.; edge- connector, 122-pin wire wrap	60	840/450 in. ³	Hinged front door, back- plane assembly, I/O panel with connectors, extender cards	
	17 x 5.25 x 11.50	14	4.5 x 9.25	1.2	1/16-in.; edge- connector, 72-pin wire wrap	60	840/688 in. ³	Hinged front panel, extender cards	
Stanford Applied Engineering, Inc., 2165 S. Grand Ave., Santa Ana, Calif. 92705 (714) 540-9256	17 x 7.0 x 7.28 (7)	30	4.0 x 6.1	0.54	-	36-16 pin	1,080/610 in. ³	-	
						42-14 pin	1,260/610 in. ³		
	17 x 7.0 x 9.88 (7)	30	6.6 x 6.1	0.54	-	72-16 pin	2,160/830 in. ³		
						84-14 pin	2,520/830 in. ³		
Unitrack division of Calabro Plastics Inc., Upper Darby, Pa. 19082 (215) 789-3820	16.875 x 6.00 x 7.00	21	6.0 x 4.5	0.75	Can accept card thicknesses ranging from 0.040 to 0.100 in.	-	-	Plastic & metal card guides	
		30	6.0 x 4.5	0.50					
		40	6.0 x 4.5	0.20					
Vector Electronic Co., 12460 Gladstone Ave., Sylmar, Calif. 91342 (213) 365-9661	16.85 x 3.5 x 9.0	108	2.73 x 6.5	0.15	-	-	-	-	
		21	2.73 x 6.5	0.75					
	16.85 x 3.5 x 12.0	108	2.73 x 9.60	0.15	-	-	-	-	
		21	2.73 x 9.60	0.75					
	16.85 x 5.25 x 9.0	108	4.5 x 6.5	0.15	1/16-in., various materials, PC & wire wrap	70	2,520/796 in. ³	Extender cards & shielded cases	
		21	4.5 x 6.5	0.75					
	16.85 x 5.25 x 12.0	108	4.5 x 9.6	0.15	1/16-in., various materials, PC & wire wrap	111	3,996/1,061 in. ³	2,331/1,061 in. ³	
		21	4.5 x 9.6	0.75					
	16.85 x 8.75 x 9.0	108	7.98 x 6.5	0.15	-	-	-	-	
		21	7.98 x 6.5	0.75					
	16.85 x 8.75 x 12.0	108	7.98 x 9.6	0.15	1/16-in., various materials, PC & wire wrap	209	7,524/1,061 in. ³	Extender cards & shielded cases	
		21	7.98 x 9.6	0.75					
	Vero Electronics Inc., 171 Bridge Rd., Hauppauge, N.Y. 11787 (516) 234-0400	17.0 x 3.5 x 11.0	32	2.75 x 8.0 (maximum)	0.5 in. (minimum)	1/16-in., 2-oz. copper, gold or tin plate, perforated with etched IC patterns/ socket panels	30	960/655 in. ³	Connectors, wire wrap pins, instrument cases, front panels, IC sockets, card handles, extender cards
							50	1,600/655 in. ³	
60							1,920/655 in. ³		
		960/981 in. ³							
17.0 x 5.25 x 11.0	32	4.5 x 6.5 (maximum)	0.5 in. (minimum)			960/1,309 in. ³			
17.0 x 7.0 x 11.0	32	6.25 x 8.0 (maximum)	0.5 in. (minimum)			960/1,636 in. ³			
17.0 x 8.75 x 11.0	32	8.0 x 8.0 (maximum)	0.5 in. (minimum)			960/1,636 in. ³			
Zorak Co., 103 Morse St., Watertown, Mass. 02172 (617) 924-1221	17.22 x 5.22 x 7.0	42	6.0 x 4.5	0.2	-	-	-		

32-bit mini addresses megabyte directly

'Megamini' plus a 16-bit computer introduce new line of high-performance, low-cost machines from Interdata

by Wallace B. Riley, Computers Editor

A minicomputer architecture that can directly address more than 16 million bytes—so that some people might not consider the design a minicomputer—appears in two new machines introduced by Interdata Corp. Called the Interdata 7/32 (or "Megamini") and 7/16, the new machines are the first of a series capable of performance levels far beyond those traditionally ascribed to minicomputers. The 7/16 replaces the company's 70 and 74 minicomputers; the 7/32 (at left, below) is all new.

To address 16 million bytes—the upper limit is actually 16,777,216—requires a 24-bit address, which in turn is part of a 48-bit instruction word. (Some other instructions are 16 or 32 bits long and directly address smaller areas of memory.) Interdata describes the 7/32 as having a 32-bit word length. But it's a 32-bit machine from the programmer's point of view only. It has two sets of internal registers; there are 16 registers in each set and 32 bits in each register. One set is available for the user, for indexing, local temporary storage of operands, partial results, and the like; the other is reserved for a variety of miscellaneous func-

tions such as the input-output requirements of the machine's operating system software. The data paths among these registers are 32 bits wide. But the 750-ns memory is only 16 bits wide—one access by the program requires two memory cycles, for a total cycle time of 1.5 microseconds. And the address path is 20 bits wide, allowing a maximum of 1,048,576 bytes to be directly addressed; but this is a hardware limitation, readily expandable within the architectural design to the larger capacities.

Like most other minicomputers, the 7/16's word length is 16 bits; its direct addressing limit is 65,536 bytes. To address larger memories, other computers use complex segmentation and relocation schemes, and put an additional burden on the programmer to implement them. The 7/16 is limited to 65,536 bytes but is readily upgraded to a 7/32 with its million-byte limit.

The new Interdata 7/32 sells for a mere \$9,950, including a 32,768-byte memory. Larger memories cost more—the megabyte system is \$171,650, and many in-between sizes are available. The 7/16 is offered at \$3,200, with 8,192 bytes of

memory. These prices are to be compared with Interdata's older machines, the 70 at \$6,800 and the 74 at \$3,600, both with 8,192 bytes; and with competitive equipment, such as Data General Corp.'s Nova 840, about \$14,000, and Digital Equipment Corp.'s PDP 11/40, for \$16,000, both with the 32,768 bytes.

Interdata's core memories for the 7/32 come in minimum modules of 32,768 bytes on one 15-inch-square board, in either 1-microsecond or 750-nanosecond cycle times. Both 8,192- and 16,384-byte modules are also available for the 7/16. (Data General recently announced the availability, for its computers, of 16,384 words—the same number of bits as Interdata's—on a single board, with a 1,200- μ s cycle time [*Electronics*, Aug. 16, p. 30.] Digital Equipment Corp. also offers a similar module.) Interdata says that a relatively slow semiconductor memory will be offered later on the 7/32, when 4,096-bit n-MOS chips become available in quantity. It also hints at another new line, starting with the 8/32, that will have the same architecture as the 7/32 but a fast semiconductor memory also, Schottky transistor-transistor logic, and a full 32-bit-wide data path throughout.

Control in the 7/32 is maintained by a microprogram in a read-only memory, which is a large-scale bipolar integrated-circuit structure with 60-ns access time and 250-ns microinstruction-execution time. The machine's repertoire contains 147 instructions, including those that maintain compatibility with Interdata's 16-bit machines.

Interdata Inc., 2 Crescent Place, Oceanport, N.J. [339]

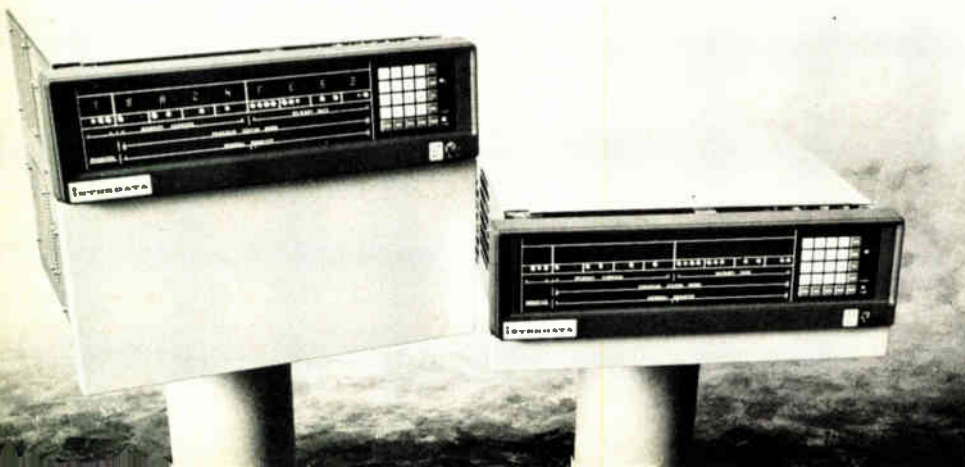

To design engineers, she's
a great mini-solution for
instrument & system
requirements.

To purchasing agents,
she's a small blessing
for big money savings.



*Duncan's
little
sweetheart
has something
for
everyone.*



PIXIEPOT®

For complete information, specs, prices
or evaluation samples, call or write:

DUNCAN ELECTRONICS
SUBSIDIARY

SYSTRON  DONNER

2885 FAIRVIEW ROAD • COSTA MESA, CALIFORNIA 92626
PHONE: (714) 543-8281 TWX: 310-525-1128

Circle 143 on reader service card

Dialight sees a need:

(**Need:** Single source supply for all indicator lights.)

See Dialight.

Dialight has so many kinds of indicator lights—approximately 1,500,000 on our shelves—that we have set up a special magic eye seek-out system to help you find the one you need in a wink. Whether it's a flasher, placard, press to test, oil tight, water tight, dust tight, dimmer, or nondimmer, we have them all, some with incandescent, neon or LED lamps, from 1.35 to 220 volts. Sizes vary from small indicators (mount in 0.120" clearance holes) to large indicators (mount in 1 $\frac{3}{8}$ " clearance



holes), and are available in a variety of terminations and finishes, lens-cap shapes and colors with or without hot-stamped, engraved or film legends. We've developed a 14-digit code number that tells any of our 120 stocking distributors in the U.S. and Canada just what indicator you want for off-the-shelf prompt delivery. If you would like to see for yourself how our code works, just write for your free copy. At Dialight it's a designer's choice because we see your need.



Dialight is a company that looks for needs . . . and develops solutions. That's how we developed the industry's broadest line of indicator lights, readouts, and LED light sources. No other company offers you one-stop shopping in visual displays. And no one has more experience in the visual display field. Dialight can help you do more with indicator lights than anyone else because we have done more with them. Talk to the specialists at Dialight first. You won't have to talk to anyone else.

And also be sure to send for your free copy of our latest 56-page Indicator Light Selector Guide. It will show you how easy it is to quickly find your way to the indicator light you need. This handy guide describes in detail the many indicator light choices—shapes and colors of their lens caps, available terminations, mounting data, available finishes, and LED, incandescent and neon light sources for which they are compatible.

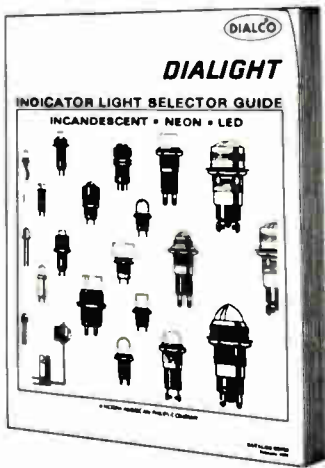

Please send me INDICATOR LIGHT SELECTOR GUIDE.

NAME _____

TITLE _____

COMPANY _____

ADDRESS _____

CITY _____

STATE _____

DIALIGHT

Dialight Corporation, A North American Philips Company
60 Stewart Avenue, Brooklyn, N.Y. 11237 (212) 497-7600

New products

Semiconductors

Op amp slews at 320 V/ μ s

Inverting-only unit for fast data systems provides pulsed output of 50 mA

There are many applications—in some types of data acquisition systems, for example—where high speed is the primary requisite, and it's possible to trade off system flexibility to get the desired speed.

These kinds of applications are what Harris Semiconductor has in mind for its new wideband operational amplifier, designated the HA-2530/2535. It has a slew rate of 320 volts per microsecond, three times faster than previously available in a monolithic op amp.

Because of the high speed, Harris has sacrificed some applications in general-purpose systems. The 2530/35 is an inverting-only type, not a full differential op amp. Harris views it as an extension of its HA-2500 series, which previously covered the slew-rate range of 30 to 120 V/ μ s at 25°C. Settling time is 500 nanoseconds.

The 2530/35 uses Harris' high-frequency linear process that combines high-frequency npn and pnp devices with Schottky transistors and MOSFET devices to achieve the higher performance levels. An open-loop gain of 2 million is combined with a bandwidth of 70 megahertz, 0.8-millivolt offset voltage, a bias current of 15 nanoamperes, and a pulsed output current of 50 mA.

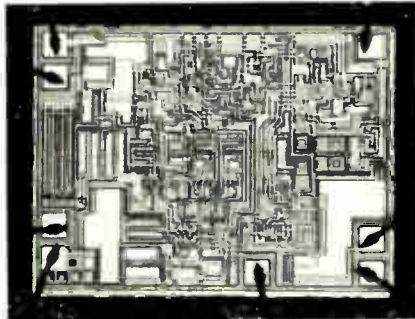

In addition to fast data-acquisition systems, the conjunction of high slew rate and output current makes the 2530/35 suitable for applications in video summation, high-speed integrators, X-Y drives for CRT displays, waveform generators, voltage-to-current converters, pulse amplification in radar systems, and coaxial line drivers.

In quantities of 100 to 999, price is \$14.30 each for the HA-2535 (0°C to 70°C) and \$33 for the HA-2530 (-50°C to +125°C). Both versions of the operational amplifier come in 8-pin TO-99 packages.

Harris Semiconductor, Melbourne, Fla. 32901 [411]

Broadband power transistors deliver up to 40 watts

A series of broadband, high-gain, 12-volt power transistors with outputs of up to 40 watts cover 136 to 175 megahertz. The J0 4020, 4030, and 4040 series devices incorporate internal impedance-matching elements and are 100% tested in fixed-tuned broadband circuits, so frequency changes have a minimal effect on impedance. This relieves the

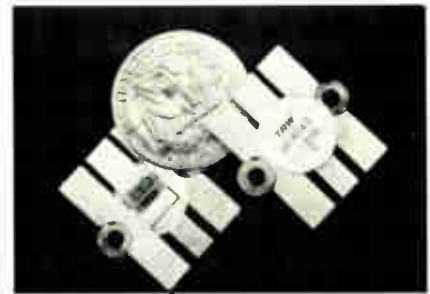

designer of the need for major tuning in the circuit. Price in 100-lots is \$27.75 each.

TRW Semiconductors, 14520 Aviation Blvd., Lawndale, Calif. 90260 [413]

Light-activated thyristors are compatible with LEDs

Offering wavelength compatibility with Motorola's visible and infrared LEDs, a line of annular, light-acti-

**Today the "hot-spot" temperature
will approach 200 C, with a
90% chance of moisture, and
contamination could be severe.**



Protect your systems with silicone compounds.



Sooner or later, the electronic devices you design will have to stand up to persistent and inherent problems: corrosion, high heat, water, chemicals, oils, salts. Anything but rosy.

But think about this. Dow Corning dielectric compounds handle harsh environments, and retain excellent electrical properties from -40 to 200 C. They're ideal for high voltages, and a wide range of frequencies. Won't dry out, bleed, or melt; are oxidation resistant, odorless, and practically nonvolatile. And they fill several functions at the same time.

For instance, Dow Corning® 2 compound is a dielectric sealer that prevents copper corrosion. Use it on connectors or communications cables. If you need a good lubricant, a water repellent, and a corrosion preventive for switches or terminals, try Dow Corning® 3 compound. And Dow Corning® 4 compound, a moistureproof dielectric sealer, is great for high-altitude ignition systems.

We have a heat-sink system, too. Pot diodes and transistors for excellent thermal conduction. Then, for maximum protection, apply our heat-sink compound between the device and chassis.

Versatility, economy, performance, and easy application. Good reasons why silicone compounds should be your design tools. Write for full information to Dow Corning Corporation, Dept. C-3335, Midland, Michigan 48640.

Silicones; simply the best way to protect electronic circuits.

DOW CORNING

DOW CORNING

New products

vated thyristors are available in both metal and plastic packages. Applications include solid state relays, sensing, detection, opto-logic control, card-reading-counting-sorting, photocoupling, and other control and driving circuits. The plastic-packaged versions are designated parts MLS101 through MLS105, and the metal versions are parts MLS201 through MLS205. Specifications include: peak reverse blocking voltages from 15 to 200 v, forward rms current of 250 and 400 milliamperes respectively, and peak forward surge current of 5 A. In 100-lots, prices range from 84 cents to \$2.45 each, depending on type and ratings.

Motorola Inc., Semiconductor Products Division, Box 20924, Phoenix, Ariz. 85036 [420]

Sample-hold analog memory works with a-d converters

For use in front of analog-to-digital converters, the model 5023 sample-and-hold analog memory offers high speed (aperture uncertainty is 200 picoseconds maximum) with TTL compatibility. The unit is useful in systems having an update rate of 10 megahertz. Bandwidth of the model 5023 is dc to 30 megahertz, and inputs are compatible with C-MOS, TTL, and Schottky logic. Price is \$173, with quantity discounts available.

Optical Electronics Inc., Box 11140, Tucson, Ariz. 85706 [415]

Quad operational amplifier has low current drain

A true differential-input low-power operational amplifier, designated the model LM324, is part of a family of quad-function building-block integrated circuits. The device consists of four high-gain internally compensated op amps, designed specifically to operate from a single power source of 3 to 30 volts. Operation from split supplies from ± 1.5 to ± 15 Vs is also possible. Total current drain for all four op amps is

800 microamperes at 5 v. This low drain, plus the unit's ability to operate over a 3- to 30-v supply range, makes it ideal as a C-MOS interface element. Price in 100 quantities is \$2.50.

National Semiconductor Corp., 2900 Semiconductor Dr., Santa Clara, Calif. 95051

RAM accepts data while contents are being read

Designated the model 82S21, a bipolar random-access memory accepts data while its contents are

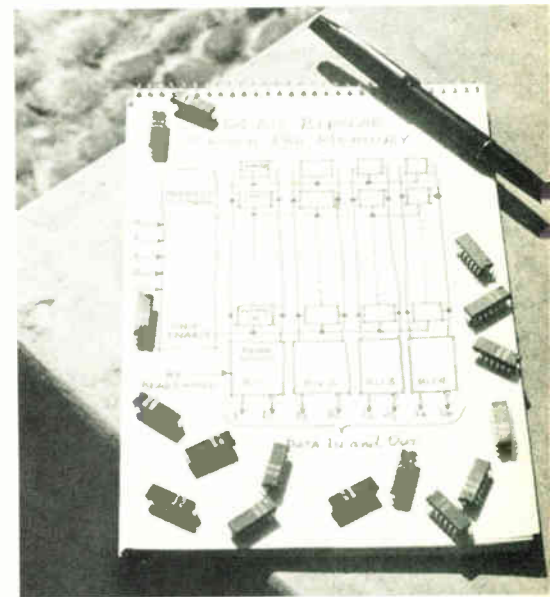

being read. It is for use in scratch-pad memories, control stores, buffer memories, and as the memory element in high-speed accumulator registers. The unit is a 64-bit TTL device organized into 32 words of 2 bits each. Read access time is 25 nanoseconds, and address lines are buffered.

Signetics Inc., 811 E. Arques Ave., Sunnyvale, Calif. 94086

Modulator operates from 0.5 to 1,000 MHz

A broadband biphasic modulator, called the model FP-CDB-185, operates over the range from 0.5 to 1,000 megahertz and can be modu-

JACKS, PINS & TERMINALS

SHIPMENTS FROM STOCK

TEFLON/MICRO MINI/SUB MINI/STANDARD/
PRINTED CIRCUIT/BRASS SOLDER

Hundreds of configurations in stock

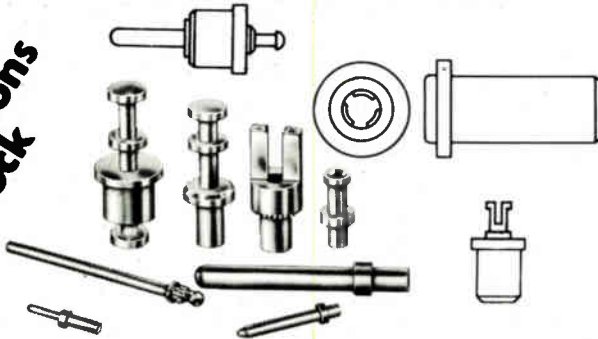

WE PRECISION-MANUFACTURE AND PLATE TO MIL SPEC IN GOLD, SILVER, TIN, SOLDER, AND OTHERS TO ORDER. FREE CATALOG AVAILABLE.

CONCORD ELECTRONICS CORPORATION

37 GREAT JONES STREET, NEW YORK, N. Y. 10012
(212) 777-6571 TWX 710-581-4930

Circle 148 on reader service card

The HS-200S... a wire memory offering speed, capacity, cost and reliability of ample proportions.

This is our latest wire memory. It gives you access time of 180 ns and cycle time of 250 ns. Memory elements, of course, consist of our own special development, magnetic wires. Non-destructive read-out is featured. HS-200S means maximum reliability at minimum cost. In fact, you get a 65 kilo-byte assembly with an MTBF figure of 10,000 hours. HS-200S is a component precisely matched to computers of the new age.

Wire Memory System HS-200S Specifications

1. Memory elements Non-destructive read-out
2. Storage capacity 8 kwords/80 bits, 16 kwords/40 bits, 32 kwords/20 bits
3. Access time 180 nanoseconds
4. Cycle time Write-in Read-out 250 nanoseconds
5. Interface levels TTL logic . . . H +2.4—+5V L -0.5—+0.5V
6. Dimensions 500×300×112mm (Basic unit capacity is 65 Kbytes. Expansion to one megabyte is possible.)
7. Required power +30V, +15V, +5V, -15V

Please contact our sales department if you have special requirements.



TOKO, INC.

Head Office: 1-17, 2-chome, Higashi-Yukigaya, Ohta-ku, Tokyo, Japan
New York: Toko New York Inc.
350 Fifth Avenue, New York, N.Y. 10001 U.S.A. Tel: 565-3767
Los Angeles: Toko, Inc. Los Angeles Liaison Office
3440 Wilshire Blvd., Tishman Building, Suite 1106 Los Angeles, Calif.
90010, U.S.A. Tel: 380-0417
Düsseldorf: Toko Elektronik G.m.b.H.
4 Düsseldorf, Lakronstrasse 77, W. Germany Tel: 0211-284211

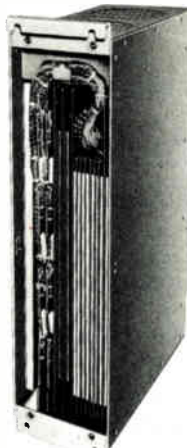

New products

lated at frequencies from dc to 500 MHz. Both intermediate-frequency junctions of the double-balanced

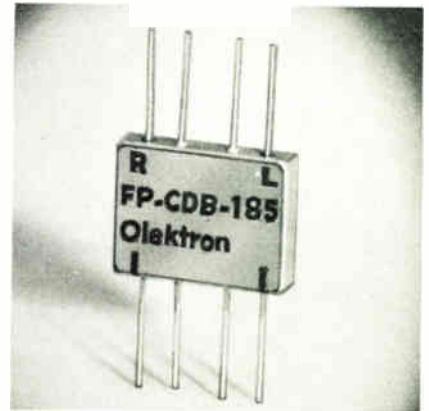

device are external to permit a balanced modulator drive. Applications include mixing, multiplying, and quadriphase modulation. The device is available in a flatpack version, as well as in a standard pin-and-connector package. Price is \$29 each for 1 to 24.

Olektron Corp., 6 Chase Ave., Dudley, Mass. 01570 [418]

Converter accepts ECL, drives MOS circuits

A dual ECL-to-MOS-level converter and interface integrated circuit, designated the model SN75368, accepts ECL output signals and creates high-current, high-voltage levels suitable for driving MOS circuits. It may be used to drive address, control, and

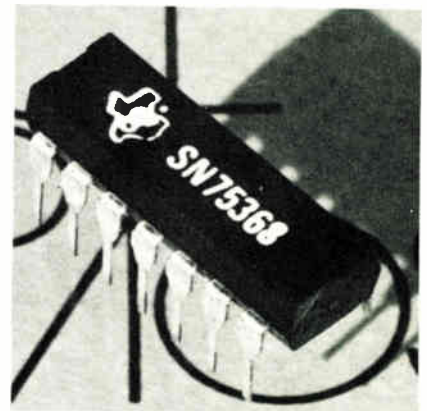

timing inputs for MOS RAMs. Operation is over the 0-to-70°C industrial

Encore!

It's our latest monolithic analog multiplexer with internal overvoltage protection--the HI-507A Dual 8 Multiplexer. And it's pin for pin interchangeable with the DG-507.

Just recently we introduced the first monolithic multiplexer with internal overvoltage protection—our HI-506A 16-channel multiplexer, featuring performance characteristics previously unavailable. Now we offer a dual 8-channel unit incorporating all the advantages of the 16-channel unit.

As with the HI-506A, this new device combines our DI/CMOS (dielectric isolation) process with a unique circuit design to provide on-board protection against analog input overvoltage. In the event of

overvoltage in one channel there is no output error when other channels are being addressed. This same protection circuit also eliminates latch-up, as well as unpredictable operational characteristics that could result from transient voltages originating in either the signal or supply. A second similar circuit provides the necessary safeguards against static charges. Additionally, break-before-make switching eliminates undesirable channel interaction. Applications for the new device

include data acquisition, telemetry systems, process control and general analog switching. The device is available in volume now for off-the-shelf delivery. For details see your Harris distributor or representative.

Features:

Internal overvoltage protection, both analog and digital

No channel interaction with power loss

Break-before-make switching

DTL/TTL and CMOS compatibility

Supply current 4mA at 1 MHz toggle rate

Power requirement 7.5mW disabled

Power requirement 7.5mW enabled

Access time 500 ns

Power supply ±15V

Signal range ±15Vdc

Supplied 28-pin DIP

100-999 units

HI 1-506A-5/HI 1-507A-5

0°C to +75°C \$28.60

HI 1-506A-2/HI 1-507A-2

-55°C to +125°C \$57.20

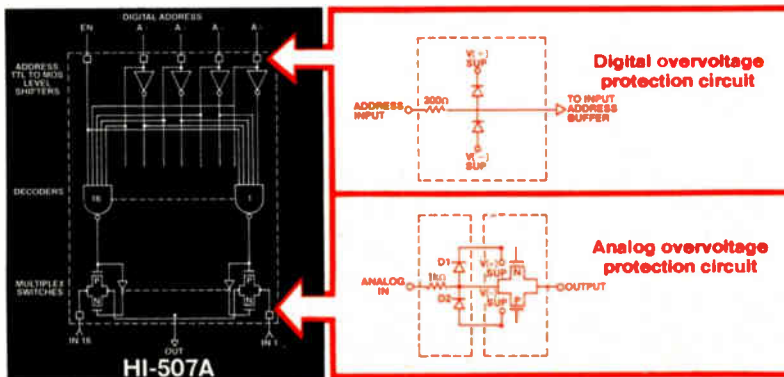

Harris



HARRIS
SEMICONDUCTOR
A DIVISION OF HARRIS-INTERTYPE CORPORATION

P.O. Box 883, Melbourne, Florida 32901
(305) 727-5430

WHERE TO BUY THEM: ARIZONA: Phoenix—Liberty, Weatherford; Scottsdale—HAR (802) 946-3558 CALIFORNIA: Anaheim—Weatherford, El Segundo—Liberty; Glendale—Weatherford; Long Beach—HAR (213) 426-7687; Mountain View—Elmar; Palo Alto—Weatherford, HAR (415) 964-6443; Pomona—Weatherford; San Diego—Weatherford, Western COLORADO: Denver—Elmar, Weatherford WASHINGTON, D.C.: HAR (202) 337-3170 FLORIDA: Hollywood—Schweber; Melbourne—HAR (305) 727-5430 GEORGIA: Atlanta—Schweber ILLINOIS: Chicago—Schweber; Schaumburg—HAR (312) 894-8824 MARYLAND: Rockville—Schweber MASSACHUSETTS: Lexington—R&D; Waltham—Schweber; Wellesley—HAR (617) 237-5430 NEW MEXICO: Albuquerque—Weatherford NEW YORK: Melville—HAR (516) 249-4500; Syracuse—HAR (315) 463-3373; Rochester—Schweber; Westbury—Schweber OHIO: Beachwood—Schweber; Dayton—HAR (513) 226-0636 PENNSYLVANIA: Wayne—HAR (215) 687-6680 TEXAS: Dallas—Weatherford, HAR (214) 231-9031; Houston—Weatherford WASHINGTON: Seattle—Liberty, Weatherford.

LEGEND FOR HARRIS SALES OFFICES & DISTRIBUTORS: Harris Semiconductor (HAR); Elmar Electronics (Elmar); Harvey/R&D Electronics (R&D); Liberty Electronics (Liberty); Schweber Electronics (Schweber); R. V. Weatherford Co. (Weatherford); Western Radio (Western).

The fast and easy way to troubleshoot

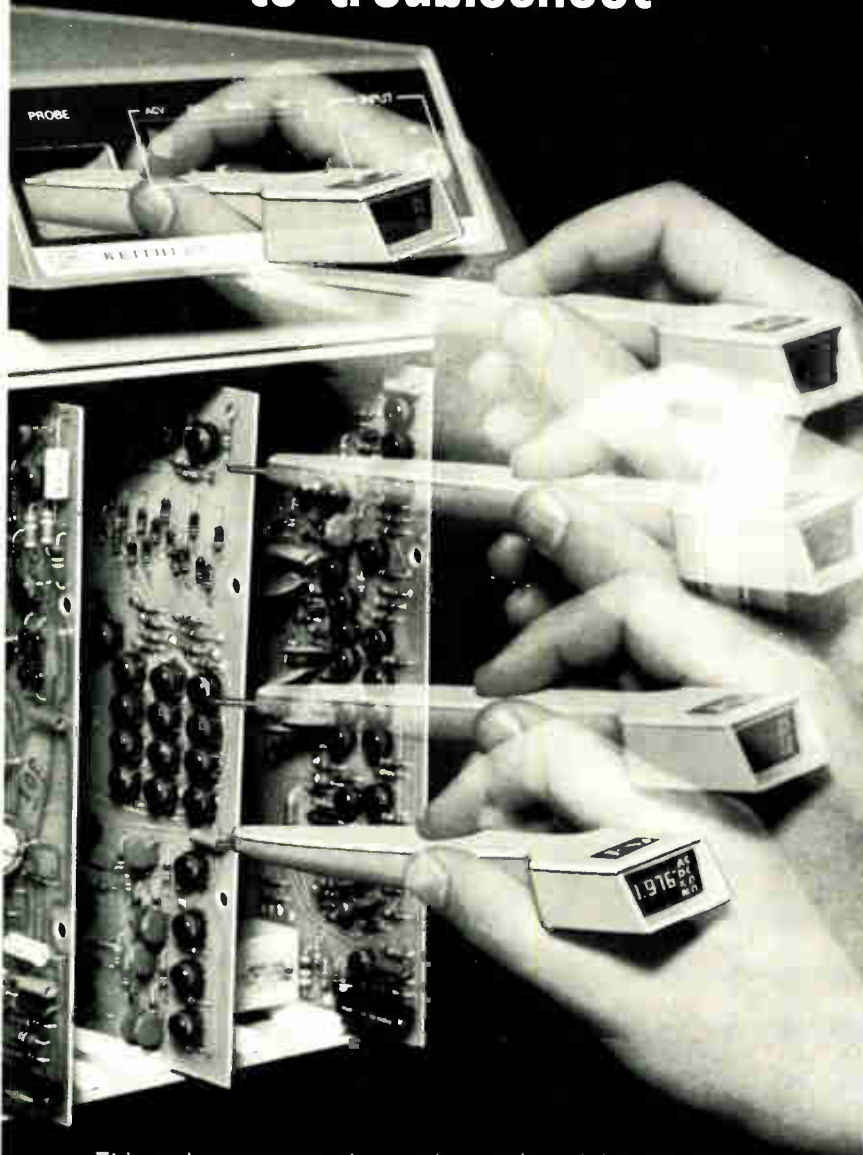

This unique, automatic ranging, ac/dc digital multimeter puts the data right at your fingertips.

The Model 167 Auto-Probe DMM:

- measures dc voltage - 1 mV to 1000 volts
- measures ac voltage - 1 mV to 500 volts rms
- measures resistance - 1 ohm to 20 megohms
- measures current - with optional shunts
- battery operated (line adapter optional)

It's fast (saves time!), it's accurate, and its readout is right in the hand-held probe.

The Model 167 Auto-Probe DMM — only \$325. Send for more details.



**KEITHLEY
INSTRUMENTS**
U.S.A.: 28775 AURORA ROAD, CLEVELAND, OHIO 44139
EUROPE: 14, AVENUE VILLARAIN, 1009 PULLY, SUISSE

New products

temperature range. Price is \$3.24 each in 100-lots. A ceramic version is priced at \$3.64 in the same quantity.

Texas Instruments Incorporated, Box 5012, M/S 308, Dallas, Texas 75222 [419]

Silicon diodes are designed for TV applications

Especially designed for television applications, particularly color TV, a family of silicon diodes measure 0.4



inch and are built in a hexagonal shape that permits assembly and encapsulation in a minimum of space. The units, which offer fast recovery and high-voltage operation, are good for use as building blocks in rectifier circuits. High-surge capability is also provided.

Electronic Devices Inc., 21 Gray Oaks Ave., Yonkers, N.Y. 10701 [414]

Rf power transistors are for citizens'-band operation

Two high-gain citizens'-band rf power transistors can be used separately or in tandem for a 10/25-watt Class E system design. Available from Communications Transistor Corp., the devices are called the CD1802, which delivers 10 watts, and the CD1803, which is rated at 25 w. Both power transistors are designed for the 12-v, 220 megahertz band.

Communications Transistor Corp., 301 Industrial Way, San Carlos, Calif. 94070 [389]

We think of our enclosures as silent salesmen. The first ten seconds of display for an electronics unit focus simply on the package. Its color (and the other colors available), its finish and style. It won't *break* a sale—the equipment inside does that. But it sure can help *make* one. Our award winning designs and

total color range have proved it.

Does a client need a ventilating grille? A blower? What about writing surfaces, drawers, casters? We have them in production, on line and ready to go—offering the access, flexibility and mobility your clients require. We even paint our units inside and out, and assemble

them for final inspection—including most options and accessories—at the plant.

We're ready with all this, and more. Ready right now.

Write Optima Enclosures, 2166 Mountain Industrial Blvd., Tucker, Georgia 30084 or call (404) 939-6340.

OPTIMA

Before you choose your next enclosure, show this ad to your salesmen.



Other Scientific-Atlanta Inc. Divisions are • Cable Communications • Instrumentation • Electro-Systems • Southern Tool and Machine • Security

Instruments

Plotter samples repetitive inputs

X-Y recorder can vary resolution from 60 to 500 points per display

Borrowing a leaf from the book written by the makers of sampling oscilloscopes, General Radio has developed an X-Y recorder for accurately plotting those repetitive swept measurements that are too fast for conventional plotters. The new sampling recorder, which can also be used in a conventional direct-recording mode, automatically plots one data point for each sweep of the input signal. Resolution can be adjusted from 60 to 500 points per display; the higher resolutions obviously require more time to plot.

Although it is a general-purpose instrument, the model 1715 recorder is specifically optimized for use with GR's 1710 rf network analyzer. Its input range is 0 to +4 v for the X axis, and -2 to +2 v for the Y axis. Maximum speeds of the 1715 are 20 inches per second in the direct mode, and 1 point every 20 ms in the sampling mode. These speeds are sufficient to record automatically any sweep time of the 1710

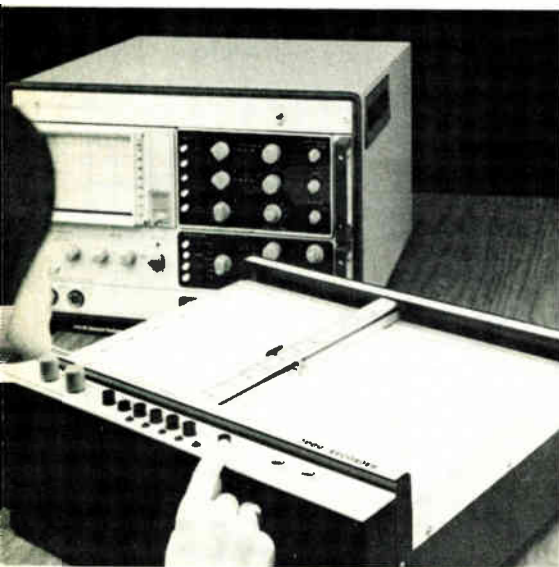

analyzer from 0.01 to 10 seconds.

The recorder accepts any paper size up to 11 by 17 inches. Its vacuum paper hold-down, its skip-free pen, and its positive pen drive allow the unit to be mounted vertically or horizontally without any adverse effect on operation.

Maximum nonlinearity of the 1715 is 0.4% of full scale, and repeatability is within 0.2% of full scale. Price of the instrument is \$1,500.

General Radio Co., 300 Baker Ave., Concord, Mass. 01742 [351]

Logic-state analyzer shows data-flow truth tables on CRT

Using a technique from the early days of logic design, Hewlett-Packard Co. has developed a logic analyzer that shows in truth-table formats how a logic assembly operates. The H-P 1601L, introduced this month at Wescon, captures up to 12 TTL, ECL, or MOS data channels with probes, stores the data streams in shift registers, and displays them as 12-bit sequences of 1s and 0s on a 7-inch-diagonal cathode-ray tube.

By itself, the instrument answers such trouble-shooting questions as "which loop is the assembly stuck in?" and "where did the program branch to?" Moreover, trigger and clock outputs allow the analyzer to be coupled to an oscilloscope or counter for investigation of glitches and clock misfires or to determine such factors as number of words per sequence, number of passes for which an algorithm remains in a loop, percentage of time a microprocessor spends on subroutines, and randomness of state changes in pseudo-random noise generators.

The H-P 1601L's display page consists of 16 lines of 12-bit words. Triggering controls allow virtually any sequence in a data stream to be accessed through windows, starting anywhere from 15 states before a trigger to 100,014 states after the trigger. A trigger word starts the display, stops it to show events prior to the trigger, or delays the presenta-

tion for as long as 99,999 clock cycles. The display-format can run free, as well.

Among the display-format options are 16 consecutive 12-bit words running line by line down the screen, three columns of four bits each corresponding to binary-coded decimal groups, four columns of three bits each for octal presentations, logic-sense inversion for analysis of negative-true logic systems, and blanking of unused and "don't-care" bits. Erratic states are indicated by 1 superimposed on a 0.

A new probe system simplifies connections to integrated circuits. It consists of a connector interface, a clock pod, two six-channel data pods, and 13 miniature probes. The probes for dual in-line packages are grouped in multiples of six with a single cable. The probes attach directly to device pins. However, the pin grabbers may be removed from the probes, revealing standard 0.025-inch-square pin sockets that connect directly to clips or backplane test points.

The probes present a nominal load of 40 kilohms shunted by 12 picofarads. They are protected to ± 15 volts. "No-clock" and "no-trigger" lights indicate combinations that prevent display. The "no-clock" lights also distinguish high, low, and floating levels with respect to a TTL or variable (10-v) threshold.

Deliveries of the analyzer begin late this month. The price in the U.S. will be \$2,050.

Hewlett-Packard, Co. 1501 Page Mill Rd., Palo Alto, Calif. 94304 [352]

Digital panel meter provides autoranging

A 3½-digit panel meter, designated the model DM-2000AR and priced at \$149, provides autoranging, eliminating the need to continually change the full-scale-range switch. The direct-reading meter has no multipliers or scale factors to forget or misinterpret. The meter shifts automatically, repositioning its decimal point to any of three places when the sampled voltage falls into

DECODERS/DEMULPLEXERS

SN54LS/74LS138
3-line-to-8-line
decoder/demultiplexer
SN54LS/74LS139
Dual 2-line-to-4-line
decoder/demultiplexer
SN54LS/74LS155
Dual 2-line-to-4-line
decoder/demultiplexer

ARITHMETIC ELEMENTS

SN54LS/74LS83 4-bit full adder
SN54LS/74LS86 Quadruple exclusive-OR gate
SN54LS/74LS136 Quadruple exclusive-OR-Gate
(with open collector output)
SN54LS/74LS181 Arithmetic logic unit/function
generator
SN54LS/74LS266 Quadruple exclusive-NOR Gate
open-collector

COUNTERS

SN54LS/74LS190 4-bit up/down decade counter
(with down/up control)
SN54LS/74LS191 4-bit up/down binary counter
(with down/up control)
SN54LS/74LS192 4-bit up/down decade counter
(dual clock with clear)
SN54LS/74LS193 4-bit up/down binary counter
(dual clock with clear)
SN54LS/74LS196 4-bit decade counter (=10)
SN54LS/74LS197 4-bit binary counter (=16)

DATA SELECTORS/ MULTIPLEXERS

SN54LS/74LS151
8-input data selector/
multiplexer (with strobe & comp)
SN54LS/74LS152
8-input data selector/
multiplexer
SN54LS/74LS153
Dual 4-line-to-1-line data
selector/multiplexer
SN54LS/74LS251
Three-state version of
SN54LS/74LS151
SN54LS/74LS253
Three-state version of
SN54LS/74LS153

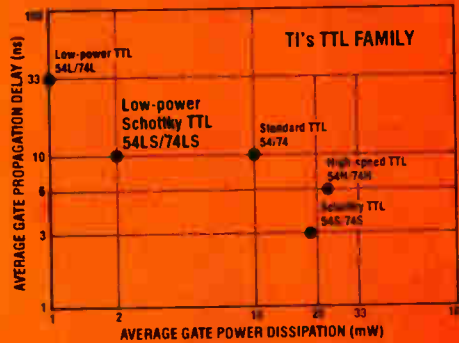

NAND/NOR/AND/OR/GATES, INVERTERS, BUFFERS

SN54LS/74LS00 Quad-2 input NAND gate
SN54LS/74LS01 Quad-2 input NAND gate (with open-
collector output)
SN54LS/74LS02 Quad-2 NOR gate
SN54LS/74LS03 Quad-2 input NAND gate (with open-
collector output)
SN54LS/74LS04 Hex inverter
SN54LS/74LS05 Hex inverter (with open-collector
output)
SN54LS/74LS08 Quad-2 input AND gate
SN54LS/74LS09 Quad-2 input AND gate (with open-
collector output)
SN54LS/74LS10 Triple-3 input NAND gate
SN54LS/74LS11 Triple-3 input AND gate
SN54LS/74LS15 Triple-3 input AND gate (with open-
collector output)
SN54LS/74LS20 Dual-4 input NAND gate
SN54LS/74LS21 Dual-4 input AND gate
SN54LS/74LS22 Dual-4 input NAND gate (with open-
collector output)
SN54LS/74LS26 Quad-2 input hi-voltage interface
SN54LS/74LS27 Triple-3 input NOR gate
SN54LS/74LS28 Quad-2 input NOR buffer
SN54LS/74LS30 Single-8 input NAND gate
SN54LS/74LS32 Quad-2 input OR gate
SN54LS/74LS33 Quad-2 input NOR buffer (with open-
collector output)
SN54LS/74LS37 Quad-2 input NAND buffer
SN54LS/74LS38 Quad-2 input NAND buffer (with open-
collector output)
SN54LS/74LS40 Dual-4 input NAND buffer
SN54LS/74LS51 Dual 2 wide 2 input AND-OR-invert gate
SN54LS/74LS54 4 wide 3-2-2-3 AND-OR-invert gate
SN54LS/74LS55 2 wide 4 input AND-OR-invert gate

SHIFT REGISTERS

SN54LS/74LS95A
4-bit right-shift left-shift
register (PI-PO)
SN54LS/74LS194
4-bit bidirectional universal
shift register (PI-PO)
SN54LS/74LS195
4-bit parallel-access shift
register (PI-PO)
SN54LS/74LS295
Three-state version of
SN54LS/74LS95AN

DUAL FLIP-FLOPS

SN54LS/74LS73 JK F/F with clear
SN54LS/74LS74 D F/F
SN54LS/74LS76 JK F/F with preset & clear
SN54LS/74LS78 JK F/F with common clock
& clear
SN54LS/74LS107 JK F/F with clear
SN54LS/74LS109 JK F/F with preset & clear
SN54LS/74LS112 JK F/F negative edge triggered
with preset & clear
SN54LS/74LS113 JK F/F negative edge triggered
with preset
SN54LS/74LS114 JK F/F negative edge triggered
with common clock & clear

LATCHES

SN54LS/74LS174 Hex D-type flip-flop with clear
(no complement)
SN54LS/74LS175 Quadruple D-type flip-flop with
clear

SCHOTTKY

Functions in abundance.

Design at <2mW per gate and 10 ns speeds
...with **low-power Schottky**

Low-power Schottky offers new system designers four outstanding benefits: Speed. Low power. Full TTL Compatibility. And fast off-the-shelf delivery.

Sixty functions are available now – and 25 more MSIs will be ready before the year ends.

Low-power Schottky has the

best speed/power relationship in the TTL family, reducing power requirements as much as 80%. Also, high stability over a broad range of temperatures qualifies the functions for military applications.

All 60 low-power Schottky 74LS functions are pin compat-

ible with 7400 Series. In fact, low-power Schottky can drive up to five TTL 7400 Series loads.

For data sheets, please indicate by type number and write: Texas Instruments Incorporated, P. O. Box 5012, M/S 308, Dallas, Texas 75222.



TEXAS INSTRUMENTS
INCORPORATED

SURPRISE!

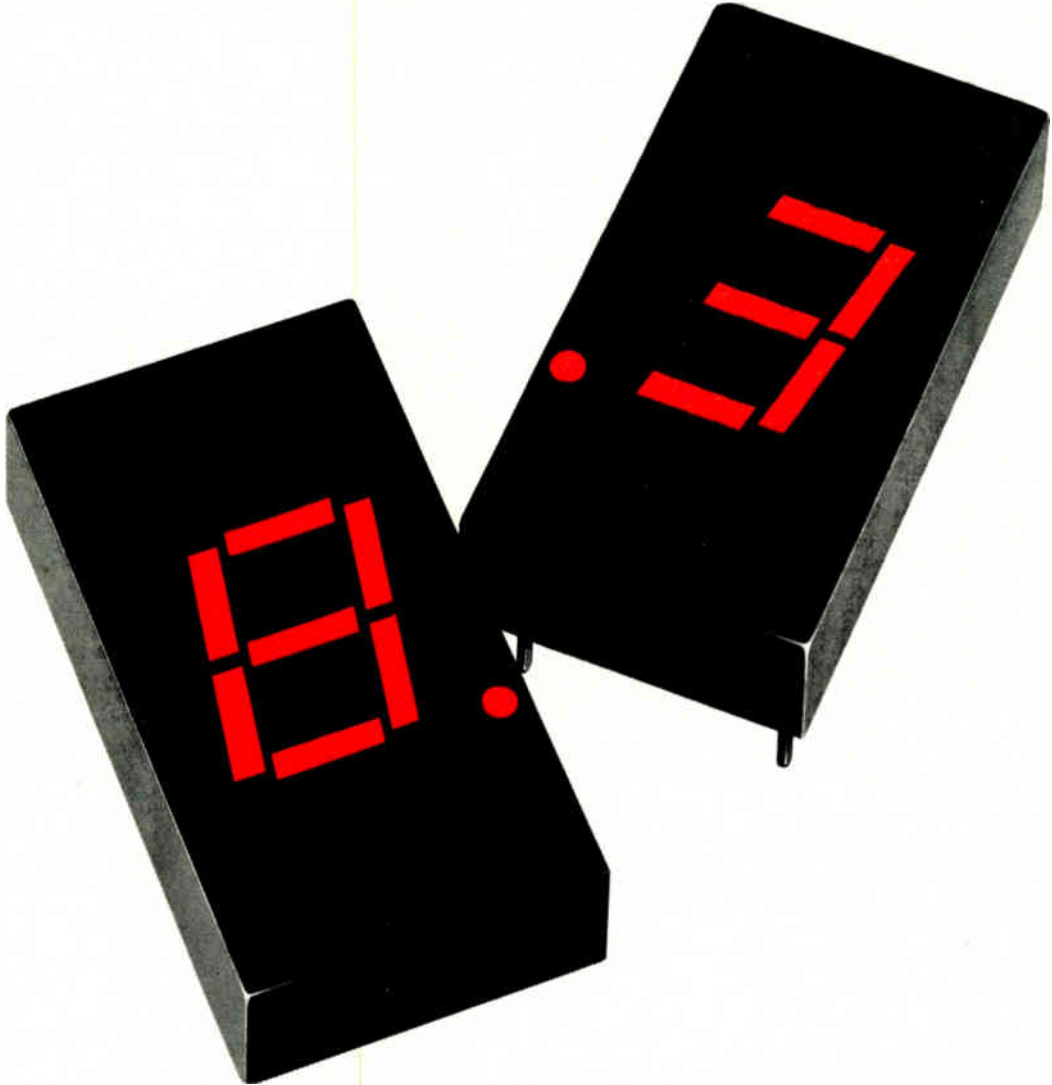

New common cathode display just \$2.70*

Now, the great-looking HP display is available in either common cathode and common anode configuration. Both at the new low price of just \$2.70* in 1K quantities. Both have the same wide viewing angle and large 0.3 inch character and uniform segment illumination that assures excellent readability.

Specify either the 5082-7730 series (common anode) or -7740 (common cathode) for any commercial application. Reduce your display system costs by choosing the display that complements your drive electronics.

And get traditional HP quality.

Contact your HP distributor for immediate delivery. Or, write us for more details. These displays are worth a closer look.

01332

*1K quantity; Domestic USA Price Only.

154 Circle 154 on reader service card

HEWLETT  PACKARD

Sales, service and support in 172 centers in 65 countries.
Palo Alto, California 94304. Offices in principal cities throughout the U.S.

Electronics/September 27, 1973

SURPRISE! SURPRISE!

Now your HP distributor
has still another way to keep
you looking good.

Distributor Stocking Locations:

HALL-MARK ELECTRONICS

Huntsville, Alabama
(205) 539-0691
Lenexa, Kansas
(913) 888-4747

St. Louis, Missouri
(314) 521-3800

Raleigh, North Carolina
(919) 832-4465

Tulsa, Oklahoma
(918) 835-8458

Dallas, Texas
(214) 231-6111

Houston, Texas
(713) 781-6100

SCHWEBER ELECTRONICS

Toronto, Canada
(416) 925-2471

Hollywood, Florida
(305) 927-0511

Elk Grove Village, Illinois
(312) 593-2740

Rockville, Maryland
(301) 881-2970

Troy, Michigan
(313) 583-9242

Waltham, Massachusetts
(617) 890-8484

Somerset, New Jersey
(201) 469-6008

Rochester, New York
(716) 328-4180

Westbury, New York
(516) 334-7474

Beachwood, Ohio
(216) 464-2970

WYLE

DISTRIBUTION GROUP

Liberty Electronics/Arizona
Phoenix, Arizona (602) 264-4438

Liberty Electronics
El Segundo, California (213) 322-8100

Elmar Electronics
Mt. View, California (415) 961-3611

Western Radio
San Diego, California (714) 235-6571

Elmar Electronics
Commerce City, Colorado (303) 287-9611

Liberty Electronics/Northwest
Seattle, Washington (206) 763-8200

EUROPE

Celdis Ltd.
37-39 Loverock Road, READING, Berks, England
Tel.: READING 58 22 11

I.S.C. France
20, rue Gambetta, 92-Boulogne, France
Tel.: 604.52.75

Ingenieurbüro Dreyer
238 Schleswig, Flensburger Strasse 3, Germany
Tel.: (04621) 2 31 21

EBV Elektronik
8 Munich 2, Gabriel-Max-Strasse 90
Tel.: (0811) 644055-8

6 Frankfurt/Main 1, Myliusstrasse 54
Tel.: (0611) 720416-18

B. V. Diode
Hollantlaan 22, Utrecht City, The Netherlands
Tel.: (03088 42 14)

Interelko A. B.
Sandsborgsvagen 50, 12 233 Enskede, Sweden
Tel.: (08) 49 25 05

HEWLETT  PACKARD

New products



a different full-scale range. In effect, this increases the dynamic range of the instrument by 40 decibels and produces readings from 20 volts to 100 millivolts. Dynamic range is 103 dB.

Datel Systems Inc., 1020 Turnpike St., Canton, Mass. 02021 [353]

Digital panel meter is ac-powered

A 3½-digit panel meter with Sperry gas-discharge displays is ac-powered. Designated the AD2006, it features a differential input, ratio-metric operation, usable ± 15 -volt dc and 5-V dc power outputs, and a safe barrier-strip connection for the ac line power. Full-scale range is



± 1.999 v, and maximum error is 0.05% of reading ± 1 digit. Temperature coefficient is less than 50 ppm/ $^{\circ}$ C. Further, internal triggering is set at five readings per second, and for data-acquisition applications, up to 90 conversions per second can be externally triggered.

Analog Devices Inc., Rte. 1 Industrial Park, Box 280, Norwood, Mass. 02062 [354]

Oscilloscope provides 10-megahertz bandwidth

A five-inch oscilloscope, the model 455, has a 10-megahertz bandwidth and 10-millivolts-per-centimeter

vertical sensitivity. It is intended for TV servicing, as well as industrial and education applications. In addi-



tion to auto-synchronization, the scope offers retrace blanking, and a sweep frequency that is adjustable from 1 hertz to 200 kilohertz in five overlapping ranges. Horizontal sensitivity is 300 mV/cm, with bandwidth from dc to 500 kHz. Price is \$295.

Simpson Electric Co., 5200 W. Kinzie St., Chicago, Ill. [355]

Laser power meter offers four scales

A portable laser power meter, priced at \$450, has a broadband response from 300.0 nanometers to 30 micrometers. The meter also provides four scales with readout ranges from 300 milliwatts, 1 W, and 3 W to 10 W. The model 210 is suited for measuring outputs of moderate-power ultraviolet, visible, or infrared continuous-wave lasers.

Coherent Radiation, 3210 Porter Dr., Palo Alto, Calif. 94304 [356]

Digital ohmmeter measures resistance to 0.0001 ohm

A low-level wide-range digital ohmmeter offers resistance measuring from 0.0001 ohm to 199.99 megohms. The 1-ohm full-scale range is suited for measuring the resistance of motor windings, crimped-lug terminals, transformer windings, relays, solenoids, contacts, and cable resistance. Low power dissipation is

New products

incorporated to provide compatibility with thermistor-resistance measurement. Price is \$895.

Valhalla Scientific Inc., 7707 Convoy Ct., San Diego, Calif. 92111 [357]

Amplifier is aimed at ultrasonic applications

The A7200 series amplifier, designed for ultrasonic applications, has a flat response of better than

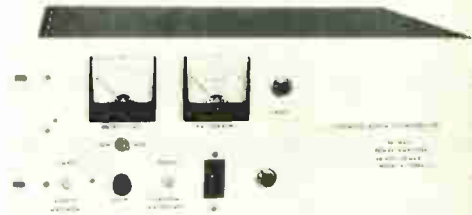

± 0.5 decibel from 50 kilohertz to 10 megahertz at full power. Useful power is to 20 kilohertz. The instrument is overload-protected to infinite VSWR and offers distortion of less than 5%. In addition, gain control of 50 dB is provided on the front panel.

Scientific System Technology Inc., 603 Business Parkway, Richardson, Texas 75080 [358]

Power supplies provide up to 50-kV dc output

With up to 50 kilovolts of dc output, series 205 laboratory power supplies are designed for nuclear instrumentation, cathode-ray tubes and electron-beam applications. Models are available with outputs from 0 to 1 kV dc at 30 milliamperes to 0 to 50 kV dc at 0.3 mA. Remote programming and reversible polarity are features. Regulation and ripple are 0.001%, and temperature coefficient is 50 ppm/ $^{\circ}$ C. The series 205 is fully solid-state and has plug-in circuit boards and encapsulated high-voltage circuitry. Prices for the units start at \$450.

Bertan Associates Inc., 180 Miller Place, Hicksville, N.Y. 11801 [359]

TRIMLINE CASES

88 SIZES

23 COLORS

2 WEEK SHIPMENT ARO

(YOUR CHOICE OF SIZES AND COLORS)



Complete catalog and prices on request...

PREMIER METAL PRODUCTS COMPANY

337 Manida St., Bronx, N.Y. 10474/(212) 991-6600

Circle 156 on reader service card

RELIABLE SPACE SAVERS...



NEW! IMPROVED DESIGN
provides longer life and greater dependability.

SNAP ACTION feature
permits a high 6 Amp rating.

GOLD FINISH on contacts and terminals for easier soldering and longer shelf life.

ISOLATION BARRIERS between poles and terminals, inside and out.

CASE MATERIAL of DAP for strength, better arc and flame resistance, lower leakage.

WIDE CHOICE of 1, 2, 3 and 4 pole models in Momentary and Push On/Off.

OPTIONS... Waterproof seals, PC or Wire Wrap terminals.

NEW FRAME DESIGN allows use on 250VAC circuits.

Ask for our illustrated "New Product Selection Guide" — containing a detailed listing of all series, options and pricing.



INVESTIGATE & COMPARE
ALCOSWITCH

Mfd. by ALCO ELECTRONIC PRODUCTS, INC. NORTH ANDOVER, MASS.

156 Circle 200 on reader service card

MOS Metric Converter Calculator Array



U.S. TO METRIC or METRIC TO U.S.

36 DIFFERENT CONVERSIONS

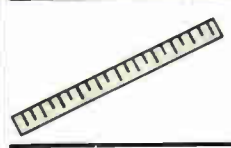

LENGTH
 IN. ↔ CM. YD. ↔ M.
 FT. ↔ M. MI. ↔ KM.

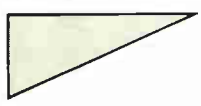

AREA
 IN.² ↔ CM.² YD.² ↔ M.²
 FT.² ↔ M.² MI.² ↔ KM.²

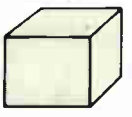

VOLUME
 IN.³ ↔ CM.³ YD.³ ↔ M.³
 FT.³ ↔ M.³ MI.³ ↔ KM.³



LIQUID
 OZ. ↔ CC. QT. ↔ L.
 GAL. ↔ L.



MASS
 OZ. ↔ G.
 LB. ↔ KG.



TEMPERATURE
 °F ↔ °C

FIVE FUNCTION CALCULATION WITH MEMORY

$\frac{C}{CE}$	CONVERT	%	— U ³
7 MI./KM.	8 GAL./L.	9 LB./KG.	÷
4 YD./M.	5 QT./L.	6 OZ./G.	X
1 FT./M.	2 OZ./CC.	3 °F/°C	+
0 IN.-CM.	.	M↕ U.S.	= U ²

Need Details? We've A Data Sheet That Delivers.
 Simply Write Or Phone.

HEADQUARTERS — Applications Mgr.: Mr. Julius Hertsch;
 MOS Technology, Inc., Norristown, Pa. 19401
CENTRAL REGION — MOS Technology, Inc., 838 S. Des Planes
 St., Chicago, Illinois 60607 · (312) 922-0288
EASTERN REGION — Mr. William Whitehead, Suite 307 — 88
 Sunnyside Blvd., Plainview, N.Y. 11803 · (516) 822-4240
WESTERN REGION — MOS Technology, Inc., 2172 Dupont Dr., Suite
 221, Patio Bldg., Newport Beach, Calif. 92660 · (714) 833-1600

WE'VE TURNED
 A TECHNOLOGY
 INTO A
 COMPANY



MOS TECHNOLOGY, INC.
 VALLEY FORGE CORPORATE CENTER, NORRISTOWN, PA. 19401 (215) 666-7950

an affiliate of
ALLEN-BRADLEY 

The first name in sweep generators is also no. 1 in price/performance value.

Telonic Sweep Generators have a lot more built into them than just components. For example — more experience and application know-how than you'll find in any instrument; operating features we've incorporated from talking to hundreds of users; dependability based on designs that are field-proven in thousands of locations. Today, Telonic sweepers give you a lot more than just specs. They give you maximum instrument for your investment.

Consider: 1) The Model 1202, solid state, all modular, covering 100 kHz to 100 MHz, built-in single or harmonic markers, built-in 102 dB of attenuation, variable sweep rate, excellent flatness, linearity, resolution and accuracy, with a basic price of only \$895.00.

2) The Model 1204 with all those same fine features, for use in the 1 MHz to 500 MHz frequency range, and it starts out at \$1,095.00.

3) The Model 1205 gives you all the benefits of our other models, operates out to 1500 MHz, and it, too, is a big value with a base price of \$1,395.00.

4) For displaying swept signals, the Model 121 Oscilloscope is an ideal mate for any of the above sweepers. It incorporates an 11" diagonal screen, is sensitive to 1 mv/division, has a bandwidth of 15 kHz and is priced at \$495.00.

5) The Model 122 Oscilloscope is a dual display unit for two sweeper traces or a reference trace, and it's not twice the price, only \$695.00.

Who was it that said, "investigate before you invest"? We have a new 60-page catalog on sweepers, oscilloscopes, and detectors. We would like you to investigate it, it's free.

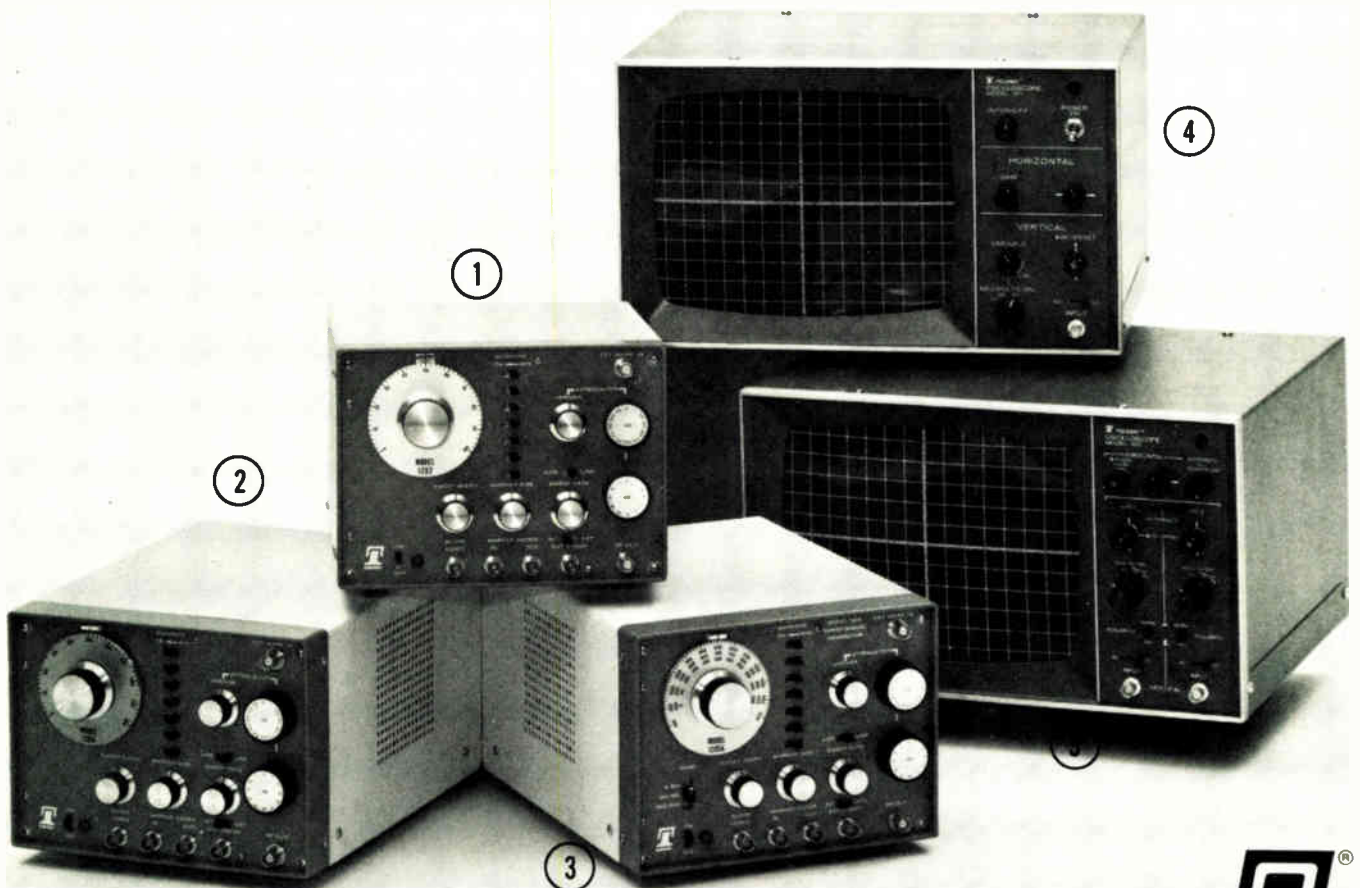

TELONIC INDUSTRIES, INC.



Components

V-tails hold socket in place

Positive retention of DIP unit assured during wave-soldering process

When inserted automatically into a 1/16th-inch board, a low-profile socket for dual in-line packages latches firmly into place, thanks to its V-shaped tails, and requires no external form of retention during wave-soldering.

Produced by Augat Inc., the device is available in both 14- and 16-pin configurations. A 0.020-in. standoff keeps it clear of the board and provides for circuit clearance and for flux cleaning.

Sockets can be mounted end to end for continuous 0.100-in. spacing, or else side by side. The tails require 0.035-in. ± 0.002 -in.- diameter mounting holes.

The socket is fabricated from a U/L rated SE-0 glass-filled material. Contacts are beryllium copper with either gold or tin plating. The OEM price ranges from 15¢ to 38¢ each, depending on plating and the quantity ordered.

Augat Inc., Attleboro, Mass. 02703 [341]

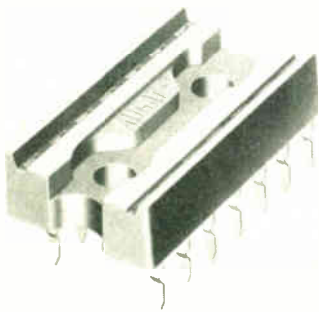

Cermet fixed resistor offers capless design

Most failures of film resistors are caused by the devices' end caps, according to Allen-Bradley Co. Logi-

cally enough, therefore, the firm, which till now has been known for its carbon composition resistors, chose a capless design for its first entry into the film-type fixed-resistor market.

Designated type CC, the 1/4-watt cermet-film unit has an alumina core, wire leads that are both weldable and solderable, and a conformal insulating coating. To provide more reliable interconnection than end caps, it joins sintered end terminations with high-temperature metallurgically fused leads embedded in the core.

The company says its new resistor

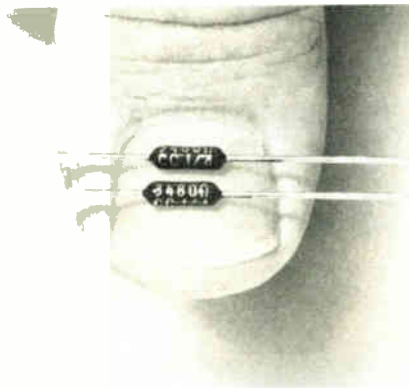

has performance characteristics that are substantially superior to reliability specification MIL-R-39017 and stability specification MIL-R-10509. Average temperature coefficient is well below 100 ppm/ $^{\circ}$ C. The alumina core has high strength and high purity to reduce the possibility of failure related to hot spots and hairline fractures, according to the company.

Resistance values range from 10 ohms to 1 megohm, and tolerance is $\pm 1\%$. Principal fields of application include computers, instrumentation, communications, industrial and military equipment.

The company says pricing of the type CC resistor, which is 0.250 inch long and 0.090 in. in diameter, will be in the range of 14 to 11 cents each in 250- to 1,000-unit quantities. Delivery time will be six to eight weeks, depending on quantities ordered.

Marketing Dept., Electronics Div., Allen-Bradley Co., 1201 S. Second St., Milwaukee, Wis. 53204 [342]

Displays stand 0.550 inch high

Gas-discharge readout assemblies are packaged into a single unit containing three to 10 or more digits with decoder/driver circuits and an optional power supply. The displays use seven-segment characters, which, however, appear as continuous unbroken digits. Color of the displays is orange, and they give off a brightness of 210 foot-lamberts with high contrast ratio. Character height is 0.550 inch with center-line spacing of 0.531 inch. Life expectancy is 10 years. Price is as low as \$7.20 per digit in quantity.

Master Specialties Co., 1640 Monrovia, Costa Mesa, Calif. 92646 [381]

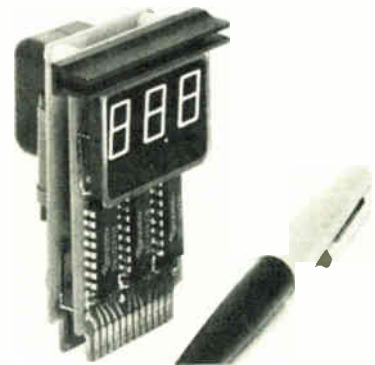

Solid-state relay can handle 480 volts

A solid-state relay available, in an 8-ampere current rating, is capable of handling 480 volts ac. Partic-

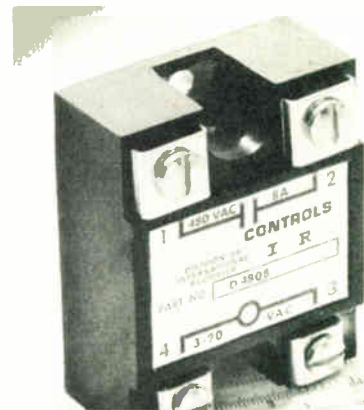

MOVE to

THE PEOPLE DOING
THINGS THAT MATTER...
IMAGINATIVELY

ELECTRONIC RESEARCH CO. • A TRISTAR DIV.

SERIES 9400 SCANNER



- 10 Channel System—\$484
- Capacity—1000 Channels
- Multi-Mode Operation
- Scan rates to 100 Channels-Per-Second
- High Channel-to-Channel Isolation
- System Building Blocks

Telephone (913) 631-6700
7618 Wedd
Overland Park, Kansas 66204
Mail to: P.O. Box 913, Dept. 179
Shawnee Mission • Kansas 66201
TWX: (910) 749-6477

all new

TIME CODE RECEIVER

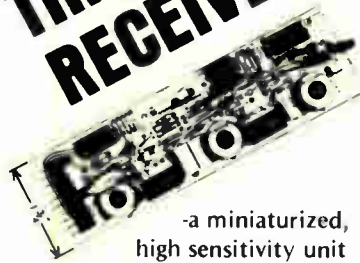

-a miniaturized,
high sensitivity unit
for receiving WWVB
transmissions. Operation guar-
anteed anywhere within 1800
miles of xmitter.

Price: \$390.00
including antenna.

Write for catalog sheet 873-1

TRUE TIME INSTRUMENT CO.
2225 Melbrook Way
Santa Rosa, Calif. 95405

Circle 250 on reader service card

New products

ularly useful overseas where line voltages of 380 v, 50 hz are common, the device will allow solid-state zero-voltage switching of such loads as high-voltage power supplies and small, high-voltage motors. The device is compatible with transistor logic levels and can operate from computer outputs. Two models are available, the D4808 for dc control signal applications and the A4808 for ac control signal applications. Price of the model D4808 in 100-lots is \$23.40 each.

International Rectifier Corp., 1521 Grand Ave., El Segundo, Calif. 90245 [343]

2-A relay is designed for high-density packaging

A 2-ampere, single-pole, double-throw relay is intended for high-density packaging such as 0.6-inch spacing on printed-circuit boards. Designated the R50, the relay has a special contact design that permits switching 2 A at 26 volts dc or 1 A at 120 v ac, resistive. The unit has a



sensitivity to 125 milliwatts and a nominal power rating of 750 mW. Operate and release times are both 5 milliseconds maximum. The R50's gold-plated terminals are situated on 0.1-inch centers, and the 4-ounce relay measures 1.09 by 0.59 by 0.415 in. high (seated).

Potter & Brumfield Division, AMF Inc., Princeton, Ind. 47670 [344]

Two DIP reed relays plug into one socket

A dry-reed relay housed in a DIP, but with a single line of terminals, is designed so that two of the relays plug into one 14-pin dual in-line package socket. -The MRRQ1A has

RELIABLE SPACE SAVERS...



Terminal guarantees a permanent seal.

NEW! IMPROVED DESIGN provides longer life and greater dependability.

LEVER STOP feature prevents "push-in" of toggle, protects internal moving parts.

HIGH TORQUE BUSHING withstands mechanical abuse.

NEW FRAME DESIGN allows use on 250VAC circuits.

GOLD FINISH on contacts and terminals for easier soldering and longer shelf life.

FINE SILVER CONTACTS and heat sinks provide a conservative 6 Amp rating.

ISOLATION BARRIERS between poles and terminals, inside and out.

CASE MATERIAL of DAP for strength, better arc and flame resistance, lower leakage.

Ask for our illustrated "New Product Selection Guide" — containing a detailed listing of all series, options and pricing.

INVESTIGATE & COMPARE ALCOSWITCH

Mfg. by ALCO ELECTRONIC PRODUCTS, INC. NORTH ANDOVER, MASS.

The CRT display isn't really obsolete. DIGIVUE® just makes it look that way.

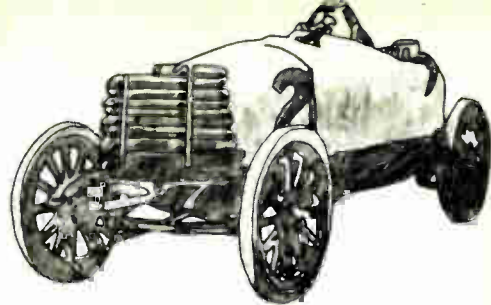

And Design Adaptability Is One Reason Why . . .

Digivue is the plasma display device from Owens-Illinois that delivers computer-generated alpha-numeric and graphic displays at microsecond speeds. Digivue provides drift-free images, selective write/erase, inherent memory, hard copy printout potential, rear-projection capability.

Digivue units are flat panel devices with panel depth independent of display size. Depth of panel and case for the 512-60 Digivue unit is a slim 7 inches, allowing for a variety of installation possibilities—in desks, drawers, walls, and physical compatibility with a variety of drive systems.

The bulky, boxy CRT display just can't match that kind of style.

If you'd like to know more about the next generation in display systems, take a look at tomorrow—take a look at Digivue.

Call or write:
Electro/Optical Display Business
Owens-Illinois, Inc.
P.O. Box 1035, Toledo, Ohio 43666
(419) 242-6543 Ext. 66-415

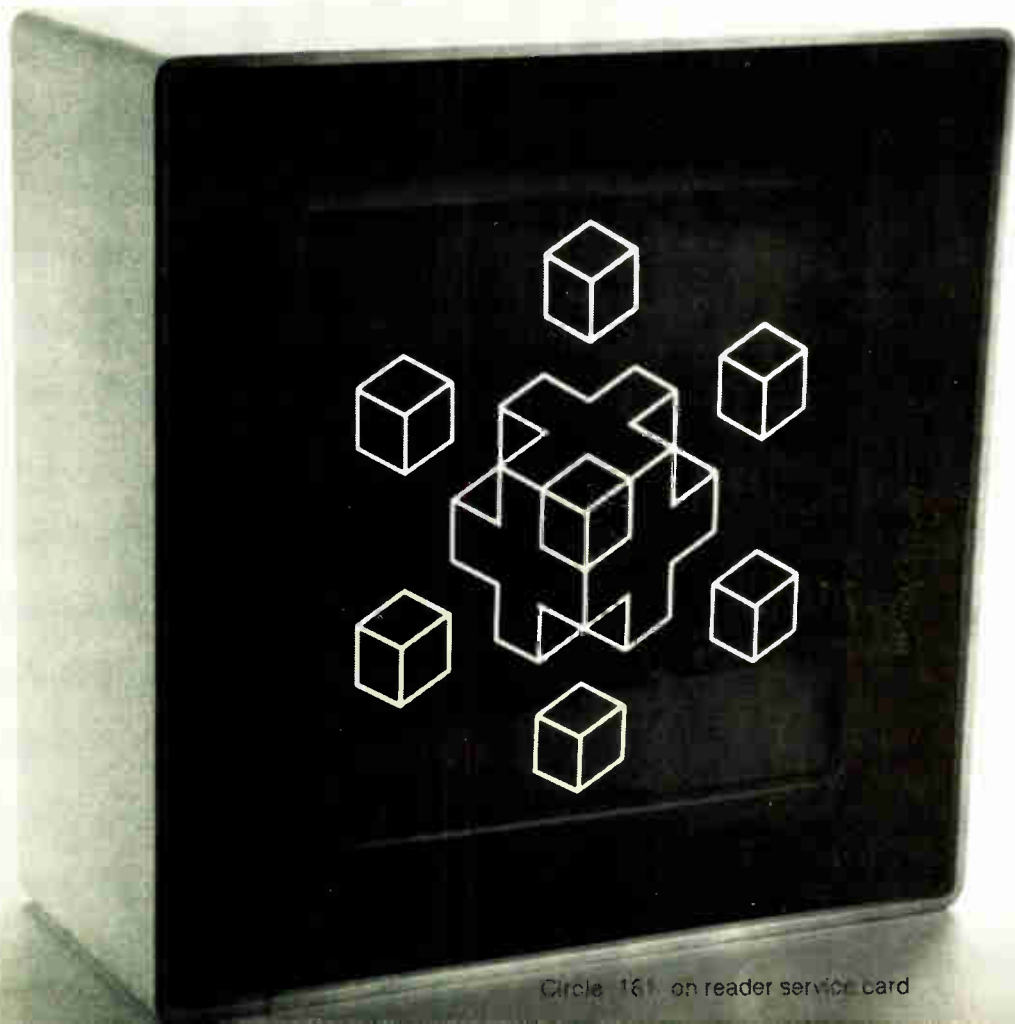

Circle 161 on reader service card

Simulated graphics on screen.



**magnetic
bubble
materials
from Tokin**

ORTHOFERRITE SINGLE CRYSTALS

For Magnetic Bubble Research & Development
Orthoferrite single crystals possess the required characteristics for new generation memories employing magnetic bubble devices. Tokin produces various types of high grade orthoferrite single crystals via the zone melting process, which avoids crucible or flux contamination. We invite you to evaluate these single crystals in your magnetic bubble R & D program.

Materials
YFeO₃, TbFeO₃, DyFeO₃

Products
Single Crystals: 7mm dia. rod, axis direction (C axis)
Wafers: Polished and annealed according to requirements

If you have additional requirements regarding form, crystal direction, shape or dimension, please forward your inquiry to—

Tokin
Tohoku Metal Industries, Ltd.
Head Office
13-10, 7-chome, Ginza, Chuo-ku, Tokyo, Japan
☎03-542-6171
Los Angeles Representative Office
1277 W. Redondo Beach Blvd.,
Gardena, Calif. 90247, U.S.A.
☎213-329-4137, 4138
Düsseldorf Representative Office
c/o Nippon Electric Co., Ltd.
4 Düsseldorf, Immermannstrasse 22, W. Germany
☎0211-357088, 357089, 357080

Circle 162 on reader service card



For the finest in
Instrument **KNOBS**

- Silk-Screening
- Hot Stamping
- Frosting

You can depend on
BUCKEYE

To supplement the recognized high quality of the BUCKEYE MATCHING INSTRUMENT KNOB LINE, Buckeye Craftsmen have developed unique capabilities in fine silk-screening, hot stamping and frosting. They can decorate or mark to your specific requirements any of the wide selection of styles, types, colors and sizes of Buckeye Knobs and Skirts. To see for yourself the quality of Buckeye Craftsmanship, ask for **FREE** sample of the knob illustrated above. You can depend on Buckeye for your control knob needs . . . and other instrument-packaging products.

 the **BUCKEYE** stamping co.
555 Marion Road, Columbus, Ohio 43207
Quality Products Since 1902

162 Circle 201 on reader service card

New products



single-pole, single-throw, normally open (type A) contacts rated at 10 volt-amperes. Coil voltages are 5 v dc, 12 v dc, and 24 v dc. A 50-mw coil is available for use with ICs and discrete logic circuits. Price is \$2.45 each in lots of 100, except for the 50-mw version, which is \$3.15.

Struthers-Dunn Inc., Pitman, N.J. 08071
(345)

Proximity limit switch built for programable controllers

A proximity limit switch for program controllers and other automation equipment can also be used in switching for valves, relays, solenoids, indicators, and computer input. The series 5PC operates over a power range of milliwatts to 100 w, and at full rated power has an electrical life of up to 100 million cycles. Use of the proximity limit switch is limited to ac circuits.

Tann Controls Co., 20210 Sherwood, Detroit, Mich. 48234 [346]



Discrete LED is compatible with low-power applications

Designated the CM4-83, a T-1¼-size high-luminous-intensity discrete LED is compatible with IC and other low-power applications. The diode is encapsulated in a red diffused plastic lens for front- or rear-panel mounting. Output is 3 millicandelas

PLASMA-CLEAN Critical Surfaces

— remove organic films,
stains and particulates
without acids, solvents
or high temperatures.

Now you can *ultra clean* critical surfaces of alumina, quartz, metal and plastic objects to an even greater degree, using a new process developed by LFE.

This method is especially valuable to facilitate defect-free deposition and increased bonding strength to the precleaned surfaces.

The unique LFE Plasma Ultra Cleaner is based on a completely *dry* process. Because the plasma reactions occur at *low temperatures*, fragile parts with critical dimensions run little risk of mechanical or structural deformations.

For further information or a demonstration in your facility under your particular process requirements, contact:

LFE Corp. Process Control Division
1601 Trapelo Rd., Waltham, MA 02154
Telephone (617) 890-2000, ext. 438

In Europe: George Kent Electronic Products Ltd.
3, Hunting Gate, Wilbury Way
Hitchin, Hertfordshire SG4 0TJ, England
Telephone Hitchin 4333

In Japan: Nissei Sangyo Co., Ltd.
C.P.O. Box 1316, Tokyo 100-91 Japan
Telephone Tokyo 501-5311

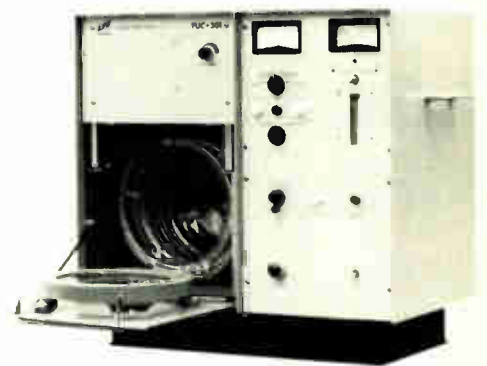

CORPORATION

Process Control Division

Circle 163 on reader service card

GAS EXHAUST OUTLET

RF POWER
COUPLED
INTO GAS

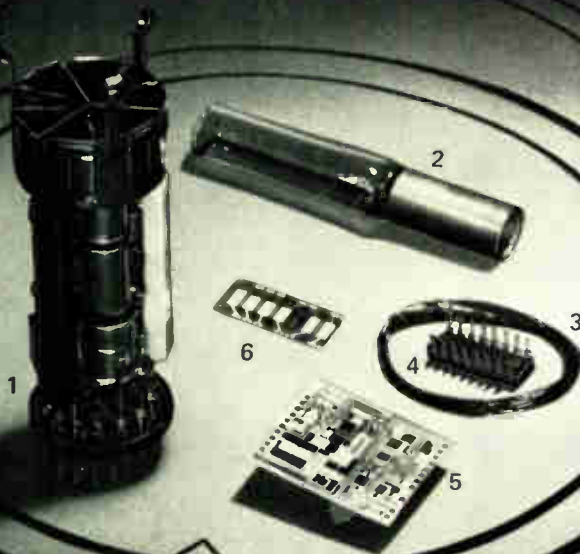

GAS INLET

commercial grades
of atmospheric gases,
reactive and inert
combinations,
or special blends
of polyatomic
gases
and carriers.

1. CRT ELECTRON GUN
2. KOVAR-TO-GLASS JOINT
3. BERYLLIUM-COPPER WIRE
4. SEMICONDUCTOR HEADER
5. THIN-FILM CIRCUIT
6. QUARTZ FILTER

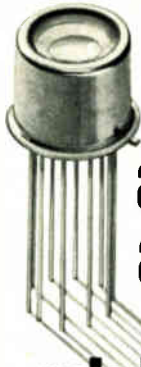

Silicon photo detector and pre-amplifier in one miniature package

...delivered in volume to meet your production requirements.

The Bell & Howell 509 Optical Detector combines a large area silicon photodiode, low-noise operational amplifier and a gain determining network — all hermetically sealed in a miniature TO-5 size transistor package. Units available for extremely low level light sensing, fast rise time light pulses, and high resolution applications.

- Sensitivities to 10^{-12} watts
- Spectral Range 0.35 to 1.12 microns
- 7 Decade Linear Dynamic Range
- Bandwidths from DC to 10 MHz
- Output Noise less than 1 millivolt over full bandwidth
- NEP's to 10^{-12} watts/ $\sqrt{\text{Hz}}$
- Large Detector Active Area, 10 MM²
- Other diode sizes available.

Modification of these units can be made to meet specific requirements on volume orders.

CONTROL PRODUCTS DIVISION
706 Bostwick Ave., Bridgeport, Conn. 06605 (203) 368-6751

 **BELL & HOWELL**

Circle 164 on reader service card

The Brush 440 portable recorder. A general purpose recorder that does more.

The Brush 440 has four 40 mm channels, two event markers, eight pushbutton chart speeds, and built-in signal conditioners. There's pressurized ink writing and linearity guaranteed to 99½%.

Write Gould Inc., Instrument Systems Division, 3631 Perkins Avenue, Cleveland, Ohio 44114. Or Kouterveldstraat Z/N, B.1920 Diegem, Belgium.



 **GOULD**

164 Circle 202 on reader service card

New products

at 20-milliamperere drive. Price is 17 cents each in quantities of 100,000. Chicago Miniature Lamp Works, 4433 N. Ravenswood Ave., Chicago, Ill. [347]



Switches come in snap, butt-action configurations

A momentary contact push-button switch is available in both snap-action and butt-contact construction. The P-style snap-action models are recommended for low-energy circuits and are priced at \$2.55 in quantities of 1 to 24. The MP butt-contact switches are for applications where space is at a premium. They are priced at 90 cents in the same quantity.

Raytheon Co., Distributor Products Operation, Fourth Ave., Burlington, Mass. 08103 [348]

Touch-operable switches are designed for MOS gates

The 400 series of solid-state touch-operable momentary switches are designed especially for direct interfacing to MOS gates. The series eliminates the need for the switch-signal conditioning or buffering that is normally required when mechanical switches are being interfaced to MOS logic. The units are available with normally low or normally high output over an operating voltage range of 5 to 15 v dc. Price ranges from \$1.96 to \$5.95 depending on quantity and whether a lighted or unlighted version is ordered.

Magic Dot Inc., 3361 Republic Ave., Minneapolis, Minn. 55426 [349]

FUJITSU quality on sale in By-pass Capacitors for High-speed TTL and ECL.

HIGH-SPEED SPACE-SAVING LOW-COST BY-PASS CAPACITORS

FUJITSU Fujitsu's newly developed by-pass capacitors for high speed logical circuits enable TTL and ECL printed-circuit-boards to eliminate additional ceramic/film capacitors and result in high density mounting.

Two types are available.

(1) Aluminum solid electrolytic capacitor. . . . High speed pulse. (TTL)

(2) Tantalum solid electrolytic capacitor. . . . Ultra high speed pulse. (ECL)

○ These solid electrolytic capacitors have been developed as by-pass capacitors to by-pass noises generated in power supply by logical elements during rise and fall of high speed pulse in the circuit.

○ High density mounting in printed circuit board.
○ Low Equivalent-Series-Resistance (E.S.R.) against rise and fall of high speed pulse.
○ Low inductance.
○ Small in size yet large in static capacity.
○ Lead pitch the same as that of terminals for Dual-In-Line package IC.
○ Widely utilized in Fujitsu FACOM computers with excellent results and outstanding reliability.

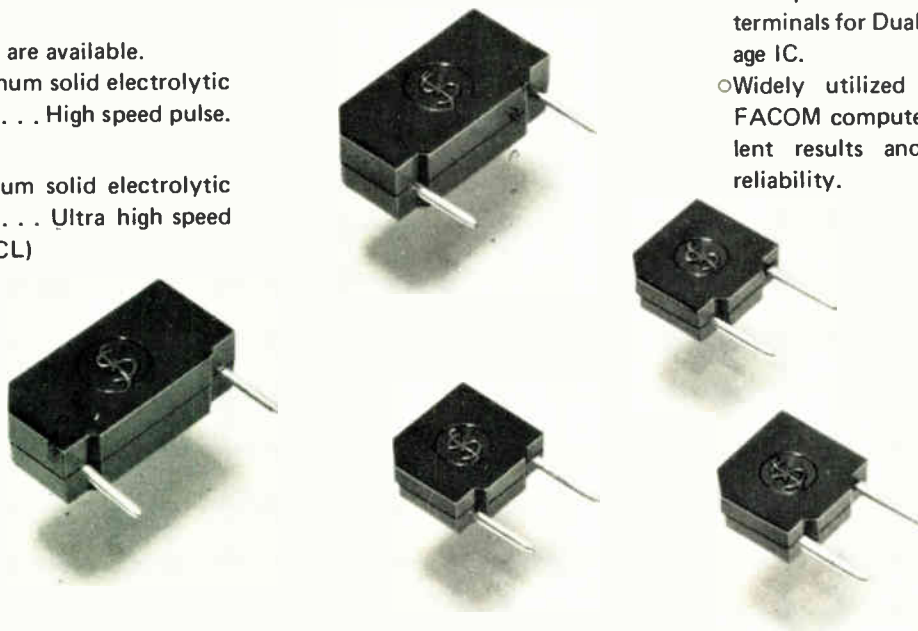

RATINGS AND SPECIFICATIONS:

Capacitors	Static Capacity	Static Capacity Tolerance	Rated Voltage	Body Dimensions (Terminal pitch)	Operating Temp. Range	Permissible R.H.	Dissipation Factor (Tan δ)	Leakage Current	E.S.R.	Inductance
High Speed (Aluminum)	1.0 μ F	-20% +not specified	16V DC	12.5 x 6.2 x 4.4 mm (0.40 inch)	-55°C ~ +85°C	95% Max.	8% Max. at 120Hz.	3 μ A Max.	1.5 Ω Max. at 10MHz.	Typical 10nH at 200MHz.
Ultra High Speed (Tantalum)	3.3 μ F		10V DC	7.0 x 6.35 x 2.54mm (0.20 inch)			10% Max. at 120Hz.	1 μ A Max.	0.5 Ω Max. at 10MHz.	Typical 5nH at 200MHz.

FUJITSU LIMITED
Communications and Electronics
Marunouchi, Tokyo, Japan

For further information, please contact:
Head Office: 6-1, Marunouchi 2-chome, Chiyoda-ku, Tokyo 100, Japan Telex: J22833
New York Office: 680 Fifth Avenue, New York, N.Y. 10019, U.S.A. Phone: (212) 265-5360
Fujitsu California Inc.: 1135 East Janis Street, Carson, California 90746, U.S.A. Phone: (213) 636-0858, (213) 537-8930

MAIN PRODUCTS □ Telephone Exchange Equipment □ Carrier Transmission Equipment □ Radio Communication Equipment □ Space Electronics Systems □ Electronic Computers & Peripheral Equipment (FACOM) □ Telegraph & Data Communication Equipment □ Remote Control & Telemetry Equipment □ Electronic Components

IS AN HONEST DAY'S WORK FOR AN HONEST DAY'S PAY AN OLD-FASHIONED ATTITUDE?

Not in Georgia.

In our smaller towns, you'll find people who are eager to work. People who value good jobs. Manpower is one of our State's greatest assets.

With a trainable labor force estimated at 100,000 strong, Georgia has undertaken one of the most aggressive educational programs in the nation.

And to attract the industries we need, we train your employees for you. Free.

It's called our Quick Start Program. Totally state supported, it utilizes the resources at vocational-technical schools near your new plant.

Our industrial specialists coordinate pre-employment training with your plant opening. And continue with on-the-job training as long as necessary.

What other advantages are in Georgia's smaller towns? Conservative government. Favorable tax policies. And access to your market.

In Georgia's smaller towns, you'll make a good living, and enjoy living — close to cultural centers, big-league cities, and year 'round recreation and entertainment.

Mail the coupon today for more detailed information on Georgia's smaller towns. We're ready to go to work for you.

GEORGIA

GOOD FOR BUSINESS. GOOD FOR PEOPLE.

Georgia Department of Community Development
Industry Division, Dept. EL-42
Box 38097
Atlanta, Georgia 30334

Please send me information regarding Georgia's available labor and free training services.

Name		Title
Company		
Address		
City	State	Zip

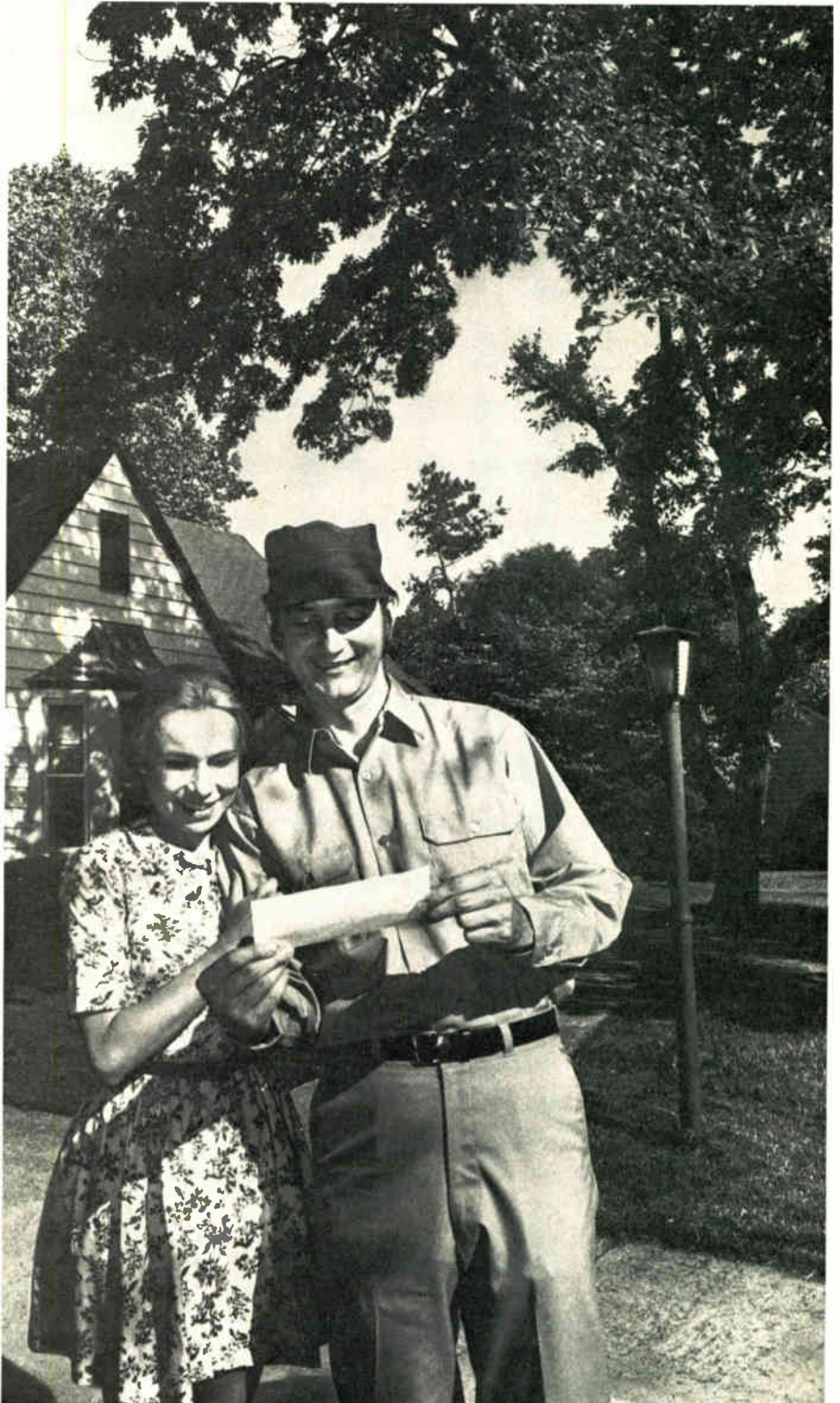

New products

Packaging & production

Wafer cleaner is automatic

Spinner can handle 600 wafers an hour; cycle times are adjustable

Semiconductor manufacturers, discovering that pre-epitaxial and inter-process cleaning of silicon wafers increases chip yields, are rapidly outgrowing manual methods of "spin-swab" cleaning. The low output per operator using single-head spinners and manual wafer-loading and scrubbing makes efficient manual cleaning costly.

Headway Research Inc. has therefore developed a highly automated four-head, tray-loading spinner with automatic wiper mechanisms. A single operator can run two such machines and thus clean almost 1,200 wafers per hour.

Designated the MC-55, the mechanical wafer cleaner accepts four tray-loaded wafers 1 to 3 inches in diameter, spins them up to 12,000 times a minute, and floods each spinning wafer with the first cleaning fluid—usually distilled water or a detergent solution, says R.L. Rich, marketing manager for the Dallas-based process-equipment manufacturer. Then a balanced, stainless-steel wiper mechanism is gently lowered, with a pre-adjusted force, onto each wafer, presenting a clean, wet polishing cloth to the surface of the spinning wafer.

As the wiper rises off the wafer, the wet cloth is automatically indexed to provide a clean portion of

the material for the next cycle. An optional second rinsing fluid—water or alcohol, for example—replaces the first cleaning fluid just before the spin-dry cycle.

"The entire sequence is automatic, with each step time-variable," Rich says. Indicator lights show each step.

At the heart of the system is a new ac synchronous two-phase motor, designed and built by Headway. "We originally designed it because a dc system is basically unreliable," he says. "We try to spin these motors at 10,000 rpm with fast acceleration, and the only way to do that with a dc motor is to overdrive it." Because there is no arcing in an ac motor, there is no possibility of explosion if fluids should enter the motor chamber, which Headway has protected from fluids with vacuum seals. "The ac motor can run only at the desired rpm," he says, "and will not fluctuate, regardless of the force presented to it."

But the real boon to manufacturers, as Rich sees it, is the volume of wafers possible with the MC-55. "With a typical 24-s cycle, 600 wafers per hour can be cleaned on the MC-55," he says, "and a single operator with two machines can clean almost 1,200 per hour."

The single-fluid model sells for \$6,275; with two-fluid capability, it's tagged at \$8,775.

Headway Research Inc., 3717 Forest Lane, Garland, Texas 75042 [391]

Tester checks out calculator chip sets

A low-cost tester for calculator chips offers an alternative to manual testing or use of an expensive general-purpose test system. The Macrodata MD-16 calculator-set tester costs only \$20,000, but in exchange for the lower cost, the user gives up versatility. The MD-16 is specifically designed to test calculator circuits.

The tester checks out single or multiple calculator chips as sets. Programs are keyed in on a calculator-type keyboard (or optional teletypewriter or paper-tape reader),

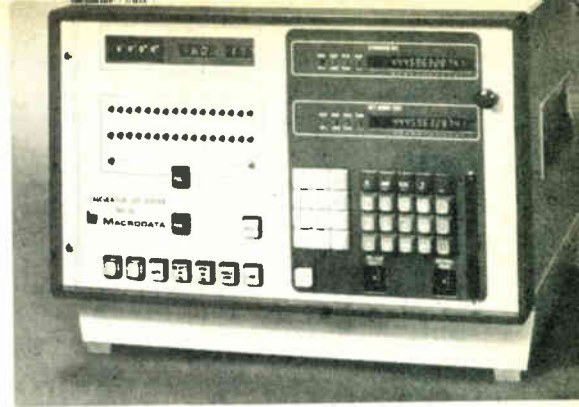

then stored in semiconductor memory. The circuit is tested by stepping the part under test through the program simultaneously with a known good part, and the outputs are compared. The two outputs are displayed on a 12-digit or an optional 16-digit Panaplex display. The machine can be set to stop on failures, or simply bin good and bad parts. Testing by the MD-16 takes a few seconds, while manual testing by plugging a part into a calculator may take a minute or longer. However, the MD-16 can also be stepped through the program manually.

To change from one calculator chip or chip set to another, personality boards—designed to exercise specific sets—are replaced. Supply voltage is programable up to 70 v, simulating dropping battery voltages in portable calculators. This capability, obtained with digital-to-analog converters, also permits parametric tests of leakage current and power-supply drain, prime indicators of marginal parts that are likely to fail in the field.

The MD-16 tests either n- or p-channel parts with up to 48 pins, the practical maximum for a commercial calculator. There are 20 input keys, which can be set up for different functions. The decimal point is adjustable.

A two-channel multiplexer for the MD-16 is available for \$5,000. It also provides continuity tests for wafer probing, and has counters for good and bad parts.

Macrodata Corp., 6203 Variel Ave., Woodland Hills, Calif. 91364 [392]

Test system can handle 72,000 ICs per hour

The exploding demand for integrated circuits, coupled with their

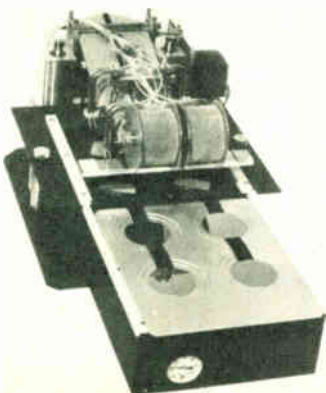

Introducing the ROTEK

Series 300 E/I/R CALIBRATOR...



the only calibrator designed for DIGITAL (as well as analog) METERS

- ▶ High accuracy — 0.005% DC; 0.05%, AC
- ▶ Broad operating range — 6 voltage ranges; 6 resistance ranges; 7 current ranges; frequencies to 10 kHz
- ▶ Closed-loop operation — provides instant, automatic response to dial settings... eliminates fussy manual adjustments
- ▶ Digital error readout
- ▶ Programmable operation available — Model 310
- ▶ Unprecedented flexibility — ideal for calibrating analog meters and panel meters of all types, including 3, 4 and 4½ digit AC or DC ammeters, voltmeters, multimeters and A-to-D converters

Complete specifications
and data are now available
on the Series 300.
Send for your free copy
today.



ROTEK

INSTRUMENT CORP.

40 Guinan Street, Waltham, Mass. 02154 Tel. (617) 899-4611

Circle 168 on reader service card

86397045

New NDP 1255-8

from NATIONAL ELECTRONICS
featuring

Gas Discharge Display Panel

- Large Character (.3")
- Edge Connector Plug In
- Multiplexed • Low Cost



NATIONAL ELECTRONICS
a varian division
geneya, illinois 60134 (312) 232-4300

168 Circle 203 on reader service card

New products

growing complexity, is putting pressure on test-equipment manufacturers to improve speed. Datatron's response is a computer-controlled system, based on but much faster than its model 4400, and with hardware and software changes that reduce programming time and program overhead.

The Hustler 44 digital module tester can check up to 72,000 ICs an hour as against the earlier machine's 36,000, though both figures are dependent on handling equipment, which typically slows the Hustler's actual throughput to 56,000. Price remains about the same, at around \$110,000 for a typical eight-station, 16-pin system. The system tests all popular logic, including TTL, ECL, and MOS.

The two major features of earlier Datatron equipment—parallel drive-detectors for each pin, and simple English-language programming—are retained in the new system, but with considerable changes. The interchangeable pin electronics cards may be individually programmed for each pin and will simultaneously force and measure each pin for high parametric and functional test rates. Up to 256 cards can be used, so that devices or circuits with up to 256 pins can be tested. Use of the pin cards eliminates the need for relatively slow reed-relay switching matrixes, and the interchangeability of the cards simplifies servicing and system expansion; any card is usable in any location.

Other features of the 44 include a new computer, the Data General Nova 1200 instead of the earlier Nova, and software changes for improved editing, diagnostics and debugging. A basic question-and-answer routine for new device programming enables test technicians or engineers to learn how to program tests in a few hours. The routine also adds on-line program debugging and diagnosis at one station without interfering with testing at other test stations (of which up to eight may be provided.)

Test rate of the system is a maximum of 2.5 million go/no-go tests per second, and functional exercising rate is over 100 kilohertz for a

New generation of high-performance, low-cost, ultra-precision resistors

Tolerances: .01% to 1%
Temp. Coeff.: 5 to 25 PPM/°C
T.C. Matching: to 1 PPM/°C

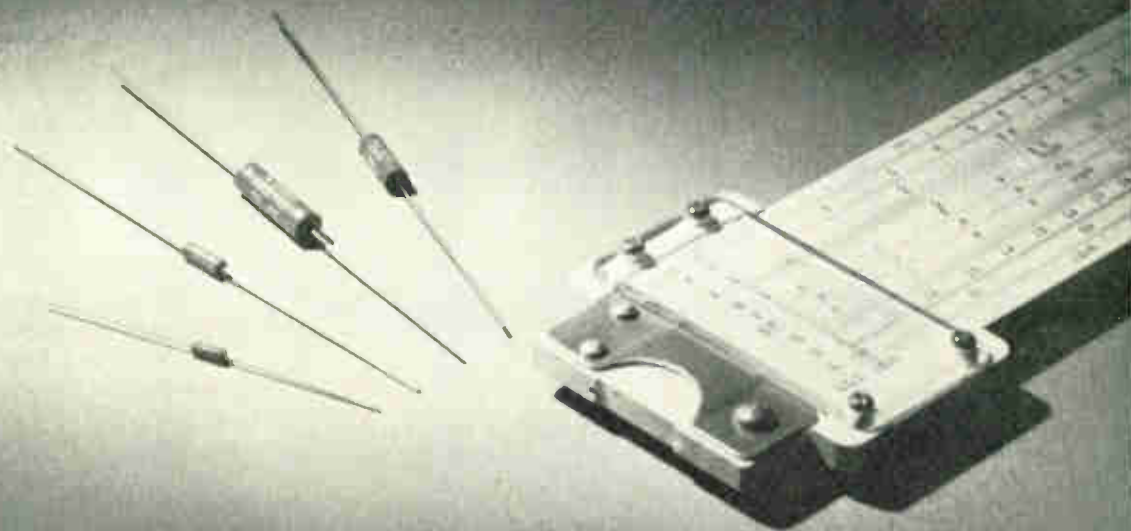

Caught in a cost/performance bind on precision resistors? Solve the problem with TRW/IRC's new MAR Series of ultra-precision metal film resistors. Where speed and precision count, they offer the ultimate in cost/performance ratio. And by "performance," we mean *better* than premium wirewounds.

With the MAR Series, you get an ultra-stable, ultra-precision resistor with an extremely low temperature coefficient. You also get the non-measurable noise, low voltage coefficient and stress stability previously available only in pre-

cision wirewounds. Yet you still have the high-frequency response, reliability, pulse stability and resistance/size ratio of metal film.

Also available as part of the MAR technology are resistor matched sets and modules providing additional performance and cost advantages. For comprehensive technical data and MAR samples, contact your TRW representative. Or write TRW/IRC Fixed Resistors, 2850 Mt. Pleasant St., Burlington, Iowa 52601. Phone: (319) 754-8491.

IRC TYPE	RESISTANCE RANGE (Ohms)	TEMPERATURE COEFFICIENTS -20° C to +85° C (± ppm/°C)	TOLERANCES (± %)	POWER RATING @ 85° C (Watts)	VOLTAGE RATINGS (Volts)	DIMENSIONS IN INCHES		
						Body Length (L Max)	Body Diameter (D Max)	Lead Gage (A)
MAR3	20-100K	T10 = 15	1.00, 0.50, 0.25,	1/20	200	.191	.082	≈ 26 .016**
MAR5	20-250K	T13 = 10	0.10, 0.05, 0.02,	1/10	250	.281	.102	≈ 22 .025
MAR6	20-500K	T16 = 5	0.01	1/8	300	.425	.155	≈ 22 .025
MAR7	20-1 Meg			1/4	500	.650	.195	≈ 22 .025

* Wider ranges available. Contact factory

** Lead length 1.00 ± .062

TRW[®] IRC RESISTORS

New forced air cooling package dissipates 450 watts; costs only \$6.50*

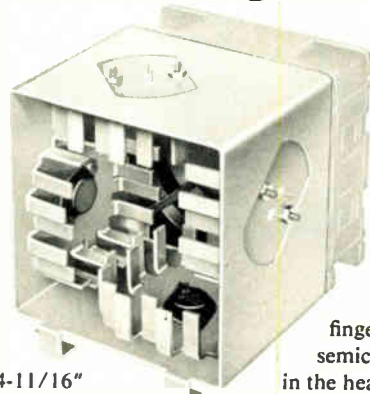

*1000-pc qty.; fan not included.

Our new Series FAHP4 blower package measures only 3-3/4" x 5-3/16" x 4-11/16" and weighs only 14 ounces, yet dissipates 450 watts in a 25°C ambient with a case rise of less than 95°C. The secret to its high performance and low cost is the use of four standard IERC HP3 staggered

finger heat sinks. Since the semiconductor hole pattern is in the heat sinks we assemble the FAHP4 from standard off-the-shelf heat sinks and shrouds. Ask for our new data sheet. IERC, 135 W. Magnolia Blvd., Burbank, Calif. 91502, a subsidiary of Dynamics Corporation of America.



Heat Sinks

Circle 170 on reader service card

Here's an optical tachometer for tape drive control

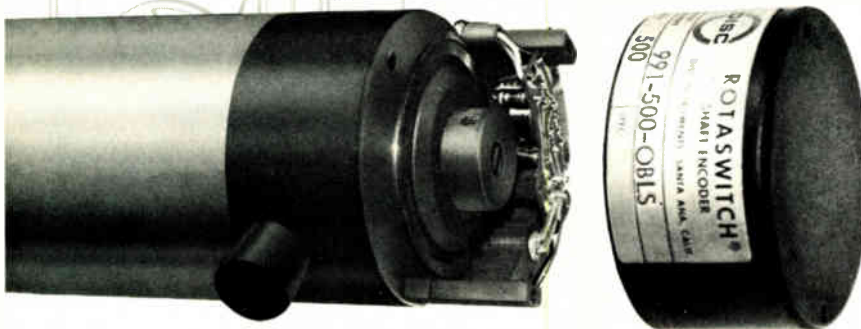

(that won't blow your manufacturing costs!)

- Mounts directly to drive motor
- Frequency output <0.7% FM deviation
- Uses LED light sources, extremely reliable
- Square wave, TTL compatible output
- Temp. range of -20°C to +80°C
- Priced under \$35.00 in quantity

Write or call for spec sheet on Disc's new 990 Series Tachometers.



DISC Instruments, Inc. 102 E. Baker St., Costa Mesa, Calif. 92626, Phone (714) 979-5300

Disc Instruments Division
Finnigan GmbH
Dachauer Strasse 511, 8 München 50, Germany
Phone: (0811) 142291 (2)

Disc Instruments Division
Finnigan Instruments Ltd.
Paradise, Hemel Hempstead, Herts, England
Phone: (0442) 57261

See DISC Encoders at ISA International Show, Booth 556, Houston, Texas, October 15-18.

170 Circle 204 on reader service card

New products

16-pin device. This gives a typical test time of 50 milliseconds for small-scale TTL, ECL, and MOS ICs, and about 60 ms for medium-scale devices.

The system is furnished with a teletypewriter, and optional peripherals include a high-speed paper-tape reader and punch, cassette or IBM-compatible magnetic tape, and line printer. Cost range is \$70,000 to \$150,000.

Datatron Inc., 1562 Reynolds Ave., Santa Ana, Calif. 92711 [340]

Wave solderer aimed at board-repair work

A wave-soldering unit, called the Minipot, has a reservoir capacity of 115 pounds. A precision-micrometer hand-wheel wave-height adjustment is accurate to within $\pm 1/64$ th inch. Interchangeable nozzles are also offered, giving a choice of several different wave configurations. The small pot capacity makes the unit suitable for applications that involve frequent changes in the solder alloy, tinning, and circuit-board repair. The unit is designed for continuous high-temperature requirements to 850°F and can be used on polyurethane-insulated wires, where it will melt the insulation and tin the copper conductor in the same operation.

Electrovert Inc., 86 Hartford, Ave., Mount Vernon, N.Y. 10553 [393]

Aluminum packages allow custom-designed housings

Available in 165 stock sizes, pre-designed aluminum packages enable the user to design custom housings. All parts mate with each other by means of tongue-and-groove construction, and sizes range from 2 by 2 by 4 inches to 4 by 8 by 12 in. or longer. Each mating part is slotted on the inside with 1/16-inch card guides to accommodate 3.775-in.-

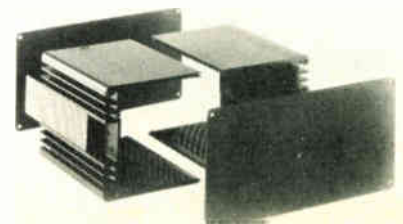

FREE

new Heath/ Schlumberger Electronic Instruments Catalog



Gives complete details and specifications on hundreds of high performance, budget-conscious instruments for research and industrial applications. Here are just a few examples:

NEW High performance strip chart recorder...4 switch-selected input ranges from 10 mV to 10 V full scale...10 chart speeds...accuracy within 1%...complete remote control capability...switchable input filtering...easy paper loading...disposable nylon-tip pen. Only \$365*.

NEW 110 MHz frequency counter...5 Hz - 110 MHz guaranteed, 2 Hz - 130 MHz typical...15 mV input sensitivity guaranteed, 3-10 mV typical...input sensitivity control...autoranging with four automatically selected ranges...1 MHz time base w/1 part in 10⁶/mo stability...7-digit LED readout. \$325*.

Dual trace oscilloscope...DC-15 MHz bandwidth w/24 nsec risetime...50 mV/cm sensitivity...200 nsec to 0.5 sec/cm sweep rates...triggered sweep...X-Y capability. \$595*.

For your free copy, mail coupon or use reader service number.

Heath/Schlumberger Scientific Instruments
Dept. 531-288
Benton Harbor, Michigan 49022

Please send new electronic instruments catalog.

Name _____

Title _____

Company/Institution _____

Address _____

City _____ State _____ Zip _____

*Mail order prices; FOB factory. **EK-395**

EUROPEAN STATISTICS

5 YEAR FORECASTS OF MARKET DATA AND 3 YEAR HISTORICAL PRODUCTION STATISTICS COVERING 13 WEST EUROPEAN COUNTRIES.

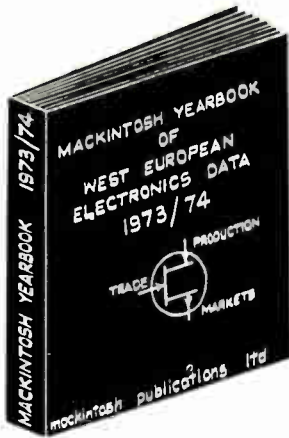

BREAKDOWN OF PRODUCT SECTORS:

- DATA PROCESSING**
 - COMPUTERS
 - PERIPHERALS
 - ELECTRONIC CALCULATORS & CASH REGISTERS
- CONTROL & INSTRUMENTATION**
 - MACHINE TOOL CONTROL
 - INDUSTRIAL PROCESS CONTROL
 - TEST & MEASURING INSTRUMENTS
- COMMUNICATIONS**
 - RADIO COMMUNICATIONS
 - RADAR & NAVIGATIONAL AIDS
 - PUBLIC BROADCASTING
- TELECOMMUNICATIONS**
 - EXCHANGES
 - TRANSMISSION
 - SWITCHING EQUIPMENT
 - SUBSCRIBER APPARATUS & OTHER
- CONSUMER ELECTRONICS**
 - COLOUR & MONOCHROME TV
 - AUDIO EQUIPMENT
 - OTHER ELECTRONIC APPLICATION AREAS
- COMPONENTS**
 - ACTIVES
 - PASSIVES
 - AUDIO COMPONENTS

MANY OF THE ABOVE SECTORS WILL BE BROKEN DOWN INTO FURTHER SUB-DIVISIONS

\$75 PRE-PUBLICATION PRICE

20% DISCOUNT FOR ORDERS OF 5 OR MORE.

PUBLICATION DATE: 31st OCT 1973

TO: MACKINTOSH PUBLICATIONS LTD,
33 BRUTON STREET, LONDON W1X 8BQ, ENGLAND.

PLEASE RESERVE... COPY(S) OF ELECTRONICS YEARBOOK AT PRE-PUBLICATION PRICE OF \$75 (POST PUBLICATION \$90) PER COPY

NAME _____ TICK AS APPROPRIATE:

COMPANY _____ CHEQUE ENCLOSED (P & P INCLUDED)

ADDRESS _____

INVOICE ME / MY COMPANY (P & P EXTRA)

Circle 172 on reader service card

New products

wide circuit boards, thus providing a captive fit for cards.

E-Tronics, 16774 Schoenborn St., Sepulveda, Calif. 91343 [394]

Lead cutter-former

handles radial devices

The model 700 capacitor lead trimmer and former handles the leads of radially formed parts, regardless of case configuration, with lead center



spacing from 0.025 inch to 0.680 in. with no adjustment or die changes. A standoff is formed in opposite directions in each lead, which keeps the capacitor upright, as well as keeping the excess conformal coating on the leads out of the holes in printed-circuit boards. Price is \$495. Boulder Valley Industries Inc., Box 1577, Boulder, Calif. 80302 [395]

Bond tester checks

interconnects, pins, leads

The model BTU tester is designed to perform tensile, compression, shear, and fatigue tests on wire interconnects, boned elements, pins, and ribbon leads. Components are mounted on a 3-by-3-inch tool plate. Coarse prepositioning to 2 inches in the X and Y axes is supplemented by 0.5-in. final micrometer positioning. Vacuum hold-down is offered, as well as the capability for making high-load tests. Pull or push angle is manually adjustable, from horizontal to vertical. A protractor monitors tool plate attitude to an accuracy within 1°. Rate of pull or push is adjustable through a variable-speed dc motor and silicon-controlled-rectifier controller

compact temperature controllers

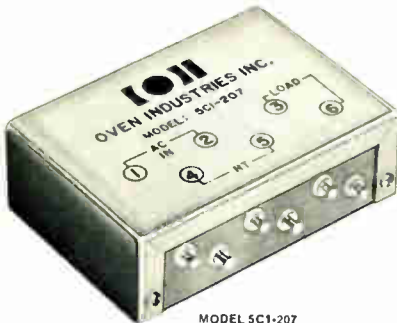

MODEL 5C1-207
Only \$62.50

- FULL PROPORTIONAL
- AC POWERED FROM 50 TO 400 HERTZ
- $\pm 0.005^\circ \text{C./}^\circ \text{C.}$ SET POINT STABILITY OVER A $20^\circ \text{C. TO } +70^\circ \text{C.}$ AMBIENT RANGE
- $\pm 0.0025^\circ \text{C./VOLT}$ SET POINT STABILITY WITH LINE CHANGE FROM 100 TO 140 VAC OR 200 TO 240 VAC

REQUEST A COPY OF BULLETIN NO. C673 TODAY!

OVEN INDUSTRIES, INC.
1106 E. SIMPSON RD. P.O. BOX 229
MECHANICSBURG, PA. 17055
PH. (717) 766-0721 Cable: "OVENMETRIC"

1/4 W

CARBON FILM RESISTOR

Flame Proof

OTHER PRODUCTS:

- FIXED COMPOSITION RESISTORS
- TRIMMER RESISTORS
- SPARK PLUG SUPPRESSORS
- GENERATOR CONDENSERS

TAIYO DENKI CO., LTD.

225-3, 7-cho, Nakamachi, Ohtori, Sakai City,
Japan 593 Phone: 0722 (62) 8281

Circle 206 on reader service card

172 Circle 205 on reader service card



**Mary Lou, Martha, Mollie and Judy
are sold on the AO STEREOSTAR® Zoom Microscope.**

Here's why.

The AO STEREOSTAR Zoom stereoscopic microscope was specifically designed for convenience, working ease and optical performance. Zoom controls are located on both sides for convenience. It eliminates awkward reaching when changing magnification. The high resolution optical power pack may be rotated 360° to accommodate most any assembly or inspection situation. Full optical equipment offers a magnification range of 3.5x through 210x. Working distance of 4.0 inches is maintained at all magnifications in basic models, and if that's not enough, add a 0.5x

auxiliary lens to make it 5.7 inches. STEREOSTAR Zoom microscope assures a wide field of view, up to 2.25 inches with the 10x high eyepoint eyepieces. It also features an extremely efficient illuminator that stays cool even after long hours of continuous use. See for yourself. Contact your AO dealer or sales representative for a convincing demonstration.



**AMERICAN OPTICAL
CORPORATION**

SCIENTIFIC INSTRUMENT DIVISION • BUFFALO, N. Y. 14215

NOW!

42 NEW MODULAR A/D converters



One of two compact cases (2"x4"x.39") that contain the 42 new Phoenix Data modules.

All 42 units in Phoenix Data's six new series of modular A/D converters—ADC1300 through ADC1800—employ the highly reliable and stable voltage switching successive approximation conversion technique. Note these features:

- 8 through 14 bit resolution.
- Overall T.C. to 2.5PPM/°C.
- No adjustments over 10°C to 40°C range.
- Factory calibrated and pre-trimmed.
- RFI and EMI shielded.
- Pin selectable input ranges.
- Conversion time to 2 μ sec: 8 bits; 4 μ sec: 12 bits; 10 μ sec: 14 bits.
- Optional temperature ranges from -55°C to +125°C.
- Guaranteed monotonicity.
- Accuracy to 0.01%.

If it's stability, accuracy, speed, or all-around quality you need in Data Conversion, contact Phoenix Data *now!*



PHOENIX DATA, INC.

3384 W. OSBORN RD. PHOENIX, AZ 85017
Ph. (602) 278-8528, TWX 910-951-1364

New products

with a potentiometer dial.
Engineered Technical Products Inc., 3421
U.S. Highway 22, Somerville, N.J. [396]

Universal panels support
wire-wrapped jacks for DIPs

Universal panels that provide packaging flexibility in integrated-circuit systems are designated the 707-1040 series. The pc power-panel boards support wire-wrapped jacks arranged in columns 0.300 inch apart

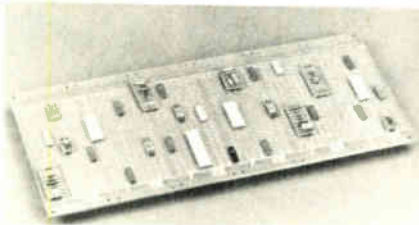

to accept dual in-line packages with 0.300- or 0.600-inch alignment. Two 40-pin DIPs can be inserted in any column length, using two columns spaced 0.600 in. apart.

Cambridge Thermionic Corp., 445 Concord Ave., Cambridge, Mass. 02138 [397]

Coaxial contacts permit
multiple connections

Multiple coaxial cable interconnections in miniature circular connectors are possible with a line of matched-impedance coaxial contacts, designated the RG-174, 178, and 188. The coax cables are designated 316/U. They are designed to fit inserts for #12 size contacts in 48-series miniature connectors, made by Amphenol. Previously, the series 48 would only accept power contacts, but now any combination of power and coaxial contacts within a given circular connector design is possible.

Amphenol, Rf Division, 33 E. Franklin St., Danbury, Conn. 06810 [398]



The Elegant Molded Parts



For elegant applications. Custom-made or standard, EPC parts come with thin walls down to 5 mils, tolerances to $\pm .05\%$ — even threaded bushings. In six different materials: fluorocarbon, nylon, glass-reinforced nylon, DAP, polyester and epoxy. For temperature ranges that go up to 200°C.

It's just the sort of selection and craftsmanship that you expect from EPC as an EAI component company. Look to EPC also for transformer kits. Or to EAI

for thick-film audio amps. Capacitors. Custom coils. Solenoids. Active filters. Analog/digital converters and other special function modules. Plus a growing list of other elegantly crafted etceteras.



EPC

Electrical Plastics Corporation
500 Long Branch Avenue
Long Branch, New Jersey 07740
Tel. (201) 870-9500

A Subsidiary of Electronic Associates, Inc.

Circle 174 on reader service card

Circle 207 on reader service card

Complete Trimmer Satisfaction

One design...9 pin styles

Still the industry's best trimmer value
... Less than **50¢** each in production quantities

CTS 360 Series offers:

Stability of $\pm .03\%$ and environmental performance requirements of characteristic C of Mil-R-22097

- 1.5% average ENR noise resistance
- 0.5% average CRV
- 1/2 watt @ 70°C

You can choose from an expanded line of compact trimmers. .150" — .125" — .100" in-line terminal spacing and TO-5 pin spacing all available in top and side adjust. Plus .200" delta (.100 grid) in top adjust. All available from your CTS Distributor. **Still the best value in the industry.** CTS of Berne, Inc., Berne, Indiana 46711. Phone: (219) 589-3111.

CTS CORPORATION

Elkhart, Indiana



A world leader in cermet and variable resistor technology

Circle 175 on reader service card

ON OCTOBER 25, ELECTRONICS
MAGAZINE WILL PRESENT:

THE GREAT TAKEOVER

AN ENTIRE ISSUE DEVOTED TO THE
PROLIFERATION OF ELECTRONICS
INTO INDUSTRY, GOVERNMENT
AND OUR PERSONAL LIVES

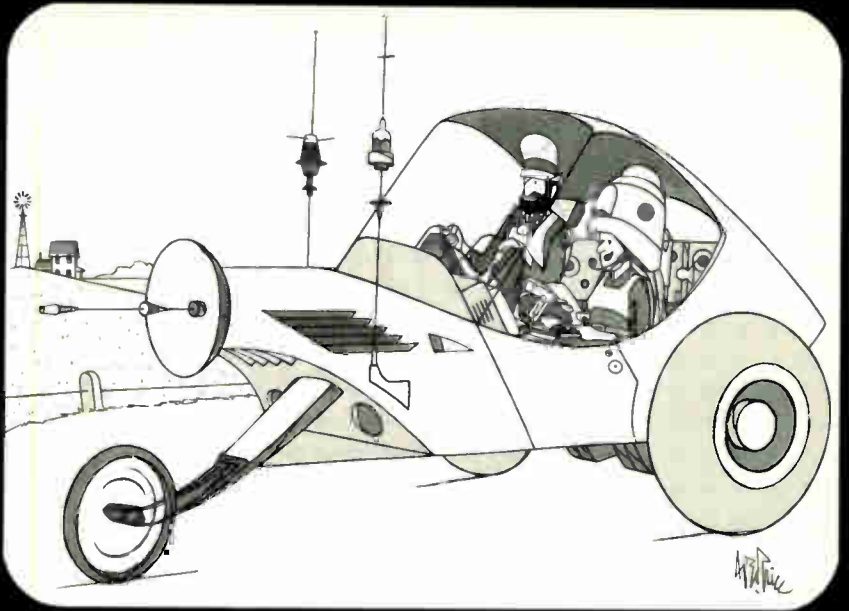

Our editorial purpose is to inform you of the potential economic power of the work you are doing, alert you to the vast opportunities for technical and market growth in the future, and, in effect, to fuel that growth by encouraging engineers and managers to be more aggressive about turning advanced technology into exciting new businesses.

"The Great Takeover" is being put together by the editors of Electronics under the direction of Associate Editor, Howard Wolff. Virtually hundreds of leaders and movers of electronics technology throughout the world will make their presence known through essays, interviews, and opinions appearing in this special issue.

Covered in the October 25 issue:

Review and forecast of key technologies that are making and will make proliferation of electronics possible. Covering basic semiconductor technologies, displays, instrumentation, computer technology from large machines through microprocessing, communications and production.

How large, medium, and small companies are taking advantage of technologies, how they organize to penetrate new markets, what their objectives are, lessons that have been learned, the role of venture capital.

Why has electronics penetrated new markets? Unsuccessful attempts. Disappointments explained. Lessons to be learned. Detailed examination of the exploding point-of-sale business and its implications as example of how proliferation happens.

Takeovers of the future and what has to be done to make them happen.

What we can expect in science, labor, trade and tariffs, military R&D, legislation related to consumerism, auto regulation, etc.

If you aren't already a subscriber to Electronics, fill out and mail us the subscription application located in the back of this issue. And, be sure to join us in "The Great Takeover"—October 25.

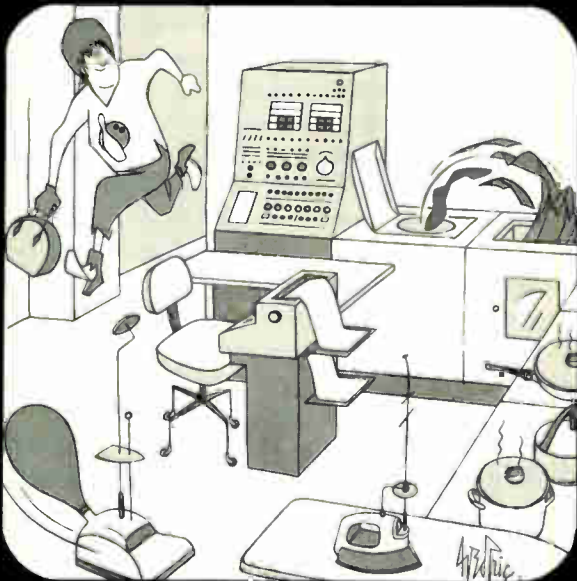

Electronics **McGraw Hill**

“Florida Profit Potentials in Electronics”

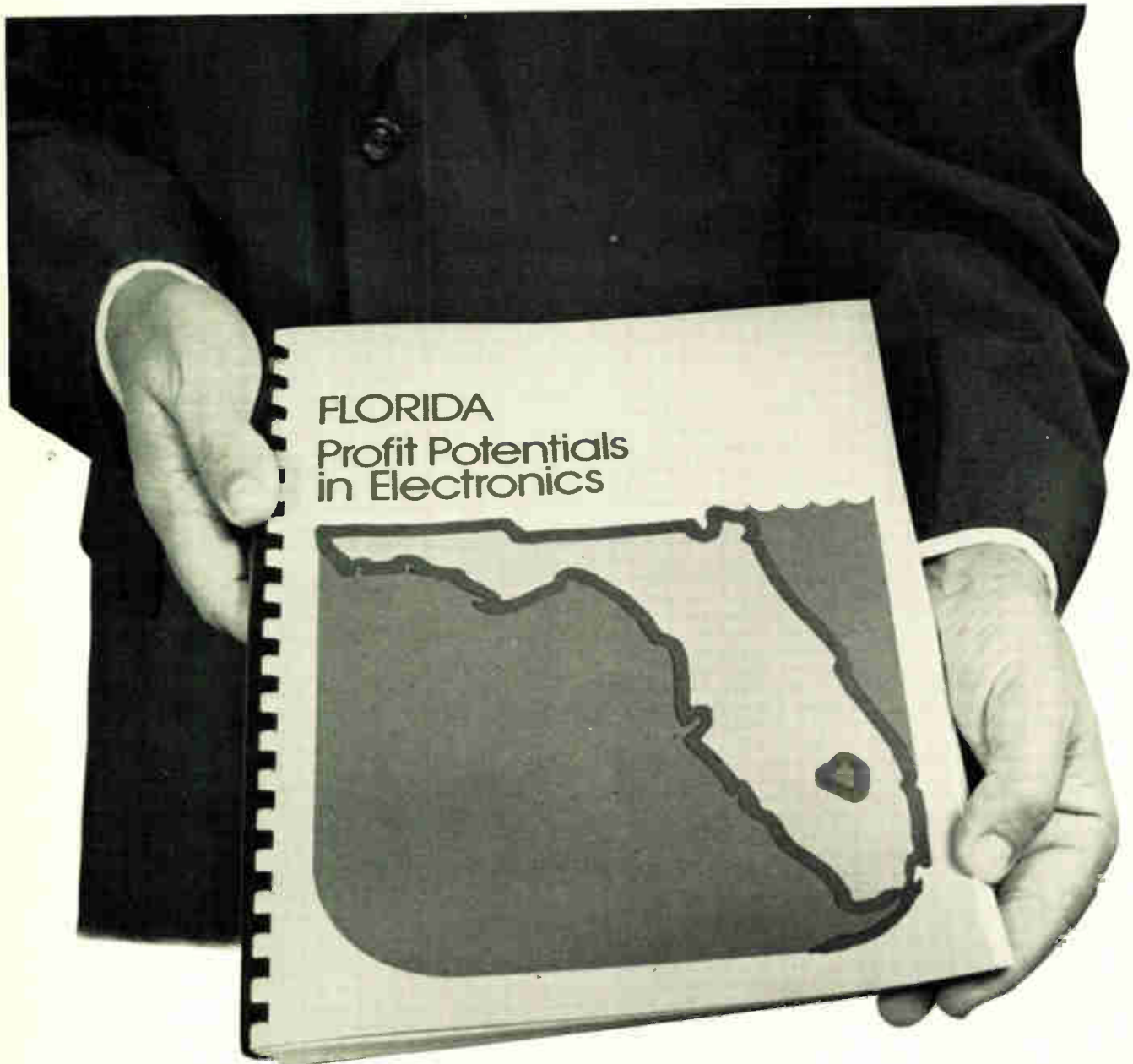

A detailed study concerning Florida's future participation in the growth of the nation's electronics industry; documenting Florida's major advantages of labor availability, costs and productivity.

For instance, labor costs which, on the average, comprise about 90% of an elec-

tronics firm's total variable operating costs, are less in Florida than in the other leading electronics states.

This and other equally significant facts are to be found in this new reference work. Be sure to get your copy by writing on your letterhead to:

*Bureau of Marketing Development
Florida Department of Commerce
Collins Building, Room 5109M
Tallahassee, Florida 32304*

FLORIDA
COMPATABILITY BETWEEN ENVIRONMENT AND THE ECONOMY

COUNTERSCAN SYSTEMS INTRODUCES TWO STATE OF THE ART PRODUCTS

A Sophisticated Multiple Conductor WIRE ANALYZER



Bench model shown.
Larger units are floor consoles.

Designed Exclusively For:

High Density Backplane Testing
High Density Cable Testing
Multiple Circuit Wire Verification

Now for the first time, you can get a wire checker that has followed the state of the art. Once programmed, all you need to do to test different cables, harnesses, backplanes, PW boards, etc., is to press a program select button. No mess with putting on reels of tape, cards, or hooking up other peripheral equipment. This machine is completely self contained and even includes a built-in special purpose computer. Programs are stored in electrically reprogrammable MOS LSI ROM's, and the first program is supplied FREE with the machine. The program content can consist of anything of your choosing. Machine capacities available from 240 points to 384,000 points, in 240 point increments.

Super sophisticated electronic circuitry utilizes CMOS technology almost exclusively. The high density switching is accomplished entirely by CMOS LSI bi-directional switches. Advanced packaging techniques reduce the select/deselect switching component volume by 87%. Choice of various test frequencies and test voltages is continuously available and is part of the program. Any pin connection to the device under test may be used as an input or output. An innovative cable attached keyboard/display unit contains all controls for machine operation. Prices for the basic models range from \$3810.00 complete for the 240 point unit and up. Price includes a printer, mating connectors, programming, and a spare parts kit.

A High Density 480 Channel MULTIPLEXER



A giant multiplexer/demultiplexer is now introduced to satisfy all high density switching and selecting requirements. This innovative and extremely sophisticated unit utilizes the very latest in switch technology. State of the art solid state LSI-CMOS switches are used throughout. The physically compact unit has a tremendous capacity of 480 channels that may be used both as a Multiplexer and Demultiplexer. Each channel is fully bi-directional and capable of passing plus or minus 12 VDC and 12 V peak AC to greater than one megahertz. The small size of the plug-in-able unit is made possible by one high density wire wrap panel and the utilization of the very new LSI-CMOS switches.

The LSI-CMOS integrated circuits support the Multiplexer design better than any other solid state devices in existence. The CMOS-LSI circuitry permits extremely low power consumption, high reliability, are fully bi-directional, extremely compact unit configuration, and uses electronics that represents the threshold of a new and coming technology. A nine hit parallel straight binary code supplies the address to all channels. Full address decoding with latching selects and maintains switch closures until a reset is desired. Interfacing and supporting components contained on the relatively small size wire wrap panel are a state of the art devices and includes a miniature high density data connector that contains 408 contacts and a miniature edge connector that terminates a 122 wires of a flat cable simultaneously with no preparation.

Prices for the Multiplexers start at \$1800.00 for a quantity of one.

COUNTERSCAN SYSTEMS P.O. BOX 536 PHONE 402-773-3875 SUTTON, NE 68979

Circle 177 on reader service card

Circle 178 on reader service card

THE CHAMP ...PICTURE TAKER

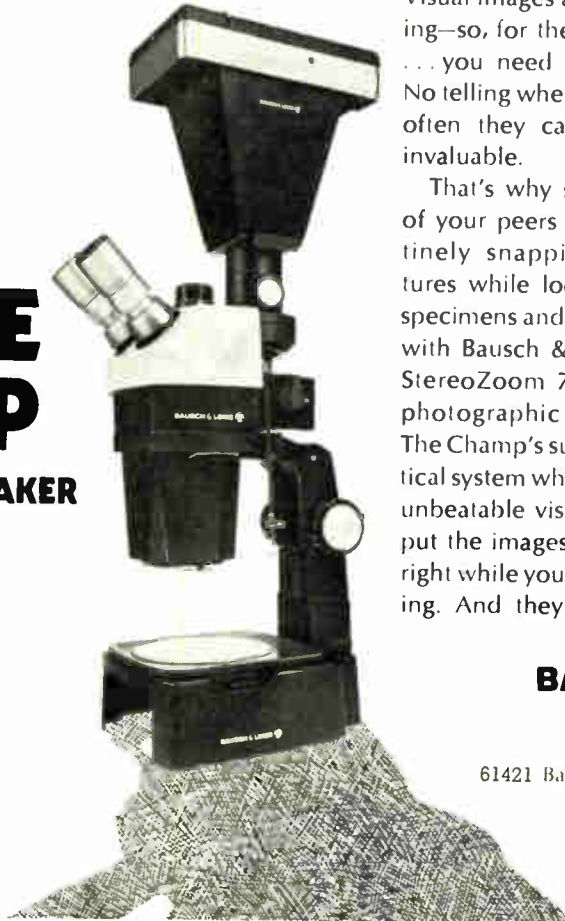

Visual images are fleeting—so, for the record, ... you need pictures. No telling when or how often they can prove invaluable.

That's why so many of your peers are routinely snapping pictures while looking at specimens and samples with Bausch & Lomb's StereoZoom 7 visual-photographic system. The Champ's superb optical system which gives unbeatable visuals will put the images on film right while you're looking. And they will be

available as often as you want to refresh your memory, make comparisons, prove points.

There's a choice of most camera formats with the new Integrated Cameras, Series II with optional exposure meter. They're integral, but do not interfere with the optical system and interchange to fit varying needs.

Be ready. Write for our new Stereomicroscope catalog 31-15 and our free demonstration offer.

BAUSCH & LOMB 

SCIENTIFIC OPTICAL
PRODUCTS DIVISION

61421 Bausch Street, Rochester, N.Y. 14602

StereoZoom, Reg. T.M.
Bausch & Lomb.

For Literature Circle #208 on Reader Service Card.
For Demonstration Circle #209 on Reader Service Card.

When it comes to electronic alloys we speak your language.

“Exactly,” “Precisely,” “Unequivocally,” the properties you need.

We specialize in magnetic and controlled expansion alloys

Ni-Fe. Ni-Co. Ni-Co-Fe. Ni-Mo-Fe. Ni + selected additives. Complete nickel-iron families. Also stainless steel, beryllium, copper, etc., in strip down to 0.0005" thick. Or we'll custom-make alloys to your requirements.

We pride ourselves on tight physical property control

Rigid chemistry control of the alloy ingredients assures exact lot-to-lot consistency of electronic parameters—permeability, resistivity, saturation flux, expansion, thermal conductivity. Impurities concentration less than 0.005%.

Circle 193 on reader service card

You can get evaluation lots or production lots
Strip, rod or wire—order five pounds or five tons.

Also, consider photo-etching your parts. Send us a print and we'll send you a quote

We can produce any configuration in nearly any magnetic or specialty alloy. With precision replicas in pilot or production quantities. And without expensive dies. Photo-etching is especially effective—and economical—for thicknesses of 0.000125" to 0.030".

Circle 194 on reader service card

For information about other alloys
we make, Circle 195 on reader service card



MAGNETICS

A DIVISION OF SPANG INDUSTRIES INC.

Butler PA 16001.

CIRCUIT-STIK introduces

GP BOARDS

**GENERAL PURPOSE
CIRCUIT BOARDS**
Plug-in & Chassis Mounting
and **ELECTRONIC
PACKAGING MATERIALS**

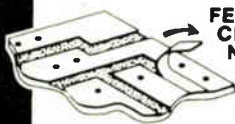
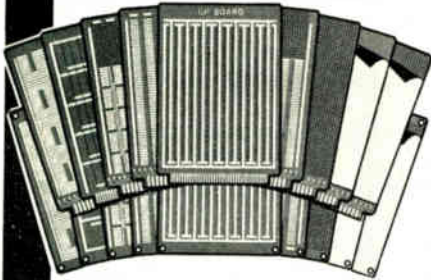

**FEATURING
CIRCUIT-STIK'S
NEW CUT &
PEEL BOARDS**

GP CIRCUIT BOARDS

HIGH QUALITY

- FR-4 Blue Epoxy Glass
- Computer "DRILLED", High Accuracy Holes (not punched)
- Mil-Spec Plating
- Precision Routed Edges

VERSATILITY

- Mix All Types of DIP Sockets (8 to 40 Leads)
- Low, Medium and High Profile Interconnections
- Hybrid Designs for Mixing Discretes and Sockets
- Designed for Edge Connector "Plug-In" or Chassis Mounting
- RFI Shielding

HIGHEST DENSITY

- Up to 50 DIP's on one 4½" x 6½" Plug-In Card Plus Space for 50 Decoupling Capacitors

COMPLETENESS of STANDARD DESIGNS

- Choose from 74 Off-the-Shelf Boards
- 4 Sizes of Boards available

APPEARANCE

- Beautiful Gold, Blue and Bright Tin

FULL LINE of ACCESSORIES (HIGH QUANTITY PRICING AVAILABLE)

- Sockets - Low and Standard Profile, P.C. and Wire Wrap - Molded Nylon and Highest Quality Gold Contacts
- Adapterplugs
- Connectors
- Card Pull Handles

EPOXY GLASS BOARD MATERIALS

- 76 Standard off-the-Shelf Boards
- Including Unclad, Copper Clad, Cut & Peel Copper Clad, Pre-etched "X-Y" Pattern and Plated thru Hole Copper Clad
- .100" Grid Hole Pattern or Undrilled

SEND FOR YOUR FREE CATALOG

circuit-stik®

P.O. BOX 3396
Torrance, California 90510
Phone (213) 530-5530

New products/materials

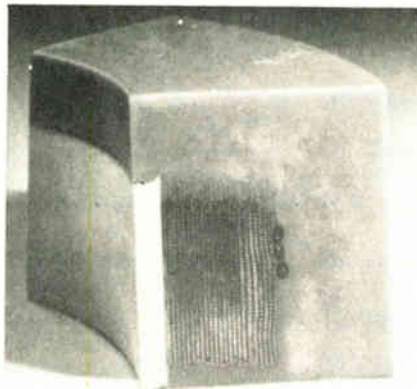

A two-part epoxy is recommended for potting military and industrial grade transformers because of its resistance to thermal and mechanical shock, and to conditions where a high degree of moisture exists. Called material 169, the epoxy shows good electrical properties at high temperatures. Its dielectric constant is 3.8 at 25°C, 100 kilohertz. Price is about \$25 per gallon.

Castall Inc., Weymouth Industrial Park, E. Weymouth, Mass. 02189 [476]

Metaduct 1206 is a one-part electrically conductive epoxy silver adhesive that is used as a cement for light-emitting diodes. It comes ready to use directly from the container and can be dispensed automatically. Other applications include replacement of solder on printed-circuit boards, screen-printing of ICs, and rf shielding.

Mereco Products Division, Metachem Resins Corp., 530 Wellington Ave., Cranston, R.I. 02910 [477]

Ekonol linear polyester for plasma spray coatings comes in thicknesses from 0.1 mil to 250 mils and can be applied to a variety of substrates with available equipment. The final coating offers good bond strength and low coefficient of friction and may be ground to a 5- to 7-micron finish. Long-term temperature resistance is to 550°F.

The Carborundum Co., Carborundum Center, Niagara Falls, N.Y. 14302 [478]

Hybrid thick-film conductor materials known as molecular bonding films are for microelectronics appli-

cations, and offer good adhesion and resistance to degradation under severe thermal cycling. In addition, the materials are highly resistant to solder leach. Air-fireable gold, silver and aluminum films are available. The bonding films are also said to offer the design engineer cost advantages not available previously.

Electro Metallics Department, Engelhard Industries, 1 W. Central Ave., E. Newark, N.J. 07029 [479]

Bear-Tex non-woven nylon abrasives are used for cleaning, finishing, and deburring components. The materials are also resin-impregnated. Specific products include compressed wheels for printed-circuit boards, fm wheels for wet deburring and cleaning, and general-duty hand pads for spot touch-ups.

Norton Co., Coated Abrasive Division, Troy, N.Y. 12181 [480]

A one-component, pure gold conductive epoxy adhesive, designed to withstand wire-bonding temperatures, is for use on microelectronic devices. Called Ablebond 58-1, it can be machine-dispensed in 5-mil dots or can be screened on. The adhesive retains 0.0005 ohm-centimeter resistivity to 400°C and has a 1,250 pounds per square inch lap shear strength after 1,000 hours at 150°C. Ablebond 58-1 cures as low as 125°C, is noncorrosive, and is insensitive to moisture during application and prior to cure.

Ablestik Laboratories, 833 West 182nd St., Gardena, Calif. 90248 [401]

A punchable FR-4 type printed-circuit-board laminate called Super Punch allows holes to be punched rather than drilled in pc boards. It is said to reduce manufacturing costs as much as 30%, mostly through reduced tool wear—drill bits typically last as much as three times longer. As many as six boards can be stacked and drilled simultaneously on numerically controlled machines. Further, the boards are said to show improved flatness even after wave-soldering, as well as improved peel strength and resistance to blistering. Westinghouse Electric Corp., Industrial Materials Division, Hampton, S.C. 29924 [402]

BIG 4K PROM

MMI—first with 1K and 2K PROMs—is doing it again: Announcing another industry first: 4096-bit TTL PROM.

- The part number: Commercial—6340 Military—5340.
- Fan-in: a low $250\mu\text{A}$.
- Access: 90ns guaranteed over temp and Vcc.
- Configuration: 512 x 8 bits.
- ROM-Mate: pin-compatible 4K TTL masked ROM.

- And a faster (60ns) 4K ROM, too—H6240.
- Availability: **NOW**.
- Price: \$95 (100-999) for the 6340.
\$140 (100-999) for the 5340.

If you need parts, call, TWX or write Dale Williams. 1165 East Arques Avenue, Sunnyvale, CA 94086, (415) 739-3535/
TWX 910-339-9229.

Monolithic Memories, Inc. 

EASTERN AREA SALES OFFICE: (617) 653-3158 • NEW ENGLAND REGION: (603) 883-1520 • NEW YORK REGION: (607) 748-3211 • CENTRAL AREA SALES OFFICE: (317) 844-3241 • WESTERN AREA SALES OFFICE: (213) 595-5651
Representing your best buy in memories: ALABAMA, Huntsville (205) 539-1771; ARIZONA, Phoenix (602) 264-7971; CALIFORNIA, San Diego (714) 747-3015; Palo Alto (415) 369-4671; COLORADO, Denver (303) 623-8713; CONNECTICUT, North Haven (203) 239-9762; FLORIDA, Orlando (305) 423-7615; ILLINOIS, Chicago (312) 593-0200; INDIANA, Ft. Wayne (219) 744-4331; KENTUCKY, Louisville (502) 893-7303; MARYLAND, Baltimore (301) 825-3330; MASSACHUSETTS, Boston (617) 444-2484; MICHIGAN, Detroit (313) 358-2020; Grand Rapids (616) 451-8901; MINNESOTA, Minneapolis (612) 929-6721; NEW JERSEY, Teaneck (201) 692-0200; NEW MEXICO, Albuquerque (505) 265-6794; NEW YORK, NYC / L.I. (201) 692-0200; NORTH CAROLINA, Raleigh (919) 834-6591; OHIO, Cincinnati (513) 521-2290; Dayton (513) 298-9546; Cleveland (216) 228-7525; OKLAHOMA, Tulsa (918) 627-4159; OREGON, Portland (503) 292-5656; PENNSYLVANIA, Willow Grove (215) 674-3850; Pittsburgh (412) 242-0100; TEXAS, Dallas (214) 239-9148; Houston (713) 721-1054; WASHINGTON, Seattle (206) 455-2778.

Just
15 minutes reading
could save you
hundreds of hours,
thousands of dollars
in design/drafting.

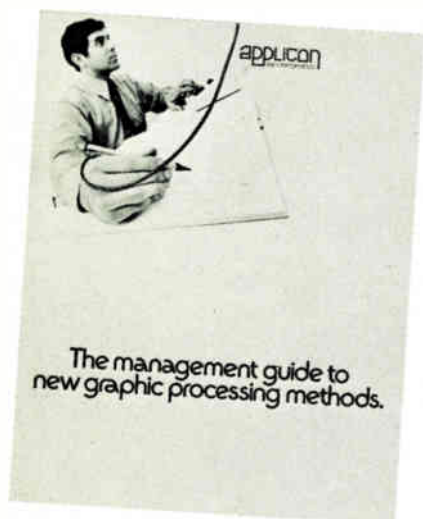

The *Management Guide to Graphic Processing Methods* describes how designers/draftsmen utilize the Applicon Graphic System to realize dramatic cost and time savings.

The AGS 700 handles input, storage, manipulation and output of drawn lines fed into a minicomputer. Comes ready-to-use. Available with a wide range of standard options. Integrates with your current drafting and production methods.

For free guide, send reader service card or mail coupon.

APPLICON, INCORPORATED		EL-3
154 Middlesex Turnpike Burlington, Mass. 01803		
Please send Applicon Graphics Processing Guide directly to:		
NAME	_____	
TITLE	_____	
COMPANY	_____	
STREET	_____	
CITY	_____	
STATE	ZIP	_____

APPLICON
INCORPORATED

New literature

Power supplies. Power supplies specifically designed to fit in spaces that would not accommodate conventionally shaped supplies are described in bulletin 73-1 from Acopian Corp., Easton, Pa. 18042. Specifications and prices are given, as well as space-saving methods of mounting. Circle 421 on reader service card.

Switching system. A turnkey store and forward communications switching system, designed for brokerage firms without large-scale in-house systems, is described in a brochure from Bunker Ramo, Information Systems Group, 35 Nutmeg Dr., Trumbull, Conn. 06609 [422]

Microwave capacitors. American Technical Ceramics, 1 Norden Lane, Huntington Station, N.Y. 11746. Uhf-microwave capacitor kits for rf design are described in a handbook that is also available with the purchase of each kit. [423]

Temperature recorders. Adhesive-backed temperature recorders for 100° to 350°F are described in a four-page technical bulletin from Telatemp Corp., Box 5160, Fullerton, Calif. 92632. Special designs, specifications, and incremental values are given. [424]

Products brochure. Glenair Inc., 1211 Air Way, Glendale, Calif. 91201. Capabilities of the company are described in a brochure that gives descriptions of products including emi/rfi connector accessories, shield-terminating devices, and cable assemblies. Custom capabilities for cable assemblies are also discussed, along with underwater cables and connectors. [425]

Rotary switch. A complete line of rotary switches made by Janco Corp., 3111 Winona Ave., Burbank, Calif., is described in catalog 127, which also opens into a wall chart. [426]

Power supplies. A line of encapsulated power supplies from California Electrical Manufacturing Co. Inc., Box 555, Alamo, Calif., is the

subject of a four-page brochure that gives prices, specifications and general information. [427]

Butterfly packages. Metal butterfly microelectronic packages, both single-piece and modular versions, are described in a 10-page product bulletin from Tekform Products Co., 2770 Coronado Ave., Anaheim, Calif. 92806 [428]

Connectors. Methode Electronics Inc., Connector Division, 7447 W. Wilson Ave., Chicago, Ill. 60656. A connector catalog lists the company's line of connectors. [429]

Multiplexer. A three-channel multiplex system that can be used on any four-wire facility for both order wire service and as a carrier-equipment test facility is described in a two-page bulletin from Karkar Electronics Inc., 245 11th St., San Francisco, Calif. 94103 [383]

Lasers. A booklet describing the history and objectives of the Laser Institute of America is available from the Laser Institute of America, c/o General Photonics Corp., 3004 Lawrence Expressway, Santa Clara, Calif. 95051 [384]

Snap-action switch. Control Switch Inc., 1420 Delmar Dr., Folcroft, Pa. 19032, has issued a two-page bulletin describing the company's series D200 heavy-duty momentary snap-action switch. Diagrams and schematics are provided. [385]

Data products. Bell & Howell Co., Electronics & Instruments Group, 360 Sierra Madre Villa Ave., Pasadena, Calif. 91109. A 12-page short-form catalog describes examples of the company's line of products including magnetic tape recorders, business data products and recording oscillographs. [386]

Measuring devices. E S Enterprises, 10418 La Cienega Blvd., Inglewood, Calif. 90304, has published a six-page catalog describing the line of digital products including programming instruments, controls, timers, and counting devices. [387]

Computer builders get more than a motor from TRW/Globe

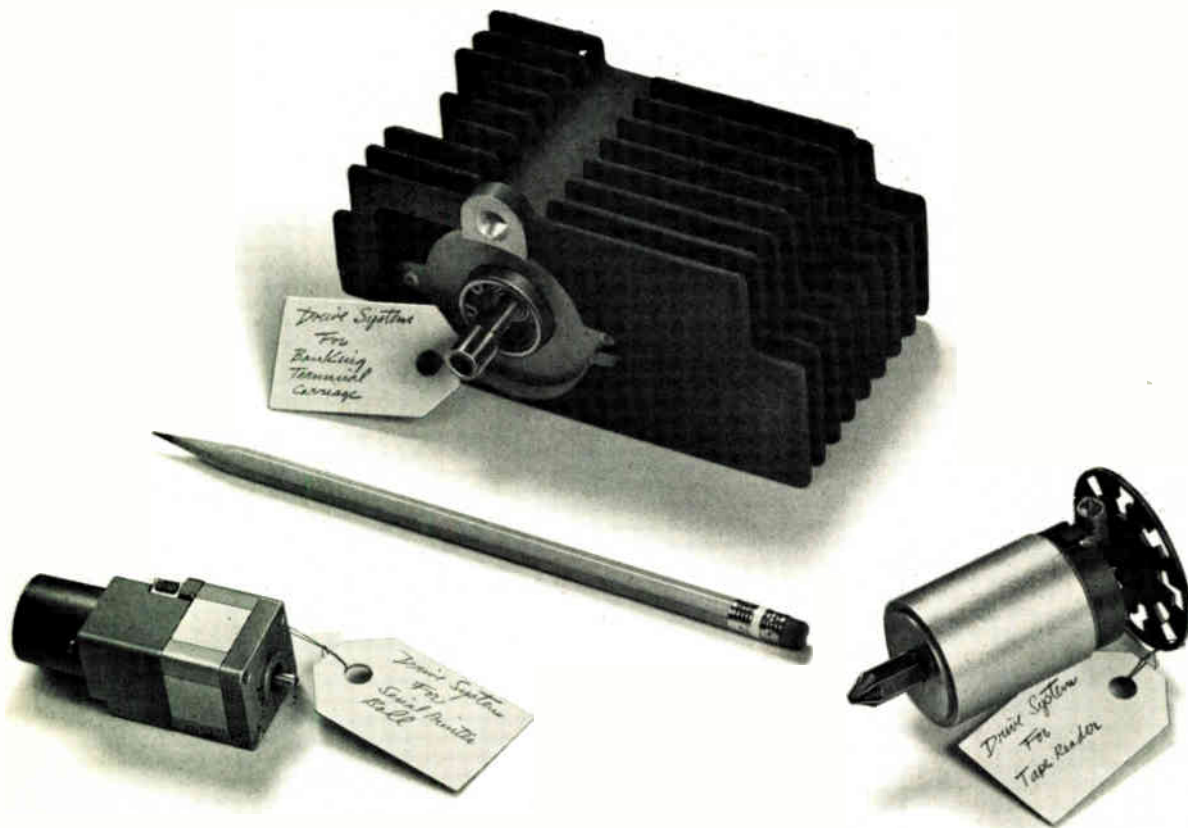

TRW/Globe customers can achieve a combination of motorized functions in minimum space while eliminating unnecessary assembly operations and simplifying inventory requirements.

They do it by ordering a Globe functional "package" instead of just a motor. For example, take the items above, produced for three of the leading builders of business machines and computers:

The package on the left drives the printing ball on a serial printer and indexes it horizontally, with a DC motor. A DC tach generator provides feedback to the rest of the system. And a hollow motor shaft permits another shaft from a linear solenoid to index the ball vertically.

At the top is a drive for a banking terminal carriage. Globe's integrally cast heat sink permits the high torque motor to operate reliably without burning up and causing costly downtime.

The third package drives a computer tape reader. Widened poles and spiralled armature slots assure smooth motion even though torque changes constantly. The tach wheel is read by an electric eye for feedback, and Globe supplies the drive hub.

When you can't afford the cost of failure, call or write: TRW/Globe Motors, an Electronic Components Division of TRW Inc., Dayton, Ohio 45404 (513-228-3171).

TRW® GLOBE MOTORS

CLASSIFIED ADVERTISING

SEARCHLIGHT SECTION

BUSINESS OPPORTUNITIES
USED OR SURPLUS EQUIPMENT

IMMEDIATE DELIVERY Minis & Peripherals DEC—HIS SEL—HP—MOHAWK

CPU, Card, Printer, Tape, Disk
NEW • MOHAWK 4320 PRINTERS
• DATA PRINTER V132
• CENTRONICS 101A

\$750 Minis

TELETYPE 35 & 37

For Sale/Rent
617/261-1100

Send for Free Report "Maintenance of Computers"
AMERICAN USED COMPUTER CORP.
P.O. Box 68, Kenmore Sta., Boston, MA 02215

CIRCLE 951 ON READER SERVICE CARD

free catalog

POTTING APPLICATORS
MANUAL OR AIR OPERATED

2 1/2cc 6cc 12cc 30cc
FOR POTTING, ENCAPSULATING ETC.

PHILIP FISHMAN CO., INC.
7 CAMERON ST. WELLESLEY, MASS 02181

CIRCLE 952 ON READER SERVICE CARD

WANTED: MONOLITHIC CHIP CAPACITORS

Usage requirements up to 10 million pieces per year.
Maximum size:11x.053x.050
Capacitance:10pf to 125pf
Tolerance:±5%
Material:NPO
Termination:Hot pin dipped, gold or
palladium silver

MORVAY ELECTRONICS AGENCY
420 Morris Ave., Springfield, N.J. 07081
(201) 467-0666

CIRCLE 953 ON READER SERVICE CARD

RADAR SYSTEMS GROUND AND AIRBORNE AUTOMATIC
TRACKING ANTENNA SYSTEMS, NIKE AJAX, NIKE HER-
CULES M-33, MSQ-1A, MPS-19, MPS-9, SCR 584, TFS-1D,
TFS-2B, FAA-ASR-2, AIRBORNE SYSTEMS APN-84, APN-102,
APS-20, APS-27, APS-45, DPN-19, DIGITAL COMPUTERS
IBM 650, IBM 704

LARGEST INVENTORY OF RADAR AND
MICROWAVE EQUIPMENT IN THE WORLD.
RADIO RESEARCH INSTRUMENT CO.
3 QUINCY ST., NORWALK, CONN. 06850 (203) 853-2600

CIRCLE 954 ON READER SERVICE CARD



EMPLOYMENT OPPORTUNITIES

RESUME KIT

Free Engineer's Resume Kit for Electrical,
Mechanical and Industrial Engineers.
Scientific Placement, Inc., Employment
Service, 5051 Westheimer, Houston,
Texas 77027.

SOLD!

"Please discontinue our ad in 'Searchlight' as we have
sold the equipment through this advertising."
Can "Searchlight" Serve You?

Job-seekers... be the first to know with McGraw-Hill's Advance Job Listings

By having our new weekly ADVANCE JOB LISTINGS sent First-Class (or by Air Mail, if you prefer) to your home every Monday you can be the first to know about nation-wide openings you qualify for both in and out of your field.

This preprint of scheduled employment ads will enable you to contact anxious domestic and overseas recruitment managers BEFORE their advertisements appear in upcoming issues of 22 McGraw-Hill publications.

To receive a free sample copy, plus information about our low subscription rates (from one month to 12), fill out and return the coupon below.

ADVANCE JOB LISTINGS / P.O. BOX 900 / NEW YORK NY 10020

PLEASE SEND A SAMPLE COPY
OF ADVANCE JOB LISTINGS TO:



NAME _____

ADDRESS _____

CITY _____

STATE _____

ZIP _____

E9/27/73

New literature

Calculator. A 12-page booklet from Hewlett-Packard Co., 1501 Page Mill Rd., Palo Alto, Calif. 94304, provides information on how to save engineering design time with the desktop calculator model 9800. Hardware and software solutions are given. [256]

Sequence controller. Square D Co., Milwaukee, Wis. 53201. A manual is available on the Class 8871 Type PSC program sequence controller. [257]

Test equipment. PRD Electronics, 1200 Prospect Ave., Westbury, N.Y. 11590. A catalog and guide includes vector voltmeters, power meters, standing-wave detectors, frequency meters, and attenuators. [258]

Thermistors. Short-form catalog L-4A from Fenwal Electronics, 63 Fountain St., Framingham, Mass. 01701, introduces thermistor users to a variety of thermistor sensors and sensor assemblies. [259]

LSIs. A four-page brochure from Macrodata Corp., 6203 Variel Ave., Woodland Hills, Calif. 91634, describes the MD-154 LSI test system and how to use it. [260]

SCRs. International Rectifier Corp., Semiconductor Division, 233 Kansas St., El Segundo, Calif., has published a product summary sheet on 12 series of SCRs and six series of low-power silicon rectifiers made by the company. [261]

Communications tools. P. K. Neuses Inc., Box 100, Arlington Heights, Ill. 60006, has issued a catalog of its line of small tools for the communications, telephone, and electronic industries. [262]

Keyboards. Micro Switch Division, Honeywell Inc., Spring St., Freeport, Ill. 61032. Product sheet 50SW11-50 describes a data entry keyboard with programable read-only memory, and product sheet 70SW12-1 describes a keyboard that includes control codes for remote batch equipment and a separate numeric entry block. [263]

THE WORLD'S FASTEST N-MOS RAM ***Delivering now as a device, card*** ***or memory system***

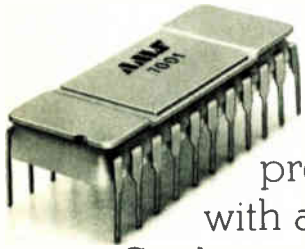

AMS 7001 STATIC MOS RAM 60 ns access time and 180 ns cycle time make this the fastest 1K MOS RAM (1024 words by 1 bit). The 7001 RAM has been proven in a working system where it has been exercised with all standard patterns under wide operating margins. It

is static. So there is no need for costly and difficult refresh circuits; and the 7001 consumes less power than equivalent speed bi-polar RAMs. Distributors have the AMS 7001 in stock and it is multiple sourced. Ask us for design help and for an absolutely free data sheet and a price list.

AMS 7001 MEMORY CARD Using the AMS

7001 RAM, this card offers a cycle time of 200 ns, a 100 ns access time (from address) at ECL levels, and only one load per input. This AMS memory card is now in

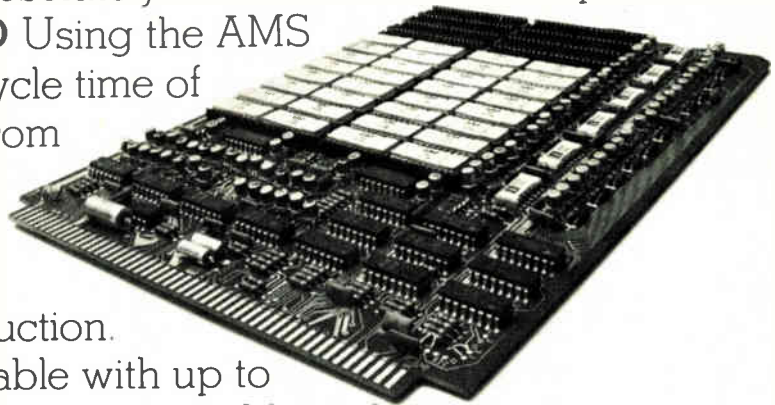

production.

Available with up to 48K bits addressable as 1, 2, or 4 bit words. The AMS 7001 card provides the cost and power advantages of MOS plus the speed advantages of bi-polar.

AMS 7001 MEMORY SYSTEM 110 ns access time from address at the backpanel with ECL levels. Cycle time for the 7001 System is 200 ns. The 7001 system can be organized in words or bytes. It is modular and contains up to 4 bays within one integral assembly. Each bay can be organized in up to 192K \times 18 bits, 96K \times 36 bits, or 48K \times 72 bits. Shipping now.

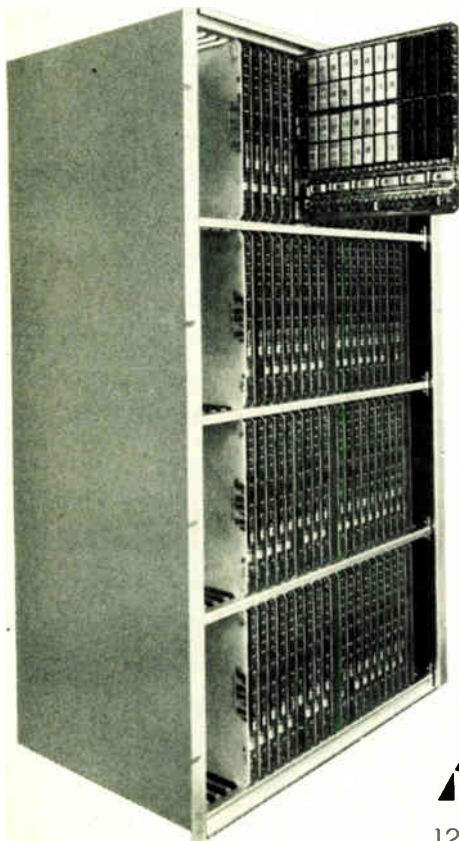

AMS Advanced Memory Systems

1276 Hammerwood Avenue, Sunnyvale, California 94086 (408) 734-4330

Electronics advertisers

September 27, 1973

Abbott Transistor Labs, Inc. Technical Adv. Agency	6	Fujitsu Limited Asian Advertisers, Inc.	165	Rohde & Schwarz Rotek Instrument Corp.	1E
Adams & Westlake Company Relay Division	24	General Electric Co., Miniature Lamp Div.	46	Buck Associates	168
ADC Products (OEM) Midland Associates, Inc.	20	G. E. Co. Semi Prod. Dept. General Electric Company, Utility & Process Auto. Prod. Dept.	81	Rotron, Incorporated Black-Russell-Morris	77
Advance Electronics Ltd. Evan Steadman (Services) Ltd.	43E	General Instrument Europe S.P.A. Studio Hedy	48-49	Schauer Manufacturing Corp. Nolan, Keelor & Stites	188
Advanced Memory Systems, Inc. Robert A. Schloffeldt	185	Grad Associates	50E	Schoeller Sigma Studio 1	44E
Advanced Micro Devices Keye/Donna/Pearlstein	14&15	Georgia Department of Community Development Gerold Rafshoon Advertising, Inc.	11E	Schlumberger Solartron Scott MacTaggart Advertising	68-69
Advanced Micro Devices Keye Donna Pearlstein	16E	Gould, Inc./Instrument Systems Div. Carr Liggett Adv., Inc.	166	Scientific Atlanta/Optima Mohr & Co., Inc.	151
Alco Electronic Products, Inc. Marketronics Advertising	156-160	Grinnell Fire Protection Syst. Co., Inc. Hutchins/Darcy, Inc.	164	1/2 Sescosem Perez Publicite	29E
Allegheny Ludlum Steel Corporation VanSant Dugdale and Company, Inc.	21	G. T. Scheldahl Co. Chuck Ruhl Assoc. Advertising, Inc.	190	Siemens Aktiengesellschaft Linder Presse Union GmbH	56
Allen-Bradley Company Hoffman, York, Baker & Johnson, Inc.	28	Harris Semiconductor Tucker Wayne & Company	32	Signetics Corp., Sub. of Corning Glass Works	62-63, 25
American Microsystems, Inc. Wilton, Coombs & Coinett, Inc. Advertising	82-83	Heath/Schlumberger Scientific Instruments Advance Advertising Services	149	Silec Electronic France M-1	39E
American Optical—Scientific Instrument Division Wilson, Haight & Welch, Inc.	173	Hewlett Packard Richardson, Seigle, Rolfs & McCoy, Inc.	171	Siliconix Robertson West, Inc.	104
AMP, Incorporated Aitkin-Kynnett Co., Inc.	9-12, 13	Hewlett Packard Tallant Yates Advertising, Inc.	154-155	Simpson Electric Co. Amerad Advertising Services, Inc.	79
AMP Italia Studio Dolci	4E	Hewlett Packard McCarthy, Scelba, and DeBiasi Adv. Agcy., Inc.	50-51	Snelling & Snelling, Inc. Evo Mattern & Bobb	196
Amphenol Components Group—Bunker Ramo Corp. Marsteller, Inc.	26-27	Hewlett Packard Richardson, Seigle, Rolfs & McCoy, Inc.	1	Sodeco PR Service	41E
Analog Devices, Inc. Schneider Parker Guy, Inc.	70, 188	Industrie Bitossi S.A.S. C.E.T.I.	72-73	Sprague Electric Company Harry P. Bridge Company	8
Anritsu Electric Co. Ltd. Diamond Agency Co. Ltd.	38E	International Electronic Research Corporation Van Der Boom, McCarron, Inc. Advertising	54E	Stackpole Carbon Company, Electronic Components Division Ira Thomas Associates, Inc.	92
Appicon Incorporated Johnson, Raffin & Lingard, Incorporated	182	Invest Export Interwerbung	170	Stran Steel Corp. Rives, Dyke & Co., Inc.	191
Atlantic Richfield Co. Needham, Harper, & Steers	194	ITT Semiconductors Hall & McKenzie Advertising	43	D. Swarovski Rainer Froemelt	40
Augat Creamer, Trowbridge, Case & Basford, Inc.	134, 135	Keithley Instruments, Inc. Chagrin Valley Marketing Associates	39	Syntronic Instruments, Inc. Moody & Harrison, Inc.	44
Bausch & Lomb, Inc. Wolf Assoc., Inc.	178	Keppo Incorporated Weiss Advertising	150	Systron Donner Concord Instruments Bonfield Associates	55
Bell & Howell, Control Products Div. Porter & Mills Advertising	164	LFE Corporation, Process Control Division LFE Advertising	5	Taiyo Denki Co., Ltd. Dalyusha, Inc.	172
Bourns, Inc. Marlborough Assoc., Inc.	81	Litronix, Inc. Regis McKenna, Inc.	163	Takeda Rilken	13E
The Buckeye Stamping Company Wheeler Kight & Gainey, Inc.	162	Lockheed Electronics Company McCann-Erickson, Inc.	41	TEAC Corp. Dentsu Advertising Ltd.	33E
Burndy Intermarco Publicism	5E	LTT Publibel	88-89	Tektronix, Inc. McCann Erickson, Inc.	22-23
Cambridge Thermionic Corporation Chirurg & Cairns, Inc.	61	Lyon Metal Products, Inc. Reincke, Meyer & Finn, Inc.	48E	Tektronix-IDD Young & Roehr, Inc.	158
Carlo Erba Studio Dema	47E	Mackintosh Consultants Company Ltd. Magneti Marelli S.p.A. Publicist	195	Telonic Ind. Inc. Jansen Associates, Inc.	116
Celanese Corporation D'Arcy-MacManus International, Inc.	2nd cover	Magnetics, Inc. Lando, Inc.	172	Teradyn, Inc. Quinn & Johnson, Inc.	116
Cherry Electrical Products Corp. Kolb/Tookey and Assoc., Inc.	125	Matsushita Electric Trading Hakuhodo Inc.	55E	Texas Instruments Incorporated, Semiconductor Group Tracy-Locke Advertising, Inc.	153
Circuit-Stik, Inc. Haaga Advertising	180	Micro Power Systems Associated Ad Ventures, Inc.	179	† Thomas & Betts Company McCarthy, Scelba, DeBiasi Advertising Agency, Inc.	68-69
CIT Alcatel Promotion Industrielle	46E	Molex (International) Incorporated Total Communications Service	51E	Thomson CSF Bazaine Publicite	138
Clairax Corporation Black-Russell-Morris	4th cover	Monolithic Systems Broyles, Allebaugh & Davis, Inc.	78	Tohoku Kinzoku K.K. K & L Advertising Agency	162
Concord Electronics Corp. Sound Advertising	148	Monsanto Commercial Products Co., Electronic Special Products Advertising Promotion Services	17E, 24E	Toko, Inc. Hakuhodo, Inc.	148
Counterscan Systems	178	MOS Technology, Inc. Henry S. Goodsett Advertising, Inc.	181	True Time Instrument Co. Balsam Advertising	160
CTS Corporation Reincke, Meyer & Finn, Inc.	175	Mullard Ltd. Roles & Parker Ltd.	66-67	TRW, Electronic Components Division The Bowes Company	108, 109
Dana Laboratories Dailey & Associates	132, 133	National Electronics Lea Advertising	157	TRW/Globe Motors Odiome Industrial Advertising, Inc.	183
Data General Corporation Scali, McCabe, Stoves, Inc.	90-91	National Semiconductor Corp. Chiat/Day, Inc. Advertising	52E	TRW/IRC Resistors Gray & Rogers, Inc.	169
Data Technology Corporation Rose Associates Advertising & Public Relations	3rd cover	Nippon Chemical Condenser Co., Ltd. Daiichi-Tsushin Co., Ltd.	168	TRW Electronics, Semiconductor Division The Bowes Company	7
Delco Electronics Division, General Motors Corp. Campbell-Ewald Company	16-17	Norron Technik Marketing	115	Unitrode Corporation Impact Advertising	31
Deutsch Electronics Smith & Hennings Advertising	47	Oscilloquartz SA, Neuchatel M. R. Hofer Werbeagentur BSR/EAAA Bern	84	Universal Oil Products, Norplex Div. Campbell Mithun, Inc.	85
Dialight Corporation Michel-Cather, Inc.	144, 145	Oven Industries, Inc. Foltz-Wessinger, Inc.	26E	† Wavetek Indiana Chapman Michetti Advertising	52
The Digiltron Company Jansson Advertising, Inc.	36E	Owens-Illinois, Inc.—Digivue Howard Swink Advertising	49E	Westinghouse Elect. Corp. Fluorescent & Vapor Lamp Div.	192, 193
Disc Instruments, Inc. Jansen Associates, Inc.	170	Oxy-Metal Reinhardt Publicite	172	Yokogawa Electric Works Ltd. General Advertising Agency, Inc.	27E
Dow Corning Industrial Ketchum, MacLeod & Grove, Inc.	146, 147	Phillips N. V. P11/T & M Division Marsteller International S.A.	161	La Zinco-Lere S.p.A. Studio Dr. Giuliano Blei	45E
Duncan Electronics, Inc., Sub. of Systron Donner Corp. Enyart & Ross Advertising, Inc.	143	Phoenix Data Craig Miller Advertising	8E		
Eastman Kodak Company, Business Systems Markets Div. J. Walter Thompson Co.	19	Pignone Sud Limes Spn	31E		
E-H Research Laboratories, Inc. Hal Lawrence, Inc.	187	Pitney Bowes Douglas Tumer, Inc.	189		
Electronic Associates, Inc. Gerald Clarke, Inc.	174	Portaseap IVA AG	37E		
Electronic Engineering Co. of Calif., Electronic Prod. Div. Mealer & Emerson, Inc.	130	Premier Metal Products Corp. Commercial Press, Inc.	156		
Electronic Navigation Industries Hart Conway Co., Inc.	45	Procond S.p.A. Quadrangolo	56E		
Electronic Research Co. ERC Advertising	160	Raytheon Microwave & Power Tube Division Provandis Eastwood & Lombardi, Inc.	15E		
Electronics—McGraw-Hill, Inc. EMR-Telemetry	6E-7E	RCA Electronic Components Al Paul Lefton Company, Inc.	35E		
Fairchild Semiconductor, Inc. Carson/Roberts, Inc. Adv., Div. of Ogilvy & Mather, Inc.	136, 137	RCA Ltd. Marsteller Ltd.	2E-3E		
Ferroxcube Black-Russell-Morris	126	RCA Solid State Division Al Paul Lefton Company, Inc.	86-87		
Florida Department of Commerce Arthur L. Gray & Associates, Inc.	177	RCL Electronics, Inc. Morway Advertising Agency	18		
		† Rental Electronics, Inc. Humphrey Browning MacDougall, Inc.	58		

Classified & Employment Advertising

F J Eberle, Manager 212-971-2557

EQUIPMENT (Used or Surplus New) For Sale	
American Used Computer Corp.	184
Philip Fishman Co., Inc.	184
Morway Electronics Agency	184
Radio Research Instrument Co., Inc.	184

For more information on complete product line see advertisement in the latest Electronics Buyer's Guide
 * Advertisers in Electronics International
 † Advertisers in Electronics domestic edition

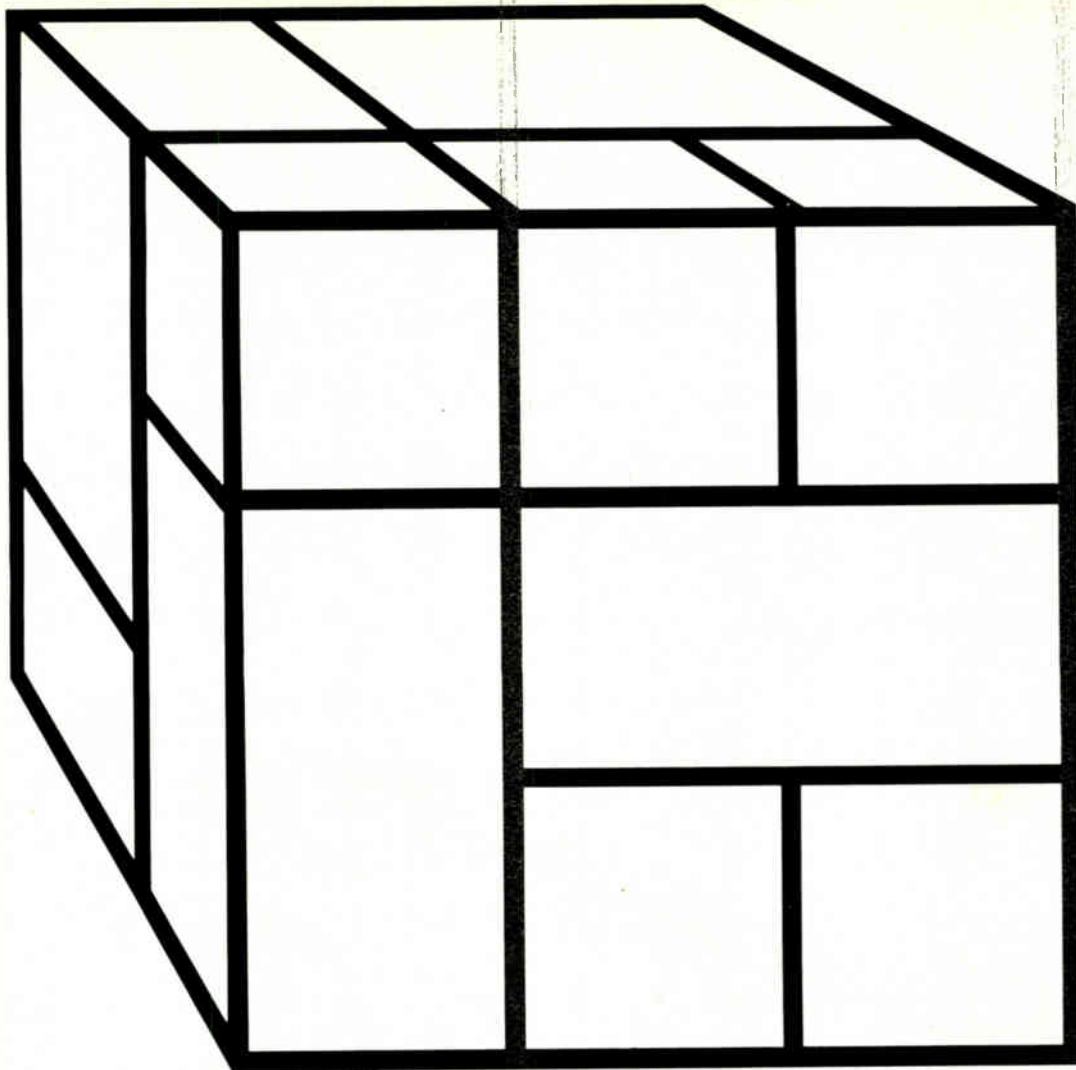

E-H MODULAR SYSTEMS

Building the solution to your measurement problem.

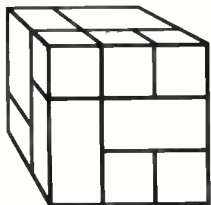

An E-H 4800 Series system is a collection of field-proven instrument modules that have been integrated to do a specific job. Jobs that are too large for our bench-top instruments, too small for

our large computer-controlled test system. The kind of system you would build yourself — if you had the time.

But E-H already has done most of the work for you.

We've designed a system that you can configure to suit your exact requirements. It contains the right stimulus and measurement modules for your applications, all controlled by a special-purpose, test-oriented system controller using a simplified test language.

A system like this can solve a variety of testing problems. It can handle measurement-only

applications, such as the measuring and interpreting of analog or digital signals, or the complete stimulus, interface, and measurement problem. This includes testing digital or analog ICs, PC boards, black boxes, passive components, delay lines, and instrument and module calibration. You can use it for engineering evaluation, incoming inspection or production line testing.

Write for our brochure; it contains an E-H 4800 system configurator to get you started. Then call our application engineers.

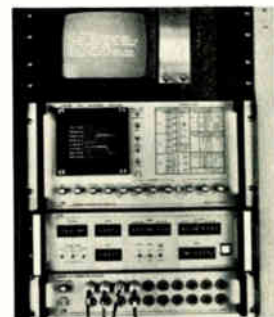

**E-H RESEARCH
LABORATORIES, INC.**

515 11th Street, Box 1289
Oakland, California 94604
(415) 834-3030



NEW SHORTER CASE! SCHAUER 1-WATT ZENERS

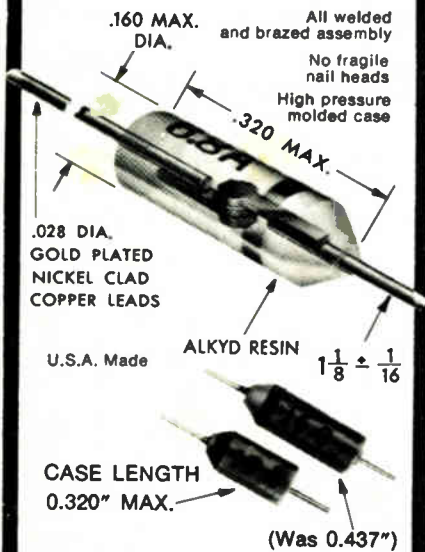

**SAME LOW PRICES FOR
1% TOLERANCE ZENERS
ANY VOLTAGE
FROM 2.0 TO 18.0**

Quantity	Price Each
1-99	\$1.07
100-499	.97
500-999	.91
1000-4999	.86
5000 up	.82

IMMEDIATE SHIPMENT
Send for rating data and
20%, 10%, 5% and 2%
tolerance prices.

Semiconductor Division

SCHAUER

MANUFACTURING CORP.

4514 Alpine Ave., Cincinnati, Ohio 45242
Telephone 513/791-3030

Advertising Sales Staff

Pierre J. Braudé [212] 997-3485
Advertising Sales Manager

Atlanta, Ga. 30309: Joseph Lane
100 Colony Square, 1175 Peachtree St., N.E.
[404] 892-2886

Boston, Mass. 02116: James R. Pierce
607 Boylston St. [617] 262-1160

Chicago, Ill. 60611:
645 North Michigan Avenue
Robert W. Bartlett (312) 751-3739
Paul L. Reiss (312) 751-3738

Cleveland, Ohio 44113: William J. Boyle
[716] 586-5040

Dallas, Texas 75201: Charles G. Hubbard
2001 Bryant Tower, Suite 1070
[214] 742-1747

Denver, Colo. 80202: Harry B. Doyle, Jr.
Tower Bldg., 1700 Broadway
[303] 266-3863

Detroit, Michigan 48202: Robert W. Bartlett
1400 Fisher Bldg.
[313] 873-7410

Houston, Texas 77002: Charles G. Hubbard
2270 Humble Bldg. [713] CA 4-8381

Los Angeles, Calif. 90010: Robert J. Rielly
Bradley K. Jones, 3200 Wilshire Blvd., South Tower
[213] 487-1160

New York, N.Y. 10020
1221 Avenue of the Americas
Warren H. Gardner [212] 997-3617
Michael J. Stoller [212] 997-3616

Philadelphia, Pa. 19102: Warren H. Gardner
Three Parkway,
[215] 997-3617

Pittsburgh, Pa. 15222: Warren H. Gardner
4 Gateway Center, [212] 997-3617

Rochester, N.Y. 14534: William J. Boyle.
9 Greylock Ridge, Pittsford, N.Y.
[716] 586-5040

San Francisco, Calif. 94111: Don Farris
Robert J. Rielly, 425 Battery Street,
[415] 362-4600

Paris: Alain Offergeld
1 rue Georges Bizet, 75 Paris 16, France
Tel: 720-73-01

Geneva: Alain Offergeld
1 rue du Temple, Geneva, Switzerland
Tel: 32-35-63

United Kingdom: Keith Mantle
Tel: 01-493-1451, 34 Dover Street, London W1

Milan: Robert Saldel
1 via Baracchini Phone 86-90-656

Brussels: Alain Offergeld
23 Chaussee de Wavre
Brussels 1040, Belgium
Tel: 13-73-95

Stockholm: Brian Bowes
Office 17, Kontor-Center AB, Hagagarten 29,
113 47 Stockholm. Tel: 24 72 00

Frankfurt/Main: Fritz Krusebecker
Liebigstrasse 27c
Phone 72 01 81

Tokyo: Tatsumi Katagiri, McGraw-Hill
Publications Overseas Corporation,
Kasumigaseki Building 2-5, 3-chome,
Kasumigaseki, Chiyoda-Ku, Tokyo, Japan
[581] 9811

Osaka: Ryji Kobayashi, McGraw-Hill
Publications Overseas Corporation, Kondo
Bldg., 163, Umegae-cho Kita-ku [362] 8771

Australasia: Warren E. Ball, IPO Box 5106,
Tokyo, Japan

Business Department

Stephen R. Weiss, Manager
[212] 997-2044

Thomas M. Egan,
Production Manager [212] 997-3140

Carol Gallagher
Assistant Production Manager [212] 997-2045

Dorothy Carter, Contracts and Billings
[212] 997-2908

Frances Vallone, Reader Service Manager
[212] 997-6057

Electronics Buyers' Guide

George F. Werner, Associate Publisher
[212] 997-3139

Regina Hera, Directory Manager
[212] 997-2544

There's a lot to Analog Devices.

It's all in our 1973 Product Guide. 208 pages describing digital panel meters, linear integrated circuits, A-D converters, amplifiers, dual monolithic transistors, function circuits and power supplies.

In addition to the specs you'll find guides to selection and application.

And it's free. Just check our number on the reader service card, or give us a call at 617-329-4700, and we'll send you a copy.



**ANALOG
DEVICES**
Analog Devices, Inc.,
Norwood, Mass. 02062

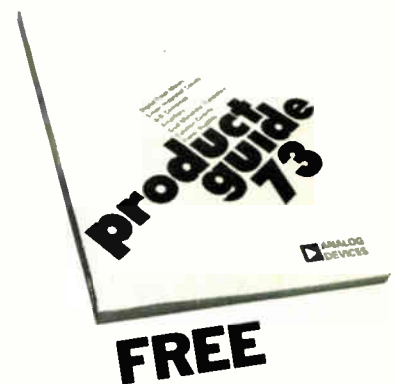

How many paperflow troublespots can you spot?

No, this isn't a game for time-study men. It's an exercise for top management. A walk around the office like you've never taken before.

Start where the mail comes in. Ever wonder why it's late to your desk? Or ripped? Or minus a return address? Is your mail opened by hand?^①

Ever get a copy of a report that has two page 2's? Or, worse yet, none? Peek into the conference room. Chances are, you'll see hands gathering sheets of paper into sets.^②

Walk by your office. Secretary missing again?^③ She's probably been "volunteered" for another folding and inserting session.^④

Stop by the mailroom on your way home. Can your mailing equipment handle the billing that's got to get out tonight?^⑤ Do your hand-typed invoices look businesslike? Is every name and address correct?^⑥

Why take this walk? Simply this. Since paper represents the written record of your business, your business can travel only as fast as the paper can flow in, through and out of your office.

Any Pitney Bowes representative can spot your particular paperflow problems and recommend systems to solve them. Give him a call today, or write to Pitney Bowes, 8991 Pacific Street, Stamford, Conn. 06904. Or call one of our 190 offices throughout the U. S. and Canada. Postage Meters, Mailing Equipment, Copiers, Collators, Counters and Imprinters, Addresser-Printers, Labeling and Marking Systems.



Pitney Bowes

Because business travels
at the speed of paper

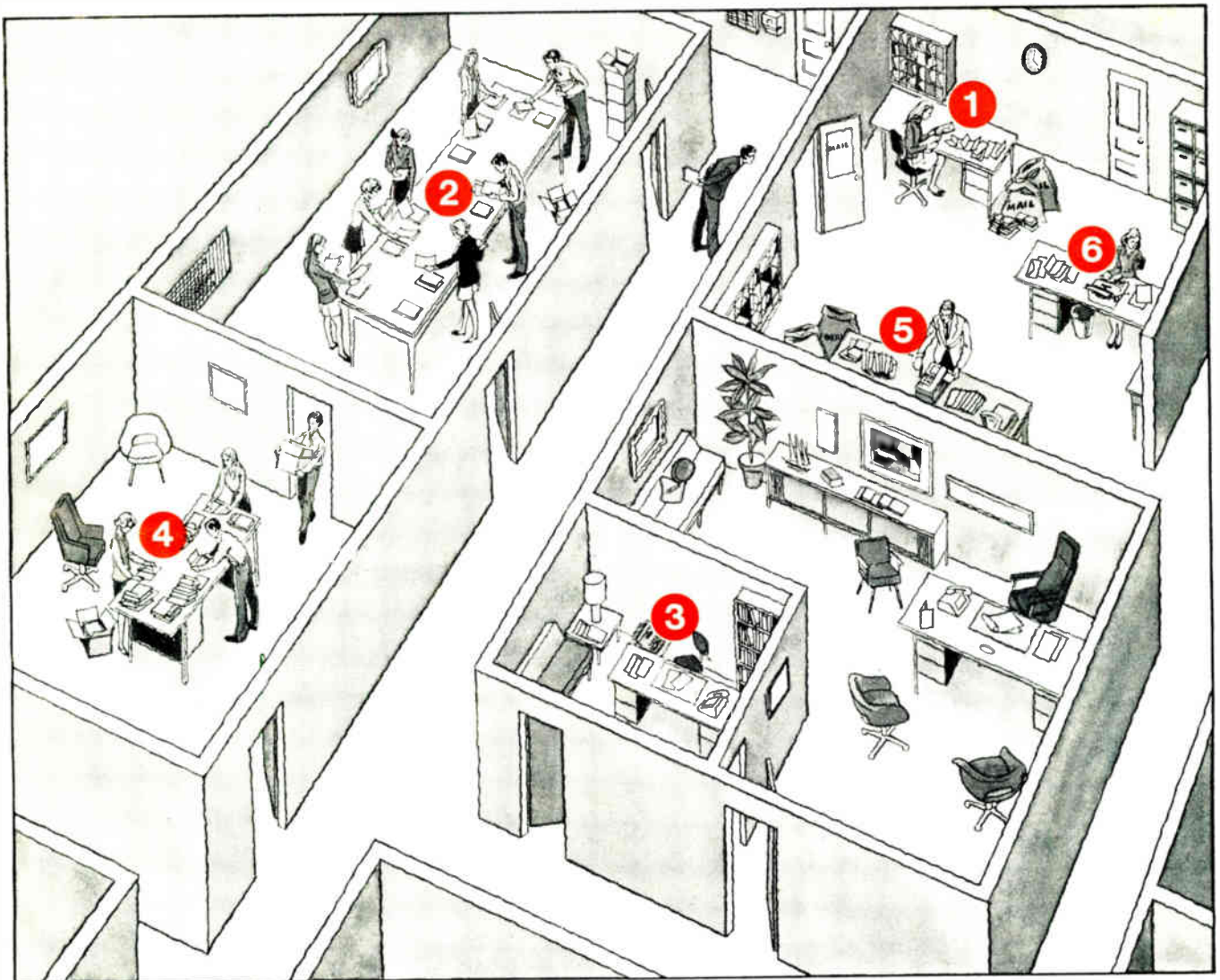

Other sprinklers protect you against fire. Grinnell's Aquamatic protects you against fire and water.

Any sprinkler can control or put out a fire.

But Grinnell's new Aquamatic On-Off sprinkler does more. It shuts itself off when the fire's out. It puts the water only where it's needed—on the fire, and not outside the fire area. So it keeps water discharge to a minimum.

Aquamatic is ideal for places where you have high value inventories, materials extremely sensitive to water, flash fire exposures, or expensive equipment and machinery. Because of its efficient use of water, it helps eliminate excessive down

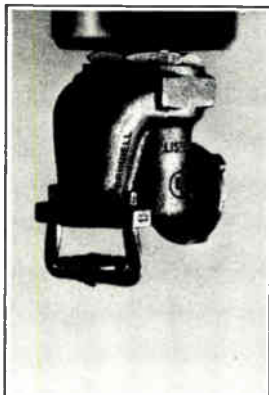

time after a fire, and puts you back in business faster.

Aquamatic is maintenance free—it doesn't require replacement or adjustment after a fire. It automatically resets itself and is ready to go as often as needed.

And Aquamatic is interchangeable with other sprinklers. It can be installed in existing systems or designed into new construction.

Want to know more? Let us demonstrate Aquamatic in your office, or send for our new brochure. Just fill out and mail the coupon below.

Grinnell Fire Protection Systems Company, Inc.
10 Dorrance Street
Providence, Rhode Island 02903

- Yes, I would like to see a demonstration of the new Aquamatic On-Off Sprinkler. Have a Grinnell Sales Representative contact me.
- Send your Aquamatic brochure (no obligation).

Name _____ Title _____

Company _____

Street _____

City _____ State _____ Zip _____

Telephone _____

European Headquarters:
Kopperschmidt Sprinkler G.m.b.H.,
D-2358, Kaltenkirchen, Germany.

 **GRINNELL**
GRINNELL FIRE PROTECTION SYSTEMS COMPANY, INC.

The energy crisis is going to mean higher utility costs in your new building.

Unless it's Stran.

When supply goes down, prices rise. That's a fact of business. And it's one that is becoming increasingly apparent in heating and cooling costs. Every kind of energy is going to cost more next year, and you'll find few experts that will predict any kind of relief soon.

But when you decide to construct a new building, there is a way that you can hedge on higher utility costs —

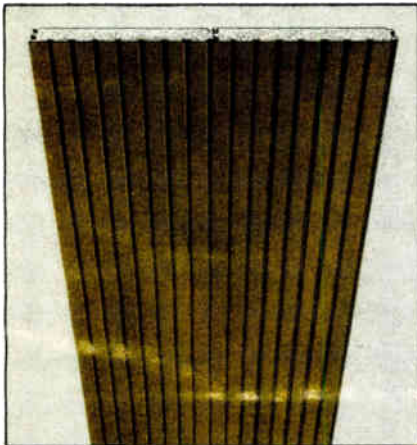

build a building that requires less energy to heat and cool. Build a Stranwall 70 building. You'll save on the initial cost of construction with Stran's systems approach to building, and Stranwall 70 will help hold utility costs down.

Stranwall 70 is a wall panel with 2½ inches of polyurethane insulation sandwiched between architecturally designed steel in a variety of finishes and colors. It's designed to make your building look great as well as give you super insulating efficiency. For example, in Decatur Illinois, a Stranwall 70 building would require 46% less tons of air conditioning than the same size building made from 8-inch concrete block. And it would cost 54% less to heat for one year.

We have the facts to prove that Stranwall 70 can cut utility usage anywhere from 19 to 70% over ordinary masonry construction like concrete block, brick, cinder block, clay tile and tilt-up concrete. The reason is the superior insulating efficiency of the polyurethane we use and the way we are able to stop conductivity at the joints between each panel.

When you add the savings in utility usage and the speed and reduced costs of construction that Stran's systems approach to building gives you, you've got a money-saving building



right from the start. And the advantages don't stop there. You still get design flexibility, a complete line of

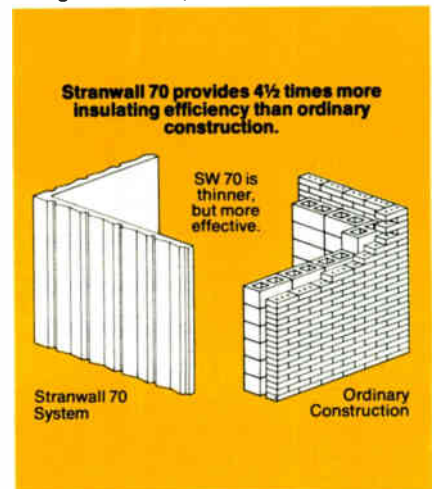

factory-assembled accessory panels and door units, maximum use of interior floor space, and a total construction service from one of Stran's more than 550 Builders.

Stran
The other way to build

Write for the facts in a very specific brochure about utility costs.
Stran-Steel Corporation, Dept. PB-73E, P. O. Box 14205, Houston, Texas 77021.

Name _____

Address _____

Phone _____

City _____

State _____

Zip _____

I'm interested in a building approximately ____ ft. by ____ ft. for use as _____

CIRCLE 707 ON READER SERVICE CARD

**Style-Tone...the first
mercury lamp with the
warm color of an
incandescent.**



H33GL-
400/N
STYLE-TONE
LifeGuard
U.S.A.
° °

Westinghouse has put the extraordinary savings of highly efficient mercury vapor lamps in a warm new light. All the color appearance you'd expect to find in an incandescent lamp has been captured in our exclusive Style-Tone™ Mercury Vapor lamp.

Style-Tone is the ideal mercury vapor lamp for use anywhere you want to impart a warm atmosphere. The way it flatters people and makes merchandise come alive—you'd think it was incandescent lighting. But the maintenance records tell a different story; our Style-Tone lamp is rated to last more than 24,000 hours, *with twice the light output of incandescent lamps.* And

with Style-Tone lamps, you can now place mercury vapor fixtures adjacent to incandescent fixtures and achieve a pleasant, warm blend throughout. That's how little color difference there is. (You can also substitute Style-Tone for any phosphor-coated mercury vapor lamp now being used in your present fixtures.) Available in 400, 250 and 175 watt sizes that operate on regular mercury lamp ballasts.

Call or write your Westinghouse representative to find out how this new lamp color can create new lighting opportunities for you. Ask, too, about Beauty Lite,™ Merchandising White and Supermarket White, the other exclusive Westinghouse vapor and fluorescent lamps developed to answer specific lighting requirements. Westinghouse Electric Corporation, Fluorescent & Vapor Lamp Division, Bloomfield, N.J. 07003.

You can be sure if it's Westinghouse.



**Westinghouse
helps make it happen**

Petroleum and You (A History of the Former)

Chapter Four: Growth at Home, Expansion Abroad

Total U.S. output in 1859, the year of Drake's Titusville well, was an estimated 2,000 barrels, yet in just four years that figure had climbed to an astounding 3,000,000, and would have soared even higher if the industry had not insisted on using such large barrels.

With increased production came attendant problems of shipment and transportation. The tank car proved beneficial in this area, although early models came in for severe criticism since they could be opened only by a large tin key, and once opened were no longer of any real use except as rhododendron planters.

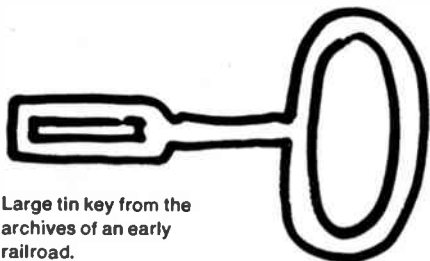

Large tin key from the archives of an early railroad.

Pipelines also came into widespread use, and in 1861 the first cargo of oil—in wooden barrels—was shipped across the Atlantic to England aboard the 19th century brig "Elizabeth Watts." Upon its arrival all London turned out decked in finery to greet the tired but happy crew, sparking a mood of infectious revelry and spirited hi-jinks that left hundreds injured.

Then in the decades following 1870 a small group of American businessmen with bulldog determination transformed the petroleum business from a lusty infant into an indispensable sinew of this country's industry, an accomplishment even more impressive when one takes into account the fact that many of them still found time to work in the yard.

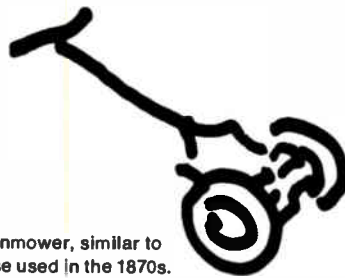

Lawnmower, similar to those used in the 1870s.

In the meantime the industry was proceeding apace in other parts of the globe. The 1870s saw the development of oil fields in the Caspian Sea region, and it was here that the first tanker was put into service. Built in 1879, it was christened the "Zoroaster," after an ancient Persian prophet who, ironically enough, had always maintained that petroleum should be left where it was.

And in 1884 in far-flung northern Sumatra natives looked askance as an enterprising Dutchman, Jans Zijlker, set up a crude drilling rig. In fact, even after he had struck oil and established a prosperous company they continued to look askance, and it was not until 1932 that this was properly diagnosed as a mild form of astigmatism.



Effective cure for looking askance in northern Sumatra.

A British merchant, Marcus Samuel, began shipping oil from Russia to the Orient in 1890, and eventually merged his concern with the Dutch company. The Rothschilds were originally a partner in the venture, but later sold their interest, preferring instead to keep their money in money.

Throughout this period petroleum continued to be used primarily as an illuminant. But with the turn of the century came a quaint invention called the horseless carriage which was to shake the industry to its very foundations. (See forthcoming chapter entitled: Foundations, Water Seepage, And How They Affect Personal Hygiene.)

This is the fourth chapter in a seven-part series presented as a salute to the industry. In addition we would like you to know that we offer a full line of lube oils, greases, cutting oils, fuels, motor oils, white oils, LP-Gas, and specialty products, with a complete network of service facilities.

For further information and for a booklet of all seven chapters of the *Petroleum and You* series write to Mr. Frank Laudonio, Atlantic Richfield Company, P.O. Box 71169, Los Angeles 90071. (You might also indicate any product interest and your business.)

ARCO



Petroleum Products of

Atlantic Richfield Company

CIRCLE 708 ON READER SERVICE CARD

THERE'S ONLY ONE NAME TO CALL FOR BOTH FURNITURE AND EQUIPMENT

With Lyon as your single source for both furniture and equipment everything becomes more predictable. Including product quality, packaging, shipping and installation. You'll have the many benefits of Lyon leadership going for you.

Like reliability. As the leader in our industry, we do whatever it takes to maintain our leadership. This includes stocking over 1600 items for business, industry, institutions and offices. It includes more manpower in the field, four strategically located plants and making certain we have a dealer in your area. It means maintaining rigid quality control. Providing the finest unit packaging. Plus prompt delivery. More of what we know it takes to please you from the early planning stages through delivery and installation.

Lyon leadership service covers both furniture and equipment! Call your Lyon Dealer and see! Lyon Metal Products, Inc. General Offices: 975 Monroe Ave., Aurora, Ill. 60507. Plants in Aurora, Ill., York, Pa., Los Angeles. Dealers and Branches in All Principal Cities.

YOU'RE IN LYON COUNTRY



LYON METAL
PRODUCTS

For Business, Industry and Institutions

LYON METAL PRODUCTS, INC.
975 Monroe Avenue, Aurora, Illinois 60507
Please send me a copy of Catalog No. 100

Name _____
Firm _____
Address _____
City _____ State _____ Zip _____

Look for us in the Yellow Pages under
LYON "STEEL SHELVING," "LOCKERS" or "SHOP EQUIPMENT"

the future is what we sell

People who qualify at Snelling and Snelling want more than just a job. They want jobs with a future. And that's one good reason we may know the people you're looking for—those productive people who make the difference between a company and a company-on-the-move. So, why spend a lot of time and money searching for someone we've already found—administrative, technical, sales, secretarial, and clerical. Let us introduce you. Over 500 offices coast to coast. Look us up in the White Pages for the office nearest you.

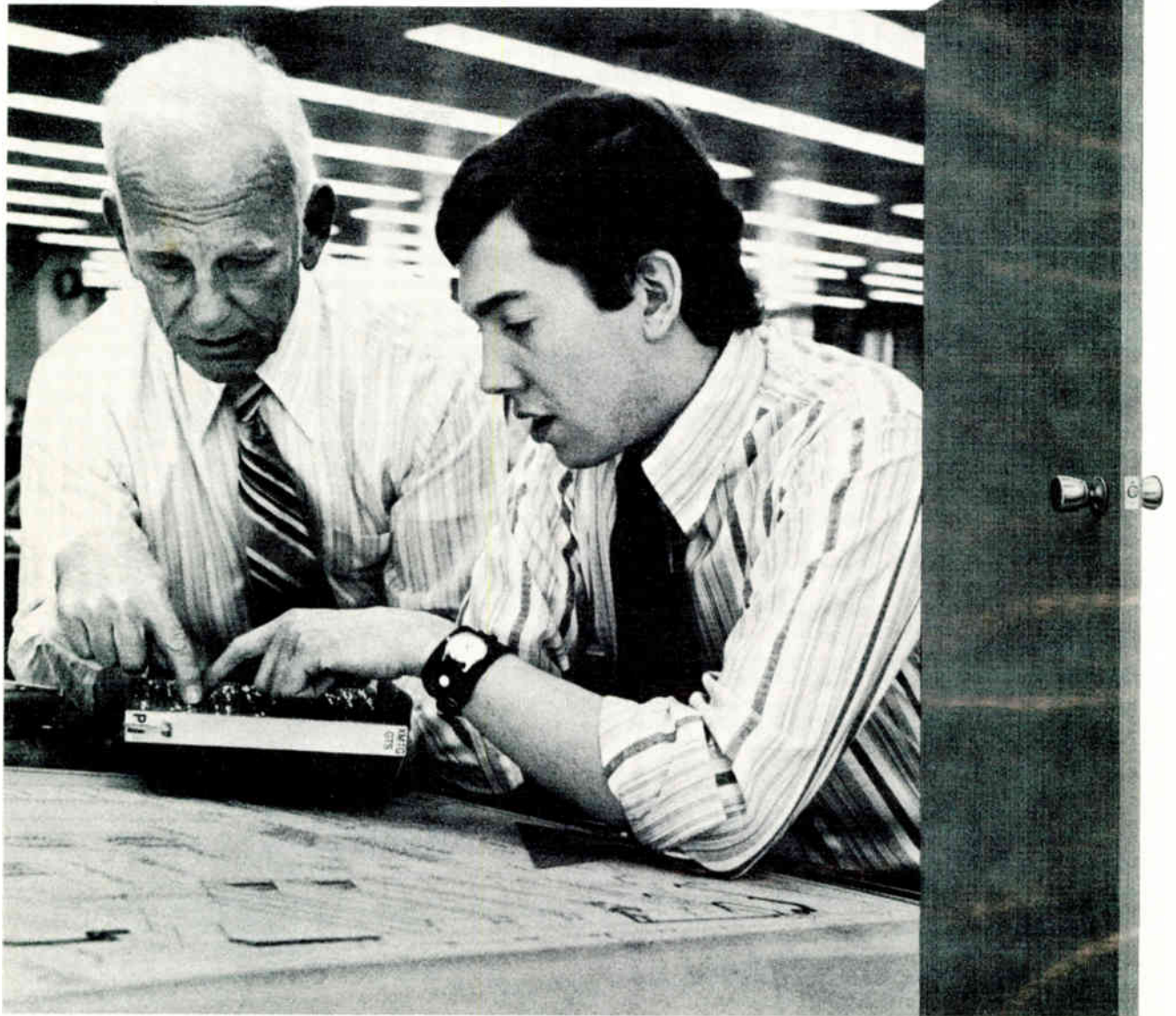

Where New Futures Begin . . .

Snelling AND **Snelling**®
World's Largest Employment Service



4999 counts instead of 1999.

That's one difference between our 3½ digit DVM and their's.

If a 3-digit DVM reads to 999 and a 4-digit DVM reads to 9999, a 3½-digit DVM should read to 4999. Our's does. Their's doesn't.

Their 3½-digit DVM will read up to 1999 with 100% overrange. If your input exceeds 2000 counts you have to change ranges with loss of resolution. But Data Technology has changed all that.

Our new Model 30 has a full 1 through 5 readout in the first position. You have 4-digit accuracy for 5V and 20V logic, 20V and 30V telephone applications, 24V industrial supplies, 28V aerospace and analog applications, 36V military and 230V/440V/480V industrial voltages plus the same accuracy for 22, 27, and 47 ohm resistors. More importantly, the Model 30 provides

this capability for less money than any comparable meter: \$279 for line operation; \$299 with rechargeable batteries.

Using the bright new Sperry display, its low power requirements allow the Model 30 to operate 10-12 hours without recharging the batteries. A 26-range instrument, the Model 30 has five AC and five DC voltage ranges; six resistance ranges; five AC and five DC current ranges.

The 4999 counts instead of 1999 will be the first difference you'll notice between our 3½-digit DVM and their's, but there are lots of others. Try one and see for yourself.



the new data technology corp.

2700 S. FAIRVIEW ROAD, SANTA ANA, CALIF. 92704 (714) 546-7160 TWX: 910-595-1570



Circle 901 on reader service card

Clairex phototransistors give you higher sensitivity at extremely low illumination levels...and they cost no more.

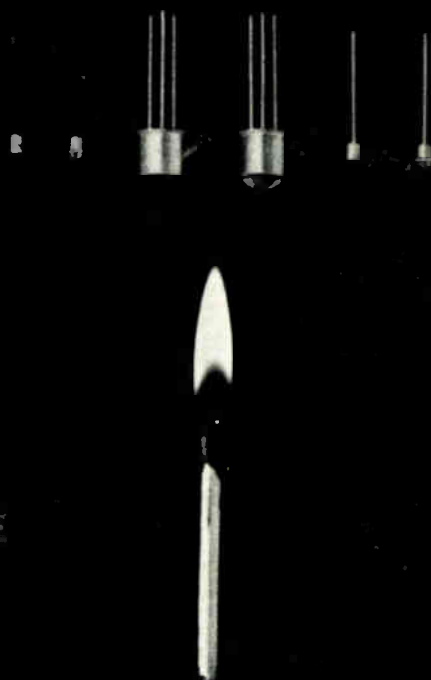
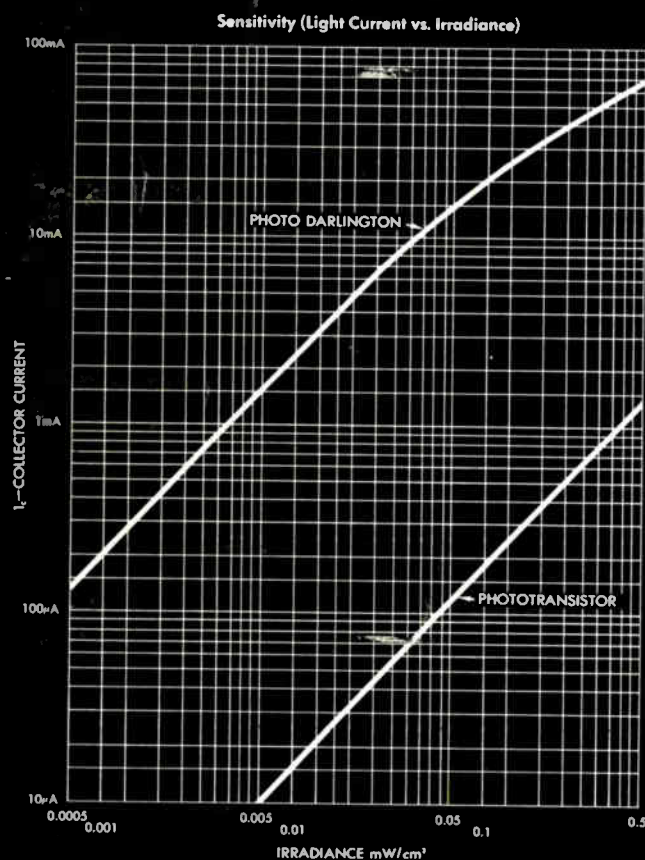

One of our customers is using our phototransistors to detect signals from an LED at distances up to 60 feet.

If you need phototransistors to give you more current at lower light levels, call (914) 664-6602, or write Clairex®, 560 South Third Avenue, Mount Vernon, New York 10550.

CLAIREX ELECTRONICS

A DIVISION OF CLAIREX CORPORATION

Circle 902 on reader service card